

Electronics®

Field-effect transistors in filter design: page 98

Direct-reading transducers: page 102

New radar on the missile range: page 108

March 8, 1965

75 cents

A McGraw-Hill Publication

Below: new impedance meter tests the market at IEEE Show, page 74

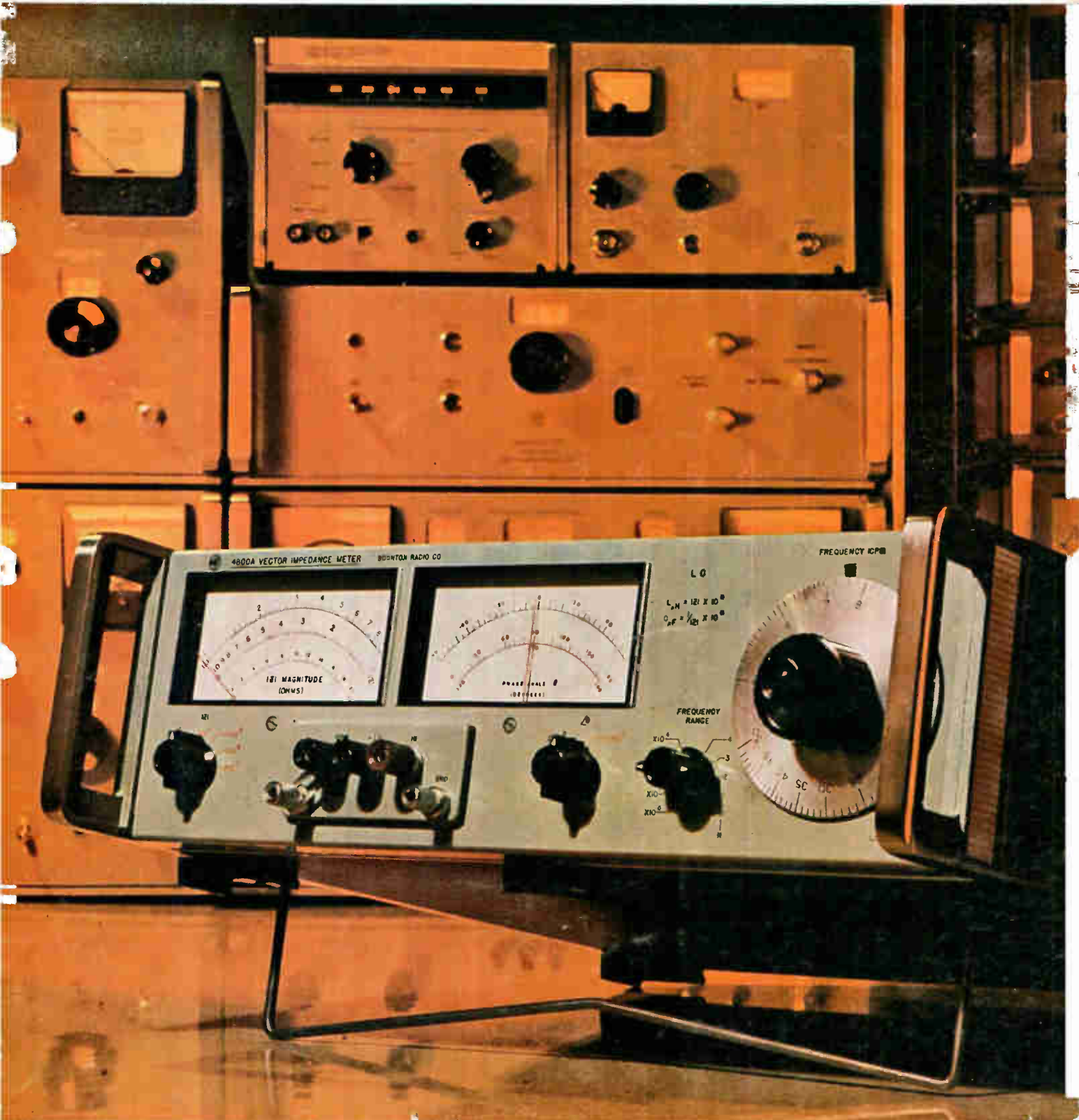

**"SPECIAL"
CUSTOM BUILT**



POWER TRANSFORMERS & INDUCTORS

TO YOUR SPECIFICATIONS

Exceptional quality and reliability is provided in all UTC designs. Over 30 years of engineering knowledge and experience backed by complete environmental testing and life testing facilities assure the highest standard in the industry. Full analysis and evaluation of materials are conducted in UTC's Material and Chemical Laboratories. Rigid quality control measures coordinated with exhaustive statistical findings and latest production procedures results in the industry's highest degree of reliability. Range covered in Power Transformers is from milliwatts to 100 KVA. Some typical applications include: Current Limiting, Filament, Isolation, Plate, Transistor Inverter, Transistor Supply.

MILITARY AND COMMERCIAL TYPES FOR EVERY PHASE OF THE ELECTRONICS ART

POWER TRANSFORMERS • AUDIO TRANSFORMERS • INDUCTORS • PULSE TRANSFORMERS • ELECTRIC WAVE FILTERS • LUMPED CONSTANT DELAY LINES • HIGH Q COILS • MAGNETIC AMPLIFIERS • SATURABLE REACTORS • REFERENCE UNITS

Write for catalog of over
1,200 UTC HIGH RELIABILITY
STOCK ITEMS
IMMEDIATELY AVAILABLE
from your local distributor.



<p>Low capacity current limiting filament transformer. Primary 118 V. 60 cycles to 6.3 V. at 3 A., 8 A. at short circuit. 25 MMFD capacity. 30 KV hipot and 200:1 capacity divider; 5 x 3 3/4 x 4 1/2", 9 lbs.</p>	<p>MIL-T-27B ultraminiature Scott connected power transformer, 5/16 Dia. x 13/32" H., 1/10 Oz. Primary 28 V 400 — with taps @ 50% & 86.6%. Two units provide 28 V two phase from three phase source.</p>	<p>Molded Power Transformer 3 Phase. Input 200V, 380-420 cps. Electrostatic Shield, 8 output windings, 26 terminals. MIL-T-27B, Grade 2 Class S. Max. Alt. 50K Ft. Size 6 x 2 1/2 x 5", 8 lbs.</p>
<p>Commercial type molded power transformer. Primary 115/230 V., 50/420 cycles to 680 VCT.-.015 A., 6.3 VCT.- 1.2 A., 6.3 V.-.6A. Size: 2 1/2 x 3 x 2 7/8", weight: 1.6 lbs.</p>	<p>Three phase high voltage power transformer. Primary jumper hardware for easy conversion from delta to wye inputs. Made to MIL-T-27B specifications. Primary: 440 V 60 cycles delta or wye 3 phase input. Secondary: 2100 V line to line or 1215 V line to line @ 242 ma.</p>	<p>High current filament transformer. Primary 140/156 V., 47/63 cycles to 1.8 V.-1070 A. Current limiting through separate primary reactor, MIL-T-27B; 10 x 10 x 11 1/2", 150 lbs.</p>

UNITED TRANSFORMER CORP.

150 VARICK STREET, NEW YORK 13, N. Y.

PACIFIC MFG. DIVISION: 3630 EASTHAM DRIVE, CULVER CITY, CALIF.
EXPORT DIVISION: 13 EAST 40th STREET, NEW YORK 16, N. Y. CABLE: "ARLAB"

Circle 900 on reader service card

At IEEE Booth No.'s 2413-2414

Universal Counter

with a
full measure
of plug-ins!



No counter gives you as much measuring capability (to 3000 mc) at so great a value as the Hewlett-Packard 5245L. The versatility of seven different plug-ins is combined with the solid-state performance of the basic counter to mean more measurements, made more accurately and conveniently at a lower price.

Plug-in units can be added to increase the counter's basic 50 mc range, its 100 mv sensitivity and the variety of measurements it can perform. Rectangular indicator tubes retain full numeral size, permitting an easy-to-read display. Measurements are automatic with measurement unit and correctly positioned decimal displayed. Solid-state design provides an instrument only 5½" high, bench and rack mount in one; modular plug-in circuit construction provides easy maintenance, and conservative design features provide operational stability and eliminate calibration problems.

Check out the plug-ins listed here—then call your Hewlett-Packard field engineer for complete specifications and a demonstration. Or write Hewlett-Packard, Palo Alto, California, 94304, Tel. (415) 326-7000; Europe: 54 Route des Acacias, Geneva; Canada: 8270 Mayrand Street, Montreal.

Plug-ins for the hp 5245L Counter, \$2950

- 5251A Frequency Converter to 100 mc, \$300
- 5253B Frequency Converter to 500 mc, \$500
- 5254A Frequency Converter 300 mc to 3000 mc, \$825
- 5261A Video Amplifier for 1 mv rms sensitivity, \$325
- 5262A Time interval Unit, 1 μ sec to 10⁸ sec, \$300
- 5264A Preset Unit—for measuring N x frequency, period, ratio, time N events; divides input by N, with N=1 to 100,000 selectable, \$650
- 5265A DVM plug-in—six-digit measurement of dc, 10, 100 or 1000 v full scale, accuracy 0.1% of reading, \$575

Or increase the stability of measurements, to 15 gc, with the Hewlett-Packard 2590A Microwave Frequency Converter, \$1900, which automatically phase locks an internal transfer oscillator to the signal frequency, providing counter time base accuracy, stability of 5 parts in 10¹⁰ short term or 3 parts in 10⁹ per day.

Data subject to change without notice. Prices f.o.b. factory.

HEWLETT  **PACKARD**
An extra measure of quality

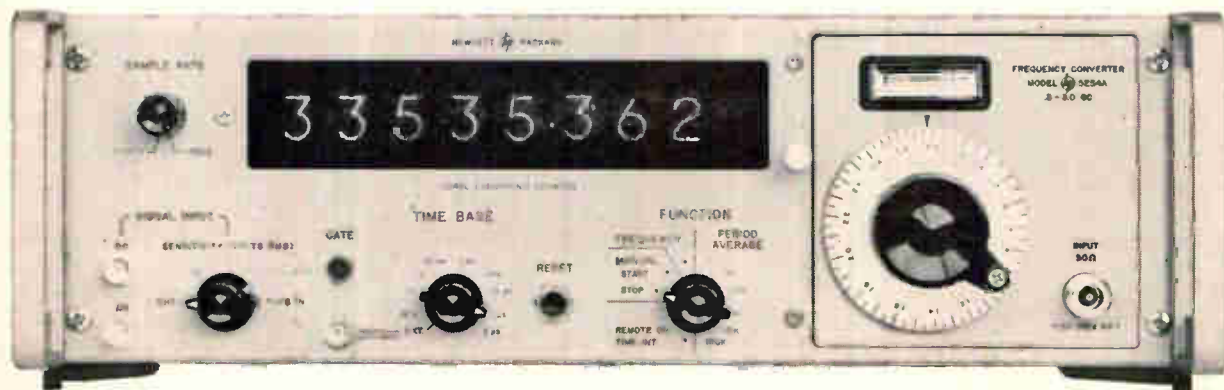

984Q

New Sanborn Tape System

7 CHANNELS plus monitoring track

**6 ELECTRICAL SPEEDS without
capstan change**

40 db or better SIGNAL/NOISE RATIO

0.2% P-P FLUTTER

IRIG compatibility

for under \$9,000



Now you can have precision instrumentation tape system performance at *substantially lower cost than ever before*, with this completely new Sanborn 3900 Series incorporating a specially-designed Hewlett-Packard transport. The primary objective was to provide a highly flexible, reliably useful system with *stable* tape motion, *simple* operation and *no* maintenance — at a significantly *lower cost*. These objectives have

been successfully accomplished, in a system which has:

- Greatly reduced interchannel crosstalk with a new magnetic head assembly design using improved shielding.
- High signal/noise ratio, gentle tape handling and reduced tape wear, through precisely controlled tape tension, driving and braking torques, and guide element designs.
- Plug-in solid-state electronics with record/reproduce amplifiers on the same cards, and equalization plug-ins necessary only for speeds to be used.
- No need for maintenance or lubrication, except for cleaning tape path.
- Built-in footage counter accurate to 99.95%.
- Quick, easy snap-on tape reel loading.
- Cabinet, rack or portable case mounting.

Check the key specifications here, then call your local H-P Field Engineering Office for complete details and prices. Or write Sanborn Company, Industrial Division, 175 Wyman Street, Waltham, Massachusetts 02154.

SERIES 3907A (7-channel), 3914A (14-channel)

SPEEDS	6, electrically controlled, pushbutton selected, 1 1/2 to 60 ips; other speed ranges optional. Max. start 2 sec., max. stop 1 sec.; $\pm 0.25\%$ max. variation in tape speed at nominal line frequency.
TAPE	7-channel 1/2"; 14-channel 1"; 2400 feet 1.5 mil, 3600 feet 1.0 mil; 4800 feet 0.65 mil; 10 1/2" reels.
RECORDING MODES	Direct, FM or Pulse Record/Reproduce via interchangeable solid state plug-in electronics; 7-channels in 7 1/2" panel space. Single-ended inputs, push-pull with optional coupler. Adjustable input/output levels.

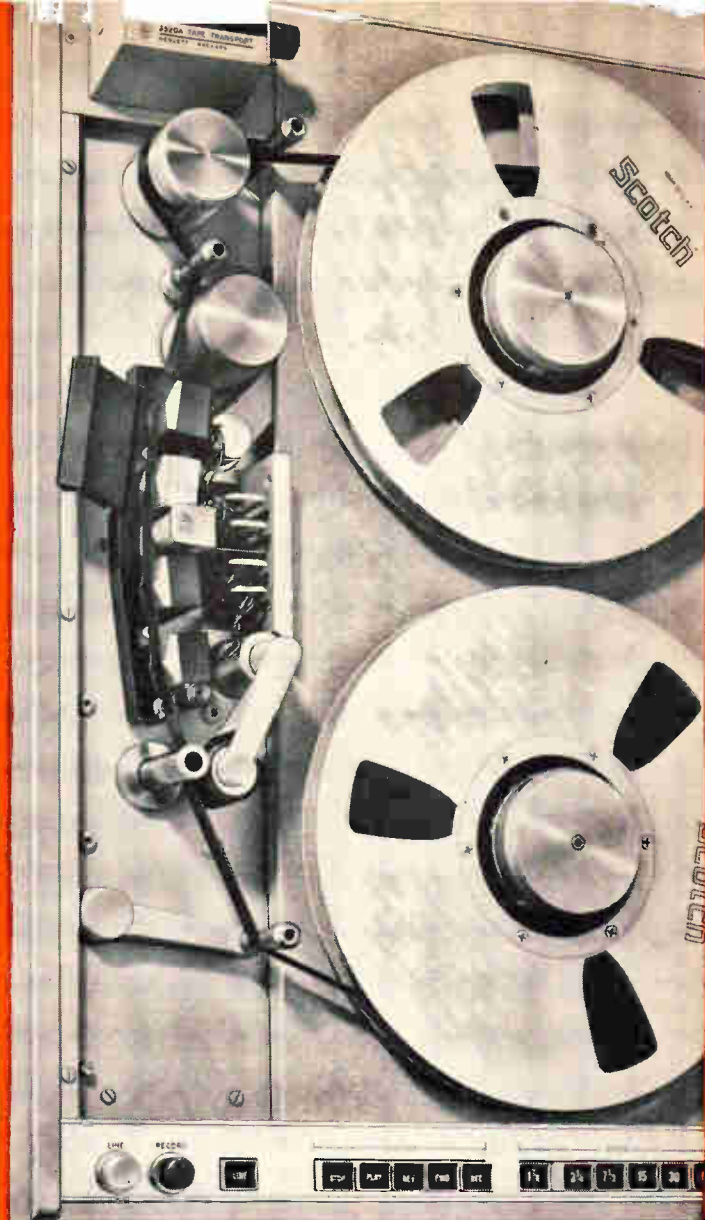

BANDWIDTH	RESPONSE	SIGNAL/NOISE RATIO (RMS)
Direct (60 ips) 100-100,000 cps	≈ 3 db	40 db
FM (60 ips) 0-10,000 cps (Wideband systems available soon — 250 KC direct, 20 KC FM)	$\approx 0, -1$ db	44 db without flutter compensation 48 db with flutter compensation
P-P FLUTTER (30 & 60 ips)	0-1 KC, 0.2% max. 0-5 KC, 0.5% max.	

CONTROLS

Power, Stop, Play, Reverse, Fast Forward, Record; all can be remotely controlled

PRICES (f.o.b. Waltham, Mass.) (Systems represent two of many choices available. Prices are correspondingly lower for fewer speed filters, or where direct record/reproduce electronics are specified, and higher when filters for all six speeds are ordered.)

Complete 7-channel system for FM recording and reproducing, with filters for 3 speeds, extra (8th) channel for monitoring, and console cabinet: **\$8900**

Same system, for 14-channels: **\$13,370**

SANBORN 
A DIVISION OF HEWLETT-PACKARD

See our dynamic displays of measuring, recording and readout instruments at IEEE Booths 3513, 3515 and 3517

Electronics

March 8, 1965
Volume 38, Number 5

Page 4	Readers Comment
8	People
10	Meetings
15	Editorial
17	Electronics Newsletter
57	Washington Newsletter
149	New Products
208	New Books
210	Technical Abstracts
216	New Literature

Electronics Review

Page 41	Faster memories	44	Thin shield
41	Check the spelling	44	Cool soldering
41	Bigger ears	44	Flatpack conflict
42	No more shock	46	Scratchpads
43	On the front burner	47	Information please
43	Flying low	48	Satellite static

Electronics Abroad

219	Along the wall	221	Fadeproof phones
220	Silent Spectra	222	Status symbol
220	Mideast muddle	223	Around the world
221	Party line		

Probing the News

125	Putting integrated circuits in their place
129	Direct digital control systems
130	Beefing up moon photos

Technical Articles

I. Design

Product development	74	IEEE Show: new product crucible A close examination of some of the more significant new products discloses why they were introduced
	75	Instrumentation
	81	Components and hardware
	83	Semiconductors
	85	Subassemblies and systems
	88	Microwaves
	90	Production equipment
Circuit design	92	Designer's casebook Electronically turned hybrid notch filter; pnp plus npn equals unijunction transistor; scr multivibrator switches reliably
Solid state	96	Nonreactive filter converts triangular waves to sines With a field effect transistor, filter achieves less than 1% harmonic distortion R.D. Middlebrook, California Inst. of Tech. and I. Richer, Technical University of Denmark

II. Applications

Instrumentation	102	Digital system continuously converts transducer data into meaningful units Data often arrives in the wrong form. A new technique makes it usable quickly Peter Johnson, Hewlett-Packard Co.
Military electronics	108	Modernizing the missile range; Part 2 To improve precision tracking of space probes, the ranges are debugging their pulse and continuous-wave radar systems John F. Mason, military electronics editor

Title R registered
U.S. Patent Office;
© copyright 1965
by McGraw-Hill, Inc.
All rights reserved,
including the right to
reproduce the contents
of this publication,
in whole or in part.

Electronics

Editor: Lewis H. Young

Senior editors

Technical: Samuel Weber
News: Kemp Anderson, Jr.

Senior associate editors: John F. Mason, George Sideris

Department editors

Avionics: W.J. Evanzia
Circuit design: Michael Elia
Communications: Alexander A. McKenzie
Components: Michael F. Tomaino
Consumer electronics: Richard Lipkin
Industrial electronics: Louis S. Gomolak
Instrumentation: Carl Moskowitz
Manufacturing: George Sideris
Military electronics: John F. Mason
New products: William P. O'Brien
Solid state: Jerome Eimbinder
Space electronics: Joel A. Strasser
Staff writers: Leon H. Dulberger, Stanley Zarowin

Regional editors

Boston: Thomas Maguire, editor; Robin Carlson
Los Angeles: William B. Wallace, editor; June Long
San Francisco: Laurence D. Shergalis, editor; Mary Jo Jadin
London: Derek Barlow, editor

Copy editors

Howard Rausch, Sally Powell, Walter Barney

Graphic design

Art director: Saul Sussman
Assistant art director: John C. Wright, Jr.
Editorial production: Ann Mella
Production editor: Arthur C. Miller

Editorial secretaries: Claire Benell, Mary D'Angelo, Lynn Emery, Kay Fontana, Carolyn Michnowicz, Lorraine Rossi, Lorraine Werner

McGraw-Hill news service

Director: John Wilhelm; **Atlanta:** Fran Ridgeway; **Chicago:** Bruce Cross;
Cleveland: Arthur Zimmerman; **Dallas:** Marvin Reid;
Detroit: Donald MacDonald; **Los Angeles:** Michael Murphy,
Ron Lovell; **San Francisco:** Margaret Ralston, Ed. Addeo;
Seattle: Ray Bloomberg; **Washington:** Arthur L. Moore, Glen Bayless,
Charles Gardner, Herbert W. Cheshire, Seth Payne

McGraw-Hill world news service

Bonn: Richard Mikton; **Brussels:** Arthur Erikson; **London:** John Shinn;
Mexico City: Wesley Perry; **Milan:** Bruce Bendow;
Moscow: Donald Winston; **Paris:** Dan Smith;
Rio de Janeiro: Leslie Warren; **Tokyo:** Marvin Petal, Charles Cohen

Circulation manager: Hugh J. Quinn

Reprints: T.M. Egan

Publisher: C.C. Randolph

Electronics: March 8, 1965, Vol. 38, No. 5

Printed at 99 North Broadway, Albany, N.Y.
Second class postage paid at Albany, N.Y.

Subscriptions are solicited only from those actively engaged in the field of the publication. Position and company connection must be indicated on orders. Subscription prices: United States and Possessions and Canada, \$6.00 one year, \$9.00 two years, \$12.00 three years. All other countries \$20.00 one year. Single copies, United States and Possessions and Canada 75¢. Single copies all other countries \$1.50.

Published every other Monday by McGraw-Hill Inc. 330 West 42nd Street, New York, N.Y. 10036. Founder: James H. McGraw, 1860-1948.

Subscribers: The Publisher, upon written request to our New York office from any subscriber, agrees to refund that part of the subscription price applying to copies not yet mailed. Please send change of address notices, subscription orders or complaints to Fulfillment Manager, Electronics, at the address below. Change of address notices should provide old as well as new address, including postal zone number if any. If possible, attach address label from recent issue. Allow one month for change to become effective.

Postmaster: Please send Form 3579 to Fulfillment Manager, Electronics, P.O. Box 430, Hightstown New Jersey 08520

Readers Comment

That cascode follower

To the Editor:

Regarding Per Bugge-Asperheim's letter [Feb. 8, p. 6] in which he makes reference to R. W. Johnson's article "Circuit with a twist: the cascode follower" [Dec. 6, 1963]:

Both gentlemen err in considering that this is a new circuit.

The basic circuit has been used by the writer, on and off, for nearly 20 years.

In fact, a multivibrator version of the circuit was the subject of a U. S. patent application filed by the writer on Nov. 13, 1952 . . . and the patent application described, among the various modifications, a transistorized version of the circuit (as per Bugge-Asperheim).

Louis E. Garner Jr.
Silver Spring, Md.

To the Editor:

. . . the cascode follower in tubes was seen as early as 1946. David Greene, then doing circuit design at Submarine Signal in Boston, asked me as a technician to breadboard it to check the actual output impedance. Having made a phone amplifier with voice coil feedback (similar to the Williamson circuit, but using pentodes), he thought of this as a way out of using the output transformer.

John E. Adams
Burlington, Mass.

To the Editor:

. . . I, and associates of mine, have used the circuit or adaptations since before 1951. A particularly interesting version, coupling two double cathode followers, is used in amplifiers marketed by Cohu Electronics, Inc.

The direct-coupled output circuit uses one DCF to divide the power supply and provide biases for the other DCF, which is used as a direct-coupled output stage. Cross-couplings balance currents in the power supply, or make output impedance zero or negative dependent on values selected. Power-supply ripple and variations may

Extreme Size Reduction, Unusual Capacitance Stability Achieved with Filmite® 'K' Polycarbonate Film Capacitors



New Filmite 'K' Polycarbonate Film Capacitors are more than 13 times smaller than paper capacitors of equivalent capacitance value and voltage rating.

Designed and developed by the Sprague Electric Company, their polycarbonate film dielectric provides exceptionally high capacitance stability over the entire temperature range, due to the inherently low coefficient of expansion of polycarbonate film and a dielectric constant which is nearly independent of temperature.

Filmite 'K' Capacitors exhibit almost no capacitance change with temperature — dramatically better than polyester-film types, they even surpass polystyrene capacitors. The low dissipation factor (high Q) makes these capacitors extremely desirable where high current capabilities are required, as in SCR commutating capacitor applications.

Low dielectric absorption, considerably lower than that of many other commonly-used film dielectrics, over a broad frequency/temperature spectrum makes Filmite 'K' Capacitors ideal for timing and integrating.

Type 260P Filmite 'K' Capacitors are metallized, utilizing non-inductive construction. They feature special self-healing characteristics in the rare event of dielectric breakdown. Designed for operation at temperatures from -55 C to +105 C, these metal-clad capacitors are hermetically sealed and are available in a variety of mounting styles. Types 237P and 238P are of high-purity foil construction, and are hermetically sealed in metal cases. Their operating temperature range is -55 C to +125 C.

For complete technical data on Type 260P and on Type 237P and 238P Capacitors, write for Engineering Bulletins 2705 and 2700, respectively, to Technical Literature Service, Sprague Electric Co., 35 Marshall St., North Adams, Mass.

45C-416

Circle 5 on reader service card

6 Reasons Why SPRAGUE is a Major Resistor Supplier

FILMISTOR® PRECISION FILM RESISTORS



metal-film, molded case

Distinct limited temperature coefficients and low tolerances to meet exacting application requirements. Rugged end cap construction for long-term stability and reliability. Superior resistance to humidity and mechanical damage. Surpass MIL-R-10509E requirements. Send for Bulletin 7025B.



deposited-carbon, molded case

Approach precision wirewounds in reliability and stability, yet are smaller in size and have lower self-inductance. Low, controlled temperature coefficient. Dense molded case provides outstanding humidity protection. Send for Bulletin 7000A.



deposited-carbon, conformal coated

Full rated load operation at 70 C with no wattage derating. Assured uprated loads at lower operating temperatures. Ideal for circuitry where small size, humidity resistance, and close tolerance ($\pm 1\%$) are required. Send for Bulletin 7005A.

CIRCLE 270 ON READER SERVICE CARD

ACRASIL® PRECISION/POWER WIREWOUND RESISTORS



silicone-encapsulated

Combine the best features of both precision and power wirewound types. Resistance tolerances to $\pm 0.05\%$. Unusually tough encapsulation protects against shock, vibration, moisture, fungus. Meet MIL-R-26C requirements. Smaller than conventional wirewounds, yet greater in stability. Send for Bulletin 7450.

CIRCLE 271 ON READER SERVICE CARD

BLUE JACKET® VITREOUS ENAMEL POWER WIREWOUND RESISTORS



All-welded end cap construction with special vitreous coating for long-term dependability. Axial-lead style for conventional wiring or on printed boards. Tab terminals for higher wattage applications. Meet MIL-R-26C requirements. Send for Bulletins 7400B, 7410D, 7411A.

CIRCLE 272 ON READER SERVICE CARD

KOOLOHM® CERAMIC-SHELL POWER WIREWOUND RESISTORS



Exclusive ceramic-insulated resistance wire permits "short-proof" multilayer windings for higher resistance values. Standard and non-inductive designs. Non-porous ceramic shell for moisture protection and electrical insulation. Axial-lead, axial-tab, and radial-tab styles. Send for Bulletins 7300B, 7305, 7310.

CIRCLE 273 ON READER SERVICE CARD

GLASS-JACKETED POWER WIREWOUND RESISTORS



Ferrule terminals soldered to metallized ends of glass casing for true hermetic seal. Virtually failure-proof, even in extremely corrosive industrial and salt atmosphere. Standard and non-inductive windings. External meter-multiplier types also available. Send for Bulletins 7350, 7420, 7421.

CIRCLE 274 ON READER SERVICE CARD

For complete technical data, write for engineering bulletins on the resistors in which you are interested to: Technical Literature Service, Sprague Electric Company, 35 Marshall Street, North Adams, Massachusetts.

STACKOHM® POWER WIREWOUND RESISTORS



Flat silhouette permits stacking of resistor banks in close quarters. Aluminum thru-bar simplifies mounting and conducts heat from resistance element. Vitreous enamel protective coating. Meet MIL-R-26C performance requirements. Send for Bulletin 7430.

CIRCLE 275 ON READER SERVICE CARD

SPRAGUE®

THE MARK OF RELIABILITY

*Sprague' and ® are registered trademarks of the Sprague Electric Co.

Only from Sprague!

DOUBLE FEATURE!

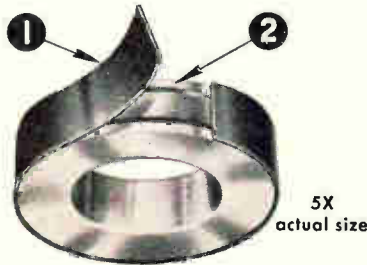

Dynacor® Bobbin Cores have 2 built-in reasons for long operating life without degradation...

1 TOUGH ARMAG® JACKET. Withstands ambient temperatures to 180 C and is compatible with poured potting compounds, permitting Dynacor Cores to be used with normal encapsulation techniques.

2 JET-SMOOTH BOBBIN. Finely-polished stainless steel, completely eliminating sharp protrusions, square corners, or other abrasive action on copper wire windings. Improved manufacturing process results in a bobbin with a more uniform radius than that of an ordinary machined bobbin.

Dynacor Bobbin Cores are also available with ceramic bobbins where needed.

A large stock of popular sizes and flux values insures prompt delivery.

Special cores to customer specifications are quickly and accurately processed.

For complete technical data, write for Engineering Bulletins on Dynacor Bobbin Cores to Technical Literature Service, Sprague Electric Company, 35 Marshall St., North Adams, Mass.



*Sprague® and ® are registered trademarks of the Sprague Electric Co.

155P-170-43

6 Circle 6 on reader service card

be balanced out. The balanced circuit also minimizes drift due to tube aging and heater voltage fluctuation. The neon lamp indicates overloads. The currently marketed version of the amplifier is the Model 112A.

James L. Kimball

Chief Engineer
Kintel Division
Cohu Electronics, Inc.
San Diego, Calif.

To the Editor:

... the cascade follower appears as a "double cathode follower" on page 157 of "Electronic Engineering," by S. Seeley, McGraw-Hill Book Co., 1956. Seeley indicates that the circuit was discussed by C. Hammock in MIT Radiation Laboratory. Report 469 of 1943, six years before the transistor appeared on the scene ...

James A. Cronvich

Electrical Engineering Dept.,
Tulane University
New Orleans, La.

To the Editor:

... The cascode-follower is frequently referred to as the "White cathode-follower" after the man who I think invented it: E. L. C. White, U. S. Patent No. 2,358,428, September 19, 1944. (An earlier patent was issued to him in Great Britain.) The circuit is also attributed to Forbes, who "invented" it during World War II at the M.I.T. Radiation Laboratory. This "invention" was not published in the open literature. Since then, the circuit has been reinvented at least 8 times (Electronics published at least two of these "originals"), and has been variously called a "cascode follower," "stacked cathode-follower," "augmented cathode-follower," etc. Mathematical analyses have appeared in Review of Scientific Instruments (Moody, Batell, Howell, and Taplin, Rev. Sci. Instr. 22, 557 (1951) and Brown, Rev. Sci. Instr. 31, 403 (1960).

In my lifetime, I expect to see the circuit reinvented and reanalyzed several more times.

Edward Fairstein

President
Tennelec Instrument Company,
Inc.
Oak Ridge, Tenn.

▪ Reader Fairstein sums up why we ran engineer Bugge-Asperheim's letter. Classical circuits continually are rediscovered. And it proves "there's nothing new under the sun."

Party line

To the Editor:

In the story "Party-line radio" [Jan. 25, p. 40], you say the network was developed by Motorola Communications & Electronics, Inc. Actually, the USC-3 was designed by Motorola's Military Electronics division. One part of the system, the oscillator, was designed by the Communications division.

Peter J. DeTroy

Military Electronics division
Motorola, Inc.
Chicago

New argument

To the Editor:

In Readers Comment [Jan. 25, p. 6] I find the "correct expression" for the noise figure to be in error. The argument x of $\log x$ must be dimensionless. Hence

$$\left[\frac{N_T^2 + N_R^2}{N_R} \right]^{\frac{1}{2}}$$

which has the dimensions of (volts)^{1/2}, cannot be the argument. I would wager that

$$\begin{aligned} N.F. &= 20 \log \frac{[N_T^2 + N_R^2]^{1/2}}{N_R} \\ &= 20 \log \left[\frac{N_T^2 + N_R^2}{N_R^2} \right]^{1/2} \end{aligned}$$

is correct. Note that the argument of the logarithm is dimensionless. A way to see that the equation is correct is to rewrite the noise figure as

$$N.F. = 10 \log \frac{N_T^2 + N_R^2}{N_R^2}$$

Here we see that the argument of the logarithm is a ratio of powers, assuming both numerator and denominator are referred to the same resistance. The numerator is the power due to signals N_T and N_R are uncorrelated, so the power due to N_T and N_R is simply $N_T^2 + N_R^2$.

Douglas Daetz

University of California
Berkeley

NEW

At the IEEE Show

Booths 3201-3208



Completely Automatic Capacitance Bridge

- Automatically selects range, makes balance, displays measured values.
- Wide Range . . . C, 0.01pF to 1000μF, direct reading; G, 0.1nS to 1μS.
- In-Line Readout of C and G (or D) . . . also locates decimal point and presents correct units of measurements.
- Fast . . . measurement completed in 1/2 second at 1 kc/s.
- Accurate . . . ±0.1% of reading.
- Stable . . . a true bridge with accuracy dependent only on passive standards and transformer ratios.
- BCD output (1-2-4-2 code) for data processing systems.

Type 1680-A Automatic Capacitance Bridge . . . \$4850

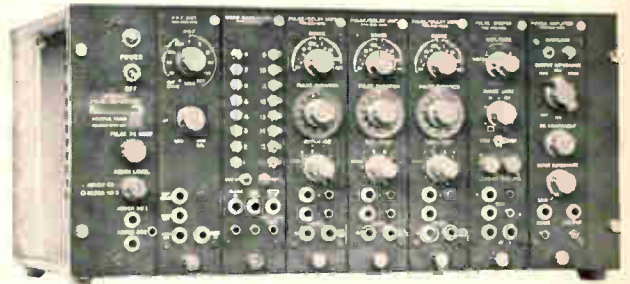

Modular Pulse Generator

Combine These Modules In Various Ways to Suit Your Needs

PRF Unit: rep rates adjustable from 2.5 c/s to 1.2 Mc/s.

Pulse/Delay Unit: adjustable from 100 ns to 1 s.

Pulse Shaper: rise and fall times independently adjustable from 100 ns to 10 ms.

Power Amplifier: capable of a 20-V pulse of either polarity into a 50-ohm load.

Word Generator: produces a pattern of up to 16 bits . . . several instruments can be cascaded to provide 112-bit capability.

The main frame accommodates up to seven modules . . . contains the power supply, two adder circuits, and dc bias control. You can use the output from any of the modules, or use the "sums" of various modules which are available at the adder outputs. Price, Type 1395-A Main Frame, \$500; individual module prices begin at \$150.

**0-10 Mc/s
Basic Counter
\$1495**



Type 1153-A Digital Frequency Meter . . . 100 mV, p-to-p input sensitivity . . . input controls give choice of sensitivity, dc or ac coupling, and trigger level . . . counting interval and display time are adjustable . . . in-line digital readout. Price, \$1495. Models available with data output.

**0-100 Mc/s
10 ns Pulse-Pair Resolution
\$1995 complete**



Add the Type 1156-A Decade Scaler for measurements to 100 Mc/s at sensitivities of better than 100 mV, p-to-p . . . can be used with any counter or frequency meter to extend upper frequency limit by a factor of 10 up to 100 Mc/s . . . Output, 5 V, p-to-p, open-circuit or 1V, p-to-p into 50Ω. Price, \$490.

**0-500 Mc/s
with High Selectivity
for measurements in noise . . . \$3090 complete**



Add the Type 1133-A Frequency Converter for coverage to 500 Mc/s . . . sensitivity better than 10 mV from 100 kc/s to 500 Mc/s . . . choice of narrow-band operation for measuring noisy signals or wide-band operation for routine measurements . . . useful with any frequency measuring system where a 5-Mc reference signal is available (reference signal can be derived from 1153-A Counter). Price, \$1525.



Decade Frequency Synthesizers . . .

100-kc, 1-Mc, and 12-Mc models . . . frequency increments as small as 0.01 c/s and 0.1 c/s . . . models with calibrated continuous tuning and sweep capability . . . programmable models. Prices start at \$3200.

This General-Purpose Oscillator Has Everything

Wide range, 2 c/s to 2 Mc/s; output flat within ±2% over most of range (to 200 kc/s) . . . all solid state . . . high output, 20V open circuit . . . low distortion, 0.25%, even under short-circuit conditions . . . constant 600-ohm output . . . sync for locking to external signals or for synchronizing other oscillators. Price, Type 1310-A, \$295.00.



Also see these instruments: Standard Sweep-Frequency Generator • Standard-Frequency Oscillator • Tone-Burst Generator • Megohm Bridge • Recording Wave Analyzer • Many Others

and in recognition of our 50th anniversary, a historical display of the early instruments of electronics.



GENERAL RADIO COMPANY

WEST CONCORD, MASSACHUSETTS

IN CANADA: Toronto 247-2171, Montreal (Mt. Royal) 737-3673
IN EUROPE: Zurich, Switzerland - London, England

NEW YORK, N. Y., 964-2722
(Ridgefield, N. J.) 943-3140

CHICAGO
(Oak Park) 848-9400

PHILADELPHIA
(Ft. Washington) 646-8030

WASHINGTON, D.C.
(Rockville, Md.) 946-1600

SYRACUSE
454-9323

DALLAS
FL 7-4031

SAN FRANCISCO
(Los Altos) 948-8233

LOS ANGELES
469-6201

ORLANDO, FLA.
425-4671

CLEVELAND
886-0150

Circle 7 on reader service card

High-Power Electron Tubes For High Energy Physics

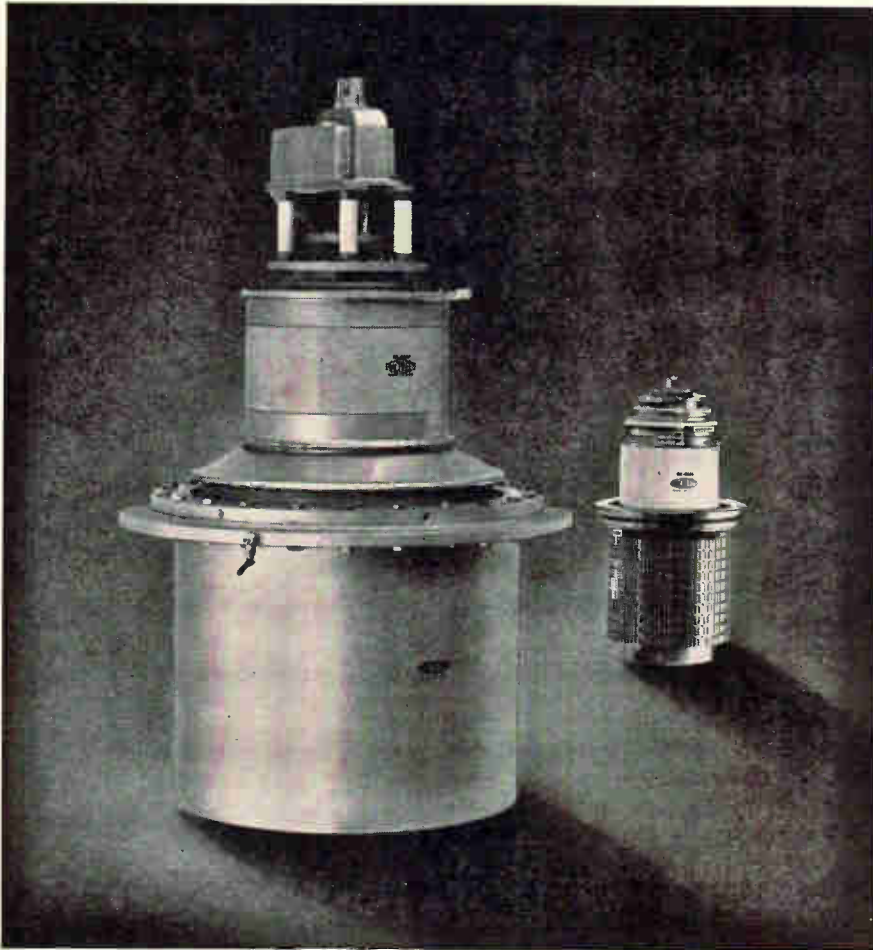

Machlett's power tubes have long served the advanced scientific community. Above are two of the latest developments adding to the expanding group of tubes especially suited for high-energy physics applications—The ML-8545, world's highest power tetrode, capable of 300 kw cw output at 50 Mc and 1.7 Mw pulsed rf power, and the ML-8549, magnetically-beamed triode, capable of 2.5 Mw cw output and 10 Mw pulsed rf power. Write for details: The Machlett Laboratories, Inc., Springdale, Conn. 06879. An Affiliate of Raytheon Company.

MACHLETT

ELECTRON TUBE SPECIALIST

People

Engineer, administrator, teacher, science-fiction buff, amateur actor and wine-maker—they all describe **Bernard M. Oliver**, the new president of the Institute of Electrical and Electronics Engineers.



The 48-year-old scientist, who holds a doctorate (magna cum laude) in electrical engineering, is vice president of research and development at the Hewlett-Packard Co. Previously, he worked for Bell Telephone Laboratories on automatic radar tracking systems and television transmission.

Oliver's chief interest is the future of man and science. An article he wrote on the radio search for life in space has been placed in a time capsule at the World's Fair.

He lives with his wife and three children on a 150-acre ranch near Santa Cruz, Calif.

The glamour phase of the integrated-circuit field is over. Producers are starting to slug it out on cost and performance, and that's where discipline counts.



Providing the discipline for the semiconductor division of Sylvania Electric Products, Inc., is 37-year-old **Alvin B. Phillips**, who was recently given the job of converting the company, a subsidiary of the General Telephone and Electronics Corp., into a heavy-weight in integrated circuits. For example, his engineers are holding dimensional tolerances of the devices to one-half micron.

The division is spending several million dollars to build a production capacity of 100,000 circuits a month. This is the second time that Phillips has taken on such a job. Before joining Sylvania, he headed Motorola, Inc.'s integrated circuits engineering and production.

Swimmer cracks world backstroke record

At the Tokyo Olympics last summer, the world record for the 200 meter backstroke was broken in the new time of 2 minutes 10.3 seconds! Now try this for speed when you need power supplies: Acopian guarantees to ship any of their 62,000 different power supplies in three days! They're all transistorized and plug-in. Available single or dual output. Request detailed 12-page catalog and price list from Acopian Corporation, Easton, Pennsylvania, or call collect (215) 258-6149.

One of a series of "Great Moments in Time".
Send for color reprint suitable for framing.

Acopian

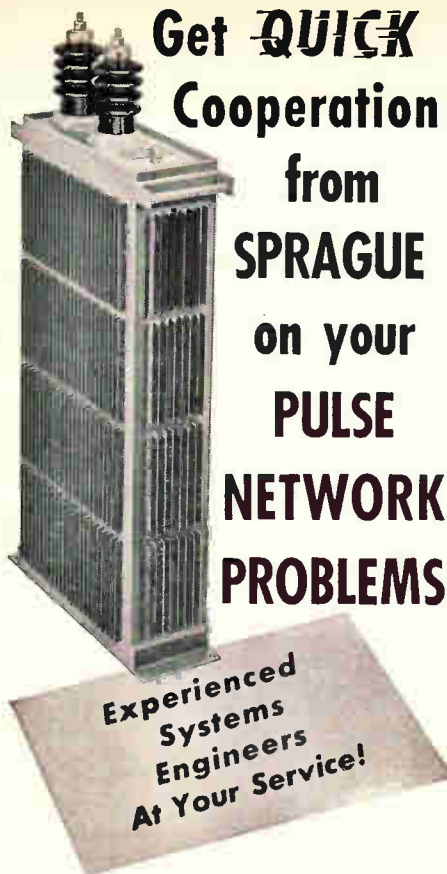

Get **QUICK**
Cooperation
from
SPRAGUE
on your
PULSE
NETWORK
PROBLEMS

Sprague has much to offer to designers of radar systems, laser systems, tube testing systems, and other specialized systems. A highly-technical special engineering section devoted exclusively to pulse capacitors and networks includes systems as well as pulse network engineers. *We can help you with your problems because we fully understand your problems!*

But Sprague service does not end here. Following up the design aspect, we can quickly and efficiently estimate pulse network sizes and prices for bidding purposes. We're also equipped to give quick reaction capabilities for your breadboard and prototype units.

A pioneer in pulse networks, Sprague is a major supplier of custom units from less than 1 KV up to 500 KV over a broad range of power levels.

For application engineering assistance, or additional information, write to Pulse Network Section, Sprague Electric Company, 35 Marshall Street, North Adams, Massachusetts 01248.

45 PPI-4155



Sprague and *®* are registered trademarks of the Sprague Electric Co.

Meetings

Particle Accelerator Conference, AIP, NSG/IEEE, NBS, USAEC; Shoreham Hotel, Washington, Mar. 10-12.

EIA Spring Conference, EIA; Statler Hilton Hotel, Washington, Mar. 16-19.

ISA National Conference on Instrumentation for the Iron and Steel Industry, ISA; Pick-Roosevelt Hotel, Pittsburgh, Mar. 17-19.

Management Conference on Operations Research, Systems Engineering and Electronic Data Processing, University of Pennsylvania, Philadelphia, Mar. 17-19.

Goddard Memorial Symposium, AAS; Marriott Key Bridge Hotel, Washington, Mar. 18-19.

Society of Broadcast Engineers Annual Meeting, SBE; Shoreham Hotel, Washington, Mar. 21.

IEEE International Convention, IEEE; N.Y. Coliseum and New York Hilton Hotel, New York, Mar. 22-25.

Society of Motion Picture and Television Engineers Semiannual Conference and Exhibit, SMPTE; Ambassador Hotel, Los Angeles, Mar. 28-Apr. 2.

Association of Electronic Manufacturers National Convention, AEM, Inc.; New York Hilton Hotel, New York, Mar. 29-Apr. 1.

Electron Beam Annual Symposium, Pennsylvania State University, Alloyd Corp.; Pennsylvania State University, University Park, Pa., Mar. 31-Apr. 2.

Electronic Parts Distributors Show, Electronic Industry Show Corp., New York Hilton and Americana Hotels, New York, Mar. 31-Apr. 4.

IEEE Seminar on Space Vehicle Reliability, IEEE; Airport Marina Hotel, Los Angeles, Apr. 2.

National Packaging Exposition, AMA; McCormick Place, Chicago, Apr. 5-8.

IEEE Lectures on Microelectronics, IEEE; Chicago Lane Technical Institute, Chicago, Apr. 5, 12, 19, 26.

Cleveland Electronics Conference, IEEE, ISA, CPS, Western Reserve University, Case Institute of Technology; Cleveland Public Auditorium, Cleveland, Apr. 6-8.

Conference on Impact of Batch-Fabrication on Future Computers, PGEC/IEEE; Thunderbird Hotel, Los Angeles, Apr. 6-8.

Airlines Electronic Engineering Committee General Session, AEEC of

ALCAC; Eden Roc Hotel, Miami Beach, Apr. 7-9.

IEEE Region 3 Meeting, Robert E. Lee Hotel, Winston-Salem, N.C., Apr. 7-9.

Electronic Components International Exhibition, FNIE, SDSA, Parc des Expositions (Fair Grounds), Paris, Apr. 8-13.

IEEE Region Six Annual Conference, Las Vegas Convention Center, Las Vegas, Apr. 13-15.

Telemetering National Conference, AIAA, IEEE, ISA; Shamrock-Hilton Hotel, Houston, Tex., Apr. 13-15.

Specialists Conference on Thin Film Action Devices, G-ED/IEEE, NASA; Johns Hopkins University, Baltimore, Apr. 14-15.

Numerical Control Society Annual Meeting, NCS; La Salle Hotel, Chicago, Apr. 21-23.

Society of American Value Engineers National Convention, SAVE; Statler-Hilton Hotel, Boston, Apr. 21-23.

Anti-Missile Research Advisory Council Meeting, IDA; Institute for Defense Analyses, Arlington, Va., Apr. 26-30.

Rocky Mountain Bioengineering Annual Symposium, IEEE, USAF Acad., Fitzsimmons Gen. Hospital, et al; Brown Palace Hotel, Denver, May 3-4.

American Astronautical Society Annual Meeting, AAS, IIT Research Institute; Conrad Hilton Hotel, Chicago, May 4-6.

Packaging Industry Annual Conference, IEEE; Milwaukee Inn, Milwaukee, Wis., May 4-6.

Call for papers

Reprogramming Conference, ACM, Applied Data Research, Inc.; Nassau Inn, Princeton, N. J., June 1-3. Mar. 15 is deadline for submitting 1500-word summary to H. R. Wallden, Applied Data Research, Inc., Route 206 Center, Princeton, N. J. 08540.

Military Electronics Conference (MIL-E-CON 9), IEEE; Washington Hilton Hotel, Washington, Sept. 22-24. Apr. 15 is deadline for submitting in triplicate 500-word abstract to Leon H. King, Technical Program Committee, Atlantic Research Corp., Shirley Hwy at Edsall Rd., Alexandria, Va.

Astrodata's New Astrolock*^{*}-loop FM Subcarrier Discriminator



Stability

Within $\pm 0.01\%$ of center frequency for
24-hours after a 5-minute warm-up.

Linearity

Better than $\pm 0.02\%$ of full
bandwidth, best straight line.

The Astrodata Model 402-201, all solid-state FM subcarrier discriminator utilizes the new Astrolock phase-frequency detector, crystal-referenced, FET chopper-stabilized VCO, and current mode loop filter, which are proprietary developments of Astrodata, Inc.

This completely new and different type of locked-loop discriminator gives performance exceeding that of both conventional phase-locked-loop and pulse-averaging types of discriminators.

The new crystal-referenced, FET chopper-stabilized VCO provides state-of-the-art performance in stability and linearity, without a temperature controlled oven.

The Astrolock detector, with its composite phase-frequency characteristic, assures positive lock-in at any signal

level within the 66 db dynamic range. True locked-loop performance is provided for deviations up to $\pm 40\%$, with specified linearity. A quadrature detector mode of operation, selected by a switch on the front panel, provides correlation detection for extremely low S/N signals.

The Model 402-201 introduces a new method of tape-speed compensation in which the reference frequency is processed in the frequency domain. As a result, tape speed compensation is perfect at any fixed frequency from lower bandedge to upper bandedge, and is better than 30 db for intelligence frequencies up to a modulation index of 4. Deviations of more than $\pm 3\%$ anywhere in the band can be accommodated. No adjustments are necessary.

With this new Astrodata Tape Speed Compensation system, the over-all

stability for a given data channel is that of the data discriminator alone, whereas in a conventional system the over-all stability is the sum of the stabilities of both the data discriminator and the reference discriminator.

A complete line of accessories is available for use with the Model 402-201. Channel Selectors and Low Pass Filters are provided for all standard IRIG and Constant Bandwidth center frequencies up to 300 kc. Six discriminators and one common power supply mount in a rack adapter which occupies a panel space of 7-in. x 19-in.

For complete technical information on Astrodata's unique Astrolock-loop FM Subcarrier discriminator and full line of telemetry components, call your local Astrodata engineering sales representative or write to us directly.



ASTRODATA INC.

P. O. Box 3003 • 240 E. Palais Road • Anaheim, California 92803

FROM GUDEBROD—A CONSULTANT'S REPORT

SURVEY of HARNESS
TYING OPERATION
for
YOUR COMPANY

Area Code 215, WA 2-1122 • TWX 215-869
ROS. SILK CO., INC.
FOUNDED IN 1870

Silks Division
PHILADELPHIA, PENNSYLVANIA

OFFICES •

NEW YORK, NEW YORK
25 West 34th Street, Area Code 212

BURBANK, CALIFORNIA

1038 Ontario Street, Area Code 818
Pennsylvania 19464 TWX 215-869

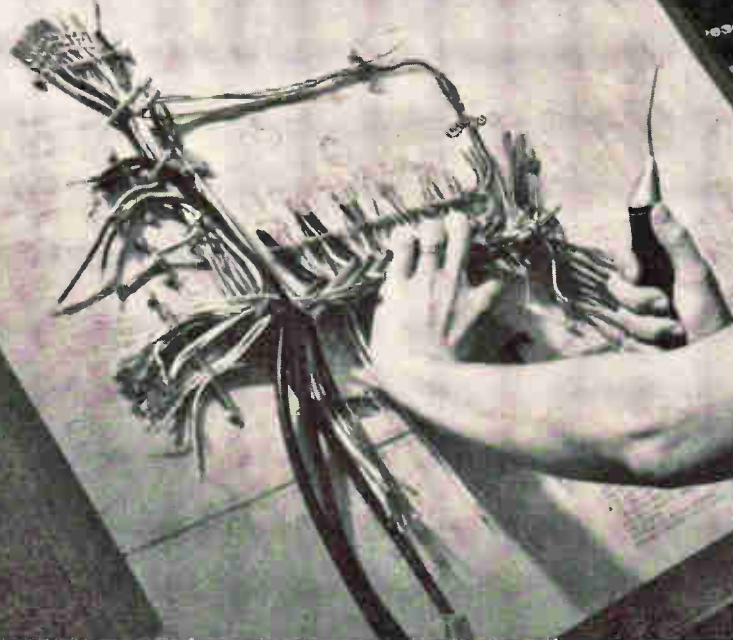

.. so that you may improve your harnesses
... while you save money, too!

**GIVE YOUR HARNESS OPERATION
A FULL REVIEW ... with this
Gudebrod Survey (AT NO COST TO YOU, OF COURSE)**

"Improve" is the guide-word of the electronics field—but has your harness operation kept pace? If you could improve your harness product—and save money at the same time—wouldn't you be interested? Where do you go for help in achieving this desirable situation? To Gudebrod—there is no comparable source for such help in the industry. That's why management at the Gudebrod Electronic Division is offering to make a Consultant's Report on your harness department operation. With self-interest they believe that improving the state of the art in the industry will improve their own business atmosphere. So—why not take advantage of Gudebrod's wealth of tape engineering experience and knowledge—there is no cost or obligation attached to it!

STANDARDS

To improve your standards specifications, Gudebrod can suggest tapes for high or low temperature use, for fungistatic qualities, for burnproof features, for vacuum use, as well as for material specifications and for tensile strength. The more than 200 types of flat tape in the Gudebrod line are specially designed, not only to meet various specifications but to facilitate the tying operation. Production quantities of tape especially for your use can be made if necessary. With this intimate knowledge of lacing tape, the recommendations contained in the Gudebrod Consultant's Report will help *your* Standards Engineer—to improve your product and to save money.

METHODS

In designing lacing tapes to meet various specifications, the Gudebrod research and de-

velopment operations have kept in mind the basic idea of producing tapes that "tie themselves." The originator of the flat braided tape which did so much to improve wire harnessing and at the same time tremendously increase the safety factor for workers, Gudebrod continues to pioneer in the use of better materials, and in a closer regard for specifications. Taking advantage of the "tie-ability" of Gudebrod tapes is important to your Methods Engineer. The recommendations contained in the Gudebrod Consultant's Report will help *your* Methods Engineer to improve your product and save money.

PRODUCTION

Implementing the requirements of the Specifications and Methods Engineers in economical operation is the problem of the Production Engineer. Gudebrod can show how to use the Cable-Lacer, how to take advantage of dispensing packages, cut lengths, special rigs and other labor speeding and easing means. Whether your harness work is custom or production there are ways of improving your operations that may not have occurred to you—that's why the recommendations contained in the Gudebrod Consultant's Report will help *your* Production Engineer—in improving your product—in saving money.

SURVEY AND CONSULTANT'S REPORT —FREE

Here is all you have to do—write or phone Gudebrod. At your convenience a Gudebrod representative will complete a survey working with your Standards, Methods and Production Engineers. This will be reviewed by engineers at the Gudebrod Home Office. Written recommendations will be prepared and sent to you. There will be absolutely no cost or obligation. Why not get your Consultant's Report under way—get in touch with Gudebrod today.



GUDEBROD BROS. SILK CO., INC.

FOUNDED IN 1870



Electronics Division

12 SOUTH 12th STREET, PHILADELPHIA, PENNSYLVANIA 19107

Area Code 215, WA 2-1122

See us at Booth Number 4032 IEEE Show

Circle 13 on reader service card

NEW DIFFERENTIAL AMPLIFIER: LOW DRIFT, FAST SLEWING



actual size:
1" x 1 3/4" x 1/2"

Computer grade, general purpose differential amplifier: the ADO-12, with buffered output. Differential input, single-ended output for DC-coupled, high gain amplification in conversion systems. Made with high reliability Fairchild Silicon Planar components. • High output current: 50mA • Fast slewing rate: 4V/ μ sec • Low voltage

drift: 3 μ V/ $^{\circ}$ C • Guaranteed from -55° C to 125 $^{\circ}$ C • Meets MIL-D-16400 and MIL-E-5400.

Also available in smaller package, with lower, non-buffered output: ADO-11. Both amplifiers can be modified to provide a slewing rate of 12V/ μ sec. Price: \$150 ea. Direct inquiries for these two new amplifiers to factory.

OTHER FAIRCHILD SOLID STATE AMPLIFIERS...

Type	1-4	5-9	10-24	25-99
Operational A00-7 — $\pm 100V$ swing	\$195	\$182	\$172	\$164
Differential ADO-3 — high performance, low cost	63	59	56	53
Differential ADF-1 — 1 μ V/ $^{\circ}$ C thermal drift	190	177	167	160
Operational A00-4 — slewing rate: 4.8V/ μ sec	92	86	81	77
Operational A00-6 — 1 μ V/week long term drift	230	215	203	192

AND ACCESSORIES

Power Supply 1PS-1 — for up to five A00-7's (\$295)
High Stability Voltage Reference Source RVL-1 (1-4, \$125; 5-9, \$116; 10-24, \$107)
Power Supply Regulator PSR-1 (\$87)

FAIRCHILD
SEMICONDUCTOR
(INSTRUMENTATION)

FAIRCHILD SEMICONDUCTOR INSTRUMENTATION REPRESENTATIVES

ARIZONA Scottsdale: G. S. Marshall, 946-4276. **CALIFORNIA** Los Angeles: Fairchild Semiconductor, 464-7464/Palo Alto: Fairchild Sales Office and Factory, 962-2451/San Diego: G. S. Marshall, 278-6350/San Marino: G. S. Marshall, 681-3292. **COLORADO** Denver: Hyer Electronics, 771-5285. **CONNECTICUT** Greenwich: Circuit Sales, 869-2244. **ILLINOIS** Oak Park: Fairchild Semiconductor, 848-5985 **IOWA** Cedar Rapids: Engineering Services Co., 366-1591. **MARYLAND** Bethesda: Bartlett Associates, Inc., 656-3061. **MASSACHUSETTS** Watertown: Circuit Sales, 926-1031. **MICHIGAN** Detroit: WKM Associates, Inc., 892-2500. **MISSOURI** Kansas City: Engineering Services Co., 363-6000/St. Louis: Engineering Services Co., 726-2233. **NEW MEXICO** Albuquerque: Hyer Electronics, 268-6744. **NEW YORK** Elmstord: SBM Associates, Inc., 592-8850/Long Island: CDB Enterprises, 692-5200/Massapequa, L.I.: Fairchild Semiconductor, 799-4590/Rochester: SBM Associates, Inc., 271-7430/Syracuse: SBM Associates, Inc., 454-9377. **OHIO** Cleveland: WKM Associates, Inc., 885-5616/Dayton: WKM Associates, Inc., 298-7203. **PENNSYLVANIA** Pittsburgh: WKM Associates, Inc., 892-2953/Wayne: Bartlett Associates, Inc., 688-7325. **TEXAS** Dallas: Norvell Associates, Inc., FL 7-6451/Houston: Norvell Associates, Inc., MO 5-0558. **WASHINGTON** Bellevue: Cane-Jessup Co. Inc., GL 4-0691.

STOCKING DISTRIBUTORS

ARIZONA Phoenix: Hamilton Electro of Arizona, 272-2601. **CALIFORNIA** Los Angeles: Hamilton Electro Sales, 870-3300/Palo Alto: Hamilton Electro Sales—North, 321-7541/San Diego: Denny-Hamilton, 279-2412. **CONNECTICUT** Greenwich: L. L. Schley Co., 869-2244/Hamden: Cramer Electronics, 288-7771. **ILLINOIS** Chicago: Semiconductor Specialists, 622-8860. **MASSACHUSETTS** Newton: Cramer Electronics, 969-7700/Watertown: L. L. Schley Co., 926-0235. **MARYLAND** Beltsville: Powell Electronics Washington, Inc., 474-1030. **NEW YORK** Westbury, Long Island: Schweber Electronics, 334-7474. **PENNSYLVANIA** Philadelphia: Powell Electronics, 724-1900.

844 CHARLESTON RD., PALO ALTO, CALIFORNIA, 962-2451 ■ TWX: 415-492-9414 ■ FAIRCHILD SEMICONDUCTOR, A DIVISION OF FAIRCHILD CAMERA AND INSTRUMENT CORP.

Editorial

IEEE's technical sessions

The engineer who comes to New York on March 22 to attend the IEEE technical sessions is in for a big disappointment. From the program, the sessions seem to be poorer in quality than ever, a continuation of years of steady decline.

The merchandising aspects of IEEE completely outshadow the technical.

There was a time when an electronics engineer attended the annual meeting of the International Radio Engineers—one of IEEE's two forebears—to hear about the latest technical developments. The exhibits were lagniappe. IEEE's other forebear, the American Institute of Electrical Engineers, held only technical sessions—no exhibits at all—at its annual conclave until just before it merged with IRE.

Today the tail is wagging the dog. The merchandising aspects have assumed such importance that the technical sessions suffer seriously from lack of attention. IEEE has diluted the quality of the sessions even further this year by designing them to be "tutorial." That's a euphemism for no new technical material, a rehash of established techniques.

In the planning sessions at technical societies' headquarters, there's always somebody who thinks that tutorial sessions are the way to improve attendance because more people say they are interested in established techniques than in advanced technology. The real complaint, however, is that most advanced technology sessions are conducted so badly nobody can bear to sit through them. So nobody attends.

The tutorial role belongs to short courses and seminars at colleges, to regional and sectional meetings of IEEE, and to books and magazines.

The IEEE meeting in March should be something special—technically.

Certainly the business side of IEEE week is essential to the industry. In fact this year's show will be crucial for a lot of companies that plan to introduce products there [see p. 74]. Many a company's future will hang on how well its new products are received by the potential customers who attend the show.

Further, the show acts as a rallying point for the industry. Its arrival forces engineers to solve that last problem on the product scheduled for introduction; its size makes it a bonanza for the tireless salesman; and the appendages set up around the show by recruiters help a job-hunting engineer solve a career problem.

Yet these are basically business benefits. The technical sessions ought to be at least on a par in importance. Just how badly the sessions stack up can be seen by the attendance figures. Although 75,000 people will push their way into the show, only about 5,000 will take in the sessions and many of them will be college students.

Attendance at the technical sessions can be stimulated if they are made as important as the exhibits. And there is an easy way to do this: insist that the presentations report only significant advances in technology.

If anybody wants a model, the American Association for the Advancement of Science has been following this prescription for years. Any paper accepted for presentation at one of the AAAS's annual sessions must make a contribution to technology. In recent years AAAS audiences have heard some truly exciting reports, such as the first detailed description of the Van Allen radiation belts in space and a new theory on the composition of matter.

In addition to insisting on a significant development, IEEE could require each author to prepare his presentation in such a way that an engineer can understand it; that it puts the technical development in proper perspective with respect to the work of others; and that it explains the significance of the development for engineers who are not specialists in his field.

There's no substitute for a dialogue between the man who has done an important piece of work and the engineer who is anxious to learn about it. The only way to arrange such a transfer—in large numbers—is to establish good technical sessions.

The annual electronics meeting in March was born as a technical affair. It should become technical again.

NOW...P&B QUALITY IN A FULL LINE OF

SOLID STATE **time delay relays**

**FAST
ACCURATE
RELIABLE**

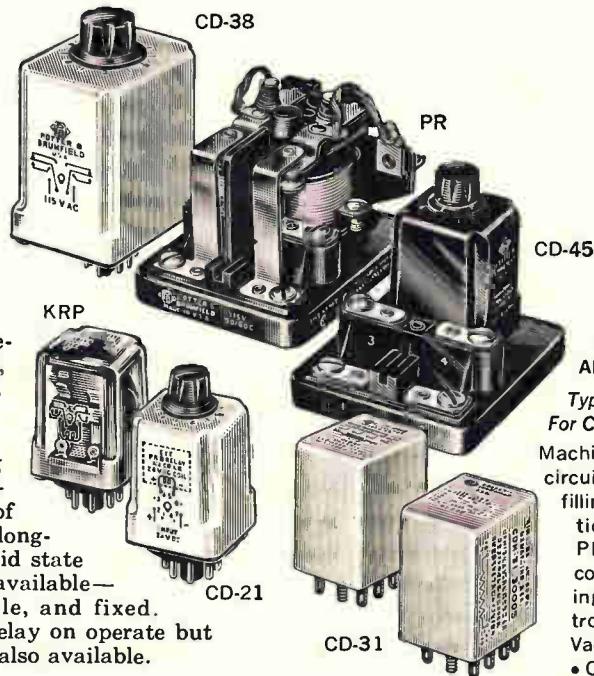

A wide range of time delay requirements can be met with these accurate, easy-to-use solid state relays. All built to P&B's exacting standards of reliability, this new series offers a multitude of advantages, including timing repeatability of $\pm 2\%$; nearly instantaneous (milliseconds) reset; a choice of sizes, mountings and terminations; long-life inherent with non-mechanical solid state switching. Three modes of timing are available—knob-adjustable, resistor-adjustable, and fixed. Most standard relays provide time delay on operate but relays with time delay on release are also available.

CD-38 HAS RELIABLE P&B DPDT RELAY MOUNTED INSIDE CASE
An internally mounted DPDT relay has contacts rated to 10 amps, 115V AC, resistive. Fixed time delay can be specified or relay can be adjusted with knob or external resistor.

CD-21 TIME DELAY PAIRS WITH POPULAR P&B KRP SERIES RELAYS
Compact AC or DC units available to time in increments from 0.1 to 180 seconds. For use with popular P&B KRP relay which provides up to 3PDT switching. Delay time may be fixed or adjusted with knob or external resistor.

USE CD-45 WITH PR RELAY FOR HEAVY DUTY APPLICATIONS
Designed for use with PR power relay in elevator controls, machine tools and other industrial applications. Contacts will switch up to 25 amps at 115V AC non-inductive, or 1 HP at 115/230V AC single phase. Heavy-duty screw terminals. Time delay: fixed or knob-adjustable.

CD-31 USED WITH KH RELAY PROVIDES 4PDT SWITCHING
Only slightly larger than one cubic inch. Available with fixed or resistor-adjustable time delay. Match with KHP relay for up to 4-pole switching capacity. Plug-in convenience when used with socket having solder or printed circuit terminals.

Now available at leading electronic parts distributors

SOLID STATE TIME DELAY RELAYS ARE EASY TO APPLY IN ANY CIRCUIT

- Typical Applications*
For CD Series Time Delay Relays
- Machine tool sequencing
 - Motor starting circuits
 - Vending machines
 - Container-filling control
 - Data processing operations
 - Warm-up or turn-on delay
 - Photographic process control
 - Recorded message repeater
 - Heat sealing
 - Induction heating
 - Elevator controls
 - Die casting
 - Alarm circuits
 - Vacuum processing
 - Injection molding
 - Conveyor control

THESE STANDARD TIME DELAY RELAYS ARE AVAILABLE FROM ELECTRONIC PARTS DISTRIBUTORS

Type	Time Delay in Seconds	Input Voltage	Notes	Sugg. Resale Price
CDB-38-70003	0.1 to 10	115V AC	1	43.80
CDB-38-70004	0.6 to 60	115V AC	1	43.80
CDB-38-70005	1.8 to 180	115V AC	1	43.80
CDD-38-30003	0.1 to 10	24V DC	1	41.55
CDD-38-30005	1.8 to 180	24V DC	1	41.55
CDB-21-70003	0.1 to 10	115V AC	2	38.70
CDB-21-70001	1.8 to 180	115V AC	2	38.70
CDD-21-30003	0.1 to 10	24V DC	3	38.35
CDD-21-30001	1.8 to 180	24V DC	3	38.35
CDH-31-30005	180 (note 5)	24V DC	4 & 5	38.90
CDB-45-70002	0.6 to 60	115V AC	6	37.05
CDB-38-70012	0.6 to 60	115V AC	1 & 7	52.45
CDD-38-30012	0.6 to 60	24V DC	1 & 7	49.50

- NOTES**
- Has internal relay with DPDT contacts rated at 10 amperes, 115V AC.
 - Use with Potter & Brumfield relay KRP5AG—115V AC, KRP11AG—115V AC or KRP14AG—115V AC.
 - Use with Potter & Brumfield KRP5DG—24V DC, KRP11DG—24V DC or KRP14DG—24V DC relay.
 - Use with Potter & Brumfield KHP17D11—24V DC relay.
 - Resistor-adjustable.
 - Use with Potter & Brumfield PR11AY—115V AC relay.
 - Provides delay on release; all others have delay on operate.



POTTER & BRUMFIELD

Division of American Machine & Foundry Company, Princeton, Indiana
In Canada: Potter & Brumfield, Division of AMF Canada Ltd., Guelph, Ont.
Export: AMF International, 261 Madison Avenue, New York, N.Y.

Electronics Newsletter

March 8, 1965

Semiconductors make laser news

Semiconductors are making laser experimentation news at the Massachusetts Institute of Technology's Lincoln Laboratory. In one test, indium antimonide was optically pumped; in another, coherent emission, parallel with, rather than perpendicular to, the diode current was obtained with the same material.

Robert H. Rediker and Robert J. Phelan Jr. used the emission from a gallium arsenide laser to pump the n-type indium antimonide. It was the first time a semiconductor had been optically pumped; indications are that the technique can be used for most present-day diode laser materials, according to Rediker.

Ivars Melngailis obtained the parallel laser action. His technique could free designers from some structural restrictions and permit, for instance, diode laser arrays.

Dispute closes satellite tracker

Grumbling about the younger generation is nothing new, but the military has good reason to be unhappy about its new generation of satellite trackers.

First the giant radar at Eglin Air Force Base, Fla., burned to the ground; now a dispute has its little brother—the only other member of the family—under lock and key. It's a \$5-million electro-optical sensor at Cloudcroft, N.M. The Air Force blames a contract dispute with the developer, the Radio Corp. of America. "There are certain things that have to be done to meet performance requirements," an Air Force spokesman says. "The government says the contractor should do them under the original contract."

Not so, says RCA. There is no "contract dispute"; the building has been shut down because "the tests there are completed and we are writing our reports now."

Presumably RCA and the Air Force will eventually come to terms. And word is that the \$30-million Eglin installation will be rebuilt.

Government to end computer babble

The federal government will concentrate on getting its computers to talk the same language, rather than attempt to standardize all its electronic data-processing equipment. The Budget Bureau, wrapping up a two-year study of computer policies, says that the government spends \$3 billion a year in acquiring and operating computers, and controls nearly one-third of the computers in the nation.

FCC would widen tv reception

The Federal Communications Commission plans to liberalize its regulations in an effort to broaden television reception for sparsely populated areas in the United States. The agency also is seeking to encourage applications for assigned but unused tv channels.

The agency has invited comments by March 15 on its proposal to extend 100-watt output translators—unmanned stations that pick up and amplify existing tv signals—to ultrahigh-frequency channels 14 to 69. Current rules limit uhf translators to channels 70 to 83. In addition, the proposed rule would permit a boost in power output for unoccupied

Electronics Newsletter

very-high-frequency tv channel allocations to 100 watts from 1 watt.

The agency says it will give translator operators an opportunity to originate tv broadcast operations if their local markets develop.

Hybrid circuits vs. monolithics

The debate over which microcircuits perform best at the lowest cost (see p. 125) is about to become very real for two companies: the Electronic Components division of the Burroughs Corp. and the Semiconductor division of the Fairchild Camera & Instrument Corp.

Fairchild is readying integrated circuits that will compete directly with the hybrid-circuit modules Burroughs is introducing to drive Nixie indicator tubes (see p. 75). Fairchild has developed a single-chip decade counter with 23 transistors, 10 diodes and 25 resistors and a single-chip binary-to-decimal decoder with 26 transistors and 25 resistors. Each chip is only 0.05 inch square.

J. E. Price, a Fairchild engineer, disclosed the designs at the Solid State Circuits Conference last month. He said the circuits would drive Nixies and would be priced competitively. The initial price for a counter would be above \$10. The family will include a buffer-storage circuit.

Blast ruins pad, delays moon shot

The space agency's man-on-the-moon program, already three years behind schedule, hit another snag last week: a test rocket that was to carry a model of the Surveyor moon explorer exploded on the pad. The blast destroyed the only Cape Kennedy pad that can accommodate such a launch vehicle.

5 firms to study avionics for F-111A

Five companies will conduct four-month definition studies for the Mark II avionics subsystem to be installed on the Air Force F-111A fighter-bomber. The five, picked from a field of 10, are the General Dynamics Corp., prime contractor for the plane; Hughes Aircraft Co.; Sperry Gyroscope Co.; Autonetics division of North American Aviation Corp.; and Westinghouse Electric Corp.

Bombproof radio planned for SAC

The Air Force has awarded a \$27 million contract to the Westinghouse Electric Corp. for a low-frequency communications network. The major role of the top-secret system; to provide reliable communication for the Strategic Air Command during and after a nuclear attack.

The major item in the contract is the erection of an undisclosed number of tower antennas, nearly as high as the Empire State Building (1,472 feet). Among the technical requirements are a 100-kilowatt solid-state transmitter and a technique for using 20,000 feet of wire, which acts as a low-frequency antenna, trailing from a SAC plane.

Addenda

The launching of the Communications Satellite Corp.'s Early Bird satellite, initially set for March 23, was delayed because of transistor failures. The maker, Texas Instruments, Inc., is replacing the transistors. . . . The Air Force has selected four companies—the Boeing Co., General Electric Co., Douglas Aircraft Co., and Lockheed Aircraft Corp.—to perform 60-day preliminary design studies on its manned orbiting laboratory.

WANTED

 YOUR 

CIRCUIT DESIGN PROBLEMS

We can't solve all of them. But we can come a little closer than any other supplier.

From tubes to Triacs. From wet slug capacitors to SCR's. General Electric is your Number One Source for a full range of electronic components . . . for circuitry knowledge . . . for continuing innovation. Turn the page and see for yourself.

GENERAL  ELECTRIC

LATEST ROUNDUP

TO HELP SOLVE YOUR CIRCUIT PROBLEMS

CASH

REWARD

TRIAC NOW CUTS 60~120 V STATIC CONTROL CIRCUIT COSTS

Now at even lower prices, Triac offers circuit economies in such a-c control applications as replacement of relays and contactors, manual switches, back-to-back SCR's, single SCR inside a diode bridge, and bi-directional diode switches with their associated transformer and circuitry. Triac simplifies control of full wave a-c power and is available in

both 6- and 10-amp ratings. Innovator: Semiconductor Products Department, Syracuse, N. Y.

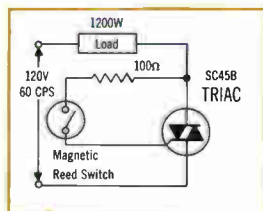

LIFE SENTENCE

20,000,000 operations. SPDT rounds out GE reed switch line

Advantages:

- 20,000,000 operation full load life.
- 150 milliohm max. contact resistance.
- 500-v breakdown (min. 60 cps. RMS).
- 3.100" max. length (with leads).
- 0.215" max. diameter.
- 15 volt-amp contact rating up to 1 amp or 250 volts.

Innovator: Tube Department, Owensboro, Kentucky.



WATCH FOR BLACK HAWK*

NEW SHAPE IN COMMERCIAL USE CAPACITORS

For test and measurement rigs, communications equipment, and consumer product applications. *Black Hawk* capacitors deliver unusual mechanical advantages . . . special features like molded encapsulation, welded leads, precise dimensions ($\pm .005"$), mounting feet, damage resistance, extended foil construction and modern design. Humidity and moisture resistance, efficient space utilization, and ease of handling are also well worth checking. *Black Hawk* capacitors will operate at temperatures up to $+125^{\circ}\text{C}$. Innovator: Capacitor Department, Hudson Falls, N. Y.

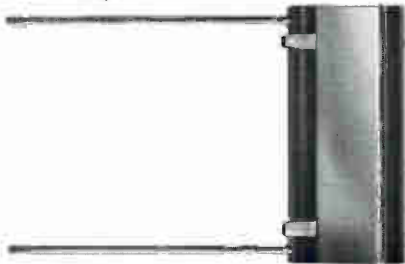

* Trademark of General Electric Co.

DANGER

VERY SENSITIVE

This *electrostatic I.O.* reduces power requirements of comparable, low-light-level systems 30 to 1, weight 20 to 1, and size 5 to 1. Measures just 13.125", weighs 11 oz. Focussing and deflection are self-contained. Available with S-10 or S-20 photocathodes. Innovator: Tube Department, Syracuse, N. Y.



ELECTRONIC COMPONENTS SALES OPERATION

GENERAL  ELECTRIC

SPACE STEALER

COMPACTRON REPLACES 2—
EVEN 3—IF AMPLIFIER TUBES

Lower cost, improved performance level, reduced space requirements—all are GE 9BJ11 COMPACTRON advantages.

Inside it—a double-pentode with dual-control input section and sharp cutoff output section. This new unit may be used in a 2-stage IF amplifier with performance level comparable to conventional 3-stage amplifiers in monochrome TV receivers. It reduces sockets required, associated circuitry, and labor costs; and eliminates need for an un-bypassed cathode resistor to utilize full gain capability. Innovator: Tube Department, Owensboro, Ky.

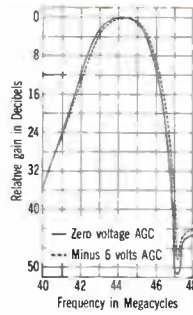

Response of 9BJ11 IF amplifier

QUICK ON THE TRIGGER

CADMIUM SULFIDE CELL WITH
5 MILLISEC. MAX. RISE TIME



Response speed of GE's A36M1 cadmium sulfide cell approaches that of cadmium selenide cells while retaining excellent temperature (see curve 1) and life test stability (curve 2). Notice how the GE A36M1's resistance changes rapidly with small changes in illumination (curve 3). Ideal for electronic shutter controls on cameras, computer readout cards, and similar applications requiring fast response times. Innovator: Tube Department, Owensboro, Ky.

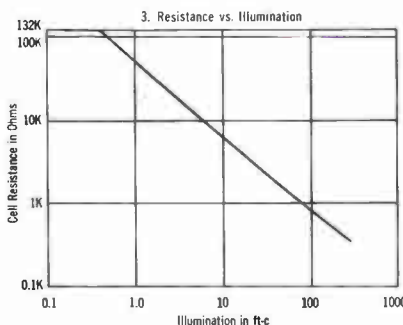
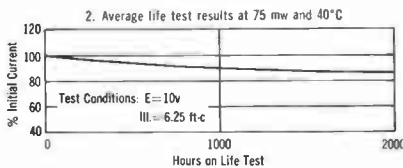
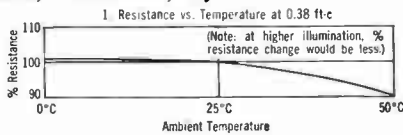

FOUND: SMALL PACKAGE

ZP-1061 TRIODE SIMPLIFIES CAVITY
DESIGN FOR OSCILLATOR SERVICE

This new high performance, metal-ceramic coaxial triode for NAVAID application features internal feedback that simplifies cavity design for oscillator service. Large cathode area offers long and reliable tube life. Grid-pulsed oscillator service simplifies modulator requirements, and small tube-cavity package size is ideal for miniaturization. Innovator: Tube Department, Sch'dy, N. Y.



JOINS WET SLUG GANG

NEW LOW IMPEDANCE CAPACITOR

The key is simplicity. GE has eliminated 75% of the internal connections found in packaged competitive Tantalum capacitors. This reduces chance for failure and helps eliminate high resistance contact—the primary cause of high impedance. High volt- μ f rating remains stable throughout life, and all capacitors in the line meet Mil-C-3965 requirements. Innovator: Capacitor Department, Irmo, S. C.



FEEDBACK

TEMPERATURE

SIZE

SHOCK

Radiation

VOLTAGE

Reliability

COST

FREQUENCY

WEIGHT

CURRENT

SPEED

VIBRATION

TIME

POWER

MIL

LIFE

RESISTANCE

MOUNTING

CIRCUIT-COST ROBBERS

AMPLIFIER—TRANSISTORS COST < \$1

Utilizing GE Economy transistors 2N2926 and 2N3391, the Darlington Amplifier below gains you excellent economics through high current gain at low collector circuits, low leakage currents, low collector capacitance and good f_t at low currents. These transistors provide an input impedance greater than 50 megohms up to 25 kc, with a circuit input capacitance of only 0.25 pf.

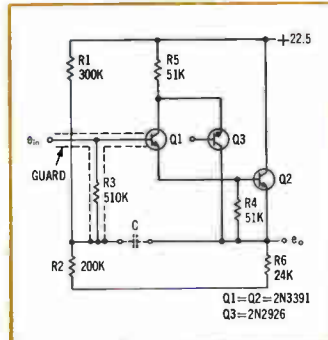

VERSATILE LOGIC—SEMICONDUCTORS COST < \$1

2-level gate in this circuit permits fan-in in excess of 10 into either the AND or the OR gate. Use of a gold-doped, GE Economy transistor 2N3605 with a f_t of 300 mcs. lowers the propagation delay to well under one microsecond under any combination of inputs and outputs. Innovator for both: Semiconductor Products Department, Syracuse, N. Y.

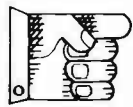
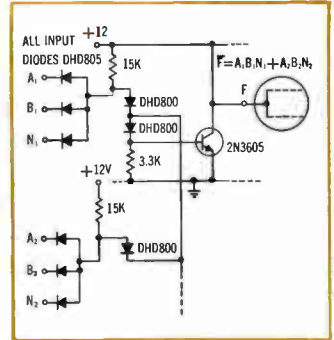

NOTICE

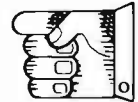

We don't offer everything you want from one supplier. We just come a little closer than anyone else.

Be sure to visit General Electric's IEEE one-source capabilities exhibit. All innovations described on these pages, plus many more, are displayed for you in Booths 2906 through 2944. Ask any GE engineer/salesman there for specs, price details, or application help. Call or write any regional or local Electronic Components Sales Office. Write us at 1 River Road, Schenectady, N. Y. or ask your local GE distributor.

NEW ENGLAND REGION—O. J. SCHOPP
Area Code 617, 482-1800
31 St. James Ave., Boston, Mass. 02117
Area Covered: Northeastern N. Y.; Me.; N. H.; Vt.; Mass.; R. I.; Conn.

EMPIRE REGION—BILL ROBUSTO
Area Code 315, 456-2062
Electronics Park, Syracuse, N. Y. 13201
Area Covered: Western N. Y.; Northeastern Pa.

EASTERN REGION—JOE UTTAL
Area Code 516, 921-8840
175 Jericho Turnpike, Syosset, N. Y. 11791
Area Covered: Long Island; Manhattan; Westchester; Fla.

GARDEN STATE REGION—JOHN NELSON
Area Code 201, 472-8100
200 Main Ave., Clifton, N. J. 07014
Area Covered: N. J.

ATLANTIC REGION—PAUL RYAN
Area Code 215, LO 8-1800
3 Penn Center, Philadelphia, Pa. 19102
Area Covered: Eastern Pa.; Baltimore; Washington, D. C.; Va.; N. and S. Carolina; Ga.; Ala.

EAST CENTRAL REGION—ED DRISCOLL
Area Code 216, 361-4464
4966 Woodland Ave., Cleveland, Ohio 44104
Area Covered: Ohio; Western Pa.; Ky.; Ind.; W. Va.

GREAT LAKES REGION—DON PUTNAM
Area Code 411, BR 1-5000
940 W. St. Paul Ave., Milwaukee, Wis. 53233
Area Covered: Mich.; Wis.; Minn.; N. and S. Dakota

CENTRAL REGION—JIM WALTON
Area Code 312, 777-1600

3880 N. Milwaukee Ave., Chicago, Ill. 60641
Area Covered: Ill.; Ia.; Okla.; Tex.; Miss.; La.; Ark.; Mo.; Neb.; Kan.; Western Tenn.

NORTHWESTERN REGION—HARRY PERLIS
Area Code 415, 434-2211
235 Montgomery St., San Francisco, Calif. 94106
Area Covered: Northern Calif.; Ore.; Wash.; Utah; Colo.; Northern N. M.; Ida.; Mont.; Wyo.; Nev.

PACIFIC SOUTHWESTERN REGION—GEORGE CURTISS
Area Code 213, BR 2-8566
11840 W. Olympic Blvd., Los Angeles, Calif. 90064
Area Covered: Peripheral Los Angeles, Southern Calif.; Ariz.; Southern N. M.

LOS ANGELES REGION—RAY KIDD
Area Code 213, 625-7381
212 No. Vignes St., Los Angeles, Calif. 90054
Area Covered: Los Angeles Proper

CONSUMER ELECTRONICS REGION—GEORGE CROSSLAND
Area Code 312, 777-1600
3800 N. Milwaukee Ave., Chicago, Ill. 60641
Area Covered: All major consumer electronics customer locations in the Midwest.

Innovations in Action

GENERAL ELECTRIC

ELECTRONIC COMPONENTS SALES OPERATION

TWO GREAT NEW CHAMPS

*See them at IEEE
March 22-25
Booth 3038*



NEW COAX

Recording 1.5 mc on as many as fourteen tracks, Mincom's new Portable Coaxial Recorder offers the industry's highest performance per cubic foot. Stands under two feet high. 14-inch NAB precision reels. $1\frac{7}{8}$ to 120 ips. Two playback channels. RFI-shielded, this new system is unequalled for van, shipboard and similar installations.

NEW PCM

Digital data in an improved parallel format at 120,000 bits per second per track — that's the story of Mincom's newest solid-state system. Sixteen channels for NRZ digital input, clock, timing and voice. Seven push-button speeds from $1\frac{7}{8}$ to 120 ips. Controls and adjustments front-accessible for CRT display and digital electronics.

Mincom Division **3M**
COMPANY
300 South Lewis Road, Camarillo, California

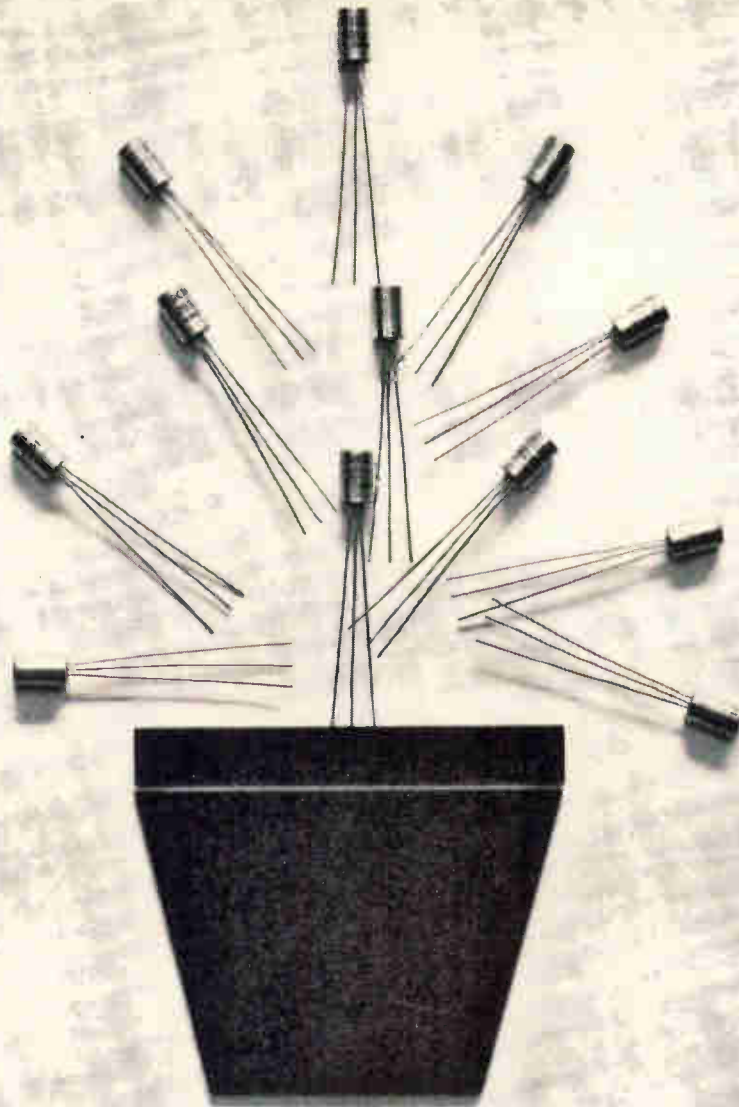

Tree of plenty

And Hitachi invented the way to make it grow. The fruits of this invention are called PM-type silicon transistors. Hitachi is now the only electronics manufacturer in the world that can produce such transistors by the millions! ■ This transistor family began as an idea. That idea was to develop Planar-type transistors that could eliminate surface contamination and retain optimum efficiency. This was achieved. The PM transistor was developed. But, only on a small scale. And it remained at this stage until Hitachi took over the task of mass production. ■ This proved to be almost as difficult as the original conception. But by the pains-taking development of a special sealing technique the problem was solved . . . mass production was possible for the first time. ■ The windfall of advances this brings to the electronics field are considerable: a transistor that is dependable due to longer lasting efficiency . . . a high collector inverse voltage . . . a small collector saturation current . . . current gain that does not drop off in low current operation . . . and, most important, a cost rate that makes it financially more than practical. ■ This is our tree of plenty . . . this is how to enjoy its benefits. Write to the addresses below.



HITACHI SALES CORPORATION: 333, N. Michigan Avenue, Chicago 1, Ill., U.S.A. Tel: 726-4572/4 / 666, 5th Avenue, New York, N.Y. 10019, U.S.A. Tel: 581-8844 / 12715, S. Daphne Avenue, Hawthorne, Calif., U.S.A. Tel: 757-8143
HITACHI, LTD., DUESSELDORF OFFICE: Graf Adolf Strasse 37, Duesseldorf, West Germany Tel: 10846

NOW! Measure Noise and Field Intensity INSTANTLY with ONE Integrated Unit 1-10 gc

EXPANDABLE WITH ONE MODULE 10-22 gc



NEW!

Empire* NF-112-F Noise and Field Intensity Meter

- Automatic Variable Speed Scanning (Full and Sector)
- Impulse Noise Generator Calibration
- X-Y Plotting Provision
- Average, peak and metered slideback detection
- Dual Bandwidths—Narrow and Broadband

NOW you can measure noise and field intensity INSTANTLY over the entire 1-10 gc frequency range with ONE integrated unit, and CONVENIENTLY over the entire 10-22 gc range with ONE tuning module.

The new EMPIRE NF-112-F Noise and Field Intensity Meter combines advanced versions of the 1-10 gc tuning modules of the field-accepted NF-112 into one convenient package — your assurance of dependability and full compliance with the most stringent of military and commercial test requirements.

PLANNED UN-Obsolescence — is the unique METRICS concept of designing state-of-the-art instruments capable of fulfilling your expanding needs. Typical is

the Empire NF-112-F, which provides modular range expansion from 10 to 22 gc, and anticipates dramatic operational improvements. You save today and tomorrow through *Planned Un-obsolescence*.

INSTANT INTEGRAL operation is possible through Automatic Scanning and complete functional one-unit design. The NF-112-F is the world's only NFI Meter to provide Automatic Variable Speed Scanning, Impulse Noise Generator Calibration, and range-extendability *all in one light, integral package*. It is ideal for rack or field vehicle installation.

With the NF-315 (20 cps - 15 kc), NF-105 (14 kc - 1gc) and NF-112 series, the entire frequency range of 20 cps to 22 gc is covered with just three instruments.

MATCHED SYSTEMS CAPABILITY

Another exclusive! Typical is the *Empire PA-210 Spectrum Signature Analyzer*, which provides rapid display of RFI signals, and is matched to the NF-112-F and other *Empire NFI Meters*.

Empire devices are designed to match existing and planned instrumentation—minimizing complications in systems design—such as impedance matching and extra calibration.



Contact your Metrics Representative for descriptive literature and demonstration.

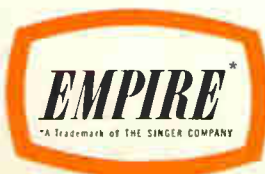

THE SINGER COMPANY
METRICS DIVISION

915 PEMBROKE ST., BRIDGEPORT, CONNECTICUT
PHONE (203) 306-3201 • TWX 710-453-3483

Design and production of PANORAMIC • SENSITIVE RESEARCH • EMPIRE • GERTSCH instruments for measurement

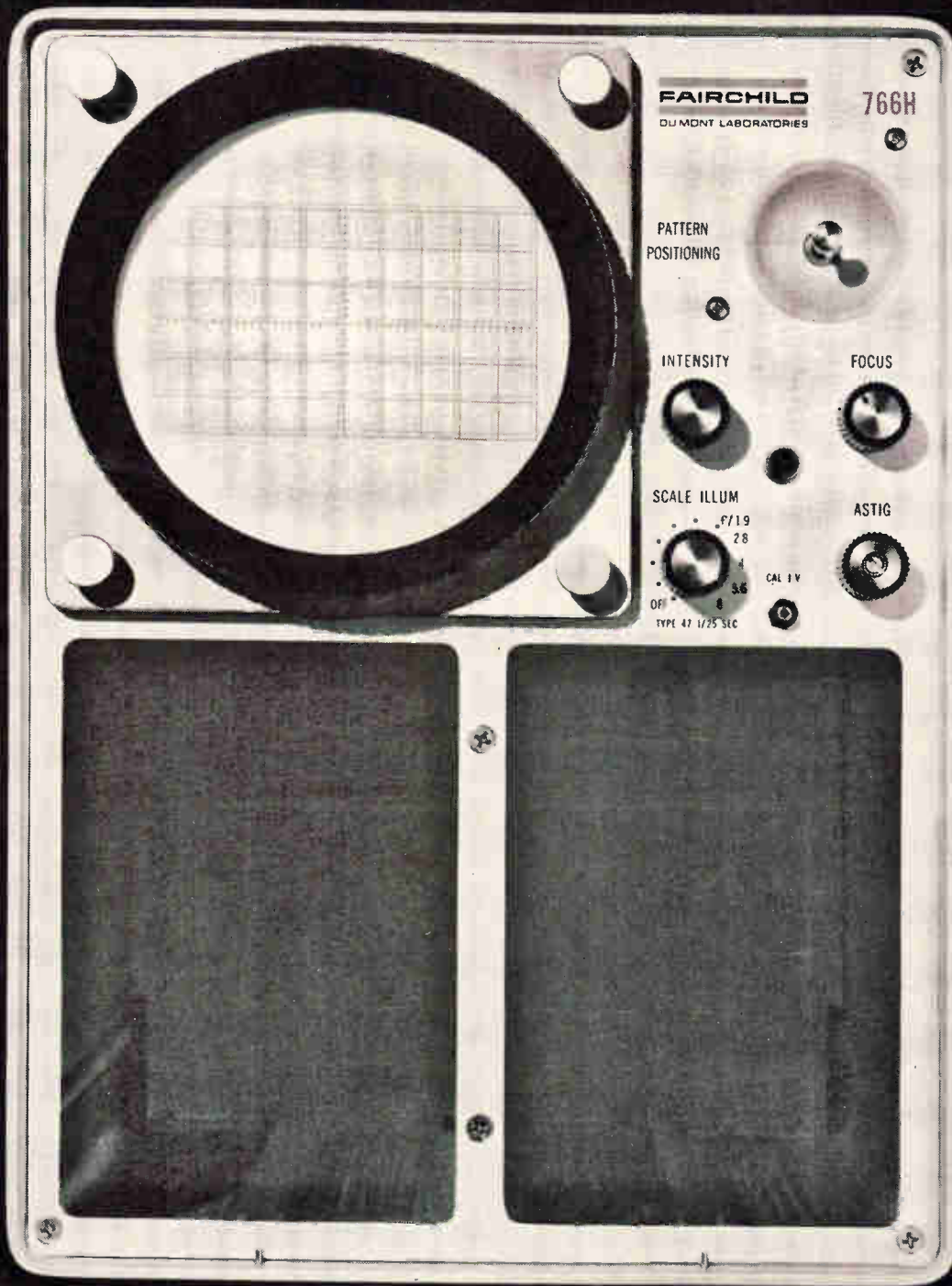

*Technological Obsolescence

WITH THIS SCOPE AND THOSE PLUG-INS...

Your oscilloscope applications change with the work you're doing and the state-of-the-art. Over the years, you **could** buy a lot of special purpose scopes for that reason. But you don't have to. There are now 20 plug-ins available for the Fairchild Series 765H main frame (and more are on the way). The versatility not only helps you beat the high cost of T.O.—Technological Obsolescence; it lets you add new capabilities at low cost if and when you need them. Other factors that contribute to Fairchild value are . . . all solid-state circuitry for long term reliability . . . deflection circuitry in the plug-in . . . four main frame configurations (bench, rack, portable, and dual gun).

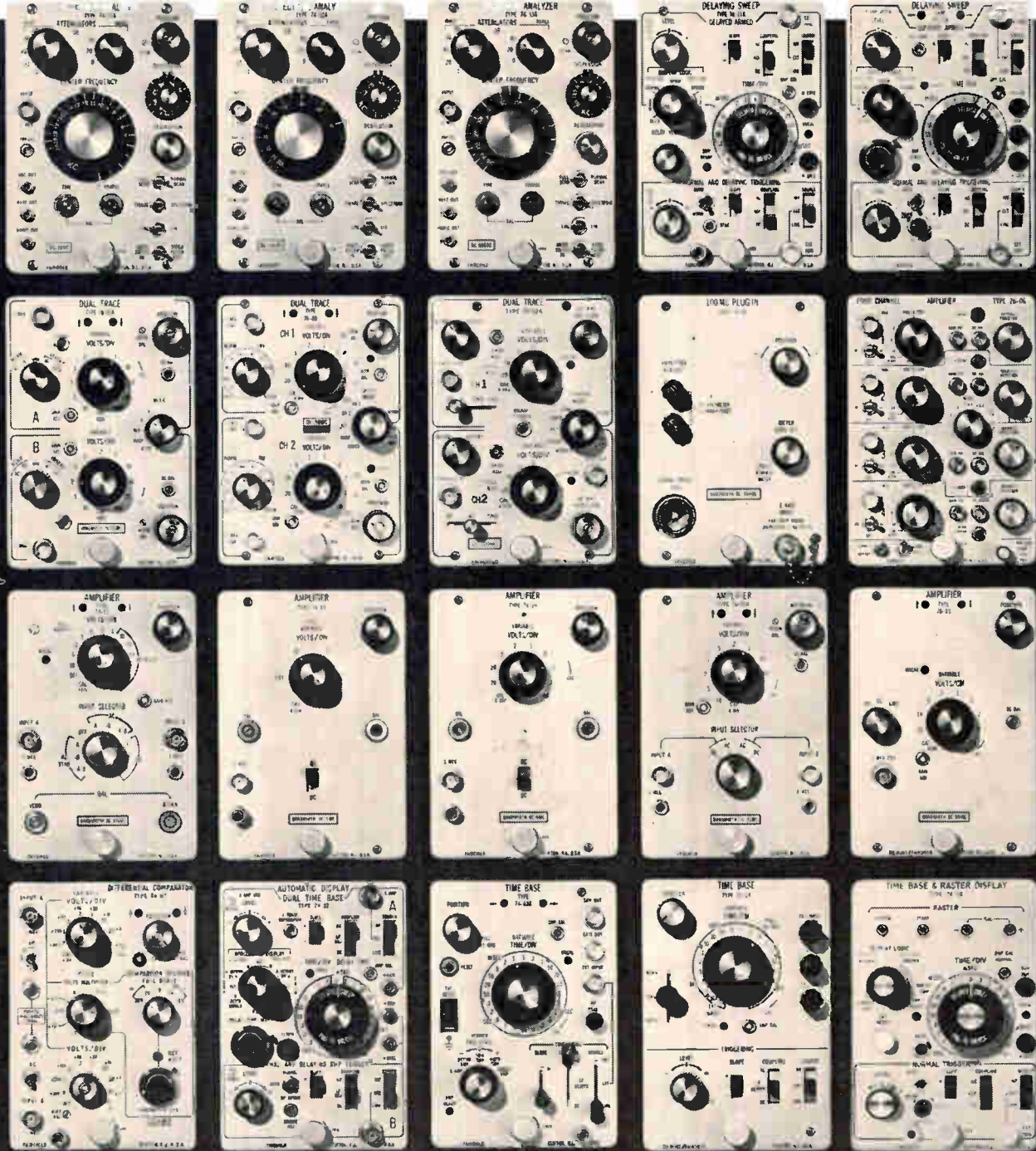

...WHO NEEDS COSTLY SPECIAL PURPOSE SCOPES?

Ask your Fairchild Field Engineer for a demonstration of the Series 765H. Judge it on performance and by your own standards of value analysis. For a new catalog describing the Series 765H and other Fairchild scopes write Fairchild Scientific Instrument Dept., 750 Bloomfield Ave., Clifton, N. J. Visit Fairchild at the IEEE Show — Booth Nos. 2701 thru 2717.

FAIRCHILD

DU MONT LABORATORIES
SCIENTIFIC INSTRUMENT DEPARTMENT

Circle 27 on reader service card

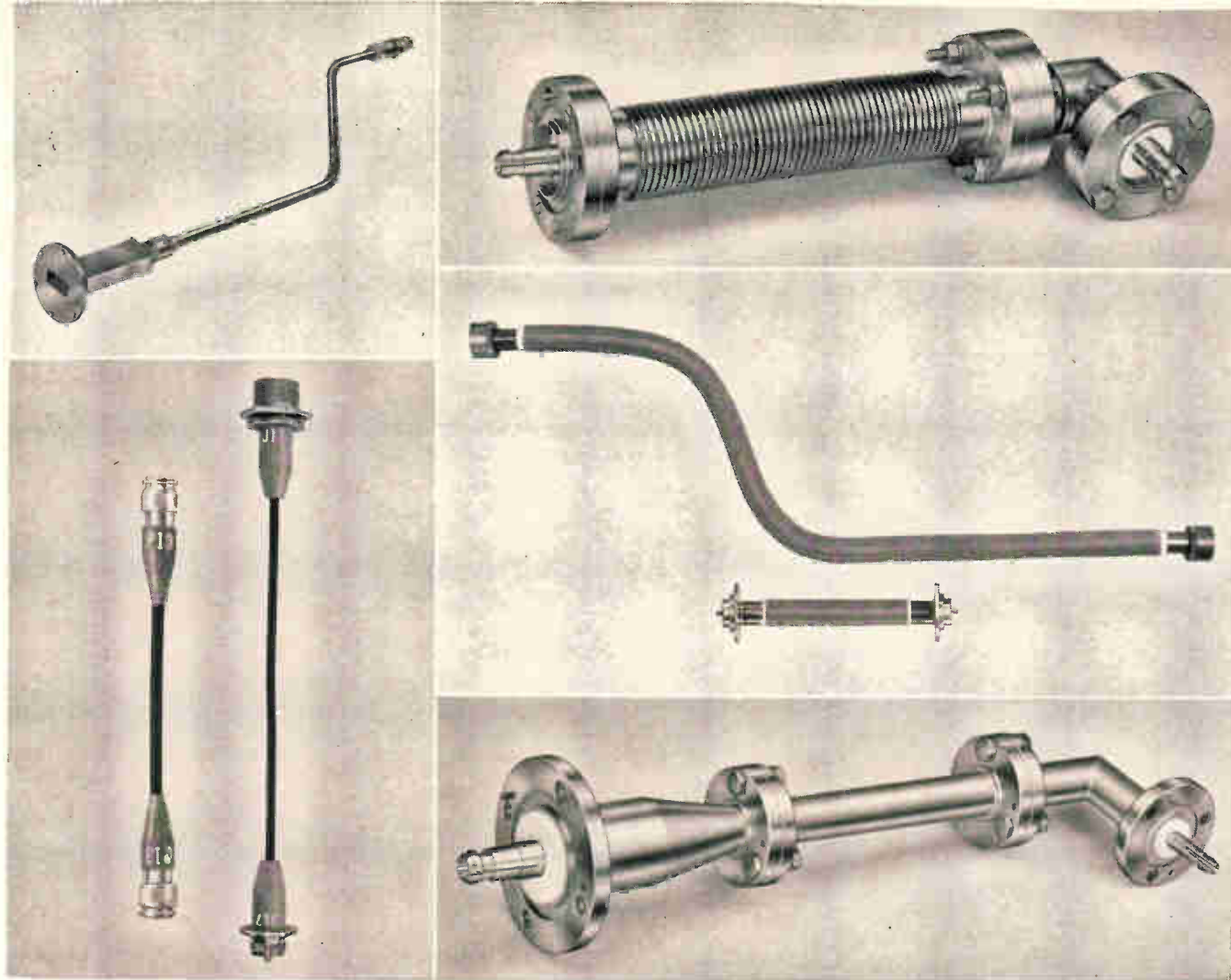

Coaxial cable assemblies. Ingenious solutions to very special installation and transmission problems.

Phelps Dodge Electronic's coaxial cables are available by the mile or by the foot. They are also available in unique, one-of-a-kind shapes and configurations which greatly extend application parameters. For instance, in transmitter installations, a cable assembly can eliminate the need for elbows and other high cost RF plumbing. In tight physical confines, or under difficult environmental conditions, a special cable assembly might well be the answer.

We have made hundreds. And, they are all different. Tracking antenna harnesses, as an ex-

ample, sections of cable which accurately place each antenna element in phase with other elements. Special local oscillator and receiver lines, each a section of Styroflex® coaxial cable cut to very tight electrical length for transition to waveguide. An airborne vibration isolator, an extremely flexible corrugated assembly connecting rigid line to shock mounted gear. Or, in equalizing and balancing networks. Matching sections.

We would like to hear about your needs. Write for Bulletin CC-1.

PHELPS DODGE ELECTRONIC PRODUCTS
NORTH HAVEN, CONNECTICUT



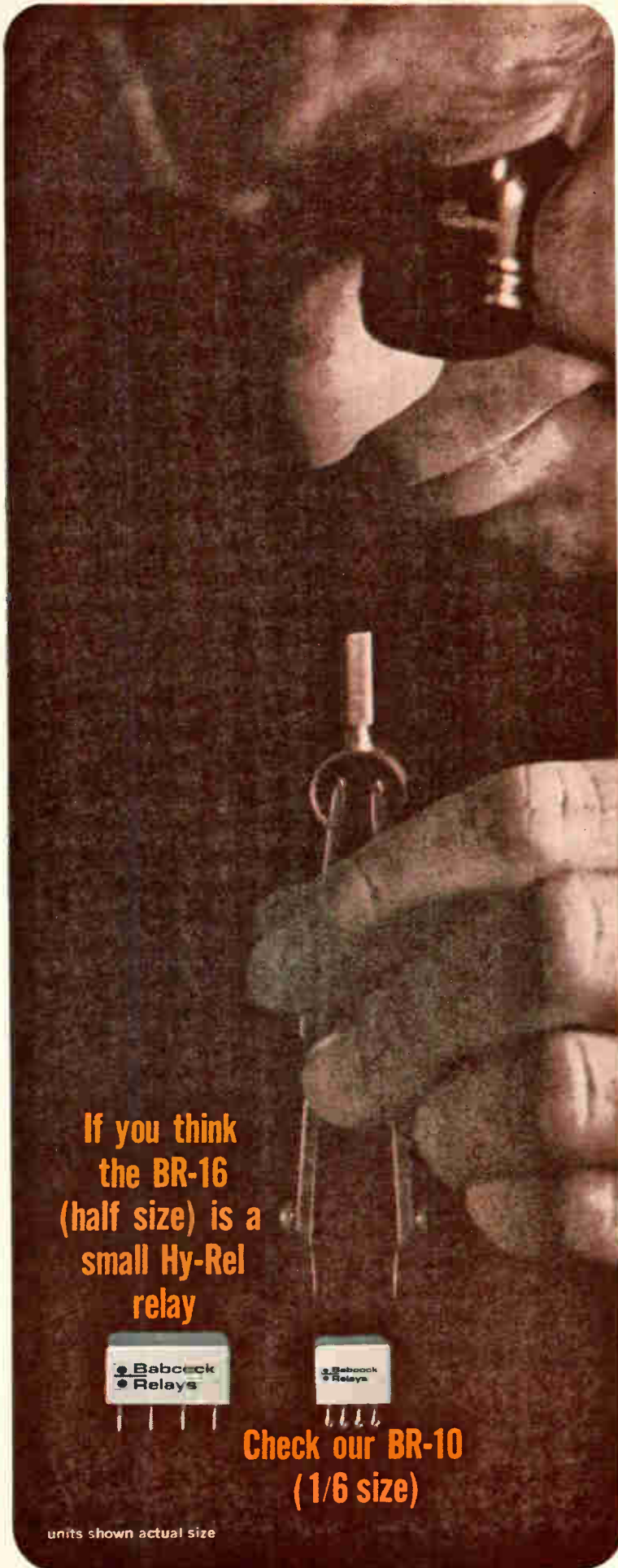

If you think
the BR-16
(half size) is a
small Hy-Rel
relay



Check our BR-10
(1/6 size)

units shown actual size

Babcock's new BR-10 1/6-size crystal can relay will switch dry circuit to 1-amp loads with the same sensitivity as DPDT types many times its size. Designed for low profile mounting, it exceeds MIL-R-5757D requirements and withstands severe environmental conditions encountered in airborne applications. Available both single pole and double pole.

For 2-amp contact requirements, the Babcock BR-17 (latching) and BR-16 (non-latching) half-size crystal can relays provide the same reliability and, like the BR-10, incorporate the exclusive Babcock Vycor getter to adsorb outgassed organic contaminants after production degassing. Various mounting arrangements and either plug-in or solder hook terminals can be supplied as standard. Write for complete details in our new 24-page catalog.

	BR-16	BR-17	BR-10T	BR-10W
Operation	Non-Latching	Latching	Non-Latching	Non-Latching
Contact Arrangement	DPDT	DPDT	DPDT	DPDT
Construction	All Welded	All Welded	Solder Seal	All Welded
Sensitivity	175mw	175mw	100mw	100mw
Contact Rating	2A @ 26VDC	2A @ 26VDC	1A @ 26VDC	1A @ 26VDC
Size	.131 cu. in.	.131 cu. in.	.046 cu. in.	.046 cu. in.
Weight	.25 oz.	.25 oz.	.15 oz.	.15 oz.
Vibration	30g 30-2000 cps	30g 30-2000 cps	30g 40-3000 cps	30g 40-3000 cps
Shock	50g 11 msec.	50g 11 msec.	150g 11 msec.	150g 11 msec.

See us at Booth 2927 IEEE

BABCOCK RELAYS

A DIVISION OF BABCOCK ELECTRONICS CORPORATION
3501 HARBOR BLVD., COSTA MESA, CALIF. (714) 546-2711

How to increase the utility of your Hewlett-Packard Counter:



hp 5245L Electronic Counter



DY-2546

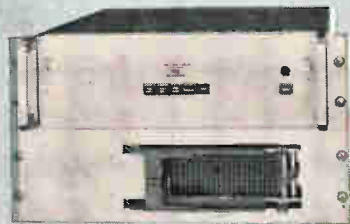

DY-2526

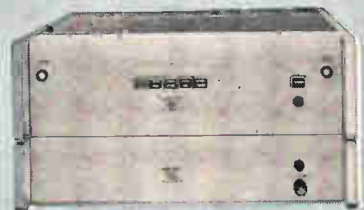

DY-2545

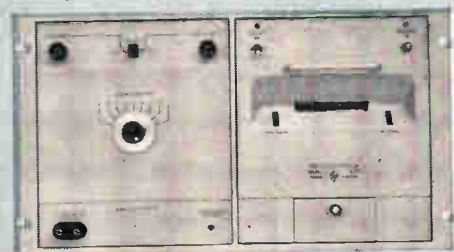

hp 562AR

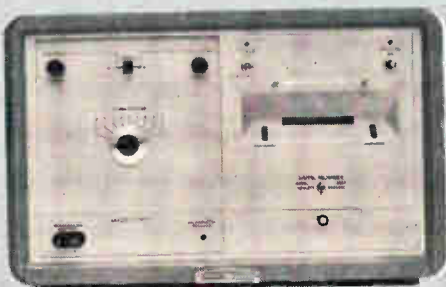

hp 562A



DY-2514A

Make permanent records of your hp counter measurements

- printed paper tape
- punched paper tape
- punched cards
- magnetic tape
- x-y plots
- analog strip-chart records
- analog voltage and current



hp 580A



Moseley 680A



hp 581A



Moseley 7000

Use these accessories to increase the usefulness and value of your counter:

These instruments, available from Hewlett-Packard and its Dymec and Moseley Divisions, increase the usefulness of your counter measurements by permitting you to make a wide variety of permanent records ideal for later study or processing.

hp 562A Digital Recorder—Solid-state device with parallel data entry and low-inertia moving parts allowing printing rates as high as 5 lines/sec, each line up to 11 digits (12 on special order); data transfer as fast as 2 msec; available for BCD and 10-line codes, \$1600, depending on options; 562AR rack mount, \$1575.

DY-2545 Tape Punch Set—Operates with Teletype BRPE 11 Tape Punch, records at 110 characters/sec; accepts 10 input digits in BCD form from electronic counter, produces IBM 8-level code; up to 16 input characters and other 5 to 8-level output codes optional; features data storage for high speed; all solid state; \$3900, including tape punch.

DY-2526 Card Punch Set—Couples counter to IBM 526 Card Punch; standard model accepts 10 input digits in BCD form; features data storage; all solid state; \$3100.

DY-2546 Magnetic Tape Recorder Set—Operates with Cook Model 150 Incremental Tape Recorder; records at 150 characters/sec; standard model accepts output format for maximum computer compatibility; data storage; all solid state; \$8565, including tape transport.

hp 580A, 581A Digital-to-Analog Converters—Accept 4-line BCD output from counters, provide output for galvanometer and potentiometer strip-chart recorders; differ only in physical dimensions; \$525.

DY-2514A Digital Scanner—Scans up to 6 data sources, up to 10 digits from each source; compatible with BCD output of all hp solid-state counters; sequential and random scanning modes, transfers data as fast as 20 readings/sec; \$2500.

Moseley 680A Strip-Chart Recorder—Solid-state 6" recorder; 8 chart speeds; continuous zero set; zener reference; 10 ranges, 5 mv to 100 v full scale; accuracy better than 0.2% of full scale; \$750.

Moseley 7000 X-Y Recorders—Variety of 11" x 17" recorders; accepts dc inputs on each axis; 10, 11 or 16 ranges; most models with built-in time sweep; one model omits time base, is designed for computer use, will accept ± 100 v computer reference; \$1490 to \$2050.

Discuss how to get maximum usefulness from your hp counter with a call to your local Hewlett-Packard field engineer. Or describe your problem and request complete data with a letter to Hewlett-Packard, Palo Alto, California 94304, Tel. (415) 326-7000; Europe: 54 Route des Acaacias, Geneva; Canada: 8270 Mayrand Street, Montreal.

Data subject to change without notice. Prices f. o. b. factory.

HEWLETT  **PACKARD**
An extra measure of quality

Magneline®

THE INDICATORS WITH INHERENT MEMORY

12000 SERIES



PANEL SPACE..... $2\frac{3}{4}$ " wide x $1\frac{1}{16}$ " high
($2\frac{3}{4}$ " x 1" if bracket mounted)
NUMBER OF CHARACTERS..... up to 10
NUMBER OF TERMINALS..... 5, plus a common*
WATTS..... 3
PULSE TIME..... 500 milliseconds
DUTY CYCLE..... 25% (pulsing same coil)

*Requires switching of lead in conjunction with reversal of polarity to change character

14000 SERIES



PANEL SPACE..... $\frac{1}{2}$ " wide x $2\frac{1}{4}$ " high
($\frac{1}{2}$ " x $1\frac{1}{8}$ " if bracket or earless mounted)
NUMBER OF CHARACTERS..... up to 11
NUMBER OF TERMINALS..... 11, plus a common
WATTS..... 2.5
PULSE TIME..... 500 milliseconds
DUTY CYCLE..... 50% (25% if pulsing same coil continuously). Continuous duty available in some voltages.

15000 SERIES



PANEL SPACE..... $\frac{1}{2}$ " wide x $2\frac{1}{4}$ " high
($\frac{1}{2}$ " x $1\frac{1}{8}$ " if bracket or earless mounted)
NUMBER OF CHARACTERS..... up to 10
NUMBER OF TERMINALS..... 5, plus a common*
WATTS..... 1.5
PULSE TIME..... 500 milliseconds
DUTY CYCLE..... 50% or continuous (must be specified)

*Requires switching of lead in conjunction with reversal of polarity to change character

16000 SERIES



PANEL SPACE..... $\frac{7}{8}$ " wide x $3\frac{3}{4}$ " high
($\frac{7}{8}$ " x $2\frac{1}{16}$ " if bracket or earless mounted)
NUMBER OF CHARACTERS..... up to 12
NUMBER OF TERMINALS..... 12, plus a common
WATTS..... 3
PULSE TIME..... 650 milliseconds
DUTY CYCLE..... 50% or continuous (must be specified)

17000 SERIES



PANEL SPACE..... $1\frac{1}{2}$ " wide x 5" high
NUMBER OF CHARACTERS..... up to 12
NUMBER OF TERMINALS..... 12, plus a common
WATTS..... 3
PULSE TIME..... 2 seconds
DUTY CYCLE..... 50% or continuous (must be specified)

All MAGNELINE® Indicators are available in 6, 12, 24 or 28 volts (as specified) and the standard operating temperature range is from -20 deg. C to +71 deg. C. Options, at extra cost, include special voltage, broader temperature range, special characters, trim-spacer strips, internal lighting, solder terminals, dust tight-drip proof construction, and dummy models with fixed digit or black window.

SEE THEM AT
BOOTH 3050
IEEE SHOW

YOU GET ALL THESE FEATURES WITH MAGNELINE:

Long life • Minimum maintenance cost • Easy readability in all kinds of light • A wide variety of mounting methods to give you best use of panel space.

For complete details and the name of our nearest representative, write to us at Waterbury. Better yet, call us at (203) 756-3636 or get in touch by TWX (203) 753-9341

PATWIN® ELECTRONICS

A DIVISION OF THE PATENT BUTTON COMPANY
WATERBURY, CONNECTICUT • 06720

new ●●●● dc to 18 gc fixed attenuator



MODEL 2
ACTUAL SIZE

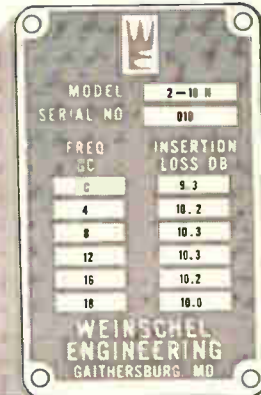

- LOW VSWR AND FREQUENCY SENSITIVITY
- NEW TYPE N CONNECTORS
- 10 AND 20 DB VALUES
- CONTINUOUS FREQUENCY COVERAGE

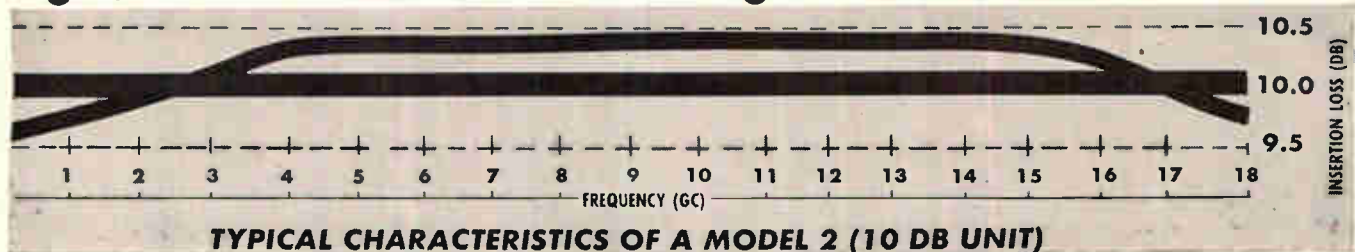

Designing this new DC to 18 Gc attenuator required the unique combination of Ψ experience in developing attenuators, connectors and test equipment. The Ψ Model 2 will broaden the range of applications for coaxial systems—including use of the 12.4 to 18 Gc band usually reserved for waveguide.

An entirely new semi-precision Type N connector, plus a 7 mm slotted line and accessories, had to be developed before work could start on the attenuator. The new connector can be mated and used with older Type N fittings. This is an important factor in the use of the attenuator. These 18 Gc upper limit connectors together with the test equipment will soon be available commercially.

The flat attenuation and low VSWR characteristics of the Model 2 Fixed Attenuator are based on design principles* used by Ψ in the DC to 10 Gc Model 1 attenuators introduced last year. An attenuating card, with a recently developed Ψ resistive film deposited at red heat on a ceramic base, is the key to the design. Elements of this type have been proven through use to be stable with time. They are also able to withstand overloads of either CW or pulse power without damage.

*Patent No. 3,157,846



WEINSCHEL ENGINEERING

GAITHERSBURG, MARYLAND • TEL: AREA CODE 301; 948-3434 • TWX: 301-926-3730
SANTA MONICA, CALIFORNIA • 1318 SECOND STREET • TWX: 213-879-0490

SPECIFICATIONS

Frequency Range—DC to 18 Gc
Standard Nominal Values—10 and 20 db
Maximum Deviation from Nominal Value**— $\pm 5\%$ in db
VSWR—DC to 3 Gc—1.2 Maximum
 3 to 10 Gc—1.35 Maximum
 10 to 18 Gc—1.50 Maximum
Input Power—1 Watt CW Maximum; 1 KW Peak Maximum
Power Sensitivity— < 0.001 db/db/Watt
Temperature Coefficient— < 0.0001 db/db/ $^{\circ}$ C
Calibration Frequencies—(with insertion loss values stamped on nameplate)—DC, 4, 8, 12, 16, and 18 Gc
Connectors—Type N, 50 ohms, stainless steel—One male and one female
Length—2.85"
Diameter—25/32"
Weight—3 $\frac{3}{4}$ oz.

**Includes frequency sensitivity

*You Are Cordially Invited
to Attend the Symposium on Precision
Microwave Measurements at the
Sherry Netherland Hotel
781 Fifth Avenue, New York City
March 22, 23, 24, and 25, 1965*

Now—from AE Printed Circuit Correesds with 5 new features!

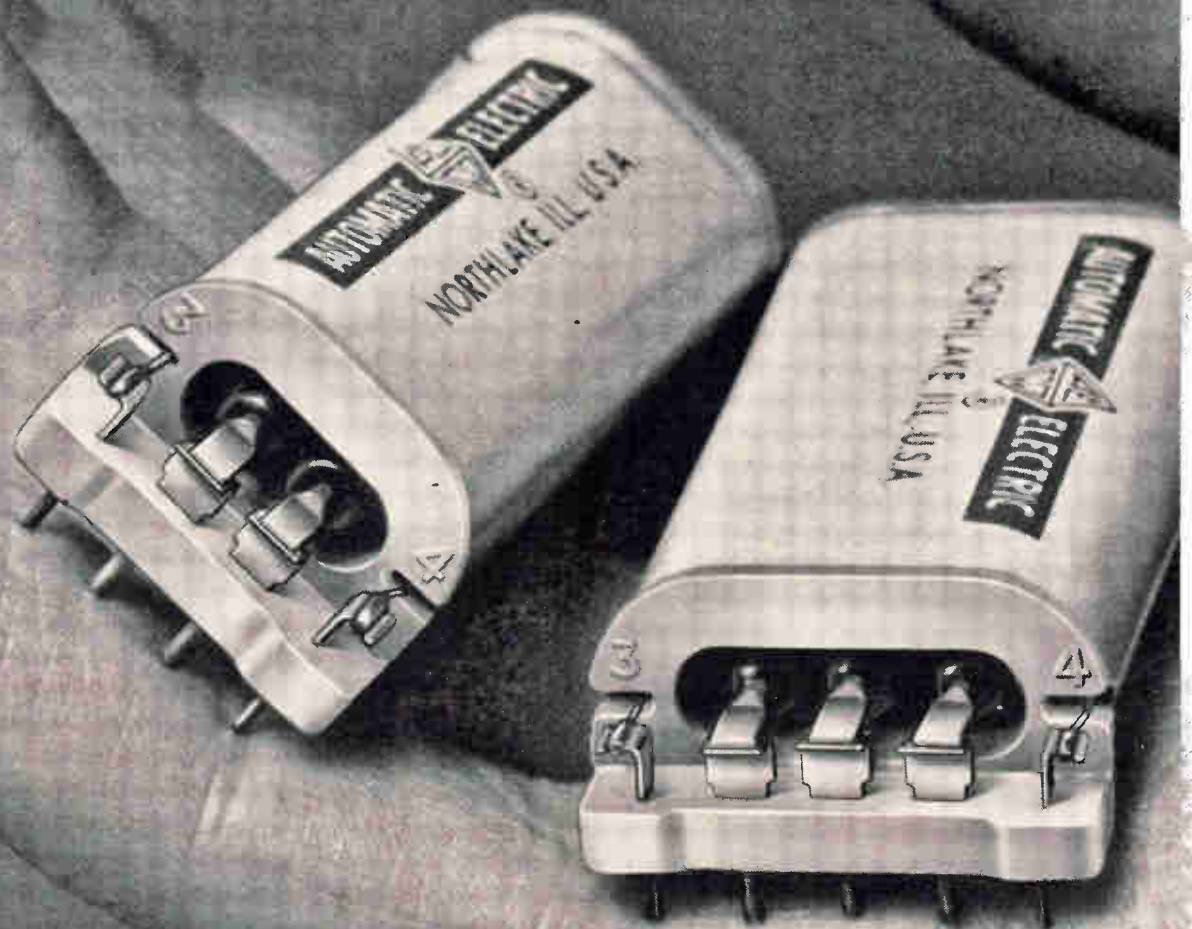

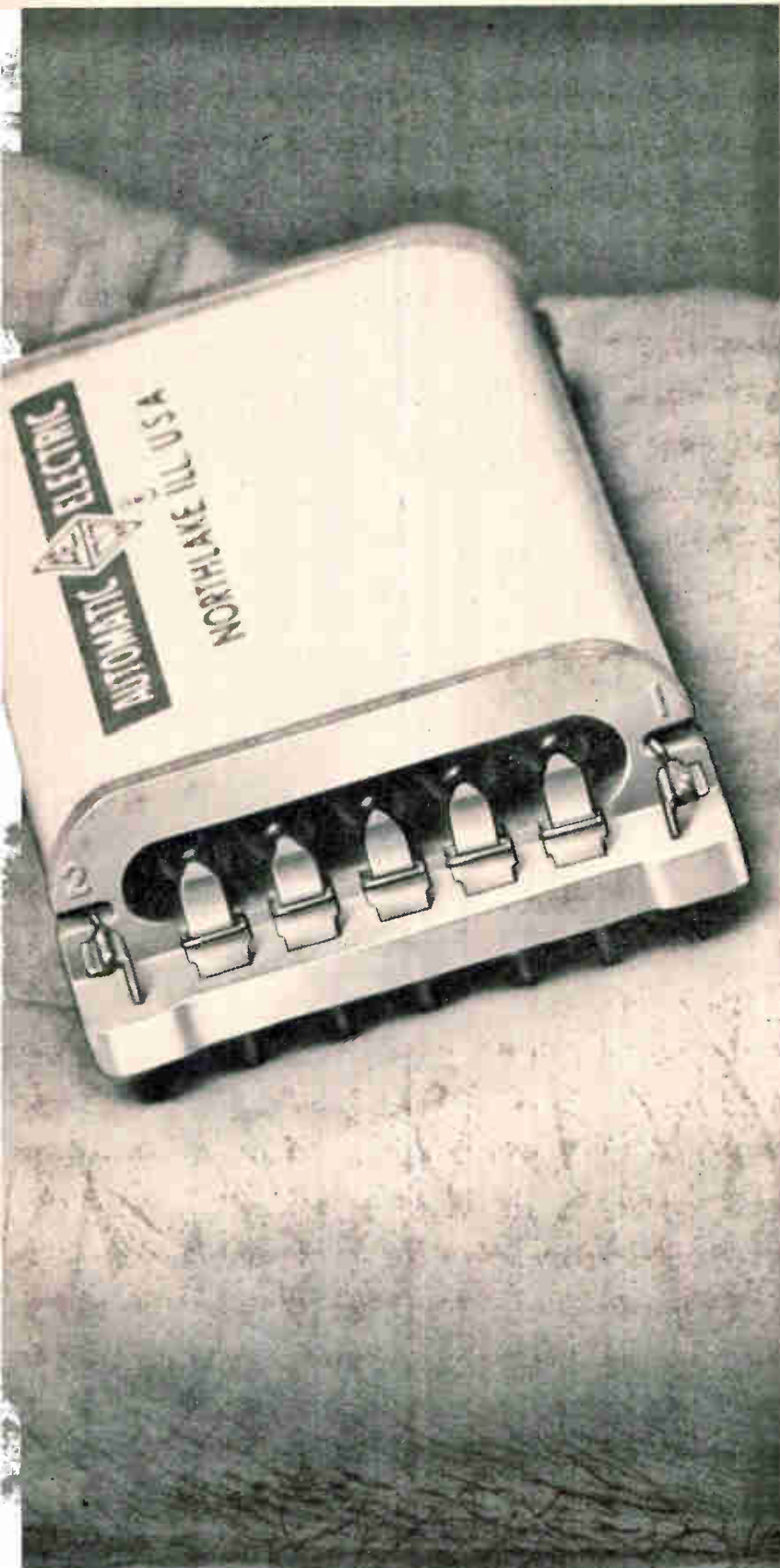

AUTOMATIC ELECTRIC
SUBSIDIARY OF
GENERAL TELEPHONE & ELECTRONICS **GTE**

AE has developed a new Correed that overcomes the principal mechanical and electrical shortcomings of conventional dry-reed switches designed for mounting on printed circuit boards. The result: new 1-, 2-, 3- and 5-capsule PC Correeds* and a single-capsule magnetic latching type, all incorporating the five advanced features...

1 Separate Terminals—The capsule leads are not used as terminals. Separate terminals provide superior electrical contact and eliminate strain on the glass capsules.

2 "I-Beam" Strength—The terminals are longitudinally "ribbed" for added strength and rigidity. This facilitates insertion into printed circuit boards.

3 Welded Connections—The contact terminals are welded—not soldered—to the capsule leads, assuring serviceable connections. Capsules can be removed without having to remove the entire package.

4 Moisture Resistance—AE uses glass-filled plastic bobbins for greater strength and to eliminate electrical failure due to moisture absorption.

5 "Standard" Measurements—Measurements between terminal centers are multiples of 0.200 inches, in accordance with industry standards for circuit boards. Standardized terminal size and spacing also allow for greater package density.

These new PC Correeds have magnetic shields surrounding the coils, to avoid interaction between adjacent Correeds; also provisions for soldering diodes directly to the upper side of the terminals.

For the full facts on how these new AE Printed Circuit Correeds meet the requirements of modern electronic circuitry, write to the Director, Electronic Control Equipment Sales, Automatic Electric Company, Northlake, Illinois 60164.

[*U. S. Patent applied for.]

SPECIAL INTRODUCTORY OFFER

FREE

Because electronic and control engineers have a lot of questions that need current, quick, clear answers and because books written by specialists in various branches of electronic and control engineering have those answers, the Electronic and Control Engineers' Book Club has been organized. It brings to your attention outstanding books in your field that you might otherwise miss.

OUTSTANDING SELECTIONS AT SUBSTANTIAL SAVINGS.

Possibly just one idea from one of these books could mean more to you in actual dollars and cents than many times the cost of the book. By taking advantage of this special introductory offer you will receive absolutely FREE a copy of *Design Manual for Transistor Circuits*, together with your choice of any one of these twelve books as your first selection—at the special club price. (If you already have Carroll's work, you may take another of the books listed in the coupon as your gift copy.)

Selections cover the sound, hard core of electronic and control engineering practice. These books suggest the quality of the volumes that are available to you as a Club member. All books are chosen by editors and specialists whose thoroughgoing understanding of the standards and values of technical literature is your guarantee of authoritativeness.

FOR EXAMPLE — SEE COUPON.

The Club will describe all forthcoming selections to you. Periodically you will receive free of charge *The Electronic and Control Engineers' Book Club Bulletin*, as issued. This gives complete advance notice of the next main selection as well as a number of alternate selections.

From this point on, the choice is yours. If you want the main selection you do nothing; the book will be mailed to you. If you want an alternate selection or if you want no book at all for that particular period, you notify the Club by returning the convenient card enclosed with your *Bulletin*. We ask you to agree only to the purchase of four books in two years. Certainly out of the large number of books in your field offered during this time there will be at least four you would buy in any case. By joining the Club you will save, in cost, about 15 per cent from publishers' prices.

YOUR NO-RISK GUARANTEE

Remember, the goal of this economical technical reading program is your satisfaction. We ask you to take no risk whatever. If you are not delighted with the volumes you receive for this introductory offer, return the books within ten days and your membership will be cancelled without further obligation. So while this offer is in effect, put your coupon in the mail today!

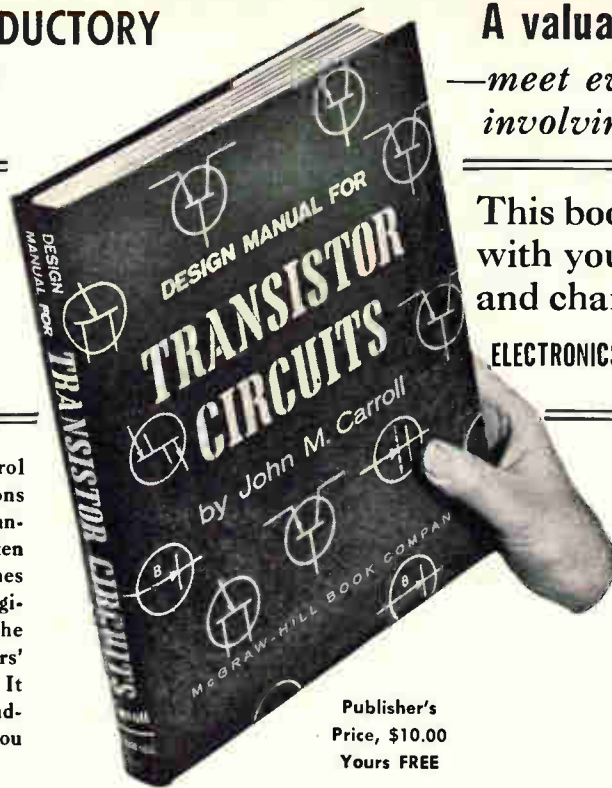

Publisher's Price, \$10.00
Yours FREE

A valuable guide to help you meet everyday design problems involving transistors

This book will be given to you with your first selection and charter membership in the ELECTRONICS AND CONTROL ENGINEERS' BOOK CLUB

Design Manual for Transistor Circuits
By John M. Carroll

Author, Modern Transistor Circuits, and Transistor Circuits and Applications; Managing Editor, Electronics

Here's a wealth of practical information to help you meet everyday design problems involving the use of transistors and other semiconductor devices. Conveniently arranged for easy use, this information—in the form of articles, design charts, nomographs, and actual ready-to-use circuits—covers a wide range of applications—from simple one-transistor "push-pull" amplifiers . . . to complex computer switching circuits.

MAIL ENTIRE COUPON FOR FREE BOOK AND SELECTION

The Electronic and Control Engineers' Book Club
330 West 42nd Street, New York, N. Y. 10036

Please enroll me as a member of the Electronic and Control Engineers' Book Club. I wish to take as my first selection the book checked below:

- Electronic and Radio Engineering**, 4th Ed.,* by P. E. Telman. Publisher's Price, \$16.00. Club Price, \$13.60.
- Information Transmission, Modulation, and Noise** by Mische Schwartz. Publisher's Price, \$12.50. Club Price, \$10.65.
- Mathematics for Electronics with Applications** by H. M. Nodelman and F. W. Smith, Jr. Publisher's Price, \$7.00. Club Price, \$5.95.
- Digital Computer and Control Engineering*** by R. S. Ledley. Publisher's Price, \$14.50. Club Price, \$12.35.
- Electronic Designers' Handbook*** by R. W. Landee, D. C. Davis, and A. P. Abrecht. Publisher's Price, \$18.50. Club Price, \$15.75.
- Electronic Measuring Instruments** by Harold E. Soisson. Publisher's Price, \$7.50. Club Price, \$6.40.
- Magnetic Tape Instrumentation** by G. L. Davies. Publisher's Price, \$9.50. Club Price, \$8.10.
- Electrical Engineering for Professional Engineers' Examinations** by John D. Constance, P.E. Publisher's Price, \$10.00. Club Price, \$8.50.
- Electronic Switching, Timing, and Pulse Circuits** by J. M. Pettit. Publisher's Price, \$8.95. Club Price, \$7.60.
- Adaptive Control Systems***, Edited by Eli Mishkin and L. Braun, Jr. Publisher's Price, \$17.50. Club Price, \$14.95.
- Transistor Circuit Design*** by the staff of Texas Instruments Incorporated. Publisher's Price, \$15.00. Club Price, \$12.75.
- Control Engineer's Handbook***, Edited by J. C. Truxal. Publisher's Price, \$23.50. Club Price, \$19.95.

I am to receive FREE with the book checked above a gift copy* of *Design Manual for Transistor Circuits* or an alternate gift copy of

Bill me for my first selection at the special Club price, plus local tax, and a few additional cents for delivery costs. Forthcoming selections will be described to me in advance and I may decline any book. I need only take 4 books in two years of membership. All further selections I choose will be at the member's special price.
*Titles marked with an asterisk carry an extra \$1.00 charge.

(Print)
Name

Address

City State Zip Code

L-3-8



ONE STOP

SHOPPING
FOR ALL MAGNETIC MATERIALS
at IEEE Booths 2410-12

PERMANENT MAGNETS: Cast Alnico, Sintered Alnico and Ceramic Magnets (Arnox).
MAGNETIC CORES: Silectron-C Cores and Distributed Gap Cores. Tape Wound Cores of Deltmax, Supermalloy, Permalloy, Supermendur and Silectron. **POWDER CORES:** MO-Permalloy Powder Cores, Iron Powder Cores and MSS Iron Powder Cores. **TRANSFORMER LAMINATIONS AND HARDWARE:** Nickel-Iron, Silicon-Steel Laminations, Transformer Cans and Hardware, Tube Shields. **SPECIAL MAGNETIC MATERIALS:** Vicalloy, Permendur and Vibralloy.

And they are all precision engineered. The Arnold engineering facilities are among the world's largest and most complete, devoted exclusively to helping solve your magnetic device problems.

In addition, Arnold is a prime source for precision metal rolling . . . ferrous and non-ferrous strip, close tolerances and ultra-thin gauges . . .



ARNOLD
SPECIALISTS in MAGNETIC MATERIALS

THE ARNOLD ENGINEERING COMPANY, Main Office: MARENGO, ILL.
BRANCH OFFICES and REPRESENTATIVES in PRINCIPAL CITIES

COLD-WELDED CRYSTALS?

a little
make \vee room for  the newest from
REEVES-HOFFMAN



Reeves-Hoffman's newest series of crystals, packaged in cold-welded TO-5 transistor cans, are designed for operation at frequencies from 3 to 125 mc. Frequency tolerance over the temperature range from -55°C to $+105^{\circ}\text{C}$ is $\pm 0.004\%$. (Upon special request, $\pm 0.0025\%$ can be provided.) Shock and vibration ratings exceed the requirements of MIL-Spec 3098D. Aging at 65°C is 6 parts in 10^6 per year. Cold welding eliminates solder and attendant flux and heat, removes undesirable damping and corrosion, solves problems of thermal isolation. Leak rate is better than 10^{-9} cc of helium per second. The results: substantial increases in the reliability and stability of crystal units, oscillators and filters; further opportunity for miniaturization; faster delivery; lower cost. Write for data.

Visit Booth 1202, IEEE Show

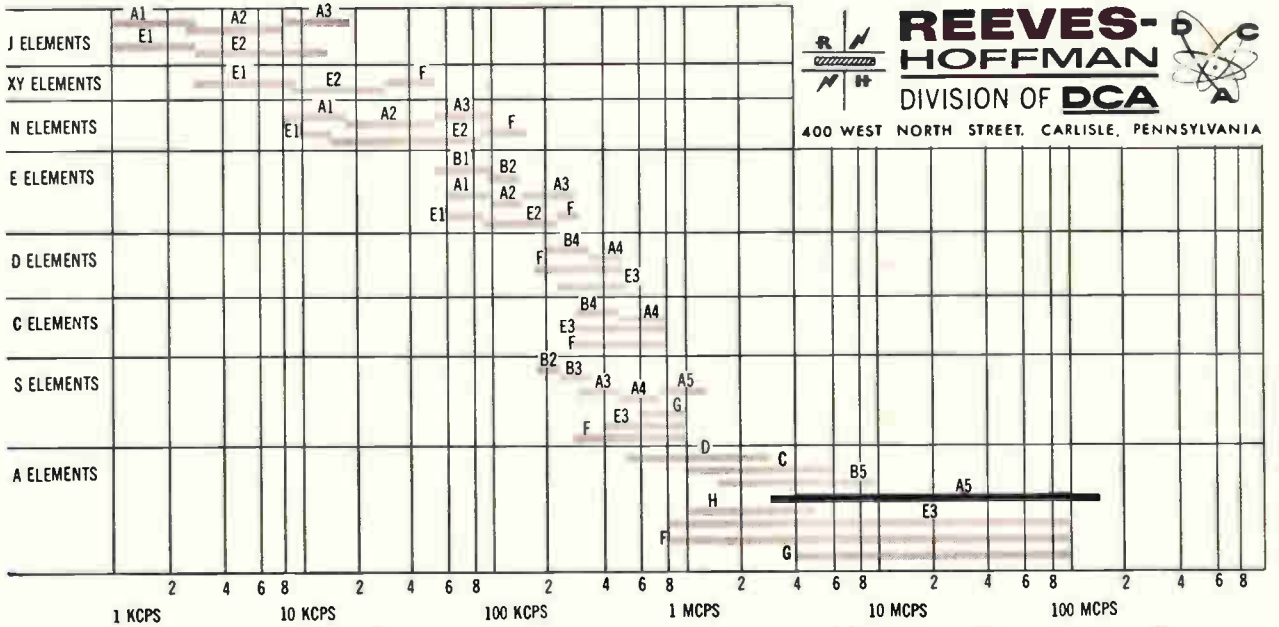
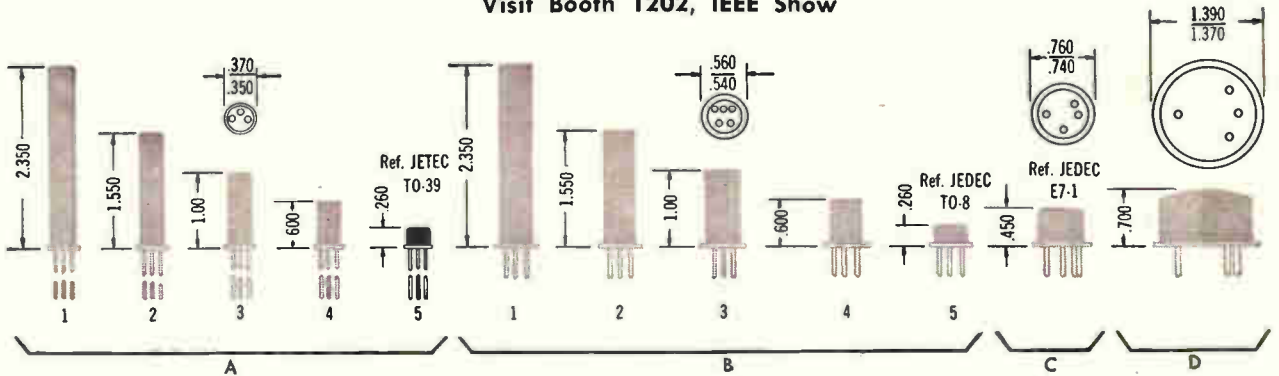

REEVES-HOFFMAN
DIVISION OF **DCA**



400 WEST NORTH STREET, CARLISLE, PENNSYLVANIA

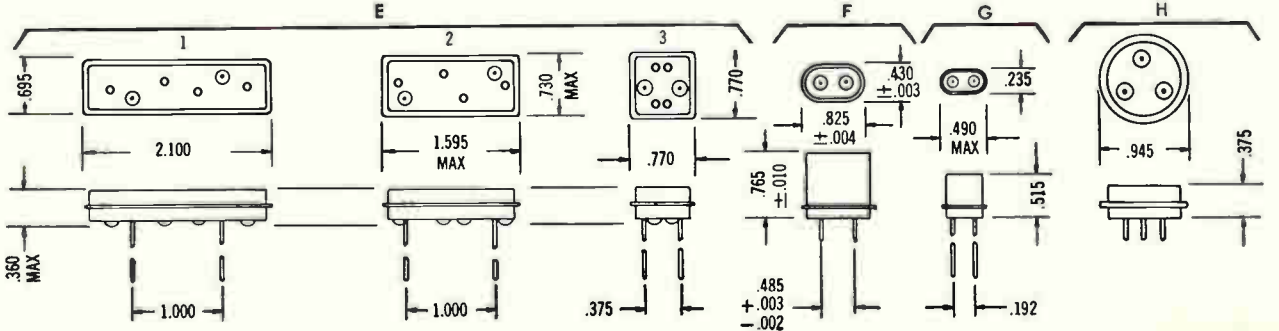



You can depend on DuPont Reagents for

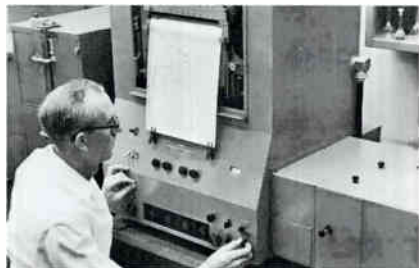

Quality

Over 65 years experience in manufacturing reagents (and the highest quality "crudes") has enabled Du Pont to identify and eliminate sources of contamination. Rigid quality tests are made on each lot—during manufacturing, in the analytical laboratory, and again before shipment—to meet Du Pont's own strict standards and those of the ACS. In all, Du Pont Reagents receive twenty-three stringent quality checks to assure you of getting the highest possible quality and uniformity.

Service

A nation-wide distributor network assures you of fast delivery and dependable service on Du Pont Reagents... and in many cases on other Du Pont quality chemicals. There are 160 Du Pont Reagents distributor locations across the country to give your order prompt attention. Your source of supply is as close as your phone. The next time you need reagents, contact your nearest distributor and specify "Du Pont." Du Pont Reagents are available in 1 and 5 pint bottles and 6½ and 13 gallon carboys.

Safety

Du Pont pioneered many of the outstanding features for safety and convenience in reagents handling. And Du Pont Reagents offer them to you. These include... color coding of labels and caps to provide instant identification and to reduce mistakes... safety-grip handles on 5 pint bottles for a firm grip, easier carrying and pouring... dripless sleeves for accurate pouring, fewer spills and burns... Fome-Cor shock absorbent cartons for nitric acid... and one-way bottles—no deposit or storage of "empties."

GLACIAL ACETIC ACID

Acetic Acid (CH ₃ COOH)	Min. 99.7%
Residue after Evaporation	Max. 0.0010%
Chlorides as Cl	Max. 0.00005%
Sulfates as SO ₄	Max. 0.00005%
Iron (Fe)	Max. 0.00002%
Heavy Metals as Pb	Max. 0.00005%
Substances reducing KMnO ₄	Pass ACS Test
Dilution Test	Pass ACS Test

NITRIC ACID

Nitric Acid (HNO ₃)	Min. 70.0%, Max. 71.0%
Chlorides as Cl	Max. 0.00008%
Residue after Ignition	Max. 0.0002%
Heavy Metals as Pb	Max. 0.00001%
Sulfates as SO ₄	Max. 0.00008%
Iron (Fe)	Max. 0.00001%
Arsenic (As)	Max. 0.000005%
Chromium (Cr)	Max. 0.00001%
Phosphates as PO ₄	Max. 0.00002%
Copper (Cu)	Max. 0.00005%
Nickel (Ni)	Max. 0.00005%

AMMONIUM HYDROXIDE

Ammonia (NH ₃)	Min. 28.0%, Max. 30.0%
Chlorides as Cl	Max. 0.00005%
Phosphates as PO ₄	Max. 0.00005%
Heavy Metals as Pb	Max. 0.00005%
Substances reducing KMnO ₄ as SO ₂	Max. 0.002%
Carbon Dioxide (CO ₂)	Max. 0.002%
Residue after Ignition	Max. 0.0003%
Total Sulfur as SO ₄	Max. 0.0002%
Iron (Fe)	Max. 0.00002%

HYDROCHLORIC ACID

Hydrochloric Acid (HCl)	Min. 36.5%, Max. 38.0%
Sulfites as SO ₂	Max. 0.00008%
Sulfates as SO ₄	Max. 0.00008%
Free Chlorine (Cl)	Max. 0.00005%
Heavy Metals as Pb	Max. 0.00005%
Residue after Ignition	Max. 0.0004%
Iron (Fe)	Max. 0.00001%
Arsenic (As)	Max. 0.000001%
Ammonium (NH ₄)	Max. 0.0003%

SULFURIC ACID

Sulfuric Acid (H ₂ SO ₄)	Min. 95.0%, Max. 98.0%
Nitrate (NO ₃)	Max. 0.00005%
Chloride as Cl	Max. 0.00002%
Ammonium as NH ₄	Max. 0.0001%
Residue after Ignition	Max. 0.0004%
Iron (Fe)	Max. 0.00002%
Heavy Metals as Pb	Max. 0.00005%
Arsenic (As)	Max. 0.000005%
Substances reducing KMnO ₄ as SO ₂	Max. 0.0001%

FORMIC ACID 90%

Formic acid (HCOOH)	Min
Dilution Test	Pass ACS Test
Residue after Evaporation	Max 0.002
Acetic Acid (CH ₃ COOH)	Max 0.4
Ammonium (NH ₄)	Max 0.005
Chloride (Cl)	Max 0.01
Sulfate (SO ₄)	Max 0.002
Sulfite (SO ₃)	Pass ACS Test
Heavy Metals as Pb	Max 0.0005
Iron (Fe)	Max 0.0005

You Can Depend on Du Pont Reagents
... for Quality, Service and Safety



Better Things for Better Living
... through Chemistry

Du Pont Company, Room 2211C • Wilmington, Delaware 19898
Send () name of nearest distributor () Reagents Catalog Sheet () prices.

NAME _____
 TITLE _____
 FIRM _____
 ADDRESS _____
 CITY _____ STATE _____ ZIP _____



PRINCETON APPLIED RESEARCH CORP., Box 565, Princeton, N. J., 799-1222, code 609

- automatic ranging
- automatic polarity
- 10 meg input impedance
- >100 db common mode rejection
- truly floating differential input
- 0.1% absolute accuracy
- 1 millivolt sensitivity
- solid state / reed relay design
- rugged printed circuit construction
- no stepping switches
- price: \$995.00
- measures only 6½" wide, 5" high, 8" deep. Weighs 9 lbs.
Model CS-3.1

Write for Bulletin No. 107D

world's smallest digital voltmeter with all of these features



Electronics Review

Computers

Faster memories

If you ask a computer to print the names of all the redheads it knows, the machine has to question in sequence every item it has stored before it can come up with an answer. That's a relatively time-consuming job. But if the computer could fetch the data from its memory without reference to the location of the bits of information, it could answer in one swift memory cycle.

It's the difference between calling out to an audience: "Will all redheads please stand up?" and going through it to ask each person in turn to remove his hat.

Such a concept, called associative memory, has been incorporated in a memory delivered to the Navy's Bureau of Ships by the Goodyear Aerospace Corp., a subsidiary of the Goodyear Tire & Rubber Co. The technique represents one of the early steps toward developing a new generation of computers that use parallel processing instead of the conventional sequential processing.

Experimental stage. Several companies have been experimenting with associative memories in one form or another. Various memory elements are being investigated, including cryotrons, thin films, tunnel diodes, transistors and the ferrite cores that Goodyear used in its associative memory.

Here are four stunts an associative memory could perform if it contained personnel records: Let one associative memory word contain a complete personnel record, such as, Jones, Harold, bookkeeper, age 35, \$60/week.

Then a search for a whole word would yield all employees whose names are Harold Jones, who are bookkeepers, who are 35 years old and who make \$60 a week. Another search could also yield Jones and

all the names that follow his in alphabetical order, or all the names that precede his, or all the names between Jones and Smith.

In any order. The records need not be arranged in alphabetical order in the storage. This is one of the prime advantages of associative memory.

Goodyear's associative memory contains 256 words of 30 bits and the cycle time is 6 microseconds. The memory, which is connected with either of two computers via a



Memories are made of this. Goodyear Aerospace technician checks circuit of an associative memory, a technique that may lead to a new generation of computers.

standard input-output channel, is built of Goodyear's multiple aperture logic elements [Electronics, Nov. 15, 1963, p. 43].

The Navy is only peripherally interested in lists of redheads. But an associative memory can provide answers to military questions in real time.

For instance: there are 250 planes, friendly and unfriendly, under surveillance. Which friendly craft are closest, suitably armed, and adequately fueled to carry out an attack mission on the enemy planes?

The answer would come in microseconds.

Check the spelling

The Air Force is testing a computer to proofread words being fed into another computer by optical readers.

The proofreading computer contains shift registers that work with an optical reader and a disk-memory file. If the computer's shift register can't match a word read with any of the words on file in its memory, it calls for a correction.

The machine, being tested at the Rome Air Development Center, was developed by the Philco Corp. for military applications.

One error in 1,000 words. Air Force engineers hope the system will catch spelling errors made by either the optical reader, the operator or the machine that printed the document. The goal is to reduce the error rate to 0.1%. The machine can't catch all the errors—only errors in numbers or letter combinations that are stored in its memory.

The present machine can only read words that are presented to it in a special form. The next step is to improve the machine so it can handle words in any form.

The optical reader was supplied by Philco under an earlier contract. It can read 16 printing fonts, plus special symbols, at 2,000 characters—about 125 words—a minute. A keypunch operator can only put about 20 words a minute into a computer. The disk file was made by Laboratory for Electronics, Inc.

Advanced technology

Bigger ears

Space beyond the solar system will be more closely examined by a new family of radio telescopes:

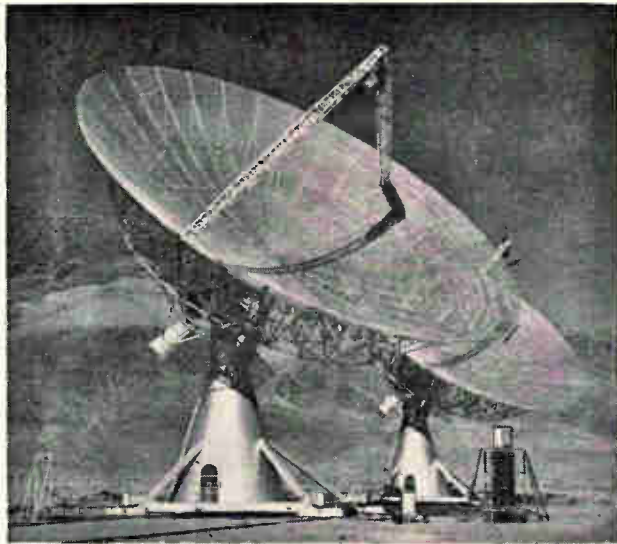

Listening to space. Twin 90-foot dish antennas will be linked next year with 130-foot antenna planned for the Owens Valley Radio Observatory of the California Institute of Technology.

mobile dishes that are nearly half the size of football fields.

The first of eight to ten such telescopes, with 130-foot dishes, is being built now by the Westinghouse Electric Corp. for the California Institute of Technology's Owens Valley Radio Observatory. It will be completed by the middle of next year. The initial cost of the project is being financed by a \$1.6 million grant from the National Science Foundation. Additional 130-foot dishes are expected to cost \$1 million each.

The antenna, mounted on wheels, can be moved along tracks that form an inverted T. The stem of the T will ultimately extend three miles and the bar of the T will measure 7,500 feet. The antennas will be linked to an existing pair of 90-foot dishes.

The mobility of the antennas will permit the telescopes to aim at large or small sections of the universe. They will be able to aim sharply at a point in space that is only 10 seconds of arc wide. Resolution limits on existing radio telescopes is in minutes of arc.

The principal target of the Owens Valley radio telescopes, until something more exciting comes along, are quasars—quasi-stellar sources of radio signals recently discovered in far space.

Originally, optical astronomers interpreted them, as stars; however, recent data indicates they are receding into space at speeds of 0.4 to 0.6 the speed of light. They are

believed to be some four billion light-years away—near the absolute limit of the observable universe. While they appear to be stars, they radiate energy at a rate equivalent to 100 times the energy of a galaxy the size of the Milky Way. The energy output, according to astrophysicists, is beyond anything that can be explained by nuclear or other known phenomena.

Consumer electronics

No more shock

The do-it-yourselfer standing on a wet cellar floor is in trouble if there's an electrical defect in the power drill he's using. The fuse box protects the house against currents exceeding 15 amperes, but it only takes about 9 milliamperes to give Mr. Handyman a lethal shock. A faulty electric tool and a wet floor could lock him into the 110-volt current, and 250 milliamperes could leak through him to ground.

A device called Circuit-Tron, developed at a small laboratory in Lee, N. H., is designed to detect such leakages and cut off power, its inventor says. Circuit-Tron senses leakage of current and opens relay contacts to shut down the line. It cannot be reset until the fault has been corrected.

The device was developed by Andrew J. White, of Lee, and Joseph P. Marino, of Lincoln, R. I.

The units are being manufactured at the Electronic Instruments Corp. in Lincoln.

Wet hands. In a laboratory demonstration, White placed a lighted lamp with its wires exposed into a large glass tank of water. He held one hand in the water, wet the other hand thoroughly, and touched a steel sink nearby. The light went out before the current could give him a shock.

Circuit-Tron monitors the current in the line, and any deviation from the usual flow activates the device. The unit can be set for various values; 9 milliamperes is usual. Response characteristics of the device don't vary with changes in the load, Marino says.

The heart of the Circuit-Tron is a transformer, which provides a high degree of voltage regulation. The transformer is center-tapped. Under usual conditions, the transformer and other components aren't energized; they are in a passive, steady state on the line. When a leakage occurs—from an electrical defect or from a person who may "tap" himself into the circuit—it shows up on either leg of the transformer, and current flows. The current operates the relay contacts and they cut off power.

In tests at the University of New Hampshire, the device detected leakages as small as 0.38 milliamperes.

\$500 a home. The first devices were bulky and expensive; they are being used to monitor industrial equipment. White estimates it would cost about \$500 to protect all the circuits in a home at the present stage of development. "We are working on a design using smaller components. This, together with volume production, might eventually bring the unit cost down to about \$75," he says.

Meanwhile, a portable model costing \$179.50 is being used by several construction companies in Rhode Island to protect workers running power tools in wet areas.

A Circuit-Tron at the Bostitch Co. in East Greenwich, R. I., monitors the assembly line where portable electric tools are handled by women. At the Draper Co. textile mill in Hopedale, Mass., it is

plugged into the power line when maintenance workers are working with electric tools in hazardous areas.

White says the Circuit-Tron is fast enough to shut down a faulty electric line in an explosive atmosphere before arcing can take place. Tests are now being made to determine its effectiveness in operating rooms, where explosive anesthetics are used. And plans are under way for installation of a Circuit-Tron at an oil tank farm of the Sonneborn Refining Corp., Butler, Pa., where electric cables crisscross the oil tank field.

On the front burner

Some airline hostesses will soon be cooking with microwaves.

Trans World Airlines, Inc., has warmed to the idea of microwave cooking and expects to have the new equipment on all its jet aircraft by late fall.

Although the cost of the airborne ovens hasn't been disclosed, industry sources estimate a price tag of about \$1,200 plus substantial installation costs. The units were developed by the Atherton division of Litton Industries, Inc.

Several other airlines are weighing the use of fast-cooking microwave ovens for in-flight food preparation, and for warming precooked food. One carrier, American Airlines, Inc., is understood to be testing the Litton unit also.

Price a problem. Although microwave ovens have been around for many years, the public has been slow to accept them. The main reason is price—microwave units still cost several hundred dollars more than conventional ovens. Generally, demand for microwave ovens has come from institutions and commercial operations, where fast cooking has a priority over price. One railroad, the New York Central, has been using a microwave oven on one of its dining cars for some time. The line hasn't decided yet whether to expand their use.

The oven that TWA will be using weighs 60 pounds and measures 12 inches wide, 17 inches deep and 22 inches high. The

oven's tube, a magnetron, operates at 2,450 megacycles and its input power to the cooking cavity is 1,200 watts; the line power into the unit is 200 volts at 10 amperes, 3 phase and 400 cycles per second.

Extra care. Litton is taking extra precautions to shield the oven. It's using power-line filters, special radio-frequency cases and connector fittings. Should r-f energy leak out of the oven door, a crystal-operated radiation detector circuit will shut off the oven and turn on a warning light.

Added fare. Because the ovens cook five times faster than the electric ovens being replaced, TWA plans to broaden its menu. It expects to be able to provide freshly cooked meals of greater variety to more than 120 passengers in 30 minutes.

Avionics

Flying low

When a plane drops from the sky to tree-top level to make a bombing

depends on the altimeter to make safe landing approaches to carriers or airfields.

Many of the Navy's fighter planes, based on aircraft carriers, are now being equipped with highly accurate pulse radar altimeters that measure the precise distance between the plane and the ground or other objects below.

The unit, designed and built by the Bendix Corp., is being installed on Douglas A4's, Grumman A6's, Ling-Temco-Vought F8's, McDonnell F4B's and the North American T39D, a trainer.

The altimeter, which transmits at C-band (4,300 megacycles) operates from 0 to 5,000 feet and has an absolute accuracy of ± 5 feet or $\pm 5\%$, whichever is greater.

Check bounce. Altitude is measured by determining the time it takes for a radar pulse, transmitted from the craft, to bounce off the ground and be received by the plane. The technique eliminates errors caused by doppler shifts or averaging returns that are inherent in nonpulse altimeters; fast, low-flying craft accentuate these errors. The pulse width of the transmitter's signal is only six nanoseconds.

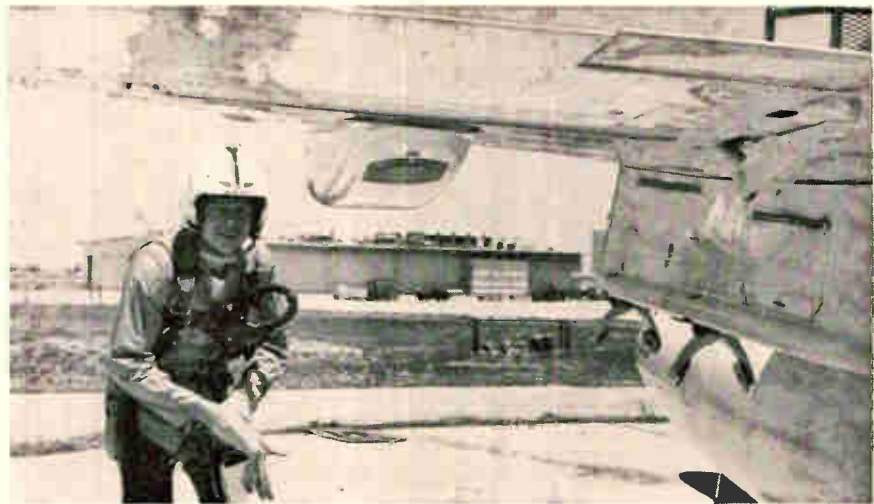

Tucked under the wing of a fighter plane is Bendix Corp's highly accurate radar altimeter. The instrument is being installed on many Navy fighter planes.

run at speeds up to 800 miles an hour, the pilot's best friend is his altimeter. It helps him fly at a safe distance above the ground no matter what the weather and no matter what the terrain. And he de-

The entire radar unit is solid state, except for one ceramic triode in the final stage of the transmitter and another ceramic triode in the receiver's front end. High-density welded circuits are used through-

out the system, and the total unit—which consists of a receiver, transmitter, microwave switch, cockpit indicator and two antennas—weighs 11½ pounds and takes up 175 cubic inches of space.

The Navy is testing the AN/APN-141 for use with reconnaissance and antisubmarine warfare planes.

Materials

Thin shield

A new family of ultrathin plastics with a high dielectric constant may help make miniature circuits even smaller. The plastics are polyparaxylenes—parylenes for short. The Union Carbide Corp., the developer, is test-marketing parylene capacitors one-fifth the size of comparable capacitors that use polystyrene as an insulating material.

The parylenes can be deposited as a thin layer on a substrate, or they can encapsulate tiny components. They are applied by heating them until they vaporize and letting the vapor condense. Surface replicas can be formed that reproduce details only 100 angstroms high, the company says.

Union Carbide is investigating the use of parylenes in integrated circuits and magnetic computer memory elements, and as insulation in logic and memory circuits. The company believes that they can be etched by the same photo-masking or photoresist techniques that are used for thin films and silicon chips.

Blow hot, blow cold. Early tests indicate that the material withstands wide fluctuations in temperature. The parylenes melt at about 750°F; near absolute zero their insulation is better than other plastics', Union Carbide says. The company reports that cycling the temperature from 2°K to room temperature does not significantly affect the electrical or physical properties.

The parylenes are also an effective shield against reactive chemicals. For example, an aluminum

sheet coated with a layer 0.016 mil thick is protected against the corrosive attack of sodium hydroxide.

Manufacturing

Cool soldering

The vexing problem of bonding large numbers of contacts or leads simultaneously to complex microcircuits may have been solved by a technique in which the molecules of two metals are mixed.

Arthur Shafran, an engineer with the Lockheed Aircraft Corp.'s Missiles and Space division, uses gallium, which is liquid at room temperature. He coats a gold-plated surface with the liquid and puts it against another gold-plated surface. After a few hours at room temperature, the gold and the gallium form an alloy and the resulting bond has a temperature limit of 400° to 500°C. The bond has a shear strength equal to soldered joints, although the bend strength is less because the gallium alloy is brittle.

But the long-term stability of such bonds is still in doubt. The oldest experimental bonds date back only a few months. Results so far show that alloys of gallium-gold, gallium-tin and gallium-cobalt are satisfactory, but gallium-silver bonds fell apart after a few months.

Refrigerated leads. The liquid gallium can either be wiped onto gold-plated leads, such as Kovar, Dumet or copper, or the gallium can be electroplated at 40°F and the leads kept in a refrigerator until ready for use. When leads previously coated with solder as well as gold are used, the gallium, gold and solder diffuse into one another.

Besides bonding small leads, Shafran has also bonded integrated circuit leads to copper-clad printed circuit boards and has lap bonded two solar cells to connect them in series.

Shafran will report on his work this month at the IEEE Convention in New York. The technique is based on a method devised by the

National Bureau of Standards about two years ago to bond thermocouple leads. However, NBS mixed gallium with other metal powders to raise the melting point above room temperature and packed the powder and the leads into a hole. This method could not be used for lap bonds because the powder particles prevented good contact between the surfaces.

Packaging

Flatpack conflict

A committee representing integrated-circuit users, unhappy about the flatpack size standards approved by a circuit manufacturers' committee, is asking producers to revise them.

The users want to minimize problems in equipment packaging design and in automating production-test and assembly machines by using only two standard sizes. However, the manufacturers have agreed on 11 sizes, basically the same as those proposed last fall by the Joint Semiconductor Committee 10 (JS-10) of the Electronic Industries Association and the National Electrical Manufacturers Association [Electronics, Nov. 2, 1964, p. 28]. By mid-February, JS-10 had registered eight package outlines, a procedure that has the effect of making the outlines (package configurations) standard.

JS-10 has only put "an envelope" over the existing flatpack variations, complains the users' committee on Microcircuit Applications (MCA), another EIA-NEMA joint committee. Last month, MCA drafted its own proposal for a size standard.

Users' proposal. MCA's two sizes are 0.050 inch high and up to 0.185 inch wide, and 0.065 inch high and up to 0.260 inch wide. This would eliminate several larger package sizes now being made and simplify assembly machines.

Package length would standardize on the present 14-lead package that has five leads coming out each

KIN TEL

**world's
largest
DC amplifier
manufacturer**

**has an
amplifier
to fit
your**

requirements



Solid state, non inverting amplifier

Model 121A/A. Response from DC to beyond 200 kc. Input impedance >10 megohms; output capability ± 15 volts, 100 ma; output impedance <0.2 ohm in series with 50 microhenries. Price: \$995.

Floating, differential amplifier

Model 114C. High common mode rejection, low effective input capacity. DC to 85 cps. Input impedance >40 megohms; output capability ± 10 volts, 10 ma; output impedance <0.25 ohm to 500 cps; <1 ohm to 2 kc. Price: \$995.

Floating, differential amplifier

Model 114A. Effective input capacity less than $1\mu\text{fd}$, high common mode rejection. 100 cycle bandwidth. Input impedance >5 megohms. Output capability ± 10 volts, 10 ma; output impedance <2 ohms, DC to 1 kc. Price: \$895.

Wideband amplifier

Model 112A. Four different plug-in attenuator units. DC to 40 kc. Input impedance 100 K ohms; output capability ± 35 volts, 40 ma; output impedance <1 ohm in series with 25 microhenries. Prices: \$575 to \$680.

Visit our Booth Number 3602 at IEEE Show, March 22-25

All KIN TEL DC data amplifiers: have drift less than $2\mu\text{v}$ • accuracy of 0.01% for any single gain step • fit six to a standard 19-inch rack • are available in portable cabinets • have an integral power supply • are chopper-stabilized • have exceptional linearity and low output impedance.

All prices FOB, San Diego, California. (Additional export charge.)
Write for detailed information. Representatives in all major cities.

Box 623
San Diego, California 92112
Phone (714) 277-6700



FOR
DRILLING
AND ROUTING
CIRCUIT BOARDS
AND
REINFORCED
RESINS

SOLID
CARBIDE

◀ DRILLS

◀ FLUTED
ROUTERS

◀ FIBERGLASS
ROUTERS

UNEQUALLED METAL REMOVAL
COMPANY SERVICE, QUALITY
AND SELECTION INCLUDING:

1. World's largest inventory of centerless ground drill blanks and finished tools ready-for-shipment.
2. Fifteen centerless grinders in production of drills and rotary carbide tools.
3. Every size carbide drill, ground from-the-solid . . . the smallest — .008" diameter to the largest — 1.500" diameter.
4. Precision ground to 5 micro-inch finish or better.
5. Delivery from stock, through our distributors, of any standard solid carbide tool in 48 hours.

Your assurance of product quality, lowest cost and dependable service is the fact that the nation's leading carbide tool users are placing their tool contracts with The Metal Removal Company.

THE METAL REMOVAL COMPANY
1859 W. Columbia Avenue
Chicago, Illinois 60626
Plants Located in CHICAGO • LOS ANGELES • SAN JUAN



MASTER TOOL AND WHEEL
MAKERS FOR THE WORLD

Electronics Review

side, plus two dog-leg leads at each end, with the leads spaced 0.050 inch apart. Leads would be numbered from 1 to 7 up one side and 8 to 14 down the other side.

The 14-lead package could be converted to a 10-lead one by eliminating the dog-leg leads numbered 1, 7, 8 and 10, and decreasing package length. If two such packages were butted together, the distance from the number 5 lead of the first package to the number 1 lead of the second package would be 0.050 inch.

This standard, MCA says, would enable any number of flatpacs to be mounted on standard interconnection arrays and be welded or soldered in place automatically by going from lead to lead.

JS-10 allows lead thicknesses to be from 0.0035 to 0.006 inch thick. This complicates the setup of welding schedules, MCA says. It wants only one thickness—0.004 ±0.0008 inch after plating—and only one width, 0.014 to 0.016 inch.

Carriers, too. Manufacturers now use various types of molded plastic holders and miniature printed circuit boards as test and shipping carriers for circuits in flatpacs. MCA wants these standardized, too, so they can be plugged in for breadboarding equipment or loaded into standard magazines for production testing, lead trimming and equipment assembly.

MCA hasn't set the carriers' specifications, but it has decided on design criteria: a carrier has to be suitable for loading into magazines; it should carry the circuit's serial number; it should have a place for writing or color-coding inspection markings and the circuit type should be identified by a color code, because the small lettering now used is difficult to read.

A five-cent cost for the carrier is another target.

Solid state circuits

Scratchpads

Is \$5 per bit too much for a computer memory? Not if it's an all-integrated-circuit memory nearly as

fast as the fastest logic circuits. At any rate, that's the way the Fairchild Semiconductor division of the Fairchild Camera & Instrument Corp. sees it.

"It's a bargain," said Rex Rice, manager of digital systems techniques, who believes the cost may drop to around \$2.50 a bit in volume production.

More bits. Fairchild has developed small buffer memories that operate in 50 nanoseconds. The upshot is more bits per dollar in a given time. The semiconductor memories are about six times as fast as the fastest thin-film memories, which cost up to \$1.50 a bit, and they are about 20 times as fast as the small, high-speed core memories priced at around 50 cents a bit.

Although buffer memories cost far more than large, conventional core memories, they can lower the over-all system cost by increasing computing speed and efficiency. Some computers use them as "scratchpads," or temporary storage, during logic operations, instead of relying on the slower mass memories.

Other memories. Rice described Fairchild's \$5-a-bit buffer at a panel discussion during the International Solid State Circuits Conference in Philadelphia last month. He claims it is the first semiconductor memory that is competitive on cost-performance terms.

At the same session, J. L. Buie, a researcher at Thompson Ramo Wooldridge, Inc.'s Space Technology Laboratories, reported on one that was built two years ago, but had an access time of 200 nanoseconds.

Donald Murray, an engineer at Motorola, Inc., said his company is developing one that will operate at 30 to 50 nanoseconds. Faster memories are wanted, he noted, to complement the 2-nanosecond logic circuits that can now be built.

Some new digital computers are already using semiconductor scratchpads. Electronic Associates, Inc., put an integrated-circuit, register-type, 100-nanosecond scratchpad inside the otherwise discrete-component data-processor section of its EAI 8400 computer. The

International Business Machines Corp. plans to use scratchpads as well as local storage memories in the large Model 92 of the System 360 series.

Radical change. Rice expects this trend—toward the use of buffers or scratchpads to balance logic and memory speed in a system—to accelerate and to result in radical changes in computer organization. Designers, he thinks, will begin scattering high-speed semiconductor memories throughout computer logic sections. Mass memories would only be used for bulk storage, such as programs, and not for actual processing.

As an example, Rice mentioned a computer named Solomon, developed by the Westinghouse Electric Corp. It uses concurrent arithmetic units, each a sort of baby computer. One Solomon, constructed with 4,000 integrated circuits for the Air Force, has 100 such units.

Memory on a board. Fairchild's working model has 92 flatpaks of integrated circuits mounted on a double-sided printed circuit board 7 by 9 inches. Of the 92 flatpaks, 64 contain storage elements and the others contain auxiliary circuits such as drivers.

Each storage-element package contains two bits—two input gates, two flip-flops and two output gates—for a buffer total of 16 words of eight bits each.

The number of words in the buffer can be multiplied by adding more circuits, at the expense of three to five nanoseconds of additional delay for the drivers. A 256-word buffer would still operate in the 50-nanosecond range, Rice said. It will soon be possible, he added, to put eight or nine storage elements on an integrated-circuit chip, so that the same card could carry 24-bit words.

Information, please

Integrated circuits are winning wide acceptance, but users are worried that they may soon face a problem that hurt them with transistors. They want to make sure, it was made clear at an informal

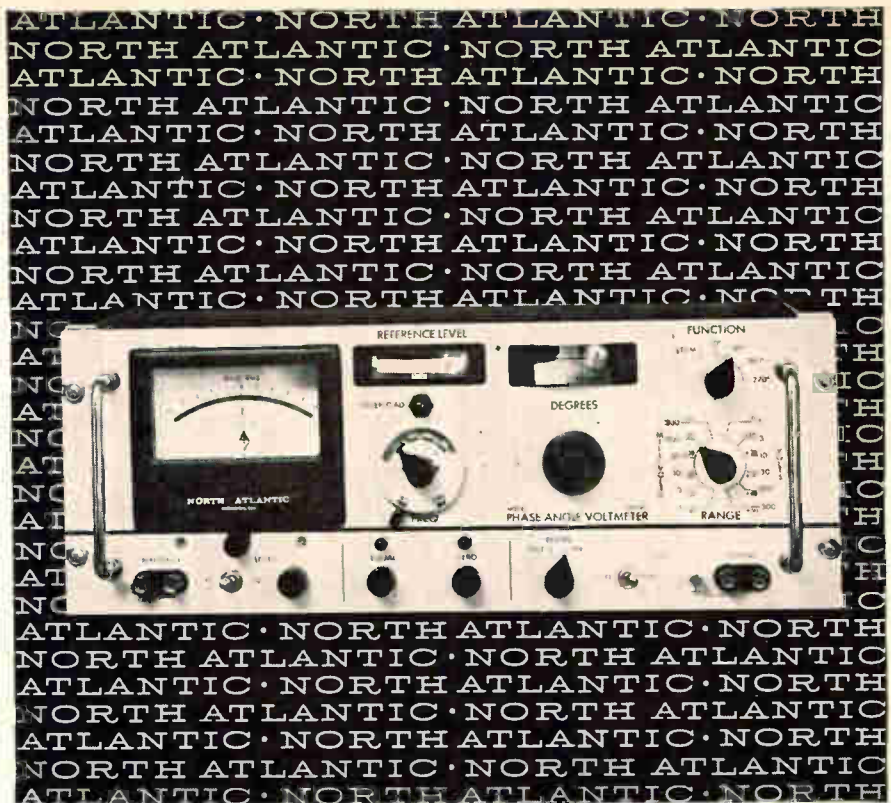

how to measure in-phase, quadrature and angle while sweeping frequency to 100 kc

North Atlantic's latest addition to the PAV line of Phase Angle Voltmeters* enables you to make measurements while frequency is varying over half-decades without recalibration. The VM-301 Broadband Phase Angle Voltmeter* provides complete coverage from 10 cps to 100 kc, and incorporates plug-in filters to reduce the effects of harmonics in the range of 50 cps to 10 kc with only 16 sets of filters. Vibration analysis and servo analysis are only two of the many applications for this unit. Abridged specifications are listed below:

Voltage Range.....	1 mv to 300 volts full scale
Voltage Accuracy.....	2% full scale
Phase Dial Range.....	0° to 90° with 0.1° resolution (plus 4 quadrants)
Phase Accuracy.....	0.25°
Input Impedance.....	10 megohms, 30μf for all ranges (signal and reference inputs)
Reference Level Range.....	0.15 to 130 volts
Harmonic Rejection.....	50 db
Nulling Sensitivity.....	less than 2 microvolts
Size.....	19" x 7" x 10" deep
Price.....	\$1990.00 plus \$160.00 per set of filters

North Atlantic's sales representative in your area can tell you all about this unit as well as other Phase Angle Voltmeters* for both production test and ground support applications. Send for our data sheet today.

*Trademark



NORTH ATLANTIC industries, inc.
TERMINAL DRIVE, PLAINVIEW, L. I., NEW YORK • OVerbrook 1-8600

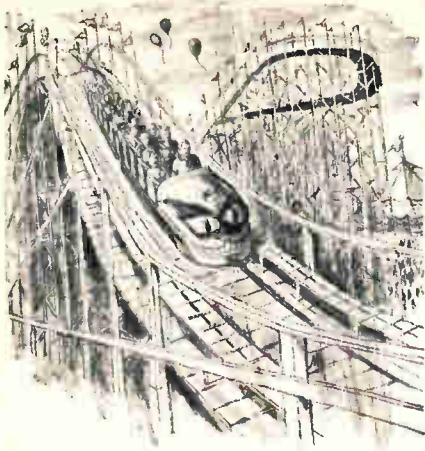

Interested in a better RIDE?

... then look to IsoMode!

For 23 years we have been manufacturing vibration control devices, not only to make things ride easier, but to control noise and shock.

Our experience? Just about anything you can think of — miniature mounts for electronic instrumentation — packaging mounts to insure your product reaching its destination in the same condition it left your plant — aircraft engine mounts (we made the mounts for the Boeing 727) — outboard engine mounts, in fact the roller coaster is about the only thing we haven't attempted, but we're willing to give it a try.

We would like to put our shock and vibration experience to work for you. Just write, phone, wire, or TWX and stand by for action, we'll have the answer for you.

Please send Free
"POSITIVE MOTION
CONTROL" Brochure



Name _____

Firm _____

Address _____

City _____ State _____

Dept. _____

IsoMode

DIVISION

3310 VANOWEN STREET / BURBANK, CALIFORNIA 91504
(213) 849-7181 TWX 213-846-0004
(Formerly: Vibration Control Division—MB Electro)

Electronics Review

panel session at the Solid State Circuits Conference that they are forewarned of any change in manufacturing techniques.

Barely was the session under way when one panelist charged manufacturers with altering the characteristics of commercially available transistors by changing production techniques. The user, Jack Fort, manager of the National Cash Register Co.'s component department, said he was afraid the practice might spread to the integrated circuit field.

Useless data. His complaint: reliability data compiled for a type of transistor becomes useless when the production methods are changed. The problem is compounded because producers' data sheets are incomplete, he added.

His suggestion: that integrated circuit makers include in their data sheet information about materials, production methods, device geometry, layout and interconnections.

Defending the producers was Gerry Luecke, manager of the advanced integrated circuit department of Texas Instruments, Inc., who claimed that the release of such data might restrict the manufacturer, and keep him from improving the product. All a user needs, he explained is a guarantee of a device's electrical specifications.

The moderator, Phillip G. Thomas, represented a company that is both a producer and a user. He's manager of the digital section of the integrated circuit department of the Sperry Rand Corp. Thomas said that changes in production techniques often make a device useless for some applications, even though the modified device works in most places for which the original was designed.

Space electronics

Satellite static

Satellite communication systems—who will build them and who will use them—have government and

industry in synchronous orbit. But they're at opposite poles.

The military has been rebuffed by the White House in its bid for an advanced satellite system. And the Communications Satellite Corp.—consequentially or merely sequentially—has been turned down for the third time in a bid to provide a communications system for the Pentagon.

Military satellite communications powerful enough to overcome enemy interference will have a large excess capacity during peacetime. The industry is worried about just how far the Pentagon intends to go in providing government communications.

Billion-dollar baby. The stakes are high. The government spends about \$1 billion a year on communications. The bulk of the amount is for overseas communications, although there is no official breakdown.

Last December, the Pentagon asked some 20 companies for proposals on an advanced satellite system that is to be in service by 1968 or 1970. Classified specifications called for a capacity of 13 color television channels—about equal to 3,000 voice channels—plus a power output of 6 watts.

When word of the specifications got out, the Federal Communications Commission went right to the White House to protest. President Johnson tried to calm industry fears with a statement that the decision to build a separate military satellite system "does not alter the policy under which the national communications system and other government services will use the commercial satellite and other common carrier communications systems for the transmission of the bulk of their traffic between the U.S. and overseas areas."

No more color. Shortly thereafter, on Feb. 18, the Defense Communications Agency dropped the requirement for the 13 color tv channels, and postponed the date for submission of proposals to March 17 from Feb. 24.

The Pentagon contends the matter is classified and thus won't discuss it. One spokesman, however, says that the "net effect of the

change is a decrease in requirements.”

Industry spokesmen contend that the change is largely for the record, and amounts to little substantively. The 6-watt power requirement they say, gives the satellite a large inherent channel capacity.

The issue boils down to a matter of use. The military wants the high power in order to be certain of forcing a few clear communications channels through even under enemy interference. But in peacetime, industry wants a safeguard against the military's becoming the government communicator because of available capacity. Multiple access to the military system by global defense units will sop up some of the extra capacity, but probably not all of it.

Three strikes. Comsat has made three unsuccessful bids to supply the military with satellite communications service. Initially, it wanted the Pentagon to share in Comsat's basic system. When this was rejected last November, Comsat quietly offered to put up a net of six synchronous satellites for a flat \$50 million. This offer, too, was rejected.

Comsat's latest offer, made early this year, was to build 24 satellites for launch by the military, then charge only for the actual use of the system. Total cost to Comsat would have been about \$14 million.

The Philco Corp., however, which held a \$24.6-million contract to build 24 communications satellites for the Air Force, cried tilt over Comsat's plan to make the Hughes Aircraft Corp. its sole source. Philco got FCC backing and Comsat was forced to throw the procurement open to competition. By then, only Philco and Hughes were interested in competing, though a dozen or so companies considered the matter.

Meanwhile, the Pentagon decided it wasn't interested in the offer anyway, so the whole plan was dropped. The Pentagon contended that the satellites being developed by Philco were superior to Comsat's from a cost and performance standpoint. Comsat questions the decision, but can't do anything about it.



DDS-1000 PCM Ground Station



SC-1100 PCM Bit Synchronizer and Signal Conditioner



SS-1100 PCM Signal Simulator

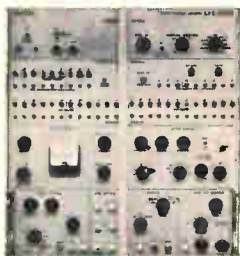

SPS-2000 PCM Stored Program Simulator



EA-1270 PCM Bit Error Rate Analyzer

PCM

TELEMETRY

FROM

BENDIX-PACIFIC

For advanced Pulse Code Modulation telemetry Bendix-Pacific offers a full line of components, subsystems and systems.

From the complete Model DDS-1000 solid state PCM ground station which is adaptable to all bit, word, frame and code formats—to the Bit Error Rate Analyzer which automatically displays rate of error, these developments represent a new state of the art in PCM telemetry.

In addition, Bendix-Pacific continues to be a major source for FM/FM telemetry equipments. For full information please contact Bendix-Pacific, North Hollywood, California.

Bendix-Pacific Division



DATA COMMUNICATIONS • DYNAMIC CONTROLS
RADAR & GUIDANCE • USW & OCEAN SCIENCES

Solid state microwave using new transistors

Low noise amplification to 15 Gc, useful power to 17 Gc, clear way for all-solid-state microwave communications equipments

Improved reliability, smaller size and reduced power consumption are among the benefits users will reap from all-solid-state communications equipments. Now, for the first time, it is practical to design such equipments using new transistors and varactor diodes from Texas Instruments.

Semiconductor devices of proven performance are now available to replace older devices. Benefits include smaller size, simpler circuitry, improved reliability, reduced power consumption, fewer heat dissipation problems, improved reliability, and—in many instances—reduced bill of material costs. Here are some of the applications that can now employ TI transistors and diodes.

Microwave power generation

Harmonic generators. Figure 1 shows the block diagram of a varactor tripler that delivers 63 mw at 12 Gc—an output and a frequency designed to serve as a pump source for a parametric amplifier.

The diode employed is the new epitaxial gallium arsenide A908 from TI. While A900-908 varactors have been optimized for harmonic generator service such as this, they also may be used as tuning elements, microwave switches and parametric amplifiers.

A612 varactors have been used in two varactor triplers that deliver 7 mw output power at 16.5 Gc. These triplers are part of the local oscillator for the TI K_u -band pre-amplifier converter shown in Figure 6.

TI also offers the A706 series of epitaxial silicon varactor diodes for harmonic generation, tuning and switching in the 100 mc to 5 Gc range.

Like all TI varactors, both these new series feature uniformity that permits plug-in replacement. This minimizes circuit design and production problems encountered using some other varactors.

Oscillators. TIXS-12 and TIXS-13 silicon transistors are offered in a new low-loss coaxial package. They will deliver a guaranteed P. O. minimum of 250 mw and 125 mw respectively at 1.5 Gc. 25 mw at 12.3 Gc has been produced by a TIXS-12 driving two X3 multipliers.

The TIX3016A silicon planar epitaxial transistor has the highest frequency capability of any silicon unit presently on the market. It has delivered 25 mw at 9.2 Gc when operated as a 2.3 Gc fundamental oscillator driving an X4 multiplier.

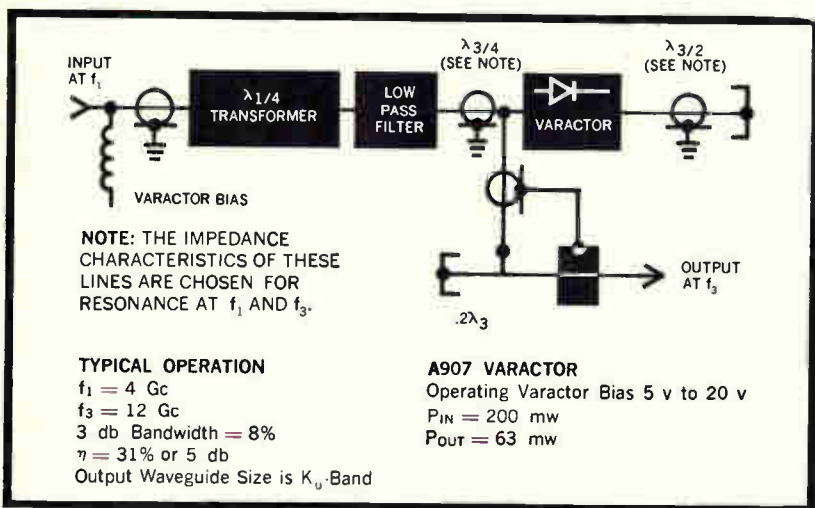

Figure 1. 12 Gc varactor tripler using the A907

Type & Package	f_{max} Guaranteed Minimum	F_{-}		Noise Figure		Fundamental Oscillator P.O. (mw)		Area of Operation
		Typical	Guaranteed Minimum	Typical	Guaranteed Maximum	Typical	Guaranteed Minimum	
High Frequency Silicon Transistors								
TIXS12							250 mw at 1.5 Gc 15 v, 100 ma	L Band Oscillator
TIXS13							125 mw at 1.5 Gc 15 v, 100 ma	L Band Oscillator
TIX3016A	1.7		6 db at 1 Gc			50 mw at 2.0 Gc	30 mw at 2 Gc 20 v, 15 ma	L & S Band Oscillator
TIXS09	1.4		3.5 db at 450 mc			60 mw at 1.5 Gc	30 mw at 1.5 Gc 20 v, 15 ma	L Band Oscillator
TIXS10	1.2		4.5 db at 450 mc			70 mw at 1.0 Gc	30 mw at 1.0 Gc 20 v, 15 ma	L Band Oscillator
2N3570-72	2.75 Gc	1.7	1.5 Gc	6 db at 1 Gc	7 db at 1 Gc $R_g = 50$ ohms	60 mw at 1.0 Gc		UHF & L Band Amplifier
High Frequency Germanium Transistors								
TIX3024	4.5 Gc	1.7 Gc	1.5 Gc	1.6 db at 200 mc 4.5 db at 1 Gc	5.0 db at 1 Gc			L & S Band Amplifier
2N2999	3.3 Gc	1.6 Gc	1.4 Gc	5.0 db at 1.0 Gc	7.0 db at 1.0 Gc			L Band Amplifier S Band Oscillator
2N2998	2.2 Gc	1.0 Gc	600 mc	6.5 db at 1.0 Gc	8.0 db at 1.0 Gc			UHF Amplifier L Band Oscillator

NOTE: The above devices can be supplied in TO-18, μ mesa*, or μ line packages. Please contact your nearest TI sales office.

Figure 2. High-frequency small-signal TI transistors

Unit Type (Series)	Package	f_{co}	CT (Range)	BV_{R1} (Range)	Operating Range	Primary Application	Technology
A706	Cartridge	140 Gc	0.4-30 pf	24-120 v	1-5 Gc	Harmonic Generator	Si Epitaxial
A900	Dbl. Pill Prong	300 Gc	0.4-1.4 pf	30-50 v	1-10 Gc	Harmonic Generator	GaAs Epitaxial
A580	Moly/G*	5 Gc	22-47 pf	35-65 v	dc-500 mc	Electronic Tuning (Voltage Variable Capacitor)	Si Epitaxial
XD500	Cartridge	150 Gc	0.4-1.0 pf	8 v	1-5 Gc	Parametric Amplifier	Diffused GaAs
TIV011	Pill	100-300 Gc	0.35-1.0 pf	6 v	1-15 Gc	Parametric Amplifier	Diffused GaAs
A612	Pill	150 Gc	0.45-1.0 pf	8 v min	1-18 Gc	Parametric Amplifier	Diffused GaAs
A660	Uni/G*	11 Gc	9-17 pf	15 v min	dc-1 Gc	AFC Electronic tuning	Diffused Si

NOTE: Where range is given, it means that family of devices covers the range—not necessarily each device.

Figure 3. TI varactor diodes—summary of characteristics

* Trademark of Texas Instruments Incorporated

communication now practical and varactors from TI

A special version of the TIX3016A transistor is operated at 1.8 Gc to deliver 60 mw output to varactor triplers in the preamplifier converter shown in Figure 6.

Low-noise microwave amplification

Low-noise solid state amplification of microwave frequencies is a reality today using TI varactors and transistors in parametric amplifiers. The noise figure chart in Figure 5 shows that the A612 varactor diode has demonstrated typical noise levels of 3 db at 8 Gc and 4 db at 15 Gc. These same varactors have also been operated in 8 Gc cooled parametric amplifiers. Noise temperatures of 50°K have been obtained at 77°K and 18°K at 4°K.

An A612 varactor is used in the nondegenerate param of the K_u -band preamplifier converter shown in Figure 6. Over-all noise figure is typically 4 db — far lower than the 10 db encountered when other converters are used. Measured noise figures for the param are 3.6 db typical at 13.5 Gc. The new TIXV01 series offers even better performance through improved cut-off frequencies.

Conventional transistor amplifiers in the 1 to 3 Gc range may be designed using the TIX3024 germanium epitaxial transistor. This same unit is also ideal for broadband amplifiers in the 0.5 to 1.5 Gc range.

Just Off the Press — TI Communications Handbook

Here is the latest communication reference library available. In two volumes shown in Figure 7 you will find answers to questions most often asked TI specialists. The two 6" x 9" paperback volumes total 366 pages and contain 417 illustrations. Here are just a few of the subjects covered:

- Sensitivity of y Parameters — Stability Concepts — Linvill Chart Preparation — Lossless Matching Techniques — Biasing FET's for Stability — Square-law Behavior of FET's — Basic Impedance Multipliers — Noise Sources and Equivalent Circuits — Sources of Distortion in Transistors — Distortion Reduction — Noise Figure Calculation — Gain-controlled Amplifier Stages — Frequency Stability — Measurement and Test Circuits — 200 mc and 1 Gc NF Measurement.

Price is \$3.50 per two-part set. Send check or money order to MS-75, Texas Instruments Incorporated, P. O. Box 5012, Dallas, Texas 75222. If you prefer, you may purchase from your TI distributor.

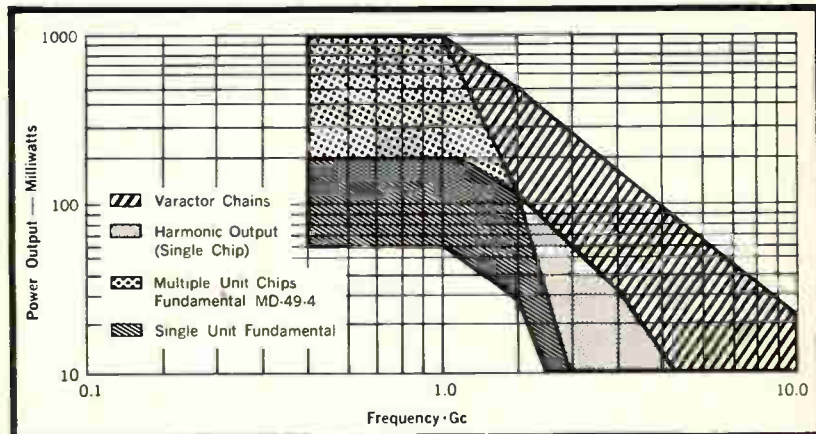

Figure 4. Output power vs frequency . . . TIX3015-16 transistors

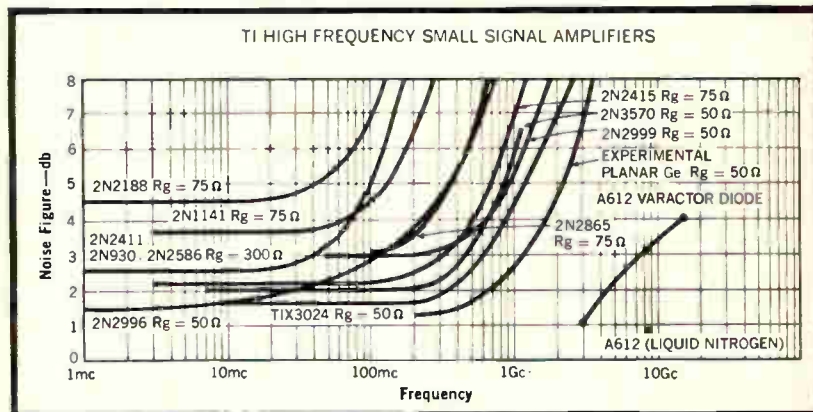

Figure 5. Noise figure chart . . . high frequency transistors and varactor diodes from TI

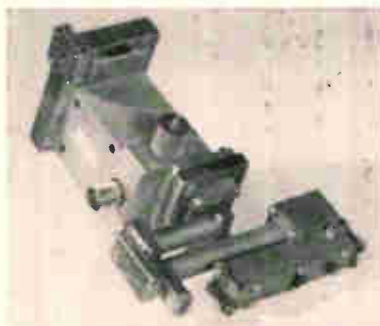

Figure 6. 12.5-17 Gc TI K_u -band preamplifier converter uses TIX3016A transistors and A612 varactors

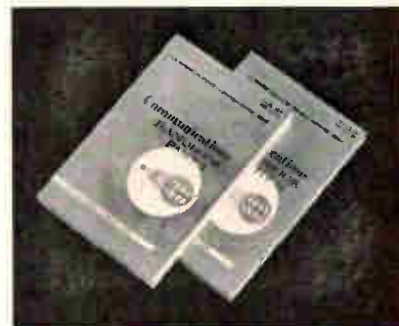

Figure 7. New two-part TI communication handbook



TEXAS INSTRUMENTS
INCORPORATED
13500 N. CENTRAL EXPRESSWAY
P. O. BOX 5012 • DALLAS 22, TEXAS

TOTAL SEMICONDUCTOR CAPABILITY FROM SEMICONDUCTOR PLANTS IN
BEDFORD, ENGLAND • NICE, FRANCE • DALLAS, TEXAS

20631

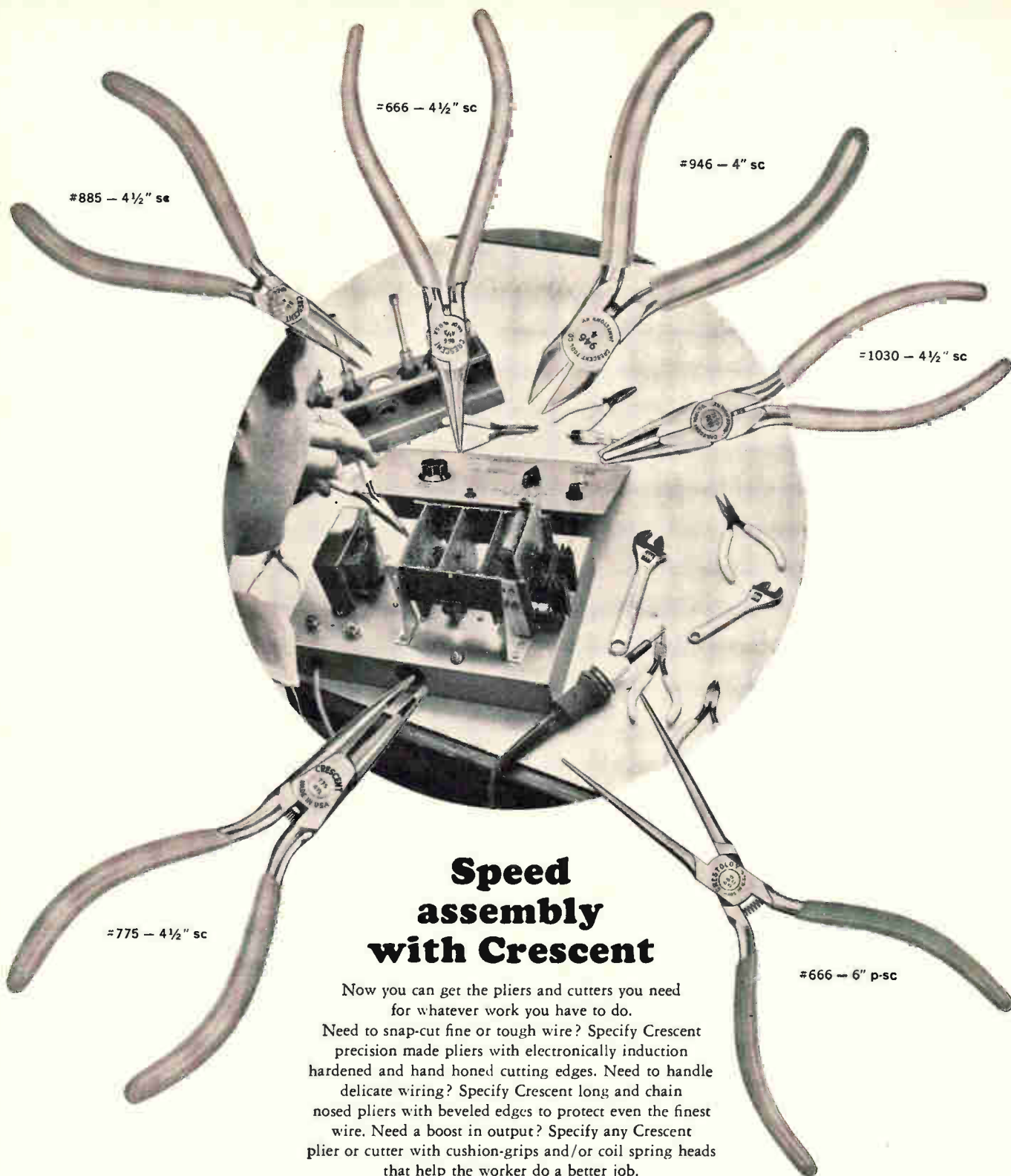

Speed assembly with Crescent

Now you can get the pliers and cutters you need for whatever work you have to do. Need to snap-cut fine or tough wire? Specify Crescent precision made pliers with electronically induction hardened and hand honed cutting edges. Need to handle delicate wiring? Specify Crescent long and chain nosed pliers with beveled edges to protect even the finest wire. Need a boost in output? Specify any Crescent plier or cutter with cushion-grips and/or coil spring heads that help the worker do a better job. These and more are standard features available with the full line of Crescent pliers and cutters for the electronic and industrial user.

Special designs available too . . . whatever you need to speed assembly. Call your Crescent Distributor, Sales Representative, or call the Crescent Tool Company, Jamestown, New York. All inquiries welcome.

Visit the Crescent booth #4514 at the IEEE Show, in New York's Coliseum.

CRESCENT®

CRESCENT TOOL COMPANY / DIVISION OF CRESCENT NIAGARA CORPORATION / JAMESTOWN, NEW YORK



3



5



OR **10** TURN

PRECISION POTENTIOMETERS
FOR AS LITTLE AS \$500 EACH

series 62 multi-turn precision potentiometers will fill the bill for all your requirements in industrial and instrument applications . . . and the price is right! Check these outstanding features for a typical 10-turn model: ■ Absolute linearity— $\pm 0.25\%$ ■ Resistance Tolerance— $\pm 5\%$ ■ Power Rating—2 watts @ 25°C ■ Dielectric Strength—1000 V. rms for 1 minute at atmospheric pressure. Add to this, your choice of number of turns up to 10 and you've truly got top performance at lowest cost. Send today for complete details. . . .



CLAROSTAT

MFG. CO., INC. DOVER, NEW HAMPSHIRE

VISIT CLAROSTAT BOOTH 26 N. Y. HILTON

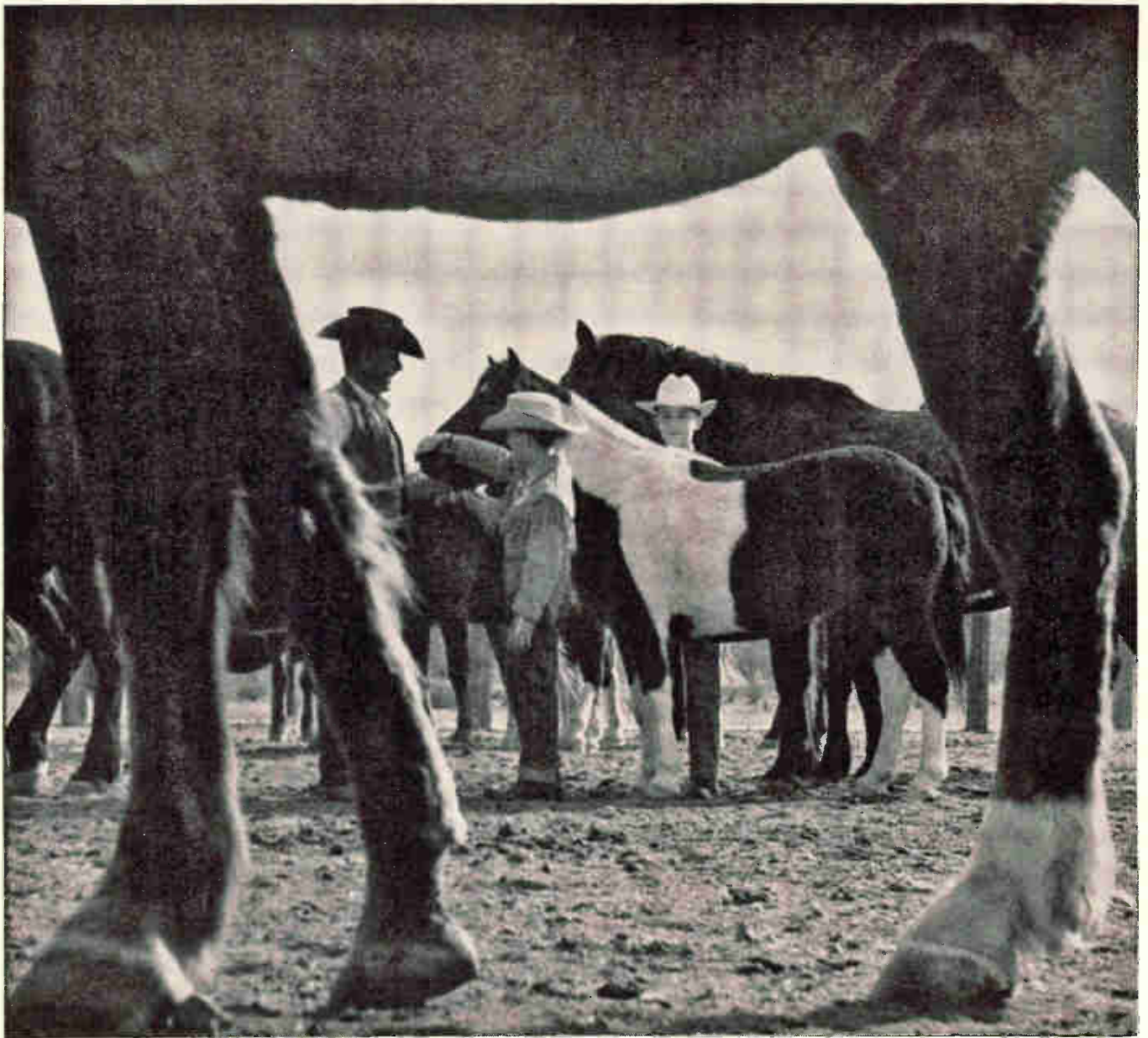

Investment Opportunity

A dozen years from now these boys will be riding trail for real—herding cattle to help feed your children.

Till then, how much patience and love and planning must go into their training? How much effort into keeping our society free and our economy stable, so young people can develop into responsible, productive adults?

You have an investment in these boys. To protect it, you can join with other leading American businessmen to promote the Treasury's Payroll Savings Plan for U. S. Savings Bonds. The Treasury Department's Plan helps to encourage the habits of self-reliance and thrift we so need in all our

citizens . . . it helps us maintain that love of individual liberty which is basic to the well-being of our nation.

When you bring the Payroll Savings Plan into your plant—*when you encourage your employees to enroll*—you are investing in the young people who will help feed the world a decade from now. You are investing in all the ranchers and herders and farmers of America's tomorrow. In America's future. In freedom itself.

Don't pass this opportunity by. Call your State Savings Bonds Director. Or write today directly to the Treasury Department, United States Savings Bonds Division, Washington, D.C. 20226.



In your plant...promote the PAYROLL SAVINGS PLAN for U.S. SAVINGS BONDS



This is Vitro Electronics' Telemetry Receiver • It is Type 1037A • It is not new It is thoroughly field-proven • It is in its fifth production run • It is the standard for comparison

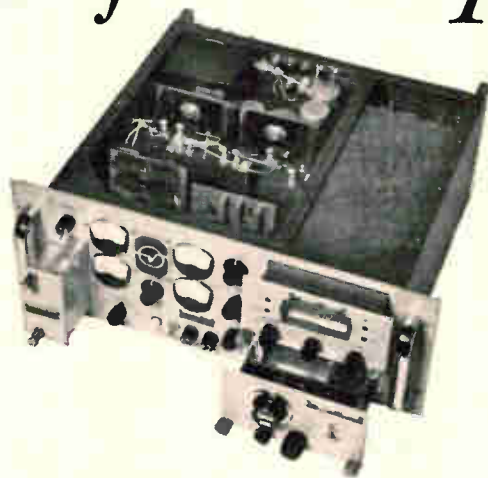

The 1037A is still the only advanced type telemetry receiver that is in full production with a long and successful history of field-proven performance and reliability. The 1037A offers a wide choice of off-the-shelf plug-in RF tuners covering a range of 55-2300 mc and the most versatile group of IF demodulators available which include true phase with long or short loop, linear phase for special PCM applications, phase tracking, high capture ratio, phase lock, FM and AM for all known telemetry formats. Integral plug-in predetection converters and spectrum display units optional. Improved adjacent channel rejection and optimum combination of RF mixers and solid state design avoid the dynamic range problems inherent in solid state RF tuner designs. Vitro Electronics is also the only manufacturer with a complete line of off-the-shelf solid state pre- and post detection combiners, dual diversity receivers, up and down converters, multicouplers, preamplifiers, etc.

*For a complete new catalog or additional details please write to
Vitro Electronics, 919 Jesup-Blair Drive, Silver Spring, Maryland.*

VITRO CORPORATION OF AMERICA • 90 PARK AVENUE • NEW YORK, N. Y. 10016

Vitro

10^{12} traces/sec.
500 traces/in.
is this
enough-
or do you
need more?



This is the writing speed and resolution of a new Du Mont cathode ray tube with fiber optics faceplate (Type K2427). In addition, the tube was designed to occupy minimum space and to withstand severe environmental conditions.

Maybe you don't need this kind of performance—or maybe you need more. In either case look to Fairchild's Du Mont Laboratories first. DuMont has designed and built over 4,000 discrete tube types — CRTs, Storage Tubes, PMTs and Power Tubes. Many of these are off-the-shelf, the rest quickly available. If the tube parameters of your job are so far-out that no existing tube meets them, that's all the more reason to talk to Du Mont first. No one is better equipped to design and build it for you. That's how most of our 4,000 types came into being. Call your Du Mont sales engineer or get in touch direct with the Electronic Tube Div. of Fairchild's Du Mont Laboratories, Clifton, New Jersey.

Selected career engineering opportunities are available. An equal opportunity employer.

FAIRCHILD

DU MONT LABORATORIES
ELECTRONIC TUBE DIVISION

Washington Newsletter

March 8, 1965

Monmouth probe appears unlikely

The planned Senate investigation into contract awards made by the Army Electronics Command at Fort Monmouth, N. J., will probably be dropped. When seeking operating funds, the preparedness investigation subcommittee told the Rules Committee it wanted to probe allegations that Monmouth employees had accepted "excessive gratuities and entertainment" from some companies and had given those companies favored treatment. Subcommittee sources now say that no evidence has been found that's strong enough to warrant public hearings.

But the issue of gifts to and entertainment of government defense and space employees is far from dead. The General Accounting Office has conducted an extensive investigation into the activities of more than 30 companies. A draft of a forthcoming report to Congress is now awaiting comments from the Pentagon and the National Aeronautics and Space Administration. The report is expected to be made public within two or three months.

The GAO won't discuss its findings at this stage. But congressional sources feel the report will be a "hot one," possibly leading to hearings on contractor attempts to influence government personnel and a tightening of conflict-of-interest laws.

The use of a Michigan hunting lodge for entertaining defense personnel is said to figure prominently in the GAO report.

The "clean-living" edict issued by Defense Secretary Robert S. McNamara last year was a backfire set against the GAO report. To jump the gun on GAO disclosures, McNamara barred defense employees from accepting virtually any favors from contractors.

CATV regulation favored by FCC

The Federal Communications Commission went on record last week as being strongly in favor of federal regulation of community antenna television (CATV) systems. There is some question as to whether the FCC already has the authority to regulate or must seek legislation. A handful of CATV stations transmit by microwave and thus come under federal control; the rest pick up television signals and carry them to homes entirely by cable, thereby escaping federal jurisdiction under the present interpretation.

Commercial broadcasters see in CATV a threat to free television, and have been pressuring the FCC to impose some kind of controls. The agency on its part, fears that CATV competition might undercut its effort to pump new life into ultrahigh-frequency tv. With both commercial broadcasters and government favoring control, the only question is how. FCC chairman E. William Henry promises a decision on policy within a month.

2 firms to study copter substitute

Divisions of the Lockheed Aircraft Corp. and the United Aircraft Corp. beat out 10 other competitors for project definition studies in the Army's Advanced Aerial Fire Support System (AAFSS). The new vehicle, to replace present armed helicopters, will be equipped with advanced integrated avionics.

The Army wants a vertical-takeoff craft somewhat like a helicopter with fixed wings—shades of the old Autogiro—that can fly more than

Washington Newsletter

200 miles per hour and come to a hover quickly. It must have considerably more stability and control and greater firepower than existing helicopters.

Present helicopters are largely restricted at night and in bad weather. The new vehicle will require automatic navigation, terrain-avoidance radar and electronic means for maintaining separation in formation flying during such periods of near-zero visibility.

The Army will consider the Integrated Helicopter Avionics System, which the Navy expects to develop for use on AAFSS.

Competition cuts subcontract costs

The Pentagon soon will require more competitive subcontracting on its main awards. The Air Force recently recruited six companies—the Avco Corp., Martin Co. division of Martin Marietta Corp., General Electric Co., Douglas Aircraft Co., Hughes Aircraft Co. and Lockheed Aircraft Corp.—to field-test the idea, and found that preliminary estimates of 25% savings were conservative. As a result, tougher requirements for competitive subcontracting will show up soon in revisions of the Air Force purchase system review manual (70-3). Within six months, a version of the Air Force system will be adopted throughout the Defense Department.

The new regulations mean that engineers will have to begin working earlier and more closely with their companies' purchasing departments. The Air Force found that large sums can be saved in early design stages if some parts can be purchased competitively.

Radio crowding: FCC grinds slowly

Nearly a year ago, the FCC said it would form a government-industry advisory committee to investigate the complex problem of crowded land-mobile radio channels [Electronics, Dec. 28, p. 84]. Late last month Commissioner James E. Cox, who is directing the effort, announced that his personnel had been selected and his organization table perfected. There will be an executive committee; standing committees on operations, technical aspects, and frequency utilization and administration; and a number of working groups for each committee.

The time needed to enlist the more than 200 persons on the committee and the diversity of the organization indicate the long-range nature of the study.

Snooping probe a surprise hit

Sen. Edward V. Long (D., Mo.) aroused more interest than he expected with his Congressional hearings on electronic surveillance. "Bugged" roses and eavesdropping martini olives make for good reading. Long has been encouraged to pursue his investigation, which he believes will at least reduce the use of spying devices by nonsensitive government agencies. His goal is legislation to restrict snooping generally.

Meanwhile, a New York state court declared unconstitutional a state law that allows police to use electronic bugging devices in a suspect's premises. The decision is expected to be appealed.

Pentagon to pool data with NASA

The Defense Department and NASA are establishing a system for pooling descriptions of current research work. The material will be stored in an automated data bank.

The new system will make available to both agencies a comprehensive picture of current research.

You can cool with air...

(if you have a lot of space)

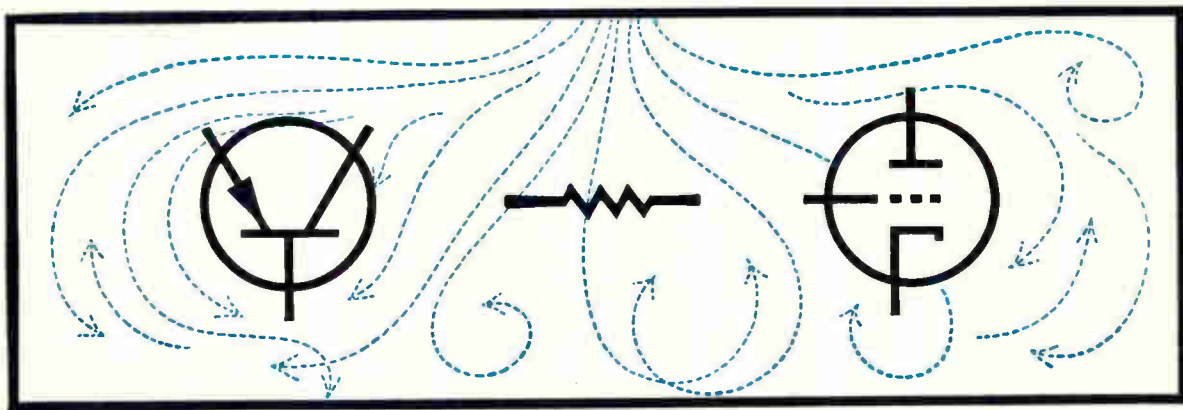

OR

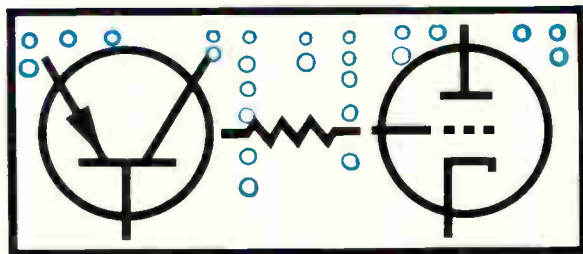

use FREON[®] dielectric coolants

(if you don't)

FREON carries heat away hundreds of times better than air. Close-packed assemblies can operate efficiently at safe temperatures. FREON compounds have outstanding characteristics as heat transfer media either by boiling or by convection.

These inert coolants will work for you in your high-density electronic equipment—wherever you have a reliability problem from “hot spots” in power tubes, transistors, resistors, transformers, packaged electronics, etc. FREON coolants can make your design more compact—at low to moderate cost, while improving reliability through close thermal control.

These five FREON dielectric coolants range in boiling point from +38.8°F. to +237.0°F., offering a wide range of use:

FREON-114	CClF ₂ CClF ₂	B.P. + 38.8°F.
FREON-113	CCl ₂ FCClF ₂	B.P. +117.6°F.
FREON-215	CCl ₂ CF ₂ CF ₂	B.P. +165.0°F.
FREON-112	CCl ₂ FCCl ₂ F	B.P. +199.0°F.
FREON-214	CCl ₂ CF ₂ CF ₂ Cl	B.P. +237.0°F.

Send the coupon for complete technical information based on our 33 years' experience with cooling problems.



Better Things for Better Living . . . through Chemistry

Du Pont Company
Room 2360
Wilmington, Delaware 19898

Please send me complete technical information on FREON dielectric coolants.

Name _____

Address _____

City _____

State _____ Zip _____

Offer good in U.S.A. only.

New Model 5013 data acquisition system...

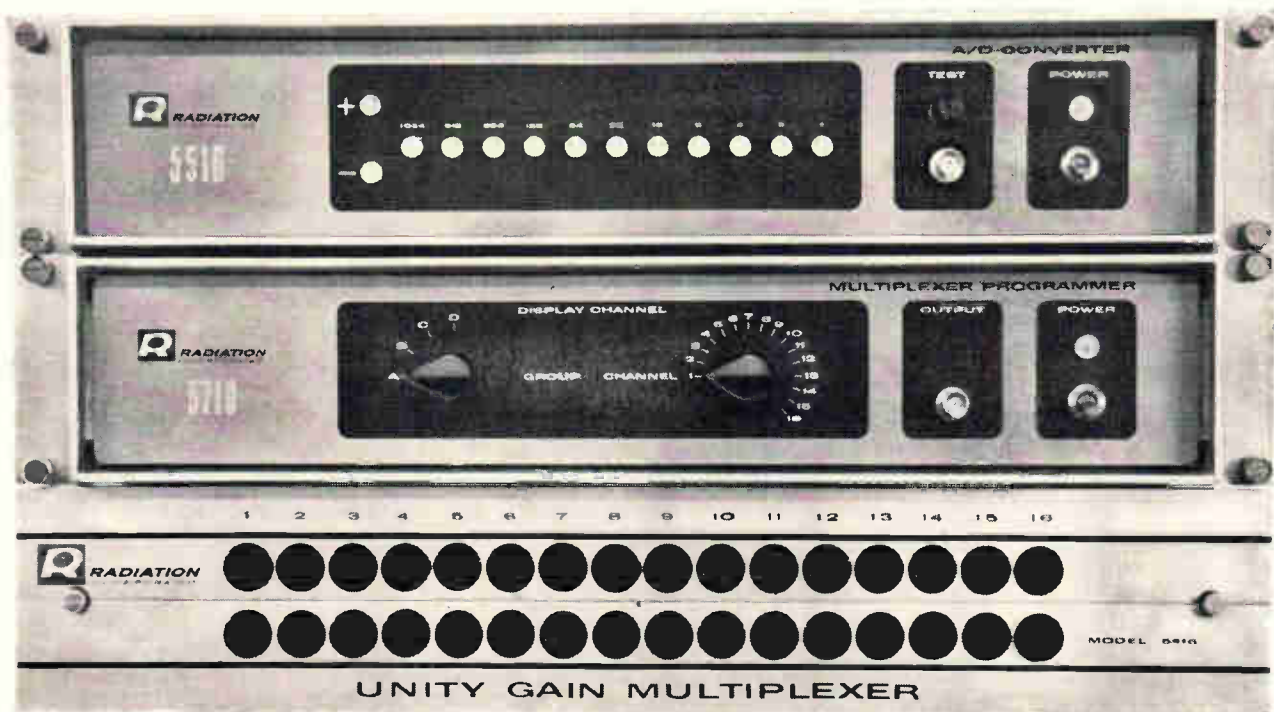

From analog data to computer tape

for only \$9,500 plus cost
of recorder

- 50,000 samples/sec
- 12-bit resolution
- 16 analog inputs

New Radiation high speed system provides outstanding performance at unusually low cost

Do you acquire analog data which eventually must be processed in a digital computer? If so, now you can do it more economically and in one step with this new Radiation system, the Model 5013.

The basic system consists of A/D converter, multiplexer programmer, unity gain multiplexer, and formatting logic. Yet, this compact system requires only 10.5" of vertical panel space. While intended for rack mounting, the system is also available in a portable cabinet for desk-top use.

Model 5013 accepts analog data from up to 16 sources. The inputs are multiplexed, and each is converted into a 12-bit binary word. The system then formats these data for entry into the write amplifiers of the digital tape recorder of your choice.

Radiation's new Model 5013 is available for delivery. If you wish, we will be glad to provide interfacing equipment for the digital recorder of your choice or engineer a complete installation based on this unique, low-cost system. Additional options offered are: up to 64 input channels, pre-set digital information inputs, digital time coding, gapped-tape capability—using core buffer, plus any of the equipments shown at right.

Send the coupon for technical details or contact Radiation for applications assistance. Radiation Incorporated, Products Division, Department EL-03, Melbourne, Florida 32902. Phone: (305) 723-1511.

MODEL 5013 SYSTEM—BRIEF SPECIFICATIONS

High reliability and long life are assured by solid state modular construction and wire-wrap connections. Circuit changes and maintenance are simplified through use of plug-in Radiation Digital Logic Modules. The three units comprising Model 5013 are human-engineered for ease of operation. Each is only 3.5" high, resulting in unusual compactness. The system consists of:



A/D Converter (Model 5516) \$3,741

Has input of ± 5 v, full scale, 50 kc word rate, is self-contained unit. Output format is 12-bit binary or 11-bit binary plus sign. Options are: 1. built-in sample and hold, add \$233; 2. display, add \$293; 3. buffered output, add \$83.



Multiplexer Programmer (Model 5710) \$1,995

Incorporates selector for displaying each individual channel on the A/D Converter without interrupting the normal coding process. Supplies necessary sequencing and programming signals to accommodate up to four Unity Gain Multiplexers for a 64-channel system. Derives clock from Model 5516 or may be externally synchronized.



Unity Gain Multiplexer (Model 5416) \$1,995

Has wide input flexibility and high reliability (MTBF 16,767 hours). This modular building block accepts single ended, differential or mixed inputs. Offset and zero drift are less than $5 \mu\text{V}$, 20 to 30°C. Maximum sampling rate is 50 kc, two or more channels.

OPTIONAL UNITS—BRIEF SPECIFICATIONS

The highly stable, solid-state units below are designed to increase the flexibility of the basic Model 5013 System:



D/A Converter (Model 5610) \$3,950

Accepts 8-bit parallel binary multiplex, provides 12 inputs, 12 D/A converter outputs. Adjustment free. Output: 0 to -5 v excursion for zero to full scale. Voltage resolution: 0.39% (9.76 mv). Settling time: less than $2 \mu\text{sec}$. Available without display at \$3,750.



Read/Write Electronics (Model 5810) \$6,000

Adaptable to 7 or 9-track requirements. Binary or BCD: 200, 556 or 800 bits/inch. Manual write lockout control. Contains parity generator on write and parity check on read. Adaptable to write heads with either center-tapped or single winding.



RADIATION PRODUCTS DIVISION A DIVISION OF RADIATION INCORPORATED

MELBOURNE, FLORIDA 32902

Gentlemen: Please send technical data on products listed below:

Model 5013 Model 5516 Model 5710 Model 5416 Model 5610 Model 5810

Name _____ Title _____

Firm _____

Address _____ City _____ State _____ Code _____

RBM STANDARD CONTROLS



A. C. Industrial Contactors

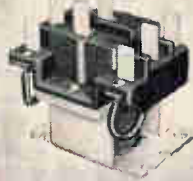

A. C. General Purpose Relays

D. C. Power Contactors



A. C. Power Contactors

D. C. Computer Relays



Miniature D. C. Sensitive Relays

Bi-Reed Relays

When you use RBM STANDARD CONTROLS you are assured of...

Immediate Availability—sold by leading Industrial Electronic Distributors* in major marketing areas—AT OEM PRICES IN ANY QUANTITY.

Highest Quality—millions of controls—field proven under most exacting requirements—have earned mass market customer acceptance.

Competitive Prices—RBM CONTROLS mass production facilities—geared to serve major markets—assure lowest cost.

Stocked In Depth—all standard controls stocked in Chicago warehouse with bulk (back-up) stock at the factory.

Service Replacement—over 3,000 custom designed controls are replaceable from standard catalog stock. Consult nearest RBM CONTROLS Authorized Distributor or Branch Sales Office for replacement recommendations.



Type 84



Type 129

RBM Standards

Modern Design • Totally Enclosed • Screw Terminals • Operates In Any Position • Normally Open and Double Throw Contact Forms • Inductive and Resistive Ratings

**RBM CONTROLS DIVISION
ESSEX WIRE CORPORATION**

131 Godfrey Street • Logansport, Indiana

- *RBM DISTRIBUTORS**
- ALABAMA**
Specialty Distributing Co.
Mobile
 - ARKANSAS**
Bluff City Distributing Co.
Jonesboro
 - ARIZONA**
Kierulff Electronics Inc.
Phoenix
 - CALIFORNIA**
Fisher Switches
Palo Alto
Kierulff Electronics
Los Angeles
 - COLORADO**
Kierulff Electronics, Inc.
Denver
 - CONNECTICUT**
Cramer Electronics, Inc.
Hamden
 - FLORIDA**
Electronic Equipment Co.
Miami
Hammond Electronics
Orlando
 - GEORGIA**
Specialty Distributing Co.
Atlanta
 - ILLINOIS**
Allied Radio Corporation
Chicago
 - INDIANA**
Graham Electronics Supply Inc.
Indianapolis
 - MARYLAND**
Powell Electronics
Beltsville
 - MASSACHUSETTS**
Cramer Electronics, Inc.
Newton
 - MICHIGAN**
Radio Electronic Supply Co.
Detroit
 - MINNESOTA**
Lew Bonn Company
Minneapolis
 - MISSISSIPPI**
Bluff City Distributing Co.
Greenville
 - MISSOURI**
Burststein-Applebee Co.
Kansas City
Interstate Industrial
Electronics, Inc.
St. Louis
 - NEW MEXICO**
Kierulff Electronics, Inc.
Albuquerque
 - NORTH CAROLINA**
Dixie Radio Supply Co.
Charlotte
 - NEW YORK**
Electro-Tech Equipment Co.
New York
Roburn Agencies, Inc.
New York (Export)
 - OHIO**
Pioneer-Standard Electronics
Cleveland
SREPCO-Div. Pioneer-
Standard Electronics
Dayton
 - OKLAHOMA**
Engineering Supply Co.
Tulsa
 - OREGON**
Lou Johnson Co., Inc.
Portland
 - PENNSYLVANIA**
Powell Electronics
Philadelphia
 - SOUTH CAROLINA**
Dixie Radio Supply Co.
Columbia
 - TENNESSEE**
Bluff City Distributing Co.
Memphis
 - TEXAS**
Engineering Supply Co.
Houston
Tekko, Inc.
Dallas
 - WASHINGTON**
Western Electronics Co.
Seattle
 - WISCONSIN**
Radio Parts Company
Milwaukee

FREE
WRITE FOR
SC-1 CATALOG



In products, performance, purpose ... Essex measures up!

See us at Booth 2423, IEEE Show

OHMITE

Exclusive,
smallest size
transformer

Exclusive adjustable extension shafts
Unique heat-sink quick-change brushes

Model VT1 (1.0 and 1.2 amp)

New
intermediate
size transformer

Model VT02 (1.75 and 2.0 amp)

it's
triplets!

Model VT3 (2.6 and 3.0 amp)

SHOWN 2/3 SIZE



New low-power variable transformers

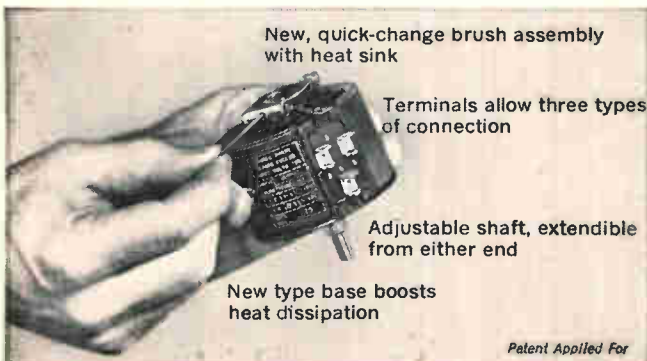

■ There are lots of exciting things about this new series of Ohmite v.t.[®] transformers. They give you six closely spaced ratings down to one ampere . . . plus quickly replaceable brushes that can't work loose or get out of alignment . . . plus insulated metal bases that boost heat dissipation . . . plus terminals you can connect to by soldering, 1/4" push-on connectors, or No. 2 screws and nuts . . . plus adjustable shaft, extendible from either end. Input is 120 volts. Variations include fixed and portable enclosures, ganged assemblies, and motor-driven arrangements. **WRITE FOR BULLETIN.**

OHMITE
MANUFACTURING COMPANY
3610 Howard Street, Skokie, Illinois 60076
Phone: (312) ORchard 5-2600

RHEOSTATS • POWER RESISTORS • PRECISION RESISTORS • VARIABLE TRANSFORMERS • TANTALUM CAPACITORS • TAP SWITCHES • RELAYS • R.F. CHOKES • SEMICONDUCTOR DIODES

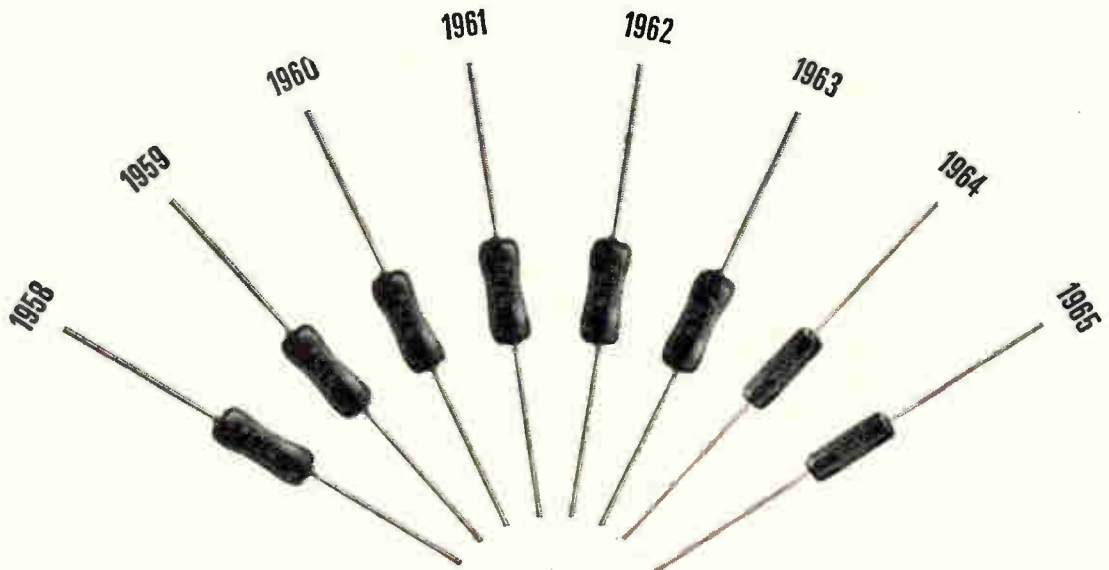

The eighth year of significant improvements in CORNING® precision resistors

You'd never know it just by looking at them, though. Our engineers don't even have taillights to change from year to year.

But on the little things inside, they're tigers.

Take TC, for example. Back in 1958, our CORNING® N-Insulated Series of resistors went on the market with a TC of ± 500 ppm. Not too bad, not too good.

We went to work on it and whittled the TC down to ± 300 ppm in our 1960 model. In 1961, we'd squeezed TC down to ± 200 ppm—it was getting tougher.

Then, in the 1962-63 versions of CORNING RN Resistor types, we screwed the TC down to ± 150 ppm.

And last year, in the CORNING® NA Resistor Styles, we held TC to ± 100 ppm. But TC isn't everything.

Soon we will announce a major advance in the over-all stability and performance of CORNING precision resistors—once again improving our basic glass tin oxide component which already holds well-established benchmarks for long, flat load-life performance.

Actually, we made a big interim improvement in that stability with the CORNING® NA-Resistor. Look at the Design Tolerances we've assigned to the Characteristic D NA-Resistor— $\pm 1.9\%/20,000$ hours for the NA55D and NA60D; $\pm 3.2\%/20,000$ hours for the NA65D, and $\pm 4.3\%/20,000$ hours for the NA70D—all calculated within 3 sigma limits.

These Design Tolerances include the 1% purchase tolerance and all ΔR due to TC and load-life drift.

With the CORNING NA-Resistor,

you *know* the parameters of its performance under load.

PHYSICAL CHARACTERISTICS

Mil Type	Corning Type	Wattage	Resistance (ohms)	
			Min.	Max.
RN55D	NA55D	$\frac{1}{8}$	51	150K
RN60D	NA60D	$\frac{1}{4}$	10	249K
RN65D	NA65D	$\frac{1}{2}$	10	500K
RN70D	NA70D	$\frac{3}{4}$	51	1 Meg.

Order from your nearby Corning distributor, or write for full technical data to Corning Glass Works, 3913 Electronics Dr., Raleigh, N. C.

CORNING
ELECTRONICS

WIDE DYNAMIC RANGE

(up to 3 times full scale)



BACKED-UP BY FAST AUTORANGING

(< 6 milliseconds/range)

The wide dynamic range offered by the new DY-2401C Integrating Digital Voltmeter from Dymec lets you measure signals up to three times full scale. It has 5 ranges with highly accurate 300% overranging on the most sensitive 4. Get the convenience of one-setting measurements in the much-used 1-to-3 area (e.g. 3 volts on the 1 v range, 30 v on the 10 v range, etc.) A 6th digit displays the most significant figure.

Should the measured signal exceed 310% of range setting, overload circuitry changes range to 1000 v and tells you your dvm is overloaded.

The autoranger available for the solid-state DY-2401C requires only 6 milliseconds per range to change and lets you take successive readings at opposite ends of the measuring range with <34 milliseconds range-change time. This is the fastest autoranger available. For data acquisition system applications, this means less time changing range, therefore less per-channel time.

Not only are you able to range the 2401C, but you can also set the sixth (10 mv) range provided by the accessory DY-2411A Preamp. When using the DY-2410B AC/Ohms Converter, you can automatically change ac and resistance ranges.

Increases or decreases in signal magnitude are precisely tracked, range is changed where necessary and only the correct answer is displayed. With noisy signals, no waiting while the meter hunts for the answer, and no bad guesses or indecision. You get the right answer the first time.

DY-2401C improvements include a new reversing counter—you can accurately measure signals in the zero region, even with positive/negative going noise on the signal. No zero fold-over problems. You also get higher instrument accuracy: Now 0.01% of reading, +0.005% of full scale +1 digit (at 25°C).

DY-2401C, \$3950; autoranger adds \$250.

Call your local Hewlett-Packard field engineer for information and complete specifications, or write direct to Dymec, 395 Page Mill Road, Palo Alto, California 94306. (415) 326-1755.

Data subject to change without notice. Prices f.o.b. factory.

See the new DY-2401C
at IEEE

HEWLETT
PACKARD  DYMEC
DIVISION



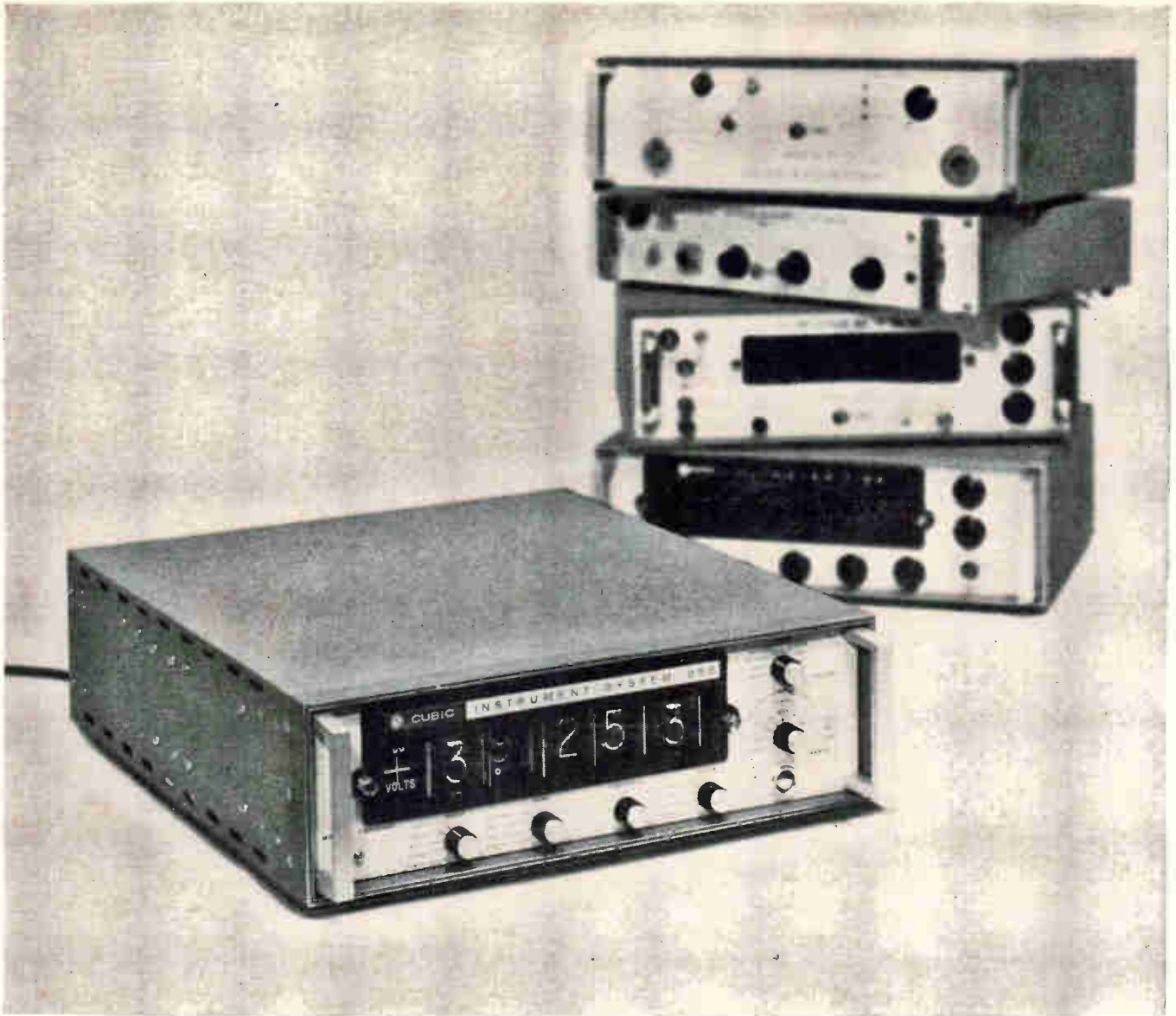

One Cubic Instrument System performs the function of four separate instruments!

The industry-leading approach to digital instrumentation is offered by Cubic Corporation's Instrument Systems. Each employs plug-in modules to perform five different measurements. These include DC volts, bipolar DC ratio, AC volts, ohms, and low-level DC to 1 micro-volt. Function Selector Knob on the instrument face changes function . . . without changing plug-in modules. A Cubic Instrument System eliminates the need for other instruments to make basic measurements.

Designed for easy expansion

Each Instrument System is based on a flexible design. Adding basic input and output devices or separate peripheral equipment quickly

alters capabilities. Accessory connector modifications or field programming of accessory plugs also changes an Instrument System to meet new requirements. Front panel functions are programmable, for adaptation to varied systems.

Four models available

Instrument System 150—Low-cost industrial 5-digit DVM unit.

Instrument System 250—Current-summing, reed relay DVM for reliability.

Instrument System 350—5-digit DVM features solid state switching for speed.

Instrument System 240—Cubic's rugged 4-digit, reed relay DVM.

Accessories

Input Modules: Preamplifiers, AC-DC Converters, Ohms-to-volt Converters, Scanners.

Output Modules: Data Translators and Buffers.

Peripheral Accessories #640 Scanner, #800 Data Translator, #811 Printer, Typewriters, Tape Punches. For information about Instrument Systems, write: Cubic Corporation, Dept. D-128, 9330 Balboa Ave., San Diego, Calif. 92123.

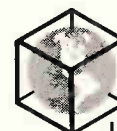

CUBIC
CORPORATION
SAN DIEGO, CALIFORNIA 92123
INDUSTRIAL DIV.

can you use
TC zener diodes
with test currents
of 500 μ A
1.0 mA
2.0 mA
or 4.0 mA?

NEW
DICKSON
6.4 VOLT SERIES
GIVES YOU EXTREME STABILITY
AT THESE LOW CURRENTS

■ These new Dickson temperature compensated zener diodes are ideal for applications requiring extreme stability at a 6.4 Volt reference level where power is at a premium. Temperature coefficients to $\pm .0005\%/^{\circ}\text{C}$ are available over a temperature range of -55°C to $+100^{\circ}\text{C}$ and 0 to $+75^{\circ}\text{C}$ at test currents of 500 μ A, 1, 2, and 4 mA. Coefficients of $\pm .01\%/^{\circ}\text{C}$ to $.001\%/^{\circ}\text{C}$ are also available for less critical applications.



■ The Dickson 1N4565-1N4584A series is produced by the Dickson "Lifeguard" process. This exclusive new technique—
a — decreases the electrical field at the surface of the junction to make the unit non-sensitive to airborne impurities, micro-cracks, and other undesirable surface effects.

b — completely eliminates the thermally induced stresses which cause bonding cracks and shifts in device operating characteristics.

■ The result is a diode with a level of reliability and stability that far exceeds that of comparable devices. Analysis of over two million hours of life test data has indicated the complete elimination of catastrophic failures. The units are

so stable as a function of time that it is difficult to establish adequately stable test instrumentation to yield significant results.

DICKSON 6.4 VOLT
TEMPERATURE COMPENSATED REFERENCE DIODES

JEDEC TYPE NUMBER	ZENER TEST CURRENT	MAXIMUM TEMPERATURE COEFFICIENT	MAXIMUM DYNAMIC IMPEDANCE
	mA	$\pm\%/^{\circ}\text{C}$	ohms
1N4565A	.5	.01	200
1N4566A	.5	.005	200
1N4567A	.5	.002	200
1N4568A	.5	.001	200
1N4569A	.5	.0005	200
1N4570A	1.0	.01	100
1N4571A	1.0	.005	100
1N4572A	1.0	.002	100
1N4573A	1.0	.001	100
1N4574A	1.0	.0005	100
1N4575A	2.0	.01	50
1N4576A	2.0	.005	50
1N4577A	2.0	.002	50
1N4578A	2.0	.001	50
1N4579A	2.0	.0005	50
1N4580A	4.0	.01	25
1N4581A	4.0	.005	25
1N4582A	4.0	.002	25
1N4583A	4.0	.001	25
1N4584A	4.0	.0005	25

TEMPERATURE RANGE — "A" suffix = -55 to $+100^{\circ}\text{C}$
No suffix = 0 to $+75^{\circ}\text{C}$

VISIT IEEE BOOTH 1122

See these low current "Lifeguard" diodes sealed and tested at the Dickson booth . . . and, if you like, make your own free sample.



DICKSON
ELECTRONICS CORPORATION

310 WELLS FARGO, SCOTTSDALE, ARIZONA
PHONE (602) 947-5751, TWX 602-949-0146

Manufacturers of quality zener diodes, rectifiers, tantalum capacitors, solid state circuit breakers, field effect transistors.



UNIQUE

DECADE SYNTHESIZER-EXCITER TYPE NO 263

100 KC TO 30 MC FREQUENCY RANGE

Ideally used for transmitters, receivers, radar, molecular resonance, crystal filters, and frequency measurement, the No 263 provides a continuously variable frequency, a maximum output of 1 watt, and a resolution of 0.1 cps/division.

- Extremely stable built-in crystal, aging rate better than 5×10^{-9} /day.
- Modulation facilities provided for AM (A3b) and FM (FSK).
- All circuits monitored by meter on front panel.
- No tuning devices (lamps, meters, etc.) required.
- No warm-up time required from stand-by position.
- Simplified version No 262 with 5 cps resolution consists of upper and lower chassis only.

Circle No. 246



FIELD STRENGTH METER TYPE HFH

0.1 to 30 Mc
 Frequency Range

Measures electric and electromagnetic components of a field directly by means of one calibrated rod and three rotatable loop antennas. Does not require use of calibration charts because it has a built-in tracking calibrating oscillator.

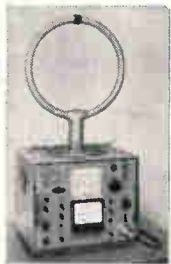

- Linear range of 20 db and logarithmic ranges of 40 and 60 db.
- As field strength meter, its range is 0 to 120 db ($1 \mu\text{V}/\text{m}$ to $1\text{V}/\text{m}$).
- Calibration is independent of aging of tubes and components.
- Can be operated from 12 volt battery for field operation.
- Measures average and peak value.

Circle No. 247



FREQUENCY SYNTHESIZER TYPE XUA

30 Cycles to 30 Mc
 Continuously Adjustable

This extremely popular instrument combines excellent resolution (0.5 cps) with wide range. Frequency is read on only three scales in Mc, kc, and cycles. It is widely used for determining frequency characteristics of filters, frequency selective networks, amplifiers and communications systems without need for accessory counters or frequency meters.



- Adjustable in crystal-controlled steps of 100 kc and 1 kc.
- 0 to 1000 cycle scale has 0.5 cps reading accuracy.
- Output voltage continuously variable from $100 \mu\text{V}$ to 1 V by means of precision attenuator and output voltmeter.
- Stability of built-in crystal is 2×10^{-8} per day.

Circle No. 248



POLYSKOP SWEPT-FREQUENCY SYSTEM TYPE SWOB Two Channel Frequency Response Display

The Polyskop is a visual display swept-frequency signal generator with a frequency range of 500 kc to 1200 Mc. It provides an automatic display of the response a



given quantity exhibits with a change in frequency, thereby providing instantaneous answers and eliminating point-by-point measurements.

- Solves problems up to 50 times faster.
- 0.5 to 1200 Mc frequency range covers radio and television up to UHF.
- Dual display trace facilitates simultaneous checking of two mutually independent quantities.
- System is entirely self-contained — replaces five units.
- Reduced range model — 500 kc to 400 Mc — also available.

Circle No. 249



Please have salesman call on me. Circle No. 250



ROHDE & SCHWARZ

ELECTRONIC MEASURING EQUIPMENT FOR THE UNCOMPROMISING

111 LEXINGTON AVE.
 PASSAIC, N. J.
 201-773-8010



SEE US AT IEEE BOOTH 3000-A & B



New microcircuit module now available



Hamilton Standard has developed a new microcircuit modular packaging technology. New, low-cost, hermetically sealed modules permit the interconnection of integrated and thin-film hybrid circuits, or a combination of both, in a protected all-welded assembly. Up to ten discrete wafers provide a maximum of 360 interconnections.

Fifteen standard modules including digital and linear circuits are avail-

able for evaluation or for production quantities. Special circuits also are easily adapted to the modular package. Flexible automation permits the economical production of limited quantities. Electron-beam welding assures high reliability and strength without the use of organic materials.

Delivery of standard circuits for evaluation is approximately 30 days. Mail the coupon for specifications of modules, and for more information.

**Attention: Sales Manager,
Electronics Department
Hamilton Standard
Division of United Aircraft Corporation
Broad Brook, Connecticut**
Please send the list of standard circuits available for evaluation and the new microcircuit module brochure.

NAME _____
TITLE _____
COMPANY _____
ADDRESS _____
CITY _____
STATE _____ ZIP CODE _____

Hamilton Standard DIVISION OF UNITED AIRCRAFT CORPORATION

**U
A**

Visit us during the IEEE Show at the New York Hilton, Booths nos. 19-20-21

ELECTRONICS • ATTITUDE CONTROLS • STABILIZATION SYSTEMS • ENVIRONMENTAL CONTROLS • FUEL AND AIR INDUCTION CONTROLS • ELECTRON BEAM MACHINES • PROPELLERS • STARTERS • TURBOMACHINERY • GROUND SUPPORT EQUIPMENT • INDUSTRIAL VALVES • OVERHAUL AND REPAIR

CALIBRATE YOUR COUNTER IN MINUTES

to parts in

10^6 , 10^7 , 10^8 , 10^9 , 10^{10} , 10^{11}

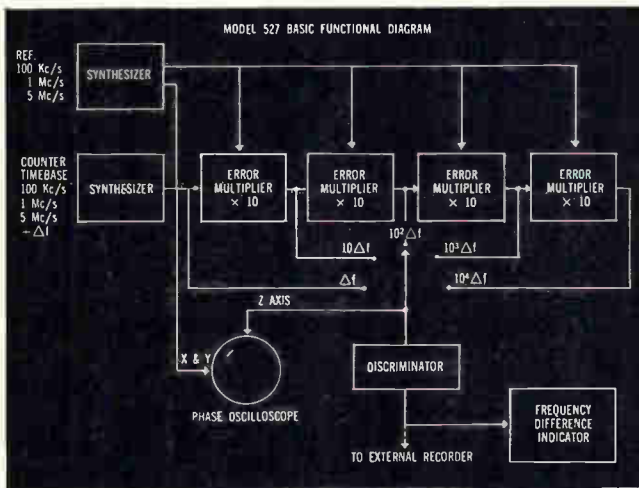

Simply connect your time base oscillator to the TRACOR Model 527 Frequency Difference Meter and compare with your local standard by reading the front panel meter. Adjust oscillator to obtain desired accuracy. No waiting is required as the Model 527 provides an instantaneous direct meter indication of frequency difference between the two oscillators. Error multiplication as high as $f \times 10^4$ is selectable by a front panel meter for accuracies as high as 1×10^{-10} . A built-in oscilloscope aids in quick, simple adjustment and provides accuracies to 1×10^{-11} .

Any local frequency standard can be used. The SULZER Model 1 B or 2.5 is recommended. The TRACOR Model 892 portable VLF Receiver with a built-in SULZER 1 B oscillator provides a compact package having an oscillator accuracy to 2×10^{-9} traceable to NBS from any point in the U.S.A. Both WWVB (60KC) and WWVL (20KC) are received by the single receiver.

For stability to 1×10^{-10} , the SULZER Model 2.5 is recommended. The TRACOR Models 599G and 599H VLF Receivers, tunable over 242 channels, allow comparison of local standards to NBS, U.S. Navy stations or other VLF transmissions anywhere in the world. VLF Receiver Models 890, 892 and 599H have a built-in recorder.

TRACOR IEEE Booth #3946 features oscillator calibration to 1×10^{-11} . A TRACOR representative will demonstrate equipment in your laboratory on request. Telephone 512-476-6601 collect or write: TRACOR, Inc., 1701 Guadalupe Street, Austin, Texas 78701 for complete information.

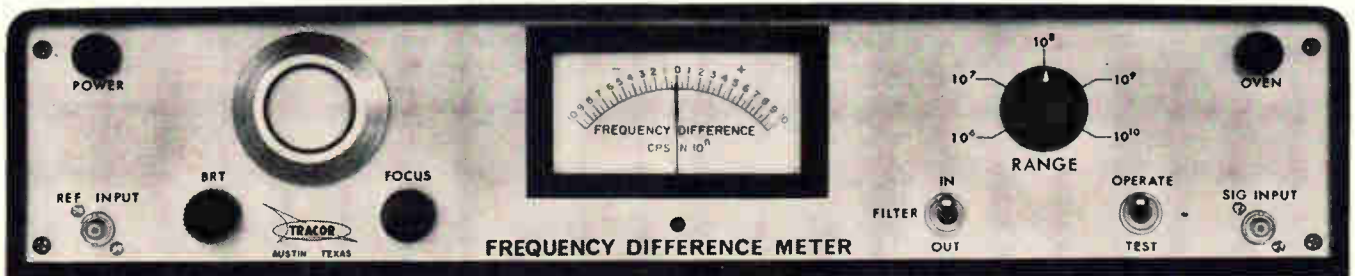
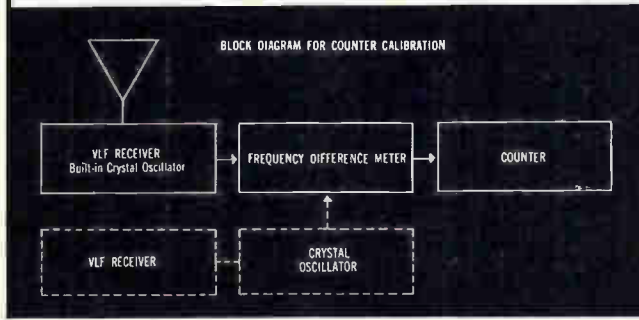

Advanced State of the Art Products.

TRACOR
INSTRUMENTS

TRACOR, Inc., Austin, Texas / Representatives in principal cities.

4



BONUS FEATURES! New G & HG resistors offer more versatility than any other wirewounds!

1. MORE POWER in MIL SPEC SIZE

G SERIES*							HG SERIES					
DALE TYPE	MIL-R-26C TYPE	MIL-R-23379 TYPE	POWER RATING (WATTS)		RESISTANCE RANGE (OHMS)		DALE TYPE	MIL-R-18546C TYPE	POWER RATING (WATTS)		RESISTANCE RANGE (OHMS)	
			Date	Mil.	.05%, .1%, .25%	.5%, 1%, 3%			Date	Mil.	.05%, .1%, .25%	.5%, 1%, 3%
G-1	—	—	1.0	—	10 to 950	1 to 3.4K	HG-5	None	15	—	1 to 6.5K	1 to 24.5K
G-3	RW-70	RWP-18	2.25	1	1 to 2.7K	.1 to 10.4K	HG-10	RE-65	20	10	1 to 12.7K	.1 to 47.1K
G-5C	RW-69	RWP-20	5	3	1 to 8.6K	.1 to 32.3K	HG-25	RE-70	35	15	.5 to 25.7K	.1 to 95.2K
G-15	RW-68	RWP-23	15	10	.5 to 73.4K	.1 to 273K	HG-50	RE-75	50	20	.5 to 73.4K	.1 to 273K

Major Environmental Specifications: LOAD LIFE: 1% Max. ΔR in 1000 hours at full power. OVERLOAD: .5% Max. ΔR at 3, 5, or 10 times momentary overload per applicable Mil. Spec. OPERATING TEMPERATURE: -55°C to +275°C

*G Series models are typical: 10 resistors in complete line.

2. THE SAME POWER in LESS SPACE

1 Watt Silicone Coated Resistor
Conventional MIL-R-26C and MIL-R-23379

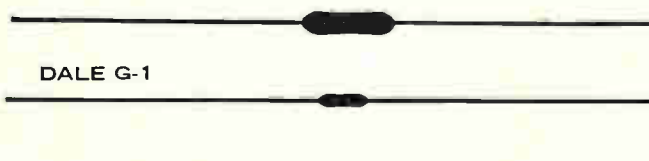

15 Watt Mil. Rated Housed Power Resistor
Conventional MIL-R-18546C Size

DALE HG-5

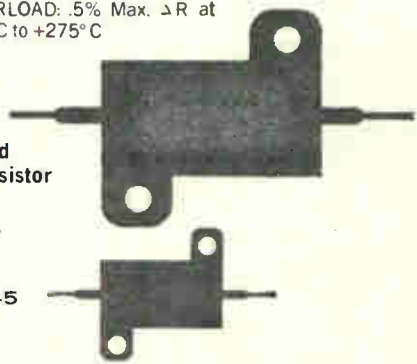

3. EXCEPTIONAL STABILITY at CONVENTIONAL RATINGS

Two RW-69, MIL-R-26C resistors (Dale G-5C and conventional silicone-coated wirewound) operated at Mil power levels.

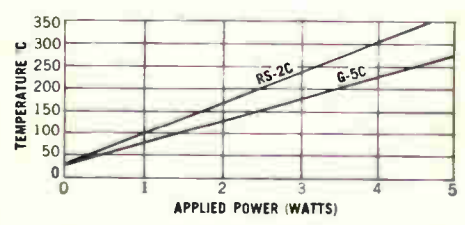

Two RE-65, MIL-R-18546C resistors (Dale HG-10 and conventional housed power wirewound, RH-10) operated at Mil power levels.

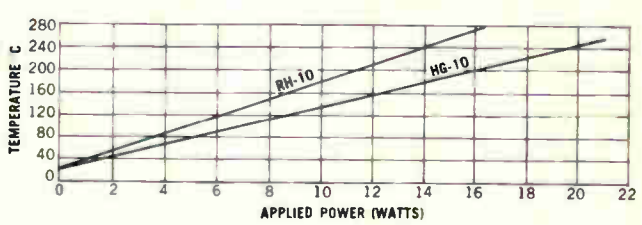

4. IMPROVED THERMAL EFFICIENCY

The chart at right shows the outstanding heat dissipation advantages which the beryllium oxide cores used in Dale G and HG resistors have over conventional core materials. To complement this advantage, Dale uses a special high temperature silicone coating on the G Series and a new extruded aluminum housing for the HG Series.

Core Conductivity at 275° C	BTU-Ft Ft·Hr·F
ALUMINUM - 130	
BERYLLIUM OXIDE (BeO) - 64	
STEEL - 33	
ALUMINUM OXIDE - 8	
STEATITE - 1.5	

FOR COMPLETE INFORMATION
WRITE FOR CATALOG A
See Us at Booth
2829-31, IEEE Show



DALE ELECTRONICS, INC.
1300 28th Avenue, Columbus, Nebraska
Also Sold by Dale Electronics Canada, Ltd., Toronto, Ontario, Canada



STANCOR STANDARD TRANSFORMERS



RECTIFIER

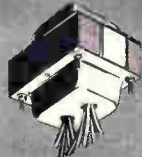

POWER



STEP-DOWN

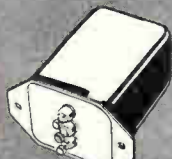

FILTERS



CHOKES



PLATE

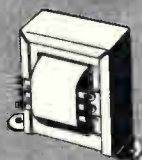

CONTROL



ISOLATION



FILAMENT



TOROIDAL

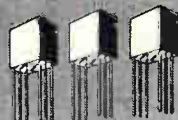

TRANSISTOR

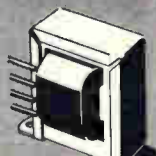

AUDIO



When you use STANCOR STANDARD Transformers you are assured of...

Immediate Availability—sold by over 150 Industrial Electronic Distributors in major marketing areas—AT OEM PRICES IN ANY QUANTITY.

Highest Quality—Stancor has specialized in manufacturing millions of standard transformers, time-tested and field-proven for over 35 years.

Competitive Prices—mass production facilities—to supply its extensive distributor organization—enable Stancor to manufacture at lowest costs.

Stock In Depth—over 300,000 transformers stocked in Chicago with branch warehouses at Dallas, Los Angeles and New York.

Service Replacement—available from over 1000 Industrial and Service Parts Electronic Distributors located in 525 cities throughout the U.S.

Write for Standard Catalog CS-102.

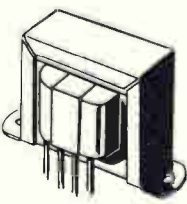

FILAMENT TRANSFORMERS
A Stancor Standard

Over 75,000 in stock ranging from 100 to 10,000 of over 100 types.

Specification Ranges

- Primary Voltage 115-230 volts, 50/60 cycle and 400 KC
- Secondary Voltage 2.5 to 25.2 volts
- Secondary Current 0.6 to 51 amperes



STANCOR ELECTRONICS
ESSEX WIRE CORPORATION
3501 W. Addison Street • Chicago, Illinois 60618

In products, performance, purpose... Essex measures up!



See us at
Booth 2423,
IEEE Show

Technical Articles

**IEEE Show:
Crucible for new products
page 74**

Today, an electronics company's growth and future depend more than ever on its ability to generate successful new products. Many of those scheduled to be introduced at this year's IEEE show will solve hardware engineering problems. But to engineers, a key question is how the products were developed, and where the idea came from. (More new products on pages 149 to 207.)

**Nonreactive filter
converts triangular
waves to sines
page 98**

The field effect transistor's design makes possible many unusual applications. For example, the drain characteristic of the FET can be exploited in a nonlinear, nonreactive filter when it is necessary to convert triangular waveforms to sinusoidal waveforms. The major caution, however, is to minimize the introduction of harmonics. One approach produces distortion of less than 1%.

**Digital system
converts data to
meaningful units
page 102**

Data from a missile or industrial control system test arrives in the wrong form—d-c voltages or pulse rates. It has to be converted to usable units—degrees of temperature, pounds per square inch, etc. A new technique provides direct readout in meaningful units. It is more accurate and more flexible than normal analog methods.

**Modernizing
the range: Part 2
page 108**

Pulse and continuous-wave radars on the missile range are being debugged to support our ambitious space programs. Future plans call for putting pulse radar in aircraft and satellites.

**Coming
March 22**

- The international controversy over color tv
- Using varactor diodes for r-f switching
- Starting a series on cold-cathode tubes
- Bonding techniques for hybrid circuits

IEEE Show: New product crucible

Engineers under pressure to come up with new products, will be looking at this year's
crucible for help in understanding why, how and where good ideas develop

The route from inspiration to production is rarely a short, straight path. After more than four years of painstaking effort, marked by as many disappointments as successes, Boonton Radio has perfected a vector impedance meter (cover) that takes the tedious manual work out of measuring complex impedances. The company will exhibit the first working model of this significant instrument at the IEEE show in New York on March 23.

Boonton won't be the only company to show a new product that represents the culmination of development processes which are often long, painful, tedious and expensive. Traditionally, the week of the annual meeting of the Institute of Electrical and Electronic Engineers (going back to the time, before 1963, when it was the Institute of Radio Engineers) has been the occasion to introduce major new products. This year, the pressure is on. With government research and production money harder to find, many companies are banking their future on the commercial success of the items they will show at the IEEE convention. That's why Electronics is taking a close look at a number of important new products to analyze why and how they were developed.

A good new product idea can come from anywhere. It may

- Answer a long-term need—the precision insertion loss measuring system (page 89) developed by DeMornay-Bonardi for use at microwave frequencies.

- Improve the capability of an established device—the new phase-sensitive meter (page 80) to be previewed by the Industrial Test Equipment Co.

- Be purchased from somebody who doesn't have the facilities to manufacture the product—Raytheon's new digital strobe display (page 85) is an example of this.

Culling the most interesting and significant products from this year's offerings, Electronics' editors identified a few important trends.

Companies are attacking the price barrier on a lot of products, bringing out new components, in-

struments and systems that are markedly cheaper than current models. Collins Radio has a mechanical filter (page 81) for citizens' band equipment, costing only a third as much as other filters.

New materials are responsible for some other new products. For example, Varo Inc. (page 84) can offer microelectronic devices of high power—up to 18 watts—because new materials have been worked into them.

Reducing the size of devices has led to a variety of new equipment. By water cooling a high-power microwave termination instead of air cooling it, and using a dielectric with high thermal conductivity as good as metals'.

Bird Electronics has produced a unit (see page 88) that is far smaller than air-cooled units. New high power varactor diodes to be offered by Motorola (page 83) will shrink the size of some microwave equipment by replacing traveling-wave tubes with significantly smaller solid-state components.

Advanced techniques and new components have produced some other items. Field effect transistors shrink the size of a sine/square-wave generator built by Waveforms, Inc. (page 76).

More than ever before, new products are the fruit of ideas bought outside a company. It's partially a sign of the pressure on companies to develop more new products. And partially, it's an indication of companies' efforts to diversify. Raytheon is not the only company that will show a new product whose design or idea was purchased. Materials Research Corp. bought the idea for its new thin-film x-ray diffractometer from Franklin Institute Laboratories (page 90).

The IEEE show is more than a panorama of new equipment. It can supply an insight into some of the major changes that are taking place in the electronics industry and indicate the pace at which these changes are happening. Here, then, is an examination of some of the significant new products to be introduced at the show. Other new products, examined in less detail, will be found on pages 149 to 207.

Changing direction saved a product program

While engineers at the Burroughs Corp.'s electronics division in Plainfield, N. J., were doing the final testing on a new hybrid microcircuit last year, the International Business Machines Corp. announced its System 360 computer line, taking almost an identical approach to modular components. Burroughs decided to carry its work a step further in hopes of topping IBM in quality if not in timing.

From that extension has come a development that adds significantly to the hybrid circuit. Burroughs has perfected a technique for passivating silicon semiconductor devices with pyrolitic glass, eliminating the ordinary packaging or encapsulation, the hermetic seal, and the leads to the active components.

The coating is similar to the one that IBM has put on System 360 components. IBM deposits its coating by centrifuging a glass frit onto the silicon chip and baking it. Burroughs passes a gas mixture that contains silicon oxide over the chip, which has been heated. The high temperature causes the glass to deposit and coat the chip.

Picking up the pieces of its development work that had been aced out by IBM, Burroughs changed direction, determined to develop an inexpensive line of microcircuit products. Studying microelectronic equipment, Burroughs learned that the package was the best candidate for cost reduction. It represented nearly 75% of the cost of a microelectronic device. Previous study at Burroughs' corporate research laboratory in Paoli, Pa., had shown that glass passivation was technically feasible. Only a commercial process was needed.

To develop such a process, the company hired a materials specialist from a pharmaceutical company where he had learned to work with silicon and silicon dioxide. Burroughs won't talk about how its high-temperature process works, but the resultant glass-like seal is so good that the company tests it for pinhole leaks by inserting it in an atmosphere of hydrochloric acid gas at high pressure and 1,200°F.

The new package is so inexpensive that Burroughs offers a silicon controlled switch with three resistors—the equivalent of a high-voltage flip-flop—for only \$1.25 in quantities of a thousand. Normally, a microelectronic flip-flop would cost at least \$3.

With its new process, which company people call glassivation, Burroughs has three new product lines that will be introduced at the IEEE show: components, circuits and equipment.

First, Burroughs will show glass-passivated components such as silicon controlled switches (a

Burroughs semiconductor specialty), some transistors and diodes. In addition, it will offer custom-made hybrid microcircuits. These are ceramic rectangles, postage-stamp size and single-sided, meaning that all contacts are brought out on the same side. A typical circuit contains resistors, capacitors and conductors, positioned according to a customer's specifications. Active devices, in the form of tiny silicon squares, have metal contact pads on one surface and are dropped into place in the circuit before the ceramic stamp is passivated.

In such circuits, the new process does away with hermetic sealing operations, wire bonding to device header and posts, and certain tests that usually have to be performed before and after each production step. Instead, all testing can be done before the active device is diced.

Finally, the hybrid microcircuits are being used in Burroughs hardware products. Burroughs, which pioneered the Nixie tube for display purposes, has produced a tiny—0.490 inch wide, 0.650 inch high and 0.775 inch deep—Nixie tube to work with the microcircuits. The first application is in a tiny binary decoder with memory for an airborne navigation system. Shortly after the IEEE show, the first unit will be flight-tested in a latitude-longitude indicator.

The unit, complete with Nixie tube, sells for only \$49 in quantities of thousands. Without the new microcircuits, such a unit would cost at least \$250 because of the work needed to miniaturize the circuitry.

The miniature decoder memory has two main parts: a 12-diode decoder and a 12-silicon-controlled-switch memory-driver circuit. The decoder is biquinary: it converts the binary signal into one of five pairs of odd-even numbers instead of directly into one out of ten. The driver then converts the biquinary number to a decimal.

One feature of the unit is its low power consumption, only 670 milliwatts. That includes the Nixie tube, which draws up to 340 milliwatts.

Instruments

Impedance measurement without knob-twiddling

A measuring instrument should be easily applied and easily read, but sometimes the complexity of the measurement and the accuracy desired smother the goal of simplicity. Such was the case with impedance measurement. But now the Boonton division of the Hewlett-Packard Company has devel-



Direct reading of magnitude and phase is provided by two large meters on Vector Impedance Meter.

oped a self-contained instrument that provides complex impedance measurements directly on two front panel meters.

The instrument, the Vector Impedance Meter model 4800A, overcomes the frequency limitations of bridge-type measurements. Its accuracy—5% of full scale—is independent of the operator's ability to determine a null by using earphones or an oscilloscope. It avoids the errors introduced by the resolution limitation inherent in dial settings.

The 4800A measures impedance from 5 cycles per second to 500 kilocycles per second. The panel meters provide the magnitude Z of any impedance from 10 ohms to 10 megohms and its phase angle θ from 0 to 360 degrees. The test frequency is selected by a range switch and dial.

The measurement technique employed is as old as Ohm's law itself. On the lower impedance ranges, the measurement is made by applying a constant alternating current to the unknown and reading the voltage across it. This voltage is proportional to the magnitude of the impedance, Z . On the higher ranges, a constant voltage is applied to the unknown and the current is measured. The applied voltage levels are minimized so that non-linear devices may be measured under small signal conditions for best accuracy. Phase angle is measured with a synchronous detector which reads the difference between the phase of the current through

the unknown impedance and the phase of the voltage across it.

Besides being an impedance-measuring device, the 4800A is useful as a direct reading L-C meter. It can measure inductance from 1 microhenry to 100 kilohenries and capacitance from 0.1 picofarads to 10,000 microfarads.

The meter can also be used as a Q-meter over its entire frequency range. This is accomplished by using the "Q by delta f" approach. The frequency response of the component under test is measured on the Z meter, which has an additional scale calibrated in decibels for convenience, and the Q is easily computed as the ratio of the center frequency f_0 to the bandwidth Δf between 3-db points.

Analog outputs proportional to impedance magnitude, phase angle and frequency are an optional provision so that a direct plot of impedance as a function of frequency can be obtained when connected to an X-Y recorder. These outputs could also be used to actuate limit switches or operate digital or expanded scale voltmeters.

Specifications

Frequency range:	5 cps to 500 kc in 5 bands
Impedance magnitude range (Z):	1 ohm to 10 megohms in 7 ranges, accuracy: 5% of full scale
Phase angle range (θ):	0 to 360 in 2 ranges (Both ranges are zero centered to facilitate easy reading of leading or lagging value of θ), accuracy: 5% of full scale $\pm 2^\circ$
Inductance range:	1 μ h to 100,000 h in 11 ranges
Capacitance range:	0.1 pf to 10,000 μ f in 11 ranges
Power requirement:	115/230 volts, 50-60 cps, 15 watts
Dimensions:	5 7/32" x 16 3/4" x 16 3/8"
Weight:	25 pounds
Price:	\$1,490
Delivery:	From stock after September.

Kit bag holds trouble-shooter

Component developments are putting laboratory instruments right into the field service engineer's briefcase. Waveforms, Inc., of New York City has built an audio-video sine and square wave generator, dubbed the 511A, that includes an audio oscillator, a radio-frequency oscillator, a square wave generator and an attenuation system in a

6-pound, 153-cubic-inch package. Designed primarily for testing audio and data tape recorders, the basic design can be adapted to field uses in the railroad and telephone industries, and to a number of other applications.

Even with solid state circuitry, the package could not have been built without two key component developments: field effect transistors of the metal oxide semiconductor type, and miniature tantalum capacitors.

To achieve the design and packaging objectives, all solid state design was necessary. But, according to Waveforms, traditional solid-state audio os-

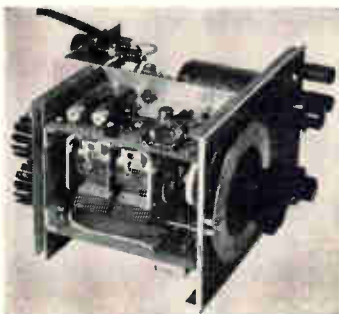

Internal view of portable generator shows solid-state design.



Field engineer can pack his lunch along with sine and square wave generator (lower left) and other equipment.

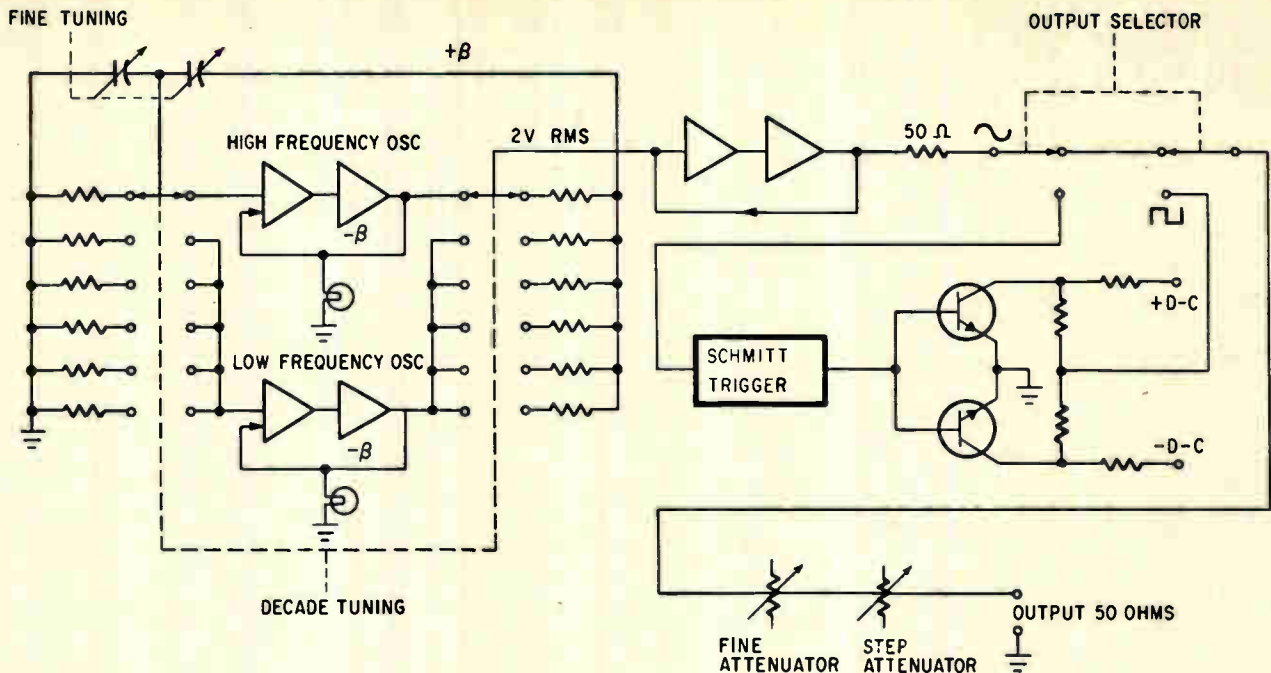

The complementary symmetry output switch in the Waveforms, Inc., sine/square-wave generator is used as the square-wave output circuit and allows direct coupling to the output, maintains constant output Z for both the positive and negative portions of the waveform, and is short-circuit proof.

oscillators were not desirable, and what was desirable was not available.

There were solid state RC audio oscillators of the fixed capacitance, variable-resistance type. But the design engineers were reluctant to use composition, ganged "pots" for resistive tuning because they do not age well and because their temperature coefficient was not considered ideal. With variable wire-wound controls, on the other hand, infinite tuning resolution is a two-step process: the small but discrete steps in the wire-wound control, and a vernier to adjust between them.

According to the Waveforms engineers, a variable capacitance approach combines all the advantages of composition and wire-wound controls with none of their disadvantages.

Electron tube audio oscillators have been built with variable capacitors for years. But it was not possible to construct a simple transistor amplifier with sufficiently high impedance to operate with a variable-capacitance network. The impedance must be on the order of a few hundred megohms, because the available capacitance of variable capacitors is small. To load the RC network with a low-impedance amplifier would destroy its tuning properties.

Then came the MOS FET, opening up new possibilities to the solid-state circuit designer. It has an input impedance even higher than that of electron tubes. By incorporating the RCA 3N98 FET in the 511A, Waveforms engineers arrived at their double design goal, variable-capacitance tuning and solid state.

The circuits in the 511A, Waveforms engineers say, are conventional adaptations of electron tube circuits in use for many years. For example, the

low frequency oscillator (10 cps to 120 kc) is a Wien bridge audio type consisting of a 3N98 and 2N3053 in cascade. The high frequency oscillator (100 kc to 12 Mc) is of the same type, but with the transistors and operating points chosen for use at the higher frequencies.

For a square wave output, the low frequency oscillator actuates a Schmitt trigger which activates the two output transistor switches in sequence. These transistors are fed from a positive and negative d-c supply. Current through them and their associated load resistors develops the square wave output voltages.

The step attenuator is a four-position device using pi configuration attenuators. The attenuation ratio is 20 db per step. While this system is conventional, the video attenuator of 60 db requires careful layout of components.

Connections are made at the front of the instrument, and the frequency is set by turning a large dial.

Specifications

Frequency range:	sine waves: 10 cps to 12 Mc square waves: 10 cps to 0.1 Mc
Dial accuracy:	±3%
Output level:	3 v into 50 ohms; 6 v open circuit
Response:	±1 db
Attenuator steps:	3 v, 300 mv, 30 mv, and 3 mv
Fine attenuator control:	continuously variable
Sine wave distortion:	0.25% at 1 kc; 1% at 1 Mc; 2% at 10 Mc
Square wave rise time:	0.5 microsecond
Power requirements:	33 volt amps, 110 or 220 volts a-c, 50 to 400 cps
Size:	6" x 4 1/4" x 6"
Price:	\$700
Availability:	immediate

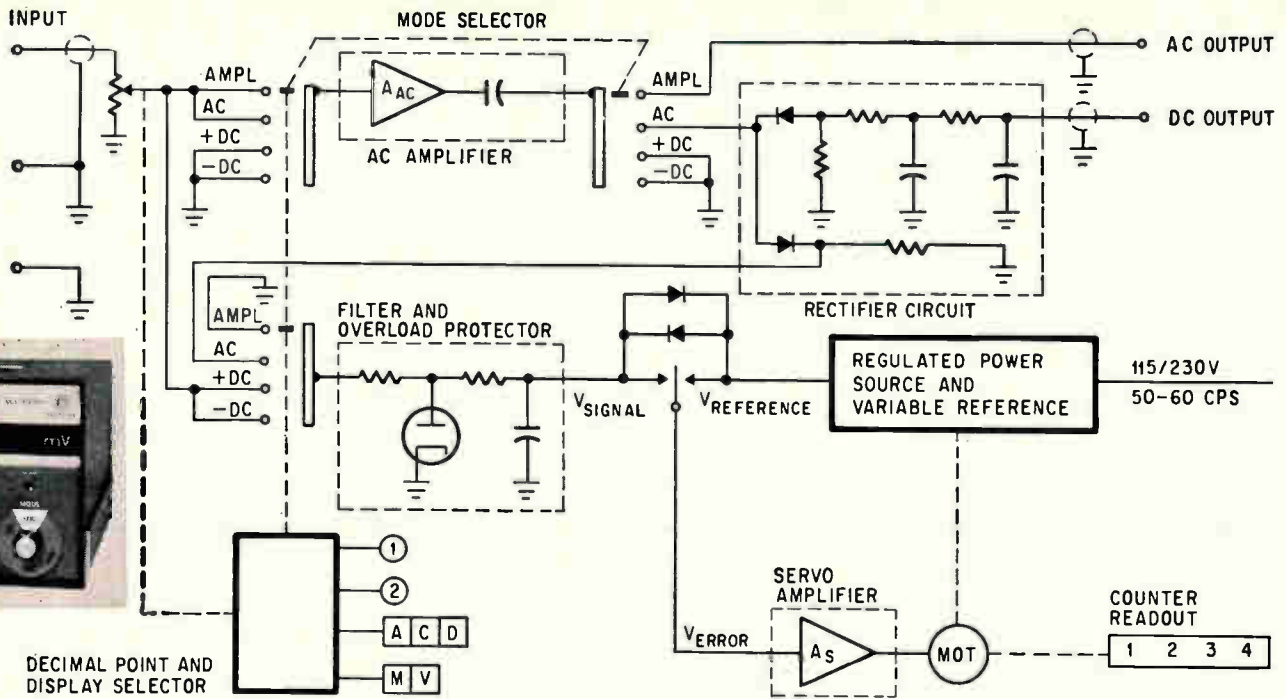

Ballantine's model 355 digital voltmeter uses a servo motor to drive its digit counter. Mechanically coupling the counter and a reference supply provides the servo amplifier with feedback. The amplifier drives the motor until the output of the reference supply and the unknown signal are equal but of opposite polarity. The "stop" position of the motor is a measure of the input to the dvm.

(Photo inset) The vernier enables the last figure to be read to the nearest tenth.

Cutting the cost of digital voltmeters

Digital voltmeters are easy to read and thus well-suited to production line and quality-control applications, in which a yeoman might be confused by the dial of an analog meter. But the development of digital meters has concentrated on increased accuracy—some instruments have five or more digits—and the result has been price tags that begin at about \$1,000. Ballantine Laboratories, Inc., fills a gap with its new 355 digital meter, which it says matches the accuracy of analog meters in its price range (\$590).

Ballantine combined a drum-type digit counter, a servo motor, and low-cost analog circuitry to produce an a-c/d-c digital meter capable of making measurements up to 500 volts with an accuracy of 0.25%, full scale. A vernier added to the fourth digit drum eliminates the normal plus or minus one digit of fully-digitized displays. The user can interpolate the last digit to the nearest tenth.

The instrument can't compete with more expensive digital meters for accuracy, but it is good enough for the production line, Ballantine says. The meter won't be available until August.

Digits on the 355 are large and well-lighted. The mode and range switches light up "d-c" "a-c" and the "mv" or "v" indicators, and the proper location of the decimal point. A warning light indi-

cates the requirement for manual range switching. A hand- or foot-operated switch may be used to hold readings and reduce the time between successive readings.

The front or rear of the meter may be elevated for easier reading; and with the use of an accessory kit, one or two of the meters can be mounted in a standard 19-inch relay rack panel without any modifications in the basic instrument.

Preliminary specifications

	a-c	d-c
Voltage range	10 mv to 1000 v in 6 ranges (30 cps to 250 kc)	100 mv to 1000 v in 5 ranges
Accuracy (% full scale) (1 mv to 500 v)	50 cps to 10 kc — ±0.25% 50 kc to 250 kc — ±1%	±0.25%
Maximum balancing time	4 sec	
Input impedance	All ranges, excluding most sensitive Most sensitive	2 megohms in parallel with 25 pf 2 megohms in parallel with 40 pf
Stability		
Line voltage		Less than 1 digit change per 10% deviation from 115 V
Drift		Less than ±0.2% after 10 min warmup
A-C rejection in d-c mode		60 cps 45 db 120 cps 40 db
Common mode rejection (a-c mode, input shorted)		At 60 cps >100 db At 100 kc >80 db
Availability (from stock)		after July
Price		\$590

FET's raise accuracy of distortion analyzer to within 0.03%

A 15-year-old instrument is finally succumbing to the increasingly rigid demands on distortion analyzers. The Hewlett-Packard Co. has redesigned its model 330 to increase accuracy and take advantage of improvements in components. The results are the models 331-A and 332-A.

Stricter specifications stem from the growing interest in high-fidelity music and from the cramming of more and more voice channels into narrow bands for telephony.

In telephony, where distortion appears as cross-talk between channels, distortion must be held under 0.1%. The new Hewlett-Packard instruments give meaningful readings to 0.03%.

Low harmonic content is also a requirement in broadcasting. Measuring this requires an instrument capable of operation at high frequencies. The new analyzer's broad range extends to 60 megacycles.

The model 331A consists of a broadband amplifier, a frequency-selective circuit and a high-impedance voltmeter. The 332A is similar, but adds an amplitude-modulation detector for design-testing high-quality broadcast facilities. By using field-effect transistors, both instruments can measure distortion at levels hitherto undetectable.

Two FET's are used: one in the impedance converter, another in the notch filter. The necessary high input impedance, unattainable with regular solid-state devices, was accomplished by using an FET. However, to reduce the distortion that could occur from the voltage-sensitive junction capacitances in the FET's Hewlett-Packard designers bootstrapped elements of the FET. In bootstrapping, the gate voltage is lifted above ground by a value derived from its output voltage. This also increases the FET's input impedance. Clamp diodes protect the input FET from burn-out.

The tunable notch filter consists of an input amplifier, a Wien bridge feeding into the high-impedance FET, and an output amplifier. The voltage from the input amplifier is fed simultaneously to the tunable Wien bridge and to a voltage divider. The output of the divider goes to the source of the FET and the output of the Wien bridge goes to the gate of the FET. The attenuation of the divider and the bridge are equal for the desired frequency, and the voltages at the source and gate are of equal amplitude and phase. Thus at resonance, the drain voltage on the FET is zero. At other frequencies, there is a drain voltage and the FET has zero attenuation. The notch filter rejects the fundamental frequency; therefore only harmonics pass through the FET to the output amplifier. The



Model 331A distortion analyzer can be bench- or rack-mounted. Controls are simple to use; meter, calibrated in decibels, percentage and volts, is easy to read. The frequency, set with the large dial, is accurate to within 2%.

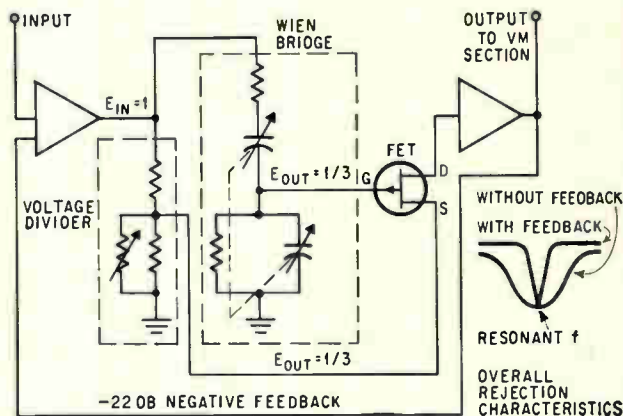

Sharp over-all rejection is achieved in the tunable filter section of the distortion analyzer. The combination of the capacitively tuned Wien bridge and 22 decibels of negative feedback in this section give more than 80 decibels of fundamental frequency rejection.

notch-filter characteristic is sharpened by adding about 22 decibels of feedback around the loop.

The notch-filter circuit also bootstraps the source of the FET and increases the gate impedance to thousands of megohms. This results in a high output impedance of the Wien bridge, avoids the nonlinearities that would have prohibited tuning the bridge to low frequencies, and allows the instrument to be rated down to five cycles per second.

Specifications

Distortion	0.1% to 100% in seven ranges of any fundamental frequency from 5 cps to 600 Kc			
Voltage	300 microvolts to 300 volts rms full scale over frequency range from 5 cps to 3 Mc			
Accuracy of harmonic frequency measurement				
harmonic frequency		input		
0.3% to 100% full scale	0.1% full scale	below 30 v	above 30 v	
10 cps-1 Mc	20 cps-200 kc	± 3%	± 3%	
1 Mc-3 Mc	500 Kc-1 Mc	± 5%	±12%	
	10 cps-20 cps	±12%	±12%	
Fundamental rejection	better than 80 decibels			
Voltmeter accuracy	±5% from 20 cps to 1 Mc			
Weight	15 pounds			
Price of Model 331A	\$590			
Price of Model 332A	\$620 (includes precision a-m detector for distortion analysis of modulated envelopes)			



Vector voltmeter can measure in-phase and quadrature components of voltage while rejecting noise and harmonics over the entire frequency range.

Phase-sensitive voltmeter goes wideband

When the makers of inertial guidance components for missiles began shrinking them by moving into higher audio frequencies, the makers of test equipment had to follow.

"Time was when we had to concern ourselves with 400 cycles and a couple of other frequencies," says sales engineer Melvin Schreiber of Industrial Test Equipment Co., Port Washington, N. Y. "Now we've been pushed into wideband."

His company is introducing a vector voltmeter which can make measurements at many fixed fre-

quencies. It can also operate over a selected band of audio frequencies without realignment at each frequency change. In addition, it goes a long way toward simplifying phase measurements, one of the most difficult aspects of component testing.

The Phazor vector voltmeter 300B is designed for use by manufacturers of rate gyros, tachometers, synchros and resolvers who need accurate measurement of residual null components, phase angle and total voltage.

Most such voltmeters use a linear discriminator to derive phase sensitivity, and filters to eliminate harmonic components and extraneous noise in both the input and reference channels. Phase misalignment is a problem when sweeping over the frequency bandwidth of a filter, so a large number of filters must be used.

Model 300B avoids the costly and error-susceptible multiple filter concept through the use of an electronic multiplier. The new circuit multiplies the instantaneous amplitudes of the input and reference signals. The meter then displays the time average of the resultant product. Since the multiplier responds only to input frequencies that match the reference, it rejects all harmonics and noise to give a true phase-sensitive reading.

The meter deflection is proportional to the product of the input and reference voltage and the cosine of the angle between them. To measure the in-phase (cosine) component of the input voltage as well as the quadrature (sine) component, it is necessary to maintain the reference amplitude constant over the entire frequency range and also be able to shift its phase a precise 90°. The phase shift is controlled by a 90° amplifier in the reference channel, and the amplitude is controlled by

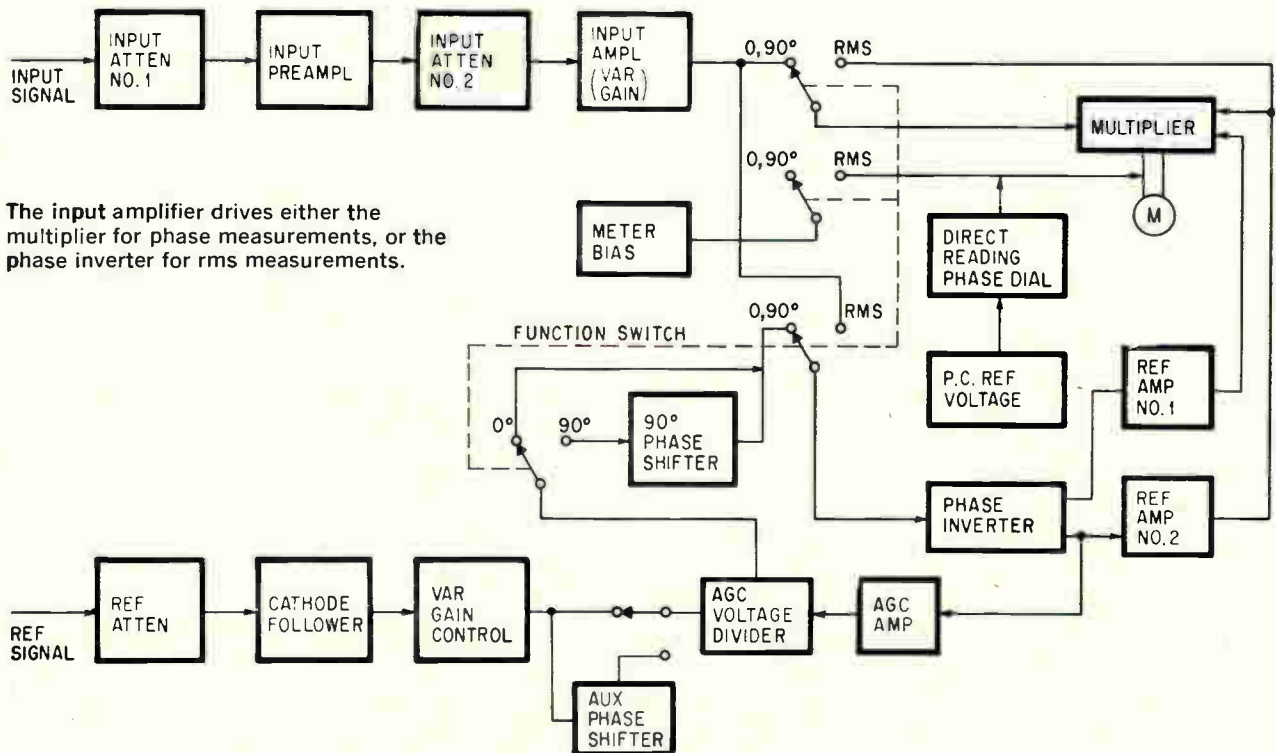

The input amplifier drives either the multiplier for phase measurements, or the phase inverter for rms measurements.

an automatic gain control amplifier. Phase angle can be read off a dial even though the signals may be complicated by harmonics and noise. A simple nulling procedure will adjust the dial to any angle from 0° to 360° without ambiguity as to quadrant.

Measurement requirements usually include total voltage, and phase-sensitive meters generally employ a conventional vacuum tube voltmeter for this purpose. In the Model 300B however, this is done with the input signal impressed on both the input and reference channels while the multiplier performs a squaring function. This results in a meter readout which is true root mean square.

Conventional meters give a true rms reading only for a pure sine wave.

Specifications

Accuracy:	±2% of full scale
Crest factor:	3 (For rms measurements)
Noise & harmonic rejection:	40 decibels down
Nulling sensitivity:	10 microvolts
Sensitivity:	1 millivolt full scale
Max. input voltage:	300 volts rms
Max. reference voltage:	400 volts
Max. reference d-c component:	400 volts
Input impedance:	10 megohms shunted by 25 picofarads
Max. reference voltage:	220 volts rms
Min. reference voltage:	0.5 volts rms
Max. reference d-c component:	400 volts d-c
Reference input impedance:	2 megohms shunted by 25 picofarads
Phase angle range:	0°-360°
Phase angle accuracy:	±1°
Power supply:	115 volts at 60 cps
Dimensions:	5¼" high, rack panel is 19", Depth behind panel is 13".
Weight:	35 lbs. approx.
Price:	\$1,100
Delivery:	8 weeks

Components

Filtering the chatter on citizens' band

It took overcrowding of the citizens' band to reduce the price of an electromechanical filter. When Collins Radio Co. surveyed the CB market, it discovered such a potential that production engineers went directly to work. Collins already made a filter for the military; dropping military environmental requirements and stepping up production made possible a 455-kilocycle, 6-kilocycle bandwidth filter, with signal-to-noise improvement up to 8 decibels, at no more than \$7 a unit.

That price is for quantities of more than 100. Single units are \$12—still far below the price of present hand-built filters.

Under Federal Communications Commission rules, the power output of CB transmitters is severely limited. Satisfactory reception, especially in noisy locations or when nearby transmitters are operating on adjacent channels, is a problem. Collins says that the way to solve it is to use a filter to increase selectivity and sensitivity.

The Collins filter offers narrower bandwidth than an intermediate frequency transformer and its electrical characteristics are several times more stable, especially under severe temperature changes and with rough handling. Its variation due to aging is less than that of a transformer.

The unit is essentially a transformer in which the primary and secondary are mechanically coupled over a narrow frequency range. The manufacturer recommends that signal input voltage be limited to 5 volts root-mean-square and direct current to two milliamperes. Shunt feed to eliminate direct current from the transducer coils can be provided by a suitable choke or resistor. A common ground, effective shielding between input and output and short leads are required to enhance rejection of

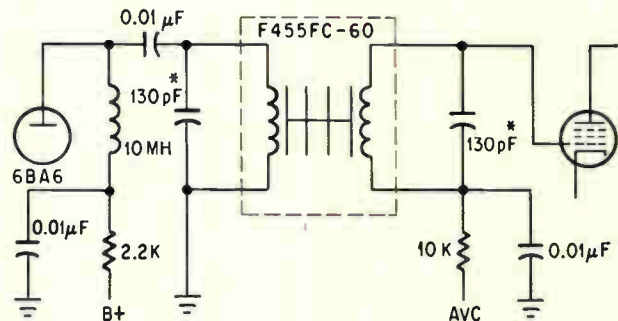

*INCLUDES STRAY CAPACITANCE

Representative i-f stage using the electromechanical filter. Direct current is blocked from the transducer coils by shunt feet.

The Collins mechanical filter has been packaged to mount on the chassis of a CB receiver.



unwanted signals by the filter circuit.

In electron-tube circuits, the filter is tuned to parallel resonance with a fixed capacitor shunted by a variable capacitor to peak the filter for maximum output at its center frequency. Both input and output must be resonated.

As the coupler in a transistor i-f amplifier, the filter is tuned to series resonance for low impedance and to parallel resonance for high impedance.

Specifications

Center frequency:	455 kc
Frequency bandwidth:	
3 db attenuation:	6 kc
60 db attenuation:	20 kc
Resonating capacitance:	130 pf
Direct voltage, maximum:	300 v
Source and load impedance:	
parallel resonance:	60,000 ohms
series resonance:	500 ohms
Price, more than 100, per unit:	\$7.00
less than 100, per unit:	\$12.00
Delivery:	60 days (prototypes from stock)

Constant-voltage transformer unaffected by frequency shifts

Since its invention in 1938, the Sola Electric Co.'s constant-voltage transformer has crossed the two-million mark in sales. Only one "bug" has limited its application somewhat: its inherent frequency sensitivity in lower power units. When line frequency changes only one cycle per second, the transformer output may change as much as 1.8 volts.

At the IEEE Show, Sola Electric, a division of the Basic Products Corp., will demonstrate its answer to the problem: a regulating transformer that's completely insensitive to frequency shifts.

The original Sola Electric device is a static magnetic regulator that depends on the transformer's core-saturation characteristics; it's controlled by a capacitor across one of its windings. Based on the principle of ferroresonance, it achieves 1% regulation for line variations up to $\pm 15\%$ without any moving parts or complex electronic circuitry.

The new version, a 150-volt-ampere unit, retains $\pm 1\%$ regulation of output voltage while operating from 50 to 400 cycles. Its other characteristics are the same as in the standard Sola Electric device.

Although patent considerations prevent Sola from giving design details on its frequency-insensitive transformer, Donald A. Davenport, Sola's director of electronic research, says compensation for fer-

roresonant frequency sensitivity involves a capacitance effect that tracks linearly with the frequency of the impressed voltage. He says the new transformers develop "unusual flux paths" using four secondary windings on four-legged laminations in an auto-transformer configuration.

The new transformer should find military applications because gasoline- or turbine-driven standby power lacks close frequency regulation. This has precluded use of constant-voltage transformers for equipment that must be operated with standby rigs, such as communications, radar and computers.

They may also eliminate much special equipment now needed to regulate voltages on systems that operate off foreign power sources. Such sources are lax on frequency control by United States standards, according to Davenport, ranging over $\pm 2\%$ to $\pm 3\%$ compared with the typical U.S. standard of one cycle variation in 24 hours, an infinitesimal error.

The standard product line for the new transformer will include 50- 60- and 400-cycle units. Pilot designs of 40, 60 and 120 volt-ampere units will be supplemented by designs ranging from 10 to 1,000 va. Sola Electric says it will offer custom-made, frequency-insensitive, constant-voltage transformers for sale after the IEEE Convention.

Selenium rectifiers challenge silicon

Silicon has always been considered superior to selenium for high-voltage applications, because it has lower leakage current. It has also been considered better for use in high temperature environ-

ments. As a result, selenium ran far behind in the rectifier market.

Now a new technology for selenium, developed over a four-year period by the International Rectifier Corp., El Segundo, Calif., results in smaller rectifiers that combine improved forward characteristics for higher cell-current with higher peak inverse voltage ratings. IRC claims its process increases voltage capabilities, permits fewer units in a series, improves uniformity and requires less power dissipation per cell.

In addition to improving three existing lines, IRC has added a fourth, featuring higher current-carrying capability and called SD-7 superdensity rectifier cells.

Price has always been an important advantage of selenium over silicon rectifiers. The company sees markets opening up in conversion of older equipment to solid-state circuits. Arc welders, electroplating equipment, and devices now using high-current glass diodes are some possibilities.

Selenium units have self-healing properties that lets them recover quickly after being subjected to excess voltage surges. IRC claims their selenium

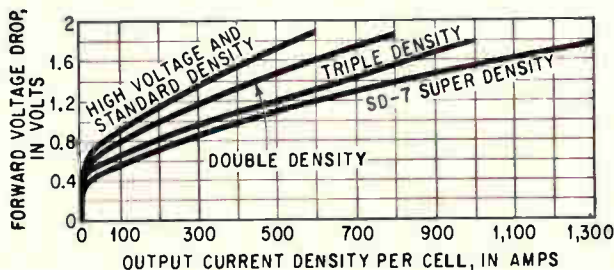

Typical forward voltage drop vs. current density of four types of selenium cells.

rectifiers now have the added virtue of higher current density levels. In addition, IRC engineers say the new process has increased the life expectancy of selenium, previously its major drawback. According to Frank Gift, chief engineer, short-term and accelerated life tests show better stability.

IRC says the new selenium process has resulted in a 25% increase in voltage ratings and a 20% reduction in cubic volume, in addition to greater current-handling capability—1.3 amperes per square inch of surface fan-cooled at a rate of 1,000 linear feet per minute. Standard density plates are

now rated at up to 50 volts; the double density, up to 50 from 36 volts; and triple density, increased from 33 to 40 volts.

The process, IRC says, does not sacrifice selenium's ability to recover from transients with little or no deterioration of performance. No complex protective circuits are needed, IRC engineers add.

The plates are now being manufactured in loose form for customer assemblies and in preassembled stacks for installation in circuits. Prices will be about 10% higher than for equivalent items made by previous processes.

Semiconductor

Pill-size power varactor for solid-state telemetry

The latest high-power varactor at Motorola, Inc., is a pill-type prong-mounted power unit that can handle a 12-watt input at one gigacycle with a typical efficiency of 58% in frequency-doubler circuits. The previous power limit at 1 Gc was 6 watts.

According to Gerald Schaffner, group leader of research on microwave-devices, pill-sized varactors of this type will be able to replace traveling-

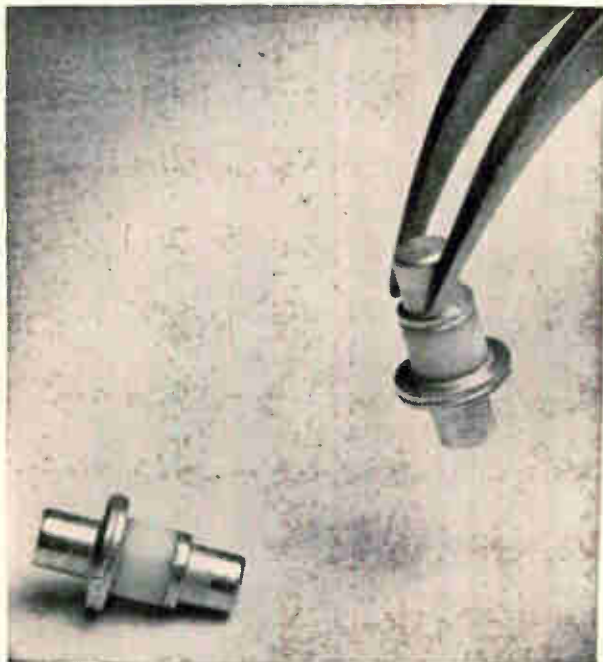

High power output at frequencies in the gigacycle range are provided by Motorola's new varactor diode.

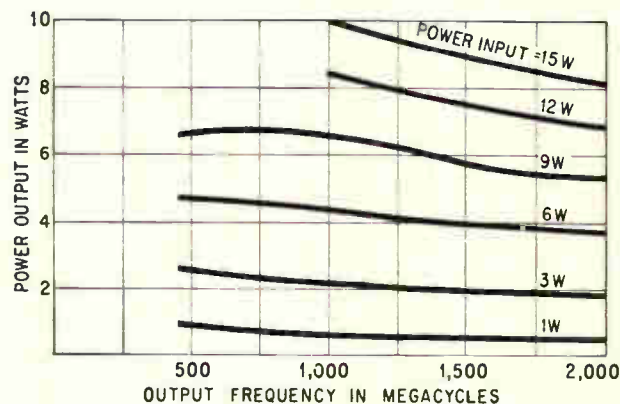

Efficiency of pill size varactor is 58% at 12 watts in frequency-doubler circuit.

wave tubes in many space applications. Designated the MV1808B, this varactor makes possible completely solid-state microwave radio relay systems, solid-state telemetry, and high power all-solid-state television transmitters. It will be useful in any application where light weight and the inherent reliability of a solid-state device is desired.

The diode's typical Q is so high at 70 volts and 50 megacycles that it cannot be readily measured for many units. However, Motorola guarantees a minimum Q of 1,000. The typical Q at six volts and 50 Mc is 400. The silicon device has a diameter of only 0.16 inch.

This is the first step in an expansion of Motorola's line of varactor diodes. Other packages electrically equivalent to the MV1808B are planned, as are devices with higher power capabilities.

Motorola's varactor diode line also includes larger stud-mounted varactor diodes, but this is the company's first venture into the ultraminiature varactor diode field.

Specifications

Minimum reverse breakdown voltage:	75 volts
Typical reverse breakdown voltage:	80 volts
Typical reverse current at 65 volts and 75°C:	0.5 microamperes
Typical efficiency at 1 Gc:	58%
Maximum input power:	12 watts
Over-all physical dimensions:	0.215 by 0.16 inches
Price per unit (100 or more):	\$28

Backward diode uses germanium at 150°C

The Navy's Bureau of Ships wanted a highly reliable germanium backward diode for microwave mixing and detecting in its electronic countermeasures systems. Specifications called for the diode to operate in X-band (9.375 Gc) at 150°C. Using aluminum alloy-junction construction the Philco Corp. produced a device that is expected to penetrate the silicon point-contact mixer diode market.

The devices, designated L14164 through L14167 depending on the packaging, are the first germanium backward diodes that operate at high temperature. They exhibit a much higher impedance level than previous devices, and they are thus more compatible with existing video detecting systems. Further, the detected output voltage of the diode

does not vary with temperature, so that temperature stability is no longer a problem.

The diodes offer 30 db improvement over silicon point-contact diodes in receiver noise figure in mixer systems with 1 kc i-f frequencies. They are available as welded ceramic cartridges, pill-prong cartridges, pill packages, or pill packages with tabs.

Specifications

Burnout rating by single pulse	3.0 ergs
Typical noise figure at:	
f_{rr} of 9.375 Gc and f_{if} of 30 Mc	7.5 db
f_{rr} of 9.375 Gc and f_{if} of 20 Kc	12 db
Detector data at $f_{rr} = 9.375$ Gc and video bandwidth = 10 Mc:	
Figure of merit (typical)	250
Tangential sensitivity (typical)	54 db
Video resistance (typical)	5000 ohms
Package dimensions:	
Welded ceramic	0.23" by 0.78"
Pill-prong	0.12" by 0.20"
Pill	0.123" by 0.058"
Pill with tabs	0.123" by 0.058"
Price per unit (100 or more)	\$98 to \$110
Price per matched pair (100 or more)	\$39 to \$44

Hybrid microcircuits handle 18 watts in memory cores

In any argument that pits hybrid against monolithic microcircuits, the discussion inevitably gets around to the power-handling limitations of microelectronics. Clearly, hybrid circuits can handle larger power. Varo, Inc. has enhanced this advantage of hybrid microelectronic devices by devising a line that can handle 18 watts—twice as much as anybody else can handle, according to Varo.

This development is made possible by new materials. The Varo line uses an epoxy-filled aluminum case banded to an alumina substrate by a high-conductivity material.

With these devices, circuits that have high-power outputs—such as memory-core drivers and servo amplifiers—can be converted to thin-film hybrid microcircuits.

Varo developed the hybrid device specifically to drive a thin-film memory core, and expects to begin full production this month.

With a heat sink at 100°C, the interior surface of the substrate undergoes a temperature rise of 3°C per watt per square inch over that of the heat sink. Although designed primarily for mounting on a heat sink, the device can also be mounted in free air; then the rise is 40°C per watt per square inch above the air temperature.

The package accommodates any circuit using TO-50 or TO-51 flat-packs or tab transistors. The packing density of a typical circuit permits including 8 flat-pack transistors, 20 resistors (11 to 1,800

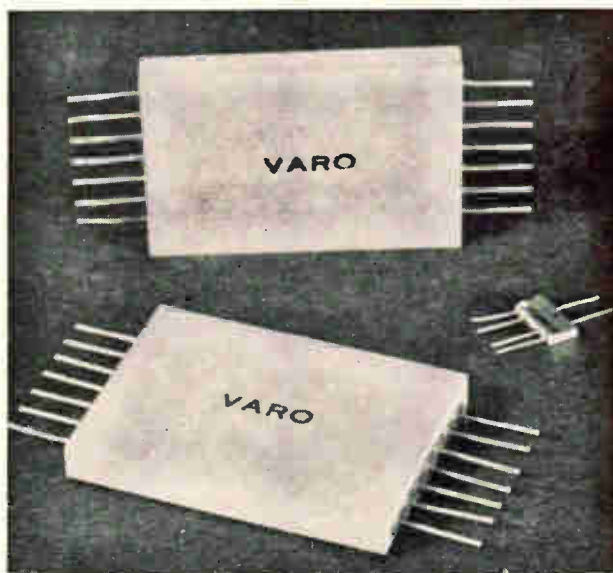

Thin-film hybrid module dissipates 18 watts when mounted on a heat sink. It can drive a core memory. Small unit is conventional two-transistor flatpack version.

ohms) and 6 capacitors (two 470-picofarad, two 300-picofarad and two 150-picofarad). Gold-plated ribbon leads on 0.1-inch centers are used and may be brought out of any two opposite ends. The price of the module depends on the type of transistor used and the complexity of the circuit.

Specifications

Dimensions:	1.2 x 0.8 x 0.15 inches
Leads:	14 total, 7 at each 0.8" x 0.15" end
Power dissipation:	3°C per watt per square inch (substrate-to-heat sink)
Typical density of circuit:	8 flat-pack transistors 20 resistors (11 ohms to 1,800 ohms) 6 capacitors (2-470 pf, 2-300 pf, 2-150 pf)
Power density thin-film can withstand	300 watts per square inch
Price per module:	\$150 to \$350 (depends on transistor used and complexity of circuit)

Now an electronic use of the strobe: display

The stroboscope, or speedlight, can make whirring gears and turbine blades stand still for inspection. Now the Raytheon Co. is using the same techniques to generate flickerless displays.

Fewer components, low operating power and high reliability are the result of coupling the stroboscopic principle with time-sharing of electronic circuits in the Datastrobe, a new readout device.

The company also sees advantages of simplicity and versatility over other projection readouts and over glow discharge, electroluminescent, electro-mechanical and edgelighted displays. Datastrobe needs no amplifiers, switches, relays or other mechanical devices for intermittent motion. Any type of character or symbol can be etched into the drum. The optics permits printout, including microfilming.

Last fall, Raytheon bought from Norman J. Appleton, a New Jersey inventor, the rights to his stroboscopic readout device. Six months and many market-research hours later, the company will show the first production model at the IEEE show. Some of the engineering has been simplified, but the device is basically the same. Appleton has joined Raytheon and is helping to develop a series of Datastrobes, some with memory and printout features.

Datastrobe uses rotating drums, a xenon flash lamp; all-solid-state circuits; and an optical projection system, to produce a high-contrast, white-on-black multidigit display from binary coded decimal (BCD) input signals.

The flash tube is surrounded by a continuously rotating cylinder, which has transparent characters on it. The tube replaces as many as 66 incandescent bulbs in conventional project displays.

The readout operates directly from the four-bit BCD input, using a one-volt signal and four milliamps per bit. The basic device can be modified to give full alphanumeric or other symbols in any number of columns. In the first production model, the numbers will be five-eighths of an inch high.

Datastrobe's time-shared, all-solid-state logic reduces the number of components. This means increased reliability at lower cost, according to Raytheon's engineers. The decoding system works so that either the correct readout is given or the device fails. "Erroneous readouts are virtually impossible," says a Raytheon design engineer.

In the first production model, two drums are used, one with coding and the other with six columns of characters etched into it. Both drums are mounted on the same shaft, and rotate at 2,500 rpm.

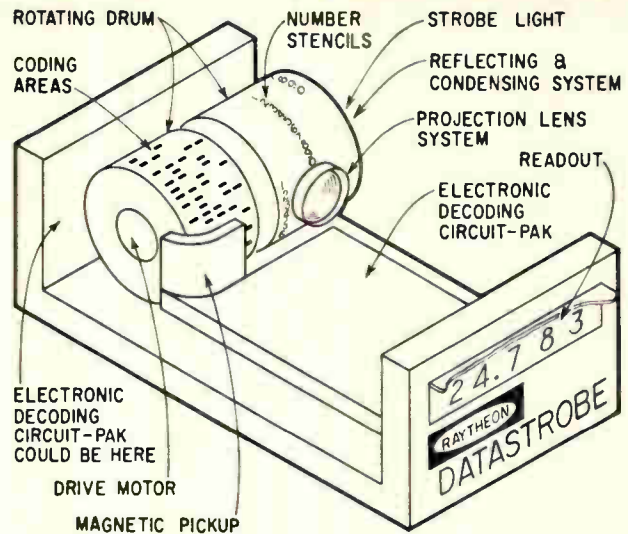

First production model of the Datastrobe has two rotating drums mounted on a single shaft and turning at 2,500 revolutions per minute. The coding columns are on one drum and the readout characters etched into the other.

The basic Datastrobe accepts up to six columns of parallel, four-bit BCD information directly from the user's output. This information is serialized by the gating logic, actuated by signals from its drum column pickup. As each column comes to the proper position, the corresponding four bits are supplied to the single decoder-comparator circuit. When the desired number is in the viewing area, a trigger pulse from this circuit fires the flash tube. Because of the high scanning rate, the six-digit presentation appears on the screen in parallel as a sharp, high-contrast, flickerless display. The decoder in the first model uses a reluctance type pickup of voltages in an 8-4-2-1 code.

The time-sharing principle permits low voltage, low current operation. A six-column readout has a maximum of four bits energized at any one time. This time-sharing of a single tube and single decoding logic circuit over all six character-columns reportedly gives advantages in reliability and economics over systems which require a separate decoding matrix per column or a separate strobe tube per column.

The rotating drums, Datastrobe's only mechanical moving parts, require no close speed control, the logic being self-synchronizing. No brushes or rubbing contacts are used, and no gears. The six-digit display is expandable to 12 by putting two drums on a single shaft.

"Everyone seems to want digital readouts today," commented Niles P. Gowell after extensive market research. "It's just a matter of economics and device engineering." The Datastrobe inherently lends itself to customizing, so prices will vary greatly. A basic Datastrobe, without accessories or special features such as memory, is expected to sell for \$50 to \$60 per character available for readout. Gowell, who is special programs manager for Raytheon's component division, sees the Datastrobe as competitive with any readout device of three digits

or more. "The more digits, the more competitive we are," says Gowell.

Applications are being explored in radar range readout, industrial process control, flight control displays, and navigation system readouts. Data-strobe is considered specially attractive for on-the-bridge displays aboard automated ships. Only four bits per digit are required for input, and this significantly reduces the number of wires needed from remote data points.

Specifications

Speed of drum:	2500 rpm
Presentations per second:	45
Input:	110 v 60 cps.
Character height:	Typically 5/8"
Number of digits in display:	5 to 50
Lamp power:	A few watts
Motor power:	A few watts
Over-all dimensions:	9" x 5" x 3" high
Required input:	4 bit BCD
Estimated price:	\$50-\$60 per readout character
Floating decimal point availability	

The compleat receiver

A 15-watt bulb won't give out enough light to read by, yet 15 watts is all the power needed to run a new communications receiver of unparalleled versatility—covering the entire frequency range from 5 kilocycles to 30 megacycles.

Solid-state technology also provides high reliability in a variety of fixed and portable applications for the HRO-500, manufactured by the National Radio Co., Melrose, Mass.

Now in prototype production, it is described by National as the only transistorized professional receiver on the market and the single unit with the widest frequency coverage. The HRO-500 was developed for applications in government, commercial ship-to-shore, amateur communications, and laboratory work.

For hams, this receiver is in the Cadillac class; the wider market will be in military and other gov-

ernment applications. The HRO-500 has been designed with airliftable shelters and moving vehicles in mind. Low power consumption makes it attractive where concentrations of military electronic gear cause a heat-dissipation problem. Other government markets include monitoring, surveillance and direction-finding tasks of the Federal Communications Commission and the Central Intelligence Agency, the radio-teletype system of the Federal Bureau of Investigation, and point-to-point communications for the National Aeronautics and Space Administration.

The totally transistorized receiver covers the very-low-frequency through high-frequency spectrum in 60 500-kc bands, with identical dial calibration and tuning rate throughout that range. Single sideband sensitivity is better than 1.0 microvolt for a signal-plus-noise to noise ratio of 10 decibels in the 500-kc to 30-Mc range, with minimum image rejection of 60 db.

Its frequency range and stability, sensitivity and high image rejection qualify the HRO-500 as a

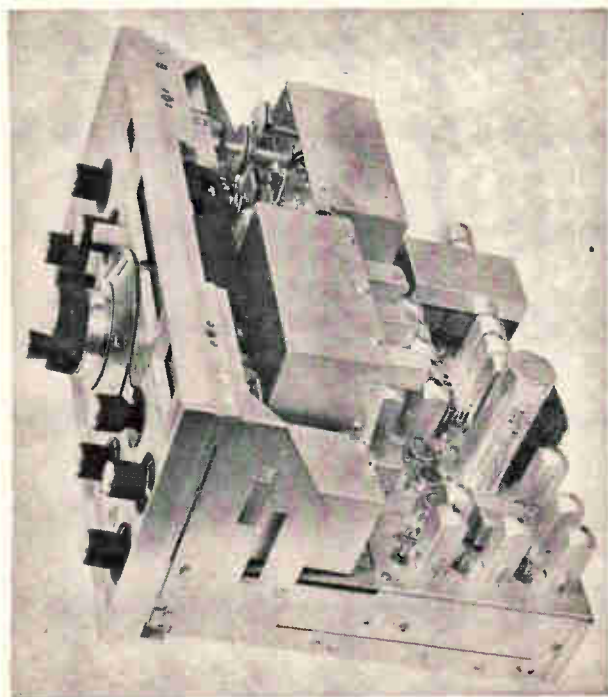

Compact receiver weighs only 32 pounds, was designed primarily for mobile military applications, also for low power consumption.

Specifications

Frequency range:	5 kc to 30 Mc in 60 500 kc bands, continuous coverage
Modes:	Upper sideband, lower sideband, a-m, c-w
Calibration accuracy:	Within 1 kc over entire 500 kc tuning range of the beat frequency; within 250 cps when zeroed to nearest 50 kc calibration point
Frequency stability:	Over-all stability from turn-on, 100 cycles per second in any 10-minute period including 30° C change in ambient temperature or plus-or-minus 20% a-c line voltage variation
Receiver a-m sensitivity (nominal):	5 kc to 30 Mc with very-low-frequency preselector; better than 2 microvolts for 10 db signal-to-noise. 5 kc to 500 kc without preselector; 25 to 50 microvolts for 10 db signal-to-noise.
Receiver single sideband/continuous-wave sensitivity (nominal):	Better than 1 microvolt for 10 db signal-to-noise (between 5 kc and 30 Mc with very-low-frequency preselector).
Selectivity at 6 db points:	500 cycles, 2.5 kc, 5 kc, 8 kc
Image rejection:	Minimum 60 db between 500 kc and 30 Mc. Minimum 80 db between 5 kc and 500 kc when used with preselector
Automatic gain control merit:	Less than 10 db change in output for input variation between 5 and 50,000 microvolts
Size:	Seven and five-eighths inches high, 16½ inches wide, 12¾ inches deep.
Weight:	32 pounds
Price:	\$1295

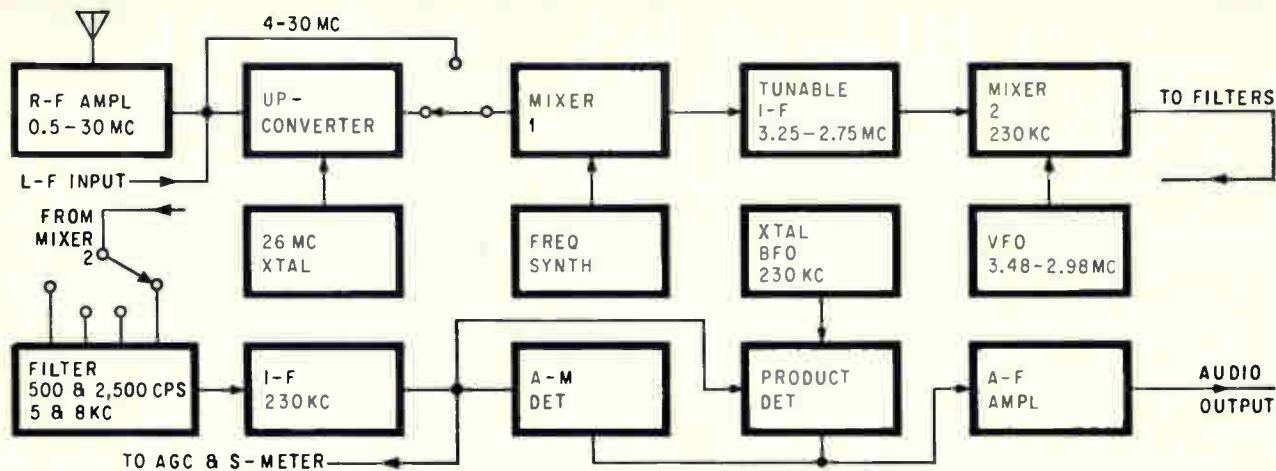

Circuit of the HRO-500 solid-state receiver features triple conversion, high sensitivity, unusual selectivity, and frequency synthesis.

laboratory instrument for wide range detection, calibration, spectrum analysis and frequency measurement.

The receiver can operate on 200 millamps directly from a 12-volt d-c battery supply or on 15 watts from 115/230 volts a-c. Transistors give instant-on operation without delay or warm-up drift.

Frequency is determined by a phase-locked crystal frequency synthesizer which eliminates multiple crystal oscillators for high frequency oscillator injection. Band-to-band calibration is eliminated. A tunable oscillator is phase-locked to the output of a 500-kc master reference oscillator, so that any time a 500-kc segment is changed, the tunable oscillator is locked to another harmonic of the master oscillator. There is no difference in accuracy, therefore, between any of the 500-kc segments.

Intermediate-frequency selectivity in the HRO-

500 is obtained by means of a tunable six-pole filter employing ferrite cup-cores at 230 kc. Bandwidths (at 6 db) available are 500 cycles, 2.5 kc, 5 kc and 8 kc to meet any combination of single sideband, continuous wave, or amplitude modulation receiving conditions.

Selectable sideband or single signal c-w reception is available by means of passband tuning in the 500-cycle and 2.5-kc bandwidths. The frequency of the filter is moved across the intermediate-frequency sideband with the front panel passband tune control to enable the operator to "drop out" interfering signals without changing the frequency of the desired signal.

A rejection tuning filter with an extremely sharp rejection notch may be controlled from the front panel to eliminate interfering heterodynes. The filter's heterodyne rejection capability is 50 db.

Space-saving solar cells get jobs in industry

Silicon solar cells, widely used to supply power to satellites in the space program, are finding their way into industrial equipment. Used in a new tape reader, the result has been more reliable operation for longer periods of time—up to 15,000 hours without error. Use of the cells in the Rheem Electronics Corp. model RRS 302 combination tape reader-spooler also resulted in a 40% cut in the number of electronic components required. The resulting space savings have enabled engineers to fit in switches and circuitry needed to actuate the spooler. This solved a serious design problem of providing space in the chassis for the spooler as

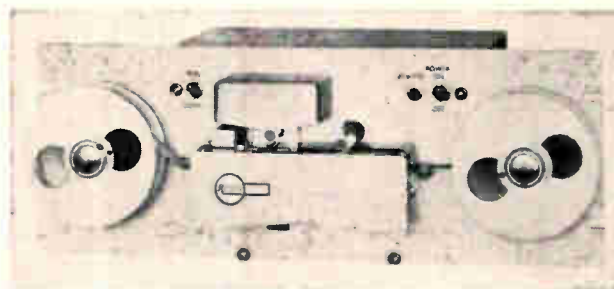

Reader-spooler combination uses photovoltaic cells for more reliability and longer life and has a "soft" take-up feature that prevents tape breakage.

well as the reader while keeping the unit small.

Use of the cells improves system life and reliability because the low deterioration rate of the cells gives the reader-spooler an indefinite life cycle. Competing systems that use photodiodes for character reading require replacement of the diodes periodically, while solar cells last indefinitely, the manufacturer claims.

Created with company funds in a two-year de-

Tiny r-f load handles 1-kw coolly

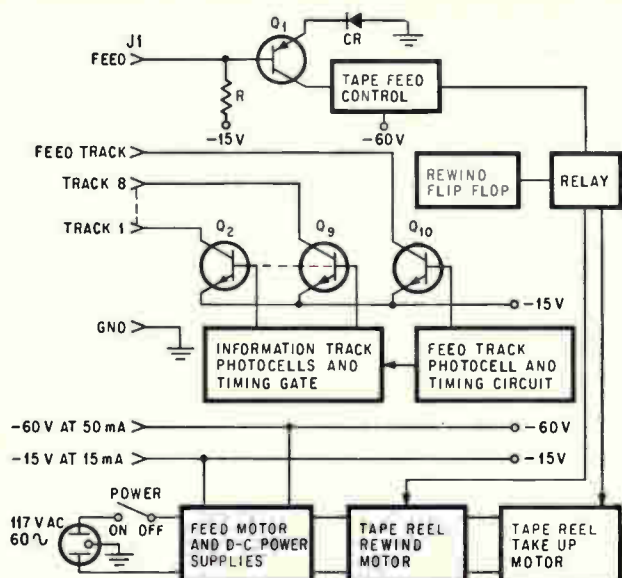

Eight information track outputs and one timing track output are provided for use with standard five, seven and eight channel tapes.

velopment program by a team of electrical and mechanical engineers, the model RRS-302 will soon be in use by the National Aeronautics and Space Administration at Cape Kennedy in Saturn V telemetry systems.

The photovoltaic cells are light-sensitive silicon slabs divided into nine etched elements to give nine outputs and wired with one common cathode or anode (either is available) for sensing. The nine elements provide eight information track outputs and one timing track output for use with standard five, seven and eight channel tapes. The eight information track outputs are gated by the timing track so that all outputs appear simultaneously.

The spooler portion of the unit has a "soft" take-up. When the tape is rewound, the spooler accelerates slowly until servo arms pull the tape to its limit. A motor-driven potentiometer built into the chassis then increases the power slowly, preventing breakage in the standard 11/16-inch tape sometimes caused by the sudden spooling normally found in such units.

The present design is faster than available mechanical readers, Rhecem claims. The unit is capable of reading 300 characters per second compared with 120 characters per second by its closest mechanical counterpart.

Specifications

Reading speed:	300 characters per second continuously, 100 characters per second asynchronously.
Tape start time:	8 milliseconds from rest position.
Tape stop time:	Less than 0.5 milliseconds.
Tapes:	Reads 5, 7 or 8-track tapes.
Amplifier outputs:	0 volts at 5 ma., -15 volts at 50 microamperes in mode 3.
Drive control inputs:	0 volts to -1 volt at 0.2-ma max; -10 volts to -15 volts at 5 ma max.
Weight:	32 pounds
Price:	\$1,150
Delivery:	Immediate

The customer had a problem: he needed a one-kilowatt average power r-f load as big as a blunt cigar—about one-thousandth the volume of a conventional air-cooled load with the same dissipation rating. Since he was an old customer, Bird Electronic Corp. went to work and came up with the water-cooled Termaline Model 8710.

The miniature load is nonmagnetic and can be used to terminate a 50-ohm coaxial line where space is limited or difficult of access—for instance, inside the focusing coil of a tube.

Many bends, twists and connectors are often required to run a coaxial cable from a tight interior space to an external termination. Bends and mechanical connections in a coaxial cable system cause high voltage standing-wave ratio. The 8710 can be located close to the power source; its vswr is less than 1.2 from d-c to 3,000 megacycles, and slightly higher at frequencies up to 4,000 Mc.

Other than indicating that their customer is non-military, Bird won't say who he is. They feel they've



Both of these r-f terminations can dissipate 1,000 watts. The smaller is the Termaline Model 8710, made by Bird Electronic Corp. It is the only direct water-cooled load of its capacity available. The miniature r-f load can be located in tight physical spaces eliminating most vswr problems.

got a lead in a new market and want to keep it.

Bird isn't telling how the load is made, either, except to say that it uses a dielectric having a thermal conductivity as good as metals'. The resistor is deposited on one side of the dielectric and the cooling water runs on the other. With a water flow rate of one quart per minute in the unit and at 1 kilowatt dissipation, the resistor is cool to the touch.

The miniature termination costs less than its air-cooled equivalent, but the microwave system designer must consider the cost of providing plumbing for the 8710.

The problem in designing the unit was one of finding the proper material and then obtaining

maximum heat transfer. Leo Lesyk, Bird Electronics' project engineer and a specialist in the heat transfer field, conceived, developed and built the miniature load.

Bird has several 8710s available at \$200 each. There is a substantial discount for quantity orders.

Specifications

Average power dissipation:	One kilowatt
Impedance:	50 ohms
Weight:	5 ounces
Frequency range:	d-c to 4,000 Mc
Water coolant:	One quart/minute to 30° input temperature
Connector type:	N
Price:	Under \$200 in quantity orders
Delivery:	30 days

Bridging a loss easily and precisely

Measuring insertion loss and attenuation required a whole battery of instruments until DeMornay-Bonardi division of Datapulse, Inc., came up with a device that does it more simply and more accurately to boot. The Model 1500 Precision Insertion Loss Measurement Set (PILMS), a microwave analog of the wheatstone bridge, makes the measurements with one basic instrument and two accessories—an amplitude modulated radio-frequency generator and a voltage standing-wave ratio meter. DeMornay-Bonardi claims an absolute accuracy of ± 0.003 decibels and a relative accuracy of ± 0.001 db, 10 to 20 times better than the old rigs.

The accuracy makes the 1500 suitable for the microwave standards laboratory, where it can be used to verify and calibrate the accuracy of other standards. The instrument can also be used in radioastronomy where measurement of insertion loss can be used to discriminate between outer space noise and environmental noise. And the 1500's portability makes it ideal for field use. It weighs only 17 pounds.

The 1500 uses a dual-range audio bridge to compare the input and output signals from any two-port network. The audio signal is derived from the demodulated r-f signal, which is fed into the network under test. R-f signals up to 90 gigacycles can be handled.

Readings are made by comparing the signals from a reference bolometer and a test bolometer. The bridge is balanced, both before and after insertion of the test device, by adjusting a ratio transformer until a null is indicated on the vswr meter. The dial of the ratio transformer provides a direct readout of the transformer's setting.

The 1500's dynamic range is 20 decibels for a single-step measurement. This range can be extended by using two or more steps with calibrated standard attenuators.

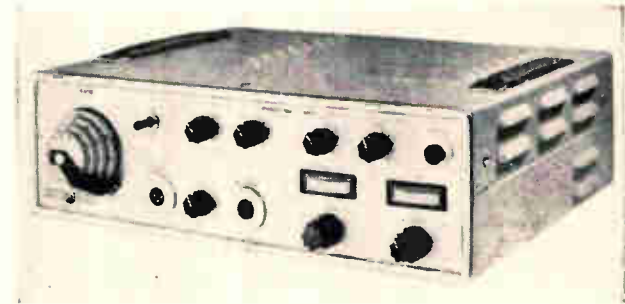

All controls, including the bolometer connecting points, are on the front panel of the model 1500. It requires only two additional instruments to measure insertion loss.

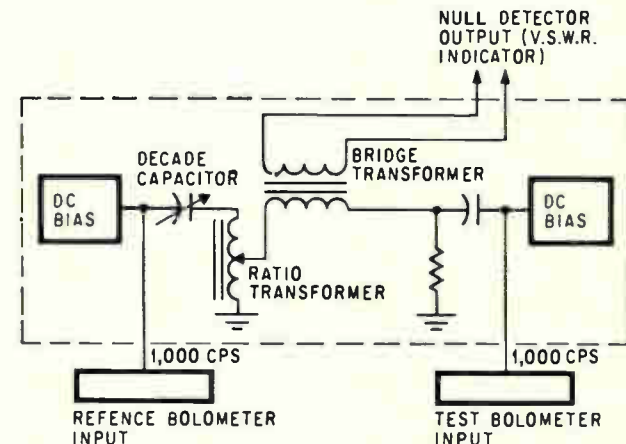

Simplicity of the measuring scheme is evident from the block diagram. The ratio transformer is used to balance the signals from the reference and test bolometers and the null is read on the external vswr meter. The ratio is then read directly from the dial.

Specifications

Frequency range:	100 cps to 1kc (direct input)
R-f range:	any signal that can be modulated at 1 kc rate with an accurate square law detector up to 90 gigacycles
Dynamic range:	20 db maximum single-step measurement
Accuracy:	± 0.001 db (relative) ± 0.003 db (absolute)
Input power:	115 v, 60 cps, 0.5 amps
Dimensions:	17" x 5" x 15"
Weight:	17 pounds
Price:	\$2245 f.o.b. Pasadena
Delivery:	from stock

Machine whirls wafers through chemical processes

In the past, the Kulicke and Soffa Manufacturing Co., of Fort Washington, Pa., has concentrated on equipment for the tail end of semiconductor processing lines—automatic probes that test all the devices on a silicon slice, and machines that cut the slices apart and bond leads to the devices.

This year, K&S is introducing a machine that can be used all along the line. It's a wafer wet-processing machine. The etching, washing and rinsing jobs (repeated again and again when making a transistor or integrated circuit) are done automatically in the machine.

It was designed, says a K&S spokesman, "to transcend the beaker-on-a-bench approach"—the familiar method of having a girl pick up each wafer with a pair of tweezers and put it into a wet processor or simply slosh the wafer in a rinse tank.

The new machine processes 10 wafers at a time, with as many as eight liquids. The operator picks up the wafers with a vacuum pencil and puts them on a circular carrier. After the carrier is put in the machine, it drops down, leaving the wafers



Wafers go onto carrier



Carrier fits on chuck

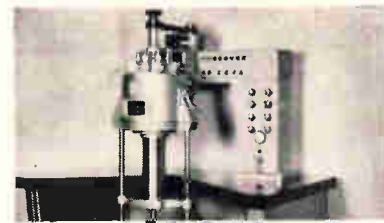

Chuck rises and closes machine

X-rays to evaluate thin-film processes

The answers to thin-film processing problems can be found more quickly if an x-ray diffractometer can be used to measure the effects of process changes on properties of the films.

This is the sales logic behind the introduction of an unusual little vacuum-deposition system by the Materials Research Corp., of Orangeburg, N. Y. Thin films can be grown and annealed under varying deposition conditions, while the chamber is in a diffractometer.

A diffractometer is a laboratory instrument that is used to determine the structure and defects of crystals, or polycrystalline materials like thin films, by the way in which the material reflects x-ray beams of varying angles of incidence.

Usually, the analyses of thin films are qualitative. For example, the x-ray photos will indicate what the grain structures look like. Materials Research says that its system is the first commercially available system that will provide quantitative measure-

ments as well as qualitative measurements.

The vacuum chamber contains the fixtures needed to grow a film at various rates and temperatures. The film-substrate temperature can be varied from -190°C to about 300°C . The chamber also has beryllium windows so the x-ray beam can enter, strike the film and leave the chamber where its presence is recorded by a geiger counter and pulse-height analyzer. The complete angular range of a

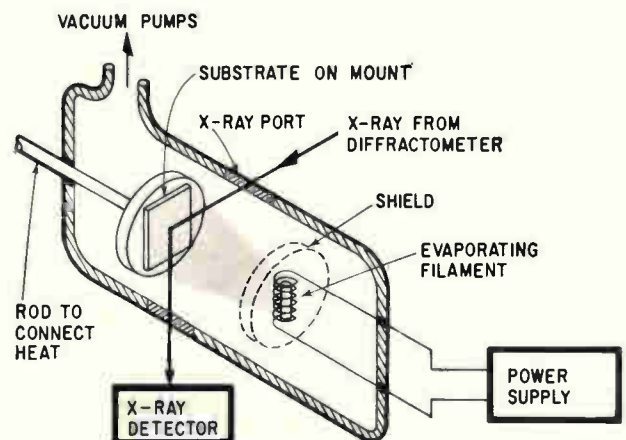

Vacuum-deposition system has ports which allow x-rays to enter and leave vacuum chamber.

mounted on vacuum chucks. The chucks rotate under the nozzles, which spray the wafers with liquid or air while the wafers rotate for even distribution of the fluid over the wafer surfaces. Afterwards, the carrier can be used to carry the wafers to the next processing station.

The spraying is done in a pressure-tight vessel that is opened and closed by a ram which moves the chuck up and down. Spray timing and flow is preset into a control panel. The liquids can be heated by hot-air nozzles.

In a typical cleaning cycle, the wafers would be sprayed with detergent or solvent, drained, sprayed with deionized water, drained, sprayed with alcohol and dried with warm air. The machine can also be set up to develop and strip photoresist and etch passivation layers or thin-film contact coatings.

K&S cites two chief advantages of using the machine. Since vacuum pencils, instead of tweezers, are used to handle the wafers, there is less physical damage. Also, processing is more uniform because 10 wafers are processed in a batch; there is less batch-to-batch variation because process times and temperatures are controlled.

The spray technique results in less undercutting during etching. "No one is sure why this happens," says K&S, "but they are not displeased."

Price is approximately \$3,000, depending on accessories. The machine operates with normal line current and factory air and water supplies. Delivery is eight weeks.

standard diffractometer can be used.

This enables diffraction profiles to be directly compared for the same films before and after process changes, at different film thicknesses, before and after the films are annealed or after other temperature changes. Such comparisons cannot be made with precision if the substrates must be removed from the chamber for analysis.

The prototype for the chamber was developed in 1963 by R. W. Vook and F. R. L. Schoening at the Franklin Institute Laboratories in Philadelphia. At the time, there was no suitable method for making quantitative analyses of thin films under processing conditions.

Vook and his associates used the chamber and pulse-height analysis for an intensive study of evaporated copper films. The method proved to be very sensitive. For example, comparison of diffraction profiles for two copper films showed distinct variations—possibly because in one case the copper was evaporated from a tungsten basket while in the other case a tantalum basket was used. Apparently, some of the tantalum was evaporated with the copper, although tantalum isn't supposed to be soluble in molten copper.

Materials Research has not yet set a price for the chamber, but it is expected to be around \$6,000, including power supply.

Instant solder mask peels from workpiece

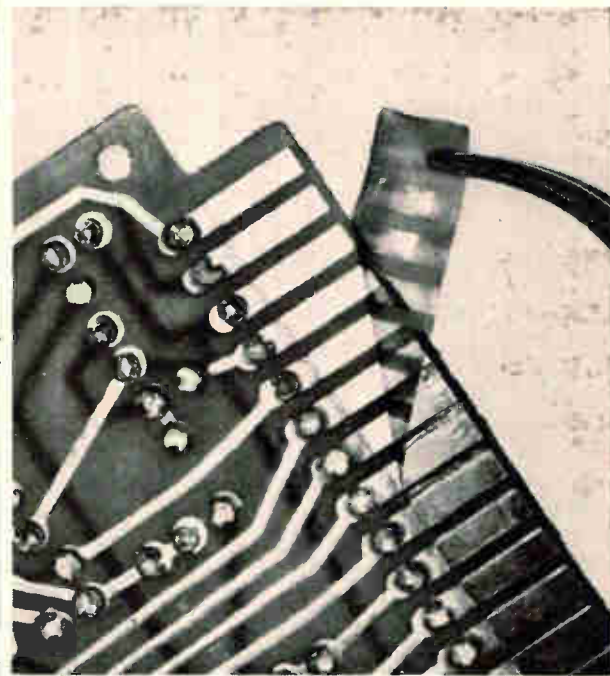

Vinyl-film solder resist is peeled off printed circuit board contacts after board has been dip soldered.

A solder resist that can be peeled off by hand is expected to simplify two-step soldering of printed circuit boards. According to Alpha Metals, Inc., of Jersey City, N. J., it is the first liquid-type resist that does not require heat-softening or solvents for removal.

The material, a vinyl plastic called Stripcoat, is applied by brushing, dipping or flowing. It dries in air in a few minutes, or can be cured by hot air in a few seconds. After soldering, the coating is simply pulled off the workpiece.

A typical application is where some components are dip-soldered into a printed circuit board and heat-sensitive components are soldered later by hand. The Stripcoat is used to prevent the extra mounting holes from being plugged by the solder during dip-soldering.

The material can also be used for other solder-resist needs, such as keeping solder from coating the gold-plated contact fingers on circuit boards.

Stripcoat is available in pints, quarts and gallon containers.

Specifications

Stripcoat material:	vinyl-type polymer
Drying time, 70°F:	1 to 2 minutes
Flash point:	35°F
Density, 77°F:	0.888 grams/cc
Color:	deep red

Designer's casebook

Designer's casebook is a regular feature in Electronics. Readers are invited to submit novel circuit ideas, packaging schemes, or other unusual solutions to design problems. Descriptions should be short. We'll pay \$50 for each item published.

Electronically tuned hybrid notch filter

By Morris Cohen and George Rullman

Loral Electronics Corp., Bronx, N.Y.

Nonreflective, hybrid stop-band microwave filters are usually made up of a short slot hybrid and two resonant elements. The resonator elements can be two-port, band-pass filters having matched load terminations, or one-port cavity resonators that are loaded with lossy dielectric material. For the two constructions, both resonant elements and the filter frequency are fixed, or the resonant elements are mechanically adjusted for variable filter frequency.

If a narrow band-pass filter consists of a short slot hybrid and two yttrium-iron-garnet (YIG) spheres as resonant elements, it can be tuned electronically.

A single crystal YIG sphere contains unpaired electrons that yield magnetic moments as a result

of their spins. A d-c field applied to the sphere, causes a change in the orientation of these magnetic moments about the axis of the applied field, H . The change occurs at a rate $f_0 = 2.8H$ called the ferrimagnetic resonant frequency (f_0 is in megacycles and H is in oersteds).

This resonance phenomenon is the basis for the electronically tuned YIG resonator. The YIG sphere behaves like a resonant circuit at frequency f_0 . The magnetic field, H , is electronically controlled by the current through the coil of an electromagnet.

As in standard cavity type microwave resonators, the frequency rejection in a YIG resonator depends upon the unloaded Q (Q_u) and external Q (Q_e). The unloaded Q is a function of the quality of the yttrium-iron-garnet and its degree of surface polish. The unloaded Q can be calculated from the linewidth, ΔH , of the YIG sphere. Linewidth is a specific characteristic associated with a YIG crystal sphere and is analogous to the unloaded bandwidth Δf , of standard cavities, where

$$\Delta f = 2.8 \Delta H$$

and Q_u can be calculated from

$$Q_u = f_0 / \Delta f.$$

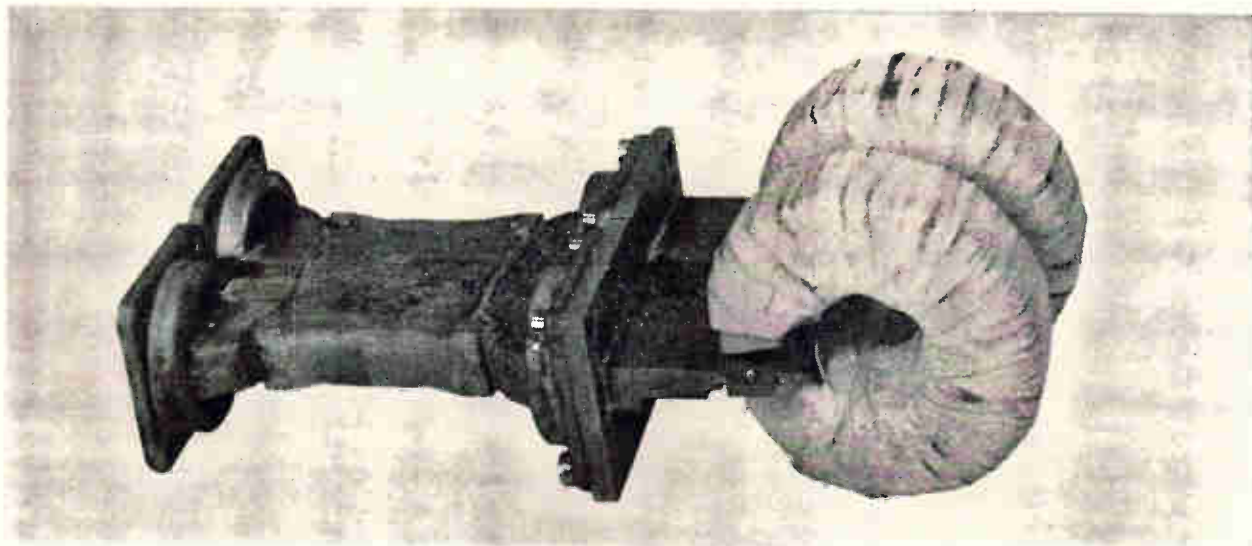

Electronically tunable hybrid filter has a very narrow rejection band and is nonreflective. The resonant element is a YIG crystal sphere mounted near the end wall of each shorted transition section, and within the field of the electromagnet. The rejected frequency band varies as the intensity of the magnetic field. The field of each magnet varies equally and simultaneously. The height of the X-band waveguide was reduced in four sections from 0.40 inch to 0.05 inch to obtain maximum filter rejection loss.

The external Q is determined by the magnetic saturation flux density, the volume of the YIG sphere, and the microwave structure containing the sphere. The external Q of a YIG sphere, centrally located one-half wavelength from a short circuit in standard waveguide operating in the TE₁₀ mode is

$$Q_e = \frac{60 \pi a b}{\mu_o \omega_m V_m} \left(\frac{\lambda_g}{\lambda} \right)$$

where

- a = guide width in meters
- b = guide height in meters
- μ_o = intrinsic permeability of free space, 1.256×10^{-6} henries/meter
- V_m = volume of YIG sphere
- ω_m = angular frequency, 6π (1670 Mc) for YIG
- λ_g = wavelength in guide
- λ = wavelength in air

For a particular frequency band, Q_e can only be varied by a change in guide height, or diameter (i.e., volume) of YIG sphere, or both.

The loaded Q (Q_L) is determined from the standard equation,

$$\frac{1}{Q_L} = \frac{1}{Q_e} + \frac{1}{Q_u}$$

and the maximum rejection loss, L_n , is

$$L_n = 20n \log \left(\frac{Q_u}{Q_L} \right)$$

where n is the number of resonators having equal

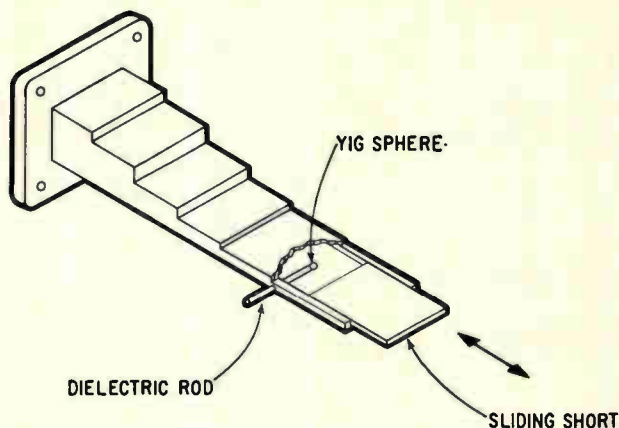

Distance between the YIG sphere and end wall of the transition section affects the magnitude of the rejection loss. The sliding short is first adjusted to obtain maximum rejection.

Q_u values, and L_n is in decibels.

The filter design was based on the fact that a YIG sphere located near the shorting end-wall in a waveguide, exhibits an absorption type cavity response (analogous to matched terminations at the adjacent ports of a hybrid) when resonated by an applied magnetic field. The frequency at which this effect occurs is given by the first equation. At all other frequencies, the waveguide input appears reactive due to the shorting end-wall. The amount of power absorbed by the resonant YIG sphere is a function of Q_u and Q_e , that is, the surrounding

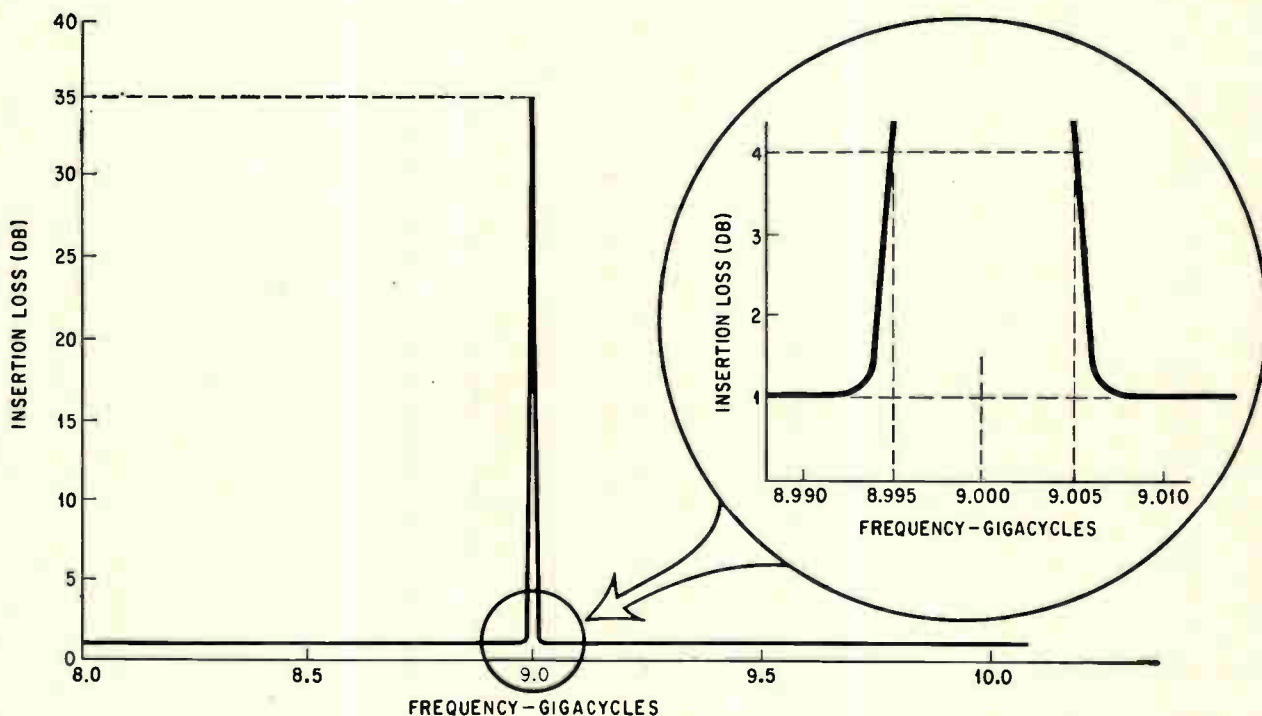

Measured insertion loss versus frequency performance characteristics of the hybrid notch filter. The notch (rejection) frequency for this measurement was tuned to 9.0 gigacycles. The notch is nominally 0.010 gigacycles wide, and can be tuned over a range of 8.2 to 12.4 gigacycles with a rejection of 30 to 36 db. The input vswr is less than 1.5.

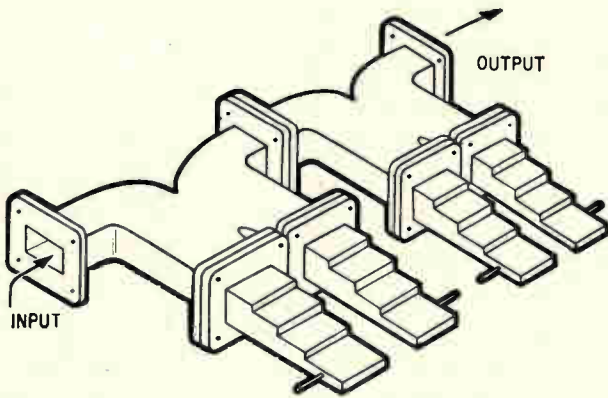

Cascading two hybrid notch filters results in a significant reduction in vswr. It is also possible to tune each hybrid filter to a separate notch frequency with no interaction between hybrids.

microwave structure.

A YIG sphere was mounted near the end wall in each of two equal lengths of shorted X-band waveguide. The waveguides were affixed to the adjacent ports of a short slot hybrid. Electronic tuning was achieved by means of external electromagnets located directly over the YIG spheres in each guide, as shown in the photo. The magnetic fields were varied equally and simultaneously.

The filter was designed as a two-resonator filter. The pertinent parameters of the YIG were,

$$\Delta H = 0.3 \text{ oersteds}$$

diameter = 0.025 inches

The center frequency was 10 gigacycles.

Maximum rejection was achieved by reducing the height of the X-band guide from 0.400 inch to 0.050 inch by a four-step transition section (transformer). The shorting end-wall in the transformer section shown on page 93, is adjusted to optimize the distance between the YIG sphere and the end wall for maximum rejection loss. The YIG spheres were mounted on dielectric rods and inserted in the side wall of each transformer section.

The filter was tested over a range of frequencies from 8.2 Gc to 12.4 Gc. Measured data indicated filter rejection notches of 30 to 36 db over the frequency band with an input vswr = 1.5. A typical response curve is on the preceding page.

Higher values of nonreflective loss can be achieved by cascading filters. With nonreflective filters it is possible to cascade filters tuned to different frequencies with no interaction.

A notch filter requiring only a single electromagnet could be fabricated with a half-height folded hybrid (0.900" x 0.200").

Reference

1. R. D. Wanselow, "A Nonreflective Hybrid Stop-Band Filter," IRE Transactions on Microwave Theory and Techniques (Correspondence), Vol. MTT-10, Jan., 1962, p. 91.

Pnp plus npn equals unijunction transistor

By Roy A. Wilson,

Hycon Mfg. Co., Monrovia, Calif.

Unijunction transistors are often used in trigger and oscillator circuits. But in low power versions of these circuits, the designer finds that the interbase resistance of the UJT, usually about 9,000 ohms, is too low. With normal semiconductor supply voltages, the UJT dissipates from 10 to 150 milliwatts in the interbase resistance during its quiescent state. A more expensive circuit that behaves like a UJT but dissipates only microwatts of quiescent power is shown at right.

A positive voltage V applied to terminal B_2 in the simulated UJT circuit, biases the base of transistor Q_1 at a voltage $VR_1/(CR_1 + R_2)$. If the emitter of Q_1 is less positive than this bias voltage, both Q_1 and Q_2 turn off, and only a few microwatts of

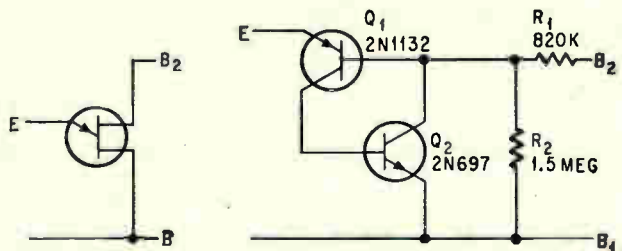

Circuit has same characteristics as a single unijunction transistor but dissipates no power during quiescence.

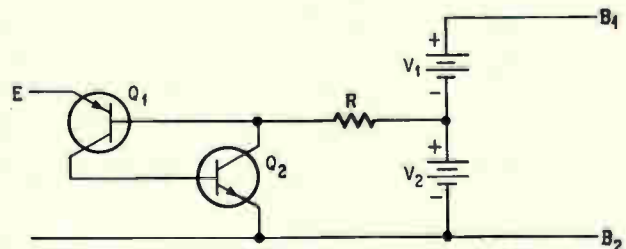

Resistor divider is unnecessary if precise bias voltages are available.

power are dissipated in the resistor divider. When the voltage on the emitter of Q_1 becomes greater than the base bias voltage, transistor Q_1 conducts current to the base of Q_2 and Q_2 starts to conduct. As Q_2 turns on, it reduces the impedance between the base of Q_1 and terminal B, lowering the base bias voltage and causing Q_1 to conduct harder. This regeneration continues, thereby simulating

the negative resistance characteristics of a uni-junction transistor.

If two separate supply voltages are available, such as clamp voltage and collector voltage supplies ordinarily used in digital circuits, the voltage divider can be eliminated.

The value of R is selected to meet the requirements of the designer.

Scr multivibrator switches reliably

By H. D. Valliant

Dominion Observatory
Department of Mines and Technical Surveys, Ottawa

The multivibrator shown below uses silicon controlled rectifiers as switching elements. This circuit switches 0.75 amperes into a solenoid load at a frequency of about 20 cycles per second.

When silicon controlled rectifier Q_2 is conducting and scr Q_1 is turned off, capacitor C_3 charges through R_3 and Q_2 . When the voltage across C_3 equals the zener voltage of D_1 , the zener diode begins to conduct current in the reverse direction. Q_1 is switched on, its anode potential suddenly falls to ground, and the resulting negative-going pulse is coupled to the anode of Q_2 through commutating capacitor C_2 , turning off Q_2 . Then, C_1 charges through diode D_2 and Q_1 , and the cycle is repeated.

Zener diodes D_1 and D_3 improve the temperature stability of the circuit. The instant of triggering is defined by the zener voltage rather than by the highly temperature-sensitive gate current of the scr's. In this circuit, the frequency varies less than

0.2% per degree centigrade.

The circuit includes the option for the monostable mode of operation. The supply voltage is removed from terminal B and the load can be energized by a single +150-volt pulse applied to terminal A. This pulse is simultaneously applied to the gate of Q_2 (through R_5 and D_3) and to the anode of Q_2 (through D_4 and the load). Q_2 is turned on and supplies power from the trigger source to the load, for the duration of the input trigger pulse. Diodes D_2 and D_5 prevent the trigger pulse from entering the unused portion of the circuit.

Diode D_4 prevents continuous Q_2 conduction when +150 volts is applied to terminal B and the multivibrator is operated in the free-running condition.

The advantages of an scr multivibrator are high reliability, simplicity and low cost. A disadvantage exists in the power wasted in the dummy load R_1 , but this power can be reduced by operating the circuit in an unbalanced condition, where R_1 does not match the load resistance. Tests showed that for the scr's used, R_1 may be increased to a maximum of 2,200 ohms, and Q_1 maintains conduction. With R_1 and load resistance unequal, the value of C_1 must be increased slightly to maintain the desired duty cycle. The power lost in R_1 may be reduced to about five watts for a 50% duty cycle.

The circuit has been tested at up to 50°C.

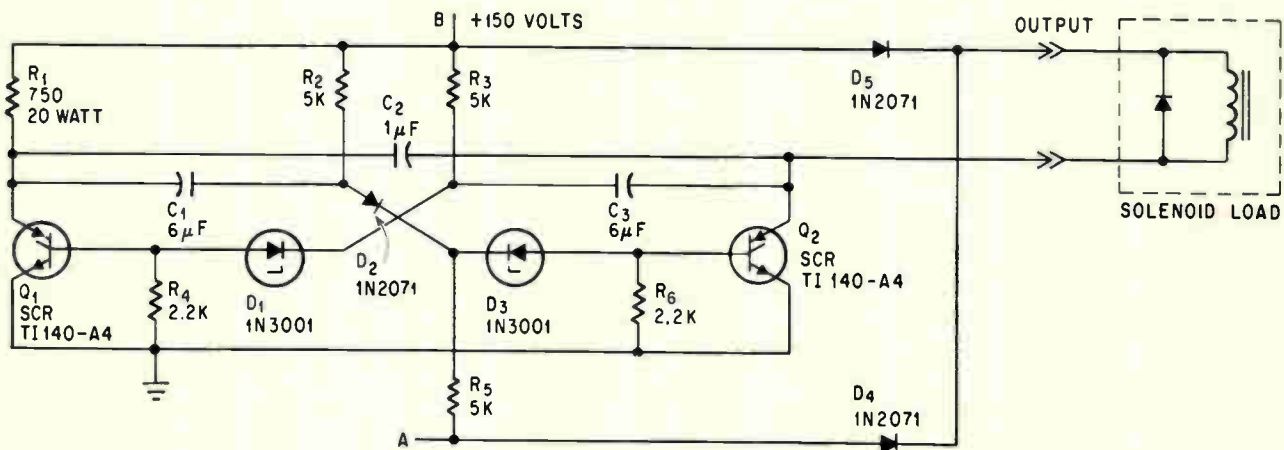

Scr's switch up to 750 milliamperes at 20 cycles per second. The zener diodes stabilize the switching frequency with temperature by fixing the trigger level. The circuit may be operated in a monostable mode by removing the d-c supply voltage from terminal B, applying a + 150-volt pulse at terminal A.

Nonreactive filter converts triangular waves to sines

Less than 1% total harmonic distortion is achieved with a field-effect transistor filter. It accepts wide range of frequencies and requires only 2 critical adjustments

By R.D. Middlebrook

California Institute of Technology, Pasadena, Calif.

I. Richer

Technical University of Denmark, Lundtofte, Lyngby

The drain characteristic of a field-effect transistor can be exploited to advantage in a nonlinear, non-reactive filter. Such a filter is useful in applications where it is desirable to convert triangular waveforms to sinusoidal waveforms. Many systems, telemetry for example, require this type of conversion. However, care must be taken to minimize the introduction of harmonics of the input waveform.

The most straightforward method of reducing harmonics is to use a linear filter containing reactive elements, but this is only satisfactory over a narrow frequency band. A second method uses a filter comprising nonlinear elements to provide a shaped characteristic to attenuate harmonics of a particular input waveform.

The new filter contains a single section, and requires only two critical adjustments to provide a total residual harmonic distortion under 1%. One adjustment is of a linear resistor; the other is of the input-signal amplitude.

Circuit operation

The basis for the filter action is the drain characteristic of a field-effect transistor below pinch-off. For a fixed gate voltage, the drain current as a function of the drain voltage between zero and pinch-off resembles a quarter sinusoid. Therefore, a full-wave rectified triangular voltage waveform of appropriate amplitude V_m between drain and source will give rise to an approximately sinusoidal full-wave rectified drain current. The basic circuit shown on page 97 uses a bridge rectifier and an

n-channel FET with gate bias fixed at zero volts. The output signal is the current I into the bridge, in the form of a restored approximate sinusoid as indicated by the waveform construction shown on page 97. The bridge rectifier effectively reflects the first-quadrant drain characteristics into the third quadrant, so that the residual distortion in the output current contains only odd harmonics.

FET properties

To evaluate the total harmonic distortion (see equation 6) it is necessary to know I as a function of V . This function is determined by the FET properties in the basic filter shown on page 97. The drain current I as a function of the gate voltage V_g of an FET in the pinch-off region can be approximated by a power law.¹ This power law may be generalized to include operation below pinch-off. The complete drain characteristics in the depletion mode are then given by:

$$\frac{I}{I_o} = \left(1 + \frac{V_g}{V_p}\right)^n - \left(1 + \frac{V_g - V_d}{V_p}\right)^n, \quad \begin{cases} -V_p \leq V_g \leq 0 \\ 0 \leq V_d \leq V_p \end{cases} \quad (7a)$$

$$\frac{I}{I_o} = \left(1 + \frac{V_g}{V_p}\right)^n, \quad \begin{cases} -V_p \leq V_g \leq 0 \\ V_p \leq V_d \end{cases} \quad (7b)$$

where V_g and V_d are the gate-source and drain-source voltages for an n-channel FET (see page 00), V_p is the pinch-off voltage, I_o is the pinch-off drain

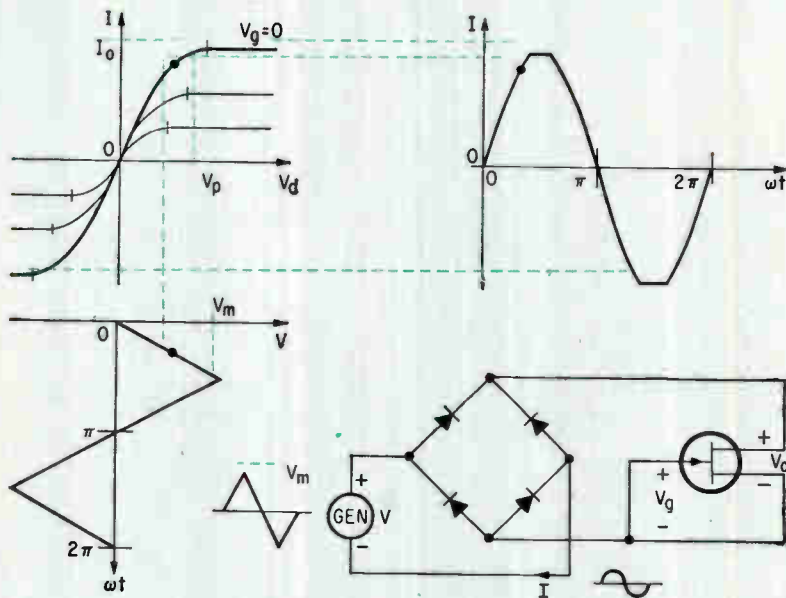

Basic filter circuit uses a bridge rectifier and an n channel FET with fixed zero gate bias. The bridge rectifier reflects the first-quadrant drain characteristics into the third quadrant.

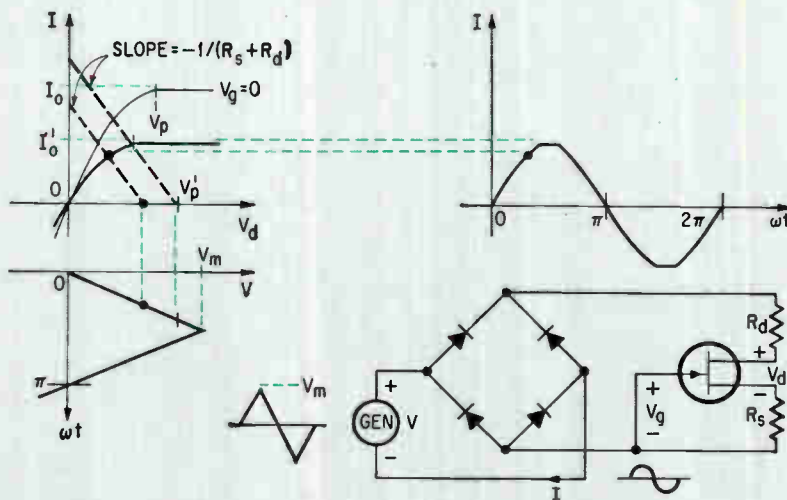

Modified filter circuit produces additional shaping, reducing distortion further by use of drain series resistance, R_d and source degeneration resistance, R_s .

current at zero-gate voltage and n is an exponent that lies in the range $2 \leq n \leq 2.25$, the value depending upon the physical construction of the device.² For most FET's it is sufficiently accurate to take $n = 2$, in which case equations 7a and 7b reduce to

$$\frac{I}{I_o} = 2 \frac{V_d}{V_p} \left(1 + \frac{V_g}{V_p} - \frac{V_d}{2V_p} \right), \quad \begin{cases} -V_p \leq V_g \leq 0 \\ 0 \leq V_d \leq V_p \end{cases} \quad (8a)$$

$$\frac{I}{I_o} = \left(1 + \frac{V_g}{V_p} \right)^2, \quad \begin{cases} -V_p \leq V_g \leq 0 \\ V_p \leq V_d \end{cases} \quad (8b)$$

In the basic filter circuit shown above,

$V_g = 0$ and $V_d = V$ if voltage drops in the diode bridge are ignored. Thus equations 8a and 8b reduce to

$$\frac{I}{I_o} = \frac{V}{V_p} \left(2 - \frac{V}{V_p} \right), \quad 0 \leq V_d \leq V_p \quad (9a)$$

$$\frac{I}{I_o} = 1 \quad V_p \leq V_d \quad (9b)$$

Harmonic distortion

Equations 9a and 9b may be substituted into equation 6 to find the output total harmonic distortion as a function of the single parameter V_m/V_p , which is identified as the amplitude of the input triangular voltage waveform normalized to the FET

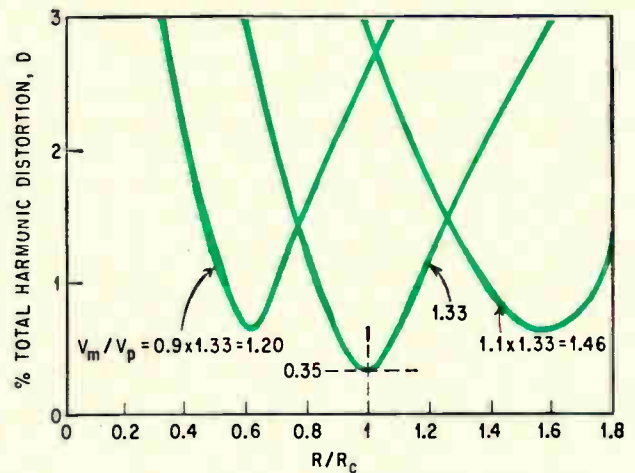
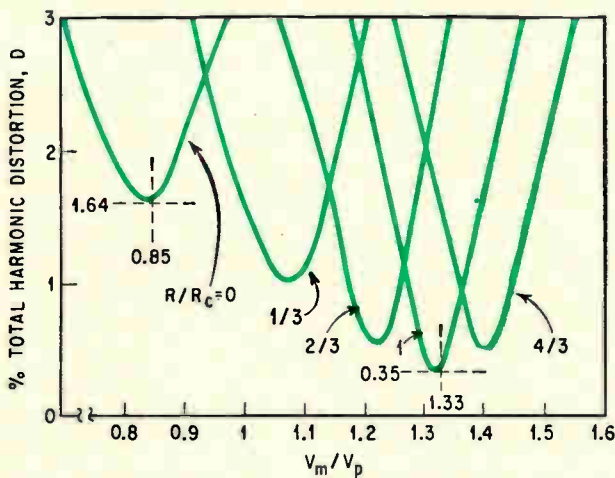

Solutions obtained by computer show the total harmonic distortion as a function of two parameters for the modified filter circuit. The $R/R_c = 0$ curve corresponds to the solution obtained in equation 10 for the basic filter circuit.

pinch-off voltage. The result is

$$D = 100 \sqrt{\frac{\pi^6}{15 \times 2^6} \frac{3(V_m/V_p)^2 - 15(V_m/V_p) + 20}{8[V_m/V_p + (\pi/2)(1 - V_m/V_p)]^2} - 1}, \quad 0 \leq V_m \leq V_p \quad (10a)$$

$$D = 100 \sqrt{\frac{\pi^6}{15 \times 2^6} \frac{15(V_m/V_p) - 7}{8(V_m/V_p)^5 [1 - \cos(\pi V_p/2 V_m)]^2} - 1}, \quad V_p \leq V_m \quad (10b)$$

Both expressions are equal at $V_m = V_p$. When the amplitude of the input voltage just reaches the FET pinch-off voltage, the output total harmonic distortion is

$$D_{(V_m=V_p)} = 100 \sqrt{\frac{\pi^6}{15 \times 2^6} - 1} = 3.82\% \quad (11)$$

However, this is not the smallest value of the distortion that can be obtained. By differentiating D with respect to V_m/V_p in equation 10a, setting the result equal to zero and solving for V_m/V_p , we get $(V_m/V_p)_{\min} = 0.85$ (12)

Then substituting this optimum value into equation 10a we get D_{\min} :

$$D_{\min} = 100 \sqrt{\frac{\pi^6}{2^{10}} \frac{1}{4\pi^2 - 25\pi + 40} - 1} = 1.64\% \quad (13)$$

The minimum distortion of 1.64% is not low enough for precision instruments. However, further shaping for the nonlinear filter characteristic is achieved by introducing drain series resistance R_d and source degeneration resistance R_s . This circuit, together with the modified graphical construction for the output current, is shown on page 97. The gate and drain voltages are now related to the input voltage by $V_g = -IR_s$, $V_d = V - I(R_s + R_d)$. Substitution into equation 8a shows that pinch-off occurs at a current I_o' and an input voltage V_p' given by

$$\frac{I_o'}{I_o} = \left(\frac{\sqrt{1 + 2R_s/R_c} - 1}{R_s/R_c} \right)^2 \quad (14)$$

$$\frac{V_p'}{V_p} = 1 + \frac{1}{2} \left(\frac{R_d}{R_c} \right) \left(\frac{I_o'}{I_o} \right) \quad (15)$$

where $R_c = V_p/2I_o$ is the channel resistance at zero gate and drain voltages. The over-all filter characteristic is then described by:

$$\frac{1}{4} \left[\left(\frac{R_d}{R_c} \right)^2 - \left(\frac{R_s}{R_c} \right)^2 \right] \left(\frac{I}{I_o} \right)^2 + \left(1 + \frac{R_d + R_s}{R_c} - \frac{R_d}{R_c} \frac{V}{V_p} \right) \left(\frac{I}{I_o} \right) - \frac{V}{V_p} \left(2 - \frac{V}{V_p} \right) = 0, \quad 0 \leq V \leq V_p' \quad (16a)$$

$$\frac{I}{I_o} = \frac{I_o'}{I_o}, \quad V_p' \leq V \quad (16b)$$

Harmonic distortion

To examine the residual output harmonic distortion as a function of the input triangular voltage waveform amplitude, the output current I is expressed as a Fourier series of the form

$$I = I_m \sin \omega t + (\text{odd harmonics}) \quad (1)$$

where ω is the fundamental angular frequency of the input triangular voltage waveform, and I_m is the amplitude of the output fundamental given by:

$$I_m = \frac{1}{\pi} \int_0^{2\pi} I \sin \omega t d\omega t \quad (2)$$

The total percentage harmonic distortion D is defined as 100 times the square root of the mean square of the total signal minus the mean square of the fundamental component, divided by the rms value of the fundamental component:

$$D(\%) \equiv 100 \frac{\sqrt{\frac{1}{2\pi} \int_0^{2\pi} I^2 d\omega t - \frac{1}{2} I_m^2}}{I_m / \sqrt{2}} \quad (3)$$

and the total harmonic distortion is obtained by insertion of the solution of equations 16 for I/I_0 into equation 6 thus giving D as a function of the three normalized parameters V_m/V_p , R_s/R_c , and R_d/R_c .

This procedure cannot be conducted analytically in closed form, but numerical results may be obtained by digital computer. Preliminary computations showed that the value of D with respect to the three parameters is a minimum very close to $R_s = R_d = R_c$.

The resulting minimum value of the total harmonic distortion is

$$D_{\min} = 0.35\% \quad (17)$$

which occurs at a normalized input voltage amplitude

$$\left. \frac{V_m}{V_p} \right|_{\min} = 1.33 \quad (18)$$

From equations 14 and 15, $V_p'/V_p = 3 - \sqrt{3} = 1.27$ for $R_s = R_d = R_c$, so that $(V_m/V_p')_{\min} = 1.045$. This shows that in the optimum condition the minimum distortion occurs when the input amplitude is sufficient to carry the FET just beyond pinch-off, in contrast to the condition for zero external resistance in which minimum distortion occurs when the FET remains substantially below pinch-off.

It is important in practical applications to know both the minimum distortion obtainable and how sensitive the value of distortion is to change in circuit adjustment or environmental conditions. Since the minimum in D occurs for $R_s = R_d$, considerable simplification results if the two resistance

variables are combined into one normalized variable $R_s/R_c = R_d/R_c \equiv R/R_c$. In particular, equation 16a then reduces from a quadratic to a linear equation. However equation 6 still cannot be solved in closed form.

Numerical results

Numerical solutions of equation 6 give the total harmonic distortion, D , as functions of the two remaining circuit parameters V_m/V_p and R/R_c . On the left, page 98, D is plotted as a function of V_m/V_p for five values of R/R_c , including $R/R_c = 1$ for which the minimum occurs. The curve for $R/R_c = 0$ corresponds to the analytical solution obtained in equation 1 for the basic circuit which is shown on page 97. On the right, page 98, D is plotted as a function of R/R_c for three values of V_m/V_p , including $V_m/V_p = 1.33$ for which the minimum occurs.

Temperature dependence

Numerical solutions of equation 6 for D as a function of the important environmental parameter, temperature, are shown below, right. A reference condition is chosen such that the circuit parameters R and V_m have their optimum values R_c and $1.33V_p$, respectively, at room temperature of 25°C . The temperature dependence of the circuit is assumed to reside solely in the device normalization parameters R_c and V_p , such that

$$R_c[T] = R_c[25^\circ\text{C}] \left(\frac{T}{298} \right)^m \quad (19)$$

$$V_p[T] = V_p[25^\circ\text{C}] + (dV_c/dT)(T - 298) \quad (20)$$

where T is the absolute temperature. Equation 19

By substitution for I_m from equation 2, this becomes

$$D = 100 \sqrt{\frac{\pi \int_0^{2\pi} I^2 d\omega t}{\left[\int_0^{2\pi} I \sin \omega t d\omega t \right]^2} - 1} \quad (4)$$

Since the input signal is triangular, each integration in the above equation need be performed over only a quarter cycle instead of a full cycle of the fundamental. Over this range the input voltage V is linear with time:

$$V = V_m \frac{\omega t}{\pi/2}, \quad 0 \leq \omega t \leq \pi/2 \quad (5)$$

For analysis, it is more convenient to express equation 4 in terms of V/V_m . With these changes in variable and in integration range, the result for the output total harmonic distortion becomes

$$D = 100 \sqrt{\frac{\int_0^1 I^2 d(V/V_m)}{2 \left[\int_0^1 I \sin(\pi V/2V_m) d(V/V_m) \right]^2} - 1} \quad (6)$$

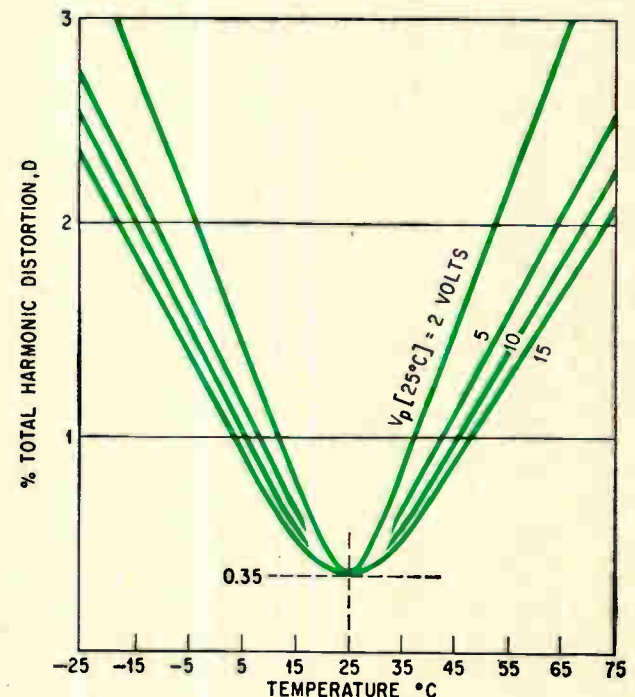

Temperature has an effect on the total harmonic distortion as is shown by numerical solutions of equation 6.

expresses the power-law temperature dependence of the channel mobile-carrier mobility,³ and equation 20 expresses the linear temperature dependence of the gate-channel contact potential, V_c .⁴ Because of the forms of these two temperature dependences, V_p (25°C) remains as a parameter while R_c (25°C) does not. Although both m and dV_c/dT vary somewhat in different FET's, the typical values $m = 2$ and $dV_c/dT = -2$ millivolts/°C have been used in obtaining the temperature dependent curves.

Examination of the numerical results shows that D is quite sensitive to V_m . Nevertheless, for the optimum case the distortion remains under 1% if the input amplitude is stable to within about $\pm 3\%$. On the other hand, D is relatively insensitive to R in the neighborhood of the minimum value of D and the distortion remains under 1% even if R is off as much as $\pm 15\%$. The total distortion is relatively independent of temperature. Higher pinch-off voltage FET's give less sensitivity than low pinch-off voltage units because the temperature variation of the contact potential represents a smaller fraction of the applied voltage. However, little further improvement is realized for pinch-off voltages greater than about 5 volts. For V_p (25°C) = 5 volts, the total filter distortion remains under 1% for temperature variations up to about $\pm 17^\circ\text{C}$.

Practical design

In the practical realization of the nonlinear, non-reactive filter it is desirable to make some changes in the actual circuit. If the bridge rectifier shown on page 97 is used, crossover distortion is caused because of the nonzero forward-voltage drops of real diodes. A more satisfactory practical circuit is shown above, right, in which need for signal rectification is eliminated by using the symmetrical properties of an FET with respect to source and drain: the diodes and resistors R_2 effectively switch the gate between source and drain when the input triangular voltage changes sign every half cycle. The resistors R_1 and R_2 therefore each play the role of R_s and R_d alternately.

Since the theoretical discussion has shown that the optimum condition is $R_s = R_d$, it is merely necessary to make R_1 and R_2 equal. (Had the optimum condition occurred for $R_d > R_s$, additional resistance $R_d - R_s$ could have been inserted in series with the signal source. However, a condition $R_d < R_s$ could not be realized with this circuit). A further advantage of the practical circuit is that the output signal is developed as a voltage across R_1 or R_2 , and a relatively large fraction of the filter input is available as output.

Ideally, only odd harmonics of the fundamental signal frequency exist anywhere in the filter circuit. In practice, some even harmonics are also present; these may be introduced by asymmetry of the FET characteristics with respect to source and drain, or they may be brought in as distortion of the original input triangular waveform. FET

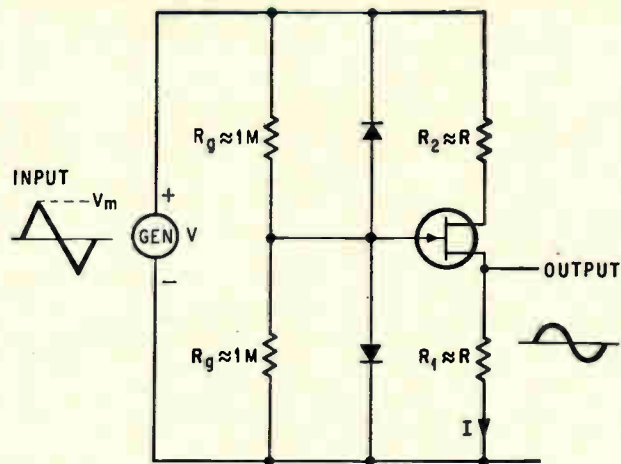

Practical filter circuit eliminates the need for signal rectification by using the symmetrical properties of an FET with respect to source and drain.

asymmetry is due primarily to unequal bulk resistance in series with the internal source and drain (especially in units that have large structural asymmetry). The harmonic distortion can be minimized by a compensating unbalance in the external resistances R_1 and R_2 . The adjustment of the unbalance of R_1 and R_2 can simultaneously compensate for even harmonic distortion present in the input signal, to the extent that the total even harmonic distortion at the output of the filter can actually be less than that at the input.

Selection of FET type

Several types of FET's have been used in the practical circuit to test the validity of the theoretical results. For p-channel units, it is necessary merely to reverse the diodes. Plots of total harmonic distortion for a Fairchild FSP 401 characterized by $V_p = 2.9$ volts and $R_c = 6.2$ kilohms are shown on page 101. The temperature dependence has not been checked. The input signal was a one-kilocycle triangular wave derived from a function generator (Exact Electronics Type 240) and applied to the filter through an audio power amplifier to ensure low source impedance. The filter output harmonics were measured individually by a wave analyzer (Hewlett-Packard Model 310A). The even harmonic distortion (mostly second) at the input to the filter was 0.4%, and for each nominal value $R \approx R_1 \approx R_2$, R_2 was adjusted to minimize the second harmonic distortion in the output. The resulting even harmonic distortion in the output was about 0.3%, and was essentially the same for all conditions anywhere near the optimum for minimum total distortion. The distortion curves include the even harmonics.

It may be noted that the minimum total distortion observed was slightly over 0.3% so that the odd harmonic distortion was less than the theoretically predicted minimum of 0.35%. Therefore, the departure of the actual FET characteristics from the theoretical forms of equations 8a

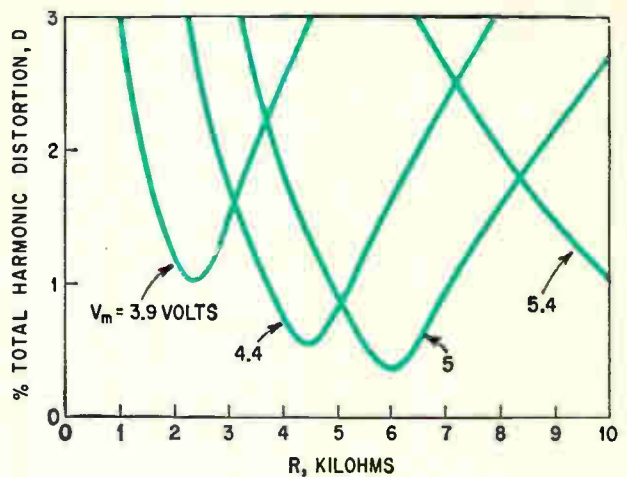
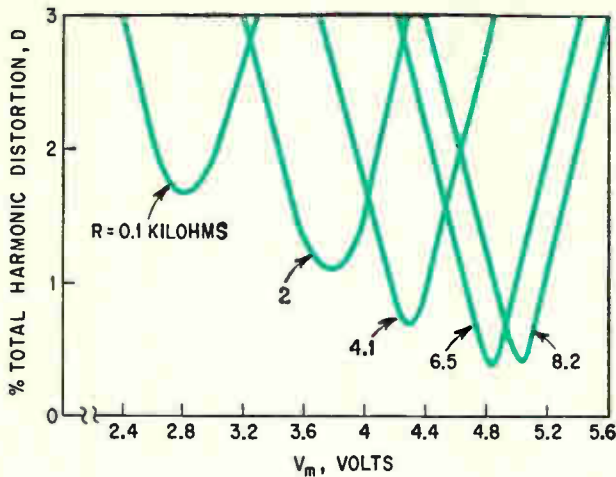

Total harmonic distortion for the practical circuit is plotted against two parameters, the input amplitude V_m and the external resistance, R .

and 8b allow the theoretical performance to be slightly exceeded. As a consequence, a little more leeway is available in adjustment of the actual circuit than is theoretically predicted: maladjustment of the input amplitude by $\pm 3.8\%$, or of the external resistance by $\pm 19\%$, ensures that the total output harmonic distortion remains under 1%. Comparison of the harmonic distortion curves suggests that the theoretical FET characteristics of equations 8a and 8b are adequate for the design of practical circuits.

Design considerations

It has been demonstrated that a simple, non-linear, nonreactive filter containing an FET can be designed to convert triangular to sinusoidal voltage waveforms with residual total harmonic distortion that should be reliably maintained at under 1%.

The design requires only a characterization of the FET by approximate values of the pinch-off voltage V_p and the zero-bias channel resistance R_c . In the practical filter circuit R_1 and R_2 are each set roughly equal to R_c , and the amplitude of the input triangular wave is set roughly to $1.33V_p$.

Choice of diodes and gate bias resistors is non-critical. Diodes of the same semiconductor material as the FET are to be preferred, since at least a partial compensation of the second-order effects due to gate-channel contact potential and diode forward drop may be achieved. Any gate bias resistance is satisfactory that is high enough not to load the signal source and low enough adequately to forward bias the diodes. Such a rough design will ensure operating conditions in the neighborhood of the optimum for minimum total harmonic distortion. Only two critical adjustments are then needed: R_2 is trimmed to minimize the output second harmonic distortion, and then V_m is adjusted to minimize the output total harmonic distortion.

Alternatively, and perhaps even more simply, R_2 and V_m can be adjusted simultaneously to minimize the output total harmonic distortion. This method requires only a total distortion meter rather than a wave analyzer.

Acknowledgement

This work was supported by the U. S. Naval Ordnance Test Station, Pasadena, Calif., under Contract No. N123-(60530)342844.

References

1. I. Richer and R.D. Middlebrook, "Power-Law Nature of Field-Effect Transistor Experimental Characteristics," Proceedings of the IEEE, p. 1145, Aug. 1963.
2. R.D. Middlebrook and I. Richer, "Limits on the Power-Law Exponent for Field-Effect Transistor Transfer Characteristics," Solid-State Electronics, p. 542, Sept.-Oct., 1963.
3. M.B. Prince, "Drift Mobilities in Semiconductors, II Silicon," Physical Review, p. 1204, Mar., 1954.
4. H.C. Lin and A.A. Barco, "Temperature Effects in Circuits using Junction Transistors," Transistors I, RCA Laboratories, p. 369, 1956.

The authors



R. D. Middlebrook is associate professor in the division of Engineering and Applied Science at the California Institute of Technology, where he conducts research in solid-state devices and circuits.

He received a master's degree from Cambridge University, England, as well as a master's and a doctorate from Stanford University.



I. Richer received his doctorate from the California Institute of Technology in 1964 and is now engaged in research on nerve behavior at the Technical Institute of Denmark under a NATO Postdoctoral Fellowship.

Digital system continuously converts transducer data into meaningful units

More accurate and flexible than analog methods, it allows engineers to monitor complex processes and to spot trends before they become big problems

By Peter Johnson

Dymec Division, Hewlett-Packard Co., Palo Alto, Calif.

When testing a missile or studying an industrial-control process, the engineer receives information from transducers about such variables as temperature, pressure, speed and fluid flow—but often in the wrong form. The data comes to him in the form of d-c voltages or pulse rates; he has to convert it into more meaningful units such as degrees of temperature or pounds per square inch. This can require correction for scale factor, transducer offset and linearity [see glossary at end of article].

If he performs the correction manually—a slow, tedious process—the engineer has to refer repeatedly to the transducer's characteristic curve to correct his measurements. If a computer is available, this correction can be done automatically, but usually this involves a lengthy wait to get the data processed. Also, computer time is expensive. Existing methods to perform the conversion in the measuring equipment are analog in nature. Some examples are: nonlinear recording paper, nonlinear operational amplifiers, nonlinear potentiometers in servo systems and nonlinear shaft digitizers. These methods are inflexible, inaccurate and unstable.

A new digital technique eliminates these problems and provides direct readout in meaningful units of transducer measurements. This system employs a Dymec DY-2401C integrating digital voltmeter. It allows the engineer to monitor his

measurements continuously, spotting trends before they become big problems.

Unlike analog methods, which require changes in measurement hardware for different types of transducers, the digital system can be adapted easily to different transducers.

The digital system has the added advantage of high accuracy and resolution; analog components are usually no better than 1% accurate. The system's flexibility allows any necessary linearization to be performed as accurately as desired.

Because digital techniques are inherently free of drift effects, the new method is stable. Analog systems, in contrast, are subject to zero drift and to variations in gain; they're also difficult to calibrate, requiring a precise voltage source, usually in the millivolt range. The use of an internal reference in the digital system also allows easy, precise calibration.

Digitizing is accomplished by converting the analog input into a proportional pulse rate in the voltage-to-pulse rate converter and counting these pulses over a fixed sample period. The sensitivity of the rate converter is 100,000 cycles per second—for full scale inputs of 0.1, 1, 10, 100 and 1,000 volts. Sample periods of 0.01, 0.1 or 1 second, therefore, give a display reading directly in volts or millivolts (with appropriate positioning of the decimal point). This principle of operation lends itself readily to scaling, zero offsetting and linearizing.

Translating into meaningful units

For scaling an input, the digital voltmeter can be programmed externally for a sample period of any duration. For example, in the idealized thermocouple characteristic shown in the graph at top left on the facing page, the sample period could be preset to 0.25 second instead of 0.1 second, and the display decimal point positioned appropriately. Then an input of four millivolts could be displayed as

The author



Peter Johnson, a native of England, taught electronics at the Royal Military College of Science prior to joining the Dymec division of the Hewlett-Packard Co. As publications manager, he is responsible for technical manuals, data sheets, field training and supervision of Hewlett-Packard's printing services in the Palo Alto, Calif. area.

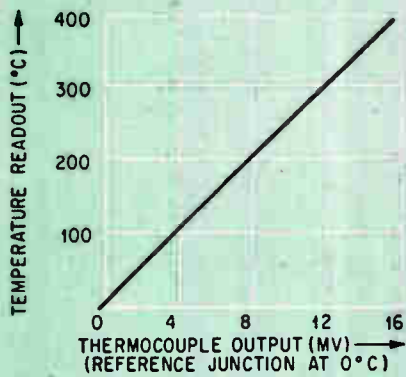

Thermocouple characteristic (idealized) illustrates the temperature-voltage scale factor (25° C per millivolt) necessary to obtain a meaningful readout.

Thermocouple characteristic adjusted to compensate for transducer zero offset phenomenon.

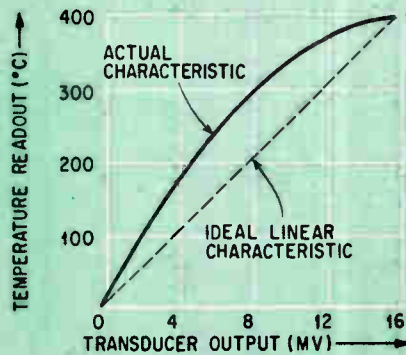
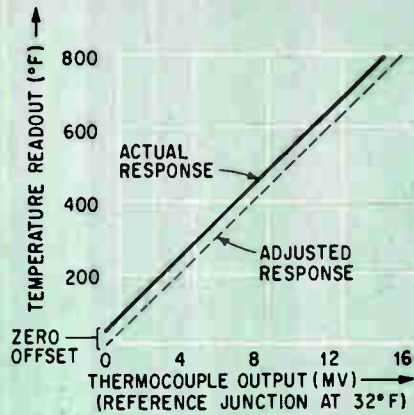

Nonlinear characteristic of a typical thermocouple, exaggerated for clarity, demonstrates the magnitude of the linearization problem.

Nonlinear thermocouple characteristic curve is approximated with linear segments in the linearization process. The segments, AB, BC and CD have slopes peculiar to each.

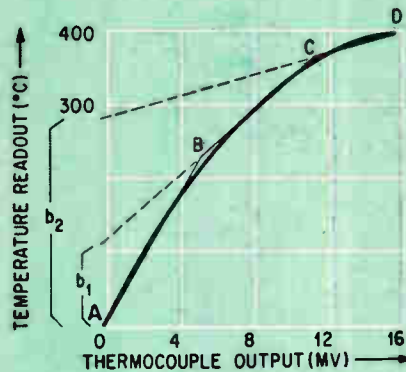
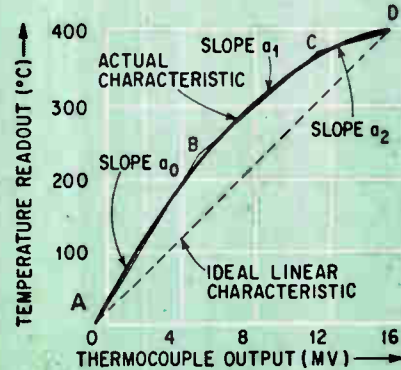

Segment offset (b_1 and b_2) must be accounted for in the linearization process.

Divergence between the approximating line segment and the actual curve gives rise to segment error. This error is shown as e_1 , e_2 and e_3 .

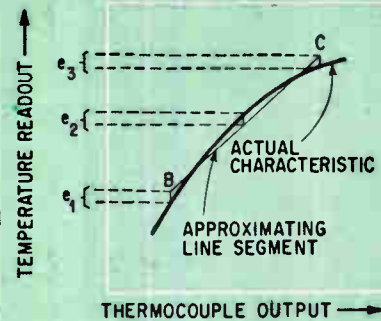

100°C.

This method also works for tachometers and turbine flowmeters whose outputs are pulse rates proportional to an analog input; they can be applied directly to the counter portion of the digital voltmeter. Since the counter can handle frequencies up to 300 kilocycles, it can accommodate most types of pulse-producing transducers.

The digital voltmeter's counter uses display decades that can be preset. When the transducer has a zero offset, this can be compensated for by introducing a preset count that is equivalent to the offset. The decades are reversible, so the display can handle transducer offset of either polarity.

Digital linearizing is accomplished by making successive linear approximations to the characteristic curve (right center graph above).

The ideal situation is where one equation de-

scribes a straight line as shown in the graph at the top left. Here a single equation, $y = ax$, relates the temperature readout y to the transducer voltage x . The coefficient a is the scale factor.

With the successive-approximation approach, each segment shown in the center graph above at the right has its own equation. These are

$y_{AB} = a_0x$, $y_{BC} = a_1x + b_1$, $y_{CD} = a_2x + b_2$
For all segments except the first, a segment offset is introduced. These offsets are b_1 and b_2 . They are shown in the left bottom graph.

The length of each segment is determined by the degree of nonlinearity of the transducer characteristic and the accuracy required. In the graph above at the bottom right, the runout errors, e_1 , e_2 and e_3 are kept within predetermined limits, say, for example, $\pm 0.1^\circ\text{C}$. Therefore, to achieve a given measurement accuracy, the more nonlinear

the characteristic curve, the shorter and more numerous the segments must be.

The system can select the proper segment. The transducer voltage, and hence the operating point on the characteristic curve, is measured by sampling the output of the voltage-to-pulse rate converter. The voltage value is integrated to obtain a d-c voltage; this is compared with a series of preset voltage levels, each corresponding to a segment end point.

When the transducer voltage exceeds A but is less than B [see center figure, right, p. 103], a logic circuit selects the appropriate sample period for the slope a_n of the segment AB. For a voltage between B and C, the logic circuit selects the sample period corresponding to the slope a_1 of segment BC. The offset of each segment is also corrected digitally by entering an appropriate initial count into the voltmeter. These initial counts correspond to b_1, b_2 , etc. for each segment.

Although the number of segments, the segment end points, the related sample periods and the segment offset conditions are different for each

over-ranging to $\pm 300\%$ of full scale extends these ranges to ± 300 millivolts, ± 3 volts and ± 30 volts respectively. The most sensitive range is useful for strain-gage bridges, thermocouples and other transducers producing maximum outputs around 50 millivolts. The higher ranges can accommodate transducers whose maximum outputs are about three to five volts. A guarded data amplifier can be added if necessary to achieve maximum accuracy with low-level inputs. This amplifier provides a gain of 10 and results in a full scale input range of 10 millivolts, extended to 30 millivolts by valid over-ranging.

Data linearizer

Within the data linearizer are the converter rate detectors and the circuits necessary to provide the binary-coded-decimal commands for the voltmeter sample period (scale factor), and the preset count (transducer zero offset and segment offset). The linearizer also selects the decimal-point position and measurement-unit indication in the voltmeter display window. A functional diagram of the

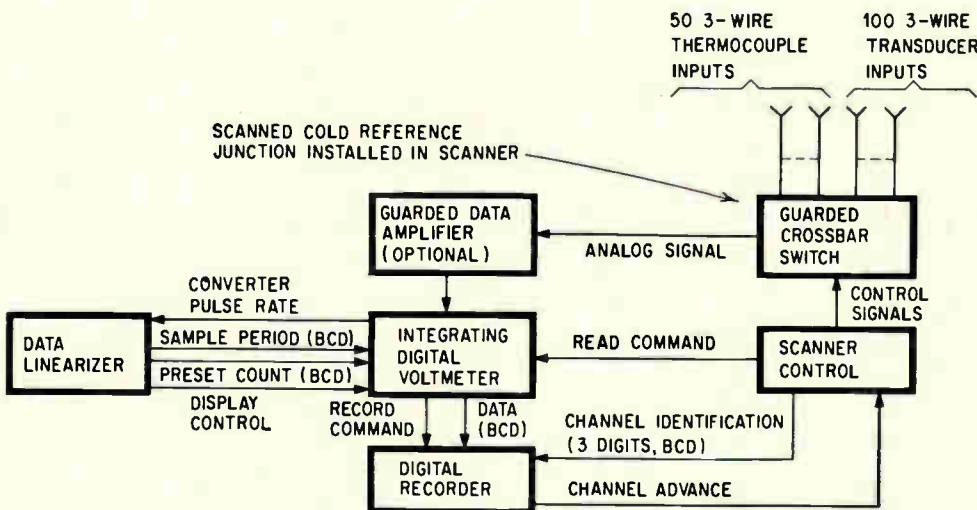

Data-acquisition system modified for direct-reading of transducer outputs by the incorporation of a digital voltmeter and data linearizer.

type of transducer, they can be predetermined for any transducer, and have been for the most commonly used transducers with the aid of a computer. Thereafter, the change from one type of transducer to another only entails changing control settings and diode matrices.

Guarded crossbar speeds scanning

The digital method of transducer measurement employs an input scanner, an integrating type of digital voltmeter, and a printer or other type of digital recorder. Speed and flexibility are greatly enhanced when a guarded crossbar scanner is used as the input scanning device. For direct-reading transducer measurements, some modification of the scanner and voltmeter and the addition of an accessory instrument are necessary to permit the scaling, transducer offset correction and linearization that may be required. In the Dymec system, the accessory is designated a data linearizer.

Full-scale input ranges for the basic system are ± 100 millivolts, ± 1 volt and ± 10 volts. Valid

data linearizer is given on the facing page.

A transducer-output characteristic may be approximated by up to 10 segments with this instrument. However, if transducer characteristics are expected to be especially nonlinear, the system may be expanded to include more segments. The data linearizer can also be expanded to include 10 additional independent scale factors. These may be used to obtain direct readouts from transducers that do not require linearization.

Two or more data linearizers can also be used in a system for further expansion and increased capability.

The preset linearization characteristic or any one of the 10 independent scale factors can be selected by a front panel switch or by an external selector such as the system programmer.

The segment end points, slopes and offsets for commonly used thermocouples are predetermined by computer. The end points are expressed in millivolts and degrees centigrade, offsets are in degrees centigrade and the slopes are given

in degrees per millivolt. No external equipment is needed for the linearization of a specific thermocouple. A swingaway panel permits adjustments and setup changes to be made easily from the front of the instrument.

The rate detectors, which determine the segment end points, are mounted on plug-in cards, three to a card. The detector's trigger levels are adjusted by reference to a stable, variable voltage source in the linearizer. This source, consisting of a temperature-stabilized zener diode and a 10-turn potentiometer, is set in turn to each segment end point, the voltage of which is displayed directly on the voltmeter. The corresponding rate detector is then adjusted for triggering. An external indication of triggering is provided by a small lamp next to the adjustment point of each detector.

To select the voltmeter sample period, binary-coded-decimal commands are set up by inserting diode pins into a plug-in card. One card accommodates 12 segments, with five selectable decades per segment. This is equivalent to 20 binary-coded-decimal lines per segment.

also been included for positioning the decimal point by external command. In addition to such indications as voltage, frequency and resistance, provided by the standard voltmeter, the annunciator panel has been modified to display special measurement units such as degrees of temperature, revolutions per minute, pounds per square inch, foot-pounds, microinches per inch.

Thermocouple input scanner

A modified guarded crossbar switch is used for operation with thermocouples. Inside the guard shield is a thermocouple reference junction, designed for operation at ambient temperature and electrically compensated to simulate a reference temperature of 0°C. This junction is scanned together with the external thermocouples. Consequently, each thermocouple input occupies two 3-wire scanner channels. The 50 thermocouple inputs shown in the figure on the facing page leave 100 three-wire channels for use with other transducer inputs.

The proportion of input channels requiring a

Data linearizer showing how system can be programmed externally.

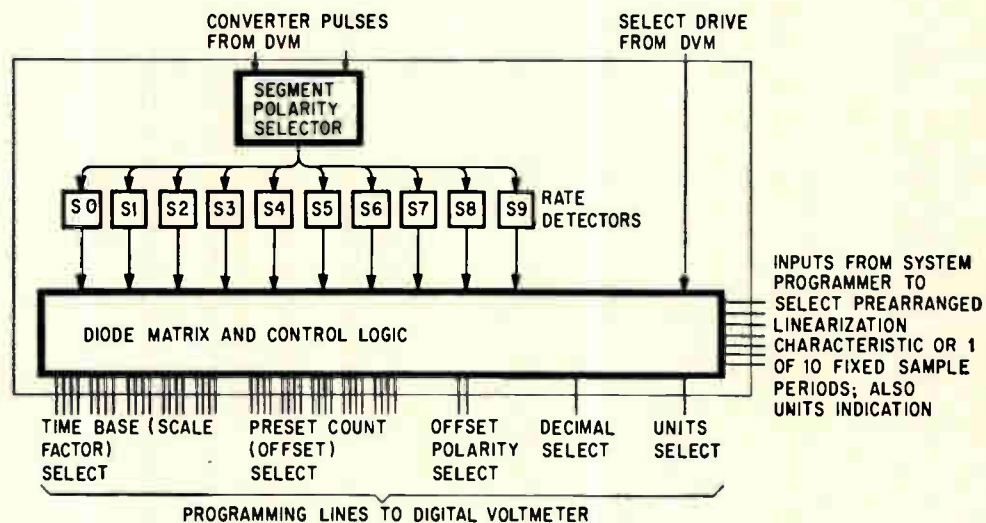

A similar technique is used to set up the commands for entering the preset count for each segment. However, an additional pin per segment is necessary to indicate if the offset (y-axis intercept) is positive or negative. These settings can easily be checked by switching the voltmeter to its frequency mode and reading the offset, which is displayed in millivolts. Similarly, by switching the voltmeter to the check mode, the scale factor can also be validated.

Digital voltmeter

Special time-base decades are installed in the integrating voltmeter to permit selection of sample periods from 10 microseconds to one second, in 10 microsecond increments, by external binary-coded-decimal commands. The sample periods usually will be between 0.1 second and one second.

Although it has presettable, reversible decades as standard feature, the digital voltmeter has been modified to allow positive or negative preset counts to be entered by external commands. A means has

scanned reference junction can be tailored to suit any particular application. However, the number of thermocouple inputs must be a multiple of 10.

When a programmer is used, the prearranged linearization characteristic or any of the 10 fixed scale factors from the data linearizer may be applied to any scanner input channel.

How accuracy is achieved

The convenience of direct readout is evident. The user will also want to know how accurate his final answer is. The following discussion is directed toward thermocouple transducers, because linearization and zero-offset correction are usually required for this type of transducer. The same reasoning applies to any type of transducer.

Inaccuracy of measurement can result from errors in the measurement conversion to direct readout, in the data-acquisition system itself and the individual transducers.

Errors during the conversion of a measurement can arise from scale factoring, transducer zero-

Sources of system errors

Error source	100 MV Range		10 MV Range	
	Without Amplifier		With Amplifier	
	% fs	% rdg.	% fs	% rdg.
Stability	.03	—	.04	—
Linearity	.005	—	.006	—
Noise	.019	—	.11	—
Attenuator	—	.005	—	.012
Internal reference	—	.01	—	.01
Arithmetic sum	.054	.015	.156	.022
RMS Sum	.036	.011	.117	.016
Error for Max. possible		.55%		.18%
10 MV Signal Probable (rms)		.37%		.13%
Error for Max. possible		5.41%		1.58%
1 MV Signal Probable (rms)		3.61%		1.19%

All errors are \pm .

Sources of transducer errors

Error source	Temperature ($^{\circ}$ C)				
	0	100	200	300	400
Scale factor	.000	.005	.010	.015	.020
Offset, (transducer zero & segment)	.005	.005	.005	.005	.005
Segment run-out	.100	.100	.200	.300	.400
Segment end-point	.000	.027	.023	.021	.022
Data acquisition system (arith.)	.390	.412	.434	.488	.525
(rms)	.293	.293	.294	.300	.327
Total system error (arith.)	.495	.549	.672	.829	.972
(rms)	.309	.311	.357	.425	.503
Transducer (arith.)	1.300	1.300	1.700	2.100	2.500
(rms)	.755	.755	1.050	1.360	1.720
Overall readout error (arith.)	1.8	1.9	2.4	3.0	3.5
(rms)	0.8	0.8	1.1	1.4	1.8

Figures apply to a copper-constantan thermocouple. All errors are \pm .

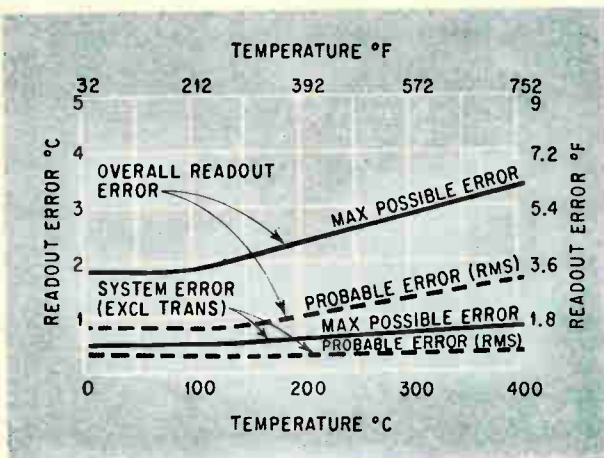

Magnitudes of errors due to the transducer alone are compared with system without transducer in this graph of over-all readout accuracy. The most serious source of error in the final readout is due to the transducer.

offset compensation and linearization.

Errors in scale factor are determined by errors in the voltmeter's sample period. In the Dymec digital voltmeter this error is kept to a minimum by deriving the standard sample periods from a crystal oscillator. Compensation for the small error from this source is performed during the instrument's calibration. Only the resolution error of the sample-period selector circuits remains. The use of a five-decade preset divider keeps this to only $\pm \frac{1}{2}$ count in 10^5 , or $\pm 0.005\%$ of a reading.

Compensating for transducer zero offset may introduce an error into the voltmeter which is associated with the preset count. A five-decade preset counter is used, keeping the error to $\pm \frac{1}{2}$ count in the voltmeter reading. The resultant measurement error is dependent on the scale factor used. For example, with a thermocouple whose scale factor is 25° C per millivolt, 1° C is displayed as 0001.0° C. The $\pm \frac{1}{2}$ count error corresponds to $\pm 0.05^{\circ}$ C. This can be reduced further through the use of the guarded data amplifier. The 1° C is then displayed as 001.00° C; the count error now corresponds to $\pm 0.005^{\circ}$ C.

Inaccuracies during linearization are caused by errors associated with segment run-out, end-point selection, scale factor and offset.

Segment scale factor and offset errors have already been discussed.

Segment run-out is the maximum discrepancy between the National Bureau of Standards curve for the particular transducer and the linear approximation for each segment. For transducers with the same tolerance over their nominal response characteristic, segments are selected to achieve the same run-out for each segment. However, with thermocouples, the response tolerance is not uniform throughout the operating range. Therefore the segments must be chosen to adjust the run-out error proportional to the variation in the thermocouple tolerance. The 10-segment capacity of the data linearizer is sufficient to keep the run-out error of a copper-constantan thermocouple smaller than $\pm 0.1^{\circ}$ C. This is four times better than the Instrument Society of America's standard for special grade wire.

Variations in the rate detector's trigger levels, used to set the segment end points, result in a small additional error in segment run-out. These variations change with the operating point and are inversely proportional to the converter pulse rate. The magnitude of the resultant error in readout is a function of the slope divergence between adjoining segments. Using a 10-segment approximation for a copper-constantan thermocouple, the error is smaller than $\pm 0.17^{\circ}$ C, or within $\pm 0.03^{\circ}$ C if the data amplifier is used.

There are several possible sources of system error. These are tabulated at the top of this page. The contribution shown for each source is the worst-case condition. The noise specification refers to random internal noise with the shortest sample period used, 0.1 second. The temperature effects do not require consideration, because the system can be calibrated for use at any desired temperature.

Ambient temperature variations of $\pm 5^{\circ}\text{C}$ result in error less than $\pm 0.05^{\circ}\text{C}$ in the final readout.

The system is fully guarded; this eliminates errors from common-mode noise—spurious signals appearing from input to ground. Common-mode rejection specifications are the same for the standard crossbar scanner and voltmeter combination—110 decibels at 60 cycles per second and 130 decibels at d-c. The use of the optional amplifier will result in a reduction of common-mode rejection by only six decibels. The voltmeter provides additional superimposed noise rejection through averaging. The degree of rejection is a function of the noise frequency and the sample period. Even with a sample period as short as 0.1 second, as may be required in the scaling process, rejection of superimposed noise will be better than 20 decibels. The combination of shielding and averaging results in effective common-mode rejection of greater than 130 decibels at 60 cycles.

Transducer errors

The transducer itself is a contributor of errors. With a thermocouple, for example, wire error and reference-junction error must be considered.

Wire error is the deviation of a thermocouple output from its nominal characteristic curve. The characteristic curves for pairs of thermocouple materials are defined by the National Bureau of Standards. The permissible deviations are defined by the Instrument Society of America standards. For example, the wire error for copper-constantan, type T, special grade, is $\pm 0.4^{\circ}\text{C}$ from -60° to 100°C and $\pm 0.4\%$ of reading from 100° to 400°C .

Under operating conditions it is seldom possible to use the same wire for the sensor and reference junctions. The reference junction is usually built into the equipment, and may not match the sensor material perfectly. Therefore the wire errors of both the reference and sensor junctions contribute to system inaccuracies and are additive.

The difficulty of maintaining the reference junction at the true ice-point also must be taken into account. True ice-point junctions, held automatically at 0°C by refrigeration, are capable of maintaining a temperature of $0^{\circ}\text{C} \pm 0.05^{\circ}$. They create a shielding problem because they are too bulky to package within the scanner chassis. In addition, they are expensive.

This problem can be averted by using electrically compensated reference junctions. These provide reference temperatures of $0^{\circ}\text{C} \pm 0.5^{\circ}$. Although less accurate, they are small enough to be incorporated within the scanner's guard shield. The resulting large reduction in common-mode noise more than compensates for the additional error associated with the use of an electrically compensated reference junction. All of these transducer effects are additive and can produce a maximum error of $\pm 1.3^{\circ}\text{C}$ with a copper-constantan thermocouple over temperature from -60° to 100°C . The maximum probable error is $\pm 0.75^{\circ}\text{C}$.

The system's accuracy

Final readout accuracy is influenced greatly by

A glossary of conversion terms

Scale factor is a multiplying factor that converts a transducer's electrical output into engineering units. For example, a thermocouple exhibits a change in output voltage for every change in temperature. The measuring device, therefore, must display a change in voltage as a change in temperature. Thus with a sensitivity of 40 microvolts per degree centigrade, a change of one millivolt in the thermocouple's output must be converted to a change of 25° in the displayed variable (top graph, left, p. 103). The millivolt output, therefore, must be multiplied by the scale factor of 25°C per millivolt. Similarly, for a strain-gage bridge, a typical scale factor would be 20 pounds per square inch per millivolt or, for a flowmeter, 10 gallons per minute per cycle per second.

Transducer zero offset represents the amount by which the transducer output differs from zero at the zero level of the measured variable. Consider a thermocouple that has no zero offset, as shown (top graph, left, p. 103). If the display were in degrees Fahrenheit instead of centigrade, an offset would occur since the transducer produces a finite negative voltage at 0°F . This offset must be compensated before scaling takes place (top graph, right, p. 103).

Maximum possible readout error is the system error figure, based upon the arithmetic sum of all contributory error sources under consideration, taking them at their worst cases.

Maximum probable readout error is the system error figure, based upon the root-mean-square sum of all contributory error sources under consideration, taking them at their worst cases.

the type of transducer used, and it is not meaningful to quote a general figure accuracy. The bottom table on the facing page summarizes the pertinent data for a typical thermocouple, copper-constantan. This thermocouple provides an output of 0 to 16 millivolts over the temperature range of 0° to 400°C . The optional amplifier is employed to lower the full-scale input range. The maximum possible readout errors and the maximum probable readout errors are shown in the figure on the facing page. To facilitate a comparison the system error, excluding transducer error, is plotted on the same graph.

It can be seen that for a typical thermocouple, the maximum probable error—in measurement, conversion to engineering units and linearizing—is $\pm 0.5^{\circ}\text{C}$, or $\pm 1^{\circ}\text{F}$. This error is much smaller than that contributed by the thermocouple itself. Using matched thermocouples for all channels, or providing individual reference junctions for each channel, can reduce the thermocouple error to about $\pm 0.5^{\circ}\text{C}$ (1°F), giving an over-all readout error of $\pm 1^{\circ}\text{C}$ (2°F). However, reducing thermocouple error this way is expensive; it's feasible only in setting up an entirely new installation.

It is interesting to note that the use of platinum resistance probes instead of thermocouples does not significantly improve accuracy. Unmatched platinum probes are equivalent to unmatched special-grade thermocouples, and calibrated probes are comparable with matched or calibrated thermocouples.

This digital technique is valuable in a data-acquisition system. It allows a direct readout capability to be added to any data-acquisition system without affecting measurement accuracy and approximation for linearization to be made as close as desired. Measurement accuracy is principally determined by the errors inherent in the transducer.

Modernizing the missile range; Part 2

As our space program reaches farther from the earth, more precise tracking is needed. Engineers are improving existing gear. Plans include pulse radar for aircraft and satellites.

By John F. Mason

Military Electronics Editor

Not far from some of the most beautiful beaches in the Caribbean, on the island of Antigua halfway between Cape Kennedy and Ascension Island, a group of radar engineers spent many months repairing and revising the newest, most advanced pulse tracking radar on the Air Force's Eastern Test Range. After almost 500 modifications, the long-range sensor, designated the AN/FPQ-6, performed even better than the Radio Corp. of America's specifications had promised.

"The need for so much work didn't mean the radar was designed badly," said Antigua's radar manager, Ron Spears of RCA. "Modifications are always needed. All complex new systems have flaws. Techniques used for the first time usually need smoothing out. The results we've had with the radar are beyond anything we'd hoped for."

Within sight of the FPQ-6, right down by the sea, another group of engineers is putting the finishing touches on Glotrac, a system that uses continuous-wave and pulse radar information and has a range of 20,000 miles.

On the island of Eleuthera, about 280 miles from Cape Kennedy, a group of engineers headed by Bob Pickett is getting the final bugs out of the General Electric Co.'s Mistram 2, the most accurate continuous-wave radar in operation on the range and one that has been the most difficult to put into good operational form. Here again, the modifications don't reflect on the design. Like any complex system, Mistram 2 needs modification.

Work on these islands is typical of the activity on all the missile-range stations from Cape Kennedy to Pretoria, South Africa. Existing instrumentation must be vastly improved to support the 70 or more missile and space projects now scheduled. All the existing pulse and continuous-wave radar systems are being modified and improved, some c-w systems are being expanded, and pulse ra-

dars may be put into aircraft and even satellites.

Pulse radar

One important task of pulse radar is range safety. When a missile leaves Cape Kennedy, radars from the Cape to Antigua watch the vehicle to see if it's behaving as it should. If the missile is off course and threatens life or property, the range safety officer can blow it up.

After a missile's power is exhausted, the course cannot be changed; but the vehicle is monitored down the range, and finally it is tracked by ship radar as it reenters the atmosphere.

Unlike c-w radar, pulse radar can track a target with or without a cooperative beacon transponder. Last May, for example, the FPQ-6 at Antigua picked up the Soviet Cosmos satellite at 865 miles, an impressive distance. It tracked the 135-foot Echo II balloon satellite at 2,200 nautical miles, and followed Ranger 7 from horizon to horizon—a period of 500 seconds. Ranger was about 850 miles from the radar and 100 miles above the earth when it sank below the horizon. If Ranger had not been below the horizon when it went into its transfer orbit (when the vehicle leaves the earth orbit for its trip to the moon), the long-range FPQ-6 could easily have tracked the entire maneuver.

A transportable version of the FPQ-6, designated the TPQ-18, on Grand Turk tracked Ranger 7 for 371 seconds, and Saturn 6 for 500.

The Antigua radar had a definite role in the early portion of the Ranger 7 mission. It watched the restartable Agena vehicle during its first burn—the first period of powered flight. The data was used to determine the characteristics of the parking orbit, and this information was sent to Ascension, to Pretoria and to tracking ships for use in determining the transfer orbit. Data on that crucial portion of the mission was sent to the Jet Propulsion Lab-



Pulse and c-w radars. Most of those shown are already installed and operational; the others will be in by 1969.

oratory in California, which directed the flight.

The FPQ-6 and the transportable TPQ-18 [Electronics, Nov. 30, 1962, p. 20] are the newest pulse radars on the range and are considered to be so advanced that no new tracking pulse radars are being developed to replace them. The effort is going into debugging them, and devising new ways to get better performance.

The FPQ-6 evolved from the FPS-16, which is also still used on the range, along with its trailer-mounted version, the MPS-25.

All of these pulse radars operate in C-band and were developed and built by RCA. The FPS-16 can track a one-square-meter target without a beacon at up to 150 nautical miles; the FPQ-6, to 300 miles. With beacons, unambiguous range goes up for the FPS-16 to 1,000 miles, and for the FPQ-6 to 32,000 miles.

More metric data

Engineers are trying several ways to get more precise measurements of position and velocity for space shots from pulse radar. To date, c-w radar provides such information more accurately—particularly rate data, the target's speed in relation to the radar. But c-w radar has disadvantages: it requires a cooperative transponder, it must be installed with a long baseline (a precisely measured distance between two ground-based receivers), and it must function in conjunction with other remote stations. Pulse radar, installed in one spot, is simpler.

Range engineers plan to modify three pulse radar stations to measure vector velocity from three radial velocity components. This, they believe, would provide accuracy of velocity comparable with that of existing c-w systems.

Mike Wilson, of the Pulse Radar division at Patrick Air Force Base, Fla., says that precise

velocity data and multiple target resolution could be obtained if the FPQ-6 were modified for coherent Doppler operation. This could be done by using a fine-line tracking technique to extract fine-grain information from the pulse signal spectrum. The Doppler information could be extracted by transmitting an ultra-stable frequency signal and using a fine-line (narrow-band) filter in an automatic-frequency-controlled servo loop.

The filter would track the returned spectral line corresponding to the transmitted carrier frequency. In the fine-line tracking mode, the procedure is similar to a c-w system's.

With this technique, Wilson says, radial velocity measurements accurate to 0.1 foot per second have been demonstrated with a feasibility model. And greater tracking range is expected from the increased signal-to-noise performance obtained from the fine-line signal-processing technique.

Upgrading the radar

Though the narrow antenna beam-width (0.4°) of the FPQ-6 provided greater range and precision than the 1.2° of the FPS-16, it was slow in finding the target—especially if good acquisition information hadn't been passed on to the radar from another source.

This problem was solved by installing a beam spoiler—a waveguide switch that causes the transmitter to emit energy from all five horns of the Cassegrainian feed system rather than from only one. Usually, the center horn transmits and the four horns surrounding it act as receivers. Transmitting through all five decreases range and accuracy, but it does broaden the beam during the acquisition mode. Once the target is acquired, the operator switches back to the narrow beam. The radars at Grand Turk and Antigua are already equipped with beam spoilers. Although the technique is a good

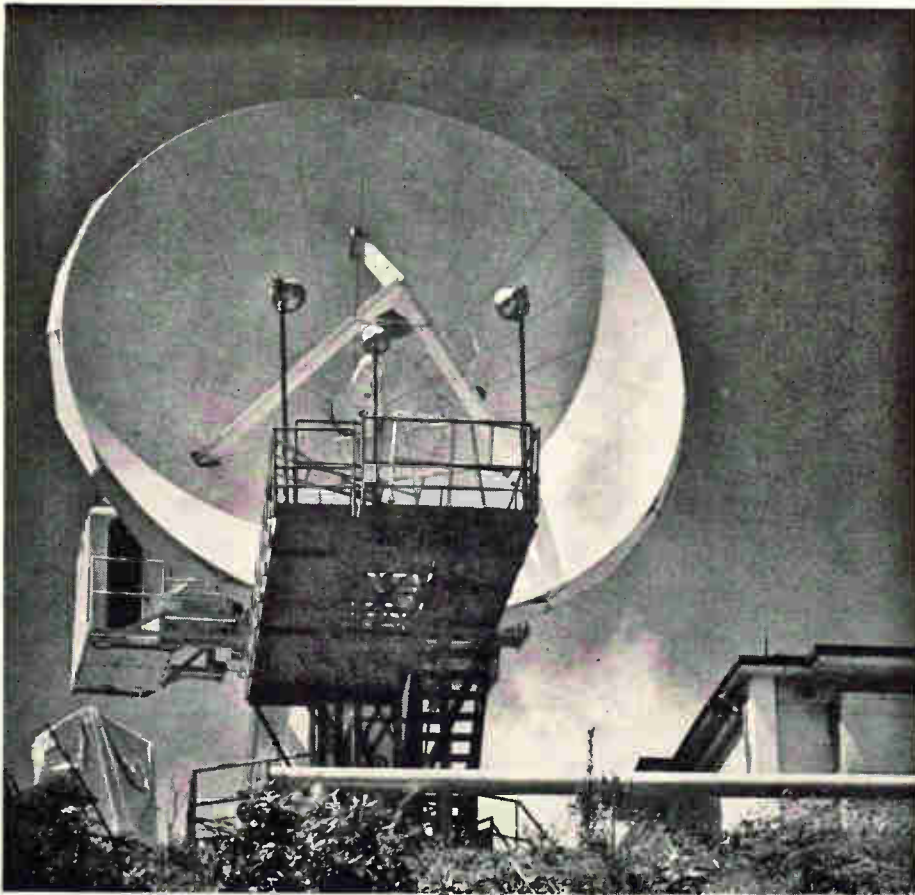

photographs by John F. Mason

AN/FPQ-6 radar required almost 500 modifications after it was installed at Antigua. Now it performs beyond expectations. Last May it picked up the Soviet Cosmos satellite at a range of 865 miles.

one, it will ultimately be replaced by electronic scanning, which is better.

Electronic scanning

Acquisition and multitarget tracking capabilities of the C-band radars used on the two Atlantic range instrumentation ships will be improved in another way. These 30-foot dish radars are used to provide range, angle and amplitude information on ballistic missiles as they reenter the atmosphere. As the primary trackers on the ships, they are used to direct the L- and X-band radars also on board.

Both acquisition and multitarget tracking will be improved by modifying the radar to scan electronically. In November, the Air Force's Electronic Systems division at Hanscom Field, Mass. issued invitations for proposals to bid on feasibility studies of such a technique. The solution will probably involve an array of phase-shifting elements in front of the reflector or across the reflector. Exactly where they will be placed and what kind of elements they will be will come out of the contractor's report.

The engineers at Hanscom Field are also studying the whole reentry instrumentation problem. They are trying to identify the kinds of radar and optical gear that will be needed over the next five years.

Side-lobe lock-on

With the ground-based FPQ-6 and FPS-16 radars, it is possible for an operator to lock on to a

target with the side lobe and think it is the main lobe. This would give him erroneous track information. To prevent such an error, the range is having side-lobe indicator and positioning (SLIP) systems built for all the FPQ-6's on the range.

SLIP will detect a side-lobe track condition and automatically reposition FPQ-6 antennas on the main beam. The SLIP modification adds a passive, conical scan system with a 36-inch parabolic antenna mounted on the present antenna mast. The system receives azimuth and elevation-angle error signals from a skin or beacon target independently of the main radar antenna.

Collimating radar with tv

Since the first AN/FPQ-6 became operational on the range 14 months ago, several independent studies have shown elevation errors that exceed specifications. Most of the errors indicate either feed-horn droop or dish distortion at various elevation angles, or poor calibration of the boresight tower.

In the attempt to isolate these errors, it became clear that existing methods of collimation with the boresight tower were inadequate. The Air Force now plans to buy a television-optical tracker that will provide the necessary optical alignment between the r-f axis and the mechanical axis of the radar system under dynamic as well as static conditions. The target will be a 12-inch reflectivity balloon.

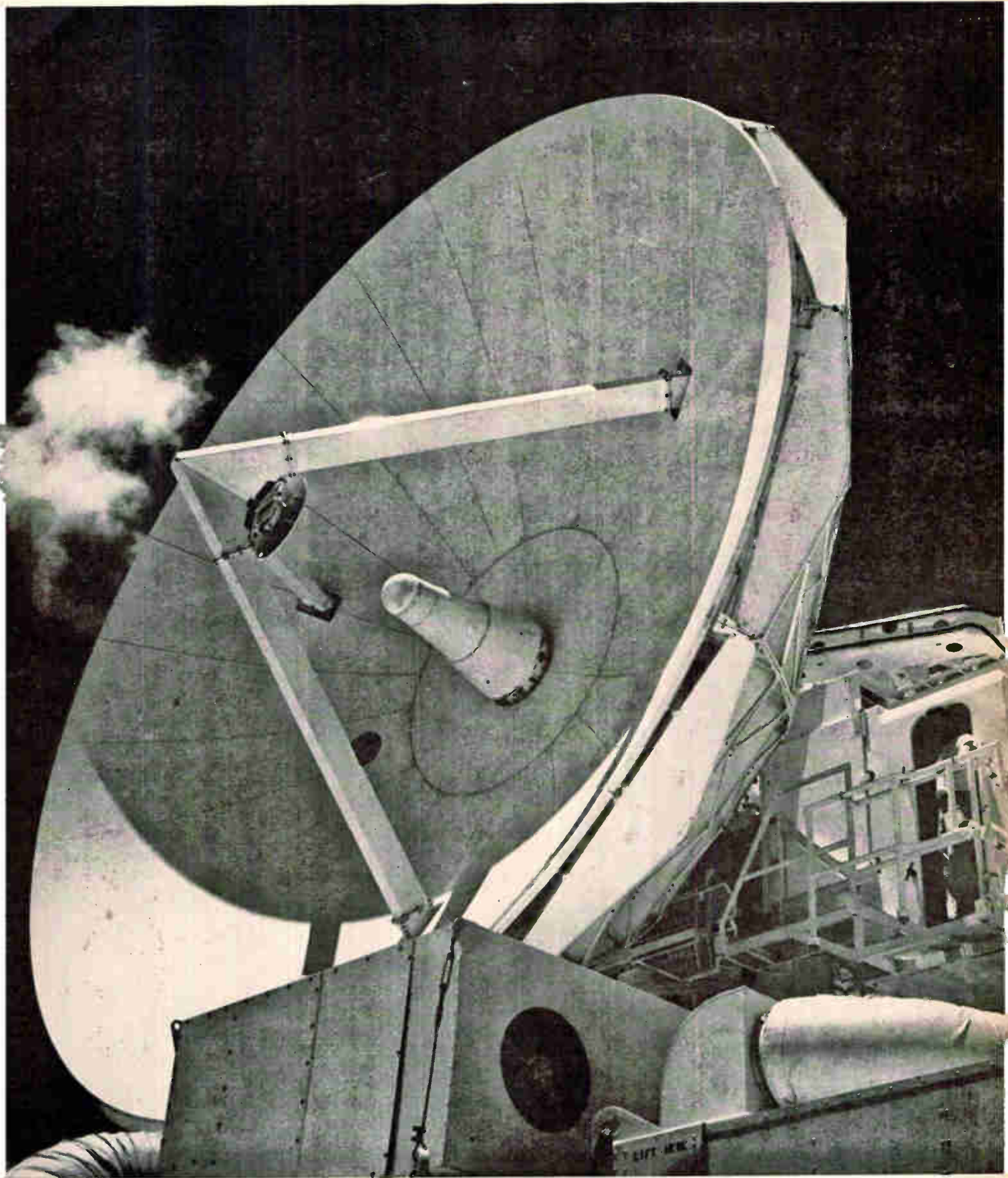

Radar now going into downrange stations is six times more effective than its predecessor. This AN/TPQ-18 at Grand Bahama Island is the transportable version of AN/FPQ-6. The Atlantic range is getting four transportable and two permanent installations. RCA builds all of them.

The engineers also would like to improve the range of the FPQ-6 when the target is at low elevation and has low angular velocity. The Air Force is buying parametric amplifiers to increase the range approximately 30%.

Guard against false data

All the FPQ-6's will soon get pulse coders for their transponders as a guard against spurious signals or interference.

The coder is designed to be used with the FPQ-6 and the FPS-16. It will simultaneously generate three codes; the coding selected is determined by the transponder in the missile.

At present, all tracking systems are on land or aboard ship. Studies are under way at Hanscom Field, however, for an airborne instrumentation platform for precision tracking of cooperative targets (project 7817) and for a satellite-based tracking station (project 5930). Although aircraft are already used on the range, they are for telemetry and communications relay, not for tracking.

Easier tracking

The advantages of putting a tracking station in a plane are numerous. Tracking stations are often needed where there is no land or where the land is owned by a foreign government that may put restrictions on its use. Planes are more maneuverable than ships and cost less, they get above much of the earth's atmosphere, and they extend line-of-sight transmission. For tracking vehicles close to the earth, aircraft are expected to be about as accurate as ships.

The Mitre Corp. made a four-month study for Hanscom Field last year on the feasibility of using an aircraft for tracking purposes. The engineers simulated, on a computer, the entire problem and the performance of an airborne C-band radar. The results were promising; now the Air Force would like to breadboard the equipment and try it out.

A navigation system for a tracking aircraft has already been tested at Hanscom Field. Since any position error in the aircraft itself would compound an error in calculating the missile's velocity as well as create a big acquisition problem, the highly accurate GAM-87 navigator, used in the defunct Skybolt missile, was chosen.

System modified

The stellar-inertial-Doppler system, which was developed by the Nortronics division of the Northrop Corp., was modified to include a vidicon tube in place of the photomultiplier associated with the star tracker. The system was installed in a C-131 cargo plane. The star tracker was then used to acquire and track the Echo I balloon satellite to see how well it could generate azimuth and elevation angles from an aircraft. The aircraft's position was tracked accurately by several ground radars, and the position of Echo I is always accurately known.

The device tracked Echo I on six passes for a

total of 17.6 minutes. Although the results have not yet been fully evaluated, the engineers believe they will be good.

Air Force engineers also tested the GAM-87 for two potential problems. They flew the C-131 over water to see how this affected the Doppler, and they operated the system in a gravitational anomaly area. The preliminary conclusion is that there was some degradation of the Doppler's efficiency over water, but not too much. There is no information yet on the gravitational anomaly test. The Air Force believes that the results will be good enough to proceed with the program.

Antenna bids sought

One problem in the proposed airborne platform is to get a good antenna. It must be a broad-band, three-aperture device, using C-, S- and vhf-band, though final specifications may eliminate the vhf-band requirement. It will be no bigger than 7½ feet in diameter, and will probably be a dish. Requests went out recently for proposals to bid on antenna study contracts. In addition to proposals for the antenna itself, contracts will be awarded to study the mounting problem, stabilization methods, propagation effects, radome positioning and materials.

The aircraft will use other tracking sensors, such as lasers and infrared detectors. These are good for angle determination, while radar provides good range and range-rate information. An airborne computer will also be needed.

Satellite tracker

The General Electric Co. and the Lockheed Corp. have been working since July on one-year study contracts to determine the practicability of tracking with pulse radar from a satellite. One such platform, strategically placed in synchronous orbit, could monitor the entire test flight of a long-range missile. The project is ambitious, but the potential in such a system is great. The satellite would also relay telemetry, command and communication signals between ground sites and space vehicles.

Early-launch tracking

There is a real need for equipment that will pick up a missile the moment it leaves the launch pad and continue to track up 60,000 feet, when Mistram (missile trajectory measurement) can take over. It is important to track the missile during this crucial lift-off stage to evaluate the performance of the engine and the guidance system.

Three feasibility studies were carried out on early-launch tracking systems at Rome Air Development Center.

One technique calls for eight microwave radars installed in a V in front of the launch pad. The radars fanned out between points 100 and 25,000 feet from the pad. The missile carried a transponder. This approach was expensive and it took up a lot of space. At some sites, the line of radars would have to extend into the ocean.

Another technique used gamma radiation. This

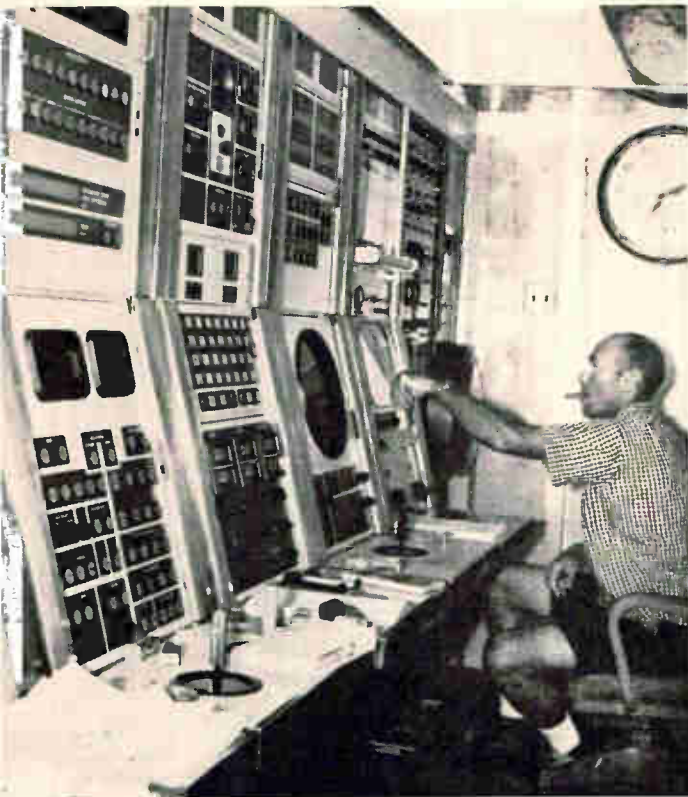

Grand Bahama's chief radar engineer, R. S. Marchant, operates the AN/TPQ-18 tracking radar from a van.

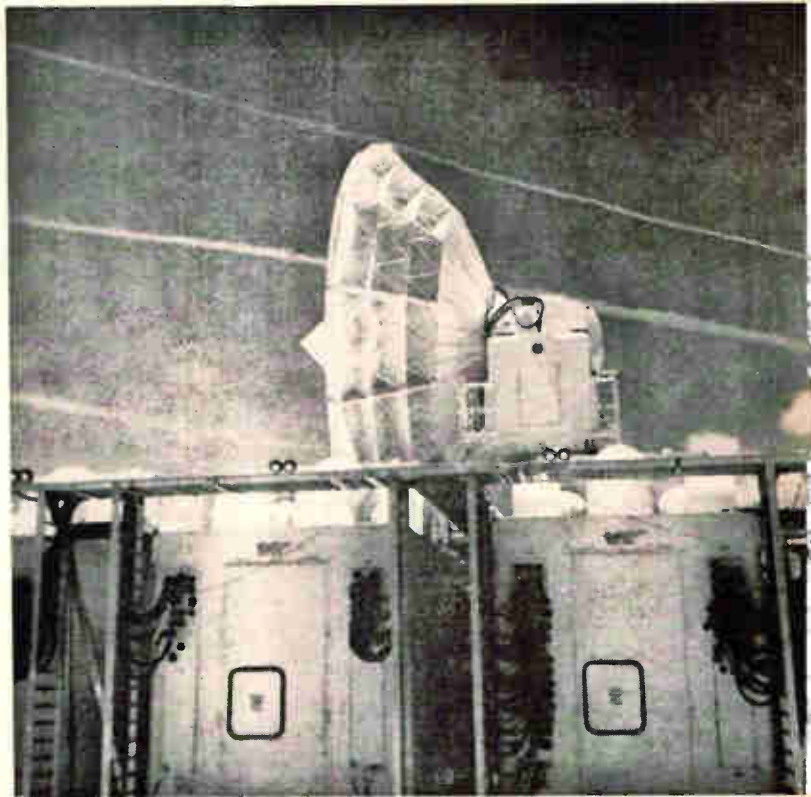

TPQ-18's airconditioned vans look like big refrigerators. Nine of these shelters are needed at each site.

approach had no propagation problems or blackout by smoke, but its range was only about 1,000 feet and it caused a radiation hazard.

The third, and most promising, technique uses a laser. RCA is developing an active laser tracker [Electronics, Jan. 10, 1964, p. 10], and the Perkin-Elmer Corp., a c-w gas laser [Electronics, Apr. 20, p. 30].

Rome was working with a c-w gas laser. Funds ran out, however, and the program stopped, at least temporarily.

The problem of calibrating c-w and pulse radars precisely enough is so great that the Air Force plans to put up satellites that contain transponders to do the job. Since the exact position of an established satellite is always known, the slightest error in any ground-based measuring device will be revealed.

Two types of satellites

In Project 7818, the Electronic Systems division, in cooperation with the Space Systems division,

Lowest price wins

Although the missile ranges will continue to be a good electronics market, the Defense Department's cost-reduction program is a source of growing frustration to many contractors.

One industry official said: "The government's insistence on buying electronic hardware from the lowest bidder, the way they buy desks, chairs and wastebaskets, results in the government's often getting junk—which is never really a bargain. The procedure, in fact, is probably indirectly injuring our space effort."

That view is prevalent among suppliers and government and military officials. All sources asked to remain anonymous.

"In a fixed-price, invitation-to-bid procurement, the bidder simply submits a price, and low price wins the award. There is no consideration given to originality, creativity, improvements or genuine advances of any kind," the industry executive continued.

"The immediate result is to squelch any desire on the part of the potential contractor to risk proposing quality hardware. Then, once the contract is awarded, changes are difficult to make. For example, during the course of a long-term contract, it's very possible that the state of the art improves, or the government's requirements change. But due to the type of contract involved, it is not easy to change. The specs remain the way they were and the government loses the opportunity to take advantage of new technological developments.

"It would be much better to have a negotiated fixed price, or more fixed price plus incentive."

Of the first 383 contracts awarded by the Electronic Systems division in fiscal 1965, 75 were fixed price and only one was fixed price plus incentive.

Cost reimbursement accounted for 106 contracts; cost plus fixed fee 189; cost plus fixed fee plus incentive, 9; and cost sharing, 3.

will put up two kinds of satellites. Project 7818.02 will be a satellite equipped with four kinds of transponders: S-band and C-band to check the Verlorp and Prelorp radars used by the National Aeronautics and Space Administration, and a vhf transponder and two uhf transponders to check the radars aboard the range ships. The satellites will also have a telemetry system and a command-and-control capability.

The Space Systems division will buy the booster, integrate it with the satellite, launch it, and control its operation once it is in orbit. The satellite will be launched into an orbit that is near-polar—80° to 95°, and near-circular, 300 to 500 nautical miles high. It will be spin-stabilized. Hanscom Field hopes to have three satellites launched, the first in December, 1965.

Project 7818.03 will consist of two satellites. Each will carry an X-band transponder for Mistram, a special transponder for Glotrac in the 5,000 megacycle range, and a C-band transponder for the pulse radars. The first of these satellites will go up in February, 1967. Its inclination will be 30° to 40° at launch, its orbit will be nearly circular at 300 to 500 miles altitude, and the satellite will be spin-stabilized.

Refraction work

Errors in angle measurements due to refraction are a serious headache for both c-w and pulse radar trackers. In an attempt to correct them, Hanscom Field has three studies under way at the Air Force Cambridge Research Laboratory, the National Bureau of Standards and the Mitre Corp.

Cambridge is trying to come up with a system whereby the refractivity index of the atmosphere at any given time can be determined by measuring meteorological conditions. The lab has put meteorological equipment and an airborne refractometer into a C-130, which is flown through the clouds over Cape Kennedy at altitudes up to 20,000 feet. A U-2 flies above the C-130 and takes photographs of it and the cloud conditions. Later, the appearance of the clouds is matched with the refractometer readings taken in the C-130. It is hoped that enough comparisons will make possible a refractivity index based on cloud profiles.

The Bureau of Standards is taking a series of readings from which it hopes to make tables that will show the index when variables such as temperature, pressure, wind and moisture content are known.

On a mountain in Hawaii, 10,000 feet high, the bureau has a transmitter. About 15 miles away, at sea level, there is a receiver. The angle of elevation is about 5°. The bureau transmits continuously, measuring the refraction all the time, and matching it with the variables.

Mitre is attempting to develop a line integral refractometer to provide almost instantaneous read-out of the refractivity index by determining the moisture content in the atmosphere, which is the biggest variable, and the oxygen content. The

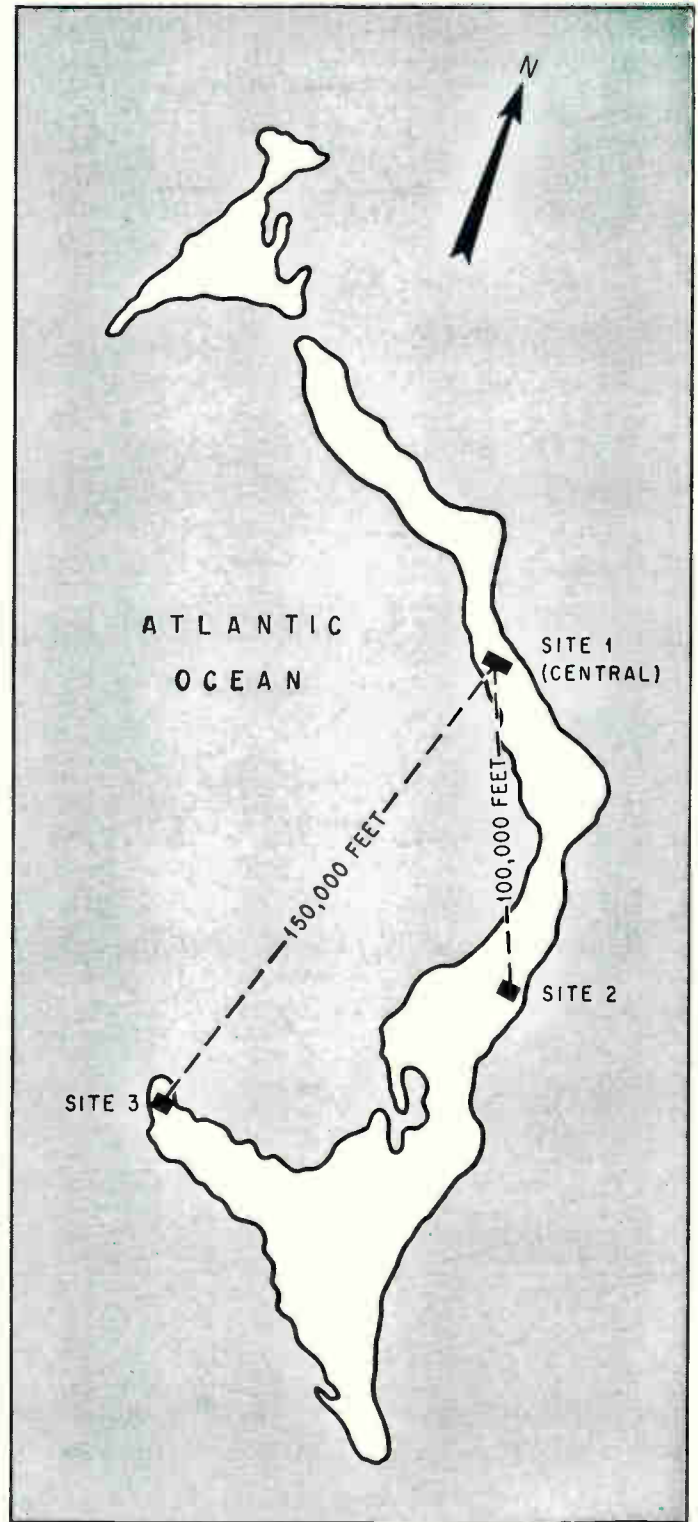

Mistram 2, on the island of Eleuthera, has three sites. The central station (Site 1) equipment includes the tracking antenna and receiver, the transmitter and receiving antenna, ten receivers, data extraction circuits, communication and recording equipment, refractometer, optical tracker, simulator, operator and coordinator consoles and power equipment. Each remote station (Sites 2 and 3) houses a simple receiving antenna slaved to the central station antenna, a receiver for beacon signals, a receiver for phase stabilization, a refractometer, communication equipment and power. Communication between the central station and the remote stations is by microwave link.

method is to transmit radio signals at frequencies above and below the water absorption band (22 gigacycles) and the oxygen band (60 Gc). The differences in phase delay between the two signals are directly proportional to the moisture content and the amount of oxygen. With this information, a working approximation of the refractivity is figured out, almost in real time.

Continuous-wave radar

Continuous-wave radar systems on the range measure position and velocity more precisely than pulse radars do because c-w derives information from the easily measured Doppler shift. Pulse radar measures range accurately enough, but must depend on the mechanical changes in the antenna's azimuth and elevation to determine the velocity.

At present, four types of c-w systems are used on the test range: Azusa, Glotrac, Mistram, and Udop (ultra-high-frequency Doppler). The systems complement each other because of their locations and their particular capabilities.

Azusa Mark 2 is at Cape Kennedy and measures position and velocity up to about 400 nautical miles downrange. It can pick up the missile very quickly after it leaves the pad—at an altitude of about one mile—and the readout is in real time.

Glotrac has a range of up to 20,000 miles. When it becomes fully operational, it will be useful for space missions. Results are not in real time, but may be in the future. Glotrac depends on Azusa as one of its station inputs.

Mistram doesn't have the range of Glotrac, but it is the range's most accurate c-w system. It is capable of full accuracy up to 600 miles. Mistram picks up the missile when it is about 5° above the horizon. Data obtained from the system is available in real time and is used for range safety and for impact prediction.

Udop, a real-time system, has one complex in the launch area and one at Grand Bahama. Like Azusa, it picks up the target at low altitude. Udop is the only range system that has reliably tracked through staging events of solid-propellant vehicles.

All c-w systems require a cooperative beacon transponder in the target, a transmitter on the ground, and three or more receivers at separate, precisely located sites. The line between any two receivers is called a baseline.

Fundamentally, a c-w system transmits a signal from the ground station to the target, where the frequency is multiplied and transmitted back to the ground. The ground receivers compare the phase of the returned signal with a coherent phase reference.

The speed with which the target's range changes is measured at each receiver. This data is derived by comparing the received signal with a reference in a quadrature phase detector. The output produces one pulse for every 90° of phase rotation. Each pulse represents a discrete change in radial range. The digital recording system records at a sampling rate of 10 and 20 points a second. The pulses are stored in a computer which is capable

of a readout speed of 10 pulses a second. The data is then processed to give the range rate.

Range difference, the difference in distance of the target from each receiver, is measured by comparing the signals received by the different receivers. The difference in phase of the signals is proportional to the difference in range.

The target's range is measured at the receiver by comparing the phase of the received signal with a reference. The phase difference is proportional to the electrical distance to the target.

All range systems use variations of this basic approach. The differences in system capabilities are due to the precision and speed of the techniques used. Accuracy is directly proportional to the baseline length, that is, the distance between receiving stations. However, as the baseline is lengthened, phase error and survey problems increase.

Azusa, the oldest c-w radar

The oldest c-w radar on the range is Azusa, a C-band short-baseline (1,500 feet) system consisting of nine receivers and one transmitter located along two crossed baselines. The length of the electrical baseline is maintained with precision by connecting the receivers by waveguides constructed in temperature-controlled trenches. The central conical-scan receiving antenna tracks the target and positions the other receiver and transmitter antennas. All the antennas are high-gain parabolic dishes.

Azusa determines position by continuous comparison of phase differences between microwave signals to and from the transponder. The frequency-controlled signals from the ground transmitter are beamed to the transponder, which retransmits them to the ground receivers, where they are converted to a form usable for phase comparison. These phase differences are a measure of two direction cosines and the slant range, three quantities that provide enough information to determine the position of the missile.

Glotrac—the newest

Glotrac is a new system on which a great deal of work is planned. It will go on new ground sites, and on at least one ship. The bulk of the work, however, will consist of services and equipment to improve system reliability and performance and reduce maintenance costs.

Originally, Glotrac was designed as a global tracking network for the military communications satellite Advent. It was to consist of several C-band pulse radars (FPS-16 or equivalent) integrated with the Mark 2 Azusa and several new portable c-w tracking systems compatible with Azusa. During the booster's flight, the pulse radars were to acquire position data and the c-w elements would receive rate data, all in a form suitable for postflight evaluation of launch vehicle guidance.

Although the Advent program was canceled, the Air Force decided to go on and install the c-w por-



When a Minuteman missile launched from Cape Kennedy reaches an altitude of 60,000 feet, RCA engineer Sam Lynch picks it up on Mistram 2 at Eleuthera. The entire Mistram 2 complex is operated at this console.



The countdown console (right) is positioned so that lead engineer Bob Pickett can watch it and the operator's console in front of him.

tions of Glotrac downrange for regular missile-range work.

Glotrac consists of several semitrailer vans and parabolic tracking antennas installed beside the vans. Each van contains a five-gigacycle receiving system fed by an external receiving antenna that automatically tracks the transponder in the missile by conical-scan techniques.

Atomic standards

One transmitter interrogates the bird at C-band with a signal referenced to an internal atomic standard. Remote vans compare the received signal with their own atomic standards. To synchronize the data at all vans for processing, timing modulation is also transmitted, and timing marks are recorded at each van. No common-reference or electrically-stable baselines are needed because of the ultra-stable references at each van, the extended baselines used, and the timing modulation.

The receiving system detects the Doppler present on the received signal, reads the Doppler cycle count ten times a second, and records the readings on magnetic tape. Each 60th reading may be transmitted in real time by teleprinter to the IBM 7094 at the Cape, if communication links are available.

Some vans also contain a five-kilowatt c-w transmitter capable of interrogating either an Azusa transponder or a specially developed Glotrac transponder.

Glotrac's accuracy is limited by the precision with which the timing modulation provides synchronization, the accuracy with which the initial vehicle position is known, and survey information. Large parabolic tracking antennas and parametric amplifiers are used to enhance sensitivity and ensure Glotrac's accuracy at space-probe ranges.

Various plans are being considered for extending Glotrac coverage. For instance, ships could be instrumented and moved out to solve tri-lateration solutions with existing Glotrac stations. At present, however, the test range is considering adding rate baselines to the existing transmitter stations at Bermuda and Antigua, and instrumenting one ship only. The ship could be moved about to reinforce the particular baseline being used, thereby extending coverage. A single-baseline system can operate accurately down to an elevation of 5° above the horizon. A reinforced baseline extends high-quality data coverage down to 2° . This could mean a range extension of 300 miles.

The new baseline system would be different from the one being installed at Pretoria, which uses an over-all automatic-frequency-control (AFC) technique for controlling the airborne transponder to keep the ground-received frequencies constant at 5,000 megacycles. A better approach would be to use an existing fixed-frequency ground transmitter and allow the computer to compensate for baseline electrical length changes which result from receiving variable frequencies.

Procurement for '65

A good deal of equipment will be bought this year for Glotrac.

- Very-low-frequency receivers will be used to correlate more closely each station's reference frequency to a common signal generated by the National Bureau of Standards. Each station can then set reference oscillators to the same atomic standard, and frequency correlation between stations can be improved by almost one order of magnitude.

- Severe heat within the synthesizer's power supply has caused repeated failure. A modular, solid-

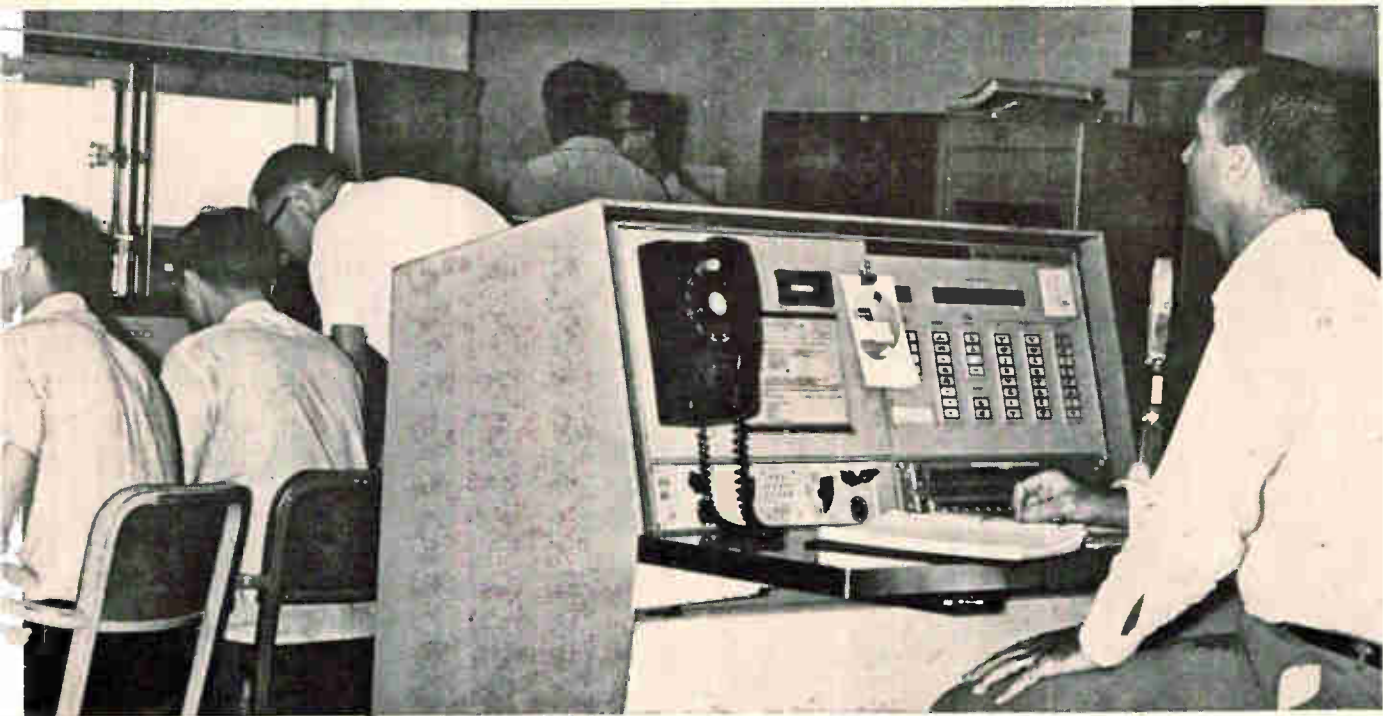

state power supply is being considered to improve the system's reliability.

- Continued failure of parametric preamplifiers has made it necessary to provide a more reliable mixer-preamplifier assembly.

- Teletype converters will be bought to provide acquisition and system checkout aid for remote vans.

- Frequency conversion is needed to move Azusa and Glotrac out of the radio astronomy operating band. The new frequency will be 5,008 megacycles.

- The range will get an operational G transponder in 1965. The C transponder now used has limited Glotrac capabilities but is compatible with the Glotrac system. The G transponder would operate throughout the mission. The proposed G transponder will weigh 5.25 pounds; the C weighs 19 pounds.

Plans now call for Glotrac to be installed in the Pacific, the Indian Ocean and Alaska.

Mistram—brightest hope

Mistram, the system with the greatest potential for accuracy—ten times that of any other electronic tracking system on the range—has required a great deal of debugging. Work continues to realize the system's real potential, however, at both Mistram sites—Mistram 1 at Valkaria, Fla., about 30 miles south of Cape Kennedy, and Mistram 2 at Eleuthera, about 280 miles downrange.

Mistram uses c-w phase comparison techniques to measure range from a central station, and range difference across orthogonal baselines. The two determine position, and the rate at which they change determines velocity. Range is measured by counting the number of wavelengths traveled by the signal to the missile and back to the central station.

Range difference is found by counting the difference in the number of wavelengths traveled by the signals from the missile to each end of the baselines. A computer is used to compute trajectory.

Mistram 1 and 2 can operate independently or cooperatively. One can operate as a receiver while the other is transmitting. In some programs, hand-over is accomplished: in the Saturn flights, Mistram 1 was active and Mistram 2 passive during the first 300 seconds, and then the systems switched roles. Together they tracked the big missile for more than 600 seconds.

Mistram has tracked Titans, Minuteman missiles, Saturns and Gemini.

Sometimes the Mistram signal is lost because of plasma sheath blackout. On a Minuteman test earlier this year, such an interruption occurred 60

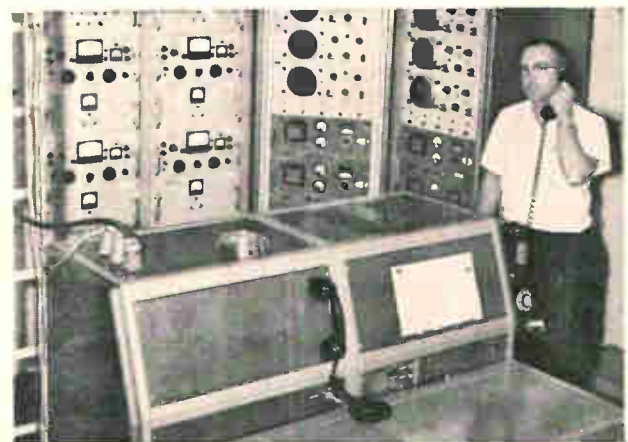

Udop leader Gene Hillesland at Grand Bahama Island checks by telephone with remote sites of this c-w tracking system. Udop tracks missiles during engine burn.

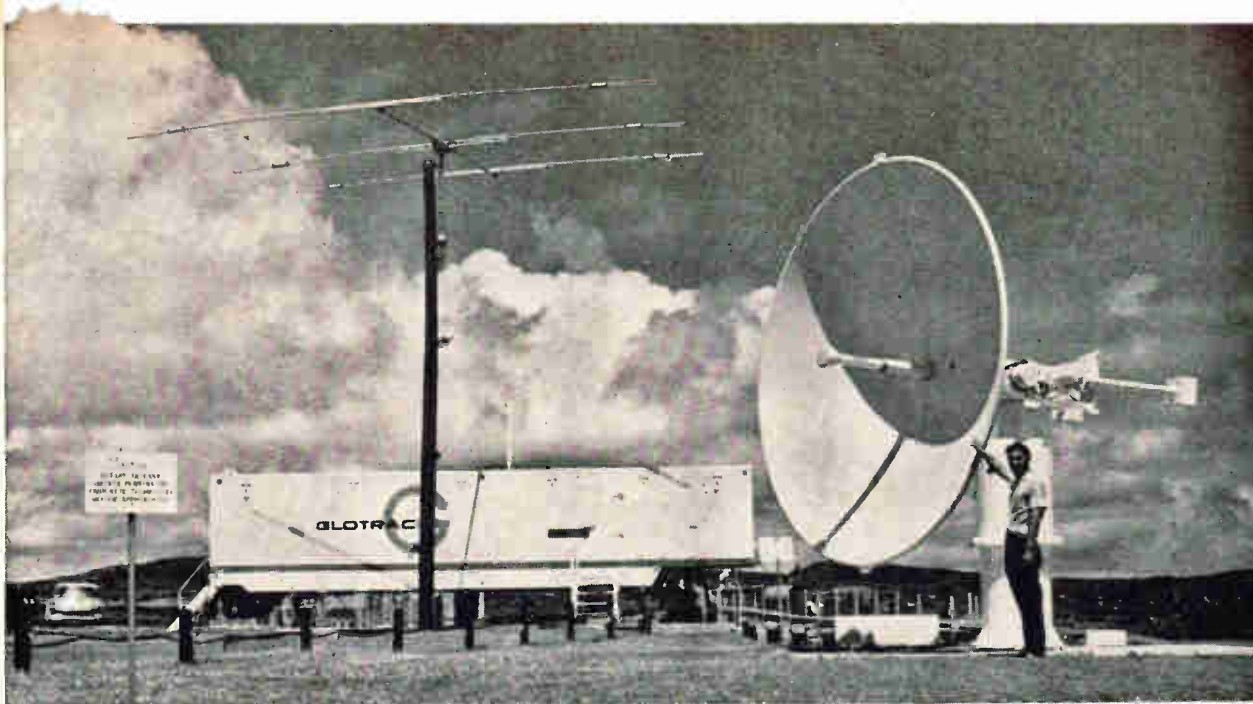

Glotrac measures, with extreme accuracy, position and velocity of missiles as far out as 20,000 miles. The hybrid c-w pulse radar/computer system will be useful for deep space probes. This trailer and antenna station is at Antigua.

seconds after lift-off, the first stage event; at 80 seconds, when the skirt separated; and at 120 seconds, at the end of the second-stage burn. New techniques have cut the duration of signal loss to about one second.

Problems remain

There are still problems, however:

- **Mistram 1 data printout.** Checkout, maintenance and calibration results cannot now be read on-site. At present, adjustments are made in the equipment, a simulation is run, and the data is transmitted to the Cape, where it is recorded on magnetic tape. The tape is then printed out and analyzed to determine the adequacy of the adjustments. Because of these delays, the same problem could occur in a subsequent test. A high-speed printer will be bought to permit engineers at the site to determine the validity of the calibration and to diagnose possible troubles. Mistram 2 already has this capability.

- **Analog recorders.** The charter recorder system that came with the instrumentation was designed for installation and checkout only. It has been found deficient in the number of recordings it can make and in the way the data is organized.

These failings result in performance analysis reports being delayed and incomplete. A contract is currently being concluded to buy more recorders which would add event pens to existing recorders and regroup the data functions to provide a more logical organization.

- **R-f leakage.** Phase errors between the various signals occur in Mistram because of r-f leakage. This causes ambiguities in the data output. To identify the sources and effects of the r-f leakage, a coherent leakage detector is now being used.

- **Airborne antennas.** The range engineers have prepared criteria for airborne antennas and have

requested that range users modify their antennas accordingly. Major problems exist with the Minuteman and Gemini antennas. Because Mistram uses two frequencies, side lobes in the antenna pattern result in phase errors between the continuous and calibration channels and introduce ambiguities in the data.

The Gemini program office has given range engineers an antenna for evaluation and testing in conjunction with Mistram 2.

- **Transponder.** The range is developing an improved space-rated Mistram transponder which will be lighter, require much less power input, have greater power output and more reliability. It is expected to be easier and cheaper to produce and easier to manufacture. This transponder should achieve a greater amount of passive data and increase the range of coverage. The Air Force plans to include NASA's Manned Space Flight Center's workmanship specifications, mounting requirements, and environmental specifications for support of NASA programs.

Udop

One system near the Cape is run by NASA. The second, operated by the range, is installed on Grand Bahama and four of the island's cays.

The transmitter is ulf and the transponder replies at double the transmitted frequency. Phase coherence and Doppler data is fed into a digital processor, which converts them to cycle counts. The precision of individual Udop receivers is approximately one-tenth of a Doppler cycle, or about 0.1 foot. Data is sent to the Cape in real time.

Acknowledgment

The author acknowledges the help of Robert B. Pickett, lead engineer for Mistram 2 at Eleuthera.

Of course you've heard of



CTS Corporation

and the



James Knights Company

But what about



CTS Knights, Inc.

THE NEWEST MEMBER OF THE GROWING CTS FAMILY

You'll be hearing a lot about CTS Knights, Inc., formerly The James Knights Company of Sandwich, Illinois. But, you'll still be talking to your same James Knights Company friends in Sandwich when you need crystals, crystal filters, crystal oscillators, and crystal-component ovens. The same management, the same staff, and the same fine quality product line will continue to serve you.

Meet the Family.

CTS Corporation, Elkhart, Indiana, Founded 1896.....

Principal Products

Variable Resistors and Trimmers
Selector Switches

Subsidiaries

CTS of Asheville, Inc., Skyland, No. Carolina.....

Variable Resistors and Trimmers

CTS of Berne, Inc., Berne, Indiana.....

Variable Resistors and Trimmers
Cermet Resistor Modules

Chicago Telephone of California, Inc., So. Pasadena, Calif.....

Variable Resistors and Trimmers
Selector Switches

CTS Microelectronics, Inc., Ridgefield, Connecticut.....

Cermet Hybrid Microelectronic Circuits

CTS of Paducah, Inc., Paducah, Kentucky.....

Loudspeakers

CTS Research, Lafayette, Indiana.....

Cermet Resistor-Capacitor Modules
Trimmers

CTS of Canada, Ltd., Streetsville, Ontario, Canada.....

Variable Resistors and Trimmers
Selector Switches and Industrial Control Equipment

and now:

CTS Knights, Inc., Sandwich, Illinois.....

**Crystals, Crystal Filters, Crystal Oscillators, and
Crystal-Component Ovens.**

Contact your closest CTS or Knights sales representative for further information.

This is Siemens

Serving the entire field of electronics and nucleonics, the Siemens Group is one of the world's most diversified electrical engineering organizations.

The particular strength of the Siemens Group is in its all-round capabilities—both in the overall handling of large-scale technical projects, from planning to final delivery, and also in the quantity production of electrical components and electronics devices. Distribution companies and agencies in 80 countries, backed by Siemens factories and hundreds of depots maintained in all parts of the world, guarantee customers a maximum of service. In cooperation with their central offices, they provide or arrange for every conceivable form of service that may be required in connection with electrical installations.

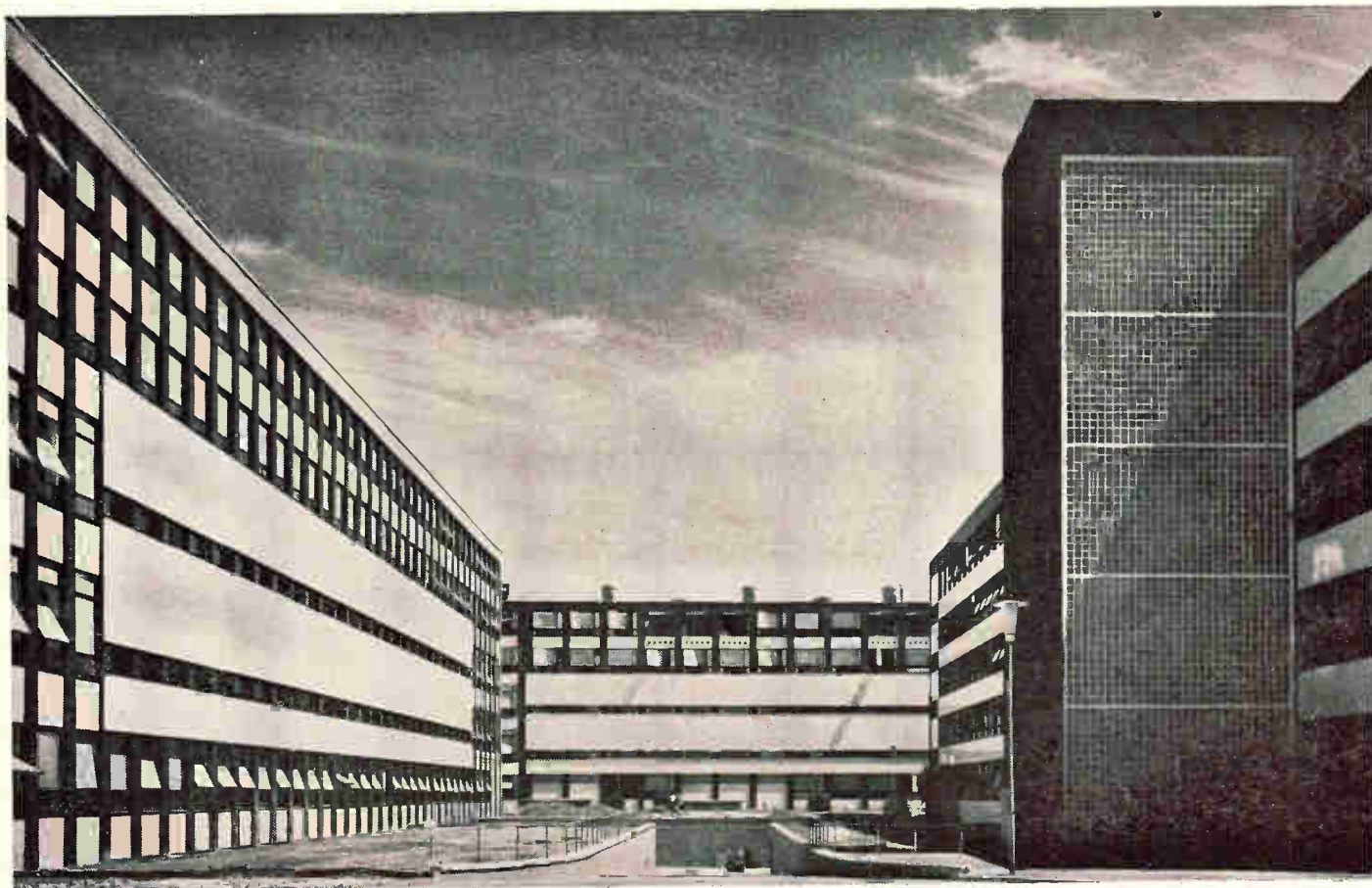

Siemens & Halske AG
Components Division

Siemens ferrite pot cores

Precision-engineered for adjustable, high-stability, high-Q coils

These pot cores meet the most critical requirements for filters used in multiplex and other carrier-frequency applications. They're unique in performance because of these built-in advantages—easy adjustment to precise inductance, high stability, high Q, low distortion, plus self-shielding that allows compact component density without regeneration or coupling.

Unique manufacturing controls Siemens pot cores offer uniform electrical characteristics month after month—complete dependability to close standards.

Wide range of materials 7 different types provide optimum properties for frequency ranges up to 40 mc/s for oscillating and filter coils—up to 400 mc/s for transformers.

Wide range of sizes Diameters range from 0.22" to 2.75" including all International Standard Sizes. Most of the listed pot core sizes, materials, and A_L values are stocked for immediate shipment from White Plains, N.Y.

Stability Less than 0.2% change in permeability in 10 years at temperatures up to 70° for typically gapped cores used in filter coils.

Temperature coefficients are closely controlled.

High Q value with high stability is typical. For example, a 26 x 16 core of N22 or N28 material A_L 315 at 100 kc/s shows a Q value of approximately 950.

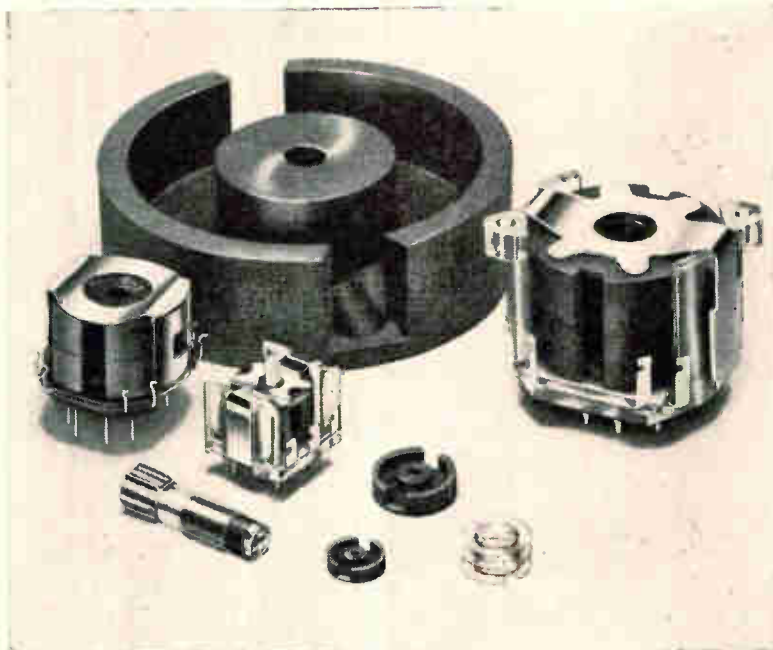

Complete line of "hardware" includes coil formers with one to four sections, mounting assemblies for chassis or printed circuits, adjustment devices and keys.

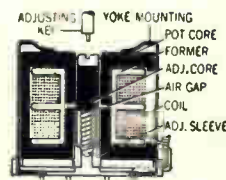

WRITE NOW for complete information on Siemens pot core application

SIEMENS AMERICA INCORPORATED

350 Fifth Avenue, New York, N.Y. 10001

A Corporation of THE SIEMENS GROUP IN GERMANY
Berlin • Munich • Erlangen

In Canada:

SIEMENS HALSKE SIEMENS SCHUCKERT (CANADA) LTD.
407 McGill Street, Montreal 1, P.Q.

AIRPAX ELECTRONICS

Incorporated

Product lines of the Cambridge Division of Airpax include miniature, sub-miniature and micro-midget choppers, both electromechanical and transistor types; a new line of single circuit and branch circuit protectors with ratings to 20 amperes and sensitive high speed relays. The illustrations show typical examples of these devices.

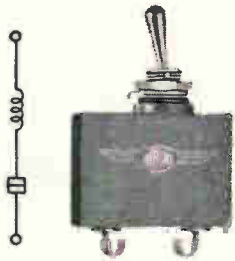

Series AP1 electromagnetic circuit protector provides positive protection in current ranges from 50 ma to 20 amps. It is obtainable with remote contacts to actuate a warning light or signal, when the main contacts open.

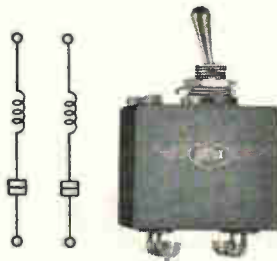

Two pole AP12 protectors guard two independent circuits which may be inter-active. Both circuits open simultaneously should an overload occur in either branch. Trip-free design prevents closing while the overload persists.

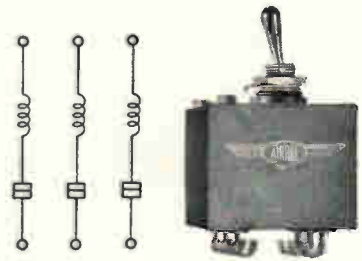

The three pole AP112 series protects three individual circuits. Each pole of the 2 and 3 pole protectors may have a different current rating and fast, medium or slow delay action. All AP protectors exceed MIL-C-39019 specs.



Airpax Types 175-13 and 300-13 electromechanical choppers (60 and 400 CPS respectively), are packaged for PC board mounting. Both have SPDT, BBM contact action with 10 V, 1 ma ratings. Noise is low, life is 5000 hours.



Model 36A is a micro-midget electro-mechanical chopper having a drive voltage of 6.3 V at 60 CPS. Noise is 6 uv max. into 1 meg. Weighing 21 gr., it occupies a space of only 0.455 cu. in. The 46A uses a 400 CPS drive.



Type 2557 (60 CPS) and Type 2757 (400 CPS) are DPDT high performance, low noise electro-mechanical choppers with drive leads out the top. Long life (5000 hours), high shock (100 G) and temp. range to 100°C.

The new Ugon relay is a sub-miniature, highly sensitive device suitable for transceivers, missile guiding heads, aircraft equipment and similar uses where fast response, light weight and small volume are demanded.



Airpax relay R40-1 has SPDT contact action, with an operate and release time of 2 milliseconds max. Life is in excess of 100,000 operations, dry circuit condition. Coil power dissipation is 350 milliwatts. Leads are spaced for PCB.

THE ONLY EXISTING TEXTBOOK ON CONTACT MODULATORS



250 pages and 320 fully detailed illustrations discussing chopper circuitry, DC Amplifiers, Computing Amplifiers, Transistor Choppers and a wide variety of associated and important engineering services.

\$5.50

IEEE BOOTH No. 2902

PHONE:
228-4600 (301)

TWX:
301-228-3558

CAMBRIDGE DIVISION AIRPAX ELECTRONICS INCORPORATED CAMBRIDGE, MARYLAND

Insulation of MYLAR® on Sigma relay increases thermal range 50% ...costs remain the same

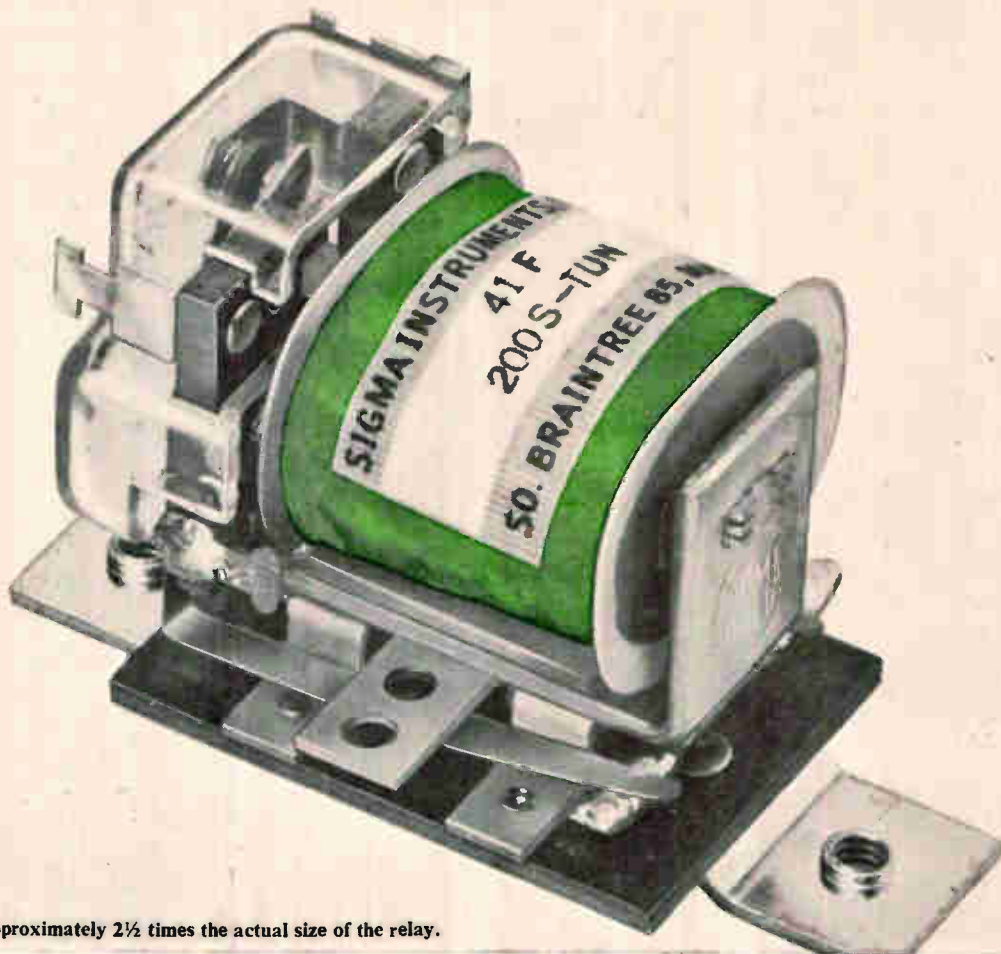

This photo is approximately 2½ times the actual size of the relay.

Sigma met the problem of increased thermal specifications by switching to insulation of MYLAR* polyester film. With its higher temperature rating, MYLAR upgraded the thermal range of Sigma's Series 41 relay by 50%. This surpassed the specifications required and broadened applications for the relay.

In addition, the switch from acetate film to MYLAR in other relays made by Sigma Instruments, Inc., of Braintree, Massachusetts, also meant:

- a smaller coil, since the high dielectric strength of MYLAR permits the use of thinner, more pliable film.
- longer life is designed into the coil by the use of MYLAR, which does not dry

out or change characteristics with age.

• insulation costs remain the same, because less MYLAR is needed for equivalent dielectric strength, as compared with most other insulators.

As a result, relays are now more reliable and versatile and are used in a wide array of applications ranging from furnace flame-out safety controls to automatic traffic and street-lighting controls.



*Du Pont's registered trademark for its polyester film.



For information on how MYLAR can probably help you design a better product—lighter, smaller, lower in cost—mail coupon today.

Du Pont Company, Room 2200B
Wilmington, Delaware 19898
Please send me information about MYLAR®
I am especially interested in its application for

Name _____

Title _____

Company _____

Address _____

City _____ State _____ Zip Code _____

In Canada: Du Pont of Canada Limited, P.O. Box 660, Montreal

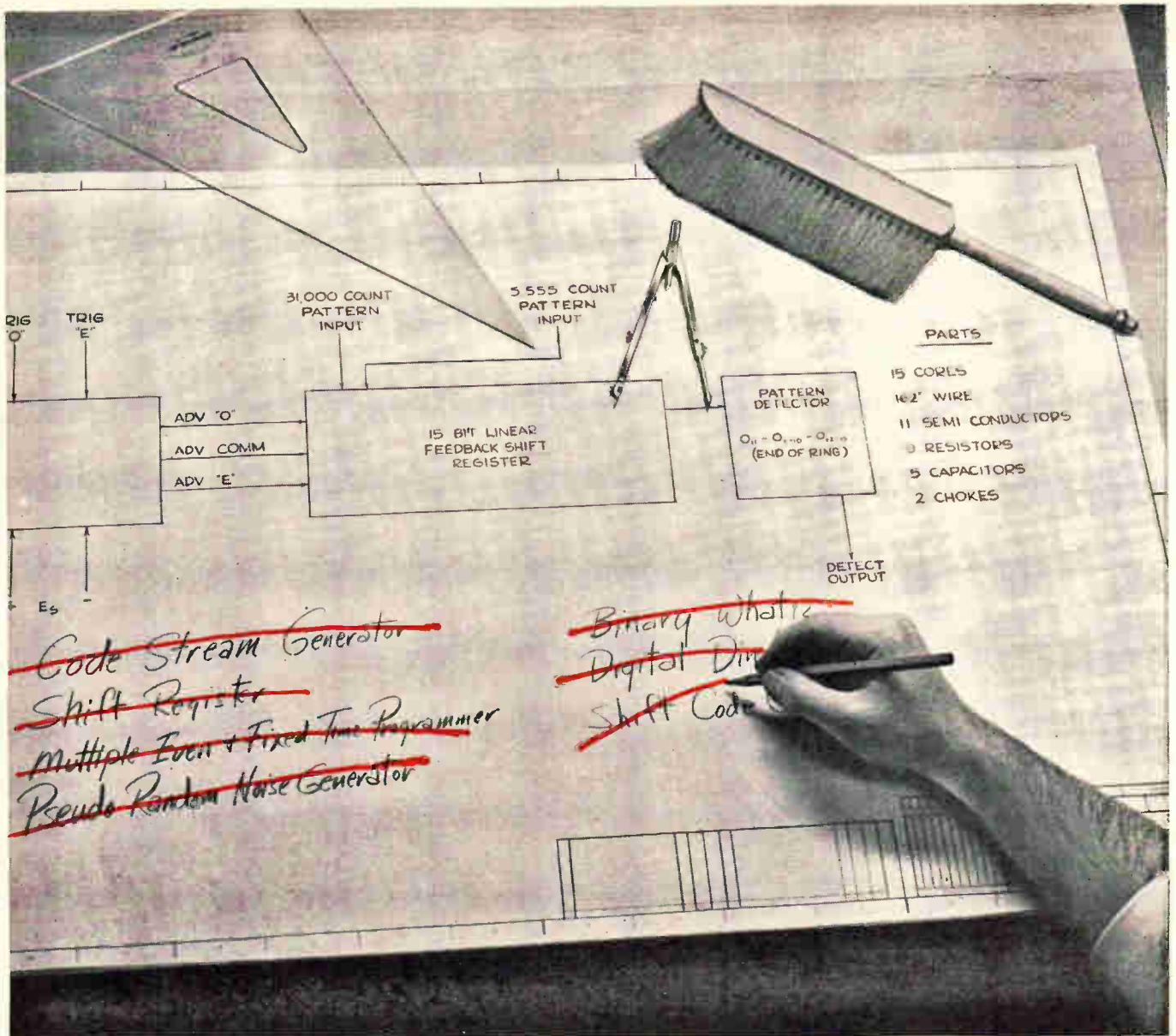

What would you call this?

Check the parts list—Used together they create a unit that generates up to a 32,767 step cycle and signals the end of the cycle.

The consensus among our engineers is that it should be called a LINEAR FEEDBACK SHIFT REGISTER. But they admit it could also be called a Code Stream Generator, a Shift Register Sequence Generator, or even a Pseudo Random Noise Generator . . . depending, of course, on how you want to use it. We're open to suggestions.

No matter what you call it, here's what this compact new assembly was designed to do:

The 15 cores and wire build a ring generator $2^{15}-1$ steps long (a 15 bit magnetic shift register and a magnetic exclusive OR); seven semi-conductors, two chokes, six resistors and three capacitors generate the shift pulses in response to input voltage triggers. Four semi-conductors, two capacitors and three resistors signal the end of the ring. The ring generator can be wired to accept any desired starting pattern up to 32,767 steps from the end. By starting the cycle with a pattern representing a given number of steps from the end point, the device becomes an accurate counter for timing, sorting, programming or control in electronic operations: at count rates of up to 5 Kc.

What's in a name? Plenty, when you see what AMP's magnetic specialists have packed on a $4\frac{1}{2}'' \times 5''$ circuit

board: Part Number 696944-1

- Voltage Range: +24V DC to +32V DC
- Temperature Range: -50° C to +75° C
- Average Current at 1.5 Kc: 50 ma max. at 28V DC
- Average Current at Rest: 0 ma
- Trigger Inputs: +5V min. for 5 μ sec into 1 K Ω load
- Pattern Detect Output: +5V, 1K Ω min. load impedance
- Circuit Board: Double-side printed, glass epoxy with gold plated contacts

Two models are available—0 to 1.5 Kc and 0 to 5 Kc.

When you write for more information, please reference AMP's Linear Feedback Shift Register. We'll know what you mean. And . . . let us know if you come up with a better name.

*Trademark of AMP INCORPORATED



A-MP* products and engineering assistance are available through subsidiary companies in: Australia • Canada • England • France • Holland • Italy • Japan • Mexico • West Germany

Probing the News

Meeting report

Putting integrated circuits in their place

Users at the Solid State Circuits Conference weren't drawn into the hybrid-vs.-monolithic controversy. Cost and performance still determine their choices

The keynote session on "Hybrid vs. silicon monolithic circuits" at the Solid State Circuits Conference in Philadelphia last month was billed as controversial. It was—for manufacturers. Users didn't seem to take sides; their interest was more in how to put integrated circuits into systems than in what kind they were.

Peter B. Myers, director of research and development for the Defense Systems division of the Bunker Ramo Corp., summed it up for the users. He told an interviewer: "Hybrid and monolithic integrated circuits are supplementary, not opposing, technologies. It doesn't cost a user anything to stay uncommitted, but it can be very expensive if you lock yourself in with a choice."

I. The criteria

Though the conference management did its best to keep the pot boiling, most users indicated that their decision is still based on two age-old engineering criteria: cost and performance. Two rules of thumb emerged:

▪ **Cost:** In general, monolithics are preferred when large volumes are needed (unless the user can afford an expensive mechanization program). If volume requirements are low, hybrids usually have the edge when monolithics are not available as off-the-shelf components.

▪ **Performance:** Since monolithic integrated circuits cannot perform well enough for many of today's applications, either hybrid integrated or discrete circuits are sometimes mandatory.

Jobs for hybrids. Throughout the conference, the limitations of monolithic integrated circuits had speakers spotting specific applications for hybrid components.

▪ **Item.** "Hybrid integrated circuits are desirable in low power applications because they allow the use of the big capacitors and resistors that are needed"—in an informal evening session on micro-power circuit technology.

▪ **Item.** "You have to use hybrid integrated circuits in a precision digital-to-analog converter because you need resistors held to tolerances of one-tenth of one percent."—Professor James B. Angell, Stanford Electronics Laboratories, Stanford University.

▪ **Item.** "Hybrid circuits look attractive in microwave applications because they are easier to package."—Jack Kilby, manager, Texas Instruments, Inc.

▪ **Item.** "At circuit speeds around one nanosecond, discretes are still favored because lead length and parasitics make packaging tricky."—Rex Rice, Semiconductor division of the Fairchild Camera & Instrument Corp.

Rice contends that the main reason hybrids are now favored for the difficult circuits—especially linear circuits—is "inadequacies in monolithic-circuit processing techniques."

"Integrated-circuit manufacturers have had to concentrate their

Comparing hybrids and monolithics . . .

Technology Parameter	Thick/Thin Film Hybrid	Monolithic	
		Diffused	Deposited
Resistivity (ohms per square).....	10-100K	100-300 Also 2-3	50-400
Resistor Values (ohms).....	10-500K	50-20K	10-100K
Tolerance.....	½-2%	10-30%	8-20%
Temp. Coeff. of Resistance. (ppm/°C)..	10-300	1000-3000	40-150
Roll-Off Freq.....	1-2 Gc	10-100MC	0.5-1Gc

Technology Parameter	Thick/Thin Film Hybrid	Monolithic	
		Diffused	Deposited
Capacitors (pf).....	1-100,000	10-400	10-1,000
Cap. Tolerance.....	½-10%	15-20%	2-20%
Temp. Coeff. of Capacitance. (ppm/°C).	50-400	1000	50-200
Inductors (μh).....	To 10	None

Technology	1 Gate/Package		3 Gates/Package	
	Monolithic	Hybrid	Monolithic	Hybrid
"Chip Cost" (Unit cost).....	1	3	2	9
Packaging Cost.....	15-20	6	24	7
Total Cost/per circuit.....	16-21	9	9	5



GARLOCK FREE-FLEX* CIRCUITRY

IS THE

FIRST

FLEXIBLE CIRCUITRY
TO BE LABELED BY

UNDERWRITER'S LABORATORIES

UNDER APPLIANCE
WIRING MATERIALS
CLASSIFICATION.

Another Free-Flex* Circuitry breakthrough in the industrial-commercial equipment fields. For more detailed information, contact your Garlock Electronic Products representative, or write direct:

FREE-FLEX* ENGINEERING HANDBOOK

This new handbook gives complete technical and practical data on Garlock FREE-FLEX* Circuitry. Your free copy is waiting, just write to:

*Garlock Trademark

GARLOCK
ELECTRONIC PRODUCTS
CAMDEN, NEW JERSEY 08101

talent on high-volume digital circuits," Rice, an advocate of monolithic circuits, explains. "Now that these lines have been established, we can turn our engineers to linear circuit design and processing. You will now see a very drastic acceleration in the rate at which monolithics take over functions other than digital."

At one session on computer memories, engineers from Motorola, Inc., Norden division of the United Aircraft Corp., and Texas Instruments all reported that their companies were developing lines of monolithic memory drive and sense circuits—types of circuits that now use hybrid technology.

II. In defense of hybrids

Probably the most eloquent advocate of the hybrid integrated circuit was E. M. Davis, manager of component development at the International Business Machines Corp. Davis, who had made the first technical presentation describing the hybrid components in IBM's System 360 computer series last summer, said monolithics are so popular largely because of their potential for reducing the size of components and costs. But he insisted that such potential lies far in the future; today hybrids are superior. "Only hybrid techniques permit the economical production of many of the difficult circuits found in large systems," he said.

No other way. To prove his point, he compared the range of component values available today [see first two charts on p. 125]. Hybrid techniques allow a broad range of resistors and capacitors. Inductors to 10 microhenries are also possible.

He also cited two useful hybrid integrated circuits that cannot be built economically by monolithic techniques at present. One is a four-input gate which operates at $1\frac{1}{2}$ nanosecond speed; the other a memory sense amplifier whose output of 40 milliamperes is controlled to 40 milliamperes. Hybrid circuits were responsible for the speed of the gate and the precise control of the amplifier, he claimed.

Cutting costs. Hybrid circuits can be less expensive than monolithics, primarily because they are easier to package [see third chart on p. 125]. The development of

glass passivating techniques drastically cut the cost of packaging by eliminating the hermetic seal and header normally required. Both IBM and the Burroughs Corp. [see p. 75] can now coat active element chips with glass.

Packaging, almost everybody at the conference agreed, represents by far the biggest portion of costs. Davis pointed out, "Silicon chips which contain one, two or three transistors are so inexpensive, the cost of packaging a circuit is more than the cost of implementing it."

Because the ceramic substrate of the hybrid circuit is always bigger than the monolithic silicon chip, it is easier to connect leads. During the panel session, a member of the audience offered the opinion that IBM's packaging technique for System 360 components put hybrid integrated circuits far ahead of monolithics for practical applications.

Making a choice. Davis concluded his presentation with a rule of thumb for choosing hybrid or monolithic integrated circuits. The key, he said, is the ratio between the number of active and passive components. If the ratio is small, hybrid integrated circuits are probably preferred; if more active elements are needed, the choice is probably for monolithic.

III. The case for monolithics

Following Davis to the podium was E.A. Sack of the Westinghouse Electric Corp.'s Molecular Electronics division, speaking for monolithic integrated circuits. He started by attacking the high cost of automation required to build hybrid circuits in volume. After seeing the film Davis showed to illustrate how IBM System 360 components are built, Sack had quipped, "All of you who have \$100 million for automation equipment don't have to hear any more."

Sack's argument was based on two predictions. He forecast early improvement of the four major batch processes by which most monolithic integrated circuits are produced; this will cut costs by increasing yields, he said.

And he predicted rapid acceleration of a trend to incorporate more devices on a single chip. Monolithic techniques are compatible with such a trend; hybrid circuits are not compatible. Sack thinks costs of

monolithic integrated circuits will be cut by 80%.

Wave of the future. To Sack, the wave of the future is the multigate functional block. He said, "In integrated circuits, we get transistors for less than one cent apiece . . . With active elements practically free, we'll see a lot of startling designs." One device he believes the industry is ready to offer is a 30-gate add-subtract on one chip in one package. Currently, several companies offer devices which have six gates on a single chip.

Though almost everybody agreed with Sack's thesis, the stumbling block may be packaging. Gordon Moore, director of research at Fairchild's Semiconductor division, one of the panelists who answered questions after Davis and Sack spoke, called packaging "about 90% of the cost."

IV. The supply problem

One questioner asked if much of the defense of hybrid circuits weren't academic; few companies supply them, he noted, and one of the biggest makers, IBM, won't sell them to outsiders. Although no panel member cared to rebut the statement, evidence is building up that the number of suppliers of hybrid circuits is about to increase.

At the IEEE show later this month, for example, both Burroughs and Varo, Inc., will introduce new lines of hybrid circuits. The General Instrument Corp. is preparing a line of hybrid components for consumer devices; only production problems will block its introduction at the show. These companies will join such concerns as the Sprague Electric Co., (which builds custom circuits by hybrid techniques), Digital Equipment Corp., CTS Corp., National Semiconductor Corp. and Hughes Aircraft Corp., which already supply hybrid circuits.

After the session, Prof. Stephen Angello of the University of California at Santa Barbara offered an opinion that the two technologies were slowly merging. He said, "Hybrid makers are using more monolithic techniques and the monolithic makers are going to have to use more hybrid interconnection techniques. Eventually, we'll have a difficult time distinguishing between what is a monolithic and what is a hybrid integrated circuit."

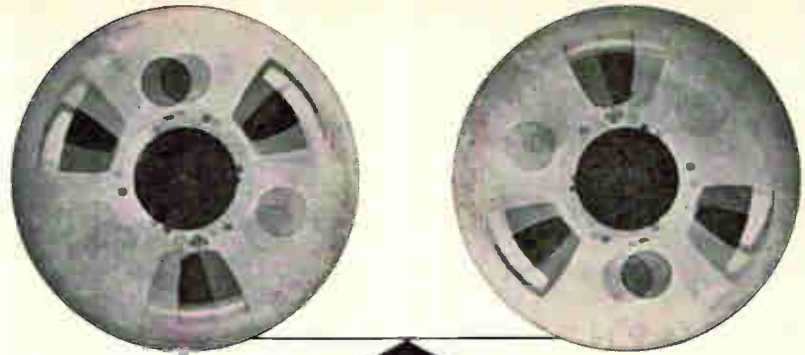

093857

Locate taped data fast!

The EECO 858 Time Code Generator/Reader is the low-cost, practical answer to referencing large volumes of analog data . . . and finding any desired segment quickly. It generates a modified IRIG code (Format B less days) and reads out hours, minutes and seconds on high visibility digital read-out tubes.

To accommodate a wide range of applications, you can vary the read rate from 1/20 to 200 times the record speed . . . and read in reverse, too! While generating or reading the mag tape code, the 858 simultaneously produces slower codes for recording on oscillographs or strip charts . . . a parallel time code for digital data acquisition systems . . . and four pulse rates to control analog multiplexers, etc. Actually, the 858 makes any analog tape deck into a com-

plete time marking and manual search system.

For a fully automatic search system, you can add the EECO 859 Automatic Search Unit.

And, because of dual use of most circuits, the 858 costs little more than you'd pay for either a generator or reader alone . . . Prices start around \$4,000! The 858 is one more good reason to look to EECO for precision timing products . . . automatic programming equipment . . . test instrumentation . . . data handling equipment . . . and complete timing and data systems.



See us at IEEE Show, Booth 95, New York Hilton



EECO's "2-in-1" instrument time-references analog data as it's recorded on mag tape... then, as fast as 200 times the record rate, finds the data segment you want



Write... wire... or phone

Electronic Engineering Company of California

1601 EAST CHESTNUT AVE. • BOX 58 • SANTA ANA, CALIF. • KIMBERLY 7-5501

2½ ounces light; and only this big...

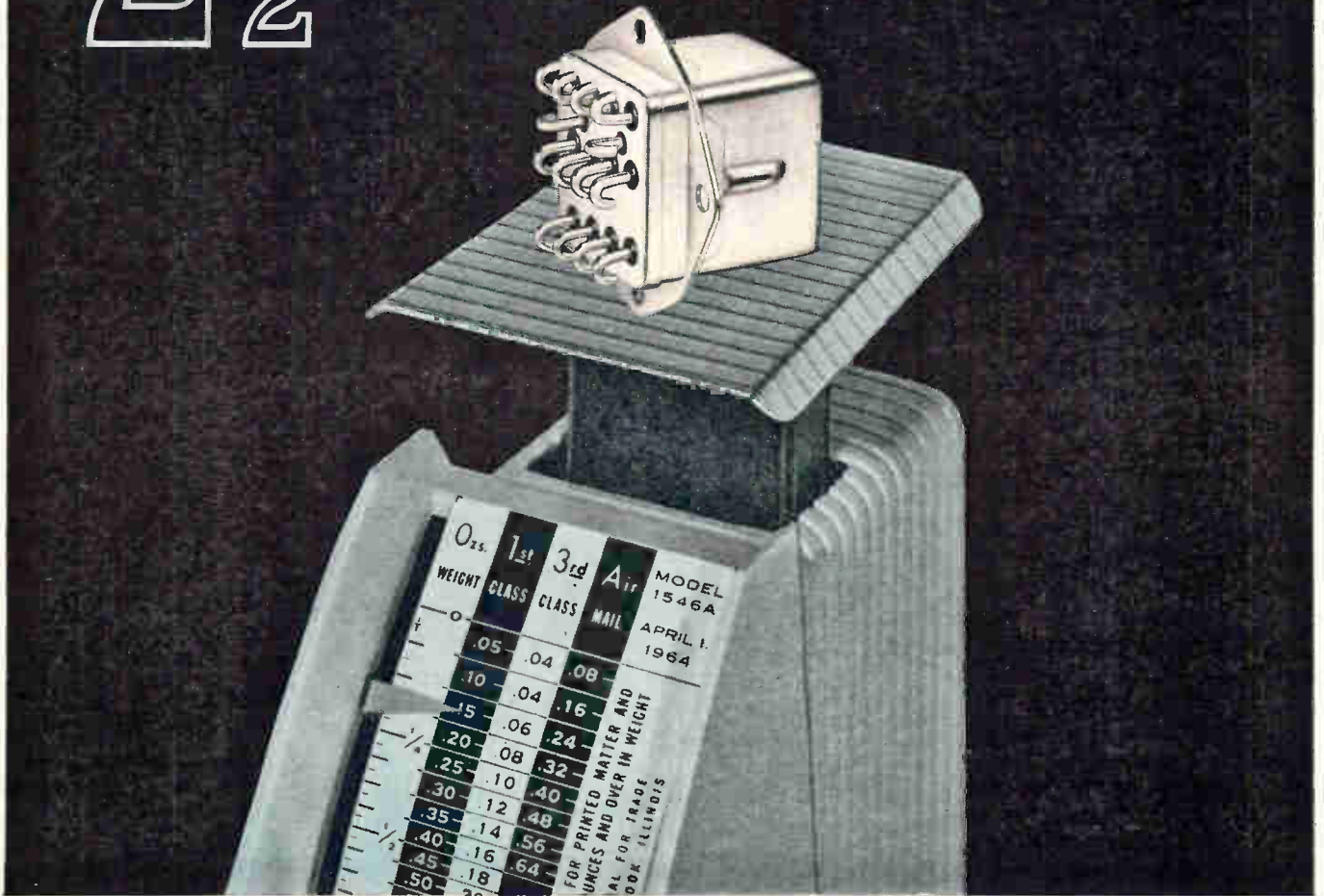

yet it switches 10 amps

Want to save size? Or weight? Or both? This new Guardian series 4005 relay is the smallest 4PDT relay commercially available that will switch a *three-phase* 10 ampere inductive or resistive load for its full rated life with case grounded. Or it will handle a 5 amp. motor or a 3 amp. lamp load. It's rated 28VDC or 115 or 115/200V 400 cycle AC. All this in a relay weighing less than 2½ ounces and occupying a space only 1.14" x 1.125" x 1.03". ■ Other features? You bet! It has a full 1500 volt RMS dielectric insulation. Internal soldered connections have been minimized. And it meets or exceeds MIL-R-6106-D with no restrictions on overload or rupture tests. ■ The Guardian series 4005 specification sheet shows mounting dimensions and gives complete electrical and mechanical information. Send for your copy now without cost or obligation. Guardian Electric Mfg. Co., 1550 W. Carroll Ave., Chicago 7, Ill. Dept. EC-53.

GUARDIAN®  ELECTRIC

Direct digital control systems, biomedical engineering in spotlight

Both rapidly-emerging technologies will be subjects of conference symposia; DDC hardware to be described

The first experiment in direct digital control for industry was carried out at a Monsanto Co. plant in Texas City, Tex., only three years ago. Minnesota Mining and Manufacturing Co. offered the first commercial system a year and a half ago. Yet DDC has come of age; 18 firms will take part in a three-session symposium at this year's IEEE show and the emphasis will be on hardware currently on the market.

Biomedical engineering has also bloomed into an important field for electronics; but at present the field is at a plateau. Two sessions will be held in a Symposium on Artificial Organs, Prosthetic Devices, and Sensory Aids. The aim is to survey achievements and future needs in the hope of attracting new technicians to the field, which needs new ideas.

I. Turn to digits

Direct digital control systems replace analog systems with a digital computer. The computer can handle a number of control loops on a time-sharing basis; it provides both monitoring and closed-loop control ranging from simple on-off set point operations through the optimizing of an entire industrial complex.

Considering their scope, DDC systems are not expensive, which is one reason that they have gained acceptance so quickly. Another is that analog systems and digital supervisory optimizing systems have definite limitations. DDC is simpler and requires less-complicated programming than supervisory.

Telling the world. The DDC sessions are likely to provide most of the public information on the subject this year, because new users of the systems do not yet have much to say. Dr. Theodore J. Wil-

liams, senior engineering supervisor at Monsanto and the man who did more than anyone to develop DDC, told Electronics that

potential users would find the systems already available impressive. Dr. Williams indicated that the user would have to match the

Program for direct digital control sessions

The Direct Digital Control symposium at the IEEE show will be held in three sessions. At the first:

Ferranti Ltd. will discuss its hardware and experience with DDC. The company recently sold six systems to Imperial Chemical Industries Ltd. in England.

Foxboro will report on DDC experiments. This company gets computers from the Digital Equipment Corp. and supplies complete systems; it has sold at least two, one of which is now being installed at a Standard Oil Co. of New Jersey plant.

Westinghouse, which has its own computer, will talk about its application to DDC. The company already has sold a two-computer system to Monsanto.

IBM will discuss its control system for DDC. It announced hardware last year.

Honeywell, which also has its own computer—and uses thin-film components in its system—will talk about what it feels is a new approach to DDC. The company recently sold a system to the Shell Oil Co.

Digital Equipment Corp. will provide information on closed-loop digital control of a nuclear reactor. This company uses a type of chip circuitry in its computer; it is supplying Foxboro as well as selling its own full system.

At the second session:

Bunker-Ramo will discuss its system, which uses a computer built by Computer Control Corp. That company will sell the computer to any systems builder.

General Electric may introduce an integrated circuit computer for DDC. GE claims that its integrated software-hardware design provides a "total systems approach" to DDC.

Leeds & Northrup will discuss its system, which employs a computer built by Scientific Data Systems.

Control Data Corp. will give a paper on "The Heart of DDC."

Systems Engineering Laboratories will discuss preset and digital control of a steel mill. The company is expected to show a new DDC system.

At the third session:

E-A Industrial, which is linked to the British firm, Elliot Automation, will discuss its limited multi-level system, which uses a simple digital computer. The system cannot carry out some complex tasks, such as adaptive or feed-forward control. Its design permits strict replacement for analog controllers.

Fisher & Porter will talk about a new DDC system, of limited capability, to replace an analog system.

Minnesota Mining and Manufacturing will discuss a flexible DDC system.

Data Systems, which was recently acquired by Union Carbide, is expected to offer an integrated DDC system with attractive specifications at a low price. Union Carbide will use the equipment, and also make it available to other users.

Taylor Instruments will talk about a single-loop two-mode system which is a digital replacement, loop for loop, for an analog system, rather than a multiplexed system.

Allis-Chalmers and Electronic Associates, Inc. listed earlier as participants, have withdrawn.

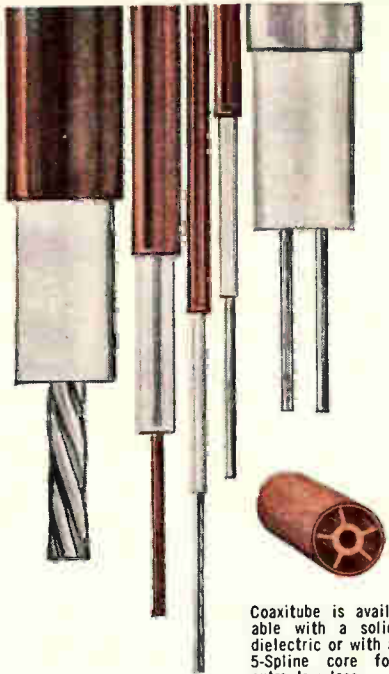

Coaxitube is available with a solid dielectric or with a 5-Spline core for extra low loss.

For Better RF Transmission COAXITUBE

Tubular-Shielded Coaxial Cable

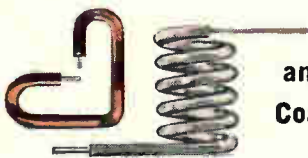

and Pre-Fab
Coax Shapes

For VHF and UHF transmission lines, where perfect RF shielding, excellent frequency response, and low attenuation are important considerations, Precision Coaxitube tubular-shielded coaxial cable is the ideal choice. It is comprised of a solid or stranded inner conductor, insulated with dielectric of Teflon or polyethylene, and covered with a seamless, non-ferrous metal jacket. The resulting coaxial cable construction is impervious to moisture, and has uniform electrical properties which surpass those of conventional braid-shielded cable. Coaxitube is offered in types equivalent to all the standard RG/U cables. Ask for more data.

Phone or write for prices
to your specifications

PRECISION
TUBE COMPANY, INC.
North Wales, Pa.
215-699-4806—Telex: 083-381

speed and inventiveness of the manufacturer, who has come from nowhere in three years. "DDC gives both parties a chance for innovation and application which should revolutionize the field of process control," he added.

II. Four approaches

Essentially, the papers presented will deal with hardware and problem-solving. Companies presenting them divide into four groups:

- Those using DDC to enter new markets. Examples are Minnesota Mining and Manufacturing, Systems Engineering Laboratories, Inc., Union Carbide Corp. with Data Systems, Inc., and E-A Industrial Corp. All make complete systems.
- Those adding DDC to their line of process control systems. All offer complete systems, and most make their own computer main frames. Examples are Ferranti Ltd., of Britain, International Business Machines Corp., Bunker-Ramo Corp., General Electric Co., and Control Data Corp.
- Old-line industrial instrument makers, such as Leeds & Northrup Co., the Foxboro Co., Honeywell, Inc., Taylor Instrument Co., and Fisher & Porter Co.
- Companies building computer

main frames, the heart of DDC systems, but staying away from end-use systems. These include Digital Equipment Corp., Computer Control Co., and Scientific Data Systems. The latter, for example, sells main frames to Leeds & Northrup. These companies consider input-output systems to be money-losing operations. Most are eager to supply more than one manufacturer.

III. Mixed disciplines

Biomedical engineering draws on a number of technologies other than electronics; among them are chemistry, hydraulics, pneumatics—and, of course, medicine. This interrelationship of many disciplines is shown very clearly in the papers to be given at the symposium on artificial organs, prosthetic devices, and sensory aids.

Among subjects of interest are:

- A booster heart that has been connected to conscious dogs for 41 hours continuously. Dr. Adrian Kantrowitz of the State University of New York College of Medicine will describe his device, which he calls an auxiliary ventricle. It provides long-term assistance to a failing heart. The booster is timed by an electrocardiogram wave which triggers an electronically-

Space electronics

Beefing up moon photos

Computer technique perfected on the Ranger 7 shot helped improve resolution of Ranger 8 pictures

By William B. Wallace

Los Angeles Regional Editor

When Ranger 8 swept across the face of the moon into the Sea of Tranquility Feb. 20, its low angle of descent (about 42°) caused blurring and reduced the resolution of the pictures it sent back to earth. Scientists were deliberately trading resolution quality for a gain in other factors—such as getting a better three-dimensional effect.

That they were able to make the swap was due in part to Ranger 8's better cameras [Electronics, Feb. 22, p. 60] and in part to a computer technique of improving resolution developed by Robert N. Nathan of the Jet Propulsion Laboratory.

Rocket bearing Ranger
lifts off from Cape Kennedy ▶

controlled solenoid valve on a compressed-air tank. A number of materials, such as Silastic 372 reinforced with Dacron, and polyurethane coated with other materials are being tested to prevent clotting problems. A battery-operated power unit has also been developed, to bypass the air tank, and is being evaluated.

▪ The cybernetic aspects of medical orthotic (assisting) and prosthetic (replacement) research will be discussed in a two-part paper by Dr. R. W. Cornell of the University of New Hampshire, and Dr. J. B. Reswick and Dr. L. Vodovnik of Case Institute of Technology. An overview of man and machine control theory will be followed by a detailed study of the Case Research Arm-Aid, a basic research tool that supplements arm muscles and has clinical applications far in the future.

This is the first time the cybernetic concepts of the arm-aid will be reviewed. It uses a numerical control system similar to some machine tool controls.

The paper will also discuss an artificial neural bypass system with which a patient who has lost limb control can use shoulder motions to provide information from useful to paralyzed muscles.

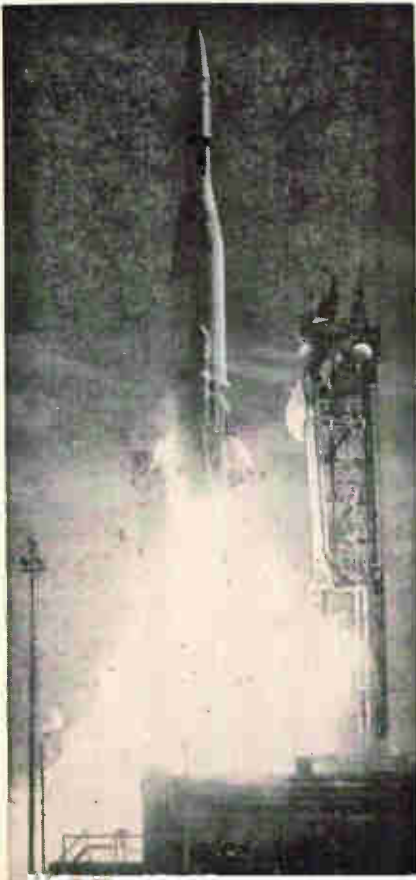

**PULSE
YOUR
IF**



**KAY
5070-B**

10-120 mc **PULSED** rf Signal Generator

The 5070-B is a fully transistorized pulsed carrier generator with a pulsed output that provides sharp rise and decay, and flat tops; 80 db OFF-LEVEL.

10-120 mc cw Oscillator

The unit also provides a stable cw signal from 10 mc to 120 mc—continuously—in five overlapping bands. A direct reading frequency dial is calibrated to $\pm 1\%$. The front panel meter of the 5070-B monitors the cw rf output continuously

and a toggle switch attenuator provides 1 db steps of attenuation to a total of 101 db.

- 100 ns to 100 μ s Pulse Generator
- 10 ns rise, 80 db off

RF output of the 5070-B is held at the same peak levels during either cw or pulsed rf operation. Carrier pulses are flat (including overshoot) within $\pm 5\%$ and rise and decay times are less than 10 ns.

SPECIFICATIONS

CARRIER FREQUENCY RANGE: 10 to 120 mc with a direct reading dial in 5 overlapping ranges with an accuracy of $\pm 1\%$.

OUTPUT AMPLITUDE: 0.5 volts rms into 50 ohms; video pulse—plus or minus 3 volt peak into 50 ohms.

CARRIER-OFF LEVEL: 85 db to 30 mc, 80 db to 70 mc, 70 db to 120 mc.

PULSED CARRIER RISE AND DECAY TIMES: Less than 10 ns.

VIDEO PULSE RISE AND DECAY TIMES: Less than 20 ns.

PULSE REPETITION RATE: 50 pps to 5000 pps.

PULSE WIDTH: 100 ns to 100 μ s.

ATTENUATOR: 101 db in 1 db steps plus approximately a 6 db continuous variation.

SYNC OUTPUT: 2.5 volts peak into 50 ohms with 20 ns rise time. Sync pulse precedes the output pulse by approximately 40 ns.

EXTERNAL TRIGGER INPUT: Approximately a +2 volt pulse required.

PRICE: \$875.00

VARIABLE RISE AND DECAY CONTROL AT EXTRA COST

For Complete Catalog Information, Write

KAY ELECTRIC COMPANY
PINE BROOK, MORRIS COUNTY, N.J.

**YOU CAN SPLIT LOGS,
hairs, votes, and some
heat-shrinkable tubings,
BUT YOU CAN'T SPLIT**

FLEXITE SHRINKDOWN



PLASTIC TUBING

when properly selected from these four grades and applied according to Markel recommendations:

1

HT-105, Flexible Class A (105°C) Shrinkdown
Extruded tubing similar to Flexite HT-105; outstanding dielectric properties; adaptable for many uses; it shrinks at less than 200°F.

2

SD-105, Semi-Rigid Class A Shrinkdown
For uses where greater mechanical strength and rigidity are needed, and over components sensitive to higher than 200°F temperatures.

3

PD-135, Flexible Class B (130°C) Shrinkdown
Thermally stable tubing of specially formulated polymers; excellent electrical, chemical and oil resistance. Shrinks at 235°F. Meets MIL-I-23053 (wep), Class I.

4

TE-250, Flexible Class C (250°C) Shrinkdown
Of modified polytetrafluoroethylene; offers exceptional electrical, thermal, and chemical-resistance properties. Shrinks at 621°F.

Markel customers are saving many dollars and much valuable time with these magic tubings that shrink 50% in diameter with the flash of a heat gun—adding a sheath of mechanical and electrical protection over terminals, connectors, cables, components, and other irregular shapes. Let's see how this idea could serve you; write for technical data and samples.

L. FRANK **MARKEL** & SONS
SINCE 1922

ONE SOURCE FOR EXCELLENCE
Insulating Tubings and Sleeveings
High Temperature Wire and Cable
MORRISTOWN, PENNSYLVANIA 19404

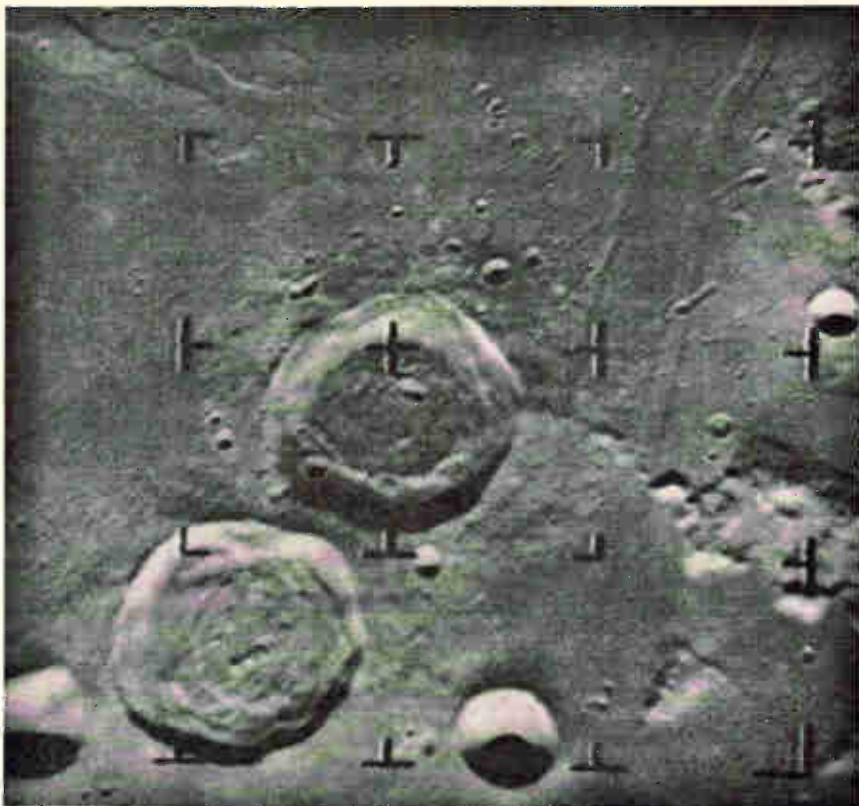

Ranger 8 moon photo was taken from 151 miles up.

Dr. Nathan is the man who wasn't satisfied with Ranger 7's pictures—even though they were five times better than any moon photos ever taken [Electronics, Aug. 10, 1964, p. 17]. After some setbacks, he proved his point by doubling the quality of those pictures. And when Ranger 8 came along, his techniques were good enough so that the new pictures could be computerized as they came in.

The project began 3½ years ago, when Nathan first saw the Russian

pictures of the moon's far side. "I was certain we could do much better," he says. "It was quite clear that extraneous signal noises had distorted their pictures and severely handicapped analysis."

The problem was to attenuate the noise interference. The solution bore some additional advantages.

Ranger 7 carried six cameras: two full-scan, f-type and four partial scan, p-type. Both types contain a one-inch vidicon; but the f-type has 1152 scanning lines in an 0.44 square inch format and

Dr. Robert Nathan (left) and Robert Selzer of the Jet Propulsion Laboratory check computer output of moon photo resolution technique.

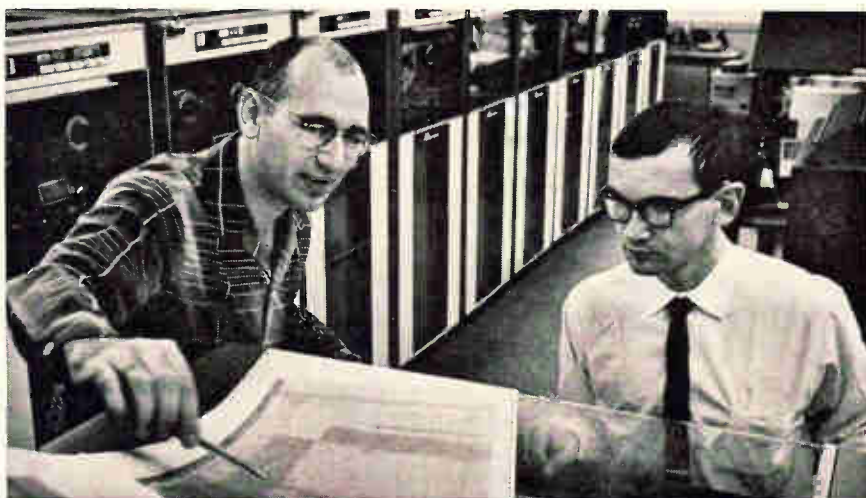



"Follow the man from Schiller Park.

**He's showing a new Portable
Dynograph® Recorder at IEEE.
It's priced under \$1,300.
You ought to see it!"**

Visit Booth 3407. Learn how you can save \$500 or more on your next 2-channel direct-writing recorder. It's available with ink curvilinear, ink rectilinear or heat rectilinear recording media. It weighs less than 40 pounds,

provides millivolt sensitivity, extreme ruggedness and maximum operator convenience. If you can't see it at IEEE contact your local Offner Division Sales Engineering Representative or write for Data File 718.

Beckman®

INSTRUMENTS, INC.

OFFNER DIVISION

SCHILLER PARK, ILLINOIS • 60176

INTERNATIONAL SUBSIDIARIES: GENEVA, SWITZERLAND; MUNICH, GERMANY;
GLENROTHES, SCOTLAND; PARIS, FRANCE; TOKYO, JAPAN; CAPETOWN, SOUTH AFRICA



550
500
450
400
350
300
250
200
150
100
+50

**GLASS CLOTH
INSULATING
TAPE
WITHSTANDS
PHENOMENAL
TEMPERATURE
EXTREMES!**



0°-F
-50
100
110

Mystik 7000 Hi-Lo Temperature Glass Cloth Tape provides 4000 volt dielectric strength throughout a temperature range of -110° F to $+550^{\circ}$ F. Completely inorganic, it has a tightly woven, high tensile glass cloth backing and pressure-sensitive silicone adhesive. High temperature insulation for motors, generators, electrical equipment and appliances are but a few of its many applications. Printable, too! Mystik 7000 is just one of a host of special purpose Mystik electrical tapes you should know about. Call your Mystik man now or write Mystik Tape, Inc., Northfield, Ill.



FREE SELECT-A-TAPE SAMPLE GUIDE!

Takes the guesswork out of tape selection. Gives physical characteristics of all Mystik tapes, typical applications and sizes, principal advantages. Send for your copy today. MYSTIK TAPE, INC., 1700 Winnetka Ave., Northfield, Ill.

NAME _____
 COMPANY _____
 ADDRESS _____
 CITY _____ STATE _____ ZIP _____



the p-type cameras scan 300 lines in an 0.11 inch format. One f-type and two p-type cameras have 75 mm f:2.0 lenses; their light sensitivity was improved in Ranger 8 by increasing the signal intensity. The other lenses, 25 mm f:0.95, were unchanged in Ranger 8.

I. Point by point

The camera signals come directly from the tape in combined form. They are demodulated, and each channel is digitized. The computer sees a partial-scan picture as 300 lines with each line divided into

The big picture

Some scientists doubt that it will be possible to determine the nature of the moon's surface from any pictures—no matter how good. After studying Ranger 7 pictures, the consensus was that the surface would support a landing; with Ranger 8's 7,000 pictures as additional evidence, the experts aren't so sure. The initial consensus is that the surface may be volcanic—and therefore very dangerous—under a dust-like cover. Dr. Gerard P. Kuiper of the Lunar and Planetary Laboratories at the University of Arizona says, "Ranger 8 pictures indicate to me that the surface may be a frothy material; however, there is no way of determining if it is hard underneath. We will have to wait for the Surveyor mission—or even Apollo."

Surveyor is a soft-landing probe. Apollo will be manned.

300 points so that the resultant computer view of the picture is similar to a newsprint half-tone engraving.

The computer converts the 90,000 points that make the picture into 90,000 six-bit words. This provides 64 possible degrees of shades between dead white and black for each point. A new tape of the digitized signal is made and then processed through a link film recorder.

When the system was first used with Ranger 7 pictures, the results were disappointing; the quality of the picture appeared to decrease rather than increase. Close examination, however, revealed that an increase in picture resolution had brought up noise interference not discernible in the original cathode ray tube reproduction.

II. Noise problem

Nathan analyzed the interference pattern and determined that it was caused by an oscillator in the vidi-

con erasing system of an adjacent camera. Through computer analysis, he developed the noise pattern and was able to produce a picture of the noise alone. By nulling the pattern signal, he was able to remove the noise from the picture, and thus achieved the improvement he sought.

Other noise interference that can be removed or greatly reduced includes the mesh noise that is detectable in calibration pictures, ghosting noise caused by retention of previous image on the vidicon, and clamp-error noise causing a shift of intensity for the whole video line. The distortion-correction crosses and other such fiducial marks can also be removed.

The digitized tape might save otherwise lost pictures. It will be much easier to find the line sync in a weak signal. If a picture should fall out of sync and be ripped into unintelligible confusion, it might be salvagable on the new tape. Correction for photometric distortion caused by nonuniformity in camera sensitivity will be possible, as will correction for geometric distortions caused by non-linear sweep deflection in the camera.

III. Photometric usage

Various photometric functions, such as enlargement of selected portions of the picture or correction of geometric distortion caused by a low angle of picture taking, are possible. A major advantage of computer enlargement over photometric enlargement is the quality of definition. In photometric enlargement, the film grain is enlarged along with the image, and there is a loss of definition. When enlarged by the computer, the beam size of the film recorder remains the same regardless of the enlargement factor.

Although the link recorder has a beam nearly twice the diameter of the RCA recorders from which the initial pictures come, a quadruple enlargement would have half the loss of definition since the enlargement from the RCA picture would have to be made from a photograph of the tube face and the beam width would be enlarged with the image.

Picture contrast can be adjusted if desired, and contrast control can be used to enhance the image if

"WHERE'S THAT TAPE OF 'THE ALLIGATOR GLEE CLUB AT CARNEGIE HALL'?"

Oh, hello Rip! You got here just in time. Drop that demo on the bench and listen to this tape. It's part of a new batch that Station 16 just sent in — even worse than the ones I was telling you about.

Worse? I'll say! Sounds like a sped-up playback of "Concerto for Seagulls and Fish Pier"! But I thought you said you were getting groans and burps?

That's what's rough — the stations NEVER know what kind of interference they'll get next! You told me I don't need two separate filters — how is this one Krohn-Hite black box going to clear up the confusion?



Because the 315-A is two filters . . . matter of fact, three, on one chassis. As I get it, your radio-telephone transmissions are being loused up by all kinds of noise and interference — above, below, or right in the middle of the intelligence band, and never in the same place twice. Now start that "Screaming Meemy" tape again, while I plug the 315-A into the monitor output and listen through the filter with these earphones. At the stations, they'd do just about the same on live transmission, except that when they had set the filter to maximize the intelligence, they would just switch it right into the line at any convenient a-f stage. . . . I see what you mean — I can barely make out the voice, with a horrible hash above it and below it too. Now let me switch to band-pass, and move in from the ends with both cut-offs independently. I'll spin through that top decade below 200 kc fast, since for this work you'd never hear the difference. But I just dropped out a thump somewhere down around 30 cycles — probably someone chopping liver! Here you are . . . listen to this . . . clear as a bell!

So far so good. But keep listening. Just about here I think a pig got stuck — skewered real good at about 2 kc. Watch the gain!

Owwwww — I just found it! Quick — let me find a real DEEP null for my aching ears! We turn to band-reject, sneak in from the sides with both dials, and . . . I think somebody just told that pig "down boy! 60 db down!!" Listen for yourself. That makes both types we've cleaned up!

I think you've just made yourself a sale. But wait a minute — you said the 315-A is THREE filters. What's the third function?

High-pass! ALSO tuneable all the way from 20 cps to 200 kc, with the same 24 db per octave attenuation outside the pass band. And if you ever get squawk patterns in the same spots, don't forget — the dials are direct reading and calibrated to 10%. Log 'em and kill 'em fast. Now — how about lunch to celebrate, at a low-decibel restaurant?

I'm with you!



**KROHN-HITE
CORPORATION**

580 Massachusetts Avenue, Cambridge 39, Mass.
Area Code 617 491-3211

Pioneering in Quality Electronic Instruments

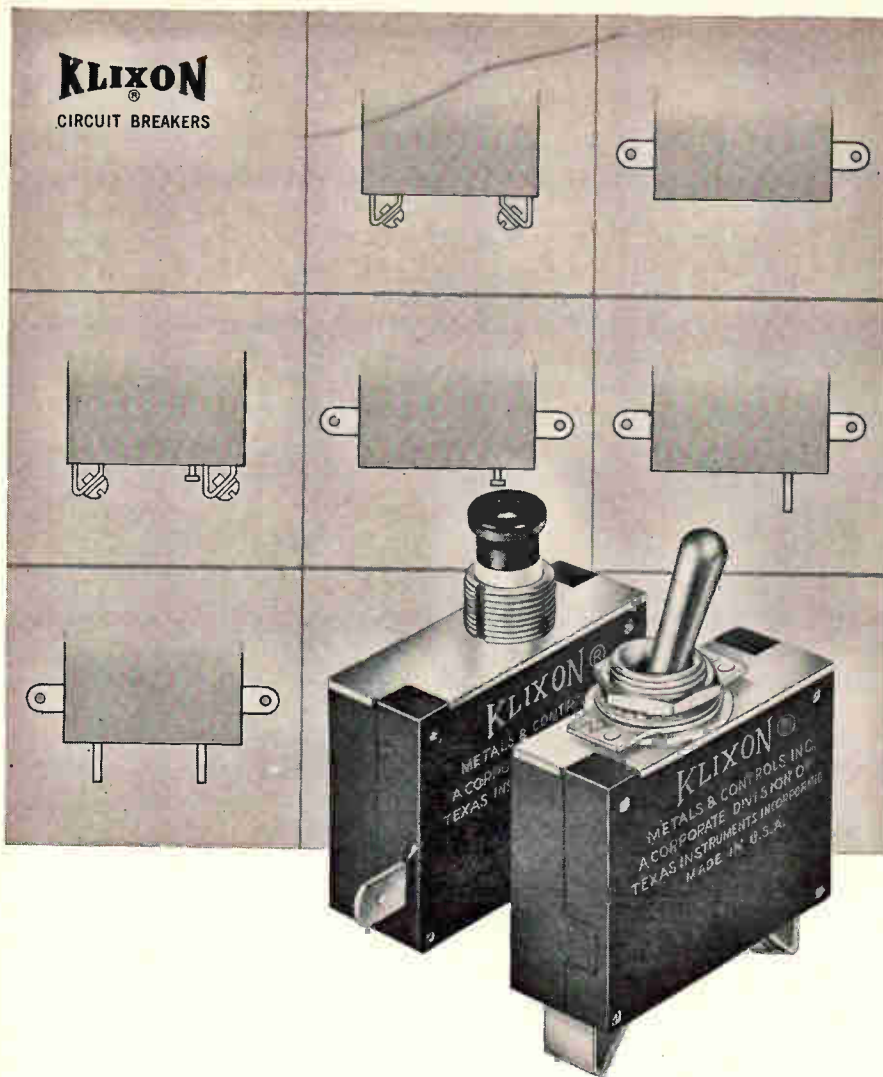

When magnetic circuit breakers must give you design freedom ...TI DELIVERS!

No other magnetic circuit breakers match the scope of design options offered by KLIXON® 2MC (toggle) and 3MC (push-pull) Series Circuit Breakers . . . the only units of their type with both kinds of actuation.

Among the 132 standard types, you'll find such options as: ratings from 0.050 to 20 amp; two, three or four terminals with either quick-connect, solder or screw-type termination; internal circuits for series shunt, calibrating tap or relay trip; remote indication or control, instantaneous or time-delay trip.

Bulletin CIRB-28 gives you all the information you need to evaluate these trip-free, off-the-shelf magnetic circuit breakers. Get a copy today from your distributor or TI in Attleboro, Mass. For immediate information call: Harold Damberg, Sr. Product Engr. at 617 222-2800.

DISTRIBUTORS

CALIFORNIA, Culver City
Western Electromotive, Inc.

FLORIDA, Miami
Aviation International Corp.

ILLINOIS, Chicago
Newark Electronics

MASSACHUSETTS, Canton
Engineering Supply Company

MASSACHUSETTS, Natick
Lafayette Industrial Electronics

MISSOURI, Kansas City
Engineering Supply Company

NEW YORK, Lynbrook, L. I.
Peerless Radio Corp.

OHIO, Cleveland
Pioneer-Standard Electronics, Inc.

OHIO, Dayton
SREPCO, Inc.

OKLAHOMA, Tulsa
Engineering Supply Company

OREGON, Portland
Almac Electronics Corp.

TEXAS, Dallas
Engineering Supply Company

TEXAS, Houston
Engineering Supply Company

WASHINGTON, Seattle
Almac Electronics Corp.

KLIXON
CONTROL PLANTS IN
Attleboro, Mass. • Versailles, Ky.
Richmond Hill, Ontario
Holland • Italy • Australia
Argentina • Brazil • Mexico



METALS & CONTROLS INC.
5003 FOREST ST., ATTEBORO, MASS.
A CORPORATE DIVISION OF
TEXAS INSTRUMENTS
INCORPORATED

the range of contrast causes some detail to drop out. By dropping out some of the shade values at either end of the spectrum, the lost details can be brought up at the other end by assigning binary word values to smaller increments of shade. As an example, using full contrast from white to black, seven degrees of shade may appear between two specific shades; with the shifted scale that never reaches full white or full black, 10 degrees of shade may occur between the same two shades.

Desert station tunes in

It's predawn in the Mojave Desert in California; chilly, dry, serene. An 85-foot dish stares silently at the moon, its tracking movement barely perceptible.

The quiet scene belies the electric tension that men feel as they await the moment when an historic threshold may be crossed. Inside a low building in the shadow of the antenna, more than 20 engineers and technicians turn dial and crowd around monitoring machines to await pictures scheduled to be made 240,000 miles away. The images will be sent by three transmitters situated inside a cone-shaped can about the size of a tv camera and tripod, weighing 808 pounds and speeding along a collision course with the moon.

A man wearing a colorful sport shirt yells: "Here comes the first one—it looks good!" It's the start of a 7,000-picture stream, closeup after closeup as the six cameras zoom in on their lunar subject. A cheer goes up; then the crew at the Goldstone Deep-Space Tracking Center settles down to the routine of recording pictures from tv screens.

Those pictures wouldn't have been possible without the down-to-earth engineering at that desert station.

I. Double redundancy

The receiving system, first used in July for Ranger 7's flight to the moon, uses two receivers to pick up the same f-m signal. According to the Radio Corp. of America, prime contractor for the equipment, it's a combination of the two analog signals being transmitted from the two types of cameras aboard the spacecraft.

The combined signal is received, amplified and fed into tape decks, each of which records the signals from both receivers on two different tracks. Thus the single, combined signal from Ranger is recorded in four different places.

In addition to being fed to the tape decks, the amplified signal is fed into a demodulator that separates the two video signals. The signals are processed

Initial experiments make it seem probable that contour maps of the lunar surface can be automatically drawn from the Ranger pictures. JPL experimenters reasoned that the varying shades of gray are related to the slope of the terrain. They hope to be able to establish provable correlation between specific shades and altitude. Several experimental contour maps have been made using this theory; they appear about as would be expected, though there are one or two deviations still unexplained.

on the moon

for framing and synchronization, and fed into two film recorders. Each film recorder consists of a cathode-ray tube, a 35-millimeter strip camera looking at the screen through an image divider, and a Polaroid camera looking at the screen from the other side of the divider. A viewing port is also provided; however, the picture trace on the screen is so slow that initial elements start to fade before the picture is fully traced, and the human eye is incapable of perceiving the complete picture. This is why the Polaroid camera is used to monitor the pictures on the screen.

II. Cameras synchronized

Two full-scan cameras on Ranger are full frame; each picture fills one frame and contains 1,152 lines. Each full-frame camera transmits a picture every 5.12 seconds. One camera erases its vidicon and prepares for the next picture while the other camera scans its vidicon and transmits the picture. Pictures from the four partial-scan cameras are quarter-frame—four pictures fill one frame—and contains 300 lines each. A picture is transmitted every 0.2 second from one of the four partial-frame cameras.

The signals from each partial-scan camera go to a specific quadrant of the cathode-ray screen. The 35-mm strip camera is sequenced to move a frame every fourth picture instead of for each picture, as with the camera on the full-scan recorder.

The main control and tracking site is backed up by a nearly identical installation a few miles away. Across the equator, two other stations in the deep-space network follow Ranger, but without video receivers. These are at Woomera, Australia, and Johannesburg, South Africa.

Ranger telemeters information on 15 variables, including temperature, altitude, power-supply level and positions of solar panels. Its trajectory, velocity, position and maneuver commands are determined at the Jet Propulsion Laboratory in Pasadena and relayed to the stations for transmission to Ranger.

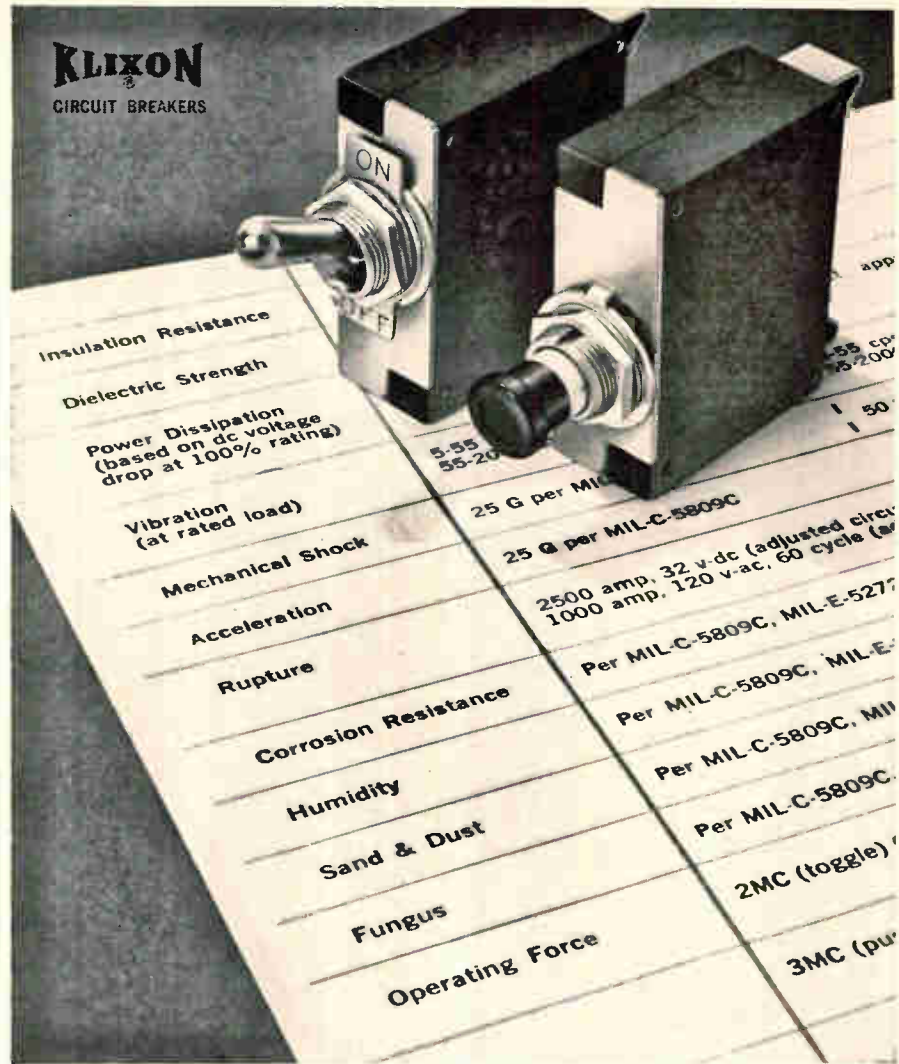

When magnetic circuit breakers must meet military specs

...TI DELIVERS!

Reliability in hostile environments is a certainty when you specify KLIXON® 2MC (toggle) or 3MC (push-pull) Series Magnetic Circuit Breakers. Tested in accordance with applicable procedures of MIL-C-5809C and MIL-E-5272C, they qualify as dependable protectors of electronic circuits and equipment.

You have a choice of 132 standard types! Specifications include: ratings from 0.050 to 20 amp at 32 v-dc or 120 v-ac, 60 or 400 cps; trip-free protection; trip response of 5 to 20 ms at 200% rating; endurance cycling of 10,000 operations at 100% rating; many design options.

Bulletin CIRB-28 gives you all the facts about these off-the-shelf circuit breakers. Get a copy today from your distributor or TI in Attleboro Mass. For immediate information call: Harold Damberg, Sr. Product Engr. at 617-222-2800.

DISTRIBUTORS

CALIFORNIA, Culver City
Western Electromotive, Inc.

FLORIDA, Miami
Aviation International Corp.

ILLINOIS, Chicago
Newark Electronics Corp.

MASSACHUSETTS, Canton
Engineering Supply Company

MASSACHUSETTS, Natick
Lafayette Industrial Electronics

MISSOURI, Kansas City
Engineering Supply Company

NEW YORK, Lynbrook, L. I.
Peerless Radio Corp.

OHIO, Cleveland
Pioneer-Standard Electronics, Inc.

OHIO, Dayton
SREPCO Electronics Inc.

OKLAHOMA, Tulsa
Engineering Supply Company

TEXAS, Dallas
Engineering Supply Company

TEXAS, Houston
Engineering Supply Company

WASHINGTON, Seattle
Almac Electronics Corp.

KLIXON
CONTROL PLANTS IN
Attleboro, Mass. • Versailles, Ky.
Richmond Hill, Ontario
Holland • Italy • Australia
Argentina • Brazil • Mexico



METALS & CONTROLS INC.
5003 FOREST ST., ATTLEBORO, MASS.
A CORPORATE DIVISION OF
TEXAS INSTRUMENTS
INCORPORATED

**NEED 14-BIT A-TO-D CONVERSION AT 200 KC?
OR 8-BIT AT 1 MC? ADAGE HAS IT!**

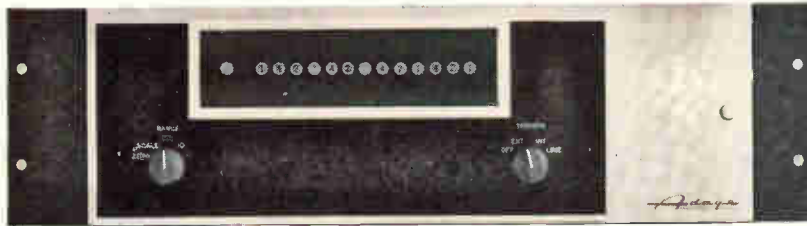

The high-speed, high-resolution VT13-AB and ultra high-speed VT7-AB are the latest additions to the Adage VOLDICON™ line of voltage digitizers. Based on a novel design combining techniques of successive approximation and parallel threshold decoding, the VT13-AB accomplishes a 14-bit analog-to-digital conversion in less than 4 microseconds. The 8-bit VT7-AB performs a complete conversion in under 800 nanoseconds.

Other Voldicon models include:

VS Series A-to-D Converters

2 μ sec. per bit conversion time
14-bit binary or 16-bit BCD
 $\pm .01\%$ accuracy

D-to-A Converters

$\pm 150v$ output
 $\pm .01\%$ accuracy
14-bit resolution

And look at these other Adage data systems components!

Series VMX™ Multiplexers

100,000 samples per second
 $\pm .002\%$ offset spread; $.01\%$ gain spread — no adjustments required
Systems-organized flexible programming



Sample-and-Hold Amplifier, Model SA3

Tracks within $.01\%$ in 10 μ sec. for FS input step change
100 nanosec. aperture
100 μ sec. recovery from 10X FS overloads

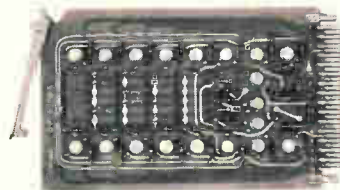

Operational Amplifier, Model OP3

Over 5 MC gain-bandwidth product
Approximately 100 pico-amps leakage current
Less than 30 μv offset drift

HZA™ Isolation Amplifiers

100,000 megohms input impedance
 $\pm 150v$ input voltage range
1 part in 1,000,000 gain accuracy
Single-ended and differential with 120 db common mode rejection

Digital Logic

Designed for analog /digital system requirements
Compatible modules for digital control, decoding, formatting and interfacing

AC Signal Conditioners

$.01\%$ of final value achieved within 15 cycles of lowest frequency
 $\pm .05\%$ accuracy

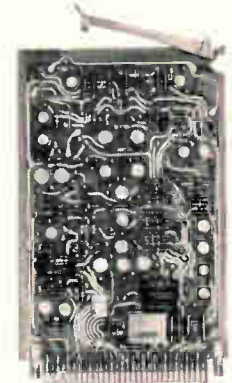

Next time, get a quote from Adage — for components or complete systems. We think you'll like our prices, too. Call or write I. R. Schwartz, Vice President, 617 UN 4-6620.

Adage
INC

1079 Commonwealth Avenue
Boston, Massachusetts 02215

Adage, Inc. welcomes employment inquiries from professional engineers.

Burroughs

single-sided glassivated semi-conductors in hybrid circuits to your specifications

Burroughs semiconductor devices feature single-sided construction with terminals available through the glassivated "hermetic" seal. The unique design allows drastically reduced cost through batch processing fabrication techniques which completely eliminate:

1. the need for hermetically sealed packages.
2. individual bonding of wires.
3. duplicate test procedures.

All fabrication processes up to and including testing, are performed on the wafer, making this the lowest cost-per-device capability in existence.

Diodes and transistors or the unique four-terminal silicon controlled switches can be made available in hybrid circuit modules designed to meet your specific circuit requirements. The use of the reliable cermet thick film circuits insures a high degree of device isolation and makes possible the use of resistor values and tolerances which are difficult or impossible to obtain in monolithic integrated types at any price.

For more information, ask for our new hybrid circuit modules brochure. Or better yet, tell us about your micro-circuit requirements. Our engineers will be glad to discuss your requirements for custom micro-circuit modules. Write Burroughs Corporation, Electronic Components Division, Hybrid Circuit Department, P.O. Box 1226, Plainfield, New Jersey. Phone (201) 757-5000.

Typical circuits developed with Burroughs SCS, dual diodes and transistors

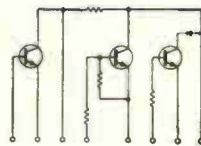

3 STAGE AMPLIFIER

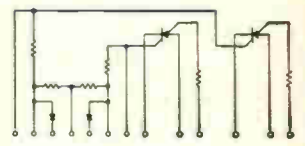

SCS FLIP-FLOP

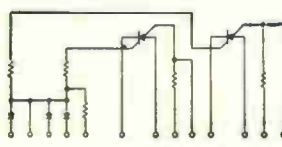

DECODER LATCH

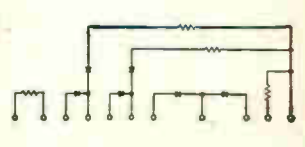

RESISTOR DIODE-NETWORK



Burroughs Corporation

ELECTRONIC COMPONENTS DIVISION
PLAINFIELD, NEW JERSEY

Circle 139 on reader service card

See us at the IEEE Booths 1211-1217

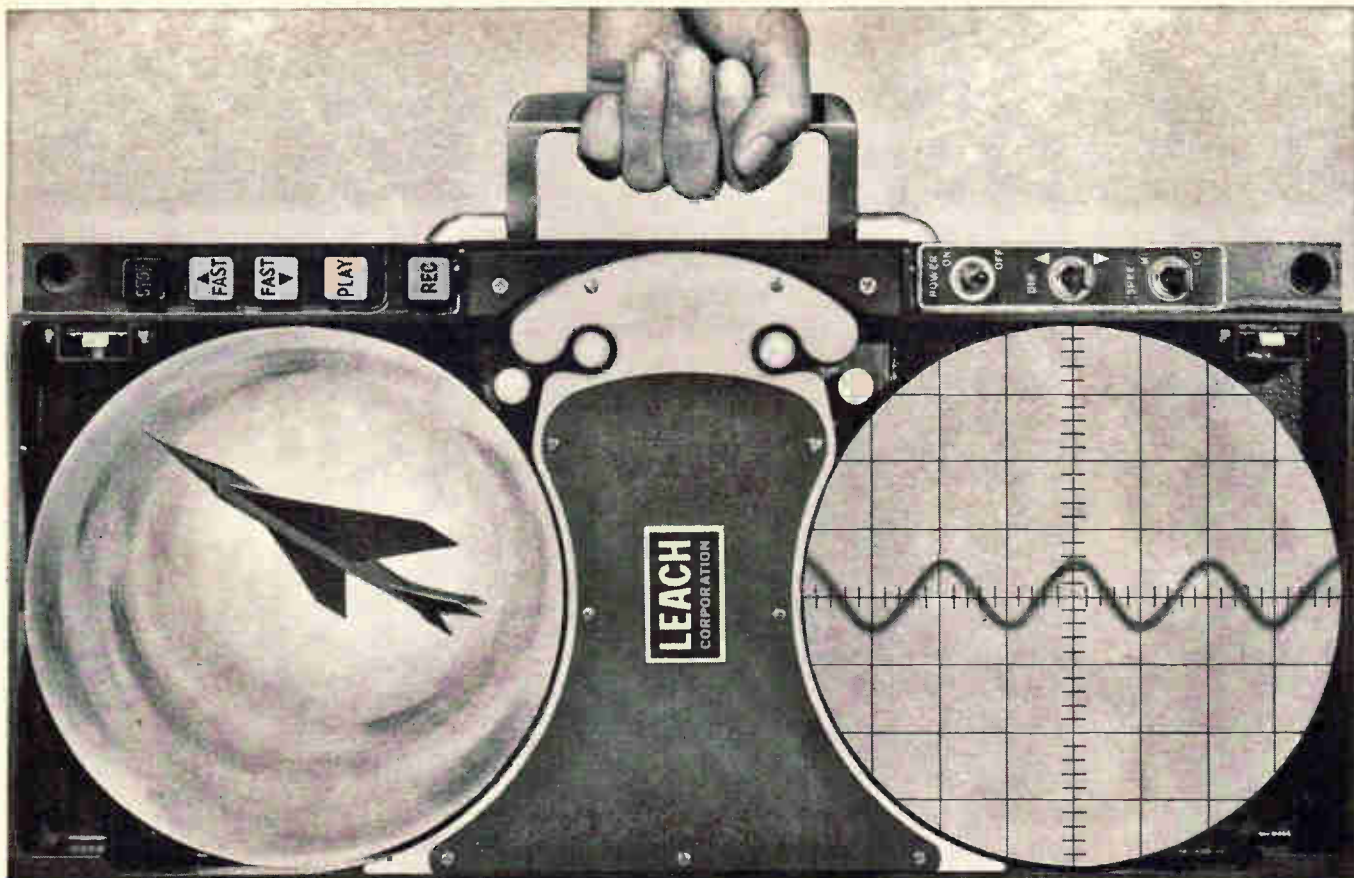

This Tape Recorder/Reproducer is Reliability With a Handle

In any critical application, and especially under extreme environments, the MTR-3200 provides precise recording, storage and reproduction of data. Mil-type components are used throughout the unit, and special features are incorporated such as the dual differential capstan drive to control tape tension. The unit's rugged construction insures overall reliability while providing precise instrumentation quality data. Environmental features: Shock, 10 g - 11 ms $\frac{1}{2}$ sine - 3% p/p flutter; Vibration, 10 g rms random operating - 6% p/p flutter; Flutter, less than 0.5% peak-to-peak at 60 ips; Acceleration, 25 g operating; Temperature, -40°C to 70°C operating; Humidity, 95% operating; Altitude, 150,000 ft. (unlimited for 20 hours).

Versatility is as broad as any application. The unique instrumentation in the MTR-3200 provides up to 14 channels Analog and FM or 16 Digital channels which can be used in any combination. Seven tape speeds are available, and with a simple belt change, are electrically-selectable in speed pairs. Since minimum power is required for operation and it has local or remote control, the MTR-3200 is suitable for any test site. The entire unit is compatible with IRIG standard data reduction equipment.

Maximum Performance in the MTR-3200 offers a wide range of "extra" capabilities. Data bandwidths are ex-

tended beyond standard IRIG requirements. In Analog and FM, input and output level controls are independently adjustable for each channel and reproduce amplifiers include adjustable equalization to accommodate tape differences. Mechanical precision provides low bit dropout error and minimum jitter in digital recording. On special order, many other electronic options are offered to meet specific application requirements.

Convenience in the MTR-3200 requires carrying only 44 pounds. This means that you carry it to the field or find a small place for it in the lab. Because of its simple design and operation, the chance of operator error is minimized.

For further information on the MTR-3200 Tape Recorder/Reproducer write to:

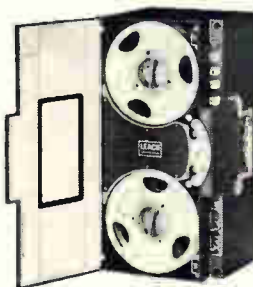

LEACH

CORPORATION

CONTROLS DIVISION

717 North Coney Avenue, Azusa, Calif.

Phone: (213) 334-8211

Export: LEACH INTERNATIONAL S.A.

Glass-Amp's got a sister

(very protective!)



The New One-Watt Glass-Amp® Zener

POWER DISSIPATION

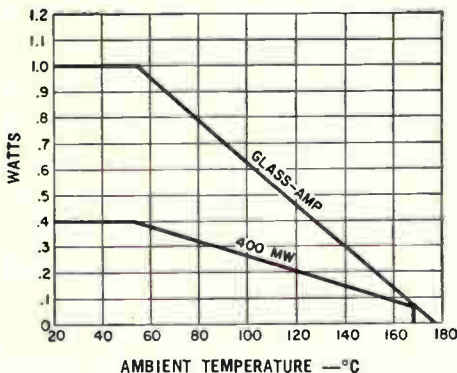

COMPARE! NEW Glass-Amp ONE-WATT ZENER is competitively priced with 400 milliwatt zeners—yet has more than twice the power dissipation at any practical operating temperature. Why take a chance of failure from unexpected combinations of high temperatures and loads when Glass-Amp Zeners cost little if anything more than you're paying now? (And, incidentally, Glass-Amp Zeners are much smaller than metal zeners of equal capability!)

- HERMETICALLY SEALED glass diode package.
- FULLY INSULATED body needs no coatings or sleeves with their possible breakdown hazards.
- SMALL SIZE (.360" x .150") and symmetrical shape permit flush mounting, automatic reel packaging, and use of automated insertion equipment.
- NO PROBLEMS of porosity of metal-to-metal welds.
- HIGH ALTITUDE or deep-space operation with very little de-rating.
- 32 types, registered as 1N4162 through 1N4193, cover the range from 10 volts nominal to 200 volts.
- COMPARABLY priced with 400mW zeners, and less than 1-watt flangeless types which can't match Glass-Amps' unique features.
- FREE SAMPLE, full specs on request. Write to me, GI Ginny, on your company letterhead, stating voltage you're interested in.

GENERAL INSTRUMENT CORPORATION
SEMICONDUCTOR PRODUCTS GROUP

600 West John Street, Hicksville, New York



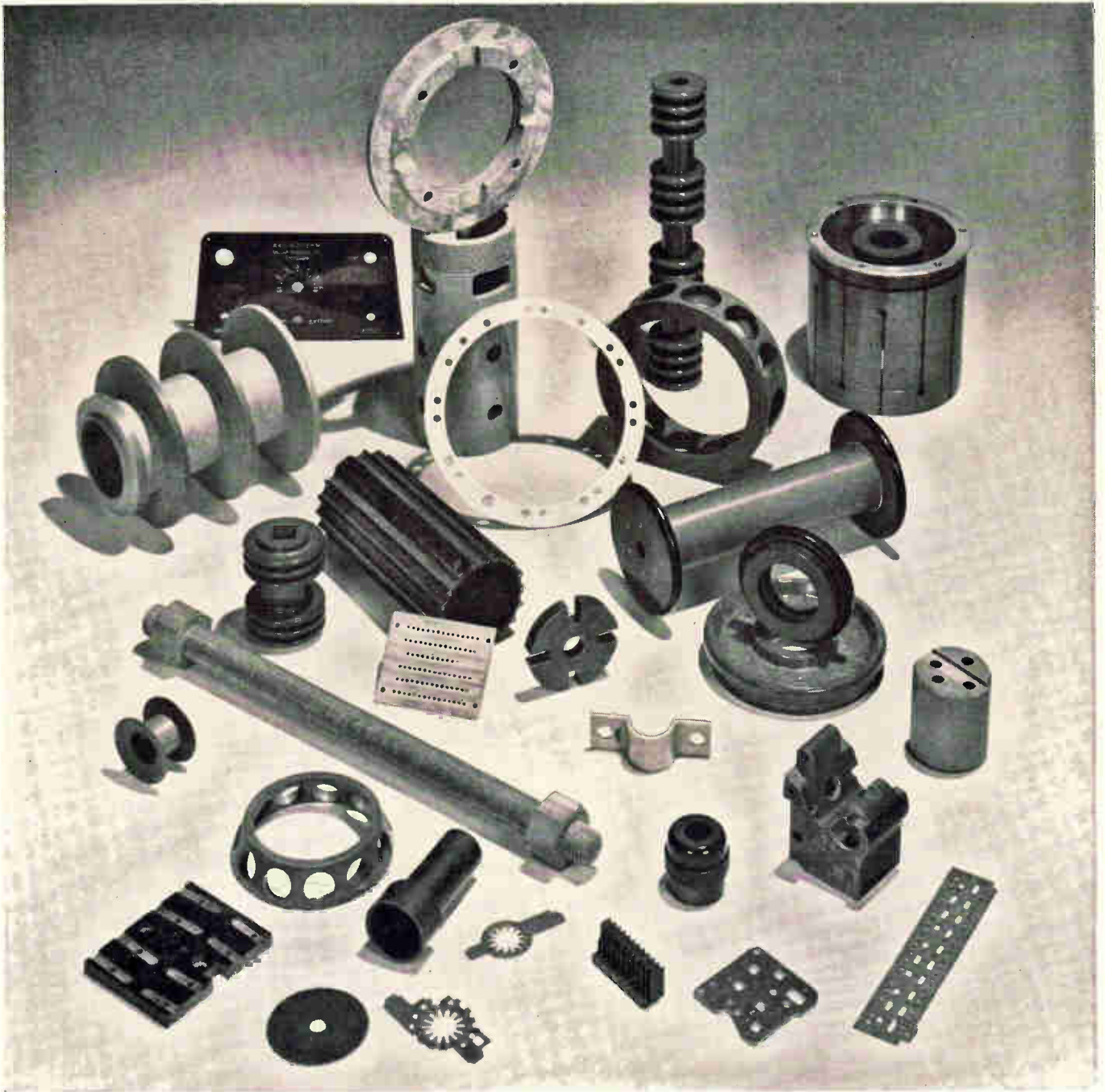

Each a tough case the "81" helped to crack

Everyone of these products posed for designers a tough problem in material selection.

Some required light weight; some, resistance to chemicals, wear, heat or moisture. Others required flame retardance, excellent electrical properties, high impact or tensile strength, or easy machinability. In nearly

142 Circle 142 on reader service card

every instance a balance of many properties was essential.

Each one was solved by the use of Synthane laminate plastics. This is understandable because Synthane makes 81 different grades of Synthane laminates. Our representative in your area carries samples, descriptions and properties of all 81.

Get in touch with him through your Yellow Pages directory or contact Synthane Corporation, 36 River Road, Oaks, Pa.

SYNTHANE
CORPORATION **S** OAKS, PENNA.
Synthane-Pacific, 518 Garfield Avenue, Glendale 4, California

Circle 143 on reader service card →

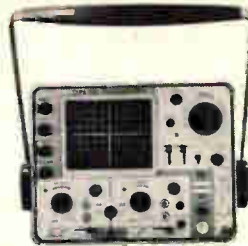

Here's an oscilloscope that doesn't care where you take it, how you take it there, or what you do with it after you get it there. It figures it can pretty well handle most situations that come along... and it figures correctly.

It's the

new

**Tektronix Type 422
Dual-trace DC-to-15 Mc
portable oscilloscope**

Light weight—less than 21 pounds, with panel cover and included accessories.

Small size—only 7 $\frac{1}{8}$ " high, 10" wide, 16" deep, overall.

Low cost—only \$1325 (AC version).

U.S. Sales Price, f.o.b. Beaverton, Oregon

*See for yourself at
Booth 3609-3617, IEEE Show*



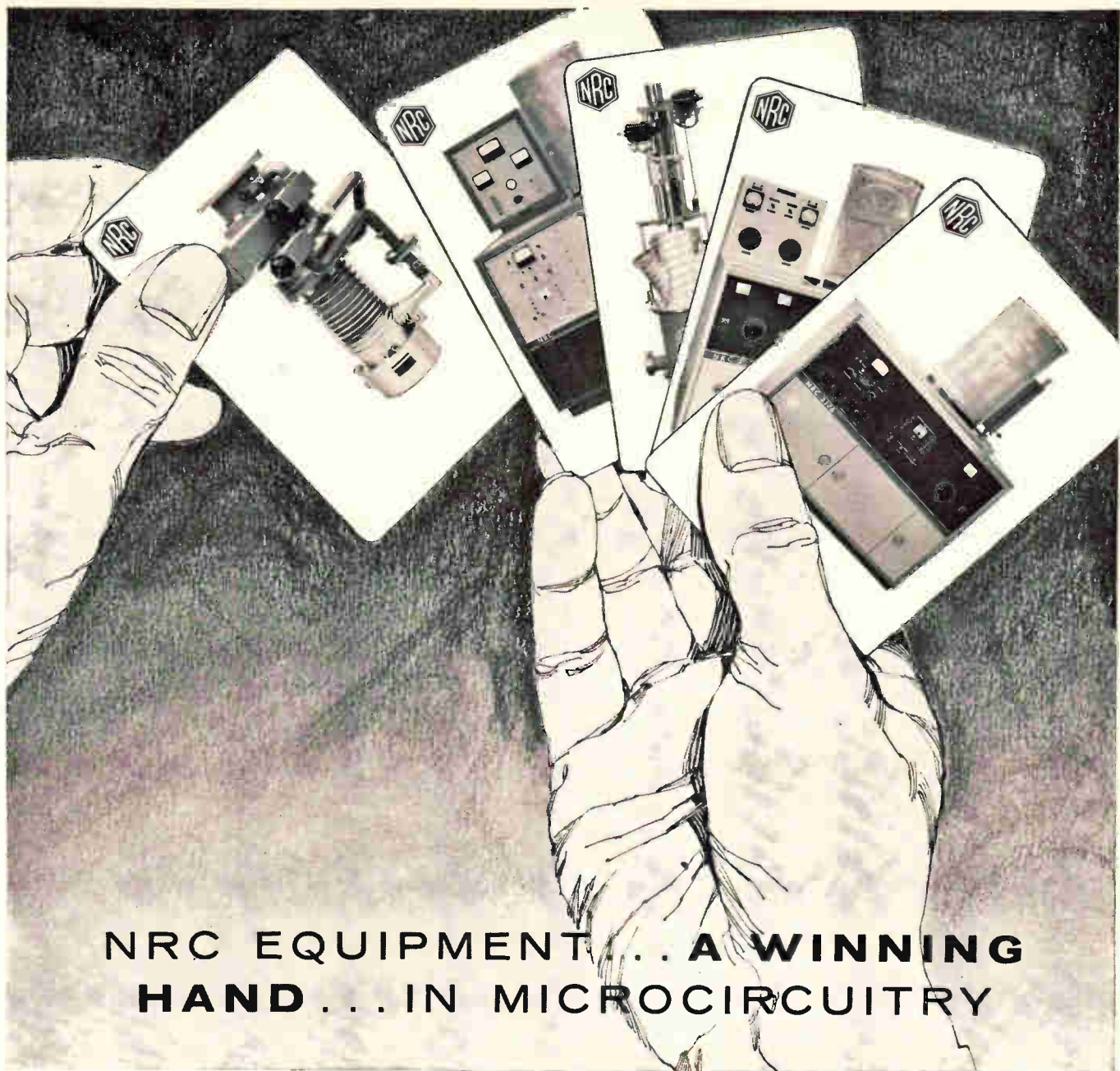

NRC EQUIPMENT ... A WINNING HAND ... IN MICROCIRCUITRY

Whether your microcircuit project requires a small bell jar coater for thin film research or complete deposition systems for high volume production, NRC has equipment that does the job. We start at the heart of any vacuum system — *with the pumps*, and build up from there, manufacturing a whole range of coaters, heat sources, feedthroughs, pumping systems, and back-up equipment.

The payoff comes in the performance. NRC evaporators produce the highest net pumping speed *while the process is underway*, not just low pressure in an empty chamber. Net pumping speed in microelectronics can mean net profit for business. This business end of high vacuum is just one advantage in getting an NRC system. For detailed information on our complete line of evaporators and associated equipment for microelectronics, write or call today. Just a few of these products are listed below.

EVAPORATORS • PUMPING STATIONS • POWER SUPPLIES • FEEDTHROUGHS • CRYSTAL PULLERS
TUBULAR FURNACES • ELECTRON BEAM HEAT SOURCES • LEAK DETECTORS

See us at new location
IEEE Show, 1st Floor
Booth #1821-1823



EQUIPMENT DIVISION
NATIONAL RESEARCH CORPORATION
A SUBSIDIARY OF NORTON COMPANY

160 Charlemont Street, Newton, Massachusetts 02161



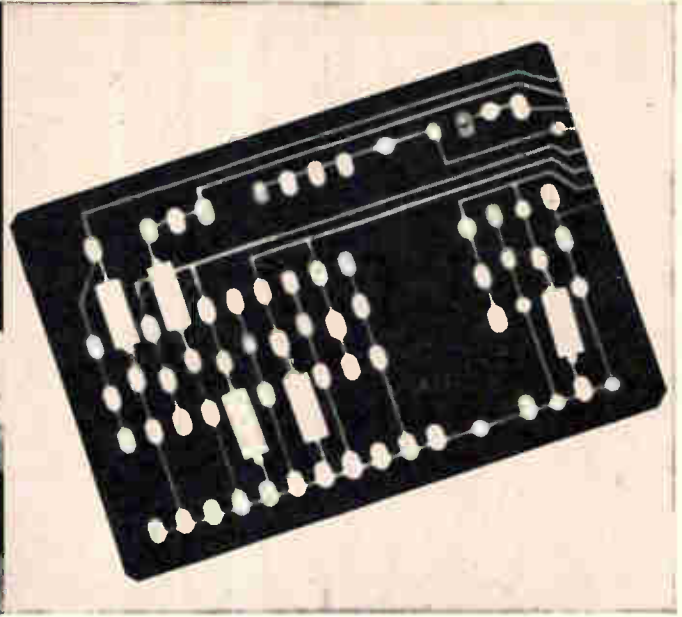
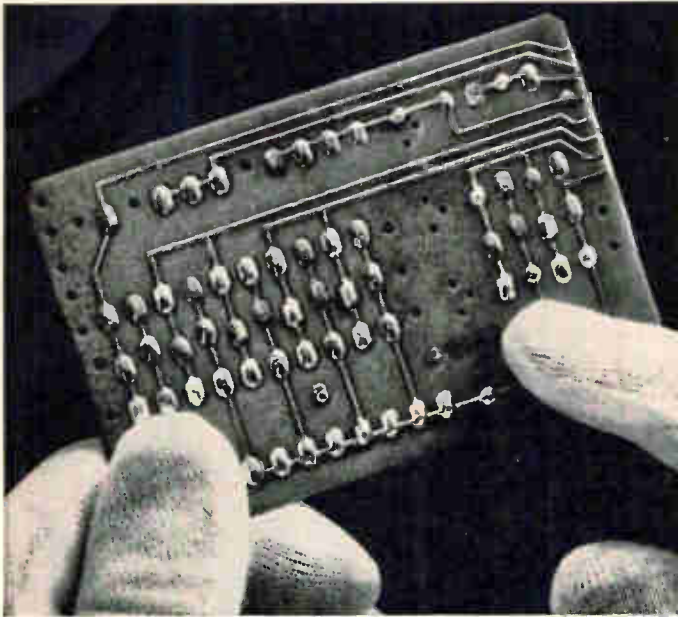

***Heat it,
test it,
touch it...***

***or simply X-ray
it with Ansco
Superay***

There are several ways to test the quality of a printed circuit: infra-red; running voltage tests; or just physical inspection.

But the surest way of finding discontinuity or tiny imperfections is to get a radiograph on Ansco Superay® 'H-D' Industrial X-ray film.

This ultra-fine grain Class I film has very high contrast. It provides the ultimate in image quality, extending the effective range of radiographic interpretation by recording detail which would be marginal in conventional films. Superay 'H-D' maintains its high definition characteristics and maximum image quality throughout the full KvP range.

For further details, see your Ansco X-ray Representative. Or write X-ray Dept., Box E 222

gaf

GENERAL ANILINE & FILM CORPORATION

140 WEST 51 STREET • NEW YORK 10020

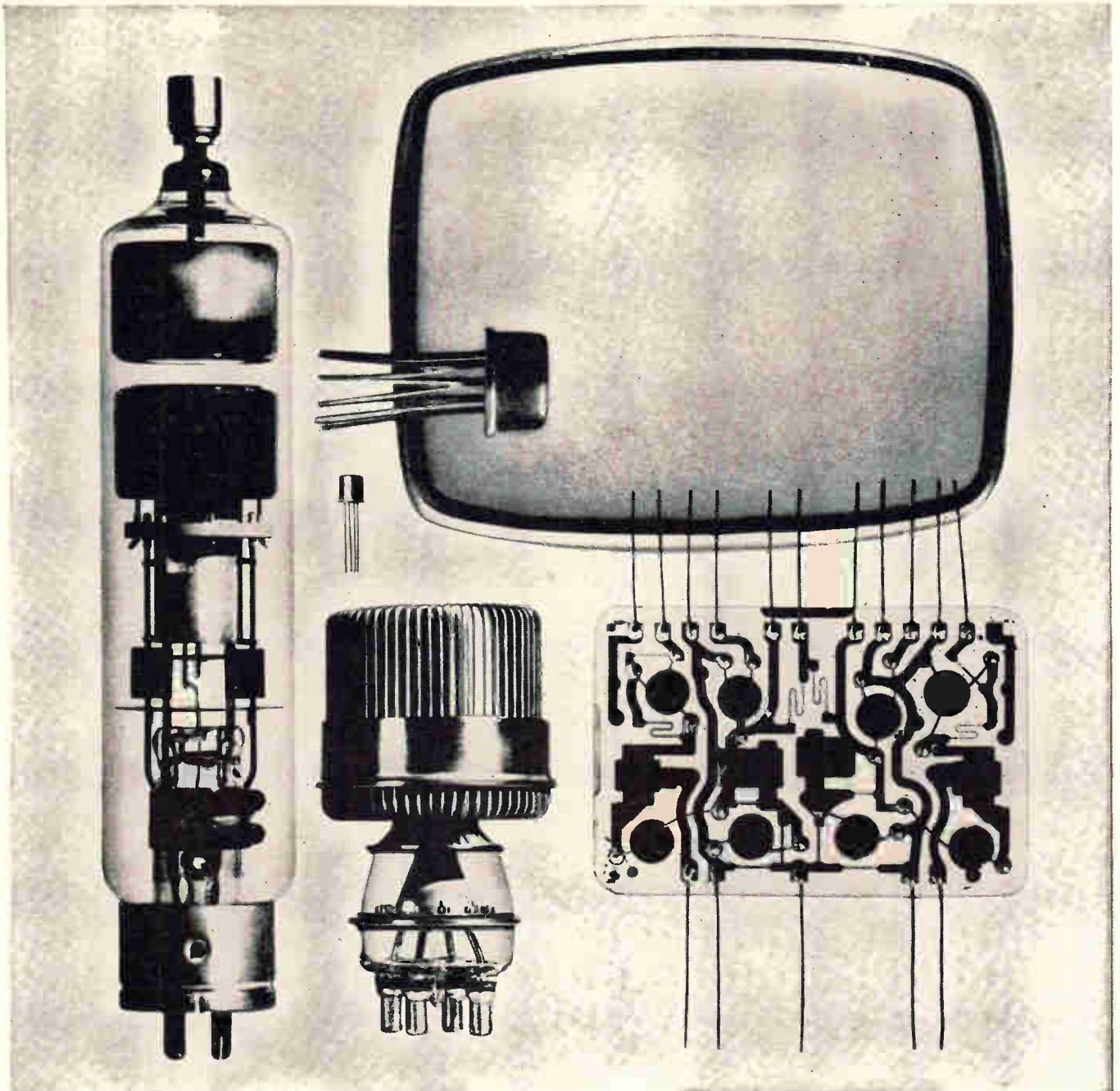

the product is only part of the deal

To the equipment manufacturer it is not the components alone which are all-important. He sees them only as part of a transaction which should provide him with research and applications know-how, technical data and assistance in many forms, and an assurance of dependability which can only come from exceptional experience in production and quality control.

This is the kind of support that goes with Mullard products, and with emphasis on quality and performance. The plants in which the products are made are

purpose-built; much of the intricate machinery and test gear is designed and engineered on the spot; even glass is specially made and metals processed from the basic raw materials so that quality may be controlled from the earliest stage.

Fourteen separate plants, twenty thousand employees, serving the Electronics Industry... if we are not serving your Company already, please let us know if we can help you.



Mullard

MULLARD LIMITED · MULLARD HOUSE · TORRINGTON PLACE · LONDON · W.C.1 · ENGLAND

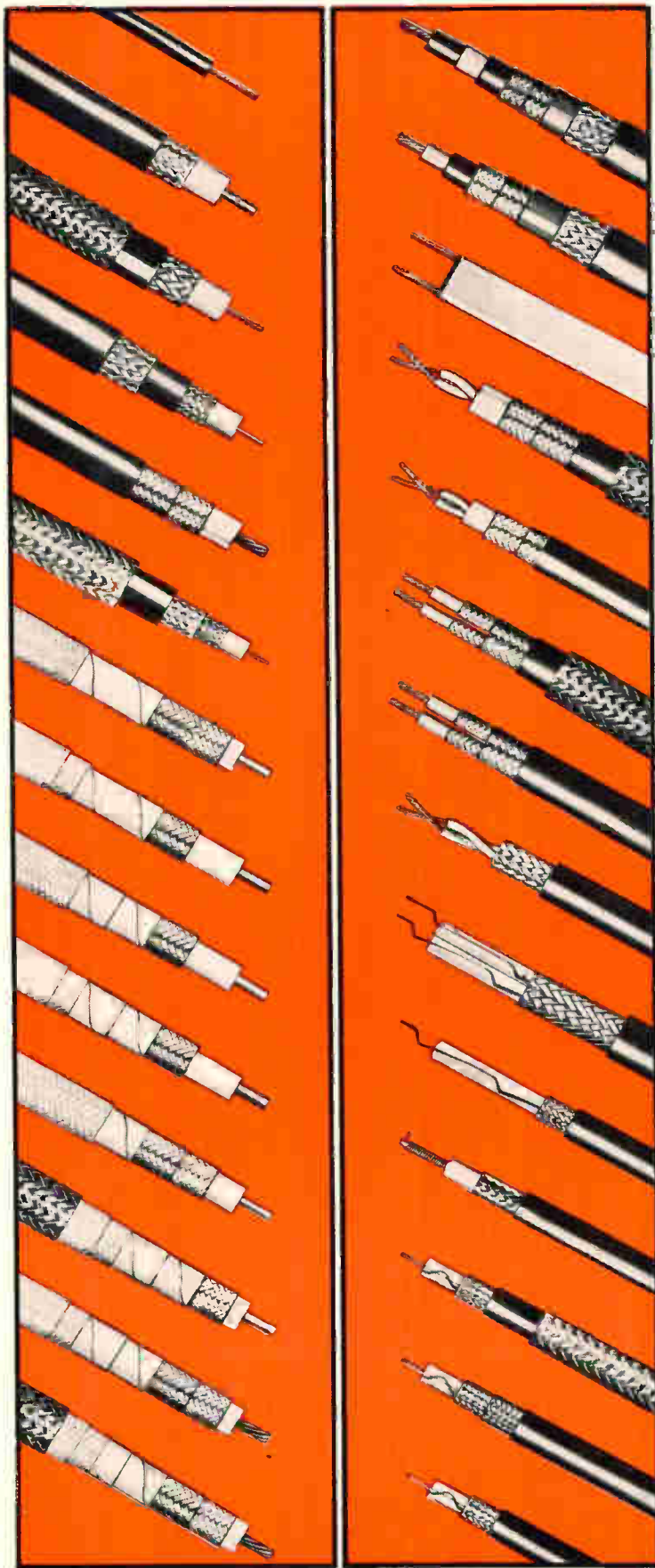

The COAX you need is made by ITT

ITT makes nearly every standard type of coaxial cable currently being manufactured . . . and is the *only* source for many of them. So chances are you can't need a cable that we don't already have on the shelf or on-line.

We make them with solid and semisolid TFE; with foam FEP; with solid, semisolid, and foam polyethylene; irradiated and unirradiated; with silicone rubber; and with polypropylene. We make them to military specifications, industrial specifications, customer requirements. In standard, miniature, and subminiature sizes—in general-purpose, high-temperature, and special-characteristics types—for usual, unusual, and special applications. We make them for every environment, from ocean bottom to outer space, from -100° to $+500^{\circ}$ F.

ITT also manufactures an unlimited variety of specially designed, one-of-a-kind coaxials. So if your requirements are unique, we'll gladly get out the slide-rule and drawing board.

For ITT coax see your local electrical or electronic distributor or your ITT sales representative—for engineering assistance or technical data write: Dept. E, ITT Wire and Cable Division, International Telephone and Telegraph Corporation, Clinton, Mass. In Canada, write or call ITT Royal Electric Company (Quebec) Limited, Pointe Claire.

wire and cable division

ITT

Now: Signetics new LU-Series Integrated Circuits less than \$1.50 per gate function



Now: a new low-cost Utilogic series that provides more insurance against random noise errors than any other integrated circuits being offered for commercial/industrial applications. LU-Series circuits have an 800 mv minimum noise margin. Operation is guaranteed from +10°C to +55°C. Fan-outs of up to 17 from Gates and J-K Binary element assure low system can-counts. High capacitive driving capability eliminates most commonly encountered line capacity problems. Available in TO-5 can...and guaranteed by the world's oldest exclusive manufacturer of integrated circuits: Signetics. New address: 811 E. Arques Avenue, Sunnyvale, California.



LU320
J-K BINARY ELEMENT



LU316 DUAL EXPANDABLE
NOR GATE



LU315
DUAL 3-INPUT NOR GATE



LU314
7-INPUT NOR GATE

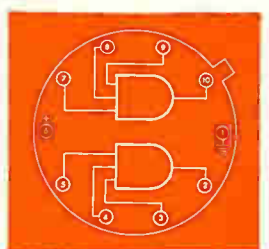

LU306
DUAL AND GATE



LU305 AND GATE



LU300 GATE EXPANDER

Prices	1-24	25-99	100-999
LU300	\$4.05	\$3.25	\$2.70
LU305	1.45	3.55	2.95
LU306	1.45	3.55	2.95
LU314	1.45	3.55	2.95
LU315	1.75	3.55	2.95
LU316	1.45	3.55	2.95
LU320	8.80	7.60	6.35



SIGNETICS INTEGRATED CIRCUITS

Signetics is the oldest exclusive maker of integrated circuits in the world. Founded: 1961. Sunnyvale, California. Subsidiary of Corning Glass Works.

AUTHORIZED SIGNETICS REPRESENTATIVES AND DISTRIBUTORS: ALA. Compar Southern, Huntsville, 881-3294 □ ARIZ. Compar Rocky Mountain, Phoenix (Scottsdale), 947-4336 □ CALIF. Compar Los Angeles, Los Angeles (Glendale), 245-1172; Jack Pyle Company, San Francisco (Representative) 349-1266; Compar San Francisco, San Francisco (Distributor) 697-6244, □ COLO. Compar Rocky Mountain, Denver (Littleton), 798-2431 □ CONN. Compar New England, Hamden, 288-9276 □ DISTRICT OF COLUMBIA (see Hyattsville, Md.) □ FLA. Compar Southern, Orlando, 293-5202 □ ILL. Compar Chicagoland, Chicago 46, 775-5300 □ MD. Compar Chesapeake, Baltimore 15, 523-7700; Compar Chesapeake, Hyattsville, 927-7222 □ MASS. Compar New England, Boston (Newtonville 60), 969-7140 □ MICH. Compar Michigan, Inc., Detroit 2, 865-5550 □ MINN. Compar Twin Cities, St. Paul 4, 922-7011 □ MO. Compar Ozarks, St. Louis 2, 428-5313 □ N.J. Compar Philadelphia, Camden (Haddonfield), 429-1526 □ N.M. Compar Rock Mountain, Albuquerque, 265-1020 □ N.Y. Compar Albany, Albany 6, 436-8536; Compar Albany, Binghamton (Endwell), 723-8743; Compar Albany, Buffalo (Depew), 684-5731; Compar New York, New York (Little Neck 62), 225-3820 □ N.C. Compar Southern, Charlotte 5, 333-7743 □ OHIO Compar Ohio, Cleveland (Fairview Park), 333-4120; Compar Ohio, Dayton (Fairborn), 878-2631 □ ORE. (see Washington) □ PENN. Philadelphia (see Camden, New Jersey) □ TEX. Compar Southwest, Dallas 18, 327-3944 □ VA. Compar Southern, Richmond, 266-2060 □ WASH. Compar Northwest, Seattle, 622-0622 □ CANADA Aero Sales Engineering Company, Rexdale, Ontario, 249-9139.

SIGNETICS REGIONAL SALES OFFICE—NEW YORK-METROPOLITAN AREA: (201) 992-3980

SIGNETICS EASTERN REGIONAL SALES OFFICE: Francis J. Bigda, 591 North Ave., Wakefield, Mass., Phone (617) 245-8200, TWX: (617) 245-8367

SIGNETICS WESTERN REGIONAL SALES OFFICE: Jack Halter, 8820 Sepulveda, Los Angeles 45, Calif., (213) 776-2295/2296, TWX: (213) 670-4303

See Signetics at IEEE, Booth 2901-2903

Circle 148 on reader service card

Photocells feature stability and high speed

Devices use a new light-sensitive substance that combines CdS and CdSe to realize the best qualities of both

Not too long ago, design engineers wanting to use photocells were faced with a constant dilemma. They had a choice of devices with high response speeds and inadequate stability, or units with good stability and sluggish response. Today, however, the need to compromise between speed and stability for a growing number of applications no longer exists, due to the development of a new light-sensitive material known as 5H. This substance combines cadmium sulfide and cadmium selenide to realize the best features of both materials.

The resulting photocells have the high response speeds of CdSe and the stable memory and temperature characteristics of CdS, as shown in the accompanying comparison table. Identified as the CL705HL, CL905HL and CL905-HLL, the devices exhibit a virtually linear curve for resistance versus

light level. Their speed is 1-2 msec (about 10 times that of CdS cells) and memory is 15 times better than CdSe cells.

One industrial example of what 5H cells can do is the case where a manufacturer of teletypewriter equipment is producing a line of teleprinters that use about 54 photocells (one to match each of the keys on the printer keyboard). Since the operation of this printer called for fairly high response speeds, the designers had a batch of cadmium selenide cells built into the equipment. These teleprinters, as they now function, require a warmup period of a half hour to 45 minutes at the start of each day. All of the cells must be brought out of the dark phase of their light history into the light phase before the equipment can start to function. With the use of 5H cells, however, the warmup period is no longer necessary. The

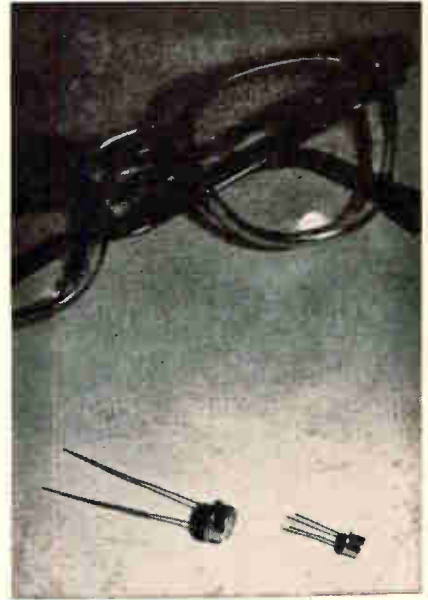

manufacturer of the equipment described can build 5H cells into his production runs, and, in addition, could make up a changeover kit or provide some other means of letting purchasers of the units update them.

Another example is the case of a plastics manufacturer who uses a photocell to count the little plastic pieces as they travel from a molding machine into a hopper. The molding, mixing and other machinery has a faster warmup time than the photocells he was using. By changing over to 5H, his counter can keep pace with the rest of the machinery when it is started up each day.

Among the many applications which the company foresees for 5H photocells are included choppers, a-to-d converters and position servos.

The new units are offered in hermetically sealed, transistor-type metal cases of the TO-18 and TO-5 variety. Price range is 80 cents to \$2. Delivery is immediate. Clairex Corp., 8 West 30th St., New York 1, N.Y.

Circle 350 on reader service card

Representative photosensitive materials

Characteristic	5H	Material CdS (Type 5)	CdSe (Type 3)
General Characteristics	Fast, Stable	Very Stable	High Speed
Response speed @ 100 ft. candles			
Rise	0.002 sec.	0.007 sec.	0.001 sec.
Fall	0.001 sec.	0.014 sec.	0.002 sec.
Temp. coeff. @ 1 ft. can. from 0° to 75° C (100% conductance @ 25° C)	0.186%/°C	0.066%/°C	1.57%/°C
Light history effect @ 1 ft. can. (change in conductance between cell types measured from long exposure @ 30 ft. can., and long exposure to dark)	24%	9%	200%
Percent relative response (2854° K light source=100%)			
2250° K	101%	110%	132%
6500° K	106%	81%	34%
Resistance vs. light, linearity slope (0.1 fc to 100 fc)	0.92	0.74	varies from super linear to sub linear
Peak spectral response	5500 ang. (like human eye)	5500 ang. (like human eye)	7350 ang. (near infra-red)
Minimum ratio from 2 fc to dark within 5 seconds	1:1000	1:1000	1:10,000



EDGERTON, GERMESHAUSEN & GRIER, INC.

NOW
CUSTOMIZED
TO YOUR SPECS



THE SD-100
PHOTODIODE

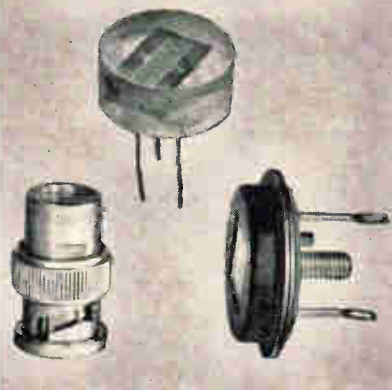

Wide spectral range. Nanosecond response. High sensitivity. Low noise. Linearity of response. Circuit design simplicity. These proven parameters, collectively unavailable in any other light detecting unit, characterize the versatile EG&G silicon surface barrier SD-100.

This EG&G photodiode has broad applications in laser and guidance systems, and for pulsed light, light intensity and waveform measurements. It can now be modified by EG&G into special cell and package configurations to meet your exact requirements: larger or smaller area photodiodes, bi-cells, quadrature cells, matrix arrays, radiation detectors. Each is hermetically sealed in standard JEDEC package or to custom configuration, and can be integrated with fibre optic cables or light pipes for optimal coupling.

RISE TIME:..... 4×10^{-9} sec. @ 90v
FALL TIME:..... 15×10^{-9} sec. @ 90v
SPECTRUM:..... 0.35 to 1.13 microns
SENSITIVITY:..... $0.25 \mu A/\mu W$ @ 0.9u
LOW NOISE:..... 1×10^{-12} watts
LINEARITY OF RESPONSE:..... Over 7 decades

For complete information, write Products Division, 176 Brookline Avenue, Boston, Massachusetts 02215.

EDGERTON, GERMESHAUSEN & GRIER, INC.



New Components and Hardware

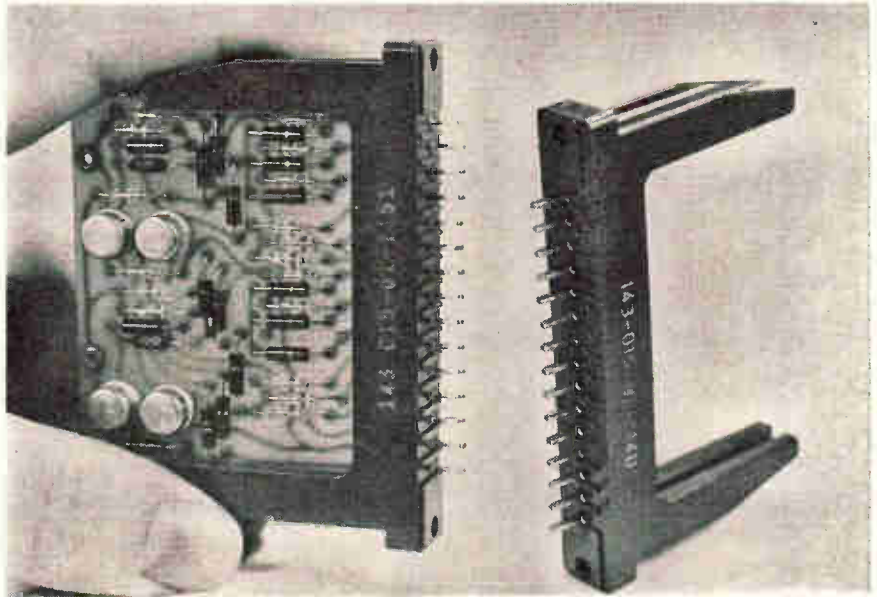

Connector offers more p-c board support

A new connector with integral card guides offers more p-c board support than is currently available from conventional board guides. Integral card guides extend $1\frac{3}{8}$ inch above the main body of the new connector; conventional card guides, which must be attached mechanically, extend less than half an inch. The longer projections prevent board rocking and provide positive alignment in blind-spot installations. The series 143 connector is available in 15- and 22-contact models with slots between contacts for Delrin keys. This feature permits keying without loss of contacts. Both employ the manufacturer's tuning fork con-

tacts, which tests show resist corrosion and changes in contact resistance even after 500 cycles of insertion and withdrawal during a 49-hour salt-spray bath. The dielectric material of the connectors is mineral-filled diallyl phthalate, according to MIL-M-14 Type MDG. The connectors themselves meet the performance requirements of MIL-C-21097B. However, since the connectors can be made to meet special requirements, virtually any thermosetting dielectric material is available, along with a wide variety of contact materials, platings and tail styles.

Amphenol Connector Division of Amphenol-Borg Electronics Corp., 1830 S. 54th Ave., Chicago, Ill., 60650. [351]

Capacitors feature precision dimensions

New form-mold encapsulated capacitors offer over-all size efficiencies and precision dimensions for greater spacing accuracy in printed circuits, plus welded leads for more reliable electrical contact. The BlackHawk capacitors are designed for test and measurement, control, communications and consumer

product applications. Initial availability includes two case sizes with ratings from 0.001 to 1.0 μF and from 100 to 600 v d-c at 85° C. The units are noninductively wound, incorporating capacitor grade Mylar dielectric and high-purity aluminum foil. Operating temperature range is from -55° C to +125° C. Units are designed for continuous operation at rated voltage at 85° C. In addition to standard $\pm 20\%$ tolerance, the new ca-

New...40 volts at 10 amps
in a constant current power supply for \$325.00

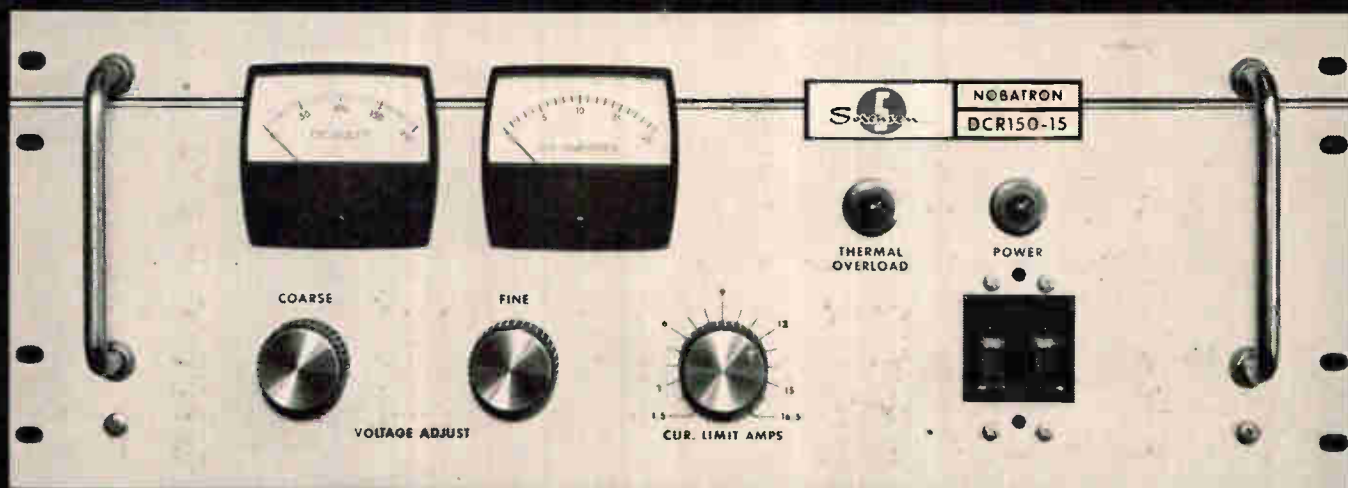

Now...19 DCR supplies from 0-400 to 0-2400 watts

1. 19 SILICON CONTROLLED RECTIFIER SUPPLIES AVAILABLE... Delivery in 30 days or less.
2. LOW PRICES... Starting at \$325 (Voltmeter and Ammeter included with no increase in price)
3. COMPACT PACKAGING... 7" or 5 1/4" Rack Height
4. HIGH EFFICIENCY
5. CONSTANT VOLTAGE REGULATION... with continuously adjustable current limiting.
6. CONSTANT CURRENT REGULATION... with continuously adjustable voltage limiting.
7. AUTOMATIC CROSSOVER... full automatic transition from constant

voltage to constant current operation, or from constant current to constant voltage operation, at any operating point.

8. REMOTE PROGRAMMING... Voltage and Current
9. REMOTE SENSING... At distances up to 200 feet
10. SERIES OR PARALLEL OPERATION
11. VOLTAGE REGULATION... (as low as $\pm 0.1\%$ or 15 mv) Line and Load combined
12. CURRENT REGULATION... As low as ± 15 ma
13. LOW RIPPLE... 0.5% + 50 mv (RMS)
14. UNITIZED CONTROL CIRCUITRY... for easy maintenance
15. COARSE AND FINE CONTROLS... for Voltage Output

For complete data on the DCR series and other Sorensen products, send for the new, 140-page "Controlled Power Catalog and Handbook." Write to: Sorensen, Richards Avenue, South Norwalk, Connecticut. Or use Reader Service Card Number 200.

DCR ELECTRICAL AND MECHANICAL SPECIFICATIONS:

MODEL NUMBER	VOLTAGE RANGE (VDC)	VOLTAGE REG. (LINE & LOAD COMBINED)	OUTPUT CURRENT (AMPS.)	CONSTANT CURRENT RANGE (AMPS.)	CURRENT REG.	RMS RIPPLE	TRANSIENT RESPONSE	WIDTH	PACKAGE SIZE (INCHES) HEIGHT	DEPTH	WEIGHT (LBS.)	PRICE
DCR 300-1.25	0-300	$\pm 1\%$ or 60mv	0-1.25	0.125 to 1.37	± 15 ma	0.5% + 50mv	30msec	19	5 1/4	15	52	\$325
DCR 150-2.5	0-150	$\pm 1\%$ or 30mv	0-2.5	0.25 to 2.75	± 15 ma	0.5% + 50mv	30msec	19	5 1/4	15	52	325
DCR 80-5	0-80	$\pm 1\%$ or 30mv	0-5	0.5 to 5.5	± 15 ma	0.5% + 50mv	30msec	19	5 1/4	15	56	325
DCR 40-10	0-40	$\pm 1\%$ or 15mv	0-10	1 to 11.0	± 20 ma	0.5% + 50mv	30msec	19	5 1/4	15	55	325
DCR 300-2.5	0-300	$\pm 1\%$ or 60mv	0-2.5	0.25 to 2.75	± 15 ma	0.5% + 50mv	30msec	19	5 1/4	18	77	525
DCR 150-5	0-150	$\pm 1\%$ or 30mv	0-5	0.5 to 5.5	± 15 ma	0.5% + 50mv	30msec	19	5 1/4	18	77	525
DCR 80-10	0-80	$\pm 1\%$ or 20mv	0-10	1.0 to 11.0	± 20 ma	0.5% + 50mv	30msec	19	5 1/4	18	77	525
DCR 60-13	0-60	$\pm 1\%$ or 15mv	0-13	1.3 to 14.3	± 20 ma	0.5% + 50mv	30msec	19	5 1/4	18	77	525
DCR 40-20	0-40	$\pm 1\%$ or 15mv	0-20	2.0 to 22.0	± 25 ma	0.5% + 50mv	30msec	19	5 1/4	18	77	525
DCR 300-5	0-300	$\pm 1\%$ or 60mv	0-5	0.5 to 5.5	± 15 ma	0.5% + 50mv	30msec	19	7	18	95	710
DCR 150-10	0-150	$\pm 1\%$ or 30mv	0-10	1.0 to 11.0	± 20 ma	0.5% + 50mv	30msec	19	7	18	95	710
DCR 80-18	0-80	$\pm 1\%$ or 20mv	0-18	1.8 to 19.8	± 25 ma	0.5% + 50mv	30msec	19	7	18	98	710
DCR 60-25	0-60	$\pm 1\%$ or 15mv	0-25	2.5 to 27.5	± 25 ma	0.5% + 50mv	30msec	19	7	18	100	710
DCR 40-35	0-40	$\pm 1\%$ or 15mv	0-35	3.5 to 38.5	± 35 ma	0.5% + 50mv	30msec	19	7	18	102	710
DCR 300-8	0-300	$\pm 1\%$ or 60mv	0-8	0.8 to 8.8	± 20 ma	0.5% + 50mv	30msec	19	7	18	115	825
DCR 150-15	0-150	$\pm 1\%$ or 30mv	0-15	1.5 to 16.5	± 25 ma	0.5% + 50mv	30msec	19	7	18	115	825
DCR 80-30	0-80	$\pm 1\%$ or 20mv	0-30	3.0 to 33.0	± 30 ma	0.5% + 50mv	30msec	19	7	18	120	875
DCR 60-40	0-60	$\pm 1\%$ or 15mv	0-40	4.0 to 44.0	± 40 ma	0.5% + 50mv	30msec	19	7	20	130	900
DCR 40-60	0-40	$\pm 1\%$ or 15mv	0-60	6.0 to 66.0	± 60 ma	0.5% + 50mv	30msec	19	7	20	131	925



A UNIT OF RAYTHEON COMPANY

Circle 151 on reader service card



more general-purpose features, higher performance and quality with TI's 6613 pulse generator

The Model 6613 General Purpose Pulse Generator fills the need for a low-cost, high-quality test instrument with exceptional performance specifications. It is a general purpose instrument ideal for most pulse applications such as testing integrated circuits, digital circuit design, system design and checkout, testing of diodes and transistors.

The 6613 provides coincident positive and negative pulses determined by an internal clock generator or external source, with rep rate variable in 6 steps. Pulse width and delay are also variable in 6 steps. Amplitude is variable from near zero to 10 volts, with overload protection provided. Solid-state circuitry is utilized throughout. The compact unit measures 8½ in. high, 8½ in. wide, 12 in. deep and weighs only 10 lb.

SPECIFICATIONS

Clock Pulse Repetition Frequency

15 cps to 150 cps	15 to 150 kc
150 to 1500 cps	150 kc to 1.5 mc
1500 cps to 15 kc	1.5 mc to 15 mc

Delay

30 to 300 nano-sec	30 to 300 microsecs
300 nanosecs to 3 microsecs	300 microsecs to 3 milliseccs
3 to 30 microsecs	3 to 30 milliseccs

Width

30 to 300 nano-sec	30 to 300 microsecs
300 nanosecs to 3 microsecs	300 microsecs to 3 milliseccs
3 to 30 microsecs	3 to 30 milliseccs

Pulse Amplitude—10 v into 50 ohms

Rise and Fall Times—variable: less than 10 nanosecs to 1 microsec, 1 microsec to 100 microsecs, 100 microsecs to 10 milliseccs, minimum rise time typically 8 nanosecs

New Components



capacitors are available with $\pm 10\%$ and $\pm 5\%$ tolerances. Dimension accuracy provided by form-mold encapsulation facilitates automatic insertion in circuit board designs, eliminating machine jam-ups that could result from less critically dimensional dip-encapsulated capacitor designs. The epoxy case also resists soldering damage that might occur during installation. The BlackHawk units incorporate radial leads that are welded to the foil. This fused metal-to-metal bond maintains positive low-resistance contact even at signal-level voltages and greatly reduces losses and rejects due to broken leads. Mounting feet molded into the base of the capacitor elevate the body of the unit above the circuit board, thus providing a natural escape route for soldering by-products, since circuit board holes are not blocked by gases during dipping and soldering operations. Extensive life tests demonstrate that the new units can withstand 500 hours at 85° C and 125% of the rated d-c voltage applied, with not more than one failure in 12. Price ranges from \$53 to \$305 for thousand-lot quantities.

General Electric Co., Schenectady, N.Y. [352]

Wirewound trimmer rated at ¾ watt

A new ¾-w, 15-turn wirewound trimmer is designed with military stability, yet is economically priced. It measures 1 in. by 0.320 in. by 0.180 in. Series 160 is completely insulated and sealed in a diallyl phthalate housing with no metal parts outside. For maximum dielectric strength, the adjustment end

INDUSTRIAL
PRODUCTS
GROUP



**TEXAS INSTRUMENTS
INCORPORATED**
P. O. BOX 66027 HOUSTON, TEXAS 77006
7 RUE VERNONNEX GENEVA, SWITZERLAND

712

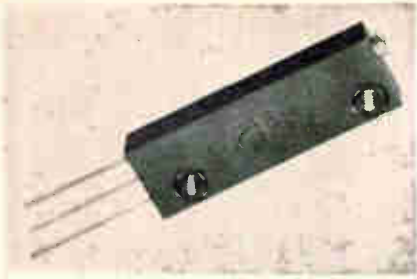

of the shaft is molded nylon. A simple positive clutch mechanism is built into the lead screw. Element terminations are free from mechanical strain because of a low resistance foil welded to the termination wire. All fixed electrical connections are welded into place. Maximum power dissipation is achieved by a high temperature epoxy insulated copper mandrel. For positive engagement with the lead screw, the metal drive block is threaded. A one-piece wiper welded directly to the drive block gives positive contact between the resistance element and the center collector. Bare solid wire on Teflon insulated stranded leads are available. Resistance range is 100 ohms to 20,000 ohms and temperature coefficient is 70 ppm maximum. Price is under \$3 each in production quantities; delivery, 5 to 6 weeks.

CTS of Berne, Inc., Berne, Ind. [353]

Connector makes substrates pluggable

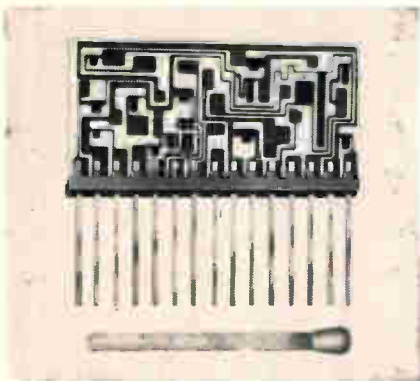

Several new microelectronic packaging techniques and connector applications are being introduced. One such approach will be a connector which makes substrates pluggable. A single row of contacts on 0.100 in. centers and a maximum width of 0.095 in. permits

Four Best Buys



recti/riter® RECORDERS

Circle 265 on
reader service card

... best galvo buy for the laboratory, offer outstanding convenience—true rectilinear writing, bench-top portable case or modern flush-mount, swing-out chart carriage with writing desk, push-button speed changer, choice of input ranges. See *recti/riter* recorder quality and reliability.

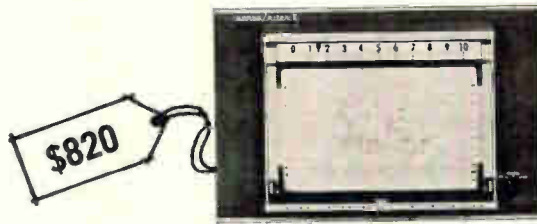

servo/riter® II RECORDERS

Circle 266 on
reader service card

... best buy for analytical and testing applications, offer high-performance specifications—high-impedance and high-rejection inputs, electronic integration capability, up to six channels on a single chart in flush style plus TI convenience features. See *servo/riter II* recorder versatility.



event/riter® RECORDERS

Circle 267 on
reader service card

... best buy in operations recorders, ideal for missile test stands—only pen-deflection instrument with 42 channels per single chart. Portable or flush, narrow or wide chart units accommodate 10, 20, 30, or 42 solenoid operated pens. See *event/riter* recorder adaptability.

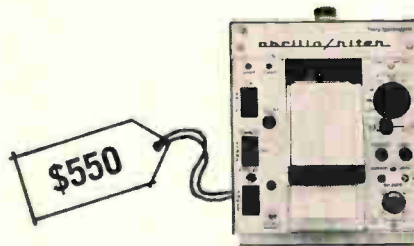

oscillo/riter® RECORDERS

Circle 268 on
reader service card

... best buy in direct-writing oscillographs, provide unexcelled operator convenience for applications up to 200 cps. Features are—push-button controls, interchangeable amplifiers, roll or Z-fold charts, ink or heat writing. See *oscillo/riter* recorder economy.

*Trademark of Texas Instruments

INDUSTRIAL
PRODUCTS
GROUP



TEXAS INSTRUMENTS
INCORPORATED
P. O. BOX 66027 HOUSTON, TEXAS 77006
7 RUE VERNONNEX GENEVA, SWITZERLAND

732

NEW, MULTI-RANGE frequency to d-c converter

Foxboro FR-520 frequency to d-c converter

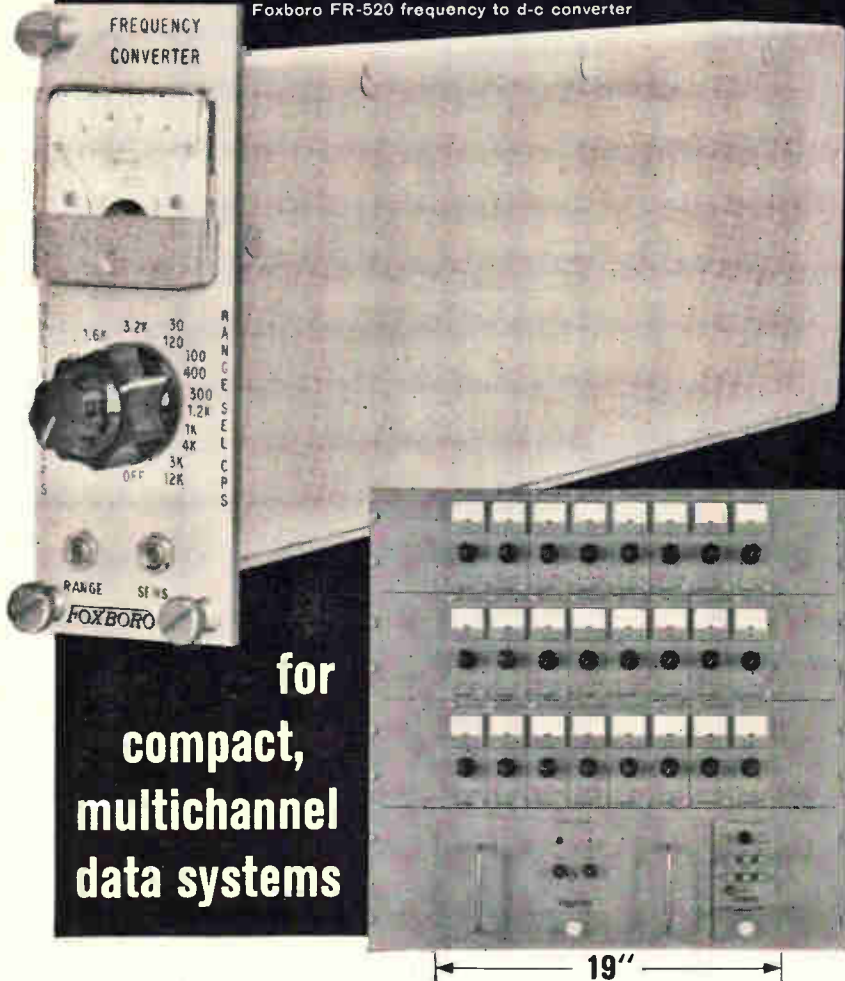

for
compact,
multichannel
data systems

VERSATILITY Five input frequency ranges between 10 to 30 and 10 to 12,000 cps . . . 4 to 1 full-scale adjustment in each range . . . makes possible instantaneous calibration. Two outputs: 0-5 volts d-c . . . and square wave pulse at input frequency to permit accurate remote readout for recorders and counters.

LINEARITY $\pm 0.1\%$ **REPEATABILITY** 0.05% of full scale.

RELIABILITY All solid-state construction. Output independent of wave form or signal level and regulated against changes in line voltage or ambient temperature.

NOISE REJECTION Rolloff circuitry decreases sensitivity as input frequency increases, rejects noise.

DIMENSIONS 2 x 5.22 x 12.875 inches.

For detailed specifications, write for GS 1-7N2 C. The Foxboro Company, Van Nuys Division (formerly Waugh Engineering Division), 7740 Lemona Avenue, Van Nuys, California.

Note for the Systems Engineer: A wide range of options such as 0.25 ohm output impedance, calibration frequency source, and power supplies are available.

FOXBORO
REGISTERED TRADEMARK

Specialists in Process and Energy Control

SEE THE FR-520 CONVERTER in BOOTHS 85-86, IEEE Show
at the Hilton

New Components

stacking substrates with back panel wiring on an 0.100 in. square grid. The same model is also available with contacts in a single row on 0.050 in. centers. The plug shown on p. 153 is available up to 4 in. in length; 0.020 in. square male contacts can be supplied in lengths up to 0.600 in. for use with a variety of connection means such as plug and receptacle, welding, dip-soldering, solderless, wrapping, etc. Insulation is diallyl phthalate; contacts are brass with gold flash over nickel plating. Right angle mounting versions are also available. Elco Corp., Willow Grove, Pa. [354]

Tiny trimmers weigh under a gram



A line of tiny trimmer capacitors permits industrial and military users to pack circuits more densely than ever before, according to the manufacturer. The trimmers, ranging from 1.5 to 30 pf, measuring only $\frac{1}{16}$ in. in diameter and weighing less than a gram, operate from 1 to 70 Mc, from -15° C to $+85^{\circ}$ C. After 1,000 hours at 85° C, with applied voltage three times working voltage, capacitance is reported to drift no more than 5% of 0.5 pf. A proprietary technique of multi-layer electrode metalizing permits low wattage soldering directly to electrodes, without fear of burnoff or amalgamation. The trimmers are available in three models. One is the DA813, where minimum size is most important. The DA814, packaged for horizontal or vertical mounting in p-c boards, has a slotted shaft for screwdriver adjustment. Preassembled connecting wires permit flexibility in positioning the trimmer within the layout. The DA815, mounted for cord-

Now...a "Flat-Pack" Welder for less than \$1500!



Available now—a 100% repeatable "flat-pack" welder, with feedback control, for just \$1425. How? We added a constant voltage accessory (Model VC-2) to our regular module welder! The VC-2 automatically compensates for changes in lead size, plating, and material consistency. Send for details...today!

SEE US AT THE IEEE SHOW
We'll be at Booth 4504, N. Y. Coliseum
March 22-25. Bring samples to weld!

Weltek

Precision Welders

by **WELLS ELECTRONICS, INC.**

1701 S. Main Street, South Bend, Indiana, U.S.A.

Circle 213 on reader service card

ALUMINUM INSTRUMENT KNOBS

UPGRADE YOUR EQUIPMENT
WITH • NEW • MODERNIZED
• DECORATIVE KNOBS OF
FABRICATED ALUMINUM.

- ☆ 1-PIECE CONSTRUCTION
- ☆ SUPERIOR APPEARANCE
- ☆ MODERATELY PRICED
- ☆ EXPENSIVE STYLING

NATURAL ALUMINUM			
MODEL	SIZE	SHAFT	POINTER
K-500A	.500	" $\frac{1}{8}$ " or " $\frac{1}{4}$ "	Black
K-700A	.750	" $\frac{1}{8}$ "	Black
K-900A	.937	" $\frac{1}{8}$ "	Black
K-1250A	1.250	" $\frac{1}{8}$ "	Black

GOLD ANODIZED			
MODEL	SIZE	SHAFT	POINTER
K-500G	.500	" $\frac{1}{8}$ " or " $\frac{1}{4}$ "	Red
K-700G	.750	" $\frac{1}{8}$ "	Red
K-900G	.937	" $\frac{1}{8}$ "	Red
K-1250G	1.250	" $\frac{1}{8}$ "	Red

BLACK ANODIZED			
MODEL	SIZE	SHAFT	POINTER
K-500B	.500	" $\frac{1}{8}$ " or " $\frac{1}{4}$ "	White
K-700B	.750	" $\frac{1}{8}$ "	White
K-900B	.937	" $\frac{1}{8}$ "	White
K-1250B	1.250	" $\frac{1}{8}$ "	White

*Specify Shaft

STOCK KNOBS

Available off the shelf
in production quantities



Natural
Aluminum



Gold
Anodized



Black
Anodized

WRITE FOR SPECIAL LOW O.E.M. PRICES

ALCOSWITCH

Lawrence, Mass. Dept. Q-50



K-700A

K-900G

K-1250B

a remarkable

NEW POWER SUPPLY from Deltron



"DUET" twin amplifier
controls voltage or current with
automatic electronic crossover

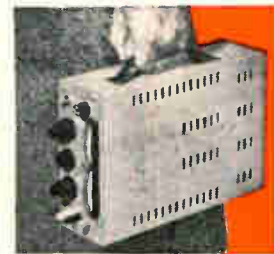

Built-in handle makes it easy to carry the "Duet". It's about half the size of an average briefcase.



Examine for yourself the superior design, workmanship, and components in the "Duet".

- Dual output range:
0-40 V at 0.75 amp . . .
0-20 V at 1.5 amps.
- 0.01% regulation.
- Ripple — less than
200 microvolts.
- All specifications are *guaranteed* without any need for external programming resistors.
- No overshoot on turn-on . . .
turn-off . . . or power interruption
in either voltage or current
mode.
- Automatic series and parallel
operation without complicated
connections.
- Half-rack size . . . permits rack
mounting as singles or duals . . .
as well as portable use.
- One free demonstration will
prove the "DUET" superior in
PERFORMANCE . . . QUALITY . . .
and PRICE . . . to any other on
the market.

16 OTHER RP MODELS
AVAILABLE IN A WIDE
RANGE OF RATINGS

For more information . . . or to arrange a
demonstration, write to . . .

VISIT US AT THE IEEE SHOW
...BOOTH 1132

Deltron inc.

FOURTH AND CAMBRIA STREETS, PHILADELPHIA, PA. 19133
PHONE: (215) 739-1101 TWX: (215) 569-8686



REFRACTORY METALS APPLICATION NOTES

G-E Moly rod makes the heat, or takes the heat. Anyway you cut it, it's protean.*

Consider the versatility of this form of General Electric molybdenum. Moly rod is used to heat and stir molten glass. It makes ideal furnace resistance heating elements and structural parts. It is easily machined into complex shapes for use in electronic power tubes or as fasteners in high temperature applications. Here are a few examples of parts made of G-E Molybdenum rod:

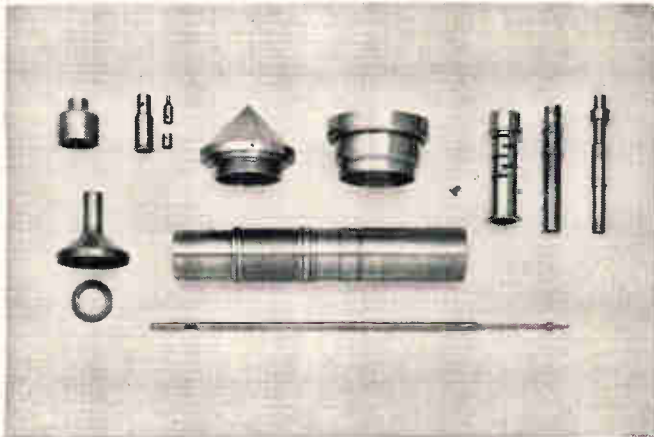

General Electric unalloyed powder metallurgy moly rod is available in diameters .020" through 4". Standard diameters can be delivered *off the shelf*. Alloyed or unalloyed arc-cast moly rod is also available.

G.E. makes most other forms of moly, too—including powder, wire, sheet, plate, foil and pressed and sintered shapes. No matter what form you need, if it's molybdenum call General Electric Lamp Metals & Components Department. For a starter, write today for information on G-E Powder Metallurgy Molybdenum rod. We'll send it to you along with data on other moly forms in which you indicate interest.

Write to: General Electric Co., Lamp Metals & Components Dept., 21800 Tungsten Rd., Cleveland, Ohio 44117. Or call (216) 266-2970.

**Pro-te-an, adj. 1. (P-), of or like Proteus. 2. readily taking on different shapes and forms.*

Progress Is Our Most Important Product

GENERAL  ELECTRIC

new, low cost!

Reliable Circuit Breaker



VISIT US
IEEE SHOW
BOOTH NO. 2911

Model 375 at 90¢ (prod. qty.) designed with the famous TAYLOR Bi-metal patented Blade for unsurpassed repeatability and reliability.

Write for Data Sheet 375.



**WOOD ELECTRIC
CORPORATION**

244 Broad Street, Lynn, Mass. (617) LY8-5313

Circle 215 on reader service card

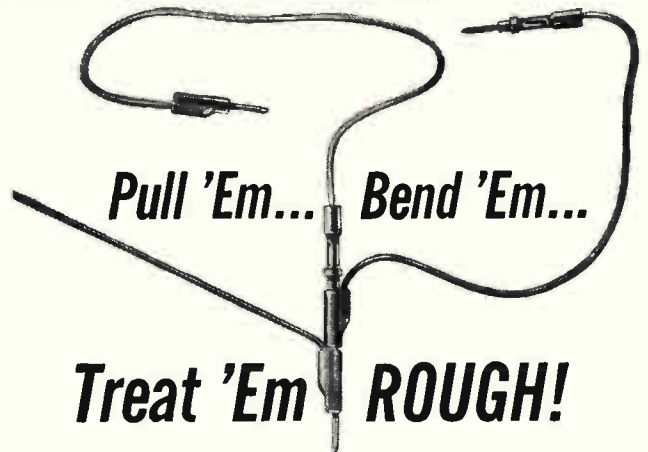

No half-way performance here! These miniature plugs and jacks from CAMBION® are made to do a man's job. Plugs are attached to wire to *stay* by means of Mil type four-point crimp. Completely flexible, plug can be bent up to 90 degrees — maintain 100% perfect contact — tens of thousands of cycles.

Exceptionally versatile, CAMBION Plugs and Jacks are ready for instant use in countless test board applications, breadboard set-ups, computer circuits and for production equipment or wherever .040" plugs and jacks and plug-jack terminations are used. Cage jack principle permits solid contact with low contact resistance. CAMBION Plugs and Jacks permit self-stacking for multiconnection at a single point. Made to meet international specifications, CAMBION Plugs and Jacks provide unlimited applications for prototype and production. For free samples and information, write to CAMBRIDGE THERMIONIC CORPORATION, 401 Concord Ave., Cambridge, Mass. 02138.

CAMBION®

"DIAL-A-PART" SERVICE

Standardize on CAMBION...The Guaranteed Electronic Components

New Components

wood packaging, also has a slotted shaft for screwdriver adjustment. Rotors are of temperature compensating ceramic, stators of high alumina ceramic. Insulation resistance after one minute is a minimum of 50 v d-c. Charge at 25° C is greater than 10,000 megohms. Centralab, Electronics Division of Globe-Union, Inc., 998 E. Keefe Ave., Milwaukee 1, Wisc. [355]

Pot stresses high precision

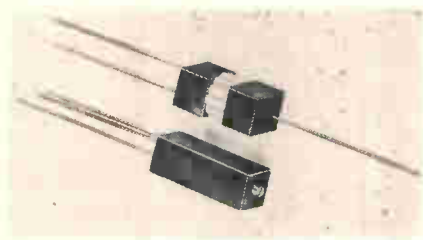

The new Verni-Trim potentiometer is said to offer an improvement of 10 to 100 times in resolution, resistance stability, resistance range and temperature coefficient over conventional design trimmers. The devices are suited for high precision applications which cannot be met by conventional design units as well as for general laboratory usage requiring precisely adjustable resistances. The resistance element is 5 to 20 in. long against the 3/4 in. of conventional design trimmers. The extra length magnifies resolution and stability by several orders of magnitude. Resolution is infinite from 0.5 ohm through 200 ohms. In these values actual resistance or voltage adjustments can be made through 0.005% as against approximately 1% in conventional finite resolution trimmers. Resolution is finite from 100 ohms through 200,000 ohms. Although the resolution is determined by the number of wire turns, it is still 10 to 50 times better than that of conventional design pots of the same resistance value. A fixed resistor of any specified value can be embedded optionally within Verni-Trim's case and connected in series or shunt with the adjustable element. This feature expands Verni-

MODULES POTTED IN *TIMONIUM*



LEVEL DETECTOR

An extremely sensitive and relatively fast acting circuit similar to a Schmitt Trigger. Differences of a few millivolts between input and reference voltages can be detected at switching speeds in excess of 2 Mc. Hysteresis of the circuit is 2 or 3 millivolts. 2.0 in. long x 0.7 in. wide x 0.8 in. high. Available in silicon (EM3051) or germanium (EM2651).

- Standard digital module families to 250 KC and 2 MC
- Power supplies
- Special function boards
- Specialized designs at "off-the-shelf" cost and delivery

EMC
ELECTRONIC
MODULES
CORPORATION

1949 GREENSPRING DRIVE • TIMONIUM, MD.
CLearbrook 2-2900 TWX-301-252-0723

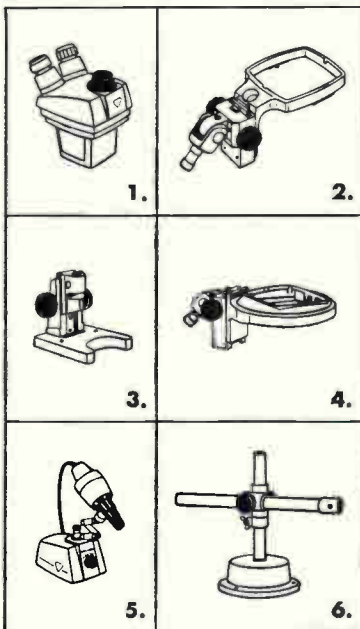
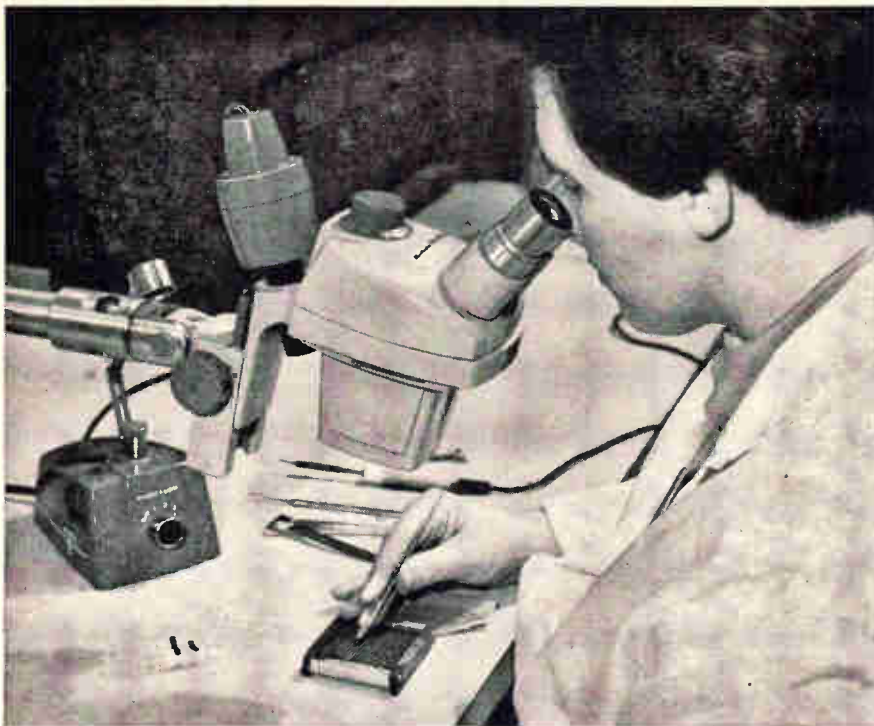

Some Basic Components for Custom Mountings

1. 4 Power Pods—Zoom and Fixed magnification
2. Stationary Arm, mounts any Power Pod
3. Bench Stand
4. Rotatable Arm, mounts any Power Pod
5. Nicholas Spot Illuminator
6. Universal Stand, simple version

Additional components and accessories to make special adaptations are available from B&L in greater variety than from any other maker of stereomicroscopes.

UNIVAC* uses Bausch & Lomb StereoZoom® to produce microminiature parts

The UNIVAC Microelectronic Aerospace Computer has 1,952 parts. It is only 6" square by 7" high. In a single second it can do 125,000 additions or subtractions, 30,000 multiplications, 15,000 divisions, or compute 8,000 square roots. UNIVAC uses the StereoZoom Microscope to assemble this microminiature marvel. Guided by StereoZoom's big, sharp *three-dimensional* image, an operator easily inserts 1,243 microelectronic circuits by hand with a pair of tweezers. A circuit is $\frac{1}{4} \times \frac{1}{8}$ inch and is $35/1,000$ of an inch thick.

If you need to assemble or inspect parts that are too small even to be measured with a micrometer, StereoZoom can help you. In addition to 24 basic models, Bausch & Lomb sells the necessary components to fit your special needs. Call your dealer, or write for Catalog 31-15. Bausch & Lomb, 61415 Bausch Street, Rochester, N. Y. 14602.

*Univac is a registered trademark of Univac Division of Sperry Rand Corporation.

BAUSCH & LOMB 

New Components

Trim's resolution to anything one may wish to specify while limiting proportionately the range of adjustment. Range is 0.5 ohm through 1 megohm wirewound. Temperature coefficient is as low as 2.5 ppm/° C between pot terminals. Stability is 0.01% either short or long term. Sizes vary from 0.312 in. diameter by 1.0 in. long to 0.500 by 0.406 by 2.0 in.

Verni-Trim Corp., 44 Prospect St., Yonkers, N.Y. [356]

Relay lives clean, lasts longer

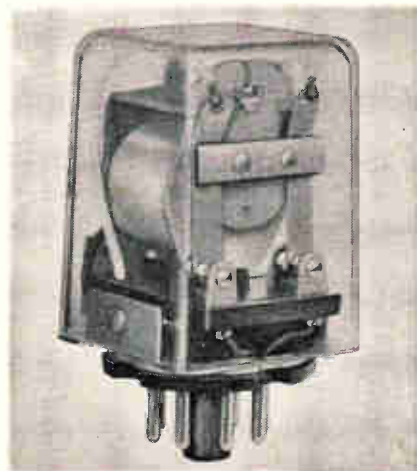

A new general purpose relay is available with an 8- or 11-pin octal type plug-in base. With the 22AP relay, dust covers of butyrate plastic or aluminum provide longer life with less maintenance by protecting the mechanism against dirt and other contaminants. In addition, the relays have been designed with fewer parts than most in their price range. Lower pull-in voltages are claimed as another advantage (d-c: 70% of nominal voltage; a-c: 75% of nominal voltage). Designed for heavy-duty spdt, dpdt or 3 pdt switching on a-c or d-c inputs, the relays are rated at loads of 5 or 10 amps at 115 v a-c. They weigh only $3\frac{1}{2}$ oz. Standard contact material is gold-plated silver cadmium oxide, with other materials available on request. The a-c version of the 22AP has operating

voltages of 0.5 to 250; current range is 0.005 amp to 10 amps; and temperature range is -55°C to $+72^{\circ}\text{C}$. The d-c version has operating voltages of 0.2 to 130. Current range is 0.005 amp to 10 amps and temperature range is -55°C to $+85^{\circ}\text{C}$. Coil voltages on the a-c range from 6 to 230, and on the d-c from 6 to 110.

E.W. Bliss Co., Eagle Signal Division, Davenport, Iowa. [357]

Thin pot licks space problem



A new mil-spec style RJ12 trimming potentiometer is designed for applications where mounting space is limited. The model 56 Helitrim trimmer is less than 0.200 in. thick and requires only about $\frac{2}{3}$ the board space of a conventional style RJ11 trimmer. It has plastic housing and is available with either pins or leads. An improved epoxy method was used to guarantee sealing of the unit far beyond the requirements of most environmental specifications. In addition, the model 56 offers a cermet resistance element with essentially infinite resolution and standard resistances from 10 ohms to 2 megohms. Power rating is 1 w at 85°C . and the ambient temperature range is -65°C to 175°C .

Helipot Division of Beckman Instruments, Inc., 2500 Harbor Blvd., Fullerton, Calif., 92634. [358]

Fuse designed for small spaces

A series of special purpose Pico-fuses, for fusing terminal strips and connectors, is announced. The subminiature Pico-fuse is designed for multipurpose applications in



This is PEMCO'S 17-pound Portable

It stands apart from the crowd of "portable" instrumentation recorders that weigh anywhere from 65 to 200 distressingly unportable pounds. It logs data from DC to 100 KC with laboratory precision* on only 20 to 45 watts (d-c or a-c). And it offers such large-instrumentation-recorder features as:

- Tape widths of $\frac{1}{4}$ ", $\frac{1}{2}$ ", or 1"
- Standard speeds from $1\frac{5}{16}$ to 60 ips
- Record times from $3\frac{1}{2}$ minutes to $3\frac{1}{2}$ hours
- All-solid-state, plug-in Direct or FM electronics
- Up to 14 channels (I.R.I.G. compatible)
- Performs in any position to altitudes of 70,000 feet

It could be just what the doctor ordered. If the prescription fills your need, ask about the PEMCO Model 110 General-Purpose Data Recorder. You'll receive our 12-page product brochure forthwith.

*FOR EXAMPLE

- FM center carrier drift within 0.1% over a full reel of tape
- Signal-to-noise ratio of 40 db FM, 35 db Direct at 30 ips



**PACIFIC
ELECTRO
MAGNETICS**

942 Commercial Street, Palo Alto, Calif. 94303/(415) 321-1177/Cable: PEMCO

now

from BURR-BROWN

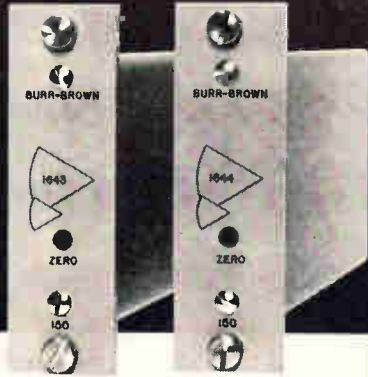

STABILIZED 50V & 100V SOLID-STATE OPERATIONAL AMPLIFIERS

You'll find no other solid-state operational amplifiers give you the superior performance of Burr-Brown's new stabilized 1643 and 1644. They are ideal for computer use . . . and for integrator and amplifier circuits requiring the high voltage—extreme stability combination. Current stability from -20°C to $+65^{\circ}\text{C}$ is better than $\pm .01\text{na}/^{\circ}\text{C}$. . . voltage stability is $\pm 1\mu\text{v}/^{\circ}\text{C}$. Both units feature internal zero control. And, you can mount up to 16 units in a $3\frac{1}{2}'' \times 19''$ rack. The Burr-Brown 1643 and 1644 are priced at \$275 and \$295 in unit quantity. For complete technical information or applications assistance, write, wire or phone Burr-Brown, today.

	#1643	#1644
High Voltage @ 10 ma	$\pm 50\text{V}$	$\pm 100\text{V}$
High DC Gain	160 db	160 db
Broad Bandwidth	2.5 Mcps	2.5 Mcps



FOR OTHER NEW OPERATIONAL AMPLIFIERS SEE ME AT BOOTH #3051-3 IEEE SHOW

BURR-BROWN

RESEARCH CORPORATION
Box 6444 TUCSON, ARIZONA
Telephone: 602-623-0328 • TWX: 602-792-2681

New Components

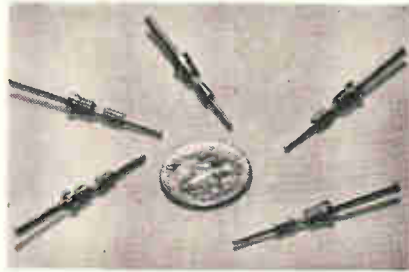

single and multipin connectors, rack and panel connectors, p-c connectors, terminal strips, and terminal boards. They are ideal where conventional fuse posts or holders are too big. For most applications, the tiny Picofuse is terminated with pins that simply plug into a terminal strip or board, or connector. Threaded pins are also available for positive hold-down. Picofuses are easily replaced if blown, and all fuses are readily accessible since they are right at the connection junction for easy servicing. In addition, such fused connectors prevent tampering by unqualified service personnel. The fuse is available in a wide range of amperage ratings from $\frac{1}{8}$ through 5 amps at 125 v. All models have short circuit interrupting capacity of 300 amps at 130 v d-c. The ceramic body fuse couples low resistance with high speed action. It provides extreme accuracy in blowing time at a minimum of 300% of rating. The body, not including terminals which may vary in length, is approximately $\frac{8}{32}$ in. The fuse weighs $\frac{1}{5}$ gram and offers high reliability with excellent shock and vibration characteristics. Littelfuse, Inc., 800 E. Northwest Highway, Des Plaines, Ill. [359]

Flatpack holds circuit chip

The flatpack is designed to accommodate or hold an integrated circuit chip (die). It consists of a substrate holder (shown on p. 162), cover, and solder preform. All are procured separately. One of its more distinctive characteristics is the flatpack's superior glass-to-

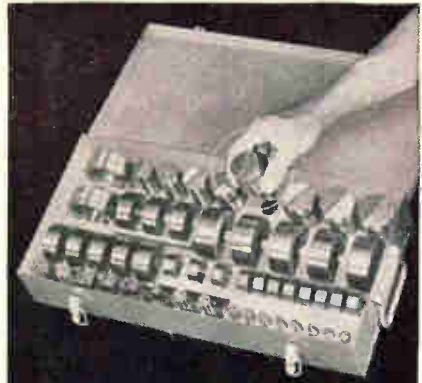

the right punch & die at your finger tips . . .

NEW DI-ACRO PUNCH PAKS

Punch Pak No. 1 - \$139.50
Punch Pak No. 2 - \$259.50

- Off the shelf delivery
- Adapters to fit any punch press

Di-Acro Punch-Paks save you money, cut production delays. No time lost looking for the right size or waiting for special orders. Cost is approximately 10 per cent less than individual punch and die sets—with the rugged, steel store-or-carry chest free. All Di-Acro Punches and Dies are precision made of quality tool steel.

PUNCH-PAK NO. 1 contains 30 sizes of round punches and dies from $\frac{3}{64}''$ to $\frac{1}{2}''$ in increments of $\frac{1}{64}''$.

PUNCH-PAK NO. 2 contains round punches and dies from $\frac{1}{16}''$ to $\frac{1}{2}''$ in $\frac{1}{16}''$ increments, round sizes from $\frac{1}{2}''$ to $2''$ in $\frac{1}{8}''$ increments, squares in $\frac{1}{2}''$, $\frac{5}{8}''$, $\frac{3}{4}''$ and $1''$ sizes, one die holder and two die adapters.

Die Adapter A-2 $\frac{3}{4}''$ diameter— $1\frac{1}{4}''$ bore, Die Adapter B-2 $\frac{3}{4}''$ diameter— $2\frac{1}{8}''$ bore.

DIMENSION DATA

All Di-Acro Punches to $\frac{1}{2}''$ have $\frac{1}{2}''$ diameter shanks, $2\frac{13}{32}''$ length. All Di-Acro Punches from $\frac{1}{2}''$ to $2''$ have $1''$ diameter shanks, $3\frac{1}{8}''$ length. All Di-Acro Dies to $\frac{3}{4}''$ are $1\frac{1}{4}''$ diameter, $\frac{3}{4}''$ high. All Di-Acro Dies from $\frac{3}{4}''$ to $1\frac{3}{8}''$ are $2\frac{1}{8}''$ diameter, $\frac{7}{8}''$ high. All Di-Acro Dies from $1\frac{1}{2}''$ to $2''$ are $2\frac{3}{4}''$ diameter, $1\frac{5}{32}''$ high.

PUNCH AND DIE HOLDERS

which adapt Di-Acro Punches and Dies to any punch press are listed in literature on single station punch and die program. Ask for it . . . also for literature on new Adjustable Punch and Die program.

For full information consult Yellow Pages of your phone book under Machinery-Machine Tools for the name of your Di-Acro distributor or write us.



Pronounced die-ack-ro

DI-ACRO CORPORATION

Formerly O'Neil Irwin Mfg. Co.

433 Eighth Avenue

Lake City, Minnesota • U.S.A.

A wide range of Daystrom Precision Trimming Potentiometers to fill all your needs. Typical examples include...

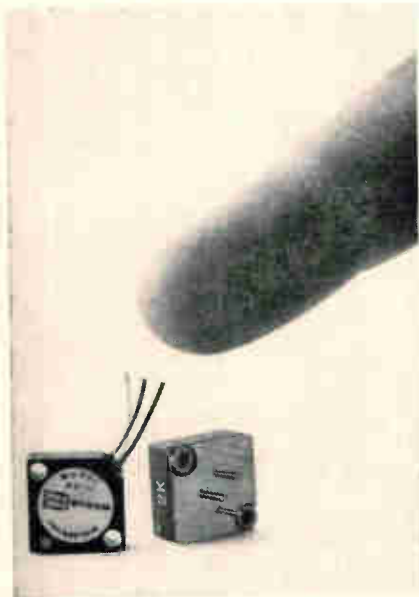

1. For Military Applications

Daystrom Squaretrim® Potentiometers Style RT-22 are made and tested in complete compliance with MIL-R-27208A and have additional features too.

The black anodized aluminum case provides maximum heat dissipation, maximum rigidity and effective electrical shielding. The resistance elements are wound by the unique wire-in-the-groove process which assures locked-in linearity and resolution. A gear ratio of 45:1 permits the user to take full advantage of the available electrical resolution for precise pick-off values.

Models 313-118 HS, Style RT 22 L with flexible leads and Models 318-105 HS, Style RT-22P with base pins are available.

2. For Precision Instruments

Daystrom Series 510 Transitrим is closer to being completely hermetically sealed than any available potentiometer. It is designed with a vacuum-tight glass-to-metal seal header, in addition to an O ring under compression on the adjustment screw.

The series 510 employs the compact T0-5 configuration with an all-metal housing .335" Dia. (flange .360" Dia.). Power rating is 1.25 watts in *still air* at 50° C with an operating temperature range from -55° C to 175° C. Available resistance range is from 10 Ω to 30K, with or without stops.

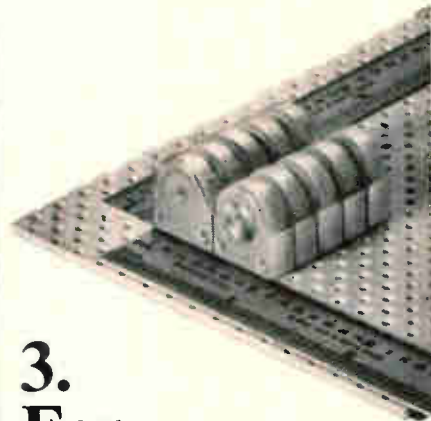
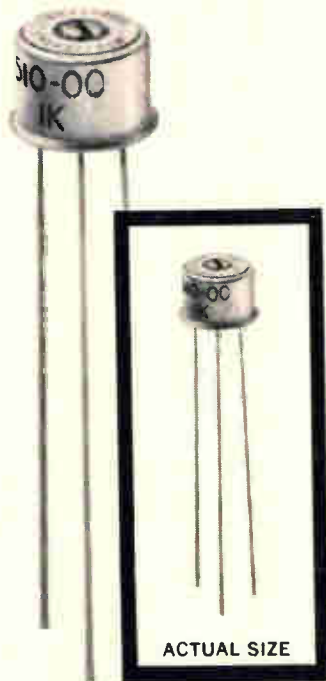

3. For Commercial Applications

Daystrom Series 333 Trimming Potentiometers are *low in cost* (\$1.45 each in 100 lot quantities) and *compact* (10 units can be fitted into 1/2 cubic inch of space on a PC board).

The resistance element is made by the same unique wire-in-the-groove method used in high reliability MIL-type Daystrom Squaretrim Potentiometers. The Series 333 offers dual adjustment—single turn finger tip on the knurled knob or fine adjustment (4 to 1 ratio nominal) with an Allen wrench. It dissipates 0.2 watt in *still air* at 40° C. Available with resistance values from 50 Ω to 10K, (Lower and higher values on special order).



Write for complete data and samples for evaluation on these "Quality by Design" potentiometers or see your Weston salesman. In Canada, Daystrom Ltd., Cooksville, Ont.



DAYSTROM POTENTIOMETERS ARE ANOTHER PRODUCT OF
WESTON INSTRUMENTS, INC.
ARCHBALO, PENNSYLVANIA 15403



There's only one way to go...computerized filter and transformer design



Here's the newest, shortest way to accuracy and top performance in filters and transformers: design by computers.

It's your fastest route. Computer designs take minutes instead of hours. No crossroads or by-passes, either. Computer design explores possible approaches, guides you straight to the best solution when you're in a hurry.

And no detouring for trial-and-error prototype costs. Designs are "performance tested" before production starts. Genisco's computer method searches through existing designs and singles out any that can be used.

Your filters and transformers arrive on time and at lower shipping cost because Genisco plants are on the map in key market areas. Price quotations are fast and accurate. There's never any guessing about costs with Genisco computer design of filters and transformers.

Find out how this new design capability can put you on the right track. Write today for complete information.

Genisco

TECHNOLOGY CORPORATION



INSTRUMENTS DIVISION
(Wave Filters)
9036 Winnetka Ave.
Northridge, California
(213) 341-4320

CEECO DIVISION
(Wave Filters & Transformers)
3223 W. Armitage Ave.
Chicago 47, Illinois
(312) 327-3130

TRANSONIC DIVISION
(Transformers)
808 16th Street
Bakersfield, California
(805) 327-5701

New Components

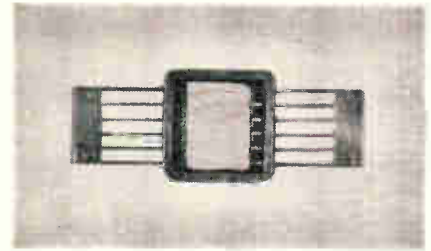

metal seal, which provides an excellent temperature coefficient. The final sealing process utilizes a solder preform. Three types can be supplied; a tin-antimony preform with a eutectic of 252° C, a gold-tin preform with a eutectic of 280° C and a gold-germanium preform with a eutectic of 356° C. The gold-tin preform offers a gold-to-gold junction in the solder as well as a relatively small grain structure for sealing capability. The eutectic point of the gold-tin preform also provides a large temperature differential from that of the 372° C gold-silicon eutectic of the integrated circuit die, which insures package/circuit integrity during final sealing. The flatpack utilizes two materials to provide a matched glass-to-Kovar sealing. A proprietary glass is used which provides excellent thermal tracking over the temperature range of 0° C to +300° C. Glass flow external to the package is kept to a minimum, thereby easing the requirements for final lidding. Plating is 100 μ in. minimum. Initial offering, 10-299100-1 (substrate holder), 10-299198-1 (cover), and 10-299175-1 (preform) is a 3/8 in. by 3/8 in. square flatpack.

Bendix Scintilla Division, Sidney, N.Y. [360]

Gold button contacts cut connector cost

Welded gold buttons preserve high reliability with only 5% of the gold needed to plate wire-wrap and other automated connectors. Limiting coverage to the actual contact area inside female receptacles can cut connector costs 15 to 20%, depending on the size of the connector, according to the company. The plated gold buttons are in-

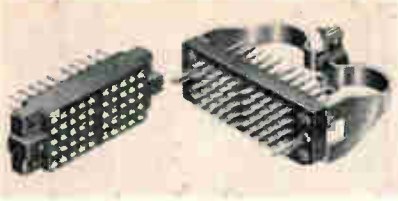

serted in a pre-formed seating area on the contacts and welded into place with a proprietary technique which bonds the button without affecting its plated gold. Costs for the new contact are higher than for overall plating, but savings in the amount of gold required result in lower over-all connector costs. Gold button contacts, developed in collaboration with Western Electric, are currently used with wrap post terminations. The technique is also applicable to a broad range of connector and termination styles, for p-c boards as well as rack and panel types. Assemblies including 50 of the new contacts are available from company stock. Additional assemblies of 60 and 72 contacts, or special sizes of 12, 18 and 26 contacts, can be made up to suit customer requirements.

Cinch Mfg. Co., 1026 S. Homan Ave., Chicago 24, Ill. [361]

Resistor network is stable, rugged

A new line of cermet resistor networks has superior load life stability. The passive networks, initially available in 4, 6 and 8-lead configurations, can be adjusted to 0.25% tolerance after firing and still retain better than a 1.0% change in resistance load life. Within a single network, the cermet is capable of maintaining temperature coefficient tracking from resistor path to path within 25 parts per million per degree centigrade, linearly, from low to high temperature range. The networks feature a consistent positive temperature coefficient of 200 ppm/° C (nominal). Resistance range is from 10 ohms to 500,000 ohms, and dissipation is 12 w per sq in. Environmental and life characteristics exceed the requirements of MIL-R-10509. Tolerances offered are from 0.25% to 5%. The maximum number of resistors on the 4-lead substrate is 3; for the 6-lead

CHOOSE FROM A COMPLETE FAMILY OF STRUTHERS-DUNN Airframe Power Relays

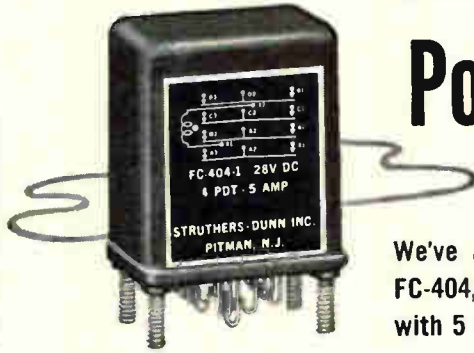

We've added this smaller Type FC-404, 4P-DT airframe relay with 5 amp bifurcated contacts.

Together with our FC-400 and FC-406 Series below, our newest addition gives you the convenience of a complete family of airframe power relays . . . all built to strictest design and performance standards by the most trusted name in military relays. Check these outstanding characteristics of the full series:

- ★ Tested to MIL-R-6106E
- ★ For class B8, A5 or A8 service
- ★ Balanced armature design
- ★ High shock and vibration resistance
- ★ Hermetically sealed under clean room conditions
- ★ Fully dependable under minimum current, rated load, severe overload conditions and temperature extremes
- ★ Plug-in and hook type solder terminals
- ★ Can be modified for MIL-R-5757D electronic applications
- ★ Plus—reliability the specs can't show
You can't see it, feel it, measure it. But it's in every Struthers-Dunn military relay. It comes from over 30 years' experience engineering and manufacturing the world's largest line of military relays for the most critical aerospace applications. It's an extra assurance of dependability when you specify Struthers-Dunn relays.

Type FC-400
4P-DT.
10 ampere
contacts.



Type FC-406
6P-DT.
5 ampere
contacts.



For complete specifications on all three relays, write for Bulletin FC-400, or call your Struthers-Dunn sales engineer. Address us at Pitman, N. J. 08071

STRUTHERS-DUNN *Inc.*

Pitman, New Jersey 08071

World's largest, most diversified relay line



SALES ENGINEERING OFFICES IN: Albuquerque • Atlanta • Belmont, Calif. • Boston • Buffalo • Cedar Rapids • Charlotte • Cincinnati • Clearwater, Fla. • Cleveland • Clifton • Dallas • Encino • Englewood Glen Ellyn, Ill. • Houston • Kansas City • Memphis • New York • Phoenix • Pittsburgh • St. Louis • St. Paul • Salt Lake City • San Antonio • Seattle • Southfield • Wichita • Wilmette. Canadian Licensee: Renfrew Electric Co., Ltd., Toronto. Export Department: 1505 Race St., Philadelphia, Penna. 19102, U.S.A.

See us at the IEEE Show—Coliseum Booth M-14

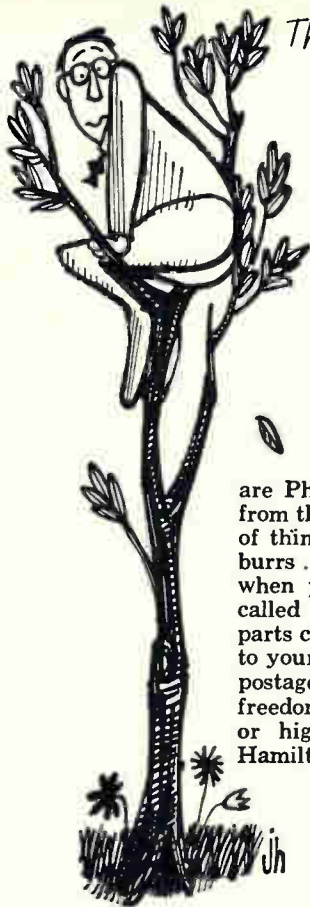

Thin, flat, odd-shaped precision parts have you up a tree ???

use the
theory of probability
to solve your problems

This is where experience counts! Chances are Photoforming by Hamilton will get you quickly from the drawing board stage to prototype production of thin, odd-shaped precision parts. No dies . . . no burrs . . . no bent edges . . . no stresses . . . no delays when parts are produced by the Hamilton process called Photoforming. Another plus, Photoformed parts can be heat-treated, plated, or formed according to your specifications. □ What can you lose? Invest a postage stamp and discover greater flexibility and freedom of design. Write for the facts—no obligation or high-pressure sales talk—just useful data on Hamilton's Photoforming and other facilities.

HAMILTON
WATCH COMPANY
INDUSTRIAL AND MILITARY PRODUCTS DIVISION • LANCASTER, PA.

Circle 221 on reader service card

New Components

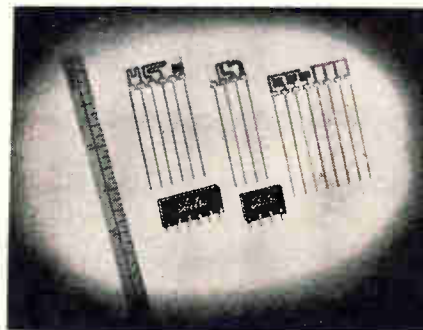

network it is 5 and for the 8-lead device 7. A precise orientation index is cast into the body of the epoxy encapsulation to simplify accurate manual or mechanized insertion. The module is rugged enough to be stapled into circuit boards by conventional assembly machines. Prices vary according to configurations and operating characteristics.

Electra Mfg. Co., Independence, Kan., 67301. [362]

Pads team up to save space



Originally developed for use in the Gemini space capsule, Transipad models 10054 and 10055 team up for maximum space utilization wherever TO-18 transistors are mounted on an 0.125-in. grid board. Company figures show a 12½% increase in packaging efficiency on board surface with this combination. With a maximum square dimension of 0.240 in., this assembly allows full use of each grid intersection of the 0.125 pattern. Space is saved by rotating the emitter tab into the grid area of the transistor itself. The transistor first enters Transipad 10055, which firmly seats it and provides strain relief. Leads then inserted into the 10054 are spread from 0.100 diameter to the 0.125 grid pattern. As the assembly

Read Instantly . . . Reset Precisely



With CEI's New Digital Frequency Counters

Receiver frequencies from 30 to 300 mc can be quickly read and reset to within one digit (1 kc), using CEI's new DRO-300 counter in conjunction with a CEI or other receiver having a 21.4 mc IF. The DRO-300's six-digit display provides a high resolution readout of tuned frequency, accomplished by counting the local oscillator, subtracting the IF, and displaying the difference on big, bright Nixie indicators. Information is updated every 20 milliseconds, but no flicker is apparent since only the final count is shown. The receiver

may thus be tuned or switched to other bands with instantaneous readout.

Solid state throughout (except for the display tubes), the DRO-300 requires just 3½" of rack space and consumes only 23 watts, permitting operation over a wide range of ambient temperatures without a cooling fan.

Similar counters offering ± 100 cps accuracy are available to match HF receivers with 455 kc, 500 kc or 3.9 mc IF's.

For further information please contact:



COMMUNICATION ELECTRONICS INCORPORATED

6006 Executive Boulevard, Rockville, Maryland 20852, Phone (301) 933-2800

is pressed together, the transistor and Transipad 10055 automatically rotate 45° to place the emitter tab directly over the emitter wire, preventing its projection into the adjacent grid area. With an overall height of 0.185 in., this assembly has 0.035-in. spacer feet which raise it from the board for thorough wash-out of solder-flux residue and prevent moisture trap. Because of above-board space required for other components, the manufacturer points out, this area between assembly and board may be "free" and not evaluated as a "trade-off". The two Transipads are molded from glass filled diallyl phthalate meeting MIL-M-14F type SDG specifications. The company makes no charge for small quantities to be used for experimental design research.

Milton Ross Co., Southampton, Pa. [363]

Resistor networks meet MIL-R-10509D

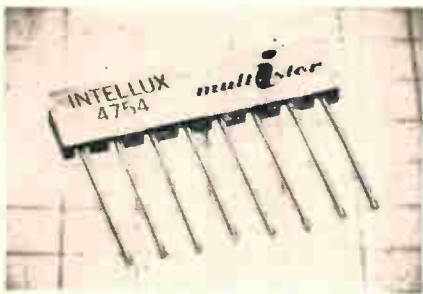

The Multistor is a thin-film, passive device wherein tin oxide is deposited on a high resistivity glass substrate, photo etched, terminated with fired ceramic silver and hermetically sealed with a fused glass superstrate. Individual resistors are interconnected with an electroplated copper cross-over pattern. The company says it is able to provide a network with precisely controlled temperature coefficient tracking, negligible inter-element capacitance and low noise. Resistivity range is 40 to 120 ohms/square standard, and 20 to 400 ohms/square special, with tolerances of 10%, 5% and 2½%. Multistors are in full compliance with performance requirements of MIL-R-10509D and are available on short notice.

Intellux Inc., 30 S. Salsipuedes St., Santa Barbara, Calif. [364]

Ballantine Sensitive DC/Volt/Ammeter

Model 365

Price: \$650

Extremely Wide Voltage and Current Range

Unmatched Accuracy for all Indications

Built-in Calibration Standard



Measures 1 μV to 1,000 V dc 0.001 μA to 1 A dc

Now you can measure with unmatched accuracy dc voltages with an extremely wide range of 1 μV to 1 kV and currents from 0.001 μA to 1 A.

Ballantine's Model 365 Sensitive DC Volt/Ammeter, an analog indicator with a single logarithmic scale and range selector, measures voltages above 1 mV with a constant accuracy of 1% of indication. It measures currents above 0.1 μA with an accuracy of 2% of indication.

The Model 365's accuracy is supported by a high order of stability gained by ac and dc feedback techniques and conservative operation of all components. If you need further assurance of accuracy, a reliable internal standard is available to check its calibration, which can be switched on in a second.

Signal-ground isolation of the Model 365 allows floating measurements to 500 volts above panel ground, and ac rejection is provided to reduce the effects of common-mode signals.

PARTIAL SPECIFICATIONS

Voltage	1 μV — 1 kV	Current	1 nA — 1 A
Accuracy	1% of indication above 1 mV	Accuracy	2% of indication above 0.1 μA
Impedance	1 MΩ above 1 μV; 5 MΩ above 0.1 mV; 10 MΩ above 0.1 V	Impedance	< 10 kΩ above 1 nA; < 100 Ω above 10 μA; < 1 Ω above 10 mA
Impedance Between Signal and Panel Grounds: R > 100 MΩ, C = 0.1 μF, 500 V Peak Max			
Usable as DC Amplifier: 100 db max gain, 0.1 to 1 V output for each decade input range			

Member Scientific Apparatus Makers Association



— Since 1932 —
BALLANTINE LABORATORIES INC.
Boonton, New Jersey

CHECK WITH BALLANTINE FIRST FOR LABORATORY VACUUM TUBE VOLTMETERS, REGARDLESS OF YOUR REQUIREMENTS FOR AMPLITUDE, FREQUENCY, OR WAVEFORM. WE HAVE A LARGE LINE, WITH ADDITIONS EACH YEAR. ALSO AC/DC LINEAR CONVERTERS, CALIBRATORS, WIDE BAND AMPLIFIERS, DIRECT-READING CAPACITANCE METERS, AND A LINE OF LABORATORY VOLTAGE STANDARDS 0 TO 1,000 MC.



PRECISION RESISTORS WITH

PLUS FACTORS

- + Precision Tolerance, Down to $\pm .002\%$
- + High Reliability
- + Long Term Stability
- + Military and Higher Environments
- + Broad Product Line Exceeding MIL-R-93C

Carefully controlled manufacturing procedures and continuous attention to quality control insure resistors of matchless quality and reliability.

Typical controls include: Tension-free windings • Temperature cycling • Spot-welded terminations and • Epoxy vacuum impregnation.

Aging and drift are minimized in Genistron resistors to insure excellent long term stability.

Resistors and/or networks as well as RCL combinations are available. These are hermetically sealed or epoxy encapsulated for extreme environmental conditions.

Contact Genistron's Application Engineering Dept., or for complete information write for data file IS-2409-3

Genistron
INCORPORATED

6320 W. Arizona Circle, Los Angeles, Cal. 90045 (213) 776-1411
111 Gateway Road, Bensenville, Ill. 60106 (312) 766-6550
7100 Baltimore Ave., College Park, Md. 20740 (301) 864-4811

Genisco
TECHNOLOGY CORPORATION
a subsidiary of

See us at IEEE—March 22-25, Booth 1516

New Instruments



Dvm gives top performance at low cost

A digital voltmeter that the manufacturer represents as a breakthrough in the low-price field is being introduced. It is expected to bring the time- and moneysaving benefits of highly accurate, automatic, digital voltage measuring to many users who formerly could not make the necessary initial investment for automatic equipment. Model 5005 dvm offers features previously available only in instruments costing 40% more, according to the manufacturer. It supplies four-digit display of d-c voltages from ± 0.001 to ± 999.9 v in ranges of $\pm 9.999/99.99/999.9$ v. Accuracy is $\pm 0.01\%$ of reading + 1 digit. High common mode noise rejection reduces the effect of spurious noise by 106 db at 60 cps, even when the noise has 1,000 ohms unbalance.

(Noise from a balanced noise source is easier to reject, but a balanced source is rarely encountered in practice.) The instrument contains an input filter to reduce signal mode noise. Input impedance is 10 to 1,000 megohms. Circuitry is all-transistor. The highest grade instrument construction is employed throughout; circuits are mounted on highest quality, interchangeable, plug-in, etched circuit, epoxy-fiber-glass boards. The dvm has been life-tested to an equivalent of 20 years' use for eight hours a day at one reading every two seconds. The design was proven by operation at an ambient temperature of 150°F, much too hot to handle without gloves. Price of the model 5005 is only \$985.

Non-Linear Systems, Inc., Del Mar Airport, Del Mar, Calif. [381]

Sweep oscillator covers wide range

A new sweep oscillator, model VR-50M, represents a state-of-the-art improvement in sweep generator technique, according to the manufacturer, because it can cover from 500 to 1,000 Mc using hybrid solid

state and nuvistor circuitry, eliminating the need for expensive backward-wave oscillators or heterodyned output. The oscillator, plugged into the basic SM-2000 chassis, provides a sweep generator designed for production, inspection or laboratory testing. The wide sweep width of the VR-50M makes it particularly useful in test-

500 kc-1300 mc WIDE SWEEP and MARKER GENERATOR



Kay's electronic, 300 mc wide, video-uhf Sweep and Marker Generator

NOW

- Voltage-controlled Oscillator; External Input: dc to 20 kc.
- Newly Transistorized Circuits.
- Extended Narrow Sweep Operation over the Full Frequency Range.
- Ruggedized Layout with Standard "Plug-in" Simplicity.
- P-123A Plug-in Head, Sweeps an Octave, 100 to 1000 mc.
- Optional Added 0-10 db, 1 db step Attenuator.

The 121-C delivers 0.5 volts rms into load—after a built-in attenuator—with excellent flatness and waveshape. Provides flat, wide sweeps and stable narrow sweeps; linear frequency output, agc'd rf level, and a frequency marker system. Harmonic marks at 1, 10 and 100 mc and circuits for an external variable marker are provided. A direct-reading 0-300 mc digital frequency dial provides smooth center frequency control and remarkable vernier adjustment for narrow sweep operation.

The electronic frequency modulation eliminates the microphonics, instability and frequent breakdowns of mechanical sweeps.

SPECIFICATIONS

Frequency Range: 500 kc to 1300 mc
Sweep Width: 5 kc to 500 mc
VHF (0.5 to 300 mc): 50 kc to 300 mc
UHF (200 mc to 1050 mc):
@ 220 mc, 5 kc to 50 mc;
@ 500 mc, 25 kc to 225 mc;
@ 800 mc, 35 kc to 350 mc.
P-122A (900-1300 mc): 200 kc to 400 mc
P-123A (100-1000): any octave, 100 to 200 mc, 200 to 400, 300 to 600, etc.

RF Output: .5 volt rms into 50 ohms, metered.
Flatness: ± 25 db to 800 mc.
 ± 5 db to 1300 mc.
Markers: crystal-controlled harmonics of 1, 10, 100 mc, or as specified.
Attenuation: 60 db in 10 db steps.
Sweep Rate: 10 to 60 cps, external from dc to 20 kc.
Price: \$1295. P-122A head: \$335.
P-123A head: \$335.
Markers: \$145.

KAY ELECTRIC COMPANY

MAPLE AVENUE, PINE BROOK, N.J., PHONE (201) 226-4000

RELIABILITY
is built-in



PERFORMANCE
is read-out

KEITHLEY DC
Differential
Voltmeters



The 0.02% 660A and 0.01% 662 dc differential voltmeters are so stable they maintain their accuracy for a full year. You can forget about periodic standardization or manual recalibration!

Only these differential voltmeters feature a guarded null detector with f.s. sensitivities from 100 μ v to 500 v. At null, input resistance is infinite to 500 v. Each model uses a photochopper-stabilized 500 v supply with T.C. Zener reference, and a Kelvin-Varley divider. Annoying reversal error is virtually eliminated. Easy operation is accentuated by a front-panel polarity switch and in-line readout.

Choose the features
that meet your needs

Feature	Model 660A	Model 662
Accuracy	0.02%, or 20 μ v	0.01%, or 10 μ v
Repeatability	0.005%	0.0025%
Readout	5 dials	6 dials
Price	\$650	\$995

Send for Engineering Notes
on our Differential Voltmeters



KEITHLEY
INSTRUMENTS

12415 Euclid Avenue • Cleveland 6, Ohio

New Instruments

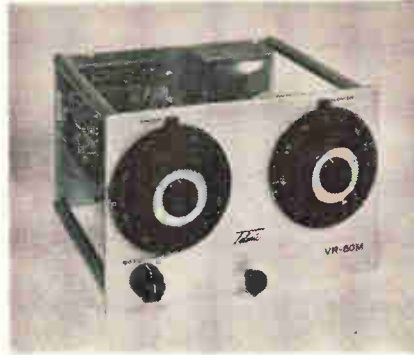

ing broadband equipment, such as parametric amplifiers and multiplexer equipment. General laboratory applications may also be fulfilled, because of the variable sweep width, center frequency and repetition-rate features. The VR-50M can be operated in four modes: sweep, c-w, modulated sweep and modulated c-w. The amplitude-modulated sweep or c-w mode generates a square wave with frequency variable from 800 to 1,200 cps. The unit can sweep manually (to scan any portion of the display), internally, externally, or internally variable from 0.01 to 100 cps. The sweep to retrace ratio can be switched from 1 to 1 or 10 to 1 for oscilloscope display. A built-in variable marker covers the entire 500 to 1,000 Mc range. Plug-in crystal-controlled harmonic and single frequency markers, at customer specified frequencies, allow infinite marking capabilities. Sweep width is continually variable from 5 to 500 Mc with a leveled output of 0.3 v rms. Nuvistor and transistor hybrid circuitry provide the VR-50M sweeper with the optimum in reliable performance. Price is \$695; delivery is 60 to 90 days. The basic SM-2000 control chassis (\$775) accepts 19 plug-in oscillator heads covering the frequency range of audio to 3 Gc.

Telonic Industries, Inc., 60 N. First Ave., Beech Grove, Ind. [382]

True rms ammeters
in 2 configurations

Two multirange true rms ammeters are announced. They feature a maximum current range of 1,000

Precision drawn
and cut glass
tubing and rod

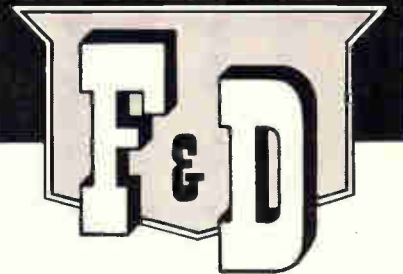

GLASS TUBING & ROD
redrawn and cut to
your specifications

Over 44 years experience in redrawing glass enables us to supply you with redrawn glass tubing and glass rod to your specifications. We can redraw tubing finer than a human hair or as large as .225" and be consistent about it. Perhaps you would like your tubing diamond saw cut to lengths of .020" upwards to tolerances of $\pm .001$ " or supplied in regular mill lengths.

We maintain adequate stocks of redraw blanks from many glass formulas, some of which are EN-1, KG-12, R-6 or N-51A. We can deliver what you need in a hurry. We can produce experimental lots or large quantities both at competitive prices. You will find, as many others have, that our quality is tops and our service fast and dependable. We welcome your inquiries.

FRIEDRICH & DIMMOCK, INC.
MILLVILLE, NEW JERSEY

Serving industry for nearly half a century

amperes with full scale accuracy over the entire range of 0.5% at frequencies from 50 cps to 10 kc. The first is a model 500 CTE which consists of a model 500 Transquare meter used in conjunction with an external current transformer for all ranges. It has the ranges 10/20/50/100/200/500 and 1,000 amps. The other configuration is designated model 560CT. This meter has self-contained ranges of 1/2/5/10/20/50/ and 100 amps. The additional ranges of 200, 500 and 1,000 amps are provided by means of a compact, external current transformer. A unique feature, according to the manufacturer, is the ability to change ranges by means of a small integral switch mounted on the meter panel. The high-current circuit is left undisturbed, and the necessity for changing the number of turns around the transformer in order to switch ranges has been eliminated. Prices range from \$925 for the model 500 CTE (including transformer) and \$725 for the 560 CT. The 1,000-amp current transformer is an additional \$350. Greibach Instruments Corp., 315 North Ave., New Rochelle, N.Y. [383]

Laboratory-type power supplies

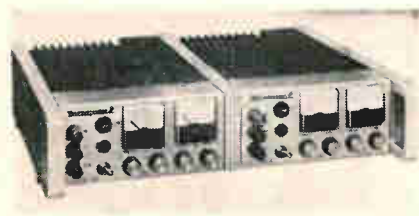

Solid state, laboratory-type power supplies are available in two series, LS and L, comprising 76 different models. A result of more than 18 months of development, these all-silicon, modular-construction supplies unlock hidden power capabilities, the company says, by means of state-of-the-art switching circuits. They double voltage or current rating without adding the usual penalties of size, weight and cost. The user receives essentially the same performance as with a competitive supply of twice the power rating, according to the manufacturer. Efficiency is in the order of 80% to 90%, combined with regulation ac-

aci

... new
connective
dimensions



A
New
"PITCH"
a new manufacturing
technique!

aci
announces
**SPREAD-
PITCH** and
MICRO-PITCH!

This latest achievement of aci eliminates the drawbacks of etched, ribbon and other types of circuitry and permits almost universal application of flat conductor cable!

aci, with "spread-pitch" for flat cable conductors, achieves compatibility with p.c. boards or other interconnection hardware already in production . . . and with "micro-pitch", produces narrower cable of extremely small conductor center to center dimension!

With "spread-pitch" and "micro-pitch" you also have all the advantages of flexibility, mobility with retractile roll-ups, accordions, or other pre-formed shapes . . . and the cost, weight, and space savings provided by aci Flat Conductor Cable Systems!

Check with us on your shielded circuitry requirements too . . . aci has many interesting new developments of Shielded Flat Conductor Cable Systems to minimize or eliminate cross talk, RF or magnetic circuitry problems.

See for yourself what we mean by "spread-pitch" and "micro-pitch" as part of "new connective dimensions" at aci's Booth 1005, IEEE Convention

... new
connective
dimensions



ADVANCED CIRCUITS INTERNATIONAL

DIVISION OF KENT CORPORATION

206 CENTER, PRINCETON, N.J. 08540 PHONE 609/924-3800

Trygon RS Series:

71°C all- silicon power supplies

for high-reliability systems!

71°C without derating, external heat sinking or forced air—3½" rack height—hermetically-sealed rectifiers—temperature stabilized reference diodes and semiconductors—computer grade filter capacitors—all for extreme reliability! Constant voltage/constant current, with automatic mode crossover. Seven models, from \$359. Write today for complete specs. Dept. E-30.



TRYGON®
POWER SUPPLIES
Roosevelt, L. I., N. Y. (516) FR0001 8-2800

New Instruments

curacy up to 0.01%, and stability up to 0.01% 1 mv. Panel heights have been reduced below most accepted industry sizes, and reliability objectives in excess of 25,000 hours mean time between failure have been achieved. The LS series illustrated is available in 38 models up to 160 v d-c and 25 amps. They provide 0.01% line and 0.03% load regulation, and include as a standard feature overvoltage load protection, using automatic semiconductor circuitry. Operation up to 80°C is permissible, and all units have provisions for adjustable current limiting, programming, tracking, constant voltage/constant current with automatic crossover, and power limiting. Parallel operation is possible with unique proportional sharing of the load current in accordance with power rating. The L series is also available in 38 models up to 160 v d-c and 25 amps. They provide 0.1% line and 0.3% load regulation, and operation up to 80°C is permissible. These units provide adjustable current limiting, programming, remote sensing, and series operation. Prices of the LS series range from \$295 to \$995; the L series, \$175 to \$620.

Technipower, Inc, a subsidiary of Benrus, 18 Marshall St., Norwalk, Conn. [384]

Bridge/analyzer features versatility



A professional-grade instrument has been announced for precision measurements of resistance and capacitance, also for diode reverse and transistor quiescent current measurements, insulation testing and resistance-capacitance-inductance comparison with external

NEW! FREE! NEW! FREE! NEW!

FREE! NEW! NEWARK 1965 INDUSTRIAL ELECTRONICS CATALOG!

Listing over 1000

TEXAS INSTRUMENTS



Semiconductors

including the new

"SILECT"™ TRANSISTORS



These economically-priced silicon transistors are designed for consumer and industrial applications.

They are packaged in silicone plastic that will not burn or deform at soldering temperatures and is naturally opaque. Sample lots have been tested to the moisture resistance requirements of MIL-STD-202B, method 106A, with no failures.

"SILECT" Transistor series currently available include high frequency (NPN), medium-power (NPN), low-noise, low-level (NPN), unijunctions and PNP transistors.

- Immediate Delivery from Stock
- Factory OEM Prices

NEWARK CATALOG 80

- Industry's Most Complete Catalog
- Over 640 Pages • Over 70,000 Items
- Over 600 Standard Brand Lines
- Eight Stocking Warehouses
- Over \$6,000,000 Industrial Electronics Inventory

NEWARK ELECTRONICS CORPORATION

Main office and warehouse • Dept. EL
223 West Madison • Chicago, Ill. 60606

Authorized Texas Instruments
Warehouses in:

CHICAGO, ILL.
(312) ST 2-2944

CINCINNATI, OHIO
(513) 421-5282

DENVER, COLORADO
(303) SK 7-3351

DETROIT, MICHIGAN
(313) JO 4-5490

GRAND RAPIDS, MICHIGAN
(616) 452-1411

LOS ANGELES AREA
(213) OR 8-0441

Other Newark Warehouses in:

NEW YORK CITY
(212) AL 5-4600

SAN FRANCISCO AREA
(415) 593-1881

MOVE UP



IN DIGITAL SYSTEMS AT NCR, LOS ANGELES

You can build a bigger future in an organization that's moving today. Join the NCR Electronics Division and go to work now creating ideas and hardware for NCR markets in more than 120 countries.

You'll share technical challenges with the men responsible for such successes as the NCR 315 EDP System, the CRAM magnetic-card concept in random-access memories, the 420 Optical Journal Reader, and the NCR 315 RMC—the first commercially available system with an all-thin-film main memory. And you'll go as far as your ideas can take you. NCR is moving forward, moving fast. Time now to make your move.

DESIGN AUTOMATION

DESIGN AUTOMATION SUPERVISOR / Requires previous supervisory experience in programming for design automation, good understanding of engineering and hardware problems, BS degree in math, engineering or related field.

DESIGN AUTOMATION PROGRAMMERS / Requires previous experience in programming for design automation, good understanding of engineering and hardware problems, BS degree in math, engineering or related field.

PRODUCT ENGINEERING

POWER SUPPLY DESIGN / Intermediate and senior level positions are available for circuit designers experienced in worst-case design of solid-state power supplies. BS or MS in EE required.

PACKAGING / These positions entail layout and design of packaging for computer systems. Applicants must have previous experience with electronic computers or electromechanical devices. Background in miniaturization utilizing thin films and integrated circuits is desirable. BSEE required.

VALUE ANALYSIS / These intermediate and senior level positions entail organizing and conducting value-analysis projects on company products. Work also involves assisting in locating new products and services, and participation in design and producibility review. Requires BS in engineering and three years' experience with electronic computers or electromechanical devices.

ADVANCED COMPUTER DEVELOPMENT

MECHANISMS DEVELOPMENT / An opening is available for a specialist in analysis and design of complex computer mechanisms. Must have knowledge of applied mechanics and high-level mathematical ability. PhD required.

CIRCUIT DESIGN / Openings are available at all levels for design of advanced integrated-circuit computers. Must have good knowledge of transistors and worst-case circuit design techniques. BS or MS in EE required.

ARRANGE IMMEDIATELY FOR INTERVIEWS DURING IEEE CONVENTION NYC, MARCH 22-25

For a confidential interview at the IEEE Convention in New York, please send a resume immediately, including training, experience and salary history, to Bill Holloway, Personnel Dept. If time does not permit sending a resume, call the NCR suite between March 22 and 25 at the New York Hilton, 247-4750.



The National Cash Register Company
ELECTRONICS DIVISION
2816 W. El Segundo Blvd., Hawthorne, Calif.
Telephone: Area Code 213-757-5111

An equal-opportunity employer

TRYLON ROTATABLE LOG PERIODIC ANTENNA

Single-layer, horizontally polarized,
for 6.5 to 32 mc. 65° azimuth beamwidth.
6 db gain/std. dipole. Power to 50 kw PEP

**“One cannot continually disappoint a Continent.”
We have designed, constructed, and installed
antenna and tower systems in North America,
South America, Europe, Asia, Africa, Antarctica.
We wish someone from Australia would call us.**



Elizabethton, Pa. 19520 (215) 942-2981 — International Division, 750 Third Ave., New York, N.Y. 10017, U.S.A.

Circle 228 on reader service card

**NEED NEW DESIGN FREEDOM? ACI OFFERS ...
3 DOZEN RESISTOR STYLES ...
TO CHOOSE FROM ...**

Conformal Coated

Molded

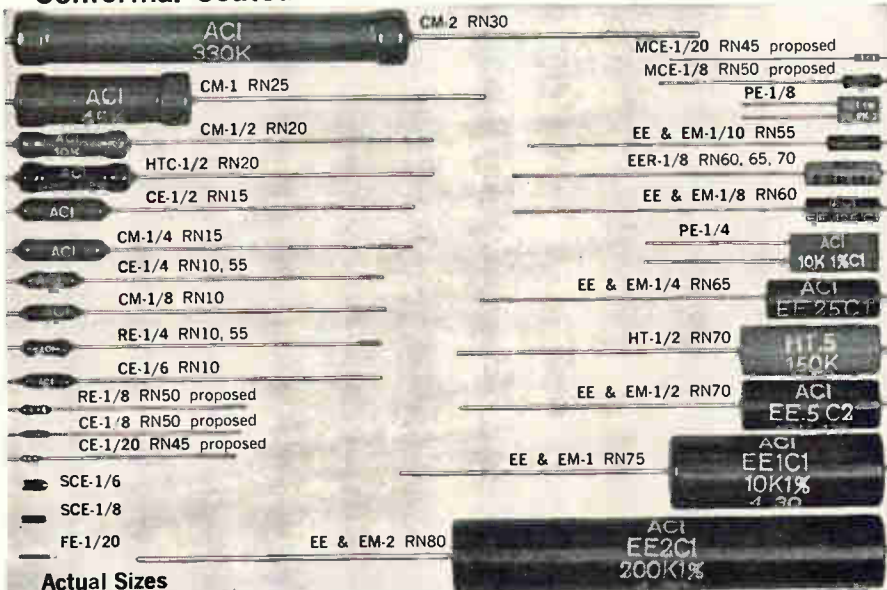

Actual Sizes

For military and commercial specifications, these precision metal film resistors offer design flexibility from .05 watt through 2 watts, in space-saving conformal coated, or rugged molded styles. For more information, write for ACI's condensed specification catalog, Bulletin 900.



American Components, Inc.

8th Ave. & Harry St., Conshohocken, Pa. 215 828-6240

172 Circle 172 on reader service card

New Instruments

standards. Model 965 Faradohm bridge/analyzer does not damage capacitors. It offers instant vtvm zeroing. The unit includes a 6-range vtvm, full overload protection, variable polarizing voltage, and an 11-range micro/milliammeter. Capacitance ranges are 5 to 10,000 pf, 500 pf to 1 μ f, 0.5 μ f to 100 μ f, 50 μ f to 5,000 μ f. Power factor is 0 to 80% at 60 cps. Resistance ranges are 0.5 to 1,000, 50 to 100,000 ohms, 5,000 ohms to 10 megohms, 5 to 500 megohms directly and up to 200,000 megohms using a metered variable d-c supply. D-c voltages are 1.5, 5, 15, 50, 150 and 500 v full scale into a 10-megohm input. D-c current ranges are 0.15, 0.5, 1.5, 5, 50 μ a, 0.15, 0.5, 1.5, 5, 15 ma (75 mv drop across terminals). Accuracy is \pm 5% on all except power factor when reading below 30%. The resistance - capacitance - inductance comparator range is 0.025 to 50 (ratio). Bridge supply potential is less than 0.5 v rms, 60 cps, except 10 v rms on lowest capacitance and highest resistance ranges. Variable d-c is 0.4 to 1.5, 1.4 to 5, 4 to 15, 14 to 50, 40 to 150, 140 to 500 v at 10 ma max. Power requirements are 32 to 45 w at 115 v a-c, 60 cps. The unit is 8½ in. high by 12½ in. wide by 9 in. deep. Weight is 15 lb. Price is \$129.95.

EICO Electronic Instrument Co., 131-01 39th Ave., Flushing, N.Y. [385]

Portable oscilloscope covers d-c to 15 Mc



This portable oscilloscope, type 422, weighs approximately 20 lbs.

with A supply, including power cord and panel cover. It combines easy portability with high performance, even under rugged field conditions. The scope can be used for testing and servicing high-speed computers, telemetering equipment and other modern instrumentation where space for test instrumentation is limited. Type 422 is 6.75 in. high, 8.5 in. wide and 16 in. deep. Bandwidth of d-c to 15 Mc, sensitivity to 10 mv/div, dual-trace operation, and sharp, bright displays provide laboratory oscilloscope performance for field-site applications. The unit is said to be ideal for aerospace studies and geophysical research. Type 422, with the d-c power supply option, operates four hours or more on self-contained rechargeable batteries, recharging them through its own circuitry, or can operate from any common a-c or d-c source. Low power drain makes it very useful for the installation and maintenance of equipment in remote locations. A 4-in. rectangular crt, with illuminated, internal graticule, provides 8.2 sq. in. of display area, with bright sharp traces even under high ambient light conditions. Four operating modes include each channel singly, alternate or chopped electronic switching between channels, or both channels added algebraically. In the added algebraically mode, channel 2 can be inverted for differential operation. Other features include sweep range from 0.5 μ sec/div to 0.5 sec/div, a 10 \times sweep magnifier and a highly adaptable triggering system which includes automatic and channel 1 only. Price is \$1,325.

Tektronix, Inc., P.O. Box 500, Beaverton, Ore., 97005. [386]

Fast and accurate frequency comparator



A new frequency-error expander provides frequency comparisons between a test signal and a stable frequency reference to a resolu-

pick a signal

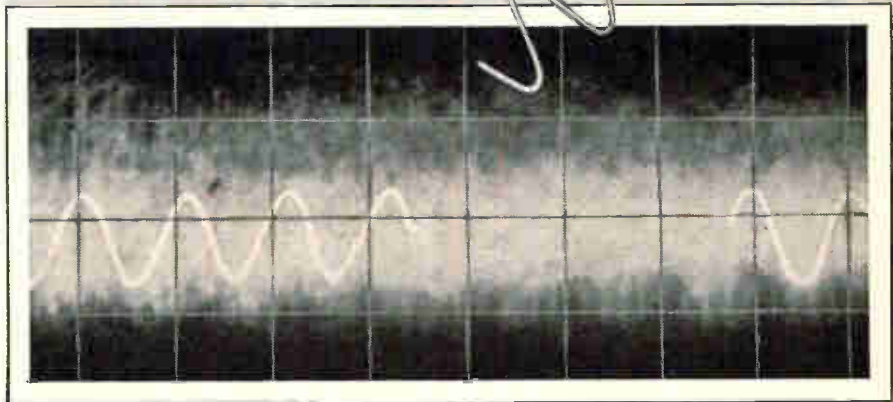

out of a 38 db noise background and reproduce it clean at 1v rms. with INTERSTATE'S AUTOMATIC SIGNAL TRACKING FILTER

■ Automatic Bandpass Filter ■ AM and FM Demodulator ■ Automatic Doppler Signal Tracker ■ Variable Bandpass: 2.5 to 100 cps ■ Wide Frequency Range ■ Solid State ■ Third Order Filter ■ Reliable.

This all solid state variable bandpass filter picks a signal out of -38db signal: noise. Its center frequency locks to the frequency of the signal to be tracked, then tracks it anywhere through a 100 cps to 120 kc spectrum. Output is a clean replica of the tracked signal. Send for brochure.



Interstate

ELECTRONICS CORPORATION

A SUBSIDIARY OF INTERSTATE ENGINEERING CORPORATION

707 East Vermont Avenue, Anaheim, California

Telephone: (714) 772-2222, TWX (714) 776-0280

Worldwide Representatives

Designed for



Application



90923

RACK MOUNTED OSCILLOSCOPES

Illustrated is No. 90923, one of the Millen line of rack mounted oscilloscopes. No. 90923 is complete with amplifiers and sweep. Good low frequency response and linearity. For monitoring, production test, or laboratory use. Compact. Uses type 3XP1 3" x 1 1/2" rectangular cathode ray tube.

JAMES MILLEN MFG. CO., INC.

**MALDEN
MASSACHUSETTS**

Circle 229 on reader service card



TYPE CMM



TYPE CLL

1 1/4" DIA. HIGH OUTPUT D.C. MOTORS & GEARMOTORS

Globe Type CMM and CLL motors are commercial versions of experience-proven Type MM and LL MIL-spec motors, carefully re-designed with relaxed environmental protection to offer compact size and military performance at a modest price. Outputs are 1/100 hp, 8-18,000 rpm (Type CMM) and 1/75 hp, 6-15,000 rpm (Type CLL).

Both Type CMM and Type CLL motors are available with a high quality planetary geartrain offering 83 ratios from 4:1 to 46,656:1 with torques from 3.0 to 1000 oz. in. Motors and gearmotors operate on 6 to 75 v.d.c. Request Bulletin CMM-CLL.

Globe Industries, Inc., 2275 Stanley Avenue
Dayton, Ohio 45404, U.S.A., Tel.: 513 222-3741

GLOBE



**VISIT US AT
BOOTH 1100
IEEE SHOW**



PRECISION CIRCUITS, INC.

*Specialists in the
art of producing
MULTI LAYER BOARDS
meeting customers
requirements.*

Inquiries invited.

*Originators of the CIRLOC process
(pat. app. for).*

PRECISION CIRCUITS, INC.

93 Weyman Ave.,
New Rochelle, N. Y. 10802
Phone (914)—235-4300

"where performance is equal to promise."

New Instruments

tion of 10^9 in one second, 10^{10} in 10 seconds, and 10^{11} in 100 seconds. The unit uses a single connector to handle eight test inputs ranging from 100 kc to 5 Mc. Eliminating the need for external dividers and multipliers, the test instrument achieves fast, accurate measurement of short and long term frequency stabilities and the calibration of frequency instruments, electronic counters and oscillators. The frequency error expander provides up to 10,000 times greater resolution in the same count period than can be obtained using a digital counter directly. In operation, the frequency error expander converts the test input signal to a common 1-Mc signal and mixes it with 900 kc synthesized from the 1-Mc or 100-kc reference. The output of 100 kc is then multiplied 10 times to provide a 10 times error expanded signal at 1 Mc. This process is repeated to achieve error expanded outputs up to 10,000 times, always at an output frequency of 1 Mc. Output levels are 1 v rms into 3,000 ohm load for the error expanded outputs and 1.5 v rms into 3,000 ohm load for the reference outputs. Price of the error expander is \$1,495. Delivery is in four weeks. Motorola Inc., Communications Division, 4501 Augusta Blvd., Chicago, Ill., 60651. [387]

Function generator uses plug-in principle

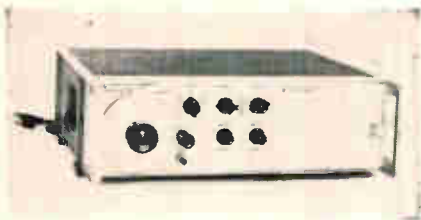

Extending the plug-in idea to function generators, the model 3300A is a compact, convenient, multi-purpose source of test waveforms. It provides two simultaneous outputs that may be any two of three waveforms. These are of common frequency and constant amplitude. Frequency is controllable either by

NEW... from the leader in thin film logic



The lowest priced microcircuits available for the non-military user.

Hybrid thin-film technology, as pioneered by Intellux, is a proven art. After some ten years of company sponsored research and development, production of tin oxide thin-film microcircuits began in 1961 with the introduction of a complete line of digital functions for the MIL Spec user. Today, thousands of these modules are functioning in the full military performance and environmental spectrum.

The Intellux Commercial/Industrial microcircuit is not a "fall-out" of the MIL-Spec production line. It has been specifically developed for use in systems where the design criteria are economy, compatibility, reliability and high noise immunity in a 0 to 85 C temp. environment. Voltage ranges for the 1mc modules are 6-9v and 6-12v. The voltage range for the 5mc line is 6-9v.

This custom design for the non-military user has now been phased into production at our new and modern facility. With the introduction of recently developed semi-automatic equipment, maximum economy is achieved through rigid production and quality control.

Complete data and specifications are available. Write, phone or TWX Intellux or call your local sales engineering representative.

1 MC Microcircuit PRICE LIST

	<u>1-50</u>	<u>51-100</u>	<u>101-500</u>	<u>501-1000</u>
FF1413BH JK Flip-Flop	6.00	5.25	4.25	3.50
GB1413GH Gate and Buffer	5.00	4.25	3.25	2.50
GG1413BH Dual 3-Input Gate	5.00	4.25	3.25	2.50
GG2413BH Dual 2-Input Gate	5.00	4.25	3.25	2.50
ST1513BH Schmitt Trigger	8.50	7.75	6.75	5.75
DM3510BH Delay Multivibrator	8.00	7.25	6.25	5.25

* Mixed quantity discount applied to orders in excess of 500 units.

26 COROMAR DRIVE
P.O. BOX 548
GOLETA, CALIFORNIA
PHONE (805) 968-3541

intellux
INCORPORATED

HIGHER DENSITY PACKAGING

with Netic & Co-Netic Magnetic Shielding Foils

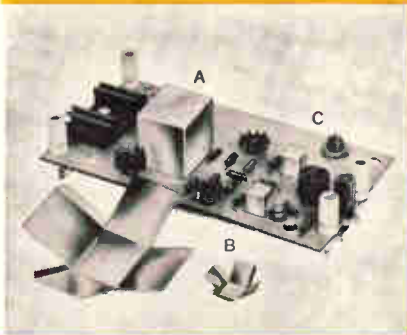

Higher density packaging . . . minimum magnetic interaction . . . no critical orientation . . . by enclosing magnetically sensitive components A, B, & C in Netic or Co-Netic.

Saves Space, Time, Money, Weight

Cuts easily to any outline . . . saving valuable time and weight, minimizing waste and tooling costs. Ideal for shielding hard-to-get-at components. Thicknesses from .002".

EXPLORER IV



Permanently Pre-annealed Netic and Co-Netic are shock insensitive, non-retentive. They have innumerable military, scientific, laboratory and commercial uses demanding permanent, trouble-free protection against magnetic fields.

MAGNETIC SHIELD DIVISION

Perfection Mica Company

1322 N. ELSTON AVENUE, CHICAGO, ILLINOIS 60622

ORIGINATORS OF PERMANENTLY EFFECTIVE NETIC CO-NETIC MAGNETIC SHIELDING

Circle 230 on reader service card

Specialist in

CUSTOM-BUILT TRANSFORMERS

TO YOUR SPECIFICATIONS

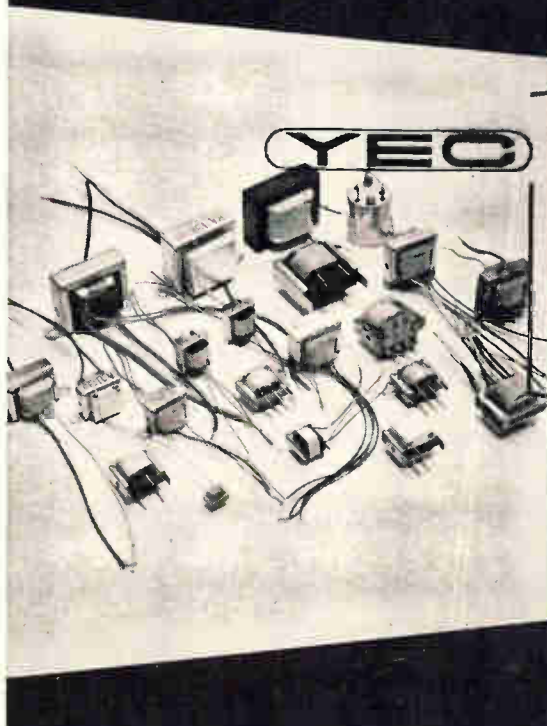

YUTAKA ELECTRIC invites you to submit your detailed specifications and quantity information to our engineering and production staff.

YUTAKA ELECTRIC MFG. CO., LTD.

1253, 1-chome, Yutaka-cho, Shinagawa-ku, Tokyo, Japan
Tel: (04472) 2171-3 Cable Add: "EDOYUTACO" Tokyo

176 Circle 176 on reader service card

New Instruments

a front-panel dial or by an external voltage to a rear-terminal connector, useful for controlled sweeps or programed frequency. The basic instrument produces sine, square or triangular waves ranging from 0.01 cps to 100 kc. With the model 3302A plug-in, the generator will deliver a single cycle on demand, in known phase with an outside signal, or multiple-cycle operation with variable start/stop phase. A phase-lock loop makes it possible to synchronize the 3300A to any periodic signal with a frequency from 10 cps to 100 kc. An exclusive front-panel meter positively displays achievement of lock. The loop also provides 360° of phase variability. Two output amplifiers are integral; either may be balanced or single-ended, and floating. Each will deliver 36 v peak-to-peak open circuit (4 v p-to-p into 50 ohms). The output system is d-c coupled and fully floating with respect to power line ground. Model 3300A will add convenience to the design and test of servo systems, for electrical simulation of mechanical phenomena, for sweeping filters, amplifiers, and other frequency-dependent devices. It may be programed to deliver frequencies for production testing. The solid state instrument is housed in a rack-convertible modular cabinet 5 in. high. The basic model 3300A generator is \$570; model 3301A basic plug-in, \$20; and model 3302A, \$190. First deliveries are expected to begin in June.

Hewlett-Packard Co., 1501 Page Mill Rd, Palo Alto, Calif. [388]

Price breakthrough claimed for dvm

A price breakthrough is claimed for the model 5005 digital voltmeter. The unit offers features previously available only in instruments costing 40% more. Major features are: four-digit display of d-c voltages from ± 0.001 to ± 999.9 v in ranges of $\pm 9.999/99.99/999.9$ v; accuracy of $\pm (0.01\%$ of full scale +1 digit); high com-

Electronics | March 8, 1965

mon mode noise rejection achieved by guard shielding; fully floating input circuit; a life expectancy of 20 years at one reading every 2 seconds for 8 hours a day; automatic range and polarity changing; built-in input filter; 10 to 1,000 megohms input resistance; minimum speed of 2 sec/reading; transistor circuitry throughout; interchangeable plug-in epoxy fiber-glass circuit boards; and operation over a wide ambient temperature range (0° to 140° F.) Some applications are: testing electronic and electrical components and circuits, strain gage and thermocouple readout (in conjunction with a pre-amplifier), environmental testing, gyro and accelerometer testing, medical electronics, nuclear research, and industrial process monitoring. The 5005 can measure length, pressure, temperature, stress, strain, velocity, acceleration, frequency, flow rate, light intensity, weight or any other quantity that can be converted into voltage by an external transducer. Price is \$985.

Non-Linear Systems, Inc., Del Mar Airport, Del Mar, Calif. [389]

Interference analyzer for 14 kc to 1 Gc

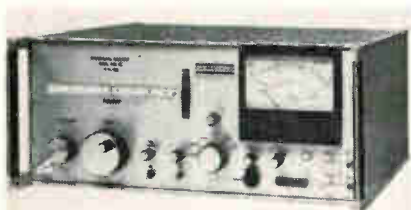

A solid state instrument for measuring radio frequency interference has been developed for the range 14 kc to 1 Gc. Model EMC-25 interference analyzer meets the latest military and commercial requirements for automated rfi data acquisition. The unit is capable of being electronically scanned over the entire frequency range and has remotely controllable band selection. It incorporates an internal battery supply in addition to capability for a-c operation. Besides being small and light, the EMC-25 offers sensitivity and operational simplicity. A choice of two bandwidths in each of 15 bands from 50 cps to 500 kc is standard

Tried tuning forks to solve frequency or optical control problems?

*Latest advances from BULOVA—
the leader—can help you!*

AMERICAN TIME PRODUCTS, now a part of Bulova Electronics, has pioneered just about every major advance in the use of tuning forks in the last 20 years.

AMERICAN TIME PRODUCTS —ATP for short—leads the industry with the most complete and advanced group of units to meet your frequency needs. For example, *only* ATP gives you:

- Fork units up to 25 kc.
- Complete fork oscillators in sizes as small as .35 cu. in. or in flat cans only .35 in. high for circuit board mounting.
- Operating temperature range from -65°C to 125°C—higher, if necessary.
- Tuning forks that chop, scan, modulate and otherwise manipulate light or energy beams—including torsional forks.
- Forks that withstand vibration and shock better because of unique construction.
- Tiny iso-elastic Accutron forks.
- Both magnetic or dynamic drives.
- All this, with stabilities as high as .001%.

This is what BULOVA does! Want to see how tuning forks can solve your problems? Just drop us a line—or better, call us—and outline your needs. Address: Dept. E-11.

Light Chopper! Dark Chopper!

Want to manipulate a beam of light? Or invisible ions? Chances are you'll do it better—or only—with an AMERICAN TIME PRODUCTS Optical Chopper. Using the balanced, vibrating times of a tuning fork, the ATP chopper offers these advantages:

- No lubrication needed
- Minimum space requirements
- Extremely lightweight—3 ounces max.
- Minimum power requirements—as low as 300 MW
- Operating temperature range of -65° C to 125° C
- Reference signal voltage available
- No wearing parts

It's so new, here are some of the uses to date:

- Star trackers • Spectrophotometers • Horizon sensors
- Film deposition control • Industrial process control
- Colorimeter • Oensitometer

Call or write us to discuss your problem. We'll make a unit to fit your needs.

BULOVA / **ELECTRONICS DIVISION**
WATCH COMPANY, INC. 61-20 WOODSIDE AVE., WOODSIDE 77, N.Y., 212 NE 9-5700



Crown
DATA RECORDERS

MODULAR SOLID STATE



SS 822
\$1295⁰⁰

2 CHANNEL

Two Channel Performance



SS 844

4 CHANNEL

\$1985⁰⁰

Features: 1/4" tape, 10 1/2" reels, two inputs per channel, Electro Dynamic Braking.

WRITE ...

for complete catalogue and specifications

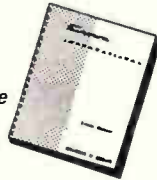

IPS	RESPONSE	WOW	S/N
15	± 2db 30-30,000 cps	0.06%	57
7 1/2	± 2db 30-20,000 cps	0.09%	56
3 3/4	± 3db 30-10,000 cps	0.18%	50 db

CROWN INTERNATIONAL, Box 1000, Elkhart, Ind., U.S.A.

Circle 231 on reader service card

**ELECTRONIC HARDWARE
COMPONENT PRODUCTS**

FASTENER SPECIALISTS for ELECTRONICS

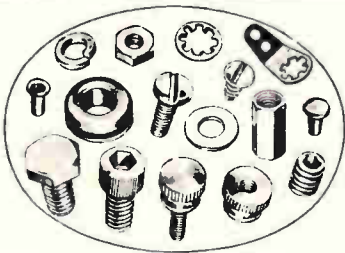

ONE SOURCE OF SUPPLY FOR FASTENERS

Screws - Nuts - Bolts - Washers - Lock Washers - Spade Bolts - Weld Screws - Sens Screws - Thread Cutting Screws - Socket Screws - Lock Nuts - Stop Nuts - Swedge Nuts - Weld Nuts - Miniature Fasteners - Rivets - Eyelets - Non-Corrosive Fasteners - AN-MS-NAS Fasteners - Nylok Fasteners - Nylon Fasteners - Insulating Washers - Spacers - Standoffs - Grommets - Burners - Terminals - Spring Pins - Components

Distributors For
UNITED SHOE MACHINERY CORP.
Complete Stocks of SE Eyelets

We carry in stock thousands of Standard and Special Items essential to the
ELECTRONIC • INSTRUMENT • AUTOMATION
Manufacturing Industries
SPECIAL COLD HEADED PRODUCTS
STAMPINGS — SCREW MACHINE PRODUCTS
Made to order in all metals

FEDERAL SCREW PRODUCTS, Inc
3917 N. Kedzie Ave., Chicago, Illinois 60618
Area Code 312—Tel. 478-5744

Write for CATALOG 64ES for Purchasing & Design

DC POWER SUPPLIES



CONTINUOUS VOLTAGE COVERAGE—4.7 to 60 vdc.
Input: 105-125 vdc, 50-400 cps
Regulations: From ±0.05%
Ripple: From .002% or 1 mv, rms
Temp. Coeff.: From ±0.01%/°C
Voltage Adjustments: ±5%
Max. Temp. of Base: 65°C

- WIDE VARIETY OF CURRENT RATINGS
- ELECTRONIC SHORT CIRCUIT PROTECTION
- FULLY REPAIRABLE
- 7 STANDARD SIZES (OVER 450 MODELS)
- PRICE RANGE **\$45-\$225**



INSTRUMENTS: EEM ('63-64 Pg. 902)
EBG (1964 Pg. 462)
POWER SUPPLIES: EEM ('64-65 Pg. 1341)
EBG (1963 Pg. 307)
VOLTAGE STANDARDS: EEM ('64-65 Pg. 929)

DYNAGE, inc.

390 CAPITOL AVE., HARTFORD, CONN.

Circle 232 on reader service card

New Instruments

in the unit. Detector functions provided are carrier, peak, 60-db scan, slideback and f-m deviation. In 60-db scan, a full 60-db range can be read on the meter without changing input attenuator settings. Outputs for phones, external meter, X-Y recorder, i-f and video are incorporated in the instrument. Price is \$8,200.

Electro-Metrics Corp., 88 Church St., Amsterdam, N.Y., 12011. [390]

Temperature controllers are read directly



New laboratory-style proportional temperature controllers feature cabinet-type construction and a new direct-reading dial. The CU-300 series uses a high-precision proportional controller capable of regulating temperature to a fraction of a degree. A thermal loop compensates for the effects of time lags in the system being controlled. This compensation, including both rate and reset actions, is made adjustable to allow maximum flexibility in controlling a wide variety of thermal loads. The controllers are thus ideal for a precision temperature control of ovens, furnaces, test fixtures, plastic molding machinery, extruders and a wide variety of similar industrial and laboratory equipment. A 10-turn potentiometer is used to obtain maximum accuracy and repeatability in setting the temperature. The temperature is read on a 4 1/2-in. direct-reading dial that can be set quickly to the desired tem-

A REAL OPERATING DIGITAL COMPUTER



ONLY \$4.98

Ingenious mechanical equivalent of a digital computer—designed by two PhD's—in durable plastic, lets computer operations be seen and understood. In kit form (assembly about an hour) the "DigiComp-1" can be programmed to check out accuracy of assembly, add, subtract, multiply, carry, shift complements, compare, store and retrieve. Teaches binary arithmetic. Manual contains complete, understandable explanation of concepts behind the modern digital computer, and complete programming instructions for a variety of educational problems.

A valuable educational aid for children in upper grades or high school . . . a big help in explaining the computer to your wife and friends . . . will fascinate the most advanced computer expert. Full money-back guarantee. Only \$4.98 + 63¢ shipping charges. Send cash, check or Money Order to

ROYAL ADVTG. CORP., DEPT. 40, LYNBROOK, N. Y.

IEEE Booth 1816



Cut your wire preparation costs with high-speed wire strippers

Eubanks wire strippers are noted for easy set-up changes, high-speed operation, and clean stripping without nicking or scraping. Whether you need battery cables, printed circuit board jumpers, leads for electric watches, coaxial cables, or washing machine harnesses, chances are excellent that we have a machine to meet your requirements. Pictured is our Model 87 Utility Wire Stripper, which produces up to 12,000 leads an hour. Write for free information on this and other Eubanks wire stripping machines to Eubanks Engineering Co., 225 W. Duarte Rd., Monrovia, California.



EUBANKS
ENGINEERING COMPANY



ELECTRONIC ENGINEERS

at all levels are needed

to Manage Installation, Maintenance, & Reliability Programs for Navy Shipboard and Submarine Systems

The Electronics Maintenance Engineering Center (EMEC) at Norfolk is a new kind of field activity of the Bureau of Ships . . . a concept that has caught on, and that offers the versatile electronic engineer the widest possible latitude of operation and growth. Basically, EMEC is responsible for increasing the readiness of the Navy through improvements in the installation, design, documentation, training, parts supply, and test equipment pertaining to new equipments and systems on Naval vessels—surface, subsurface, and amphibious—and, therefore, for developing maintenance programs as well as assuring continuous at-sea operation under all conditions.

This, then, is engineering at the *user level* . . . involving the design, development and evaluation of equipment/system modifications . . . providing statistical analyses of failure data . . . acting as liaison among Bureau headquarters, industrial contractors, and the operational commands . . . and writing technical reports . . . in the following areas:

- RADAR • SONAR • COMMUNICATIONS
- ECM . . . DATA DISPLAY • COMPUTERS
- TEST EQUIPMENT/INSTRUMENTATION
- NAVIGATION AIDS

EMEC is scheduled to almost DOUBLE its size, so now is the time to compare interests and objectives . . . particularly if you're the sort of engineer who wants to gain insight into electronic systems on the widest possible scale. We would like to hear from recent graduates with no experience (\$5,990 to start, or \$7,050 with B average or upper 25% standing) . . . with 1 year experience (\$7,050 to start) . . . with 2 years' experience (\$7,710 to start) . . . and with 3 or more years' experience (\$8,945 to \$12,075 to start). All positions include the benefits of Career Civil Service, and regular salary increases in grade.

Write to the Director, Electronics Maintenance Engineering Center, Box SECTION, Hampton Roads Branch Post Office, Norfolk, Virginia 23511. *An Equal Opportunity Employer.*





**WHERE
QUALITY
COMES
FIRST**

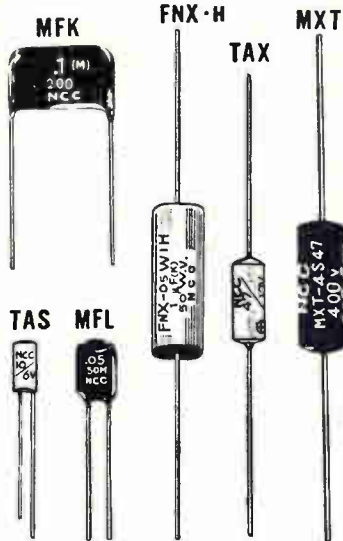

POLYESTER FILM CAPACITOR:

	Capacitance Range	Voltages
TYPE MFL Dipped Flat Shape	.001 MFD to 47 MFD	35, 50, 100, 200v.DC
TYPE MFK Dipped Flat Shape Non-inductive Construction	.01 MFD to .22 MFD	100, 200, 400 600v.DC
TYPE MXT In Plastic Tube	.001 MFD to .22 MFD	100, 200, 400, 600v.DC

METALLIZED POLYESTER FILM CAPACITORS

TYPE FNX-H Mylar Wrapped Semioval With Epoxy End Seal	1 MFD to 10 MFD	50v DC
---	-----------------	--------

SOLID TANTALUM CAPACITORS

TYPE TAX MIL-C-26655A Hermetically Sealed	1 MFD to 220 MFD	3, 6, 10, 15, 20, 25, 35v.DC
TYPE TAS Sealed with Epoxy Resin	1 MFD to 220 MFD	3, 6, 10, 15, 20, 25, 35v.DC

**MATSUO
ELECTRIC
CO., LTD.**

HEAD OFFICE :

3-5, 3-CHOME, SENNARI-CHO, TOYONAKA-SHI,
OSAKA, JAPAN.

TOKYO OFFICE :

25-2-CHOME, KANDA AWAJI-CHO, CHIYODA-KU,
TOKYO, JAPAN.

Cable Address "NCC MATSUO" OSAKA

New Instruments

perature without the need for a calibration chart. The controller is mounted in a cabinet, complete with deviation indicator, on-off switch, pilot light, fuse, line cord and connection plug. Any temperature range can be furnished between -200° and $+1,100^{\circ}$ C. Standard forms have power outputs up to 6 kw. The controller can also be furnished with temperature-alarm circuits that are activated whenever the temperature is not at the desired set point. Harrel, Inc., 16 Fitch St., E. Norwalk, Conn. [391]

**Panel instruments
offered in 3 sizes**

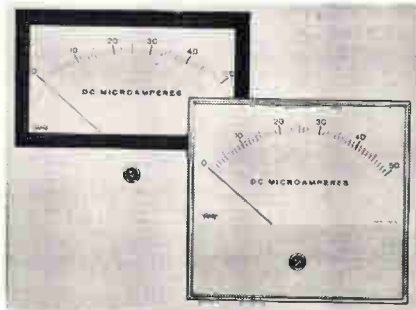

A new panel instrument features flexibility and interchangeability, with an optional mounting bezel for behind-the-panel mounting and dramatic picture-window effect. The G-series is available in three sizes: $2\frac{1}{2}$, $3\frac{1}{2}$ and $4\frac{1}{2}$ in. providing selection opportunities for the user. The instruments also feature the company's Bar-Ring d-c movements that provide exact, reliable readings and are self-shielded from stray magnetic fields. The Bar-Ring design also allows more torque, faster response and more ruggedness. A long dominant scale has a large dial area for multiple scales and other applications. In addition, a flat insert for the masked portion of the meter front may be painted any color and can be imprinted with company logos, instructions, etc., subject to special handling fees. The G-series panel instruments are available in a-c ranges from 10 ma, and d-c ranges from $5 \mu\text{a}$. Prices are from \$11.60 and up. Deliveries

Physicists and Electrical Engineers for research into

**NEW
COMPONENT PART
CONCEPTS**

Unusual opportunities now exist in the field of component development and performance analysis, due to a conceptual approach developed by our Research and Development Laboratories. These positions demand the ability to perform laboratory evaluation on existing components and prepare a critical analysis of their performance. Where the state of the art is a limiting factor, new approaches must be proposed and development work initiated to provide the required component performance.

In the process of developing new approaches to the solution of component problems, papers must be prepared which will be used as the basis for proposals.

Well equipped laboratories are provided in which the applicant can employ the latest techniques in development and instrumentation to assist in the exploitation of his ideas.

Qualifications should include at least a BS degree from an accredited university in Physics or Electrical Engineering. In addition, the applicant must be able to demonstrate 5 to 10 years of progressive creative experience through issued patents or publications in technical journals.

Please airmail your resume to:

MR. ROBERT A. MARTIN
Head of Employment
Hughes Aerospace Divisions
11940 W. Jefferson Blvd.
Culver City 36, California

Creating a new world with electronics

HUGHES

HUGHES AIRCRAFT COMPANY
AEROSPACE DIVISIONS

An equal opportunity employer.

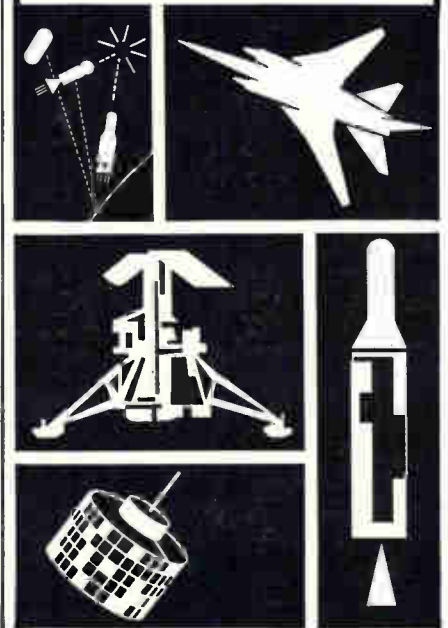

are made in 45 to 60 days.
The Triplett Electrical Instrument Co.,
Bluffton, Ohio. [392]

Spectrum analyzer augments scope



Type L-10A spectrum analyzer plug-in unit covers the frequency range of 1 Mc to 36 Mc. It fits all the company's oscilloscopes that accept letter-series or I-series plug-ins. The combination provides calibrated dispersion with optimized cross-coupled resolution to simplify operation—yet each control can be operated independently. Calibrated sweeps of the oscilloscope permit measurements such as pulse repetition rates—not possible with ordinary analyzers, according to the manufacturer. Oscilloscope usefulness is doubled, since it can be used for either spectrum analysis or video displays without changing plug-in units. Versatile triggering facilities of the oscilloscope are said to allow unique applications. The first i-f amplifier of the L-10A is at 60 Mc. Thus, the image and other spurious responses are well outside the frequency range of this instrument. Basic characteristics of the L-10A include a dial accuracy of $\pm(100 \text{ kc} + 1\% \text{ of dial reading})$; sensitivity, -100 dbm at 10 cps resolution; dispersion, 100 cps to 20 kc calibrated in eight steps plus uncalibrated search position; resolution, 10 cps to 1 kc; display—log, linear, linear $\times 10$, video, 100 mv/cm variable, 10 cps to oscilloscope vertical bandwidth approximately equal to 50-ohm input resistance. Price is \$1,200. Available during the second quarter of 1965.

Tektronix, Inc., P.O. Box 500, Beaverton, Ore., 97005. [393]

LAPP GAS FILLED CAPACITORS ARE DESIGNED FOR

HIGH
VOLTAGE

HIGH
CURRENT

HIGH
CAPACITANCE

APPLICATIONS



These uniquely designed Lapp Gas-Filled Capacitors are completely unaffected by atmospheric or dust conditions. They are precision built and of extra strong construction to assure years of accurate, trouble-free operation. ■ Lapp Gas-Filled Capacitors are available in either fixed or variable models. All are equipped with an external safety gap to protect against internal flashover on excess voltage peaks. Capacitance available up to 30,000 mmf, safety gap settings up to 85 kv peak and current ratings up to 400 amps at 1 mc. ■ Write for Bulletin 302... get our complete Gas-Filled Capacitor story. Lapp Insulator Co., Inc., Radio Specialties Division, 228 Sumner St., LeRoy, N.Y. 14482.

Lapp

Coils FAST FROM YOUR Delevan Distributor

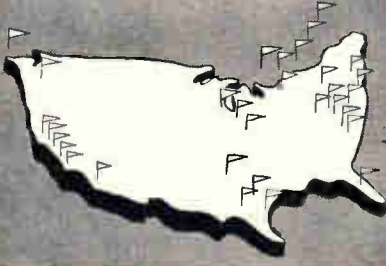

There's a Delevan Distributor near you to help

- Cut your shipping costs
- Provide immediate delivery
- Technical assistance

ARIZONA
Midland Specialty Co.
Phoenix

CALIFORNIA
Elmar Electronics
Oakland 7
Federated Purchaser, Inc.
Los Angeles 64
Fortune Electronics Corp.
San Francisco 24
Milo Electronics Corp.
Temple City
R. V. Weatherford Co.
Glendale 1

FLORIDA
Industrial Electronics
Associates, Inc.
Lake Park

ILLINOIS
Radio Distributing Co., Inc.
Chicago 44

INDIANA
Radio Distributing Co., Inc.
South Bend 24

MARYLAND
Milgray/Washington, Inc.
Hyattsville
Valley Electronics, Inc.
Baltimore

MASSACHUSETTS
P. J. Engineering
Supply Co.
Watertown

MISSOURI
Engineering Supply Co.
Kansas City

NEW JERSEY
Federated Purchaser, Inc.
Mountainside

NEW YORK
Milgray Electronics, Inc.
New York 13

Summit Distributors, Inc.
Buffalo 2
Valley Industrial
Electronics
Utica
Arrow Electronics Inc.
Farmingdale

OKLAHOMA
Engineering Supply Co.
Tulsa

PENNSYLVANIA
D & H Distributing Co., Inc.
Harrisburg
Milgray/Delaware Valley,
Inc.
Philadelphia 7
Radio Electric Service,
Inc.
Philadelphia 6

TEXAS
Engineering Supply Co.
Dallas 35
Engineering Supply Co.
Houston 36

WASHINGTON
Seattle Radio Supply, Inc.
Seattle 1

CANADA
Alpha Aracon/Radio
Electronics, Ltd.
Toronto
Alpha Aracon/Radio
Electronics, Ltd.
Ottawa
Cesco Electronics, Ltd.
Montreal 1
Cesco Electronics, Ltd.
Ottawa
Cesco Electronics, Ltd.
Quebec
A. Deskin Sales
Vancouver

Delevan's distributors provide national coverage in strategic electronic-oriented locations. They stock in depth all standard series lines of coil products including items for MS requirements. For your next "HOT" coil requirement, try the one located nearest you.

MOLDED FIXED SERIES 1025, 1537, 1840, 2150, 2500, 2531, 2890, 3500, 4500



TUNABLE 4000, 4100, 4400



SHIELDED 1537-700 1537-800



Delevan Electronics Corp.
Subsidiary of American Precision Industries Inc.
270 Quaker Road, East Aurora, N. Y. 14052

New Semiconductors

Integrated circuit low-level switch

A monolithic integrated-circuit, low-level switch, available in models 4JP345 and 4JP358, offers a typical "on" resistance of 10 ohms at 160 kc. Such a low resistance, the manufacturer says, is difficult to achieve in integrated circuits. The reduction in resistance is attributed to epitaxial deposition and a unique construction feature in which N⁺ deposition islands are placed under the transistor collector-base junction. This results in low resistance paths and relatively high inverse small H_{FE} (beta) of the output transistors. Another primary feature is the low offset voltage in the "on" state: 5 mv. This new circuit is designed primarily for shunt switching applications. Possible uses are in industrial and military digital-to-analog converters, time-sharing circuits, displays and other applications in which an element is to be shorted out for a time and then placed back on the line. Each package contains two switches which are operated inde-

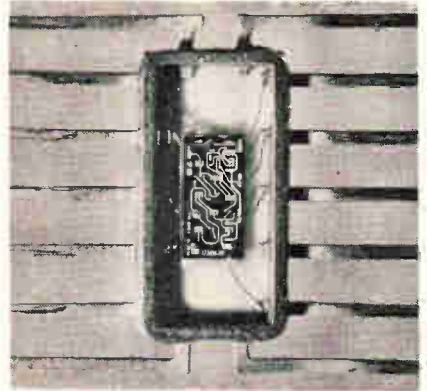

pendently through internal diode resistor networks. The 14-lead network flatpack measures 0.135 by 0.260 by 0.045 in. Other ratings: output current, 1 ma; power dissipation, 50 mw at 85°C output; and input breakdown voltage, 5 v. Price for the 345 type is \$19.90 in quantities of 100, while the 358 version sells for \$17.50.

General Electric Co., Schenectady, N.Y. [371]

Diode limits charging voltage

The Amp-Gate diodes, to be introduced publicly at the IEEE show, are designed for battery recharging or other voltage-limiting applications. Advantages claimed include two-hour recharge times, extension of battery life, and overvoltage protection. Amp-Gate diodes consist of one or more series-connected, forward biased p-n junctions, available in combinations of 0.4 and 0.7 v per junction. The diodes equalize voltages applied to series-connected cells by providing a shunting path which prevents overcharging. The company developed the circuit to control charge on nickel cadmium cells, up to 5 ampere-hours capacity. It now can produce diodes handling up to 25 amps. Diodes are connected in parallel with rechargeable cells, so the

anode of each diode is common with that of a cell. When a cell reaches full charge, its voltage triggers the diode; which then prevents overcharging by shunting the charging current around the cell. In the circuit, it functions much as a low-voltage zener diode—drawing only slight amounts of current until the cell reaches the clamping voltage—at which point it passes abruptly into high conduction. Simultaneously, charging current through the cell decreases sharply. Ability of the device to clamp the voltage and reduce the charge rate through the cell at the end of the charge assures safe, reliable operation under continuous unattended charge conditions, according to the company. Amp-Gate diodes make it possible to recharge low cells in less than two hours—reducing the charge-to-discharge time ratio from 20:1 to nearly 1:1. The device's ability to prolong cell life was

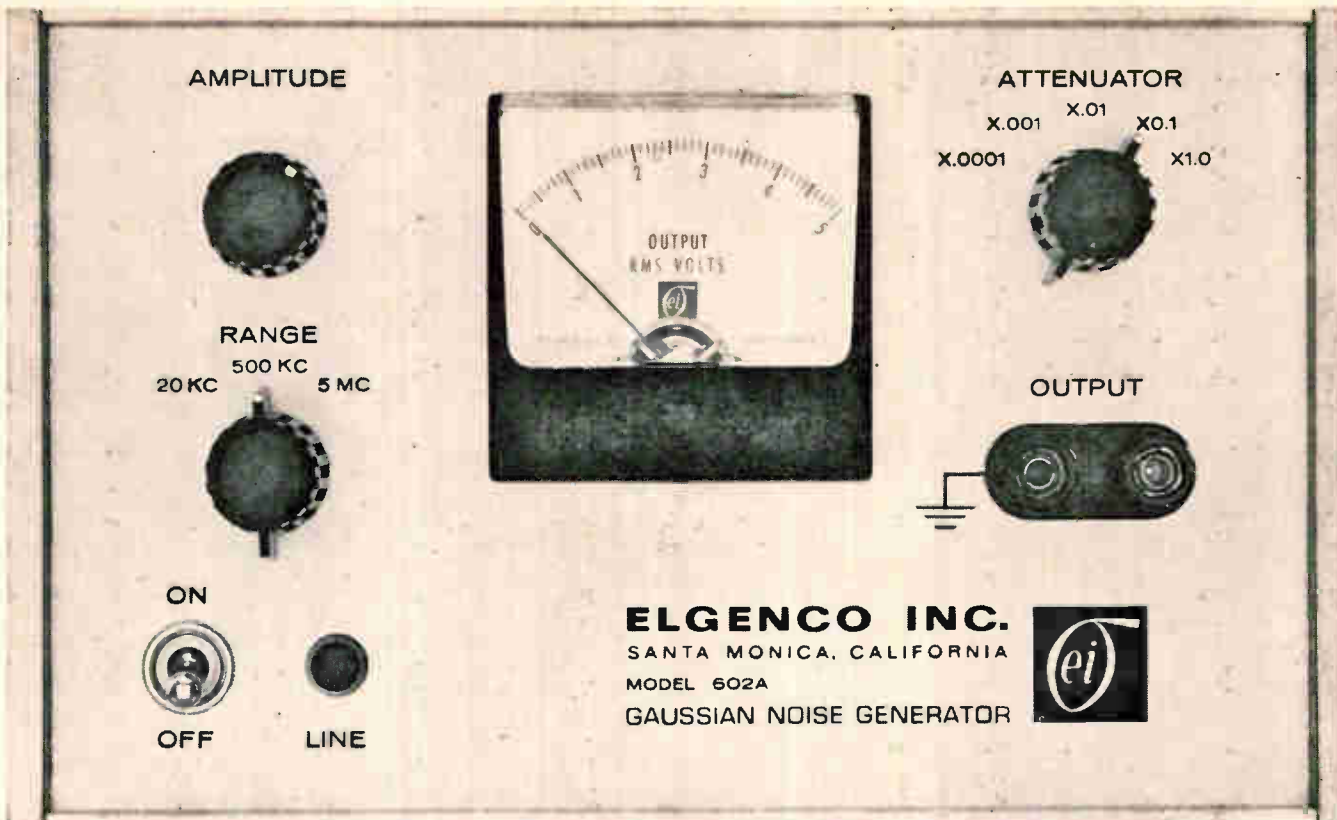

NEW ELGENCO ALL SOLID STATE MODEL 602A . . . PRICE, \$290.

Delivery: Stock to 30 days; Gaussia Distribution: Symmetrical non-clipped waveform all ranges; Output Impedance: Direct output constant 900 ohms, step-attenuated output 200 ohms; Output Spectrum: Uniform from 20 cps to 20 kc within ± 1 db. 20 cps to 500 kc within ± 8 db. 500 kc to 5 mc within ± 8 db; Output Voltage: Max open circuit output at least 3 volts 20 kc range, 2 volts 500 kc range, 1 volt 5 mc. PHONE YOUR LOCAL ELGENCO REP OR (213) 451-1635. NEED BETTER OR DIFFERENT SPECS? ELGENCO'S MANY NOISE GENERATOR MODELS COVER DC TO 5 MC.

Circle 183 on reader service card

To order reprints from Electronics

Fill in, cut coupon below, insert in envelope and mail to:

Electronics reprint dept.

330 West 42nd Street, New York, N. Y. 10036

Reprint order form

For listing of reprints available see the reader service card

To help expedite mailing of your reprints please send cash, check, or money order with your order.

1964 Complete Electronics Index, 40 Pages

Send me copies of Key no. R-69 at \$1.00 each.

For reprints of previous special reports fill in below:

Send me reprints of Key no. (s) @ ¢ each

For prices see the reader service card.

Name

Number and Street

City, Zone No., State

Hilton Booth No. 68
**ONE OF 25 NEW
 3 WATT MINIATURE
 POWER SUPPLIES**

from **transformer
 electronics
 Company**

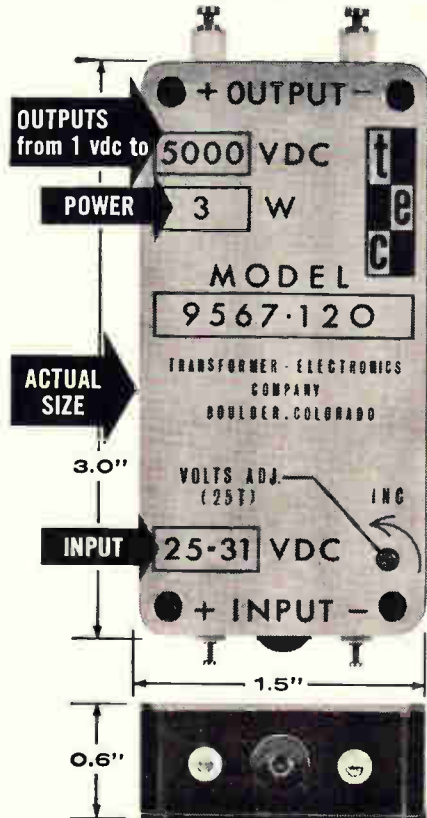

THE 9567 SERIES fulfills many requirements where DC-DC and DC-AC voltage conversion is required. Predominant features are: light weight (4 oz.) ... low cost (prices start at \$150.00) ... all silicon semiconductors ... black anodized aluminum case ... silicon rubber encapsulation ... transient, reversed polarity and short circuit protection ...

INPUT: 25-31 VDC (output regulated to 0.25%)
 OUTPUTS: 1.5 VDC to 5000 VDC
 ± 15 VDC to ± 100 VDC (dual output)
 1.5 VAC to 1000 VAC (3 to 5 kc)
 (adjustable $\pm 10\%$)
 POWER: 3 WATTS
 TEMPERATURE: -55 to 100°C

FOR ADDITIONAL INFORMATION CONTACT:

**TRANSFORMER
 ELECTRONICS
 COMPANY**

BOULDER INDUSTRIAL PARK
 BOULDER, COLORADO
 TWX 303 443-2561 • PHONE (303) 442-3837

**POWER SUPPLIES • INVERTERS
 CONVERTERS • TRANSFORMERS**

New Semiconductors



demonstrated in cycle tests subjecting nickel cadmium cells to two-hour charges at 1.2 amp, and 39 minute discharges at 0.5 amp. Unprotected cells showed 100% loss in capacity, compared with 3% losses after 345 cycles and 7% after 615 cycles by diode-protected cells. Delivery on sample Amp-Gate diodes is 30 days, according to the company. Unit cost for sampling lots is \$25, in groups of three to five units.

P.R. Mallory & Co. Inc., Burlington, Mass., 01801. [372]

**Advance claimed
 for p-channel FET's**

Two new field effect transistors are being introduced. Both are enhancement mode, p-channel, insulated gate devices. The FN-1034 is said to outperform significantly any other device for chopping, switching, analog-to-digital and digital-to-analog converting, and multiplexing applications. It features zero offset voltage, low-turn-on voltage, low ON resistance and unconditional stability. Typical specifications for critical characteristics are: gate threshold voltage of 1.5 v, claimed to be a three-fold improvement over competitive units; channel resistance of only 200 ohms at -10 v applied gate voltage, said to be half that previously offered; and gate-to-source capacitance of only 2.8 pf. The FN-1024 FET is offered for applications requiring high input impedance, low noise, high gain, and excellent stability. Typical uses include vhf amplifiers, frequency mixing, or initial stages following pressure, temperature or strain transducers. Transconductance,

**Find
 the
 product...
 Fast!**



It's quick and easy to locate any of the thousands of electronic and allied products in your **Electronics Buyers' Guide**. All are listed clearly and unmistakably, cross-indexed with end use terms synonyms and newly devised terms. And, all advertisers in the EBG are carefully cross-referenced to their catalog advertisement. EBG has the most complete, accurate and authentic product listings in the industry!

Electronics Buyers' Guide

A McGraw-Hill Publication
 330 West 42nd Street,
 New York, N. Y. 10036



measured at -1 ma, is $1600 \mu\text{mhos}$. Noise figure at 10 kc does not exceed 2 db. Gain-bandwidth product, at -10 ma, is 160 Mc. Input resistance and capacitance are 10^{15} ohms and 4.0 pf, respectively. Both FET's are packaged in TO-18 cases with four leads: drain, gate, source, and substrate. Maximum voltage for each device is 50 v; total device dissipation, 300 mw; and thermal resistance, 2 $\text{mw}/^\circ\text{C}$. Price is $\$27.50$ each for quantities of 1 to 99 .

Raytheon Co., Semiconductor Operation, 350 Ellis St., Mountain View, Calif. [373]

Silicon diodes are radiation-tolerant

A series of radiation-tolerant diodes, with ratings up to 2 amps at 300 v, will be exhibited at the IEEE show. According to the manufacturer, demand for radiation-tolerant semiconductors is increasing from customers who have radiation-resistant specifications on their total equipment and systems. Industry interest is said to be focused particularly on diodes that have radiation tolerance and can switch sizable amounts of power. The new diffused silicon epitaxial diodes will switch up to 2 amps in speeds ranging from 100 to 300 nsec, switching from 10 mils forward to 10 mils reverse and recovering to 5 mils. The radiation tolerance is inherent in the junction design. The diodes will tolerate neutron levels of 1×10^{15} neutrons versus time; electron radiation of 1×10^{16} electrons per sq cm. They will be unaffected by gamma radiation. Temperature range, -195°C

"ZERO
IN"

on component stability



ZERO T.C. thin line porcelain capacitors

The new *thin line* VY® Porcelain Capacitors are available with a temperature coefficient of 0 ± 25 ppm/ $^\circ\text{C}$ or $+105 \pm 25$ ppm/ $^\circ\text{C}$.* Designed with a flexibility unmatched by any capacitors of equivalent rating, they also offer a choice of lead configurations and lead materials in any combination you require. Axial, Face Radial, or Edge Radial configurations feature monolithic construction and are available in capacitance values to $10,000$ pf! *Thin line* capacitors offer the same outstanding electrical and physical characteristics inherent in all "VY" Capacitors.

- Capacitance Range: 0.5 pf to $10,000$ pf
- Temperature Range: -55°C to 125°C
- Voltage Rating: to 100 VDC
- Meets requirements of environmental tests as outlined in MIL-C-11272

* Temperature coefficients from $+105 \pm 25$ ppm/ $^\circ\text{C}$ to -100 ± 25 ppm/ $^\circ\text{C}$ available on special order.

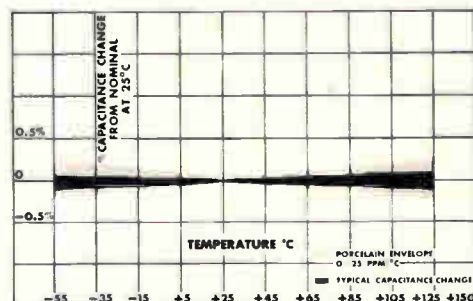

Booth Nos. 2406 - 2408 IEEE

© Vitramon, Inc. 1965

Vitramon
INCORPORATED

Box 544 Bridgeport, Connecticut 06601

In United Kingdom contact:
Vitramon Laboratories Limited
Bourne End, Bucks
England

IF...
your computer,
calculator,
automated machines,
process instrumentation,
or communications equipment
failed in the
next five minutes...
do you have a man
who can fix it?

Almost every company in the United States is using sophisticated electronics equipment in its office, production and distribution operations. All of it demands expert maintenance and service . . . work that can only be handled by men who know basic electronic theory and principles.

Whose responsibility is it to train these men — the man's or the Company's?

Many companies believe this responsibility rests squarely on their shoulders . . . and know the right time to start this training is when plans are made to buy and install the equipment. They'll have trained men ready and able to prevent the failure of expensive, sophisticated equipment when it goes into operation. They know that providing this training is just as critical as planning and purchasing the equipment.

Since 1934, Cleveland Institute of Electronics has "tailored" electronics training programs to the specific needs of many companies. It's fast, effective and most economical. Send coupon below for complete information. Cleveland Institute of Electronics, Dept. E-10, 1776 East 17th St., Cleveland, Ohio 44114.

SEND COUPON TODAY

Cleveland Institute of Electronics

Dept. E-10, 1776 E. 17th St., Cleveland, Ohio

Gentlemen: I am interested in learning more about your Electronics Home Study Programs. Please send complete information.

Name _____

Title _____

Company _____

Address _____

City _____ State _____ Zip _____

Accredited Member, National Home Study Council.

New Semiconductors

to +175°C, is inherent in design of the whiskerless, void-free package. The silicon die is metallurgically bonded to the two pins, and over that assembly is a glass sleeve fused directly to the silicon and to the two pins.

Unitrode Transistor Products Inc., Waltham, Mass. [374]

Diffused silicon npn transistor



A new diffused silicon, epitaxial npn transistor is made by planar techniques. Model 3TE240 is intended for high-gain, Class B and C, r-f amplifiers up to 250 Mc. It utilizes a new mounting arrangement with the emitter connected to the case. The device is ideally suited for grounded emitter amplifier use where high power gain is needed. It features up to 10 w output at 40 v and 250 Mc; greater than 15 w output at 40 v, 13 db typical gain, 150 Mc. Maximum ratings (at 25°C case temperature unless specified) are: collector-base voltage, 80 v; collector-emitter voltage, 80 v; emitter-base voltage, 4.0 v; collector current d-c, 3 amps; total power dissipation, 25 w; de-rating above 25°C, 0.167 w/°C; storage temperature, -65 to +200°C; junction temperature, 175°C.

Clevite Semiconductor, 1801 Page Mill Road, Palo Alto, Calif. [375]

Building blocks for high-level logic

A manufacturer will debut in integrated circuitry at the IEEE show by introducing three building blocks for high-level logic. A single

WHO SAYS "HANDLING" IS NOT IMPORTANT?



BUD HANDLES HAVE FASHION and FUNCTION



only the cost is ordinary!

Bud Handles add to the utility and enhance the appearance of the devices to which they are attached. They are beautifully made of brass, steel or cast aluminum with attractive finish. There is a wide variety of sizes and styles to fit your requirements. See them at your Bud distributor, or write us for literature.



BUD RADIO, INC.

Willoughby, Ohio

IEE READOUTS PROVIDE MORE UNIQUE ADVANTAGES THAN ANY OTHER TYPE THANKS TO THEIR PATENTED REAR-PROJECTION PRINCIPLE.

IEE readouts are miniature rear-projectors using lamps, lenses, film, and a screen. They provide a unique combination of advantages that cannot be matched—even in part—by any other type of readout available today. Why not judge for yourself? Here's a partial list of IEE features:

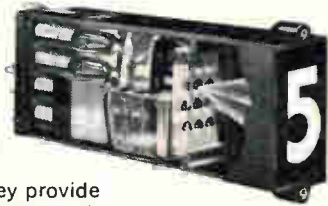

- **SINGLE-PLANE PRESENTATION** assures visual crispness and easy readability. Only the message that's "on" is visible; there is no visual hash from tandem filaments.
- **INFINITE DISPLAY VERSATILITY** permits you to display anything that can be put on film—colors, symbols, numbers, letters, words.
- **12 MESSAGE POSITIONS** per readout may be displayed individually or in any combination.
- **BOLD, READABLE CHARACTERS** may be selected to meet latest human factors and Mil Spec requirements.
- **BALANCED RATIO OF BRIGHTNESS TO CONTRAST** provides optimal readability without eye strain.
- **FAIL-SAFE CHARACTERS** make false indications impossible. Failure of a single lamp is immediately apparent; replacement is easy and requires no tools. Commercial or MS lamps used provide up to 30,000 hours of operation per lamp.
- **FIVE SIZES OF READOUTS** provide choice of maximum character heights of 3/8", 5/8", 1", 2", 3 3/8".
- **EASY TO OPERATE** either from straight decimal input or conventional binary codes with IEE low current driver/decoders. 6 to 28 volt operation depending on lamps specified.

SEND TODAY FOR COMPLETE INFORMATION!



INDUSTRIAL ELECTRONIC ENGINEERS, INC.

7720 Lomona Avenue • Van Nuys, California
Phone: (213) 787-0311 • TWX (213) 781-8115

©1965 IEE

Representatives in Principal Cities

Circle 234 on reader service card

Around the world ...

KYORITSU Measuring Instruments

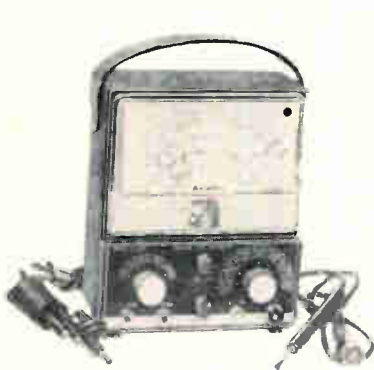

K-142

Vacuum Tube Voltmeter
(190x170x105 m/m)



VR-2P VU Meter
(42x42x37 m/m)



P-60 6'' Meter



Kyoritsu

ELECTRICAL INSTRUMENTS WORKS, LTD.

120, Nakane-cho, Meguro-ku, Tokyo, Japan

Cable address: KYORITSUKEIKI TOKYO

Telex: TK 2849

Direct Inquiry Welcomed

Circle 235 on reader service card

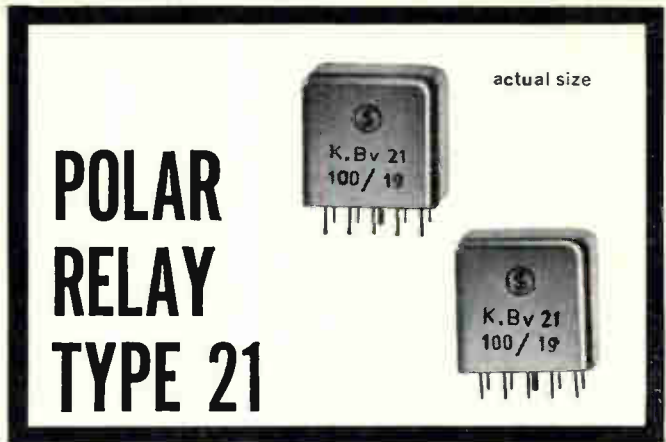

POLAR RELAY TYPE 21

This subminiature polar relay of advanced design is widely applicable in small-size, light-weight communications equipment and control equipment for telephony, carrier telegraphy, data transmission in telemetry, automatic control, data processing, etc. It features extremely efficient magnetic circuits, unique chatter-free contact mechanism, and long-life contacts. Advanced hermetically sealed design is combined with long life (100 million operations), high sensitivity (0.7 mw), high speed (1.5 ms), and high stability against external magnetic fields.



MICRO RESONANT REED SELECTOR

This radically miniaturized micro resonant reed selector of the single-reed, plug-in type finds widespread use in diverse types of tele-controlling systems, portable equipment, and other transistorized circuits. It is composed of a composite cantilever vibrator, driving system, contact, and their supporting structures, all accommodated in a metallic case. In addition to its small size and light weight, since the vibrator is mechanical, its selectivity is sharp, and since variation of the resonant frequency due to changes in ambient temperature or aging is very slight, a high order of stability is obtained.



FUJITSU LIMITED

Communications and Electronics

Marunouchi, Tokyo, Japan

THE NISSHO AMERICAN CORP. 80 Pine St., New York 5, N.Y.
Phone: Whitehall 3-7840

THE NISSHO PACIFIC CORP. 120 Montgomery St., San Francisco 4, Calif.
Phone: YUkon 2-7901~7908

NISSHO (CANADA) LTD. 100 University Avenue, Toronto
Phone: EMpire 2-4794

Circle 187 on reader service card

187

BIG, BOLD, ANGULAR NUMERALS

FOR *SUPERIOR* LEGIBILITY
with **RUGGED CONSTRUCTION**
and **LONG LIFE LAMPS**
for

UNMATCHED RELIABILITY



CAPTIONS are displayed as programmed in this auxiliary module.

DIALCO READOUTS ARE ADAPTABLE

MODULAR

- Decimal point, comma and colon optional in any module
- Modules for **CAPTIONS** and **PLUS-MINUS**
- Simple bracket provides common base

ALL POWER VOLTAGES

- 14-16 volts or 24-28 volts
- 150-170 volts (120V AC, full wave rectified)

STANDARD FULL SIZE LAMPS

- Long life neon
- 100,000 hour incandescent
- Obtainable everywhere

ALL INPUT SIGNALS

- Seven line, **DIALIGHT** display code
- Straight decimal
- Binary coded decimal

OFF THE SHELF—IN STOCK NOW

FOR BINARY INPUT

Integral Translator-Driver

The Module illustrated is typical of those provided with translator-driver for BCD input. Most logic levels are readily accommodated. Memory may be included.

When space back of the panel is small, the circuit board is furnished as a separate unit for offset mounting.

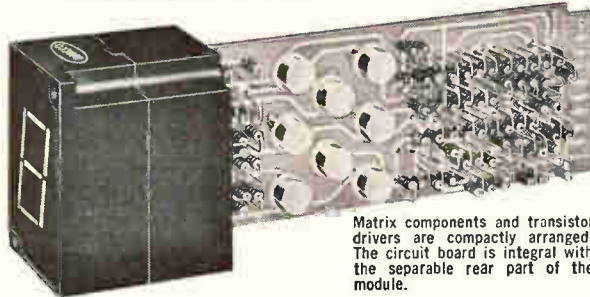

Matrix components and transistor drivers are compactly arranged. The circuit board is integral with the separable rear part of the module.

For complete data, request current catalog.

DIALCO

Foremost Manufacturer of Indicator Lights

DIALIGHT CORPORATION

60 STEWART AVENUE, BROOKLYN, N.Y. 11237 212 HYACINTH 7-7600

Booths 2623-2625 at the IEEE Show

New Semiconductors

eight-input nand/nor gate, dual four-input nand/nor gate, and dual four-input nand/or gate are announced. Each will be available in two temperature ranges— -55°C to 125°C and 0°C to 75°C . The three integrated circuits are basic elements of a planar epitaxial high-speed logic family with a propagation delay range of 8 to 20 nsec. Another feature is high capacitive driving capability. According to the company, the output design of the circuits enables them to drive 300 pf with ease. Short-circuit protection is also built into the output. Each of the three basic logic elements is available in a TO-5 can or a flat package. Each element is also available for either of two fan-out requirements. One type is designed for a fan-out of 1 to 20 to similar units; the other for 1 to 7 to similar units. Production quantities will be available from inventory.

Transitron Electronic Corp., Wakefield, Mass. [376]

Reliability enhanced in hot carrier diode

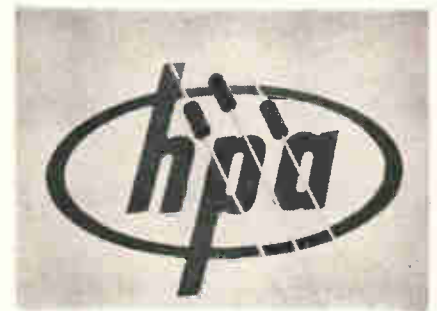

A hot carrier diode incorporates advances in metal-silicon technology, the company reports. The 2200-series diodes have higher forward current and breakdown voltage, and broader temperature range. Minority carrier charge storage and low internal noise generation have been practically eliminated. Type 2201 features $B_V > 30\text{ v}$; $I_R < 300\text{ na}$ at $V_R = -15\text{ v}$; $I_F > 50\text{ ma}$ at $V_F = 1.0\text{ v}$; and $C_O < 1.0\text{ pf}$ at $V_R = 0$. The 2202 differs only in $B_V > 20\text{ v}$ and $I_R < 500\text{ na}$ at $V_R = -15\text{ v}$ from the 2201 specifica-

tion. The 2203 specification features $B_V > 20$ v; $I_R < 500$ ma at $V_R = -15$; $I_F > 50$ ma at $V_F = 1.0$ v; and $C_0 < 1.2$ pf at $V_R = 0$. All devices in this series have minority carrier lifetime of less than 200 picoseconds. The operating and storage temperature range extends from -60° to $+150^\circ$ C. Power dissipation at 25° C is rated at 100 mw and peak pulse power exceeds 5 ergs. The 2200-series hot carrier diodes are said to meet the requirements of MIL-S-19500 C. They are suitable for use in ultrafast logic switching and pulse shaping. Low internal noise generation, due to the negligible charge storage, enhances the operation of mixer and detector circuits in uhf and vhf design. Prices for 1 to 99 range from \$8.70 to \$9.60 each; for 100 to 999, from \$5.80 to \$6.40.

HP Associates, 620 Page Mill Rd, Palo Alto, Calif., 94304. [377]

Cartridge-type silicon rectifiers

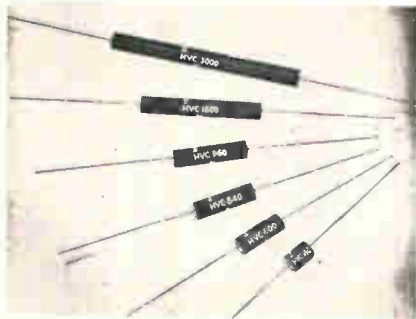

High-voltage silicon rectifiers of the cartridge type are available with avalanche characteristics. They are said to be comparable in performance to units that do not have avalanche characteristics. The avalanche characteristics provide built-in protection against transient overvoltages. The new line consists of 17 units ranging in piv rating from 1,800 to 30,000 v. The units have a d-c ma rating from 250 to 50, depending on the voltage. Maximum forward voltage drop at rated current ranges from 4 v for the smaller units to 50 v d-c for the largest type. The HVC silicon rectifiers are all $\frac{3}{8}$ in. in diameter and are contained in epoxy-sealed phenolic tubes. The tube lengths range from $\frac{1}{8}$ in. to $4\frac{1}{8}$ in. depending

ANY ENCLOSURE... ...ANY WEIGHT



VENT-RAK 3500 Series Cabinet

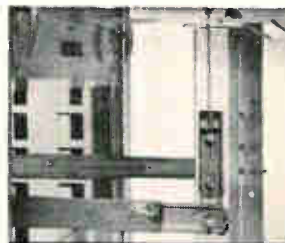

C-300 to 50 lbs.

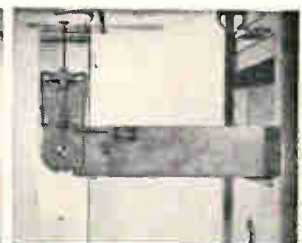

C-230 to 100 lbs.



D-600 to 125 lbs.

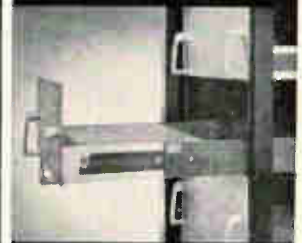

CTB to 175 lbs.

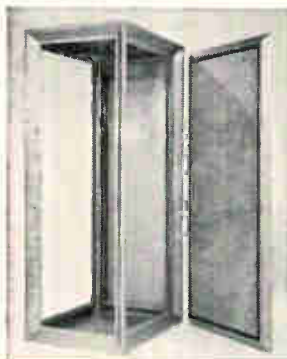

VENT-RAK 1000 Series Cabinet

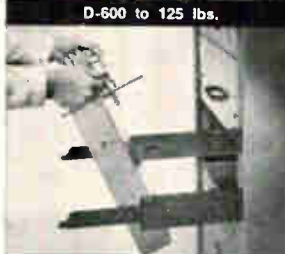

CTHRD to 275 lbs.



VCB to 350 lbs.

IEEE BOOTH 4001

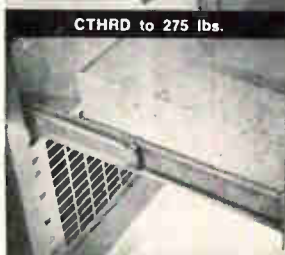

CB to 1000 lbs.



VENT-RAK Modular Chassis

From Chassis-Trak you get the broadest range of slide weight capacities and the ideal enclosure for your application. Flexibility . . . plus uncompromising Chassis-Trak quality . . . have made Chassis-Trak a part of the package on every major missile project.

Just make sure the slides you order have the Chassis-Trak of Indianapolis, Seal of Quality . . . your protection against inferior imitations . . . ask about Vent-Rak cabinets.

With Chassis-Trak, you get:

- Ultra-thin slides for standard racks and cabinets
- Choice of tilt, non-tilt, tilt-lock versions in most models
- Poxylube 75 dry-film lubricant
- Choice of solid or roller bearings
- Delivery from stock in standard models

A Package for Every Major Missile Project from

525 South Webster Avenue, Indianapolis, Indiana



AT LAST!

An Amazing D. C. BRUSHLESS MOTOR



**Scores Sensational
Breakthrough in
Electromechanics
By Inventing
Motor With
No Brushes-
No Commutator-
No Contacts**

For years and years inventors have considered a Brushless D. C. Motor to be as far beyond their reach as a perpetual motion machine! But the product development teams at Haydon Switch & Instrument, Inc. did it! Thus marking another brilliant milestone on HSI's long road in mating solid state technology with electromechanics!

This fabulous, new BRUSHLESS D. C. MOTOR incorporates these vital features:

No brushes—no commutator—no contacts; long life assured.

Radio Frequency interference minimized by diode suppression of the electronic switching.

The electronic circuitry can be synchronized to any desired accuracy by using the optional synchronizing terminal.

Available with integral gear reduction and standard output speeds.

Rotor and output shaft bearings are sintered bronze and vacuum impregnated for life of motor.

Long life nylon gears and pinions require no lubrication.

For complete technical data on the SERIES 37 BRUSHLESS D. C. MOTOR, including wiring and dimensional diagrams and chart showing standard speeds, write Haydon Switch & Instrument, Inc., 1500 Meriden Road, Waterbury, Conn. 06720 for Bulletin No. 37-1.

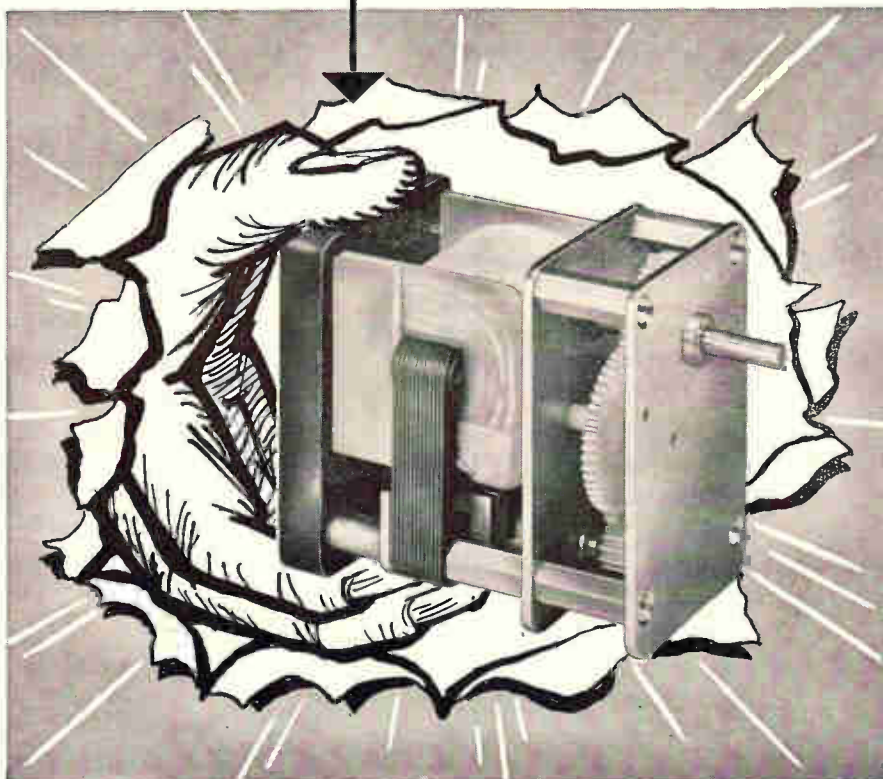

Write Dept. E-3



HAYDON SWITCH & INSTRUMENT, INC.

Building Confidence Through Dependability

1500 MERIDEN ROAD, WATERBURY, CONN. 06720 AREA CODE (203) 756-7441

New Semiconductors

upon the voltage. They are supplied with 2-in. leads of 0.032-in.-diameter goldplated wire. Sarkes Tarzian, Inc., 415 College Ave., Bloomington, Ind. [378]

Germanium transistors in plastic packages

A new line of germanium epitaxial transistors is announced for consumer and industrial circuit applications. The company says their use will give with no price premium, much lower noise figure, better gain and improved automatic gain control performance than older devices. Designated the TIXMO1 through MO8, they are the first of the manufacturer's new line of pnp germanium epitaxial planar transistors in plastic packages. The MO1 through MO4 units are designed for service in the r-f and i-f sections of a-m and f-m receivers. High receiver sensitivity is possible using these transistors because of their extremely low noise figure (3.0 db typical at 100 Mc) and high gain (calculated maximum available gain is 28 db at 100 Mc). The TIXMO5-8 are said to be outstanding for vhf-tv tuners and tv i-f strips. Their use allows circuit designs which give good picture quality in both fringe and strong signal areas. This is due to their forward age characteristics (20.5 db minimum gain reduction through small signal current transfer ratio fall-off alone). Typical noise figure for the TIXMO5 is 2.8 db at 200 Mc, giving superior tuner performance. All eight transistors are in a new plastic package. Standard TO-18 pin circle lead configuration is used. The package is capable of withstanding the heat of all normal soldering operations without damage, and it gives excellent stability under high-humidity conditions. The transistors have been tested to the requirements of MIL-S-202C, method 103A, without failures. Prices range from 25 to 35 cents in production quantities.

Texas Instruments Inc., 13500 North Central Expressway, Dallas, Texas. [379]

NEW MAGNETIC LATCHING RELAY plugs into your Printed Board!

NO Springs, NO Wiring,
NO Sockets, NO Soldering,
NO Mechanical Linkage



Printact® Series LS/LD, Latching Series G, Standard

PLATED CONDUCTORS ON YOUR PC BOARD
ARE THE FIXED CONTACTS OF THIS NEW RELAY

Save SPACE, MONEY and MANHOURS with these new small, lightweight, highly reliable Standard and Latching PRINTACT Relays.

Available with Bifurcated Palladium or Gold Alloy contacts for more than 10 million cycle 2 or 3 pole switching. Handles up to 3 amp. res. loads. Coils for 6, 12, 24 and 48 vdc at 500 mw. Operating temperature -30°C to $+95^{\circ}\text{C}$. Operate time 7 ms. The little gem is an 0.8 oz. $\frac{7}{8}$ " cube.

Quality features include: double-break contacts; balanced armature, enclosed housing, plug-in application; encapsulated coil; self-wiping contacts and inherent snap-action—and the cost is lower than you think!

Write today, on your letterhead, for data and prices.

Executone inc. PRINTACT RELAY DIVISION

47-37 Austell Place, Long Island City, N. Y. 11101
Circle 236 on reader service card

BETTER PERFORMANCE with NEYETCH®

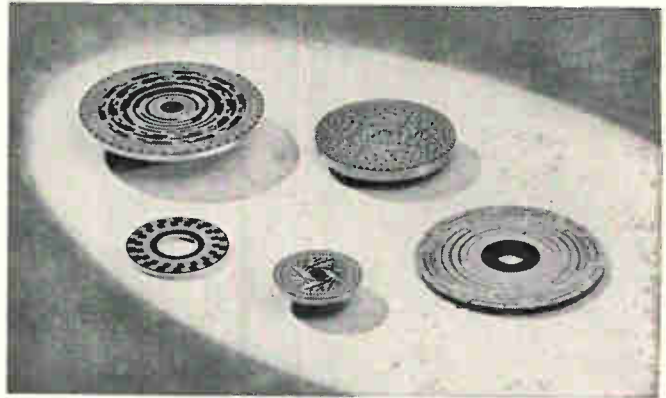

**BECAUSE IT'S SOLID PRECIOUS METAL
ALL THE WAY THROUGH THE PATTERN**

Neyetch is a process of achieving intricate patterns of solid homogeneous precious metal alloys bonded to a rigid insulator. It eliminates costly machining and gives the advantages of controlled solid precious metal alloy. Greater strength, hardness and wear resistance, extended shelf life, elimination of common plating defects such as porosity, flaking, peeling, pits and inclusions all add up to greater reliability.

BETTER PERFORMANCE with NEYORO® G for commutators PALINEY® 7 for brushes PERFECTLY MATCHED ALLOYS

With Paliney 7 heat treated brushes on Neyoro G heat treated commutators you have two matching alloys, high in noble content, yet hard and strong and, as a pair, very resistant to wear. In one case, encoder life was extended five times by using Paliney 7 brushes on a Neyetch commutator. This combination produces no excessive oxide film, provides low electrical noise, low contact resistance and high corrosion resistance.

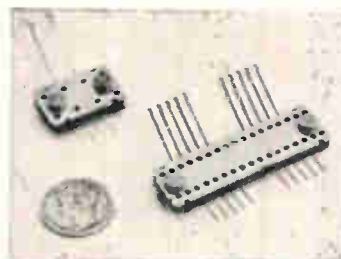

STANDARD MOLDED
BRUSH BLOCK
ASSEMBLIES
AVAILABLE

SEND FOR NEW ILLUSTRATED CATALOG

THE J. M. NEY COMPANY
Maplewood Ave. Bloomfield, Conn.

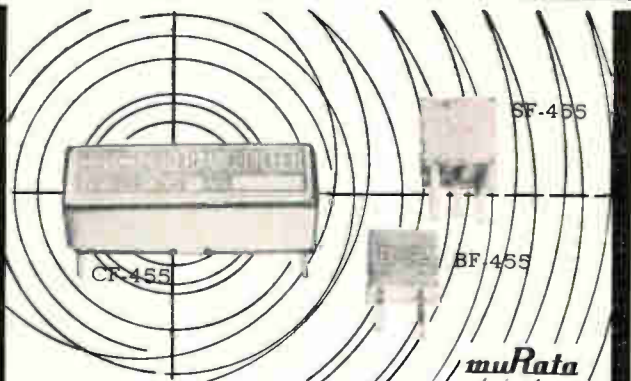

CERAMIC FILTER

Ladder type ceramic filter CF-455, for I-F stages of high quality superheterodyne radio receivers.

Series type ceramic filter SF-455 is a resonance type filter of 455kc. Replaces the IFT of transistor radios, or makes a superior Intermediate Frequency Amplifier in combination with IFT.

Ceramic filter BF-455 improves the selectivity of transistor radios when used as emitter by-pass in I-F stages.

*See Booth No. 1631 at IEEE Show

MURATA MFG. CO., LTD.

Nagaoka-cho, Kyoto, Japan
Cable address: MURATA KYOTO

high temp QUARTZ CEMENT



**new,
unusual**

High Temperature Quartz Cement, (developed in our laboratories for cementing pure fused quartz to quartz), while a relatively new product, has exhibited characteristics that suggest a wide variety of applications.

For example, it is highly resistant to extreme temperatures and is unaffected by severe thermal shock. It has excellent thermal and electrical insulating properties. It can be formed and cast like a ceramic and can be either air dried or fired.

Contrary to our normal \$5.00 shipping minimum, for a limited time we will ship one pound sample orders for \$2.50.

If you would like to receive Thermal American's free 32 page catalog on Vitreosil pure fused quartz laboratory ware, industrial ware, quartz tubing and special products, please check the coupon below.

- PLEASE BILL US
- PAYMENT ENCLOSED
- SEND MORE ON CEMENT
- SEND FREE CATALOG

Name _____

Company _____

Address _____



New Subassemblies and Systems

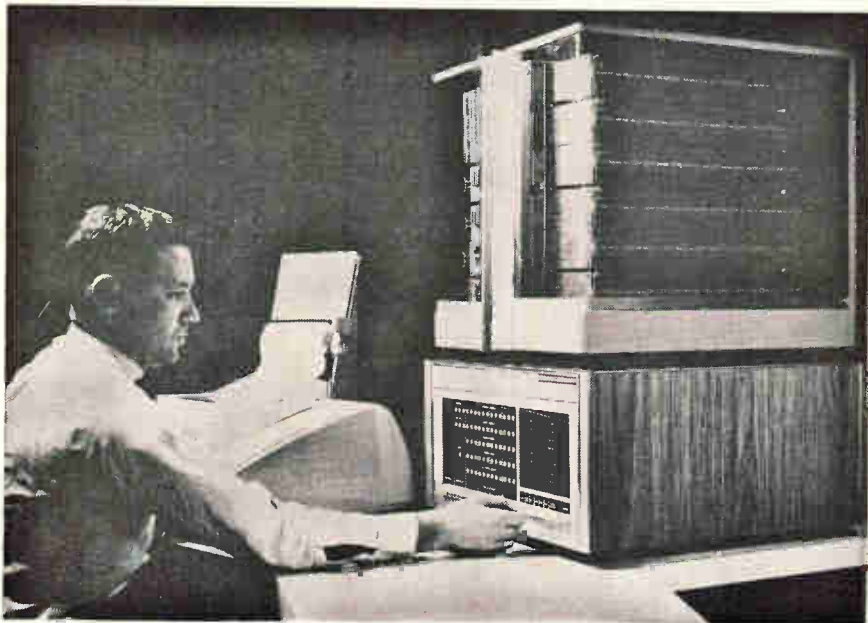

Digital computer at lower cost

The Programmed Data Processor-8 will be exhibited for the first time at the IEEE show this year. Low price of the computer is made possible through the use of integrated circuits, according to the manufacturer. The PDP-8 is intended for high-speed data handling and processing in computation centers, laboratories, and process control systems. All processing circuits in the computer use silicon semiconductors, many in the company's new 10-Mc Flip Chip integrated circuit modules. Wiring of the central processor is done with a wire-wrap machine under automatic control. The basic PDP-8 will sell for \$18,000 with 4,096 words of 12-bit core memory. It has a 1.6- μ sec memory cycle, adds in 3.2 μ sec, and transfers data at rates up to 625,000 words per second. The basic sys-

tem will be a console teleprinter with a 10-character-per-second paper tape reader and punch, and complete software package including Fortran, macro assembler, and on-line debugger. The programming system also contains symbolic editing programs, standard Fortran libraries, input/output programs, single and multiple precision and fixed and floating point arithmetic routines, and utility and maintenance routines. Because of the low price, compactness, speed, ease of use, and simplified programming systems, the manufacturer predicts that many smaller laboratories and industrial processors will be able to use the PDP-8 to take advantage for the first time of modern computation and control techniques.

Digital Equipment Corp., Maynard, Mass. [401]

Crystal oscillator warms up fast

The highest stability packaged crystal oscillator currently available is the FFO-160, according to the manufacturer. This unit measures only 4½ in. by 2¼ in. by 2¼

in. and provides a long term stability better than five parts in 10¹⁰ per day and one part in 10⁸ per month. Output frequency is 1 Mc; output level, 1 v rms into 500 ohms. Operating ambient temperature is -40°C to +65°C. The new crystal oscillator was designed specifically to supply a signal of very high sta-

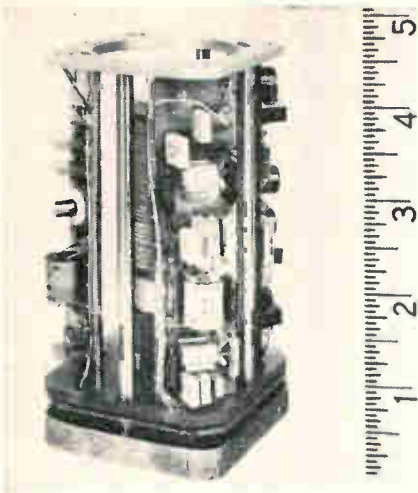

bility over a broad range of environmental conditions. Its fast warm-up capability and outstanding operational characteristics over extremes of temperature, humidity, shock and vibration well suit the FFO-160 to airborne, shipboard, mobile and space, as well as fixed station, applications. A proportionally controlled oven maintains the crystal's temperature constant within a few millidegrees over the unit's operating ambient temperature range. The oscillator stage employs automatic gain control to maintain constant crystal current. Low impedance buffer amplifiers protect the oscillator from load variations while an internal regulation system virtually eliminates the effects of power supply fluctuations.

Manson Laboratories Division, the Hallcrafters Co., 77 Danbury Road, Wilton, Conn., 06897. [402]

Display module for binary input

Highly legible bar matrix display modules are available in a new form adaptable directly to logic circuits. The new products provide translator-drivers as an integral part of each module. An inherent advantage of the seven-lamp display is the reduction in the drivers required from the usual 10 to seven. A diode matrix converts from BCD to the display code directly, avoiding any costly double conversion to decimal and then to the seven-line input to the lamps. Models are offered for power from 14 and 28 v d-c and for 120 v, 60 cps (rectified). All logic levels and polarities are

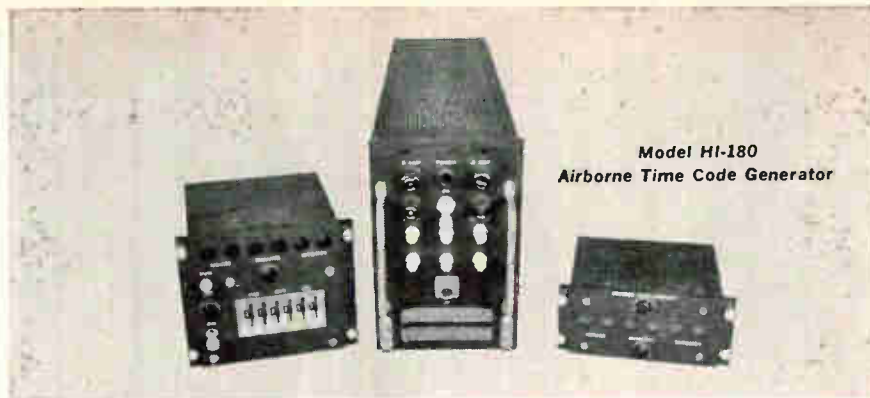

Model HI-180
Airborne Time Code Generator

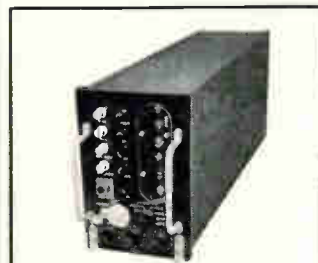

Model HI-188
Airborne Time Code Generator



Hyperion

THE NAME
FOR PRECISION TIME
INDEXING AND AUTOMATIC
SEARCH EQUIPMENT
AND SYSTEMS

Hyperion's digital field of concentration is precision time indexing and automatic search for desired data blocks on different recording media such as magnetic tape, camera film, oscillograph strip chart recordings, etc.

Hyperion can furnish to your specifications and application requirements. Your inquiry is invited.

Hyperion

INDUSTRIES, INC.

134 COOLIDGE AVENUE, WATERTOWN, MASSACHUSETTS, 02172
TWX: WTNW MASS - 860 TEL. WA 6-0140

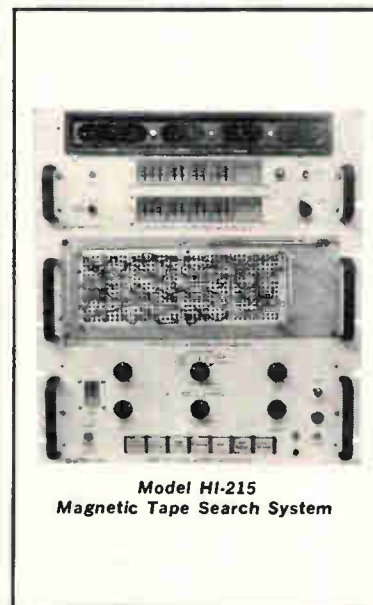

Model HI-215
Magnetic Tape Search System



Model HI-140
Ground Station Precision Time Code Generator

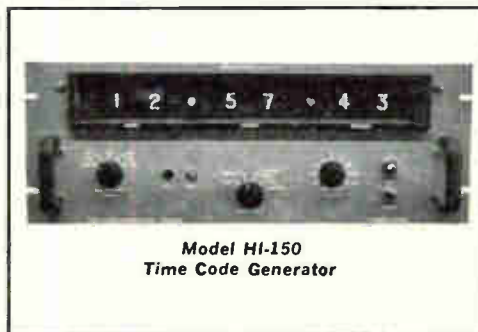

Model HI-150
Time Code Generator

SEE US AT BOOTHS 3604-3608, IEEE SHOW

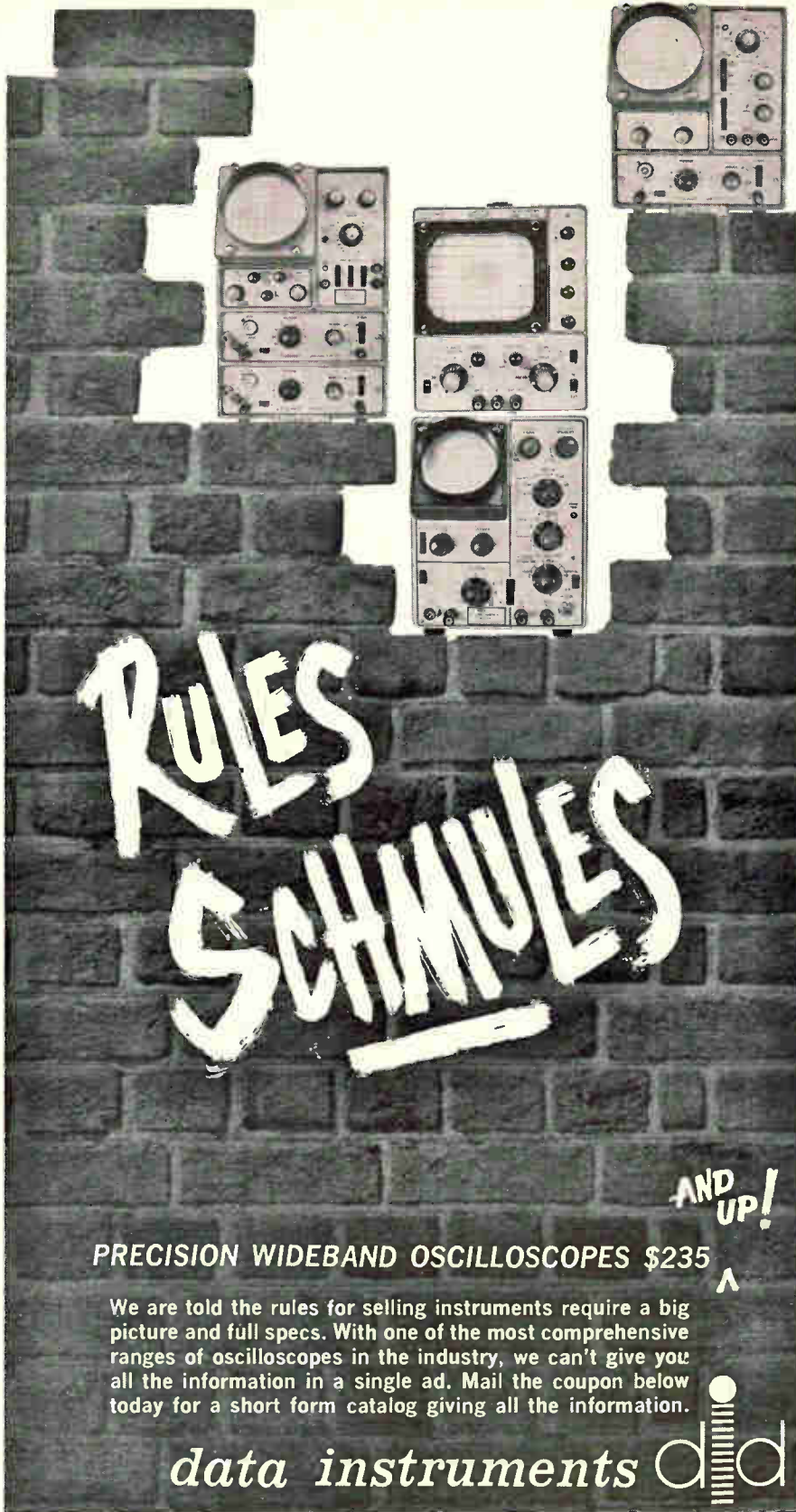

**RULES
SCHMULES**

AND UP!

PRECISION WIDEBAND OSCILLOSCOPES \$235

We are told the rules for selling instruments require a big picture and full specs. With one of the most comprehensive ranges of oscilloscopes in the industry, we can't give you all the information in a single ad. Mail the coupon below today for a short form catalog giving all the information.

data instruments 

Name _____
 Address _____

 Company _____ Title _____

data instruments
 7300 Crescent Boulevard
 Pennsauken, New Jersey
 609-662-3031

A Division of Industrial Electronic Hardware Corp.

New Subassemblies

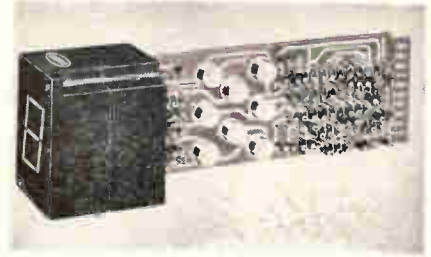

provided for and memory is optional. One-inch digits are displayed while panel area and depth projection are small. Punctuation—decimal, comma and colon—is optional in every module. An auxiliary module displays descriptive captions.
 Dialight Corp., 60 Stewart Ave., Brooklyn, N.Y., 11237. [403]

Digital printer solves decoding problems

The Accudata 200 oscillograph digital printer converts electrical data into printed digits on the left-hand margin of Visicorder oscillograph records, printing up to four digits per line at a maximum rate of 200 lines per second. This system makes possible the direct recording of digital data in precise time coincidence with analog traces on oscillograms. Until the introduction of the Accudata 200, real time or range time codes recorded on oscillographs by galvanometers required visual decoding, and actual digital equivalents had to be manually annotated on the record. The Accudata 200 solves these problems through the use of a new high-speed recording technique. The system uses a matrix of tiny light sources (as illustrated on p. 196) encapsulated in a recording head which is mounted within the Visicorder oscillograph. The numbers are formed by turning on remotely the appropriate combination of light sources in the matrix. The cycle time of these light sources is measured in nanoseconds, permitting extremely high printing rates at fast paper speeds. Time coincidence with analog data is achieved by mounting the recording head in the same plane as the galvanometer recording spots. The

Exploration of the universe by spacecraft capable of safely transporting men takes vast down-to-earth preparation. To accomplish this, Douglas has built what may well be the most advanced company-owned space complex in the world, the Douglas Space Systems Center. Here, in 11 buildings containing the most modern equipment—including a space simulation chamber 39 feet in diameter capable of housing a complete manned

MAN-RATED SPACECRAFT

...AND WHAT DOUGLAS IS DOING ABOUT THEM

spacecraft—work is going forward on huge space pro-

grams. In advanced development is the *Saturn* S-IVB, the 58 foot long Douglas stage which will power the three *Apollo* astronauts from earth orbit to moon orbit.



To further these and other programs, Douglas is seeking graduate engineers experienced in reliability, electronics, propulsion or structures. Please send your resume to Mr. G. H. Snodgrass, Douglas Missile and Space Systems Division, 2730 Ocean Park Blvd., Santa Monica, California. An equal opportunity employer.



MISSILE & SPACE SYSTEMS GROUP

GET ALL 5

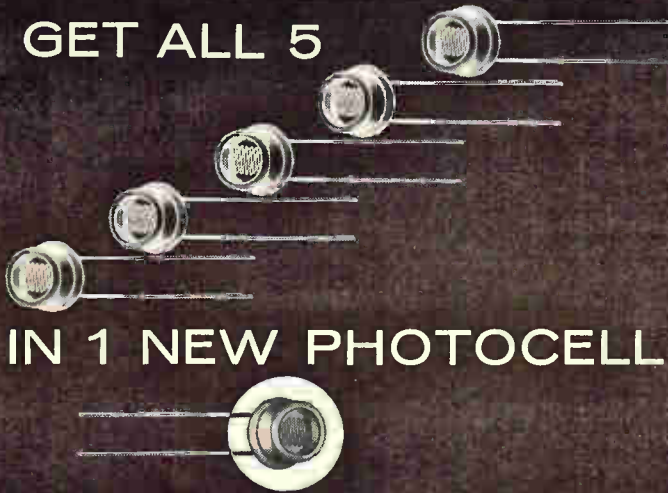

IN 1 NEW PHOTOCELL . . .

Now, the 5 best characteristics of CdSe and CdS are combined in 1 new Clairex CdS photosensitive material, the type "5H".

1. High speed (1-2 millisecond response)
2. Low temperature coefficient (0.5%/°C)
3. Low memory (15 X lower than CdSe)
4. High linearity (slope of 0.9 from 0.1 to 100 FC)
5. Uniform color temperature response (100% - 106%, 2854°K-6700°K)

Detailed information on type "5H" photocells plus the new Clairex 16 page Designers' Manual free on request.

CLAIREX

"The LIGHT Touch in Automation and Control"

8 West 30 Street, New York, N. Y. 10001, 212 MU 4-0940

See us at IEEE Show Booth 1725

Circle 238 on reader service card

New Subassemblies

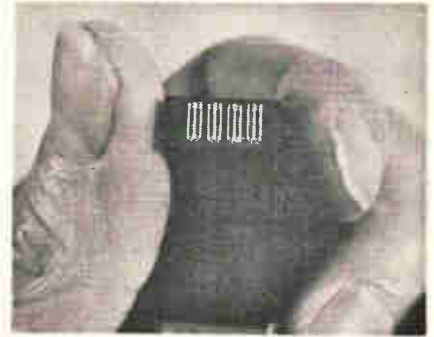

Accudata 200 may be programed to print any number of different data information blocks in any sequence. Simple programing can also provide time coincident event marks and data identification codes. Digital data can be recorded in time sequence or in any sequence on command, such as during a predetermined incremental change in value, or during an excursion beyond a predetermined level.

Honeywell, Denver Division, 4800 E. Dry Creek Road, Denver 10, Colo. [404]

All-silicon, plug-in modular power supply

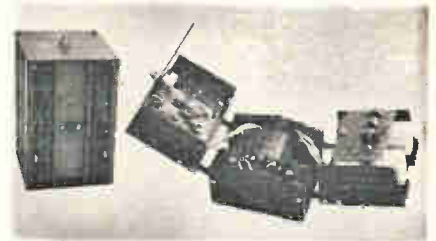

A line of 1/2-1/4 amp, plug-in modular power supplies are announced for military and precision industrial application. The GS series of all-silicon units have outputs of 3 to 90 v at 500 ma in 5 voltage ranges. Electronic automatic short-circuit protection is built in and mean-time-before-failure is over 20,000 hours. Input is 105 to 125 v a-c, 50 to 400 cps, single phase. Regulation is $\pm 0.02\%$ line, $\pm 0.05\%$ load or ± 5 mv; ripple, 200 μ v; ambient, -20° to $+65^\circ$ C; stability, $\pm 0.005\%$ per $^\circ$ C typical; transient response, 50 μ sec or less; size 5 3/4 in. high by 3 5/8 in. wide

NEW BLILEY BPCO SERIES
PROPORTIONAL TEMPERATURE CONTROL
FOR MIL-TYPE CRYSTAL UNITS

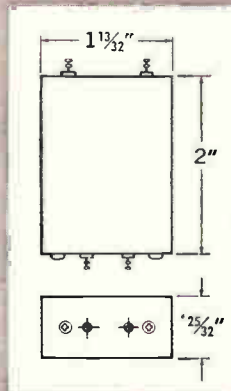

- Mounts flat on PC Board
- Accommodates HC-6/U and HC-12/U Crystal Units
- Maintains $\pm .05^\circ$ C. at fixed ambient
- Silicon transistors assure reliable noise-free performance

Bulletin 539A available.



if you buy quality

BLILEY ELECTRIC COMPANY • ERIE, PENNSYLVANIA

See us at Booth 1318 IEEE Show

by 1/4 in. deep. These supplies are intended for use in systems designed to MIL-E-4518, MIL-E-5400, MIL-E-16400, and FAA 777. Transistor Devices Inc., Route 53, Mt. Tabor, N.J., 07878. [405]

Magnetic timer offers extended delay

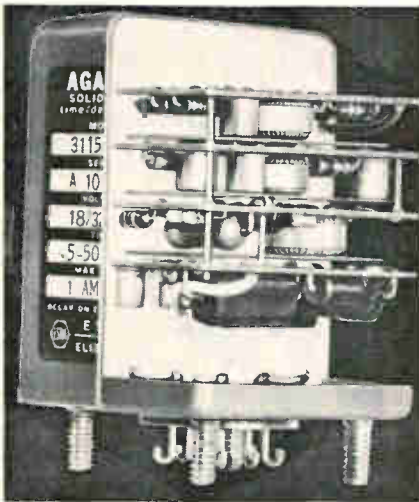

A series of precision electronic timing instruments uses the magnetic core counter principle. Principal features are high repeat accuracies, extended delay periods, and outstanding reliability, according to the manufacturer. The 3100 series delay-on-energizing timers offer ranges from milliseconds to months or years, with stock models providing 100:1 adjustment ratios. Typical accuracies are $\pm 0.25\%$ at fixed voltage and ambients, with 0.05% attainable in some models. Operating at 18-32 v d-c, they will switch up to 4 amps when supplied with static output, or up to 3 amps resistive at 32 v d-c with relay outputs. Two basic models are offered, designed for ambients of -55°C to 85°C or -55°C to 125°C . Standard delay ranges cover a total span from 0.05 to 500,000 seconds, with others supplied on special order. Timing is set at the factory, or may be externally adjusted, depending on type selected. All standard units measure 1 1/2 in. square at the base, with height governed by timing range. Typical height for a 5,000 second timer is 3 in. A variety of mounting styles is available. Agastat Timing Instruments, Elastic Stop Nut Corp. of America, 1027 Newark Ave., Elizabeth, N.J. [406]

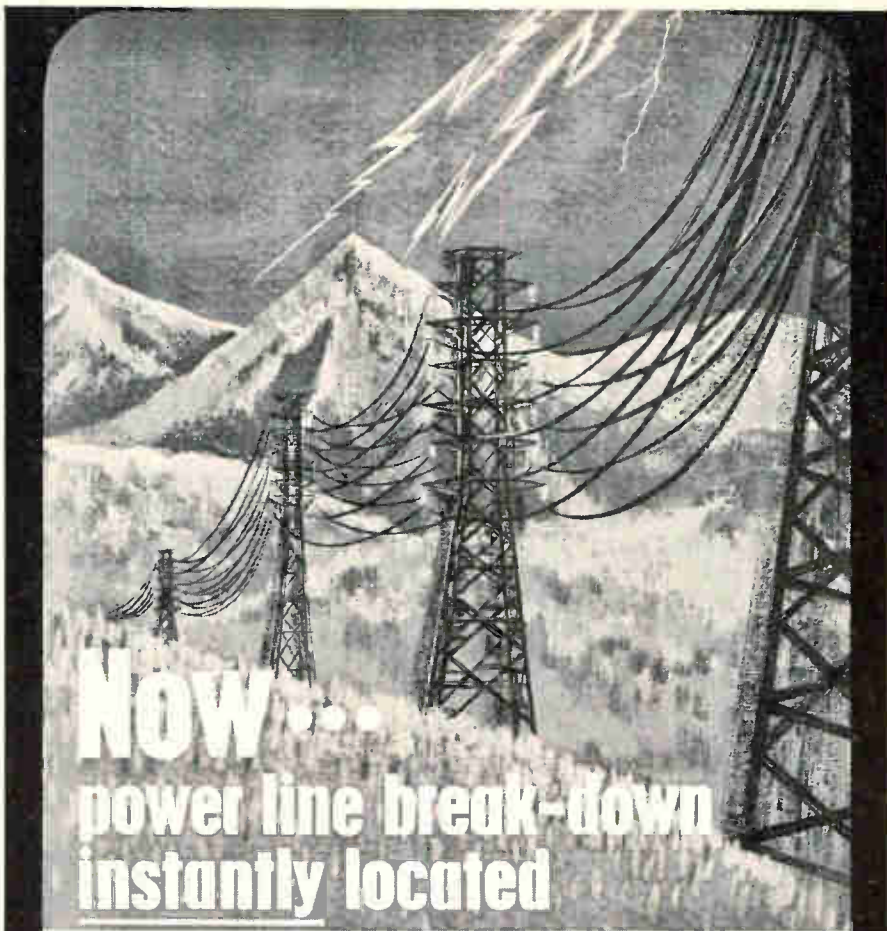

Expensive power line patrol crews: obsolete! Complex equipment that can't locate lightning faults, erosion faults, and other invisible faults: obsolete! In fact, Toshiba's new Type C Fault Locator makes all previous equipment obsolete, because it is the first unit of its kind ever to pinpoint any and every fault instantaneously.

The Fault Locator's system is simplicity itself. A unit emits an impulse signal over the power line and—upon the appearance of a fault or break in the line—the Locator counts the time required for the signal to return. A light panel flashes on and pinpoints the fault to within 0.5 mile.

Toshiba scientists went to work on this problem more than a decade ago. Exhaustive research resulted in this fool-proof system that is now rapidly becoming standard equipment throughout Japan's mountainous terrain.

For further information visit Toshiba booths Nos. 2337 and 2339 at IEEE Show or write directly to the office nearest you.

Products on display

Fault Locator • Electron tubes • Semiconductors • Field effect transistors • Communications equipment

New York: 20th Fl., The Bank of New York Bldg., 530 Fifth Avenue, New York, N.Y. 10036.

Chicago: Room 1238, Board of Trade Bldg., 141 West Jackson Boulevard, Chicago, Illinois 60604.

San Francisco: Merchants Exchange Bldg., 465 California St., San Francisco 4, Calif. 94104.

Tokyo Shibaura Electric Co., Ltd. Tokyo, Japan

Toshiba Quality Since 1875

Quick Reaction Capability that Counts



JANUS
Model B100-82
Forward-Backward
Counter Module with Display

HERE'S WHY:

These 1-mc Forward-Backward Decade Counters may be applied quickly and easily to systems and products requiring reliable high-speed bi-directional counting.

JANUS Model B100-80 Series Forward-Backward Counters Provide:

SPEED: Accept pulses to 1-mc in either direction.

QUICK REVERSING TIME: Less than two microseconds.

RELIABILITY: All transistorized, silicon circuitry throughout.

LOW COST:* \$115.00 (or less) for units with display. \$46.50 (or less) for units without display. Less costly than making them yourself.

FAST DELIVERY: From stock.

Available (with or without display) individually or in quantity for use in high speed counter applications where quality, low-cost and reliability are important.

Write for Technical Literature.

The Next Time You Need Counters
Count on JANUS

*Price (FOB Newton, Mass.)
even lower in large quantity.



JANUS CONTROL CORPORATION
HUNT ST., NEWTON, MASS. TEL. 926-1037

New Microwave

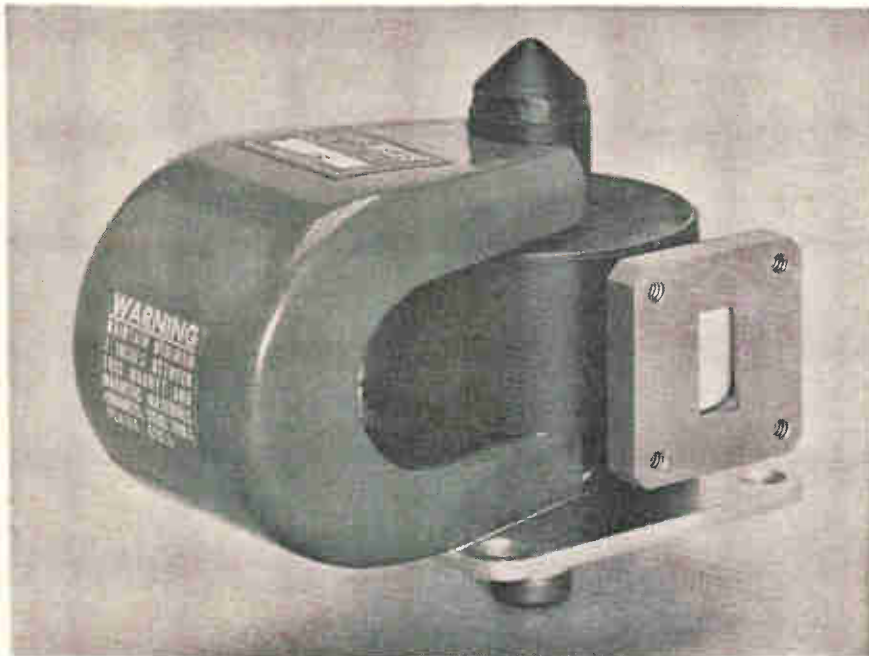

Coaxial magnetrons operate at Ku band

A new family of metal-ceramic coaxial pulse magnetrons operates at 16 to 17 Gc. The most important tube in the line is the L-3958, rated at 10 kw peak power with fixed frequency at 15.5 Gc. This is claimed to be the highest power ever produced in so small a package (maximum weight is 3.0 lb). The highly-efficient tubes feature low-frequency pushing and pulling, resulting in excellent spectrum coverage. Longer life is anticipated, since the tubes are designed with large

emitting areas. The devices may be used in weather and surveillance radar, airborne and missile systems and pulse doppler systems. Operating conditions are: heater voltage, 6.3 v; heater current, 1.6 amps; pre-heat time, 60 seconds minimum; pulse voltage, 5.0 kv d-c nominal; pulse current, 5.0 amps. Pulse length is 2.0 μ sec; duty cycle, 0.002; anode temperature, 150°C; cathode temperature, 175°C; vswr, 1.3:1; altitude, 25,000 ft.

Litton Industries, Electron Tube Division, San Carlos, Calif. [421]

Directional couplers feature low vswr

A series of 18 standard precision coaxial directional couplers is announced. It covers the frequency range of from 120-245 Mc to 4-10 Gc with a coupling accuracy of ± 1.0 db over the specified range. In each range, couplers are available with 10, 100 or 1,000 w power ratings. In addition to low vswr, the couplers offer high directivity. This makes them specially useful in reflectometer systems, in meas-



uring antenna efficiency or in any laboratory application where there is a requirement to measure the power in one direction without disrupting the line. The vswr in coupling output is only 1.2 to 1

maximum and coupling can be specified for 10, 20 or 30 db. The units are made with lightweight aluminum and Teflon with silver plate finish. The type N or TNC female connectors are silver-plated brass. Prices start at \$100 and range up to \$225, depending on the frequency range, coupling and power rating.

RLC Electronics, Port Chester, N.Y. [422]

Marker generator spans 5 Mc to 12.4 Gc

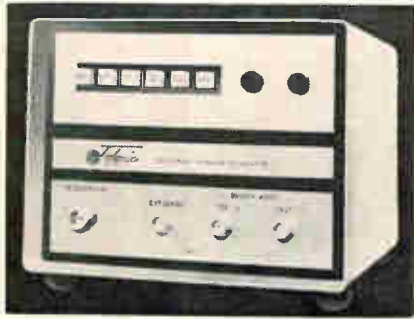

The TMS-1 microwave marker generator provides sharply defined trace excursions on an oscilloscope or X-Y recorder to give precise indication of frequency intervals during a trace. Generally used with a swept frequency generator, the all solid state instrument enables the user to evaluate rapidly a frequency response curve by providing marks every 5, 10, 50 or 100 Mc over a range of 5 Mc to 12.4 Gc. In operation, the generator samples an unknown r-f from the swept source and mixes this sample with harmonics produced by its own internal crystal oscillator. The mixer output is then channeled to a low noise video amplifier and combined with the vertical input to an oscilloscope or X-Y recorder. Accuracy of the resulting markers is 0.001%. Marker frequency intervals are determined by a convenient push-button system allowing rapid selection or changing of marker spacing. If intervals other than standard are desired, an r-f connection on the front panel permits use of an external oscillator for any frequency, from 2 Mc to 200 Mc. This circuit is also activated by push button. Other controls include size and bias adjustment to regulate height of the

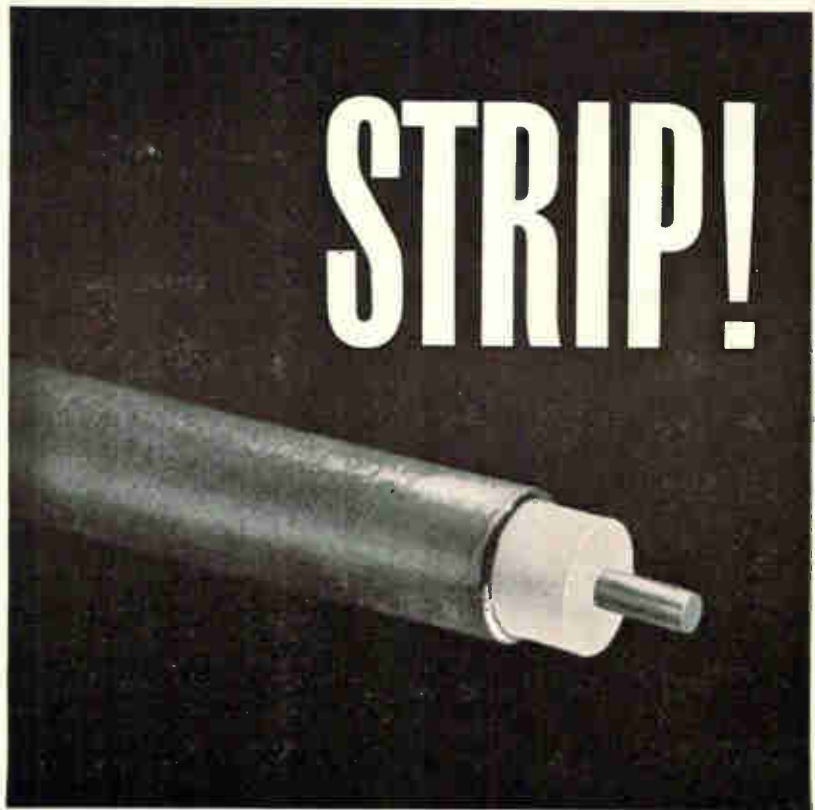

Standard MicroCoax is a miniature solid-jacketed coaxial cable. It strips easily. No "fuzz" from braided ends.

We list advantages here. If you're not acquainted with them, we hope that brevity will help.

Close tolerance, total shielding, environmental stability, easy soldering. Also: it's easily formed into bends or coils, ideally suited for use with stripline or waveguide. We verify mechanical and electrical properties.

MicroCoax has been used for microwave transmission and delay lines, totally shielded connections, high-speed computer leads. Other designers have chosen to use it for audio crosstalk suppression, or low-noise amplifier isolation. Or in mixers and klystrons.

Conductor materials are varied. To fit your application, we stock aluminum, aluminum alloys, copper and its alloys, iron alloys, nickel and nickel alloys, Beryllium-copper, precious metals, reactive metals and stainless steel.

Choose organic or inorganic dielectrics, silver-plated copperweld (or silver plated solid copper) plus Tophet C and BeCu center conductors.

Impedances vary in sensible steps from 1 to 125 ohms.

Our Bulletin 202B is more chatty, with columns of technical data. Send for it.

Visit Booth No. 4321 at IEEE Show

MicroDelay Division

UNIFORM TUBES, INC.



Collegetown, Pa. • (215) 489-7293 • TWX 215-277-1673

For distribution outside the Continental U. S.
—Ad. Auriema, Inc., 85 Broad St., New York

MISSIMERS PRECISION SERIES TEST CHAMBERS

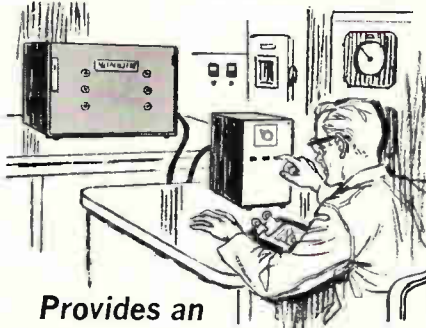

**Provides an
"Instrument" approach
for extreme Accuracy
in Temperature Testing**

This unique design provides close temperature gradients of special variations in the test area, as well as providing for flexibility of use, performance, ease of maintenance and repair. Accessories such as component mounting boards, electrical access connectors, load cards, power supplies, scanners etc. can be added.

The BFT series is CO₂ or LN₂ cooled and can be bench or rack mounted. The units are available in four models; sizes of one-half and two cubic feet and temperature ranges of -100° F. to +600° F. and -300° F. to +600° F. The FT 1.5 series is mechanically refrigerated with a temperature range of -100° F. to +350° F.

WRITE FOR FREE BROCHURES



BFT 2



FT 1.5

Reliable Test Equipment Since 1932



New Microwave

marks, an extremely convenient feature when working on steep slopes of the response curve. All controls and connections are made at the front panel of the instrument. Price is \$1,485.

Telonic Engineering Co., a division of Telonic Industries, Inc., 480 Mermaid St., Laguna Beach, Calif. [423]

Peak power meter spans 3 to 300 mw

The Microline 66A3 peak power meter has been developed. Accurate, direct readout of peak power can be taken continuously and instantly with this high precision, completely-transistorized instrument. Microwave peak power measurements over the range of 3 mw to 300 mw can be made directly with unparalleled ease and accuracy, the company says. The Microline 66A3 requires no special skill to operate or additional equipment other than a bolometer mount with a calibrated barretter. The completely portable operation, and the small size and weight, permit simple field measurements. Four full scale ranges of 10, 30, 100 and 300 mw peak power are provided; accuracy is $\pm 5\%$ of full scale. Repetition rate is 50 to 10,000 pps, and pulse width is 0.25 to 10 μ sec. Price is \$890.

Sperry Microwave Electronics Co., P.O. Box 1828, Clearwater, Fla. [424]

Miniature oscillator delivers 10 watts



The BETO oscillator, designated BTO-20, is one of a family of volt-

DIVERSIFIED

**BLUE CHIP
INDUSTRIES
MOVE TO
CALIFORNIA'S
COMFORT
COMMUNITY
RIVERSIDE**



CITY OF CLIMATE, CULTURE COMMERCE and COOPERATION

The city of Riverside offers raw and fully developed industrial land—over 1500 acres ready to go—priced from \$4,500 per acre. Less than 30 freeway minutes from Los Angeles and Orange Counties' high land prices. Large labor pool, major transportation facilities, plus freeways to major cities in California. Excellent schools—4 colleges, including University of California at Riverside—plus a most enjoyable year 'round climate. Where else in the West can you find these comfort community qualifications in the center of a key marketing area with an effective annual buying income of over 19 billion dollars? We'll rush complete information—confidentially—upon request.

PLANT LOCATION COORDINATORS
4261-B Main Street, Riverside, California
Circle 239 on reader service card

NOW! APPLY KODAK PHOTO RESISTS this new AEROSOL way



**QUICK
CONVENIENT
ECONOMICAL**

Three types to suit all your etching needs now available at local industrial photo dealers

TYPE-P containing Kodak KPR* —for copper, copper-clad laminates, other metals. 16 oz. \$5.95

TYPE-M containing Kodak KMER* —for aluminum, stainless steel, titanium, other metals. 16 oz. \$5.95

TYPE-T containing Kodak KTRF* —for high resolution etching of thin films. 16 oz. \$6.95

*KPR, KMER, KTRF are products of Eastman Kodak Co.

**INDUSTRIAL CHEMICAL
SPECIALTIES CORPORATION**
1595 Black Rock Tpke., Fairfield, Conn.

Please rush me more information on Spray Resist products and, also, name of nearest dealer:

NAME _____

COMPANY _____

CITY _____ STATE _____

age-tunable magnetrons now available. It is a low noise, magnetically shielded tube delivering at least 10 w over any 600-Mc range specified between 2.6 and 3.7 Gc. Power flatness is ± 1 db. Said to be the smallest 10-w package available, it weighs only 19 oz with heat sink. This rugged, miniature oscillator is ideal for applications requiring compact, lightweight packaging. The magnetic circuit configuration results in a negligible external magnetic field and permits the tube to contact other ferromagnetic materials without degrading performance. The integral heat sink allows the BETO oscillator to operate within specifications for more than two minutes without auxiliary cooling, starting from an ambient temperature as high as 160°F. Other characteristics include: noise power, below carrier, greater than or equal to 1 Mc from carrier is 80 db/Mc; modulation sensitivity, 1.8 ± 0.1 Mc/v; maximum anode voltage, 2300 v d-c; injection electrode voltage, 525 ± 50 v d-c. Varian Associates, Bomac Division, Beverly, Mass. [425]

Klystron power supply for exacting lab use

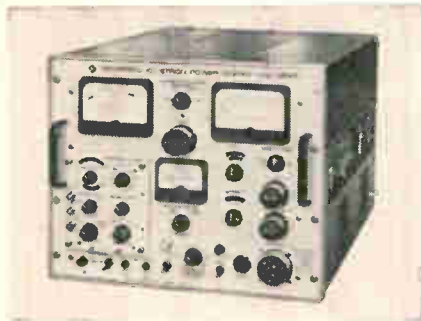

A new universal klystron power supply, Model Z815C, has been designed for laboratory operation of most reflex klystrons, as well as many other microwave tubes. It features a digital readout dial for accurate presetting of the 4,200 v, 360 w beam supply and two separate reflector outputs. The unit offers a grid supply for positive or negative grid operation, and a 0.15 v d-c filament supply. All supplies have excellent line and load regulation and extremely low ripple. For example, the regulation of the beam supply is 0.005% for line and load;

MEASURE SOUND LEVELS OVER THE FULL DYNAMIC RANGE WITH MASSA SOUND PRESSURE MICROPHONES

RMS Sound Pressure (Dynes per cm²)

2 x 10⁶
10⁶
+100
10⁵
10⁴
+50 (bar)
10³

0 2 x 10

Rocket Eng
Jet Plan
at Take-Off

Large Sir

Large
Pneuma
Riveter

Heavy

Su

Hea

M-125
Freq. Range Cps
20-30,000

MK-103
Freq. Range Cps
20-30,000

M-141
Freq. Range Cps
20-30,000

M-215
Freq. Range Cps
20-70,000

M-213
Freq. Range Cps
20-100,000

Broa

Ru
(Quiet Night)

Massa Sound Pressure Microphones provide accurate and reliable sound pressure measurements from low levels to the ultrasonic region under practically any acoustic environment. Important features include:

- Linear Dynamic Ranges to sound pressures in excess of 200 db (re: 0.0002 microbars).
- No D.C. Polarizing required.
- Exclusive ADP (Ammonium Dihydrogen Phosphate) Crystals for uniform reliability, stability, and accuracy.
- Frequency Ranges from 20 cps to 100,000 cps.
- Omni-Directional to high frequencies for sure pickup of sound in difficult areas.
- Near Infinite Acoustic Impedance or no loading of the sound field.

Complete Portable Systems are also available for use where reliable measurements must be made at inconvenient locations.

Write for **FREE Pocket Size Sound Level Measurement Chart**



MASSA DIVISION
DYNAMICS CORPORATION OF AMERICA
HINGHAM, MASS. 02043

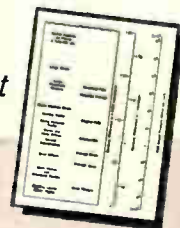

PUT GREATER

Sale-ability

INTO
YOUR
INSTRUMENTS

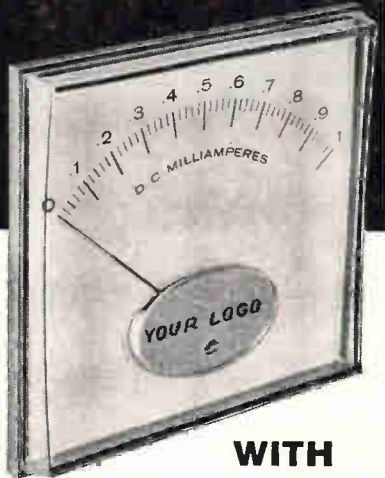

WITH
BEEDE METERS

Yes, put a Beede "Designer Line" Meter into the instruments you make and you've given your products greater *sale-ability*. Offer your line with the professionally styled appearance that speaks of quality and prestige — without increasing the cost.

Here are a few important points to remember:

- Oval escutcheons present your logo effectively
- Colored escutcheons brighten but do not overwhelm
- Clean, open faces compel attention and please the particular taste
- Concave windows reduce reflection

Send for Beede's new brochure on Scale Design which was prepared to offer you professional advice on designing dials that will take full advantage of the styling possibilities offered by the Beede forward-looking Designer Line.



BEEDE

ELECTRICAL INSTRUMENT CO., INC.
PENACOOK, NEW HAMPSHIRE

Area Code: 603-753-6362/TWX: 603-753-4727

New Microwave

maximum ripple is 2.5 mv rms. A modulator section provides square wave, pulse, sawtooth and sine wave modulation which can be applied to reflector I or the grid. Counters or dials are provided for very accurate presetting of d-c voltages. The filament voltage is continuously monitored with an accurate voltmeter. The controls of the other supplies can be calibrated through a switchable metering circuit to an accuracy of $\pm 0.25\%$. Metering of beam, grid and filament current is also included. The supply is available on eight weeks delivery and is priced at \$1,975. Microlab/FXR, Livingston, N.J. [426]

Phase-lock synchronizer and sweeper marker

A microwave phase-lock synchronizer and sweeper marker is being introduced. The synchronizer, model 244, is designed for the control of microwave frequency sources. It uses an i-f of 25 Mc and provides both discrete lock-point frequencies and continuous tunable coverage in the 2-to-15 Gc band. The 244 will phase-lock klystrons, backward-wave oscillators and other voltage tunable sources to an internal crystal reference or to an external reference. An external 5-Mc crystal-controlled reference oscillator can be used with the 244 for coherent control of microwave frequencies to crystal reference accuracies. When used with sweepers, the 244 can utilize its internal 10 Mc and 50 Mc precision marking points throughout the band with an accuracy of 0.001%. The 10 and 50-Mc increments can be used to extend the frequency range down to 35 Mc or up to 15,025 Mc. It is capable of controlling microwave frequencies to quartz reference accuracies; for example, a 10,000-Mc source to an f-m drift stability of 50 cps, and a long-term drift to 1,000 cps. Model 244 measures 3½ in. by 17 in. by 19 in. and weighs 30 lb. Price is \$1,750 per unit; delivery, 30 to 60 days. LFE Electronics, 1601 Trapelo Road, Waltham, Mass. [427]

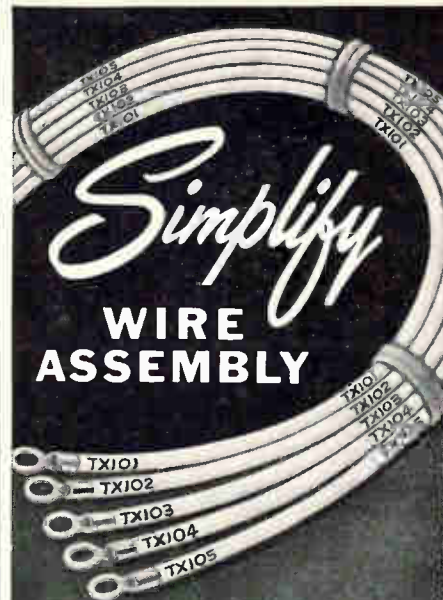

with a
KINGSLEY
Wire and Tube
Marking Machine

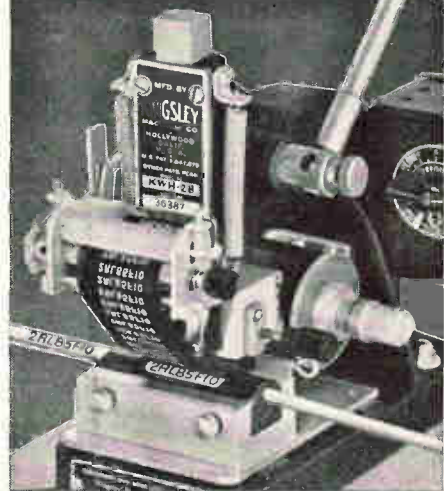

Now you can mark each wire or piece of plastic tubing with its own circuit number... quickly... economically, right in your own plant.

You reduce wire inventories because you need only one color of wire for as many circuits as necessary.

Simplify your assembly methods and speed production with the same machine that has proven so successful in the aircraft and missile field. Write for details.

KINGSLEY MACHINES
850 Cahuenga • Hollywood 38, Calif.

See us at Booth 4311—IEEE Show—March 22-25

Co-ax dummy loads for 0.2 to 10 Gc

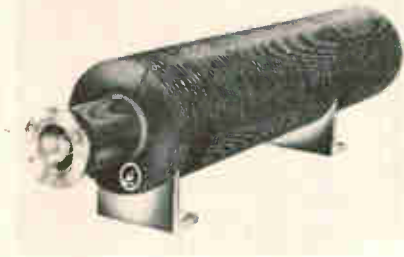

Three new series of coaxial dummy loads are announced. They operate in the 0.2 to 10 Gc region and employ high temperature refractory material as the load elements. They are available with maximum power ratings up to 15 kw average and 40 Mw peak, and are supplied with EIA or JAN flanges or type N connectors. Maximum vswr is 1.20. The unfinned TT series and the transverse finned TV series are designed for free air convection cooling. The TW series loads are high power, liquid-cooled units. Each series is available in 14 combinations of connector series and frequency ranges. All three series are priced from \$400, with availability set at 4 weeks. Special units can be custom designed to meet specific requirements.

Microlab/FXR, Livingston, N.J. [428]

Ultraminiature mixer-preamplifiers

A line of ultraminiature integrated mixer-preamplifiers is designed to be compatible with the manufacturer's microminiature i-f amplifiers. The units find applications in missile and aerospace systems where small size and weight are needed and extremes of environment are present. Featuring low noise performance, rfi construction, a calculated mean-time-between-failure of over 200,000 hours, and very low power drain, these units are available from vhf to Ka band. Typical of this series is model MMP34/2B. Its r-f is 34 to 36 Gc; i-f, 60 Mc; i-f bandwidth, 20 Mc; noise figure, 11db; gain, 20 db.

RHG Electronics Laboratory, Inc., 94 Milbar Blvd., Farmingdale, L.I., N.Y. [429]

Custom-Spooled

Aluminum Bonding Wire

Bright aluminum assures better bonding... Minimum diameter .0007"... Many sizes available from stock... Write for engineering and price data
SIGMUND COHN CORP. 121 South Columbus Ave., Mount Vernon, N.Y.



BOOTHS 4322-4324 IEEE SHOW

SIGMUND COHN CORP. OF CALIFORNIA, Burbank, Cal. / SIGMUND COHN-PYROFUZE, INC., Dallas, Texas

Circle 242 on reader service card

*do inductors and transformers
have you behind
the 8 ball???*

use the
**theory of
probability**
to solve your problems

This is where experience counts! Chances are Hamilton has just the toroidal inductor or pulse transformer you need in the 2 oz. and under class. These components provide the ultimate in reliability—not one reject in 25,000! Every component is backed by Hamilton's reputation for extraordinarily high quality and technical competence. We welcome the opportunity to provide quotations on large or small volume requirements for fast delivery. □ What can you lose? Invest a postage stamp and you will find the answer that will quickly and economically solve your problem. Write for the facts—no obligation or high-pressure sales talk—just useful data on Hamilton's electronic components and other facilities.

HAMILTON
WATCH COMPANY
INDUSTRIAL AND MILITARY PRODUCTS DIVISION • LANCASTER, PA.

GREEN

PRINTED CIRCUIT DRILL for versatility at LOW COST



NEW... Spindle feed control provides infinite range of controlled feed rates.

For prototype panels or high production work, drill quickly and easily without specialized labor or expensive tooling. The Green D2 Pantograph Engraver with D2-201 Pneumatic Attachment provides manufacturers with a Printed Circuit Drill having unlimited application flexibility. Check these features:

- Spindle speeds to 26,000 R. P. M.
- Drill speeds and feeds independently adjustable
- May be used for profiling and engraving
- Boards can be stacked 4 deep for fast production
- Operates on "In Plant" compressed air or tank air (very small volume required)

Whatever your requirements, the Model D2-201 is the answer — complete and ready to operate. Write or call today for full details.

**GREEN INSTRUMENT
COMPANY, INC.**

Dept. 63 • 295 Vassar Street
Cambridge, Mass. • Eliot 4-2989
IEEE Show, Booth 4338

New Production Equipment

Fast-recovery diffusion furnace

Design of the model DKT ceramic element diffusion furnace, featuring a high thermal mass heat sink, is said to set new performance standards in the semiconductor industry. A 200 gram load of wafers inserted into this furnace has no more effect on thermal load than a drop of cold water falling into a pan of boiling water. The furnace has extremely high oxidation resistance both in the heat sink and in the heating elements, and thus can operate hundreds of degrees above normal diffusion operating temperatures. It is capable of continuous operation at temperatures up to 1,400°C. This leads to high thermal safety and extremely long equipment life. Model DKT provides extremely high thermal conductivity by means of the heat sink; this feature evens out temperature ripples and greatly simplifies instrumentation by permitting complete temperature control through a single instrument system.



It maintains flat zones of $\pm 0.5^\circ$ over the entire length of the heat sink. The sink design provides high thermal mass, so that work can be placed in the furnace and brought to operating temperature with no overshoot. The DKT sells for less than \$4,000 per unit.

C.I. Hayes, Inc., Cranston, R.I. [451]

Single-action air guns punch, drive and cut

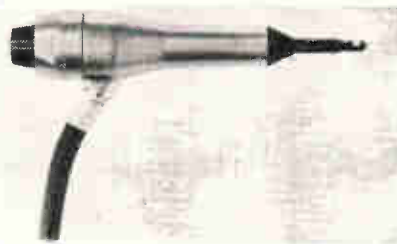

A line of single-action air guns for cutting and driving has been introduced. They are offered initially in eight different configurations for driving taper pin terminals, setting plastic rivets, driving retainer clips, center punching, and for cutting, crimping or bending nonferrous wire. Each gun is a single-purpose tool. A light squeeze on the throttle button triggers a piston blow with a maximum force of 65 lb. The

piston action produces no kick and very little noise. The guns are designed to operate on an exclusive, patented "exploding air" principle, and are said to be the first of their kind ever offered to industry. Driving and punching guns, weighing 9¼ oz. are made of steel. Cutting guns weigh 6½ oz and are made of aluminum. The company reports that field tests in electronics manufacturing applications have proven the capabilities of the new single-action guns to achieve significant savings in time and labor. The cutting guns are used for quick trimming of wires on circuit boards. The driving guns can set captivated or non-captivating taper pin terminals with uniform pressure through any number of cycles. They are said to offer advantages over the hammer-and-punch method when used for setting rivets. The Aro Corp., Industrial Division, Bryan, Ohio. [452]

SELF-CALIBRATING ±0.03° ACCURACY

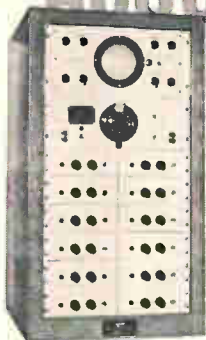

PRECISION PHASE STANDARD 70N0



DELAY



PHASE CALIBRATION



MEASUREMENT

Capability of up to 12 plug-in frequencies • Crystal controlled frequency selection, 30cps to 50kc; others available • Includes Oscilloscope, Precision Phase Shifter, Lissajous Pattern Generator, each of which can also be used independently • IDEALLY SUITED FOR STANDARDS DEPARTMENTS, INSTRUMENT CALIBRATION.

COMPLETE **ACTON** DATA ON REQUEST

Laboratories, Inc.

533 Main Street • Acton, Massachusetts
A Subsidiary of Bowmar Instrument Corporation

Circle 243 on reader service card

HEAD FOR PLANT CITY FLORIDA

Plant City, only 20 miles east of Tampa, RIGHT NOW offers more advantages for industrial locations than other Florida areas. Why?

FIRST—In the direct growth pattern of rapidly expanding Tampa Bay area. Low cost sites... Don't wait... Investigate now.

SECOND—More convenient to ALL Florida markets. Closer by actual miles.

THIRD—Two major railroads, a superb highway network including new Interstate 4. All utilities, including natural gas. Plus approved FAA airport adjacent to municipal, active industrial park.

FOURTH—Favorable construction costs and financing.

FIFTH—Excellent local labor market. Full educational, civic and cultural advantages. WRITE TODAY for surveys and facts. All contacts in strict confidence.

DICK PREWITT, General Manager
INDUSTRIAL DEVELOPMENT COMMITTEE
P. O. Box 1509-A PLANT CITY, FLORIDA

City MOST Convenient to ALL Florida

Circle 244 on reader service card

PROVEN RELIABILITY— SOLID-STATE POWER INVERTERS, over 260,000 logged operational hours— voltage-regulated, frequency-controlled, for missile, telemeter, ground support, 135°C all-silicon units available now—

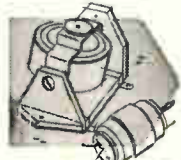
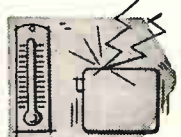
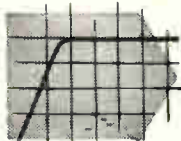
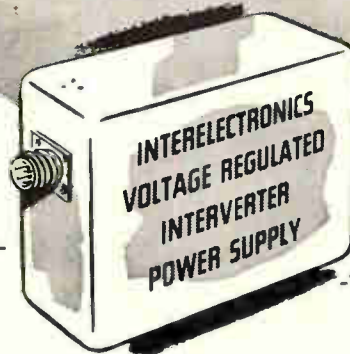

Interelectronics all-silicon thyatron-like gating elements and cubic-grain toroidal magnetic components convert DC to any desired number of AC or DC outputs from 1 to 10,000 watts.

Ultra-reliable in operation (over 260,000 logged hours), no moving parts, unharmed by shorting output or reversing input polarity. High conversion efficiency (to 92%, including voltage regulation by Interelectronics patented reflex high-efficiency magnetic amplifier circuitry.)

Light weight (to 6 watts/oz.), compact (to 8 watts/cu. in.), low ripple (to 0.01 mv. p-p), excellent voltage regulation (to 0.1%), precise frequency control (to 0.2% with Interelectronics extreme environment magnetostrictive standards or to 0.0001% with fork or piezoelectric standards.)

Complies with MIL specs. for shock (100G 11 msec.), acceleration (100G 15 min.), vibration (100G 5 to 5,000 cps.), temperature (to 150 degrees C), RF noise (I-26600).

AC single and polyphase units supply sine waveform output (to 2% harmonics), will deliver up to ten times rated line current into a short circuit or actuate MIL type magnetic circuit breakers or fuses, will start gyros and motors with starting current surges up to ten times normal operating line current.

Now in use in major missiles, powering telemeter transmitters, radar beacons, electronic equipment. Single and polyphase units now power airborne and marine missile gyros, synchros, servos, magnetic amplifiers.

Interelectronics—first and most experienced in the solid-state power supply field produces its own all-silicon solid-state gating elements, all high flux density magnetic components, high temperature ultra-reliable film capacitors and components, has complete facilities and know how—has designed and delivered more working KVA than any other firm!

For complete engineering data, write Interelectronics today, or call 914 Elmwood 8-8000.

INTERELECTRONICS CORP.

700 U. S. Route 303 Congers, New York 10920

Circle 205 on reader service card

205

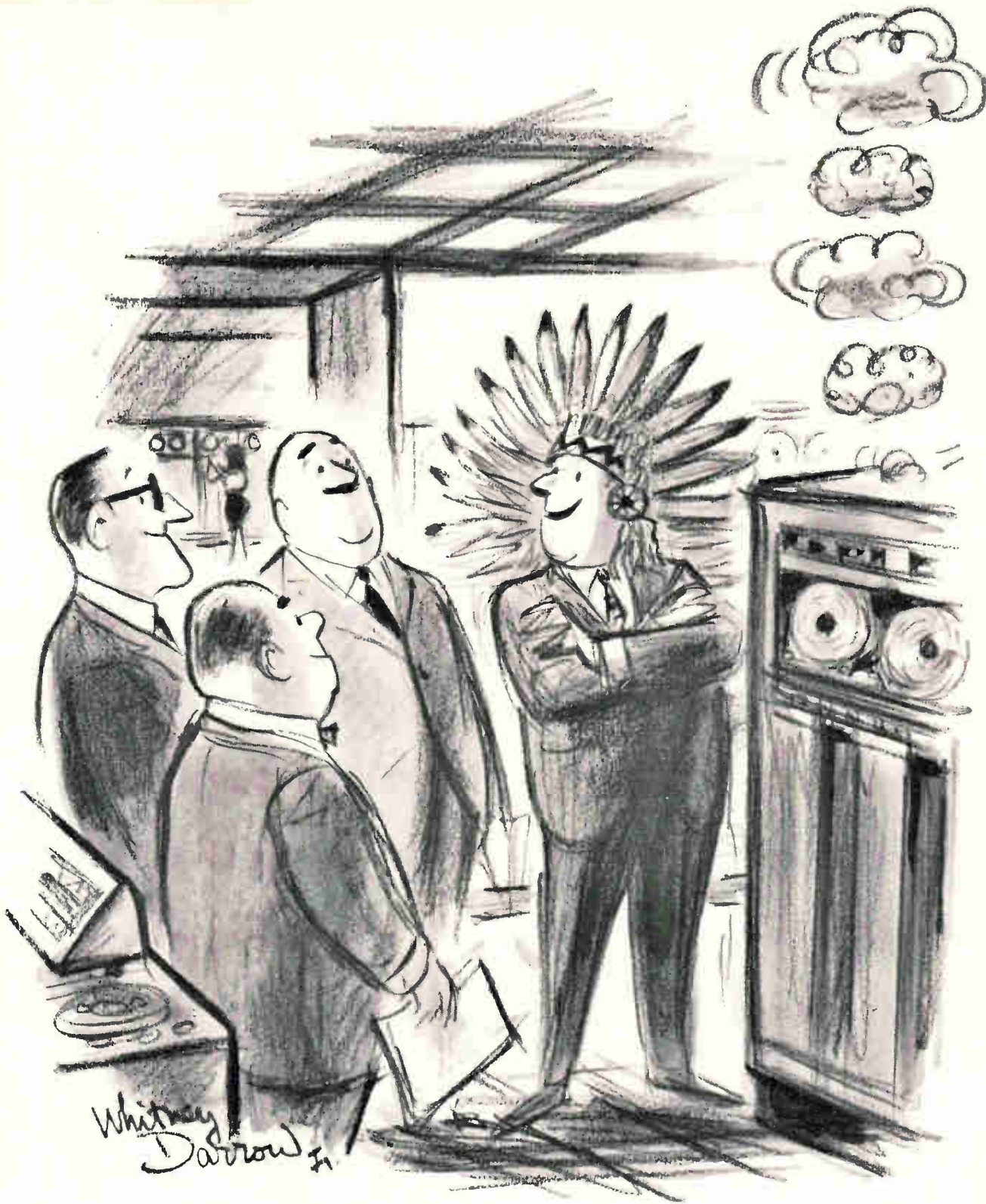

Him say, "When reliability counts, count on Mylar®."

There'll be no signaling from your computer (or its operators) if you make certain that all your tapes are on a base of "Mylar"*. That's because "Mylar" is strong (a tensile strength of 20,000 psi), stable (unaffected by

temperature or humidity changes) and durable (no plasticizer to dry out or become brittle with age). No wonder it has been the most used tape base for the past ten years. Remember: When reliability counts, count on "Mylar".

DU PONT
REG. U.S. PAT. OFF.
 Better Things for Better Living
 ... through Chemistry

only DU PONT makes
MYLAR®
 POLYESTER FILM

*Du Pont's registered trademark for its poly-ester film

New Materials

Silicon carbide fibers in quantity

Single crystal silicon carbide whiskers are now in large quantity production. Previously, the making of whiskers has been confined to the laboratory where only a few grams at a time have been available for research purposes. The whiskers (shown magnified in the photo) are needle-like single crystals of from 0.5 to 3 microns in diameter and 10 to 300 microns in length. Tensile strength of the fibers is from 3 to 10 million psi. Fiber purity is 99.5% SiC. They are corrosion resistant to acids and aqueous alkalis, and retain strength of 2 to 3 psi up to 3,200°F. The company says there is no limit as to the quantities that can be produced. Twenty-five pounds can be supplied off the shelf. In small quantities, the whiskers would cost \$100 per gram; large-quantity production has reduced this price to \$100 an ounce, when supplied in 25-lb quantities. The crystals have potential as a structural reinforcement of plastics, metals and ceramics. Because silicon carbide is



opaque to infrared radiation, the fibers may be extremely useful for both cryogenic and high temperature insulation. Principal high volume application is for NASA and defense, as a high temperature resistance material for space applications.

The Carborundum Co., P.O. Box 337, Niagara Falls, N.Y. [441]

Two-part, heat-curing potting compound

A high-temperature resisting, elastomeric cable molding and potting compound is said to offer many advantages over conventional materials (including the polysulphides, polyurethanes and silicones). Designated EC-2273 B/A, it approaches or exceeds the requirements of Mil Spec 8516-C for sealing compounds used with electric connectors and electric systems. The potting compound has good low temperature properties at -60°F and is outstanding for applications where temperatures as high as 375°F will be maintained for 1,000 hours. It will also withstand temperatures of 500°F for four hours and 600°F for short periods of time without deterioration. The compound has the added

advantage of weight reduction since its density is only 1.17 grams/cc. It provides excellent and consistent adhesion to many materials including primed metals, neoprene, PVC, etched Teflon, nylon and other wire insulation materials. EC-2273 B/A is a two-part, heat curing material which can be mixed in an open container at normal room temperatures. It is characterized by a long, 24 hour room temperature, non-moisture sensitive pot life and a relative fast cure of about 2½ hours at 225°F. The long pot life permits interruption in the application and curing operations when necessary. The material does not generate heat during cure and shrinkage is minimal. The new potting compound has a Rex durometer hardness of 60, and a Shore durometer hardness of 55.

Adhesives, Coatings and Sealers Division, 3M Co., 2501 Hudson Road, St. Paul, Minn., 55119. [442]

ONLY AUTOMATIC OFFERS ALL 5!



*PATENTED

economical!
reliable! efficient!
**rf coaxial
connectors**

Now you can select the connector which best meets your requirements!

They can be supplied in most of the standard connector styles and series from Micro-miniature through LC/LT, and for virtually all popular cables from 1/16" through 9/16" diameter.

Write or phone for literature . . .

automatic

METAL PRODUCTS CORPORATION
323 Berry Street, B'klyn 11, N.Y. Tel: (212) EV 8-6057

AT THE IEEE SHOW • BOOTHS 2802-4

FAMOUS ENCAPSULATING TECHNIQUES

with hull



... and by HULL

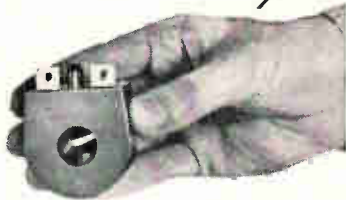

for **BIG** coils, too!

Not all electrical or electronic components for encapsulation by transfer molding are peanut-size! Take coils, for example, as used in transformers, solenoids, and motors. Hull has the field-proven process for your component . . . whether it's a tiny diode, or a coil 5" in diameter!

Whatever your encapsulating problem, Hull engineers can help you choose the most profitable solution. Hull techniques include direct encapsulation by transfer molding, by vacuum potting, and by continuous dispensing with the Blendmaster.

Get the "Hull Package"

From Hull, you get a complete service package: engineering, compound selection, design of mold and fixtures, presses, the work set-up, and assistance in start-up. Why not call or write us today to find out how Hull can help keep your quantity/quality ratios in line?

HULL CORPORATION, 5032 Davisville Road, Hatboro, Pa. 19040. Phone (215) 675-5000. H-21

See us at Booth No. 1918
at the IEEE Show



New Books

Measurements

Electronic Precision Measurement Techniques and Experiments
Members of the Staff, Philco Technological Center
Edited by John E. Remich
Prentice-Hall, Inc.
1964, 336 pp., \$13

This is a general-purpose reference and training text which will be valuable to engineers and technicians interested in accurate tests and measurements. For example, the chapter on "Mathematic Evaluation of Errors" makes a clear distinction between the terms "accuracy" and "precision," something which is not always well understood by many engineers. The book's dominant theme of accuracy is skillfully interwoven with a second theme—the use and calibration of electrical and electronic instruments.

Although the major emphasis of the book is on electrical and electronic instrumentation, three of the thirteen chapters deal with other related subjects. Dimension measurements and calibrations are covered, as well as physical measurements and calibrations for force, pressure, temperature, optics, shock, vibration, and radioactivity.

An important aspect of the book is its attention to calibration—something which should make it of real interest to personnel doing standard laboratory and calibration laboratory work. For example, in addition to the chapter on errors, there are three other chapters dealing with "Introduction to Standardized Calibration," "Systems and Units of Measurement," and "Basic Standards and Measurements." Also, all of the remaining nine chapters of the book discuss calibration techniques in their respective equipment or measurement categories. Ten calibration procedures are given as training exercises at the end of some of the chapters.

The book is valuable for reference, although it does not have too much indexing in depth. However, the information is grouped logically in the various chapters and therefore is relatively easy to find. Forty-four pages of the book

GRAPHIC VISUAL CONTROL

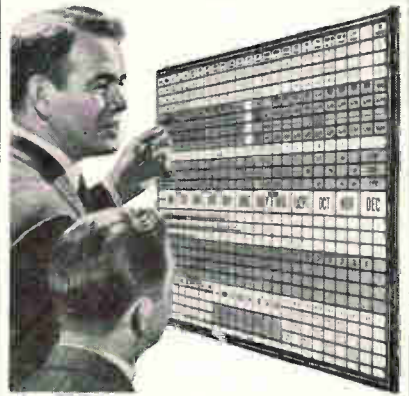

You SEE How To Get Things Done With The BOARDMASTER System

You see a Graphic Picture of your operations, spotlighted in color. You have facts at Eye Level. Saves time, cuts costs and prevents errors.

Ideal for Production, Maintenance, Scheduling, Inventory, Sales, Traffic, Personnel and many other uses.

Simple and flexible tool. You write or type on cards and post on board. All cards are interchangeable.

Compact and Attractive. Made of Aluminum. Over 1,000,000 in use.

Complete Price \$49⁵⁰ Including Cards

FREE 24-Page BOOKLET No. C-10
Mailed Without Obligation

Write Today for Your Copy

GRAPHIC SYSTEMS
925 Danville Road • Yanceyville, N.C.

Circle 245 on reader service card

Major Supplier of INDIUM

Dimensions and weights of Standard (99.99%) and 59 (99.999%) Grade Indium shapes available as follows:

Ingots - 321.5 tr. oz. (this size in Standard Grade only), 100 tr. oz., 10 tr. oz. **Sheets** -

maximum width of 5 in., minimum thickness of 0.002 in. **Wire** - minimum diameter

0.01 in. **Ribbon** - minimum thickness 0.005 in., maximum width 0.75 in. **Powder** -

several sizes from -100 to -325 mesh. **Shot** - approximate diameter 1/8 in. **Indium Compounds** -

sulphate, chloride, oxide and hydroxide in crystal or solution form.

Wide range of sizes of **Preforms** available in Standard and 59 Grades INDIUM

and custom alloys based on these grades. Fabricated shapes include discs, spheres,

squares, rectangles and washers. Very close tolerances maintained. Enquiries invited for special shapes, sizes and analyses.

COMINCO PRODUCTS, INC.

ELECTRONIC MATERIALS DIVISION,

818 West Riverside Ave., Spokane, Wash. 99201

Phone 509 747-6111 Telex 032 610

5606 TWX 509-328-1464

are devoted to appendix material for reference use.

From the training point of view, this book is well suited for classroom use by groups, for on-the-job training, or for self-improvement study by an individual. Fundamental principles of measurement and instrumentation are covered well. In addition, there are numerous questions, problems and exercises at the conclusion of many chapters. Answers to problems are given on a separate page at the end of the book.

An earlier edition was published in 1962 by the TechRep division of the Philco Corp. under the title "Precision Measurement Techniques." The major change in the new edition appears to be the addition of the training material in the form of questions, problems, and exercises.

In spite of the fact that the type was entirely reset for this edition, some errors have been carried over from the 1962 edition. For example, on pages 227 and 228, the value of microwave attenuation obtained by the audio substitution method is incorrectly described as being the average of two values, A_1 and A_2 , instead of one-half of the distance of the values A_1 and A_2 . The book is not excessively mathematical, but basic equations are given.

The book is not a completely up-to-date text, because some of the material dates back five or more years prior to the 1962 Philco edition. However, this is incidental to the fundamental principles of measurements, calibrations, and instrumentation which are so well covered by this book. Also, this is one of the few books of its kind in this important field of accurate measurements and tests.

Lloyd B. Wilson

Sperry Gyroscope Co.
Great Neck, N.Y.

Recently published

Handbook of Electron Tube and Vacuum Techniques, Fred Rosebury, Addison-Wesley Publishing Co., 598 pp., \$17.50

Engineering Systems Analysis, A.G.J. MacFarlane, Addison-Wesley Publishing Co., 272 pp., \$8.50

Understanding Lasers and Masers Stanley Leinwoll, John F. Rider Publisher, 88 pp., \$1.95

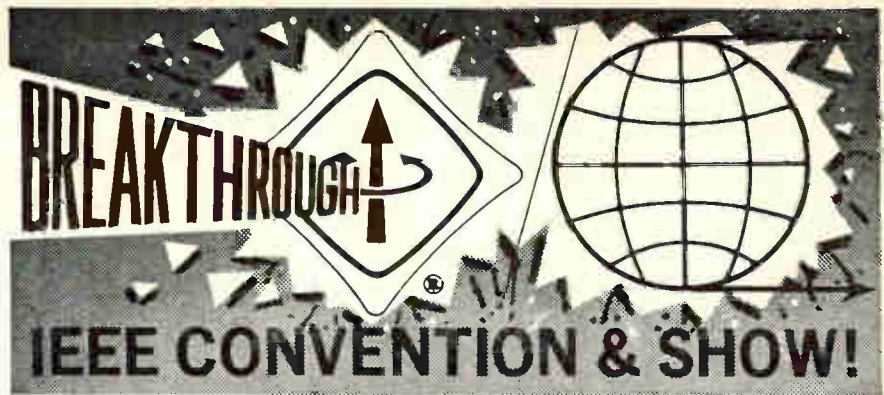

March 22-26, 1965

ELECTRICAL-ELECTRONICS

- ◆ Exhibit hours (4 days): Monday & Thursday, 9:45 a.m.-9 p.m.; Tuesday & Wednesday, 9:45 a.m.-6 p.m.
- ◆ Technical sessions (5 days) 10 a.m.-5 p.m. (Hilton, Tuesday to 10 p.m.)
- ◆ 80 subject-organized technical sessions presenting 400 vital "breakthrough" papers.

◆ Over 1000 Exhibits using 140,000 running feet of display units in N.Y. Coliseum & N.Y. Hilton.

◆ Gala IEEE Banquet on Wednesday, March 24, 1965 at 6:45 p.m. in Grand Ballroom, N.Y. Hilton.

◆ Registration: \$2.00 IEEE Members, \$5.00 Non-members. High School students admitted Thursday afternoon only, \$2.00 if accompanied by an adult (not over 3 per adult).



NEW YORK COLISEUM and the NEW YORK HILTON

Buses every few minutes

Circle 252 on reader service card



For your vidicon, image orthicon and professional movie cameras, Cosmicar lenses are available in focal lengths from 12.5mm up to 1000mm.

New zoom lenses are now available.



ICHIZUKA OPTICAL CO., LTD.

2-568, SHIMOOCHIAI, SHINJUKU-KU, TOKYO

CABLE ADDRESS: "MOVIEKINO TOKYO"

4ways NEW

SPACE-SAVER PANEL METERS

WITH VALUABLE FEATURES
ENGINEERS HAVE
ALWAYS WANTED

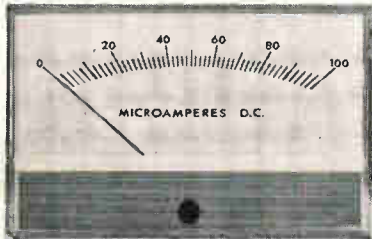

**Minimum height design
to save panel space!**

NEW! 15% longer scale —
40% less space.

NEW! Crisp, low profile for
modular styling. Per-
mits the equipment designer to
achieve the ultimate in design.

NEW!

Quick clip
mounting saves
90% of normal
installation time.
No washers, nuts
or screws.

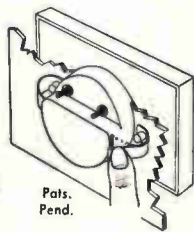

NEW! Recessed terminals
require less chassis
depth, leave more space for
components.

FOR YOUR APPLICATION,
MAY WE QUOTE ON YOUR
SPECIFICATIONS, OR HAVE
OUR REPRESENTATIVE CALL?

Experienced manufacturers of meters in
volume, for both commercial and military
applications, including ruggedized
and sealed meters to military standards

Designed and Manufactured by

DIXSON, INC.

METER DIVISION DEPT. B

GRAND JUNCTION, COLORADO

Technical Abstracts

Mechanical modulator

Frequency modulation of a
GaAs diode laser
C.S. Kim, H. Raillard, J. M. Smith,
S.W. Tehon and R. Vuilleumier
Electronics Laboratory,
General Electric Co., Syracuse, N.Y.

Hydrostatic pressure, applied by a piezoelectric transducer, appears to be the most precise technique yet devised for directly modulating the frequency of gallium-arsenide diode lasers. The technique enables the diode to be operated at a constant power level, which avoids the temperature changes induced in the laser by the more conventional method of modulating the diode input current. Such temperature changes cause linearity in emission intensity, wavelength and radiation pattern and make it difficult to obtain coherent optical transmission.

Current modulation can result in frequency variations of several hundred gigacycles, while hydrostatic modulation gives a frequency stability of around 5 megacycles, or about 10^{-4} angstrom units in wavelength. A hydrostatic pressure of 50 atmospheres will change the wavelength of a gallium arsenide laser by 1 angstrom.

The feasibility of hydrostatic modulation is demonstrated by the following structure: a diode laser is mounted between two tungsten disks which provide electrical and thermal contact. This structure is placed on a copper heat sink. To the top disk is coupled a copper plate over which the lead-zirconate-titanate transducer is located. The diode electrodes are soldered to the heat sink and plate, and the transducer electrodes to the plate and transducer.

For convenience the laser is operated in a pulse mode at a temperature of 77° K (it can be lased continuously at 3° K). The transducer's ultrasonic resonance frequency is 2.5 megacycles. The compression and extension of the transducer is applied in phase with the diode current pulses by inserting a delay-line and 13-stage binary countdown circuit between the 2.5-mc oscillator and the diode pulse supply. The diode is pulsed for $1\frac{1}{2}$ microseconds, 300 times a second.

Analysis of the diode's spectral response shows that the wavelength shifted by about 1.4 angstroms during alternating voltage cycles, including a thermal shift of about 0.1 angstrom. The wavelength shift is 0.01 angstroms per volt, for a transducer voltage swing of 130 volts. Modulation is 500 megacycles per volt. An optical phase shifter is required to detect modulation.

The technique is less complex and requires considerably less power than laser modulators which depend upon the birefringent effect in crystals such as KDP (potassium dihydrogen phosphate).

The hydrostatic-pressure effect was previously noted by G. E. Fenner in the *Journal of Applied Physics*, p. 2955, 34/1963. (During discussion of the paper, J. P. Vasseur, of CSF Laboratories, France, said that a similar experiment had been carried out there.)

Presented at the International Solid-State Circuits Conference, Philadelphia, Feb. 17-19.

Laser logic

GaAs laser inverter
W.F. Kosonocky, R.H. Cornely
and F.J. Marlowe
RCA Laboratories, Radio Corp. of
America, Princeton, N.J.

Because the decay times of diode lasers are 10^{-11} or 10^{-12} seconds, digital logic elements made with such lasers may operate 10 to 100 times faster than transistor-type logic. Laser logic devices may provide signal gains of 100 to 1,000 and delay times around 10 nanoseconds.

Several types of laser logic devices have already been reported by Kosonocky and other experimenters. This paper reports early tests of a laser inverter that can perform logic functions such as OR-NOT and AND-NOT.

The basic inverter is a gallium-arsenide crystal 10 mils wide, 30 mils long and 4 mils high, with the junction a horizontal plane 10 by 30 mils. The rear 26 mils of the two long sides are roughened with abrasive and the opposite end is lapped to a 15-degree angle. This, in effect, creates two lasers, one an amplifier along the long axis and the other

an oscillator whose axis is between the unroughened ends of the long sides.

If the beam of another diode laser enters this laser along the amplifier axis, it quenches the oscillations in the oscillator section, turning off the normal output through the two unroughened portions of the long sides of the laser. The amplified input beam then exists through the angled end of the laser and can be used as an input to another inverter.

The same crystal has been converted into a dual laser-oscillator by sawing a groove into the top surface, at the back edge of the oscillator portion, and providing separate electrical inputs to each portion. The large section then provides the quenching signal directly to the oscillator.

The measured quenching time of the dual laser is 1 nanosecond, but it is probably actually in the picosecond range, since a photodiode with limited response was used for signal detection. Also, gain must be more than 10 for quenching.

Among the problems still to be solved before such devices become practical are signal coupling and the necessity for operation at cryogenic temperatures.

Presented at the International Solid-State Circuits Conference, Philadelphia, Feb. 17-19.

Semiconductors vs. ferrites

Isolators using semiconductors
J. Gremillet
Compagnie Generale de Telegraphie
Sans Fils, Puteaux (Seine), France

The electromagnetic helicon effect can be used to make semiconductor devices, such as isolators, circulators and phase shifters, at frequencies impractical for gyromagnetic devices made of ferrites. The helicon effect is useful at any frequency between a few cycles per second to 10 gigacycles.

The helicon effect refers to the corkscrew-like motion of an electron in the presence of d-c magnetic induction and a pulsating electric field. It was first reported by P. Aigran in 1960.

Details are given for an 80-megacycle isolator with a power rating of 10 watts when cooled by air. It is made of indium antimonide semiconductor crystal and built into a coaxial cable. The operating frequency is too low for a practical

HERE IT IS FROM ENGLAND!

As Beulah Electronics, Ltd.
Promised In Our
Previous Advertisements . . .

The Revolutionary

WESGROVE VIDEO TAPE RECORDER

Using Only 1/4" Recording Tape

TRANSISTORIZED
KIT FORM **\$450.00**

Wired By Special Order Only \$650.00

"BEUKIT" TRANSISTORIZED TV CAMERA KIT

Complete with Vidicon
(less lens) **\$226.75**

All Priced Above F.O.B. Bayonne, N. J.



For full
Information
write to:

P. A. F. ENTERPRISES

32 East 22nd Street
Bayonne, N.J. 07002

Distributors for Beulah
Electronics, England
Complete line of Video
Cameras and Lenses.

Circle 253 on reader service card

TINSLEY

- POTENTIOMETERS
- GALVANOMETERS
- BRIDGES

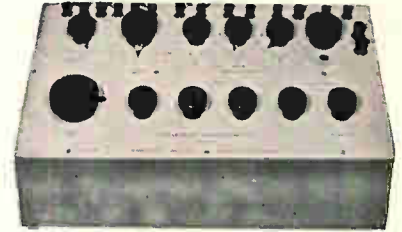

Ultra High Precision
Laboratory, Industrial
Lecture Hall, Student Types

Send for Free bulletin describing these units
in addition to ultra precision AC-DC power
supplies, standards and AC voltage stabilizers.



**NORTH HILLS
ELECTRONICS, INC.**
Glen Cove, N. Y. 11542
Code 516, ORiole 1-5700

Circle 254 on reader service card

NIMS

NATIONWIDE IMPROVED MAIL SERVICE PROGRAM

For Better Service

Your Post Office

Suggests

That You Mail Early In The Day!

Looking for PROFIT?

Look into NEBRASKA

A free booklet

full of facts about industry, agriculture, people, education, resources, power, transportation, taxes, financing—all things you will like about Nebraska.



CONSUMERS POWER DISTRICT
Community Development Dept.
1401 O Street, Lincoln, Nebraska 68508

Please mail free booklet "Look into Nebraska" to

NAME _____
ADDRESS _____
CITY _____
STATE _____ ZIP _____

Circle 212 on reader service card



SCREWS



HEX NUTS



WASHERS



BUSHINGS



COIL BOBBINS



WIRE TIES



WIRE CLAMPS

Widest Selection of MOLDED NYLON SCREWS

- High quality—close tolerances—clean accurate threads
- Sizes from miniature No. 6 to 1/4"
- Lengths from 1/8" to 1-1/16"
- Standard commercial heads, Slotted or Phillips
- Set screws with plain and standard points
- Hex nuts from No. 4 to 5/16"
- Screws also available in Delrin

When you need nylon screws you want GRC! Send for: stock list . . . HUNDREDS of sizes . . . samples and specification sheet.

GRC stock plastic parts are available in many sizes and types . . . are precise, uniformly high in quality and economical because they are mass produced by exclusive automatic single cavity techniques. These advantages apply to "specials" and parts to your specs . . . in Nylon, Delrin and other engineering thermoplastics. Send prints for quotation and details on GRC's special methods for molding (and die casting, too). NO SIZE TOO SMALL!

Write, wire, phone TODAY for samples, prices, literature.



GRIES REPRODUCER CORP.

World's foremost producer of Small Die Castings and Plastic Moldings

151 Beechwood Ave. New Rochelle, N.Y.
(914) New Rochelle 3-8600

Circle 255 on reader service card

Technical Abstracts

ferrite device. The insertion losses of such circulators are typically less than 1 decibel at frequencies between 30 and 1,000 megacycles.

Presented at the International Solid-State Circuits Conference, Philadelphia, Feb. 17-19.

Optoelectronic coupling

An optically-coupled digital integrated circuit

J.D. Merryman, Texas Instruments, Inc., Dallas

Optoelectronic techniques can achieve circuit functions previously difficult or impossible to reduce in microelectronic form. The electrical isolation provided by optical coupling permits a considerable common-mode rejection between input and output.

An optoelectronic pulse amplifier (OPA) is a digital integrated circuit which performs the function of a broadband pulse transformer with response extending to zero frequency. It uses optical coupling internally to provide an electrically isolated input. It has applications in transmitting either a-c or d-c signals across computer subsystem interfaces, where circulating currents make it undesirable or impossible to interconnect subsystem grounds. The devices can also be used to reject common-mode noise at the receiving end of long transmission lines. Transformers customarily used have limited bandwidth and do not transmit d-c.

The OPA is packaged in a standard semiconductor flatpack and operates from a single power supply of 3-6 volts.

The input terminals are connected to a thin flat gallium arsenide injection-luminescent diode which may be driven by 5-ma pulses at 1.2 volts. The optical output is coupled by a thin layer of a ternary selenium glass to a silicon photodiode built in a p-type substrate. The diode output feeds an amplifier circuit in the same substrate. The amplifier produces 5-volt output pulses of 300 nanosecond rise time when operated from a 6-volt power supply. Smaller amplitudes and longer rise times are obtained with a three-volt power supply.

Presented at the International Solid-State Circuits Conference, Philadelphia, Feb. 17-19.

Planning to change your address?

Use the form below to indicate a change of address. Because our issues are addressed in advance, please try to allow at least 5 weeks for change of address to become effective. Attach the address label from your most recent issue in the space provided below.

(Please print the following information for proper service)

Title or position

Name

Chief job responsibility

Company and Div.

Product or Service Approx. No. of employees

Address

City Zone State or Prov.

Mail to: Fulfillment Manager, Electronics
P.O. Box 430, Hightstown, N.J. 08520

*Paste present mailing label or address from wrapper or envelope here.

**How does IBM
trim a resistor only
.04 inch wide?**



We sandblast it!

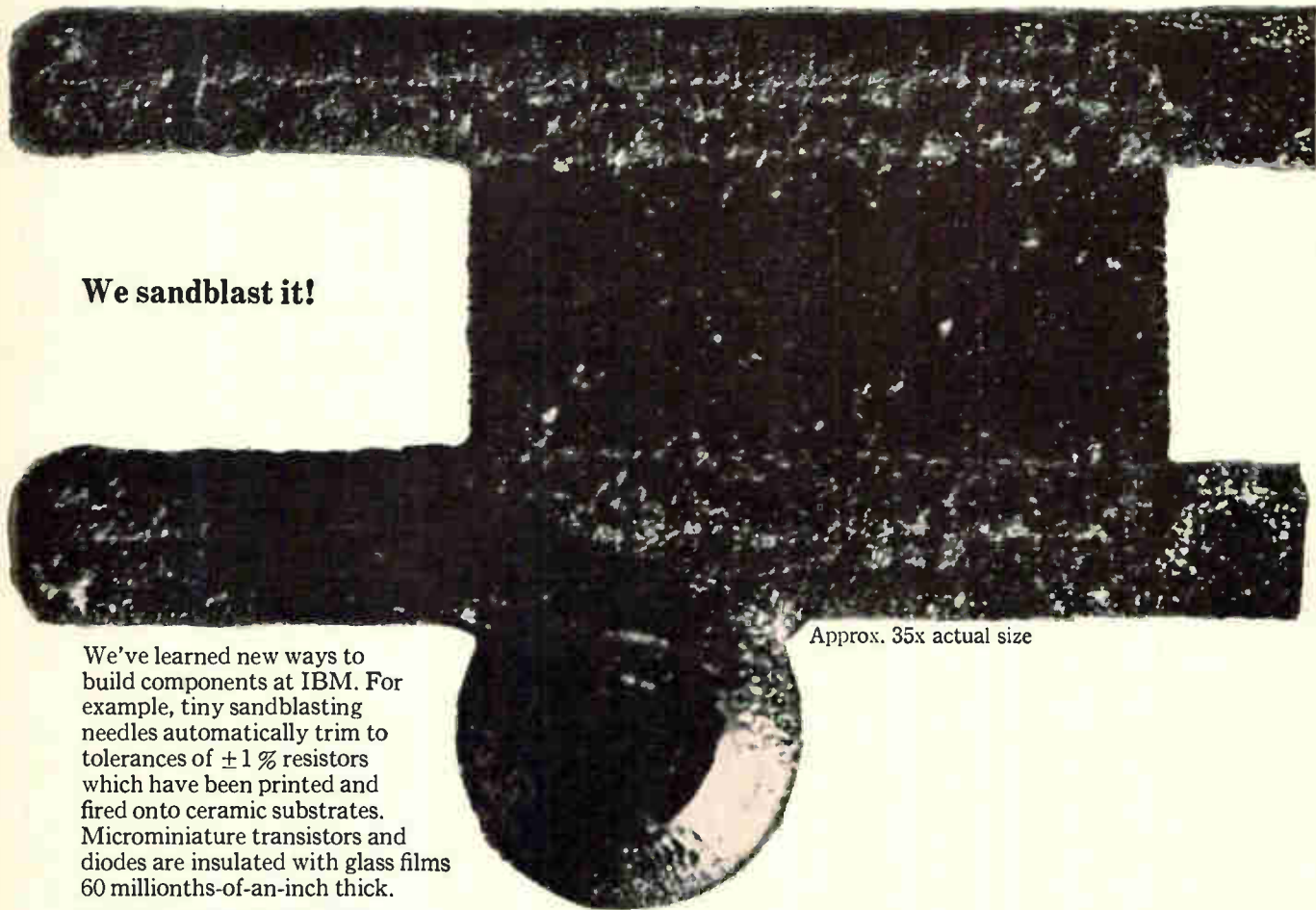

Approx. 35x actual size

We've learned new ways to build components at IBM. For example, tiny sandblasting needles automatically trim to tolerances of $\pm 1\%$ resistors which have been printed and fired onto ceramic substrates. Microminiature transistors and diodes are insulated with glass films 60 millionths-of-an-inch thick.

Solid state scientists at IBM are engaged in a broad program of materials research, device and circuit development, and systems design. One result: Solid Logic Technology, the basis for the new System/360 computers. Alongside this program, manufacturing research engineers are developing automatic methods to manufacture and test new devices.

Component technology at IBM is a rapidly advancing field. Semiconductor device engineers, component manufacturing engineers, electrical engineers, and mechanical engineers will find many opportunities to apply their new ideas. Write to Manager of Employment, Dept. 554C2 IBM Corporate Headquarters, Armonk, New York 10504.

IBM[®]

An Equal Opportunity Employer

AUTOTRACK ANTENNA MOUNT

300 degree azimuth, 210 degree elevation sweep with better than 1 mil. accuracy. Missile velocity acceleration and slewing rates. Amplidyne and servo control. Will handle up to 20 ft. dish. Supplied complete with control chassis. In stock—immediate delivery. Used world over by NASA, USAF. TYPE: MP-61 B. SCR-584. NIKE AJAX mounts also in stock plus several airborne trackers.

SCR 584 AUTOMATIC TRACKING RADARS

Our 584s in like new condition, ready to go, and in stock for immediate delivery. Ideal for telemetry research and development, missile tracking, satellite tracking, balloon tracking. Used on Atlantic Missile Range, Pacific Missile Range, N.A.S.A., Wallops Island, A.B.M.A. Write us. Fully Desc. MIT Rad. Lab. Series, Vol. 1, pps. 207-210, 228, 284-286. Compl. inst. Bk. avail. \$25.00 each.

PULSE MODULATORS

MIT MODEL 9 PULSER

1 MEGAWATT—HARD TUBE

Output 25 kv 40 amp. Duty cycle, .002. Pulse lengths .25 to 2 microsec. Also .5 to 5 microsec, and 1 to .5 microsec. Uses 6C21. Input 115v 60 cycle AC. Mfr. GE. Complete with driver and high voltage power supply. Ref: MIT Rad. Lab. Series, Vol. 5, pps. 152-160.

500KW THYRATRON PULSER

Output 22kv at 28 amp. Rep. rates: 2.25 microsec. 300 pps, 1.75 msec 550 pps, .4 msec 2500 pps. Uses 5C22 hydrogen thyatron. Complete with driver and high voltage power supply. Input 115v 60 cy AC.

2 MEGAWATT PULSER

Output 30 kv at 70 amp. Duty cycle .001. Rep rates: 1 microsec 600 pps, 1 or 2 msec 300 pps. Uses 5948 hydrogen thyatron. Input 120/208 VAC 60 cycle. Mfr. GE. Complete with high voltage power supply.

15KW PULSER—DRIVER

Biased multivibrator type pulse gen. using 3E29. Output 3kv at 5 amp. Pulse lgths .5 to 5 microsec. easily adj. to .1 to .5 msec. Input 115v 60 cy AC. \$575. Ref: MIT Rad. Lab. Series, Vol. 3, pps. 157-160.

MIT MODEL 3 PULSER

Output: 144 kv (12 kv at 12 amp.) Duty ratio: .001 max. Pulse duration: .5, 1 and 2 microsec. Input: 115 v 400 to 2000 cps and 24 vac. \$225 ea. Full desc. Vol. 5. MIT Rad. Lab. series, pp. 140.

250KW HARD TUBE PULSER

Output 16 kv 16 amp. duty cycle .002. Pulses can be coded. Uses 5D21, 715C or 4P160A. Input 115 v 60 cycle ac. incl. H.V. pwr supply \$1200 ea.

5949 THYRATRON AGING RACK

Compl. Chatham Electronics Console incl. 15 kv power supply & PFN's. \$1800.

H.V. POWER SUPPLIES

1) 12 kv .75 amps nominal \$1400 ea. 2) 22 kv 100 ma nominal \$2200 ea. Std. 60 cycle inputs.

MICROWAVE SYSTEMS

E-4 FIRE CONTROL SYSTEM

Hughes Aircraft X Band. Complete. In stock.

C-BAND RADAR

250 KW output, C-band, PPT indicator, 5C22 thyatron modulator. Antenna hi gain parabolic section. Input 115 volts 60 cycle AC. complete \$2750.00.

300 TO 2400MC RF PKG.

300 to 2400 MC CW. Tuneable. Transmitter 10 to 30 Watts. Output. As new \$475.

500KW "L" BAND RADAR

500 kw 1220-1359 mcs. 160 nautical mile search range P.P.I. and A Scopes. MTI. thyatron mod. 5J26 magnetron. Complete system.

PHILCO MICROWAVE LINKS

C Band Microwave Link terminal bays and repeater bays in stock. Now \$1500 each or \$2500 per pr.

10KW 3 CM. X BAND RADAR

Complete 10" head including transmitter, receiver, modulator. Uses 2442 magnetron. Fully described in MIT Rad. Lab. Series Vol. 1, pps. 616-625 and Vol. II, pps. 171-185. \$375. Complete System \$750.

100—800MC. CW SOURCE

150 watts CW nominal output 115 v 60 Cy AC input. \$1600.

100KW 3CM. RADAR

Complete 100 kw output airborne system with AMTI, 5C22 thyr. mod. 4452 magnetron, PPI, 360 deg az sweep, 60 deg. elev. sweep, gyro stabilizer, hi-gain revr. Complete with all plugs and cables.

M-33 AUTO-TRACK RADAR SYSTEM

X band with plotting board, automatic range tracking, etc. Complete with 1 megawatt acq. radar.

400 CYCLE SOURCE

Output: 115v 400 cycle 1 ph 21.7 amps cont. duty input: 208v 60 cycle 3 ph. req. 30v dc static exc. New. \$325 ea.

3KW RCA PHONE & TELEG XMTR

2—30 MC. 10 Autotone channels plus MO. Input 230 vac. 50/60 cycles.

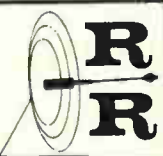

**Radio-Research
Instrument Co.**
650 5th Ave. New York 36, N.Y.
Tel. JUdson 6-4881

CIRCLE 951 ON READER SERVICE CARD

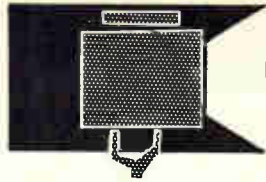

SEARCHLIGHT SECTION

• CLASSIFIED ADVERTISING • BUSINESS OPPORTUNITIES
• USED OR SURPLUS EQUIPMENT

V·I·S* SERVICE

FASTEST TO
BOTH COASTS

FOR YOUR
*VERY IMPORTANT
SHIPMENTS

2nd DAY

between Chicago—
Milwaukee and
Eastern Terminals*

4th DAY

between Chicago—
Milwaukee and West Coast.

LIFSCHULTZ FAST FREIGHT

NEW YORK — CHICAGO — PHILADELPHIA — BOSTON
HOLYOKE — BALTIMORE — BLOOMFIELD, N. J.
NEW HAVEN — PROVIDENCE — MILWAUKEE
LOS ANGELES — SAN FRANCISCO

CIRCLE 952 ON READER SERVICE CARD

ELECTRON TUBES

KLYSTRONS • ATR & TR • MAGNETRONS
SUBMINIATURES • C.R.T. • T.W.T. • 5000-
6000 SERIES
• SEND FOR NEW CATALOG A2 •
A & A ELECTRONICS CORP.
1063 PERRY ANNEX
WHITTIER, CALIF.
696-7544

CIRCLE 953 ON READER SERVICE CARD

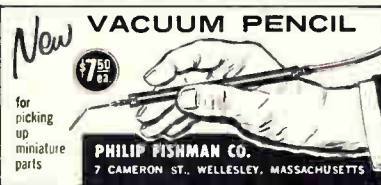

CIRCLE 954 ON READER SERVICE CARD

5 BP1A CATHODE RAY TUBES

Original cartons, recent mfg., production quantity at fraction of cost, also quantity of RX 21A tubes. Write for free price list.

ELECTRO SALES CO.
1608 Milwaukee Ave.
Chicago, Ill., 60647 BR. 8-8080

CIRCLE 956 ON READER SERVICE CARD

ROTRON EQUIPMENT COOLING FAN

Computer pullouts. Like new. "Muffin Fan" in-audibly cools amplifiers, tuners, tape recorders, etc. Lengthens tube and equipment life—improves their performance. 4 11/16" sq. x 1 1/2" deep. 100 cfm. For 110-120 v. 60 cycle AC. 1 1/4 lbs. \$8.50 each.

MARS SALES P. O. Box 72832
Los Angeles, Calif. 90016

CIRCLE 957 ON READER SERVICE CARD

SMALL AD but BIG STOCK

of choice test equipment
and surplus electronics

Higher Quality—Lower Costs
Get our advice on your problem

ENGINEERING ASSOCIATES
434 Patterson Road — Dayton 19, Ohio

CIRCLE 958 ON READER SERVICE CARD

SEMICONDUCTORS MAJOR BRANDS

INTERGRATED CIRCUITS • DIF. AMPS DAR-
LINGTONS • POWER DIODES & TRANSISTORS
• SPECIAL DEVICES

Write for Catalog S-1
SEMICONDUCTOR SALES OF CALIF.
1063 Perry Annex Whittier, Calif.
(213) 696-7544

CIRCLE 959 ON READER SERVICE CARD

"Opportunity" Advertising:

Think
"SEARCHLIGHT"
First

FREE CATALOG! NEARLY 4,000 BUYS FOR INDUSTRY

OPTICS! SCIENCE! MATH! GIANT 148 PAGES

Many on-the-job helps . . . Quality Control Aids! Write for this completely new, 1965 Catalog. New items, new categories, new illustrations. 148 easy-to-read pages packed with hundreds of charts, diagrams, illustrations. A treasure-house of optical and scientific information . . . unusual bargains galore. Optics for industry, research labs, design engineers, experimenters, hobbyists! Instruments for checking, measuring—to speed work, improve quality, cut production costs. We give you facts: what it is—how it works—where it's used!

COMPARATORS, MAGNIFIERS, MICROSCOPES

Hard-to-get war surplus bargains—ingenious scientific tools—imported—domestic. Thousands of components: lenses, prisms, wedges, mirrors, mounts—accessories of all descriptions. Dozens of instruments: magnifiers, stereo microscopes, telescopes, binoculars, infrared equipment, photo attachments. Shop by mail. No salesman will call. Use the Catalog of America's greatest Optics—Science—Math Marf. Known for reliability. Mail coupon below for catalog "EX". No obligation.
EDMUND SCIENTIFIC CO.
Barrington, N. J.

MAIL COUPON FOR FREE CATALOG "EX"!

EDMUND SCIENTIFIC CO., Barrington, N. J.
Please send FREE Giant 148-page Catalog "EX"
NAME
ADDRESS
CITY ZONE STATE

CIRCLE 955 ON READER SERVICE CARD

BAYNTON SPECIALS

TEKTRONIX

53B High Gain Wide Band Plug-in.....	\$78.50
121 Wide-Band Preamp gain 0.1 to 100.....	\$165.00
190A Constant-Amplitude Sig. Gen., 350KC to 50 MC.....	\$190.00
315D, 3" Lab. type oscilloscope.....	\$390.00
511A, Wide Range Oscilloscope.....	\$185.00
511AD, Wide Range Oscilloscope.....	\$255.00
512A, DC Coupled Oscilloscope.....	\$355.00
513D, High-Sensitivity—Wide Range.....	\$695.00
514AD, Laboratory Oscilloscope.....	\$395.00
524AD, Television Oscilloscope, DC to 10MC.....	\$575.00
524D, Television Oscilloscope.....	\$475.00

BOONTON RADIO COMPANY

160A Q Meter, measures Q.....	\$350.00
202B FM Signal Generator, 54MC to 216MC.....	\$485.00
260 Q Meter, C & L Measures Q, C, and L.....	\$675.00

HEWLETT-PACKARD

151A, High Gain Amp—Plug-in for 150A Scope.....	\$118.00
200B, Audio Oscillator 20 cps. to 20 KC.....	\$109.50
200ABR, Audio Oscillator—20 cps. to 40KC.....	\$115.00
202A, Low Frequency Function Generator.....	\$425.00
205AG, Audio Sig Gen—5W, 20 cps. to 20 KC.....	\$340.00
206A, Audio Sig. Gen—20 cps. to 20KC.....	\$360.00
211A, Square-Wave Generator, 1 cps. to 1MC.....	\$225.00
212A, Pulse Generator.....	\$320.00
400C, RMS V.T.V.M., 10 cps. to 4MC.....	\$99.50
410B, V.T.V.M., 20 cps. to 700MC.....	\$149.00
415A, Standing-Wave Indicator.....	\$39.50
116A, Ratio Meter, Reflection coefficient.....	\$360.00
491A, Traveling Wave Tube Amplifier, 2 to 4KMC.....	\$500.00
"S" band, 1W output.....	\$675.00
500A, Frequency Meter, Direct reading.....	\$95.00
524A, Frequency Counter, Counts to 10MC.....	\$895.00
540A, Transfer Oscillator, 10MC to 5GC. Extends range of 524 to 12.4KMC.....	\$475.00
510B, Transfer Oscillator, 10MC to 12.4GC.....	\$475.00
560A, Digital Recorder, Prints 11 digit.....	\$845.00
616B, Signal Generator, 1.8 to 4.2KMC, Pulse, CW, or FM modulation.....	\$1175.00
621A, Sig. Gen. "X" band, 8.5 to 10KMC.....	\$695.00
624B, Signal Generator "X" band, 8.5 to 10KMC, Output 3 uv.....	\$995.00
670HM, Swept Freq. Oscillator, 7 to 10KMC.....	\$490.00
670JM, Swept Freq Oscillator, 5.85 to 8.2KMC.....	\$190.00
711A, Lab Power Supply, 0 to 500V @ 100ma.....	\$125.00
712B, Lab Power Supply, 0 to 500V @ 200ma.....	\$260.00
717A, Klystron Supply, 800 to 1000V @ 25ma.....	\$180.00

GENERAL RADIO

561D, Vacuum Tube Bridge.....	\$395.00
620A, Heterodyne Freq Meter 300KC to 300MC.....	\$275.00
631BL, Stroboscopic (Stroboscopic Tachometer).....	\$145.00
650A, Impedance Bridge.....	\$175.00
120A, Heterodyne Freq Meter, 10 to 3000MC.....	\$229.00
726A, RMS Voltmeter.....	\$58.50
736A, Wave Amplifier.....	\$825.00
740B, Cap Bridge, 5 mmt. to 1100 mtd.....	\$190.00
801C, UHF Signal Generator, 8MC to 300MC.....	\$325.00
805A, Standard Sig Gen, 16KC to 15MC.....	\$850.00
805C, Standard Sig Gen, 16KC to 50MC.....	\$1350.00
1106B, Frequency-Transfer Unit, 1 to 10MC.....	\$580.00
1106C, Frequency-Transfer Unit, 10 to 100MC.....	\$620.00
1107A, Interpolation Oscillator, 0 to 5000 cps.....	\$620.00
1301A, Beat Frequency Oscillator, 20 cps. to 20KC.....	\$235.00
1481K, Standard Inductor 1h ± 0.25%.....	\$19.50
1652A, Resistance Limit Bridge.....	\$295.00

BERKELEY

554 E-Put Meter, counts to 100KC.....	\$325.00
---------------------------------------	----------

SUPER-SPECIAL VECTRON

SA25 Microwave Spectrum Analyzer with 20X Plug-in Unit. (X Band).....	\$695.00
---	----------

WESTERN ELECTRIC

TRANSMISSION TEST EQUIPMENT

2B Noise set (Similar to Daven 34B and C).....	\$695.00
J-61030A Transmission Measuring Set.....	\$895.00
J-64031B Transmission Measuring Set.....	\$875.00

POWER SUPPLIES KEPCO

KR6M 195 to 325V @ 600ma, 0.1% reg. (metered) Rack mount.....	\$149.00
KR11M 0 to 150V @ 125ma, 0.1% reg. (metered) Rack mount.....	\$105.00
315 0 to 300V @ 150ma, and 150V Bias @ 5ma, Bench model.....	\$85.00

LAMBDA

25 200 to 325V @ 100ma, Bench model.....	\$35.00
32 200 to 325V @ 300ma, Rack mount.....	\$77.50
35 100 to 200V @ 300ma, Bench model.....	\$95.00
62M 245 to 305V @ 600ma, Rack mount.....	\$145.00
61M 100 to 200V @ 600ma, Rack mount.....	\$135.00
65M 0 to 100V @ 50-600ma, Rack mount.....	\$185.00
C881 125 to 325V @ 800ma, Rack mount.....	\$175.00
151 275 to 325V @ 0-1500ma, 0.25% reg. Rack mount.....	\$295.00
C1518M 125 to 325V @ 0-1500ma, 0.25% reg. Rack mount.....	\$315.00

This is just a sample listing—send for free 48 page catalog.

WE GUARANTEE QUALITY

We overhaul and painstakingly lab-test and calibrate every piece of equipment before it leaves our warehouse. We maintain one of the most up-to-date test equipment maintenance shops and standards labs, to be positive that our equipment meets original factory specifications.

BAYNTON ELECTRONICS CO.

2918 NORTH 16th ST., PHILADELPHIA, PA. 19132
AREA CODE 215 Baldwin 9 9800

CIRCLE 960 ON READER SERVICE CARD

EMPLOYMENT OPPORTUNITIES

The advertisements in this section include all employment opportunities—executive, management, technical, selling, office, skilled, manual, etc.

Look in the forward section of the magazine for additional Employment Opportunities advertising.

— RATES —

DISPLAYED: The advertising rate is \$32.00 per inch for all advertising appearing on other than a contract basis. Contract rates quoted on request.

An advertising inch is measured 1/8" vertically on a column—3 columns—30 inches to a page.

Subject to Agency Commission.

UNDISPLAYED: \$2.70 per line, minimum 3 lines. To figure advance payment count 5 average words as a line. Box numbers—count as 1 line.

Discount of 10% if full payment is made in advance for 4 consecutive insertions.

Not subject to Agency Commission.



E. E.'s for FEE-PAID Positions WRITE US FIRST!

Use our confidential application for professional, individualized service—a complete national technical employment agency.

ATOMIC PERSONNEL, INC.
Suite 1207L, 1518 Walnut St., Phila. 2, Pa.

PROFESSIONAL SERVICES

GIBBS & HILL, Inc.

Consulting Engineers

Systems Engineering
Operations Research • Development
Field Studies • Design • Procurement
Power • Transportation • Communications
Water Supply • Waste Treatment
393 Seventh Avenue New York 1, N. Y.

Your Inquiries to Advertisers Will Have Special Value . . .

—for you—the advertiser—and the publisher, if you mention this publication. Advertisers value highly this evidence of the publication you read. Satisfied advertisers enable the publisher to secure more advertisers and—more advertisers mean more information on more products or better service—more value—to YOU.

IBM

ELECTRICAL ENGINEERS

Power Supplies: Design of power supply circuitry utilizing power semiconductors and magnetic components.

Facilities Engineering: Design for building construction, including industrial power systems and commercial and industrial lighting.

Test Equipment: Design and support of test equipment.

Machine Controls: Develop electrical circuits and machine controls.

Logic Design: Logic design of memory testers, including equipment design and floor support.

Circuit Design: Implementation of circuits and analog equipment required in chemical process control.

RFI: Develop suppression techniques that enable products, subassemblies, circuits, and components to meet MIL and Federal EMC specifications.

Qualifications: B.S. or advanced degree preferred. Related industrial experience desired.

Location: These openings are in the mid-Hudson Valley at Poughkeepsie and Kingston, N. Y. There are varied programs for continued education, comprehensive personal and family benefits, and exceptional facilities for outdoor recreation. Relocation expenses are paid.

Please write: Outline your qualifications and interests to A. E. Short, Dept. 554C, IBM Corporation, Box 390, Poughkeepsie, New York. IBM is an Equal Opportunity Employer.

IBM

SPECIAL OFFER: Reprints of Special Reports from Electronics

Now, for your reference file—a complete set of Special Reports reprinted from the pages of Electronics in 1964. A total of 172 pages of valuable and informative articles combined in an attractive folder. The reports are individually bound. The special discount price for the reports is \$2.50 which includes both handling and shipping costs. Order now, using the coupon below. The following reprints are included in this offer:

- Electronic Telephone Switching 16 pages.
- Direct Digital Control in Industry 24 pages.
- Transistor Heat Dissipators 32 pages.
- Oceanography 15 pages.
- Magnetics 24 pages.
- Electronic Markets New Directions 1963-64-67 24 pages.
- Digital Instrumentation 16 pages.
- Modern Electronic Packaging 16 pages.

Send your order to: Electronics Reprint Dept. McGraw-Hill Inc.
330 W. 42nd Street, New York, N.Y. 10036

Reprint order form

A-1

For reprints of feature articles or special reports fill in below:

Send me reprints of Key No.(s) at ¢ each.

For prices and listing please see the reader service card.

Send me complete set(s) of special reports listed above at \$2.50 per set.

Name

Number of street

City, State, Zip code

MICO

NEW SIX-RATIO STANDARD ENGRAVER

CAT. NO.
259

FOR LIGHT
AND MEDIUM
DUTY WORK

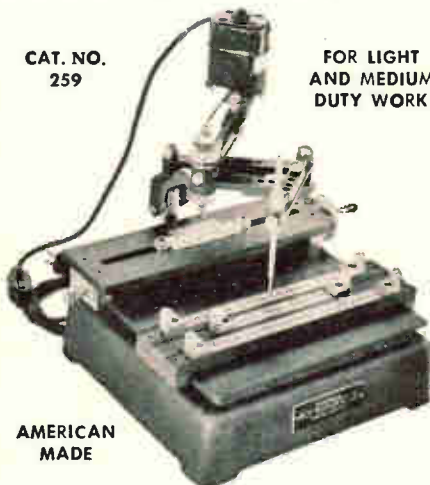

AMERICAN
MADE

- Engineered for ruggedness and simplicity.
- Six pantograph ratios—from 1.5:1 to 4:1.
- Ball-bearing spindle uses 1/8" shank cutters and has true .250" micrometer depth control.
- Sturdy one-piece ratio studs anchor in ESNA stop-nuts for quick locking of pantograph arms.
- Master copy and work right-side up—in full view of operator. Raising stylus raises cutter.
- Attachments available for increasing versatility.

Send for bulletins and prices

MICO INSTRUMENT CO.

77 Trowbridge St. Cambridge 38, Mass.

216 Circle 216 on reader service card

Reed Relays



New
Flat-Pac Coil

accommodates 3, 4, 5 or 6 Form C reed switches. Ideal for encapsulation or direct tie-down to printed circuit board or chassis, its shape is more compatible with advanced packaging. (Shown actual size)

New Double Pole, Double Throw

miniature relay contains 2 Form C reeds, operates as low as 96 milliwatts. (Shown actual size)

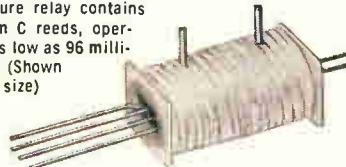

Write for catalog and prices of our standard line of magnetic reed relays. For special requirements, give complete details for quotation.

Coto-Coil COMPANY INC.
65 Pavilion Ave.
Providence, R. I. 02905
Phone: (401) 941-3355

(Key Sales areas available for representation. Please Inquire.)

Circle 257 on reader service card

New Literature

Relays. Eagle Signal, a division of The E.W. Bliss Co., 736 Federal St., Davenport, Iowa. A 16-page brochure describes and illustrates a line of general purpose and medium power relays. Circle 461 on reader service card

Soldering gun. Wen Products, Inc., 5810 Northwest Highway, Chicago, Ill., offers a bulletin on the model 450 All soldering gun that features automatic thermal regulation, said to provide heat to the tip 36 times faster than a comparable 500-w soldering iron. [462]

Microwave radio. Lenkurt Electric Co., Inc., 1105 County Road, San Carlos, Calif., has issued a brochure describing its type 76E microwave radio system for use in the industrial and auxiliary broadcast frequency bands between 12.2 and 13.25 Gc. [463]

Pressure transducers. Computer Instruments Corp., 92 Madison Ave., Hempstead, L.I., N.Y., has available a completely revised 24-page catalog featuring precision-film potentiometer pressure transducers. [464]

Nickel cadmium cells. Gulton Industries, 212 Durham Ave., Metuchen, N.J. New D-size Adhydrode, sealed nickel cadmium cells with substantially reduced charging time are described in bulletin VO120a. [465]

Analog multipliers. American Aerospace Controls, Inc., 123 Milbar Blvd., Farmingdale, N.Y., has available a four-page bulletin describing its 0.1% accurate, feedback controlled series 3050 analog multipliers. [466]

X-Y recorders. Houston Instrument Corp., 4950 Terminal Ave., Bellaire, Texas. 77401. A new short-form bulletin gives essential specifications, features and prices of a complete line of X-Y recorders. [467]

High density packaging. Magnetic Shield Division Perfection Mica Co., 1322 No. Elston Ave., Chicago, Ill., 60622. Data sheet 175 shows how higher density packaging can be achieved by enclosing magnetically sensitive components of any size or shape in shields that are easily, quickly cut to shape from permanently preannealed Netic and/or Co-Netic foil alloys. [468]

Industrial laminates. General Electric Co., Laminated Products Dept., Coshocton, Ohio. A 16-page booklet describes Textolite copper-clad laminates, thin glass laminates for multilayer circuitry, sheets, tubes and rods. [469]

Dual directional couplers. Adams-Russell Co., Inc., 280 Bear Hill Road, Waltham, Mass., 02154. A technical data sheet describes two dual directional couplers that provide constant coupling over the frequency range from 2 to 100 Mc. [470]

Porous anode capacitors. General Electric Co., Schenectady, 5, N.Y. GET-2993A is a 20-page bulletin describing polar, tantalum porous anode capacitors with thixotropic liquid electrolyte. [471]

Electronics | March 8, 1965

Hardware. Atlee Corp., 2 Lowell Ave., Winchester, Mass., offers a general catalog covering its line of component holders and clips, tube shields and inserts for industry. [472]

Thermistor terminology. Victory Engineering Corp., 136 Springfield Ave., Springfield, N.J. Bulletin MTD131 defines 22 terms commonly used in connection with thermistors, and explains the significant parameters pertinent to these temperature-sensitive resistive components. [473]

Trimming potentiometers. Helipot Division of Beckman Instruments, Inc., 2500 Harbor Blvd., Fullerton, Calif., 92634, has available a data sheet covering commercially priced Helitrim model 75 trimming pots. [474]

Photocells. Clairex Corp., 8 W. 30th St., New York 1, N.Y., has available a 16-page photocell designers manual. [475]

Frequency response tracer. B&K Instruments, Inc., 3044 W. 106th St., Cleveland 11, Ohio. A four-page specification booklet has been released on the new model 4709 frequency response tracer with 14-in. crt. [476]

Digital sequence controllers. Emerson Electric Co., 8100 Florissant Ave., St. Louis, Mo., 63136. A two-color specification sheet covers Accra-count direct digital controllers for sequential operations. [477]

Solder and flux kit. Alpha Metals, Inc., 56 Water St., Jersey City, 4, N.J., has issued a bulletin describing the new solder and flux kit for pre-soldering in research and development and for solving pre- and post-soldering production problems. [478]

X-Y recorders. Houston Omnigraphic Corp., 4950 Terminal Ave., Bellaire, Texas, 77401. A single-sheet bulletin contains complete specifications, features and prices covering the company's newest X-Y recorders. [479]

Passive networks. Electra Mfg. Co., 800 North 21st St., Independence, Kansas, 67301. Bulletin 864101 tells how, why and when to design with Microelectron thin-film passive networks. [480]

Nickel cadmium batteries. Gulton Industries, Inc., 212 Durham Ave., Metuchen, N.J., has issued an illustrated brochure describing its expanded KO series of rechargeable, pressure-vented, nickel cadmium batteries. [481]

Capacitor specifications. Union Carbide Corp., Kemet Department, 11901 Madison Ave., Cleveland, Ohio, 44101. Two bulletins now available relate the benefits of Kemet solid tantalum capacitors to the new high reliability MIL specifications. [482]

Voltage reference source. Epsco, Inc., Data System Products Division, 411 Providence Highway, Westwood, Mass. Technical bulletin 96401 describes the model VRS-611 portable voltage reference source. [483]

Semiconductors. Ampere Electronic Corp., Slatersville, R.I., 02876, has announced the latest edition of its condensed semiconductor catalog. Copies may be obtained by writing to the manufacturer on company letterhead.



NEW...HI-RES-PLASTI-POT

Conductive Plastic Mil-Grade Potentiometer

New HI-RES-PLASTI-POT products of the most sophisticated design concepts . . . joined to a tradition of reliability and performance upon which the Gamewell reputation has been built. Here is a source for custom-engineered conductive plastic pots that can fulfill your most exacting parameters.

Let your pot requirements take a turn for the better . . . write for complete information about Gamewell HI-RES-PLASTI-POTS, for faster action call 617-244-1240 or wire or write us at 1601 Chestnut Street, Newton, Mass. 02164.

HI-RES-PLASTI-POTS feature:

- Precise Functional conformities
- High resolution (virtually infinite)
- 360° one-turn continuous, or with limiting stops
- Power ratings up to 3 watt
- Resistance to 100 K ohms
- Life tested beyond 5,000,000 operations
- Size: 7/8" to 3" diameter
- Designed to comply with proposed MIL-R-39023
- Low Cost

BLISS



GAMEWELL

A DIVISION OF THE E. W. BLISS COMPANY

MOTION MEASUREMENT REPORT



REPORT NUMBER 1

New miniature crystal accelerometer eliminates the 6 biggest problems in measuring vibration.



CEC's Type 4-281 Piezoelectric Accelerometer, the latest refinement of the low-output-impedance concept pioneered by CEC, makes measuring dynamic acceleration easier and more precise than ever before. The miniature 4-281 solves the 6 major problems familiar to every user of piezoelectric devices:

Impedance Matching...No external electronics are required; low-impedance output is preconditioned for direct readout.

Cable Capacitance...No capacitance-vs-output calculations are needed; performance is independent of cable considerations.

Sensitivity Variation...Voltage sensitivity is constant from system to system, application to application.



Mass Loading...No penalty in size and weight, the 4-281 is as small and light as most conventional piezoelectric accelerometers.

System Noise...Low noise at the output achieves exceptionally high signal-to-noise ratio (less than .05 g equivalent).

Case Sensitivity...No "breeze disease" or other case effects; the sensing element is physically isolated.

And that's just the beginning of the story. The 4-281's "compliant rod" sensing element and source follower are *electrically and mechanically isolated*, enclosed in an all-welded stainless steel case. In addition, the new accelerometer contains a built-in voltage insertion circuit for functional checkout and system calibration, as well as an integral connector and detachable mounting stud.

Unequaled by any other instrument in the world today, the following specifications show how the 4-281 can make your measurement task easier and more productive:

- ☐ Basic Voltage Sensitivity—30 mv/g nominal.
- ☐ Output Impedance—150 ohms max.
- ☐ Frequency Response—4 to 10,000 cps $\pm 5\%$.
- ☐ Acceleration Range—Up to 100 g.
- ☐ Cross-Axis Sensitivity—3% max. in any axis.
- ☐ Temperature Range— -100°F to $+300^{\circ}\text{F}$.
- ☐ Noise—3 mv p-p max.
- ☐ Mass—Less than $\frac{1}{8}$ cubic inch; less than 1 oz.

The 4-281 is a case in point why CEC has become the acknowledged leader in

the field of motion measurement. Only CEC offers a complete line of transducers for measuring static and dynamic acceleration, vibration, and shock. Furthermore, *all* of these are standard products which may be readily modified to meet special requirements.

This growing family of proven performers now consists of:

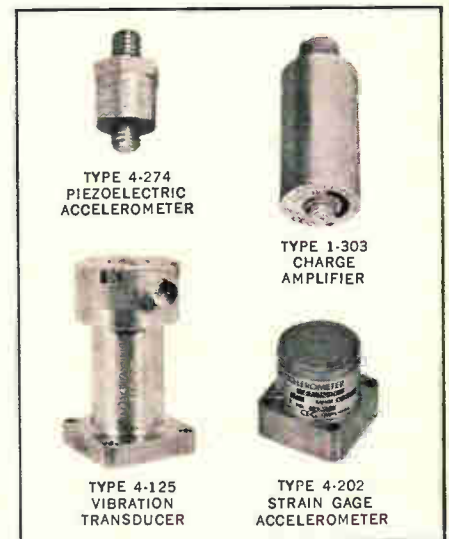

- ☐ Miniature piezoelectric accelerometers and amplifiers, high sensitivity to low output impedance, source followers to charge amplifiers.
- ☐ Strain gage accelerometers, high g to low g, 1 axis to 3.
- ☐ Velocity transducers, from miniature to high temperature, linear and rotary.

For complete information on the 4-281, call your nearest CEC Sales and Service Office or write for Bulletin CEC 4281-X7.

CEC
Transducer Division

CONSOLIDATED ELECTRODYNAMICS

A SUBSIDIARY OF BELL & HOWELL/PASADENA, CALIF. 91103
INTERNATIONAL SUBSIDIARIES: WOKING, SURREY, ENGLAND
AND FRIEDBERG (HESSSEN), W. GERMANY

Germany

Along the wall

Ever since its construction by East Germans on Aug. 13, 1961, the seven-mile-long Berlin Wall has been a formidable barrier to travel between East and West Berlin. But it's a puny obstacle to modern electronics.

Radio and telephone communication across the wall is simple, frequent—and dangerous.

Families who find themselves separated by the cold war, although in waving distance of each other, often maintain contact via ordinary telephones connected by a beam of infrared light shining between their apartments. Some enterprising tinkerers have refined their systems with multiplexers and amplifiers. Others, with more money and daring, sometimes use small f-m sets of 1 or 2 watts.

Sinister aspects. A report on Aunt Helga's health isn't the only kind of information smuggled across the wall. A few years ago an East German spy who lived next door to United States Army Headquarters in West Berlin was arrested while posing as a press photographer. He had converted his camera into a Morse-code transmitter, using an infrared light beam to carry his messages over the wall.

The battle of wits and watts is carried on below ground, too. East German security police are said to use deep metal probes and highly sensitive microphones to detect digging, as for tunnels. The probes go down to about 300 feet and are connected in groups to central consoles, where operators switch in and listen for unusual noises.

The East Germans still remember the U. S. Central Intelligence Agency's feat of tunneling into East Berlin and tapping the central telephone exchange for a year before being discovered.



The wall, seen from West Berlin.

Bugging the Reichstag. Listening equipment, for tapping into official telephone lines in West Berlin, is reported to be installed in an abandoned railway tunnel connecting the Reichstag to the former Reichs-Chancellery in East Berlin.

Committees of the West German Parliament meet regularly in the old Reichstag building. During the past month, several officials meeting in the south wing have noticed extraordinary activity in a five-story office building about 140 feet to the east—across the wall. The West Berlin police are convinced that East German cameramen were filming the committees' proceedings, using telescopic lenses.

West German officials believe that several other rooms in the Reichstag, those with eastern exposure, are regularly monitored by sensitive "big ear" microphones set up just east of the wall. Meetings dealing with security matters are held in the far end of the building. But the foreign relations committee, still insecure, has moved out of the Reichstag entirely, into quarters in a federally owned building far from the wall.

War of the airwaves. At longer range, the electronic war is waged across the Berlin Wall by radio and television. West Berlin has six radio stations, including the Free Berlin Transmitter (SFB), which

also operates a tv transmitter. East Berlin has four radio stations, including the Volga transmitter operated by the Soviet Union.

Western tv programs seem to be popular in the East. A foreign guest, in an East Berlin hotel used chiefly by Communist party functionaries, switched on the tv set in his room recently and was surprised that the only program he could get was from SFB in West Berlin. When he asked why, a party official explained. "I'm sorry, but our antenna is fixed to only point west."

About 48% of East German homes have tv sets, and 70% of these are believed to tune in occasionally to programs that originate in the West. For the highly industrialized southern part of East Germany, the West operates transmitters in northern Bavaria and along the Iron Curtain.

Despite the constant propaganda barrage by airwave, little jamming is practiced. Technicians are even reported to exchange news over the air when things are slow.

Electronic wall? A steady trickle of clues indicate that East Germany is seeking an electrical and electronic substitute for the ugly wall covered with barbed wire. Border guards who escaped to the West in recent weeks say engineers are trying to develop "a per-

fect national border" by 1970.

In January, the East Berlin police erected a short stretch of trip-wire fence of low voltage, possibly as a test installation.

Silent Spectra

The most likely challenger of the International Business Machines Corp.'s preeminence in the European computer field would seem to be the quiet combination of two giants—the Radio Corp. of America and Siemens & Halske AG of West Germany.

Last month the Siemens 4004 system was introduced. The accompanying fanfare omitted one significant fact: the central processors are RCA's new Spectra 70. The only Siemens equipment is in peripherals — printer, punched-tape unit and typewriters.

Fast action. It's the first large-scale introduction of Spectra 70 equipment in Europe, although customers must wait until late this year for delivery. The move stems from a long-discussed agreement the two companies signed in December, by which they share licenses and sales facilities [Electronics, Sept. 21, p. 100].

Siemens is secretive about its new computer. It even refuses to tell who's buying it, but some customers are known to be companies that had considered buying the Siemens 3003, a transistorized unit in the microsecond class. The 4004 is rated in nanoseconds.

New generation. Siemens says all components for the Spectra 70 are already in production in Germany, but units for the first customers will be imported, almost in toto, from the U. S. The company concedes it's still a year away from assembling them into a third-generation system that will probably be named Siemens 5005. A company official says Siemens labs have developed thin-film techniques and solid-state circuits comparable with RCA's and with those of other concerns in the United States.

Programing is a different matter. Industry observers believe this may be RCA's biggest contribution in



The Reichstag: is it bugged?

the Siemens transaction.

Punched-card equipment for the 4004 comes from IBM.

Counterattack. Siemens' new push into microcircuitry and nanosecond speeds seems to be a reaction to two American companies' moves into the German market: IBM, a perennial power made stronger with the new System 360; and the General Electric Co., which invested \$43 million last summer in Compagnie des Machines Bull in France.

Although it's one of Western Europe's top 10 industrial concerns, Siemens is a relative newcomer in the computer field. Its first commercial unit, the 2002, was introduced about six years ago. The 2002 was able to compete technically, but was considered too expensive. The 3003, introduced last spring, has been somewhat more successful.

Siemens has installed about 70 computer systems in West Germany, accounting for 3% of the market. IBM dominates the field with about 65% of all installations and Machines Bull has about 5%.

Fierce competition. The European computer market is expected to be rich and cutthroat. Market analysts see a 25% annual climb in sales—double that in the U. S. By 1970, new installations in Germany are forecast at 6,000 to 7,000, compared with 1,274 installed now; in Western Europe, 15,000 computers

will be added to the present 3,920.

But of 17 companies now selling computers in West Germany, only half a dozen are expected to still be in the race five years from now.

Mideast muddle

When Gamal Abdel Nasser invited East Germany's Communist Party leader to visit Cairo, the West German government offered Egypt's president a sop. Bonn announced that it was halting further arms shipments to Israel.

The announcement produced surprise in many world capitals. West Germany had disclosed a well-kept secret. Since 1961, Bonn has sent about \$64 million worth of arms to Israel, fulfilling 80% of a commitment made by former Chancellor Konrad Adenauer. German exports of electrical and electronic equipment to Israel in 1963—the last full year for which figures are available—totaled \$6.5 million, with more going via Italy and, presumably, other countries.

When Walter Ulbricht arrived in Cairo on Feb. 24, Bonn considered it an indication that Egypt might recognize East Germany. West Germany halted all economic aid and hinted at a break in diplomatic relations.

Loser all around. The news of West Germany's private deal with Israel spotlighted a program of military sales and aid that the government had been conducting in the Middle East and Africa with little publicity and almost no controversy. The program is valued unofficially at \$200 million over the last three years, much of it in electronics equipment. This is in addition to commercial exports. Now both military and commercial exports to that portion of the world are in jeopardy.

Israel imposed a counterboycott on the German companies that halted military shipments.

For West German companies the commercial stakes are large. The United Arab Republic's imports from West Germany total \$100 million a year, including about \$10.5 million worth of electrical and electronic equipment. Egypt's partners

in the Arab League account for more business: Syria, \$2.3 million worth of electrical and electronic gear; Iraq, \$3.6 million; Jordan, \$700,000.

No comment. West Germany's two biggest electronics companies—Telefunken AG and Siemens & Halske AG—have refused to answer any questions about the effect of the threatened break with Egypt. Another company, Imperial Rundfunk und Fernwerk, says it has a \$5 million contract with Cairo to supply 20,000 portable Astronaut television sets in knocked-down form for reassembly in Egypt.

In the past nine months, Imperial Rundfunk says it has shipped 5,000 of the 19-inch, battery-powered sets at \$250 apiece. The company expects to complete the transaction, its largest order from abroad.

If East Germany succeeds in gaining recognition in Cairo, it could use this as a wedge elsewhere. Besides Israel, nine other countries have received or negotiated for military aid from Bonn.

Tanzania, composed of the former countries of Tanganyika and Zanzibar, already has accepted an East German consulate general in Dar es Salaam, the capital, and probably will be stricken from Bonn's aid list. East Germany has official representatives in 36 non-communist countries.

Chile

Party line

President Eduardo Frei calls his economic reform program "revolution with liberty." In the past month he has broadened its scope with moves toward nationalization of Chile's telephone and electric power systems.

The actions are designed to step up expansion of communications and power in this ribbon-like country that extends along the Andes Mountains, 2,600 miles north to south with an average width of only 100 miles. They're aimed, too, at Chilean control of public utili-



President Frei moves toward nationalization of Chile's telephone industry.

ties. If the moves on the eve of the March 7 congressional elections also increase the popularity of Frei's Christian Democratic Party, he figures so much the better.

More phones. The government arranged for the acquisition of 49% of the shares of the Chilean Telephone Co. from the International Telephone and Telegraph Corp. The shares will be owned by the government and by private investors. Ultimately Frei hopes to nationalize the telephone industry.

Chile now has 251,000 phones—about 2.8 per 100 residents. Under a five-year expansion plan, the government expects that number to rise to 436,000. The purchase and expansion will cost \$125 million.

More jobs. ITT also has agreed to manufacture in Chile 88% of the equipment necessary for the expansion. Frei expects this to result in more industrial investment and in more jobs—about 1,300—for Chilean workers.

When the power agreement is completed, Chile will own 90.5% of the Chilean Electric Co.'s shares, with the rest held by private Chilean citizens. The company is a subsidiary of the American & Foreign Power Co. Chile also owns Chile's Electric Enterprise, Inc., a power complex that produces 69% of the country's electricity.

Great Britain

Fadeproof phones

High-frequency telephone circuits between London and New Delhi

are field-testing a system designed to overcome heavy noise and fading. The new electronic link combines a-m and f-m transmission.

The Post Office, which operates Britain's telephone network, designed the system, called Lincompex. It says Lincompex is providing satisfactory reception under conditions that would block conventional two-way phone communication entirely. Lincompex is said to set a new standard of reliability under changing conditions of radio propagation.

Control signal. The compression and expansion functions at the transmitter and receiver are linked by a separately transmitted control signal. At the transmitting end, the speech input is applied to a compressor, which gives a constant output irrespective of the speech-input level. The compressor's response eliminates even syllable-to-syllable changes in amplitude. The compressor always fully modulates the radio transmitter to assure optimum signal-to-noise ratio. The compressor also produces a separate control signal proportional to the speech level at the input.

The control signal is transmitted over the radio link by frequency modulation of a subcarrier. The f-m system makes the signal relatively immune to fading.

At the receiving station the compressed speech and control signal are separated by filters. The control signal is demodulated in a discriminator. Meanwhile the compressed speech is applied to a variable-gain expander amplifier. Amplification in the expander is controlled by the demodulated control signal, which restores the original amplitude variations of the speech.

No singing. This linked system eliminates the need for singing suppressors, which are commonly used in international telephony to prevent instability due to high net gain around the circuit in the go and return pattern. The suppressors, acting as voice-controlled switches, insure that only one direction of transmission is connected at any time. Under poor propagation conditions, lock-out can occur where noise operates one of the suppressors, preventing one subscriber

Acts fast at set point

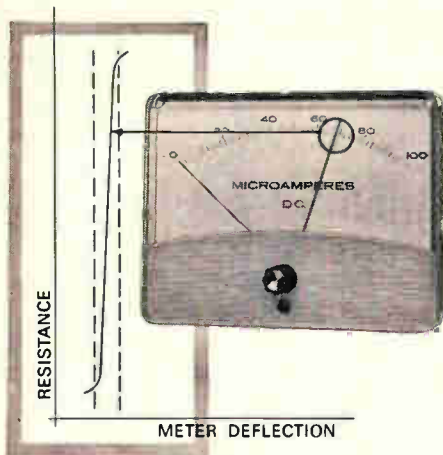

Almost instantaneous—that's the response at set point of API's contactless (optical) meter-relay.

Highly efficient use of internal light results in a "slope" of at least 100 to 1 between the extremes of resistance of a photoconductor. This ratio insures fast response (see curve above).

Above all, API's contactless meter-relay is simple and direct in operation—and therefore reliable and easy to apply. It's sophisticated but not complicated.

It's also inherently fail-safe and unaffected by ambient light—and it continuously indicates, either side of set point, an unamplified signal from any variable.

Trim new package includes circuitry



Here's the latest in convenience — a contactless meter-relay with all control components in an attached barrel. Simply hook up line power, signal and load—and it's ready to operate. Details in Bulletin 43.

See it at IEEE Show
Booth 2921-23

API's contactless meter relay comes in all popular current and voltage ranges, including AC. Many in stock for quick delivery. Ask for literature with prices and circuits.

api

INSTRUMENTS CO.

Formerly Assembly Products, Inc.

CHESTERLAND, OHIO • PHONE: 216-423-3131

Electronics Abroad

from breaking in to switch the circuit over. In the Lincompex system, the circuit has constant loss, and singing suppressors are unnecessary.

In addition, the control signal is used between words to mute the expander so that radio noise from the link is muted during silence intervals.

India

Status symbol

New Delhi, which is still struggling to stamp out vestiges of India's ancient caste system, has a new status symbol: the television antenna.

The capital of the second most populous country on earth has exactly 551 registered tv receivers. Nearly one-third of these are in government-owned tv clubs, a few dozen others are in schools, and a handful more are communally owned. That leaves precious few in private residences in this city of 2.5 million residents.

The picture may change drastically when the government launches its five-year plan for a \$210-million network to serve most of the country's 450 million inhabitants.

Why the hurry. There's a sense of urgency in government offices where tv plans are being drawn. Television is considered vital in reducing illiteracy from its present 76%, encouraging family planning, improving hygiene, spreading agricultural information, and generally bringing 20th-century technology to this backward nation.

There's another, less altruistic reason: politics. National elections are scheduled in the spring of 1967. The ruling Congress Party would like to use tv as a campaign medium. Party leaders are trying to lure foreign capital and technicians to India long before the campaign begins.

High hurdles. The obstacles are formidable: 14 recognized languages and hundreds of dialects,

and a critical shortage of foreign exchange, to name a couple.

India's only tv station is a five-kilowatt transmitter in New Delhi, financed by the Ford Foundation in 1959 and operated as a test station by the state-owned All-India Radio Broadcasting Co. It now broadcasts two hours a week in addition to a few hours of special school programs. Immediate plans call for boosting this to 2½ hours a day.

Government leaders say high priority will have to be given to receiver production.

The first phase of tv development would be the construction of high-power transmitters in New Delhi, Bombay, Calcutta and Madras. Later, transmitters would be built in smaller cities and all stations would be linked by a network of relay stations.

Who'll pay. One obstacle to financing is the anti-advertising stand taken by Mrs. Indira Gandhi, India's minister for information and broadcasting, and by other government leaders. Without commercials, Indian tv would have no chance of becoming self-supporting.

Communist East Germany has engaged in some hard selling to persuade India to let East German technicians install the tv system. The Germans have offered a \$50-million credit, much of it to go toward tv development. There's one string: India must recognize East Germany. So far, India has rejected that condition.

West Germany says it has offered no foreign aid for India's tv. Two companies—Telefunken AG and Siemens & Halske AG—have shown interest in doing business with India, but they're not talking about credit.

A British-led consortium also is said to have offered to supply equipment.

Propaganda. There's also pressure in Parliament for building a radio network to counteract anti-Indian propaganda from Communist China. The government plans to establish one high-power, medium-wave transmitter in Calcutta in December, strong enough to reach most of Northeast and South-

east Asia. It will also build two 250-kilowatt stations and one 100-kilowatt unit in New Delhi. These will begin operation this year.

The government is trying to obtain these transmitters from Communist countries and to pay for them in rupees.

Around the world

Hong Kong. A cable-laying vessel sailed into Hong Kong harbor one day recently after a stormy voyage through the typhoon-infested South China Sea, and completed the first phase of a round-the-world telephone cable. The system is called Seacom—for Southeast Asian sector, British Commonwealth telecommunications project—now links Hong Kong with the Malaysian cities of Singapore and Jesselton. The next phase will extend the link to Australia.

Seacom will provide 80 high-quality telephone circuits or their equivalent in teleprinter or data circuits. Equipment is supplied by Standard Telephones and Cables, Ltd., the British subsidiary of the International Telephone and Telegraph Corp. So far, STC has received orders totaling more than \$61 million.

Italy. Pleasure craft cruising in the Mediterranean may soon have bright-display radars—at least those owned by dolce vita sailors who are willing to pay \$3,150 for the luxury. The transistorized device was shown at the fourth International Nautical Show in Genoa by Selenia, the Italian subsidiary of the Raytheon Co.

Its antenna uses a two-inch-thick horizontal blade that spins at 80 revolutions per minute. The antenna is a slotted-waveguide array, providing a 1.6° horizontal and 23° vertical beamwidth.

Trinidad & Tobago. The Caribbean will have its first television plant when Sylvania Electric Products, Inc., opens an assembly line in Port of Spain early this spring. Sylvania, a subsidiary of the General Telephone & Electronics Corp., will produce a full line of tv sets, radios, stereophonic phonographs, and telephone and telecommunications equipment.

For Digital Computers . . . A NEW MEMO PAD

Now, "write" instructions to your general purpose digital computer with the GRAFACON Model 1010 . . . New low-cost, two-dimensional digital graphical input system. Based upon the Rand Tablet, it comprises a "writing tablet," stylus and associated electronics. The 10" x 10" integral printed-circuit screen (with capacitive-coupled encoding) accommodates 10⁶ input locations, with excellent linearity and 100 lines/inch resolution in both x and y. The GRAFACON Model 1010 electronics is completely solid-state, and occupies 7" of panel space in a standard 19" rack.



In x-y plotters . . . NEW PLOTAMATICS

Model 600—Low-cost, 8½x11 inch, transistorized plotter; 16 d-c input ranges, potentiometric mode, 1000 sec. variable time base (automatic reset), 0.2% full scale accuracy, 1 meg. constant all ranges; table or rack mount.

Model 800A—Transistorized 11x17 inch plotter; 17 d-c input ranges, potentiometric mode, 1500 sec. variable time base (automatic reset), 0.15% full scale accuracy, 1 meg. constant all ranges; table or rack mount.

Model 850—Transistorized 11x17 inch point plotter; NEW PRINTAMATIC SYMBOL PRINTER eliminates troublesome ribbons, features long-lasting self-contained ink supply and easier alignment; 600 ppm, rate, 16 variable sensitivities 0.5 mv/in. to 100 v/in.



See these advanced instruments on working display at IIEEE, Booth No. 88, at the Hilton.



DATA EQUIPMENT COMPANY
DIVISION BBN CORPORATION (DELAWARE)
2120 South Lyon Street, Santa Ana, Calif. 92705
Tel: (714) 546-5330 TWX: (714) 546-0437

Electronics advertisers

March 8, 1965



■ AMP Incorporated Garceau, Hargrave & McCullough Inc.	124	■ Cohn, Sigmund Corporation William G. Seidenbaum & Company	203	Fairchild Semiconductor Johnson & Lewis Inc.	14
API Instrument Company George Z. Griswold	222	Cohu Electronics, Kin Tel Division Erwin Wasey, Ruthrauff & Ryan	45	Federal Screw Products Inc.	178
Acopian Corporation Mort Barish Associates Inc.	9	Cominco Products Inc. McKim Productions Limited	208	Foxboro Company Reach, McClinton & Co. Inc.	154
■ Acton Laboratories Inc. Engineering Writers	205	Communication Electronics Inc.	164	■ Friedrich & Dimmock Inc. Wyble Advertising	168
Adage Inc. Fuller & Smith & Ross Inc.	138	Consolidated Electrodynamics Corporation Hixson & Jorgensen Inc.	218	■ Fujitsu Limited Hakuhodo Inc.	187
Advanced Circuits International Div. of Kent Corporation Richard L Renner Industrial Advertising	169	Consumers Power District Swanson, Sinkey, Ellis Inc.	212	Garlock Inc. Clawges Associates Inc.	126
Airpax Electronics Inc. Welch, Mirabile & Company Inc.	122	Corning Glass Works The Rumrill Company Inc.	64	General Aniline & Film Corporation Hazard Advertising Company Inc.	145
Alco Electronic Products Inc. Marktronics Advertising	155	Coto Coil Company, Inc. The Williams Company	216	■ General Electric Company, Electronic Components Sales Div. George R. Nelson Inc.	19 to 22
American Components Inc. T.K. Thompson Associates Inc.	172	Crescent Tool Company The Rumrill Company Inc.	52	■ General Electric Company, Lamp Metals & Components Div. Dix & Eaton Incorporated	156
Arnold Engineering Company Burton Browne Advertising	37	Crown International Frank Crowley Advertising	178	■ General Instrument Corp. Semiconductor Products Group Norman Allen Associates Inc.	141
Astrodata Inc. Bonfield Associates Inc.	11	Cubic Corporation Phillips-Ramsey Inc.	66	General Radio Company K.E. Morang Co.	7
Automatic Electric Company Kudner Agency Inc.	34, 35	■ Dale Electronics Inc. Swanson, Sinkey, Ellis Inc. Advertising	71	Genisoc Technology Corporation Getz and Sandborg Inc.	162, 166
■ Automatic Metal Products Corporation Davon Service Corporation	207	Data Equipment Company Leland Oliver Company Inc.	223	■ Globe Industries Inc. Odiorne Industrial Adv. Inc.	174
Babcock Relays Jay Chiat and Associates	29	Data Instruments, Div. of Industrial Electronic Hardware Corp. A.D. Adams Advertising Inc.	194	Graphic Systems Inc. Caswell Adv. Agency	208
■ Ballantine Laboratories Lang-Lawrence Advertising Inc.	165	Delevan Electronics Corporation Clayton A. Stahlka Advertising Company	182	Green Instrument Company Inc. S. Gunnar Myrbeck & Company	204
Bausch & Lomb Inc. Wolff Associates Inc.	158	Deltron Inc. Benn Associates	155	Gries Reproducer Corporation Harold Marshall Advertising Co. Inc.	212
Beckman Instruments Inc. Offner Division Erwin Wasey, Ruthrauff & Ryan Inc.	133	Department of Navy GLM Associates Inc.	179	Guardian Electric Mfg. Co. K & A Incorporated	128
Beede Electrical Instruments Company Inc. S. Gunnar Myrbeck & Company	202	Di-Acro Corporation Charles E. Brown Adv.	160	Gudebrod Bros. Silk Co. Inc. Lee Ramsdell & Co. Inc.	12, 13
Bendix Corporation, Bendix-Pacific Division John B. Shaw Company Inc.	49	Dialight Corporation H.J. Gold Co. Advertising	188	Hamilton Standard Div. of United Aircraft Corporation Cunningham & Walsh Inc.	69
■ Bliley Electric Co. Barber & Drullard Inc.	196	Dickson Electronics Corp. N.A. Winter Advertising Agency	67	Hamilton Watch Company Beaumont, Heller & Sperling Inc.	203, 221
Bliss Gamewell Div. of E.W. Bliss Company Feeley Advertising Agency Inc.	217	Dixson Inc. Gail Advertising Company	210	Haydon Switch & Instrument Inc. Cory Snow Inc.	190
Borden Chemical Company, Mystik Tape Division Fuller & Smith & Ross Inc.	134	Douglas Aircraft Co. Inc. J. Walter Thompson Company	195	■ Hewlett-Packard Company Lennen & Newell Inc.	1, 30, 31
■ Brush Instruments, Div. of Clevite Corporation Carr Liggett Adv. Inc.	3rd Cover	DuPont Reagents The Rumrill Company Inc.	39	Hitachi Ltd. Dentsu Advertising Ltd.	24
Bud Radio Inc. Allied Advertising Agency Inc.	186	DuPont de Nemours & Co. Inc. E.I. Batten, Barton, Durstine & Osborn Inc.	59, 123, 206	■ Hughes Aircraft Company Foote, Cone & Belding Inc.	180
■ Bulova Watch Company, Electronics Division Carpenter, Matthews & Stewart Inc.	177	■ Dymec, A. Div. of Hewlett-Packard Co. Lennen & Newell Incorporated	65	Hull Corporation The Michener Company	208
Burr-Brown Research Corporation N.A. Winter Adv. Agency	160	■ Dynage Inc. F.W. Prella Advertising	178	Hyperion Industries Inc. S. Gunnar Myrbeck & Company	193
Burroughs Corporation Conti Advertising Inc.	139	Edgerton, Germeshausen & Grier Inc. Reach, McClinton & Co. Inc.	150	IEEE Raymond Schoonover Advertising	209
■ CTS Corporation Burton Browne Advertising	119	Electronic Engineering Co. of California Barnes Chase Advertising	127	Ichizuka Optical Co. Ltd. Matsushita Inc.	209
Cambridge Thermionic Corporation Chirurg & Cairns Inc.	156	Electronic Modules Corporation Ray Thompson & Associates	157	Industrial Chemical Specialties Corp. Jack Goehring Advertising Inc.	200
■ Chassis Trak Inc. Curtiss, Quinlan, Keene & Peck Inc.	189	Elgenco Incorporated Lewco Advertising	183	Industrial Electronic Engineers Inc. Gumpertz, Bentley & Dolan Adv.	187
■ Clairex Corporation Michel Cather Inc.	196	Eubanks Engineering Company Moore-Bergstrom Company	179	Intellux Inc. Kemble & Clapham Advertising	175
■ Clarostat Mfg. Co. Lescarbours Advertising Inc.	53	Executone Inc. J.A. Richards Advertising	191	■ Interelectronics Corporation Mark III Advertising Ltd.	205
Cleveland Institute of Electronics Carr Liggett Advertising Inc.	186	Fairchild Dumont Laboratories. The Roger & Wilbur Co. Inc.	26, 27, 56	ITT Wire & Cable Division West, Weir & Bartel Inc.	147

Executive, editorial, circulation and advertising offices: McGraw-Hill Building, 330 West 42nd Street, New York, N.Y., 10036. Telephone Area Code 212-971-3333. Teletype TWX N.Y. 212-640-4646. Cable: McGrawhill, N.Y. Officers of the Publications Division: Shelton Fisher, President; Vice Presidents: Joseph H. Allen, Operations; Robert F. Boger, Administration; John R. Callahan, Editorial; Ervin E. DeGraff, Circulation; Donald C. McGraw, Jr., Advertising Sales; Angelo R. Venezian, Marketing. Officers of the Corporation: Donald C. McGraw, President; Hugh J. Kelly, Harry L. Waddell, L. Keith Goodrich, Executive Vice Presidents; John L. McGraw, Treasurer; John J. Cooke, Vice President and Secretary. Title R registered U.S. Patent Office; © copyright 1964 by McGraw-Hill, Inc. All rights reserved, including the right to reproduce the contents of this publication, in whole or in part.

Electronics advertisers

March 8, 1965



Isomode Division of Cal/Val Research & Development Corp. Packard/Mitchell Advertising Inc.	48	P.A.F. Enterprises Mark Advertising Agency Inc.	211
Janus Control Corporation L.K. Frank Co. Inc.	198	Pacific Electro Magnetics Co. Inc. Hal Lawrence Inc.	159
Kay Electric Company Josephson, Cuffari & Company	131, 167	Patwin Electronics Company Graceman Advertising Inc.	32
Keithley Instruments Inc. The Bayless Kerr Company	168	Perfection Mica Company, Magnetic Shield Division Burton Browne Advertising	176
Kingsley Machine Company Nides Cini Advertising Inc.	202	■ Phelps Dodge Electronic Products Corp. Smith, Dorian & Burman Inc.	28
Krohn-Hite Corporation Stern/Frank Advertising Inc.	135	Plant City Clayton and Mohler Advertising	205
■ Kyoritsu Electrical Instrument Works, Ltd. Nichiden Adv. Ltd.	187	Potter & Brumfield Div. of American Machine & Foundry Co. Grant, Schwenck & Baker Inc.	16
■ Lapp Insulator Company Inc. Wolff Associate Inc.	181	Precision Circuits Inc. Harold Marshall Advertising Company Inc.	174
■ Leach Corporation Hixson & Jorgensen Inc.	140	■ Precision Tube Company Inc. George Moll Advertising Inc.	130
Machlett Laboratories Inc., The Fuller & Smith & Ross Inc.	8	Princeton Applied Research Corporation Mort Barish Associates	40
■ Markel & Sons, L. Frank George Moll Advertising Inc.	132	RBM Controls Division of Essex Wire Corporation Bonsib Inc.	62
Massa Division of Dynamics Corporation of America L.K. Frank Co. Inc.	201	■ Radiation Inc. G.M. Basford Company	60, 61
Matsuo Electric Co., Ltd. Asahi Advertising Agency & Co.	180	Radio Corporation of America Al Paul Lefton Company	4th Cover
McGraw-Hill Book Co. Inc.	36	Reeves-Hoffman Division of Dynamics Corporation of America Adams Associates Inc.	38
Metal Removal Company The Advertising Producers Associated Inc.	46	Riverside Chamber of Commerce Hogan & Vecchio Advertising Agency	200
Mico Instrument Company	216	Rohde & Schwarz Inc. Armand Richards Advertising Agency	68
Millen Mfg. Co. Inc. James	174	Royal Advertising Corporation	179
Minnesota Mining & Mfg. Co. Mincom Division Reach, McClinton & Co., Inc.	23	■ Sanborn Co., A Div. of Hewlett-Packard Company Culver Advertising Inc.	2
Missimers Inc. Ad Lab Advertising & Public Relations	200	■ Siemens America Inc. Mann-Wesley Inc. Advertising	120, 121
■ Mullard Ltd. Marsteller Inc.	146	Signetics Corporation Cunningham & Walsh Inc.	148
■ Murata Mfg. Co. Ltd. Dentsu Advertising Ltd.	191	Sinclair Radio Laboratories Inc. John E. Hayes Company Inc.	225
Mystik Tape Inc. Division of The Borden Chemical Company Fuller & Smith & Ross Inc.	134	■ Singer Company, Metrics Division Hepler and Gibney Inc.	25
■ NRC Equipment Company S. Gunnar Myrbeck & Company	144	■ Sorensen Inc. Fuller & Smith & Ross Inc.	151
National Cash Register Company Allen, Dorsey, & Hatfield Inc.	171	Sprague Electric Company The Harry P. Bridge Co.	5, 6, 10
Newark Electronics Corporation Stral Advertising Company Inc.	170	Stancor Electronics Division of Essex Wire Corporation Bonsib Inc.	72
■ Ney Company, J.M. Peck-Adams Incorporated	191	Struthers-Dunn Inc. The Harry P. Bridge Company	163
North Atlantic Industries Inc. Murray Heyert Associates	47	Synthane Corporation Arndt, Preston, Chapin, Lamb & Keen Inc.	142
■ North Hills Electronics Inc. N.S. Advertising	211	Tektronix Inc. Hugh Dwight Adv. Inc.	143
■ Ohmite Mfg. Company The Fensholt Adv. Agency	63	Texas Instruments Incorporated Industrial Products Group Robinson-Gerrard Inc.	152, 153
		Texas Instruments Incorporated Metals & Controls Inc. Horton, Church & Goff Inc.	136, 137
		TEXAS INSTRUMENTS INCORPORATED Semiconductor-Components Division Don L. Baxter Inc.	50, 51

■ For more information on complete product line see advertisement in the latest Electronics Buyers' Guide



VHF Model M-150-4B

SEE US AT
BOOTH 2812
IEEE SHOW

NEW... SMALLEST 50 WATT MOBILE DUPLERER!
IN EITHER UHF OR VHF... FOR LESS THAN \$60.00*

Sinclair's Mobile Duplexers are only slightly larger than a package of cigarettes, but give big unit performance in the duplex operation of mobile transmitters and receivers in either the 150 or 450 Mc bands. Only 5 Mc separation between Tx and Rx frequencies, too! It's ruggedly engineered to take the bumps and jolts of tough mobile service and go on performing dependably for years.

The units are completely enclosed in self-mounting housings for external installation to the transmitter-receiver cabinet. Special packaging information available on request.

*VHF Model M-150-4B
Investigate today! Write for a complete FREE Sinclair Communications Catalog.

SINCLAIR RADIO LABORATORIES, INC. 523 FILMORE AVENUE, DEPT. 101 TONAWANDA, NEW YORK



To order reprints
from Electronics
fill in, cut out
coupon below,
insert in envelope
and mail to:
**Electronics Reprint
Dept.**
330 West 42nd Street
New York, N. Y. 10036

Reprint order form

For listing of reprints available see the reader service card

To help expedite mailing of your reprints please send cash, check or money order with your order.

For reprints of the latest Special report:

Electronics Markets 1965

Send me reprints of key no. R-67 at 50¢ each.

For reprints of previous special reports fill in below:

Send me reprints of key no.(s)

..... at .. ¢ each.

For prices see the reader service card.

Name

Number & Street

City, State

Zip Code

Thermal American Fused Quartz Company Knip Associates	192
■ Tokyo Shibaura Electric Co. Ltd. Hakuhodo Incorporated	197
Tracor Inc. David G. Benjamin Inc.	70
Transformer Electronics Company	184
■ Trygon Electronics Inc. Carpenter, Matthews & Stewart Inc.	170
■ Tylon Inc. George Moll Adv. Inc.	172
Uniform Tubes Inc. The Michener Company Advertising	199
■ United Transformer Corporation Philip Stogel Company Inc.	2nd Cover
■ Vitramon Inc. Ted Sommers Inc. Advertising	185
Vitro Corporation of America Buchen Advertising Inc.	55
■ Weinschel Engineering Company S. Gunnar Myrbeck & Company	33
Wells Electronics Inc. Weco Adv.	155
Weston Instruments Incorporated G.M. Basford Co.	161
Wood Electric Corporation L.K. Frank Co. Inc.	156
Yutaka Electric Mfg. Co. Ltd. Nichiden Adv. Ltd.	176

Classified advertising

F. J. Eberle, Business Mgr.	
Professional services	215
Employment opportunities	213, 215
Equipment (Used or Surplus New) For Sale	214-215

Classified advertisers index

■ A & A Electronics Corp.	214
Atomic Personnel Inc.	215
■ Baynton Electronics	215
Edmund Scientific Co.	214
■ Electro Sales Co.	214
■ Engineering Associates	214
■ Fishman Co., Philip	214
International Business Machines	213, 215
Lifschultz Fast Freight	214
Mars Sales	214
■ Radio Research Instrument Co.	214
Semiconductor Sales of Calif.	214

Advertising sales staff

Gordon Jones [212] 971-2210
Advertising sales manager

Atlanta, Ga. 30309: Gus H. Krimsier,
Michael H. Miller, 1375 Peachtree St. N.E.,
[404] TR 5-0523

Boston, Mass. 02116: William S. Hodgkinson
McGraw-Hill Building, Copley Square,
[617] CO 2-1160

Chicago, Ill. 60611: Robert M. Denmead,
645 North Michigan Avenue,
[312] MO 4-5800

Cleveland, Ohio 44113: Paul T. Fegley, 55
Public Square, [216] SU 1-7000

Dallas, Texas 75201: Richard P. Poole, The
Vaughn Building, 1712 Commerce Street,
[214] RI 7-9721

Denver, Colo. 80202: John W. Patten, David
M. Watson, Tower Bldg., 1700 Broadway,
[303] AL 5-2981

Houston, Texas 77025: Kenneth George,
Prudential Bldg., Halcombe Blvd.,
[713] RI 8-1280

Los Angeles, Calif. 90017: Ashley P.
Hartman, John G. Zisch, 1125 W. 6th St.,
[213] HU 2-5450

New York, N.Y. 10036:
Donald R. Furth [212] 971-3615
Frank LeBeau [212] 971-3615
George F. Werner [212] 971-3615
500 Fifth Avenue

Philadelphia, Pa. 19103: William J. Boyle,
Warren H. Gardner, 6 Penn Center Plaza,
[215] LO 8-6161

San Francisco, Calif. 94111:
James T. Hauptli, 255 California Street,
[415] DO 2-4600

London W1: Edward E. Schirmer, 34 Dover
Street, Hyde Park 1451

Frankfurt/Main: Gerd Hinske, 85
Westendstrasse Phone: 77 26 65 and
77 30 59

Geneva: Michael R. Zeynel,
2 Place du Port 244275

Paris VIII: Denis Jacob, 17 Avenue
Maignon ALMA-0452

Tokyo: Nobuyuki Sato
Shiba, Minato-ku (502) 0656

Osaka: Kazutaka, Miura, 163, Umegae-cho,
Kilta-ku [362] 8771

Nagoya: International Media Representatives,
Yamagishi Bldg., 13, 2-Chome,
Oike-cho Naka-ku

Hugh J. Quinn: [212] 971-2335
Manager Electronics Buyers' Guide

David M. Tempest: [212] 971-3139
Promotion manager

Milton Drake: [212] 971-3485
Market research manager

Richard J. Tomlinson: [212] 971-3191
Business manager

Theodore R. Gelpel: [212] 971-2044
Production manager

■ For more information on complete product line see advertisement in the latest Electronics Buyers' Guide

Electronics reader service

Use these handy post cards for more detailed information on: products advertised, new products, new literature.

Circle the number on the Reader Service post card that corresponds to the number at the bottom of the advertisement, new product item, or new literature in which you are interested.

Please print clearly. All written information must be legible to be efficiently processed.

If someone has beaten you to the post cards, you may obtain the needed information by writing directly to the manufacturer, or by sending your name and address, plus the reader service number, to Electronics reader service department.

All foreign inquires that cannot reach Electronics before the expiration dates noted on the Reader Service post card, must be mailed directly to the manufacturer. The manufacturer assumes all responsibilities for responding to inquiries. Electronics merely provides and clears requests for information from inquirer to manufacturer.

Correct amount of postage must be affixed for all foreign mailings.

To subscribe to or to renew Electronics

Fill in the "For Subscriptions" area on the card if you desire to subscribe to or renew your present subscription to Electronics. Send no money. Electronics will bill you at the address indicated on the Reader Service post card.

Multi-product advertisements

For information on specific items in multi-product advertisements which do not have a specific Reader Service number indicated write directly to manufacturer for information on precise product in which you are interested.

5	March 8, 1965 Card Expires May 8, 1965	14
Name _____	title _____	
Company _____		
Address _____		
For Subscriptions <input type="checkbox"/> new <input type="checkbox"/> renewal <input type="checkbox"/> 3 years \$12.00 <input type="checkbox"/> 1 year \$6.00		
1 20 39 58 77 96 115 134 153 172 191 210 229 248 267 286 305 324 343 362 381 400 419 438 457 476 495 514 962 2 21 40 59 78 97 116 135 154 173 192 211 230 249 268 287 306 325 344 363 382 401 420 439 458 477 496 515 963 3 22 41 60 79 98 117 136 155 174 193 212 231 250 269 288 307 326 345 364 383 402 421 440 459 478 497 516 964 4 23 42 61 80 99 118 137 156 175 194 213 232 251 270 289 308 327 346 365 384 403 422 441 460 479 498 517 965 5 24 43 62 81 100 119 138 157 176 195 214 233 252 271 290 309 328 347 366 385 404 423 442 461 480 499 518 966 6 25 44 63 82 101 120 139 158 177 196 215 234 253 272 291 310 329 348 367 386 405 424 443 462 481 500 900 967 7 26 45 64 83 102 121 140 159 178 197 216 235 254 273 292 311 330 349 368 387 406 425 444 463 482 501 901 968 8 27 46 65 84 103 122 141 160 179 198 217 236 255 274 293 312 331 350 369 388 407 426 445 464 483 502 902 969 9 28 47 66 85 104 123 142 161 180 199 218 237 256 275 294 313 332 351 370 389 408 427 446 465 484 503 951 970 10 29 48 67 86 105 124 143 162 181 200 219 238 257 276 295 314 333 352 371 390 409 428 447 466 485 504 952 971 11 30 49 68 87 106 125 144 163 182 201 220 239 258 277 296 315 334 353 372 391 410 429 448 467 486 505 953 972 12 31 50 69 88 107 126 145 164 183 202 221 240 259 278 297 316 335 354 373 392 411 430 449 468 487 506 954 973 13 32 51 70 89 108 127 146 165 184 203 222 241 260 279 298 317 336 355 374 393 412 431 450 469 488 507 955 974 14 33 52 71 90 109 128 147 166 185 204 223 242 261 280 299 318 337 356 375 394 413 432 451 470 489 508 956 975 15 34 53 72 91 110 129 148 167 186 205 224 243 262 281 300 319 338 357 376 395 414 433 452 471 490 509 957 976 16 35 54 73 92 111 130 149 168 187 206 225 244 263 282 301 320 339 358 377 396 415 434 453 472 491 510 958 977 17 36 55 74 93 112 131 150 169 188 207 226 245 264 283 302 321 340 359 378 397 416 435 454 473 492 511 959 978 18 37 56 75 94 113 132 151 170 189 208 227 246 265 284 303 322 341 360 379 398 417 436 455 474 493 512 960 979 19 38 57 76 95 114 133 152 171 190 209 228 247 266 285 304 323 342 361 380 399 418 437 456 475 494 513 961 980		

Business reply mail
No postage stamp necessary if mailed in the United States

Postage will be paid by

**Electronics
Reader service department
Box 444
Hightstown, N.J. 08520**

First class
Permit no. 42
Hightstown, N. J.



5	March 8, 1965 Card Expires May 8, 1965	14
Name _____	title _____	
Company _____		
Address _____		
For Subscriptions <input type="checkbox"/> new <input type="checkbox"/> renewal <input type="checkbox"/> 3 years \$12.00 <input type="checkbox"/> 1 year \$6.00		
1 20 39 58 77 96 115 134 153 172 191 210 229 248 267 286 305 324 343 362 381 400 419 438 457 476 495 514 962 2 21 40 59 78 97 116 135 154 173 192 211 230 249 268 287 306 325 344 363 382 401 420 439 458 477 496 515 963 3 22 41 60 79 98 117 136 155 174 193 212 231 250 269 288 307 326 345 364 383 402 421 440 459 478 497 516 964 4 23 42 61 80 99 118 137 156 175 194 213 232 251 270 289 308 327 346 365 384 403 422 441 460 479 498 517 965 5 24 43 62 81 100 119 138 157 176 195 214 233 252 271 290 309 328 347 366 385 404 423 442 461 480 499 518 966 6 25 44 63 82 101 120 139 158 177 196 215 234 253 272 291 310 329 348 367 386 405 424 443 462 481 500 900 967 7 26 45 64 83 102 121 140 159 178 197 216 235 254 273 292 311 330 349 368 387 406 425 444 463 482 501 901 968 8 27 46 65 84 103 122 141 160 179 198 217 236 255 274 293 312 331 350 369 388 407 426 445 464 483 502 902 969 9 28 47 66 85 104 123 142 161 180 199 218 237 256 275 294 313 332 351 370 389 408 427 446 465 484 503 951 970 10 29 48 67 86 105 124 143 162 181 200 219 238 257 276 295 314 333 352 371 390 409 428 447 466 485 504 952 971 11 30 49 68 87 106 125 144 163 182 201 220 239 258 277 296 315 334 353 372 391 410 429 448 467 486 505 953 972 12 31 50 69 88 107 126 145 164 183 202 221 240 259 278 297 316 335 354 373 392 411 430 449 468 487 506 954 973 13 32 51 70 89 108 127 146 165 184 203 222 241 260 279 298 317 336 355 374 393 412 431 450 469 488 507 955 974 14 33 52 71 90 109 128 147 166 185 204 223 242 261 280 299 318 337 356 375 394 413 432 451 470 489 508 956 975 15 34 53 72 91 110 129 148 167 186 205 224 243 262 281 300 319 338 357 376 395 414 433 452 471 490 509 957 976 16 35 54 73 92 111 130 149 168 187 206 225 244 263 282 301 320 339 358 377 396 415 434 453 472 491 510 958 977 17 36 55 74 93 112 131 150 169 188 207 226 245 264 283 302 321 340 359 378 397 416 435 454 473 492 511 959 978 18 37 56 75 94 113 132 151 170 189 208 227 246 265 284 303 322 341 360 379 398 417 436 455 474 493 512 960 979 19 38 57 76 95 114 133 152 171 190 209 228 247 266 285 304 323 342 361 380 399 418 437 456 475 494 513 961 980		

Reprint service

All Electronics editorial matter available in reprint form:

For reprints of special reports and feature articles see list on right side of this page. Send your order to Electronics Reprint Department at the address indicated. To expedite mailing of your order for single reprints please send cash, check or money order with your order.

Bulk reprints of editorial matter can be ordered from current or past issues. The minimum quantity is 100 copies. The higher the quantity ordered, the more economical the cost per copy. Prices quoted on request.

To order reprints or for further information, please write to: **Electronics Reprint Department, 330 West 42nd Street, New York, N.Y. 10036.** Telephone: Area code 212 971-3140.

You may order the following reprints by key number using order form on page 183.

Prices for the below listed reprints unless otherwise specified are 1-10 copies 50¢ each; 11-24 copies 35¢ each; 25-99 copies 25¢ each; price for 100 or more is 20¢ each.

Key no. R-69 1964 Complete Electronics Index
Catalogs all technical articles — newsletter items, Electronics Review, Electronics Abroad, and Probing the News stories, manufacturers mentioned in these articles plus a complete advertisers index.
40 pages. \$1.00

Key no. R-68 Designing Against Space Radiation, 18 pages.

Key no. R-67 Electronics Markets 1965.
24 page forecast report with 6 page foldout chart.

Key No. R-66 Field Effect Transistors, Part III
16 pages.

Key No. R-65 Field Effect Transistors, Part II
24 pages.

Key No. R-64 Field Effect Transistors, Part I
24 pages.

Key no. R-62 Electronic Telephone Switching, 16 pages.

Key no. R-61 Direct Digital Control In Industry, 24 pages.

Key no. R-60 Transistor Heat Dissipators, 32 pages.

Key no. R-58 Oceanography, 15 pages.

Key no. R-57 Magnetics, 24 pages.

Key no. R-56 The Case For Magnetic Logic, 8 pages. 35¢

Key no. R-53 Digital Instrumentation, 16 pages.

Key no. R-48 Modern Electronic Packaging, 16 pages.

Key no. R-45 Today's Semiconductors, 24 pages.

Key no. R-40 Tunnel Diodes, [4 part series] 26 pages.

Key no. R-38 Family Tree of Semiconductors, [22" x 11" foldout chart].

Key no. R-31 1962 Electromagnetic Spectrum Chart, [22" x 30" foldout chart]. \$1.00

Key no. R-30 Graphical Symbols For Electronic Diagrams, [29" x 11" foldout chart].

Key no. R-26 Lasers Devices and Systems, [1961 4 part series] 23 pages: \$1.00

Business reply mail

No postage stamp necessary if mailed in the United States

Postage will be paid by

**Electronics
Reader service department
Box 444
Hightstown, N. J. 08520**

First class
Permit no. 42
Hightstown, N. J.



5	March 8, 1965 Card Expires May 8, 1965																																													14
Name	_____ title																																													
Company	_____																																													
Address	_____																																													
1	20	39	58	77	96	115	134	153	172	191	210	229	248	267	286	305	324	343	362	381	400	419	438	457	476	495	514	962																		
2	21	40	59	78	97	116	135	154	173	192	211	230	249	268	287	306	325	344	363	382	401	420	439	458	477	496	515	963																		
3	22	41	60	79	98	117	136	155	174	193	212	231	250	269	288	307	326	345	364	383	402	421	440	459	478	497	516	964																		
4	23	42	61	80	99	118	137	156	175	194	213	232	251	270	289	308	327	346	365	384	403	422	441	460	479	498	517	965																		
5	24	43	62	81	100	119	138	157	176	195	214	233	252	271	290	309	328	347	366	385	404	423	442	461	480	499	518	966																		
6	25	44	63	82	101	120	139	158	177	196	215	234	253	272	291	310	329	348	367	386	405	424	443	462	481	500	900	967																		
7	26	45	64	83	102	121	140	159	178	197	216	235	254	273	292	311	330	349	368	387	406	425	444	463	482	501	901	968																		
8	27	46	65	84	103	122	141	160	179	198	217	236	255	274	293	312	331	350	369	388	407	426	445	464	483	502	902	969																		
9	28	47	66	85	104	123	142	161	180	199	218	237	256	275	294	313	332	351	370	389	408	427	446	465	484	503	951	970																		
10	29	48	67	86	105	124	143	162	181	200	219	238	257	276	295	314	333	352	371	390	409	428	447	466	485	504	952	971																		
11	30	49	68	87	106	125	144	163	182	201	220	239	258	277	296	315	334	353	372	391	410	429	448	467	486	505	953	972																		
12	31	50	69	88	107	126	145	164	183	202	221	240	259	278	297	316	335	354	373	392	411	430	449	468	487	506	954	973																		
13	32	51	70	89	108	127	146	165	184	203	222	241	260	279	298	317	336	355	374	393	412	431	450	469	488	507	955	974																		
14	33	52	71	90	109	128	147	166	185	204	223	242	261	280	299	318	337	356	375	394	413	432	451	470	489	508	956	975																		
15	34	53	72	91	110	129	148	167	186	205	224	243	262	281	300	319	338	357	376	395	414	433	452	471	490	509	957	976																		
16	35	54	73	92	111	130	149	168	187	206	225	244	263	282	301	320	339	358	377	396	415	434	453	472	491	510	958	977																		
17	36	55	74	93	112	131	150	169	188	207	226	245	264	283	302	321	340	359	378	397	416	435	454	473	492	511	959	978																		
18	37	56	75	94	113	132	151	170	189	208	227	246	265	284	303	322	341	360	379	398	417	436	455	474	493	512	960	979																		
19	38	57	76	95	114	133	152	171	190	209	228	247	266	285	304	323	342	361	380	399	418	437	456	475	494	513	961	980																		

Business reply mail

No postage stamp necessary if mailed in the United States

Postage will be paid by

**Electronics
Reader service department
Box 444
Hightstown, N.J. 08520**

First class
Permit no. 42
Hightstown, N. J.



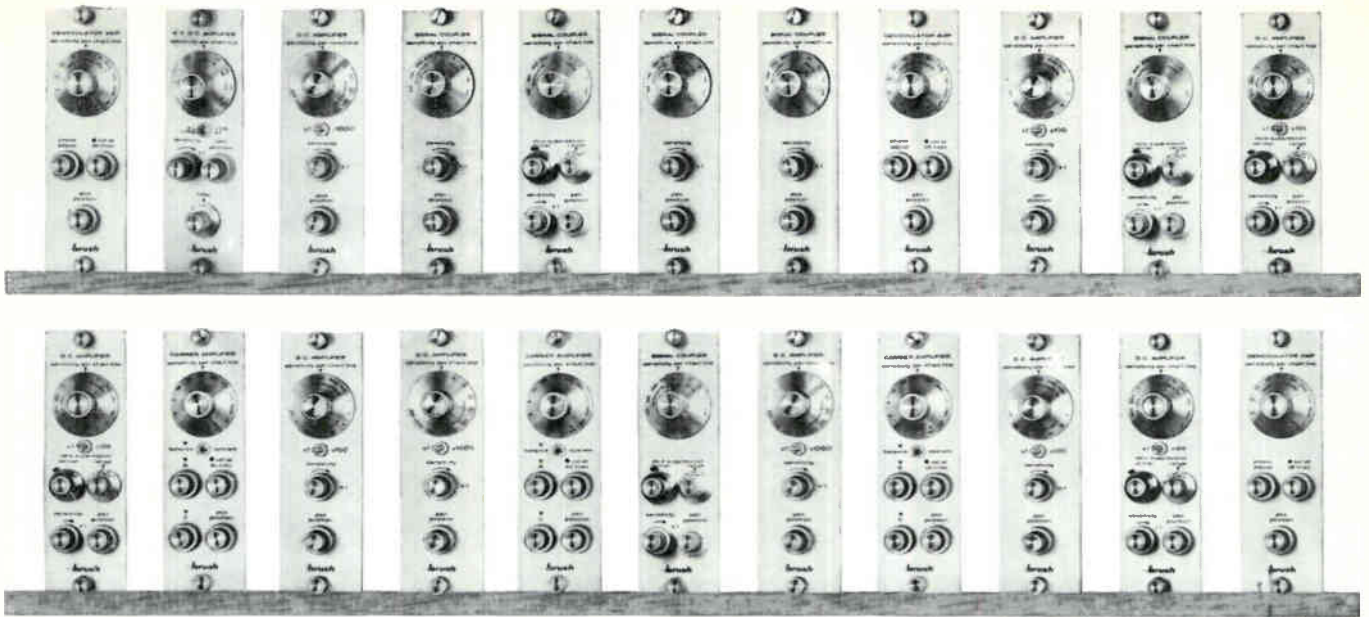

Brush has an "off-the-shelf" preamplifier for almost any recording requirement that comes to mind.

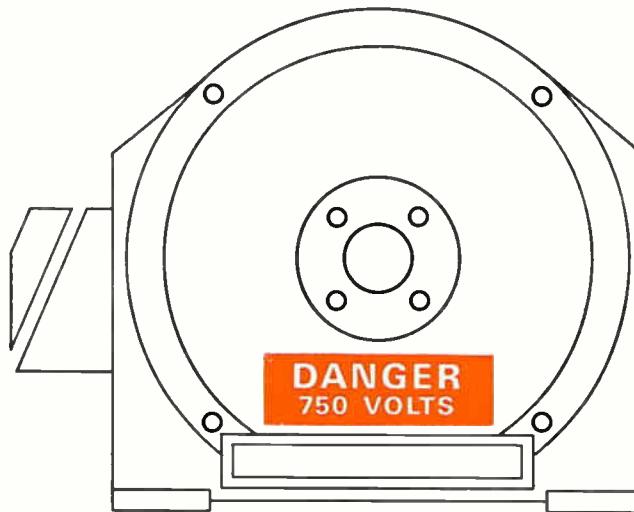

Take high voltage motors for instance.

Recording *their* electrical performance is especially tough. But thanks to a new free-floating, high gain Brush preamplifier, (second from left, top row) it's just another job. This newest addition to the Brush line of 22 different preamplifiers accepts signals up to 1000 volts DC OFF-GROUND, potential differences to 1000 volts DC; plugs into any advanced model Brush Direct Writing Recorder; eliminates possibility of damaged equipment, disruptive downtime and



danger to personnel. Surprised that Brush stocks such a highly specialized preamplifier? Don't be. And don't be surprised either, when the folks at Brush promise to meet *your* direct-writing recording requirements with an optimum-performance system of "off-the-shelf" modular sub-systems. They can . . . better and faster than anyone else in the business. See for yourself. Write: Brush Instruments Division, Clevite Corporation, 37th & Perkins, Cleveland, Ohio 44114.



brush

CLEVITE

INSTRUMENTS DIVISION



Take Two...RCA-A15487 and -A15488

THEY'RE SMALLER

Oscillator, 4 3/8" x 7/8"
 Amplifier, 4 3/8" x 7/8"
 Combined Total Weight, 7 oz.

THEY'RE BETTER

2.5 Kw Peak Plate Input (at 0.001 Duty)
 500 Watts (Min.) Peak Power Output
 Duty Factor: 0.01 to 0.001. Meets All FAA (AIMS)
 Requirements Even Under Worst Combinations

Reflecting a new total capability for precision control of both tube and cavity, RCA introduces its new L-Band A15487 and A15488. These two developmental units are a pulsed pencil tube-cavity oscillator and a grounded-grid amplifier, respectively. Designed to transmit automatic traffic-control identification and altitude information for aircraft at 1090 Mc, the A15487 and A15488 demonstrate important system advantages. For example:

- They meet frequency stability requirements for antenna VSWR specifications with a mismatch up to a VSWR of 4.0:1.
- With a total weight of only 7 ounces, they are from 45% to 75% lighter than similar transponder cavities.

- They achieve their performance levels without exceeding a 1000-volt dc supply voltage. And they do so with greater efficiency over a wider temperature range—from -54° to +95°C (equipment ambient).
- Their integral design approach permits improved efficiencies as well as better life and stability at less weight and small size. In addition, this approach greatly simplifies maintenance and logistic requirements.

For more detailed information on the RCA-A15487 and RCA-A15488, see your RCA Representative. Also ask him about other RCA Microwave devices, such as the A15481, A15499, A15501, and A15511. Or write: Manager, Microwave Marketing, RCA Electronic Components & Devices, Harrison, N.J.



S-Band Type A15481
 Size: 1 3/8" x 3/4"
 Tuning: ±15 Mc
 Power Output: 105 Watts



A15499 Ceramic-Metal Pencil Triode. High Power Grid and Plate Pulse Service. Power Output: 1.8 Kw at 3300 Mc.



X-Band Type A15501
 Size: 2 1/2" x 1 1/2" x 1"
 Tuning: ±75 Mc
 Power Output: 5 mw

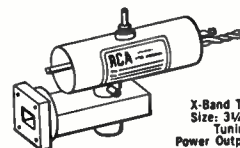

X-Band Type A15511
 Size: 3 1/4" x 2" x 1"
 Tuning: ±50 Mc
 Power Output: 100 mw



The Most Trusted Name in Electronics