

Electronics®

boosting voltage with power transistors: page 56

simple cell vies with complex parts: page 67

new production uses for electron beams: page 82

November 16, 1964

75 cents

A McGraw-Hill Publication

Below: now microelectronic circuits
are in a digital voltmeter, page 92

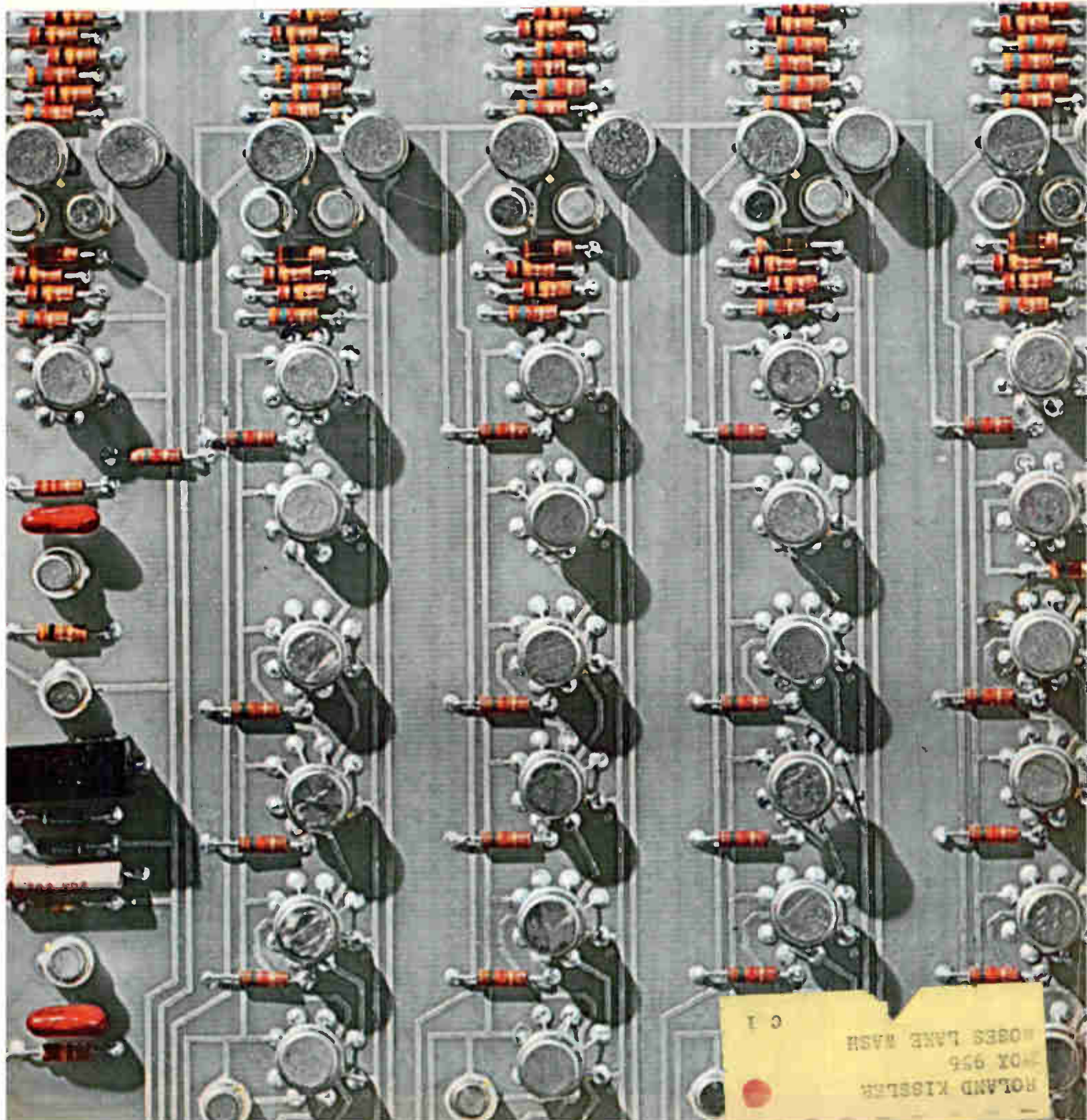



HI-FI



Transistor output; matches any PP transistor to 4, 8, 16 Ω speaker. Primary 48, 36, 12 Ω C.T.; 20 μ to 20 KC; 40 watts.

MINIATURE MIL TYPE



Metal case hermetically sealed to MIL-T-27B. Gold Dumet leads spaced on 0.1 radius, for printed circuit application.

CHOPPER



Magnetic shielded plus electrostatic shield for voltage isolation of 2×10^4 . Primary 200K C.T. to within 0.1%. Secondary 50K.

HIGH POWERED AUDIO



Low distortion 2.5 KW output transformer, PP 450 TH's 18,500 ohms C.T. to 24/6 ohms, 20 KV hipot. 520 lbs.

CATHODE FOLLOWER OUTPUT



Provides equal voltages to 5 loads. Primary inductance maintained to 5% with 20% change in DC unbalance and 30% change in AC voltages.

SPECIAL (CUSTOM BUILT) AUDIO TRANSFORMERS TO YOUR SPECIFICATIONS

HI-FREQUENCY CARRIER TO MIL-T-27B



Electrostatically shielded, humbucking, +30 dbm level. Within .5 db 250 cycles to 110 KC. 600/135; 600 centertapped to .1% tolerance.

HYBRID TRANSFORMER



Two transformers each 600 Ω primary, 40K Ω C.T. secondary 250 cycles to 5 KC within 1/4 db. 40 db isolation over band.

MICROMODULE



Life tested per micromodule specs: no failures. 10K Ω C.T. to 10K Ω , 100 mw from 400 μ to 20KC.

SUBMINIATURE MOLDED TRANSFORMER



Grade 3 with printed circuit leads for transistor application. 150 Ω to 150 Ω at 10 dbm level. Size 1/2 x 1/2 x 1/2"; weight 5 grams.

BOLOMETER TRANSFORMER



Primary 10 ohms, secondary 530K ohms, 230:1 ratio, response from 1/2 cycle to 25 cycles. 120 db magnetic shielding, plus full electrostatic shielding.

ULTRA-MINIATURE



Electrostatically & magnetically shielded output transformer 1/16 D. x 1/4" H. Pri. 15K Ω , Sec. 8K Ω ; max. level 50 mw; audio range response. To MIL-T-27B, grade 4.

Exceptional quality and reliability is provided in all UTC designs. Over 30 years of engineering knowledge and experience substantiated by extensive field performance assure the highest quality and most reliable components in the industry. Complete environmental testing facilities are incorporated to prove out new designs. Full analysis and evaluation of materials are conducted in UTC's Material and Chemical Laboratories. Rigid quality control measures coordinated with exhaustive statistical findings and latest production procedures results in the industry's highest degree of reliability. Range covered in Audio Transformers is from 0.1 cycles to 400 MC . . . microwatts to 50 KW.

MILITARY AND COMMERCIAL TYPES FOR EVERY PHASE OF THE ELECTRONICS ART

POWER TRANSFORMERS • AUDIO TRANSFORMERS • INDUCTORS • PULSE TRANSFORMERS • ELECTRIC WAVE FILTERS • LUMPED CONSTANT DELAY LINES • HIGH Q COILS • MAGNETIC AMPLIFIERS • SATURABLE REACTORS • REFERENCE UNITS

Write for catalog of over 1,200 UTC HIGH RELIABILITY STOCK ITEMS IMMEDIATELY AVAILABLE from your local distributor.



UNITED TRANSFORMER CORP.

150 VARICK STREET, NEW YORK 13, N. Y.

PACIFIC MFG. DIVISION: 3630 EASTHAM DRIVE, CULVER CITY, CALIF. EXPORT DIVISION: 13 EAST 40th STREET, NEW YORK 16, N. Y. CABLE: "ARLAB"

Circle 900 on reader service card

Only with 175A Plug-ins:

1 mv/cm at 20 mc, dual channel

50 mc bandwidth at 10 mv/cm

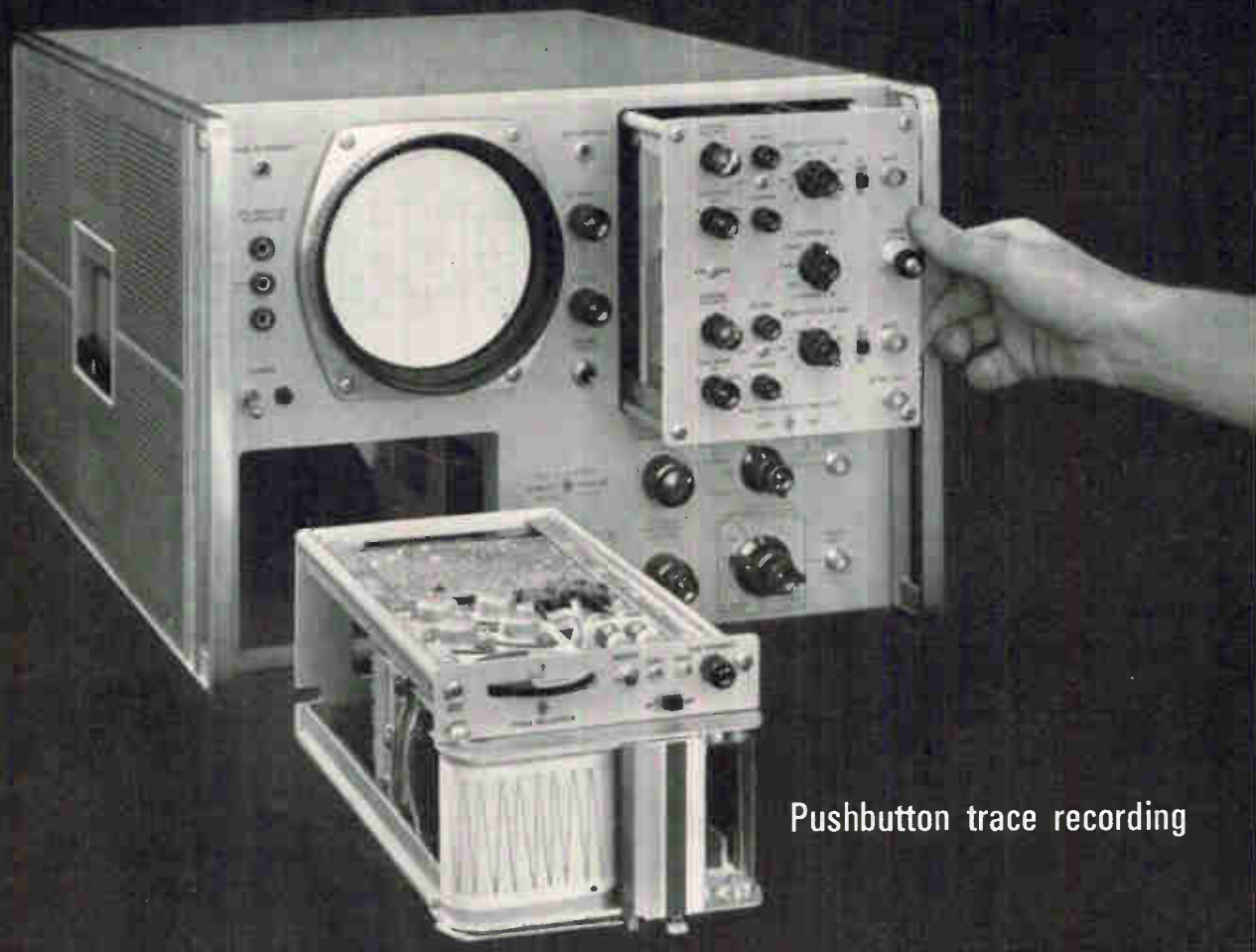

Pushbutton trace recording

comparison proves

the hp 175A is your best 50 mc scope buy! Unmatched measuring performance and value are yours with the 175A 50 MC Oscilloscope. First, many of its performance capabilities are exclusive and not available from any other scope manufacturer. Second, the 175A offers a dual plug-in versatility that means it can do more tasks for you than single plug-in scopes. Compare the 175A with other scopes, consider performance and versatility versus cost. You'll find your best all-around buy in the hp scope.

For example, the high-performance 1755A Dual-channel Vertical Amplifier, at only \$575, offers these sensitivities: 1 mv/cm at 20 mc bandwidth, 5 mv/cm at 40 mc or 10 mv/cm through 5 v/cm at 50 mc. Features include A + B operation, differential A - B use for common mode rejection, a sync amplifier for triggering on Channel B input. This unmatched performance for the price of the 1755B, plus the 175A main frame, \$1325.

Or for economy performance, the 1750B Dual-trace Amplifier, \$325, offers 50 mv/cm to 20 v/cm sensitivity, dc to 50 mc (7 nsec rise time). It lets you trigger on Channel B input, too.

Now compare the horizontal plug-in flexibility of the 175A: The 1784A Recorder plug-in permits permanent records of wave-

forms. It's easy to operate. Simply push a button to record. And it's economical, too. You can make 20 recordings for the cost of one photograph. Other horizontal plug-ins include a scanner for large trace recordings on an external recorder, sweep-delay operation, and time markers.

Other vertical plug-ins include a 50 mc single-channel unit, a 5 mv/cm differential amplifier, a high-gain amplifier and a four-channel plug-in with 40 mc bandwidth.

Compare performance versus cost of the 175A with any other available scope or combination of scopes. Then call your hp field engineer for a demonstration of the scope and plug-ins. Or write for complete information: Hewlett-Packard, Palo Alto, California 94304, Tel. (415) 326-7000; Europe: 54 Route des Acacias, Geneva; Canada: 8270 Mayrand Street, Montreal.

Data subject to change without notice. Prices f.o.b. factory.

**HEWLETT
PACKARD**



An extra measure of quality

New Sanborn Tape System

7 CHANNELS plus monitoring track

**6 ELECTRICAL SPEEDS without
capstan change**

40 db or better SIGNAL/NOISE RATIO

0.2% P-P FLUTTER

IRIG compatibility

for under \$9,000



Now you can have precision instrumentation tape system performance at *substantially lower cost than ever before*, with this completely new Sanborn 3900 Series incorporating a specially-designed Hewlett-Packard transport. The primary objective was to provide a highly flexible, reliably useful system with *stable* tape motion, *simple* operation and *no* maintenance — at a significantly *lower cost*. These objectives have been successfully accomplished, in a system which has:

- Greatly reduced interchannel crosstalk with a new magnetic head assembly design using improved shielding.
- High signal/noise ratio, gentle tape handling and reduced tape wear, through precisely controlled tape tension, driving and braking torques, and guide element designs.
- Plug-in solid-state electronics with record/reproduce amplifiers on the same cards, and equalization plug-ins necessary only for speeds to be used.
- No need for maintenance or lubrication, except for cleaning tape path.
- Built-in footage counter accurate to 99.95%.
- Quick, easy snap-on tape reel loading.
- Cabinet, rack or portable case mounting.

Check the key specifications here, then call your local H-P Field Engineering Office for complete details and prices. Or write Sanborn Company, Industrial Division, 175 Wyman Street, Waltham, Massachusetts 02154.

SERIES 3907A (7-channel), 3914A (14-channel)

SPEEDS	6, electrically controlled, pushbutton selected, 1 $\frac{1}{8}$ to 60 ips; other speed ranges optional. Max. start 2 sec., max. stop 1 sec.; $\pm 0.25\%$ max. variation in tape speed at nominal line frequency.
TAPE	7-channel $\frac{1}{2}$ " ; 14-channel 1" ; 2400 feet 1.5 mil, 3600 feet 1.0 mil; 4800 feet 0.65 mil; 10 $\frac{1}{2}$ " reels.
RECORDING MODES	Direct, FM or Pulse Record/Reproduce via interchangeable solid state plug-in electronics; 7-channels in 7 $\frac{1}{2}$ " panel space. Single-ended inputs, push-pull with optional coupler. Adjustable input/output levels.

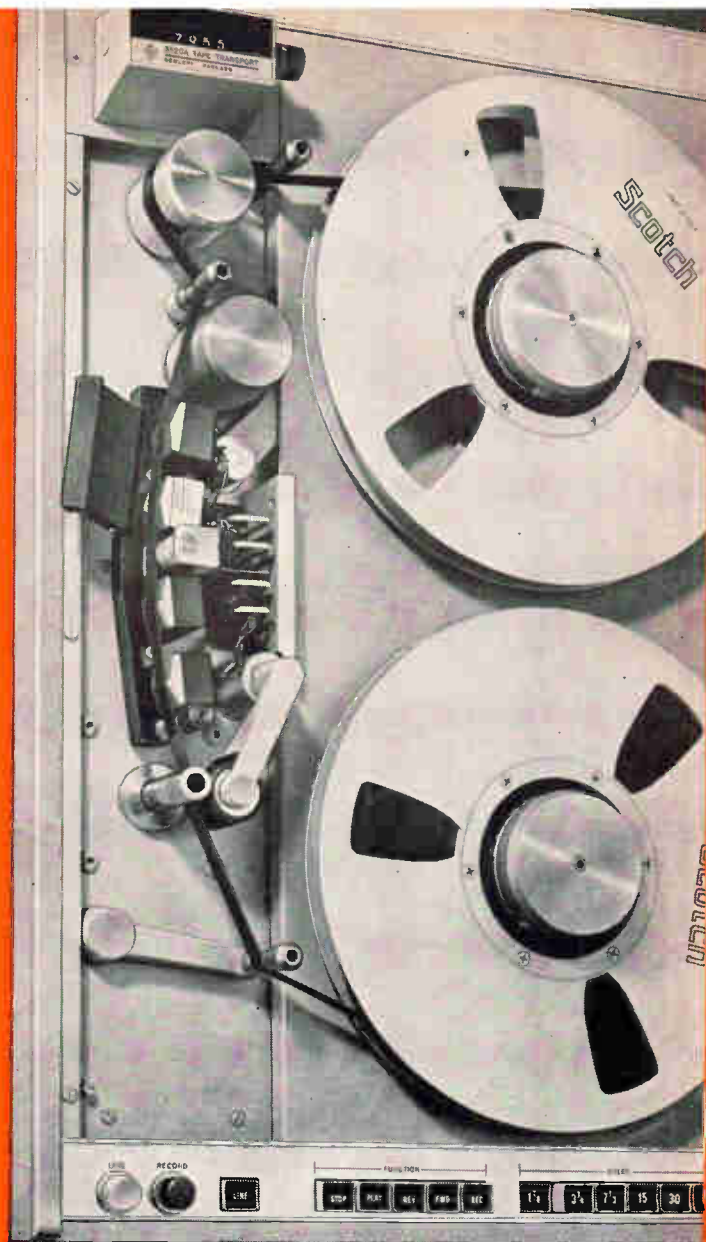

BANDWIDTH	RESPONSE	SIGNAL/NOISE RATIO (RMS)
Direct (60 ips) 100-100,000 cps	≈ 3 db	40 db
FM (60 ips) 0-10,000 cps (Wideband systems available soon — 250 KC direct, 20 KC FM)	$\approx 0, -1$ db	44 db without flutter compensation 48 db with flutter compensation
P-P FLUTTER (30 & 60 ips)	0-1 KC, 0.2% max. 0-5 KC, 0.5% max.	
CONTROLS	Power, Stop, Play, Reverse, Fast Forward, Record; all can be remotely controlled	

PRICES (f.o.b. Waltham, Mass.) (Systems represent two of many choices available. Prices are correspondingly lower for fewer speed filters, or where direct record/reproduce electronics are specified, and higher when filters for all six speeds are ordered.)

Complete 7-channel system for FM recording and reproducing, with filters for 3 speeds, extra (8th) channel for monitoring, and console cabinet: **\$8900**

Same system, for 14-channels: **\$13,370**

SANBORN
A DIVISION OF HEWLETT-PACKARD 

Electronics

November 16, 1964
Volume 37, Number 29

Electronics Review

Page 25	Nobel Prize winners	28	Designing filters
25	Auto design	30	Weather in 3-D
26	Defense cuts still hurt	30	Lightning watch
27	Seeing stars	32	Man or mouse?
28	Sapphire-growers' harvest	32	Phosphor and video

Electronics Abroad

175	Alpine ground station	177	Transflux or memory
175	Hit show	177	Trade fair in Peking
176	Vive la switch	178	Resuming the climb
176	Concorde dilemma	178	Decibel war

Probing the News

103	Westinghouse camera wins moon trip
105	Choosing an agency: as hard as finding a job
110	NASA's new manned space center
114	Semiconductor handle

Page 4	Readers Comment
8	People
10	Meetings
15	Editorial
17	Electronics Newsletter
37	Washington Newsletter
121	New Products
164	New Books
166	Technical Abstracts
173	New Literature

Technical articles

I. Design

Solid state	56	Boosting d-c voltage with silicon transistors High speed circuits in compact packages convert at high efficiencies Harry T. Breece III, Radio Corporation of America
Components	67	Simple cell competes with complex components Reversible and reusable, it generates delays, integrates and stores Herbert Feitler, Bissett-Berman Corp.
Circuit design	72	Designers casebook Chart supplies real and imaginary components; transistor circuit converts voltage to regulated frequency; variable resistor controls differential amplifier gain
Industrial electronics	75	Finding malfunctions before they happen Nondestructive testing equipment opens new applications for electronic equipment Robert C. McMaster, The Ohio State University
Manufacturing	82	Can electron beams produce incredibly small circuits? Researchers are trying to pack 100 billion thin-film tubes into a cubic inch, with electron beam techniques George Sideris, manufacturing editor

II. Applications

Instrumentation	92	Noise-proofing a digital voltmeter with microelectronics A new integration technique is made economically feasible by off-the-shelf components Stephen K. Ammann, Fairchild Semiconductor Div., Fairchild Camera & Instrument Corp.
------------------------	----	--

Title R registered
U.S. Patent Office;
© copyright 1964
by McGraw-Hill, Inc.
All right reserved,
including the right to
reproduce the contents
of this publication,
in whole or in part.

Electronics

Editor: Lewis H. Young

Senior editors

Technical: Samuel Weber
News: Kemp Anderson, Jr.

Senior associate editors: John F. Mason, George Sideris

Department editors

Advanced technology: George V. Novotny
Avionics: W.J. Evanzia

Circuit design: Michael Elia

Communications: Alexander A. McKenzie

Components: Michael F. Tomaino

Computers: Stephen B. Gray

Industrial electronics: Louis S. Gomolak

Instrumentation: George J. Flynn

Manufacturing: George Sideris

Military electronics: John F. Mason

New products: William P. O'Brien

Solid state: Jerome Eimbinder, G.G. Tirellis

Space electronics: Joel A. Strasser

Staff writers: Leon H. Dulberger, Peggy Jackson

Regional editors

Boston: Thomas Maguire, editor; Robin Carlson

Chicago: Cletus M. Wiley, editor; Leslie Krimston

Los Angeles: June Long

San Francisco: Laurence D. Shergalis, editor; Mary Jo Jadin

London: Derek Barlow, editor

Copy editors

Howard Rausch, Sally Powell, Stanley Zarowin

Graphic design

Art director: Saul Sussman

Assistant art director: John C. Wright, Jr.

Editorial production: Ann Mella, Sandra A. Le Mond

Editorial secretaries: Claire Benell, Mary D'Angelo, Lynn Emery,
Kay Fontana, Carolyn Michnowicz, Lorraine Rossi, Lorraine Werner

McGraw-Hill news service

Director: John Wilhelm; Atlanta: Fran Ridgeway; Chicago: Bruce Cross;

Cleveland: Arthur Zimmerman; Dallas: Marvin Reid;

Detroit: Donald MacDonald; Los Angeles: Michael Murphy,

Ron Lovell; San Francisco: Margaret Raiston, Ed. Addeo;

Seattle: Ray Bloomberg; Washington: George Bryant Jr., Glen Bayless,
Charles Gardner

McGraw-Hill world news service

Bonn: Richard Mikton; Brussels: Arthur Erikson; London: John Shinn;

Mexico City: Wesley Perry; Milan: Bruce Bendow;

Moscow: Donald Winston; Paris: Dan Smith;

Rio de Janeiro: Leslie Warren; Tokyo: Marvin Petal, Charles Cohen

Circulation manager: Hugh J. Quinn

Reprints: T.M. Egan

Publisher: C.C. Randolph

Electronics: November 16, 1964, Vol. 37, No. 29

Printed at 99 North Broadway, Albany, N.Y.

Second class postage paid at Albany, N.Y.

Subscriptions are solicited only from those actively engaged in the field of the publication. Position and company connection must be indicated on orders. Subscription prices: United States and Possessions and Canada, \$6.00 one year, \$9.00 two years, \$12.00 three years. All other countries \$20.00 one year. Single copies, United States and Possessions and Canada 75¢. Single copies all other countries \$1.50.

Published every other Monday by McGraw-Hill Inc. 330 West 42nd Street, New York, N.Y. 10036. Founder: James H. McGraw, 1860-1948.

Subscribers: The Publisher, upon written request to our New York office from any subscriber, agrees to refund that part of the subscription price applying to copies not yet mailed. Please send change of address notices, subscription orders or complaints to Fulfillment Manager, Electronics, at the address below. Change of address notices should provide old as well as new address, including postal zone number if any. If possible, attach address label from recent issue. Allow one month for change to become effective.

Postmaster: Please send Form 3579 to Fulfillment Manager, Electronics, P.O. Box 430, Hightstown New Jersey 08520

Readers Comment

Xlation

Since xmitter is a useful and frequently used abbreviation for transmitter, and xformer for transformer, I respectfully suggest that we adopt xistor as a universal abbreviation for transistor.

Rudolf F. Graf

New Rochelle, N.Y.

▪ How about xducer, xfer, xform, xient, xpose, xit and xom?

Games

Judging from the interest some time ago in number problems, I thought your readers might enjoy another problem on a little different scale. A friend of mine gave me the problem and it took me about an hour to work it out. Our chief engineer did it in about half the time.

(Ooddf)² = Wonderful. Or, the square root of wonderful is ooddf. Numbers 1 through 9 are used, but not zero.

Good luck!

Gary Hoonsbeen

Nortronics Co., Inc.

Minneapolis, Minn.

▪ To get in shape for reader Hoonsbeen's problem, try this old one: send + more = money.

Number prefixes

I wish to suggest a possible system for printing very large or very small numbers without the use of special typographical symbols or awkward and confusing prefixes. I have devised the following notation based on the vowel sequence a, e, i, o, u and the letters b and l:

ab = 10³, eb = 10⁶, ib = 10⁹, etc.

abab = 10¹⁸, abeb = 10²¹, abib = 10²⁴, etc.

al = 10⁻³, el = 10⁻⁶, il = 10⁻⁹, etc.

alal = 10⁻¹⁸, alel = 10⁻²¹, alil = 10⁻²⁴, etc.

Thus 15 nanoseconds equals 15 ilseconds, and 105 megacycles equals 105 ebcycles.

The advantages of this system, which might easily replace many if

New from Sprague!

DUET* 50-VOLT DUAL-EMITTER CHOPPER TRANSISTORS

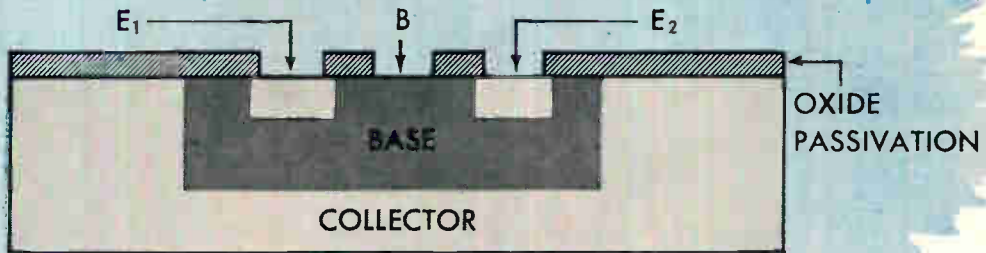

for maximum protection...

3 times the emitter voltage previously available!

**COMPARE THESE PARAMETERS
WITH THOSE OF
ANY OTHER DUAL-EMITTER!**

Type No.	BV_{EEO}	I_{EEO}	V_o
3N93	50V	1nA	50 μ V
3N94	50V	1nA	100 μ V
3N95	50V	1nA	200 μ V
3N90	30V	1nA	50 μ V
3N91	30V	1nA	100 μ V
3N92	30V	1nA	200 μ V

*Trademark

Sprague DUET* low level dual-emitter choppers are fully passivated PNP silicon planar epitaxial transistors. They feature guaranteed emitter voltage of up to 50 volts, three times the emitter voltage previously available.

The Sprague DUET* is ideally suited for applications such as low-level chopping, multiplexing, comutating, etc., where low leakage current, low saturation resistance, and close matching are required. The DUET* is a product of Sprague's extensive research effort in silicon planar epitaxial and silicon based microcircuit technology.

The high emitter voltage ratings mean circuit design simplification, improved circuit reliability, and reduction in the number of components required. When designing chopping circuits where maximum voltage is required, do it with DUET*.

For complete information, write to Technical Literature Service, Sprague Electric Company, 35 Marshall Street, North Adams, Mass. 01248

SPRAGUE COMPONENTS

TRANSISTORS
CAPACITORS
RESISTORS
INTEGRATED CIRCUITS
THIN-FILM MICROCIRCUITS
455-4156

PULSE TRANSFORMERS
INTERFERENCE FILTERS
PULSE-FORMING NETWORKS
TOROIDAL INDUCTORS
ELECTRIC WAVE FILTERS

CERAMIC-BASE PRINTED NETWORKS
PACKAGED COMPONENT ASSEMBLIES
BOBBIN and TAPE WOUND MAGNETIC CORES
SILICON RECTIFIER GATE CONTROLS
FUNCTIONAL DIGITAL CIRCUITS



*Sprague and ® are registered trademarks of the Sprague Electric Co.

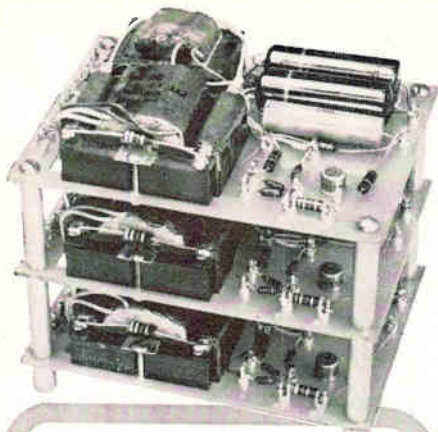

VecTroL[®] SILICONTROL[®] OPEN-CARD SCR GATE DRIVES

- Meet triggering requirements for completely balanced SCR firing in 3-phase applications.
- Particularly useful in control of d-c motors, 3-phase a-c motors, high-slip or solid rotor 3-phase induction motors, polyphase rectifier circuits, and similar applications.
- Gate firing characteristics are balanced to within 5° over full 180° excursion in all pulse patterns.
- Each gate signal output is a constant amplitude pulse which provides a full range of control at all phase angles without SCR damage.
- During anode negative periods, gate signal is suppressed to prevent thermal runaway.
- Pulse amplitude is 3.5 volts minimum into a 32 ohm load—never exceeds 10 volts at 10% above rated line voltage.
- Components terminal-mounted on fiberglass cards, assembled in tiers for easy installation in minimum space.

For complete technical data, write for Engineering Bulletin 85520 to the Technical Literature Service, Sprague Electric Co., 35 Marshall St., North Adams, Mass. 01248

45V-4130R2



Sprague and *®* are registered trademarks of the Sprague Electric Co.

not all those now in use, may be briefly stated as:

1. Mnemonic value; "b" stands for "big," "l" stands for "little," and the vowel sequence is well known.

2. The prefixes themselves are short, even for extremely large or small values.

3. The sequence can easily and logically be expanded to any scientifically meaningful number.

As for pronunciation, I would suggest the short sounds of the vowels for aesthetic reasons, but this is not a crucial matter.

Randall Taubenheim
Bell & Farrell, Inc.
Madison, Wis.

Laser welders

Your otherwise comprehensive laser welder article of Oct. 19 ["Laser welders: out of the lab and into the factory," p. 96] failed to mention the Lear Siegler, Inc., laser systems center at Ann Arbor, Mich.

This laser team is also producing welders and was in fact the first to pierce metal with a laser—the famous razor-blade experiment—in 1961.

Ed Bruening
Laser Systems Center
Lear Siegler, Inc.
Ann Arbor, Mich.

▪ Was this the feat that launched a thousand imitators, and led to the coining of that splendid name for the unit that measures a laser's output power, the gillette?

The article was not intended as a detailed survey, but rather as news of some of the more recent developments.

Long-pulse welding

I read with interest your article in the Oct. 19 issue regarding laser welders and I do not agree with what you implied the state of the art to be. We have two companies that are involved in welding, both electron-beam (Applied Energy Co.) and laser welders (Applied Laser, Inc.). We presently are basing our laser-welding efforts on long pulses and high repetition rates. We found that welds approaching 10 pulses per second have a completely different characteristic than those in single-shot,

one-pulse-per-second systems.

We have made extensive studies in schemes of making deeper penetrations and, with 20 joules, have been able to weld materials up to thicknesses of 0.070 inch and achieve complete penetration. These results are completely dependent upon the flash lamp waveform and the focusing of the laser beam. Using these techniques, we have been able to actually run a bead and raise the metal up from the surface, rather than crater the metal.

Our model 1010c2 laser system can be used for welding at 10 joules per pulse, four pulses per second, and the whole system is priced at less than \$15,000.

We presently are developing a laser system which we feel to be within the present state of the art and capable of 20 pulses per second with 10 joules per pulse and priced about \$45,000. We expect to make butt welds up to one-quarter-inch thickness with this type of device.

Glenn A. Hardway
Applied Lasers, Inc.
Stoneham, Mass.

Wrong rating

I realize metal-oxide-semiconductor field-effect transistors are good, but I was surprised to read on page 18 of your Oct. 19 issue that a competitor has a 25-volt, 300-ampere unit. And in a TO-18 package, too.

Dick Lee
Siliconix Inc.
Sunnyvale, Calif.

▪ Sharp-eyed reader Lee is right; it should be 300 milliamperes.

Colored-light organ

[Lajos de] Bodroghy's letter about his colored-light organ [June 15, p. 6] shows ignorance about the three different and measurable quantities of color; luminous flux, purity and dominant wavelength corresponding to the color sensations of brightness, saturation and hue, respectively. He lacks knowledge of the curves of response (sensitivity) of the eye to the three primary colors, of broadband versus frequency filters, of the wavelength of visible light. . . .

S.A. Russo
Belo Horizonte, Brazil

Our SCS Counter is Bi-directional Planar Passivated Silicon Controlled Switch SCS

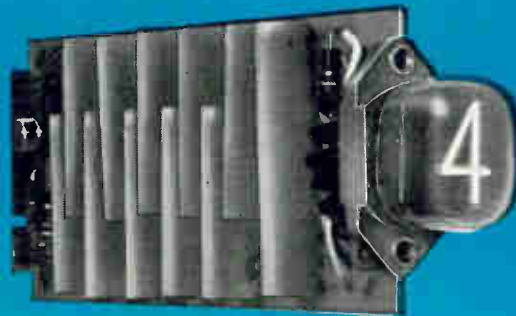

but that's just part of the story.

Our new counter, the BIP-8054, takes advantage of the remarkable planar passivated silicon controlled switch to give you a completely reversible decade counter that is fast (operates to 110 KC and there's no cascade delay time) — highly reliable (only ten active components greatly reduce circuit complexity and over-all component count) — flexible (it counts up or down in response to a command pulse on the control line or as directed by non-coincident pulses in forward and reverse lines) — low cost (under \$100 in small quantities and price includes NIXIE® Tube readout making it ideal for control applications such as machine tool control, X-Y plotting, etc. which until now were tied to electromechanical techniques because of the high cost of electronic devices).

Write for complete specifications on our SCS counters. These reversible counters are so good, they get you coming and going.



Burroughs Corporation

ELECTRONIC COMPONENTS DIVISION
PLAINFIELD, NEW JERSEY

WORLD'S HIGHEST POWER TETRODE



The New Vapor-Cooled ML-8545

Another Machlett innovation. The ML-8545 is a general-purpose tetrode capable of 300 kW continuous output as a Class C amplifier or oscillator at frequencies to 50 Mc. Maximum plate input is 420 kW, and is substantially higher during momentary overloads or intermittent operation.

Applications include:

- High-power broadcast and communications
- All-purpose rf generation
- Particle acceleration

For further data on the ML-8545 and the ML-8546, water-cooled version, write: The Machlett Laboratories, Inc., Springdale, Conn. An affiliate of Raytheon Company.



ELECTRON TUBE SPECIALIST

People

Sylvania Electric Products, Inc., has selected **Eugene J. Vigneron** to spearhead its drive for conversion from defense to commercial products. Vigneron sees his job—vice president and general manager of the Commercial Electronics division—as one of “using the defense resources of the company—both personnel and technology—and applying them to the commercial and industrial electronics business.”



The division was created by splitting the former Home and Commercial Electronics division into two branches.

Vigneron, 47 years old, has been with the company, a subsidiary of the General Telephone & Electronics Corp., since 1936. He's had management experience in both defense and commercial products.

Eugene H. Miller could claim most of the credit for the tryout that electron-beam techniques will soon be getting in the Microcircuit Processor system (see p. 82). But he won't. It's difficult to get him to talk about his role in this project or in other microcircuit manufacturing development programs. As a senior project engineer in the Materials Laboratory at Wright-Patterson Air Force Base, Ohio, he's responsible for supervising government-sponsored work on a number of advanced materials and processing contracts. Miller's government career parallels the advance of microelectronics. The ink was hardly dry on his bachelor's degree in physics (John Carroll University) in 1953 when he began working on some of this country's first thin-film-component programs. Around 1958, he began to focus on thin-film and integrated circuits. He began to propose electron-beam techniques in 1960.



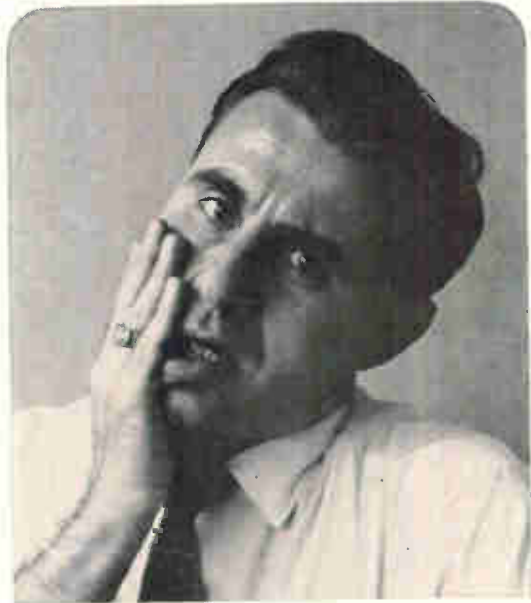

**Ray Colucci is the man who improves our DAP germanium line.
He's just about worked himself out of a job.**

Over the years he's refined, improved, tested, proven reliability and generally made our Diffused Alloy Power transistor line the best available. But he's getting a little concerned about what he can do for you (and us) next.

He's broadened the line so we have a 3, 10, 25 and 50 amp series (with P_c from 5 to 170 watts and collector voltages up to 200 volts), with DC current gain (h_{FE}) running as high as 140. And, for high current switching, they'll handle 330, 1200, 3000 or 4500 watts (3, 10, 25 & 50 A) in microseconds. Ray has complete reliability data on all types (we have 33 different 2N types in the JEDEC TO-3, TO-5, TO-37 and TO-41 packages). He can meet military specifications on the 25 amp DAP, and he's even worked out some special features that make the DAP very attractive for TV deflection circuits. (They're used a

lot in ignition systems, core drivers, hi-fi amplifiers, ultrasonics and power converters, too.)

And Ray helped us work out our SOAR (Safe Operating Area) method of specifying switching transistors. As long as our units are operated within the SOAR envelope, secondary breakdown is avoided. The 2N type number listing shows the appropriate SOAR envelope values for these germanium transistors, in all cases for switching times smaller than 50 μ sec from saturation to cutoff, $T_j \leq 110^\circ\text{C}$, and a turn-on and turn-off base current smaller or equal to one-tenth of the maximum specified collector current.

But after all of this, Ray hasn't given up. He's busy working on more DAP improvements. So next time

you're talking to your Bendix sales office, ask what Ray has done lately. It might be a money maker for you.

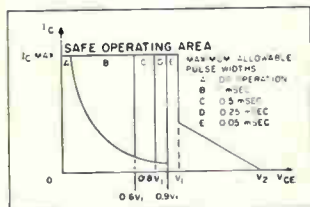

TYPE NUMBER	Ic Max A	V1 V	V2 V
2N2284, 2N2469	3	70	110
2N1073B, 2N2290	10	70	110
2N1430	10	80	120
2N1653, 2N2287	25	60	100
2N2638	25	80	120
2N2359	50	50	90

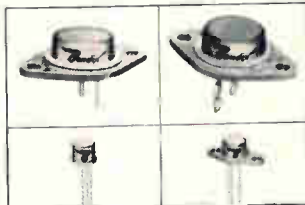

Bendix Semiconductor Division
HOLMDEL, NEW JERSEY



Baltimore (Towson), Md.—(301) 828-6877; Chicago—(312) 637-6929; Dallas—(214) 357-1972; Detroit—(313) Jordan 6-1420; Holmdel, N. J.—(201) 747-5400; Los Angeles—(213) 776-4100; Miami Springs, Fla.—(305) 887-5521; Minneapolis—(612) 926-4633; San Carlos, Calif.—(415) LYtell 3-7845; Syracuse, N. Y.—(315) 474-7531; Waltham, Mass.—(617) 899-0770; Export—(212) 973-2121; Cable: "Bendixint," 605 Third Avenue, New York; Ottawa, Ont.—Computing Devices of Canada, P.O. Box 508—(613) TALbot 8-2711.

New from Sprague!

A Molded Solid Tantalum Capacitor That Makes Sense!

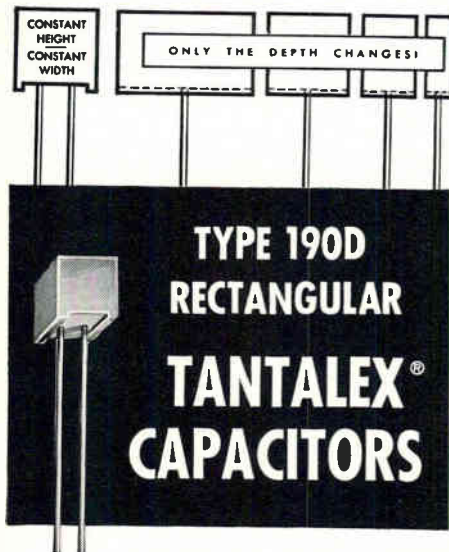

Especially qualified for applications such as printed circuits, where space is at a premium and must be fully utilized.

- Only the depth changes from case to case — face area remains constant. Well-suited for automatic insertion.
- Carefully selected height (0.350") corresponds with most acceptable maximum height in normal printed board spacing.
- Uniform width permits neat, space-saving alignment on wiring board. Lead spacing based on popular 0.100" grid.
- Tough molded case with excellent dielectric properties.
- Stand-off feet permit air circulation, preventing moisture and solvent traps.



For complete technical data, write for Engineering Bulletin 3531 to the Technical Literature Service, Sprague Electric Co., 35 Marshall St., North Adams, Mass. 01248.

45C-414



Sprague and *®* are registered trademarks of the Sprague Electric Co.

Meetings

Annual Science Conference, Belfer Graduate School of Yeshiva University; Hotel Astor, New York, Nov. 16-17.

Bioastronautics and the Exploration of Space International Symposium, Aerospace Medical Div., Southwest Research Institute; Granada Hotel, San Antonio, Tex., Nov. 16-18.

Engineering in Medicine and Biology Annual Conference, BME/IEEE, ISA; Cleveland-Sheraton Hotel, Cleveland, Nov. 16-18.

Machine Tools Industry Annual Conference, MTI-TC, IEEE; Statler Hilton Hotel, Hartford, Conn., Nov. 16-18.

Space Simulation Testing Conference, AIAA, PTGAS/IEEE; Pasadena, Calif., Nov. 16-18.

Magnetism and Magnetic Materials Conference, IEEE, AIP; Radisson Hotel, Minneapolis, Nov. 16-19.

Microelectronics and Large Systems Symposium, Information Systems Branch of ONR, Univac div. of Sperry Rand Corp.; Dept. of the Interior Building, Washington, Nov. 17-18.

Tri-Service Conference on Electromagnetic Compatibility, U.S. Army, Navy and Air Force; Museum of Science and Industry, Chicago, Nov. 17-19.

American Astronautical Society National Meeting, AAS; Kresge Auditorium, Massachusetts Institute of Technology, Cambridge, Mass., Nov. 18-19.

Definition and Measurement of Short Term Frequency Stability Symposium, NASA, IEEE, Goddard Space Flight Center, Greenbelt, Md., Nov. 23-24.

Mid-America Electronics Conference (MAECON), Kansas State University, Hotel Continental, Kansas City, Mo., Nov. 23-24.

1964 Winter Annual Meeting, Nuclear Engineering Div. of ASME; Statler-Hilton Hotel, New York, Nov. 29-Dec. 4.

New Horizons in Solid State Electronics, Rochester Institute of Technology; Schraffts Motor Inn, Rochester, N.Y., Nov. 30-Dec. 2.

The Road to Commercial Electronics: A Conference on Converting Military Capabilities to Civilian Markets, Electronics Magazine, IIT Research Institute; Grover M. Hermann Hall, Chicago, Dec. 1-2.

Professional Technical Group on Vehicular Communications Annual Conference, IEEE; Sheraton Hotel, Cleveland, Dec. 3-4.

General Systems Knowledge Symposium, Society for General Systems Research, IEEE; American Association for the Advancement of Science, Montreal, Dec. 26-31.

Reliability and Quality Control National Symposium, ASQC, IEEE, IES, SNT; Hotel Fontainebleau, Miami Beach, Jan. 12-14.

Fundamental Phenomena in the Material Sciences Annual Symposium, Ilikon Corp.; Sheraton Plaza Hotel, Boston, Jan. 25-26.

Winter Power Meeting, PEEC/IEEE; Statler Hilton Hotel, New York, Jan. 31-Feb. 5.

Winter Convention on Military Electronics, PTGMIL & L.A. Section of IEEE; Ambassador Hotel, Los Angeles, Feb. 3-5.

Electrical/Electronic Trade Show, Electrical Representatives Club, Electronic Representatives Assn.; Denver Auditorium Arena, Denver, Feb. 15-17.

Solid-State Circuits International Conference, University of Pennsylvania, IEEE; University of Pennsylvania and Sheraton Hotel, Philadelphia, Feb. 17-19.

Particle Accelerator Conference, AIP NSG/IEEE, NBS, USAEC; Shoreham Hotel, Washington, March 10-12.

Call for papers

National Aerospace Electronics Conference (NAECON), IEEE; Dayton, Ohio, May 10-12. Dec. 15 is deadline for submitting both a 250 to 300 word abstract and a biographical sketch in triplicate to Francis J. Catanzarite, NAECON Papers Chairman, 493 Darnell Drive, Dayton, Ohio 45431.

P.I.B. International Symposium on System Theory, Polytechnic Institute of Brooklyn, AFOSR, ONR, ARO; New York, April 20-22. Jan. 15 is deadline for submitting papers to Jerome Fox, Secretary, Symposium Committee, Polytechnic Institute of Brooklyn, 333 Jay St., Brooklyn, N. Y. 11201.

ASTRODATA

ADVANCED SOLID STATE AMPLIFIERS FOR YOUR CONTROL AND INSTRUMENTATION APPLICATIONS



ASTRODATA advanced design instrumentation amplifiers raise state-of-the-art standards to higher levels for measurement... conditioning... monitoring... indicating... control.

For custom designs, Astrodata's extensive experience provides a well-qualified capability for satisfying your specific performance needs.

Model 884 Wideband (dc to 100 kc) Floating, Guarded Amplifier...
Model 885 Wideband (dc to 10 kc) Differential, Isolated Amplifier...

high-gain/performance amplifiers for low-level, wideband systems at lowest cost. Completely transistorized, these state-of-the-art amplifiers use field-effect transistors in place of mechanical choppers to achieve lowest drift rate, freedom from microphonics and maximum reliability. Gain range to 3000 and a continuously adjustable 10-turn vernier control are provided as standard features. Two differential models with ± 10 ma or ± 100 ma output current from a low impedance can drive long lines, A to D converters, multiplexers, galvanometers or tape recorders. Transfer characteristic is optimized to provide wide frequency response with minimum overshoot, fastest settling and overload recovery times, and minimum phase shift. Common mode rejection is greater than 120 db with up to ± 300 volts dc or peak ac common mode voltage.

All models have built-in power supplies, feature drift less than $1 \mu\text{V}$ per week, wideband noise less than $4 \mu\text{V rms}$, linearity better than 0.02%. Can be used either separately or in the same rack module with Model 1155 Universal Signal Conditioning Unit or Model 890 Electronic Filter to form complete, isolated signal conditioning channels.

Model 885-135 Differential Amplifier to drive multiplexers, tape recorders and A to D converters.

GAIN RANGE: 1 to 3000
INPUT RESISTANCE: 100 megohms
BANDWIDTH: dc to 10 kc
OUTPUT: ± 5 volts at ± 10 ma
DRIFT: $\pm 1 \mu\text{V}$ for 40 hours
TEMP. COEFF: $\pm 0.2 \mu\text{V}/^\circ\text{F}$
NOISE: $2 \mu\text{V rms}$



Model 885-235 Differential Amplifier to drive data systems, long lines and galvanometers.

GAIN RANGE: 3 to 3000
INPUT RESISTANCE: 100 megohms
BANDWIDTH: dc to 10 kc
OUTPUT: ± 10 volts at ± 100 ma
DRIFT: $\pm 1 \mu\text{V}$ for 40 hours
TEMP. COEFF: $\pm 0.2 \mu\text{V}/^\circ\text{F}$
NOISE: $2 \mu\text{V rms}$



Model 1155 Universal Signal Conditioning Unit

Uses plug-in circuit cards to supply excitation or bias, attenuation, circuit completion, balancing, filtering and calibration. Used with low-level or high level signals from thermocouples, strain gages, resistance temperature sensors, thermistors, potentiometers and voltage sources. Can function separately or in same rack module with Models 884 or 885 Amplifiers or Model 890 Filter to provide complete conditioning, calibration and normalizing of transducer signals.



Model 126-101 Charge Amplifier. All solid-state unit with internal dynamic calibration.

INPUT RESISTANCE: 10,000 megohms
INPUT RANGE: 1 to 10,000 psi, g lbs
GAGE FACTOR RANGE: 1 to 11 or 10 to 110 pcmb per psi, g or lb, continuously adjustable
FREQUENCY RESPONSE: 0.3 cps to 150 kc
STATIC CALIBRATE MODE: Extends response virtually to dc for dead weight testing.



Model 120 Nanovolt Amplifier gives you high-gain/low-noise amplification for seismic transducer signals, cryogenic studies, thermocouple or strain gage signals.

GAIN RANGE: 200 to 1,000,000
BANDWIDTH: dc to 100 cps
NOISE: $0.05 \mu\text{V rms}$
INPUT RESISTANCE: 1 megohm
OUTPUT LEVEL: 0 to ± 5 volts at ± 5 ma



Model 121Z Nanovoltmeter provides $0.1 \mu\text{V}$ full scale bridge balance detector or thermocouple indicator for standards and calibration work, in the field and in laboratories.

FULL SCALE RANGES: $\pm 0.1 \mu\text{V}$ to ± 100 mv
INPUT RESISTANCE: 1 megohm
ZERO SUPPRESSION: $\pm 0.5 \mu\text{V}$ to ± 5 mv
AMPLIFIER OUTPUT: Gain 30 to 3 million, delivers ± 5 volts at ± 5 ma
Overload Indicator



Contact your Astrodata engineering representative for a demonstration... or write today for technical literature giving complete specifications.



ASTRODATA INC.

P.O. Box 3003 • 240 E. Palois Road, Anaheim, California • 92803

TEL. (714) 772-1000 • TWX 714-776-3760 • FAX • TELEX 06-78828 • CABLE ADDRESS • ASTRODATA, Anaheim

100 mc

10 mv/cm

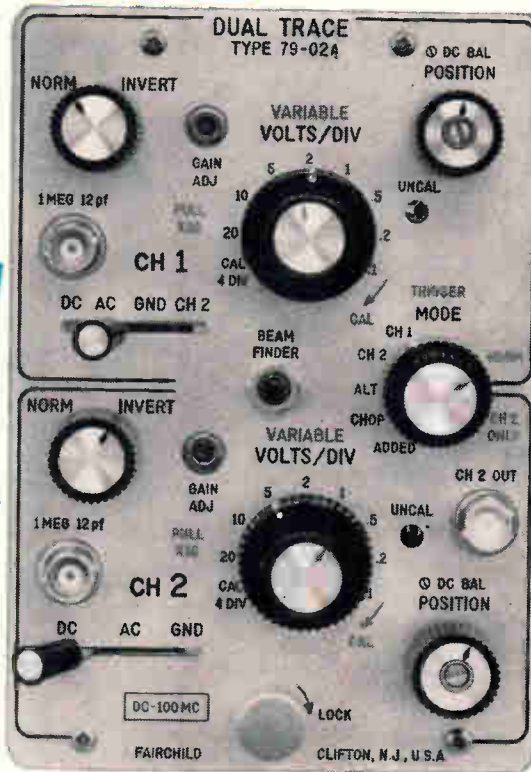

EVERY SCOPE EXCEPT FAIRCHILD HAS NOW DEPRECIATED A BIT

New all solid state dual trace plug-in gives Fairchild scopes 100 mc bandwidth and 10 mv/cm sensitivity.

Fairchild has just extended the capabilities of Series 765 oscilloscopes to new ground. Now these scopes—alone—meet the higher bandwidth and sensitivity demands of so many present-day applications. Every Series 765 scope, old or new, becomes an even more versatile instrument than ever. And all solid state design affords size, weight and reliability advantages no tube scope can match. **Another first from Fairchild...**a solid state scope that fully outperforms tube scopes in all specifications. A new dual trace plug-in—Type 79-02A—provides full 100 mc bandwidth with sensitivity of 10 mv/cm. This combination of bandwidth and sensitivity is unique; no other direct-reading scope available today can approach it.

If the gap is widening between your oscilloscopes and your measurement needs, you are losing money. Update scope equipment today with the most advanced, most versatile instrument you can buy—the fully transistorized Fairchild 765 Series with its choice of 20 plug-ins—now including the Type 79-02A dual trace, 100 mc unit.

See it demonstrated in your plant. A limited number of Type 79-02A plug-ins have been allocated to Fairchild field engineers for in-plant demonstrations. Phone or write to arrange for a showing to your staff. Your request will be telegraphed to the Fairchild field engineer in your area, and he will call you to set a date.

BEFORE YOU BUY ANY HIGH FREQUENCY SCOPE, KNOW HOW FAIRCHILD CAN HELP WITH YOUR TEST AND MEASUREMENT PROBLEMS

Fairchild's new Type 79-02A dual trace 100 mc plug-in for Series 765 oscilloscopes meets a need for higher speed and sensitivity in computer, radar and communications work, or for solid-state investigations. The Series 765 with its other available plug-ins is not only the most versatile of present-day scopes; its capabilities can always be updated because all functional circuitry is in the plug-ins—the main frame serves only as a power supply and indicator. While the Series 765 is in every sense a quality laboratory instrument, its transistorized circuitry, rugged construction, light weight and complete reliability make it preferred for use in the field.

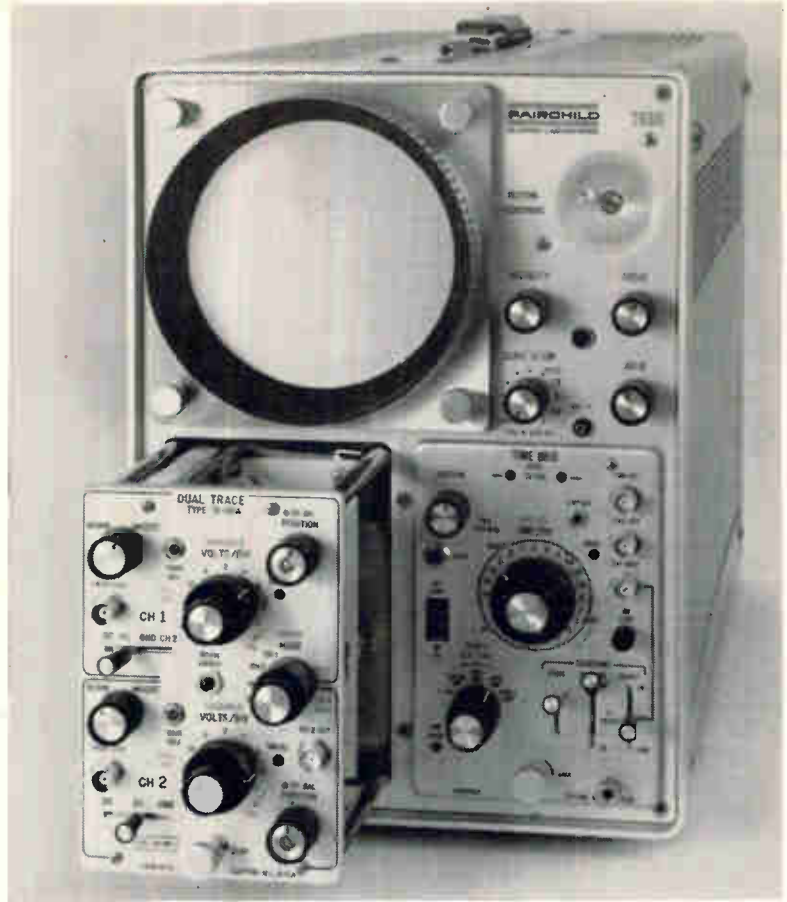

Compare these features of the Type 79-02A plug-in with the capabilities of any wide band dual trace scope.

BANDWIDTH

Direct coupled: 0.1V/cm DC to 100 mc down 3 db; 0.01 V/cm DC to 90 mc down 3 db. Capacitively coupled: Down 3 db at 16 cycles. Rise time: 3.5 nanoseconds.

SENSITIVITY

Calibrated Operation Provided by frequency-compensated attenuator in 8 steps of 1, 2 and 5 sequence from 10 mv/cm to 20 v/cm when Variable Gain Control is set to CAL. Attenuator accuracy is 3%.

Uncalibrated Operation Continuously variable from 10 mv/division to 50 v/division. Variable Gain Control permits 2½ to 1 continuous sensitivity adjustments between VOLTS/DIV steps, extends the 20 v/div. range to 50 v/div.

Cascaded Amplifier Operation 1 mv/cm down 3 db at 50 mc.

Output Range Full 6 cm of vertical output scan. Overshoot and preswing each less than 3% at 4 cm scan.

INPUT DATA

Input Coupling Channel 1 has 4-position lever switch for AC, DC, Off, and Channel 2 cascaded input.

Channel 2 has 3-position lever switch for AC, DC and Off.

Polarity Inversion Provided in both channels.

Input Impedance 1 megohm shunted by 14 pf.

CALIBRATION

Attenuator includes CAL position which applies line-frequency square wave signal directly to input amplifier. Calibration is

accomplished with 4 divisions of vertical deflection.

OPERATING MODES

5-position switch enables selection of following displays: (1) Channel 1 only; (2) Channel 2 only; (3) Channels 1 and 2 switched alternately; (4) Channels 1 and 2 in chopped operation. Two chopping rates are provided, selected by internal slide switch. Chopping rates are 100 Kc and 1 Mc. Switching transients on CRT are automatically blanked; (5) Channel 1 plus Channel 2. Use of polarity inversion switches give Channel 1 minus Channel 2 or Channel 2 minus Channel 1 presentation.

SIGNAL DELAY

230-nsec balanced distributed bifilar helical delay line is sufficient to view base line and leading edge of the signal triggering the time base.

INTERNAL TRIGGER SELECTION

Two-position switch provides trigger take-off after the switch stage (Ch. 1 and Ch. 2) or take-off from Channel 2 only.

CASCADED AMPLIFIER OPERATION

An internal connection from Channel 2 OUT connector to Channel 1 input connector can provide series connection of Channel 1 and Channel 2 amplifier. Channel 2 OUT BNC provides output of 0.5v.

ENVIRONMENTAL SPECIFICATIONS (OPERATING)

0°C to 50°C; 30 g shock; 2 g vibration from 10 to 55 cps; altitude to 15,000 ft.

Let the Fairchild field engineer show you how you can update your precision instruments with new generation Fairchild scopes. Call your local Fairchild field engineer for a demonstration in your laboratory or ask him for application assistance and detailed specifications. Write Fairchild Scientific Instrument Dept., 750 Bloomfield Ave., Clifton, N. J.

FAIRCHILD

DU MONT LABORATORIES
SCIENTIFIC INSTRUMENT DEPARTMENT

NOW PLANAR II in a HI-REL INSULATED GATE M-O-S FET

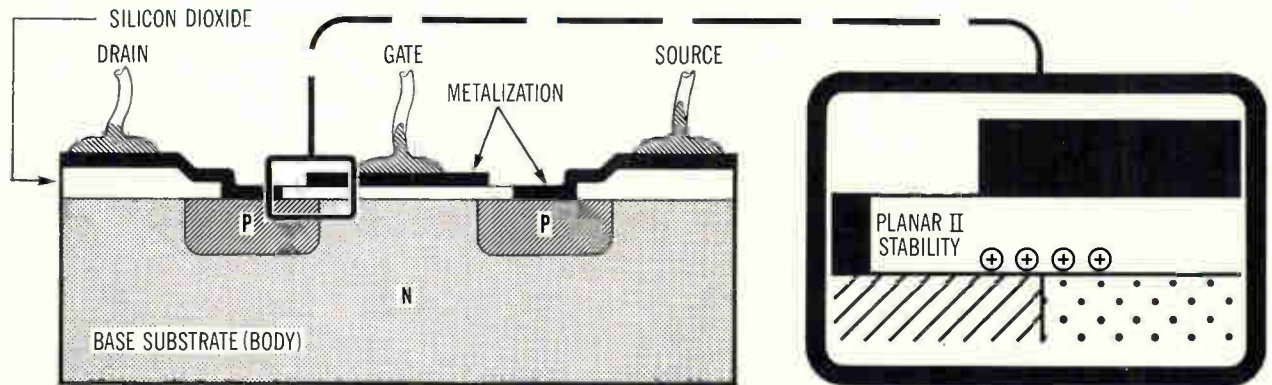

Cross-section shows insulated gate structure of Fairchild's new FI-100 – a voltage-controlled, self-biasing, hole-conducting, Metal-Oxide-Silicon field effect transistor with enhancement mode operation – with new high reliability because of Fairchild's PLANAR II process.

The PLANAR II process eliminates channel development and locks the surface charge by prohibiting ion movement even under intense fields (over 1,000,000 volts/cm) at temperatures up to 200°C. The result is an improvement in stability by at least three orders of magnitude – and unprecedented reliability for M-O-S devices.

New FI-100 P-Channel M-O-S FET features 10^{15} ohms DC input resistance and is guaranteed from -55°C to 175°C operating temperature, -55°C to 200°C storage temperature.

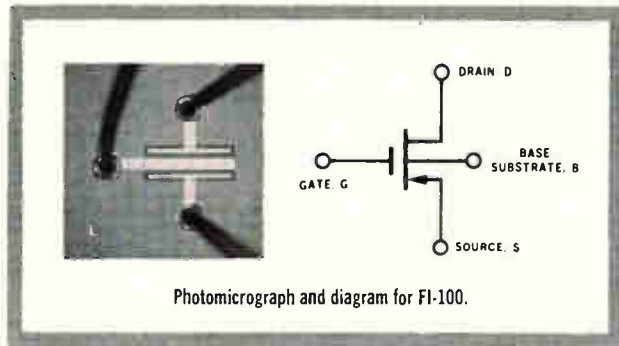

Photomicrograph and diagram for FI-100.

- High Voltage: $BV_{DSS}=50V$
- Extremely low and extremely stable leakage: $I_{DSS}=50\text{ pA}$
- Low input and output capacities: $C_{gs}=2.5\text{ pf}$; $C_{gd}=0.4\text{ pf}$; $C_{ds}=1.9\text{ pf}$
- Proven stability under both positive and negative gate bias
- Enhancement mode operation

4 BASIC APPLICATIONS: (1) The FI-100 makes a highly efficient digital switch with almost infinite fan-out and low power drain. (2) In linear amplifiers, it eliminates the need for large by-pass or coupling capacitors. (3) For chopper or multiplex switch use, it features a high ratio of "off" to "on" impedance and no offset voltage. (4) It features high input impedance in amplifiers. Write for data sheet containing complete specifications.

IMMEDIATELY AVAILABLE FROM DISTRIBUTOR STOCKS

FAIRCHILD
SEMICONDUCTOR

FRANCHISED DISTRIBUTORS

AVNET Chicago, Ill., 678-8160; Toronto, Canada, 789-2621 • BOHMAN Orlando, Fla., 425-8611 • CRAMER ELECTRONICS Newton, Mass., WO 9-7700; Hamden, Conn., 288-7771 • CRESCENT ELECTRONIC SALES Orlando, Fla., 423-8586 • DART SALES Syracuse, N.Y., GL 4-9257; Buffalo, N.Y., 684-6250 • DENNY-HAMILTON, San Diego, Cal., 279-2421 • DURBIN-HAMILTON, St. Louis, Mo., 966-3003 • EASTERN SEMI-CONDUCTOR Syracuse, N.Y., 454-9247 • E. C. ELECTRONIC SALES Minneapolis, Minn., 888-0102 • HAMILTON Phoenix, Ariz., 272-2601; Los Angeles, Cal., 870-0236; Palo Alto, Cal., 321-7541; Seattle, Wash., 282-3836 • HYER Denver, Colo., 761-0754; Albuquerque, N. Mex., 268-6744; Salt Lake City, Utah, 322-5819 • MARSHALL Scottsdale, Ariz., 946-4276; San Marino, Cal., MU 1-3292; San Diego, Cal., BR 8-6350; Redwood City, Cal., EM 6-8214 • NORVELL Dallas, Tex., FL 7-6451; Houston, Tex., MO 5-0558 • POWELL Beltsville, Md., 474-1030; Philadelphia, Pa., 724-1900 • SCHLEY Watertown, Mass., WA 6-0235 • SCHVEBER Westbury, L.I., N.Y., ED 4-7474 • SEMICONDUCTOR SPECIALISTS Chicago, Ill., 622-8860; Minneapolis, Minn., UN 6-3435; Dearborn, Mich., LU 4-5901 • SHERIDAN Cincinnati, Ohio, 761-5432; Cleveland, Ohio, 884-2001; Dayton, Ohio, 277-8911 • SOLID STATE Chicago, Ill., 889-8033 • STANARD Buffalo, N.Y., TT 3-5000 • SUMMIT DISTRIBUTORS Buffalo, N.Y., 884-3450 • TAYLOR Baldwin, L.I., N.Y., BA 3-8000 • TEC-SEL Huntsville, Ala., 837-4541 • VALLEY Winter Park, Fla., 647-1216; Baltimore, Md., NO 8-4900; Cherry Hill, N.J., NO 2-9337.

FAIRCHILD SEMICONDUCTOR/A DIVISION OF FAIRCHILD CAMERA AND INSTRUMENT CORPORATION/313 FAIRCHILD DR., MOUNTAIN VIEW, CALIF./962-5011/TWX: 910-379-6435
FAIRCHILD'S M-O-S FET IS MFRD. UNDER U.S. PAT. NOS. 3025589, 3064167, 3108359.

Editorial

Science vs. politics

While the political campaign thundered to a noisy end, a congressional subcommittee sounded a warning that was nearly lost on an election-minded Washington. The House Subcommittee on Science and Research cautioned against awarding federal research and development funds on any basis other than technical and scientific merit.

To many a supplier in space electronics, the suggestion struck a responsive chord. A suspicion has been growing that the National Aeronautics and Space Administration has been playing politics with some of its contracts. A frequent complaint from contractors is that NASA sometimes puts contracts into suppliers' hands on the basis of screams from a congressman or senator rather than on technical or scientific merit.

The subcommittee also confirmed what a lot of people already knew: that a few states and a relatively small number of recipients get a major portion of federal R&D expenditures.

Now that the election is over, the problem is likely to get tackier. Candidates of both parties have made liberal promises of contracts to the defense-blighted areas of California, New York, Massachusetts and the South. The worry is that the winners of the local elections will pay off on their promises on some basis other than ability to do the work.

Even before the election, 100 congressmen told President Johnson they would oppose all his legislation if their districts did not receive some contract help. Since the President seems solidly committed to holding military expenditures at the present level and retaining the strict criteria for using them, NASA's \$5-billion-a-year budget looks like the easy answer.

To keep the congressmen happy, NASA may fall back on political expediency as a basis for awarding contracts.

Almost every government agency is accused at some time of awarding contracts for political reasons.

Often the charge is false. But in NASA's case, there has already been enough smoke to warrant somebody's looking for the fire.

In 1963, when the Defense Department decided to end several projects prematurely, legislators in some states complained bitterly about the resultant economic decline and local unemployment. Shortly afterward, NASA contracts were awarded to some of the affected suppliers.

For example, insiders charged that NASA had selected the Hughes Aircraft Co. to be the contractor for a lunar orbiter photographic project and that an announcement was pending. But the agency abruptly awarded the contract to the Boeing Co. after congressmen from the state of Washington protested the Pentagon's folding of the Dynasoar program. The same experts say Hughes would have received the project if Dynasoar had lasted only two more weeks.

When NASA decided it wanted its own electronics research center, selection of a site became a political football. Every congressman with a political problem in his state wanted the research center there. Cloakroom gossip says Sen. Edward Kennedy of Massachusetts, who had run for office on the slogan "I have a voice that will be listened to in Washington," had the most political influence.

On the surface, Boston did indeed have a problem. Defense cutbacks had seriously hurt many of the companies that had made Massachusetts' Route 128 famous. Apologists for NASA rationalized the choice by pointing out that the Boston area did have a surplus of electronics engineers and technical facilities to support such a center.

Now NASA says it will have to go out recruiting because Boston has all the wrong kinds of engineers. And last month in Chicago, NASA Administrator James Webb said that proximity to the center would be no guarantee of contracts, and that the center would search out suppliers all over the country.

NASA exploded almost overnight from a tiny agency operating a few wind tunnels to a \$5-billion-a-year organization probing the universe. With such spectacular growth, inefficiencies were inevitable. Many of NASA's contract awards have been questionable [story on p. 103]. But there's no excuse for turning the nation's space program into a political grab bag.

There is much at stake here. National reputation and prestige are among the less important factors. NASA has the resources to remake electronics technology, to make possible consumer, medical and industrial products not even imagined today, and to resolve some of man's most nagging worries about his universe.

Ward politics should not interfere.

NEW FROM ALLIED

SMALLEST 6PDT RELAY

COMPARE

ALL WELDED
CONSTRUCTION

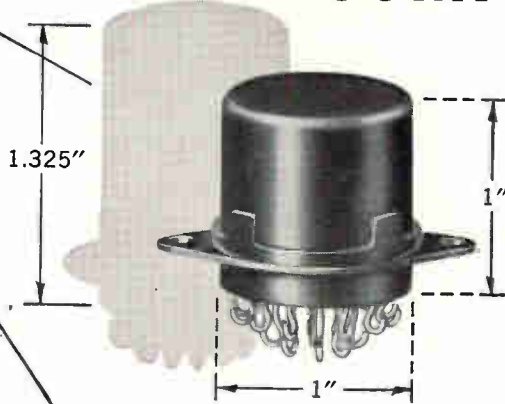
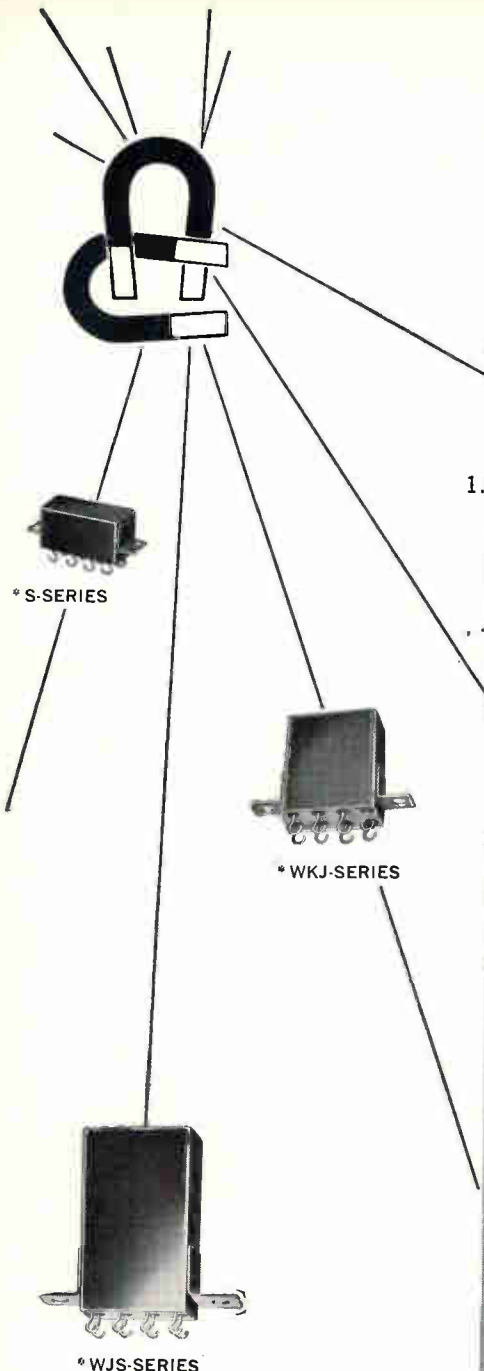

WMR SERIES



The WMR Series represents a unique combination of advanced design technology and miniaturization. It is suitable for upgrading existing equipment, and particularly recommended for dependable centralized switching in new systems.

PAT. PENDING

- Compact 1" dia. X 1" high
- Welded Construction .. No solder flux
- Reliable Bifurcated, gold plated contacts
- Versatile Low level to 3 amperes, to 6PDT
- Rugged 30G, 2000 CPS vibration; 100G Shock
- Stable Low friction, ball bearing armature
- Interchangeable Conforms to MIL-R-5757/1 and /7

SEND FOR WMR CATALOG SHEET

* ALL WELDED
SERIES



ALLIED CONTROL COMPANY, INC.

2 EAST END AVENUE, NEW YORK, N. Y. 10021

Electronics Newsletter

November 16, 1964

Townes bolsters Tyco laser claim

Tyco Laboratories, Inc., has acquired an influential supporter of its claim to having achieved laser action in silicon carbide. He's Nobel laureate Charles H. Townes.

In answer to a question at the Northeast Electronics Research & Engineering Meeting's session on quantum electronics, Townes said, "The Tyco people recently showed me their results, and I am convinced they have a working laser unless I completely misunderstand the nature of the experiments they have done."

Townes said he has not seen any Tyco experiments in progress; he based his judgment on "data and pictures." He referred to a 1963 paper by A. I. Mlavsky of Tyco in which laser action was claimed, and to an attempted refutation by Robert N. Hall of the General Electric Co., a semiconductor expert. [Electronics, Nov. 15, 1963, p. 19]. "I don't think either paper was convincing," Townes said, adding that he based this opinion on subsequent data.

"We are not prepared to discuss this subsequent data," Tyco president Arthur J. Rosenberg said. "I do not think it would be proper to discuss the results of an experiment without also discussing the way it was done. In this instance, we are not prepared to tell the how of it."

Silicon carbide is the first compound of its class for which laser action has been claimed. Tyco reported continuous operation at room temperature, with emission in the blue region of the spectrum, at 4560 angstroms.

Pay-tv firm files suit in California

Pay television received a setback when California voters approved a proposition that prohibits pay tv. As a result, Sylvester Weaver, president of Subscription Television, Inc., said the company is suspending its operations immediately and removing equipment from 6,000 subscribers' homes in Los Angeles and San Francisco. At the same time, however, Weaver vowed an all-out legal battle against the proposition. His lawyers have filed suit in State Supreme Court asking a writ to prevent Frank Jordan, California Secretary of State, from ordering that the proposition take effect as law. Weaver said the company would shift its operations to other states until the constitutionality of the ban is determined. Subscription Television has been talking to officials in Philadelphia, Boston, New York, Chicago and Minneapolis.

Microcircuits hurt connector sales

A barometer of the microcircuit storm sweeping the electronics industry is the way some manufacturers of printed-circuit-card connectors are slashing sales estimates. One predicts a 75% slump in 18 months, another a 75% drop in two or three years—it depends on how fast commercial electronic systems, as well as military, go micro. Sales of card connectors are estimated at \$45 million this year.

Microcircuit systems need only a few cards at the subsystem level. A card that contained a few conventional circuits can carry dozens of packaged microcircuits.

The use of cards will be reduced further when equipment manufacturers perfect ways to use unpackaged microcircuit chips, interconnected en masse in single packages. That goal was a major theme at a round-table

Electronics Newsletter

discussion Oct. 27 of the Society of Automotive Engineers' committee on welded electronic packaging. A subcommittee was formed to study advanced joining methods.

Representatives of the Elco Corp. and AMP, Inc., took part in the conference. These companies, and other leading connector manufacturers, are pressing to get mass-interconnection systems ready in time to meet the anticipated demand. Conventional connectors won't be small enough for mass interconnections. They've been microminiaturized to the point where spacing between contacts is 20 or 25 mils, but that's their limit.

Air Force to buy attack-proof net

The Air Force is completing procurement of a low-frequency communication system that might survive a nuclear attack. It would link the Joint Chiefs of Staff and the Strategic Air Command. Planned as a SAC communications back-up, the system, called 487L, will consist of high-power low-frequency ground-transmission stations, ground receive-only sites for low-frequencies and very-low frequencies, and airborne transmit-receive equipment for low and very-low frequencies. Selected to submit bids are the Space General Corp., and the Westinghouse Electric Corp. The Space General group includes the Philco Corp. and Sylvania Electronic Systems, a subsidiary of the General Telephone & Electronics Corp. Westinghouse's associates include DECO Electronics, Inc., and National Company, Inc.

Radar for blind may use a laser

The blind may receive help from the laser if work at the Massachusetts Institute of Technology's Lincoln Laboratory turns out successful. Dr. Robert Rediker of Lincoln, speaking at an electron-devices meeting in Washington, said a prototype has been built of a radar using a solid-state diode laser.

It's about the size of a flashlight, operates at room temperature, puts out 6 watts in 10-microsecond pulses, and uses a half-inch-long gallium-arsenide diode laser. It's powered by a silicon controlled rectifier circuit. The radar would be one of the first practical applications of a solid-state diode laser at room temperature.

Integrated circuits in RCA computers

The Radio Corp. of America is following the International Business Machine Corp.'s example with a line of integrated-circuit computers comparable to IBM's 360 series. The stress is on low cost and high circuit speeds, using monolithic integrated circuits in the central processor. By the end of the year, RCA is expected to introduce five models, the first a little smaller than the model 30 in the 360 line, the largest somewhat bigger than the model 50. The smaller computers in the line will use hybrid circuits.

Service stations for satellites

Within the next few weeks the Communications Satellite Corp. is expected to select the company that will work on the design of ground stations to service communications satellites. Six companies are in the running: American Telephone & Telegraph Corp.; ARCS Industries, Inc.; Daniel, Mann, Johnson & Mendenhall; Hughes Aircraft Corp.; Page Communications Engineers, Inc., and Westinghouse Electric Corp.



If you ship from 5 to 50 pounds anywhere in the U. S. you're missing a bet

...unless you check Air Express.

There are many reasons why. For example, you can actually ship a 20 pound package from New York to Chicago by Air Express for less than motor carrier (\$6.20 vs. \$6.82) ... and at a sizable saving in time.

Among air cargo services, Air Express is often cheapest *and* quickest too.

Another point. Air Express rates are figured door-to-door. You only

have one call, one waybill.

And there's more. Air Express can deliver by sunset tomorrow to any one of 21,000 U.S. cities.

Pickup is made within 2 hours of your call. Your packages get top priority on every scheduled airline after air mail.

On the ground, 10,500 delivery trucks speed deliveries between you, the airports and your customers. Compare this with any other

service available.

There is only one Air Express... it's a joint venture of all 39 scheduled airlines and R E A Express. No wonder it gives you the best service in the air and on the ground.

Next time you ship from 5 to 50 pounds, try Air Express. Simply call your local R E A Express office for detailed information.

Air Express outdelivers them all ... anywhere in the U.S.A.

Air Express
Division of REA Express



... AT LAST — THE FIRST TRUE HYBRID COMPUTER

A completely new kind of signal processor, the Adage AMBILOG™ 200 computer is designed from the ground up to exploit the best of both analog and digital techniques. It combines parallel hybrid arithmetic with stored-program sequential operation.

High processing speeds (often ten times faster than comparably-priced conventional machines) and extensive input/output for both analog *and* digital data make AMBILOG 200 ideal for data acquisition, simulation, and information display.

PARALLEL HYBRID ARITHMETIC

AMBILOG 200 achieves high processing speeds through parallel organization of hybrid computing elements all operating simultaneously on analog and digital operands. Word length of digital operands is 15 bits; analog accuracy is .01%. A fast 30-bit digital accumulator augments the 15-bit hybrid arithmetic.

A typical configuration performs 12 additions, 2 multiplications and 1 division in ten microseconds.

Hybrid arithmetic, A/D and D/A conversion, comparison, and signal routing and conditioning are all carried out under direct control of the stored program.

SEQUENTIAL STORED-PROGRAM OPERATION

Fifteen and 30-bit data words are transferred at high speeds to and from memory and all other parts of the AMBILOG 200 under flexible stored-program control. Core memory word length is 30 bits; cycle time is 2 microseconds. Memory sizes up to 32,768 words are available, all directly addressable. Digital I/O devices include punched tape, typewriter, magnetic tape, and direct data channels. A unique multiple priority interrupt system permits complete servicing of interrupts in as little as 3 microseconds, and facilitates interconnection for multi-processor installations.

PROGRAMMING

Instruction word length is 30 bits, permitting simultaneous control of memory, source and destination selection, word rotation, and Boolean logical operations. The order structure includes provision for recursive indirect addressing and indexing, a number of conditional and unconditional jumps, and program traps.

The AMBILOG 200 Symbolic Translator permits programming in symbolic source language and is easily extended to accept any problem-oriented source language.

Software support includes programmer and maintenance training, installation and maintenance services, system programs, standard sub-routines, and complete documentation.

BROAD APPLICATION

Flexibility, economy, and real-time processing power make AMBILOG 200 a "natural" for

- Biomedical monitoring
- Seismic data processing
- Sonar and radar signal enhancement
- Test stand instrumentation
- Programmed automatic checkout
- Factory test and inspection
- Communications research
- Process control
- Space-vehicle simulation
- Simulator trainers
- Telemetry receiving stations
- Visual display systems

For more facts, contact I. R. Schwartz, Vice President 617-UN 4-6620.

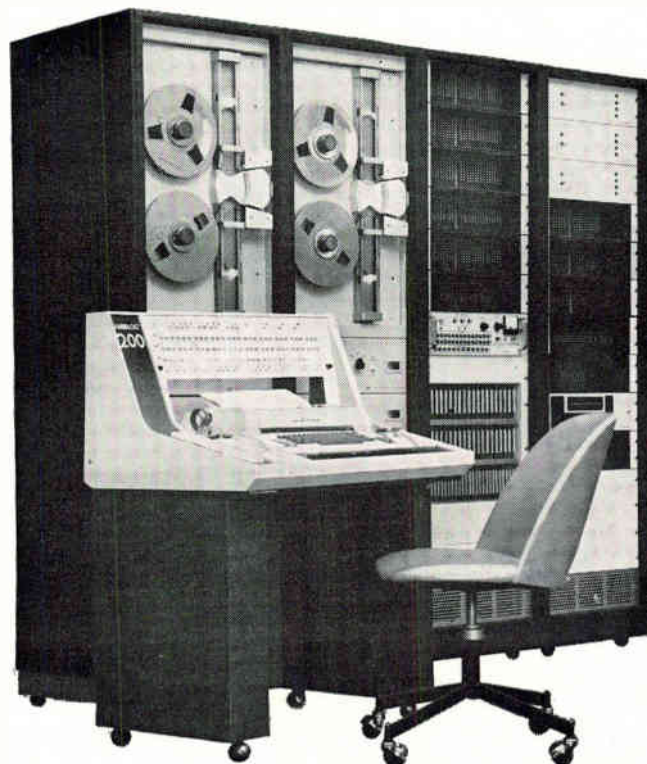

Adage
INC

Main Office and Factory
292 Main Street
Cambridge, Massachusetts 02142

West Coast Plant
1145 East Ash Avenue,
Fullerton, California 92631

Adage, Inc. welcomes employment inquiries from professional engineers.

AC-AC AC-DC DC-DC DC-AC

**SOLID STATE POWER SUPPLIES
& STATIC FREQUENCY CHANGERS**

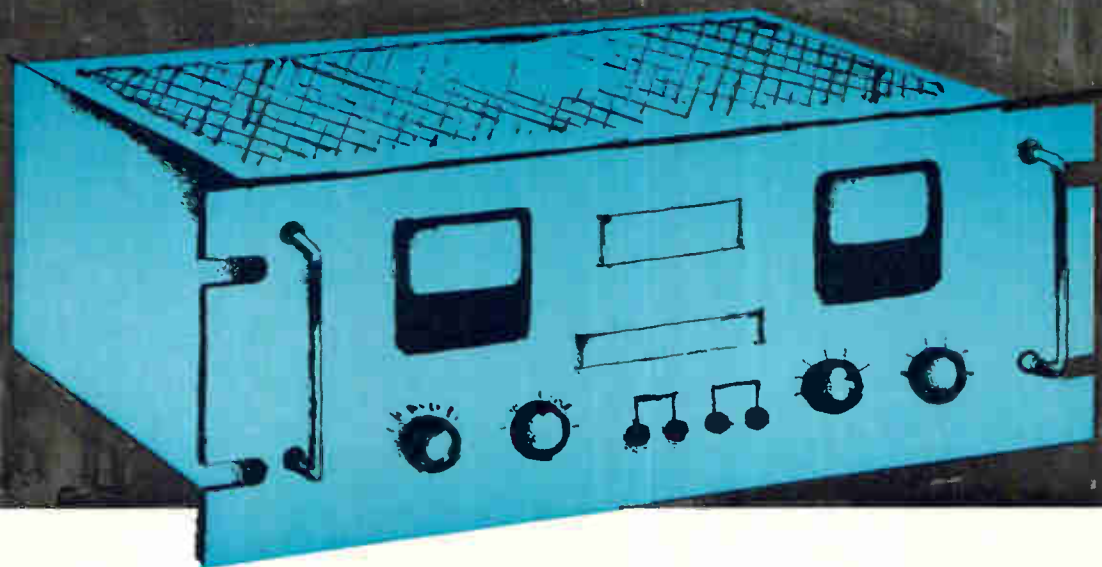

That's all there is in power supplies and Chatham builds them all

Some are standard production. Most are specially designed and custom built. Some meet the severe requirements of MIL-E-4158, 8189 or 16400. Others are made to industrial or commercial standards. Some plug into laboratory equipment. Others power computer input-output gear, telemetry and communications systems, avionics, or ground support equipment. All have this in common: Chatham's years of experience in translating advanced power supply concepts into efficient, accurate, reproducible designs. Write for more detailed information and describe proposed application.

CHATHAM ELECTRONICS

LIVINGSTON, N. J. TWX: 201-992-7350

DIVISION OF TUNG-SOL ELECTRIC INC.

New products from TI to help you

New one-amp glass rectifiers offer high power, small size

Small size, high power capability and high reliability are three good reasons why you should consider TI's new series of one-amp glass-encapsulated rectifiers. This combination of features makes them ideal for both industrial and military applications.

As you can see in Figure 1, they are up to 10 times smaller than top-hat, flangeless and epoxy types. A fully-insulated cylindrical package, weldable leads, and the absence of protruding flanges simplify assembly and permit high-density packaging for added space savings.

The new 1N4383-85 rectifiers provide high current capability (1 amp continuous at 100° C, 50 amps surge) and high inverse voltage rating (up to 600 volts) in a hermetically sealed glass package only 0.360" long and 0.150" in diameter. For detailed specifications, simply circle 187 on the reader service card.

Replace more than thirty older chopper types with new planar PNP choppers

More than thirty older types of alloy and electro-chemical choppers can now be replaced with the industry's first planar, epitaxial-base chopper transistors. Typed as the 2N2944-46 series, the new TI transistors offer circuit designers the benefits of a true planar device, with extreme ruggedness and improved electrical characteristics.

Planar construction eliminates the mechanical problems seen in older types of construction, and is capable of withstanding over 30,000 G's stress in the centrifuge. Breakdown voltage is 40 volts, min.; collector cutoff current is 25 nanoamps, max, at 100° C; and offset voltage is 0.8 millivolts, max, at 200 microamps. The units (shown in Figure 2) are packaged in the TO-46 case.

The 2N2944-46 planar choppers are now available from authorized TI distributors. Circle 188 on reader service card for data sheets.

For chopper applications requiring very high input impedance: TIS05

The unique TI P-channel field-effect chopper, the TIS05, offers low "on" resistance, improved high-frequency performance, low capacitance, and low leakage. It is especially suitable for choppers, analog switches, high-gain amplifiers, and other applications requiring high-input-impedance chopping. "On" resistance is typically 90 ohms, and the units' high Y_{fs}/C_{iss} ratio gives improved high frequency performance. Offset error is minimized.

Circle 189 on reader service card for data sheet.

New 50-amp germanium power transistors combine economy with high reliability

You can simplify and reduce the cost of high-power industrial power supplies by using new TIG05-TIG10 germanium power transistors. You can also increase circuit efficiency, improve reliability and reduce equipment size.

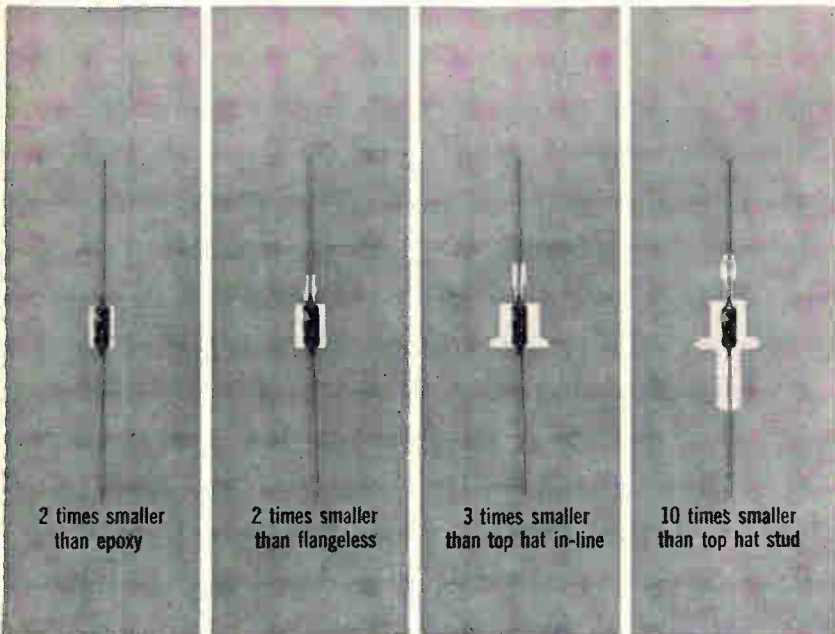

Figure 1. New 1N4383-85 rectifiers are much smaller by volume than other types

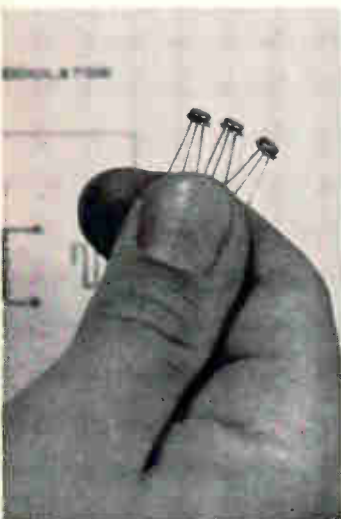

Figure 2. 2N2944 series chopper transistors



Figure 3. Interdigitated geometry of TIS05 P-channel field-effect choppers

*Trademark, Texas Instruments Incorporated

improve performance and reduce costs

The new transistors offer you characteristics in an advanced new TO-3 package (Figure 4) which were formerly available only in significantly larger and more expensive TO-36 devices. These include high beta at high current (20 to 80 at 30 amps), high dissipation (150 watts at 25° C case temperature), low saturation voltage (0.5 volts at $I_C = 30$ amps and $I_B = 3$ amps), and exceptionally low thermal resistance ($\theta_{J-C} = 0.5$ C° / watt).

Circle 190 on the reader service card for information.

Forty standard diode types, six new types now available with planar construction

Three new series of planar diodes have been announced by Texas Instruments. The new lines, which include zeners and high-conductance switching diodes as well as general purpose devices, offer many advantages unique to the all-planar construction.

The planar general-purpose types include the JAN 1N645, 1N482-486 (including A and B types), 1N456-459A, and the 1N461 series. Packaged in the *Moly/G* diode package, these units feature outstanding stability plus low leakage currents at elevated temperatures.

Planar zener types are the 1N962B-973B. Also in the proved *Moly/G* package, these diodes give the circuit designer low-noise performance, excellent regulation at low zener voltage levels and stable reverse characteristics with life.

The new high-conductance planar switching diodes are designated TID11-16. Electrical characteristics include extreme stability, high conductance and high breakdown voltage. They are offered in the *Uni/G** diode package.

Circle 191 on reader service card for data sheets.

New TI GCS switches 750 watts in 6 microseconds

High power-switching capability, fast switching times, and high turn-off gain are major advantages offered by TI's new TIC11-TIC15 gate controlled switches. These features allow you to reduce capacitor size, cut drive-power requirements, lower equipment costs, and improve reliability.

These new GCS's are well suited for a wide range of uses, such as high-frequency d-c switching applications, power inverters and converters, high-speed relay and hammer drivers, power flip-flops, and electronic circuit breakers. Other applications: high-power pulse modulators, switching-mode power supplies and regulators, fluorescent ballast replacement and auto ignition systems.

Characteristics include high current turn-off gain (only 200 ma is required to turn off 5 amps at 100 volts), high voltage capability (100 to 500 volts), high power switching (750 watts up to 7.5 amps), and fast switching speed (typically 6 μ sec).

Also contributing to reliable performance is TI's new TO-3 cold-weld package shown in Figure 6. The new design features an all-copper header and can assembly for cooler operation. (See Figure 4 also.)

Circle 192 on the reader service card for full information.

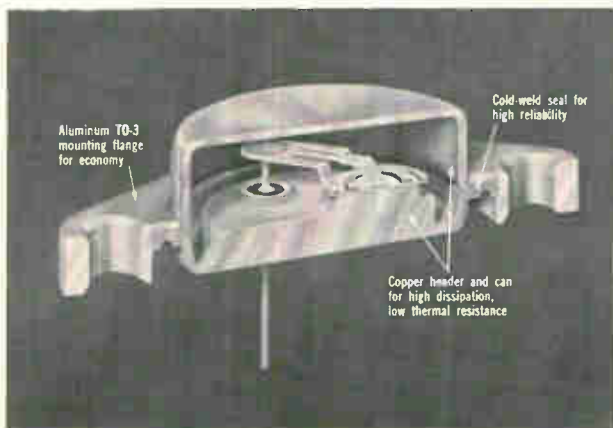

Figure 4. New TO-3 package for TIG05-10 germanium power transistors and TIC11-15 GCS's

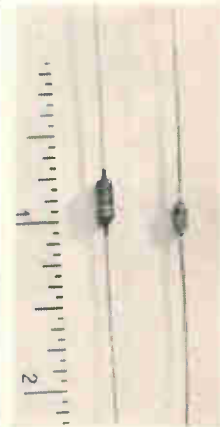

Figure 5. *Moly/G* and *Uni/G** packages for new TI planar diodes

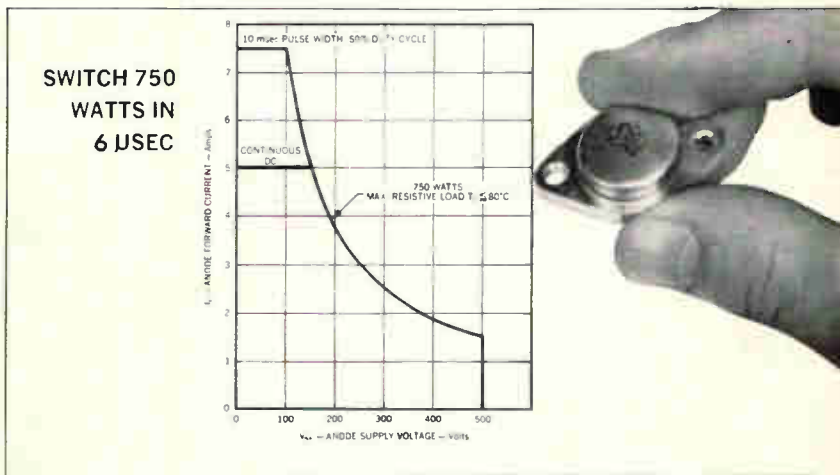
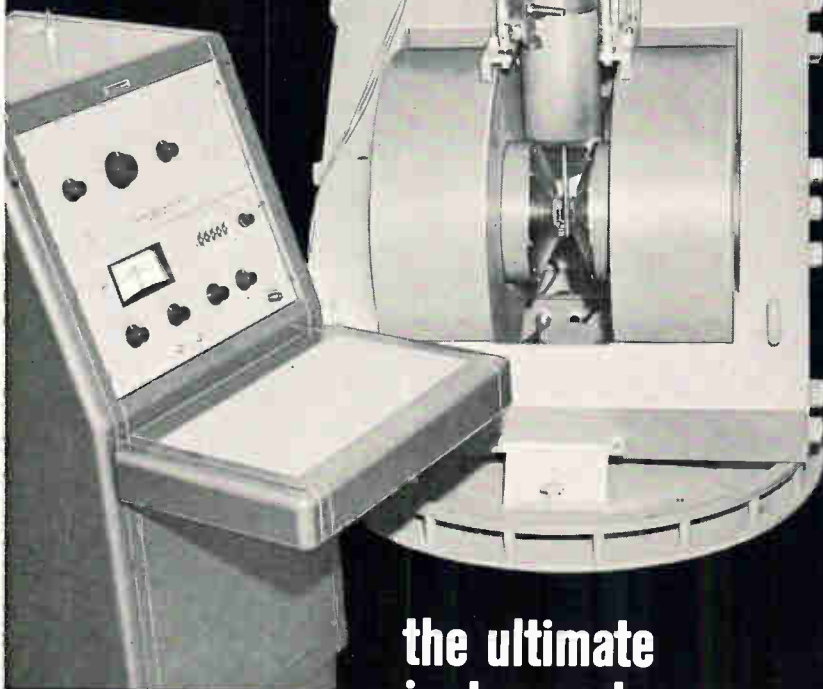

Figure 6. New TIC11-15 GCS's switch high power... fast! (See Figure 4 also.)



TEXAS INSTRUMENTS
INCORPORATED
13500 N. CENTRAL EXPRESSWAY
P. O. BOX 5012 • DALLAS 22, TEXAS

FONER VIBRATING SAMPLE MAGNETOMETER



the ultimate
instrument
for investigating
magnetic
properties
of matter

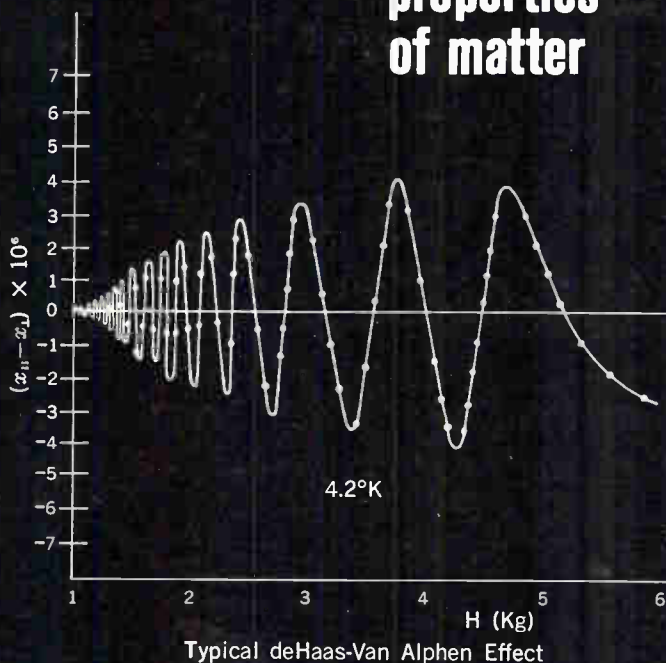

In studies of the structure of matter, magnetic properties have long been of paramount importance in providing information of a fundamental nature. This has been true in such widely diverse fields as the study of free radicals in bio-chemical systems, the study of the deHaas-Van Alphen effect in metallic crystals at low temperatures and investigations of the nature of the bonds in intermetallic compounds. The limitations imposed by classical methods of magnetic measurements, those of low sensitivity and of high field homogeneity, have however made precise meaningful measurements difficult and slow and hence have restricted their ultimate useful employment.

The development by Foner of a versatile and sensitive Vibrating Sample Magnetometer* and its commercial availability through PAR now make possible the extension of magnetic measurement techniques both to experiments requiring sensitivities and resolutions heretofore unobtainable, and to routine measurements which require simple set up procedures and quick sample changes. With this magnetometer, permanent and/or induced magnetic moments may be precisely measured in a uniform magnetic field as a function of temperature, field, crystallographic orientation, or time. This is done by placing a small sample of the material whose magnetic moment is to be determined in a sample holder located at the end of a vibrating rod and vibrating it perpendicular to the magnetic field of the magnet. The resulting oscillating dipole field induces an AC voltage in a pair of stationary pick-up coils mounted securely to the pole faces of the magnet. The induced voltage is measured electronically in a system whose signal-to-noise ratio is near the limit set by the Johnson noise of the pick-up coils. From the magnitude of this measured voltage, the magnetic moment of the sample is deduced.

An extremely wide range of magnetic moments can be measured with high precision and the instrument has a simple calibration procedure, exhibits very high stability, and minimizes most sources of error. Cryogenic techniques may be used to measure moments over an extended range of temperature down to the liquid helium range. Magnetic moment measurements of Ferromagnetic, Paramagnetic, Diamagnetic, Ferrimagnetic, Antiferromagnetic, Metamagnetic and Superconducting materials have been made utilizing this system. Various versions of this instrument have now replaced most of the classical methods for magnetic moment measurements in numerous laboratories throughout the world. Price \$12,500. Your inquiries on specific magnetic measurement problems are invited.

*Manufactured exclusively by PAR
under license in U.S. Patent No. 2,946,948.

Write for Bulletin No. 116 to:

P
A
R

PRINCETON APPLIED RESEARCH CORP.

Dept. D
Box 565, Princeton, New Jersey

Electronics Review

Volume 37
Number 29

People

Nobel Prize winners

One American and two Russians, pioneers in the young science of microwave spectroscopy, will receive the Nobel Prize for physics on Dec. 10.

Charles H. Townes, 49 years old and holder of the fundamental patent on the maser, will receive half of the \$53,000 prize. The other half will be shared by Aleksander M. Prokhorov and Nikolai G. Basov of the Lebedev Physics Institute in Moscow.

The prize comes 10 years after Townes reported a new type of amplifier, using a beam of ammonia molecules fired into a resonant cavity with a low loss of energy. He called it "maser," for microwave amplification by stimulated emission of radiation."

The Soviet physicists used a similar ammonia-beam technique to make the circuit losses less than the gain supplied by the excited molecules. But Townes and his group at Columbia University built the first successful maser, late in 1953.

Works on sound. Townes, professor of physics and provost of the Massachusetts Institute of



U. S. winner Charles H. Townes



Soviet winners Nikolai G. Basov and Aleksander M. Prokhorov

Technology, is continuing his research in quantum electronics, heading an MIT research project on phonon masers. His group has been bombarding crystals with ruby laser beams to produce extremely high-frequency sound waves. Thus far they have measured hypersonic vibrations up to 60 gigacycles.

Much of Townes' work in recent years has been aimed at examining fundamental relations of length and time as predicted by Einstein's relativity theory. He believes that these experiments can open the way to more precise standards, and that the wavelength of light may become the ultimate standard of length and time [Electronics, March 22, 1963, p. 74].

Shared Lenin prize. Prokhorov and Basov are accustomed to sharing things. They shared the Lenin Prize in 1959 for their laser work, which is praised in the West as being of high quality theoretically. Unlike the United States, where any high school science laboratory can make or buy a laser, the Soviet Union does not manufacture lasers

commercially. Almost all its theoretical work in lasers is done at the Lebedev Institute.

The Russians have recently reported a semiconductor laser whose efficiency approaches 100%, compared with 1% for gas or ruby lasers. Basov, chief designer of the laser, claims that such a device could be measured in tenths of a millimeter, but that its output could be hundreds of thousands of times that of the most efficient ruby generator. He says it could be used for intermittent and continuous operation in computers or high-density communications engineering, as well as in certain types of commercial light sources.

Computers

Auto design

An auto designer can now exchange information with a computer as easily as he communicates with his colleagues.

Systems to make this possible

have been announced by the General Motors Co. and International Business Machines Corp.

The new systems add flexibility to existing methods of computer graphics where an engineer uses a light-pen to talk to a computer.

GM system. GM's is the first completely electronic styling system for automobiles. It has broad implications for automobile drafting, engineering and production.

It uses time-sharing of its central processor for normal engineering problems and for electronic designing of cars. The system, called DAC-1 for "design augmented by computers," is reported to be faster and more flexible than the Ford Motor Co.'s use of numerically controlled drafting machines to turn out drawings [Electronics, June 1, p. 64].

The difference. What's new is the drawing system built to GM's specifications by IBM. A camera records manually drawn designs on 35-millimeter film that is developed in 30 seconds. The film is placed between a cathode ray tube and a phototube. As the crt scans the film, the light patterns are picked up by the phototube and recorded as digital information by the computer.

A drawing to be worked on is continuously regenerated, point by point, on the display console. If, for

instance, the designer wishes to erase a line he pushes the erase button and passes the light-pen (a photodiode) over that line.

The photodiode senses the instance when each point is regenerated. The computer then knows the "address" of the line it should erase from its memory. Similarly, a line may be added.

When the design is finished, the data can be used to punch tapes, drive numerically controlled drafting machines, or control tapes for numerically controlled tools.

The GM system has been operating eight hours a day since early 1963 and is reported to have been used for experimental drawings of some 1966 and 1967 Buicks and Oldsmobiles.

The IBM system won't be available commercially until 1966. Until then it will be difficult to tell how it compares with other methods of computer analysis of design problems. The system adds \$12,300 a month to the cost of the computer.

Use of the IBM equipment for electronic transient analysis was demonstrated [photo below, left].

An engineer drew an r-c circuit on a cathode-ray tube, with variable resistor and capacitor in the center, axes for an input curve at the left, and axes for an output curve at the right. He then drew in an input curve, and an output curve appeared automatically on the graph at the right.

Next he raised the value of the variable resistor by pointing the light pen to the head of the arrow; this also changed the output curve. Extending this technique to more complicated circuits, an engineer could find out immediately what the output of a circuit would be with any input for any range of component values, IBM says.

Wide potential. Irving Abzug, manager of image-processing systems for IBM's Data Systems division, says any engineering design discipline can be programed into the system.

IBM System. IBM's image display allows for graphic problem solving in any design situation.

An IBM 2250 display unit, introduced as part of the System/360 computer is used with a 2282 film

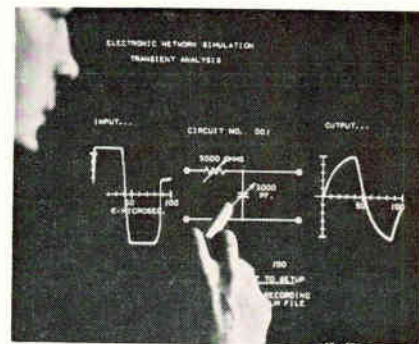

Engineer, light-pen in hand, demonstrates the use of IBM's graphic data-processing system for transient analysis.

scanner and film recorder. The scanner converts microfilm images to digital form for computer storage. With the recorder, an engineer can get a microfilm record of any piece of his calculations within 48 seconds, according to the company.

In addition to computer-aided design, the IBM system can be used to develop engineering drawings and prepare statistical business graphs. With the light-pen and proper programing, the operator can add or delete lines, modify a curve, change a physical dimension or identify a piece of information.

Business

Defense cuts still hurt

The recent leveling off of the United States' defense budget is pinching the pocketbooks of many electronics companies around the nation.

Companies with a major share of their output tuned to the military were hardest hit. But even some concerns with a relatively small emphasis on defense products found business bleak. Many companies that posted gains in their commercial markets found that these gains were insufficient to offset sharp declines in military business.

Others, with a sharp eye on cost cutting, were able to report gains in profits despite a drop in military sales.

Bucking the trend. However, a



Electronic styling lets designer at GM add or remove a line by pressing the proper button and running a light-pencil over the face of the display. He can also enlarge a view or change the perspective.

few companies bucked the trend of the industry by reporting sales and profit increases. Despite the general wave of complaints that military cutbacks are crushing the industry, a handful of concerns say they see a bright future in the defense business because they are producing the products that the military needs instead of trying to adopt yesterday's military tools to today's complex warfare.

Generally, electronics companies agree: The health of the industry depends on its ability to cut costs and to diversify.

A brief look at several electronics companies around the country provides a clue to the future for the industry and an indication of the causes of the current ills.

▪ **The General Electric Co.** reported sales and operating profit declined in the nine months ended Sept. 30 from the like year-earlier period. The dip in sales—to \$3.48 billion from \$3.58 billion—was registered despite record commercial volume.

The culprit: lagging defense business.

The lag contributed in pulling GE's earnings down to \$253.2 million from \$354.7 million.

What is GE doing to offset this decline?

Aside from stepping up emphasis on its commercial products in the U.S., the company is looking overseas. GE will invest some \$43 million in three companies formed from the nondefense activities of Compagnie des Machines Bull of France. Also, GE will invest in Olivetti & Co. of Italy.

▪ **The Northrop Corp.**, which posted sharp declines in both sales and profit for the fiscal year ended July 26, recognizes the industry's need for diversification, but also recognizes the dangers.

Its fiscal 1964 profit fell to \$6.7 million from \$9 million, while sales skidded to \$301.8 million from \$346.9 million.

Says Thomas V. Jones, president: "As managers we are fully aware of coming changes in the level and composition of the defense program. . . . But we are equally aware of the hazards . . . of attempting to conduct both defense and com-

mercial business under the same general roof."

▪ **The Raytheon Co.**, with 85% of its business conducted with the government, smarts under the defense cutback. But cost cutting has offset these declines. Although sales in the nine months ended Sept. 30 dropped to \$323.8 million from \$364.4 million, profit soared to \$6.4 million from \$5 million.

It plans to remain a major defense supplier while continuing to cut costs.

But Raytheon is hedging its bet. It has recently acquired three companies and it is "looking at dozens more," says a spokesman.

▪ **The Narda Microwave Corp.**, a relatively small company, registered declines in sales and earnings in the nine months to Sept. 30. Narda's nine month sales in the quarter ended Sept. 30 fell to \$634,251 from \$704,239. Operating profit slipped to \$38,259 from \$40,049.

John C. McGregor, chairman, and William A. Bourke, president, say they will continue to explore acquisitions to boost sales and profit, but because of the "general decline in the military electronics business, care is being taken in such a move."

▪ **Litton Industries, Inc.**, as some financial advisers put it, "has found the formula." In the year ended July 31, net profit rose 28% to \$29.7 million and sales jumped 24% to \$686.1 million. Nearly 60% of its business is military.

How, then, with such a heavy dependence on military business, has Litton shown such strong gains? First, although Litton concedes that the over-all military budget is going to slip a bit in the immediate future, over the long run the amount spent for defense is going to rise. Second, Litton happens to be in, and plans to remain in, the areas that are and will be on the rise. Roy L. Ash, president of the diversified concern, lists these areas of growth: command and control systems to "manage" military forces; telecommunications; inertial guidance systems; nuclear submarines; submarine detection; and also in aerospace technology.

▪ **The Lockheed Aircraft Corp.**,

a leader in the aerospace field, reported a dip in earnings and sales in the nine months to Sept. 27. Sales totaled \$1.17 billion, down from \$1.37 billion, and profit fell to \$32.2 million from \$32.6 million. Part of the decrease, explains the company, was due to the government's increased use of fixed-price rather than cost reimbursement contracts. Four-fifths of Lockheed's business is now under fixed-price and incentive-type contracts in contrast to one-fourth in 1961. Although sales and profit declined, the ratio of sales to earnings climbed to 2.75% in the third quarter from only 2.37% a year earlier. Lockheed says it has been able to earn a higher profit rate by accepting greater risks on contracts.

Advanced technology

Seeing stars

One major advantage large reflecting telescopes have over smaller ones is that they are able to "see" and photograph fainter stars. But since large telescopes—such as the 200-inch instrument at Mount Palomar—are scarce, any way of intensifying the image would be a boon for astronomers.

Such an image intensifying tube has been developed for telescopes. The principle is used now for electron microscopes [Electronics, Oct. 5, p. 32]. The instrument was designed in a joint effort by the Radio Corp. of America, Mount Wilson, Mount Palomar and Lowell Observatories, the U.S. Naval Observatory and the National Bureau of Standards.

The intensifier triples the amount of light a telescope can record. RCA notes that the device can't increase the capability of enormous telescopes because of their optical limits. However, Merle A. Tuve, chairman of the joint committee that developed the device, says: "Now smaller telescopes could rival the unaided capability of the world's largest instruments." The technique will be 10 times more sensitive in practice than the best

available photographic emulsions, customarily used to record faint stars.

Red and blue. Used with a telescope, the three-inch diameter, five-inch-long tube receives the telescope's focused image on a photocathode. The electrons that are driven out of the photocathode are accelerated by a magnetic field and focused on an intensifying phosphor screen, where they are multiplied and reimaged onto an output screen. A second state of intensification produces a still brighter image on a screen, where it can be viewed or photographed.

In addition to multiplying the intensity of light in the blue region of the spectrum—the most useful portion to astronomers—the tubes also have an extended sensitivity in the red region.

Twenty of the 40-pound tubes have been ordered from RCA for delivery to various observatories. The total price is \$100,000.

Manufacturing

Sapphire-growers' harvest

While the thin-film experts have been busily growing single-crystal silicon on sapphire for field-effect transistors [Electronics, Oct. 19, p. 18], the sapphire experts have not been idle. They've learned how to grow the sapphire itself more cheaply.

At least three laboratories have grown sapphire rods from melted aluminum oxide with the Czochralski method, rather than the older verneuil, or powder-and-flame, process. The modern hydrothermal approach produces high-quality, though small, crystals. The verneuil process generally grows crystals with strains and inhomogeneities.

The Lincoln Laboratory of the Massachusetts Institute of Technology and the Raytheon Co. are using the Czochralski technique. Although the Linde Co. division of the Union Carbide Corp. will not confirm it, Linde is reportedly using it to grow sapphire as well as "superperfect" ruby rods for lasers. Industry sources say that Linde is

getting better sapphire than other experimenters are producing.

A more plentiful supply of less expensive and possibly, better quality sapphire may be in the offing. Some researchers think that eventually sapphire will cost no more than quartz.

From rod to web? Sapphire rods, similar to semiconductor crystal rods can be grown and substrates could be sliced on semiconductor machines.

There is speculation that sapphire might also be grown as dendritic web. This would provide flat plates without slicing, polishing and etching the gem. If a web of silicon [Electronics, Sept. 21, p. 34] could be grown on a web of sapphire, it would eliminate the deposition processes required to grow silicon crystals on sapphire.

Thomas B. Reed of MIT points out that sapphire has a sharp melting point, unlike quartz which becomes plastic before it melts. Because of this, Reed explains, and because sapphire is nearly diamond-hard, the promise of dendritic sapphire is very attractive.

In the crucible. Sapphire growth also represents an advance in high-temperature crystal growing: from 1,600°C for calcium tungstate to 2,050° for sapphire.

At the October meeting of the Electrochemical Society, Reed and his colleague, R. E. Fahey, said the size of their crystals was about 1½ centimeters in diameter by 3 centimeters long. The crystal seed is pulled about a half-inch per hour.

Molten Al₂O₃ goes into an iridium crucible. This is surrounded by a heater, a tantalum cylinder split in the middle. The crucible is heated to between 2,100° and 2,200°C. The furnace requires about six kilowatts and uses 60-cycle instead of radio-frequency power.

"It's cheaper and easier to control," says Reed.

The current goes down one side and back up the other of the split cylinder. An argon atmosphere is used to prevent oxidation of the iridium crucible.

This kind of crucible costs about \$300. One made of molybdenum, costing about \$12, was tried but

the crystal was slightly gray, perhaps because of interaction between crucible and melt. Reed and Fahey plan to experiment soon with crucibles of tantalum and tungsten.

Raytheon has grown crystals nearly an inch in diameter with few strains. The melt is heated in a tungsten crucible, coupled to a 420-kc, 20-kw generator. Pulling rate is ½ to 1½ inches an hour.

Solid state

Designing filters

Designing thin-film, band-rejection filters is a complex operation requiring the use of a computer. Now the Boeing Co.'s molecular electronics group has developed a technique to design such a filter using simple analytic expressions.

They use the partitioned-capacitance technique, which was developed two years ago by Kenneth W. Heizer of Southern Methodist University, to realize the desired filter characteristics of active resistance-capacitance networks. These are significantly lighter and smaller than the conventional resistance-inductance-capacitance networks that are generally used and can be mounted on printed-circuit boards with discrete resistors and capacitors.

Exit irrationality. Until recently, it was impractical to use tapered r-c networks to form r-c active networks because they have irrational admittance functions (hyperbolic functions of a complex variable). As a result, they could not be incorporated into active r-c networks because of the great difficulty in calculating phase and amplitude characteristics. Heizer's distributed network results in rational admittance functions that permit the realization of networks from simple analytic functions of such characteristics as capacitance and resistance. From the resistivity and dielectric constants of the material used, one can determine the network dimensions that give the necessary capacitance and resistance.

Dielectric sandwich. A parti-

When highways need a shining light

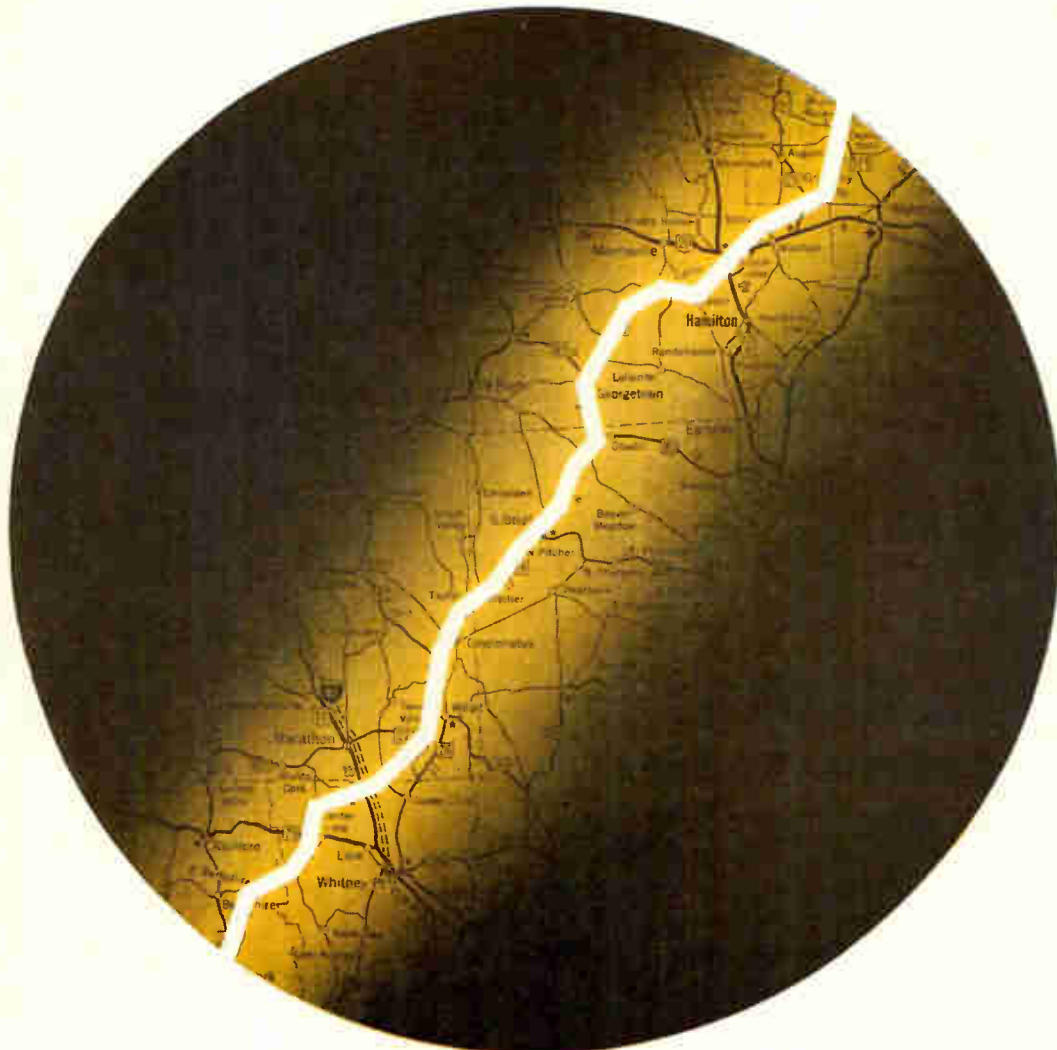

©GENERAL DRAFTING CO., INC

Airco argon helps mercury vapor glow

One of the more "visible" uses for argon gas is helping to create the bright glow in the mercury-vapor lamps illuminating many of our highways. It also "shines" in the role of current carrier for fluorescent luminous tubes and filling agent for incandescent lamps.

The electronics industry also employs argon gas to create a protective atmosphere for growing germanium and silicon crystals used in transistors. In addition, argon serves as a shielding gas during arc-welding of electronic components. For these and many addi-

tional uses, Airco supplies argon of extremely high purity. Airco argon is available in cylinders, bulk systems, and by liquid delivery.

If your product or process requires the use of gaseous or liquid argon, Airco can serve you with dependable supplies and expert technical assistance. You can also rely on Airco for oxygen, nitrogen, hydrogen and helium, in both gaseous and liquid forms. For more details, write to: *Air Reduction Sales Company, 150 East 42nd Street, New York, N.Y. 10017.*



AIR REDUCTION

tioned-capacitance network consists of a dielectric layer between a resistive layer and a highly conductive layer. The conductive layer is cut along a curve calculated to give certain network characteristics. Since this process is two dimensional, shaping the network is relatively simple.

Boeing's engineers built an r-c active band-rejection filter that consists of two distributed networks, a fixed resistor, a fixed capacitor and a negative-impedance converter. The company says that synthesizing the same network with discrete r-c components would have required four capacitors and five resistors, in addition to the negative-impedance converter.

The filter was designed to have a center frequency of 30 kilocycles, with a rejection band about 30-kilocycles wide at the -3 decibel level. However, the measured center frequency was 29 kilocycles and the maximum attenuation was 28 decibels, close enough for a first attempt, according to the Boeing engineers.

Researchers from several other companies are working on similar hybrid-type networks. Still others, along with those at Boeing, hope to eliminate all the discrete components.

Space electronics

Weather in 3-D

Wanted: A super cooler so satellites can see the weather in 3-D.

The National Aeronautics and Space Administration is seeking to replace the television cameras on its Nimbus satellites with infrared cloud detectors, which provide a three-dimensional "image."

To detect clouds both in daylight and at night, infrared detectors must operate in the clear portion of the 8- to 13-micron region of the optical spectrum, from 10 to 12 microns. The detectors are available—doped germanium photoconductive detectors are best suited for the 8- to 13-micron band.

But the detectors must be cooled to 50° K. and the coolers don't exist.

NASA needs coolers that must be able to operate for a year or more. They must consume less than five watts of power, weigh less than 50 pounds and be able to withstand the environment in space. This rules out liquid-cycling systems.

Cool and compatible. The infrared sensors would be compatible with all existing ground systems for television reception, including those for the automatic picture transmission system and the advanced vidicon camera system.

So far, NASA has only been able to cool infrared detectors down to 200° K.—by radiation cooling on Nimbus I—but those detectors were restricted to the 3.4- to 4.2-micron band. Engineers at the agency's Goddard Space Flight Center plan to experiment with solid argon and hydrogen to cool detectors of lead selenide and indium antimonide to about 77° K, although these detectors are limited to 7 microns.

Instrumentation

Lightning watch

Scientists at Cape Kennedy are using an electronic sky scanner to alert them that a thunderstorm may be brewing. The aim is to protect both space vehicles and themselves from lightning.

Bolts of lightning can cause havoc in areas of sensitive electronic missile equipment and explosive fuels. And thunderstorms are common at the Cape.

Weathermen at the missile area are experimenting with a set of atmospheric interference detectors (sferics) to monitor sudden build-ups of electromagnetism. Such buildups signal the possible birth of a thunderstorm.

The detection system, called Sparsa—for spheric pulse amplitude rate spectrum—was developed by D. A. Kohl of Litton Industries, Inc.'s Applied Sciences division [Electronics, May 18, p. 27].

The instrument monitors the area within 200 miles of the missile center.

Batten down the hatches. A tip that a storm is brewing alerts the missile men to batten down the hatches and tuck a poised missile inside a hanger if there is time.

The instrument comprises three stations. The main one is at Patrick Air Force Base, some 15 miles south of the Cape. Another is at Bithlo, 25 miles to the west, and the third is at Ponce de Leon Inlet, about 45 miles up the coast.

Each station has four antennas mounted on a single turntable. With a bit of calculation, messages from the three stations can pinpoint an electromagnetic buildup and its path can be traced.

The outputs of the four antennas and their receivers are measured by an automatic control circuit. If there are no sferics signals present, the turntable remains stationary. If sferics signals are detected above a preset level, the control circuit causes the turntable to scan in steps of 5.625 degrees per step. The turntable holds for 10 seconds after each step, and then rapidly recycles back to the initial position upon completion of the eighth hold position.

Scanning continues as long as the omnidirectional sferics output exceeds the threshold.

Data remotely monitored. Data from the two remote sites is fed over phone lines to the main station at Patrick. All the data is then fed to a processor along with the readout from a weather radar, which is used to provide direction, range and height data on clouds.

At the main station, the output from each Sparsa station is displayed on cathode-ray tubes that are monitored by vidicon cameras. The vidicon signals are mixed and shown on a 21-inch television screen with a map overlay of the area.

Only a warning. Weathermen are hopeful of getting up to two hours' warning of impending electrical storms—plenty of time to remove workmen from missile gantries, disconnect umbilicals and secure all ground-support equipment.

But the two-hour warning isn't good enough. It takes three and a half hours to move a Saturn V moon rocket back to a vertical as-

Regulate down to zero power factor with Sorensen's new silicon controlled rectifier ACR Voltage Regulators

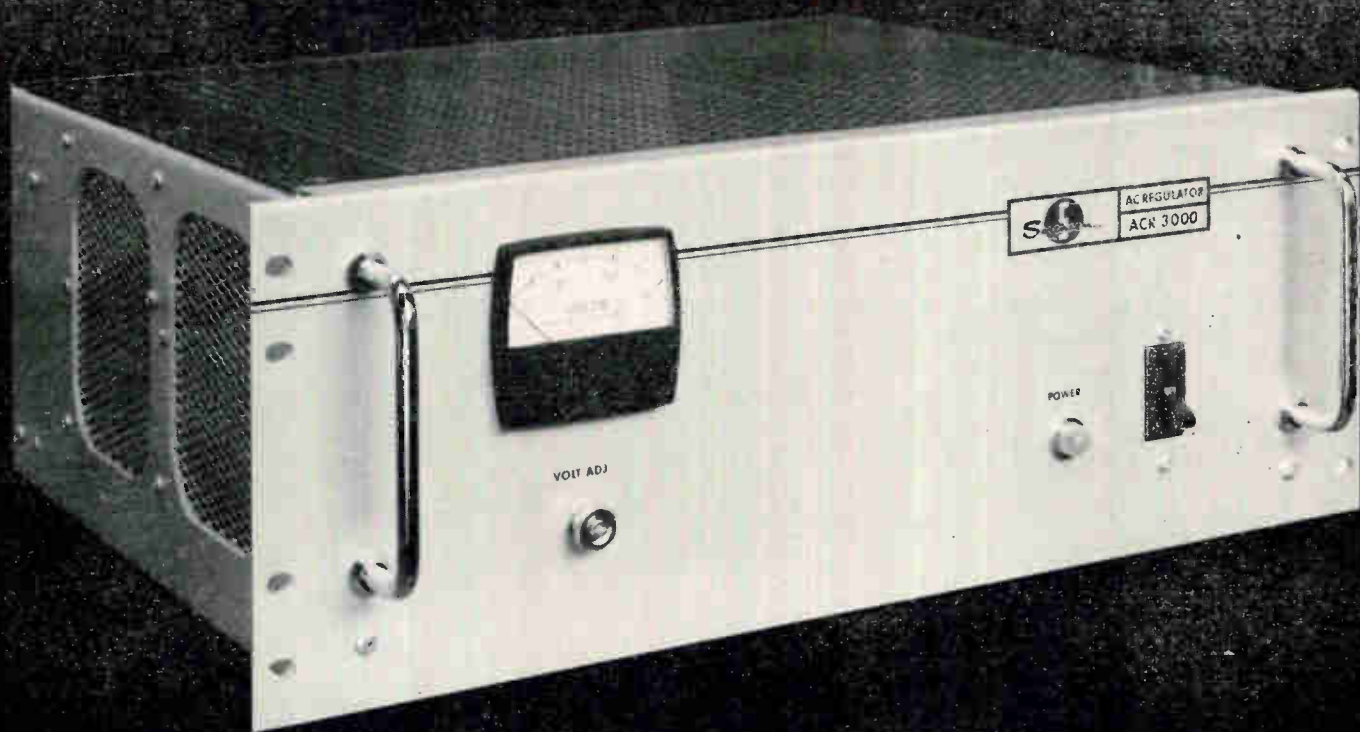

Ideal for motor starting, lamp loads, tube filaments, x-ray applications, etc., ACR Series regulators are designed to control the RMS voltage to a variety of loads requiring precision regulation, fast response time, and low distortion.

- 1 5 MODELS AVAILABLE (500, 1000, 2000, 3000, 5000VA)
- 2 LOW PRICES (starting at \$290)
- 3 SMALL SIZE AND WEIGHT (about half the volume of competitive regulators)
- 4 FULL INPUT VOLTAGE RANGE 95-130 VAC; OUTPUT RANGE 110-120 VAC
- 5 FAST RESPONSE to line or load changes (30ms)
- 6 LOW DISTORTION (3% max.)
- 7 STABILITY (.05%/8 hours—after a 30-minute warm-up)
- 8 UP TO 95% EFFICIENCY
- 9 REGULATION $\pm 0.1\%$ RMS
- 10 PROGRAMMABLE
- 11 REMOTE SENSING
- 12 CONVECTION COOLED
- 13 EASY MAINTENANCE (removable "plug-in" printed circuit)

For complete data on the ACR Series and other Sorensen products, send for the new, 140-page book, "Controlled Power Catalog and Handbook." Write to Sorensen, Richards Avenue, South Norwalk, Conn., or use Reader Service Card Number 200.

ACR ELECTRICAL AND MECHANICAL SPECIFICATIONS:

MODEL NUMBER	OUTPUT VA RANGE	REGULATION ACCURACY		EFFICIENCY (FULL VA)	TYPICAL POWER FACTOR	TEMPERATURE COEFFICIENT		DIMENSIONS (INCHES)				PRICE**
		LINE	LOAD			AMBIENT (°C)	(°C)	WIDTH	HEIGHT	DEPTH	RACK HEIGHT	
ACR 500	0-500	$\pm 0.1\%$	$\pm 0.1\%$	88%	75%	0-50	.015%	15*	5	9	5 $\frac{1}{4}$	\$290
ACR 1000	0-1000	$\pm 0.1\%$	$\pm 0.1\%$	90%	75%	0-50	.015%	19	5 $\frac{1}{4}$	11	5 $\frac{1}{4}$	340
ACR 2000	0-2000	$\pm 0.1\%$	$\pm 0.1\%$	92%	75%	0-50	.015%	19	5 $\frac{1}{4}$	15	5 $\frac{1}{4}$	435
ACR 3000	0-3000	$\pm 0.1\%$	$\pm 0.1\%$	95%	75%	0-50	.015%	19	7	15	7	555
ACR 5000	0-5000	$\pm 0.1\%$	$\pm 0.1\%$	95%	75%	0-50	.015%	19	7	20	7	715

*A 19 inch adapter (rack) panel is available.

**Optional Meter \$22.



A UNIT OF RAYTHEON COMPANY

Circle 31 on reader service card

sembly building from a launching pad, so development of the warning system is continuing.

Man or mouse?

No heavy-footed gopher is going to set off the intruder-detection system being installed at 100 Atlas and Titan missile launch sites across the United States. An electronic detective that can distinguish between man and beast will soon replace more than 1,300 airmen on sentry duty.

The Area Security Surveillance System uses doppler radar techniques. It will report the presence of nonhuman intruders to underground command posts and alert security forces. Each system consists of a transmitter, receiver and an annunciator with audible and visual alarm. The number of transmitters and receivers depends on the site. The single annunciator in the command post sounds an alarm and lights up on a display panel the sector that has been invaded.

A typical installation at an Atlas F site includes three transmitters and receivers and one annunciator. The doppler radar works in the S-band, between 1,700 and 1,800 megacycles, and uses a specially developed microwave tube with a machined cavity for precise frequency response.

Over the threshold. The transmitters blanket a sensitive sector with an electromagnetic field and, under normal conditions, the receivers get a constant signal. The entry of bird, beast or object into the field causes shifts in frequency and intensity as the signal bounces off the intruder. The differences in frequency and intensity between direct and reflected waves are detected and measured. If they exceed certain thresholds built into the receiver-processor, an alarm is triggered.

Thresholds are tuned to certain "signatures" of a human being—such as height, target density, movement into the sensitive area at a rate equal to or greater than one 15-inch step per second. The intruder would betray a human signature if he attempted to "do useful work" like tampering with the launch silo cover. Tests of the sys-

tem give a mean-time-between-failure rating of 6,000 hours.

If the system is jammed, or if certain crucial components fail, the alarm goes off. Redundancy is built into some parts. If a noncritical component fails, the system switches over to the standby component. But the system cannot be reset until the defective component is replaced.

Air Force installations. Under a program that has reached the \$15-million level to date, the Air Force is installing the security system at all Atlas F and Titan II locations. The first installation, at the Strategic Air Command Base, Plattsburgh, N.Y., is in limited operation. Sylvania Electronic Systems division, a subsidiary of the General Telephone & Electronics Corp., is scheduled to deliver the last of the equipment by next month. Installations are expected to be completed in mid-1965. The program, tagged the 410-L, is managed by Major Hubbard L. Wood, Jr., at the Air Force Electronic Systems division, Hanscom Field, Mass.

Under a separate program, Sylvania has received \$32 million to date for development of electronic security systems for Minuteman launch sites.

Medical electronics

Phosphor-video diagnosis

Researchers at the General Electric Corp.'s x-ray division in Milwaukee have used a characteristic of phosphor to develop a potential diagnostic aid for women suffering from breast cancer. They believe it may replace infrared technology in thermographic identification of possible cancer sites.

The diagnostic method, used on patients in Montreal last month, exploits the tendency of phosphors to light up with temperature changes. Dr. R.N. Lawson of the Royal Victoria Hospital, who conducted the tests, and L.L. Alt, the GE scientist who searched out the application, reported their findings to a Washington meeting on unconventional photographic systems sponsored by

the Society of Photographic Scientists and Engineers.

Lawson, a pioneer in thermal identification of cancer sites, calls the phosphor-video system the best diagnostic tool of the eight to ten thermographic systems he's tried in the last decade.

Heat picture. Films of zinc cadmium sulfite phosphors, Alt explains, sprayed on the skin of the patient (or element) and exposed to a constant excitation by long-wave ultraviolet radiation, emit light as an inverse function of the temperature of the body. The light output, picked up by 875-line video scanners, produces clear, sharp heat "pictures" of the body being scanned.

Light output under ultraviolet excitation, Alt reports, can jump by as much as 15% to 20% for each degree centigrade. Dark, sharply defined sites on the screen represent what Dr. Lawson has come to know as "hot spots" identified with cancer sites.

Scanners can pick up fractions of a degree change. Further instrumentation, densitometers for instance, can enhance the sensitivity of the system.

Scanner. Though improved phosphors may extend even further the ability of an examiner to take optical readings of light output change without instrumentation, Alt believes the scanner will remain an integral part of the thermographic system. This is because the scanner can intensify both amplification and contrast, if necessary. It can also be adjusted to eliminate undesirable background radiation.

In a related development, Dr. Ernest H. Wood, radiologist at the University of North Carolina, last month, reported that temperature gradients across the skull may indicate the approach of a stroke. A coolness on one side of the head is regarded as a sign of a decreased blood supply and is a danger signal.

Wood's findings, made by conventional thermography, might be implemented by the phosphor-video technology, which is capable of seeing temperature drops that reflect possible blockages in discrete blood vessels near the surface.

LOOK, DAD, NO CAVITIES*

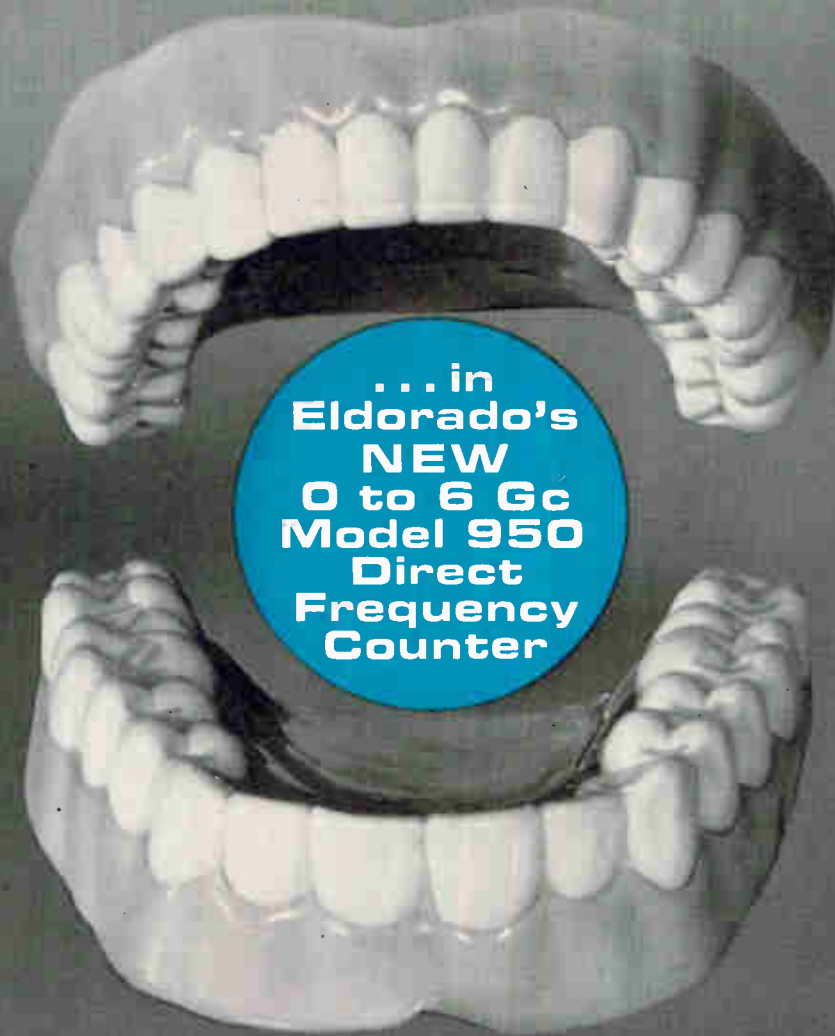

* NO HETERODYNE, NO TRANSFER OSCILLATOR!

Now, measure 0 to 6.4 gigacycles without the use of heterodyning, transfer oscillators, prescaling, or time consuming calculations. The new Eldorado Model 950 provides a direct Nixie® readout in these frequencies direct from the unknown source with no adjustments. Operator error and fatigue are virtually eliminated.

Accuracy of the seven digit Model 950 is 1 part 10^7 , with one part 10^8 optional. Accuracy of nine digit Model 951 is 3 parts 10^9 . Input sensitivity of both instruments is 50 millivolts rms (typical) with input impedance of 50 ohms. Both units may be used with Model 980 Frequency Extender to measure frequencies to 18.4 gigacycles.

® BURROUGHS CORPORATION

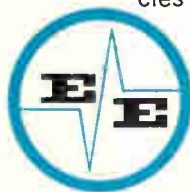

*For additional information,
write, wire or phone today!*

ELDORADO ELECTRONICS

601 CHALOMAR ROAD • CONCORD, CALIFORNIA, U. S. A.
Telephone (415) 686-4200

Circle 33 on reader service card



SOMETIMES WE SAY "NO"

We don't make impossible promises at Milo. It's true that most orders are shipped the same day they're received. Our broad-line inventory and snap-action procedures enable us to fill a wide variety of requests from stock.

But occasionally we have to say "Sorry—we can't ship today." We'll level with you, and then go to work to get your order delivered as fast as humanly possible. We won't tell you one day if it really takes two. And, most important—we'll keep you posted on our progress. We even have a fully-staffed Customer Service

Department of nine people devoted exclusively to follow-up, expediting, and special traffic control for open orders! (Only Milo has C.S.D.)

We've been in this business of industrial electronics distribution for two decades, working to make friends and steady customers. So we're not about to damage our hard-earned reputation with an impossible promise given under the pressure of "getting the order." This is only one of the many reasons you can count on Milo—because Milo really cares about your needs, and takes extra care to meet them.



MILO ELECTRONICS CORP.

530 CANAL STREET, NEW YORK, N.Y. 10013 • TEL 212-BE 3-2980 • TWX 212-571-0195

BRANCH WAREHOUSES AND SALES OFFICES IN PRINCIPAL INDUSTRIAL AREAS



**It takes
only small change**



to buy new Stangard trimmer capacitors

Put the squeeze on trimmer capacitor costs! Specify new Stangard capacitors for such non-military instrument and commercial applications as bridges, frequency standards, calibrators, spectrum analyzers, signal generators . . . even radio, TV and FM applications. Stable Stangard trimmers eliminate additional hardware and fixed ceramic temperature compensating capacitors and simplify circuit design when used to replace threaded tubular ceramic trimmers. Stangards have a greater sensitivity than comparable units in this low cost price range. • You can choose from a wide range line, too. Stangard trimmers with glass dielectrics are available in panel mounting and in printed circuit units in four capacitance ranges. Panel mount and printed circuit units are also available with ceramic dielectrics for greater capacitance.

NOTE THESE STANGARD ADVANTAGES:

- Extremely low cost without sacrifice of quality.
- Smooth adjusting torque.
- Vinyl encapsulation provides additional mechanical protection under shock and vibration stress.
- Inherent structural strength.
- No derating over -55 to $+125^{\circ}\text{C}$ operating temperature range.
- Special dielectrics provide outstanding high Q's.

WRITE FOR BULLETIN STD 64

Stangard units shown actual size

Components Division

JFD ELECTRONICS CORPORATION, 15th Ave. at 62nd St., Brooklyn, N. Y. 11219
JFD NORTHEASTERN, Ruth Drive, P. O. Box 228, Marlboro, Mass. 07152
JFD NEW YORK-NORTHERN, Damiano Pl., P. O. Box 96, New Hartford, N. Y. 13503
JFD MID-ATLANTIC, 313 E. Broad St., Palmyra, N. J. 08065
JFD MID-ATLANTIC-MARYLAND, P. O. Box 7676, Baltimore, Maryland 21207
JFD MIDWESTERN, 6330 W. Hermione St., Chicago, Illinois 60646
JFD MIDWESTERN-OHIO, P. O. Box 8086, Cincinnati, Ohio 45208
JFD WESTERN, 9 Morlan Place, Arcadia, California 91006
JFD CANADA LTD., 51 McCormack Street, Toronto, Ontario, Canada
JFD ISRAEL LTD., Industrial Area B, Bldg. 23, Azur, Israel
DUCON CONDENSER PTY., LTD., Christina Road, Villawood, N.S.W., Australia
LCC STEAFIX, 128 Rue de Paris, Boite Postale 51, Montreuil-sous-Bois, Seine, France
MURATA MANUFACTURING CO., LTD., Nagaoka Otokuni, Kyoto, Japan
STANDARD TELEPHONE & CABLES LTD., Footscray, Sidcup, Kent, England

DISTRIBUTED BY
**JFD ELECTRONICS
CORPORATION**

Variable Trimmer Piston Capacitors ■ Metalized Inductors ■ LC Tuners ■ Ceramic Fixed and Variable Capacitors ■ Fixed and Variable Distributed and Lumped Constant Delay Lines

INTERNATIONAL RECTIFIER

SILICON SCR and RECTIFIER ASSEMBLIES

1 to 100,000 AMPERES...1 to 1,000,000 VOLTS



High-voltage encapsulated sticks, 1 KV to 75 KV per stick, 0.25 to 1.25 amps. Basic building blocks for high voltage assemblies.

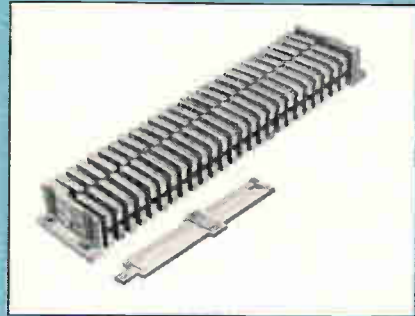

Super-high-voltage rectifier columns, 5 KV to 500 KV PRV and up to 25 amps. Power density over 1 KW per cubic inch.



Power encapsulated bridges, 1 to 25 amps, up to 400 volts PRV. Designed for volume commercial applications.

Any Type Any Configuration



Epitaxial SCR and rectifier bridge stacks, 1- and 3-phase power from 1 to 365 amps, 1,300 volts PRV per junction. Also assemblies for inverter and cyclo-converter applications.

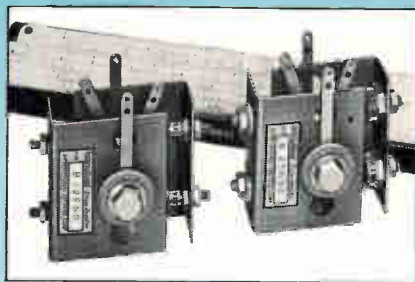

Self-contained silicon rectifier stacks with cooling fins, basic units, 50 amps, up to 900 volts PRV per stack.

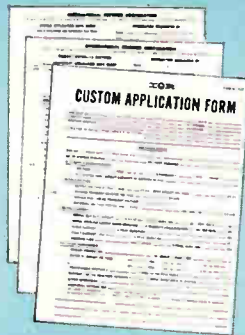

Designers' checklists for specifying rectifier and SCR assemblies available from International Rectifier on request.

WHAT'S THE POWER END POINT? At IR there is none. SCR and rectifier assemblies with ratings of one hundred thousand amperes or one million volts are merely indicative of the unparalleled breadth and depth of the engineering and manufacturing capabilities that can

be applied to your needs. Do you have a challenging application?

For assistance, contact your local International Rectifier sales office or 233 Kansas Street, El Segundo, California.

WORLD'S LARGEST RECTIFIER SPECIALISTS



INTERNATIONAL RECTIFIER

INTERNATIONAL RECTIFIER CORP., EL SEGUNDO, CALIF., PHONE OR 8-6281 • CABLE RECTUSA • REGIONAL OFFICES IN NEW YORK CITY, CH 4-0748 • FORT LEE, N. J., WI 7-3311 • SYRACUSE, N. Y. HE 7-8495 • CAMBRIDGE, MASS., UN 4-6520 • ARDMORE, PA., MI 9-3667, GR 3-3932 • SILVER SPRING, MD., JU 9-3305 • MIAMI, FLA., 445-5201 • CHICAGO, ILL., OR 6-4090 • CLEVELAND, OHIO, 734-4100 • DAYTON, OHIO, 223-7691 • HUNTINGTON WOODS, MICH., LI 8-1144 • ST. LOUIS, MO., TE 8-6333 • MINNEAPOLIS, MINN., 920-1200 • DALLAS, TEX., LA 1-0110 • LOS ANGELES, CALIF., 750-0550 • IN CANADA: TORONTO, ONT., PL 9-7581 • MONTREAL, QUE., 861-0562

EUROPEAN GENERAL SALES OFFICE: 38 AVENUE DES ARTS, BRUSSELS 4, BELGIUM • TELEPHONE: 111774

Washington Newsletter

November 16, 1964

Old problems for new Congress

Despite the Johnson Administration's landslide victory at the polls, critical defense problems remain and a thorough policy review is in progress. Come January, the clamor for change will be amplified by critics among both parties in Congress—whose strength was not diminished by Democratic gains.

On major military committees of Congress, both Democrats and Republicans are worried about Communist China's atomic bomb and the Soviet Union's change in leadership. Partisanship will recede now that the election is over, but the old issues remain—over-reliance on missiles, missile reliability, need for new strategic systems and better antiguerrilla methods. These will be tackled seriously by both parties.

McNamara critics survive landslide

Voters returned some of Defense Secretary Robert S. McNamara's most persistent critics to Congress. Republicans Bob Wilson and Charles S. Gubser of California retain their seats on the House Armed Services Committee. Reps. Gerald R. Ford (R., Mich.) and Melvin R. Laird (R., Wis.) return to the Military Appropriations subcommittee, where congressmen have their greatest impact on the military budget. Ford and Laird, both bright and aggressive, will be shaping policy on defense issues for the national Republican party.

Barry Goldwater will be gone from the Senate and from its Armed Services Committee. But his departure opens a Republican seat for another McNamara foe, Sen. J. Strom Thurmond (R., S.C.), Thurmond lost his own Armed Services seat by quitting the Democratic party. But Republican leaders are expected to let him fill Goldwater's niche.

Changes due at the Pentagon

At the Pentagon, only one major civilian change is expected. But there will be several among the brass.

Assistant Secretary Thomas Morris will be leaving. He was the architect of such sweeping procurement reforms as the centralization of buying in the powerful Defense Supply Agency. His job is specialized and sensitive, and the appointment won't be political. **One possibility: Paul R. Ignatius, undersecretary of the Army for installations and logistics.** He's a former professor at the Harvard Graduate School of Business Administration.

Upcoming changes in the military include Gen. Curtis LeMay, whose term as Air Force chief of staff expires in January; Gen. Thomas S. Power, head of Strategic Air Command, who retires next month; and Gen. John K. Gerhart, commander of the North American Air Defense Command, who retires early next year.

Avionics order nears for Teledyne

The Teledyne Systems Corp., a subsidiary of Teledyne, Inc., should wrap up a development contract within a month for the Navy's integrated helicopter avionics system. The Navy is in the final stages of negotiating the concept, design approach, management plans, schedule and cost. **Teledyne appears to have beaten two other competitors: the Notronics division of the Northrup Corp. and Texas Instruments, Inc.** At first the Pentagon doubted that Teledyne could meet its performance claims,

Washington Newsletter

and demanded a penalty clause. But Teledyne came up with a guarantee that satisfied the government, and it looks like it will get a development agreement worth about \$25 million.

The development can lead to some big orders for Teledyne. The Pentagon's Office of Defense Research and Engineering is trying to coordinate the Navy's needs with those of the Army and Marine Corps, which also have an interest in the system. The system will feed into a central computer data on communications, navigation, terrain-following radar, station-keeping and friend-or-foe identification. The pilot and copilot will operate it through a control console with audio and visual equipment.

Humphrey to give computers a plug

When Hubert H. Humphrey moves into the vice presidency, he will give a big lift to one of his pet projects: automated data handling for science and technology.

His interest already has sparked the use of computers in the National Library of Medicine and computer-sharing among government agencies. Humphrey will be an important conduit into the Administration for new ideas in science, technology and planning for defense cutbacks. He becomes chairman of the National Aeronautics Space Council in January.

Army improving shopping habits

The Army is trying to meet persistent criticism that it does too much buying on a sole-source basis. The latest blast came from the General Accounting Office, which has been prompted by the House Defense Appropriations Subcommittee to investigate military buying of electronics equipment. The Army, says the GAO, wasted \$2.2 million in a sole-source procurement of 502 radar sets from the Sperry Gyroscope Co., a subsidiary of the Sperry Rand Corp. The purchase of portable surveillance radar, it is charged, was made despite knowledge that the sets were too cumbersome and inaccurate. Resulting modifications ate up 15 months' production time. Later Aeronca Mfg. Co. won a contract by undercutting the price paid Sperry Gyroscope by 55%. The Army is passing the GAO criticism along to all its procurement commands.

And it has set up tighter controls to assure that equipment deficiencies disclosed in engineering and service tests are reported to procurement officials.

Fm-stereo on the beam

The Collins Radio Co. and McMartin Industries, Inc., will have the inside track to supply equipment when the Federal Communications Commission works out a rule to require fm-stereo broadcasting stations to monitor their own signals. Monaural stations are already required to monitor, and FCC engineers believe that Collins and McMartin equipment will do the job for the full range of stereo signals.

Addenda

New NASA quality standards for hand-soldering electronic connections are being received by contractors and field centers. They go into effect Dec. 26. . . . The election delayed the Pentagon briefings for the defense industry on the long-range outlook for government spending. Mark these new briefing dates on your calendar: Los Angeles, March 3-4; New York, March 16-17; Chicago, March 31-April 1; Dallas, April 14-15; Washington, April 28-29.



FLYING TIGER FLIES THE OUTSIZE CARGO

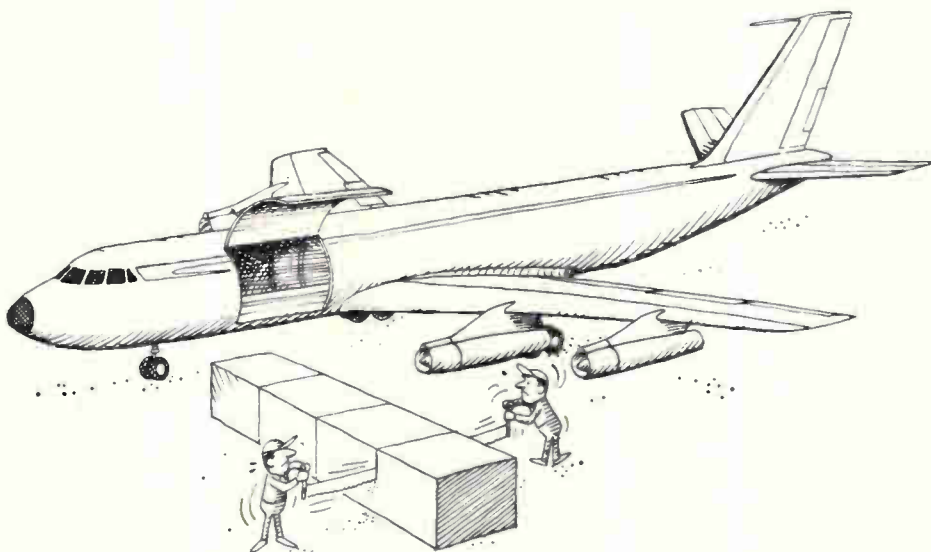

JET FREIGHTERS WON'T TAKE OR CAN'T HANDLE

You'll find passenger airlines which also carry cargo aren't very accommodating when you have a large single piece of freight. On all-cargo jets, for example, most draw the line at anything over 7 ft. wide, 10 ft. long, or 6 ft. 8 in. high. But not Flying Tigers. It's everyday routine for our Swingtail-44s to get that really big shipment of yours aboard, which side-loading jet cargo

freighters won't or can't physically handle.

Next time you have an airfreight shipment, out-size or any size, trust it to the airline that will carry all your freight. The one that will get it to over 2,500 U.S. markets, thanks to "Skyroad," Tigers' combined air/rail/trucks system. Or to anywhere in the world by charter. Flying Tiger ... the world's largest scheduled all-cargo airline.

the airfreight specialist **FLYING TIGER LINE**



New General Electric components

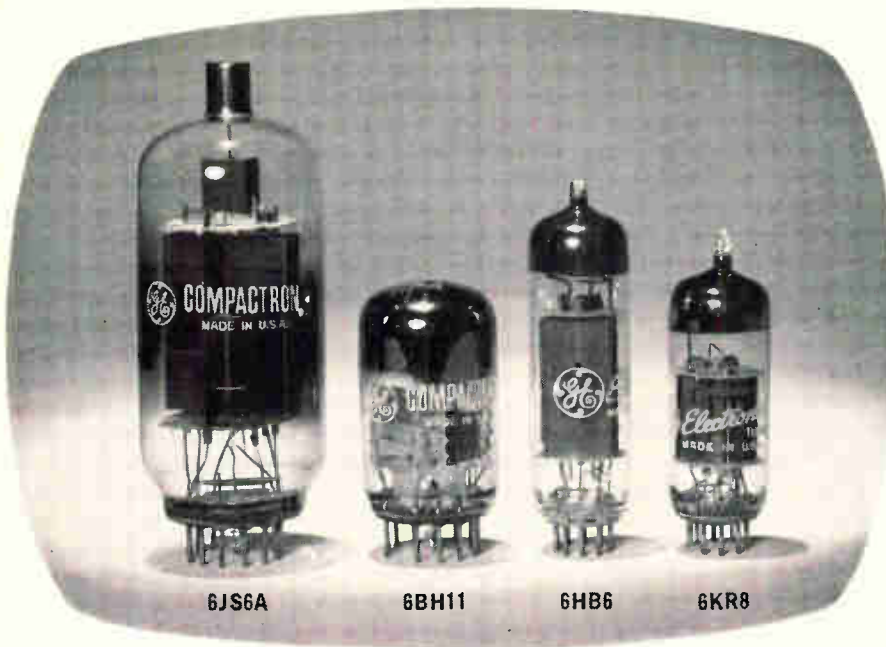

New G-E compactrons and miniature tubes provide added design flexibility for color TV sets

General Electric's new compactron and miniature tubes now offer expanded design capability for color television receivers, and other electronic applications. Four new types with added functions are available, specifically designed to meet demanding color TV needs:

6JS6A—Pentode Compactron

With improved anti-sniwet control, this horizontal output amplifier can eliminate special circuitry and voltage needs. Its space-saving, low-cost design offers more usable output, expanded application possibilities in all-channel color television receivers.

6BH11—Twin-triode Pentode Compactron

This new general-purpose, twin-triode pentode combination gives you the same quality and reliability as the popular miniature type 6GH8A tube. Its pentode and triode characteristics are identical to the 6GH8A.

6HB6—Low-cost High-gain Pentode Miniature

Low-cost video amplifier, with special grid construction, matches the performance of its type 6KR8 companion. This general-purpose miniature with test-proved, high-gain performance is ideally suited for economical color circuitry.

6KR8—High-gain Pentode Triode

This tube will deliver 27,000 μ mho in practical video circuitry. It features a high-quality, 3-strap frame grid, and general-purpose high-gain triode. Its rugged construction and high performance make it particularly suitable for color TV.

General Electric compactrons and miniature tubes lower design and manufacturing costs, increase reliability and performance. Compare for yourself the many advantages they offer. Your G-E Sales Engineer has the details and can provide application or prototype assistance.

New G-E 7911 ceramic tube Size and weight reduced, Performance increased

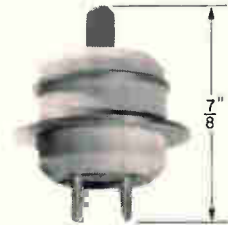

General Electric's new 7911 miniature planar ceramic microwave triode offers advantages in size, weight and performance over previous types. Weight is slashed at least 75%, height reduced to only $\frac{7}{8}$ ". You get up to 3 times greater tube gain-bandwidth product and trans-conductance/ma. It is ideally suited for beacons and radar altimeters, and new broadband concepts for DME-TACAN-IFF equipment.

A comparison of the 7911 with two other popular types is shown below. For specific application information, contact your G-E sales representative, or write to TIPS for more information.

Characteristic	New miniature ceramic 7911	Standard lighthouse planar types	
		6442	7815
G_m	27,000 μ mhos	16,500 μ mhos	25,000 μ mhos
G_m/ma	1,080	470	360
Tube gain-bandwidth	2,900 mc	1,150 mc	2,000 mc
W_h	3.3 W	5.7 W	6.3 W
Cath. area	0.34 cm ²	0.32 cm ²	0.50 cm ²
Length	$\frac{7}{8}$ in.	2 $\frac{3}{8}$ in.	2 $\frac{5}{8}$ in.
Max. diam.	$\frac{3}{4}$ in.	1 $\frac{1}{16}$ in.	1 $\frac{1}{4}$ in.
$F_{max.}$	6,000+ mcs.	5,000 mcs.	3,000 mcs.
Eff. @ 4 Gc.	33%	25%	10%
Outline	Grounded cathode	Grounded grid	Grounded plate
C_{g-k}	5.0 pf	5.0 pf	6.3 pf
C_{g-p}	1.5 pf	2.3 pf	2.0 pf
C_{k-p}	0.05 pf	0.045 pf	0.035 pf
$T_{max.}$	250 C	175 C	250 C
Solderable	Yes	No	No
Weight	$\frac{1}{4}$ oz.	1 oz.	2 $\frac{1}{2}$ oz.
W_p	6.5 W	7.5 W	10 W
$W_r/area$	9.7 W	17.8 W	12.6 W
$E_p max.$	3.0 Kv	3.0 Kv	3.5 Kv
I_k	8.2 a/cm	10.8 a/cm	6.6 a/cm

expand design opportunities

G.E. expands reed-switch line: Adds high-voltage and miniature types for design flexibility

When your application requirements call for *higher voltages*, check the rating of General Electric's new type 2VR15 reed switch.

At 5,000 volts (rms), this vacuum reed switch opens new design possibilities. It requires only 113 (± 20) ampere-turns for operate, 55 (± 10) ampere-turns release. Maximum carrying current is 3 amps, contact rating is 15 volt-amps, and contact resistance is 0.05 ohms.

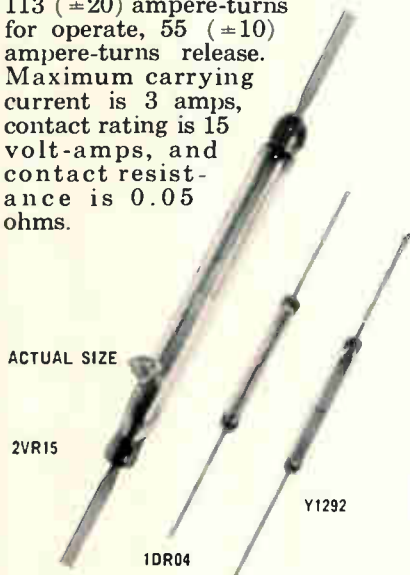

When it is *small size* you need, new G-E miniature reed switches, measuring only 2 inches over-all (glass capsule 0.78 in.), offer field-proved reliability and performance.

The type 1DR04, with diffused gold contacts, is ideally suited for either inductive or resistive loads. Full load (160 ma, 25V d-c) life is estimated to 25 million operations.

Type Y1292 miniature switches, with rhodium-plate contacts, have higher dissipation and current ratings. In life tests by one major manufacturer at 60 milliamps, 15 vdc, no failures occurred after 1.75 billion operations.

Compare for yourself the advantages and operating characteristics of General Electric vacuum reed switches. Some 20 different types are available in a variety of sizes, ratings, sensitivity and speeds. Ask your G-E sales representative for prototype samples, or write to TIPS for full details.

New cadmium-selenide photoconductive cells

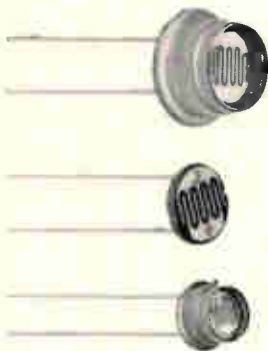

You can now get increased photocell performance and longer life with General Electric's new cadmium-selenide hermetically sealed or plastic-encapsulated photoconductive cells.

Available hermetically sealed in $\frac{1}{2}$ " or $\frac{3}{8}$ " diameters, with encapsulated equivalents, these new cadmium-selenide photocells are ideally suited for applications requiring fast response time and high sensitivity. They react to longer light wave lengths, matching incandescent and some other infrared light sources—even a small change in light level produces high resistance change. See table for specification details of present designs.

Response Time							
Approx. 1000 to 1 resistance change in 10 millisecon. with 25 fc applied in darkness							
Photocell Description							
$\frac{1}{2}$ " hermetic Type Y1206	$\frac{1}{2}$ " plastic Type C425P1	$\frac{3}{8}$ " hermetic Type Y1332	$\frac{3}{8}$ " plastic custom-built				
Operating Voltage							
250 volts	250 volts	30 volts	30 volts				
Sensitivity							
dark-ness	2 fc	dark-ness	2 fc	dark-ness	2 fc	dark-ness	2 fc
2.5 meg-ohms or more	1500 Ω	5 meg-ohms or more	10000 Ω	2 meg-ohms or more	1000 Ω	2 meg-ohms or more	1000 Ω
Dissipation							
250 milli-watts (500 milli-watts with heat sink)	200 milli-watts	75 milli-watts	50 milli-watts				

See your G-E sales representative, or write to TIPS for more information. Samples for prototype work are available immediately.

G-E vidicon tube offers high performance and light weight

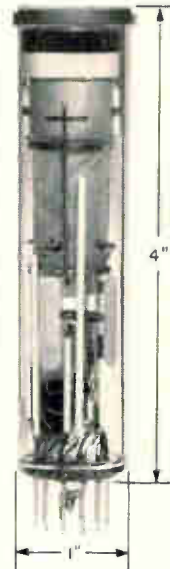

General Electric's new type Z-7845 vidicon tube combines the high resolution performance of all-magnetic vidicons with compact size and light weight.

Operating on a new electron-optical principle, Focus Projection and Scanning (FPS), this new vidicon provides a resolution of 800 TV lines with 750-volts beam acceleration.

The new Z-7845 is especially designed for applications where space and weight are critical, such as, TV missile guidance, star trackers and battlefield surveillance equipment.

General Specifications (Approx.)

Length (exclu. pins) . . . 4 in.

Diameter

Body 1 in.

Target ring 1 $\frac{1}{8}$ in.

Weight

Tube 80 grams

Magnet 120 grams

Heater power 3 to 5 watts

Spectral response S-18

Focusing method magnetic

Deflection method electrostatic

Usable target dia. 0.84 in. max.

Progress Is Our Most Important Product

GENERAL ELECTRIC

For more information, write G-E Tube Dept., Technical Information and Product Service (TIPS), Room B27002, Owensboro, Kentucky. Please specify product(s).

We sell solid performance

More and more exceptional solid-state devices are on the way from Sanders — pioneers in TRI-PLATE® strip transmission line. All are unique designs, created by New Direction thinking to meet the engineer's fast-changing needs in UHF and microwave technology.

Here are just a few . . .



Solid-State Oscillators

Low cost — low input power — all-new line of solid-state UHF oscillators require minimum power of only 16 volts nominal. Input-output power ratio is highly efficient. Between 100 and 250 milliwatts output — depending on choice of eight models already available over broad frequency ranges between 50 and 600 MC. All these economical new oscillator models deliver consistent specified performance between -30°C and $+60^{\circ}\text{C}$.

Solid-State Switches...



Newest switch models — each covering broadband segments from DC to 8 GC — achieve extremely fast switching, high isolation, low insertion loss, minimum dribble voltage. Typically, Model DS 508 (shown) has a rise time of less than 50 nanosec, operates from 1.0 to 4.0 GC with 30 db minimum isolation, 1.5 db typical insertion loss, VSWR of 2.1:1 maximum!

These exceptional operating characteristics are constant in all Sanders solid-state devices — the result of long experience and imaginative leadership in strip transmission line and solid-state techniques. For com-

and Drivers



A Sanders exclusive: mating switch drivers are specifically designed to maintain finely balanced control voltages for uniform ultra-high-speed switching. Model DC 502 Driver — as shown — is offered in four different versions for single or dual trigger inputs with 5 MC or 1 MC repetition rates.

plete data — or assistance in engineering Sanders solid performance into your products — write Sanders Associates, Inc., Microwave Products Dept., 98 Canal St., Nashua, New Hampshire.

Sanders Associates, Inc.

CREATING NEW DIRECTIONS IN ELECTRONICS



©Reg. T.M. Extensive Patent Coverage, Sanders Associates, Inc. *T.M., Sanders Associates, Inc.



Weight is the only thing missing...

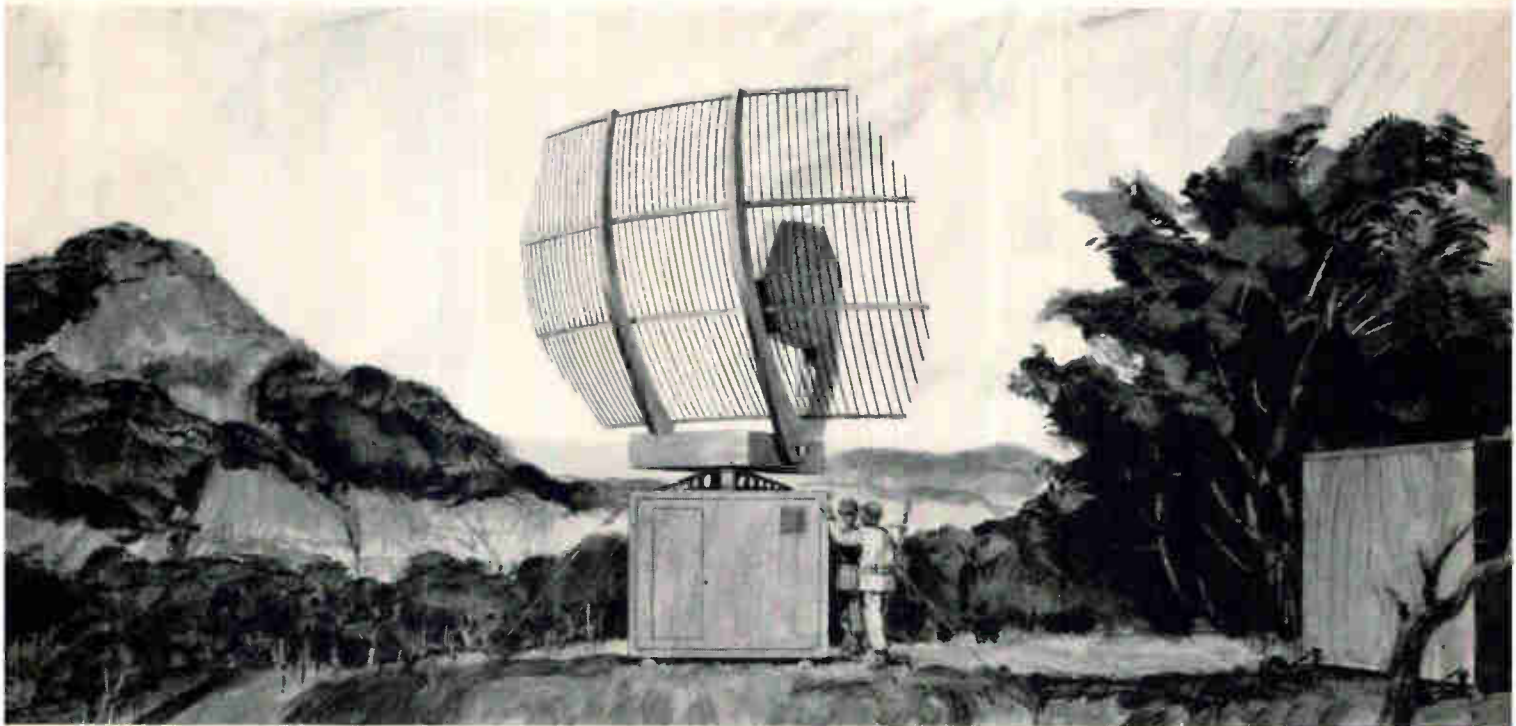

from this new Westinghouse tactical radar system

Westinghouse has designed a tactical radar system so light it rides into combat in a single helicopter load, so simple it sets up in 30 minutes or less. Yet this lightweight unit has all of the sensing, coverage, range, height accuracy and performance of present systems weighing many times more.

Design of this new breed of radar draws

on Westinghouse experience in developing the first successful, fully transportable, long range tactical radar and the first successful 3-D tactical radar.

Pioneering in micro-miniaturization (thin film and molecular circuitry), Westinghouse radar experts have applied these advanced techniques to today's proven

systems, as well as to future designs.

The result: a dramatic improvement, not only in size and weight reduction, but in overall performance and reliability.

For further information on what's really new in tactical radar and communications, write Westinghouse Electric Corporation, Box 868, Pittsburgh, Pennsylvania 15222.

J 02364

You can be sure if it's Westinghouse



Circle 43 on reader service card

MITSUBISHI MICROWAVE ANTENNAS FOR TELECOMMUNICATIONS



Japan today has the second largest microwave network in the world. Mitsubishi Electric, with the longest microwave antenna experience in Japan, has supplied 90% of the antennas used in the trunk lines of this extensive network. Mitsubishi antenna systems include parabolic, scatter, horn reflector and radar types, as well as a complete line of waveguide components and accessories. Frequencies from 900 Mc. to 24 KMc. are covered. The IU-62, shown above and specified at the right, is typical of the outstanding performance of Mitsubishi microwave antennas. Full technical information on any of these types of antennas is available at your request.

IU-62 Horn Reflector Antenna

Frequency Range :	3,000-12,000 MC
Aperture :	9m ²
Max. width :	4,050mm
Max. depth :	2,560mm
Max. height :	7,418mm
Gain at 3,900MC :	V 41.5 db H 41.2 db
Gain at 6,100MC :	V 44.9 db H 45.0 db
VSWR :	1.01
Front/Back (over 60 degrees) :	67-70 db
Discrimination of cross polarization :	V 57 db (at 3,900MC) H 78 db V 45 db H 37.5 db (at 6,100MC)
Guaranteed wind velocity :	140 miles/hr



MITSUBISHI ELECTRIC CORPORATION

Head Office: Mitsubishi Denki Bldg., Marunouchi, Tokyo. Cable Address: MELCO TOKYO



■ IU-61 parabola antenna

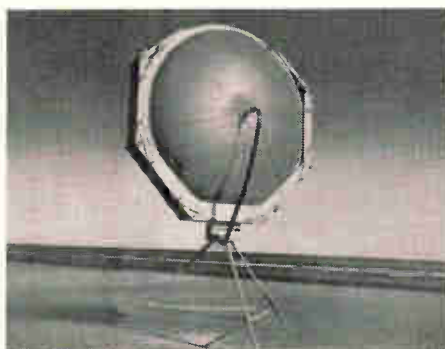

■ Air inflated parabola antenna

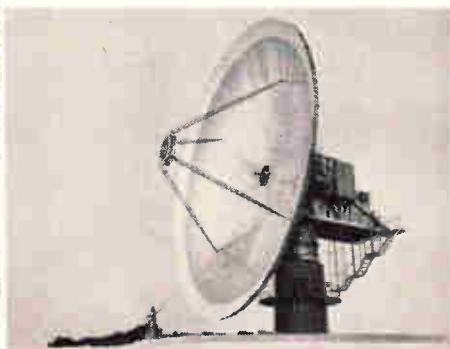

■ 20 meter diameter antenna for satellite communication

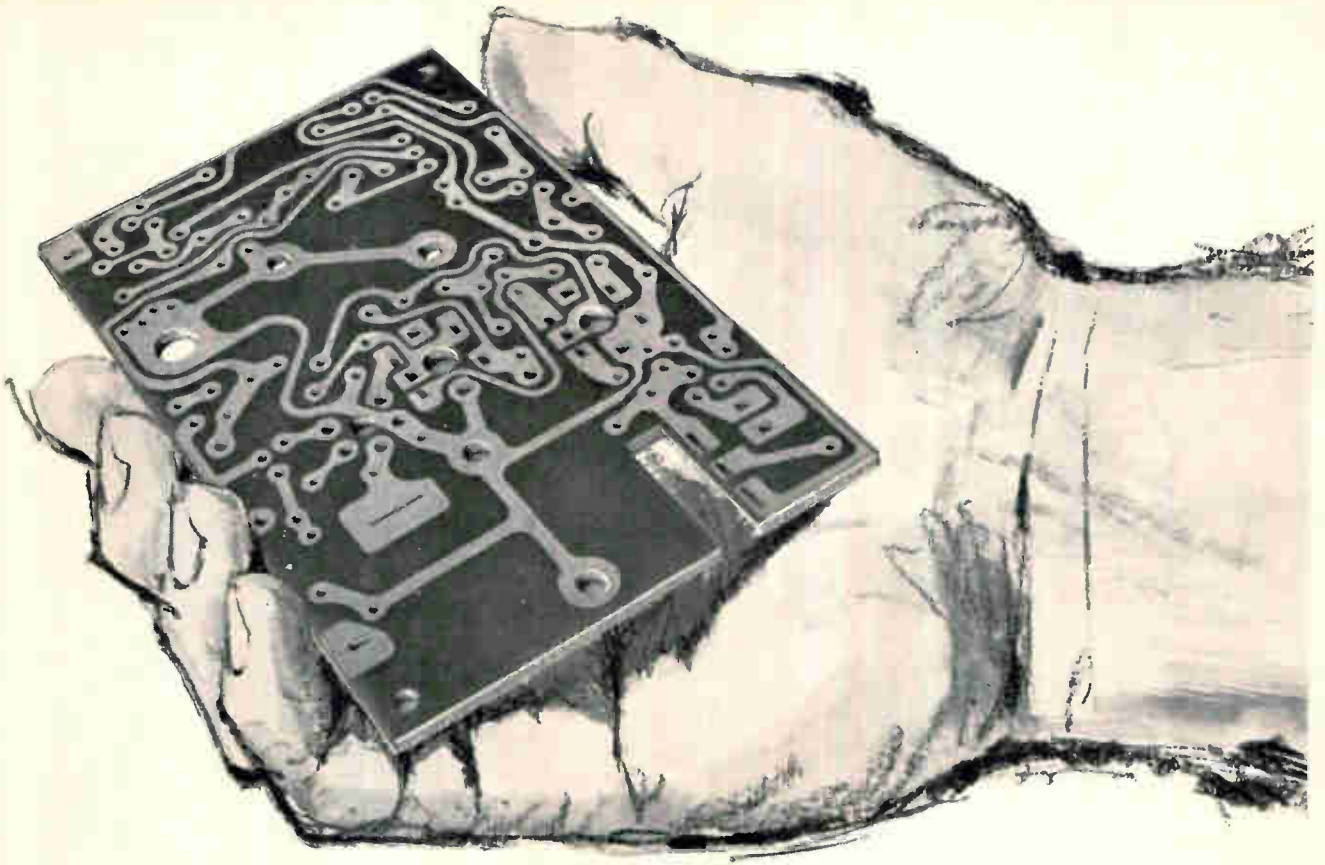

Copper clad

10 different copper clad laminates are available from Formica . . . paper-phenolics, paper-epoxies, nylon-phenolics, glass-epoxies. Flame retardant materials—FR-2, FR-3, FR-4 . . . three grades accepted by UL for support of current-carrying parts at temperatures up to 105°C. Grades with MIL spec properties, NEMA properties . . . property combinations to meet any need.

WRITE FOR DATA ON:

- Copper clad laminates
- Electrical /electronic grades
- Mechanical grades
- Engraving stock

FORMICA CORPORATION

DEPT. I-427, CINCINNATI 32, OHIO

subsidiary of

CYANAMID



industrial plastics

Formica presents The World's Fair House to introduce the newest and best in carefree, contemporary living.

KLEIN PLIERS *Speed up electronic wiring*

When the crystal set was a seven-day wonder, Klein long nose pliers were used to adjust the cat's whisker. Through the era of B and C battery sets, Klein kept pace by providing pliers specially adapted for electronic wiring.

Today, more than 100 different styles and sizes of Klein pliers are available to provide the exact tools needed for any job. Klein engineers have developed a special plier for wiring printed circuits; a high hardness

plier for cutting nickel ribbon wire; a transverse end cutting plier for cutting closely in confined spaces; extremely small pliers for wiring midget assemblies—and many others.

Klein has also developed special pliers to do special jobs requested by electronic manufacturers.

For better work done more quickly and at lower cost, be sure the pliers you use are exactly suited to the job . . . made by Klein, of course, "Since 1857."

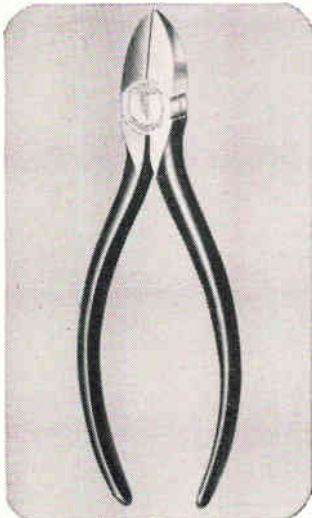

202-5C Oblique Cutting Plier with narrow nose. Available with coil spring. 5½-, and 6-in. sizes.

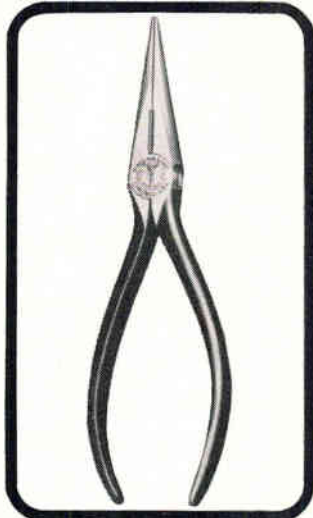

203-5C Long Nose Side Cutting Plier. Available in 5½-, 6½- and 7-in. sizes. Supplied with coil spring.

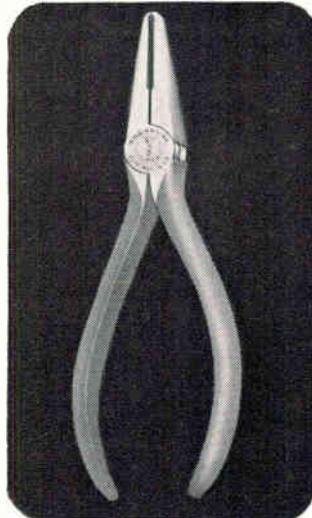

204-6C Transverse End Cutting Plier, 6-in. long. Supplied with coil spring to hold jaws open.

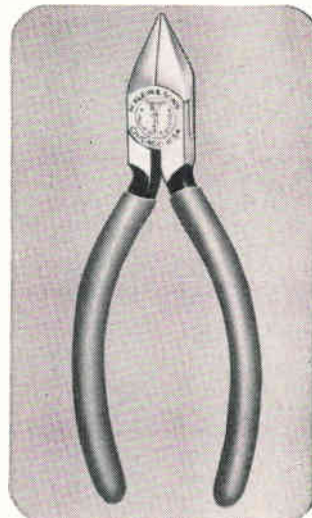

D209-5C Lightweight, Pointed Nose, Flush Cutting Plier. Supplied with coil spring to hold jaws open.

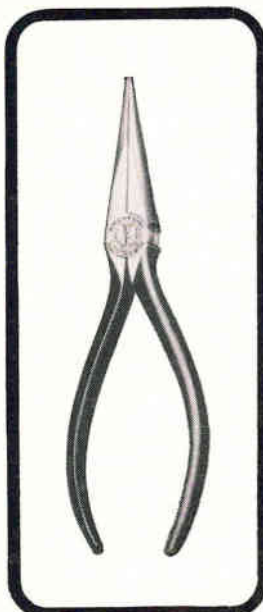

301-5C Long Nose Plier. Available in 5½-, 6½- and 7-in. lengths. Coil spring.

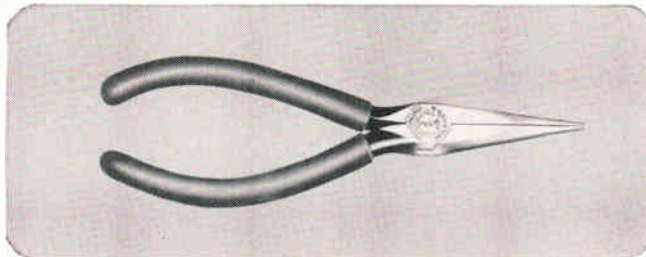

D307-5 ½C Slim Long Nose Plier for reaching into confined spaces. Yellow plastisol handles. Supplied with coil spring to hold jaws open.

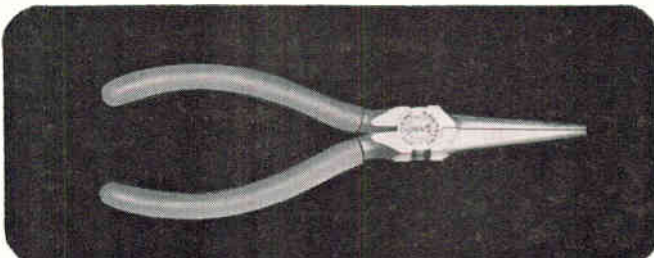

D310-6C Slim Long Nose Plier. Handles are yellow plastisol covered. Supplied with coil spring to keep jaws open.

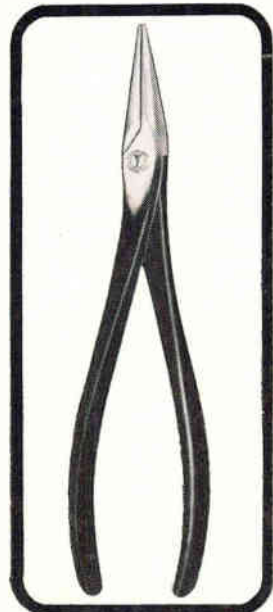

314-8 8-in. Long Nose Plier. Jaws have knurl.



Mathias **KLEIN** & Sons
 Established 1857 Chicago, Ill., U.S.A.
 INCORPORATED
 7200 McCORMICK ROAD, CHICAGO 45, ILL.

See Your Distributor
 Foreign Distributor: ITT Export
 Corporation, New York

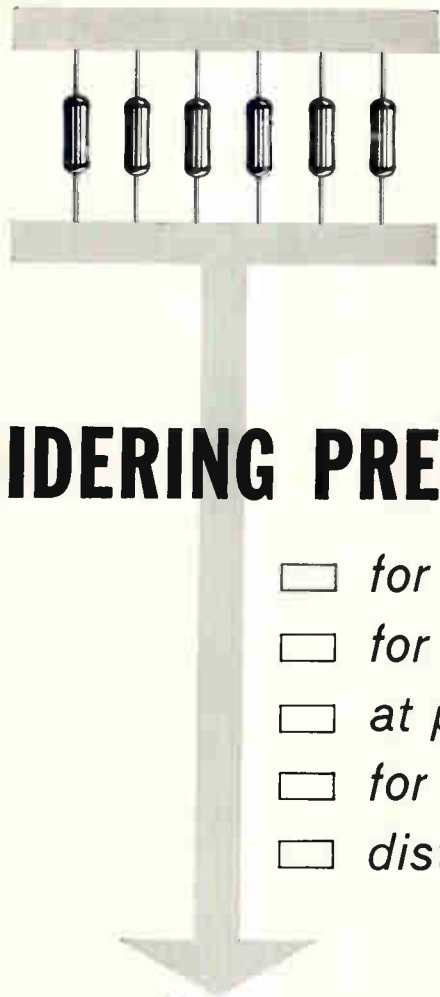

CONSIDERING PRECISION RESISTORS?

- for military requirements?*
- for commercial requirements?*
- at penny-pinching prices?*
- for prompt deliveries?*
- distributor availability?*

...then consider Campbell!

You can't afford not to consider Campbell for your precision resistor requirements. Military or commercial types, we offer fast deliveries, quality resistors, and **penny-pinching** prices to meet almost any budget requirement.

Military types supplied include RN55D, RN60D, RN65D, RN70D, RN75B, and RN80B all to MIL-R-10509E. Metal film units available to MIL-R-22684B in RL-07 and RL-20 sizes.

Commercial type, deposited-carbon precision resistors feature the perfect combination of quality plus economy. As an example, our Type CEP ½ Watt 1% tolerance unit can be purchased in volume quantities for less than 4½¢ per unit. As we said earlier . . . you can't afford not to CONSIDER CAMPBELL for all your precision resistor requirements. Remember too, Clarostat stocking distributors across the country offer you fast delivery, off-the-shelf, for those immediate requirements.

CAMPBELL INDUSTRIES, INC.

subsidiary of

CLAROSTAT

CLAROSTAT MFG. CO., INC. DOVER, NEW HAMPSHIRE

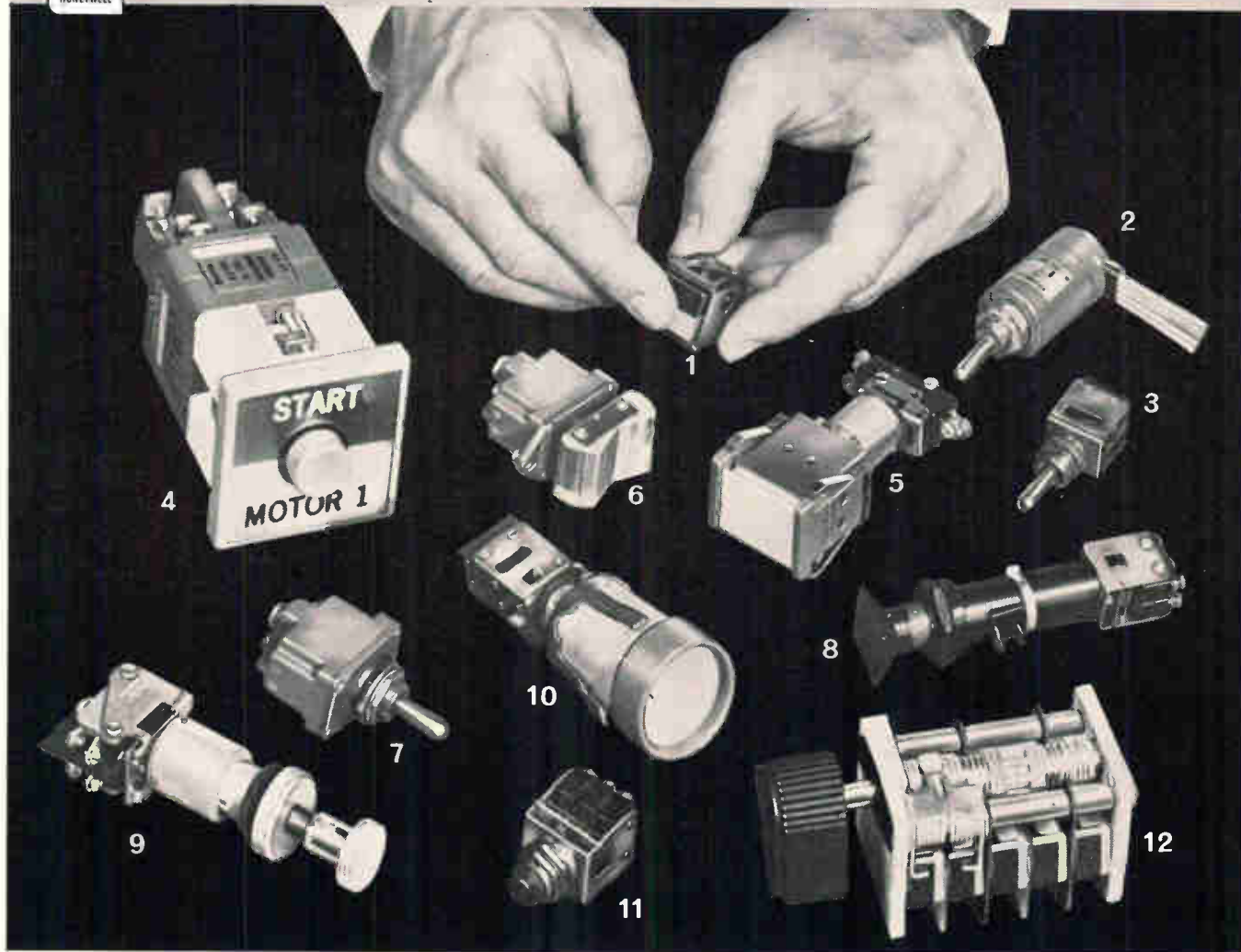

HUNDREDS AVAILABLE to give you the right one...quickly



Answers to literally thousands of control problems are ready for you in the broad selection of panel switches by MICRO SWITCH. Because of this wide choice, you are protected from compromise on design, quality and cost.

The MICRO SWITCH selection is the result of years of experience in developing switches for every known requirement throughout industry—commercial, aerospace, electronics, etc. And, a staff of experienced engineers is ready to give you seasoned design and application assistance.

For information, call your MICRO SWITCH Branch Office (see Yellow Pages), or write for catalogs.

- 1. Miniature lighted pushbutton switch. Indication and control in less than one cubic inch.
- 2. Magnetic hold-in toggle switch. Completely sealed.
- 3. Multi-circuit toggle switch. Gold or silver contacts.

- 4. Coordinated Manual Control. Pushbutton and/or rotary operation, lighted display.
- 5. Modular lighted pushbutton switch. 20 switch modules.
- 6. Rocker-actuator switch. Toggle versatility, pushbutton control.
- 7. Sealed 3-position toggle switch. Complete circuitry selection.
- 8. Lighted pushbutton switch. Small size, easy mounting.
- 9. Heavy-duty pushbutton switch. Rugged. Oiltight panel seal.
- 10. Modular lighted pushbutton switch. Round companion to No. 5.
- 11. Multi-circuit miniature pushbutton switch. Features good switching action feel.
- 12. Rotary-selector switch assembly. Up to 8 poles available.



MICRO SWITCH

FREEPORT, ILLINOIS
A DIVISION OF HONEYWELL

IN CANADA: HONEYWELL CONTROLS LIMITED, TORONTO 17, ONTARIO

HONEYWELL INTERNATIONAL—SALES AND SERVICE OFFICES IN ALL PRINCIPAL CITIES OF THE WORLD. MANUFACTURING IN UNITED STATES, UNITED KINGDOM, CANADA, NETHERLANDS, GERMANY, FRANCE, JAPAN.



Now... a really new s-c tester featuring digital programming and low cost

TI's Model 658 Transistor/Diode Test System has many new features to make production/inspection testing easier, faster, more economical. An out-of-the-way digital programming section uses digit-switch and rotary selectors for choosing test conditions. Both d-c and pulse tests can be performed with each module. Up to 48 plug-in modules may be mounted vertically or in slide-out drawers. Tests may be programmed in any sequence. Test duration is independently adjustable from 50 milliseconds to 5 seconds.

The 658 features digital control of test circuitry; close proximity of clamps and limiters to device under test; Kelvin connections eliminating IR drop errors; front panel lights displaying go/no-go results; memory storage permitting sorting and classification into 16 categories with an accessory sorter; swing-out card racks and plug-in assemblies for simplified maintenance and long-term reliability. Bias and reference supplies are digitally programmable with repeatability better than 1%. Readout accuracy is 1%.

Write for information.

INDUSTRIAL
PRODUCTS
GROUP



TEXAS INSTRUMENTS
INCORPORATED

P. O. BOX 66027 HOUSTON, TEXAS 77006
7 RUE VERNONNEX GENEVA, SWITZERLAND

650

HOW TO MAKE A "COMPACT" INSTRUMENTATION CABLE

To any engineer who has ever tried to design a 1¼" instrumentation cable into a 1" space, Rome-Alcoa dedicates this new, "compact" component insulation.

The material that makes this new insulation possible is colored Heat Sealable Mylar* polyester film.

We wrap two spiral layers directly over the shielding braid of the individual component...thus replacing thicker, extruded insulations of polyethylene or polyvinyl chloride.

Besides the obvious advantages of significantly smaller cable diameters and lighter weight, this new material offers the additional advantages of high dielectric strength, moisture resistance and excellent mechanical protection. Because of the reduced build-up of a cable component, longer, continuous, unspliced lengths of finished cable may be possible.

HOW IT'S MADE Each of the Mylar layers is coated on one side with polyethylene. The first layer is spiral-wound over the shielding braid with the polyethylene side facing outward. The second layer is spiral-wound over the first with the polyethylene side facing inward.

The component is then heated to a temperature high enough to fuse the adjacent coatings into one homogeneous polyethylene layer. This bonds both Mylar layers into one tough, flexible, waterproof lamination to give mechanical protection inside and out.

INSULATION QUALITIES The Mylar insulation is at least as reliable as extruded plastics, with these added benefits—it reduces the chances of "pinholes"—it is lighter—it gives the finished cable a smaller diameter—it is more flexible than extruded insulations and is therefore easier to work with.

Mylar-wound insulation has electrical properties superior to nylon and approximately equal to PVC and polyethylene. It has greater resistance to electrical breakdown than any of the extruded plastics. For example, typical



tests have shown dielectric strength breakdown voltages of 4000 volts/mil as compared to 800 volts/mil for polyethylene.

One of the most significant characteristics of Heat Sealable Mylar polyester film is its excellent resistance to cut-through and abrasion. Mylar has been shown to resist cut-through better than PVC extrusions having three to four times the Mylar thickness.

WHERE TO APPLY IT To the user of instrumentation cable, this new Rome-Alcoa product means a wider range of component insulating materials available for selecting the precise cable construction you need.

In some cases—notably where either small diameter, lighter weight or longer lengths of unspliced cable are vital—we recommend Mylar-wound shield isolation. In others, we may recommend other standard materials.

ASK THE EXPERTS The increasing complexity of instrumentation cable and the choice of insulation materials available to you make it more necessary than ever to go to an authority on instrumentation cable. You can help protect the functioning of your system by having instrumentation cable designed and constructed by experts.

Rome-Alcoa is, frankly, one of the few companies that qualify. We've been designing and constructing these cables since their conception. If you're going to need instrumentation cable soon, call us. As a starter, send for our 24-page booklet entitled, "Instrumentation Cables, Cable Assemblies and Hook-up Wires." In it, we describe instrumentation cable constructions, cable production, military specifications, and our qualifications. For your copy, write **Rome Cable Division of Alcoa**, Dept. 27-114 Rome, N. Y.

Rome Cable
DIVISION OF ALCOA

*DU PONT REGISTERED TRADEMARK

Lab standards for your most critical requirements



Model 172 Variable Frequency Calibration Console—provides current and voltage output within $\pm 0.05\%$ of reading, up to 2500 cps. Wattage outputs within $\pm 0.1\%$. Variable frequency output from 50 to 10,000 cps. Short term stability 0.01%.



Models 1493-1 1494-1 Bolometer Bridge and Reference Current Generator—provides automatic measurement of microwave power with $\pm 0.1\%$ accuracy. Supplied for standard rack mounting or with individual cases.

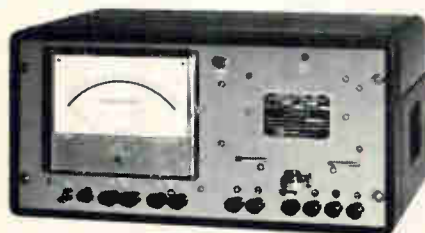

Model 1483 Inductronic Wattmeter — a primary standard for measuring AC/DC power. Transfer accuracy DC to AC within 0.01%. Excellent frequency range. DC output to drive strip chart recorders.



Model 64 DC Voltage Calibrator — gives simple, rapid and accurate DC instrument calibration. Automatically divides range into as many as 15,000 equal parts. Accuracy within $\pm 0.05\%$ of indicated value.

Model 1572 AC/DC Volt-Ammeter — self-contained, portable instrument with digital readout. Measurement accuracy within $\pm 0.05\%$ of indicated value. True RMS response for AC measurements. Self-contained Zener reference.

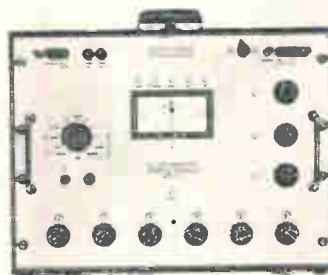

Model 1573 Direct-Reading AC/DC Thermo Voltmeter — usable on DC and AC to 50 kc. Accuracy: 0.015% on DC, 0.025% on AC, 0.005% as a transfer standard. Range: 1 to 1,000 volts, 6-place readout. Voltmeter, transfer standard, and DC reference for digital voltmeter calibration.

QUALITY BY DESIGN



WESTON INSTRUMENTS, INC.

614 Frelinghuysen Avenue, Newark, New Jersey, 07114

Circle 51 on reader service card

UNIQUE...

*first low level solid-state unit
joins industry's most versatile
line of telegraph relays*

Radiation's new solid-state low level to high level neutral relay is the first of its kind. The unit, Model 9338, is designed for such applications as conversion of low level computer outputs to higher telegraph levels, and for computer/computer switching.

This advanced relay features modular construction and unlimited service life without maintenance. Because it operates at an input level of ± 6 v at 50 to 100 μ a, conducted and radiated RFI are greatly reduced.

Radiation Telegraph Relays are supplied with octal bases in three standard models (at right). They can replace all electromechanical units except in rare applications. These versatile units are completely solid state, and are powered by input loop current alone.

Special Plug-In Adapters are available in all popular types (examples at right), and permit you to update your present system easily and quickly. Radiation can also supply special adapters, units wired for direct replacement, or devices on plug-in printed circuit cards.

All **Radiation Solid-State Relays** operate at speeds up to 2400 bits/second with less than 3% distortion. Input is essentially resistive. They do not induce transients in the line as do electromechanical units. And a unique Radiation circuit protects inputs against abnormal line conditions such as spikes and overvoltages.

In addition, Radiation Relays are extremely resistant to environmental extremes. They require no adjustment, and will operate for an indefinite period of time without attention.

Radiation engineers will be glad to assist if you have a unique application or would like help in evaluating system requirements. Write for information, or describe your needs. Products Division, Dept. EL-11, Radiation Incorporated, Melbourne, Florida.

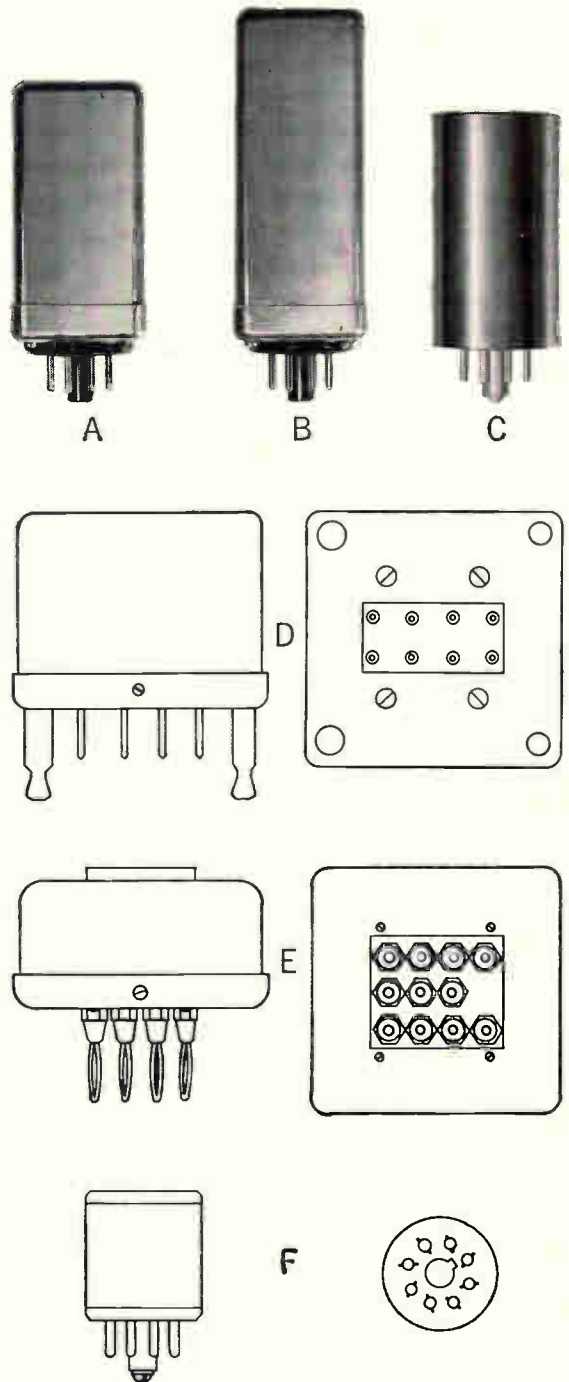

RADIATION SOLID-STATE RELAYS

Type	Model	Body Size	Figure
Neutral	9214	1.46 x 2.86	A
Neutral	9220	1.46 x 2.86	A
Polar	9212	1.46 x 3.66	B
Univ.	9218	1.38 x 2.63	C
Low Level	9338	1.38 x 2.63	C

Note: Other configurations are available, including plug-in circuit cards.

Standard Plug-In Adapters

Octal-to-Western Electric 255-A	D
Octal-to-Western Union 202-A	E
Octal-to-Octal	F

Note: Other adapters are available, or units can be wired for direct replacement.

What's a Sendzimir mill doing in a watch factory?

We are not just a watch factory. Actually, the Sendzimir mills (we have more under one roof than anyone else, anywhere) are part of our Precision Metals Division. They are used to cold-roll strip or foil of most any known alloy to ultra-thin, uniform thicknesses with smooth edges, excellent surfaces. We work to minimum thicknesses of .00008" and widths of .030"

Ours is a completely integrated metals processing operation capable of solving problems of tolerances, thin gages, limited availability of alloys, superior mechanical properties or reproduction of exact specifications from lot to lot. We'll fill any order from experimental lots to production quantities. Write for our Precision Metals Brochure, to Department 1911, Lancaster, Pennsylvania.

PRECISION METALS DIVISION—ONE OF THE MANY DIMENSIONS OF THE
✦ *HAMILTON WATCH COMPANY*
Lancaster, Pennsylvania

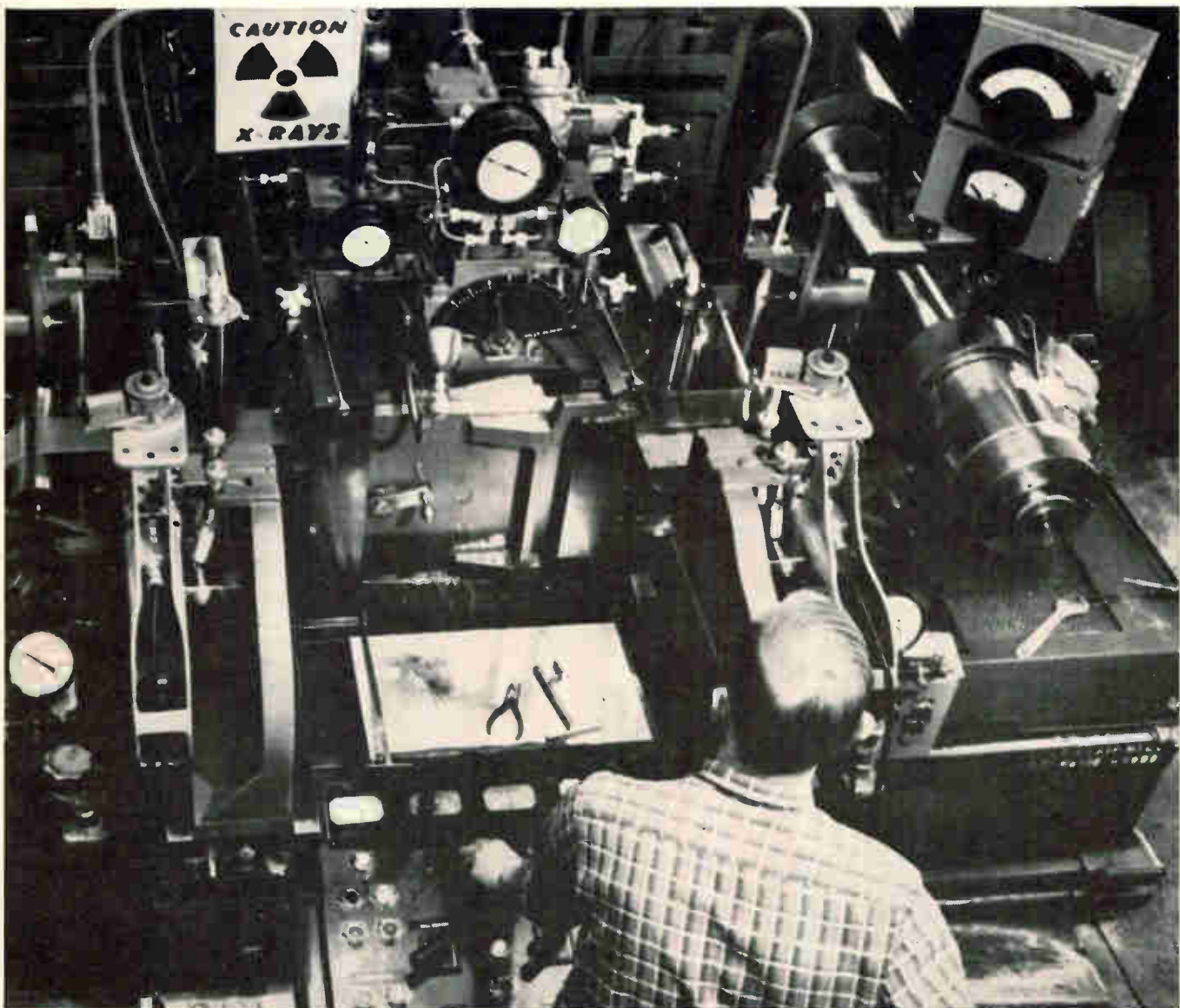

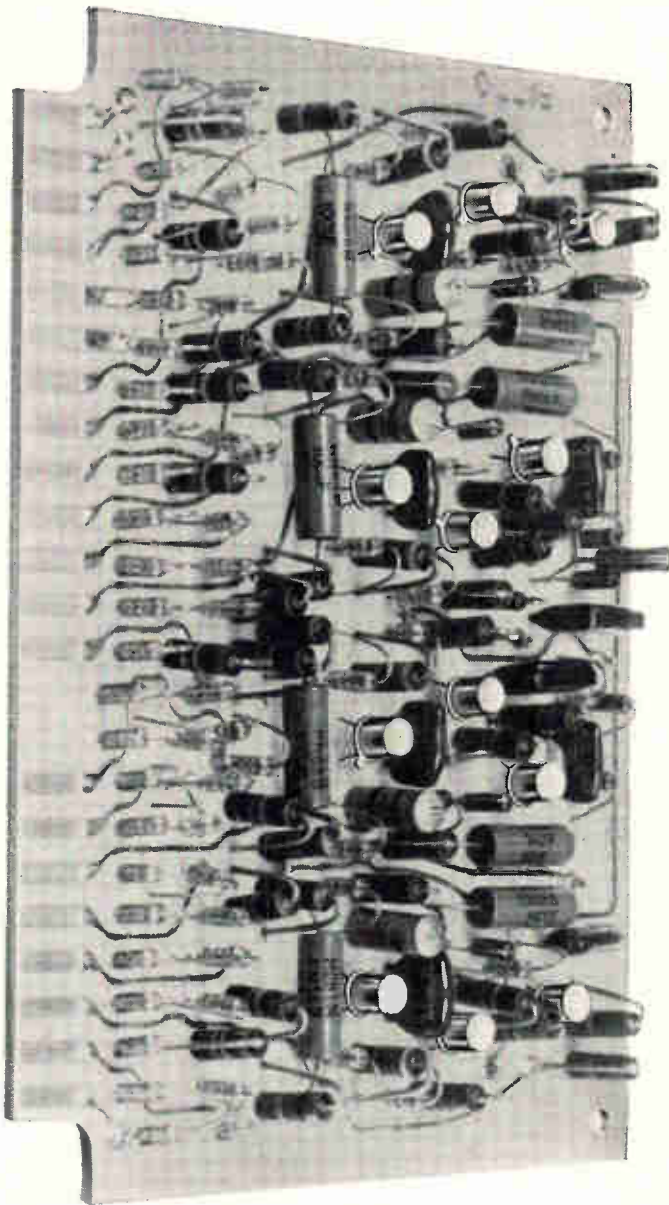

transistor cost
\$8.04

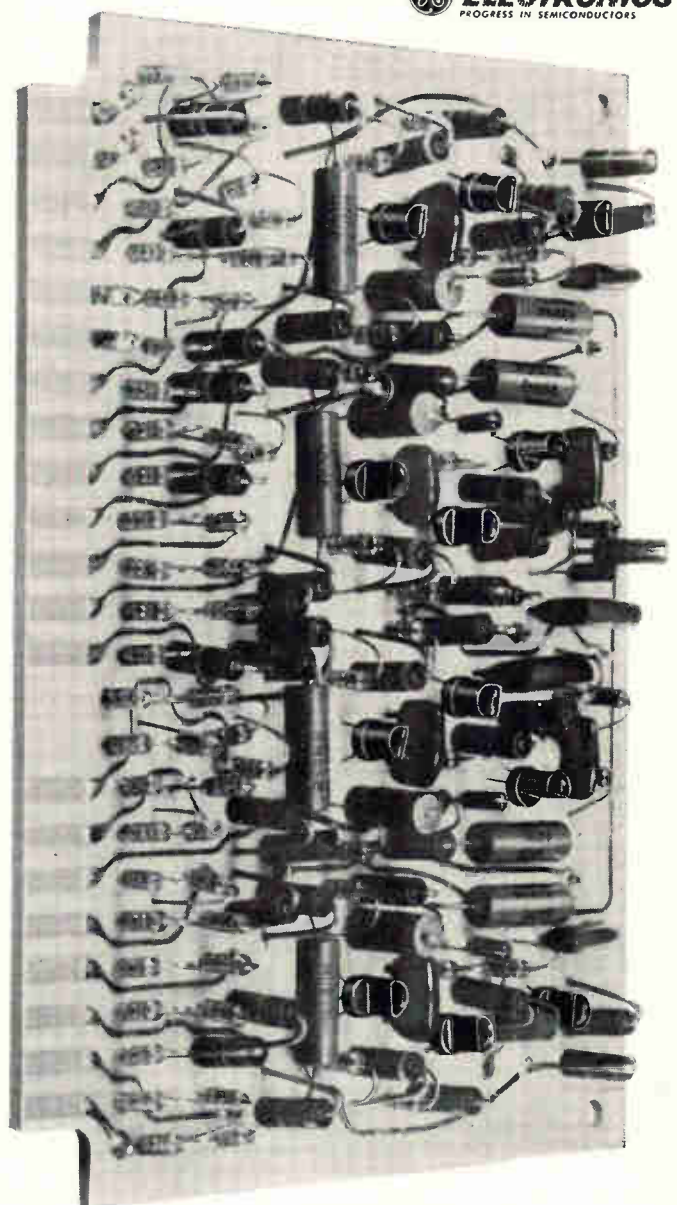

transistor cost
\$4.68

You're not seeing double . . . (look at the price)

You could save \$3.36 per board (based on OEM 10,000 and up prices) by replacing TO-18 high speed switches with G-E "Economy Line" Silicon Planar 2N3605 devices in the circuit shown. The 2N3605 units on the right are interchangeable with the 2N706, 2N708, and 2N914. And in most circuits no re-engineering is required. As a matter of fact, in 70% of the applications the 2N3605 is a direct plug-in replacement for the other three.

The beauty of the "Economy Line" devices is that while you enjoy real savings in transistor costs in your circuits, you also profit from proved reliability. Millions of "Economy Line" transistors have been used in the field over the last two-and-a-half years in some pretty rough environments . . . and they're still in use.

Find out how you can get the same performance and reliability

in your circuits . . . with really important cost savings. Contact your G-E Semiconductor District Sales Manager, or write to us at Section 16K176, Semiconductor Products Department, General Electric Company, Electronics Park, Syracuse, New York. In Canada: Canadian General Electric, 189 Dufferin Street, Toronto, Ont. Export: International General Electric, 159 Madison Avenue, New York 16, N.Y.

AVAILABLE THROUGH YOUR G-E SEMICONDUCTOR
DISTRIBUTOR IN QUANTITIES UP TO 1,000

GENERAL  ELECTRIC

Technical Articles

**Boosting d-c voltage
with silicon transistors:
page 56**

Mobility in space and under the oceans has imposed a new requirement for electronic equipment: the need to change low-voltage direct current generated by unconventional power sources to voltage high enough to run microwave or sonar gear. New circuits to do this are using power transistors.

**Simple cell competes
with complex parts:
page 67**

The electrochemical cell used to be just a source of power. Now a tiny cell does far more. It can generate time delays, integrate pulses and store signals. And it is reversible and reusable.

**Can electron beams
produce incredibly
small circuits?
page 82**

The high resolution of an electron beam can make tiny microcircuits. Industry, however, is not yet convinced that it's a practical technique. Still, the possibilities are intriguing; under design is a data-processing system that would contain 100 billion thin-film components in a cubic inch.

**Noise-proofing a digital
voltmeter with off-the-
shelf microelectronics:
page 92**

A step-by-step integration technique makes a new digital voltmeter noise-proof. The complex technique is made economically feasible by the use of off-the-shelf microelectronics. It is proof that microelectronics is moving into commercial and industrial products.

**Coming
November 30**

- **Starting: A series on the field-effect transistor**
- **Instruments to measure effects from lasers**
- **Analyzing signals for medical electronics**
- **A solid-state device for microwave delay lines**

Boosting d-c voltage with silicon transistors

High-speed circuits in compact packages are able to step up voltages at improved efficiencies

By Harry T. Breece, III

Radio Corp. of America, Somerville, N.J.

As science probes farther out into space and deeper beneath the ocean, the need for portable electronic equipment grows. So engineers are focusing more attention on lightweight, small and efficient gear. One major problem is changing low-voltage direct current to high-voltage direct current to drive microwave equipment, radar and sonar.

Recent advances in the production of silicon power transistors opened the door for developing high-speed circuits that will make the conversion at efficiencies of 80% to 90% at power loads of as much as 25 kilowatts and at frequencies up to 100 kilocycles.

What this means to the engineer designing a particular electronic package is a substantial reduction in the size and weight of the capacitors and inductors used to convert the low-voltage d-c to high-voltage a-c for some applications and to high-voltage d-c for other applications.

The term inverter in this article is used in the generic sense; transforming d-c to d-c is commonly referred to as conversion.

Designing the inverter

The design of a high-speed transistorized inverter is based on the available supply voltage, the required output voltage and power and the

The author



Harry T. Breece, III, joined the Radio Corp. of America in 1962 and worked on high-speed silicon power transistors for two years. He is currently at Purdue University studying for his Ph.D. in electrical engineering.

range of ambient temperature over which the inverter must operate. Moreover, the inverter's specifications usually provide additional preliminary design information, such as size, weight, operating frequency and stability.

The following procedure is used to design the inverter circuit:

1. The power delivered to the output transformer T_2 is computed as follows:

$$P_{out'} = \frac{P_{out}}{\eta_2} \quad (1)$$

where P_{out} is the required output power of the inverter circuit and η_2 is the transformer efficiency. A value of 90% to 95% is usually assumed.

2. An estimate of the transistor collector current for a square wave (I_C') can then be obtained from the ratio of $P_{out'}$ to the supply voltage, V_s , that is,

$$I_C' = \frac{P_{out'}}{V_s} \quad (2)$$

3. Determine from the manufacturer's data the transistor saturation voltage, $V_{CE(sat)}$, that corresponds to the collector current, I_C' , and case temperature, T_c . The transistor collector current should now be recomputed as follows:

$$I_C'' = \frac{P_{out'}}{V_s - V_{CE(sat)}} \quad (3)$$

4. From the manufacturer's data determine the base-to-emitter voltage, V_{BE} , required for the collector-to-emitter saturation voltage, $V_{CE(sat)}$, as given in step 3, at the collector current, I_C'' , and the case temperature, T_c . Also, find the common-emitter forward-transfer ratio, h_{FE} , at this collector current and case temperature. A value of h_{FE}' that is low enough to insure saturation (usually, h_{FE}' is about half of h_{FE}) is then used, together with

A close look at a basic circuit used for high-speed inverter operations (below) provides the background for understanding the technique.

In this circuit, a saturable base-drive transformer, T_1 , controls the inverter switching operation at base-circuit power levels, and a linear output transformer couples the output to the load. Because the core material of output transformer, T_2 , isn't allowed to saturate, the peak collector currents of the transistors in the inverter are determined principally by the value of the load impedance.¹ This feature makes possible high circuit efficiency. The inverter circuit works this way:

Because of a small inherent imbalance in the circuit, one of the transistors, say Q_1 , initially conducts more heavily than the other. The resulting increase in the voltage across the primary of output transformer T_2 is applied to the primary of base-drive transformer T_1 in series with the feedback resistor, R_{fb} . The secondary windings of transformer T_1 are arranged so that transistor Q_2 is reverse biased and driven to cutoff, while transistor Q_1 is driven to saturation. As transformer T_1 saturates, the rapidly increasing primary current causes a greater voltage drop across feedback resistor R_{fb} . This increased voltage across R_{fb} reduces the voltage applied to the primary of transformer T_1 ; thus, the drive input, and ultimately the collector current of transistor Q_1 are decreased.

Reverse polarities

The decrease in the collector current of transistor Q_1 causes a reversal of the polarities of the voltages across all

Inside the black box

transformer windings. Transistor Q_1 , therefore, is rapidly driven to cutoff, and transistor Q_2 is then allowed to conduct. The inverter operates in this state until the saturation of transformer T_1 in the opposite direction is reached. The circuit then switches to the initial state, and the cycle is repeated at a frequency determined by the design of transformer T_1 and the value of feedback resistor R_{fb} .

The external base resistors, R_b , reduce the effect of the transistor base-to-emitter voltage, V_{BE} , on the operation of the circuit. These stabilizing resistors are needed because V_{BE} varies among individual transistors with temperature and operating time.

The collector current in each transistor must rise to a value equal to the load current plus the magnetization current of transformers T_1 and T_2 and the feedback current to produce the required drive. Because the output transformer, T_2 , isn't allowed to saturate, the magnetization current is only a small fraction of the load current. In the switching operation, transistor Q_1 will continue to conduct after the drive is removed because of the excess charge that was stored in the base during saturation. However, transistor Q_2 won't conduct until the core of transformer T_1 has been reverse-magnetized and current has been injected into the base of transistor Q_2 . In the single-

transformer inverter^{2,3}, both transistors conduct heavily during the switching time; in the two-transformer circuit neither transistor conducts during the switching time and thus very low power supply impedance is not necessary for fast switching.

Smooth changeover

The energy stored in the output transformer by its magnetizing current is sufficient to assure a smooth changeover from one transistor to the other with no possibility of the inverter oscillations stopping.

Operation of the high-speed inverter is relatively insensitive to small system variations that may result in a slight overloading of the circuit. Under such conditions, the base power losses will increase; but these losses are so small anyway that a slight increase in them won't noticeably affect circuit performance. The amount of energy stored in the output transformer will also be increased. Although this increase will result in a greater transient dissipation, the inverter switching will still be smooth. Because the output transformer is not saturated, the collector currents are always determined by the circuit load impedance and not by small system variations.

A practical design of the high-speed inverter should include a means of initially biasing the transistors into conduction to assure that the circuit will be started reliably. Such biasing networks can be readily added to the inverter, and are much more dependable than just assuming that circuit imbalance will immediately shock the inverter into oscillation.

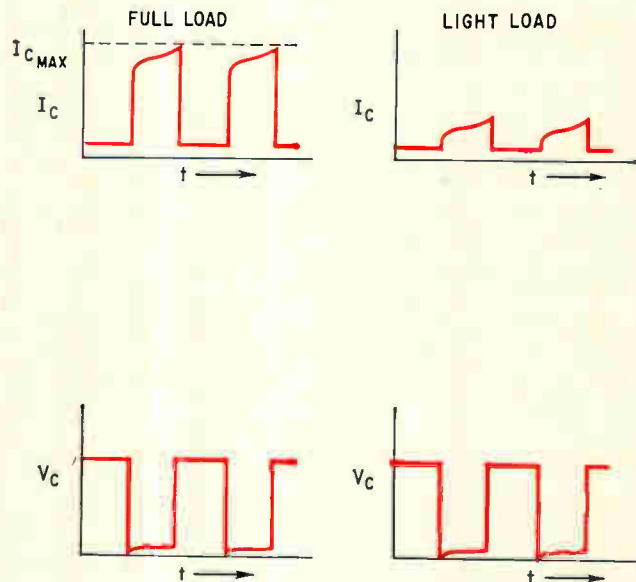
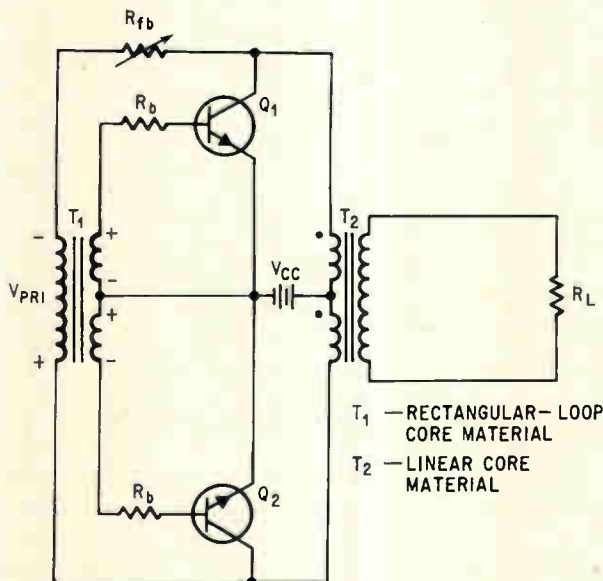

High-speed inverter has a saturable base-drive transformer that controls the inverter switching operation at base-circuit power levels. Because output transformer isn't allowed to saturate, the peak collector current is determined by the load impedance. Collector-current and collector-voltage waveforms for the transistors in the inverter with a resistive load are shown on the right.

PULSE DURATION CURVES APPLY TO EACH TYPE.
DC CURVES APPLY TO INDICATED TYPES.

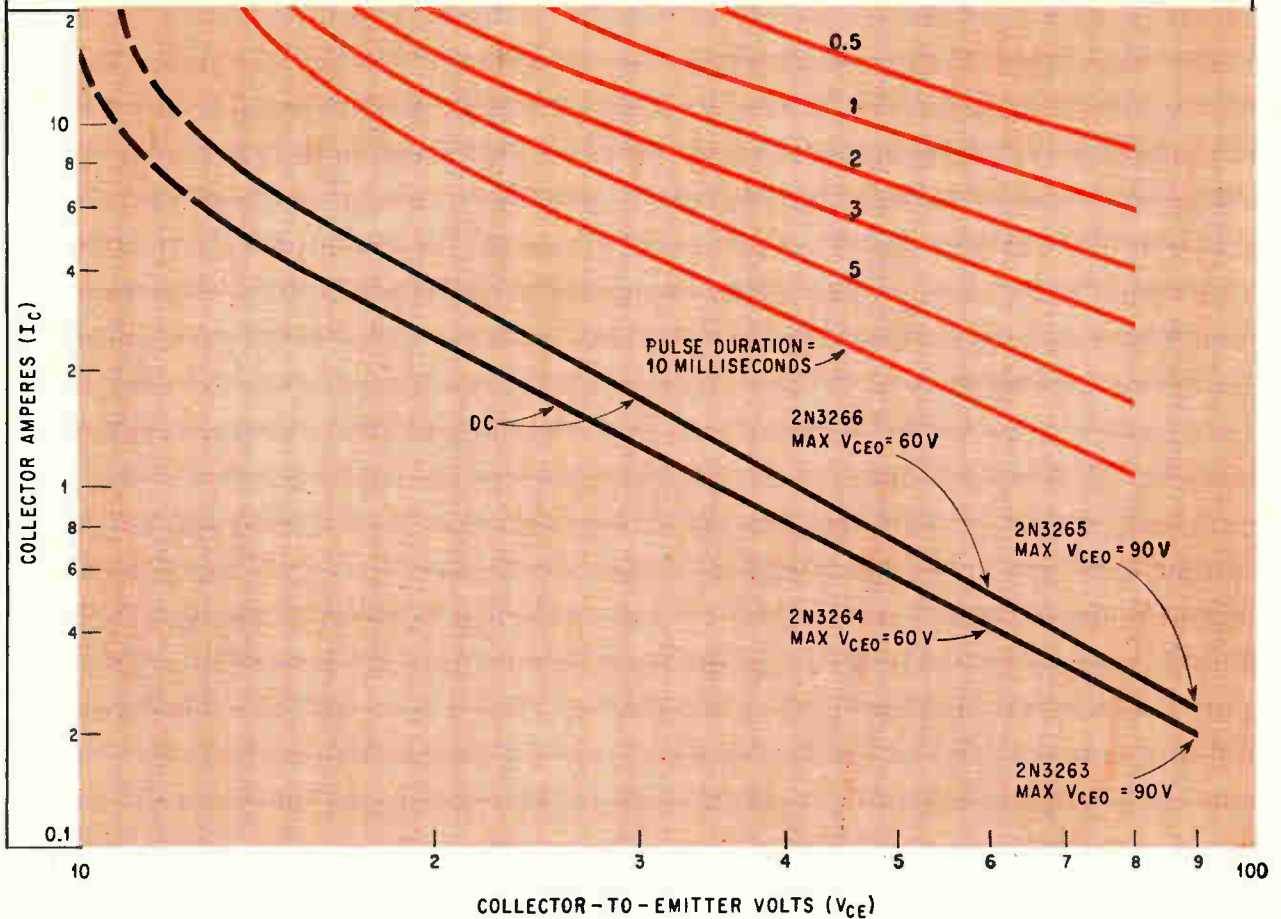

Graph taken from 2N3265 data sheet shows the safe region of operation for various pulse durations. The circuit operates safely at 50 kilocycles (10 microseconds pulse duration).

the value found for V_{BE} , in the following equation to estimate the base-circuit input power, P_{in} :

$$P_{in} = V_{BE} \left[\frac{I_c''}{h_{FE'}} \right] + \left[\frac{I_c''}{h_{FE'}} \right]^2 R_B \quad (4)$$

The base stabilizing resistance, R_B , is small and is usually chosen so that the voltage dropped across it will be about half of V_{BE} .

5. The input power to base-drive transformer, T_1 , can be approximated on the basis of the base-circuit input power, P_{in} , and the transformer efficiency, η_1 , as follows:

$$P_{in'} = \frac{P_{in}}{\eta_1} \quad (5)$$

6. The collector current can now be approximated on the basis of the total power developed in the inverter circuit:

$$I_c = \frac{P_{out'} + P_{in'}}{V_S - V_{CE(sat)}} \quad (6)$$

If the collector current given by equation 6 is significantly higher than that given by equation 3, steps 4, 5 and 6 should be repeated with this higher value of collector current substituted for I_c'' .

7. The turns ratio of output transformer T_2

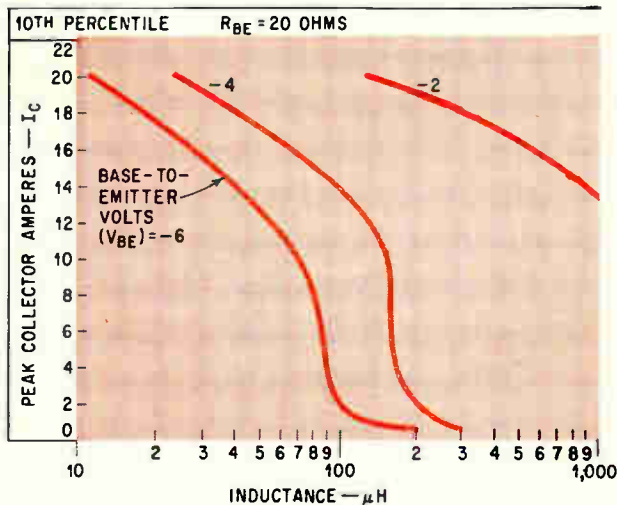

Operating conditions that will cause 10% of the 2N3265 transistors to enter secondary breakdown. More than 90% will operate without hazard of reverse bias second breakdown in the area to the left and below the curves.

A close look at a basic circuit used for high-speed inverter operations (below) provides the background for understanding the technique.

In this circuit, a saturable base-drive transformer, T_1 , controls the inverter switching operation at base-circuit power levels, and a linear output transformer couples the output to the load. Because the core material of output transformer, T_2 , isn't allowed to saturate, the peak collector currents of the transistors in the inverter are determined principally by the value of the load impedance.¹ This feature makes possible high circuit efficiency. The inverter circuit works this way:

Because of a small inherent imbalance in the circuit, one of the transistors, say Q_1 , initially conducts more heavily than the other. The resulting increase in the voltage across the primary of output transformer T_2 is applied to the primary of base-drive transformer T_1 in series with the feedback resistor, R_{fb} . The secondary windings of transformer T_1 are arranged so that transistor Q_2 is reverse biased and driven to cutoff, while transistor Q_1 is driven to saturation. As transformer T_1 saturates, the rapidly increasing primary current causes a greater voltage drop across feedback resistor R_{fb} . This increased voltage across R_{fb} reduces the voltage applied to the primary of transformer T_1 ; thus, the drive input, and ultimately the collector current of transistor Q_1 are decreased.

Reverse polarities

The decrease in the collector current of transistor Q_1 causes a reversal of the polarities of the voltages across all

Inside the black box

transformer windings. Transistor Q_1 , therefore, is rapidly driven to cutoff, and transistor Q_2 is then allowed to conduct. The inverter operates in this state until the saturation of transformer T_1 in the opposite direction is reached. The circuit then switches to the initial state, and the cycle is repeated at a frequency determined by the design of transformer T_1 and the value of feedback resistor R_{fb} .

The external base resistors, R_b , reduce the effect of the transistor base-to-emitter voltage, V_{BE} , on the operation of the circuit. These stabilizing resistors are needed because V_{BE} varies among individual transistors with temperature and operating time.

The collector current in each transistor must rise to a value equal to the load current plus the magnetization current of transformers T_1 and T_2 and the feedback current to produce the required drive. Because the output transformer, T_2 , isn't allowed to saturate, the magnetization current is only a small fraction of the load current. In the switching operation, transistor Q_1 will continue to conduct after the drive is removed because of the excess charge that was stored in the base during saturation. However, transistor Q_2 won't conduct until the core of transformer T_1 has been reverse-magnetized and current has been injected into the base of transistor Q_2 . In the single-

transformer inverter^{2,3}, both transistors conduct heavily during the switching time; in the two-transformer circuit neither transistor conducts during the switching time and thus very low power supply impedance is not necessary for fast switching.

Smooth changeover

The energy stored in the output transformer by its magnetizing current is sufficient to assure a smooth changeover from one transistor to the other with no possibility of the inverter oscillations stopping.

Operation of the high-speed inverter is relatively insensitive to small system variations that may result in a slight overloading of the circuit. Under such conditions, the base power losses will increase; but these losses are so small anyway that a slight increase in them won't noticeably affect circuit performance. The amount of energy stored in the output transformer will also be increased. Although this increase will result in a greater transient dissipation, the inverter switching will still be smooth. Because the output transformer is not saturated, the collector currents are always determined by the circuit load impedance and not by small system variations.

A practical design of the high-speed inverter should include a means of initially biasing the transistors into conduction to assure that the circuit will be started reliably. Such biasing networks can be readily added to the inverter, and are much more dependable than just assuming that circuit imbalance will immediately shock the inverter into oscillation.

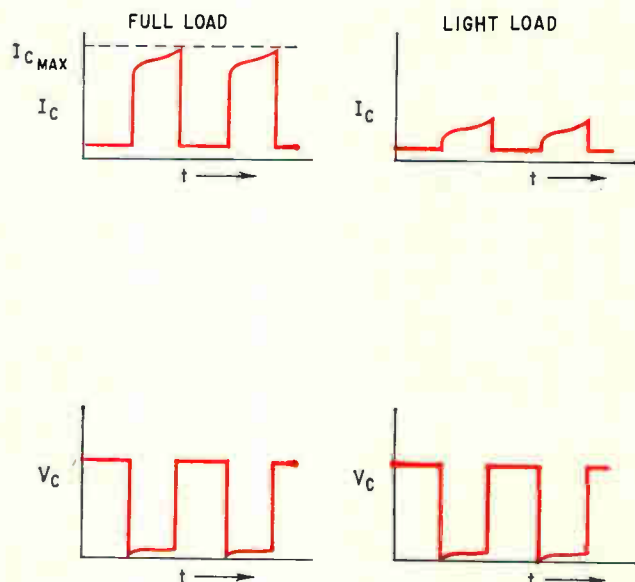
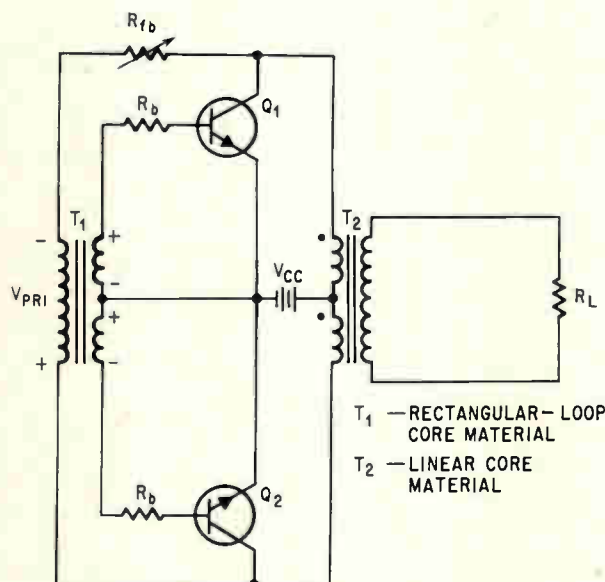

High-speed inverter has a saturable base-drive transformer that controls the inverter switching operation at base-circuit power levels. Because output transformer isn't allowed to saturate, the peak collector current is determined by the load impedance. Collector-current and collector-voltage waveforms for the transistors in the inverter with a resistive load are shown on the right.

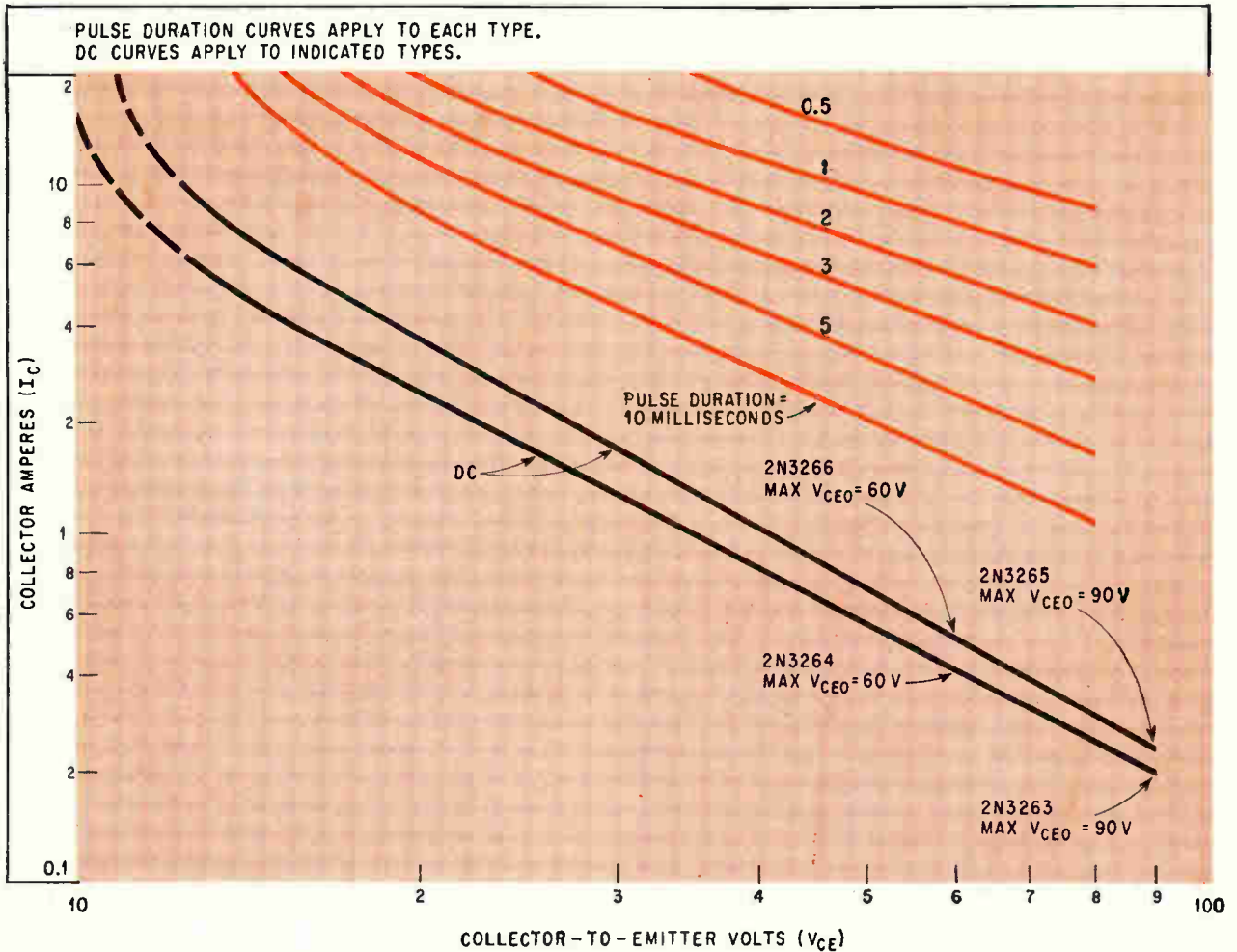

Graph taken from 2N3265 data sheet shows the safe region of operation for various pulse durations. The circuit operates safely at 50 kilocycles (10 microseconds pulse duration).

the value found for V_{BE} , in the following equation to estimate the base-circuit input power, P_{in} :

$$P_{in} = V_{BE} \left[\frac{I_C''}{h_{FE}'} \right] + \left[\frac{I_C''}{h_{FE}'} \right]^2 R_B \quad (4)$$

The base stabilizing resistance, R_B , is small and is usually chosen so that the voltage dropped across it will be about half of V_{BE} .

5. The input power to base-drive transformer, T_1 , can be approximated on the basis of the base-circuit input power, P_{in} , and the transformer efficiency, η_1 , as follows:

$$P_{in}' = \frac{P_{in}}{\eta_1} \quad (5)$$

6. The collector current can now be approximated on the basis of the total power developed in the inverter circuit:

$$I_C = \frac{P_{out}' + P_{in}'}{V_S - V_{CE(sat)}} \quad (6)$$

If the collector current given by equation 6 is significantly higher than that given by equation 3, steps 4, 5 and 6 should be repeated with this higher value of collector current substituted for I_C'' .

7. The turns ratio of output transformer T_2

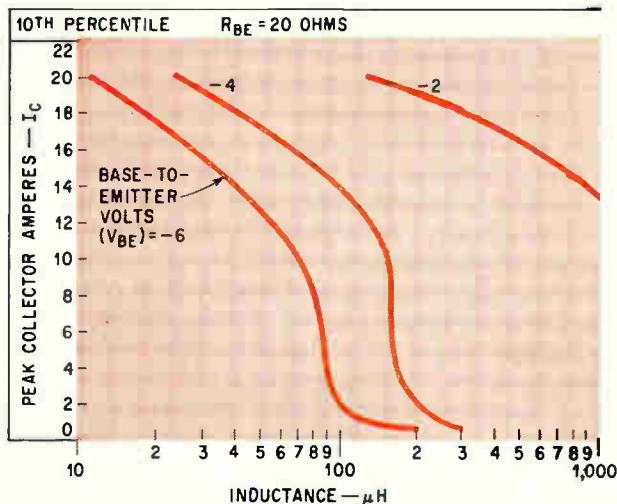

Operating conditions that will cause 10% of the 2N3265 transistors to enter secondary breakdown. More than 90% will operate without hazard of reverse bias second breakdown in the area to the left and below the curves.

may now be computed using the specified load impedance, (Z_L), and the reflected impedance, (Z_L'), determined by

$$Z_L' = \frac{V_s - V_{sat}}{I_C} \quad (7)$$

Thus, the turns ratio for T_2 is determined from the following relationship:

$$n^2 = \frac{Z_L}{Z_L'} \quad (8)$$

8. The value of the feedback resistor, R_{fb} , is usually chosen so as to drop about half of the available voltage.⁴ Thus, $V_{pri1} = (V_s - V_{sat})$ with a primary current as follows:

$$I_{pri1} = \frac{P_{in}'}{V_{pri1}} \quad (9)$$

where P_{in}' is the value determined from equation 5.

9. The turns ratio for transformer T_1 is given as follows:

$$n_1 = \frac{V_{BE} + I_B R_B}{V_{pri1}} \quad (10)$$

where $I_B = \frac{I_C}{h_{FE}'}$

The general design procedure outlined above presupposes that the transistors to be used are selected on the basis of the operating requirements specified for the inverter circuit and that the transformers used in the circuit are the best types for high-speed inverter applications. Also, because of the variety of arrangements possible, no provisions are included in the general procedure for the design of a bias-starting network.

Transistor requirements

The transistor selected for use in a high-speed circuit is dictated by the following conditions:

- In the high-speed inverter, the peak value of the collector-to-emitter voltage of each transistor will be equal to twice the supply voltage plus the amplitude of the voltage spikes generated by transient elements. Therefore, the collector-to-emitter breakdown voltage, V_{CEO} , of the transistors should be slightly greater than twice the supply voltage (usually an additional 20% is sufficient).

- The transistors must be able to handle the currents that are necessary to produce the required output power at the given supply voltage, and their saturation voltage at these currents must be low enough so that the desired efficiency can be obtained.

- The junction-to-case thermal resistance of the transistors must be low enough so that for the given ambient temperature and the available heat-sink and cooling apparatus, the manufacturer's maximum ratings aren't exceeded.

The maximum collector current, the dissipation and the heat-sink thermal resistance of the transistors can be approximated on the basis of these limiting conditions:

The maximum collector current is approximately

$$I_C = \frac{P_{out} / \eta_2}{V_s - V_{CE(sat)}} \quad (11)$$

where V_s is the supply voltage, $V_{CE(sat)}$ is the tran-

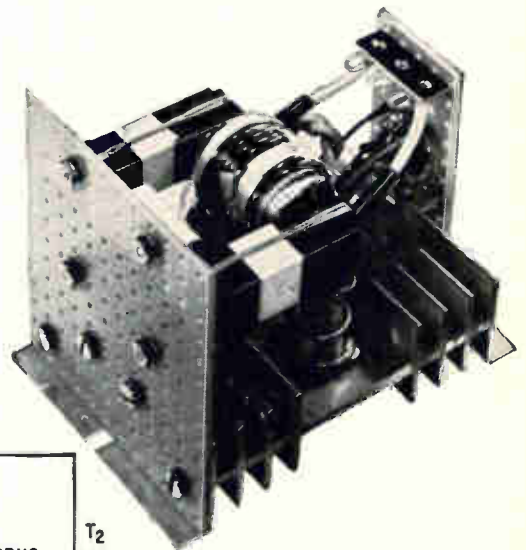

Practical 250-watt, 50-kilocycle inverter circuit as designed step-by-step in this article. Values of feedback resistance and bias-starting resistance were arrived at experimentally using the calculated values as a beginning.

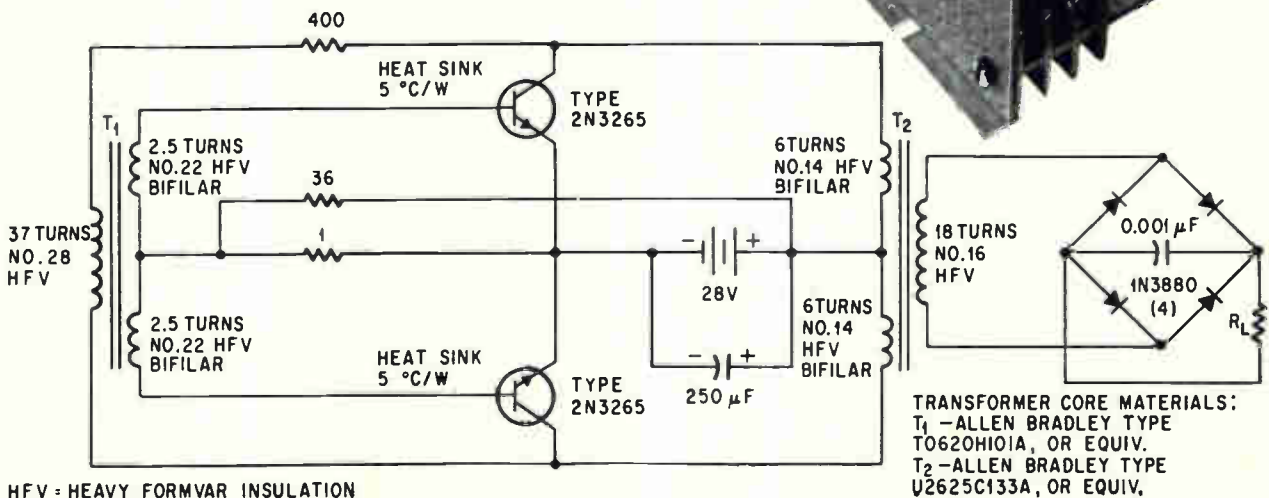

sistor collector-to-emitter saturation voltage (for a specific I_c), P_{out} is the required power output and η_2 is the desired efficiency of the output transformer (usually 90% to 95%).

The transistor dissipation can be approximated as follows (because the base dissipation is very small, it is neglected here):

$$P_D = \frac{T_1}{T} (V_{CE(sat)} I_C + 2I_{CEX} V_S) + \frac{t_{on} + t_f}{T} \frac{(V_S I_C)}{3} \quad (12)$$

where V_S is the supply voltage, $V_{CE(sat)}$ is the transistor saturation voltage (for a specific I_C); I_C is the collector current, as given by equation 11; I_{CEX} is the collector current with the base reverse-biased (for $V_{CE} = 2V_S$); t_{on} is the transistor on time at I_C given by equation 11 and h_{FE}' given in step 4 of the general procedure; t_f is the transistor fall time (at I_C given by equation 11) and h_{FE}' given in general procedure; $T_1 = \frac{1}{2} [T - (t_{on} + t_f)]$.

Equation 12 is used as a guide for the first stages of design; the exact dissipation is determined experimentally. The transistor saturated switching characteristics must be fast enough so that the transient dissipation terms don't become excessive.

The required heat-sink thermal resistance may be approximated by

$$\theta_{c-A} = \frac{\Delta T}{P_D} - \theta_{j-c} \quad (13)$$

where ΔT is the permissible junction temperature rise ($\Delta T = T_{jmax} - T_A$); P_D is the transistor dissipation; and θ_{c-A} is the case-to-air thermal resistance, including mounting, interface, any insulation material and heat sink.

The estimate of the required heat-sink thermal resistance together with the manufacturer's maximum rating curve or safe operating region will complete the determination of transistor requirements.

Transformer design

A ferrite type of core material is the most suitable for both the output transformer and the base-drive transformer. The base-drive transformer (T_1) should use a rectangular-loop ferrite core, while the output transformer (T_2) should use a linear ferrite core. At the frequencies used in high-speed inverters, iron cores cannot compete successfully with ferrite cores, either in performance or in economy. Even at the low end of the inverter frequency range, ferrite cores are more economical because the iron must be in the form of very thin laminations or tape-wound toroids. In addition, ferrites have fairly constant losses up to about 40 kilocycles; the losses increase as $f^{0.1}$, where f is the operating frequency. At higher frequencies, the losses increased as $f^{0.6}$. These rates are much lower than would be possible with an iron core.^{5,6}

The core of a transformer is selected on the basis

of power-handling requirements and frequency and temperature of operation. Temperature is an important consideration of the selection of a ferrite core because the Curie temperature for many ferrites is low. (Magnetization is zero above the Curie temperature.) Another important feature in the core material selection is the desired transformer efficiency. The efficiency can be used to obtain an approximation for the magnetic power to be dissipated, P_M . The necessary volume of core material can then be estimated on the basis of the value of P_M and the core loss factor for the chosen material at the operating frequency. The core loss factor is determined from the core-material manufacturer's data.

Producer's data on the ferrite core material indicate its maximum operating temperature. The Curie temperature must be considered together with the variation in flux density as a function of temperature and the desired operating value of flux density, B . For the base-drive transformer, a temperature rise results in a decrease in flux density and an ultimate increase in operating frequency. The ambient temperature and the maximum operating core temperature are used to compute the maximum permissible temperature rise, ΔT . A second estimate of the volume of core material must then be made on the basis of the magnetic power to be dissipated and the temperature rise ΔT . A rule of thumb for most ferrites is that the temperature rises according to $3.2 \text{ mW/cm}^2/\text{°C}$.⁶ This volume should be compared with the volume selected above on the basis of core losses; the final volume used should satisfy both requirements.

Although the rule used to determine the temperature rise in ferrites is fairly accurate, the factor varies among ferrites as a function of operating conditions and with the amount of core surface that remains after the installation of the windings. Most ferrite manufacturers are conducting tests to obtain more temperature-rise data, which should be available soon. At present, exact temperature-rise information may be obtained from the core-material manufacturer for each application.

The output power transformer is designed to satisfy the following familiar equation:

$$N_P = \frac{V_{pri} \times 10^8}{4 f A B} \quad (14)$$

where V_{pri} is the primary voltage in volts, f is the operating frequency in cycles per second, A is the transformer core area in square centimeters and B is the flux density in gauss. In the design of the output transformer for high-power, high-frequency inverters, excessive primary turns should be avoided to assure minimum power dissipation, to assure that the transformer can be made in view of the large wire sizes and the relatively small cores which are usually employed, and to assure that a low value of leakage inductance is maintained. Good balance and close coupling between primaries is

normally achieved by the use of bifilar windings. Flux density for the output transformer is determined by the usual compromise—the wire size selected on the basis of a 50% duty cycle must be large enough so that power dissipation will be low. If the wire size is inadequate, dissipation will be appreciable and a high transformer-core temperature will result.

The design of the saturable base-drive transformer isn't as straightforward as that of the output transformer, because when the transformer saturates, a sharp drop in the applied primary voltage must be produced. Thus, the magnetizing current must increase considerably from a small value to one that is comparable with primary current, as given by equation 9. The following equation must be used in addition to equation 14 to arrive at the number of primary turns because of the saturation requirement:

$$H_s = \frac{1.26 N_p I_M}{l} \quad (\text{see reference 4}) \quad (15)$$

where N_p is the number of primary turns, I_M is the value of magnetizing current at saturation in amperes (chosen to be comparable with I_{pri} —a value of $\frac{1}{2} I_{pri}$ is usually acceptable), l is the length of the magnetic path in centimeters and H_s is the value of the magnetizing field strength at saturation in oersteds (a value of five to ten times the coercive force is usually used). Equations 14 and 15 must both be satisfied for the proper design of base-drive transformer T_1 .

The value of feedback resistance (R_{fb}) for a given primary current, I_{pri} , is computed such as to drop one-half the collector-to-collector voltage of the two transistors. The other half of the voltage is applied to the primary of transformer T_1 . The optimum value of the feedback resistor is then determined experimentally. A decrease in the value

of R_{fb} will cause the magnetizing current to increase, thus increasing the voltage across the primary. As may be inferred from equation 14, the operating frequency will then increase.

An increase in R_{fb} causes a greater voltage drop across it, and less voltage is then available to the primary of transformer T_1 . However, if the value of R_{fb} is increased excessively, the frequency will increase, because sufficient base drive won't be available to saturate the transistor for the proper period, and the saturation of the base-drive transformer won't be complete. Thus, R_{fb} can be used to control frequency only over a limited range.⁴

Getting it going

The circuit shown on page 57 will not necessarily begin to oscillate, especially if it is heavily loaded. To make sure that it does, a starting bias may be applied so that the circuit will have a loop gain greater than unity. Two methods are possible. The bias can be applied only during starting or a permanent bias arrangement can be used.

Two practical starting circuits:

- The inverter below uses a resistive voltage-divider network to supply the necessary starting bias. The required value of resistor R_1 can be found from

$$R_1 = \frac{V_S}{I_S} = \frac{V_S}{2I_B + \frac{V_{BE} + I_B R_B}{R_2}} \quad (16)$$

The denominator of the fraction in equation 16 is equal to the desired value of starting current. Assuming a value of starting current I_S , this relationship can be used to determine the value of R_2 . A compromise of reliable starting current and minimum bleeder current must be reached by trial and error.

- The diode starting circuit below in which the

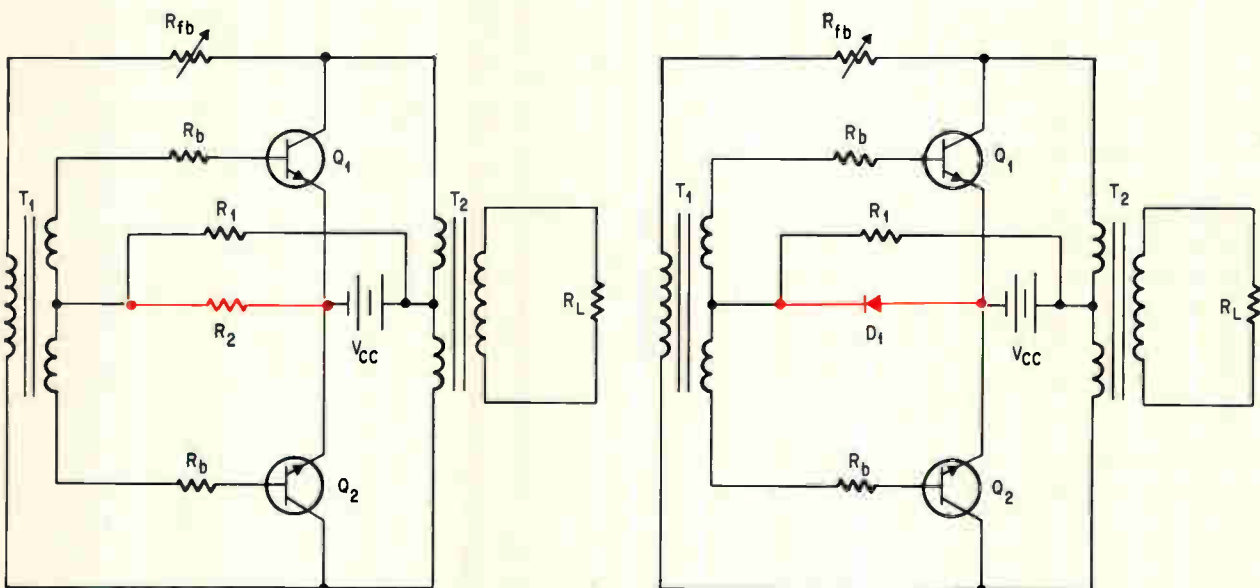

Two practical starting circuits. Inverter on the left uses a resistive voltage-divider network to supply the necessary bias. Inverter on the right uses a diode-type starting circuit.

bases of the two inverter transistors are supplied by a resistance, R_1 , is determined as follows:

$$R_1 = \frac{V_s}{2I_B + I_d} \quad (17)$$

As the inverter begins to oscillate, the base current flows through the base-emitter diode and in the forward direction through the starting diode. Usually, additional drive is needed to compensate for the diode voltage drop. Low-voltage silicon diodes, which must be capable of carrying the base current continuously, generally are used.

Second-breakdown effects

High-speed, high-power inverters require transistors with high power-handling capabilities and very fast saturated-switching speeds. Second breakdown (see *Electronics*, p. 66, June 15, 1964) is a factor that must also be considered in the design of these circuits.⁷ In general, second breakdown is a condition in a junction transistor that causes the output impedance to change instantaneously from a large positive value to a negative value and then to a final small positive value. In some respects, second breakdown appears similar to a normal avalanche breakdown, either collector-to-base (BV_{CBO}) or collector-to-emitter ($V_{CE(sus)}$). There are, however, two major differences: (1) The second-breakdown final limiting voltage is always in the 5- to 30-volt range, while BV_{CBO} and $V_{CE(sus)}$ usually have much higher limiting values, and (2) second breakdown is energy-dependent while BV_{CBO} and $V_{CE(sus)}$ are independent of energy to a first order approximation.

Physically, second breakdown is a local thermal runaway effect induced by severe current concentrations. These concentrations can result from biasing conditions, excessive transverse base fields and defects in the base region or junctions, or both. It can be found to some degree in all junction transistors. However, in many transistors, primarily small-signal and low-frequency power types, the maximum steady-state dissipation rating limits the voltage-current product to something less than the critical value necessary to produce second breakdown. Results show that transistors with higher frequency characteristics undergo second breakdown at lower power ratings. This behavior is attributed to a narrower, active-base spacing, which increases the severity of transverse base fields,

amplifies biasing effects and raises the defect level relative to the greater tolerances required.

If the on time of the transistor is decreased or the frequency of operation is increased, the critical voltage-current product necessary to produce second breakdown becomes greater. This condition results from the fact that the rate of localized heating is governed not only by current concentration, but by the thermal time constant of the semiconductor material. Therefore high-frequency, high-power transistors can safely handle large power dissipation without incurring second breakdown in high-speed switching circuits.

Thus, this class of transistors is rated for second breakdown in two ways: (1) a safe operating-range curve for forward-bias drive conditions, with time as the running variable, and (2) a safe operating range curve showing second-breakdown energy as a function of reverse-bias voltage and inductance.

Forward-bias second breakdown can be analyzed as follows: During the turn-on time the transistor is subjected to high dissipation in the active region. A plot of the experimentally determined load line superimposed on the transistor safe operating region curve for the appropriate time duration, t_{on} , will determine whether the circuit is operating in the safe operating region for second breakdown.

Reverse-bias second breakdown can be analyzed as follows: During the fall time, t_r , the transistor is subjected to high energy as a result of energy stored in the output-transformer leakage inductance. This leakage inductance can be made small by careful winding of the transformer to obtain close coupling. An approximation of the value of leakage inductance can be obtained by measuring the primary inductance with the secondary winding short-circuited. As will be shown, the leakage-inductance value and the peak collector current can be used to provide an analysis of reverse-bias second breakdown.

Design example

The techniques described here will now be applied to a practical high-speed inverter.

The operating requirements upon which the design is based are as follows:

- Power output, $P_{out} = 250$ watts d-c
- Operating frequency, $f = 50$ kilocycles
- Supply voltage, $V_s = +28$ volts
- Load resistance, $R_L = 25$ ohms
- Ambient temperature, $T_A = 25^\circ C$

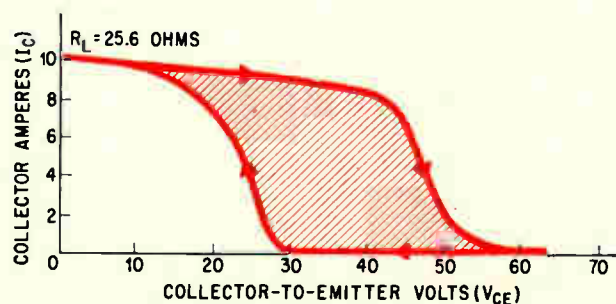

Area enclosed by transistor load line for the 2N3265 transistor using a load resistance of 25.6 ohms and a supply voltage of 28 volts shows that high dissipation occurs during switching.

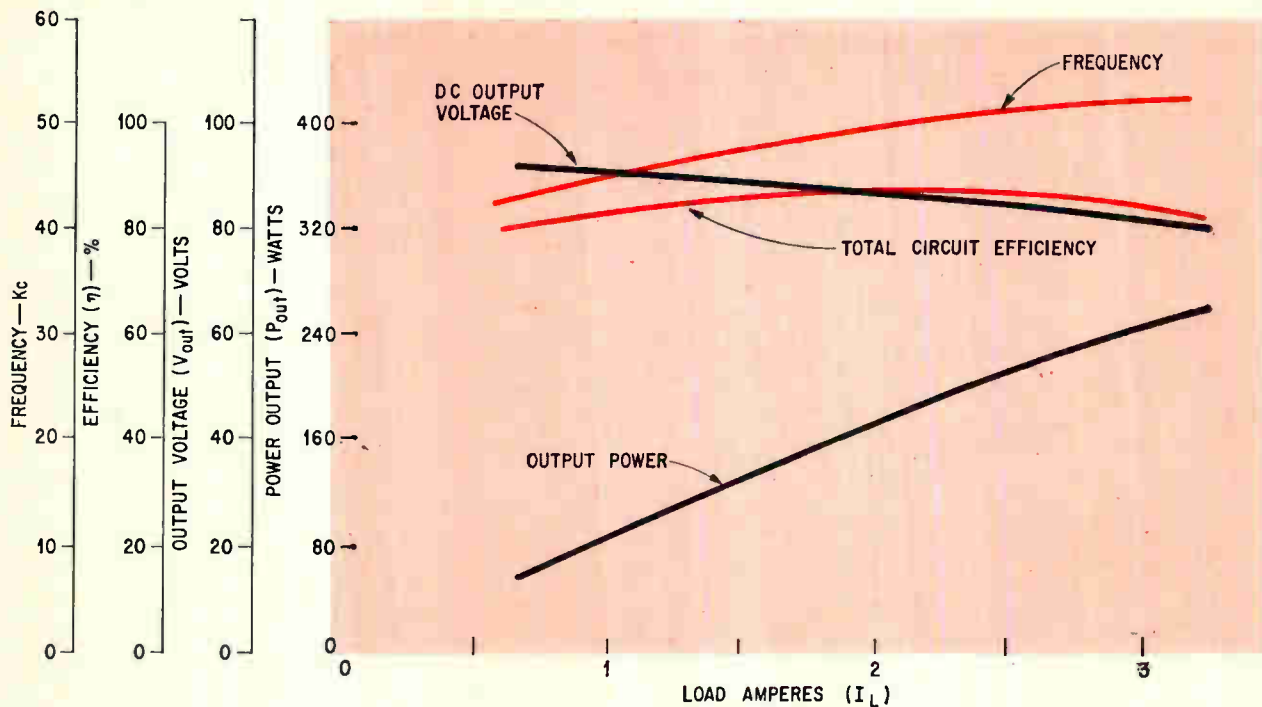

Output characteristics of the 250-watt inverter as a function of load as measured at the output terminals of the rectifier bridge.

The first step in the selection of the transistor for the inverter is to compute the power input to the output transformer, P_{out}' ; a transformer efficiency of 95% is assumed. Thus, from equation 1,

$$P_{out}' = 250 / .95 = 262.5 \text{ watts}$$

Equation 2 is now used to make the initial estimate of the transistor collector current that is necessary to produce the required output power:

$$I_C' = 262.5 / 28 = 9.4 \text{ amperes}$$

The transistors used in the inverter circuit must have a collector-to-emitter breakdown voltage, V_{CEO} , equal to at least twice the supply voltage plus an additional 20% to allow for transient voltage spikes. Thus,

$$V_{CEO} \geq 2 (28) (1.20) = 67 \text{ volts}$$

The RCA type 2N3265 silicon power transistors selected for the inverter circuit have a $V_{CEO(sust)}$ of 90 volts, and their collector-to-emitter saturation voltage, $V_{CE(sat)}$, of 0.75 (which is given in the manufacturer's data for a collector current, I_C , of 15 amperes) is low enough to insure that the desired high operating efficiency can be obtained. The switching times for the 2N3265 transistor are as follows:

Fall time, $t_f = 500$ nanoseconds (at $I_C = 15$ amps)

On time, $t_{on} = 500$ nanoseconds (at $I_C = 15$ amps)

These switching times are short in relation to the 20-microsecond period of the 50-kilocycle operating frequency.

$$I_C'' = 262.5 / (28 - 0.75) = 9.62 \text{ amperes}$$

The data given for the 2N3265 transistor are used to determine the h_{FE} ratio and base-to-emitter voltage, V_{BE} , of the transistor at this level of collector current. The minimum h_{FE} of 40 at a collector current of 10 amperes (95% of the transistors will meet this requirement) is close enough to the value calculated for I_C'' . The forced value for this ratio, h_{FE}' , is chosen to be 20, which is small enough to assure that the transistor will saturate. The base-to-emitter saturation voltage, $V_{BE(sat)}$, at the collector current of 10 amperes is found to be 1.3 volts. The values of the following parameters can now be computed:

$$I_B = \frac{I_C''}{h_{FE}'} = \frac{9.62}{20} = 0.481 \text{ amp}$$

$$R_{in} = \frac{V_{BE(sat)}}{I_B} = \frac{1.3}{0.481} = 2.7 \text{ ohms}$$

The total base-circuit input resistance, R_{in}' , is the sum of the quantity R_{in} and the transistor bias resistor R_B . The value of R_B is chosen as 1 ohm. Thus, R_{in}' is equal to 3.7 ohms. The base-circuit input voltage V_{in}' , can be readily determined, either from the product of R_{in}' and I_B or as follows:

$$V_{in}' = V_{BE(sat)} + I_B R_B = 1.3 + 0.481 = 1.781 \text{ volts}$$

In the design of a high-speed inverter circuit, the value of the feedback resistor is usually chosen so that the available voltage is divided equally across this resistor and the primary of the base-drive transformer. The voltage across the primary,

Collector-current waveform for 2N3265 transistors exhibits the transformer saturation current. Collector-voltage waveform exhibits the voltage spikes resulting from the transformer leakage inductance.

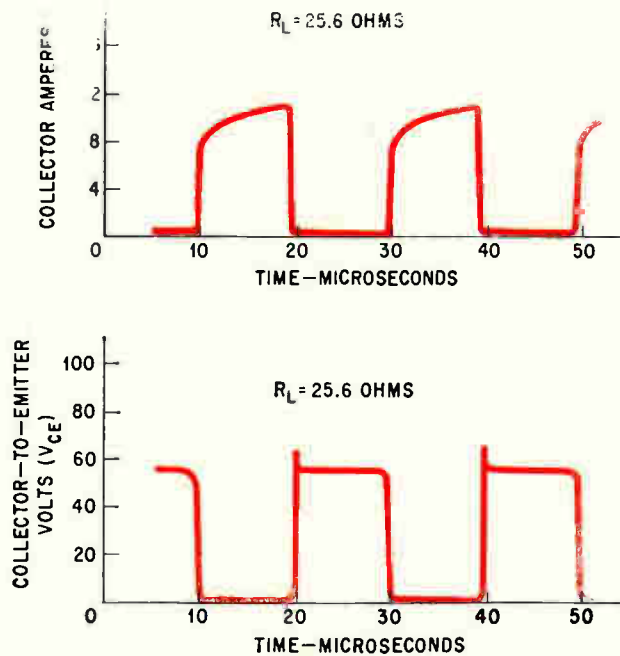

V_{pri} , is determined, therefore, as follows:

$$V_{pri} = (0.5)(2)(V_S - V_{CE(sat)}) = (0.5)(2)(28 - 0.75) = 27.25 \text{ volts}$$

The base-circuit input power, P_{in} , is determined from equation 4 or from the product of the V_{in}' and I_B as

$$P_{in} = (1.781)(0.581) = 0.86 \text{ watt}$$

If a transformer efficiency of 95% is assumed, the power input to the base-drive transformer is found to be

$$P_{in}' = 0.86/0.95 = 0.902 \text{ watt}$$

The primary current is determined to be $I_{pri} = 0.902/27.25 = 0.0332$ amp. The feedback resistor, R_{fb} , is computed for a magnetizing current equal to I_{pri} :

$$R_{fb} = \frac{V_{pri}}{I_{pri}} = \frac{27.25}{0.0332} = 820 \text{ ohms}$$

The value of the bias resistor R_1 (a resistive voltage-divider starting circuit is used) required to produce 0.481 ampere of starting current is determined as follows:

$$R_1 = \frac{V_S - V_{BE(sat)}}{I_B} = \frac{28 - 1.3}{0.481} = 55 \text{ ohms}$$

It now is possible to calculate the transistor collector current on the basis of total power in the inverter circuit, $P_{out}' + P_{in}'$. The value obtained is $I_C = (262.5 + 0.902)/27.25 = 9.65$ amps

The impedance reflected into the primary of the output transformer, R_L' , is computed on the basis of this value of collector current:

$$R_L' = 27.25/10 = 2.84 \text{ ohms}$$

The ratio of the specified circuit load impedance, $R_L = 25$ ohms, and this reflected impedance defines the transformer turns ratio n_2 :

$$n_2^2 = R_L/R_L' = 25/2.84 = 8.85$$

$$n_2 = 2.98$$

On the basis of a transformer efficiency of 95%, the magnetically dissipated power in the output transformer is given by

$$P_M = P_{out}(100-95\%) = 12.5 \text{ watts}$$

For an operating frequency (f) of 50 kilocycles, the Allen-Bradley type WO-3 ferrite core material, or equivalent, is acceptable. From the manufacturer's data sheet for the ferrite, the maximum usable core temperature is 125°C. For linear operation at this temperature the flux density, B_M , should be 1,000 gauss.

The core-loss factor ρ , for $B_M = 1,000$ gauss and $f = 50$ kilocycles is given as

$$\rho = 3.2 \frac{\mu w}{cm^3 cps}$$

Thus, at 50 kilocycles, the frequency-dependent core loss, ρ' , is calculated as follows:

$$\rho' = \left(3.2 \frac{\mu w}{cm^3 cps}\right) 50 \times 10^3 cps = 160 \frac{mw}{cm^3}$$

The maximum temperature rise is

$$T = 125^\circ C - 25^\circ C = 100^\circ C$$

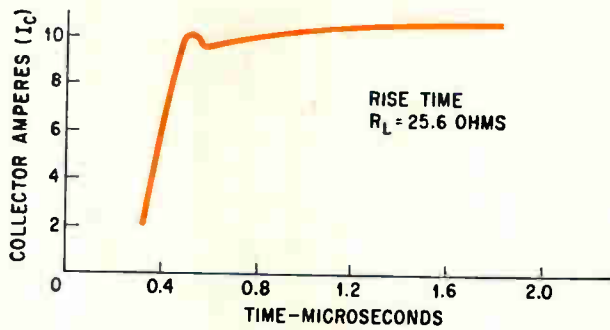

Collector current with an expanded time scale showing the current rise and fall times.

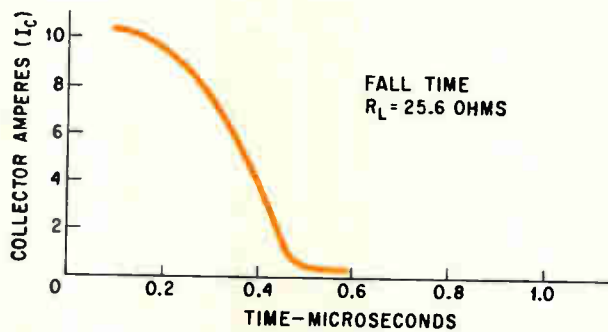

When the temperature-rise factor⁶ of 3.2 mw/cm³°C. is used,

$$\rho'' 3.2 = \frac{mw}{cm^3 \text{ } ^\circ C} 100^\circ C = 320 \frac{mw}{cm^3}$$

The minimum core volume would be determined from the core loss due to the temperature used and is given as

$$\text{volume} = \frac{P_M}{\rho''} = \frac{12.5}{320} = 39 \text{ cm}^3$$

for a pair of C cores, type U2625C133A (Allen-Bradley) or equivalent, which have the following dimensions:

area = 2.04 cm²

length = 16.4 cm

volume = 40 cm³

The number of primary turns is then determined by the following calculations.

$$N_p = \frac{27.25 \times 10^8}{4 \times 5 \times 10^4 \times 2.04 \times 10^3} = 6.55 \text{ turns}$$

if $N_p = 6$ turns, then $N_s = (6)(2.98) \cong 18$ turns

From the manufacturer's data sheet, it is found that for linear operation the value of $H = 0.189$ oersted should not be exceeded. This value corresponds to a magnetizing current of

$$I_M = \frac{(16.4)(0.189)}{(1.26)(6.55)} = 0.376 \text{ amp}$$

The transformer wire sizes should be selected to prevent excess power dissipation and the primary should be wound in a bifilar manner. The trans-

former is constructed with a minimum amount of tape applied to the core in order to reduce the core temperature.

Drive-transformer calculations

The type RO3 (Allen-Bradley) rectangular-loop ferrite core material, or equivalent, is suitable for use in the base-drive transformer. The flux density, B_m , of the drive transformer should be 3,000 gauss and the saturation field strength, H_s , should be 1 oersted.

The core loss factor for 3,000-gauss flux density and 50-kilocycle operating frequency is given by

$$\rho = 63 \frac{\mu w}{cm^3 \text{ cps}}$$

and the core loss at 50 kilocycles is found as follows:

$$\rho' = 63 \times 50 \times 10^3 \times 3.15 \frac{w}{cm^3}$$

which is in excess of the factor for temperature rise and thus determines the minimum usable core volume.

On the basis of a transformer efficiency of 95%, the magnetically dissipated power in the drive transformer is given by

$$P_M = P_{in}(100-95\%) = 0.86 \times 0.05 = 0.043 \text{ watt}$$

the minimum volume is thus

$$\text{Vol} = \frac{P_M}{\rho'} = \frac{0.043}{3.15} = 0.0136 \text{ cm}^3$$

To meet this minimum volume requirement, a core type TO620H101A (Allen-Bradley) or equiv-

alent, is chosen. This core has the following dimensions:

$$\begin{aligned} \text{area} &= 0.119 \text{ cm}^2 \\ \text{length} &= 1.53 \text{ cm} \\ \text{volume} &= 0.182 \text{ cm}^3 \end{aligned}$$

The number of turns in the primary, therefore, should be

$$N_p = \frac{27.25 \times 10^8}{4 \times 5 \times 10^4 \times 0.119 \times 3,000} = 37.5 \text{ turns}$$

The turns ratio, n_1 , is determined as follows:

$$\begin{aligned} R_{in}' &= 3.7 \text{ ohms,} \\ R_{pri} &= 27.25/0.033 = 830 \text{ ohms} \end{aligned}$$

$$n_1^2 = \frac{830}{3.7} = 224$$

$$n_1 = 15$$

Therefore,

$$N_s = \frac{37.5}{15} = 2.5 \text{ turns}$$

The saturation magnetic field strength, H_s , is then computed as

$$H_s = \frac{(1.26)(37)(0.033)}{1.53} = 1.01 \text{ oersted}$$

Thermal-resistance calculations

From equation 12 and using $I_{CEX} = 20\text{mA}$ (from data sheet), the average transistor dissipation is

$$\begin{aligned} P_D &= \frac{(20 - 1)}{2(20)} \left[(0.75)(9.65) + 2(.020)(28) \right] \\ &+ \frac{1}{20} \frac{(28)(9.65)}{3} = 8.65 \text{ watts} \end{aligned}$$

For a junction temperature of 125°C , the maximum temperature rise is

$$\Delta T = 125^\circ\text{C} - 25^\circ\text{C} = 100^\circ\text{C}$$

The total junction-to-air thermal resistance including heat sink, mounting and junction-to-case thermal resistance is found to be

$$\theta_{j-c} = \frac{100}{8.65} = 11.6^\circ\text{C/W}$$

For the 2N3265, the thermal resistance is

$$\theta_{j-c} = 1^\circ\text{C/W}$$

The mounting thermal resistance will be about 0.25°C/W . Thus, the heat sink

$$\theta_{HS-A} = 11.6 - 1.25 \leq 10.35^\circ\text{C/W}$$

Experimental results

The output transformer was constructed and the leakage inductance as measured on a Q meter was about 0.5 microhenry. From the previous calculations, the peak collector current is about 10 amperes

and the reverse base-to-emitter bias voltage is about -2 volts. Data for the 2N3265 transistor for reverse-bias second breakdown are shown on page 58. For the operating peak collection current and the measured transformer leakage inductance more than 90% of the 2N3265 transistors will operate without risk of reverse-bias second breakdown. The operating conditions for the constructed output transformer are well within the safe area.

Also obtained from the 2N3265 data sheet is the safe operating area for forward-bias second breakdown as a function of pulse duration (see page 58). At the maximum collector-to-emitter operating voltage of 67 volts, the design is within the safe area for forward-bias second breakdown for the 50-kilo-cycle operating frequency (10-microsecond pulse duration).

Both transformers were constructed with a minimum of tape to give as much surface area as possible so that the core temperature remains low.

The circuit diagram for the practical design is on page 59. The values for the feedback resistance and for the bias-starting resistance were arrived at experimentally using the calculated values as a beginning. The photograph on page 59 shows the size of the completed circuit.

The output characteristics of the inverter as a function of the load are shown on page 63. The output characteristics are measured at the load at the output terminals of the rectifier bridge. Thus, the efficiency that is plotted is the total circuit efficiency. The range of values indicated on the efficiency curve (82% to 88%) takes into account the transistor dissipation, transformer losses, rectifier-bridge losses and all other circuit IR losses.

The experimental transistor load line for a load resistance of 25.6 ohms and a supply voltage of 28 volts is shown on page 62. The area enclosed by the load line shows that high dissipation occurs during switching. This area is decreased somewhat if slightly capacitive loads are used.

The collector current and voltage waveforms are shown on page 64. The collector current waveform exhibits the transformer saturation current. The collector voltage waveform exhibits the voltage spikes resulting from the transformer leakage inductance. The collector current with an expanded time scale showing the current rise and fall times is shown on page 65.

References

1. J.L. Jensen, "An Improved Square-Wave Oscillator Circuit," IRE Transactions on Circuit Theory, September, 1957.
2. Brown, Morgan and Stephenson, "The Design of Transistor Push-Pull D-C Converters," Electronic Engineering, October, 1959.
3. C.R. Turner, "Design of Transistorized D-C-to-D-C Converters," Electronic Design, Sept. 16, 30, 1959.
4. J.R. Nowicki, "New High Power D-C Converter Circuits," Mullard Technical Communications, April, 1960.
5. T. Roddam, "Transistor Inverters and Converters," 1963, Van Nostrand, New York.
6. H.M. Schlicke, "Essentials of Dielectromagnetic Engineering," (pp. 66, 104, 1961), John Wiley, New York.
7. Z.F. Chang and C.R. Turner, "Characterization of Second Breakdown in Silicon Power Transistors," 1963, RCA Application Note, SMA-21.

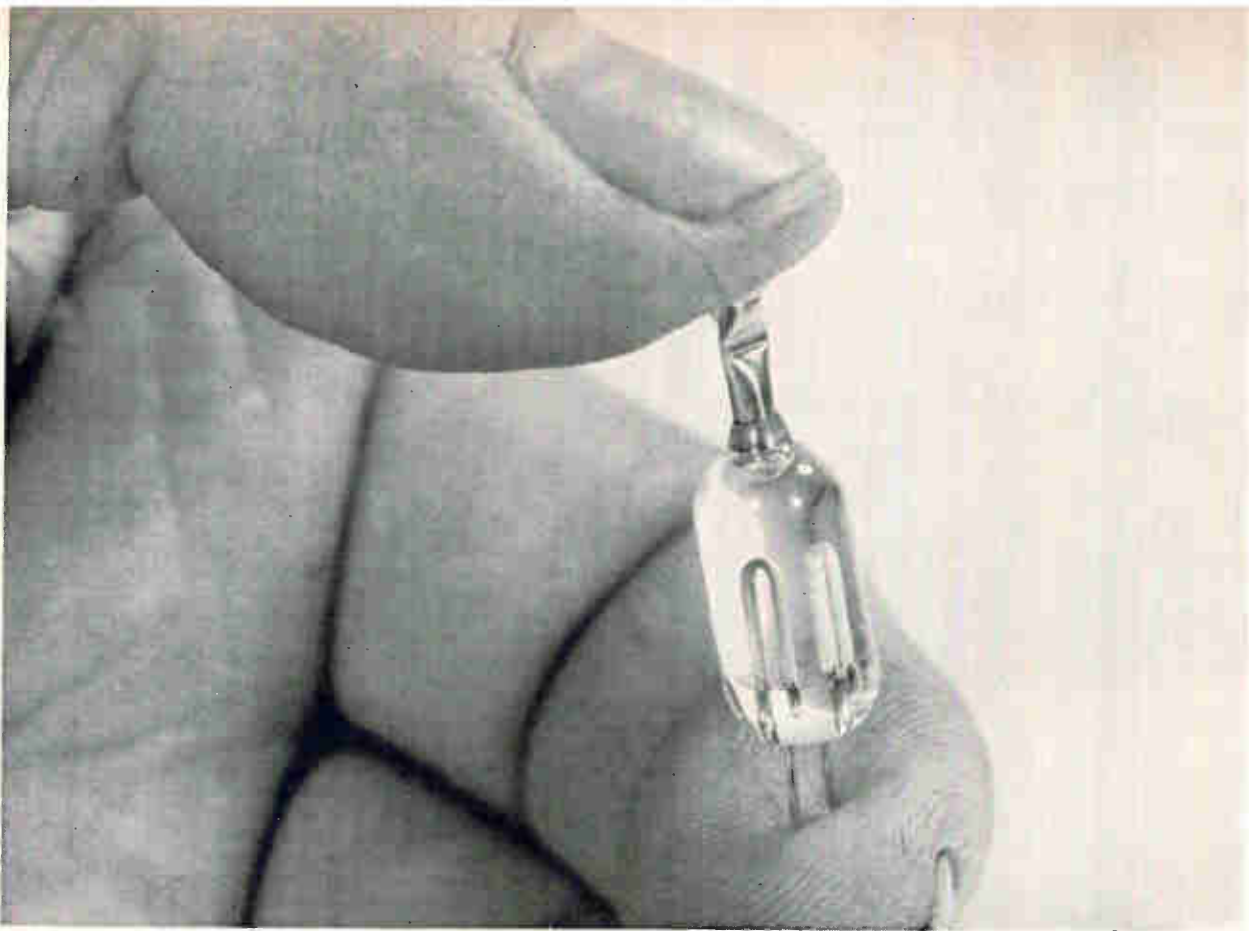

Sealed capsule contains completely reversible electrolytic system.

Components

Simple cell competes with complex components

Reversible, reusable device generates delays, integrates and stores. Its uses range from simple timer circuits to sophisticated memories

By Herbert Feitler

Bissett-Berman Corp., Santa Monica, Calif.

An electrolytic cell, no larger than a transistor, can generate time delays, integrate pulses and store signals. It performs timing and integrating functions never before achieved with a simple low-cost cell.

The device has no moving parts. Time is meas-

ured as a function of current in an electroplating action. There is no decomposition of the electrolyte. When one plating cycle is completed, the plating action may be reversed so that another plating cycle can begin instantly. This reversible plating action gives the device its versatility. The cell can

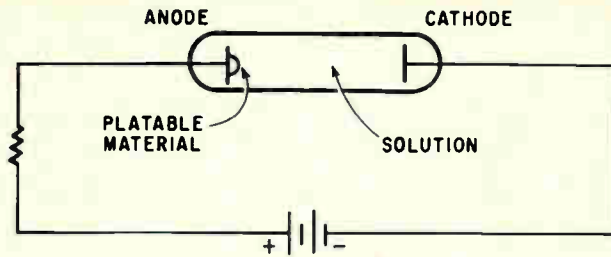

Schematic of electrolytic cell shows a simple plating system. A precisely known quantity of metal atoms is transferred from anode to cathode, and back again when current is reversed.

generate accurate time delays, or integrate pulses for analog memory circuits, computer logic, and sequential timing applications.

Performance

The device requires only microwatts of power, obtainable from common batteries, to generate time delays from seconds to weeks with accuracies from $\pm 1\%$ to 5% , even when operating over temperatures ranging from -55° to 75° C. In this range, the cell can store or integrate signals from 0.01 to 1,000 microamperes. Improved accuracies to $\pm 0.1\%$ are anticipated.

The cell is a sealed capsule that holds an electrolytic solution and two or more electrodes. In the sealed electrolytic system (diagram, above) is a quantity of platable material that has been deposited on the anode. The solution contains ions of the platable material. When the cell is connected to a battery, material is transferred from the anode to the bare electrode, or cathode. The platable material goes into solution at the anode and comes out of solution at the cathode.

During this electrolytic action, the voltage drop of the cell typically is under 100 mv. When all of the material has been transferred from one electrode to the other, the cell's voltage drop increases

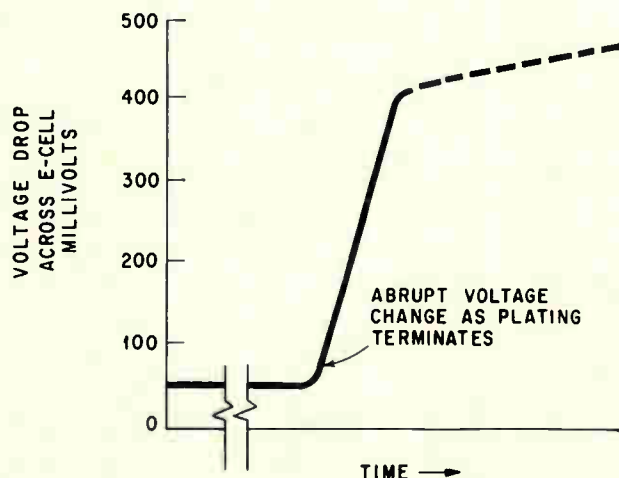

Abrupt voltage change occurs at the end of each plating cycle. The current is held constant during the cycle.

very rapidly. This is shown in the diagram at the left. The increased voltage drop may be used to fire a transistor or a silicon controlled rectifier, as illustrated by a simple timing circuit shown on page 69. Both electrodes are identical, so either electrode may be used as the anode or cathode. Because of this symmetry, the cell's action is reversible.

A solid-state component in parallel with the cell not only provides an electrical output, but limits the end-of-plating voltage drop to less than 0.5 volts. By thus limiting the voltage drop across the cell, electrolyte decomposition is avoided and the cell can be used again. Whether all the platable material is transferred, as in generating a time delay, or only part of the material is transferred, as in integration or analog memory applications, the cell instantaneously begins another cycle when current flow through the cell is reversed.

Details of manufacture and electrolytic composition are proprietary information. The platable material is silver. Cell preparation, particularly the preparation of the electrode surface, is as important as the composition of the electrolyte. A significant achievement has been to develop an electrolyte that functions down to -55° C, where most water-based liquids freeze.

Electronic clockworks

Resistance-capacitance networks have been used to generate time delays and integrate or store information for fractions of seconds up to one minute. Longer term analog memory or integration has been accomplished by positioning a potentiometer. Binary counters and clockwork mechanisms have been used to generate time delays from minutes to weeks. Both in concept and in practice, the electrolytic cell allows long-term analog memory and integration in a single component with no moving parts. As a timing component, the new timer generates delays at the upper end of the r-c network range and over much of the binary counter network range.

A simple timer

Electrolytic timer circuits may be as simple as the one shown. A regulated power supply, current-setting resistor(s), and a voltage sensing component such as a silicon-controlled rectifier along with electrolytic cell make up a complete timer that occupies less than 0.5 cubic inches volume. The timer weighs less than 0.5 ounces, has no moving parts, and has withstood 6,000 g shocks. It operates with 5 to 100 μ a current from a 5.4 volt supply.

The length of time required to transfer a certain amount of platable material depends upon the magnitude of the current used. For this reason, the capacity of the cell is given in current-time units. As an example, consider a 120 μ a-hour cell. Using a 5 μ a operating current, a delay of 24 hours is generated. Using a 60 μ a current, a delay of two hours is obtained. Varying time delays can be generated by changing a single resistor.

The same features that make the electrolytic cell

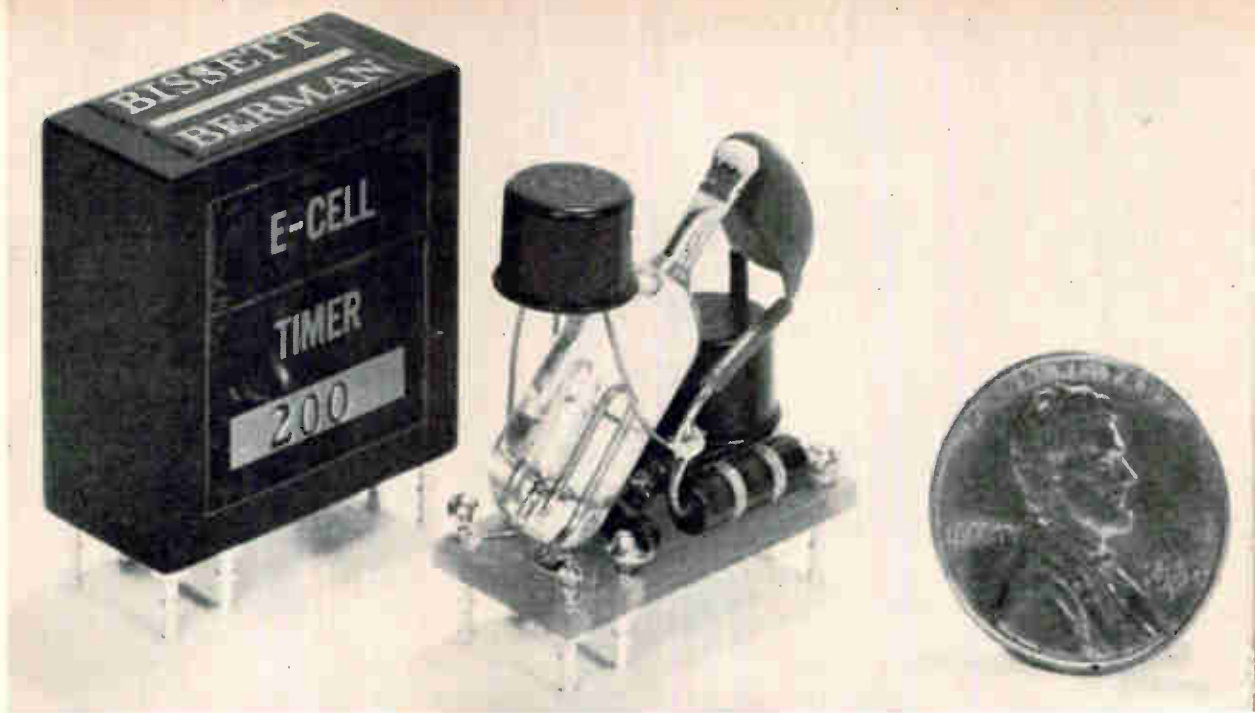

Timer is compatible with solid-state components.

Coulometry

During World War II, the German V-2 rocket used an electroplating cell as an integrator. But the electrolytic concept was not new. In 1833, Michael Faraday found that the amount of platable material transferred between electrodes was proportional to the quantity of electricity passing through the solution in which the electrodes were immersed. The quantity of electricity required to deposit 0.0011180 grams of silver was defined as one coulomb, equivalent to one ampere flowing for one second.

Silver and copper coulometers are still used to determine quantities of electricity precisely. Under rigidly controlled conditions coulometers are accurate to better than 0.05%.

Commercial electroplating involves temperature control, agitation, frequent solution additions, and high power consumption. For the electrolytic cell it was necessary to have a coulometric system (100% current efficiency for material transfer) completely reversible, so that the electroplating system in a nonstirred, sealed cell would provide accurate operation over a wide temperature range.

The electrolytic cell is not the first component to use electroplating techniques. Several electroplating elapsed-time or ampere-hour indicators are commercially available. They are manufactured by such companies as the Leland Airborne Products division of American Machine and Foundry, Inc., Siemens & Halske AG, Curtis Instruments, Inc. and Bergen Laboratories, Inc.

A typical elapsed-time indicator operates at a known current and has a copper anode whose length permanently and irreversibly decreases as a function of time [Electronics, Dec. 9, 1960, p. 98]. The cell wall is transparent and graduated so that the anode decrease may be measured to determine elapsed time. Other elapsed-time indicators plate a column of liquid mercury whose length is the measure of time. All of these devices are based on coulometric principles.

Were the new electrolytic cell another coulometer that provided single-shot, elapsed-time measurements by visual readout, it would be of little interest to electronics design engineers. But the device is reusable, reversible, capable of generating time delays, and can be used with other electronic components to provide electrical readout. This makes it a versatile and flexible new component for the engineer.

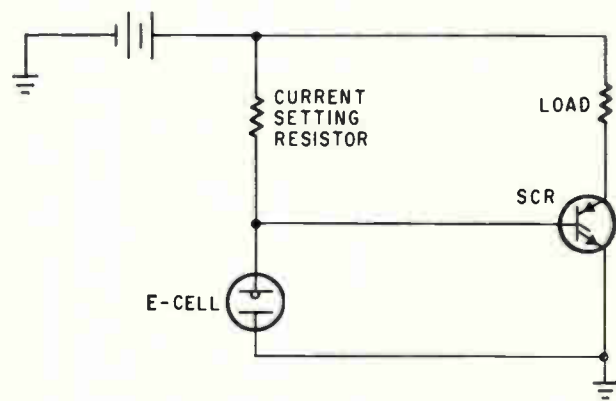

Simple timing circuit

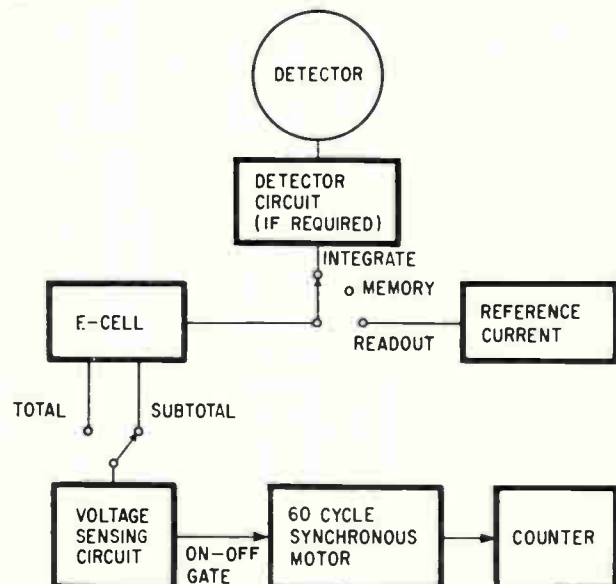

Electrolytic cell can be used in a radiation-integration and readout instrument.



Electrolytic cell is the heart of this radiation integrator. Instrument sets off alarms at various levels of radiation.

a desirable timer make it a useful analog memory-integrator. Of particular advantage is the ability of the device to store information for periods measured in hours, days or weeks. On a steady-state basis, signals ranging from $0.01 \mu\text{a}$ to $100 \mu\text{a}$ can be integrated, as can pulses as high as one ampere depending on the pulse's duration. When integrating an electrical signal, that signal is accumulated over a period of time. The electrolytic cell is applied directly to measure time as a function of current.

A cell for analog memory-integrator use contains

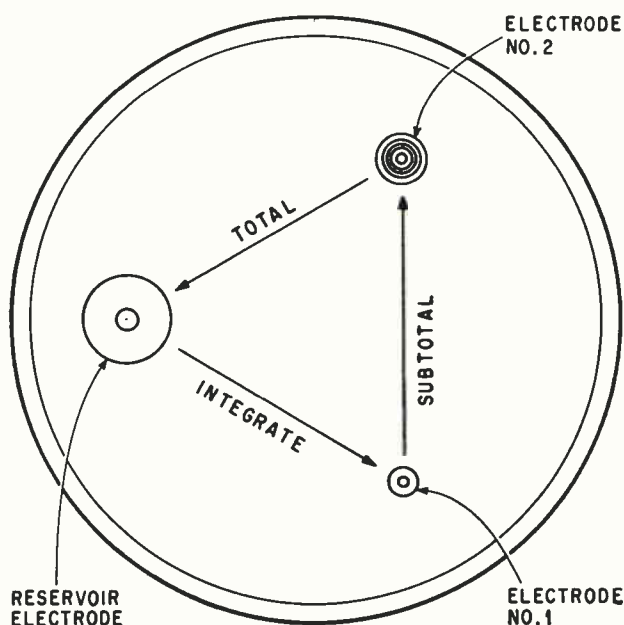

A three-electrode cell is used in counters to get subtotals.

a greater amount of platable material than is plated by the average current over the integration period. This material is located on the anode, or reservoir electrode. During the integration period, platable material is transferred from the reservoir electrode to a bare cathode.

To read out the stored integral, a known current is passed through the device to return the platable material to the reservoir. Time required for the material to return to the reservoir is a measure of the integrated signal. As in timing applications, when all the platable material is transferred, the rapidly increasing voltage drop across the cell is used to fire a voltage-sensing device and provides the equivalent of a contact closure.

A block diagram of a typical integration and readout system is on page 69. At the start of readout, a 60-cycle synchronous motor is turned on. The motor drives an indicating or printing digital counter. The contact closure shuts off the motor and, in the case of the printing counter, causes the counter to print the integrated value. Where a-c power is not available, readout may be accomplished by using clock-pulse generators coupled to appropriate counter-driving circuits.

Obtaining subtotals

The block diagram shows that it is possible to obtain subtotals as well as totals with integrators. In applications where subtotals are desired, a three-electrode cell is used. This is shown in the diagram at the left.

During integration, material is transferred from the reservoir electrode to electrode 1. A subtotal is obtained by measuring the time required to transfer the material accumulated on electrode 1 to electrode 2. To obtain the total, the material

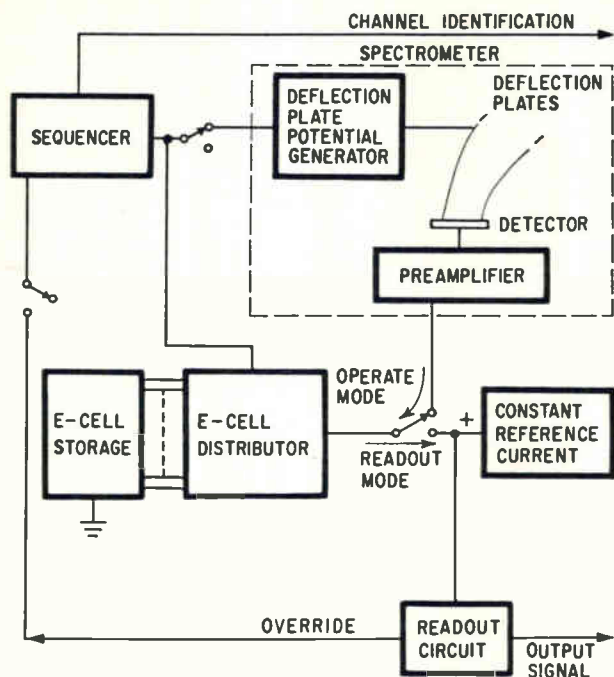

How electrolytic cells can be arranged in a mass spectrometer or gas chromatograph system.

accumulated on electrode 2 from the subtotals is returned to the reservoir.

Radiation monitor

One application of the electrolytic cell as an integrator is in a radio-frequency power-density meter. Conventional meters provide instantaneous values of power density. However, body damage is a function of the time of exposure to microwave radiation. To properly assess the hazard present in an area, it is necessary to determine the total incident energy over a period of time.

There is a battery-operated integrating power-density meter which uses the clock-pulse generator system. The r-f radiation integrator¹, shown on page 69 is a later version of this instrument. Integration readout is accomplished by passing a known current through the cell to return to the reservoir the plated material which represents the integrated signal. The time required for the return of the material is the measure of the integrated value; different lengths of time represents various integrated r-f values. With simple logic circuits, the time for the material's return may be compared to times representing first-, second- and third-level alarm conditions. Appropriate audible and visible alarms can be actuated.

Mass spectrometers

Another application for electrolytic integrators is the accumulation, integration, storage and readout of data from multichannel analyzers such as mass spectrometers and gas chromatographs. In a mass spectrometer, for example, molecules are bombarded by an electron beam which knocks off electrons, making positively charged ions. These ions are accelerated and, depending upon their

mass, they achieve different kinetic energies. Voltage applied to deflection plates allows only those ions of a particular kinetic energy to strike the detector. By varying the deflection-plate potential it is possible to detect ions of known masses both in terms of mass weight and quantity.

In actual practice, mass spectrometers perform a sequential scanning function by varying the deflection plate potential and recording the readout at each plate potential. In the diagram at the left a sequencer selects both the deflection-plate potential representing a particular mass weight and an electrolytic cell in which the data is to be accumulated. After a preset time, the sequencer selects another deflection-plate potential and the data is recorded in a second cell. In this fashion, each channel of information is recorded in a separate electrolytic cell.

To read out the data, a constant reference current is sequentially directed to each cell via the electrolytic-cell distributor. The end of readout on one channel causes the distributor to advance to the next channel for its readout. As in other integration applications, the time of readout is the measure of the integrated value.

Other applications

A future use of the electrolytic cell is seen for sequential timing circuits where delays of different length may be required. A simple logic circuit may be used to sequentially switch current-setting resistors and power-supply polarity. In this fashion, the end of one delay period initiates the next delay, which may be of different length.

Delay times of cells and timer circuits have ranged from one minute to 15 days. Cells are now being built for intervals measured in weeks and months. Timing applications have ranged from safing, arming and firing to ending the output of various transmission devices.

Since the advantages of the electrolytic cell include small size, light weight, very low power consumption, high accuracy, ruggedness, ease of delay adjustments and low cost, it is fairly certain that circuit designers will find many uses for it.

References

1. G. Heimer and M. Mintz, "New Techniques for Microwave Radiation Hazard Monitoring," Sixth National Symposium on Electromagnetic Compatibility, June 8, 1964.

The author



Herbert Feitler is manager of engineering services at the Bissett-Berman Corp. He is 36 years old, married, has two children, and finds time for tennis and great books discussion groups.

Designer's casebook

Designer's casebook is a regular feature in Electronics. Readers are invited to submit novel circuit ideas, packaging schemes, or other unusual solutions to design problems. Descriptions should be short. We'll pay \$50 for each item published.

Chart provides alpha components

By N. R. Fines

Defence Research Telecommunications Establishment
Ottawa, Ontario

Transistors introduce phase shift in high-frequency amplifiers, oscillators and other linear circuits. This phase shift can be calculated from the real and imaginary components of α , the common base current gain. Ordinarily, the real and imaginary components of α are determined from measurements taken over a range of frequencies on a transfer-function bridge. But these tedious measurements now can be eliminated by using the chart below.

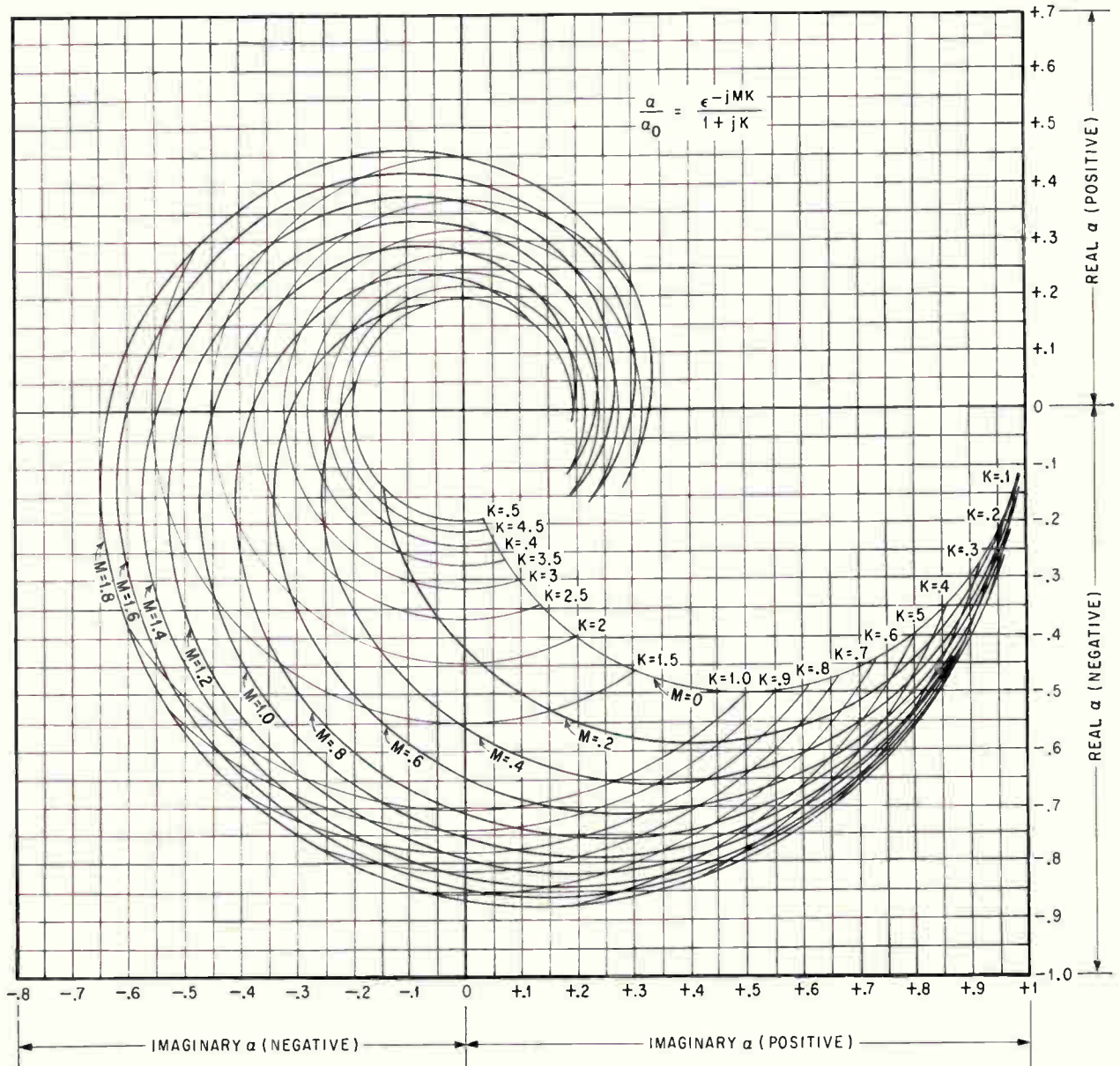

Intersection of the loci of M and K yields the normalized real and imaginary components of α (High-frequency phase shift).

The curves in this chart are calculated from the high-frequency expression for α . In practice, this expression is found to be accurate at frequencies up to five times the alpha cutoff frequency, f_α .

$$\alpha = \alpha_o \frac{e^{-jM/f_\alpha}}{1 + j(f/f_\alpha)}$$

This equation is normalized with respect to α_o , simplified by making $K = f/f_\alpha$, and results in

$$\frac{\alpha}{\alpha_o} = \frac{e^{-jMK}}{1 + jK}$$

This is expanded into trigonometric form to permit the calculation of the real and imaginary components. The resulting expression is of the form $A + jB$, and is given by

$$\frac{\alpha}{\alpha_o} = \frac{1}{1 + K^2} [(\cos MK - K \sin MK) - j(\sin MK + K \cos MK)]$$

The following definitions apply to the equations given above.

- α_o = low-frequency, common base short circuit forward current transfer ratio
- f_α = frequency at which $|\alpha| = 0.707\alpha_o$
- f = frequency at which the real and imaginary components of α are to be determined
- M = the excess phase shift at f_α .

The value of M depends on the gradation of impurities in the base region. This value isn't usually

given on transistor data sheets, but a good approximation is $M = 0.2$ for diffusion type transistors and 0.6 for drift type transistors.

Another approximation of M can be obtained from

$$M = \frac{(f_\alpha/f_T) - 1}{\alpha_o}$$

where f_T = frequency at which the common emitter forward current gain is unity.

As an example, determine the real and imaginary components of α at 500 Mcs for a 2N709 transistor with the following specifications:

- $f_\alpha = 1280$ Mcs
- $f_T = 805$ Mcs
- $\alpha_o = 0.987$

First, determine the values of M and K for this transistor at the frequency of interest.

$$M = \frac{(1280/805) - 1}{0.987} = 0.6$$

$$K = (500/1280) = 0.39 = 0.4$$

The intersection of the curves given for these values of M and K on the chart results in

$$\frac{\alpha}{\alpha_o} = 0.75 - j0.55$$

$$\begin{aligned} \alpha &= 0.987 (0.75 - j0.55) \\ &= 0.74 - j0.542 \\ &= 0.923 \angle 36.7^\circ \end{aligned}$$

Transistor circuit converts voltage to regulated frequency

By William H. Voelker

G.A.W. Inc., Newbury, Ohio

A simple and inexpensive voltage-to-frequency converter is shown in the circuit diagram at right.

Unijunction transistor Q_5 is connected as a conventional relaxation oscillator, but with Q_4 supplying the charging current for capacitor C . The charging current is measured by the voltage drop across resistor R and is compared with the input voltage by the differential amplifier Q_1 and Q_2 . The difference signal is amplified by Q_3 , which controls the capacitor-charging current through Q_4 . This negative feedback maintains the voltage across R equal to the input voltage. This causes the charging current and, therefore, the output frequency to be proportional to the input voltage.

The circuit can provide zero output frequency because the Q_4 collector-emitter leakage current

is smaller than the Q_5 base-emitter leakage current. To obtain zero frequency at zero input voltage, select transistors Q_1 and Q_2 having equal base-emitter voltage characteristics. For economy, the

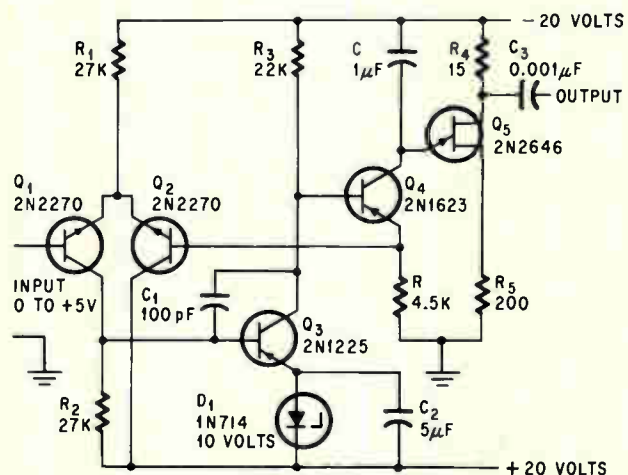

Transistor Q_4 controls the charging current for capacitor C , which regulates the output frequency of the unijunction relaxation oscillator.

base-emitter voltages of Q_1 and Q_2 can be equalized effectively by inserting a resistor of appropriate value in the base or emitter lead of the transistor with the lower V_{BE} drop. In the circuit shown, this can be accomplished by simply inserting a variable resistor of 500 ohms between the emitters of Q_1 and Q_2 and with the variable arm connected to R_1 . Adjust this variable resistor to obtain zero output frequency at zero input voltage.

Since the peak point voltage of a unijunction transistor is directly related to its interbase voltage, the output stability of the circuit is directly proportional to the stability of the -20 volt supply. Sufficient negative feedback exists in this circuit so that the regulation of the $+20$ volt supply isn't critical.

In extending the use of this circuit to other frequency or input-voltage ranges, several factors must be considered that contribute to the linearity of the input-voltage versus output-frequency characteristic. The base current of Q_2 and Q_4 as well as the emitter-leakage current of Q_5 flow through the current sensing resistor R , but don't contribute to the charging of timing capacitor C . The discharge time of the capacitor must be small compared with the minimum charging time.

The stability depends on the temperature coefficients of R , C , the unijunction peak point voltage and the differential amplifier offset voltage. The temperature coefficient of the unijunction peak-point voltage can be minimized by proper selection of the series base resistor.

The linearity and stability also was improved by using the zener diode D_1 instead of a resistor to bias the emitter of Q_3 .

The performance characteristics of the circuit are as follows:

Input	0 to +5 volts
Source loading	5 microamps
Output frequency	0 to 100 cps
Linearity	0.1%
Stability	0.01% per °C

Variable resistor controls differential amplifier gain

By Gerald Beene

Electronic Communications, Inc., St. Petersburg, Fla.

The gain of a differential amplifier can be controlled by a variable resistor.

The effect of a balanced gain control with one variable resistor, R_1 (above) can be illustrated by replacing the delta network in the dashed lines

with its equivalent wye network. The single variable resistor in the delta network has the same effect as two equal ganged variable resistors in the wye network (where $R_A = R_B$ at all times). As the value of R_1 is varied in the delta network, the value of R_C in the wye equivalent also varies. However, the variation of R_C is negligible compared to the high dynamic impedance of the constant current source represented by Q_3 .

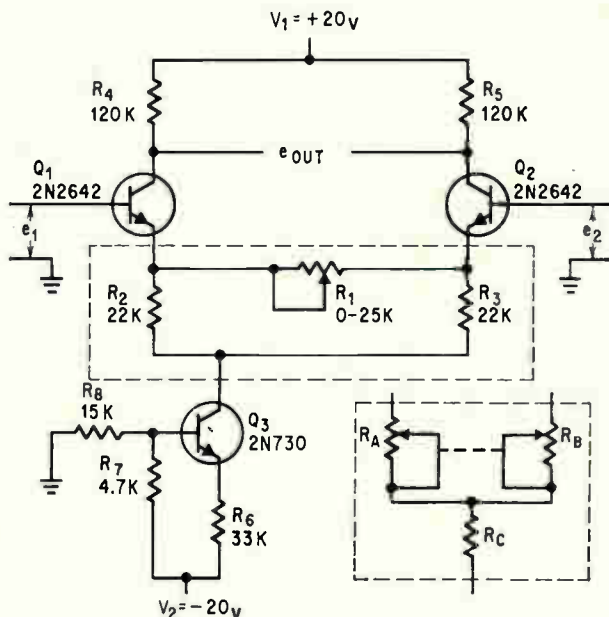

Gain of the differential amplifier is varied as R_1 . The gain can be calculated by replacing the delta network with the equivalent wye network in the dashed box below the circuit diagram.

The high dynamic impedance of the constant current source gives the differential amplifier a high common mode rejection ratio (in this circuit, the ratio of the voltage at either base to the voltage difference between the bases which will produce the same output voltage), and makes the balanced gain control possible.

The value of R_A or R_B can be calculated from the delta-wye transformation equations.

$$R_A = R_B = \frac{R_1 R_2}{R_1 + R_2 + R_3}$$

The voltage gain can be approximated by considering the differential amplifier as a common-emitter transistor where

$$\text{Gain} = \frac{2R_4}{R_A}$$

and is shown to be a function of the value of R_1

$$\text{Gain} = \frac{2R_4(R_1 + R_2 + R_3)}{R_1 R_2}$$

Finding malfunctions before they happen

New techniques in nondestructive testing detect flaws that might get past inspectors of finished products

By Robert C. McMaster

The Ohio State University, Columbus

The critical reliability required in aerospace, nuclear and process-control systems is spurring interest in nondestructive testing. New electronic techniques are making these advances possible.

New methods are finding defects that might not show up until the product had been in use for many months. For example, a crack below the surface of a printed circuit board might not be detected in functional testing but could cause considerable trouble later.

Nondestructive testing is also catching flaws early in the production process, while they can still be remedied economically. A faulty weld, for instance, can be repaired quickly if it's found while the part is still in the jig.

Destructive tests detect many of these latent failures by subjecting units to overloads and other abuses. But these tests can be performed only on a sampling of finished products, because articles that pass are as useless after testing as those that fail.

Increased sensitivity of apparatus is reducing the time required for nondestructive testing. Simplified readout equipment is making it possible for less-technical people to interpret test results. And both

advances are reducing the cost of testing.

Here are four significant advances in nondestructive testing that should have considerable industrial application:

- Electronic imaging of x-rays combines the minute detail of the radiograph with the speed and the economy of the fluoroscope.

- Neutron radiography makes it possible to differentiate between materials with the same density but different atomic number.

- Television pictures from ultrasonic waves pinpoint internal flaws in test objects.

- Microwave instruments measure the thickness of metallic and nonmetallic coatings.

Electronic imaging

Recent developments in the electronic imaging of x-rays give instantaneous read-outs without the delays inherent in processing of radiographic film. Two classes of electronic x-ray image systems have emerged. The first is the electrostatic x-ray image tube that converts x-rays into light images and then into video signals for display. The second class is the photoconductive-target television-camera tube that converts incident x-ray images directly into video signals without any intermediate conversion.

A typical electrostatic image-tube includes a phosphor layer that fluoresces in response to x-radiation, and a coincident photo-cathode layer that emits electrons when excited by light from the fluorescent screen. The electrons given off from the photo-cathode are focused and accelerated through a high-voltage electrostatic field and a lens system similar to that in a conventional tv tube. The electrons strike a smaller-diameter phosphor

The author



Robert C. McMaster edited the two-volume *Nondestructive Testing Handbook*, published in 1959 for the Society for Nondestructive Testing, Inc. He teaches a graduate course in this field at Ohio State University where he is professor of welding engineering.

target at the opposite end of the image-tube.

The electrostatic method gives images 3,000 to 4,000 times brighter than with conventional fluoroscopic screens. The resultant small image may be inspected through a lead-glass protective window that exclude x-rays. The image may be enlarged with an optical system or closed-circuit television system.

Even at full size, the output image is brighter and easier to view than a direct-screen fluoroscope image. Resolution approaches that of film radiography. It is also possible to inspect a moving part continuously. A typical application is in inspection in pipe mills, where the entire welded product is continuously inspected on the production line.

Photoconductive television-camera tubes responsive to x-rays were investigated during the 1950's by Philips Gloeilampenfabrieken, N. V., in The Netherlands, and by the Radio Corp. of America, the DuMont Laboratories division of the Fairchild Camera & Instrument Corp., and the x-ray division of the General Electric Co. In general, however, these tubes used lead-oxide targets with excessive time delay, so that images blurred when articles

were inspected while in motion.

In research at Ohio State University, sponsored by the Watertown Arsenal laboratories, an improved system has been developed that uses a selenium-target tube. This system, less than a year old, provides detailed resolution—enough to capture a wire 10 microns thick—with image contrast exceeding that of fine-grain, high-contrast x-ray films for steel up to 0.1 inch thick. A picture of near comparable quality may be achieved with thicker parts or less radiation at the expense of motion by using an image-integration system. In this system, scanning in the camera tube is delayed so that the radiation has a chance to build up acceptable voltage on the selenium target. The target is then scanned and fed to the closed circuit tv system. Memory circuits allow the picture to be retained for several minutes, or a permanent facsimile to be generated.

Equipment of this type, available under license through Philips Electronics Instruments, the Dutch company's United States affiliate, has been used by several aerospace companies during the past year for inspecting thin materials and welds, missile

Technician checks transistor on vidicon x-ray television image enlargement system—a product of Philips Electronic Instruments. Diagram at right shows the complete system.

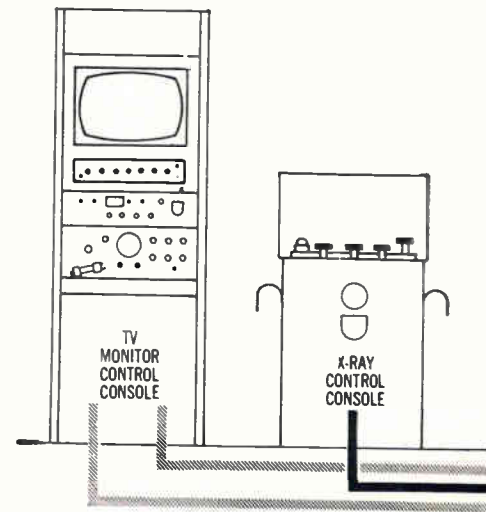

Kinescope



Transistor with broken lead

cases, biological specimens and components such as transistors, capacitors, resistors, diodes and other semiconductor assemblies (photo below).

Inspecting articles in motion

When an article is in motion, inspection with the television x-ray image enlarger provides unique insight into the properties of materials. Fine cracks show up as flashes on the screen only within narrow angles of the x-ray beam during continuous scanning, and would frequently be missed with x-ray exposures at fixed angles.

When an image is enlarged 30 times, a defect about 1/32 inch in length appears almost one inch long on the tv monitor screen. The picture clearly shows voids and porosity in brazed joints and welds smaller than .001 inch in diameter. Filletting in brazed honeycomb-sandwich structures can be examined in detail.

With such equipment, a unique form of very fine porosity has been found along the fusion lines in some electron-beam welds. The detailed resolution is remarkable in the case of very thin, low-density specimens. For example, in the biomedical field, it

has been possible to observe the emergence of larvae from a fly, the passage of each larva during birth and its movements after birth.

Television x-ray image-enlargement also has potential for in-process control systems of high sensitivity. One such system was applied experimentally to automatic arc welding of a high-strength aluminum alloy. The tv system showed the metal being transferred, the action of gas porosity and inclusions in the molten weld pool, the fusion of the molten metal as it penetrated to the root of the weld, the formation of cracks in the solidified weld metal and even their disappearance.

An aerospace company is considering the system for directing the welding of large missile cases and domes, using the x-ray source and camera mounted directly on the welding machine-carriage. The system is designed to detect and correct defects before the weld solidifies, and to complete inspection simultaneously with the welding. Immediate correction of improper welding conditions can avoid difficult and costly weld repairs after structures have been removed from the welding fixtures.

Continued next page

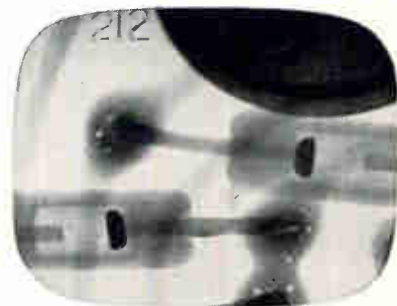
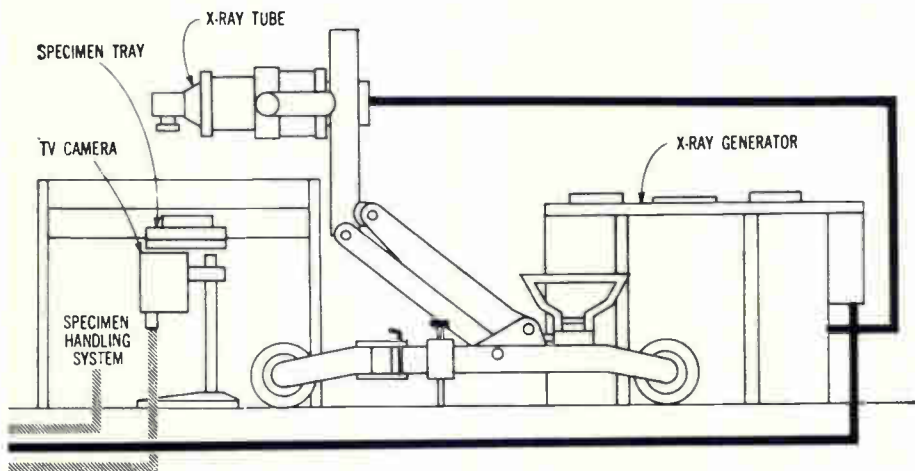

Diodes in electronic assembly

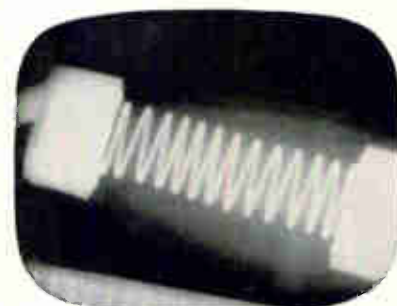

Undamaged wire-wound resistor

shows objects under test



Cracks in a titanium weld



Glass resistors with holes, cracks



Voids in brazed sandwich

Neutron testing

Experiments at the Argonne National Laboratory indicate considerable potential for neutron radiography for tests of hydrocarbons and heavy-density materials such as uranium.

Thermal neutron radiation differs from x- or gamma-radiation. Neutron radiation testing is not directly responsive to material density, but rather to atomic number and atomic properties. For example, a piece of waxed string can be shown clearly within a lead brick, a task that would be nearly impossible with an x-ray system.

Sources of neutrons include nuclear reactors with moderators and collimating systems (to adjust the speed of and to focus the neutron stream), or devices such as accelerators or high-yield antimony-beryllium neutron emitters. Images of neutron beams are recorded on conventional x-ray film. The film is in contact with a screen that emits photographically-detectable radiation when bombarded with neutrons. Gold, indium and dysprosium screens have been tried in post-exposure transfer techniques, where the screen is first exposed to the neutron-image formed by the test specimen, and later placed in contact with film for image transfer.

For direct exposure, where the film contacts the screen during neutron bombardment, gadolinium and rhodium screens have been used. Variations of 1% to 2% of the thickness of the part have been detected. Problems of neutron radiation, scattering and elimination of effects of gamma rays remain to be controlled. In spite of this, neutron radiography appears to be a promising technique for nondestructive tests of heavy metals, for detection of light metals or hydrocarbon materials in assemblies, and for studies of hydrogen-containing materials such as organics, wood or biological specimens.

Private industries' use of this technique in shop or field exposures must await the development of portable high-output neutron sources. Also necessary is experience in interpreting neutron radiographs of industrial materials and components.

The prospect of rapid developing of images is offered in a recently announced Polaroid scintillator-film camera system, using a lithium-enriched screen in contact with the film during exposure. The contrast sensitivity however, is far below the level commonly obtained with x-ray films. For a detail, such as a hole, to be clearly seen, its depth must be at least 12% to 15% of the thickness of the part; compared with x-ray film where detail need be only 1% or 2% of the thickness.

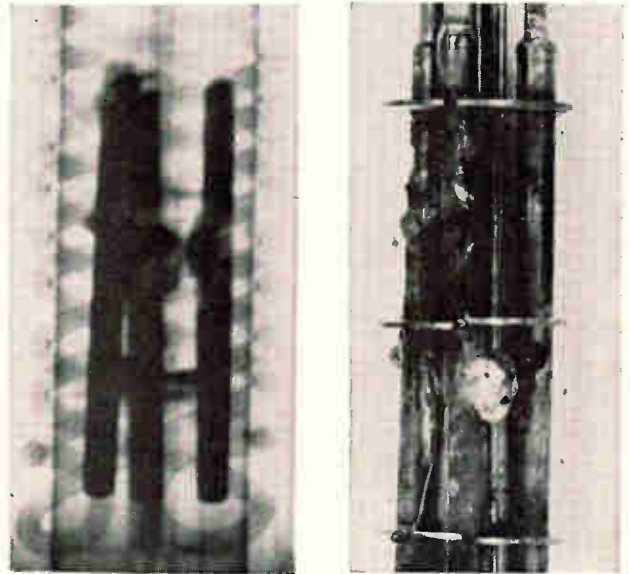

Neutron radiographic facility at Argonne National Laboratories' Juggernaut reactor is shown at right prepared to test a radioactive fuel cell. The tall container

is used to ship the cell. From this container the fuel cell is lowered into the path of the neutron beam. The beam then passes through to the indium metal screen that the technician is placing into the drawer, then through to the huge cylinder that stops the neutrons. Shown above is a neutron radiograph of an unopened fuel cell and an optical photograph of clad fuel specimens after capsule was opened. The radioactivity of the specimen would have made x-ray inspection difficult.

Mass absorption coefficients of the elements

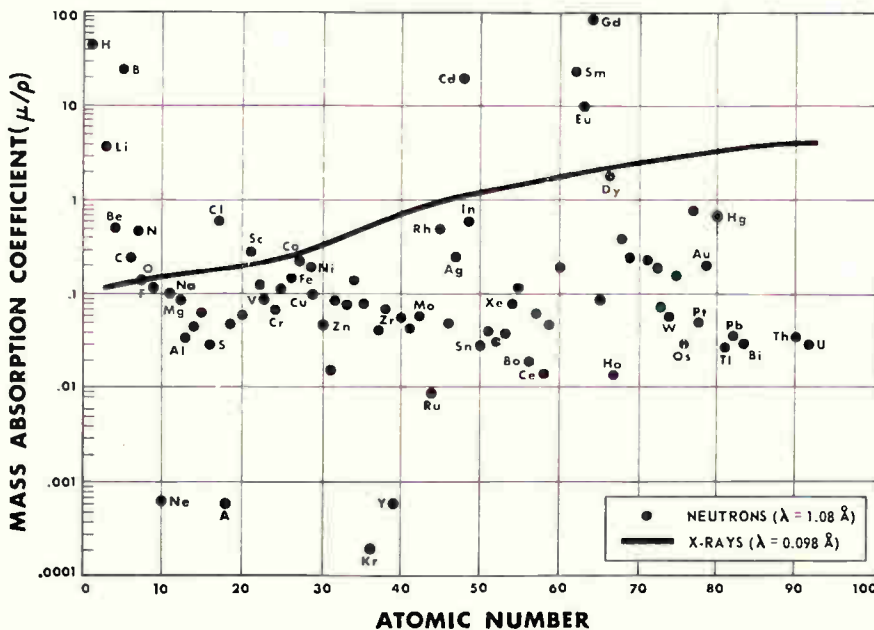

Spread of coefficients of absorption of each element for thermal neutron radiation (dots) is much greater than for x-radiation (line). Thus, discriminating between materials by radiography is facilitated.

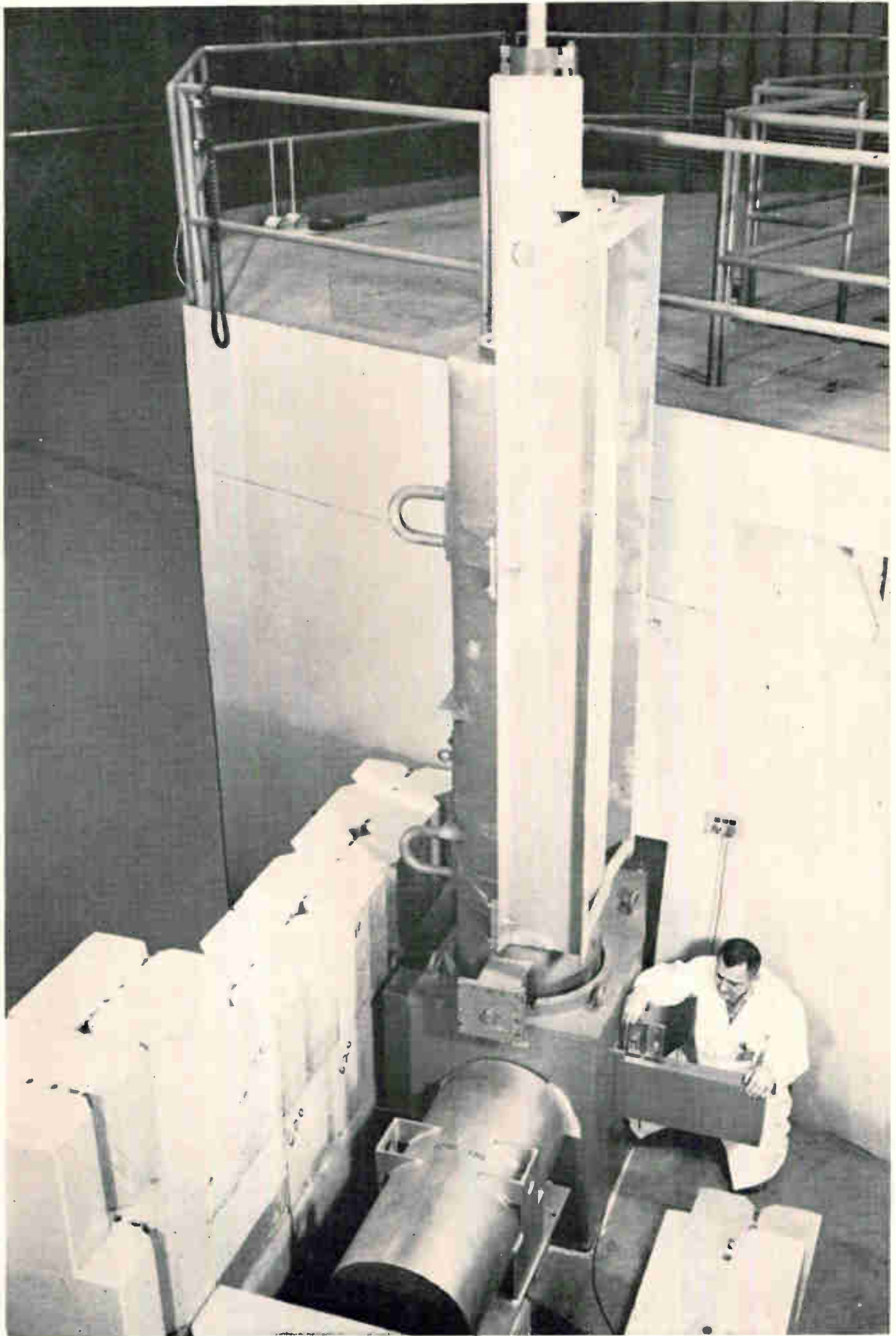

Television ultrasonic imaging

There are two types of ultrasonic testing equipment: through-transmission, where the waves travel through the part and is attenuated by the flaws thus disclosing their location, and pulse-echo where the waves bounce off flaws in sonar fashion. Each has undergone significant refinements.

It is now possible to detect surface and internal

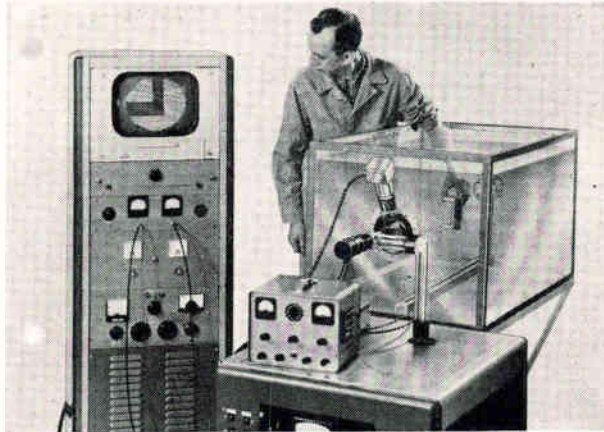

Ultrasonic imaging system of James Electronics, Inc., in retouched photo above shows how test results might appear if setup worked ideally. In a test shown in the diagram below, the object was held close to the pickup tube. The actual tv image (bottom right) shows an oval nonbond area in the central portion of the picture. The circular shape around this is the outline of the active piezoelectric target on pickup tube (bottom left). Images outside that circle are of wire and glass inside the tube.

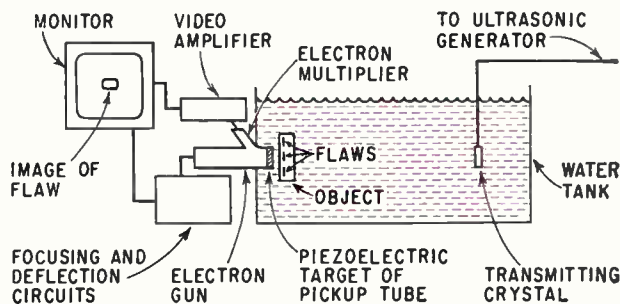

Testing technique

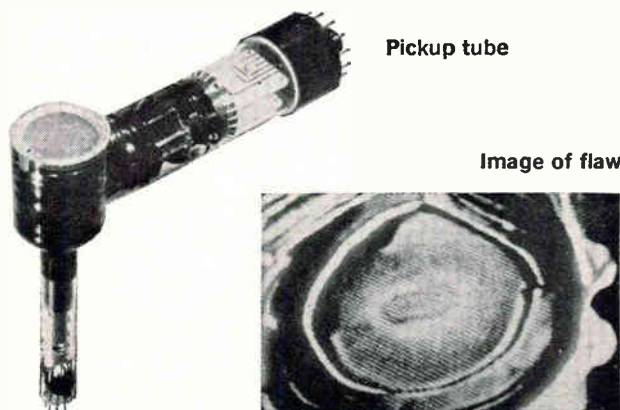

cracks, laminations, seams and laps, inclusions, segregations and other discontinuities as small as 1/64 inch long and of infinitesimal thickness. The big breakthrough is in television and facsimile read-out systems that produce a plain view of the part and its defects that is similar to a radiograph.

Ultrasonic waves in the megacycle region are produced by piezoelectric crystals that vibrate when a high-frequency alternating current is applied. Other piezoelectric crystals act as receivers by producing electric currents when subjected to the changing pressures of the transmitted sound. Because ultrasonic waves are almost completely attenuated in air, they are transmitted by immersing both the crystals and the part in water or by placing the crystals in contact with the part through a thin film of oil.

In one television imaging system for immersion ultrasonic testing, a sound beam is transmitted through the part and the coupling water to the face of a camera tube or image converter. The face of the tube is a bariumtitanate piezoelectric target two inches in diameter. Since the intensity of the transmitted sound varies, depending on whether it passes through the solid test piece, the water, or the flaws, different sound intensities reach the target. The voltage pattern created on the target by the sound is removed by electronic scanning in the tube, producing video signals in the same way that the charges caused by the photoelectric effect in an ordinary camera tube are removed by electronic scanning. These signals are processed and displayed by a closed-circuit tv system. The resulting image appears similar to a radiograph.

In the pulse-echo technique, the transmitter and receiver are mounted together. Interfaces such as the front or back of the test piece, or any flaws in between, reflect back to the receiver a sound pulse that originates in the transmitter. Time-separated pips on an oscilloscope, corresponding to the reflections from each interface, locate any discontinuities.

Two new pulse-echo systems, which also produce electronic imaging, have been developed by Automation Industries, Inc., under sponsorship of the Aeronautical Systems division, Air Force Systems Command, Wright-Patterson Air Force Base, Ohio.

In a technique known as isometric scan, multiple transducers with focusing lenses revolve around the test object submerged in a water-filled tank. The reflected signals interpreted by computer circuitry produce an apparent three-dimensional perspective image of defects and test-object outlines on a cathode-ray tube.

In the delta-scan technique, sound is propagated into the submerged test object at an angle of about 20°. Sound is reflected by discontinuities straight up and out of the test object to focused receivers that scan the object mechanically. Line by line, the image of the piece and its flaws is produced by facsimile. In tests made on butt welds, facsimile recordings have showed finer detail of the porosity in the weld than corresponding x-ray images.

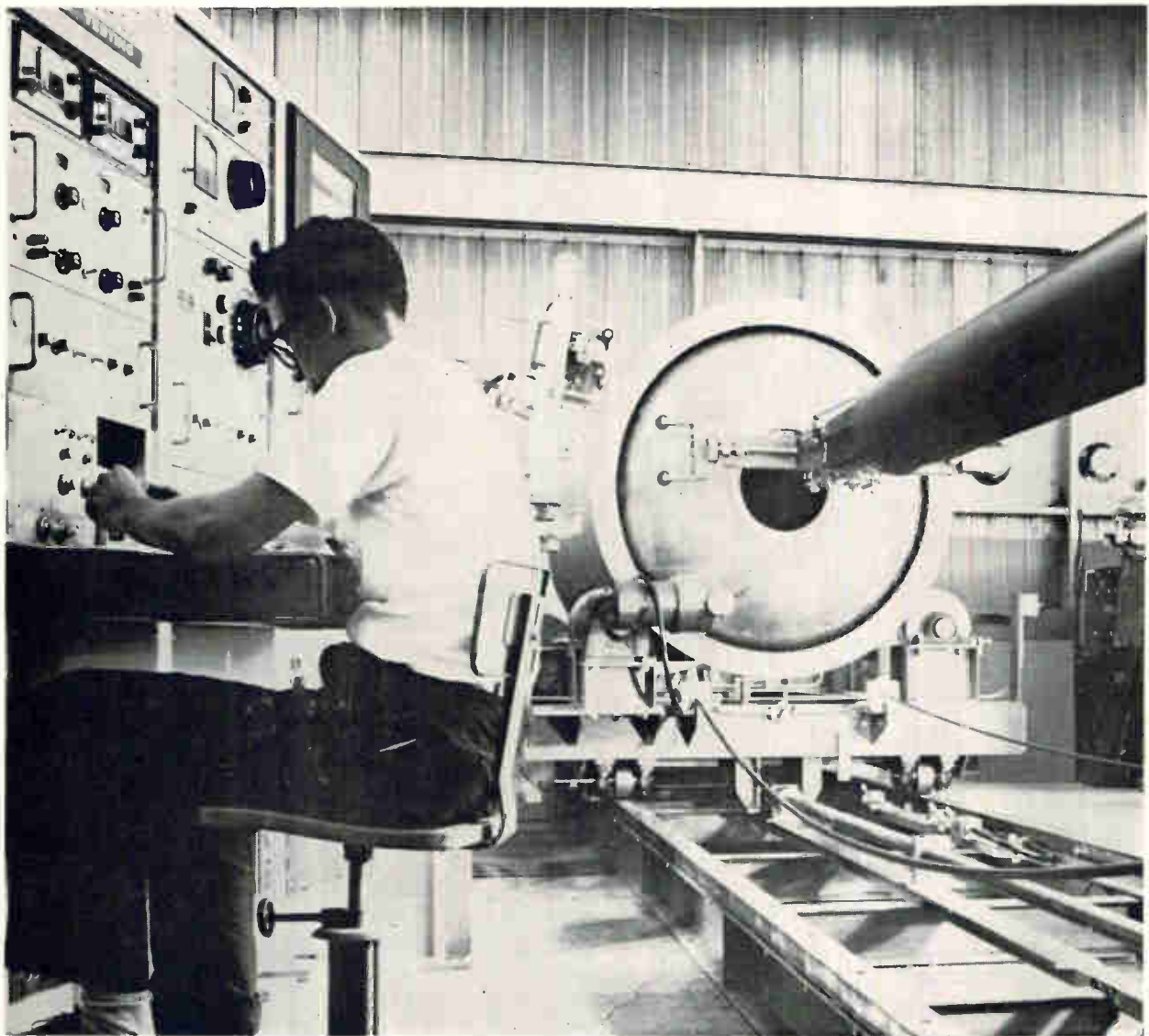

Magnaflux Corp. tester uses microwaves as one medium for testing one million miles of glass-epoxy filament that comprise the Polaris A-3 motor case. Microwave signals are transmitted through the case (from left) to a passive reflector mounted on the boom, which is inside the case during test. As the case is rotated, a void or other flaw causes a change in the amplitude or phase of the reflected wave, which is recorded on a chart recorder.

Microwave tests

Very-high-frequency electromagnetic waves, or microwaves, represent a relatively new portion of the electromagnetic spectrum for use as a probing medium for nondestructive tests. By propagating along a coated surface, the consistency of the coating can be measured. The coating to be tested may be either a conducting material on a nonconducting surface or the opposite. Any variation in the coating's conductivity or thickness will effect the phase or amplitude of the wave, revealing the flaw. The photo (below) illustrates another type of microwave test.

The Microwave Instruments Co. of Corona del Mar, Calif., has developed microwave nondestructive

test systems specifically for testing nonmetals. These systems are used for thickness measurements, flaw detection in some materials, measurement of dielectric constant and for vibration analysis. Materials that can be tested with microwaves include plastics, rubber, ceramics, resins, wood, concrete and certain chemicals and petroleum products. Tests of dimensional stability can also be made on tubes and on special shapes that perform as waveguides or cavity resonators with sensitive response to shape and dimensions.

Microwave techniques may take their place among the well-established test methods in the present decade. But much additional basic research is needed to obtain reliable correlations between microwave test indications and material properties related to serviceability.

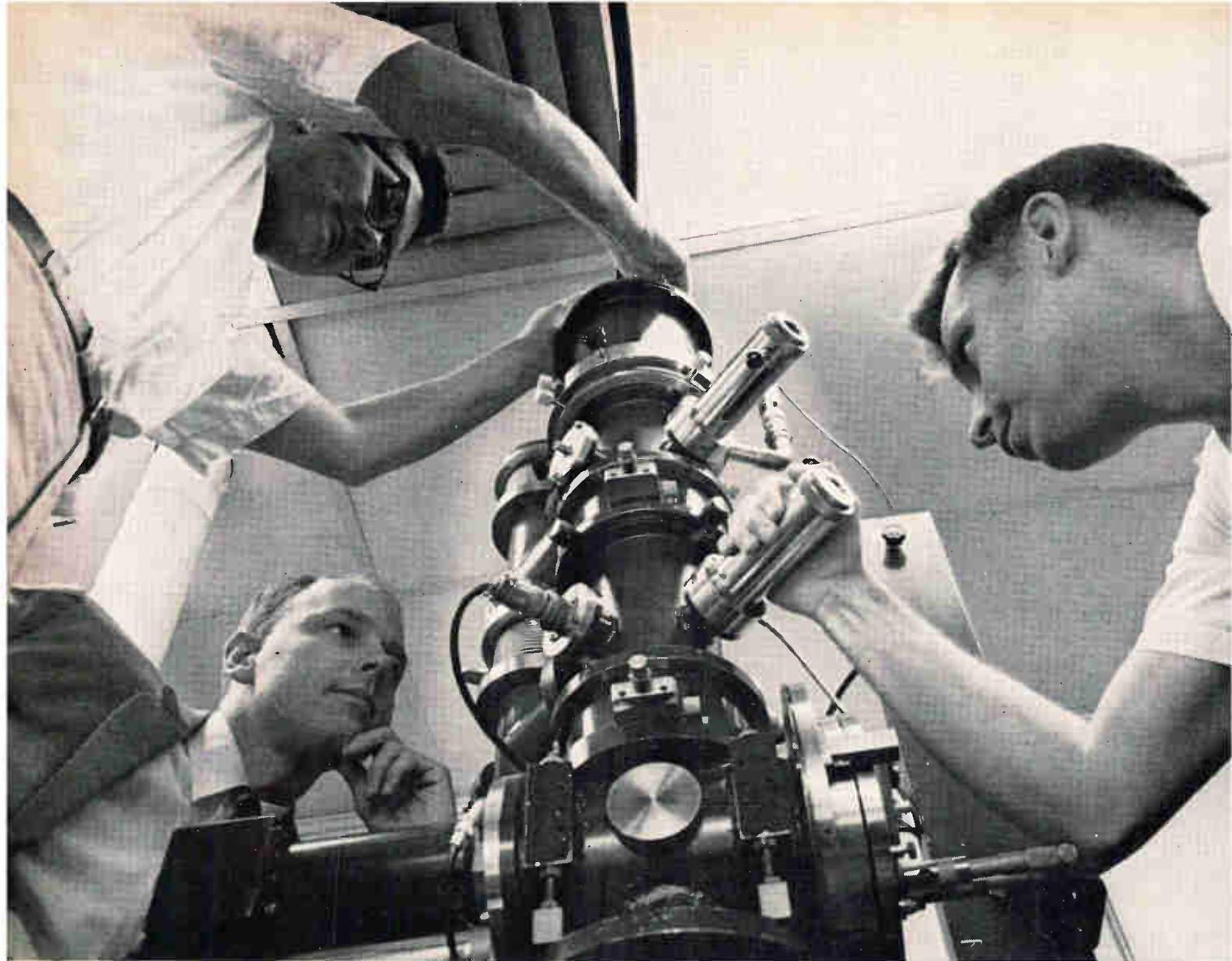

Electron-beam column of the Westinghouse Electric Corp.'s scanning electron microscope. Its developers are (left to right), O.C. Wells, T.E. Everhart and R.K. Matta.

Manufacturing

Can electron beams produce incredibly small circuits?

Some researchers are trying to pack 100 billion thin-film tubes in a cubic inch; others want to make micron-sized transistors

By George Sideris
Manufacturing Editor

A stunt popular in the electron-beam fraternity is the use of a finely focused beam to carve micron-wide monograms in thin films. This may make the world's most unusual autograph book, but what use is it to electronics production?

The significance, explain researchers, is that the high resolution of electron beams—beams like those made by cathode-ray-tube guns, but with smaller spot sizes—can be put to work making smaller microcircuits. Beams may be used to make components whose dimensions are measured in microns and angstrom units, not inches and mils.

This is the opinion of researchers. Industry is unconvinced, although researchers are beginning to turn up evidence that electron-beam techniques will become useful—perhaps essential—for producing large microcircuit arrays. In the last several years, military agencies have spent more than \$2 million on that research.

Stanford Research Institute is tooling up to make a data-processing system that would contain 100 billion thin-film components in a cubic inch and call up 10 billion bits of data a second. Richard Wilcox, who monitors this contract for the Office of Naval Research, expects techniques development to be at the prototype stage "within a couple of years."

Within 10 years, unless there is a different revolution in molecular electronics, he expects electron beams will be economically producing billion-word memories and self-organizing computers with as many as 10^{14} components per cubic foot.

The design and production concepts for such systems were published in 1960 by Kenneth R. Shoulders of Stanford.¹ He and his associates have since built the fabrication equipment and are making experimental components.

In 1960, Shoulders was considered visionary—"in fact, a lot of people thought he was nuts," Wilcox recalls. The Navy didn't; it granted Shoulders about \$100,000 a year since 1958.

Viewed as a 'prophet'

Today, Lee R. Ullery, Jr., who heads an electron-beam program at the Hamilton Standard division of the United Aircraft Corp., calls Shoulders a "prophet." Ullery is building a manufacturing research system for the Air Force as part of a \$650,000 program aimed at applying electron-beam methods to integrated-circuit manufacturing.

In the system, microcircuits will be made in high vacuum or controlled environments to investigate new microcircuit manufacturing methods.

A similar system, with similar goals, has been built by the Pomona division of the General Dynamics Corp. It was completed, without fanfare, about a year ago as part of a company-funded program to develop advanced microcircuits.

A third major program, financed by about \$300,000 in company funds and \$300,000 of Air Force money, is under way at the Westinghouse Electric Corp. Westinghouse thinks that it can shrink the size and raise the frequency of transistors by elec-

tron-beam processing. The goal is production of high-density arrays of integrated circuits with computer-programed interconnections, so that large subsystems can be produced on a single slice of silicon.

It is too early to tell whether these programs, and companion programs investigating selective semiconductor doping with ion beams, will bring a new wave of microelectronics technology.

Electron beams have become standard laboratory analysis tools, but industrial applications are highly specialized and each application poses a new set of problems.² Present microcircuit manufacturing methods, based on light optics rather than electron optics, are swifter, more reliable and far cheaper. But they are nearly at their limit of precision, while electron beams have only begun to demonstrate their limits.

Last February, for example, the International Business Machines Corp. reported an electron-beam photographic data-recording system with a reading and writing speed of a million bits a second and a density of a million bits per square centimeter.

Tiny components

The Navy is less concerned with the size of the systems proposed by Shoulders than with obtaining an economical way of producing mass memories and logic systems. Wilcox thinks the electron-beam way will prove "vastly cheaper" because beams can be programed to rapidly produce large arrays of components, if the components are tiny.

One micron is a handy component size for the beam. Strain-free films can't be grown much thicker than two microns. Some components will measure 0.1 micron.

This size, in turn, fits in with plans for small but fast and complex self-organizing systems like the pattern recognizers described by W. R. Ashby.³ Such systems could also recognize classes of complex equations—or military problems—and solve them without elaborate programing.

Recent conversations with Shoulders and Wilcox indicate that the points made four years ago are

Orders of magnitude

Micron-sized devices are easy enough to talk about, but too small to pick up in your hands and look at. In a world accustomed to inches and centimeters, microns are abstractions.

A micron is one-millionth of a meter, or about 0.000039 inch.

Even the micron is too gross a measurement for some microelectronic work. To more exactly define dimensions, the angstrom unit is used.

An angstrom is one ten-billionth of a meter or 0.0000000039 inch.

Theoretically, electron-beam resolution can be 0.1 angstrom. If the electron-beam machines are pushed to their limit, what then? Waiting in the wings are the field-ion microscopes that can inspect on an atomic scale and perhaps eventually fabricate on that scale.

still valid. Most of the equipment being designed then has been built, experimental production is under way and a multistation production machine is on the drawing boards.

Shoulders does not plan to use semiconductor devices; he finds them inadequate for his system. He considers the use of beams to make semiconductor components an interim step that will be replaced by his thin-film approach. Despite the rapid advance of thin-film field-effect transistor development, the uniformity of the effect and the materials cannot be controlled in such small solid-state devices, Shoulders says.

He deposits thin films of a few basic metals and oxides (mostly molybdenum and alumina) and shapes them into field-emission (tunnel-effect) vacuum tubes, photo-optical devices and electro-mechanical relays and filters. He expects such components to last several hundred years.

So far, he has made simple field-effect tubes, yttrium-doped aluminum-oxide light generators, photodetectors and filters. Filters are cantilever beams that vibrate, like relay reeds, in r-f fields. Their operating range is 1 to 10 megacycles with Q of about 1,000; some filters go to 60 megacycles. Relays would also be beams.

The data store for the information retrieval system will resemble microfilm. A thin film will be micromachined into about 10^{10} areas per square inch, each representing 10 optical intensities as individual bits of data. The microdocument will be placed on a substrate carrying circuits to form a subsystem 0.1-inch thick. The light generators would light up the data bits and the detectors and other circuits would read them.

Wilcox expects to see one of these "postage stamps" in about two years. Shoulders expects to complete the laboratory phase in a year or two, then run into a "surprise phase" of unexpected problems. Eventually, 10 subsystems may be stacked into a one-inch cube, optically coupled. This could provide a billion-word memory.

Micromachining thin films

Shoulders' 1960 report should be read by anyone with more than a passing interest in electron-beam technology. It is a 200-page catalogue of possible techniques, materials and directions. A brief review of the micromachining methods is worthwhile

The ultimate computer?

Kenneth Shoulders doesn't claim the system he is working on will be the ultimate in microelectronics.

He once suggested a plasma computer: gas-like arrays of ions in quasi-static structures, slalom-focused electron-beam interconnections, beams in persistent-current loops to serve as memories. The plasma would be confined and controlled by electric fields.

The microminiaturization problems would be trivial, he said, because the computer could be built large and then scaled down by changing field frequency.

now because it helps to explain and put in perspective the newer programs.

There are three basic operations: deposition, resist-masking and molecular-beam etching. These processes are carried out on films activated by the electron beam and monitored by electron microscopy, electron microprobing (x-ray) and mass spectrometer analysis of materials flux.

Films are deposited by thermal evaporation or reactive deposition. In thermal evaporation, the source material is bombarded by electron beams, evaporates and collects on a relatively cool substrate in a vacuum chamber. In reactive deposition, a chemical decomposes on a hot substrate; Shoulders prefers this method because the hot substrate makes the film cleaner and more stable.

Electron-beam masking

Before a desired pattern on a thin film can be etched, the film must be masked by a coating of material that resists the etchant. The conventional method is to polymerize Kodak Photo Resist (KPR) by exposing it to light through an optical or mechanical mask, and washing off the excess. This means the film must be removed from the vacuum chamber to clean off the residues.

To take advantage of the electron beam's high resolution, a technique called beam masking is used. A programmed beam is used to polymerize the resist pattern. KPR can be used, but a resist that will readily evaporate is preferred, so the excess can be removed by heating. Triphenylsilanol or silane, a silicon alcohol, will do this. Shoulders has found the best resist to be tetrakis(triphenyl)siloxysilane. Where the beam has polymerized the resist, a silica pattern is left as the remainder evaporates. Resolutions as good as 100 angstroms after etching have been obtained. To obtain this resolution, the electron-beam system is baked out at 900°C. in a vacuum of 10^{-12} torr.

For experimental work, the beam is used in a scanning mode, like a tv-tube electron gun. Resist patterns are formed by programming the spot. For rapid production of arrays, optical images used to mask the beam will enable the spot to make patterns. If the substrate is moved in step-and-repeat-camera fashion, up to 10^9 bits per second can be reproduced in the resist.

Molecular-beam etching

The film exposed by the resist pattern is etched by a molecular beam. A molecular beam is a stream of molecules obtained by evaporating a material, as opposed to electrons emitted from a filament. Halogens obtained by evaporating chemicals such as chloride and fluorides react with the heated film surface to produce volatile products that can be evacuated. When analyzers detect a change in the volatile flux, it indicates that all of a particular film has been etched.

When low-temperature reactions are required, the etchant is an atomic beam created by an r-f discharge in low-pressure gas. When material must

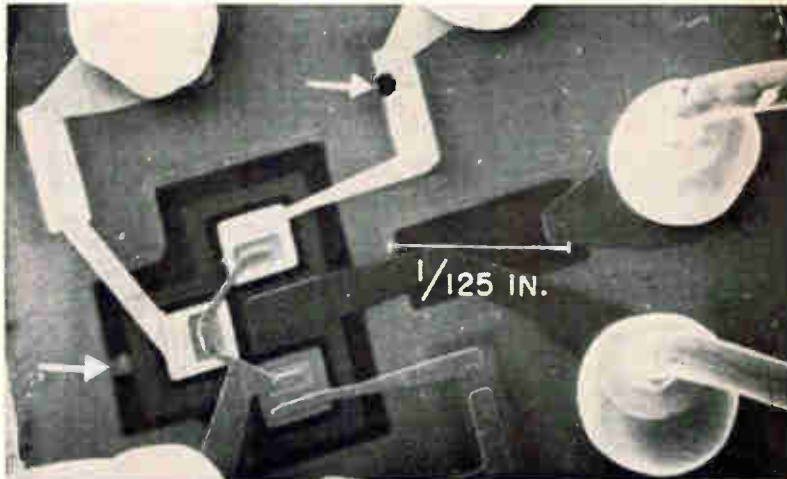
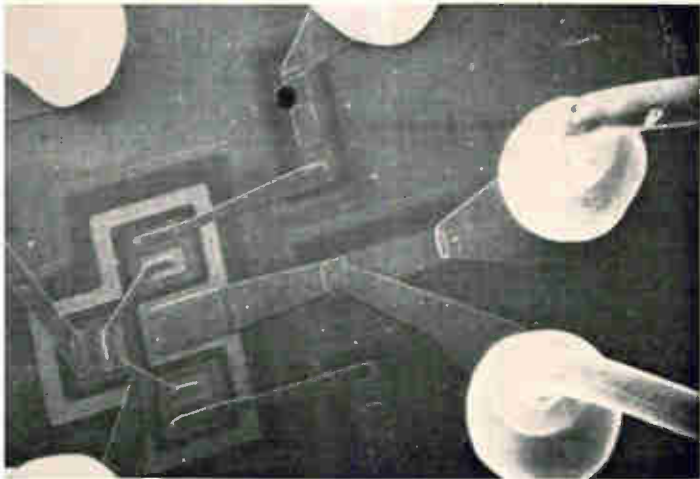

Scanning electron micrograph at left shows surface topography of integrated circuit. At the right, the junctions have been biased and voltage contrast indicates electrical structure. Arrows point to flaws. The circuit is a NOR gate.

be removed without heat, and deep, straight-sided cavities are needed, the etchant is a sputtering ion beam.

Aside from development of specific techniques, Wilcox thinks the program has more than paid its way by generating new information on high-vacuum technology and in the development of new equipment, such as a quadruple mass spectrometer and a simple absolute voltmeter.

Goal: custom systems

The Westinghouse program is less far-out than Shoulders'. The aim is to overlap present technology by developing ways to produce and analyze semiconductor devices with a scanning electron microscope, called the Micro-Scan.

It has been used to polymerize KPR and make transistors and rudimentary integrated circuits. This method has been combined with electron microscopy to fabricate automatically and reduce the size of gate electrodes on field-effect transistors (illustration on p. 87).⁴

But there is a larger goal in mind: The economical production of custom circuits and systems. J.W. Thornhill, who supervises the program at

Westinghouse's laboratories in Churchill, Pa., doesn't expect beam processes ever to be competitive in production of "garden variety, mass-produced circuits."

"A problem that looms large in integrated-circuit manufacturing today is how to quickly customize circuits. We feel we can solve that problem in the coming year."

Conventional masking costs are justified in mass production, not custom production. A method that can reduce costs per mask grows more attractive as the prices of standard circuits drop and the profit in custom circuits rises by comparison, he explains. An electron-beam machine, slaved to a flying-spot scanner that scans a black-and-white mask design, can do custom masking. The rest of the circuit processing can be conventional.

An added fillip is the possibility of producing a variety of custom circuits one after the other on a silicon slice or dendritic web.⁵

This summer, Westinghouse moved toward computer control of such a production system by building a digitally controlled scanning electron microscope. While the conventional analog machines require manual or flying-spot scanner programing,

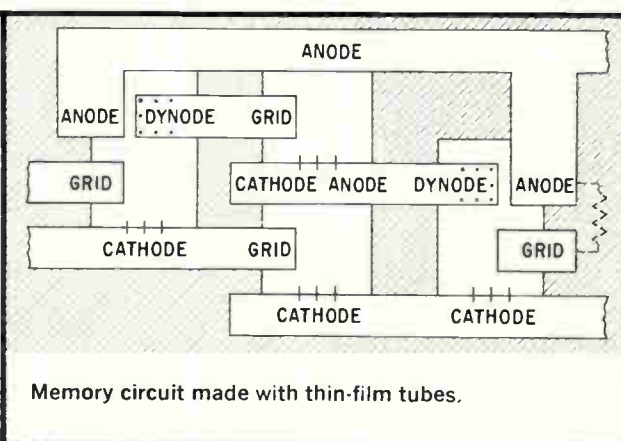
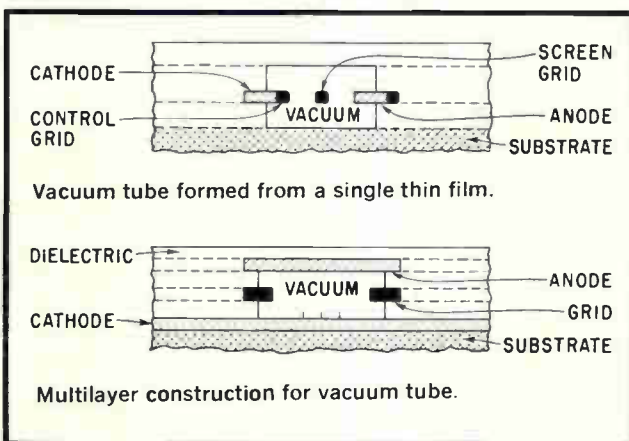

Tunnel-effect vacuum tubes proposed by Shoulders for all-thin-film system.

digital machines can be programmed by punched cards or tape.

Programed interconnections

"Within two years," Thornhill predicts, "we will be able to program circuit interconnections" on silicon slices containing large numbers of conventionally produced circuits.

Feasibility studies indicate this would reduce the cost and improve reliability of large arrays by eliminating the cutting, packaging, retesting and then interconnecting of each circuit as an individual unit.

Small arrays of circuits now can be interconnected on a slice by standard techniques and interconnection masks. But if a large array—say 150 circuits—are needed, the large number of possible combinations of good and bad circuits makes mechanical masking expensive. Thornhill says the beam will be cheaper.

Others say this approach is all wrong because it anticipates continued production of a substantial number of bad circuits per slice. They would rather try to raise the yield of good circuits on each slice nearer to 100%.

As long as yields are under 100%, the individual circuits have to be tested. Conventional point probes and physical handling make the results uncertain until the circuit is packaged. By then, Thornhill adds, the circuit has become valuable.

He proposes using the beam to analyze circuits and using the results of the analysis to program the resist-masking for interconnections. But first, ways of doing it quickly are needed. The analog Micro-Scan takes several hours to check a slice. A digitally controlled testing machine, with an on-line computer to analyze test signals, can conceivably do it in a few minutes.

Throw-away systems

Eventually, Thornhill thinks, it will become practical to make, test and interconnect as a system up to 400 circuits, with up to 5,000 transistors plus additional components, on a slice.

"The whole operation would be so cheap, ideally, that if the system fails, you throw it away and plug in another."

Such circuit densities might eliminate the requirement for testing each circuit. It wouldn't matter if some circuits were bad, since redundant circuit organization could be used. For high reliability, testing and redundancy could be used.

The beam as an analyzer

Besides its well-known uses, a scanning electron microscope can display a device's electrical structure. The beam generates hole-electron pairs in the semiconductor. When a junction is biased, the resulting induced current produces a clear picture of it. So precise is the technique that inversion

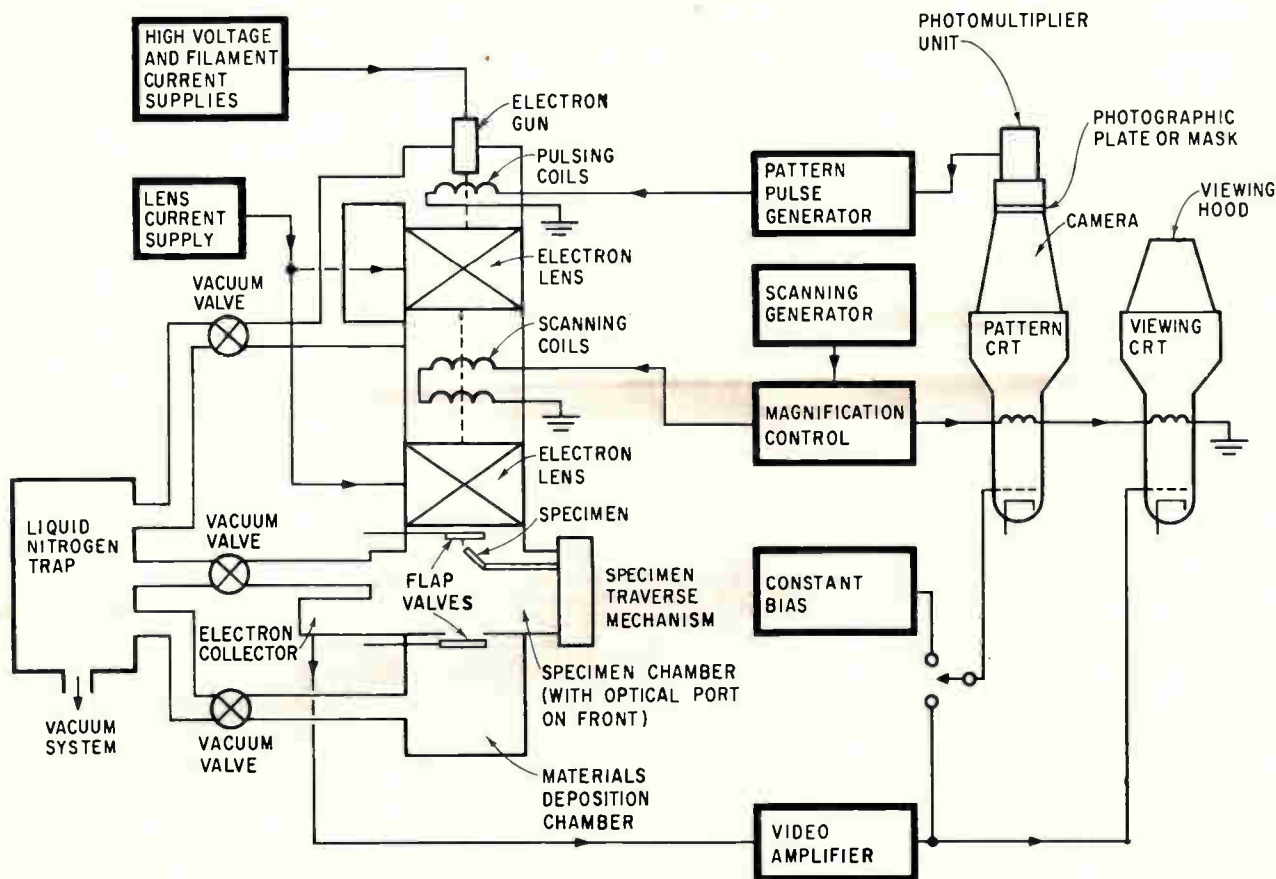

Resist-masking setup for the Micro-Scan. The scanning electron beam is gated as the pattern crt (flying-spot scanner) scans a film or black-and-white pattern of the resist pattern.

Electron beam forms transistor gate

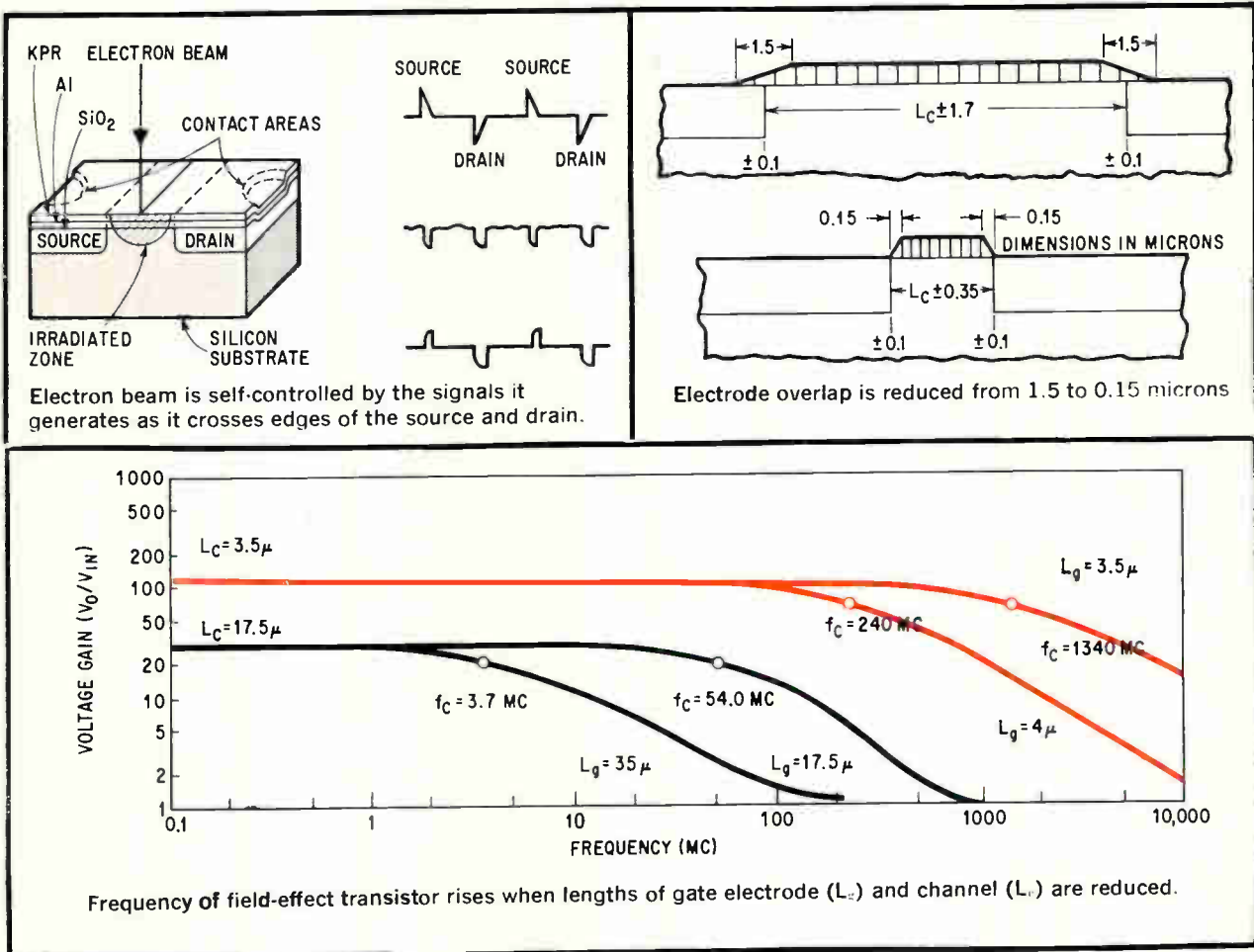

layers and crystal structures have been seen.

The Micro-Scan has a beam spot size of 0.1 to 2 microns and a magnification range to 2,500X. The University of Cambridge, England, has one with a spot size of 30 to 50 angstroms that magnifies to 30,000X. T.E. Everhart, a Cambridge man who was a leader of the Westinghouse research in 1962-63, is building one for semiconductor analysis at the University of California. That one will have a beam of 100 to 1,000 angstroms.

An x-ray version called the microprobe can not only see device structures, it can also indicate what materials cause faulty junctions. Under ideal conditions it will detect 10^{-14} gram of an element. Several papers on device analysis using the microprobe were presented last month at the 1964 Fall Meeting of the Electrochemical Society.

Westinghouse's new digitally controlled scanning electron microscope permits a device's physical and electrical structure to be superimposed, so correlations can be studied. Points of interest can be displayed, greatly enlarged.

The digitally generated waveform that controls the beam permits the beam to go to any point on a 1,000-by-1,000-point raster in less than 20 microseconds. The coordinates can be set into a flip-flop array.

"If I see something interesting on the display,

I can go right back to it," explains Paul Waters, a Westinghouse senior physicist.

The machine is not yet set up for automatic digital control. Some programs, however, are prepared by computers and inserted manually. Plans are to install a punched-card reader, or link the scanning electron microscope directly to a general-purpose computer.

Incredibly small transistors

"Some day we'll be making ISTs—incredibly small transistors," say David Green and Richard Matta of Westinghouse.

An electron beam's intrinsic resolution is 0.1 angstrom. The practical limit of Westinghouse's equipment is an edge sharpness of 0.14 micron (line edges can waver 0.07 micron) in a KPR film 0.2-micron thick. The best resolution for optical masking, I.M. Mackintosh of Westinghouse reports, is 0.5 micron and a practical limit is about 1.5 micron. He says that the theoretically smallest transistor that can be made optically, 10 microns, is "well within reach" of beam techniques, which might make 3- or 4-micron transistors.⁴

However, others who have considered production use of beam masking say the apparent advantages are lost because subsequent etching and diffusion degrade the resolution. Also, the electrons tend

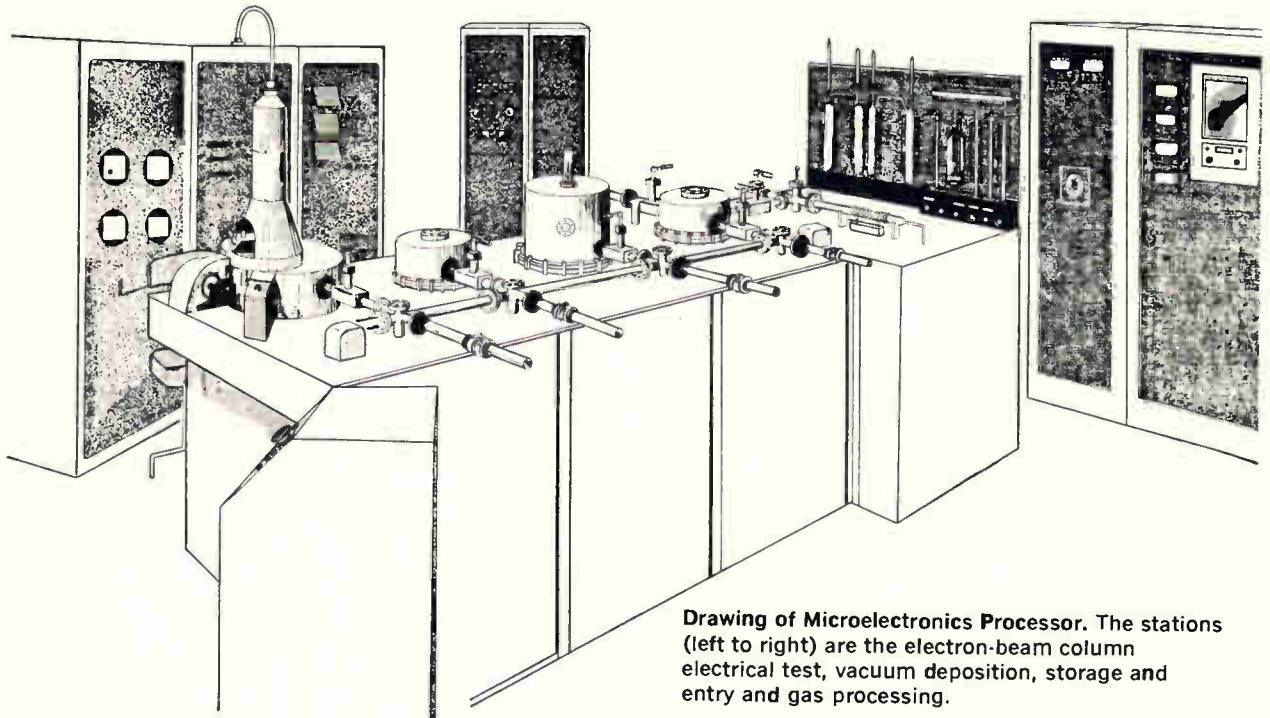

Drawing of Microelectronics Processor. The stations (left to right) are the electron-beam column electrical test, vacuum deposition, storage and entry and gas processing.

to spread in the resist, lowering intrinsic resolution. The net gain in resolution may be only 25%, not 1,000%.

Beam-masking proponents agree—in part. However, it takes several oxidation, masking, etching, diffusion and deposition cycles to produce a circuit. The percentage of improvement in resolution climbs back up with each layer, because an electron beam can register each resist mask more precisely than can optical methods. If a small hole or diffusion spot is placed in the base crystal, the beam can find it and use it as a layer-to-layer index.

Westinghouse has used combined sensing and resist scanning to position gate electrodes on its Scout (surface-controlled oxide unipolar transistor), a field-effect type. With beam masking, Mackintosh calculates, size can be reduced five times and frequency response multiplied 25 times.

Thornhill considers this to be a practical technique now.

University researchers often use a method called contaminant masking, polymerizing thin films of oil exuded by vacuum diffusion pumps. Silicone oil leaves a silicone polymer resist.

A.N. Broers of Cambridge University has used this technique with a 100-angstrom beam, obtaining lines 500 angstroms wide and with an edge resolution of 100 angstroms. Using dust particles as a resist, and etching with an argon ion beam, he formed cones on silver crystals. Cone points can be made as sharp as 50 to 100 angstroms. This technique might make incredibly small mesa transistors if a suitable way could be found to connect them.

Thornhill, however, sees a more fundamental limitation on how small an IST can be: "In large devices impurity concentrations average out, but we will eventually come down to a size in which

the impurities will not be randomly distributed."

Is it nondestructive?

A recurrent objection to electron beam use is that a beam working on one layer will damage an underlying layer. Specialists say that adequate beam control prevents all but one form of damage: beam induced effects, which degrade device behavior.

Physical damage doesn't occur at the Micro-Scan beam energies, (10^{-11} to 10^{-9} ampere and 5 to 50 kilovolts), but the bombardment effect can cut a transistor's beta in half. The damage, however, can be removed by annealing.

The Autonetics division of North American Aviation, Inc., tested a group of radiation-sensitive transistors (2N2369) to determine if microprobe analysis harmed them. Beta dropped as much as 30%; annealing at 275°C. for four hours restored beta and longer annealing raised beta to higher than 100% in some transistors.⁶ But although the annealed transistors were apparently undamaged, Autonetics wouldn't use them in missile systems.

Thermal electron beams pose even more severe damage problems than the nonthermal beams discussed above. Thermal beams are those intense enough to alloy films to form junctions, or to dissociate chemical films or gases to form diffusion areas, or to deposit films. If this is tried on a micron-size spot, thermal conductivity of the semiconductor substrate quickly draws heat away from the spot. So the beam must be made more intense, which widens the spot and damages underlying material.

Thornhill thinks this problem will eventually be circumvented by a method that will make etch resist masking unnecessary. Materials that can readily be activated by the beam are under develop-

ment, he says. Researchers, he adds, have been keeping quiet because proprietary interest is high.

The Hamilton Standard system is called the Microelectronics Processor (MP). But Eugene Miller, Air Force project engineer, emphasizes that it will not be used as a production system. It will be used for pilot production of devices entirely within high vacuum and controlled environments.

Equipment designed for a variety of advanced energy-beam methods is being developed to investigate such techniques. Variables in conventional processes will also be checked out by controlling the variables, such as water vapor, and analyzing the effect on the devices.

Miller lists 11 types of process to be checked out, singly and in combination:

- 1 and 2. Single and simultaneous evaporation.
- 3 and 4. Dissociating and recombining chemicals with electron beams and photon beams.
- 5. Surface activation, such as electron bombardment cleaning.
- 6 and 7. Micromelting and microzone refining. The use of stationary or scanning beams for such processes as alloying.
- 8. Zone heating. Energy inputs controlled in geometry and magnitude for such processes as diffusion.
- 9. Annealing with programmed temperatures, in spots or large areas.
- 10. Microassembly or joining. An example is welding leads to thin films.
- 11. Microthermal subtractive processes. Removing material in three-dimensional configurations.

Of these, only No. 1 has wide use in microcircuit production. The rest have limited use or are experimental.

"We don't expect to refine these processes to the nth degree," Miller says. He expects those that prove useful will be more readily accepted by industry since the equipment will have been designed under the program.

Technology for today

"Our concept is not as advanced as Shoulders', but it fits into today's epitaxial techniques," says Lee Ullery of Hamilton Standard. "The techniques (to be used in the MP) are all available, but they have to be combined, assimilated and refined."

He thinks the MP will make a real contribution to device performance because no further substantial improvement can be expected from conventional methods.

"I think these programs will change the character of the industry. We are getting closer to the point where you can pour sand in one end of a machine and get devices out the other—and it is not going to be a fantastic system, either.

"By pinning down the causes of failures, we will also raise yield. No other business can tolerate yields of 30%," Ullery adds.

Whether the MP should be built as one big chamber divided into zones by differential pumping or a series of stations divided by interlocks was

not decided until this month. The equipment, to be assembled by next June, will be similar to the sketch on page 88.

It will have five stations with parallel entry through a vacuum corridor:

- An electron-beam column for scanning microscopy, x-ray analysis, micromachining, resist masking and engraving connective and resistive films. Beam operating currents will range from 0.1 to 400 microamperes and accelerating potentials from 5 to 50 kilovolts. Spot size will be 1 micron or less.

Ullery and his project engineer, Robert Lewis, don't want to use photo resists or contaminant masking, since these represent uncontrolled variables. Only cryogenic and ion pumps will be used. All parts of the column will be made of stainless steel and refractory materials, so it can be baked out at 10^{-9} torr and 400°C . Systems that cannot be baked are too dirty for microcircuit production, and their use has retarded the acceptance of electron-beam processes, Ullery claims.

- Gas processing station, for resist deposition, etching, diffusion and bakeout. Hot-wall or cold-wall tubes can be attached to the vacuum port. Plans are to use silane to form silica resists and to etch with ion beams.

- Vapor-deposition station. Thin-film materials will be evaporated by electron-beam guns. To deposit alloys, two rate-controlled guns will be used and the alloying will be done in the vapor phase. The metals will be pure electron-beam-refined stock.

- Electrical test station. Tests will be made in high vacuum or under controlled contaminant conditions, so causes and effects can be correlated.

- Substrate entry and storage section.

Plans are to install a laser in the gas processing station to investigate photon-beam processes. Programming of the laser beam will be similar to electron-beam programming. The beam spot will be scanned electronically, or a mask will be inserted in the optical system to project an image, or the image can be programmed to make an array. There will also be mechanical masking facilities.

A series of processes, typical of those that will be tried initially, is illustrated on page 90. Silane masking doubles the thickness of the passivation coating. The ion-etching beam removes the masks formed from silane, but only cuts windows in the silicon-dioxide passivation layer.

Thin-film cathodolysis

This summer, Horizons, Inc., completed an Air Force study to determine how well electron beams can form thin-film circuits directly on a substrate by dissociating gases. This has been done, but reproducibility is still too low for practical use. The company expects its technique, called cathodolysis, to become valuable in production of thin-film field-effect devices, and has made FETs with it.

Work on the technique began in 1959. Tough, cross-linked dielectric films, with capacitances of around 1.6 nanofarads per square millimeter, have

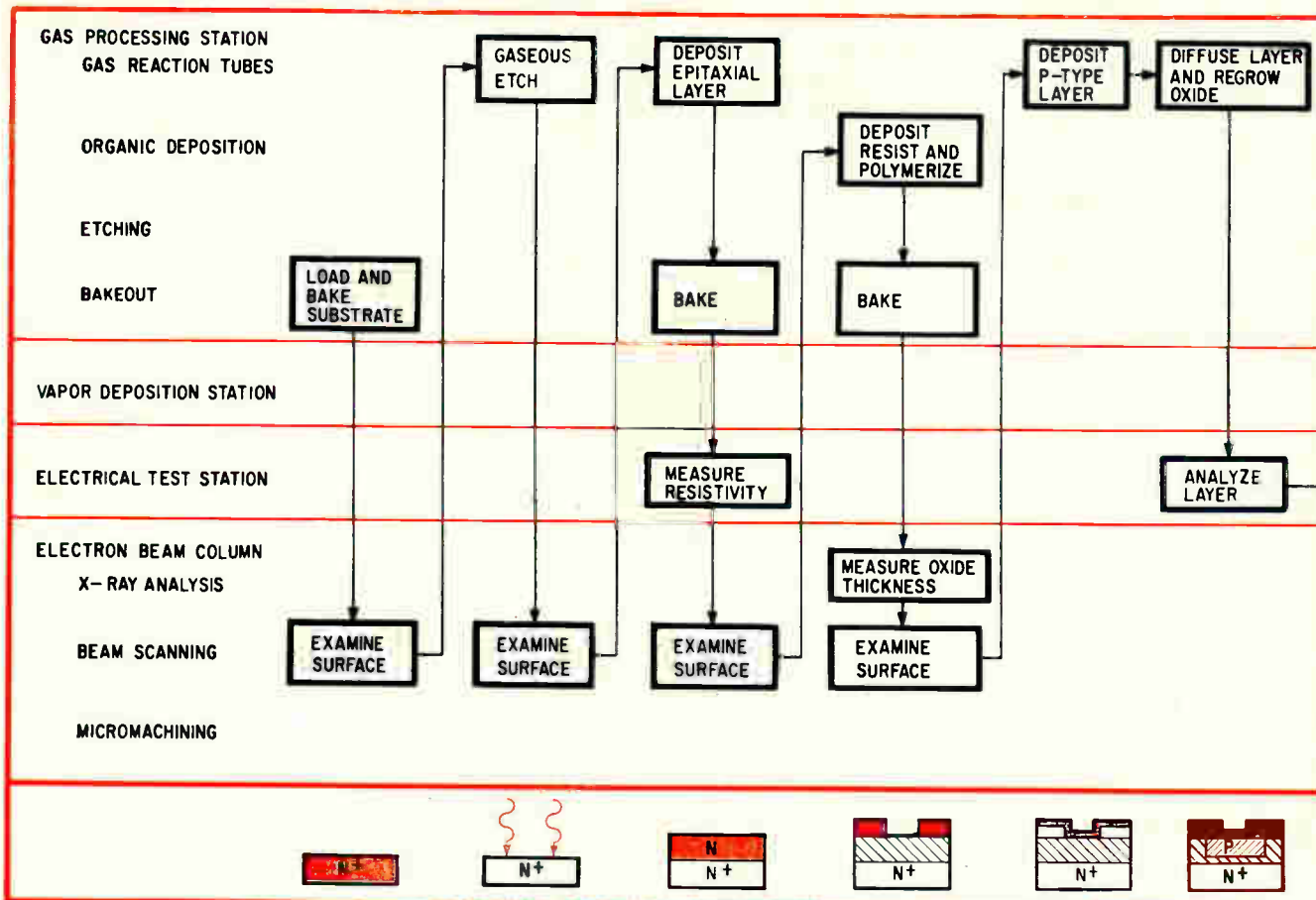

Diagram shows fabrication cycle in the Microelectronics Processor when electron-beam masking is used to make npn silicon planar transistor. Name of process is on same level as equipment in which it is performed. Colored areas on device cross-section indicates what the process does at each step.

been made from styrene and other hydrocarbons. Decomposed tungsten hexycarbonyl provides resistances of 130 ohms to 530 kilohms per square, and germanium tetranitride deposits 1 to 10 megohms per square. Conductive films are zinc deposited on surfaces sensitized by bombarding butyltin trichloride with the beam.⁷

Gas is introduced into the vacuum chamber at a vapor pressure of about 10^{-4} torr. It condenses on the relatively cool substrates. Then an electron beam, obtained from a modified vidicon, sweeps the condensate with a 0.01-inch spot. Punched cards control the beam and gas valves. It takes about five minutes to produce a component.

Looking for pinholes

The Naval Research Laboratory detects pinholes in dielectric films by scanning a film with an electron beam. A charge accumulates on the film surface. If there is a pinhole, leakage current flows through it to the film's aluminum backing, is detected, and the hole location is shown on a tv monitor.⁸

The laboratory is trying to find out why thin, high-capacity films fail so often. In experiments, the films are sealed in a cathode-ray tube, because that's a ready-made electron-beam system. For production testing, the gun could be used in the deposition chamber.

Compared with conventional and electron-beam semiconductor processing methods, ion-doping is elegantly simple. No etching or thermal diffusion is required, and the potential resolution also is higher than optical methods.

Ion implantation—driving a beam of ions into the crystal—is generally scoffed at because most published reports indicate mediocre results. However, the Ion Physics Corp., another Air Force contractor, says it can now make solar cells competitive in efficiency (13%) with diffused cells, and radiation counters with resolution (50 keV for heavy particles) comparable to diffused counters, depletion depth of 1,000 microns and a better insensitive surface region (dead layer).^{9, 10}

Ion Physics drives boron or phosphorus ions into silicon through the oxide passivation coating. Junction depth can be controlled to within 0.1 micron by using discrete beam energy levels between 50 and 2,000 keV. The high-energy ions distort the crystal lattice, but this is corrected by annealing the crystal at temperatures too low for diffusion. Diffusion would spread the junction.

In the experimental equipment, the crystal is rotated to obtain uniform doping concentration by changing the beam's angle of incidence. That technique is too slow for commercial production. Ion Physics says it has a new technique, not disclosed,

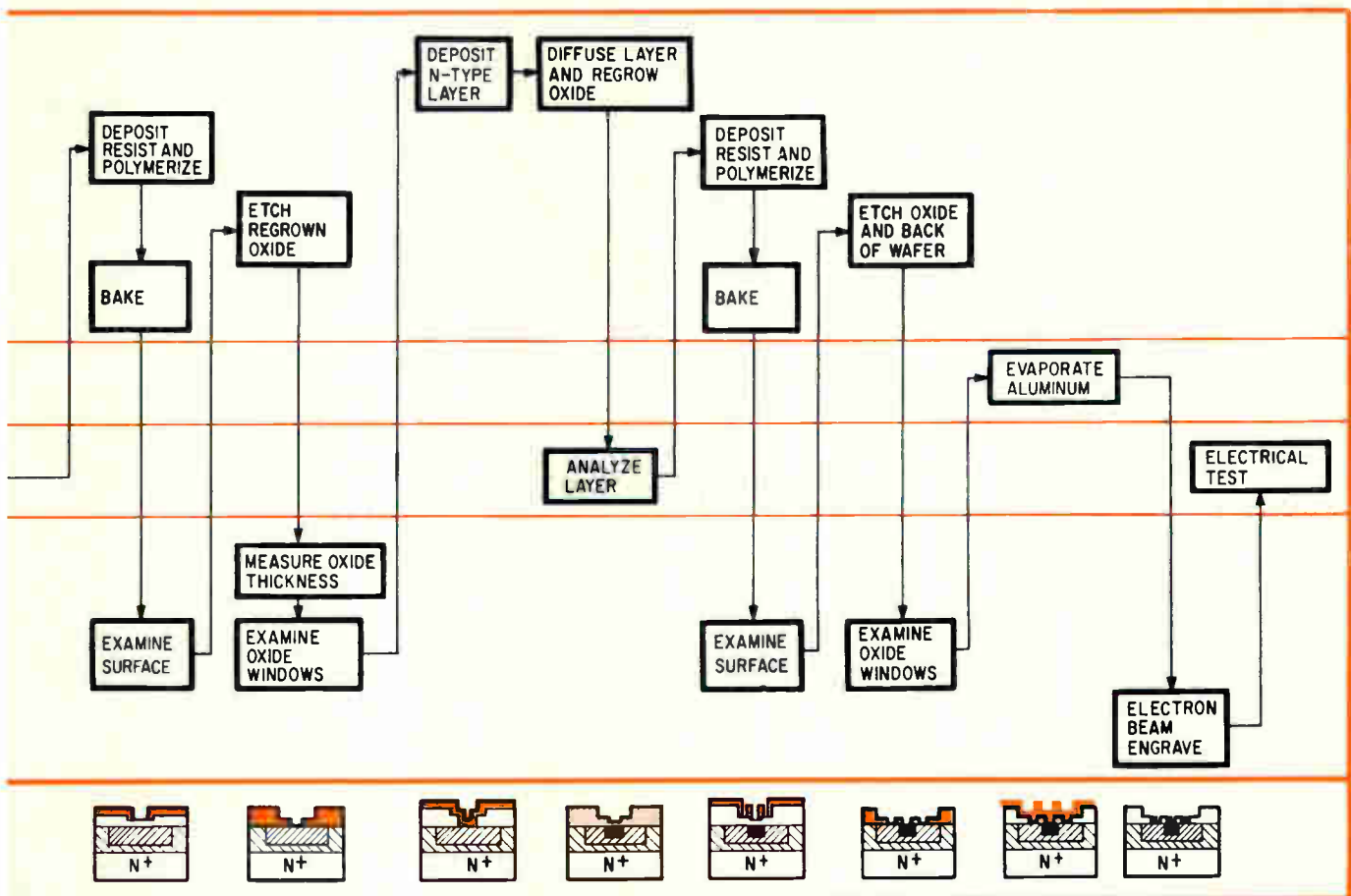

and will soon build a production system that will produce 1-by-2-centimeter solar cells at a rate of 5,000 a week.

So far, masking has been used to control junction area. However, the company proposes a maskless method of making transistors in 1 or 2 seconds. The beam would be narrowed to a 1-micron spot size by an aperture and programmed in intensity, duration and location by a code film read by a flying-spot scanner.

Low-energy ion beams

Under a Navy contract, CBS Laboratories division of Columbia Broadcasting System, Inc., will soon begin doping experimentally with low-energy ion beams of about 20 kev.

Low-energy (about 10 kev) cesium beams have been tried, but results were poor. Cesium isn't a good dope, and junction depths were hard to control. Some experimenters have used ion-propulsion engines.

CBS will use beams from an ion generator designed for doping. Gallium, and perhaps indium, will be used, so junctions can be compared directly with junctions that are diffused with the same dopes. CBS hopes to make shallow, concentrated emitters in the center of a diffused base. If this works, the process may be used to produce tiny micropower-circuit elements.¹⁰

The project engineer, Oliver Wells, is "absolutely confident." He says ion beams are as controllable as electron beams. He is another alumnus of Cam-

bridge, and, he worked with Everhart at Westinghouse. Wells is also hopeful of restarting CBS's electron-beam fabrication research, which has been put aside.

He doesn't think beam processes will replace optical processes. He thinks they will prove to be an aid for making small, critical elements and interconnecting large arrays.

References

1. K.R. Shoulders, "Research in Microelectronics Using Electron-Beam-Activated Machining Techniques," PB 171027, Office of Technical Services, U. S. Department of Commerce, September, 1960.
2. R. Bakish, "Introduction to Electron Beam Technology," John Wiley & Sons, Inc., New York, 1962.
3. K.C. Wehr, "Conditioned-reflex circuits," *Electronics*, Aug. 24, 1964, p. 66.
4. I.M. Mackintosh, "The Application of High-Resolution Electron Beams to Solid-State Devices"; T.E. Everhart, O.C. Wells, and R.K. Matta, "Evaluation of Passivated Integrated Circuits Using the Scanning Electron Microscope"; Wells, Everhart and Matta, "Automatic Positioning of Device Electrode Using the Scanning Electron Microscope." Papers presented at the Fall Meeting of the Electrochemical Society, New York, 1963.
5. "Circuits by the yard," *Electronics*, Sept. 21, 1964, p. 34.
6. C.C. Nealey, C.W. Laakso and P.J. Hagon, "Planar Silicon Device Analysis with the Electron Probe Microanalyzer," *Electrochemical Society Washington Meeting*, October, 1964.
7. J.M. Hlavin and R.A. Fotland, "The Fabrication of Electronic Components Using Low-Energy Beams," *First International Conference, Electron and Ion Beam Science and Technology*, Toronto, May, 1964.
8. F.H. Harris, "Low-Velocity Electron Probe Investigation of Thin Dielectric Films," *National Electronics Conference*, October, 1964.
9. T. Maguire, "Ion implants forge tailor-made junctions," *Electronics*, April 19, 1963, p. 26.
10. W.J. King, "Ion Beam Doping in Silicon," *National Electronics Conference*, 1964.
11. W.W. Gaertner and M. Schuller, "Micropower circuits," *Electronics*, July 19, 1963, p. 47.

Noise-proofing a digital voltmeter with off-the-shelf microelectronics

Meter uses dual-slope integration; simple design makes price competitive with conventional instruments

By Stephen K. Ammann

Fairchild Semiconductor division,
Fairchild Camera & Instrument Corp., Mountainview, Calif.

Conventional digital instruments that measure voltage have one major drawback: They can be fooled by noise.

To sidestep the noise problem, engineers use complex and relatively expensive circuits. But even these instruments can be misled under certain circumstances.

However, an integrating scheme has been developed for a virtually fool-proof digital meter that uses fewer components and many off-the-shelf microelectronic circuits. And the price of the instrument, about \$2,000, makes it competitive with meters that don't use integrating techniques.

The new meter is basically a four-digit instrument. It is accurate to within 0.01% of the reading ± 1 count.

The technique was uncovered almost by accident. During the course of a study of possible uses of the company's line of operational amplifiers, the instrument circuit was hypothesized. The basic idea was to integrate an input voltage for a preset time, then change the input of the integrator to an opposite polarity reference voltage and measure the time—with an oscillator and counter—required for the integrated output to return to zero. A breadboard of the circuit performed to 0.01% accuracy and needed fewer components than other schemes.

The author



Stephen K. Ammann, a native of Zurich, Switzerland, has a degree in electrical engineering from the Canton of Zurich Institute of Technology. He has designed scientific instruments and high-speed semiconductor test equipment.

The decision was then made to incorporate the scheme in a prototype and to produce the digital voltmeter. Three types of standard microelectronic circuits are used, all in the display counter section. Transistors in these circuits account for two-thirds of all those used in the instrument.

How it works

To understand the operation (drawings on page 93), (see above), assume an unknown d-c voltage is applied to the input terminals. The over-all gain of amplifier A_1 is set by the value of the negative feedback resistor, which is selected by the range switch. Output A_1 is limited to a maximum of 15 volts, keeping the integrating circuit that follows from being saturated. Circuit conditions just before a measurement cycle begins are represented by the left side of the timing diagram. A start pulse is generated by the control logic and is fed into the measuring logic. The recurrence rate of the start pulse is controlled manually—or by an external program—and can vary from four measurements per second to one every two seconds.

The leading edge of the start pulse—time t_0 , on the timing diagram—resets the counters, not to zero but to 10,000. These reset lines are indicated on the block diagram but are not detailed. The start pulse duration—about 1 millisecond—provides enough time for this reset function.

The trailing edge of the start pulse, time t_1 , starts the instrument on a measurement cycle. The signal generated by the trailing edge of the start pulse feeds through the voltage-select logic to cause solid-state switch 1—a semiconductor circuit that acts like a very-high-speed, single-pole, double-throw switch—to connect the output of A_1 to the input of the integrating circuit. The integrator consists of amplifier A_2 and feedback capacitor

C_1 . Simultaneously, solid-state switch 2, which is similar to switch 1, unclamps the integrator, allowing its output voltage to build. At t_1 the start signal feeds through the reset-operate logic and opens the AND gate to pulses from the clock or oscillator.

Clock pulses feed through the AND gate and into the counter while the output voltage of A_2 continues to build. The counter can hold 19,999 counts (the most significant digit is either 0 or 1—a short decade), and has been set to 10,000. So when 9,999 pulses have entered the counter, it reads 19,999 and is full. The next pulse overflows the counter to 00,000 and generates a pulse in the short-decade that feeds into the measurement logic.

This pulse, shown at t_2 on the timing diagram, activates the zero detector and also causes solid-state switch 1 to connect the reference voltage to the input of the integrating amplifier. Not shown in the diagram is a polarity sensing circuit that looks at the output of A_2 and selects the correct polarity of reference voltage to drive the output of A_2 toward zero.

The output of A_2 goes to zero at a constant rate because the reference voltage is derived from a zener diode temperature compensated to more than 0.001% per degree C; reference voltage is stable to 1 or 2 parts in 10^6 . Temporary changes in the slope can be produced by noise, but these are self-canceling if the noise has equal negative and positive areas—averages to zero.

The time required for the output of A_2 to reach zero is proportional to the integrated input voltage. Pulses counted during this interval— t_2 to t_3 —accumulate in the decade counter, which continues

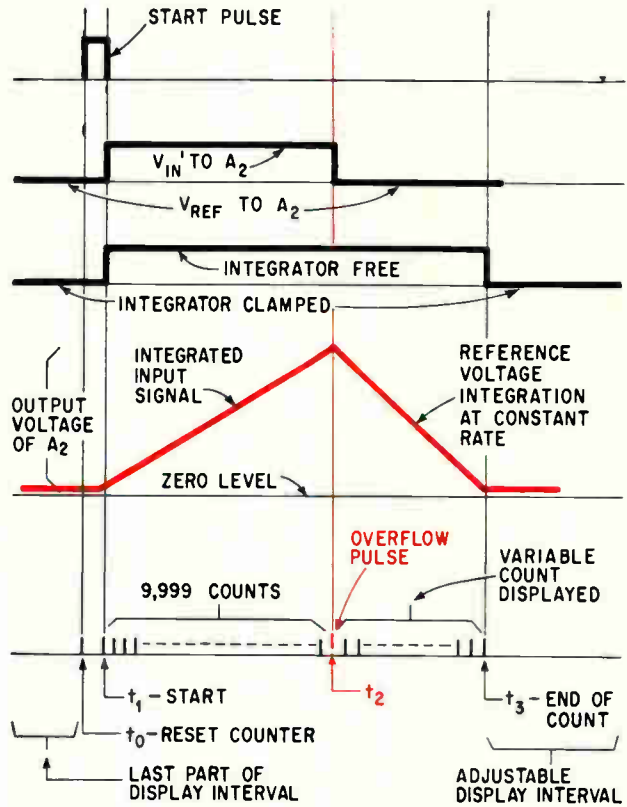

Integrating digital voltmeter designed to eliminate errors caused by noise. Many of the components are standard equipment. Amplifier A_2 (below) integrates the signal voltage being measured for 9,999 counts, which brings the decade counter to its maximum count. The next pulse overflows the counter and causes solid-state switch 1 to feed the reference voltage to A_2 . As indicated by the waveforms above, the return of the output of A_2 to zero ends the measurement.

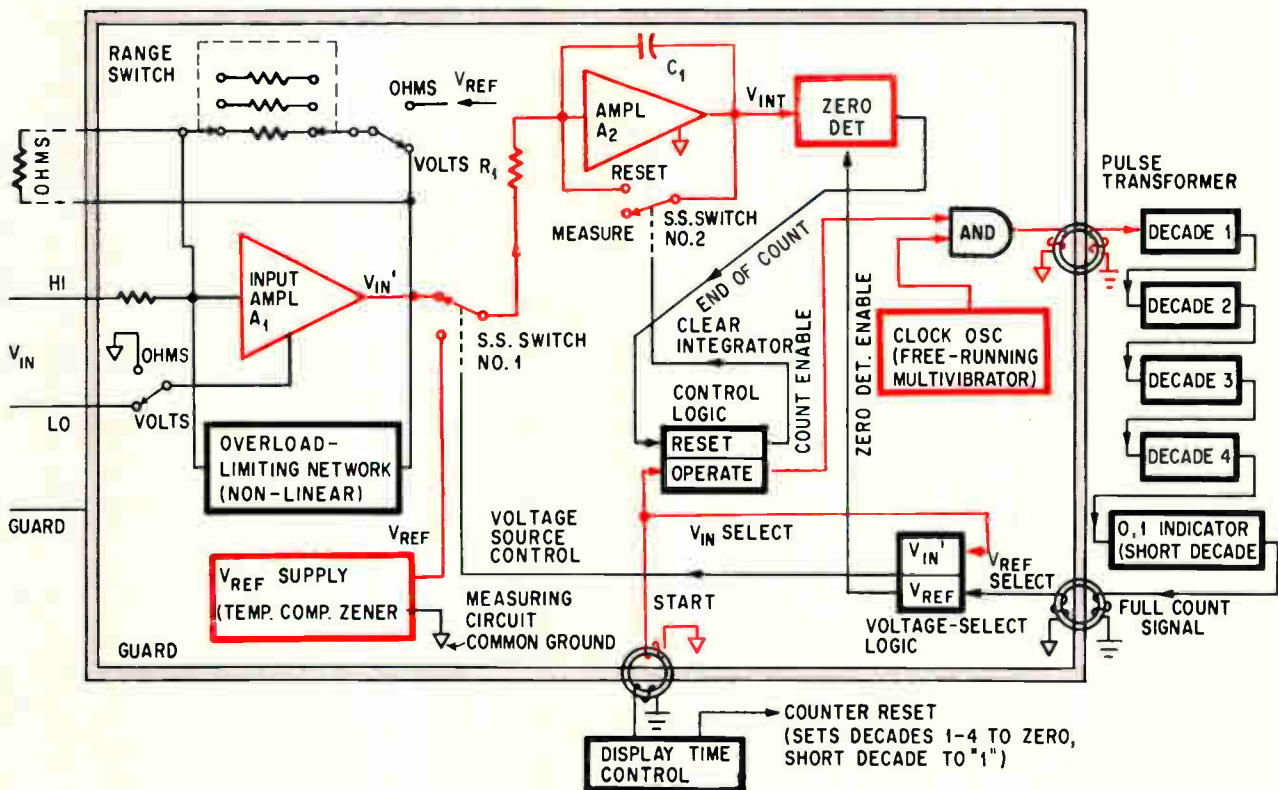

counting but now starts from 00,000 because of the overflow.

The zero detector senses when A_2 output reaches zero and generates a pulse that, acting through the reset-operate logic, closes the AND gate to the clock and clamps the integrator. The instrument then holds the measured value until the next start pulse. Counter capacity, clock frequency and range-switch calibration are designed so that the readout is in volts.

Watching the wave forms

Actual waveforms of noise and the integrated voltage output of A_2 are shown in the oscilloscope traces at right. In the top trace, a low-frequency signal is superimposed on a low d-c voltage. The noise actually drives the signal seen at the voltmeter input below the zero level. The integrated voltage from A_2 (next trace) is negative at the beginning of the integration because the first part of the noisy input is negative. The next two scope traces show first an input with a higher frequency noise, and next the input signal to the integrating amplifier over the full measurement cycle. The two lower traces show the output of integrating amplifier A_2 and condition of solid-state switch 2.

The reference voltage used to drive A_2 to zero is either +10 or -10 as required by the measurement. But the output of A_1 is allowed to be as high as 15 volts. This means that the output of A_2 can build up at a faster rate than the reference voltage can drive it down. As a result, the output counter is allowed to overflow once during the time the reference voltage is being integrated and thus can indicate a count of 15,000, or a 50% over-range of the normal four-digit 9,999 count. If the output of A_1 exceeds 15 volts, the overload circuit reduces A_1 gain to prevent damage and also turns on a panel light to inform the operator that the measurement is off the scale.

Accuracy maintained

The dual integration technique makes accuracy independent of long-term drift in the two external components used with integrating amplifier A_2 —that is, R_1 and C_1 —and also independent of long-term drift in the clock oscillator. Long-term changes in R_1 , C_1 or clock frequency may change the total measurement time slightly but not the measurement accuracy because the effects cancel over the two integrating periods. If clock frequency increases, for example, less time will be required to overflow the counter and to start A_2 back to zero. But A_2 will not have as far to go and the fast clock will provide extra pulses to even things out. Thus this error cancels.

If R_1 should increase slightly, this will decrease both voltages applied to the integrator by the same percentage and the effects cancel. Similar reasoning applies to an increase in R_1 and to changes in C_1 . Thus the integrator is not a critical circuit.

Only short-term instabilities occurring during the

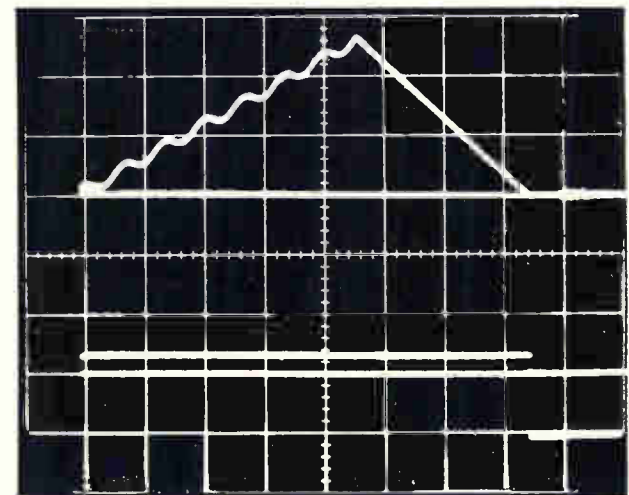
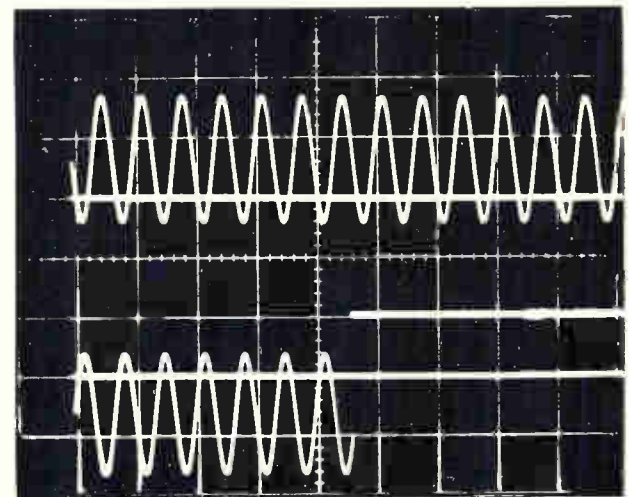
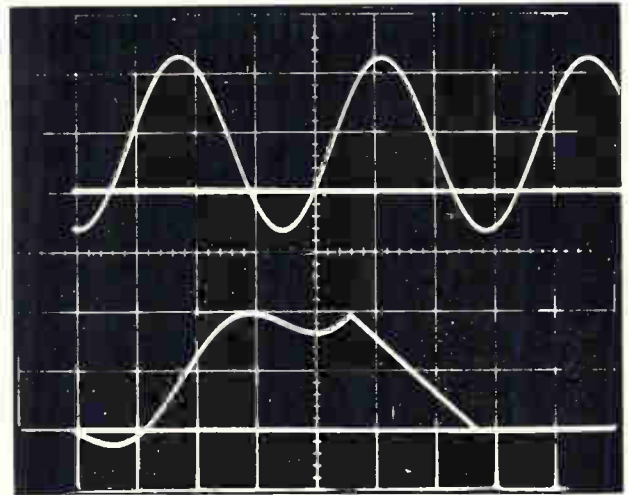

Oscilloscope photos of instrument waveforms. Top waveform is a 9-volt peak-to-peak a-c noise signal superimposed on 6-volt d-c. The second trace is the output voltage of the integrating amplifier. The next four traces show, respectively, a noisy signal, the input to integrating amplifier A_2 , the output of A_2 and the state of solid-state switch 2, which frees the integrator during a measurement cycle.

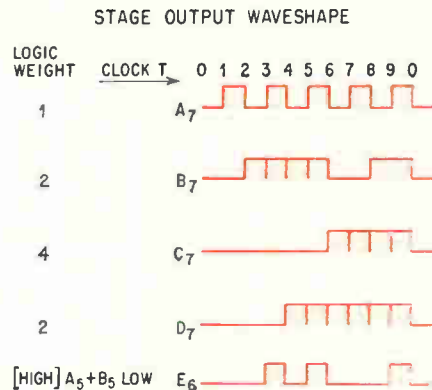
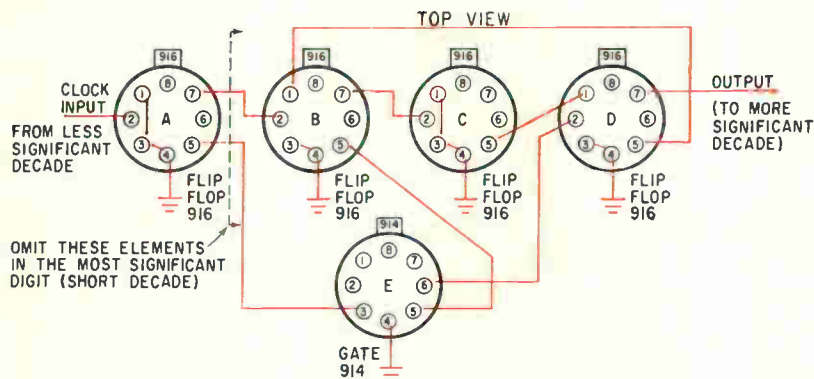

Wiring for one decade of counter using integrated circuits

approximately 30-millisecond measuring interval can cause errors, and such instabilities are nearly nonexistent in solid-state circuits. As one result, the clock is allowed to run at 600 kilocycles $\pm 5\%$ except for the most sensitive ranges, where it operates at 120 kilocycles $\pm 5\%$.

Instrument accuracy is limited primarily by the stability of the voltage reference supply and the gain stability of input amplifier A_1 . Much of the total available design time was therefore spent refining these circuits to make them as accurate and stable as possible.

One small timing error occurs when solid-state switch 1 operates and changes the input signal to A_2 . The time required to make this change is approximately one microsecond. Since the total time allowed for integrating the input signal is 16,666 microseconds (10,000 counts) the error caused by the switching delay is about 0.0001%. This is two orders of magnitude smaller than the instrument's over-all error of 0.01%, and thus negligible.

Why dual slope integration?

The dual integration scheme has some clear advantages over other types of integrating techniques. In some instruments, the voltage-to-frequency converting method, for example, can produce incorrect readings if noise on the input signal drives the total input signal across the zero-voltage level. Instead of allowing negative noise to cancel positive noise, the negative part of the waveform may be integrated and considered part of the signal. The final average reading in such cases does not equal the true d-c level of the signal. In addition, the polarity sign may be wrong if the measurement ends while the signal is on the negative side of the zero-voltage level.

Meters using a scheme that recognizes zero crossings and subtracts these parts of the signal avoid this type of error. These schemes add complexity, however, and can still make wrong readings if a crossover occurs during an integration or reset pulse.

Integrated circuits

Types and quantities of integrated circuits used

in the decade counter are shown in the table. The wiring required to set up a decade (above) is simple. Other connections (not shown in the sketch) are made to cathodes of the readout display tubes and for power.

The J-K flip-flop [p. 96] used as a general purpose counter in these circuits differs from an ordinary flip-flop in that simultaneous inputs (ONEs) at the set and clear terminals cause it to toggle or reverse state. This means there is never ambiguity about the state of the flip-flop; also, it eliminates the need for external feedback connections other than those required to convert from binary to decimal code. Propagation delay of the basic resistor-transistor-logic circuits is typically less than 40 nanoseconds.

Chopper stabilization

Operational amplifiers A_1 and A_2 have open-loop d-c gains of more than 10^8 and a gain-bandwidth product of 1 megacycle. Chopper stabilization is used in these circuits. Frequencies below 30 cycles per second are chopped photoelectrically at 250 cycles per second. The 250-cycle-per-second

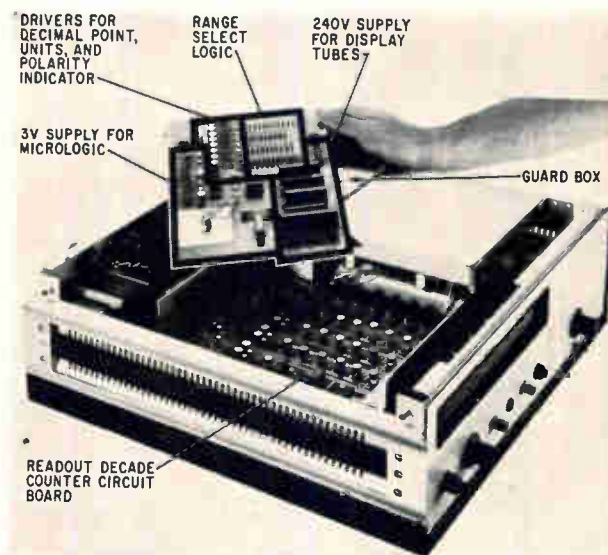

All circuits are contained on 11 plug-in cards. Common mode rejection is 140 db at d-c, 120 db for a-c. Teeth on side of cabinet are ventilation ports.

Use of micrologic integrated circuits

Type	Voltage	Power (1 unit)	Number used
910 (double gate)	3	4 mw	12
914 (dual two-input gate)	3	24 mw	4
916 (J-K flip-flop)	3	52 mw	17

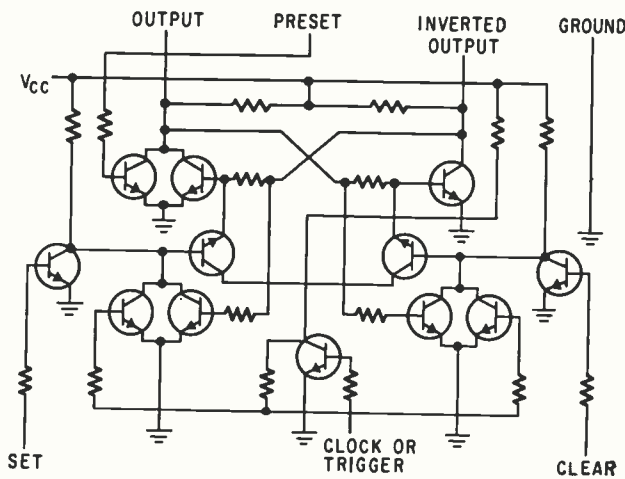

Microelectronic flip-flop has no ambiguous output states even for simultaneous inputs at set and clear terminals.

Readout tubes plug into counter circuit board. Short decade is at left.

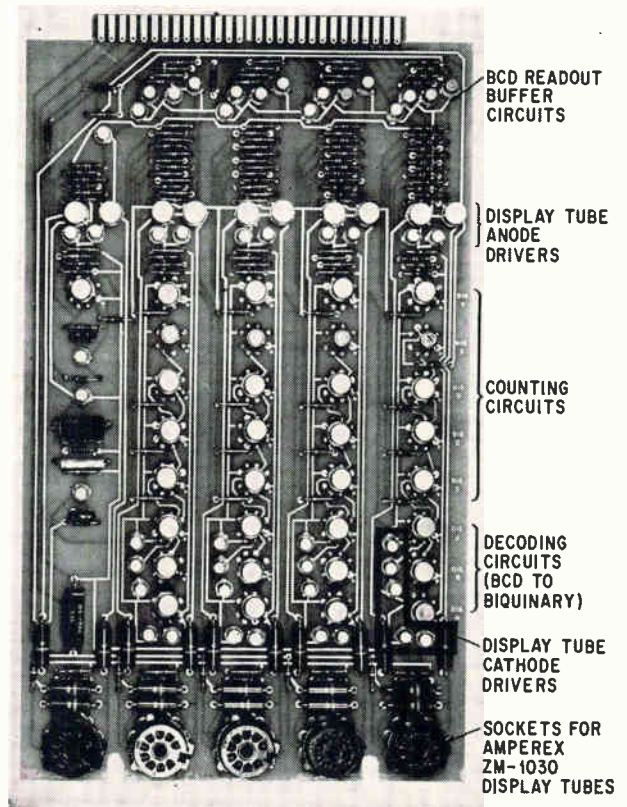

signal is amplified, then demodulated and fed to a differential amplifier having high speed and response down to d-c.

Photoelectric choppers are used because they last longer than electromechanical choppers. In addition, the filtering action of the light-activated chopping circuit eliminates electrical spikes or transients that can produce voltage and current drift and noise in the following differential amplifier.

Negative feedback is used in all stages of the operational amplifiers, and the equivalent input current offset is less than 20 picoamperes. The guard shown in the block diagram isolates the circuits within it and leaves them floating with respect to instrument ground. This circuit isolation technique helps achieve a common mode rejection ratio of 120 decibels for a-c and 140 decibels for d-c. The transformers shown bridging the guard maintain the isolation of the measurement circuits.

The operation of the meter was explained with respect to a voltage measurement. Resistance is measured by connecting the unknown resistor in the feedback circuit of A_1 as shown in the block diagram on page 93. The reference voltage is applied to the input of A_1 through a voltage divider and the over-all gain of A_1 then is a function of the unknown resistance. Circuit operation is the same as for voltage measurements with readout in ohms.

Voltage ratios from 1 to 1,500 can also be measured. One of the two voltages involved in the ratio is applied to the regular voltage input. Then the precision reference voltage is switched out (not shown in the block diagram) and the other

voltage of the ratio is used as a reference during the second half of the integration cycle. The only restriction is that the voltage serving as a reference must be less than 15 volts to avoid saturating the integrator.

On the most sensitive voltage range—150 millivolts full scale—resolution is 10 microvolts; other voltage ranges are 1.5, 15, 150, and 1,500. Resistance ranges are 15 kilohms to 15 megohms, with resolution to 1 ohm on the most sensitive scale.

Plug-in modules are being designed to provide automatic ranging and a-c to d-c conversion to allow a-c measurements. These will be on circuit cards and will fit inside the basic cabinet. The instrument as a complete system is designed to operate for at least six months without requiring recalibration.

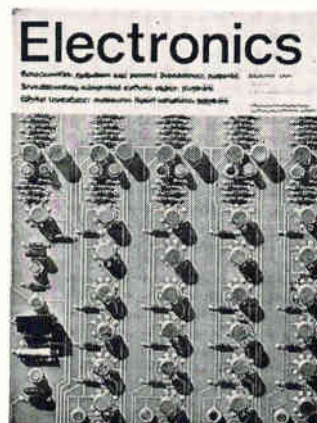

The cover

Integrated circuits play a key role in Fairchild Semiconductor's new digital voltmeter. Off-the-shelf microelectronic units are used in the display counter section. Shown here is the readout decade counter circuit board.

ELECTRO INSTRUMENTS ANNOUNCES

NEW LINE

OF INTEGRATING DIGITAL MULTIMETERS



A FOUR-IN-ONE ADVANTAGE—FEATURING
A COMPLETELY DIFFERENTIAL MICROVOLTMETER

By Dr. Walter East

President, Electro Instruments, Inc.

In today's scientific and engineering circles, one thing is certain: You are never quite sure, on waking in the morning, that the "state of the art" is what it was the evening before! The rate of improvement in scientific instruments is nothing short of phenomenal.

For example, our design engineers have come up with a series of digital multimeters which outperform anything heretofore available.

One of these, Model 630, is literally four instruments in a single package. It offers one microvolt sensitivity, for low level measurement. For highly accurate evaluation work, it offers one part in a hundred-thousand resolution.

An Old Problem Solved

Noisy signals, always a problem in the past, have been eliminated by differential input and true integrating logic.

And topping off these advantages are high speed operation, compact design, totally transistorized circuitry, printer connection, built-in reading storage, and others.

Fulfills Basic Need

The need to measure both DC volts and frequency is probably one of the most fundamental and common jobs encountered both in the laboratory and on the production line. By combining these capabilities in one instrument, we have taken a long step forward to serve a very basic need.

Get Full Facts Today

I urge you to get full facts today about our quite revolutionary new 600 Series Digital Multimeters. Why not either call one of our local field offices or write me direct.



Electro Instruments, Inc.

8611 Balboa Avenue, San Diego, California 92112

ELECTRO INTERNATIONAL, INC., ANNAPOLIS, MD. • TRANSFORMER ENGINEERS, SAN GABRIEL, CALIF.

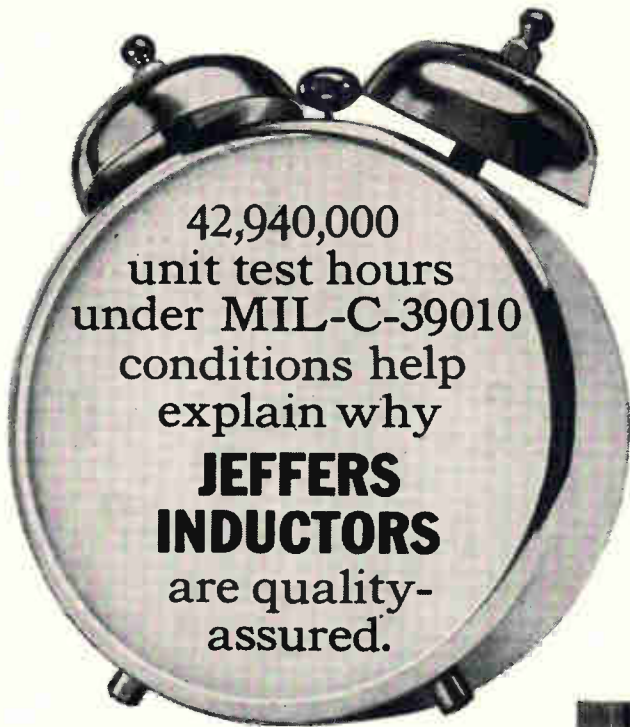

JEFFERS INDUCTORS CONFORM TO REQUIREMENTS OF MIL-C-15305C - TABLE 1

Jeffers Type	46 MS75055	37 MS75054	31 MS75053	30	28 MS91189	25 MS75052	24	22 MS16222	19 MS75008	15 MS18130	09
Case Dia.	.468	.375	.310	.300	.280	.250	.240	.220	.190	.156	.095
Case Size L	.687	.625	.560	.740	.940	.560	.740	.560	.440	.375	.250
Lead Wire Size AWG	21	21	21	20	21	22	20	22	22	22	24
Inductance Range uh	1500 thru 10000	470 thru 1000	180 thru 390	11000 thru 24000	1.2 thru 120	47 thru 150	3900 thru 10000	0.47 thru 3600	0.15 thru 1000	0.15 thru 240	0.10 thru 100

Standard inductance tolerances: $\pm 5\%$, $\pm 10\%$, $\pm 20\%$. Special inductance tolerances available on request. Color coded as specified in MIL-C-15305, or available with printed marking using highly solvent resistant materials. Weldable leads available as specified in MIL-STD-1276.

JEFFERS QUALITY ASSURED INDUCTORS DEMONSTRATED RELIABILITY - TABLE 2

Inductor Type	Inductance Range	Unit Test Hours at 105° C	Failures	Proven Failure Rates	
				60% Confidence	90% Confidence
09	0.10 μ h to 10.0 μ h	4,600,000	0	0.020%	0.049%
15	0.15 μ h to 33.0 μ h	8,200,000	0	0.012%	0.027%
19	0.15 μ h to 27. μ h	14,140,000	0	0.0065%	0.016%
28	1.2 μ h to 120. μ h	16,000,000	0	0.0058%	0.014%
Total Solenoid		42,940,000	0	0.0024%	0.0060%

Reliability data listed above was obtained under conditions outlined in the new Established Reliability General Specification MIL-C-39010 for fixed R. F. molded coils.

Jeffers coil types 15, 19 and 28 meet the requirements of MIL-C-15305C and applicable military standard detail documents.

Quality Control and Inspections facilities and procedures for every stage conform to MIL-Q-9858.

Tape packaging is optional for parts supplied for automatic assembly techniques.

Non-standard inductors are produced on special order. (Over 1,000 specification prints are in our files.) Product uniformity and quality control are comparable to those for standard grades.

Need technical assistance on your special requirements or application problems? Jeffers is always happy to help.



Dept. 4811, St. Marys, Penna. 15857
Speer Carbon Co. Is A Division of Air Reduction Company, Inc.

ULTRASONIC spectrum analyzer

SB-15a / ultra-compact / ultra-versatile / ultra-fast!

100 cps to 600 kc



GPL DIVISION ENGINEERS SPECTRUM ANALYZE RADAR DOPPLER SIMULATOR

Panoramic Model SB-15a Spectrum Analyzer automatically and repetitively scans 1 kc to 200 kc spectrum segments through its entire range... plots amplitude vs frequency instantly on a calibrated long-persistence CRT display, or on a 12 x 4 1/2" chart (optional RC-3b/15). Automatic optimum resolution (selectivity) provides detailed examination of signals as close as 100 cps. Selectivity can also be manually set from 100 cps to 4 kc bandwidth. The SB-15a is self-checking with internal frequency markers every 10 kc and internal amplitude reference; 8 3/4" high; and completely self-contained, including power supply.

FEATURES: ■ Quick signal location, minimum chance of missing weak signals or holes in spectrum ■ Faster measurements — no tedious point-by-point plots ■ Reliable spotting of low level discrete signals in noise ■ Positive identification and dynamic analysis of all types of modulation.

APPLICATIONS: ■ Noise, vibration, harmonic analysis ■ Filter and transmission line checks ■ Telemetry analysis ■ Communication system monitoring and testing ■ Spectral density analysis with Model PDA-1 Analyzer ■ Response plotting with Model G-15a Companion Sweep Generator.

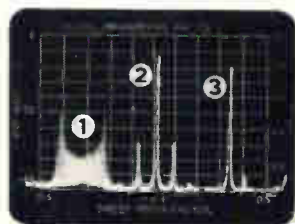

Dynamic analysis shows SB-15a versatility: (1) FM (shows dynamic deviation), (2) AM, (3) SSB with sine wave modulation.

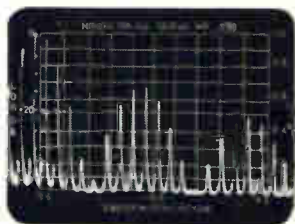

Harmonic analysis of 20 μ sec 11,000 pps video pulse waveform on SB-15a 200 kc sweep width, linear amplitude scale.

Frequency Range — 100 cps to 600 kc, temperature stabilized
Sweep Width — Variable, calibrated from 1 kc to 200 kc
Center Frequency — Variable, calibrated from 0 to 500 kc
Markers — At 10 and 100 kc intervals, $\pm 0.02\%$ acc.
Resolution — IF bandwidth variable 100 cps to 4 kc
Sweep Rate — 1-60 cps, free-running or synchronized

Amplitude Scales — Lin, 40 db log (usable 60 db), 2.5 db EXP
Distortion — Harmonic and IM at least 60 db down
Sensitivity — 200 μ v to 100 v full scale deflection
Accuracy — ± 0.5 db any 200 kc segment 200 cps-525 kc
Attenuators — 0 to 120 db, step and smooth
Smoothing Filter — 0 to 0.25 sec time constant, low pass

ASK YOUR METRICS SALES REPRESENTATIVE ABOUT THE NEW SINGER TIME PAY AND LEASE PROGRAMS



THE SINGER COMPANY METRICS DIVISION

915 PEMBROKE ST., BRIDGEPORT, CONNECTICUT
TELEPHONE (203) 366-3201 • TWX 710-453-3483

Design and production of PANORAMIC • SENSITIVE RESEARCH • EMPIRE • GERTSCH instruments for measurement

NOW IN PRODUCTION... CORES FOR THE DEFLECTION YOKE AND TRANSFORMER SYSTEMS OF THE NEW 90° COLOR C.R.T.

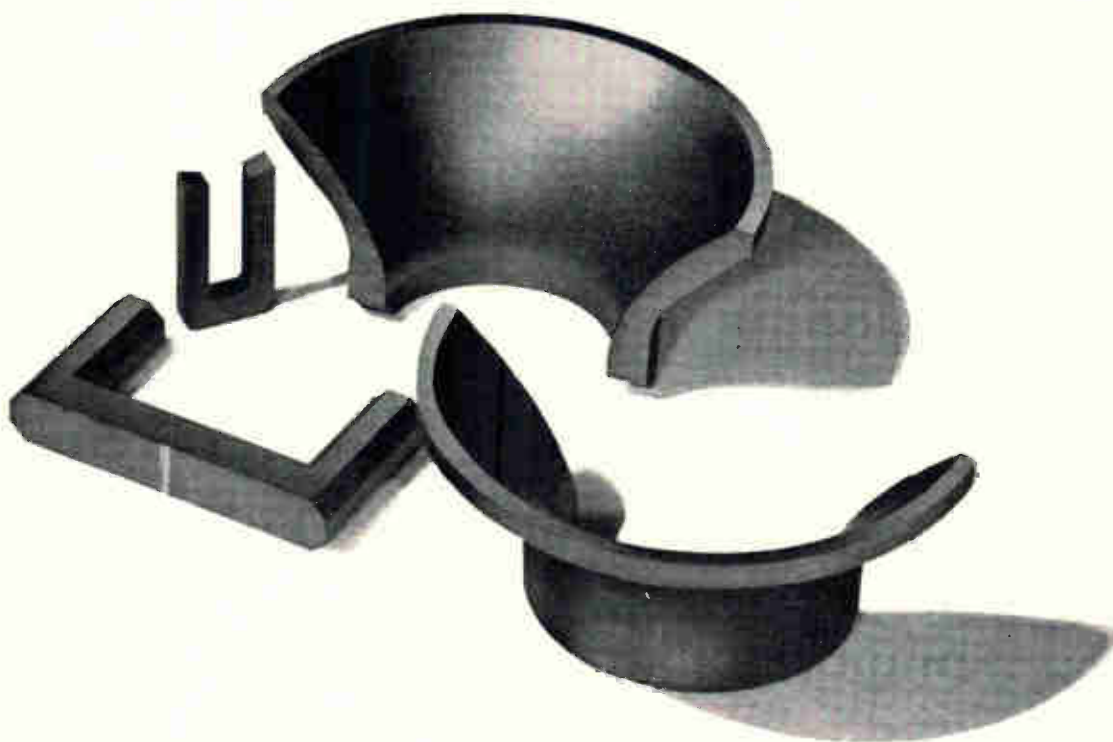

Stackpole, pioneer of ferrites for commercial applications, introduces Ceramag® deflection yoke and transformer cores and cores for the convergence system of wide-angle color television tubes. Production quantities of these highly uniform, fully dependable units are available for prompt delivery. They offer the same high standards

of quality and performance that have made Stackpole the foremost name in ferrites. This is why every major U. S. television manufacturer specifies Stackpole. For samples or additional technical information, write: Stackpole Carbon Company, Electronic Division, St. Marys, Pa. Phone: 814-834-1521 — TWX: 814-826-4808.



STACKPOLE
ELECTRONIC COMPONENTS DIVISION

Another New High Order of Reliability!

El-Menco

* MYLAR-PAPER DIPPED CAPACITORS

TYPE
MPD

ASSURE A LOW FAILURE RATE OF
Only 1 Failure in 7,168,000 Unit-Hours for 0.1 MFD Capacitors*

14,336,000

Setting A New High Standard Of Performance!

★ Life tests have proved that El-Menco Mylar-Paper Dipped Capacitors — tested at 105°C with rated voltage applied — have yielded a failure rate of only 1 per 1,433,600 unit-hours for 1.0 MFD. Since the number of unit-hours of these capacitors is inversely proportional to the capacitance, 0.1 MFD El-Menco Mylar-Paper Dipped Capacitors will yield ONLY 1 FAILURE IN 14,336,000 UNIT-HOURS.

CAPACITANCE AND VOLTAGE CHART
● Five case sizes in working voltages and ranges:

200 WVDC —	.018 to .5 MFD
400 WVDC —	.0082 to .33 MFD
600 WVDC —	.0018 to .25 MFD
1000 WVDC —	.001 to .1 MFD
1600 WVDC —	.001 to .05 MFD

SPECIFICATIONS

- **TOLERANCES:** 10% and 20%. Closer tolerances available on request.
- **INSULATION:** Durez phenolic, epoxy vacuum impregnated.
- **LEADS:** No. 20 B & 5 (.032") annealed copper clad steel wire crimped leads for printed circuit application.
- **DIELECTRIC STRENGTH:** 2 or 2½ times rated voltage, depending upon working voltage.
- **INSULATION RESISTANCE AT 25°C:** For .05MFD or less, 100,000 megohms minimum. Greater than .05MFD, 5000 megohm-microfarads.
- **INSULATION RESISTANCE AT 105°C:** For .05MFD or less, 1400 megohms minimum. Greater than .05MFD, 70 megohm-microfarads.
- **POWER FACTOR AT 25°C:** 1.0% maximum at 1 KC

These capacitors will exceed all the electrical requirements of E. I. A. specification RS-164 and Military specifications MIL-C-91B and MIL-C-25C.

Write for Technical Brochure

MINIMUM LIFE EXPECTANCY FOR **1.0 MFD* MYLAR-PAPER DIPPED CAPACITORS AS A FUNCTION OF VOLTAGE & TEMPERATURE

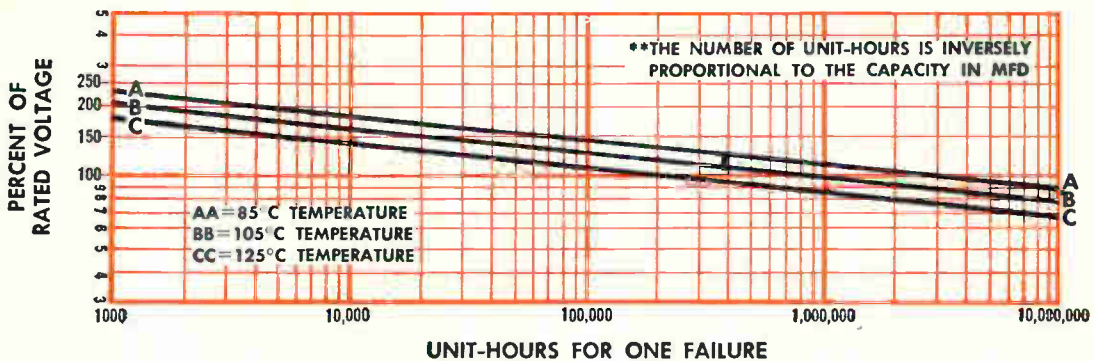

* Registered Trade Mark of DuPont Co.

THE ELECTRO MOTIVE MFG. CO., INC.
WILLIMANTIC, CONNECTICUT

Dipped Mica • Molded Mica • Silvered Mica Films • Mica Trimmers & Padders
Mylar-Paper Dipped • Paper Dipped • Mylar Dipped • Tubular Paper

ARC ELECTRONICS, INC., Community Blvd.,
Great Neck, L. I., New York
Exclusive Supplier to Jobbers and Distributors
in the U. S. and Canada

West Coast Works/Instruments Division
COLLINS & HYDE CO. 1028 Corporation Way
Palo Alto, California
5380 Whittier Boulevard, Los Angeles, California

MANUFACTURERS OF
El-Menco
Capacitors

**WHERE
IT
PAYS
TO BE
'YES MEN'**

CHECK LIST FOR A COMMAND AND CONTROL CONTRACTOR

EVALUATING: **LTV** MILITARY ELECTRONICS
A DIVISION OF LING-TEMCO-VOUGHT, INC.
P. O. BOX 6118 • DALLAS, TEXAS 75222

EXPERIENCED

YES	NO	
<input checked="" type="checkbox"/>	<input type="checkbox"/>	TRACKING SYSTEMS
<input checked="" type="checkbox"/>	<input type="checkbox"/>	COMMUNICATIONS
<input checked="" type="checkbox"/>	<input type="checkbox"/>	DATA PROCESSING
<input checked="" type="checkbox"/>	<input type="checkbox"/>	DISPLAY SYSTEMS
<input checked="" type="checkbox"/>	<input type="checkbox"/>	GROUND SUPPORT SYSTEMS
<input checked="" type="checkbox"/>	<input type="checkbox"/>	SYSTEMS MANAGEMENT
<input checked="" type="checkbox"/>	<input type="checkbox"/>	FIELD SERVICES
		FACILITIES

LTV MILITARY ELECTRONICS
 offers years' experience systems management
 . . . strong in updating existing equipment, developing interface and new generation equipment
 . . . backed in depth by parent, Ling-Temco-Vought, Inc.

Probing the News

Space Electronics

Westinghouse camera wins moon trip; other firms deplore lack of competition

NASA now plans to use only one television camera on Apollo; RCA's version, developed for lunar mission at \$2 million cost, will be used only in orbits of the earth

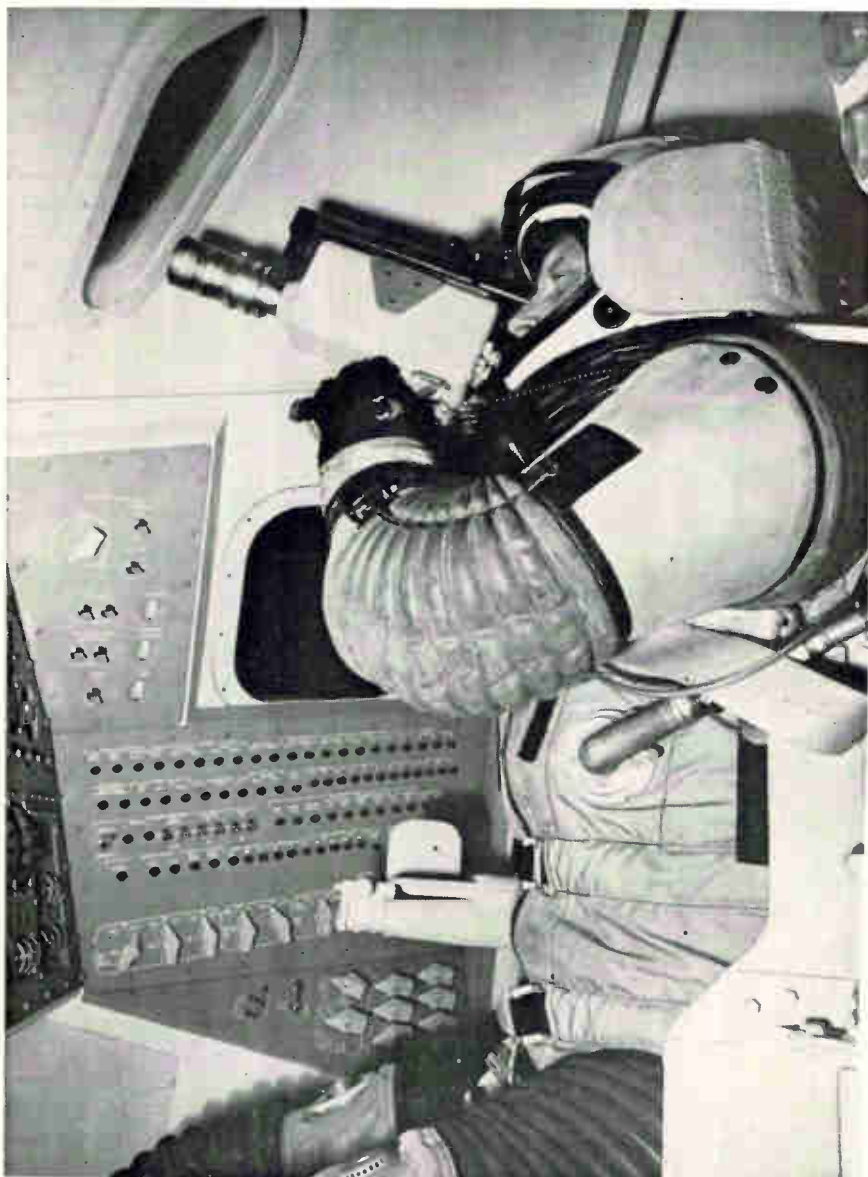

RCA lunar tv camera will never get to the moon. Company is paid about \$2 million to develop this model for early test flights.

The National Aeronautics and Space Administration has chosen a camera to roam the moon, and kicked off a down-to-earth controversy over its method of awarding the contract.

The contract, worth \$2.29 million and inestimable prestige, went to the Westinghouse Electric Co. The hassle involves two other companies—the Radio Corp. of America and General Electrodynamics Corp.—that say they should have had a chance to bid on the camera.

RCA previously received a \$2 million contract to develop a television camera that, it now appears, won't make the scheduled trip to the moon in 1969 aboard the Apollo spacecraft. Under the original plan, RCA's camera was to have journeyed to a moon orbit in the Apollo command module; a second camera was then to have landed on the moon aboard Apollo's excursion module. The latest plan calls for only one camera—Westinghouse's—to travel to the moon. The RCA camera will be used only in orbits of the earth.

I. Broadcasting in the dark

The Westinghouse camera is now scheduled for use in both modules. It employs a unique image-sensor, sensitive enough to operate in almost total darkness and sturdy enough to survive the journey and the moon's rugged environment. Light on the moon can be as intense as 12,600 foot candles by day and as weak as 0.007 foot

candles at night. Temperatures range from -300° to $+250^{\circ}$ F.

Westinghouse devised its single-camera approach with the Army Research and Development Laboratories. The Army invested \$600,000 in its development, but Westinghouse owns the patents for the tube. The technique is called secondary emission conductivity (SEC).

Sole source. NASA is sold on Westinghouse's solution to such an extent that it awarded the contract without competitive bidding. David M. Hickman, the agency's project manager for the tv camera, explained, "No other company in the country has any experience with this particular approach."

That's where the argument broke out. General Electrodynamics' president, Francis J. Salgo, declared: "We can think of several practical approaches that could be produced for considerably less money. But since we have never been shown the exact requirements and have never been asked to submit a proposal, it is impossible for us to state what approach we would pursue."

"If the SEC vidicon approach makes the Westinghouse proposal proprietary," Salgo continued, "we can think of several approaches which would at least produce equi-

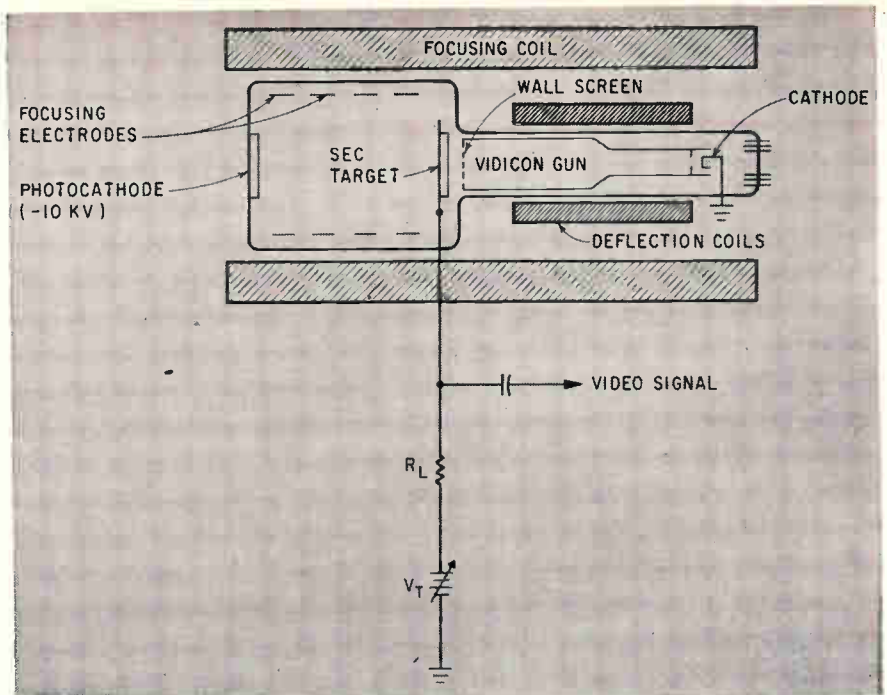

Lunar television camera is built around SEC vidicon tube, which offers high target gain, permitting application in low light levels. Camera circuits are about 60% integrated, 40% hybrid.

valent results. And so could our competitors."

General Electrodynamics has asked the House Select Committee on Small Business to advise how the company can get a chance to bid on the cameras for Apollo. And RCA says it will use its own money to develop a better camera than the one accepted by NASA.

The Westinghouse camera is heavier than RCA's but more rugged. It weighs 7.5 pounds compared with RCA's 4.2. Much of the additional weight consists of material to dissipate heat.

Hickman conceded that the tube wasn't configured for space environments, but he insisted that it seems to be the best bet for meet-

Here's how the Westinghouse television camera will be used on the moon.

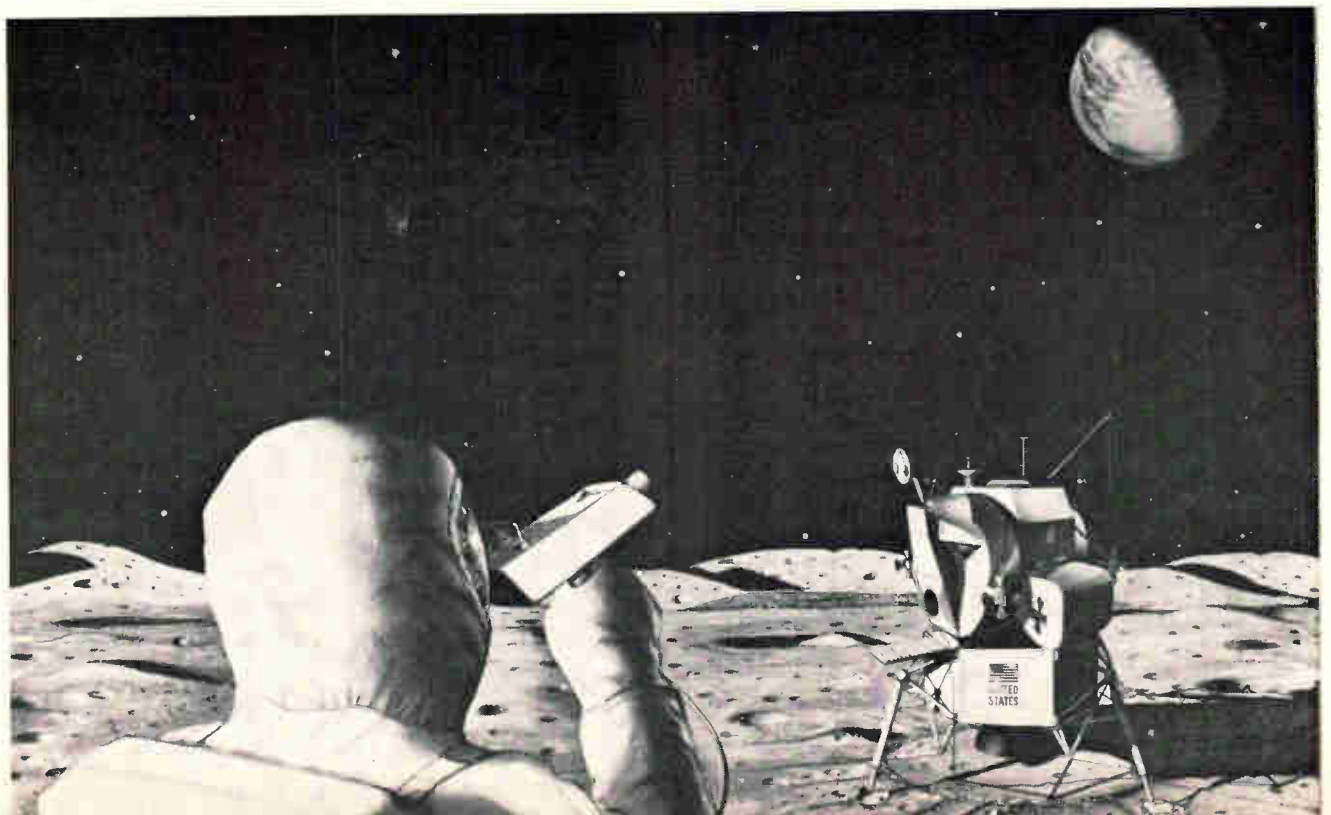

ing the requirements "We are doing more development on the tube," he said, "primarily beefing up the structure to make it survive the vibration."

The camera is chiefly for sending pictures of the moon to the public, but some scientific benefits are expected.

The tv system has a 500-kilocycle bandwidth, about one-eighth of the 4-megacycle standard for commercial television. Scan-conversion has been a problem from the beginning, Hickman said, "but we think we have it beaten. We have a system working in the laboratory now, developed in-house, that gives us some very, very good pictures."

NASA has chosen a scanning speed of 10 frames per second, with 320-line resolution. This will be converted to the 30 frames and 525 lines used in commercial tv.

Scan conversion. Westinghouse also has a \$96,700 contract to refine a scan-conversion system that was developed by NASA. It's one of three contracts awarded on scan-conversion. Litton Industries, Inc., is making a feasibility study for \$24,700, and Image Instruments, Inc., completed work last year on a \$75,000 contract whose nature has not been disclosed.

NASA's system uses a separate kinescope tube and separate vidicon camera. Westinghouse's work involves the same principle, with the kinescope and vidicon in one tube. The agency plans to award a production contract for the scan-conversion system early in 1965.

RCA also worked on scan conversion under its contract for a camera for the Apollo command module. That contract was awarded by North American Aviation, Inc., prime contractor for the command module.

III. It's Westinghouse, to be sure

The decision to use the RCA camera was made by the Apollo project office. About a year ago, that office was stripped of its power to make many decisions of a purely technical nature. This authority was given to the Manned Spacecraft Center's assistant director of engineering and development, who decided on the single-camera approach.

From the day that the single-camera approach was decided

upon, Westinghouse seems to have had the inside track. Hickman said, however, that other methods were considered.

One way would be to use a vidicon tube and try to build an image intensifier in front of it to attain the required sensitivity to light. This system "works fine for still pictures," Hickman said, "but with motion like we will have all during the mission, you observe

smear and motion breakups in the image sensor.

"So we discarded that approach," he said.

Another approach would involve a large orthicon tube, such as those commonly used in all network broadcasting. "This is an extremely sensitive tube," Hickman said, "but the tube is very bulky and requires power supplies that are heavy." It's also fragile, he added.

Employment

Choosing an agency: as hard as finding a job

Some agencies blanket companies with resumes that don't match the engineer's qualifications to a firm's needs

"It used to be that the only qualifications you needed for a job were a warm body, a degree and a slide rule—but it's a lot tougher now," laments one unemployed West Coast engineer.

Tighter military budgets and a growing stress on specialties have changed the employment picture. Now the out-of-work engineer faces a problem that's becoming more difficult to solve: how to get a job.

Aside from reading newspaper want ads and turning to friends in the field, the engineer who is unemployed or who is seeking a better job, looks to professional job-hunters—the employment agencies.

Many engineers, unfamiliar with the workings of agencies, are in for some surprises.

I. Engineer's woes

Here are a few examples a coast-to-coast survey by Electronics magazine has uncovered:

"An employment agency that was supposed to help me find a better job, made me lose the one I had. They sent my resume to my own company."

"When I signed a contract with an agency, all I got was a list of companies that were hiring. I chucked the list in the trash can

without looking at it and went on my way. Eight months later I got a job through the recommendation of a friend at a company that turned out to be on the list. When the agency found out where I was working, they sued for their fee.'

Unusual?

Not really, considering that some 30% of all engineering jobs are filled by employment agencies and the caliber of agencies ranges from the reputable firm—which carefully screens each applicant to match him with a particular job—to the "paper mill or mail-order house"—which indiscriminately mails out hundreds of resumes, hoping one or two works out.

Says one personnel man for a major electronics firm: "The best agencies are local ones staffed by conscientious technical people who understand the engineer and the companies in the area and who match their files with each job order."

Buckshot approach. The paper mills are big leaguers, mostly national outfits. When an engineer files an application with them, they clip his name off the resume, run off copies and send them to the 500 companies on their mailing list. The result is that personnel men are

AIRBORNE VIBRATION MONITORING SYSTEM

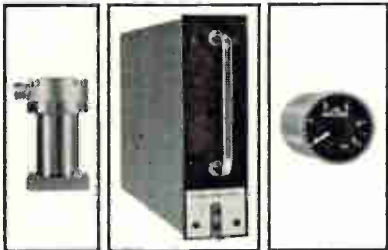

CEC's 3 steps to reliability—The new CEC Airborne Vibration Monitoring System is the most reliable yet conceived. Reason: the advanced design of the system's three basic components.

CEC 4-125 Vibration Transducers—one to three per amplifier—will operate continuously at 700°F, are impervious to shock and are virtually maintenance-free. There are no lubricants to wear out, and special gold-palladium bearing rings actually reduce friction with wear.

CEC solid-state amplifiers—up to four per module with a single power supply—are easily accessible for inspection, and are physically and electrically interchangeable.

CEC's precision indicator—continuously displays the vibration level being measured on a given engine. The indicator is compensated to correct for varying ambient temperatures, and may be calibrated to customer specifications.

For full information, call or write CEC for Bulletins in Kit #5046-X3.

CEC

Transducer Division

CONSOLIDATED ELECTRODYNAMICS

A SUBSIDIARY OF BELL & HOWELL/PASADENA, CALIF. 91109
INTERNATIONAL SUBSIDIARIES: WOKING, SURREY, ENGLAND
AND FRANKFURT/MAIN, GERMANY

flooded with resumes.

Complains John Anderson, placement manager at the Fairchild Semiconductor division of the Fairchild Camera & Instrument Corp. in San Francisco: "They send garbage and I must wade through piles of stuff . . . They do so little investigating that even when a resume looks interesting, the man often hasn't been available for some time, or his salary is way out of line, or he isn't the type of person who would fit in."

Some major electronics firms fight back at this scattered-shot approach by the paper mills. Joseph W. Dwyer, personnel director at the Sperry Gyroscope division of the Sperry Rand Corp., says that if an agency fails to screen applicants properly or sends unsolicited resumes, "we will refuse to do business with them."

But one personnel chief concedes: "When we're looking for a man with unusual qualifications, such as an optics man, we look at everything, even the 'wallpaper' the paper mills mail out."

II. Agency answers

Answering the critics or the mail-order house is the director of one big East Coast agency who declined to be identified: "How can an engineer object when his resume

is read by 500 companies? The personnel men who don't like to be flooded with unsolicited resumes from agencies may read them with disdain—but they read them."

The agency director's reply to the personnel men's complaints is partly true—except when the resume goes where it can hurt, not help, the job seeker. This happens when a resume goes to the company for whom the engineer currently works. The paper mills, however, insist that by clipping the name off the resume, the applicant's identity is protected—even if the resume goes to his own company. But if a resume contains any worthwhile information, a personnel man can usually identify an applicant who is actually working in his company.

The mail-order agency seeks volume. Since it gambles the price of postage against a beefy commission, it doesn't have to place too large a percentage of its applicants to be successful. Generally, for the service provided by the agency, a company pays between 5% and 10% of the engineer's annual salary. For positions paying over \$15,000, a company may pay more than 15%. It is rare for an engineer to pay the fee.

Bad guys. The "pirate" agency is the unsavory third cousin of the

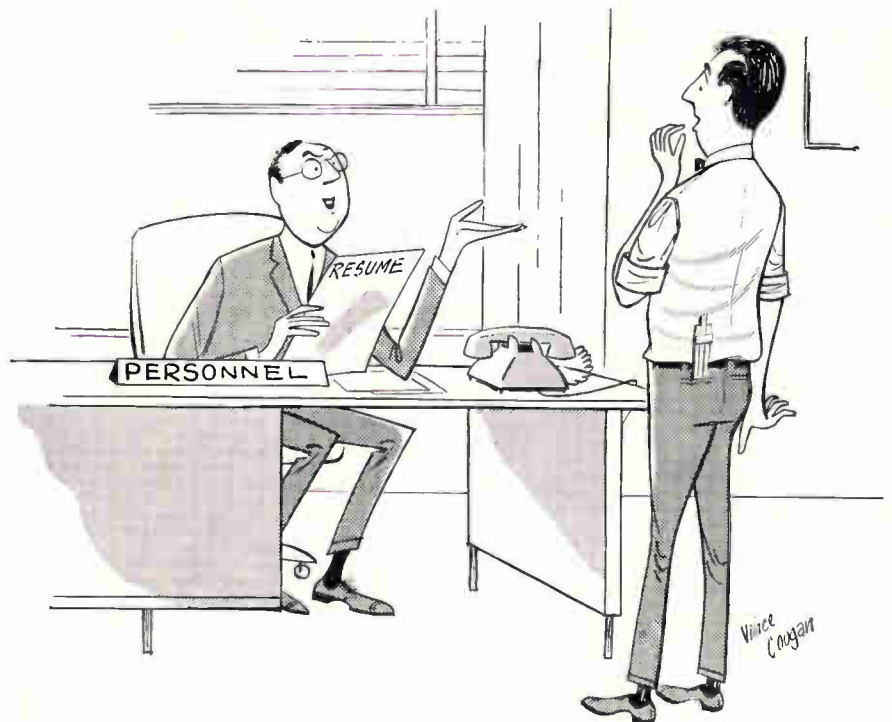

"It's from your employment agency. They think you're ideally suited for your own job."

IF YOUR PRODUCT DEPENDS ON ELECTRICAL CONTROL OF ANY KIND...

*you're
better off
starting
here*

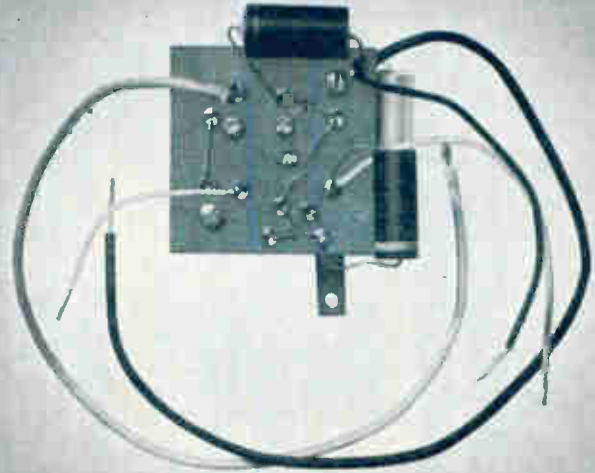

*instead
of
here*

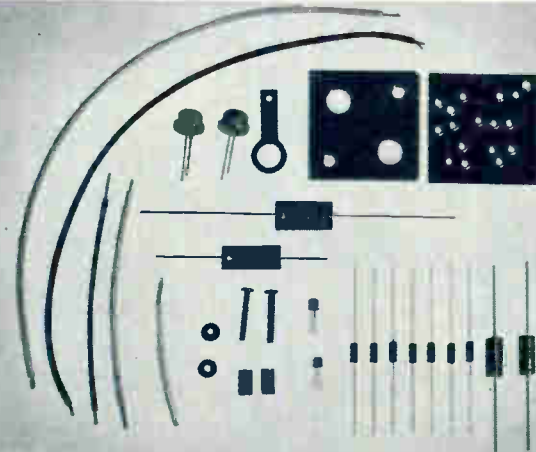

Motorola Solid State Modular Subsystems Offer A Sensible, Practical Way To...

✓ REDUCE COSTS:

Procurement, inspection, piece-parts inventory — you can sharply reduce funds tied up in these areas by using packaged solid state modules rather than individual electrical components. At the same time, you'll free in-plant personnel for other important duties.

✓ SIMPLIFY PRODUCTION:

With packaged modules, assembly personnel simply plug in or "hook up" complete control or regulator circuits. Motorola can design, prototype, mass produce and test assemblies to your specific requirements in virtually any rating or configuration.

✓ IMPROVE RELIABILITY:

Hundreds of thousands of dollars in modern test equipment ensure that Motorola's modular assemblies meet specifications. This overall quality is reflected in your product and provides an element of value your customers will recognize — and appreciate!

From the standpoint of innovation, miniaturization or cost reduction in your product area, Motorola solid state assemblies are definitely worth evaluating. Motor speed, lighting and heat control circuits; compact, reliable, low cost reference amplifiers; rectifier assemblies far smaller than a penny, yet capable of handling 1 full ampere; high current assemblies rated in thousands of amperes — regardless of your requirements, you'll find Motorola a willing *and able* supplier.

WRITE FOR YOUR FREE COPY

... of this comprehensive brochure describing Motorola's custom and standard modular subsystems. Or, for immediate information, contact Motorola Technical Information Center, Box 955, Phoenix, Arizona 85001.



MOTOROLA

Semiconductor



how to measure resolver or synchro position with 30 second repeatability

In both production test and ground checkout systems, North Atlantic's high performance Angle Position Indicators provide exceptional operator ease and precision in the measurement of synchro and resolver position. Features include digital readout in degrees and minutes, 30 second resolution, continuous rotation, plug-in solid-state amplifier and power supply modules. Due to the design flexibility of these units, they can be readily provided with a variety of features for specific requirements. Typical units in this line incorporate combinations of the following features:

- Single Synchro or Resolver Input
- Dual Synchro or Resolver Inputs
- Retransmit Synchro, Resolver, Potentiometer, or Encoder
- 2-Speed Synchro Input
- Multi-frequency Inputs
- DC Input
- 0-999 Counter

BASIC SPECIFICATIONS

Range	0°-360° continuous rotation
Accuracy	6 minutes (standard)
Repeatability	30 seconds
Slew Speed	25°/second
Power	115 volts, 400 cps
Size	API-8025 1¼" h x 9½" w x 9" d
	API-8027 3½" h x 4¼" w x 9¾" d



Your local North Atlantic representative has complete data on the API line. Call him today or write direct for technical literature.

NORTH ATLANTIC industries, inc.
TERMINAL DRIVE, PLAINVIEW, L. I., NEW YORK • Overbrook 1-8600

paper mills. Such an agency gets hold of a company's telephone book and calls every engineer on the staff in an effort to persuade him to sign up as an applicant, even though no specific job is available. Such pirates are more trouble to the company than to the engineer. However, many engineers who want to change jobs have found that prospective employers may like their qualifications but are prejudiced by an applicant's association with a pirate agency.

Fake talent search. These agencies have been known to contrive a resume of someone who has published an article and then send it out without his knowledge. When the agency gets a reply, it calls the man and tells him that it represents a talent-search organization and has chosen him to fill a position. A legitimate talent-search group gets the job requirements first and then does a publication search.

III. A few suggestions

Here are some points that personnel men suggest engineers keep in mind when looking for an agency.

- Avoid the general agency; stick with a local technical agency that knows the companies in the area. Make sure that electronics placement is a large part of its business; that is, it should have at least one man full time on just electronics. He should be a specialist in the field so that he knows the jargon, learns your qualifications, knows which companies would show the most interest in you and knows who has what contracts. An interview is the only way to get a feeling about an agency.

- Ask a personnel man to recommend an agency. If you have been laid off, ask at your own company—it will be glad to help.

- Sign up with two or three agencies in the localities where you'd like to work.

- Make sure the agency fee structure meets standard practice.

- Don't forget the college alumni-replacement office, the engineering society placement service and the professional placement center of the state employment office. You don't have to be unemployed to use these services and because there's no fee, more and more companies are listing with them.

TRYGON Half Racks



Model HR40-5A

Model	Volt	Amps	Regulation	Ripple	Price
HR-20-1.5*	0-20	0-1.5	0.01% line 0.05% load	0.25 mv	\$164
HR40-750*	0-40	0-0.75		0.15 mv	\$149
SHR20-3A	0-20	0-3	0.01% line 0.01% load	0.5 mv	\$225
HR20-5A	0-20	0-5			\$299
HR20-10A	0-20	0-10			\$379
SHR40-1.5A	0-40	0-1.5			\$199
HR40-2.5A	0-40	0-2.5			\$299
HR40-5A	0-40	0-5			\$349
SHR60-1A	0-60	0-1			\$235
HR60-2.5A	0-60	0-2.5			\$379
HR60-5A	0-60	0-5			\$449

NEW

NEW

NEW

*Single Meter Units

... the most versatile power supplies going!

In the lab—you'll find you can't beat a Trygon Half Rack for versatility and low cost! Want constant voltage with adjustable current limiting? You've got it! Want constant current with adjustable voltage limiting? You've got it! Want to select voltage and current with a remote control? You've got this too!

But check the features at the right—and the prices—for yourself. And remember—every Trygon power supply, large or small, goes through the same test procedures before shipment. Each is aged—burned in; each is subjected to stability runs. Each must pass shock and vibration tests—your assurance of long, trouble free performance along with versatility.

In a system—you merely take off the Half Rack dust cover, reverse it, add an inexpensive Trygon adapter, and you have a unit that slides right into a rack. What's more, you can place two Half Racks in a 19" rack width, occupying only 5 1/4" of panel height.

For complete specs—on the Half Rack Series as well as our catalog showing the complete line of over 100 Trygon Power Supplies, write to us today. Address: Dept. E-6.



Two Trygon HR20-1.5's, rack-mounted side by side.

FEATURES

- **CONSTANT VOLTAGE OPERATION** with adjustable current limiting.
- **CONSTANT CURRENT OPERATION** with adjustable voltage limiting.
- **COMPLETE RANGE REMOTE PROGRAMMING** furnishes voltage and current selection from a remote control.
- **REMOTE SENSING** provides rated regulation at the load, available at both front and rear terminals.
- **HIGH RESOLUTION** for setting current and voltage is provided by coarse and fine adjustments for both (4 controls).
- **AUTOMATIC OVERVOLTAGE PROTECTION**—Trygon's unique overvoltage protection is available as an option.

TRYGON

ELECTRONICS INC.

111 Pleasant Avenue
(516) FReeport 8-2800

Roosevelt, L.I., N.Y.
TWX (516) 868-7508



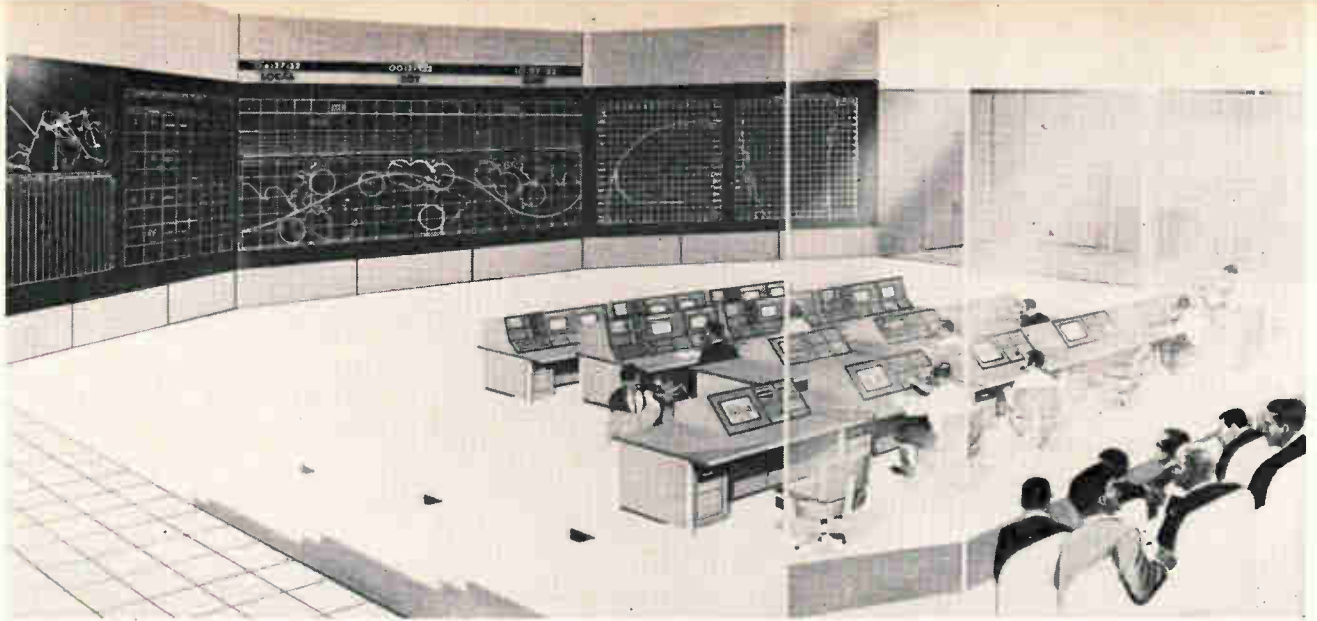

Wall-to-wall display will provide top brass with quick—but not very accurate—picture of what Gemini will be doing during a flight. Spectators sit behind screen. Experts controlling mission sit at small tv sets.

Space electronics

Manned space center combines glamor and complex equipment

First job of multimillion-dollar facility near Houston will be monitoring and guiding Gemini flight next year

By Marvin Reid

McGraw-Hill World News

When Gemini astronauts Gus Grissom and John Young are lifted into orbit early next year, a covey of top brass will be following their progress from probably the most expensive three-story windowless building ever built.

For more than \$85.4 million, the National Aeronautics and Space Administration is building an instrument-crammed manned spacecraft center near Houston that was designed to satisfy both the kibitzer and the expert guiding the craft.

Wall-to-wall map. Highlight of the center—from the spectator's point of view—is an elaborate television projection screen and plot boards that wrap 60 feet around one side of a control room's wall.

The screen, dotted with blinking lights superimposed on a map of the world and multicolored wavy lines, are supposed to keep the kibitzer informed on the location and condition of the spacecraft. What the multicolored display lacks in accuracy, it makes up in showmanship. From the expert's point of view—aside from not having an onlooker peering over his shoulder—the highlight of the center is not the Hollywood-type world-map display, but all the other complex equipment.

Eventually, the center will handle the ground operational support work from lift-off to recovery on all manned spaceflights. The center also will include facilities to

train astronauts by simulating space missions.

I. No blue sky

Although the center will be bigger and have more sophisticated electronic equipment than the Mercury Control Center at Cape Kennedy, it doesn't contain any blue-sky gear. For the most part, the facilities, which are nearing completion, use off-the-shelf equipment. But, as a NASA official points out, this is the first time so much complicated gear has been put under one roof—and that was tough.

For the first couple of manned space flights, Mercury Control and the new center will share responsibility for controlling flights, but

New from **E-I**

High Voltage Glass-Bonded Ceramic Seals

PATENTS PENDING

Compare!



GLASS-TO-METAL SEAL . . .
2500 V.

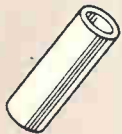

CERAMIC PART



GLASS-BONDED CERAMIC SEAL . . .
10,000 V. PLUS

Meet High Voltage Requirements —AT LOWER COST!

ELECTRICAL INDUSTRIES announces new Glass-Bonded Ceramic Seals (Glass-Ceramic-Metal) which are produced at considerably lower cost than conventional ceramic-to-metal types. Designed to provide an economical solution to problems involving high voltages, E-I Glass-Bonded Ceramic Seals can be supplied in a range of sizes to meet specific requirements. Consult our engineering department for design assistance.

GLASS-BONDED CERAMIC SEALS vs. GLASS-TO-METAL SEALS COMPARATIVE DATA FOR SEALS ILLUSTRATED

PEAK VOLTAGE							
GLASS-TO-METAL SEALS				GLASS-BONDED CERAMIC SEALS			
2500 V.				10,000 V. PLUS			
SURFACE RESISTANCE							
GLASS-TO-METAL SEALS				GLASS-BONDED CERAMIC SEALS			
Temp. °F.	Megohms	Temp. °F.	Megohms	Temp. °F.	Megohms	Temp. °F.	Megohms
150	∞	350	32 k	150	∞	350	∞
200	∞	400	5 k	200	∞	400	∞
250	∞	450	—	250	∞	450	1800 k
300	200 k	500	—	300	∞	500	800 k

A Division of Philips
Electronics and
Pharmaceutical
Industries Corporation



ELECTRICAL INDUSTRIES

MURRAY HILL, NEW JERSEY 07971 — Telephone: (201) 464-3200

PATENTED IN THE U.S.A., NO. 3,035,372; IN CANADA, NO. 523,390; AND IN THE UNITED KINGDOM, NO. 734,583; OTHER PATENTS PENDING.

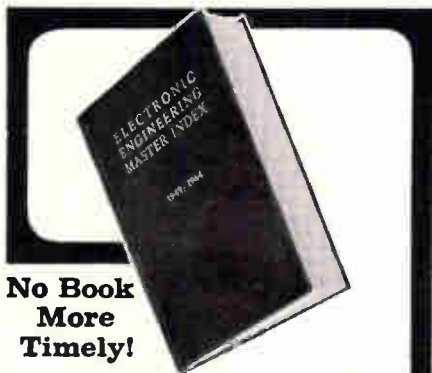

**No Book
More
Timely!**

None More Indispensable!

THE ELECTRONIC ENGINEERING

MASTER INDEX

(January 1949 - June 1964)

A definitive compilation indexing over 20,000 articles from more than 100 scientific and engineering periodicals.

YOUR MASTER KEY TO INFORMATION RETRIEVAL

The Master Index gives you, in minutes, exhaustive bibliographies on over 400 subjects in research, development and production problems in electronic engineering. Alphabetically arranged, these subjects cover the spectrum from Acoustics to Zener diodes, including such major topic areas as Antennas, Computers, Data Processing, Electronic Controls, Information Theory, Instrumentation, Integrated Circuits, Lasers, Magnetics, Masers, Plasma Physics, Semiconductors, Superconductors, Systems Engineering, Telemetry, Transducers, Transistors—in fact, all subjects as reflected in the immensely rich engineering literature of the past 15 years.

This Statement of the Engineer's Joint Council Highlights The Unique Usefulness of The Master Index:

"The ever expanding volume of technical information makes it impossible for those engaged in research and development to scan all the literature in their field. More than ever before, vital information needed for a successful project may be overlooked. The result of information unavailability is expensive duplication of work, wasted time, and wasted scientific and engineering talent."

SUMMARY REPORT, 1963

Avoid such waste in your organization by ordering The Electronic Engineering Master Index now. On approval if desired. Check below.



**Clothbound—\$29.75
460 pages, 7x10**

**MASTER INDEX SERVICES, INC.
151 West 18th Street
New York, N. Y. 10011**

Send me _____ copies of the Electronic Engineering Master Index.

NAME _____

TITLE _____

COMPANY _____

ADDRESS _____

BILL ME BILL COMPANY ON APPROVAL

eventually Mercury Control will be phased out and used as a ground station in the tracking network.

The heart of the new center will be a computer information and display system that will be able to process about 10 times as much data as Mercury Control can handle. Other major advantages over the old center are:

- An internal tv system, the first of its kind to be used in a control room.

- Communications - processing equipment that will handle high-speed, low-speed and wide-band input data; the Mercury facility only has low-speed switching capabilities.

- Two mission-control rooms, compared with one for Mercury.

- A recovery room equipped with essentially the same display gear as the mission control rooms.

- Staff support rooms equipped with control and display equipment

for each major support group.

The center will also have such added touches as a pneumatic-tube message system and equipment that will make copies of tv displays.

Big on computers. The communications-processing equipment will consist basically of two Univac 490s and peripheral gear. There will be four IBM 7094s in the computer complex. Aside from the world-map display and plot boards, there will be 64 individual tv consoles for operators taking part in mission control, simulation or recovery work. Each console will have a 14-inch precision monitor tv screen.

In operation, data will come into the communications processor from various tracking sites. It will receive radar and telemetry data by teletype from all sites in the tracking network. It will receive high-speed (2,000 bits of information per second) tracking data from three stations, Cape Kennedy, Bermuda

Gemini spacecraft raised to top of gantry for mating to Titan II. Similar craft will be launched next year and guided from space command center near Houston.

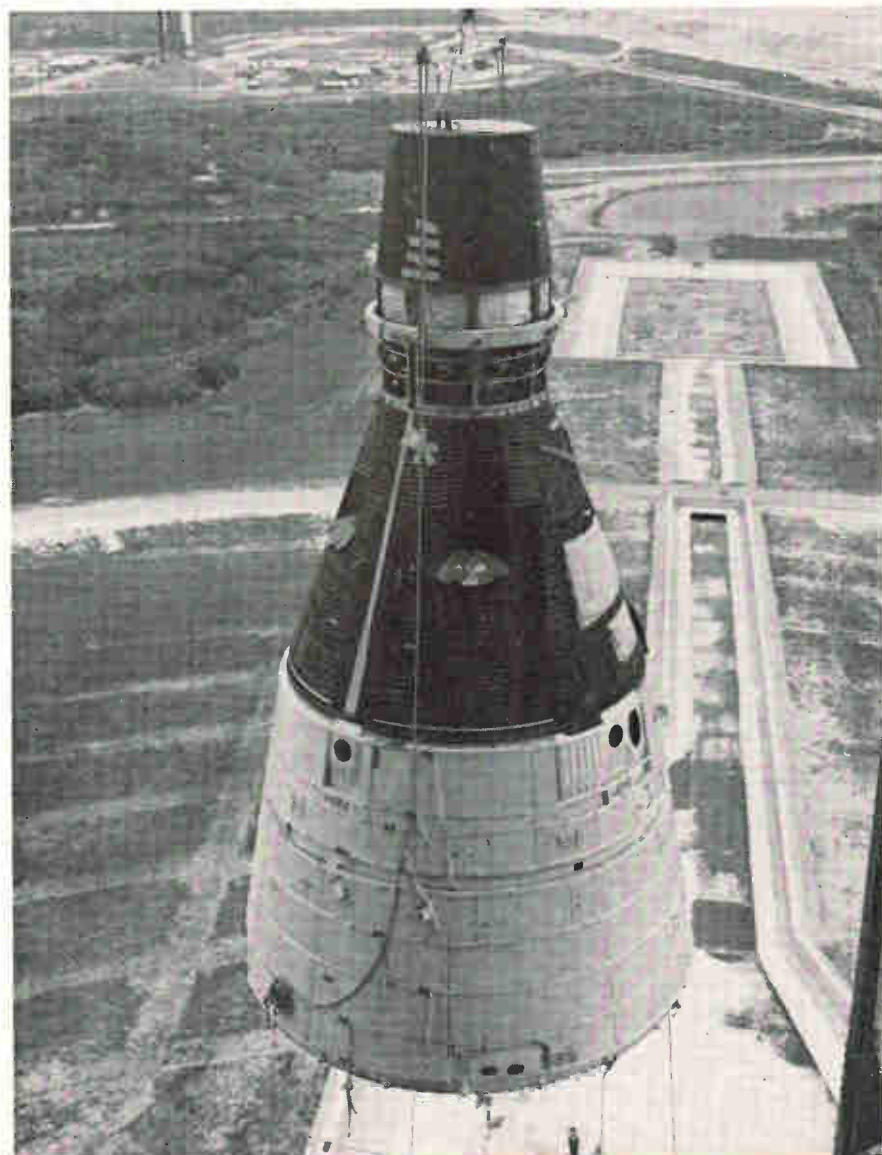

DON'T try all these tests on any other resistor!

11-watt unit
enlarged 2½ times



OHMITE Series 99
Insulated, Axial Lead Wire-Wound Resistors
"molded" in vitreous enamel
...a new development in protective coatings.

- Proved by over **24,500,000** unit-hours of load-life testing as of Oct. 1, 1964.
- Meet MIL-R-26C requirements.
- 1½, 2¼, 3¼, 5, 6½, 9, 11-watt sizes.
- Get the whole story on this important development. Write for Bulletin 103.



SOAK IT IN SOLVENT! Soak a Series 99 resistor in any organic solvent used in degreasing and flux removal. Then try to rub off the markings. You can't; they're *part* of the coating.



ABRADE IT! Use a glass fiber eraser, for example, on the markings. Rub them hard. Nothing happens. The markings don't come off, because they are vitreous ceramic, *fired into* the molded vitreous coating.

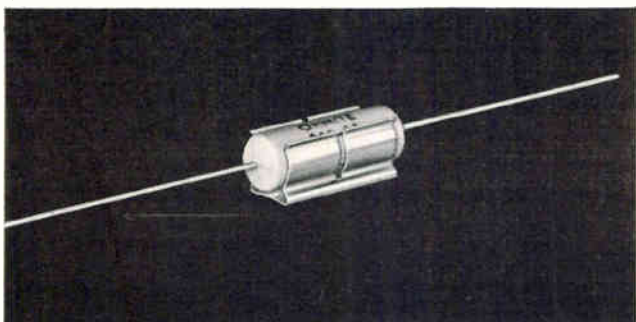

TORCH IT! Withstands temperatures of 1500°F without a sign of deformation. No other vitreous-enamelled resistor will stand 1500°F without burning, softening, or dripping away. There's absolutely no effect on markings either.



BEND THE LEAD at the resistor body! There's no damage. Conventional (dipped) vitreous-enamelled resistors have a meniscus at this point which ruptures, damaging the coating. Series 99 (molded) have no meniscus.

CLIP IT! Insert a molded Series 99 resistor into a metal clip. Don't baby it. The hard coating which provides 1000 VAC insulation won't cut, chip, or scratch. On a metal chassis, heat-sink action may increase wattage rating as much as 100%.



OHMITE

MANUFACTURING COMPANY
3610 Howard Street, Skokie, Illinois 60076
Phone (312) ORchard 5-2600

RHEOSTATS • POWER RESISTORS • PRECISION RESISTORS • VARIABLE TRANSFORMERS
TANTALUM CAPACITORS • TAP SWITCHES • RELAYS • R. F. CHOKES • SEMICONDUCTOR DIODES

and Texas. High-speed telemetry will be received from Bermuda and Texas, wide-band (40,800 bits of information per second) telemetry from Cape Kennedy and the eastern Texas range.

II. Data handling.

The communications processor will send out high-speed commands to the Cape, Bermuda and Texas.

Data coming into the communications processor will be in digital form and will be transformed to one of the four computers.

The computer will take the data, reduce it and extract meaning. It will then drive most of the display equipment. Some data, however, will be stripped from the telemetry ground station and converted from digital to analog form to drive meters in the staff support room. This data will bypass the computer processor and computers.

From the computer, data will go through an IBM 7281 into a digital tv distributor. From this unit, it will pass on to a digital tv converter. Here, data will be fed into a General Dynamics Corp. Charactron tube. A tv camera (945-line system) will pick up the display from this tube, and this will become one input into a large video switching matrix.

Information please. An optical window in the Charactron will permit reference slide information to be mixed with the electron-beam information and presented on the face of the tube.

A video switch matrix will permit flight controllers to switch their individual consoles to any of 70 inputs. The system is also capable of calling up background and reference slide information from the computer on demand.

An industry source connected with the project says the tv system being used is similar to systems used in theater television. It is a tv monitoring system that provides displays for the consoles, which are slaves.

The center should have all the computing equipment it will need. Only one of the four IBM 7094s will be used on a mission. Another will be standby or backup, while the remaining two will be used for mission simulation. All four, of course, would be available if needed on actual missions.

Manufacturing

Semiconductor handle

Leads that look like cantilever beams will make it easier to automate production and assembly of microcircuits

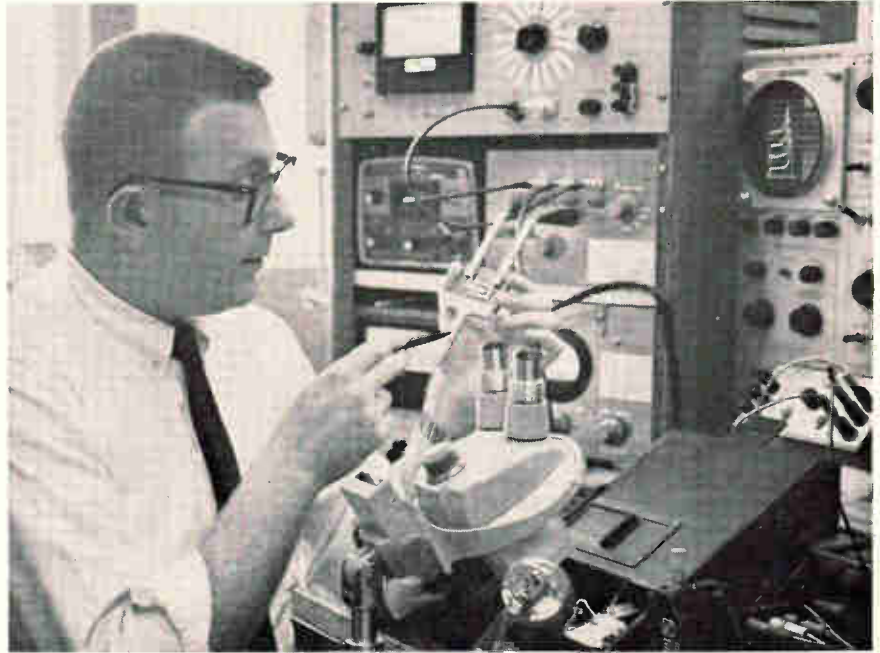

Model of a beam-leaded transistor, 300 times actual size, is shown by M. P. Lepselter, who devised the beam-lead technique.

The man who invented the lollipop and the man who invented the new beam-lead technique of connecting planar transistors, diodes and integrated circuits both found solutions to sticky problems.

Lollipop sticks solve the problem of goopy fingers. Beam leads—thick gold bars made as integral handles for tiny semiconductor-device chips—may solve a series of sticky production problems that have so far defied automation.

The design and potential uses of beam leads were disclosed by a Bell Telephone Laboratories, Inc., development team on Oct. 29 at the Electron Devices Meeting in Washington [Electronics, Nov. 2, 1964, p. 17]. Bell Labs is the research arm of the American Telephone & Telegraph Co.

The reports—by M.P. Lepselter, H.A. Waggner, R.W. MacDonald and R.E. Davis—were the hit of the meeting. The reports were applauded by a standing-room-only crowd of more than 400 people.

While the beam-lead concept appears simple, once seen, it is considered a basic advance. Reaction at the meeting indicated that it will soon be adopted by semiconductor manufacturers. Beam-lead devices are fully compatible with existing integrated-circuit technology and with the thin-film and multichip approaches to microcircuitry.

Electroforming the leads. Manufacturers won't have to overhaul their production lines to make and use beam-lead devices.

To make transistors and diodes, the masking, plating and etching stations required to convert a conventional planar device to a beam-lead device can be added to conventional processing lines.

The devices or circuits are made as usual in arrays on a slice of silicon. The beam leads are electroformed. Electroforming is a special form of plating [see Electronics, Sept. 11, 1959, p. 114].

A report on the specific techniques used at Bell Labs will not

be ready until next spring.

Bell Labs is using gold because it is readily plated and can be bonded or welded. And since the beams are large compared with the chip size, and flexible, the structure is surprisingly strong. Nickel could also be used.

Lepselter, the inventor, told the meeting that the gold leads are 10-micron-thick extensions of the thin-film electrodes generally used on planar devices. The gold is bonded to the substrate by a titanium and platinum interface.

Handles for the chips. After the beams are electroformed, the silicon slice is etched to remove the excess silicon between the devices. If the beam ends are stopped close to the device, the devices come out of the etching baths as individual devices with the beams extending beyond the edges of the chips like tiny cantilever beams.

To assemble the chips to header or thin-film circuits, the chips are turned upside down and the beam ends bonded to external conductors. The ends can be welded or thermocompression-bonded to thin-film conductors on a substrate, or to conductors on a header.

Chemical batch processes—plating and etching—have been substituted for three mechanical operations that normally require manual handling: scribing and dicing the slices to divide them into chips; brazing the chips to fasten them to headers, and bonding individual wire leads one at a time.

In addition, the beam-lead bond-

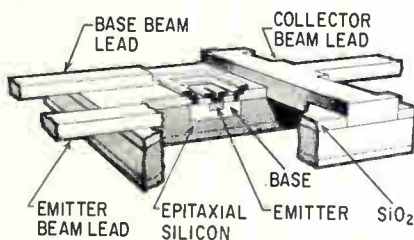
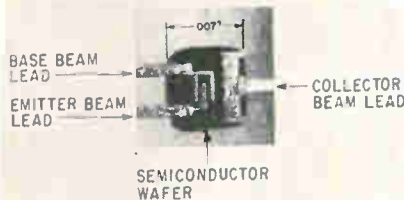

Electroformed leads are massive compared with the chips they connect to external conductors.

Dual readout— in-phase and quadrature voltage ratios —with high accuracy



CRB-8 complex ratio bridge for testing transformers, synchros, AC transducers, resolvers, tach-generators, amplifiers, and gyros.

This *Gertsch* bridge measures both in-phase and quadrature ratios of 3- and 4-terminal networks to an accuracy of .001% (10ppm). Voltage ratios are read from the *RatioTran** dials as rectangular coordinates ($R+jX$), or phase angle between signal and reference may be read directly in degrees.

Broad-band coverage—Instrument makes measurements at all frequencies from 350 to 5100 cps without using plug-in filters or networks. Completely self-contained, the CRB-8 requires no external calibration sources or detector.

Continuously tuned null amplifier drives the detector circuit so that minute values of off-null voltage can be detected without harmonics or noise. Extremely high signal input impedance minimizes loading of the device under test. Except for five tubes, instrument is designed with all solid state circuitry.

Other complex ratio bridges in the *Gertsch* line, available in both cabinet and rack-mounted types, include compact, fully transistorized units...militarized units designed to withstand severe environments, and a complex ratio bridge

which makes precision voltage and phase comparisons automatically, in less than 10 seconds.

For complete details and applications assistance, contact your nearest *Gertsch* representative or the address below, requesting Bulletin CRB.



Model CRB-6—militarized to withstand wide temperature extremes.



Model CRB-4RS—rack-mounted unit with connector for plugging in external oscilloscope.



THE SINGER COMPANY
METRICS DIVISION

3211 S. LA CIENEGA BOULEVARD, LOS ANGELES, CALIFORNIA • TELEPHONE (213) 870-2761 • TWX 213-836-0466

Design and production of PANORAMIC • SENSITIVE RESEARCH • EMPIRE • GERTSCH instruments for measurement

Acme  Electric
**CUSTOM-DESIGNED
 PERFORMANCE
 IN**

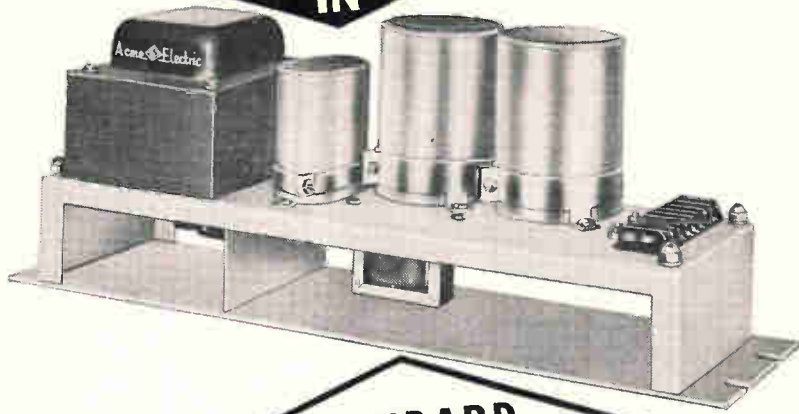

**STANDARD
 STOCK MODEL**

**REGULATED D. C. POWER SUPPLIES
 AT NO ADVANCE IN PRICE**

Acme Electric magnetically regulated power supplies were designed for industrial control and systems applications where high reliability of performance is of prime importance.

Simplicity of design, employing a minimum of components, avoids the possibility of failure present in more complex circuits. Components are conservatively rated for continuous duty at full output under conditions of industrial use.

All solid state components for stability and reliability. Convection cooled—no fan or other moving parts. May be paralleled in operation for multiplying current capacity. Fast response to line and load changes.

Regulation: Line: $\pm 1\%$ for $\pm 13\%$ line voltage change. Load: $\pm 2\%$ for any load change between $\frac{1}{2}$ load and full load. Ripple: 1% RMS maximum. Operating temperature range: 0°C. to 50°C.

**PARTIAL LISTING OF STOCK MODELS AVAILABLE
 SINGLE PHASE, 100-130 VOLTS; INPUT, 60 OR 50 CYCLES**

CATALOG NUMBER	D.C. OUTPUT			CATALOG NUMBER	D.C. OUTPUT		
	Volts	Amps	Watts		Volts	Amps	Watts
PS-47509	10	4	40	PS-47638	28	8	224
PS-47508	15	2	30	PS-47712	28	25	700
PS-41422	24	2	48	PS-41424	48	4	192
PS-41423	24	6	144	PS-47519	48	10	480
PS-47125	24	15	360	PS-47718	100	4	400
PS-47173	24	25	600	PS-41425	125	2	250
PS-1-47127	24	50	1200	PS-47457	125	6	750
PS-1-47461	24	75	1800	PS-41426	150	2	300
PS-1-47200	24	100	2400	PS-41427	200	1	200
PS-47202	26	4	104	PS-41428	250	1	250

Acme  Electric

Engineers and Builders of...

3111 WATER STREET, CUBA, NEW YORK
 Canadian Representative: Polygon Services, Ltd.
 50 Northline Rd., Toronto 16, Ont.

SAAS808-3119
 REGULATED POWER SUPPLIES
 STATIC POWER RECTIFIERS
 VOLTAGE STABILIZERS
 VOLTAGE REGULATORS

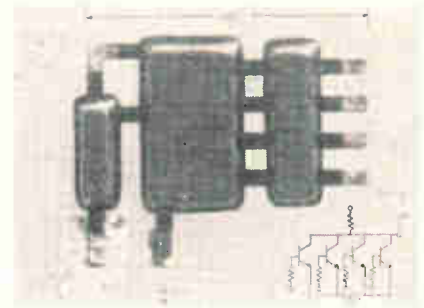

Isolith circuit bonded face down: Gaps between parts isolate the load resistor (left) from the four transistors (center) and the four input resistors (right).

ing process may be automated. Because lead locations are fixed during electroforming, bonding and welding machines can be set up to position the lead ends and bond or weld all the ends simultaneously.

Strings or arrays of devices can be made by electroforming continuous beams between devices. Testing and bonding machines might be further automated by feeding them such strips or arrays.

Isolith circuits. Bell Labs calls beam-leaded integrated circuits "Isoliths"—they are made like monolithic circuits, but isolated like multichip circuits.

Isolation is needed to eliminate parasitic capacitances that slow down logic circuits. Isolath circuits attain this isolation when the excess silicon between circuit parts is etched away. The beams bridge the gaps that provide isolation.

This technique makes it possible to use regular epitaxial silicon for circuits. The processing steps required to obtain high-resistivity silicon, diffusion of isolation regions, or deposition of polycrystalline silicon isolation are avoided.

In addition, beam ends can be shaped during electroforming—tapered to provide smooth impedance matches or flared to facilitate heat-sinking.

Reliability. Beam-leaded structures have withstood centrifugal force of 135,000 g, corrosion testing in wet salt at 360°C for 200 hours and 1,000 hours in steam at 360°C .

The use of beam leads also avoids the purple and black plagues—intermetallics that degrade or destroy performance. These contaminants can be formed when conventional gold-to-aluminum bonds are subjected to high temperature.



0010111010001011

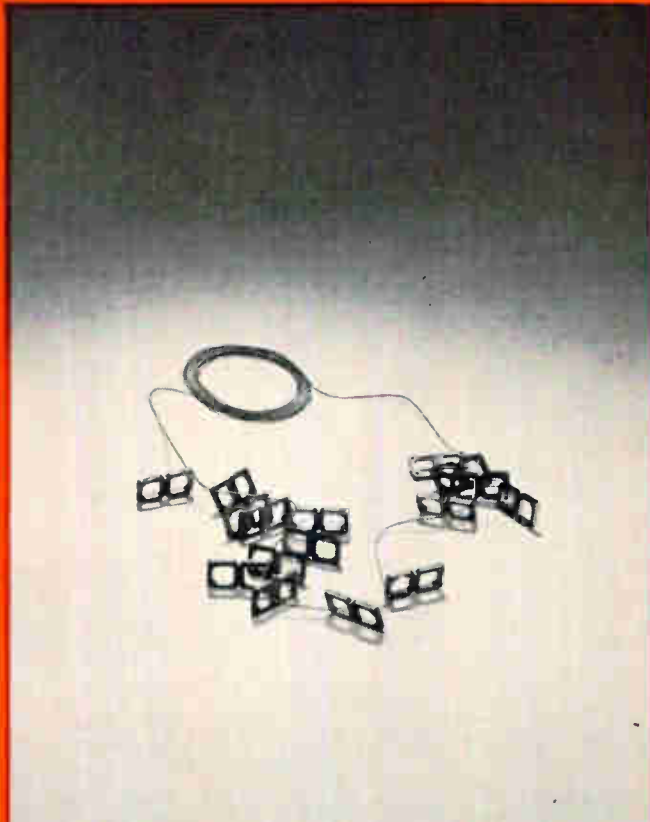

0010111010001011

Check the bits, the same, aren't they, but, does your **BINARY SEQUENCE DETECTOR** know this?

There is a mountain of difference between the ordinary binary sequence detector (left) that uses a whole pile of transistors, diodes, resistors and capacitors and the AMP MADNETIC* Binary Sequence Detector that just uses ferrite cores and wire. That's a *big* difference when you think of how one component failure or malfunction can affect a binary lock.

And that's only one of the big differences! Our Binary Sequence Detector offers others. For instance:

- No standby or non-operating power is required, even to retain *memory* of lock word.
- No shifting or chance of accidental alteration of lock word—it's wired in. ○ Checks for proper "key" by testing each sequence—can also be modified into a "word" detector. ○ Rejects simultaneous application of "1" and "0". ○ Operation assured over a temperature range of -50°C to $+75^{\circ}\text{C}$.

If you're dealing with electronic locks, command and control circuits, or segments of multiple event fixed time programmers, you'll want to get the different story on our Binary Sequence Detector. Our evaluation unit will do just that. Write today for further information.

Want to see what the difference really is? Then try our evaluation unit . . . a 16-bit Binary Sequence Detector complete with drivers . . . you jumper in your "lock" word . . . unit tests every sequence of 2^{16} combinations.

Here are the vital statistics:

AMP Part No.: 396978-1

Voltage Range: +24 V DC to +32 V DC

Temperature Range: -50°C to $+75^{\circ}\text{C}$

Average Current at 1 KC Bit Rate:

40 ma. maximum @ 28 V

Average Current at Rest: 0 ma. @ 28 V

Information Input: +5 V (minimum) for

5μ seconds into 1 K Ω load

Output Pulse: +5 V. for Correct Sequence

Signal-to-Noise Ratio \geq 15 to 1

Load Impedance 250 Ω minimum

*Trademark of AMP INCORPORATED



AMP* products and engineering assistance are available through subsidiary companies in: Australia • Canada • England • France • Holland • Italy • Japan • Mexico • West Germany

New Printed Circuit Process Announced by Photocircuits

Glen Cove, N.Y.—A completely new process for the manufacture of printed wiring boards has been announced by Photocircuits Corporation, Glen Cove, N. Y. and Anaheim, Calif., world's largest printed circuit manufacturer.

The patented process, known as "CC-4", is "additive" in that the desired circuit pattern is added to the bare insulating base rather than selectively etched from foil clad material. The CC-4 process, developed by the Photocircuits R&D laboratory, utilizes chemical deposition of ductile, fine-grained copper on non-conductive, catalytic adhesive inks which have been selectively applied to an insulating base. The deposited copper has excellent bond strength to the base insulator and is extremely solderable. The thickness of the copper can be suited to the application—as thin as .0001" or up to .060" or more. Research on CC-4 began in 1955 when Photocircuits saw a future need for a lower cost method of manufacturing printed circuits. Various additive processes such as die stamping, electroplating, powdered metal fusing, metal spraying and vacuum deposition were investigated but discarded because of high tool and set-up costs or poor electrical and mechanical characteristics.

The CC-4 process is compatible with artwork and tooling of conventional etched circuit boards, with costs substantially lower since the raw material used is unclad. In addition to cost savings, the new technique offers many advantages not possible with conventional printed wiring. Besides the commonly used base materials such as XXXP, G-10 and polyester glass mat, CC-4 copper circuitry has been applied to flexible films, ceramics, molded plastics and epoxy coated metals. Plated-through holes can be made at very little additional cost with the new process. One or two sided copper boards with plated holes provide low cost printed circuits for commercial applications that have superior solder joints and greatly improved repairability characteristics. Evaluations by large volume users of printed circuits have shown that the superior solderability of CC-4 copper compared to foil results in savings in board assembly.

For further information on the CC-4 process: Photocircuits Corporation in Glen Cove, N. Y. or Photocircuits of California in Anaheim.

First Announcement Made at National Electronics Conference

Announcement of the CC-4 process was made by Photocircuits in a technical paper and company exhibit at the National Electronics Conference in Chicago, Ill.

The paper was co-authored by Robert L. Swiggett, Executive Vice-President, and Frederick W. Schneble, Director of Research and Development. Mr. Swiggett is a member of the Board of Directors and is also a Past-President of the Institute of Printed Circuits.



Robert L. Swiggett

Frederick W. Schneble

CC-4 Process Offers Striking Cost Reductions

The new Photocircuits process resulted from research on substantial cost reduction in printed circuits. Robert L. Swiggett, Executive Vice-President of the firm, pointed out that this breakthrough in manufacturing technology can provide significant dollar savings. "The management of firms with captive printed circuit facilities must re-evaluate 'Make or Buy' decisions to be sure they are not investing in uncompetitive, obsolete techniques" he noted.

A substantial portion of the savings provided by Photocircuits' new process results from the elimination of the cost of applying copper foil to the base laminate. Typically, the difference in price between XXXP clad with one ounce copper and the same grade of material unclad is 22c-25c per square foot. Since raw materials and chemicals in the printed circuit process can run as high as 60-65% of the sales price in large quantity requirements, this difference is quite significant. With the CC-4 process, Photocircuits can produce the finished circuit patterns applied to insulating backing at a total cost equal to that paid for the raw material alone by users of older processes.

Wide Use Seen in Flexible Circuitry

Photocircuits is presently investigating the commercial application of the CC-4 process to the manufacture of flexible circuitry. Glass cloth has been impregnated with CC-4 ink and holes punched in the material. Application of a reverse mask to both sides and CC-4 copper deposition produces a flexible circuit with plated-through holes. The excellent bond strength of the adhesive and the plated-through holes solve a common problem associated with flexible circuits—lifting of terminal areas or destruction of the support material during soldering. Tests have shown CC-4 flexible circuits can be easily soldered and repaired.

CC-4 Licensees Include Western Electric, Grundig

Manufacturing information and patent licenses have been granted by Photocircuits on the new CC-4 process. In the United States, Western Electric Company has a licensed CC-4 facility in operation at Kearny, N. J. Facilities have been installed by several of Photocircuits' foreign licensees such as Ruwel, Fuba, Grundig and Telefunken in Germany and Lares in Italy. Other foreign licensees include Autophon in Switzerland, Cromtryck in Sweden and Mathias and Feddersen in Denmark.

AUGUST 27, 1962

Mariner II interplanetary probe launched from Cape Kennedy; successful midcourse correction of orbit brings it close to Venus.



Many of the outstanding achievements in science and technology during the past 10 years have been recorded, analyzed and preserved on tapes of "Mylar." When reliability counts, count on "Mylar." *Du Pont registered trademark for its polyester film.



BETTER THINGS FOR BETTER LIVING... THROUGH CHEMISTRY

SPLIT SCREEN STORAGE

WITH A TEKTRONIX OSCILLOSCOPE
(for stored or conventional displays)

FOR ONLY \$1035

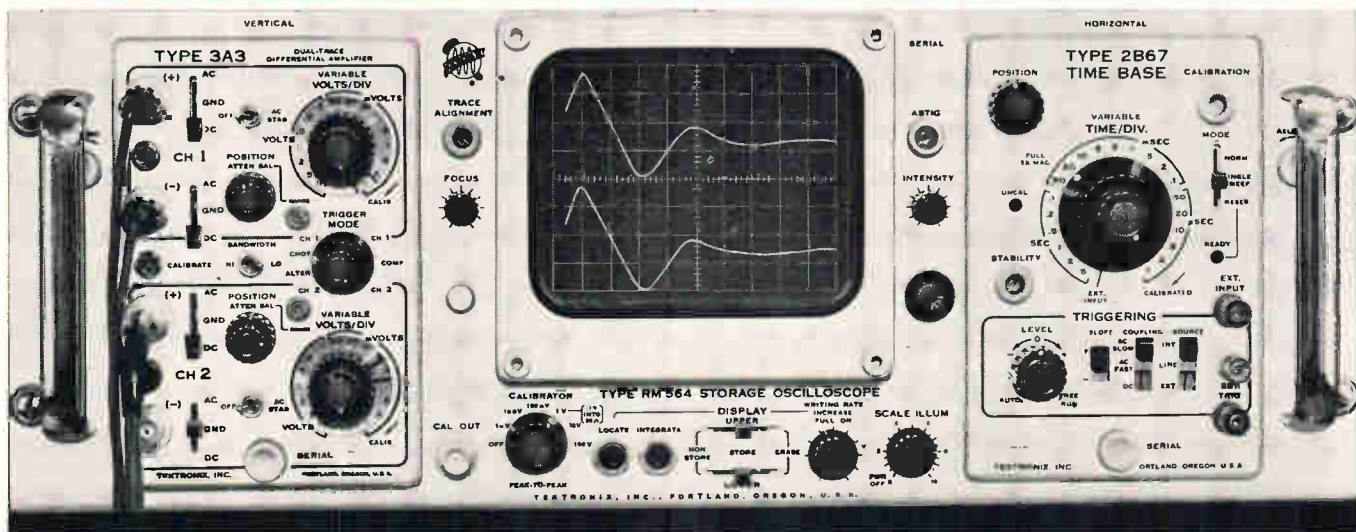

SAVES FILM, JUST STORE AND ANALYZE
ACCEPTS COMBINATIONS OF 17 PLUG-IN UNITS
SAVES SPACE, ONLY 7 INCHES RACK HEIGHT
OPERATES SIMPLY AND RELIABLY

Display shows ability of the Type RM564 to store single-shot events. Waveforms represent displacement of leaf springs due to imparted shocks given them during test. Split-Screen Facility—with independent storage and erase of upper and lower half of the crt—permits easy comparison of test waveforms to a reference display.

Type RM564 Storage Oscilloscope	\$1035
Type 2B67 Time-Base Unit	210
Type 3A3 Dual-Trace Differential Amplifier Unit	790
Cabinet Model also available	950

15 other plug-in units available—
Oscilloscope prices without plug-in units
U. S. Sales Prices f.o.b. Beaverton, Oregon

CALL YOUR FIELD ENGINEER FOR A DEMONSTRATION — 8-PAGE SPECIFICATION BOOKLET AVAILABLE

Tektronix, Inc.

P.O. BOX 500 • BEAVERTON, OREGON 97005 • Phone: (Area Code 503) Mitchell 4-0161 • Telex: 036-691
 TWX: 503-291-6805 • Cable: TEKTRONIX • OVERSEAS DISTRIBUTORS IN 25 COUNTRIES
 TEKTRONIX FIELD OFFICES in principal cities in United States. Consult Telephone Directory

Tektronix Australia Pty., Ltd., Melbourne; Sydney • Tektronix Canada Ltd., Montreal; Toronto
 Tektronix International A.G., Zug, Switzerland • Tektronix Ltd., Guernsey, C. I. • Tektronix U. K. Ltd., Harpenden, Herts



Compensator boosts transducer accuracy

Error correction by shaft-angle adjustment is simpler and often less expensive than electrical trimming

Accuracy of rotary electromechanical transducers and systems can be increased tenfold with an angle compensator based on a gearless differential mechanism. There are several applications for which the model 252R differential compensator is said to be ideally suited. These include compensating magnetic deviation errors in navigational systems; providing high-accuracy tracking between ganged oscillators, potentiometers or variable capacitors; improving over-all accuracy in servo systems and analog computers (where many different components contribute to total errors); linearizing precision gear trains; achieving high conformity in function generating potentiometers; and interpolating between the fixed angular positions of digital drive mechanisms.

Error correction is accomplished by adjusting the shaft position of the transducer until its output reaches the desired value. In effect, angular deviations introduced by the compensator are made exactly equal but opposite to the transducer's own errors. Careful com-

pensator adjustment, by means of 36 individually adjustable compensation screws spaced at equal intervals around the compensator's case, produces a profile of angular deviations matched to the transducer's errors over its full 360° rotational range.

Correction of errors by shaft-angle adjustment is simpler, less time consuming, and often less expensive than electrical methods for reducing transducer errors. For example, a single-turn potentiometer-plus-gear train can be made accurate to 0.005%. Comparable accuracy from electrical trimming, if feasible, would involve an array of hand-calibrated electrical networks and the cost would be high.

Model 252R compensator reduces angular errors in rotary mechanisms from $\pm 1^\circ$ to ± 1 minute of arc. (This is a correction of 60:1). Where a larger correction range is exchanged for a reduction in correction accuracy, a mechanism can be provided that reduces 10° errors to ± 12 minutes of arc. Angular compensation is provided for both directions of rotation. Max-

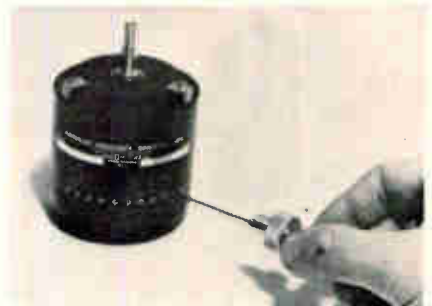

imum transmitted torque is 2 oz in. The compensator's input and output shafts can be located concentrically at one end, as shown in the accompanying sketch, or arranged in tandem at opposite ends. Over-all size of the instrument is 3-in. diameter by 2½ in. long.

Besides correcting for angular errors in rotary mechanisms, another compensator application is generating rotary nonlinearities. Used with a linearly calibrated potentiometer, for example, model 252R can place a tailor-made 10° bump anywhere along the track of a perfectly linear single-turn pot. The compensator's ease of adjustment enables the shape and position of the bump to be modified as the system's design parameters change. No special tooling at high initial investment is involved and the regular pot can be returned to other uses at the end of the test experiments.

Delivery for small quantities of model 252R is 8 to 10 weeks. Price depends upon shaft arrangements, mounting method, and compensation range.

American Aerospace Controls, Inc., 123 Milbar Blvd., Farmingdale, N.Y.
Circle 301 on reader service card

36 INDIVIDUALLY ADJUSTABLE SCREWS DEFINE PATH (LOCUS) OF ROLLER TRAVEL

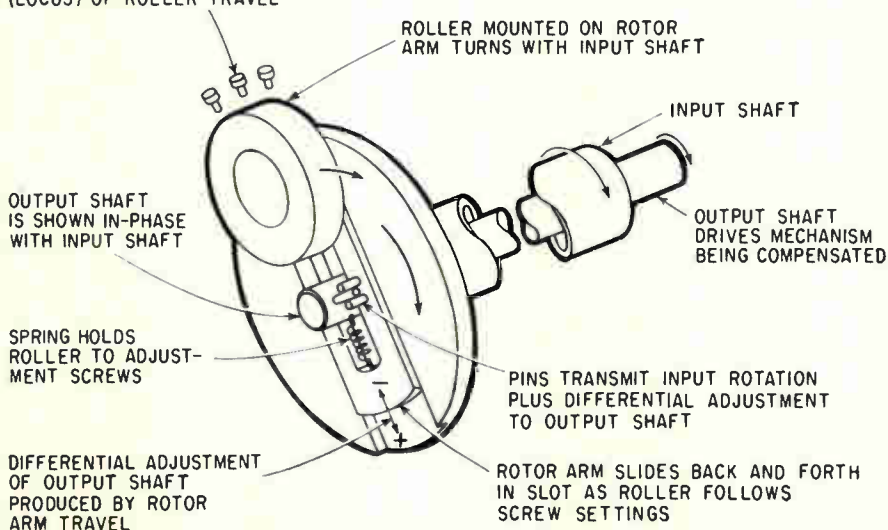

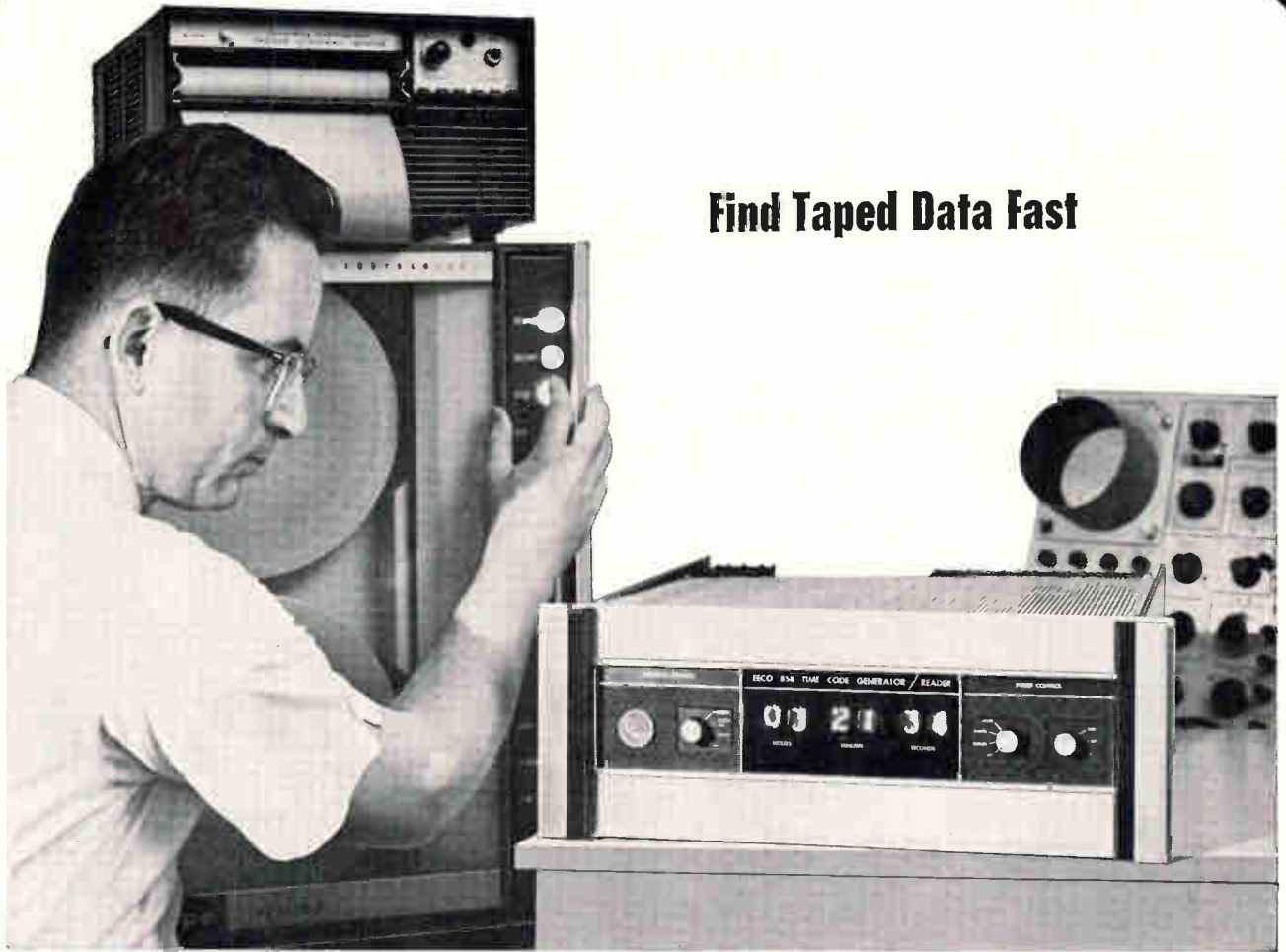

Find Taped Data Fast

Now you can time-reference magnetic tape and pinpoint data during playback with a single low-cost time code generator/reader

What is it? The EECO 858 is a combination unit—a time code generator and reader. It generates a modified IRIG code (Format B less days) for recording on mag tape with analog data. In reproduce mode, visually reads out hours, minutes, and seconds on high-visibility Nixie indicators over a wide dynamic range: from 1/20 to 200 times record speed. Reads in both directions. Lightweight, cool operating, compact, rack mount or bench unit. An add-on EECO 859 Automatic Search Unit converts the 858 into a complete automatic search system.

When do you need it? Whenever it is necessary to quickly reference or locate segments of analog data buried in long reels of mag tape. Makes any analog tape deck into a complete time marking and manual search system. Also assists visual analysis during playback by slowing down time code for recording on oscillographs or strip charts.

What does it cost? Hardly more than you'd pay for either function alone, assuming equivalent capabilities.

How to investigate? Write to Electronic Engineering Company of California, Box 58, Santa Ana, California, or Phone (714) 547-5501.

ELECTRONIC ENGINEERING COMPANY

of California
EE-3-72R



Power film resistor housed in aluminum



This housed power film resistor, claimed to be the industry's first, bridges the performance gap between conventional film resistors and housed power wirewound resistors. In some cases, circuit designers desiring to use the high stability, low reactance properties of metal film have been handicapped by the low power ranges available. In other cases, designers

using housed power wirewounds have been handicapped by their relatively narrow resistance range and low working voltage as contrasted with metal film. The new housed power film resistor, designed to overcome both these limitations, is designated as the D5. It is rated at 4 w in a resistance range of 50 ohms to 1 megohm. Standard temperature coefficients are ± 25 ppm/ $^{\circ}\text{C}$ and ± 50 ppm/ $^{\circ}\text{C}$ within an operating temperature range of -55°C to $+175^{\circ}\text{C}$. An upper resistance limit of 2 megohms can be obtained on special request. Standard tolerances are 0.1%, 0.2%, 0.5%, 1% and 2%. Functionally the D5 meets the physical specifications for MIL-R-18546C for housed resistors and the electrical specifications of MIL-R-10509E for film resistors. Its resistance element is molded into an aluminum housing which screw mounts on the chassis for maximum heat transfer.

Dale Electronics, Inc., P.O. Box 488, Columbus, Neb. [311]

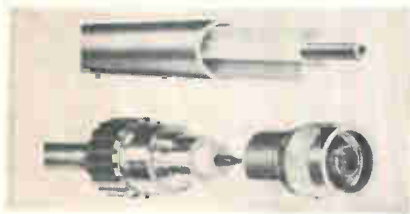

Air-dielectric coaxial cable

New five-spline Coaxitube is a semiflexible coaxial cable for low-loss r-f transmission. Characteristic impedance is 50 ohms. Five longitudinal splines of Teflon support the tubular center conductor within a seamless aluminum or copper tube. The resulting air-dielectric coaxial cable exhibits extremely low loss, virtually no r-f radiation, is light in weight and mechanically strong. A specially-designed adapter is available to permit termina-

tion of the cable in standard UG-series connectors.

Precision Tube Co., Inc., Church Road and Wissahickon Ave., North Wales, Pa. [312]

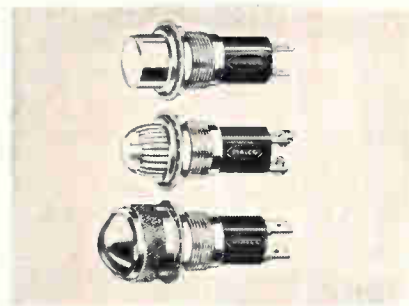

Indicator lights have built-in resistor

This series of indicator lights is designed to utilize the many advantages of the high-brightness neon glow lamp NE-51H. The

**One ZENER
replaces all**

One zener for six wattage ratings! Now just one miniature axial-leaded zener — Unitrode's general purpose, universal UZ type — replaces *all* devices for applications between 400 mw and 3 watts.

That means only one type of zener to buy, to work with, to stock, to test. You can even specify the test current you want, simply by changing a part number suffix. Yet these "in-plant" savings cost no compromise in performance. Operating characteristics are better at every wattage rating . . . in a device no bigger than:



For performance/profit proof, just turn the page.

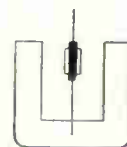

UNITRODE

Why Ticor II has a name instead of a number

Because it deserves it. Because it's the first and only recorder of its kind. Because of the simple fact that it can do what the others can't.

Record on any standard system, play it back on TICOR II.

Your data analysis will be a thousand times better. This is backed up by months of day-to-day operation in data labs since we put this system on the market last March.

With time displacement error held within $\pm 0.5 \mu\text{sec}$, TICOR II updates all your data reduction equipment. Write for specs. Ask for a demonstration.



Mincom Division **3M**
COMPANY

300 South Lewis Road, Camarillo, California



SPACE-SAVING MINIATURE EDGEWISE PANEL METER

new slim profile for 1½" edgewise meters...no barrel...easy stacking

International Instruments' new Model 1122 edgewise meter is completely flat, from scale to terminals. There's no back-of-panel barrel projection. Saves you precious space on the panel and behind it. You have complete freedom of component placement.

A new shielded movement makes possible unlimited stacking — side-by-side or one on top of another. The shielding eliminates magnetic interaction between meters and allows interchangeable installation on either magnetic or non-magnetic panels (with or without flange).

The new movement also gives you improved performance. Its single through-pivot provides better coil alignment. Torque-to-weight ratio is exceptionally high, too.

The compact Model 1122 is available in vertical- and horizontal-reading models. In 27 standard AC and DC voltage and current ranges.

If you have a tight-space problem or need comparative readout, have a look at our new data sheet. Just ask for Bulletin 385.

 **international
instruments inc.**
8703 Marsh Hill Road, Orange, Connecticut 06477
SA-3044

Circle 205 on reader service card

New Components

lamp may be operated at about three times the level of current that may be applied to other lamps of this type, according to the manufacturer, and it will produce eight times as much light, with long life. The lamp itself is very rugged, vibration-resistant and small (approximately 1¼ in. by ¾ in. overall). Very low power is required—less than 1 w on a 250-v circuit. Since neon lamps require a current-limiting (ballast) resistor, the required resistor is built-in—an integral part of Dialco assemblies in this series. The resistor itself is completely insulated in molded phenolic and sealed in metal. Its value for bright light on 110-120 v a-c circuits is 22,000 ohms. Other resistor values can be built in for direct connection of the indicator light to commercial circuits of 210-250 v a-c/d-c. Lights in the high-brightness series are available in 2 sizes—for mounting in 11/16 in. and 9/16 in. diameter panel clearance holes. Insulation of the socket shell is molded phenolic of military specification grade.

Dialight Corp., 60 Stewart Ave., Brooklyn, N.Y. 11237. [313]



Trimmer pot for solder-mounting

A new hermetic feed-through, sub-miniature trimming potentiometer is designed for solder-mounting. It

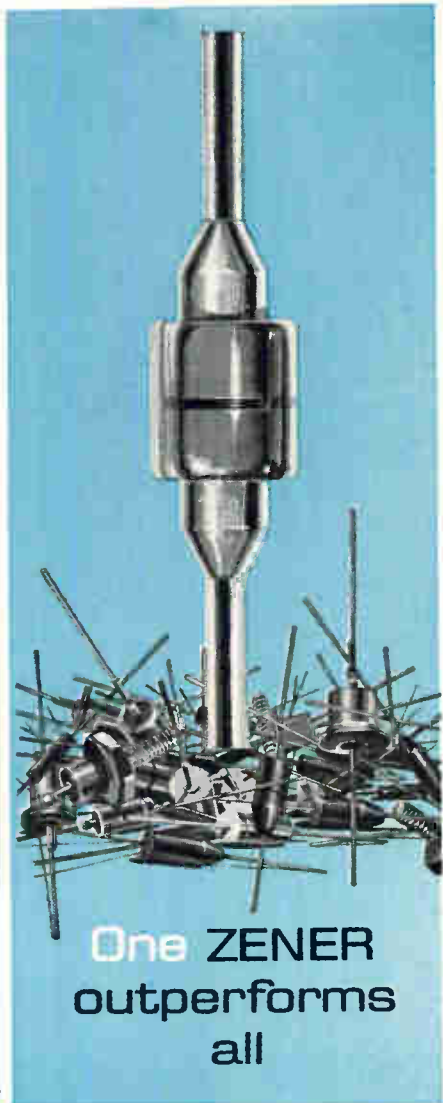

The only all-purpose zener — the Unitrode miniature universal UZ type — is also your one *best* zener for superior electrical characteristics. Operating at up to 3 watts, in ratings from 6.8 to 400 volts, Unitrode zeners are electrically "shock-proof" — withstand repeated 50-watt surges. Even so, they're smaller than 250-mw types — in fact, so big:

These remarkable properties result from unique whiskerless construction, with the junction fused in glass to maintain characteristics *permanently*, regardless of operating conditions.

Now, how much more do you pay for so much more performance in a single zener type? Turn the page again — you're in for a surprise!

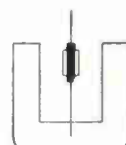

UNITRODE

Circle 123 on reader service card

125

**NOW! TRANSMIT LIGHT
IN FLEXIBLE CURVES...**

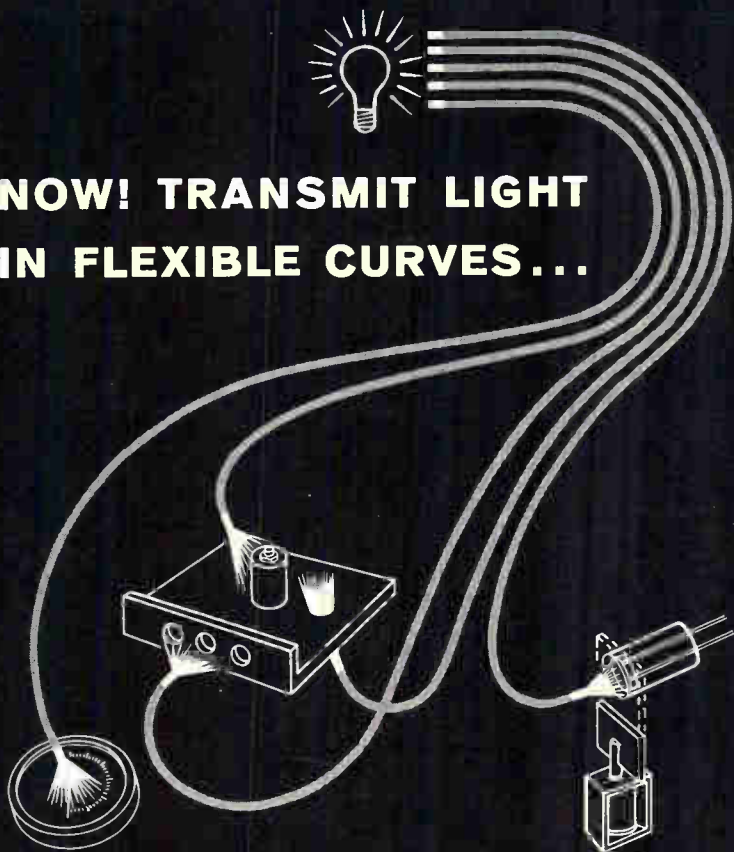

NEW Bausch & Lomb LIGHT WIRES

Your first low-cost source for production-run incoherent fiber optics! Out of the "high-priced, laboratory stage" . . . and into your hands to be designed and engineered into your products and systems as a practical economical tool. That's the big news from Bausch & Lomb, leaders in fiber optics research.*

Thin glass fibers, each about 15 microns in diameter, are made to transmit light by a process of total internal reflection. Each fiber is clad in a coating of lower refractive index than itself . . . bundles of these high optical quality fibers are clustered together into flexible "wires" . . . the ends are bonded, ground and polished . . . and you have Bausch & Lomb LIGHT WIRES! They can be specified by known parameters . . . and ordered by diameter and length . . . to fit your design problem.

LIGHT WIRES transmit light and light impulses efficiently around flexible curves and into inaccessible areas. As flexible as electrical wires, they can be bent and twisted around corners, harnessed together by butt-contact splicing and fed through conduits, to move light signals or illumination from one point to another. Applications in illuminating, signaling, monitoring, and actuating are virtually unlimited . . . where higher efficiency, reliability, space reduction, potential fire and explosion, lower cost, and inaccessibility are design problems.

Write for complete information Catalog D-2045, Bausch & Lomb Incorporated, 61411 Bausch Street, Rochester 2, New York.

Light Wires is a registered trademark

**Another Bausch & Lomb first in fiber optics . . . "The FLEXISCOPE" . . . a great new tool for production and quality control, which transmits images from inaccessible areas. Catalog D-2042 available on request.*

BAUSCH & LOMB



In Canada, write Bausch & Lomb Optical Co., Ltd., Dept. 614, Scientific Instrument Division, 16 Grosvenor St., Toronto 5, Canada

New Components

features glass-to-metal hermetic type terminals and an electro-tin-plated housing, ensuring true hermetic sealing of the equipment when solder-mounted. Known as Circuitrim 118, the units use simplified construction which eliminates the complex mechanical linkage normally used for adjustments. Standard resistance range is from 10 ohms to 50,000 ohms, with standard tolerance of $\pm 5\%$. Power rating is 1.0 w at 50°C, and the operating temperature range is -55°C to 150°C. Price is \$4.90 in quantities of 100.

International Resistance Co., 401 N. Broad St., Philadelphia, Pa. [314]

Relay coils offered in flat package

New Flat-Pac relay coils contain up to 6 magnetic reed switches. Designed to be more compatible with advanced packaging than round shapes, the new Flat-Pac coils are available with 3, 4, 5 or 6 Form A or Form C reeds (or various combinations with Form B). They are said to be ideal for encapsulation or direct tie-down to a printed-circuit board or chassis. Length of coil is 2 in., thickness is $\frac{3}{4}$ in., and

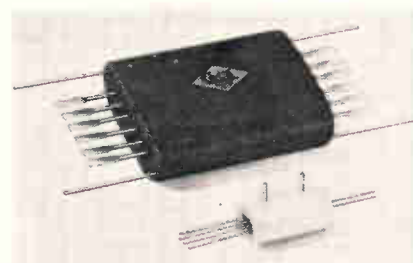

width varies from $1\frac{1}{8}$ in. (with 3 reeds) to $1\frac{3}{4}$ in. (with 6). Available from stock 12, 24, 32, 48 or 110 v d-c, $\frac{3}{4}$ in. No. 20 T/C wire leads are standard, with other terminations available as required. Also announced is a new dpdt miniature relay, containing 2 Form C reeds, operating as low as 96 mw. This unit measures only 0.375 in. by 0.500 in. by 0.800 in., and is shown with pin termination.

Coto-Coil Co., 61 Pavilion Ave., Providence, R.I. 02905. [315]

**Manufacturing
Quality Resistors
under Rigid
Reliability
Control**

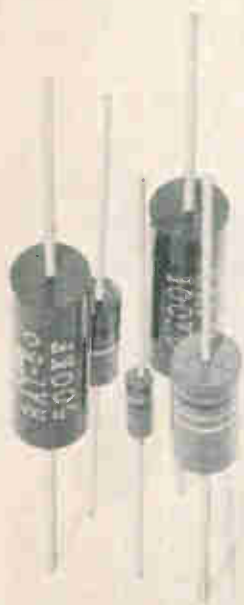

Rohm

METAL FILM RESISTOR
CARBON

**TOYO
ELECTRONICS
INDUSTRY
CORPORATION**

P. O. BOX 103 CENTRAL
KYOTO, JAPAN

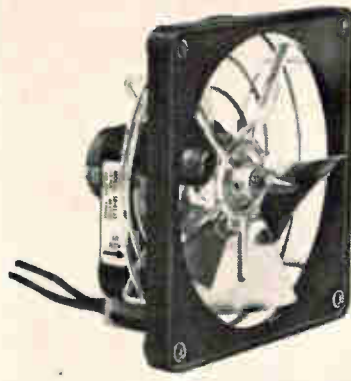

**Air-cooling unit
delivers 108 cfm**

Model SK-4125 fan has been designed for electronic and instrumentation cooling in tight space requirements. It carries a guarantee of 5 years at 125°F maximum and clean atmosphere based upon engineering review and approval of application, according to the manufacturer. Air output is 108 cfm. The motor, 5-bladed aluminum fan, steel plated grille and high-impact phenolic front housing are integrated to form a complete and efficient air-cooling unit. It mounts on 4 1/8 in. square. The maintenance-free, UL-approved motor has permanent sealed-in lubrication, operates at an extremely low noise level and may be mounted on any plane.

Ripley Co. Inc., Middletown, Conn.
[316]

**Ceramic-metal tetrode
withstands environment**

A ceramic-metal, external anode tetrode has been introduced for use in low-duty pulse applications. The



Now you pay less for *all* the zeners you need! Ordering just one type — Ultra-reliable Unitrode Universal UZ zeners — for all your requirements between 400 mw and 3 watts, you profit from volume price reductions. What's more, for even greater quantity discounts, you can combine voltages . . . even place blanket orders with deliveries scheduled over 12 months!

These price advantages guarantee you *direct savings*, plus the operating economies you gain using the only zener offering unmatched characteristics — fused permanently in glass — in a unit this small:

One all-purpose type, a generation ahead in design, yet actually at lower cost . . . Shouldn't this triple-threat zener be working for you? Contact Unitrode Corporation, 580 Pleasant St., Watertown, Mass. 02172. Tel: (617) 926-0404, TWX: (617) 924-5857.

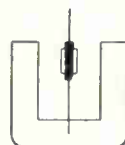

UNITRODE

NEW LOW PRICED

BEATTIE-COLEMAN OSCILLOTRON

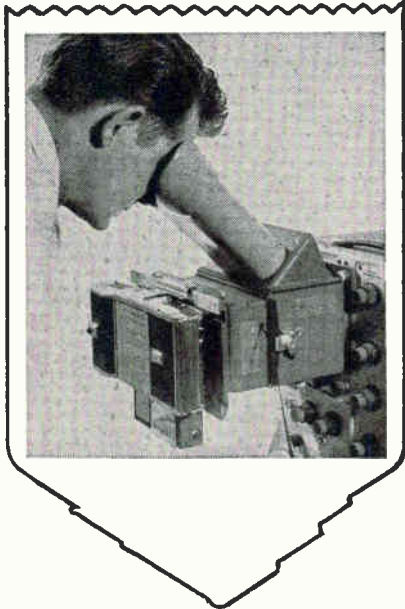

POLAROID® PRINTS IN 10 SECONDS

It's new! It's efficient! It's versatile! It's the Beattie-Coleman K5 Oscilloscope Camera.

- Direct view while recording.
- Single traces at 1:0.9 ratio or 13 traces at 1:0.7 on one frame of Polaroid Land film.
- Choice of Polaroid roll film back or 4x5 back for Polaroid or regular cut film holders.
- Uses Polaroid Land 10,000 speed film.
- f/1.9 Oscillo-Raptar lens.

\$395 complete

ACCESSORIES:

- Electric shutter actuator.
- Data recording chamber.

Circle number on card for info. on full Oscilloscope line.

"Polaroid"® by Polaroid Corp.



1004 N. Olive St., Anaheim, Calif. • PR 4-4503

128 Circle 128 on reader service card

New Components

4CN15A is designed for severe environmental applications employing frequencies up to 500 Mc in Class C, r-f power amplifier or oscillator, plate modulated r-f amplifier, and Class AB1, r-f linear power amplifier-single sideband applications. It is less than 2½ in. high, and 1 in. in diameter. Weight is 2½ oz. When air-cooled the new tetrode has a plate dissipation of 15 w but this can be increased by the use of a heat sink or a liquid coolant. The 4CN15A is priced at \$41 in lots of 5 or more.

Raytheon Co., Industrial Components Division, 55 Chapel St., Newton 58, Mass. [317]

Magnetic reed relay in miniature size

A new spdt, sensitive magnetic reed relay is only 0.90 in. long by 0.375 in. in diameter (not including leads). It is available with 6, 12, or 24-v coils, and has a contact rating of 3 w or 0.250 amp; maximum resistance is provided. The contacts are hermetically sealed in glass and are true break before make. No magnetic bias is required. Relays can be supplied with preformed leads for p-c board mounting. Magnetic shielding is available if required. Delivery is 4 to 6 weeks after receipt of order.

Win-Elco, 799 Main St., P.O. Box 65, Half Moon Bay, San Mateo, County, Calif. [318]

New ten-turn pots for industrial use

Two new, low-cost, 10-turn potentiometers are priced for industrial applications. Both units feature precious metal contacts, gold-plated



terminals and low-temperature-coefficient resistance elements. In addition, the diallyl phthalate housing material is non-hygroscopic and therefore dimensionally stable. Model 162, a ½-in. unit, is available in standard resistance ranges from 100 ohms to 50,000 ohms with a standard linearity of ±0.3%. Power rating is 2 w at 40°C and operating temperature is -55°C to +125°C. Price in unit quantity is \$10 each. Model 530, a ⅞-in. unit, is available in standard resistance ranges from 500 ohms to 100,000 ohms with a standard linearity of ±0.25%. Power rating is 3 w at 40°C and operating temperature is -55°C to +105°C. Price in unit quantity is \$7 each.

Spectrol Electronics Corp., 1704 South Del Mar Ave., San Gabriel, Calif. [319]

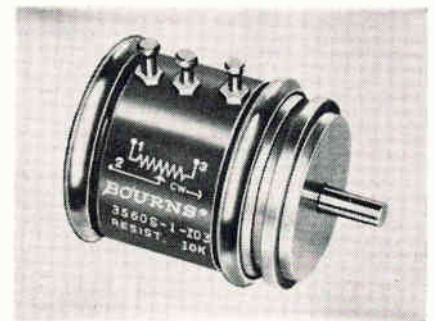

Three-turn pot resists humidity

A three-turn, servo-mount pot has been announced that measures ⅞ in. in diameter. Model 3560 is housed in an all-plastic, moisture-resistant case to meet the humidity cycling requirements of MIL-R-12934C. The manufacturer's Silver-weld termination eliminates the chief cause of precision pot failure. Ganging is available up to 8 cups. Specifications include: standard resistance range, 25 to 100,000 ohms; resistance tolerance, ±3%; resolution, 0.15 to 0.031%; linearity, ±0.25%; power rating, 1.5 w at 70°C; operating temperature range, -65 to +125°C; weight, 1.0 oz; price, \$17 in quantities of 100 pieces.

Bourns, Inc., 1200 Columbia Ave., Riverside, Calif. [320]

Electronics | November 16, 1964

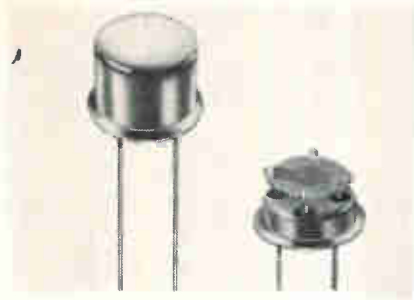

H-f quartz crystal comes in a TO-5 case

A new series of low aging crystals offer precision frequency control from 10 to 125 Mc in a TO-5 transistor case. The Koldweld sealing process assures a heatless, contamination-free seal for better aging characteristics and longer life. Frequency tolerance is $\pm 0.001\%$ at a specified oven temperature, $\pm 0.005\%$ from -55°C to 105°C with tighter tolerances available on request. Short-term stability is 5×10^{-8} per day after aging. Crystals will withstand 50 g shock and 10 g, 10 to 2,000 cps vibration.

Monitor Products Co., Inc., 815 Fremont Ave., South Pasadena, Calif. [321]

Ceramic r-f coils for printed circuits

A line of printed-circuit, ceramic adjustable r-f coils range from 0.1 μ henry to 1 millihenry. Excellent performance characteristics over the range of -55 to $+85^{\circ}\text{C}$ com-



bined with the space-saving ceramic form provide a high degree of stability for p-c board applications. Available for both horizontal and vertical mounting, the series 46A and 47A coils are furnished with standard p-c board terminals. Price is as low as 53 cents in production quantities.

J. W. Miller Co., 5917 South Main St., Los Angeles, Calif. 90003. [322]

Override transient power losses

WITH GENERAL ELECTRIC MOTOR-GENERATOR SETS

When equipment must receive steady, reliable AC power, G-E electric motor-generator power supplies will give you the line isolation capabilities static power supplies cannot. Their simple, brushless design includes no "wear-out" components. General Electric motor-generator sets use their own inertia to ride over transient power losses, line voltage fluctuations and wave shape distortions. Their inherently low MTBF (mean-time-between-failure) has already been proved in missile applications. Choose from 7 different motor-generator types. Ask your G-E sales engineer for bulletin GEA-7175, or write to Section 865-03, General Electric Co., Schenectady, N. Y. 12305

GENERAL  **ELECTRIC**

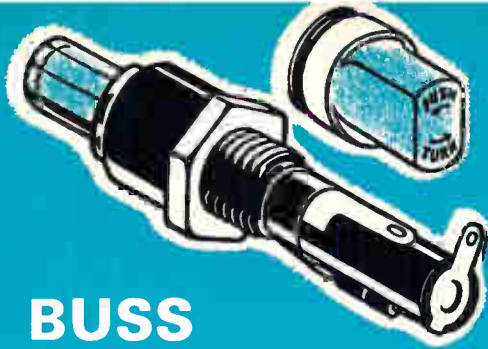

FLATSIDED
KNOB ALSO
AVAILABLE

BUSS FUSEHOLDERS

LAMP INDICATING SERIES HJ AND HK
FOR $\frac{1}{4}$ x 1 AND $\frac{1}{4}$ x $1\frac{1}{4}$ INCH FUSES

Quick, positive, visual identification of faulted circuit. Bayonet type, *transparent* knob permits indicating light to be readily seen.

Fuseholder designed to withstand severe vibration. Terminals held mechanically as well as by solder.

Holder can be used in panels up to 3/16 inches thick.

BUSS

Write for BUSS
Bulletin SFB

BUSSMANN MFG. DIVISION, McGraw-Edison Co., St. Louis, Mo. 63107

Circle 131 on reader service card

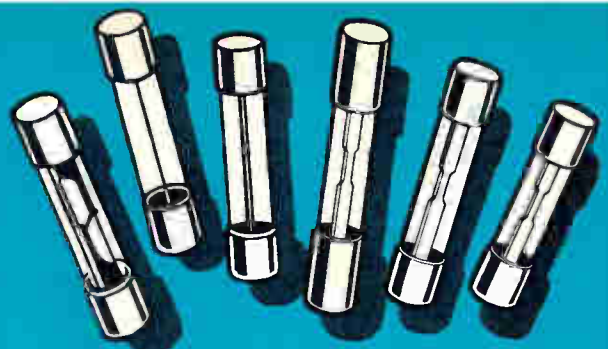

BUSS *quick-acting* Fuses

"Fast Acting" fuses for protection of sensitive instruments or delicate apparatus;—or normal acting fuses for protection where circuit is not subject to starting currents or surges.

BUSS

Write for BUSS
Bulletin SFB

BUSSMANN MFG. DIVISION, McGraw-Edison Co., St. Louis, Mo. 63107

Circle 131 on reader service card

BUSS: 1914-1964, Fifty years of Pioneering

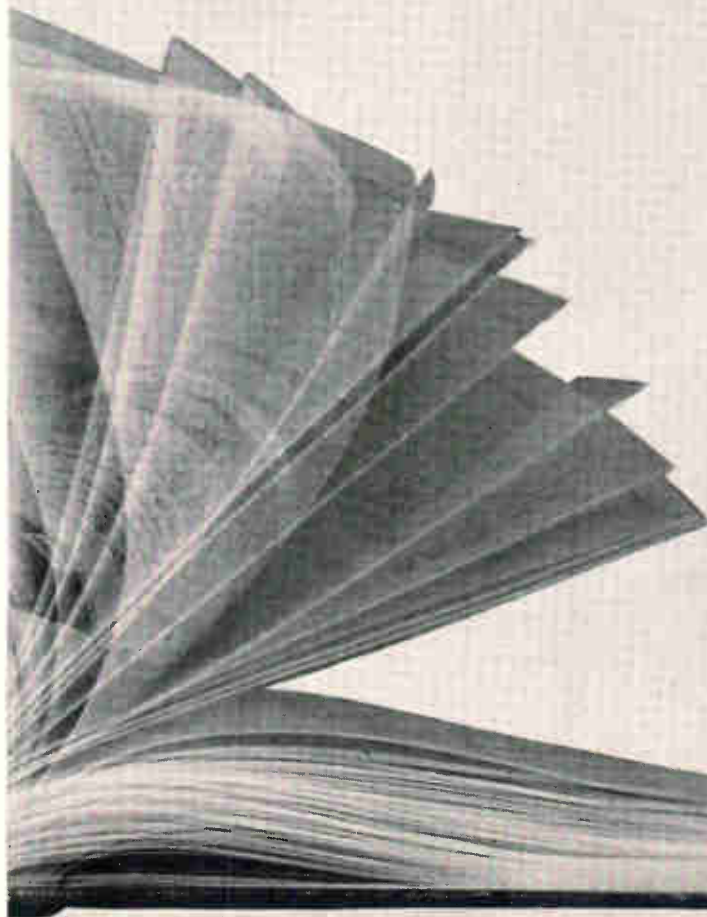

Find the manufacturer... Fast!

It's just a matter of seconds to get the valuable information you need about electronic manufacturers and suppliers in the Electronics Buyers' Guide. The EBG has over 200 pages listing the names, addresses, phone numbers and key individuals of manufacturers of electronics equipment, related components and materials. All this plus vital company statistics. At a glance you know important facts about the company, exactly what each company makes, and where to find the manufacturers' representatives in your area. No wonder the EBG is the industry's standard catalog-directory!

Electronics Buyers' Guide

A McGraw-Hill Publication

330 West 42nd Street, New York, N. Y. 10036

New Instruments

Comparator provides two reference traces

A solid-state, three-switch comparator has been developed to improve sweep frequency measurement techniques. According to the manufacturer, model TC-3 can substantially improve the efficiency of production line testing operations. It provides not one but two reference tracks with which the unit under test is compared, thus pro-

viding an instant go/no-go scope display. At the same time, the TC-3 is considered very useful for highly accurate laboratory measurements. The comparator covers the entire frequency spectrum between 0 and 1200 Mc. An unusual feature of the TC-3 is that the switches themselves can be snapped out and moved closer to the unit under test. This enables the engineer to use shorter test leads, resulting in greater accuracy, the company says.

The units can be internally or externally driven. Isolation is high, and insertion loss is exceptionally low. While it is designed for 50 ohm operation, plug-in heads make the TC-3 easily adaptable to other impedances.

Jerrold Electronics Corp., 15th and Lehigh Ave., Philadelphia 32, Pa. [351]



Pressure transducer for aerospace use

A small and reliable strain-gage pressure transducer, model FG-100, is designed to meet the high quality standards required in aerospace applications. The stress-carrying diaphragm is an integral part of the transducer body, eliminating the use of O-rings and all sealing

..New Developments in Electrical Protection



SIGNAL
ACTIVATING
•
LAMP
INDICATING
•
SERIES
HKA

BUSS FUSEHOLDERS

FOR $\frac{1}{4}$ x $1\frac{1}{4}$ INCH BUSS GLD FUSES, $\frac{1}{2}$ TO 5 AMPS.

When fuse opens, indicating pin completes a circuit that lights indicating lamp in holder and makes contact on external signal circuit. External signal can be an audible alarm or another lamp mounted at a distance, or it can operate a relay.

BUSS

Write for BUSS
Bulletin SFB

RUSSMANN MFG. DIVISION, McGraw-Hill Co., St. Louis, Mo. 63107

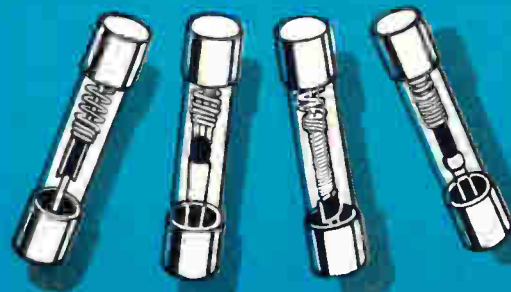

FUSETRON dual-element Fuses

time-delay type

"Slow blowing" fuses that prevent needless outages by not opening on motor starting currents or other harmless overloads—yet provide safe protection against short-circuits or dangerous overloads.

BUSS

Write for BUSS
Bulletin SFB

RUSSMANN MFG. DIVISION, McGraw-Hill Co., St. Louis, Mo. 63107

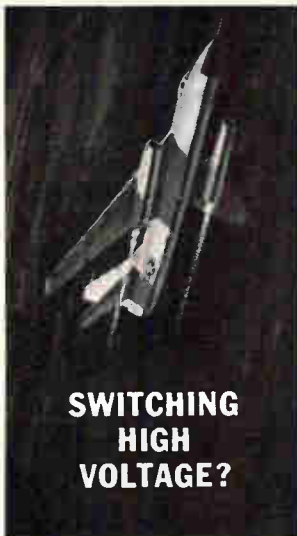

**SWITCHING
HIGH
VOLTAGE?**

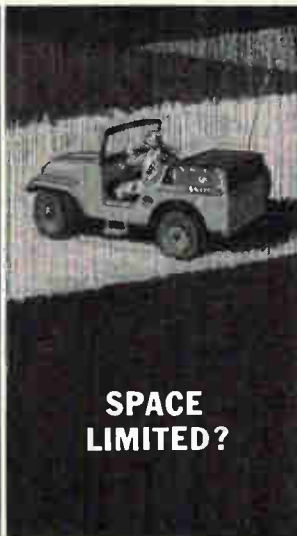

**SPACE
LIMITED?**



**FAST
ACTION
DESIRABLE?**





The Solution Is Jennings Vacuum Relays

Here's why. High strength vacuum dielectric requires only minimal contact separation to withstand high voltage. Consequently vacuum relays can be made extremely small and will operate at high speed. Further, the absence of oxides and contaminants insures low, stable contact resistance for utmost reliability. In addition many of these relays are specially designed for superior performance in high shock and vibration environments or at high altitudes.

Jennings vacuum relays have already

proved their worth in such applications as airborne, mobile, or marine communications systems for antenna switching, switching between antenna couplers, tap changing on RF coils, switching between transmitter and receiver, pulse forming networks, and heavy duty three phase switching in radar power supplies.

Illustrated are only a few of the many Jennings vacuum transfer relays available to solve your specialized applications. More detailed catalog literature is available on request.

	<p>TYPE RJ1A Operating voltage (16 mc) 2 kv pk Continuous current (16 mc) 7 amps rms Length 1 3/8" Weight 1 oz.</p>
	<p>TYPE RA24A Contact arrangement 3 PST (three phase) Operating voltage 115 v (60-400 cps) Continuous current Up to 120 amps rms each phase Interrupting rating 1000 amps rms Length 5 1/16"</p>
	<p>TYPE RB1R Test voltage (60 cycle) 18 kv pk Continuous current (60 cycle) 15 amps rms Operate time 3 milliseconds max. Length 2 1/2" max.</p>
	<p>TYPE RE6B Test voltage (60 cycle) 30 kv pk Rated operating voltage (16 mc) 15 kv pk Continuous current 9 amps rms DC interrupting rating 25 kw (not to exceed 5 amps or 10 kv)</p>

RELIABILITY MEANS VACUUM | VACUUM MEANS

Jennings[®]

JENNINGS RADIO MFG. CORP., 970 McLAUGHLIN AVE., SAN JOSE 8, CALIF., PHONE CVpress 2-4025

New Instruments

and reliability problems associated with their applications. Accuracy is better than 0.25% of the full scale output. Output levels are from 3 mv per v to 50 mv per v unamplified. The units are temperature compensated from cryogenic temperatures to 600°F. Model FG-100 weighs 3 oz., measures 1.5 in. high by 1.00 in. in diameter, and is constructed of all stainless steel. It also features infinite resolution, and a-c and d-c response.

F&F Engineering, Inc., Maple Shade Industrial Center, Maple Shade, N.J. 08052 [352]



Differential-input digital multimeter

An integrating digital multimeter, model 630 provides a four-in-one advantage of measuring d-c volts, frequency, period and time interval from a single instrument. True differential input, which is floated and guarded throughout, literally eliminates problems due to noisy signals. On its most sensitive d-c range, the model 630 can resolve 1 μ v while providing full five-digit measurements. The problems of false-polarity indication, insensitivity near zero, and zero foldover error are not present in the instrument. Frequency measurements extend from 10 cps to 1 Mc. Price is \$3,295.

Electro Instruments, Inc., 8611 Balboa Ave., San Diego 12, Calif. [353]

Delay line uses trombone setter

Picosecond delays, half and quarter wavelengths, and uhf/vhf signal phase can now be directly dialed with a trombone setter to realize more accuracy and save time. Reso-



lution of 0.2 mm ($\frac{2}{3}$ picosec) and range of 44 cm (1.4 nsec) are provided for high-speed digital circuit testing, propagation delay measurement, sampling scope sweep calibration, coincidence gating, nuclear instrumentation, uhf/vhf impedance/admittance measurement and array phasing. Permanent, no-parallax calibration eliminates indirect or improvised calibration and setting procedures. The precision drive has negligible backlash. Bishop Instrument Co., 3 Grumman Ave., Wilton, Conn. [354]

Solid-state indicator shows field strength

A new uhf field strength indicator has a range of 27 to 100 db above 1 $\mu\text{V}/\text{meter}$. The emphasis is on compact design and portability, nevertheless its accuracy of ± 6 db is more than adequate for most practical applications, in particular for contour mapping and propagation measurements. Type HUZU consists of an all-transistor receiver and a log-periodic broadband antenna connected by an r-f cable of 120-cm length. The antenna is attached to the receiver during the measurement and can be adjusted in any direction or polarization plane. It is operated from built-in



Ballantine Sensitive DC/Volt/Ammeter

Model 365

Price: \$650

Extremely Wide
Voltage and
Current Range

Unmatched Accuracy
for all Indications

Built-in Calibration
Standard



Measures 1 μV to 1,000 V dc 0.001 μA to 1 A dc

Now you can measure with unmatched accuracy dc voltages with an extremely wide range of 1 μV to 1 kV and currents from 0.001 μA to 1 A.

Ballantine's Model 365 Sensitive DC Volt/Ammeter, an analog indicator with a single logarithmic scale and range selector, measures voltages above 1 mV with a constant accuracy of 1% of indication. It measures currents above 0.1 μA with an accuracy of 2% of indication.

The Model 365's accuracy is supported by a high order of stability gained by ac and dc feedback techniques and conservative operation of all components. If you need further assurance of accuracy, a reliable internal standard is available to check its calibration, which can be switched on in a second.

Signal-ground isolation of the Model 365 allows floating measurements to 500 volts above panel ground, and ac rejection is provided to reduce the effects of common-mode signals.

PARTIAL SPECIFICATIONS

Voltage	1 μV — 1 kV	Current	1 nA — 1 A
Accuracy	1% of indication above 1 mV	Accuracy	2% of indication above 0.1 μA
Impedance	1 M Ω above 1 μV ; 5 M Ω above 0.1 mV; 10 M Ω above 0.1 V	Impedance	< 10 k Ω above 1 nA; < 100 Ω above 10 μA ; < 1 Ω above 10 mA
Impedance Between Signal and Panel Grounds: R > 100 M Ω , C = 0.1 μF , 500 V Peak Max			
Usable as DC Amplifier: 100 db max gain, 0.1 to 1 V output for each decade input range			

Member Scientific Apparatus Makers Association



— Since 1932 —

BALLANTINE LABORATORIES INC.
Boonton, New Jersey

CHECK WITH BALLANTINE FIRST FOR LABORATORY VACUUM TUBE VOLTMETERS, REGARDLESS OF YOUR REQUIREMENTS FOR AMPLITUDE, FREQUENCY, OR WAVEFORM. WE HAVE A LARGE LINE, WITH ADDITIONS EACH YEAR. ALSO AC/DC LINEAR CONVERTERS, CALIBRATORS, WIDE BAND AMPLIFIERS, DIRECT-READING CAPACITANCE METERS, AND A LINE OF LABORATORY VOLTAGE STANDARDS 0 TO 1,000 MC.

TRYLON ROTATABLE LOG PERIODIC ANTENNA

Single-layer, horizontally polarized,
for 6.5 to 32 mc. 65° azimuth beamwidth.
6 db gain/std. dipole. Power to 50 kw PEP.

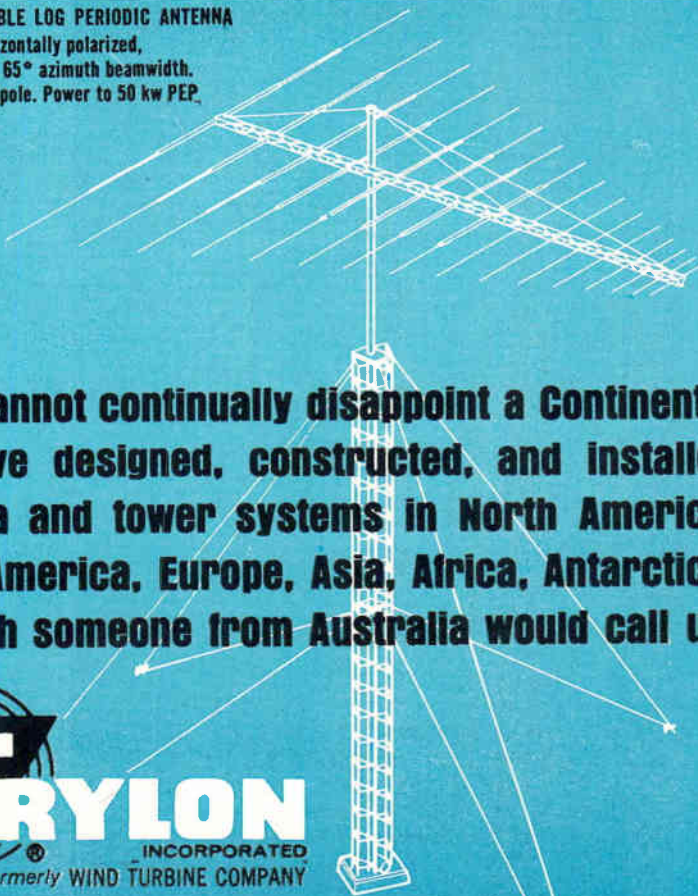

**“One cannot continually disappoint a Continent.”
We have designed, constructed, and installed
antenna and tower systems in North America,
South America, Europe, Asia, Africa, Antarctica.
We wish someone from Australia would call us.**



Elverson, Pa. 19520 (215) 942-2981 — International Division, 750 Third Ave., New York, N.Y. 10017, U.S.A.

Circle 134 on reader service card

N I M S

NATIONWIDE IMPROVED MAIL SERVICE PROGRAM

For Better Service

Your Post Office

Suggests

That You Mail Early In The Day!

New Instruments

sealed storage batteries. Applications include determining the propagation conditions for tv signals, measuring unwanted radiations, polarization and gain of antennas and determining the radiation patterns of transmitting antennas. The instrument can also be used as a selective microvolt meter. Price is \$2,670.

Rohde & Schwarz Sales Co., Inc., 111
Lexington Ave., Passaic, N.J. [355]



Ultrasonic generator for the researcher

This multipurpose, high frequency ultrasonic generator is expected to provide an answer to a multitude of processing problems currently faced in production and research laboratories. Type 250FF Multisons generator essentially comprises a light weight power generator (17 by 9½ by 11 in.) which drives a submersible transducer excited around 800 kc. The unit is equipped with variable output control, 0 up to 80 w. When used as a submicronic aerosol generator, the 250FF can disperse up to 750 cc/hr of a water-like solution (average particles diameter 0.4 to 0.7 micron). Accelerations up to one-half million times greater than gravity are observed in the axial highly directive beam. It is said that the unit brings a new dimension in sonic processing since the accelerations and strong internal turbulence can result in molecules bond breakage, cell disruption or destruction, emulsification, polymerization crystallization effects, catalysts activation, oxidation, accelerated diffusion phenomena and submicronic aerosolization. The new tool makes available many new possibilities

for the researcher. In the past he has been limited mainly to low-frequency experimentation (10 to 100 kc) according to the manufacturer.

Macrosonics Corp., 1001 Roosevelt Ave., Carteret, N.J. [356]

High-reliability strip-chart recorder

This strip-chart potentiometric recorder, Servo/Riter II, features an all-transistor amplifier, nonmechanical photoconductive chopper and infinite resolution slide wire. The amplifier and servo system are said to provide performance characteristics not usually found in conventional instruments. Exceptional small signal resolution is obtained with $\frac{1}{4}\%$ accuracy — detecting changes of 0.1% of full scale. Dead-band is almost nonexistent—less than $\frac{1}{10}\%$. Pen speeds from 0.4 to 24 sec are available. Dynamic frequency response is 5 cps at 10% of full scale. External circuit resistance rating is specified at 25,000 ohms. Longitudinal a-c interference rejection is 100 db minimum. Quality materials and components are selected for Servo/Riter to provide longer life and reliability, according to the manufacturer. The solid-state amplifier utilizes p-c board construction. Bearing and wear surfaces use long-life, quiet-running acetal plastic. The slidewire has infinite resolution and needs only to have the contacts changed after millions of cycles. Rugged die castings provide closer tolerance, better fitting assemblies. Basic price of a single-channel, wide-chart, flush-mounting d-c potentiometer is \$840.

Texas Instruments Inc., Industrial Products Group, P.O. Box 66027, Houston, Texas 77006. [357]

Controllable output pulse generator

This solid-state pulse generator features completely controllable output pulses over a broad frequency range. All of the following performance ranges are fully adjustable and are completely independent of each other: frequency,

the only thing NOT UNIQUE about the 610B is the name ELECTROMETER

The Keithley 610B Electrometer measures more parameters over broader ranges than any other dc test instrument! One compact measuring system now gives you the capability to investigate:

VOLTAGE—20 microvolts to 100 volts, without circuit loading (10^{14} ohms input resistance)

CURRENT— 10^{-15} ampere to 0.3 ampere

RESISTANCE—2 ohms to 10^{14} ohms

CHARGE— 10^{-13} coulomb to 10^{-5} coulomb

In addition, this neat package has only 200 microvolts per hour zero drift. That's ten times better than you can expect from any other tube electrometer, and it approaches the stability of costly vibrating reed devices. Unique, too, is the 610B's 1% meter accuracy, and its .005% unity gain output for impedance matching. An extra large 6-inch taut-band meter and two easy-to-read dials accent ease and convenience of operation.

The remarkably superior 610B replaces the 610A . . . and sells for the same price . . .

\$565

Send for Engineering Note
on 610B Electrometer

other electrometers

Model 610BR	
Rack mounting 610B	\$585
Model 621	
37 ranges, line operated.	\$390
Model 600A	
54 ranges, bat. operated.	\$395
Model 603	
50 kc bandwidth amplifier.	\$750



**KEITHLEY
INSTRUMENTS**

12415 Euclid Avenue • Cleveland 6, Ohio

dc microvoltmeters • differential voltmeters • high voltage supplies

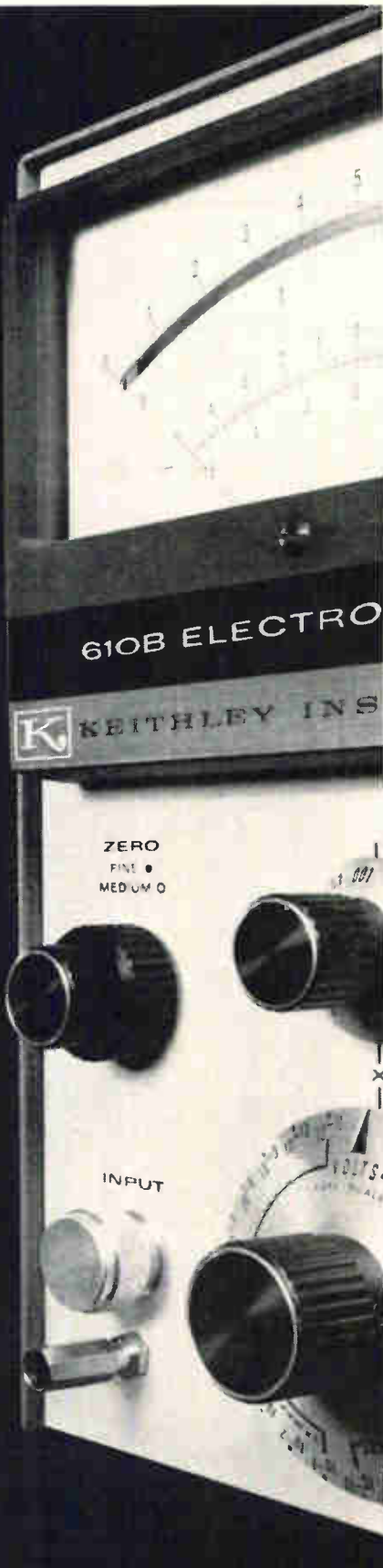

Take a handful of These—add one wrench—

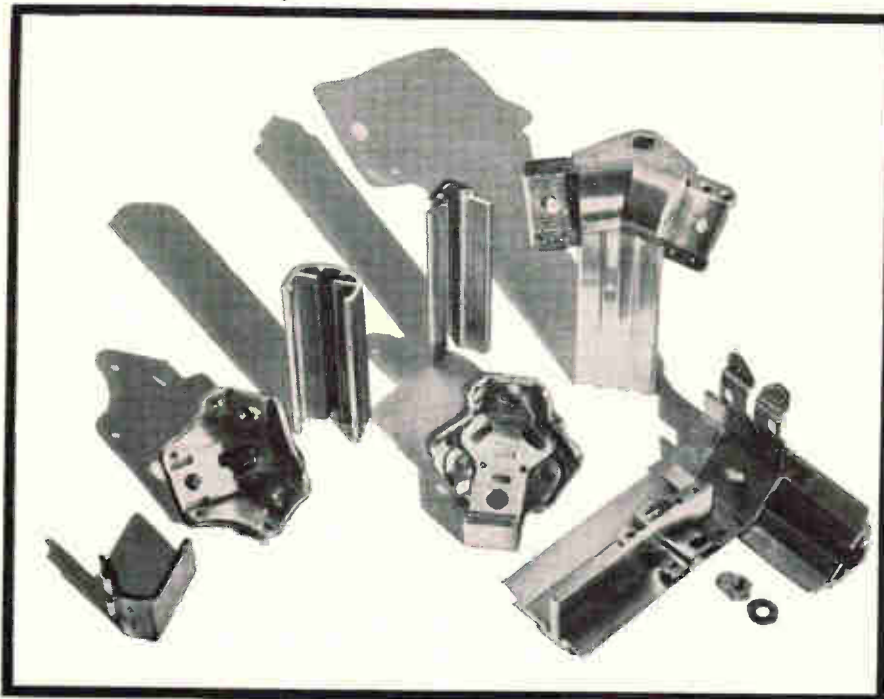

plus a dash of imagination...

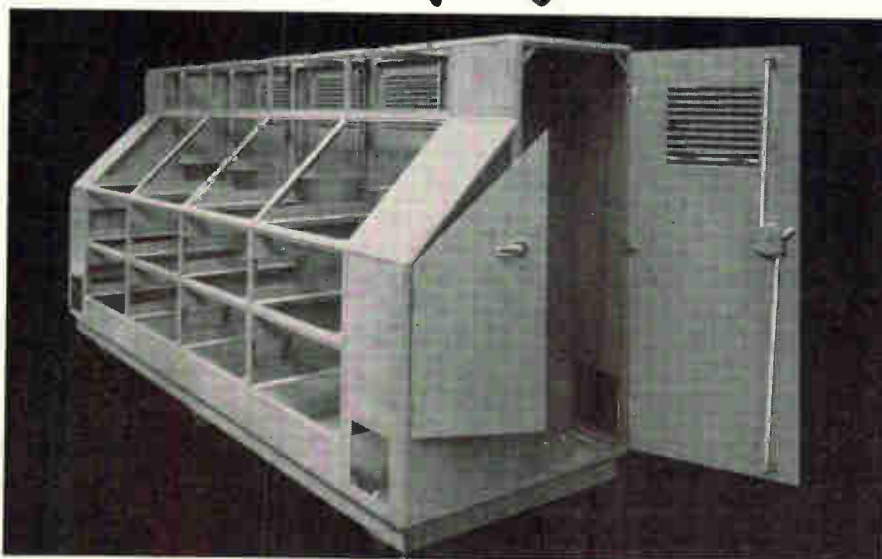

recipe for custom MIL Spec cabinets

Cabinetry to full military specifications can be rapidly and economically produced in your own plant using Widney Dorlec—the original construction system. Full software backup is available.

Call or write today for full information.

Widney Dorlec

did data instruments

7300 CRESCENT BOULEVARD, PENNSAUKEN, NEW JERSEY 609-662-3031

A Division Of
INDUSTRIAL ELECTRONIC HARDWARE CORP.

New Instruments



3,000 cps to over 10 Mc; amplitude from 0.5 v to 12 v; rise time, 20 nsec to 200 nsec; fall time, 20 nsec to 200 nsec; and duty cycle, 1:3 to 3:1. The generator is a current device and will deliver up to 0.15 amp or will accept up to 0.12 amp. Short circuit protection is provided and the output may be shorted to ground without damage, or may be terminated in 43 ohm, 50 ohm, 600 ohm or other desired impedance within current rating. Amplitude is essentially independent of output load and jitter is less than 0.5% of period. A synchronize input is available, requiring 5 to 25 v negative step function with 0.1 μ sec rise time. Sync input impedance is 1,000 ohms. Power input required is only 10 w, 115 v a-c, with 6-ft-long, UL-approved, 3-conductor power cord attached. The unit measures 3 by 4 by 14 in., and weighs 5 lb. Price is \$345. Walkirt Co., 10321 S. LaCienega Blvd., Los Angeles, Calif. [358]

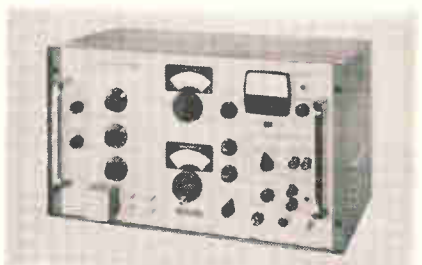

Capacitance bridge with 0.1% accuracy

A new 100-ke bridge provides capacitance measurements from 0.0002 pf to 110,000 pf with a basic accuracy of 0.1%. Model 74D also measures conductance from 0.001 μ mho to 1,000 μ mhos and shunt resistance from 1,000 ohms to 1,000 megohms. It may be operated in either the three-terminal (direct) mode in which measurements are essentially independent of capacitance to ground, permitting pre-

F.A.A. Lens-Like Antenna Grid* Connected, Spaced, and Supported by more than 73,000 *Preformed* Fittings TRADEMARK



The unique helically-shaped wire fittings illustrated were used extensively in the construction of this revolutionary high-frequency antenna.

Through their use, rigid connectors and hand-wired joints are completely eliminated. Excellent electrical conductivity and superior mechanical strength are maintained.

PREFORMED fittings are simple to apply and adjust. Once attached, they cannot shift or loosen. They are light in weight, low in cost.

Current applications of PREFORMED products of the types shown here include RHOMBIC and LOG PERIODIC ANTENNAS, CONICAL MONOPOLES, MICROWAVE COMMUNICATION TOWERS, HORN ANTENNAS and other GRID-TYPE TRANSMITTING AND RECEIVING ARRAYS. PREFORMED Connectors are in use on many U. S. Government and commercial installations throughout the world.

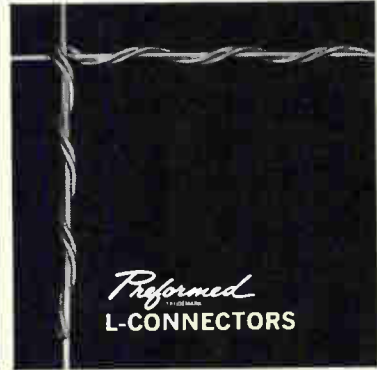

Details of the antenna are contained in the February 28, 1964 issue of ELECTRONICS. A reprint is included in the Tower & Antenna Products Data Folio. You may obtain this folio by requesting it from:



PREFORMED LINE PRODUCTS COMPANY

5349 St. Clair Avenue • Cleveland, Ohio 44103
UTah 1-4900 (DDD 216)

600 Hansen Way • Palo Alto, California 94306
327-0170 (DDD 415)

* Segment of the F.A.A. "Luneberg" Lens antenna designed by Dr. R. L. Tanner of TRG-West and installed at the International Flight Service Receiver Station, Molokai, Hawaii.
Circle 137 on reader service card



ANY COMBINATION!

New thin line "VY"
Porcelain Capacitors
offer these 3 critical
features in...

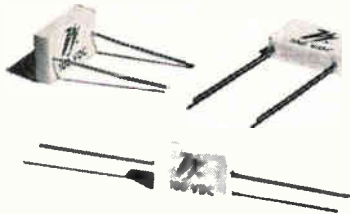

- Capacitance Range: 0.5 pf to 10,000 pf
- Temperature Range: -55°C to 125°C
- Voltage Rating: to 100 vdc
- Meets requirements of environmental tests as outlined in MIL-C-11272

Temperature Coefficients
+ 105 ± 25 ppm/ $^{\circ}\text{C}$ and
 0 ± 25 ppm/ $^{\circ}\text{C}$ (From
+ 105 ± 25 ppm/ $^{\circ}\text{C}$ to
- 100 ± 25 ppm/ $^{\circ}\text{C}$ available.)

Lead Materials

Solder Coated Copper,
Dumet, Nickel A, etc.

Lead Configurations

Edge Radial, Face Radial, Axial

... plus all the outstanding electrical
and physical characteristics built in to
all "VY" Porcelain Capacitors.

For complete specifications, write for
Data Sheet P 10A.

© Vitramon, Inc., 1964



Vitramon
INCORPORATED
Box 544 Bridgeport, Connecticut 06601

In United Kingdom contact:
Vitramon Laboratories Limited
Marlow Road
Bourne End, Bucks
England

Circle 207 on reader service card

NEW 1/2 INCH TWO WATT PHOTOCELLS



**AVAILABLE
NOW!**

Additional data plus
new 16 page photo-
cell manual for de-
sign engineers free
on request.

Clairex now offers a new "5M"
Series of photoconductive cells with
two watts power dissipation in a
rugged, hermetically sealed metal
case only .490" in diameter. Avail-
able in all standard Clairex CdS and
CdSe photosensitive materials offer-
ing numerous combinations of re-
sponse time, sensitivity and spectral
response. Suitable for direct relay
operation and many other applica-
tions.

CLAIREX

"The LIGHT Touch in Automation and Control"

8 West 30 Street, New York, N. Y. 10001, 212 MU 4-0940

138 Circle 138 on reader service card

New Instruments

cise remote measurements, or in
the conventional two-terminal
(grounded) mode. The new bridge
is completely self-contained, in-
cluding 100-kc test oscillator and
detector, d-c bias supply, and all
required power supplies. Addi-
tional features include: test signal
continuously adjustable from 4 v
down to 1 mv; internal d-c bias
adjustable from +110 v to -7 v;
provision for external bias up to
 ± 400 v; negligible warm-up drift;
capacitance drift less than 0.001
pf in 24 hours; standard arm is ac-
cessible at front panel, permitting
use as a comparison bridge; a d-c
output directly proportional to
bridge unbalance for go/no-go
testing. Price is \$1,350.

Boonton Electronics Corp., Parsippany,
N.J. [359]

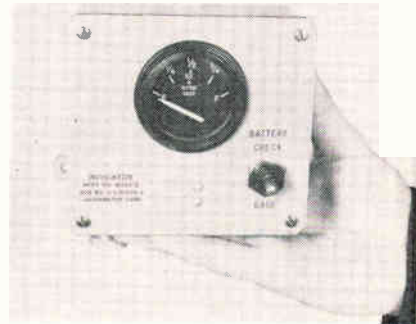

Battery-powered remote reading gage

A remote reading indicator that is
battery-powered can be used where
no external power source is avail-
able. As a float-actuated liquid-
level measuring system, it is highly
accurate and unaffected by tank
pressures on dielectric properties
of the liquid. The level transmitter,
itself, is custom built to the size
of the tank, and for compatibility
with liquids of all types including
hydrocarbons and cryogenes. Oper-
ating by the direct-lift method,
model B1133 gage is essentially an
indicator which is remotely ener-
gized by a sealed circuit within a
tank-mounted vertical track. It is
magnetically coupled to the float
which is free to travel up and down
with the level of the liquid. Besides

tank content measurement, the indicator may be used with a position transmitter mechanically linked to the rudder of a boat, a valve, or other moving surfaces. For this purpose, the dial face can be calibrated in angular degrees, height or percent of total travel. The system is operated simply by manipulation of a three-position toggle switch. In its down position, the toggle permits remote readout of information conveyed to it from the tank. Its up position is for checking battery strength. The neutral position to which the toggle automatically returns, disconnects the battery from the circuit to conserve the charge, which should last about one year with normal usage. A selector switch can be supplied where use with more than one transmitter is required.

The Liquidometer Corp., Long Island City 1, N.Y. [360]

Sampler unit used with scopes

The all-solid-state model S-30 sampler is a completely self-contained unit that allows inputs to be sampled by an electronic switch with an equivalent closed time of less than 350 picoseconds. This unit,



when used with any general purpose oscilloscope, becomes a complete sampling system, with full performance — variable gain, d-c offset, sweep expand, and triggering controls. Model S-30 features sweep speeds from 10 nsec to 5 μ sec per sweep with full control of expansion to $\times 100$; a constant minimum delay which allows viewing of the same starting point of signal at all sweep speeds; complete sweep and triggering controls including manual or external sweep. Price is \$850.

Electro Design, Inc., 8141 Engineer Road, San Diego, Calif. 92111. [361]

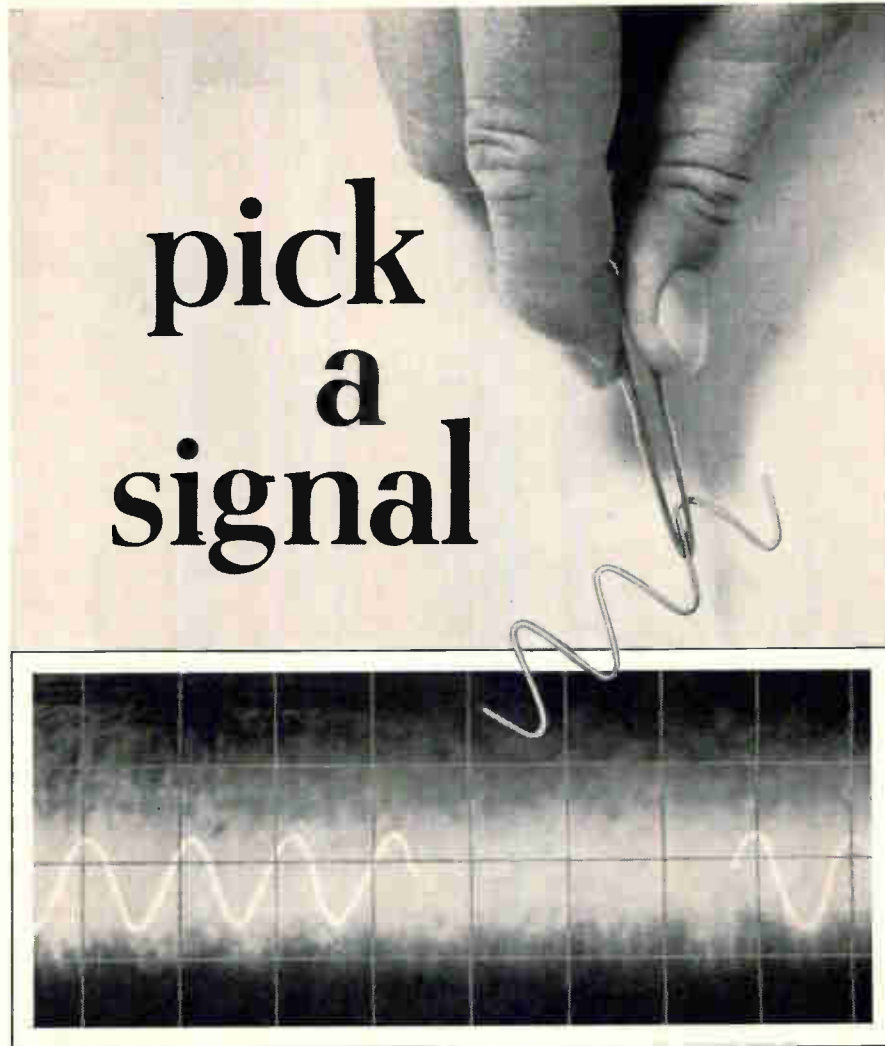

out of a 38 db noise background and reproduce it clean at 1v rms. with INTERSTATE'S AUTOMATIC SIGNAL TRACKING FILTER

- Automatic Bandpass Filter ■ AM and FM Demodulator ■ Automatic Doppler Signal Tracker ■ Variable Bandpass: 2.5 to 100 cps ■ Wide Frequency Range ■ Solid State ■ Third Order Filter ■ Reliable.

This all solid state variable bandpass filter picks a signal out of -38db signal: noise. Its center frequency locks to the frequency of the signal to be tracked, then tracks it anywhere through a 100 cps to 120 kc spectrum. Output is a clean replica of the tracked signal. Send for brochure.



ELECTRONICS CORPORATION

A SUBSIDIARY OF INTERSTATE ENGINEERING CORPORATION

707 East Vermont Avenue, Anaheim, California

Telephone: (714) 772-2222, TWX (714) 776-0280

Worldwide Representatives

CRITICAL ELECTRONIC FOIL REQUIREMENTS?

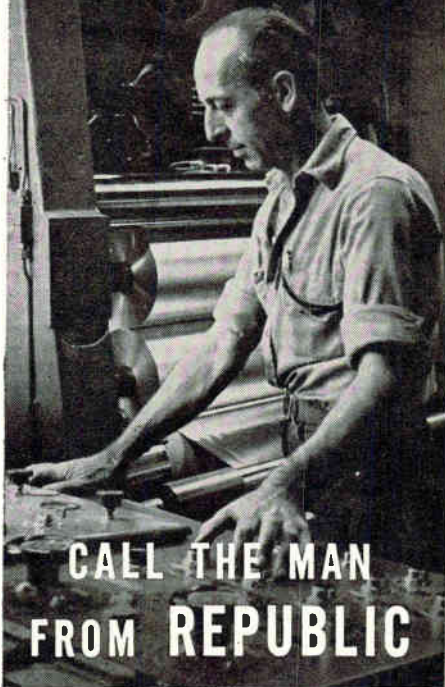

CALL THE MAN
FROM REPUBLIC

He has had extensive experience in the development and production of consistently superior aluminum foils . . . every plain and etched foil order processed is produced to complete product specifications, rigidly adhered to by highly trained individuals . . . in all phases of the operation from initial rolling to final inspection and boxing. Standard in-process checks and laboratory tests result in a consistently high quality foil guaranteed to meet the most critical electronic foil requirements.

Republic's complete aluminum foil line includes:

- LIGHT GAGE FOIL for paper and film wound capacitors of all types.
- ETCHED ANODE & CATHODE FOIL
- PLAIN FOIL FOR ETCHING
- PLAIN FOIL for electrolytic capacitors, coil winding, and other uses.

LET US SEND YOU . . .

literature describing Republic's foil line along with the name of the man technically qualified to assist you with your foil requirements.

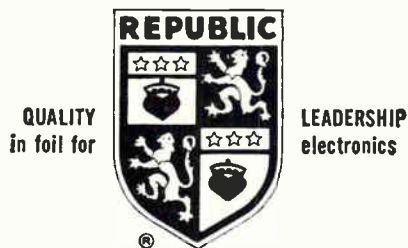

REPUBLIC FOIL INC.

General Offices & Rolling Mill Div., Danbury, Conn.
ELECTROCHEMICAL DIV. — Salisbury, North Carolina
CONSOLIDATED BAG & FOIL DIV. — Somerville, Mass.
BRANCH SALES OFFICES —
5306 West Lawrence Ave., Chicago 30, Illinois
Electrical Specialty Co., San Francisco 3, Cal.

New Semiconductors

Integrated circuits in 7 basic modules

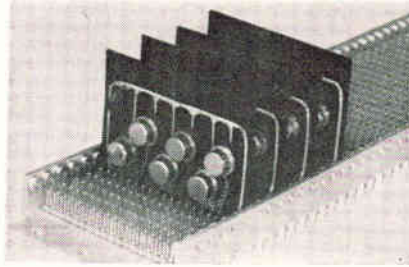

A new line of integrated circuit modules is announced. It is designed to perform all logic functions in seven basic plug-in modules, thus simplifying checkout and maintenance. The modules permit system speeds to 5 Mc, have noise rejection margins in excess of 1 v, and can drive, typically, 12 NAND gates and 200 pf of stray capacitance. The new line incorporates packaging, intercon-

nection and interfacing techniques which permit a practical application and immediate use of integrated circuits in digital systems. A complete group of peripheral circuits is available including lamp and relay drivers, multivibrators and single shots. Interface circuits permit communication in both directions between the integrated circuits and other equipment. Compatible mounting hardware provides packing densities as great as 2300 NAND gates or 1150 J-K flip-flops per 3½ in. of vertical 19 in. rack space. Miniature silicon power supplies provide the single voltage required at desired current levels. Interconnections between modules are accomplished by wire wrap, solder or weld. Abacus, Inc., 1718 21st St., Santa Monica, Calif. [331]

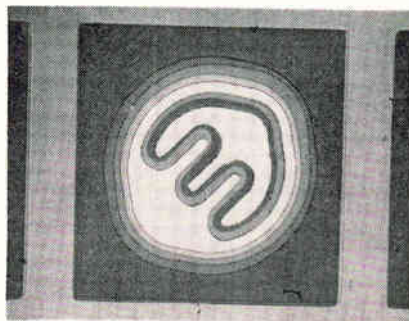

Nonchanneling silicon transistors

The first bipolar devices to be manufactured using the new Planar II process are announced. The family of pnp silicon epitaxial transistors is impervious to channeling problems. Planar II prevents ion concentration at the silicon-oxide interface, thereby eliminating the channeling effect which develops when sufficient countercharge is drawn to the interface in the bulk material. The transistors are for use in high-speed switching circuits and d-c to uhf amplifiers. The devices are designated 2N3502,

-3, -4 and -5. They offer high voltage rating, high gain bandwidth, fast high current switching speed, and uniformly high current gain from 10 μ a to 500 ma. The 2N3502 and 3503 are available in the standard TO-5 package; the 2N3504 and 3505 in the TO-18. Switching times of the new transistors are: T_{on} (max) of 40 nsec at 300 ma/30 ma; T_{off} (max) of 100 nsec at 300 ma/30 ma/30 ma. Prices for 1 to 99 range from \$12 to \$15; for 100 to 999, from \$8 to \$10.

Fairchild Semiconductor, 545 Whisman Road, Mountain View, Calif. [332]

High-voltage silicon rectifiers

Small size, high piv and high current ratings are featured in a new line of high-voltage molded silicon rectifiers. Peak inverse voltages up to 5,000 v, and forward current ratings up to 500 ma are available in an axial lead cartridge 0.38 in. long and 0.2 in. in diameter. Ideal for high-voltage power supply applications, these new silicon rec-

WILL THE DESIGN ENGINEER WHO WANTS THE INDUSTRY'S MOST POWERFUL RECTIFIERS, PLEASE PICK THEM UP!



2000 volt, 500 amp, 6RW62

1000 volt, 470 amp (RMS) 6RW71

No matter what your requirements in rectifiers and Silicon Controlled Rectifiers, General Electric is your first source. For example, do you have high current, high voltage problems? Want transient PRV as high as 2,000 volts? Just ask for the 2,000 volt, 500 amps 6RW62. Or perhaps you need a high current diode rectifier which is qualified to MIL-S-19500/246A. The G-E A70 meets this spec, and it's rated at 100 amps, up to 1,200 volts. As a matter of fact, we've also got a rectifier rated as high as 2,000 volts, 250 amps. Just ask for the 6RW51.

In the Silicon Controlled Rectifier area, General Electric's long time leadership in rectifier technology has made possible an entire family of high power devices. The G-E C150 SCR is rated at 1,300 volts, 110 amps (rms) and features superior dv/dt capability. *Minimum* guaranteed dv/dt is 200 volts per microsecond on all voltage grades. The C150 is

one of our new generation of all-diffused SCR's, and a lot of time and trouble has gone into making it ideal for those 240 and 480 volt applications. Another new star in our SCR line is the 1,000 volt, 470 amp rms 6RW71.

The selection is there. The reliability is there. The technological leadership is there. So why don't you give us a call? See your local G-E Semiconductor District Sales Manager. If you have any problems he'll be glad to contact our Application Engineering Center. Or drop us a line to Mr. Gregory Ellis, General Electric Co., Section 16K146, 1 River Road, Schenectady, N.Y.

GENERAL  **ELECTRIC**

GOOD COMPANY!

THAT'S THE KIND WE KEEP

Government: NASA HEADQUARTERS / MARSHALL SPACE FLIGHT CENTER / KENNEDY SPACE CENTER / MANNED SPACECRAFT CENTER / GODDARD SPACE FLIGHT CENTER / JET PROPULSION LABORATORY / DEPARTMENT OF DEFENSE / NATIONAL BUREAU OF STANDARDS

Industry: AVCO / BELL TELEPHONE LABORATORIES / BOEING / CHRYSLER / DOUGLAS / FAIRCHILD STRATOS / GENERAL DYNAMICS / LING-TEMCO-VOUGHT / LOCKHEED / MARTIN / NORTH AMERICAN

Universities: CALIF. INSTITUTE OF TECHNOLOGY / PENN. STATE UNIVERSITY / STATE UNIVERSITY OF IOWA / UNIVERSITY OF ILLINOIS

Foreign Governments: FRANCE / GREAT BRITAIN / ITALY

This is a representative list of our customers. For them we have solved problems in Systems Analysis and Design, Operations Research, RF Systems, Instrumentation, Telemetry, Signal Conditioning, Power Systems, Automatic Checkout, Payload Systems, Welded Circuitry, Custom Fabrication, and Packaged Electronics.

Do you have a problem in these areas? If so the chances are excellent that we can solve it quickly, efficiently and at a cost that will make your comptroller smile.



Direct your inquiries to

Space Craft, Inc.
8620 S. MEMORIAL PARKWAY, HUNTSVILLE, ALABAMA

Circle 208 on reader service card

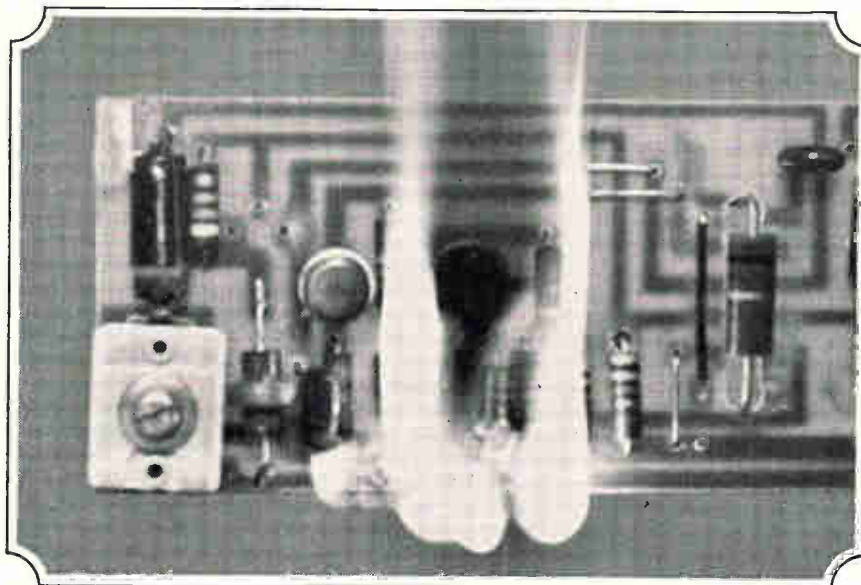

PREVENTION IS A HYPERSENSOR

HYPERSENSORS, "NANOSECOND FUSES," PREVENT COSTLY TRANSISTOR BURN-OUTS.

Save a transistor; save a circuit; save a computer; save a mission. Solid state Hypersensors react in time to prevent transistor burnout... in nano-seconds... and they can be reset over and over again with application of only 12 V. Standard units, TO-18 transistor size, rated 10 to 300 ma, available from stock. Subminiature, axial lead Hypersensors made to order. For information, write or phone, 1100-1 E. Ash Ave., Fullerton, California, 92631. Phone: 871-1930 (714)

QUALTRONICS CORPORATION



New Semiconductors

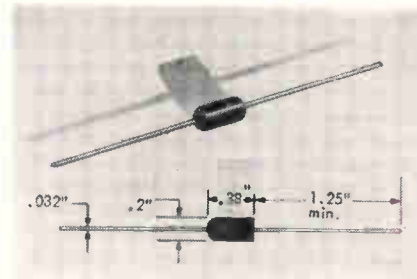

tifiers also offer extremely low leakage, high surge capability and diffused junctions as well as an insulated body for easy component board mounting or potting. They are particularly useful for radio and tv transmitters, receivers, microwave and radar equipment, portable transmitters and other high-voltage power supply applications where space is at a premium. The price for the EJ300 (3000 piv—200 ma) is \$2.08 each in a quantity of 100 pieces.

Electronic Devices, Inc., 21 Gray Oaks Ave., Yonkers, N.Y. [333]

Glass-passivated silicon transistors

MIL Annular transistors, USA 2N2904 through USA 2N2907, are now available. These devices are glass-passivated, high-voltage silicon pnp Star transistors for high-speed switching circuits, d-c to vhf amplifier applications, and complementary circuitry, processed to the requirements of MIL-S-19500/290-1. The high voltage rating is a result of the company's Annular process, which permits true surface passivation of h-v pnp transistors by eliminating the detrimental effects of uncontrolled channeling. Some characteristics of the devices are: collector-base voltage, 60 v max; collector-emitter voltage, 40 v max; emitter-base voltage, 5 v d-c max; collector current, 600 ma d-c max; and operating junction temperature, -65°C to $+200^{\circ}\text{C}$. The USA 2N2904 and 2N2905 are available in the TO-5 package; 2906 and 2907, in the standard TO-18 package. Prices in quantities of 100 and up range from \$5.55 to \$6.75. Motorola Semiconductor Products Inc., P.O. Box 955, Phoenix, Ariz. [334]

FOUR NEW HOT LITTLE NUMBERS

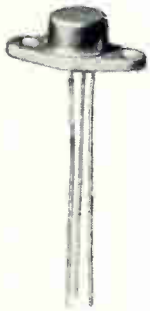

2N3212



2N3213



2N3214



2N3215

FROM
DELCO

Now from Delco Radio come four remarkable new miniature Nu-Base† transistors for people who need high current, high voltage and fast switching in a very small package.

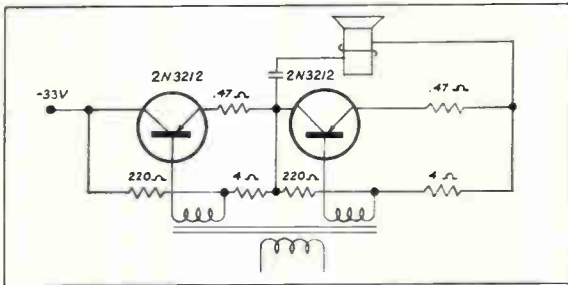

Miniature Class AB audio power amplifier:
Maximum RMS power output 18 watts at 200 cps

Each of these devices is rated at 5 amperes, maximum continuous collector current. Ranging from 30 to 80 volts, their VCEO ratings make them especially useful where high voltages and high currents are encountered. In addition, their relatively low saturation resistance and high speed give them excellent efficiency and reliability for switching applications.

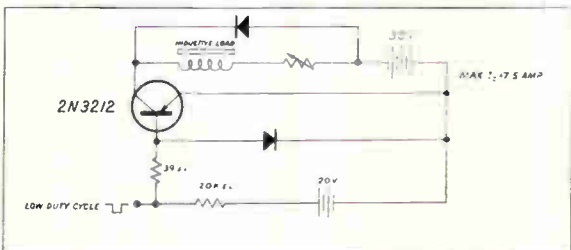

Miniature Solenoid Driver: Excellent high current gain of 2N3212 enables intermittent operation of solenoids at high currents such as 7.5 amperes. Duty cycles of 1 millisecond at 15 millisecond repetition rates are typical.

†Delco's name for drift field non-uniform diffused base construction.

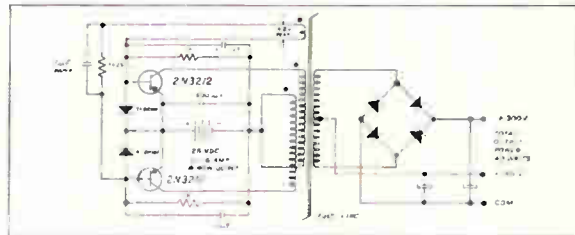

Miniature converter in which 2N3212 high gain, high current and fast switching speed characteristics provide a 40-watt output at an efficiency of over 87 percent.

The Delco Nu-Base construction features a husky element with built-in protection from current "hot spots" to assure freedom from secondary breakdown over the operating range.

These units will dissipate over 5 watts at 71°C case temperature, operate over a range of -65°C to 110°C and lend themselves easily to automatic insertion—all this in a TO-37 package.

The shortest distance between you and more detailed information is a call or letter to one of our sales offices or your Delco semiconductor distributor. Right now is as good a time as any.

TYPE	2N3212	2N3213	2N3214	2N3215
Vcbo	100	80	60	40
Vceo (@ Ic=20ma)	80	60	40	30
hFE (@ 3A)	30-90	30-90	30-90	25-100
Vce (sat) (@ Ic=5A)	0.5v	0.5v	0.5v	0.5v
Vce (sus) @ Ic=3A	80	60	40	30
Conditions for Vce (sus.)	Pulse Width = 1.4ms Duty Cycle = 4% Inductance = 6mh			

Operating temperatures = 110°C max., -65°C min.; max. storage temperature = 125°C

Union, New Jersey*
324 Chestnut Street
MURDOCK 7-3770
AREA CODE 201

Palo Alto, California
201 Town & Country Village
DAVENPORT 6-0365
AREA CODE 415

Syracuse, New York
1054 James Street
GRANITE 2-2668
AREA CODE 315

Detroit, Michigan
57 Harper Avenue
TRINITY 3-6560
AREA CODE 313

Santa Monica, California*
726 Santa Monica Blvd.
UPLON 0-8807
AREA CODE 213

Chicago, Illinois*
5151 N. Harlem Ave.
775-5411
AREA CODE 312

General Sales Office*: 700 E. Firmin, Kokomo, Ind., Gladstone 2-8211—Ext 500 • Area Code 317

*Office includes field lab and resident engineer for applications assistance.

DELCO
RELIABILITY
RADIO
RELIABILITY

Division of General Motors, Kokomo, Indiana



Did you say

BROADBAND MIXERS?

LEL offers the widest selection of multiple-octave coax and full waveguide range mixer models. Take LEL's 12-18 Gc Mixer, for instance. This tiny mite measures a mere 2 cu. inches but delivers top performance with highest isolation . . . lowest noise figure. It's one of more than twenty broadband mixer models covering the entire spectrum, from 100 Mc to 18 Gc.

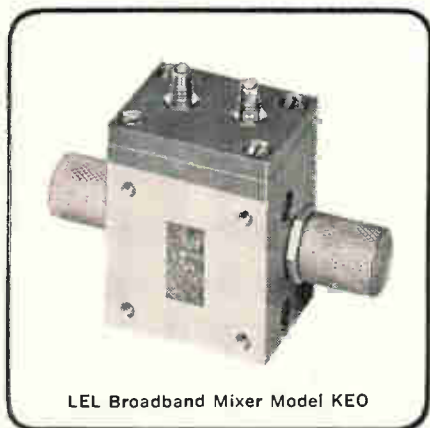

LEL Broadband Mixer Model KE0

For all your receiver requirements . . . call on LEL capability!

Send for your FREE copy of LEL's Catalog '64



New Subassemblies and Systems



Computer memory features versatility

A seven-bit, 2048-character addressable register has been developed which indicates the address input on its front panel. The lightweight, modular construction of the model CM7112 computer memory, which utilizes the manufacturer's standard digital logic modules, permits many variations to the number of channels, mode of operation or memory capacity required for such applications as paper or magnetic tape, printer or typewriter interface with a computer, or as the memory of a special purpose peripheral computer. The unit uses magnetostrictive delay lines to provide a lightweight, rugged, low power buffer store requiring no moving parts. The output is always the information located at

the address except during the search or transfer gate signal. The address will be internally reset to zero and automatically sequence in numerical order on a character read or load signal. The first read after load does not sequence the address. When an address set pulse is received the sequencing will begin at the new address input at that moment. The memory full signal indicates that the zero address has appeared again and is reset with the next address set pulse. The internal character rate can be set to be equal to the character rate of the external machine. A work or group of characters from 1 to 2048 can be transferred at this high rate.

Avron-Dero, Huntington, N.Y. [371]

Nonencapsulated circuit cards

A completely compatible line of d-c to 20-ke digital circuits feature high quality and reliability at low cost. Ideally suited for industrial control and general data processing applications not requiring high speed, the DCOIX circuits perform counting, storage, gating and timing

functions. The 2.75 in. by 6.0 in. cards are etched circuits on G-10 epoxy glass. Maximum turn-on time is 3.5 μ sec; maximum turn-off, 5.0 μ sec. DCOIX circuits operate between -55°C and $+55^{\circ}\text{C}$.

Control Logic, Inc., 3 Strathmore Road, Natick, Mass. [372]

I-f amplifiers provide high power

High-power, class A post-amplifiers have been developed for applications requiring substantial i-f power levels. These units have been designed to operate from typical sources capable of 0 dbm and provide 1 w of linear output. Stand-

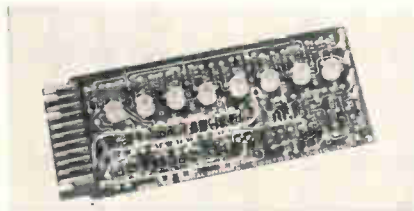

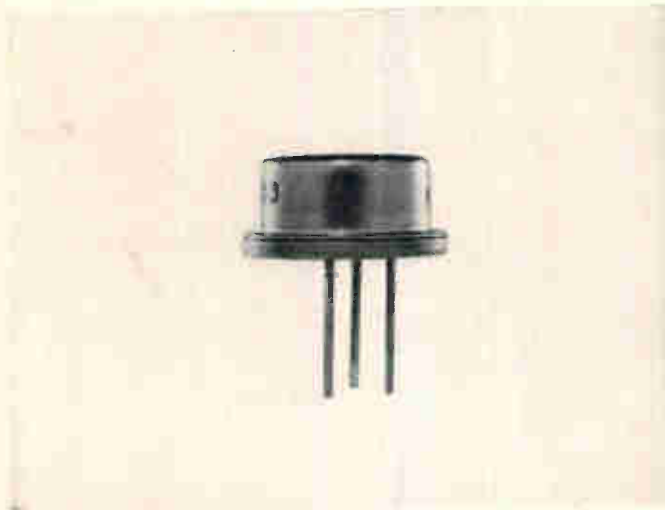

Meeting MIL specs?

***AnSCO lets you see
the reliability***

If you've invested millions in an in-plant reliability program, you should include Superay® 'H-D' Industrial X-ray film. Why? Because it can show up best the tiniest imperfection in your electronic components. This ultra-fine grain Class I film has very high contrast and microscopic definition throughout the entire KvP range. It's designed for high definition radiography and the ultimate in image quality.

For the X-ray "reliability" your components deserve, ask your AnSCO Representative about AnSCO Superay 'H-D' Industrial X-ray films. Or write:

gaf

ANSCO

X-RAY PRODUCTS OF
GENERAL ANILINE & FILM CORPORATION
140 WEST 51 STREET · NEW YORK 10020

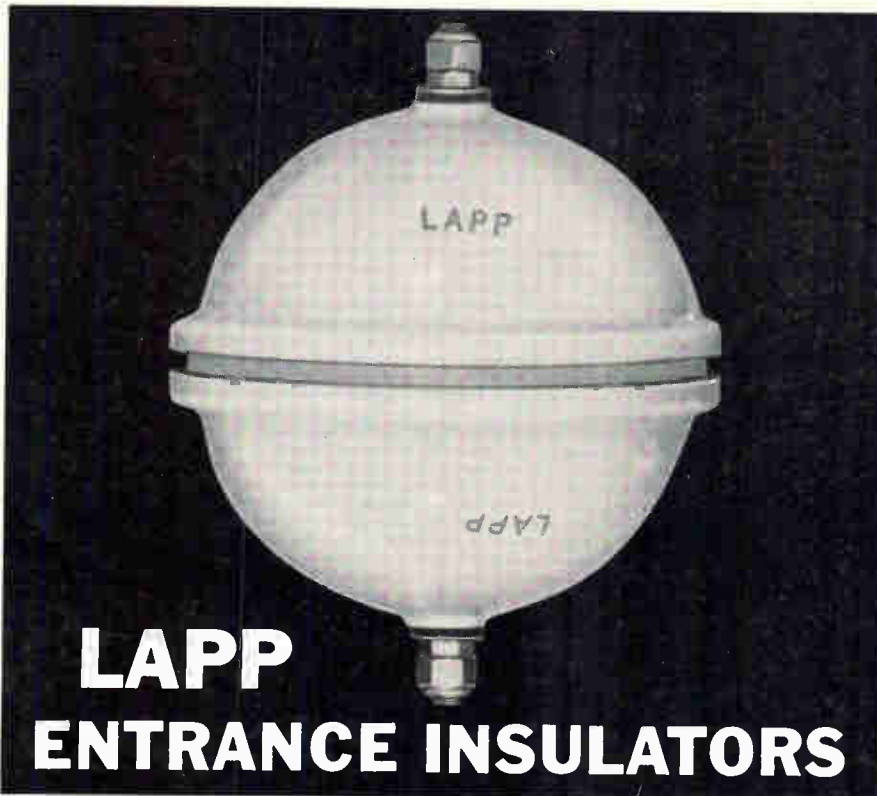

LAPP ENTRANCE INSULATORS

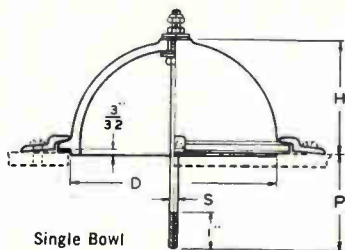

**...in all these
standard sizes
to save you time
and money**

DIMENSIONS IN INCHES AND RATINGS									
Single Bowl	Double Bowl	Material	D*	H	P	S	Dry Flashover 60 kv eff.	Radio Rating kv eff.	
9164 26846	7185 26841	Porcelain Steatite	3	1 $\frac{1}{6}$	1 $\frac{1}{2}$	$\frac{1}{4}$	22	9 17	}
9165 26847	7181 26843	Porcelain Steatite							
9166 26004	9167 26845	Porcelain Steatite	6 $\frac{1}{2}$	4 $\frac{1}{6}$	3	$\frac{1}{2}$	38	12 $\frac{1}{2}$ 24	}

*D is mounting hole diameter.

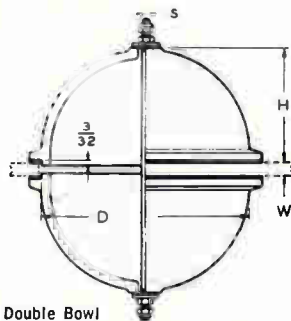

When you design, keep our *standard* sizes in mind. They really cut down on costs and delay. Lots of other standard sizes for heavy duty, low voltage and apparatus applications. And, of course, if you need specials, we'll meet your specs as fast as possible, at a price you'll agree is fair.

Lapp

WRITE for Bulletin 301-R.
Lapp Insulator Co., Inc.,
224 Sumner Street,
LeRoy, New York.

New Subassemblies

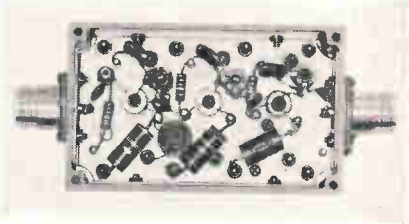

ard models provide 30, 60 and 70-Mc center frequencies with bandwidths to 30 Mc, provide 30 db of gain and operate in 50-ohm systems. Stud-mounted silicon transistors are employed, utilizing improved chassis thermal designs to assure long transistor life. Prices start at \$325.

RHG Electronics Laboratory, Inc., 94 Milbar Blvd., Farmingdale, N.Y. [373]



Digital computer designed for teaching

A solid-state digital computer has been designed specifically for teaching digital computer programming, applications and computer maintenance. The Digiac 3080 is a complete teaching system which includes its own IBM Selective typewriter for direct input-output, a paper tape punch and reader, and a control console. It uses a magnetic drum memory for internal storage with a capacity of either 1,024 words or 4,096 words. A Fortran compiler will be available, especially designed for training. The new educational unit is a full-size computer which may also be used for applications in the areas

of scientific research, management controls, instrumentation, statistical analysis, accounting, engineering, and problem solving. Some of its 105 instruction operations include addition, subtraction, multiplication, division, logical multiply, shift (left and right) and punch. Some typical operation times for the various functions are 1½ millisecond for add/subtract, 8 millisecond for multiplication, 8 millisecond for division and an average access time of 9 millisecond. When used for training purposes, the Digiac 3080 will enable the student to learn computer logic, understand computer circuits and perform basic trouble-shooting. Price is \$14,900.

Digital Electronics, Inc., 2200 Shames Drive, Westbury, N.Y. [374]

Digitally controlled graphic display system

Automation of engineering and drafting departments is nearer reality with the introduction of a new, all-digital graphic display system. The 675 automatic drafting system offers greater speed, accuracy and versatility than can be obtained from systems selling at several times its price, according to the manufacturer. Features include all-digital control logic that is designed specifically for automatic drafting operations. The unit is not an adapted version of a control intended for other purposes. An all-digital drive system features specially designed digital stepmotors to provide unequalled accuracy and reliability, eliminating drift and fluctuations experienced with other types of systems, the company states. Input formats are in accordance with numerical machine tool control standards ensuring adaptability to any BCD formats. A plotting table provides a light but rigid and stable display surface in a range of sizes from 5 ft by 5 ft to 5 ft by 20 ft. The table can be in-



COAXIAL SWITCHING MATRICES

REMOTE CONTROLLED
PRE-PROGRAMMABLE VIDEO AND DATA SWITCHING

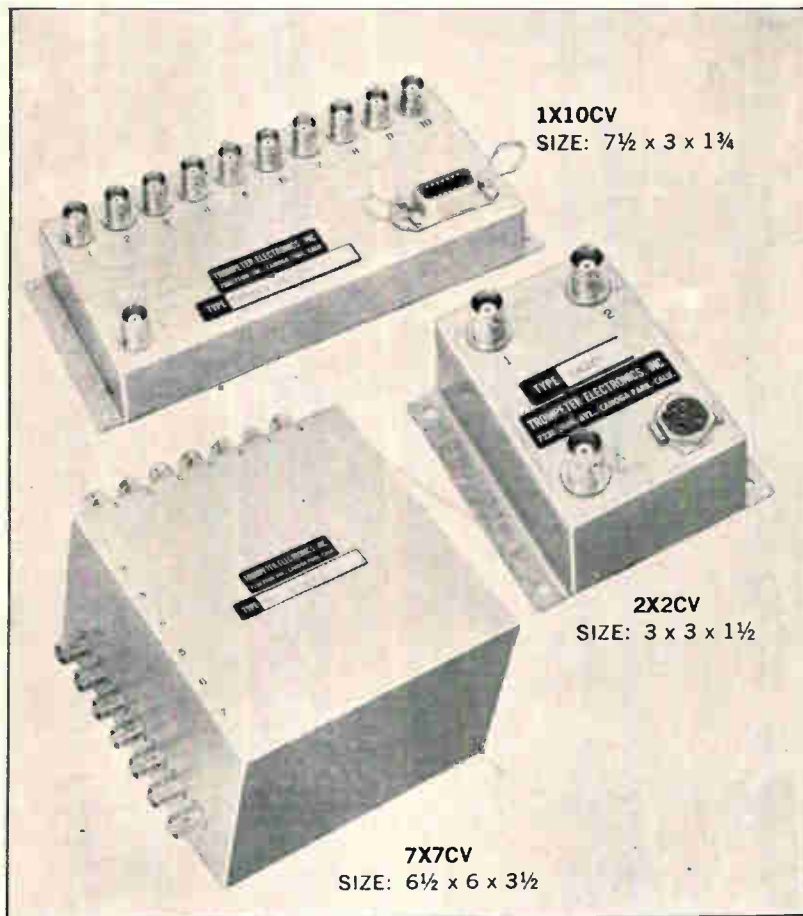

NOW AVAILABLE!! A complete series of switching matrices for analog or digital switching up to 5 mc., and coax or twinax video switching up to 60 mc. The matrices allow any input or series of inputs to be connected to any output or multiple of outputs. They are available in 1 by 2 up to 25 by 25 crosspoint versions. Also available are multiple pole (up to 25 points) single throw coaxial switches. Switching control can be accomplished by a remote control panel, pre-programmed punched card or tape, or computer control for automatic checkout applications.

SPECIFICATIONS

Crosstalk characteristics:

Digital and analog to 5 mc.	— 60db minimum
Video to 20 mc.	— 80db minimum
Maximum insertion loss	0.2db at 60 mc.
Control voltage	12 to 48 volts dc.
Actuation time	1 millisecond

TROMPETER ELECTRONICS

7238 Eton Avenue • Canoga Park • California • Telephone (213) 346-1550

MINIATURE SOCKETS NEED MUSCLES, TOO!

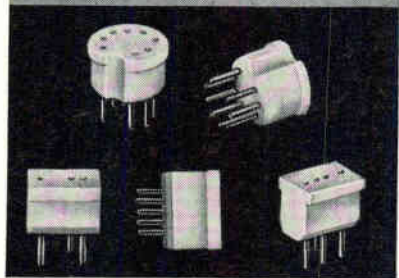

A prevailing problem with miniature sockets has been the ease of pulling the pin from the socket during either the manufacturing process, while servicing, or through general use. Garlock has solved this problem with a newly designed contact which will consistently withstand up to a 7 lb. pull test.

GARLOCK MANUFACTURES A WIDE-RANGE OF STANDARD AND CUSTOM SOCKETS FOR TRANSISTORS, MICRO-MODULE AND MICRO-LOGIC ELEMENT APPLICATIONS.

For complete information, ask for your copy of Catalog EP-169.

NEW!

12-PIN TRANSISTOR SOCKET

By utilizing TFE (Fluorocarbon plastic) and silver-plated, gold-flashed Beryllium copper, Garlock has developed a socket that exhibits unusually good electrical qualities with minimum pin-to-pin and pin to-chassis capacitance. Compression mounted. Ask for details on Part No. 69012-0019.

GARLOCK
ELECTRONIC PRODUCTS
CAMDEN, NEW JERSEY 08101

New Subassemblies

clined to any position between the horizontal and the vertical by means of an electric motor drive. Table configuration of the 675 is adapted to applications requiring accuracies up to 0.005 in.

The Gerber Scientific Instrument Co., P.O. Box 305, Hartford 1, Conn. [375]

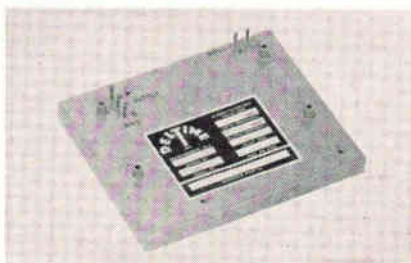

Magnetostrictive delay line

A new 1,000- μ sec magnetostrictive delay line, model 190M, has been designed specifically for application in airborne and high vibration environments. The unit, operating under vibration without isolators per MIL-E-5400, Curve I, features a minimum signal-to-noise ratio of 5 to 1 under all pulse conditions, while storing up to 1,000 bits of data. It also meets all applicable environmental requirements of this MIL specification. Temperature range of operation is from -54°C to $+71^{\circ}\text{C}$ with a maximum delay drift of only $+0.20 \mu\text{sec}$. Weight of the model 190M is 13.5 oz.

Deltime Inc., 225 Hoyt St., Mamaroneck, N.Y. [376]

Decade divider module features high speed

A compact, all-silicon decade divider module has been developed for use without modification in a wide variety of visual displays. Capable of counting at rates in excess of 2Mc, the model B100-10 incorporates many features that give the system designer considerable latitude of application. For example, there is provision for the arbitrary setting of the input voltage level, thus making it possible

DC POWER SUPPLIES



CONTINUOUS VOLTAGE COVERAGE—4.7 to 60 vdc.

Input: 105-125 vdc, 50-400 cps

Regulations: From $\pm 0.05\%$

Ripple: From .002% or 1 mv, rms

Temp. Coeff.: From $\pm 0.01\%/^{\circ}\text{C}$

Voltage Adjustments: $\pm 5\%$

Max. Temp. of Base: 65°C

- WIDE VARIETY OF CURRENT RATINGS
- ELECTRONIC SHORT CIRCUIT PROTECTION
- FULLY REPAIRABLE
- 7 STANDARD SIZES (OVER 450 MODELS)
- PRICE RANGE **\$45-\$225**



INSTRUMENTS: EEM ('63-64 Pg. 902)
EBG (1964 Pg. 462)

POWER SUPPLIES: EEM ('64-65 Pg. 1341)
EBG (1963 Pg. 307)

VOLTAGE STANDARDS: EEM ('64-65 Pg. 929)

D *DYNAGE, inc.*

390 CAPITOL AVE., HARTFORD, CONN.
Circle 209 on reader service card

NEW! and NOW!

IRRADIATED

Polyolefin Shrinkable Tubing PENNTUBE ∇

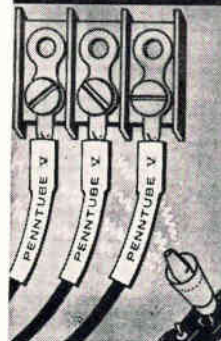

from
PENNSYLVANIA
FLUOROCARBON
COMPANY

2:1 shrink ratio.
Meets
all applicable
specifications.

Write for product data
sheet and free sample
NOW!

P **PENNSYLVANIA
FLUOROCARBON CO., INC.**
Holley Street & Madison Ave.,
Clifton Heights, Pa.
Phone: (215) MADison 2-2300
TWX: 215-623-1577

Export Dept. Room 5710 Empire State Bldg. N.Y. 1, N.Y.

One source for:

TEFLON* TFE
Shrinkable
(Penntube-I-E)

TEFLON FEP
Shrinkable
(Penntube-IISMT)

IRRADIATED
Polyolefin Shrinkable
(Penntube ∇)

*Du Pont Reg. T.M.

†Penna. Fluorocarbon Reg. T.M.

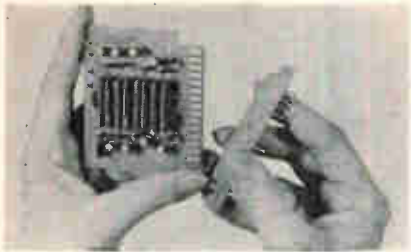

to use the model B100-10 in conjunction with a wide variety of both standard and non-standard logic control levels. Also, the new decade divider is a truly universal device designed for immediate installation and use in timing systems, industrial control systems, computational equipment, and all other applications where high speed, high reliability counting is required. The output code is 8-4-2-1; with bipolar excursion provided for each bit representing both binary 1 and binary 0. The quantity price of the B100-10 is \$25.50.

Janus Control Corp., Hunt St., Newton, Mass. [377]



Frequency detectors are passive devices

A line of miniature magnetic frequency detectors can be used as an economical and reliable method of converting frequency to proportional current. Used wherever frequency measurements are required, the units have application for industrial control manufacturers, speed sensing devices, meter manufacturers and automation equipment. They are completely passive devices based on the principle of the saturating core. Accurate to within 1%, the units provide 1 ma

Right now

you can get your free copy of the new G-E bulletin on sub-miniature incandescent lamps! Lists 197 lamps in 6 bulb sizes from T-1 to T-2; 18 drawings with dimensions and tolerances; 4 pages of design and product data. In addition, it's cross-referenced for federal stock and military standards numbers. Also punched to fit all standard ring binders.

Write now:

To: General Electric Company, Miniature Lamp Dept. M4-27
Nela Park, Cleveland, Ohio 44112
Please send me a copy of sub-miniature lamp bulletin 3-4274.

Name _____ (Please Print)

Title _____

Company _____

Address _____

City _____ State _____ Zip Code _____

Progress Is Our Most Important Product

GENERAL  ELECTRIC

NEW

DIGITEC DIGITAL VOLTMETER & PRINTER



Model 6200

- 0.1% or 0.2% FS Certified Accuracy.
- Readings from 0.1 MV to 1000 V DC.
- Floating or Grounded Input.
- Reliable Silicon Transistor Circuit.
- Individually Calibrated & Certified.
- BCD 1-2-4-8 Coded Output in Parallel Form.

\$1210

complete system



Model 600

- BCD 1-2-4-8 Parallel Input (+6 V or +12 V).
- Prints 2 Banks of 4 Columns.
- Automatic Negative Sign Print.
- 48 Line/Minute Print Rate.
- Uses Standard 2 1/4" Paper Tape.
- Remotely "Programmable".

ALSO AVAILABLE

- Coded Output on All DigiTec Instruments.
- Time, Identification and Serializing Accessories.
- Printer to Provide Addition and Subtraction Functions.

UNITED SYSTEMS CORPORATION

918 Woodley Road, Dayton 3, Ohio (513) 254-3567
Stocking Reps throughout United States, Canada, England and France

Circle 211 on reader service card

TR MICRO TV TUNER



MODEL TU-15U

This MICRO TV TUNER, using 3 transistors, provides you with excellent performance while keeping high quality stability, thanks to our latest technical advancement. Spurious radiation meets the requirements of FCC and is guaranteed for performance of more than 40,000 operations. We also offer you many other lines of components for your use. Please write us asking for catalogs available on the following products:

Main Products

Polyvaricon, IF Transformers, Oscillator Coils, Antenna Coils, Variable Resistors, FM Tuners, TV Tuners, Micro-motors, Sockets.



MITSUMI ELECTRIC CO., LTD.

Head Office Komae, Kitatama, Tokyo, Japan.
New York Office 11 Broadway, New York 4, N.Y., U.S.A.

150 Circle 150 on reader service card

New Subassemblies

of d-c output for full scale frequency with 1 mw of usable output. They receive an input signal of a given frequency and deliver an output of 0 to 1 ma which is proportional to the frequency input. For example, on a 0 to 1,000 cps full scale rated detector, an input frequency of 1,000 cps will produce the 1-ma output. However, an input frequency of 500 cps will produce only 0.5-ma output. This proportionally holds throughout the range of the detector. Operating from -55°C to +100°C, the magnetic frequency detectors are available to be driven direct from 115 v line or by transistors. Full scale frequencies range from 50 cps to 3,200 cps. Transistor drive units require 12 v d-c in combination with transistors having low saturation resistance. Five series are offered in either rectangular or cylindrical configurations. Silicon diodes, combined with military type magnetic components encapsulated in epoxy resin, assure optimum reliability even under extremely rugged environments.

Military & Computer Electronics Corp.,
900 NE 13th St., Ft. Lauderdale, Fla.
[378]

Block reader memory module

A solid-state block-reader memory module that can store a block of information up to 20 characters long, with 8 bits per character, has been developed. It is basically a flip-flop memory into which individual characters are distributed under control of a built-in counter and appropriate gating. Information can be accepted by the mem-

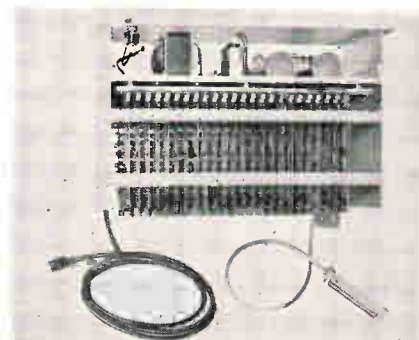

Electronics | November 16, 1964

ory at speeds up to 50 μ sec/character. Fundamentally, the unit is designed to operate with the manufacturer's perforated tape reader as an input device. However, as long as the appropriate logical and signal conditions are met on the input device, any type of reader can be used. The block reader can be stopped on a predetermined code in the tape; permitting variable block lengths. When used with the company's bidirectional perforated tape reader, reading may occur while moving either forward or reverse. One of the advantages claimed in using the unit, in conjunction with the manufacturer's reader and spooler, is the high-speed searching capability on a block-to-block basis. Through utilization of the rapid advance feature of the company's spoolers, searching can be accomplished at speeds up to 2,000 characters per sec. Dimensions of the block reader are 19 in. wide by 7 in. long by 12½ in. deep.

Digitronics Corp., Albertson, N.Y. [379]

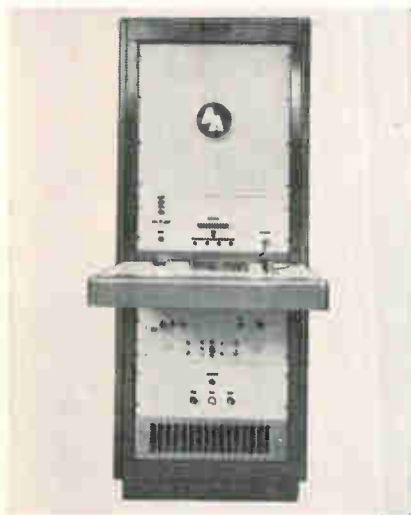

Semiconductor tester offers high speed

This semiconductor test set completes 20 tests in 1 sec to an accuracy of better than 1% on a go/no-go basis. While the system is designed to test encapsulated diode matrices, the use of solid state logic, combined with operational amplifier techniques, permits the basic design to be used in testing most semiconductors. It utilizes a self-check method to assist in main-

PROBLEM IN FREQUENCY CONTROL?

*Chances are **BULOVA**—the leader—has already solved it!*

Bulova Electronics now offers the widest range of frequency control components of any company in the business! For example:

- Crystals of all types from 2 kc to over 125 Mc
- Ovens of every type: snap-action thermostat, proportional-controlled, or patented Transistat solid-state thermostat for extreme reliability
- Packaged crystal oscillators from 1 cps to 200 Mc with stabilities approaching frequency standards
- Tuning fork resonators and oscillators ranging from 1 cps to 25 kc with stabilities as high as .001%
- Crystal filters of all kinds from 7 kc to 30 Mc—SSB, symmetrical, band elimination and comb sets
- Servo amplifiers, both miniature and conventional, employing solid-state circuitry
- LC filters and coils from dc to 30 Mc

How does this help you? Well, in building this leading product line and developing this capacity, we have probably solved a problem just like yours. We have solved problems for such programs as Nimbus, Apollo, Polaris, Bullpup, TFX, Minuteman and Pershing. *No matter what your problem is—stability, reliability, precise control or price—call Bulova Electronics, the company with the widest product line! Or write us, at Dept. E-9.*

BULOVA PACKAGED CRYSTAL OSCILLATORS ... to 200 Mc

Bulova offers a full line of packaged crystal oscillators from 1 cps to 200 Mc, featuring:

- Stability up to ± 5 pp 10⁹ per day
- Proportional-controlled ovens
- Temperature compensated units (TCXO)
- Voltage controlled units (VCXO)
- Sine wave, square wave and pulse outputs
- Divider and multiplier networks
- Miniature size—down to .4 cubic inches
- Environmental specs of MIL-E-5400, MIL-E-16400, and MIL-E-4970

What's your problem? Chances are we've already tackled it! Just write us at Dept. E-9—or better, call us.



BULOVA / **ELECTRONICS DIVISION**
WATCH COMPANY, INC. 61-20 WOODSIDE AVE., WOODSIDE 77, N.Y., 212 NE 9-5700



SPECIFY PENDAR SWITCHES

when quality, dependability,
 and long life are needed.

NEW 4PDT features snap-action, illuminated pushbutton switch for panel mounting. Light circuit is independent from other switching circuits. Available in momentary or alternate action. $\frac{5}{8}$ " metal housing assembly. Meets or exceeds military specifications.

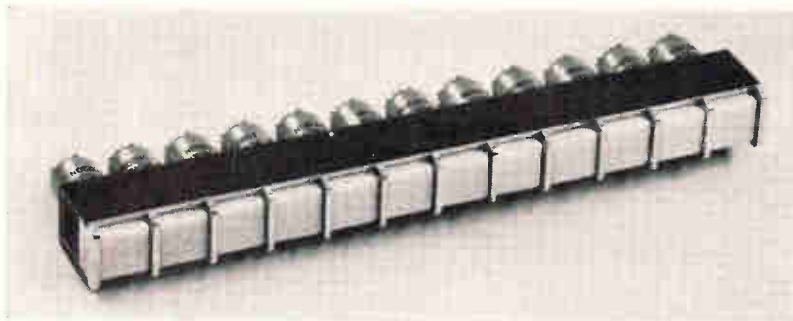

COMPACT SERIES II multi-station gang switch assemblies give high performance. Luster-finish metal barriers between pushbuttons beautify electrical and electronic equipment. Available in 12 different mechanical locking and inter-locking actions. Mountings on 1" or $\frac{7}{8}$ " centers.

PENDAR has been manufacturing reliable electronic components for the past 18 years. Pendar switches and indicators are used in panels, consoles, electrical and electronic keyboards around the world. Pendar engineers are continually designing new products for advanced electronic systems. Many new switch models, now undergoing life tests, will be on the market early in '65. Look for them.

manufacturers of precision-made pushbutton switchlights and indicators



New Subassemblies

tenance and employs special cards containing resistors to program the test parameters. This test set is capable of reading out with a high-speed digital voltmeter, the exact value of any one parameter during normal operation without interfering with the operation of the system. The system, which uses indicator lamps as a readout, can be furnished to supply printed readout such as a paper tape, punched card, or hard copy.

Aerotronic Associates, Inc., Contoocook, N.H. [380]



Crystal oscillators in plug-in package

A complete line of packaged crystal oscillators is announced for the frequency range of 10 kc to 100 Mc. Both non-temperature controlled and oven-controlled units are available with stabilities to 0.0001% per day over the ambient range of -55°C to $+60^{\circ}\text{C}$. The oscillators are housed in octal base plug packages of $1\frac{1}{2}$ in. diameter and a seated height of either $2\frac{1}{4}$ in. or $3\frac{1}{2}$ in. Typical oscillator current drain is 20 ma. and a typical oven will demand 15 w during warm-up and will require average power of approximately 5 w. Prices vary with frequency and quantity, but prototype prices are often in the \$90 to \$150 range.

Ovenaire Inc., 706 Forrest St., P.O. Drawer 1528, Charlottesville, Va. [381]

Receiving system covers 30 to 1,000 Mc

The SR-212 provides a-m/f-m/c-w reception over a frequency range of 30 to 1,000 Mc. It is a modular, solid-state, vhf-uhf receiving sys-



tem for use in either fixed-station or portable applications for the reception, detection, display and monitoring of r-f signals. The tuning is divided into four bands: 30 to 100, 90 to 300, 250 to 500 and 490 to 1,000 Mc. These four r-f heads plus a signal display unit are all mounted on one 3½ in. high panel. For portable operation the signal display unit may be replaced by a rechargeable nickel cadmium battery pack which furnishes ±12 v d-c for receiver operation. The receiver requires only 25 w of power. Four i-f bandwidths of 20 kc, 75 kc, 150 kc and 3 Mc are provided with the 3 Mc operable at all times and the others through a panel selection switch. Receiver front ends have at least two section preselectors at the r-f input to maximize reduction of cross-modulation and inter-modulation interference.

Astro Communication Laboratory, Division of Aero Geo Astro Corp., 801 Gaither Road, Gaithersburg, Md. [382]



Molded-construction full-wave bridges

A series of 1.5-amp, full-wave rectifier bridges features rugged molded construction. The rectifiers, called the NSS series, are a compact ½ in. by ½ in. with high quality, solid silver leads. Colored dots identify the leads. Output current is 1.5 amps at 50° C; 1.0 amp at 100° C. Standard units have a peak inverse voltage of 50 to 600 v; custom units offer 1,200 v (piv). Price of the 100 piv NSS series is 23 cents per junction in lots of 1,000 pieces.

North American Electronics, Inc., 401 N. Broad Street., Philadelphia, Pa. 19108. [383]

NEW FROM NRC

thin film vacuum coater



NRC's Model 3176 Vacuum Coater is a unique vacuum evaporation system for thin film deposition in R&D and production programs. Unmatched for versatility, reliability and ease of operation, the Model 3176 is used in the areas of solid state electronics, optics, magnetic films, memory planes and solar cells.

Exclusive features include: ■ **Fastest Useful Pumping Speed . . .** with high performance, lowest backstreaming NRC diffusion pump rated at 1500 liters/sec. ■ **Highest Conductance/Lowest Outgassing . . .** with the new NRC Slide Valve which was specifically developed for maximum pump efficiency. ■ **More Efficient Baffling . . .** with single circular chevron cold trap-baffle combination. ■ **Easy, Fast Operation . . .** with all controls (manual or automatic) conveniently mounted on front panel. ■ **Maximum Versatility . . .** used with 18" or 24" work chambers — electrical and mechanical feed-throughs interchangeable.

The Model 3176 has a new sophisticated appearance and is ready to operate. Merely connect power and water supply. Write or call for data sheet.

NRC EQUIPMENT CORPORATION

A SUBSIDIARY OF NATIONAL RESEARCH CORPORATION



A Norton Company Affiliate



160 CHARLEMONT STREET • NEWTON, MASSACHUSETTS • 617 332-5800

THERMOELECTRIC COOLERS

Standard line...
for immediate delivery!

New, exclusive CAMBION® line provides design engineer advanced TE cooling modules and assemblies for unlimited applications. All offer high heat pumping capacity, low current requirements — backed by the CAMBION name for proven design, quality manufacture. Latest versatile models include...

MODULE 3950-1

For spot cooling—especially in electronic components. Heat pumping capacity 6.8 watts; voltage 2.6 VDC; current 7 amps DC. Module mounted between aluminum plates for mechanical strength, uniform junction temperatures.

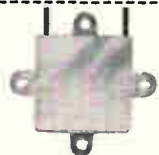

MODULE 3951-1

Similar in configuration to 3950-1, but with higher 20-watt heat pumping capacity. Voltage 6.4 VDC; current 7 amps DC.

MODULE 3952-1

Very low current requirements (1500 milliamps), high heat pumping capacity (2000 milliwatts) — yet very small (.786" sq. x .196" thick) and light (less than ¼ oz.). Ideal for hot spot problems in circuits with low available power.



ASSEMBLY 3970-1

Complete TE cooling system: cold plate, heat sink, fan and bracket. High 40-watt heat pumping capacity, low 7-amp DC current load. Unit measures only 4¼" x 5" x 4½".

COLD PLATE 7200-1

Newest laboratory device offers researchers a large area cold surface 6" x 3" down to -15°C — yet draws only 1 amp on standard 110-115 VAC, 60 cycle current!



Get Complete Data. Mail Coupon Now!

CAMBION®

Standardize on CAMBION...
The Guaranteed Electronic Components

Cambridge Thermionic Corporation
211 Concord Ave.
Cambridge,
Mass. 02138

- Enclosed is my order.
 Rush me details on CAMBION TE coolers.
 I wish applications assistance.

Name.....Title.....

Company.....Dept.....

Street.....

City.....State.....Code.....

New Microwave

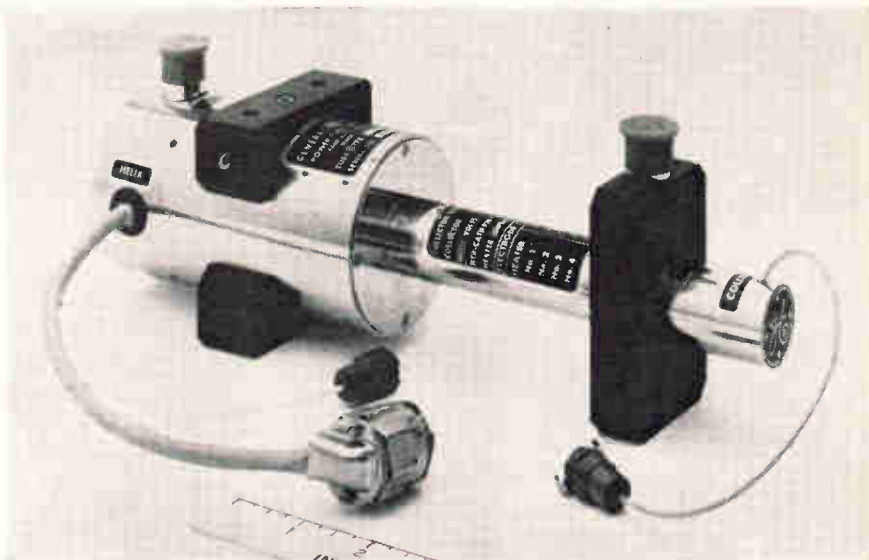

Ppm-focused twt's with low noise figure

A family of X-band, ppm-focused traveling wave tubes are said to provide the lowest noise figures ever obtained from any commercially available tube of this type. Noise figures of 8 db are available for four narrowband tube types covering the 7 to 10 Gc range. Three broadband versions offer power output greater than 10 mw over the 7 to 11 Gc range and more than 5 mw over the 8 to 12 Gc range. Small signal gain is greater than 30 db over the entire band for all tubes. The new tubes are of metal and ceramic construction.

The combination of small size, light weight, and rugged construction makes them ideal for high-performance military applications such as radar, electronic countermeasures, radiometry and instrumentation. They weigh 5.5 lb, measure 10.7 in. in length. They have been tested to withstand shock of 30 g for 11 millisecc and 15 g vibration to 2,000 cps. They will operate successfully at 100,000-ft altitude and at an ambient temperature range from -60°C to +92°C.

General Electric Co., Owensboro, Ky. [391]



Variable attenuators with flat response

Two new attenuators cover the range of 1.4 to 2.5 Gc and 3.5 to 6.75 Gc. They feature low insertion loss, flat response, wide range, and fine resolution. An insertion loss of

only 5 db at the zero db setting allows the attenuators to be used where limited power is available. Calibrated attenuation range for the 1.4 to 2.5 Gc (E102) model is 0 to 60 db; for the 3.5 to 6.75 Gc (E104) model, 50 db. Frequency sensitivity is less than +½ db at minimum attenuation with external terminations possessing a vswr of less than 1.1:1. Fine resolution is achieved by an expanded 8-in. dial scale which is four times longer than other coaxial attenuators. At midband, calibration is ±0.2 db or ±2%, whichever is greater. Other characteristics include good directivity for use as a directional coupler with high decoupling action or

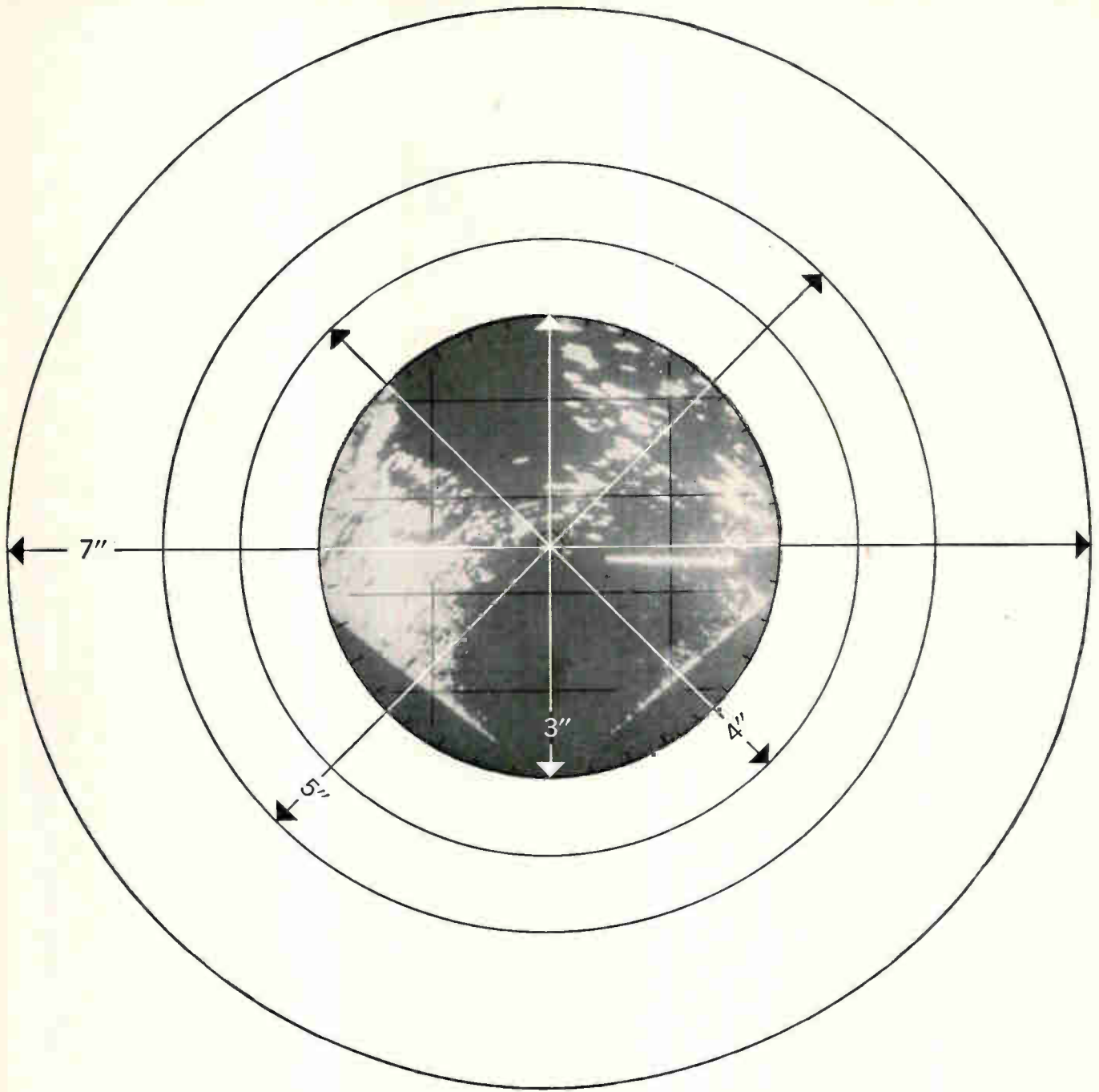

**Now there's a whole family of
high-contrast storage tubes that take 85 volts
instead of 10,000 to remove background brightness**

Now you can get a dark background *without* switching the phosphor high voltage—thanks to a patented new Westinghouse design. This reduces weight, volume and demand on the power-pulse source from a 10,000-volt pulse to 85 volts.

These new storage tubes bring "TV contrast" to radar display by combining extremely high contrast with the ability to reproduce as many as seven half tones (shades of gray).

And if it's rugged, long-life reliability you're looking for, look no further! Westinghouse display storage tubes withstand up to 10 G's vibration and 30 G's of

shock—2,500 operating hours, and -65°C to 150°C . At 120 lines per inch, their resolution leads the industry.

Diameters of 3", 4", 5" and 7" can be made with writing speeds to 1,000,000 inches per second, brightness to 3,000 foot Lamberts and storage times to 60 seconds. For complete data, write Westinghouse Electronic Tube Division, Elmira, N. Y. Or Westinghouse International Corp., 200 Park Avenue, New York, New York.

You can be sure if it's Westinghouse



ET-4105

Reprints Available from Electronics

Special Reprint Offer: For your reference file—a complete set of Special Reports reprinted from the pages of Electronics in the past year. A total of 155 pages of valuable and informative articles combined in an attractive folder. The reports are individually bound. The special discount price for the reports is \$2.50 which includes both handling and shipping costs. Order now using the coupon at the bottom of this page. The following reprints are included in this offer:

Oceanography—A survey of the growing electronics technology associated with underseas exploration. 15 pages.

Magnetics—An Electronics special report on what's new in today's magnetic technology. 24 pages.

Digital Instrumentation—A look at some new techniques in instrumentation. 16 pages.

Modern Electronic Packaging—How to locate, connect and afford protection for electronic devices and components. 16 pages.

Electronic Markets New Directions 1963-64-67—Surveys present markets and forecasts future electronics marketing opportunities. Includes marketing statistics and projections. 20 pages.

Today's Semiconductors—Survey of the newest semiconductor devices available to circuit designers. Tells how and where to use them to the greatest advantage. 24 pages.

Materials for Space Age Electronics—A comprehensive survey of a materials technology that is now shaping the course of the Electronics industry. 16 pages.

Radio Frequency Interference—Causes, effects and cures. How RFI has grown in the electronics industry making what was once a nuisance to a few an industry wide problem. 24 pages.

Remember to refer to this special offer when you order. Price is \$2.50 for the complete set or you may order them individually at 50¢ per copy.

Send your order to:
Electronics Reprint Dept. 330 West 42nd Street
New York, N.Y. 10036

Reprint order form

To help expedite mailing of your reprints please send cash, check or money order with your order.

For reprints of the latest special report:

Electronic switching

Send me reprints of key no. R-62 at 50¢ each.

For reprints of previous feature articles or special reports fill in below:

Send me reprints of key no(s) at ¢ each.

For prices and listing see the reader service card

For complete set of special reports (See special offer above)

Send me complete set(s) of special reports offered for \$2.50 per set.

Name

Number & Street

City, State

Zip Code

New Microwave

as a variable coupler for mixer applications. Maximum power rating is 100 w. Price of model E102 is \$450; E104, \$480.

Alfred Electronics, 3176 Porter Drive, Palo Alto, Calif. 94304. [392]

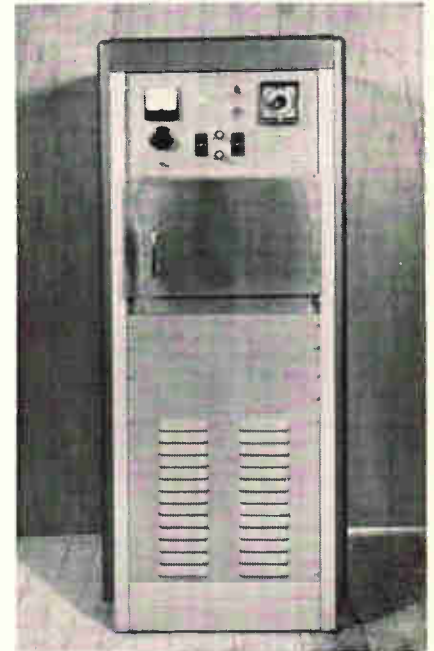

Microwave oven operates at 2,450 Mc

A fully instrumented, portable microwave heating system has been developed for experimentation in laboratories and pilot-scale industrial processing. Operating at 2,450 Mc. off a 220-v line, it is a broadly useful research tool with multiple applications in scientific investigation of the interaction of r-f waves with matter; biological, chemical, medical and pharmaceutical research; development of cooking, food-processing and vending machinery; bonding, curing, heat-setting of adhesives, fibers, films, finishes, plastics, resins and other natural and synthetic materials; and other industrial microwave applications. The system provides an adjustable range of usable heating power, from 800 to 1,400 w, in a 10 in. by 7½ in. by 6½ in. cavity, suitable for a wide variety of applications where maximum field strength is desired. Other cavity sizes can also be furnished. The

system is of modular construction, comprising a liquid-cooled, long-life magnetron of advanced design; air-cooled power supply; all necessary electronic control and programming functions and complete personnel, power line and component protection. It is packaged in a 25 in. by 27 in. by 62 in. free-standing cabinet, mounted on casters for easy mobility, ready to be plugged directly into any 208/224/240 v, 50/60 cycle, single-phase a-c circuit. Controls, indicator lights, magnetron current ammeter, circuit breakers and fuses are easily accessible on the front panel.

Comtek, Inc., 135 Main St., Woburn, Mass. [393]

Molded epoxy waveguide loads

Molded loads are available in a variety of configurations to fit standard waveguides. The amount of attenuation possible is a function of the iron content and the configuration of the molded load. The loads are machine molded with heat under high pressure to insure that they are void free and perfectly homogeneous. Advantages of molded loads over machining a cast shape are lower cost, elimination of air voids within the loss material, the accuracy and repeatability with which molded loads can be made, and no waste material. The most important advantage, however, is that molding produces a uniform load, in production quantities, that does not vary from piece to piece. The load is molded from an epoxy molding compound with an especially fine iron-powder filler. It is a semiconductor at low frequency since each iron particle

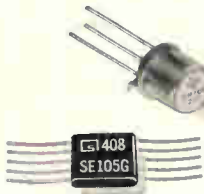
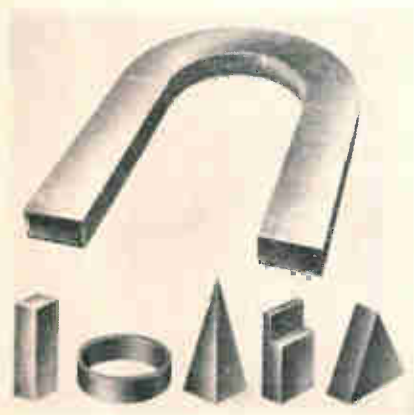

Need to say a lot
in a little space?

(or make markings
more **durable**...or
more **economical**...
or at **higher rates**?)

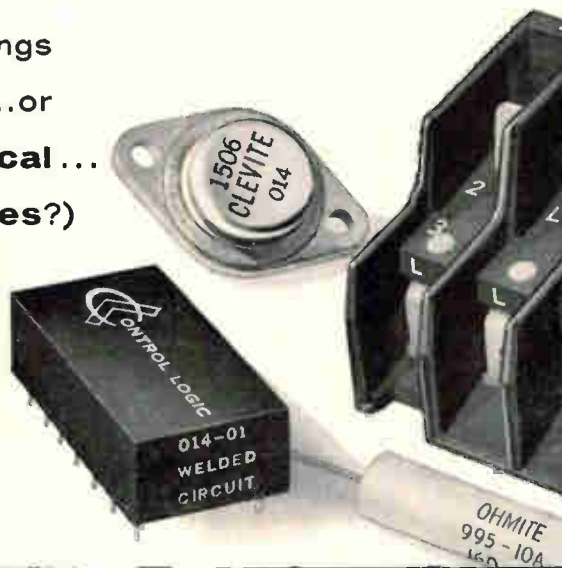

We can show you how

We can show you how to identify products so they will resist extreme amounts of handling, abrasion, many solvents and other atmospheric conditions . . . or how to sequentially number and identify components with savings of more than \$50 per 1000 . . . or how to print trademark, type number, value and date code on 90 units a minute . . . or how to produce an imprint that remains readable after 1000 hours at 200°C . . . or get 10 digits and 2 letters in a micro-circuit area of 0.090" — or 21 characters on a TO-5 case with interchangeable type number and date code . . . or save 75 cents of every dollar you now spend on buying, applying, inventorying and discarding obsolete reprinted labels.

The answers are in proven Markem machines, type and specialty inks, which daily produce better product or package identification by reducing costs, smoothing production control and increasing customer acceptance. And while Markem machines, type and inks are helping to produce better products through more complete and lasting identification, they frequently pay for themselves in the savings they make possible. Tell us what *you* make, what it must say, and for how long: we'll give you a specific recommendation and cost estimate right away. Write Electrical Division, Markem Machine Co., 305 Congress St., Keene, New Hampshire 03431.

MARKEM



"I solemnly swear to tell the truth $\pm .003\%$ "

Our new Portametric Voltmeter testifies to an accuracy several times better than most laboratory potentiometers. This means it can easily double as a voltage calibration system for laboratory potentiometers, digital and differential voltmeters.

Everything you need to start making measurements is conveniently built into the portable case, and you buy the works for one low price—\$895.

Up to now, there has been nothing on the market at this price with this kind of accuracy. We offer it as witness to ESI measurement capabilities and invite you to be the judge. ESI, 13900 NW Science Park Drive, Portland, Oregon (97229).

Model 330 Portametric Voltmeter
Voltmeter Ranges: 5–1 microvolt to 1200 volts.
Potentiometer Accuracy: ± 10 ppm of reading ± 1 ppm full scale on each range.
Voltbox Accuracy: ± 10 ppm.
Standard Cell Accuracy: ± 10 ppm.
Input Impedance: Infinite at null on ranges 1, 2 and 3. 10 megohms on ranges 4 and 5.
Battery Life: Approximately 1000 hours.
Null Detector: High-gain solid-state guarded detector; more than 5 microvolts dc sensitivity; input impedance: about 1 megohm.

esi Electro Scientific Industries

New Microwave

is surrounded completely by epoxy. At r-f it is a conductor. When the material is molded into the proper configuration, it functions as an infinite attenuator for r-f signals. The loads can be used in isolators, circulators, as a protector for bearings in rotary joints or anywhere in microwave circuitry where it is desirable to completely dissipate a signal.

Epoxy Products, Inc., 133 Coit St., Irvington, N.J. 07111. [394]

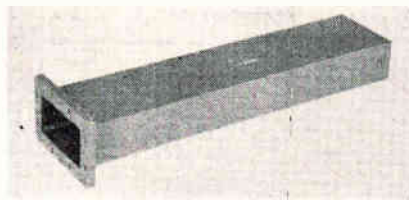

Waveguide termination for 3.3 to 4.9-Gc use

A medium-power waveguide termination is available for use over the frequency range of 3.3 to 4.9 Gc in the normal microwave communication band. It has an average power capacity far in excess of the usual low-power termination, but still maintains the same relative size and weight characteristic. The WS-229 termination is designed to provide minimum vswr values over the entire waveguide operating-frequency range within a minimum length configuration. According to the manufacturer, the excellent power handling capability is assured through the use of a newly developed terminating element and the careful selection of close tolerance waveguide material. Vswr is 1.10 maximum; average power, 25 w maximum; and overall length, 10½ in.

Waveline Inc., Caldwell, N.J. [395]

R-f pulsed modulator for 500 to 5,900 Mc

A high-power signal source—model 18500 r-f power pulser—is designed for any fixed frequency from 500 to 5,900 Mc, adjustable with

Find the product... Fast!



It's quick and easy to locate any of the thousands of electronic and allied products in your **Electronics Buyers' Guide**. All are listed clearly and unmistakably, cross-indexed with end use terms synonyms and newly devised terms. And, all advertisers in the EBG are carefully cross-referenced to their catalog-advertisement. Top this off with 6,000 trade names indexed alphabetically and you have the most complete, accurate and authentic product listings in the industry!

Electronics Buyers' Guide
 A McGraw-Hill Publication
 330 West 42nd Street,
 New York, N.Y. 10036



a vernier to $\pm 2\%$. Peak pulse r-f power is variable from 5 to 2,500 w in the 500 to 3,000-Mc range; 5 to 2,000 w—3,000 to 4,000 Mc; 5 to 1,500 w—4,000 to 5,400 Mc; and 5 to 1,000 w—5,400 to 5,900 Mc. Pulse width is continuously variable from 0.25 to 2 μ sec. Internal and external syncs are also continuously variable; the former from 150 to 4,000 pps, and the latter from 0 to 4,000 pps. Maximum duty is 0.002. The instrument includes a pulse modulator, r-f triode oscillator and cavity within a 8½ in. high by 18 in. wide by 12 in. deep cabinet. Price ranges from \$1,975 to \$2,475, depending upon peak power, frequency and frequency tunability requirements. Narda Microwave Corp., Plainview, L.I., N.Y. [396]

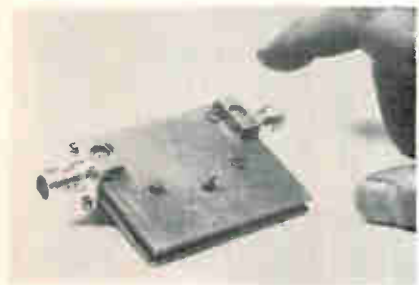

Variable attenuators cover broad bands

By refining inherently phase stable designs with compensating techniques, the manufacturer claims to have achieved remarkably low phase variation vs attenuation over broad frequency bands and temperature ranges. The 757 series covers broad bands from 50 Mc to 4,000 Mc; up to 15-db attenuation; less than 0.6 db insertion loss; attenuation typically flat within ± 0.5 db; phase shift vs attenuation, $\pm 2^\circ$ to $\pm 3^\circ$. Price is \$575 to \$750 each. Premier Microwave Corp., Port Chester, New York. [397]

NEW MAGNETIC ITC COMPONENTS



It's New ...

LV SERIES

VARIABLE INDUCTORS

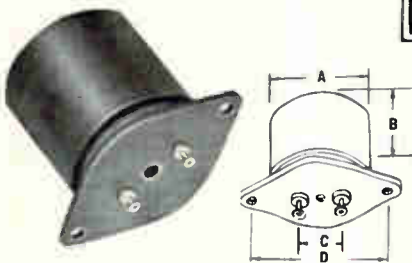

Specially designed for accurate inductance where close tolerances are required for final tuning of equipment. Unique parallel gap construction provide the following advantages.

1. Negligible distortion.
2. Up to core saturation—very low changes of (L) inductance with increased D.C. (See charts above.)
3. Exceptionally high Q for the size units.
4. Wide frequency band 0-100 KC.
5. Wide Inductance ranges.

Series No.	A	B	C	D
10 LV	.82	.63	.37	1.00
20 LV	1.25	1.25	.60	1.56
30 LV	1.80	1.25	0.9	2.06

Size of unit a direct function of ...

A. Maximum permissible voltage is the given constant Cv times frequency or 400 V RMS—whichever is lower. B. Q—changes with rotation and frequency (see appropriate curves)*

C. Max. permissible DC for the reactor to be linear. This is a function of rotation, size, and part number (see table)* $Cdc \times \text{Rotation} + \text{a constant}$. D. Maximum permissible heat dissipation (see table)* $= (I_{dc}^2 + I_{ac}^2) \times Rdc \text{ lac} = V \times wL = V / 6.28 \text{ fl}$

*To understand the direct functions and to follow the example shown send for I.T.C. Magnetic Components Catalog.

EXAMPLE: Part No. 20 LV 121 has a max. of .12 henries, Cv of .024 therefore at 400 CPS maximum applicable voltage which should be used is $400 \times .024 = 9.6$ Volts. To determine the max. permissible current for linear inductances at .2 turn rotation would be (see table) $630 \times .2 + 16 = 142$ m.A. at .2 turns we have 25% of L max. = .03 henries. The AC current $= V / 2\pi fL = 9.6V / 6.28 \times 400 \times .030 = 127$ m.A. A.C. The total permissible current for maximum temperature rise is determined by the sum of the square of the AC and DC current. Therefore $(.127^2 + .142^2) \times 22 \text{ ohms} = .8$ watts, which is adequate for this unit (2.5 watt max.). Curve under 20 LV Series shows Q = 38 at .2 turns and 1000 cps. To estimate the Q at 400 cps it may be shown as $Q_{400} = 400 \div 1000 \times Q_{1000}$ or $Q = 400 / 1000 \times 38 = 15.2$. Other windings obtained on request.

INDUSTRIAL TRANSFORMER CORP.

GOULDSBORO, PENNSYLVANIA • Tel.: (717) VICTOR 2-2111 • New York (212) WALKER 5-9860

Circle 212 on reader service card

NEW 30,000 V 20 MA POWER SUPPLY

Model PSA 30-20



COMPACT—10½ Inch Panel Height

LIGHT WEIGHT—65 Lbs.

WRITE FOR COMPLETE DETAILS

- Portable or Rack Mount
- Adjustable .05% Resolution
- 4½ in. Meters 2% Accuracy
- Control Function Indicator Lights
- Low Ripple
- Low Regulation
- Air Insulation
- External Interlock
- Reversible Polarity
- Solid State Rectification
- Conservatively Rated
- Over and Under Current Trip
- Over and Under Voltage Trip
- Surge Limiting
- Zero Interlock
- Multi-Range



ELECTRONICS DIVISION

RESEARCH-COTTRELL, INC., BOUND BROOK, NEW JERSEY
CHOICE REPRESENTATIVE TERRITORIES AVAILABLE

RG-279E



INFORMATION DISPLAYS, INC.

CURVILINE® CHARACTER GENERATOR

Low cost, reliable character generator which writes symbols like you do — with continuous straight and curved lines.

- **FAST**
... up to 100,000 characters/second, standard.
- **COMPACT**
... only 9 printed circuit cards for full alpha-numeric vocabulary... only 12 printed circuit cards for 70 symbol vocabulary.
- **LEGIBLE**
... continuous line character formation gives crisp, bright symbols.
- **NON-AMBIGUOUS**
... straight and curved lines distinguish between similar characters.
- **VERSATILE**
... triggered or free running operation.
- **EXPANDABLE**
... no practical limitation on number of additional symbols which can be provided.

... and MORE!

WRITE FOR
COMPLETE DETAILS!

408R USAF 651
04DEC62=001527
13760FT 3196S
17676E1030L16R
TH337XXXXXXX
XXXXXXXXXXXXXX



... from \$2,400

INFORMATION DISPLAYS, INC.

Formerly RMS ASSOCIATES, INC.

... data processing & display products

102 E. Sanford Blvd., Mt. Vernon, N.Y. 10550
914 OWens 9-5515



"VITREOSIL"® is the word for VITREOUS-SILICA (PURE FUSED QUARTZ)

Pure fused quartz is no longer a laboratory curiosity. More and more industrial production in chemical, semiconductor, electronic, optics, etc. find quartz the only answer to many demands of higher production. Virtually chemically pure quartz does not contaminate any process, operates up to temperatures of 1100°C continuously, takes unlimited thermal shock, is unaffected by most acids, has excellent electrical and heat insulating qualities and is exceptional for light transmission. Write for more details on **VITREOSIL** pure fused quartz.

**THERMAL AMERICAN
FUSED QUARTZ CO.**

RT. 202 & CHANGE BRIDGE RD.
MONTVILLE, NEW JERSEY
Circle 213 on reader service card

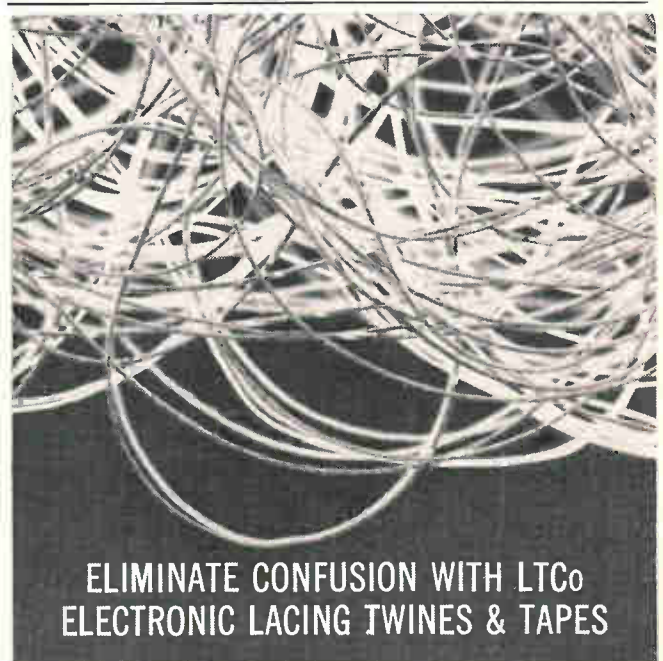

ELIMINATE CONFUSION WITH LTC_o ELECTRONIC LACING TWINES & TAPES

LTC_o cords and tapes simplify circuits. Choose from a variety of natural and synthetic fibers: nylon, teflon, linen, cotton and polyester. Free brochure describes put-ups, constructions and finishes. Write:



THE LINEN THREAD CO.

Blue Mountain, Alabama

A DIVISION OF INDIAN HEAD MILLS, INC.

New Production Equipment

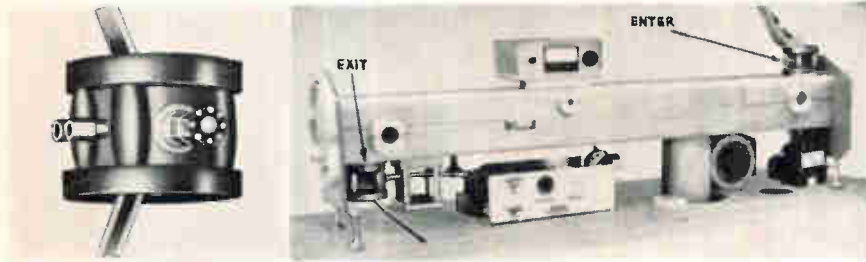

Transfer lock improves vacuum processes

A device is now available for atmosphere-to-vacuum and vacuum-to-atmosphere pass-through. It is a small vacuum lock with a rotating member that transfers objects rapidly from atmosphere into a vacuum chamber, or vice versa, without interfering with the vacuum in the chamber. This vacuum transfer lock makes practical the design of continuous flow processes for microelectronic film depositions, materials testing, evaporant recharging, vacuum tests for propellant ignition, electron microscope sample comparisons, etc. The rotary vacuum lock has been proven in production use in a continuous

in-line tantalum sputtering system. Process repeatability, film quality, and production output are greatly enhanced by continuous, unbroken vacuum processes. Significant economies are realized in pump-down, bakeout, and cooldown time and from protection from system contamination between runs. For microelectronics applications, the substrates can be handled without special frames, magazines, or intralock manipulators. At no time does the circuit-surface of the substrate come into physical contact with the lock.

Vacuum Processes, Inc., P.O. Box 523L, Richardson, Texas 75081. [421]



Micropositioner table for small components

Rapid and ultra-precise positioning of small parts is made possible by the XY-500 micropositioner table series. Initially designed for the semiconductor industry for the fabrication, probing, bonding and welding of integrated circuits and

transistor wafers, the table is expected to have wide application. It is claimed that the two-axis table has a total travel of 2 in., both X and Y, at speeds of 0.150 in. per sec, achieving an accuracy of 95 millionths of an inch. Two possible methods of programming, both electronic, are offered. Model XY-501 has two thumb-wheel switches for straight X- and -Y indexing up to 0.0995 in. per step and typically can be programmed to probe a 0.050-in. spaced pattern on a 1-in. slice in less than 10 minutes. Model XY-533 uses a punched-tape reader for complex programs (as illustrated). With a tape spooler, it can be programmed for hundreds of points. A position feedback system is available as an optional item. Price range is from \$3,750 for the basic XY-500 table to \$7,550 for the complete tape-driven XY-533 system.

Transistor Automation Corp., 101 Erie St., Cambridge, Mass. 02139. [422]

MINIATURE BLOWER FOR SPOT COOLING



nugget[®] blower

The NUGGET BLOWER will deliver 14 CFM of air for spot cooling in commercial electronic equipments such as radio transmitters, power supplies, instrumentation, office machinery, PA systems, tape recorders, projectors, TV cameras and telephone applications. The air impeller and blower housing are molded of high impact strength polycarbonate plastics. New "Centraxial" wheel offers greater volume-to-pressure characteristics than conventional squirrel cage types.

- 14 CFM FREE DELIVERY
- LIGHTWEIGHT—ONLY 0.6 LBS.
- COMPACT DESIGN—ONLY 3-19/32" x 4-1/32" x 2 1/4"
- CAN BE MOUNTED IN ANY POSITION
- 115 VOLTS, 60 CPS, SINGLE-PHASE, 3200 RPM
- DRAWS ONLY 7 WATTS
- SUITABLE FOR OPERATING IN AMBIENT TEMPERATURES TO 72°C.
- EXTREMELY QUIET OPERATION
- LOW, LOW COST
- COMPLETE ACCESSORIES INCLUDING PLUG AND CORD ARE AVAILABLE

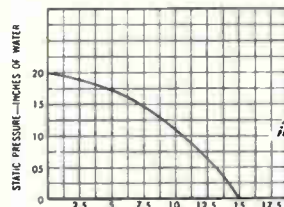

Write today for complete information.



ROTRON

MFG. CO., INC.
WOODSTOCK, NEW YORK
914 ORiole 9-2401

West Coast: Rotron/Pacific, Glendale, Calif.
Canada: The Hoover Co., Ltd., Hamilton, Ont.

Silicone compound cures fast without air

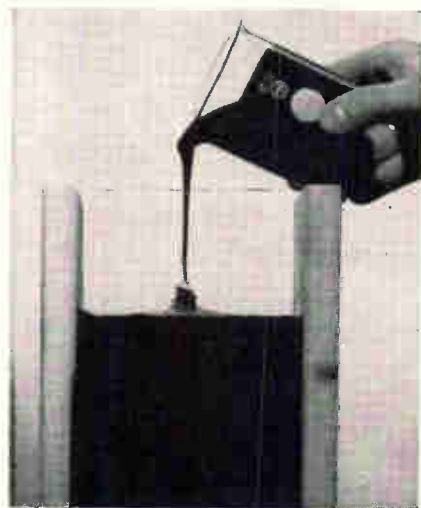

A new RTV silicone rubber potting and encapsulating compound offers 15-minute cure at 150°C for faster production line use; a cure system that requires no air; improved pourability, and tensile strength superior to conventional RTV silicone rubbers, according to the manufacturer. RTV-616 is an easily pourable black liquid which cures by addition of a catalyst to a solid, opaque, resilient rubber. The material protects electronic circuitry, electromagnets and other units and assemblies against moisture, mechanical shock, vibration, thermal shock, heat, ozone, chemicals and

voltage stress. It retains good physical properties from -65 to 250°C. In addition to its ability to cure quickly at 150°C, RTV-616 will also cure tack-free at room temperature in 24 hours. Unlike some potting compounds, the product utilizes a cure system that requires no air and yields no by-products. Typical viscosity in uncured form is 4,000 centipoises, which is claimed to be less than any previous filled liquid silicone rubber. Tensile strength is in the 800 to 1,000-psi range. This compares to about 650 psi for conventional RTV silicones. Quantity price is \$3.97 per lb in 55 gallon drums. General Electric Co., Waterford, N.Y. [411]

Vinyl compound insulates cables

A multipurpose vinyl cable insulation has been developed with a wide temperature range and low odor. Wires insulated with this vinyl compound, known as Plasticote LO-105, are U/L and CSA approved and exceed their low temperature flexibility test requirements, including voltage breakdown after cold bend. These wires also comply with a special low temperature brittleness test which is said to be more severe than the usual industry standards. For high temperature internal wiring applications, wires insulated with this compound have many 105°C approvals. Wires with Plasticote LO-105 also surpass the rigid standard test for low odor and taste levels. Chester Cable Corp., 101 Oakwood Ave., Chester, N.Y. [412]

High-temperature insulating cement

A new high-temperature insulating cement called Magolite is composed of powdered ceramic and a mixing fluid. Said to be an excellent electrical as well as thermal insulation, it is used to encapsulate mi-

crowave tube bases. The cement has also been impregnated with carbon for use as a high-power microwave load. It is suitable for any application of this type which requires a high-temperature porous ceramic base. Solid and liquid parts of the Magolite will keep indefinitely until they are mixed. When the two components are mixed together, they will harden at room temperature to provide a very effective heat barrier for temperatures up to 5,000°F. Magolite can be formed in place or pre-cut and used as slabs. After curing, it can be machined. The cement is available from stock in lots of 1 to 10 lb at \$20 per lb.

Semicon Associates, P.O. Box 832, Lexington, Ky. 40501. [413]

Epoxy encapsulants for single-dip use

Two new 100% solid, one-component epoxy encapsulating materials are designed for single-dip application, eliminating multiple coat systems. Sterling Y-293 and Y-318 require no mixing prior to use, involve a minimum amount of handling with their one-dip process, eliminate use of a wax overcoating, afford excellent moisture and chemical resistance, have good

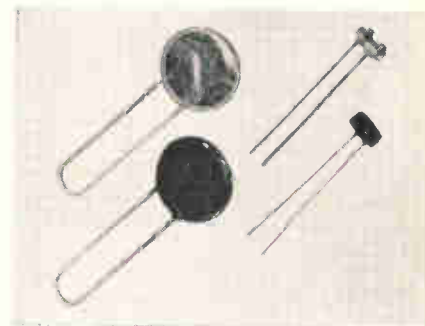

electrical characteristics, prevent sag and flow during cure due to their thixotropic nature, possess long shelf life, pass thermal shock tests, and provide improved heat resistance. Y-318 is a flexible dip encapsulant for ceramic capacitors that meets thermal shock requirements from -35°C to +85°C. Power factor, Q factor, insulation resistance and corona resistance are excellent after thermal cycling. These properties are obtained after short cures at 135° to 150°C. Y-293 is a flame retardant coating for Mylar and mica capacitors. It affords excellent moisture resistance and electrical properties. It passes UL No. 492 for flame retardance for radio and tv equipment. Mylar units treated with Y-293 also meet thermal shock requirements from -40°C to +150°C. The Sterling Varnish Co., Haysville Boro, Sewickley, Pa. [414]

The first ready-to-use RTV silicone rubber that flows, adheres and flexes



RTV-112 silicone rubber has four characteristics that make it an easy-to-use production line sealant.

Pourable. It's conveniently dispensed automatically or manually.

Ready-to-use. No catalyst to be mixed beforehand. No stirring, either.

Adhesive. Bonds to most surfaces without a primer.

Flexible. Absorbs shock and vibration. Puts no stresses on components.

RTV-112 handles like paint. It can be sprayed and brushed. Parts can be dipped in RTV-112 for easy encapsulation. It's tack-free in 30 minutes, and cures in 24 hours at room temperature. No solvents, so there's no flammability hazards and virtually no shrinkage.

RTV-112 silicone rubber is unique. Virtually ageless, it won't crack, crumble or harden. You can cut it away

and add more for easy repairs. Stays rubbery from -85°F to 300°F . It also has excellent electrical properties. It's waterproof.

Where should RTV-112 be used? Because of its easy pour-on protection, RTV-112 is a natural for many production line applications... conformal coatings for electronic components and assemblies, high temperature seam sealing and potting of intricate electrical apparatus to mention a few.

We'll be glad to fill you in even more on RTV-112, the first free-flowing, precatalyzed, high temperature, elastomeric adhesive, sealant and encapsulating compound. We'll include a list of suppliers of automatic dispensing equipment. If you'd like a free sample, drop a note on your letterhead describing your application to Section N11127, Silicone Products Dept., General Electric Company, Waterford, New York.

GENERAL  ELECTRIC

FOR POSITIVE SHOCK PROTECTION

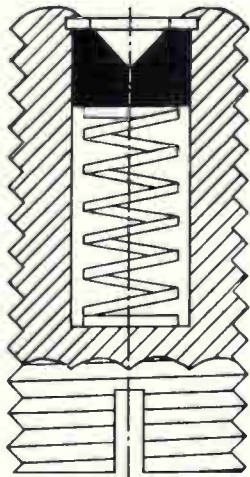

USE BIRD CUSHION JEWELS IN INSTRUMENT ASSEMBLIES

Bird Jewel Assemblies mounted with resilient silicone rubber or spring cushioning provide inexpensive shock resistance for any instrument. Variable cushioning absorbs acceleration and deceleration shocks and severe vibratory stress without damage to pivot point.

Cushion Jewels maintain perfect alignment, through controlled jewel movement, provide greater accuracy and longer life. For only pennies more Cushion Jewels will protect your instruments.

BIRD COMPLETE JEWEL ASSEMBLIES are available in screws or bushings of any style, ready for product assembly. Our engineering staff is at your service for all your jewel bearing needs. Write for our catalog with full details on properties and uses of sapphire and glass jewels.

Richard H. Bird & Co., Inc.
1 SPRUCE STREET, WALTHAM, MASS. 02154

Serving Industry with Fine Jewels since 1913

New Books

Superpower engineering

High Power Microwave Electronics
P.L. Kapitza
Pergamon Press, The MacMillan Co.
New York, 1964, 145 pp., \$9

The subject of this book is crossed-field and waveguide microwave electronics for power rather than communication. The content is a relatively small part of what is implied by the title.

Even with regard to modern crossed-field devices, the book is limited in scope. Hence it is not adequate as a text for the purpose cited on the jacket. It contains about 139 pages of discussion on the foundations of the theory of high-power devices of the linear and reentrant magnetron type, including some experimental results. About 103 pages of these are on the theory of electromagnetic oscillations in linear and reentrant-bar or ladder-line type resonators.

Few of the topics considered represent the present state of the art, let alone advances. However, the few that do are significant contributions in the fields of internal losses, end effect, unique applications and valuable labor-saving analytical techniques.

Emphasis is on the M-type or crossed-field interaction, which develops the electromagnetic field in the associated reentrant and linear-bar or ladder-type symmetric resonator. Electric interaction, as involved in drift-space tubes such as the klystron and in O-type growing-wave tubes such as the traveling-wave tube, is excluded from the text on the premise that space-charge limitations normally imposed on high-power electronic processes are eliminated by the inherently high-efficiency crossed-field interaction.

This exclusion, however, ignores the fact that recent klystron generator work has mitigated space-charge limitations. Also, klystrons are not plagued by most of the power-limiting factors inherent in crossed-field devices, except a few such as multipactoring, and these only at much higher power. Thus the power capability of the klystron generator is generally superior to that of the crossed-field

generator at a given wavelength, even though the latter's efficiency is significantly higher, even at microwave—over 70% compared with less than 60%. However, the superior efficiency of the crossed-field generator is a major factor in its favor in competition with the higher power capability of the klystron generator even on a specific weight basis, such as kilowatts per pound.

Coverage of crossed-field interaction phenomena is limited to the magnetron and planotron—in the roles of microwave generator, microwave rectifier and microwave frequency converter. Their resonant systems are restricted to the bar or ladder-line with and without septums.

The fact that these resonant systems were analyzed, developed and published in the United States and France since World War II is not acknowledged in the text. Only a few fleeting references are cited, making it difficult for the uninitiated reader to distinguish between what is new and what is well known.

The book lacks a list of symbols, which would avoid the need for tedious searching for their identification, especially since a few symbols have different meanings in different sections of the text. Some symbol identifications are omitted altogether.

The book is organized satisfactorily; it is fairly lucid, relatively free of errors, written in an appealing style, and tactfully illustrated. It should be easy to read for anyone with engineering or scientific training.

The material covered is relatively extensive, especially with respect to the planotron. Several important problems are thoroughly discussed, and various labor-saving mathematical methods are carefully introduced and developed in a way that does not obscure their physical meaning. The text contains well-chosen topics, some supporting experimental examples.

Ernest Okress
American Standard Research Division
American Radiator & Standard Sanitary Corp.
New Brunswick, N.J.



2" BLOWERS a.c. or d.c.

Globe's 2" diameter VAX-2 vaneaxial blowers give you substantial amounts of cooling air in a rugged, compact, lightweight package. Check over these versatile blowers.

VAX-2-MC. Designed for 50 cfm. @ 2.1" H₂O back pressure, unit operates on 200 v.a.c., 400 cycle, 3-phase or 115 v.a.c., 400 cycle, 1-phase. Variable speed high altitude units available. Length is 1½"; weight is 5 oz. Flange mounting. MIL specs.

VAX-2-MM. Designed for 37 cfm. @ 1.5" H₂O back pressure, unit operates on 26 v.d.c., but other versions may be wound for up to 115 v.d.c. operation. Length is 2"; weight is 5 oz. Flange mounting. Designed for MIL specs. Also smaller and larger blowers available. Request Bulletin VAX-2.

Globe Industries, Inc., 1784 Stanley Avenue,
Dayton, Ohio 45404, U.S.A., Tel. 513 222-3741

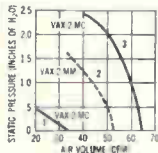

1. VAX-2-MC P/N 19A1150
200 v.d.c., 400 cps
2. VAX-2-MM P/N
19A907 26 v.d.c.
3. VAX-2-MC P/N 19A774 for
200 v.a.c., 400 cps or 19A790
for 115 v.a.c., 400 cps

Circle 215 on reader service card



Your responsibility?

One advantage of buying laminated plastic fabricated parts from us is that mistakes in machining are ours.

You pay for what you order. Material spoiled is our headache.

Rejects can happen. Even in our fabricating shop, probably the largest of its kind in U.S. and with 35 years of working with laminated plastics, they can happen. We keep them down through strict quality control. We keep them down because correct cutting speeds, feeds, clearances, sharp tools, knowledge of the laminates (which we make) and proper construction of dies, jigs and fixtures are second nature. If you want to save trouble and money, order laminated plastics parts direct from Synthane. Send for a copy of our new booklet—"Laminated Plastics Parts... Make or Buy?" Synthane Corporation, 36 River Rd., Oaks, Pa.

You furnish the print... we'll furnish the part

SYNTHANE

CORPORATION **S** OAKS, PENNA.

Synthane-Pacific, 518 Garfield Avenue, Glendale 4, California



Lepel

Induction Heating's Most
Trusted and Creative
Craftsmen Since 1926

High Frequency

INDUCTION HEATING UNITS

for

- BRAZING
- MELTING
- SOLDERING
- ZONE REFINING
- HEAT TREATING
- CRYSTAL GROWING
- BOMBARDING
- PLASMA TORCH

ELECTRONIC TUBE GENERATORS

Kilocycle Frequency Units

Megacycle Frequency Units

Dual Frequency Units

- SPARK GAP CONVERTERS
- ACCESSORY EQUIPMENT

FREE APPLICATION ENGINEERING SERVICE—Our engineers will process your work samples and submit recommendations.

WRITE FOR NEW LEPEL CATALOG
Lepel HIGH FREQUENCY LABORATORIES, INC.

55th St. & 37th Ave., Woodside 77, N.Y.C.

Chicago Office for Sales & Service: 6246 W. NORTH AVE.

Circle 216 on reader service card

Circle 165 on reader service card

165

Technical Abstracts

High-efficiency converter

Low-input voltage converter-regulator
Peter Ramirez Jr., Electro-Optical
Systems, Inc., Pasadena, Calif.

The converter-regulator can produce usable voltages from low-voltage power sources such as solar cells, fuel cells, thermionic diodes or thermal electric generators. An input voltage of 0.75 to 1.5 volts d-c is converted to 28 volts and regulated to within $\pm 1\%$. The power capability is 50 watts and the over-all efficiency is 75%.

The converter consists of a Dreisbach self-excited circuit that has high efficiency. There are no bias-network losses, no rectifier losses and the switching losses are low because not all of the output power is switched. The transformer secondary voltage is added to the input voltage through the base-emitter of the "on" transistor, which also acts as a rectifier. The Dreisbach converter has a low input resistance that minimizes the losses due to high input current.

The converter input current is limited by the transistor collector current rating, and the output current is limited by the base current rating.

Germanium power transistors were selected for the converter because of their low saturation resistance, low base drive losses as a result of high current gain and small losses of switching power.

Orthonol was selected as the core material for the converter transformer because of its narrow hysteresis loops (low core losses) and high saturation flux density (less iron and copper required, minimizing transformer size and increasing efficiency). The transformer windings were interleaved and bifilar-wound to reduce the leakage inductances that give rise to voltage spikes that damage transistors.

Conduction losses were kept at a minimum by proper selection of wire sizes. Contact losses were reduced by gold-brazing techniques where possible.

To obtain high efficiency, a non-dissipative type of regulator was

used to maintain the output voltage within the required limits. The regulator consisted of a multivibrator, flip-flop, integrator, two emitter followers, a Schmitt trigger, a diode gate circuit, a driver and a push-pull amplifier in the output stage where the output voltage is added to the input voltage. The feedback loop was completed by sampling the output voltage and comparing it with a reference voltage in the differential amplifier circuit. Silicon diodes and transistors were used in the regulator, and the operating temperature range was from 0° to 85°C .

Presented at the 1964 Western
Electronics Show and Convention
(Wescon), Aug. 25-28, Los Angeles.

Radar octopus

A method for generating
television mosaic displays
C. Bernes and John Conway
Raytheon Co., Wayland, Mass.

When a group of radar sets is used to monitor a large area, each set generates its own display of the particular area it covers. In some applications, however, such as air-traffic control, it would be advantageous to take data from a group of scattered radars and produce one display in a central location.

This paper describes a technique for producing such a display from as many as eight radars. First, the area for which each separate radar is to provide data is selected, taking advantage of any overlaps that exist to avoid blind spots. The areas can be any shape or size, and the coverage area of one radar can encompass some or all the coverage area of another radar.

Next, a slide is prepared in various shades of gray—including black and white, with each shaded area having the same shape as the coverage of a given radar. This slide is then scanned by a video camera. The output signal from the camera then has a different voltage level for each of the shaded areas and this signal is used with logic circuits to gate data from the corresponding radar set into the over-all display screen. The radar data is actually a televised

view of a given radar set's plan position indicator.

Besides an over-all view of a large area, views of limited areas can be obtained on separate monitor screens. This operation is obtained by using digital counters to delay unwanted parts of the composite display and allow just the desired parts to appear on the screen.

Included with the system description are block diagrams and waveforms—12 drawings in all. The television mosaic-display system was developed for the Federal Aviation Agency to increase the effectiveness of air-traffic control.

Presented at the Society for
Information Display National
Symposium, Oct. 1-2, Washington.

Sputtering resistors

Characterization of vacuum evaporated
and sputtered nickel-chromium films*
I.H. Pratt, U.S. Army Electronics
Laboratories, Fort Monmouth, N.J.

This report leaves little doubt that cathodic sputtering has definite advantages over vacuum evaporation as a controllable method of making thin-film alloy resistors, although sputtering is not generally used. The results from sputtering are more predictable than the results from vacuum deposition. This is demonstrated by both chemical analysis and electrical measurements of the deposited films.

The report compares films of varying sheet resistivities made from Nichrome V, a resistive alloy whose nominal composition is 80% nickel and 20% chromium.

When this alloy is evaporated, the chromium evaporates about 75 times faster than the nickel, because chromium is more volatile. As a result, the deposited films contain up to 95% chromium depending on sheet resistivity (the thicker the film, the lower the sheet resistivity and chromium content). Moreover, the films have an oxide content that decreases with film thickness and there are other metallurgical variables.

The electrical characteristics of vacuum-evaporated films vary as a consequence of the metallurgical variations. The greatest variance is in coefficient of resistivity. It varies

* Presented at the National Electronics
Conference, Oct. 19-21, Chicago.



Build "Years Ahead" Features into Your New Equipment

... Using Low-Cost Motorola MECL* Integrated Circuits

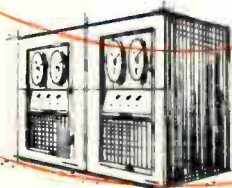

COMMERCIAL COMPUTERS

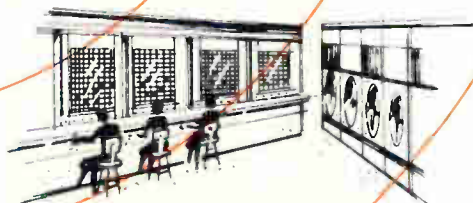

MANUFACTURING CONTROL SYSTEMS

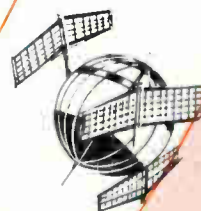

INSTRUMENTATION

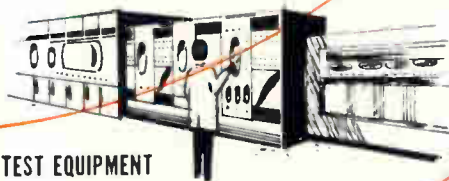

TEST EQUIPMENT

Now it is economically practical to take advantage of the added equipment features you get by designing and building electronic equipment with integrated circuits. A new series of Motorola low-cost high-speed integrated circuits, which cuts seven years out of projected pricing predicted by many industry experts, has spurred immediate wide-spread application of integrated circuits in all types of commercial electronic gear!

The circuit complement, types MC352 through MC361, includes flip-flops, half adders, bias drivers, gate expanders, dual 2-input gates, 3-input gates, and a 50 mc J-K flip-flop... with features such as:

SPEED — Low propagation delay (6 nsec) which makes possible a new generation of commercial computers with reduced size as well as increased logic capability per unit volume.

LOW PRICES — Circuit costs that are actually below those of many circuits using discrete components and presently manufactured in large quantities.

PACKAGE CHOICE — Available in either TO-5 or ceramic flat package, permitting immediate use in printed circuit boards or for new compact packaging which utilizes the small flat package.

Compare These New Low Circuit Prices

TYPE	1-24	25-99	100-199
MC352 Flip-Flop	\$4.55	\$4.00	\$3.65
MC353 Half Adder	5.95	5.20	4.75
MC354 Bias Driver	2.45	2.15	1.95
MC355 Gate Expander	2.80	2.45	2.25
MC356 3-Input Gate	3.55	3.15	2.85
MC357 3-Input Gate (no output resistor)	3.55	3.15	2.85
MC358 J-K Flip-Flop	9.50	8.35	7.60
MC359 Dual 2-Input Gate	3.70	3.25	2.95
MC360 Dual 2-Input Gate	3.70	3.25	2.95
MC361 Dual 2-Input Gate	3.70	3.25	2.95

*Suffix G = TO-5 Package Suffix F = Flat Package (slightly higher priced)

For usual commercial equipment temperature performance requirements (+10°C to +60°C), the 0 to +75°C ambient temperature rating of this circuit series offers added design freedom.

Increased speed of computers and relief from many interconnection problems are made possible by the large fan-in and fan-out capability (25)... and the unique current mode logic design which provides *simultaneous complementary functions (AND/NAND-OR/NOR) at each gate!*

See your local Motorola semiconductor distributor or your nearest Motorola district office for immediate local delivery on all circuit types. For complete technical details write: Motorola Semiconductor Products Inc., Technical Information Center, Box 955, Phoenix, Arizona 85001.



MOTOROLA[®]
Semiconductors

*Trademark of Motorola, Inc.

235-11

Articles, manufacturers and advertising are all cataloged in the 1964 Electronics Index

Tom Egan
Electronics Reprint Dept.
330 West 42nd St., New York, N. Y. 10036

Enclosed is my check for \$1.00.
Please send me a copy of the 1964 Electronics Index.

NAME _____

COMPANY _____

ADDRESS _____

Use this coupon to order your copy

Now, readers of Electronics can get an Index to the magazine that will help them find out not only technical articles by subject — but also references to any electronics company, company advertisements, and news and feature material.

This new, easy to use Index will be available in January for \$1.00. It will be published in addition to the regular abbreviated index in the December 28th issue of the magazine.

The Index — attractively bound, 8½ by 11 inches in size — will have three sections:

ARTICLES: This section contains a complex index of technical articles, news, features, and the key new products. They're grouped in more than 250 categories and cross-indexed for easy reference.

MANUFACTURERS: This corporate reference gives the page and issue for each mention of an electronics company in the editorial pages of the magazine. It will also reference government and military organizations.

ADVERTISERS: Every advertiser in the 1964 issues of Electronics will be listed in this section alphabetically with the issue dates and page numbers of their ads.

This Index is a valuable, year-round reference tool for your home, office or company library. Use the coupon above to order your copy today. Enclose check or money order — no stamps please. Your copy will be mailed to you as soon as the Index is off the press.

Electronics

A McGraw-Hill Market-Directed Publication
330 West 42nd Street, New York, N. Y. 10036

from about —300 parts per million per degree Centigrade for sheet resistivity of about 1,500 ohms per square, to about +300 ppm/°C at 5 ohms/sq. This effect is apparently due to the varying oxide content.

When the alloy is deposited by sputtering, the chromium content of the film varies only between 18% and 10% and the alloy's other metallurgical properties are close to that of the starting material. The relationship between film thickness and sheet resistivity is much more linear than in deposited films. The temperature coefficient of resistivity is positive and remains within the range of 100 to 200 ppm/°C over the range of 3 to 1,000 ohms/sq.

Laser interference patterns

Interference fringes in laser systems*
C.L. Rudder, D.A. Hayler
Missile & Space Division
Douglas Aircraft Co.

Interference phenomena can be significantly more important with lasers than with other light sources because of the lasers' coherence characteristics. Interference fringes may have various effects on the operation of systems involving lasers, such as communications systems. The nature of such interference effects is studied here, and a theoretical model is established for double-ray interference; the conclusions are compared with experimental work.

Detailed descriptions are given of the fringe patterns established when c-w gas laser light hits various flat and curved optical surfaces, such as lenses and mirrors and their combinations.

As for practical laser systems, the effects of interference fringes are concluded to be especially the changes of intensity distribution within the laser beam and scattering of light. Intensity distribution changes, which are liable to adversely affect very long laser communication links, can be minimized with antireflection coatings on the optical surfaces.

The authors also warn against spurious results that may be obtained in some precise small-scale laser-beam measurements if the possible effects of interference fringes are not taken into account.

*Presented at the National Electronics Conference, Oct. 19-21, Chicago.

Around the world ...

KYORITSU Measuring Instruments

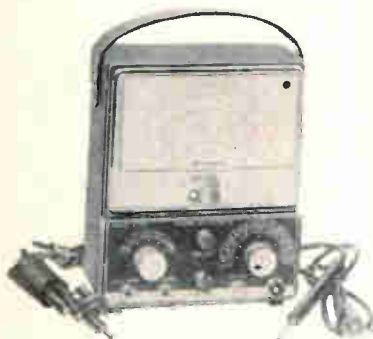

K-142

Vacuum Tube Voltmeter
(190x170x105 mm)



VR-2P VU Meter
(42x42x37 mm)



P-60 6" Meter



Kyoritsu

ELECTRICAL INSTRUMENTS WORKS, LTD.

120, Nakane-cho, Meguro-ku, Tokyo, Japan

Cable address: KYORITSUKEIKI TOKYO

Telex: TK 2849

Direct Inquiry Welcomed

Circle 217 on reader service card

Planning to change your address?

Use the form below to indicate a change of address. Because our issues are addressed in advance, please try to allow at least 5 weeks for change of address to become effective. Attach the address label from your most recent issue in the space provided below.

[Please print the following information for proper service]

Title or position

Name

Chief job responsibility

Company and Div

Product or Service Approx. No. of employees

Address

City Zone State or Prov.

Mail to: Fulfillment Manager, Electronics
P.O. Box 430, Hightstown, N.J. 08520

*Paste present mailing label or address
from wrapper or envelope here.

Over 500,000
HIGH RELIABILITY
Shielded **INDUCTORS**
in stock for

24 HOUR DELIVERY

Over 400 Standard Types
from 0.10 μ h through 180,000 μ h

- ★ Meets requirements of MIL-C-15305C, Grade 1, Class B.
- ★ Subminiature components.
- ★ Package volume 200,000 per cubic foot.
- ★ Unique coupling — less than 3% with two units side by side.
- ★ Operating temperature —55°C to 125°C.
- ★ Very low direct current resistance.

SUPER WEE-DUCTOR Ultra-reliable molded-shielded inductor stocked in 73 standard values. Inductance range 0.10 μ h to 100,000 μ h with $\pm 10\%$ tolerance. Molded envelope 0.410" in length by 0.157" diameter. Units color coded.

WEE-DUCTOR Offers exceptional inductance range 0.10 μ h to 180,000 μ h in 76 stock values. Encapsulated, non-flammable envelope only 0.375" long by 0.157" diameter. Pertinent data printed. Following are standard tolerances:

0.10 μ h to	1.0 μ h	$\pm 20\%$
1.2 μ h to	22 μ h	$\pm 10\%$
27 μ h to	1,000 μ h	$\pm 5\%$
1,200 μ h to	56,000 μ h	$\pm 10\%$
68,000 μ h to	180,000 μ h	$\pm 20\%$

WEE WEE-DUCTOR Smallest shielded inductor available — in 49 stock values. Encapsulated, non-flammable envelope only 0.335" long by 0.125" diameter. Inductance range of 0.10 μ h to 1,000 μ h with following tolerances: 0.1 μ h to 1.0 μ h $\pm 20\%$ and 1.2 μ h to 1,000 μ h $\pm 10\%$. Color coded markings.

FOR COMPLETE
ENGINEERING DATA, WRITE Dept. K
OR PHONE (AREA CODE 201) 464-9300

NYTRONICS

550 Springfield Ave., Berkeley Heights, N. J.

Design leaders
STANDARD components to meet
CUSTOM requirements

PERT (Program Evaluation and Review Technique) Provides Blueprint Visibility to Space Managers during the Production Planning Phases.



space architects



A Motorola RF Receiver Subsystem for DSIF will Provide Communication Links Between Earth and Vehicles on Future Interplanetary Flights.

PERT charts provide the foundation and framework for the development by scientists and engineers at the Western Center of Motorola's Military Electronics Division of history-making space communications systems. Examples: Mariner and Ranger 7.

Motorola, a part of NASA's space-conquering team, is now at work on the RF Subsystem that will be the heart of the DSIF system. Other state-of-the-art projects now on the drawing board or in the blueprint stage of development include communication equipments for the Apollo and future flights to Mars and Venus. Write today to learn how you can join our Motorola staff of space architects. **Specific opportunities are:**

Antennas & Propagation
Solid State R. F.
Microwave Techniques
Missile & Space Instrumentation
Operational Support Equipment
Integrated Circuitry

Reliability Analysis
Parts Reliability
Reliability Program Coordination
Data Acquisition, Processing & Display
CW Transponders
Radar and Radar Transponders

Guidance & Navigation
Command & Control
Space Communications
Signal Processing
ECM, CCM & Surveillance
Tracking & Telemetry

Contact Phil Nienstedt, Manager of Recruitment, Department 6511



Military Electronics Division • Western Center • P.O. Box 1417, Scottsdale, Arizona
MOTOROLA ALSO OFFERS OPPORTUNITIES AT CHICAGO, ILLINOIS—AN EQUAL OPPORTUNITY EMPLOYER

EMPLOYMENT OPPORTUNITIES



The advertisements in this section include all employment opportunities—executive, management, technical, selling, office, skilled, manual, etc.

Look in the forward section of the magazine for additional Employment Opportunities advertising.

— RATES —

DISPLAYED: The advertising rate is \$52.00 per inch for all advertising appearing on other than a contract basis. Contract rates quoted on request.

An advertising inch is measured 1/8" vertically on a column—3 columns—30 inches to a page.

Subject to Agency Commission.

UNDISPLAYED: \$2.70 per line, minimum 3 lines. To figure advance payment count 5 average words as a line.

Box numbers—count as 1 line.

Discount of 10% if full payment is made in advance for 4 consecutive insertions.

Not subject to Agency Commission.



E. E.'s
for **FEE-PAID Positions**
WRITE US FIRST!

Use our confidential application for professional, individualized service . . . a complete national technical employment agency.

ATOMIC PERSONNEL, INC.
Suite 1207L, 1518 Walnut St., Phila. 2, Pa.

ADDRESS BOX NO. REPLIES TO: Box No. Classified Adv. Div. of this publication.

Send to office nearest you.

NEW YORK, N. Y. 10036: P. O. Box 12

CHICAGO, Ill. 60611: 645 N. Michigan Ave.

SAN FRANCISCO, Cal. 94111: 255 California St.

SELLING OPPORTUNITY AVAILABLE

Available large showroom for permanent exhibit, office facilities, telephone, centrally located in Paris. Would handle sales for electronic equipment, radio, TV. Please write n°83—Publicite' DENO 23 quai de l'Horloge Paris 1^{er}—France

PROFESSIONAL SERVICES

GIBBS & HILL, Inc.
Consulting Engineers

Systems Engineering
Operations Research • Development
Field Studies • Design • Procurement
Power • Transportation • Communications
Water Supply • Waste Treatment
393 Seventh Avenue New York 1, N. Y.

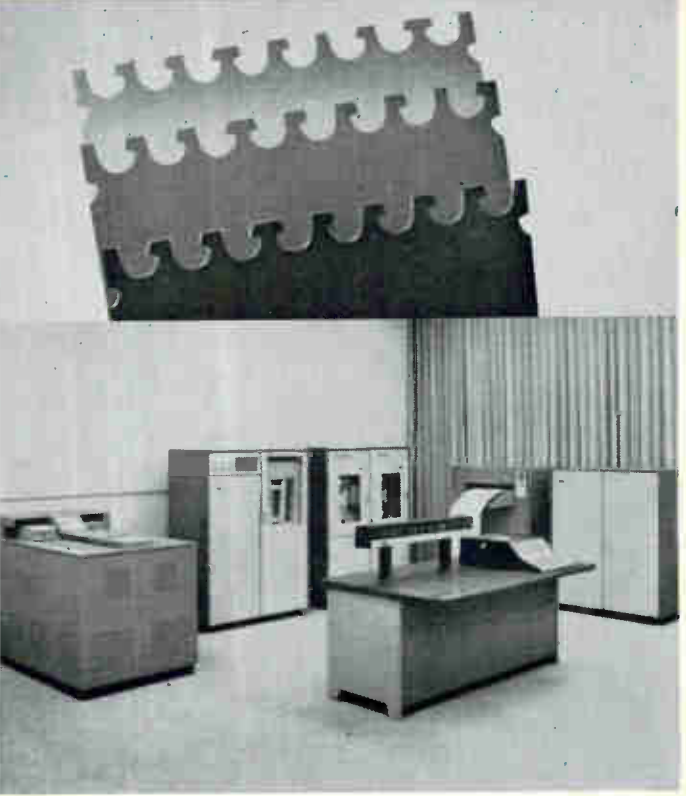
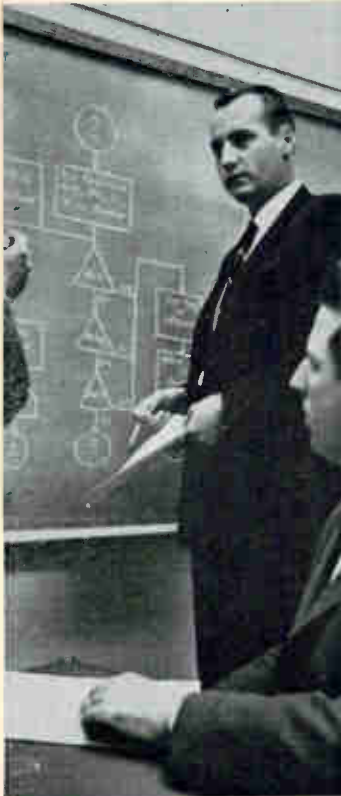

ACROSS-THE-BOARD OPPORTUNITIES IN DIGITAL SYSTEMS AT NCR, LOS ANGELES

SYSTEMS ANALYSIS

Advanced central and on-line systems—all levels

Experience in the preparation of functional specifications for processors, controllers, buffers, peripheral equipment, random-access memories, on-line systems, and selected devices. Knowledge of logical design and elementary programming necessary. At higher levels heavy experience in advanced systems design—multi-programming, list processing machines—and a good knowledge of data transmission techniques, traffic load studies, and scanning and polling schemes is required.

Evaluation—all levels

Experience in preparing comparative analyses of data processing systems, using analytic techniques, including queuing theory and simulation. Knowledge of programming essential.

PROGRAMMING DEVELOPMENT

Research and software development—all levels

Experience in advanced programming applications such as list-processing systems, syntax-directed compiling, executive

systems, generators, information-retrieval systems, and natural language processing.

Design automation supervisor

Requires previous supervisory experience in programming for design automation. Good understanding of engineering and hardware problems. BS degree in math, engineering, or related field. Additional programming openings are available at all levels.

PRODUCT ENGINEERING

Packaging design—all levels

Position entails layout and design of packaging for computer systems. Applicants must have experience with memories and miniaturization utilizing thin-films and integrated circuits. BSEE or MSEE required.

Product design, electronic and mechanical—all levels

These positions require BSEE and BSME degrees respectively, with experience in design of digital computer and peripheral equipment. Experience in maintaining liaison with manufacturing essential.

Component analysis—all levels

Experience required in electronic device characterization, electro-mechanical parts and compo-

nents. Must have ability to evaluate engineering drawings and specifications and to select reliable standard parts and components. Degree required.

ADVANCED COMPUTER DEVELOPMENT

Memory development—all levels

Positions will entail analysis and design of advanced thin-film memory systems, both linear select and coincident current. Also advanced random-access development on magnetic-card and disk-file systems. Requires BSEE, with advanced degree desired at senior levels.

Logic design—all levels

Positions available in advanced logic design of central processing equipment, buffering systems, on-line computing and transmission systems, and computer peripheral equipment. BSEE and good knowledge of state-of-the-art required.

Circuit design—all levels

Openings in design of advanced integrated-circuit computers. Good knowledge of transistors and digital worst-case circuit design techniques required. BSEE required.

Mechanisms development—all levels

Entails analysis and design of complex computer mechanisms. Knowledge of applied mechanics and good mathematical ability required. BSME required, with PhD required at high specialist level.

Magnetic recording—all levels

Senior and intermediate positions available for men with 3 to 4 years' experience in advanced magnetic recording techniques. Knowledge of media, circuitry, and magnetic head design necessary. Requires BS degree with MS desirable.

ARRANGE NOW FOR AN INTERVIEW IN YOUR AREA

Confidential interviews will be held soon in various parts of the country. To arrange an appointment, please send a resume immediately, including training, experience and salary history, to Bill Holloway, Personnel Dept., or telephone collect.

The National Cash Register Company



ELECTRONICS DIVISION
2816 W. El Segundo Blvd.
Hawthorne, Calif.
Telephone: Area Code 213-757-5111

an equal-opportunity employer

AUTOTRACK ANTENNA MOUNT

360 degree azimuth, 210 degree elevation sweep with better than 1 mil. accuracy. Missile velocity acceleration and slewing rates. Amplidyne and servo control. Will handle up to 20 ft. dish. Supplied complete with control chassis. In stock—immediate delivery. Used world over by N.A.S.A., USAF, T31E, M1-61 R, SCR-584, NIKE AJAX mounts also in stock.

SCR 584 AUTOMATIC TRACKING RADARS

Our 584s in like new condition, ready to go, and in stock for immediate delivery. Ideal for telemetry research and development, missile tracking, satellite tracking, balloon tracking. Used on Atlantic Missile Range, Pacific Missile Range, N.A.S.A., Wallons Island, A.B.M.A. Write us—Pully Dose, MIT Rad. Lab. Series, Vol. 1, pps. 207-210, 228, 284-286, Compl. Inst. Bk. avail. \$25.00 each.

PULSE MODULATORS

MIT MODEL 9 PULSER

1 MEGAWATT—HARD TUBE

Output 25 kv 40 amp. Duty cycle, .002. Pulse lengths .25 to 2 microsec. Also .5 to 5 microsec. and .1 to .5 microsec. Uses 6021. Input 115v 60 cycle AC. Mfr. GE. Complete with driver and high voltage power supply. Ref: MIT Rad. Lab. Series, Vol. 5, pps. 152-160.

500KW THYRATRON PULSER

Output 22kv at 28 amp. Rep. rates: 2.25 microsec. 300 pps., 1.75 msec 350 pps., .4 msec 2500 pps. Uses C22 hydrogen thyatron. Complete with driver and high voltage power supply. Input 115v 60 cy AC.

2 MEGAWATT PULSER

Output 30 kv at 70 amp. Duty cycle .001. Rep rates: 1 microsec 600 pps., 1 or 2 msec 300 pps. Uses 5948 hydrogen thyatron. Input 120/208 VAC 60 cycle. Mfr. GE. Complete with high voltage power supply.

15KW PULSER—DRIVER

Biased multivibrator type pulse gen. using 3629. Output 3kv at 5 amp. Pulse lths .5 to 5 microsec. easily adj. to .1 to .5 msec. Input 115v 60 cy AC. \$375. Ref: MIT Rad. Lab. Series, Vol. 5, pps. 157-160.

MIT MODEL 3 PULSER

Output: 144 kw (12 kv at 12 amp.) Duty ratio: .001 max. Pulse duration: .5, 1 and 2 microsec. Input: 115 v 400 to 2000 cps and 24 vdc. \$325 ea. Full desc. Vol. 5, MIT Rad. Lab. series, pg. 140.

250KW HARD TUBE PULSER

Output 16 kv 16 amp. duty cycle .002. Pulses can be coded. Uses 5D21, 715C or 4PR60A. Input 115 v 60 cycle ac. \$1200 ea.

5949 THYRATRON AGING RACK

Compl. Charham Electronics Console incl. 15 kv power supply & PEN's. \$1800.

H.V. POWER SUPPLIES

1) 12 kv .75 amps nominal \$1400 ea. 2) 22 kv 100 ma nominal \$2200 ea. Std. 60 cycle inputs.

MICROWAVE SYSTEMS

E-4 FIRE CONTROL SYSTEM

Hughes Aircraft X Band. Complete. In stock.

C-BAND RADAR

250 KW output, C-band, PPI indicator, 5C22 thyatron modulator. Antenna hi gain parabolic section. Input 115 volts 60 cycle AC. complete \$2750.00.

300 TO 2400MC RF PKG.

300 to 2400 MC CW. Tuneable. Transmitter 10 to 30 Watts. Output. As new \$475.

500KW "L" BAND RADAR

500 kw 1220-1359 mes. 160 nautical mile search range P.P.I. and A Scopes. MTI, thyatron mod. 5J26 magnetron. Complete system.

10 CM. WEATHER RADAR SYSTEM

Raytheon, 275 KW output S Band. Rotating yoke P.P.I. Weather Band. 4, 20 and 80 mile range. 360 degree azimuth scan. Price \$975 complete.

10KW 3 CM. X BAND RADAR

Complete RF head including transmitter, receiver, modulator. Uses 2J42 magnetron. Fully described in MIT Rad. Lab. Series Vol. 1, pps. 616-625 and Vol. 11, pps. 171-185. \$375. Complete System \$750.

50KW 3 CM RADAR

Airborne radar. 50 kw output using 725A magnetron. Model 3 pulser. 30-in. parabola stabilized antenna. PPI scope. Complete system. \$1200 each. New.

100KW 3CM. RADAR

Complete 100 kw output airborne system with AMTI, 5C22 thyr. mod. 4J52 magnetron. PPI. 360 deg az sweep, 60 deg. elev. sweep, gyro stabilizer, hi-gain revr. Complete with all plugs and cables.

M-33 AUTO-TRACK RADAR SYSTEM

X band with plotting board, automatic range tracking, etc. Complete with 1 megawatt acq. radar.

400 CYCLE SOURCE

Output: 115v 400 cycle 1 ph. 21.7 amps cont. duty input: 208v 60 cycle 3 ph. req. 30v dc static exc. New. \$325 ea.

3KW RCA PHONE & TELEG XMTR

2-30 MC. 10 Autotone channels plus MO. Input 220 vac. 50/60 cycles.

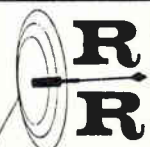

**Radio-Research
Instrument Co.**
550 5th Ave. New York 36, N.Y.
Tel. JUdson 6-4691

CIRCLE 951 ON READER SERVICE CARD

SEARCHLIGHT SECTION

(Classified Advertising)

BUSINESS OPPORTUNITIES

EQUIPMENT - USED or RESALE

DISPLAYED

—RATES—

UNDISPLAYED

The advertising is \$27.25 per inch for all advertising other than on a contract basis.

AN ADVERTISING INCH is measured 7/8" vert. on a column, 3 cols.—30 inches—to a page. EQUIPMENT WANTED or FOR SALE ADVERTISEMENTS acceptable only in Displayed Style.

\$2.70 a line, minimum 3 lines. To figure advance payment count 5 average words as a line.

BOX NUMBERS count as one line additional.

DISCOUNT of 10% if full payment is made in advance for four consecutive insertions.

Send NEW ADVERTISEMENTS or Inquiries to Classified Adv. Div. of Electronics, P. O. Box 12, N. Y. N. Y. 10036

ARROW FREIGHT FORWARDERS

Sub. of LIFSCHULTZ TRANSPORT, Inc.

FASTEST COAST TO COAST

5th & 6th DAY EAST COAST TO
CAL., ARIZ., NEV., ORE. and WASH.

7th DAY TO EAST COAST
from CAL., ARIZ., NEV., ORE. and WASH.

Specialists in Shipment of
Electronics Products
Call for information

NEW YORK — PHILADELPHIA
BALTIMORE — BOSTON — NEW JERSEY
HOLYOKE — NEW HAVEN — PROVIDENCE
LOS ANGELES — SAN FRANCISCO — SEATTLE

CIRCLE 952 ON READER SERVICE CARD

FREE Catalog OF THE WORLD'S FINEST ELECTRONIC GOV'T SURPLUS BARGAINS



HUNDREDS OF TOP QUALITY
ITEMS—Receivers, Transmitters,
Microphones, Inverters, Power Sup-
plies, Meters, Phones, Antennas,
Indicators, Filters, Transformers,
Amplifiers, Headsets, Converters,
Control Boxes, Dynamotors, Test
Equipment, Motors, Blowers, Cables,
Keys, Chokes, Handsets, Switches,
etc., etc. Send for Free Catalog—
Dept. E-4.

FAIR RADIO SALES
2133 ELIDA RD. • Box 1105 • LIMA, OHIO

CIRCLE 953 ON READER SERVICE CARD

SMALL AD but BIG STOCK

of choice test equipment
and surplus electronics

Higher Quality—Lower Costs
Get our advice on your problem

ENGINEERING ASSOCIATES
434 Patterson Road — Dayton 19, Ohio

CIRCLE 954 ON READER SERVICE CARD

OVER 2,000,000

RELAYS IN STOCK!

Send for Catalog \$5

Universal RELAY CORP.

42 WHITE ST., N.Y. 33, N.Y. • WAlker 5-6900

CIRCLE 955 ON READER SERVICE CARD

TRINIDAD AND TOBAGO ELECTRICITY COMMISSION TENDER

Tenders are invited for:

"RADIO COMMUNICATION SYSTEM
FOR THE SOUTHERN AREA"

Specifications may be obtained on writing to the Purchasing Officer, Trinidad and Tobago Electricity Commission, 63, Frederick Street, Port-of-Spain, Trinidad, W. I.

Closing date: 17th December, 1964.

EMPLOYMENT OPPORTUNITIES:

for all employment advertising
including Positions Vacant or
Wanted and Selling Opportuni-
ties Offered or Wanted.

SEARCHLIGHT SECTION:

A national medium for Surplus
New or Used Equipment and
other Business Opportunities.

PROFESSIONAL SERVICES:

A dignified method for Special-
ized consultant skills and services.

BENEFIT YOURSELF BY ADVERTISING IN THESE SECTIONS

For Rates and Information Write:

Electronics

Classified Advertising Div.,

P.O. Box 12, New York, 10036

New Literature

Seamwelder. Nyborg Engineering Co., 533 Dawson Drive, Camarillo, Calif. 93010. A 4-page bulletin describes model 160 automatic spot seamwelder that provides true hermetic seals in circular, cylindrical or conical patterns. Circle 451 reader service card

All-purpose ovens. Gruenberg Electric Co., Inc., 9 Commercial Ave., Garden City, N.Y. Bulletin 271-64 illustrates and describes all-purpose laboratory and production-bench ovens. [452]

Infrasonic analyzer. White Instrument Laboratories Inc., Box 9006, Allandale Station, Austin, Tex., 78756, has published a brochure on an infrasonic analyzer that is comprised of the model 110 active filter manifold and model 120 rectifier smoothing manifold. [453]

Audio wire and cable. Phalo Corp., 530 Boston Turnpike, Shrewsbury, Mass., 01546, announces a 12-page illustrated catalog listing a complete line of audio wire and cable. [454]

Precision resistors. Muirhead & Co. Limited, Beckenham, Kent, England. The 150 variations of the company's range of precision wirewound resistors are given in a new brochure. [455]

Stepping switches. C. P. Clare & Co., 3101 Pratt Blvd., Chicago, Ill., 60645. Manuals 601 and 602 describe a full line of rotary stepping switches and enclosures. [456]

Crystal-can relays. Hi-G, Inc., Spring St. & Route 75, Windsor Locks, Conn. A product bulletin covers the Side-Step crystal-can relay series designed for use on printed circuit boards. [457]

F-m discriminator. Airpax Electronics Inc., Fort Lauderdale, Fla. Bulletin F-114 covers model FDS30, a compact, single-channel, f-m telemetry discriminator. [458]

Electronic comparator. Electronic Associates, Inc., West Long Branch, N.J., has issued a bulletin on a new electronic comparator designed for use with its TR-48 general-purpose analog computer. [459]

Power semiconductors. General Electric Co., Schenectady, N.Y. An eight-page brochure abstracts 47 technical application notes, manuals and reprints written to aid designers in the selection, application and testing of power semiconductors. [460]

Magnetostrictive delay line. Delttime Inc., 225 Hoyt St., Mamaroneck, N.Y. Bulletin DT-23 contains full specifications for the model 190M magnetostrictive delay line designed for use in airborne and high vibration environments. [461]

Series regulators using zener diodes. Trio Laboratories, Inc., Plainview, L.I., N.Y., has published a bulletin that describes a way of making a simple series regulated power supply by using a Super/Reg zener diode as the combination reference source, amplifier, and driver power. [462]

Miniature pliers. Crescent Tool Co., Jamestown, N.Y. A 16-page illustrated catalog describes a complete line of miniature pliers designed for exacting assembly-line production operations in the electronics industry. [463]

Digital readout systems. Tektronix, Inc., P.O. Box 500, Beaverton, Ore., 97005, has available booklets describing types S-3101 and S-3401 digital readout systems for semi-automated, dynamic testing of electronic switching devices and computer logic modules. [464]

IR detectors. Infrared Dept., Lansdale Div., Philco Corp., Lansdale, Pa., has published a guide that simplifies the selection of the optimum-performance detector compatible with a specific spectral requirement and clearly indicates the type of detector required for coupling with selected semiconductor injection lasers and emitters. Request copy on company letterhead.

Continuous-wave laser. Maser Optics, Inc., 89 Brighton Ave., Boston 34, Mass., has issued a technical bulletin describing model CW-1 solid-state, continuous-wave laser device. [465]

Glass-to-metal products. Latronics Corp., 1101 Lloyd Ave., Latrobe, Pa. 15650, has issued a catalog on its complete line of glass-to-metal hermetic seals and terminals for electrical and electronic applications. [466]

Superconducting systems. Union Carbide Corp., Linde Division, 270 Park Ave., New York 10017. Brochure F-2004A describes superconducting magnet systems. [467]

R-f coaxial filters. Bird Electronic Corp., 30303 Aurora Road, Cleveland, Ohio 44139. CF-65 is an illustrated brochure listing 80 representative r-f coaxial low-pass, band-pass and high-pass models with cut-off frequencies from 30 to 2,700 Mc. [468]

Waveguide isolators. Raytheon Co., Special Microwave Devices Operation, 130 Second Ave., Waltham, Mass., 02154, has issued a new short form catalog covering more than 70 high-power waveguide isolators. [469]

Crimping tool. Buchanan Electrical Products Corp., Hillside, N.J., announces a 2-page bulletin describing a cycle-controlled, automatic feed crimping tool for crimping pin and socket connectors. [470]

Direct Reading Electrical Thermometer



Measures Temperatures from -100° to 500°C to an Accuracy of $\pm 0.75^{\circ}$ traceable to NBS.

Model 212 is a compact, battery operated solid state instrument employing a miniature platinum resistance element. Temperature changes in liquid or gas are indicated instantly (within 0.5 sec.); surface temperatures can be measured using an aluminum block where heat source is sufficient. A zener referenced regulator assures constant current to the bridge circuit.

The probe consists of a 5-ft cable having four equal length silver clad conductors arranged to cancel lead temp. effects, insulated with Pyrex glass and terminated with gold plated contacts. The cable can be placed in same temperature as the sensing tip. The element is at the end of the 0.1" diam x 2" tip for high resolution measurements.

Unit is enclosed in a handsome vinyl covered aluminum case 10" x 6 $\frac{1}{2}$ " x 3 $\frac{1}{2}$ " equipped with carrying handle and protective housing for probe. Weight is 5 lbs. Price \$530. complete.

Complete technical details on the Model 212 as well as applications information on Temperature Measurement techniques are available on request from Radio Frequency Laboratories, Inc.



NEW 30,000,000 WATT RADAR SYSTEM!

L/UHF dual-frequency, pencil-beam radars pioneer new concepts in super power research systems

LTV Continental Electronics Division is systems contractor for two unique radar systems now in operation at White Sands Missile Range: the AN/FPA-22 and the AN/FPA-23. Each system is powered by two Continental 30 megawatt transmitters: one L-band, one UHF. Peak transmitter power is 30 megawatts; average power is 30 kilowatts. Pulse width for both systems is $1\mu\text{s}$ and $10\mu\text{s}$. Pulse forming lines are triggered by ignitrons; timing pulses come from an exciter/synchronizer. Both techniques are outgrowths of other LTV Continental Electronics contracts.

Electronics for the two systems are almost identical: the AN/FPA-22 uses an 84-foot dish antenna, the AN/FPA-23 uses a 30-foot dish.

The AN/FPA-22 UHF system has a range of 1100 nautical miles: the AN/FPA-22 L-Band system, 2000 nautical miles. The AN/FPA-23 UHF system has a range of 440 nautical miles: the AN/FPA-23 L-Band system, 710 nautical miles.

Other Continental radar transmitters have been used at Trinidad, Prince Albert, all transmitters at all three BMEWS sites, MIT El Campo Laboratory, Stanford University and Nike-Zeus R & D sites. Earlier radar work led to the development of the AN/FPT-5 transmitter for MIT Millstone Hill Laboratory. Among many other notable achievements, this transmitter bounced signals off Venus in 1958.

For information on these and similar super power radar projects, write Department 25, Continental Electronics Manufacturing Co., P. O. Box 5024, Dallas, Texas 75222.

LTV Continental Electronics
A DIVISION OF LING-TEMCO-VOUGHT, INC.

UHF waveguide, filter,
transmission line and
mode suppressors

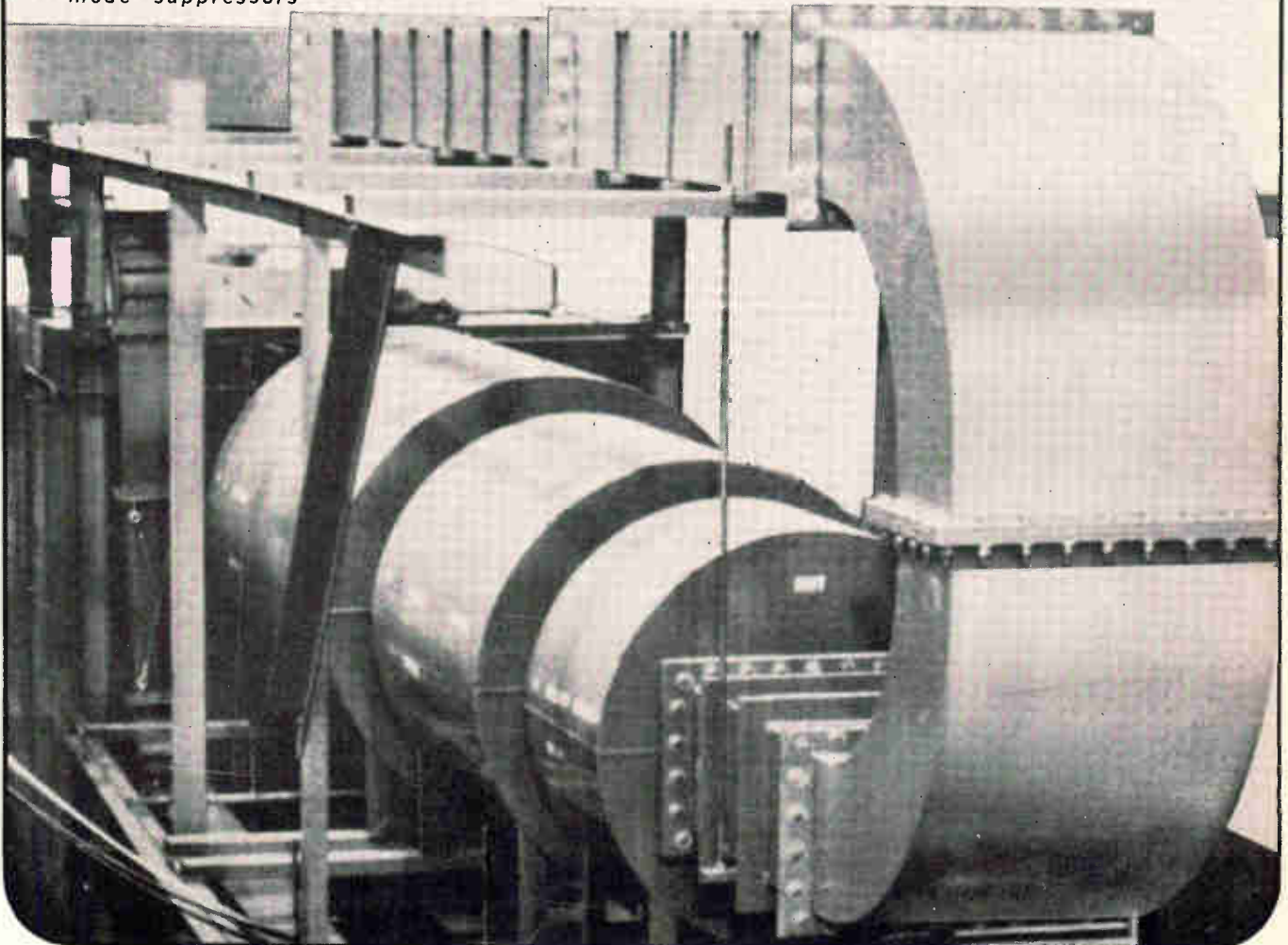

Electronics Abroad

Volume 37

Number 29

West Germany

Alpine ground station

From the hot floor of the Mojave Desert in California to a cold valley high in the Bavarian Alps came a four-gigacycle signal on Oct. 20 with a power equivalent to one lightning bug. It opened West Germany's first satellite communication with the United States.

The signal began a 10-minute television film that was seen later that evening by millions of Germans. The country's entry into satellite communications came two years after the announcement of Germany's first ground station at Raisting, about 25 miles south of Munich.

Advanced design. With the completion of the first of four planned antennas at a cost of \$10 million, after a year of frenzied construction, Germany is the third European country to put satellite communications on a commercial basis. Unlike France and Britain, which followed United States leadership in designing antennas, the Germans came up with a combined Cassegrain and horn-parabolic design that is probably the most advanced in commercial operation.

Raisting relies considerably, nevertheless, on the American Telephone & Telegraph Co.'s experience at the Andover, Me., ground station. The Bavarian antenna employs a control system and a ruby maser, both from the Bell Telephone Laboratories, as well as \$2 million of components that are not yet available elsewhere in Europe. Siemens & Halske AG was project manager.

Catching the Early Bird. When completed, the Raisting station will handle from 240 to 1,000 wideband telephone channels between Germany and the United States, depending on the satellite being used. After the current series of tests

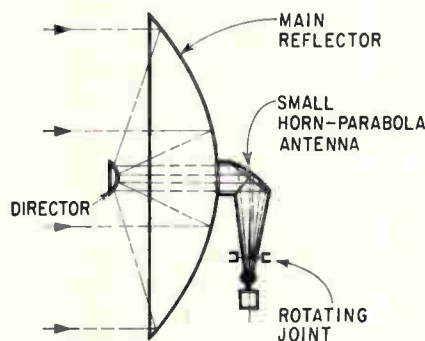

Cassegrain antenna with horn-parabola feed

employing the Relay and Telstar satellites ends about Dec. 15, transmission and receiving directions will be adjusted for the Early Bird satellite, which should go into a stationary orbit over the Atlantic Ocean early in March.

Signals received at Raisting will be transmitted by a directional beacon to a beacon atop Germany's highest mountain, the 9,720-foot Zugspitze, and then on to Munich, where they will enter the government-owned tv network.

Small and sensitive. The 82-foot-diameter Raisting antenna performs with the sensitivity of the horn at Andover. But the antenna in Maine is a horn-parabolic design, 154 feet long and 3,320 square feet in surface, needing a length about $2\frac{1}{2}$ times the aperture diameter. The Raisting antenna, on the other hand, allows smaller dimensions.

A small horn antenna is used at Raisting to provide excitation. It is placed immediately behind the parabolic reflector. The horn design makes it possible to put the signal source in the horizontal plane. With the signal path on the horizontal plane, delicate communications equipment can be connected to the small horn by a rotating joint so that it does not have to move horizontally when the antenna does.

Ruby maser used. The receiver for the weak four-gigacycle satellite signal—a few billionths of a

watt—consists of a ruby maser developed by Bell Labs, employed in a Siemens-designed preamplifier built on the traveling-wave principle. Minimum gain is 57 decibels. Liquid helium, cooling at 4°K , keeps the maser's inherent noise to a low level. A double set of receivers is installed in case one fails.

The transmitter consists of a preamplifier and a power section, both employing traveling-wave tubes from Siemens with an output power of two kilowatts. Gain is 60 decibels at the transmitting frequency of six gigacycles.

Protecting the 300-ton steel antenna from the elements is a 158-foot-diameter radome.

Antenna control is possible with an accuracy of 0.02° , adjustable in special cases to 0.002° .

Hit show

"Electronica," Munich's controversial component show, was a big success.

About 14,300 persons from 33 countries attended the eight-day show by 407 exhibitors that closed Oct. 28. The 165 American participants—the show's largest contingent—report satisfaction with the attention they received from prospective customers.

The fair, inspired by United States companies was opposed by some West German concerns.

Return in '66. The clearest indication of success is the announcement that there will be another component show in 1966.

Also, support seems to be forthcoming from Germany's influential Association of Electro-Technical Industries, which had opposed Electronica as "superfluous."

The show was visited by large contingents from Germany's three biggest electronics companies—Siemens & Halske AG, Telefunken AG and Valvo GmbH—all of which had refused to participate.

How they did it. The most suc-

cessful companies at the fair fell into one or both of the following groups:

- Those that used German representatives rather than scientists and salesmen imported from the United States;

- Those that emphasized new production and equipment rather than new components.

Many small American companies used German nationals and gained a big advantage over giants such as the Radio Corp. of America and the General Electric Co. This adds weight to the contention that the best appeal to a foreign market is through nationals because they best understand their countrymen's views and needs.

New design. This is not to say that advanced designs were ignored. Microminiature components of every type were in great demand, as were integrated circuits. There were reports at the show that Zuse KG, the big German company recently acquired by Brown-Boveri & Cie of Switzerland, has begun using integrated circuits in its computers.

Components shown for the first time in Germany included ferrite storage matrices.

France

Vive la switch

Overshadowed by research into supersonic aircraft and nuclear weapons, French scientists are quietly developing electronic switching systems that could streamline their country's antiquated telephone network.

One such system will be field-tested in January at Lannion, in northern Brittany. Called Aristote, a French acronym for "electronic system integrating and systematizing all telephone operations," it uses crosspoints consisting of two transistors working together, one pnp and the other npn.

Ramses in control. Aristote is controlled by a general-purpose computer named Ramses I, for

"realization of mathematical automation for an electronic sequential system." The computer has an 8,000-word capacity that may soon be expanded to 16,000 words, and a 32-bit memory with access time of two microseconds and cycle time of five microseconds.

Real-time processing is attained with seven levels of priority interruptions. Transfer is possible from the fast memory to secondary drum memories consisting of magnetic drums of 16,000 words each.

Exit relays. Even more advanced is a switching system based on time-division multiplexing. It would replace all mechanical and transistor relays with semiconductor gates.

A prototype of this system, called Platon, is being built at Lannion and scheduled for limited testing around the end of 1965. With Platon, each subscriber would be assigned a signal with a distinctive timing. All subscribers would be served from a common cable. To connect subscribers, delay-line memories would match their gates.

Little work has been done on a computer for Platon. But the French are known to be building Ramses II, described by officials as "the largest and fastest general-purpose computer ever constructed by a French company. It's being built at the Paris research facility of Socotel, a company owned 51% by the French government and 49% by five private companies.

First step. One modern switching system is already operating on a limited scale in Lannion, connecting employees' homes and various sections of the Socotel laboratory. Outside subscribers are scheduled to be connected into the network next year.

The system, called Socrate, employs conventional crossbar switches. But officials at Lannion say work on reed relays is advanced enough for use in the first switchboards manufactured for a general telephone system.

Such a system will probably be ready for general use "in a few years," Socotel officials say.

But it may be longer before President Charles de Gaulle ap-

proves the big changeover. Telephones rank low on the missile-minded President's priority list.

Great Britain

Concorde dilemma

While Britain's government negotiates the fate of the Anglo-French supersonic transport plane, her electronics industry is already suffering from the indecision.

Elliott Automation, Ltd., is convinced some potential customers in West Germany are holding off buying Elliott flight-control systems until they know what's going to happen to the Concorde. Elliott is the chief contractor for Concorde flight controls.

An Elliott spokesman explains: "The Germans want a European source of integrated flight controls, but if the Concorde project folds up they are more likely to turn to American sources."

Delay expected. Predictions of cancellation or delay in the Concorde project are becoming more prevalent. Adherents of this view cite an expected increase in development costs, problems involved in supersonic boom, and the need for a 10-hour flight day for the planes to justify their costs.

Some estimate the program's cost at \$3 billion. That would require 240 planes to be sold if the project is to break even. Britain and France are now sharing costs.

Whatever the decision, it's not expected before December. British and French officials have completed one round of talks and plan another.

If the British do drop out of the Concorde project, and if the French can continue without them, American subcontractors figure to reap healthy benefits. The French wanted to give many of the electronics awards to United States concerns anyway, but acceded to British insistence that the contracts be placed across the English Channel.

Navigation system. Coinciden-

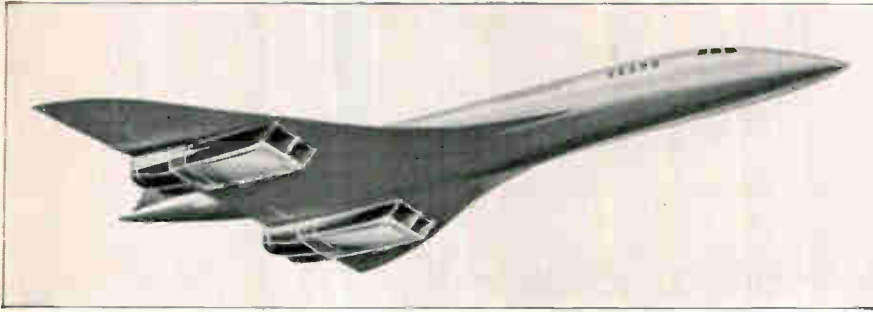

Concorde: toward the horizon . . . or oblivion?

tally, while confusion is growing, the first details of the Concorde's proposed navigation system have been disclosed.

A self-contained system is proposed, using either a combined doppler and attitude reference platform or an inertial navigator. In either case, referencing data would be derived from ground radio-aids and fed into the system to correct cumulative navigation errors. No navigation specialist would be carried; loran A, loran C and Dectra long-range navigation aids are the only systems available for referencing.

The Royal Aircraft Establishment favors the Dectra system using two pairs of transmitters, one in Newfoundland and the other in Britain. A second referencing system is also recommended, such as loran A, which can be used with aircraft equipment to resolve any conflicts in navigational data.

Another requirement is a topographical display to present data in the form of a record of tracking or a series of fixes.

Transfluxor memory

A transfluxor circuit that acts as a memory for an analog computer has been developed by the Flight Automation Research Laboratory of Elliott-Automation, Ltd.

In an autopilot system, the unit replaces servo-driven potentiometers for storing data.

The transfluxor system uses a toroidal ferrite core, with a small hole through the core's edge to carry interrogation and output windings. The input winding goes

around the core normally, opposite the section containing the hole.

Square loop. The core's square-loop characteristic allows the input winding to control the core's magnetic state. When the input signal is removed, the magnetic state remains unchanged.

The two windings through the hole allow the operator to examine the flux pattern without introducing a permanent change in the magnetic state.

Nondestructive readout is obtained by applying an alternating voltage to the interrogation winding. The resultant signal in the output winding has a nonlinear relationship to the magnetic state of the entire core which, in turn, is dependent on the input voltage.

Servo system. To provide analog voltage storage, the transfluxor's nonlinear characteristics are removed by incorporating the transfluxor in a high-gain closed-loop servo system. The system includes an input-summing amplifier, a store-read switch, the transfluxor with its associated interrogation circuits, and the output integrator.

To store a signal, the store-read switch is closed so that the transfluxor is in the feedback loop. The output signal is slaved to the input voltage and sets the magnetic level in the transfluxor.

For storage, the store-read switch is opened and the transfluxor's magnetic state can be interrogated to determine the input voltage-level storage. In the experimental versions, system bandwidth of 100 cycles per second are obtained with errors of less than 1%. In future models, errors of only 0.1% are envisaged.

China

Trade fair in Peking

Electronics and chemicals dominated Chinese scientists' attention at a \$3 million British industrial exhibition in Peking that ended Nov. 14.

Instruments and communications equipment received particular notice. The 230 exhibits featured translations into Chinese of technical papers, and explanations in English.

The exhibition was not open to the public. Invitations were sent to government agencies, foreign trading concerns and to thousands of plants throughout Communist China.

The 130,000-square-foot fair consisted of 100 tons of units prefabricated in Great Britain and assembled in Peking by Chinese carpenters.

Communications. The British see a big Chinese market for communications equipment. Companies such as Pye Telecommunications, Ltd., and the General Electric Co. of Britain had big displays of broadband communication links, ranging from a 960-channel unit for transmitting color television, to very-high-frequency motorcycle communication sets.

The biggest electronics display, by the Marconi Co., included complete tv-camera chain equipment for airborne navigation, direction-finding equipment and telegraph receivers fitted with circuits for correcting errors automatically.

Ekeo Electronics, Ltd., expected good sales of airborne weather-radar gear. Generally, all equipment that is shown at foreign exhibitions in Communist countries is purchased at the end of the trade fair.

Computers. Instrument exhibits included accurate digital-to-analog converters operating at 20,000 transfers a second, digital voltmeters and high-pressure flowmeters.

Peking has boasted that Chinese-made computers have been used to predict the weather over large

sections of China, and to arrange efficient allocation of tractors in Hopei Province and of fertilizer throughout the country. Computers also have helped the Chinese plan more than a dozen huge dams, and found uses in laboratories.

Trade trends. China now buys about \$2.7 billion worth of products abroad. Sixty percent of the purchases are made in the West, contrasted with five years ago when two-thirds of China's imports came from the Soviet bloc.

Principal sources of industrial goods for China are Britain, France, Italy and Japan.

China accounts for \$1.5 million, or 0.9%, of Britain's exports of electronic instruments.

Besides the products shown, the exhibition offered 39 lectures on British engineering developments. Those on electronics emphasized transmission systems, crossbar switching and point-to-point high-frequency communications.

Japan

Resuming the climb

Japan's electronics industry has dramatically reversed last year's slowdown in its growth. And one big reason is the success of the country's birth-control program, started in 1948.

Companies are bracing for a new economic phenomenon: a labor shortage. They're beginning to look much more favorably on automation and computers.

The Japanese birth rate, once one of the highest in the world, is now 17.2 per 1,000. That's lower than the United States' 21.6, and less than half the Philippines' rate of 50 per 1,000.

Industrial electronics boom. Industrial electronics is leading the resurgence. There's a boom in medical electronics, computers and numerical controls for machine tools.

Even back in 1962, before the brief slowdown, Japan opened the world's first closed-loop control of wet-process cement kilns. The system was installed at the Chichibu

Cement Co. by the Bunker-Ramo Corp., which is now controlled by the Martin Marietta Corp.

Computers, for industrial controls and for data-processing, are one of Japan's fastest-growing fields. Last year, while the electronics industry's growth slipped to 4% from 14% in 1962, Japan's computer output doubled. This year's computer production is up only 16.5% compared with the electronics industry's 18% gain; but next year, computer output is expected to climb 35.6% to \$83 million.

Communications come back.

While industrial electronics scores the most spectacular gains, communications remain the biggest segment of Japan's electronics industry. And this segment is bounding back strongly from last year's sluggish record, caused by near-saturation of the domestic television market and concentration on sets with 12-inch screens or smaller.

This year, tv sales are expected to rise 5% from last year's \$502 million. And increasing affluence among consumers is spurring the replacement market. There is a clear emphasis on bigger screens. Sales of 19-inch sets were up 600% in the first half of 1964.

Color tv is also making inroads. Less than 1% of Japan's tv sales involve color sets; next year the figure is expected to climb to 5%.

Radios on the rise. Radio sales also are advancing—an estimated 10% this year over 1963. There is now an average of 1.07 radios per Japanese household.

When f-m is approved, as is expected late this year or early in 1965, it should give another boost to radio sales. Japan has no commercial f-m yet, despite the second-largest number of radio and tv sets in the world. The only f-m stations in operation now are run by the Japan Broadcasting Co. (NHK), the noncommercial broadcasting system.

Components also are contributing to the boom, with output up about 40% from 1963. Besides domestic sales, demand is increasing from the United States, Hong Kong and a new market—Taiwan.

Latin America

Decibel war

Soviet broadcasts come in loud and clear in Latin America—8 to 14 decibels louder than British radio signals of the same 15-megacycle frequency. And Radio Peking does even better—10 to 15 decibels stronger than Radio Moscow.

Now United States scientists may have found out why. The Communists are thought to use transmitters atop high mountains, rather than the near-ground-level origin of U.S. and British broadcasts.

Less bounce. The advantages would be many. Lofty transmitters would need only one bounce off the ionosphere to send a signal to a receiver; others often ricochet three to five times. They could transmit at angles of only 1° to 2° above the horizon, permitting relatively clear transmission over polar paths that are usually subject to atmospheric disturbances.

They would also be less subject to the effects of magnetic storms and clouds of sporadic E-layer ionization.

Another mystery. Another phenomenon had U.S. engineers scratching their heads for a long time: a periodic rise and fall of three or four decibels when the Russians or Chinese begin transmitting. The higher level is maintained for 30 seconds up to a few minutes, then the signal is stepped up again.

Walter Bain, an engineer at Page Communications Engineers, Inc., has suggested the Communists may be backscattering part of the signal to check its path, then making adjustments at the transmitter to assure the best possible reception abroad.

Engineers at the U.S. Information Agency say it would be difficult to emulate the Communist technique because most Voice of America stations are "guests" in other countries and many requirements—location of antennas, availability of power—are specified by the host nation.

New!

VHF

OSCILLATOR



TYPE
3200A

10 Mc - 500 Mc

Features:

$\pm 0.002\%$ Frequency
Stability

External AM and Pulse
Modulation

Waveguide-Below-Cutoff
Output Attenuator

Solid-State Power Supply

The VHF Oscillator Type 3200A is designed for general purpose laboratory use including receiver and amplifier testing, driving bridges, slotted lines, antenna and filter networks, and as a local oscillator for heterodyne detector systems in the frequency range from 10 to 500 mc.

The push-pull oscillator is housed in a rugged aluminum casting for maximum stability and extremely low leakage; six frequency ranges are provided for adequate bandsread on the slide-rule dial. Internal CW operation is provided; AM and pulse modulation may be obtained through the use of a suitable external source. The RF output is coupled through a waveguide-below-cutoff variable attenuator; in addition, an electrical RF level vernier is included as a front panel control.

A solid-state power supply furnishes all necessary operating voltages including regulated dc to the oscillator heaters for minimum hum modulation and maximum tube life.

Specifications:

Radio Frequency Characteristics

RF RANGE: 10 to 500 mc

RF ACCURACY:
 $\pm 2\%$ (after $\frac{1}{2}$ hour warmup)

RF STABILITY:
Short Term: $\pm 0.002\%$ (5 minutes)
Long Term: $\pm 0.02\%$ (1 hour)
Line Voltage: $\pm 0.001\%$ (5 volts)

*After 4 hour warmup, under 0.2 mw load

RF OUTPUT:

Maximum Power:
> 200 mw* (10-130 mc)
> 150 mw* (130-260 mc)
> 25 mw* (260-500 mc)

*Across external 50 ohm load

Range: 0 to > 120 db attenuation from
maximum output

Load Impedance: 50 ohms nominal

RF LEAKAGE: Sufficiently low to permit
measurements at $1 \mu\text{v}$

Amplitude Modulation Characteristics

AM RANGE: 0 to 30%

AM DISTORTION: < 1% at 30% AM

EXTERNAL AM REQUIREMENTS: Approx.
30 volts RMS into 600 ohms for 30% AM

Pulse Modulation Characteristics

EXTERNAL PM REQUIREMENTS: 140 volts
peak negative pulse into 2000 ohms for
maximum power output; typically 10
volts peak (except 50 volts on 260-500
mc range) for 1 mw peak power output

Physical Characteristics

DIMENSIONS: Height: $6\frac{1}{2}$ " (16.5 cm)
Width: $7\frac{25}{32}$ " (19.8 cm)
Depth: $12\frac{1}{32}$ " (31.8 cm)

Power Requirements

105-125/210-250 volts, 50-60 cps, 30 watts

Price: 3200A: \$475.00

F.O.B. Rockaway, New Jersey



BOONTON DIVISION

PRECISION ELECTRONIC INSTRUMENTS SINCE 1934
GREEN POND ROAD, ROCKAWAY, NEW JERSEY 07866



Hewlett-
Packard
Company

TELEPHONE: (201) 627-6400 • TWX: (201) 627-3912 • CABLE ADDRESS: BOONRACO

How to sell commercial products profitably!

18 electronics authorities to discuss problems
of non-military markets at Chicago conference.

On December 1st and 2nd, 18 of the country's most successful electronics marketing and technical executives will be in Chicago to discuss how to invade the commercial markets profitably. They will speak at a conference titled: "The Road to Commercial Electronics," sponsored by Electronics magazine and the Illinois Institute of Technology Research Institute.

THE ROAD TO COMMERCIAL ELECTRONICS

Although top management in defense-oriented electronics companies recognize the need to diversify into other market areas, the big problem has been how to go about it. The two-day conference will deal extensively with the problems—product planning, marketing, engineering and manufacturing.

Each of the speakers, recognized authorities in their area, have been chosen on the basis of long and successful experience in the commercial electronics markets. Keynoting the conference will be Dr. L. T. Rader, vice president of The General Electric Co.'s Industrial Electronics division whose subject will be the management view of commercial operations.

CONFERENCE PROGRAM

This is the conference program and some of the speakers. Other speakers will be announced later.

NEED TO KNOW

Dr. E. H. Schulz, Director, IIT Research
Keynote: Management view of commercial operation
Dr. L. T. Rader, Vice President, Industrial Electronics, General Electric Co.

Session I.

Comparing Commercial and Military Product Planning
Philip Bardos, Director of Corporate Planning, Consolidated Electro-Dynamics, Bell & Howell Corp.

What is a good idea?

Dr. Peter Goldmark, President, CBS Laboratories

Panel:

Consumer electronics: N.W. Aram, Vice President, Zenith Corp.

Industrial electronics: W.E. Vannah, Director of Research, Foxboro Corp.

Medical Electronics: F.F. Offner, Professor of Biophysics, Northwestern Univ.

Session II.

Engineering organization and philosophy
Cost Consciousness in design

Profile of the engineer for commercial work

W.R. Smith, Director, Cooperative Education, Illinois Institute of Technology

Session III.

Slanting production to commercial markets

The engineering aspects of commercial manufacturing

Kurt Rosenbaum, Consultant, Automation Associates

Session IV.

The basis of commercial marketing

Stephen J. Welsh, Partner, Cresap, McCormick and Paget

Marketing Opportunities

W.N. Eldred, Vice President, Marketing, Hewlett-Packard, Inc.

Marketing Panel

Consumer electronics

Industrial electronics

Medical electronics

The distributor's view

The retailer's view

REGISTRATION

The conference will be held at Grover M. Hermann Hall, 3241 South Federal Street, Chicago, on the Illinois Institute of Technology campus. Registration fee is \$30.00. The fee includes the Tuesday luncheon. Registration forms are available by writing to:

Carolyn M. Vogel

IIT Research Institute

10 West 35 Street

Chicago, Illinois 60616

Electronics

A McGraw-Hill Market-Directed Publication

330 West 42nd Street, New York, N.Y. 10036

Electronics advertisers

November 16, 1964



■ AMP Inc	117	■ General Electric Company, Rectifier Components Div.	141	Princeton Applied Research Corp.	24
Garceau, Hargrave & McCullough Inc.		Ross Roy Inc. Advertising		Mort Barish Associates	
■ Acme Electric Corp.	116	■ General Electric Company Semiconductor Products Dept.	54	Qualtronics Corporation	142
Scheel Adv. Agency		Ross Roy Inc. Advertising		Hal Lawrence Incorporated	
Adage Inc.	20	■ General Electric Company, Silicone Products Dept.	163	■ Radiation Inc.	52
Fuller & Smith & Ross Inc.		Ross Roy Inc. Advertising		G.M. Basford Company	
Air Express Div. of REA Express	19	■ General Electric Company, Tube Dept.	40, 41	Radio Corporation of America	4th Cover
Ketchum, MacLeod & Grove Inc.		Technical Information & Product Service		Al Paul Lefton Company	
Air Reduction Sales Company	29	George R. Nelson Inc.	115	■ Radio Frequency Laboratories	173
G.M. Basford Company		■ Gertsch Products Inc.	165	J.A. Brady & Company	140
■ Allied Control Company Inc.	16	Balsam Advertising Inc.		■ Republic Foil Inc.	159
Michel-Cather Inc.		■ Globe Industries Inc.	53	John S. Kemble Advertising	159
Anso, A Div. of General Aniline & Film Corp.	145	Odiorne Industrial Adv. Inc.		Research-Cottrell Inc.	50
Hazard Advertising Company Inc.		Hamilton Watch Company		Michel Cather, Inc.	50
Astrodata Inc.	11	Van Sant Dugdale & Co. Inc.		■ Rome Cable, Div. of Alcoa	161
Bonfield Associates Inc.				The Rumrill Co. Inc.	
■ Ballantine Laboratories	133	■ Industrial Transformer Corp.	159	■ Rotron Mfg. Co. Inc.	161
Lang-Lawrence Adv. Inc.		Information Displays Inc.	160	Lescarboura Advertising Inc.	
Bausch & Lomb, Inc.	126	Taubert Studios	125	■ Sanborn Co., A Div. of	
Wolff Associates, Inc.		International Instruments Inc.	36	Hewlett Packard Co.	2
Beattie-Coleman, Inc.	128	Thomas R. Sundheim Inc.		Culver Adv. Inc.	42
Taggart & Young Inc.	9	■ International Rectifier Corp.	139	Sanders Associates	42
Bendix Semiconductor Products		Communication Associates		Chirurg & Cairns, Inc.	99
MacManus, John & Adams Inc.	164	Interstate Electronics		■ Singer Company, Metrics Division	99
■ Bird & Company Inc. Richard H.		Jones, Maher, Roberts Adv.		■ Sorensen & Company Division of	31
Stanley R. Tippett & Associates	179	■ JFD Electronics Corporation	35	Raytheon Co.	
■ Boonton Division of Hewlett-Packard		Michel Cather Inc.	132	Fuller & Smith & Ross Inc.	142
George Homer Martin Associates	151	■ Jennings Radio Mfg. Corp.	132	Space Craft Inc.	
■ Bulova Watch Company		L.H. Waldron		Preiss and Brown Adv. Inc.	98
Carpenter Matthews & Stewart Inc.		Keithley Instruments Inc.	135	Speer Carbon Company	
Burroughs Corp. Electronics Components Div.	7	Bayless-Kerr Company	46	Hazard Advertising Company Inc.	5, 6, 10
Conti Adv. Agency Inc.		■ Klein & Sons, Mathias	169	Sprague Electric Company	
■ Bussmann Mfg. Co., Div. of		The Buchen Company		The Harry P. Bridge Company	100
McGraw Edison Company	130, 131	Kyoritsu Electrical Instrument Works, Ltd.		Stackpole Carbon Co.	
Henderson Advertising Company		Nichiden Adv. Ltd.		Meek and Thomas Inc.	165
Cambridge Thermionic Corp.	154	■ Lapp Insulator Co., Inc.	146	Synthane Corp.	
Chirurg & Cairns Inc.		Wolff Associates, Inc.	144	Arndt, Preston, Chapin, Lamb & Keen Inc.	
Chatham Electronics, Div. of Tung-Sol Electric Inc.	21	LEL Inc.	165	Tektronix Inc.	120
E.M. Freystadt Associates Inc.	138	Snow & Depew Advertising		Hugh Dwight Adv. Inc.	
■ Clairex Corporation		Lepel High Frequency Labs. Inc.	160	Texas Instruments Incorporated	
S. Paul Sims Company	47	Apex Graphic Company		Industrial Products Group	49
■ Clarostat Mfg. Company		Linen Thread Company	102	Robinson-Gerrard, Inc.	
Lescarboura Advertising Inc.		Robert Luckie Advertising		Texas Instruments Incorporated, Semiconductor Div.	22, 23
Cohu Electronics, Kin Tel Division	3rd cover	Ling Temco Vought Military Electronics Division		Don L. Baxter	
Erwin Wasey, Ruthrauff & Ryan	106	Wyatt, Allen & Ryan, Inc.		Thermal American Fused Quartz Co. Inc.	160
Consolidated Electrodynamics Corp.		Machlett Laboratories Inc., The Fuller & Smith & Ross Inc.	8	Knip Associates	
Hixson & Jorgensen, Inc.	174	Markem Machine Company	157	■ Toyo Electronics Ind. Corp.	127
Continental Electronics Sub. of Ling Temco Vought		Culver Advertising Inc.		Dentsu Advertising	147
Evans, Young, Wyatt Advertising		Master Index Services Inc.	112	Trompeter Electronics Inc.	109
Data Instruments, Div. of Industrial Electronic Hardware Corp.	136	The Powerad Company Adv.		A.D. Corsini & Associates	109
A.D. Adams Advertising Inc.	143	■ Micro Switch Div. of Honeywell	48	■ Trylon Inc.	134
■ Delco Radio		Batten, Barton, Durstine & Osborn Inc.		George Moll Adv. Inc.	
Campbell Ewald Company	119	Milo Electronics Corporation	34	United Systems Corporation	150
DuPont de Nemours & Co. E.I.	148	Industrial Marketing Associates Div. of J.M. Schrier, Inc.		Advertising and Merchandising Inc.	
Batten, Barton, Durstine & Osborn Inc.		Minnesota Mining & Mfg. Co. Mincom Division	124	■ United Transformer Corporation	2nd Cover
■ Dynage, Incorporated		■ Mitsubishi Electric Corporation	44	Philip Stogel Company Inc.	
The F.W. Prell Company		Hakuhodo Inc.		Unitrade Corporation	123, 125, 127
Eldorado Electronics	33	■ Mitsumi Electric Co., Ltd.	150	Chirurg & Cairns Inc.	
Sturges & Associates		Dentsu Advertising Ltd.		■ Vitramon, Inc.	138
Electrical Industries Inc.	111	Motorola Semiconductor Products Inc.	107, 167	Ted Sommers, Inc.	
George Homer Martin Associates		Lane and Bird Advertising Inc.		Westinghouse Electric Corp.	43
■ Electro Instruments Inc.	97	■ NPC Equipment Co.	153	Ketchum, MacLeod & Grove Inc.	155
Teawell Inc. Adv.		S. Gunnar Murbeck & Co. Inc.	108	Westinghouse Electric Corp. ITSM	
■ Electro Motive Mfg. Co. Inc., The	101	North Atlantic Industries, Inc.	169	■ Weston Instruments, Incorporated	51
Cory Snow Inc.		Murray Hevert Associates		G.M. Basford Company	
Electro Scientific Industries Inc.	158	Nytron's Inc.		Classified advertising	
Nadler and Larimer Inc.		Stukalin Advertising Agency Inc.		F. J. Eberle, Business Mgr.	
Electronic Engineering Co. of California	122	■ Ohmite Mfg. Co.	113	Employment Opportunities	170-171
Compton Advertising Inc.		The Fensholt Advertising Agency		Equipment	
Fairchild Dumont Laboratories	12, 13	Pendar Inc.	152	(Used or Surplus New)	
The Roger and Wilbur Co. Inc.		Showacre, Coons, Shotwell, Adams, Inc.		For Sale	172
Fairchild Semiconductor	14	Pennsylvania Fluorocarbon Co. Inc.	148	Classified advertisers index	
Johnson & Lewis Inc.	39	John B. Ferguson Jr. Adv.		Atomic Personnel, Inc.	170
Flying Tiger Line	45	Photo-circuits	118	Arrow Freight Forwarders	172
Hixson & Jorgensen, Inc.		Duncan-Brooks Inc.		■ Engineering Associates	172
Formica Corp.	182	Preformed Line Products Company	137	■ Fair Radio Sales	170
Perry-Brown Inc.		The Bayless-Kerr Company		Motorola	171
■ Fujitsu, Limited				National Cash Register Co.	172
Hakuhodo Inc.				■ Radio Research Inst. Co.	172
■ Garlock Company Inc.	148			■ Universal Relay Corp.	172
Clawges Associates Inc.					
■ General Electric Company, Apparatus Dept.	129				
George R. Nelson Inc.					
■ General Electric Company, Miniature Lamp Div.	149				
Batten, Barton, Durstine & Osborn Inc.					
■ For more information on complete product line see advertisement in the latest Electronics Buyers' Guide					

Executive, editorial, circulation and advertising offices: McGraw-Hill Building, 330 West 42nd Street, New York, N.Y., 10036. Telephone Area Code 212-971-3333. Teletype TWX N.Y. 212-640-4646. Cable: McGrawhill, N.Y. Officers of the Publications Division: Shelton Fisher, President; Joseph H. Allen, Operations; Robert F. Boger; Administration; John R. Callahan, Editorial; Ervin E. OeGraff, Circulation; Donald C. McGraw, Jr., Advertising Sales; Angelo R. Venezian, Marketing. Officers of the Corporation: Donald C. McGraw, President; Hugh J. Kelly, Harry L. Waddell, L. Keith Goodrich, Executive Vice Presidents; John L. McGraw, Treasurer; John J. Cooke, Vice President and Secretary. Title R registered U.S. Patent Office; © copyright 1964 by McGraw-Hill, Inc. All rights reserved, including the right to reproduce the contents of this publication, in whole or in part.



Advertising sales staff

Gordon Jones [212] 971-2210
Advertising sales manager

Atlanta, Ga. 30309: Gus H. Krimsier,
Michael H. Miller, 1375 Peachtree St. N.E.,
[404] TR 5-0523

Boston, Mass. 02116: William S. Hodgkinson,
McGraw-Hill Building, Copley Square,
[617] CO 2-1160

Chicago, Ill. 60611: Robert M. Denmead,
Daniel E. Shea, Jr., 645 North Michigan
Avenue, [312] MO 4-5800

Cleveland, Ohio 44113: Paul T. Fegley, 55
Public Square, [216] SU 1-7000

Dallas, Texas 75201: Richard P. Poole, The
Vaughn Building, 1712 Commerce Street,
[214] RI 7-9721

Denver, Colo. 80202: John W. Patten, David
M. Watson, Tower Bldg., 1700 Broadway,
[303] AL 5-2981

Houston, Texas 77025: Kenneth George,
Prudential Bldg., Halcombe Blvd.,
[713] RI 8-1280

Los Angeles, Calif. 90017: Ashley P.
Hartman, John G. Zisch, 1125 W. 6th St.,
[213] HU 2-5450

New York, N.Y. 10036:
Donald R. Furth [212] 971-3615
Frank LeBeau [212] 971-3615
George F. Werner [212] 971-3615
500 Fifth Avenue

Philadelphia, Pa. 19103: William J. Boyle,
Warren H. Gardner, 6 Penn Center Plaza,
[215] LO 8-6161

San Francisco, Calif. 94111:
James T. Hauptli, 255 California Street,
[415] DO 2-4600

London W1: Edward E. Schirmer, 34 Dover
Street, Hyde Park 1451

Frankfurt/Main: Matthee Herfurth, 85
Westendstrasse Phone: 77 26 65 and
77 30 59

Geneva: Michael R. Zeynel,
2 Place du Port 244275

Paris VIII: Denis Jacob, 17 Avenue
Matignon ALMA-0452

Tokyo: Nobuyuki Sato, 1, Kotohiracho,
Shiba, Minato-ku (502) 0656

Osaka: Kazutaka Miura, 163, Umegae-cho,
Kilita-ku [362] 8771

Nagoya: International Media Representatives,
Yamagishi Bldg., 13,2-Chome,
Oike-cho Naka-ku

Hugh J. Quinn: [212] 971-2335
Manager Electronics Buyers' Guide

David M. Tempest: [212] 971-3139
Promotion manager

Milton Drake: [212] 971-3485
Market research manager

Richard J. Tomlinson: [212] 971-3191
Business manager

Theodore R. Geipel: [212] 971-2044
Production manager



actual size

MICRO RESONANT REED SELECTOR

This radically miniaturized micro resonant reed selector of the single-reed, plug-in type finds widespread use in diverse types of tele-controlling systems, mobile radio systems, portable equipment, and other transistorized circuits. It is composed of a composite cantilever vibrator, driving system, contact, and their supporting structures, all accommodated in a metallic case. In addition to its small size and light weight, since the vibrator is mechanical, its selectivity is sharp, and since variation of the resonant frequency due to changes in ambient temperature or aging is very slight, a high order of stability is obtained.

actual size

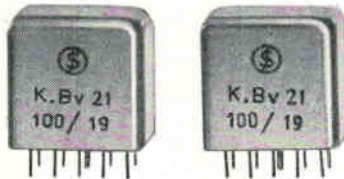

POLAR RELAY TYPE 21

This subminiature polar relay of advanced design is widely applicable in small-size, light-weight communications equipment and control equipment for telephony, carrier telegraphy, data transmission in telemetry, automatic control, data processing, etc. It features extremely efficient magnetic circuits, unique chatter-free contact mechanism, and long-life contacts. Advanced hermetically sealed design is combined with long life (100 million operations), high sensitivity (0.7mw), high speed (1.5ms), and high stability against external magnetic fields.



FUJITSU LIMITED
Communications and Electronics
Marunouchi, Tokyo, Japan

For full technical data and application information, write to the sales representatives listed below.

THE NISSHO AMERICAN CORP.
80 Pine St., New York 5, N.Y.
Phone: WHitehall 3-7840

THE NISSHO PACIFIC CORP.
120 Montgomery St., San Francisco 4, Calif.
Phone: YUkon 2-7901, 7906

NISSHO (CANADA) LTD.
100 University Avenue, Toronto
Phone: EMpire 2-4794

Circle 182 on reader service card

**HELP YOUR POST OFFICE
TO SERVE YOU BETTER
BY
MAILING EARLY IN THE DAY
NATIONWIDE IMPROVED MAIL SERVICE
PROGRAM**



DELIVERS CLOSED-CIRCUIT TELEVISION SYSTEMS TO MEET YOUR REQUIREMENTS

COLOR cameras
ENVIRONMENT-RESISTANT cameras
HIGH-RESOLUTION cameras
INDUSTRIAL cameras
MINIATURIZED cameras
RADIATION-RESISTANT cameras
SELF-CONTAINED cameras
SPACE cameras
TEMPERATURE-EXTREME cameras
UNDERWATER cameras

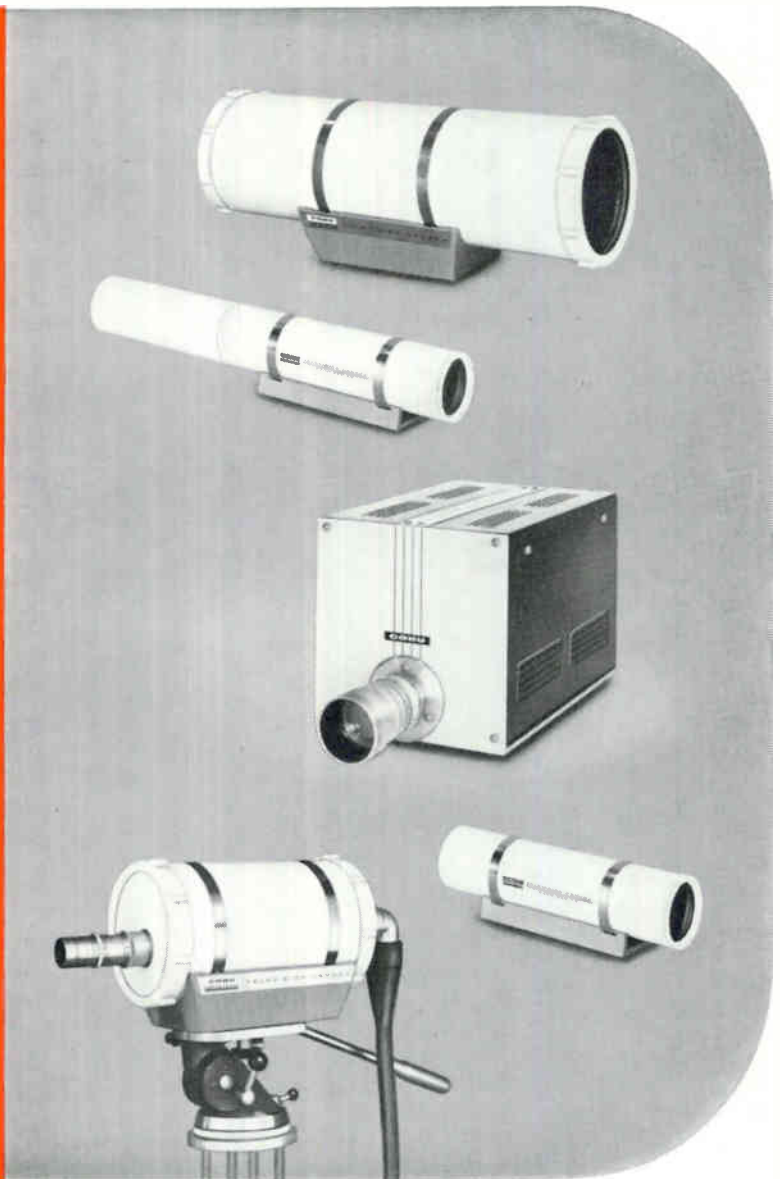

and ALL ACCESSORIES including monitors, control units, fixed-focus and zoom lenses, pan/tilt units, video cable, video switchers, synchronizing generators, cabling, tripods, vidicons...

WRITE for technical information and systems engineering. Representatives in all major cities.



Box 623
San Diego, California 92112
Phone (714) 277-6700

Circle 901 on reader service card

RCA STEPS UP OVERLAY POWER

TO 17 W TYP @ 100 Mc / 10 W TYP @ 260 Mc

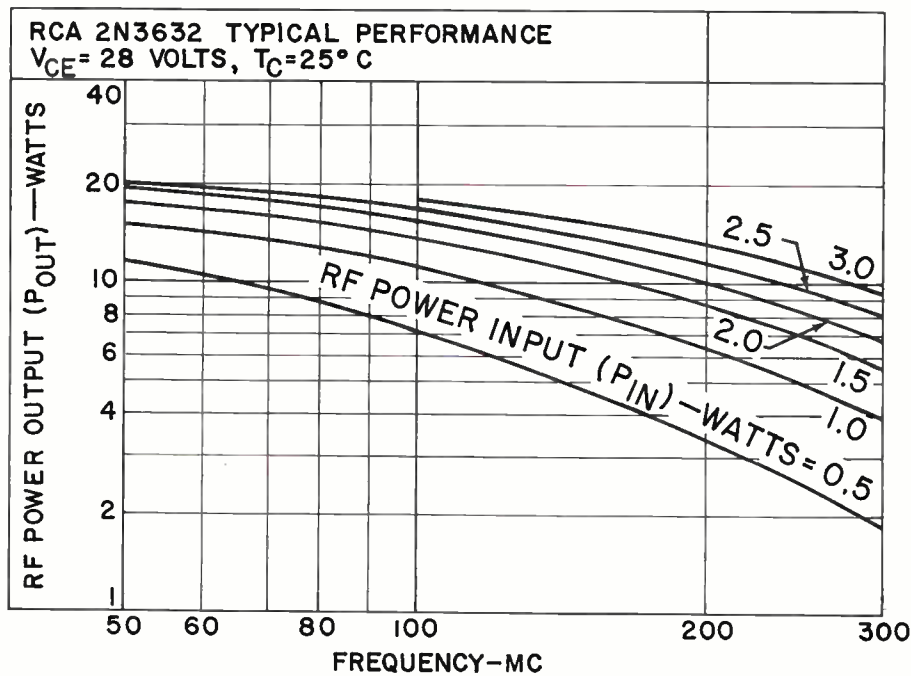

RCA 2N3632 RF PERFORMANCE / DOLLAR BREAKTHROUGH

Delivers 30 watts typ in low-cost

175 Mc all-transistor chain

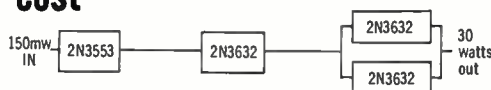

Now RCA introduces the 2N3632, new high output version of overlay type 2N3375, for 50 to 260 Mc applications. Utilizing RCA's multiple-emitter overlay construction for high-efficiency, high-frequency performance and economy, 2N3632 offers:

- 13.5 Watts Min. Output at 175 Mc 70% Min. Collector Efficiency
- $BV_{CEV} = 65V$ Min.
- $BV_{CEO} = 40V$ Min.
- I_C Max. = 3 Amps
- f_T at 150 ma = 400 Mc. Typ.



In an all-transistor chain with RCA-2N3553 or 2N3375, the 2N3632 can bring new reliability and new efficiency to military, commercial, and industrial mobile and portable equipment. Stud package (TO-60) with isolated collector, high breakdown voltages, and 100% RF testing make RCA-2N3632 an important new asset for new design and retrofit. For price and delivery see your RCA Representative or RCA Distributor. For technical data, write: RCA Commercial Engineering, Section IN11-3, Harrison, N. J.

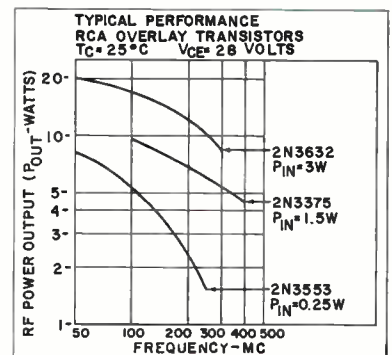

AVAILABLE THROUGH YOUR RCA DISTRIBUTOR
 RCA Electronic Components and Devices, Harrison, N. J.

Circle 902 on reader service card



The Most Trusted Name in Electronics