

# Electronics®

Previewing Wescon: page 60

Understanding pnpn devices: page 66

Driver circuits for optoelectronics: page 77

August 10, 1964

75 cents

A McGraw-Hill Publication

Below: Comsat's first satellite for worldwide communications, page 90

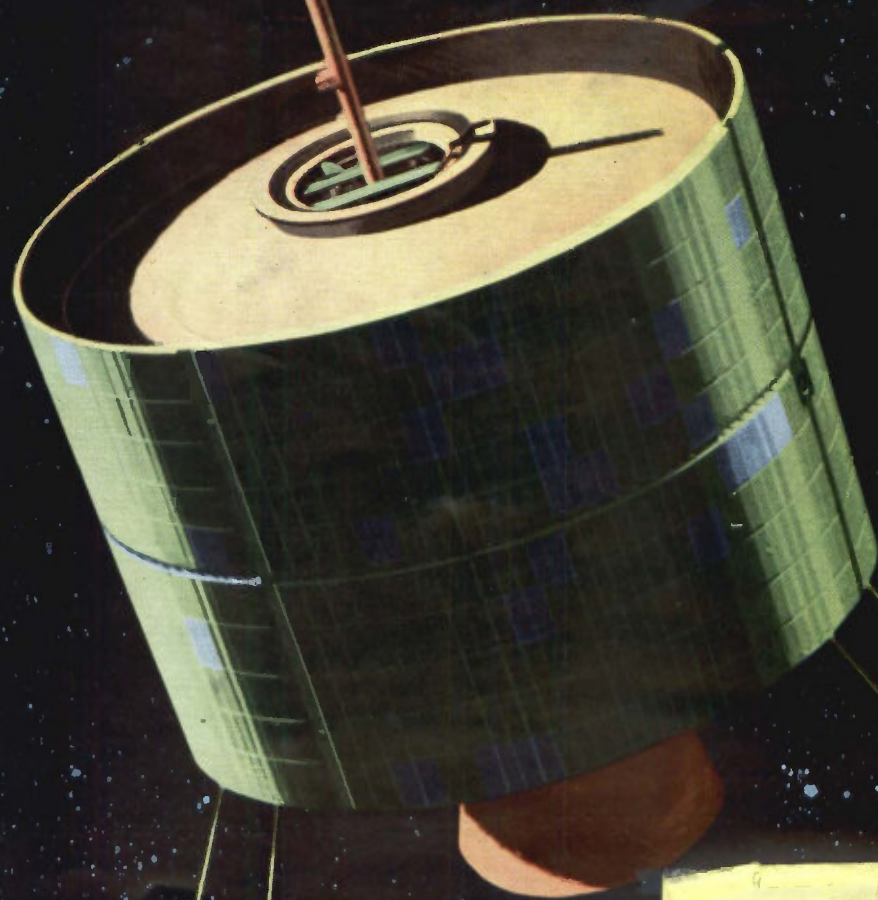

R D SKINNER  
1020 COVINGTON RD  
LOS ALTOS CALIF  
L

# At WESCON



**Type 1680-A**  
Automatic Capacitance Bridge Assembly . . . \$4850

RANGES	120c	400c	1kc
Frequency			
Capacitance	100pf to 1000 $\mu$ f 4 ranges	0.01pf to 100 $\mu$ f 7 ranges	0.01pf to 100 $\mu$ f 7 ranges
Conductance	1 $\mu$ S to 1S 4 ranges	0.1nS to 1S 7 ranges	0.1nS to 1S 7 ranges

Dissipation Factor: 0.0001 to 1.0 in one range

## NEW Automatic Bridge

### A Departure from Conventional Bridge Techniques

- ★ Completely automatic . . . on command, instrument:
  1. Selects range.
  2. Makes balance, displays measured values.
  3. Presents digital output data for printers, memory-base systems, and other digital equipment.
- ★ Direct reading in capacitance and dissipation factor (or conductance) . . . Numerik indicators also give direct presentation of units and decimal-point location
- ★ Fast . . . balance is completed in 1/2 second . . . measurement rate can be set from 2 per second to 1 every 10 seconds.
- ★ Accurate . . .  $\pm 0.1\%$  of reading . . . permits accurate remote measurements.
- ★ Optimum logic . . . logic circuits handle equally well successive measurements that are either a long way or a short way from previously measured value.
- ★ A "true" bridge circuit . . . both unknowns are balanced simultaneously.
- ★ A three-terminal, guarded bridge . . . dependent only on stable passive standards.
- ★ BCD outputs for data printers or other processing equipment.
- ★ Ideal for tracking varying capacitances, reliability studies, and large-quantity component tests.



**NEW** Type 1115-B Standard-Frequency Oscillator . . . \$2050  
A 5-Mc, 5th-overtone crystal oscillator with a short-term stability of better than  $1 \times 10^{-11}$ , measured over a 1-second averaging time . . . additional outputs at 1 Mc and 100 kc . . . all silicon transistor circuits . . . built-in battery supply and charger for emergency operation up to 35 hours . . . spectral line width less than 0.25c at 10 Gc.



**NEW** Type 1123-A Digital Synchronometer® Time Comparator . . . \$2950  
A solid-state digital clock for time and frequency standardization . . . operates with the 1115-B Standard-Frequency Oscillator for time comparisons to 10  $\mu$ sec . . . Numerik in-line readout of hours, minutes, and seconds . . . readout can be programmed to read up to 100 hours before recycling. Self-contained 24-hour emergency power supply.

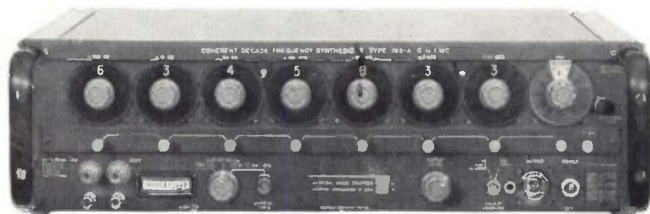

## NEW COHERENT DECADE FREQUENCY SYNTHESIZERS

Many Models Available, \$3255 to \$5600

*Provide precisely known stable signals, continuously variable, or in crystal-locked steps.*

**Type 1162-A Synthesizer, illustrated . . .**  
dc to 1Mc continuously or in 0.1-cycle crystal-locked steps.

Consists of seven convenient modular decades plus a continuously adjustable unit that permits either step- or continuous-frequency selection. At least 9-figure readability including two significant figures provided by the continuously adjustable decade, which can be self-calibrated to three figures or more. Models are available complete or in stripped-down

versions with as few as 3 digits installed; remaining digits can be added later, as desired. Frequency can be varied by an external dc voltage — can be swept, fm modulated, or phase-locked to other signals. Operates from self-contained crystal standard or from external standards. Up to 2v output into 50 ohms. Fits into only 5 1/4 inches of rack space.

## Also on display

**Digital Time & Frequency Meter** . . . measures frequencies to 400kc, periods to 20kc, and frequency ratios. Has input circuits that permit a choice of input sensitivity, impedance, trigger level, and ac or dc coupling.

**Digital-to-Analog Converter** . . . 0.1% accuracy D/A converter capable of 10,000 conversions per second.

**Capacitance Bridge** . . . 0.01% direct-reading with 6-figure resolution.

**New Megohm Bridge** . . . 1-kilohm to 1000-teraohm ( $10^{15}$  ohms) range . . .  $\Delta R$  dial for incremental resistance measurements . . . 7 test voltages from 10v to 1000v . . . built in null detector and self-checking standards.

**New Microwave Oscillator** . . . 1.7 to 4.1 Gc

**Slotted-Line Recorder System** . . . For automatic recording of VSWR from 1.001 to 1.20 over a 300Mc to 9Gc range.

**Precision Coaxial Connector** . . . A low-VSWR connector — less than 1.002 to 1Gc, 1.01 to 9Gc. Many new coaxial accessories also on display.

**Wave Analyzer 20c to 50kc range** . . . 3-, 10-, and 50-cycle bandwidths . . . accessory recorder available for automatic recording of spectra.

**Sound and Vibration Analyzer** . . . A one-third and one-tenth octave-band analyzer operating over a 2.5c to 25kc range. Also drives auxiliary chart recorder.

**New Tone-Burst Generator** . . . a coherent gate for any waveform. Useful in simulating pulsed, audio, and ultrasonic signals over a dc-to 500-kc range.

Booths 1343-1346 — August 25-28 — Los Angeles Memorial Sports Arena

## GENERAL RADIO COMPANY

WEST CONCORD, MASSACHUSETTS

IN CANADA: Toronto 247-2171, Montreal (Mt. Royal) 737-3673  
IN EUROPE: Zurich, Switzerland — London, England

NEW YORK, N. Y., 964-2722  
(Ridgefield, N. J.) 943-3140

CHICAGO  
(Oak Park) 848-9400

PHILADELPHIA, 424-7419  
(Abington) 887-8486

WASHINGTON, D. C.  
(Rockville, Md.) 946-1600

SYRACUSE  
454-9323

DALLAS  
FL 7-4031

SAN FRANCISCO  
(Los Altos) 948-8233

LOS ANGELES  
469-6201

ORLANDO, FLA.  
425-4671

CLEVELAND  
886-0150

Circle 900 on reader service card

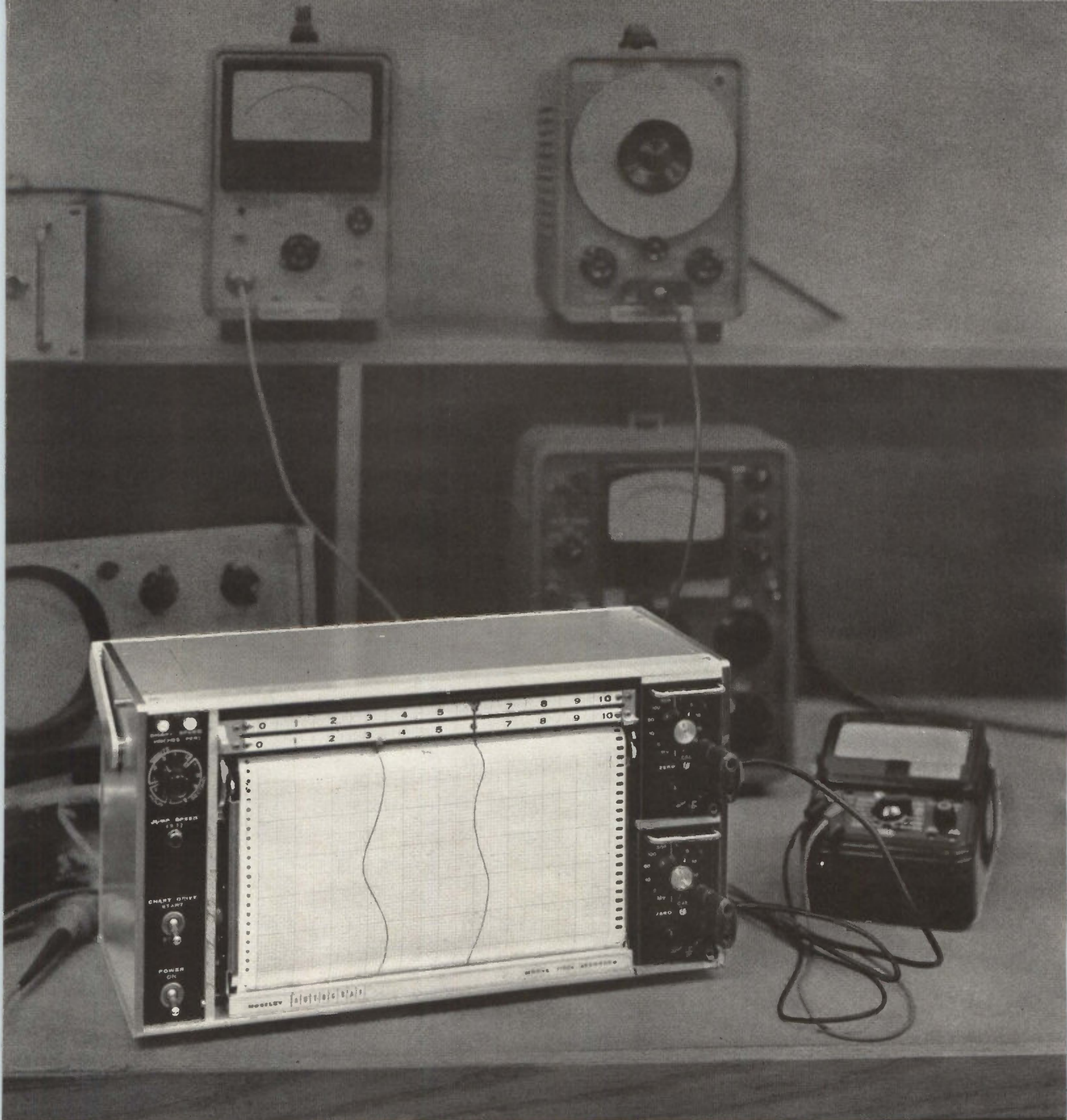

1 MEG INPUT IMPEDANCE  
 INSTANT CHART-SPEED CHANGE  
 EASY-LOADING MAGAZINE  
 TOTAL MEASURING VERSATILITY

**MOSELEY** 

an affiliate of Hewlett-Packard

See us at WESCON '64 . . . Los Angeles Sports Arena, Booth No. 1403-1404

New MOSELEY 7100A (two-pen) and 7101A (single-pen) 10" Strip Chart Recorders provide high impedance at null on all ranges, shift chart speeds in milliseconds with an exclusive 12-speed changer (10:1 remotely-controlled jump speeds optional) and make life easier with an exclusive modular loading system for 120' chart rolls. Circuitry is rugged, compact, solid state, cool running; offers better than 0.2% accuracy and 120 db DC common mode rejection. Half-second balance time, 10 calibrated input ranges, level continuously variable from 5 mv to 100 v (1 mv optional). Ample power to drive retransmitting pots, event markers, limit or alarm switches. Model 7100A, \$1800; Model 7101A, \$1390. Try on your bench or in your rack; call your Moseley/Hewlett-Packard field engineer. F. L. MOSELEY CO., 409 N. Fair Oaks Avenue, Pasadena, California.

9099R

CIRCLE 1 ON READER SERVICE CARD

# BREADBOARD

**with this solid state operational amplifier**

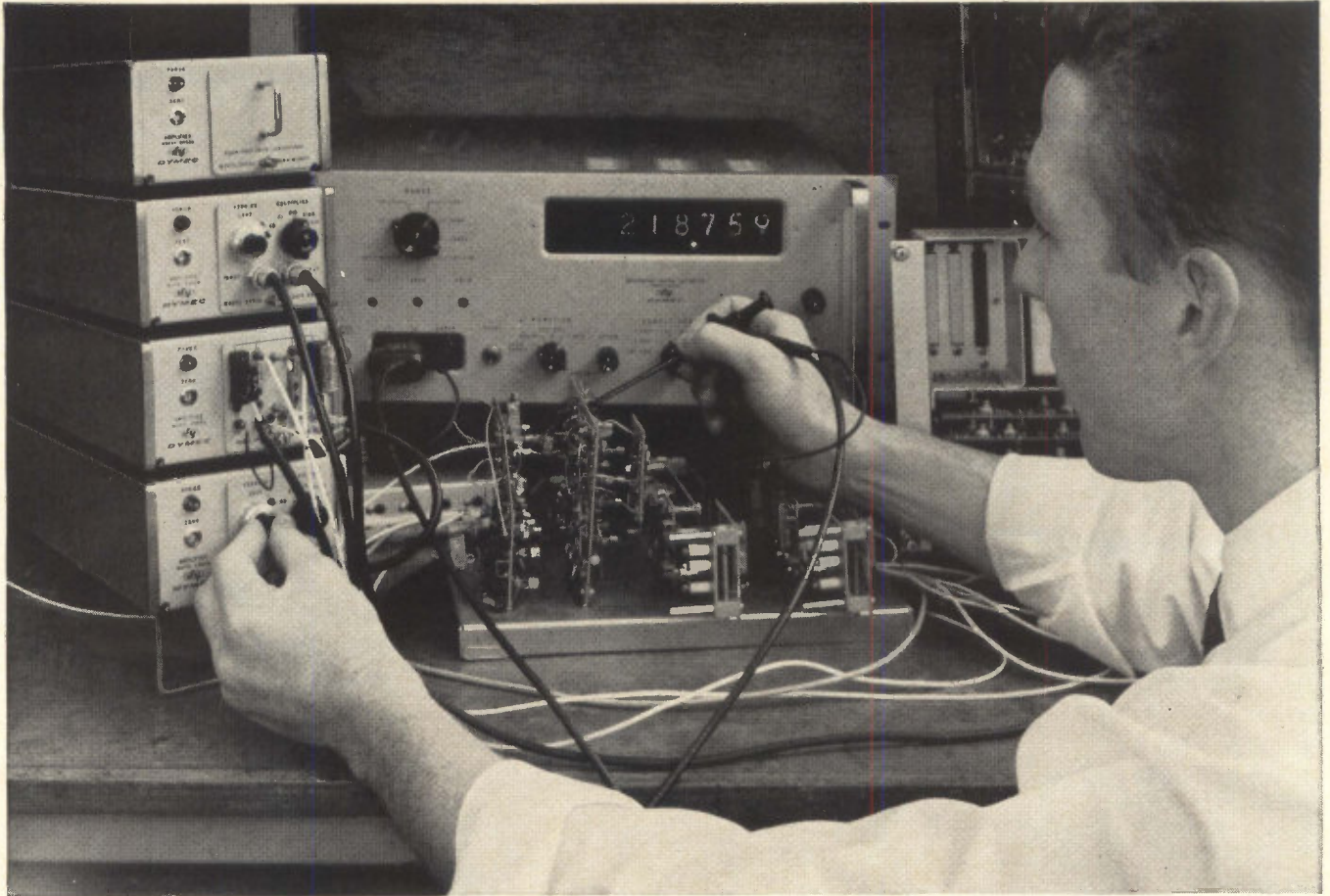

*Use the DY-2460A as an active element of your newly designed circuits...*  
**AMPLIFIER ■ SUMMER ■ HIGH IMPEDANCE ISOLATOR ■ INTEGRATOR ■ INVERTER**

Check out new design concepts and ideas in a hurry with the DY-2460A DC Amplifier as a circuit element. This wideband, solid state instrument is ready-made for a wide variety of circuit applications which will save you time and effort.

The low-cost DY-2460A is designed for general purpose use. Amplitude and phase response are properly controlled beyond unity gain to permit a variety of feedback networks. A self-contained power supply in each instrument provides highest isolation when operating a group of amplifiers at different potentials. A non-synchronous photoconductive chopper eliminates all effects of ac pickup.

Plug-in design of the 2460A increases its versatility. A patch unit plug-in brings input, output, summing point and feedback circuit to the front panel; other plug-ins

provide switchable gains in steps from 1 through 1000, vernier adjustment through 11,000, and a high-accuracy plus-one configuration with greater than  $10^{10}$  ohms input resistance.

The 2460A will supply an output of  $\pm 10$  v peak at 10 ma. Zero drift is less than  $1\mu\text{v}$  per week, noise less than  $4\mu\text{v}$  peak to peak.

Ask your Dymec/Hewlett-Packard field engineer for all the details on how the DY-2460A can make your breadboarding easier.

Price: DY-2460A Amplifier, \$445. DY-2461A-M1 Data Systems Plug-in, \$85; DY-2461A-M2 Bench-use Plug-in, \$125; DY-2461A-M3 Patch Unit Plug-in, \$75; DY-2461A-M4 Plus-one Gain Plug-in, \$35.

Data subject to change without notice. Prices f.o.b. factory.

## DYMEC

A DIVISION OF HEWLETT-PACKARD COMPANY

DEPT. E-8, 395 PAGE MILL ROAD, PALO ALTO, CALIF. • PHONE (415) 326-1755 TWX 415-492-9363

See us at WESCON . . . Booths 1407-1410, Los Angeles Sports Arena

# Electronics

Page 4	Readers comment
8	People
10	Meetings ahead
15	Editorial
17	Electronics newsletter
45	Washington newsletter
121	New products
158	New literature
161	New books
163	Technical abstracts

## In this issue

### Electronics review

Page 29	Ranger succeeds at last	32	GE expands
30	Production breakthrough	32	X-ray subtracter
30	Ring, dish and tire	34	Computers in cement
31	Digital weather	34	An inside job
32	Crystals: drop by drop	36	Weather by wire

### Probing the news

103	What makes Wescon run?
104	Dude goes West
106	How the West wins business
112	Our man in Washington

### Technical articles

#### I. Design

Meeting report	60	<b>Significance of Wescon's technical program</b> The decline in West Coast electronics business shows up in the region's technology Lewis H. Young, editor
Components	66	<b>Transistor analog: the pnpn device</b> There's more to be learned about pnpn devices if you consider them in terms of transistors Richard A. Stasior, General Electric Co.
Circuit design	74	<b>Designer's casebook</b> Oscillator generates sine and cosine functions simultaneously; 1,500-volt hybrid switch has low "on" impedance; servo comparator amplifier handles high voltages
Solid state	77	<b>Driver circuits for light-emitting diodes</b> Behind the light-emitting diode must be a driver circuit; here are some useful transistorized ones Edward L. Bonin, Texas Instruments, Inc.

#### II. Application

Avionics	83	<b>Straining the noise out of radar data</b> A new technique makes the air traffic controller's job easier William J. Evanzia, avionics editor
Space electronics	90	<b>The Early Bird: bigger and better (cover)</b> Comsat's first satellite will be bigger and better than any yet launched Joel A. Strasser, space electronics editor

# Electronics

**Editor:** Lewis H. Young

**Managing editor:** John M. Carroll

**Senior editors**

**Technical:** Samuel Weber  
**News:** Kemp Anderson, Jr.

**Senior associate editors:** John F. Mason, George Sideris

**Department editors**

**Advanced technology:** George V. Novotny  
**Avionics:** W.J. Evanzia  
**Circuit design:** Jerome Eimbinder  
**Communications:** Alexander A. McKenzie  
**Components:** Michael F. Tomaino  
**Computers:** Stephen B. Gray  
**Industrial electronics:** Louis S. Gomolak  
**Instrumentation:** George J. Flynn  
**Manufacturing:** George Sideris  
**Military electronics:** John F. Mason  
**New products:** William P. O'Brien  
**Solid state:** G.G. Tirellis  
**Space electronics:** Joel A. Strasser  
**Staff writers:** Leon H. Dulberger, Peggy Jackson

**Regional editors**

**Boston:** Thomas Maguire, editor; Susan Turner  
**Chicago:** Cletus M. Wiley, editor; Leslie Krimston  
**Los Angeles:** Harold C. Hood, editor  
**San Francisco:** Laurence D. Shergalis, editor; Mary Jo Jadin  
**London:** Derek Barlow, editor

**Copy editors**

Howard Rausch, Sally Powell

**Illustration**

**Art director:** Howard R. Berry  
**Assistant art director:** John C. Wright, Jr.  
**Editorial production:** Ann Mella, Sandra A. LeMond

**Editorial secretaries:** Claire Benell, Lynn Emery,  
Kay Fontana, Lorraine Rossi, Lorraine Werner

**McGraw-Hill news service**

**Director:** John Wilhelm; **Atlanta:** Fran Ridgeway; **Chicago:** Bruce Cross;  
**Cleveland:** Arthur Zimmerman; **Dallas:** Marvin Reid;  
**Detroit:** Donald MacDonald; **Los Angeles:** Michael Murphy,  
Ron Lovell; **San Francisco:** Margaret Ralston, Ed. Addeo;  
**Seattle:** Ray Bloomberg; **Washington:** George Bryant Jr., Glen Bayless,  
Charles Gardner

**McGraw-Hill world news service**

**Bonn:** Richard Mikton; **Brussels:** Arthur Erikson; **London:** John Shinn;  
**Mexico City:** Wesley Perry; **Milan:** Bruce Bendow;  
**Moscow:** Donald Winston; **Paris:** Dan Smith;  
**Rio de Janeiro:** Leslie Warren; **Tokyo:** Richard Halloran, Charles Cohen

**Circulation manager:** Hugh Quinn

**Reprints:** T.M. Egan

**Publisher:** C.C. Randolph

**Electronics:** August 10, 1964, Vol. 37, No. 22

Printed at 99 North Broadway, Albany, N.Y.  
Second class postage paid at Albany, N.Y.

Subscriptions are solicited only from those actively engaged in the field of the publication. Position and company connection must be indicated on orders. Subscription prices: United States and Possessions and Canada, \$6.00 one year, \$9.00 two years, \$12.00 three years. All other countries \$20.00 one year. Single copies, United States and Possessions and Canada 75¢. Single copies all other countries \$1.50.

Published every other Monday by McGraw-Hill Inc. 330 West 42nd Street, New York, N.Y. 10036. Founder: James H. McGraw, 1860-1948.

**Subscribers:** The Publisher, upon written request to our New York office from any subscriber, agrees to refund that part of the subscription price applying to copies not yet mailed. Please send change of address notices, subscription orders or complaints to Fulfillment Manager, Electronics, at the address below. Change of address notices should provide old as well as new address, including postal zone number if any. If possible, attach address label from recent issue. Allow one month for change to become effective.

**Postmaster:** Please send Form 3579 to Fulfillment Manager, Electronics, P.O. Box 430, Hightstown, New Jersey 08520

## Readers Comment

### Mail sorting

We need more men in high positions in the federal service with the insight that S.H. McNeill and A. Kiron showed in their July 13 letters [p. 6]. May I take this opportunity to encourage them to present their ideas to the Post Office Department? They should present their ideas to a man who is big enough to have no need to build a research empire. Maybe the greater consciousness of the effectiveness-to-cost ratio, which has been evident in the government in recent months, will give them an audience that will be more responsive than I had in June, 1963, when I presented a similar concept to an official in the Office of Research and Engineering for the Post Office.

I do not deny that we have a distinct need for readers that can read any alphabet in any font or even in script—but I do not agree that the Post Office is justified in financially supporting such research for developing machines for its use.

Charles P. Hedges  
General Electric Co.  
Santa Barbara, Calif.

To add to the references to "Scanning the Mails" [June 15, p. 115; Comment, July 13, p. 6], here are a few state-of-the-art ideas that could easily be installed:

1. The most important key information, the zip code, is now the last bit of information at the end of the address. If the mail moves through several sortings, each time several lines must be scanned to get to the zip code. I would think the Post Office would want the code first, and the addressee's name last. For instance:

10036 N. Y., New York  
West 42 St., 330  
Electronics Magazine  
Editor

2. Really simple sorting could be done by the stamps being placed in predetermined areas on the envelope. . . . Other squares around the periphery of the envelope could designate large cities, states, etc. . . . Also, the stamps

## New Bridge Design For Safe, Accurate, Easy Measurement of 'Lytic Capacitors

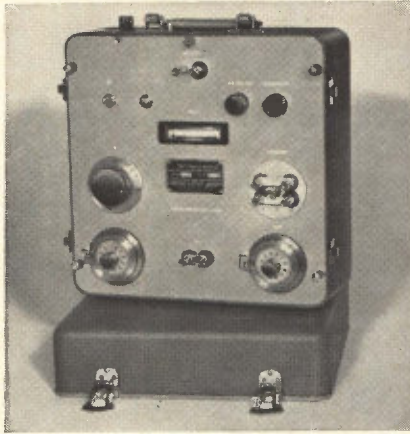

The Sprague Model 1W2A Capacitance Bridge introduces new, improved technical refinements as well as restyling for added attractiveness and ease of operation. Built by capacitor engineers for capacitor users, it incorporates the best features of bridges used for many years in Sprague laboratories and production facilities.

### Precision Measurements over Entire Range from 0 to 120,000 $\mu$ F

The internal generator of the 1W2A Bridge is a line-driven frequency converter, and detection is obtained from an internal tuned transistor amplifier-null detector, whose sensitivity increases as the balance point is approached. It has provision for 2-terminal, 3-terminal, and 4-terminal capacitance measurements, which are essential for accurate measurement...  $\pm 1\%$  of reading +  $10\mu\mu$ F... of medium, low, and high capacitance values, respectively.

### No Damage to Capacitors

The model 1W2A Capacitance Bridge will not cause degradation or failure in electrolytic or low-voltage ceramic capacitors during test, as is the case in many conventional bridges and test circuits. The 120 cycle A-C voltage, applied to capacitors under test from a built-in source, never exceeds 0.5 volt! It is usually unnecessary to apply d-c polarizing voltage to electrolytic capacitors because of this safe, low voltage.

### Complete Specifications Available

For complete technical data on this precision instrument, write for Engineering Bulletin 90,010A to Technical Literature Service, Sprague Electric Company, 35 Marshall Street, North Adams, Massachusetts.

45SP-128-63

Circle 5 on reader service card

# Did you know Sprague makes...?

## MAGNETIC LOGIC DEVICES

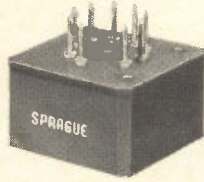

Core-diode and core transistor magnetic shift registers and magnetic counters for switching and storage applications in computer and logic circuitry.

CIRCLE 277 ON READER SERVICE CARD

## MOLDED PULSE TRANSFORMERS

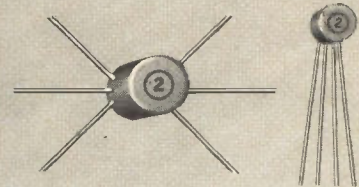

Miniature Pulse Transformers with tough molded cases for increased protection against physical damage and severe atmospheric conditions.

CIRCLE 278 ON READER SERVICE CARD

## NANOSECOND PULSE TRANSFORMERS IN TO-5 TRANSISTOR CASES

Special design offers distinct advantages: (1) Miniature size. (2) Welded hermetic seal. (3) Increased reliability. (4) Compatibility with transistor mounting techniques.



CIRCLE 279 ON READER SERVICE CARD

## SOMETHING NEW IN COUNTING TECHNIQUES

Simple yet versatile, low-cost yet reliable counters available for predetermined (2 to 11) or selectable (5 through 10) counting cycles.



CIRCLE 280 ON READER SERVICE CARD

## DYNACOR® BOBBIN CORES



Series "300" Cores with logical flux values in popular physical sizes are stocked in production quantities for fast delivery. They're value engineered for quality with economy!

CIRCLE 282 ON READER SERVICE CARD

## HERMETICALLY-SEALED TO-5 ENCASED SWITCH CORES

Designed especially for high-speed, low-power switching up to 100 kc, adaptability with conventional transistor packaging techniques, and performance under MIL-S-21038 environmental conditions.



CIRCLE 281 ON READER SERVICE CARD

## ELECTRONIC MODULES TO CUSTOMER REQUIREMENTS



Custom packaging is no novelty at Sprague's Special Products Division, where "specials" are continually being developed and produced with countless variations in electrical characteristics and mechanical configurations.

CIRCLE 283 ON READER SERVICE CARD

For application engineering assistance (without obligation, of course) on any of the above products, write or call the Special Products Division, Sprague Electric Company, 35 Union Street, North Adams, Massachusetts.

45SP-111-63 R4

Get the Full Story at WESCON Booths 141 Thru 146

# SPRAGUE®

THE MARK OF RELIABILITY

\*Sprague\* and \*S\* are registered trademarks of the Sprague Electric Co.

**from Sprague, of course!**

**SEPT<sup>®</sup>**

**SILICON  
PLANAR  
EPITAXIAL  
TRANSISTORS**

**Conforming to  
ALL requirements of**

**MIL-S-19500/251A(EL)  
2N2219**



**and**

TO-5 CASE

**MIL-S-19500/255A(EL)  
2N2222**



TO-18 CASE

For complete technical data, write to:  
TECHNICAL LITERATURE SERVICE  
SPRAGUE ELECTRIC COMPANY,  
35 MARSHALL ST.  
NORTH ADAMS, MASS.

**SPRAGUE<sup>®</sup>**  
THE MARK OF RELIABILITY

\*Sprague and ® are registered trademarks of the Sprague Electric Co.  
GET THE FULL STORY AT WESCON BOOTHS  
141 THRU 146

could be colored to give further information. . . . Mail thus marked could be dumped into a simple hopper for an initial sorting, then through other sorters; no "scanning" would be needed. Simple photoelectric and magnetic sorting devices are now available.

3. Make envelopes with an IBM-type card backing, with a small strip along the edge, in which holes can be punched to give destination information. . . .

Anthony H. Lamb  
Atlantic Instruments &  
Electronics, Inc.  
Boston

### Digital speed control

In your June 29 issue, at the bottom of pages 46 and 47, there are a few paragraphs indicating that digital control of d-c motor speed is a new method of speed control that is under development. In late 1962 we developed a digital d-c motor speed control for use at Tektronix, Inc. The control was completely electronic with no moving parts such as relays, etc., except for the input transducer. The unit was used to control the line speed of a plastic extrusion process. We used a crystal oscillator as a speed reference, scr's as controlled motor-drive elements, transistorized digital comparison circuitry, a Tektronix type 183 pulse-generating tachometer as the motor-speed generator, and digital speed settings with up to four-place accuracy. This unit achieved a 0.1% control of motor speed under varying line-voltage and load conditions using a comparison period of 0.1 seconds. The degree of control was limited by the number of tachometer pulses per comparison period that could be generated.

Mel D. Christensen  
Tektronix, Inc.  
Beaverton, Ore.

### Superpower tubes

We have read with interest Professor Eastman's article, "Superpower tubes: their capabilities and limitations," in the July 13 issue [p. 48]. We have noted his comment on the limitation due to a current density of 2 amp/cm<sup>2</sup>.

About ten years ago at Philips

Laboratories, Irvington, New York, an impregnated cathode was developed which is capable of producing current densities of at least 10 amp/cm<sup>2</sup> and these cathodes have been in production at Philips Metalonics in Mt. Vernon for the past four years. These cathodes are used in many of the tubes specified in the article at higher current densities than the 2 amp/cm<sup>2</sup> cited. As far as we know at this time, Philips of Holland is not producing any cathodes of higher current densities than those stated above.

Philips Metalonics  
Mt. Vernon, N. Y.

Roberto Levi

### Color code

In the Nov. 15, 1963, issue of Electronics there appeared on page 37 the color codes for various electronic components. The color code for chassis wiring was given in two columns. One column listed the wire colors under the present standard, and the other column listed the wire colors under a new standard proposed by the EIA.

Could you tell me whether the standard has been approved at this date or when it may be approved?

Fred A. Albrecht  
Geotechnical Corp.  
Garland, Tex.

▪ The standard has not yet been approved, and no estimate was available on when it may be. About 40 companies have agreed to the proposed standards, but 7 or 8 others have either voted against it or want minor changes.

### UHF circuits

In the July 13 article, "Basic uhf circuit forms amplifiers and multipliers," the oscillogram caption on page 60 reads: "Each x-axis large division represents 2.5 milliwatts of output power. Each y-axis large division is equivalent to 8 Mc."

I think the axes should be reversed, y-axis for watts and x-axis for frequency.

Albert C. W. Saunders  
Saunders Radio & Electronic  
School, Inc.  
Boston

▪ Right—reverse the axes.



# Regulate down to zero power factor with Sorensen's new silicon controlled rectifier ACR Voltage Regulators

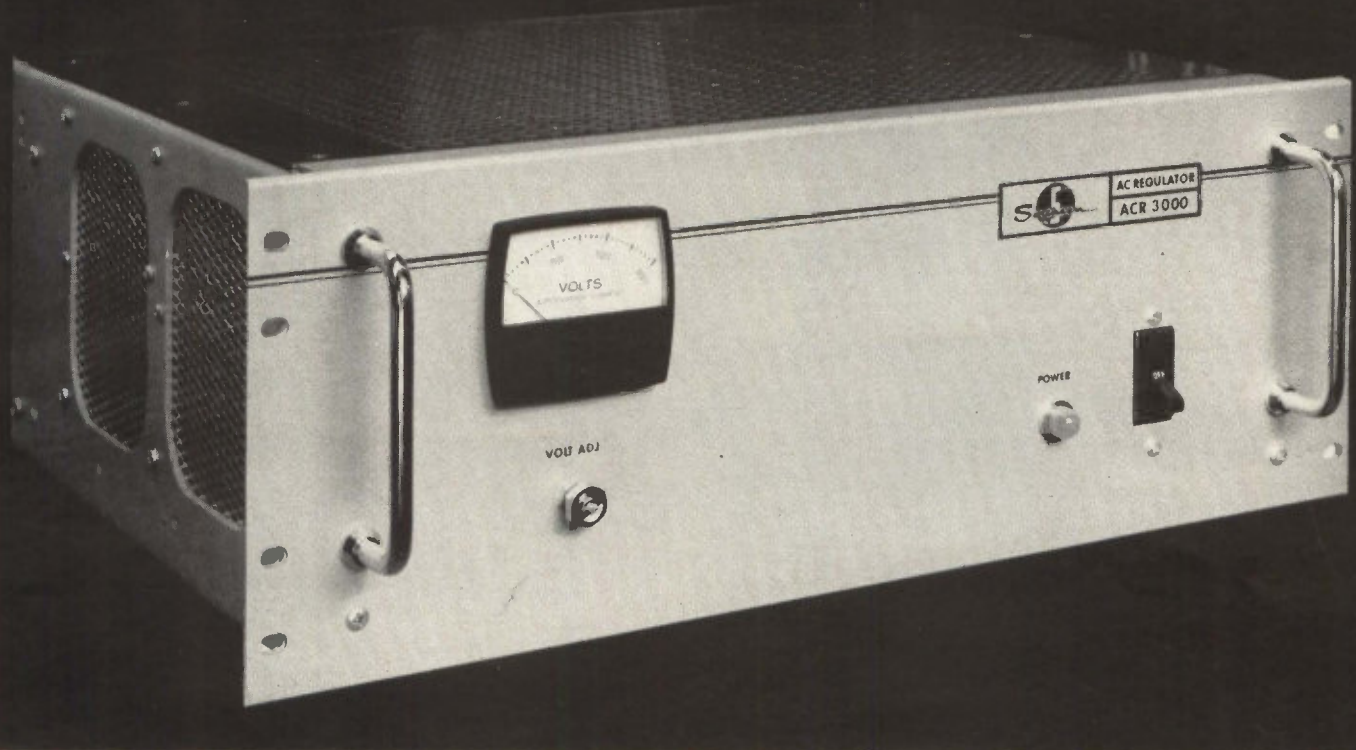

Ideal for motor starting, lamp loads, tube filaments, x-ray applications, etc., ACR Series regulators are designed to control the RMS voltage to a variety of loads requiring precision regulation, fast response time, and low distortion.

- 1 5 MODELS AVAILABLE (500, 1000, 2000, 3000, 5000VA)
- 2 LOW PRICES (starting at \$290)
- 3 SMALL SIZE AND WEIGHT (about half the volume of competitive regulators)
- 4 FULL INPUT VOLTAGE RANGE 95-130 VAC; OUTPUT RANGE 110-120 VAC
- 5 FAST RESPONSE to line or load changes (30ms)
- 6 LOW DISTORTION (3% max.)
- 7 STABILITY (.05%/8 hours—after a 30-minute warm-up)
- 8 UP TO 95% EFFICIENCY
- 9 REGULATION  $\pm 0.1\%$  RMS
- 10 PROGRAMMABLE
- 11 REMOTE SENSING
- 12 CONVECTION COOLED
- 13 EASY MAINTENANCE (removable "plug-in" printed circuit)

For complete data on the ACR Series and other Sorensen products, send for the new, 140-page book, "Controlled Power Catalog and Handbook." Write to Sorensen, Richards Avenue, South Norwalk, Conn., or use Reader Service Card Number 200.

## ACR ELECTRICAL AND MECHANICAL SPECIFICATIONS:

MODEL NUMBER	OUTPUT VA RANGE	REGULATION ACCURACY		EFFICIENCY (FULL VA)	TYPICAL POWER FACTOR	TEMPERATURE COEFFICIENT		DIMENSIONS (INCHES)			PRICE**	
		LINE	LOAD			AMBIENT (°C)	(°C)	WIDTH	HEIGHT	DEPTH		RACK HEIGHT
ACR 500	0-500	$\pm 0.1\%$	$\pm 0.1\%$	88%	75%	0-50	.015%	15*	5	9	5 1/4	\$290
ACR 1000	0-1000	$\pm 0.1\%$	$\pm 0.1\%$	90%	75%	0-50	.015%	19	5 1/4	11	5 1/4	340
ACR 2000	0-2000	$\pm 0.1\%$	$\pm 0.1\%$	92%	75%	0-50	.015%	19	5 1/4	15	5 1/4	435
ACR 3000	0-3000	$\pm 0.1\%$	$\pm 0.1\%$	95%	75%	0-50	.015%	19	7	15	7	555
ACR 5000	0-5000	$\pm 0.1\%$	$\pm 0.1\%$	95%	75%	0-50	.015%	19	7	20	7	715

\*A 19 inch adapter (rack) panel is available.

\*\*Optional Meter \$22.



A UNIT OF RAYTHEON COMPANY

CIRCLE 7 ON READER SERVICE CARD

# [ SUPER POWER TRIODE ]

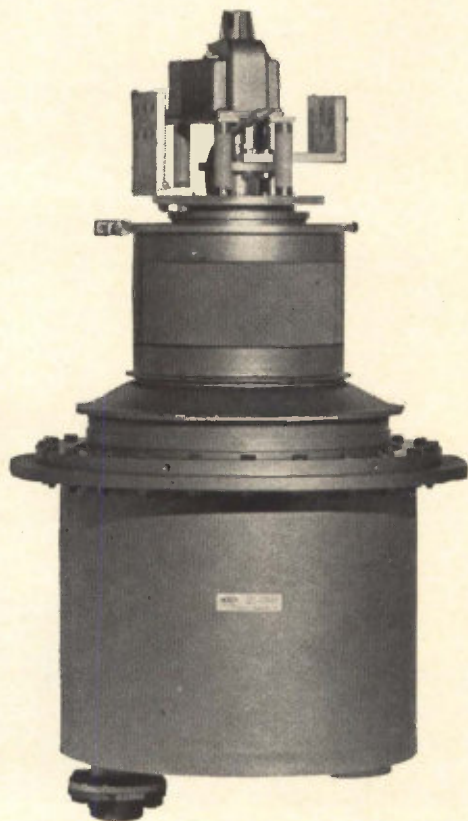

**New ML-8549 Super Power Triode provides extremely favorable output/drive ratios. Typical power capabilities:**

- 60 Mw pulse power . . . approximately 70 kw drive
- 10 Mw rf power, plate pulsed . . . approximately 33 kw drive
- 2.5 MW rf power, CW . . . approximately 10 kw drive
- 1.1 MW rf power, CW-plate modulated . . . approximately 4 kw drive

These extremely favorable output/drive ratios result from a novel beaming principle which permits a typical grid-to-plate current division of 100 to 1. Because of the very high power gain afforded, drive requirements are unusually low. Unique design of the ML-8549 utilizes two concentric anode cylinders permitting double-sided cathode operation resulting in low internal tube drop and highly efficient operation. Pulsed efficiencies higher than 90% are achieved. For data write: The Machlett Laboratories, Incorporated, Springfield, Connecticut. An affiliate of Raytheon Company.

**See the ML-8549 at Wescon, booths 335-336.**



**ELECTRON TUBE SPECIALIST**

## People

**Donald E. Larson**, a former advertising man, doesn't believe in the hard sell. He is quiet and soft spoken. But under his management, Wescon, the West Coast's answer to the IEEE show, has grown from 234 booths in the Long Beach



Civic Auditorium in 1952 to the 1,250 booths expected this year in the Los Angeles Sports Arena.

Larson took over the job of managing Wescon as a sideline in 1954. He was running his own advertising agency then. In 1956, his friends at the Western Electronics Manufacturers Association persuaded him to sell the agency and become full-time manager of Wescon.

Larson stays relaxed when the pressure is greatest. A sense of humor helps keep him going between January and August as business picks up for the yearly show. During that period, he averages three to five evening meetings a week. He estimates that he is away from his home—in the Bel-Air section of Los Angeles—twenty weeks each year.

Despite the hectic pace, Larson enjoys most of the numerous board meetings and committee assignments that go with his job. He is particularly proud of his membership on the board of directors of the National Association of Exhibit Managers, a 150-member organization that meets in June and December—off months for conventions—to go over problems and plans.

Wescon's continuous growth is attributed by Larson to innovations. He cites, for example, a first for this year's show: "We've bought space on 120 billboards in the Los Angeles area to plug the show."

His full-time enthusiasm for Wescon probably provides more satisfaction than his after-hours enthusiasm for the Los Angeles Dodgers. They were in seventh place a month before the show.

# This Is Not the First 1<sup>13</sup>/<sub>16</sub>" 10-Turn Precision Potentiometer. Just the Best.

SEE BOURNS PRODUCTS  
AT WESCON, HOLLYWOOD PARK  
BOOTH NUMBERS 363, 4, 5

Under punishing side-by-side environmental tests, the new BOURNS® Model 3400 performed dependably long after competitive units had sagged, sogged or snapped under the strain. In rotation-life tests it displayed far greater mechanical strength than any other unit. In vibration and shock tests, it kept operating after broken pigtails and terminations had put competitive units out of commission.

This new kind of industrial reliability stems from Bourns' many years of experience in developing potentiometers for military and aerospace use. Model 3400 has a molded, all-plastic case for superior humidity performance... sliding contacts to eliminate fragile pigtails... an extra-large slider block for high stability. And it has the exclusive, virtually indestructible SILVERWELD® termination that replaces vulnerable single-wire terminations to overcome the chief cause of potentiometer failure.

Model 3400 undergoes 100% in-process and final inspections, and is subjected to the famous Bourns Reliability Assurance Program. In reliability and in performance, it is a premium potentiometer. One of its best features is that there is no premium in price.

Write today for free technical data.

Model 3400, 1<sup>13</sup>/<sub>16</sub>" Diameter, Bushing Mount  
**LINEARITY:** ±0.15%, STANDARD  
**Resistances:** 100Ω to 500K, standard  
**Power rating:** 5.0W at 40°C  
**Humidity:** Steady state  
**Operating temp. range:** -65 to +105°C  
**Resolution:** 0.005 to 0.045%  
**Length (body):** 1.75"

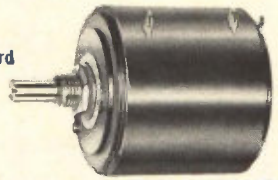

ONE-HALF ACTUAL SIZE



BOURNS, INC., TRIMPOT DIVISION  
1200 COLUMBIA AVE., RIVERSIDE, CALIF.  
PHONE 684-1700. TWX: 714-682 9582  
CABLE: BOURNSINC.

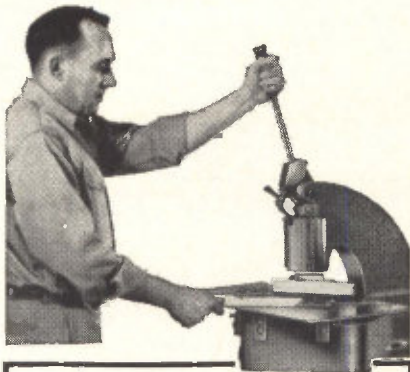

NEW DI-ACRO

# TAB NOTCHER

ONE PULL CUTS BOTH  
TAB AND NOTCH

Here's a new, easy way to make strong tabbed boxes from any material up to 16 gauge steel. One pull of the Tab Notcher handle cuts both corner notch and tab angle. Tabbed ends enclose sides when formed, making box self-aligning. Easy to spot weld for extra rigidity.

New Tab Notcher is available for hand or power operation. Cuts up to 6"x6" notch with or without tab up to 1" deep. Shears up to 6" width. Comes equipped with self-squaring adjustable gauges. Ask your Di-Acro distributor for details or write us.

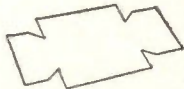

Tab-notched blank

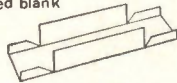

Easy to form

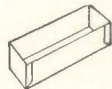

Result:  
a stronger box



**DI-ACRO CORPORATION**

438 EIGHTH AVENUE  
LAKE CITY, MINNESOTA

Di-Acro manufactures a complete line of benders, rod parters, brakes, press brakes, press brake dies, shears, notchers, rollers, punch presses, layout machines, spring winders and punches and dies. Write for catalog.

## Meetings

**UAIDE Annual Meeting**, Users of Automatic Information Display Equipment; International Hotel, Sepulveda and Century Blvds., Los Angeles, Aug. 12-14.

**Quantification of Human Performance Symposium and Workshop**, University of New Mexico, EIA M-5.7 Subcommittee on Human Factors; University of Mexico, Albuquerque, N.M., Aug. 17-19.

**Symposium of Ultra Low Frequency Electromagnetic Fields**, NBS Central Radio Propagation Lab. and National Center of Atmospheric Research; Boulder Laboratories, Boulder, Colo., Aug. 17-20.

**Electronic Packaging International Symposium**, University of Colorado, Cahners Publishing Co.; University of Colorado, Boulder, Colo., Aug. 19-21.

**Distributor-Manufacturer-Representative Conference**, WESCON; Ambassador Hotel, Los Angeles, Aug. 24.

**AIAA/ION Astrodynamics Guidance and Control Conference**, American Institute of Aeronautics and Astronautics, Institute of Navigation; University of California, Los Angeles, Aug. 24-26.

**Association for Computing Machinery Annual Conference**, ACM; Sheraton Hotel, Philadelphia, Aug. 25-27.

**WESCON 1964**, 6th Region IEEE, Western Electronic Manufacturers Assoc.; Los Angeles Sports Arena and Hollywood Park, Los Angeles, Aug. 25-28.

**International Conference on the Physics of Type 11 Superconductivity**, Western Reserve University, Cleveland, Ohio, Aug. 28-29.

**International Conference on Microwaves, Circuit Theory and Information Theory**, Inst. Electrical Comm. Engrs. of Japan; Akasaka Prince Hotel, Tokyo, Sept. 7-11.

**International Exhibition of Industrial Electronics**, Swiss Industries Fair; Basel, Switzerland, Sept. 7-11.

**International Convention on Military Electronics (MIL-E-CON-8)**, IEEE; Shoreham Hotel, Washington, Sept. 14-16.

**Operations Research Society Annual International Meeting**, Western Section of ORSA, ORSJ, University of Hawaii; Sheraton Meeting House and Princess Kaiulani Hotel, Waikiki, Honolulu, Sept. 14-18.

**Ceramic-To-Metal Session**, American Ceramic Society, Philadelphia, Sept. 17.

**Annual Northwest Computing Conference**, Northwest Computing Association, University of Washington Computing Center; University of Washington, Seattle, Wash., Sept. 17-18.

**Engineering Management Annual Conference**, IEEE-ASME; Pick-Carter Hotel, Cleveland, Sept. 17-18.

**AIAA Military Aircraft Systems and Technology Meeting**, (Secret), AIAA, USAF, and BuWeps; NASA-Langley Research Center, Va., Sept. 21-23.

**AE-4 Electromagnetic Compatibility Conference**, SAE; McDonnell Aircraft Corp., St. Louis, Mo., Sept. 22-23.

**Profession Technical Group on Antennas and Propagation International Symposium**, PTGAP/IEEE; International Hotel, John F. Kennedy International Airport, N.Y., Sept. 2-24.

## Call for papers

**Electrical Insulation Conference**, IEEE, NEMA; New York Hilton Hotel, New York City, Sept. 13-16, 1965. Deadline is **September 1, 1964** for submitting a preliminary abstract to John Lenkey, Anaconda Wire and Cable Co., 605 Third Ave., New York, N.Y. 10016. Papers should report new developments in electrical insulation materials or applications, or explain basic insulation behavior or user experience and observations. General topics include rotating machinery, electronics, transmission and distribution, materials science and applications.

**Remote Sensing of Environment Symposium**, Office of Naval Research; The University of Michigan, Ann Arbor, Mich., Oct. 14-16. **September 1** is deadline for submitting a comprehensive abstract to Dana C. Parker, Institute of Science and Technology, The University of Michigan, P.O. Box 618, Ann Arbor, Mich. 48107. Topics include applications for remote sensing, design considerations for sensors and carrying vehicles, data analysis programs and techniques.

# ASTRODATA

## ADVANCED TIME CODE GENERATORS FOR YOUR TIMING SYSTEMS APPLICATIONS

Astrodata's advanced time code generators give you state-of-the-art design for a wide range of timing requirements.

You can select the basic generator most suited to your system. When desired, standard circuit cards can be installed for special

requirements or for updating your present system.

All presently used codes can be furnished, or special codes can be devised to provide the timing most compatible with your instrumentation data.

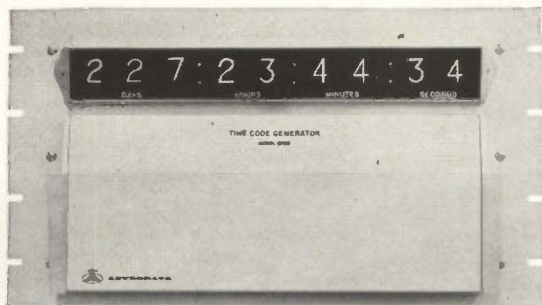

Model 6190 provides up to 10 dc shift and carrier modulated codes simultaneously... drift rate less than 5 parts in  $10^9$  per day... more than 30 options available... code matrix cards easily replaced to meet changing requirements.

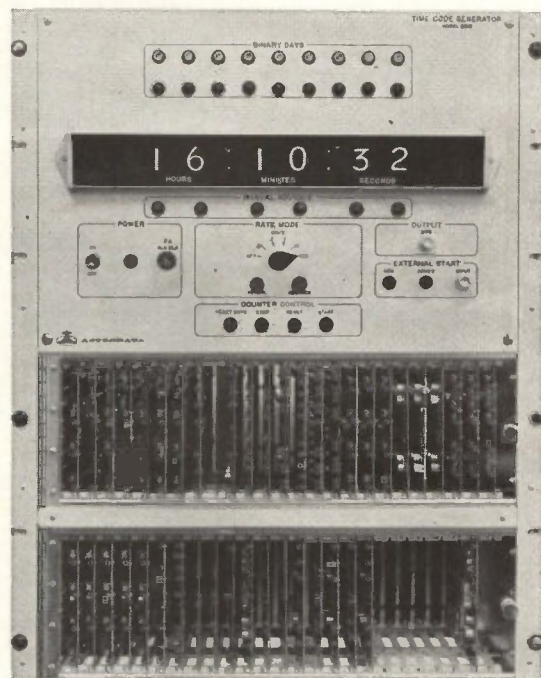
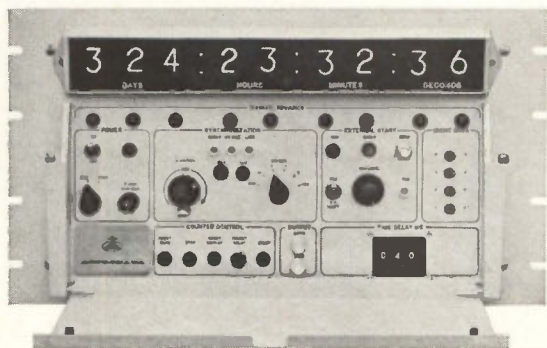

Model 6120 provides all required serial time codes simultaneously... pulse rates... decimal display... stability to 5 parts in  $10^9$  per day... front access to circuit cards.



Model 6140 provides up to 3 specified code formats simultaneously... drift rate less than 1 part in  $10^8$  per day... standard pulse rates... decimal display.

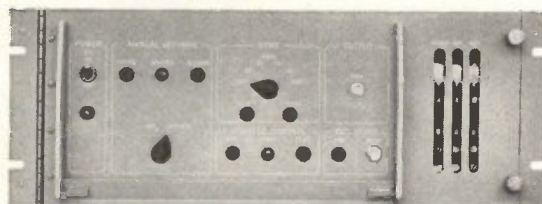

Model 6100 provides up to 3 specified code formats simultaneously... drift rate less than 1 part in  $10^8$  per day... standard pulse rates... binary-coded display.

Write for your copy of the 20-page brochure "Capabilities and Experience of Astrodata in Timing Instrumentation and Systems."



**ASTRODATA INC.**

240 East Palais Road • Anaheim, California  
Phone (714) 772-1000 • TWX 714-776-3760

# Hewlett-Packard introduces

a new technique for testing broadband devices... more completely, more accurately and in a fraction of the time required by slotted line methods

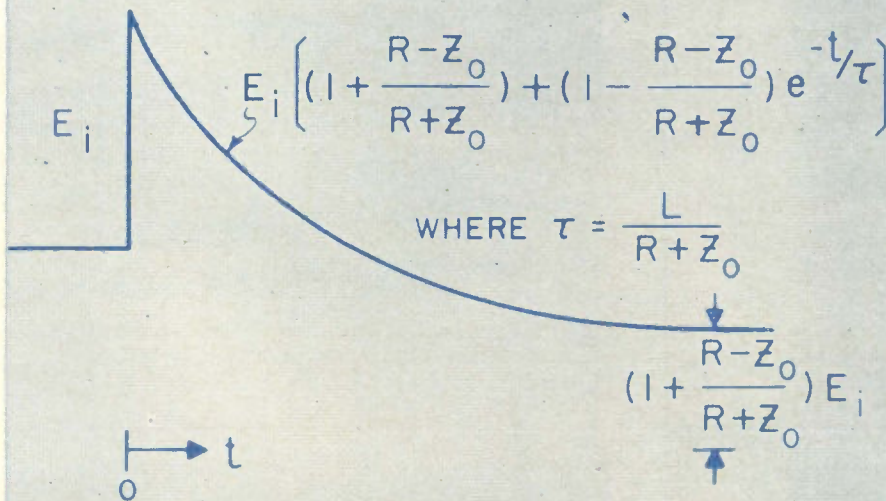

## Time Domain Reflectometry

with the versatile 140A Oscilloscope

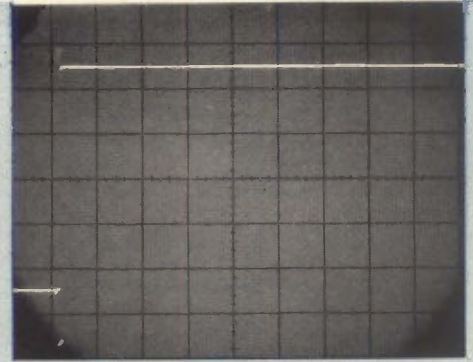

Test step sent down transmission line from the 1415A Time Domain Reflectometer. Sweep lengths to 20,000 cm of polyethylene line allow long lines to be examined. Note step flatness.

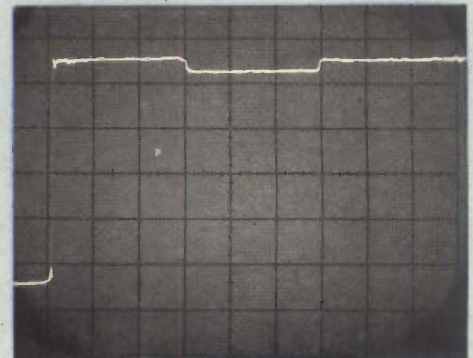

48 inches of RG-58A/U cable spliced into a 50 ohm line. Sweep speed, 40 cm of polyethylene line/cm; sensitivity in reflection coefficient, 0.2/cm. Trace is an accurate impedance profile of the line.

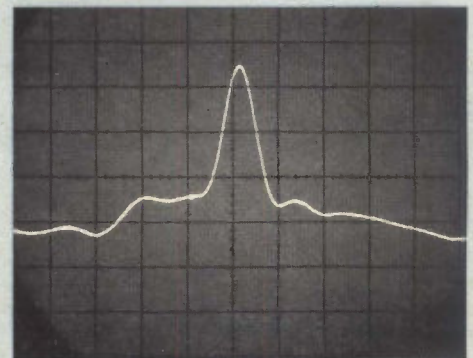

An expanded view showing the BNC connector joining two 50 ohm cables. Note the small inductive discontinuity. Sweep speed, 2 cm of polyethylene line/cm; sensitivity in reflection coefficient, 0.01/cm.

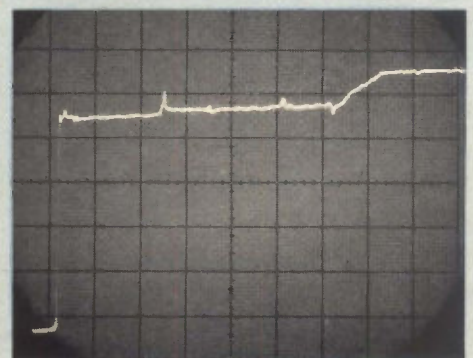

A 50 ohm (unbalanced) to 200 ohm (balanced) balun followed by a section of twin lead tapering from 200 to 300 ohms. The slope is produced by the tapered section.

# Determine location, magnitude and type of discontinuities!

Plug the new Hewlett-Packard 1415A into the double compartment of the 140A Oscilloscope and you have a complete unit for time domain reflectometry. You can measure the transmission quality of broadband devices, since the 1415A allows you to locate and analyze discontinuities. It's ideal for checking cables and connectors or broadband loads. And it's a natural for designing and maximizing the response of coaxial switches, strip lines, attenuators, and antennas.

Time Domain Reflectometry (TDR) is a closed loop radar technique where a voltage step is sent down the line and the echoes displayed on a scope. Each reflection from a discontinuity produces a characteristic echo distinct from all others. Interpretation is extremely simple, and the effect of changes can be seen instantly.

TDR avoids difficulties encountered in conventional SWR techniques for testing broadband devices. SWR measurements must be made at many frequencies to determine the broadband quality of a device, and the technique reveals only the aggregate effect of what may be many individual discontinuities. TDR reveals at a glance the characteristic impedance of the line, plus the position and nature of each individual discontinuity (resistive, inductive or capacitive). And the measurements are immediate. Often an entire system can be corrected in less time than required for the first set of SWR measurements.

The 1415A consists of a fast-rise pulse generator, single-channel sampler and time base generator, all in one plug-in. Rise time less than 150 psec for the system, lets you separate —on the scope—discontinuities as close as 1 cm. Vertical calibration is directly in reflection coefficient for a 50 ohm system and has a maximum calibrated sensitivity of 0.005/cm (SWR corresponding to 1.005).

Horizontal time scale is calibrated in distance for easy measurement of the distance between discontinuities. On the slowest sweep, 300 meters (985 feet) of airline or 200 meters of polyethylene can be displayed. A sweep magnifier lets you equate one cm on the scope face with 1 cm of actual polyethylene line, permitting examination of connectors. Calibrated delay, too, for looking at every section of a line when magnified.

The 1415A in the 140A Scope is exceedingly easy to operate, just as TDR techniques are extremely simple to master, even for non-technical personnel. Use the attached coupon to get your copy of TDR Application Note 62. Then ask your Hewlett-Packard Field Engineer for a demonstration of the scope and time domain reflectometer.

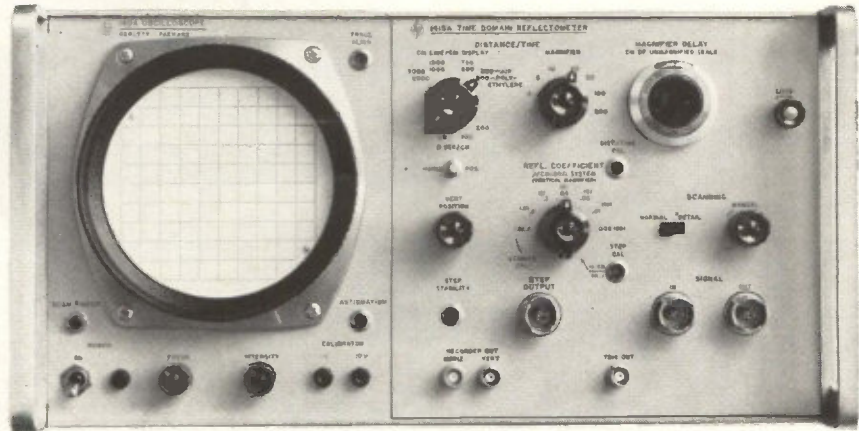

## hp 140A PLUG-IN OSCILLOSCOPE

The hp 140A Oscilloscope offers you the best value today and tomorrow. Basic unit incorporates big, no-parallax 10 cm x 10 cm crt with 7.5 kv accelerating potential for bright traces; large, heavy-duty power supplies with enough reserve power for any new plug-in; push-button beam finder;  $\pm 1\%$  calibrator. All other functions are provided by plug-ins: half-size for standard vertical and horizontal functions, full-size for TDR and other special functions. Look over the plug-ins and see how the 140A will do your job. Price \$575.

### PLUG-INS AVAILABLE NOW

**1400A Differential Amplifier**, sensitivities to 100  $\mu\text{V}/\text{cm}$  at 400 kc bandwidth, differential operation on all sensitivity ranges, low dc drift, \$210.

**1401A Dual Trace Amplifier**, sensitivities to 1 mv/cm at 450 kc bandwidth, differential operation with separate input attenuators, \$325.

**1402A Dual Trace Amplifier**, sensitivities to 5 mv/cm at 20 mc bandwidth, signal delay for viewing rise time, A + B operation, \$550.

**1415A Time Domain Reflectometer**, described at left, \$1050.

**1420A Time Base**, sweeps to 50 ns/cm with stable, automatic triggering to 20 mc, \$325.

Other plug-ins nearing production are the 1403A, 10  $\mu\text{V}/\text{cm}$  AC Differential Amplifier and the 1421A Time Base and Delay Generator.

**HEWLETT PACKARD**  *An extra measure of quality*

Visit Hewlett-Packard at WESCON '64  
1400 Aisle — Sports Arena — Los Angeles

9376

A complete description of Time Domain Reflectometer techniques is contained in Application Note 62, yours for the asking, without obligation. Information on the complete 140A Scope System will accompany the material. Address the coupon to Hewlett-Packard, Palo Alto, California 94304, telephone (415) 326-7000; Europe: 54 Route des Acacias, Geneva; Canada: 8270 Mayrand Street, Montreal.

Gentlemen: Please send Application Note 62.

Name ..... Title .....

Company ..... Address .....

City ..... State .....

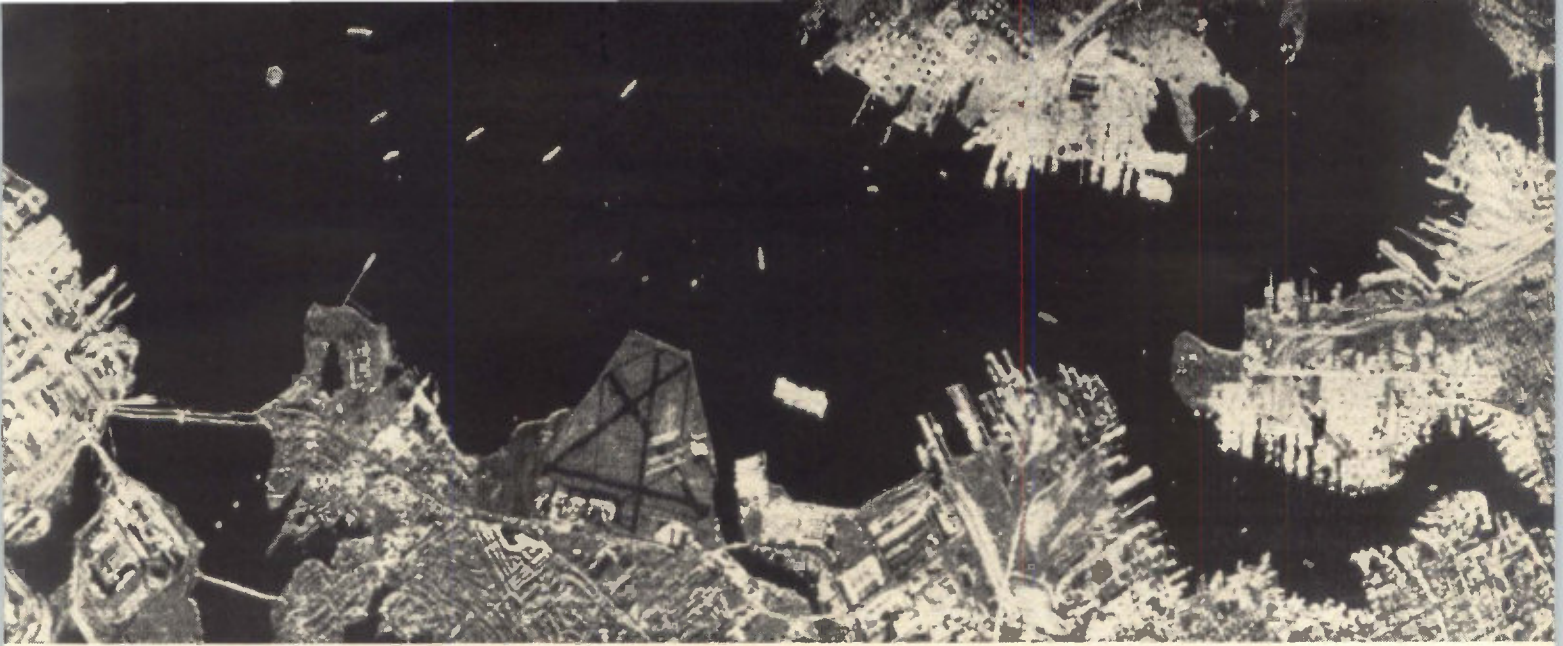

8 years ago, Westinghouse radar made this picture through clouds over Baltimore

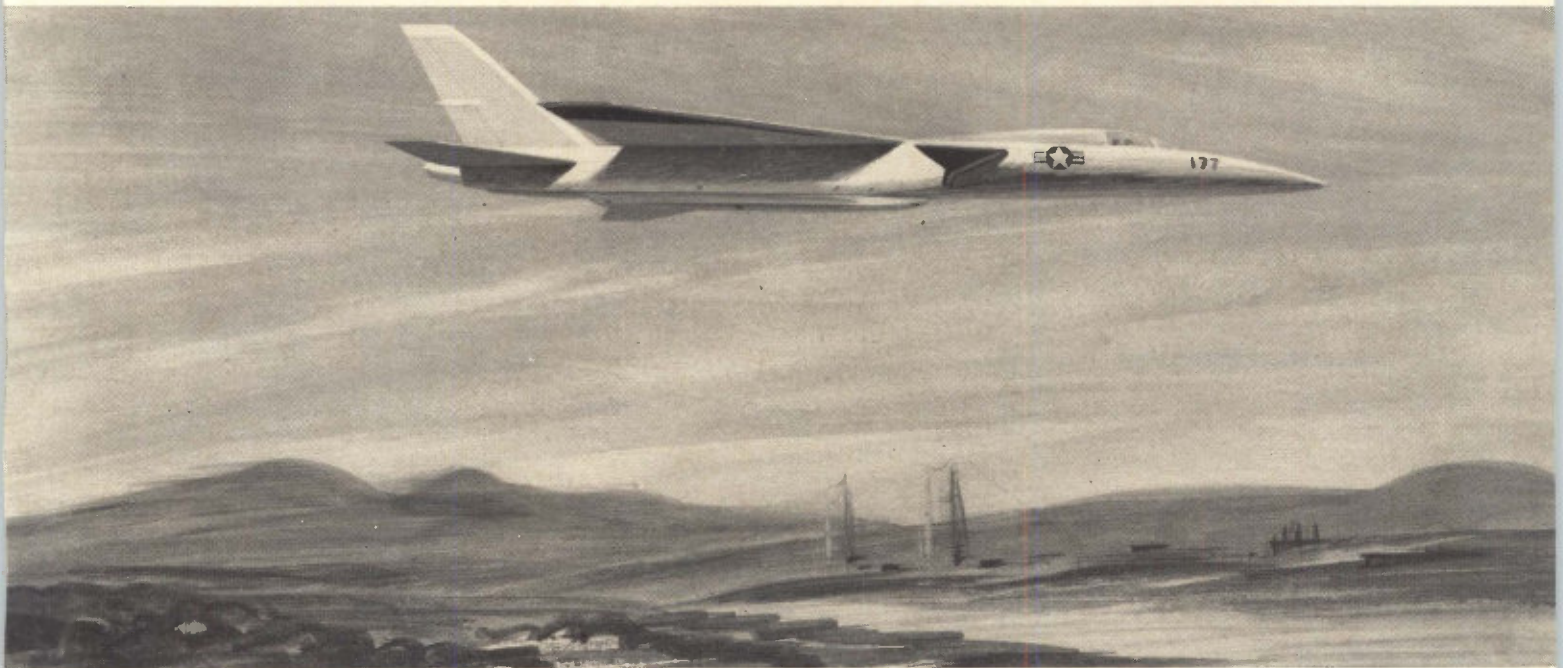

### Now we can take a better look—faster, too

Install a side-looking mapping radar in a Mach 2 aircraft, flying "on the deck" over target areas. Acquire a detailed photographic record of every installation en route—regardless of light conditions, weather or visibility.

This is the capability of such radar systems as the AN/APD-7, now operational, and the AN/APQ-97 high resolution mapping radar Westinghouse is delivering to the military.

And we are continuing the design and

development of high-resolution radars that are particularly suited to ground, air, and space missions. Our goal? To rival photographs in sharpness and detail even while penetrating darkness and cloud cover. Using sophisticated molecular electronic techniques we add another dimension—equipment that is smaller, lighter, and more reliable than ever.

Especially important is the management factor. At the Westinghouse Defense Center in Baltimore, the Aerospace Division

applies broad management experience to all airborne and spaceborne projects. On-time delivery at the quoted cost gets equal emphasis with equipment performance. Value engineering, cost management, PERT, total product support—all are concepts Westinghouse has employed for years. This is the sound basis of Westinghouse leadership in electronics for defense and space systems. For further information, write Westinghouse Electric Corporation, Box 868, Pittsburgh, Penna. 15222. J-02360

You can be sure if it's Westinghouse





---

Editorial

---

# Whose side are we on?

Last month in the Caribbean, one of the Navy's keenest trouble-shooting units carried out a mock evacuation of nationals as part of an exercise to keep its fighting men razor sharp. In one phase of the maneuver, the Navy landed a battalion of marines for the peaceful occupation of the evacuation areas.

The marines performed superbly but the electronic equipment nearly snafued the whole operation.

At the start, a planned assault had to be postponed when one reconnaissance team apparently disappeared. Air-sea rescue operations discovered the team was not lost; its voice communication transmitter had conked out.

Later, helicopters patrolled the captured beachhead communicating with a command center aboard a converted aircraft carrier. At one time, all four electronic communication systems the 'copters used were out of action, simultaneously. Not tactically struck down, just plain malfunction.

What is so distressing about all this is most of the marines' electronic equipment was World War II vintage. In this day of microelectronics, solid state, and magnetic components, our ground forces are carrying tubed equipment. And this gear still has a lot of the faults that hurried the switch to transistor design.

Questioned about their electronic equipment, marines complained that too many of the designs engineers produce today are just too complex for battlefield use. And too much of it can't be maintained by troops on the move in a hurry.

The marines who scamper ashore from landing boats know exactly what they need: 1) light, reliable and easily maintained radio equipment; and 2) a battlefield radar that will work when it has to.

Why don't they have these things? None of them sound beyond the reach of current technology.

For one thing, the big money has gone to the spectacular projects, those that make good publicity as well as good weapons. You don't find many tubes in missile guidance systems, either in the birds or on the ground. For another, engineers caught up in sophisticated military electronics programs don't seem able to handle the simple straightforward design needed in battlefield electronics.

Today the military has focused its attention on limited warfare. The big projects are phasing out and reverses in Vietnam and Laos have forced new attention in this direction. Despite the decline in over-all military procurement, spending is increasing for the items that can be used to fight guerilla warfare.

For companies used to doing business with the military, here is a relatively untapped market. Although the business procedures remain the same, the engineering has to be totally different. For this market, simplicity and reliability have to be paramount. And cost is important too. Many of these electronic communications systems will be given away to native troops of another country so the cost has to be low enough that the taxpayers can afford such gifts in large numbers.

We feel it's bitterly ironic that taxi drivers in many U.S. cities have transistorized radio transmitters but our marines and infantry do not.



WESCON Booth 441  
Hollywood Park

# SILICON POWER INDUSTRIAL TRANSISTORS

**2N3233 2N3234 2N3235 2N3236 2N3237**  
**2N3238 2N3239 2N3240**

Silicon Transistor Corporation, the leading manufacturer of silicon power products, is now producing an entirely new series of low-cost, industrial power transistors. Our basic product philosophy of manufacturing high quality devices will not deviate, despite the low prices on these new power transistors.

This series is in the all-copper TO-3 header with a maximum junction temperature of 200°C. The D.C. power capabilities range from 117 to 200 watts, with peak switched power ratings for approximately 20 times the D.C. ratings. Maximum collector current capability ranges from 7.5 to 20 amps with  $BV_{CEO}$  ratings ranging from 60 to 160 volts. Saturation resistance values range from types having 0.1 ohms @  $I_c = 10A$  to others having 0.8 ohms @  $I_c = 3A$ .

This series is now available from stock and from your local Silicon Transistor Corporation distributor. For complete specifications and information on reducing your silicon power transistor costs for industrial applications, contact:

 **SILICON TRANSISTOR CORPORATION** 

CARLE PLACE, L.I., NEW YORK 516-Pioneer 2-4100

DISTRICT OFFICES: LONG BEACH 2, CALIF., 217 ELM AVE. (213) 437-2788. TWX 213-549-1972.

DAYTON 19, OHIO, 49 PARK AVE. (513) 298-9913. TWX 513-944-0372. HUNTSVILLE, ALA., POST OFFICE BOX 1467. (205) 881-4793

---

# Electronics Newsletter

---

August 10, 1964

## Not much room for improvement

While justifiably proud of the smashing success scored by Ranger 7 last week (p. 29), one scientist at the Jet Propulsion Laboratories of the California Institute of Technology cannot help but feel a little disappointed that the lunar photographs were so good.

For several years Robert Nathan has been developing a complex computer program, used with the lab's IBM 7094, to improve the quality of televised pictures. Paradoxically, the excellence of the transmitted pictures, didn't give the Ranger scientist a chance to add lustre to an already shining achievement. He was ready to do a spectacular cleaning-up job if the images had been inferior. But despite the excellent quality of the pictures, they can be improved, and the job is now under way.

The pre-launch calibration procedures included a computerized ground check out of Ranger's cameras for photometric distortion—uneven response over the surface of the vidicon to a given intensity of light—and for geometric distortion. The crosses in the moon photos provide bench marks for correcting this type of distortion. The 7094 compensates for both conditions.

The first post-launch chore performed in cleaning up pictures is the digitizing of a video analog signal received from magnetic tape. The computer, programed to search for any "noise bursts" along television raster scan lines, removes and replaces these with the average of corresponding light intensities along neighboring lines—six pictures showing a common lunar area are superimposed to obtain this average. If not removed, the noise bursts would appear as spots on the picture. Another set of programs enables removal of the distortion-correction crosses from the pictures.

Nathan is now working with the simpler 300-line pictures from the partial-scan cameras, to make sure his process is working. Later, he will "clean up" the 1,152-line pictures from the full-scan cameras. Since the cameras slated for the Surveyors are of lower quality than the Ranger cameras, it is expected that much more computerized cleanup will be needed on those pictures.

## Circuit makers seek new market

Two more leading integrated-circuit manufacturers are getting into the business of selling equipment developed for their own production lines. Equipment sales, however, are still restricted to the assembly and test end of a line, rather than the highly proprietary equipment that is used to make the actual circuits.

The two new sellers are the Semiconductor Products division of Motorola, Inc., and the Semiconductor division of the Fairchild Camera & Instrument Corp. Motorola will sell scribes, used to cut up semiconductor slices into individual circuits or chip components, equipment for bonding the chips or dies to headers and for bonding connector wires to the dies, and package welders. It will also be selling high-speed test equipment.

These products will put Motorola into direct competition with Texas Instruments, Inc., which has been selling both test and assembly equipment. The Signetics Corp., another major producer, has been selling flat-pack test jigs and elevated-temperature test sets.

The Instrument division of Fairchild has been selling test instru-

---

# Electronics Newsletter

---

ments. With Fairchild Semiconductor selling such assembly equipment as wire bonders and welders, it looks like a three-way competition between Texas Instruments Inc., Motorola Inc. and the Fairchild division.

## Breakthrough for guidance system

The Sperry Gyroscope division of the Sperry Rand Corp. has scored a breakthrough into the commercial market. It's a sign of things to come. Inertial air navigation systems, heretofore used in quantity only aboard guided missiles, will now be used for the first time on commercial airliners for long-range navigation.

The Sperry system can be used, with a few changes, in the supersonic transport planes. The Raytheon Co., now building a suitcase-sized guidance computer for the Apollo project, is readying a proposal for use of another system aboard commercial supersonic aircraft. It would provide the navigation computations and automatic guidance needed for Mach 3 speeds.

The Pan American World Airways Corp. has given Sperry a \$12.5-million order for Sperry SGN-10 inertial platforms. Pan American expects the Sperry system to release some 170 experienced fliers, now being used as navigators, for pilot duty. The system will perform the navigating chores. Airlines have had trouble recruiting trained pilots because of the Air Force emphasis on missiles over manned aircraft.

## Persuading the Pentagon

Air Force communications planners go before Pentagon officials this month seeking funds for new systems for survivable communications. This brings up an old problem. Before granting the funds, the Pentagon must be convinced that the Air Force needs can't be met by existing commercial systems, since it may have to justify the expenditure to Congress. Congress customarily has refused to fund any special military communications where the need can be filled adequately by commercial systems. But it and the military don't always see eye to eye on what comprises an adequate system. This year, the Air Force is interested in four-way microwave communications which would temporarily "heal" a network if ground stations were blown up. The microwave links, acting as temporary systems until ground forces reestablished communications, would function air-to-air and air-to-ground, would permit airborne switching and trunking of ground links on a temporary basis.

The Air Force is also interested in development programs to get aircraft into the sphere of communication satellites. Proposed programs include air-to-air communications via satellite, air-to-ground via satellite—in fact, all combinations of satellite, air and ground.

## FCC middleman for home tv

Viewers in areas far from television stations may get better reception and a greater program choice, thanks to a Federal Communications Commission proposal to establish a Community Antenna Relay Service. The service would absorb the microwave systems licensed under the Business Radio Service that now relay programs to community antennas for transmission to home sets. Twenty 12.5-megacycle channels would occupy frequencies from 12,700 to 12,950 Mc. After February, 1971, new technical standards would double the number of channels that are available now.



NEW FROM  
TEKTRONIX

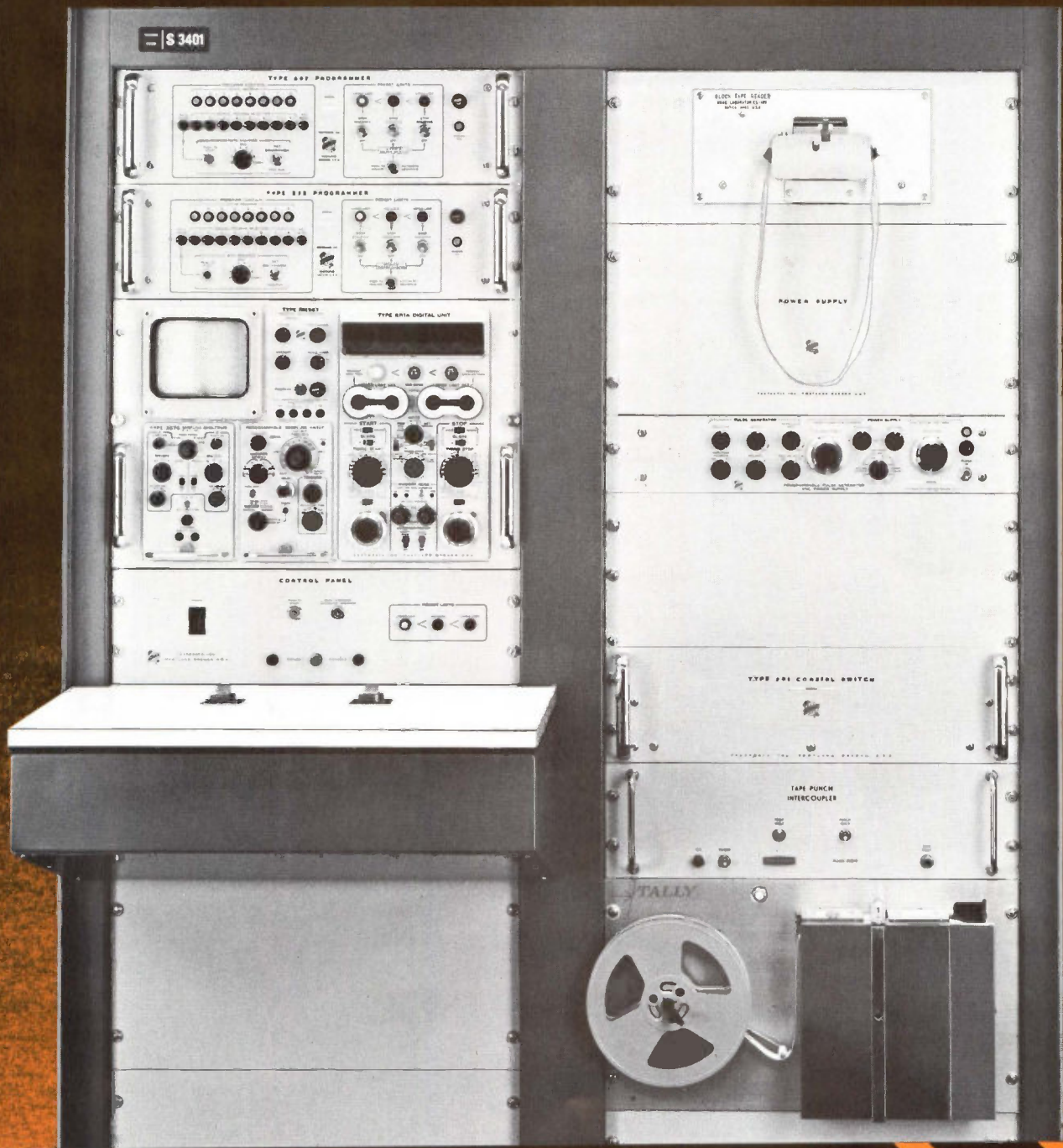

**semi-automated testing systems  
for integrated circuits** further information on back

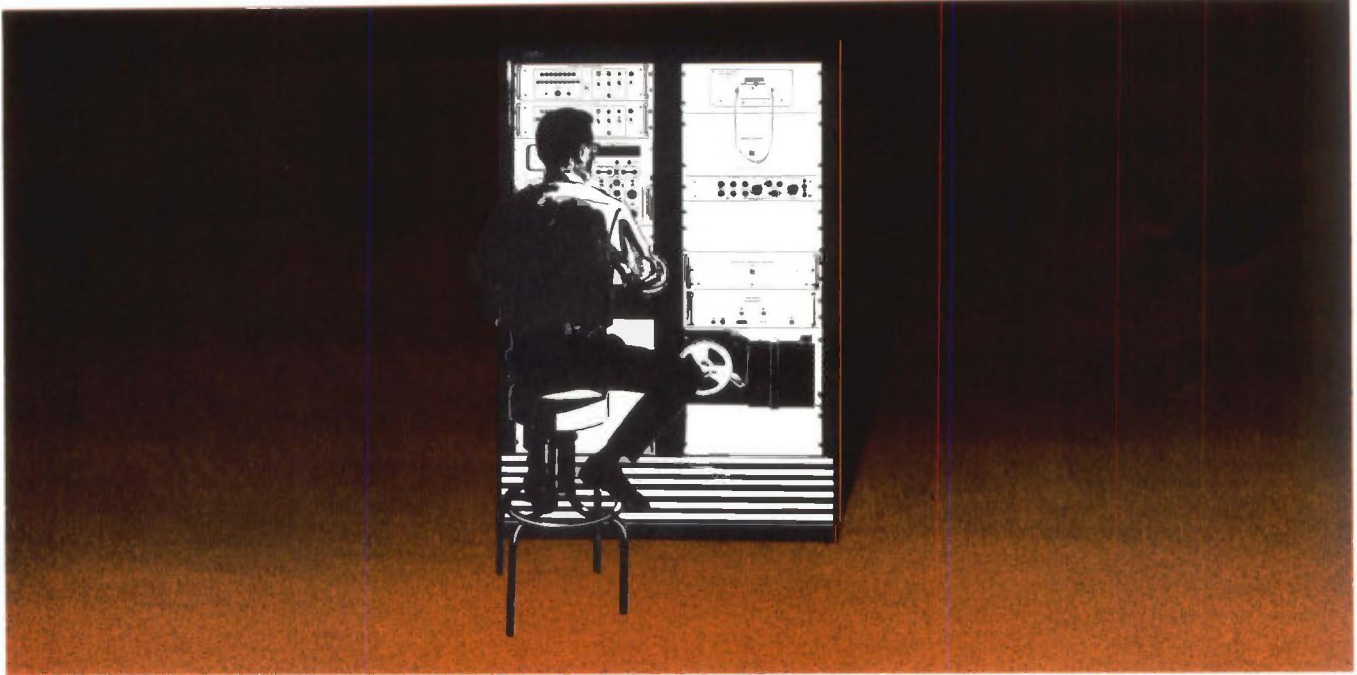

**Tektronix now offers integral equipment packages custom-designed for semi-automated dynamic testing of switching devices and logic modules.**

As an example, the Tektronix System illustrated has been designed to make switching-time and voltage measurements on integrated circuit logic modules, transistors, and discrete component logic circuits. Actual-use circuit conditions can be simulated by equipping the system with custom-designed, interchangeable test-fixture boards. Integral, complementary instrumentation provides regulated dc supplies and pulse stimulation for a wide variety of devices. Test-fixture logic switching, programmable dc supplies, and programmable pulse generators permit complete programming of automatic waveform tests on 14-lead devices such as flip-flops and dual 4-input gates.

## measurements

- Dual-trace, 0.4-nsec risetime signal sampling.
- High impedance signal probes.
- Time parameters measured to percentage or voltage pickoffs.
- Voltage measurements and timing pickoffs referenced to ground (or to a calibrated dc level).
- Programmable time base and signal sensitivity ranging.
- Automatic digital readout of typical switching logic parameters: risetime, falltime, turn-on time, turn-off time, average propagation time, delay time, storage time, and voltage levels.
- Programmable Go, No-Go limits.

## test conditions

- Single or dual test-fixture sockets.
- Custom test-fixture boards for logic module switching risetimes down to 3 nsec. (1-nsec capability on single input-output devices.)
- Programmable pulse generator to 1-nsec risetime.
- Programmable dc supplies.

## programming

Tektronix System illustrated provides for automatic sequencing of test and measurement programs up to 4 per second. The System has large program storage capacity, in one-inch Mylar® tapes (DuPont registered trademark). Two programmers provide capacity for up-to-8 measurement parameters each. With the punched tape block reader, the system allows a virtually unlimited number of combinations of the following functions to be programmed:

- Measurement parameters.
- Time and sensitivity ranging.
- Upper/lower Go, No-Go limits.
- Test fixture logic.
- DC supply voltages.
- Pulse input parameters.
- Measurement number print out.
- Serializing of test data.



## data recording

Go, No-Go limits, automatic out-of-limits sequence inhibit, and Nixie® (Burroughs registered trademark) digital readout are standard with each system. System illustrated has optional 8-level tape-punch data recording.

**Other optional equipment is available for providing parallel or serial entry digital recording on printer, punched cards, typewriter, or magnetic tape. For more information on how one of these new Tektronix Systems can fit your own particular requirements, please call your Tektronix field engineer or representative.**

## Tektronix, Inc.

P. O. BOX 500 · BEAVERTON, OREGON 97005

Phone: (Area Code 503) Mitchell 4-0161

Telex: 036-691 · TWX 503-291-6805

Cable: TEKTRONIX

OVERSEAS DISTRIBUTORS IN 25 COUNTRIES  
TEKTRONIX FIELD OFFICES in principal cities  
in United States. Consult Telephone Directory.

Tektronix Australia Pty., Ltd., Melbourne, Sydney.  
Tektronix Canada Ltd., Montreal, Toronto.  
Tektronix International A.G., Zug, Switzerland.  
Tektronix Ltd., Guernsey, C.I.  
Tektronix U. K. Ltd., Harpenden, Herts.

# KLEIN PLIERS *Speed up electronic wiring*

When the crystal set was a seven-day wonder, Klein long nose pliers were used to adjust the cat's whisker. Through the era of B and C battery sets, Klein kept pace by providing pliers specially adapted for electronic wiring.

Today, more than 100 different styles and sizes of Klein pliers are available to provide the exact tools needed for any job. Klein engineers have developed a special plier for wiring printed circuits; a high hardness

plier for cutting nickel ribbon wire; a transverse end cutting plier for cutting closely in confined spaces; extremely small pliers for wiring midget assemblies—and many others.

Klein has also developed special pliers to do special jobs requested by electronic manufacturers.

For better work done more quickly and at lower cost, be sure the pliers you use are exactly suited to the job . . . made by Klein, of course, "Since 1857."

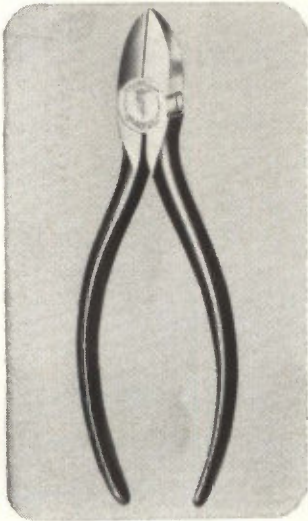

202-5C Oblique Cutting Plier with narrow nose. Available with coil spring. 5½-, and 6-in. sizes.

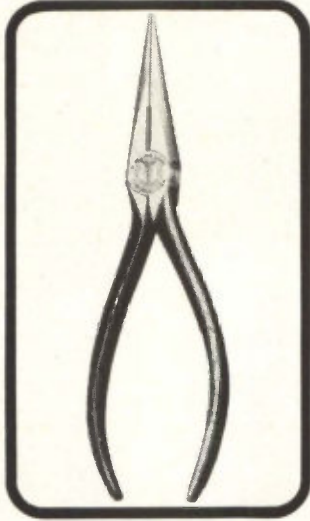

203-5C Long Nose Side Cutting Plier. Available in 5½-, 6½- and 7-in. sizes. Supplied with coil spring.

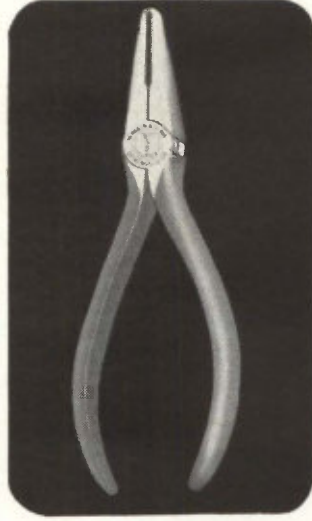

204-6C Transverse End Cutting Plier, 6-in. long. Supplied with coil spring to hold jaws open.

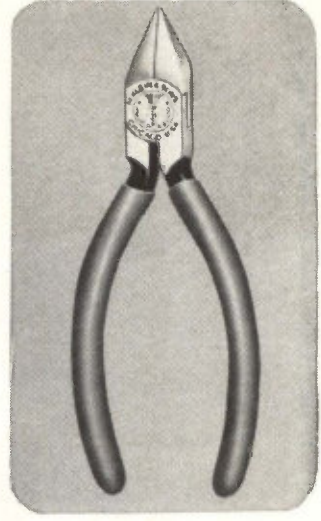

D209-5C Lightweight, Pointed Nose, Flush Cutting Plier. Supplied with coil spring to hold jaws open.

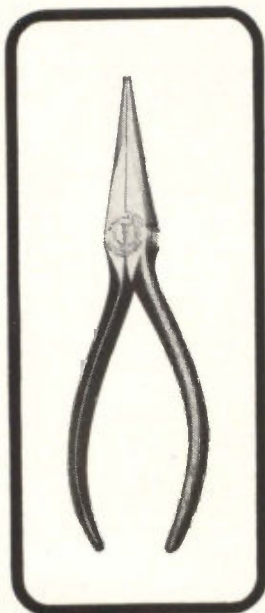

301-5C Long Nose Plier. Available in 5½-, 6¼- and 7-in. lengths. Coil spring.

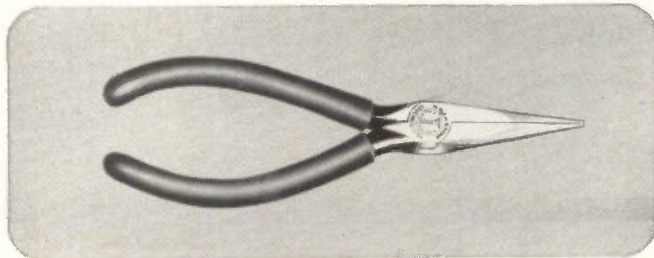

D307-5½C Slim Long Nose Plier for reaching into confined spaces. Yellow plastisol handles. Supplied with coil spring to hold jaws open.

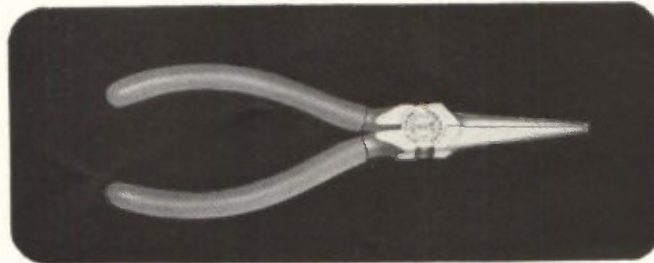

D310-6C Slim Long Nose Plier. Handles are yellow plastisol covered. Supplied with coil spring to keep jaws open.

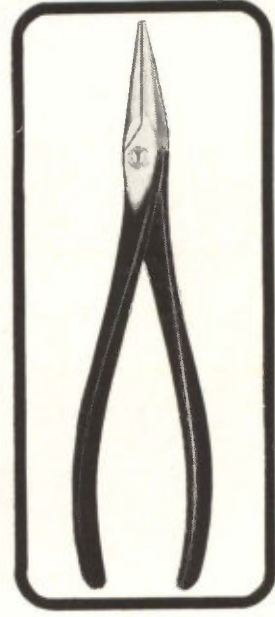

314-8 8-in. Long Nose Plier. Jaws have knurl.

At the WESCON Show  
See the  
Klein Display  
Booth 1553



**Mathias KLEIN & Sons**  
Established 1857 Chicago, Ill., U.S.A.  
INCORPORATED  
7200 McCORMICK ROAD, CHICAGO 45, ILL.

See Your Distributor  
Foreign Distributor: ITT Export  
Corporation, New York

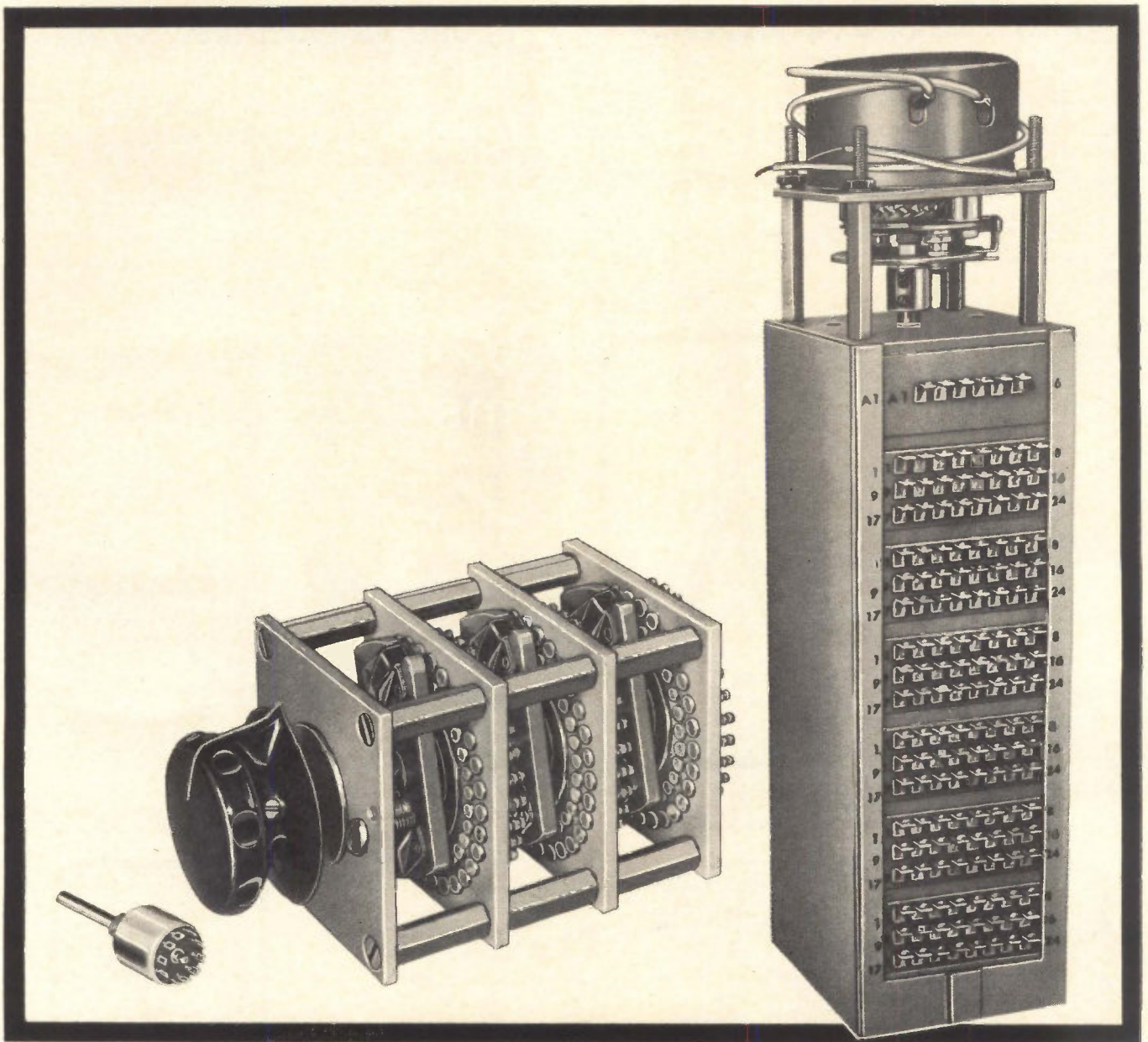

## We can miniaturize or standardize or generalize.

For example: the Series G (shown at left) is the smallest rotary selector switch ever made. Daven whittled it down and nobody has been able to match it yet. One-half inch diameter. Explosion-proof and waterproof. Meets mil-specs on temperature, humidity, corrosion, vibration, acceleration, shock and immersion. A real beauty. (Incidentally, a lower-cost instrument grade switch of this type is now available).

We standardize in a big way, too.

Our 87 adjustable stop switches actually replace 2,001 standard types. All are available off-the-shelf in 48 hours. And the cost is equal to, or less than, standard counterparts.

Generally speaking, our general line of switches is the best in the business. And the widest. You can ask for the Series M miniature ceramic, pre-wired assemblies, terminal board, solenoid-operated, progressive shorting type, high speed, hermetically-sealed or spring return switch. And get it fast.

All are built with solid silver alloy contacts and wiper arms. Most have patented enclosed "knee-action" silver alloy multi-leaf rotor blades, high grade accurately machined dielectric, and accurate contact positioning. Switch stops are independent of switch blades.

Ask yourself if the switch is important to your equipment. Then ask Daven for details. Today.

**DAVEN**   
 LIVINGSTON, NEW JERSEY  
 (201) WYman 2-4300 • TWX 201 992-7356 • Cable: DAVEN LIVINGSTON N J



# Ohmite Pee-Wee Rheostats solve knotty problems

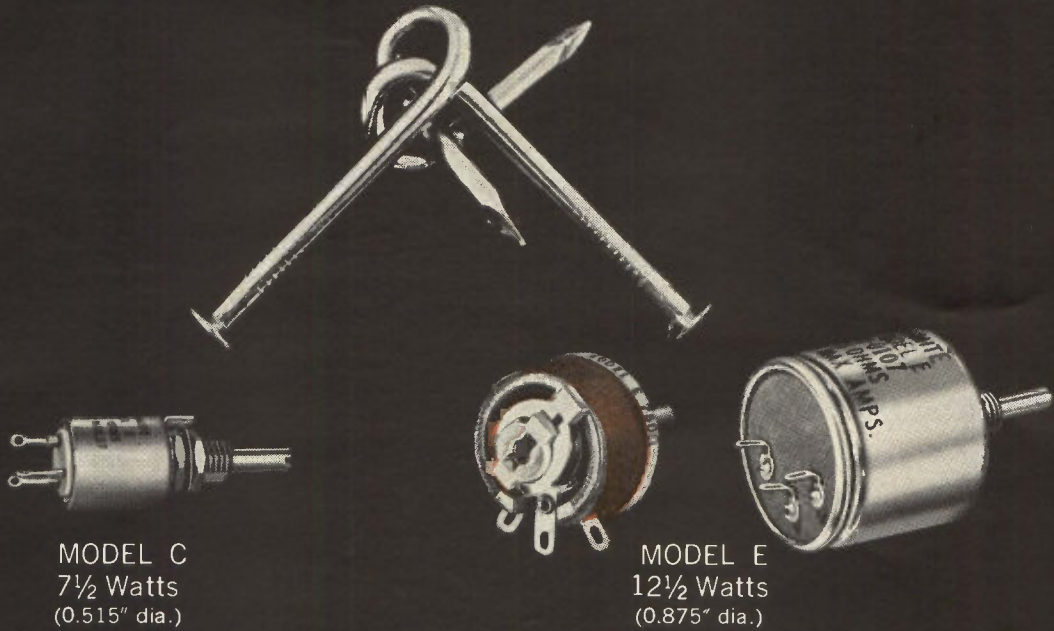

MODEL C  
7½ Watts  
(0.515" dia.)

MODEL E  
12½ Watts  
(0.875" dia.)

both are wire-wound...ceramic and metal construction

■ Here's the answer to such puzzlers as how to boost power levels without increasing equipment size . . . what to use when temperatures will run high . . . how to miniaturize without sacrificing reliability . . . and what to substitute for low-temperature, low-power pots in high ambients.

Both the Model C and Model E retain the same principles of rheostat construction that have proved so reliable in Ohmite's 10 larger sizes. They dissipate their full ratings of 7½ and 12½ watts respectively at 40°C ambient on a metal panel, and operate to 340°C maximum hotspot temperature *without charring, shrinkage, or deterioration.*

## Stocked for Fast Delivery

Model C (7½ watts) is stocked in 18 resistance values from 10 to 5000 ohms as an enclosed model with either a standard or locking shaft. Three-pin transistor sockets can be supplied for plug-in mounting.

Model E (12½ watts) is stocked in 31 resistance values from 1 to 15,000 ohms as open models or in metal enclosures. Tandem assemblies, special shafts, and other variations can be engineered for you. *Write for Bulletins 201 and 203.*

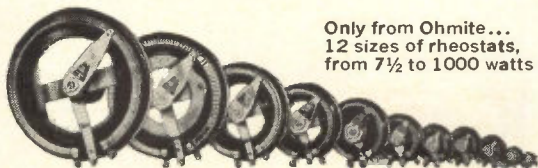

Only from Ohmite...  
12 sizes of rheostats,  
from 7½ to 1000 watts



**OHMITE**  
MANUFACTURING COMPANY  
3610 Howard Street, Skokie, Illinois 60076  
Phone (312) ORchard 5-2600

RHEOSTATS • POWER RESISTORS • PRECISION RESISTORS • VARIABLE TRANSFORMERS • TANTALUM CAPACITORS • TAP SWITCHES • RELAYS • R.F. CHOKES • SEMICONDUCTOR DIODES

# So when I got back from lunch Jake was still up to his eyeballs in strip charts. They were spilling from the table onto the floor, and there was a big pile in the corner that he hadn't even touched. There was this wild gleam in his eye.

"Found out yet why Test Op Twenty-seven went ker-boom?" I asked innocently.

"Don't be a wise guy," Jake snarled. "I just got word from the Chief Engineer that he has to have some preliminary answers by fourteen hundred. Hah! I'd like to see *him* trying to line up forty-three channels on eight strip charts that were recorded at four different speeds."

"All it takes is a little patience," I reminded him. "You told me so yourself."

"All right, smart apple," he growled, "maybe I wish I'd recorded with one of those time code rigs like you said, but it's too late now. Don't just stand there, see if you can help me unscramble this mess."

"I'll do better than that," I said, "I'll give you your birthday present early this year." I pulled a reel of mag tape out from behind my back and showed it to him.

"What's that?" Jake said, looking as if it might bite him.

"I have to admit I played a dirty trick on you," I said. "I borrowed a time code generator<sup>1</sup> from Dr. Adams over at standards lab and patched it into the extra recorder along with the telemetry signal from the firing stand. The whole sequence is right here, timed with IRIG Format B."<sup>2</sup>



Jake's mouth was doing a beautiful imitation of a dying mackerel.

"I also borrowed a tape search and control system,"<sup>3</sup> I continued. "Step over to my test rack and see how the big boys do it."

I threaded the tape into the transport and selected the discriminators for the channels we were most interested in. "Do we know yet when the beast blew?" I asked Jake as I turned on the power.

"About T-zero plus eight," he told me weakly, "and I hope you're not wasting my time. In just ten minutes the Chief

Engineer is going to walk in here roaring like a million pound booster."

"We'll be ready for him," I said. I translated T-zero plus eight into clock time. I preset the automatic start time at ten seconds before the engine had exploded and the stop time at five seconds after. You do it with decimal switches, and it's easier than playing Yankee Doodle on the piano with one finger.



I set the T S and C to "Automatic" and pushed the "auto search start" button. The transport revved up to search speed and the Nixie tube time display lit up showing days, hours, minutes and seconds. In a few moments the transport had reached the preset start time and overshoot. It automatically reversed until it was positioned in advance of the starting spot on the tape. Then the search and control system's "drive playback" indicator light came on and traces started appearing on the oscillograph paper.

"What's that picket fence on Channel 1?" Jake asked, eyeing it suspiciously.

"That's the time code," I told him. "No more counting hundreds of pulses to correlate events. You can read days, hours, minutes, and seconds directly from the pattern of pulse widths in any segment of the recording."



"Who can?"

"You'll learn. It's easy."

Before the system had even reached the preset stop time, we were starting to get somewhere.

"Look," I said, "Channel 6 shows that flame was established at 10:48:19, but Channel 14 says the main fuel control valve still hadn't opened all the way at 10:48:22. Now look at Channel 20. By 10:48:24 pump pressure had gone off scale. Then it drops to zero."

"That must mean the fuel line ruptured. Fuel would have started spilling into the combustion chamber," Jake theorized.

"Yes, and she blew at just a hair beyond 10:48:26, that's when all the on-board transducers go dead. *Now* will you sign those requisitions for a time code generator and an automatic tape search and control of our own?"

"Wait a minute," Jake said. "Let's see if we can tell *why* the main fuel valve didn't open all the way." Some people are never satisfied.

It was hard to spot the fine-scale sequence of events at the tape playback rates we were using, so I showed him another jazzy trick. I set the system to magnify the time scale in the short critical interval just where the valve had failed to open. Then the answer became obvious. The combustion chamber pressure switch should have closed before the valve actuation signal from the sequencer, but it had closed several milliseconds late. The blame was pinned on the switch.

"So now you're ready for the Chief," I said, rubbing it in, "and you still have thirty seconds to spare."

He didn't know whether to hit me or kiss me, so he did both. I forgot to mention that I'm pretty cute for a test engineer. In fact, I'm the only female in the department. Which goes to show that not even a woman needs to rely on intuition, much less on counting pulses, when there's a time code system<sup>4</sup> handy.



<sup>1</sup> Wise Dr. Adams loaned them an EECO 811 Time Code Generator. All solid-state, rugged card construction. Less than 40 pounds. Power consumption under 100 watts. Easy access to test points for simple maintenance. Frequency stability 5 parts in 10<sup>9</sup> per day. This and other models available immediately for ground, mobile airborne or seaborne applications. Brochures on request.

<sup>2</sup> Model 811 produces any four code formats simultaneously in both level shift and modulated forms including choice of any IRIG, NASA, AMR, etc. Other models furnish 17-bit binary, 20- or 24-bit BCD codes. EE 3-58R3

<sup>3</sup> It was an EECO 831 Tape Search and Control System (TS & C) which automatically searches modulated-time-coded-referenced tape in IRIG or NASA BCD formats. It speeds up to 100 times recording speed or slows to 1/20 recording speed, forward or backward. They might have used an EECO 835, for which interchangeable decoder modules can handle IRIG, NASA, AMR, PMR, WS117L, Eglin AFB, and White Sands, either modulated or level shift.

<sup>4</sup> If you're wondering where to go for your time code system, here are some hints. Our first one was designed way back in 1949. Every major test base in the U.S. uses EECO products or systems. Circle this footnote and mail to EECO, Mail Station 1910, Box 58, Santa Ana, Calif., 92702. You'll receive FREE a wallet-size guide for reading IRIG B and AMR D1, the two most commonly used time codes.

See us at WESCON • Hollywood Park • Booths 524-525

# NOW, Philco Offers Eight Milliwatt Micrologic Circuits OFF-THE-SHELF

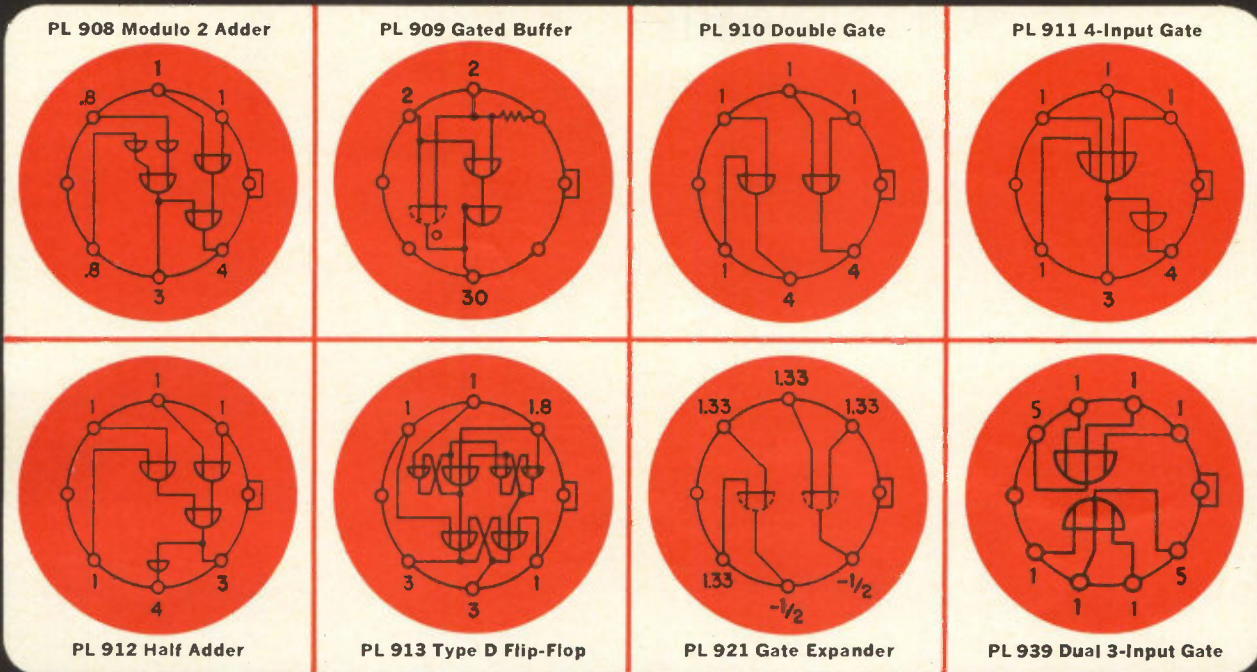

Enlarged illustration of standard metal transistor-type TO5 can.

## IN TO5 OR FLAT PACK



Enlarged illustration of Philco Flat Pack all-glass hermetically-sealed package.

Designers and users may now order circuits in the Philco Milliwatt Micrologic family for immediate off-the-shelf delivery. Those units which are covered by published "extra-rigid" specifications may also be ordered at considerable savings from bonded lots produced to those specifications.

In addition to the eight circuits illustrated, a J-K Flip-Flop Milliwatt Micrologic Circuit will soon be available.

Philco Milliwatt Micrologic offers the advan-

tages of a complete family of integrated logic circuits, low power consumption, economy, second-source strength and the choice of Flat Pack or TO5 packaging.

When you consider low-power integrated logic circuitry, consider all the advantages offered by Philco Milliwatt Micrologic. Complete data will be sent upon request to Department E 81064.

*Philco Milliwatt Micrologic circuits are manufactured under a cross-licensing agreement with Fairchild Camera and Instrument Corporation using the Planar Epitaxial Process.*



MICROELECTRONICS OPERATION

**PHILCO**<sup>®</sup>

A SUBSIDIARY OF *Ford Motor Company*

LANSDALE DIVISION, LANSDALE, PA.  
In Canada: Don Mills Road, Don Mills, Ontario, Canada

Circle 25 on reader service card

First showing at WESCON/64, Booths 1356-57-58



## New FLUKE MODEL 883AB – first of a series of all-solid-state differential voltmeters



### Battery or Line Powered

Also available line powered only as Model 883A.

### Compact

Single configuration for cabinet use or half-rack mounting. 8½" wide x 6½" high x 14¾" deep.

### Lightweight, Easy to Use

Total weight, including batteries, only 14 lbs. Equipped with fold-back tilting bail.

*Technical data subject to change without notice.*

Fluke, world's foremost manufacturer of differential voltmeters, expands the line with the introduction of the all-solid-state, AC and DC differential voltmeter Model 883AB.

This instrument operates from either internal, rechargeable battery pack or 50-440 cps line power. Battery power is ideal for measurements where maximum accuracy demands complete line isolation. Input is 0-1000V AC or DC in four ranges. Full-scale deflection of null meter includes seven ranges, 100  $\mu$ v through 100V. DC and AC accuracy are  $\pm(0.01\% + 5 \mu\text{v})$  and  $\pm(0.1\% + 25 \mu\text{v})$  of input, respectively. Six-digit in-line readout is obtained by four decade switches plus high-resolution interpolating vernier. Decimal point placement is automatic according to instrument range.

Development of the new Model 883AB has included thorough mil-spec temperature, humidity, shock and vibration tests for proven performance under severe environmental conditions. Make it a point to see and price the new Model 883AB at the Fluke WESCON display and to plan its application to your laboratory or production line requirements.

For price and full specification data on the new Model 883AB, contact your Fluke representative or write JOHN FLUKE MFG. CO., INC., Box 7428, Seattle, Wash. 98133. Tel. 206-776-1171; TWX 910-449-2850; TLX 852, Cable: FLUKE.



# FLUKE

AT  
WESCON/64

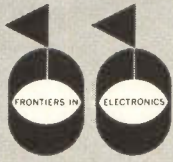

SPORTS ARENA  
BOOTHS

1356-  
57-58

*New instruments  
on display*



**ALL SOLID STATE  
DIFFERENTIAL VOLTMETERS**

Models 883A8-881AB

Battery or line powered

Also available line powered only

**DC POWER SUPPLIES**  
408B-4108-412B



**THERMAL TRANSFER  
STANDARD 540B**



**ISOLATION AMPLIFIER A88**



**ELECTRONIC GALVANOMETERS  
MODELS 840B-840C**



**FLUKE PRECISION  
POTENTIOMETERS-RHEOSTATS**



**MONTRONICS FREQUENCY  
EQUIPMENT—See the  
new VLF receiver Model 205**



Circle 203 on reader service card

## FLUKE DECADE and

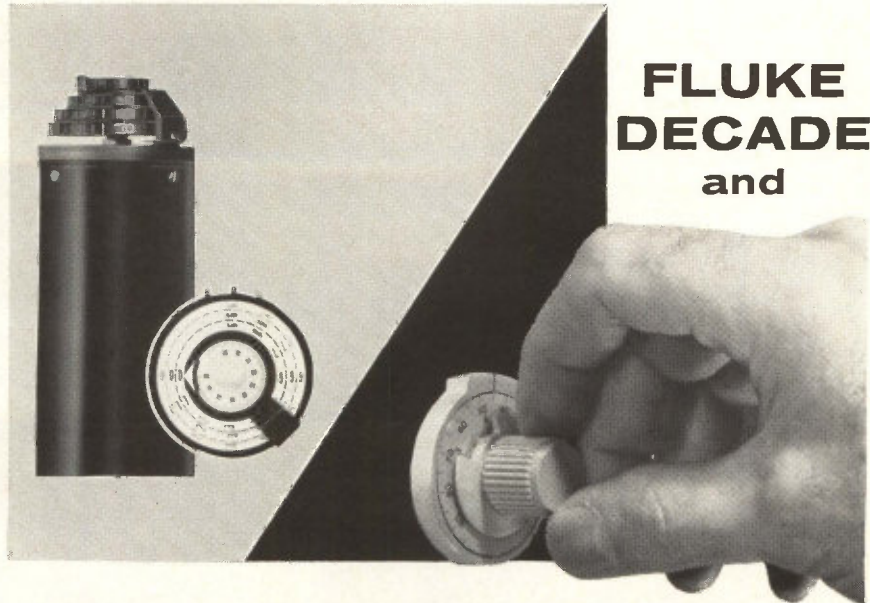

### VERNIER POTENTIOMETERS

**for systems and instrument applications  
demanding highest accuracies and reliability**

Fluke military and commercial decade potentiometers and rheostats feature coaxial in-line readout, precision wirewound resistors, superior switch design and rugged construction. Three potentiometer models provide linearities ranging from  $\pm 0.05\%$  in the Model 40A to  $\pm 0.0025\%$  in the Model 60A. Five models of Fluke decade rheostats each have an accuracy base of  $\pm (0.025\%)$ . For complete data on all eight models, circle Reader Service No.

#### 10-turn resolution with $1\frac{1}{2}$ turns

Fluke vernier potentiometers feature fast, accurate adjustment, for a considerable saving in operator time. High resolution, linearity ( $\pm 0.5\%$  standard) and low residual reactance allow operation at higher frequencies than other potentiometers with similar DC specifications. For complete data on any model below, circle Reader Service No.



**MODEL 20A** Price \$8.50  
10 turn resolution  
with only  $1\frac{1}{2}$  turns  
Resistance range, ohms . . . . . 100 to 25K  
Resolution . 1K and above, better than 0.02%  
Power rating, watts . . . . . 2 at 20°C



**MODEL 21A** Price \$10.00  
10 turn resolution  
with only  $1\frac{1}{2}$  turns  
Resistance range, ohms . 30K, 40K and 50K  
Resolution  
30K and above, better than 0.008%  
Power rating, watts . . . . . 3 at 20°C



**MODEL 22A** Price \$15.00  
10 turn resolution  
with only  $1\frac{1}{2}$  turns  
Resistance range, ohms . . . . . 1K to 100K  
Resolution . 1K and above, better than 0.02%



**MODEL 30A** Price \$30.00  
40 turn resolution  
with only  $2\frac{1}{2}$  turns  
Resistance range, ohms . . . . . 1K to 100K  
Resolution  
1 part in 50,000, or better than 0.002%  
Power rating, watts . . . . . 5 at 20°C

Fluke vernier and decade "pots" and rheostats are available from stock. Contact nearest representative, or JOHN FLUKE MFG. CO., INC., Box 7428, Seattle, Wash. 98133. Tel. 206-776-1171; TWX 910-449-2850; TLX 852, Cable: FLUKE.



Circle 27 on reader service card 27

# When reliability counts, count on MYLAR®!

When you are recording or processing data, you want to be able to depend on your tape without worrying about it. If your tape is on a base of "Mylar"\*—you can! "Mylar" is strong (a tensile strength of 20,000 psi). "Mylar" is stable (unaffected by temperature or humidity changes). "Mylar" is durable (no plasticizer to dry out or become brittle with age). "Mylar" is proven in use (a ten-year record of successful performance). When reliability counts, count on "Mylar".

\*Du Pont's registered trademark for its polyester film.



BETTER THINGS FOR BETTER LIVING THROUGH CHEMISTRY

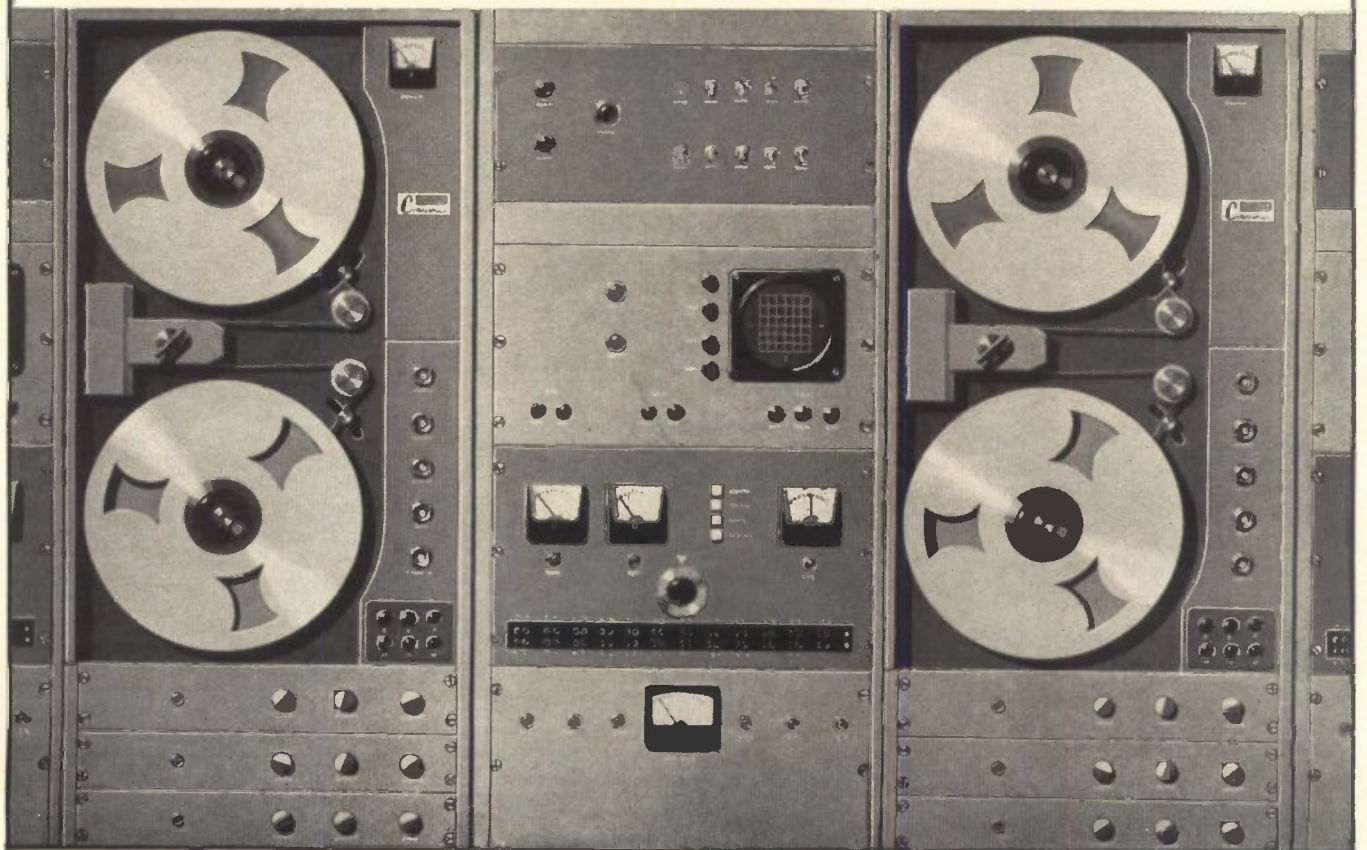

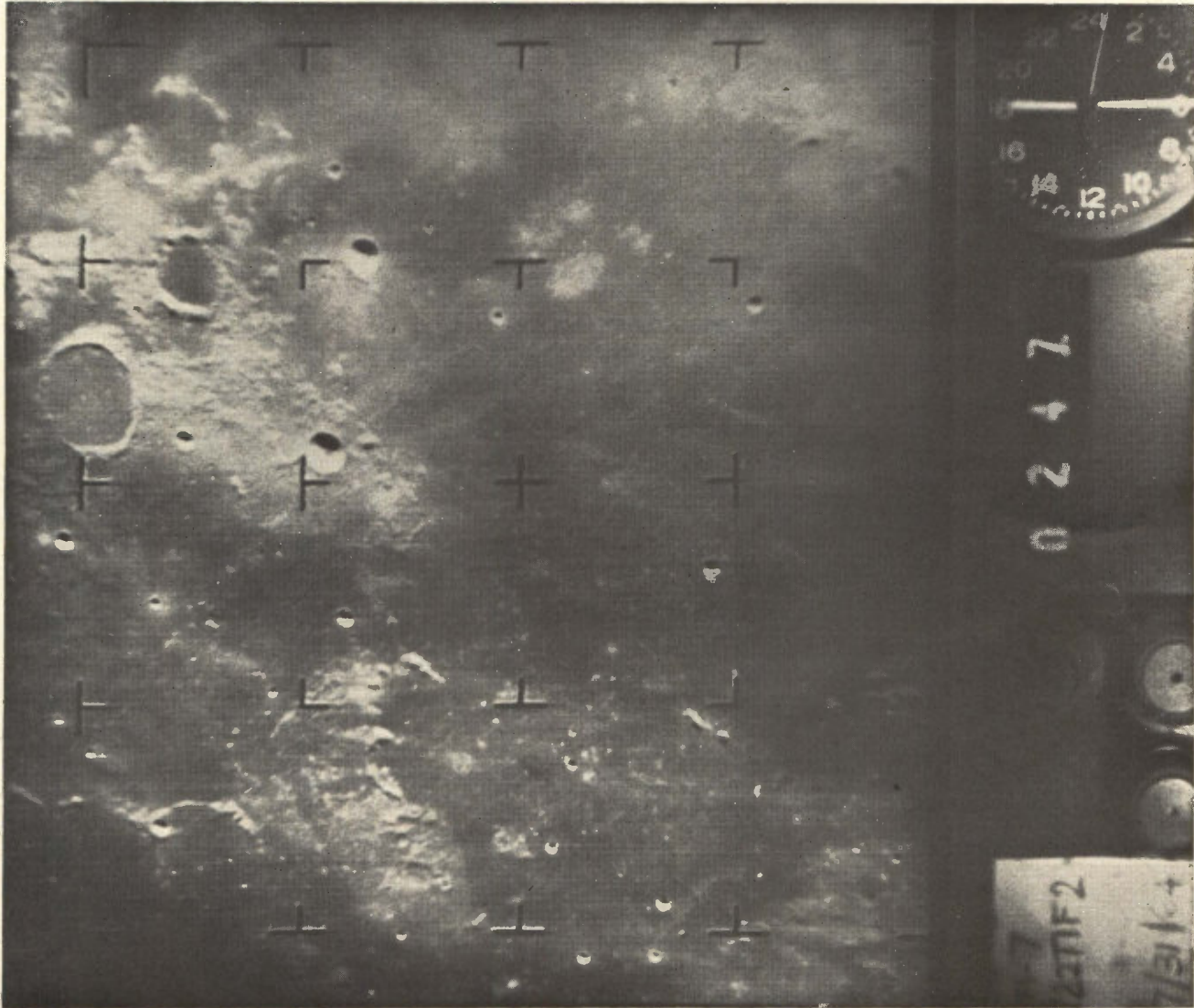

Picture televised from Ranger 7 looks like an optical photograph because of the dense scan-rate of 1,152 lines. Picture was made by a wide-angle camera at an altitude of about 500 miles. Grid marks indicate little or no distortion.

## Space electronics

### The space probe that tried and tried

The moment of truth for the California Institute of Technology's Jet Propulsion Laboratory arrived at exactly 6:10 A.M., Pacific Daylight Time, on Friday, July 31st.

For 68 hours, Ranger 7, the successor to six previous attempts, had

been streaking to its target on the moon. Now, scientists were ready to turn on the probe's six high-resolution television cameras. Gingerly, a button was pushed. An excited technician shouted, "We're receiving pictures."

In 10 minutes, 4,316 pictures of the face of the moon were received at the ground station. The first photos, taken by two cameras with 1,152-line scan, were so clear that they were indistinguishable from fine photographs. Astronomers were jubilant. A quick look at Polaroid camera shots told them that the photographs were 1,000 times clearer than any ever taken through telescopes on earth. One JPL staffer, deliriously happy, shouted "Every one's a bull's-eye."

The happiness was not feigned. JPL was in deep trouble with the Ranger program. It had had six failures in a row and in June the National Aeronautics and Space Administration stepped in to reorganize the laboratory. Ranger 6 had been a monumental disappointment. It flew beautifully, landed successfully, but failed to get any pictures.

**Failure insurance.** Special design precautions taken in Ranger 7 paid off. Acting on the assumption that the television system in Ranger 6 had turned on while the probe was still in the atmosphere and had burned up, engineers designed safeguards against any accidental turn on of the camera system.

First payoff of the successful operation, which stirred people around the world, is in new tangible information about the moon. For example, astronomers discovered that the moon's dry seas are pitted with small craters, not smooth as they appear on telescopes. The dust layer is probably only 2 to 12 inches deep, not bottomless as has been imagined. There are a myriad of tiny craters dotting the lunar surface, some as small as  $1\frac{1}{2}$  feet in diameter.

**Survey next.** Recognizing success, NASA announced it would transfer some engineers from the Ranger project to the follow-on Surveyor program. Seventeen Surveyor probes are planned to land softly on the moon and take more television pictures.

For the tv contractor, the Radio Corp. of America, Ranger 7's success had added meaning. Never has the ability of television to peer into inaccessible places been demonstrated so effectively. The clarity of the pictures was likely to stir up a lot of new tv applications.

The control supplier, the Northrop Corp., had something to boast about too. Ranger's electronic controls brought the probe to within 10 miles of its target on the moon after a journey of a quarter of a million miles. The flight was so perfect that at the end of the trip, the tv cameras were pointed just as they should have been—right at the moon.

**Impact on Apollo.** Ranger's findings are not expected to lead to any significant changes in the design of the Surveyor spacecraft or in the Lunar Excursion Module of the Apollo spacecraft.

The landing control systems of both Surveyor and the manned-landing module were designed "right down the middle," NASA officials said. They could be used whether the surface was bare rock or a layer of dust. The rigid surface apparently found by Ranger, however, means an added margin of safety.

**Television system.** Ranger 7's television system began taking pictures about 1,000 miles above the moon's surface. First, two cameras with wide-angle lenses went into operation. They scanned the lunar scenes with 1,152 lines. Then, four narrower-angle cameras scanning at 300 lines were started up. The vidicon-camera signals were converted to f-m signals and transmitted to earth by two 60-watt transmitters operating at frequencies of 959.52 and 960.58 mc.

---

### Solid state

---

#### Production breakthrough?

In about a year, Anthony van den Heuval of the Illinois Institute of Technology Research Institute in Chicago hopes to solve one of the major problems in thin-film technology: producing a complete circuit with transistors and passive elements on a single substrate. At present, transistors are processed separately and attached to thin-film passive circuits.

Van den Heuval has made, in the laboratory, cadmium-sulfide crystals with promising characteristics. He is now doing research on methods of producing the crystals in such a way that complete circuits can be made by a single automated process.

**High mobility.** Van den Heuval has grown cadmium-sulfide crystals as large as one square centimeter and with unusually high mobilities. He has attained mobilities of 1,500

cm<sup>2</sup>/volt-second, compared with values of 200 and 300 cm<sup>2</sup>/volt-second previously reported by other researchers. He accomplished this the hard way, making his measurements in the dark. Light pumps the crystals and makes their mobilities even higher.

Electron mobility is the figure of merit for thin-film crystals. A high figure must be achieved if thin-film transistors are to have useful gains at frequencies around 100 megacycles.

Van den Heuval says he realizes that the figures obtained in the laboratory may be higher than can be achieved consistently in a production process. He would be satisfied with production of 400 cm<sup>2</sup>/volt-second for cadmium sulfide.

**Production methods.** Van den Heuval has tried three production methods: the Gilles-Van Cakenberghe flux-diffusion technique, micro-zone melting and squashing.

Flux diffusion has given the highest mobility. Crystals are melted to a film; then they are recrystallized by adding silver to the film and baking it in argon. The silver diffuses into the cadmium-rich film, neutralizes excess cadmium, causing recrystallization.

Micro-zone melting involves melting the crystal in the middle by using a radio-frequency coil or an electron beam, then allowing the film to recrystallize.

In squashing, molten cadmium sulfide is compressed between glass or quartz. One surface is covered with carbon, so the film sticks only to the other surface. This produces a single-crystal layer on the substrate.

---

### Communications

---

#### Ring, dish and tire

If the Army, Navy and Air Force had tried to come up with three directional antennas that looked less alike, they could not have done better than three new antennas now going into service or scheduled for tests.

**The ring.** The Navy has finally



disclosed a few details about the large circular array erected at the Skaggs Island Navy Security Group Activity in Sonoma, Calif.

Composed of elements modeled after the German Wullenweber antenna, the antenna provides a wide-aperture, broadside array effect with narrow beams that can be directed to any azimuth angle. The array provides the equivalent of rhombic rosettes which would require far more ground area.

**The dish.** Air Force scientists have erected on Prospect Hill, Waltham, Mass., one of the most accurate, sensitive antennas ever built for communications research at extremely high frequencies.

The 29-foot-diameter millimeter-wave antenna has been placed on its mount and is now undergoing final adjustment. Engineers must adjust 30 separate petals to within 0.012 inch to form a true parabola.

Tests will continue until 1966, when transmissions will be made with a kilowatt of power. Beam energy will be so concentrated that if the beam were aimed at the moon, it would cover an area only 250 miles in diameter on the moon's surface.

Extraordinary precautions are being taken to guard against the antenna warping because of thermal expansion. One inch of insulation covers the dish's steel support.

**The tire.** Not unlike a giant rubber tire is an inflatable antenna designed by Goodyear Aerospace Corp., of Akron, Ohio. It is intended for portable applications, such as a tropospheric-scatter antenna, mobile tracking antenna, packaged shipboard antenna, or post-attack emergency antenna. It was developed under an Army study contract.

Goodyear has already built five-foot-diameter models, and the Army has ordered a ten-foot model. These sizes can be pumped up by hand, but larger sizes will probably require a compressor.

The reflective surface is a paint flexible enough to withstand several inflations and deflations without cracking. It is made with powdered alumina.

Originally designed as antennas

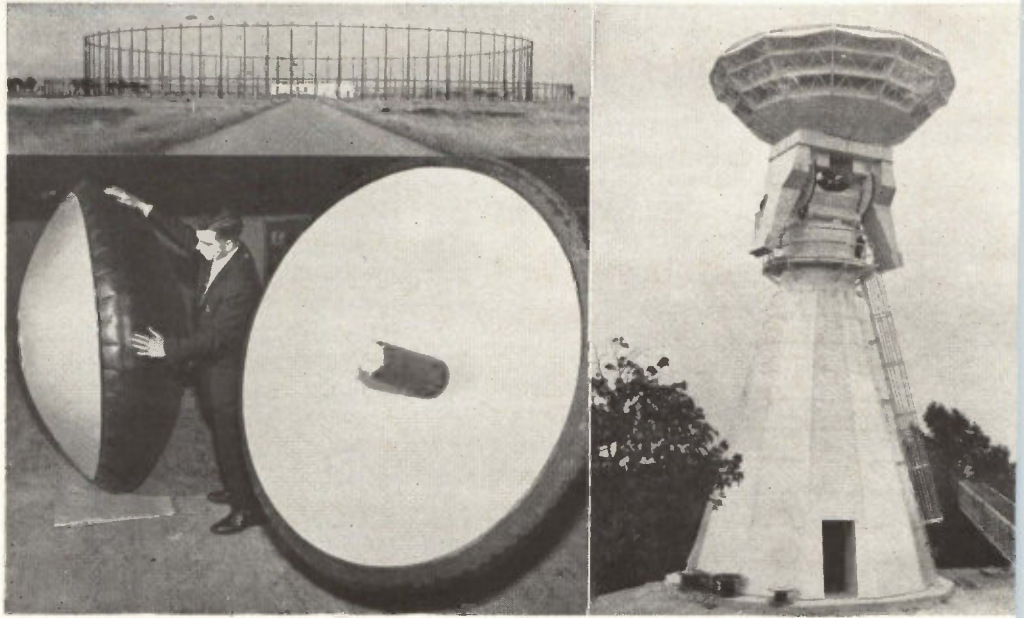

The round, the short and the tall: the Navy's new Circular array antenna, the Army's inflatable antenna, and the Air Force's high-precision dish.

with Cassegranian feed, the units can also be used as a conventionally supported feed horn.

### Digital weather

Navy ships will soon be able to receive weather information more quickly through observer reports and forecasts transmitted as digital data. The high-speed transmission system is a 27A Datatel made by the Lenkurt Electric Co., a subsidiary of the General Telephone and Electronics Corp. It uses the duobinary coding technique [Electronics, March 22, 1963, p. 61] to achieve a speed of 2,400 bits per second (bps). The same system can be used to transmit secure voice signals.

Before Lenkurt won the contract, the Navy Fleet Numerical Weather Facility tested the system over a combination of wire, microwave and high-frequency radio circuits between Monterey, Calif. and Pearl Harbor, Hawaii. Data signal patterns, accepted in serial form by the 27A equipment, were converted to 16 parallel channels of 150 bps. These were transmitted as a duobinary wave with a pulse length of 6.6 milliseconds per channel to avoid expected time smear of 3 to

5 msec. The 16 frequency-modulated duobinary outputs were frequency-multiplexed at 170-cycle spacing into a 3-kilocycle bandwidth, with the low channel centered at 425 cycles per second and the high channel at 2,975 cps.

At the far end of the 2,425-mile high-frequency radio link, diversity reception was used with combiners on each of the 16 channels. The best input path was enhanced by a ratio-squared post-detection combiner. The output of each channel combiner was converted by the duobinary technique to conventional binary data at 15 bps. The 16 channels in a parallel-to-serial converter produced binary serial data at synchronous speed of 2,400 bps.

**Raw material.** At the weather facility, eight teleprinter lines feed in weather observations from more than 4,000 points at the rate of 100 words a minute every six hours. This data is transferred to punched or magnetic tape and fed into the computer. On instruction the computer digests and sorts the information for a specific area, makes comparisons with previous reports and finally plots out, upon a blank map form, a forecast for the next 30 to 48 hours. At the present time, these maps are transmitted to Navy weather centrals, such as Pearl

Harbor, Guam, Norfolk, Va., and Suitland, Md., for transmission to the fleet by facsimile. Forecasts are also transmitted to a computer at Point Mugu Calif., headquarters of the Pacific Missile Range, directly from the Monterey computer.

At present, Monterey distributes weather and sea condition forecasts to more than 100 ships and stations throughout the world every day.

---

### Advanced technology

---

#### Crystals: drop by drop

A unique technique for achieving almost instantaneous freezing of molten alloys (at a cooling rate of 4,000,000° F per second) has resulted in a device that creates artificial superconducting alloys from combinations of elements which are not normally superconducting.

A research team at the California Institute of Technology, headed by Pol Duwez, designed and built the ultra-fast cooling device. So far they've used it on mixtures of gold and germanium. They are investigating other alloys and believe that their project, sponsored by the Atomic Energy Commission, may also lead to new types of transistor materials and materials with new magnetic properties or modified electrical resistance.

**Pounds them out.** Alloys are placed in a cylindrical crucible and heated to melting temperature by a surrounding electrical coil. When a globule of the material drops through a small hole in the bottom of the crucible it trips a photoelectric-cell light beam, and actuates a

When a drop of molten metal falls between the hammer and anvil, it is pounded and cooled into a thin superconducting crystal.

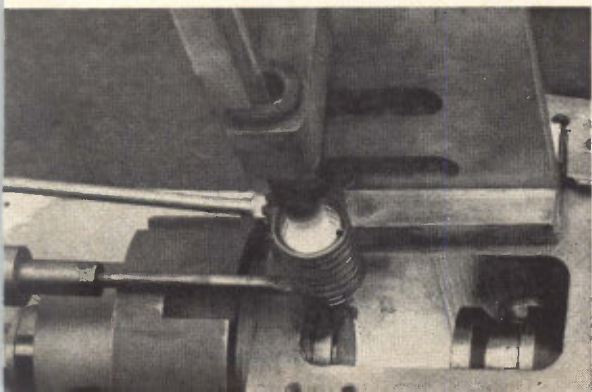

pneumatic hammer. The hammer slams the globule onto a copper alloy anvil. In the process, the copper quickly soaks up the droplet's heat and a thin foil of the new alloy results.

The size of the foil produced is limited by that of the heat-absorbing equipment used. To date, the maximum diameter achieved is approximately one inch. Thicknesses vary from two to five thousandths of an inch. These sizes fall within the range useful in electronic devices, says the research group.

No clear-cut explanation of the phenomenon has yet been given, but variations in crystal structure between the fast-cooled alloy and its counterpart, cooled at a normal rate, have been observed with an electron microscope. For example, when gold and germanium are melted together and allowed to cool at the normal rate, discrete crystals of gold and germanium in an alternating pattern result. This material is not superconducting.

**New patterns.** However, when this same melt is fast-cooled, the atoms do not have time to align themselves into normal patterns. There is a new pattern, with new chemical bonding properties and a much finer grain structure. The new alloy is superconductive at a temperature of -456.64° F.

"The significance of the finding is not that a new superconducting alloy has been found," Pol Duwez explained, "but rather that we are now able to produce such an alloy from two non-superconducting-metals that do not produce this quality by normal alloying methods. We have demonstrated that rapid cooling from the liquid state will eventually lead to useful new materials."

Duwez claims that mixtures of other metals fall into predictable patterns of superconductivity when fast-cooled.

---

### Computers

---

#### GE expands in Europe

The General Electric Co. seems to be girding to challenge the Interna-

tional Business Machines Corp.'s domination of the computer market in Western Europe.

GE has agreed to invest \$43 million in the French Compagnie des Machines Bull, and is working on an arrangement with the Olivetti Co. in Italy. IBM is estimated to get more than half of Western Europe's computer business. Installed computers there are expected to climb from 1,000 to 10,000 by 1970.

The French agreement will result in three jointly owned subsidiaries: manufacturing and research companies owned 51% by Machines Bull, and a sales company in which GE will have 51% interest. There may also be a fourth company that would produce military equipment, but that would be entirely French-owned.

Under the proposed agreement in Italy, Olivetti would put its present computer facilities into a new company that would be owned jointly with GE, with the United States company holding majority control.

GE has already reached manufacturing and sales agreements with companies in Britain and Germany [Electronics, July 27, 1964, p. 18].

---

### Medical electronics

---

#### X-ray subtracter

Doctors at the Mayo Clinic are using equipment developed by Motorola, Inc. to locate brain tumors or defective blood vessels hidden behind dense bones of the skull.

The company's communications and electronics division based its system on an x-ray subtraction technique conceived by a Dutch radiologist in the 1930's. The apparatus will be marketed this summer.

**Reversed image.** A closed circuit television receiver is flanked by two cameras, each pointing down at an x-ray viewing box. A conventional x-ray film of the skull being studied goes into the left viewing box. The right viewing box receives an angiogram, made by injecting

# LAMBDA MULTI-CURRENT-RATED™

power supplies offer maximum flexibility for any application at any ambient to 71°C

NOW 0-60, 0-40, 0-20 VDC IN ¼ and ½ RACK MODELS

ALL  
SILICON  
Modular-Subrack  
LH  
SERIES



Lab  
Ambient  
30°C

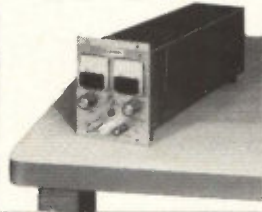

Industrial  
Ambient  
50°C

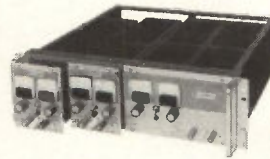

Elevated  
Ambients  
60°C 71°C

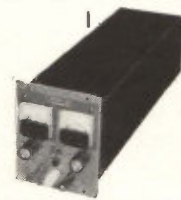

CURRENT RANGE AT AMBIENT OF: (1)

Model	Voltage Range	30°C	50°C	60°C	71°C	Price (2)
LH 121	0-20VDC	0-2.4A	0-2.2A	0-1.8A	0-1.5A	\$159.00
LH 122	0-20VDC	0-5.7A	0-4.7A	0-4.0A	0-3.3A	\$260.00
LH 124	0-40VDC	0-1.3A	0-1.1A	0-0.9A	0-0.7A	\$154.00
LH 125	0-40VDC	0-3.0A	0-2.7A	0-2.3A	0-1.9A	\$269.00
LH 127	0-60VDC	0-0.9A	0-0.7A	0-0.6A	0-0.5A	\$184.00
LH 128	0-60VDC	0-2.4A	0-2.1A	0-1.8A	0-1.5A	\$315.00

(1) Current rating applies over entire voltage range. DC OUTPUT Voltage regulated for line and load

(2) Prices are for non-metered models. For metered models and front panel controls, add suffix (FM) to model number and add \$25.00 to the price. For non-metered chassis mounting models, add suffix (S) to model number and subtract \$5.00 from the non-metered price.

- AC INPUT—105-135 VAC, 45-480 cps
- REGULATION—Line or Load—.015% or 1 MV
- RIPPLE—less than 250 microvolts rms and 1 millivolt P-P
- TEMPERATURE COEFFICIENT— .015%/°C
- MEETS RFI SPECIFICATIONS—MIL-I-26600, Class 3
- CONSTANT CURRENT/CONSTANT VOLTAGE
- REMOTELY PROGRAMMABLE AND CONTINUOUSLY VARIABLE
- SIZE: LH 121, 124, 127 5<sup>3</sup>/<sub>16</sub>" x 4<sup>3</sup>/<sub>16</sub>" x 15<sup>1</sup>/<sub>2</sub>"  
LH 122, 125, 128 5<sup>3</sup>/<sub>16</sub>" x 8<sup>3</sup>/<sub>8</sub>" x 15<sup>5</sup>/<sub>8</sub>"
- RACK ADAPTERS  
Model RA-1 for ruggedized mounting—Price \$60.00  
Model RA-2 for conventional mounting—Price \$25.00

SEND FOR COMPLETE LAMBDA CATALOG.



**LAMBDA ELECTRONICS CORP.**

515 BROAD HOLLOW ROAD • MELVILLE, L. I., NEW YORK • 516 MYRTLE 4-4200

SALES OFFICES AND REPRESENTATIVES CONVENIENTLY LOCATED IN MAJOR CITIES

BE SURE TO VISIT LAMBDA'S WESCON SHOW BOOTH NO. 470-471 AT HOLLYWOOD PARK

Circle 33 on reader service card

a substance opaque to x-rays, into the blood vessels of the skull. The angiogram images are then electronically reversed, converting the white areas to black and vice versa. The images from the two viewing boxes are matched by an integrator and delivered by the tv camera to the receiver.

Since the black of the skull bones on one image cancels out the white of the same bones on the other, the tumors or blood vessel defects hidden by bone in the angiogram are revealed for identification and treatment.

Dr. Colin Holman of the Mayo Clinic says the new technique permits five percent more diagnoses than before. It is of some help in all cases and very helpful in some cases.

When B. B. Ziedses des Plantes first developed this diagnostic method, more than a quarter of a century ago, there was no way of sharply contrasting vessels in the skull. His method also required long photo lab time; the tv technique produces matched images in seconds.

The Motorola system can modify the contrast density of the x-ray films. It can also magnify a half-inch of the film area to fill an entire screen.

---

### Industrial electronics

---

#### Computers in cement

The Universal Atlas Cement division of the United States Steel Corp. has ordered a General Electric Co. computer control system, the tenth in the cement industry and the sixth installed in the past year.

Product consistency and higher production rates are the major factors spurring computer plant control. The cement industry expects to sell about 360 million barrels of cement this year at a cost of around \$1.1 billion. Plants with computer installations find they can sell better cement, spend less money, and increase their profits.

**Where they are.** The other nine

computers are in the United States and Japan. General Electric has installed its GE-312 at the California Portland Cement Co. It runs on-line, closed loop, and controls blending and kiln burning.

The Bunker-Ramo Corp. has a 300 (closed-loop) in the Chichibu Cement Co. and a 330 at the Tokuyama Soda Naugo Works, both in Japan. A BR-300 (closed-loop) and a 330 are being used on kilns at two plants of the Riverside Cement Co. in California.

The International Business Machines Corp. installations include 1710 control systems (using 1620 computers) at the Huron Portland Cement Co. and Northwestern States Portland Cement Co. According to Lynn A. Wallace, director of systems development for Huron, on-line operation of mixing and proportioning is expected by the end of this year. For the Northwestern plant, Allis-Chalmers Manufacturing Co. supplied the digital and analog instrumentation that connects the computer to the process.

A Foxboro Co. 97400 will be installed later this year at the Petoskey, Mich. plant of Penn-Dixie Cement Co., in what will be, at first, a data logging operation.

The 10th computer system, an LN-3000 installed by the Leeds & Northrop Co., is being set up and tested.

**Running a mill.** Generally, computers keep track of the quantities of raw materials such as limestone, shale, sand, gypsum and iron ore that make up cement. The raw materials are fed, under computer direction, to raw-grinding mills. The output of crushed material is classified by x-ray, then fed in various quantities to blending silos. When a certain cement is needed, the computer selects the specific silo with the right mix and feeds the material to the kiln. The kiln, directed by the computer, burns the mixture into clinkers that go, along with specific amounts of gypsum, etc., to finish-grinding mills. The finished product is stored in silos for shipment.

Universal Atlas Cement expects to modernize its Hannibal, Mo.

plant and have it running under computer control by late '65. Besides the control computer, x-ray equipment will analyze the raw slurry leaving the grinding mills; this data will help in proportioning calculations. Throughout the process the computer will reset set points on conventional analog controllers.

**Linings last.** Computers reduce fuel consumption of the kiln through more accurate control of the firing process. This also makes the expensive brick lining of the kiln last longer. Production stops completely when the brick linings of the kilns, huge rotating cylinders 300 to 400 feet long, are periodically replaced. The drive system on Universal's kiln will be powered by a GE Silcomatic adjustable-speed drive that uses silicon controlled rectifiers. The computer system is the GE/PAC (General Electric/Process Automation Computer) 4000 and the panel controllers and instrumentation will be GE/MAC (Measurement And Control) devices.

#### An inside job

The beer you drink in the future may taste even better than it does now because of electronics. The Continental Can Co. is working with a process, using glow discharge, for coating the inside of tin cans. The method could save the can industry 75% of the \$30 million it spends every year for coating materials. It could also mean a

**Electronic coating of the inside of a tin can (within the dome at right) may save the canning industry some \$22.5 million a year in the cost of coating materials.**

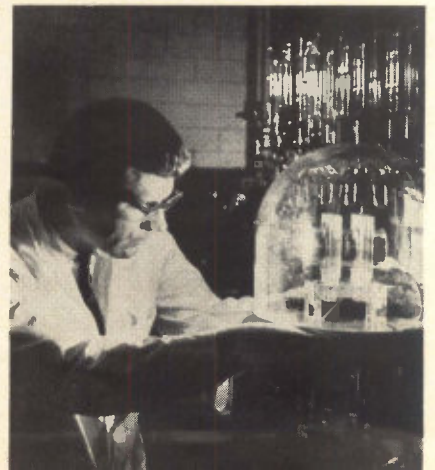

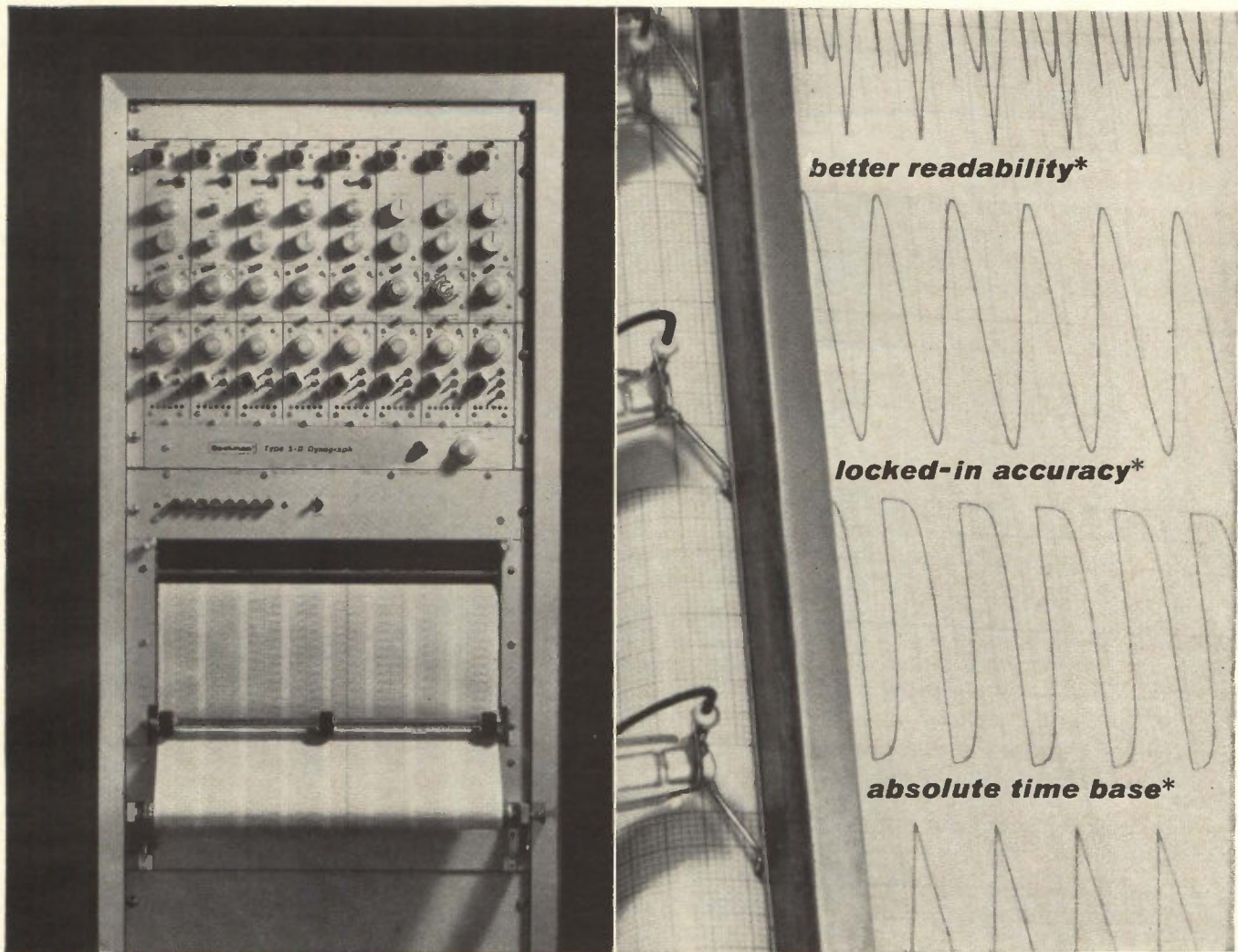

\*with every stroke of every pen

## Dynograph® pressurized ink-rectilinear recorder

**Better Readability**... The completely new pressurized ink system is controlled by a pump that maintains an unvarying pressure at all times while the instrument is in operation. This means that the tracing will retain its high resolution characteristics, regardless of variations in paper speed or signal frequency... never any skipping, or broadening of the line.

**Locked-in Accuracy**... Servo-control feed-back from the pen tip constantly matches the pen position to the input signal... for unsurpassed recording accuracy.

**Absolute Time Base**... All the pen tips are constrained to the same straight line by the slide-wire assembly... in effect a "straight edge" guarantee that completely valid time comparisons can be made between any or all channels.

**Reliability**... The all solid-state circuitry in the Dynograph recorder has been proven in the field for over seven years. In the event that problems do arise, the "plug-in" construction expedites service to minimize downtime.

**Versatility**... A multitude of inexpensive input couplers allow the conditioning of virtually any type of signal, making unnecessary the purchase of expensive special-purpose amplifier systems.

**Interested?**... Check the specification box, then contact your local Offner sales engineering representative, or write for Data File S645.

### SPECIFICATIONS

Number of Channels	1-8 standard
Sensitivity	with preamp, 1 $\mu$ v/mm to 5 v/mm. without preamp, 1 mv/mm to 5 v/mm.
Frequency Response	DC to 150 cps
Linearity	$\pm 0.25\%$ , or less
Drift	1 mm/hr
Input Impedance	1 megohm DC; 1 megohm shunted by 1,000 p.f. or less AC.
Power Required	230 watts, maximum (8 channels)
Input Couplers	28 standard, plus specials

**Beckman®** INSTRUMENTS, INC.

**OFFNER DIVISION**  
Schiller Park, Illinois

new market for electronics.

Most tin cans have an inside coating of lacquer to let foods and liquids keep their natural taste and color. If the lacquer separates from the sheet of tin when the can is being formed—always a possibility—strange things happen. When the can is filled with beer, for example, the beer reacts chemically with the raw tinplate and tastes like iron.

A drawback of lacquer as a coating material is that it can break away from a can under mechanical stress and flake into the contents.

**Getting a glow on.** Continental's scientists place a tin can in a vacuum chamber and attach leads from a power supply to the can and to an electrode centered inside the can. The chamber is evacuated.

A gaseous form of an organic material, such as styrene plastic, is fed into the chamber. An operator flips the power supply switch and applies 500 volts, frequency-modulated at 1 to 50 kilocycles, between the can and the electrode.

The difference in potential between the can and the electrode causes a current to flow that breaks down the gas, ionizing it. The ionized atoms of gas deposit evenly over the inside of the can. The glow is caused by energy released from the gas atoms as they shift to a lower quantum, or energy, level.

**Plastics.** One advantage of glow discharge is that cans can be coated with plastics that resist attack by strong organic solvents.

Another plus is that the inner coatings can be applied after the can is formed. At present, flat tinplate is coated in a lacquering machine, then baked in a long oven to remove solvents and harden the coating. The new electronic process will eliminate this step and speed handling.

The process may also be modified for use by the paper industry where the extrusion coating process now used for paper containers is costly.

**The odds.** But the glow is not all rosy. The stocky, greying president of Continental Can, Ellison Hazard, says that "the chances are 50-50 that this process is commercially

feasible. So far it is limited to the lab bench models. It will be at least two years before we reach the production stage."

Continental will spend \$1 million within the next two years to find the right material and then set up a pilot production line.

---

## Electronics abroad

---

### Weather by wire

Lighthouse keepers in Britain may soon be relieved of another job—telephoning weather information to a central station. The British Meteorological Office is studying an automatic reporting system that would transmit weather information over telephone lines to a central point.

The 12-channel system, designed by E.M.I. Electronics, Ltd., of Hayes, England, can report on 10 weather parameters from as far as 500 miles from the central station. It provides relatively low-cost telemetry by using simple techniques and slow data-transmission.

The United States Weather Bureau is using an automatic weather station, primarily for aviation, that measures more parameters than the E.M.I. system but that costs \$45,000—about triple the cost of the British system. Systems costing as little as \$5,000 have been developed in the United States—but, like one developed by the French, they measure fewer parameters than the British system and transmit information by radio rather than by telephone. By using telephone transmission, the operating charges for a weather report are equivalent to those for a two-minute call over the distance that is involved.

**Push-button trigger.** A receiver at the central station is connected by telephone lines to a telemetry transmitter at an unattended station. To obtain data from an outlying point, an operator at the central station dials a telephone number. The ringing current turns on the telemetry transmitter, which

announces its own telephone number and location. When the operator at the central station has received this information, he presses a button that triggers the remote transmitter to send meteorological data.

Data transmission is by time-division multiplex, with the data converted into audio tones whose frequency is proportional to the standardized zero-to-one-volt output of the meteorological instruments. Each variable is sampled for 16 seconds. The incoming information is displayed on meters and punched out in digital form on tape.

**Raining bucketsful.** Of the 10 parameters, three—the barometric pressure, air temperature and wet-bulb depression—are measured by standard meteorological instruments. Total rainfall is measured with two tilting buckets. Each time one bucket fills to capacity and tilts, a pulse circuit advances a counter. The system can store up to 10,000 counts, representing a total rainfall of one meter—a little over three feet. The counter's output is converted into an analog signal and fed to the telemetry transmitter.

For rainfall rate, a metered opening permits droplets of uniform size to pass between a light source and a photocell. The pulses produced are counted for two to five minutes and result in an analog step voltage proportional to the rate of rainfall.

Visibility is determined by measuring light attenuation over a fixed path, using a fixed-intensity light source and a photocell detector. Sunshine measurement is from a phototransistor at the center of a rotating hemisphere with alternate opaque and transparent segments. When sunlight hits the hemisphere, a series of shadows passing over the phototransistor generates a pulse train output. The directness of the sunlight governs the sharpness of the shadow edges and thus the rise time of the pulses in the train. A relay operates when the rise time corresponds to the standard meteorological definition of bright sunshine.

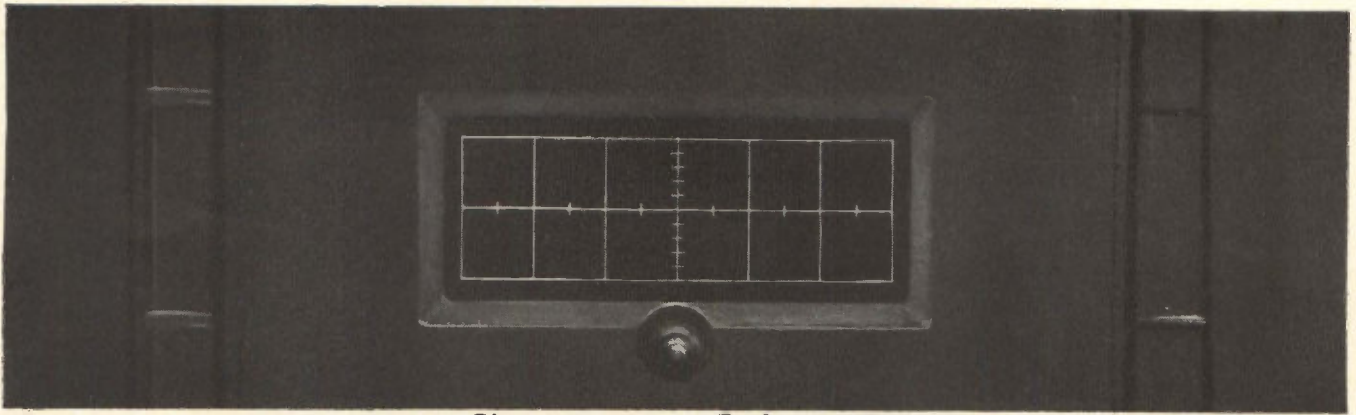

**See anything?**

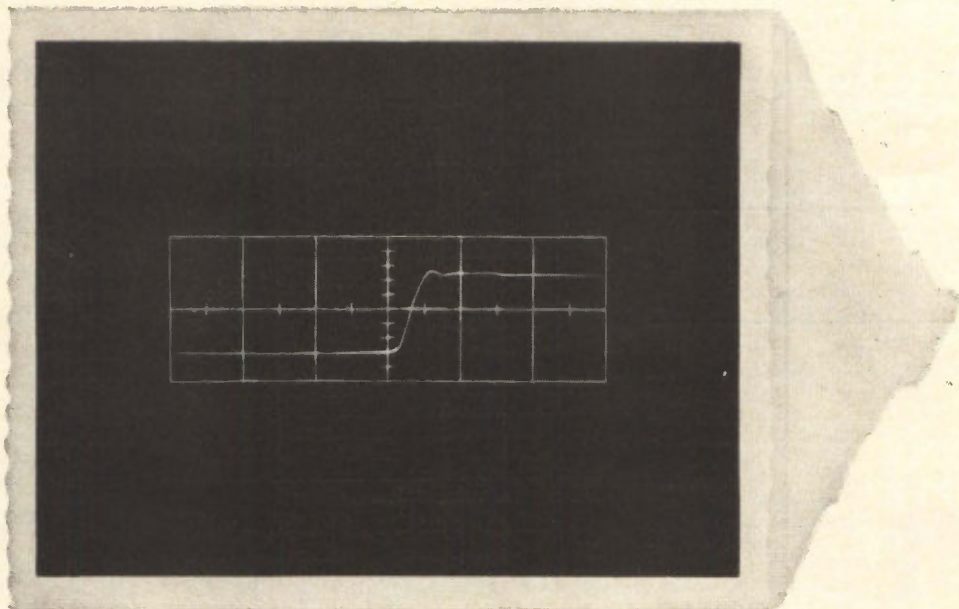

**This new film did.**

This new film saw something the eye couldn't: the rise time of a single pulse on a Textronix 519 scope at a sweep rate of 2 nanoseconds/cm. The new film, Polaroid PolaScope Land Film, actually extends the usefulness of existing oscilloscopes by supplying "brightness" that the scope hasn't got!

The reason is that this PolaScope film has an ASA equivalent rating of 10,000, which means it can see things your eye cannot. It has about twice the writing rate of the Polaroid 3000-speed film, currently the standard for

high speed oscilloscope photography. (No other commercially available films come anywhere near the speed of PolaScope film.) And because it's made by Polaroid you get a finished usable print—see above—ten seconds after exposure.

PolaScope film will also give you better shots of slower pulses and stationary waveforms. So little light is required, camera aperture and scope intensity can be reduced considerably, and that's how to get really sharp oscilloscope pictures.

And wherever else light is at a premium—such as photomicrography and Kerr Cell photography—PolaScope film will make new applications possible, old applications more useful.

PolaScope Type 410 Film is packed 12 rolls to the carton. The price is about the same as the Polaroid 3000-speed film. For the name of the industrial photographic dealer nearest you, write to Technical Sales Department, Polaroid Corporation, Cambridge 39, Massachusetts.

POLAROID®

**New Polaroid Land 10,000-speed film for oscillography**

In "check out" system similar to this, EI engineers first developed the input filter now standard on all EI voltmeters.

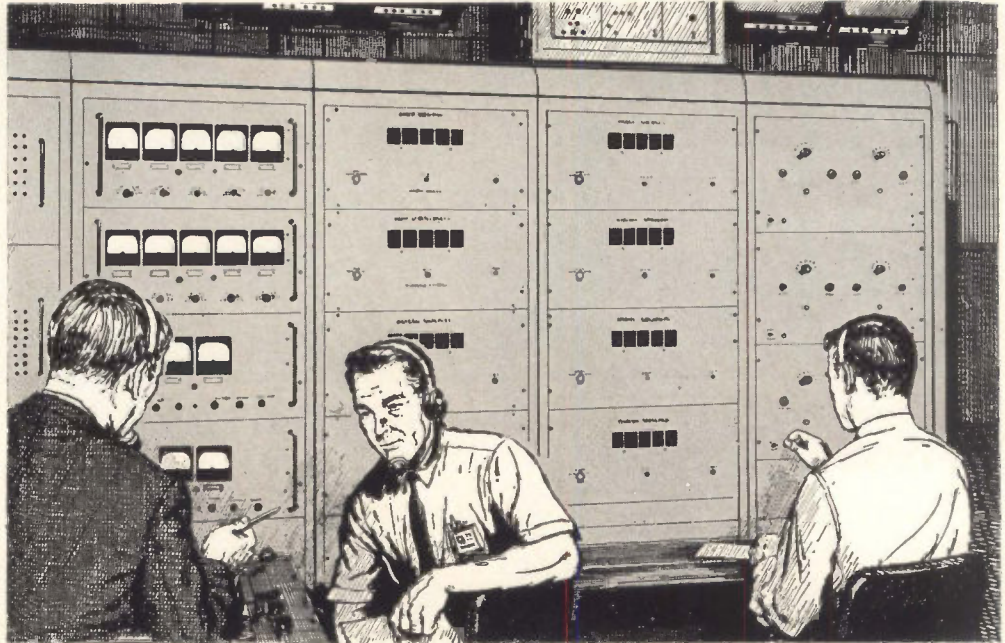

# Classic Jobs of Measurement

*Performed by Electro Instruments*

## THE EI VIEWPOINT

by Dr. Walter East  
President, Electro Instruments, Inc.

Almost never, in actual practice, is a purely stable source of voltage encountered in measuring DC voltages. Minor variations go undetected if measurement is done with an instrument employing a mechanical needle movement, because of the friction involved in the

needle movement itself. On the other hand, a digital voltmeter — highly sensitive to, and reacting rapidly to minute voltage changes — reflects even small variations faithfully. The trouble is, rapid voltage fluctuations will have the voltmeter reacting so rapidly that accurate, stable reading is impossible.



Dr. East

### Two Types of Interference

Besides variations inherent in a voltage source, a secondary set of variations can come about with the introduction of a magnetic field, either natural or man-made. We know these variations as normal mode and common mode interference voltages, with unwanted normal

### Filtered EI Voltmeter Ends Threat to Aircraft Program

What is today a standard feature of Electro Instruments' voltmeters was first developed to meet the emergency needs of a major aircraft designer\*. In actually flight testing a new type aircraft, it had been planned to telemeter information gathered by transducers placed throughout the ship to a ground-located monitoring station. Equipment of latter included several EI digital voltmeters.

#### Threat of Costly Delay

Despite satisfactory preliminary tests, actual engine run-up produced unwanted normal mode voltages so great that accurate voltmeter readings were impossible. Trouble was traced to electrical wiring within the aircraft. Re-

mode voltages being called "ripple." It was over two years ago that Electro Instruments took the forward step that other digital voltmeter manufacturers still have to make. Recognizing that, in 95% of cases, unwanted variations in DC voltage measurements result from normal mode voltages rather than common mode voltages, we incorporated an input filter in every model voltmeter in our extensive line.

An interesting story about "ripple" appears above. It's another actual instance in which we fulfilled our promise: "You name it, we'll find a way to measure it!"

wiring would mean a 30-day program delay, and a loss of \$100,000.

At this point, EI engineers suggested filtering out the undesirable noise at the input to the voltmeters, and letting major portions of all transmitted information be channeled through them. The suggestion was adopted, and a satisfactory filter developed within days. This first successful use of a "ripple" filter led to its being made an integral part of future Electro Instruments' voltmeter models. \*Name on request.

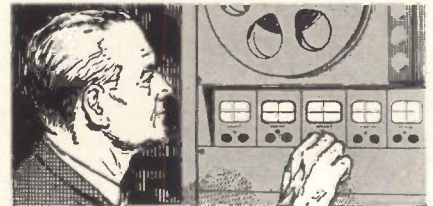

### Oscilloscope Raises Level of Confidence in Tape Recordings

The mere presence of recorded electronic impulses on tape does not necessarily constitute usable information. Operational tests of aircraft, missiles, spacecraft, etc., rely on tape recordings for depth analysis of performance. Mechanical needle movement metering provides only quantitative observation. Use of monitor oscilloscopes provides qualitative presentation as well, increases confidence level of tape recorded information.



**Electro Instruments, Inc.**  
8611 Balboa Avenue, San Diego 12, California

EI SALES, SAN DIEGO, CALIF. • ELECTRO INTERNATIONAL, INC., ANNAPOLIS, MD. • TRANSFORMER ENGINEERS, SAN GABRIEL, CALIF.



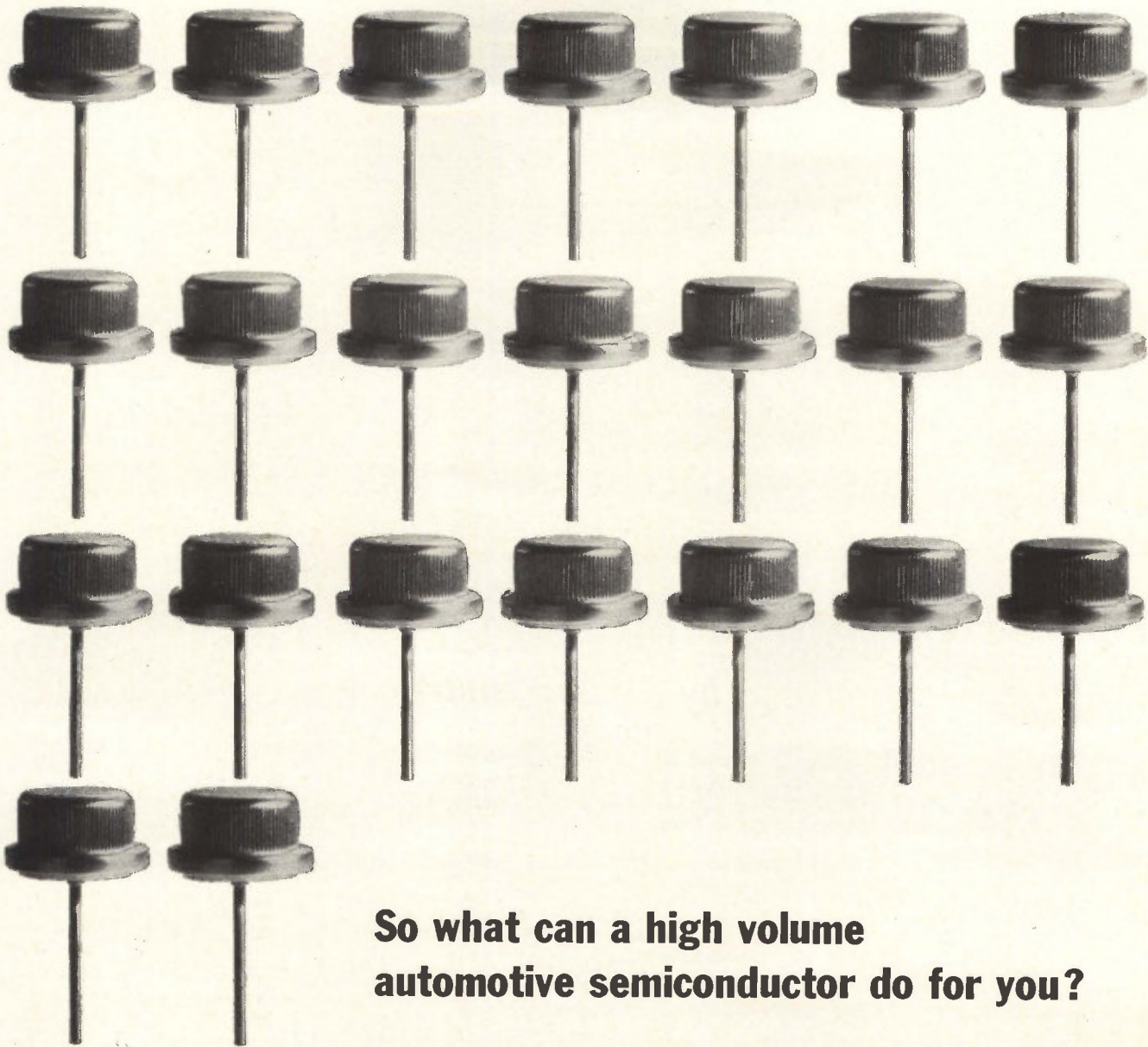

## So what can a high volume automotive semiconductor do for you?

### Save you money, for one thing.

Consider Delco Radio's press fit and stud base rectifiers.

They're designed and built for rugged automotive applications, where devices don't stick around long unless they're especially reliable—(successful operation for several billion device hours insure this)—and they don't get used at all unless their price is low.

The 18-ampere 1N3491-93 press fit series in 50, 100 and 200 P.R.V. ratings will withstand current surges to 300 amperes. Hermetic sealing and extensive thermal cycling assure stability of operation from  $-65^{\circ}\text{C}$  to  $+175^{\circ}\text{C}$ —for as low as two cents an amp.

For stud mounting, the same basic rectifier is available in the 15-ampere 1N3208-10 series with stud

package. They will maintain full-rated peak reverse voltages of 50, 100 or 200 volts to  $+175^{\circ}\text{C}$  which extends through the forward current derating range of  $150^{\circ}\text{C}$  to  $175^{\circ}\text{C}$ .

Or maybe you'd be interested in other rectifiers being readied for high volume applications such as: the new 750 ma, 50 or 100 volt silicone encapsulated DRS 100 series, the DRS 150 series of 1.5 ampere "top hats," or the heavy-duty 800 to 1200-volt, 250-ampere DRS-250 series.

For the full story on delivery, price and reliability advantages these high volume devices can offer you, contact any Delco Radio sales office. They'll supply you with data, prices and applications assistance.

\*Union, New Jersey  
324 Chestnut St.  
MURdock 7-3770  
AREA CODE 201

Detroit, Michigan  
57 Harper Ave.  
TRinity 3-6560  
AREA CODE 313

Palo Alto, California  
201 Town & Country  
Village  
DAvenport 6-0365  
AREA CODE 415

\*Santa Monica, Cal.  
726 Santa Monica  
Blvd.  
UPTon 0-8807  
AREA CODE 213

Syracuse, N.Y.  
1054 James St.  
GRanite 2-2668  
AREA CODE 315

\*Chicago, Illinois  
5151 N. Harlem Ave.  
775-5411  
AREA CODE 312

**DELCO RADIO**   
DIVISION OF GENERAL MOTORS, KOKOMO, INDIANA

\*Office includes field lab and resident engineer for applications assistance. General Sales Office: 700 E. Firmin, Kokomo, Ind., Gladstone 2-8211—Ext. 500 • Area Code 317

# **MITSUBISHI MICROWAVE ANTENNAS FOR TELECOMMUNICATIONS**

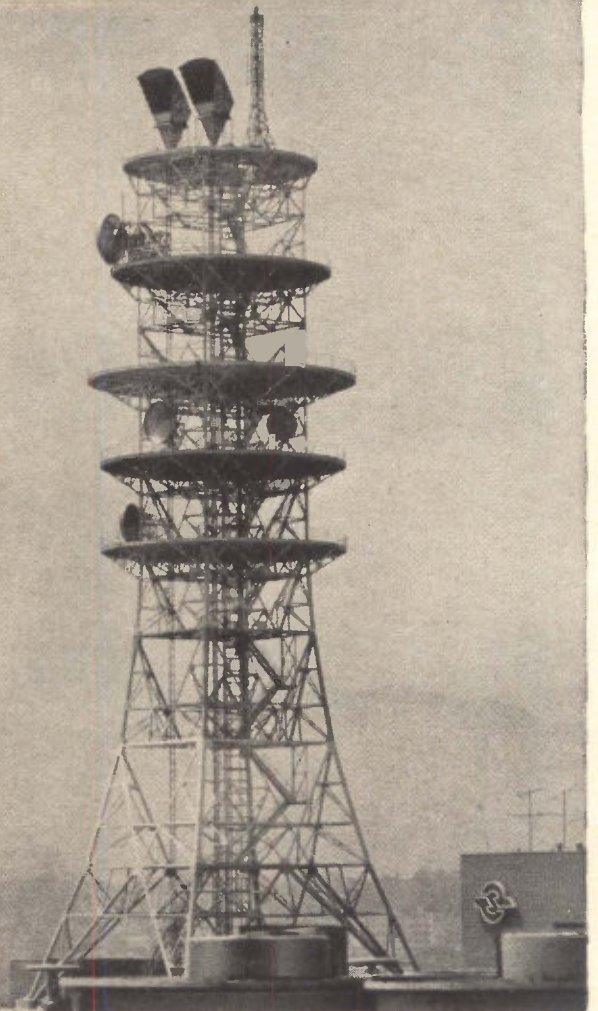

Japan today has the second largest microwave network in the world. Mitsubishi Electric, with the longest microwave antenna experience in Japan, has supplied 90% of the antennas used in the trunk lines of this extensive network. Mitsubishi antenna systems include parabolic, scatter, horn reflector and radar types, as well as a complete line of waveguide components and accessories. Frequencies from 900 Mc. to 24 KMc. are covered. The IU-62, shown above and specified at the right, is typical of the outstanding performance of Mitsubishi microwave antennas. Full technical information on any of these types of antennas is available at your request.

## **IU-62 Horn Reflector Antenna**

Frequency Range : 3,000-12,000 MC  
 Aperture : 9m<sup>2</sup>  
 Max. width : 4,050mm  
 Max. depth : 2,560mm  
 Max. height : 7,418mm  
 Gain at 3,900MC : V 41.5 db  
                           H 41.2 db  
 Gain at 6,100MC : V 44.9 db  
                           H 45.0 db  
 VSWR : 1.01  
 Front/Back : 67-70 db  
 (over 60 degrees)  
 Discrimination of : V 57 db  
 cross polarization : H 78 db (at 3,900MC)  
                           V 45 db  
                           H 37.5 db (at 6,100MC)  
 Guaranteed wind velocity : 140 miles/hr



## **MITSUBISHI ELECTRIC CORPORATION**

Head Office: Mitsubishi Denki Bldg., Marunouchi, Tokyo. Cable Address: MELCO TOKYO



■ IU-61 parabola antenna

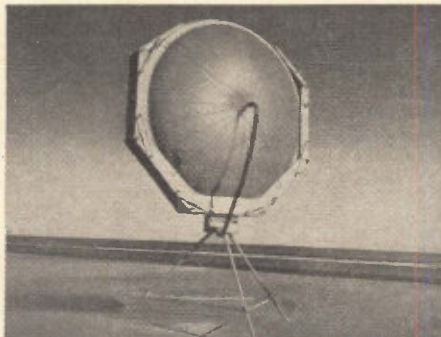

■ Air Inflated parabola antenna

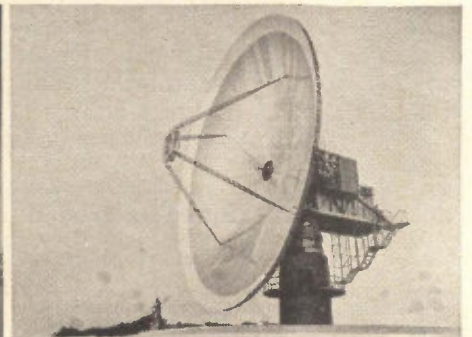

□ 20 meter diameter antenna for satellite communication

# INTRODUCING the New, Versatile Thin-Line **VY**® Porcelain Capacitors

- \* 0.5 pf to .01 mf
- \* -55°C to +125°C operation
- \* Ratings to 100 vdc

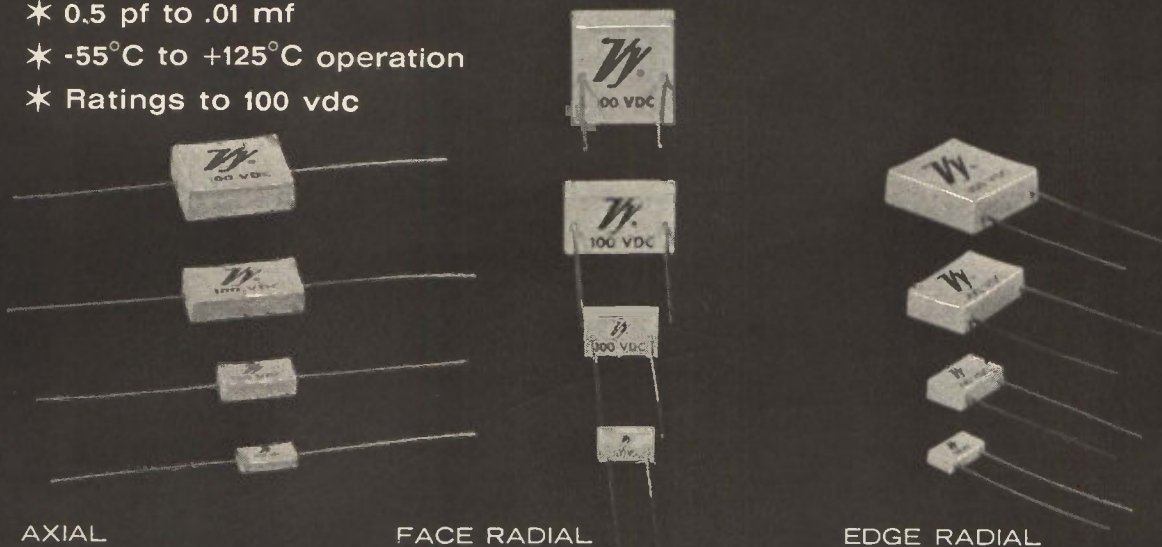

AXIAL

FACE RADIAL

EDGE RADIAL

**... with outstanding electrical and physical characteristics to meet all your requirements for design and performance!**

- \* **CHOICE OF TEMPERATURE COEFFICIENTS**  
+105±25 ppm/°C and 0±25 ppm/°C. (From +105±25 ppm/°C to -100±25 ppm/°C available.)
- \* **CHOICE OF LEAD MATERIALS**  
Solder Coated Copper, Dumet, Nickel A, etc.
- \* **CHOICE OF LEAD CONFIGURATIONS**  
Axial, Face Radial, Edge Radial
- \* **THIN-LINE DESIGN**
- \* **MONOLITHIC CONSTRUCTION**
- \* **HIGH RF CURRENT CARRYING CAPABILITY**
- \* **LOW DISSIPATION FACTOR**
- \* **HIGH INSULATION RESISTANCE**
- \* **WITHSTANDS SEVERE ENVIRONMENTAL CONDITIONS**
- \* **TEMPERATURE STABILITY**
- \* **FREQUENCY STABILITY**
- \* **DEMONSTRATED RELIABILITY**

Specify these features in any combination to meet your requirements

New space-saving feature

Quality features in all "VY" Capacitors

© Vitramon, Inc. 1964

See us at WESCON, Booth Nos. 324-325.

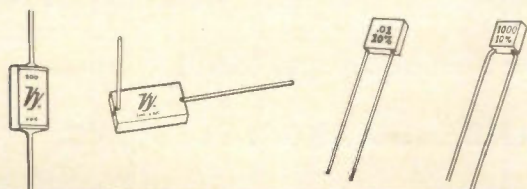

**Vitramon**  
INCORPORATED

BOX 544 • BRIDGEPORT 1,  
CONNECTICUT, U.S.A.

In United Kingdom contact:  
Vitramon Laboratories  
Limited  
45 Holloway Lane  
Harmondsworth, Middlesex  
England

**Yes**

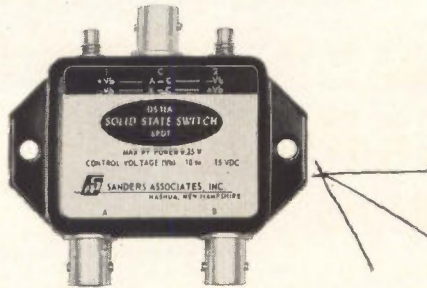

**MODEL DS 11A (SPDT)** Provides extremely fast (10 nanosec), clean switching from DC to 400 MC. Insertion loss 1 db maximum to 100 MC. Dribble voltage less than 100 millivolts. Isolation greater than 70 db to 100 MC — especially useful for switching in such equipment as receivers, multiplexers, antenna systems.

**we're the ones**



**MODEL DS 201 (SPDT)** Features high-speed switching of less than 100 nanosec over broadband range of 0.3 to 500 MC. Isolation 50 db minimum at 300 MC. Weight — 3 ounces. Ideal for multiplexing, transmit-receive switching, pulse modulation, signal steering.

**making all those**



**MODEL DS 528 (SPST)** New unit combines broadband operation (1 to 4 GC) with very high isolation (greater than 38 db over the entire band and greater than 48 db over the 2 to 4 GC portion). Switching speed typically faster than 50 nanosec. Weighs only 4.2 ounces.

**new solid-state**

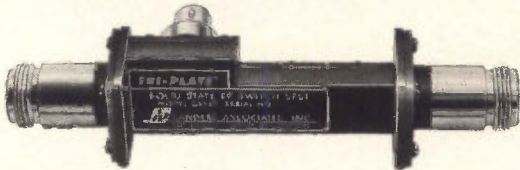

**MODEL DS 532 (SPST)** New switch offers uniquely high 50 db OFF isolation over broadband range of 4 to 8 GC — permits switching applications never before possible. ON insertion loss typically less than 2.5 db over entire operating band. Switches normally at speeds faster than 50 nanosec.

**switches**

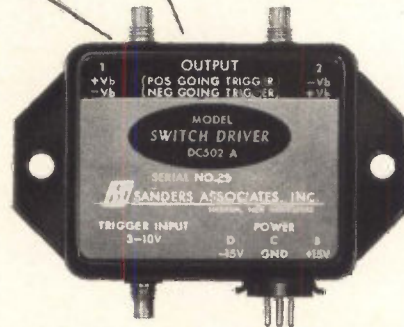

**MODEL DC 502 DRIVER** The only unit of its kind on the market, this driver is specifically designed to provide balanced control voltages for fastest, most efficient operation of Sanders solid-state switches. Four versions are available for single or dual trigger inputs with 5 MC or 1 MC repetition rates.

**and now  
their drivers,  
too!**

These few examples suggest the performance built into all Sanders solid-state switches — many other models in the standard line span broad frequency ranges from DC to 8 GC. And now, with drivers that mate with these switches to ensure optimum performance, Sanders alone offers you the convenience of complete solid-state switch/driver packages. Design of special switches

(where standard models will not serve) rounds out this total solid-state switch capability — exclusive with Sanders. Exclusive, too, is the dependable high efficiency of these switches . . . backed by the Sanders reputation for innovation and excellence in microwave technology. Write for data sheets or applications engineering to Sanders, Electronic Products Dept., 99 Canal St., Nashua, N. H.



**CREATING NEW DIRECTIONS IN ELECTRONICS • SANDERS ASSOCIATES, INC.**

At WESCON see Sanders Booth Nos. 2030 and 2031

# NEW SANGAMO 556 ELECTROLYTIC CAPACITOR LICKS WEIGHT LOSS\* AT 100° C

(\* major cause of electrolytic capacitor failure)

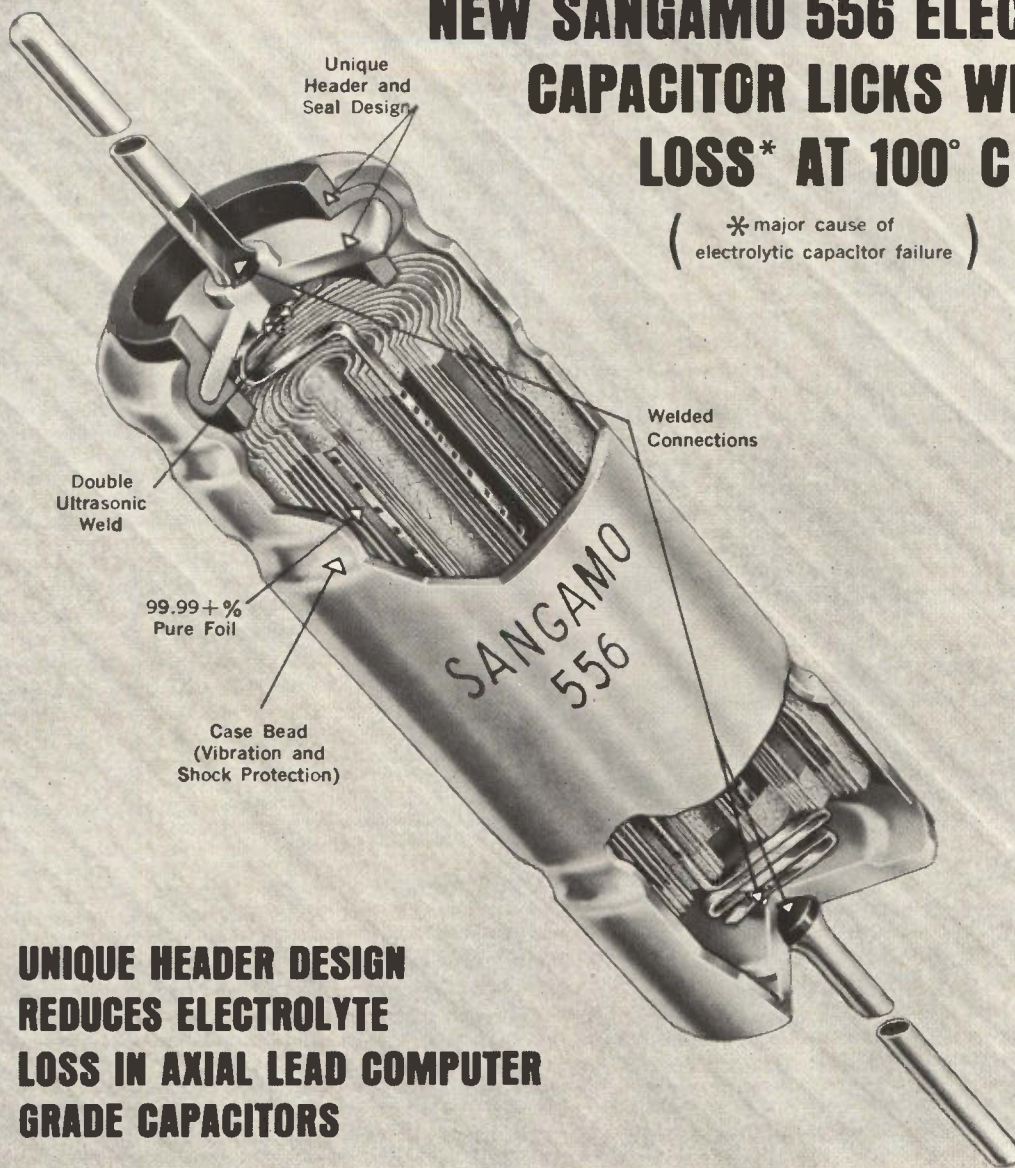

## UNIQUE HEADER DESIGN REDUCES ELECTROLYTE LOSS IN AXIAL LEAD COMPUTER GRADE CAPACITORS

### CHECK ALL TYPE 556 DESIGN FEATURES

Superior Seal — one-piece aluminum header and specially compounded rubber seal guarantee minimum rate of weight loss...less than 0.015 grams per 500 hours operation at 100° C. • Double ultrasonic weld on the anode connection • Capacitor Section composed of 99.99+ % pure aluminum foil • Exceptionally stable characteristics at 100° C. • Section secured by beading process, providing built-in protection against vibration and shock

• Voltage ratings up to 150 VDC ... capacitance up to 560 mfd • High capacitance per volume (for example: 560 mfd @ 3 VDC in 3/8" x 1 5/8" case) • Mylar sleeve for better case insulation.

Typical data on 60 mfd 10 VDC unit tested for 1000 hours:

• Leakage Current—less than 1 micro-amp • Capacity Decrease—less than 6% of initial value • Dissipation Factor—less than 7% increase • Weight Loss—less than 0.010 grams.

Maximum Stability...Longer Life... Increased Reliability... Competitively Priced... Order from your Sangamo Representative or Write:

### SANGAMO ELECTRIC COMPANY

P. O. Box 359  
SPRINGFIELD, ILLINOIS 62705  
Phone: 217-544-6411



EC64-4

See it at Wescon  
(Hollywood Park, Booths 183-184)

SINCE 1924 A LEADING MANUFACTURER OF CAPACITIVE COMPONENTS

# NEW! TRYGON Modular DC Supplies

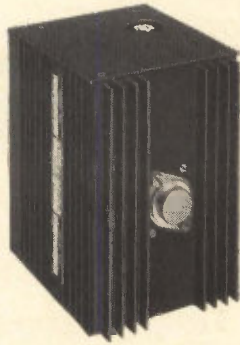

**SERIES 1, 2 & 4**  
(71°C ambient)



**SERIES 8**  
(50°C ambient)

## Plug them in anywhere... then forget them!

Whether you need Trygon modules for your own use or to incorporate into systems you are producing, you can rely on Trygon dependability. You merely select the proper Trygon module, mount it—horizontally or vertically—and forget it!

Here's why: High-efficiency circuits result in less internal heat build-up and longer life. Series 1, 2 and 4 feature all silicon semiconductors, designed to operate in ambients up to 71°C WITHOUT ANY DERATING! All series have generous built-in heat sinks—no additional heat sinking or forced air cooling is required. Current-limited short circuit protection automatically resets when the fault is removed—so again, you don't have to worry about where you place a Trygon module in a system.

Remote sensing and programming provisions are also built-in. And premium components plus derated circuits yield MTBF figures in excess of 30,000 hours. All components are readily accessible. For additional flexibility, input/output connections are available with either terminal strips, solder lugs or octal sockets.

Overvoltage protection is available on all units as an optional extra. Series 1 is provided with Fixed Overvoltage Protection (FOV) while all other modules (Series 2, 4 and 8) are available with Trygon's standard Automatic Overvoltage Protection (OV).

See the chart for standard models, then contact your Trygon rep. Or, write for complete catalog to Dept. E-24.

### ELECTRICAL SPECIFICATIONS

Model	Reg: Load	Reg: Line	Ripple mv RMS	Recovery Time	Ambient Oper. Temp.
Series 1, 2 & 4	0.02%	0.01%	Less than 0.5	Less than 50 $\mu$ sec	-20°C to +71°C
Series 8	0.01%	0.01%			-20°C to +50°C

Complete line of module rack adapters available for assembly of complex power supply systems to meet your specific needs.

### MODELS

Series	Model	OUTPUT		PRICE†	Overvoltage Protection
		Volts	Amps		
1*	PS20-400	0-20	0-0.4	\$140	For Fixed Overvoltage Protection (FOV) add \$75 per unit.
	PS32-250	0-32	0-0.25	140	
	PS50-150	0-50	0-0.15	155	
	PS3-1.5F	2.5-3.5	0-1.5	130	
	PS6-1F	4-8	0-1	120	
	PS12-900F	10-14	0-0.9	115	
	PS15-800F	13-17	0-0.8	120	
	PS18-800F	16-20	0-0.8	120	
	PS24-700F	22-26	0-0.7	120	
	PS28-600F	26-30	0-0.6	120	
PS48-400F	46-50	0-0.4	130		
2	PS10-2	0-10	0-2	160	Note A
	PS20-1.5	0-20	0-1.5	160	
	PS32-1.25	0-32	0-1.25	165	
	PS50-750	0-50	0-0.75	180	
4	PS10-4	0-10	0-4	195	Note B
	PS20-3	0-20	0-3	195	
	PS32-2.5	0-32	0-2.5	200	
	PS50-1.5	0-50	0-1.5	215	
8	PHR20-5	0-20	0-5	250	Note C
	PHR20-10	0-20	0-10	325	
	PHR40-2.5	0-40	0-2.5	250	
	PHR40-5	0-40	0-5	295	
	PHR60-2.5	0-60	0-2.5	325	
PHR60-5	0-60	0-5	395		

\*Lower current models also available, at lower prices

†Write for discount prices on larger quantities

A. For Automatic Overvoltage Protection (OV) add \$90 per unit.

B. For Automatic Overvoltage Protection (OV) add \$95 per unit.

C. For Automatic Overvoltage Protection (OV) add \$95 per unit, except for Model PHR60-5, \$125.

# TRYGON

## ELECTRONICS INC.

111 Pleasant Avenue

Roosevelt, L.I., N.Y.

(516) FReeport 8-2800

TWX (516) 868-7508



---

# Washington Newsletter

---

August 10, 1964

## Command-control design changing

The Strategic Air Command wants to make changes in the Defense Department's 487-L project, a highly reliable, secure survivable communications system for command and control messages. The news has shaken nine electronic suppliers who submitted bids for the multimillion dollar project on June 25. Their proposals were based on the original concept.

Since other agencies will also use the communications system Pentagon officials are still weighing SAC's proposal. A decision is expected by September.

## Crackdown on citizens' band

The Federal Communications Commission is cracking down on abuses of the citizens' band and may even forbid use of the wavelength if the new regulations don't produce results. Originally intended for personal and business communications over short distances, the bandwidth is now used mostly by hobbyists who jam the channels with chatter. The new FCC regulations, effective Nov. 1, are designed to take the citizens' band away from the hobbyists and return it to use for business and essential personal communications.

## 19 nations adopt Comsat formula

The Communications Satellite Corp. has won the lion's share—61%—of the international communications satellite system, but this could drop as low as 50.6% if other countries exercise their option to join. A tentative agreement has been reached between the United States and 18 countries; it includes an ownership formula that reduces the shares of each country as new countries join. Each country will own its own ground station—either publicly or privately. Final signatures will be attached to the document beginning August 19.

Only countries owning 1.5% of the system are eligible for a seat on the 12-man international committee that will decide all major technical and policy matters, and approve all contracts over \$500,000. Decisions require the votes of the U.S. plus a combination representing 12.5% foreign ownership. In case of a deadlock, a 60-day clause reduces the necessary margin to the votes of the U.S. and 8.5% of the remaining ownership. The U.S. had wanted a 66.6% vote to swing decision; the foreign nations had hoped for a 76% vote plus veto power.

Suppliers for the \$200-million system will be chosen on a "best buy" basis—without regard to nationality. If comparable offers are made, purchasing will be distributed on a percent-of-ownership basis.

## Check list for sole-source buys

The Air Force is again trying to cure its sole-source headache. It has come up with a method of checking on prime contractors who buy parts from sole sources instead of in open competition. The first test of the new system covers air-frame and engine manufacturers, with missile and electronic system suppliers next on the list. The check system uses electronic data processing cards supplied to the contractors for parts purchases of \$10,000 or more. Coding covers 11 justifications accepted for sole-sources buying in lieu of open competition. Screening is carried

---

# Washington Newsletter

---

only to the point where the first valid justification is reached, such as requirement of special test or inspection facilities, need of proprietary data for satisfactory production, or a degree of reliability needed which isn't obtainable from other sources.

## Traffic-control parley planned

The Bureau of Public Roads will sponsor a conference in Washington on Sept. 14 and 15, to study the application of modern technology to existing highway systems. It hopes to persuade electronic suppliers and computer makers to attend. But the big obstacle to widespread automation of traffic control remains: too few traffic engineers understand the electronic equipment or are willing to learn about it.

## Computers studied for mail routes

A new area of computer use is being explored by the Post Office Dept. It is studying the application of its IBM 1401 computers to airmail route selection; later it may add rail and truck routes, or any combination of rail, truck and air. The department itself—and a wide variety of shippers—could thus find the fastest, most economical routes.

The National Bureau of Standards has done an experimental study of air routes selection using Fortran and IBM 7090. The program determines all usable routes from among 2,000 trip segments, evaluates links, transfer-points and times, compares interline and intraline transfers, cost reliability factors, and even the ground distances involved. Currently, the bureau is working with the problem of deciding computer capability requirements that will make the technique feasible to a wide variety of shippers.

## New plane plugs military hole

The new billion-dollar strategic reconnaissance aircraft SR-71 announced by President Johnson is believed to be only a slightly modified version of the new high-flying A-11 craft shown in February. The Air Force has redesignated the A-11. It is now the YF-12-A (prototype fighter); it will be used as a 2,000 mph aircraft interceptor.

Officially, the Pentagon will not talk about the SR-71's mission. Unofficially it is expected to fill a current gap in the United States military structure. The plane will be a forward spotter, assessing missile damage to targets. Additionally, it will augment satellites in peacetime aerial reconnaissance.

## Dual-sales report readied

A report being prepared by the Small Business Subcommittee headed by Rep. James Roosevelt (D.-Calif.) will focus attention on dual distribution, a subject which interests both the Justice Dept. and the Federal Trade Commission. As the result of an inquiry into the practice in 45 industries, Roosevelt is proposing new legislation that would require the maintenance of price differentials by firms that are engaged in more than one level of sale. In consumer electronics, for example, a manufacturer could not charge less to his own captive outlet than he charges to an independent retailer or wholesaler. The independents complain that dual distribution abuses lead to discount competition they can't meet.

The subcommittee can only investigate; it cannot legislate. Thus, any proposed legislation will be referred to other committees, such as the Judiciary and Commerce, and in those committees it faces a fight.





## Flawless

### The Solid State SR-209 SURVEILLANCE RECEIVING SYSTEM

The SR-209 by Astro Communication Laboratory has been called today's finest surveillance receiving system... for its sensitivity, versatility, flexibility, long MTBF and just plain all-around performance.

You can credit solid state design ingenuity—and an all-modular approach—for many of the 209's virtues. The exclusive use of transistors makes for light weight, compact size and minimum power consumption. We've translated this into complete portability for field use, if your requirements demand it, by providing a plug-in nickel-cadmium battery pack; thus equipped, the 209 is totally self-sufficient *anywhere*. Other features? Consider these: plug-in sig-

Model SR-209 VHF/UHF Receiving System:  
 AM, FM, CW, Pulse reception; covers 30-2000 mc with 5 plug-in RF tuning heads; 20 kc, 60 kc, 100 kc, 300 kc, 500 kc, 1 mc, 2 mc, 4 mc, and 8 mc IF bandwidths available; completely solid state; plug-in signal display unit and plug-in rechargeable battery pack; carrier operated relay available; requires only 25 watts power; just 3½" high.

nal display unit, at least two section preselectors at the RF input of all receiver front ends to minimize interference; AGC on all tuners; nine IF channels with matching FM and AM demodulators; switchable bandwidths. That's just a sample. For the rest of the story—noise figures, sensitivity, stability, IF and image rejection, etc.—you'll have to write us.

Ask for "SR-209 data sheets," and expect some pleasant surprises.

**ASTRO COMMUNICATION LABORATORY**  
 DIVISION OF AERO GEO ASTRO CORPORATION  
 801 Gaither Road, Gaithersburg, Maryland  
 Phone 301-948-5210  
 TWX 703-354-0334 · WU Telex 089-435  
 "RF Equipment for the Systems Engineer"



# MICRO SWITCH Precision Switches

## AUXILIARY ACTUATORS

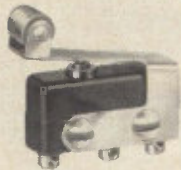

ROLLER LEAF

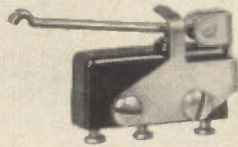

FORMED LEVER



STRAIGHT LEAF

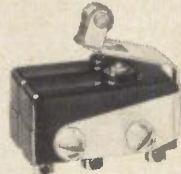

TANDEM ROLLER LEAF



TANDEM LEAF



FORMED LEAF

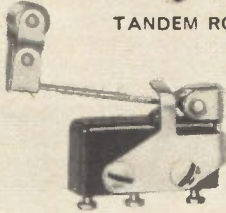

ONE-WAY ROLLER LEVER

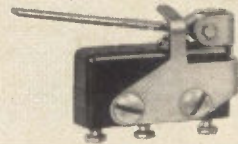

STRAIGHT LEVER

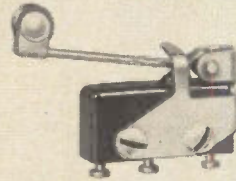

ROLLER LEVER

## INTEGRAL ACTUATORS

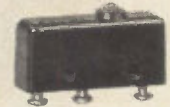

PIN PLUNGER

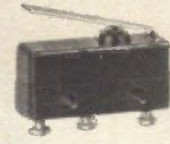

STRAIGHT LEAF



ROLLER LEAF

## TERMINAL VARIATIONS

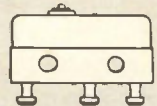

SINGLE TURRET



DOUBLE TURRET

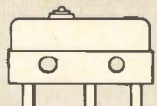

QUICK-CONNECT

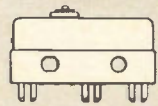

SLOTTED POST

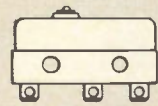

SOLDER

## TEMPERATURE VARIATIONS



-100° TO +180°F.



HIGH TEMP.

# Now, it's easier than ever to find the right Subminiature !

For years (since 1948) our subminiature switch has been the ideal combination of small size, high capacity and long life. The performance and versatility of this reliable work-horse is constantly being improved to meet the growing demands of the space age.

For example, the following variety of design features is now available right off the MICRO SWITCH "shelf":

Actuators (integral or auxiliary types); Terminal shapes; Operating characteristics; Electrical ratings; Contact arrangements; Contact materials.

For complete information and expert application assistance, call a Branch Office (see Yellow Pages) or write for Catalog 63.

VISIT US AT THE WESCON SHOW AUGUST 25-28 BOOTHS 229-230

## Ask about The NEW 10-amp. Subminiature

A new Subminiature with a high electrical rating of 10 amps. is now available, making this space-saver practical for a new wider range of applications. For complete details, write for Data Sheet 180.

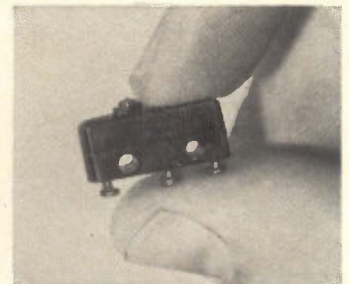

## MICRO SWITCH

FREEPORT, ILLINOIS 61033

A DIVISION OF HONEYWELL

IN CANADA: HONEYWELL CONTROLS LIMITED, TORONTO 17, ONTARIO

HONEYWELL INTERNATIONAL—SALES AND SERVICE OFFICES IN ALL PRINCIPAL CITIES OF THE WORLD. MANUFACTURING IN UNITED STATES, UNITED KINGDOM, CANADA, NETHERLANDS, GERMANY, FRANCE, JAPAN.

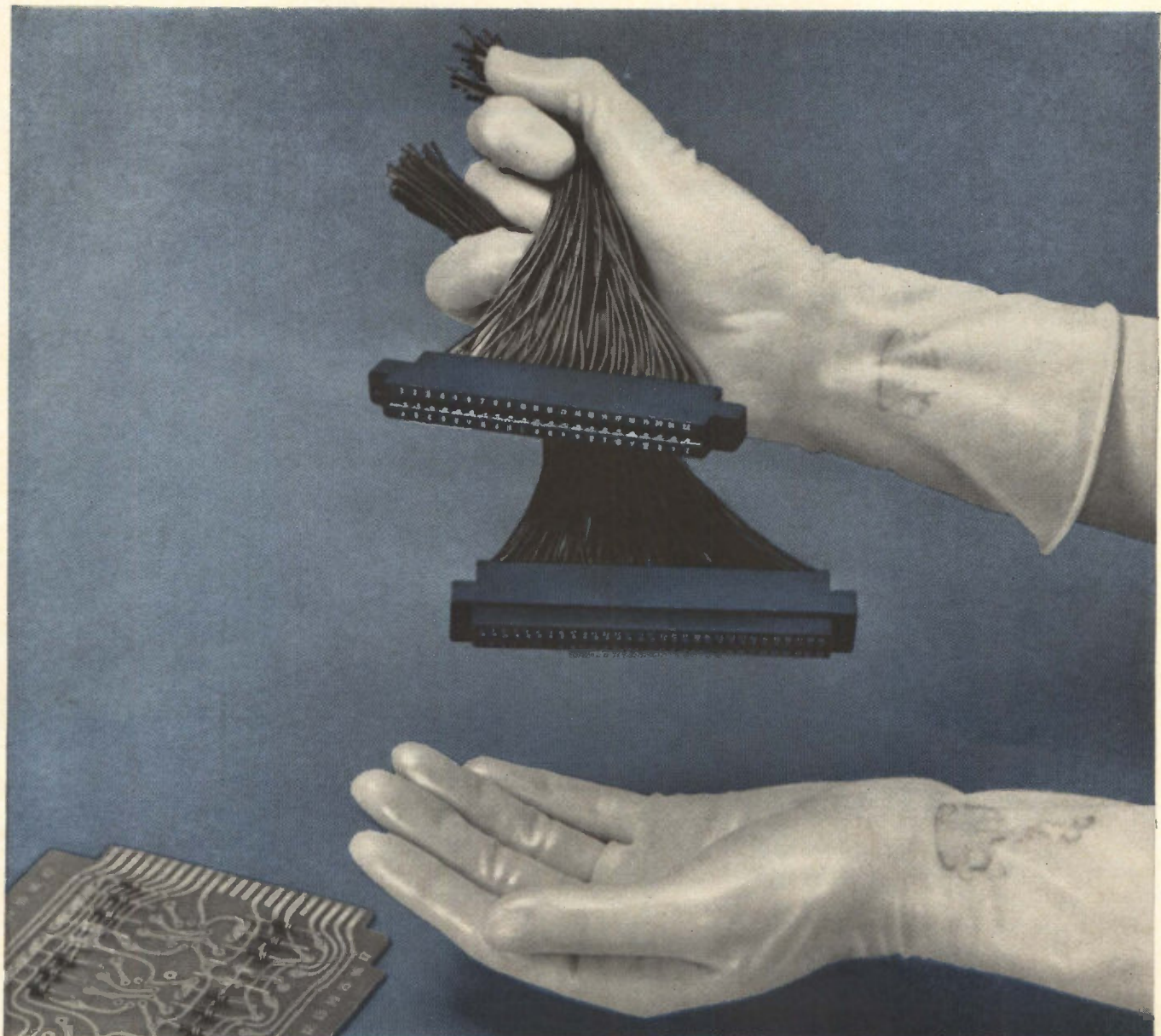

## Twins or quads delivered to order

If you're planning an addition to your printed circuit connector family, AMP delivers new maximums in range and versatility at the lowest installed cost.

The new twin- and quad-position AMP-TAB★ Connectors are just what the doctor ordered. A choice of three contact spacings— .100, .125 and .156 inches. With all these connectors you make changes, replacements or repairs in a twinkling . . . without removing the board.

The dual housing accepts two tab terminals per position into a single contact. This commons the top and bottom paths of the board. The quad type accepts four tab terminals per position. Two common to the top of the printed circuit board, two common to the bottom. Board paths are not commoned.

Lowest installed costs are assured because:

- Tab terminals are: (1) crimped on wire with high speed application tooling; (2) quickly hand inserted into the rear of the connector; (3) held firmly in place by a mechanical locking device; (4) easily removed from rear of connector without removal of the board.
- sleeving is eliminated — egg-crate design completely insulates terminals
- alpha-numeric contrasting color cavity identification assists in circuit wiring

- one hand crimping tool is used for entire wire range (#18-#26 AWG).

In addition other features include . . .

- standard AMP gold over nickel plating on phosphor bronze
- diallyl phthalate block material — conforms to MIL-M-14F, Type SDG-F
- available in 10, 15, 18, 22, 30, 31, 41 and 43 positions for wire range #18 through #26 AWG
- dimensions and performance conform to MIL-C-21097.

There's still more to tell, so send today for the whole information package.

★Trademark of AMP INCORPORATED



A-MP★ products and engineering assistance are available through subsidiary companies in: Australia • Canada • England • France • Holland • Italy • Japan • Mexico • West Germany

VISIT US AT THE WESCON SHOW AUGUST 25-28, BOOTH 209-212

# HIGH RELIABILITY in Frequency Control Devices from Reeves-Hoffman's COLD WELD TECHNIQUE



## EXPLOSION TESTS RUPTURE THE HOLDER, NOT THE SEAL

Explosion tests, designed to determine the reliability of the cold weld, consistently result in rupture of the holder, not the seal. Tests were photographed (as shown in center and right photos above) with a high speed movie camera at 3000 frames per second.

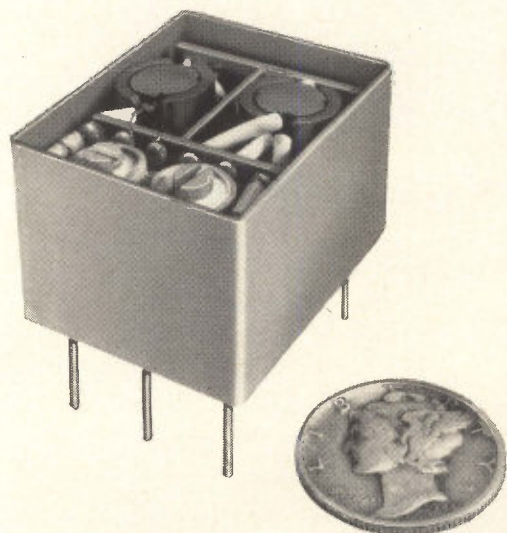

## HIGH RELIABILITY, MINIATURE FILTER

is actually two units in one. Each can be used independently and is controlled by two crystals in cold-welded holders. Each has a center frequency in the 500 kc region. This filter, designed to customer requirements, has the following approximate characteristics: bandwidth at 3 db is 0.1% of center frequency—at 20 db, 0.3%—at 30 db, 0.5%.

Reeves-Hoffman's new cold welding process provides crystal holder seals with a leak rate reliability of more than 100,000 times better than the requirement of MIL Spec 3098. Elimination of solder, and attendant flux and heat, removes undesirable damping and corrosion . . . solve problems of thermal isolation. The result: substantial increases in the reliability and stability of crystal units, oscillators and filters . . . further opportunity for miniaturization . . . faster delivery . . . lower cost.

Cold-welded holders have enabled Reeves-Hoffman to produce precision crystals no larger than power transistors. These units are much more rugged, many times lighter, and much smaller than their glass-enclosed equivalents. As proof of their ability to withstand severe environmental conditions, Reeves-Hoffman crystal units in cold-welded holders are being used in the Mariner space probe that will soon be on its way to Mars.

Reeves-Hoffman production crystals, from 1 kc to 100 mc, are available in cold-welded holders for use in networks of your own manufacture, or as components of Reeves-Hoffman filters, oscillators or standards.

SEE COLD-WELDED UNITS AT WESCON BOOTH 549

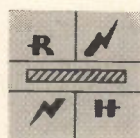

# REEVES-

# HOFFMAN

CARLISLE, PENNSYLVANIA

DIVISION OF DYNAMICS CORPORATION OF AMERICA

Frequency Range	0-1500 mc	Silver Plated		Frequency Range	0-1500 m
VSWR	Less than 1.1 to 1	Break before make		VSWR	Less than 1.1 to
Insertion Loss	Less than 0.1 db	Single Pole	1 position	Insertion Loss	Less than 0.1 d
Cross Talk Rejection	Over 70 db	Single Pole	3 position	Cross Talk Rejection	Over 70 d
Impedance	50 ohms	Single Pole	4 position	Impedance	50 ohm
Input Power	100 watts	Single Pole	5 Position	Input Power	100 watt
Operating Life	100,000 cycles	Single Pole	6 position	Operating Life	100,000 cycle
Connectors	BNC, TNC, N	4 Poles	2 position	Connectors	BNC, TNC,
Operating Temperature	-55° to +85°C		2 position	Operating Temperature	-55° to +85°
2 Poles	2 position	Operating Temperature	-55° to +85°C	2 Poles	2 positio
4 Poles	2 position	Connectors	BNC	4 Poles	2 positio
Single Pole		Operating Life		Single Pole	6 positio
Single Pole		Operating Life		Single Pole	5 Positio
Single Pole		Cross Talk Rejection		Single Pole	4 positio
Single Pole		Insertion Loss		Single Pole	3 positio
Break before make		Impedance		Single Pole	2 positio
Silver plated		Input Power			
Break before make		Operating Life			
Single Pole		Operating Life			
Single Pole		Cross Talk Rejection			
Single Pole		Insertion Loss			
Single Pole		Cross Talk Rejection			
Single Pole		Insertion Loss			
Single Pole		Operating Life			
Single Pole		Operating Life			
Single Pole		Connectors			
4 Poles		Operating Temperature			
2 Poles		Operating Temperature			
Operating Temperature		Connectors			
Connectors		Operating Life			
Operating Life		Input Power			
Input Power		Impedance			
Impedance		Cross Talk Rejection			
Cross Talk Rejection		Insertion Loss			
Insertion Loss		VSWR			
VSWR		Frequency Range			
Frequency Range					

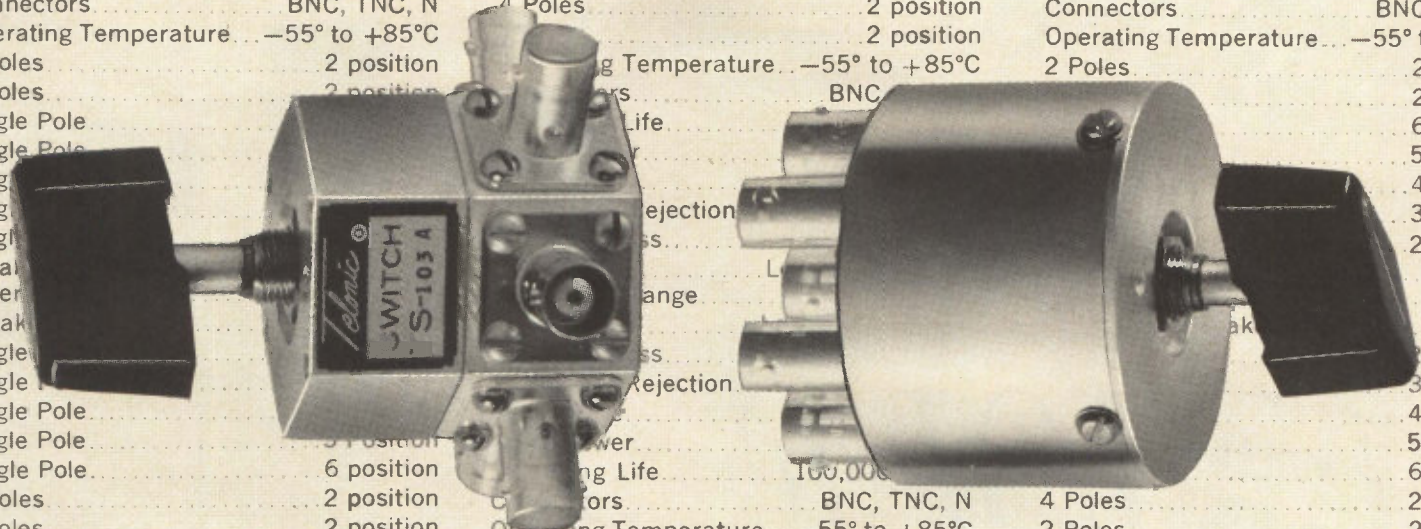

# Telonic Coaxial Switches (0 to 1500 MC) with SPECS TO SPARE

Telonic engineers have given you plenty of elbow room when they designed the manually operated coaxial switches shown above. Their specifications are well in excess of normal requirements. The frequency range, for example, covers the microwave band, video, VHF and UHF signals. Other specs such as minimum insertion loss (less than 0.1 db at 1000 MC), low VSWR (less than 1.1 to 1 to 100 MC) and negligible cross talk rejection (over 70 db at 1000 MC) are meant to impress. The coaxial switch allows you to monitor, align, and adjust several RF and IF circuits without changing cable connections. Time generally allotted for quality control is dramatically reduced. Telonic coaxial switches are lightweight and low cost, yet have silver plated, self-cleaning switch contacts for positive action and long life. Off-the-shelf delivery of most models. Models available include: double pole, double throw; 4 pole, double throw; and single pole from two to six positions. All units are available with ganged wafer switch sections so that DC and low frequency circuits can be switched simultaneously with the coaxial RF Section. Write for data.



**60 North First Avenue, BEECH GROVE, INDIANA**  
 Representatives in: Baltimore, Boston, Chicago, Cleveland, Dallas, Dayton, Denver, Huntsville, Indianapolis, Los Angeles, New York City, Orlando, Philadelphia, San Francisco, Seattle, St. Louis, Syracuse and principal cities throughout the world.  
 • SWEEP GENERATORS • RF ATTENUATORS • CW OSCILLATORS • COAXIAL SWITCHES

Circle 51 on reader service card

# UNIQUE...

*first low level solid-state unit joins industry's most versatile line of telegraph relays*

Radiation's new solid-state low level to high level neutral relay is the first of its kind. The unit, Model 9338, is designed for such applications as conversion of low level computer outputs to higher telegraph levels, and for computer/computer switching.

This advanced relay features modular construction and unlimited service life without maintenance. Because it operates at an input level of  $\pm 6$  v at 50 to 100  $\mu$ a, conducted and radiated RFI are greatly reduced.

Radiation Telegraph Relays are supplied with octal bases in three standard models (at right). They can replace all electromechanical units except in rare applications. These versatile units are completely solid state, and are powered by input loop current alone.

Special Plug-In Adapters are available in all popular types (examples at right), and permit you to update your present system easily and quickly. Radiation can also supply special adapters, units wired for direct replacement, or devices on plug-in printed circuit cards.

All Radiation Solid-State Relays operate at speeds up to 2400 bits/second with less than 3% distortion. Input is essentially resistive. They do not induce transients in the line as do electromechanical units. And a unique Radiation circuit protects inputs against abnormal line conditions such as spikes and overvoltages.

In addition, Radiation Relays are extremely resistant to environmental extremes. They require no adjustment, and will operate for an indefinite period of time without attention.

Radiation engineers will be glad to assist if you have a unique application or would like help in evaluating system requirements. Write for information, or describe your needs. Products Division, Dept. EL-08, Radiation Incorporated, Melbourne, Florida.



**RADIATION**  
INCORPORATED

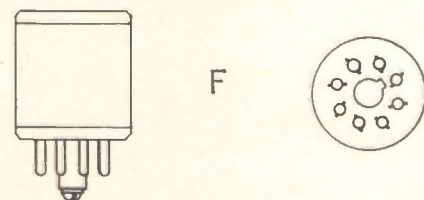
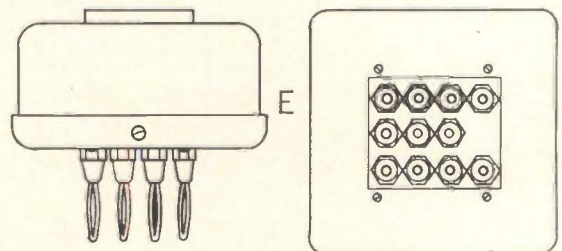
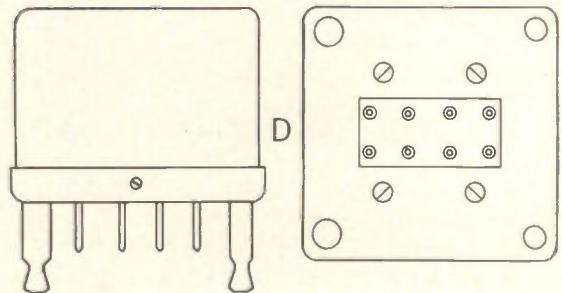
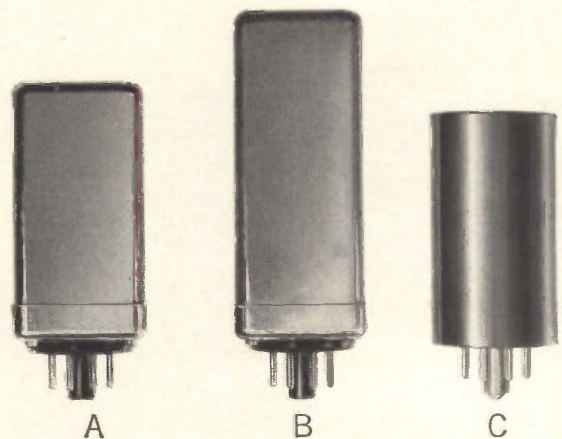

## RADIATION SOLID-STATE RELAYS

Type	Model	Body Size	Figure
Neutral	9214	1.46 x 2.86	A
Neutral	9220	1.46 x 2.86	A
Polar	9212	1.46 x 3.66	B
Univ.	9218	1.38 x 2.63	C
Low Level	9338	1.38 x 2.63	C

Note: Other configurations are available, including plug-in circuit cards.

### Standard Plug-In Adapters

Octal-to-Western Electric 255-A	D
Octal-to-Western Union 202-A	E
Octal-to-Octal	F

Note: Other adapters are available, or units can be wired for direct replacement.

# SELECTED FOR THE MINUTEMAN PROJECT

*More than 6 million El-Menco Dipped Mica Capacitors have been used in the Minuteman ground support and control equipment.*

**After 64,000,000 ACTUAL TEST unit-hours at 85°C with 225% of the rated DC voltage applied, no failures of any type occurred.**

The accumulated  $64 \times 10^6$  test unit-hours without any failures can be used to calculate many different failure rates depending upon the confidence level desired. However, we shall explore the meaning of the results at a 90% confidence level.

Assuming no acceleration factor for either temperature or voltage, we have verified a failure rate of less than 0.004% per 1000 hours. (Actually, there is a temperature effect and it has been found that, with the DC voltage stress remaining constant, the life decreases approximately 50% for every 10°C rise in temperature. There is also a voltage effect such that, with the temperature stress remaining constant, the life is inversely proportional to the 8th power of the applied DC voltage.)

Assuming no temperature acceleration factor and assuming the voltage acceleration exponent is such as to yield an acceleration factor as low as 100, we have nevertheless verified a failure rate of less than 0.00004% per 1000 hours.

Assuming no temperature acceleration factor and assuming the voltage acceleration factor is on the order of 250 (test results are available to confirm this) we have accumulated sufficient unit-hours to verify a failure rate of less than 0.000015% per 1000 hours!

*All above failure rates are calculated at a 90% confidence level!*

Write for a complete reliability study on your company letterhead.

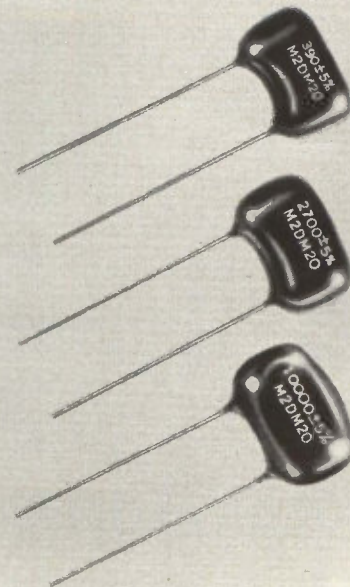

**DIPPED MICA  
CAPACITORS  
TYPE M2DM**

**THE ELECTRO MOTIVE MFG. CO., INC.**

MANUFACTURERS OF

**El-Menco**  
*Capacitors*

**WILLIMANTIC, CONNECTICUT**

*Dipped Mica • Molded Mica • Silvered Mica Films • Mica Trimmers & Padders  
Mylar-Paper Dipped • Paper Dipped • Mylar Dipped • Tubular Paper*

ARCO ELECTRONICS, INC., Community Drive,  
Great Neck, L. I., New York  
*Exclusive Supplier to Jobbers and Distributors  
in the U. S. and Canada*

*West Coast Manufacturers Contact!*  
COLLINS & HYDE CO., 1020 Corporation Way  
Palo Alto, California  
5380 Whittier Boulevard, Los Angeles, California



(See it at Wescon)

## A family of FREON<sup>®</sup> liquid dielectric coolants

The TV set above operates *continuously* while immersed in FREON 113<sup>®</sup> fluorocarbon, one of our family of five moderate-cost dielectric coolants listed at right. Obviously, only a top dielectric could let the high-voltage circuitry operate. But the FREON also keeps the components at safe temperatures because, by boiling or by convection, it is an efficient *heat-transfer medium*.

You don't make TV sets? Fine. But think what these inert coolant liquids could do in your own electronic or electrical design—wherever you have a reliability problem from "hot spots" in power tubes, transistors, transformers, packaged electronics, etc. At low to moderate cost, these FREON coolants can make your design more compact—while improving reliability through close temperature control!

These five FREON dielectric coolants range in boiling point from +38°F. to +237°F., so the field of possible use is very large. We'll help you develop any ideas you have! First step, *send the coupon* or Reader

Service Card for complete technical information, based on our 33 years' experience with cooling problems!

FREON-114	CClF <sub>2</sub> CClF <sub>2</sub>	B. P. +38°F.
FREON-113	CCl <sub>2</sub> FCClF <sub>2</sub>	B. P. +118°F.
FREON-215	CCl <sub>2</sub> CF <sub>2</sub> CF <sub>2</sub>	B. P. +165°F.
FREON-112	CCl <sub>2</sub> FCCl <sub>2</sub> F	B. P. +199°F.
FREON-214	CCl <sub>3</sub> CF <sub>2</sub> CClF <sub>2</sub>	B. P. +237°F.

**FREON<sup>®</sup>** dielectric coolants



BETTER THINGS FOR BETTER LIVING . . . THROUGH CHEMISTRY

Du Pont Co., FREON<sup>®</sup> Products Division  
N-2420E-3, Wilmington, Delaware 19898

Please send technical data on FREON<sup>®</sup> dielectric coolants.

Name \_\_\_\_\_ Title \_\_\_\_\_

Company \_\_\_\_\_

Address \_\_\_\_\_

Any particular uses in mind? \_\_\_\_\_



# familiar faces from the world's broadest line of indicating relays

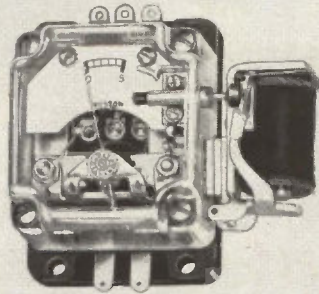

*Model 813 Miniature* — compact and lightweight; sensitive and Sensitrol (magnetic) contacts; single or double contact; ranges as low as 2-0.2  $\mu$ a.

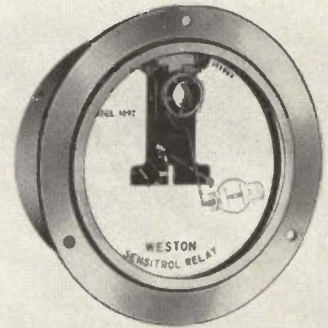

*Model 1092 Sensitrol*—low cost; all purpose; magnetically shielded; wide range adjustability; ideal for use in engineering breadboard circuits.

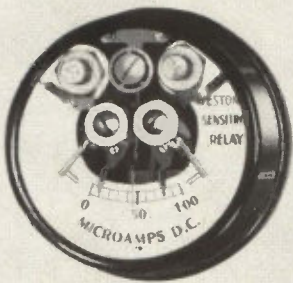

*Model 705 Sensitrol*—highly sensitive; surface or flush mounted; single or double, fixed or adjustable contact; ranges as low as 0.5-0.0.5  $\mu$ a.

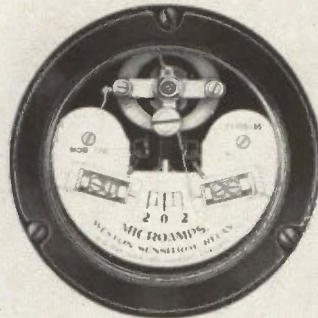

*Model 723 Sensitrol*—sealed; shielded; internal reset; solder terminals; single or double magnetic contact; ranges as low as 1-0.1  $\mu$ a.

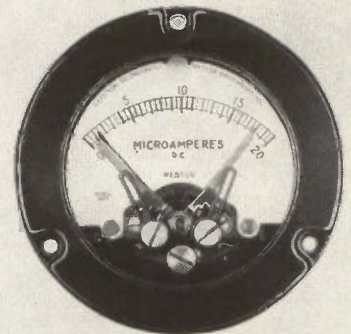

*Model 1097 Ruggedized 3 1/2" Relay*—LCCA type fully meets applicable portions of military ruggedized spec; sealed; long scale; shielded; solder terminals; single or double adjustable contacts.

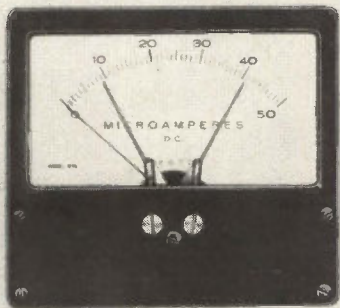

*Model 1075 Photronic*—operates without physical contact; single or double adjustable set points; continuous reading beyond set point; taut band frictionless mechanism; solid state switching circuit; ranges from 10  $\mu$ a.

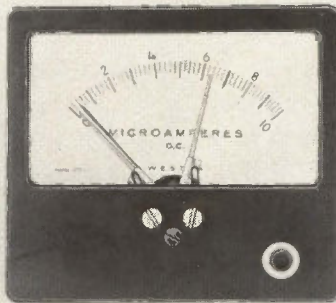

*Model 1073 Mag Trak*—long scale; shielded; positive contact; combines LCAA with magnetic attraction; self-contained reset; single or double adjustable contacts, ranges from 10  $\mu$ a.

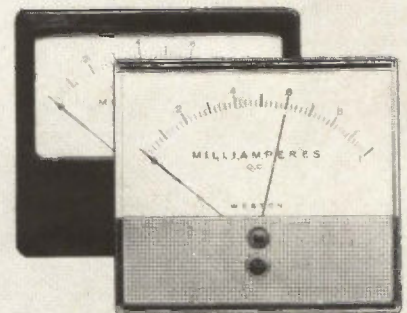

*Model 1930/1940 Photronic*—3 1/2" and 4 1/2" in either bakelite or plastic front; low cost; add-on power supply and solid state switching circuit; shielded; non-physical, adjustable contact.

world's standard in measurement and display

**WESTON**  
INSTRUMENTS & ELECTRONICS

614 Frelinghuysen Ave.,  
Newark 14, New Jersey  
Division of  
Daystrom, Incorporated

Circle 55 on reader service card

All-crimp hermetic multi-pin breakthrough...

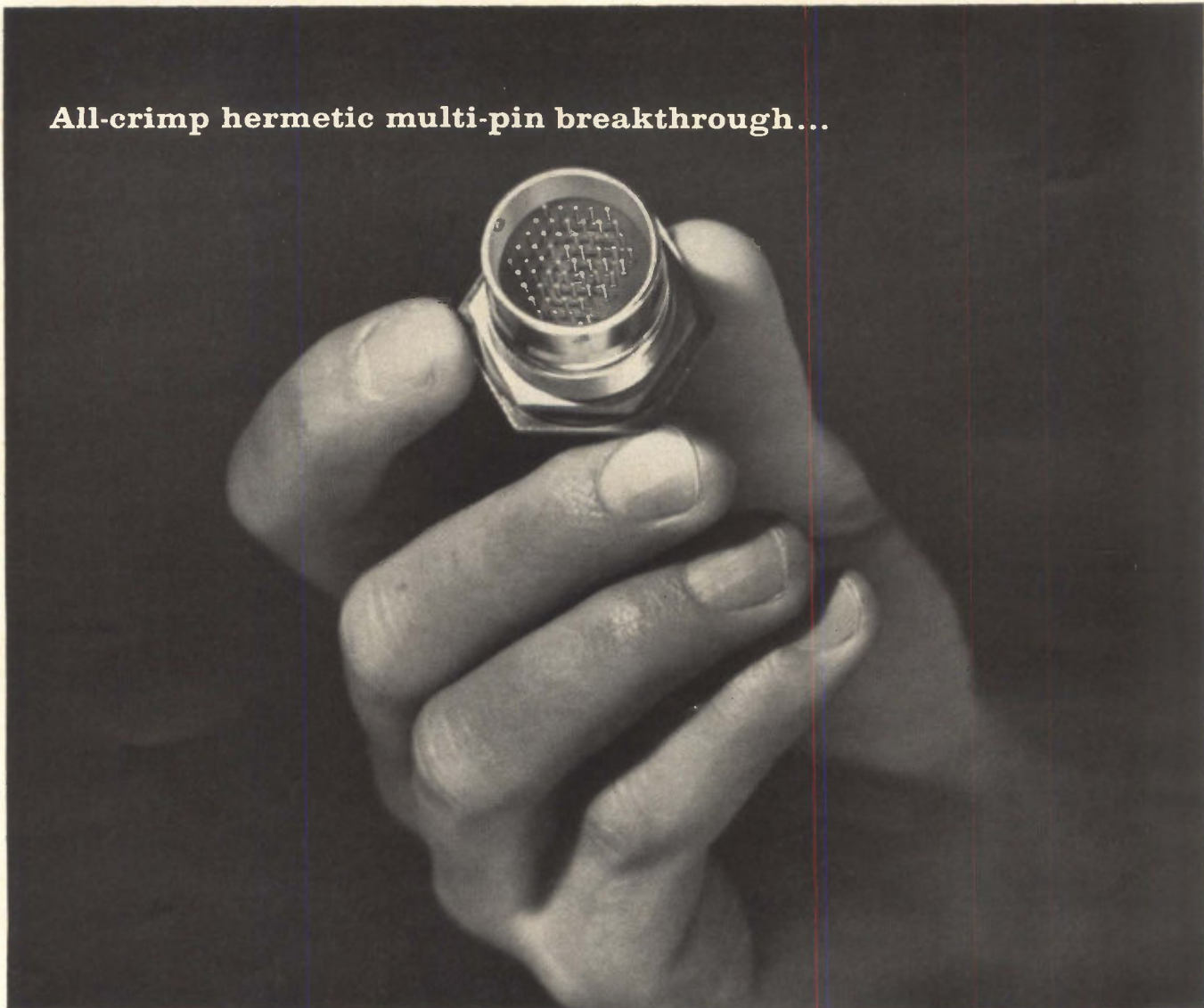

## SOMEDAY MIL-SPECS WILL REQUIRE WHAT THIS NEW MICRODOT CONNECTOR PROVIDES TODAY

You're looking at a revolutionary hermetic design utilizing crimp-type contacts in a multi-pin layout. Developed by Microdot Inc., it represents an important breakthrough in connector technology. For example, leakage rate exceeds the requirements of MIL-C-26482 and MIL-C-26500B by a factor of approximately 100; temperature rating is from  $-67^{\circ}\text{F}$  to  $+257^{\circ}\text{F}$ ; insulation resistance is more than 5000 megohms between pins; the connector is rated for 1000 V test, 750 V rms working at sea level, 350 V rms at 70,000 feet.

The unique Microdot design results in a superior strength seal by compression bonding the glass

insert within its hermetic housing. Up to 61 double-ended pins spaced on 80 mil centers can be embedded in this insert. **No heat damage can occur . . . not to the glass seal, not to the insulation!**

Behind the insert is an insulator with the appropriate number of recesses containing *crimp-type power sockets*. A spring-loaded follower assembly keeps the insulator immune to vibration. Standard interchangeable parts are used wherever possible and only a standard hand crimping tool is required for connecting conductors to sockets.

This state-of-the-art breakthrough could not have been anticipated

when present MIL-SPECS were written. But because this connector far exceeds these MIL-SPECS, numerous deviation requests have been initiated by subcontractors and it is now incorporated in their military equipment. Doesn't your equipment deserve the latest, newest connector?

*For full information on the industry's first hermetically sealed, circular, multi-crimp connector, write direct or use reader service card.*

See us at Wescon  
Booth 2003-4-5



**MICRODOT INC.**  
220 Pasadena Ave., South Pasadena, Calif.

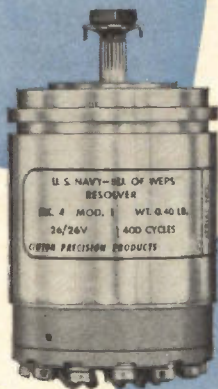

**SIZE 15**

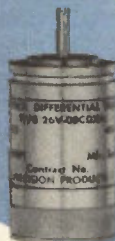

**SIZE 8**

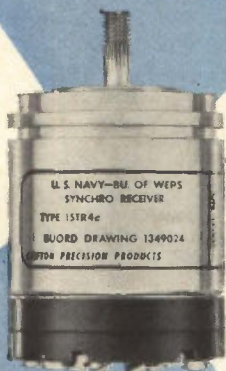

**SIZE 15**

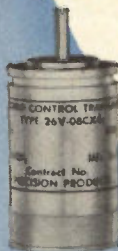

**SIZE 8**



**SIZE 11**

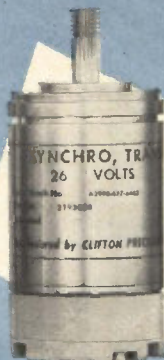

**SIZE 11**

# cppe II for BuWeps Synchros



Clifton Precision is building a wider and wider line of BuWeps synchros. Size 8 CX's, CT's, and CD's are the latest. 115 volt and 26 volt size 11's were introduced some time ago. The 15's we have been building for years. Clifton has BuWeps synchros operational in the important Terrier and Talos shipboard missiles. Think of Clifton for BuWeps synchros. Think of Clifton for *quality* rotating components! For further information, contact: Sales Dept. 215 MADison 2-1000, TWX 215 623-6068— or our Representatives.

**CLIFTON PRECISION PRODUCTS**

*Division of Litton Precision Products, Inc.*

cppe  
II

Clifton Heights, Pa.  
Colorado Springs, Colo.

## **ES** Product of the month: GUARANTEED INSTRUMENT MOTORS



As a direct result of its experience in designing and producing electric motors and power systems for military applications, Electronic Specialty has developed a complete line of high quality, reliable sub-fractional horsepower motors—Series 0211—for industrial instruments such as strip chart recorders. All units carry a two year guarantee on the motor and the gear train. These competitively priced motors meet or exceed NEMA specifications and include normal and high slip induction, reluctance synchronous, hysteresis synchronous, and low inertia servo designs, with and without gearheads. **The 0211 Series incorporates:** encapsulated windings; close tolerance through-bore construction; low noise Delrin gears in primary stages; heavy duty, standard-pitch gears in secondary stages for reliability; hardened steel motor pinions; stainless steel shafts; die cast rotors; interchangeability with existing designs; standard NEMA class 2-11 frame sizes and ratings. Thirty standard gear ratios are available off-the-shelf; other gear ratios can be provided upon request.

For further information write to William Marcy, Director of Marketing, address below.

**ES** is a diversified, dynamic, multi-divisional organization serving defense and industry over a broad range of vital areas with advanced systems, sub-systems, and state-of-the-art components. Major contributions are currently being made in the following:

### **ELECTRONIC AND ELECTROMECHANICAL CONTROLS:**

gyroscopes, relays, static switching devices, sensors, flashers, regulators, converters, rotary and linear actuators, motors, generators, weapon and camera controls, electromechanical assemblies for aerospace applications.

### **COMMUNICATIONS:**

antennas, flexible and rigid waveguides, coaxial switches, diplexers, power dividers, filters, radio telescopes, solar furnaces, matching networks, antenna drive motors and controls.

### **POWER:**

precise power systems, dynamotors, computer power sources, motor-generators, actuators, starter generators, power conversion systems, transmission towers for public utilities.

### **SPACE CONDITIONING:**

electronically programmed environmental controls and systems for industrial, commercial, and military applications.

### **SYSTEMS:**

Systems Laboratories conduct research, development and study programs in reconnaissance, electronic countermeasures, interferometer phased array systems, and total energy packages; integrating divisional components, sub-systems, and specialized technical skills.

*For information concerning the corporate systems capability, product line, or research and development programs, write to the Director of Marketing, address below.*

**ES ELECTRONIC SPECIALTY CO.**  
5121 SAN FERNANDO ROAD, LOS ANGELES, CALIFORNIA 90039

# Technical articles

---

## Highlights

---

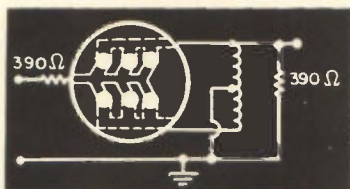

### Wescon preview: page 60

This year's technical program is a mixed bag of West Coast technology. The emphasis on tutorial articles reflects the region's concern about sagging business. Also, **How Wescon and the West do business**, page 103. New products at the show starts on page 121.



### Understanding pnpn devices: page 66

Four-layer pnpn semiconductor devices are versatile: They can switch, control, rectify and latch current. Their ratings vary from a few microwatts to voltage ratings of 1,000 and higher.



### Drivers for optical diodes: page 77

A variety of applications have put the semiconductor light-emitting diode to work in communications, computers and military equipment. An essential to proper application is how to drive them. Here are some suggested transistorized circuits.



### Early bird—bigger and better: page 90

The first commercial communications satellite will be more powerful and versatile than any yet launched. Its design has profited from lessons learned with earlier satellites.

**Coming  
August 24**

- A survey of logic trainers
- Where to use ceramic tubes
- More on learning machines
- A new technique for dense recording

## Wescon preview

The technical program is a mixed bag of West Coast technology with a few Eastern and Midwestern contributions. It reflects the anxieties of the hard-hit industry.

By Lewis H. Young\*

Editor

When the Western Electronic Show and Convention opens in Los Angeles on August 24, showgoers will sense the tension in the industry and the pall that hangs over it. Military electronics is king on the West Coast but the king's crown is slipping. A leveling off of spending on military projects coincided with the phasing out of major tactical projects in the Pacific area. The result was unprecedented unemployment among engineers and some sales declines among companies.

Wescon's technical program (page 64) mirrors the unsettled and anxious feelings on the West Coast. It offers more tutorial sessions than ever, hopefully to retrain some of the engineers who found their specialties wiped out by the end of major projects. It explores microelectronics more thoroughly than was expected. This emphasis reflects the concentration of suppliers around the San Francisco Bay area and the hope that microelectronics will pull the West Coast out of its electronic doldrums. Still, a lot of the papers report on work in military projects.

If the organizers of Wescon had hoped the conference would spur the regional economy, they missed the mark. Too few of the papers hold much promise for diversification or the new business the Western firms pine for. One session on the automation of steam electric generating plants is probably too narrow for many of the military contractors who would like an introduction to commercial applications. Another, on automatic control, stresses military applications exclusively. Still a third, on extra high voltage direct-current transmission, will make a lot of engineers wonder why it is even on the program.

The program is heavy with papers on microwave

—microwave tubes, microwave systems, and millimeter waves—though the microwave segment of the industry is probably the sickest. Almost every paper reports a military application; none touches on the industrial applications that are the expressed goal of almost every microwave company.

This year Wescon has only one session on lasers, realistically reflecting the rear seat the device has taken temporarily. Unfortunately none of the papers tackle the number one laser problem: finding practical applications.

Despite its faults, the Wescon program is a sampling of West Coast technology—with a few Eastern and Midwestern contributions. Here are some highlights.

### Microelectronics

Probably the one subject that will generate the most interest at Wescon is microelectronics. Three sessions (A, two, and 18) are devoted to integrated circuits and thin-film components. But the subject overflows into many other sessions too.

Linear microcircuits have been used sparingly because of sticky manufacturing and design problems. But David Breuer, TRW Space Technology Laboratories, has examined one aspect of such linear circuitry—high frequency d-c amplifiers (paper no. 2.2). His starting point is advanced processing: epitaxial techniques, small-geometry components, and thin-film resistors.

Breuer suggests a circuit organization which he calls spaf for series parallel alternate feedback. With this design, parasitic capacitances developed in the integrated circuits are not necessarily detrimental. In fact Breuer claims they can enhance the circuit's performance.

One of his designs uses triple-diffused components. A second has thin-film resistors and buried-layer epitaxial active components.

What makes spaf worth noting are the amplifiers gain-bandwidth characteristics, better than any yet

\*With reports from Los Angeles by Harold Hood and Ron Lovell; San Francisco, Laurence D. Shergalis; and Chicago, Cletus M. Wiley.

achieved. The miniaturized amplifiers can be used in high-speed computers where it is desirable that a tiny amplifier match the small size of thin-film memory planes.

Most microcircuits operate best within specified—sometimes very narrow—temperature limits. That's why a technique for controlling the temperature of microcircuits is intriguing. B. Weir and T. Prosser of Amelco Semiconductor, Mt. View, Calif., will describe a microcircuit controller that stabilizes the temperature of another integrated circuit in a header can (paper no. 18.4).

In effect, their device is a resistance heating element controlled by a sensor that is a wheatstone bridge. Two tantalum resistors, with negative temperature coefficients, and two silicon resistors, with positive coefficients, make up the four arms of the bridge. The bridge balances at only one temperature. An error voltage from the bridge is magnified by a differential amplifier to turn the heating elements on or off, depending on the polarity of the d-c output from the bridge.

If the temperature in the header falls below a predetermined value (in the author's example, 100° C.), the bridge energizes the heating resistors until the temperature reaches 100° C. At present the device works only to raise temperature. It cannot cool (see figure at right).

The entire control—sensing bridge, error amplifier, and heater—is contained on a single silicon chip soldered to a small heat sink. Taps on one of the tantalum resistors allow the temperature control point to be adjusted.

Because there are still no two-dimensional inductive components for integrated or thin-film circuits, designers devise interesting ways around inductance. In the paper "Quartz/Uni-wafer filter, a thin-film device" (paper no. 18.2), four engineers from the Clevite Corp., Cleveland, Ohio—one of the few Eastern influences at the show—discuss an approach to the design of quartz filters and resonator networks.

Clevite deposits thin-film electrodes on a single quartz wafer to build a complete crystal filter. If the individual electroded areas are operated below the cutoff frequency for wave propagation in the crystal as a whole, the resulting vibratory energy, excited in each resonator, is confined to its electrode area, its energy decreasing exponentially with distance from the edge of the electrode. By choosing appropriate design parameters, Clevite's engineers put all the resonators required for a filter within a single quartz wafer.

This work pushes integrated circuits into still another area. With such techniques, a designer can order a crystal filter that is compatible with thin-film and integrated network systems.

So far, Clevite has built both lattice and ladder filters, for 10 and 20 Mc, with from two to nine resonators per filter.

To handle the filters, Clevite has mounted them on ceramic circuit boards using silicone rubber pads and silver-foil leads. They are protected by

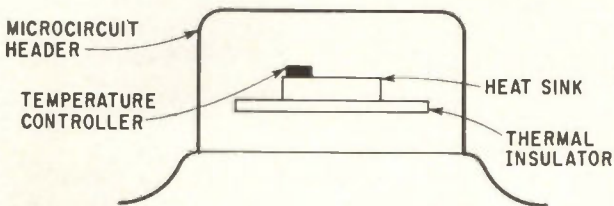
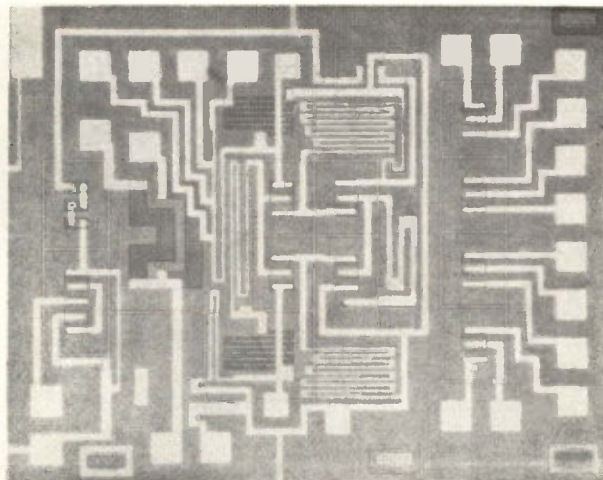

Silicon-chip temperature controller (circuit above) stabilizes temperature of microcircuit in a header.

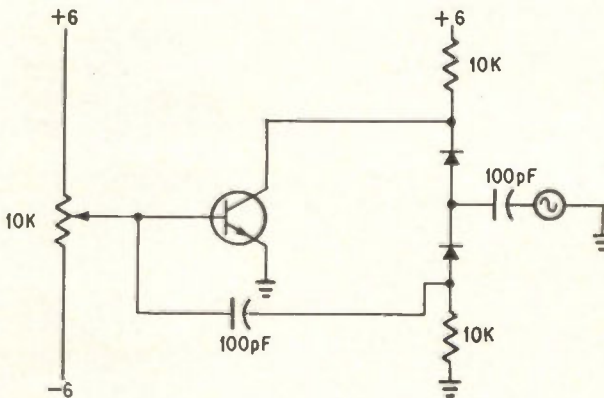

One-transistor flip-flop can be integrated. It's inexpensive and fast.

glass cover plates. In the future, the company expects to hermetically seal the filters in flat packages.

### Components

One example of how microelectronics overflows into other sessions is the one-transistor flip-flop circuit described in the session on new circuit elements and principles. B. E. Briley, Automatic Electric Laboratories, will emphasize that this circuit (paper no. 18.3) is unique because all its components can be integrated (see circuit above).

Even if they could not, the circuit would still be

interesting. The one-transistor flip-flop is less expensive, more reliable, and possibly faster-acting than more complicated units. It can change state in under 100 nanoseconds.

In his design, Briley uses a conventional bipolar junction transistor but unconventionally exploits the collector-following effect, a minority carrier phenomenon.

Here's how it works. When the base potential of a common-emitter transistor, which is saturated and has a high collector resistor, is moved rapidly to cutoff, the collector voltage follows the base and remains at its farthest point of excursion for a time before rising to the collector supply voltage. If the collector is positive with respect to ground, both diodes in the flip-flop are reverse biased and offer a high impedance path. The base receives an attenuated signal. If the base is biased so the amplitude of this signal is insufficient to make the transistor conduct, the transistor stays cut off and its collector remains positive. This condition is one stable state.

The other stable state occurs when the collector is negative. Then the diodes are forward biased and offer a low impedance path so a strong signal reaches the base. The transistor turns on.

In effect the one-transistor flip-flop is a closed circuit r-f transmission system. The collector causes the diode pair to modulate the input. A capacitor, connected to the base, serves as the transmission medium.

Possible applications of the circuit include a double-rank shift register, a radiation detector, and a delay. The register shifts comfortably at a 25-kc rate.

Because this flip-flop is sensitive to minority carrier lifetime, it can change its state if that lifetime is reduced. Thus it appears useful as a radiation detector. Since neutron bombardment of a transistor develops recombination centers that lower the effective lifetime of minority carriers, radiation could cause the flip-flop, set in its negative state, to change state and trigger an alarm.

By combining several one-transistor flip-flops into one circuit, a designer can produce a delay which is precise, variable and repeatable.

## Microwaves

In many microwave applications, there is need for a better receiver; one that is stable and has good linearity. "Microwave superhetrodyne receiver featuring electrical tuning and preselection" (paper no. 6.2) is interesting because it describes a new approach to receiver design. It tells how to build a receiver that has solid-state preselector-preamplifiers that operate at 1 to 2 Gc and 2 to 4 Gc.

Yttrium iron garnet (YIG) devices are responsible for the improved characteristics of the receiver designed at the Watkins-Johnson Co., in Palo Alto. The receivers tune fast electrically, have good linearity, good stability, and are self-protecting against overloads, and, to a certain extent, self-limiting. The authors (there are five of them)

claim sweep rates up to 100 sweeps per second.

One of the design techniques reported puts a YIG device ahead of a traveling-wave tube to prevent out-of-band signals from saturating the twt. The garnet device prevents undesirable intermodulation effects and rejects unwanted signals up to 80 db.

But using YIG devices this way raises this question: how can two or more electrically-tuned devices be tracked? The authors offer one answer. They use an operational amplifier (see figure page 63). In their receivers, the YIG devices are tuned with a precisely-controlled magnetic field. An operational amplifier drives a solenoid. The specially designed amplifier is a feedback type having a power transistor driver with complementary symmetry.

Another tough problem with this receiver design is how to build the local oscillator. It has to be linear to work with a linear filter. The authors suggest building a discriminator of two linear YIG filters. Outputs are detected and each sets off one half the bandwidth of the receiver. Or, they recommend a YIG-tuned tunnel diode oscillator. It is basically linear but develops nonlinearities at each end of its operating range.

For many years, microwave specialists have envisioned transmitting high levels of energy by microwave. Peter P. Keenan, Lockheed-California Co., believes the need for a wireless power cable in space may be the spur that will change the vision to reality. Design of large antennas that can radiate the outputs of already available superpower microwave generators make the idea technically feasible today.

In his paper, "Power beaming and high level microwave rectification," (paper no. 6.3), Keenan describes an essential link: a high level rectifier to convert the energy from a power beaming system into d-c electrical power. His report is a West Coast version of one he delivered in May at an IEEE meeting in Florida. But the Wescon paper has extensive additional background—a bow to the committee's plea for tutorial articles. In addition to describing his rectifier design, Keenan discusses the experiments of others (notably Brown at the Raytheon Co. and Goubau at the Signal Corps, Fort Monmouth, N. J.). Then he covers the theory of beam modes and compares beaming high power in wave guides to radiating antennas.

He claims high efficiencies for his rectifier: 59% with a single phase microwave cavity and 92% when modified to permit two-phase rectification. But he warns that his efficiency figures were obtained by analysis; he has no experimental results as yet.

Keenan's rectifier operates on what is called multipactor discharge. Multipactor is derived from the words multiple electron impact. A multipactor discharge consists of a thin electron cloud driven back and forth across a gap, in response to an r-f field applied across the gap. If one of the electrodes that make up the gap has a much higher secondary



# New microwave receiver

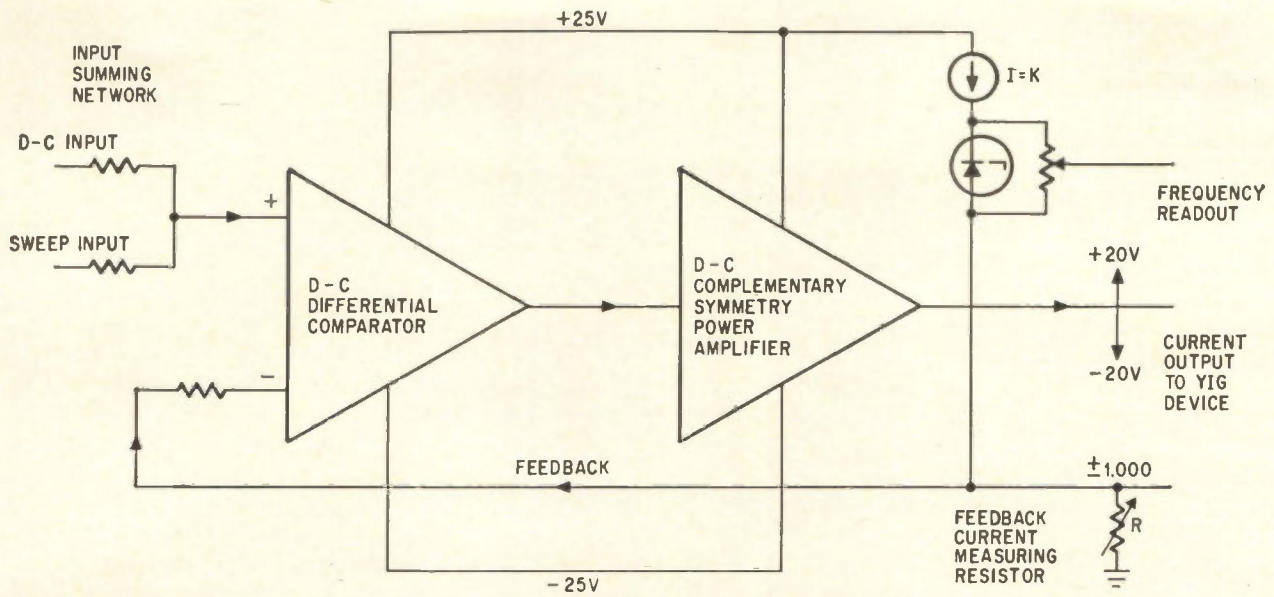

Operational amplifiers track two or more YIG tuning elements. With electrically tuned devices, tracking is a problem.

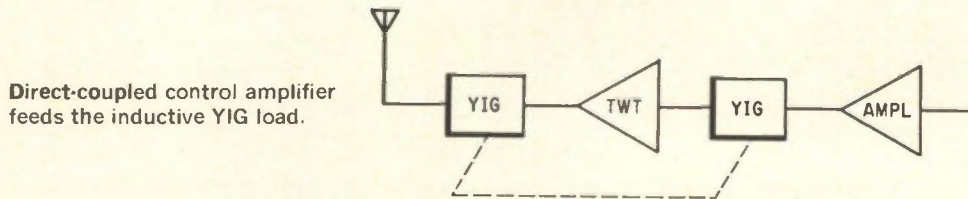

Direct-coupled control amplifier feeds the inductive YIG load.

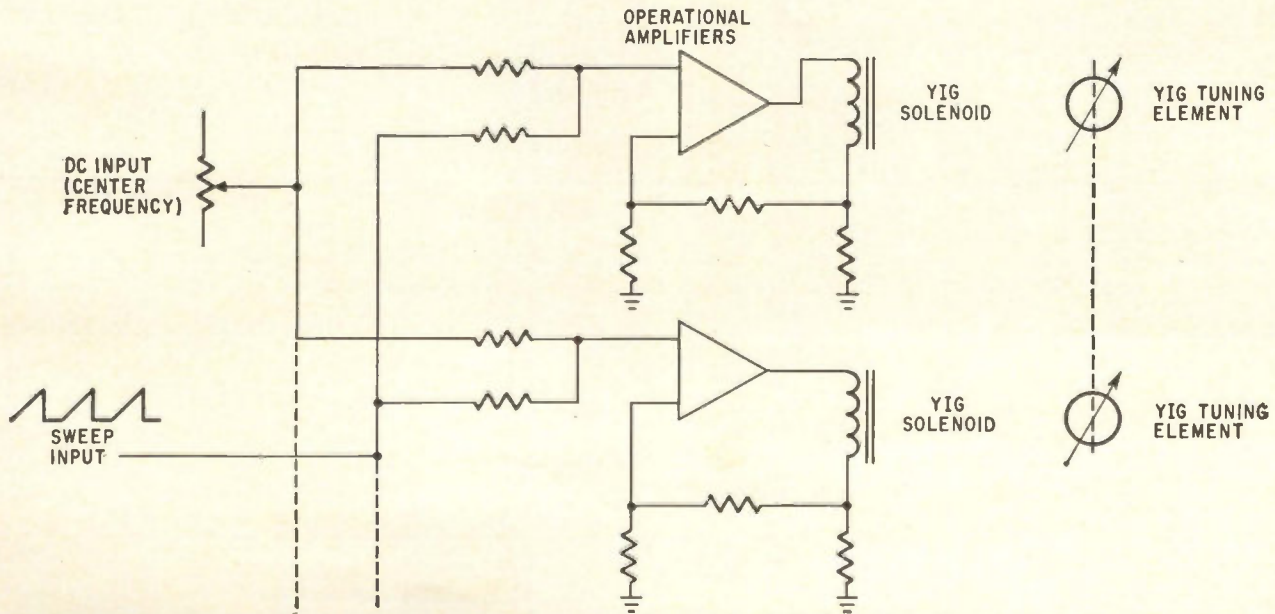

Schematic of microwave receiver with electrically tuned YIG filters, discussed in paper no. 6.2.

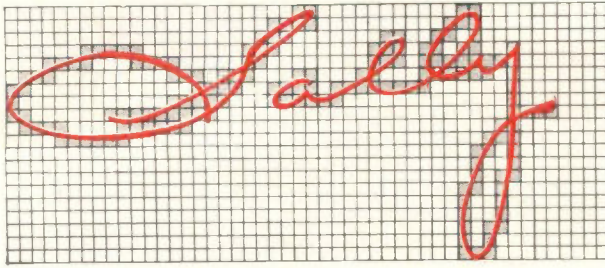

Grid breaks handwritten name into 980 cells for computer to study.

emission coefficient than the other, electrons will flow from the high emitter to the low emitter, thus rectifying the current. This is half-wave rectification with an efficiency of only about 24%. Keenan is interested in the more efficient full-wave rectifier.

To make a full-wave rectifier, he employs a reentrant microwave cavity. Secondary emitting electrodes are placed at the center of the cavity where the electric fields are concentrated.

Although a lot of the pieces are available now to make it possible to beam microwave power, Keenan does not expect an immediate acceptance. In Florida, he admitted, "It is still pretty far out." But someday his device may have applications in space power systems or as a sensor for laser beams.

### Pattern recognition

In many laboratories, engineers are wrestling with the problem of building a machine that can read handwriting. So far nobody is close to coming up with a commercial device and one aspect of the problem will be discussed at Wescon by Frank N. Marzocco, the System Development Corp. (Paper no. 8.2): "Computer recognition of handwritten first names."

Marzocco inserted a learning program, incorporating a version of stimulus-sampling theory, into a digital computer. Handwritten signatures were coded on a grid which served as input to the program. Under one condition, the computer examined only those grid cells in which a part of the pattern fell; in another condition, each of the 980 grid cells was examined.

One purpose of the study was to determine the amount of preprocessing needed to obtain effective

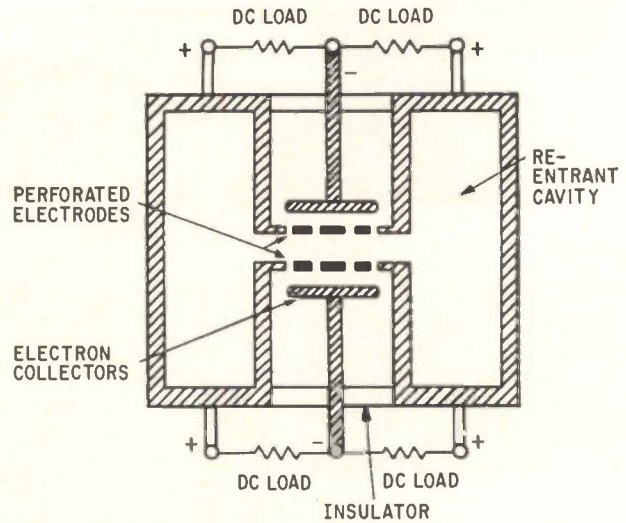

Full-wave rectifier for high power microwaves needs no filaments, anode power supplies nor magnetic fields.

recognition of handwritten words, Marzocco now believes less preprocessing is required than had been assumed previously.

The reason is that some of the items deemed essential for preprocessing—such as the isolation into the number of loops or the number of times the loops cross some horizontal line—are implicit in the binary coding used by the researchers. No special techniques are needed to isolate these characteristics.

This work is similar to that reported at Wescon last year by Bernard Widrow's group at Stanford University. But Marzocco started with a different point of view. A psychologist by training, he used stimulus-sampling models and his mathematical formulations were quite different from those of the Stanford group. Still unresolved are all the similarities and differences between Marzocco's work and the studies of the Stanford Group and between Marzocco's work and the pattern-recognition studies conducted by the Perceptron group at Cornell University.

### Instruments

Not surprisingly, a number of papers will

### Wescon sessions

Tuesday	A. Microelectronics	1. Microwave tubes	2. Microelectronics
Wednesday	B. Instrumenting the sea floor—why and how	6. Microwaves	7. Component parts
	C. Extra high voltage direct current transmission		
Thursday	D. Information sciences	11. Millimeter waves	12. Silicon devices for high frequencies
Friday	E. Apollo electronics—design and present status	16. Antennas	17. Lasers

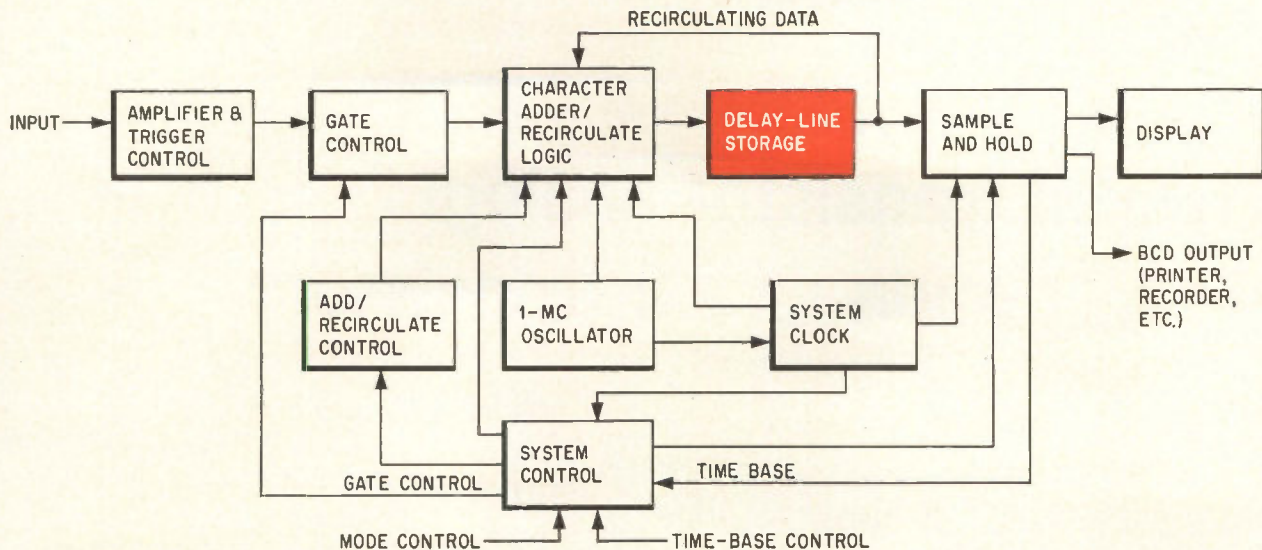

Delay line replaces logic element flip flops in new counter.

describe commercial products to be introduced soon on the market. Some of these incorporate interesting technological advances and are worth noting. For example, one presentation, "Digital counter utilizing dynamic memory" (paper no. 14.1), describes a counter with a delay line instead of conventional flip-flops. The device was shown as a prototype at the IEEE show last March.

In the new counter, the delay line memory stores time-base and accumulated count data. Its major advantage is increased reliability because there are no logic elements and high speed. The delay lines operate at a propagation rate which allows data to enter at any point on the line at least once a microsecond. The instrument can run at rates up to 2 Mc.

The author, D. E. Lehmer, Berkley division, Beckman Instruments, Inc., believes this device is the first laboratory instrument to use serial dynamic logic. It is a fully clocked system and synchronous.

Normally, a conventional system with logic flip-flops can be built for about one fourth the cost of a synchronous one. However Beckman's device, with its electromagnetic delay-line accumulator, replaces enough binary elements to make its cost compar-

able to a conventional counter with a logic accumulator—even though it is synchronous.

Data is stored in bit-parallel, character serial form, using a decimal coding which has a biquinary form.

#### Turbulence

Two other papers are worth noting as a sign of the turbulent times on the west coast.

The Clevite Corp.'s West Coast semiconductor division is keeping a tight-lipped silence about paper no. 12.1, "Surface controlled avalanche transistor". Rumors say it will describe a new transistor that switches high power at high speed, up to 7 Gc. To build suspense, Clevite's paper will be presented by William Shockley, one of the developers of the original transistor at Bell Telephone Laboratories and now a Clevite scientist.

Paper no. 2.4 has been cancelled and will not be presented. It was to describe an integrated-circuit differential amplifier fabricated by the Molecro Corp. But a management change at the company swept out the chief author who was also the president. Now the new management has no interest in this development.

- |  |   |  |
|--|---|--|
| 3. Learning systems                      | 4. Automatic control                          | 5. Electron devices in the power industry          |
| 8. Pattern recognition                   | 9. Static power conversion and control        | 10. Automation of steam electric generating plants |
| 13. Information theory and communication | 14. Instrumentation and navigation            | 15. Power communications and protective relays     |
| 18. New circuit elements and principles  | 19. Data handling and communications in space | 20. Power transmission and distribution            |

# Helpful transistor analog: 4-layer pnpn $\approx$ 2 transistors

Characteristics of pnpn devices are discussed in terms of the now-familiar type transistors to help designers understand how and where to use them

By Richard A. Stasior

General Electric Co., Syracuse, N.Y.

**Four-layer pnpn** semiconductor devices are versatile, efficient and inexpensive circuit elements. They are the equivalent of pnp and npn transistors connected in a positive feedback configuration but circuits designed with them have fewer connections, fewer parts and tighter parameter limits than possible with two separate transistors. And costs are lower.

The devices can switch, control, rectify and latch current, and are capable of extraordinary gain in inexpensive circuits. The smallest four-layer rectifier can be triggered in a few microseconds with control signals of only a few microwatts; large ones are capable of voltage ratings to 1,000 volts and higher.

The two-transistor analog suggests many different applications. A four-layer pnpn diode can be used as a cross-point switch in telephone applications. Pnpn silicon controlled rectifiers, scr's, have been used for motor speed control, light dimmers, voltage regulators, voltage inverters and thyatron replacements. More recently, they have joined pnpn silicon controlled switches, scs's, to invade the low-power industrial control market as neon and incandescent lamp drivers, solenoid drivers, ring counters, voltage-threshold sensors and d-c current amplifiers. In these applications, pnpn's feature pulse-actuated latching characteristics, low drive requirements and the ability to operate from a-c or d-c power.

In space applications, the small size, low weight and simple circuits of scs ring counters allow them to compete favorably with equivalent transistor circuits.

Many circuit designers are unfamiliar with the versatility and potential of pnpn devices. This is because discussion has been limited, mostly, to mathematical models intended to advance circuit design. The following examination of pnpn characteristics, derived from well-understood transistor behavior will help designers understand the operation, and appreciate the possibilities, of four-layer semiconductor devices.

## The equivalent circuit

The four-layered pnpn device can be represented in a number of ways, as shown in the diagram on page 69. The basic structure, A, can be considered a npn transistor with a diode in series with the collector, B; or a pnp transistor with a diode in series with its collector, C. But neither of these circuits suggest the regeneration inherent in a pnpn device. Thus, the two-transistor circuit, D, is a more accurate representation. To these two transistors, we can add the collector saturation resistance,  $R_{sat}$ , base spreading resistor,  $r_{b1}$  and collector junction capacitance,  $C_{ob}$ , which are inherent in all semiconductor devices, and derive the circuit E. This circuit, in turn, leads to a distributed circuit, F, of several transistor pairs joined by the sheet resistance of each semiconductor layer. While circuit F is most versatile, it is not used generally.

The common symbols for the silicon controlled rectifier, G and H, ignore the central n region. The Shockley diode symbol I shows leads to the outside regions only; while the silicon controlled switch, represented in J and K has leads to all

SHOCKLEY DIODE

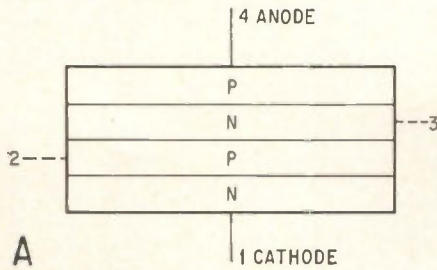

CONVENTIONAL SCR

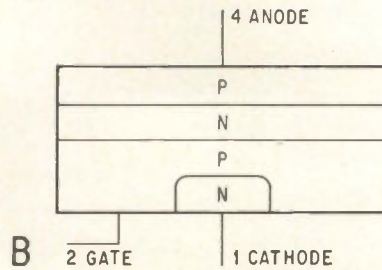

WESTINGHOUSE TRINISTOR

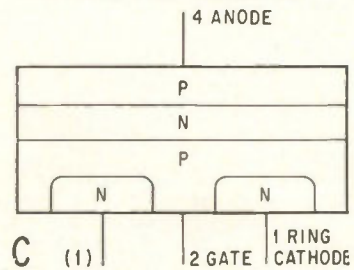

PLANAR PNP

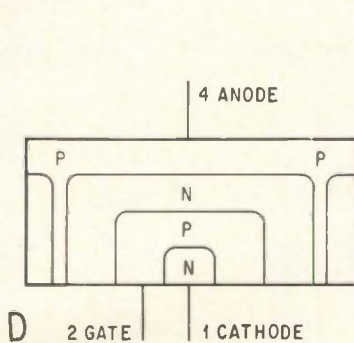

TWO VERSIONS OF THE SILICON CONTROLLED SWITCH

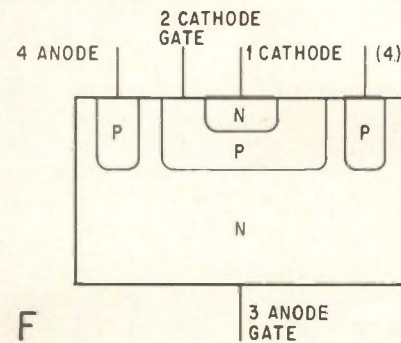
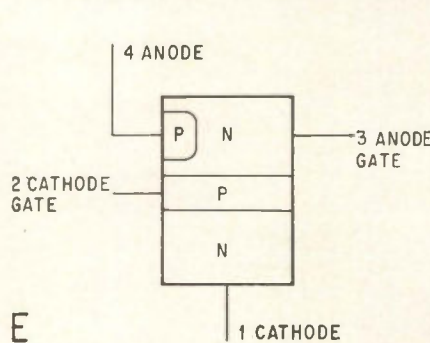

Sectional views of various types of pnpn devices used in electronic circuits. Geometry of the layers determines their function and application.

four regions.

The best choice of equivalent circuit depends on the specific parameters of interest and the actual physical construction and geometry of the device.

#### Actual construction

The detailed geometry of a pnpn device determines the important elements of an equivalent circuit. Various configurations are shown in the diagram above. The arrangement shown in A leaves limited areas for connections to the central junctions, so this construction is suitable only for a four-layered diode. The equivalent circuit of the geometry in A can therefore ignore resistance  $r_b$ , but must include capacitance  $C_{ob}$  and the collector breakdown voltage, since the latter two determine the maximum blocking voltage under transient and d-c conditions respectively.

The geometry of the pnpn devices, marked B and C, show common scr structures which add an n-type cathode to the basic pnp transistor. The gate lead can be attached at one side, as in B, or in a hole at the center of the n region, as in C.

A planar version of a pnpn device is shown in the diagram as D. The anode region can be extended to the lower surface, along with other regions, by a number of manufacturing processes. The structure of the silicon controlled switch is represented in E of the diagram. Basically, it is an npn transistor with an additional p region located to form a pnp transistor. A new planar scs structure is shown by F of the diagram. This device also is basically an npn transistor surrounded

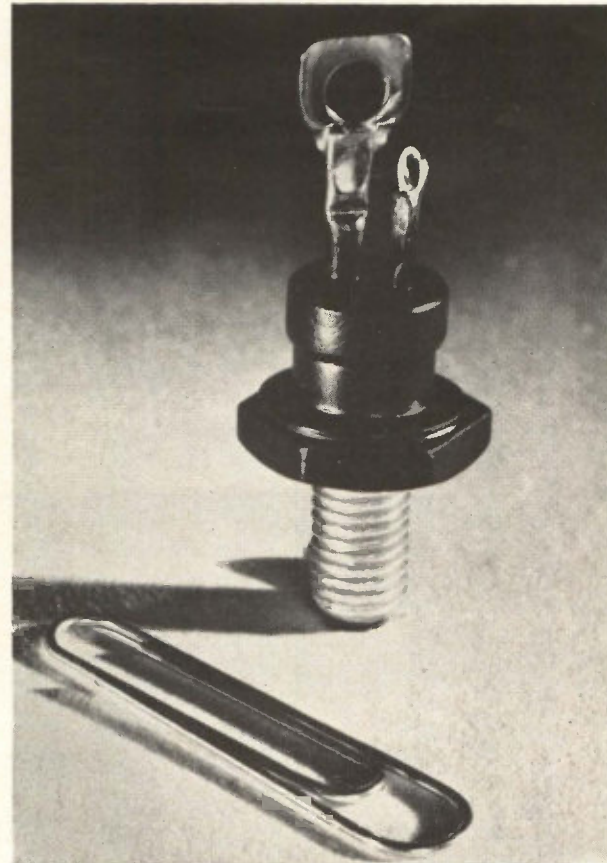

High-speed scr's of this type have broad potential for use as choppers, inverters, regulated power supplies, induction heaters, ultrasonic generators, high-frequency lighting supplies and sonar and radar transmitters.

by a diffused ring of p-type material to form a pnp transistor across the surface. Since the p base and p ring anode can be diffused simultaneously, this structure requires no more processing steps in its manufacture than a planar npn or pnp transistor. All four layers are readily accessible for attaching and the current is concentrated near the surface where cooling by radiation is optimum. This geometry gives the parameter stability inherent in oxide passivated planar structures.

As can be expected, such varied geometries given in these examples yield equivalent circuits which quantitatively are quite different.

### Biasing voltages

With the basic structure (A on p. 69) considered as an npn transistor with a diode in series with the collector, it is possible to determine what effect different biasing will have on the structure. Using the equivalent circuits in the diagram (top right) we find that npn transistor action can occur only if the collector is positive with respect to the emitter shown in A of the diagram. If current is to flow through the anode of the diode, it in turn must be positive with respect to the collector. When the anode of the diode is returned to a positive voltage, the collector current of the transistor is controlled by the transistor base.

Reverse biasing the emitter junction keeps the transistor cut off. The voltage across the pnpn device is sustained across the collector-to-base junction. The center junction breakdown limit determines the maximum blocking voltage, which is defined as the maximum permissible positive anode voltage. Generally, the emitter junction has a low breakdown voltage to enhance emitter efficiency and therefore beta. If the anode is returned to a negative voltage, the diode becomes reverse-biased and the transistor's emitter and collector interchange roles, as shown by C.

The maximum reverse voltage (or the maximum negative anode voltage that can be applied), is limited to the diode breakdown voltage plus the breakdown voltage of the inverted transistor. The latter is the transistor's emitter breakdown voltage. The common manufacturing processes result in equal breakdown voltages for the collector and the diode, and in much lower breakdown voltages for the emitter. Therefore specifications for pnpn devices show equal blocking and reverse ratings.

If the emitter junction is reverse biased, the collector or anode cannot conduct as long as the collector junction breakdown voltage is not exceeded. In lieu of reverse biasing, the base either can be left disconnected or can be connected to the emitter through a resistor or directly. All of these lead to lower collector breakdown voltages than reverse biasing.

The pnpn device is turned on by forward-biasing the base. Base current increases about tenfold for each 0.1 volt increase in base voltage. This is true until regeneration occurs, as will be

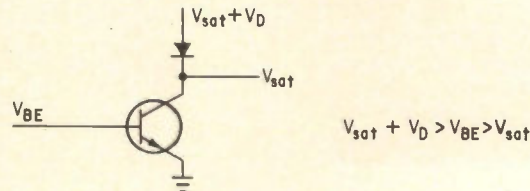
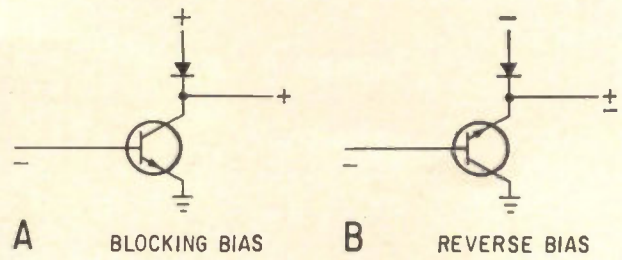

C PNPN CONDUCTING  
Relationship of blocking and reverse biases of a pnpn device

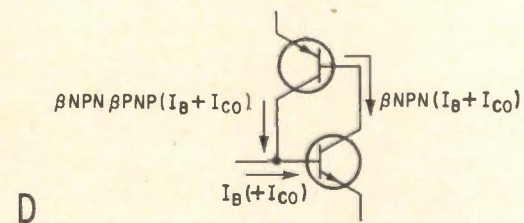
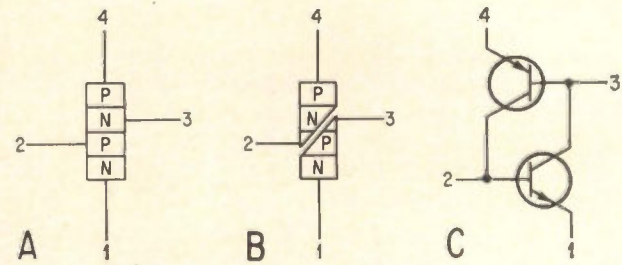

D Diagrams help explain how the two-transistor circuit of a pnpn device is derived.

Basic structures of pnpn devices, equivalent circuits, and common symbols used to express the silicon controlled rectifier, the Shockley diode and the silicon controlled switch ▶

shown later. Once the pnpn device is on, the collector and anode differ in potential only by the diode forward voltage. This is equally true of circuit C (top), if polarities appropriate to the pnp transistor are substituted. In this case, however, the pnp emitter breakdown voltage is equal to that of the npn collector, while the diode breakdown is less than 15 volts.

### Complementary transistors

In general, the pnpn device behaves like two

BASIC STRUCTURES OF PNPN DEVICES

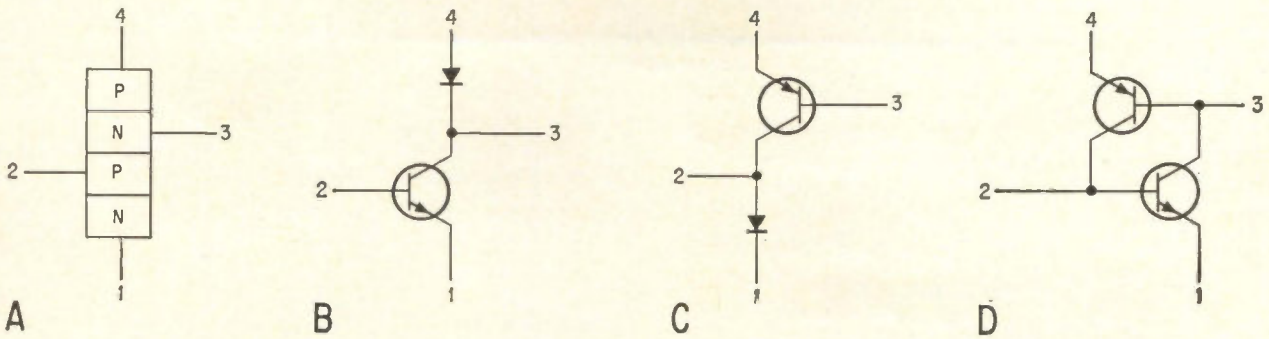

EQUIVALENT CIRCUITS OF PNPN DEVICES

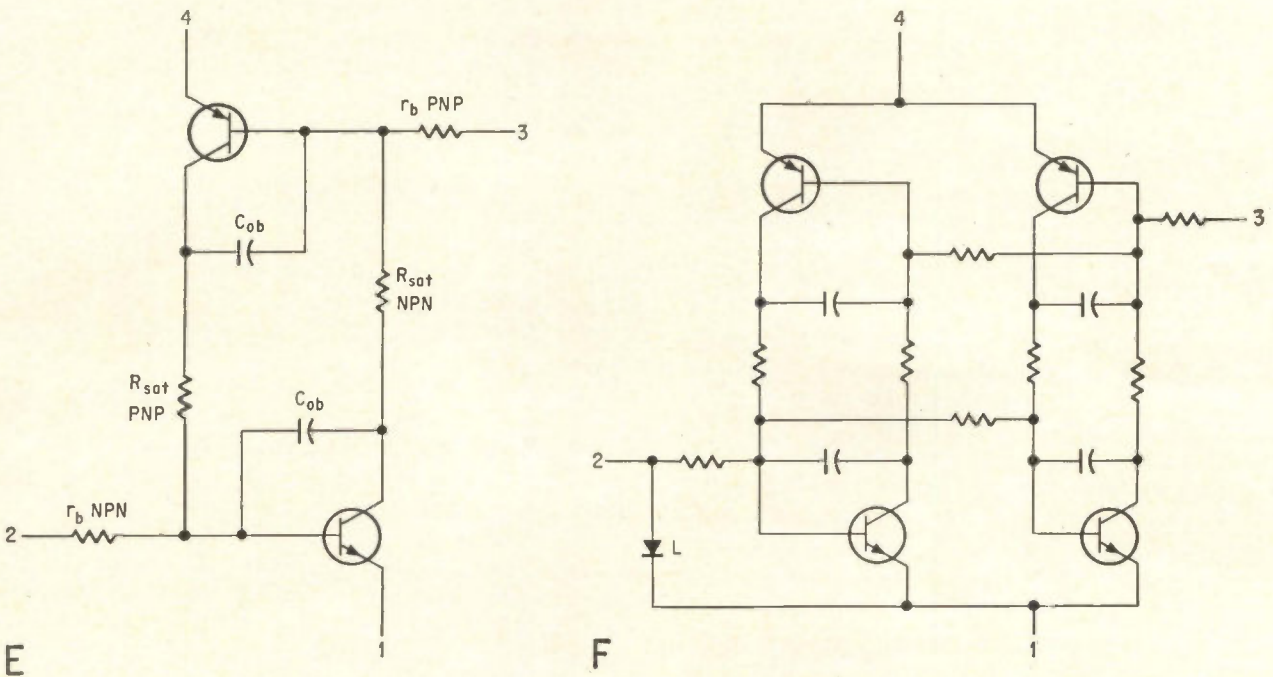

COMMON SYMBOLS USED FOR THREE TYPES

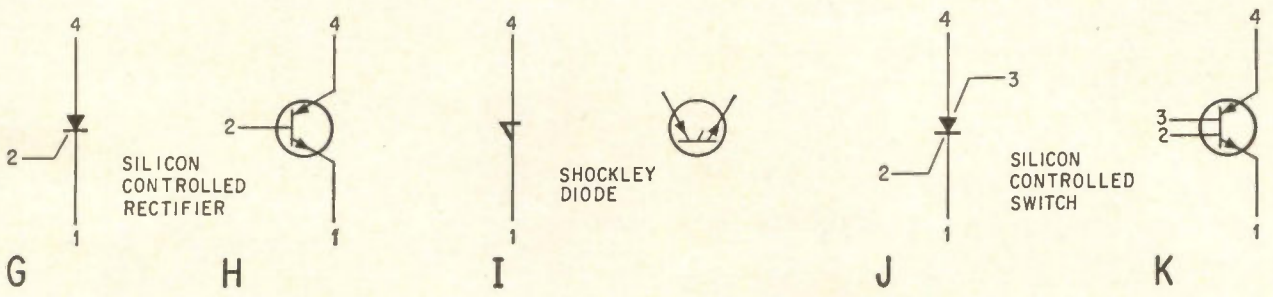

complementary transistors in a regenerative feedback configuration. The lower diagram, page 68, shows how the two-transistor circuit is derived. The diode in the preceding diagram is now the emitter junction of the pnp transistor. Base current into the npn is multiplied by the npn beta and becomes base current for the pnp. After being multiplied by the pnp beta, it reinforces the initial npn base current. If the reinforcing current exceeds the initial base current, that is if  $(B_{nnp})(B_{pnp}) \geq 1$ , the currents build up regeneratively, driving both

transistors into saturation. Therefore the product  $(B_{nnp})(B_{pnp})$  is the critical factor that determines if the pnp will switch on.

To keep the pnp nonconducting it is necessary to realize that beta is a function of collector to emitter voltage,  $V_{CE}$ ; collector current  $I_C$ ; base to emitter voltage  $V_{BE}$  and temperature, as shown in the curves of the diagram above below. Beta increases as the collector junction breakdown is approached, in turn causing the collector current to increase. Therefore, the device can be

triggered by raising the anode voltage to a value near the collector breakdown voltage. A suitable two-transistor equivalent circuit is shown at top of page 71.

The curve under the diagram plots collector current  $I_c$  as a function of base current  $I_B$ ; base to emitter voltage  $V_{BE}$ ; and  $I_{co}$  (d-c collector current when collector junction is reverse biased and base open-circuited) for a typical silicon transistor. When the base is reverse biased,  $I_B$  is very nearly  $I_{co}$ . When open circuited, the base floats at a potential of about 0.5 volt and the collector current rises as  $I_{co}$  takes on the role of base current. The slope of the curve, defined by  $h_{fe}$ , continues to increase until it is reduced by the emitter efficiency. The curve shows that reverse biasing the base, or at least keeping it below 0.4 volt, makes the base current very nearly  $I_{co}$  and  $h_{fe}$  very nearly zero, ensuring that  $(B_{npn}) (B_{pnp}) < 1$ .

Some pnpn devices can be triggered with a negative base current. The mechanism is as follows. With the base forward-biased between 0.4 and 0.5 volts, beta may increase sufficiently to trigger the device. Since leakage current flows out of the base, this would be defined as triggering with a negative input current. If triggering occurs at 0.5 volt, this corresponds to zero input current. Generally, specifications show the maximum current required to trigger the device.

The preceding discussion ignores the interaction between the two transistors, the presence of parasitic resistors and the loading effects of the instruments used to measure these characteristics.

A typical tracer plot at the cathode gate of a pnpn device as an a-c voltage is applied to it is shown at lower right, page 71. This curve can be interpreted using the equivalent circuit above it. The base resistance is shown in two portions,  $r_b$  and  $r_b'$ . The zener represents the emitter junction breakdown voltage. At point A of the diagram showing the tracer plot,  $I_B$  is equal to  $I_{co}$  as the zener and npn transistor are both cut off and pnp

beta is generally very low. At point B, the product of the betas results in triggering. The load current,  $I_A$ , now divides into  $I_{A1}$  and  $I_{A2}$ . Current  $I_{A2}$  causes the base voltage to increase to C. The amplitude of the jump is proportional to  $I_A$ . Base to emitter voltage,  $V_{BE}$ , continues to rise to D as the a-c source supplies more current. Since the base resistance is modulated downward when the pnpn is on,  $r_b$  and  $r_b'$  decrease as current is increased. As the a-c source voltage drops, current  $I_{A2}$  is partially diverted into the source via  $r_b$  in the region E to F of the current-tracing. In this case,  $r_b$  is modulated upward, becoming a much higher impedance. At G, enough of  $I_{A2}$  has been diverted so that the npn transistor cannot stay in saturation and turn-off begins. It is obvious that if the device does not turn off, the zener clamps the negative excursion of the base, with  $r_b$  determining the maximum base current.

If the curve-tracer source impedance is low, it acts as a shunt for the feedback current from the pnp collector. This permits the loop gain to approach unity very closely and yet not trigger the device. This is illustrated by the negative current leading to B' where switching occurs. The point B' may lie above or below the axis for different devices, depending upon the geometry of the device.

Now, if the source impedance is zero and  $r_b$  is also low, the shunting effect on the feedback current is much greater, resulting in the locus of B'.

If the anode current is too large to be turned off by the base (the gate), the base is driven in a negative direction to H where it is clamped by the emitter junction breakdown. Curve HGED will be retraced until the device is turned off, when the cycle then begins at A.

Qualitatively, the same curves result when the triggering input is to the base of the pnp. Since  $r_b$  and  $r_b'$  are much lower in this case, the jump from B to C is smaller. Since the pnp emitter breakdown voltage is much higher than the npn

## Members of the pnpn family

Various configurations of pnpn devices are shown in the diagram on page 67. Structure A is representative of the Shockley diode made by the Clevite Corp. Devices using this configuration come in a range of breakover voltages and are recommended for a wide range of applications, such as modulators, radar, telephone cross-point elements and bistable elements for counters.

The silicon controlled rectifiers, B and C, are made for a wide range of voltages and currents. Voltage ratings go up to 1,000 volts or higher. They carry currents up to 400 amps and can handle lots of power. This structure withstands extremely large peak currents; 1,000 amps in large devices. Applications are found in motor speed controls, light-dimming applications and frequency inverters.

The structure B is typical of a conventional silicon controlled rectifier made by many manufacturers. The geometry in C is representative of the Westinghouse Trinistor.

The structures shown in D, E, and F illustrate

inherently lower-voltage pnpn devices. Their theoretical limit is about 300 volts. Many scr's on the market are in a lower voltage range and handle lower currents of one amp or less. These devices are finding application as memory elements and for memory functions, logic and computer elements, lamp drivers, and latching devices. With them there is a special advantage—an input pulse can be turned on and kept on.

Structures E and F have all four areas connected to the outside. This makes them more versatile. The fourth lead can be used to eliminate the rate effect (see p 71). When used as scr's, they can be hooked up to stay off when turned off. Small, with low leakage currents and high sensitivity, they can be used as protective devices, voltage level detectors in all kinds of alarm systems, and for level sensors. They have extremely high gain as d-c amplifiers. One microamp of current will turn such devices on. Output current can be as high as 200 mils. These devices range from small sensors to units that will trip a high-power relay or lamp. Major applications also include their use as neon drivers.



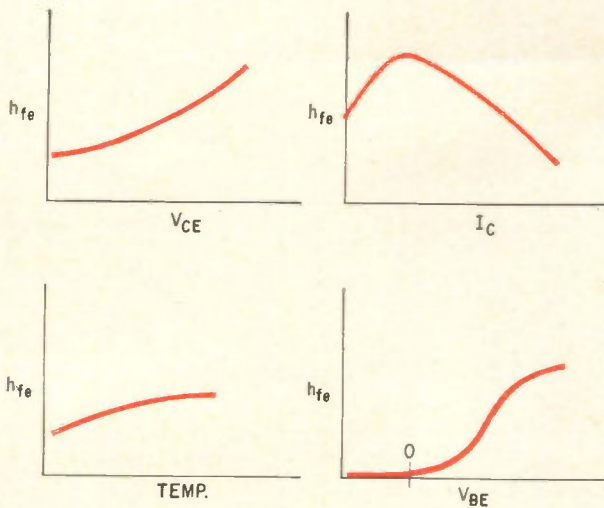

Curves show how the current gain of an individual transistor section of a pnpn device is related to various parameters of the transistor.

emitter breakdown, much higher anode currents can be turned off.

#### Rate effect

Four-layer pnpn devices may be triggered if voltage is applied suddenly to their anodes, or if they are subjected to high-frequency transients. This phenomenon, called rate effect, is explained with the help of the diagram on page 73. The diagram (top, this page) shows the zener breakdown of the center junction supplies the base currents necessary to trigger the pnpn. For high frequencies, the zener is replaced by capacitor  $C_{ob}$ . Capacitance  $C_{ob}$ , shown on page 73, is a low impedance resulting in substantial base currents and triggering. For the smallest pnpn devices high frequency may be in the order of a megacycle. The base currents are  $I_B = C_{ob} (dv/dt)$  where  $V$  is the increasing anode voltage. The equivalent circuit in the diagram suggests ways of suppressing rate effect. Shorting the cathode gate to cathode  $r_b$  diverts the  $C_{ob}$  charging current, preventing forward bias on the npn transistor. Similarly, the anode gate can be shorted to the anode to advantage. The shorts may be capacitors, if it is desired to maintain d-c triggering sensitivity. Reverse-biasing a gate will be effective only if a low-impedance bias source is used. Again, a capacitor can be used to generate the low impedance.

A far more elegant solution is shown in the lowest diagram, page 73. While the anode is reverse biased (the switch closed),  $C_{ob}$  charges up via the npn collector resistor. The switch may now be opened as rapidly as desired.

The addition of an external interbase capacitor effectively increases  $C_{ob}$ , and creates a high-rate sensitive device, for detecting transients.

#### Forward conducting voltage

The forward anode-to-cathode, voltage can be

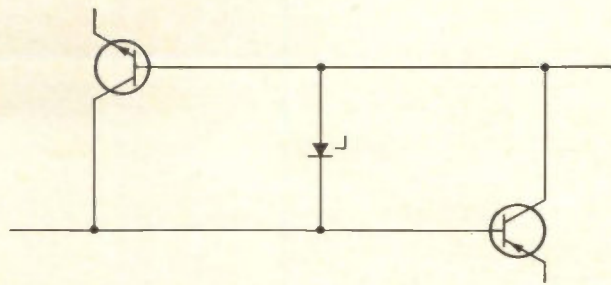

Circuit used to analyze the interaction between the two transistors of a pnpn device

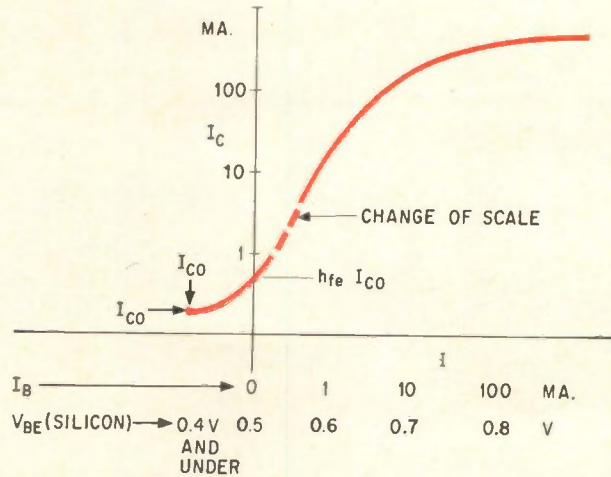

Plot shows how the collector current of an npn device relates to its input characteristics

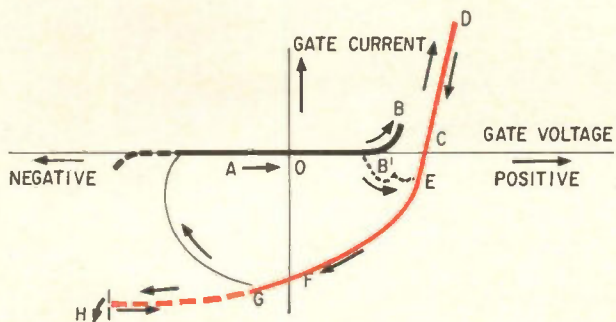
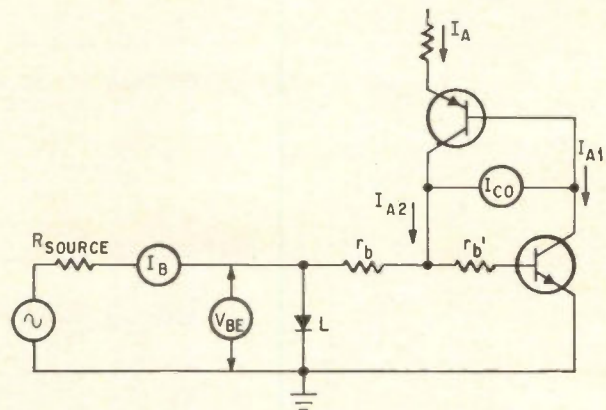

Plot of the cathode gate current of a typical pnpn device traces the locus shown above as an a-c voltage is applied. Interpretation of the current characteristic is accomplished using the equivalent circuit shown.

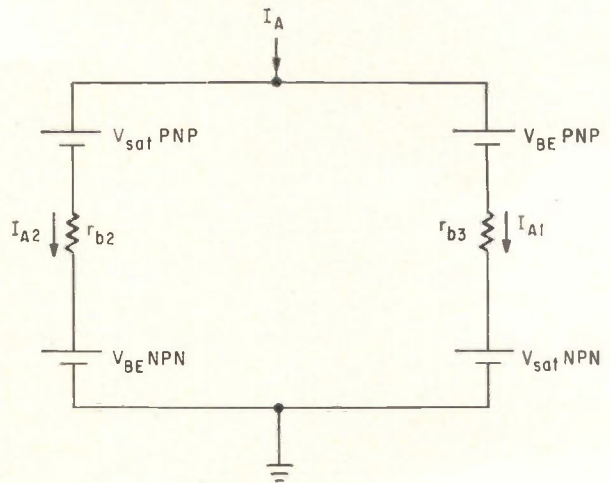
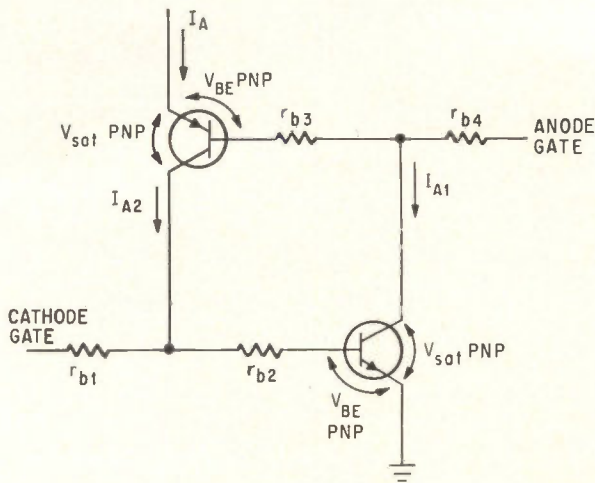

Under forward anode-to-cathode voltage conditions, equivalent circuit of pnpn device looks like this.

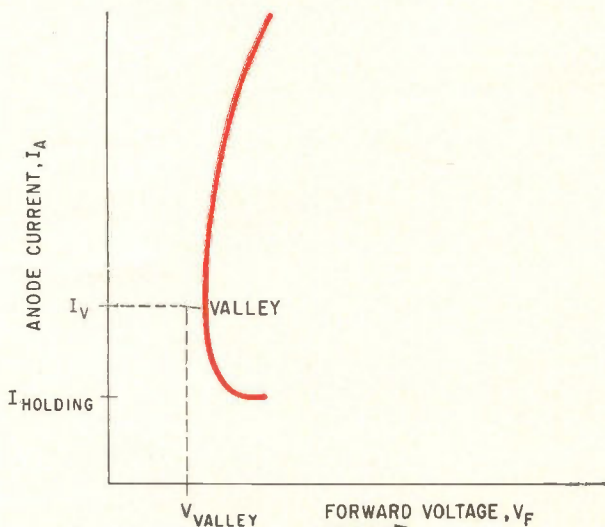

Typical forward voltage characteristic of a four layer device.

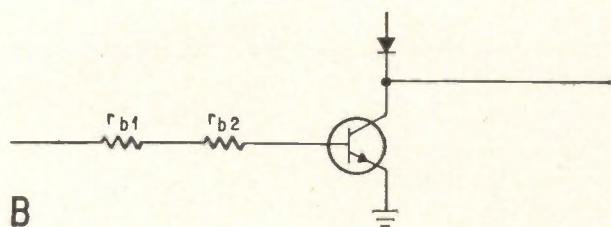
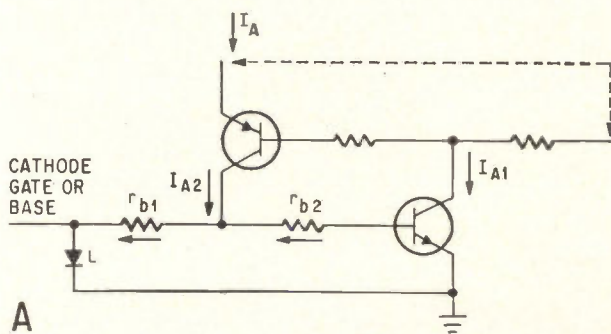

Charge storage and frequency response are limiting parameters in the switching speeds of pnpn devices. Equivalent circuit helps explain these limits.

evaluated using the equivalent circuit of the diagram, shown above. The resistors  $r_{b2}$  and  $r_{b3}$  can be considered as base or collector resistors. But since they carry minority carriers these resistors are strongly modulated and are much lower in resistance than their doping level and geometry would indicate. The currents  $I_{A1}$  and  $I_{A2}$  are determined by the transistor betas as well as by  $r_{b2}$  and  $r_{b3}$ .

Forward voltage does not change much with temperature. At high temperatures the resistors increase, while  $V_{sat}$  and  $V_{BE}$  decrease. At low temperatures the resistors decrease, while  $V_{sat}$  and  $V_{BE}$  increase to compensate.

### Holding current and valley point

As  $I_A$  is reduced, the transistors are forced to operate in their low-current, low-beta region. Eventually the betas become so low that  $\beta_{npn} \beta_{pnp} < 1$  and the pnpn device switches off.

The diagram above, center shows a typical forward characteristic. The device starts to turn off at the valley point, where the forward voltage is lowest. But as the anode voltage rises, the transistors come out of saturation, raising beta, and the device remains in the conducting state. At the holding current, increasing voltage cannot raise beta enough and the device switches off. If the gate remains open in the equivalent circuit, loop gain is high; the valley current and holding current are very low and nearly equal. If, however, the cathode gate is shorted to the cathode,  $r_{b1}$  diverts part of  $I_{A2}$ , lowering loop gain and raising both the valley current and holding current. These currents now are separated considerably, since the valley point is reached while the transistor betas are high. As a result of the high betas, a slight change in anode voltage can change the ratio of  $I_{A1}$  to  $I_{A2}$  to sustain conduction.

It is important to differentiate between holding current and valley current. While at the valley point, if the anode sees an a-c short circuit load,

(for example, a capacitive load,) the device will turn off. With a resistive load, however, the pnpn will conduct until the holding current is reached. Where the load characteristics are uncertain, the anode current should exceed the valley point current to assure conduction.

### Transient response time

The lower diagram on page 68 explains how an input base current is amplified by both transistors and fed back to the input. Each transistor introduces a delay that depends on its frequency response ( $f_a$  or  $f_T$ ) and the input current. Once regeneration starts, however, the "input current" is limited only by the maximum anode current and the pnpn turns on rapidly.

Two limiting cases are of interest. If the input current is small, there is substantial delay followed by a rapid turn on. With large inputs and low anode currents the npn transistor can be driven into saturation before regeneration is fully established. The equivalent circuit in the latter case resembles A of the blocking and reverse-bias diagram on page 68.

### Turn-off time

The circuit, A, in the lower diagram, page 72, assumes the pnpn device is turned off at the cathode gate. This is achieved by reverse biasing the npn emitter junction, diverting all of  $I_{A2}$  and pulling current out of the npn transistor base. Following the npn storage and fall times the pnp is deprived of base drive and, consequently, stops conducting. To shorten device turn-off time, it is seen that the turn-off base current should be as large as possible. By not overdriving the npn prior to turn off, storage time can be shortened. Returning  $r_{b1}$  to ground, prior to turn off, partially diverts  $I_{A2}$ . An anode-to-anode-gate short circuit would also aid recovery by reducing  $I_{A2}$ .

The turn-off input should be maintained until the anode rises to its maximum voltage, so that the pnpn device does not retrigger due to rate effect or residual charge in the pnp during its fall time.

Turning off the pnpn by reverse-biasing the anode requires the equivalent circuit shown as B in the diagram. Rapidly reverse-biasing the anode causes the anode junction to recover, isolating the anode from the rest of the device which now behaves as an npn transistor. If its base is open, eventually the base charge will recombine and the transistor will turn off. Connecting  $r_{b1}$  to ground or a negative bias helps turn off the npn more rapidly.

During turn off, there is a spike of anode reverse current while the anode junction recovers, after which the junction recovery of the device appears to be turned off. However, the npn transistor may not yet have turned off. It will cause the device to conduct again as soon as the anode of the diode becomes forward biased. Proof that the device has truly turned off is the ability of the anode (of the diode) to withstand blocking voltage.

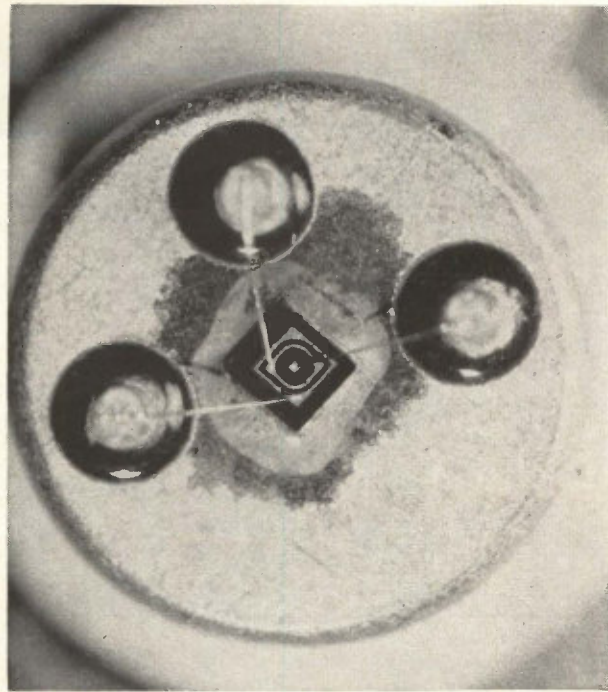

Silicon controlled switch, uncapped, has built-in immunity to voltage transients because it can take high rates of rise of forward-blocking voltage.

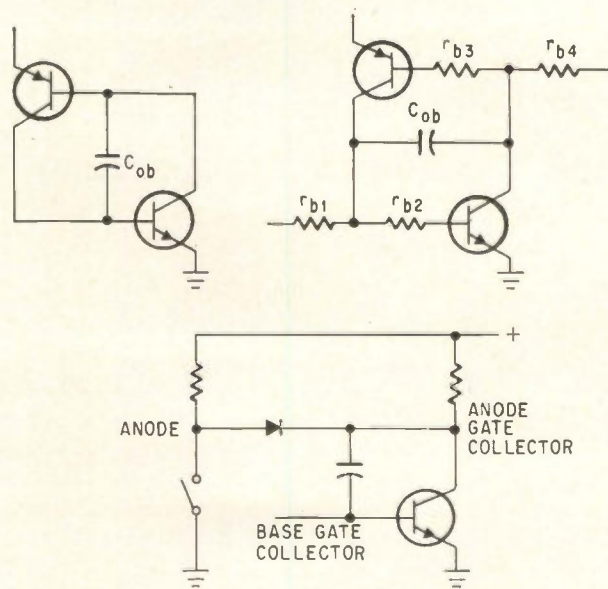

At high frequencies, capacitor replaces zener diode in equivalent circuit. Resultant low impedance may cause false triggering. This is known as rate effect.

### The author



Richard A. Stasior is an engineering consultant to the General Electric Co.'s semiconductor products department. He holds a doctorate in engineering physics from the University of Toronto.

# Designer's casebook

Designer's casebook is a regular feature in Electronics. Readers are invited to submit novel circuit ideas, packaging schemes, or other unusual solutions to design problems. Descriptions should be short. We'll pay \$50 for each item published.

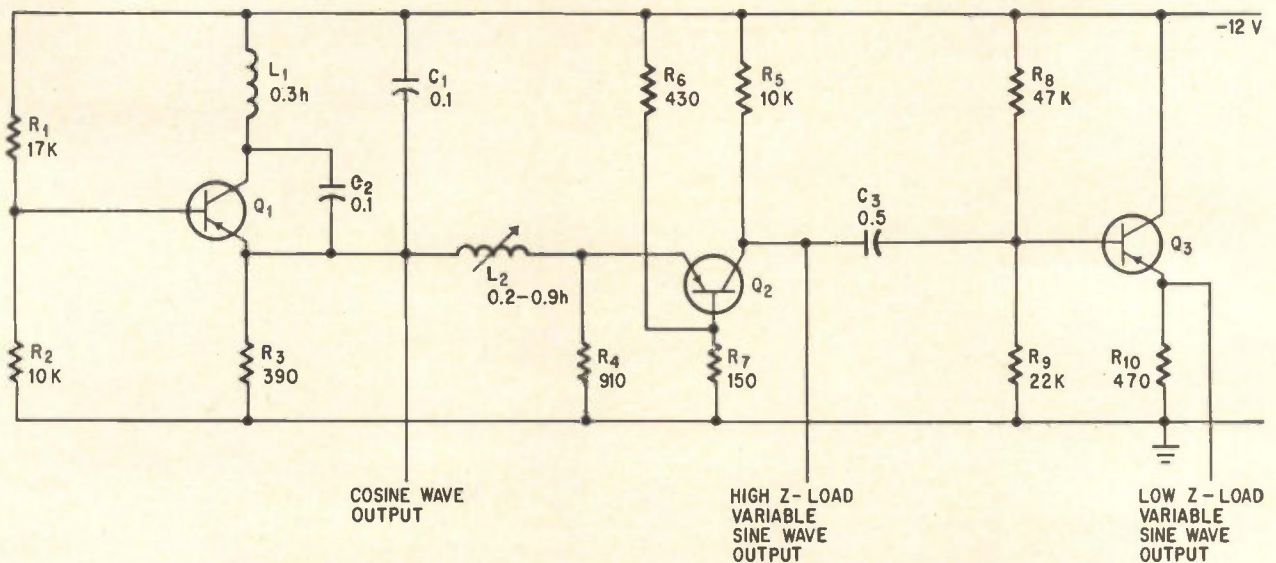

Two outputs are provided—one for high-impedance loads, the other for low-impedance loads.

## Oscillator generates sine, cosine waves simultaneously

By John G. Peddie

Aero Service Corp., Philadelphia

A low-cost oscillator was needed to test a phase detector. It had to generate a reference cosine function and a second waveform that could be varied in phase to provide from a sine to a cosine function. Temperature stability was not critical; the test oscillator was intended for use in the controlled environment of a laboratory. The circuit shown satisfied the requirements.

The first stage of the circuit is a modified capacitive-feedback Colpitts oscillator with the output taken at the emitter of  $Q_1$ . The degree of phase shift for the sine function output is determined by  $L_2$  and  $R_4$ .

The second stage provides high output impedance for use with high-impedance loads. It also has sufficient gain so that the variable-phase sine function has the same amplitude as the fixed-phase cosine function. Although the amplitude of the sinusoidal output does change slightly as  $L_2$  is varied, it is equal to that of the cosine function when the two signals are  $90^\circ$  apart in phase.

For phase shifts up to  $90^\circ$ , as required by the application, the specified range of the coil  $L_2$  is ade-

quate. If additional phase shifting is desired, a coil with a higher inductance should be used and  $Q_3$  and  $R_4$  should be replaced by a variable resistor.

An emitter-follower stage was added to the output of the second stage for use with low-impedance external loads. The emitter-follower stage offered a high-input impedance for the sine function and a low-output impedance to the circuit being tested.

The tolerance for all components was 10%. The total cost for parts, including transistors, was approximately \$3.50.

The frequency stability of the oscillator is better than 1% with a regulated power supply. The circuit will oscillate from frequencies below 1 Kc to 100 Kc depending on the values of  $L_1$ ,  $C_1$ , and  $C_2$ .

## 1500-volt hybrid switch has low 'on' impedance

By Richard E. Thomas

Naval Research Laboratory, Washington, D.C.

This circuit was used to provide a 1500-volt positive blanking pulse to the emitter of an emission microscope. The pulse is applied by turning tube  $V_1$  off (analogous to a switch being opened); when  $V_1$  conducts (analogous to a closed switch), the measured dynamic impedance at the plate of the tube is only 35 ohms.

The low dynamic impedance is achieved by

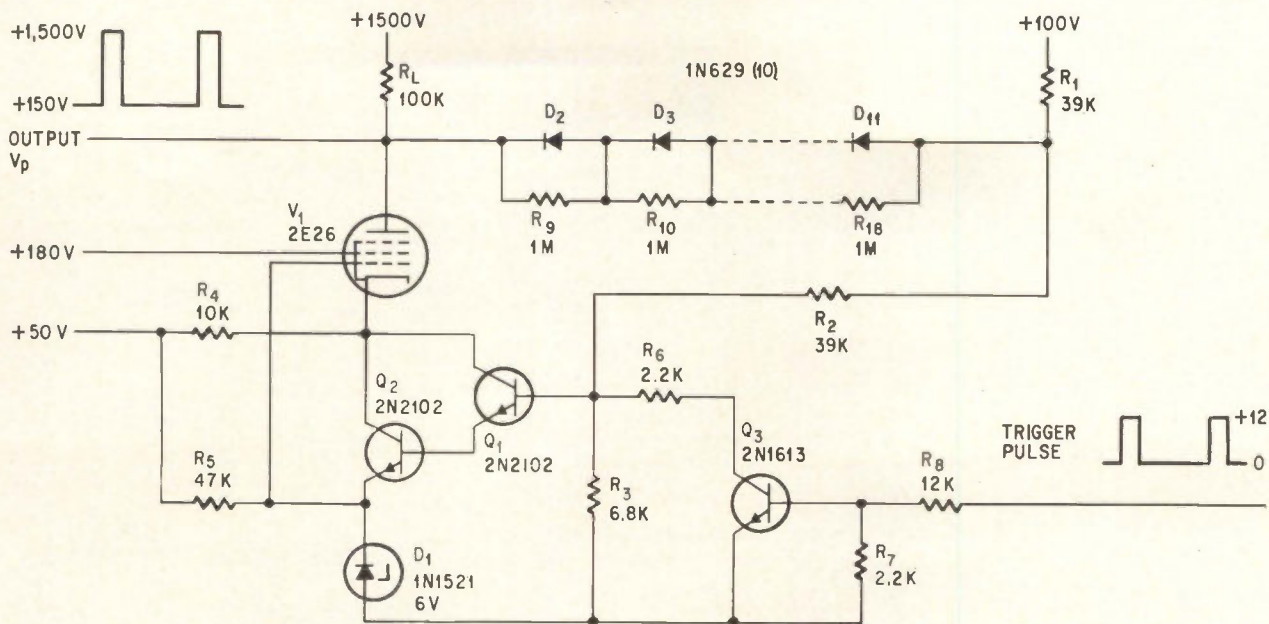

Hybrid switching circuit provides a 1500-volt output pulse when a 12-volt input pulse is applied.

negative feedback from the plate of  $V_1$  to the base of  $Q_1$ . The amount of voltage feedback is determined by  $R_1$ ,  $R_2$ , and  $R_3$ . Without a negative feedback network, the plate impedance of a saturated 2E26 measures approximately 300 ohms at a plate current of 100 milliamperes.

When the positive 12-volt trigger pulse is applied, transistor  $Q_3$  is saturated. The voltage across  $R_3$  drops below the level established by the zener diode  $D_1$ . Transistors  $Q_1$  and  $Q_2$  both turn off,  $V_1$  stops conducting. ( $V_1$ 's cathode voltage rises to 50 volts).

With  $V_1$  turned off, its plate voltage rises to the high voltage supply value—1500 volts in this application. The diode network ( $D_2$  through  $D_{11}$ ) allows the plate of  $V_1$  to rise to large positive voltages without excessive current flow through  $R_2$  and  $R_3$ . When the 12-volt pulse is removed, the circuit returns to its original state.

When  $V_1$  conducts, its plate voltage  $V_p$  is given by:

$$V_p = V_z [1 + (R_2/R_3)]$$

For this application,  $V_z = 6$  volts,  $R_2 = 39,000$  ohms,  $R_3 = 6,800$  ohms.

$$V_p = 6(1 + 39000/6800) = 40 \text{ volts}$$

The plate impedance  $Z_p$  during conduction is given approximately by the following equation:

$$Z_p = R_e [1 + (R_2/R_3)]$$

Resistance  $R_e$  is the impedance presented at the emitter of  $Q_2$  and consists of the series combination of the zener diode impedance and the  $Q_2$  emitter impedance. The zener diode impedance is typically about four ohms, with a 15-milliamperer emitter current flowing.

Resistor  $R_1$  is chosen so that the voltage at the junction of  $R_1$  and  $R_2$  is set at a voltage larger than the desired value of  $V_p$ .

The rise time for the 1500-volt pulse is about five microseconds with no external load. The rise

time is determined mainly by the plate capacitance of the tube and the load impedance. The time required for the plate voltage to drop to 50 volts and the plate current to rise from 0 to 15 milliamperes is approximately 1 micro-second.

## Servo comparator amplifier handles high voltages

By John S. MacDougall

Fairchild Semiconductor, Mountain View, Calif.

The comparator amplifier system shown uses two type 3N87 double-emitter chopper transistors to simulate a single-pole double-throw switch. The circuit precedes a power amplifier in a nulling servo system and controls up to 50 volts with an absolute

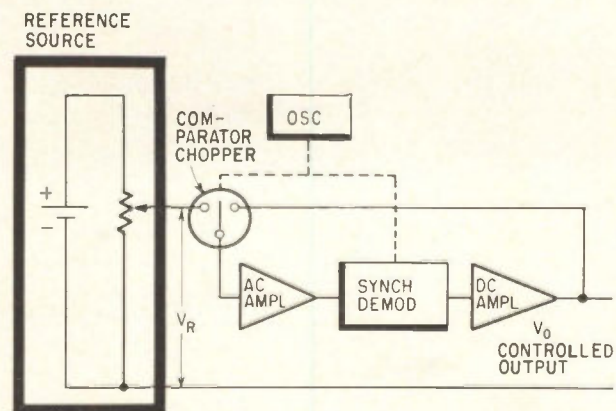

Mechanical comparator system

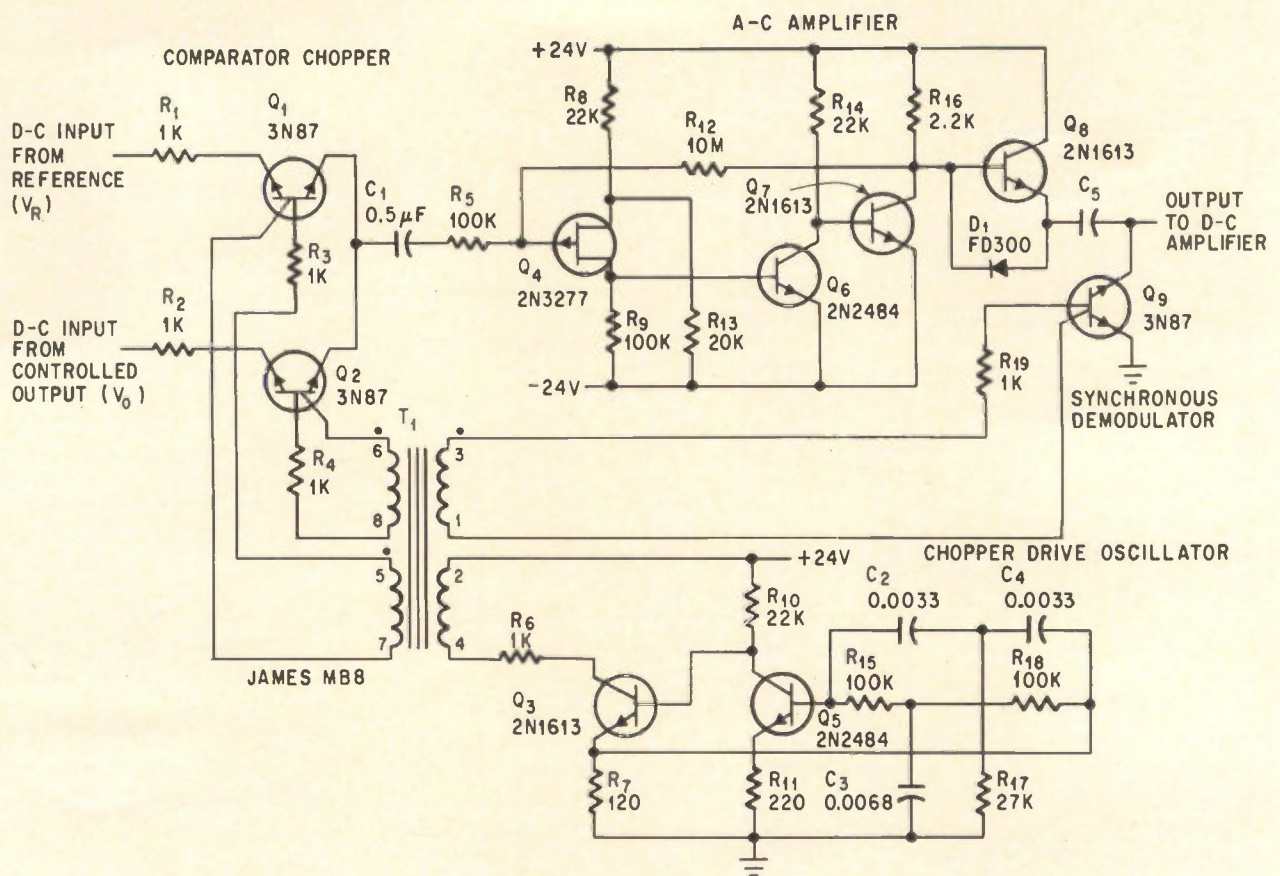

Comparator amplifier circuit uses two 4-terminal dual-emitter 3N87 transistors.

error between reference and control voltage of less than two millivolts.

The circuit operates like a simple mechanical comparator system. The comparator chopper stage, driven by the oscillator, senses the difference between the reference voltage  $V_R$  and the output signal  $V_O$  of the system, but draws very little current from the reference. Mechanical choppers have the advantage of very low noise but their life is limited and they are rather bulky.

The all-electronic comparator system is shown above. The 3N87 device used has two emitters, a single base, and a single collector. Its high impedance when off, and low impedance when conducting, make it useful as a switch. It has a very low maximum offset voltage specification of 50 microvolts. Since the comparator chopper should be floating, the chopper transistors are driven by separate windings of the oscillator transformer.

A sine-wave drive signal is used for choppers of this type to reduce the switching transients caused by interelectrode capacitance. A simple sine-wave signal source can be constructed with the bridged-T circuit. The resistance values should be about as indicated to provide proper biasing and maintain oscillation, but the capacitors can be changed (if the 2-to-1 ratio is kept) to achieve different frequencies. Since the output signal is isolated from the fre-

quency-generating circuits, different transformers and output loads can be used without altering the circuit.

The amplifier, which is d-c coupled to eliminate blocking action caused by transients, has a voltage gain of about 200. A field-effect transistor at the input helps achieve a high input impedance and allows the use of shunt feedback to provide temperature and gain stability. The emitter-follower and diode at the output can be eliminated if the load impedance is over 10,000 ohms.

A synchronous demodulator references the original signal to ground. The one used has very low impedance, handles both positive and negative signals, and requires only one winding on the oscillator transformer. It delivers  $\pm 8$  volts into a 1,000-ohm load.

The d-c amplifier shown has an open loop gain of 100 and is capable of supplying a  $\pm 20$ -volt signal across 200 ohms. Filtering of the chopper output is provided by using the amplifier as an integrator. Thus the system can control an output of  $\pm 20$  volts at a current of 100 milliamperes. Higher voltages may be obtained by adding a series floating power supply manually to the output of the d-c amplifier.

The 3N87 is made by Fairchild Semiconductor, a division of the Fairchild Camera & Instrument Corp., Mountain View, Calif.

# Drivers for optical diodes

PN-junction light emitters generate hundreds of milliwatts. Here are some practical ways to drive them for linear and pulse output.

By Edward L. Bonin

Texas Instruments, Inc., Dallas, Texas

The semiconductor light-emitting diode is rapidly becoming a practical device with many potential applications in communications, computers and industrial and military equipment.

Several transistorized drive circuits have been designed to take advantage of these spontaneous sources' compactness, speed, efficiency, power capability and ease of modulation. These circuits—to be discussed in detail later—have bias currents in the ampere range, which poses problems significantly greater than for circuits with lower bias currents.<sup>1, 2</sup>

## Spontaneous emission

A pn-junction spontaneous emission source can deliver tens of milliwatts of continuous monochromatic optical power without external cooling in addition to a heat sink and air. With appropriate cooling, continuous outputs of several hundred milliwatts can be obtained.

The optical output is approximately a linear function of bias current, which suggests a simple way to obtain linear modulation. The high-frequency response is in the megacycle range.

One such device is the SNX110, a highly efficient gallium-arsenide infrared source recently developed by the Semiconductor Components division of Texas Instruments, Inc. Its novel stud and solder-lug TO-5 package, typical heat sink and wiring connections are shown at the right. Its output for a 25°C case temperature ranges between about 15 and 50 milliwatts for a forward bias of two amperes. At the same temperature, the optical wavelength at peak emission is 0.92 micron, with a spectral width of about 300 angstroms. Cooling the device to the temperature of liquid nitrogen—196°C—increases the output by about six times for a fixed bias current. The maximum available output of the SNX110, at two amperes is about 100 times greater than for the less efficient and lower current-rated source, the SNX100 at 400 mil-

liamperes. This is a 20-fold increase in efficiency, and indicates the recent strides made in these devices.

## Bias requirements

In designing a driver circuit for a spontaneous emission source, a major consideration is the type

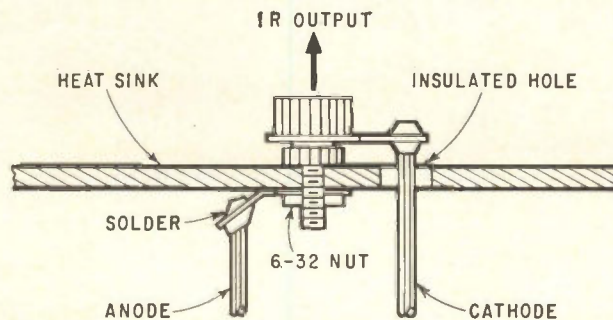
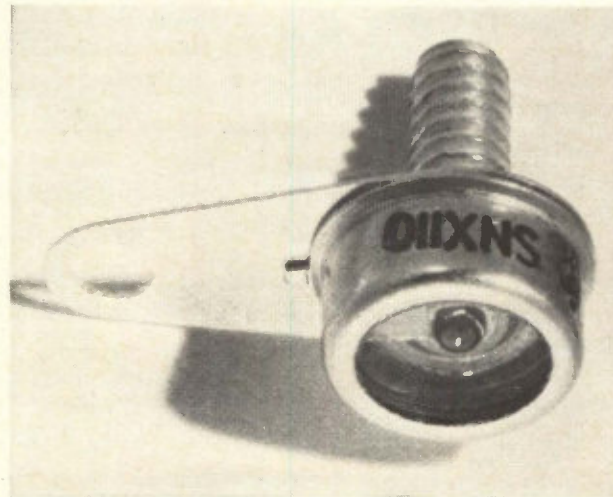

Gallium-arsenide infrared source, SNX110 with its TO-5 size stud package, is representative of semiconductor light sources. It generates tens of milliwatts of monochromatic light for two-ampere bias, requiring no cooling other than a good thermal mount.

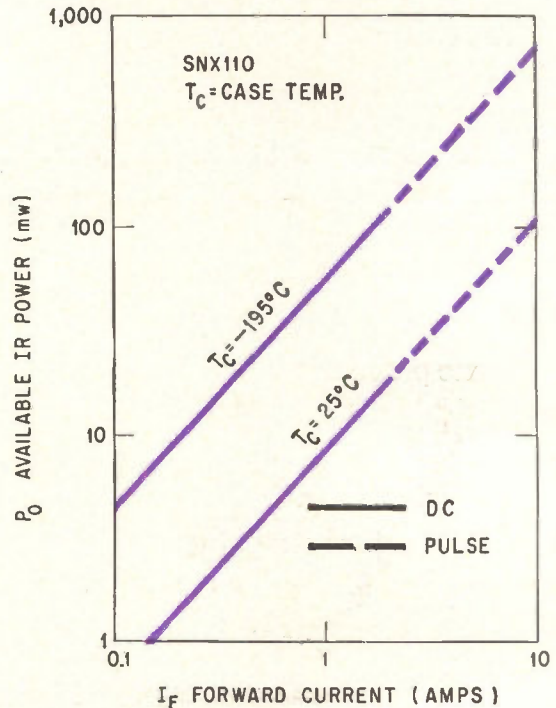
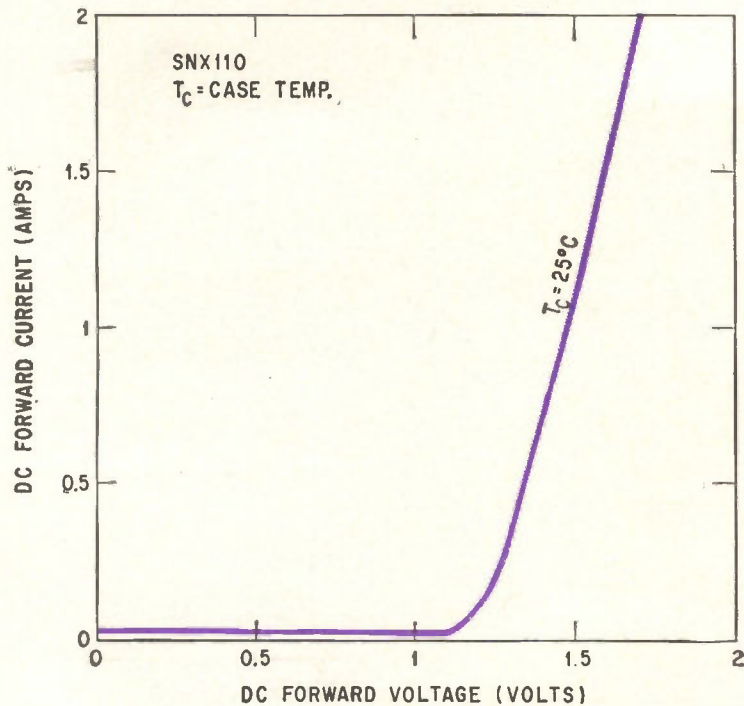

Semiconductor sources generate light efficiently when biased in the forward or "easy" direction. This highly nonlinear bias region presents problems in designing stable drive circuits, especially in obtaining linear light modulation.

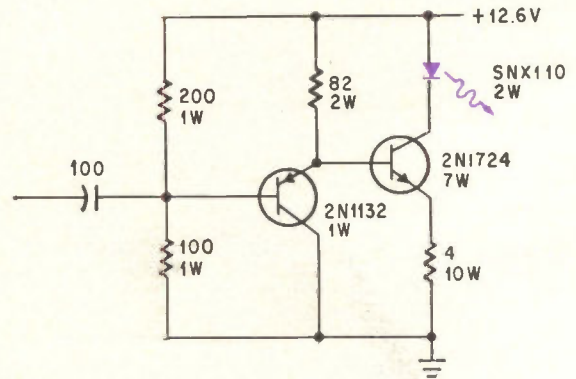
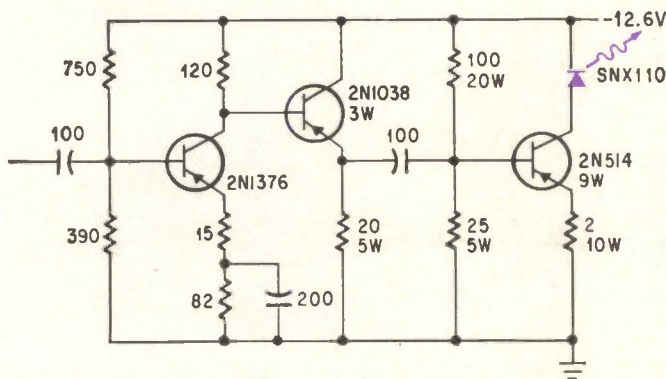

Linear light modulator at left has low distortion and requires input of 0.35 volt for 100% modulation at one-ampere average bias. A linear range of 80% modulation is obtained with the abbreviated, two-transistor linear drive circuit at right.

of bias required for the device. Efficient photo-emission occurs when a pn-junction source is forward biased, thereby presenting a low nonlinear impedance to the circuit. The circuit, therefore, must be designed to limit the junction current to provide adequate thermal stability. Also, because the static resistance (V/I) decreases as the pn-junction temperature increases, the use of a voltage supply for high-current biasing can result in destruction of the device. This process is known as thermal runaway.

The need for a current supply for biasing pn-junction sources is evident in the forward voltage-amperage characteristics as shown above for the SNX110. A relatively sharp "knee" in the V-I characteristic indicates that the diode has good light-output efficiency for lower bias currents, and a

small internal series resistance. This also shows that in the high-current region, a small increase in applied voltage results in a large increase in current.

Biasing the source with a current supply provides a stable bias and a convenient means for modulation. The optical output is approximately a linear function of forward current for the SNX110.

#### Current-limiting circuit

A basic form of current biasing consists of a large resistor in series with the light source and a voltage supply. Such a current-limiting circuit for the SNX110 at two amperes forward bias is shown on page 79. In all circuits, resistance is in ohms and capacitance in microfarads. Recommended power ratings for resistors exceeding 1/2 watt are



## Transistor complements for linear driver circuit

Transistor Type	A	B	C	Bandwidth
pnp	2N1376	2N1038	2N514	30 cps to 25 Kc
nnp	2N1132	2N1720	2N1725	30 cps to 150 Kc
nnp	2N1132	2N1720	TIX210	30 cps to 2 Mc

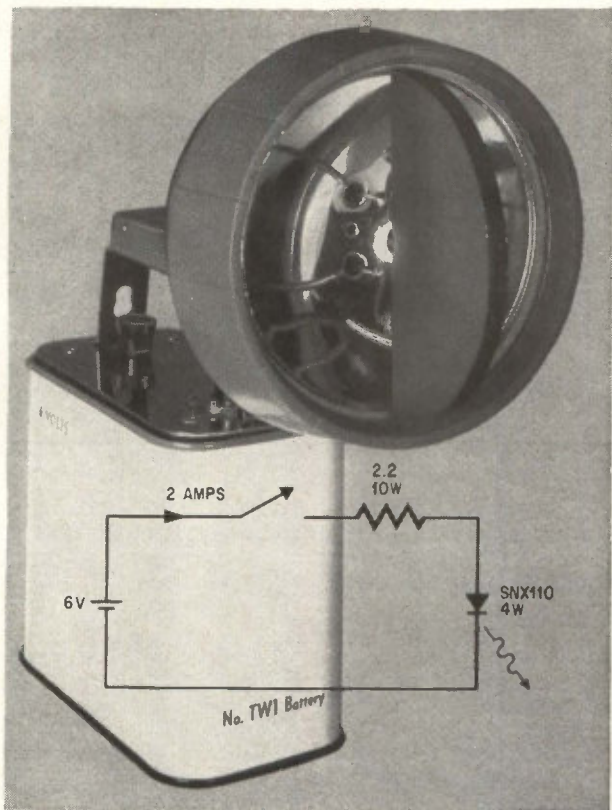

Infrared flashlight can be used with an infrared viewer to observe distant objects in the dark. It uses basic current-limiting circuit.

indicated. Power dissipations (worst case) of the emission source and transistor are indicated if a heat sink is required in 25°C ambient temperature.

This basic current-limiting circuit is used in the infrared flashlight as shown above. The infrared output of the SNX110 is directed toward a parabolic reflector and focused into a two-degree beam. The unit shown was constructed by modifying a Burgess Battery Co. type TW3 flashlight. Additions to the commercial lamp include a semi-circular heat sink extending from the reflector. The light source is mounted at the center of the heat sink, at the focal point of the reflector.

The infrared flashlight has been used to demonstrate the intense optical beams that are obtainable with spontaneous sources. With the infrared beam, objects can be seen through S-1 phosphor viewers

(such as the Model 5500 Min-I-Scope made by Varo, Inc., Garland, Tex.). The infrared flashlight has been used for illuminating objects to be photographed in total darkness.

### Linear circuits

The linear relation between light output and bias current makes spontaneous sources such as the SNX110 ideal for linear optical modulation.

A linear audio driver for one-ampere average biasing of spontaneous sources is shown on page 78. The preamplifier consists of a two-transistor direct-coupled stage. The light source is connected in the collector circuit of a linear class A power-output stage. To current-bias the emission source, current must be stabilized. This is done by adding a large resistor to the emitter circuit of the output stage.<sup>3</sup> In designing the output stage, the quiescent bias point is chosen to obtain the maximum linear operating range.

For the component values shown, the extremes of the signal drive the 2N514 power transistor into cutoff before saturation<sup>4</sup> is reached, thus providing 100% modulation capability with low distortion.

For a breadboard of the linear/audio driver circuit, an input of 0.35 volt rms at one kilocycle produced 100% modulation of the optical output. When the input was reduced to 0.31 volt rms, 90% modulation was obtained with a measured harmonic distortion of less than 2%. The amplifier's useful operating range was between about 30 cycles per second to 25 kilocycles.

The circuit's high-frequency response can be increased by using transistors with greater gain-bandwidths. Transistor complements for bandwidths up to two megacycles are shown in the table above left. The only changes required are the reversal of polarities for the light source, capacitors and voltage supply when using the npn complements.

A similar driver circuit, for operating at a lower bias current, can be derived by increasing the emitter resistor of the 2N514 and scaling the other resistors accordingly. Lower-current, high-gain transistors can then be substituted.

An abbreviated, two-transistor linear circuit, also with an average light-source bias of one ampere, is shown on page 78. Direct coupling to the power transistor improves the temperature stability of the light-source current. The current is determined largely by the voltage across the four-ohm emitter resistor. This voltage is approximately equal to the voltage at the base of the first transistor because the emitter-base voltages tend to cancel each other between two points, the base of the first transistor and the emitter of the second transistor.

The voltage at the base of the first transistor is stable because it is established with a resistor network. Variations in the emitter-base voltages of the two transistors, due to changes in the ambient temperature, also tend to cancel out, reducing the effect of temperature on the bias current.

A disadvantage of the circuit is a reduction in

the linear operating range. The linear range is compromised in designing the circuit to operate with a single voltage supply and in choosing resistor values for which the circuit will tolerate a wide range of transistor current gains. In this case, the negative extremity of the input signal

can drive the first transistor prematurely into saturation.

For a breadboard of the circuit, the maximum linear modulation coefficient was about 85%. Distortion at one kilocycle, measured for 80% modulation (2.4 volts rms input), was about 3%. This is

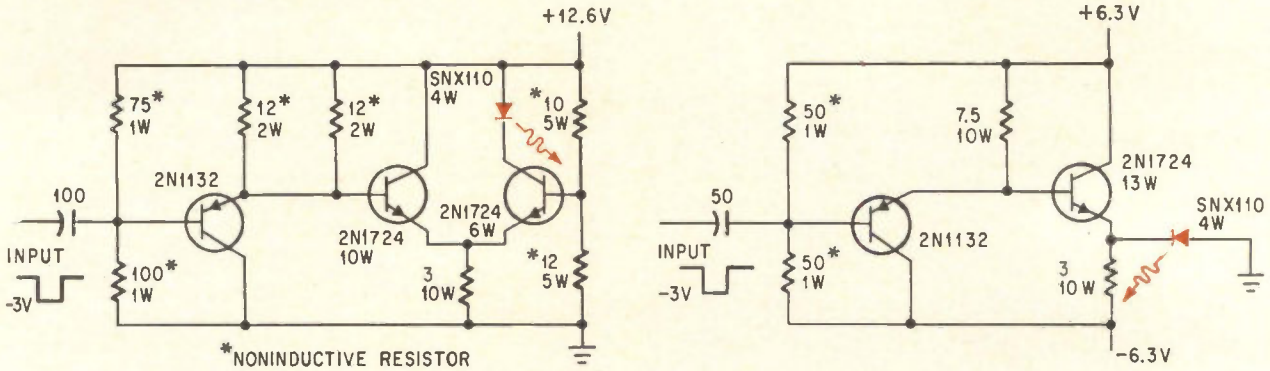

Current-mode switching circuit at left gives two-ampere peak currents with fast switching capabilities. Asterisk indicates noninductive resistor. Fewer parts are required for the two-ampere current-mode switching circuit at right when two voltage supplies are available.

## Background: electrical characteristics of light source diodes

The theory of operation of the pn junction spontaneous light source is only partially similar to that for conventional pn junction diodes of silicon and germanium. In each case, n-type and p-type regions are formed in a single crystal semiconductor, but the byproduct of energy interchange within the crystal structure of a light emitting diode is not heat—as in the ordinary diode—but photons.

### Light-source diode

The voltage-current (V-I) characteristic neglecting series resistance for a pn junction diode is given by

$$I_1 = A \exp(qV/kT) \quad (1)$$

Where  $I_1$  is the current,  $A$  is a temperature-dependent constant,  $q$  is the charge of an electron,  $V$  is the applied voltage,  $k$  is Boltzmann's constant, and  $T$  is the absolute temperature.

Equation (1) applies for both light source diodes and conventional diodes. The energy given up by each electron upon recombination for pn junctions in Si and Ge is absorbed by the crystal as heat in the region of the junction. For pn junctions in GaAs (and a few other semiconductor materials), the energy given up by each electron is, in almost every case, converted into a photon (or light). Because the amount of energy of each photon is very nearly equal to the bandgap energy  $E_g$ , the generated light will be monochromatic, i.e., the spectral width of the light will be narrow. The actual wavelength is given approximately by the Einstein equation:

$$\lambda = hc/E_g \quad (2)$$

and is a result of the recombination of electrons and holes, after they cross the pn junction.

Where  $\lambda$  is the wavelength of the light,  $h$  is Planck's con-

stant,  $C$  is the velocity of light in space, and  $E_g$  is the bandgap of the semiconductor. Inserting the appropriate constants, we obtain the approximate expression.

$$\lambda = 1.237/E_g \quad (3)$$

Where  $\lambda$  is in microns for  $E_g$  in ev (electron-volts.) For GaAs,  $E_g$  is about 1.4 ev at 25°C for which  $\lambda$  is about 0.9 micron. This is just outside the visible spectrum (0.4 to 0.76 micron). Because both the amount of light generated and the amount of bias current is proportional to the rate at which electrons and holes recombine, we would expect the light to be directly proportional to the current described by equation (1). This is true as far as we have gone, but in practice the actual current which flows in the light source diode is not exactly as described by this equation. It has been shown<sup>6</sup> that even after substantial cleaning processes which effectively eliminate resistive type leakage paths across the surface of the diode, one type of leakage remains. The effect is to produce the following approximate V-I relation (neglecting series resistance):

$$I = A \exp(qV/kT) + B \exp(qV/nkT) \quad (4)$$

Where  $I$  is the total current,  $A$  and  $B$  are constants,  $n$  is approximately a constant (varying slightly with bias) and is greater than unity, and the other symbols are as defined for equation (1). While equation (1) describes the characteristic of a single pn junction, equation (2) effectively describes that of two junctions in parallel. The first is a light-emitting diode; and the second is a leakage diode which does not generate light.

Because the constant  $B$  can be reduced to a fairly small value with thorough device cleaning and because the value of  $n$  is sufficiently greater than unity (generally about 2 to 4), the leakage current becomes negligible as the forward bias current is increased. Thus it is in the higher current region that the light output is found to be approximately linear with bias current. In the lower current region, much of the current is detoured around the light-emitting diode and the light no longer varies directly with current. For small currents, the light

small enough for good voice transmission. The bandwidth was about 30 cycles to 250 kilocycles. By replacing the 2N1724 with a type TIX210, the bandwidth could have been extended to about two megacycles.

### Switching circuits

For high duty-cycle pulse circuits, the quiescent current in the light source is zero. Pulse inputs result in a peak light-source current of two amperes. Switching-time figures for the optical output, given for each circuit, are valid with fast-input pulses.

The linear drive circuit can be modified into a two-ampere pulse amplifier by simply removing the 100-ohm resistor in the base circuit of the 2N514.

The 2N514 remains in the cutoff condition until a sufficiently large negative signal is applied to the input. A two-ampere peak current flows in the light source for a negative input pulse of about 0.5 volt. The 2N514 does not operate in the saturation region; if it did, the forward voltage of the SNX110 and the saturation voltage of the 2N514 would be major factors in determining the

current flow. Instead, the magnitude of the input signal establishes the current level. Rise and fall times of the optical output are about seven microseconds. The other transistor complements given in the table can also be used in the modified circuit for faster switching. Reversal of the component polarities, mentioned previously, again apply.

Current-mode switching circuits,<sup>5</sup> shown on page 80, provide maximum transistor switching speeds. With peak currents of two amperes, optical rise and fall times of 50 nanoseconds or less should be attainable if precautions are taken to minimize transients across the high-current leads. A large capacitor across the voltage-supply terminals of the circuit may largely eliminate transients across the battery cables.

The switching circuit shown on page 80 illustrates the current-mode principle. A common resistor is used in the emitter circuits of the two 2N1724 transistors. The high current flows continuously through this resistor and into one of the transistors, depending on the input signal. For zero signal, the flow is through the 2N1724 to the left of the resistor. For a negative three-volt input signal,

output is given approximately by

$$N = DI^n \quad (5)$$

where N is the light output and D is a constant for a constant device temperature.

Thus far in the equations describing the V-I characteristic of the diode, the resistances present in the semiconductor material on either side of the pn junction and in the electrical leads have not been considered. In practice, the voltage drop across this resistance in series with the junction can be a substantial part of the terminal voltage for large bias currents. In the higher current region, the series resistance can also become a function of current.

### High-frequency equivalent circuit

The equivalent circuit, consisting of a resistor in series with two parallel diodes applies when operating the light source diode up to frequencies in the order of a few megacycles. At some greater frequency, the device capacitances become important. The significant capacitances are those which directly shunt the junction and are given approximately by the expressions:

$$C = C_T + C_D \quad (6)$$

$$C_T = F \left( 1 - \frac{qV_D}{E_g} \right)^{1/2} \quad (7)$$

$$C_D = GI_1 \quad (8)$$

where C is the total capacitance,  $C_T$  is called the transition capacitance,  $E_g$  is the band-gap energy, q is the electronic charge,  $V_D$  is the voltage drop across the pn junction,  $C_D$  is called the diffusion capacitance,  $I_1$  is the current through the pn junction, and F and G are constants. The capacitance  $C_T$  can be described as a parallel-plate capacitance: the plates are the n- and p-regions on each side of the pn junction, and the separation of these plates is the width of the junction. The junction width varies with bias. For this reason, the voltage term appears in equations (7). Capacitance  $C_T$  is important in the low-current region where it is responsible for time-delay

effects.<sup>7</sup> As the current is increased,  $C_T$  becomes shunted by the decreasing diode dynamic resistance which is at least as small as the resistance given by

$$r = \frac{KT}{qI} \quad (9)$$

where the terms are defined for equation (1). At 25°C, equation (9) is approximately given by

$$r = \frac{26}{I} \quad (10)$$

where r is in ohms for I in milliamps. For a forward bias current I of only a millampere or so,  $C_T$  can generally be neglected.

The diffusion capacitance  $C_D$  becomes extremely large for large bias currents. It is this capacitance which is responsible for limiting the switching speed of the light output. Actually,  $C_D$  is only the equivalent value of an additional capacitance which would result in the same time response. The effect itself refers to the time interval between the crossing of the pn junction by an electron (or hole) until it recombines. Order-of-magnitude values for the switching time can be calculated using published expressions<sup>8,9</sup> and are in fair agreement with measured values.

The addition of a series inductance results in an equivalent circuit valid to perhaps 1 Gc. Typical values for several of the equivalent circuit parameters of the SNX100 and SNX110 GaAs sources are given below. The values refer to the indicated bias currents and  $C_T(0)$  refers to the zero bias value of transition capacitance. The response time of the light is given directly as  $\tau$  instead of referring to the calculated equivalent  $C_D$ .

	SNX100 (100 ma)	SNX110 (1 amp)
R	0.4	0.2
$\tau$	30 nsec	<7 nsec
$C_T(0)$	1000 pf	150 pf

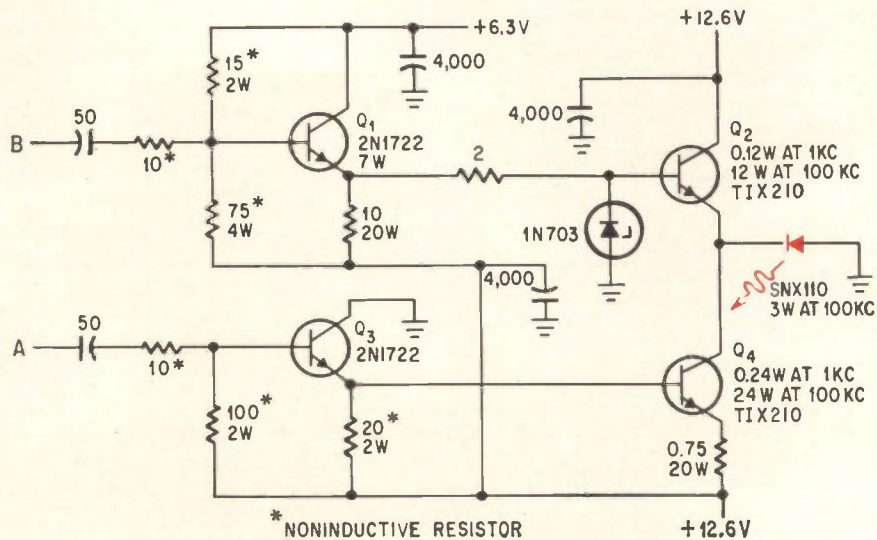
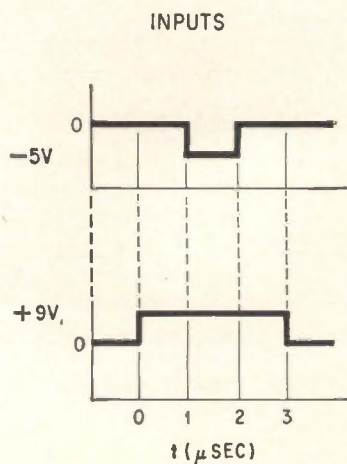

Current-mode circuit provides 10-ampere peak currents with 100-nanosecond switching times, and operates at a repetition rate of up to 100 kilocycles.

the current is switched to the other transistor and thereby through the SNX110.

### 10-amp high-repetition-rate circuit

The circuit shown above provides 10-ampere pulses into the emission source with optical switching times of about 100 nanoseconds. The optical pulsewidth should be limited to 10 microseconds with a duty cycle of up to 10%. Operation for the specific case of a one-microsecond output width and up to 100-kilocycle repetition rate is described.

The circuit consists of two sections. The section containing transistors  $Q_3$  and  $Q_4$  switches 10 amperes into  $Q_2$  prior to energizing the emission source, and turns off this current after the source is activated. This switch minimizes power dissipation in the circuit by reducing battery drain between input pulses. The switch is especially effective at low repetition rates. The section containing  $Q_1$  and  $Q_2$  is the pulse-forming circuit that energizes the emission source.

Operation of the circuit is as follows:

- In the initial state, only  $Q_1$  is conducting.
- A positive input at A results in conduction of  $Q_2$ ,  $Q_3$  and  $Q_4$ . The 10-ampere path is through  $Q_2$  and  $Q_4$ . The emission source is slightly reverse-biased as established by the operating point of  $Q_1$ .
- A negative input at B changes the operating

point of  $Q_1$  such that  $Q_2$  is biased to cutoff, and the 10-ampere bias of  $Q_2$  is switched into source S by current-mode switching as described in the section on high duty-cycle pulse circuits.

- Pulse B ends, and circuit conditions revert to those in step (b).

- Pulse A ends and conditions are as in (a).

Input A should precede and follow B by about one microsecond for the switch to function.

To obtain fast rise and fall times while switching 10 amperes, short, heavy leads must be used in the part of the circuit consisting of the bypass capacitors, light source, transistors  $Q_1$  and  $Q_2$ , and associated resistors. The large capacitors should have low series inductance, such as the Mallory type HC4040. In a breadboard version of the circuit, with moderately short leads, measured rise and fall times of the optical output were 60 and 120 nanoseconds respectively. A fall time of less than 100 nanoseconds should be attainable with careful component layout. The electrical switching time of input A is not as important as that of B in determining optical switching times; but the amplitude of A is important because it establishes the amplitude of the high current pulse.

### References

- R.H. Rediker et al., Gallium-arsenide diode sends television by infrared beam, *Electronics*, Oct. 5, 1962, pp. 44-45
- C.R. Seashore, *IEEE Proceedings*, December 1963, p. 1,781
- R.F. Shea, *Principles of Transistor Circuits*, J. Wiley and Sons, Inc., New York, 1956, p. 98
- Ibid.* pp. 141-145
- J.A. Walston et al., *Transistor Circuit Design*, McGraw-Hill Book Co., New York, pp. 141-145
- J.R. Biard, E.L. Bonin, W.N. Carr and G.E. Pittman, *IRE electron devices meeting*, Washington, October, 1962
- W.N. Carr, to be published in *Semiconductor Products and Solid State Technology*
- R.N. Hall, *Recombination processes in semiconductors*, *Institution of Electrical Engineers*, March, 1960, pp. 923-931
- S. Mayburg, *Direct recombination in gallium arsenide and some consequences in transistor design*, *Solid-State Electronics*, February, 1961, pp. 195-201

### The author



Edward L. Bonin applies semiconductor light sources in integrated circuits at Texas Instruments, Inc., where he has worked since 1957. He is attending the graduate school of Southern Methodist University.



Typical PPI presentation of a radar video signal in heavy clutter. Target at 180° is lost in the weather return.

Same target, same weather, but after processor was put into the line. Note that meteorological noise is at a minimum.

## Cutting through clutter in flight-control radar

Digitized video signals extend controller's vision and give him more time to do his job accurately

By William J. Evanzia

Avionics Editor

**Digitized, uncluttered** air-traffic data is extending flight controllers' "vision" and increasing the available time in which to perform their increasingly complex functions.

The system, called radar video data processor, resolves targets and reduces reaction times by presenting clear, uncluttered displays. It converts radar and beacon signals into digital words that

can be transmitted over telephone lines to the control station, where they are reconverted to a form that can be displayed on a radar screen.

A processor of this type was developed by the Burroughs Corp. in Paoli, Pa., under a contract with the Federal Aviation Administration.

At present, raw radar and beacon video signals are transmitted from remote radar sites back to the

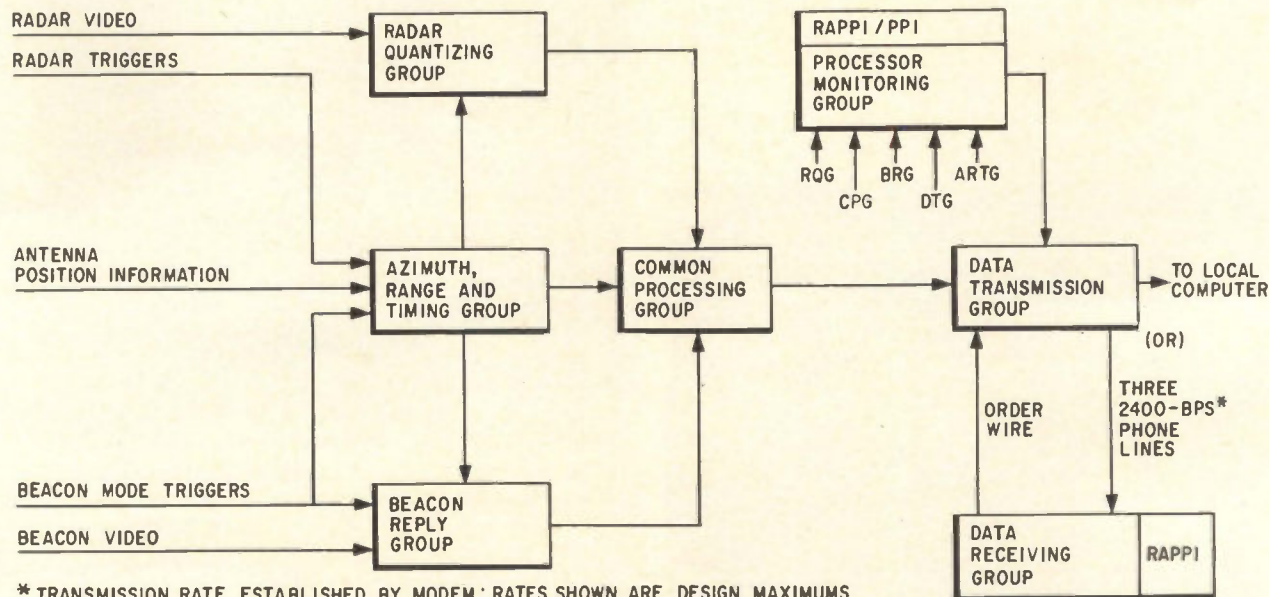

\* TRANSMISSION RATE ESTABLISHED BY MODEM; RATES SHOWN ARE DESIGN MAXIMUMS

FAA/RVDP system diagram shows the main functional groups. The FAA/RVDP of the National Airspace System performs digitizing and statistical detection of radar and beacon video signals, and prepares this information for telephone-line transmission to data-processing and display equipment.

control center via microwave links. A long-range radar (90 miles from a control center) requires costly microwave relay equipment, while the processor transmits over relatively inexpensive telephone lines. This makes transmissions possible over greater distances at proportionally less cost.

### Basic functions

In addition to handling radar and beacon video signals, the processor buffers, controls and monitors output. The system comprises functional groups for azimuth, range and timing, radar quantization, beacon reply input, common radar-beacon processing, data buffering and transmission, and data receiver and filter. These are shown in the figures above. Off-line maintenance and system monitoring is provided in the performance monitor.

The synchronizer accepts radar and beacon triggers and antenna-position information from the input sensors. The system's timing clock operates at about 2.5 megacycles and provides timing pulses at 1/32-radar-mile intervals. These pulses are synchronized with the radar trigger.

The total of the timing pulses is maintained in a range counter, which is reset by the radar trigger, and provides the range (in fractions of radar miles) of each radar return or beacon reply. Azimuth pulses and a scan-reference pulse are either generated internally from antenna synchro information or are accepted directly from an antenna pedestal commutator. In either case, these pulses are syn-

chronized to the radar trigger and occur at range zero.

Azimuth pulses are counted, and the scan-reference pulse is used to preset the counter so the counter content equals zero as the antenna passes north. The clock and elapsed azimuth pulses, and the contents of the range and azimuth counters, are used for timing and synchronization in all functional groups of the processor except data transmission and the data receiver and filter. These groups are synchronized with the transmission rate established by the data modems (telephone terminal equipment). The system is designed to be compatible with airport surveillance radars, which have pulse-repetition rates of 1,050 and ranges of 60 miles, and with air route surveillance radars, which have pulse-repetition rate of 360 rps and range of 200 miles.

### Determining the target

When the traffic controller sees a target on his display, he wants to know quickly whether it is a plane or a meteorological disturbance. During periods of heavy weather—high incidence of clutter—he must be able to distinguish the target amid the clutter. When an object comes within range of the radar sensors, the processor immediately begins to analyze and determine the validity of the target.

The first examination of the raw video takes place in the radar-quantization group. Here the white "noise" is reduced, the radar video is converted to

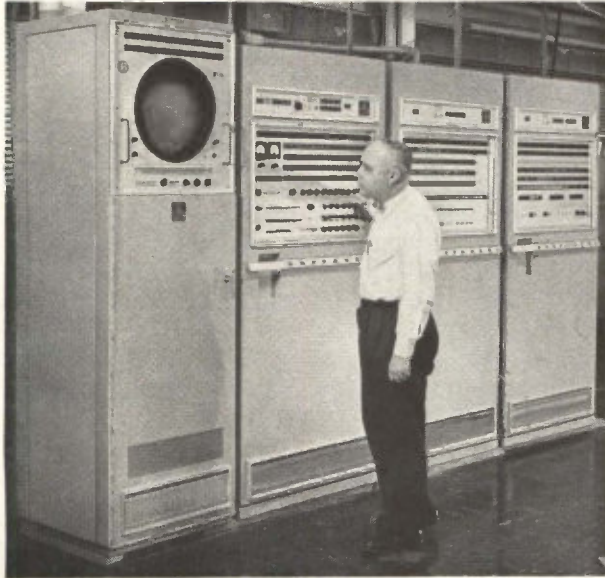

Project manager Paul Pasquine of Burroughs tests processor at a radar site. The cabinets contain the monitor and azimuth generator, the basic and common processing groups and the data-transmission group.

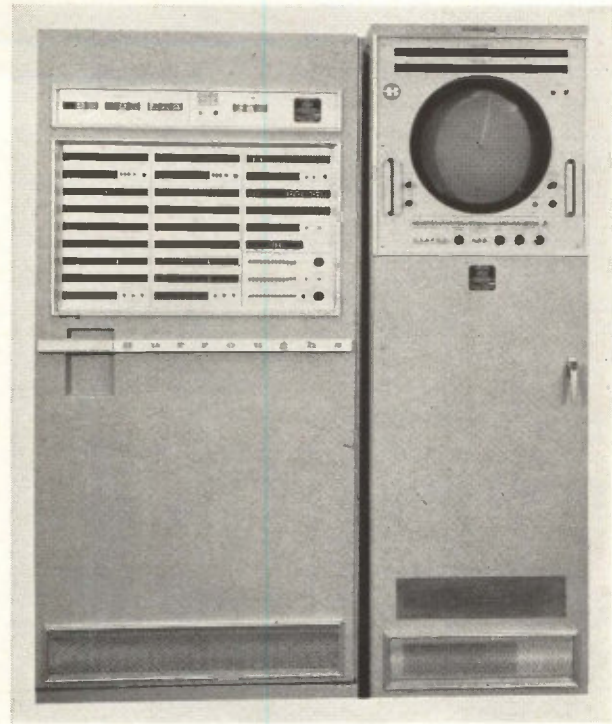

Data receiver group and monitor assembly, located at the Central Computer Complex. If the transmitter and computer are together, these units are not used.

digital data, and the digitized signal is synchronized with the system range clock. In other words, analog radar information is converted to a digital form.

The quantizer is a dynamic noise-discriminator, where noise generated in the receiver is clipped. In discriminating, a distinction is made between internal receiver noise and clutter resulting from reflection of the transmitted radar energy. The receiver noise determines the radar's minimum discernible signal. However, an integrator—either human or machine—looking at the sum of the signal plus noise, can see a valid target even though some noise is still present. Therefore, the problem is to present just the right amount of noise for optimal integration without saturation of the system.

The best solution is to present a constant noise level in areas of no clutter, allowing a minimum amount of filtering by the integrator, to permit more noise, and to increase filtering in areas of clutter. The human integrator accomplishes this by varying the intermediate-frequency gain of the radar receiver; the machine does it by varying the quantizer clip level.

The detector is capable of selecting weak target signals even when they are surrounded by noise. It can do this even though the target return may be below the mean discernible signal of the radar. It does this by examining the number of hits and misses of the target for a specific period of time. The statistics are lost, however, if the probability

of quantized noise is set so low that white noise alone results in enough quantizer output pulses to saturate the detector.

The clipping of the baseline is at an arbitrary RVDP input reference level whose average value is below that of the noise. This level is under the control of two dynamic feedback loops (figure below) whose function is to provide the optimum probability of quantized noise in clutter and clutterless areas. A level is selected that will yield the highest probability of detection in the statistical detector—part of the common processing groups—while minimizing the chance of false alarms in the detector.

The clip level is maintained automatically so that weak signals are not discriminated against and the detector is not saturated. This is done by integrating the quantizer output over a long time-constant. This output is fed back to the quantizer to develop the analog for the clip-level input.

On the way to the terminal, the aircraft may fly through sections of clutter and no clutter. When clutter is encountered, the characteristics of the radar receiver output change so rapidly that the clip level, a long time-constant, does not have a chance to react. Also, when the clutter area is passed, the quantizer must immediately recover to the stable, no-clutter clip level to retain its sensitivity to weak signals.

A second feedback loop with short time-constant reacts to the receiver's base-line shift. The second

feedback loop is switched in and out. Its movement is controlled by circuitry that determines the presence of clutter by examining the total of quantized returns in an area surrounding the last quantized return being added to the statistical detector. The effect is to break up the clutter so that the statistics of a target in the clutter can be recognized by the detector.

In this way, clutter discrimination is automatic. Clutter, which causes an increase in the noise passed by the quantizer, also increases the amount of integrator filtering by raising the threshold of detection. When the clutter is passed, the preset thresholds—quantizer and integrator—return the system to normal (figure below). The resulting effect is analogous to the human operator changing the receiver's i-f gain to "pick-out the white ash on the white rug" without degrading the rest of his display.

The circuitry automatically determines the presence and density of clutter by examining the distribution of hits stored in the memory circuits. An analog of the number of hits present is produced in a function generator which has, as a reference, a constant  $P_{fa}$  (probability of false alarms, or false targets) curve.  $P_{fa}$  is an exponential curve resulting from a plot of  $P_d$  vs  $P_n$  set in as a fixed bias in the function generator. This analog is then used to raise the detection level to a value above the number of hits from clutter alone.

Since the hits reinforce target signals as well as indicating the presence of clutter, the probability of detection ( $P_d$ ) is not significantly affected by raising the detection thresholds.

As an aid in the detection of incoming targets, the processor uses both moving-target indication (MTI) and normal video signals. A crossover gate selects either quantized MTI or quantized normal video at any range. The selected MTI/normal video can then be fitted around a clutter area. Since normal video is more sensitive than MTI, this feature of the processor permits the optimum adjustment for clutter cancellation without loss of sensitivity where MTI is not required (figure on page 87).

### Statistical detection

The next operation on the target video is statistical detection. The statistical detector is part of

#### Editor's note

Surveillance of airspace over the continental United States, for air-traffic control and air defense, has been performed for several years by radars operated jointly by the Air Force and the Federal Aviation Administration.

Evaluations by FAA and Air Force engineers have indicated that such joint uses result in substantial savings. The processor described in this article provides for common usage of an economical means of data remoting.

Evidence of the high interest in joint use is shown by recent government contracts for equipment, installation and maintenance of radar remoting equipment. These awards were made under the communications agreement of February, 1963, between the FAA and the Department of Defense Commercial Communications Office. The awards were to the Southern Bell Telephone and Telegraph Co. of Atlanta, Ga., and the American Telephone and Telegraph Co.

the common processing group, where the quantized video is statistically examined for validity. Quantized video is the sum of reflected radar signal and a percent of the receiver noise.

Examination of the target is made by a technique known as the "sliding window". The window is really a register, or memory-case, capable of storing the maximum number of quantized returns—radar hits—on a target as the radar beam scans it.

As the target approaches, the processor must declare that a target is indeed present. Quantized returns (hits) are written into the register, which has been addressed (selected) by the processor's range counter. The contents are shifted through the register each time the range-counter addresses it, and if no quantized returns are present, a zero (miss) is written.

An examination of the history stored in the window, plus the presence or absence of a return in the current radar period, is made every radar period during each radar interval (memory read-write cycle). This is shown in the figure on page 88. The basis for target declaration is a threshold setting that is normally greater than one-half of the capacity of the register. The declaration of target is made when the examination shows that the total of returns is greater than the threshold, usually one more than half the possible number of hits in a window. This is called the target-leading edge  $T_L$ . End of target, or target-trailing edge  $T_T$ , is declared when the returns fall below a second preset value (figure on page 87).

A window is provided for each radar range interval—the transmitted pulse width—in which the basic radar can resolve a target. The radar window size is the result of a determined number of radar periods; therefore, the sliding window contains the total of returns for one antenna beam-width.

Target azimuth is also determined in the detection memory. The process is called beam-splitting. One-half of the run length of the target—the elapsed azimuth between  $T_L$  and  $T_T$ —is subtracted from the azimuth counter contents at  $T_T$  to determine the target's true azimuth.

High target resolution or optimum target processing is achieved by registers for every range at which a target is expected. This permits targets with the minimum allowable slant-range separation to be identified separately. The registers are sequentially addressed in synchronism with the radar timing. The number of required registers is determined by resolution capability of the radar times the maximum nominal radar range ( $r_s \times R_n$ ).

The target reports that are transferred out of the processor contain range accuracy information that indicates in which quarter or half of the range-resolution interval (memory address) the target was received. Thus the separation capability of the radar— $1/8$  radar mile for a one microsecond transmitted pulse, and  $1/4$  radar mile for a 3  $\mu$ sec transmitted pulse—is corrected for  $1/16$  radar-mile accuracy—quantizer sampling interval—by the



radar video data processor.

An air route surveillance radar requires 800 words, representing a 200-mile range at ¼-mile resolution. The memory actually contains 1,024 words of 51 bits per word allowing for expansion to a 250-mile range. A thousand words represents 250 miles. Twenty-four words are for internal processor tests. Range accuracy of 1/16 radar mile is obtained by storing two bits of accuracy data in each memory word.

### Data transmission

The aircraft's target signal has now been quantized, detected, processed and validated. The signal arrives next at the data-transmission group, where the output is buffered and controlled.

The processor, a real-time device, processes target information as fast as the radar sensors can see it. However, the transmission modems—telephone terminal equipment—handle all the data at an average rate. For example, if the video information to the data-transmission group has a peak of 4,000 bits per second for some finite time, the group will buffer it, store and disseminate it at the modem average rate—perhaps 2,400 bits per second.

The time-in-storage is calculated for each message read out of the buffer memory. Messages that have remained in storage for more than a manually preselected maximum time can be discarded by the group. Radar-only targets occupy one word, beacon-only or beacon-radar targets occupy two words. This establishes a minimum capacity of 256 messages, for beacon-only or beacon-radar, and a maximum capacity of 512 messages for radar only, map messages and/or status messages, in the memory unit. The memory employs two cyclic address-counters, and works on a first-in, first-out basis. Beacon information is accommodated by write-write and read-read cycles.

The data transmission group is designed to work with three 2,400-bit-per-second modems transmitting over telephone lines. It operates asynchronously when located next to the data processor receiving the data. When data transmission is required, the data-transmission group operates from the modem clock and is basically compatible with all available modems and data rates for telephone-line transmission.

### Receiving data

The final leg of the video signal's journey through the processor is along the telephone lines and into the data receiver group. This group is located at the computer end of the data-transmission facility if the processor is remote from this location. The group provides for parity checks, for the assemblage of messages into characters for entry into the processor/digital filter equipment, and for direction of status messages to a status display. The data receiver group contains identical channels for each transmission line from all remote sites.

Generation of system-control messages, such as manual map outlines, automatic mapping on-off,

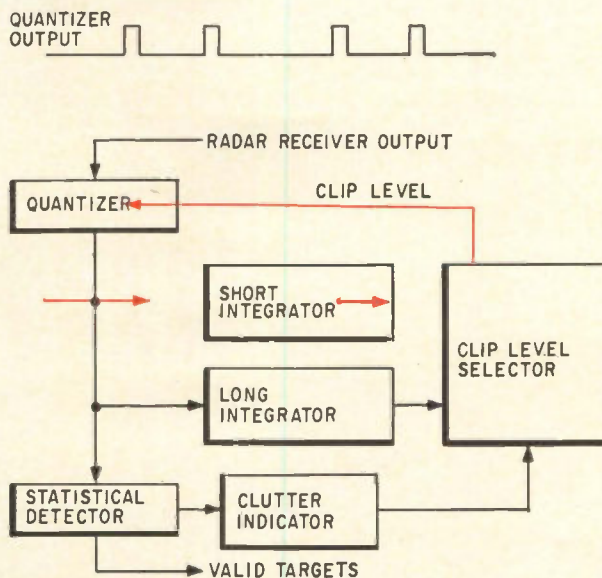
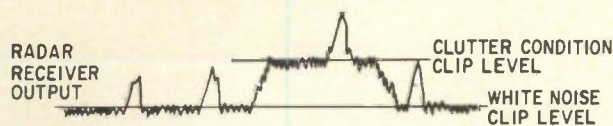

**Automatic clutter eliminator.** Processor contains circuitry that determines the presence and density of clutter by examining the distribution of hits being stored in the sliding windows. An analog of the number of hits present is generated (above) that has as a reference a constant  $P_{fa}$  (probability of false alarms) curve. This analog is then used to raise the  $T_L$  and  $T_T$  to a value above the number of hits from the clutter along. Feedback loops around the quantizer and statistical detector (below) determine the clutter-no clutter clip level.

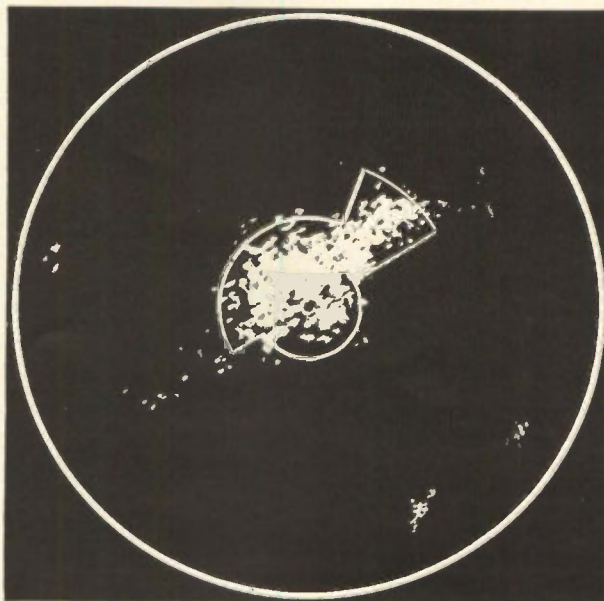

**Crossover gate** is used to select quantized MTI video to the maximum range of the ground clutter, and quantized normal video from that range to the maximum range of the radar. The crossover point can be selected at any range for each of three adjacent sectors of any angular size. This compensates for irregularities in the ground-clutter pattern.

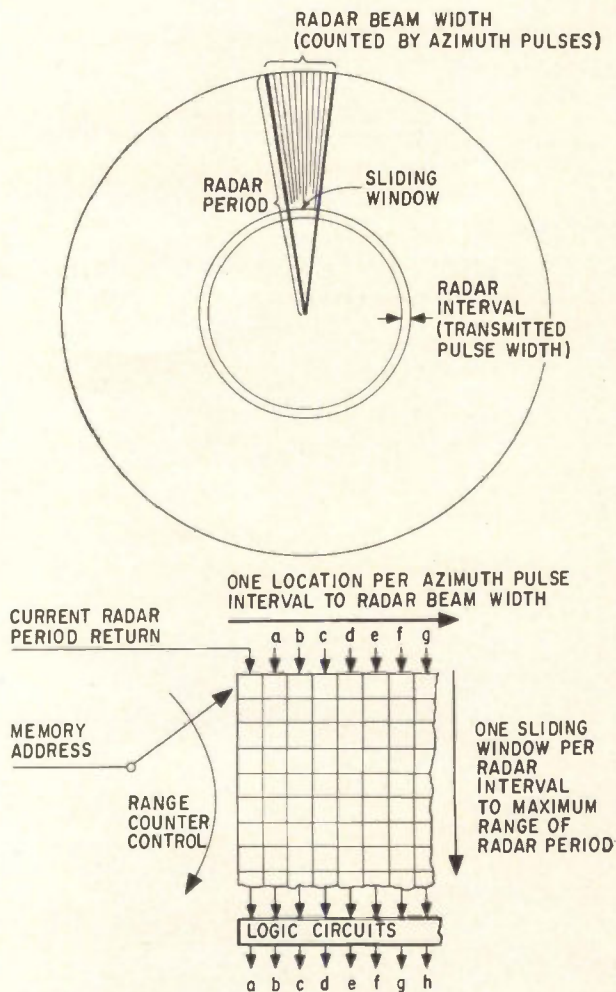
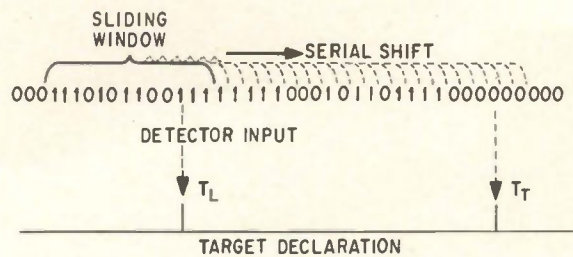

Memory organization for statistical detection. Declaration of  $T_L$  and  $T_T$  by the sliding window (top).  $T_L$  is declared when the number of hits exceeds a preset threshold.  $T_T$  occurs when the hits fall below a second threshold setting. Threshold is usually one more than half the number of possible hits in the window. Determination of radar period and beam width is shown in the lower figure. The beam width is counted by counting azimuth pulses. A sliding window (radar interval) is shown for every interval out to the maximum range of the radar. For each range counter address, a separate sliding window is addressed in the memory. When the windows are addressed, all the information is read out of the memory address. The logic circuits compare it and put it back into the memory. It is then moved over one place and new returns are stored in the first position. The memory circuits simulate the antenna movement.

radar and beacon range-limiting, are handled by the data-receiving group and transmitted to the processor over an orderwire circuit. The group includes a random-access plan position indicator (RAPPI) for monitoring incoming targets and messages.

### Displaying the target

A monitor display scope (RAPPI PPI) presents processor target data in highly readable radar-scope presentation. Two modes of operation are possible: PPI and RAPPI (Random-Access PPI).

The selection of the display mode is dependent upon the equipment operator. The PPI will display radar-input information in the same manner as any standard radar repeater. Its information is synchronized with the transmitter's timing signals. The RAPPI accepts asynchronous target information from the processor's interval-processing and output points, converts the digital range and azimuth information to an analog, and positions the target blip on the scope as if it were a synchronous PPI presentation. The RAPPI display looks like repeater information, but without the clutter. The same type of display is presented to the air traffic controller.

### Beacon signals

Suppose the target receives an interrogation signal from a beacon transponder and sends out a reply. The common processing group must validate the beacon reply codes and correlate the beacon information with the radar targets for transmission by the processor.

The beacon reply group decodes beacon information received from a ground interrogator. It must sense the presence of a potential reply, and resolve the replies that can be transmitted as messages to the common processor group (figure on page 89).

The beacon video pulses are tested and noise pulses are eliminated, in the beacon-reply group. Accepted pulses are standardized and enter the detection logic which senses bracket-pulse pairs—framing pulse timing—and aligns the code information. The detected bracket or framing-pulse pairs are used in the common processing group for beacon-target declaration in a manner similar to the search-radar hits. Separate sliding windows are provided for each identification and altimeter report, in the same memory as the radar sliding window.

Alignment in range is accomplished by delay elements. This compensates for the beacon system delays, such as transponder reply time, and for the search automatic-clutter-elimination detection delays, so that the declaration of a beacon target is correlated with the declaration of the same target from search radar returns. The beacon codes are processed while target history is being accumulated for target detection.

### Map messages and sector scanning

In areas of high clutter, the function generator

that controls the threshold level can easily be made to provide different false alarm rates. The threshold control is designed to provide a constant level of false alarms in clutter.

A remotely controlled override is provided, by which this function can be overridden in any sector of any prescribed size. With this technique, the threshold can be raised to reduce false alarms, or lowered to provide "see-through."

The mapped area is automatically defined at the system displays by map messages. These messages are generated at the radar video data processor and transmitted with the target messages. Automatic map outlines are generated when the clutter encountered is so severe that detection of targets is impossible. No target detection is allowed in this area. The clutter density at which this blanking function takes over can be adjusted to meet specific requirements.

Provision is made at the processor's input for area-blanking signals. These can be furnished by a rotating-disk mapper unit. The mapper is furnished by the customer and is external to the processor.

The disk, similar to a phonograph record, is positioned in front of a miniature cathode-ray tube. As the electron beam sweeps the face of the scope, and as the transparent portion—the map outline—revolves in front of it, an optical device will pick up the light signal. These gated clock-pulses are light signals that are sent to the quantizer as inhibit signals. Thus, radar returns in the masked area are prevented from reaching the statistical detection.

### Reducing interference

The Archimedian spiral, or "running rabbit," is caused by nearby radars with the same pulse-repetition frequency. In all cases, this type of interference is reduced, and in most cases it is eliminated, by the statistical detector. This is because it fails to meet the detection threshold. However, strobe or "spoke-type" interference, caused by a directional noise signal, can saturate the memory just as it can saturate the display used by the human integrator.

Removal of strobe interference requires, first, that it be identified, and second, that it be inhibited. The identification of a strobe is accomplished by counting the quantized returns present in a sweep, and comparing the total count with a preset threshold. By displaying the total on each sweep, the system loading is made available for monitoring. The strobe eliminator function can be switched on to inhibit any sweep exceeding the preselected threshold. For each strobe eliminated, a return is stored in an unused (close-in range) memory word, and is subjected to the same beam-splitting process as a valid target. The output of the strobe eliminator is presented to the PPI monitor for system-performance monitoring. If this output results in a completed target, it is reported to the computer, to alert the system to the severity of interference.

### Monitoring

The processor-monitoring group constantly

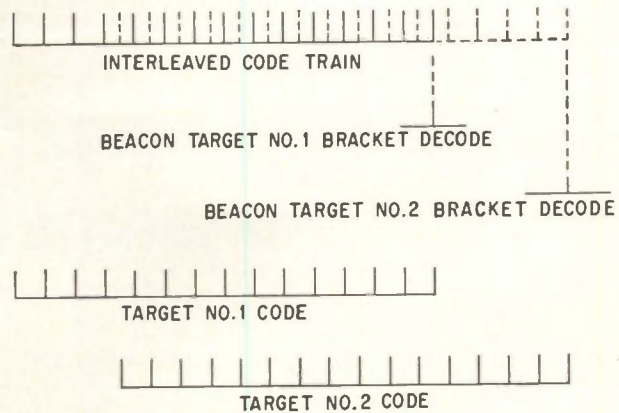

Beacon reply group tests each video pulse received, and discriminates against pulses whose characteristics indicate they were the result of noise. It accepted, each pulse is standardized, except in width. A wide pulse may be the result of overlapping of pulses from two trains. The standardized pulses enter the detection logic, which senses bracketed pulse pairs and aligns the code information bracketed by the framing pulses at the output of a decoding delay line. A second delay line, in series with the first, tests for garbling and separates interleaved codes.

monitors the status of logical checks built into the system. Failure of radar triggers, azimuth synchro data, modem clocks, timing circuitry, power supplies and other basic functions trigger a visual and audible alarm at the processor. The processor-monitoring group generates a status message once per scan, and the message is transmitted to the data-processing and display equipment. In case of an alarm, a status message, which identifies the failure, is immediately generated and transmitted.

Fixed, internal test targets are generated in the processor and checked by the process-monitoring group after they have circulated through the system. Test-target generation is also provided to generate search and beacon targets for internal and external use, with position and run-length switch-controlled. This provides an aid for maintenance of the processor and associated equipment.

### Components and construction

Surveillance and beacon radar information from the processor must be available on-line to air-traffic controllers. Therefore, field-proven components and construction techniques had to be employed. Flexibility requirements also demanded that the assembly be compatible with various installations with different radar plants and data-transfer requirements.

The processor's logic elements employ a hybrid transistor diode logic system developed by Burroughs. The system has been used successfully on an airborne siliconized computer for bombing and navigation, as well as in previous data processors.

The author thanks Walter Ivins, senior engineer, and Richard Brady, communication services manager of the Burroughs Corp., for their assistance.

# Early Bird: a bigger and better communications satellite

Syncom technology and enthusiasm abroad are helping the Communications Satellite Corp. Here are the details

By Joel A. Strasser

Space Electronics Editor

**The Early Bird**, the world's first commercial communications satellite, will be more powerful and versatile than the Syncoms from which it evolved. The Communications Satellite Corp. has tentatively set March 2, 1965, as the launch date for its commercial station in the sky.

From a stationary position over the Atlantic Ocean, the satellite—called HS 303 and nicknamed Early Bird—will link North America with Western Europe by electronic circuits. It will transmit television programs live, or provide up to 240 two-way telephone-grade circuits—each of about 300 to 3,000 cycles per second—for phone conversations or for data transmission. One telephone-grade circuit will be able to carry 22 or more telegraph messages simultaneously, depending on the terminal equipment used.

A control center is being built in Washington, and terminal stations are being constructed or modified elsewhere in the United States as well as in Canada, Britain, France, Italy and Germany.

The design of the HS 303 is an outgrowth of the Syncom satellites launched by the National Aeronautics and Space Administration. The civilian space agency's experiments with Syncom I, II, and III proved to Comsat that a spin-stabilized active-repeater satellite, placed into a synchronous orbit and kept on station with reaction jets, was practical. The first Syncom failed but Syncom II, launched on July 26, 1963, is still operating successfully and Syncom III is scheduled to be launched Aug. 18 or later into a stationary orbit over the Pacific Ocean. Comsat decided to adopt the basic Syncom design, improve upon it, make it meet new frequency specifications, and launch it as the corporation's first commercial venture. The HS 303 spacecraft is now being built by the Hughes Aircraft Co.,

builders of the Syncom series.

Unlike any of the Syncoms, Early Bird will have two wide-band transponders (25 mc each) that will be able to transmit commercial-quality television. Syncom II did have two transponders, but one was limited to a 5 mc channel and the other had two 500 kc channels. On Syncom III, one transponder's bandwidth was increased to 10 mc; the other is 5 mc wide.

Early Bird's frequencies conform with the new allocations by the International Telecommunications Union meeting at Geneva. Early Bird will receive signals at the up-link frequency of about 6,000 mc and will transmit 4 watts at the down-link frequency of about 4,000 mc. The up-link frequency of both Syncoms is 7,360 mc and the down-link frequency is 1,815 mc; both satellites radiate two watts of power.

In order to obtain stronger signals and wider coverage, gain of the communications transmitting antenna has been increased from 6 db on Syncom II and III to 9 db on HS 303. Receiving-antenna gain was boosted from 3 to 6 db. Command and telemetry subsystem functions have been integrated with the communications subsystem, and nonessential telemetry channels have been eliminated.

## More solar cells

HS 303 will be a bigger and better spacecraft. It will have additional solar cells to boost its power capability from 29 to 45 watts. It will be able to handle the bigger transponders and the doubled output power plus housekeeping functions such as keeping on station and controlling temperatures. Early Bird will be powered by about 6,000 solar cells compared with 3,850 cells on the cylindrical surfaces of a Syncom satellite. The width of the



new satellite's solar-cell-laden cylindrical surface has been increased from 15.5 inches to 23.25 inches. Radiation resistance of the solar cells is being increased by using n-on-p cells instead of p-on-n, and by covering the cells with 12-mil fused silica quartz. Solar cells on Syncom II were covered with 6-mil glass to cut down the effects of radiation, but the improved cells and cover plate have been included on Syncom III.

Explosion of a tank of nitrogen in the reaction control system has been pinpointed as the most probable cause of the failure of Syncom I, the first of the experimental synchronous communications satellites. The Early Bird will have two hydrogen peroxide systems. Syncom III will also use hydrogen exclusively, but Syncom II carried both hydrogen peroxide and nitrogen units for reaction control jets.

The thrust-augmented Thor-Delta was chosen to place both Syncom III and HS 303 into orbit because it required fewer stationkeeping adjustments. Syncom II, which was launched with a regular Thor-Delta that has lower boost power, requires regular orbital adjustments.

#### Wide-band communication subsystem

HS 303 is an active-repeater satellite that has redundant transmitters and traveling-wave-tube amplifiers. It is designed to receive and translate incoming signals from ground stations from 6,000 Mc to 4,000 Mc. Band-center frequencies of 6,301.02 Mc from Europe and 6,389.97 Mc from North America are planned for the satellite. Alternate communications frequencies are provided at 6,389.97 Mc from Europe and 6,404.79 Mc from North America. The pattern of the receiving antenna is symmetrical about the satellite's spin axis. Signals are received

Visibility limits for 10 degree and 15 degree inclined synchronous orbits of the HS 303.

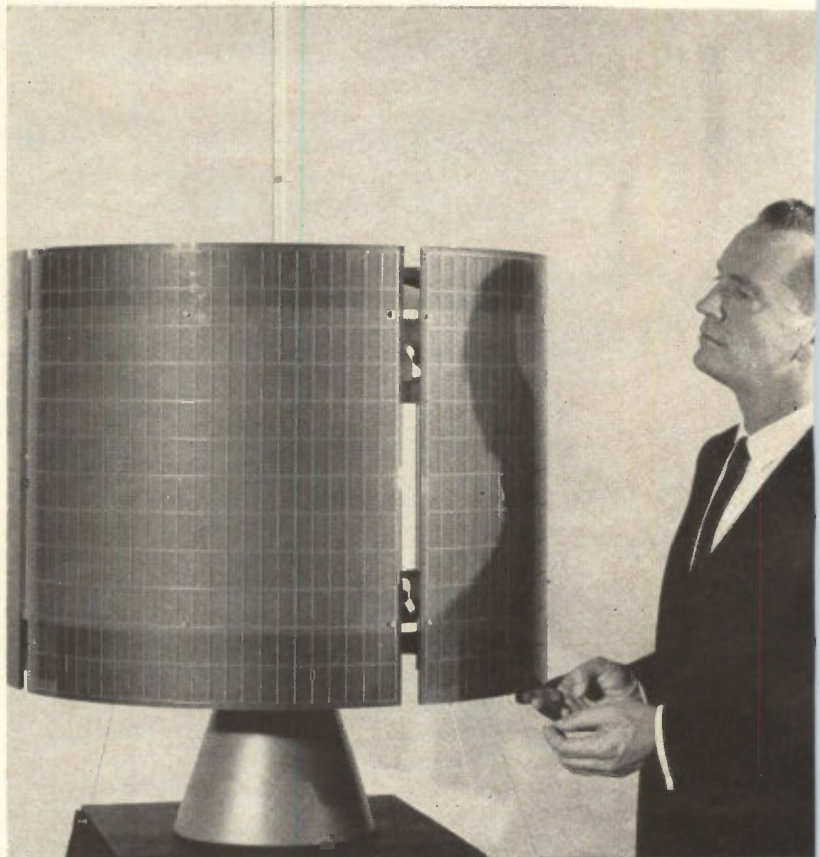

First commercial communications satellite, HS 303, is being built by the Hughes Aircraft Co., builders of the Syncom series. It will have about 6,000 solar cells compared with Syncom's 3,850. Project manager Richard M. Bentley examines a model.

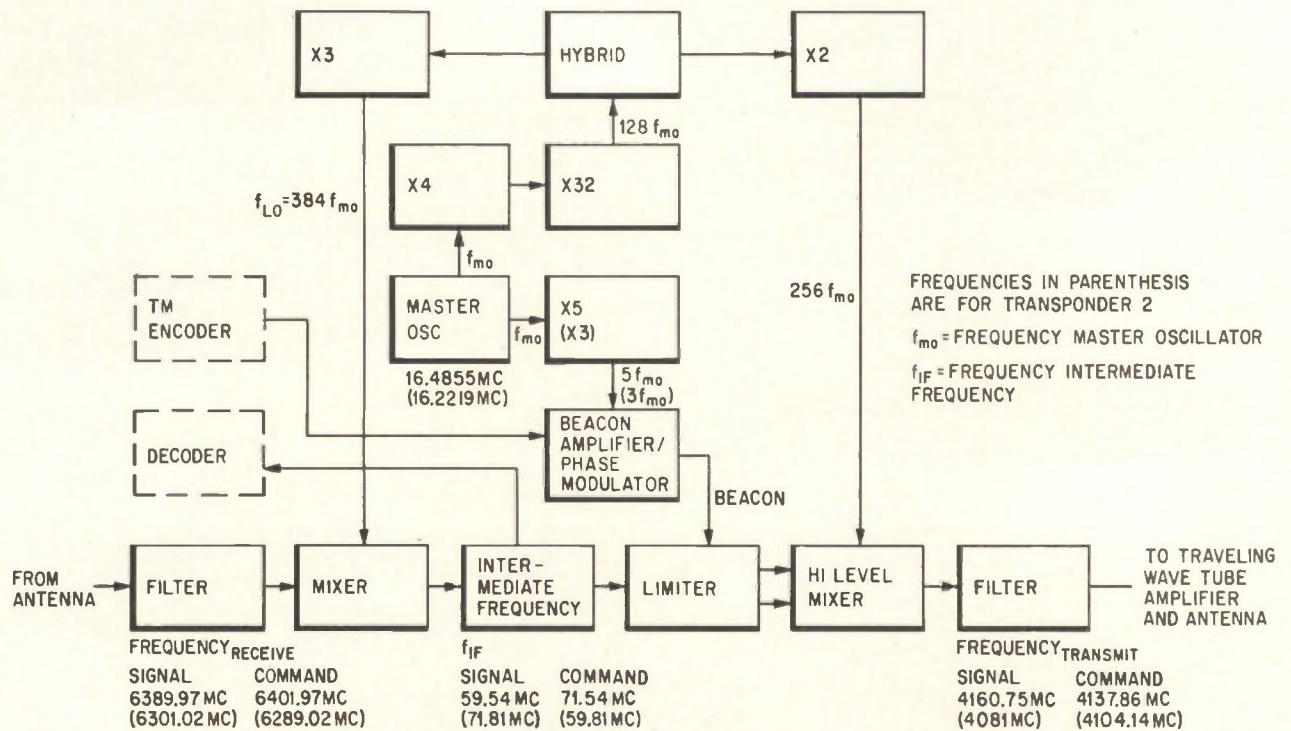

Simplified block diagram of one of two redundant transponder systems aboard HS 303

by two receivers that operate continuously. Each receiver has a flat bandwidth (0.5 to 1 db down) of 25 Mc and consists of a mixer, local oscillator, intermediate-frequency amplifier and a limiter amplifier.

Following the receiver limiters, the outputs are mixed with a reference signal to provide a frequency-translated low-level output with a nominal carrier frequency of 4,000 Mc. Band-center frequencies are 4,160.75 Mc to Europe and 4,081 Mc to North America, with alternates of 4,170 Mc to Europe and 4,100 to North America. In a 30-Mc band centered around these frequencies, one or more carriers may be used for f-m transmission. Traffic will include multichannel voice, telegraphy, video or other services.

These outputs are connected to a single hybrid network, the outputs of which are, in turn, connected to the two traveling-wave-tube transmitters. Either traveling-wave tube may be selected by command for use with both receivers, but the transmitters are interlocked so that only one transmitter may be used at any one time. A turn-on command to either transmitter automatically turns the other off. Incoming signals from Europe and North America can be received simultaneously on separate receivers at frequencies differing by 89 Mc. Both are amplified in one traveling-wave tube and transmitted by one of the redundant transmitters.

The reference signal, derived through frequency multipliers from the receiver master oscillator, is also transmitted and can be used on the ground for range (distance) and range-rate (radial velocity) determination. It can be used as a beacon for track-

ing the satellite with the ground communication system equipment, and also as a carrier for transmitting satellite telemetry data.

The transmitter's output is 4 watts. Each transponder receiver with either transmitter is designed to operate at all times except when the satellite is in eclipse—in the shadow of the earth—regardless of whether the batteries are operating or not. The synchronous satellite does go into eclipse during the autumnal and vernal equinox for about 70 minutes maximum each time. It will be in partial eclipse for 20 days before and after each equinox.

The transmitting antenna is a coaxial slot array on the spin axis. Its gain is 9 db and the pattern is independent of angle about the spin axis. The

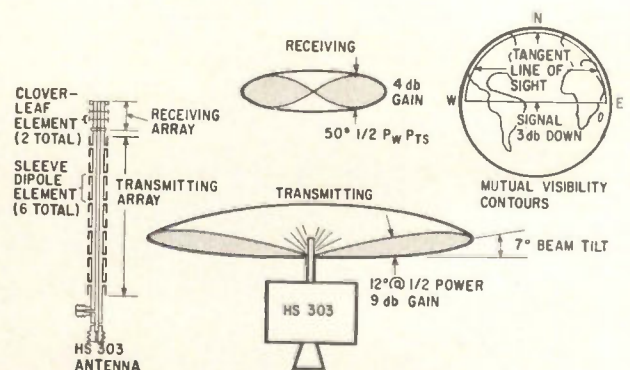

Transmitting antenna is a coaxial slot array on the spin axis and has a gain of 9 db. Antenna beam is conical, with maximum gain in the direction of the ground terminals and is about 12 degrees wide. Receiving antenna is a 4-db colinear array.

antenna beam is conical, about  $12^\circ$  wide with maximum gain in the direction of the ground terminals.

Channel capacity specifications include a satellite effective radiated power (transmitter power output per carrier, less line loss, plus antenna gain) of 10 dbw. Path attenuation, which is 196.8 db, less the 57.5-db antenna gain of the station at Andover, Me., yields a net path loss of 139.3 db. Received power per carrier is anticipated at  $-129.3$  dbw.

Measurements made at Andover on a clear day show a noise temperature of  $50^\circ$  K at the antenna. Signal-to-noise ratio is 50 db for a 1-mw test tone. The specification takes into consideration use of a preemphasis network that will improve the signal-to-noise ratio by 4 db at the uppermost frequency.

Center frequencies of the tracking beacons are 4,104.14 and 4,137.86 Mc. Alternate frequencies of 4,147.30 and 4,123.37 Mc are provided. Additional frequencies in the 136 and 148 Mc bands will be

used for initial tracking and housekeeping. The beacon signals will be phase modulated by telemetry information from the spacecraft.

Forty-five watts of electric power are supplied by a subsystem made up of silicon n-on-p solar cells, a nickel-cadmium battery and combined voltage regulators and switches. The solar cells are arrayed on the external cylindrical surface. The sun line will make an angle of  $23.5^\circ$  with the axis of the cylinder. The Heliotek Corp., a division of Textron Electronics, Inc. will supply the solar cells.

### Command and telemetry

The command subsystem is designed to turn the communications and vhf telemetry transmitters on and off, and to provide all the necessary control system functions.

The subsystem comprises the communications antenna, microwave receivers and decoders. Com-

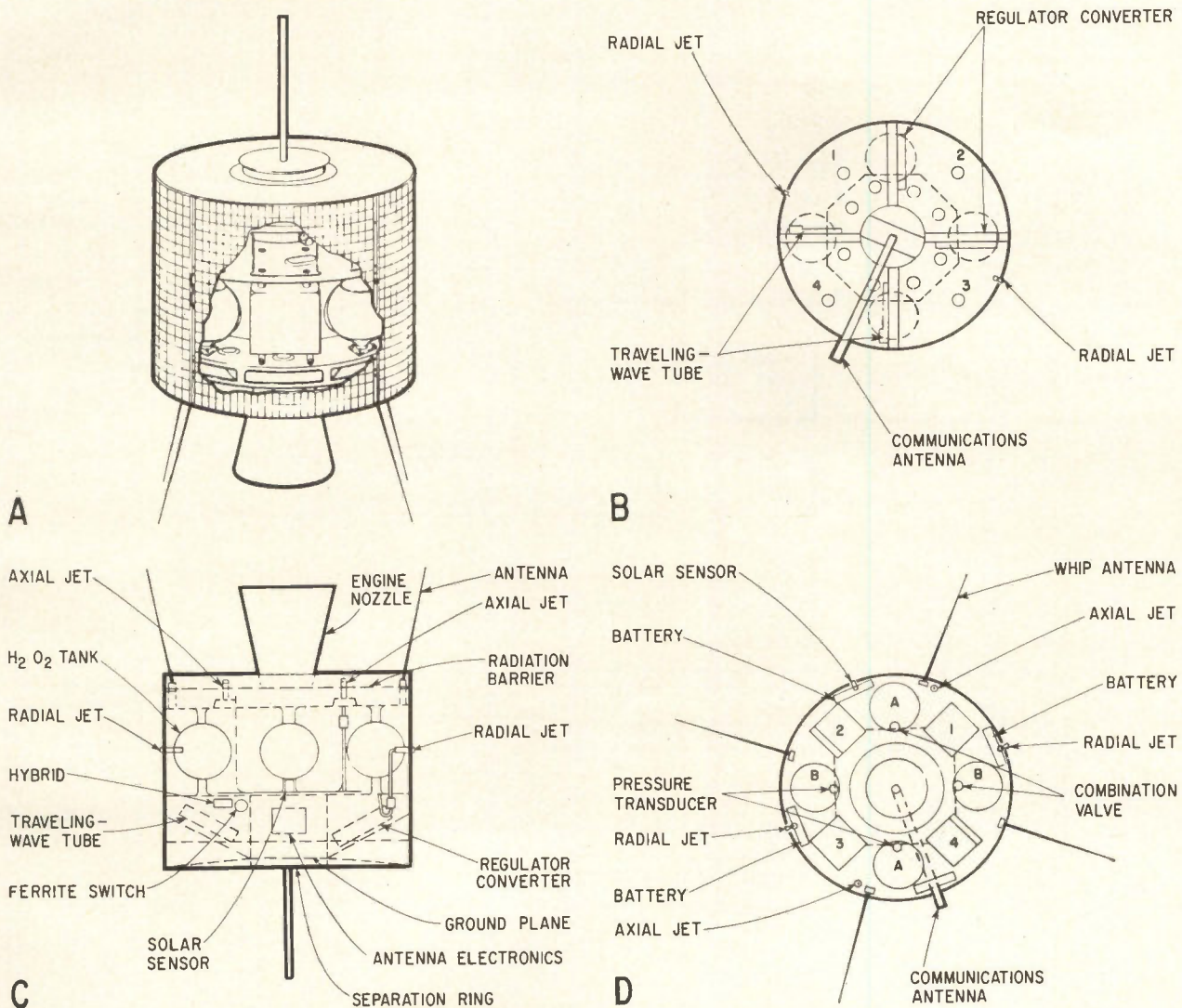

Component placement aboard HS 303 is shown in cutaway and construction views of the spacecraft. Traveling-wave tubes are located in quadrants 1 and 4 in forward view (b). Position of the apogee-kick engine nozzle is shown in side view (c). Aft view (d) shows position of batteries while cutaway view (a) shows extent of solar-cell panels.

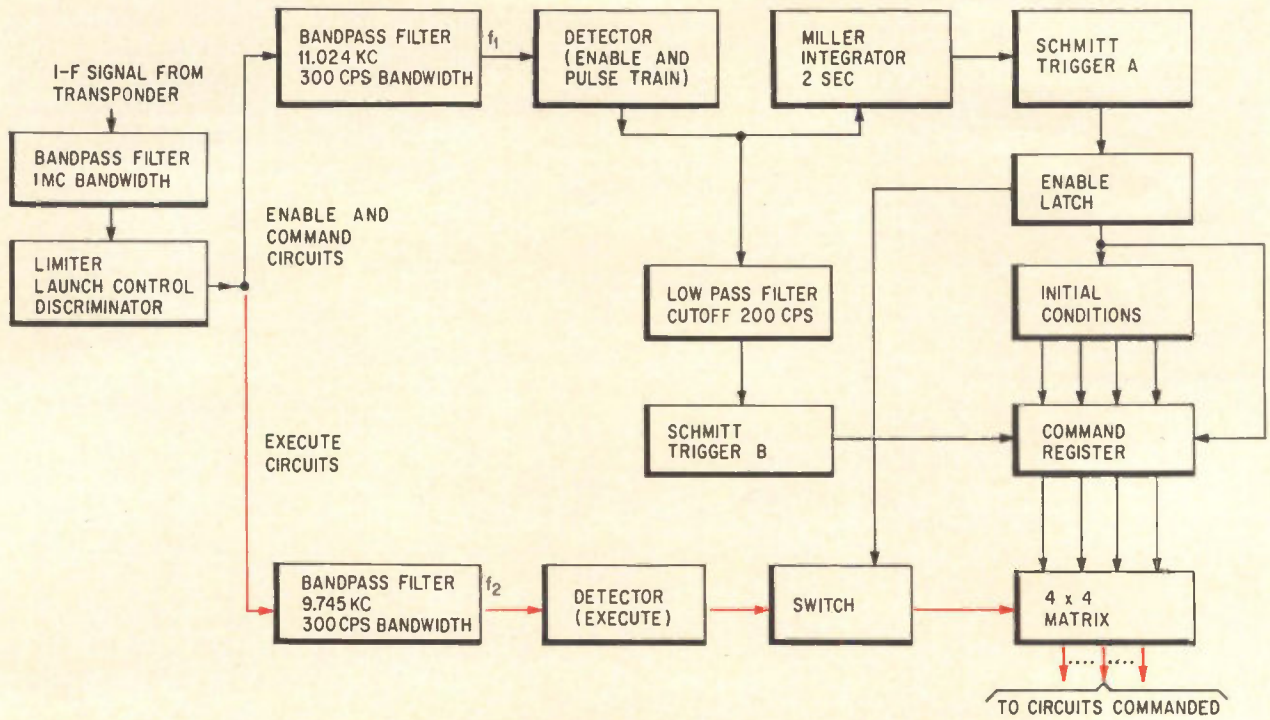

Command subsystem turns communications and telemetry transmitters on or off, and provides a number of spacecraft control functions

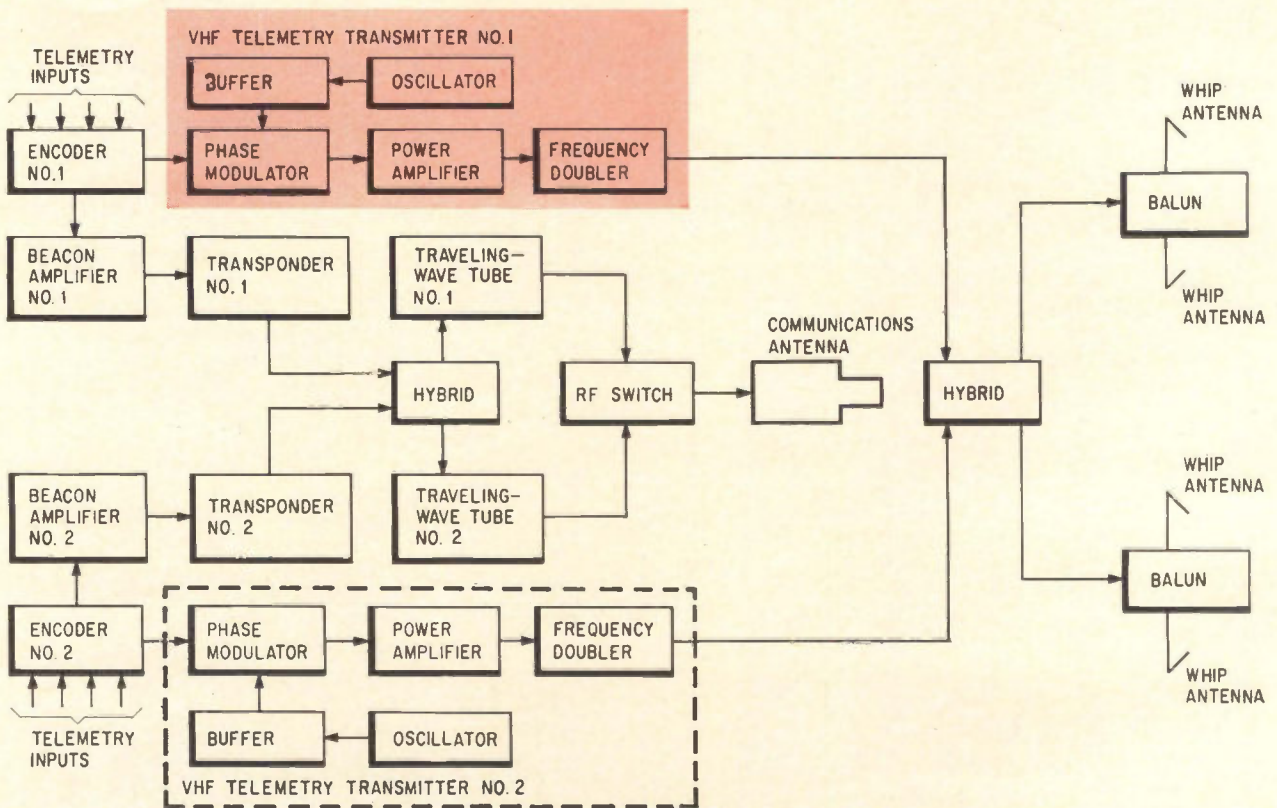

Telemetry subsystem transmits ten channels of environmental and performance data to ground station monitors



mands are transmitted at the up-link frequency of about 6,000 Mc.

The two command receivers are identical; parallel units each having a mixer, intermediate-frequency amplifier and frequency modulation discriminator. The detector outputs of the two receivers provide audio output tones recovered from the modulation on the command transmission from the ground. Each command receiver is associated with one of the two redundant command decoders. Either receiver-decoder can control the spacecraft. One decoder is switched on automatically when the other fails.

A control subsystem establishes the spacecraft's longitude, controls orbital velocity to synchronous altitude and orients the satellite's spin axis from boost altitude to operating altitude. Solar sensors measure the attitude and position of the spacecraft with respect to the sun and telemeter this data to the ground. On command from the ground, the control circuits activate the hydrogen peroxide reaction jets to change the spacecraft's orbit or orientation. The reaction jet systems are being supplied by Walter Kidde & Co., Inc.

The telemetry subsystem aboard HS 303 will handle 10 channels of time-multiplexed data including spacecraft temperatures, hydrogen peroxide tank pressures, stored commands and battery, power bus and reference voltages. Solar-sensor pulses frequency-modulate the transmitters directly.

The system consists of the communications antenna, the four vhf whip antennas, two vhf transmitters, the communications transmitters, two encoders and the signal conversion elements. The encoders modulate both the vhf carrier and transponder beacon.

With the two encoders operating continuously, the method of transmitting the telemetry signals is determined by the transmitter in use. During the launch and transfer orbit phase, the vhf system will be used. Later, when the communications trans-

ponders are activated, telemetry will be carried by the 4,000-Mc beacon. Vhf telemetry and transponder operation, however, can be used simultaneously.

### Ground Facilities

Ground command and control of HS 303 will originate at the Comsat control center in downtown Washington in the corporation's office at 2100 L Street, NW.

Basically, Comsat's control center will comprise three large sections: teletype, computer and display. Information from Andover, in data and message form, will come into the teletype section. Here, status reports on the satellite, telemetry data to aid in determining the satellite's spin axis, polarization measurements and various type of tracking data will be collected to be fed to the computer.

The computer section will have an IBM 7040 and associated peripheral equipment to calculate the orbit and spin-axis rotation. The computer will provide the six orbital parameters, including the satellite's apogee (high point), perigee (low point), inclination (the angle the satellite's orbit makes with the equator in degrees), period (the time it takes the satellite to complete one full orbit of the earth), nodal progression (change of satellite's point of equator crossing due to anomalies) and the line of apsides (line between apogee and perigee passing through the earth).

This information will be sent to the display section, which will display the data and make command decisions. The displays will be manually operated since no speed is required for entering the data. Commands will be sent by telephone and teletype to the command station at Andover, operated by the American Telephone & Telegraph Co.

Andover will become the main station for communications and control in the system to be formed by the HS 303. The station was originally built by Bell Telephone Laboratories, Inc. for use with the

## HS 303 system ground station specifications

Location	U. S. A. Andover, Maine	France Pleumeur- Bodou	England Goonhilly Downs	Italy Fucino	Germany Raisting	Canada Mill Village, Nova Scotia
Antenna type	68-foot horn	68-foot horn	85-foot parabolic dish	30-foot parabolic dish being modified to 44 foot	82-foot parabolic dish	85-foot parabolic dish with Cassegrainian feed system
Polarization	linear	linear	linear	linear	linear	linear
Transmitting amplifier	Traveling-wave tube	Traveling-wave tube	Traveling-wave tube	Klystron	Traveling-wave tube	Klystron
Power output	3 Kw	2 Kw	7-10 Kw	7-10 Kw	2 Kw	10 Kw
Receiving antenna noise temperature	50°K @ 5° elevation	50°K @ 5° elevation	50°K @ 5° elevation	200°K modified to 150°K @ 5° elevation	75°K @ 5° elevation	75°K @ 5° elevation
Receiving antenna efficiency	to 75%	to 75%	50% minimum	50% minimum	50% minimum	50% minimum

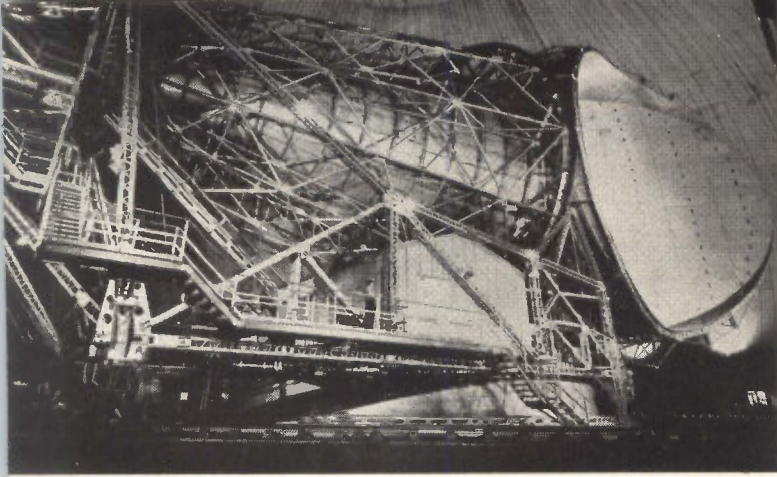

Horn reflector at AT&T's Andover, Me., station forms part of the main station for the Early Bird ground network. Giant horn is 177 feet long, weighs 370 tons.

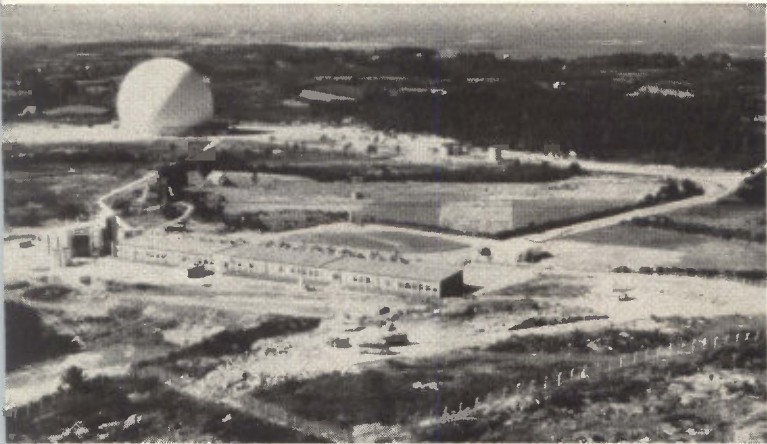

French ground station at Pleumeur-Bodou is operated by the National Center for Telecommunication Studies of the Ministry of Posts and Telegraphs. Design is patterned after Andover, Me., station

## Is time delay a problem?

Coping with the time delay caused by the distance of the communications path of a synchronous satellite may present a serious problem for users of satellites at synchronous altitudes. Orbiting a satellite at that altitude has an obvious advantage: the satellite is moving at exactly the same speed as the earth rotates so it appears to remain stationary over one point on the globe.

But on one 22,300-mile bounce, or 25,000 miles at the satellite's range, the time delay for a radio signal making the 50,000-mile round trip is 0.3 second.

In an experimental telephone conversation via Syncom II last October 29 between Russ Burke, Syncom project manager at NASA headquarters and the author, it was observed that the time delay, while noticeable, did not materially impede the conversation. There was one echo suppressor in the circuit between the author's New York office and Burke's office in Washington.

Echo suppressors are devices that prevent an echo from coming back while a person is speaking on a circuit. They are sensitive to the voice on the other end of the conversation and inhibit a return transmission. In a sense, an echo suppressor is analogous to an automatic press-to-talk telephone.

If two synchronous satellites were required to reach a point halfway around the world, however, the one-way delay would be 0.6 second. This would amount to a 1.2-second delay for a question to be asked and answered. Unfortunately, nothing can be done to overcome time delay since it is based on a physical law that cannot be violated—namely the speed of light.

Telstar satellites. It has been used with NASA's Relay satellite and with Syncom II.

By agreement, AT&T will lease the station to Comsat for two-thirds of the total number of hours in each month. If Comsat serves notice on AT&T, it can use the station full time, except for a total of five hours each month when AT&T can experiment with Telstar II.

The Andover ground station is now being modified to provide the tracking, telemetry, command and communications functions for the HS 303.

Five changes are being made at Andover to handle the telemetry and command functions for Early Bird. A 136-Mc auto-track system for the horn antenna is being added. It will include vhf probes, vhf couplers and vhf receivers to provide azimuth and elevation error signals and a sum signal at the vhf frequency. These signals will point and track the horn antenna drive to the satellite. A microwave linear polarization auto-track system will be added to include a new coupler and probes with the parametric amplifiers tuned to the 4137-Mc beacon. These changes are necessary because of the change of frequency. The system will point and track the horn to the satellite during the transfer ellipse (the elliptical orbit immediately after launch and before apogee kick, which places the satellite on station at the height of the ellipse at synchronous altitude) after the satellite's traveling-wave tube has been turned on.

As for the command transmitter, the communications transmitter's frequency will be changed to provide the command capability on either of the HS 303's transponders. On the command antenna, 6 Gc command signals will be sent through the horn antenna if the horn can be pointed accurately enough ( $\pm 0.01^\circ$ ). If not, a 15-foot parabolic antenna will be mounted on the horn to transmit the command signals.

The 6 Gc transmit feed system will be modified to transmit linearly polarized signals in the plane orthogonal to the 4-Gc receive polarization. This transmitter-polarizer will also be used in normal communications.

At Andover, transmit and receive filters and carrier supplies will be added to the existing equipment to permit transmission at 6301 Mc and reception of signals from Early Bird on either 4160.75 or 4081 Mc. A new traveling-wave synthetic ruby maser, tunable by varying the magnetic field over the range from 4050 to 4200 Mc, will permit operation at 4081 Mc. It can be rotated to find the best polarization sense for tracking the received signals. Azimuth and elevation, and range and range-rate data will be processed for transmission to the control center in Washington.

For the Andover communications transmitter, the station uses AT&T's TH microwave radio relay equipment except for the power amplifier stage that uses a specially developed Bell Labs traveling-wave tube, type M4040. The conventional helix design was considered inadequate for this application. Because of poor heat dissipation of helix-type

tubes at average power levels greater than 1 Kw, Bell Labs chose slow-wave circuit consisting of a disk-loaded circular waveguide. Transmitting frequencies are 6389.97 Mc and 6301.02 Mc for operation with Early Bird. Effective radiated power is 96 dbw (decibels referred to 1 watt); maximum modulating frequency, 4500 kc; maximum deviation, -800 kc; frequency tolerance, -110 c; and radiation in the horizontal plane, 56 dbw. The azimuth of radiation is 115.6° minimum and 140.7° maximum. Specifications are the same for the command transmitter except that during the launch phase, the azimuth of radiation is 180° and 190°.

For the horn antenna at Andover, the gain is specified as 61 db at 6 Gc. Minimum elevation for the communications function is 5°, and for the command function, 11.5°. Additional specifications are summarized in the table.

The receiving portion of the horn antenna accepts communications frequencies of 4081.0 Mc and 4160.75 Mc with a gain of 57.5 db. Polarization is linear, orthogonal to transmit polarization. Telemetry is received at the horn antenna at 136.44 Mc and 136.98 Mc with a gain of 28 db. Polarization is elliptical. The quad-helix telemetry antenna has 17 db gain and right-hand circular polarization. Beacon telemetry signals will be received at 4137.86 Mc and 4104 Mc.

#### Foreign ground stations

Many countries, eager to be among the first in space communications, are now converting existing experimental ground stations to operate with Comsat frequencies, or are rushing their unfinished stations to completion.

A 177-foot long, 370-ton horn reflector, exactly like the one at Andover, will be used at the French station at Pleumeur-Bodou to communicate with the Early Bird. Modifications will be made soon to equip the French station to operate at the Comsat frequencies of 4000 and 6000 Mc.

The British will close the Goonhilly Downs station for six months starting in September to make alterations in preparation for the launch of the HS 303. Their modifications will cost \$4,480,000.

The existing antenna, designated A1, will be refaced with 24 metal plates and a 25-foot center section to make the 85-foot dish more sensitive for use with synchronous altitude satellites.

A new 85-foot dish, designated A2, will be built near A1 at Goonhilly Downs. Its associated electronics will be contained in a large building mounted on a turntable that moves the antenna and building horizontally. Vertical movement will be counterbalanced by a weight moving on slides. A computer will probably be used on line to control the movements of the new antenna, with satellite orbital data fed into its memory beforehand.

New trunk lines and services will be installed between Goonhilly Downs and the international telephone switching center in London to cope with the increased demand.

The two antennas will make it possible for Goon-

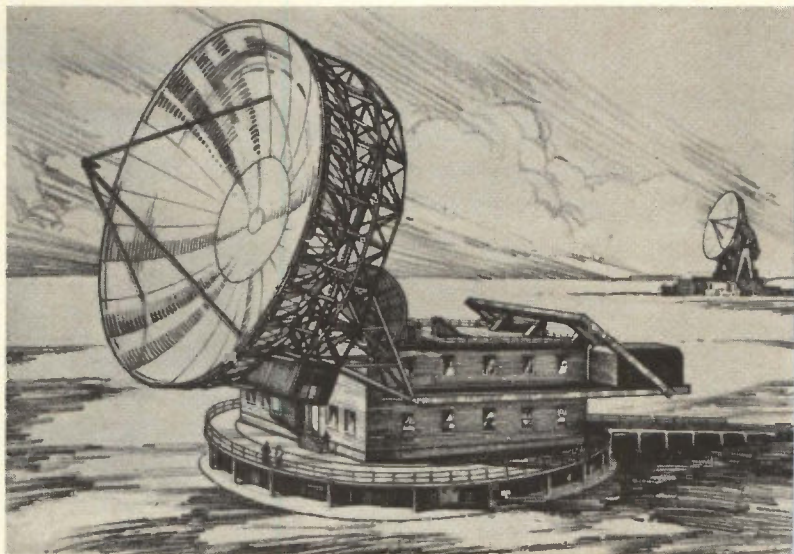

At Goonhilly Downs, England, a new 85-foot dish will be built. It's associated electronics will be housed in the building below it.

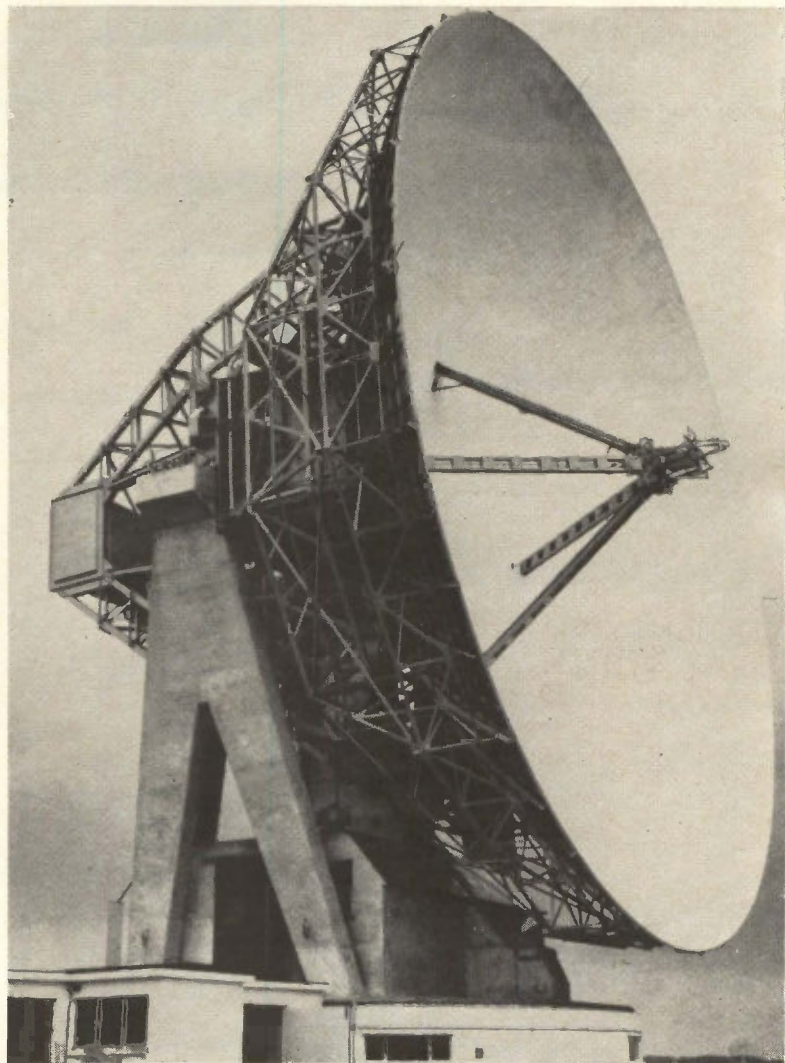

Existing antenna at Goonhilly Downs will be refaced with 24 metal plates and a 25-foot center section to make the 85-foot dish more sensitive to signals from the high-altitude Early Bird.

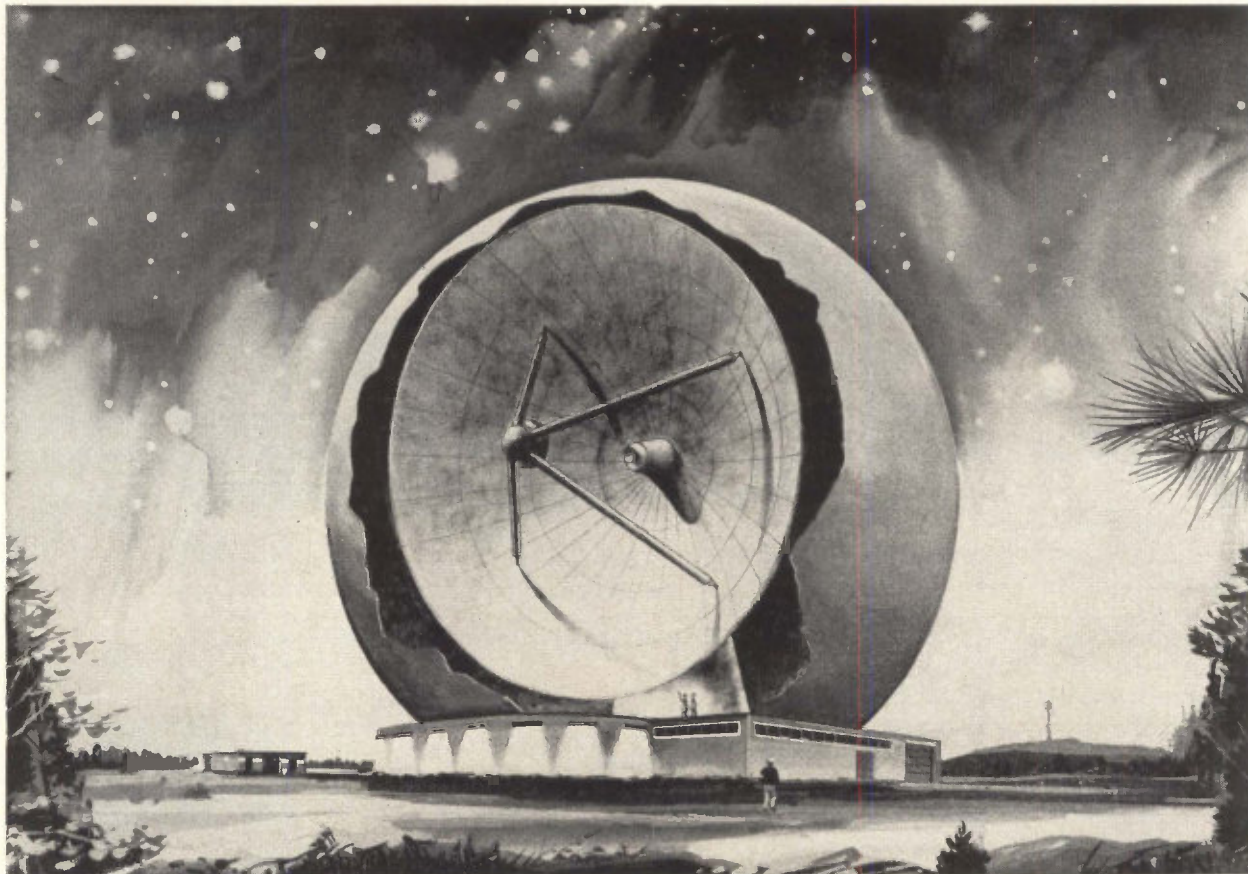

Canada's ground station at Mill Village, Nova Scotia will have an 85-foot diameter parabolic reflector enclosed by a 120-foot diameter radome. It will be completed by mid-1965.

hilly to operate with both medium and synchronous altitude satellites simultaneously. Antenna A1 will be modified by March, 1964, and A2 will become operational by early 1966. Either of the two antennas could also be used for experimental satellite communications as well.

The Telespazio facility at Fucino, Italy—about 50 miles northeast of Rome—is switching from a 30 to a 44-foot parabolic antenna. The station will be used to a limited extent with HS 303. Other modifications include increasing the output power from 2 Kw to 10 Kw, and reducing the noise tem-

perature from 200° K to 150° K.

The Deutsches Bundespost, Post Office of the Federal Republic of Germany, is nearing completion on its new station near Raisting, about 300 miles south of Munich. The wide-band antenna is an 82-foot parabolic dish with a horn reflector feed. It is scheduled to go into operation late this year. Performance will be similar to the stations in France, England and Andover.

Canada's Department of Transport is building a station at Mill Village, Nova Scotia. It should be completed in mid-1965. The \$5-million station is being built by RCA Victor Co., Ltd.

The station will have a 120-foot radome covering an 85-foot reflector and will have full tracking capability. It will be capable of both f-m and single sideband transmission at an output of 10 Kw.

Specifications for the receiving system are: r-f frequency, communications at pilot band 3.7 to 4.3 Gc; system noise temperature (on the communications band with the antenna at 7.5° elevation) 65° K; and f-m threshold level, -91 dbm.

Front-end specifications for the Canadian station are: parametric amplifier—gain, 24 db; bandwidth, 3 db, 500 Mc; noise temperature, 20° K (maximum, with design objective 10° K); tunnel diode amplifier—gain, 20 db minimum; i-f frequency, 70 Mc; and channel capacities—300 channels of f-m or 1200 channels of pulsed modulation.

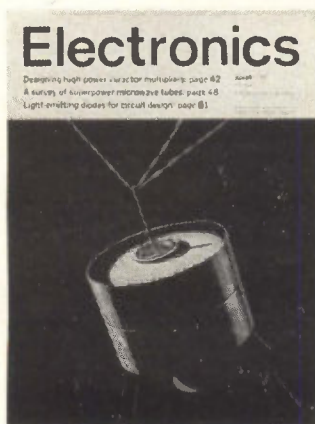

#### The cover

The Early Bird satellite will link Europe and the United States 24 hours a day by telephone, teletype, facsimile and television. The spacecraft is an improved version of Syncom III, due to be launched August 18 over the Pacific Ocean.

# New Sanborn Tape System

**7 CHANNELS plus monitoring track**

**6 ELECTRICAL SPEEDS without  
capstan change**

**40 db or better SIGNAL/NOISE RATIO**

**0.2% P-P FLUTTER**

**IRIG compatibility**

**for under \$9,000**



Now you can have precision instrumentation tape system performance at *substantially lower cost than ever before*, with this completely new Sanborn 3900 Series incorporating a specially-designed Hewlett-Packard transport. The primary objective was to provide a highly flexible, reliably useful system with *stable* tape motion, *simple* operation and *no* maintenance — at a significantly *lower cost*. These objectives have been successfully accomplished, in a system which has:

- Greatly reduced interchannel crosstalk with a new magnetic head assembly design using improved shielding.
- High signal/noise ratio, gentle tape handling and reduced tape wear, through precisely controlled tape tension, driving and braking torques, and guide element designs.
- Plug-in solid-state electronics with record/reproduce amplifiers on the same cards, and equalization plug-ins necessary only for speeds to be used.
- No need for maintenance or lubrication, except for cleaning tape path.
- Built-in footage counter accurate to 99.95%.
- Quick, easy snap-on tape reel loading.
- Cabinet, rack or portable case mounting.

Check the key specifications here, then call your local H-P Field Engineering Office for complete details and prices. Or write Sanborn Company, Industrial Division, 175 Wyman Street, Waltham, Massachusetts 02154.

## SERIES 3907A (7-channel), 3914A (14-channel)

<b>SPEEDS</b>	6, electrically controlled, pushbutton selected, 1 7/8 to 60 ips; other speed ranges optional. Max. start 2 sec., max. stop 1 sec.; $\pm 0.25\%$ max. variation in tape speed at nominal line frequency.
<b>TAPE</b>	7-channel 1/2"; 14-channel 1"; 2400 feet 1.5 mil, 3600 feet 1.0 mil; 4800 feet 0.65 mil; 10 1/2" reels.
<b>RECORDING MODES</b>	Direct, FM or Pulse Record/Reproduce via interchangeable solid state plug-in electronics; 7-channels in 7 1/2" panel space. Single-ended inputs, push-pull with optional coupler. Adjustable input/output levels.

See us at WESCON Booth 1451-1453 Sports Palace

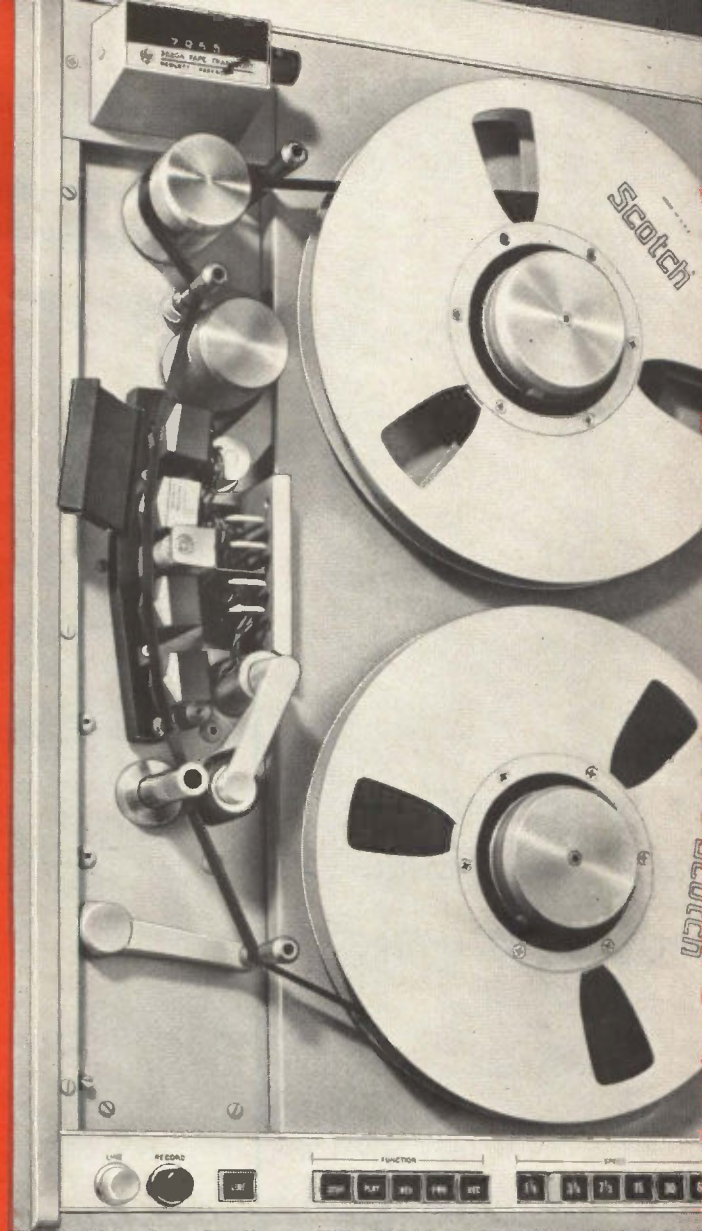

BANDWIDTH	RESPONSE	SIGNAL/NOISE RATIO (RMS)
Direct (60 ips) 100-100,000 cps	$\pm 3$ db	40 db
FM (60 ips) 0-10,000 cps (Wideband systems available soon — 250 KC direct, 20 KC FM)	$\pm 0, -1$ db	44 db without flutter compensation 48 db with flutter compensation
<b>P-P FLUTTER</b> (30 & 60 ips)	0-1 KC, 0.2% max. 0-5 KC, 0.5% max.	
<b>CONTROLS</b>	Power, Stop, Play, Reverse, Fast Forward, Record; all can be remotely controlled	

**PRICES** (f.o.b. Waltham, Mass.) (Systems represent two of many choices available. Prices are correspondingly lower for fewer speed filters, or where direct record/reproduce electronics are specified, and higher when filters for all six speeds are ordered.)

**Complete 7-channel system** for FM recording and reproducing, with filters for 3 speeds, extra (8th) channel for monitoring, and console cabinet: **\$8900**

Same system, for 14-channels: **\$13,370**

**SANBORN**   
A DIVISION OF HEWLETT-PACKARD

Circle 99 on reader service card

# GYROS?



CONTROL



TELEMETRY

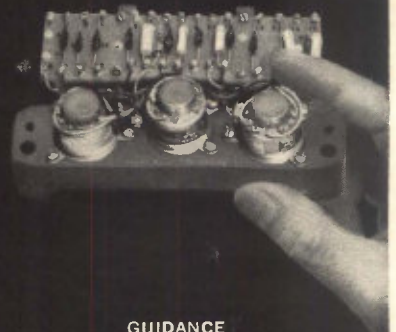

GUIDANCE

## FAIRCHILD E·S·P\* CAN MEET YOUR TOUGHEST SPECS

Practical evidence of Fairchild E·S·P\* capability for meeting tough gyro specs is found in the broad array of Fairchild gyro packages and rate switches now in service.

Fairchild's three-axis rate gyro telemetry system, for example, is the smallest, lightest package of its kind. Solid state inverters and demodulators are included in the package where required to provide DC performance while maintaining the high linearity, low friction and noise characteristics of the AC gyros.

These gyro packages are built around service-proven sub-miniature floated rate gyros—the smallest, lightest production units made. Maximum rates from 5°/sec to 5000°/sec, threshold rates as low as 0.01°/sec, 150g shock, 30g sinusoidal and 8g<sup>2</sup> random vibration. Small size and high performance permits ready combination in multi-axis groups, or with Fairchild acceleration sensors, into miniature

measurement or control packages to your exact requirements. Self test is available. Call or write to have Fairchild E·S·P put its gyro experience at your service today.

# FAIRCHILD

# CONTROLS

A DIVISION OF FAIRCHILD CAMERA AND INSTRUMENT CORPORATION  
225 PARK AVENUE, HICKSVILLE, L. I., NEW YORK  
TELEPHONE: (516) WE 8-5600 • TWX: 516 433-9146

\* E·S·P is the Fairchild Controls concept of Integrated Engineering, Service and Production that assures highest performance and reliability in your specific application. Write for brochure that shows how E·S·P can serve you.

# YOU GET 50% HIGHER WATTAGE RATING

from



Series 300,  
320 & 321

## AT NO EXTRA COST

Excellent heat sink  
of carbon-ceramic  
construction  
makes it possible

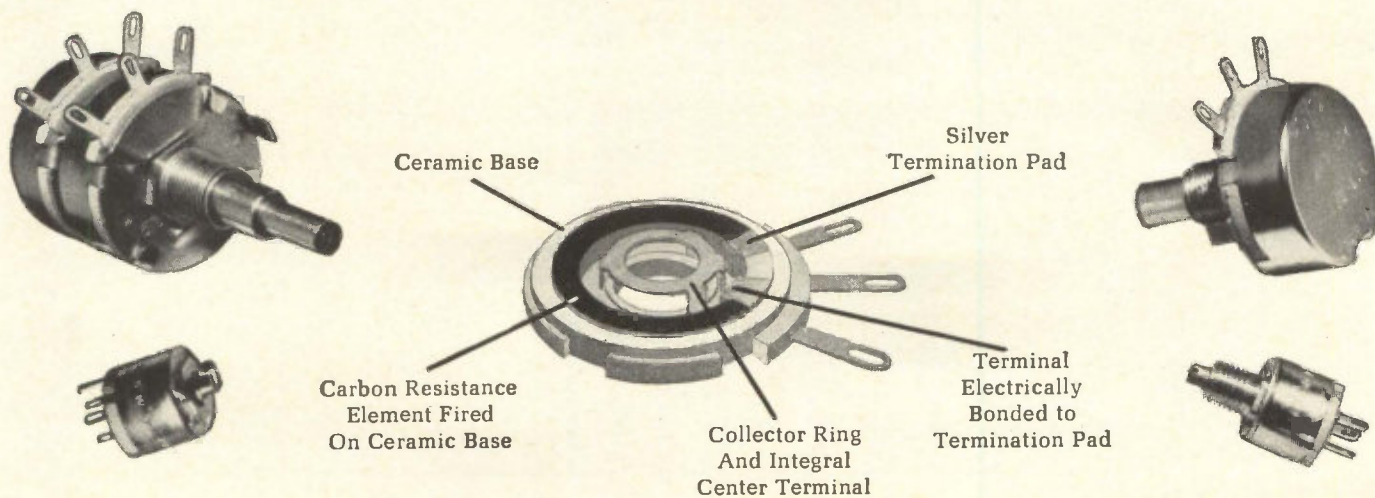

### CTS Series 300 Series 320 VARIABLE RESISTORS EXCEED STYLES RV4 & RV6 MIL-R-94B

Diameter	Resistance Range	Power Rating	Application	Data Sheet	CTS Type No.
1/2"	100 ohms to 2.5 megohms	3/4 watt @ 70°C derated to no load @ 150°C	Exceeds Char-Y of MIL-R-94 Style RV6	2450	300
1-1/16"	250 ohms thru 2.5 megohms	3 watts @ 70°C 2 watts @ 85°C derated to no load @ 150°C	Exceeds Char-Y of Mil-R-94B Style RV4	1400	320
1-1/16"	250 ohms thru 2.5 megohms	3 watts @ 70°C 2 watts @ 85°C derated to no load @ 150°C	Industrial & Commercial	1401	321

Special constructions available for your applications, such as in-line tandems, concentric shaft tandems, p.c. mounting, locking bushings, etc.

Request Applicable Data Sheets  
Visit Wescon Booth 345 Hollywood Park



CHICAGO TELEPHONE  
OF CALIFORNIA, INC.

1010 SYCAMORE AVENUE, SOUTH PASADENA, CALIFORNIA 91031  
SUBSIDIARY OF CTS CORPORATION • ELKHART, INDIANA

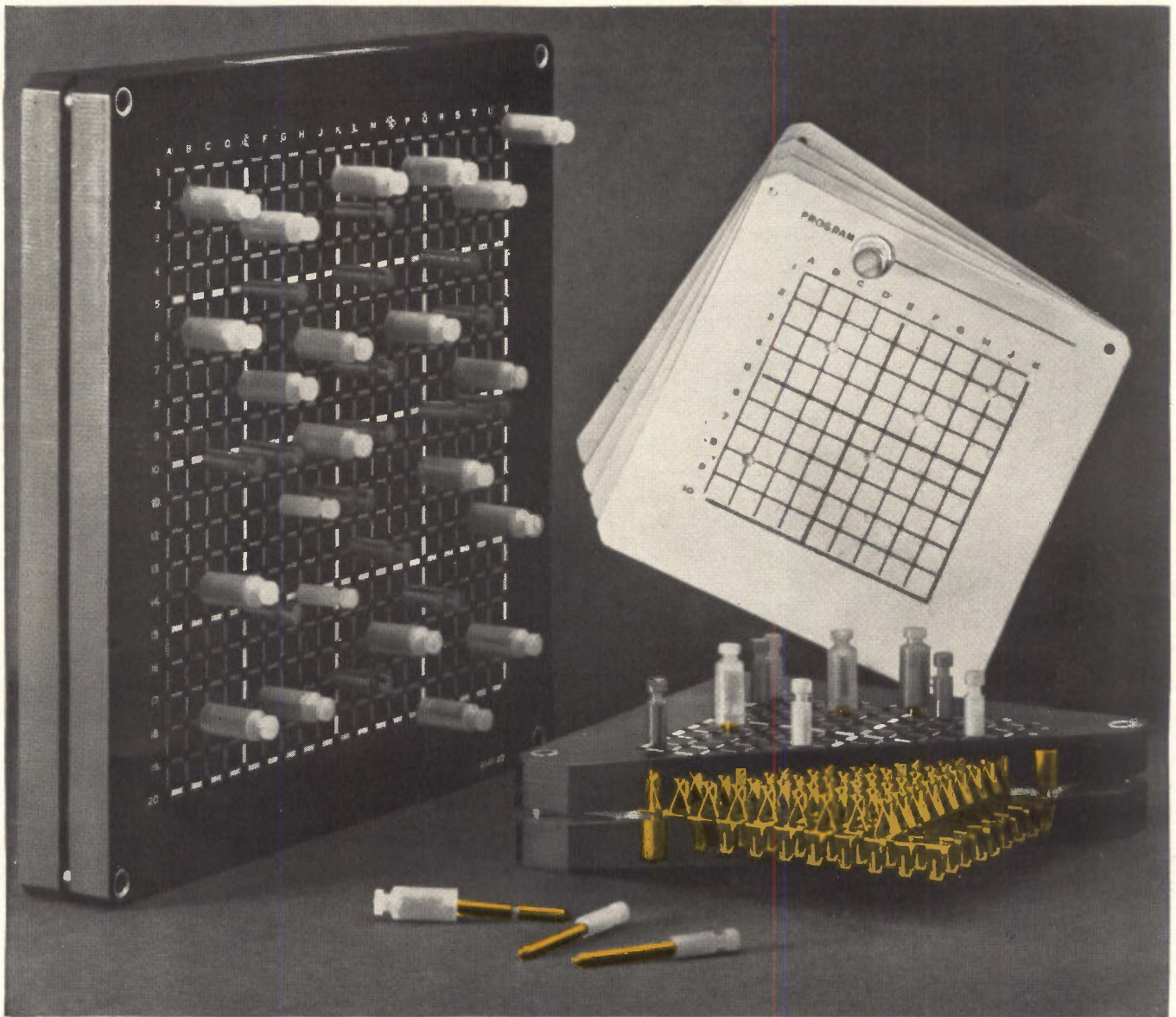

## What's a good matrix pinboard really like?

That's a natural question, if you go sifting through claims. But why wade through the echoes of claims? If your reputation rests on the choice of a quality pinboard, the best way to judge is through engineering features.

What has gone into the making of the pinboard? The answer to this question tells you what level of pinboard performance you can expect. Take a moment and check these features against those of any other pinboard on the market. Our pinboard offers:

- precision made and fitted solid phenolic blocks
- precision formed busses plated with hard alloy gold over nickel
- special "funnel" designed contacts of X-Y coordinates assure positive entry of pins
- shorting, diode and other component carrying pins that won't bend, buckle or malfunction, regardless of number of insertions and extractions
- interchangeable templates, pre-programmed by pencil punch-out, permit storing of hundreds of intricate switching combinations

- .250" x .250" grid design which accepts .095" diameter pins

Somewhere in your design, right at the heart of it, there's a need for pinboard programming. Possible applications range from vending machines on through digital computers and include such functions as digital memory, sequencing and input-output switching. Why short-change your plans with anything less than the best pinboard.

The best proof is the real board on your desk. But before that happens you can write and get all the sound engineering facts on what makes it the best. Isn't that a good way to approach a decision? Try it. Write today.

\*Trademark of AMP INCORPORATED



A-MP\* products and engineering assistance are available through subsidiary companies in: Australia • Canada • England • France • Holland • Italy • Japan • Mexico • West Germany

VISIT US AT WESCON SHOW AUGUST 25-28, 1964, BOOTH 209-212



# Probing the News

Meeting report

## What makes Wescon run?



It's brasher and more colorful than its Eastern counterpart. The volunteers who run it seek—and find—new approaches

By Ron Lovell

McGraw-Hill World News

**Bright and early** on Aug. 25, attendants will strap biomedical telemetry equipment onto a horse and jockey at the Hollywood Park racetrack in California. As horse and rider move around the track, their electrocardiograms will be displayed in the clubhouse.

The object is not to improve the breed, but to signal the opening of the 1964 Western Electronics Show and Convention in Los Angeles.

The Wescon committee also plans to compare the operation of vacuum-tube, transistor and micro-electronic telemetry equipment during the demonstration.

**More zip.** Wescon tries to open the show with more originality than its bigger but more staid counterpart in New York, the annual convention and show of the Institute of Electrical and Electronics Engineers.

The IEEE show (before the merger of the IEE with the Institute of Radio Engineers it was called the IRE show) usually opens with a ribbon-cutting ceremony.

To open the 1963 Wescon in San Francisco, an engineer stripped to the waist to demonstrate life-support equipment for astronauts. In Los Angeles in 1962, a laser beam was used to free a tethered balloon. In 1961 there was no ceremony, but in the two previous years, welcoming messages were

transmitted via satellites.

The 1959 stunt fell flat because the teletypewriter operator in San Francisco thought the coded message was garbled and decided not to retransmit it to the Cow Palace.

**No beauty queens.** Partly because of such hijinks, and because of some unusual parties thrown for Wescon showgoers, the Western show is often considered flamboyant. But that's not entirely true. In some respects, Wescon is more of a working affair than the IEEE show. The Wescon management discourages razzmatazz inside the exhibit halls.

"You can't go out and hire a beauty queen with the low-cut jazz," says Ted Shields, of West Associates, the Wescon public relations counsel. If there's a pretty girl in the booth, she's a company employee—a receptionist, engineering secretary or even a woman engineer.

There's a practical reason: Dumb blondes can't answer questions.

### I. Volunteer spirit

Wescon has more esprit de corps than the IEEE show, and people seem to be having more fun. The IEEE show seems to have a more professional, less social air.

The extra sparkle at Wescon is due in part to the direct sponsorship of Western electronics companies. Western business is less

formal than Eastern business on the average (see p. 106). The convention is sponsored by both the Western Electronic Manufacturers Association and the IEEE's Region 6 organization.

The companies are generous in giving their engineers and managers time off to make Wescon preparations. Volunteers staff all of the 14 standing committees. The committees buy supplies for cocktail parties, hire buses to shuttle conventioners between the show's two exhibit halls at the Sports Arena and Hollywood Park, and they perform many other necessary tasks.

The only full-time, paid people are Donald E. Larson, Wescon manager, and some clerical help.

**Intercity rivalry.** Another impetus to Wescon's energy is the rivalry between Los Angeles and San Francisco, where the convention is held on alternate years. Each tries to outdo what the other has done the year before, so the format is constantly changed and improved.

### II. Racetrack vs. tent show

The most obvious change this year is the use of two locations for the show and a third, the Statler-Hilton Hotel, for technical sessions.

A few critics don't think that splitting up the show is much of an improvement. They see the di-

vision as evidence that the show has grown too big. They fear not enough people will see their products. This year there will be 1,250 exhibit booths occupied by more than 800 companies.

"There is no question that some companies decided to stay out," concedes Ted Shields of West Associates, "but they were replaced by others." Few booths, if any, are expected to be unoccupied by show time.

The split is better than the alternatives—sweltering under the tent that was used as an annex to the Sports Arena in 1962, or being left out because of insufficient booths.

### III. Survey of interests

Wescon began preparing for the split during last year's show. It asked the 40,000 attendees to fill out forms indicating their industry, occupation and interest in various types of products.

The answers were put on punched cards and tabulated into an analysis of the showgoers' personal and practical interests. This is the breakdown, to the nearest tenth of a percent: circuit components were listed as their major interest by 22.9%; communication and detection, 21.6%; data processing and conversion, 13%; measurement, 9%; automatic control, 7.6%; air and space control systems, 5%; medical and educational, 5%; and audio and television, 4.2%.

As a result of these findings, exhibits featuring components, automatic control and data-processing and conversion will be at the race-track, while the other types of exhibits will be at the Sports Arena. Buses will shuttle visitors between the two locations, as well as to and from downtown Los Angeles and the airport.

The survey results were given to the industry well in advance of booth-renting time, as part of the plan to head off the din of disapproval that was expected. The din never materialized.

**First company seminars.** Another innovation at WESCON this year is a series of company-sponsored technical seminars. In the past these have been rump sessions that sometimes conflicted with the regular technical sessions [Electronics, Aug. 9, 1963, p. 29].

## Dude goes West

Is the electronics business on the West Coast different from the East Coast? After Electronics news people reported how companies did business in their regions copy editor Howard Rausch, a native New Yorker, put together this fanciful view of what it is like selling electronics out West. For an insight into the real differences, however, see the story which starts on page 106.

### INTEROFFICE MEMORANDUM

**TO:** J. Frumington Hrumph, Pres.

**FROM:** Larry Lovewell, Sales Mgr.

**RE:** Expense account for West Coast trip

I realize some items on the enclosed expense sheet are unusual, so here's a brief explanation of the ones you might question.

Please try to remember that business is done differently out there in the West, and you have to live like the natives if you want to sell 'em.

#### ■ ■ ■ Item (4). \$9 for shirt.

To fully understand this one, you need a clear picture of a business meeting, Western style. The locale is one of California's 50,000 private swimming pools. In addition to scuba tanks and fins, everybody gets a pitcher of martinis.

Near the end of the pitcher, things sometimes get a little out of hand. I'm not sure of all the details;



suffice to say your boy held his own and got the contract. But the piano-shaped pool (it used to belong to Liberace, now it's the property of John O'Halloran, president of a

sales rep firm) had to be drained because the filter got clogged with my shirt—with me still in it.

#### Item (6). \$30 for neckties.

I took a bunch of Motorola people, plus some of our boys, out to a truly ranch-flavor steak house called Pinnacle Peak, 20 spine-jarring miles across the desert from Phoenix. The Westerners wore open-neck sport shirts, but we maintained our Eastern dignity with white shirts and ties.

Well, those cowgirl waitresses have some kind of a phobia about ties. A couple of them wiggled up to us and before we knew what was happening they whipped scissors out from under their trays and six ties got snipped off about two inches below the adam's apple.

When I looked around I saw hundreds of tie ends hanging from the rafters and walls. Each tie was exhibited like a scalp, with a business card attached—and you'd recognize some of the names.

Another quaint custom at this beanery: Anybody who dares to

order his steak well-done gets a well-aged leather boot (a real one!) on his platter.

One chauvinistic note: The best steak there, as well as everywhere else in the West, is called a New York cut.

**Item (11). Extra \$110 for car rentals.**

If you're going anywhere here, you need a car. And if you're going to get anywhere with a customer, it has to be a convertible with air conditioning.

It's very common to drive 50 miles for a movie in the evening,

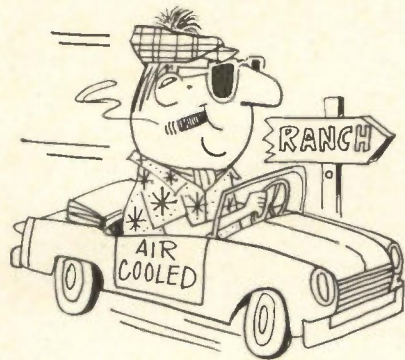

or 30 miles to meet a guy who works 60 miles away, for lunch.

Besides, trains aren't always safe. Especially if you're dealing with a way-out company like the Electronic Specialty Co. in L.A. Bill Marcy, the vice president, was tipped off once that a visiting Swiss rep was bringing along his son, who thought the West was just like the shoot-'em-up movies.

Marcy had some of his officers and production supervisors dress up as cowboys and Indians. He also cued in the conductor, who was "shot" as the train pulled in. There was a full-scale gun battle, and then a stagecoach roared up to kidnap the Swiss father and son. The stagecoach took off across a plain, only to be attacked later by "Indians." The boy loved it.

**Item (13). \$20 for campaign buttons.**

No, I'm not politicking. At least not for Johnson or Goldwater or anybody like that. But O'Halloran has signed up 12 booths at Wescon for some of his clients, and is using a political convention theme.

I'm sure you'll understand if you hear that your West Coast delega-



tion approached prospective customers while wearing 12-inch buttons with some slogans that, frankly, I wouldn't have invented if it'd been up to me. Some said "Win With Wiltron," "Soar With Sorensen," and "We're Tootin' for Boonton."

**Item (15). \$125 for special clothing.**

In Paris you try to avoid looking like an American tourist, and in L.A. you don't want anybody to suspect too quickly that you're an Eastern salesman. Therefore you need native dress.

I saved the company money by not buying a silver-pommeled saddle, vicuna chaps and Hawaiian shirts. Believe me, the stuff I bought was essential—a five-gallon hat, a pair of cowboy boots, four pairs of shorts, a sheriff's a badge and half a dozen string ties.

To partially compensate for this unforeseen expense, I never had my gray silk suit cleaned or pressed on the Coast.

**Item (18). \$100 for bail bond.**

This item distresses me as much as it must you. It's an easy one to prejudice, but I'm counting on your fairness. After you read my explanation, I'm sure you'll agree that the expense couldn't be avoided.

Wescon will have the annual cocktail party Aug. 25 at Hollywood Park as usual. This year, as usual, they're trying something new. We got a little preview of it. They've got this great idea of dispensing cocktails at the pari-mutuel \$2 window.

I tried it, naturally, partly to get into the spirit of the Western way of doing things, and partly as a conditioned reflex. Receiving something tangible for my \$2 was an

unusual and, frankly, a heady experience. So I did it again. And again. And again.

The subsequent events aren't very clear, because things happened so fast. I do remember the judge saying something about thirty dollars or thirty days but the rest is a blur. I also remember that my lawyer was very helpful.

**Item (19). \$75 lawyer's fee.**

In light of Item (18) this is self-explanatory.

**Item (20). \$60 for weekend at dude ranch.**

To recuperate from episodes in Items (18) and (19).

**Item (21). \$100 to bellboy at above ranch.**

For negatives of photos taken during my recuperative weekend mentioned in Item (20). You know my wife. Remember the fuss she kicked up over the blonde secretary I had? The one you transferred to your office?



**Item (22). \$40 for riding lessons.**

Donald Duncan, president of Duncan Electronics, Inc., in Costa Mesa, Calif., used to boast that his was the only electronics plant with a hitching post outside the reception lobby. He often came to work on horseback until the San Diego Freeway and some housing developments got in the way.

Robert Krausz, president of the Rantec Corp. in Calabasas, Calif., still often comes to work on horseback. And Charles (Tex) Thornton chairman of Litton Industries, Inc., sometimes gets up at 5 a.m., flies from his home in Brentwood, Calif., to his ranch near Thousand Oaks, to ride for an hour or so before

going to work in Beverly Hills.

The opening ceremony of this year's Wescon conference will involve a racehorse. While the bang-tail circles the track, electrocardiograms from horse and jockey will be telemetered to a large display panel for the crowd to follow.

All this background is so you'll appreciate the vital role of the horse in West Coast life and business. My lessons were a way of sharpening a tool of my trade.

#### Item (25). \$5 for a shave.

I guess I forgot to mention before that I grew a beard. There were a couple of good reasons for this. First, during and after the episodes cited in Items (18) through (22) I was too busy, or whatever, to shave. That gave me a good head start. Second, the beard is a common status symbol out here, along with the patio, the surf-board on the lawn and the ski rack on the car.

There must be a higher percentage of beards in Western plants than at a House of David picnic.

#### Suggestion.

In view of the success of our Western junket, and of the know-how we accumulated in overcoming the obstacles, I'd like to make a suggestion. When and if we decide to establish a permanent sales office on the Coast, I recommend me.

## How the West wins business

It camouflages its hard-sell approaches and clothes that are deceptively casual, relaxed, almost indifferent

By Harold C. Hood and Laurence D. Shergalis

Regional Editors



The social climate out West is relaxed and informal; the livin' is easy. The business climate is different too. Industry has grown in a pioneer environment and adapted to it. Business generally moves faster in the wide West than in the East. The Western technique is deceptively casual and extremely effective.

The record indicates that the approach works. In just two decades, the West Coast has almost caught up with the East's 50-year-old electronics industry. The West designs and produces \$4 billion in electronic products a year, 25% of the industry's total. The Los Angeles area alone accounts for well over \$2 billion worth.

A common locale of business entertainment is around the family swimming pool, patio or barbecue pit. Night life in Los Angeles and San Francisco doesn't compare with New York's or Chicago, but it has some distinctions. Few Easterners can forget the bullfights in Tijuana, just south of the border, or dinners at the famed waterfront eateries of San Francisco or San Diego. Nor can they forget who took them there.

#### I. Pirate maps and a clipper ship

Occasionally a Western company will sponsor a blast, particularly at Wescon time. And the imagination at some of these parties is startling to Easterners accustomed to the cocktails and dinner parties in the ballroom of a New York hotel.

At last year's Wescon, for ex-

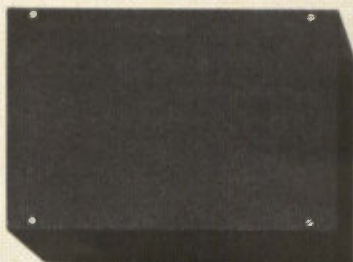

Portable Five-Dial Potentiometer: \$535

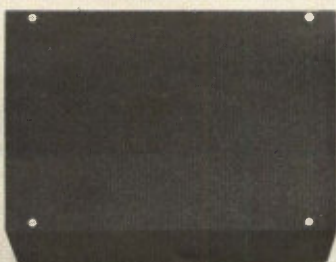

Volt Box: \$135

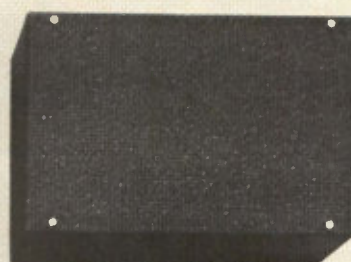

Pico-ammeter: \$485



Five-Dial Voltage Divider: \$320



Portable Wheatstone Bridge: \$600



Portable Kelvin Bridge: \$650

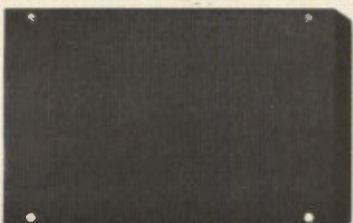

Direct Reading Comparison Bridge: \$500

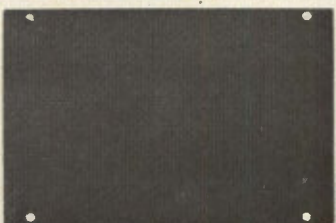

Direct Reading Ratiometer: \$450



Electronic Null Detector: \$325

We packed \$4,000 worth of measuring capability into this new portable package.

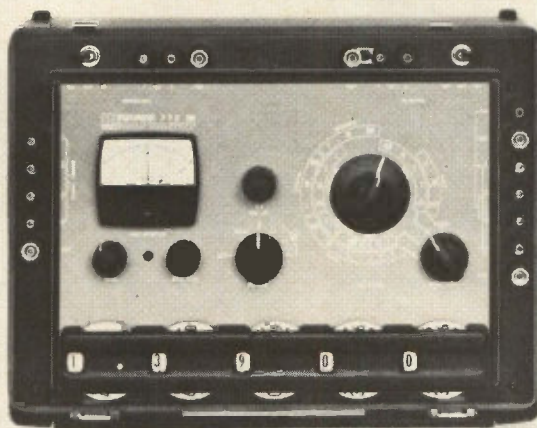

For \$750 it does the work of 9 devices.

We call this versatile instrument our Portametric PVB. That stands for Potentiometric Voltmeter Bridge.

Actually, it's more than a potentiometric voltmeter and more than a bridge. But how many words can we reasonably put in an instrument name?

At the moment, you may not feel you need all the capabilities, or the degree of accuracy the PVB can deliver. But extra measuring power is something like reserve horsepower in

your car. When you need it, you need it bad. Then you're glad you didn't buy just one or two of those black boxes above when you could have had the works at our price.

If you know ESI, you know we put a lot more emphasis on performance than price. We only mention price here because it illustrates the kind of technical advance that made this 18-pound package possible. ESI, 13900 NW Science Park Drive, Portland, Oregon (97229).

Function	Ranges	Full Scale	Minimum Step
Voltmeter	5	0.051110 to 511.10 volts	1 microvolt
Ammeter	8	0.51110 $\mu$ a to 5.1110 amperes	10 picoamperes
Resistance Bridge (4 terminal, guarded)	10	0.51110 ohms to 511.10 megohms	10 microhms
Comparison Bridge (4 terminal, guarded)	To 5.1110 times reference standard	1.0000	0.01%
Ratiometer (Direct reading)	3	0 to 1.00000 0 to 0.051110 0 to 0.0051110	1 part in 10-5 1 part in 10-6 1 part in 10-7

Null detector: Sensitivity—5 microvolts; Input impedance—approximately 1 megohm; AC rejection 60 cps and up; 80 db, guarded, battery operated. Accuracy:  $\pm$  0.02% of reading or 1 switch step on virtually all ranges and functions. Comes in portable case; battery operated; 2,000 hour battery life.

**esi** Electro Scientific Industries, Inc.

Circle 107 on reader service card

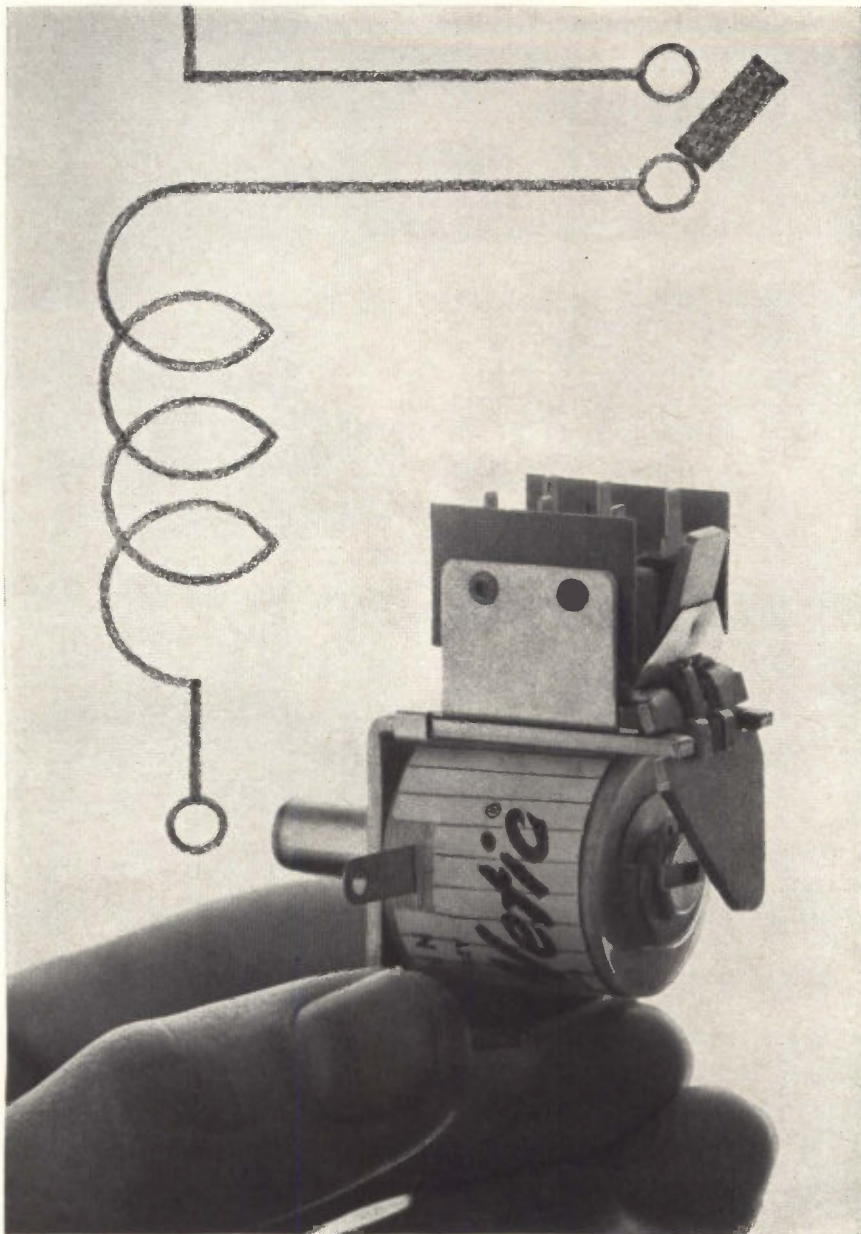

## WHY USE TWO IF ONE WILL DO?

The Heinemann Type B Time-Delay Relay can double as its own load relay. It's got a continuous-duty coil. Once actuated, it can remain locked-in indefinitely. This, combined with DPDT snap-action switching at up to 5 amps, can obviate the need for a separate slave relay in many applications.

Yours might be one of them. Here's a quick rundown of the Type B's specs:

**Standard Timings:** 1/4, 1/2, 1, 2, 3, 4, 5, 8, 10, 15, 20, 30, 45, 60, 90, 120 seconds.

**Contact Capacity:** 5 amperes at 125V or 250V AC; 5 amperes at 30V DC, resistive; 3 amperes at 30V DC, inductive.

**Coil Voltages:** 60 cycles AC: 6, 12, 24, 48, 110, 115, 120, 208, 220, 230, 240 volts; DC: 4, 6, 12, 24, 28, 48, 64, 110, 120 volts. (Others available.)

For more detailed specifications on the Type B (and on all the other time-delay relays in the Heinemann line), write for Bulletin 5005.



**HEINEMANN**  
ELECTRIC COMPANY  
2600 Brunswick Pike, Trenton 2, N. J.

SA 2578

ample, the Giannini Controls Corp. of Duarte, Calif., broke loose from the hotel hospitality-suite format—"three dull nights in a hotel room," in the words of a Giannini official.

Giannini gave several hundred customers and friends tickets for San Francisco cable cars, with "secret" pirate maps and plots to take over a clipper ship moored near the end of the trolley line at Fishermans Wharf. The party was held aboard the Baclutha, which is actually a nautical museum.

**Romanoff's finale.** This year, Giannini is taking over Romanoff's restaurant in Los Angeles for its Wescon party. The famous Hollywood bistro will be torn down soon, and Giannini's will probably be the last big shindig there.

The invitations read: "When our President says we should have our annual Wescon meeting at Romanoff's and Romanoff's has been closed for six months . . . guess what we do. We have our annual Wescon meeting at Romanoff's . . . if the front door is locked, try the kitchen window."

There are solid business advantages. "The salesman has a truly unusual event to invite his customers to," a Giannini spokesman explains, "and the sales force is occupied only one night during the show rather than the three the traditional hospitality suite required."

In June, the Astronautics division of the General Dynamics Corp. wanted to show the Cape Kennedy press corps its plants in San Diego and Los Angeles. Instead of using routine transportation for the 120-mile journey, the company hired a 1926 railroad car and served lunch and cocktails en route. Every guest received an engineer's cap and a chance to blow the train whistle.

Spendthrift? Not really. The reporters had to be fed anyway; besides, anybody who purchases 16 first-class railroad tickets is entitled to hook a private car onto a train. It's in the tariff regulations.

**Wild-West show.** One of the wildest entertainment stunts was staged by the Electronics Specialty Co. It greeted a visiting Swiss representative and his family with a wild-west cowboy-and-Indian raid. The actors were all company executives and supervisors.

The stunt has been put to business use on several occasions. The

company made a movie of the raid and call it a "capabilities film." At dull briefings, it often shows the film on the theory it will wake up the prospects.

Some Easterners dispute the contention that the West has more business entertainment. The West, they point out, doesn't have a Forum of the Twelve Caesars, nor a Four Seasons, nor a Broadway, and nowhere near the number of company yachts.

But it's tougher to compete in the East because relationships between buyers and sellers are longer, and more cemented.

**Simple fare.** The usual Eastern entertainment is a simple business lunch at a nearby restaurant, a hospitality suite at a trade show, and occasionally a show or dinner. For instance, the General Radio Co., of West Concord, Mass., one of the oldest—founded in 1915—largest and most reputable instrument manufacturers, limits business entertainment to lunches.

Its salesmen are all engineers who consider themselves more "professional advisers" than hucksters. Flamboyant salesmanship is alien to the company, which is owned by its professional employees, and completely out of phase with the colonial, campus-type atmosphere of its engineering and production facilities. The buildings are little more than a troutline-cast from Walden Pond, where Thoreau lived and wrote.

"Tiny" (Paul G.) Yewell, president of Yewell Associates of Burlington, Mass., is known throughout the industry as an aggressive, imaginative and promotional-minded salesman. Many consider it paradoxical that he is also a New Englander.

"I'm sometimes chided as a Westerner doing business in Yankeeeland," he says.

Yewell thinks the electronics industry's flux and mobility during the last few years has to a large extent homogenized the differences between East and West.

## II. Employee relations

Kenneth Miller, general manager of the Metrics division of the Singer Manufacturing Co., is a transplanted Westerner.

When Metrics took over part of an old sewing-machine factory in

# SQUELCH

# RFI

# AND KEEP CABINETS

# ~~COOL~~

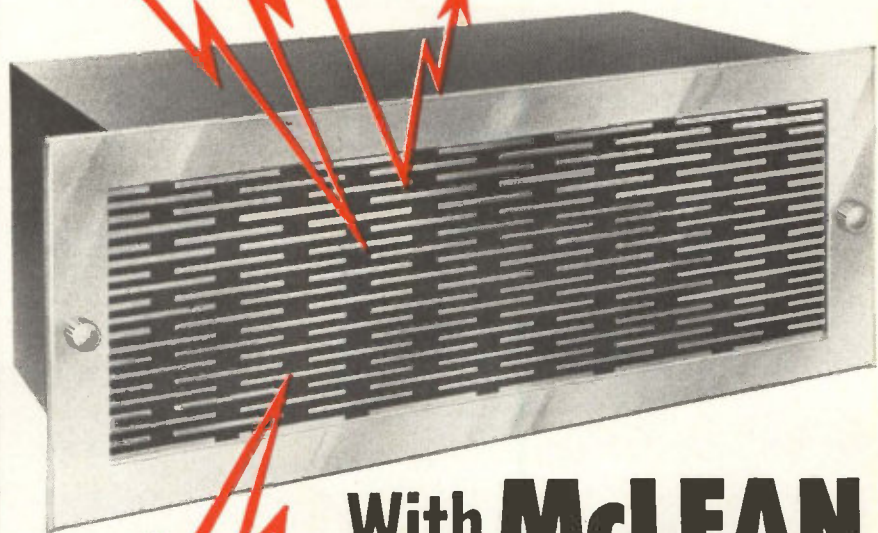

## With McLEAN RFI Shielded Blowers and Filter-Grille Assemblies

McLean RFI blowers are shielded to prevent passage of RFI noise signals both *inward* and *outward* through the air stream that cools systems and their components . . . they assure unimpeded function and reliability. All models approved by Government Agencies and certified to MIL-I-6181D, MIL-I-26600, MIL-I-11748B and MIL-I-16910. Smart new styling, 3-D 3/4-inch thick extruded aluminum grilles. Filter completely invisible.



SEND FOR NEW  
1964  
44-PAGE CATALOG

**McLEAN ENGINEERING  
LABORATORIES**

P.O. Box 228, Princeton, New Jersey  
Phone 609-799-0100 • TWX 609-799-0245



THE ORIGINATOR AND LEADER IN PACKAGED COOLING  
VISIT US AT THE WESCON SHOW, BOOTH 1841

Bridgeport, Conn., the employees called everybody "mister," Miller recalls. He's trying to change this.

Last year, Metrics held an open house for employees and served refreshments. It was the first time some of the employees—much less their families—had seen the entire plant.

This, however, is not typical of Eastern companies. The annual employees' picnic, Christmas party and open house are fixtures at many Eastern concerns, as are bowling leagues and baseball or bridge teams.

**Class system.** There is less class-consciousness on the West Coast, Miller says. "Here, the wife of a vice president cannot really play bridge with the wife of a more junior type, whereas on the Coast they wouldn't think twice about it."

In the older Eastern companies, managers have frequently spent far more time working their way up, and relationships are often more formal.

In the West, companies are generally newer and employees are younger. Western electronics com-

panies often have a higher proportion of engineers to factory workers, so average incomes and intellectual levels are higher. Employees are less tradition-bound.

One reason why the West is more relaxed in its employee relations is its long drive to recruit technical talent from the East. The beach-patio-shirtsleeves atmosphere was stressed as an inducement.

Besides the usual employee activities, Western companies go in heavily for golf tournaments, sportscar clubs and charter trips to Europe. At the Rand Corp., employees sponsor a chamber orchestra.

The West's chief mode of transportation, the automobile, is also more conducive to getting employees together for social events. Hopping into a car is infinitely easier than figuring out train and bus schedules for a get-together at somebody's home.

**Fewer roots.** The relative newness of many Western companies is another factor. "So many people out here have only been here a

couple of years and don't have a lot of other social ties," explains Ted Shields of West Associates, a public relations concern. "They tend to go together a bit more in the company group than they would otherwise."

The fact that new electronics plants are outside of the cities in the West—up and down the California coast, for example, or in the desert near Phoenix, Ariz.—also encourages employee social activities. More people live near their jobs.

### III. The sales meeting

Westerners take their jobs seriously, but they look casual.

Giannini Controls, for example, prides itself on its unusual and effective sales meetings. This year, its salesmen met at an authentic working ranch and were outfitted with shorts and sheriffs' badges bearing their names. They were divided into competitive teams that attempted solutions to sales problems. Team members even shared bunkhouses for the three-day meeting.

The informal atmosphere en-

**PAKTRON'S NEW 50-volt capacitors are**



couraged participation and honesty, according to F. E. Rushlow, sales manager. One stout salesman lied about his waist measurement, so the shorts ordered for him didn't fit. Being out of uniform for the first day and a half of the meeting, says Rushlow, made him think twice about falsifying figures in the future.

Even more unusual are some of the sales parties that the Electronics Specialty Co. stages. Other Western companies don't consider this high-pressure company typical. It has been putting together a systems-manufacturing complex by buying up older companies.

**Pregnant seahorse.** Every eight or nine months, the company gathers the staffs of the various divisions for discussions of what each is doing. After several days of concentration, they have a party.

The last party, at the home of William J. Marcy, vice president, resembled a zoo. Each staffer brought an animal. Marcy got 40 animals—an assortment of hamsters, guinea pigs, white rats, a spider monkey, a snake, a large al-

ligator, 10 turtles, a pregnant sea-horse and a goat.

That goat was shuttled from one

executive office to another until somebody sold it back to the original owner at a \$25 discount.



Sun-powered electric car, which has plugged International Rectifier Corp. solar cells around the country, chugs through Central Park in New York. It was first billed as a "smog-free" car for Los Angeles.

...mite size mylar\*



New miniature high performing Mylar\* film/foil capacitor for quality transistorized circuits. Epoxy coated for excellent moisture resistance. Uniform size. Capacitance value to 0.47 mfd with tolerance to  $\pm 5\%$ .

The "white" series has an internal design to protect the high performance Polyester film and an external design to satisfy any circuit construction system. Detailed information available on request.

\*DuPont

**Working Voltage:** 50v DC

**Tolerance:**  $\pm 5\%$ ,  $\pm 10\%$ ,  $\pm 20\%$

**Dissipation Factor:**  $4 \times 10^{-3}$  max. @  $25^\circ \text{C}$ , at 1 KC

**Temperature Stability:** 4% max. deviation from  $25^\circ \text{C}$  value in range of  $0^\circ \text{C}$  to  $85^\circ \text{C}$ , at 1 KC

**PAKTRON**  
DIVISION ILLINOIS TOOL WORKS INC.  
1321 LESLIE AVENUE • ALEXANDRIA, VIRGINIA



Today's show often promotes tomorrow's contract.

Military electronics

## Our man in Washington

The Washington rep is part of an expensive, sometimes-distasteful—but necessary—way of doing business

By Seth Payne

McGraw-Hill World News

As military spending declines about 4% a year and competition for government business becomes fiercer, more and more responsibility falls on company representatives in Washington.

Yet the Washington rep remains one of the least-understood and most-maligned people in the electronics industry.

Contrary to some opinion, he's not primarily a lobbyist nor a public-relations man, though his duties sometimes involve those functions.

Nor is he a "buyer" of people or of information. Basically he's a businessman, representing his company in a city where it's not enough to have a good product and a reliable organization.

He's a local contact, easy to reach if a government project manager has a problem on a contract with the rep's company. He salves hurt feelings if disagreements arise. But most important, he scouts for leads on new business.

**Lunch tip.** One day recently, a

rep had an ordinary martini-and-blue-plate lunch with an acquaintance in a quiet Washington restaurant. It could have been the most valuable hour that rep ever spent. It could ultimately be worth millions of dollars to his company, a big supplier of military communications equipment.

The rep—let's call him Charley Smith, because he doesn't want his real name used—learned that a major unit of one of the armed services wants a new approach to

developing a worldwide communications system. Charley's company and eight other bidders already have a big investment in the original system and, therefore, a very large stake in the Pentagon's decision.

Back in his office, Charley explained the choice to his superior. "Should we beat the drums at the Pentagon for our concept? Or gear up for the new approach?"

"I think we have the jump on our competition," he confided, "but you can never be sure."

A decision by the Pentagon is still about two weeks away, but Charley's company—and perhaps others whose Washington reps are as sharp—have a clear edge on the rest.

**Tidbits.** Not all of a rep's entertaining is as important as Charley's luncheon chat. Most of the information he gathers consists of tidbits to be added to data from other sources to give a more-or-less complete picture of a particular project or piece of business.

"In a sense we're really company intelligence officers," says the representative of an East Coast company. "You hear something from one source, match it with what another source tells you, and before long you begin to get the picture."

#### 1. Who he is

The typical Washington representative has a technical background and has had three to five years' job experience in his specialty before coming to Washington. He is 35 to 40 years old, and earns \$14,000 to \$16,000 a year. Generally he remains in Washington four to five years. Then, with a promotion, he returns to company headquarters, where his Washington experience is expected to enhance his value to the company.

Most reps are cleared for classified information up through the secret level. "A man without a security clearance is dead in this game," a veteran rep declares.

Classified projects are often discussed at luncheons. "Of course your government contact has to know you," one rep explains, "but when you have a good relationship established it is done."

The Washington rep corps is several hundred strong. Large companies may have 20 or more in one

## END GREASE-PENCIL GUESSWORK IN PRODUCTION MEASUREMENTS



## NEW JERROLD 890 SWEEP GENERATOR and TC-3 COAXIAL SWITCHER

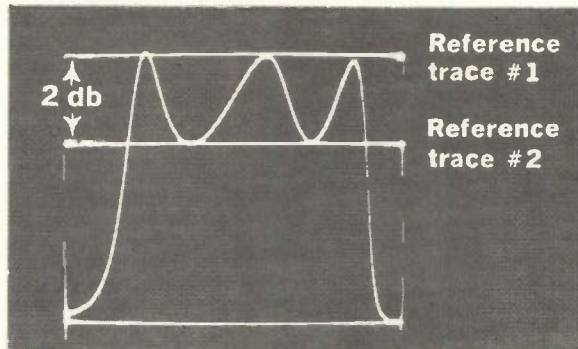

Typical network rf loss displayed with upper and lower limits by Jerrold 890 Sweep Generator and TC-3 Coaxial Three-Way Switcher.

This new medium-priced team lets you throw away your grease pencil—and all your troubles with drift and inaccuracy. It provides precise, drift-free electronically-produced upper and lower limits.

The Model 890 Sweep Generator has a frequency range from 500 kc to 1,200 mc, and offers sweep widths from 100 kc to 200 mc. Extremely stable output.

The solid-state TC-3 Coaxial Switcher (frequency range 0 to 1,200 mc) features three-position operation, enabling the insertion through variable attenuators of two reference traces in addition to the test trace.

Write for free brochure explaining details of this and other applications of comparative sweep techniques. Ask for demonstration.



Model 890 Wide-Band Sweep Generator. Price \$845



Model TC-3 Solid-State Three-Position Coaxial Switcher. Price \$295.



Industrial Products Division, Philadelphia, Pa. 19132  
SWEEP GENERATORS • PRECISION ATTENUATORS • AMPLIFIERS • COMPARATORS

**SEE US AT WESCON, BOOTHS 1108-1111**

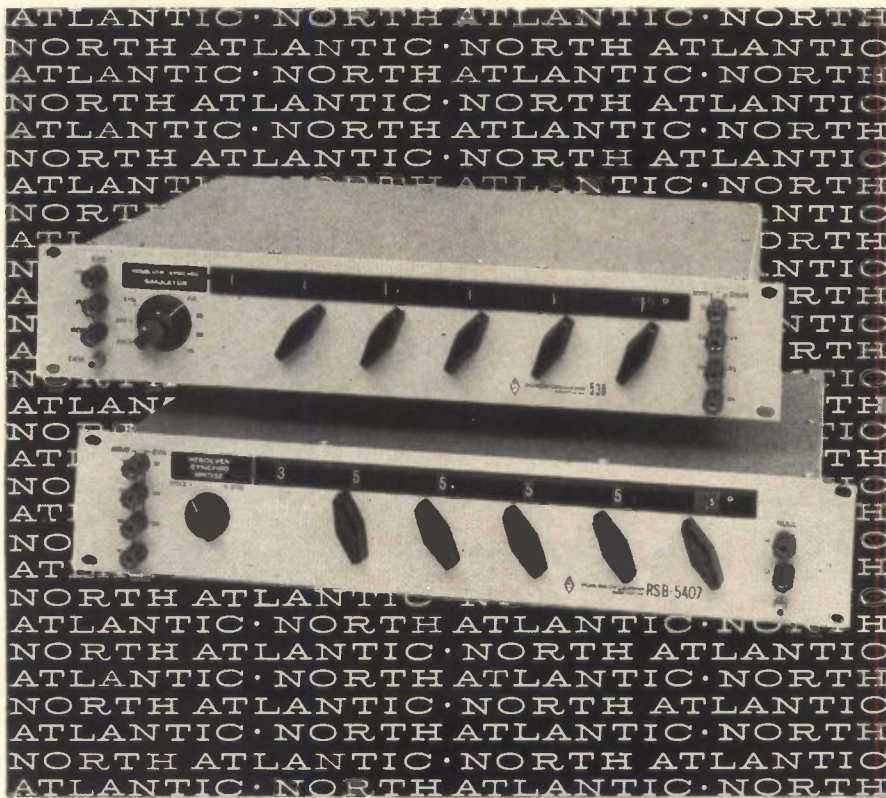

## you are looking at the state-of-the-art in resolver/synchro testing

These two instruments provide the widest measurement capability available today for resolver/synchro testing. Each is a dual-mode unit, measuring both resolvers and synchros. Series 530 Simulators are ideal transmitters, and Series 540 Bridges are ideal receivers.

In addition to their dual-mode capability in 3½" of panel space, both series provide in-line decimal readout continuously switched through 360°, 2 second accuracy at any angle, and input/output isolation.

### SERIES 530 SIMULATORS FEATURE

- Resolution 0.001°, 1°, or 5°
- Dual 26/115 volt excitation
- Switch selected line-line voltages 11.8, 26, 90, and 115 volts
- Low matched output impedance

### SERIES 540 BRIGGES FEATURE

- Resolution 0.0001°, 1°, or 5°
- 500K input impedance
- Constant null-voltage gradient at all line-line voltages
- Unaffected by null detector loading

Prices range from \$1480.00 to \$2680.00

The flexibility of these instruments meets every need for rapid and accurate testing in the engineering laboratory, in production, and in ground support equipment. Used with a Phase Angle Voltmeter, they provide a complete facility for component or system test.

Programmable models with decade or binary input are also available. Your North Atlantic representative will be glad to arrange a demonstration. Call or write him today.



**NORTH ATLANTIC** industries, inc.  
TERMINAL DRIVE, PLAINVIEW, L. I., NEW YORK • OVERbrook 1-8600

office. Small concerns may have only one or two.

**Technical background.** Most reps have a technical background, but normally they don't attempt to solve technical problems on contracts they're servicing. When these occur, the company sends experts from the main office. One reason, according to an experienced rep, is that the Washington man probably isn't qualified to handle the problem. Another is that "the customer feels he is getting better service when the company sends in a team of experts."

## II. How he operates

About half of a Washington rep's time goes into servicing existing contracts. This can involve messenger-boy functions on routine matters, or it can get him embroiled in complex trouble-shooting conferences.

Almost without exception, the Washington rep is present any time company and customer conferences are held. In this manner and through his own plant briefings, the rep keeps abreast of all developments in the particular contracts he is servicing.

**Seeking business.** The other half of his time is devoted to scouting for new business. Often his two functions overlap; a tip on new business may come from an office where his company already has a contract.

But he also hunts on a broader front. Normally, for a large company with several Washington reps, the company man concentrates in the particular capabilities of the division he is representing—electronics, rocket propellants and such.

**Contacts.** Almost without exception, reps agree that their most valuable asset is a good network of well-placed contacts in the government.

A rep's contacts range from technical people working directly in his field to persons doing advanced planning on new programs; it includes procurement officers and even well-placed secretaries.

It is rare that a Washington rep will try to influence directly a contract decision. Most say that this can cause far more damage than good.

In cases where indirect pressure is brought by companies to win a major contract, the pressure comes from a far higher level than the Washington rep. "The pet system," as reps refer to it, translates into politics, economics and technology.

### III. How and whom he entertains

Establishing contacts and keeping them on friendly terms is a never-ending process for the successful Washington rep.

By and large, the rep operates well within legal bounds. His resources don't include a string of call girls, or authority to provide expensive gifts or vacations for his government contacts.

The mink-coat, five-percenter episodes that hit the headlines from time to time usually originate several echelons above the typical Washington rep. He doesn't deal in that kind of spending.

But he does entertain regularly. And his expense account can run into several thousand dollars a year.

"There is nothing sinister about the operation," a rep explains. "This is standard practice whether you are dealing with government contracts or industry business. Over the years you become good friends with these people, and that always makes working with them easier."

**The pattern.** There is a pattern to the way most Washington reps function with their government contacts. Normally a rep won't entertain a prospect until he has dealt with him in his office two or three times. Then he may suggest lunch together—just the two of them at a moderately priced restaurant.

After two or three luncheons over several weeks, the next step is evening entertainment. A standard Washington practice is dinner and the theater for a prospective contact and his wife. Again, the rep does not choose the big, brassy restaurants where it would be obvious that his guest—particularly if he is a military person—is being entertained by a company.

From then on, entertainment is every month or two—just enough to keep the relationship smooth. But at this rate the Washington rep is having three or four business

## THE ONLY HIGH RESISTIVITY ALLOY USED AS A RESISTANCE STANDARD

# EVANOHM<sup>®</sup>

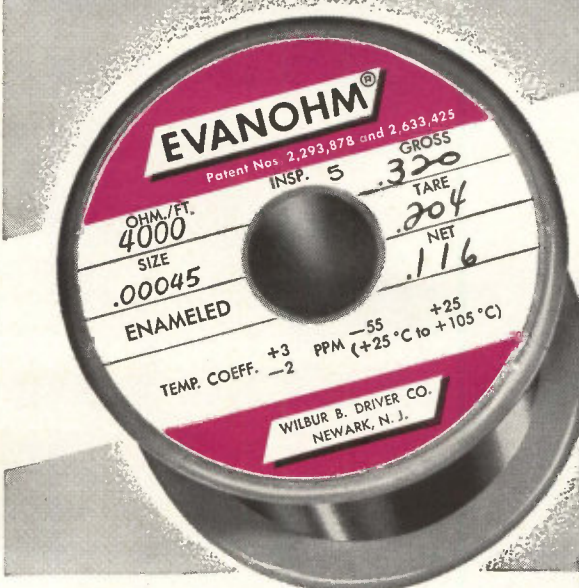

- High Resistivity
- Low TC of Resistance
- Low Thermal EMF to Copper
- High Reliability

**SPECIFICATIONS**

Nominal composition  
75% Nickel  
20% Chromium  
2.5% Aluminum  
2.5% Copper

Specific resistance 20°C  
800 ohms/cm  
134 microhm cm

Temperature Coefficient of Resistance  
-65°C to +150°C  
±.000005/°C

Coefficient of linear expansion  
20° to 100°C  
.000014/°C

Magnetic permeability  
1.0005

Average tensile strength  
180,000 psi

Mean thermal EMF vs copper -65°C to +150°C  
.2μV/°C

### Maintains Highest Stability Over Long Periods of Time and Wide Ranges of Temperature!

EVANOHM, the time-tested standard of the precision wire-wound resistor industry, features the lowest thermal EMF versus copper of all resistance alloys . . . with stability within a few parts per million per year. EVANOHM is recommended for all precision requirements where highest reliability is essential, and is well suited for analog computers and guidance equipment for space applications. EVANOHM, in .0004 and heavier gauges, can be supplied from stock, either bare or enameled, for immediate delivery. The Wilbur B. Driver Company's engineering "know how" is available to help solve your problems. Call or write WBD for recommendations on your requirements, or request EVANOHM brochure!

VISIT US AT THE WESCON SHOW—BOOTH 1740

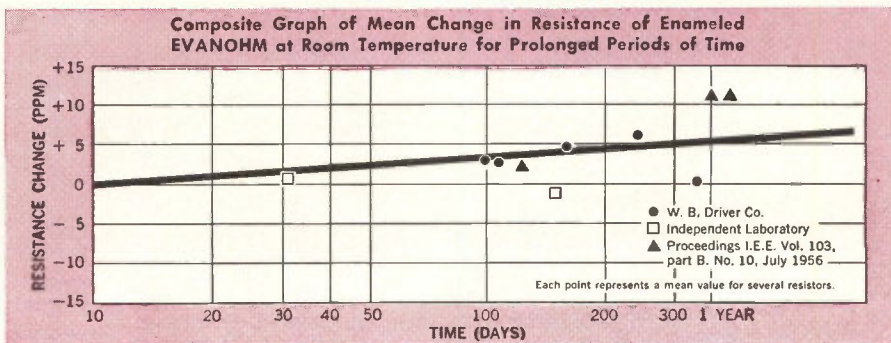

**WILBUR B. DRIVER COMPANY**  
Newark 4, New Jersey—Tel. HUmboldt 2-5550 (Area Code 201)

MFG. PLANTS—1875 McCarter Highway, Newark 4, New Jersey; 50 Ronson Drive, Rexdale (Toronto), Ontario, Canada  
BRANCH OFFICES—Chicago\*, Philadelphia, Los Angeles\*, Minneapolis, Cleveland\*, Hartford (\*Indicates Warehouse)

Melters and Manufacturers of Custom Electrical, Electronic, Mechanical and Chemical Alloys for all industries.

# ( THREE OF A KIND? )

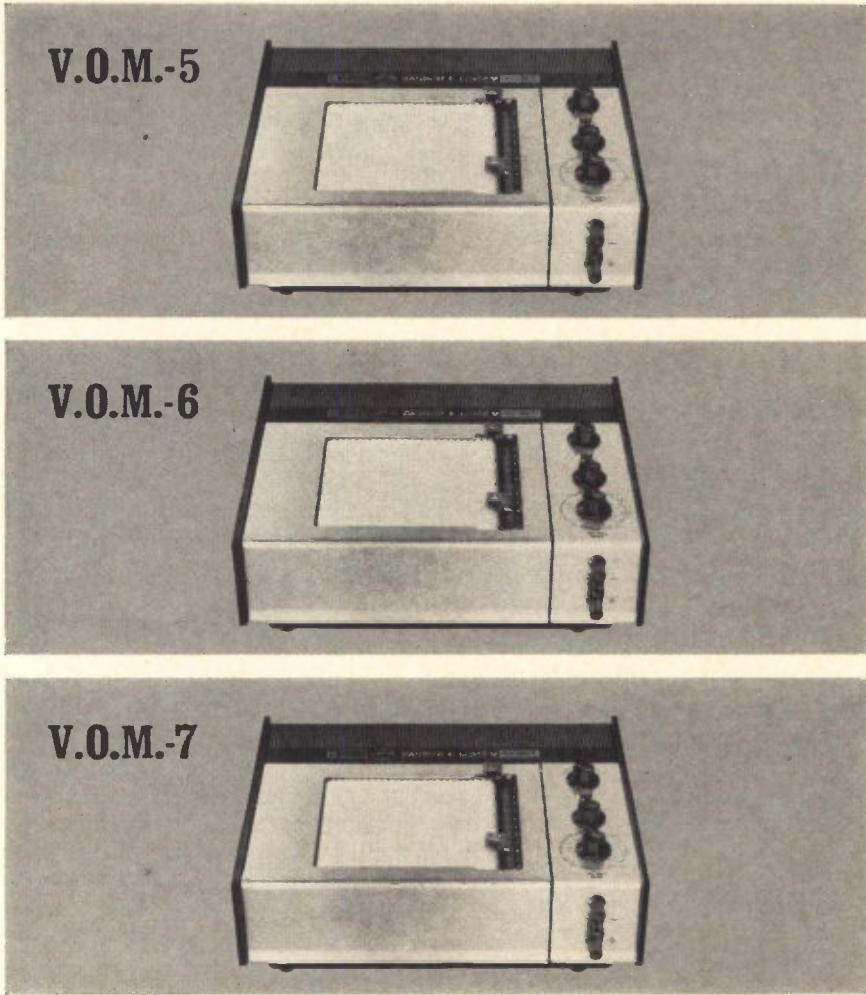

## YES – and NO!

All three of these 5-inch, strip-chart recorders are built to the same outstanding design—each one records volts, ohms, milliamps directly. But each of these Bausch & Lomb V.O.M. Recorders works in a different range.

	V.O.M.-5	V.O.M.-6	V.O.M.-7
Voltage range:	10 mv—500 v	2.5 mv—125 v	0.5 mv—10 v
Current range:	10 m $\mu$ a—100 ma	2.5 m $\mu$ a—25 ma	1 m $\mu$ a—10 ma
Resistance range:	1-100,000 ohms	0.25 ohms—25,000 ohms	1 ohm—100 K ohms
Prices: (suggested retail)	\$595 COMPLETE	\$700 COMPLETE	\$885 COMPLETE

And, at no added cost, B&L V.O.M. Recorders give you 5 built-in chart speeds, built-in event marker, built-in take-up reel, and a number of other features.

For further information just circle our ad number below on the magazine's reply card and mail it, or write Bausch & Lomb Incorporated, 61408 Bausch Street, Rochester, New York 14602.

**BAUSCH & LOMB** 

1964 MASTER DESIGN AWARD WINNER—Microscopes for Science Teaching and Flexiscope

luncheons a week and entertaining in the evening once or twice a week.

**Gifts are scarce.** Few gifts are exchanged. "They're not in vogue any more," one company man states.

Mass entertainment is held to a minimum, partly because the rep doesn't want all of his contacts brought together where they can see whom he is wooing. Exceptions are some annual conventions held in Washington. There are about a dozen of these a year. Companies often buy several tables at the formal dinner that normally occurs some time during the convention. For such an occasion, and the traditional cocktail party that precedes it, the gathering is large enough so that there is no embarrassment attached to the invitations.

"Often," confides one rep, "this brings some surprises. The contact that you thought you had in your pocket shows up at your competitor's table."

**Take me out . . .** Occasionally a contact becomes demanding in his desire to be entertained. This is usually done subtly. "One guy used to call me regularly," says a rep, "and say, 'Boy what a great football game that's going to be next Sunday—those prices are terrible, though.' Obviously, it meant that I gave up my Sunday at home and took him to the game." But, that sort of arm-twisting is unusual, reps report.

Job-hunting by government sources can plague reps, too. As military personnel begin to reach the retirement stage, they often seek employment in industry. In many cases, companies are happy to tap this source of manpower. In others, however, they don't want to hire an officer and it can become a delicate issue, particularly if he has been a good source of information. The problem is handled in different ways. "One consolation," says a rep, "is that the guy is probably working on a half-dozen other companies and may find a job before it gets too rough on you."

Regardless of the headaches and expenses involved, however, companies consider their Washington representatives almost indispensable in doing business with the government.

# IF YOU'RE DOING SERIOUS WORK WITH \* INTEGRATED CIRCUITS \* YOU'LL NEED AT LEAST THIS MUCH INFORMATION TO HELP YOU COMPARE BEFORE YOU'RE COMMITTED.

## PERFORMANCE

Is what you ultimately pay for, and d-c stability margin is one major requirement. To arrive at worst case d-c stability margin alone, Siliconix specifies 8 different parameters. Performance is proven through 18 different tests on each gate and at three temperatures . . . fifty-four tests in all. Distribution of d-c stability margin for worst case input and output loading is shown for all three ambients.

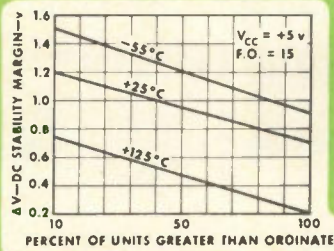

## CONSTRUCTION

is a significant contributor to performance. For instance, each circuit uses epitaxial transistors and an N+ diffusion to minimize isolation capacitance, to control output resistance, and to improve switching times and yield. For circuit uniformity and cost economy, only one set of deposition and diffusion processes is used for the entire line of circuits.

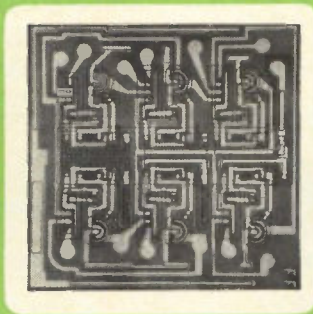

## CIRCUITS

are the increasingly popular diode transistor logic (DTL), with the best balance of propagation delay (18 nsec), d-c stability (see curve), and power drain (7 mw) when operated from a single power supply (5v nom). The high-gain circuit removes critical gain-speed tradeoff at temperature extremes on the inverter transistor, providing higher yield while improving performance.

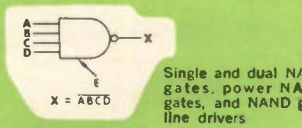
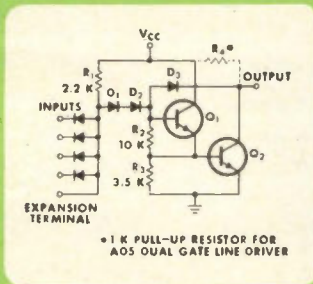

Single and dual NAND gates, power NAND gates, and NAND gate line drivers

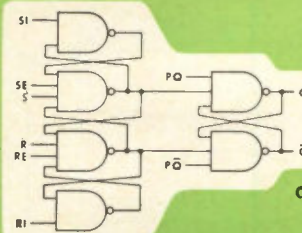

Counter, shift register

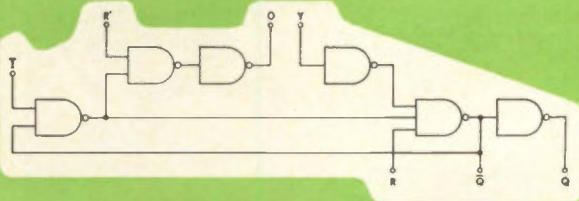

One-shot multivibrator

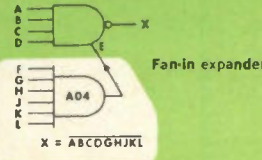

Fan-in expander

## PRICING

is geared to the evaluation order as well as the large one. For instance, if you order just one diode array, you get the 1.999 unit price of \$7. The counter, shift register is only \$29.

## BROCHURE

tells all. Write or call collect for detailed specifications on Siliconix Integrated circuits. That is, if you're serious.



**Siliconix incorporated**  
 1140 West Evelyn Ave. • Sunnyvale 33, California  
 Telephone 245-1000 • Area Code 408 • TWX 408-737-9948  
 WESCON BOOTH 526

# new

## UNIVERSAL BRIDGE

TRANSISTORIZED • PORTABLE

### \$285



Model 2700

**RANGES:**

C: 0.5pF to 1100 $\mu$ F  
 L: 0.3 $\mu$ H to 110 H  
 R: .010 $\Omega$  to 11 M $\Omega$

**ACCURACY:**

$\pm 1\%$

**FREQUENCY:**

Internal 1kc  
 External 20cps to 20kc

**ALSO  
MEASURES:**

Incremental 'L'  
 Incremental 'R'  
 'C' with bias

Write  
for detailed  
catalog sheet.

# MARCONI

**INSTRUMENTS**

DIVISION OF ENGLISH ELECTRIC CORPORATION  
 111 CEDAR LANE • ENGLEWOOD, NEW JERSEY  
 MAIN PLANT: ST. ALBANS, ENGLAND

## Now...from Weltek... MOLECULAR BONDING for Microcircuits!

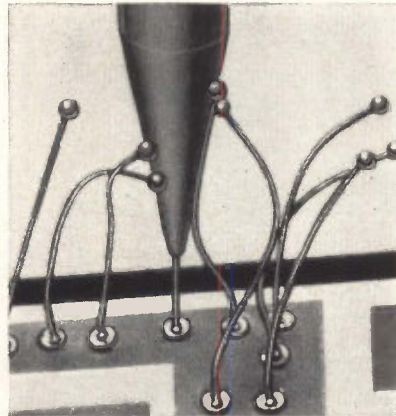

(At left) 20X blowup showing tip of Weltek Model 700 Molecular Bonder and several bonds of .001 gold wire to 1000 Angstrom thin film. (Below) New weld head for Molecular Bonder.

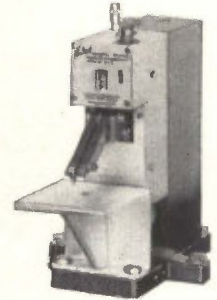

Weltek's new MODEL 700 Molecular Bonder makes diffusion bonds of various fine wires to thin films, integrated circuits, hybrid circuits, chips, and crystals. Process is similar to thermo-compression bonding but requires *no heat column*. This versatile equipment can also be used for resistance welding of flat pack leads and for microminiature soldering.

# Weltek

See us at the WESCON Show:  
 We'll help solve your welding and bonding problems. Bring materials to Booth 1823.

**Precision Welders**  
 by WELLS ELECTRONICS, INC.

1701 S. Main Street, South Bend, Indiana, U.S.A.

Circle 205 on reader service card

*Simplify*  
**WIRE  
 ASSEMBLY**

with a  
**KINGSLEY  
 Wire and Tube  
 Marking Machine**

Now you can mark each wire or piece of plastic tubing with its own individual circuit number.. quickly.. economically – right in your own plant!

Cut costs and speed production with the same machine that has proved so successful in the aircraft/missile field.

Write for details.

## KINGSLEY MACHINES

850 Cahuenga • Hollywood 38, Calif.



## Find the manufacturer... Fast!

It's just a matter of seconds to get the valuable information you need about electronic manufacturers and suppliers in the Electronics Buyers' Guide. The EBG has over 200 pages listing the names, addresses, phone numbers and key individuals of manufacturers of electronics equipment, related components and materials. All this plus vital company statistics. At a glance you know important facts about the company, exactly what each company makes, and where to find the manufacturers' representatives in your area. No wonder the EBG is the industry's standard catalog-directory!

### **Electronics Buyers' Guide**

A McGraw-Hill Publication

330 West 42nd Street, New York, N. Y. 10036

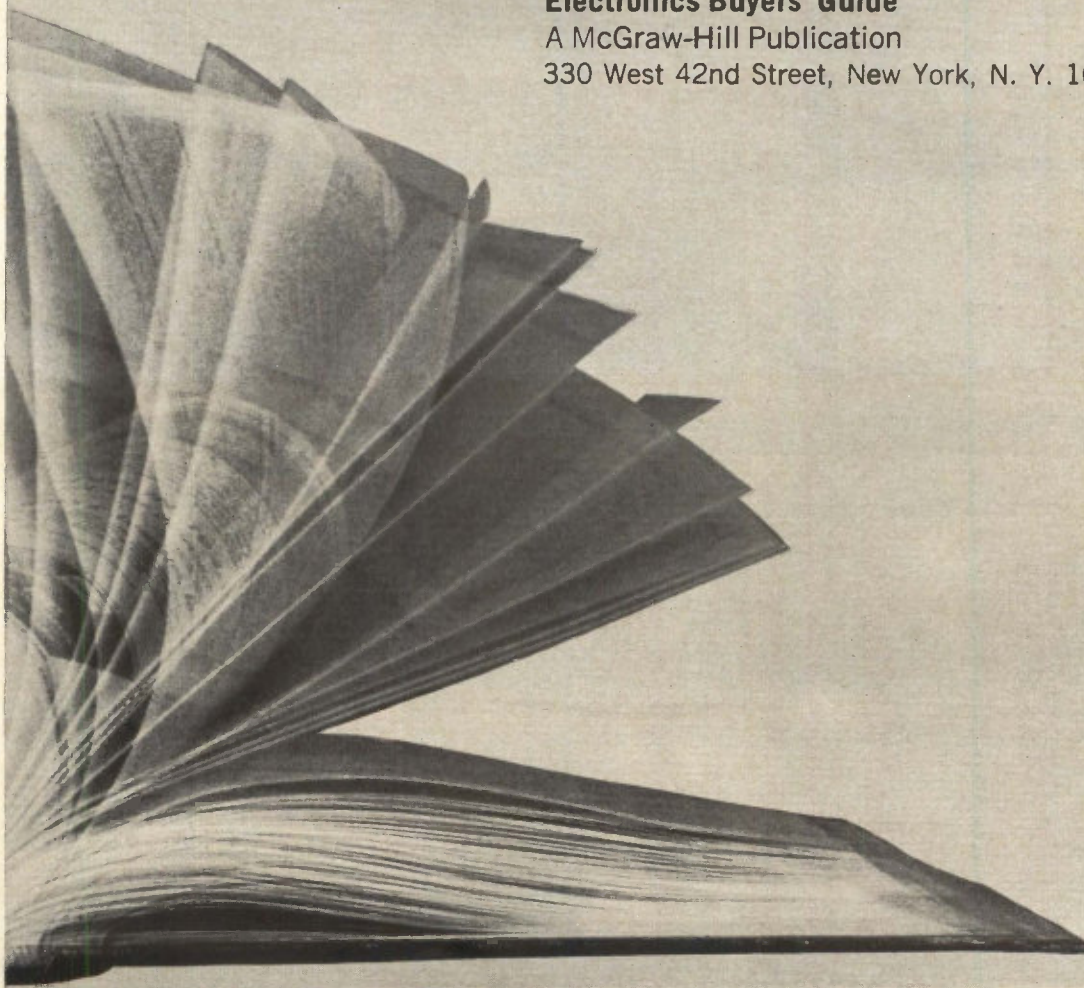

Another Sangamo First

# 8 AUTOMATICALLY SELECTED SPEEDS

(FOR BOTH TRANSPORT AND ELECTRONICS)

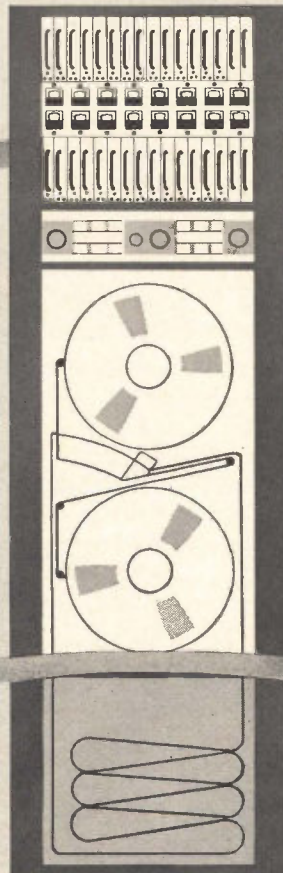

## ONLY THE NEW SANGAMO 4784 8-SPEED SYSTEM OFFERS SUCH UNIQUE FLEXIBILITY

Sangamo's automatically switched magnetic tape instrumentation system provides a time base expansion or contraction range of 128:1 . . . 4 times greater than any other system, over an FM bandwidth of 40KC  $\pm$  40% deviation and a direct bandwidth of 600KC at 120 ips.

**Only the Sangamo 4700 Series Makes  
All These Features Available**

Choice of from 1 to 8 automatically switched record/reproduce electronics

for economy and system expansion • Optional VU meters for each channel • High torque/low mass transport system • Industry's most precise servo • 1 inch and 1/2 inch tape simultaneously or interchangeably with no mechanical changes • Reel-to-reel or loop at the flick of a switch • The industry's only 1 year guarantee on parts and service.

**Compare Sangamo's Drift, Linearity,  
and Signal/Noise Ratio. For a Personal  
Demonstration...Write, Wire or Phone.**

SEE THE 4784 AT WESCON,  
SPORTS ARENA, BOOTHS 1241-1242.

# SANGAMO

ELECTRIC COMPANY

P. O. Box 359  
SPRINGFIELD, ILLINOIS 62705  
Phone: 217 544-6411 • TWX: 217 546-0947

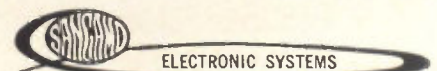

ES64-3

## Three-prism design for laser Q-switch

A total internal reflection technique provides extremely fast switching

The Daly-Sims Q-switch, according to its manufacturer, offers true single-pulse laser operation. With ordinary rotating-prism Q-switches, undesirable multiple pulses occur in high-gain systems. The new instrument uses a unique three-prism design to obtain single-pulse operation, thus preserving the beam in one brief concentrated burst. It also retains the many desirable features of the spinning reflector—that is, usefulness in the infrared, simplicity, and stability—by using a total internal reflection technique that makes extremely fast switching possible.

The three prisms used are a high-speed dynamically balanced rotating prism that operates in conjunction with a fixed-roof prism in

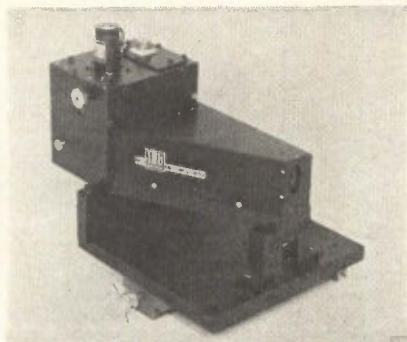

a speed-doubling arrangement, and the Daly-Sims prism.

The Daly-Sims prism uses the phenomenon of total internal reflection to provide an angle-dependent loss mechanism. The prism consists of a long plate of optically polished quartz with Brewster an-

gle entrance and exit faces. It serves as an angular mode selector and/or as a speed enhancer for rotating prism Q-switches.

By adjustment of the axis of the Daly-Sims prism relative to the axis of a laser, rays within a limited range of angles will experience total reflection while traveling through the prism. Rays outside this range of angles will experience a loss due to transmission through the surface at each reflection; they will, therefore, be attenuated when traveling through the prism. Thus, the angular spread of laser radiation can be reduced and the radiance enhanced.

TRG Inc., Route 110, Melville, N.Y. 11749. Booth 2083-2084.

Circle 301 reader service card

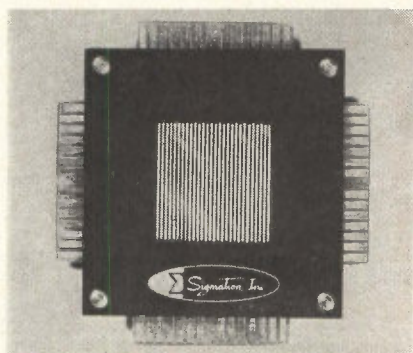

### Thin-film display panel has 33-line resolution

Miniature thin-film electroluminescent panels are available with crossed-grid electrode configuration for X-Y drive of elements. Resolution is 33 lines per inch. This unit affords an opportunity for electronic systems organizations to conduct experiments at minimal cost to evaluate the panel for display purposes. The manufacturer says this is the brightest high-

resolution thin-film panel available commercially. It has electrodes 0.020 in. wide, spaced on 0.030-in. centers with 0.010-in. gap between adjacent electrodes. Successive films of dielectric, electroluminescent phosphor and a metallic electrode are developed by the manufacturer's exclusive deposition techniques. The excited phosphor emission attains a peak of 5,800 angstroms and is insensitive to excitation frequency. Panels may be driven with sinusoidal or square-wave a-c at frequencies from 500 cps to 100 kc or with d-c. At 400 v rms, the diffuse-integrated surface brightness is approximately 300 foot-lamberts. Similar output is maintained down to the temperature of liquid nitrogen. The panel exhibits high suppression capability for unwanted excitation under all operating conditions. Exposed panel area reveals a 28-by-28-element matrix providing 784 individual electroluminescent cells. Sigmatron, Inc., Santa Barbara Airport, Goleta, Calif. Booth 1716 [302]

### Optoelectric device switches up to 300 v

A new optoelectric switch is a thin-film device suitable for switching up to 300 volts a-c or d-c. It is inherently bistable without active elements, vacuum tubes or diodes. The device is compatible with microelectronic circuits and lends itself to high-density packaging techniques. The switch utilizes the variation in conductance occurring in a photoconductive film when illuminated. Illumination is provided by means of an integral electroluminescent light source. The impedance ratio of the photoconductive film (light to dark) is up to 1 to 100,000. Discrete switch elements can be arranged to trigger each other in order to form an optoelectric shift register. Price is dependent upon size, switching speed, and other considerations.

Belock Instrument Corp., 112-03 Fourteenth Ave., College Point 56, N.Y. Sports Arena, Booth 2117. [303]

# Need Capacitors in SPECIAL PACKAGES?

Here are a few we've made recently:

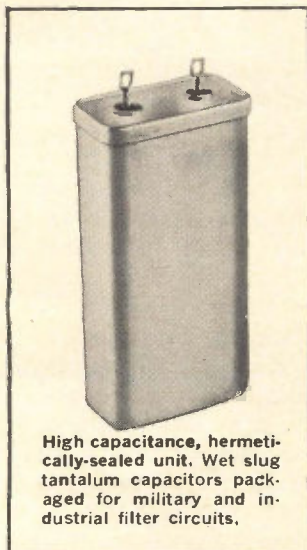

High capacitance, hermetically-sealed unit. Wet slug tantalum capacitors packaged for military and industrial filter circuits.



-55° to +125°C hermetically-sealed unit. Three Mallory HTA high-reliability aluminum electrolytics for industrial applications.



5400 mfd., 24 v., in a special mount. Four Mallory XTV wet slug capacitors in custom-designed geometry for an advanced missile program.



1000 mfd., 40 v., in 1" cube. Four Mallory wet slug tantalum capacitors packaged for a top space program.

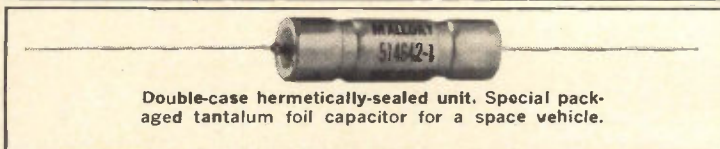

Double-case hermetically-sealed unit. Special packaged tantalum foil capacitor for a space vehicle.

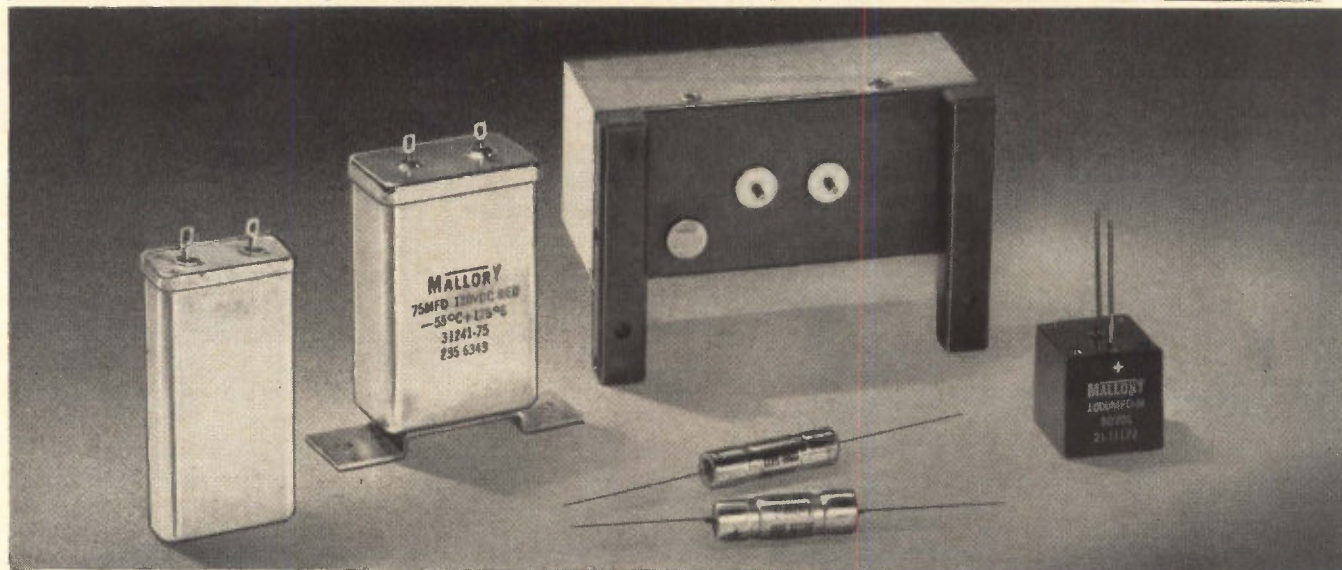

Packages have been designed for Apollo, Gemini, Pershing, TFX and other missile, space and aircraft programs. Whatever your packaging requirements, Mallory engineers can design and produce the capacity, reliability and geometry you need . . . quickly and economically. They have a full line of tantalum and aluminum electrolytic capacitors and years of experience to apply to your problem. Please write giving details such as capacity, working voltage, dimensions and environmental conditions. Or, request a consultation. Mallory Capacitor Company, Indianapolis, Indiana 46206—a division of P. R. Mallory & Co. Inc.

## MALLORY

See us at WESCON—Booths 169-171, Hollywood Park

## New Components and Hardware

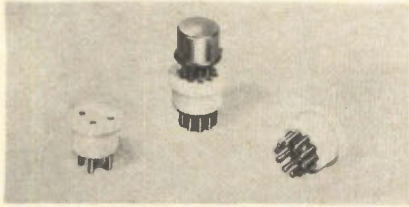

### Transistor sockets accept varied leads

A series of high-quality production and breadboard sockets for transistors and integrated circuits are available in all standard pin arrangements from three to 14 leads. Series MG sockets feature easy mounting by compression fit of a Teflon body in a round hole. Contacts are full-spring temper beryllium copper with nickel/gold plating. Positive contact retention is provided and the socket will accept a variety of leads from 0.015 to 0.025 in. diameter. Reliable contact is made for all types of rigorous use.

Barnes Development Co., 213 W. Baltimore Pike, Landsdowne, Pa. Hollywood Park Booth 101. [311]



### Rugged one-pound fan meets MIL-E-4970A

A new Sentinel fan, designed for commercial electronic cooling, will deliver up to 100 cfm of air at free delivery. It has passed the environmental tests of MIL-E-4970A. Weighing just one pound, it features an axial depth of only 1½ in. It will operate on 115 v a-c, 50-60 cps, single phase, drawing only 14 w. The fan is designed to operate at ambient temperatures up to 100°C. Airflow is instantly

reversible by turning the fan end-for-end. Venturi block and spider assembly are molded of high impact and dimensionally stable phenolic. Shaded-pole motor and stator are encapsulated in epoxy. Propeller is molded of polyolefin and grill is molded of polycarbonate. Precision stainless steel ball bearings are lubricated for life. Rotron Mfg. Co., Inc., Woodstock, N.Y. Booth 150-151. [312]

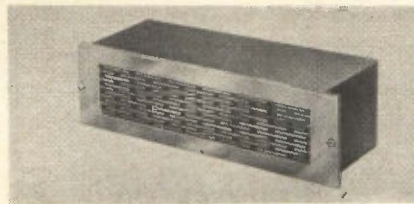

### High-velocity blower cools circuit cards

A compact blower, series 2EB350, is intended specifically for cooling rack-mounted rows of solid-state circuit cards. The blowers use a minimum of panel space, and develop 290 cfm of cool, filtered air. Models are available for top front vertical exhaust, venting the air out directly under the cards. Other models provide chimney-effect cooling. The units contain a permanent split-capacitor, 115-v 50/60 cps, single-phase motor with permanently lubricated and double-shielded ball bearings per MIL-FF-B-171. The motor meets specifications CC-M-363A. Blowers are available in 3½ in. or 5¼ in. panel heights. Price is approximately \$70.

McLean Engineering Laboratories, P.O. Box 228, Princeton, N.J. Booth 1841. [313]

### Transistor pads spread and slope leads

Two new Transipads are available that simplify mounting and soldering of economical plastic transistors to printed circuits. They are designed specifically to accommodate plastic-encapsulated transistors



## Super-Colossal Director

Call it a director, monitor, controller, or traffic cop—the API contactless meter-relay takes charge of practically every control situation, either in OEM equipment or on a production line.

It operates on a direct unamplified signal from any variable, and gives you more sophistication with less complication than any other control device.

Straightforward, simplified design means reliability and ease of application. It's inherently fail-safe.

You don't have to be an engineer to use it—but engineers appreciate it most.

### Features that make it easy to use

1. Indicates continuously—You always read the true signal, either side of adjustable set point.
2. Acts fast at set point—Control action either way at set point is almost instantaneous (10 to 20 milliseconds).
3. Near-perfect repeatability—Frictionless taut-band movement responds uniformly, unaffected by line voltage.
4. True proportioning (optional)—Analog action near set point, in band up to 5 per cent of full scale.
5. Pre-packaged circuits—Modules mount anywhere, for greatest convenience.

API contactless (optical) meter-relays are offered in all popular current and voltage ranges, including AC, and as temperature controllers. Three case styles, three sizes, double or single set point. Many available off-the-shelf from stock.

Two Wescon Booths  
Sports Arena—1016-A  
Hollywood Park—740-741

Ask for Bulletins 33-D (Prices)  
and 35-C (Circuits)



Assembly Products, Inc.  
CHESTERLAND, OHIO • AREA CODE 216 • HA 3-3131

# NEW D-C AMPLIFIER

## FROM TI

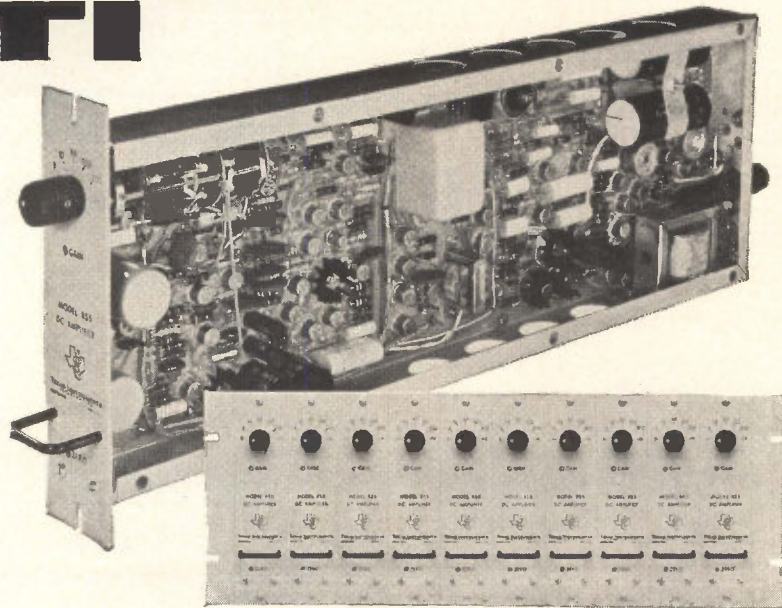

### High-precision differential unit with self-contained power supply

The Model 855 Differential D-C Amplifier is an important new addition to TI's line of high-speed data acquisition equipment. Designed primarily for data applications, the Model 855 may also be used for test and measurement applications requiring a band-width up to 1KC.

The 855 has outstanding features: completely self-contained design requiring no external power supply,

solid-state construction with no mechanical chopper, low d-c drift, short settling time, isolated input, output and chassis.

PC board construction yields a convenient package measuring only 1.7 in. wide, 7 in. high, and 17.8 in. deep and weighing 3¼ lb. A rack mounting case (19 in. wide) is available providing space for up to ten amplifiers.

#### Brief Specifications

Gain	— Selectable: 1, 3, 10, 30, 100, 300 and 1000
Gain Accuracy	— ±1% at dc; can be calibrated to better than ±0.05%
Gain Stability	— ±0.02% for 8 hrs; ±0.05% per week
Linearity	— ±0.025%
Source Resistance	— 10K ohms max
Input Resistance	— 1 megohm shunted by 0.25 µf
Rated Output	— ±10 v
Common Mode Voltage	— 500 v-dc or ac peak, max

Write for complete information

INDUSTRIAL  
PRODUCTS  
GROUP



**TEXAS INSTRUMENTS**  
INCORPORATED  
P. O. BOX 66027 HOUSTON, TEXAS 77006  
7 RUE VERSONNEX GENEVA, SWITZERLAND

678

### New Components

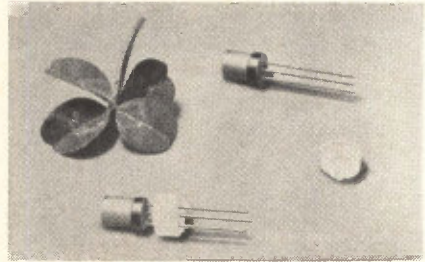

with in-line leads. By separating and gently sloping three in-line leads to the p-c boards, model 10170 makes practical the easy and dependable use of these economical packages. It spreads leads to a diameter of 0.100 in., requiring only 0.240-in. diameter of board space. This spread is ample for soldering reliable connections and preventing lead shorting. The new Transipad raises components 0.130 in. above the board to allow thorough wash-out of soldering flux. Model 10171 Transipad spreads leads to a diameter of 0.200 in. Both models are precision molded from nylon, per MIL-P-20693 specifications.

Milton Ross Co., Southampton, Pa.  
Hollywood Park Booth 320. [314]

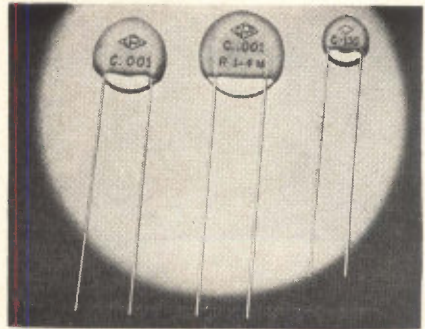

### Resistor-capacitor on single ceramic disk

A new resistor-capacitor combination, called the Disc-R-Cap, is being introduced. This device combines a capacitor and a resistor, in a parallel, on a single ceramic disk, and in addition, provides spark gap protection against overloads. The units are listed with Underwriters Laboratories and are especially valuable in antenna isolation and similar applications in-

volving shock hazard. The Disc-R-Cap can be supplied with any capacitance from 50 pf to 2,500 pf and any resistance from 100,000 ohms to 4 megohms.

Centralab, The Electronics Division of Globe-Union Inc., P.O. Box 591, Milwaukee, Wis. 53201. Booth 250-251. [315]



## Midget chopper with low noise level

An electromechanical chopper, model 6027, measuring 0.4 in. in diameter, and weighing 12 grams, is designed for p-c board use. Noise level, as measured into a 100,000-ohm load, is less than  $1 \mu\text{V}$  rms. The chopper features all-welded construction—eliminating solder or solder-flux contamination. Vibration of 10 g to 2,000 cps does not affect the operation of the rugged chopper. Almost any wave shape can be used to drive it. Frequencies of up to 1,000 cps are readily available. Life of the chopper is rated in excess of 2,000 hr. Prototype quantities are available within 10 days and are priced at \$50 each.

Cambridge Scientific Industries, Inc., 527 Poplar St., Cambridge, Md. Booth 116. [316]

## Computer-grade electrolytic capacitor

An aluminum electrolytic capacitor, type 556, is a  $\frac{3}{8}$ -in. diameter, axial-lead unit of computer-grade design. Temperature range is from  $-40^\circ\text{C}$  to  $100^\circ\text{C}$ . Available in eight case lengths, the capacitor offers ratings from  $19 \mu\text{f}$  at 150 v d-c to  $560 \mu\text{f}$  at 3 v d-c. It features a newly designed seal, the quality of which is proved by tests which show maximum weight change, due to loss of electrolyte, to be less than 0.015 gram during 500 hours of operation at  $100^\circ\text{C}$ . Other features include a double ultrasonic weld at the anode connection. Both external leads and



**\$950**

## a new one off the shelf... quality, high-spec pulse generator featuring variable rise and fall

The Model 6613 General Purpose Pulse Generator fills the need for a low-cost, high-quality test instrument with exceptional performance specifications. It is a general purpose instrument ideal for most pulse applications such as testing integrated circuits, digital circuit design, system design and checkout, testing of diodes and transistors.

The 6613 provides coincident positive and negative pulses determined by an internal clock generator or external source, with rep rate variable in 6 steps. Pulse width and delay are also variable in 6 steps. Amplitude is variable from near zero to 10 volts, with overload protection provided. Solid-state circuitry is utilized throughout. The compact unit measures  $8\frac{1}{2}$  in. high,  $8\frac{1}{2}$  in. wide, 12 in. deep and weighs only 10 lb.

### SPECIFICATIONS

#### Clock Pulse Repetition Frequency

15 cps to 150 cps	15 to 150 kc
150 to 1500 cps	150 kc to 1.5 mc
1500 cps to 15 kc	1.5 mc to 15 mc

#### Delay

30 to 300 nano-secs	30 to 300 microseconds
300 nanoseconds to 3 microseconds	300 microseconds to 3 milliseconds
3 to 30 microseconds	3 to 30 milliseconds

#### Width

30 to 300 nano-secs	30 to 300 micro-secs
300 nanoseconds to 3 microseconds	300 microseconds to 3 milliseconds
3 to 30 microseconds	3 to 30 milliseconds

#### Pulse Amplitude—10 v into 50 ohms

**Rise and Fall Times**—variable; less than 10 nanoseconds to 1 microsec, 1 microsec to 100 microseconds, 100 microseconds to 10 milliseconds, minimum rise time typically 8 nanoseconds

INDUSTRIAL  
PRODUCTS  
GROUP



**TEXAS INSTRUMENTS  
INCORPORATED**  
P. O. BOX 66027 HOUSTON, TEXAS 77006

663

# Not Everyone Can Use This Logic Card

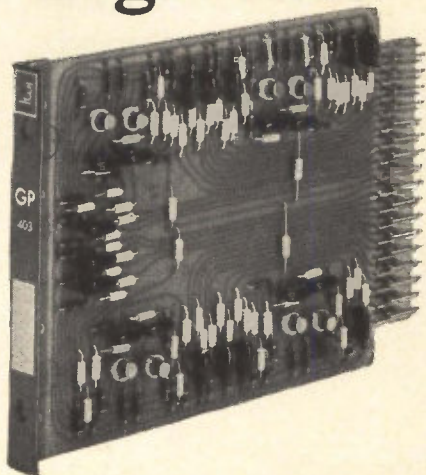

Maybe your logic system can get by with 100kc clock rates. Okay—perhaps this ad is not for you.

But if you have to work at rates above 10mc—or if you're working at very low rates, but want the advantages of short propagation delays, excellent noise rejection and high fan-in fan-out capability—Intercontinental's NAND logic cards will meet virtually any need you can name.

They're available for all digital logic operations, at both 3mc and 10mc rates, and in either germanium or silicon types for extreme environments. Prices? No more than for run-of-the-mill 100kc cards. For example:

*Indicates that 10mc unit is to be used.	GERMANIUM		SILICON	
	3mc	10mc	3mc	10mc
Digital Gates (8)	\$40	\$ 64	\$ 67	\$ 85
Diode Clusters	27	37	40	48
Basic Flip Flops (4)	40	64	70	98
Counter Flip Flops (4)	54	84	97	132
General Purpose Flip Flops (4)	60	90	100	138
Power Drivers (4)	75	110	96	150
Delay Multivibrators (2)	*	110	*	135
Free-Running Multivibrators (2)	*	141	*	175
Crystal Oscillator and Power Amplifier	*	125	*	149
Schmitt Trigger (2)	*	120	*	140
Nixie Driver and Decimal Decoder	77	87	130	169

All models are dip-soldered on 1/4" glass-epoxy G-10 laminated board, have color-coded end plates and 35-pin connectors for rack-mounted trays. Detailed specs? Just call or write.



**INTERCONTINENTAL  
INSTRUMENTS INC.**  
123 Gazza Blvd., Farmingdale, N.Y.  
Phone: (516) MYrtle 4-6060

## New Components

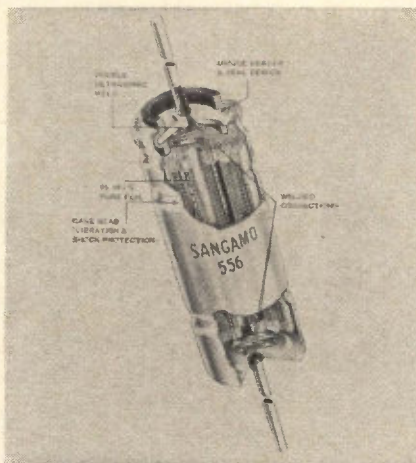

the cathode tab connection are also welded. High purity foil, 99.99+ % pure, is used in section composition.

Sangamo Electric Co., Box 359, Springfield, Ill. 62705. Hollywood Park Booth 183-184. [317]

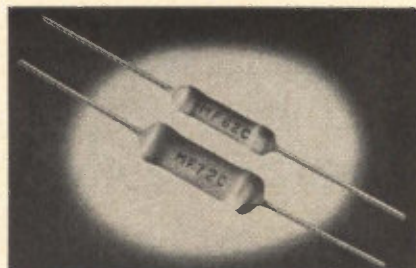

## Metal film resistors are conformally coated

A line of conformally coated metal film resistors has been developed. They are claimed to be the first of their kind to meet characteristics C, D and E of MIL-R-10509. Available units include a 1/10 watt (MF4C), 1/8 watt (MF52C), 1/4 watt (MF62C) and 1/2 watt (MF72C), all at 125°C. Temperature coefficient for all characteristic D resistors is ±100 ppm/°C, vs the MIL-R requirement of -200 to +500 ppm/°C. For characteristic C it is ±50 ppm/°C, while for characteristic E it is ±25 ppm/°C. These resistors use a high-reliability compression end cap over a noble metal band to provide superior lead attachment without restricting resistance range, according to the manufac-



## livability

(an industrial location advantage)

There's fun-filled living for you and your employees when you locate your plant in WESTern PENNSylvania. Ski on nearby slopes . . . fish for wary trout and bass . . . hunt big and small game . . . water-ski . . . listen to music by a top symphony orchestra . . . go to art festivals, opera and straw hat theaters . . . or visit reminders of a romantic past. Beautiful large-acreage sites, suitable for industry, are available on many rivers and streams. There's room to spread out . . . room to live and grow in WESTern PENNSylvania.

## WEST PENN POWER

an operating unit of ALLEGHENY POWER SYSTEM



INDUSTRIAL SHELL BUILDINGS available at \$2.95 to \$3.25 a sq. ft. completed to your specs in 60-90 days.

Area Development Department. Phone: 412-TE 7-3000  
WEST PENN POWER  
Greensburg, Pa. 15602

Yes, I'd like more information about WESTern PENNSylvania:

- 4-Season Livability  Favorable Tax Climate  
 Financing Plans  Pre-production Training  
 Industrial Properties ADA4-12 E

Name \_\_\_\_\_  
Title \_\_\_\_\_  
Company \_\_\_\_\_  
Address \_\_\_\_\_  
City \_\_\_\_\_ State \_\_\_\_\_  
Zip \_\_\_\_\_ Phone \_\_\_\_\_

Circle 207 on reader service card

Electronics | August 10, 1964



**Should you send  
a simple solid state  
microwave filter  
to do a cumbersome  
electro-mechanical  
preselector mechanism's  
job, even air-borne?**

**A Loral YIG, yes.**



Our YIG filters are highest in performance and reliability...small in size, weight and price...and go straight off the shelf into your end-use equipment. For brochure and further information write:

Advanced Products,

**Loral Electronic Systems**

A DIVISION OF LORAL ELECTRONICS CORPORATION  
825 BRONX RIVER AVENUE, THE BRONX, NEW YORK, 10472.

**Specification highlights**

Model No.	Freq. Range	Insertion Loss	Off band isolation 15 BWs away	Nominal Tuning Sensitivity
*P-201	.5- 1.0 gc	5.5 db max.	40 db min.	4.6 mc/ma
*L-201	1- 2 gc	4 db max.	40 db min.	4.6 mc/ma
S-201	2- 4 gc	4 db max.	40 db min.	4.6 mc/ma
C-201	4- 8 gc	3 db max.	40 db min.	8.46 mc/ma
X-201	8-11.5 gc	3 db max.	40 db min.	8.46 mc/ma
*P-401	.5- 1.0 gc	7 db max.	70 db min.	4.6 mc/ma
*L-401	1- 2 gc	5.5 db max.	70 db min.	4.6 mc/ma
S-401	2- 4 gc	5.5 db max.	70 db min.	4.6 mc/ma
C-401	4- 8 gc	4 db max.	70 db min.	8.46 mc/ma
X-401	8-12.0 gc	4 db max.	70 db min.	8.46 mc/ma

Typical band width for all units: 20-30 mc.

\*These models provided with heaters and thermistor output leads for temperature control.

Circle 127 on reader service card

# GUDEBROD CABLE-LACER SPEEDS AND IMPROVES WIRE HARNESS TYING—

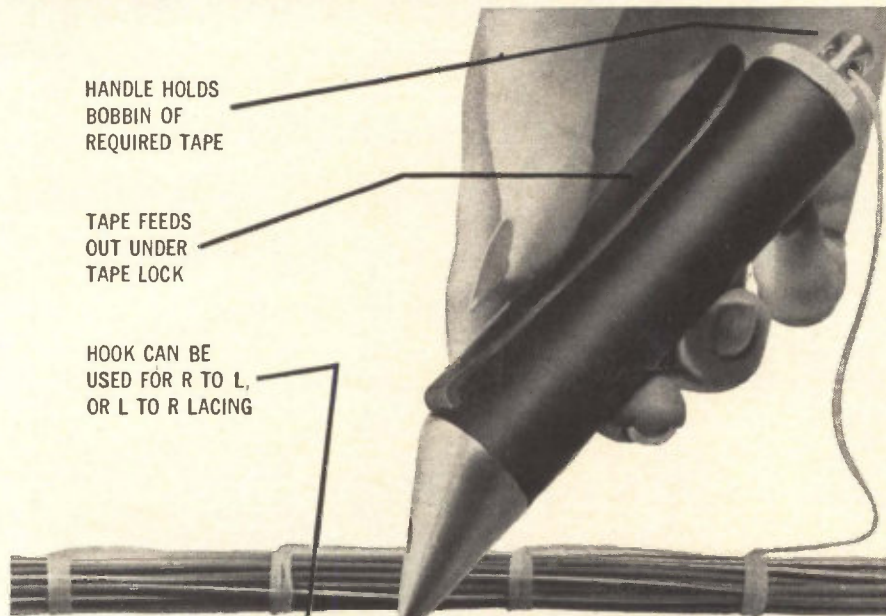

HANDLE HOLDS  
BOBBIN OF  
REQUIRED TAPE

TAPE FEEDS  
OUT UNDER  
TAPE LOCK

HOOK CAN BE  
USED FOR R TO L,  
OR L TO R LACING

## GUDEBROD FLAT BRAIDED LACING TAPES FOR EVERY NEED

Specify Gudebrod Lacing Tapes for all your requirements. They meet or exceed all MIL-T specifications and commercial requirements. They will help increase your production because Gudebrod carefully tests, measures, and maintains close tolerances for slip resistance, fray resistance, breaking strength, wax content, fungistatic effectiveness. Standard, burn proof, high temperature tapes available in regular spools or in bobbins for the Cable-Lacer.

The Gudebrod Cable-Lacer is the first production tool specifically designed to speed, ease *and improve* the lacing of wire harnesses.

A bobbin of tape in the handle feeds tape as needed making the handling of long sections unnecessary. The number of splices are reduced too.

The hook (which can be arranged for left to right, or right to left hand lacing) facilitates the passing of the tape over or under the wiring.

The tape lock provides a firm hold on the tape augmenting the hand pull for up to 30% tighter knots. Hand contact in knot tying is eliminated.

The ease of handling the tape, the speeding of the knot tying, the elimination of hazard to hands are all appreciated by the harness section worker. Efficiency improvements of 20% and more have been proven. The Gudebrod line of lacing tapes is available in bobbins for use in the Cable-Lacer.

Gain these advantages for your harness tying operation—improved worker conditions—increased production—higher quality harness. For complete information get in touch with the Electronic Division.



**GUDEBROD BROS. SILK CO., INC.**

FOUNDED IN 1870

*Electronics Division*

12 SOUTH 12TH STREET, PHILADELPHIA 7, PENNSYLVANIA  
VISIT WESCON BOOTH NO. 1618, SPORTS ARENA

## New Components

turer. Typical price is 7.7 cents per unit in quantities of 10,000 for  $\frac{1}{8}$ ,  $\frac{1}{4}$  or  $\frac{1}{2}$ -watt characteristic D units.

Electra Mfg. Co., Independence, Kansas 67301. Booth 374-375. [318]

## Subminiature switch features long life

Type 26 snap-action switch offers double-pole, double-break switching capability in one case that measures only  $\frac{1}{4}$  in. thick, 0.761 in. high,  $\frac{3}{16}$  in. wide. Each pole can handle two circuits (one normally open, one normally closed), by virtue of the Butterfly double-break mechanism. The two poles make and break simultaneously. The switch provides over 20 million mechanical cycles and 200,000 cycles minimum at full rated load; 750,000 cycles at one-half rated load. It is rated at 10 amps, 125/250 v a-c; 10 amps resistive or 7.5 amps inductive at 30 v d-c. It is available in two Form Z or two Form C contact arrangements. A choice of side or end solder terminals is offered. Type 26 series is operational from  $-65^{\circ}$  F to  $275^{\circ}$  F ambient (standard phenolic case) or to  $400^{\circ}$  F ambient (diallyl case). It is available with fine silver or gold plated contacts.

Licon Division, Illinois Tool Works, Inc., 6615 W. Irving Park Road, Chicago, Ill. 60634. Booth 177. [319]

## Tantalum capacitors for microelectronics

Miniature, solid-tantalum anode, liquid-electrolyte capacitors, design-

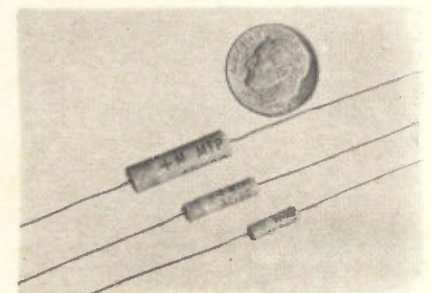

nated MTP, are being displayed. They qualify for use in the Minuteman II Program under IID-441-0765. The units, claimed to be a simultaneous breakthrough in miniaturization and reliability, come in four case sizes with ratings from 6.8  $\mu\text{f}$  at 50 v to 450  $\mu\text{f}$  at 6 v. Diameters are from 0.115 in. to 0.225 in. and lengths are from 0.312 in. to 0.775 in.

P.R. Mallory & Co., Inc., 3029 E. Washington St., Indianapolis, Ind. 46206. Booth 169-171. [320]

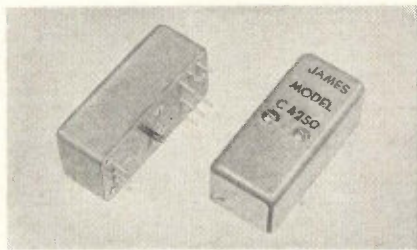

## Dpdt choppers mount on p-c boards

Double-pole, double-throw choppers have been developed with Form K, normally open contact configuration. These laydown units are designed for printed-circuit board mounting in such low-level applications as microvolt switching, analog acquisition, instrumentation, and in d-c amplifiers. They stand only  $\frac{7}{8}$  in. high above the p-c board. The series 4250 choppers are electrostatically shielded for low-noise operation. Typical noise level is 100  $\mu\text{v}$ , peak to peak, and 10  $\mu\text{v}$  rms into a one-megohm load. Operating voltage is 6.3 v rms  $\pm 10\%$ ; contact rating, 10 v at 1 ma. The choppers have a life expectancy of 2,000 hr minimum, in either 60-cps or 400-cps models. Units are completely shielded magnetically by a removable Mu-metal cover. Brass terminal pins provide low thermal connections. Series 4250 choppers are  $\frac{7}{8}$  in. high by  $2\frac{3}{8}$  in. long by  $1\frac{1}{16}$  in. wide, not including terminals. The ten 0.040-in. diameter terminal pins extend  $\frac{1}{4}$  in. from a Bakelite base. A threaded stud extending from the base provides positive mechanical mounting.

James Electronics, Inc., 4050 N. Rockwell St., Chicago, Ill. 60618. Booth 400. [321]

## CRAMPED SPACE COOLING



actual size

We can send you from stock the world's smallest useful blowers for cooling electronics. These are not toys—they're ruggedly designed to meet MIL-E-5272—and they produce up to 4 times the air output of other one-cubic inch blowers! That's 15,000 times their own volume per hour.

We'll be happy to ship you one right now—a.c. or d.c. Nominal life is 1,000 hours, but 2,000 hour life and up is routine for some units. VAX-1 blowers are the smallest of Globe's complete blower line. Request Bulletin VAX-1.

Globe Industries, Inc., 1784 Stanley Avenue, Dayton, Ohio 45404, U.S.A., Tel.: 513 222-3741

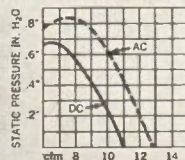

VAX-1-AC  
26 v.a.c. (115 v.a.c. w/1.2 MFD capacitor in series)  
400 cps, 320 MA., 2.0 MFD. phasing capacitor  
 $1\frac{1}{4}$ " dia. x  $1\frac{1}{4}$ " long. 1.5 oz.

VAX-1-DC  
26 v.d.c., 250 MA.  
 $1\frac{1}{8}$ " dia. x  $1\frac{1}{8}$ " long. 1.4 oz.



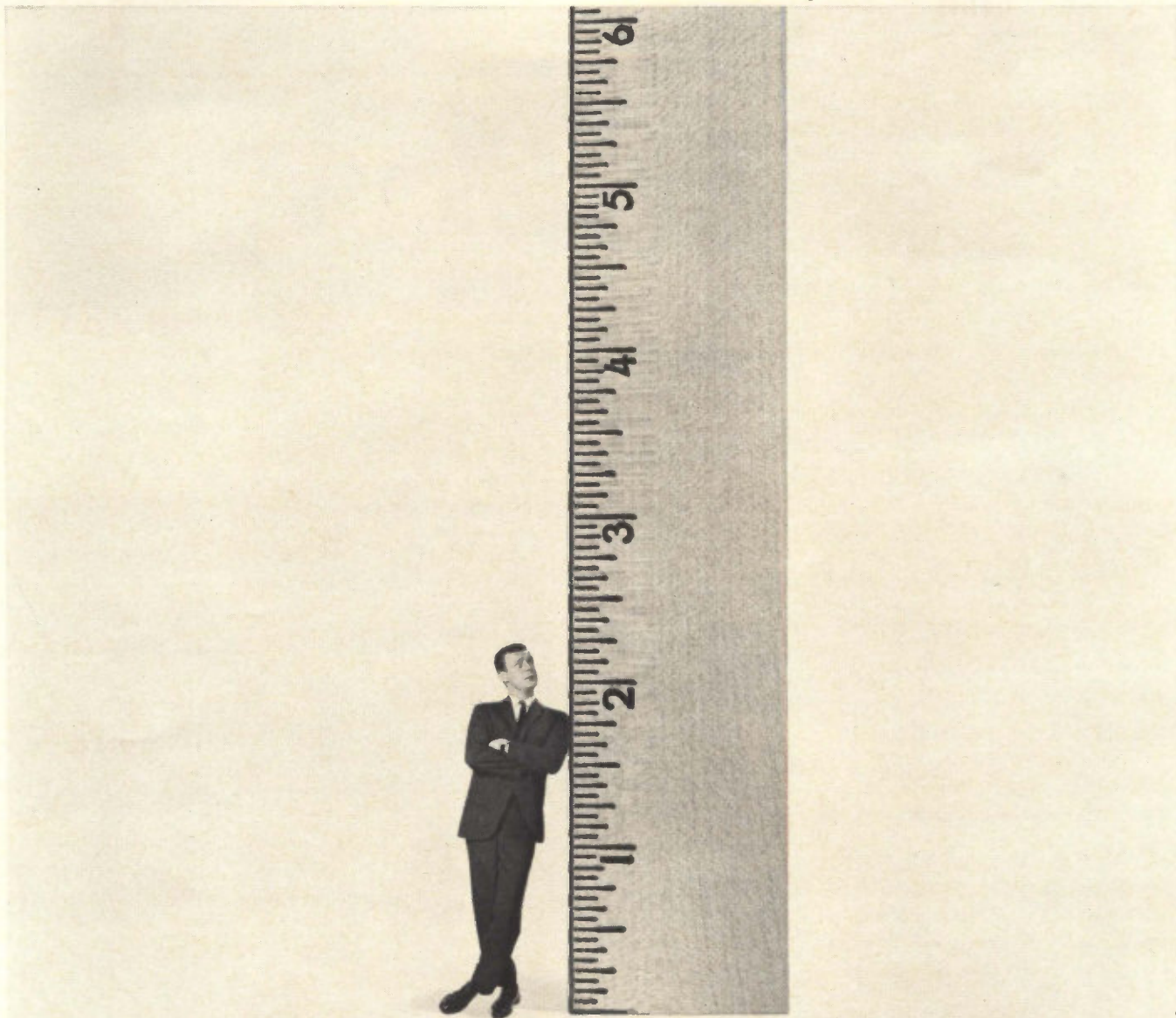

## WHY NOT?

It's a thought that frequently occurs to every organization heavily committed to microsystems. For example, we recently applied our development and production experience in microcircuits, micromemories, microinterconnection, microjoining, microcooling and micropackaging to reduce 32 cubic feet of black boxes in an operational airborne air defense system into a cool 1-foot cube. And a readily maintainable one at that. We itch to do the same with the control panels, display consoles and furniture but...

For a complete presentation of our capabilities in system microminiaturization, write 6700 Eton Ave., Canoga Park, Calif.



**LITTON INDUSTRIES DATA SYSTEMS DIVISION**

## New Instruments



### Multichannel counter has variable time base

A variable time-base counter with an integral six-channel time-base programmer features solid-state construction and wide-angle, long-life Nixie readout display. Designed for use with turbine flowmeters, tachometers, and other frequency generating transducers, the counter provides direct digital readout in engineering units, such as gallons per minute, pounds per hour, and revolutions per minute. An integral six-channel selector switch permits readout of any one of six input channels. Each channel has an independently adjustable time base and can be set from 0.0001 to 99.99 sec by means of four thumb-wheel switches and a three-position range multiplier switch. The counter has a frequency range of 1 cps to 120 kc and an input sensitivity of 10 mv rms, 3 cps to 120 kc. The unit measures 5¼ in. high, 13½ in. deep, and 19 in. wide. Price is \$1,850.

Anadex Instruments Inc., 7833 Haskell Ave., Van Nuys, Calif. Booth 1146. [351]

### Power amplifier spans d-c to 1 Mc

This compact power amplifier for the range from d-c to 1 Mc is of all-solid-state circuitry. Distortion is held below 0.01%, and unusual d-c stability is attained by the use

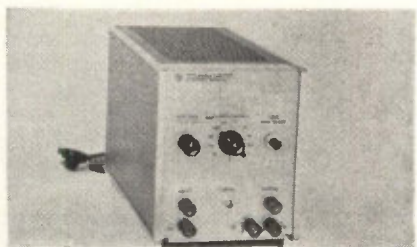

Electronics | August 10, 1964

of multiple feedback techniques. Output of the model 467A is protected at all times against short circuits, and no damage will result from accidental application of input voltages up to 200 v peak-to-peak. Input impedance is 50,000 ohms for d-c, and greater than 40,000 ohms for a-c, shunted by less than 100 pf. Gain may be varied from 1 to 10 in fixed steps accurate to 0.1%, or by a vernier control. Output is insensitive to load, with impedance less than 5 milliohms and 1  $\mu$ h. Full output of  $\pm 20$  v peak and  $\pm 0.5$  amp is available from d-c to 1 Mc. The instrument also is designed to serve as a controlled power supply with full-scale ranges from  $\pm 1$  to  $\pm 20$  v d-c at the same current. Model 467A will serve such functions as driving core memories, and amplifying transducer outputs.

Hewlett-Packard Co., 1501 Page Mill Road, Palo Alto, Calif. Sports Arena Booth 1402-1410, 1445-1453. [352]



### Multifunction test set gives fast response

A new multifunction tester, model 310, combines in one system a fast-reading microwave phase meter, an accurate impedance plotter, and a swept-frequency gain measuring device. The phase measuring capability is needed by the new phase-sensitive microwave systems—phase array radars, and f-m communications systems. The unit has a specified accuracy of  $\pm 0.01 \pm 4\%$  of the reflection coefficient magni-

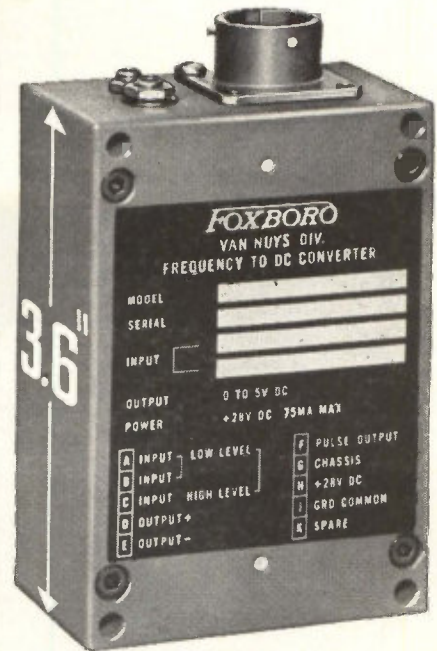

### This miniature frequency to d-c converter gives you all this:

- ▶ **Five models** convert a-c input frequencies in ranges from 10-30 to 10-12,000 cps . . . to a proportional 0-5 volts d-c. The output is independent of waveform or signal level and regulated against changes in line voltage or ambient temperature.
- ▶ **Linearity:**  $\pm 0.1$  percent.
- ▶ **Reliability:** All-solid-state construction withstands 40G shock and 20G, 5-2000 cps vibration,  $-65$  F to 160 F, per MIL-E-5272C.
- ▶ **Compactness:** Only 1.5 x 2.5 x 3.6 inches. 11 oz total weight. Threaded corner-holes for single or multiple mounting.
- ▶ **Rolloff circuitry** decreases sensitivity as input frequency increases . . . to reject and eliminate noise. Or, a manual sensitivity adjustment is also available.

For detailed specifications on the FR-320 Converter write for GS 1-7N3 D. The Foxboro Company, Van Nuys Division, 7740 Lemona Avenue, Van Nuys, California.

**FOXBORO**  
REGISTERED TRADEMARK

*Specialists in Process and Energy Control*

OFFICES IN PRINCIPAL CITIES. PLANTS IN  
UNITED STATES • CANADA • UNITED KINGDOM •  
NETHERLANDS • FRANCE • MEXICO • JAPAN

Circle 131 on reader service card

131

# LITTLE CHOPPER



# BIG PERFORMER

Where component space is limited—Bristol's Subminiature Chopper offers:

- 0.1 cu. in. size
- complete shielding
- radiation resistance
- airborne environmental ratings
- lowest noise level

Write for detailed spec sheet. **The Bristol Company**, Aircraft Division, 152 Bristol Road, Waterbury, Conn. 06720.

A subsidiary of American Chain & Cable Company, Inc. 4.7

**BRISTOL** . . . engineers for precision, builds for reliability



## New Instruments

tude and provides full flexibility in setting the point of reference. The gain-measuring capability is said to work over a wider range and with greater resolution than previously available. The 60-db range with 0.05-db resolution at any level is useful for checking forward and reverse loss of isolators, amplifiers and other components. Model 310 provides a convenient switching arrangement which automatically reconnects the microwave and electronics portion of the equipment for the measurement desired. A limitation in previous multifunction systems, according to the manufacturer, has been their inability to go from one measurement to another without patch cables and r-f reconnecting. Response time of the 310 is 0.5 millisecond, fast enough for 20 sweeps a sec on an oscilloscope. Frequency range is 1 Gc to 12.4 Gc in five bands. Price runs from \$10,000 to \$20,000 per system depending on frequency range and options.

Wiltron Co., 717 Loma Verde Ave., Palo Alto, Calif. 94303. Sports Arena Booth 1520. [353]

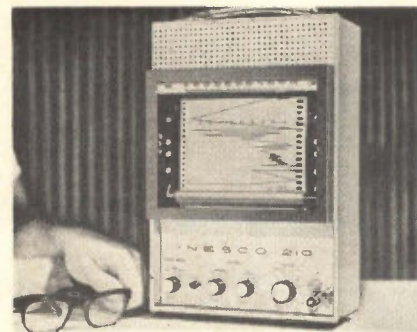

## Nine-range recorder uses capillary pen

Excessive ink flow or bleeding at slow chart speeds, said to be a defect of many recorders, is eliminated through use of the capillary pen system incorporated in the Model 210 chart recorder. The unit uses epitaxial planar silicon transistors for low noise and provides stable operation from 0 to 55° C over nine ranges from 1 mv to 10 v. It has adjustable zero control, 1/2%

accuracy, and an automatic take-up reel. Features include full-span response (max-pen traverse speed) of 0.4 sec, positioning of zero any place on chart or up to  $\pm 50\%$  off chart by panel control, and choice of any two of 16 available chart speeds. Calibrated chart width is 5 in. A remote ink reservoir has capacity for 90,000 trace-inches. The recorder's high-input-impedance, potentiometric servo system is reliable and maintenance-free. Sensitivity is less than 0.5% of scale span. Precision-tuned line-frequency notch filter minimizes response to longitudinal or transverse common mode signals. Dimensions of the unit are  $8\frac{7}{8}$  in. wide by  $13\frac{1}{4}$  in. high by  $3\frac{3}{4}$  in. deep. Weight is 13 lb. Price is \$670. Nesco Instruments Division, Datapulse Inc., 509 Hindry Ave., Inglewood, Calif. 90306. Booth 1521. [354]

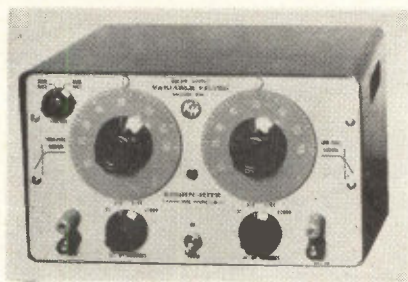

## Filter is tunable from 20 cps to 200 kc

A band-pass/high-pass filter to be displayed provides independent tuning of low-cutoff and high-cutoff frequencies from 20 cps to 200 kc. A front-panel switch on model 312 permits operation in the high-pass mode, eliminating the upper cutoff frequency and extending the pass band to 4 Mc. Attenuation rate is 24 db per octave beyond the cutoff frequencies, with pass-band gain of 0 db  $\pm 1$  db. High input impedance allows bridging connections without disturbance of signal sources, and low output impedance minimizes sensitivity to varying loads. A smooth transfer characteristic assures negligible phase or amplitude distortion of output frequency components. Major uses of model 312 include measuring sound and vibration, sound recording, wide-band data recording, controlling bandwidth of ran-

# WHAT'S THE LATEST IN DISC CATHODES? ASK SUPERIOR.

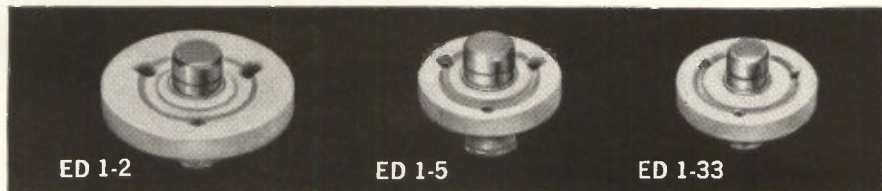

**Standard ED 1-2.** (.121" OD shank, .490" ceramic). Most widely used cathode. Standard length, .312".

**Narrow neck ED 1-5.** (.121" OD shank, .365" ceramic). For 110° deflection tubes. Standard length, .312".

**Miniature ED 1-33.** (.100" OD shank, .365" ceramic). For 110° deflection tubes. Standard length, .280".



**Miniature ED 1-11.** (.090" OD shank, .365" ceramic). Save up to 50% heater power. Standard length, .280".

**Shielded EX 271.** Permits better temperature uniformity and control of grid-cathode spacing.

**Shielded EX 270.** Permits operation with small power consumption and hence low heat generation.

## Widest choice of disc cathode designs

There are three basic types of Superior disc cathodes. Each has its own advantages. All feature close control of the E-dimension (distance between top of cap and top of ceramic), flare at the shank opening to facilitate assembly, shadow groove in the ceramic to inhibit electrical leakage and are available in wide choice of both cap and shank materials. Available in 0.121", 0.100" and 0.090" outside diameter shanks. Ceramic diameters can be either 0.490" or 0.365", with either round or triangular center hole.

## New shielded disc cathodes—EX 271 and EX 270

In the EX 271 design, the emitter is shielded from the ceramic and isolated by an exceptionally long heat-conducting path. In the EX 270 design, the slender shank, thermal shield and thin ceramic permit low heater power consumption. The shield also acts to eliminate leakage if sublimation takes place.

## Widest choice of disc cathode materials

Superior's disc cathodes feature separate nickel cap and shank alloys. Hence you may choose the most suitable material for each. The Cathaloy® series, developed and controlled by Superior Tube Co., offers alloys with high strength, high activity, low sublimation, freedom from interface impedance, or any desired combination.

**Cathaloy A-31.** Approximately twice as strong as tungsten-free alloys at high temperatures.

**Cathaloy A-33.** Combines the high emission of active alloys with freedom from sublimation and interface impedance.

**Cathaloy P-51.** More than 100% stronger than X-3014 at high temperatures.

**X-3014.** Powder metallurgy pure nickel for resistance to sublimation. Suggested for shanks.

**X-3015.** Special shank alloy for strength with resistance to sublimation and for non-emitting characteristics.

**Nickel 220, Nickel 225, Nickel 230 and Nickel 233.** Suggested for caps requiring normal emission with rapid activation.

**Driver Harris 599 and 799.** Provide rapid activation plus high level d-c emission. For caps only.

For your copy of our Catalog 51, write Superior Tube Company, 2500 Germantown Ave., Norristown, Pa.

# Superior Tube

The big name in small tubing

NORRISTOWN, PA. 19404

West Coast: Pacific Tube Company, Los Angeles, California

Johnson & Hoffman Mfg. Corp., Carle Place, N.Y.—an affiliated company making precision metal stampings and deep-drawn parts

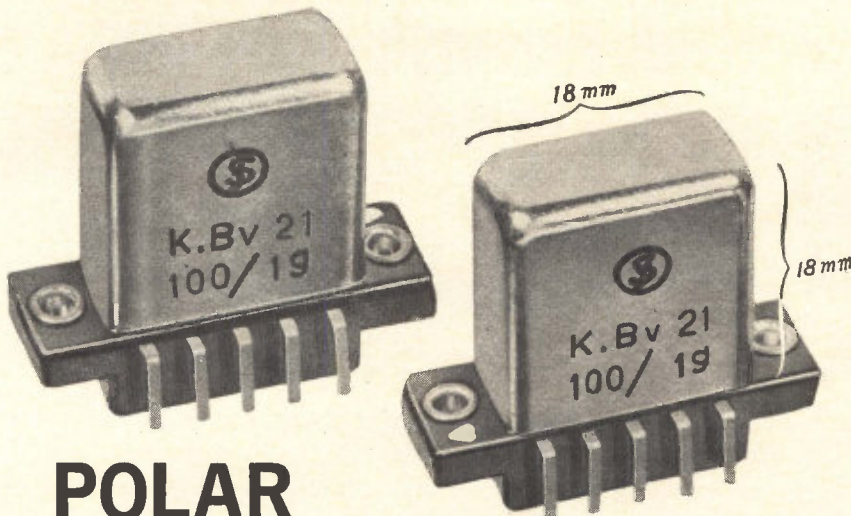

## POLAR RELAY, TYPE 21

**DESCRIPTION:** This subminiature (3cm<sup>3</sup>) relay is the result of Fujitsu miniaturization research. Advanced hermetically sealed design is combined with long life (100 million operations), high speed (1.5 ms) and high sensitivity (0.7 mw).

**FEATURES:** High-efficiency magnetic circuits, chatter-free contact mechanism, high stability against external magnetic fields. **APPLICATIONS:** Small, light-weight control equipment for carrier telephony, telegraphy, telemetry, data processing, etc.

 **FUJITSU LIMITED**  
*Communications and Electronics*

Tokyo, Japan

Represented by: U.S.A.: THE NISSHO AMERICAN CORP. 80 Pine St., New York 5, N.Y., Phone: Whitehall 3-7840 THE NISSHO PACIFIC CORP. 120 Montgomery St., San Francisco 4, California, Phone: YUkon 2-7901-7906 CANADA: NISSHO (CANADA) LTD. 100 University Avenue, Toronto, Phone: EMpire 2-4794 UNITED KINGDOM: WALMORE ELECTRONICS LIMITED 11-15 Betterton Street, Drury Lane, London W.C. 2, Phone: TEMpleber 0201-5 GERMANY: NEUMULLER & CO. GMBH 8 Munchen 13, Schraudolphstr. 2a, Phone: 29 97 24 SCANDINAVIAN: SCAPRO A.B. Kungsbroplan 2, Stockholm K, Sweden, Phone: 53 04 36, 53 04 51 ITALY: LIAISON OFFICE OF C. ITOH & CO., LTD. Via Ulrico Hoepli 8, Milano, Phone: 890953, 890975

Circle 134 on reader service card

**WANT TO  
DO BUSINESS  
WITH THE  
GOVERNMENT ????????**

Then check the Military and Government Procurement Guide in the orange section of your **ELECTRONICS BUYERS' GUIDE**.

## New Instruments

dom noise test sources, and suppressing interference in audio circuits, as well as in specialized applications such as phonocardiography. Price is \$450.

Krohn-Hite Corp., 580 Massachusetts Ave., Cambridge, Mass. 02139. Booth 1104. [355]



## Digital voltmeters operate at high speed

All-solid-state digital voltmeters have been designed to meet rigid laboratory and system requirements. Series 6000 and 6001 operate at speeds of one conversion per millisecond and are calibrated to  $\pm 0.01\%$  of reading plus 1 digit absolute accuracy. They are completely programable through circuit closures to ground and provide both binary coded decimal and 10-line decimal outputs. These signals may be used to drive a variety of output accessories or for direct integration into an instrumentation system. Other features include four ranges up to 1,200 v and 100- $\mu$ v resolution.

Electronic Associates, Inc., West Long Branch, N.J. Sports Arena Booth 1336-1337. [356]

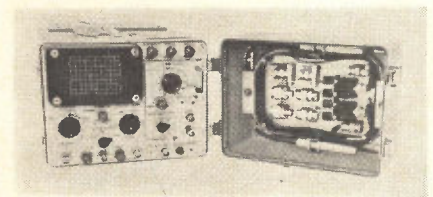

## Portable oscilloscope is all-solid-state

This portable, compact, all-transistor scope meets environmental requirements of MIL-E-16400. Model 725 is designed for field or bench use, or it can be used as a component in systems where accessory



test equipment is required, especially where space must be conserved. The instrument's vertical amplifier has a bandwidth from d-c to 5 Mc (direct coupled) and 2 cps to 6 Mc (capacity coupled). Rise time is 70 nsec, and sensitivity is 0.01 v per division to 20 v per division in 11 steps. Accuracy is  $\pm 5\%$ , and input impedance is 1 megohm shunted by 47 pf. The horizontal amplifier of the unit has a bandwidth from d-c to 500 Mc, with a sensitivity of 1 v per division, variable to 5 v per division. Input impedance is 100,000 ohms shunted by 20 pf. The sweep generator ranges from 0.1  $\mu$ sec per division to 0.1 sec per division in 19 calibrated steps. Sweep can be expanded five times with  $\pm 3\%$  accuracy.

American Electronic Laboratories, Inc., Colmar, Pa. Booth 2095. [357]

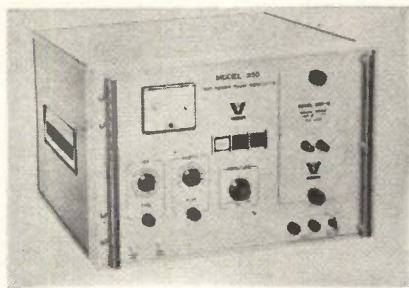

## Pulse generator for laboratory use

This high-power pulse generator offers infinitely variable output up to 20-kw peak output power, 10 amperes at 2,000 v. Model 350 is a general purpose laboratory instrument. Pulse width is continuously variable from 100 nsec to 200  $\mu$ sec. Rise time is 50 nsec and fall time is 70 nsec. Pulse repetition rate is 3 cps to 100 kc. Pulse droop is 0.05% per microsecond. Duty factor is variable to 1%. Output amplitude is continuously variable up to 2 kv into 200 ohms resistive load. Accessory plug-in output units are available to obtain d-c isolation, inversion of output pulse polarity, for output current up to 150 amps and output voltages up to 20 kv. The instrument contains overload protection and provides an output synchronizing signal. It requires 700 w from a 117 v, 50-60 cps supply. Typical applications include pulse

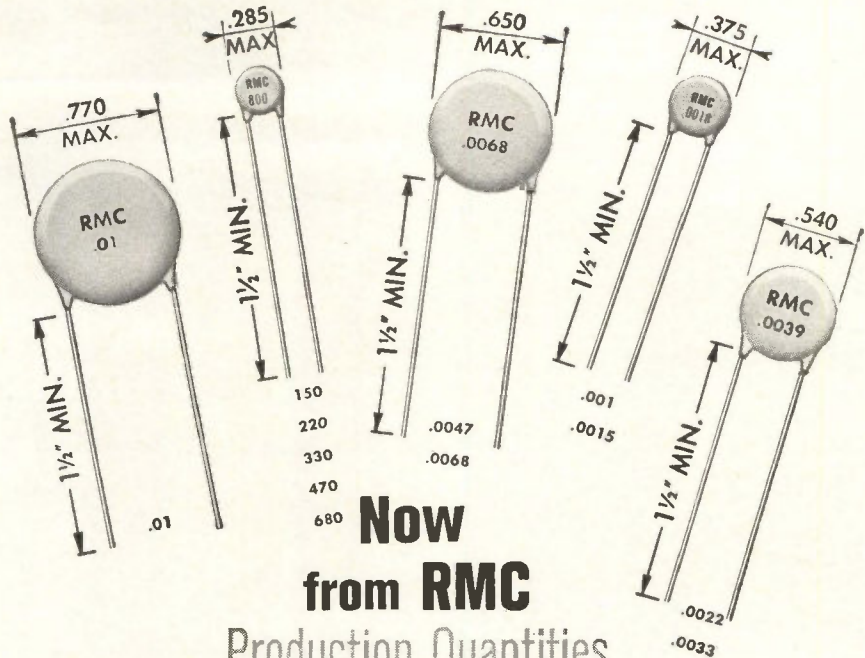

## Now from RMC Production Quantities BY-PASS DISCAPS (TYPE BA)

engineered to X5U specifications

RMC type "BA" Discaps offer high capacitance over an extended temperature range while maintaining acceptable stability characteristics. These DISCAPS can be specified, with complete confidence, for coupling and by-pass applications operating in environmental extremes. Write on your letterhead for additional information on type BA and other high quality DISCAPS.

### SPECIFICATIONS

**CAPACITANCE:** Within tolerance @ 1KC and 25°C

**CAPACITANCE TOLERANCES:**  $\pm 20\%$  or  $+80 - 20\%$

**WORKING VOLTAGE:** 500 V.D.C.

**POWER FACTOR:** 1.5% maximum @ 1KC

**INSULATION RESISTANCE:** Greater than 7500 Megohms @ 500 V.D.C.

**TEMPERATURE COEFFICIENT:** Y5U, X5U

**FLASH TEST:** 1250 V.D.C. for 1 second

**LIFE TEST:** Per EIA RS-198 Class II  
**POWER FACTOR AFTER HUMIDITY:** 2.5% maximum @ 1KC

**INSULATION RESISTANCE AFTER HUMIDITY:** Greater than 1000 Megohms @ 500 V.D.C.

**BODY INSULATION:** Durez phenolic - vacuum wax impregnated

**LEAD STYLES AVAILABLE:** Long lead - #22 AWG tinned copper-, fin-lock, kinked lead plug-in and pin type plug-in

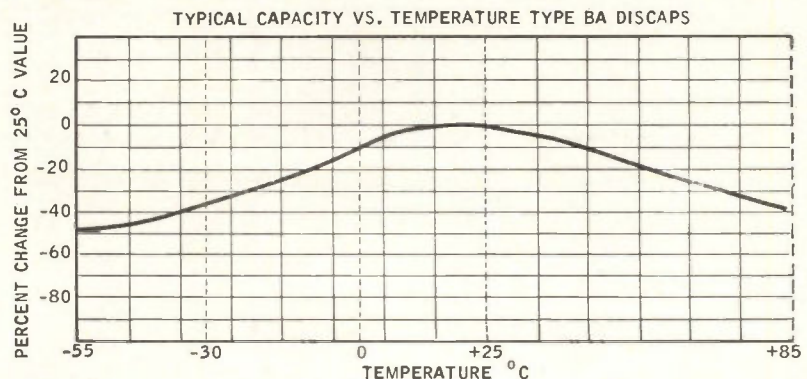

DISCAP  
CERAMIC  
CAPACITORS

RMC

**RADIO MATERIALS COMPANY**

A DIVISION OF P. R. MALLORY & CO., INC.  
GENERAL OFFICE: 4242 W. Bryn Mawr Ave., Chicago 46, Ill.  
Two RMC Plants Devoted Exclusively to Ceramic Capacitors  
FACTORIES AT CHICAGO, ILL. AND ATTICA, IND.

# Gold Plated Kovar<sup>®</sup> Ribbon (.003" x .010")

Gold  
80 microinch

Electroplated  
Copper Support

®Trademark of Westinghouse Elec. Corp.

Photomicrograph 267X

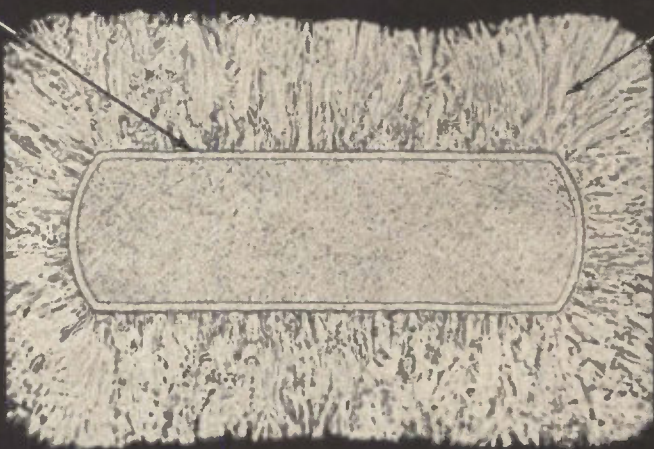

Gold Plated per Mil-G-45204 Type 1 Class 1  
and Mil-Std-1276

This ribbon has proven to be among  
the best available for ohmic connections to  
semiconductor surfaces . . .

**Sigmund Cohn Corp.**

121 So. Columbus Ave., Mount Vernon, N. Y.

Sigmund Cohn Corp. of California, Burbank, Cal. • Sigmund Cohn-Pyrotech Inc., Dallas, Texas



Circle 208 on reader service card

## USE BLILEY HB SERIES CRYSTAL UNITS

- FOR IMPROVED RELIABILITY
- FOR PC BOARD APPLICATIONS



HB2

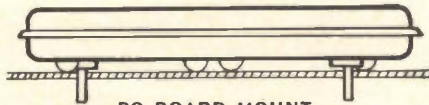

PC BOARD MOUNT

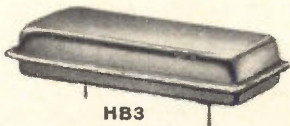

HB3

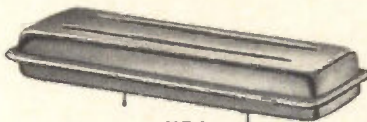

HB4

- Koldweld sealed holders eliminate contamination due to heat and flux.
- Package designed to mount horizontally on PC Boards.
- Frequency range 2 kc through 100 mc with 3 case sizes.

BULLETIN NO. 537 AVAILABLE

See us at WESCON Booth No. 163 (Hollywood Park)

**Bliley**

*if you buy quality*

BLILEY ELECTRIC COMPANY • ERIE, PENNSYLVANIA

## New Instruments

modulation of microwave tubes, twt's, magnetrons, klystrons and triodes; laser communication experiments; nondestructive semiconductor evaluation; magnetizing current tests of large pulse transformers; and a broad range of physics and biology experiments. The instrument can also be used as a high-power-output pulse amplifier. Input pulses of 10 v positive or more may be supplied to the unit to yield the high-power pulse outputs. Price of model 350 is \$3,990.

Pulse Engineering, Inc., Velonex Division, 560 Robert Ave., Santa Clara, Calif. Booth 1249. [358]

## Switching-time tester for transistors

This instrument tests delay, rise, storage, fall, on and off times with typical repeatabilities of  $\pm 0.3\%$  of full scale. Accuracy is specified as  $\pm 2\%$  plus repeatability. Measurements are made using sampling techniques and counting over ranges from 9.99 nsec to 9.99  $\mu$ sec with readout presented as a 3-digit in-line decimal. Typical test time for one cycle is less than  $\frac{1}{2}$  sec. Model 641 is an all-solid-state instrument—eliminating the drift problems often encountered with conventional instruments. Another feature is the increased readout window—at least four times the size of the usual oscilloscope visual presentation. Measurements are made with test transistors inserted into replaceable perform-

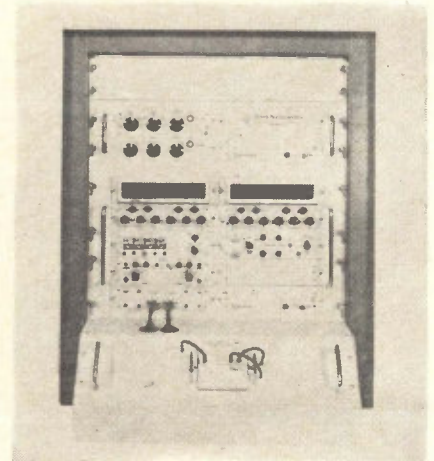

ance circuits. Performance circuits provide d-c bias and stimulus pulses. Standard pulse clock rate is 10 kc; optional high-performance pulse generators are available. The unit is furnished in a single modular-style cabinet measuring 24 in. wide, 26 in. high, 30 in. deep, containing d-c bias supplies, pulse generator, sampling and counting system, readout modules and test socket with performance circuit. Price is approximately \$12,000 depending on options.

Texas Instruments Inc., Industrial Products Group, P.O. Box 66027, Houston, Texas 77006. Booth 660-665. [359]

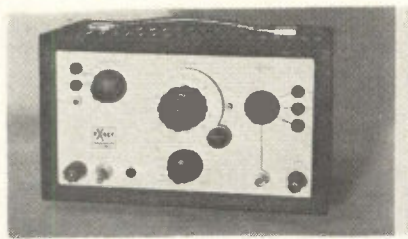

### Function generator is all-solid-state

This solid-state function generator produces square, triangle and sine waveforms simultaneously, at frequencies from 0.001 cps to 1 Mc. Outputs of the type 301 can be free-running, triggered, or gated. Modular printed-circuit boards are used throughout. Size is 6½ in. high by 10½ in. wide by 7 in. deep. Weight is less than 10 lb. Exact Electronics, Inc., 455 SE 2nd Ave., Hillsboro, Ore. Booth 1327. [360]

### Digital voltmeter offers high speed

A new digital voltmeter, series 4200, is said to offer a much higher speed than any other 4-digit, all-electronic dvm in its price range. Speed is 20 measurements per second; ranges are ±9.999/99.99/999.9 volts; input impedance is 10 megohms; accuracy is ±(0.03% of reading + 0.02% of full scale); and digital output signals and built-in automatic printer controls permit operating digital recorders. For maximum versatility, the input leads are completely isolated from chassis ground, and the instrument will reject a-c common

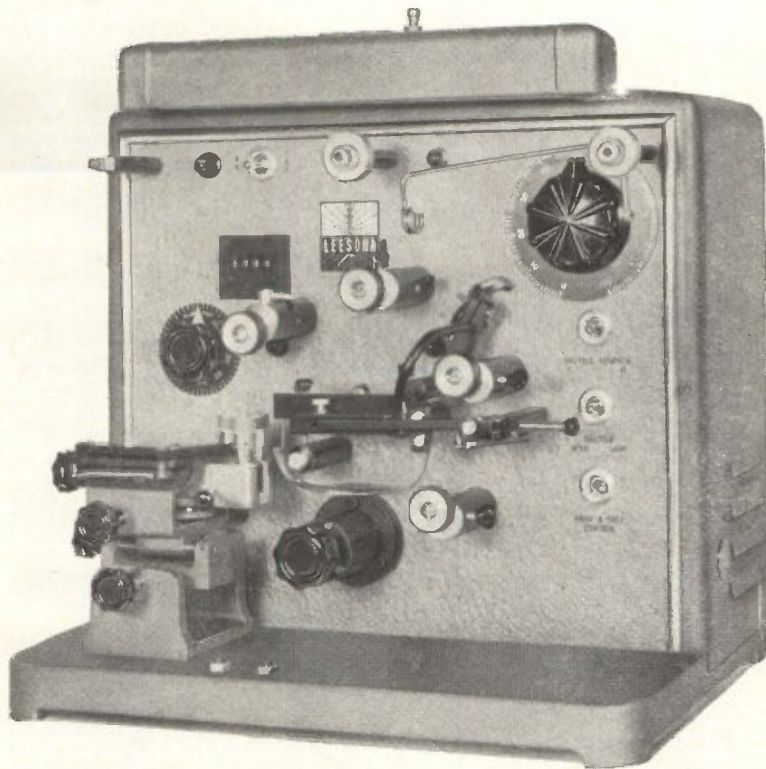

## New Leesona<sup>®</sup> Toroidal Coil Winder cuts winding costs

The new No. TO-133 Toroidal Coil Winder improves production rates and quality; reduces costs four ways:

- 1 Reduces cycle time—shuttle and slider remain in machine during loading, winding and coil removal cycles.
- 2 Greater wire storage capacity in shuttle—all shuttles 6" diameter.
- 3 Winds heavy wires on very small cores.
- 4 Matches toroids to inductance with automatic machine shutoff.

For the full story of this entirely new dimension in toroidal coil winding, write for Bulletin TO-133: Leeson Corporation, Warwick, Rhode Island.



23B.4.10R

See us at the WESCON Show, Booth 2053, Sports Arena

The Hughes/NASA Syncom stands still at 6875 mph to talk to a billion people.

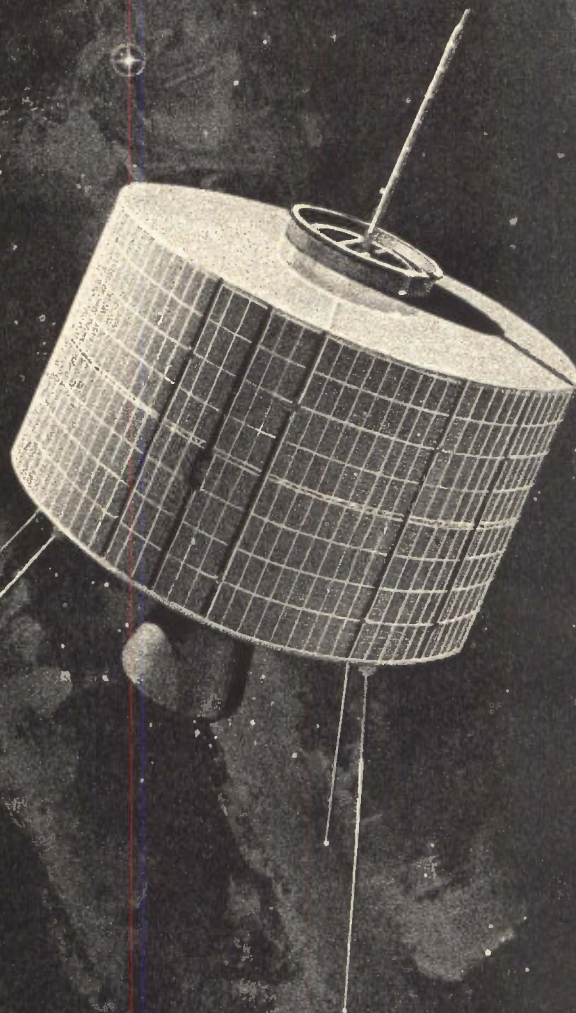

## **CIRCUIT DESIGNERS... is your appointment in space with Hughes?**

Today, Hughes is one of the nation's most active aerospace/electronics firms. Projects include: F-111B PHOENIX Guided Missile System, TOW Anti-Tank Missile, SURVEYOR Lunar Spacecraft, SYNCOM, VATE, ARPAT, POLARIS, Hard Point Defense and others. This vigor will assist the qualified engineers and scientists towards more and better opportunities for both professional and personal growth.

Many immediate openings exist. The engineers selected for these positions will be assigned to the following design tasks: the development of high power airborne radar transmitters, the design of which involves use

of the most advanced components; the design of low noise radar receivers using parametric amplifiers; solid state masers and other advanced microwave components; radar data processing circuit design, including range and speed trackers, crystal filter circuitry and a variety of display circuits; high efficiency power supplies for airborne and space electronic systems; telemetering and command circuits for space vehicles, timing, control and display circuits for the Hughes COLIDAR (Coherent Light Detection and Ranging).

If you are interested and believe that you can contribute, make your appointment today.

For immediate consideration, please airmail your resume to:

**Mr. Robert A. Martin**  
**Head of Employment**

**Hughes Aerospace Divisions**  
**11940 W. Jefferson Blvd.**  
**Culver City 22, California**

*Creating a new world with electronics*

**HUGHES**

**HUGHES AIRCRAFT COMPANY**  
**AEROSPACE DIVISIONS**

An equal opportunity employer.

U. S. CITIZENSHIP REQUIRED

## New Instruments



mode noise by at least 100 db at 60 cps. Dimensions are 5¼ in. by 19 in. by 19 in. Circuits are on plug-in, epoxy-fiberglass boards. Price will be between \$1,200 and \$1,400, depending upon specific features ordered.

Non-Linear Systems, Inc., P.O. Box 728, Del Mar, Calif. Sports Arena Booth 1209-1212 [361]

## Spectrum analyzer spans 10 Mc to 91 Gc

A modular spectrum analyzer, model 2994, covers the entire frequency range from 10 Mc to 91 Gc, providing a dispersion range of 10 kc to 2 Gc, with exceptional frequency stability obtained through the use of the phase-lock technique. Because the unit employs two high i-f frequencies, there is never an on-screen image. Furthermore, a new development makes harmonic identification extremely simple. If, when the harmonic identifier push-button is operated, the pattern moves exactly one division, then the frequency dial setting is correct—if it moves more or less, the correction is easily and rapidly made, since the degree of deviation from one division is logically related to the harmonic in use. A variable marker is provided at every range and setting of the instrument. The combination of excellent sensitivity, wide range, accurate r-f and i-f attenuation and an illuminated graticule provides the widest dynamic range, the highest level-resolution, and the widest choice of level-display mode ever offered in an instrument in this class, according to the manufacturer. Modular construction permits the user to specify a variety of capabilities in this class.

Polarad Electronic Instruments Division of Polarad Electronics Corp., 34-02 Queens Blvd., Long Island City, N.Y. Booth 1204-1205. [362]



**FAST, NEW  
ENTRY AT  
HOLLYWOOD PARK  
... See the**

# DURANT UNISYSTEM

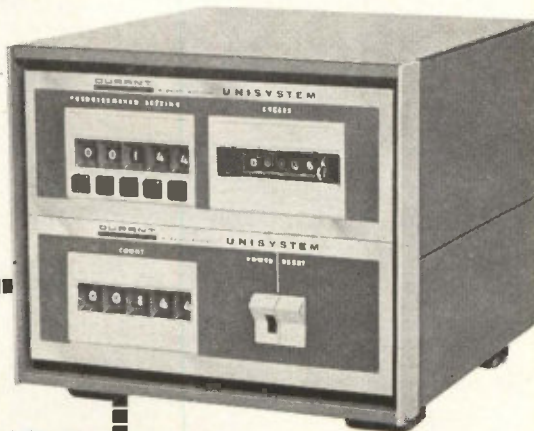

**BOOTHS  
715 & 716**

**WESCON/64**

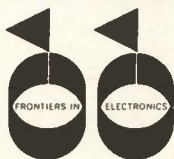

**OFF AND RUNNING with a  
NEW and LESS EXPENSIVE  
APPROACH TO ELECTRICAL  
and ELECTRONIC RECORD-  
ING, CONTROLLING, PRO-  
GRAMING and READOUT**

Flexible design allows tailoring to the specific needs of your applications.

**FROM COMPLETE SYSTEMS TO . . .**

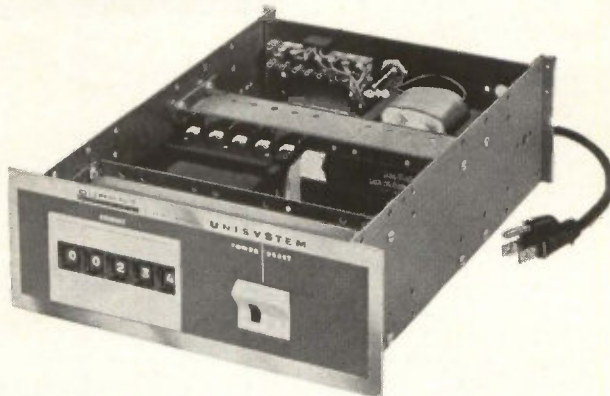

separate modules, with or without internal wiring . . . to individual components to fit your packaging requirements.

**INSPECT THESE THOROUGHBREDS before placing your bets. If you can't be there, let us know and we'll race a complete catalog to you.**

**DURANT®  
MANUFACTURING COMPANY**

612 NORTH CASS STREET • MILWAUKEE, WISCONSIN 53201

**transmitter  
oscillator  
meets  
every FAA  
transponder  
requirement**

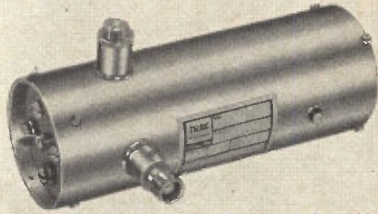

9506-1000

Trak Microwave Corporation has developed the first transponder-transmitter oscillator to meet every requirement of the Federal Aviation Authority (ARINC No. 532D). Most important, it is the first oscillator, commercially available to meet critical requirements of frequency stability and altitude.

As a triode oscillator, (Part No. 9506-1000) its advantages over other types include smaller size and operating economy. The replaceable triode means that the oscillator, at end of tube life can be brought back to optimum performance by replacement of the triode at nominal cost.

**TYPICAL SPECIFICATIONS**

Frequency: 1090 Mc.  $\pm 10$  Mc.  
Power Output: 500 watt minimum  
Power Input Requirements: 1500 VDC plate at 2.5 amp. peak plate current, -50 VDC grid bias with 80 V peak grid pulse, 6.0 VDC Efil at 1.25 amp. nominal.  
Altitude: 55,000 ft.

**TYPICAL FREQUENCY STABILITY CHARACTERISTICS ARE:**

Efil vs. frequency  $\pm 0.20$  Mc. for 6.3 V @  $\pm 3\%$  regulation  
EB vs. frequency  $\pm 0.25$  Mc. for 1500 V @  $\pm 3\%$  regulation  
VSWR vs. frequency  $\pm 1.60$  Mc. for 1.5: 1 all phase angles  
Duty vs. frequency  $\pm 0.15$  Mc. for .001 to .002 duty (.01 duty max.)  
Temp. vs. frequency  $\pm 0.50$  Mc. for -54 to +90°C  
Total typical frequency stability characteristics are  $\pm 2.70$  Mc.  
Physical: 2 in. diameter by 5 5/16 in. long, excluding projections. Weight 13 ounces in aluminum, 30 ounces in brass.

**See us at WESCON  
Booth 2075-76 Sports Arena**

Trak manufacturing facilities are geared to produce these oscillators in quantity orders to meet production schedules and Trak engineers will meet with you either at TRAK or in your facility for demonstration and consultation. Arrange a conference now. Phone COLLECT Tampa 877-6735.



**TRAK MICROWAVE CORPORATION**

5006 N. Coolidge Ave. Tampa, Florida 33614

**New Semiconductors**



**High-power scr has  
water-cooled design**

The manufacturer claims this to be the industry's first high-power silicon controlled rectifier specifically designed for water cooling. Type 224 is rated at 250 amps half-wave average through 1,000 v. A special base design with four mounting holes facilitates heat transfer to liquid-cooled radiators, heat exchangers, or sinks when used at its maximum rating of 250 amps. The high-power capability of the 224 is ideal for applications including large motor drives, power inverters, and ignition and motor generator set replacement. Westinghouse Electric Corp., Youngwood, Pa. Booths 500-504, 515-519. [331]

**J-K flip-flop  
operates at 30 Mc**

A new addition to the company's integrated-circuit line, the MC308

J-K flip-flop greatly simplifies the assembly and improves the performance of counters, communication and controls equipment and other computer and general-purpose logic configurations. It is basically a bistable element which differs from the more conventional set-reset flip-flop in that it will present a known output when two signals are simultaneously applied to the inputs. When tied together, J-K inputs will perform the toggle function. The MC308 contains four of these logic performing inputs (J and K), eliminating the need for additional gates which would be required to accomplish the same function when constructing counters and shift registers with set-reset devices. The unit will perform reliably at 30 Mc with useful operating speeds approaching 50 Mc. It is available in both the TO-5 (MC308G) and ceramic flat package (MC308F). Physically, the MC308 contains 14 transistors, 10 resistors, and 2 thin-film capacitors on a 0.080-in. by 0.060-in. by 0.006-in. monolithic silicon chip. The unit features high-temperature monometallic aluminum construction to eliminate the possibility of electrolytic action that could result in "purple plague" or other undesirable solid-state reactions. Motorola Semiconductor Products Inc., 5005 E. McDowell Road, Phoenix, Ariz. Booth 237-239. [332]

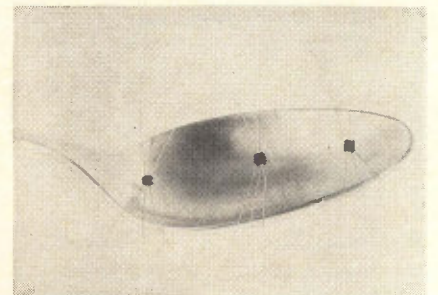

**Matched transistors  
for low-level uses**

Two matched transistors for operation in microampere-level differential amplifiers are housed in a single microminiature enclosure in the model NS7070 device. The

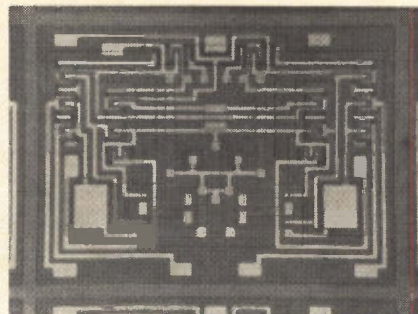

double-ended six-terminal NS7070 is 1/150 of the size of a JEDEC outline TO-5 enclosure yet contains two carefully matched transistors mounted on each side of a ceramic block. The block has an epoxy coating on each face from which the rugged 0.005-in. diameter gold-plated leads emerge. Enclosure size is 0.065 by 0.065 by 0.080 in. D-c beta of each transistor is 100 and is matched for the pair to 10% or better. Base-emitter voltages differ less than 5 mv. Change in base-emitter voltage differential is 10  $\mu$ v maximum per  $^{\circ}$ C within the temperature range from  $-55$  to  $+125^{\circ}$ C. These specifications are based on collector voltage and current of 5 v at 10  $\mu$ a.  $BV_{CEO}$  is a minimum of 45 at a collector current of 1 ma.  $I_{CBO}$  is a max of 5 na at 45 v. Price for 1 to 99 is \$37.50; for 100 to 199, \$25.

National Semiconductor Corp., Commerce Road, Danbury, Conn. Booth 193-194. [333]

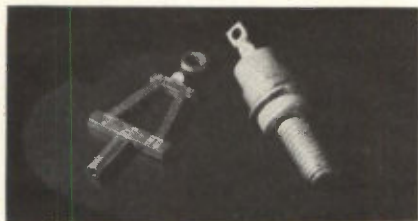

## Varactor diodes handle high power

New varactor diodes are designed for use where both voltage-controlled capacitance and high power dissipation are required. Applications include harmonic generators, voltage-controlled oscillators and solid-state power sources. Epitaxial construction provides high power dissipation with low series resistance and high stability. A copper-to-copper, cold-welded hermetic seal protects diode components within the case from dust or moisture. Internal electrical connections are either welded or hard-soldered for reliable operation at high temperatures. A series of 16 diodes is offered, ranging in breakdown voltage from 90 to 230 v, and rated at 15 and 11 w minimum power dissipation depending on junction capacitance.

Solid State Products, Varian Associates, Salem Rd., Beverly, Mass. [334]

## MODULES POTTED IN *TIMONIUM*

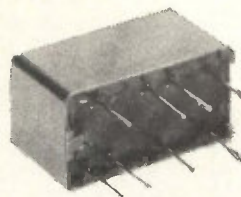

While everyone else shouts about having the best reliability, cost and delivery performance, may we whisper this: Try EMC Modules.

- Standard digital module families to 250 KC and 2 MC
- Power supplies
- Special function boards
- Specialized designs at "off-the-shelf" cost and delivery

**EMC**  
ELECTRONIC  
MODULES  
CORPORATION

1949 GREENSPRING DRIVE • TIMONIUM, MD.  
Clearbrook 2-2900 TWX-301-252-0723



Computer and Data System Designers:

### ROTATING MAGNETIC MEMORY DEVICES FROM GENERAL PRECISION

**DISCS**—Many computer and data system designers are turning to the high storage capacity of magnetic discs. For example, General Precision Random Access Magnetic Discs furnish storage up to 7,680,000 bits per disc. "Flying" heads permit high packing density of 400 bits/inch. Exclusive GP-produced plated-cobalt disc coating gives exceptionally high resolution. Excellent thermal shock resistance. Heads replaceable without special tools or danger of disc surface damage. Ultra-precision Grade 9 bearings give a service life of 10 years at 3600 rpm. Meets MIL-E-4970A. **DRUMS**—Pick the magnetic drums with a proved history of reliable performance in electronic computing systems designed for Navy, Air Force, NASA, business, engineering, and educational applications. Send for full information on drums and discs, from Commercial Computer Division, Information Systems Group (Librascope Division/Commercial Computer Division) General Precision, Inc., 100 East Tujunga Avenue, Burbank, California. TWX BRB 9884, Phone 849-6061.

For Series L100 and L200 discs (all models):

Maximum bits per inch: 400. Head inductance: 25 to 150 microhenries. Type of recording: phase modulation. Recording surface: plated cobalt coating. Playback: 50 millivolts (under most conditions). Write currents: 40 to 100 milliamperes. Ambient temperature: 32°F to 149°F limits. Thermal shock:  $\Delta T$  ambient in 10 seconds. Vibration: 15 to 55 cps (0.015 db amp, 3 directions). Mechanical shock: 4-inch edge test (4 drops).

SERIES L100 SINGLE DISCS (ONE-SIDE MAGNETIC MEMORY)					
Model No.	Disc Diameter	Maximum Tracks	Max. Bits per Track	Total Bit Capacity	Rotational Speed (rpm)
L104	4"	8	2400	19,200	3600-12,000
L106	6"	16	3600	45,600	1800-12,000
L108	8"	32	4800	153,600	1800-12,000
L111	11"	64	9600	422,400	1200-8000
L116	16"	128	10,000	1,280,000	900-3600
L124	24"	256	15,000	3,840,000	900-3600

SERIES L200 DOUBLE DISCS SIZES 8" TO 24", 307,200 TO 7,680,000 TOTAL BIT CAPACITY ALSO AVAILABLE.

#### LIBRASCOPE GROUP



COMMERCIAL COMPUTER DIVISION  
808 WESTERN AVENUE - GLENDALE 1, CALIF.

## New Subassemblies and Systems

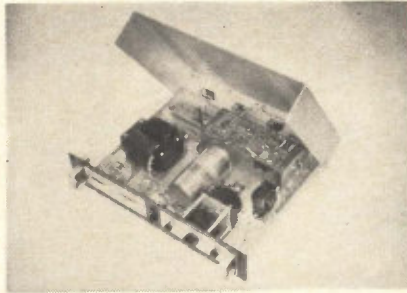

### Variable supplies in all-silicon design

These variable power supplies are suited for incorporation into end equipment as well as for laboratory, test or system applications. The SL series feature the use of silicon transistors and semiconductors which provide for maximum stability, maximum protection against overloads, and stable operation at extended temperatures. They are available in units covering the voltage range of 0 to 36 v d-c and current ratings from 2 through 12 amperes. Regulation is 0.01%; ripple, less than 500  $\mu$ v; and long-term stability, less than 5 mv. Units can operate up to an ambient temperature of +71°C free air without external cooling. Prices start at \$215.

Electronic Research Associates, 67 Factory Place, Cedar Grove, N.J. Booth 191. [371]

ceeds 10 w peak at 2,000 pps and 3- $\mu$ sec pulse widths. C-w output power exceeds 10 mw. Power output is obtained directly without using harmonic multiplication. Coherent light is produced at 4579, 4658, 4765, 4880, 4960 and 5145 angstroms. Single wavelength operation at 4765 or 4880 can be achieved without wavelength selection apparatus. Two-axis micrometers simplify cavity alignment. The universal Invar cavity permits interchange of tubes of many sizes and provides temperature-compensation to maintain rigidity and high stability cavity. The standard Brewster-angle plasma tube is made of specially-selected quartz. Precision, low-loss silica optics are selected by laser interferometric measurements. The laser is priced at \$4,950. Its compact, multi-megawatt power supply costs \$5,000. Energy Systems, Inc., 3180 Hanover St., Palo Alto, Calif. Sports Arena, Booth 2089. [372]

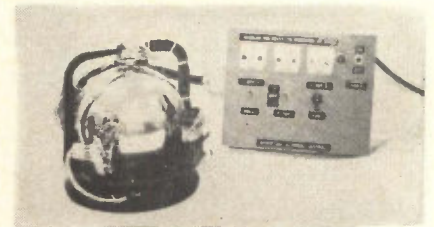

### Spherical flywheel for satellite control

The spherical flywheel is said to be a novel approach to satellite stabilization and control in that a single spherical rotor is used as an inertial mass to absorb disturbing forces, rather than the usual three-flywheel system. Disturbances to the vehicles are sensed along three axes and counter-torques applied to the sphere by three sets of torques. The spherical rotor, which is suspended by means of an air bearing, acts as a common rotor, with 360° of freedom, driven by the three sets of torques. Acting as an inertial sink, the spherical rotor stores kinetic energy of the disturbing force, in the form of rotation, about any given axis. In the case of cyclic

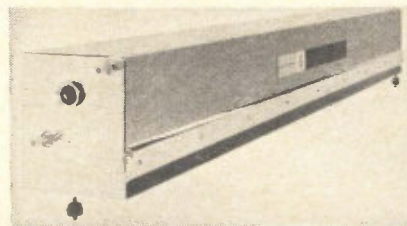

### Argon laser pierces deep-ocean water

This argon laser has a power output at blue-green wavelengths matching the maximum-transmission "windows" of deep-ocean and fresh water. Pulse operation is standard, but c-w operation is available. Pulse output power ex-





Visit us at WESCON  
Booth 631 — Hollywood Park

# Produces the most complete line of Optical Shaft-Angle Encoders

## DIGISEC® Highest Accuracy Direct Reading Encoders . . . .

Patents Pending



### 1 Arcsecond, Peak and Better

DIGISEC achieves highest accuracy in small case sizes with direct reading, continuous outputs — without code conversion, gears, brushes or reference rotor.

Optical Unit Diameter	Resolution
2.25"	to 40 arcseconds
3.5"	to 10 arcseconds
5.5"	to 2 arcseconds
10"	to 1 arcsecond

Outputs available in decimal or natural binary codes. Accuracy is  $\pm 1$  quantum, peak. For example a  $2^{20}$  DIGISEC provides resolution of 1.24 arcseconds and accuracy of  $\pm 1.24$  arcseconds, peak. Complete system consists of Optical Unit and Translator containing electronics and display. The standard Translator weighs 15 lbs., is 6.5" x 17" x 7.5", and can be miniaturized. Total input power for standard system is 30 watts. Bulletin 6310-1.

## ARCSEC™ Highest Accuracy Incremental Encoders

Similar to DIGISEC Encoders in resolution, accuracy and size of Optical Unit, but providing incremental output with reduced electronic complexity. Available with direction sensing and zero reset signal. Bulletin 6310-1.

## DIGISYN® Direct Reading Encoders for tracking, navigation, sampled data servos, indexing and positioning systems, and other readout applications.

### CYCLIC CODE

$2^{10}$  to  $2^{15}$  Digits  
Case Diameter: 3.5"  
Bulletin 760-1C

(photo: RD-15)



### CYCLIC CODE

$2^{16}$  to  $2^{17}$  Digits  
Case Diameter: 10"  
Bulletin 162-1

(photo: RD-17)



### NATURAL BINARY

$2^5$  to  $2^{17}$  Digits  
Case Diameters: 2.625" to 10"  
Bulletin 6302-2

(photo: NB-10)



## DIGITAK® Incremental Encoders for rate measurement, angle counting, machine control, inertial platform systems — available with direction sensing and zero reset signal.

### MINIATURE SYNCHROMOUNT

$2^{10}$  to  $2^{12}$  Digits  
Case Diameter: 1.437"  
Bulletin 6212-1

(photo: RI-12M)



### STANDARD SYNCHROMOUNT

$2^{13}$  to  $2^{15}$  Digits  
Case Diameter: 3.5"  
Bulletin 861-1C

(photo: RI-20K)



### PANCAKE

$2^{13}$  to  $2^{15}$  Digits  
Case Diameter: 3.5"  
Bulletin 862-2

(photo: RI-15S)



Special encoders can be designed to meet particular requirements. Available accessories include Power Supplies and Test and Display Sets. Other Wayne-George products include inertial test systems and fluid bearings.



# WAYNE-GEORGE CORPORATION

322 NEEDHAM STREET, NEWTON 64, MASSACHUSETTS (617) 969-7300

HAVE YOU CONSIDERED  
USING PHOTOCELLS?



WE'VE JUST MADE IT  
EASY FOR YOU ...

New! — from Clairex — a selection of photoconductive cells, varying in sensitivity, spectral response, speed and size to suit most applications, and including the CL505, CL603A, CL704L, CL707 and CL902 — in convenient kit form complete with technical data — only \$10.00.

Free On Request —  
Designers' Kit Information  
plus New 1964 Edition  
16 page Designers' Manual

**CLAIREX**

"The LIGHT Touch in Automation and Control"

8 West 30 Street, New York, N. Y. 10001, 212 MU 4-0940

Circle 209 on reader service card

**COSMICAR**  
INDUSTRIAL TV LENSES



90% of all Japanese ITV cameras use COSMICAR lenses.

- 12.5mm f/1.4
  - 12.5mm f/1.9
  - 25. mm f/1.4
  - 25. mm f/1.9
  - 50. mm f/1.4
  - 50. mm f/1.9
  - 75. mm f/1.4
  - 75. mm f/1.9
  - 150. mm f/4.5
- All available in  
C-mount

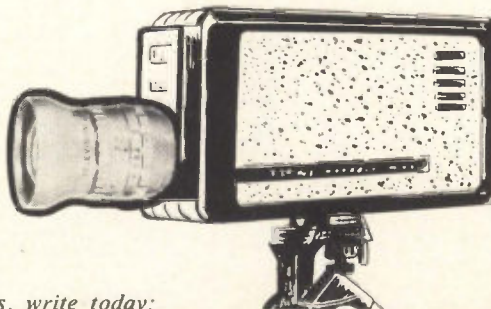

For further details, write today:

**ICHIZUKA OPTICAL CO., LTD.**

2-568, SHIMOOCHIAI, SHINJUKU-KU, TOKYO CABLE ADDRESS: "MOVIEKINO TOKYO"

## New Subassemblies

disturbances, the stored energy from one cycle is available to counteract the effect of the opposite cycle, without dissipating energy as in a gas expulsion system. The use of a single spherical flywheel eliminates cross-coupling effects and the complex compensating circuitry inherent in the three-flywheel system. This results in a smaller, lighter, and less complex system.

Belock Instrument Corp., 112-03 14th Ave., College Point 56, N.Y. Sports Arena Booth 2117. [373]

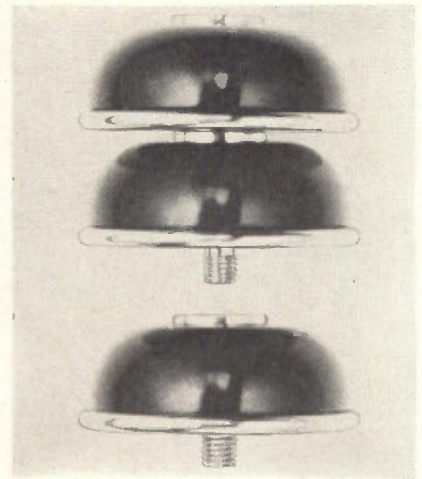

## High-voltage modules are corona-protected

A line of high-voltage modules are stackable up to 150 kv and 2 amperes. Integral anti-corona rings and polished, rounded dielectric surfaces make additional hardware unnecessary. For higher voltages, modules need only be threaded together. All are closely matched and compensated for uniform, steady-state and transient voltage distribution. For maximum internal corona protection, each diode in the module is fused in individual sleeves of highly-stable dielectric glass. There is no corona-causing void either within the diodes or the encapsulation. Use of controlled avalanche characteristics, together with high surge capability, provide transient protection, long-term stability and high reliability. Unitrode Corp., 580 Pleasant St., Watertown, Mass. Booth 104. [374]

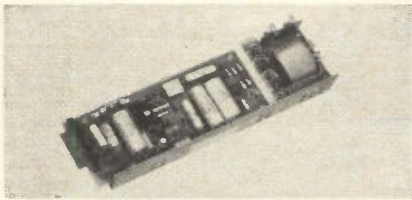

## Regulated supplies in modular design

A modular group of power supplies has been developed with 0.05% regulation and stability for laboratory or systems use. Model PAX 36-0.3 (illustrated) has a d-c output range of 0 to 36 v, 0 to 0.3 amp. Ripple is less than 0.25 mv rms. Recovery time is 50  $\mu$ sec. Ambient operating temperature is  $-20^{\circ}\text{C}$  to  $+50^{\circ}\text{C}$  max. Output voltage changes less than 0.05% per  $^{\circ}\text{C}$ . Current limiting circuitry permits continuous operation into a short circuit, without the aid of fuses, circuit breakers or relays. Output returns instantly to the operating voltage when the overload is removed. Special terminals provide for resistive voltage or current programming at 1,000 ohms per volt. Terminals are also provided for programming by means of a remotely located voltage source. Uncased dimensions of the unit are  $2\frac{1}{2}$  in. high by  $3\frac{1}{8}$  in. wide by  $12\frac{1}{8}$  in. deep.

Kepeco, Inc., 131-38 Sanford Ave., Flushing, N.Y. Sports Arena, Booth 1412-1413. [375]

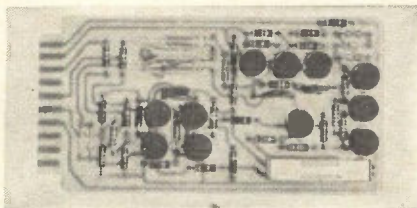

## Operational amplifiers deliver $\pm 100$ volts

A new series of solid-state operational amplifiers are high-gain, general purpose units. They can be used to perform various analog functions such as summation, inversion, integration and multiplication. Series 100 amplifiers are assembled on glass-based, plug-in circuit boards for ease of operation. A mating connector is supplied

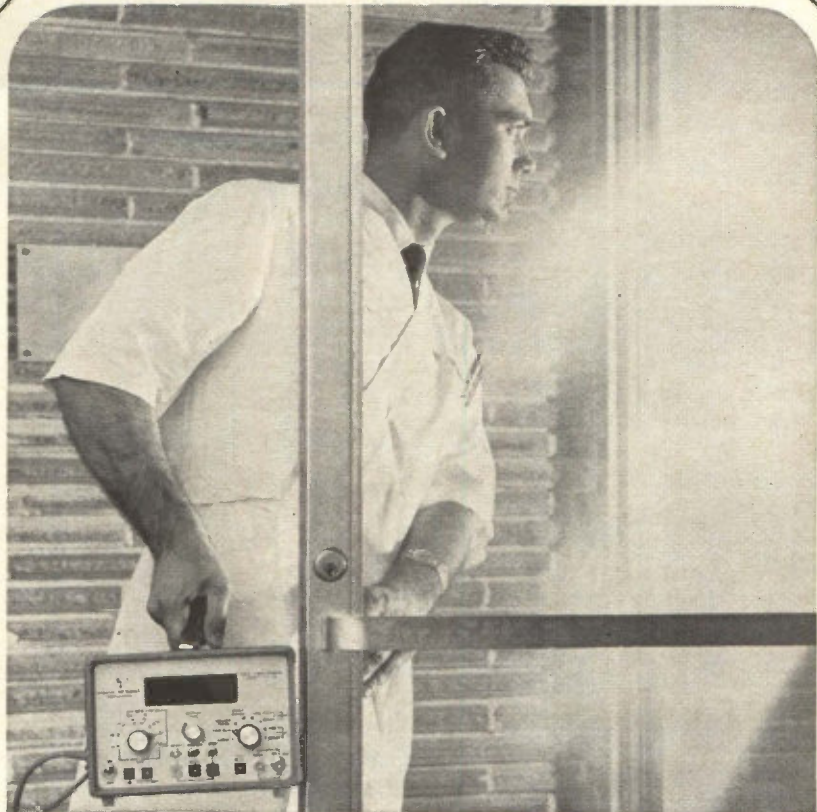

## new! portable universal 1 Mc timer counter



The TC-2A measures frequency, period, multiple period, single or dual channel time intervals and ratios.

### Six digit resolution

is achieved with a four digit, in-line readout by switching the most significant digits to the left, out of the readout. When displaying any four digits of the six digit reading, five switch-selectable gate times allow the rapid identification of the most significant digits.

The time base is derived from a 1 mcps oven controlled crystal oscillator.

AC coupled, sensitivity is 200 mv to 250 v rms; input impedance is 100 K shunted by 30 pf. DC sensitivity is 2 v to 10 v with 5 K input impedance. Frequency range is 0 to 1 Mc. Price: \$995. F.O.B. Houston, Texas. Availability: 30 days ARO.



**houston instrument corporation**

4950 Terminal Avenue / Bellaire, Texas 77401 / MOhawk 7-7403  
Cable: HOINCO / TWX 713-571-2063

# 1x10<sup>-9</sup> (torr)

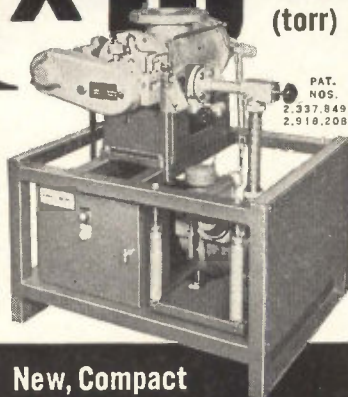

PAT. NOS. 2,337,849 2,918,208

## New, Compact ULTRA-HIGH VACUUM

Pumping Unit with  
Constant Speed Over  
Wide Pressure Range!

BLANK-OFF PRESSURE:  
LOWER THAN 1 x 10<sup>-9</sup> TORR  
SPEED (AIR):  
140 LITERS/SECOND

The new, Welch 3101A Turbo-Molecular Pumping Unit has a blank-off pressure lower than 1 x 10<sup>-9</sup> torr and a constant speed (air) of 140 liters per second over a range of 10<sup>-2</sup> to 10<sup>-9</sup> torr. It combines a Welch No. 3101 Turbo-Molecular Pump (manufactured under a license of the Becker patent for the U.S.A. and Canada) with the well known Welch "Duo-Seal" No. 1397, two-stage mechanical pump in a completely assembled and tested package, ready for use.

The clean, vapor-free, No. 3101 Turbo-Molecular Pump embodies a major advance in the design of molecular pumps which permits the use of running clearance as much as ten times that of previous designs. Risk of damage by sudden air inrush, thermal expansion and dirt particles has been eliminated. Higher pumping speeds and pressure ratios than previously attainable, have been achieved.

### APPLICATIONS

Wherever a vapor-free, high or ultra-high vacuum is required. TYPICAL USES: • Solid state studies • Semi-conductor production • Thin film metallizing • Purification of metals such as silicon and germanium • Optics coating • Separation of gases of different molecular weights • Space simulation chambers • Mass spectrometers • Roughing ion pump systems • Particle accelerator and target chamber evacuation • Evacuation of power tubes and x-ray tubes.

Send for Bulletin  
3101A today!

Booth  
1502  
WESCON  
SHOW  
Aug. 25-28

**W** SINCE 1880 **THE WELCH SCIENTIFIC COMPANY**

Foremost manufacturers of scientific equipment  
7300 Linder Ave., Dept. 906, Skokie, Ill. 60076

## New Subassemblies

with each unit. Typical specifications for the 100E are as follows: output, ±100 v at 5 ma, ±50 v at 10 ma; voltage gain, 20,000; input current, 3 na; current drift, 0.1 na/°C; offset voltage drift, 0.01 mv/°C; supply voltage, ±125 v d-c. Optimized Devices, Inc., 220 Marble Ave., Pleasantville, N.Y. Sports Arena Booth 1010. [376]

## Thermoelectric modules work on low current

Two new thermoelectric modules are model 3951-1 (module only) and model 3970-1 (complete assembly incorporating heat sink and fan, as illustrated). Featuring a high concentration of thermoelectric junctions, both models combine high heat pumping capacity with low current requirements. Model 3951-1 is said to be ideal for such applications as spot cooling of electronic components, crystal holders, memory stacks and computer circuit banks; and for maintaining temperature stability in critical processes. The unit operates on a voltage of 6.4 v d-c yet has a high heat-pumping capacity of 20 w (68 BTU/hr). The module is permanently mounted between two electrically and thermally isolated aluminum plates for improved mechanical strength and uniformity of cold junction temperatures. Base plate and top plate are both 1½ by 1½ in., and both have two mounting ears 2 in. on center, rotated 90° between base and top plates. Model 3970-1, incorporating a heat sink and forced convection fan, provides a complete package, ready to install, for operation with 12 v d-c supplies. Heat pumping capacity is 40 w

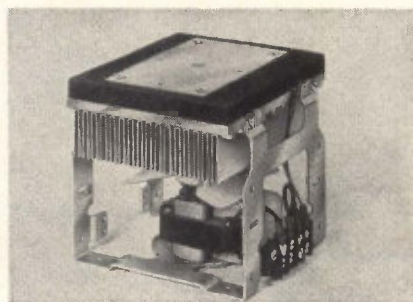

**McGRAW-HILL**  
**BOOKS**

Just Published

## HANDBOOK OF APPLIED INSTRUMENTATION

With this Handbook you can find virtually any information you need on applied instrumentation. Prepared by 70 top experts, it gives full data on how instruments are used to control machines, operations, processes, and even plants. Many examples demonstrate applications in major industries and scientific fields. Included is vital information on the kinds of variables subject to instrumentation and how they can be measured. Also provided is information on the selection of systems, advantages and limitations, and more. Editor-in-Chief, D. Conslidine, Hughes Aircraft Co. 1,180 pages, 1,000 illus., \$32.50. Payable \$8.50 in 10 days, \$8 monthly

### PHYSICS OF SEMICONDUCTORS

Just Out. An authoritative reference on semiconductor theory that starts with principles of quantum mechanics and develops the ideas of semiconductor physics and devices up to the present frontier of semiconductor research. By J. Moll, Stanford Univ. 304 pp., illus., \$11.50

### NONLINEAR-MAGNETIC CONTROL DEVICES

Just Out. Treats the basic principles, characteristics, and applications of nonlinear-magnetic control devices. By W. A. Geyger, U. S. Naval Ordnance Lab. 375 pp., 135 illus., \$12.50. Payable \$6.50 in 10 days and \$6 in one month.

### SEMICONDUCTOR CIRCUIT ANALYSIS

Just Out. From the fundamentals of semiconductor physics to the most advanced transistor applications—here are the most vital techniques, facts, and data on circuit analysis of transistor and semiconductor devices. By P. Cutler, North American Aviation. 656 pp., 543 illus., \$10.00



**10 DAYS' FREE EXAMINATION**

Convenient Mail Service

Direct from McGRAW-HILL

McGraw-Hill Book Co., L-810X  
327 W. 41st St., New York, N. Y. 10036

Send me book(s) checked below for 10 days on approval. In 10 days I will remit for book(s) I keep plus few cents for delivery costs, and return unwanted book(s) postpaid. (If you remit with coupon, plus local tax, we pay delivery costs—full refund and return privilege.)

- Conslidine—Hdbk. of Applied Instru., \$32.50
- Moll—Physics of Semiconductors, \$11.50
- Geyger—Nonlinear-Mag. Control Devices, \$12.50
- Cutler—Semiconductor Circ. Anlys., \$10.00
- check here if you want to pay on terms

Name .....

Address .....

City ..... State ..... Zip .....

Company .....

Position .....

For price and terms outside U. S.  
write McGraw-Hill Int'l., N. Y. 10036 L-810X

(136 BTU/hr), and minimum temperature change, under normal atmospheric conditions, is 45°C max. Ambient temperature limit is 50°C, and may be extended with a special fan.

Cambridge Thermionic Corp., 445 Concord Ave., Cambridge, Mass. Booth 321. [377]



## R-f coaxial filters save space and weight

Low-pass coaxial r-f filters, known as series 5420 Space Travelers, are designed to surpass the stringent aerospace MIL specs. The typical 3/4-cu-in. size features 40 db, and the 1.1-cu-in. size 60 db of stop-band attenuation to beyond the twelfth harmonic (with 400 Mc cut-off). Other cut-off frequencies are from 150 Mc to 1,000 Mc. Maximum insertion loss in the low vswr pass-band is typically 0.3 db. The midjet, 3-dram (0.7 cu-in.) filters weigh as little as 480 grains (1 oz), yet pass 100 w average in most of the passband (25 w at cut-off) with subminiature connectors.

Bird Electronic Corp., 30303 Aurora Road, Cleveland, O. 44139. Sports Arena 1314-1315. [378]

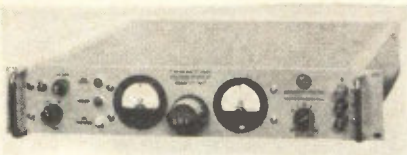

## D-c power supplies offer high stability

All-transistor models RS-361SR and RS-361OSR d-c supplies provide maximum currents of 1 and 10 amperes at any voltage up to 36 v d-c, with 0.05% voltage accuracy, 0.01% 30-day stability, and 0.0002% line regulation. Load reg-

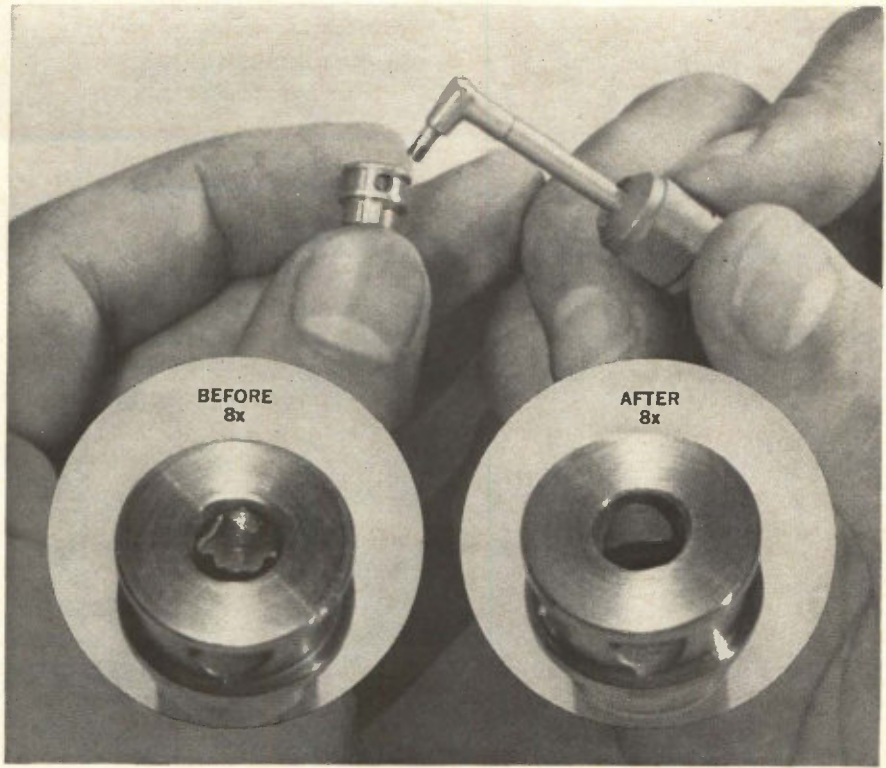

## Airbrasive® cuts deburring time 80% for tiny missile part

Those stubborn, microscopic burrs tucked away in inaccessible places are a snap for the Airbrasive.

Take, for example, the burrs at intersections in a 3/32" hole in a high-performance hydraulic filter made by the Dynamic Filters Division of Michigan-Dynamics, Inc. The filter is designed to prevent particles as small as 10 microns from entering missile servos and actuators. A burr migrating from the filter could be catastrophic.

The company tried everything — all kinds of slurries and tumbling, scraping, electropolishing—still, the best removal time was 20 minutes per part.

The Airbrasive's precision jet of abrasive blasted the burrs away in five minutes or less, with no damage to the part. Less skill was required ... less operator fatigue. Best of all, fewer rejects.

This unique tool can do hundreds of seemingly "impossible" jobs. All kinds of hard, brittle materials can be deburred, cut, shaped, and cleaned. Cost is low, too. For under \$1000 you can set up your own Airbrasive cutting unit. *Let us make a free trial for you. Send samples for test or telephone collect for a demonstration.*

See us in Booth #1818  
at the WESCON SHOW

SEND FOR  
BULLETIN 6006  
... complete information

S. S. WHITE INDUSTRIAL DIVISION  
DEPT. EU, 10 East 40th St., N. Y. 16, N. Y. Telephone MU 3-3015 collect

for superfine cutting • deburring • cleaning

hard brittle materials

*S.S. White* INDUSTRIAL AIRBRASIVE®



**Manufacturing  
Quality Resistors  
under Rigid  
Reliability  
Control**



**Rohm**

METAL  
CARBON FILM RESISTOR

**TOYO  
ELECTRONICS  
INDUSTRY  
CORPORATION**

P. O. BOX 103 CENTRAL  
KYOTO, JAPAN

**New Subassemblies**

ulation is 0.0005% for the 1-amp supply, 0.001% for the 10-amp unit. Voltage control is by means of four decade rotary switches, with provision for remote voltage control and for remote sensing to secure full regulation at a remote load. A 5-position switch permits selection of maximum current limits for load protection. Output current in both d-c supplies cannot exceed the selected limit by more than 30% under overload conditions. Removal of the load fault automatically restores operation. Overvoltage and overload conditions are indicated by panel lights for output deviation of 1 mv from the set value. Simultaneously a 3-v step signal is generated for use by remote indicators or controls. Price is \$850.

Krohn-Hite Corp., 580 Massachusetts Ave., Cambridge, Mass. 02139. Booth 1104. [379]

**Miniature hydrophone  
aids marine research**

A miniature hydrophone, said to be the smallest of its type in the industry, has been developed for use in marine seismic exploration, sonar, and general oceanographic research. It measures only  $\frac{3}{4}$  in. by  $6\frac{1}{4}$  in., weighs 6.5 oz in air and has a density of 3.25. It is a two-terminal device and contains a self-powered, solid-state, 70-db preamplifier which exhibits a nominal signal output of 25  $\mu$ v per microbar pressure at the middle of the pass-band. Frequency response is from less than 0.5 cps to greater than 20 kc. Output imped-



**MICO**  
**PRECISION DRILL PRESSES**

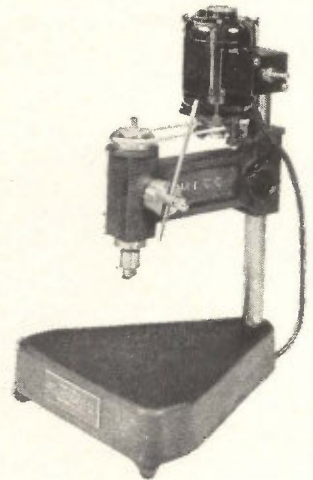

**FEATURES**

1. Durable, accurate, sensitive, variable speed;
2. Four models—with various size bases and throat dimensions from 6 $\frac{1}{2}$ " to 12 $\frac{1}{2}$ ";
3. Ball bearing spindle assemblies with built-in dust protectors. Spindles with taper-oilless bearings available.
4. Drill head can swing radially and is adjusted vertically.

Send for illustrated catalogs

**MICO INSTRUMENT CO.**  
77 Trowbridge St. Cambridge 38, Mass.  
Circle 210 on reader service card

**STUCK  
FOR  
MAGNETS?**



**CALL  
PERMAG**

We stock all sizes, all shapes, all grades, for all uses . . . all ready for 24-HOUR DELIVERY. Also magnets engineered and fabricated to your needs.

**PERMAG PACIFIC CORP.** 6176 W. Jefferson Blvd., Los Angeles, Calif. 90016 / Phone: Area Code 213 Vermont 7-4479 / TWX: 213 836-0445

**PERMAG CENTRAL CORP.** 5301 D Otto Ave., Rosemont, Des Plaines, Illinois 60018 / Phone: Area Code 312 678-1120 / TWX: 312 678-2063

**PERMAG CORP.** 88-06 Van Wyck Expressway, Jamaica, N. Y. 11418 / Phone: Area Code 212 Olympia 7-1818 / TWX: 212 479-3654

ance is 250 ohms. By amplifying signals before they are fed back to the ship, the effects of signal attenuation and noise pickup in the towing cable are minimized. Also, the small size of the new hydrophone reduces noise-producing turbulence when it is towed through the water and enhances the overall signal-to-noise ratio of the recording system with which it is being used. Power for the preamplifier is obtained from rechargeable nickel-cadmium batteries which are housed within the hydrophone.

Rayflex Exploration Co., 600-M North Central Expressway, Richardson, Texas. Booth 1150. [380]

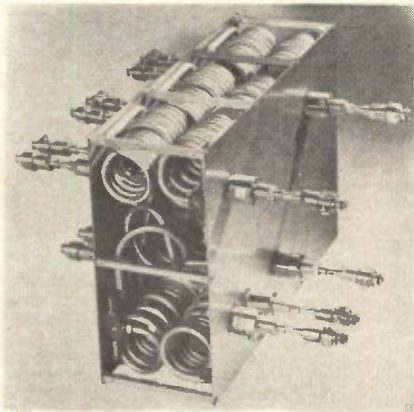

### Hybrids fabricated from coaxial cable

Narrow-band hybrids fabricated of semi-flexible coaxial cables offer a minimum of 10 db better isolation than can be achieved by broadband types, according to the manufacturer. The unit illustrated is designed for NASA telemetry frequencies. In addition to the shielding superiority providing isolation exceeding 40 db, other important characteristics are a vswr of less than 1.05, power split within  $\pm 0.1$  db and insertion loss of 3.1 db. Mechanical length tolerances of  $\pm 0.002$  in. and bend radii of  $\pm 3/16$  in. are attained without affecting the electrical characteristics of the cable. Hybrids are designed to individual specifications using coaxial cables in diameters ranging from 0.018 in. to  $7/8$  in., in 50-ohm impedance.

Phelps Dodge Electronic Products Corp., 60 Dodge Ave., North Haven, Conn. Sports Arena Booth 2085. [381]

NOW YOU CAN GET . . .

**CUSTOMIZED FEATURES**

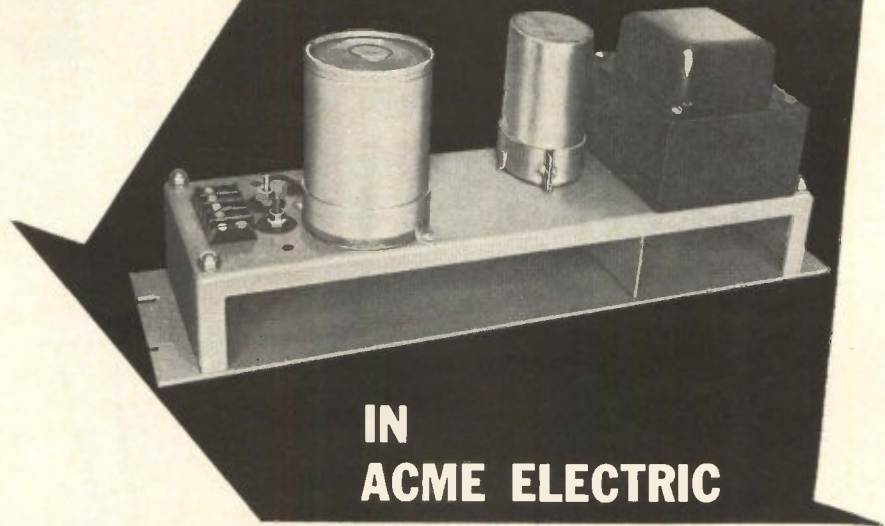

IN  
**ACME ELECTRIC**

## STANDARD POWER SUPPLIES

Why be satisfied with the performance limitations of ordinary power supplies when Acme Electric makes a **standard regulated power supply** with operating features usually obtainable only in specially designed units? This line of Acme Electric power supplies originated as custom designed models, then were simplified and standardized.

### RELIABILITY EVALUATION PROVED BY DESIGN SIMPLICITY

- Continuous duty, constant voltage transformer
- resonant capacitor with adequate bleeder to discharge after turn-off,
- computer grade, electrolytic filter,
- silicon rectifiers,
- practical positioning of terminal board provides input and output connections in one place,
- heavy gauge, relay rack panel with components spaced for maximum free air circulation,
- negligible thermal drift
- losses and instability of tubes eliminated,
- zero to full load recovery time, 0.1 second,
- practically instantaneous recovery under input voltage fluctuation,
- current limiting protection,
- ripple voltage RMS less than 1%,
- efficiency 80% or better,
- standard rack models in ratings from 50 watts to 2400 watts, 24 to 250 volts dc.
- Write for catalog 174.

**Acme**  **Electric**

**Engineers and Builders of...**

318 WATER STREET, CUBA, NEW YORK

Canadian Representative: Polygon Services, Ltd.  
50 Northline Rd., Toronto 16, Ont.

SA 3722-3038

REGULATED POWER SUPPLIES  
STATIC POWER RECTIFIERS  
VOLTAGE STABILIZERS  
VOLTAGE REGULATORS

New Modular Construction

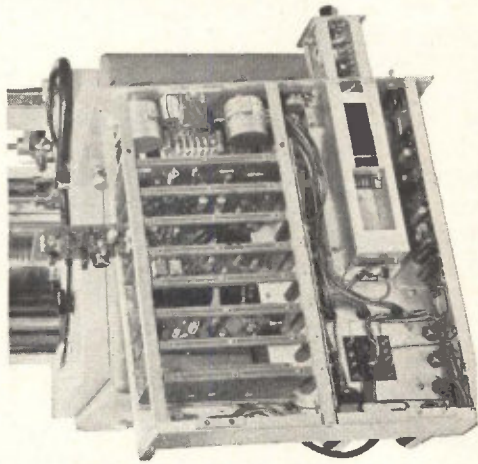

Single Compact Unit

*NEW!*

**KAY**

*Sona-Graph*

**6061-A**

The 6061-A audio spectrum analyzer is an up-to-the-minute solid state adaptation of our 661-A Sona-Graph. It provides the same permanent visual records of Amplitude vs Frequency, Amplitude vs Time, and Frequency vs Time vs Amplitude, BUT in less than ONE-THIRD THE PREVIOUS TIME and with increased clarity. Price: \$2950.

**85 cps to 8000 cps Audio Spectrum Analyzer**

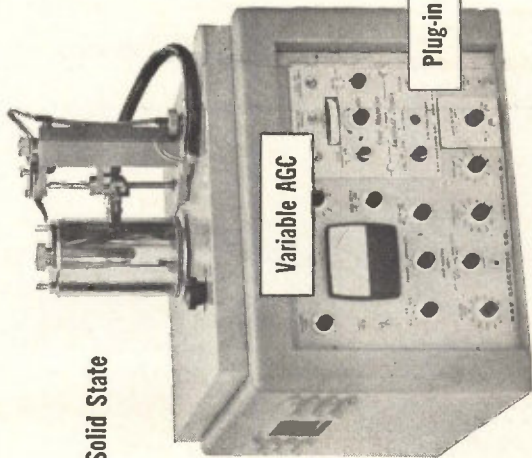

Solid State

Variable AGC

Plug-in Filter



**New storage tube brings "TV contrast" to radar display**

Depth has come to radar display—via a new line of Westinghouse display storage tubes that combine extremely high contrast with the ability to reproduce as many as seven half tones (shades of gray).

This patented new design ends the need for switching the phosphor high voltage to obtain a dark background. It thus reduces weight, volume and demand on the power-pulse source from a 10,000-volt pulse to 85 volts.

During simultaneous write-read operation, distracting background light is entirely eliminated without deterioration of other parameters.

First in this new family is the 5"-diameter WX-4951. Other sizes, such as 3", 4" and 7", can be supplied with writing speeds up to 1,000,000 inches per second, brightness to 2,500 foot Lamberts, and storage times to fit your needs. For complete data, write Westinghouse Electronic Tube Division, Elmira, New York, or Westinghouse International Corporation, 200 Park Avenue, New York, N. Y. ET-4102

You can be sure if it's Westinghouse 



## New Microwave

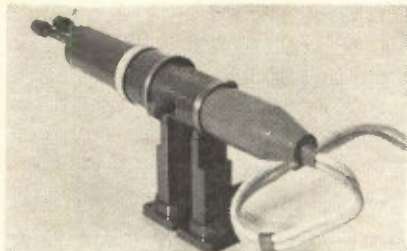

### Traveling-wave tube delivers 20 kw c-w

The highest c-w power ever offered in a traveling-wave tube, according to the manufacturer, is now available. The VA-148 is an X-band tube, conservatively rated at 20 kw. In laboratory tests, it has achieved outputs as high as 30.2 kw. The tube is said to be ideal for such applications as satellite communications, c-w-doppler radar illuminator service, and electronic countermeasures systems. It uses coupled-cavity circuits, thus offering ruggedness comparable to that of a klystron. The VA-148 can also be pulsed, with 25-kw peak power output. Other characteristics include: frequency, 7.7 to 7.9 Gc; gain, 13 db; basic efficiency, 40%; maximum efficiency with depressed collector, 55%; beam voltage, 23 kv d-c; beam current, 2.5 amp d-c; cooling, liquid.

Varian Associates, 611 Hansen Way, Palo Alto, Calif. Sports Arena Booth 2006-2013. [391]

### Safety device for microwave tubes

A device is announced that will prevent destruction of microwave tubes in transmitters. If a fault such as a tube arc, magnet undercurrent or switch-tube failure occurs in a transmitter, the power supply can discharge through the delicate microwave tube, destroying it. The safety device, called a crowbar, protects the tube by short-circuiting the power supply in less than 1  $\mu$ sec, diverting the fault energy from the tube. The crowbar can also be triggered by other devices, such as waveguide arc and

reverse-power detectors made by the company. It is an economical device for use with r-f systems of 20 kv or less; augmenting crowbars are available up to 230 kv. Triggering is accomplished by means of solid-state logic which fires an ignitron to short-circuit the power supply energy. The ignitron is coaxially mounted for reliable switching of fault currents up to 100,000 amps. An output relay is also provided for use by the customer as an optional interlock to open the power supply circuit breakers. Controls for local reset and test fire, and terminals for remote operation are provided. Triggering will occur upon receipt of a 35- to 150-v pulse from a 200-ohm source.

Energy Systems, Inc., 3180 Hanover St., Palo Alto, Calif. Sports Arena Booth 2089. [392]



### Electron multipliers have 20-nsec response

Because of their speed of response, two new electron multiplier tubes can replace complete multistage amplifiers in microwave systems. They are said to be the first five-stage electron multiplier tubes that are commercially available. Their 20-nsec response time, square pulse output and high power amplification provide ideal trigger pulses for twt's and klystrons. Type 8428 is a 5-stage secondary-emission electron multiplier capable of supplying a peak pulse output current of 4 amps and a peak pulse output voltage of 600 v. The input-to-output delay, or response time, is only 20 nsec. Type 8455 has a peak output voltage of 1,000 v and a peak output current of 4 amps. Both require negligible power input pulses,

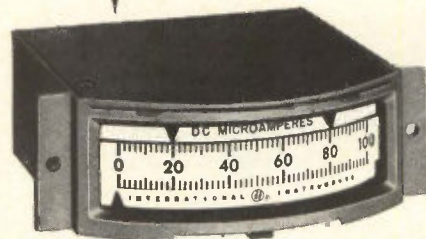

### The Control Meter that engineers swear by ... not at!

Why?

Because nobody makes one like it, let alone one that performs like it.

This is a highly reliable solid-state ELECTRONIC CONTROL METER. It generates a continuous output signal beyond its adjustable control settings. It resets automatically, gives accurate, full-scale indication at all times.

And it does all this (and more) WITHOUT CONTACTS AT CONTROL POINTS. It also features:

- Bi-level scale for minimum parallax.
- External, easily accessible zero adjust.
- Control points adjustable over full scale.
- Null control at any point.
- Choice of one or two control points.
- Available in standard and special ranges.

Power packs for circuit operation and switching, relays, cables and other accessories can also be furnished.

FOR ENGINEERING DATA SHEETS ... and for your special requirements on Electronic Control Equipment, Edgewise Meters and Panel Meters ... phone, wire or write our sales department.

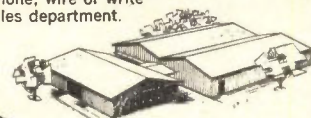

Member of NEMA  
Electrical Indicating Instrument Section

**international  
instruments inc.**

88 Marsh Hill Road, Orange, Conn., Cable: "INTERINST"

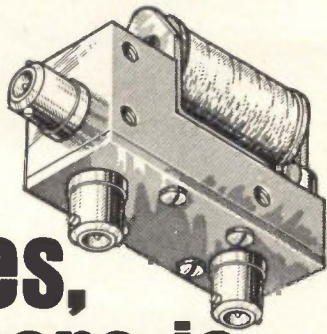

**yes,  
there is  
a better  
coaxial  
switch!**

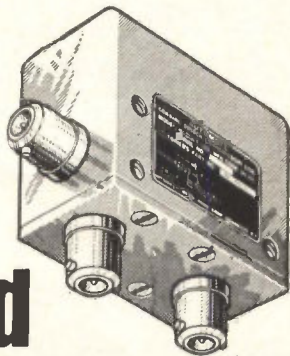

**and  
automatic  
makes it,  
too!**

automate coaxial switches and relays are designed and engineered for high performance and reliability under the extremes of environmental conditions. Excellent VSWR and crosstalk.



Minimum size and weight are featured, packaged to fit all applications. Literature is available. Write for brochure CS-363.

**automatic**  
METAL PRODUCTS CORPORATION

Leaders in the design, research and development of radio frequency coaxial components and connectors

323 Berry Street, B'klyn 11, N. Y.  
Telephone: EVergreen 8-6057

AT THE WESCON SHOW • BOOTH 420

## New Microwave

having large mutual conductances, and both deliver square pulses with 10-nsec rise times. The tubes are essentially pentode receiving tubes with the anode replaced in its normal position by a series of rings of dynodes to multiply the current output. At the center is a pure pentode. The surrounding metal rings, shown in the cutaway (p 151), are punched out in a venetian-blind effect, with the slant of the blinds reversed in each succeeding ring. Electrons that would normally hit the anode now impinge on a dynode. At each dynode they release approximately four electrons to hit the next dynode, and so on. The last dynode is solid and the collector, or relocated anode, is a wide-open venetian blind inside the dynode. These tubes have thousands of hours of life, according to the manufacturer.

Tung-Sol Electric, Inc., 1 Summer Ave., Newark 4, N.J. Booth 351-352. [393]

## Coax hybrid junctions in miniature size

A series of 10 miniature, coaxial hybrid junctions—types 4027-4036—cover the broad range of 30 to 18,000 Mc. Ranging in sizes from 2 in. by 2 in. by 2 in. to 1 in. by 3/4 in. by 3/8 in., the hybrids use dielectric loading where applicable, to reduce size and weight. Designed for use in mixers, duplexers and other circuits requiring a division of power into a pair of transmission lines, output signal amplitudes of the hybrids remain equal, but a 90° phase shift is effected. Input and output terminals are in line, permitting operation of TR tubes between a pair of hybrids. All models offer 3-db coupling with ±0.5-db maximum deviation. Minimum isolation ranges from 25 db for the lower-frequency types to 15 db for the superhigh-frequency units. The vswr of the hybrids in the 30 to



4,000-Mc bands is only 1.25; at 4,000 to 8,000 Mc, the vswr is 1.30; and at 8,000 to 18,000 Mc, vswr is 1.35. Subminiature NPM connectors, used with the hybrids, mate with most standard connectors in use today for the 0.141-in. coax line.

Narda Microwave Corp., Plainview, L.I., N.Y. Sports Arena Booth 1543-1544. [394]

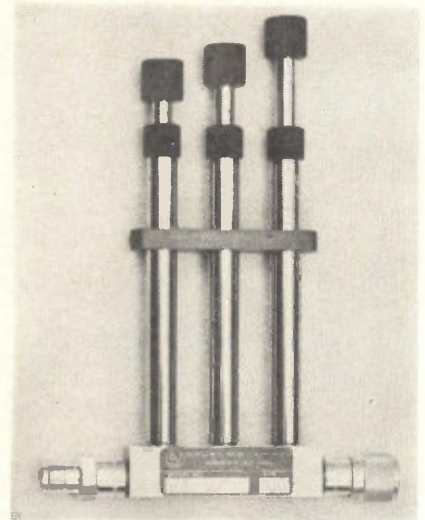

## Coax stub tuners cover from 0.2 to 12 Gc

These stub tuners are broadband devices available in single, double and triple-stub configurations covering the frequency range from 0.2 to 12 Gc in three basic models for size convenience. They are available with a wide choice of connectors—type BNC, TNC, N, C, HN and SC. Also, models are available with miniature Red Line and TM connectors.

Maury Microwave Corp., 10373 Mills Ave., Montclair, Calif. Booth 2046. [395]

## R-f assembly for airborne radar

A small r-f assembly, originally designed for missile altimeter use, is also suited for aircraft and missile systems. The 2971-1013 r-f front end comprises a transmitter oscillator, a local oscillator, a circulator, and a limiter/mixer. Operating

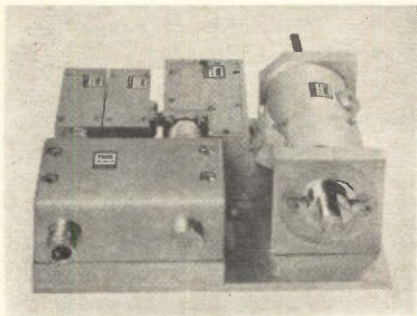

frequency is 1610 Mc; peak power output, 5 kw minimum at antenna port for load vswr of 1.2 max; pulse width, 1.0  $\mu$ sec; pulse repetition frequency, 144 pps; load vswr, 3.1 max, all phase angles; operating temperature range,  $-20^{\circ}\text{C}$  to  $+100^{\circ}\text{C}$ ; intermediate frequency, 30 Mc  $\pm$  0.5 Mc over the operating temperature range and load vswr conditions listed, and local-oscillator frequency of 1,580 Mc; system sensitivity,  $-98$  dbm for signal-to-noise ratio of 8.0 db and i-f bandwidth of 4 Mc; overall max dimensions of integrated assembly, 7 by 5 by 2½ in.; weight, 4 lb max including mounting base plate; vibration, 24 g peak, 20 to 2,000 cps; shock, 35 g, 8 millisecc half sine-wave.

Trak Microwave Corp., Tampa, Fla. Sports Arena Booth 2075-76. [396]



## Sweep oscillator spans 12.4 to 18 Gc

This backward-wave-oscillator microwave sweeper has a frequency range of 12.4 to 18.0 Gc. Model 695A features three pushbutton-controlled automatic sweeps (two broadband and one narrowband), precision leveling, digital marker readout, and provision for remote programming of frequency and amplitude. Conventional bwo grid modulation is used. Price is \$3,500. Hewlett-Packard Co., 1501 Page Mill Road, Palo Alto, Calif. Sports Arena Booths 1402-1410 and 1445-1453. [397]



## High Q Air Capacitors!

Get accuracy and tuning stability with Johanson Variable Air Capacitors. High Q—Low Inductance makes units suitable for VLF to UHF applications. Low temperature coefficient.

Working Voltage 250 V DC at from  $-55^{\circ}\text{C}$  to  $+125^{\circ}\text{C}$ . All units are hermetically sealed.

Here's top reliability for military and industrial applications.

Write for catalog on

*Johanson*

**VARIABLE AIR CAPACITORS**

**MANUFACTURING CORPORATION**

400 ROCKAWAY VALLEY ROAD, BOONTON, N. J. • Phone: (201) DEerfield 4-2676

SEE US AT BOOTH 161—WESCON SHOW

Circle 213 on reader service card

# Telrex

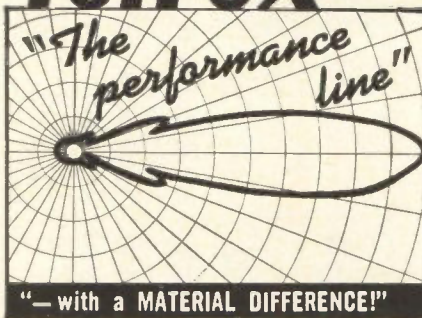

The Choice of the Discriminating Communication Engineer... the Man who Never Settles for Anything Less than THE-VERY-BEST!

## telrex "BEAMED-POWER" ANTENNAS and ANTENNA SYSTEMS

Provide optimum performance and reliability per element, per dollar. Antennas from 500 Kc to 1500 Mc. Free PL88 condensed data and pricing catalog, describes military and commercial antennas, systems, accessories, Towers, Masts, Rotators, "Baluns" and transmission line data.

ANTENNAS SINCE 1921 **telrex** LABORATORIES

Communication and TV Antennas  
Asbury Park 41, New Jersey, U.S.A.

Leading manufacturer in Japan

# Kyocera

for the electronic industry & BETTER PERFORMANCE



Widest choice of advanced ceramics.

**Forsterite, Alumina, Steatite, Zircan, Mullite, Cordierite, Magnesia, Titania, Beryllia, Multiform Glass, etc.**

**KYOTO CERAMIC CO., LTD.**

11, Haramachi, Nishinokyo, Nakagyo-ku, Kyoto, Japan.

# 100,000 MEGOHMS

# ±150 VOLTS

These unusual input specs describe the remarkable Adage HZA™ isolation amplifier.

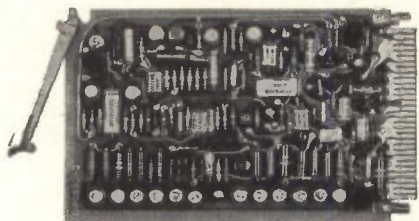

More reasons why HZA has no equal:

- Gain accuracy better than 1 part in 1,000,000
- Dynamic range greater than 1,000,000 to 1
- $10^7$  volts/sec. input swing rate
- Input current less than  $10^{-9}$  amps

We not only meet these specs — we guarantee them.

For your next isolation amplifier requirement, let us quote our HZA — available also as a differential amplifier. We think you'll like our prices, too.

## Adage INC

Main Office and Factory:  
292 Main Street, Cambridge 42, Mass.  
West Coast Plant:  
1145 East Ash Avenue, Fullerton, California

Adage, Inc. welcomes employment inquiries from professional engineers.

## New Production Equipment

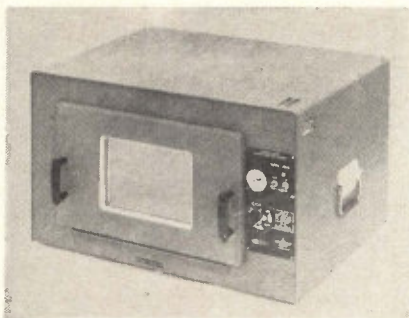

### Temperature chamber gives precise control

A new, portable temperature chamber, model 5703, features high-temperature control accuracy and low-temperature gradients in relation to relatively large internal volume and low cost. Major applications are in rapid, convenient testing of materials and electronic, electrical, and mechanical devices. Other uses include general-purpose application in scientific laboratories, quality control, and in manufacturing processes. Specifications are: range,  $-100^{\circ}\text{F}$  to  $+600^{\circ}\text{F}$ ; internal test volume, 1.85 cu ft; coolant, liquid carbon dioxide. A stainless-steel internal liner is durable, easy to clean, chemically inert and has low magnetic effect. Price is \$800.

Delta Design, Inc., 8000 Fletcher Parkway, La Mesa, Calif. Sports Arena Booth 1212. [421]

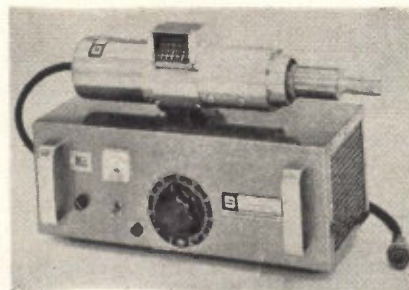

### Compact ultrasonic production transducer

A new ultrasonic standard production transducer known as the SOMAT, sound operated machine accessory transducer, has been introduced. SOMAT is designed for use in welding, soldering, grinding

and brazing. It can be operated intermittently or continuously, without warmup, with model DS-221 ultrasonic generator. Its power handling capability is 200 w continuous, unloaded, at 21 kc resonant frequency. Cooling is achieved with a self-contained blower. The unit is  $13\frac{1}{2}$  in. long,  $5\frac{1}{2}$  in. in diameter, and weighs 7 lb. It comes equipped with a stepped horn mechanical transformer and a 10-ft standard cable.

Delta Sonics, Inc., 12918 Cerise Ave., Hawthorne, Calif. Sports Arena Booth 1729. [422]

### Ultrasonic applicator cleans p-c boards

Model USWA ultrasonic wave applicator satisfies cleaning and processing requirements in many fields. It produces a constantly flowing, smooth laminar wave with an even horizontal surface 12 in. by 12 in. in area and  $\frac{1}{2}$  in. high. It can be applied most effectively in the post-cleaning of printed-circuit boards for the removal of flux and oil residue. It can also be used for precleaning before fluxing, and may be used in straight-line soldering as an independent operation.

Electrovert Mfg. Co., 3285 Cavendish Blvd., Montreal 28, Quebec, Canada. Canadian Exhibit, Area 800. [423]

### Pressurized enclosure for ultra-clean work

An ultra-clean work station with  $360^{\circ}$  visibility and  $360^{\circ}$  access to the work area has been developed for effectively removing and controlling air-borne contaminants. All units are available with an absolute type filter, 99.97% efficient on 0.3 micron particle size, and large capacity blower. There are no corners in the Cleansphere. The work opening height can be varied and microscope wells or ports can be installed. The 4-ft diameter Cleansphere will seat six people comfortably in 50% less floor space than a conventional 6-ft wide laminar flow-type work station. The Clean-

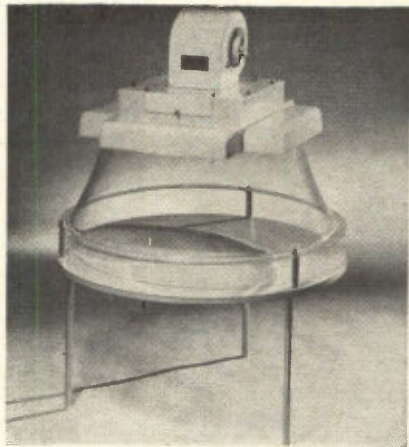

sphere will provide effective protection for operations such as ultrasonic cleaning, high-vacuum evaporation, photo resist, soldering, fume exhaust, encapsulating, assembly, inspection and packaging. Edcraft Industries, Inc., 22 Nesbitt St., Newark, N.J. 07103. [424]

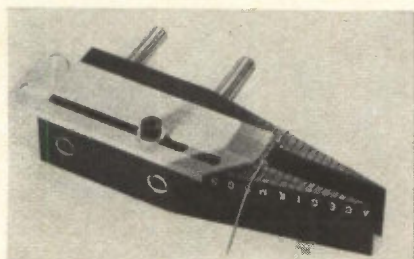

### Component positioner for bending tool

An automatic component positioner attachment has been announced for the manufacturer's model 700 component-leads bending tool. Designated No. A, the device is completely adjustable to the required body length of the smallest resistors, diodes and capacitors. Once the length is set for the bending leads, the operation of placement becomes automatic, thus providing greater efficiency and speed. The series 700 bending tool will eliminate plier damage to leads and components and will cut component losses to a minimum, according to the manufacturer. The bending tool with automatic component positioner attached is priced at \$22.80. The positioner attachment alone, for use with existing model 700 tools, is priced at \$3 with instructions for attaching. By-Buk Co., 4314 West Pico Blvd., Los Angeles, Calif. 90019. [425]

# NEW FROM NRC

## thin film vacuum coater

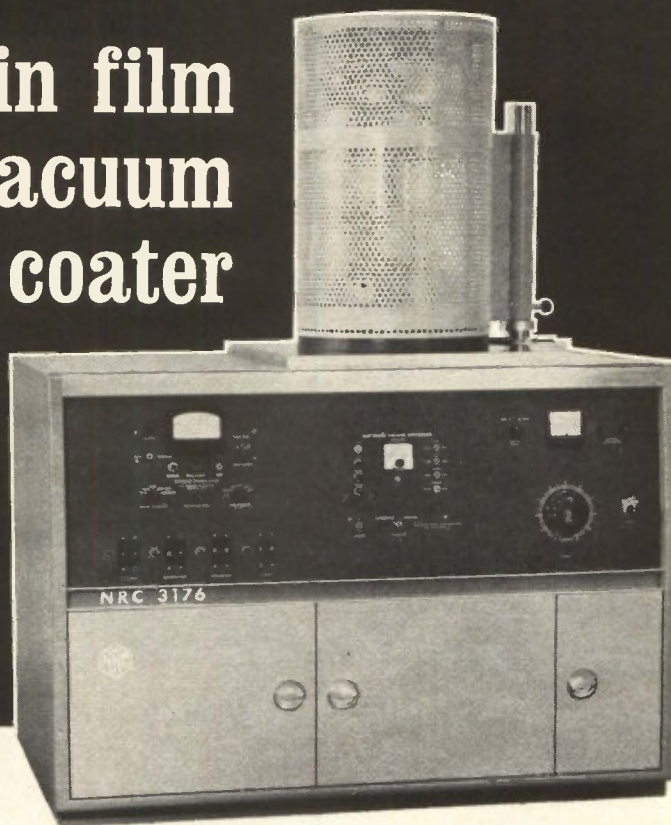

NRC's Model 3176 Vacuum Coater is a unique vacuum evaporation system for thin film deposition in R&D and production programs. Unmatched for versatility, reliability and ease of operation, the Model 3176 is used in the areas of solid state electronics, optics, magnetic films, memory planes and solar cells.

**Exclusive features include:** ■ **Fastest Useful Pumping Speed . . .** with high performance, lowest backstreaming NRC diffusion pump rated at 1500 liters/sec. ■ **Highest Conductance/Lowest Outgassing . . .** with the new NRC Slide Valve which was specifically developed for maximum pump efficiency. ■ **More Efficient Baffling . . .** with single circular chevron cold trap-baffle combination. ■ **Easy, Fast Operation . . .** with all controls (manual or automatic) conveniently mounted on front panel. ■ **Maximum Versatility . . .** used with 18" or 24" work chambers — electrical and mechanical feed-throughs interchangeable.

The Model 3176 has a new sophisticated appearance and is ready to operate. Merely connect power and water supply. Write or call for data sheet.

See us at Booths #1633 & 1634, WESCON SHOW

**NRC EQUIPMENT CORPORATION**

A SUBSIDIARY OF NATIONAL RESEARCH CORPORATION



A Norton Company Affiliate





*Got A Mixer Hangover?*

**LEL's New Broadband Mixers are better for your system...**

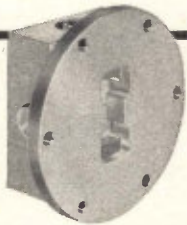

Isolation too low? Mixers too big? Bandwidths too narrow? New LEL Mixers are the perfect prescription to set your system right. LEL's multiple-octave coax and full waveguide range models cover the spectrum from 250 Mc to 18 Gc. High performance, low noise units like the LEL 12 - 18 Gc mixer come in pill-sized packages, measuring a mere 2 cu. inches. Isolation in many models is in the order of 20 - 30 db.

Chances are you're already using other LEL top quality products, so you know what to expect in terms of reliability, economy and rugged construction. Send today for full information on LEL's new mixer line.



*New...*  
**LEL Catalog '64**

**FREE...send for it today!**

**See us at WESCON Booth No. 2027**

**LEL INC.** AKRON ST., COPIAGUE, L. I., NEW YORK 11726  
(516) AMityville 4-2200 • (516) PYramid 9-8200 • TWX Code 516-691-5085

# Daka-ware **PLASTIC CASES & COVERS**

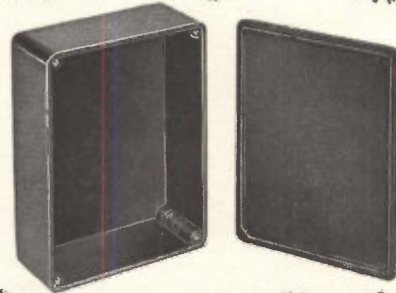

Break-resistant quality — excellent dielectric strength for insulation — high luster finish requires no painting — in industry approved sizes that are ideal for housing test equipment, electrical or electronic controls.

**STANDARD SIZES:**

- No. 220 — 4" long x 2 $\frac{7}{8}$ " wide x 1 $\frac{1}{8}$ " deep
- No. 240 — 6 $\frac{1}{4}$ " long x 3 $\frac{3}{4}$ " wide x 2" deep
- No. 260 — 6 $\frac{3}{8}$ " long x 5 $\frac{3}{32}$ " wide x 2-5. 12" deep
- No. 241 — Mating cover for No. 240 case
- No. 261 — Mating cover for No. 260 case

*Samples and prices furnished promptly.*

**HARRY DAVIES MOLDING COMPANY**  
1428 N. Wells Street • Chicago, Illinois 60610

Circle 215 on reader service card

## DELTA-T KING SIZE HEAT SINKS



... for the latest high power semiconductors

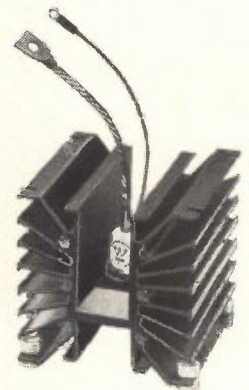

SERIES WN ... FOOT-MOUNTED

NEW Series GN and WN HEAT SINKS ... for high power SCRs and rectifiers with 1-1/16", 1-1/4" or 1-3/4" hex. Natural Convection units ... have radial fin design for increased fin efficiency.

ALSO ... NEW TECHNICAL BULLETINS

SERIES GN ... END-MOUNTED

WESCON SHOW / Booth 372, Hollywood Park

**WAKEFIELD ENGINEERING, INC.**  
139 FOUNDRY ST. / WAKEFIELD, MASS. (617) 245-5900 • TWX 617-245-9213

## New Materials

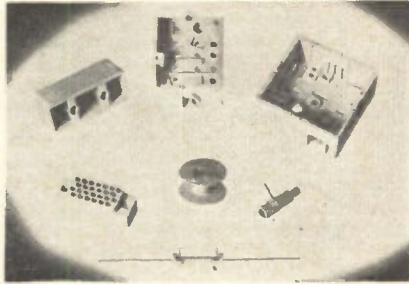

### Thermally-conductive dielectric resins

A family of dielectric resins that can be cast and molded is claimed to have thermal conductivities at least 10 times better than conventional filled resins and 100 times better than unfilled resins. The new Berlon composite materials include epoxies, phenolics, and silicones, filled with Berlox high-purity beryllium oxide. Since beryllium oxide has excellent electrical properties as well as high thermal conductivity, there is no sacrifice of dielectric strength, volume resistivity, power factor, or other electrical or mechanical property. The new materials are available as pre-filled resins, for customer blending, with curing agent for potting or encapsulation, or in the form of fabricated sheet, block, and rod, or custom-machined shapes.

National Beryllia Corp., Haskell, N.J. Booth 1619. [411]

### Materials and finishes for printed circuits

A variety of material types and circuit finishes are offered for users of printed circuits. Circuit finishes are available in copper, silver, gold, solder and tin. Plug-in contacts can be provided by electroplating—usually gold over nickel or rhodium over nickel—or by mechanical connectors attached to the printed circuit. In addition, flexible circuits are offered in several materials. Depending on the application and degree of flexibility desired, flexible circuits are available on Teflon, Mylar and other polyester bases,

and even on fiber glass epoxy laminates as thin as 0.003 in.

Avionics, Ltd., P.O. Box 200, Niagara-on-the-Lake, Ontario, Canada. Canadian Exhibit, Area 800. [412]

### Hook-up wire meets new Mil spec

A high-temperature hook-up wire, in accordance with a new spec, MIL-W-81044, combines superior mechanical toughness with appreciable weight savings, thinner walls, smaller comparative sizes, ease of fabrication and lower cost than other fluorocarbon types, according to the manufacturer. The wire is a two-layer construction of radiation crosslinked materials. The inner layer is a polyalkene and the outer layer a thin jacket of Kynar (polyvinylidene fluoride). Temperature rating is 135°C continuous. Using conventional techniques, the wire is easily marked, stripped, potted and fabricated into harnesses.

Raychem Corp., Oakside at Northside, Redwood City, Calif. Booth 1844-1845. [413]

### Semiconductive tape sheds static charges

A new semiconductive tape has properties that make it useful in equipment programing and computers. The tape, in which a special graphite coating is bonded directly to polyester film, will not build up static charges. It is lighter, more flexible and more resistant to fraying than conventional laminated tapes, according to the manufacturer. When used as a cable wrapping, it provides an extremely light shielding with a considerable range of conductivity. The tape is available in various resistances from 1,000 ohms/sq. Even in thin gages it is 100% opaque, with high tensile and dielectric strength. It will withstand temperatures to 400 degrees, about 200° higher than currently available tapes. It can be laminated, embossed, metallized and punched.

Custom Coating & Laminating Co., 717 Plantation St., Worcester, Mass. [414]

# AMPERITE

## Thermostatic DELAY RELAYS

Delays:  
2 to 180 seconds



PROBLEM? Send for Bulletin No. TR-81

Actuated by a heater, they operate on A.C., D.C., or Pulsating Current . . . Being hermetically sealed, they are not affected by altitude, moisture, or climate changes . . . SPST only—normally open or normally closed . . . Compensated for ambient temperature changes from -55° to +80° C . . . Heaters consume approximately 2 W. and may be operated continuously . . . The units are rugged, explosion-proof, long-lived, and—inexpensive!

TYPES: Standard Radio Octal, and 9-Pin Miniature.  
List Price, \$4.00

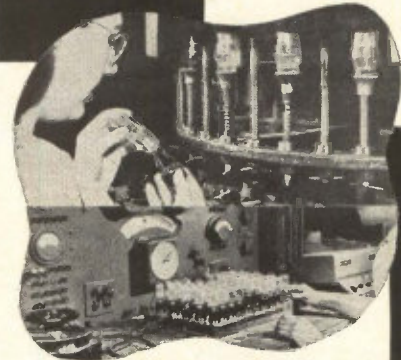

Individual inspection and double-checking assures top quality of Amperite products.

## AMPERITE BALLAST REGULATORS

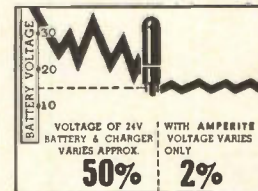

Hermetically sealed, they are not affected by changes in altitude, ambient temperature (-50° to +70° C), or humidity . . . Rugged, light, compact, most inexpensive.

List Price, \$3.00

Write for 4-page Technical Bulletin No. AB-51

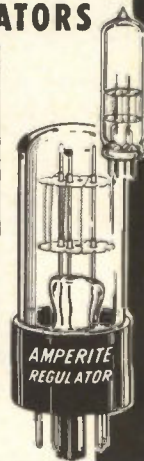

# AMPERITE

600 PALISADE AVE., UNION CITY, N.J.  
Telephone: 201 UNION 4-9503

In Canada: Atlas Radio Corp., Ltd.,  
50 Wingold Ave., Toronto 10

## CRITICAL ELECTRONIC FOIL REQUIREMENTS ?

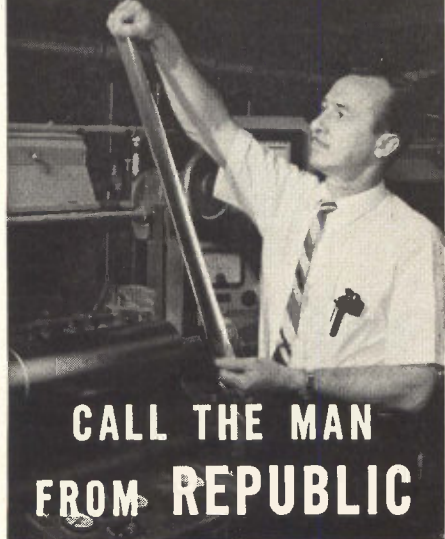

CALL THE MAN  
FROM REPUBLIC

He has had extensive experience in the development and production of consistently superior aluminum foils . . . the foil in every operation from initial rolling is under the critical eye of the Quality Control Manager . . . he double-checks final gaging, for example, that takes place during the slitting operation. These in-process inspection procedures coupled with numerous laboratory tests result in a product guaranteed to adhere to the most critical electronic foil requirements

Republic's complete aluminum foil line includes:

- LIGHT GAGE FOIL for paper and film wound capacitors of all types.
- ETCHED ANODE & CATHODE FOIL
- PLAIN FOIL FOR ETCHING
- PLAIN FOIL for electrolytic capacitors, coil winding, and other uses.

LET US SEND YOU . . .

literature describing Republic's foil line along with the name of the man technically qualified to assist you with your foil problems.



QUALITY  
in foil for

LEADERSHIP  
electronics

### REPUBLIC FOIL INC.

GENERAL OFFICES & ROLLING MILL DIVISION  
Danbury, Connecticut

ELECTROCHEMICAL DIV. — Salisbury, North Carolina  
CONSOLIDATED BAG & FOIL DIV. — Somerville, Mass.  
BRANCH SALES OFFICES —

5306 West Lawrence Ave., Chicago 30, Illinois  
WEST COAST — Electrical Specialty Co.,  
158 Eleventh St., San Francisco 3, Cal.

## New Literature

**Delay lines.** Phelps Dodge Electronic Products Corp., 60 Dodge Ave., North Haven, Conn. Company capability in the design and fabrication of coaxial-cable delay lines is discussed in an 8-page catalog.  
Circle 451 on reader service card

**Capacitors and inductors.** LRC Electronics, Inc., 901 South Ave., Horseheads, N.Y. 14845, has released a catalog illustrating a complete line of precision trimmer capacitors and inductors. [452]

**Signal conditioning system.** Allegany Instrument Co., 1091 Wills Mountain, Cumberland, Md. 21501. An eight-page booklet describes the SAM (sensor analog module) signal conditioning system. [453]

**Phono connectors.** Connector Corp., 6025 No. Keystone Ave., Chicago, Ill. 60646. Data sheet 29A contains dimensional drawings and description of a line of multi-purpose, high-reliability, modular phono-type male and female connectors. [454]

**Pulse transformers.** Gudeman Co. of California, Inc., 7473 Avenue 304, Visalia, Calif. 93278. A new catalog sheet helps eliminate the use of detailed mathematics in selecting pulse transformers for blocking oscillator circuits. [455]

**Varactor diodes.** Solitron Devices, Inc., 500 Livingston, St., Norwood, N.J. An 8-page catalog describes a line of silicon epitaxial, abrupt junction, voltage-variable capacitor diodes. [456]

**Microwave components.** Radar Design Corp., 104 Pickard Dr., Syracuse, N.Y. 13211, has published a short-form catalog entitled "Stock Microwave Components for Military and Industrial Systems." [457]

**Semiconductor pressure transducer.** Micro Systems, Inc., 170 North Daisy Ave., Pasadena, Calif., offers a data sheet covering an ultraminiature semiconductor pressure transducer, type 1004. [458]

**Integrated-circuit prices.** Signetics Corp., 680 West Maude Ave., Sunnyvale, Calif., has published a price list reflecting a downward revision of up to 33% on a line of monolithic DTL integrated circuits. [459]

**High-voltage capacitors.** Sangamo Electric Co., Springfield, Ill. Bulletin 2425 describes a complete line of type HVC high-voltage capacitors. [460]

**Regulated power modules.** Kepco, Inc., 131-38 Sanford Ave., Flushing, N.Y. 11352. A 4-page illustrated brochure, No. 146-1054, covers power modules with  $\pm 1\%$  line regulation. [461]

**Bushing-mount potentiometer.** Bourns, Inc., 1200 Columbia Ave., Riverside, Calif., has published a bulletin on the model 3530, a single-turn, bushing-mount potentiometer of  $\frac{7}{8}$ -in. diameter. [462]

**Microcircuit checklist.** Corning Electronic Products division, Raleigh, N.C., offers a checklist containing questions that should be asked about microcircuit requirements before the design process begins. [463]

**Thermistors.** Victory Engineering Corp., 136 Springfield Ave., Springfield, N.J., has available a bulletin describing military-grade disk and rod thermistors designed to meet MIL-T-23648 requirements. [464]

**Ceramic permanent magnets.** Indiana General Corp., Valparaiso, Ind. Manual 8 presents a comprehensive design guide for the application of Indox ceramic magnet materials. [465]

**Integrated circuits.** General Micro-electronics Inc., 2920 San Ysidro Way, Santa Clara, Calif. 95051, has published a brochure illustrating its capabilities for the manufacture of semiconductor integrated circuits. [466]

**Mixers and crystal holders.** Microwave Development Laboratories, Inc., 87 Crescent Road, Needham Heights, Mass. Catalog M563-5 gives mechanical and electrical details on waveguide mixers and crystal holders. [467]

**Mass soldering techniques.** Hollis Engineering, Inc., Pine St. Extension, Nashua, N.H. 03060, offers a booklet intended to up-date all facets of automatic soldering and discuss factors contributing to quality assurance in soldering printed-circuit boards. [468]

**Shielded power transformers.** James Electronics, Inc., 4050 N. Rockwell St., Chicago, Ill. 60618. A 2-page data sheet contains power transformer data for low-signal applications. [469]

**Selenium rectifiers.** Electronic Devices, Inc., 21 Gray Oaks Ave., Yonkers, N.Y. 10710. A complete line of high-voltage selenium cartridges is described in catalog SE-1004. [470]

**Microwave resistors.** Pyrofilm Resistor Co., 3 Saddle Rd., Cedar Knolls, N.J. Catalog RD25 covers the company's rod-type and disk-type microwave carbon-film resistors. [471]

**Integrated circuits.** Amelco Semiconductor, 1300 Terra Bella Ave., Mountain View, Calif., has published a comprehensive technical bulletin (No. 3) describing its OMIC (Optimized MICrocircuits) design approach to integrated circuits. [472]



## It stands alone



**Hydrazine-Activated Flux\* and Core Solder** offers an exclusive combination of advantages:

- High wetting properties for good "bite."
- Non-corrosive connections.
- Residues removed by heating or water rinse.
- No change on aging.

No one flux is best for all purposes. **TEST HYDRAZINE FLUX AND CORE SOLDER FOR YOURSELF.** The liquid permits pre-fluxing, is useful for soft-soldering a wide range of copper and copper-based alloys. The core solder flows at an ideal rate, leaves a minimum of soldering residues. Write for samples of either, or technical literature.

Available only from Fairmount and its sales agents. \*U.S. Patent No. 2,612,459 and others

## Fairmount

CHEMICAL CO., INC.  
136 Liberty St., N. Y. 6, N. Y.

Circle 217 on reader service card

## SPELLMAN RF TYPE DC HIGH VOLTAGE POWER SUPPLIES



**MODEL  
RG-30-1**  
CONTINUOUSLY  
VARIABLE 15-30  
KV REGULATED DC  
POWER SUPPLY  
WITH REGULATED  
FOCUS VOLTAGE  
TAP

A continuous duty DC supply with highly filtered outputs and regulations against line, load and drift less than 0.1% at 1 ma. Ripple less than .005%. A variable focus tap 4-6 KV for use with flying spot tubes. 19" wide x 8 3/4" high x 15" deep. With HV meter \$450. Net Less meter \$400. Net  
**MODEL RG-30**—Some as RG-30-1 except regulations against line, load and drift less than 0.5% at 1 ma. 19" wide x 8 3/4" high x 13" deep. With HV meter \$375. Net Less meter \$325. Net

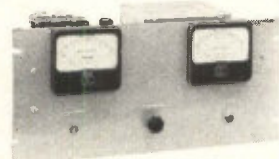

**MODEL  
LAB-10**  
CONTINUOUSLY  
VARIABLE 1-15  
KV REGULATED  
DC SUPPLY

Output current 2 ma. Regulations line and load better than .5%. Input: 117 V 60 cycles. Complete with HV and current meters. 19"W x 8 3/4"H x 13"D. \$275 net  
**MODEL LAB-10PN**—Same specifications as above except reversible polarity. \$375 net

## SPELLMAN HIGH VOLTAGE COMPANY, INC.

1930 Adee Ave., Bronx 69, N.Y.  
Kingsbridge 7-0306

Circle 218 on reader service card  
Electronics | August 10, 1964

Measuring instruments. Waveforms, Inc., 333 Sixth Ave., New York 10014. Catalog 15A gives a rundown on electronic measuring instruments manufactured—covering sub-audio through low radio frequencies — and services offered. [473]

Transformers. Protran Co., Inc., 7 Commercial St., Hicksville, L.I., N.Y., has issued a condensed catalog on transformers and high-power pulse modulator components. [474]

Transistor chopper driver. Solid State Electronics Corp., 15321 Rayen St., Sepulveda, Calif. 91343. A catalog sheet describes model TCD-101 transistor chopper driver designed to meet military specifications. [475]

Communication printer system. Anelex Corp., 150 Causeway St., Boston 14, Mass. A 4-page brochure describes a communication printer system that is compatible with any computer and operates on-line via Data-phone, microwave, and coaxial cable, or off-line from cards and tapes. [476]

Strip connectors. ITT Cannon Electric Inc., 3208 Humboldt St., Los Angeles, Calif. 90031, offers catalog MTS-2 on microminiature, 50-mil strip connectors. [477]

Magnetic definitions. Ferroxcube Corp. of America, Saugerties, N.Y. Bulletin 110 contains 12 pages of magnetic definitions, including mathematical derivations, of the most commonly used terms applied in the design of magnetic devices. [478]

Quartz crystals. Monitor Products Co., Inc., 815 Fremont Ave., South Pasadena, Calif., has published a bulletin on Koldweld frequency-control quartz crystals for missile and space applications. [479]

Telemetry transmitters. Leach Corp., 1123 Wilshire Blvd., Los Angeles 17, Calif., offers a bulletin on solid-state, 2-watt telemetry transmitters. [480]

Random-access memory system. RCA Electronic Data Processing, Camden 8, N.J. A low-cost random-access memory unit capable of storing upwards of 5.4 billion characters for split-second recall is described in a new brochure. [481]

Scientific instruments. Scientific Instrument department, Fairchild Camera & Instrument Corp., DuMont Laboratories divisions, Clifton, N.J. A 92-page catalog contains detailed specifications of the latest instruments, oscilloscopes and cameras. It is available to those writing on company letterheads.

Cooling equipment. Kooltronic Fan Co., Princeton, N.J., A 24-page catalog spotlighting 235 choices of fans, small blowers and packaged cooling units for all phases of electronic cabinet cooling is offered to qualified users who request it on company letterhead.

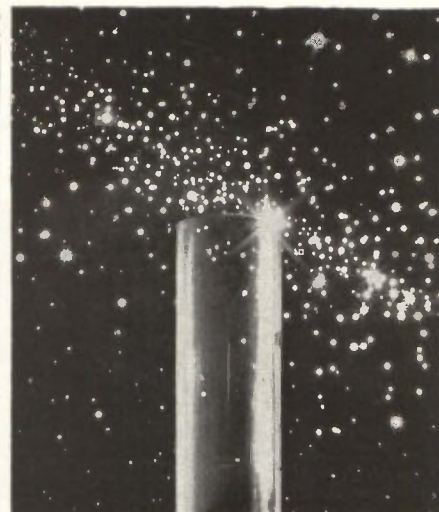

## JEOL Precision Rubies and the Dazzling LASER

Since the first coherent light beam was developed, scientists have sought for materials that lase and have adequate output for the thousands of applications which science and industry envision for the laser. In the four short years of laser development, the spectrum of laser light sources has grown to include solids, liquids and gases. Yet even today the best source remains the precision artificial ruby. The highly efficient Bernoulli-type furnaces developed by JEOL can produce center-cut rubies 0.6" diameter and 6.0" long containing 0.05% chromium with up to 100% reflection for the most exacting performance demanded. End parallelism is 2-5 seconds, surface evenness is between 0.1 to 0.2 lambda. Final annealing results in rubies with no thermal distortion nor stria, reduced crystal lattice, and extremely homogeneous chromium distribution.

Research and development at JEOL, in the search for larger light sources and concomitant higher output, have produced a sensational ruby 50% longer than existing ones. The 30" source for optically pumped laser equipment has successfully passed trial experimentation and after final standardization test by governmental and university agencies will be available for practical applications to laboratories, industry and science.

## Japan Electron Optics Laboratory (JEOL) Co., Ltd.

New Tokyo Bldg., Marunouchi, Chiyoda-ku, Tokyo.

See these JEOL precision scientific instruments at the WESCON Show: ● Variable Optical Attenuator for quantitative modification of laser beams using 3 Gland Thompson prisms. ● Parametric Laser Detector to convert beams into microwave frequencies with simultaneous parametric amplification acting as an irreversible element for microwave circuits. ● Corner Cubes—Pentagonal Prisms—Fabry Perot—Inverted Telescopes—Interferometers.

Circle 159 on reader service card 159



**Actual Size**  
*Only 1-5/8 inches long...  
 Extends just 29/32 inch  
 behind front of panel*

## BUSS Space Saver Panel Mounted Fuseholder

- Fuseholder takes 1/4 x 1 1/4 inch fuses. Converts to 9/32 x 1 1/4 inch fuses simply by changing screw type knob. Holder is rated at 30 ampere for any voltage up to 250.
- Also available in military type which meets all requirements of MIL-F-19207A.

# BUSS

Write for BUSS  
 Bulletin SFH-10

BUSSMANN MFG. DIV., McGraw-Hill Co., ST. LOUIS, MO. 63107



**GMW FUSE  
 AND HWA  
 FUSEHOLDER  
 FUSE SIZE  
 ONLY .270 x .250  
 INCHES**

## BUSS Sub-Miniature FUSE-HOLDER COMBINATION

- Light-weight, protective device for spacetight applications. Fuse has window for inspection of element. Fuse may be mounted alone or used in holder.
- Holder can be used with or without knob. Knob makes holder water-proof from front of panel.
- Military type fuse FM01 meets all requirements of MIL-F-23419. Military type holder FHN42W meets all military requirements of MIL-F-19207A.

# BUSS

Write for BUSS  
 Bulletin SFB

BUSSMANN MFG. DIV., McGraw-Hill Co., ST. LOUIS, MO. 63107

# BUSS: 1914-1964, Fifty years of Pioneering..

Circle 161 on reader service card

Circle 161 on reader service card

### To order reprints

Fill in, cut coupon below, insert in envelope and mail to:  
 Electronics reprint dept.  
 330 West 42nd Street, New York, N. Y. 10036

### Reprint order form

For listing of reprints available see the reader service card

To help expedite mailing of your reprints please send cash, check, or money order with your order.

For reprints of the latest feature article:

#### Oceanography

Send me ..... reprints of Key no. R-58 at 50¢ each.

For reprints of previous special reports fill in below:

Send me ..... reprints of Key no. (s) ..... @ ..... ¢ each

For prices see the reader service card.

Name .....

Number and Street .....

City, Zone No., State .....

## New Books

### Space electronics

Space Vehicle Electronics  
David Bruce Newman  
D. Van Nostrand Co., Princeton, N.J.,  
1964, 397 pp. \$15.75

This volume is the 11th in the generally excellent series entitled Principles of Guided Missile Design.

Aimed at the graduate student and professional engineer, the book uses a systems approach in presenting technical areas that comprise a space-vehicle design. Although labeled as an electronics volume, the book also presents a broad spectrum of nonelectronic technologies, and information useful to engineers of all specialties who are active in the aerospace field. Few circuit diagrams and electronic hardware details are included.

The first chapter discusses the flight objectives that a space vehicle might have. Typical space missions are weather observation, communication (voice and television), navigation aids, manned flight and unmanned planetary exploration.

In the chapter on space environments, basic information is listed on gravitational fields, radiation belts, temperature, density, pressure, molecular mean free path, brightness of stars and so on. More than one-fourth of the book is devoted to this chapter, as the author covers the terrestrial, cislunar, lunar, solar and galactic environments.

Basic information on vehicle motion and flight trajectories in a gravitational field is included in the chapter on celestial mechanics.

Separate chapters deal with communications, guidance, vehicle control and space-vehicle power sources.

Payload considerations such as operating laws, limitations, required capabilities and interrelations with other system elements also are treated. Space, weight, power and reliability budgets are reviewed in conjunction with installation requirements. Finally, the state of the art leading to a preliminary design for the Apollo lunar landing radar system is appraised.

Space Vehicle Electronics should be in the libraries of companies in the space business. It would also be a good textbook for training courses by companies that are retraining their experienced engineers as they move into space projects.

Sol Levine  
Deputy Technical Director,  
Gemini program  
Martin Co., Baltimore

## ...New Developments in Electrical Protection

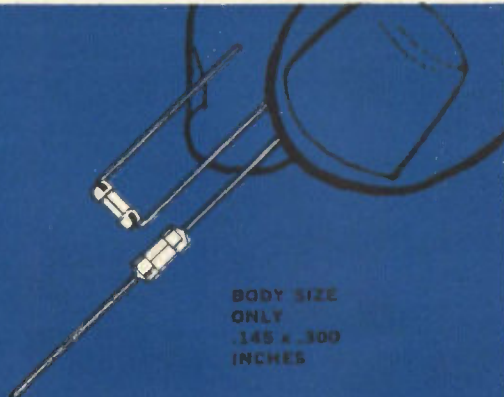

BODY SIZE  
ONLY  
.145 x .300  
INCHES

### BUSS Sub-Miniature PIGTAIL TRON FUSES

Use Tron fuses where space saving is vital—on miniaturized devices—or on gigantic multi-circuit electronic devices.

Hermetically sealed for potting without danger of sealing material affecting operation. Extreme high resistance to shock or vibration. Operate without exterior venting.

# BUSS

Write for BUSS  
Bulletin SFB

BUSSMANN MFG. DIV., McGraw-Hill Co., ST. LOUIS, MO. 63107

### THE NEWEST DEVELOPMENTS IN ELECTRICAL PROTECTION

will be shown at the

# WESCON SHOW

Booth 339  
Hollywood Park

If you can't make the show, but have a problem in electrical protection, our staff of fuse engineers is at your service to help you solve it. In any event, be sure to get latest information **BEFORE** final design is crystallized.

# BUSS

JUST CALL  
OR WRITE

BUSSMANN MFG. DIV., McGraw-Hill Co., ST. LOUIS, MO. 63107

# NOW!

## MAGNETOTHERMOELECTRICITY SINGLE CRYSTALS

Operational, Ready-To-Use  
Fabricated, Infinite Cascade  
Units of

## BISMUTH-ANTIMONY

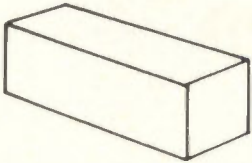

SINGLE-STAGE BISMUTH CRYSTAL

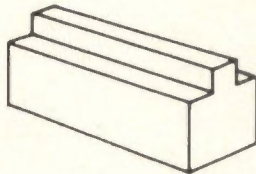

TWO-STAGE DEVICE

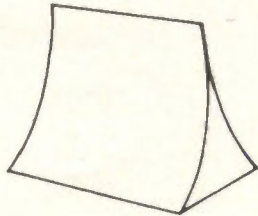

INFINITE CASCADE CRYSTAL

## Exploratory Cascade

Units of

- BISMUTH TELLURIUM
- BISMUTH LEAD
  - BISMUTH ARSENIC
  - BISMUTH SULPHUR
  - BISMUTH SELENIUM
  - TELLURIUM LEAD

## VARIOUS SIZES AVAILABLE

Operational Units From  
**\$985 to \$4,000**

Exploratory Units From  
**\$750 to \$6,000**

Magnetothermoelectricity utilizes Single Crystals of metals making possible temperature drops well over 100°C in a single cascade unit, and greater temperature drops are possible with specially designed units.



WRITE OR CALL FOR LITERATURE

# semi-elements, inc.

Saxonburg Boulevard, Saxonburg, Pa.  
Phone: 412-352-1548

## DIGITAL

- Phase angle in degrees directly represented in four digits.
- Independent of signal amplitude and frequency.
- No frequency adjustment from 20 cps to 500 kc.

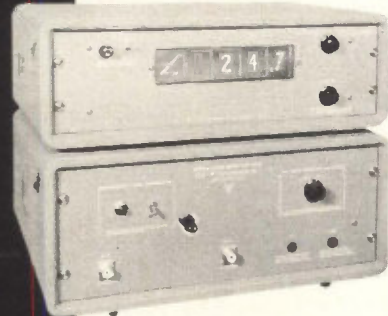

PHASE METER

### SPECIFICATIONS

Frequency Response: Continuous from 20 cps to 500 kc. Phase Range: 0 to 360.0° displayed in four digits without switching. Input Voltage: 0.3v to 50v rms. Accuracy: ±0.1° relative, to ±0.3° absolute. Analog Output: A d.c. output signal directly proportional is provided for plotting phase curve on external recorder. The d.c. potential is 0 for 0°, changes linearly to negative 3.6v for 360°. Input Impedance: 3 megohms shunted by 30 uuf. Price: \$2,165.00.

## ADYU

ELECTRONICS INC.

249 TERHUNE AVE. PASSAIC, N. J.

472-5622

Visit our Booth No. 1417 at The Wescon Show

Circle 219 on reader service card

## unidirection-reversible-start-stop IN 10 MILLISECONDS!



SERIES PC-DA

# HURST

## HEAVY-DUTY SYNCHRONOUS MOTORS

POSITIVE CLUTCH  
INSTANTANEOUS BRAKE

**Series PC-SM 40 inch ounce**  
**Series PC-DA 120 inch ounce**

For extremely fast starts and stops, motor runs continuously with clutch and brake controlled by switching actuator only. This positive clutch will start the output shaft within 10 milliseconds and the brake will stop output shaft within 1/10° at 1 RPM or within 6° at 60 RPM. Other speeds proportional.

Write for complete literature today.

Standard speeds stocked by your local distributor



# hurst MANUFACTURING CORPORATION

PRINCETON, INDIANA • Phone FU5-2564

Circle 225 on reader service card  
Electronics | August 10, 1964

## Technical Abstracts

### Redundant microcircuitry

A self-adaptive triple-redundant flight-control system constructed with integral circuit logic elements.\*  
E.A. Shemeta, Fairchild Space & Defense Systems, Palo Alto, Calif.

To demonstrate the advantages of integral circuits in computers for flight control, the author describes a laboratory model of a redundant system.

Integrated circuitry makes computers simpler, smaller and lighter than in discrete-component systems. It also requires less power and increases the computer's reliability.

In the model described, the control concept is a pre-filter model adaptive system. The model transfer function,  $2/(p + 2)$ , represents the desired aircraft performance. To assure that the model and aircraft responses are essentially the same, the sinusoidal dither generated in the adaptive system approach is compared with a fixed reference. The loop gain is controlled by detecting whether the dither amplitude is above or below the reference level.

The computer used is a digital differential analyzer. The basic components of the system are an increment memory, a magnetostrictive delay line (time-shared register), a diode-matrix network and interconnected adders and multipliers that generate the computer algorithms. A typical operating cycle of the computer is described; the generation of the two fundamental algorithms, an integration algorithm

$$P_i = P_{i-1} - Sdz_{i-1} + (y_{i-1} + dy_1 + dy_2)dx$$

and an addition algorithm

$$P_i = P_{i-1} - Sdz_{i-1} + dy_1 + dy_2$$

are shown. These two algorithms are combined in the computer to perform the computations required by the control system.

The importance of the packaged integral circuits is also demonstrated. The device's package is carefully engineered, fabricated and handled so the reliability improvements inherent in integral-circuit devices are not compro-

mised. The author finds that the integral-circuit package is 50% smaller and 40% lighter than an equivalent version using discrete components. Power consumption and the number of interconnections are reduced by an order of magnitude. In general, the complexity and logical capabilities could easily be doubled or tripled without increasing the size of the system by more than 10%.

### Compact signal source

C-band solid-state klystron.\*  
E. Guthrie, D. Lance, H. Etout, Fairchild Camera & Instruments Corp., Semiconductor division, Mountain View, Calif.

A small, compact solid-state signal source at microwave frequencies can be constructed with properties that will make it rival tubes for the low power local oscillator market. Typical units require three watts for operation with a voltage requirement of 25 volts at 120 mill-ampere. The unit, the size of a baseball, weighs one-half pound and has solid-state reliability and low power drain. This should make it especially attractive for missile applications.

The transistor oscillator doubles the normal fundamental oscillator frequency. The doubling is done by the transistor itself through its collect-to-base junction. An inductance is added to the base circuit whose reactance is negligible at the fundamental frequency. However, at the doubled frequency this inductance, along with a parallel resonant circuit at the fundamental frequency, provides a short circuit which is needed for high efficiency varactor action. An additional parallel resonant circuit is added to provide the proper impedance level for the doubled frequency output. With a quarter wavelength stub as the output circuit and the transistor can imbedded in the stub, the proper tuning is achieved with excellent heat sinking for the transistor.

The desired output microwave frequency of six gigacycles is obtained by a single fifth-order var-

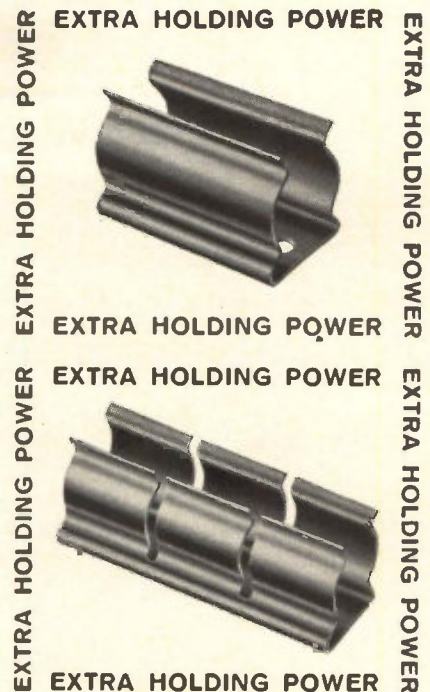

SPECIFY  
**atlee**  
**COMPONENT**  
**HOLDERS**

for  
**EXTRA HOLDING POWER**  
During Severe Shock and Vibration

... because they automatically increase their protective grip during shock and vibration.

Atlee component holders, beryllium copper and spring steel both, have a unique contour design. During shock and vibration, the holders acquire a closer "set" to the component being held. Holding power actually increases over that experienced during static conditions. This is due to the unique shape which has been designed into Atlee component holders. The result is extra holding power during shock and vibration because of increased surface area contact between the component and the holder.

To insure electrical/electronic circuit performance during adverse operating conditions, specify Atlee component holders. They deliver extra mechanical security when you need it.

A complete selection of sizes from 0.154" to 3.25" in diameter, meeting applicable military specifications. Write for our illustrated catalog which gives complete specifications.

**Representatives throughout the U.S.A. and Canada.**

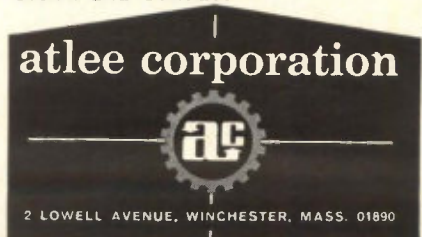

**TWO  
NEW  
MAGNELINE®  
INDICATORS  
FROM PATWIN**



SERIES 12000



SERIES 16000

Subminiature ( $\frac{1}{32}$ " character) Series 12000 and large ( $\frac{1}{16}$ " character) Series 16000 indicators now broaden both ends of Patwin's line. Both of the new series feature the famous Magneline principle for reliability and long life. Like to know more?

Write, or phone 203-756-3636  
for free literature

See us at WESCON—Booth 129

**PATWIN® ELECTRONICS**  
A DIVISION OF THE PATENT BUTTON COMPANY  
WATERBURY, CONNECTICUT · 06720

Circle 220 on reader service card

actor multiplier connected to the oscillator-doubler with doubling occurring from 600 to 1,200 Mc. Frequency stability over the entire bandwidth is about two parts in  $10^3$  from  $-50^\circ\text{C}$  to  $+100^\circ\text{C}$ . Frequency pulling characteristic over the entire band is about one Mc at a six Mc output when the source is terminated in a sliding mismatch of two to one.

\* Presented at the National Aerospace Electronics Conference, May 11-13, Dayton, Ohio.

**Computer-controlled washer**

An all-solid-state home-laundry programmer. George D. Hanchett, Radio Corp. of America, Electronic Components and Devices Dept., Somerville, N.J.

An experimental all-solid-state electronic programmer installed in a popular-brand home washer has demonstrated that improved reliability and flexibility can be obtained. This was achieved by the substitution of solid-state timing and control circuits for the conventional electromechanical circuits.

In an electronic programmer the wash cycle is initiated by the application of d-c power to dividers, spray-rinse circuits and function amplifiers. One of four pushbutton function switches is depressed to select the part of the cycle desired. The cycle selected—super-wash, regular-wash, tub-rinse, or spin-dry—determines the operating point of a shift register and the shift-register circuits to be activated.

Conventional electromechanical programming methods use fixed increments of time to establish cycle periods. For example, if the fixed increment is 60 seconds, and a wash time of 12 minutes is desired, then 12 increments of the timer would be necessary. The experimental solid-state programmer differs in that its basic clock rate is adapted to the functions required. Clock rates may be selected from a minimum of seven and one-half seconds to a maximum of 60 seconds to produce function times from two to 16 minutes by using dividers. The clock rate is automatically controlled by a d-c voltage feedback circuit activated by the shift register.

The low-level output of a shift register is amplified to operate water solenoids, clutch solenoids

introducing  
**DIGI EC DIGITAL  
THERMOMETER**

Digital  
Display of  
Temperature



Accurate to  
0.15°

**\$345<sup>00</sup>**

Portable Model 500

**Featuring:**

- Thermistor Based Instrument—
- Over 15 types of Interchangeable Probes
- Four Integral and Selectable Input Temperature Channels
- Portable or Rack Mounts

**Options:**

- Provision for linear analog output
- BCD output for printer or computer

**Typical Specifications:**

	Model 500	Model 501
Range:	59.0°F to 122.0°F	000.0°C to 100.0°C
Least Significant Digit:	0.1°F	0.1°C
Repeatability:	0.05°F	0.05°C

**Narrow Range Models Available  
(20.00°C or 40.00°F-Span)  
accurate to 0.05°C.**

**UNITED SYSTEMS CORPORATION**  
918 Woodley Road, Dayton 3, Ohio (513) 254-3567

Stocking Reps Throughout the United States, England and Canada

## No matter how you figure it:

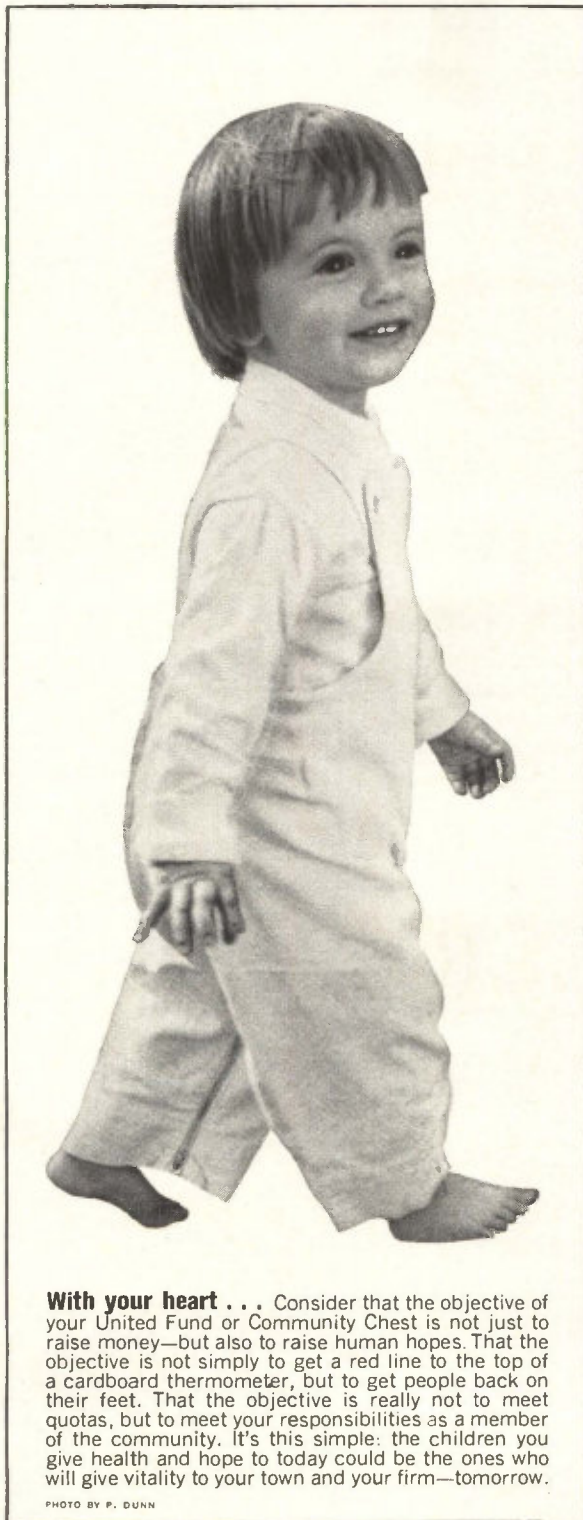

**With your heart . . .** Consider that the objective of your United Fund or Community Chest is not just to raise money—but also to raise human hopes. That the objective is not simply to get a red line to the top of a cardboard thermometer, but to get people back on their feet. That the objective is really not to meet quotas, but to meet your responsibilities as a member of the community. It's this simple: the children you give health and hope to today could be the ones who will give vitality to your town and your firm—tomorrow.

PHOTO BY P. DUNN

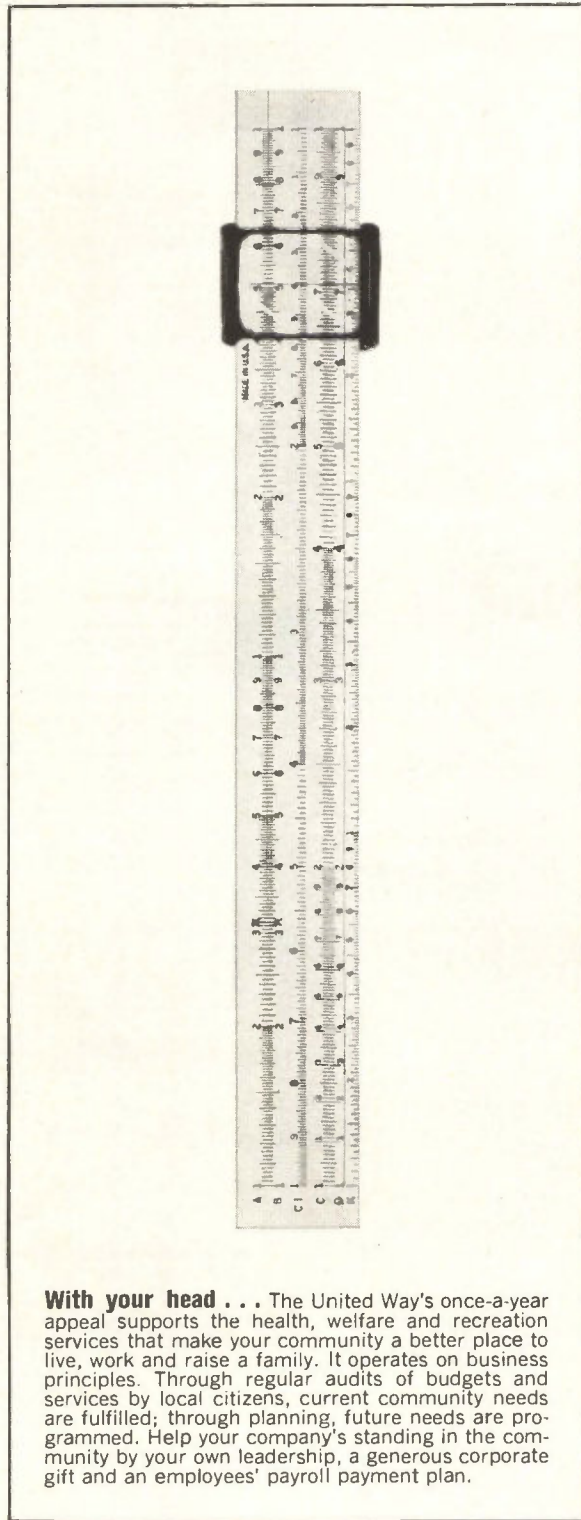

**With your head . . .** The United Way's once-a-year appeal supports the health, welfare and recreation services that make your community a better place to live, work and raise a family. It operates on business principles. Through regular audits of budgets and services by local citizens, current community needs are fulfilled; through planning, future needs are programmed. Help your company's standing in the community by your own leadership, a generous corporate gift and an employees' payroll payment plan.

# Your company should give full support to this year's United Way Campaign!



## BROADBAND STANDARD GAIN HORN ANTENNAS

COVERING THE RANGE...



NOW... AEL brings you a complete family of commercial broadband Standard Gain Horns that meet the requirements of virtually all ANTENNA TEST RANGES operating between 250 mc and 12 Gc. Features include

- Extremely low cross polarization.
- Pattern shaped symmetrically over entire band.
- High gain — 11 to 18 db.

These antennas are easy to mount... they are useful for performing difficult measurement such as axial ratio... they replace cumbersome antennas such as corner reflectors, Yagis, etc.

Send for technical data and prices.



Visit AEL at the WESCON SHOW Booth 2095

**American Electronic Laboratories, Inc.**

P. O. BOX 552, LANSDALE, PENNA.  
(215) 822-2929

and motor contactors. this amplification is more economical than the use of a high-level output to operate the controls directly.

In two-spin cycles, the program of the washer calls for four seven-second spray rinses. Because both spin cycles have two-minute durations and the basic clock-rate interval is seven and one-half seconds, this interval is used for the spray-rinse period. The spray-rinse function is controlled by AND and OR gates. The output signal from the spray-rinse gate activates a flip-flop which controls the water-valve amplifier; the spray is turned on by the output signal of the flip-flop and is turned off by the next output pulse of the clock.

In certain shift-register positions, the water-level switch may be bypassed if desired. Under such conditions, a signal is fed to a pnp control transistor through an OR gate. This action permits an npn transistor to operate and current is allowed to flow to a unijunction relaxation oscillator that forms the clock circuit and the motor-control amplifiers. A diode, in series with the transistor, blocks any reverse potential and prevents its application to the transistor when the water-level switch is in the up, or full, position.

The washer-control circuit for each function is connected to the required shift-register stages through OR gates.

In some wash cycles, it is necessary to bypass certain shift-register positions by adding one pole to the cycle-selector switch.

Because of the present cost and complexity of an all-solid-state programmer, its use in home-laundry equipment is unlikely. However, the experimental programmer contains many features that could find commercial application and acceptance when used in connection with electromechanical techniques.

Presented at the 15th Annual Appliance Conference, IEEE, May 19, Philadelphia.

### Spacecraft data storage

Apollo spacecraft data storage system. Richard C. Collum Jr., Space Systems division, Collins Radio Co., Cedar Rapids, Iowa, and P.M. Bryant, Control division, Leach Corp., Azusa, Calif.

This data storage equipment is part of the Apollo communications and



## WHERE QUALITY COMES FIRST

### MYLAR FILM CAPACITOR

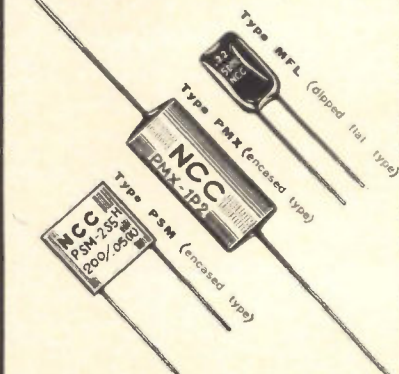

### POLYSTYREN FILM CAPACITOR

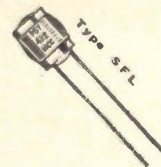

### SOLID TANTALUM CAPACITOR

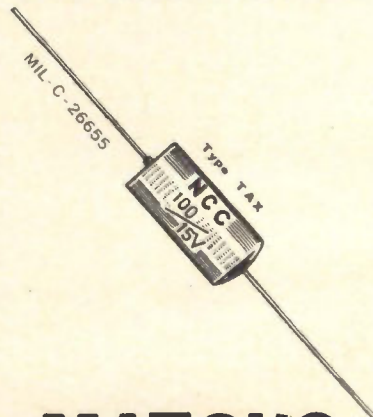

# MATSUO ELECTRIC CO., LTD.

**HEAD OFFICE :**  
3-5, 3-CHOME, SENNARI-CHO, TOYONAKA-SHI, OSAKA, JAPAN.

**TOKYO OFFICE :**  
2B, 2-CHOME, KANDA AWAJI-CHO, CHIYODA-KU, TOKYO, JAPAN.

**Cable Address "NCC MATSUO" OSAKA**



data subsystem, and operates with pulse-code modulation and analog data sources. The equipment records and reproduces five digital and nine analog channels on one-inch mylar tape.

The digital nonreturn-to-zero data is composed of two separate rates, 51.2 and 1.6 kilocycles, plus return-to-zero clock signals of the same two frequencies. The analog data signals are within the spectrum of 50 cycles to 10 kc, with a response of plus or minus two decibels. The equipment is bidirectional; it records and reproduces in both directions.

Three speeds are available: 3.75, 15 and 120 inches per second. No data is recorded at 120 ips; this speed is used to reproduce digital low-bit-rate data recorded at 3.75 ips. Analog data is reproduced only at 15 ips.

The equipment draws 35 watts and weighs about 30 pounds with two reels of tape and one empty reel; the volume is 975 cubic inches. The 51.2-kc data is recorded and reproduced only when the equipment is in the 15-ips mode. The 1.6-kc signal is recorded only at 3.75 ips and reproduced at 120 ips, maintaining an output data rate of 51.2 kc.

The two major problems were flutter under vibration and magnetic-tape deterioration after being subjected to humidity and temperature. Sources of flutter were found to be improper preloading of bearings in the capstan drive components, and insufficient structure in the frame around the reels and head-module support. The main-frame casting was redesigned and made stiffer. All components, such as drive shafts, pulleys, differentials and motors, were redesigned to eliminate the possibility of bearings becoming unloaded while being subjected to the specified environments.

Presented at the National Telemetering Conference, June 2-4, Los Angeles.

### Laser interferometer

Long-distance interferometry with a helium-neon laser.\* F.T. Arecchi and A. Sona. CISE Laboratories, Segrate (Milan), Italy.

Using a Michelson interferometer with a helium-neon continuous-

# TR MICRO TV TUNER

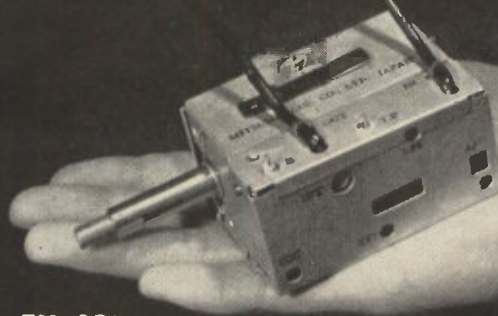

MODEL TU-15U

This MICRO TV TUNER, using 3 transistors, provides you with excellent performance while keeping high quality stability, thanks to our latest technical advancement. Spurious radiation meets the requirements of FCC and is guaranteed for performance of more than 40,000 operations. We also offer you many other lines of components for your use. Please write us asking for catalogs available on the following products:

#### Main Products

Polyvaricon, IF Transformers, Oscillator Coils, Antenna Coils, Variable Resistors, FM Tuners, TV Tuners, Micro-motors, Sockets.



## MITSUMI ELECTRIC CO., LTD.

Head Office Komae, Kitatama, Tokyo, Japan.  
New York Office 11 Broadway, New York 4, N.Y., U.S.A.

Circle 223 on reader service card

## Primo MICROPHONES

A complete line of microphone cartridges and units for the OE market

- Types:                   • Uni-Directional  
\*Velocity               • Crystal           \* Magnetic  
\*Dynamic               • Condenser       \* etc.

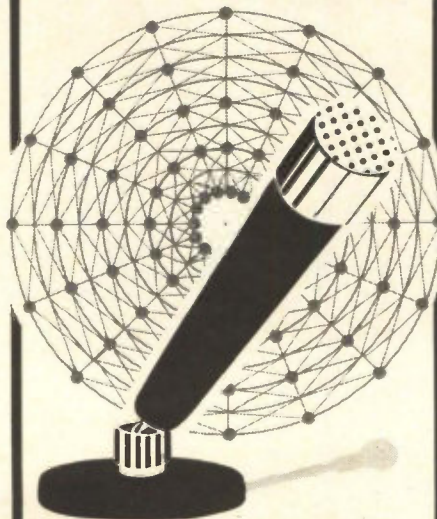

For catalog write to:

**PRIMO CO., LTD.**  
2043 MURE, MITAKASHI,  
TOKYO, JAPAN

Circle 222 on reader service card

For Quality  
Reliability & Price  
Fox Electrolytic Capacitors

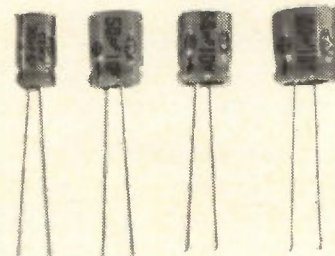

\*Solid Aluminium Capacitors  
\*Solid Tantalum Capacitors  
All Sizes & Types Available.

**FOX ELECTRONICS CO., LTD.**  
Export Dept. 1, 4-Chome  
Honkamata, Ohta-ku, Tokyo  
Head Office: Shiga Pref. Japan

Circle 167 on reader service card

Specialist in

# CUSTOM-BUILT TRANSFORMERS

TO YOUR SPECIFICATIONS

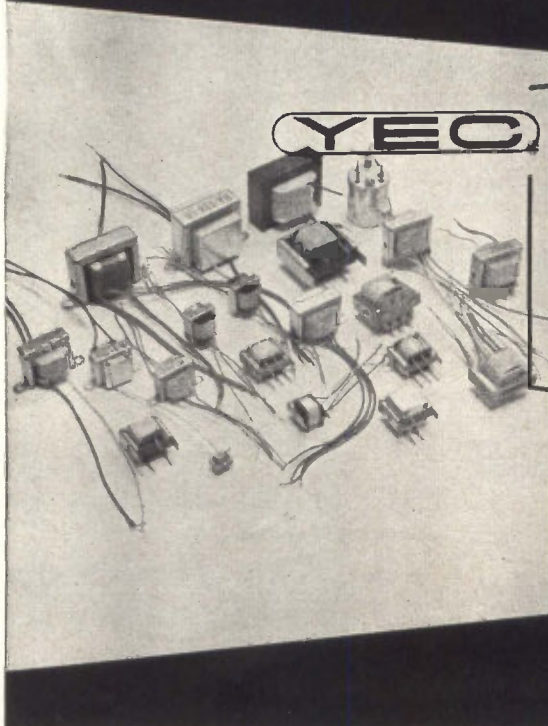

**YECO**

YUTAKA ELECTRIC invites you to submit your detailed specifications and quantity informations to our engineering and production staff.

## YUTAKA ELECTRIC MFG. CO., LTD.

1253, 1-chome, Yutaka-cho, Shinagawa-ku, Tokyo, Japan  
Tel: (04472) 2171-3 Cable Add: "EDOYUTACO" Tokyo

Circle 224 on reader service card

## SHIZUKI CAPACITORS

Injection Polypropylene Resin Molded Metallized Lacquer Film Capacitors (-30°C +85°C)

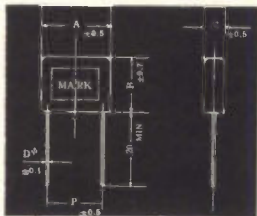

50 volts D.C. Working unit: mm

TYPE	CAP	A	B	C	D	P
PML-0.47/50	*0.47 $\mu$ F	14.0	14.0	5.0	0.6	10.0
PML-0.5/50	0.5 $\mu$ F	14.0	14.0	5.0	0.6	10.0
PML-0.68/50	*0.68 $\mu$ F	19.5	16.0	5.5	0.6	15.0
PML-1.0/50	*1.0 $\mu$ F	19.5	16.0	5.5	0.6	15.0
PML-1.5/50	*1.5 $\mu$ F	24.0	19.0	6.5	0.7	19.0
PML-2.0/50	2.0 $\mu$ F	24.0	19.0	6.5	0.7	19.0
PML-2.2/50	*2.2 $\mu$ F	24.0	19.0	6.5	0.7	19.0
PML-3.3/50	*3.3 $\mu$ F	30.0	20.0	7.0	0.7	25.0
PML-6.8/50	*6.8 $\mu$ F	31.0	23.0	10.0	0.8	25.0

\*STANDARD

- ◇ Lacquer Film Capacitors ◇ Mylar Capacitors
- ◇ Metallized Paper Capacitors for Motor running, fluorescent ballasts ◇ Noise Suppression Capacitors ◇ Ignition Capacitors ◇ Miniature Electrolytic Capacitors

### SHIZUKI ELECTRICAL MFG. CO., LTD.

HEAD OFFICE: TAISHA-CHO, NISHINOMIYA, JAPAN  
CABLE ADDRESS: "CAPACITOR" NISHINOMIYA  
TOKYO FACTORY: 10-7, ARAIYUKU, OTA-KU, TOKYO

# NEW

Packed with more important data than ever before... the 1964-65 issue of **Electronics Buyers' Guide**. Four great major sections: Product Listings; Product Advertising; Index of Electronics Manufacturers; Government, Other Agencies and Technical Services.

# USED

Week in, week out, EBG is the industry's standard catalog-directory... a necessary working tool for the men who buy and the men who sell components, equipment, systems, materials and services.

### Electronics Buyers' Guide

A McGraw-Hill Publication  
330 West 42nd Street,  
New York, N.Y. 10036

wave laser, long-distance interferometry experiments were performed up to an optical path difference of 120 meters without a substantial loss of visibility. Laser wavelength was 6,328 angstrom units.

The experiments showed that a transit time of  $10^{-6}$  seconds between the mirrors is possible with the gas laser. The limitations due to coherence time, elastic fluctuations of the instrument frame, acoustical and thermal fluctuations of the traversed medium, and thermal drifts, also were studied.

An electronic observation system was designed for checking stability and observing interference fringes. The fringes were detected by a pair of multiplier phototubes and counted on a two-channel electronic system. Phase performance of the interferometer was checked using Lissajous patterns on an oscilloscope.

### Submillimeter optics

Interferometric wavelength selection for submillimeter radiometry.\*  
R.A. Williams and W.S.C. Chang,  
Ohio State University, Columbus, Ohio.

A submillimeter-wavelength radiometer receiver for the region between 500 and 1,000 microns is described, consisting of a thermal radiation detector and a Michelson interferometric modulator. This is an optical technique applied to an electromagnetic wavelength region that is particularly difficult to detect, because it occupies only a very small fraction of the power spectrum radiated by a black body.

Two methods are described both theoretically and experimentally: the aperiodic method, in which the input radiation is chopped and the magnitude of the detector output, recorded as the movable mirror of interferometer is slowly moved to produce a graph that records the radiation amplitude; and the periodic method, in which the path length is changed rapidly so that a periodic time output is obtained in the detector. Experimental evidence given shows that the aperiodic method is more successful, although its data must be computer-processed for use.

\* Presented at the International Quasi-Optics Symposium of the Polytechnic Institute of Brooklyn, June 8-10, New York

## QUALIFICATION FORM FOR POSITIONS AVAILABLE

### ATTENTION: ENGINEERS, SCIENTISTS, PHYSICISTS

This Qualification Form is designed to help you advance in the electronics industry. It is unique and compact. Designed with the assistance of professional personnel management, it isolates specific experience in electronics and deals only in essential background information. The advertisers listed here are seeking professional experience. Fill in the Qualification Form below.

#### STRICTLY CONFIDENTIAL

Your Qualification form will be handled as "Strictly Confidential" by Electronics. Our processing system is such that your form will be forwarded within 24 hours to the proper executives in the companies you select. You will be contacted at your home by the interested companies.

#### WHAT TO DO

1. Review the positions in the advertisements.
2. Select those for which you qualify.
3. Notice the key numbers.
4. Circle the corresponding key number below the Qualification Form.
5. Fill out the form completely. *Please print clearly.*
6. Mail to: Classified Advertising Div., Electronics, Box 12, New York, N. Y. 10036.

COMPANY	SEE PAGE	KEY #
AEROSPACE PLACEMENT CORP Phila., Pa.	171	1
ATOMIC PERSONNEL INC. Phila., Pa.	171	2
IBM CORP. Space Guidance Center Owego, New York	171	3
PAN AMERICAN WORLD AIRWAYS INC. Guided Missile Range Div. Patrick Air Force Base, Florida	170	4
PRINCETON UNIVERSITY Princeton, New Jersey	169	5

(cut here)

(cut here)

## Electronics WEEKLY QUALIFICATION FORM FOR POSITIONS AVAILABLE

(Please type or print clearly. Necessary for reproduction.)

#### Personal Background

NAME .....  
HOME ADDRESS .....  
CITY ..... ZONE ..... STATE .....  
HOME TELEPHONE .....

#### Education

PROFESSIONAL DEGREE(S) .....  
MAJOR(S) .....  
UNIVERSITY .....  
DATE(S) .....

#### FIELDS OF EXPERIENCE (Please Check)

81064

- |  |  |                                       |
|--|--|---------------------------------------|
| <input type="checkbox"/> Aerospace           | <input type="checkbox"/> Fire Control        | <input type="checkbox"/> Radar        |
| <input type="checkbox"/> Antennas            | <input type="checkbox"/> Human Factors       | <input type="checkbox"/> Radio—TV     |
| <input type="checkbox"/> ASW                 | <input type="checkbox"/> Infrared            | <input type="checkbox"/> Simulators   |
| <input type="checkbox"/> Circuits            | <input type="checkbox"/> Instrumentation     | <input type="checkbox"/> Solid State  |
| <input type="checkbox"/> Communications      | <input type="checkbox"/> Medicine            | <input type="checkbox"/> Telemetry    |
| <input type="checkbox"/> Components          | <input type="checkbox"/> Microwave           | <input type="checkbox"/> Transformers |
| <input type="checkbox"/> Computers           | <input type="checkbox"/> Navigation          | <input type="checkbox"/> Other .....  |
| <input type="checkbox"/> ECM                 | <input type="checkbox"/> Operations Research | <input type="checkbox"/> .....        |
| <input type="checkbox"/> Electron Tubes      | <input type="checkbox"/> Optics              | <input type="checkbox"/> .....        |
| <input type="checkbox"/> Engineering Writing | <input type="checkbox"/> Packaging           | <input type="checkbox"/> .....        |

#### CATEGORY OF SPECIALIZATION

Please indicate number of months experience on proper lines.

	Technical Experience (Months)	Supervisory Experience (Months)
RESEARCH (pure, fundamental, basic)	.....	.....
RESEARCH (Applied)	.....	.....
SYSTEMS (New Concepts)	.....	.....
DEVELOPMENT (Model)	.....	.....
DESIGN (Product)	.....	.....
MANUFACTURING (Product)	.....	.....
FIELD (Service)	.....	.....
SALES (Proposals & Products)	.....	.....

CIRCLE KEY NUMBERS OF ABOVE COMPANIES' POSITIONS THAT INTEREST YOU  
1 2 3 4 5 6 7 8 9 10 11 12 13 14 15

#### EMPLOYMENT OPPORTUNITIES



The advertisements in this section include all employment opportunities — executive, management, technical, selling, office, skilled, manual, etc.

Look in the forward section of the magazine for additional Employment Opportunities advertising.

#### — RATES —

**DISPLAYED:** The advertising rate is \$52.00 per inch for all advertising appearing on other than a contract basis. Contract rates quoted on request.

An advertising inch is measured 7/8" vertically on a column—3 columns—30 inches to a page.

Subject to Agency Commission.

**UNDISPLAYED:** \$2.70 per line, minimum 3 lines. To figure advance payment count 5 average words as a line.

Box numbers—count as 1 line.

Discount of 10% if full payment is made in advance for 4 consecutive insertions.

Not subject to Agency Commission.

## ELECTRONIC, ELECTRICAL ENGR OR PHYSICIST

PARTICLE ACCELERATOR, Sponsored by the AEC  
Operated by Princeton Univ. & The Univ. of Pennsylvania; located at Princeton Univ.

Stimulating work in a University Program  
of Basic Research

This new basic research tool has a position available in its Electronics Division. A strong, fundamental understanding of electricity & magnetism, coupled with the capability of creative work in the field of electronics is required. A few years experience in circuit design is desirable. Work in suburban Princeton area. Salary comparable to industry. Unusual benefits include 4 weeks vacation and generous retirement plan.

## ACCELERATOR

WRITE TO: A. C. ALLAN  
P. O. BOX 682, PRINCETON, NEW JERSEY  
An equal opportunity employer

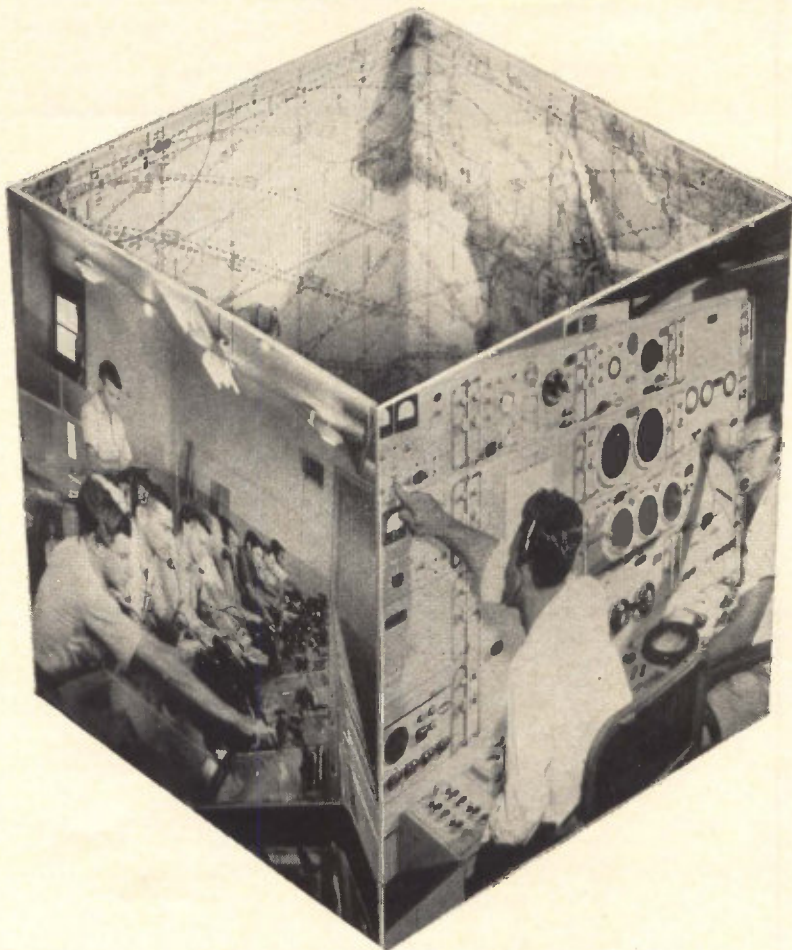

## room sized world!

### 10,000 MILE NETWORK OF COMMAND/CONTROL AND GLOBAL REPORTING IN A 3600 SQ. FT. ROOM.

This is precisely what Pan Am engineers are doing now for the Air Force Eastern Test Range, directing range support from the new Central Control at Cape Kennedy. In this one station, 64 men at 137 consoles will control simultaneously 800 range instrumentation status displays...3 separate countdown and timing systems... 4 missile trajectory plots...3 impact prediction plotters...and link with a worldwide network of communications to ships, planes and range instrumentation stations of the Eastern Test Range and other integrated ranges.

An important adjunct to this facility is the Real-Time Computer Center having a fail-safe dual computer system capability, including 2 CDC 3600's. It will compute instantaneously the impact point of ballistic missiles, the predicted orbit, apogee and perigee of orbiting vehicles, and provide acquisition data for down-range stations.

For the first time independent control of range support for simultaneous countdowns of two missile launchings and ETR support for an orbiting space vehicle will be possible.

On this and other programs providing range support for the nation's space and missile programs...over 40 scheduled in the next five years...assignments are now open in Range Planning, Systems Engineering, Systems Management, and Range Operations for graduate engineers experienced in: Pulse & CW radar / telemetry / infrared / data handling / communications / closed circuit TV / frequency analysis / command control / underwater sound / timing / shipboard instrumentation / meteorology.

Write in confidence to Manager, Professional Employment, Dept. 28H-2.



## GUIDED MISSILES RANGE DIVISION

PAN AMERICAN WORLD AIRWAYS, INC.  
P. O. BOX 4465, PATRICK AIR FORCE BASE, FLORIDA  
An Equal Opportunity Employer

# PINPOINT

## your **RECRUITMENT ADVERTISING**

to the Engineers  
and Technical  
Management men  
in the  
Electronics  
Industry . . .

When you need Engineers—remember this fact: **Electronics** serves thousands of engineers with the latest engineering developments and news of the electronics industry. Engineers read **Electronics** because its high calibre editorial content is *specially designed for them* . . . that's why your Employment advertising in **Electronics** can pinpoint a most concentrated source of experienced engineers. Your **MOST DIRECT LINK** to these qualified men is in the **EMPLOYMENT OPPORTUNITIES** section. For more facts, of placement of your ad,

For Rates and Information Write:

## Electronics

A McGraw-Hill Publication  
Classified Advertising  
Division  
P.O. Box 12, New York  
10036

**EE-MATH**

**CONFIDENTIAL  
SELECTIVE  
FEE-PAID  
ALL DEGREES**

SEND RESUME TO:



**AEROSPACE  
PLACEMENT CORPORATION**  
P.O. Box 2125 Philadelphia, Pa. 19103



**E. E.'s**  
for FEE-PAID Positions  
**WRITE US FIRST!**  
Use our confidential application for professional, individualized service . . . a complete national technical employment agency.  
**ATOMIC PERSONNEL, INC.**  
Suite 1207L, 1518 Walnut St., Phila. 2, Pa.

Advertise  
in these sections  
for fast results . . .



**EMPLOYMENT**

for all employment advertising including Positions Vacant or Wanted and Selling Opportunities Offered or Wanted.

**SEARCHLIGHT**

A national medium for Surplus New or Used Equipment and other Business Opportunities

**PROFESSIONAL SERVICES**

A dignified method for Specialized skills and services

**Act now . . .**

For Rates and Information Write:

**Electronics**

A McGraw-Hill Publication  
Classified Advertising  
Division  
P.O. Box 12, New York  
10036

**SENIOR STAFF EXPANSION:  
SCIENTISTS AND ENGINEERS**

room for  
achievement  
at **IBM**®

**Opportunities:** At all technical staff levels to work on aerospace projects and studies connected with lunar logistics vehicles, computer concepts, reconnaissance surveillance techniques, MOL, MORL, GEMINI, and SATURN I, IB and V.

Expansion of the senior staff at the IBM Space Guidance Center\* in Owego, N. Y., with groups also located at Huntsville, Ala., and Los Angeles, Calif., requires people skilled in the advanced technologies implicit in these R&D areas:

**Creative Mathematics**

- Operations research and analysis
- Space navigation (trajectory and orbital analyses)
- Systems synthesis

**Advanced Systems Design**

- Manned space flight
- Inertial guidance
- Reconnaissance data acquisition and processing
- Flight control systems
- Communications systems

**Advanced Equipment Design**

- Electronic sensors (radar processors)
- Optical/infrared sensors
- Laser systems
- Advanced aerospace computers:
  - Organization
  - Design automation
  - Logic design
  - Thin film circuits
  - Input/Output devices
  - Integrated circuits (semiconductor physics)

**Qualifications:** A scientific or engineering degree in any one of a broad range of disciplines, with related experience in one or more of the areas listed above. IBM is an Equal Opportunity Employer.

Please write, outlining your qualifications and interests to:  
**R. R. Hayden, Manager of Employment, IBM Space Guidance Center, Dept. 554V, Owego, New York 13827.**

\*The Space Guidance Center was built on a 700-acre site in 1957 to contain IBM's defense and space efforts. Current projects include TITAN II and III, MOL, MORL, GEMINI, and SATURN I, IB and V.



# Electronics advertisers

August 10, 1964

■ <b>AMP Incorporated</b> Garceau, Hargrave & McCullough Inc.	49, 102	<b>Heinemann Electric Co.</b> Thomas R. Sundheim Inc.	108	■ <b>Sanborn Co., a Sub. of Hewlett-Packard</b> Culver Adv. Inc.	99
■ <b>Acme Electric Corp.</b> Scheel Adv. Agency	149	■ <b>Hewlett Packard Co.</b> L.C. Cole Company Inc.	12, 13	<b>Sanders Associates</b> Chirurg & Cairns, Inc.	42
■ <b>Adage Inc.</b> Fuller & Smith & Ross Inc.	154	■ <b>Houston Instrument Corp.</b> Cooley & Pate Inc.	145	<b>Sangamo Electric Company</b> Winius-Brandon Company	43, 120
■ <b>Ad-Yu Electronics, Inc.</b> P & G Advertising Agency	162	■ <b>Hughes Aircraft Company</b> Foote, Cone & Belding	138	■ <b>Semi-Elements, Inc.</b> Axelband & Brown Associates	162
■ <b>American Electronic Laboratories, Inc.</b> Benn Associates	166	■ <b>Hurst Mfg. Co.</b> Franklin E. Katterjohn & Co. Inc.	162	<b>Shizuki Electrical Mfg. Co.</b> New Asia Trading News Agency Ltd.	168
■ <b>Amperite Co.</b> H.J. Gold Co.	157	<b>Ichizuka Optical Co., Ltd.</b> Matsushita Inc.	144	<b>Siliconix Incorporated</b> Angus J. Mac Donald & Assoc.	117
■ <b>Assembly Products</b> George Z. Griswold Adv.	123	■ <b>Intercontinental Instruments Inc.</b> Murray Heyert Associates	126	<b>Silicon Transistor Corp.</b> A.D. Adams Adv. Inc.	16
■ <b>Astro-Communication Laboratory</b> Astrodata Inc.	47 11	■ <b>International Instruments, Inc.</b> Thomas R. Sundheim Inc.	151	■ <b>Sorensen</b> Fuller & Smith & Ross Inc.	7
■ <b>Bonfield Associates, Inc.</b> Atlee Corporation	163	■ <b>Japan Electron Optical Laboratory</b> Co., Ltd.	159	■ <b>Spellman High Voltage Co.</b> Chelsea Advertising, Inc.	159
■ <b>Automatic Metal Products Corp.</b> Davon Service Corp.	152	■ <b>Jerrold Corp.</b> Irving Gould Adv. Inc.	113	■ <b>Sprague Electric Co.</b> The Harry P. Bridge Co.	5, 6
■ <b>Bausch &amp; Lomb, Inc.</b> Wolf Associates, Inc.	116	■ <b>Johanson Mfg. Corp.</b> Josephson, Cuffari & Company	153	■ <b>Superior Tube Co.</b> Gray & Rogers, Inc.	133
■ <b>Beckman Instruments Inc.,</b> Offner Division	35	■ <b>Kay Electric Company</b> Josephson, Cuffari & Co.	150	<b>Tektronix Inc.</b> Hugh Dwight Adv. Inc.	19, 20
■ <b>Bliley Electric Co.</b> Barber & Drullard Inc.	136	■ <b>Kingsley Machine Company</b> Nides Cini Advertising Inc.	118	<b>Telonic Industries Inc.</b> Burton Browne Adv.	51
■ <b>Bourns Inc., Trimpot Div.</b> Allen, Dorsey & Hatfield Inc.	9	■ <b>Klein &amp; Sons, Mathias</b> The Buchen Co.	21	<b>Telrex Laboratories</b> George Homer Martin Associates	153
■ <b>Bristol Co., The</b> Chirurg & Cairns, Inc.	132	■ <b>Kyoto Ceramics Co., Ltd.</b> International Ad Service, Inc.	153	<b>Texas Instruments Incorporated</b> Industrial Products Group	124, 125
■ <b>Brush Instruments, Div. of Clevite</b> 3rd Cover Carr Liggett Adv., Inc.	3rd Cover	■ <b>Lambda Electronics Corp.</b> Michel Cather, Inc.	33	■ <b>Tokyo Shibaura Electric Co., Ltd.</b> Hakuhodo Inc.	174
■ <b>Bussmann Mfg. Co.,</b> Div. of McGraw Edison Co.	160, 161	■ <b>Leeson Corp.</b> Chirurg & Cairns, Inc.	137	■ <b>Toyo Electronics Ind., Corp.</b> Dentsu Advertising	148
■ <b>Henderson Advertising Company</b>		■ <b>L E L Incorporated</b> Snow & Depew Advertising	156	<b>Trak Microwave Corp.</b> Clayton & Mohler Adv.	140
■ <b>CTS Corporation</b> Burton Browne Adv.	101	■ <b>Litton Industries, Data Systems Div.</b> West, Weir & Bartel, Inc.	130	■ <b>Trygon Electronics</b> Carpenter, Matthews & Stewart, Inc.	44
■ <b>Clairex Corp.</b> S. Paul Sims Co.	144	■ <b>Loral Electronics Corp.</b> Pritchard, Wood Incorporated	127	<b>United Systems Corporation</b> Advertising And Merchandising Inc.	164
■ <b>Clifton Precision Products Div. of</b> Litton Precision Products Inc.	57	■ <b>Machlett Laboratories Inc., The</b> Fuller & Smith & Ross Inc.	8	■ <b>Vitramon, Inc.</b> Ted Sommers, Inc.	41
■ <b>Cohn, Sigmund Corp.</b> William G. Seldenbaum & Co.	136	■ <b>Mallory &amp; Co. Inc. P.R.</b> The Aitkin-Kynett Co.	122	<b>Wakefield Engineering Inc.</b> Sales Promotion Services	156
■ <b>Daven, Div. of McGraw Edison</b> Keyes, Martin & Co.	22	■ <b>Marconi Instruments</b> Armand Richards Adv. Agency	118	■ <b>Wayne George Corp.</b> L.K. Frank Co. Inc.	143
■ <b>Davies Molding Co., Harry</b> Sander Rodkin Adv. Agency, Ltd.	156	■ <b>Matsuo Electric Co., Ltd.</b> Asahi Advertising Agency & Co.	166	<b>Welch Scientific Co., The</b> Armstrong Adv. Agcy. Inc.	146
■ <b>Delco Radio</b> Campbell-Ewald Company	39	■ <b>McGraw-Hill Book Co. Inc.</b>	146	<b>Wells Electronics Inc.</b> Weco Adv.	118
■ <b>Di-Acro</b> Charles E. Brown Adv.	10	■ <b>McLean Engineering Laboratories</b> Healy Adv. Agency	109	<b>Westinghouse Electric Corp.</b> Ketchum, MacLeod & Grove Inc.	14, 150
■ <b>Driver Co., Wilbur B.</b> George Homer Martin Associates	115	■ <b>Mico Instrument Company</b>	148	■ <b>Weston Instruments &amp; Electronics</b> a Div. of Daystrom Inc.	55
■ <b>DuPont de Nemours &amp; Co., Inc., E. I.</b> Batten, Barton, Durstine & Osborn, Inc.	28, 54	■ <b>Micro Switch Div. of Honeywell</b> Batten, Barton, Durstine & Osborn Inc.	48	<b>G.M. Basford Co.</b>	
■ <b>Durant Manufacturing Co.</b> Keck Advertising Agency	139	■ <b>Microdot, Inc.</b> Jones, Maher, Roberts Adv.	56	<b>West Penn Power</b> Fuller & Smith & Ross Inc.	126
■ <b>Dymec Div. of Hewlett Packard Co.</b> L.C. Cole Company Inc.	2	■ <b>Mitsubishi Electric Corp.</b> Hakuhodo Inc.	40	<b>White, S.S.</b> W.L. Towne Co. Inc.	147
■ <b>Electro Instruments Inc.</b> Teawell Inc. Adv.	38	■ <b>Mitsumi Electric Co., Ltd.</b> Dentsu Advertising Ltd.	167	<b>Yutaka Electric Mfg. Co., Ltd.</b> Nichiden Adv., Ltd.	168
■ <b>Electro Motive Mfg. Co. Inc., The</b> Cory Snow Inc.	53	■ <b>Moseley, F.L.</b> L.C. Cole Company Inc.	1		
■ <b>Electro Scientific Industries Inc.</b> Nadler and Larimer Inc.	107	■ <b>NRC Equipment Co.</b> S. Gunnar Myrbeck & Co. Inc.	155		
■ <b>Electronic Engineering Co. of California</b> Compton Advertising, Inc.	24	■ <b>North Atlantic Industries, Inc.</b> Murray Heyert Associates	114		
■ <b>Electronic Modules Corp.</b> Ray Thompson & Associates Inc.	141	■ <b>Ohmite Mfg. Co.</b> The Fensholt Adv. Agency	23		
■ <b>Electronic Specialty Co.</b> Grant Adv., Inc.	58	■ <b>Paktron, Div. Illinois Tool Works</b> Raymond E. Finn & Associates	110, 111		
■ <b>Fairchild Controls Corp.</b> Dunwoode Associates Inc.	100	■ <b>Patwin Electronics Co.</b> Graceman Advertising Inc.	164		
■ <b>Fairmount Chemical Co., Inc.</b> G.M. Basford Co.	159	■ <b>Permag Corp.</b> Schneider Allen Walsh Inc.	148		
■ <b>Fluke Mfg. Co., Inc., John</b> Pollock & Loth, Inc.	26, 27	■ <b>Philco a Sub. of Ford Motor Co.</b> Maxwell Associates, Inc.	25		
■ <b>Foxboro Co., The</b> Reach, McClinton & Humphrey Inc.	131	■ <b>Polaroid Corporation</b> Doyle, Dane, Bernbach Inc.	37		
■ <b>Fox Electronics Co., Ltd.</b> Nichiden Adv. Ltd.	167	■ <b>Primo Co., Ltd.</b> General Adv. Agency	167		
■ <b>Fujitsu, Limited</b> Hakuhodo Inc.	134	■ <b>Radiation Inc.</b> G.M. Basford Company	52		
■ <b>General Precision, Librascope Div.</b> Weekley and Valenti, Inc.	142	■ <b>Radio Corporation of America</b> Al Paul Lefton Co.	4th Cover		
■ <b>General Radio Co.</b> K.E. Morang Co.	2nd Cover	■ <b>Radio Materials Co.,</b> Div. of P.R. Mallory & Co.	135		
■ <b>Globe Industries Inc.</b> Odiorne Industrial Adv. Inc.	129	■ <b>Rosenbloom, Elias &amp; Associates</b>			
■ <b>Gudebrod Bros. Silk Co., Inc.</b> Lee Ramsdell & Co. Inc.	128	■ <b>Reeves Hoffman, Div. of</b> Dynamics Corp. of America	50		
		■ <b>Adams Associates, Inc.</b>			
		■ <b>Republic Foil Inc.</b> John S. Kemble Advertising	158		

■ For more information on complete product line see advertisement in the latest Electronics Buyers' Guide

## Classified advertising

F.J. Eberle, Business Mgr.  
[212] 971-2557  
**Employment Opportunities** 169-171  
Equipment  
(Used or Surplus New)

## Classified advertisers index

For Sale	172
A & Electronics Corp.	172
Aerospace Placement Corporation	171
Atomic Personnel Inc.	171
Barry Electronics	172
Engineering Associates	172
Belling, George	172
Engineering Associates	172
International Business Machines	171
Keystone Electronics Corp.	172
Lifschultz Fast Freight	172
Pan American World Airways Inc.	170
Princeton University	169
■ Radio Research Instrument Co.	172
Transistors Unlimited Company	172
■ Universal Relay Corp.	172
Waldron, A. James	172

Executive, editorial, circulation and advertising offices: McGraw-Hill Building, 330 West 42nd Street, New York, N.Y., 10036. Telephone Area Code 212-971-3333. Teletype TWX N.Y. 212-640-4646. Cable: McGrawhill, N.Y. Offices of the Publications Division: Shelton Fisher, President; Vice Presidents: Joseph H. Allen, Operations; Robert F. Boger; Administration: John R. Callahan, Editorial; Ervin E. DeGraff, Circulation; Donald C. McGraw, Jr., Advertising Sales; Angelo R. Venezian, Marketing. Officers of the Corporation: Donald C. McGraw, President; Hugh J. Kelly, Harry L. Waddell, L. Keith Goodrich, Executive Vice Presidents; John L. McGraw, Treasurer; John J. Cooke, Vice President and Secretary. Title R registered U.S. Patent Office. © copyright 1964 by McGraw-Hill, Inc. All rights reserved, including the right to reproduce the contents of this publication, in whole or in part.

# Toshiba— the ideal mechano- electronic transducer— Because it's versatile

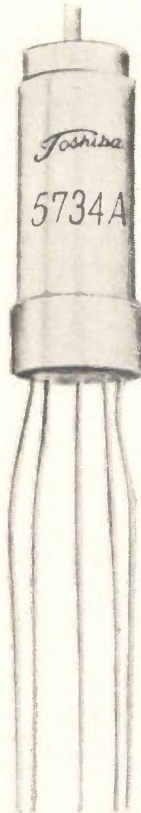

Metran-A Toshiba-made Mechano-Electronic Transducer 5734A heater-cathode medium-mu triode, metal shell, ceramic stem, no glass parts.

Experience: Excellent record as pickup component in pressure and strain gauges, roughness indicators, vibration meters, tachometers; also engine analyzers. If you find any other uses for Metran-A we'd like to hear from you.

## TYPICAL OPERATION AND CHARACTERISTICS

DC plate supply voltage	300 V
DC grid voltage	0 V
Amplification factor	20
Plate resistance	72 K $\Omega$
Transconductance	275 $\mu$ S
DC plate current	1.5 mA
Load resistance	75 K
Deflection sensitivity	40 V/degree 2300 V/radian
Moment of inertia of plate	3.4 milligram cm
Rotational compliance of diaphragm	0.013 $\times$ 10 <sup>-3</sup> radian/dyne cm 0.075 degree/gram cm
Resistance to thermal shock	300°C
Durable under high ambient temperature	300° Max.
Impact resistance	500 G
Mechanical vibration resistance	10 G
KC measurement	over 10 KC

For information: **TOSHIBA Foreign Trade Division,**  
Hibiya Mitsui Bldg., Yurakucho, Tokyo  
New York Office: 530 Fifth Ave., New York 36, N.Y.

**Toshiba**  
QUALITY SINCE 1875

Tokyo Shibaura Electric Co., Ltd. Tokyo, Japan



## Advertising sales staff

**Gordon Jones:** [212] 971-2210  
Advertising sales manager

**Atlanta, Ga. 30309:** Gus H. Krimsier,  
Michael H. Miller, 1375 Peachtree St. N.E.,  
[404] TR 5-0523

**Boston, Mass. 02116:** William S. Hodgkinson,  
McGraw-Hill Building, Copley Square,  
[617] CO 2-1160

**Chicago, Ill. 60611:** Robert M. Denmead,  
Daniel E. Shea, Jr., 645 North Michigan  
Avenue, [312] MO 4-5800

**Cleveland, Ohio 44113:** Paul T. Fegley, 55  
Public Square, [216] SU 1-7000

**Dallas, Texas 75201:** Dick Poole, The  
Vaughn Building, 1712 Commerce Street,  
[214] RI 7-9721

**Denver, Colo. 80202:** John W. Patten, David  
M. Watson, Tower Bldg., 1700 Broadway,  
[303] AL 5-2981

**Houston, Texas 77025:** Kenneth George,  
Prudential Bldg., Halcombe Blvd.,  
[713] RI 8-1280

**Los Angeles, Calif. 90017:** Ashley P.  
Hartman, John G. Zisch, 1125 W. 6th St.,  
[213] HU 2-5450

**New York, N.Y. 10036:**  
Donald R. Furth [212] 971-3616  
Frank LeBeau [212] 971-3615  
George F. Werner [212] 971-3617  
500 Fifth Avenue

**Philadelphia, Pa. 19103:** William J. Boyle,  
Wafren H. Gardner, 6 Penn Center Plaza,  
[215] LO 8-6161

**San Francisco, Calif. 94111:**  
James T. Hauptli, 255 California Street,  
[415] DO 2-4600

**London W1:** Edward E. Schirmer, 34 Dover  
Street

**Frankfurt/Main:** Matthee Herfurth, 85  
Westendstrasse Phone: 77 26 65 and  
77 30 59

**Geneva:** Michael R. Zeynel,  
2 Place du Port 244275

**Paris VIII:** Denis Jacob, 17 Avenue  
Matignon ALMA-0452

**Tokyo:** Shigeo Chiba, 1, Kotohiracho,  
Shiba, Minato-ku (502) 0656

**Osaka:** Kazutaka Miura, 163, Umegae-cho,  
Kita-ku [362] 8771

**Nagoya:** International Media  
Representatives, Yamagishi Bldg.,  
13,2-Chome, Oike-cho Naga-ku

**R.S. Quint:** [212] 971-2335  
General manager  
Electronics Buyers' Guide

**David M. Tempest:** [212] 971-3139  
Promotion manager

**Richard J. Tomlinson:** [212] 971-3191  
Business manager

**Theodore R. Geipel:** [212] 971-2044  
Production manager



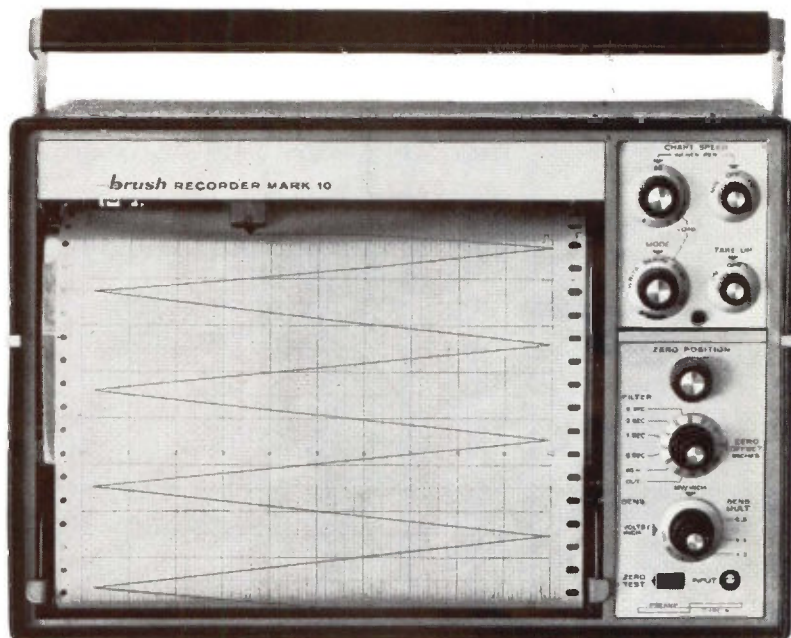
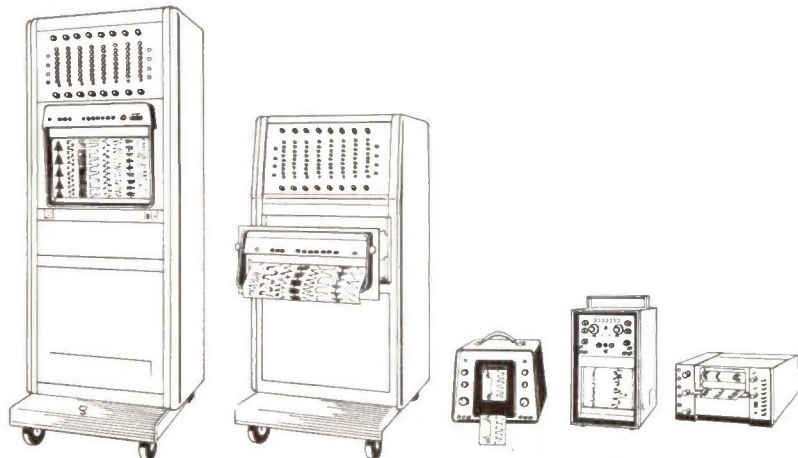

**Mark 10**  
newest addition to  
the Brush line

# A new strip chart recorder that's all solid state... even the ink!

A solid capsule is the ink supply in this new 10" servo-type recorder. Heated to flow freely from the pen . . . it dries instantly on contact with the paper. Modular electronic and mechanical assemblies simplify operation and maintenance. In addition, you have the complete flexibility of plug-in units. Check out these performance facts . . .

**Full scale span of 5 mv to 200 volts in 15 steps**

**Zero positioned to within 0.1%**

**Zero suppression—up to 10 full scales**

**Selectable input signal filtering**

**Accepts common mode voltages up to 500 volts**

**140 db common mode rejection**

**1 megohm input impedance**

**10 chart speeds**

*Call Brush collect for complete details: 216-361-3315.*

On display at WESCON—  
Booth 1225-26

**brush** INSTRUMENTS  
DIVISION OF CLEVITE 37th AND PERKINS, CLEVELAND 14, OHIO

Circle 901 on reader service card

# RCA SILICON CONTROLLED RECTIFIERS

## Cover your most important current requirements

	5 Amp $I_{FRMS}$	For 120-volt Across-the-line Applications	2N3228
<b>NEW IN RCA's GROWING LINE</b>			
	7.4 Amp $I_{FRMS}$	25-500 $V_{RM}$ (rep)	2N1770-78
	16 Amp $I_{FRMS}$	25-500 $V_{RM}$ (rep)	2N1842A-50A
	25 Amp $I_{FRMS}$	25-600 $V_{RM}$ (rep)	2N681-90

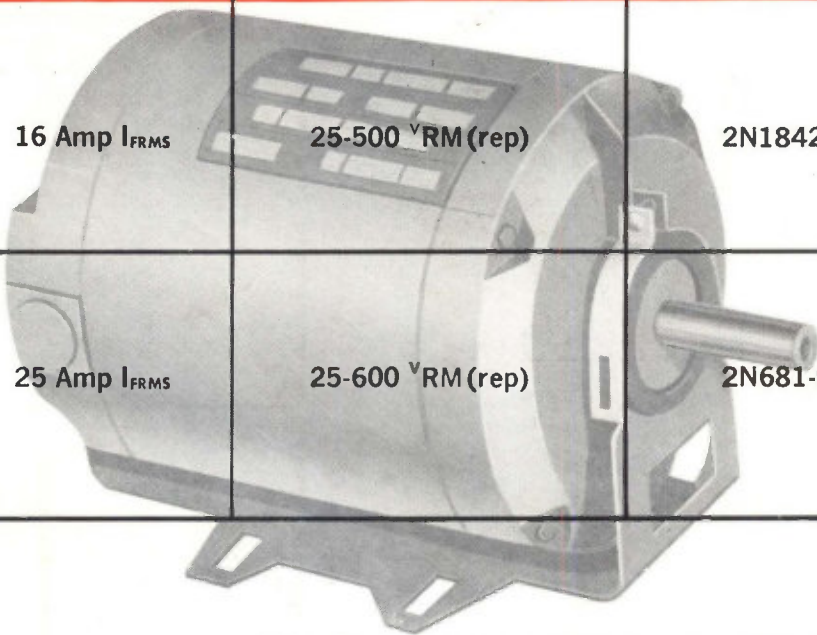

### Case, Current, Voltage...PLUS Full Name-Plate Rating Operation

A new family of SCR's—RCA-2N1770-78—joins the growing, high-performance line of RCA Silicon Controlled Rectifiers. With rated current handling capability of 4.7 amps average value, these nine units, like all RCA Silicon Controlled Rectifiers, contain the extra design features for operation at full name-plate ratings.

RCA-2N1770 family is designed for your applications in switching and phase control, solenoid drive, and other relaying and control applications in military, industrial and commercial systems. Try the new RCA-2N1770 in

your own circuit design. Write for a sample on your company letterhead; just specify the voltage you need.

See your RCA Representative for complete price and delivery information on this family and other RCA Silicon Controlled Rectifiers. Specify the case, the voltage, and the current you need.

For your copy of Application Note SMA-34 on the application of RCA-2N3228 to series-wound motors or for a technical bulletin on RCA-2N1770-78 write: Commercial Engineering, Section IN8-1, RCA Electronic Components and Devices, Harrison, N. J.

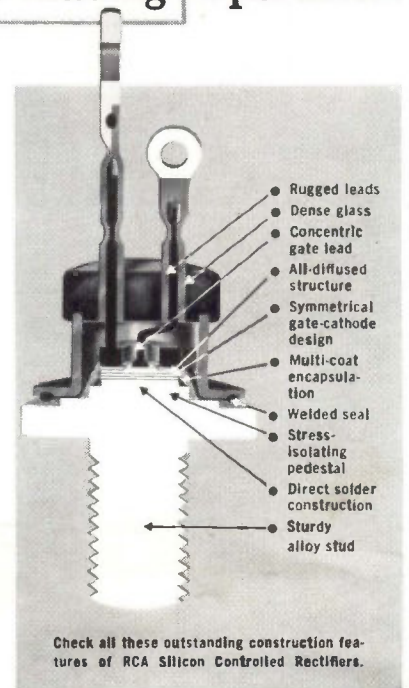

**The Most Trusted Name in Electronics**