

electronics®

A MCGRAW-HILL PUBLICATION 75 CENTS FEBRUARY 7, 1964

SPECIAL REPORT

MODERN ELECTRONICS PACKAGING

C 10-

ROLAND KISSLER
BOX 956
MOSES LAKE WASH

the **GREATEST** sweep flexibility

the **HIGHEST** accuracy

the **EASIEST** to use—
a new family of advanced sweep frequency sources from Hewlett-Packard

Today's most advanced sweep oscillators are offered in a new Hewlett-Packard series being introduced with the 691A,B (1 to 2 gc) and the 692A,B (2 to 4 gc). Unique features are combined in the instruments to make them the most flexible, easiest to use, most accurate sweepers available.

Two independent pairs of controls fix the end-points of the frequency sweeps. One pair sets the sweep limits on the slide rule scale and determines the sweep obtained by pressing the Start-Stop pushbutton; the digital controls produce (1) calibration markers for the Start-Stop sweep or (2) an independent sweep in the Marker Sweep function.

Three separate sweeps

Thus, if the broad Start-Stop sweep reveals a particular area of interest and the marker controls are used to locate that area, simple depression of the Marker Sweep button will expand it to full scale on an oscilloscope or recorder. The two independent sweeps may also be switched rapidly for testing different characteristics of a device or circuit. Either sweep may be set anywhere in the frequency range to cover any portion of the range—and the oscillators will sweep up or down, depending only on the setting of the start point in relation to the stop.

Besides sweeping from a start to a stop frequency, the oscillators will provide a symmetrical sweep about a center frequency. It's as easy as pressing the ΔF button, setting the center frequency with the CW control and adjusting the total frequency deviation with the calibrated

ΔF control. The total swing as indicated on the bottom slide rule dial is accurate to $\pm 20\%$ of ΔF in the 691 or $\pm 10\%$ of ΔF in the 692. Further, with the Sweep Selector in the CW position, rf output is provided at the frequency indicated by the CW pointer . . . for use in single frequency applications. The cw frequency can be accurately set to ± 10 mc and has less than 30 kc residual FM.

Unique with the 691/692 series is the Manual Sweep, which permits detailed investigation of a localized area of interest at the operator's convenience. More importantly, x-y recorder horizontal zero and span can be set in seconds using this control.

Sweep speeds, accuracy

In the automatic position of the Sweep Selector, recurrent sweeps are provided. Sweep speeds are continuously adjustable in four decade ranges, 0.01 to 100 seconds. Sweep also may be synced with line frequency.

For oscilloscope presentation, the output power is on except during retrace, producing a zero baseline and eliminating transients at the start of the sweep; for convenient x-y recorder presentation, an automatic pen lift circuit is provided on the two slowest sweeps. A sawtooth voltage for scope and recorder sweep is provided concurrent with the swept rf output.

Accuracy of these sweep oscillators is another indication of their superiority. Start-Stop frequency accuracy is ± 10 mc over the entire range. The same accuracy is provided over the entire range of the Marker Sweep. Marker accuracy itself, as well as accuracy of rf output in cw operation, is also ± 10 mc.

Modulation

Modulation is pushbutton selected, too, offering a choice of external AM or FM, plus an internal square wave modulator with a range of 800 to 1200 cps and on-off ratio greater than 20 db. PIN diode modulators are incorporated in the "B" models. By absorbing rf power in response to the modulating signal, these PIN modulators overcome frequency pulling and other effects normally resulting from modulation applied to BWO grids. The "A" models in the series use conventional grid modulation for less demanding applications.

The power level control, used to attenuate the rf output over a 30 db range when the leveler is not operating, becomes a level set control with at least a 10 db range when the Automatic Level Control (ALC) pushbutton is depressed.

Internal, external leveling

Two options are offered to provide level power output in these sweep oscillators, each of which incorporates a leveling amplifier.

External closed loop leveling is accomplished by driving the amplifier from a signal detected at the system point where constant power is desired. This technique has the distinct advantage of eliminating transmission variations with frequency between the oscillator and the test point. It provides the leveled output precisely where it is needed. Leveled power variation here is a maximum of ± 0.1 db, plus coupler and detector variation (± 0.2 db using hp 780 series directional detector).

For less critical applications, where the effect of transmission variations between oscillator and test point is not significant or a package free from external elements is desired, internal leveling is offered. Power variation in this configuration is a maximum of ± 0.3 db.

These features, plus high power output, the versatility of modular cabinet, and the dependability of Hewlett-Packard design, construction and conservative specifications, add up to a series of sweep oscillators unparalleled in performance, convenience and ability to help you with your measuring task. Call your Hewlett-Packard field engineer today for complete details and for a demonstration of the 691 or 692 that can satisfy your measuring needs.

Put it all together:

Model	Power Output	Modulation	Price*
691A	60 MW or greater	BWO grid	\$3500
691B	40 MW or greater	PIN diode	\$3800
692A	60 MW or greater	BWO grid	\$3300
692B	40 MW or greater	PIN diode	\$3600

*Option 01, internal leveling, add \$275

Data subject to change without notice. Prices f. o. b. factory.

**HEWLETT
PACKARD
COMPANY**



8781

1501 Page Mill Rd., Palo Alto, California 94304, (415) 326-7000. Sales and service in all principal areas. Europe, Hewlett-Packard S.A., 54 Route des Acacias, Geneva, Switzerland; Canada, Hewlett-Packard (Canada) Ltd., 8270 Mayrand St., Montreal, Quebec.

an invitation to comparison:

The new hp 691/692 Series Sweep Oscillators offer:

- Three types of automatic sweeps—Start-Stop wideband sweep; expanded sweep between marker settings; symmetrical calibrated ΔF sweep, to 10% of full band
- New convenience for scope and x-y recorder presentation—exclusive manual sweep; improved retrace blanking; automatic pen lift
- PIN diode attenuator for leveling and modulation
- Accurate, stable cw output
- CW end point and marker calibration accuracy ± 10 mc across the band
- Today's most accurate leveling, external or internal
- Digital marker readouts for easy setting
- Pushbutton controls for sweep functions, AM, leveling

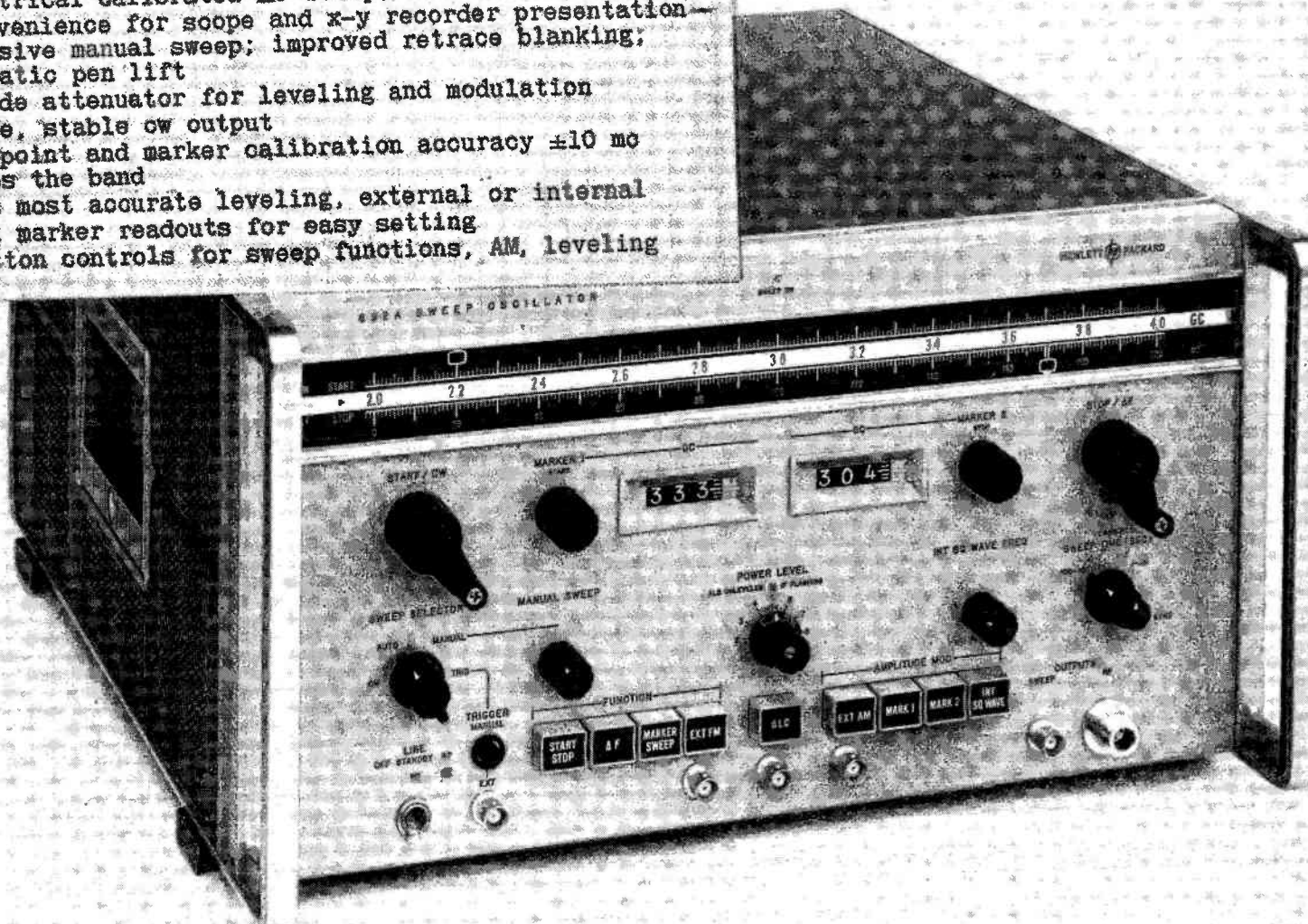

Model 692A Microwave Sweep Oscillator



INTER-OFFICE CORRESPONDENCE

FROM Sales Promotion Department

DATE 17 Sept. 1963

TO Agency Copy Department

SUBJECT 691/692 Microwave Sweep Oscillators

automatic "marker" expansion of basic sweep segment

Following are some of the major features we would like to present in telling the story of the new 691/692 series oscillators:

1. Flexibility: More versatile than any other sweep oscillators available today
2. Three types of automatic sweeps: Start-Stop wideband
Expanded between marker settings
Symmetrical, calibrated ΔF
3. Scope, x-y recorder capabilities: Manual sweep
Improved retrace blanking
Automatic pen lift
4. PIN diode attenuator for leveling and modulation
5. +10 mc accuracy across the band for cw, endpoint, marker calibration
6. Accurate, stable cw output
7. Convenience: Digital marker readouts
Pushbutton controls for sweep functions, AM, leveling

manual sweep exclusive

accuracy spec covers entire band

IDEA: Invite comparison of all these features with any other instrument.



Use big photo to show convenient controls!

TURN THE PAGE FOR DETAILS

LEWIS H. YOUNG, Editor
Dial Direct: (971-2645)
Area Code 212

J. M. CARROLL, Managing Editor (2293)

SENIOR EDITORS
Samuel Weber (2371)
George W. Sideris (3444)

SENIOR ASSOCIATE EDITORS
Michael F. Wolff (2600)
John F. Mason (2666)

ASSOCIATE EDITORS
Michael F. Tomaino (2071)
William P. O'Brien (2297)
George J. Flynn (2188)
George V. Novotny (3151)
Leon H. Dulberger (3446)
Alexander A. McKenzie (2685)

ASSISTANT EDITORS
Stephen B. Gray (2245)
Barry A. Briskman (2306)
Dan Smith (2467)
Joel A. Strasser (2127)
Vincent S. Acunto (2592)
C. R. Whetstone (3495)
Eric Valentine (2710)
Louis S. Gomolak (2472)
G. G. Tirellis (2187)

REGIONAL EDITORS
Harold C. Hood,
1125 W. 6th St., Los Angeles 90017, Calif.
(213-482-5450)
Laurence D. Shergalis,
John Hancock Bldg., 255 California St.,
San Francisco 94111, Calif. (415-362-4600)
Thomas Maguire
McGraw-Hill Bldg., 607 Boylston St.,
Boston 02116, Mass. (617-262-1160)
Cletus M. Wiley,
Blair Bldg., 645 N. Michigan Ave.,
Chicago 60611, Ill. (312-664-5800)

ART DIRECTOR
Howard R. Berry (2430)

ASSISTANT ART DIRECTOR
John C. Wright, Jr. (3430)

EDITORIAL ASSISTANTS
Lorraine Rossi, Virginia T. Bastian,
Lynn Emery, Ann Mella, Lorraine Werner,
Alice M. Moyer, Sharon Parks,
Claire Benell, Kay Fontana,
Sandra A. Le Mond, Mary Jo Jadin

FOREIGN NEWS BUREAU
DIRECTOR, John Wilhelm, (2532);
Lawrence Minton (2997), Alynne Elias
(2998)

LONDON—John Shinn, Derek Barlow,
Nicholas Landon, 34 Dover St., London
W.1, England

BONN—Richard Mikton,
Silke McQueen, Mittelstrasse 39, Bad
Godesberg, Germany
BRUSSELS—Arthur Erikson, 27 Rue Ducarle,
Brussels, Belgium

PARIS—Robert Farrell, 17 Ave. Matignon,
3rd Fl., Paris 8, France

MILAN—Bruce Bendow, Via Manzoni
No. 12, Milan, Italy

MEXICO CITY—Wesley Perry, Jr.,
Lafraqua 4-314, Mexico 1 D.F. Mexico

RIO DE JANEIRO—Leslie Warren, Rua
Mexico 3-S/1507 1509, Rio de Janeiro,
Brazil

MOSCOW—Donald Winston,
Kutuzovskiy Prospekt 19, Apt. 28-29,
Moscow, USSR

TOKYO—Richard Halloran, Charles Cohen,
John Yamaguchi, Toranomom Sangyo
Bldg., 1 Kotohiracho Shiba, Minato-Ku,
Tokyo, Japan

CIRCULATION MANAGER
Hugh J. Quinn (2310)

C. C. RANDOLPH, Publisher (3996)

electronics

A MCGRAW-HILL PUBLICATION 75 CENTS

ELECTRONICS PACKAGING. Microelectronics solves a lot of problems but it raises some too. For one thing: how do you hook on to these little critters? On our cover a Burndy VPC printed circuit connector is shown used with an RCA micromodule package. *See p 33 for a completely new look at the art of electronics packaging* **COVER**

THE NEW DEFENSE BUDGET. Even though the total defense budget for fiscal 1965 remains almost constant, weapons procurement is dropping almost \$2 billion. The shift away from strategic weapons procurement accelerates, as the Pentagon earmarks more money for general purpose forces. RDT&E money is falling off, too. *Still, an impressive amount of procurement and development involving electronics is in being or planned. Here's a concise summary* **10**

SPECIAL REPORT: MODERN ELECTRONICS PACKAGING.

The art of physically locating, connecting and protecting electronic devices or components is known as packaging. And it is every bit as important as the electrical design of a system. This special report deals with techniques for interconnection, and means of coping with hostile environments. *There is special emphasis on cooling and encapsulation as well as on the new problems raised by microelectronics.* **By A. A. McKenzie 33**

CLEAR-AIR TURBULENCE. This insidious air condition can cause death, heavy damage or severe discomfort. And it gives no visible warning. Existing techniques are inadequate to protect even present-day aircraft. New devices must certainly be devised to protect supersonic transports. *The devices may be radar, infrared or microwave radiometers, lasers or combinations.* **By A. A. McKenzie 49**

SAMPLING TEN MILLION WORDS A SECOND. Video encoder used on an Army missile range slices thirty samples out of each incoming pulse. Samples are taken at a maximum rate of one every 0.1 microsecond. Duration of the incoming pulse may range from 0.1 to 30 microseconds. *Sample values are held then converted to binary form.* **By A. Hakimoglu and R. D. Kulvin, Dynaplex Corp. 52**

H-SHAPED CERAMIC FILTER. New mechanical filter achieves narrow passband characteristics in the frequency range from 100 kc to 1 Mc. *Polarized ceramic plates of barium-lead-calcium titanate cemented to two coupled rectangular plates of Elinvar make up the H-shaped component.* **By M. Kawakami, Tokyo Univ., H. Tsuchiya, Shinshu Univ., and H. Maeda, Toko Radio Coil Labs. 55**

Published weekly, with Electronics Buyers' Guide as part of the subscription, by McGraw-Hill, Inc. Founder: James H. McGraw (1860-1948).

SUBSCRIPTIONS: Available only by paid subscription. Publisher reserves the right to refuse non-qualified subscriptions. Subscriptions to Electronics solicited only from those actively engaged in the field of the publication. Position and company connection must be indicated on subscription orders forwarded to address shown below. Subscription rates for individuals in the field of the publication: U. S. and possessions and Canada \$6 one year, \$9 two years, \$12 three years (single copies 75¢). All other countries \$20 one year (single copies \$1.50).

EXECUTIVE, EDITORIAL, CIRCULATION and ADVERTISING OFFICES: McGraw-Hill Building, 330 West 42nd Street, New York, N. Y., 10036. Telephone Area Code 212, 971-3333. Teletype TWX N. Y. 212-640-4646, Cable McGrawhill, N. Y. Printed in Albany, N. Y. Second class postage paid at Albany, N. Y. Title reg. ® in U. S. Patent Office. Copyright © 1964 by McGraw-Hill, Inc. All Rights Reserved. The contents of this publication may not be reproduced either in whole or in part without consent of copyright owner.

OFFICERS OF McGRAW-HILL PUBLICATIONS: Shelton Fisher, President; Vice Presidents: Joseph H. Allen, Operations; John R. Callahan, Editorial; Ervin E. DeGraff, Circulation; Donald C. McGraw, Jr., Advertising Sales; Angelo R. Venezian, Marketing.

CORPORATION OFFICERS: Donald C. McGraw, President; L. Keith Goodrich, Hugh J. Kelly, Harry L. Waddell, Executive Vice Presidents; John J. Cooke, Vice President and Secretary; John L. McGraw, Treasurer.

UNCONDITIONAL GUARANTEE: The publisher, upon written request, agrees to refund the part of the subscription price applying to the remaining unfilled portion of the subscription if service is unsatisfactory.

SUBSCRIBERS: Please address all correspondence regarding subscriptions, change of address notices, and subscription orders to Fulfillment Manager, Electronics, P. O. Box 430 Hightstown, N. J., 08520. Change of address notices should be sent promptly; provide old as well as new address; include zip code or postal zone number if any. If possible, attach address label from recent issue. Please allow one month for change of address to become effective.

POSTMASTER: Please send Form 3579 to Fulfillment Manager, Electronics, P. O. Box 430, Hightstown, N. J., 08520.



Audit Bureau of Circulation



Associated Business Publications

Contents continued

REFERENCE SHEET: Graphs Aid Deflection System Design. Here is a rapid method for determining output tube operating conditions in a cathode-ray tube deflection system. *All that is needed is peak-to-peak yoke current, ultor voltage and yoke inductance.* By K. W. Angel, RCA 59

RADIOTELEGRAPH GOES COMPUTER. New center for handling and switching international messages goes into operation early this year. *Computer equipment will slash delay time, with speed to spare for future improvements in transmission equipment* 64

OPTICAL SWITCHING. Series of crystal pairs routes laser or light beams to exact positions on a screen. *Applications in computers and data displays are predicted* 67

LUNAR LANDING RADAR. Ticklish job of aiding the Lunar Excursion Module to a soft-landing on the moon goes to a four-beam radar system. *Three-beam doppler will measure velocity while the fourth beam gets the altitude* 70

COMPUTER CONTROL. Two digital computers will control blast furnaces and oxygen converters at Japanese steel plant. *The owners aren't completely sold, however; they're putting in a control panel to watch the computer control* 73

DEPARTMENTS

Crosstalk. A Moose Is a CPFF Mouse 5

Comment. Transistor-Radio Jammer. Communications Range Nomograph 6

Electronics Newsletter 17

Meetings Ahead. Spring URSI Meeting and Symposium On Solar-Terrestrial Relationships 18

Washington This Week. FCC May Swing Tax Stick to Beat VHF-Tv Stockpilers 20

Research and Development. Receiver Design Technique Cuts Synchronization Time 74

Components and Materials. Equipment Makers Push Thin-Film Microcircuits 80

Production Techniques. Ferrites: Can They Be Deposited as Thin Films? 84

New Products. Oscillator Improves 1-Mc Standards 89

Literature of the Week 103

People and Plants. Littlefuse Opens \$1.75-Million Plant 105

Index to Advertisers 110

4-INPUT NAND GATES

- D-C stability
700 mv, FO = 5, $T_A = -25^\circ\text{C}$
500 mv, FO = 5, $T_A = 125^\circ\text{C}$
300 mv, FO = 15, $T_A = 125^\circ\text{C}$
on power gate
- Single power supply
- Propagation delay — 18 nsec
- Fan — in
4 per gate
10 with expander on single gate
- Power drain per gate — 7 mw

SINGLE
\$12

DUAL
\$18

DUAL-POWER
\$21

COUNTER, SHIFT-REGISTER CIRCUIT

- Clock rate up to 10 mc
- Single phase, synchronous or non-synchronous
- Direct-coupled, same static characteristics as gates
- 6 Logic inputs
- 2 Direct-set inputs

\$29

6 DIODE ARRAY

- 6 common-anode diodes
- Gate input expander
- Same characteristics as gate diodes

\$7

DUAL GATE LINE DRIVER

- For driving capacitive loads
- Propagation delay — 12 nsec
- 4 volt output-swing
- Power drain per gate — 15 mw

\$21

NEW* SILICONIX 10mc DTL INTEGRATED CIRCUITS AT ONE LOW PRICE, IN UNIT QUANTITIES UP TO 1,000

*** PRODUCT, PRICE, AND PRICING PHILOSOPHY**

All available for delivery now in TO-5 cans. Circuits meet MIL-S-19500 or MIL-M-23700. First come, first served. ■ Write for quotes on FlatPac configuration.

(and you thought we only made UNIFETS!)



Siliconix incorporated

1140 West Evelyn Avenue • Sunnyvale 33, California
Telephone 245-1000 • Area Code 408 • TWX 408-737-9948

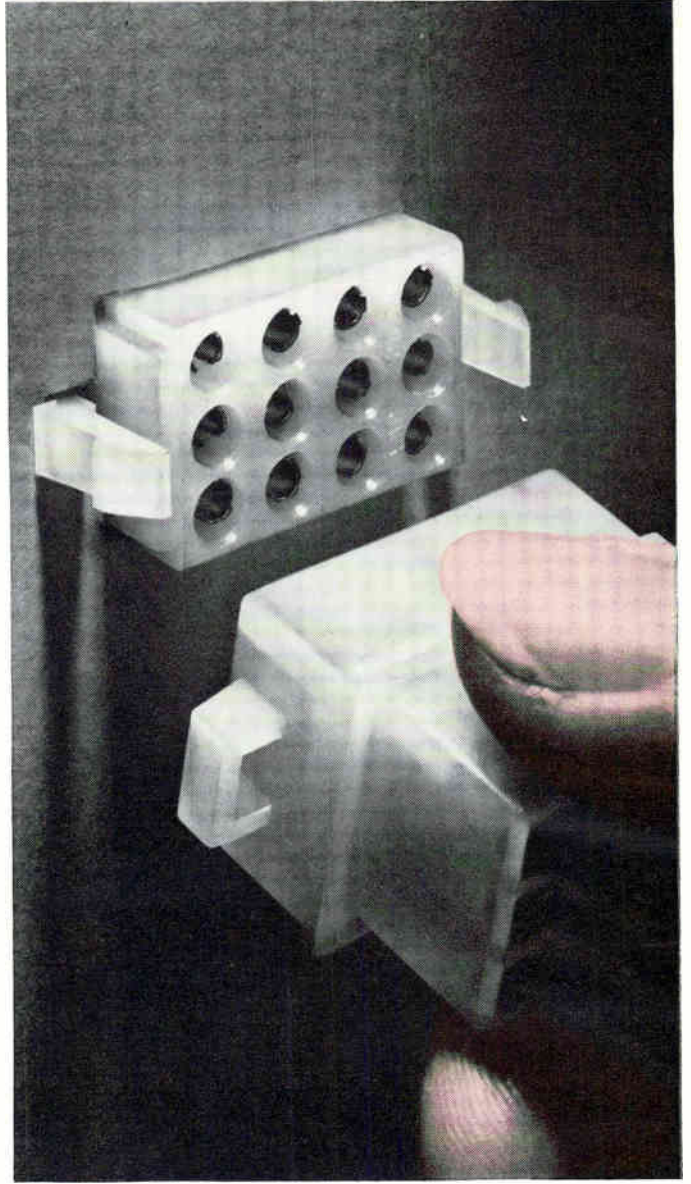
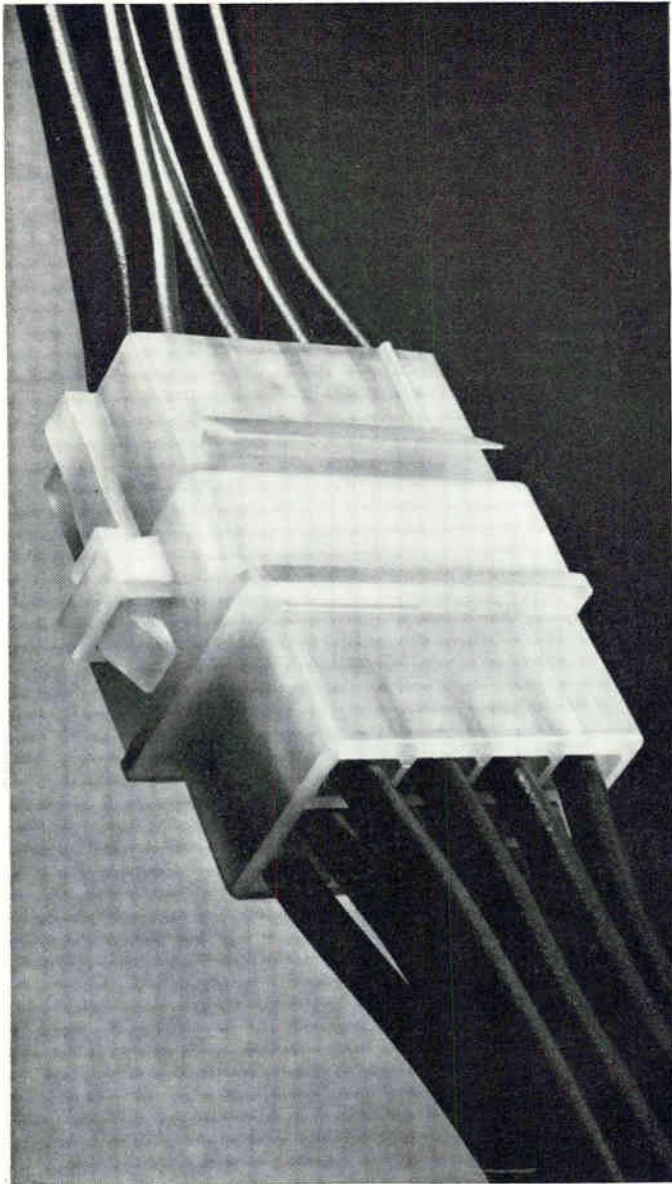

Free and easy

Choose it to use any way you like—free hanging or panel mount—our new MATE-N-LOK* Connector carries up to 12 circuits and 25 amps with no chance of accidental disengagement. Inside and out, this connector gives you every good reason to consider it for use in commercial equipment of all types.

Take the contacts. They're "clean" design. No sharp projections to hinder insertion or harm personnel. Full circumferential design gives you all 'round wiping action for all-over contact . . . assures maximum conductivity and reliability. Snap-in, crimped contacts can be inserted at any point of the compass with no concern about prior orientation. Add to all this low initial cost of formed contacts and lowest applied cost with A-MP*



AMP products and engineering assistance are available through subsidiary companies in: Australia • Canada • England • France • Holland • Italy • Japan • Mexico • West Germany
*Trademark of AMP INCORPORATED.

matching automatic tooling and you've got *real* plus value.

Everything about this connector hangs together for keeps, no matter how or where you use it, because it stays together with a built in positive locking device that won't give way under the severest conditions of shock and vibration.

Choose from hot-side panel mounts in 6, 9 and 12-way or the cold side motor mountable version in 6, 8, 10 and 12-way and you've got *one* pin and socket type connector that can be used throughout your equipment.

MATE-N-LOK Connectors are—

- U. L. Approved
- cover two wire size ranges—22-18 and 18-14 AWG
- utilize AMP's patented "F" crimp for maximum tensile strength and high resistance to vibration and corrosion
- fully polarized for error free assembly—and there's still more to tell! Write today for complete details. Your request for sample on company letterhead will be answered immediately.

A Moose Is a CPFF Mouse

THERE HAS BEEN little overt grumbling in the industry over the Pentagon's cost-cutting drive. We think the reason is that just about everybody worth his salt knows that cost competition is going to get rougher—not only in military contracting, but in civilian work, too. It's the lean ones who usually win races, and any trimming of fat in the military half of the business is bound to make a company more competitive all around.

But while the grumbles have not been loud, neither have the cheers. One exception noted was during a cost-reduction symposium last month at Martin's Baltimore works, where the company does most of the electronics production for its missile and space programs. During an explanation of the cost-reduction procedures that company uses, the divisional vice president, V. R. Rawlings, came right out with a "loud bravo" for Messers Johnson and McNamara. Explained Rawlings:

"Few programs today call for production-line techniques with the resulting savings of mass production. The degree of sophistication is compounded with each succeeding system. The cost of the dozen or half-dozen copies of today's systems is as great or greater than the cost of 100 copies of yesterday's system. And this cycle is just at the beginning. . . . That's why cost reduction today has become as great a challenge and as important to our industry as some of the milestone technological breakthroughs of the past. . . . We firmly believe a formal, disciplined cost reduction program . . . is essential for our very existence in the aerospace industry. It is as essential as superiority in our research laboratories . . . in engineering . . . quality . . . manufacturing . . . procurement—or any other of the skills we require to do business. . . .

"To achieve our objectives, we have developed or adopted a variety of management and engineering controls and techniques . . . They include value engineering and value analysis . . . standardization of parts, materials and procedures . . . elimination of unnecessary activities and unessential paperwork . . . consolidation of tasks . . . and a real hardnosed-buying philosophy . . .

"Wherever possible, we will place our subcontracts under fixed price and incentive terms . . . Much of

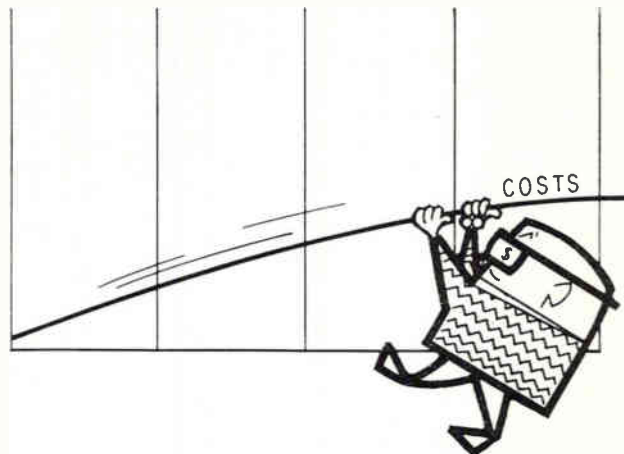

our work in the past has been let on CPFF, or cost plus fixed fee, contracts. Our executive director of program management in Baltimore—Marv Pitkin—is fond of saying . . . a moose is a CPFF mouse. Well, we hope to have more mice and fewer mooses."

Added Pitkin:

"For many years, cost reduction programs were to the defense industry what spinach was to people. It was good for us, but in the final analysis we could live well enough without really having a determined cost reduction program or a strict cost reduction management policy . . . That is no longer possible . . .

"There are three major reasons for the emergence of cost reduction (and cost avoidance) as a mandatory and unavoidable way of life. . . ."

- ▶ Excess plant capacity, built to satisfy needs of mass production programs that no longer exist.

- ▶ Changes in procurement practices away from CPFF to fixed price and incentive contracts. "Such a situation must of necessity do away, once and for all, with the somewhat complacent laissez faire attitude toward cost reduction which was likely to prevail in the CPFF climate—where the proposal price was more a hopeful declaration of intention than an inflexible commitment on the contractor's part. Let's not forget that a moose is a mouse developed and built under a CPFF contract."

- ▶ Significant increase in competition. "Many more bidders and potential contractors are trying to get a slice of the defense pie, in spite of the fact that the pie itself does not get noticeably larger and, to make matters worse, is cut up in larger wedges."

You've heard all this before? So have we. But when one of the prime prime contractors lays it on the line as bluntly as this, it seems a good time to turn words into action.

Obviously from Sprague!



Sprague Filmistor[®] Resistors equal or surpass precision wirewounds in accuracy... stability... reliability... yet they're smaller in size!

Other key features include:

- Low, controlled temperature coefficients.
- Low inherent noise level.
- Negligible voltage coefficient of resistance.
- Tough molded shell for positive protection against mechanical damage and humidity.
- Available in 5 wattage ratings— $1/10$, $1/8$, $1/4$, $1/2$, and 1 watt.

For complete technical data, write for Engineering Bulletin 7025B to Technical Literature Service, Sprague Electric Co., 35 Marshall St., North Adams, Mass.



*Sprague' and '©' are registered trademarks of the Sprague Electric Co.

COMMENT

TRANSISTOR-RADIO JAMMER

With reference to the Comment letter, Transistor-Radio Jammer (p 6, Nov. 22, 1963), I want to tell you that the jammers are also illegal in Spain, and selling them, as Name Witheld does (and boasts of doing), is against the law. His letter is just a sample of lack of morals and poor education. If Spanish hours are not in accordance with American hours, that is not strange, and he and his friends should try to take it as best they can and as I did when in the U.S.A. But if the neighbor's radio bothers his friend, the best thing to do is to tell politely the neighbor to reduce the volume of the radio set.

MARIANO MATAIX

Madrid, Spain

COMMUNICATIONS RANGE NOMOGRAPH

Your publication of my article, Communications Range Nomograph (p 41, Dec. 20, 1963), is greatly appreciated; however, the nomograph as shown on p 43 is incomplete.

On the original nomograph (shown below), various scales are joined at the ends to suggest a frame. This structure is mandatory to perform the operations per instructions.

In addition to the lack of the frame design, there are three vertical lines missing. These vertical lines represent partial products and serve as hinge points and are as important as the calibrated scales.

M. W. SHORES

General Dynamics/Pomona
Pomona, California

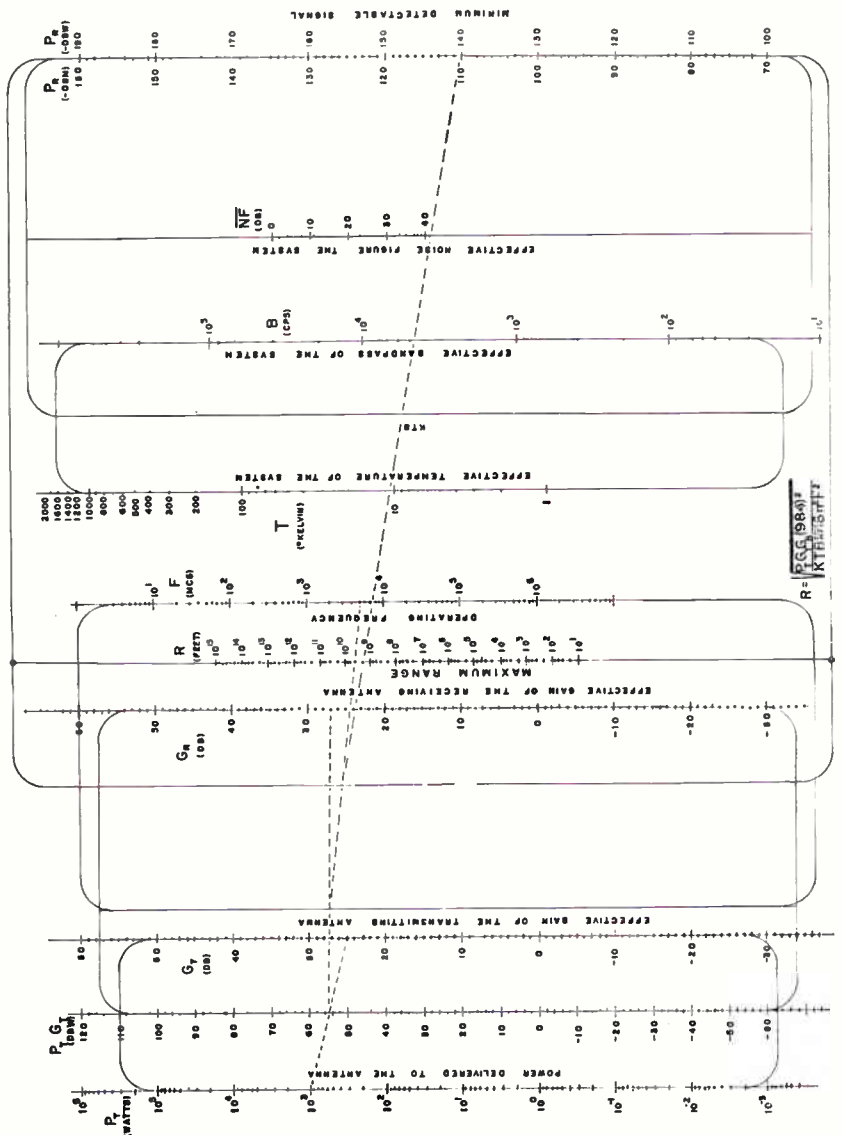

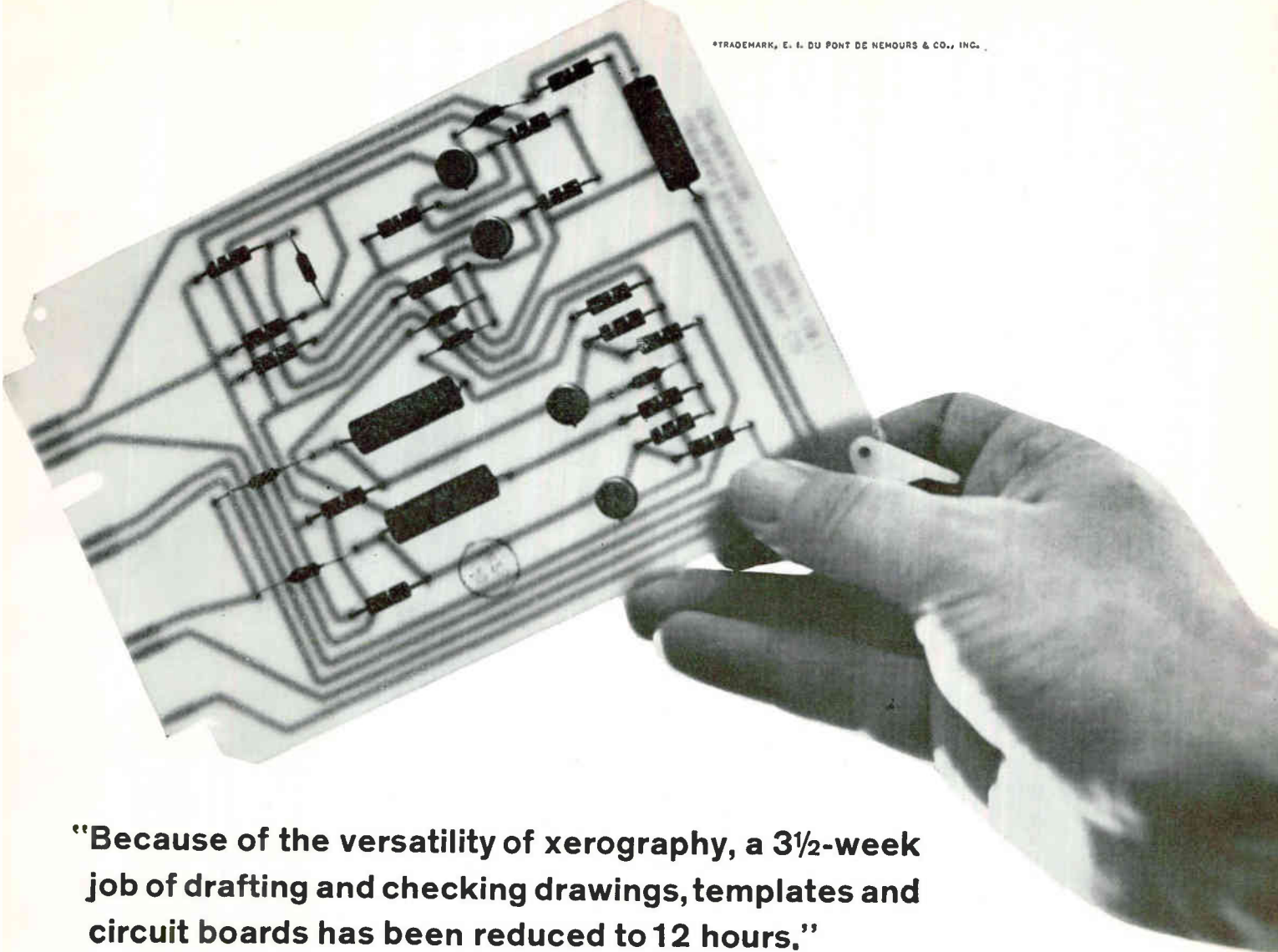

"Because of the versatility of xerography, a 3½-week job of drafting and checking drawings, templates and circuit boards has been reduced to 12 hours."

*W. F. "Pete" Harman, Chief Draftsman,
General Railway Signal Company*

They used to make three separate drawings for each new printed circuit board. Each of the drawings was checked against the others. Then a template was made. This was checked against the circuit board detail drawing and the circuit art work. Then the circuit board was made and checked again.



Now they make just one drawing. That's all. Once it's checked, they produce everything else, even the printed circuit boards, from this single drawing. Xerox Standard Equipment does it. Simple. Fast.

And guaranteed accurate.

The drawing is made twice-size on a dimensionally stable Mylar* sheet. Circuit lines are drawn in ink or by placing strips of black tape on the layout. Holes and terminal points are inked in.

Then the Xerox Standard Equipment is used to copy the drawing, reduced to the exact size required, onto the copper surface of a circuit board. Because Xerox Standard Equipment makes perfect copies, no more drawing or checking of dimensions is needed. All they have to do is put the board in the etching bath.

Total time: 12 hours.

Xerox Standard Equipment is the most versatile way to copy on just about anything that will hold still. Wiring diagrams on circuit boards. Photographs on offset masters. Draw-



ings on acetate for projection. Even an image on an egg.

Find out how many ways xerography can save you time and money. We'll lend you the equipment for 30 days. No charge. Supplies, too.

Just call your Xerox representative.

Xerox Corporation, Rochester 3, N. Y. Offices in principal U.S. cities. In Canada, Xerox of Canada Ltd. Overseas: Rank Xerox Ltd., London; Fuji-Xerox Co., Ltd., Tokyo.

Xerox Standard Equipment—the most versatile way to copy.

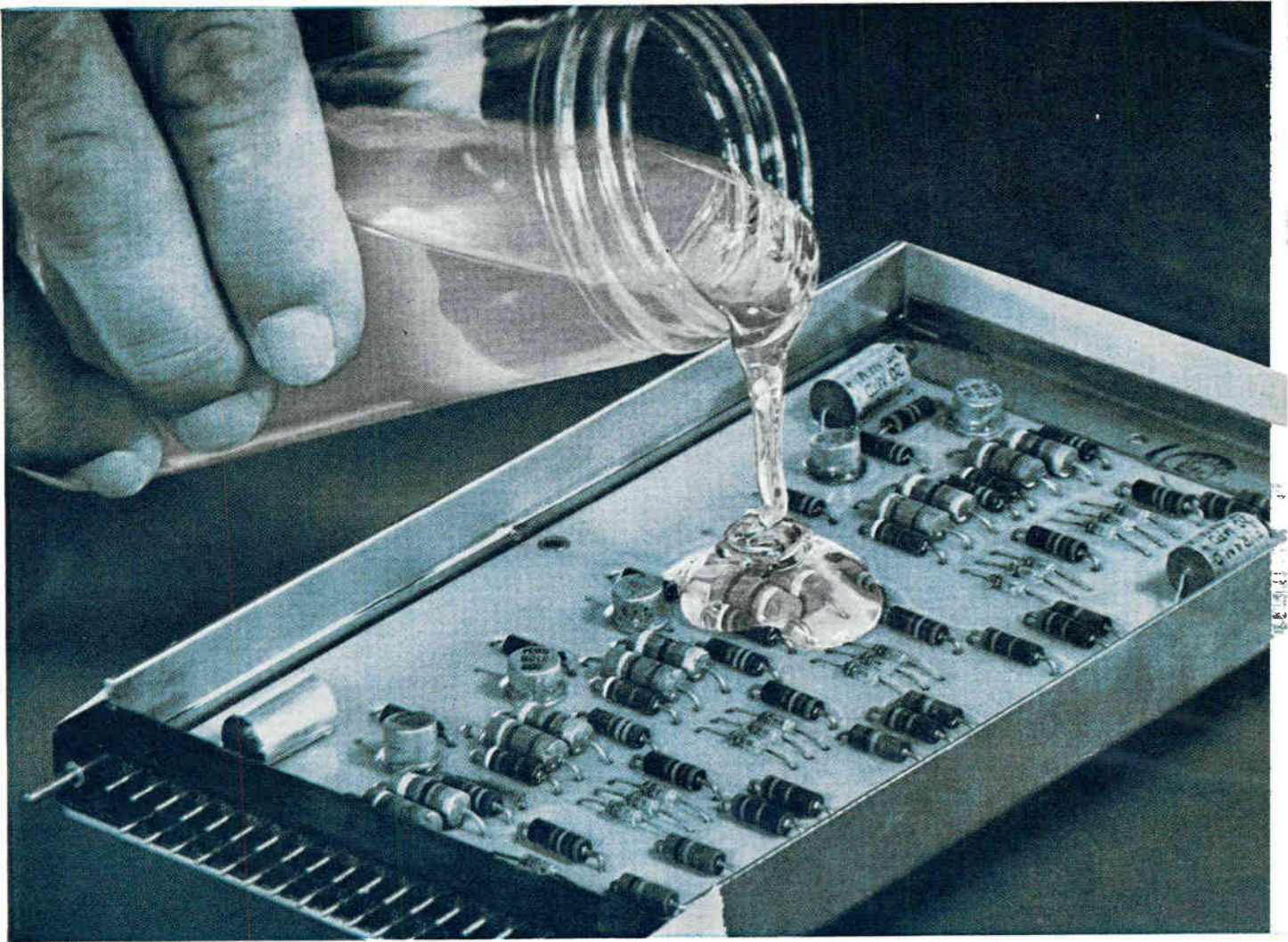

News Briefs

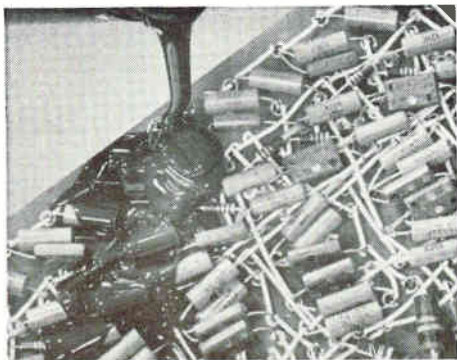

Room temperature curing Sylgard® 185 resin, companion product to Sylgard 184 resin, provides added heat conductance for circuit "hot spots" and opaqueness where transparency is not desired. A black, solventless silicone resin, it cures to form a tough, flexible embedment that assures environmental protection and cushioning for electronic components. Sylgard 185 resin cures in deep sections in 24 hours at room temperature . . . or in 15 minutes at 150 C.

CIRCLE 290 ON READER SERVICE CARD



Dip, brush or spray Dow Corning® 630 protective coating. This solution of silicone polymers air dries to a flexible, wax-like film that is highly water repellent. The excellent surface resistivity of the clear protective coating makes it ideal for the protection of printed circuit assemblies and components operating under heat and humidity conditions. High volume and surface resistivity are maintained even after prolonged exposure to harsh environmental conditions.

CIRCLE 291 ON READER SERVICE CARD

Now... a room-temperature-curing transparent packaging material, that's easy to use, easy to repair

Transparent and tough . . . firm and flexible . . . new room-temperature-curing Sylgard® 184 resin cures without applied or exothermic heat. It can be used to package and protect the most heat-sensitive components.

Sylgard 184 resin is a virtually colorless, solventless silicone material designed for the potting, filling, embedding and encapsulating of electronic circuits. Applied as a low viscosity fluid, Sylgard 184 resin flows easily around the most intricate parts. It cures, even in deep sections, in 24 hours at room temperature . . . or in 15 minutes at 150 C.

When cured, Sylgard 184 resin has a resilient, penetration resistant surface. To repair or replace defective components, the resin can be cut away and new resin poured in place and cured to re-form the embedment.

Sylgard 184 resin cushions and protects components from mechanical shock — can be twisted and bent . . . withstands elongation of nearly 100 percent. Its tensile strength ranges from 800 to 1000 psi, and it has a long service life at operating temperatures of -65 to 200 C.

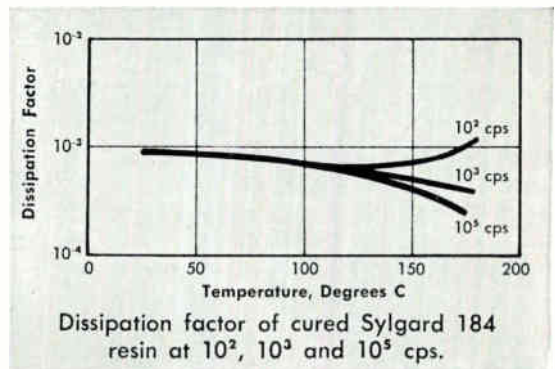

CIRCLE 289 ON READER SERVICE CARD

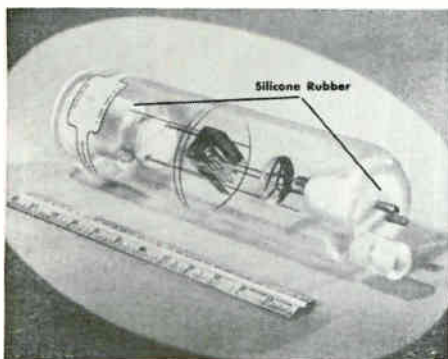

Seal, bond, insulate in one operation with Silastic® RTV silicone rubber. The Flash-X Ray tube shown utilizes it to insulate against high voltage at one end and to provide flexible support between glass and power cable at the other.

Its adhesive quality and the typical silicone properties of moisture resistance and heat stability make it suitable for use in a wide variety of applications.

CIRCLE 292 ON READER SERVICE CARD

We'll be pleased to forward full information on these and other materials that aid reliability and performance. Just write Dept. 3902, Electronic Products Division, Dow Corning, Midland, Michigan.

Dow Corning

THE NEW BUDGET:

Weapons Procurement Cut \$2 Billion

Strategic weapons buying cut, money for tactical forces holds firm

By **John F. Mason**,
Senior Associate Editor

AT FIRST GLANCE, the military budget request for fiscal year 1965 belies the talk of sharp cutbacks in military spending, gradual disarmament, and the need to divert military-oriented industry to new consumer products. The request for new money this year is almost as much as the Department of Defense got last year. Request for new obligational authority for fiscal year 1965 is \$50.88 billion—just \$120 million less than DOD got in 1964.

A closer look, however, shows that within this relatively stable

\$50-billion bundle, significant changes have taken place. In 1965, procurement will drop \$1.950-billion below that of 1964. Research, development, test and evaluation (RDT&E) will fall off by \$227 million. Classifications that make up for these reductions are non-electronic: military pay (up \$831 million), family housing, military construction and civil defense.

Not only is spending that affects the electronics industry down in general, but the shift in emphasis on specific military missions that began last year has continued. Request for new money for Strategic Retaliatory Forces dropped again this year—41 percent less than last year for procurement and 46 percent less for RDT&E. Money for General Purpose Forces which shot up last year stayed high—only 2 percent down for procurement, and six percent up for RDT&E.

The ratio of procurement money for General Purpose Forces to that for Strategic Retaliatory Forces this year is 3½ to one; last year it was two to one.

Ten percent more will be spent this year for procurement for airlift and sealift forces, but 63 percent less for RDT&E. R&D for procurement and RDT&E are both up slightly.

Strategic Forces—By June, ICBM's and Polaris missiles will just about equal bombers in number. No new bombers are in the cards, but \$306 million is requested for 1965 to equip more B-52's to fly low-level missions. Some of the money is for structural strengthening, but much of it will buy terrain-following radar, navigation and bombing gear and radio altimeters. B-52 retrofitting has already provided a \$1.6-billion market.

Phase-out will begin for Atlas and Titan missiles; each cost \$1 million per year to maintain. Emphasis is on Minuteman, and plans for it are being revised. Minuteman I and II squadrons will now be integrated into a single system through the "internetting" of their communications and control systems. Many Minuteman I silos will be retrofitted to handle Minuteman II, and the new II's will be added to the wings. The II can be launched by radio from an airborne command post. Cost of the new plan will hit \$½ billion by the end of fiscal 1969.

Other big items in the Strategic category include continued development of Polaris A-3; penetration aids for all our missiles as well as studying ways to block penetration of enemy missiles; command and control, including the National Military Command System (ELECTRONICS p 20, Apr. 26, 1963).

R&D work includes \$8 million for an exploratory development program of an advanced ICBM, an unspecified amount for an improved version of Polaris beyond the A-3, and the Medium Range Ballistic

PROCUREMENT, FY 1963-1965, (Millions of Dollars)

Functional Classification	New Obligational Authority			Expenditures		
	FY 1963	FY 1964	FY 1965	FY 1963	FY 1964	FY 1965
Aircraft						
Army.....	215	458	444	234	358	438
Navy.....	2,105	1,796	1,855	2,328	2,186	1,814
Air Force.....	3,562	3,386	3,663	3,746	4,010	3,460
Total.....	5,882	5,640	5,962	6,309	6,554	5,712
Missiles						
Army.....	558	462	283	423	531	383
Navy.....	952	1,108	673	718	857	852
Air Force.....	2,459	2,142	1,730	2,676	2,118	2,050
Total.....	3,969	3,712	2,686	3,817	3,506	3,285
Ships—Navy.....	2,919	2,060	1,966	2,522	2,280	2,117
Electronics and Communications						
Army.....	278	357	201	287	286	312
Navy.....	359	499	444	337	352	369
Air Force.....	529	485	435	804	705	540
Defense Agencies/OSD.....	10	12	16	—	14	13
Total.....	1,176	1,353	1,097	1,427	1,357	1,234
Total—Procurement						
Army.....	2,519	2,931	1,779	2,371	2,604	2,376
Navy.....	7,113	6,326	5,720	6,581	6,455	5,949
Air Force.....	6,978	6,406	6,195	7,673	7,238	6,410
Defense Agencies/OSD.....	37	43	62	7	40	50
TOTAL.....	16,647	15,706	13,756	16,632	16,337	14,785

New Obligational Authority

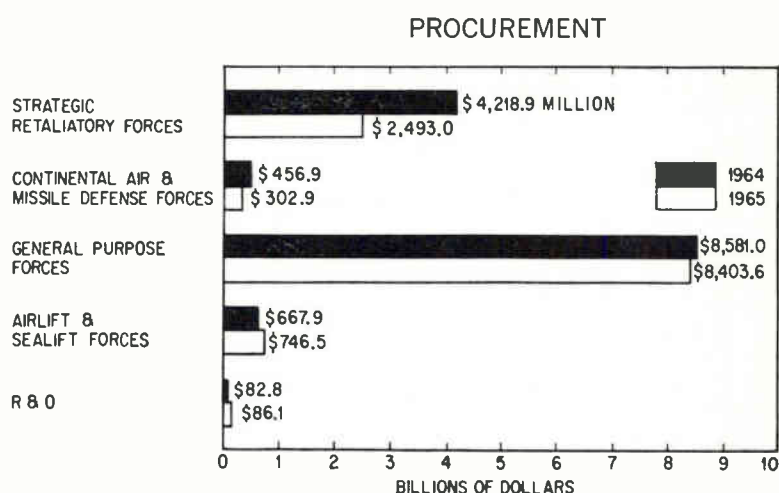
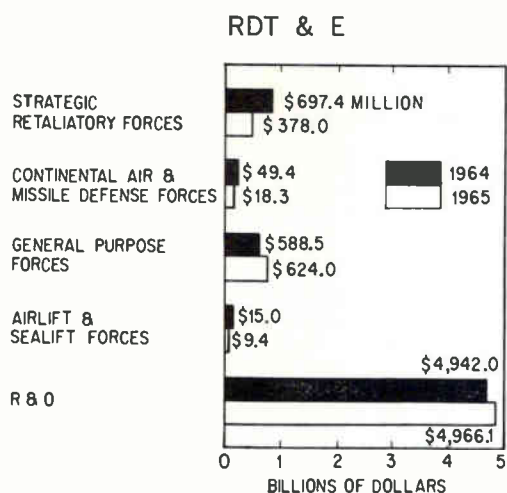

Missile (MRBM).

Plans for a strategic aircraft consist of a \$5-million study "to examine the technical feasibility and military value of possible new advanced strategic aircraft which would serve as airborne missile platforms." Also, \$200 million will be provided to finish building and test the three long-suffering B-70's.

Continental Air and Missile Defense

—Work will continue on the semi-automatic Backup Interceptor Control (BUIC) system—involving procurement of more computers. Work continues on the new F-4 and F-111 (TFX) interceptors, plus development of subsystems that a new interceptor might need.

New funds will continue improvements in the Ballistic Missile Early Warning System (BMEWS) and also further work on the new over-the-horizon radar. A four-site test complex for Nudets (nuclear detonation detection and reporting system) will be completed this year. It could result in a big production program in 1966.

Continued testing of Nike-Zeus and preliminary studies of the Nike-X system indicate that "the technical problems of at least a partial defense against a ballistic missile attack may be solved within the next several years." One big problem continues to be adequate discrimination capability. The Multifunction Array Radar (MAR) will be installed at White Sands in June, and several other phased-array radars will also be tested next year.

Success still would not guarantee installation, however, due to cost. One possible Nike-X program

would cost \$16 billion for R&D and installation alone. Request for Nike-Zeus this year is \$40 million; for Nike-X, \$334 million.

Defense against submarine-launched missiles involves three steps and therefore three areas of equipment: detection of the sub; destruction of the sub; detection, tracking and destruction of the missiles. For detection of subs, the research project Trident will continue, as will the long-range sonar program, Artemis. And more effort will be put into aircraft-monitored sonobuoys in 1965.

Destruction of the subs must be accomplished by the ships, aircraft, and submarines of the Navy's ASW forces. To detect sub-launched missiles, \$15.9 million will be spent in 1965 to modify search radar on the east, west and Gulf coasts.

Big effort continues to improve satellite-tracking techniques. Besides the big phased-array prototype radar being built at Eglin Field, Fla., an optical search system is being installed at Cloudercroft, New Mexico. Further improvements include initiation of R&D on new high-accuracy radar-tracking techniques.

Satellite Inspector will be continued, but more emphasis is going into a ground-based system to determine characteristics of unknown satellites.

General Purpose Forces—As stated last year, the goal for defense of Western Europe is to provide an adequate force using non-nuclear means alone. Achievement of this objective is scheduled for the end of 1966.

Army — Aircraft buy this year (1,182) is 13 percent lower than 1964, but 30 percent higher than in 1963. Largest single item in Army's \$443.6-million purchase is the UH-1 B/D Iroquois helicopter. More CH-47B Chinook medium transport helicopters will be bought, and one of the three competing light observation helicopters (LOH) to be delivered this year will be selected for production.

Two new Army missile systems will be bought in 1965: the Shillelagh anti-tank weapon system and the Lance, a lightweight weapon for division support. SS-11 wire-guided anti-tank missiles will also be bought.

Communications and electronics, for Army, calls for \$259.1 million. Starcom, the world-wide strategic communication system, will get \$73 million, \$38 million is needed for vehicular radios, and \$81 million of last year's funds will be spent for automatic data processing equipment.

Navy—The aircraft carrier usually programmed every other year was deleted this time, but is tentatively programmed "in a later year." Since the carrier's role in a nuclear war is decreasing, equipment changes are in the works. All but a few of the A-5 Vigilantes, heavy attack bombers, will be converted to RA-5C's, thus calling for extensive electronic reconnaissance gear.

Development of VAL, a new light attack plane, will begin immediately, using prior-year funds. The plane will be slightly larger than the A-4F Sky Hawk, light at-

(Continued on page 26)

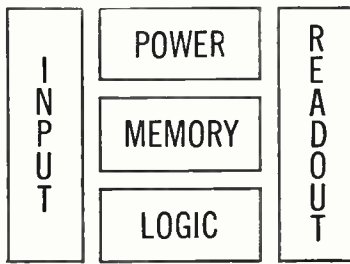

Five ways TI helps improve

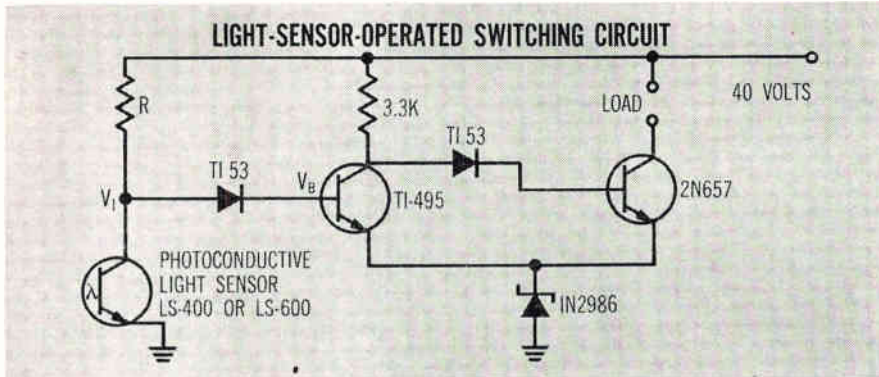
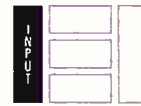

Figure 1



Improve reliability of type and card readers with TI light sensors

Now you can increase the reliability of your tape and card readers to the same high level as other parts of your data-handling chain by using TI LS-400 and LS-600 light sensors. These silicon planar NPN phototransistors feature high switching speeds and uniform high sensitivity. They can be used in the circuit shown in Figure 1 to make a tape reader that will reliably accept wide tolerances of tape quality, including dark spots on tape or transparent tape over holes. For further information on LS-400 and LS-600 light sensors, circle 180 on the Reader Service card.

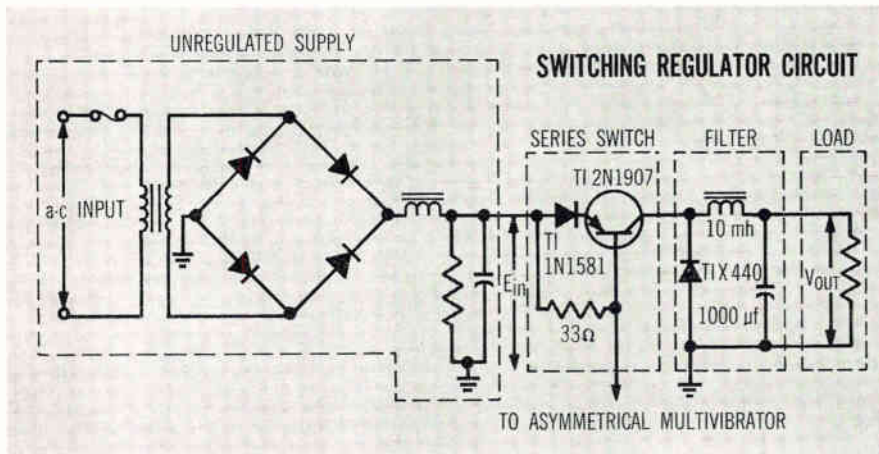
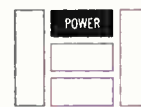

Figure 2



Switching mode regulator features small size, low internal power loss

Here is a 20-volt 5-amp switching mode voltage regulator having a no-load to full-load regulation of 0.1 percent. Collector dissipation of the 2N1907 transistor is only 7.78 watts in this circuit, while it would be 125 watts in a conventional regulator.

The low internal dissipation makes possible smaller physical size, lower total power requirements and less serious heat sink problems than would be the case with conventional regulators.

Circle 181 on the Reader Service card for the application note that gives complete data on this circuit.

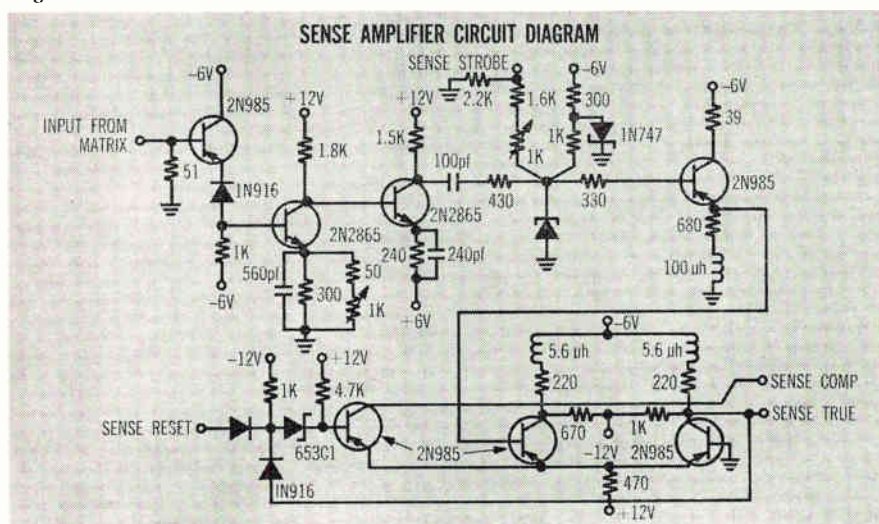

Figure 3



TI magnetic film memory combines high speed and small size

TI magnetic film memory systems are potentially faster than the fastest logic systems yet developed. This extreme speed opens the way to faster computers, lower over-all costs and smaller size memory systems.

The sense amplifier shown in Figure 3 was designed to take advantage of the high speed of TI magnetic film memory planes. The 2N2865 npn epitaxial planar silicon transistors from TI permit a gain of 200 with a bandwidth of 60 megacycles—resulting in extremely high speed for the memory system. Circle 182 on the Reader Service card for further information on TI magnetic film memory systems.

TI GP 5% resistors are used in the circuits shown
TI cannot assume any responsibility for any circuit shown
or represent that they are free from patent infringement.

computer performance



New Series 53 semiconductor networks give new logic flexibility

This new line of digital SOLID CIRCUIT[®] semiconductor networks opens the way to improved performance and lower over-all costs for digital systems. Features include high speed (clock rates to 5 mc), AND/OR/INVERT logic flexibility, high fan-out capability, and multiple logic functions in a single package.

69 component paths—including both pnp and npn transistors—are formed in each bar of silicon. This is more than twice the number of elements previously available and makes possible the formation of dual gates, four-inverter networks, or complete J-K flip-flop/shift registers in single network packages.

All six units in Series 53 are obtained from the same "Master Slice" with only lead pattern changes. This "Master Slice" also allows other special circuits to meet your special digital requirements quickly and economically.

Circle 183 on the Reader Service card for Series 53 data sheets.



Nixie[®] driver uses only 15 transistors

Here is a Nixie tube driver circuit that gives high speed and reliable operation, yet uses only 15 transistors. The circuit shown was designed for extreme reliability and employs ultra-reliable TI 2N720A npn double-diffused planar silicon transistors throughout.

TI also manufactures SCR's—which can be used in Nixie driver circuits—as well as components for D-A converters, servo amplifiers and other readout devices.

Circle 184 on the Reader Service card for further information on this circuit and the 2N720A transistors employed.

The examples on these pages indicate the breadth of application of TI semiconductors and components in computer systems. As a matter of fact, TI is the largest supplier of semiconductors to the computer industry.

For information on the full line of TI semiconductors and components, refer to your TI catalog.

"Nixie" is the registered trademark of Burroughs Corp.

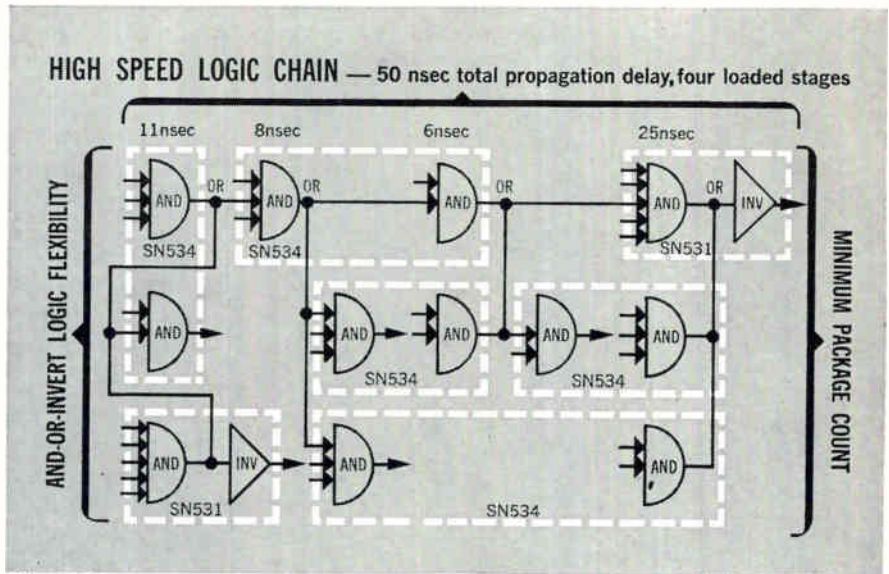

Figure 4

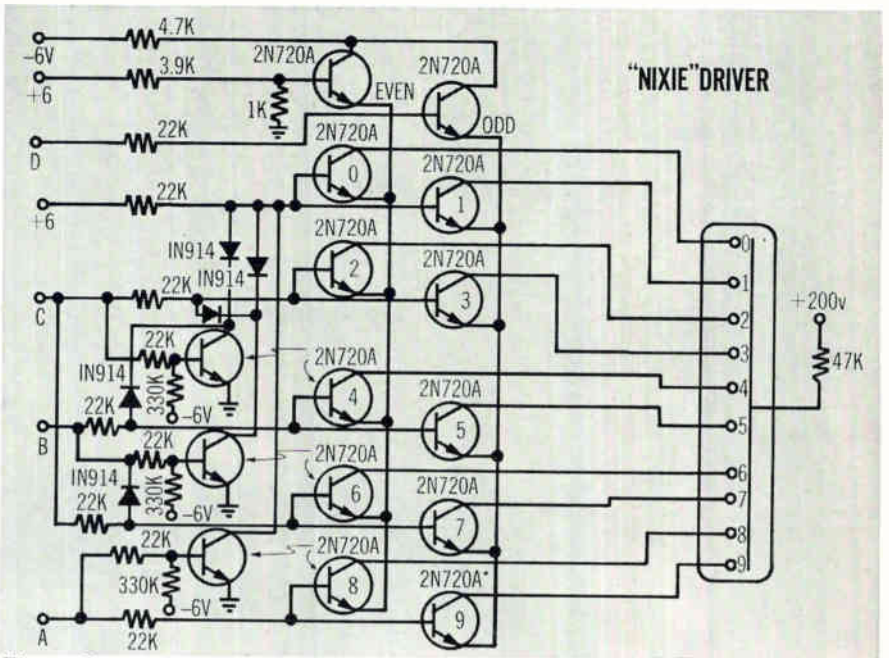

Figure 5



TEXAS INSTRUMENTS
INCORPORATED
13500 N. CENTRAL EXPRESSWAY
P. O. BOX 5012 • DALLAS 22, TEXAS

KLEIN PLIERS *Speed up electronic wiring*

When the crystal set was a seven-day wonder, Klein long nose pliers were used to adjust the cat's whisker. Through the era of B and C battery sets, Klein kept pace by providing pliers specially adapted for electronic wiring.

Today, more than 100 different styles and sizes of Klein pliers are available to provide the exact tools needed for any job. Klein engineers have developed a special plier for wiring printed circuits; a high hardness

plier for cutting nickel ribbon wire; a transverse end cutting plier for cutting closely in confined spaces; extremely small pliers for wiring midget assemblies—and many others.

Klein has also developed special pliers to do special jobs requested by electronic manufacturers.

For better work done more quickly and at lower cost, be sure the pliers you use are exactly suited to the job . . . made by Klein, of course, "Since 1857."

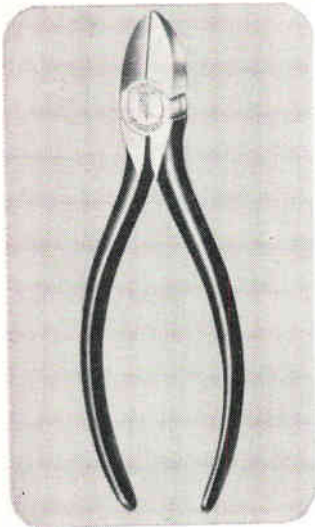

202-5C Oblique Cutting Plier with narrow nose. Available with coil spring, 5½-, and 6-in. sizes.

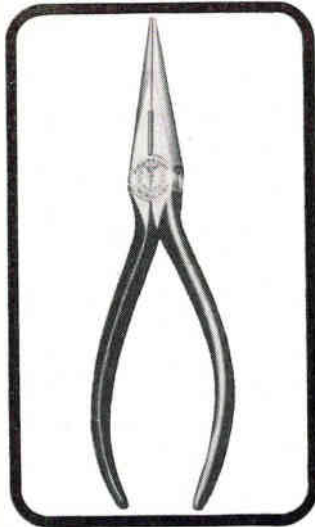

203-5C Long Nose Side Cutting Plier. Available in 5½-, 6½- and 7-in. sizes. Supplied with coil spring.

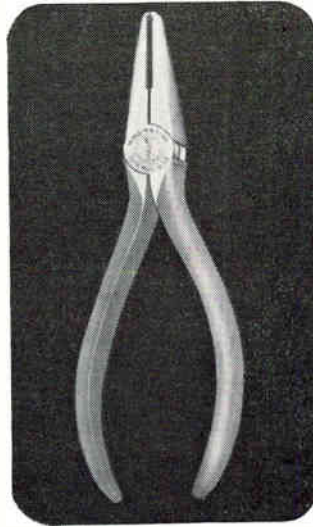

204-6C Transverse End Cutting Plier, 6-in. long. Supplied with coil spring to hold jaws open.

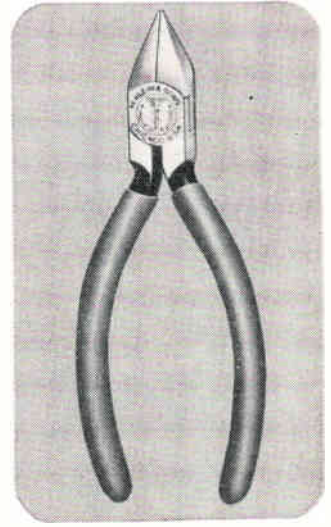

D209-5C Lightweight, Pointed Nose, Flush Cutting Plier. Supplied with coil spring to hold jaws open.



301-5C Long Nose Plier. Available in 5½-, 6½- and 7-in. lengths. Coil spring.

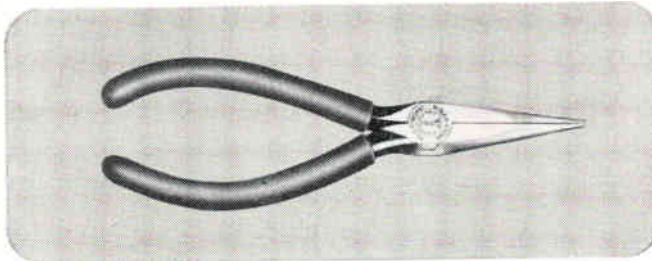

D307-5½C Slim Long Nose Plier for reaching into confined spaces. Yellow plastisol handles. Supplied with coil spring to hold jaws open.

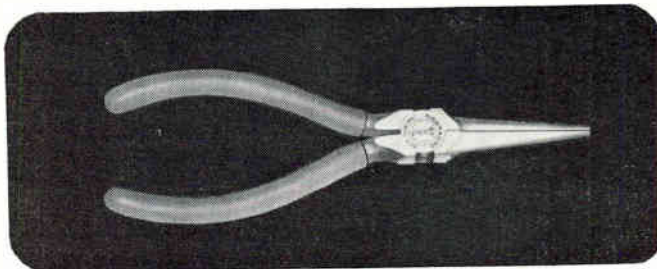

D310-6C Slim Long Nose Plier. Handles are yellow plastisol covered. Supplied with coil spring to keep jaws open.

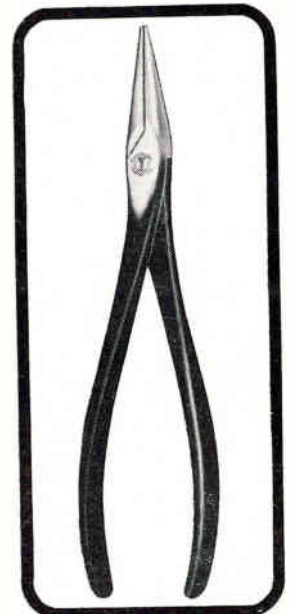

314-8 8-in. Long Nose Plier. Jaws have knurl.



Mathias **KLEIN** & Sons
 Established 1857 Chicago, ILL., U.S.A.
 INCORPORATED
 7200 McCORMICK ROAD, CHICAGO 45, ILL.

See Your Distributor
 Foreign Distributor: ITT Export Corporation, New York

ASTRODATA

MORE THAN 1,000 STANDARD ADC'S FROM A LIBRARY OF 13 BASIC CARDS



- Accuracies to 0.01%
- Conversion speeds to 30,000 per second

Astrodata low cost Series 3000 Analog-to-Digital Converters meet the requirements of virtually all data acquisition systems with 1088 standard production models. From these you can select the full scale range . . . speed . . . accuracy . . . sample-and-hold . . . resolution . . . output format best suited to your specific system.

Designed for easy integration into existing or new

data acquisition systems, standard features include individually buffered data output lines . . . adjustable output logic levels (clamped) . . . wiring installed for future addition of input amplifier or sample-and-hold circuits . . . front panel readout of data (including polarity) . . . and isothermal environment of converter network and reference voltage diode to assure maximum accuracy over wide temperature range.

Series 3000 ADC's ideal for use with time-multiplexed input data

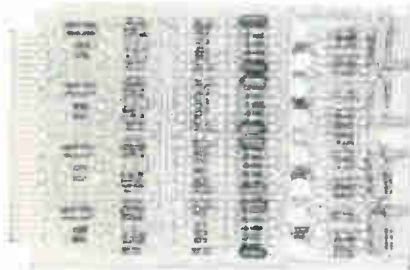

HIGH LEVEL MULTIPLEXERS

Model 155-83 low cost, high-level-input multiplexer module has been developed for high speed analog switching applications.

Inputs per card 6 one-wire or 4 two-wire
 Input Voltage = 5 volts
 Switching Time < 5 μ sec
 Crosstalk = 0.01%
 Input Impedance 1000 megohms/number of switches in multiplexer group

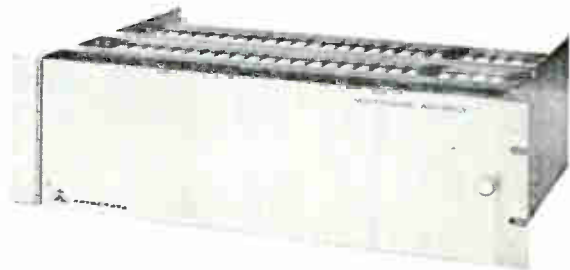

MULTIPLEXER ASSEMBLIES

Series 950 multiplexer assemblies consist of cards, shown at left, for single ended channels in multiples of 6 or differential channels in multiples of 4. Power supply and output buffer amplifier are included. Channel identification data can be furnished in binary or BCD form. The multiplexer channels can be addressed directly by computers or advanced sequentially to meet the requirements of specific systems applications.

17

Contact your nearest Astrodata representative today for a demonstration or write for technical literature giving complete specifications.



ASTRODATA INC.
 240 E. Palais Road • Anaheim, California

KEPCO

ADDS EXTRA VALUE

VIX REGULATED POWER SUPPLIES

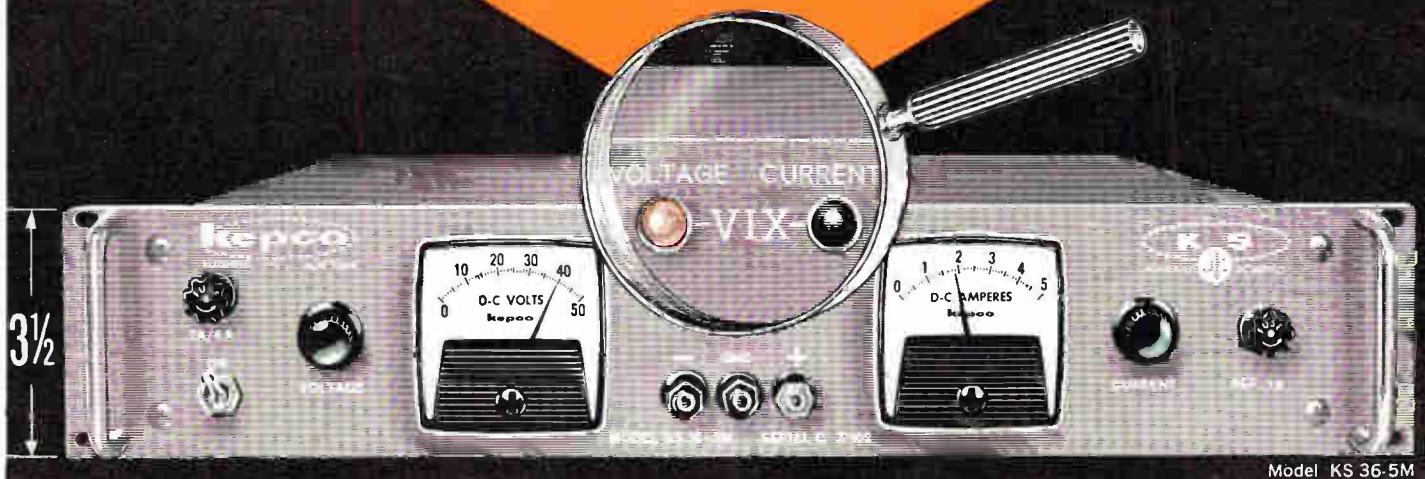

NEW VIX^{*} INDICATORS AT NO EXTRA COST!

T.M.

Kepco voltage/current regulated power supplies in the KS series now come equipped with voltage/current mode indicators called "VIX". Time saving and added utility are provided by these indicators which show at a glance whether the power supply is in its voltage regulating mode or its current regulating mode. This indication is especially useful in the Kepco KS Models since they have extremely sharp cross-over characteristics.

*VOLTAGE/CURRENT CROSSOVER SIGNAL

Send for complete data on
Kepco KS Models
featuring NEW "VIX" Indicators

CIRCLE 16 ON READER SERVICE CARD



REAR VIEW

KEPCO 3 1/2" K S MODELS
REGULATED DC SUPPLY

0.01% REGULATION and STABILITY

DC OUTPUT RANGE		MODEL	PRICE
VOLTS	AMPS		
0-8	0-15	KS 8-15M	\$595.00
0-18	0-10	KS 18-10M	550.00
0-36	0-5	KS 36-5M	495.00
0-60	0-2	KS 60-2M	495.00

kepco inc.

131-38 SANFORD AVE. • FLUSHING, N.Y. 11352
Phone (212) IN 1-7000 • TWX # 212-539-6623
Cable Address: KEPCOPOWER NEWYORK

Visit us at IEEE Show, Booths 2636-2638

Other features include:

- High Power in Compact Design
3 1/2" H x 19" W x 14" D
- SCR Preregulation
- 10-turn-pot Resolution
- Flexible Programming
- Dual Kepco "Bridge Circuitry"
with Automatic Cross-over
- Remote VIX Signal
- Key Circuitry brought to rear
Terminal Board
- Six Operating Modes with External
Connections
- Series/Parallel Versatility

† Patents issued and pending.

See our complete
Catalog in



What Happened To Ranger's Cameras?

RANGER PROJECT engineers this week were trying to figure out what happened during the last 10 minutes of the otherwise successful Ranger 6 mission. Fifteen minutes before impact on the moon the cameras were warmed up. Five minutes later, a signal was sent to Ranger to give it full power to begin taking pictures—but nothing happened. This sent JPL into a huddle and prompted NASA to appoint a four-man board of inquiry to investigate the failure and “determine the future course of the Ranger program”. NASA wants the board’s report by Feb. 17.

Telemetry data that was being reduced early this week indicated that the tv subsystem did go from 0 v to low filament voltage but then failed to achieve high voltage when the final turn-on command was given.

One NASA engineer zeroed in on the completely self-contained RCA camera system as the source of trouble. The block diagram shows that the command-and-control circuits, which are common to both channels, are vulnerable to failure. Other redundant gear is completely independent.

The JPL team analyzing the failure felt that the trouble lay in the redundant 60-w transmitter system

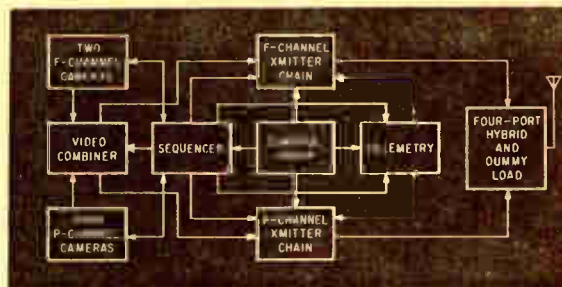

rather than the basic RCA camera system. It pointed to the fact that no r-f signals were received from the transmitters. They were to have telemetered back camera system performance results as well as video signals. The possibility that unexpected environmental extremes could have caused the failure was being investigated, too.

Launch date for another Ranger was up in the air. If the trouble is resolved quickly, another shot could go Feb. 28—the moon being in position during its third quarter. If not, the shot would have to wait 60 days because of conflicts with other programs.

Computer Memory Holds 5.4-Billion Characters

NEW YORK—A computer mass memory system with over 5.4 billion characters maximum capacity and an average access time of 300 msec was introduced last week by RCA. It is called the Race (random access computer equipment). Designed specifically for the RCA 3301 and 301 computers, Race is an external, on-line system whose storage medium is a flexible magnetic card, 16 by 4½ inches, with data recorded lengthwise on one side. Up to 256 edge-notched cards fit into a magazine.

The read-write station is integral with an eight-magazine retrieval unit; other eight-magazine units can be added on. The rental is about 7 cents a month for 10,000 7-bit (6 bits plus parity) characters. An eight-magazine unit rents for \$3,500 a month, plus \$750 monthly for the control unit. An eight-magazine add-on unit (without read-write station) is \$1,500 a month more.

Clear Trouble

CLEAR AIR turbulence (CAT) was responsible for the disintegration of an Air Force B-52 on Jan. 13, near Cumberland, Md., according to the pilot of the plane. At 33,000 feet, he climbed into “the severest turbulence” he had ever experienced, which tore off the tail of the bomber. For latest news on instrumentation to detect CAT, turn to p 49 this issue

Parametric Delay Line Improves Pulse Compression

LONDON—A new method of pulse compression in a parametric delay line has been developed by the University College of North Wales. In an experimental delay line comprising fixed inductors and a bridge arrangement of reverse-biased silicon junction diodes, compression

factors of 4 to 1 on a 30-nanosecond input signal are obtained.

Normal parametric lines suffer from the disadvantage that the bias voltage change in the diodes appears at the line output. In the new line, instead of all diodes being pumped simultaneously, they are pumped in a distributed manner with a pump signal whose velocity is such that the pump signal overtakes the signal pulse as it travels down the line. This is achieved by making the pump signal a voltage pulse traveling down a parallel delay line coupled to the diodes.

Diode Pump Raises Laser's Efficiency

BOSTON—First optical pumping of a solid-state laser with a semiconductor diode laser was reported this week by physicists at MIT Lincoln Laboratory. R. J. Keyes and T. M. Quist used a bank of five series-connected gallium-arsenide diodes

to deliver 4.5 watts of pump power to a calcium-fluoride laser mounted in a cylindrical integrating chamber. The chamber helps the laser rod absorb the GaAs radiation, and it is inserted in a liquid-helium dewar.

Significance of the experiment lies in the hope it holds out for more efficient pumping of high-power lasers. Standard flash tube pumps are only about six percent efficient in converting pump power to laser radiation. For present GaAs diodes this efficiency approaches 50 percent, and by using mixed-crystal pumps with other lasers such as neodymium, efficiency might be boosted to 80 percent.

Other advantages of injection-laser pumping are that it would reduce heat dissipation in the pumped laser by a factor of 10 or more (thus reducing thermal-gradient problems), and that since the light output from the diodes is easily modulated the diodes can be used to modulate the laser as well as pump it. Details are in the Feb. 1 *Applied Physics Letters*.

Mitre Lays Off 150, 481-L Cancellation Blamed

BEDFORD, MASS.—The DOD decision to cancel 481-L, the post-attack command and control system (p 28, March 22, 1963) is among the principal factors in a cutback at the Mitre Corp. here. About 150 employees out of 2,000 at the private, nonprofit company have received notices. Also involved in the cutback are transfer of the 438-L, intelligence handling system, to the Defense Intelligence Agency, and slowdown of the Sage work because of a consolidation of sectors.

A Mitre spokesman said the net decrease in personnel is less than 150 because the company is at the same time expanding its Washington group working on the National Military Command System (NMCS) for the Defense Communications Agency. Cancellation of the 481-L PACCS system is believed to reflect the DOD conviction that it was not enough of an improvement of the

current flying-command-post technique to warrant further development as an interim system before completion of the NMCS.

Electronics, Aerospace Shrink Spending Plans

ELECTRONICS and aerospace industries will put less into capital investments this year than they had planned to last fall (p 19, Nov. 8, 1963). This is in contrast to most other U. S. businesses, according to a McGraw-Hill resurvey of industry plans. Overall, 1964 capital investment should reach \$42.4 billion—9 percent more than last year, and 5 percentage points higher than was foreseen in mid-'63 poll. The new survey was taken to determine whether the installation of President Johnson and the certainty of a tax reduction bill had affected investment plans.

Electronics will drop 1 percent. The aerospace industry, which had estimated \$0.4 billion for this year, now plans to spend \$0.35 billion. On the bright side, electrical apparatus investments will rise 15 percent, office machinery 14 percent, and those aimed at appliances, 12 percent. On the rise also are instruments, 10 percent, and electrical machinery, 5 percent.

Japanese Extend Floor Under 12-Inch TV Prices

TOKYO — The Television Export Council, whose members are Japan's tv manufacturers, will soon include all 12-inch and under sets in its export agreement (p 18, Oct. 18, 1963, and p 17, Sept. 6, 1963). No firm date has yet been set, but it will not be later than April 1. Color tv will also be added, probably at the same time as the 12-inch and under sets. Price of color tv is not a problem now and the council does not expect to set a minimum price initially. However, other regulations, such as registration of brand names, will be enforced.

MEETINGS AHEAD

INFORMATION STORAGE-RETRIEVAL INSTITUTE, American University; University, Washington, D. C., Feb. 17-21.

PHYSICAL METALLURGY OF SUPERCONDUCTORS MEETING, AIMPE Metallurgical Society; Hotel Astor, New York, N. Y., Feb. 18.

INFRARED TECHNIQUES FOR ELECTRONICS MEETING, ITEC; Huntsville, Ala., Feb. 19-20.

INTERNATIONAL SOLID STATE CIRCUITS CONFERENCE, IEEE, University of Pennsylvania; Sheraton Hotel and University of Pennsylvania, Philadelphia, Pa., Feb. 19-21.

SOCIETY FOR INFORMATION DISPLAY NATIONAL SYMPOSIUM, SID; El Cortez Hotel, San Diego, Calif., Feb. 26-27.

WELDED ELECTRONIC PACKAGING SYMPOSIUM, WEPA; Miramar Hotel, Santa Monica, Calif., Feb. 26-27.

SCINTILLATION-SEMICONDUCTOR COUNTER SYMPOSIUM, IEEE, AEC, NBS; Hotel Shoreham, Washington, D. C., Feb. 26-28.

ELECTRONIC INDUSTRIES ASSOCIATION SYMPOSIUM, EIA; Statler Hilton Hotel, Washington, D. C., March 9.

EXPLODING CONDUCTOR PHENOMENON CONFERENCE, AFCRL; Boston, Mass., March 10-12.

IRON AND STEEL INDUSTRY INSTRUMENTATION CONFERENCE, ISA; Roosevelt Hotel, Pittsburgh, Pa. March 11-12.

COLD CATHODE TUBE INTERNATIONAL SYMPOSIUM, British Institution of Radio Engineers; Cavendish Laboratory, England, March 17-19.

NUMERICAL CONTROL SOCIETY MEETING, NCS; Hotel Commodore, New York, N. Y., March 19-20.

IEEE INTERNATIONAL CONVENTION, IEEE; Coliseum and New York Hilton Hotel, New York, N. Y., March 23-26.

RADIO TECHNICAL COMMISSION FOR MARINE SERVICES MEETING, RTCMS; Boston, Mass., March 31-April 2.

ADVANCE REPORT

SPRING URSI MEETING AND SYMPOSIUM ON SOLAR-TERRESTRIAL RELATIONSHIPS, URSI, IEEE, AGU, AAS; *National Academy of Sciences, Washington, D. C., April 15-21; March 1 is deadline for submitting 200-word abstracts in duplicate to Prof. M. G. Morgan, Secretary, USA National Committee of URSI, Dartmouth College, Hanover, N. H. Topic areas include radio measurement methods and standards, ionospheric radio, radio and radar astronomy, radio electronics, circuit theory, geoscience electronics, information theory, instrumentation, magnetospheric radio, radio propagation in non-ionized media, microwave theory and techniques.*

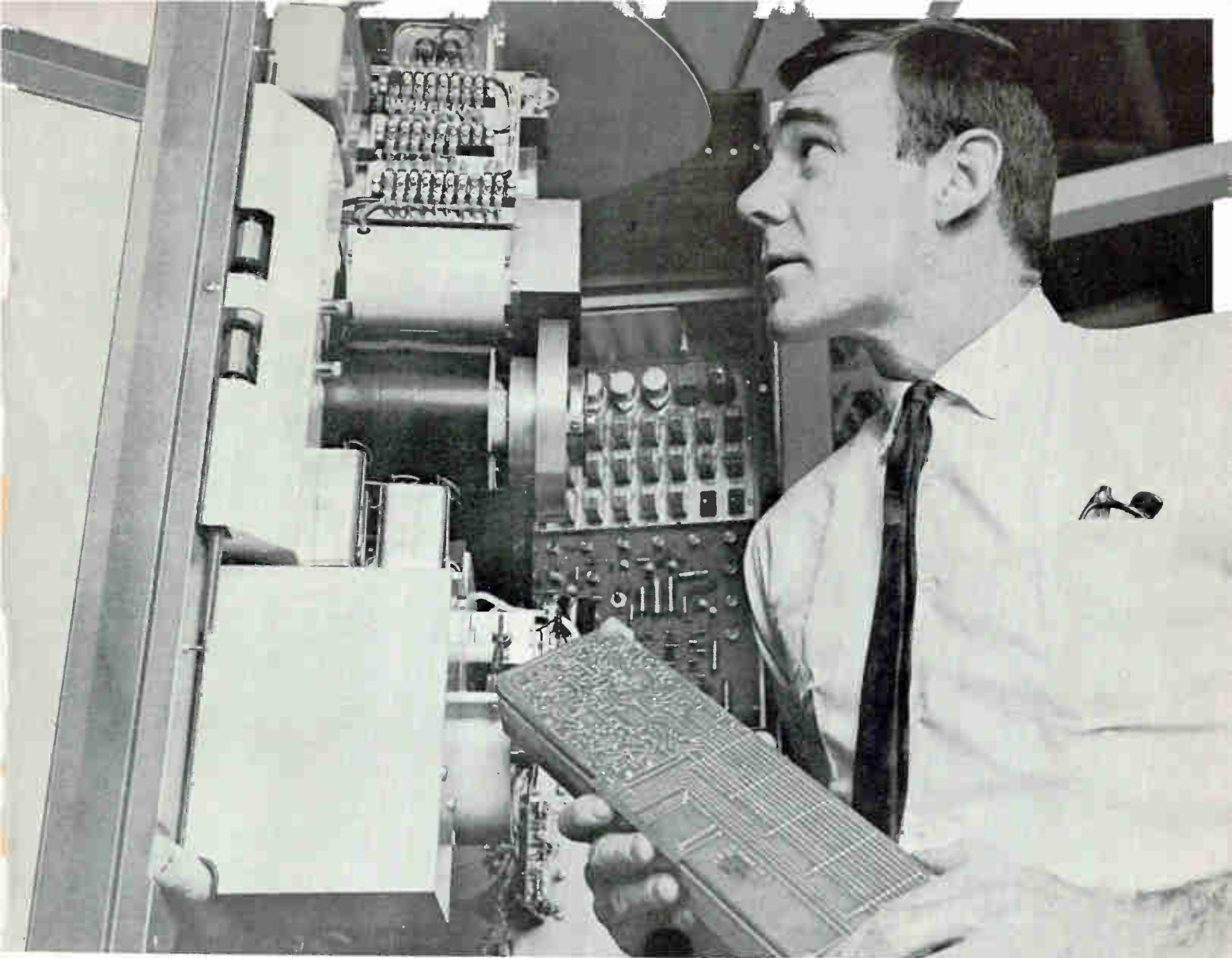

Talk about reliability and versatility!

You'll really talk about CEC's VR-2600

For this instrument is universally recognized as the finest, most versatile performer in its class. The VR-2600 is a completely integrated, multi-channel, wideband data recording and reproducing system embodying unique concepts of accuracy, reliability and simplicity. Consider these specifications...

- All solid-state electronics for high reliability and low power consumption—with color-coded, back-lighted, pushbutton controls.
- Six speeds in two ranges (1 $\frac{1}{8}$ -60 ips; 3 $\frac{3}{4}$ -120 ips) electrically selectable, with no adjustments required.
- Complete 7- or 14-channel record and playback system housed in single or dual cabinet (optional), with plug-in conditioning amplifiers available to handle Direct, FM, PDM, and PCM techniques.
- Handles data in the 400 cps—600 kc range via direct techniques; in the

d-c—80 kc with FM techniques; IRIG PDM via PDM electronics; 1000 bit inch on each of 16 parallel tracks for parallel PCM (saturation recording reproducing).

- Closed-loop tape tension control maintains a constant, non-variable tension in the tape, regardless of the operating mode.

All this adds up to the fact that the versatility of the VR-2600 makes it ideal for a wide variety of uses, including environmental testing, structural or transient studies, radar recording or telemetry. And it performs with perfection in laboratory, mobile, shipboard, trailer or blockhouse operations. Now you know why this instrument has become such a favorite for both industrial and military use.

Want full information about the VR-2600? Our pleasure. Just call or write for Bulletin CEC 2600-X3.



Data Recorders Division

CEC

CONSOLIDATED ELECTRODYNAMICS

A SUBSIDIARY OF BELL & HOWELL/PASADENA, CALIF. 91109
INTERNATIONAL SUBSIDIARIES: WOKING, SURREY, ENGLAND
AND FRANKFURT/MAIN, GERMANY

EE's & ME's—Find Your Opportunity in Product Design and Development From These New Openings at Delco Radio

■ A constant flow of new electronic products has helped Delco Radio Division, General Motors Corporation, establish a position of leadership in the electronic field. From Delco research come such exclusive developments as the unique 1964 Cadillac Comfort Control. With only one setting of the thermostat, this recent Delco development automatically maintains a constant, comfortable atmosphere within an automobile, regardless of changes in the weather outside.

As the search for new products continues at Delco, challenging opportunities prevail—in many areas—for capable engineers:

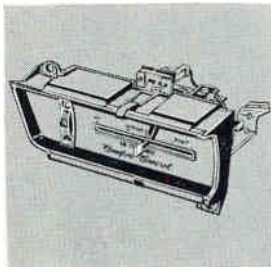

HEATER, AIR CONDITIONER, AND VENTILATION CONTROL

ME's—with 3-5 years experience, for development, engineering production liaison, and re-designing of comfort control systems including vacuum valves and mechanical controls.



SUBMINIATURE MILITARY COMMUNICATIONS EQUIPMENT

EE or ME—for assignment to development group designing all-transistor portable transmitters and receivers, operat-

ing in 2-100 mc range. FM—AM—FSK—CW—SSB modulation.

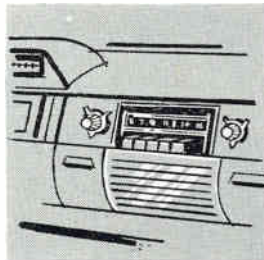

AUTOMOTIVE RADIO DESIGN AND DEVELOPMENT

EE—to work with Senior Engineer on advanced development of auto radios and other entertainment devices, including FM-AM, miniaturized circuitry and components.

ME—for design of small electronic mechanisms, including FM-AM, Signal Seeking and push-button tuners, and components modules.

EE or ME—for packaging of auto radios and associated tuners, solenoids, etc. Required to make some engineering contacts with automobile manufacturers.

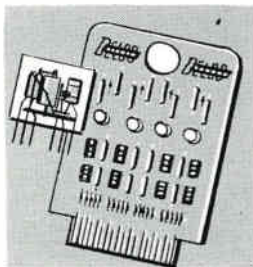

DIGITAL CIRCUITS AND SYSTEMS—includes card, module and digital systems design, and production liaison involving components and special purpose systems operating from 200 kc to 10 mc.

Project Engineer—to direct efforts of design engineers and technicians in designing and releasing digital circuits for production. Supervisory experience highly desirable.

EEs—for design and development testing and packaging of transistorized digital switching circuits from 200 kc to 10 mc.

RELIABILITY ASSURANCE

Project Engineer—to handle tests and evaluations of transistorized systems and components, both power and small signal type. Must evaluate results and associated statistical data. Also includes failure analysis work with suppliers and production.

EE—for design and development work on test equipment for semiconductors and special products.

ME or METALLURGIST—for specification writing and testing of materials and finishes. Experience in this area desirable.

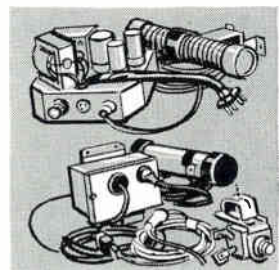

AUTOMOTIVE ELECTRONICS—nonentertainment automotive electronic development including radio control for Garage Door Operators; other transistor applications in automobile, usually involving electromechanical transducers—**ME**—for advanced development work in electromechanical systems used in automotive field.

EE—for design and development of transistorized automobile equipment.

EE or ME—with electromechanical interests for development of electronic equipment for the automotive service market.

● If your interests and experience fall in the above areas and if you're looking for an opportunity to fully exercise your personal competence . . . among men of like talent . . . in unmatched facilities . . . then let's talk. Send your resume today to the attention of Mr. Carl Longshore, Supervisor Salaried Employment.

An equal opportunity employer

solid state electronics ●



DELCO RADIO DIVISION OF GENERAL MOTORS
KOKOMO, INDIANA

IN BRIEF

Boston Breathing Easier Now

BOSTON—No one in this bean and cod center was surprised last week when NASA Administrator James E. Webb said officially he still wants his agency to build its Electronics Research Center here. But for those with sharp ears—or imaginations—a long sigh of relief could be heard. Anxieties have not ended, however. Congress, any time within 45 days, can upset NASA's decision if it so desires.

Meanwhile, Webb, during a personal tour of the area, squelched some potential opposition to location of the site here. It is known that he reached a tacit agreement with top Air Force echelons that there will be no pirating of scientific and technical personnel—an important point for the AF because of its extensive research facilities at or near Hanscom Field.

According to NASA spokesmen, a bias against pirating is built into the plan for gradual staffing of the Electronics Center over five years. Its first-year staff of only 50 or so will come principally from other NASA locations. The staff will eventually have 1,600 professional and technical personnel.

Japan Company Will Make U.S. Pots for World Market

HICKSVILLE, N. Y.—Japan Servo Co. has been licensed by Fairchild Camera to manufacture precision potentiometers for industrial use. Japan Servo will sell the potentiometers in the Far East, and Fairchild will market them throughout the rest of the world. Fairchild said it will continue to produce precision potentiometers for military uses at its Hicksville plant. Prices for the line made by Japan Servo will reflect the elimination of special military testing and the employment of Japanese production personnel, Fairchild said.

Phone System Orders Digital Tape Recorders

REDWOOD CITY, CALIF.—Ampex has received a \$965,000 contract from Western Electric for high-reliability digital tape recorders for use in a new electronic telephone switching system. First units will be installed at the Bell System's Succasunna, N. J., central office in June. The recorders will record when and

where a call was placed, its destination and how long it lasted. This will then be transmitted to an automatic message accounting system where service charges will be computed and automatically posted to the customer's account. Offices of the type installed at Succasunna may eventually be installed throughout the Bell System.

NASA, Weather Bureau Reach Accord on Satellites

WASHINGTON—The Weather Bureau and NASA have dispelled the cloud surrounding their roles in weather satellites. Under a new agreement, the Weather Bureau will fund and spell out the capabilities it wants in weather satellites and NASA will provide them. The agreement heads off a split between the two government agencies that has been in the making for some time. Basically, NASA wanted to develop more ambitious and costly meteorological satellites than the Weather Bureau feels are necessary. Last year the Weather Bureau dropped out of the polar-orbiting Nimbus meteorological satellite program after trouble and costs grew.

NAVY disclosed on Tuesday that a new solar monitor satellite has been in orbit for at least two weeks. Instrumentation measures x-ray emission in five wavelength bands, between 1 Å and 60 Å.

OPTICAL DATA on Echo II from seven Soviet observation stations, made under a U.S.-Soviet agreement, were being analyzed this week along with those made by NASA tracking stations.

DOUGLAS Aircraft and Sylvania have formed a team in industry competition for Condor, the air-to-surface tactical missile the Navy plans using with its TFX.

HUGHES Aircraft and Redifon Ltd. of London have signed a license agreement which will allow Redifon to manufacture the Hughes manpack sab, h-f transmitter-receiver in the United Kingdom. Redifon is to develop a crystal controlled switched-channel version for commercial use.

MACKAY RADIO and Telegraph Corp., an ITT subsidiary, wants to lay a 160-channel submarine cable between New Jersey and Brest, France. Mackay's request to the FCC supplements an application made in January for a cable between Cape Cod and France.

SOURCE close to the Air Force has confirmed that negotiations have been completed for purchase by the AF of a large portion of the Sudden Ranch just south of Vandenburg AFB. Several thousands of acres are involved. Reportedly, two Titan III launch pads will be built on the property.

AIR FORCE secretly launched a Navy satellite Jan. 11 to test-fly a new gravity-gradient stabilizer devised by GE to point the satellite at the earth. The earth-orientation was reportedly successful.

SYLVANIA says it has developed a laser modulator that requires less than 1 watt of power and is small enough to be held in one hand. Its tunable interference filter uses an electro-optical dielectric between the reflecting surfaces to vary the optical path.

LOW-COST navigational ground beacon for small local airfields was introduced last week by ITT. The beacon provides a pilot with continuous information on his distance from a specific airport.

FCC May Swing Tax Stick To Beat VHF-Tv Set Stockpilers

Federal Communications Commission is betraying its first sign of nervousness about the April 30 switchover from the manufacture of vhf-tv sets to mandatory all-channel ones.

Up to now, the FCC has labored with industry to make the transition smooth, exacting informal pledges from each big set maker that there would be no moves to evade the spirit of the law. And, up to now, the FCC has stoutly insisted there was no evidence of any stockpiling of vhf sets, to give sellers a backlog and an advantage over the higher-priced all-channel sets. Now, the FCC has reacted to trade reports of stockpiling, and has asked the makers individually to respond with any information on the reports.

FCC has a big stick to wield in the event of massive stockpiling. There is a possibility that Congress will vote repeal of the excise tax on all-channel sets. At present, the Treasury Department is strongly opposed to repealing the tax. But if Congress votes repeal at the request of FCC, the price of all-channel sets would be about the same, without the tax, as vhf sets with the tax. This would leave the stockpilers holding the bag with no price advantage, and foster the FCC goal of a smooth transition to all-channel tv.

Congress Likes Commission on Automation Idea

Congress seems likely to buy—in short order—President Johnson's proposal for a commission on automation. Out of the raft of bills now circulating Capitol Hill, the best bet is Sen. Hubert Humphrey's commission on automation, technology and employment. Humphrey proposes a 32-member "Hoover type" commission, drawn from the fields of science and technology, economics, political science, operations analysis and business. Among the tasks Humphrey would give the commission: how to use scientific knowledge gained in military and aerospace research for civilian production; how to plan for a shift from a defense to civilian-oriented economy; handling regional development and city planning. Possibly the commission's first task would be to decide whether automation hurts or helps the job picture. Estimates of up to 4 million job losses a year due to automation are countered by assertions that automation really creates jobs.

FAA Casts Vote Against Preventive Maintenance

Federal Aviation Agency has found it can sharply reduce routine maintenance of VOR (vhf omnidirectional radio range) navigation equipment and save money without decreasing system reliability and availability. The new schedule reduces yearly maintenance hours for VOR from 1,368 hours per facility to 987. Although corrective maintenance goes up under reduced preventive maintenance schedules, this is offset by increased equipment availability because of fewer shutdowns for preventive maintenance work. Before changing methods, FCC made a six-month study of installations, operating 112 under a reduced maintenance schedule, 32 with minimum maintenance and 198 under full preventive maintenance.

Spain OK's New Tracking Station

Negotiations for a U. S. deep-space tracking station in Spain have finally been completed. Spanish technical personnel will participate in station operation and Spanish contractors will get about \$1.5 million of the \$5 million total cost. American firms will supply the 85-foot, Goldstone-type antenna and other electronic equipment. Construction will start in about 30 days and the station is expected to go into service in 1965.

Here's a new Tektronix dual-trace unit... to update older Type 580-series oscilloscopes

DC-to-80 MC at 10 mv/cm
DC-to-85 MC at 100 mv/cm



Type 82 plug-in unit adds new convenience to display and measurement of high-sensitivity, wide-band, dual-trace presentations on the Type 580-Series Oscilloscopes.

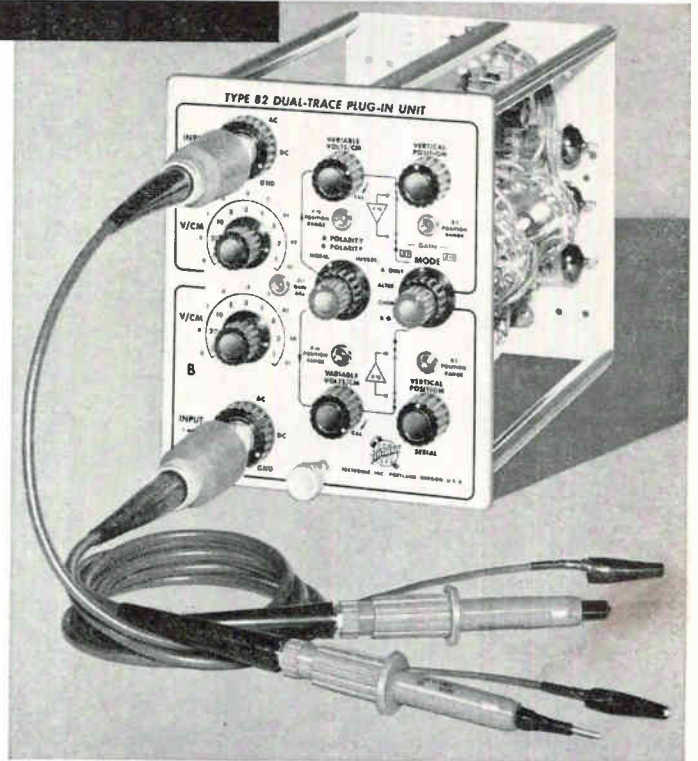

Characteristics

■ **DUAL-TRACE OPERATION** with 4 operating modes and independent controls for each channel—for individual attenuation, positioning, inversion, and ac or dc coupling as desired.

■ **PASSBAND** typically DC-TO-85 MC (3-db down) at 100 mv/cm (12-db down at 150 Mc), and typically DC-TO-80 MC (3-db down) at 10 mv/cm.

■ **CALIBRATED SENSITIVITY** in 9 steps from 100 mv/cm to 50 v/cm, and in 10X Amplifier Mode, from 10 mv/cm to 5 v/cm, variable between steps.

plus

■ **SUPPLIED SMALL SIZE PASSIVE PROBES** to simplify probe connection to signal-source points. Probes increase input R to 10 megohms and decrease input C to approximately 7 pf, with risetime (of probe, plug-in unit, oscilloscope) at over-all sensitivity of 100 mv/cm at approximately 4½ nsec.

Type 82 Dual-Trace Plug-In Unit \$650

**Risetime of
4.3 nsec**

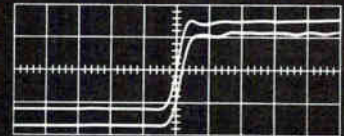

Dual-trace display of input and output pulses of a transistor amplifier at 10 nsec/cm—with lower trace delayed 1 nsec by amplifier under observation. Type 580-Series/82 combination can display time coincidence between input channels with no measurable difference at 10 nsec/cm.

Modification for Early Instruments

Some early Type 580-Series Oscilloscopes must be modified to accept the new Type 82 Dual-Trace Unit or the new Type 86 Single-Trace Unit. After modification, these oscilloscopes—with serial numbers below No. 970 for Type 581's and below No. 2585 for Type 585's—will have improved and standardized transient response (and improved performance with the Type 80/P80 combination). To determine whether your particular instrument needs this modification, please call your Tektronix Field Engineer.

Modification Kit (Part Number 040-275) \$25
U. S. Sales Prices f.o.b. Beaverton, Oregon

For a demonstration, please call your Tektronix Field Engineer.

Tektronix, Inc.

P.O. BOX 500 • BEAVERTON, OREGON 97005 • Phone: (Area Code 503) Mitchell 4-0161 • Telex: 036-691
TWX: 503-291-6805 • Cable: TEKTRONIX • OVERSEAS DISTRIBUTORS IN 25 COUNTRIES

TEKTRONIX FIELD OFFICES in principal cities in United States. Consult Telephone Directory

Tektronix Australia Pty., Limited, Sydney, N.S.W. • Tektronix Canada Ltd., Montreal, Quebec and Toronto, Ontario

Tektronix International A.G., Zug, Switzerland • Tektronix Limited, Guernsey, Channel Islands • Tektronix U.K. Ltd., London, England

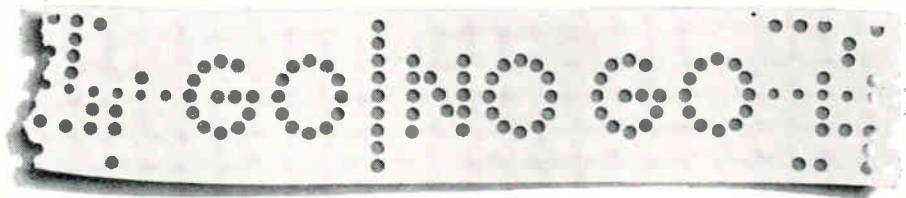

DATA PROCESSING SYSTEMS FOR SPACE

Advanced STL digital telemetry units, decoders, and command distribution assemblies are now being used on NASA's OGO and Pioneer, and the Air Force's Nuclear Test Detection spacecraft. STL hardware and experience with on-board data processing equipment is being applied in the development of new systems which will perform checkout and maintenance functions in space. This advanced technology requires circuit designers, logic designers, and digital systems engineers. For Southern California or Cape Canaveral opportunities, write Professional Placement, One Space Park, Dept. G-2, Redondo Beach, California, or P.O. Box 4277, Patrick AFB, Florida. STL is an equal opportunity employer.

TRW **SPACE TECHNOLOGY LABORATORIES**
THOMPSON RAMO WOOLDRIDGE INC.



Microwave Associates at X-BAND

*a
complete
capability*

Tubes and Duplexers

TR Tubes for all power and environmental conditions. CW and pulsed Beacon Magnetrons. BWO's with periodic electrostatic focus. Ferrite & Gas Tube Duplexers. Semiconductor Duplexers with dual SS TRs.

Waveguide & Components

Fixed and variable Attenuators. Loads. Waveguide and Coax Switches. Pressure Windows. Waveguide Accessories bends, twists, adapters. Power Dividers — many types. Detector Mounts. Tuners. Antenna Components. Circular Waveguide Components. Waveguide Castings. Stripline Components. ORTHOTEE[™] and other standard Mixers. Sideband Generators. Shutters.

Solid State

High power, narrow band Power Sources. Transistor Drivers. Broadband frequency amplifier/multiplier Harmonic Generators. Semiconductor and ferrite coax and waveguide Switches. High and low power Ferrite Isolators and Circulators. Electronically controlled Variable Attenuators. Coax Phase Shifters. Tunnel Diode Amplifiers. Tunnel Diode Oscillators. IF Amplifiers.

Semiconductors

Varactor Diodes. Tunnel Diodes. High power, microwave Switching Diodes. Silicon Mixer and Video Detector Diodes. Computer Diodes. Special Purpose Diodes.

Instruments & Assemblies

Waveguide Assemblies and Subsystems, fully proven in our high power test facilities. Tunnel Diode Receivers. Microwave Test Equipment. Research and Development.

Products also available at VHF, UHF, L, S, C, Ku, Ke and Ka Bands.



**MICROWAVE
ASSOCIATES, INC.**

BURLINGTON, MASS. • WESTERN UNION FAX
TWX: 617-272-1492 • TEL: 617-272-3000

Overseas Sales: Microwave Associates International, Inc.
Burlington, Massachusetts

United Kingdom Sales: Microwave Associates, Ltd.
Cradock Road, Luton, Beds, England

THE NEW BUDGET: Navy Wants New Fleet Missile System

tack bomber, will permit either a larger bombload or greater combat radius and a greater loiter time on station.

Navy requests new construction of 51 ships for 1965: six (SSN) nuclear-powered attack submarines, 16 (DE) destroyer escorts, and 29 others. Ship conversions will total seven.

An upheaval is taking place in Navy's ship-to-air missile arsenal, changing previous plans for ship conversion. Almost \$63 million is in the new budget for R&D on fleet missile systems. Wanted is a new standardized missile to re-completely new surface-to-air fleet place Tarter and Terrier, and a missile system. Although the Typhon missile was cancelled, work on the phased-array radar will continue. Navy is very interested in advanced shipboard radar. Last

year's destroyer conversion program was interrupted because of "a new, more elaborate radar system which has recently become available." Navy has not yet issued invitations to bid on it.

Navy will buy 584 aircraft costing \$1,389 million in 1965. More F-4 fighters will be bought plus the AN/APG-59 missile control system to improve effectiveness of the Sparrow missile; more A-6A attack planes, RF-4B reconnaissance planes, S-2E anti-sub planes, and SH-3A helicopters. The electronics and sonar capabilities of the SH-3A will be improved for tracking high-speed, deep-diving subs. Other planes Navy will buy include P-3A patrol planes, UH-1E's, CH-46A's, CH-53A's, C-2A cargo planes and T-2B trainers.

The \$900 million request for missiles is \$78 million below that

provided last year. Missiles to be bought include Bullpup-B, Sparrow III 6-B, Sidewinder I-C and a limited number of Tartar, Terrier and Talos. Development work will continue on the Phoenix air-to-air missile for the F-111 (TFX). A large number of Mk-46 torpedoes will be bought.

Electronics and Communications—Additional computer capacity will be provided for the National Emergency Command Post Afloat (ELECTRONICS, p 20, Apr. 26, 1963). Procurement will continue for the Navy Tactical Data System (NTDS) (p 43, Sept. 20, 1963). Navy's shipboard radio communications modernization program will be accelerated. This program, designed to secure a compatible communications system for all ships, will have a procurement cost of about \$27 million.

Sonobuoy equipment such as Julie, Jezebel, and bathythermographs will provide a \$50-million market.

Procurement for the Marine Corps will include the Redeye missile, a variety of radar, radio and other equipment such as the AN/TPS-32 helicopter-transportable, high-data-rate, height-finding radars for use with the Marine Tactical Data System (MTDS).

Tactical Fighters—Air Force will buy more F-4 fighters in 1965 and new electronic equipment to improve the plane's ground attack effectiveness and its intercept ability. Procurement of the F-111 will begin in 1965.

Air Force will spend \$254 million for tactical non-nuclear ordnance, including Bullpup-B missile, Bullpup trainer missiles, Shrike anti-radar missiles, Sparrow air-to-air missiles. Approximately \$61 million from 1964 funds will be spent for automatic data processing equipment.

Space Development Projects—About \$1,474 million is earmarked for space, about \$140 million less than for fiscal year 1964.

For participation in Gemini, \$15 million was allocated from 1963 and 1964 funds; \$6 million is re-

RESEARCH, DEVELOPMENT, TEST, AND EVALUATION, FY 1963-1965
(Millions of Dollars)

Functional Classification	New Obligational Authority			Expenditures		
	FY 1963	FY 1964	FY 1965	FY 1963	FY 1964	FY 1965
Military Sciences						
Army.....	179	144	154	266	193	153
Navy.....	162	173	190	160	173	183
Air Force.....	108	120	130	121	115	130
Defense Agencies/OSD.....	447	440	519	291	410	470
Total.....	897	877	994	838	891	936
Aircraft						
Army.....	59	81	73	70	87	75
Navy.....	162	226	241	116	185	223
Air Force.....	395	475	596	358	588	580
Total.....	617	781	910	544	860	878
Missiles						
Army.....	456	565	580	509	530	555
Navy.....	671	574	415	680	615	468
Air Force.....	1,340	1,008	856	1,052	1,037	855
Total.....	2,467	2,146	1,851	2,241	2,182	1,878
Astronautics						
Army.....	87	19	18	38	28	24
Navy.....	55	40	33	41	42	46
Air Force.....	1,088	1,253	947	867	1,290	1,035
Defense Agencies/OSD.....	3	—	—	—	—	—
Total.....	1,233	1,311	998	946	1,360	1,105
Total—Research, Development, Test, & Eval.						
Army.....	1,329	1,386	1,397	1,354	1,373	1,365
Navy.....	1,511	1,541	1,451	1,429	1,487	1,458
Air Force.....	3,698	3,481	3,205	3,300	3,623	3,230
Defense Agencies/OSD.....	456	541	669	291	460	527
TOTAL.....	6,993	6,949	6,722	6,376	6,943	6,580

requested for 1965. For the Manned Orbiting Laboratory, \$10 million has been taken from the 1964 emergency fund, and an undeclared amount is requested for 1965.

The communications satellite program will continue in the R&D phase while the possibility of letting the new Communications Satellite Corp. handle the military's satellite communications needs are investigated (ELECTRONICS, p 17, Jan. 31).

Research—Exploratory development will total \$1.126 million.

Army wants improved night viewing equipment; new, lighter, and more reliable electronic fuzes; new mapping and geodetic techniques.

Army requests \$41 million for combat surveillance and target acquisition. Efforts will continue to improve airborne radar, photographic, infrared and radiometric sensing devices, in-flight data processing and transfer systems. One important ground-based system is the MPO-32 radar for locating enemy mortars and artillery (ELECTRONICS, p 10, Nov. 29, 1963).

Navy wants better techniques for detection and localization of underwater, surface and air targets; environmental surveillance with emphasis on the air-ocean interface. The overall program on surveillance and command-control includes work on radar, ASW detection devices, data-correlation techniques, navigation devices, communications for ships and aircraft. In the field of ordnance, Navy wants non-nuclear air-launch systems. Missile guidance and countermeasures will be studied.

Air Force will sponsor studies, experimentation and component development in guidance, flight control and electromagnetic techniques. Technology will be improved for advanced tactical and strategic missiles, V/STOL aircraft, reconnaissance, communications, command and control, intelligence, and computer and data processing.

Advanced Research Project Agency's Project Defender will get \$128 million, to continue development of scientific and technical knowledge needed for the design of U. S. defenses against ICBM's and for penetration aids for our own ICBM's. About half the amount will be used for full-scale experiments in the Pacific.

Package Engineering Ideas by **Malco**

A New Modular Electronic Packaging concept

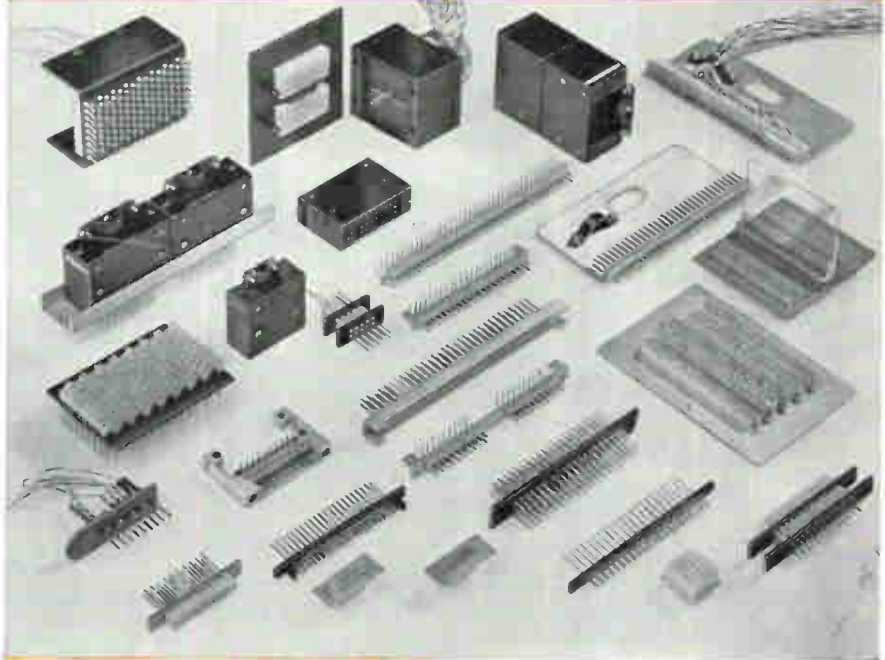

Made Possible By **WASP** Connectors

The unlimited versatility of the Wasp concept allows a "Complete Plug-In Modular Package" to be designed to your requirements. Variations in panels and terminal placements will give your products broad flexibility. Panel configuration can vary from a single row strip to an impressive 24"x 24" panel with up to 10,000 accurately spaced terminals. The use of the aluminum panel matrix gives the "Modular Package" exceptional mechanical stability.

FEATURES

- Flexible plug-in design
- High density of connectors
- High reliability
- Extremely accurate terminal placement
- Adaptability to high speed automatic wiring
- Superior electrical and mechanical characteristics
- Low cost

Ask for recommendations on your requirements. Request Bulletin 631 for general information.

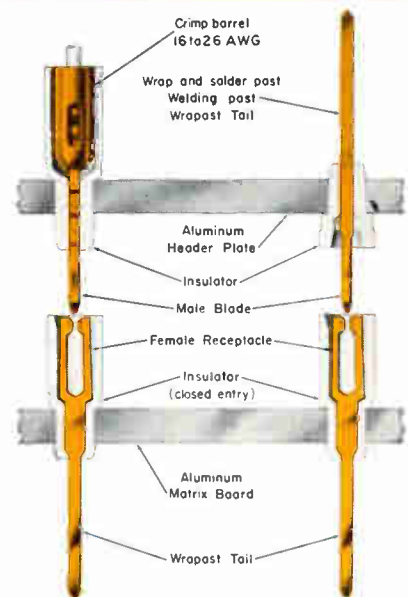

ELECTRICAL SPECIFICATIONS PER CONNECTION

Current Rating 5 amps, A.C. or D.C.
 Working Voltage 800 V. A.C.
 Breakdown Voltage approx. 3 KV.
 Contact Resistance below .002 ohms
 Insulation Resistance 1,000,000 megohms
 Operating Temperature .max. continuous 95° C.

MALCO MANUFACTURING COMPANY

4049 West Lake Street, Chicago, Illinois 60624



Now, With This Versatile *Plug-Into* Rack, Make the "Right" Combinations Of Sweeping Oscillators and Frequency Markers

20 cps to 890 mc

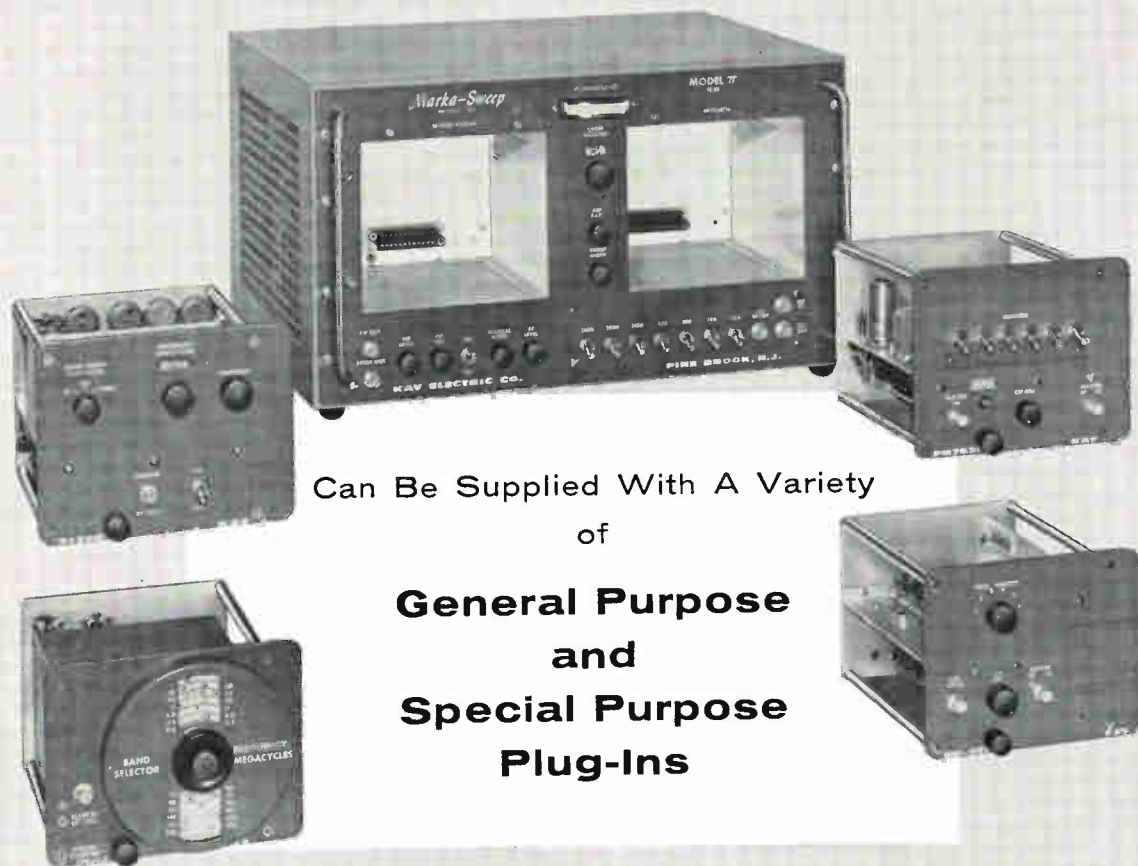

Can Be Supplied With A Variety
of
**General Purpose
and
Special Purpose
Plug-Ins**

1500:

Basic rack for both sweep and marker units. Sweeps log and linear, at 0.2 to 30 cps rate and has manual control, built-in switched 67 db attenuator and an output meter. Price: \$525 f.o.b. Pine Brook, N. J.

(860-E Rack: For sweeping oscillator only, \$450 f.o.b. Pine Brook, N. J.)

P-130 Plug-In Head: 100 cps to 2.0 mc. Excellent narrow or full sweeps. For narrow filters and video tape. Price: \$275 f.o.b. Pine Brook, N. J.

PM-7631 Plug-In Head: 5 kc to 2.0 mc. Fixed and pulse type markers, variable input. Sweep-off markers for tape.

Price: \$150 f.o.b. Pine Brook, N. J.

P-860 Plug-In Head: 2 to 220 mc, wide sweeps. Fundamental frequency output. General lab use. Price: \$445 f.o.b. Pine Brook, N. J.

PM-932 Plug-In Head: 2 to 220 mc. 30 pulse type crystal markers. For multi-stage, multi-unit alignment. Price: \$150 f.o.b. Pine Brook, N. J.

... Plus Many Others

**All-Electronic Sweeping Oscillators, and Frequency Markers
That Remain Narrow Regardless of Sweep Widths**

For Complete Catalog Information, Write

KAY ELECTRIC COMPANY
PINE BROOK, MORRIS COUNTY, N.J.

Report from

**BELL
LABORATORIES**

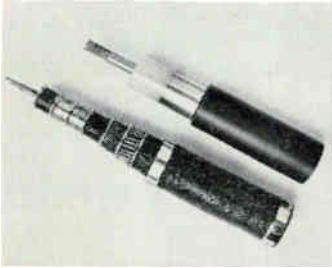

New armorless deep-sea cable (upper right) is of simpler construction, and has lower transmission losses than previous cables of the same overall diameter (lower left). Unlike armored cable, it twists very little during laying.

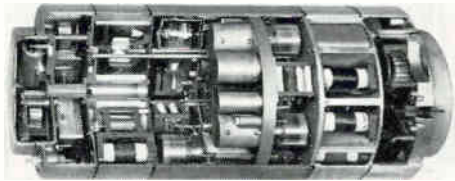

New type of deep-sea amplifier amplifies signals 100,000 times. A 3500-mile route requires 180 such amplifiers, including more than 36,000 electronic components. Each component is designed for stability and reliability far in excess of the requirements for land systems.

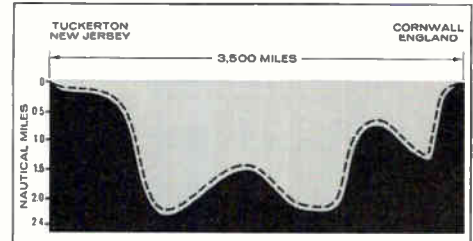

New approaches to cable laying—taking into account the dynamic characteristics of the cable, the motion of the ship, and the contours of the ocean bottom—make it possible to use a minimum length of cable to follow the mountains and valleys of the ocean floor. Care is taken to avoid mechanical strains and deformations that might cause changes in transmission performance.

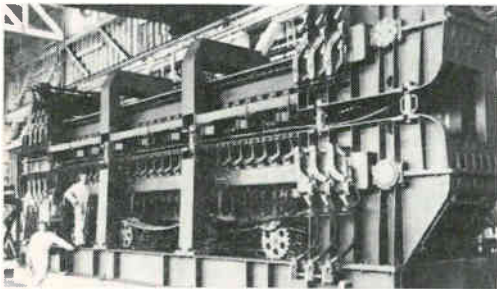

New type of shipboard cable engine holds both small-diameter cable and large-diameter amplifiers between flexible tracks. The engine pays out cable and amplifiers smoothly at a constant rate, permitting close implementation of the engineering approaches discussed above.



To energize the amplifiers, a new highly reliable 6000-volt d.c. shore-based power supply was developed. It sends precisely regulated current along the same coaxial conductors that carry the communication channels, despite varying earth potentials between the continents or islands on which the terminals are located.

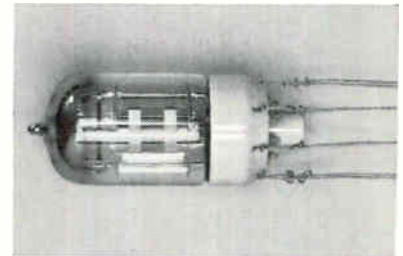

New high-vacuum tube so designed that its characteristics will not change significantly over a twenty-year life-span. Essential to this long-life performance is a new cathode material consisting of nickel with two percent tungsten and two hundredths of one percent magnesium.

Latest ocean cable system made possible by new developments

These new developments, along with others, and the scientific advances behind them, made possible our most recent telephone cable system across the Atlantic Ocean. In service beginning October 14, 1963, it transmits 128 simultaneous two-way telephone conversations. In 1964, a cable of this kind

will be laid between Hawaii and Japan, providing an extension across the Pacific Ocean of the telephone cable system now in service to Hawaii.

BELL TELEPHONE LABORATORIES

World center of communications research and development



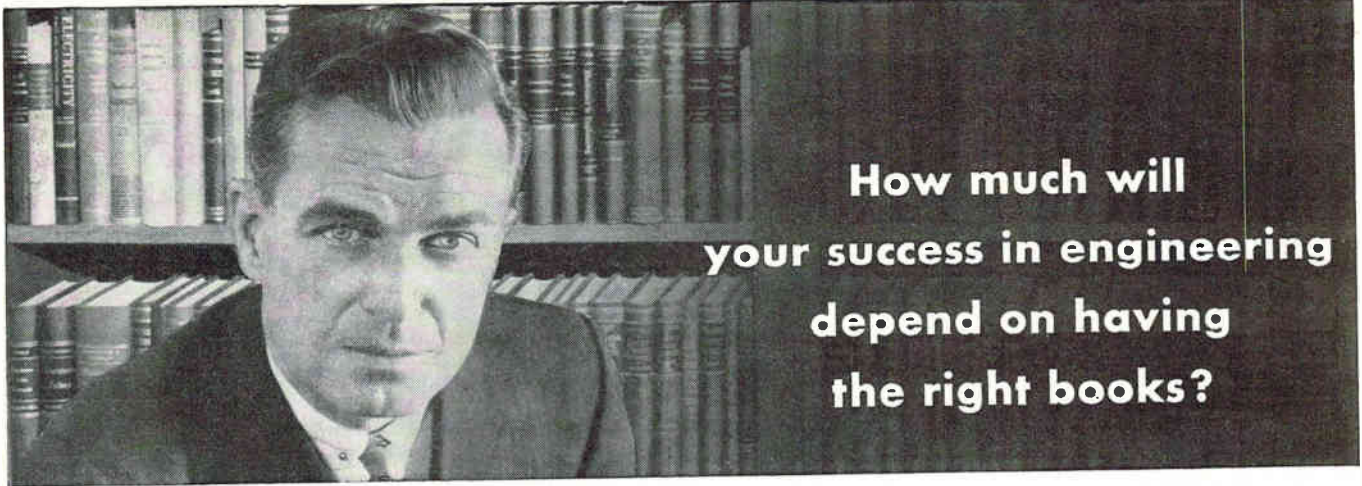

How much will
your success in engineering
depend on having
the right books?

The Electronics and Control Engineers' Book Club helps you keep ahead in your field . . . at a savings

Start your membership with any of these selections:



Electronic Switching, Timing, and Pulse Circuits by J. M. Pettit. Provides a practical understanding of operation of complex circuits.

Publisher's Price, \$8.50
Club Price, \$7.25



Information Transmission, Modulation, and Noise by M. Schwartz. A unified approach to communication systems.

Publisher's Price, \$12.50
Club Price, \$10.65



Mathematics for Electronics with Applications by H. M. Nodelman and F. W. Smith, Jr. Methods for solving practical problems.

Publisher's Price, \$7.00
Club Price, \$5.95



Digital Computer and Control Engineering by R. S. Ledley. Full coverage from basic electronic design to advanced programming techniques.

Publisher's Price, \$14.50
Club Price, \$12.35



Modern Transistor Circuits by J. Carroll. Presents almost 200 modern transistor circuits in 101 separate articles.

Publisher's Price, \$10.00
Club Price, \$8.50



Magnetic Recording Techniques by W. E. Stewart. Full description of magnetic recording methods and devices.

Publisher's Price, \$10.00
Club Price, \$8.50



Wave Generation and Shaping by L. Strauss. Essential features and techniques of practical wave-generating and shaping circuits.

Publisher's Price, \$12.50
Club Price, \$10.65

Your engineering career owes a great deal to books. Why not take advantage of this convenient, economical way to have the best professional books available when you need them? THE ELECTRONICS AND CONTROL ENGINEERS' BOOK CLUB brings you the essential technical literature in your field. It also helps you overcome today's high cost of building a professional library by saving you an average of 15% from publisher's prices.

How the Club Operates. You regularly receive free of charge *The Electronics and Control Engineers' Book Bulletin*. This gives complete advance notice of the next selection-of-the-month, as well as many alternate selections. If you want the main selection you do nothing; the book will be mailed to you. If you want an alternate selection—or no book at all—you can notify the Club by returning the convenient card enclosed with each *Bulletin*.

Saves You Time and Money. You agree only to the purchase of three books in a year. Certainly out of the large number of books in your field offered in any twelve months there are at least three you would buy anyway. By joining the Club you save both money and the trouble of searching.

Send No Money Now. Just check the book you want as your first selection on the coupon below. With it you will be sent *Transistor Circuit Design* for only one dollar. Take advantage of this offer and receive two books for less than the regular price of one. (If coupon is detached, write to The Electronics and Control Engineers' Book Club, Dept. L-2-7, 330 W. 42nd St., New York, N. Y. 10036.



ACCEPT THIS
BIG, NEW
\$15.00 BOOK

FOR ONLY \$1.00

with membership in
The Electronics and
Control Engineers'
Book Club

TRANSISTOR CIRCUIT DESIGN

Prepared by the Engineering Staff
of Texas Instruments Incorporated

Here's a practical reference that can ease your transistor circuit design work. It brings you a wealth of data and facts prepared by the engineering staff of Texas Instruments, Inc. Reflecting the combined knowledge and experience of 32 expert circuit design engineers, this book makes conveniently available the actual design procedures and circuits most often requested from Texas Instruments.

Transistor Circuit Design is typical of the selections of THE ELECTRONICS AND CONTROL ENGINEERS' BOOK CLUB. All books are chosen by qualified editors and consultants. Their thoroughgoing understanding of the standards and values of the literature in your field guarantees the authoritativeness of the selections.

(NOTE: If you already own this volume, you may substitute any other book on this page as your DOLLAR book. Check two books below and you will receive the higher priced selection for only \$1.00.)

CLIP AND MAIL THIS COUPON TODAY

The Electronics and Control Engineers' Book Club, Dept. L-2-7
330 West 42nd Street, New York, N. Y. 10036

Please enroll me as a member of The Electronics and Control Engineers' Book Club. You will bill me for my first selection indicated at right at the special club price and \$1 for *Transistor Circuit Design* (or alternate choice), plus local tax, and a few additional cents for delivery costs. (The Club assumes this charge on prepaid orders.) Forthcoming selections will be described in advance and I may decline any book. I need take only 3 selections or alternates in 12 months of membership. (This offer good in U. S. only.)

PLEASE PRINT

Name

Address

City State Zip Code

Company

NO RISK GUARANTEE: If not completely satisfied, you may return your first shipment within 10 days and your membership will be canceled.

Send as my first selection: (If more than one book is checked we will send the higher priced selection as your \$1.00 book.)

- Electronic Switching, Timing, and Pulse Circuits, \$7.25
- Information Transmission, Modulation, and Noise, \$10.65
- Mathematics for Electronics with Applications, \$5.95
- Digital Computer and Control Engineering, \$12.35
- Modern Transistor Circuits, \$8.50
- Magnetic Recording Techniques, \$8.50
- Wave Generation and Shaping, \$10.65

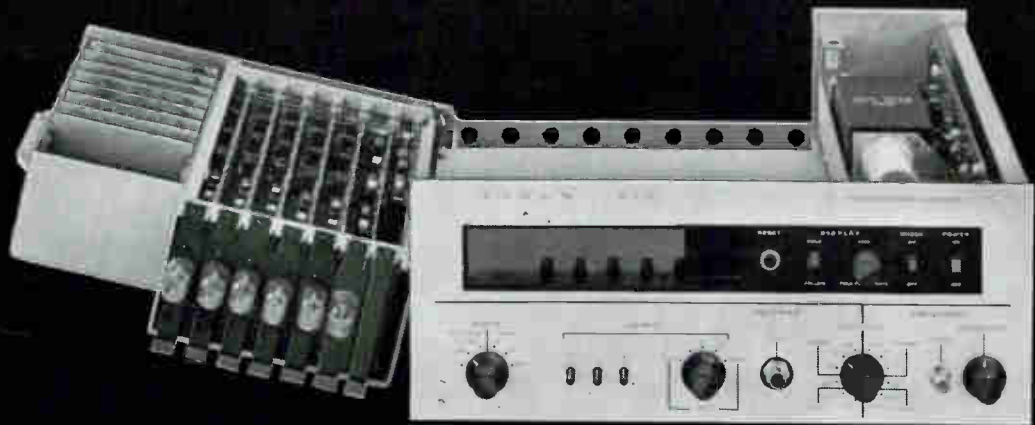

THIS NEW VIDAR INTEGRATING DVM HAS 10 MV
FULL SCALE SENSITIVITY, GUARDED AND
ISOLATED INPUT, 130 DB COMMON MODE
REJECTION, AND 10 MEGOHM INPUT IMPEDANCE

A functional beauty all the way, the Vidar 510 integrating digital voltmeter features full scale sensitivities of 10 Mv to 1,000 volts in 6 decade steps with 300% over-ranging on all but the 1,000 volt range. Input is completely guarded and isolated from the power line ground with more than 130 db common mode rejection at all frequencies including dc. Input impedance is greater than 10 megohms on all ranges. An internal calibration source provides rapid and convenient calibration on any range. Use the Vidar 510 as a 300 kc frequency counter whenever you like.

For convenient system applications, a standard BCD output is provided.

Five digit readout uses long life NIXIES[®] behind a polarized no-reflect plastic screen. Polarity, decimal

point, and units of measurement are also automatically marked.

Low leak input connectors on both the front and rear are standard. Either input can be selected by the function switch which prevents incorrect readings from parallel connections and blocks damage to delicate transducers. Selectable front and rear input connectors also allow a rack-mounted instrument to be used for system checkout and troubleshooting.

Price of the Vidar 510 is \$2,985, rack or cabinet.

For complete information, please call your Vidar engineering sales representative (listed in EEM) or write us at 77 Ortega Street, Mountain View, California.

©Trademark Burroughs Corporation

VIDAR

CIRCLE 31 ON READER SERVICE CARD

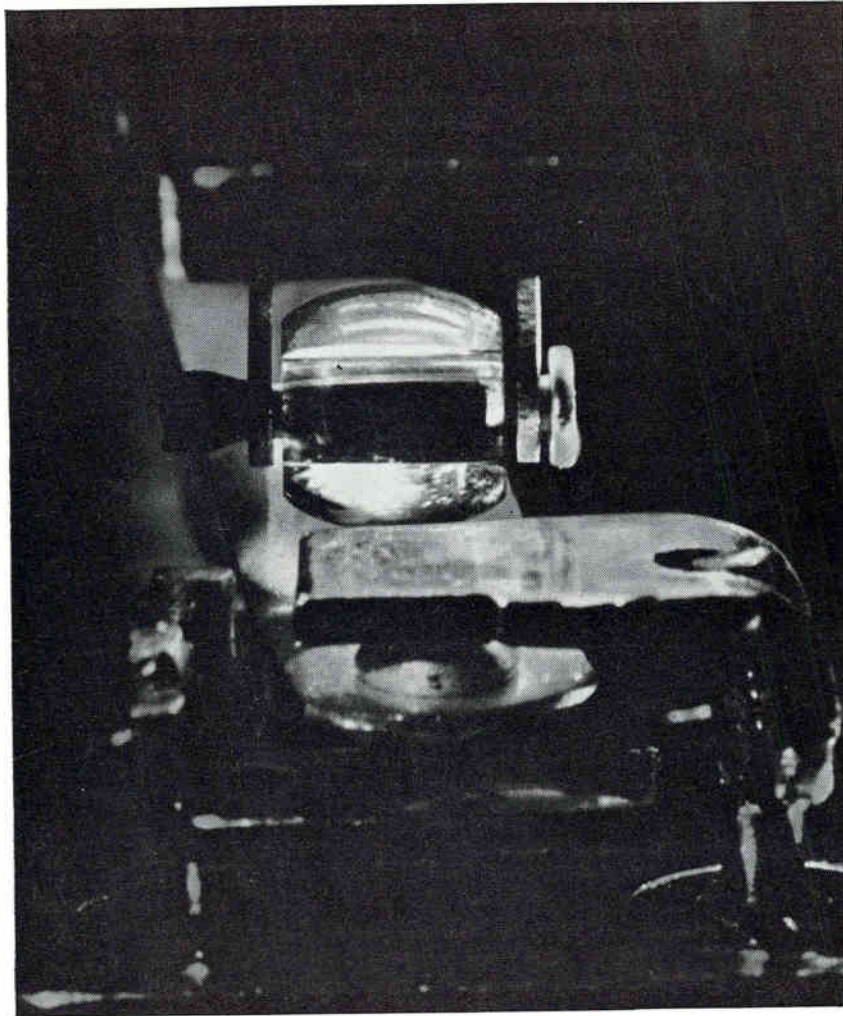

Only Sigma relays have sapphire rollers Result: Unequaled performance

Sapphire rollers to actuate relay contact springs are exclusive with Sigma Series 32 and 33 relays. For you, this means better relay performance. Here's why:

Greater Sensitivity—These hard sapphire rollers can be shaped and polished with such precision that friction virtually disappears. Result: Fast, positive reaction, even to a 50 mw signal.

Extra Ruggedness—Sapphire rollers can withstand 30 g's vibration to 5,000 cycles and shock of 100 g's. Typ-

ical result: Sigma 32's and 33's went to Venus with Mariner II and performed flawlessly.

Superior Vibration Immunity—Sigma sapphire rollers always bear on relay contact springs at a point near the contacts. Result: The spring's resonant frequency is increased to a point well beyond the rated frequency range.

High Stability and Durability—Virtually no wear and friction by-products with sapphire rollers. Result: Assured long, trouble-free performance.

Better Isolation—Sapphire has a high dielectric strength. Result: Assured isolation between motor and switch.

If superior relay performance is important to you, send for Sigma Design Bulletins on Series 32 and 33. Write to Box No. 33.

Or call your Sigma Applications Engineer. He will help you select the best switching control for your particular need—from more than 100,000 different standard Sigma relays—both latching and non-latching, electromagnetic and solid state.

SIGMA DIVISION  SIGMA INSTRUMENTS INC
Assured Reliability With Advanced Design/Braintree 85, Mass.



How do Relays Operate?

You might be surprised at what goes on in a sensitive relay between input and output. If you are interested in a complete description of the step-by-step operating sequence, we'd like to send you our new booklet on the subject. Write to Box 33A.

MODERN ELECTRONICS

PACKAGING

BY ALEXANDER A. MCKENZIE, ASSOCIATE EDITOR

INTRODUCTION

PACKAGING has been defined as the process of physically locating, connecting and protecting devices or components. Packaging information presented in this report was compiled from a comparable viewpoint.

The kinds and shapes of electronic equipment packages are diverse. They depend upon what is to be accomplished. Airborne devices, for example, must be lighter and must require less frequent maintenance than ground-based equipment that is under the constant surveillance of competent maintenance technicians. Packaging is always a function of reliability, available space or economics. It is frequently a function of all three. There is no perfect universal package because what is suitable in one application is often impractical or unnecessary for another purpose.

The history of electronics packaging evolves from a time when radio wavelengths were long and component parts were correspondingly massive. Interconnections were simple and the behavior of energy at the levels and frequencies used was not generally complex, even at that time. Radio-frequency interference has always existed but its effects were then more clearly manifest and capable of being dealt with. The shielding effect of large air spaces was understood. Boxes

were much more likely to be large and of varnished hardwood rather than small, metal and black.

Broadcasting—The epitome of functional packaging in the 1920's was a deForest radio receiver comprising a large, hardwood framework with many openings sawed into it to accommodate six-inch square panels of insulating material to each of which was mounted a single unit, such as a vacuum-tube amplifier, a multi-contact switch or a set of three honeycomb tuning coils. Connections were easily made at the rear. The overall arrangement was impressive, easily maintained and well ventilated.

In existence at this same time were many thousands of relay racks that had been developed by the telephone industry to hold the millions of electromagnetic relays employed in manual and automatic telephone switching. Probably the first standardization of electronics packaging occurred when audio, test and other smaller commercial equipment was placed upon 19-inch wide panels, restricted to heights that were multiples of the standard unit measuring just under 1¾ inches. The panels, and the loads they generally supported at the rear, were attached to the vertical side bars of the racks by machine screws fitted through

CONTINUED

© COPYRIGHT 1964 **electronics** ® A MCGRAW-HILL PUBLICATION



REPRINTS AVAILABLE SEE READER SERVICE CARD

MODERN ELECTRONICS PACKAGING

INTRODUCTION continued

holes or slots in the panels cut according to standard spacings in which threaded holes in the racks alternated on centers of $\frac{1}{2}$ inch with $1\frac{1}{4}$ inches.

Enclosures—Dust covers for individual panel units, cabinets with full-length rear access doors and eventually recessed panel racks protected by front doors were evolved. Drawer-type units were a natural later step. Concomitant problems of heat dissipation, as free air circulation became restricted, were solved using blowers and suction fans that initially exhausted into the room containing the rack cabinets.

Larger electronics equipment requiring space in

excess of that afforded by a 19-inch relay rack also needed the two-way protection afforded by metal, metal-grille or glass barriers. Increasing problems of ventilation, radio frequency interference, simple mechanical protection and danger from high voltage produced unitized construction that in many cases took the form of modified, enlarged relay-rack equipment. In general form, then, a large segment of all electronic equipment resembles the relay-rack approach to packaging. Modern packaging in this area represents a slow but significant evolution. As requirements have become more stringent, more sophisticated means have been found to shield, protect, ventilate, maintain and gain access to individual units.

Nonstandard—Consumer electronics products, on the other hand, have been sold in a different market and



INTERNAL connection of conventional electronics equipment has been relatively straightforward and simple. Yet its cost has increasingly become a major fraction of the whole. Worse still, as circuits became more complex and compact, errors in wiring, failure to fasten or to solder properly, have reduced reliability. Interconnection of units, formerly tedious and subject to error (like connecting the wrong wire to the binding post) has been speeded over the years and made almost completely reliable through the availability of increasingly effective and versatile connectors. Even radio-frequency connections between units several feet apart are now accomplished quickly at low loss and with no connector radiation through development of flexible coaxial cables or wave guides and fittings. There will always remain better ways to effect speedy and reliable interconnection of large units, but evolution will be slow because present techniques are generally satisfactory.

As equipments and their circuit units become ever smaller, the interconnection problem looms larger. In fact, interconnection is not only a problem in its own right; it is the limiting factor in reducing the size of the electronics package. A long look at solid state devices discloses that the active element takes up a good deal less volume than the overall package that is necessary to supply a protective environment. It has been pointed out that the size of lead required to give a flexible and reliable connection with other circuit elements controls overall component size. As a striking example, in a computer where over 90 percent of the volume is occupied by connections, even if the components were so reduced in size as to occupy no space

at all the resulting overall decrease in volume would be insignificant.

Reliable Joints—Engineers in charge of manufacturing miniaturized equipment are much concerned with the reliability aspect of interconnection. Since they must buy prefabricated circuit elements and then interconnect them into a proprietary circuit, they immediately lose the high reliability inherent in the original unit. This result is particularly true when units are numbered in the hundreds.

Some manufacturing engineers feel that a part of the interconnection problem can be solved by reducing number of interfaces between dissimilar materials.

Separate Chips—One solution suggested is procurement of semiconductor chips, rather than packaged components, mounting them on a substrate and interconnecting by means of a thin film. Where interconnection such as capacitive coupling is normally difficult to achieve, a capacitive chip of known value could be mounted on the substrate and connected by thin film. The relative weakness of integrated circuits for nondigital, linear circuits could likewise be overcome by suitably interconnecting separate units for which the values could be carefully controlled through selection.

Whereas welding or soldering constitute a weakening of reliability, owing to possible carelessness or ineptitude of a technician, the thin film applied through a fixed mask would necessarily provide automatic and uniform interconnection.

Present interconnection practice involves many methods of making joints and the connecting leads themselves are of materials chosen as best suited for joining. Hand soldering may always be used for a number of larger joints or touch-up work, but as the size of units decreases the uncertainty as well as the damage sometimes caused will continue to curtail use of hand soldering.

Automatic dip soldering and flow soldering involve

are likely to be packaged uniquely for sales purposes. Prices are competitive with the result that while packaging is interesting and important (for example, reduction of r-f interference from tv receivers) little money is available to pay for the kind of reliability necessary in commercial equipment. Small size is often desired, as in portable radio and television receiver, but standardization is unnecessary.

Computers and other similar devices using low unit power, operating with weak signals and generally comprising very small units demand special packaging consistent with the application to which the equipment is put to use. Hand-carried communications equipment for both military and civilian personnel requires a different kind of packaging from that used for mobile communications equipment installed in vehicles.

Unique in demands for environmental protection,

low power consumption and reliability are the equipment packages employed in space research and communications.

All three general types of equipment package have been affected since the mid-1940's by mechanized wiring that has made possible much smaller packages, beginning historically with the proximity fuze developed for antiaircraft ammunition. Transistors available after 1948 have made further size reductions possible.

Because the spectrum of data on packaging is vast, this special report must be confined to recent examples of current or projected use. Many of the techniques of microelectronics are included but mainly as they control or enhance packaging. Some information is given on related topics like soldering, welding and methods of packaging thin films or epitaxial growth devices.

certain hazards such as overheating, corrosion from flux and particles of excess solder. The joints are good only to the melting point of the solder used. Special techniques, such as the use of solder preforms and hot air, are continually under investigation but the limitations of the soft-solder joints are understood and efforts are directed to better methods of joining.

Welded circuits can be successfully made and the joints hold up to temperatures of about 1,500 F. Initial problems of obtaining satisfactory welds with tinned copper, brass and nickel-iron alloy wires have been largely eliminated through use of nickel, nickel-clad

copper and stainless clad copper. Improvements in welding techniques have produced successful joints even with formerly difficult materials. Data are still lacking on the definite improvement in reliability of the welded over the soldered joint but it may be as high as 20 to 1.

Autowelds—Since welding starts as a manual operation like soldering, the hazards of incompetence, inattention or plain miscalculation are likely to destroy as many components as are connected. Various controls and safeguards have been used in the production of

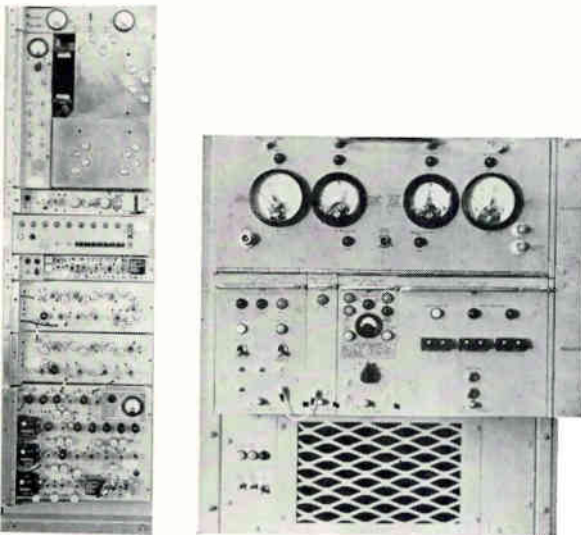

BEFORE and after comparison of multichannel tropospheric scatter exciters to which solid-state circuits and advanced packaging techniques have been applied. Typical tube-type exciter at left occupies about seven vertical feet of rack space. Prototype transistor unit requires only about two feet. Upper panel with meters is hinged for downward movement and the four separate units below can be withdrawn for repair or replacement. Ventilation problems in new unit are virtually eliminated (REL)

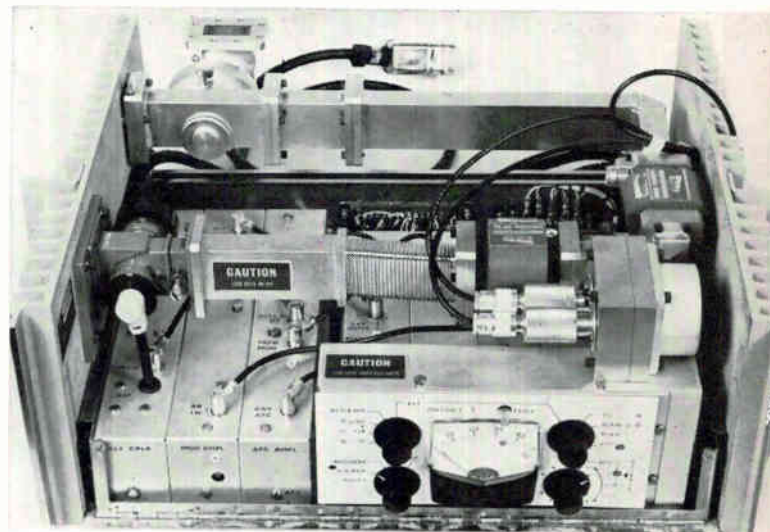

KLYSTRON transmitter (tube at left) uses a temperature-compensated Invar cavity (right) instead of quartz-crystal reference to maintain stability of better than ± 0.005 percent at normal ambient temperature. Directional filters included in manifold design permit connection to four vertical waveguide runs. A modern repackaging by Melabs for point-to-point microwave service, the transmission capability is equivalent to one NTSC tv channel. Cooling fins at sides help eliminate rotational cooling devices

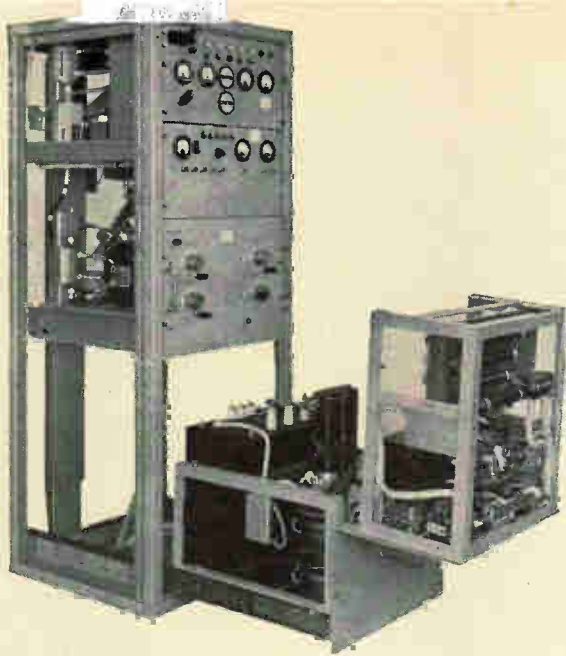

TROPOSPHERIC transhorizon communications equipment requires packaging that makes possible rapid maintenance in restricted quarters by small number of personnel, often of limited technical competence. Solution in the Radio Engineering Laboratories 1-kw power amplifier provides optimum accessibility from the front. A sliding bottom drawer carries the power supply and controls. The control unit is hinged and can be swung forward (left) to give access both to itself and to the main power components.

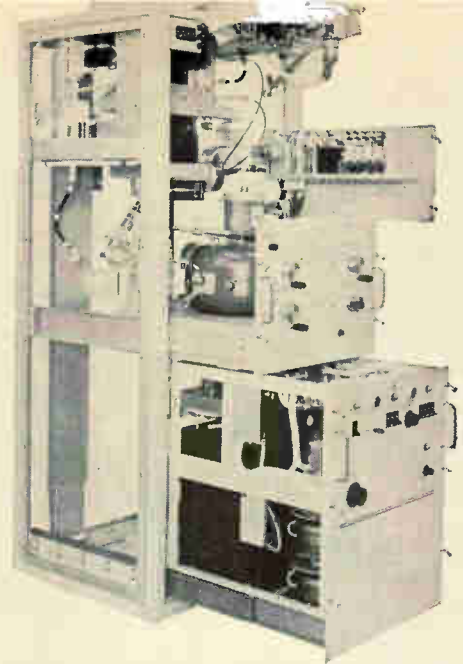

The amplifier tube (right) with tuning controls can be drawn out and the remote control rods unsnapped and removed for unobstructed access to the compartment. Meters and controls on the top panel swing upwards, leaving only a corner section attached to power circuits. By swinging a center panel to the right, maintenance can be performed on units at the rear. When necessary, connections to the various panels can be unplugged and a defective unit retired to the bench.

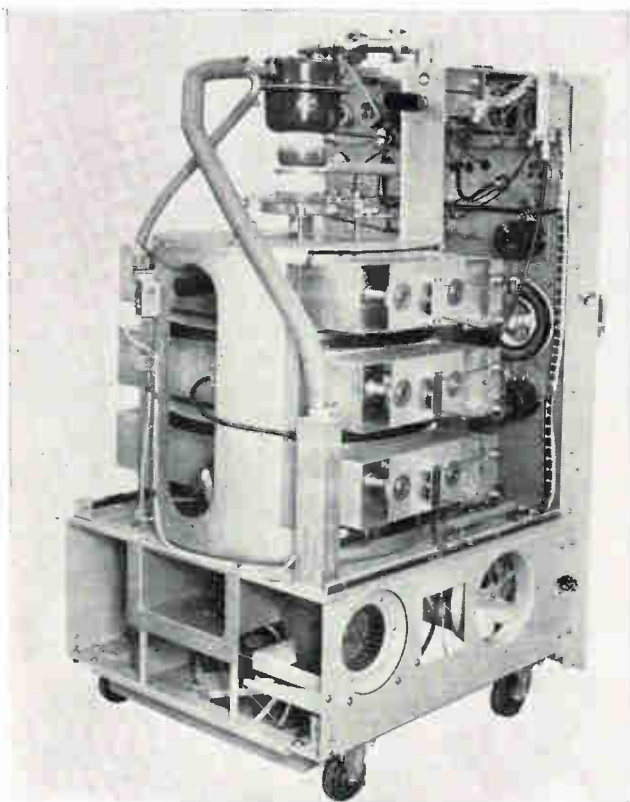

KLYSTRON assembly of a type used in the REL 10-kw power amplifier is large and heavy but relatively easy to handle because packaging was well thought out. Cavity tuning controls, meters and manual adjustment knobs are on front panel so that the whole unit can be rolled out of the transmitter enclosure, replaced by a similar unit and repaired or readjusted without further loss of air time. Blowers and fans keep the tube seals and other equipment from overheating in operation.

welded modules, including scheduling the time of the welding cycle and temperature sensing. A recent approach makes use of a radio-frequency sensing circuit that regulates the current through the weld.

Thermocompression bonds made at elevated temperatures (about 400 to 800 F) and pressures (as high as 65,000 pounds per square inch) are a result of chemical and Van der Waal forces. The materials to be bonded must be clean and fully annealed. Some bonds are best made in an inert atmosphere. Contact resistance between thin films and gold, platinum, aluminum and copper is in the order of 0.010 ohms. Nichrome, titanium and tantalum contacts are in the order of 10 ohms.

Beam Welds—An elegant approach to forming junctions is through a process of electron beam welding. Developed as a tool for microcircuit integration, its use has been along these specialized lines. Some typical parameters encountered in welding copper ribbons to nickel-plated edges of a substrate give an idea of the equipment required. All work is necessarily performed in the vacuum chamber. Beam accelerating voltage employs a cathode-anode accelerating potential of 90 kv.

Steady-state beam current is 0.4 ma. This current is controlled by adjusting electron gun grid bias against accelerating voltage. An electron beam pulse width of 5.3 milliseconds is used and typical energy delivered to the workpiece is 0.19 watt-second. To avoid craters and damage to the copper ribbon, the beam must be swung across the ribbon, being deflected by a 1,000-cycle sinusoidal wave.

Special techniques must often be developed that involve more than the welded junction itself. In the

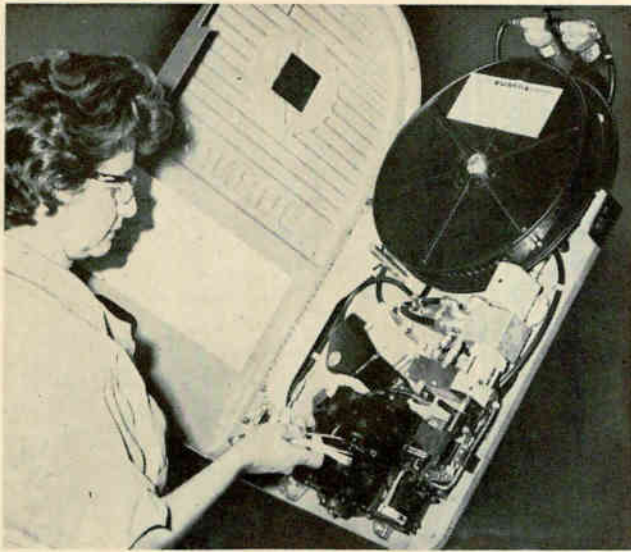

CRIMPING TOOL runs at high speed beneath protective cover, opened here to show inner workings. Machine can be adapted to a wide variety of Burndy contacts, including those used in modules. It was developed to insure quality of crimped terminal connections and turns them out at an average of 3,000 an hour. The machine can be flat mounted or set at intermediate angles up to 45 deg. There are no external moving parts and the small wire entry port gives positive protection to the operator

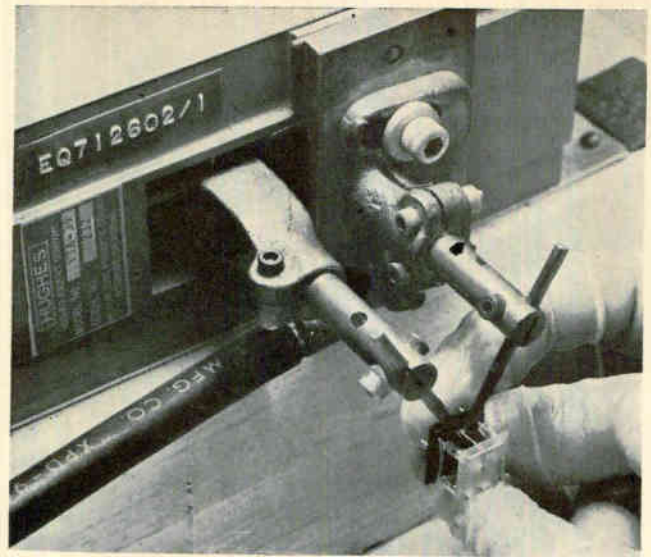

OPERATING one of twelve Hughes welders used by Martin-Orlando in fabrication of welded modules. Most welds are made at right angles, allowing the welding electrodes to close properly on the leads. Two variables, electrode pressure and power, in watt-seconds, must be proper to obtain a good weld. Before undertaking a welding program, several hundred welds are made under varying conditions. They are examined with a Hunter pull tester and the best combination chosen

wiring of a computer matrix board where spacings were so close that insulated wire was required, specially designed welding electrodes were fabricated to be used for wires with a soft, nonfibrous, high-tensile strength insulation. In practice, the electrodes displaced this insulation enough to establish contact with the wire, performed the weld to a terminal and withdrew leaving only a pinhole in the insulation.

Ultrasonics—Flexible conductor flat cable has been used to fabricate circuits when two pieces are laid crosswise and junctions are formed, or alternatively, sections are opened up. Components are attached to horizontal or vertical strips as desired. One feasibility study used ultrasonic energy applied to welding tips that melted the plastic insulation, forced the internal metal ribbons together, performed a weld and then withdrew, allowing the insulation to seal the joint hermetically. The cutting operation was performed using a special ultrasonic welding tip with a sharp chisel edge.

Light Coupling—Most spectacular approach to interconnection is a recent experiment in which a micro-circuit flip-flop is driven by impulse from a gallium arsenide light source through an arsenic trisulfide light pipe. Mechanical bonds between the light pipe and the semiconductor devices use an inorganic glass consisting of arsenic, sulfur and iodine in about equal weight proportions. However, a liquid containing arsenic tribromide, arsenic disulfide, antimony bromide and selenium may prove more satisfactory. For large-scale optical coupling, integral light sources can probably be achieved with an epitaxial layer of an efficient electroluminescent material on silicon.

ENVIRONMENT

ENVIRONMENTS in which an electronic package is expected to function may vary over many extremes. Generally, limits can be set so that design will result in reasonable costs for a given environment. Two general categories of environment are terrestrial and extra-terrestrial, with requirements for the latter being most severe. Fixed ground installations generally experience less extreme conditions than those encountered by mobile and aircraft equipment. Equipment to be used in space may run the whole gamut of environmental hazards to degrees of intensity encountered nowhere else.

There is a reverse environmental effect, too, since radio-frequency interference, the production of noise, fumes, x-rays and other unpleasant manifestations must be eliminated if they create a hostile environment for man or other equipment.

Better Protection—Fortunately, the requirements for space equipment, although severe, can be met by the most advanced packaging techniques, even if these techniques are somewhat too expensive for ground or near-ground use. There has been a decided trend towards the encapsulation of ground devices. Sometimes this potting has been combined with cooling techniques as exemplified in oil-filled power transformers. Some newer cooling fluids, although more

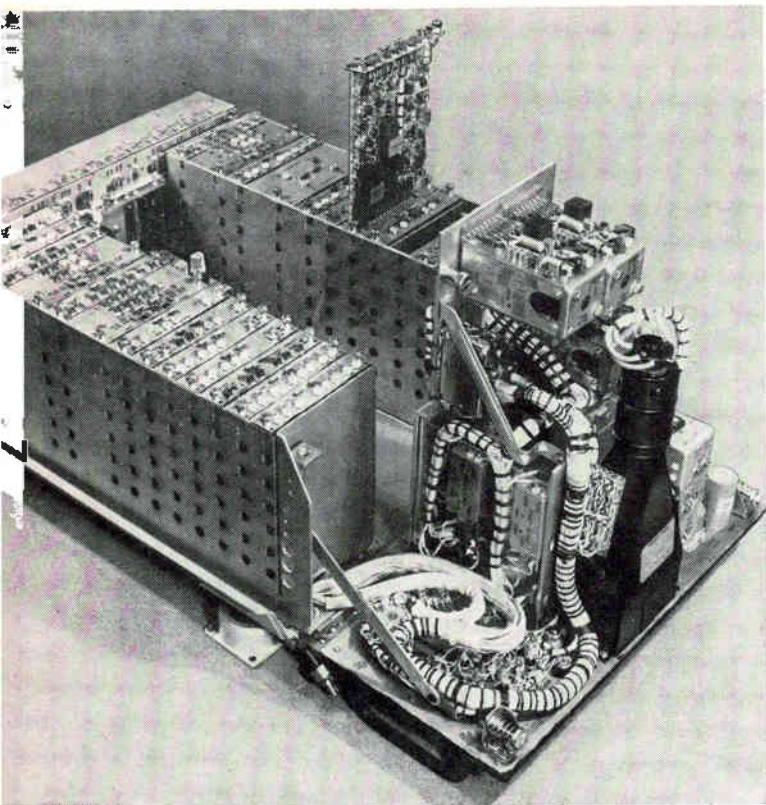

LORAN-C receiver-indicator is a complex navigational device for air and sea fixes at long distances from the ground transmitters. Operating at very low frequencies, it presents an unusual challenge in compact packaging. The ITT Federal Laboratories version shown employs modular construction for easy maintenance. Cathode-ray oscilloscope for matching pulses and direct-readout counters that display time difference are attached to the front panel, hinged to swing forward for easy access of the circuits

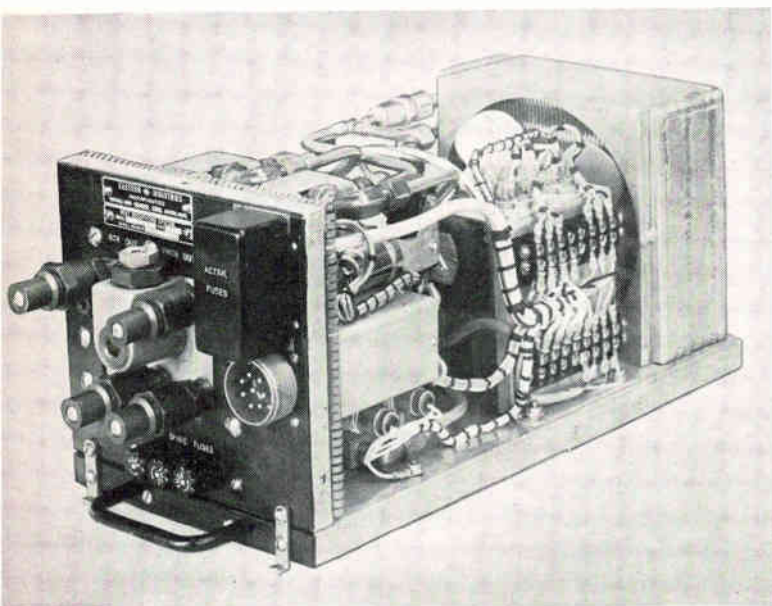

LIQUID cooling system for airborne electronic equipment can influence packaging of the basic device. Representative unit shown has been developed by Eastern Industries for a dual heat load, one equivalent to 175 watts and the other equal to 850 watts. Under these conditions, the coolant temperature out of the system never exceeds 160 F. Each path is protected by flow and temperature interlocks. A variable-speed blower compensates for lower air density at high altitudes

efficient, may produce noxious side effects, requiring even tighter sealing of the transformer enclosure. Smaller transformers that are encased or untreated have disappeared except in obsolescent equipment. Recent production of open-core transformers provides for potting or encapsulation of the windings unless the unit will end up in a protected package.

As ground equipment becomes more sophisticated, it will absorb the gains that space packaging design has made in protection from mechanical shock, heat, corrosive atmospheres and radiation.

Commercial equipment specifications can be written for operations in specific environments, but the ranges and conditions cannot be so restricted for operation of military equipment. The mobility of modern forces could well require taking radio transmitters from a sub-Arctic storage depot one day to deposit them in a steaming jungle the next. The fact that military gear visits otherwise uninhabited regions imposes a need to design a package that will survive the unknown as well as the known hazards.

Hazards—Present day commercial and military equipment must be protected from such diverse hazards as dust and sand, salt spray, heat, moisture and the effects of industrial air pollution. Liberal use of high purity aluminum, stainless steel and titanium, with or without a protecting or camouflaging coating ensures that corrosion and fungus action can not gain an initial foothold.

Complete sealing is often virtually impossible. Where dial-driven shafts are used, a sealing gland must be chosen that will retain its resiliency and resist attacks. In some equipments where sealing cannot be complete, other techniques are used to inhibit deterioration.

The use of rust preventives, fungicide varnishes or heating reduce the hazard of quick destruction. In some cases a container of dessicant absorbs leakage of air that could later condense out its moisture at lower temperature. A mechanical dessicant like silica gel, provided with a dye, can be recycled innumerable times. The gel that has turned pink is heated until a return to cobalt color indicates that moisture has been expelled. This type of drying is often preformed semiautomatically.

Dryers—Particularly for large equipment, like radio transmitters and receivers, keeping the tube filaments on continuously or keeping an electric light bulb going in the enclosure at all times will provide just the necessary amount of heat, relative to the ambient air so that moisture is effectively expelled from the equipment. Modern communications equipment is often furnished with a low-wattage heater that is useful in even the temperate zone.

Freezing—Extreme cold is encountered in Arctic regions, although the real extremes occur at high altitudes. Temperatures in the space between ground and 100,000 feet can fall as low as -125 F. Nickel-cadmium batteries, for example, deliver more power at low temperatures than do lead-acid storage batteries. Use of the latter, which may have other desirable features, may mean providing heat in some way

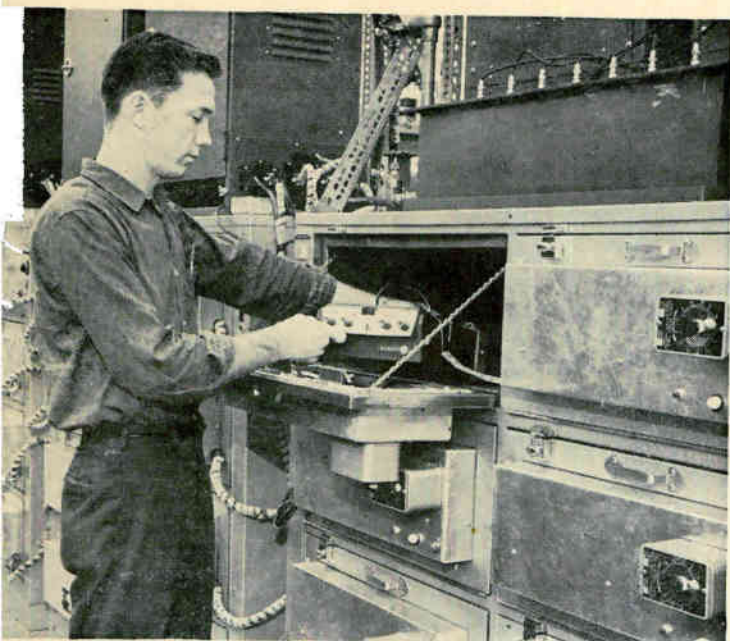

MOBILE two-way radio communications equipment is sealed into a heat chamber at 140 F for a full hour and keyed on and off at a 20-percent duty cycle. General Electric transistor lines must also undergo shock and vibration tests since equipment is used under varying environmental conditions over rough terrain. Modern packaging with emphasis on compactness with reliability has forced comparable tests for both military and commercial electronics equipment, especially when converted to use of transistors

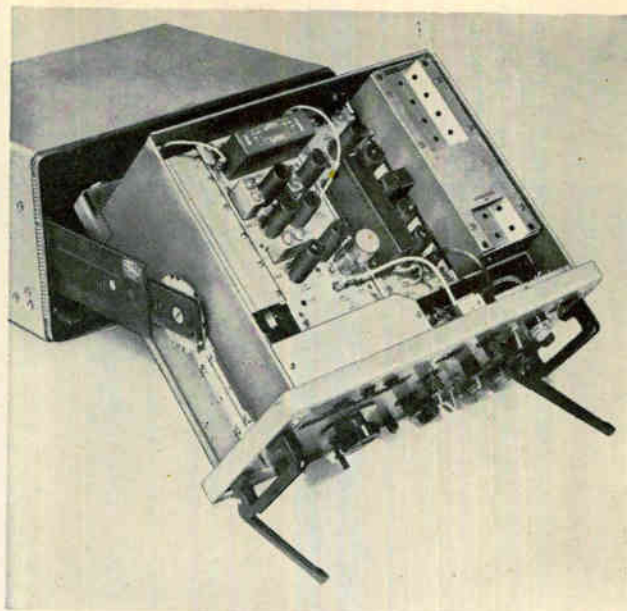

MULTIBAND low-frequency receiver tuning 14 to 600 kc achieves minimum weight and size as well as ease in maintenance through modular construction. Each module of this Capehart Corp. design is a rectangular box of square cross-section containing a complete circuit segment. It contains the specific circuit for all bands and can be tested as a separate entity. A defective module can be replaced without realignment. Short lead length and adequate cooling are insured. Chassis can be tilted up as well as down for maintenance

derived from the electronics package. Packaging is affected by the type of battery used as power source.

Another hazard for airborne gear is low pressure flashover that may burn a permanent track across the high-voltage short-circuit path. The solution is either a high-pressure package that also avoids corona effects or simply greater spacing between terminals of extremely different potential.

Less subtle but capable of great damage are vibration and shock. Whether the package is to operate in a missile where it may encounter as high as 100 g, on a railroad car in which passage over rail joints may set up a damaging resonance, or whether the package must survive a single 50-g drop in arriving at its ground-based destination, means must be found for its protection.

Strengthening—Manufacturers learned to their sorrow in World War II that the power transformer has considerable mass and can easily be torn loose from a relatively thin chassis. Modern design often uses the large transformer as a building block, tying it in with the vertical and horizontal structure for greater rigidity. It also serves as a mounting point for some associated equipment.

Ceramic tube sockets and insulators present a double hazard since, although they may have great compressive strength, can easily become cracked with careless handling or broken by g forces if made to support undue weight at a far end.

Vibration mounts are extensively employed within and outside the electronic package, but they must be

chosen carefully to eliminate rather than reinforce the effects of vibration. Using rubber compounds or metal wool, vibration units are generally poor conductors and must be bypassed for power or radio frequencies with appropriate grounding straps.

Radiation—Least known of the space hazards are those resulting from radiation. Despite careful research and painstaking design, equipments sent into space have ceased functioning simply because the true nature of the environment is so little understood and sparsely mapped. The complex nature of radiation effects has been studied in connection with nuclear reactors and much work has gone into protecting the control equipment that must be used in nuclear propulsion. But information on the whole behavior of semiconductor devices as well as of various components is spotty.

Studies recently reported indicate that transistors exposed to a steady-state source of neutrons and gamma rays were damaged in two ways, through atomic displacement, which affects the volume characteristics and through ionization that affects mainly the surface. The former damage may be both temporary and permanent, while the surface damage is generally transient. Much of the radiation damage healed after the device was no longer subjected to radiation, but not all did. This is an area of imperfect knowledge and no standards where work must continue to determine the kind and extent of shielding packaging.

Another area of concern is the interference occur-

MODERN ELECTRONICS PACKAGING

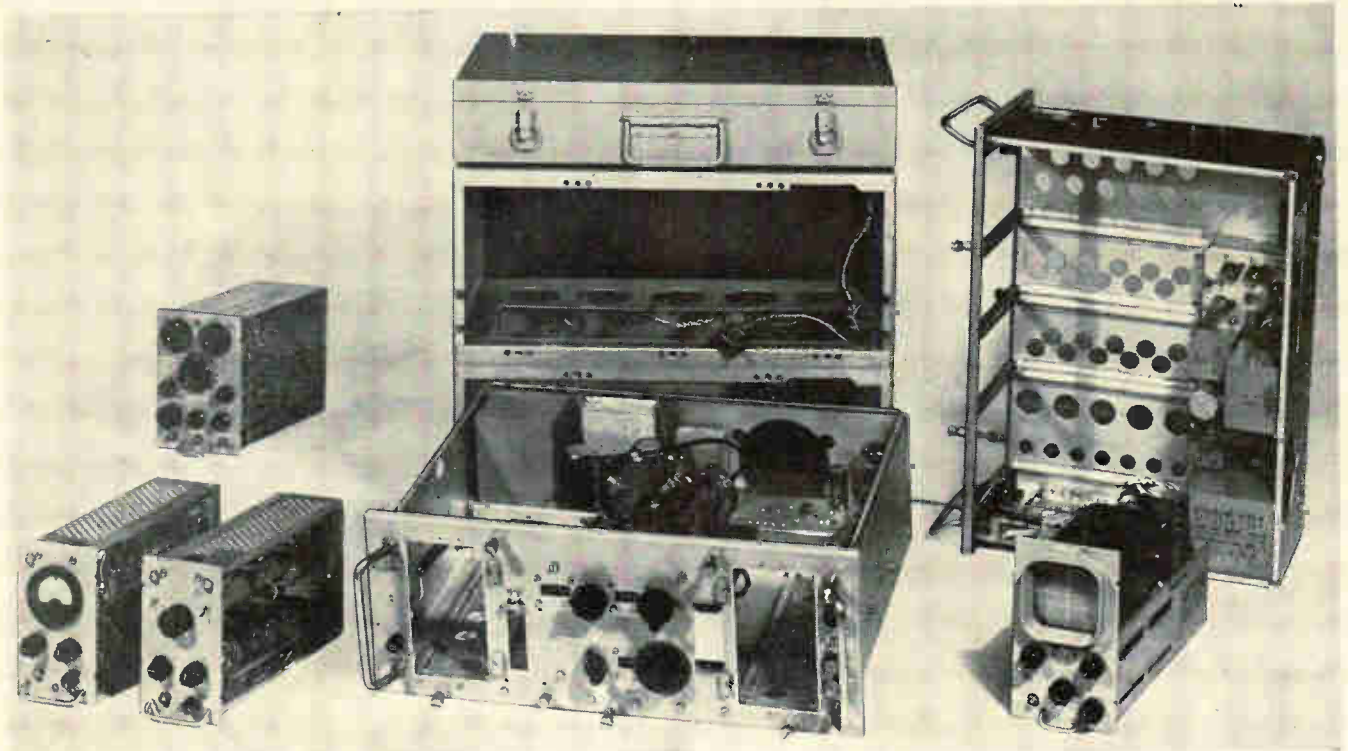

MULTIPLE function test equipment in development by Capehart Corp. uses multiplicity of separate plug-in modules that are combined into two drawers individually removable for servicing. Overall equipment comprises pulse train generator, r-f signal generator, power meter, mod-

ulator, calibrated oscilloscope and accessory carrying case. Complete interchangeability of modules without realignment is required. Density of packaging requires a blower motor and fan that cools critical components first, then passes air over the hotter components

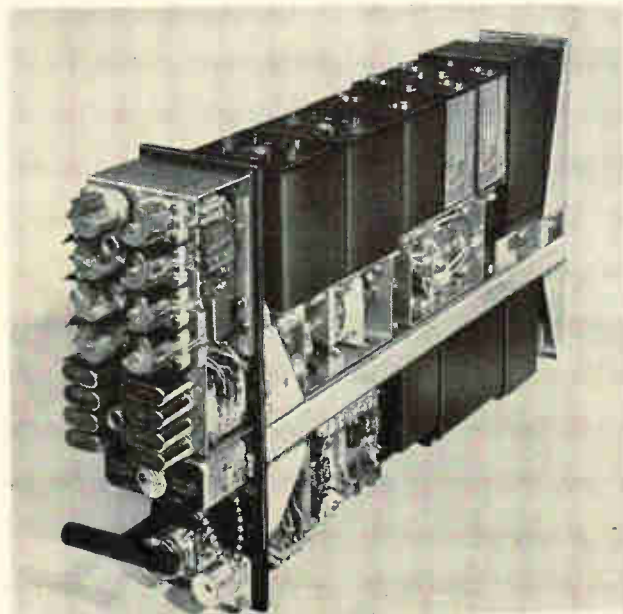

AIRBORNE teleprinter receiver is representative of Marconi line packaged for aircraft use. Power requirements are minimum for transistor operation with a minimum of heat generated. Other units adversely affected by temperature extremes, humidity, pressure or atmospheric contamination have sealed modular assemblies. A heavy-gage cover is fastened against a sealing gasket and the module is filled with inert gas. Units can be assembled in standard mountings

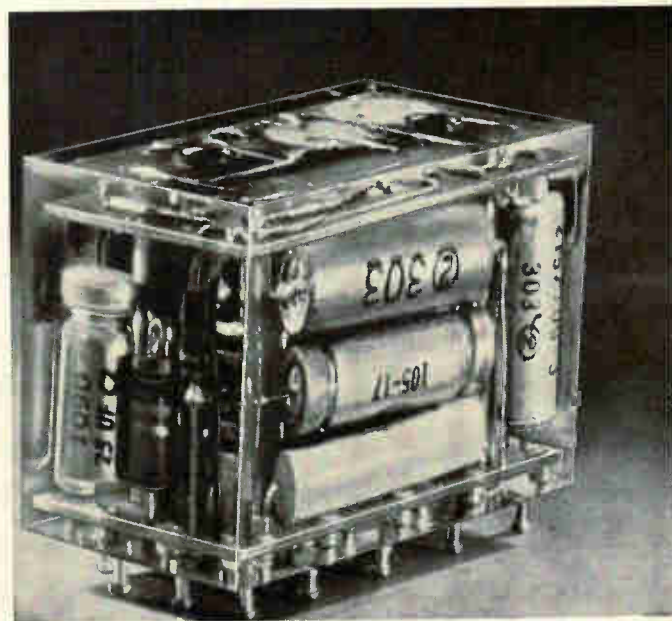

VIBRATION protection for this General Electric transistor amplifier (shown here in clear plastic case before embedment) will be afforded by filling the case with an epoxy material. Shock resistance is enhanced by raising the resonant frequency of the package above that it will encounter in normal service. Embedment of the unit and all its contents is effective in increasing its rigidity. It will then withstand two impact shocks in each plane of 35 g peak of 10 and 3 milliseconds duration

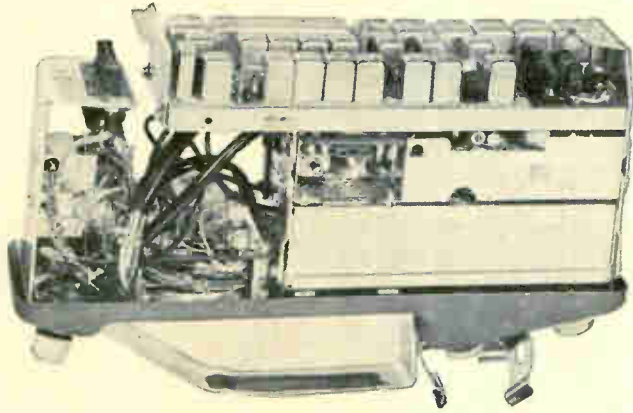

COMPARISON of Motorola two-way portable f-m radio chassis using tubes (left) and all-transistor version (right). Power amplifier output stage uses six mesa transistors in parallel to give 3-watt output in the band from 132 to 174 Mc. Batteries are contained in a lower section (not shown). Receiver and transmitter fold out for servicing. Driver and two output transistors, at the top edge of the transmitter, mount on a bracket that serves for interstage shielding and also a transistor heat sink. The six transistors forming

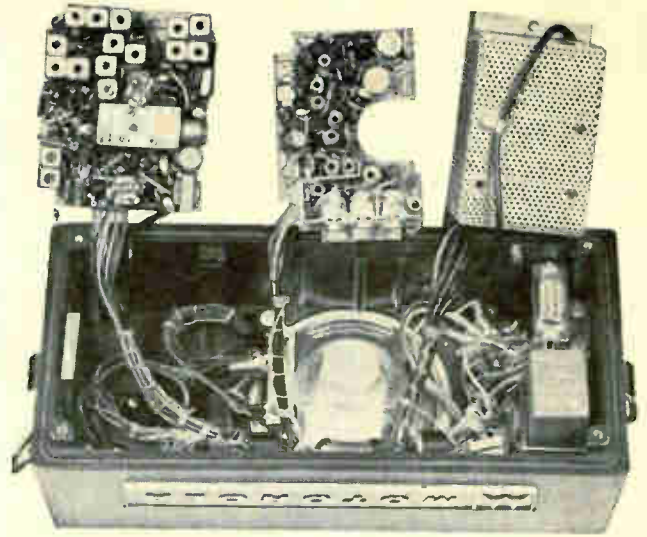

the 3-watt amplifier are mounted on a heavy copper plate. They are physically mounted symmetrically to make possible equal lead lengths. Two metal separators provide r-f shielding to reduce coupling between output and input sides of the chassis. A perforated metal screen fits over the entire chassis to shield the transmitter proper from the power amplifier. High stability crystal oscillator and reactance compensator eliminate need for heaters that require power

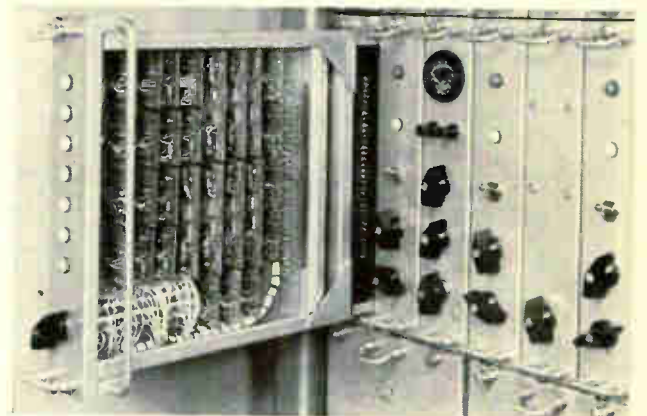
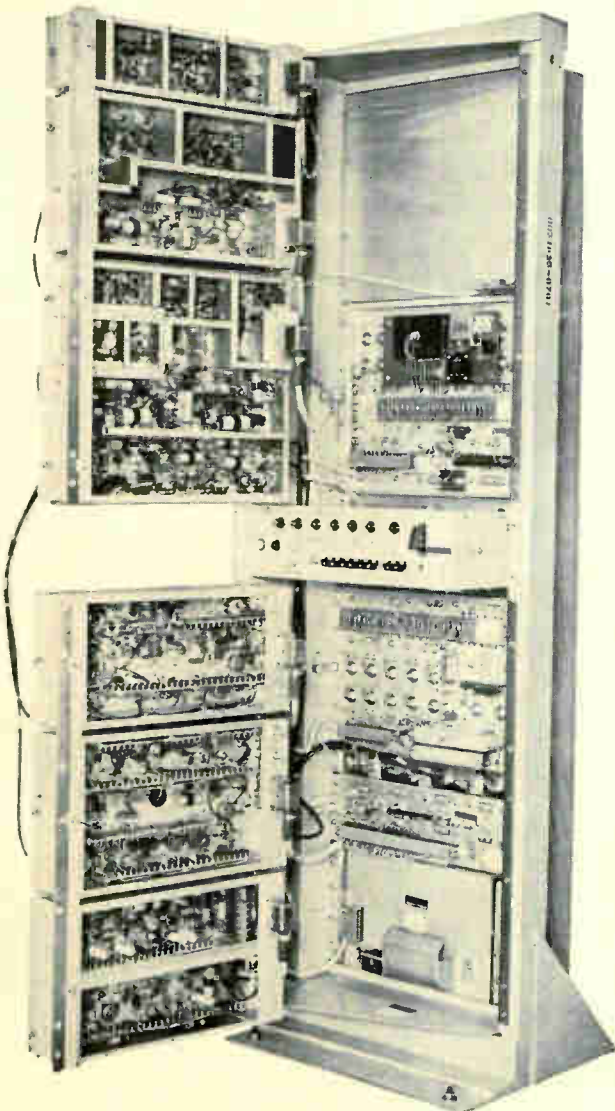

AUTOMATIC error-correcting equipment for digital data transmission has been evolved by Marconi's Wireless Telegraph Co., Ltd. for high reliability. Some adverse effects of modular design have been reduced by employing a small number of basic circuits. Dip and flow soldering, design of a new interconnection plug and socket, care in selection of components and their placement contribute to reliability. Replacement of electron tubes by transistors and diodes permits tighter packaging

BMEWS rearward troposcatter communications circuits use many receivers like the REL unit shown here with dust covers off. Major servicing is possible by swinging out side-hinged units. For extensive maintenance the connection plug at the right of the unit is removed and the slotted hinge lifted off front studs to free the whole assembly. Horizontal bars and rectangular slots at the panel edges (right) prevent equipment damage and jammed fingers as the mounting screws are removed preparatory to inspection.

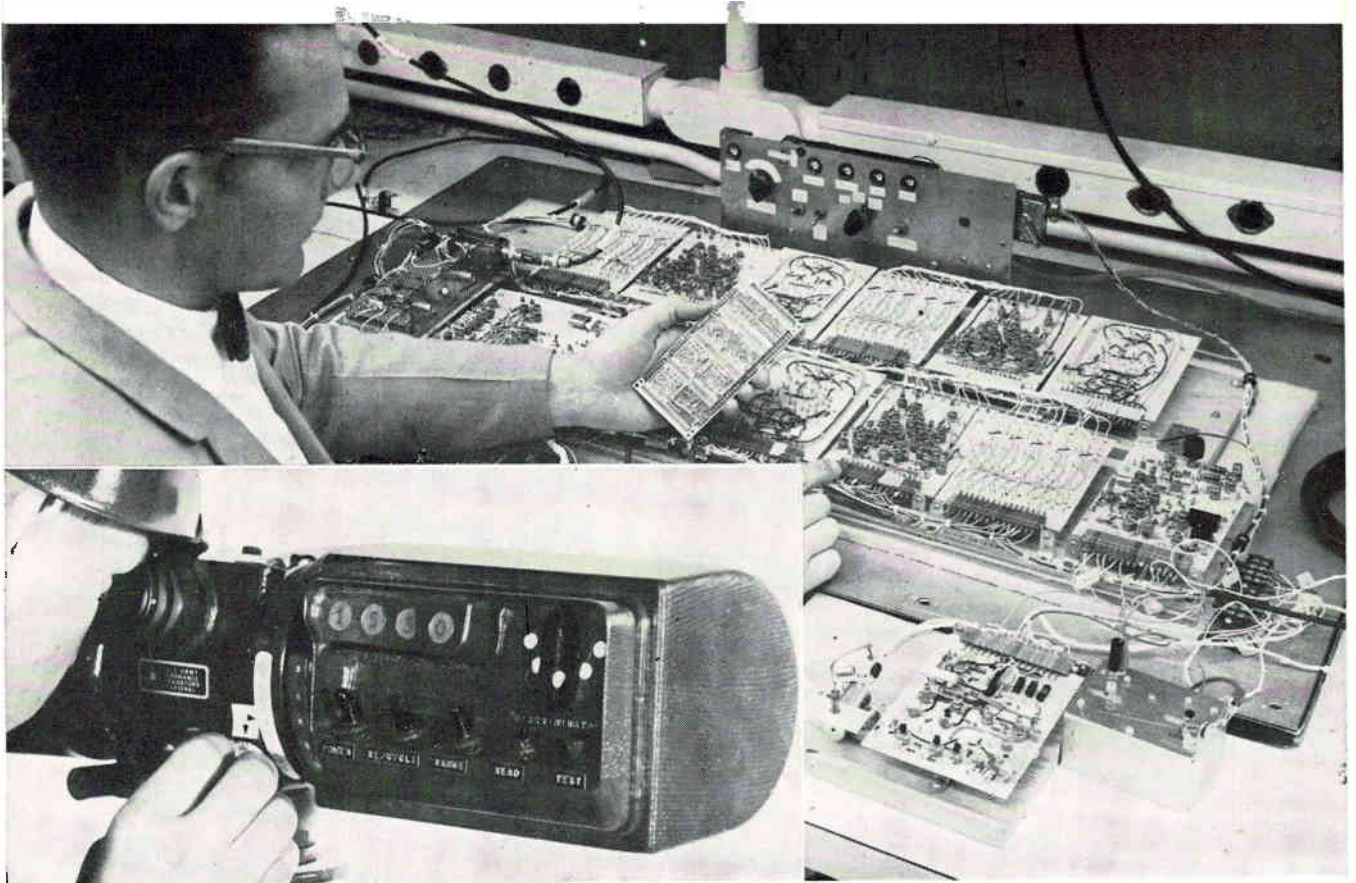

COMPARISON between thin film and printed circuit versions of laser rangefinder (inset) built by Martin-Orlando for Frankford Arsenal. The complete electronic ranging system, comprising 13 substrates or wafers with their thin

film components occupies less than 9 cu. in. and weighs less than 6 oz. The printed circuit version with the same transistors in cans weighs more than 7 pounds and occupies more than 266 cu. in.

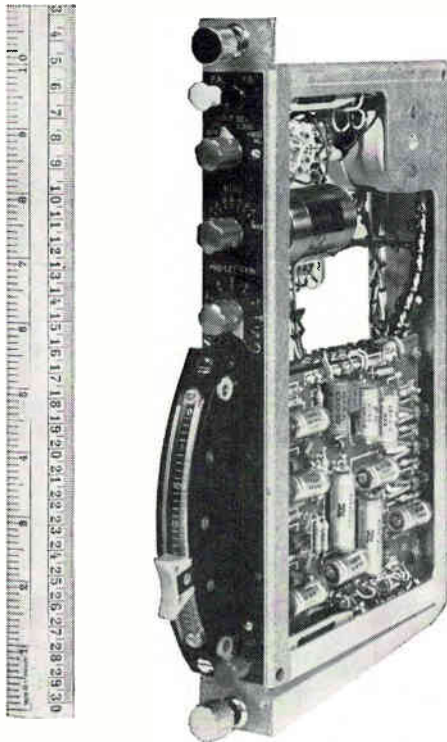

TELEVISION audio channel and echo amplifier packaging reflects the minimal space available in a sound-control console. This Marconi unit is one of many now operating in Manchester, England. Transistors are used throughout and circuits result in noise figures competitive with those in tube amplifiers, but without microphonics. The gain is controlled by vertical movement of the long lever arm that takes the place of a skirted knob on the narrow front panel.



OSCILLATOR used in telemetry system of the Q-2C jet target drone employed by Navy and Air Force for testing ground-air and air-to-air missiles. Designed to withstand 25 water landings and recoveries, the unit has been encapsulated in a room temperature vulcanizing clear silicone elastomer supplied to the manufacturer, Dorsett Electronics, by General Electric. Besides absorbing vibration energy, the silicones serve as short-term high temperature, insulators. Components can be cut out and replaced

ring in cables as a result of nuclear pulse irradiation. Signals in coaxial cables are sometimes attenuated by the pulse. In other types of coaxial conductors, interference is minimal. Such information is vital in the design of survival equipment communication packages.

COOLING

ULTIMATE heat sink has considerable influence upon packaging but it is not of concern here. Rather the importance of the route through which heat is transferred to a penultimate sink shows up most clearly as packages become increasingly smaller.

Fans and blowers for large electronic communications equipment have been known for many years, although efficient use of moving air is more recent. Liquid cooling, as in the circulation of distilled water around the plates of high-power transmitting tubes, has been understood for a considerable time. Later developments such as boiling-water cooling of tube plates and the advantages of turbulent, as opposed to laminar, flow of air are now well understood and practiced.

Lesser Problem—Although losses in electronic equipment will always cause a heat problem that must be dealt with, semiconductor devices produce a good deal less than tube equipment performing the same function. Careful design can sometimes eliminate blowers that in themselves generate heat. Some modern design is capable of eliminating other sources of unnecessary heat in equipment.

As the packaging density for thin-film microcircuits increases, more sophisticated cooling techniques will be needed to ensure reliability in a small space.

Basically all cooling is accomplished through conduction, convection and radiation. Many cooling systems use all three. Failure to obtain the amount of heat transfer desired may result from a misunderstanding of the mechanism of cooling or how to implement the basic mode. For example, a tube shield that is highly polished will be of little use in conducting heat. Even when the shield is treated with a flat black coating that is theoretically a good radiator, there may be failure. The shield must be intimately attached to a good heat sink, not merely bolted to it.

The design engineer must understand how to package resistors that dissipate considerable heat. If they are hollow tubes, it may be best to mount them side by side vertically. Convection will carry away a maximum of heat. There will also be a time when it is desirable to mount such resistors horizontally since each end will then tend to assume equal temperature. In any case, the packaging engineer must be sure that whatever is above the hot resistors will not suffer, and he must also ensure an air intake below the resistors as

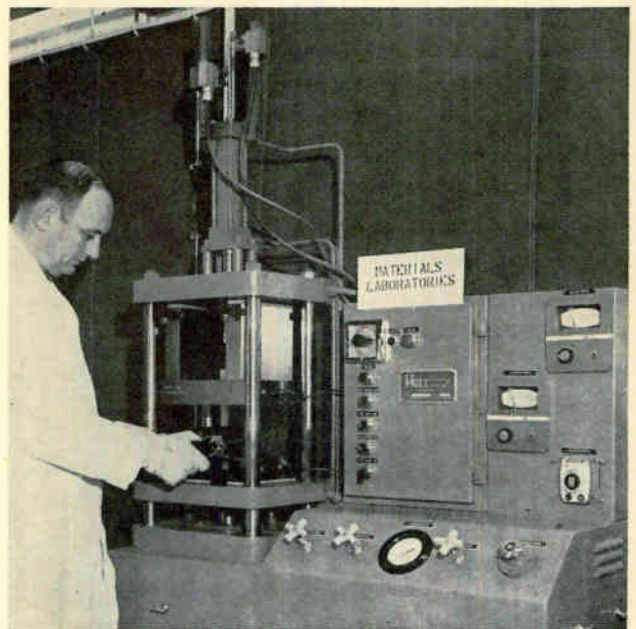
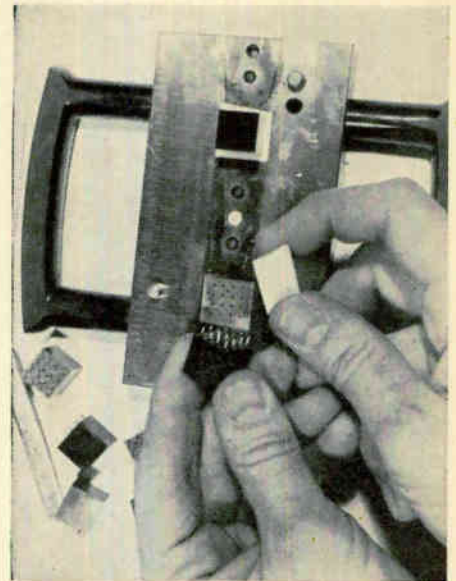
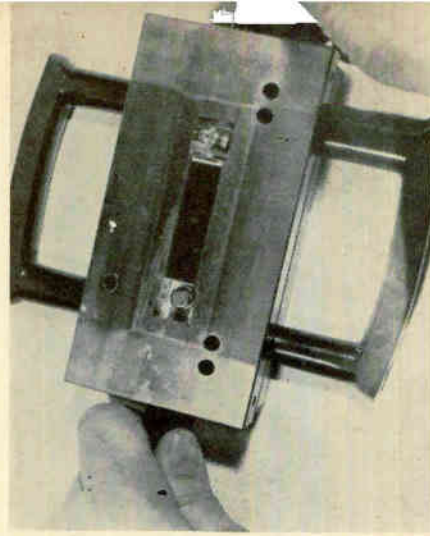

EPOXY molding powders used for encapsulating electronic assemblies. The mold with assemblies in place is put into a transfer molding press. Encapsulated units are later removed from the mold (Martin-Orlando)

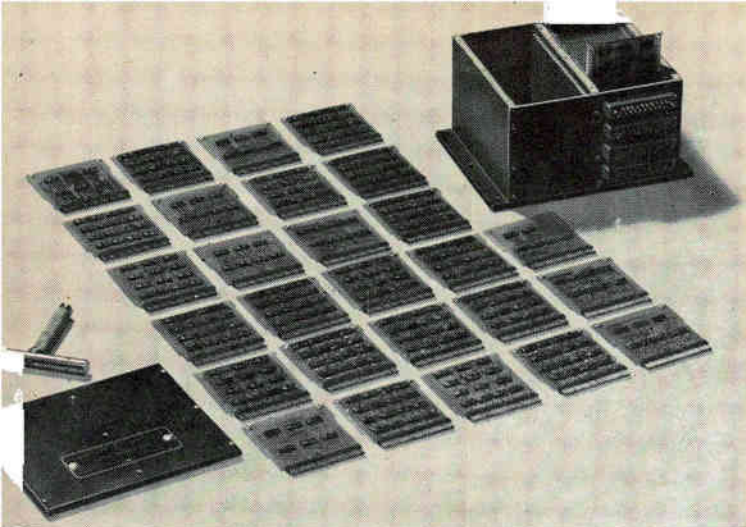

ARITHMETIC unit built by Texas Instruments for Ling-Temco-Vought. There are 542 solid circuit semiconductor networks and no conventional components in this 17-oz assembly. Plug-in cards have been removed from slots in one magazine of the device to show the diversity of interconnected flat-pack units. Total dissipation of 3.7 mw is handled by the slotted thick-metal walls acting as a heat sink. Heavy cover provides area for radiation and package can be bolted to a larger sink if required

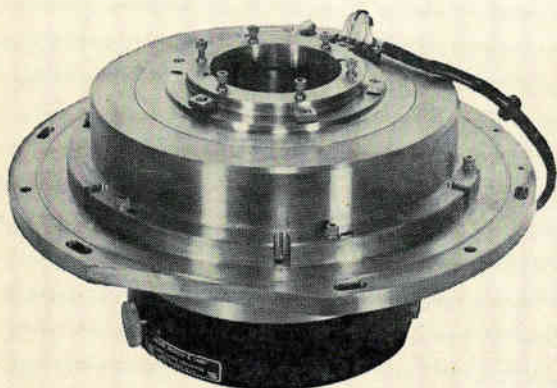

UNUSUAL package combines electronics with mechanical design. Device pictured is part of a highly accurate readout system used with radar tracking antennas. The system incorporates a 36 pole-pair synchro and a 17 bit optical encoder in one integrated unit. The readout mounts directly on the gimbal structure to avoid gearing errors. This Reeves Instrument design gives angular position in both analog and digital form. The six-inch center opening is for r-f waveguide or cabling

TRANSISTOR module has been formed in unusual shape to fit special package requirement. For ease in handling, the unit has been encapsulated in a semirigid epoxy resin that also reduces possibility of vibration and shock damage encountered in an airborne missile system. Connections are made to terminals at bottom. The component parts are sealed away from usual environment hazards, but cannot be repaired or replaced since opening package will damage it (GE)

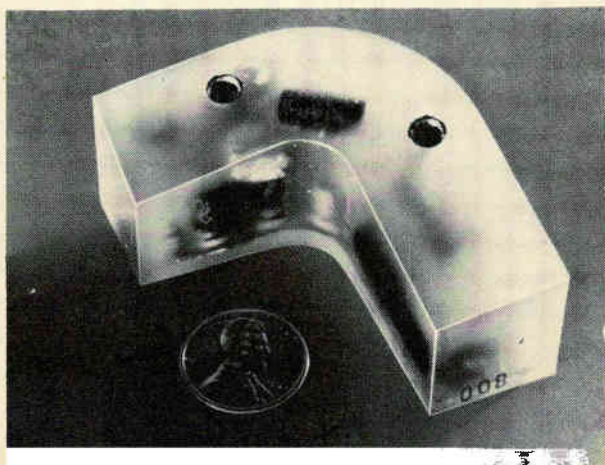

well as an exhaust above. However it is mounted, the wattage rating of the resistor depends upon its being in free air and it must not be pushed to its limit within a package.

Uneven Heat—Hot spots develop in equipment and even at points on the glass envelope of electron tubes. During the development of larger equipment, heat runs are performed during which temperature sensitive lacquers or crayon marks are observed to determine the existence and location of such hot spots, or infrared viewing may be employed.

In smaller equipment, great care must be taken to avoid burnout resulting from failure of heat sinks to function properly. Power transistors and solid-state rectifiers must be provided with effective sinks. Special precautions must be taken to insure thermal as well as apparent mechanical contact. Silicone greases that remain fluid at low temperature and do not melt away at high temperature can be used to effect a good thermal bond.

In smaller, encapsulated, packages all the known cooling techniques can be applied in miniature. The package can be laced with hollow tubing through which flows a pumped coolant. Solid metal strips can be imbedded along with the circuit wiring to serve as a local sink that can be cooled at its outside terminals by other means. Metal powder can be imbedded in encapsulating plastic to provide conduction of heat. The conductive property of the plastic itself can be modified somewhat by varying the amount of curing agent used.

Phase Change—Spray and vaporization cooling that are suitable for small equipment have little present application in miniaturized gear. Previously rejected as impractical, the phase-change method of cooling thin-film circuits is now under active study. Essentially, such a system operates on the chemical change in the cooling medium from solid to liquid to vapor or from liquid to vapor.

A more elegant solution has been found for a micromodular data processor and computer with a core memory reputed to work marginally outside the limits of 40 and 60 C. The device is refrigerated thermoelectrically using bismuth telluride cylinders against copper strip.



ENCAPSULATION of electronic equipment generally implies a hermetic seal that will provide protection from all hostile environments likely to be encountered in normal use, including the ill-effects of shock and vibration. Recently, encapsulation has become a

synonym for potting. Since, in many cases, the encapsulation is accompanied by potting, the term is used here in the popular sense.

Potting of transformers, chokes and similar units has been employed for many years. At the low frequencies encountered, the compounds used were adequate to provide moisture-proofing, mechanical support of a sort, electrical insulation and prevention of audible noise from loose laminations. The material was inexpensive, easy to heat and pour, quick to cool and difficult to remove. Such use will continue where inexpensive compounds are satisfactorily contained in metal shells.

In applications involving special insulation or unusual problems of heat dissipation, such as radar pulse transformer, an oil-filled case is used. Where appropriate, resins may be employed within a completely closed metal case. There is sufficient knowledge of new materials available to solve quickly most of the potting or encapsulation problems encountered in the large electronics package.

Small Units—The protective capsule enclosing small or microcircuit elements is likely to contain a resin. Although insulation is important, the principal reason for encapsulation is to ensure protection from hostile environment at the same time that the content of the package is secured from the effects of shock and vibration. By increasing rigidity, the resonant frequency of the package exceeds that of the vibrations to be encountered, which will cause damage to the contents.

Epoxy resins have excellent qualities and are widely used. Since there is shrinkage during the time they cure, with resultant stresses, fillers are sometimes used. Tiny glass or phenolic micro balloons are sometimes used as filler to reduce shrinkage. Asbestos material is available in combination with resins to give desired temperature characteristics.

Foams—Polyurethane rigid foams are light and yet strong enough to furnish mechanical support for small circuit packages. Air-to-water-dropped equipment frequently uses foams because the energy of impact is expended in crushing the foam cells. For this reason they can be used where high-impact protection is needed. In addition, their low dielectric constant is favorable for high-frequency applications.

Elastomers provide shock and vibration damping. Silicone compounds that pour easily and cure at room temperature are available either as transparent or opaque fluids. Their shrinkage is low and electrical properties are good. A further advantage of this type of package is that probes can easily be forced through the material to check component values, the aperture sealing again as the probe is removed.

When the transparent material is employed, it is possible to identify the location of a component, cut out a chunk of the elastomer and replace the component. After the repair, more of the compound can be poured into the hole, which is then indistinguishable after the silicone compound has cured.

Nuclear Use—For packages that may be subjected to irradiation, special care is taken to choose a suitable

material for this use. Polystyrene is highly resistant and shows major changes only after doses at 10^9 rads. Most elastomers fail at about 10^8 rads, becoming hard and brittle.

Epoxy molding powders have been employed successfully using transfer molding techniques in the fabrication of welded circuit units. High production of reliable assemblies at less cost for material and equipment is claimed.

Typical of another kind of encapsulation is a recent micromodule technique that employs electron-beam welding of header-stack assemblies and subsequent welding of cans to headers. After sealing, the units are leak checked by placing within a helium bomb for four hours followed by mass spectrometer leak check. Typical leak rates are said to be lower than 10 cc per sec. Some airborne communications and navigation equipment uses inert gas encapsulation without welding.



MICROCIRCUITS are an important part of modern electronics packaging but cannot be described here in any detail. The bibliography lists a number of papers on microelectronics, including detailed information previously published in *ELECTRONICS*.

There are, however, new trends developing. Manufacturers of completed equipments are dissatisfied with the fact that they neither buy individual components any longer nor can they afford to go into the business of producing the small modular circuit elements demanded by the type of customer or the economy that now exists. There are too many connections to be made. One solution, mentioned above, is the purchase of semiconductor chips and connecting them together by a mechanized procedure.

In another direction, very small, completely reliable connectors are still not available for certain jobs. Some manufacturers are proceeding to develop these.

By Function—The trend must be toward functional devices rather than the amalgamation of individual pieces. One engineer has given as analogy the old but pertinent example of the piezoelectric quartz crystal resonator which employs both the piezoelectric effect and mechanical resonance. Although it has a lumped circuit equivalent, neither the inductance nor the capacitance can be isolated within the quartz resonator. It reduces the number of components by replacing an LC network by a single entity. It has higher Q and greater frequency stability.

While microcircuits grow smaller for specialized uses, potential customers might gladly settle for more

size and less expense through some variation of packaging. One possible approach is the hexagonal module employing circuit boards equipped with connection plugs in the vertical dimension, a programming cap that can be required for different interconnection and an interconnecting receptacle that also contains power or other fixed-function connections.



CONCLUSIONS

PERSONNEL are more often than not involved in the use and handling of the electronic package. It must therefore be wieldy and manageable. If it cannot be moved through a standard doorway or transported by normal means it creates expense and its future maintainability may be in doubt.

Equipment can be overengineered so that it is initially too costly and expensive to operate. Sometimes the practical dimensions of the average human being are overlooked in the design of equipment packages. A pilot light can be placed so that it dazzles the eye that seeks to read the meter next to it. Sizes, shapes and close proximity of control knobs must be taken into account. If equipment is to be used outside, especially in cold regions, it must be capable of operation with gloves or mittens.

Size Limits—There are present limits in the size to which an equipment can sensibly be reduced. The home television receiver is a case in point. Although the circuits could be reduced to a much smaller volume, the size of the picture tube remains the controlling dimension. If a large manually operated control, like that of a communications radio receiver, is required, the panel size cannot be reduced much beyond its diameter. And the size of a resonant cavity is a function of its frequency.

Although much glamor is associated with packages that are eventually to be put into space, the stringent requirements must be met by employing known techniques. For example, it has been stated that within the Surveyor moon-landing electronic complex, packaging forms vary from cordwood stacking of low-signal-level components to hand-wired assemblies of large components and from the typical etched circuit board layout of low-frequency amplifiers to the hand-wired assemblies of large components and those assemblies used for high-frequency lumped-constant amplifiers and multipliers.

Page-space limitations have made it impossible to use or even acknowledge all the information and illustrations generously furnished by many individuals and organizations for this packaging study.

Continued on page 48

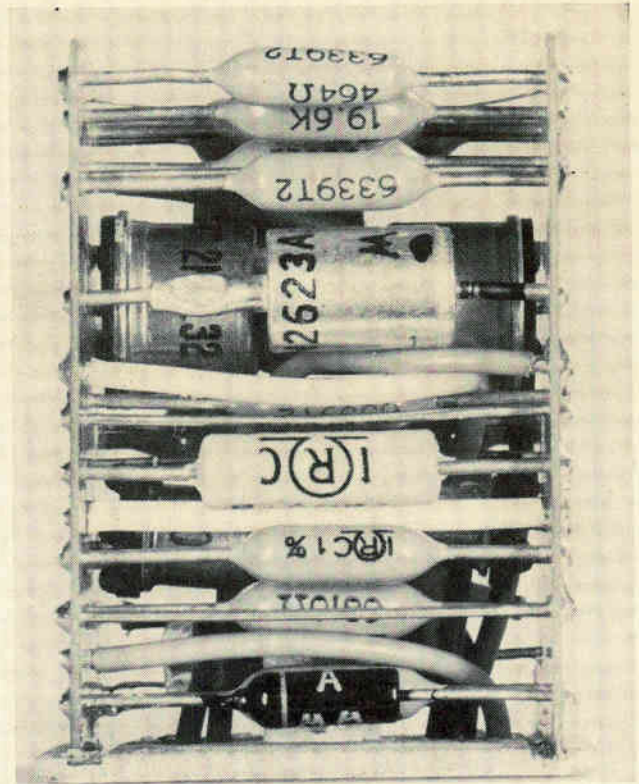

CORDWOOD module with anastomotic redundancy furnished by General Dynamics for the Ranger lunar probe. Printed circuit boards are two-sided epoxy glass and copper laminate with gold plated-through holes that connect the identical circuits etched on both sides. Cast aluminum header (bottom) is tin plated. Printed circuit boards are soldered to the header, providing a sink for the heat that flows down the component lead into the board. After foaming and sealing, transistor-circuit units have a parts density of 25 per cu. in.

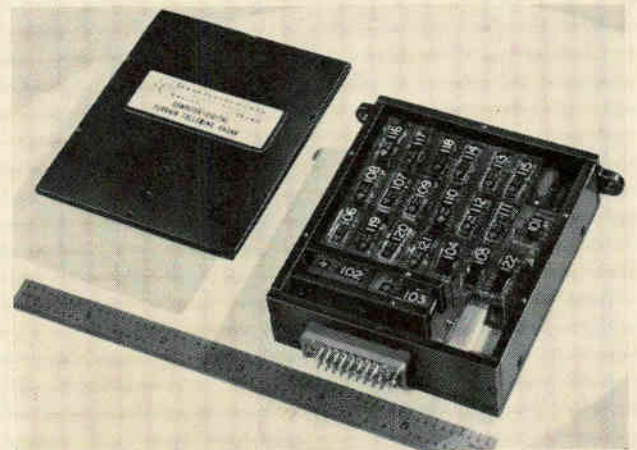

COMPUTER for navigation radar combines 108 conventional components with 217 solid circuit semiconductor networks. Designed by TI for a terrain-following radar, it accepts and compares inputs of time domain and analog domain, does digital computation and storage and produces both digital and analog outputs. The encapsulated units comprising subassemblies are plugged into the enclosure of the main package. Interconnection with other equipment is effected through multiple connector in foreground.

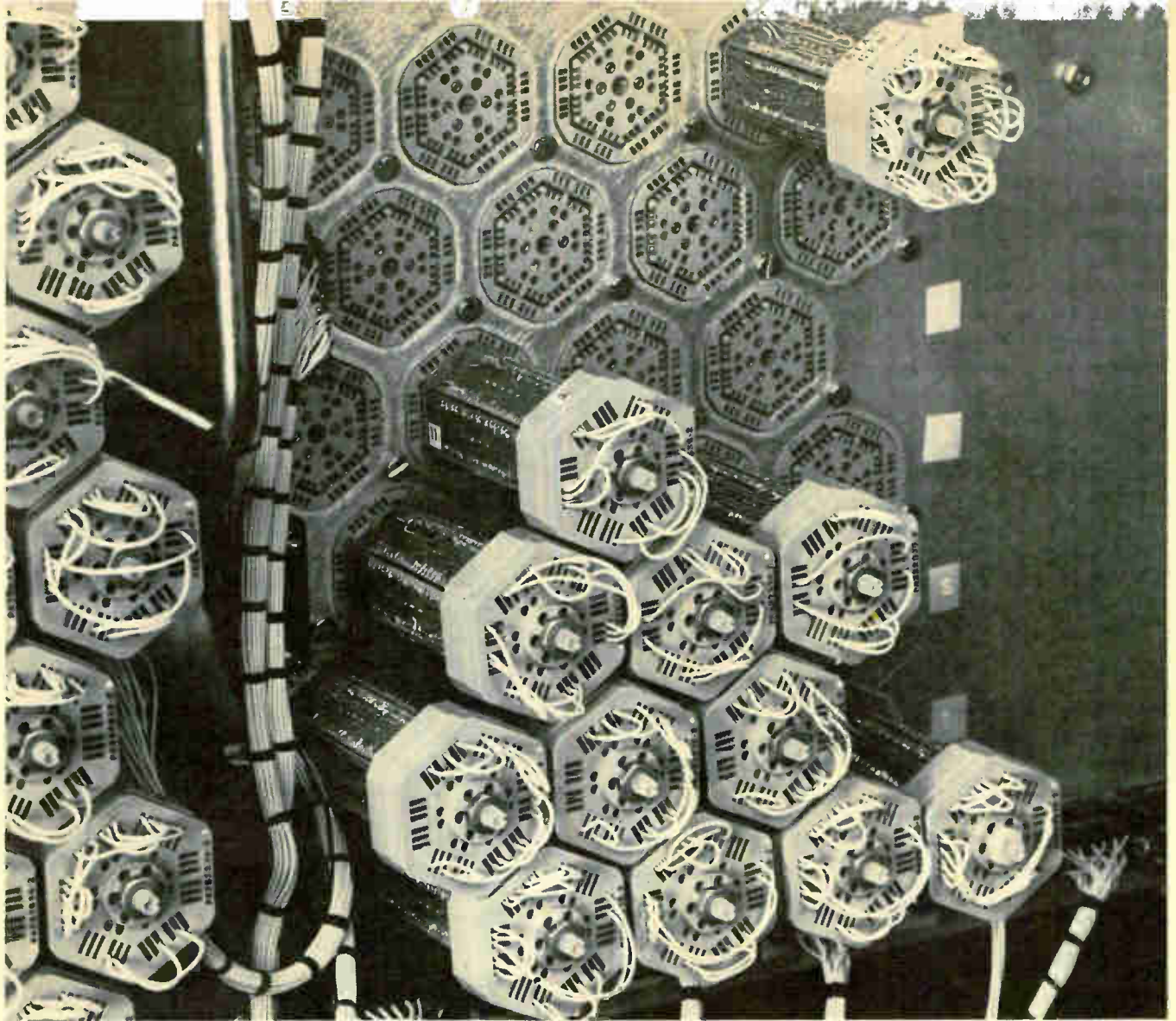

HEXAGONAL module developed for applications in which low-cost throwaway parts can be assembled quickly and with a minimum of interconnection. Designed cooperatively by ITT and Burndy, the basic component is a printed circuit board $\frac{5}{8}$ by $2\frac{3}{4}$ inches and 0.031 inch thick. Either

discrete or semiconductor integrated components are mounted on the board and dip-soldered or welded. Interconnections are made at the top. Power leads are on inner pins. An integral plug contacts socket connections to other units on the same chassis



SIGNAL conditioner for EGO satellite was furnished to Iowa State by Texas Instruments. Output is nrz binary 16-bit words read out serially. The device counts asynchronous pulses from 8 inputs, generates parity and forms digital words. Bit rate is 64 kc externally controlled. Power dissipation of this 7-oz unit is 280 mw. An example of hybrid miniaturization, this package contains 169 conventional components and 102 Solid Circuit semiconductor networks. The book type assembly of components is not unique but represents a kind of useful packaging

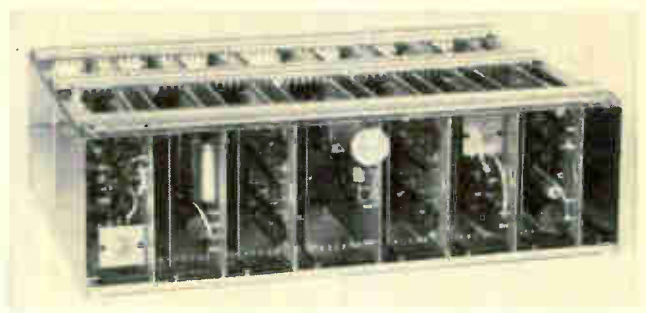

UNIVERSAL cell for packaging printed circuit cards used by Stromberg-Carlson in electronic private branch telephone exchanges has notched rails that hold removable card guides. The carrier multiplex equipment shown is less densely packaged than computer elements. Card guides are spring-loaded by rubber stripping and connectors become part of the guide rather than of the cell, insuring perfect registration. Different end plates control cell dimensions; racks can be 19 or 30-inch width. Heat transfer is optimum



BIBLIOGRAPHY

- K. W. Allen, Rail concept of electronic modular packaging, "Nat. Elec. Pack. and Prod. Conf. 1963," Chicago, p 450.
- J. L. Andre, Welding module manufacture made easier, "Nat. Elec. Pack. and Prod. Conf. 1963," Chicago, p 434.
- W. T. Appleberry, Module enclosures for a modern weapons system, "Nat. Elec. Pack. and Prod. Conf. 1963," Chicago, p 446.
- B. Barton, Miniaturized packaging of existing production electronics systems, "Nat. Elec. Pack. and Prod. Conf. 1963," Chicago, p 497.
- J. Baum and R. Jimenez, Development and implementation of standard techniques for the thermal design evaluation of electronic equipment, "Nat. Elec. Pack. and Prod. Conf. 1963," Chicago, p 1.
- G. L. Beigel, High density modular packaging techniques for 0.1% voltage regulated power supplies with optimum maintainability, "Nat. Elec. Pack. and Prod. Conf. 1963," Chicago, p 453.
- R. G. Bender, A plating method for inter-viewing pellet component microcircuitry, "Nat. Elec. Pack. and Prod. Conf. 1963," Chicago, p 253.
- J. K. Billings and J. W. Brownie, A lightweight electronic module design, "Nat. Elec. Pack. and Prod. Conf. 1963," Chicago, p 107.
- J. H. Brimson, Semi-automated packaging using a computer, "Nat. Elec. Pack. and Prod. Conf. 1963," Chicago, p 173.
- E. Both, H. P. Bruemmer, C. P. Lascaro, J. Newberg and W. Schlosser, Noise signals and carrier modulation arising in electrical cables during nuclear pulse irradiation, "1963 IEEE Int. Conf. Rec.," p 128.
- G. R. Bretts, J. Kozol and A. F. Ringwood, Techniques for encapsulating electronic parts in rigid epoxy systems, "Nat. Elec. Pack. and Prod. Conf. 1963," Chicago, p 383.
- L. J. Charles and R. Morrison, Electronics, "Nat. Elec. Pack. and Prod. Conf. 1963," Chicago, p 71.
- S. S. Cole, Jr., Basic functions affecting ceramic seals, "1963 IEEE Int. Conf. Rec.," p 104.
- C. I. Denton, Structural design of equipment to withstand high impact shock loads, "Nat. Elec. Pack. and Prod. Conf. 1963," Chicago p 408.
- H. K. Dicken, Parasitics in integrated circuits: more trouble than meets the eye, *ELECTRONICS*, p 32, July 5, 1963.
- R. J. Dickie, How to apply vibration isolators, *ELECTRONICS*, p 126, Dec. 1952.
- R. W. Dreyer, A design concept for conformal microseal circuitry, "Nat. Elec. Pack. and Prod. Conf. 1963," Chicago, p 129.
- G. W. A. Dummer, C. Brunetti, L. K. Lee, "Electronic Equipment Design and Construction", McGraw-Hill, New York, 1961.
- R. A. Dunaetz, Welded module packaging for outer space applications, "Nat. Elec. Pack. and Prod. Conf., 1963," Chicago, p 468.
- EIA Engineering Dept., "Reliable Electrical Connections", Engineering Publishers, New York, 1958.
- Electronics Staff, Microelectronics around the world, *ELECTRONICS*, p 37, Aug. 2, 1963.
- Electronics Staff, The impact of microelectronics, *ELECTRONICS*, p 51, June 28, 1963.
- D. R. Fairbanks, M. E. Stephenson, Dr. M. Mark, The influence of altitude and packaging compactness on the internal temperatures in unsealed electronic packages, "Nat. Elec. Pack. and Conf., 1963", Chicago, p 11.
- R. C. Frank, Mechanical design of a functional electronic block digital programmer for missile and spaceborne applications, "1963 IEEE Int. Conv. Rec.," p 202.
- W. W. Gaertner and M. Schuller, Micro-circuit new frontier in solid state, *ELECTRONICS*, p 47, July 19, 1963.
- L. B. Gardner and J. R. Coss, Transistor Reliability after radiation exposure, "1963 IEEE Convention Record", p 71.
- D. J. Garibotti and W. V. Lane, Micro-miniature electron beam welded connections, *Weld. Journ. Res. Supplement*, p 1, Sept. 1963.
- D. J. Garibotti and W. V. Lane, The enhanced micro-module; a disciplined approach to microcircuit integration, *Fourth Int. Electronic Circuit Packaging Symposium, Boulder, Colo.*, 1963.
- A. Gellman, Welded card assemblies, "Nat. Elec. Pack. and Prod. Conf. 1963", Chicago, p 132.
- R. A. Geshner, Welded electrical joints and criteria for progress acceptance, "Nat. Elec. Pack. and Prod. Conf. 1963", Chicago, p 287.
- M. A. Gillo and J. T. Last, Optical coupling: new approach to microcircuit interconnections, *ELECTRONICS*, p 29, Nov. 22, 1963.
- J. I. Gonzalez and D. M. Cawthon, Phase change cooling of thin film circuits, "1963 IEEE Int. Conv. Rec.," p 50.
- A. R. Greenburg, Evaluation and performance of commercial heat sinks, "Nat. Elec. and Prod. Conf., 1963", Chicago, p 17.
- C. A. Harper, "Electronic Packaging with Resins", McGraw-Hill Book Co., New York, 1961.
- G. Hass, ed., "Physics of Thin Films—Advances in Research and Development", Academic Press, New York, 1963.
- A. E. Hawley, E. A. Klein, D. D. Lenhart and L. R. Shrum, Electronic packaging techniques for surveyor lunar spacecraft, "1963 IEEE Int. Conf. Rec.," p 157.
- K. Henney and C. Walsh, "Electronic Components Handbook", McGraw-Hill, New York, 1957.
- K. Henney and C. Walsh, "Electronic Components Handbook, Vol 2", McGraw-Hill, New York, 1958.
- K. Henney, C. Walsh and H. Mileaf, "Electronic Components Handbook, Vol. 3", McGraw-Hill, New York, 1959.
- S. R. Hofstein and E. P. Heiman, The silicon insulated-gate field-effect transistor, *Proc. IEEE*, p 1190, Sept. 1963.
- J. L. Hull, Which processing technique for encapsulation with epoxies?, "Nat. Elec. Pack. and Prod. Conf. 1963", Chicago, p 201.
- G. T. Jacobi and S. Weber, ed., "The impact of microelectronics", McGraw-Hill Pub. Co., New York, 1963.
- W. G. Jezowski, An approach for achieving quality electronic module castings on a job-shop basis, "Nat. Elec. Pack. and Prod. Conf. 1963", Chicago, p 157.
- J. Jodele, Mariner spacecraft packaging, "Nat. Elec. Pack. and Prod. Conf. 1963", Chicago, p 32.
- E. Keonjian, ed, "Microelectronics", McGraw-Hill, New York, 1963.
- C. Kiley, The use of board-to-board printed circuit connectors in package design, "Nat. Elec. Pack. and Prod. Conf. 1963", Chicago, p 91.
- S. G. Konsowski, Jr. and C. W. Johnson, Combining honeycomb construction with weldable preformed circuitry, "Nat. Elec. Pack. and Prod. Conf. 1963", Chicago, p 100.
- F. A. Lally, Program of quality assurance for welded electronic circuitry, "1963 IEEE Int. Conv. Rec.," p 88.
- K. A. Larson, Packaging revolution for the microelectronic computer, "Nat. Elec. Pack. and Prod. Conf. 1963", Chicago, p 120.
- M. M. Lee, New single-package epoxy resin systems for electronic packaging, "Nat. Elec. Pack. and Prod. Conf. 1963", Chicago, p 214.
- A. E. Linden, Are printed circuits passé?, "Nat. Elec. Pack. and Prod. Conf. 1963", Chicago, p 260.
- C. Lodder, Welded flat cable circuitry, "Nat. Elec. Pack. and Prod. Conf. 1963", Chicago, p 61.
- H. H. Manko, "Solder and Soldering", McGraw-Hill, New York 1963.
- H. H. Manko and R. R. Ross, Selecting the right soldering-iron and tip, *ELECTRONICS*, p 48, Aug. 16, 1963.
- J. F. Mason, Army seeks gear for air traffic and navigation, *ELECTRONICS*, p 10, Nov. 22, 1963.
- F. E. Matthews, An economical controlled environment production line, "Nat. Elec. Pack. and Prod. Conf. 1963", Chicago, p 164.
- M. C. McKinnon and R. F. Hoeckelman, Mechanical and electrical properties of thermocompression bonds, "1963 IEEE Int. Conv. Rec.," p 93.
- A. R. McMillen, Dips and waves improve soldering, *ELECTRONICS*, p 48, July 5, 1963.
- G. Messner, Packaging with multilayer printed circuits, "Nat. Elec. Pack. and Prod. Conf. 1963", Chicago, p 272.
- J. W. Meyer and A. M. Rich, Cryogenics for the electronics engineer, *ELECTRONICS*, p 29, Aug. 30, 1963.
- E. H. Miller and D. J. Garibotti, Versatile interconnection-packaging system for integral electronics using electron beam techniques, *Proc. NEC 1963*, p 519.
- R. S. Moeller, Packaging "deliverable breadboard" electronics, "Nat. Elec. Pack. and Prod. Conf. 1963", Chicago, p 420.
- D. Navon, Diodes tolerate high radiation, *ELECTRONICS*, p 48, Nov. 29, 1963.
- H. Nicholas, Component mounting for environmental protection, "Nat. Elec. Pack. and Prod. Conf. 1963", Chicago, p 313.
- G. J. Noeth, High density subminiature coaxial and shielded cable connections, "Nat. Elec. Pack. and Prod. Conf. 1963", Chicago, p 85.
- W. L. Olds, Packaging techniques for use with automated "wire-wrap" machines, "Nat. Elec. Pack. and Prod. Conf. 1963", Chicago, p 184.
- D. S. Peck and E. R. Schmid, Surface effects of ionizing radiation, *ELECTRONICS*, p 34, Oct 4, 1963.
- C. Peirce, Application of high density packaging techniques to an orbiting satellite command receiver, "Nat. Elec. Pack. and Prod. Conf. 1963", Chicago, p 229.
- M. M. Perugini and N. Lindgren, Micro-miniaturization, *ELECTRONICS*, p 77, Nov. 25, 1960.
- J. E. Ruzicka, S. Kunica, D. Rose, and R. S. Gilfoy, Jr., Application of modern vibration control techniques in electronic packaging, "Nat. Elec. Pack. and Prod. Conf. 1963", Chicago, p 334.
- R. Saunders, The role of packaging and interconnections in microelectronics, "Nat. Elec. Pack. and Prod. Conf. 1963", Chicago, p 241.
- R. Schamp, Quality and reliability at low cost through design standardization, "Nat. Elec. Pack. and Prod. Conf., 1963", Chicago, p 477.
- A. P. Schultz, A multi-layer printed wiring board with a reliable interlayer connection, "Nat. Elec. Pack. and Prod. Conf. 1963", Chicago, p 51.
- J. Shank, Self-setting, parallel-gap welder saves time and rejects, *ELECTRONICS*, p 91, Dec. 6, 1963.
- C. D. Snelling and Dr. M. Telkis, The thermal battery system for transporting heat-sensitive material, "Nat. Elec. Pack. and Prod. Conf. 1963", Chicago, p 42.
- J. H. Sununu, The effect of spacing on the efficiency of extended surfaces for natural convection cooling, "Nat. Elec. Pack. and Prod. Conf. 1963", Chicago, p 30.
- L. W. Tobias, An advanced technique for electronic package planning "Nat. Elec. Pack. and Prod. Conf. 1963", Chicago, p 443.
- M. F. Tomaino, Materials for space-age electronics, *ELECTRONICS*, p 37, Oct. 25, 1963.
- J. W. Tunwall, Dip brazing of aluminum for electronic chassis, "Nat. Elec. Pack. and Prod. Conf. 1963", Chicago, p 222.
- S. Vogel, RFI causes effects cures, *ELECTRONICS*, p 37, June 21, 1963.
- B. L. Weigand, Vibrational properties of printed circuit board laminates, "Nat. Elec. Pack. and Prod. Conf. 1963", Chicago, p 399.
- G. H. Weiner, Chemical materials for printed circuit applications, "Nat. Elec. Pack. and Prod. Conf. 1963", Chicago, p 239.
- J. P. Welsh, Technique of cooling electronic equipment, *Electrical Manufacturing*, Dec. 1958.
- F. L. Williams, A high density circuit card packaging system, "Nat. Elec. Pack. and Prod. Conf. 1963", Chicago, p 433.
- E. J. Wooldridge, Hot air soldering machine "Nat. Elec. Pack. and Prod. Conf. 1963", Chicago, p 149.
- "Dielectric Coolants", Dow Corning Bull. 05-031.
- Microelectronic Loran-C will fly next year, *ELECTRONICS*, p 22, June 28, 1963.
- Micro-Packaging for Microelectronics, *ELECTRONICS*, p 88, Aug. 9, 1963.
- Phosphors trace heat flow patterns, *ELECTRONICS*, p 40, Aug. 23, 1963.

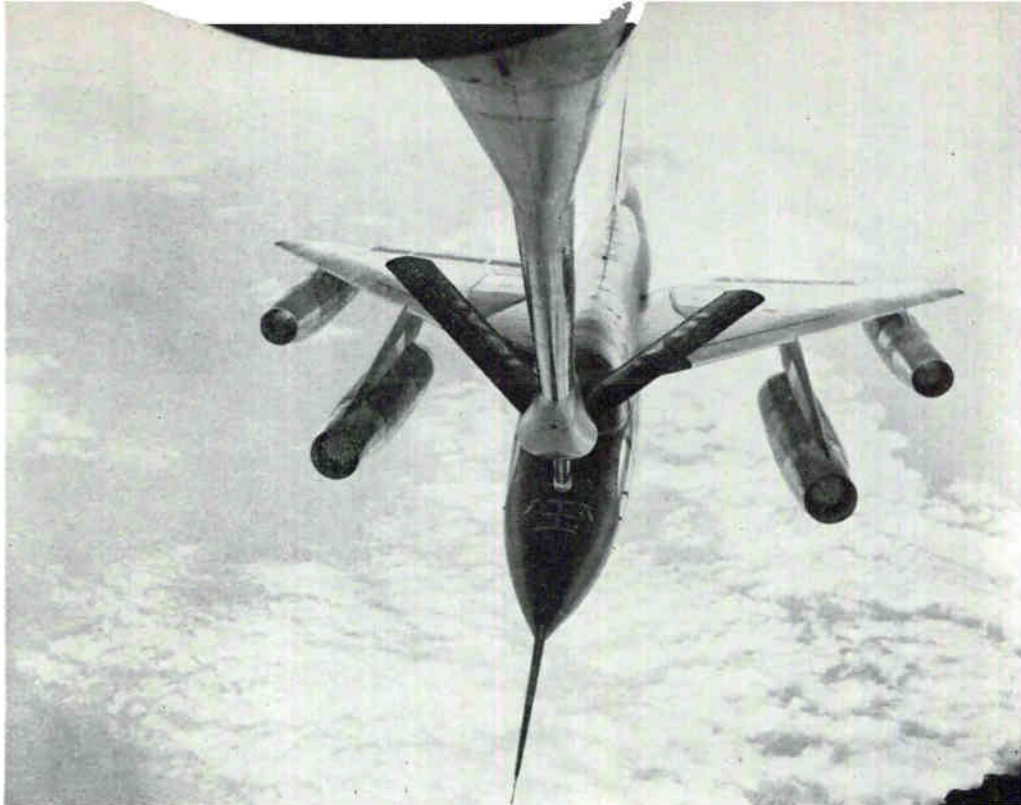

AERIAL refueling of the B-58 Hustler by a KC-135 tanker could not be achieved in an area of clear air turbulence (USAF)

WANTED | WAYS TO SPOT ROUGH AIR

High-level turbulence must be measured or forecast for SST success

By ALEXANDER A. MCKENZIE, Associate Editor

DEATH, heavy damage and severe discomfort are the direct result of turbulent air conditions encountered by military and civil aircraft. Most insidious is clear air turbulence (CAT) into which a plane can fly without visible warning. The faster the plane, the greater the hazard. Since present forecasting techniques are inadequate to protect supersonic transports now being developed, new devices must be invented to give a pilot warning in time to slow down or avoid danger areas. These devices will be electronic and could take the form of radar, infrared or microwave radiometers, lasers or combinations. Aviation cannot do without them.

The Record—Understandably, the record of death and destruction directly attributable to CAT is minimal for passenger air carriers. Like the turbulence associated with thunderstorm activity, CAT has caused spilled dinners, air sickness and a number of broken bones. But it was also responsible for the death of at least one man—head injuries suffered on a TCA

flight between Vancouver and Edmonton. Officially listed as a contributing cause, CAT snuffed out the lives of 63 people in a Northwest Airlines crash near Cannelton, Ind. An Eastern DC-8 dropped nearly two miles near Houston last November. A two-ton turbine engine was ripped off in the last-minute pull-out, and 26 passengers required medical treatment.

The Air Force record since January 1961 is scarcely reassuring. Air turbulence at high altitude has damaged structures, injured passengers and has caused crashes. Three B-52's have plunged to the ground owing to structural failure. A C-47 crashed after a wing dropped off. In these four cases, the structural damage was caused by the terrific buffeting of CAT. Pilots of two B-52 aircraft experienced temporary loss of control in clear air at high altitude. Passengers in five transport type military aircraft have been injured. A B-57 encountered clear air turbulence at high altitude that resulted in damage to skin rivets.

Soviet airliners flying between Moscow and Irkutsk carry type SP-11D accelerographs. V. N. Barakhtin

recently reported in *Meteorologiya i Gidrologiya* on a study of 6,482 accelerograms obtained on this air route showing maximum increase of acceleration of not less than 0.3 g for flight at altitudes of 8 to 10 km (approximately 24,000 to 30,000 feet). Such devices,

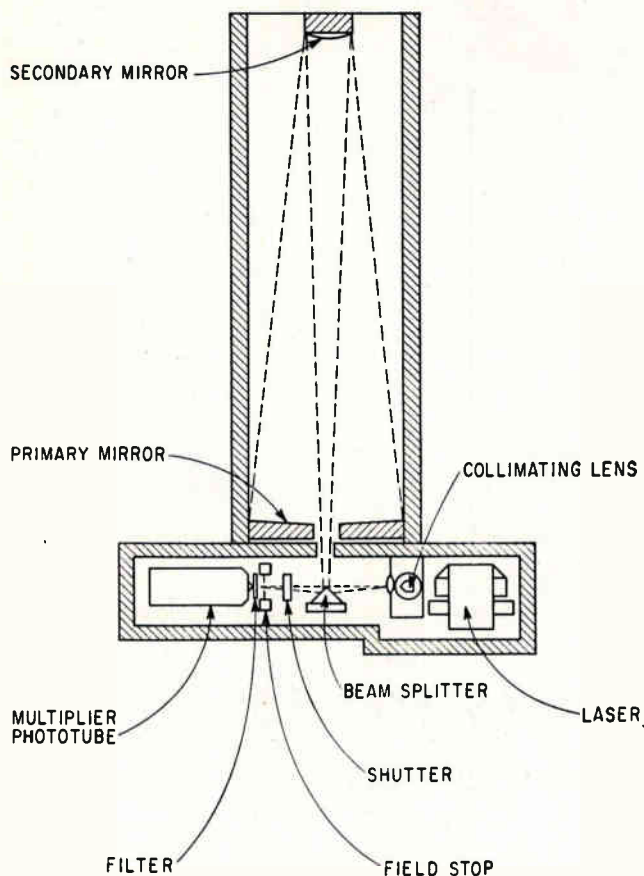

CASSEGRAINIAN optical system in a transmitter-receiver proposed for airborne CAT detection device

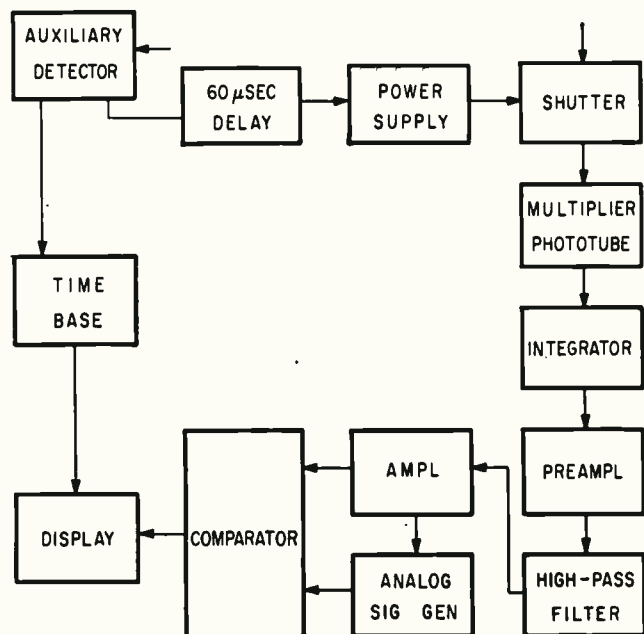

PROPOSED laser CAT detector in which the return pulse is compared with an analog pulse as standard to obtain a signal pulse that depends upon turbulence characteristic

used also in some U.S. aircraft, merely record what has happened, but are needed for objective measurements against which meteorologists can work.

What is CAT—More knowledge about the nature and occurrence of clear air turbulence may be necessary before sure-fire methods can be devised for its detection. Experts are not certain that CAT is simply a turbulence of up and down drafts and eddies—like water from a faucet churning into a wash basin. They believe it may also result from a laminar flow in the form of stationary waves or bumps caused by gravity. In this case, the aircraft itself creates the turbulence—much like a wheeled vehicle traveling along a bumpy country road.

High level turbulence exists, but not exclusively, in the tropopause, the shifting boundary zone between troposphere and stratosphere at an average altitude of 36,000 feet. Thickness of the turbulence layer varies from about 1,000 feet over the North Atlantic to some 4,000 feet in the tropics. Military craft have experienced clear air turbulence at levels two and three times as high and turbulence unaccompanied by visible indications occurs below the tropopause.

The known physical basis of clear air turbulence is complex. The phenomenon is generally associated with extreme changes in horizontal or vertical wind velocity near jet stream cores. Wind shear, the discontinuity caused by air streams of different velocities or directions, is a probable cause. Previous experience indicates that atmospheric turbulence produces variation of refractive index. Forward scatter of uhf radio waves is explained on the basis of scattering from turbulence. The phenomenon of "angels"—optically invisible radar targets—has also been explained as a refractive index effect. On this account, it should be possible to detect clear air turbulence by radio or optical devices that measure discontinuities in the index of refraction.

Radar Approach—According to R. R. Rogers of Cornell Aeronautical Laboratory and P. L. Smith associated with Carnegie Institute of Technology and Midwest Research Institute, the scattering of electromagnetic waves from a turbulent region in the atmosphere is related to the Fourier spectrum of the spatial variations of refractive index within that region. Periodic variations of surprisingly small amplitude should give a detectable radar target. As things look now, pulsed radar should be capable of detecting atmospheric turbulence. Coherent radar techniques could make detection possible in a greater number of cases. Unfortunately, turbulence would not create a detectable target unless there were a large gradient of the mean index of refraction.

RCA-Moorestown is sanguine about establishing a forecasting method since a study indicated correlation between rawinsonde observations and radar echoes about 40 miles distant. The radar was a 3-megawatt C-band (5,736-Mc) equipment driven by a 1- μ sec pulse at 855 pps. Antenna gain was 47 db, 0.9 degree beamwidth and receiver noise figure 4.5 db. In the region from 10,000 to 30,000 feet correlation was obtained between radar echo and wind shear, radar echo power and gradient of refractive index.

Clear air echoes were consistently observed, according to a report by R. J. Wagner and L. C. Conant. There is no program to develop an airborne version.

Forecasts Available—Although the Weather Bureau has abandoned experiments with S-band radar at Evansville, Indiana, it is deeply concerned about CAT. Under DeVer Colson, work goes forward using the synoptic approach utilizing all available information together with pilot reports.

Strategic Air Command is actively concerned with turbulence that sometimes causes abortion of a mission when refueling in the air becomes dangerous or impossible. SAC's weather units make CAT forecasts for all USAF aircraft flying over the North American area, according to information furnished *ELECTRONICS'* editors by the 3D Weather Wing at Offutt AFB, Nebraska. They have also developed procedures for using a complex of IBM 1401/7094 and ADX computers for predicting CAT.

Laser Detection—An engineer at Martin-Orlando has postulated a turbulence indicator comprising a pulsed ruby laser providing a high intensity collimated beam of light and a concentric detecting telescope with a field of view coinciding with the beamwidth of the laser. Turbulence would give a change in intensity of backscattered light. A system using a 10-joule source should be useful for a range up to 10 nautical miles. There is no hardware and none is presently contemplated at Martin. Minneapolis-Honeywell is reported as investigating feasibility of a laser device.

In a paper before the Institute of Navigation, Vernon I. Weihe of General Precision stresses the need for an airborne system and suggests a possible payoff if the detector were made part of a collision warning device. The turbulent wake of an aircraft is large compared with its metallic surface. If some means, such as laser or radiometer, could be developed to detect the wake, this information could be used to acquire the vehicle for radar tracking.

Work In Process—Programs that may lead to hardware are going on at Cornell Aeronautical Laboratory, Inc. in Buffalo and Stanford Research Institute at Menlo Park, California. The research programs have not yet reached the point where details are available. Basic Devices, Inc. of Wellesley, Massachusetts has available a jet-stream detection device that is used, for example, on the KC-135. In its present form it is not suitable for detecting CAT. Collins Radio at Cedar Rapids has a program to investigate the radiometric approach utilizing the near-oxygen line absorption region of the millimeter wave spectrum. Eastern Airlines reports working on a warning system.

Air Lines View—Competent meteorologists employed in the private weather services of the airlines are as concerned about the dangers of involvement in clear air turbulence as they are anxious to stay away from visible thunderstorm turbulence. They follow latest developments, cooperate in studies, participate in tests and make the best possible forecasts but have neither the manpower nor money needed for an all-out attack on the problem.

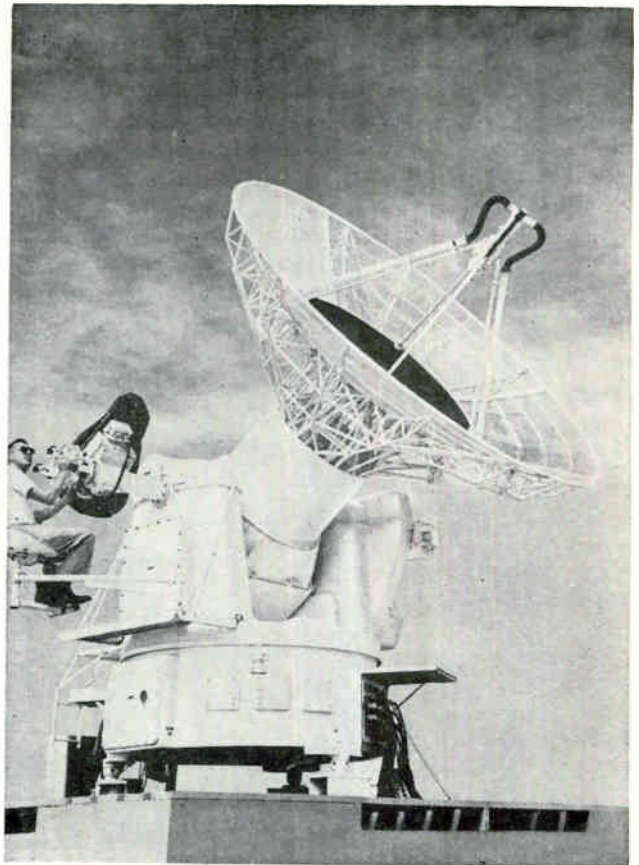

RADAR type used in experimental observation of CAT (RCA)

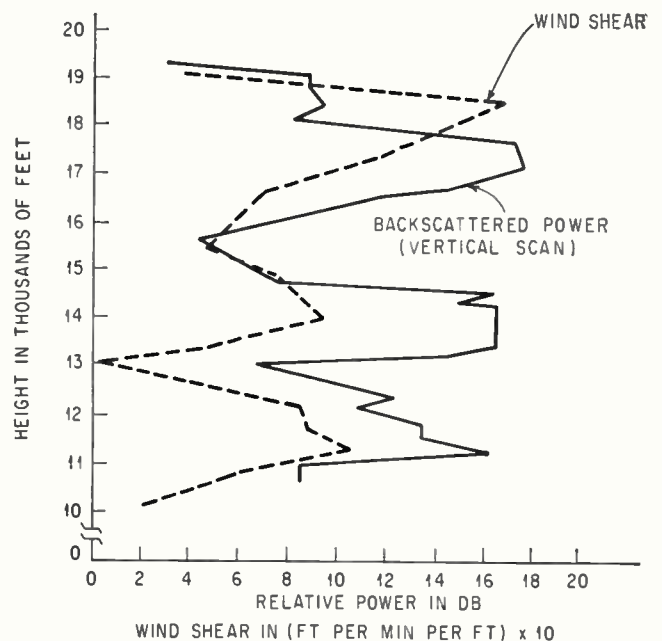

NORMALIZED backscattered power vs altitude and wind-shear vs altitude as determined in simultaneous radar and rawinsonde observations by Signal Corps and RCA

So far, the lost dinners and the cleaning bills have been counted by the air carriers as part of the cost of doing business. As one air lines man said, "If we can just get a gadget that will give the pilot a few minutes warning, he'll be able to slow down or fly an avoidance path and be safe."

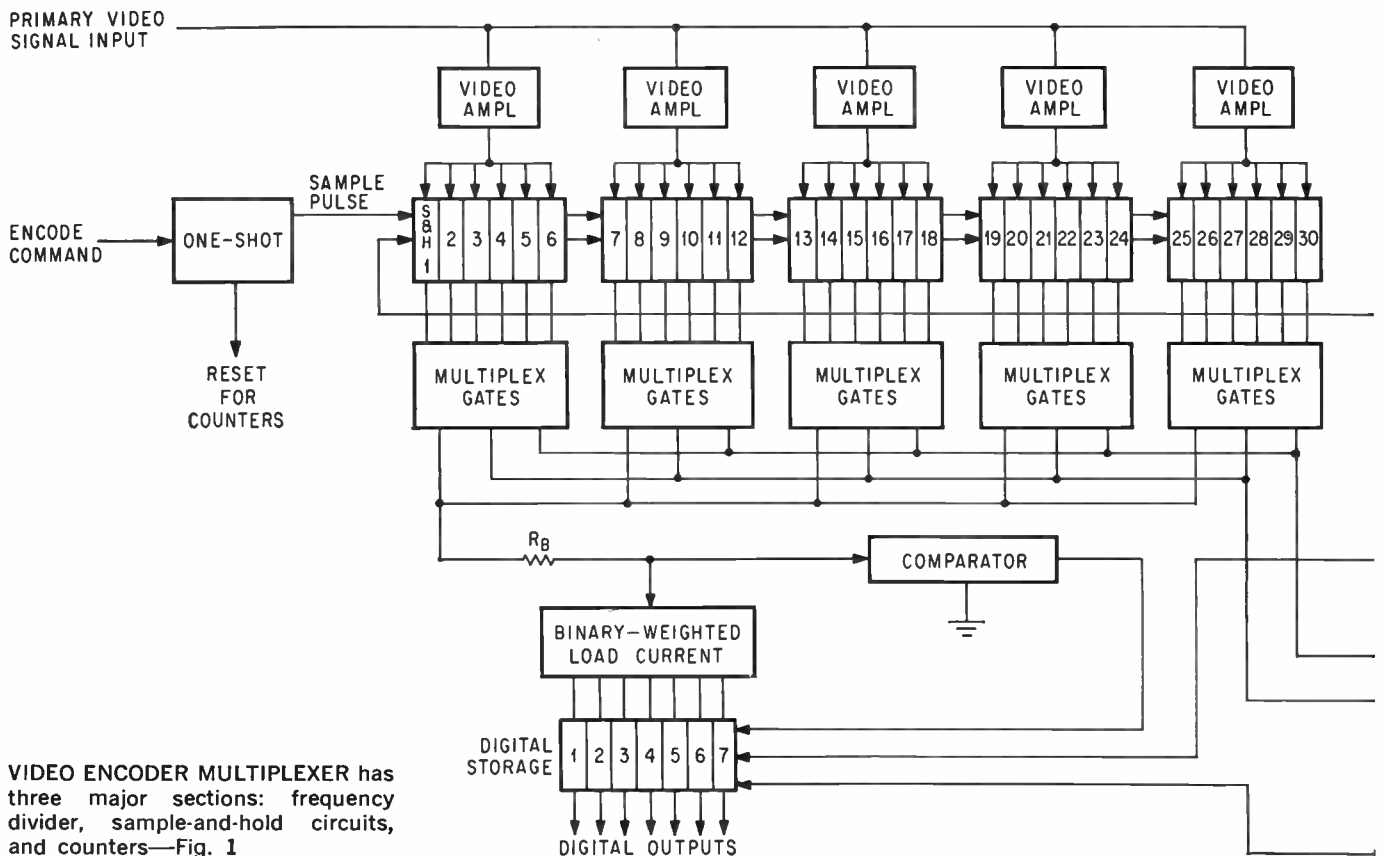

VIDEO ENCODER MULTIPLEXER has three major sections: frequency divider, sample-and-hold circuits, and counters—Fig. 1

SAMPLING TEN MILLION WORDS

Thirty analog samples are taken every $0.1 \mu\text{sec}$ of each incoming pulse of 0.1 to $30 \mu\text{sec}$ duration. The sampled values are held and then converted to binary form

By AYHAN HAKIMOGLU and RICHARD D. KULVIN, Dynaplex Corp., Princeton, N. J.

THIS HIGH-SPEED video encoder-multiplexer slices 30 analog samples out of a single incoming pulse which may have any duration from 0.1 to $30 \mu\text{sec}$, holds these sampled values and converts them to binary digital form. The design achieves the sampling of incoming pulse at a 10-Mc rate with 20 nsec effective aperture time, within an accuracy of ± 0.5 percent. The design also makes possible the holding of sampled levels for several milliseconds, then digitizing and reading out to a tape recorder at a much slower rate. Overall accuracy achieved is ± 1 percent.

In the unit, which is now operating in the field, the analog samples occur every $0.1 \mu\text{sec}$ at maximum speed, but this rate may be reduced to 0.2 , 0.4 or $0.8 \mu\text{sec}$ per sample by a selection switch. Digitizing is effected to 7 bits.

The video encoder-multiplexer circuits (Fig. 1) may be divided into three major sections:

Frequency Divider—A 10-Mc crystal clock output is fed into five countdown flip-flops. The outputs of the first, second, third and fourth flip-flops correspond to 10 , 5 , 2.5

and 1.25 Mc rates respectively. One of the outputs of the first four flip-flops is selected by a hand tap switch, based on the desired sample rate, and then fed to the sample and hold circuit as shown in Fig. 1. The circuits used in the frequency divider are high-speed flip-flops with about a 15-nsec rise time.

Sample and Hold—The video signal is fed into five unity-gain amplifiers simultaneously. These input signal amplifiers have low output impedance and are able to supply up to several hundred milliamperes of cur-

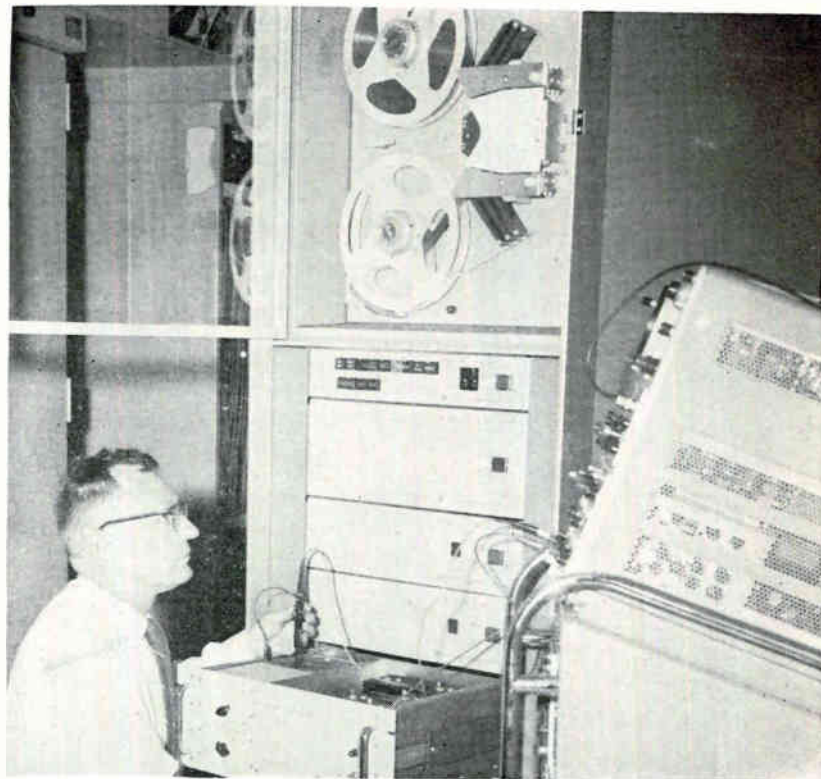
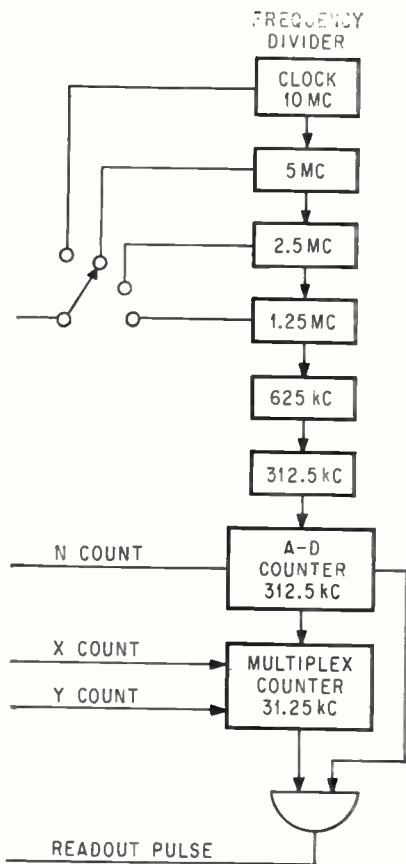

CHECKING OUT a video encoder installed by the Army in one of the AN/FPS-16 precision radars that track supersonic missiles at White Sands Missile Range

A SECOND

rent into the sample and hold circuit. These amplifiers (Fig. 2A) are unique in that they deliver extremely high bidirectional current with a bandwidth of about 10 Mc with no measurable nonlinearity. Each signal amplifier is connected to six sample and hold circuits controlled by six flip-flops. An analog gate is provided for each sample and hold output so that the levels being held may be multiplexed at the appropriate times for digitizing.

The encode command one-shot, at the receipt of a positive-going encode command signal, generates a sample pulse of very short duration which then connects the thirty sample and hold circuits to the input signal. The flip-flops (Fig. 2B), upon receipt of a sample pulse, will connect the sample and hold capacitors C_s to the signal amplifiers. At the end of the sample pulse, the sample and hold gates will be se-

quentially disconnected from the signal one at a time at the selected rate.

The effective aperture time of the sample and hold gate is about 20 nsec. This low value of aperture time is important for the definition of the sample interval and is obtained by using a high-speed transistor switch driven by a large base current. The 2N2475 transistor has a low saturation resistance of about 7 ohms at 13 ma base current. Turn-off time is about 8 nsec. Two transistors connected in reverse at the sample and hold gate achieve charging and discharging of holding capacitance C_s .

The multiplex gates will feed the signal values held by the sample and

hold circuit to the analog-to-digital converter at the proper time as selected by the multiplexer counter. The multiplexer gates operate at 31,250 words per second, as may be seen from Fig. 1.

The sample and hold gate transistors, however, like all high-speed switches, have a high offset error of about 100 mv. This offset error, as well as offset errors introduced by the multiplexer gates, is individually corrected by potentiometers, R_o , provided in each channel. Potentiometer R_o of each channel (Fig. 2B) generates an offset voltage that is adjusted to null out all offset errors introduced in the sample and hold as well as the multiplexer gates

APPLICATIONS

The basic design of this encoder-multiplexer may be used to define digitally the amplitude, shape and other characteristics of incoming pulses such as those received as reflections from radar or sonar targets, or those obtained in medical electronics from ekg or eeg measurements

and to yield a total of zero offset error from input to output.

Counters—The 312.5-kc rate generated by the countdown circuitry is fed in parallel form to five flip-flops wired to operate in special Gray code. The outputs of these flip-flops are gated by a diode matrix to generate ten sequential pulses used in digitizing. This flop-flop counter is reset at the completion of each ten count. One of the sequential outputs is buffered and drives the multiplexer counter at a

31.25 kc. The multiplexer counter consists of five flip-flops, a diode matrix, and a reset one-shot.

The diode matrix gates the output pulses from the first three flip-flops to generate eight sequential negative-going pulse outputs, labeled *X*, and also gates the four outputs of the last two flip-flops to generate four negative-going pulse outputs, labeled *Y*. The coincidence of eight *X* and four *Y* outputs generates 30 time slots. The counter is reset, however, and held at reset upon the completion of each 30 time slots of

such sequence until the next encode command is received.

A-D Converter—With the exception of the first stage, the encode command pulse will reset all digital storage stages of the analog-to-digital converter to 0 outputs. Under this condition, no current will flow through resistors R_B . However, by the end of the reset pulse described earlier, the first digital storage stage will be set to a 1 output. A binary-weighted current will flow through common resistor R_B and produce a voltage drop equal to the most significant bit. This voltage drop across R_B is of a polarity that is subtractive from the input signal.

The comparator will generate an output pulse, if the difference between the input signal and the voltage drop across R_B is less than 0 volts, such condition indicating that the digital information stored is greater than the input signal. The comparator will produce no pulse if the input signal is greater than the digital information in the digital storage unit.

At the next *N* count from the a-d counter, the first digital storage stage will be set to a 0 if there is an output pulse at the comparator. In the absence of a comparator output pulse, the first digital storage stage will remain set as a 1. The same count *N* count, moreover, will set the second digital storage unit to a 1. This will cause a current flow through R_B , producing a voltage drop equal to the second most significant bit. Digital storage unit 2 will either remain set at a 1 or set back to a 0, depending upon the comparator output at the receipt of the next *N* count.

Similarly, digital storage stages 3 through 7 will each be set to 1 in succession, and will remain set at 1's or will be set back to 0's depending on the comparator output. The digital storage flip-flops are read out from parallel outputs at the desired time slot, once for each sample stored.

The complete video encoder-multiplexer requires only 7 inches of standard 19-inch rack space. Primary power required is 115 volts, 60 cycles. Power consumption is about 50 watts. The video encoder at White Sands Missile Range appears in the lead photo.

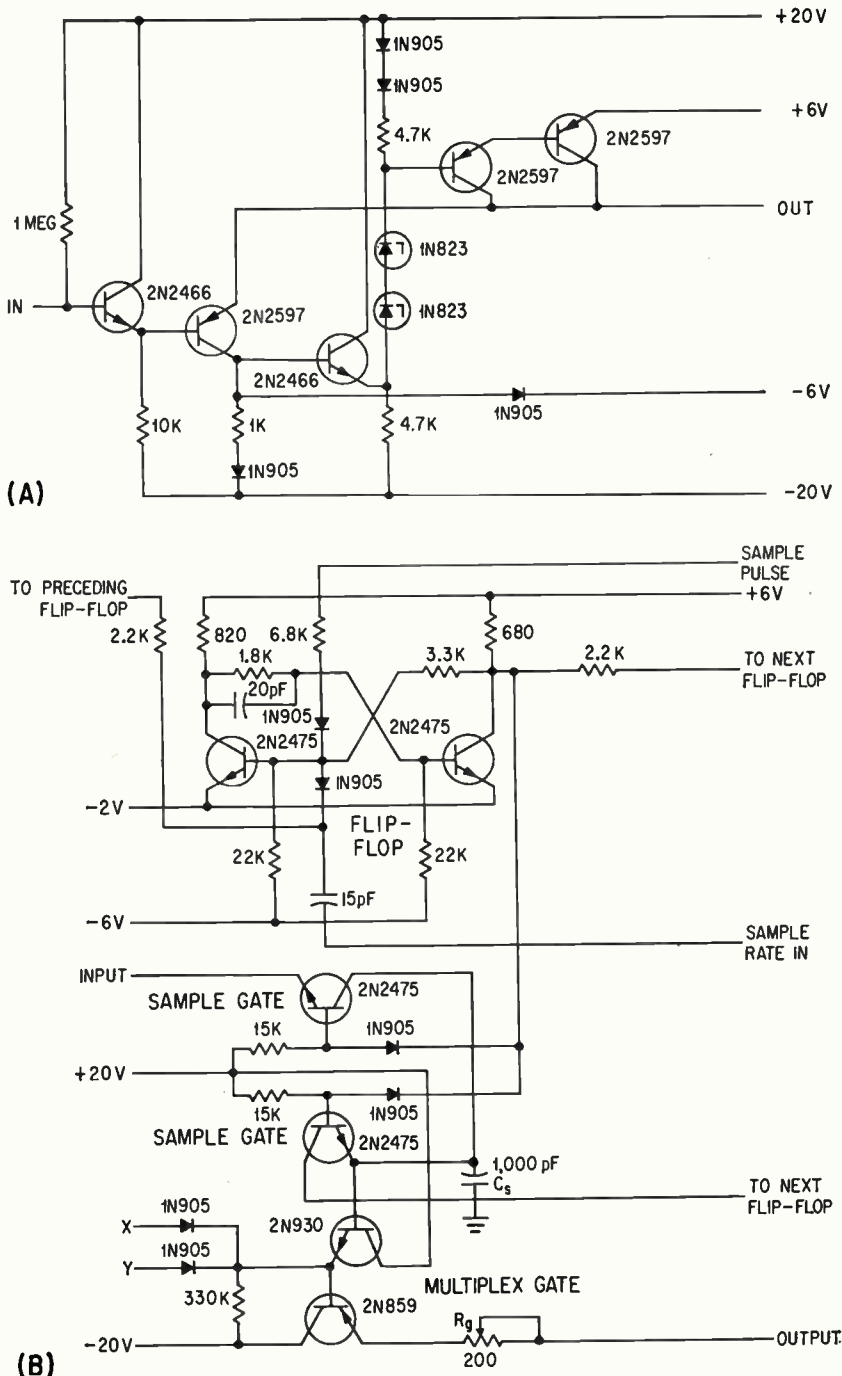

(B) VIDEO AMPLIFIER with unity gain (A); sample-and-hold circuit (B)—Fig. 2

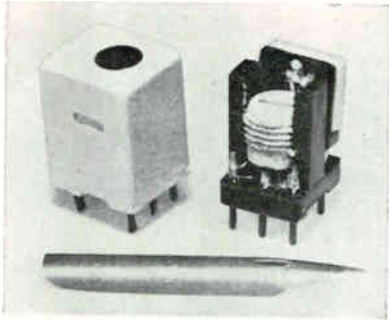

FILTER, 10 mm square and 12 mm high, as supplied to manufacturers of transistor radios

H-SHAPED CERAMIC FILTER

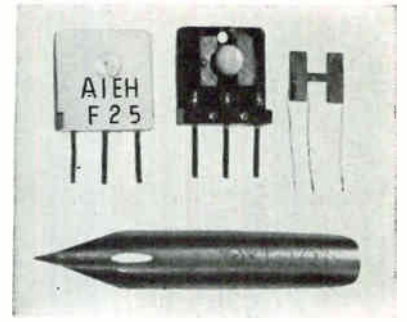

PORTION of filter assembly (opposite), showing H-shaped ceramic element and mounting

Forms Miniature I-F

New filter element has narrow passband characteristic and good skirt selectivity, is suitable for 455-kc i-f systems, and can operate from 100 kc to 1 Mc

By **MASAMITSU KAWAKAMI**, Tokyo University of Technology, Tokyo
HIDETOSHI TSUCHIYA, Shinshu University, Nagano
HISAO MAEDA, Toko Radio Coil Laboratories Ltd., Tokyo, Japan

A NEW TYPE of mechanical filter has been developed, with many advantages over comparable L-C types. It is possible to achieve a relatively narrow passband at the operating frequencies in the 100-Kc to 1-MC range without much difficulty. For convenience, it has been called the H-type mechanical filter because of its similarity to the letter H, in heavy block style.

In the design of the H-type filter, certain precautions must be observed in the choice of the geometry and the mounting methods, to prevent

spurious responses. The selection of materials is important since it will have a large influence on the electrical properties of the filter.

The alloy, commonly known as Elinvar (36Ni-9Cr-Fe), is used at present for the resonator elements. The Co-Elinvar alloy (16Ni-10Cr-36Co-Fe), has given superior temperature characteristics but, due to fabrication difficulties, was given up in favor of the former alloy because of its lower cost, while still having sufficiently desirable mechanical properties for the purpose.

For the transducer elements, a ceramic of the composition $(\text{Ba}_{0.84}\text{-Pb}_{0.08}\text{-Ca}_{0.08})\text{TiO}_3$, which has a low temperature coefficient, is being used.

Construction—In the preliminary trials, a piezoelectric ceramic plate was used for the H configuration. It was shaped by an ultrasonic process but was too fragile mechanically for practical purposes. The present form uses an H-shaped unit in one piece, made from the elinvar sheets. Polarized ceramic transducers (here-

SOME FEATURES OF THIS CERAMIC FILTER

- (1) Construction of filters, with bandwidths from 0.4 to 2 percent of the center frequency, is simple and easily duplicated.
 - (2) A typical 455-kc filter, 6-kc in bandwidth, has an attenuation of over 25 db at 10 kc on either side of the center frequency.
 - (3) The insertion loss is between 1 and 2 db.
 - (4) The filter is extremely small. A 455-kc unit is only 5.08 mm long by 5.08 mm wide by 0.762 mm thick. A compact and robust assembly is possible.
 - (5) A stable and reliable filter can be constructed with the most recently developed piezoelectric ceramic materials
-

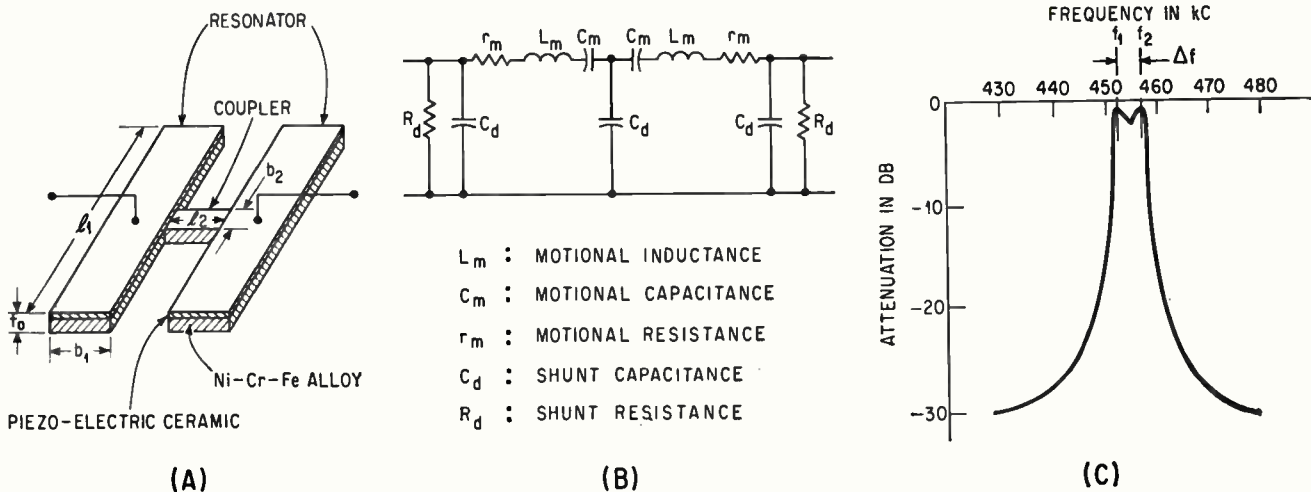

CONSTRUCTION of H-type filter (A), equivalent circuit (B), response (C)—Fig. 1

after called cermic plates) are firmly cemented with epoxy resin to the two resonators. Figure 1A shows construction of the filter element, and its equivalent electrical circuit is shown in Fig. 1B.

A response curve for a typical 455-kc H-type filter is shown in Fig. 1C. The two voltage maxima, f_1 and f_2 , can be made symmetrical by careful construction. A filter made of materials with low mechanical Q tends to have only one voltage maximum.

Coupler Dimensions—As the length of the coupler is shortened and its width broadened, the coupling between the resonators becomes

close, resulting in a response with f_1 and f_2 spread farther apart.

The total coupling stiffness consists of a strain stiffness produced by the deformation along the length, l_2 , of the coupler caused by the Poisson coupling along the length, l_1 , of the resonator, and a shearing strain stiffness caused directly by the resonator along the width, b_2 , of the coupler.

The total stiffness, s , is expressed qualitatively by

$$s = M \sin \frac{2\pi}{\lambda} l_2 + N \frac{b_2^3}{l_2}$$

where $\lambda = 2l_1$, $l_2 < \lambda/2$, $b_2 \ll l_1$, and M , N , can be calculated from the dimensions of the filter and the

modulus of elasticity of the alloy used. The internal losses of the coupler may be neglected. Figure 2A shows a plot of Δf ($= f_2 - f_1$) as a function of the width, b_2 , for various lengths of l_2 ; namely, $\lambda/4$, $\lambda/5$ and $\lambda/8$ for the 455-kc filters.

The dimensions of l_1 , b_1 and the overall thickness t_0 were kept constant throughout the experiments.

Note that, for $l_2 = \lambda/8$, a relatively short coupler length, the initial slope is steep for increasing coupler widths. Longer coupler lengths tend to broaden the response gradually.

Resonator Dimensions—The frequency constant for the longitudinal

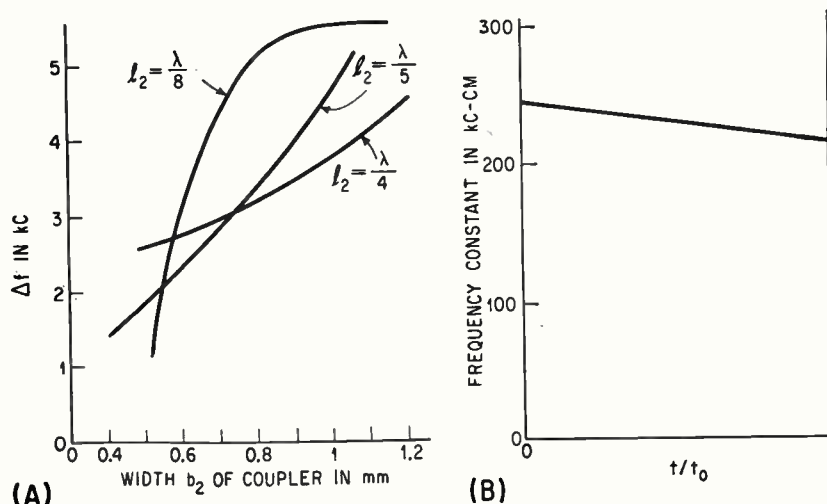

RELATION between coupler width and length (A), with 455-Kc center frequency; and relation between frequency constant and ceramic thickness (B), where ceramic area equals resonator area—Fig. 2

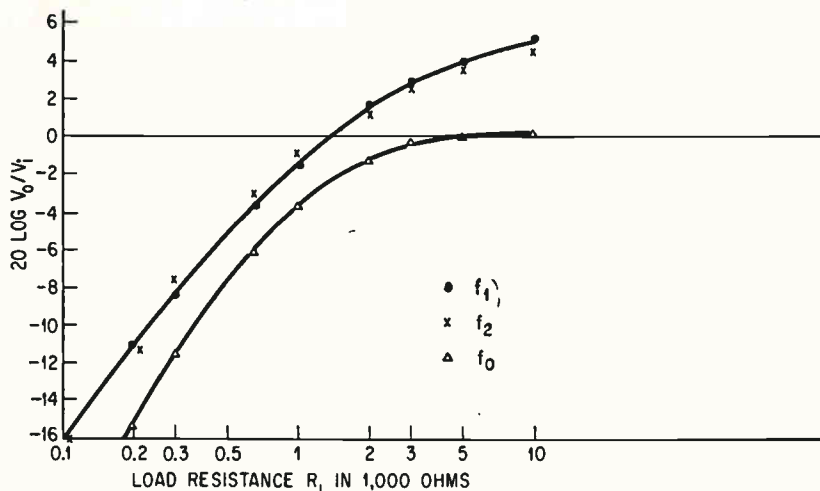

RESPONSES for f_1 , f_2 and f_0 (455 Kc) under different loads—Fig. 3

vibration mode of a rectangular metal plate upon which a ceramic plate of the same area is cemented is a linear function of the ratio of the ceramic plate thickness, t_1 to the overall, t_0 , as shown in Fig. 2B.

The frequency constant at $t = t_0$ is that of the ceramic plate.

As the Q of the resonator and the damping capacitance depend on the thickness of the ceramic plate, it is important that these factors are chosen properly, to avoid the use of excessively thin ceramic plates.

The thickness of the metal element will be determined mainly from the fabrication standpoint. By proper choice of the t/t_0 ratio (Fig. 2B), length l_1 can be determined readily.

If the area of the ceramic is selected to be considerably less than that of the resonator, a high Q and a low temperature coefficient for the filter can be realized. However, for this case, a certain amount of compensation for the resonator length will be required.

The resonator width, b_1 , must not have values close to $l_1/2$. This is because a small amount of the second harmonic input energy from the undesired bands will cause a vibration along the width of the resonator, which often results in the generation of spurious responses. From this standpoint, the resonators for operation at 455 kc should fulfill the following conditions, $l_1/2 > b_1 > l_1/3$.

If the width is made much less

than $l_1/3$, the suppression of the spurious responses will be very effective. This results from the loosening of the coupling between the vibrations along the length and width of the resonator caused by a harmonic of the input signal.

It has been found experimentally that if the overall thickness is made equal to or less than $l_1/8$, the spurious response can be kept to negligible values.

Load Characteristics—The H-type filter for 455 kc was made to match terminations of about 1,000 ohms. The filter with a Δf of 5 kc has a bandwidth of 6 kc at 3 db down.

In Fig. 3, the curves show the

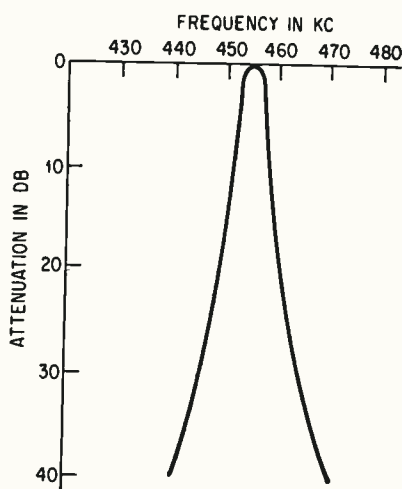

SELECTIVITY characteristics for H-type filter with input transformers—Fig. 4

relationships between the load and the output-input voltage ratios at two resonant frequencies, f_1 and f_2 , respectively, and at the resonant frequency.

In the curves, V_o and V_i are the output and input voltages, respectively.

It can be shown that

$$10 \log \frac{W_o R_L}{W_i R_i} = 20 \log \frac{V_o}{V_i}$$

where R_i = equivalent parallel resistance at input terminals, R_L = load resistance, W_i = power dissipated in R_i (input power), and W_o = power dissipated in R_L (output power).

Since the input resistance is 1,000 ohms for R_L of 1,000 ohms, the attenuation at the resonant frequencies, f_1 and f_2 , is less than 1.5 db.

From Fig. 3, the difference between the two peaks and valley for a passband of $\Delta f = 5$ kc is less than 2.5 db for a load of about 1,000 ohms. The filter has a bandwidth of 6 kc at 3 db down.

If the input and output resistances are varied by altering the size of the ceramic plate, care must be exercised in adjusting each of the resonators to the desired frequencies.

The H-type mechanical filters manufactured by the Toko Radio Coil Laboratories include the input matching coil. The selectivity characteristics of this type are shown in Fig. 4.

One company's on top of the whole antenna picture

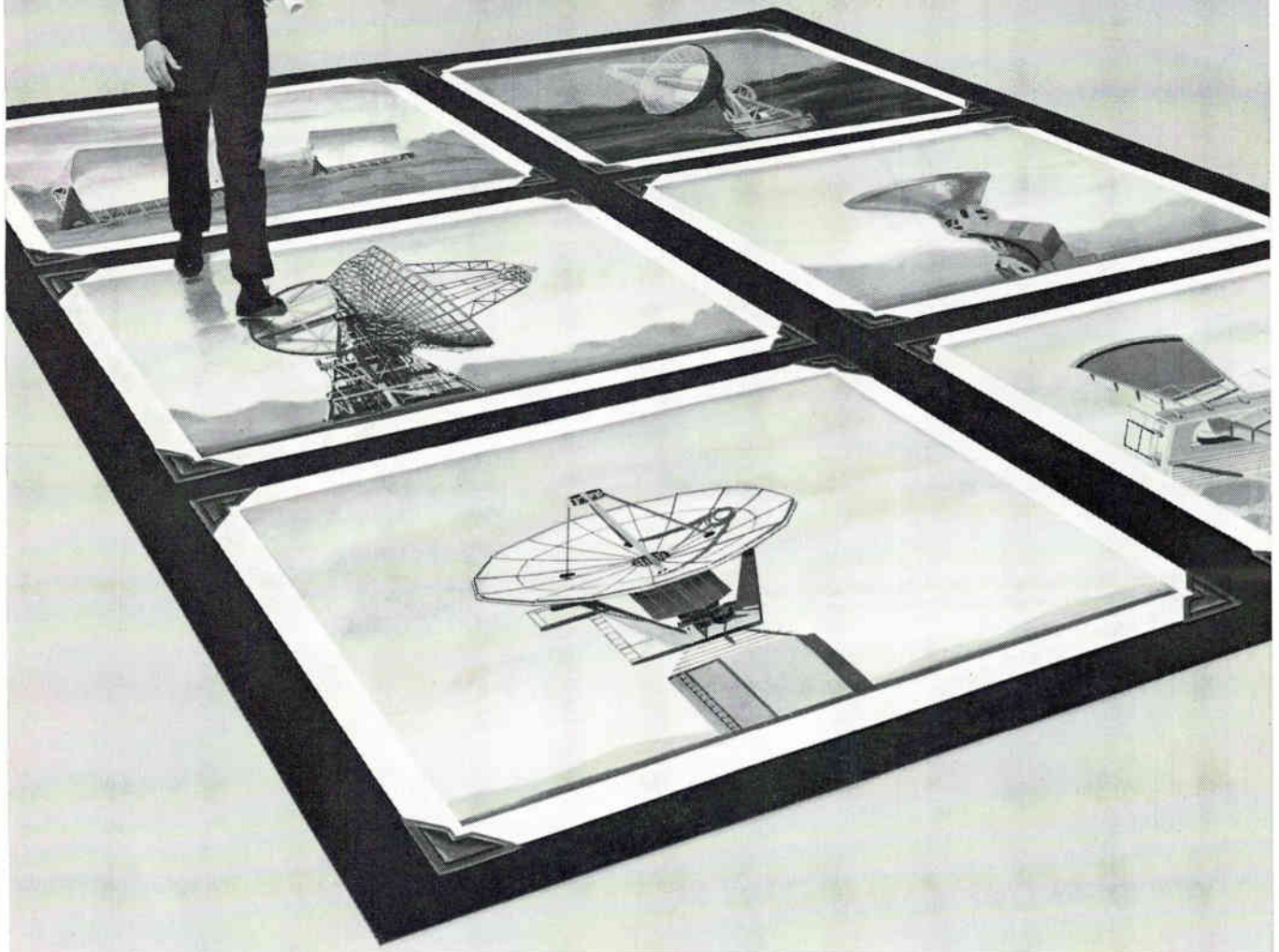

Rohr wrote the book when it comes to the manufacture of large, precision antenna hardware. Today, Rohr literally has a world of experience with a variety of antennas now operating at many remote sites. They are among the largest and most precise antenna structures in operation, and performance has exceeded customer expectations in every instance. The pictures above demonstrate the broad base of antenna engineering and manufacturing capability here . . . the 210-foot tracking antenna for JPL now under construction at Goldstone, California—the 85-foot X-Y, of which Rohr has built four—the 30-foot AZ/EL, operational at Goldstone Station since July, 1962—the 15-foot diameter millimeter radio telescope—along with Horn and Tropo scatter or billboard antennas. Because of the interdependence of the antenna structure and the servo control and drive, Rohr is ready . . . and actually prefers to furnish fully integrated systems. In all cases Rohr antenna cost quotations reflect the policy of complete customer service and

ROHR



**ANTENNA
DIVISION**
CHULA VISTA, CALIF.

include design, fabrication, packing, shipping, installation, foundation design, accommodation for RF equipment, field alignment and check-out and acceptance tests to prove performance. For the full antenna story at Rohr today, write Rohr Corporation, Antenna Division, P. O. Box 1147, Chula Vista, California.

THE ROHR ANTENNA DIVISION was officially created January 6, 1964, to provide even greater service, speed and economy for Rohr antenna customers.



MAIN PLANT HEADQUARTERS: CHULA VISTA, CALIF./PLANT: RIVERSIDE, CALIF./ASSEMBLY PLANTS: WINDER, GA.; AUBURN, WASH.

SALES OFFICES IN WASHINGTON, D. C.—DAYTON—BOSTON—LOS ANGELES—SAN FRANCISCO

ROHR CORPORATION

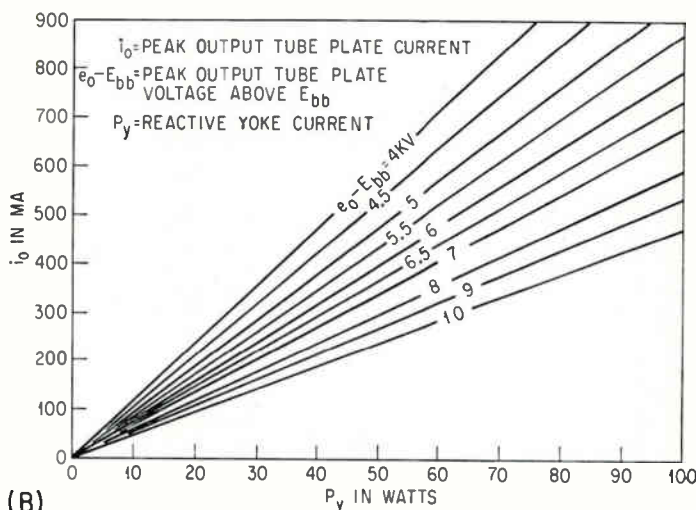
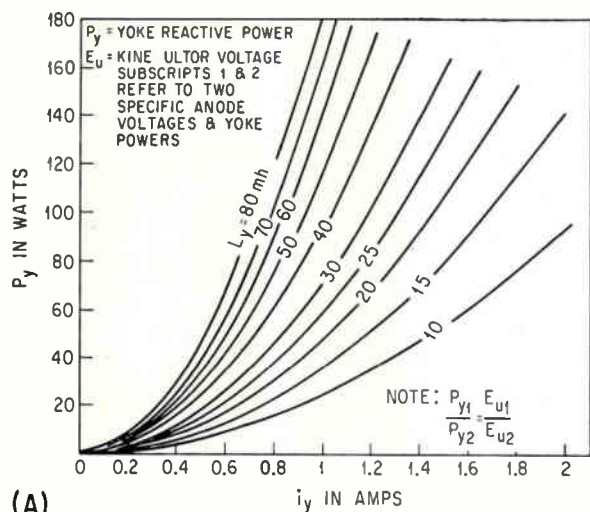

YOKE reactive power P_y , as a function of peak-to-peak yoke current \bar{i}_y and yoke inductance L_y (A) and required peak output-tube current i_o for a given yoke power and output-tube plate pulse voltage e_o (B)—Fig. 1

Graphs Aid Deflection System Design

These data provide a rapid method for determining output-tube operating conditions when only peak-to-peak yoke current, ultor voltage and yoke inductance are known

By K. W. ANGEL, Electron Tube Div., Radio Corporation of America, Harrison, N. J.

HORIZONTAL deflection system design graphs make possible a rapid determination of system requirements governing the choice of horizontal output and damper tubes. Unlike nomographs, linear design graphs of a system show the effects of changes in operating conditions and provide the designer with a graphic representation of system parameters. These curves make it possible to determine output-tube operating conditions when only the required peak-to-peak yoke current at any known ultor voltage plus the yoke inductance are known; these data are available from the yoke data sheet. Other operating conditions such as the damper-cathode pulse voltage, can also be determined from the graphs.

Yoke reactive power P_y is shown in Fig. 1A as a function of the peak-to-peak yoke current \bar{i}_y and yoke inductance L_y . The required peak output-tube current i_o for a given yoke power and output-tube plate-pulse voltage rating e_o are shown in Fig. 1B. The minimum allowable supply voltage can be found in Fig. 2A from the previously determined peak plate current and voltage of the output tube. The resultant boost voltage E_{bbb} , the damper-cathode pulse voltage e_d , and the ratio of output-tube plate dissipation to average plate current $P_{bo}/I_o(avg)$ as functions of the previously determined output-tube plate-pulse voltage and the supply voltage are shown in Fig. 2B, 3A and 3B, respectively. The ratio of output-tube plate-dissipation values of maximum brightness and zero beam, and at high line voltage and normal line voltage again

**Why buy
4 materials
when one
will
do... at
no
premium!**

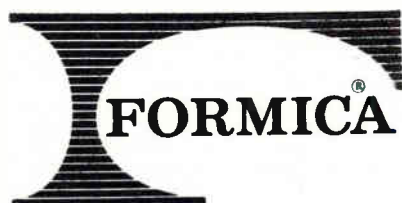

industrial plastics

FORMICA CORPORATION

Department I-420, Cincinnati, Ohio 45232

subsidiary of 

At last! A single grade which meets the property requirements of NEMA G-10, G-11, FR-4, and FR-5! It's Formica's new FR-45 . . .

New Formica FR-45 also meets requirements of MIL-P-18177 Types GEE & GEB and MIL-P-13949C Types GE, GB, GF, & GH.

New Formica FR-45 gives you the NEMA G-11 feature of high strength retention at elevated temperatures plus the excellent machining characteristics of G-10.

New Formica FR-45 easily passes through processing environments encountered in printed circuit operations with no harmful effects.

New Formica FR-45 meets the flammability requirements of NEMA LP 1-7.07E, both horizontal and vertical.

With new Formica FR-45 you have a single grade, a single inventory . . . yet, you pay no more for versatile Formica FR-45 than you would for any top-quality single-purpose grade!

Evaluation samples and detailed data available upon request.



Also write for catalogs on:

- Electrical/electronic grades
- Copper clad laminates
- Mechanical grades
- Engraving stock

See The Formica World's Fair House at New York for the newest and best in carefree contemporary living.

as functions of output-tube plate pulse voltage and supply voltage appear in Fig. 3C and 4A, respectively.

EXAMPLE—To deflect a system using a 114-degree yoke at an ultor voltage E_u of 20 kv at zero beam current, consult the yoke data and find that the peak-to-peak yoke current I_y is 875 ma at an ultor voltage of 20 kv, and that the yoke inductance is 18.3 millihenries. The available supply voltage E_{bb} is 270 volts at normal line voltage. The beam power tube to be used (6GW6) has the following design-maximum ratings: $e'_{o(max)}$ = 6,500 v, $i'_{K(max)}$ = 550 ma, i'_o = 500 ma (assuming a 10:1 plate-to-screen-grid current rating), $P_{bo(max)}$ = 17.5 watts. Now, from Fig. 1A, $P_{y(NL)}$ = 33 watts at 20 kv, and from Fig. 1B, $e'_o - E_{bb} = e_{o(max)}/1.1 - E_{bb}$ (the factor 1.1 converts the design-maximum value for e'_o to a design-center value).

$$e'_o - E_{bb} = 6.5/1.1 - 0.27 = 5.9 - 0.3 = 5.6 \text{ kv}$$

At normal line voltage, $i'_{o(NL)} = 284$ ma and at high line voltage

$$i'_{o(NL)} = i'_{o(NL)} (1.1)^{3/2} = 284 (1.154) = 326 \text{ ma}$$

Assumed that the change in current is proportional to the $3/2$ power of the change in screen voltage. This value is well below tube rating.

From Fig. 2A, the minimum allowable supply voltage $E_{bb(min)}$ is 217 volts when $i'_{o(NL)}$ is 284 ma and e'_o is 5.9 kv. This voltage is well below the available supply value of 270 volts, and provides adequate snivets protection because the load line is kept well away from the knee region of the tube characteristic curve.

From Fig. 2B, the boost voltage E_{bbb} is 675 volts when E_{bb} is 270 volts and e'_o is 5.9 kv.

From Fig. 3A, $e'_{d(HL)}$ is 4.78 kv when $E_{bb(HL)}$ is 297 volts and $e'_{o(HL)}$ is 6.5 kv

$$[E_{bb(HL)} = E_{bb} (1.1), \text{ and } e'_{o(HL)} = (1.1)]$$

From Fig. 3B, $P_{bo}/I_{o(avg)} NL$ is 84 volts when E_{bb} is 270 volts and e'_o is 5.9 kv. Then, from the typical relation

$$I_{o(NL)avg} \approx i'_{o(NL)}/2.5$$

$$I_{o(NL)avg} = 284/2.5 = 114 \text{ ma}$$

$$P_{bo} = 84 \times 0.114 = 9.6 \text{ watts at zero beam}$$

From Fig 3C, $P_{bou} = P_{bo} (1.13) = 9.6 (1.13) = 10.85$ watts at 10-percent regulation when e'_o is 5.9 kv and E_{bb} is 270 volts.

From Fig. 4A, $P_{bo(NL)} = P_{bo} (1.09) = 10.45$ watts

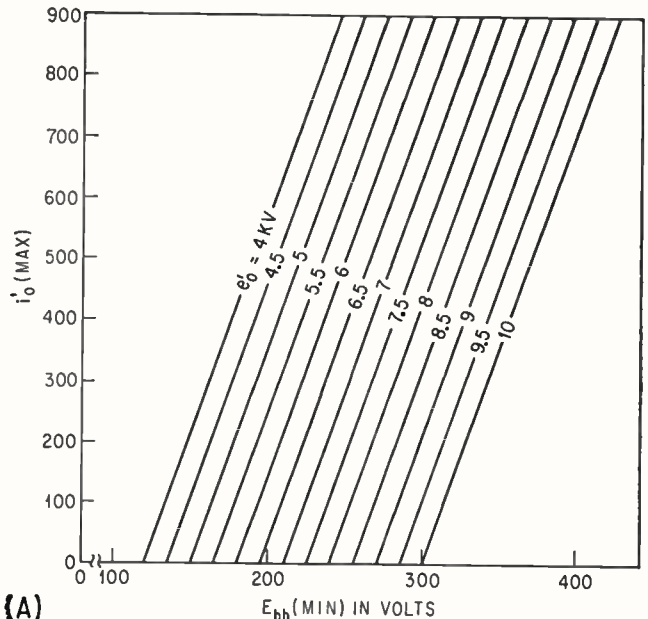

(A)

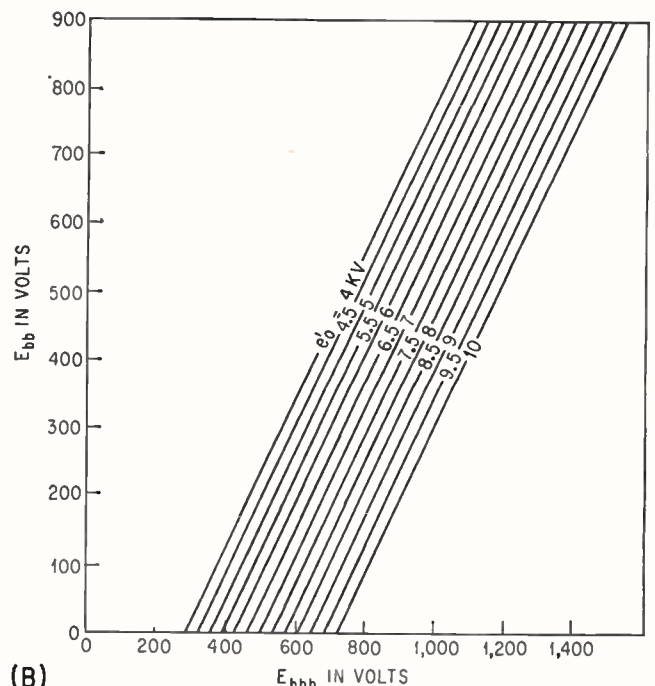

(B)

GRAPH for determining minimum-allowable supply voltage uses information obtained from Fig. 1A and 1B (A), and curves for obtaining the resultant boost voltage E_{bbb} (B) —Fig. 2

All 181 channels and a comparator



EE 3-65

The EECO 880



What you want but haven't been able to get! A complete receiver and comparator, with strip chart recorder, for phase correction of precision oscillators, time code generators, and digital clock frequencies to one part in 10^{10} . **Rapid All-Channel Tuning.** Instant station selection with decimal thumb-wheel switches. Continuous coverage in 100-cycle increments, 12 to 30 kc plus optional 60 kc channel. No channel change modules required. **Positive Lock.** Phase locked servo keeps tracking error below 1 microsecond. Servo is disabled in absence of input VLF carrier signal. **Permanent Record.** Self-contained chart recorder provides continuous recording of correction applied to local frequency standard. **Continuous Moni-**

toring with audio speaker, RF signal level/phase correction signal meter. **Simplified Maintenance.** Completely solid state circuitry with plug-in cards used extensively. Militarized version ready now! **Send for "VLF Approach to Absolute Time"** presented at 1963 Winter Convention on Military Electronics.

ELECTRONIC ENGINEERING COMPANY of California
1601 East Chestnut Avenue, Santa Ana, California,
Phone: (714)547-5501, Post Office Box 58. **Mail Station 1110**



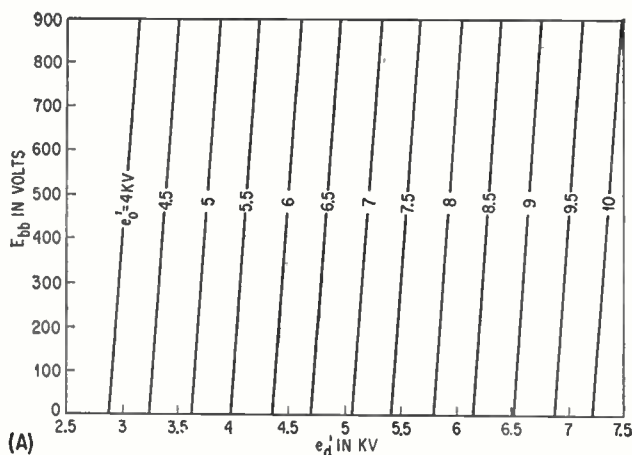

(A) DAMPER-cathode pulse voltage E_a (A), the ratio of output-tube plate dissipation to average plate current $P_{bo}/I_{o(avg)}$ (B), and the ratio of output-tube plate dissipation values at maximum brightness and at zero beam (C) may also be determined from previous curves—Fig. 3

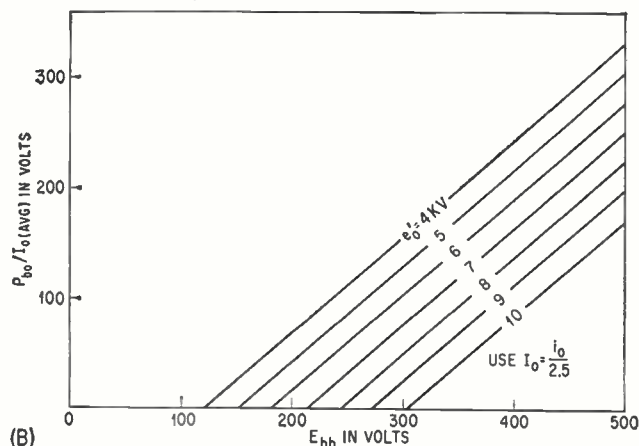

(B)

EFFECT of normal and high line voltage on output-tube plate dissipation as a function of output-tube plate pulse voltage and supply voltage (A), and schematic of the circuit considered, showing where parameters are derived (B)—Fig. 4

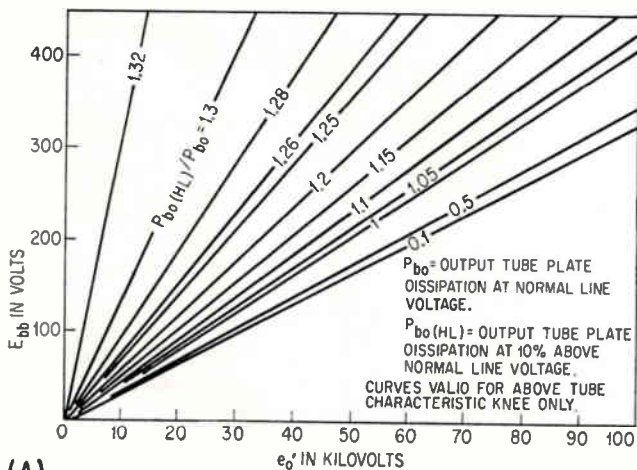

(A)

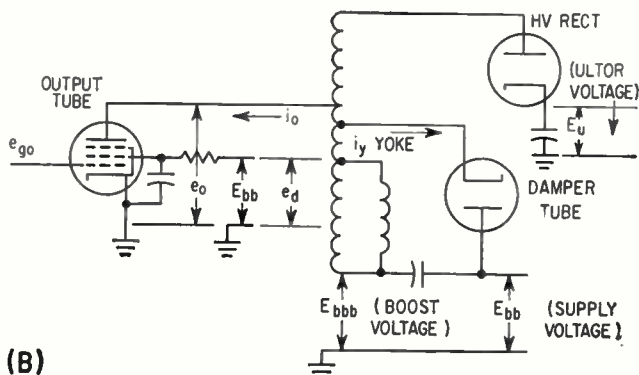

(B)

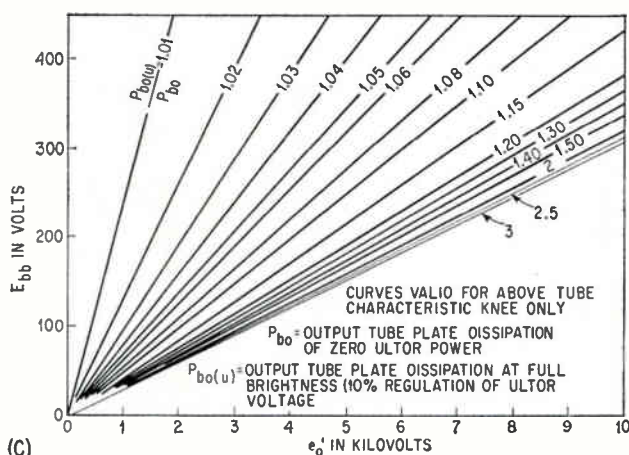

(C)

at zero beam current when e_0' is 5.9 kv and E_{bb} is 270 volts, or

$$P_{bo(HL)} = P_{bo(U)} (1.09) = 10.85 (1.09) = 11.82 \text{ watts}$$

at high line voltage and at 10-percent regulation of the ultor voltage.

In the preceding, e_0' , i_0' , e_d' and i_y' represent peak values of these quantities, \bar{I}_y is the peak-to-peak value of i_y , and symbols bearing an (avg) subscript are average values of the given quantity. Moreover, subscripts (NL), (HL) and (U) represent normal line-voltage condition, high line-voltage condition (10-percent high supply voltage) and full brightness condition of a picture defined at 10-percent regulation of the ultor voltage, respectively.

REFERENCES

- (1) O. H. Schade, "Characteristics of High-Efficiency Deflection and High-Voltage Supply System for Kinescopes", *RCA Review*, Vol 11, No 1, pps 5-37, Mar 1950.
- (2) Emlyn Jones, "Scanning and E.H.T. Circuits for Wide-Angle Picture Tubes", *Journal of IEE*, pps 23-48, Jan 1951.

Computer Runs Message Center

Semiautomatic system insures fast, accurate radiotelegraph delivery

By ALEXANDER A. MCKENZIE
Associate Editor

NEW YORK—Speed-up of present service and preparation for future advances are two reasons why RCA Communications will cut over a computer-controlled message handling system in early 1964. Delays introduced by relaying from one circuit to another will be reduced from minutes to seconds. Actual delivery by subscriber line, telephone or hard copy will be automated to increase speed and accuracy. Looking to greater use of broadband, high-speed circuits, engineers have built in capability for future advances.

Under development for six years, the Electronic Telegraph System (ETS) replaces the torn-tape technique recently hailed as the ultimate in speed and accuracy. At present, operators read message-routing information from printed, chadless punched teleprinter tape as it is spewed out of the receiving machines. Individual messages are torn by hand out of the continuous stream and sucked through pneumatic lines to a distribution point where they are further read and culled, and eventually sent out for retransmission or local delivery. These processes involve judgement, keeping messages in priorities and checking out specific destination information, and result in some errors and delays.

Computer Logic — With the computer, messages are received on memory devices and need not be initially recorded both alphabetically and in teleprinter code. An ideal message, furnished at the originating office overseas with all possible routing information, can proceed rapidly via the computer to its next stage in the system. If an element is missing in coded form, the computer searches for the needed data and inserts it before passing the message on. Working at high speed, the com-



TEST RUN on RCA Communications new switching center in New York where computer devices speed up teleprinter message handling and provide billing data. R. K. Andres demonstrates the command and interrogation features while president T. H. Mitchell looks on

puter will generally perform its work on a message before the outgoing channel can be cleared. The message is stored on a memory drum until the computer is signaled that the channel is free.

Traffic Volume — Magnitude of message handling comes into focus when it is understood that 70 countries with incoming and outgoing traffic over millions of route miles are involved. International traffic handled by RCAC has grown from 7 million words in 1920 to 254 million words in 1963. RCAC expects to top 300 million words by 1970.

Transmission is presently limited by the standard teleprinter speeds of 60 to 100 words per minute. Each of the two digital computers at the New York central office can handle 2.5 million characters or 400,000 words per second. Even if teleprinter speed multiplies, the computers will still have plenty of time for other tasks. And, as additional coaxial cable channels become available, the data processor can be programmed to transmit high-speed serial bit streams. Future traffic in the form of datagrams and filed data messages could afford data transmission facilities to subscribers whose volume is

too small for a private channel.

Library Function — Each message is preceded by internationally approved symbols that instruct the computer. These include a four-letter destination code, two-letter priority, class of service code, origin code and the number of paid words in the message.

Magnetic cores with a capacity of 131,072 characters store program instructions, message accumulation and distribution, destination tables, queue lists, code conversion and working storage for processing.

Four magnetic drums, each having a capacity of 384,000 characters, store information not requiring the short access time of the core memories. Although it may take 66 milliseconds to read out desired data from a drum, the average time is only 33 milliseconds. One drum retains 800 to 1,000 messages when transmitting channels are occupied. About 12,000 registered addresses and routing instruction codes together with a geographical index of 150,000 characters representing world cities are stored on another drum. Three languages must be available since one man's Livorno is another's Leghorn and Wien is also known as Vienna.

FACTS...



*about today's most
advanced solid state
telegraph relays*

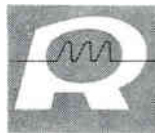

RADIATION
INCORPORATED

Are all solid-state relays alike?

No. Some are transistorized versions of mechanical units, while others are partially solid-state. Radiation Telegraph Relays are all solid-state. There are no moving parts.

Why invest in solid-state relays?

Because they eliminate routine maintenance, require no adjustments, and cut costly downtime and service calls.

How long will they operate under normal conditions?

Indefinitely.

APPLICATIONS . . .

Which mechanical relays can solid-state units replace?

All known types . . . except those rare applications where no solid-state device can be used.

How many kinds would I have to stock?

Only three: Radiation supplies polar, neutral and universal types.

Can I simply plug in your relays and expect them to work?

Yes. But because there are so many different wiring options, an adapter plug may be required to match your particular system.

How do you power Radiation Relays?

You don't. A unique circuit (patent applied for) allows the unit to operate on input current . . . the signal itself supplies the power.

TECHNICAL . . .

What are the features of Radiation Relays?

Non-polarized output contacts, high MTBF . . . 73,000 hours of actual field test without failure, high speed . . . up to 2400 bits/second, low distortion . . . less than 1% at 1000 bauds, and low leakage . . . less than 5 μ a at 130 volts. The units provide long operating life with extremely high reliability, and are designed with special protective circuitry.

What type of protective circuitry?

Thanks to a unique Radiation design, the units are highly resistant to spikes and overvoltages. Not only do they provide a cleaner telegraph signal, but they are also protected against destruction caused by abnormal line conditions.

Suppose a Radiation Relay is badly overloaded . . . how do I check it out?

We can supply our Model 7110 Solid-State Relay Tester. Incidentally, it comes with an adapter for use with electromechanical units, too.

What if the unit's actually damaged by abnormal conditions . . . do I have to throw it away?

Absolutely not! Due to modular construction Radiation Telegraph Relays are repairable.

QUALITY ASSURANCE . . .

Are your relays guaranteed?

They certainly are. Radiation warrants Neutral Model 9214 and Polar Model 9212 against all defects of performance for a year after shipment . . . providing they're used under normal conditions.

How can I prove the superiority of Radiation Solid-State Telegraph Relays?

Simply phone or write Product Sales Manager at Radiation Incorporated, Products Division, Dept. EL-01, Melbourne, Florida. We will supply technical information, and, if you wish, have a Field Engineer provide a relay to test on the line of your choice.

Why not call today? Prove to yourself that Radiation Relays assure higher circuit efficiency, lower cost operation and dependable service!

Crystals Route Laser Beam

Applications in computers and data display seen for switching technique

DEFLECTION of a laser beam by electronically switched crystals was reported last week by IBM's Data Systems Division Development Laboratory in Poughkeepsie, N. Y. Called a digital light deflector, the experimental device can project letters, numbers or other images to exact positions on a screen at rates up to several million a second.

Light deflection at electronic speeds, IBM pointed out, has been a major problem in harnessing light for data processing. Besides use in computers, the new technique shows promise for data display systems.

Branching Out — The laser beam is first passed through a stencil-like mask of the letter or number to be projected, and then through a series of crystal pairs. Each crystal pair can give the beam one of two possible directions; each additional pair thus doubles the number of positions available.

The first crystal of each pair is a thin potassium dihydrogen phosphate (KDP) crystal covered by semitransparent electrodes. Controlled by voltage applied to the electrodes, it changes the beam's polarization.

The laser beam next passes through a birefringent calcite crystal. Depending on the direction

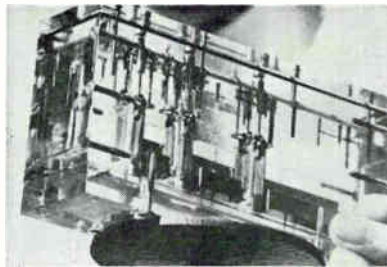

CRYSTALS are in bottom half of deflection assembly

of polarization given it by the KDP crystal, the beam takes one of two possible paths through the calcite, either deflected or undeflected.

Laser's Power Needed — Using a series of such crystal pairs, the system can provide a large number of alternate positions for the outgoing beam. While the system is applicable to any kind of light source, each crystal absorbs a part of the light energy. IBM researchers therefore resorted to the powerful laser beam, using a commercially available helium-neon gas laser with a 1.5-mw continuous output power.

Computer's High-Speed Memory is Wire Matrix

TOKYO—High-speed Mark IV computer to be completed this year by the Government Electrotechnical Laboratory (ETL) will use a wire matrix for its high-speed memory. This will be first use of the wire matrix known commercially as the Toko Memory Plane.

Previous computers developed at ETL have had great influence on the design of Japanese computers. The Mark IV may have somewhat less influence than its predecessors, because the industry is now more mature, but it certainly will not be ignored.

Model of the high-speed memory to be used was developed jointly by ETL and Toko Radio Coil Laboratories, Ltd. It consists of two planes. Each can store 32 words of 50 bits. Cycle time of the mem-

IF YOU HAD TO PRODUCE 5,000 CONNECTORS PER DAY...



HULL WOULD GUARANTEE IT!

(with the new 99B horizontal transfer molding press!)

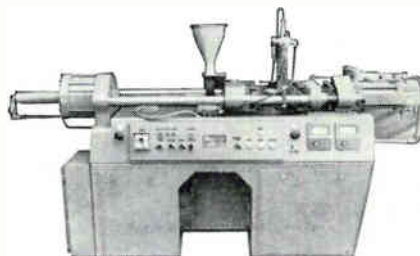

The new Hull 99B 25-ton, fully automatic transfer molding press. This machine is equipped with all controls for flawless, rapid operation.

That's just *one* sample capability of Hull's latest transfer molding package.

The new 99B transfer molding press is the heart of the package. With it, Hull can guarantee even higher production rates than ever before. At optimum cost per unit.

Of course, the 99B isn't restricted to connectors. What do *you* produce?

Send for full details on the Hull guaranteed production package... and the Hull 99B.

HULL
CORPORATION
4310 Davisville Road
Hatboro, Pennsylvania
Export Division:
1505 Race St., Philadelphia 2, Penna.



LETTERS formed by mask (at left, not shown) are projected on screen at right. Light passes through deflection assembly and pair of focusing lenses

NOW from DEI

**High Performance...Very Low Noise...
Modular**

VHF/UHF Satellite Telemetry Receiver

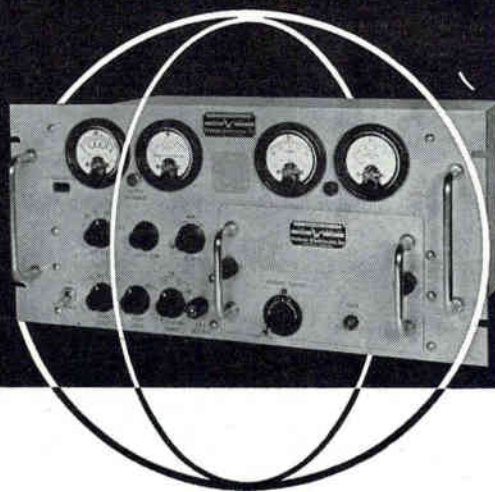

- Crystal controlled RF heads from 50 MC to 1000 MC
- IF bandwidths from 10 KC to 500 KC
- FM, AM, Phase-lock and Phase demodulators
- Plug-in pre-detection recording converters

Already used in more than a dozen unmanned earth orbit satellite programs, the Model TMR-6 telemetry receiver from Defense Electronics, Inc. has no true equivalent in its field.

The completely-modular unit has been specially-designed by DEI to accept inexpensive plug-in sub-assemblies . . . seven RF tuning heads . . . nine IF amplifiers and four demodulators . . . to cover all presently-assigned frequencies in the VHF/UHF spectrum.

The TMR-6 features crystal control of both oscillators, extremely low noise figures and can be adapted for use in PM systems by means of a phase-locked loop around the entire receiver. It is capable of tracking any frequency change introduced by Doppler shift, transmission and reception instabilities up to 0.007 per cent of the received frequency.

This versatile, low-cost receiver also accepts plug-in modules for pre-detection recording of either AM or FM with existing stationary head video tape recorders.

For real time data recovery at its finest, write for DEI bulletin TMR-6 . . . or call:



DEI *Defense Electronics, Inc.*

SERVING
GOVERNMENT
AND INDUSTRY

Rockville, Maryland

TWX: 301-949-6788 Phone: 301-946-2600

Sherman Oaks, California, Phone: 873-4322

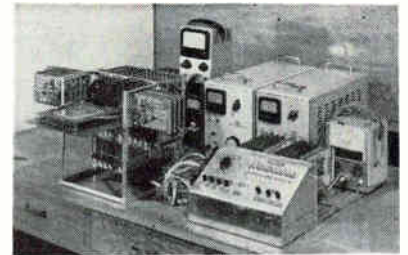

MODEL of memory and test setup

ory is reported as 0.5 microseconds.

In the model, word selection and writing of each word are manual. Reading and regeneration are electronic. Pilot lamps are provided to show what has been read. In actual use, writing will be done by logic circuits and output will also be by electronic circuits.

The Toko memory is of the destructive readout type. A magnetic film (plated) wire is used for direct writing and readout lines, and an insulated wire for the work drive line. These two types of wires are woven to form a wire-mesh matrix.

Main memory of the Mark IV will be a 128,000-word magnetic-core memory with a cycle time of 1 μ sec. Input and output of the main memory will be through the high-speed, or buffer, memory. Clock speed of the computer logic circuits is 8 Mc.

Semiconductor Lamps Record Data on Film

LONDON — Semiconductor lamp arrays are being used for recording digital information onto photographic films.

In a system developed by the British Admiralty Services, an array containing 20 gallium-phosphide-crystal lamps, each 0.03 inches in diameter by 0.05 inches, is mounted in the gate of a recording camera. The image of the array—the array size is only 1 by 1.25 inches—occupies only a portion of the picture format and so allows simultaneous recording of digital information along with the main picture. Record legibility on the moving film is obtained by pulsing the array with one-millisecond drive pulses.

Gallium-phosphide diode light sources have also been developed by the British Admiralty Services Electronics Research Lab for use in testing photomultipliers and for triggering coincidence circuits in photomultiplier scintillation observations. Drive inputs of 15-v, 20-nanosecond pulses produce light pulses with a maximum repetition frequency of 10 Mc and a rise time of 3 nanoseconds. The diode's white-light spectrum is produced by an avalanche breakdown in the reverse direction.

Computer Networks Seen For Scientific Uses, Too

CAMBRIDGE, MASS.—Time-sharing computer networks for military command-control and for scientific use are not far away. In the distance, though even now discernible, is the installation of computer network terminals in offices and even homes. These were among long-range projections last month at the first briefing on ARPA's \$13-million program of research in information processing. The briefing was held at MIT, where simultaneous use of a digital computer by several independent workers was demonstrated three years ago.

Besides Project MAC (ELECTRONICS, p 24, Dec. 20, 1963) ARPA's program includes time-sharing research programs by Systems Development Corp. at Santa Monica, Carnegie Institute of Technology, the University of California at Berkeley and Los Angeles, Stanford University and Stanford Research Institute.

MIT Prof. Robert M. Fano, MAC director, likens the time-sharing system now evolving to an electric utility serving multiple subscribers. "The computer of today is an economic and technical compromise," says Fano. "Its structure was dictated by sequential usage. Simultaneous processing will force radical changes in hardware." Among changes already in the research stage at MIT are flicker-free character-generation input devices for computer-aided design (p 16, May 17, 1963) and real-time graphic display of programming.

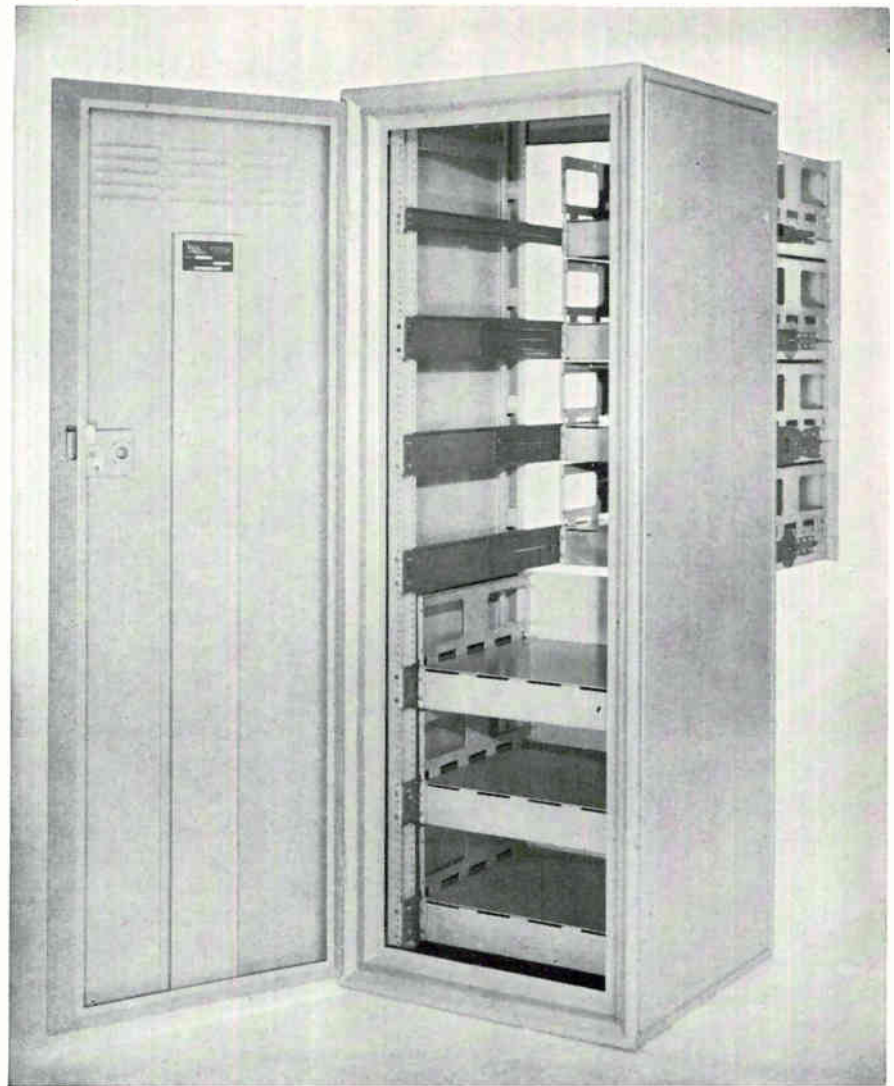

How much Engineering goes into an Electronic Cabinet?

Countless hours of engineering have resulted in a line of electronic cabinets which meet and exceed all requirements for:

- **VERSATILITY**—simplifies inspection and provides interchangeability between standard models.
- **STRENGTH**—vertical frame posts of unique cross section construction provide exceptional strength.
- **AVAILABILITY**—Vent-Rak's Indianapolis facilities offer a central geographic location to reduce shipping time.

DELIVERY IS GOOD TOO!

For information on Vent-Rak's complete line of electronic packaging components, write:

525 SOUTH WEBSTER AVENUE
INDIANAPOLIS 19, INDIANA



Four-Beam Landing Radar Set for LEM

By JOEL A. STRASSER, Assistant Editor

Three-beam doppler will measure velocity while one beam gets altitude

BURLINGTON, MASS. — A specially designed, four-beam radar system will get the ticklish job of helping two astronauts touch down on the moon in 1969-1970.

The system will go aboard the Lunar Excursion Module (LEM), the two-man landing capsule of NASA's Apollo spacecraft. LEM is supposed to make a powered descent to a soft-landing, so it can take off again.

Selection of the four-beam system—three for doppler velocity measurement and one for altitude measurement—was announced last month by RCA's Aerospace Systems division, which is responsible for major electronic subsystems on LEM under contract to Grumman.

RCA has given the radar con-

tract to Ryan Aeronautical Co. Ryan's design is an outgrowth of its work on landing radars for Surveyor, an unmanned craft that is to soft-land observation equipment on the moon in 1965. About 25 percent of the design will be new, however, says Frank J. Gardiner, RCA's LEM program manager.

The new system will have to be lightweight, without redundant equipment; it will have to meet "fantastic" reliability requirements; and it will have to operate at frequencies—in the gigacycle range—that won't be affected by the plumes of LEM's landing rockets.

Antenna Design — The antenna array consists of a transmitting antenna and four receiving antennas.

Two separate mechanically interleaved slotted-waveguide arrays, one for the velocity beams and one for the altitude beam, form the transmitting structure. In the velocity antenna, selected slot spacings and waveguide direct the beams for doppler measurement. In the receiving portion of the antenna array, the three velocity receptors are tilted away from the plane of the

LANDING RADAR DATA

Frequency:	gigacycle range
Power transmitted:	milliwatt range
Operating range:	50,000 feet to landing
Transmitting mode:	continuous wave
Signal-detection mode:	direct-to-audio, quadrature
Velocity sensing:	three beams, c-w
Altitude sensing:	one beam, f-m, c-w
Operating modes:	velocity and altitude together or independently

only **4** basic materials... **1** ...mylar*.

...a new capacitor construction concept to give high performance and low cost. Filmatic® by Paktron

transmitting antenna to obtain the velocity components and to isolate them from the transmitter. The altitude receptor is flat in the plane of the transmitting antenna.

The arrays are made from magnesium waveguide, coated to keep the temperature below that causing outgassing, and set into fiber-glass honeycomb cradles. The transmitters that are part of the antenna structure are mounted on a fibre-glass covered aluminum plate.

Solid-State Transmitters—Each of two transmitters, operating at slightly different frequencies in the gigacycle range, will consist of a basic oscillator (crystal for the velocity beams and voltage-controlled for the altimeter beam), vhf power amplifiers, and varactor frequency-multiplier chain. The state of the art will have to be advanced slightly to bring present laboratory devices into service to get optimum power output.

For both the velocity and altimeter channels, a portion of the transmitted signals is combined with returned signals in dual detectors whose outputs are audio-doppler

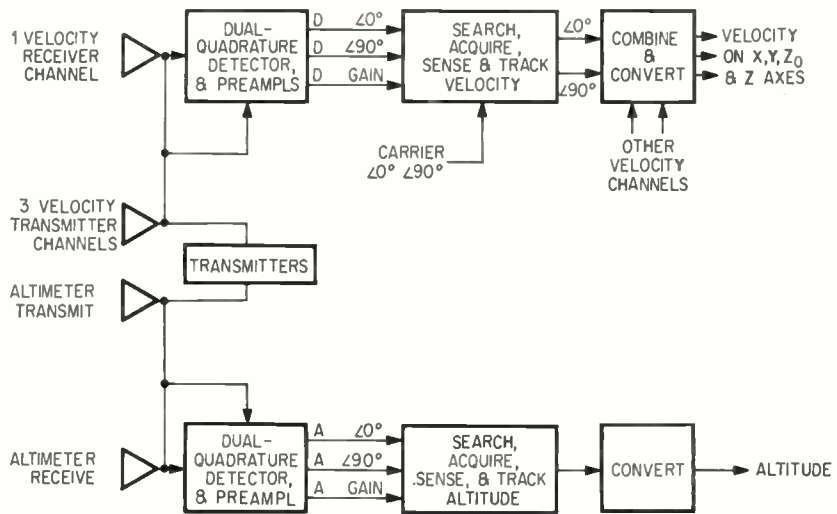

VELOCITY AND ALTIMETER stages are identical for all four beams through preamplifiers. Search-acquire-track stages differ slightly after preamp. Letter A represents audio and D doppler

signals in quadrature (see diagram). Direct-to-audio detection serves to eliminate transmitter leakage.

First stage outputs are the quadrature for sign-sensing doppler signals as well as a gain indicator. The gain indicator controls switching from search to track modes and gain-control switching circuits in the preamplifier, during lunar approach.

Up to this point, velocity and altimeter stages are identical for all four beams. The search-acquire-track stages for all four channels differ slightly after the preamplifier.

Frequency Trackers—Voltage controlled oscillators perform a search-sweep tuning function until gain signals from the preamp indicate



his unique combination provides a rugged self-case, high lead strength, excellent moisture resistance, improved life, high volumetric efficiency . . . all at a considerable savings in cost.

available in three case sizes.

range:	.001 mfd. through .5 mfd.
voltage:	50-100-200-400-600 WVDC
tolerance:	± 10% & ± 20%

DuPont

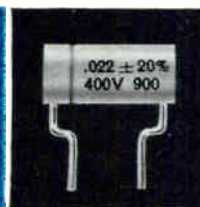

ACTUAL SIZE

Filmatic®
Capacitors
with
RIPPLEWELD™



PAKTRON

DIVISION ILLINOIS TOOL WORKS INC.
1321 LESLIE AVENUE • ALEXANDRIA, VIRGINIA

BULLETIN NO. 5005
Date of Issue: January, 1964

HEINEMANN

Silic-O-Netic[®]

TIME
DELAY
RELAYS



SHOPPING GUIDE FOR THE TD RELAY BUYER ON A TIGHT BUDGET. You get a lot for your money with Heinemann hydraulic-magnetic time-delay relays. Consider: Inherent freedom from excessive ambient temperature effect (non-thermal actuation). Fast recycling (typically only 15% of the specified time delay). Continuous-duty capability (relays can be energized indefinitely after actuation, can serve as their own load relays in many applications). □ The line is diversified. Includes plug-in, hermetically sealed and open-frame models. All are available with any of 16 standard time delays, from 0.25 to 120 seconds. SPDT or DPDT switching. AC or DC operation. □ More information? Our Bulletin 5005 will give you detailed specifications and technical data. A copy is yours for the asking.

HEINEMANN ELECTRIC COMPANY
2600 Brunswick Pike • Trenton, N. J. 08602

acquisition of the signal. Rising gain signals switch the voltage controlled oscillators to track mode, closing a tracking loop. The loop operates at an injected intermediate frequency causing the voltage controlled oscillator to track the incoming signals. Following the frequency tracker, velocity signals are processed arithmetically to get velocities of LEM along each axis.

The altitude signal is c-w, frequency modulated by a linear sawtooth waveform. Altitude tracking circuits differ from those in the velocity channel in that they have a gate to turn off the tracker during flyback time, and small shifts of the voltage controlled oscillator to decrease range quantization errors. Following the tracker, altitude signals have their doppler content (caused by the vehicle's vertical motion) removed, and then quantized.

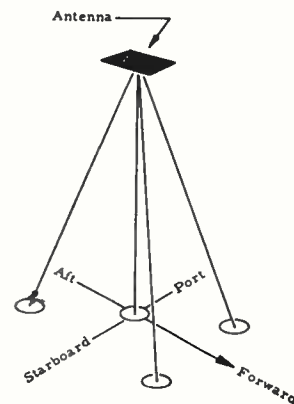
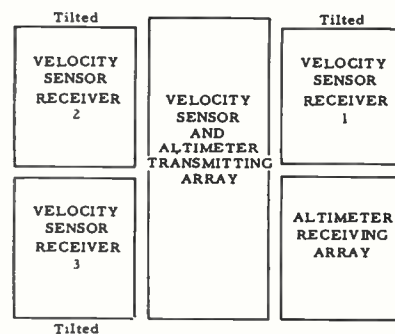
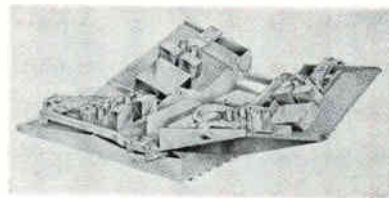

▲ ANTENNA ARRAY has three velocity receptors tilted away from the plane of transmitting antenna; altitude receptor is flat in plane of transmitting antenna

SA 2999

Japanese Steelmen Hedge On Computer Processing

TOKYO—The \$167,000 that Nippon Kokan Steel is spending for steel processing computers includes \$56,000 for duplicate control panels. One will watch the computer and the other will allow manual take-over. Management said it "does not have complete faith in computer control."

Two digital computers, built by Hokushin Electric Co., will be used. One controls a blast furnace, the other controls 3 basic oxygen converters. The HOC-300's have an add time of 300- μ sec, drum memory capacity of 8.192, 11-bit words and scanning speed is 200 points/second. The installation and program were designed on an IBM 7070.

Why Two Computers?—The computer that controls the oxygen converters will improve steel quality by tightly controlling the carbon-to-manganese ratio. Microsecond reaction time will also prevent loss of the steel coolant, and exactly control additions of alloying materials. Basic oxygen processing is also difficult because it is a batch-type process. The timing of the batch (in and out) is critical. Data from two preceding batches are stored in the memory control is a result of averaging some data, and following the trend of others.

Main reason for the second computer: to increase blast furnace capacity. Nippon Kokan expects to increase capacity from 2,000 tons per day to 2,500 tons or more per blast furnace, while increasing steel quality and furnace heat efficiency.

The oxygen process computer went on-line (open-loop) last March. It is now being connected to all three converters with on-line, closed-loop operation expected this May. The blast furnace computer is presently used as a data logger. The next step is programming, which is expected to take three months.

Modernization is not new to Japanese steel. Over the last 10 years, under two five-year plans, the industry has spent some \$2.3 million. They are now in the midst of another five-year program. With \$505 million in capital investment in fiscal 1963, steel leads all Japanese industries.



Interchange-ability with plug-in oscillo/riter* recorder amplifiers

TI offers amplifiers to satisfy any medium frequency recording application . . . all types simply plug in the front panel. Choose from an impedance matching buffer amplifier, a high gain d-c unit, a high performance carrier amplifier, a medium gain differential amplifier, and other special purpose types.

Oscillo/riter recorders offer interchange-ability in chart paper, too. For convenience and ease of ready reference, choose Z-fold charts, they read like a book, stack out of the way; or get economy with the standard roll chart furnished with each recorder.

Oscillo/riter recorders offer more pushbutton convenience than any other medium frequency recorder.

Brief Amplifier Specifications—

High-Gain—.05 mv/mm sensitivity with 10 ranges

Differential—5 mv/mm sensitivity with 8 ranges

Buffer—100 mv/mm sensitivity with 7 ranges

Carrier—10 μ v/mm sensitivity, 9 ranges, 1.78 volt rms excitation

Basic price with buffer amplifiers is \$1195.

*Trademark of Texas Instruments Incorporated

Write for complete information.

INDUSTRIAL
PRODUCTS
GROUP



**TEXAS INSTRUMENTS
INCORPORATED**
P. O. BOX 66027 HOUSTON, TEXAS 77006

636

Receiver Design Technique Cuts Synchronization Time

New criteria determine optimum synch-search system performance

By MICHAEL F. WOLFF
Senior Associate Editor

BLUE BELL, PA.—New technique for designing optimum “synch-search” equipment has been developed at Philco Corp’s communications and electronics division. Such equipment, now nearing the bread-board stage, could be used either for general search problems such as locating satellites and submarines, or for receiving signals through jamming, according to J. Z. Grayum and Constantine Gumacos, who developed the method.

Basic synch-search problem is to synchronize a receiver in time, frequency, or any combination of the two, with the received waveform. The receiver must search for synchronization with the transmitter so that the average time to obtain synch is minimized, or, for a given synchronization time, the probability of obtaining synch is maximized.

The Philco researchers claim that while such systems have been developed in the past, there has not been any absolute criterion for determining performance; thus, it was possible either to be satisfied with a bad design or to not know when a good design was achieved. Philco feels its new technique provides criteria against which projected performance can be judged, so as to obtain consistently reliable communications equipment. One calculation shows the new method can cut the time to reach synchronization from 250 seconds in a more conventional sys-

tem to 13.5 seconds.

Because the uncertainty about the relative time and/or frequency parameters of two noise-like waveforms is great, many combinations of frequency-time (f-t) parameters must be tested. These parameters are assumed to lie within some finite or infinite region of the f-t plane. This region is divided into f-t cells, as shown in Fig. 1.

The synch-search problem, therefore, requires testing a large number of f-t cells. Philco has found that

the optimum search method lies in moving rapidly from one f-t cell to another, rather than searching one cell intensively. The search mechanism remains in one cell only long enough to reduce the probability of locating the signal below that of locating it in the next most probable cell.^{1,2}

Each cell is tested with a sequential probability ratio (SPR) test. In this test a decision is made after each sample either to accept hypothesis H_1 (synch is present), or to ac-

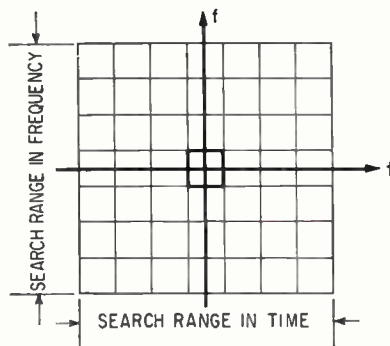

FREQUENCY-TIME search region is divided into f-t cells—Fig. 1

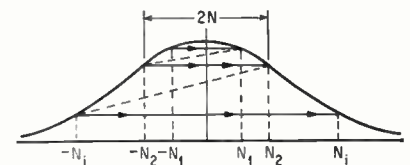

A PRIORI probability distribution and scanning process—Fig. 2

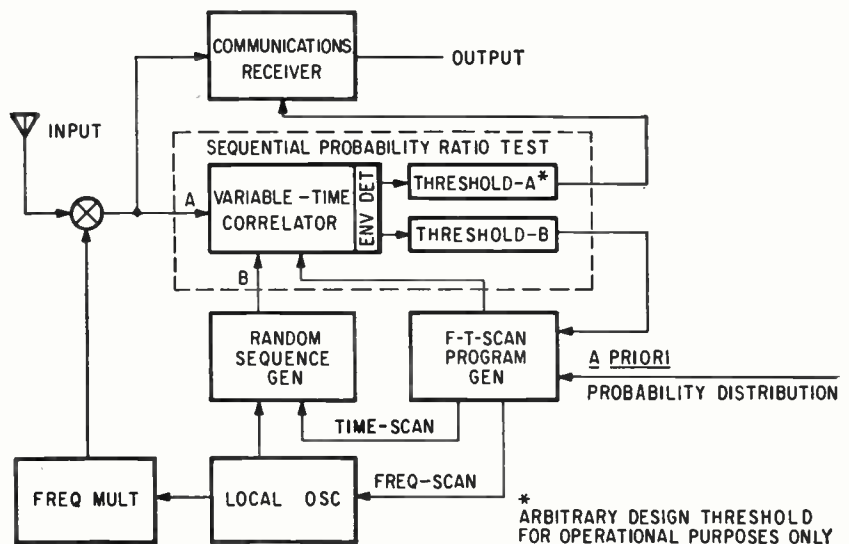

ACQUISITION PORTION of synch-search receiver—Fig. 3

* ARBITRARY DESIGN THRESHOLD FOR OPERATIONAL PURPOSES ONLY

INFINITE RESOLUTION POTENTIOMETERS?



CO-MOLDED MATCHED RESISTORS

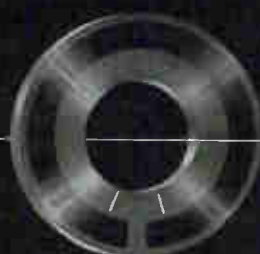

CO-MOLDED RESISTANCE ELEMENT



FAIRCHILD'S E•S•P* FOR PRECISION CONDUCTIVE PLASTIC

Infinite resolution is just one of the high-performance features you get with Fairchild's conductive plastic potentiometers.

Other features that add up to improved systems performance are:

- New materials and techniques that give superior humidity and temperature characteristics
- Operating life over 10 million cycles
- Virtually constant low electrical noise
- Linearity to close tolerance
- Stable resistance throughout operating life
- Glass-smooth, self-lubricating resistive element for minimum torque
- Co-molded element, terminals, taps and base for superior reliability through environmental extremes
- Integral trim elements to each user specification.

Already tested for many critical military specifications including Mil R12934, Fairchild's conductive plastic potentiometers are available in a complete range of sizes from 7/8" to 3", resistance values to 200K, in single units or multi-gang types. Taps, shorted or switching sections, standard or empirical non-linear function

can be supplied to meet requirements. Call or write for complete data, and the assistance Fairchild E•S•P* will give for your special potentiometer needs.

FAIRCHILD

CONTROLS

A DIVISION OF FAIRCHILD CAMERA AND INSTRUMENT CORPORATION
225 PARK AVENUE, HICKSVILLE, L. I., NEW YORK
6111 E. WASHINGTON BLVD., LOS ANGELES, CALIF.

* E•S•P is the Fairchild Controls concept of integrated Engineering, Service and Production that assures highest performance and reliability in your specific application. Write for brochure that shows how E•S•P can serve you.



THE VERNIER IS

ORNAMENTAL

(...we may have Gone Too Far)

Are we being fair to the Man in the Lab? Will he feel Left Out? Unwanted? Will his Life be Empty without the Vernier? With AUTOBALANCE®, you see, the vernier on our B221A Universal Bridge becomes a useless ornament.

The principle is simple.* Any bridge unbalance is fed to an operational amplifier, which furnishes a proportional "re-balance" voltage. Two phase-sensitive detectors give readings of the in-phase and quadrature components of the rebalance signal, (directly, on meters). Add these to the decade settings and you have the resistive and reactive answers—without touching the vernier... electronic, automatic, and terribly modern.

Think of batch-lot-checking to four digits, without touching a knob (once the decades are set at the start). Think of automatically recording component drift! The question is, is the Game worth the Candle?

Help us! Tell us you care more for efficiency than for tradition! Buy the AA221 and write us admiring and forgiving letters. (If you're not all that impulsive, at least ask for the literature.**)

One last word—if you ever feel sickeningly "over-automated" with the AA221, you can always pull out the adapter cable and "go native" with the raw B221A.

B221AQ SPECIFICATIONS

Capacitance: 0.0002 μ F to 100,000 μ F Frequency Range: 1000 or 1592 cps Internal;
Resistance: 25 μ ohms to 50,000 megohms 20 cps to 20KC External
Inductance: 5m μ H to 10⁸H Accuracy: $\pm 0.1\%$

® AUTOBALANCE is a registered trademark of Wayne-Kerr

* And patented

** While you're at it, go all the way, and ask about the B541, a $\pm 0.25\%$ Capacitance Bridge with built-in AUTOBALANCE!



WAYNE KERR

CORPORATION

1633 RACE STREET, PHILADELPHIA 3, PA. LOCUST 8-6820

INNOVATIONS in INSTRUMENTATION

cept hypothesis H_0 (synch is not present), or proceed and take another sample. Decisions are arrived at by continuously summing the differences between the measured quantities and the average value of the samples. These differences may be either positive or negative depending on whether the measured quantity is greater or less than the average. A decision to accept H_1 is made if this accumulation of differences exceeds a positive preset threshold A , and a decision to accept H_0 is made if a negative threshold B is exceeded. If neither threshold is exceeded, sampling continues.

Eliminating Threshold A—The actual procedure developed at Philco is based on an important modification of the basic SPR test: the recognition that there is no need to make a formal declaration of synch. This amounts to removing threshold A and overcomes a previous stumbling block of what to do if synch is declared erroneously.

In searching for synch, threshold B will often be crossed, indicating that synch should be sought elsewhere. Eventually at some cell the threshold will never be crossed, and, having found synch, one continues to sample that cell indefinitely without ever making any formal declaration of synch.

Another unique feature of the Philco technique is the way the cells are searched as a function of the preset threshold. Assuming that the *a priori* probability distribution of synch is gaussian, with a standard deviation of N time cells (see Fig. 2), the process consists of sampling consecutively the cells from $-N_1$ to $+N_1$. If synch is not found, a new scan is initiated from $-N_2$ to $+N_2$, over a wider portion of the probability curve, and so on. It can be shown that the process is optimized if the ratio of two adjacent ordinates of points on the probability curve is always constant. This procedure minimizes the average time to obtain synch and, for a fixed synchronization time, minimizes the probability of missing synch.

Receiver Design—The theory described above suggests a receiver of the form shown in the simplified block diagram, Fig. 3. Here the modulated carrier input is heterodyned down to i-f and fed to a correlator

which integrates the product of A and B . The integration time of this correlator is a random variable whereas in more conventional techniques it is fixed.

The integrated signal goes to an envelope detector whose output is continuously compared to the preset threshold B . If the signal crosses this threshold (meaning it is out of synch) a voltage is produced that tells the scan program generator to examine a new f-t cell. This decision clears the integrator and the process is repeated until threshold B is no longer crossed. At this time the scan is not triggered and the integration continues.

The scan program generator determines the sequence in which the various f-t cells are to be tested. This is a predetermined program designed into the equipment on the basis of *a priori* knowledge about the time and frequency uncertainties for synch. The generator output determines the cell to be tested by controlling the relative time displacement of the random-sequence generator and the frequency of the local oscillator. (A random-sequence generator allows matching a noiselike waveform with a similarly transmitted waveform.) The optional threshold A in practice can be used for some operational purpose such as switching the receiver output on or off, initiating a synch tracking mode or indicating the degree of confidence that synchronization has occurred at any given time.

Present Work—With the development of the theory completed, Philco is now engaged in putting on the theoretical model the constraints necessary to build actual equipment. These are:

1. That the correlator have a finite rather than infinite time constant.

2. That it use envelope detection rather than coherent detection since the probability of knowing the r-f phase of the received waveform is zero.

3. That the threshold be less than its theoretical value of zero. (This means a finite rather than infinite scanning velocity.)

4. That the number of different scans be limited.

A unique threshold has been determined that results in a 52-per-

DURANT

DID IT!

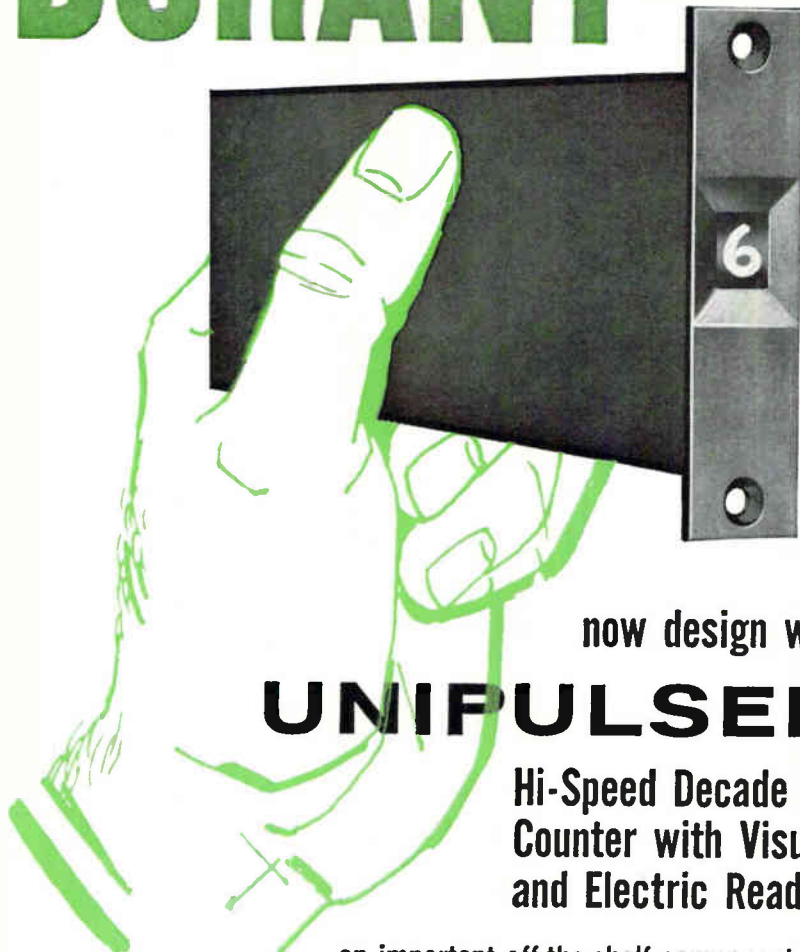

now design with

UNIPULSER®

Hi-Speed Decade Counter with Visual and Electric Readout

- 1 Accumulated data retained, even if power fails.
- 2 Unit life not subject to hours of usage (as electronic units).
- 3 Printed circuitry permits high electrical loads without relays or amplifiers.
- 4 Performs counting, controlling and readout within itself.

an important off-the-shelf component providing Extreme VERSATILITY, Space-saving COMPACTNESS, Dependable LONG LIFE, plus Attractive LOW COST

This unique, high speed, decade counter of modular design combines visual readout on a printed number wheel and electrical readout by means of an internal printed circuit switch. Each unit incorporates switching methods for resetting to zero and for transferring the pulse from decade to decade in sequential counting. A Unipulser system can be adapted to Predetermined Counting (including automatic recycle), or for many other digital control requirements. A Durant Sales Engineer will be glad to show you the Unipulser. Send for Catalog No. 90.

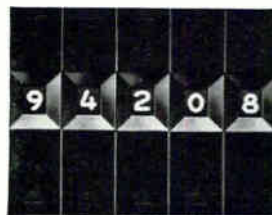

Mounted in banks . . . as many as required.

DURANT MANUFACTURING CO.

612 N. Cass St.
Milwaukee 1, Wisconsin

12 Thurbers Avenue
Providence 5, R. I.

DURANT®

PRECISION COUNTERS

REPRESENTATIVES IN ALL PRINCIPAL CITIES

THE
EXTRA
MEASURE
OF
JULIE



IS

SIMPLICITY

Resistance—Voltage—Current—Ratio—Julie offers the simplest primary standards measurement system ever developed. Compact and portable as the system is, it performs at the highest accuracy levels achieved by government primary standards laboratories. The Julie RATIOMETRIC™ System promises unique 1 part per million accuracy and delivers it. Simplicity of design and operation is the extra measure of Julie, the company that developed RATIOMETRY. Ratiometry is stable, versatile, reliable and accurate, and, as embodied in this system, covers the entire spectrum of DC calibration as required by standards laboratories. All the instruments used in the Julie System are built to perform to specification without excuses, double-talk or cumulative error. Component sections are usable independently for specialized applications since all interconnections are made by jumpers connected between front panel terminals.

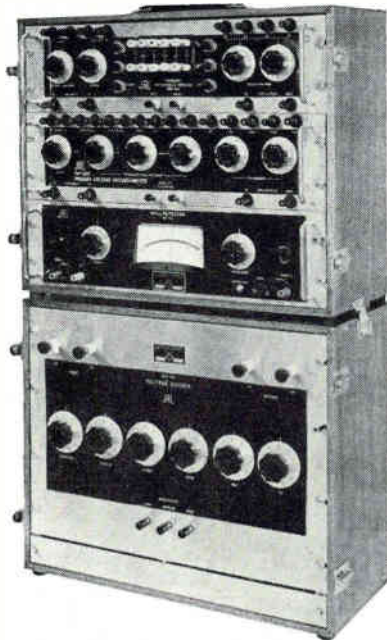

Instrument composed of SCO-106 Primary Standard Absolute Voltage Reference, VDR-106 Precision Voltage Divider and a control unit.

Write or call collect for a no-obligation demonstration of the system in your office, as well as complete details and information on how to institute your own primary standards laboratory.

**JULIE RESEARCH
LABORATORIES, INCORPORATED**

211 WEST 61st STREET, NEW YORK 23, NEW YORK • 212 CI 5-2727 © Julie Research Laboratories, Inc., 1963



cent increase in time-to-synch over the theoretical minimum. It is calculated that by using the new approach to search one million cells where the *a priori* distributions are gaussian, the best practical receiver would require, on the average, 13.5 seconds to achieve synch; if the *a priori* distribution were uniform, it would require 15.2 seconds.

REFERENCES

- (1) C. Gumacos, Analysis of an Optimum Sync Search Procedure, *IEEE Transactions on Communications Systems*, CS-11, p 89, March, 1963.
- (2) J. Z. Grayum, Optimum Decision and Scanning Techniques for Synchronization, *Proc 8th National Comm Symp*, Oct 1962.

Spark Chamber Finds Antiparticle Electrons

CHICAGO—A soaring spark chamber package has discovered antiparticle electrons—never before identified among primary cosmic rays—at the top of the atmosphere, 25 miles above the earth. The balloon-borne magnetic sorter of positive from negative electrons tended to support the theory that much cosmic radiation originates in supernovae, or exploding stars, according to Prof. Peter Meyer, University of Chicago.

Particles penetrating stacks of seven thin parallel metal plates inside two spark chambers mounted above the magnet left straight tracks through the surrounding neon gas to show direction they were traveling when they entered the gondola. Movie cameras using very high speed film recorded the tracks.

Magnetic field between poles of a 12 inch diameter, 185 pound 6,000 gauss magnet, deflected the particles, according to their charge. Two spark chambers showed changes in direction caused by the particles passing through the magnetic field. Particles passing through the equipment, their travel distances, and the impact products created inside the plates, were detected by ten special tantalum plates in a fifth spark chamber.

Two-story, helium-filled balloons launched in late July and early August near Ft. Churchill, Manitoba, recorded 188 electrons and 64 positrons during more than 22 hours of flight. Electron predominance, at 50 million to one billion electron volt level, ranged from 7-5 to 8-1.

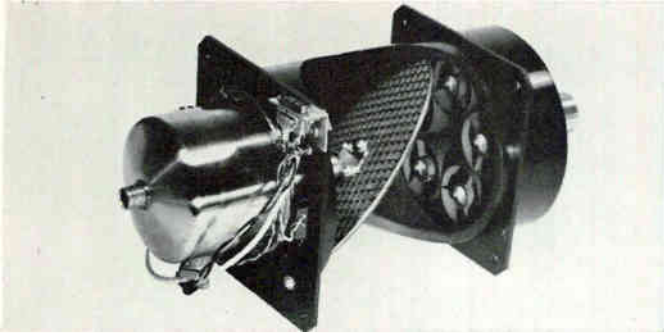

Radiometer for NIMBUS weather satellite



Interceptor IR installation

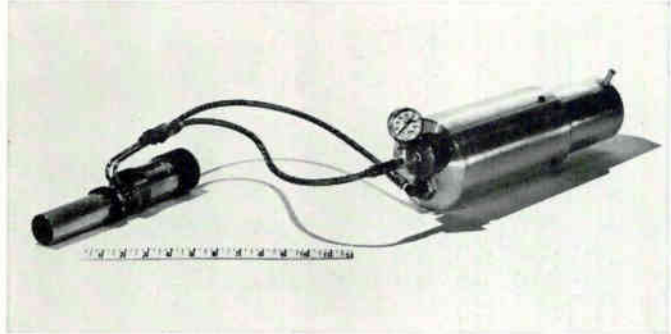

12°K closed-cycle cryostat



90C IR search/track set

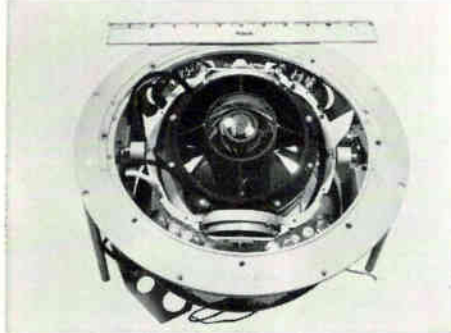

IR multi-channel tracking radiometer



Star tracker for SURVEYOR spacecraft

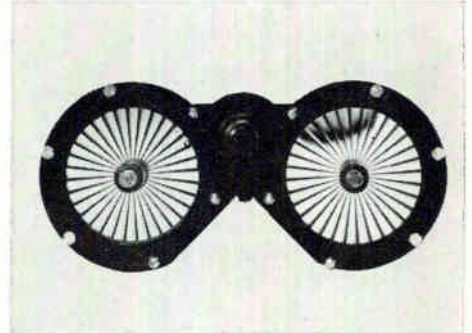

Modulated IR source

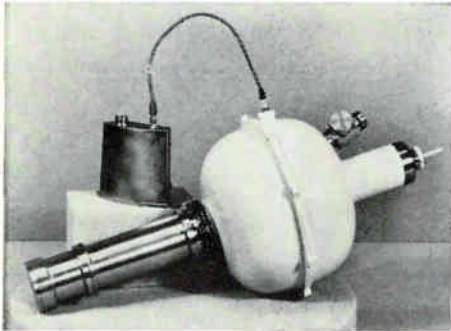

Liquid-helium-cooled IR detector



IR anti-tank missile controller

Expanding Infrared Programs

create new career assignments

Rapid growth of HUGHES Infrared activities in the Aerospace Divisions and the Santa Barbara Research Center has created many responsible positions for qualified engineers and scientists in all phases of IR systems development from conception through production engineering.

Immediately available assignments include openings in such diverse technologies as semiconductor physics, optical design, cryogenics, mechanical

engineering, precision electro-mechanisms, electronic circuit design, servo systems...and many other areas.

For immediate consideration, please airmail your resume to:

MR. ROBERT A. MARTIN
Hughes Aerospace Divisions
11940 W. Jefferson Blvd.
Culver City 10, Calif.

HUGHES

HUGHES AIRCRAFT COMPANY
AEROSPACE DIVISIONS
An equal opportunity employer

Current HUGHES IR contracts include advanced systems for space exploration, weather reconnaissance, anti-ballistic missile defense, anti-submarine warfare, interceptor weapon guidance & fire control, bomber defense and tactical weapon control.

Professional experience, an accredited degree and U.S. Citizenship required.

Equipment Makers Push Thin-Film Microcircuits

Portable communications gear being designed with compatible technique

By **MICHAEL WOLFF**
Senior Associate Editor

RESURGENCE of interest in thin-film microcircuits has become evident in recent weeks. Electronic systems manufacturers are paying increasing attention to applying thin films to both linear and digital microcircuits, indicating that the long-predicted trend toward a complementary thin-film-semiconductor technology for microelectronics is emerging.

Greater emphasis on films is due to several factors:

- Advances in processing are making thin-film deposition less of an art and more of a science, thus enabling the potentials of high performance and close tolerances to be realized. Considerable interest was expressed at a recent symposium when it was announced that IBM had overall yields of 20 percent for thin film computer panels containing a couple hundred components.

- It is becoming evident that sophisticated linear circuit design is possible with thin films and attached active components if the circuit designer first devotes enough time to learning what can and cannot be done with films.

- Progress in thin-film transistor research indicates these devices can be built and may be practical within the next 3-5 years.

The Approach—Many companies are concentrating on what appears to be the most natural extension of the complementary approach—namely, depositing film passive

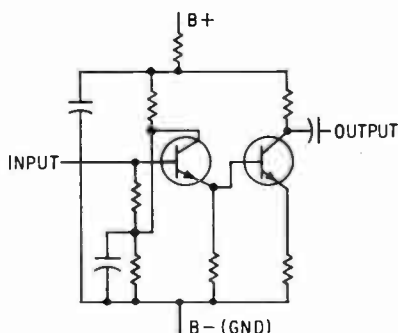

12-MC I-F AMPLIFIER on single chip is used in Motorola 120 Mc a-m receiver

components on the insulating region of the semiconductor block containing the active components. This takes advantage of the best characteristics of each technology and undoubtedly will be tried whenever film passive components are needed to perform a function that cannot be obtained solely in silicon. While there are problems associated with thermal incompatibility and diffusion from metal films through to the underlying silicon, these may be overcome through use of aluminum silicate for capacitor dielectrics and certain cermet for resistors.

CBS Labs is placing all its effort on reaching the high-temperature reliability of silicon planar devices, W. W. Gaertner told *ELECTRONICS*. He said individual silicon planar transistors can be stored at 300 C before small changes in characteristics occur and that this capability

is now being approached with the hybrid microcircuits.

Motorola has made an engineering progress report to representatives of U. S. Army Electronics R&D Lab and the Navy in which it reports considerable progress with this technique, which it terms the compatible technology (*ELECTRONICS*, p 82, May 3 1963). In a press conference called to discuss the work, Motorola engineers said they have developed the underlying processing technology to the point where it is no longer in the research and development stage. Several hundred circuits have been produced, including some that have *npn* and *pnp* transistors in the same chip, and a production department is being set up. Work was performed under a 3-year, \$1 million-plus contract with the Air Force scheduled to be completed in July. Among the circuits fabricated are sine-wave oscillators for receivers, digital computer clock oscillators and—the most complex—a 16-by-16 diode matrix on a 200-mil-square chip for encoding information into a memory.

Motorola feels this is a major way to go with integrated circuits when you want higher performance and don't care about the additional number of processing steps involved. Some of the materials used are compared with diffused components in the tables. Cermet having sheet resistances of 1,000-5,000

Comparison of Resistors (for 100 k and 1 mil linewidth)

	Nickel-Chromium	Diffused
Temp coef (ppm/deg C)	30-60	1,500-2,500
Tolerance	± 5%	± 15%
Sheet resistance (ohms/sq)	200-400	100-250
Parasitic capacitance (pf)	15-75	100-40

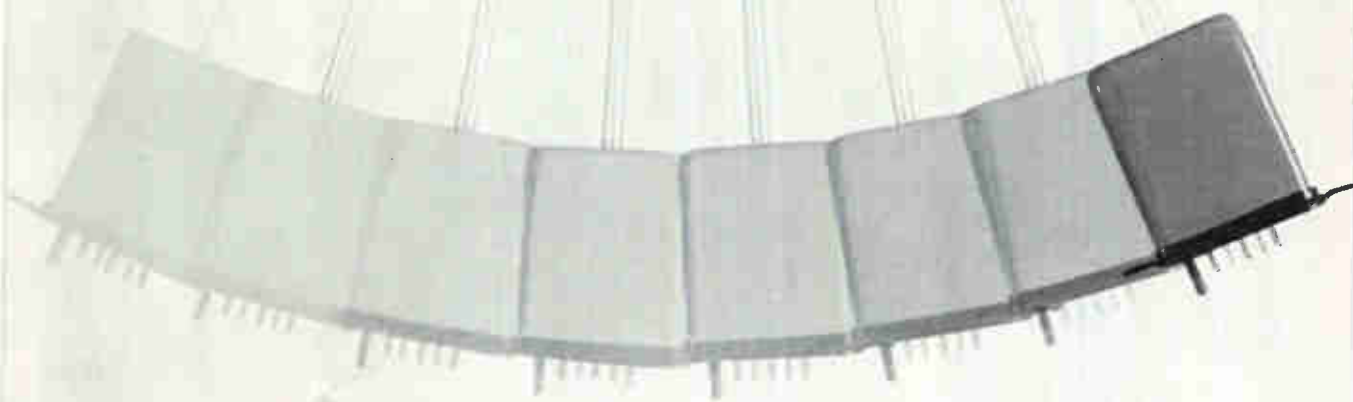

Now! 50ms to 3 year time delay capability!

New Leach Electronic Timers offer delays from 50ms to 300 hours in standard units unmatched for minimum size and weight. Also, units can be custom-built with a three year time delay capability!

It's the breakthrough you've been waiting for! Nine small standard units are now available with timing range capabilities unobtainable just yesterday. Leach made it happen by new applications of magnetic counters and time-base generators, plus the use of Leach-developed magnetic cores.

These units are available with solid state or relay output, fixed or adjustable timing, and with delay on operate or release. Over 2½ million variations of these standard time delays can be supplied, and with accuracies of $\pm 3\%$, $\pm 5\%$, and $\pm 10\%$. Depending on oscillators used, you can achieve accuracies of $\pm 0.02\%$.

New capabilities do not mean bigger sizes. The standard ms size unit above, with a 300 hour capability, takes up as little space as a unit that previously had only a 200 second capability. At the other end of the size spectrum, the half-size crystal can has a time delay range of 50ms to 10 seconds.

When long time ranges, accuracy or minimum size are essential to your specs, then specify Leach. We have off-the-shelf time delays ready for prompt delivery. Or we will custom-build them to your requirements. Write or call your nearest Leach office for more information.

LEACH

CORPORATION
CONTROLS DIVISION
717 N. Coney Ave., Azusa, California
Export: Leach International S.A.

**Manufacturing
Quality Resistors
under Rigid
Reliability
Control**

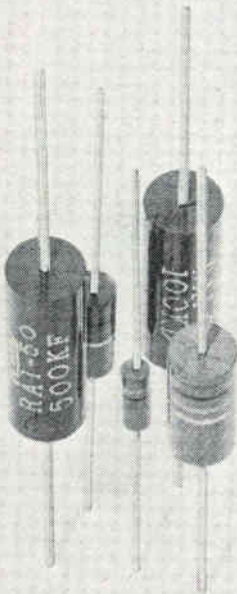

Rohm

METAL
CARBON FILM RESISTOR

**TOYO
ELECTRONICS
INDUSTRY
CORPORATION**

P. O. BOX 103 CENTRAL
KYOTO, JAPAN

Comparison of Capacitor Dielectrics

	SiO ₂	Ta ₂ O ₅	Diffused Junction
Bf/sq mil.....	0.25-0.4	0.6-2.5	0.2
Max size (sq mils).....	2,000	3,000	2,000
Max val (pf).....	500	5,000	500
Breakdown voltage (far thin layer).....	50	20	5-20
Q (10 mc).....	5-40	10-100	1-10
Dielectric constant.....	5-8

ohms per square are being emphasized in a program to develop 1 megohm resistors.

Equipment—Two pieces of portable communications equipment are being built that will use compatible circuits to improve performance. One nearing completion is a demonstration model of a 120-Mc a-m transceiver under construction at Motorola's semiconductor division. Major characteristics of the unit are 1-microvolt receiver sensitivity and 50 milliwatt, 90-percent modulated transmitter power output. It will weigh 15 ounces and occupy a volume of $5\frac{3}{4} \times 2\frac{1}{2} \times \frac{3}{4}$ inches. Compatible circuits are used in the i-f (see illustration) and r-f amplifiers.

Second equipment is a 50-Mc f-m receiver being built for USAERDL by Motorola's applied research department in Chicago. This is in the early design stages and is considered significant because no concessions have been made to integrated circuits. Receiver sensitivity is to be 0.35 microvolt and standby power drain 22 milliwatts. Compatible circuits will be used in the mixers. Design goals are equivalent to those of conventional circuits; for example, individual i-f stages will be designed to have $\pm\frac{1}{2}$ db gain stability over a 140-degree C temperature range.

**Gallium Arsenide Varactors
Achieve High Efficiency**

WOBURN, MASS.—Sylvania's gallium arsenide varactors have achieved 30 percent efficiency in a frequency tripler having an output of 34,840 Mc, according to company spokesmen. The tripler used in the test had a 300 Mc bandwidth and an

output of 80 mw. Cutoff frequencies of these varactors are in excess of 300 Gc.

**Czech Physicists Report
Nonlinear Dielectric**

VIENNA—Workers at the Institute of Physics, Prague, now report results of a detailed study on triglycine sulphate, a dielectric with pronounced nonlinear characteristics. Potential applications include use in miniature thermostats, transducers sensitive to heat transfer, electrometers, amplifiers, frequency and pulse modulators, amplifying mixers and electromechanical transducers.

A slice of triglycine sulphate, coated on both flat sides with metal, and wired, exhibits a piezoelectric effect not found in a linear capacitor. When the slice is heated, capacitance increases, reaching its highest value at its curie temperature. An applied a-c voltage of constant amplitude causes the device to stabilize its own temperature, near the curie point, while the temperature changes in the device are more than ten times smaller than that of the ambient temperature.

Prague workers, who call the device TANDEL, (Temperature Auto-stabilized Non-linear Device), have developed applications in high-sensitivity instrumentation. TANDEL, it is claimed, can detect extremely high resistance—up to 1,000 megohms, or a very small current—up to several 1,000 millionths of one ampere. References to operating conditions of triglycine sulphate will be described in a forthcoming paper by A. Glanc and co-workers of the Institute of Physics, Czechoslovak Academy of Sciences in Prague.

ANOTHER APPROVAL FOR EL-MENCO...

BELL TELEPHONE LABORATORIES
 INCORPORATED
 463 WEST STREET, NEW YORK 14 N.Y.
 AREA CODE 212
 CH 3-1000

September 13, 1962

W. P. H. STEVENS
 PURCHASING AGENT

A NOTE OF APPRECIATION
 I take pleasure in sending you an advance copy of a

You will note that you are listed as one of the companies which helped us make Telstar a success. In behalf of Bell Laboratories, I would like to take this opportunity to express again our appreciation for your cooperation in this important endeavor.

Sincerely,

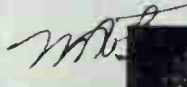

**a
 star
 performer-
 TELSTAR,
 we
 mean**

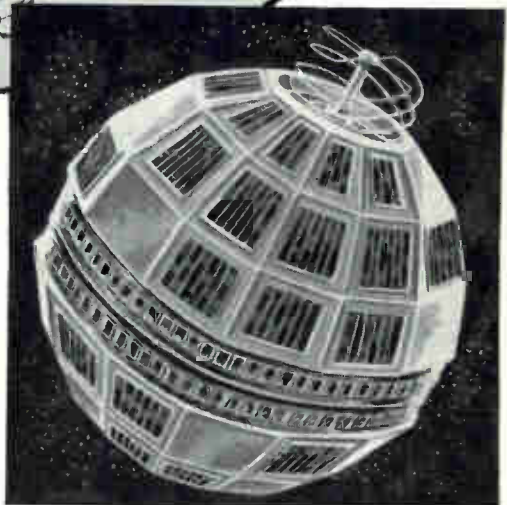

**El-Menco
 were selected
 for
 TELSTAR**

MICA CAPACITORS

■ In the words of the Bell Telephone System, El-Menco was chosen "because of its competence in its field for the job required." ■ At El-Menco we believe that competence in our work of designing and building the best practical capacitors will instill your confidence in our product. This philosophy has resulted in our producing capacitors which have a high order of *quality, reliability, and availability.* Hence the selection of El-Menco mica capacitors for many important missile and satellite programs. ■ Still widely discussed is the RCA test evaluation of El-Menco high reliability dipped mica capacitors in which enough actual test unit-hours were accumulated at *elevated temperature and with 225% of the rated voltage applied* to verify failure rates on the order of 0.0001% and 0.00004% at a 90% confidence level.

**The El-Menco high reliability dipped mica capacitors are being supplied to the Radio Corporation of America for a high reliability military ground electronics project.*

THE ELECTRO MOTIVE MFG. CO., INC.
 WILLIMANTIC, CONNECTICUT



*Dipped Mica • Molded Mica • Silvered Mica Films • Mica Trimmers & Padders
 Mylar-Paper Dipped • Paper Dipped • Mylar Dipped • Tubular Paper*

ARCO ELECTRONICS, INC.,
 Community Drive,
 Great Neck, L. I., New York
 Exclusive Supplier to

West Coast Manufacturers Contact:
COLLINS & HYDE CO.,
 1020 Corporation Way
 Palo Alto, California
 5380 Whittier Boulevard, Los Angeles, California

Jobbers and Distributors in the U. S. and Canada

Write for reliability study and technical brochures.

Ferrites: Can They Be Deposited As Thin Films?

Deposition techniques are sought as part of inductor development

RESEARCHERS AT Motorola, Phoenix, have produced thin-film, flat-spiral inductors by depositing gold through nickel-on-copper masks onto ferrite substrates. A 21-turn configuration has yielded 1.6 microhenries when deposited on a nonmagnetic material and 3.3 microhenries when deposited on a ferrite substrate (ELECTRONICS, Jan. 31, 1964, p 19).

Goal of research program is to produce 30 to 1,000-microhenry devices with Q values of 100 or more at 1 Mc, according to a Motorola spokesman. As part of the program, thin-film ferrites were deposited on ferrite substrates holding the gold flat-spiral inductors. The deposited ferrite acted as a ferrite core for the thin-film inductor. The ferrite overlay is expected to raise inductance.

Ferrite Thin Films—A technique has been developed for preparing ferrite thin films which possess properties that are compatible for use with thin spiral coils to provide increases in the air-core inductance of these coils. The films are ferrimagnetic, possess a detectable magnetic moment, are of the ferrite spinel structure, and are formed at temperatures compatible with gold coils.

Initial permeabilities have been measured and values as high as 90 attained. No measurement of film Q value has as yet been made but measurements could be made by actual construction of a device. These films have a density comparable to that of conventionally formed ferrite of similar composition. The

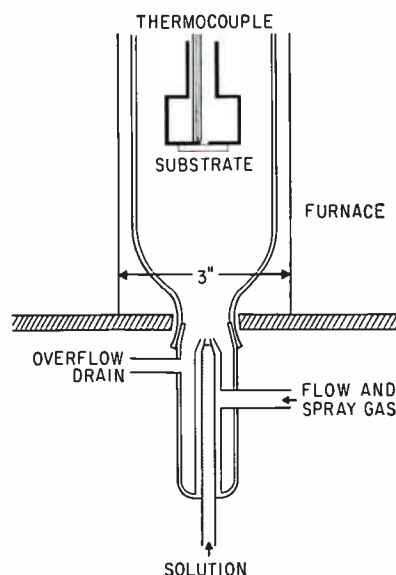

FILM DEPOSITION apparatus developed for ferrites. Above the thermocouple, and not shown in the illustration, is a vacuum system for evacuating the chamber

density would seem to indicate the useful Q values in film material could be obtained.

The composition used for the majority of the work is a nickel-zinc-cobalt ferrite. This composition — $\text{Ni}_{0.4}\text{An}_{.573}\text{Co}_{.027}\text{Fe}_2\text{O}_4$ —in bulk form has the desired properties at 1 Mc. (i.e. high initial permeability and Q value).

The main problem in the ferrite film program has been controlling the composition of the film as compared to the starting solution composition. The most difficult element to control is the zinc, which has the undesired tendency to be preferentially volatilized in reference to the other constituents. Precise control of the process temperature seems to be the most important parameter in the control of the film composition.

Spiral Coil Fabrication—The formation of a conducting spiral pattern is a three-step process. First, the required material is deposited to thickness up to 1 mil. Second, a suitable photoresist is applied, exposed, and developed to give the required spiral pattern. And third, the pattern is etched to produce the desired spiral inductor. The use of specific materials depends upon the condition of the substrate surface, and the metal being used for the conducting path.

Deposition of Metal Films—The gold or copper sheet film from which the spiral pattern is etched is deposited in two steps. Initially a thin conductive film a few thousand angstroms thick is vacuum deposited, preceded by thin nonconducting film of chromium to provide adhesion to the ferrite surface. The evaporated film is then built up to the required thickness by electroplating techniques. An alternate method for preparing the first deposit for the copper film was an electroless process using "Cuposit," (available from Shipley Company, Wellesley, Massachusetts). The process was used on ferrite surfaces which were excessively porous and not suitable for accepting a continuous evaporated film. As a third method, copper was electroplated from a copper fluoroborate solution using standard current densities. Periodic current reverse was used to obtain a smooth, pinhole-free film. Surfaces were then gold plated in a cyanide bath.

Kodak Photo-Resist (KPR) was used for the copper films and Kodak Metal Etch Resist (KMER) for gold films. Both resists were applied by spin techniques and exposed through a contact mask of the de-

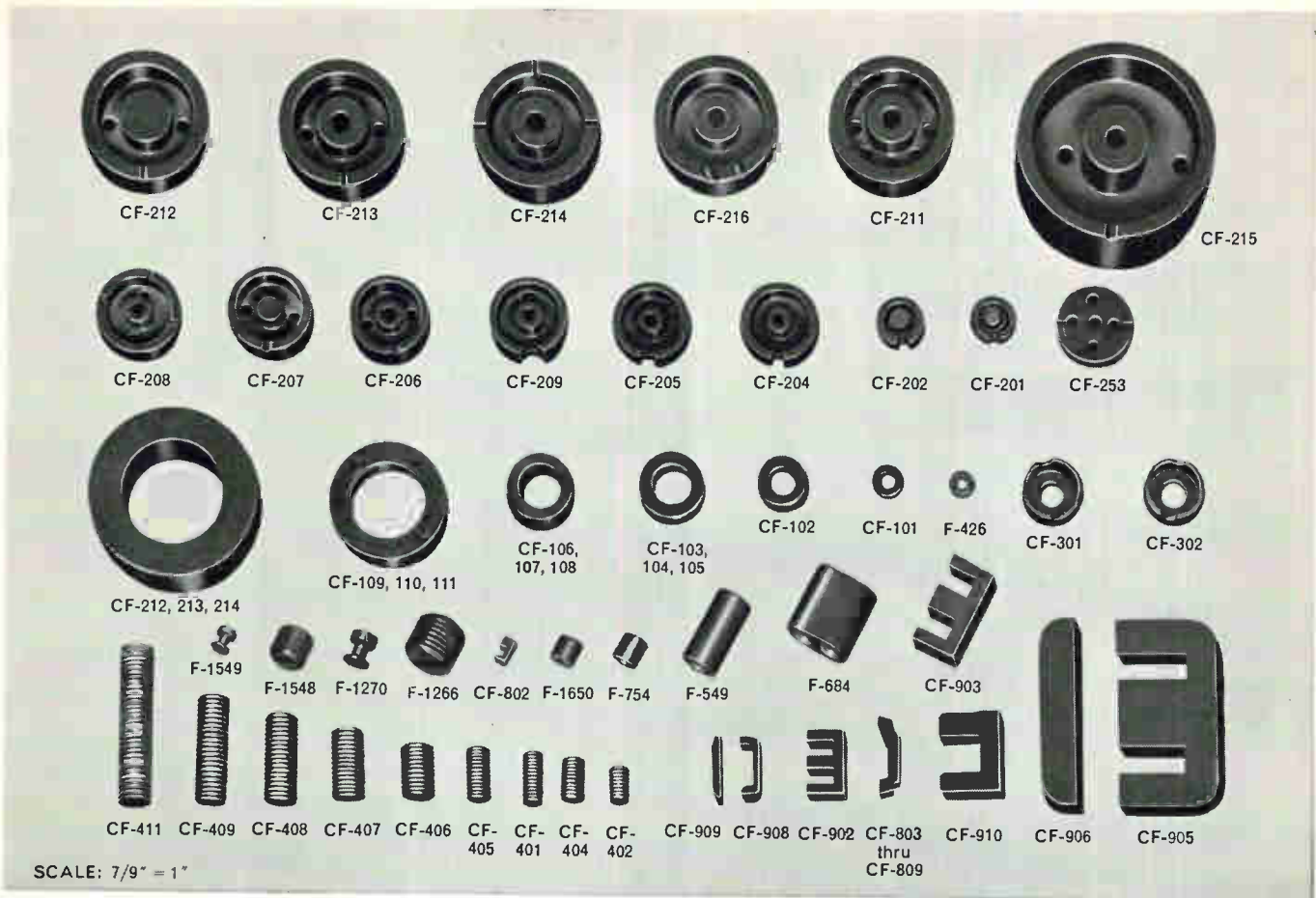

Now—delivery from stock on these special-purpose FERRAMIC® cores

Indiana General Ferrite cores are available in various materials for specific frequency bands from 1 kc to 225 mcs. Use the handy materials selector chart for quick reference.

APPLICATION	DESIRED PROPERTIES	FREQUENCY	FERRAMIC BODY	SHAPES
Filter Inductors	High μ Q, magnetic stability, sometimes adjustable	Up to 200 kcs 200 kcs-10 mcs 10 mcs-60 mcs 50 mcs-225 mcs	"O-3", "T-1" "Q-1" "Q-2" "Q-3"	Cup cores, toroids, C-cores, E-cores, slugs.
IF Transformers	Moderate Q, high μ , magnetic stability, adjustable	465 kcs 40 mcs other	"Q-1" "Q-2" Materials for filter inductors apply	Cup cores, threaded cores, toroids
Antennae Cores	Moderate Q, high μ , magnetic stability	5-10 mcs 10-60 mcs	"Q-1" "Q-2"	Rods, flat strips
Wide Band Transformers	High μ , moderately low loss	1 kc-400 kcs 1 kc-1 mc 200 kcs-30 mcs 10 mcs-100 mcs 50 mcs-225 mcs	"O-3", "T-1" "H" "Q-1" "Q-2" "Q-3"	Cup cores, toroids, C-cores, E-cores
Adjustable Inductors	High μ , moderately low loss	Same as Wide Band Transformers	Same as Wide Band Transformers	Rods, threaded cores, tunable cup cores
Tuners	High μ , moderate to high Q, magnetic stability, as much as 10-to-1 adjustability with mechanical or biasing methods.	Up to 100 mcs	For high Q selective circuits, materials under filter inductors apply. For others, materials under wide band transformers apply.	Threaded cores or rods for mechanical tuning. Toroids, C-cores, E-cores for biasing methods.
Pulse Transformers	High μ , low loss, high saturation	Pulse	Materials under wide band transformers apply	Cup cores, toroids, C-cores, E-cores
Recording Heads	High μ , low loss, high saturation, resistance to wear	Audio, pulse	"H" "O-3", "T-1"	

Fast service on sample quantities; prompt delivery on production lots. Call, wire or write for all the facts to Indiana General Corporation, Electronics Division, Keasbey, New Jersey.

INDIANA GENERAL

McLEAN

Presents

THE ULTIMATE IN PACKAGED COOLING

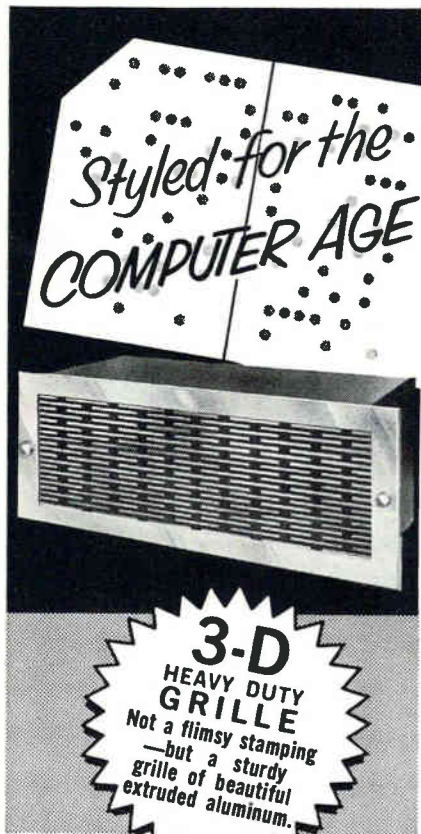

Filter element cannot be seen through grille . . . is deeply recessed for protection.

New "digital design" features sharp sculptured shadows for clean horizontal accents.

Fingertip accessibility to the filter. Filter may be easily removed without tools.

Brushed aluminum surface adds a high note of polished elegance.

Motors available with guaranteed life of 20,000 hours.

Over 100 models providing air deliveries from 150 to 1,000 CFM.

Panel sizes from 5¼" high to 10¾" high by 19" wide. Half size and special widths also available.



Send For
NEW
Illustrated
Brochure

McLEAN ENGINEERING LABORATORIES
P.O. Box 228, Princeton, New Jersey
Phone 609-799-0100 • TWX 609-799-0245
The Originator and Leader in Packaged Cooling

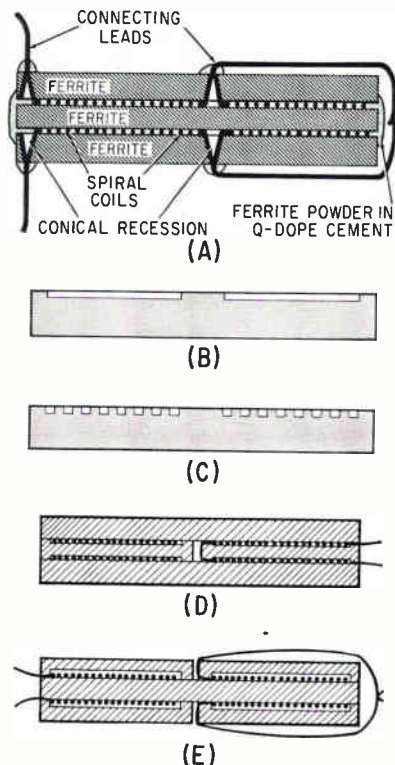

TYPICAL configurations of inductors and ferrite substrates. Typical ferrite inductor is shown in (A); ferrite substrate recessed for coil application (B); and with integral spiral pattern (C); configuration of inductor with coil formed in recess (D) and recessed ferrite used as an overlay (E)

sired spiral pattern by a strobe-flash unit. Developing was done in trichlorethylene and a post-development bake was used to further set the resist. The copper spirals were etched in a heated 50-percent solution of ferric chloride, and gold patterns in aqua regia. On occasion, the cross section of the conducting path was increased with additional electroplating to lower the resistance and, therefore, increase the Q value of the coil.

Preliminary Results—A number of coils were fabricated on various bulk ferrite wafers. The majority used a 20-turn configuration on a Ceramag 9 wafer, 0.25-inch square. Total inductance values varied between 2.5 and 4 microhenries which is an increase over the air-core value by 20 to 30 times. Q values were between 10 and 20 as measured at 1 Mc.

Preparation of Recessed Ferrites—Two different approaches to the preparation of ferrite surfaces for reducing air-gap effects were eval-

uated. One approach was to form the desired spiral pattern directly in the ferrite, and the second was to shape a recession in the ferrite in which the coil would be fabricated by the conventional techniques.

Spiral patterns were formed in ferrite material by pressing the spiral shape in the ferrite surface prior to the final firing of the ferrite, and also by etching the ferrite surface using photo-resist.

In the latter method, a negative of the desired spiral image was prepared on the ferrite surface using KMER. The ferrite surface not protected by the exposed resist was etched using a stannous chloride, disodium ethylene diaminetetraacetate, hydrochloride solution heated to 65 deg. C. This solution would satisfactorily etch the ferrite material; however, the etchant was absorbed under the KMER surface by the porous ferrite, resulting in uncontrollable pattern resolution.

Because of ferrite shrinkage during final firing, die dimensions were made about 30 percent larger than the desired pattern. To form the conducting path in the spiral recess, the entire surface was covered with the copper film and the film above the recess removed by lapping. Although this technique proved to be successful, it was not pursued beyond the feasibility stage as the ferrite material used did not possess the required permeability and Q value.

Thermal Bending Used To Check Laminate Bonds

LONDON—Unusual, nondestructive method of testing the efficiency of adhesive-bonded aluminum-alloy honeycomb panels, aluminum-alloy/balsa wood panels, copper/plastic printed-circuit blanks and similar materials has been developed by Britain's Ministry of Aviation. Heating a small area of the surface causes deformation which can be measured either by transducer or manometer.

Deflection Method—In normal operation, a stream of air from the jet in the measuring head of a Solex air-gaging apparatus impinges on the surface of the workpiece, and the height of the measuring head is adjusted until a zero reading is ob-

tained on a manometer. The region on which the air is impinging is then illuminated by a projector lamp. As temperature rises, the upper skin expands, and the panel deflects upwards. Since the honeycomb core must deform elastically for deflection, the amount of deflection provides an indication of strength.

Expansion Method—Similarly, if transducers are positioned at stations on the lower skin, regions which are not transmitting the stress due to weak bonding can also be detected. In regions where there is a lack of adhesion, or where the bond between skin and honeycomb core is very weak, the lateral expansion of the small portion of the skin being heated during the test is resisted by the adjacent bonded regions. This resistance to deformation offered by the comparatively cool portions of the panel causes the skin and the core to separate and form a "bubble" which is readily detected by a large reading on the manometer.

No Damage—Although the test may seem severe, the high reflectivity of the polished aluminum-alloy skin, together with high thermal conductivity, precludes thermal damage to the bond. Where the upper skin surface is painted, small induction heaters are employed instead of lamps, and for testing printed-circuit blanks and materials other than aluminum, a lower current is supplied to the lamp.

Low-Priced Wire Stripper

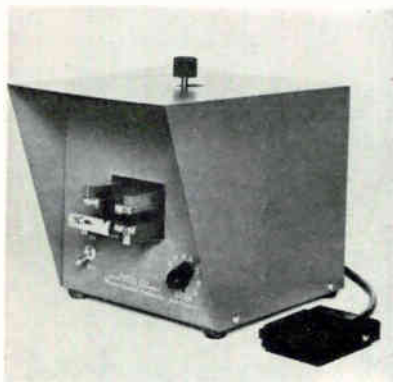
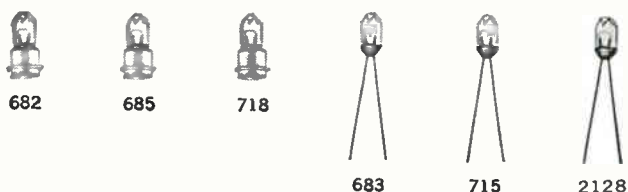

TABLE-TOP wire stripper, made by Autotherm, weighs less than 20 pounds and strips 30 to 16-gage wire.

HERE → 

is a tiny incandescent indicator lamp that lasts 100,000 hours—and here are six more Methuselahs



The 680 (top) is one of a line of seven General Electric T-1 incandescent lamps that were developed for applications where space is at a premium and service a problem. It has a design life of more than 100,000 hours—about twelve years.

This line of lamps comes in two basic types. Four of the T-1 lamps are equipped with 1" solder dipped leads to make them easy to join to circuits. These lamps are only $\frac{1}{8}$ " in diameter and $\frac{1}{4}$ " long. Three T-1's have brass bases only $\frac{3}{16}$ " in diameter. And, the entire lamp is only $\frac{3}{8}$ " long.

Because of their small size and long life, these General Electric T-1 lamps are ideal as indicators in military hardware and other instances where extreme reliability is necessary. For complete information, call or write: General Electric Co., Miniature Lamp Dept. M-44, Nela Park, Cleveland, Ohio 44112.

NO.	VOLT	AMP	DESIGN LIFE (in hours)	CAND. POWER
682	5.0	.060 ± 10%	100,000+	.029 ± 25%
685	5.0	.060 ± 10%	100,000+	.048 ± 25%
718	5.0	.115 ± 10%	40,000+	.132 ± 25%
680	5.0	.060 ± 10%	100,000+	.032 ± 25%
683	5.0	.060 ± 10%	100,000+	.053 ± 25%
715	5.0	.115 ± 10%	40,000+	.147 ± 25%
2128	3.0	.0125 ± 20%	100,000+	.001 approx.

Progress Is Our Most Important Product

GENERAL  ELECTRIC

KINNEY . . . EVERYTHING IN VACUUM

ULTIMATE PRESSURES TO 10^{-8}

WITH
KINNEY
OIL DIFFUSION
PUMPS
SERIES KDP

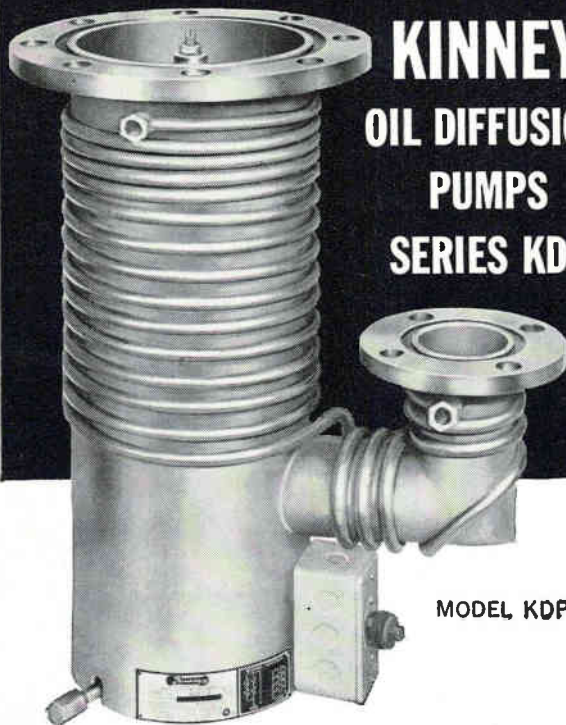

MODEL KDP.6

The KDP Series of KINNEY oil diffusion pumps provides utmost dependability, maximum pumping capacity in the high vacuum range and lowered maintenance costs. Their outstanding performance is due to fundamental design advances which include: increased inlet diameter, improved heaters, more efficient chimney design and other structural improvements.

FEATURES

- Ultimate pressures as low as 4×10^{-7} torr untrapped, and 1×10^{-8} with liquid nitrogen trap.
- Largest inlets of any comparable diffusion pumps on the market.
- Non-corroding nickel-plated steel casing with brazed copper cooling coils.
- Faster heating and cooling times shorten operating cycles.



KINNEY VACUUM

DIVISION THE NEW YORK AIR BRAKE COMPANY
3529 WASHINGTON ST. • BOSTON, MASSACHUSETTS

NEW! VERSATILE! Model 410-DVP Weld Head Makes All Kinds of Welds!

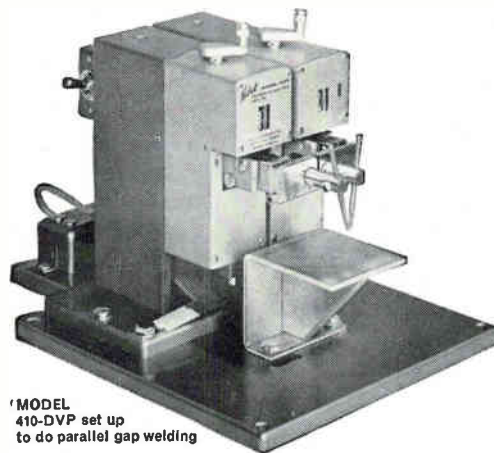

MODEL 410-DVP set up to do parallel gap welding

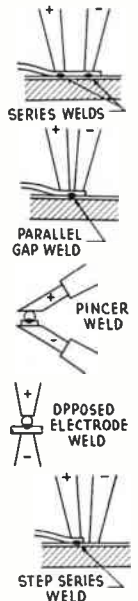

This all-purpose laboratory weld head will do 3 kinds of one-sided welding plus vertical opposed-electrode welding and vertical pincer welding! Bonds ribbon or wire from .0003" up to .050" diameter. Force range 3 oz. to 20 lbs. Compact, sturdy, easy to set up. Use with either DC or AC power supplies. Send for details.

FREE WELD SAMPLE SERVICE!

Send sample materials to Weltek Sales Mgr. Or see us at Booth 4514, I.E.E.E. Show.

Weltek Precision Welders
by **WELLS ELECTRONICS, INC.**
1701 S. Main Street, South Bend, Indiana, U.S.A.
CIRCLE 200 ON READER SERVICE CARD

Nichicon
stands for
Topnotch Capacitors

Most dependable and durable quality guaranteed by our:
Research laboratories staffed with high class engineers.
Long experienced technicians.
Performances over 40 years.
No capacitors are too big or too small to us.

Your inquiries with full specification are cordially solicited.
Will gladly offer best prices and deliveries.

MAIN PRODUCTS: Oil Paper Capacitor, Electrolytic Capacitor, Tantalum Capacitor, Metallized Paper Capacitor, Ceramic Capacitor, Mica Capacitor and Mylar Capacitor, etc.

nichicon

Nichicon Capacitor Ltd.

Head Office Uehara Bldg., Oikedori, Karasumahigashi-iru,
Nakagyo-ku, Kyoto, Japan
CABLE ADDRESS CAPACITOR KYOTO

CIRCLE 201 ON READER SERVICE CARD

February 7, 1964 electronics

Oscillator Improves 1-Mc Standards

Advantages of good long-and short-term stabilities are realized

PHASE-LOCKED oscillator model PLO-141 is designed to combine a short-term stability of 1.5 deg rms at 1 Gc with the excellent long-term stabilities of today's atomic and crystal frequency standards. It will operate in conjunction with any frequency standard containing a 1-Mc output. Unit consists of a 1-Mc crystal oscillator, its associated temperature-controlled oven, and a phase detector. The phase detector compares the internal oscillator with the external standard; any resultant output of the detector phase locks the internal 1-Mc oscillator to the external standard through a reactance control.

The high stability oscillator in the PLO-141 employs a bridge-type circuit in which the AT cut crystal

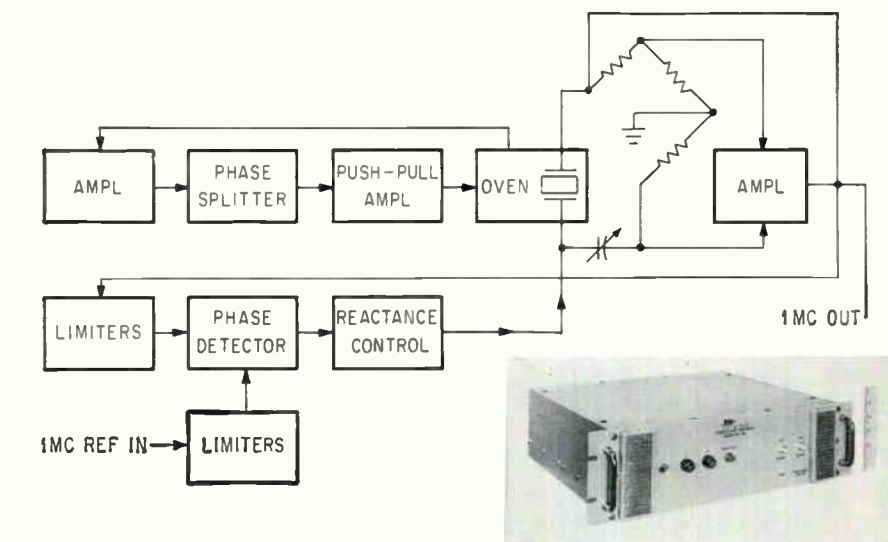

in one arm of the bridge is enclosed in an oven to maintain the crystal at its optimum operating temperature. An oven control amplifier maintains oven temperature within less than 0.001 C for each deg C change of ambient temperature. A trimmer capacitor in the oscillator circuit provides a fine frequency

adjustment and compensates for crystal aging. Frequency input is a 1-Mc sinewave at 1 v rms with 50 ohms input impedance. Output is a 1-Mc sinewave at 1 v rms into an impedance of 10,000 ohms. Manson Laboratories, 375 Fairfield Ave., Stamford, Conn.

CIRCLE 301, READER SERVICE CARD

Photoconductors Produce High Power

A GROUP of three new high-power photoconductors includes two units that are large-area cadmium-sulfide cells with a response curve approximating that of the human eye.

Designed for daylight sensing and other photocontrol applications where speed is not critical, series 5 units have a peak spectral response of 5,800 Angstroms, and are capa-

ble of directly switching relays and solenoids up to 10 watts.

Types OED 6H6 and 5H6A are hermetically-sealed cells assuring maximum stability and performance in extreme ambient humidity, ultraviolet radiation and corrosive environments over a temperature range of -40 C to +70 C. Sigma Instruments, Inc., 170 Pearl St., Braintree 85, Mass. (302)

features 4 electrically isolated outputs, and excellent temperature characteristics. Beam, anode, grid, and filament voltages are supplied from a unit occupying only 12 cu in. of space. Each output is adjustable + 5 percent - 10 percent from the nominal value. Temperature range



BWO Power Supply Has Four Outputs

MINIATURE, microwave-type power supply is designed for powering VA 163 G and similar bwo tubes in the 40-mw, 26-Gc range. It



503 MILLIOHMMETER

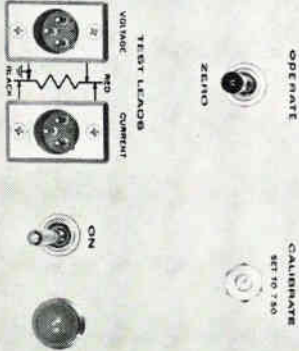
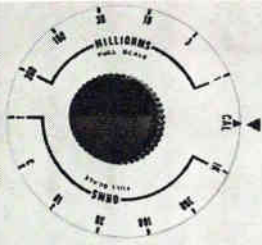

KEITHLEY

MILLIOHMMETER

The Model 503 provides fast, accurate direct-readings from 10 micro-ohms to 1000 ohms. The measurement technique involves a four terminal ammeter-voltmeter method. By using an ac test current maximum power dissipation through the sample is 10 microwatts. Thus, the 503 is useful in dry-circuit testing of contact resistance and safe measurement of fuses and squibs.

- **Range:** 0.001 to 1000 ohms fs on linear scales with 13 overlapping ranges
- **Accuracy:** 1% of fs on all ranges
- **Output:** 100 millivolts
- **Line Operated**
- **Max. Sample Dissipation:** 10 microwatts
- **Price:** \$675

also available

MODEL 502 Milliohmmeter:
Battery operated . . . \$390

Send for catalog giving full details



KEITHLEY
INSTRUMENTS

12415 Euclid Avenue • Cleveland 6, Ohio

is — 55 C to + 100 C.

Operating from a 28-v d-c input, unit supplies 4 output voltages: 900, 100, — 60, and 6.3 v d-c. Model SHX-102 meets MIL-E-5272 and is priced at \$590. Arnold Magnetics Corp., 6050 W. Jefferson Blvd., Los Angeles 16, Calif.
CIRCLE 303, READER SERVICE CARD

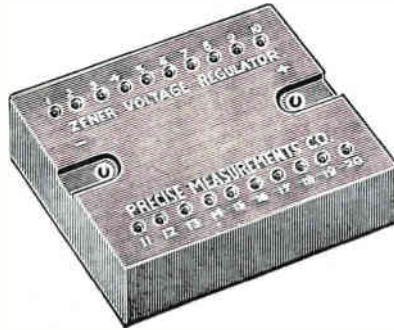

Zener Regulators Span 500 to 4,000 v

NOW AVAILABLE is a Zener voltage regulator in ranges up to 4,000 v d-c and at up to 20 w maximum dissipation. Current rating is 5 ma maximum. Up to five units may be wired in series to regulate voltages as high as 20,000 v. Additional features include built-in tap points so that as many as 20 different regulated voltages can be obtained from one regulator. The voltage range of these Zeners makes them ideal for photomultipliers. Precise Measurements Co., P. O. Box 172, Flemington, N. J. (304)



Power Transformer Designed for 400 CPS

MODEL 175E is a 175-w series power transformer that measures only 2.70 in. by 2.70 in. by 2.25 in. high. Molded in rugged diallyl phthalate, it is capable of operation at temperatures up to 105 C and meets MIL-T-27A, grades 1 and 4, class S. Primary voltage on standard units is 115 v, 400 cps \pm 20

cps, 1 phase, with secondaries available from 5 to 5,000 v a-c at 175 watts. Abbott Transistor Laboratories, Inc., 3055 Buckingham Road, Los Angeles 16, Calif. (305)

A-C Amplifier Covers Wide Range

MODEL 8502 thin-film microcircuit a-c amplifier has 46-db voltage gain over a wide frequency range, with 3-db down points below 20 cps and above 100,000 cps. Provision is made for external reduction in feedback for a maximum voltage gain of 65 db. Supply voltages of from 6 to 24 v may be used. Noise level at the output is 2.5 mv. The 8502 measures 0.65 in. by 0.7 in. by 0.2 in. and is specified for operation from — 55 C to + 85 C. Varo Inc. Special Products Div., 2201 Walnut St., Garland, Texas (306)

Triode Oscillators Are High-Power Units

HIGH-POWER series of pulsed triode oscillators are available from 400 to 3,500 Mc. Power can be optimized to 20 kw peak over a narrow range or maintained to a minimum of 10 kw over wide ranges. Models are available in three tuning ranges: fixed tuned, 10 percent, and 30 to 40 percent. Optional frequency readout is by digital dial or direct frequency reading tape dial. Delivery of models from 750-3000 Mc is within 30 days. Other frequencies from 60 to 90 days. Applied Microwave Laboratory, Inc., 106 Albion St., Wakefield, Mass. (307)

Dual-Cavity Laser Features Flexibility

NOW AVAILABLE is a dual-cavity laser that delivers up to 250 joules. The LHM-6 employs a ruby laser rod; however, other laser materials can be substituted with comparable results. Input is 20,000 joules. The new laser head was designed to give the user a high degree of flexibility. Modifications such as Q-spoiling

can be made readily without changes to the laser head inasmuch as both ends of the laser crystal are open and accessible. Design of the head also permits rapid changing of flash-tubes or laser crystal without special tools. The LHM-6 has a pulse width of 3 millisecc when used with appropriate power supply. Its 2-quart stainless steel dewar is built into the head structure. Raytheon Co., 130 Second Ave., Waltham, Mass. 02154. (308)

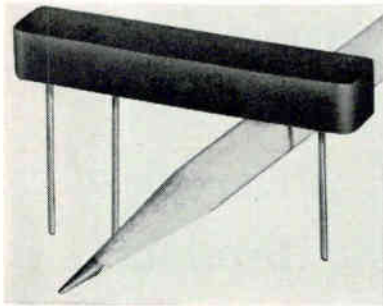

Delay Lines Are Molded in Epoxy

NOW AVAILABLE is a series of nano-second delay lines which provides delays in the range of 15 to 155 nsec, and pulse rise times from 4 to 35 nsec. Impedances of either 200 or 400 ohms may be selected. Small in size (2 in. by 0.38 in.) and molded in epoxy, the units are ideal for computer and other applications where components are mounted on printed-circuit boards. ESC Electronics Corp., 534 Bergen Blvd., Palisades Park, N. J. (309)

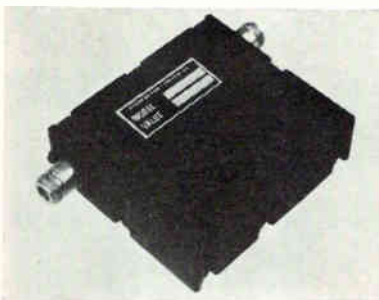

Bandpass Filter Uses Type N Jacks

MODEL D2218 has a 30-Mc bandwidth centered at 870 Mc. Attenuation is 60 db \pm 60 Mc from center frequency. Connectors are type N jacks. Impedance is 50 ohms

We are almost this fast—

filling your order for aluminum foil and sheet

We are proud of the quick service we can give you on all orders for quality foil and light gauge sheet.

In addition to nameplate, the hard alloys and brazing alloys are also on our warehouse shelves.

We can slit or sheet these to your specifications.

Give us a call the next time you need coil or rectangular foil—call us collect if you like.

Check below and we will gladly send you our price schedule.

Please send me your price schedule ALC 258-7.



American Lamotite Corporation

2914 EAST 81st ST. • CLEVELAND, OHIO 44104 • AREA CODE 216, PHONE 271-1000

CIRCLE 91 ON READER SERVICE CARD

WANT TO DO BUSINESS WITH THE GOVERNMENT ????????

Then check the Military and Government Procurement Guide in the orange section of your ELECTRONICS BUYERS' GUIDE.

HOW TO FABRICATE

in model shop
or production
with

di-acro
PRECISION
METALWORKING
EQUIPMENT

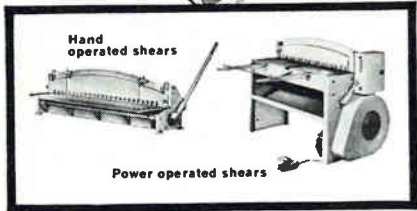
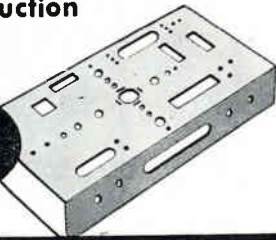

SQUARING

Power shear blanks to die accuracy at high speed—up to 16 gauge mild steel. Heavy duty construction for efficient, accurate and trouble free performance.



NOTCHING

Notcher cuts up to 6" x 6" in 16 gauge mild steel in one operation. No expensive dies, no punch press set-up—just set the gauges and toe the switch.

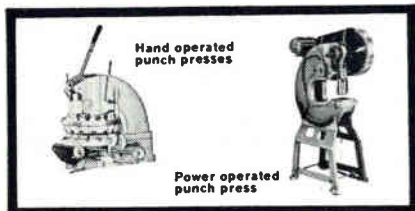

PUNCHING

OBI 5-ton punch press—single or automatic cycling—up to 190 strokes a minute. It's accurate and easy to set up. Safe to operate no special skills needed.

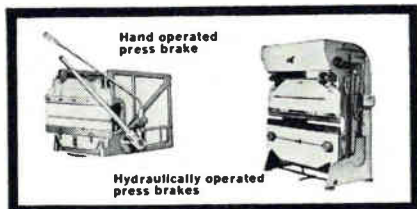

BRAKING

Hydraulic powered press brakes give full control. Dual speed cycle . . . fast approach and return—safe work speed. Available in 12, 25 and 35 ton models.

For complete information on these and all Di-Acro machines see your Di-Acro distributor or write for Catalog 62.



DI-ACRO CORPORATION
432 Eighth Avenue • Lake City, Minn.

at 1.5 maximum vswr. Three tapped mounting holes are provided in the case. Price is \$122. Radar Design Corp., Pickard Drive, Syracuse 11, N. Y.

CIRCLE 310, READER SERVICE CARD



DPDT Chopper Measures 0.509 Cu In.

MODEL 83 chopper noise is less than 25 μ v into a load impedance of 1 megohm. Its dpdt bbm contact switching action handles signal levels up to 10 v d-c, 1 ma. Unit will withstand vibration of 10 g, 55 to 2,000 cps and 30 g shock. Volume is 0.509 cu in. Price is less than \$60 each in quantity. Airpax Electronics Inc., Cambridge, Md. (311)

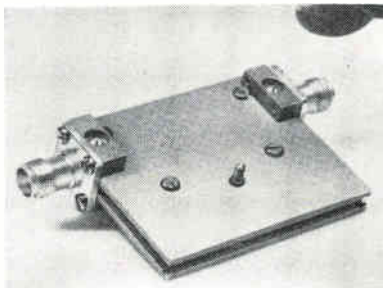

Attenuators Are Voltage-Variable

COMPLETE series of model 757 solid-state, voltage-variable absorption attenuators is available. Applications include amplitude modulators, nanosecond switches, power levelers, and active duplexers. Models are available up to 6 Gc in compact units using Flatline techniques. Attenuation up to 20 db per unit is available in narrowband versions, with over 10 db per stage in the octave band models for a

HOW TO USE YOUR ELECTRONICS BUYERS' GUIDE

Advertising Product Sections

Advertisements in the ELECTRONICS BUYERS' GUIDE are grouped together according to the kind of product advertised. All Power Supply advertisements, for example, will be found in the same section of the book. Thus it is made convenient for you to "shop" through the specifications presented to you by advertisers, without having to flip pages back and forth constantly. Keep your ELECTRONICS BUYERS' GUIDE close to your work area at all times.

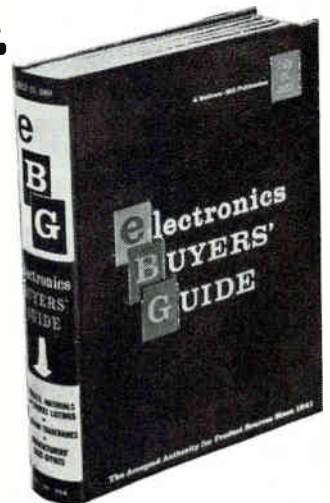

control voltage range as low as 0 to 0.75 v. All models can withstand incident c-w power of 2 w. Premier Microwave Corp., 33 New Broad St., Port Chester, N. Y. (312)

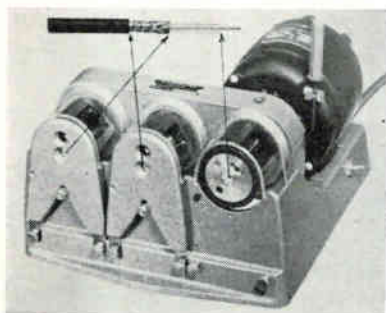

Wire Stripper Is Fast Operating

MODEL 74 three-in-one wire stripper completely strips coaxial and shielded wire at one work station. It can be equipped with any combination of single or twin Swing-Blade face plates, which makes it adaptable to a wide variety of types and sizes up to approximately $\frac{3}{16}$ in. o-d (measured over insulation). Each operation is performed as fast as the operator can insert and withdraw the wire, without damage to the conductor or shielding. There is no physical limit to the length of strip on two of the units; the third will strip up to $1\frac{3}{4}$ in. Carpenter Mfg. Co., Inc., Highbridge Road, DeWitt, N. Y. 13214. (313)

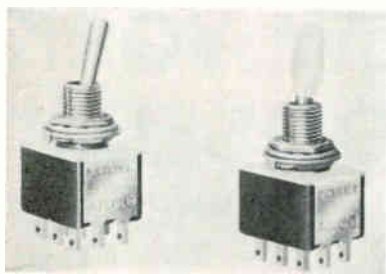

Tiny Switch Has Unitized Body

FEATURE of the one-piece unitized body is to ultra-miniaturize the space requirements of the switch by reducing the number of parts, weight, and size to a minimum, and still be consistent with good engineering specifications. The switches have a high 5 ampere rating at 115

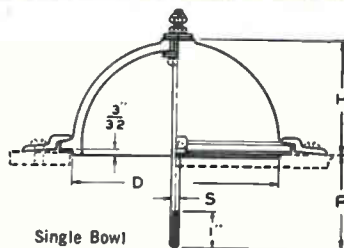

...in all these standard sizes to save you time and money

DIMENSIONS IN INCHES AND RATINGS								
Single Bowl	Double Bowl	Material	D*	H	P	S	Dry Flashover 60 ⁰⁰ kv eff.	Radio Rating kv eff.
9164	7185	Porcelain	3	1 $\frac{1}{6}$	1 $\frac{1}{2}$	$\frac{1}{4}$	22	9
26846	26841	Steatite						17
9165	7181	Porcelain	4 $\frac{3}{4}$	2 $\frac{1}{6}$	2	$\frac{1}{4}$	31	10 $\frac{1}{2}$
26847	26843	Steatite						20
9166	9167	Porcelain	6 $\frac{1}{2}$	4 $\frac{1}{6}$	3	$\frac{1}{2}$	38	12 $\frac{1}{2}$
26004	26845	Steatite						24

*D is mounting hole diameter.

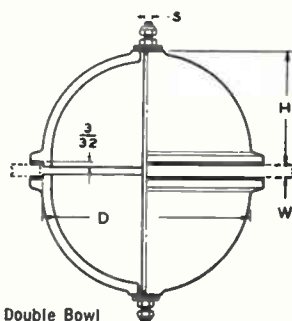

When you design, keep our *standard sizes* in mind. They really cut down on costs and delay. Lots of other standard sizes for heavy duty, low voltage and apparatus applications. And, of course, if you need specials, we'll meet your specs as fast as possible, at a price you'll agree is fair.



WRITE for Bulletin 301-R.
Lapp Insulator Co., Inc.,
214 Sumner Street,
LeRoy, New York.

v a-c, and are capable of handling multiple circuits simultaneously. In the switch mechanism, the toggle is linked directly to the movable contact member, providing positive make and break. The switch is designed to obtain positive detent action for improved "operator feel". Alco Electronics, 3 Wolcott Ave., Lawrence, Mass.

CIRCLE 314, READER SERVICE CARD

Scanner/Recorder in Single Package

MODEL 707A/9057 scanner/recorder is designed as two completely separate instruments packaged in one module. Scanner portion utilizes a 120-point crossbar switch driven by completely solid state circuitry. Scanner features include new styling, plug-in crossbar switch, true random scanning and source protection circuitry. Scanning rate is 30 channels per sec. Recorder



portion utilizes an 11-column mechanical print head driven by totally solid state circuits. Recordings are made on 3-in. wide paper tape at the rate of 3,300 characters per minute. Available for \$3,740. Electro Instruments, Inc., 8611 Balboa Ave., San Diego, 12, Calif. (315)

Pneumatic Press Stakes Small Parts

NOW AVAILABLE is model 125-VS (variable stroke) small pneumatic impact press for staking, riveting, parts assembling, and other light operations requiring accuracy and

uniformity. It weighs approximately 30 lb, but features long life and low maintenance cost. It can stake extremely small electronics terminals in plastic circuit boards without damage to the brittle plastic. At the other end of its range it can deliver a 1,500 lb impact, sufficient to impression-mark up to eight

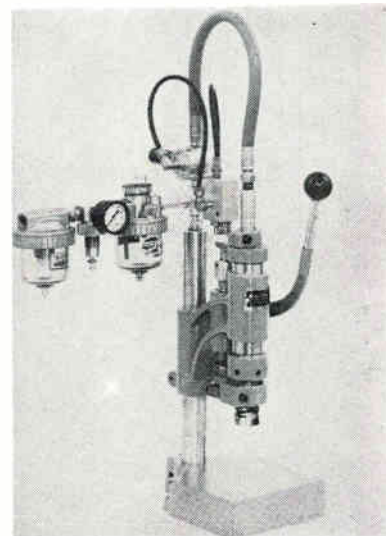

**IEEE
SHOW
'64**



**march 23-26
9:45 A.M. - 9 P.M.**

TWO BIG SECTIONS

at the
**NEW YORK
COLISEUM**
all 4 floors!

- **ELECTRONICS EXHIBITS**
- **CONVENTION PAPERS**

See the finest products of industry, hear famous men speak! Just one entrance fee lets you visit both sections.

Buses to the N. Y. Hilton every few minutes

PRODUCTS • PAPERS • PEOPLE • PRODUCTS • PAPERS • PEOPLE

$\frac{3}{8}$ -in. letters or numerals in mild steel. Heidrich-Nourse Co., 631 E. Third St., Los Angeles 13, California. (316)



Reference Mismatches Cover D-C to 4 Gc

COAXIAL reference mismatches designed to provide an accurately known fixed value of vswr from d-c to 4 Gc are announced. They are also useable up to 10 Gc with relaxed accuracy. There are 10 different models available with either

type N male or female connectors. The vswr accuracy is ± 5 percent times the nominal vswr value from d-c to 4 Gc. They will handle 1 w c-w and are supplied calibrated at 1, 2 and 4 Gc. Units are compact, rugged and highly stable. Maury Microwave Corporation, 10373 Mills Ave., Montclair, California, 91763. (317)

Audio Transformers Have Pointed Leads

MINIATURIZED audio transformers, molded and encapsulated in epoxy, have pointed leads for mounting on printed-circuit boards having standard grids. After easy insertion into the board, the leads are soldered and the excess clipped off the printed side of the board. The units are available for most audio applications and also for some r-f pulse configurations. Velco Products, River Road & B&O Railroad, Washington, D. C. 20016. (318)

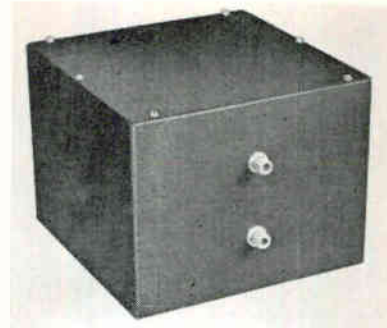

Rejection Filters Operate at 136.5 Mc

A VARIETY of rejection filters featuring extremely low signal loss are available. Models FR101 and FR102 are manufactured for telemetry operation at 136.5 Mc and are designed to reject 123 and 148-Mc signals. Both models are manufactured to extremely tight tolerances. These hermetically sealed units measure 10 in. by 10 in. by 8 in. The aluminum cabinet is fully protected against environmental conditions in accordance with

ONE GREAT SHOW!

at the
**NEW YORK
HILTON**

2 floors, including Hilton's
main exhibition area

- ELECTRICAL EXHIBITS
- CONVENTION PAPERS

IEEE Members: \$1.00
Non-members: \$3.00
Minimum age: 18

Buses to the N. Y. Coliseum every few minutes

- PRODUCTS ● PAPERS ● PEOPLE ● PRODUCTS ● PAPERS ● PEOPLE



IEEE SHOW '64

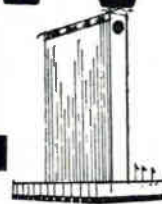

march 23-26
9:45 A.M. - 9 P.M.

HOW do you want to record your TRACES?



Continuous Flow?

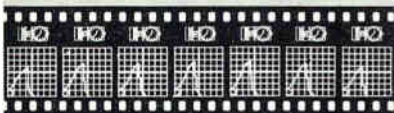

Single Frame?

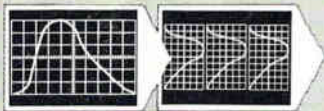

Polaroid® Prints?

The new Beattie-Coleman KD-5 Oscillotron is a most versatile 'scope camera. Available with continuous-flow 35mm electric magazine, 35mm electric pulse magazine or Polaroid back for 10 sec. prints. Dichroic mirror for simultaneous, parallax-free viewing. Rotates 90° for vert. or horiz. format. Hinged mounting for easy focusing.

RECORD DATA, TOO

Written data, counter and 24 hr. clock can all be recorded on same frame as trace. Write for information on the full Oscillotron line.



**BEATTIE-COLEMAN
INC.**

1004 N. OLIVE ST., ANAHEIM, CALIFORNIA

96 CIRCLE 96 ON READER SERVICE CARD

governing military specifications. Technical Appliance Corp., Sherburne, N. Y.

CIRCLE 319, READER SERVICE CARD



Solid State Relay for D-C/D-C Functions

ON THE MARKET is model 2200 solid state relay for d-c/d-c functions. It is a spst configuration actuated by 6-12 v d-c at 100 ma maximum. It is capable of switching 50 v d-c at 25 ma to 1 ampere depending on ambient temperature. Forward voltage drop is 2 v at 25 C. In OFF position, leakage current is 25 μ a at 25 C with a load of 50 v d-c. As there are no moving parts, contact bounce, contamination and wear are completely eliminated. Maximum switching rate is 100 cps under full load conditions. Unit will withstand vibration of 20 g, 5-2000 cps, and shock of 100 g. It is hermetically sealed to 70,000-ft altitude. It measures 1 $\frac{3}{16}$ in. square by 2 $\frac{5}{16}$ in. high, and weighs 3 $\frac{1}{2}$ oz. Hi-G, Inc., Bradley Field, Windsor Locks, Conn. (320)

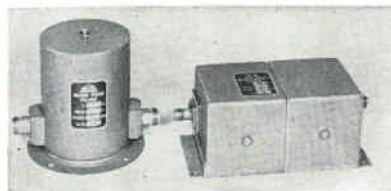

High Q Filters Are Small and Light

NEW, high Q performance filters and multiplexers have been introduced. The DMF7 filters offer outstanding performance in any fixed frequency over the range of 100 to 600 Mc as well as providing higher narrow pass bandwidths with extremely low pass-band insertion losses. Fabrication techniques utilizing capacity loaded coaxial resonators have resulted in a small, lightweight unit capable of

**Durability
and Reliability!**

SHIZUKI CAPACITORS

Using Shizuki metallized paper, mylar film and lacquer film.

- * Lacquer Film Capacitors
- * Polystyrene Capacitors
- * Mylar Capacitors
- * Metallized Paper Capacitors for motor running, fluorescent ballasts
- * Noise Suppression Capacitors
- * Ignition Capacitors

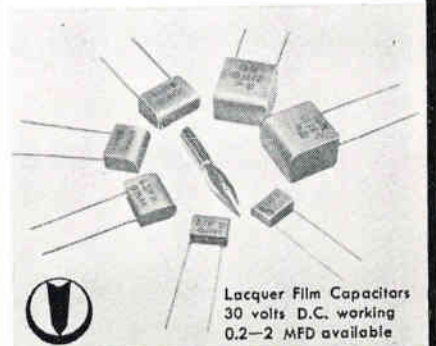

Lacquer Film Capacitors
30 volts D.C. working
0.2-2 MFD available

SHIZUKI ELECTRICAL MFG. CO., LTD.

HEAD OFFICE: 1, TAISHA-CHO, NISHINOMIYA, JAPAN
CABLE ADDRESS: "CAPACITOR" NISHINOMIYA
TOKYO FACTORY: 10-7, ARAJIYUKU, OTA-KU, TOKYO

CIRCLE 202 ON READER SERVICE CARD

J V E VACUUM COATER

Advanced technique
& many years'
experience!!

JVE's Bell Jar
Coater is vital for
all the electronics
makers!

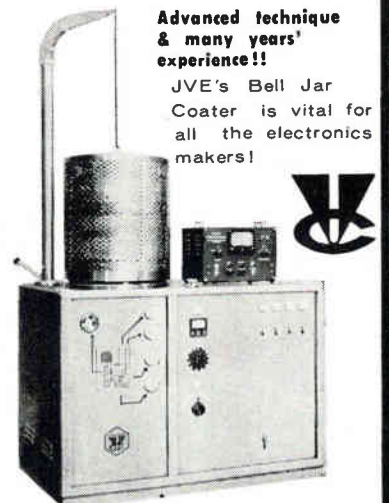

TYPE EH-6 •

- Ultimate Pressure: 1 x 10⁻⁶ Torr
- Glass Bell Jar: 400 mm dia. x 400 mm
- Pumping System: Diffusion pump using liq-N₂ trap

* For further please write to:

JAPAN VACUUM ENGINEERING CO., LTD.

No. 5, 1-chome, Ginza-nishi, Chuo-ku, Tokyo, Japan
Cable Address: "VACTEC" Tokyo

CIRCLE 203 ON READER SERVICE CARD

February 7, 1964 electronics

withstanding the most severe environmental conditions encountered in aircraft and space vehicles. Available in two models, the DMF7-1 single cavity model and the DMF7-2, two cavity model, these filters can be used as fixed tuned preselectors, for rfi elimination and for suppression of spurious transmitter outputs. Dorne & Margolin, Inc., 29 New York Ave., Westbury, L.I., N.Y. (321)

Crowbar Protects Exotic Load Devices

MODEL 6916A crowbar is intended to provide protection for exotic load devices in the event of an undesired increase in power supply output. When an adjustable voltage level is exceeded, an scr shorts the power supply output within 5 μ sec and blows a d-c fuse in series with the supply output. This model can be set to protect any supply with output from 10 to 60 v with a voltage margin of 1 to 4 v. Max output current rating of the supply being protected is 10 amp. These units can simultaneously trigger other crowbars to be triggered by an incoming pulse. Harrison Laboratories, div. of Hewlett-Packard, 45 Industrial Road, Berkeley Heights, N.J.

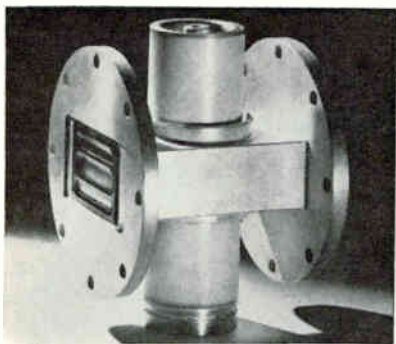

Waveguide Switch Operates at 1 Mw Peak

HIGH-POWERED broadband waveguide switch operates by interaction of the electromagnetic wave with a confined hydrogen plasma. The KU901 C-band switch has applications in duplexers, eliminating spike voltage; in high-power pulse-width

DO-IT-YOURSELF MAGNETIC SHIELDS

*Cut Quickly—
Wrap Easily*

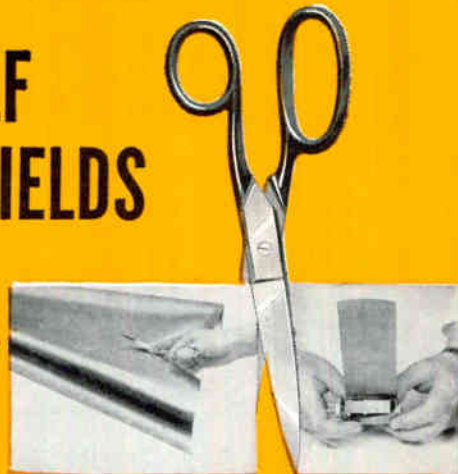

With ordinary scissors, cut flexible Co-Netic and Netic foil to any size or outline. Your component is quickly wrapped and protected—within seconds. Component performance is dramatically enhanced. Co-Netic and Netic foils stop degradation from unpredictable magnetic fields. When grounded, they also shield electrostatically. Foils are not significantly affected by dropping, vibration or shock, and do not require periodic annealing. Available in thicknesses from .002" in rolls 4", 15", and 19-3/8" wide. High attenuation to weight ratio possibilities. Widely used in experimental evaluation and production line operations for military, commercial and industrial applications.

MAGNETIC SHIELD DIVISION

Perfection Mica Company

1322 N. ELSTON AVENUE, CHICAGO 22, ILLINOIS

ORIGINATORS OF PERMANENTLY EFFECTIVE NETIC CO-NETIC MAGNETIC SHIELDING

CIRCLE 204 ON READER SERVICE CARD

WHICH DEFLECTION YOKE FOR YOUR DISPLAY ?

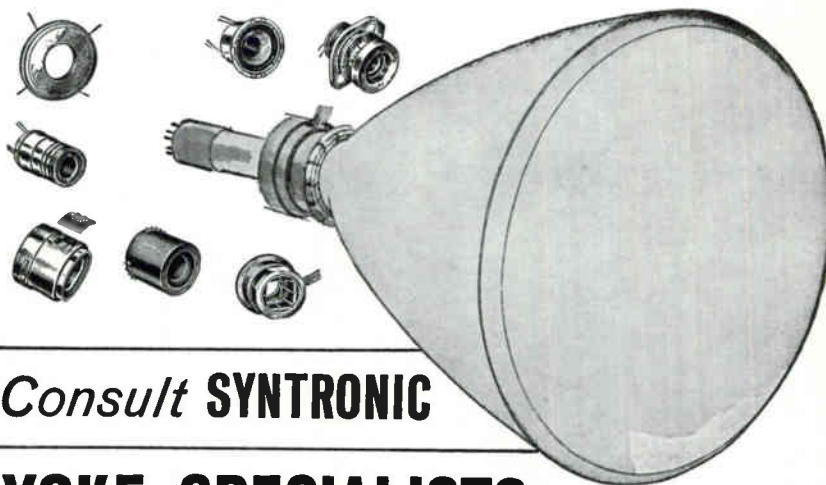

Consult **SYNTRONIC**

YOKE SPECIALISTS

Syntronic's team of experts knows more about yoke design, engineering and quality control than anyone else. A solid 10-year record of leadership—acknowledged throughout the industry. Benefit from it.

syntronic **INSTRUMENTS, INC.**
100 Industrial Road, Addison, Illinois
Phone: Kingswood 3-6444

Whatever the Special Size or Need in Wiring Duct . . .
TAYLOR = *the Reliable Source*

Two Important Considerations . . .

1. Here at Taylor, requests for special sizes and needs in wiring duct — typical of the electronics industry — are given immediate attention by experienced engineers in order to expedite delivery. Competent experts always available to help solve any problem in wiring duct design.
2. No matter where you are located there's a Taylor representative in your area to service your requirements.

Some TAYLOR DUCT Advantages . . .

- Smooth finished edges — no sharp, disagreeable corners
- The time saving one-piece channel
- More usable wiring space
- Choice of colors in high impact self-extinguishing PVC

For PROMPT quotation
 send your drawings



TAYLOR Electric, Inc.

Fisher Road / Howell, Michigan

CIRCLE 205 ON READER SERVICE CARD

modulators and shapers; and in ring resonators. It has been tested and operated in a spst circuit at 1-Mw peak power and 0.001 duty factor. It affords 30-db isolation in the open condition and 0.2-db loss when closed. A metal-to-ceramic construction permits operation at high ambient temperatures; maximum seal temperature is 250 C. The KU901 operates with a peak C-band power of 1 Mw and a switching time of 80 nsec. Operating characteristics include an anode voltage of 2 kv, 50-ampere peak anode current, and a grid trigger voltage of 100 v. ITT Electron Tube Division, Clifton, N.J.

CIRCLE 323, READER SERVICE CARD

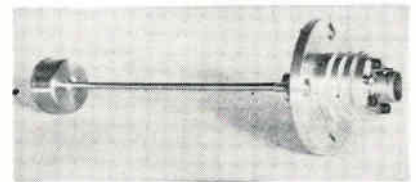

**Digital System
 Measures Temperature**

NEW SYSTEMS for digital temperature measurement uses a six-decade custom counter, signal conditioning unit and horizontal insert probe. Model TSU-1 provides repeatable accuracy better than 0.04 percent in the temperature range — 50 C to + 125 C. Display and read-out are direct temperature values; no analog conversion. Riverbank Laboratories, Box 65, Geneva, Ill.

**Plotter Control Unit
 Meets MIL-STD-826**

MODEL 10A plotter control unit is used with rfi or field-intensity receivers and X-Y recorders to obtain automatic data recordings. It translates tuning shaft position and i-f amplifier output to peak amplitude vs frequency recordings on either model 20A X-Y high-speed recorder or other commercial plotters. The result is a permanent record of measured field intensity or signal levels on a standard graph paper suitable for direct inclusion in test reports. Thus, model 10A may be used wherever hard copy of automatic interference or field intensity

Gentlemen:

TYPIT® is the perfect way to type any technical, foreign or numerical symbol — as easy as π. Over 1,000 symbols like √, -1, ∞, Ω, □, Σ, ≫, †, ≅ to choose from. A standard typewriter + TYPIT® is

all you need. Clean, inexpensive and fast

**TYPE ANY SYMBOL
 perfectly in 4 seconds**

write today for free catalog

TYPIT® manufactured by mechanical enterprises, inc.
 3127 EF Colvin Street, Alexandria, Va.

Gentlemen:

Send: Catalog Representative

Name _____ Title _____

Company _____

Address _____

City _____ Zone _____ State _____

98 CIRCLE 98 ON READER SERVICE CARD

AM-FM Tuner Unit



AM SEC. CAPACITY: MAX. 377PF
 MIN. 12PF
 TUBE : 6AQ8, 12DT8, 17EW8

PLASTIC
 VARIABLE CONDENSER

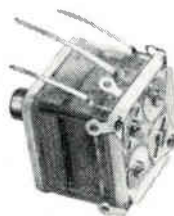

Square Size :
 15mm., 17mm.,
 20mm., 21 mm.,
 Single band :
 2 band, 3 band
 and for FM only.



**SAN ESU
 ELECTRONICS
 CO., LTD.**

Cable address: SANESVARICON TOKYO ;
 1425, 4-chome, Higashinakano, Shinagawa-ku, Tokyo, Japan.

CIRCLE 206 ON READER SERVICE CARD



Investment Opportunity

The skills he's learning today he will someday put to use for you.

But it is going to take a substantial investment before the strides he takes will be sure and swift and strong. An investment of time, of love, of money and thought.

You have a stake in that investment.

You can protect it by joining with other leading American businessmen to promote the Treasury's Payroll Savings Plan for U. S. Savings Bonds. The Treasury Department's Plan encourages habits of prudence and diligence and responsibility that are

the most valuable currency of a free society and a free economy.

When you bring the Payroll Savings Plan into your plant—*when you encourage your employees to enroll*—you are investing in the skills of tomorrow's workers. In the energy and ability of youth that is our real wealth. You are investing in America's future. In freedom itself.

Don't pass this investment opportunity by. Call your State Savings Bonds Director. Or write today to the Treasury Department, U. S. Savings Bonds Division, Washington, D. C. 20226.



In your plant...promote the **PAYROLL SAVINGS PLAN** for **U.S. SAVINGS BONDS**



JUST PUBLISHED!

IMPACT OF MICROELECTRONICS

Edited by George T. Jacobi,
IIT Research Institute
and Samuel Weber, electronics

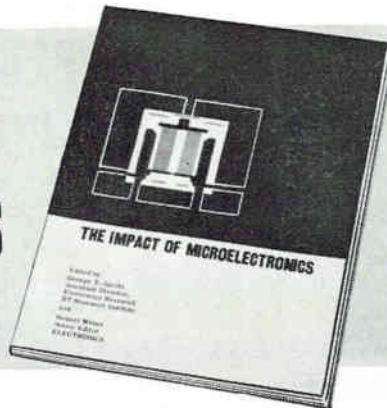

The Proceedings of the Conference on the Impact of Microelectronics, co-sponsored by the Armour Research Foundation (now IIT Research Institute) and electronics, a McGraw-Hill Publication, has just been published by electronics. The Conference, held last June 26-27 at the Illinois Institute of Technology, was acclaimed by the attendees and the industry at large. Now, in book form, all the invited papers and talks presented at the conference are available to you.

To whet your appetite, here are some of the contents:

The Electronics Components Industry and Microelectronics
by Robert C. Sprague, Chairman of the Board, Sprague Electric Company.

Profit and Loss in Microelectronics
by Robert W. Galvin, President, Motorola Inc.

Government Needs and Policies in the Age of Microelectronics
by James M. Bridges, Director of Communications and Electronics,
Department of Defense.

Management of Research and Engineering for Microelectronics Systems
by Dr. Peter B. Myers and Arthur P. Stern, Electronic Systems and
Products Division, Martin Company.

In House or Not: The Changing Buyer — Vendor Interface
by F. J. Van Poppelen, Jr., Vice President-Marketing, Signetics Corporation.

Current Technical Status and Problems in Microelectronics
by Jack S. Kilby, Integrated Circuits Dept., Texas Instruments, Inc.

Ultimate Limits of Microelectronics
by Dr. J. T. Wallmark, RCA Laboratories, David Sarnoff Research Center

Reliability in Microelectronics
by Ernest R. Jarvis, ARINC Research Corporation.

Engineering Education in an Era of Changing Technology
by Dr. John Bardeen, University of Illinois.

IMPACT OF MICROELECTRONICS is must reading for men with a marketing and technical interest in this dynamic field of activity. Crammed with useful information, this neatly designed, 120 page volume keeps you up-to-date on this fast moving technology. Order today. Only \$3.50 per copy.

ORDER FORM

electronics Reprint Department
McGraw-Hill Publishing Co., Inc.
330 West 42nd Street
New York, N.Y. 10036

Dear Sirs:

Send me _____ copies of **IMPACT OF MICROELECTRONICS**
(\$3.50 per copy)

I am enclosing _____ (cash or check)

Bill me later _____ Bill my company _____

MY NAME _____ POSITION _____

COMPANY _____

ADDRESS _____

recordings are required, such as (1) the MIL-STD-826, (2) site electromagnetic spectrum surveys, or (3) antenna patterns. Price is \$975. White Electromagnetics, Inc., 4903 Auburn Ave., Bethesda 14, Md. CIRCLE 325, READER SERVICE CARD

Multi-Drum Programmer Is Impulse-Activated

MODEL 30-B-93-S-500-EZ uses three drums—stepped simultaneously from one impulse-activated motor drive. Unit offers 30 steps, plus a home position, with 93 individual switch positions with “muscle” ratings of up to 10 amp at 115 v a-c per switch, permitting the elimination of numerous relays. Addition of the synchronized 30-step tap switch provides further information such as annunciators, program selection, or command signal selection without using the high amp drum switch positions. Tenor Co., 13460 W. Silver Spring Drive, Butler, Wisc. (326)

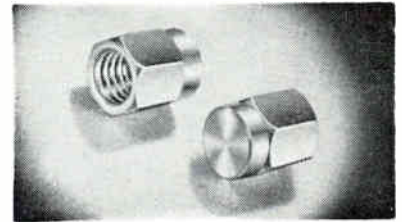

Shorting Cap for Subminiature Jacks

A D-C electrical shorting cap for 50-ohm subminiature Conhex r-f jacks is available. The unit, No. 5555, is available with or without a chain for securing to the chassis or equipment panel and features heavy 0.0001-in. gold plating. A shorting cap for 75-ohm jacks is also available, as are units for snap-on mating engagements. Sealectro Corp., 139 Hoyt St., Mamaroneck, New York. (327)

High-Field Solenoids Are Custom Designed

SUPERCONDUCTING solenoid achieves a field uniformity of $\frac{5}{10^5}$ over a $\frac{3}{8}$ -in. diameter spherical volume, at a

CHECK THESE PROPERTIES IN HITACHI COPPER-CLAD LAMINATE AND COMPARE

The copper foil used contains a minimum purity of 99.5% with no wrinkles or defects, no pinholes or discoloration. Composite sheets are uniform quality with smooth, even surfaces. There are no defects such as strains, cracks or wrinkles. Even after aging you'll find no extreme distortion, swelling, shrinkage or delamination. Dimensions are set at 1,000×1,000 mm or 500×500 mm. In both cases tolerance is ±10 mm.

These are the properties Hitachi boasts and delivers. For free samples and complete details write to Hitachi, Second Overseas Division, 8-2, Ote-machi, Chiyoda-ku, Tokyo, Japan.

A Half-Century of Progress — In Industry and the Home



Cable Address: "HITACHY" TOKYO

CIRCLE 207 ON READER SERVICE CARD

Planning to change your address?

Use the form below to indicate a change of address. Because our issues are addressed in advance, please try to allow at least 5 weeks for change of address to become effective. Attach the address label from your most recent issue in the space provided below.

(Please print the following information for proper service)

Title or position.....

Name

Chief Job Responsibility.....

Distributor
Manufacturer

Company and Div.....

Product or Service Approx. No. of Employees

Address

City Zone..... State or Prov.

Mail to home address below:

Address

City Zone..... State or Prov.

Mail to: Fulfillment Manager, electronics
330 West 42nd Street, New York City 36, N. Y.

*Paste present mailing label or address
from wrapper or envelope here.

The best in POWER SUPPLIES No requirement too difficult

CONSIDER OUR HVS SERIES DESIGNED FOR PHOTO-MULTIPLIER TUBE AND SIMILAR APPLICATIONS.

Reliability:
0.1% failure per 1000 hrs
Regulation:
0.02%
Voltages:
to 10KV
Ripple:
to 1 ppm
Temperature:
-55° C to +100° C
Shock:
100 G's, any axis
Vibration:
20 G's to 2KC
Altitude:
to vacuum

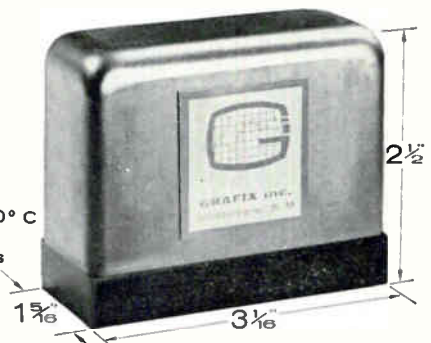

For full technical data, request specification No. 137.

CUSTOM SERVICE, QUICKLY! DELIVERY GUARANTEED TO MEET ANY REASONABLE REQUIREMENT. PRICE QUOTED UPON REQUEST.



GRAFIX inc.

Dept. 64-11, P.O. Box 3296
2014 Ridgcrest Dr. SE
Area Code 505, 265-6903
Albuquerque, New Mexico

NO MORE POWER FAILURES!

Not even a flicker of
the lights as an
ELECTRO-PAC "A"
Standby Power Supply
maintains
uninterrupted power
to the load



The ELECTRO-PAC "A" is more than an emergency inverter which changes a reserve power battery source to ac... it is a full-time voltage regulator, maintaining the ac line within $\pm 5\%$ of 120 volts.

For emergency power when a few cycles interruption can be tolerated, the economical ELECTRO-PAC "B" is available... to "invert" dc to sinusoidal ac... for use with dc generators... to provide an ac source while "floating" on a battery.

ELECTRO-PAC "A" or "B" units are available for outputs of 0.5 to 5 KVA and for use with inputs of 22-28 v., 42-56 v., and 100-140 v., dc. Efficiencies up to 80%.

Write for application bulletins on standard "A" and "B" units. Complete standby power systems also available.

**ELECTRO-SEAL
CORPORATION**

946-C North Avenue
Des Plaines, Illinois



field strength of 40,000 gauss. Over 2½-in. axial length, the field uniformity is 0.05 percent. To provide maximum experimental utility at a minimum cost, all solenoids are custom designed. To achieve rated fields they do not require training and are fully protected from damage due to accidental quenching. Magnion Inc., 144 Middlesex Turnpike, Burlington, Mass.

CIRCLE 328, READER SERVICE CARD



Automatic Control for Production Lines

AN AUTOMATIC control circuit for piece production lines and automatic handling is announced. Model TS-1 stores detection of an electrical change for rejecting or sorting parts. It operates from a change in voltage, current, or resistance. Unit may also be used as a spark detector for production testing of electrical leakage in components or parts. Existence of reject may be stored and the faulty piece rejected or sorted while next piece is being tested. Output of circuit directly controls any a-c or d-c reject or sort mechanism. Circuit time response is less than 10 μ sec. Dimensions, Inc., 95 Madison Ave., Hempstead, L.I., N.Y. (329)

Semiconductor Networks Suited for Computers

NEW DEVELOPMENT in semiconductor integrated circuits—series 53 Solid Circuit networks—will broaden their application into large, high-speed, ground-based computers. Series 53 includes six integrated circuit types: a J-K flip-flop, single and multiple logic gates, and clock driver or buffer. It features logic design flexibility through the use of AND/OR/INVERT

logic with minimum package count. High-speed gates and flip-flops, with propagation delay as low as 5 nsec, make the units ideally suited for use in present digital systems. Texas Instruments Inc., 13500 North Central Expressway, Dallas, Texas. (330)

Flux Remover Cleans Printed Circuitry

NOW AVAILABLE is S-190 Freon TMC flux remover in a 16-oz aerosol container. It is especially efficient in cleaning fragile and delicate circuitry where mechanical means are out of the question, but a fresh solvent washing action without the possibility of recontamination—so often a problem with cleaning methods—is essential. It removes both lightly and highly polymerized solder flux residues. A non-flammable product with a low level of toxicity, S-190 is safe for most printed circuitry materials because of the short contact times afforded by rapid drying. Miller-Stephenson Chemical Co., Inc., 16 Sugar Hollow Road, Danbury, Conn. (331)



Phase Meter Uses Plug-In Packages

SOLID-STATE precision phase meter provides automatic readout in degrees to phase accuracies of ± 1.0 deg absolute. The 329-A reads from 0 to 360 deg in wide 30-deg scales, with sensitivity and resolution at better than 0.2 deg. Specification accuracy is maintained in a frequency range from 30 cps to 50 kc, but the instrument is useful from 5 cps to 300 kc. The basic 329-A is operable from signal and reference inputs as low as 100 mv or up to 150 v into a 1-megohm input impedance. Several plug-in packages are available, typically extending input to a range of 1 mv to 1,000 v. Acton Laboratories, Inc., 533 Main St., Acton, Mass. (332)

LITERATURE OF THE WEEK

D-C POWER SUPPLY Electronic Research Associates, Inc., 67 Factory Place, Cedar Grove, N. J. Catalog supplement No. 139 covers the type TRO40 low cost, solid state, wide range d-c laboratory supply. (361)

C-W LASER Astromarine Products Corp., 1733 N. 33rd Ave., Melrose Park, Ill. 60165. Bulletin L-2 covers the L-100 c-w solid-state laser, a complete laser system designed for laboratory and testing program. (362)

CAPACITORS Texas Capacitor Co., 4310 Langley Road, Houston 16, Texas, offers a catalog describing a line of Mylar & foil, metalized Mylar, and Teflon & foil capacitors. (363)

WAVEGUIDES Specialty Automatic Waveguide, 12 Wilmington Road, Burlington, Mass., announces availability of a new brochure concerning the company's microwave capabilities. (364)

HIGH-SPEED LASERS Maser Optics, Inc., 89 Brighton Ave., Boston 34, Mass. Technical bulletin gives operational details and specifications on the series 6860 line of high repetition rate pulsed lasers. (365)

PHOTOELECTRONIC CONTROLLER Photomation Inc., 280 Polaris Ave., Mountain View, Calif. Bulletin 631 covers a photoelectronic controller utilizing dual beam input to provide a relay operation when coincidence occurs between two separate light measuring circuits. (367)

ENVIRONMENTAL TEST CHAMBERS Gruenberg Electric Co., Inc., 9 Commercial Ave., Garden City, N. Y. Bulletin 320 illustrates and describes high-low temperature test chambers. (368)

TEMPERATURE PROBES Trans-Sonics, Inc., Burlington, Mass. Special product note 4139 discusses dual-element temperature probes that contain two independent temperature-responsive platinum windings. (369)

INTEGRATING MOTOR GENERATORS Kearfoit Division, General Precision Aerospace, Little Falls, N. J. A single-page catalog sheet describes size 18 integrating motor generators. (370)

EPOXY ADHESIVE Tra-Con, Inc., Resin Systems div., 25 Commercial St., Medford, Mass. 02155. Technical product bulletin describes Tra-Bond 2129, a low viscosity room temperature cure, 100 percent solids epoxy resin system for rigid laminating uses. (371)

MEMORY TESTER Digital Equipment Corp., 146 Main St., Maynard, Mass. Brochure F-1521, eight pages, describes an automatic memory test system for both laboratory and production testing and analysis of ferrite planes and arrays. (372)

P-M FOCUSED BWO'S Stewart Engineering Co., Santa Cruz, Calif., offers a technical bulletin describing the square package design for its 1-to-2-Gc permanent-magnet focused backward-wave oscillators. (373)

UNIVERSAL SERVO Pioneer Central Division of The Bendix Corp., Davenport, Iowa. Bulletin 2806 covers an analog-digital type capacitance measurement servo. (374)

STEPPING RECORDERS Digi-Data Corp., 4908 Forty-Sixth Ave., Hyattsville, Md. Brochure covers the DSR 1400 series digital stepping recorders. (375)

R-F CONNECTORS Applied Engineering Products Co., 375 Fairfield Ave., Stamford, Conn., has published catalog 164 describing a complete new subminiature r-f coaxial connector line. (376)

SERVO ACCELEROMETER Donner Division, Systron-Donner Corp., 888 Galindo St., Concord, Calif., has published a technical bulletin on the model 5310 ultrarugged servo accelerometer. (377)

GLASS-DIELECTRIC CAPACITORS Electronic Products Division of Corning Glass Works, Raleigh, N. C., has available a test report giving data on performance of glass-dielectric capacitors in space environments. (378)

MAGNETOSTRICTIVE DELAY LINES Ferranti Electric, Inc., Industrial Park No. 1, Plainview, L.I., N. Y., announces a new publication designed to serve as both a design engineer's refresher or introduction to magnetostrictive delay line fundamentals, theory and applications. (379)

SOLID ELECTROLYTE TANTALUM CAPACITORS Astron Division, Renwell Industries, Inc., 255 Grant Ave., East Newark, N. J. Engineering bulletin B 401-1 on solid electrolyte tantalum capacitors is available. (380)

CURING AGENTS Columbia Technical Corp., Woodside, N. Y. 11377, announces a new, convenient chart of proprietary curing agents for epoxy resin systems. (381)

MICROELECTRIC VACUUM SOURCES R. D. Mathis Co., 1345 Gaylord St., Long Beach, Calif. A 24-page catalog describes evaporation sources and thin film vacuum deposition sources designed to fit rotary holders, micro-circuit jigs and small systems. (383)

FIELD EFFECT TRANSISTORS Atlantic Instruments & Electronics, Inc., 103 North Beacon St., Boston 34, Mass. Bulletin 101 outlines applications and performance of the Fieldtron vhf field effect transistors, types 5T3 and 6T3. (384)

TRANSDUCER-AMPLIFIER UNIT Taber Instrument Corp., 107 Goundry St., North Tonawanda, N. Y. Bulletin provides photos, description and specifications of a new Teleflight transducer-amplifier package for space vehicle and rocket applications. (386)

PRESSURE TRANSDUCERS Gulton Industries, Inc., 212 Durham Ave., Metuchen, N. J. Brochure describes solid-state, piezoresistive miniature transducers for measurement and control of pressure in aerospace and industrial applications. (387)

NEW! HIGH CAPACITY!

TWO-STAGE WELCH "DUO-SEAL" VACUUM PUMP No. 1398

50 CFM (1400 LITERS/MINUTE)

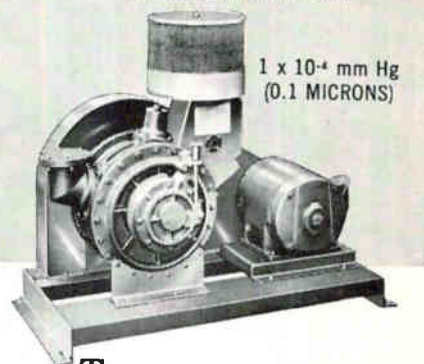

THE YOUNGEST, BUT LARGEST MEMBER of the Welch family of "Duo-Seal" oil sealed rotary vacuum pumps makes its appearance as the No. 1398. This new pump offers very high capacity and excellent ultimate vacuum characteristics with no sacrifice of long life, low maintenance, freedom from vibration and minimum noise level. These features have long made Welch "Duo-Seal" pumps the most widely used of all rotary vacuum pumps. 1398's, like all Welch "Duo-Seal" Pumps, are thoroughly run-in at the factory and tested until they exceed their vacuum guarantee.

The new 1398 is highly recommended for all industrial and laboratory applications requiring high pumping capacities and low pressures. Typical uses are electron tube evacuation, vacuum distillation, dehydration, reduction, sublimation, metalizing, metal processing, leak detection, hermetic sealing and back-filling, impregnation and general scientific studies.

IMPORTANT FEATURES:

- High pumping speed — 50 CFM (1400 liters/minute)
- Low ultimate pressure — 1×10^{-4} mm Hg (McLeod)
- Quiet, vibration-free operation
- Compact, rugged design
- Air-cooled
- Vented Exhaust Valve
- Flanged, O-Ring-Sealed Intake Port
- Totally Enclosed Belt Guard
- Air Intake Screen
- Exhaust Filter
- Trouble-free, low maintenance

WELCH "DUO-SEAL" PUMPS ARE CARRIED IN STOCK BY AUTHORIZED DEALERS.

Welch Duo-Seal Vacuum Pumps are manufactured in wide variety of capacities and ultimate vacuum characteristics. They range in capacities from 21 to 1400 liters/minute and ultimates from 2×10^{-2} mm Hg down to 1×10^{-4} mm Hg.

WRITE FOR DUO-SEAL CATALOG and BULLETIN 1398 for full description and prices.

SINCE 1880 THE WELCH SCIENTIFIC CO.
 Foremost manufacturers of scientific equipment
 1515 Segewick St., Dept. 906, Chicago 10, Ill.

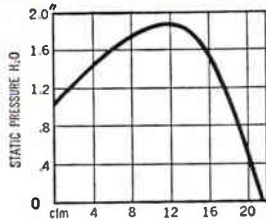
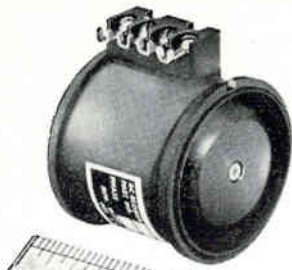

Typical performance
at 22,500 rpm

VAX-1.5 BLOWER

400 or 800 cycles a.c.

This compact high-performance spot cooling package weighs only 4.0 ounces, yet puts out up to 16 cfm of air at 1.5" H₂O back pressure! Housing and blade are precision cast aluminum, black anodized. Units are designed to meet stiff MIL environmental specs. Minimum life is 1000 hours at 125° C. Globe's new VAX-1.5-AC mounts in a 1 1/8" diameter hole using standard servo clamps. Request Bulletin VX-15 from Globe Industries, Inc., 1784 Stanley Avenue, Dayton 4, Ohio. Telephone Area Code 513 222-3741.

GLOBE

GLOBE
INDUSTRIES,
INC.

CIRCLE 208 ON READER SERVICE CARD

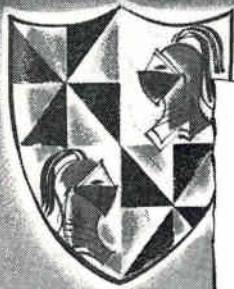

Hoffman NOW OFFERS RFI SHIELDED

ELECTRICAL ENCLOSURES*

In compatibility packaging of electromagnetic energy, Hoffman has devised shielding that controls wanted energy while preventing escape of troublesome rogue signals. The details will interest you. Write us. Standard boxes or special boxes, with or without conduit hubs. Oil and dust-tight.

*Attenuation of 60-75db at 1.8-35mc

Write for information



NEMA
12
Cabinets



JIC Terminal
Boxes



Console
Cabinets



Pushbutton
Boxes

Hoffman ENGINEERING

"has the experience"
Dept. E-221, Anoka, Minn.

CORPORATION

HOW TO USE YOUR ELECTRONICS BUYERS' GUIDE*

The Two-Way Product Locator



Most products advertised in the ELECTRONICS BUYERS' GUIDE are listed twice for your convenience. After the Product Heading, advertising page numbers appear where appropriate (when advertisements of one kind are grouped together in the book). Next to the individual product listing, the page number of associated advertising material is cited. Thus you can locate all of the advertisements for a particular product category, or any specific advertisement, quickly, accurately, and conveniently. Keep your ELECTRONICS BUYERS' GUIDE close to your work area at all times.

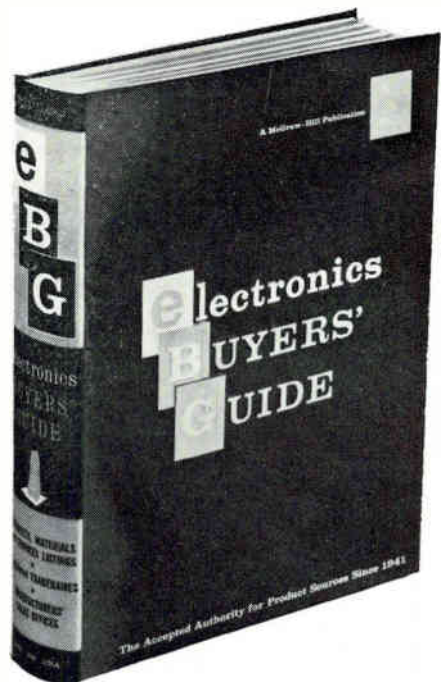



Littelfuse Opens \$1.75-Million Plant

LITTELFUSE INCORPORATED, Des Plaines, Ill., has moved into a new 125,000-sq-ft manufacturing plant in that city. The facility will house all of the firm's engineering, research, sales, administration and production personnel.

Total cost, including the 14.1 acres of land on which the plant was constructed, was estimated at \$1,750,000 by Thomas M. Blake, company president.

In discussing Littelfuse research and engineering of new products, Blake explained, "It has been our policy over the years to devote research and engineering effort towards the development of new products for the industries we serve. We are now realizing the benefits from our past efforts in the development of electromechanical products for electronic circuit protection and control purposes. In keeping with the trend to micro circuitry, we have progressed from small, to miniature to subminiature products."

While Littelfuse has always been essentially a defense-oriented electronics firm and has contributed to the military needs for its products, Blake said that approximately 90 percent of the firm's business is for commercial applications.

TI Realigns for Global Marketing

AN ORGANIZATIONAL realignment to take full advantage of expanding global markets by combining the related international activities of Texas Instruments Incorporated, Dallas, Texas, has been announced by executive vice president Mark Shepherd, Jr. Physical relocation of

people or facilities is not involved and all former International division employees have been reassigned.

"As technology, manufacturing and marketing become global, the need for combining related efforts and responsibilities has become imperative," he said. The Semiconductor-Components and Materials & Controls divisions will immediately assume the responsibility for eight

plants outside the U.S.A. manufacturing products similar to the divisions' four American plants.

Vice president Jay Rodney Reese (picture), former International division head, now will be in charge of the corporate marketing and international functions as head of world marketing (a newly created position), reporting to Shepherd. Corporate marketing had formerly been handled by Frank Gleason, who has moved over to direct a missile program.

Reese's new position has the responsibility of: (1) insuring that all TI skills and capabilities are made available to all potential customers



wherever they exist in Free World markets; (2) providing coordination and development of TI international business.

Beckman Consolidates Computer Operations

BECKMAN INSTRUMENTS has combined its analog-hybrid computer programs into one corporate unit located at Richmond, Calif. Called Beckman Computer Operations, the new organization will direct research, product development, and marketing of computers for aerospace, industrial and medical markets. It will be headed by Maxwell Gilliland, former director of research at the company's Berkeley Division and present head of a company mathematical task force.

Purpose of the move is to offer

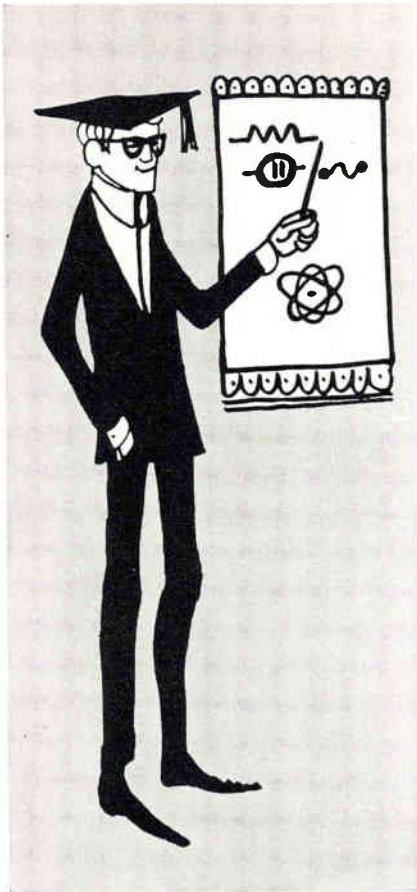

workability

(pre-production training)

WESTern PENNSylvania has a time-tested and proved-in-use plan by which employees—adaptable, productive people with a variety of industrial aptitudes—will be trained in advance for whatever skills are needed for YOUR particular operation at no cost to you. For details on this ability . . . and for complete information on financing plans for plant, machinery and equipment, and working capital . . . and WESTern PENNSylvania's favorable tax climate, mail coupon, wire or call collect.

WEST PENN POWER

an operating unit of ALLEGHENY POWER SYSTEM



INDUSTRIAL SHELL BUILDINGS available at \$2.95 to \$3.25 a sq. ft. completed to your specs in 60-90 days.

Area Development Department Phone: 412-TE 7-3000
WEST PENN POWER
Greensburg, Pa. 15602

Please send me information on: Pre-production Training
 Favorable Tax Climate Financing Plans Industrial Properties

ADA4-8E

Name _____

Title _____

Company _____

Address _____

City _____ State _____

Zip _____ Phone _____

Code _____

customers a total capability for designing new equipment and solving analog and hybrid computer problems. In the past, the company's Berkeley Division in Richmond handled development problems, while marketing was done at the Systems Division in Fullerton.

Rose Receives New Sylvania Position

JOHN T. ROSE has been appointed manager of engineering methodology for Sylvania Electronic Systems, a division of Sylvania Electric Products Inc., in Waltham, Mass. He will coordinate division programs in engineering and manufacturing standards, specifications, reliability, quality control maintainability, value engineering, value analysis, engineering design practices, tooling and production methods, drafting and testing of components and materials.

Rose replaces Paul B. Arnstein who recently was named supervisor of production engineering at the division's eastern operation in Waltham. Prior to appointment to his new position, Rose was manager of engineering support at the eastern operation.



Elect Okubo to Key Post

KEN OKUBO has been elected president of Mitsubishi Precision Co., Ltd., Tokyo, Japan, a company jointly owned by General Precision, Inc., Tarrytown, N. Y., and Mitsubishi Electric Corp. of Japan. Mitsubishi Precision Co., Ltd., was organized in 1962 to manufacture and distribute a broad range of General Precision products in the Far East.

Okubo, who is executive vice president of Mitsubishi Electric Corp., replaces Hisao Kishimoto,

who served as president during the formative stages of the joint company. Kishimoto will continue to serve Mitsubishi Precision Co., Ltd., as consultant and member of the board of directors.

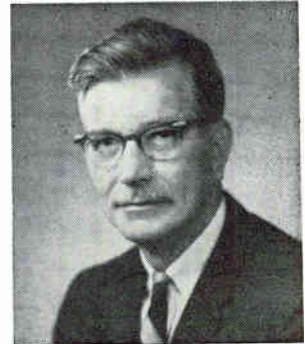

Andersen Forms New Company

WALTHER M. A. ANDERSEN announces the formation of a new company, the WMA Anderson Co. of Pleasant Valley, Conn. The firm plans to place special emphasis on a line of amplifiers of all types, particularly solid state video and band pass amplifiers, as well as ultra-linear vacuum tube amplifiers.

Andersen founded Andersen Laboratories, Inc. in 1950 and pioneered in the development of the acoustic delay line technology as well as in complex electronic subsystems utilizing acoustic delay lines.

ITTIL Appoints Research Director

APPOINTMENT of Wolfgang K. Berthold as director of research for the ITT Industrial Laboratories division of International Telephone & Telegraph Corp., Fort Wayne, Ind., is announced. He will direct basic and applied research projects in various fields, including electro-optics, telecommunications, materials studies and vacuum electronics.

Berthold, who had previously worked at ITTIL during the summer of 1962, returns to Fort Wayne from Nuremberg, Germany, where he was employed as manager, development and engineering, for the components department of an ITT associate company, Standard Elektrik Lorenz, AG.

Melpar Elevates Schreiber

ELECTION of Kenneth E. Schreiber as vice president for manufacturing for Melpar, Inc., Falls Church, Va., has been announced.

Schreiber joined Melpar in 1952, and spent the next six years in various positions in the Engineering division. Prior to his appointment as vice president, he functioned as manager of both the Minuteman and the Production divisions.

PEOPLE IN BRIEF

Angus Scott moves up to v-p in charge of sales of International Rectifier Corp. R. E. Grimm, formerly with Monitor Products Inc., appointed operations mgr. of Cor-related Data Systems Corp. Thomas C. Cleary leaves Telecomputing Corp. to join the Guidance and Control Systems div. of Litton Industries. Jack D. Wills advances to product mgr., antenna systems, at Canoga Electronics Corp. A. C. Hagen transfers from General Dynamics/Pomona to Stromberg-Carlson as mgr., production electronics mfg. Troy Bailey, previously with Philco Corp., named field mgr. of the Telemetry div of Martin-Decker Corp. Bernard A. Napier, ex-Monroe Industries, appointed asst. director of engineering at Lear Siegler, Inc., Aerospace div. of Power Equipment div. Richard J. Ferraid elevated to exec v-p of Electrical Industries. Robert B. Young raised to technical director, and Willard G. Skinner to mgr. of technical services and quality control at the Magnet Wire Div., Essex Wire Corp. John A. Granath advances to associate director of the electronics research div. of IIT Research Institute. James A. Cook moves up to mgr. of resistor products for Electra Mfg. Co. Edwin W. Templin, from Westrex Co. to D. B. Milliken Co. as chief engineer. Erwin H. Warshawsky, formerly chief, computer technology, for Douglas Aircraft Corp., has joined Mesa Scientific Corp., computer consultants. Henry E. Cooley promoted to v-p, development and mfg. operations, in the IBM Federal Systems div.

INFRARED WIDE ANGLE GERMANIUM IMMERSED THERMISTOR DETECTOR

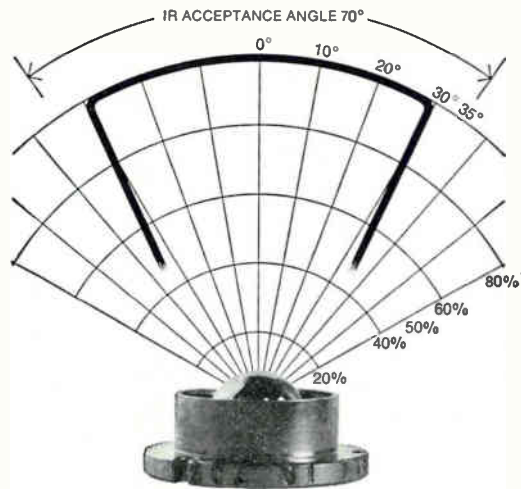

DESIGNED FOR SPACE ENVIRONMENT

Servo Corporation's new wide-angle thermistor detector features an acceptance angle of up to 70° nominal, with wider angles on special order. Operation is stable and reliable even at temperatures in excess of 100° C. The detector is coated to peak at 13 microns and may be peaked at any wavelength in the 9-15 micron region. • This is but one of the many infrared products from Servo. The company is presently engaged in advanced studies involving IR materials, detectors, and instrumentation. Facilities include a complete IR optics department.

For literature, SERVO CORPORATION OF AMERICA
write to: 111 New South Road, Hicksville, L. I., New York • (516) WElls 8-9700



CIRCLE 107 ON READER SERVICE CARD

any size panels

engraved in your own plant

Engrave 1-inch nameplates or 6-foot panels by unskilled labor.

Spindle covers 18¼" x 6" in one set-up — more than any other machine of its kind.

Bench type model I-R — \$685.

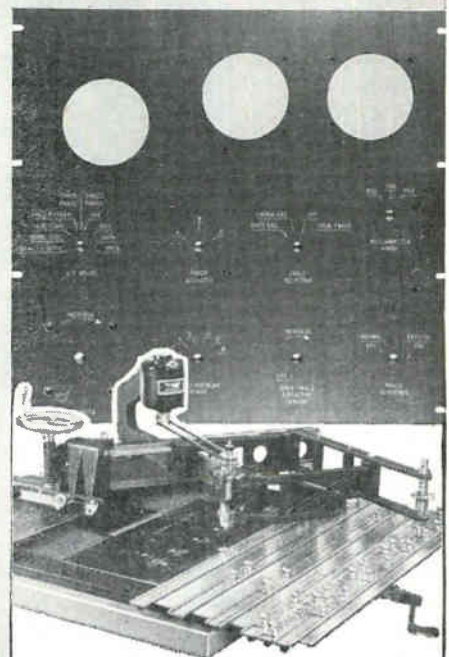

Send for complete catalog ZR-4
Write direct on your letterhead.

new hermes ENGRAVING MACHINE CORP.

154 WEST 14th STREET, NEW YORK 11, N. Y. IN CANADA: 359 St. James Street West, Montreal, P. Q.

To Order Reprints



Fill in,
Cut out coupon below,
insert in envelope
and mail to:

electronics Reprint Dept.
330 West 42nd Street,
New York, N. Y.—10036

REPRINT ORDER FORM

For Listing of Reprints Available See Reader Service Card

(To help expedite mailing of your reprints please send cash, check or money order with your order.)

For Reprints of the latest Special Report:

Modern Electronic Packaging

Send me Reprints of Key No. R-48 at 50¢ each.

For Reprints of previous Special Reports or Feature Articles fill in below:

Send me Reprints of Key No.(s) @ ¢ each. (For prices, see chart above.)

*For orders of Bulk Reprints of other editorial articles in this issue or past issues:

Send me Reprints of page (no.(s)) of issue

of article entitled

*Minimum bulk order 100 copies. You will be advised of costs by return mail.

Name

Number and Street

City, Zone No., State

INDEX TO ADVERTISERS

• AMP Incorporated	4	Kay Electric Co.	28	Texas Instruments Incorporated	
American Lamotite Corp.	91	• Keithley Instruments, Inc.	90	Semiconductor-Components	
Astrodata Inc.	15	• Kepco, Inc.	16	Division	12, 13
Beattie-Coleman Inc.	96	Kerr Corp., Wayne	76	• Toyo Electronics Ind., Corp.	82
Bell Telephone Laboratories	29	Kinney Vacuum, Div. of New		• Vent-Rak Inc.	69
Consolidated Electroynamics		York Air Brake Co.	88	Vidar Corp.	31
Corp.	21	Kin Tel, A Division of Cohu		Welch Scientific Co., The	103
• Defense Electronics, Inc.	68	Electronics Inc. 3rd cover		Wells Electronics Inc.	88
Delco Radio	22	• Klein & Sons, Mathias	14	West Penn Power	106
Di-Acro Corp.	92	• Lapp Insulator Co., Inc.	93	Xerox Corp.	7
Dow Corning Corp.	8, 9	Leach Corporation	81		
Durant Manufacturing Co.	77	• Magnetic Shield Division of			
• Electro Motive Mfg. Co., Inc.	83	Perfection Mica Co.	97		
Electro-Seal Corp.	102	Malco Mfg. Co.	27		
Electronic Engineering Co. of		McGraw-Hill Book Co.	30		
Calif.	62	• McLean Engineering			
• Fairchild Controls	75	Laboratories	86		
Fluke Mfg. Co., Inc., John 4th Cover		Mechanical Enterprises, Inc.	98		
Formica Corp.	60	Microwave Associates Inc.	25		
General Electric Co.		New Hermes Engraving Ma-			
Miniature Lamp Dept.	87	chine Corp.	107		
• Globe Industries, Inc.	104	Nichicon Capacitor Ltd.	88		
Grafix Inc.	101	Paktron, Div. of Illinois Tool			
Heinemann Electric Co.	72	Works, Inc.	70, 71		
• Hewlett-Packard Company		• Perfection Mica Co.			
inside front cover		Magnetic Shield Div.	97		
• Hitachi, Ltd.	101	Radiation Inc.	66		
Hoffman Engineering Corp.	104	Rohr Corp.	58		
Hughes Aircraft Co.		San Esu Electronics Co., Ltd.	98		
Aerospace Divisions	79	• Sangamo Electric Co.	65		
Hull Corp.	67	Servo Corporation of America	107		
IEEE	94, 95	Shizuki Electrical Mfg. Co., Ltd.	96		
Indiana General Corp.	85	• Sigma Instruments, Inc.	32		
Japan Vacuum Engineering Co.		Siliconix Inc.	3		
Ltd.	96	Sprague Electric Co.	6		
Julie Research Laboratories,		• Syntronic Instruments, Inc.	97		
Inc.	78	TRW Space Technology			
		Laboratories	24		
		Taylor Electric, Inc.	98		
		• Tektronix, Inc.	23		
		Texas Instruments Incorporated			
		Industrial Products Group	73		

CLASSIFIED ADVERTISING

F. J. Eberle, Business Mgr. (2557)

PROFESSIONAL SERVICES 109

EMPLOYMENT OPPORTUNITIES 109

EQUIPMENT

(Used or Surplus New)
For Sale 109

CLASSIFIED ADVERTISERS INDEX

Binswanger Corp. 109
Dow Chemical Company
Rocky Flats Division 109
Fabrite Metals Corp. 109
Lifschultz Fast Freight 109
Metropolitan Supply Corp. 109
• Radio Research Instrument Co. 109

• See advertisement in the July 25, 1963 issue of electronics Buyers' Guide for complete line of products or services.

This index and our Reader Service Numbers are published as a service. Every precaution is taken to make them accurate, but electronics assumes no responsibilities for errors or omissions.

electronics



Audit Bureau
of Circulation



Associated Business
Publications

AUDITED PAID CIRCULATION

JAMES T. HAUPTLI (2210)
Advertising Sales Manager

HENRY M. SHAW (3485)
Market Research Manager

DAVID M. TEMPEST (3139)
Promotion Manager

electronics Buyers' Guide

R. S. QUINT (2335)
General Manager

RICHARD J. TOMLINSON (3191)
Business Manager

THEODORE R. GEIPEL (2044)
Production Manager

NEW YORK TELEPHONE: Dial Direct:
971 plus number in parenthesis,
Area Code 212

ADVERTISING REPRESENTATIVES

ATLANTA, GA. 30309
Michael H. Miller, Robert C. Johnson
1375 Peachtree St. N.E.,
Trinity 5-0523 (area code 404)

BOSTON, MASS. 02116
William S. Hodgkinson
McGraw-Hill Building, Copley Square,
Congress 2-1160 (area code 617)

CHICAGO, ILL. 60611
Harvey W. Wernecke,
Robert M. Denmead
645 North Michigan Avenue,
Mohawk 4-5800 (area code 312)

CLEVELAND, OHIO 44113
Paul T. Fegley
55 Public Square, Superior 1-7000
(area code 216)

DALLAS, TEXAS 75201
Frank Le Beau
The Vaughn Bldg.,
1712 Commerce St.
Riverside 7-9721 (area code 214)

DENVER, COLO. 80202
John W. Patten
Tower Bldg., 1700 Broadway,
Alpine 5-2981 (area code 303)

HOUSTON, TEXAS 77025
Kenneth George
Prudential Bldg., Halcombe Blvd.,
Riverside 8-1280 (area code 713)

LOS ANGELES, CALIF. 90017
Ashley P. Hartman, John G. Zisch,
1125 W. 6th St., Huntley 2-5450
(area code 213)

NEW YORK, N. Y. 10036
Donald H. Miller (212) 971 3615
George F. Werner (212) 971 3617
Donald R. Furth (212) 971 3616
500 Fifth Avenue

PHILADELPHIA, PA. 19103
Warren H. Gardner, William J. Boyle
6 Penn Center Plaza,
LOCust 8-6161 (area code 215)

SAN FRANCISCO, CALIF. 94111
Richard C. Alcorn
255 California Street,
Douglas 2-4600 (area code 415)

LONDON W1:
Edwin S. Murphy Jr.
34 Dover St.

FRANKFURT/Main:
Matthae Herfurth
85 Westendstrasse

GENEVA:
Michael R. Zeynel
2 Place du Port

TOKYO:
Shigeo Chiba,
1, Kotohiracho, Shiba, Minato-ku

Why settle for too little or pay for too much in a digital voltmeter?

...now you can get
exactly what you need at a
sensible price from KIN TEL

These eight KIN TEL instruments, plus off-the-shelf accessories, meet every known requirement for digital voltmeters. This means you no longer have to over- or under-buy. You just select the one instrument that delivers the exact degree and combination of speed, accuracy, stability, adaptability, range, and reliability your particular applications call for.

Militarized Digital Voltmeter (Model 412). Rugged, programmable, differential input. Auto ranging, displays polarity. Measures AC and \pm DC potentials between 0.001 and 999.9 volts. Accuracy is 0.01% (of reading) \pm 1 digit for DC, 0.1% of full scale for AC. Designed to MIL-E-4158A. Ideal for use in automatic systems. Price, in quantities of five or more: \$10,000.

DC Digital Voltmeter (Model 864A). New! High speed, solid state, programmable, modular construction. Measures 0.000 to \pm 999.9 volts to an accuracy of 0.02% of full scale +0.01% of reading ($23^{\circ}\text{C} \pm 1^{\circ}$) or 0.05% of full scale (10°C to 40°C) within approximately 0.02 second — within 0.005 second when programmed to any single range scale. Bidirectionally follows inputs changing as fast as 10 volts per second on the low range, 100 volts per second on the 100-volt range, or 1000 volts per second on the high range. Has electrical outputs for BCD, BCD excess-3, or 10-line parallel signals which are accessories. Price: From \$3180.

AC/DC Digital Voltmeter/Ratiometer (Model 551). New! First to bring you 5-readings-per-second speed with mercury-wetted relays. Full 5-digit, measures DC from 0.0000 to \pm 999.99 volts to an absolute accuracy within 0.005% of full scale +0.005% of reading, AC from 30 to 10 kc between 0.0000 and 999.99 volts to an accuracy within 0.05% of full scale +0.05% of reading. Ratio accuracy is 0.005% of full scale +0.001% of reading. Adaptable without modification to fit a variety of data-logging systems. Ideal for laboratory use. Accessories include projection readout, BCD mercury-relay output, 10-line mercury-relay output, and AC converter. Price (without optional visual readout) for the basic 5-digit instrument with buffer register and auto/manual/command range: \$4150.

DC Digital Voltmeter and Ratiometer (Model 507D). Measures voltages between \pm 100 microvolts and \pm 1000 volts, ratios between \pm 0.0001:1 and \pm 999.9:1 with 0.01% (of reading) \pm 1 digit accuracy. Accessories permit AC/DC and AC/AC ratio measurements. Stepping switches guaranteed for 2 years. Price: \$3835.

DC Digital Voltmeter (Model 501B). Four-digit, fifth-digit over-ranging. Measures DC between \pm 100 microvolts and \pm 1000 volts, with 0.01% (of reading) \pm 1 digit accuracy. Automatic or programmable range; auto polarity. Combines the useful accuracy of a 5-digit voltmeter with the price advantage of a 4-digit voltmeter. Stepping switches guaranteed for 2 years. Price: \$2995.

DC Digital Voltmeter (Model 501BZ). Similar to Model 501B (see above). Circuit is automatically and continually calibrated against a Zener diode reference source instead of against an unsaturated mercury-cadmium standard cell. For submarine and other special environment applications. Price: \$3160.

AC/DC Digital Voltmeter (Model 502B). Gives you AC accuracy within 0.1% of reading; over-ranging on both AC and DC; automatic ranging and remote (programmable) control. Measures DC between \pm 100 microvolts and \pm 1000 volts, AC from 30 cps to 10 kc between 1 millivolt and 1000 volts. Five-digit readout. Stepping switches guaranteed for 2 years. Price: \$4245.

AC/DC Digital Voltmeter (Model 502BZ). Similar to the Model 502B (see above). Circuit is automatically and continually calibrated against a Zener diode reference source instead of against an unsaturated mercury-cadmium standard cell. Price: \$4410.

Write for detailed literature or a demonstration of any of these exceptional instruments. Representatives in all major cities. All prices FOB, San Diego, Calif. (Additional export charge.)



5725 Kearny Villa Road
San Diego, California 92112
Phone (714) 277-6700



CIRCLE 901 ON READER SERVICE CARD

Outstanding accuracy, wide frequency range

One compact instrument measures resistance to 0.1%, capacitance to 0.2%, inductance to 0.3% — up to 20 KC

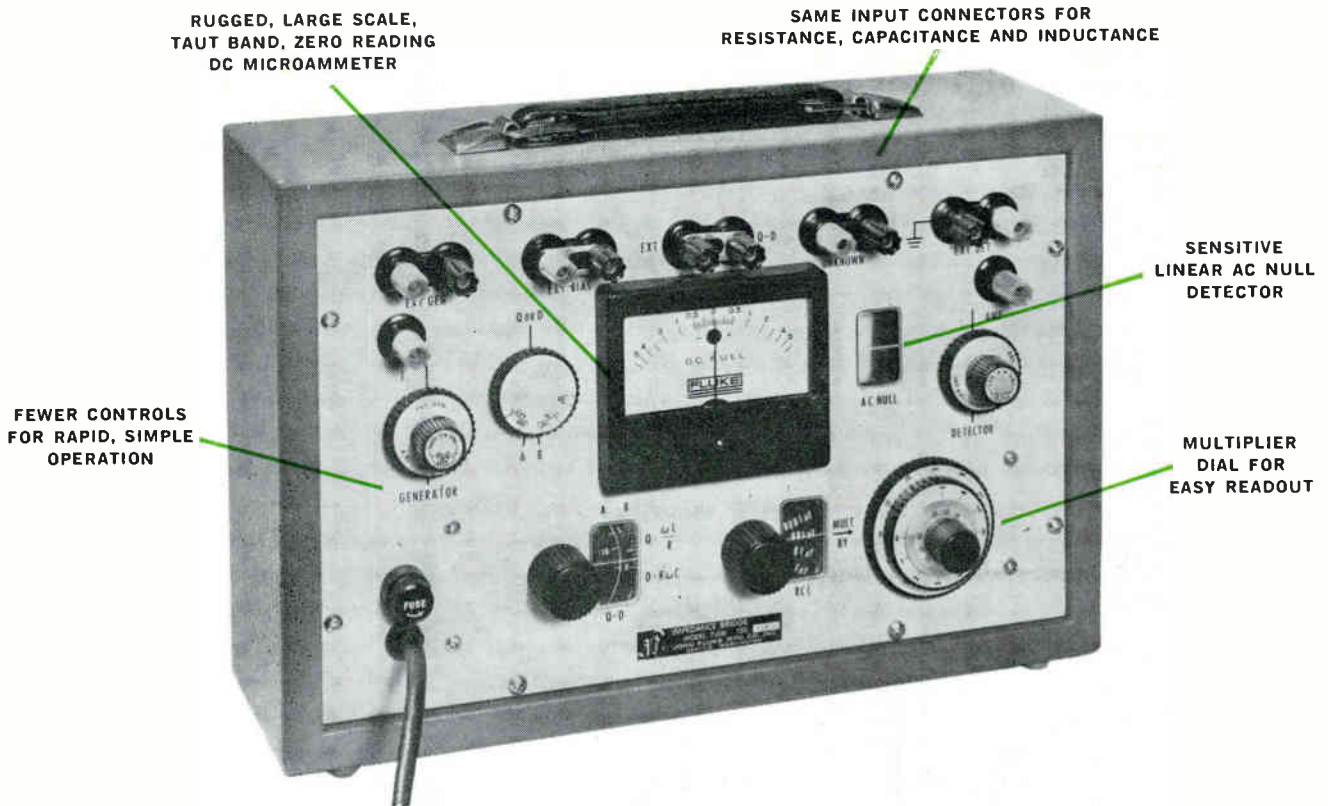

FLUKE MODEL 710B IMPEDANCE BRIDGE

BRIEF SPECIFICATIONS

RESISTANCE

Range: 0.1 milliohm to 12 megohms in 8 ranges, 0.1 milliohm per dial division on the lowest range
Accuracy: $\pm(0.1\% + 1 \text{ dial division})$

CAPACITANCE

Range: 0.1 micro-microfarad to 1200 microfarads in 7 ranges, 0.1 micro-microfarad per dial division on the lowest range
Accuracy: $\pm(0.2\% + 1 \text{ dial division})$

INDUCTANCE

Range: 0.1 microhenry to 1200 henrys in 7 ranges, 0.1 microhenry per dial division on the lowest range
Accuracy: $\pm(0.3\% + 1 \text{ dial division})$

FREQUENCY RANGE: DC to 20 KC with optional RC networks to tune AC generator-detector frequencies from 100 cps to 20 KC



710BR

SIZE

Cabinet model, 13" long x 9 1/2" wide x 6" deep
Rack model, 7" high x 19" wide x 4" deep

PRICE, f.o.b. factory

Cabinet model (710B) \$485
Rack model (710BR) \$505

Prices and specifications subject to change without notice

Unique versatility, for multiple applications

For laboratory use, the improved Fluke Model 710B provides a single instrument for the measurement of resistance, capacitance, inductance, storage factor and dissipation factor.

For receiving, permits inspection quality control.

For production, permits rapid checking of components.

Special applications include measurement of remote capacitance, incremental inductance and electrolytic capacitors with DC voltages applied.

Unique speed and ease of operation

Four-arm network of bridge standards, with fourth terminal brought out, provides a means of extending the range of dissipation factor and permits measurement in both parallel and series.

Binding post arrangement provides for (1) applying bias and polarizing voltages to the unknown; (2) for operation with external Q-D rheostat, and (3) with either external generator and detector or with internal generator and detector plug-in frequency determining circuits.

Simplified control grouping gives easiest possible balance for reading.

On request, complete Model 710B specifications and latest FLUKE Catalog Digest. Be sure your file is up-to-date on the full line of FLUKE differential voltmeters, power supplies, other precision instruments, components, and Montronics standard frequency equipment. Contact John Fluke Mfg. Co., Inc., P.O. Box 7428, Seattle, Wash. 98133. PR 6-1171; TWX, 206-879-1864; TLX, 852; Cable, FLUKE.

