

# electronics®

## BEAM DISCHARGE THROUGH SCREEN

Collimates beam  
for hot welding

(photo right)

## PHASED-ARRAY RADAR SYSTEMS

Computers help solve  
alignment problems

## ASSOCIATIVE MEMORY

Uses multi-aperture  
logic elements

**COLOR**  
**CODE**  
FOLDOUT CHART

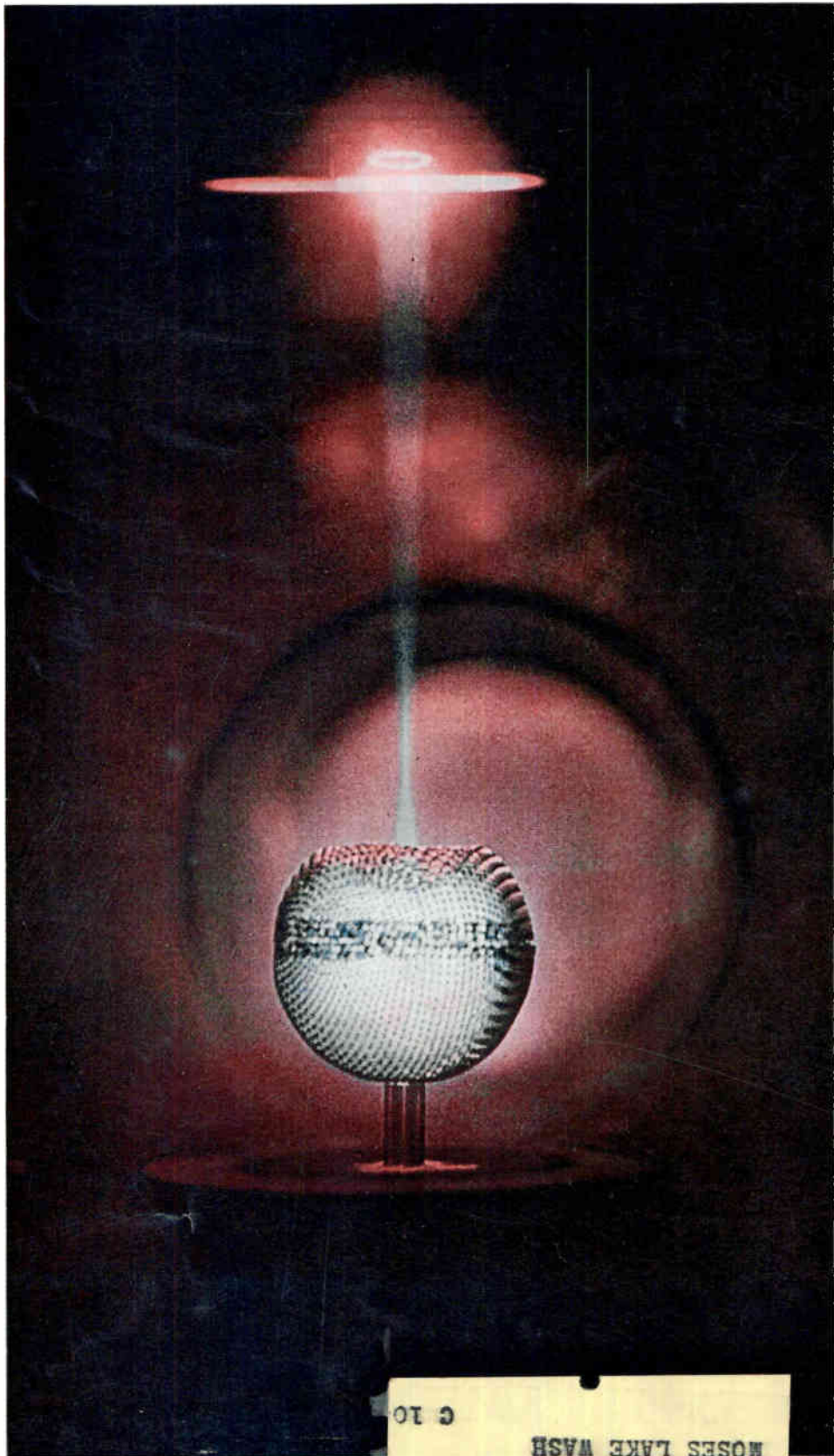

6 10 9

ROLAND KISSLER  
BOX 956  
MOSES LAKE WASH

The versatile new  $\Phi$  310A High Frequency Wave Analyzer separates an input signal so that the fundamental, harmonics or intermodulation products can be determined and analyzed. Any signal component between 1 kc and 1.5 mc may be selected for measurement. Additionally, a front panel Mode switch lets the 310A function as an efficient tuned voltmeter for accurately measuring relative or absolute signal levels, as a signal source for selective response measurements, and as either an AM receiver or carrier reinsertion oscillator for demodulating sideband signals.

High sensitivity of 10  $\mu$ v full scale, and the wide dynamic range of 75 db allows measurements of weak harmonic components down to 1  $\mu$ v or strong signals up to 100 v. A switch above the input attenuator can be flipped from Absolute to Relative to permit readings at any arbitrary point on the meter for simplifying relative-strength measurements for harmonic components.

Three passbands, selected with a front panel control, increase the versatility of the 310A even more. The 200 cps passband discriminates between harmonics for exact identification. The 1 kc passband simplifies calculations of noise power per cycle bandwidth. The 3 kc passband admits carrier channel signals for evaluation and is wide enough to pass intelligible voice signals, but contributes so little noise that even the 10  $\mu$ v range can be used. Rapid drop-off of 24 db per octave on either side of the band's cutoff frequency assures accurate readings.

The 310A is extremely easy to use. To prevent ambiguity of reading, proper voltage range, corresponding

to full scale sensitivity, is automatically shown on an illuminated display on a 15-place front panel range scale indicator. Frequency tuning is continuous and linear over the entire range with no bandswitching. Frequency can be easily read from a 4-place digital type dial which has a resolution of better than 200 cps over the entire band, any setting being accurate to  $\pm$  (1% + 300 cps).

An AFC control has a dynamic hold-in range of  $\pm$ 3 kc (at 100 kc) with response rapid enough to lock signals with drift rates in excess of 100 cps/second.

Outputs include restored frequency, which permits accurate measurement of the input frequency of the signal to which the 310A is tuned, plus a dc output for driving a recorder.

The output from the BFO is a derived sine wave that corresponds to the tuning indicator's setting, and it can be used effectively to make selective or narrow-band response tests on such as filter circuits and transmission systems. The BFO and tuned voltmeter are simultaneously controlled by the frequency indicator, tracking together, and can be conveniently used as a self-contained measuring system—the BFO output fed through a device under test, then back to the tuned voltmeter input for comparative analysis.

A carrier reinsertion oscillator is included to provide for the demodulation of single sideband signals, either normal or inverted. The demodulated signal is available for aural or recording purposes.

Call your nearby Hewlett-Packard representative today for a demonstration of this remarkable new instrument.

# ANALYZER

## SPECIFICATIONS

<b>Frequency Range:</b>	1 kc to 1.5 mc (200-cps passband); 5 kc to 1.5 mc (1,000-cps passband); 10 kc to 1.5 mc (3,000-cps passband)
<b>Frequency Accuracy:</b>	$\pm$ (1% + 300 cps)
<b>Frequency Calibration:</b>	Linear graduation, 1 division per 200 cps
<b>Selectivity:</b>	Three IF passbands; 3 db points at $\pm$ 100 cps for 200 cps passband; $\pm$ 500 cps for 1,000 cps passband; $\pm$ 1,500 cps for 3,000 cps passband. Drop off is 24 db/octave from 3 db points. Mid-passband indicated by rejection 1 cps wide
<b>Voltage Range:</b>	10 $\mu$ v to 100 volts full scale
<b>Voltage Accuracy:</b>	$\pm$ 6% full scale
<b>Dynamic Range:</b>	Greater than 75 db
<b>Input Resistance:</b>	Determined by input attenuator; 10K ohms on most sensitive range; 30K ohms on next range; 100K ohms on other ranges
<b>Automatic Frequency Control:</b>	Dynamic hold-in range is $\pm$ 3 kc, minimum, at 100 kc. Tracking speed is approximately 100 cps/sec for signal as low as 70 db below zero db reference on range attenuator
<b>Restored Frequency Output:</b>	Restored signal frequency maximum output is at least 0.25 volts across 135 ohms with approximately 30 db of level control provided. Output impedance, approximately 135 ohms
<b>BFO Output:</b>	0.5 volt across 135 ohms with approximately 30 db of level control provided
<b>Recorder Output:</b>	1 ma dc into 1,500 ohms or less for single-ended recorders
<b>Receiver Function (Aural or Recording Provision):</b>	Internal carrier reinsertion oscillator is provided for demodulation of either normal or inverted single sideband signals. AM signal also can be detected
<b>Power:</b>	115 or 230 volts $\pm$ 10%, 50 to 1,000 cps; approx. 16 watts
<b>Dimensions:</b>	16 $\frac{3}{4}$ " wide, 10 $\frac{1}{2}$ " high, 18 $\frac{3}{8}$ " deep. Hardware furnished converts panel to 10 $\frac{1}{4}$ " x 19" rack mount. 44 lbs.
<b>Price:</b>	\$2,000.00

*Data subject to change without notice. Price f. o. b. factory.*

**HEWLETT  
PACKARD  
COMPANY**

1501 Page Mill Road, Palo Alto, California, Area Code 415, DA 6-7000  
Sales and service representatives in all principal areas; Europe, Hewlett-Packard S.A., 54-54bis Route des Acacias, Geneva; Canada, Hewlett-Packard (Canada) Ltd., 8270 Mayrand Street, Montreal



CIRCLE 900 ON READER SERVICE CARD

# ver·sa·tile

(vûr'sətīl), *adj.* 1. capable of or adapted for turning with ease from one to another of various tasks, subjects, etc.; many-sided in abilities.

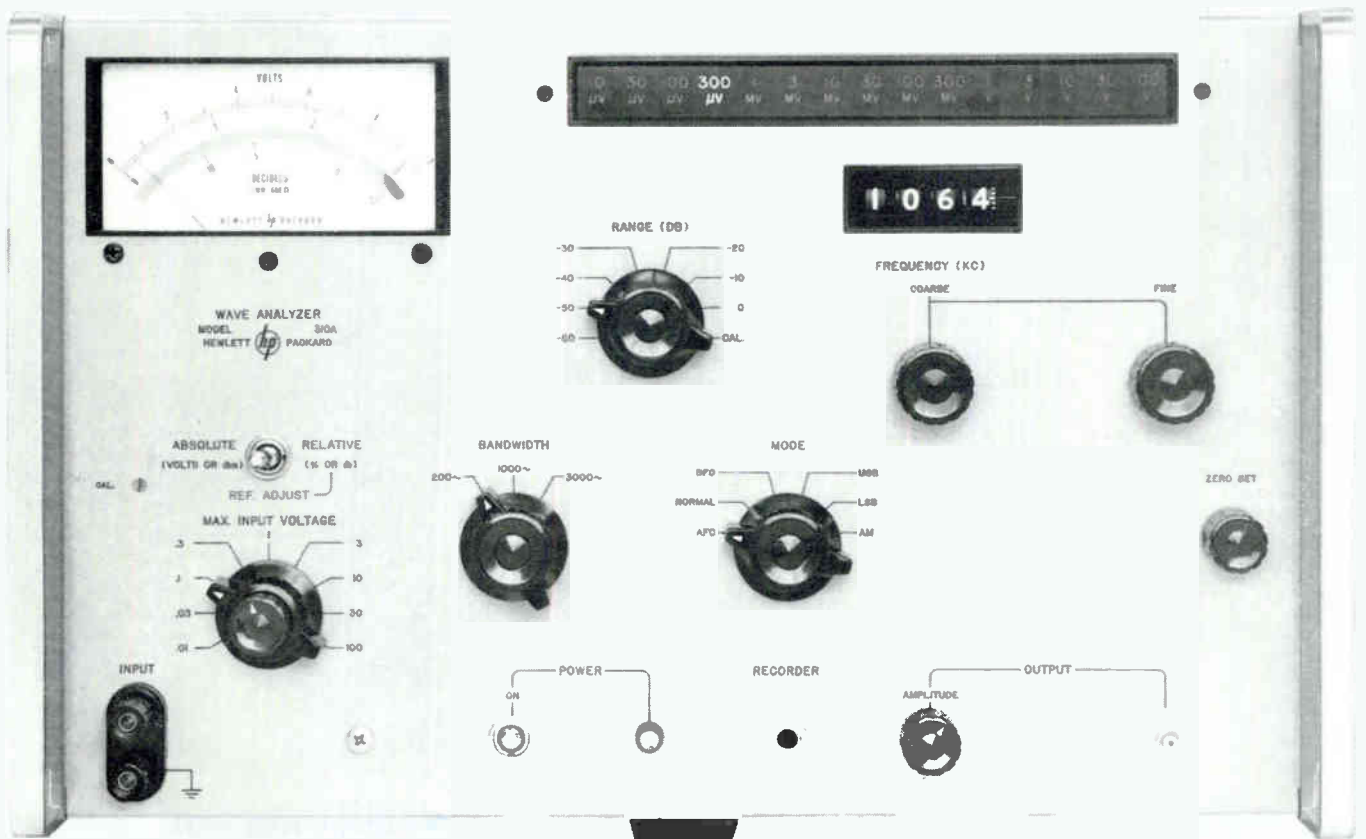

## Count the capabilities of this high sensitivity, high frequency New hp 310A Wave Analyzer

**TURN THE PAGE** for details on the usefulness of the 310A for analyzing complex audio and rf waveforms—measuring frequency response of filters and amplifiers—making multi-channel carrier measurements—making long line telephone measurements—analyzing transmission line characteristics—analyzing sonar signals...

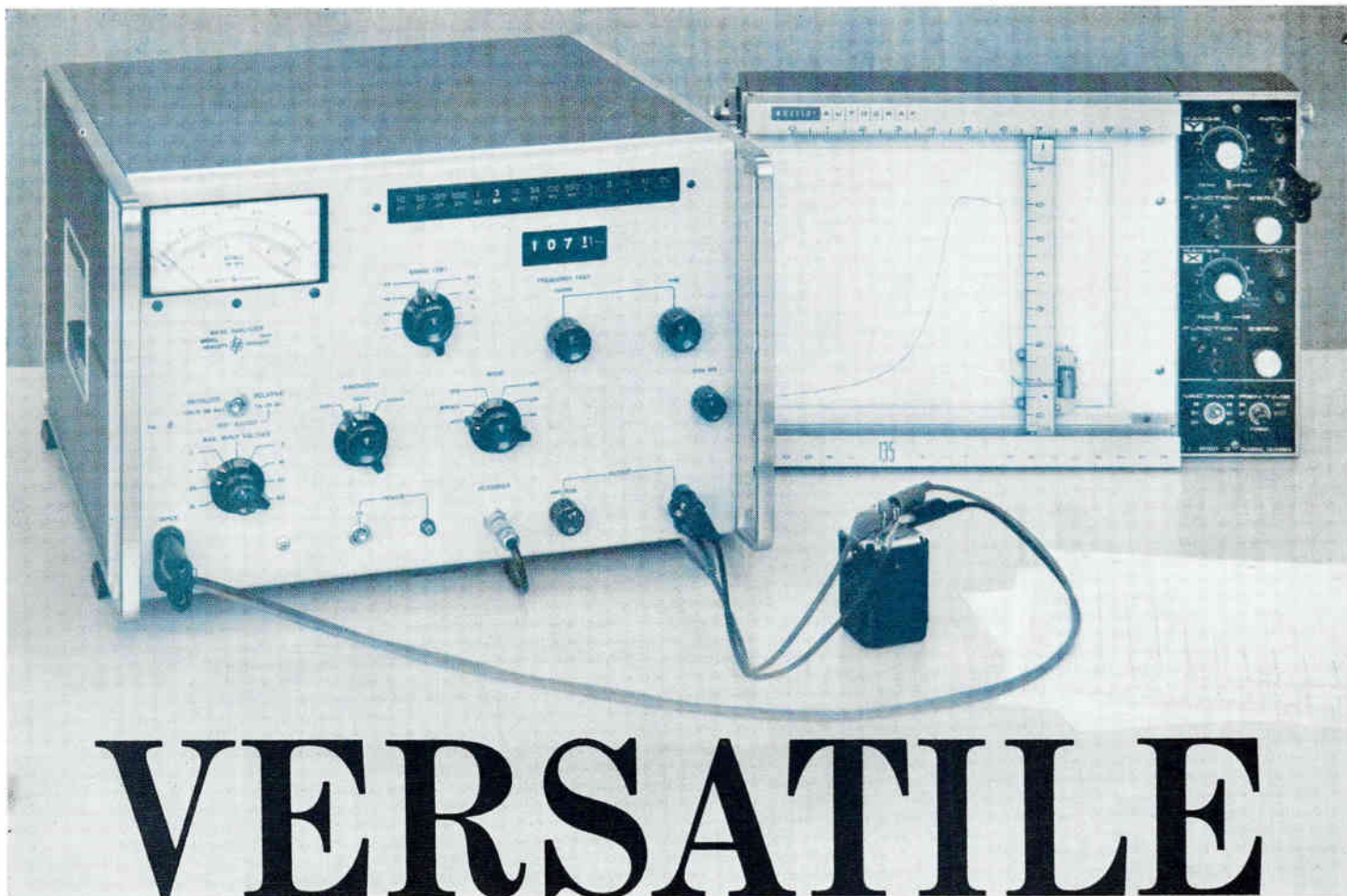

# VERSATILE

Curve on recorder shows frequency response of filter under test in 1 mc range; recording on table shows odd order harmonics of square wave:

## With the NEW hp 310A:

- Analyze complex audio and rf waveforms
- Measure frequency response of filters and amplifiers
- Measure multi-channel carrier waves
- Make long line telephone measurements
- Measure transmission line characteristics
- Analyze sonar signals

## Check these features:

- Covers 1 kc to 1.5 mc, three passbands
- High sensitivity of 10 microvolts full scale
- Wide dynamic range, over 75 db
- Continuous linear tuning, no frequency range switching
- Digital frequency readout
- Automatically tracks drifting signal
- Restored frequency output
- Carrier reinsertion oscillator
- All solid state with plug-in board construction
- High input resistance

# electronics

A MCGRAW-HILL WEEKLY 75 CENTS

W. W. MacDONALD, Editor  
Telephone Area Code 212 (971-2645)

J. M. CARROLL, Managing Editor (2293)

SENIOR EDITORS  
Samuel Weber (2371)  
George W. Sideris (3444)

SENIOR ASSOCIATE EDITORS  
Michael F. Wolff (2600)  
John F. Mason (2666)

ASSOCIATE EDITORS  
Michael F. Tomaino (2071)  
William P. O'Brien (2297)  
George J. Flynn (2188)  
George V. Novotny (3151)  
Leon H. Dulberger (3446)  
Alexander A. McKenzie (2685)

ASSISTANT EDITORS  
Stephen B. Gray (2245)  
Barry A. Briskman (2306)  
Dan Smith (2467)  
Joel A. Strasser (2127)  
Vincent S. Acunto (2592)  
C. R. Whetstone (3495)  
Eric Valentine (2710)  
Louis S. Gomolak (2472)

REGIONAL EDITORS  
Harold C. Hood,  
1125 W. 6th St., Los Angeles 90017, Calif.  
(213-482-5450)  
Laurence D. Shergalis,  
John Hancock Bldg., 255 California St.,  
San Francisco 94111, Calif. (415-362-4600)  
Thomas Maguire  
McGraw-Hill Bldg., 607 Boylston St.,  
Boston 02116, Mass. (617-262-1160)  
Cletus M. Wiley,  
Blair Bldg., 645 N. Michigan Ave.,  
Chicago 60611, Ill. (312-664-5800)

ART DIRECTOR  
Howard R. Berry (2430)

ASSISTANT ART DIRECTOR  
John C. Wright, Jr. (3430)

EDITORIAL ASSISTANTS  
Lorraine Rossi, Virginia T. Bastian,  
Lynn Emery, Ann Mella, Lorraine Werner,  
Alice M. O'Brien, Sharon Parks,  
Claire Benell, Kay Fontana,  
Sandra A. Le Mond

FOREIGN NEWS BUREAU  
DIRECTOR, John Wilhelm, (2532);  
Lawrence Mihlon (2997), Alyne Elias  
(2998)  
LONDON—John Shinn, Derek Barlow,  
Nicholas Landon, 34 Dover St., London  
W.1, England  
BONN—Bruce Bendow, Richard Mikton,  
Silke McQueen, Mittelstrasse 39, Bad  
Godesberg, Germany  
BRUSSELS—27 Rue Ducarle, Brussels,  
Belgium  
PARIS—Robert Farrell, Arthur Erikson,  
17 Ave. Matignon, 3rd Fl., Paris 8,  
France  
MILAN—Marc A. Messina, Via Manzoni  
No. 12, Milan, Italy  
MEXICO CITY—Wesley Perry, Jr.,  
Lafragua 4-314, Mexico 1 D.F. Mexico  
RIO DE JANEIRO—Leslie Warren, Rua  
Mexico 3-S/1507 1509, Rio de Janeiro,  
Brazil  
MOSCOW—Stewart Ramsey,  
Kutuzovskiy Prospekt 19, Apt. 28-29,  
Moscow, USSR  
TOKYO—Richard Halloran, Charles Cohen,  
John Yamaguchi, Toranomom Sangyo  
Bldg., 1 Kotohiracho Shiba, Minato-Ku,  
Tokyo, Japan

CIRCULATION MANAGER  
Hugh J. Quinn (2310)

C. C. RANDOLPH, Publisher (2016)

**NEW ELECTRON-BEAM PHENOMENON.** When the solid wall of a hollow-cathode discharge device is replaced with a screen wall, Martin Co. scientists discovered, the resulting cold-cathode discharge produces a self-collimating electron beam. *This beam is sufficiently energetic for welding refractory metals.*  
See p 62

COVER

**SATURN V'S ELECTRONICS.** When the giant Saturn V rocket boosts the Apollo spacecraft to the moon, it will also carry aloft some of the most flexible instrumentation developed. *One system will be a doppler tracker that reverses the usual tracking procedure*

10

**SUPERSONIC TRANSPORT.** What kind of electronics will it carry? Designers favor conventional solid-state equipment, will probably hold off on exotic or microminiature systems. *Main interest in equipment development is maintainability and reliability—there'll probably be complete redundancy*

24

**HOW COMPUTERS ALIGN PHASED-ARRAY RADAR.** Use of phased-array radar systems is growing rapidly and they are among the most complex equipments in use today. A 5,000-element array with 50 beam outputs requires a quarter million signal channels. Locating faulty circuits and aligning the array for optimum performance is as big an engineering challenge as designing it in the first place. *Here's how automatic computers can give a valuable assist.*

By A. G. Kramer and A. Slocum, Sylvania 29

**BI-QUINARY SCALING: ACCURACY AND SIMPLICITY AT 500 MC.** The feedback required in binary decade scalars creates problems at counting rates above 100 Mc. The bi-quinary scaler needs no feedback nor differentiated input. It counts in excess of 500 Mc. *Conversion to binary-coded-decimal is not difficult from bi-quinary, easy from qui-binary.*

By R. Engelmann, Consultant 34

**COLOR-CODE FOLDOUT CHART.** This 16 by 11-inch chart in full color displays color codes for chassis wiring, traveling-wave tubes, transformers, servo and capacitor motors, selenium and copper-oxide rectifiers, loudspeakers, microphones, Hall generators, industrial control wiring, stereo pickups, diodes, resistors, ceramic and molded-mica capacitors. *Where changes may be imminent, proposed codes are given also.*

By G. J. Flynn 37

**INDUCTIVE TELEMETRY IMPROVES SPIN-SYSTEM MEASUREMENTS.** Brush contact pressure and mechanical alignment create varying amounts of noise in measuring the performance of mechanical systems. This system makes use of r-f inductive coupling to get away from these problems. *Present telemeter uses nuvistors; it could use transistors if desired.*

By H. Baumann, Picatinny Arsenal 41

# electronics

November 15, 1963 Vol. 36, No. 46

Published weekly, with Electronics Buyers' Guide as part of the subscription, by McGraw-Hill Publishing Company, Inc. Founder: James H. McGraw (1860-1948).

Title © registered U.S. Patent Office; © copyright 1963 by McGraw-Hill Publishing Co., Inc. All rights reserved, including the right to reproduce the contents of this publication, in whole or in part.

Executive, editorial, circulation and advertising offices: McGraw-Hill Building, 330 West 42nd Street, New York, N. Y., 10036. Telephone Area Code 212 971-3333. Teletype TWX N. Y. 212-640-4646. Cable McGrawhill, N. Y. PRINTED IN ALBANY, N. Y.; second class postage paid at Albany, N. Y.

OFFICERS OF THE PUBLICATIONS DIVISION: Shelton Fisher, President; Vice Presidents: Joseph H. Allen, Operations; John R. Callahan, Editorial; Ervin E. DeGraff, Circulation; Donald C. McGraw, Jr., Advertising Sales; Angelo R. Venezian, Marketing.

OFFICERS OF THE CORPORATION: Donald C. McGraw, President; Hugh J. Kelly, Harry L. Waddell, L. Keith Goodrich, Executive Vice Presidents; John L. McGraw, Treasurer; John J. Cooke, Vice President and Secretary.

Subscriptions are solicited only from those actively engaged in the field of the publication. Position and company connection must be indicated on orders. Subscription rates: United States and Possessions and Canada, \$6.00 one year, \$9.00 two years, \$12.00 three years. All other countries \$20.00 one year. Single copies, United States and Possessions and Canada 75¢. Single copies all other countries \$1.50.

THE PUBLISHER, UPON WRITTEN REQUEST TO OUR NEW YORK OFFICE FROM ANY SUBSCRIBER, AGREES TO REFUND THAT PART OF THE SUBSCRIPTION PRICE APPLYING TO COPIES NOT YET MAILED.

Subscribers: Please send change of address notices, subscription orders or complaints to Fulfillment Manager, Electronics, at the address below. Change of address notices should provide old as well as new address, including postal zone number if any. If possible, attach address label from recent issue. Allow one month for change to become effective.

Postmaster: Please send Form 3579 to Fulfillment Manager, Electronics, P. O. Box 430, Hightstown, New Jersey, 08520.



Audited Paid Circulation

## Contents continued

**HOW TO QUIZ A WHOLE MEMORY AT ONCE.** An associative memory compares a data word with the entire contents of the memory. Basic element of this associative memory is called the multiaperture logic element. It has a major aperture for storage and two minor apertures that provide the exclusive OR function. *The element can be used in word lengths exceeding 100 bits.*  
By G. T. Tuttle, Goodyear Aerospace 43

**LOGARITHMIC ATTENUATOR SPANS THREE DECADES.** This passive circuit can logarithmically compress nanosecond pulses ranging in amplitude over three orders of magnitude. Output is between one-tenth and nine-tenths volt. *Either positive or negative pulses may be handled.*  
By C. D. Nail, Univ. of California 47

**AIRLINER COCKPIT RECORDERS.** FAA will require crash-proof recorders in airliners, to record crew conversations as an aid to accident analysis. Here's a rundown of proposed standards and designs. *Expected boost to the recorder market: \$10 million* 53

**DEVICE POWERS GO HIGHER.** Gains in both tube and transistor power, and at higher frequencies, are reported. One new transistor carries 156 emitter elements, another employs post-epitaxial diffusion. *In tubes, a pulsed bwo can put out an average of 324 w and peak of 107 kw at 100 Gc* 57

## DEPARTMENTS

- Crosstalk. Man's Military Role in Space 5
- Comment. Information Retrieval. Chelate Cover 6
- Electronics Newsletter. Agreement on Frequency Allocations Reached at Geneva 17
- Meetings Ahead. Society for Information Displays National Symposium 18
- Washington This Week. Change in Advisors Won't Overturn Science Policy 20
- Research and Development. CRT Recording Has Wide Bandwidth 60
- Components and Materials. How Rare Earth Chelate Lasers Work 67
- Production Techniques. Electron Beams Work Tiny Ferrites 72
- New Products. Magnetic Core Module Resists Shock 79
- Literature of the Week 92
- People and Plants. Sanders Adds Four Directors 94
- Index to Advertisers 98

# Sprague custom-designed FABMIKA® Capacitors

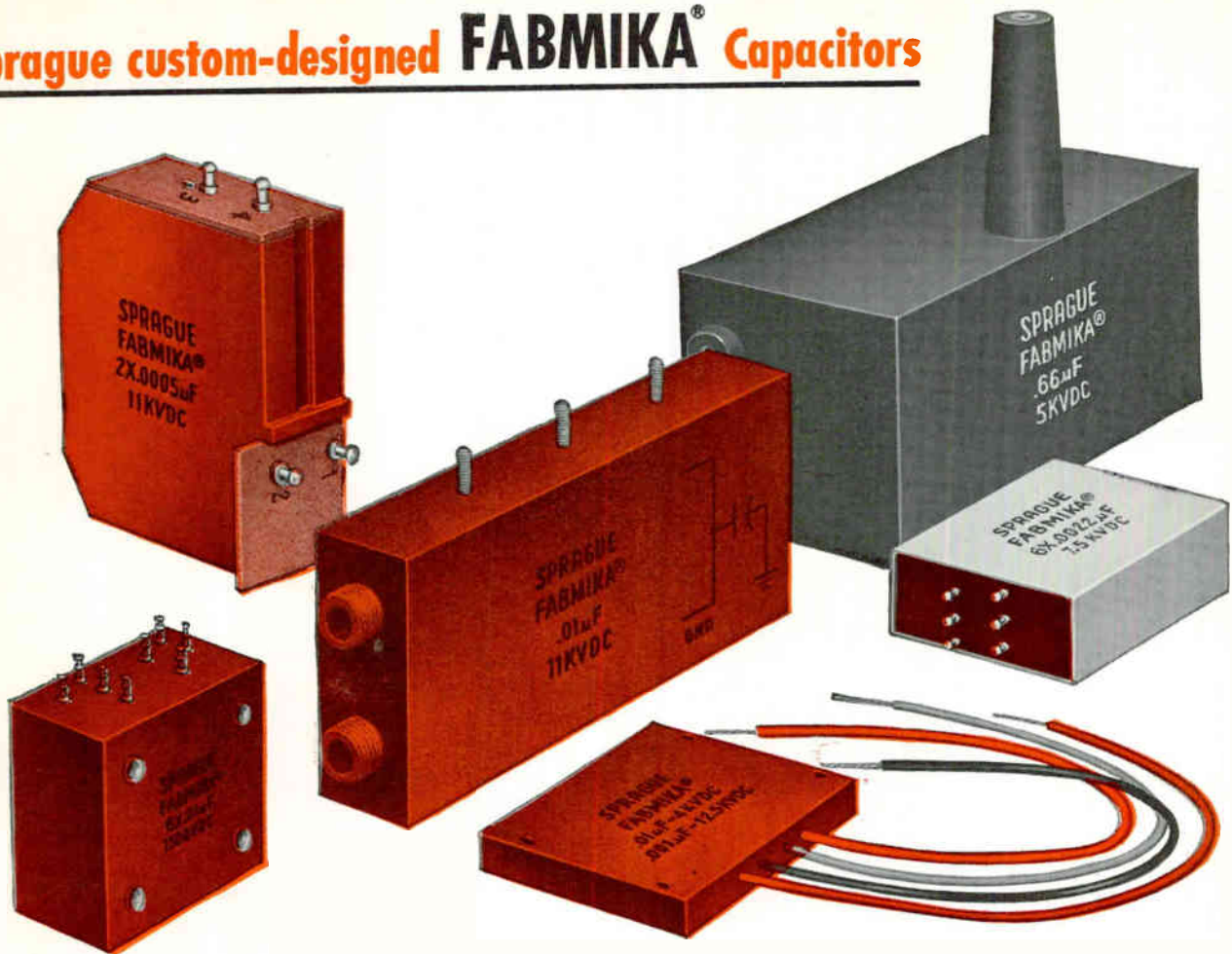

## EVERY ONE OF THESE CAPACITORS SOLVED SPECIFIC SPACE OR WEIGHT PROBLEM

At Sprague, design and manufacture of custom Fabmika capacitors is no novelty. Thousands of units have been built, each one fulfilling specific electrical and physical requirements dictated by customer's circuitry.

Cast Fabmika Capacitors lend themselves to custom design. Cast units can be tooled in irregular shapes with no specific geometrical description, where it is necessary to "fill" specific space outlines in equipment.

Custom Fabmika Capacitors are often designed as multiple-section units since size and weight are reduced considerably by one master casting in rugged epoxy.

If your circuit requirements call for capacitors with: high voltage ratings; operating temperatures to 125 C; ability to withstand moisture, humidity, vibration, shock, and corrosive atmospheres . . . plus reduced size and weight . . . investigate custom-designed Sprague Cast FABMIKA Capacitors.



For complete information, including application engineering assistance without obligation, write to Mica Capacitor Section, Field Engineering Department, Sprague Electric Company, 35 Marshall St., North Adams, Mass.

### SPRAGUE COMPONENTS

CAPACITORS  
TRANSISTORS  
RESISTORS  
MICROCIRCUITS  
INTERFERENCE FILTERS

PULSE TRANSFORMERS  
PIEZOELECTRIC CERAMICS  
PULSE-FORMING NETWORKS  
TOROIDAL INDUCTORS  
ELECTRIC WAVE FILTERS

CERAMIC-BASE PRINTED NETWORKS  
PACKAGED COMPONENT ASSEMBLIES  
BOBBIN and TAPE WOUND MAGNETIC CORES  
SILICON RECTIFIER GATE CONTROLS  
FUNCTIONAL DIGITAL CIRCUITS



'Sprague' and '®' are registered trademarks of the Sprague Electric Co.

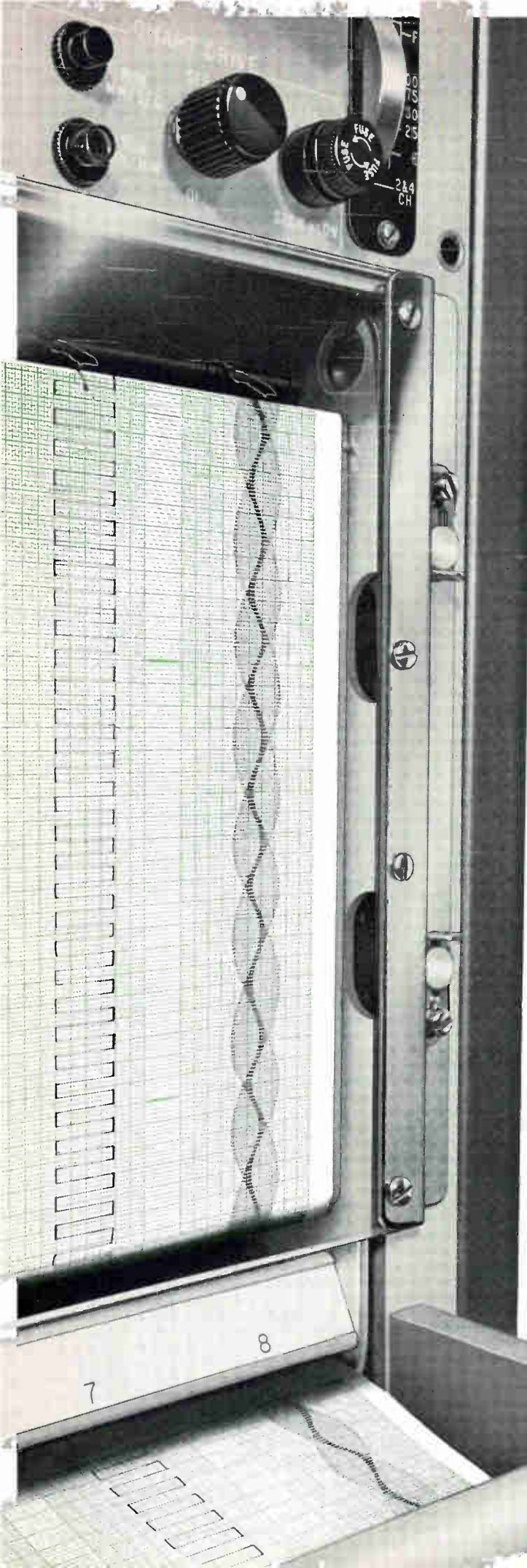

# Never a trace of doubt

Today you can buy a direct writing oscillograph that's miniaturized, or militarized, or transistorized, elaborately flexible, or economically simplified.

*But you still have to have a system that will give you a clear record of your particular signals, under your conditions of use, at a cost in time and money that you can afford.*

This is exactly why we are presenting the facts below about Sanborn *inkless, heated stylus* recording on matching Permapaper® charts—a *proven, practical and positive means of recording*. Thousands of channels made in the last 14 years show that this Sanborn recording method provides:

- **Better linearity and response speed** with Sanborn heated stylus recording.
- **No separate writing medium reservoir**—no ink on hands or clothes, with Sanborn heated stylus recording.
- **Better resolution of complex waveforms** with Sanborn heated stylus recording.
- **No parallax problems** with Sanborn heated stylus recording.
- **True rectilinear recording** without complex linkages with Sanborn heated stylus recording.
- **Straightforward electronics** with Sanborn heated stylus recording.
- **Only one electromechanical transducer** (D'Arsonval galvanometer) with Sanborn heated stylus recording.

Every one of these advantages—plus recognized reliability proven in practice—are available only from Sanborn.

## SANBORN COMPANY

INDUSTRIAL DIVISION  
WALTHAM, MASS. 02154

*A Subsidiary of Hewlett-Packard Company*



## Man's Military Role in Space

AS ANOTHER AUTUMN moves into winter, and 1963 into 1964, the Administration moves into a new round in the effort to decide what, if any, man's military role in space should be.

"It's a very tough problem, but we intend to face it, and we intend to face it right away."

This promise was made by Harold Brown, Director of Defense Research and Engineering, at the United Aircraft Corporate Systems Center, Farmington, Conn., Oct. 17.

Outcome of the long-awaited tangle with the reality of "near-earth orbit" will be of great interest to us, some hundred or so miles below, and to industry, whose efforts in this segment of defense work have been curtailed for the past two years.

The administration's decision could be positive, depending on military strategy, political pressure in an election year, or a casual statement by Khrushchev at a press conference that the Soviets are building a manned earth-orbiting laboratory—a system with obvious military potential.

At present, however, there is no indication that the decision will reflect any more enthusiasm for advanced weapon development than Brown and Secretary of Defense Robert McNamara have expressed in the past.

"We've been looking at this question (of man's military role in space) for six years now and we have not come up with very many more things than . . . (surveillance, repair of complex electronic equipment, and the return of recoverable boosters)," Brown said in Farmington.

Because of this scarcity of ideas, Brown sees doubtful military benefit in Gemini and Dynasoar. Both projects "are very limited in being able to answer the question of what man can do in space." Main value of the projects, he explained, would be to test requirements of a follow-on system, but unfortunately there are no well-thought-out plans for a follow-on system.

Others do see a military role for man in space. Khrushchev said after Titov's flight: "If you want to threaten us from a position of strength we will show you our strength. You do not have 50-and-100-megaton bombs. We have stronger than 100-megatons. We placed Gagarin and Titov in space, and we can replace them with other loads that can be directed to any place on earth."

Soviet Marshal Sokolovskiy has also spoken of orbiting nuclear weapons and military aerospace vehicles. Khrushchev has said they could knock our missiles down, and in October, 1960, Dr. Zhukov, a Soviet military analyst, wrote in *International Life*, that they can destroy our satellites.

The U.S. Air Force has responded to Soviet threats by proposing that manned satellite systems could provide command and control, and that satellite-based bombardment missiles could provide global coverage. Radiation weapons installed on orbiting platforms are also possibilities; while such devices may seem far out, ICBM's were also discounted a few years ago.

Jerome Wiesner, the President's Scientific Advisor, expressed this same viewpoint in the very statement in which he proposed emphasis on non-military research effort because "the scientific-military revolution has stabilized. . . ." Wiesner told the House Subcommittee on Science, Research and Development, Oct. 16: "At the

beginning of the 1950's many wise men did not foresee the wholly new military potentialities of development in rocket propulsion, guidance, communications, and nuclear technology. . . ."

Although Wiesner was not advancing the need for a military role for man in space, his point is applicable and timely. We, today, do not foresee all the military applications of space. And we will not unless we build and experiment with prototype, adaptable systems in the near-earth region, such as Dynasoar, Gemini, and a permanent, manned, orbiting laboratory.

Why are we not going ahead with such a program? And what can we hope for from the Administration's promise for new evaluation?

The answer lies in the Administration's stipulation to every advanced weapon proposal that it "fill a military requirement." This is as it should be. But to understand the import of this stipulation it is important to recall the Administration's views on military needs.

Last January 30, McNamara revealed the nuclear stalemate theory to Congress and backed it up by placing emphasis on conventional, limited-war arms, and only token enthusiasm for advances in strategic weapons. He also stressed the need for curtailing development of "deadly weapons." Confidence in the power of nuclear stalemate prompted McNamara to express satisfaction when told the Soviets were developing a second strike capability. "It will put less pressure on them to carry out a preemptive strike," he explained to Congress.

Faith that the stalemate will be maintained is apparently based on belief that Soviet initiative is geared to what the U.S. does. In a two-part article in *The New Yorker*, January 19 and 26, 1963, Wiesner was quoted as saying that part of his job is to keep an eye on the Defense Department so he can veto development of weapons the President might feel the enemy would consider "too hostile." Wiesner also said: "Suppose one country holds down the manufacture of a type of missile that another country thinks is specially tailored for its destruction. That might just make the other fellow a little less nervous, and he might then follow suit." Harold Brown was quoted in the same article: "the more powerful the weapons that a nation possesses, the more insecure it feels."

Until these viewpoints are changed, sizable effort in aerospace work can not be expected.

### LATE QUOTE FROM MOSCOW

"We have never said that we are going to give up our lunar project. You're the ones who said that . . . you keep expecting us to give up."

*Khrushchev, Nov. 6, 1963*

**Only from Sprague!**

**Multi-Advantage  
Construction in a  
Low-Cost  
Film Capacitor!**

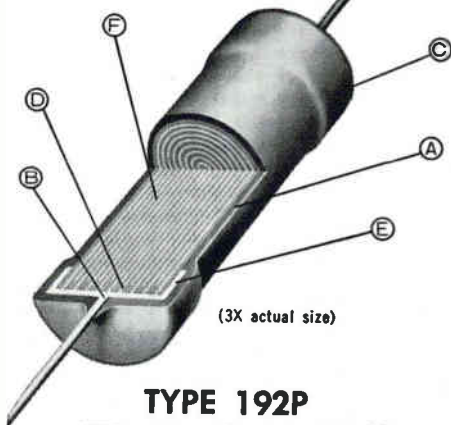

TYPE 192P  
**PACER<sup>®</sup>**  
FILMITE<sup>®</sup> 'E'  
**CAPACITORS**

- Ⓐ Hard, durable, orange epoxy protective coating.
- Ⓑ Lead firmly welded to metal end cap.
- Ⓒ Fixed diameter of metal end caps insures uniformity of capacitor size.
- Ⓓ Extended-foil capacitor roll inside end cap—every turn of electrode is positively contacted, assuring non-inductive section.
- Ⓔ Metal end cap guards against entrance of moisture.
- Ⓕ Specially selected ultra-thin polyester film dielectric permits dramatic size reductions.

For complete technical data on Type 192P Pacer Capacitors write for Engineering Bulletin 2066 to Technical Literature Service, Sprague Electric Co., 35 Marshall Street, North Adams, Mass.



Sprague and <sup>®</sup> are registered trademarks of the Sprague Electric Co. 48C-182-63-81

## COMMENT

### INFORMATION RETRIEVAL

I have read with interest your editorial, A Huge Amorphous Mass (p 5, Oct. 11). Fortunately, you have answered your own question in the first sentence of the second paragraph when, in referring to my proposal for a National Research Data Retrieval System, you stated, "if we understand it correctly."

Obviously, you have been misled on the basic concept of HR 1946. If you had covered the hearings of my committee, you would have learned that it is not the purpose of HR 1946 to concentrate on scientific research data retrieval in any one single place, but rather to develop a national system with a central clearing house which would maintain a running inventory on what is being done and where, for the immediate information of scientists.

In fairness to my committee and your readers, and since I personally highly respect your publication, I would indeed be grateful if you could find space for the speech which I delivered on this subject at the University of Maryland. It is my hope that through publication of these views, we can once and for all dispose of the erroneous impression that HR 1946 proposes to isolate the scientific community from all other cultural influence by lumping it into a single intellectual compound.

I agree with you, nothing could be more disastrous to American scientific achievement than to try to place all of their scientists under one regimen.

I do wish to thank you, however, for the rest of the editorial, which appears to support my basic proposal for a greater national effort to develop a more effective means of communication between our various research establishments.

I think you will find from reading my speech that your editorial board and I are in effect recommending pretty much the same course of action.

ROMAN C. PUCINSKI  
Member of Congress

House of Representatives  
Congress of the United States  
Washington, D. C.

• Here are some excerpts from the address of Mr. Pucinski (D.-Ill.) to the Association for Computing Machinery, at the University of Maryland, on Oct. 17:

"... First of all, my responsibilities to my constituents make it imperative that the mounting government costs in research are, in fact, spent for new and expanded research and not for a duplicate effort contained in some document drowned in an ocean of inaccessible information.

Secondly, it is my firm belief that unless our scientists are given better, faster and more accurate information wherever and whenever needed, their valuable training and creative energies will be diluted to the level of insignificance.

Thirdly, the emergence and advancement of scientific and technological competition from many countries make it crystal clear that this nation, in order to insure its economic survival, no longer can afford to ignore the development of its most important national asset: scientific information. . . ."

"... As I see it, this country will sooner or later have to establish a giant network of research information services throughout the United States, each dealing with its own particular scientific discipline, and each tied together by coaxial cable, closed-circuit television, facsimile and other electronic devices to one central command post which, through the use of electronic computers and retrieval machines, will keep a constant inventory of what is being done, where and by whom, in this nation's widespread scientific community. This command post quickly would provide to any scientist a complete record of the scientific research being sought so that he would have at his fingertips all the work previously done in a given field. . . ."

"... It is not the purpose of the proposed national information center to carry out under one roof all the operations of collecting, processing, abstracting and coding of scientific information. Clearly, this is physically impossible and operationally impractical at the present time. . . ."

"... I wish to stress that the purpose of the national information center is not to eliminate any of the existing indexing, abstracting and translating services, but rather to obtain their final work products in coded or other formalized form and make them available to the technical and business community. . . ."

### CHELATE COVER

Your Oct. 25 cover strangely reminds me of some sort of glowing, living organism that has crawled up from the ocean depths.

New York, New York

JOHN FINKBINER

• The European chelate molecule shown on that cover is a compound that attaches itself to a central atom to form a ring. The word chelate is from the Greek *chele*, meaning a claw. Part of the molecule is somewhat like the claw of a crab, and chelate means "having claws." For more on chelates, see p 67 of this issue.

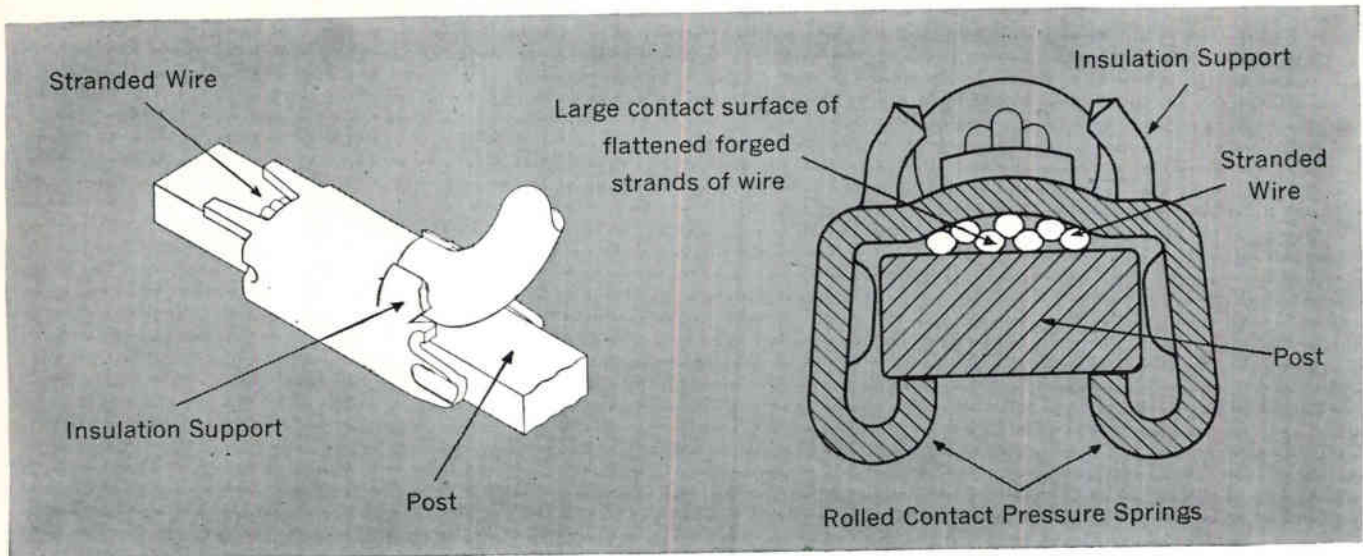

## See what's happened to stranded wire

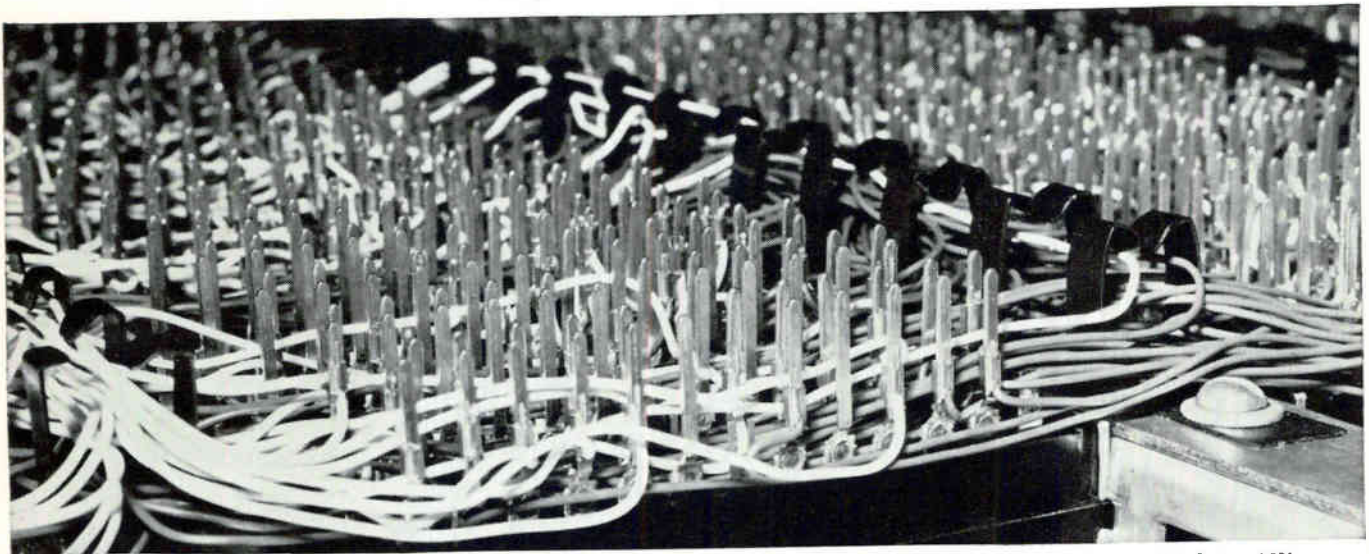

Photo Courtesy of RCA

## in high-density point-to-point applications

And not just stranded wire! Our new point-to-point wiring technique accommodates stranded, tinsel, printed and enamel wire in addition to standard solid wire and gives you a gas-tight connection with no wrap, weld or solder!

All the work is done by TERMI-POINT\* Tools and Terminals and there are two types of tools to choose from. The pneumatic tool strips the wire and affixes wire and terminal to the post—any size post. The TERMI-POINT numerically controlled wiring machine automatically strips, cuts and connects wire in required lengths in "x", "y" and oblique directions and is ideally suited for high production back panel wiring.

Multiple post connections made are gas-tight, resist shock and vibration. Large and redundant contact areas of the conductor and terminal plus the wipe-clean action of the terminating method assure maximum long-life performance.

Serviceability, despite the close spacing of posts, is extremely easy. A simple extraction tool removes TERMI-POINT terminals—any terminal from any

position on the post without electrically disturbing others—and leaves the conductor ready to be used again, if necessary.

There's more . . . a lot more to tell about this new technique and how you can benefit in your point-to-point wiring program. Find out how you can achieve greater density, even modular design; gain higher production levels at lower applied costs; eliminate stocking various pre-cut wire lengths; and service with an ease unknown in other point-to-point wiring techniques. It's all in our booklet, TERMI-POINT Tools and Terminals For A New Point-To-Point Wiring Technique. Send for your copy today.

★Trademark of AMP INCORPORATED.



AMP products and engineering assistance are available through subsidiary companies in: Australia • Canada • England • France • Holland • Italy • Japan • Mexico • West Germany

**Now  
in  
large  
quantity  
production**  
**CTS Cermet Microminiature Modules**



*prototypes ordered  
from approved layout*

*prototypes  
shipped*

*quantity production begins  
(as low as \$2.00 each)*

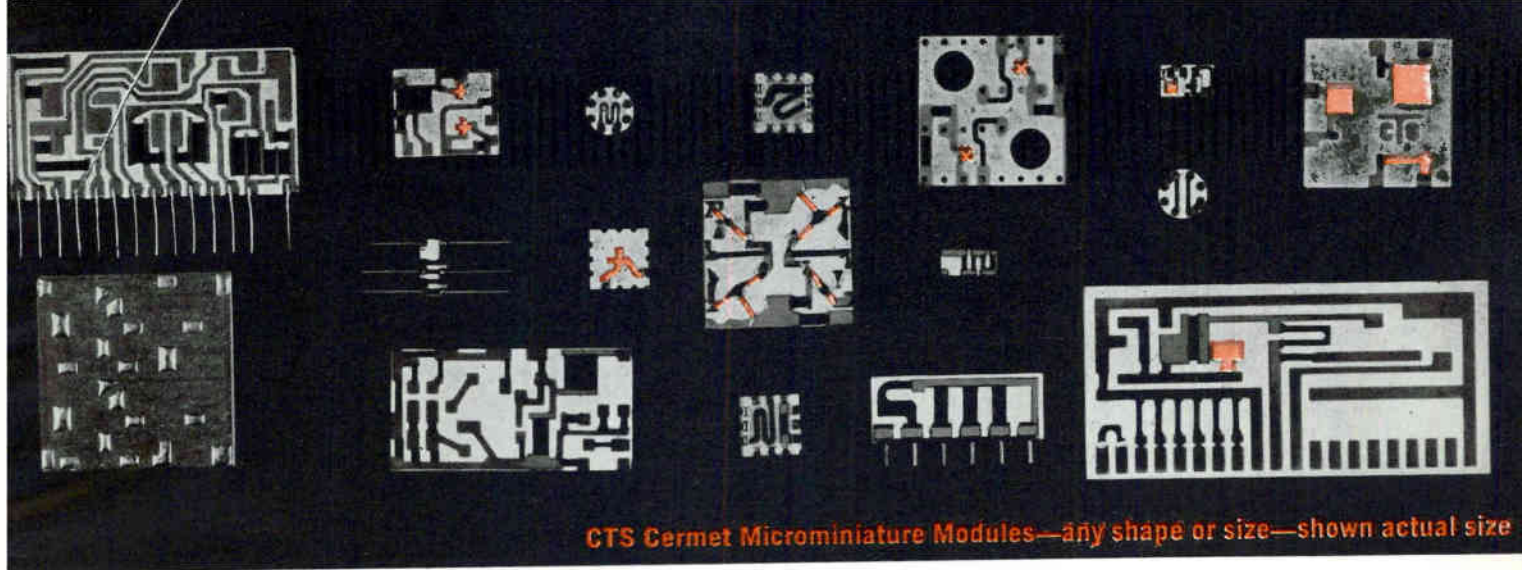

CTS Cermet Microminiature Modules—any shape or size—shown actual size

## Born reliable at 650° C.

- **Unusually stable** and substantially unaffected by the most severe environmental extremes due to the virtually indestructible combination of a matrix of inorganic material and precious metal alloys after firing.
- **Built-in heat sink** because the alumina substrates have high thermal conduction.
- **Unaffected by solder.** Modules can be immersed in solder to tin selected conductive tabs or solder discrete components without effect on the cermet resistors and capacitors.
- **Elements can't separate from substrate** during varying environmental conditions. Cermet resistors and capacitors are thermally bonded.
- **Perfect termination** due to similarity of compositions. Pt-Au conductor composition diffuses with the cermet compositions and becomes part of the substrate after firing.
- **Migration dangers eliminated** because no silver is used.
- **No cermet resistance element failures** after 36,000,000 element hours of extended load life reliability tests. Only 0.172% average resistance change at full rated load.

- **Extremely tight quality control** in purchased materials inspection, in-process control of production procedures, step-by-step product inspection, and quality assurance program on completed product.
- **Fired at temperatures exceeding 650°C** so cermet resistors, capacitors and conductive circuit take excessive overloads without failure. Cermet resistors and capacitors operate continuously at 275°C; take short periods of 500°C.

How you can benefit from our design and development experience: We'll evaluate your circuit for incorporation into the new CTS cermet resistor-capacitor module microminiaturized packaging system. Interconnecting circuitry for maximum reliability will be "designed in." Our design engineering group will propose circuit layouts on one or both sides of alumina substrates including positioning of discrete active components using "fired-on" conductive circuits and "fired-on" cermet resistors and capacitors.

## CTS Cermet Resistors meet MIL-R-10509

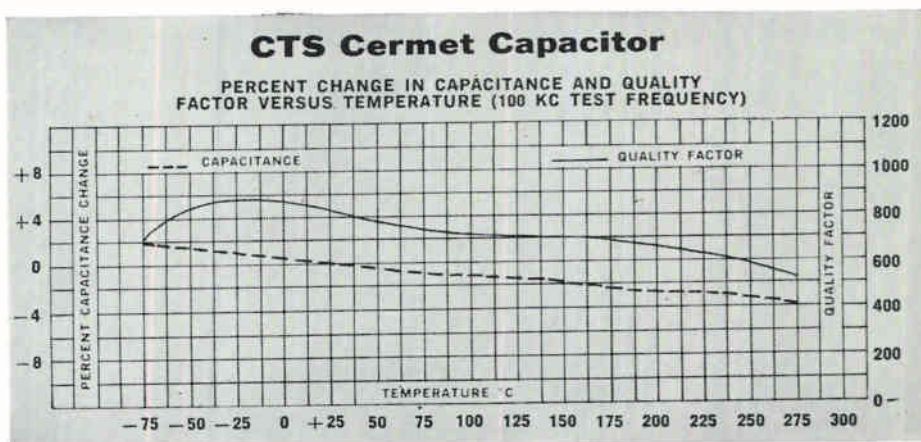

Request complete specifications and information.



Founded 1896

**CTS CORPORATION**  
Elkhart, Indiana

Sales Offices and Representatives conveniently located throughout the world.

### Principal Products

Variable Resistors  
Selector Switches  
Loudspeakers  
Trimming Potentiometers  
Microminiature Components  
& Circuit Packages

### Subsidiaries

CTS of Asheville, Inc., Skyland, N. C.  
CTS of Berne, Inc., Berne, Indiana  
CTS of Paducah, Inc., Paducah, Kentucky  
Chicago Telephone of California, Inc.,  
South Pasadena, Calif.  
CTS of Canada, Ltd., Streetsville, Ontario

# New Twist in Space Tracking: The Vehicle Tracks the Ground

Reversal of usual doppler method to add flexibility to Saturn instrumentation

By **JOEL A. STRASSER**  
Assistant Editor

**HUNTSVILLE, ALA.** — A new type of doppler tracking system will be used on Saturn V, the giant rocket that is slated to boost the three-man Apollo ship to the moon by 1970.

Normally, doppler transmitters and receivers are on the ground and the transponder is in the space vehicle. In the system under study,

this would be reversed. The transmitter and receiver would go aboard the vehicle and transponders would be on the ground at various points around the earth. This arrangement provides onboard tracking to measure range and range rate from the multiple ground stations.

The system, called AROD (Airborne Range and Orbit Determination), will add significantly to the flexibility of Saturn V instrumentation.

Many other developments are being incorporated into the booster's instrumentation system, key project officials at NASA's Marshall Space Flight Center told ELECTRONICS.

Saturn V instrumentation will be highly flexible, to meet the Apollo launch vehicle's varying mission requirements and still give the flight-parameter measurements required, according to Sherman M. Seltzer, deputy chief of systems engineering, and Andrew L. Bratcher, chief of Instrumentation Development Branch's technical data unit, both of Marshall's Astrionics division.

A typical Saturn V mission, estimated to be about seven hours long, will require about 2,252 measurements (see diagram).

**Other Tracking Systems** — Saturn V's C-band radar transponder is designed to work with the newly modified AN/FPS-16 radar planned as part of the orbital Apollo ground net. Resulting range and azimuth and elevation angle information in real time will permit rapid determination of Saturn V's position. Differentiation of this data will provide vehicle velocities.

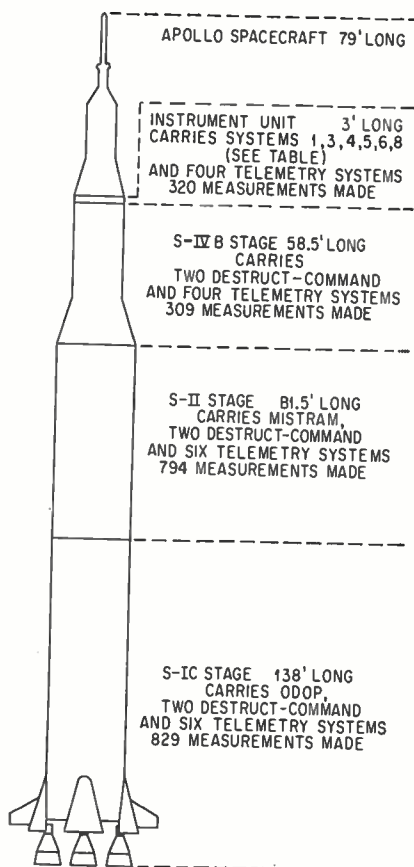

**SATURN VEHICLE** stands 360 feet high with Apollo spacecraft attached. Most of the 2,252 measurements made during a typical mission monitor physical performance and fuel consumption of the vehicle. The 103 guidance, control, r-f and telemetry measurements required are made only in the instrument unit. Table details equipment

## Performance Parameters of Saturn I/IB R-F Equipment\*

- C-BAND RADAR**: manufacturer, Motorola; bandwidth, 10 Mc; frequency, tunable from 5,400 to 5,900 Mc; input power, 24 w; radiated power, 400 w; effective range, 1,000 mi
- MISTRAM**: manufacturer, General Electric and Motorola; bandwidth, major loop closed—6 kc, major loop open—40 kc, minor loop closed—100 kc, minor loop open—1 Mc; frequency of range channel, receiver—8,148 Mc, Transmitter—8,216 Mc; frequency of calibrate channel, receiver sweeping frequency—7,884 to 7,892 Mc, transmitter sweeping frequency—7,952 to 7,960 Mc; input power, 154 w; radiated power, 200 to 500 mw per channel; effective range, 1,000 n mi
- AZUSA GLOTRAC (Type C)**: manufacturer, Convair; bandwidth, f-m noise bandwidth of 2 kc; frequency, receive—5,060.194 Mc, transmit—5,000 Mc; input power, 134 w (transponder only), 149 w (with filter); radiated power, 2.5 w min; effective range, 1,500 mi
- RADAR ALTIMETER**: manufacturer, Ryan Electronics; bandwidth, 3 Mc; frequency, 1,610 Mc; input power, 75 w; radiated power, 5,000 w peak; effective range, 250 mi max
- MINITRACK**: manufacturer, Space Craft, Inc; bandwidth, Modulation Index up to 1 radian; modulation frequency, 200 cps to 100 kc; frequency, 136.65 Mc; input power, 364 mw; radiated power, 50 mw; effective range, 1,000 mi
- AROD**: feasibility studies are incomplete at this time; first flight test will probably be on the first Saturn IB vehicles
- ODOP**: manufacturer, Motorola; bandwidth (phase-lock loop), 600 cps; frequency—Ground-to-air 890 Mc, air-to-ground 960 Mc; input power 40 w; radiated power, 1 w; effective range, 200 mi
- GUIDANCE COMMAND**: under development
- DESTRUCT COMMAND**: secure digital code, under development

\* Performance information is based on presently known requirements and state of the art developments as applied to the earlier Saturn I and IB vehicles. As requirements for the Saturn V become more clearly defined, developments will be advanced accordingly and contracts let

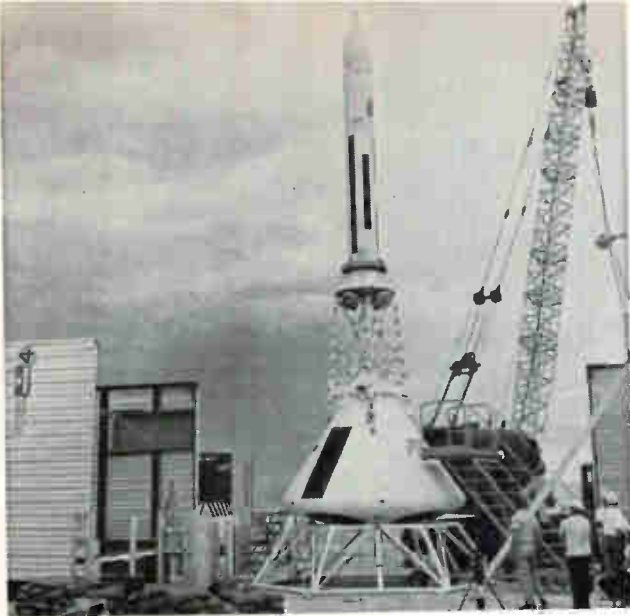

APOLLO BOILERPLATE model was mated with escape tower for abort test last week at White Sands Missile Range. The mission, first powered flight of Apollo hardware, checked escape mechanism during a pad abort



L-BAND offset doppler (ODOP) phase-locked transponder for Saturn is checked out at Motorola. Receiver threshold sensitivity is  $-130$  dbm; transmitter power output is  $1$  w min

Mistram (Missile Trajectory Measuring System) transponder on-board the operational Saturn V will be located in the S-II stage. During early R&D flights, it may be located in the instrument unit.

Azusa system on Saturn V consists of a ground station and on-board transponder. The transponder, located in the instrument unit, measures the range used to determine vehicle's position and velocity by continually comparing the phase between signals transmitted to and from the vehicle. Azusa will be used with Glotrac, the USAF global tracking system.

ODOP (Offset Doppler) c-w radar system will have its transponder in the S-IC stage. ODOP receives the signal at  $890$  Mc and offsets it to  $960$  Mc for transmission. The system is designed to check velocity and position by measuring the doppler shift between the ground-station and vehicle signals. During the critical first portion of the flight, it provides very precise tracking data.

To supplement the range, azimuth and elevation data of the other tracking systems, a radar altimeter will be used to obtain more complete tracking coverage at high altitudes. Ryan Electronics built the unit that flew aboard the SA-4 earlier this year.

An on-board orbital tracking beacon transmitter operates on a fixed frequency. It may be either unmodulated c-w or phase modu-

lated with measuring data. To permit long-duration missions, transmitter power requirements are extremely low. Minitrack ground stations require extremely sensitive receivers and precise angle-determination with highly directional antennas. Data from three or more stations would permit precise orbit determination.

**Telemetry**—Three types of telemetry will be used on Saturn V.

Pam/f-m/f-m will be used for some continuous data transmission and for the usual types of telemetry where time-division techniques are advantageous.

Digital data will be transmitted by pcm/f-m since much of the information is in quantized form before it is transmitted.

Vibration data will be transmitted by ssb telemetry in which the f-m carrier is modulated with an ssb, a-m subcarrier. This wideband capability is ideal for such data. Bandwidth efficiency of the ssb/f-m system is about 10 times that of standard f-m.

**Command System** — Command signals from the ground to the instrument unit will be transmitted with the aid of Saturn V's guidance-command system. On-board, the signals are received by the command receiver and fed into the digital computer to initiate various functions.

Saturn V's command-destruct

system permits explosives to be activated from the ground if the vehicle veers off-course. Each stage has its own safety digital command system. Each has a coded circuit designed to resist natural and man-made interference. The Apollo spacecraft, of course, would be separated from the launch vehicle prior to a command destruct signal.

Saturn V will also have recoverable film cameras and on-board tv cameras to monitor staging, internal tank conditions and the engine area. Locations and the numbers of cameras have not yet been decided upon.

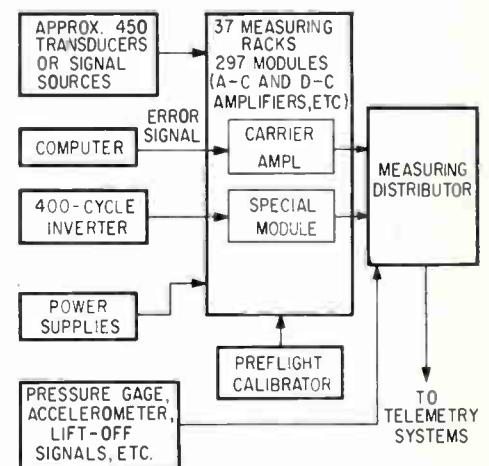

SATURN V measurements will be made with the aid of about 450 transducers or other signal sources that feed into 297 modules housed in 37 measuring racks

# MONEL alloy 400

## What is it?

## What does it offer?

## How is it used?

## Can you use it?

**MONEL\* alloy 400 contains 66% nickel and 31.5% copper (nominal). It offers high strength and toughness, plus good corrosion resistance. And it may be the answer to your electronic design problem.**

**Here's what you should know about MONEL alloy 400, as well as the other MONEL nickel copper alloys.**



**Nominal Mechanical and Physical Properties.** At 70°F the electrical resistivity of MONEL alloy 400 is about 307 ohms per circular mil foot. Tensile strength in the annealed condition is 70-85,000 psi, yield strength is 25-45,000 psi, elongation is 50-35%.



**Corrosion Resistance.** MONEL alloy 400 is remarkably resistant to corrosion caused by practically all alkalis, most acids, salts, organic substances.



**Fabrication.** MONEL alloy 400 is easily worked—hot or cold. It is available in sheets, strips, seamless tubes, rods, bars, plates, angles, wire, clad plates.

**Uses.** MONEL alloy 400 is typically used for electrical connectors, sliding contacts, plugs, jacks, magneto and rotor distributor fingers, transformer cases, resistor caps, diaphragms.



### Other MONEL Nickel-Copper Alloys

**MONEL alloy 404.** Similar to MONEL alloy 400 but with a lower nickel content, it is virtually non-magnetic at or above room temperature. Its magnetic properties are not appreciably influenced by working or heat treatment. This alloy was especially designed for applications where it is necessary to make multiple brazes in wet hydrogen.

It is typically used in structural parts for power tubes, traveling wave tubes, klystrons, wave guides, magnetrons, and in cathode supports.

**MONEL alloy R-405.** This alloy has the same composition as MONEL alloy 400 except that a controlled amount of sulfur is added to enhance machinability. It was designed for machining on automatic screw machines.

**MONEL alloy K-500.** This age-hardenable alloy is virtually non-magnetic

down to minus 150°F and is thus very useful where a strong non-magnetic material is required. It is typically used in special electronic tubes, magnet frames, Bourdon tubes, gyroscopes.

**MONEL alloy 501.** This alloy was developed to have improved machining characteristics. Parts may be machined in the annealed or cold drawn condition and subsequently age-hardened. Its properties are otherwise similar to MONEL alloy K-500.

Could one of these MONEL nickel-copper alloys be the material you're looking for?

For additional information on compositions, physical constants and mechanical properties, write for copies of bulletins T-5, Engineering Properties of MONEL nickel-copper alloys and T-9, Engineering Properties of MONEL alloys K-500 and 501.

\*Registered Trademark

**HUNTINGTON ALLOY PRODUCTS DIVISION**  
The International Nickel Company, Inc.  
Huntington 17 West Virginia



# HUNTINGTON ALLOYS





## OLD FAITHFUL



### **MINCOM SERIES CM-100 RECORDER / REPRODUCER**

Built-in reliability inspires confidence everywhere in this Mincom Wideband Instrumentation Recorder/Reproducer. CM-100's reputation for minimum downtime stems from its rugged simplicity—only twelve moving parts, four easy adjustments, dynamic braking. Plus, of course, overall electronic craftsmanship and the extreme precision achieved by Mincom's longitudinal recording with fixed heads. Versatile, too: 1.5 megacycles at 120 ips for analog data storage or simultaneous post- and predetection capabilities in FM/FM modulation, PCM, PCM/FM and other FM-type carrier systems. Seven or fourteen tracks. Write today for complete specifications.

**Mincom Division** **3M**  
COMPANY

2049 South Barrington Avenue, Los Angeles 25  
425 13th Street N. W., Washington 4, D. C.



Single Place Gyrocopter by Bensen Aircraft Corp.

From industry's viewpoint,  
 research and electronics  
 gain extra power in  
 NORTHERN VIRGINIA.

You're looking at one compelling business reason why America's first 500,000-volt power line will soon feed Northern Virginia. Research centers and light, technical industries are multiplying in this key area just across the Potomac from Washington. And they can make good use of the million new kilowatts VEPCO's line will bring.

If you have such a research or technical plant in mind, ask VEPCO about available sites. You'll find here a high concentration of specially trained

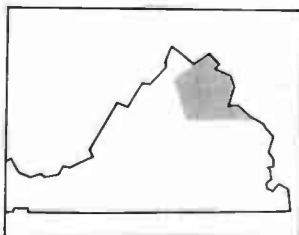

people. You'll be next door to the research resources of the nation's capital. And you'll be surrounded by some of the pleasantest living in all America. Write, wire or phone in confidence, without cost or obligation.

**VIRGINIA ELECTRIC and POWER COMPANY**   
 J. Randolph Perrow, Manager—Area Development  
 Electric Building, Richmond 9, Virginia • Milton 9-1411  
 Serving the Top-of-the-South with 2,540,000 kilowatts—due to reach 3,500,000 kilowatts by 1965.



*Many years ago Lavoie Laboratories started using Allen-Bradley hot molded resistors...time has endorsed their decision*



To insure the highest degree of accuracy and dependability in their laboratory-type oscilloscope, Lavoie engineers demanded the ultimate in performance from every component used. In fixed and variable resistors, the choice was Allen-Bradley... and for good reasons.

In the field of fixed composition resistors, none can even approach the proven performance record established by the more than ten billion Allen-Bradley hot molded resistors—now in service—without a single known instance of catastrophic failure! Furthermore, their conservative ratings, stable characteristics, and uniformity—which are possible only with Allen-Bradley's exclusive hot molding process—permit accurate prediction of long term resistor performance.

Allen-Bradley's famous Type J variable resistors—also made by the exclusive hot molding process—have a solid resistance element that provides smooth, quiet control. The "noise factor"—low as it is to start with—becomes even better with use. On accelerated tests, the Allen-Bradley Type J control has repeatedly demonstrated the life of over 100,000 operations—with less than a 10% resistance change.

Why not follow the Lavoie Laboratories' example? You, too, can benefit by standardizing on Allen-Bradley hot molded fixed and variable resistors. For more detailed information on these and other A-B electronic components, please write for Publication 6024: Allen-Bradley Co., 110 West Greenfield Avenue, Milwaukee, Wisconsin 53204. In Canada: Allen-Bradley Canada Ltd., Galt, Ontario.

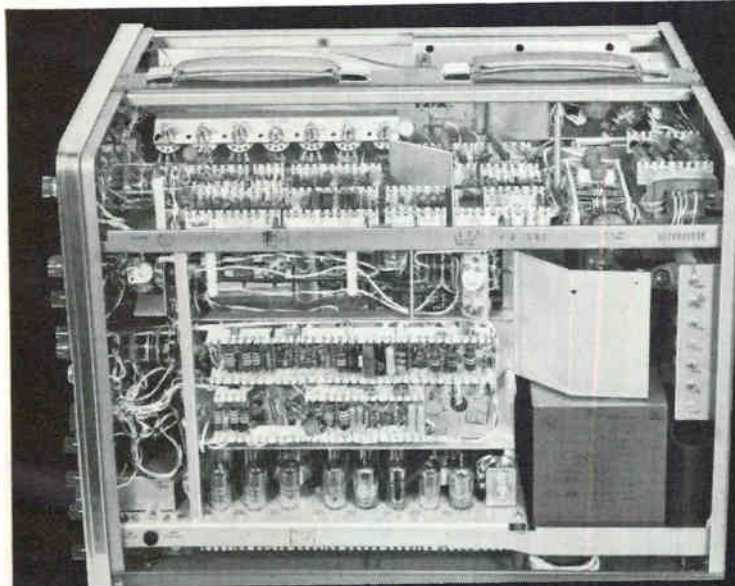

Lavoie oscilloscope LA-265A with cover removed, showing extensive use of Allen-Bradley fixed and variable resistors.



- TYPE TR 1/10 WATT      MIL TYPE RC 06
- TYPE CB 1/4 WATT      MIL TYPE RC 07
- TYPE EB 1/2 WATT      MIL TYPE RC 20
- TYPE GB 1 WATT      MIL TYPE RC 32
- TYPE HB 2 WATTS      MIL TYPE RC 42

HOT MOLDED FIXED RESISTORS are available in all standard EIA and MIL-R-11 resistance values and tolerances, plus values above and below standard limits.



A-B Type J controls are rated 2.25 watts at 70°C and are available in standard tapers and standard total resistance values up to 5 megohms. Special tapers and special, as well as higher, resistance values are also available.

# ALLEN-BRADLEY

## QUALITY ELECTRONIC COMPONENTS

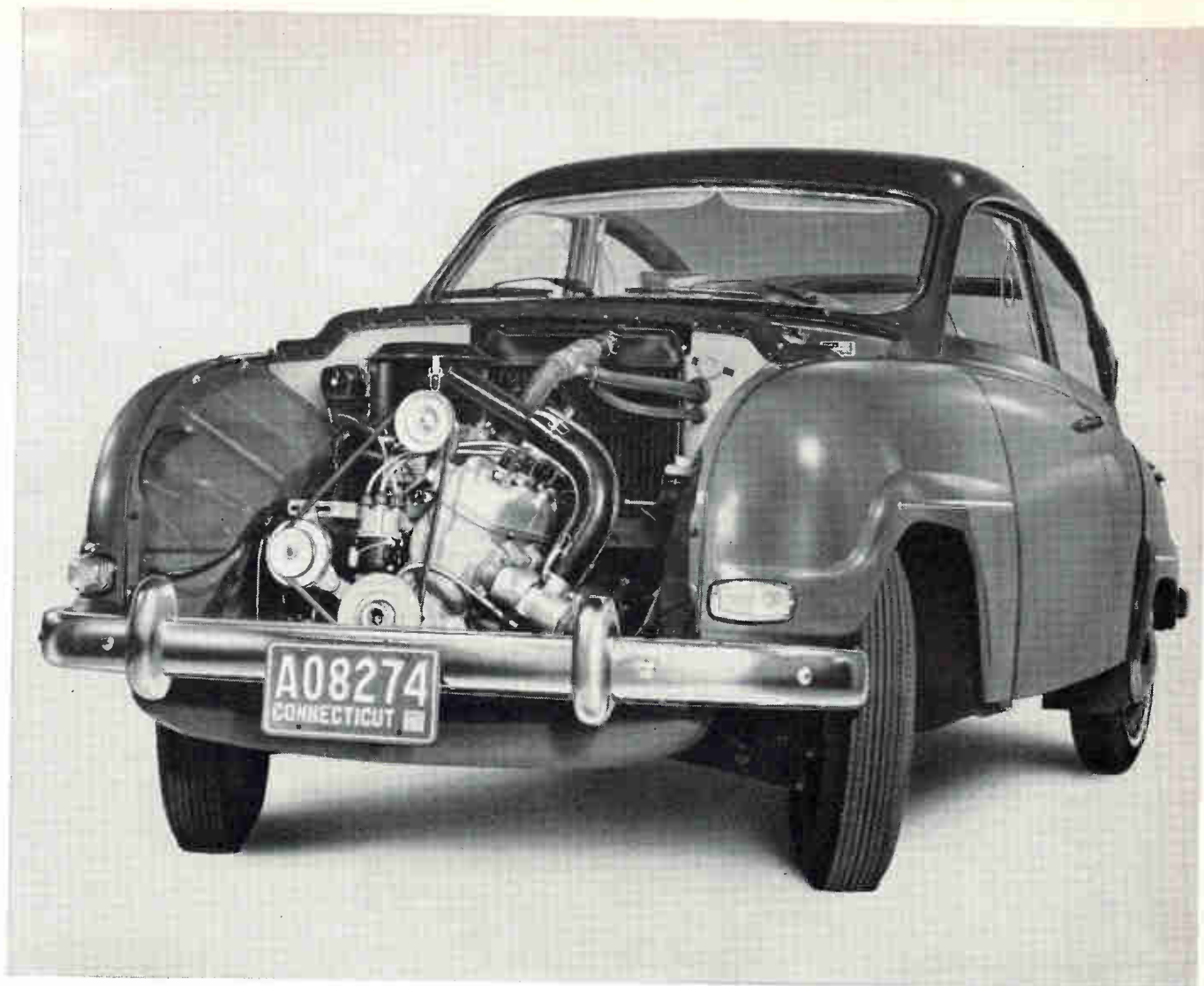

White sidewalls optional at extra cost.

## Bonneville Nationals: 103.56 mph. Yet a SAAB engine has only 3 cylinders and takes oil in the gas tank. Strange.

All cars that race at Bonneville have specially prepared engines. So did SAAB. Basically, though, the engine is the same. It is a 2-stroke engine with no valves and only 7 basic moving parts. That's hundreds fewer than conventional engines have; and hundreds fewer sources of friction, wear and potential trouble.

And because SAAB's 3-cylinder engine delivers a power stroke for every revolution, it is comparable to a 6-cylinder engine in torque, pickup and hill climb. But unlike a "6", it gets 28 to 38 mpg. It also grows old gracefully, with a minimum of maintenance. Strange powerplant. But very sensible.\*

With a SAAB, you put oil right in the gas tank (there is no crankcase). And no problem. The engine likes it that way because it continually receives a fresh bath of uncontaminated oil. There are fewer things to worry about: No oil pump. No oil filter. No clogged oil lines. No acids. No sludge. And, of course, no oil change. Strange powerplant? Ingenious powerplant! If you've never driven a car with a 2-stroke engine, see your SAAB dealer. And test-drive a 1964 SAAB. Only **\$1895**, P.O.E. Shopping imports? Write for full descriptive literature on SAAB. SAAB Overseas, Inc., Department 411, 405 Park Ave., New York, N.Y.

\*Engine, transmission and differential warranted for 2 years or 24,000 miles.



Bonneville Salt Flats 1963: Modified SAAB 96 hits 103.56 mph.

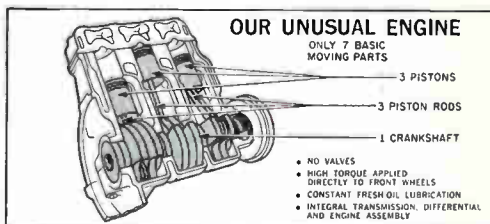

**SAAB** STURDY • STYLISH • SWEDISH  
New York • New Haven • Denver • Jacksonville

CIRCLE 299 ON READER SERVICE CARD

# ITU Agrees on Space Allocations

GENEVA—ITU conference sources here report agreement on two important issues: the allocation of 136-137 Mc for space research, and measures to ensure compatibility between space and terrestrial services sharing the same part of the spectrum, notably in the 1-10 Gc range. Intricate standards for signal strength and geographical distance coordination have been worked out.

Observers stress the generally satisfactory compromise reached between U.S. and Soviet proposals. It is believed at least 60 percent of the original U.S. proposals will come out in the final allocations, possibly as much as 90 percent. (In Washington, the State Department said "the results of the conference were satisfactory and did on the whole meet our requirements." The allocations for communications satellites "should be sufficient to accommodate anticipated traffic growth until the period 1975-80," a spokesman said.)

Here are other preliminary space allocations granted on an exclusive basis—

Space research, 15.25-15.35, Gc; telemetering, 401-402 Mc, 420-450 Mc, 1.525-1.540 Mc; radioastronomy, 2.690-2.700 Mc, 73.00-74.60 Mc, 31.3-31.5 Gc, 15.35-15.4 Gc; radio-navigation-satellites, 149.9-150.05 Mc, 399.9-400.05 Mc, 14.3-14.4 Gc.

Allocations assigned on a nonexclusive basis: space research, 30.005-30.010 Mc, 174-216 Mc, 2.290-2.300 Mc, 5.250-5.350 Mc, 8.400-8.500 Mc, 400.05-401 Mc, 31-31.3 Gc, 31.5-31.8 Gc, 31.8-32.3 Gc, 34.2-35.2 Gc, 15,762-15,768 kc, 18,020-18,035 kc, 143.6-143.65 Mc; telemetering, 136-137 Mc, 143.6-143.65 Mc; tracking, 136-137 Mc, 143.6-143.65 Mc.

Radioastronomy, 4.990-5.000 Mc, 37.75-38.25 Mc, 33-33.4 Gc, 1,660-1,700 Mc, 460-470 Mc; radionavigation, 33-33.4 Gc, 31.8-32.3 Gc; meteorological satellites, 400.05-401 Mc, 1,660-1,700 Mc, 460-470 Mc, 1,770-1,790 Mc; communication satellites (satellite-to-earth), 3.400-4.200 Mc, 4.400-4.700 Mc, 5.725-6.425 Mc, 7.250-7.750 Mc, 7.900-7.975 Mc; communications satellites (earth-to-satellite) 5.725-6.425 Mc; telecommand, 1.427-1.429 Mc; satellite identification, 30.005-30.010 Mc, 174-216 Mc.

## Airborne Infrared Unit Will Detect Submarines

INFRARED SYSTEM for ASW detection and monitoring has been designed for the Navy by Ehrenreich

## Sonar Steers Ship

BOSTON—A four-headed nautical navigator that automatically and continually plots position while a ship is underway has been developed by Raytheon for the Navy. The sonar navigator can not only "see" in front and behind but takes in port and starboard as well.

In development for five years, the device bounces four signals simultaneously off the ocean's bottom. Echoes are compared with transmitted signals and the results written in ink on the ship's navigational chart.

As the navigator gives the position at all times, a skipper can pilot his ship through fog or a blinding storm. The track displayed is more easily interpreted than ship-centered radar information, Raytheon says. In a recent trial aboard Raytheon test boat Alan on Narragansett Bay, the navigator recorded the vessel's point-to-point progress with an exactness rarely achieved by conventional methods, the firm said.

Photo-Optical Industries. Now being studied by the Navy's weapons bureau, the unit employs a closed-circuit tv photographic pulse camera mounted in a pod under a plane's wing, along with associated infrared sensor and servo tracking equipment. Entire lens display, registered through an 85-mm to 250-mm motorized zoom lens, is transmitted to an 800-line scan tv monitor.

## Electronic Bookie

FAST ON THE HEELS of the vote in New York favoring off-track betting, Electronic Assistance Corp. says it has an electronic betting system ready for citywide horse parlors if and when the state legislature makes them legal. EAC predicts that the equipment could handle more than 1 million bets daily, and could be applied to other sports. It combines push-button ticket issuing and cashing machines with conventional data recording-processing equipment, the firm says. With it, a bet could be placed in seven-tenths of a second, recorded, and later verified before payoff

## Metal-Base Transistor Developed at SRI

MENLO PARK, CALIF.—A transistor with a low-resistance metal base developed by D. V. Geppert, of Stanford Research Institute, can be used in microwave circuits, but because of low gain cannot be used at low frequencies. Metal base layer is about 100 Å thick and can be copper, gold or molybdenum, but molybdenum is preferred.

SRI is also working on large-area emitter structures, using an all-vapor-deposition technique. Structure is silicon-molybdenum-silicon. Units with alphas up to 0.7 and betas just over 1.0 have been built. SRI expects to get betas over 10 by better control of vapor deposition.

## Poor Workmanship Means Shutdowns—NASA

BOSTON—NASA will "shut down the production line" in Apollo contractors' plants whenever workmanship and quality control become substandard. That's the word from

Apollo spacecraft program manager J. F. Shea. Speaking last week at a NEREM session, Shea said that in the Mercury program, "some spacecraft were accepted with waivers at the McDonnell plant, and defects corrected at Cape Canaveral." He added: "The Cape people were not very happy about it" (p 20, Oct. 11, p 11 and 20, Oct. 18). "You have to make some tradeoffs," he said, "but at times in the Mercury program we should have shut down the production line. There's nothing like shutting down the production line to shake people up. And in Apollo, we will do it."

## 2,300-Å Laser Beams Called Boon to Chemists

BOSTON — One-megawatt laser beams at 2,300 Å should be available soon and will provide important tools for chemists, according to a research scientist from one of the principal centers pursuing nonlinear optics. In a NEREM talk last week, R. W. Minck of Ford Motor Co. Scientific Lab said the high-power output at 2,300 Å will be achievable by generating the third

harmonic of a ruby laser output for 10 to 20-nanosecond pulses. The resulting photon energy, he said, would be comparable to electron bonding energy and will cause uv-excited chains of molecules to recombine. Minck said ruby rods under development at Linde Co. may open the way for much better conversion efficiency for second and third harmonic generation and to a wider range of frequencies.

## FAA Gets Quasi-Doppler Radio Direction Finder

QUASI-DOPPLER radio direction finder system, developed by Servo Corp. of America for the FAA, has largely overcome errors due to site location and ambiguities, according to a Servo spokesman. The quasi-doppler system impresses a phase modulation on a signal received from an aircraft. The phase modulation is generated by sampling a circular array of antennas. The envelope of the phase modulation is compared to a known, fixed reference to establish the direction from which the received signal came. Volume production of the direction

finders has been started under a \$2.7-million FAA contract. The systems will be used as back-up equipment at large, busy airports, and for primary aircraft identification and position determination at smaller airports.

## France Seen Building An Electronics Giant

PARIS—Efforts to build France's electronics-computer industry into an international monolith—a government objective for some time—took a big step ahead last week with the announcement of a high-level personnel move. Jean Bigard, still number-two man at the country's leading electronics house, CSF (Compagnie de Telegraphie Sans Fil), has also become general manager of the top French computer firm, Compagnie des Machines Bull.

Insiders say it means the two outfits will coordinate R&D programs. Although both plan to retain fiscal autonomy, they are in fact linked through the Banque de Paris et des Pays-Bas which controls CSF and holds high stakes in Bull's financing. Besides these interests, the Banque has wired into a loose but real network a number of other French computer-electronics moneymakers.

## MEETINGS AHEAD

DIGITAL COMPUTER EQUIPMENT USERS SOCIETY MEETING, DECUS, Lawrence Radiation Laboratory; Livermore, Calif., Nov. 18-19.

ENGINEERING IN MEDICINE AND BIOLOGY ANNUAL CONFERENCE, IEEE, ISA; Lord Baltimore Hotel, Baltimore, Md., Nov. 18-20.

NUCLEAR ELECTRONICS INTERNATIONAL SYMPOSIUM, SFDERE; Unesco Headquarters, Paris, France, Nov. 25-27.

ULTRASONICS ENGINEERING SYMPOSIUM, IEEE-PTGUE; Marriott Motor Hotel, Washington, D. C., Dec. 4-6.

VEHICULAR COMMUNICATIONS NATIONAL CONFERENCE, IEEE-PTGVC; Adolphus Hotel, Dallas, Texas, Dec. 5-6.

FALL URSI MEETING, IEEE Seattle Section, URSI, Boeing Scientific Research Laboratories; University of Washington, Seattle, Wash., Dec. 9-12.

FIRST MICROELECTRONICS CONFERENCE, EIA; Irvine Auditorium, University of Pennsylvania, Philadelphia, Penna., Dec. 10-11.

NON-LINEAR PROCESSES IN THE IONOSPHERE MEETING, NBS; Central Radio Propagation Laboratory, Boulder, Colo., Dec. 16-17.

AMERICAN ASSOCIATION FOR THE ADVANCEMENT OF SCIENCE MEETING, AAAS; Cleveland, Ohio, Dec. 26-30.

RELIABILITY-QUALITY CONTROL NATIONAL SYMPOSIUM, IEEE, ASQC, ASME, EIA; Statler Hilton Hotel, Washington, D. C., Jan. 7-9.

INSTRUMENTATION SYMPOSIUM, ISA North Central Area; New Sheraton-Ritz Hotel, Minneapolis, Minn., Jan. 30-31.

WINTER POWER MEETING, IEEE; Statler Hilton Hotel, New York, N. Y., Feb. 2-7.

### ADVANCE REPORT

NATIONAL SYMPOSIUM, SID; *El Cortez Hotel, San Diego, Calif., Feb. 26-27, 1964; Dec. 10 is deadline for sending four copies of 250-word abstracts and summaries, plus affiliation and resume, to Mr. Sherman H. Boyd, 4281 View Place, San Diego 15, Calif. Some topics include systems development, human factors, techniques and devices, software, standardization.*

## Stress Tests Devised For Encapsulated Units

SAN FRANCISCO—Lockheed Missiles and Space Co. is developing a technique to measure stresses imposed on electronic components in encapsulated assemblies. Tiny 50-mil ferrite cores are imbedded into the epoxy at time of encapsulation, and the magnetostriction principle allows measurements of output differential which can be calibrated into stress parameters. Lockheed says it has measured stresses up to 20,000 psi with the technique, and considers the development a step toward solution of cracked resins causing component failures or changes in voltage outputs.

## IN BRIEF

### Laser Dispute: Was There Action?

BOSTON—Dispute over laser action in silicon carbide (p 17, Sept. 6) came into sharp focus last week when a paper on the room-temperature c-w laser, at 4,560 Å in the blue, was scratched from a NEREM post-deadline session by its author, Arthur J. Rosenberg of Tyco Laboratories.

He told NEREM officials he did so because there was no more to report. The previous week, GE's Robert N. Hall, disputed Tyco's claim. And the same day the paper was withdrawn, Robert H. Rediker, of MIT Lincoln Lab, told the NEREM conferees:

"Tyco will agree that they have not at this point furnished conclusive proof of laser action." He added that "with the exception of the controversial silicon carbide, all diode lasers announced to date have direct-gap transitions. The possibility of laser action is at least three orders of magnitude larger for direct-gap materials than for indirect." A mode pattern in spiking, he said, is the "proof of the pudding" of laser action.

Charles E. Ryan, chief of the Solid State Division of Air Force Cambridge Research Labs, commented that Tyco's claim has not been clearly established nor clearly disproved. The mode of lasing is not the same mode as has been observed in, say, gallium arsenide, he said. AFCRL has for years been sponsoring development of the traveling-solvent method of crystal growing, employed by Tyco. AFCRL also sponsors Hall's diode-laser investigations

**ELECTRO-OPTICAL** Systems Inc. says it has achieved chelate laser oscillation from a new five-ligand europium compound in liquid solution that could possibly go c-w (see p 67). Higher quantum efficiencies near room temperature are gained through a new method the firm calls inter-intra-molecular energy transfer.

**WESTERN PACIFIC** Railroad will install a coast-to-coast management information and control system. GE will provide the real-time computer equipment and systems engineering support.

**OWENS-ILLINOIS** and Bendix are planning to build plants in Mexico. Owens-Illinois will manufacture tv tubes and Bendix auto and boat radios and navigation aids.

**JOINT COMPANY** will be formed by Xerox and P. R. Mallory to produce adaptable microcircuit boards. First of the thin-film, multilayer devices will be a two-layer type.

**COMPANY PURCHASES** — Electronic Devices Inc. bought Raytheon's Trans-Sil Corp. Geo Space Corp. bought Electroynamics Instrument Corp. Ampex bought Allegritech's Western Division. National Aeronautical Corp. bought Electro-Nuclear Apparatus Co. Litton plans to buy Clifton Precision. United Electroynamics has agreed to purchase Allied Research Associates.

**SPERRY RAND** has been named by the Air Force to fill a \$37-million order for electronic data processing equipment (p 7, June 14). It will facilitate base-level inventory accounting at 152 sites.

**STEPS TAKEN** by the Defense Electronics Supply Center to simplify procedures for vendors will be discussed at a seminar Dec. 3 at Fort Jay, N. Y.

**FAIRCHILD** Semiconductor has reportedly developed silicon planar diodes for use as low-power microwave signal sources.

**11 STATES** have contributed \$247,000 to help Michigan continue advanced studies of electronic highway control outside Detroit (p 14, Dec. 28, 1962). Tests employ 14 closed-circuit tv cameras with wide-angle and telescopic lenses.

### Phone Companies Test

#### Electronic Switching

**ELECTRONIC** telephone switching is moving out of the labs and into the field. The concept will receive two more major trials next year by two different companies. GT&E will try out its exchange at the 2,400-line Portage, Ind., telephone network and the Stromberg-Carlson division of General Dynamics will install its 10,000-line system for Delhi Telephone Co. in Delhi, N. Y.

### Railroad Introduces Data

#### Transmission Device

**NEW YORK CENTRAL** System has devised an Intercoupler that automatically translates data from punch cards and teletypewriter, eliminating manual code conversion before and after each TTY transmission. Output is on punch cards. Designed and built by Navigation Computer Corp. to specifications of the Central, the

device can select and delete specific unwanted data and introduce spaces between data for easier readability. Data transmission time will be cut in half, saving more than \$300,000 a year.

### Ultra-Fast Memory Called

#### 'New-Generation' Device

**NEWPORT BEACH, CALIF.**—Philco unveiled a computer memory last week that it says represents a "new generation" of devices. The 10-Mc biax unit stores 50,000 bits of information in 1,024 words and is capable of reading out 48 bits of data in 0.1 microsecond. Stored data is secured in a maximum of 85 nanoseconds, with words extracted randomly or sequentially at any rate up to 10 Mc or every 100 nanoseconds. Read/write cycle time is 10  $\mu$ sec and writing is accomplished in 3.5  $\mu$ sec. The unit, developed for \$500,000, will sell for \$135,000 each.

*Simplex Electronic Cables . . .*

**Stabilize Frequency Response**

**Eliminate Radiation**

**Lower Cable Attenuation**

Newest of the Simplex electronic cables, economical Foam-Cel foam-polyethylene insulated coaxial cable, is filled with tiny air cells which provide superior insulating qualities in high frequency transmission. Ideal as community TV antennas, closed circuit TV, EDP signal transmission, and information circuits of all types, Simplex Foam-Cel has a solid aluminum outer sheath which is continuously seam-welded, making the cable impervious to liquids and gases. The resultant product is one which offers superior operating characteristics to those of conventional solid dielectric cables of the same dimensions . . . at substantial savings in cost.

#### **Deep Sea Applications**



This double-armored High Molecular Weight

Polyethylene insulated Simplex electronic cable has, in addition to power and instrumentation circuits, the required tensile strength for lowering and retrieving complicated electronic equipment in ocean depths of several miles. Balanced-torque double-armored construction minimizes residual torque of the armor wires.

#### **Reduce Low-Level Signal Noise**



Simplex special polyethylene insulated

antimicrophonic designs reduce externally caused noise to a level of 2 millivolts — 96.7% lower than a typical RG 8/U cable subjected to identical severe mechanical abuse. Stocked for immediate delivery are high demand items such as 2 conductor #18 and single conductor #16. Antimicrophonic features may be incorporated in any special cable construction.

In addition to a wide variety of standard electronic cable types, Simplex has the capability to produce specific cables to meet your particular requirements. For complete details write to Department 365, Simplex Wire & Cable Co., Cambridge, Mass.



**Simplex**

**WIRE & CABLE CO.**

EXECUTIVE OFFICES: Cambridge, Mass.

Plants at Cambridge, Mass., Portsmouth, N.H.,

Westbury, L.I., Monrovia, Calif.

CIRCLE 22 ON READER SERVICE CARD



## IN BRIEF

### Laser Dispute: Was There Action?

BOSTON—Dispute over laser action in silicon carbide (p 17, Sept. 6) came into sharp focus last week when a paper on the room-temperature c-w laser, at 4,560 Å in the blue, was scratched from a NEREM post-deadline session by its author, Arthur J. Rosenberg of Tyco Laboratories.

He told NEREM officials he did so because there was no more to report. The previous week, GE's Robert N. Hall, disputed Tyco's claim. And the same day the paper was withdrawn, Robert H. Rediker, of MIT Lincoln Lab, told the NEREM conferees:

"Tyco will agree that they have not at this point furnished conclusive proof of laser action." He added that "with the exception of the controversial silicon carbide, all diode lasers announced to date have direct-gap transitions. The possibility of laser action is at least three orders of magnitude larger for direct-gap materials than for indirect." A mode pattern in spiking, he said, is the "proof of the pudding" of laser action.

Charles E. Ryan, chief of the Solid State Division of Air Force Cambridge Research Labs, commented that Tyco's claim has not been clearly established nor clearly disproved. The mode of lasing is not the same mode as has been observed in, say, gallium arsenide, he said. AFCRL has for years been sponsoring development of the traveling-solvent method of crystal growing, employed by Tyco. AFCRL also sponsors Hall's diode-laser investigations

### Phone Companies Test Electronic Switching

ELECTRONIC telephone switching is moving out of the labs and into the field. The concept will receive two more major trials next year by two different companies. GT&E will try out its exchange at the 2,400-line Portage, Ind., telephone network and the Stromberg-Carlson division of General Dynamics will install its 10,000-line system for Delhi Telephone Co. in Delhi, N. Y.

### Railroad Introduces Data Transmission Device

NEW YORK CENTRAL System has devised an Intercoupler that automatically translates data from punch cards and teletypewriter, eliminating manual code conversion before and after each TTY transmission. Output is on punch cards. Designed and built by Navigation Computer Corp. to specifications of the Central, the

device can select and delete specific unwanted data and introduce spaces between data for easier readability. Data transmission time will be cut in half, saving more than \$300,000 a year.

### Ultra-Fast Memory Called 'New-Generation' Device

NEWPORT BEACH, CALIF.—Philco unveiled a computer memory last week that it says represents a "new generation" of devices. The 10-Mc biax unit stores 50,000 bits of information in 1,024 words and is capable of reading out 48 bits of data in 0.1 microsecond. Stored data is secured in a maximum of 85 nanoseconds, with words extracted randomly or sequentially at any rate up to 10 Mc or every 100 nanoseconds. Read/write cycle time is 10 μsec and writing is accomplished in 3.5 μsec. The unit, developed for \$500,000, will sell for \$135,000 each.

ELECTRO-OPTICAL Systems Inc. says it has achieved chelate laser oscillation from a new five-ligand europium compound in liquid solution that could possibly go c-w (see p 67). Higher quantum efficiencies near room temperature are gained through a new method the firm calls inter-intra-molecular energy transfer.

WESTERN PACIFIC Railroad will install a coast-to-coast management information and control system. GE will provide the real-time computer equipment and systems engineering support.

OWENS-ILLINOIS and Bendix are planning to build plants in Mexico. Owens-Illinois will manufacture tv tubes and Bendix auto and boat radios and navigation aids.

JOINT COMPANY will be formed by Xerox and P. R. Mallory to produce adaptable microcircuit boards. First of the thin-film, multilayer devices will be a two-layer type.

COMPANY PURCHASES — Electronic Devices Inc. bought Raytheon's Trans-Sil Corp. Geo Space Corp. bought Electro-dynamics Instrument Corp. Ampex bought Allegri-Tech's Western Division. National Aeronautical Corp. bought Electro-Nuclear Apparatus Co. Litton plans to buy Clifton Precision. United Electro-dynamics has agreed to purchase Allied Research Associates.

SPERRY RAND has been named by the Air Force to fill a \$37-million order for electronic data processing equipment (p 7, June 14). It will facilitate base-level inventory accounting at 152 sites.

STEPS TAKEN by the Defense Electronics Supply Center to simplify procedures for vendors will be discussed at a seminar Dec. 3 at Fort Jay, N. Y.

FAIRCHILD Semiconductor has reportedly developed silicon planar diodes for use as low-power microwave signal sources.

11 STATES have contributed \$247,000 to help Michigan continue advanced studies of electronic highway control outside Detroit (p 14, Dec. 28, 1962). Tests employ 14 closed-circuit tv cameras with wide-angle and telescopic lenses.

## **Advisor Change Won't Overturn Science Policy**

**Indications are** that the new presidential science advisor, Donald F. Honig, was handpicked by Jerome B. Wiesner, the retiring advisor. The choice of Honig, Princeton University professor of chemistry, will therefore leave hardly a ripple on the face of White House science and technology policy. Wiesner is expected to return to teaching at Massachusetts Institute of Technology by early spring.

Honig and Wiesner have worked together off and on since they were group leaders at the Los Alamos Scientific Laboratory in the mid-1940's. Honig joined the President's Science Advisory Committee shortly after Wiesner came to Washington in 1960. Their views are much alike on the need for balanced support for science and technology as a general stimulus to the economy as military demands on R&D level off and phase out. Honig has served as chairman of the PSAC panels on space sciences and space vehicles, and has been a supporter of military space programs in a single service.

## **UHF Tv Facing Another Battle For Key Cities**

**This week, FCC** will again try to decide the crucial vhf-tv drop-in issue. Tv set makers and broadcasters will watch the outcome closely. They can be expected to come up with some bearish views on the prospects for all-channel television if the Federal Communications Commission goes ahead with its proposal to put vhf assignments in seven big markets, instead of preserving them for uhf development (ELECTRONICS, p 7, March 1; p 12, March 15; p 10, June 14). Commissioner Lee Loevinger will cast the deciding vote, for the other members are split three to three. Already, there are sour reactions over FCC's failure to put a commercial uhf assignment in New York City, in the recently proposed new table of uhf allocations. Some savvy marketers are insisting that uhf can never be revived without a strong, pacesetting commercial uhf station in New York.

## **Congressman Says FAA Pays Too Much for Nav aids**

**FAA's long-time critic**, Rep. Henry Gonzalez (D-Tex.), has renewed his charges that the Federal Aviation Agency pays five or six times more for electronics navigation aids than airlines and state governments. The congressman lays this to the "poor judgment" of FAA Administrator Najeeb E. Halaby. The charge stems from complaints earlier this year by the Air Transport Association. But FAA contends that most of the deficiencies in its buying practices have been corrected, and ATA agrees. The overspending resulted mainly because procurement was divided among various groups, rather than being centralized, with the result that specifications were set so high that "gold-plated" purchases were being made.

## **Space Race Renewed Too Late To Help Apollo**

**The crossfire of high-level chatter** over the moon race has left Project Apollo badly wounded. President Kennedy dealt the heaviest blow with his suggestion for U.S.-USSR moon-shot cooperation. This took the urgency out of the program, possibly permanently. The confusion was compounded by Premier Khrushchev's remarks, widely interpreted to mean Russia had quit the race. Kennedy then said Khrushchev meant no such thing, and Khrushchev agreed (see p 5). Since little was known about the Russian moon effort to start with, the statements did little more than increase the confusion. The best estimate of the situation now is that the manned space platform before long will succeed the man-on-the-moon effort as NASA's glamor program, and that space spending will level off at \$5 billion a year or a little less.

**Now!**

permanent magnet torquers and  
motor synchronism  
indicators



**the Reeves 12IG is the smallest (1.2 inch diameter) miniature inertial-type floated gyro to offer these advanced design features**

**PERMANENT MAGNET TORQUER**

Permanent Magnet series are adaptable to pulse torquing techniques, and are ideally suited for digital computer applications and strap-down inertial navigation systems. P.M. models are supplied with two coils which may be wired in series or parallel, or used independently.

**SIMPLIFIED SYSTEM CHECK-OUT**

The second coil, when used independently, permits ready "end-to-end" check-out of an entire system.

**MOTOR SYNCHRONISM INDICATOR**

A built-in circuit provides positive remote indication of spin-motor operation and synchronism.

In addition to the Permanent Magnet torquer models, the 12IG can also be supplied with conventional microsynchronism torquers. Reeves has designed a companion rate gyro employing torsion bar restraint (Model 12RG) with equally high performance characteristics.

A complete line of servo amplifiers, including pre-amplifiers, power amplifiers and proportional temperature control amplifiers, is available, designed especially to be used in conjunction with the 12IG. The gyros can be supplied in either beryllium or aluminum.

For the ultimate in inertial reference and stabilization systems, specify the ultimate in Miniature Gyros — The Reeves 12IG Floated Gyro. Write for Data File 111.

**typical specifications**

PARAMETER	UNITS	MICROSYN TORQUER	P.M. TORQUER
Wheel Speed	r.p.m.	24,000/12,000	24,000/12,000
Angular Momentum	c.g.s.	30,000/15,000	30,000/15,000
Torquing Rates (max)	deg/sec	20/40	12/24 (one coil) 24/48 (two coils)
Damping Constant <sup>(1)</sup>	dyne-cm sec/rad	60,000	60,000
Gimbal Angle	degrees	±5	±5
Mom. of Inertia	gm-cm <sup>2</sup>	30	30
T.G. Sensitivity	dyne-cm	2/ma <sup>2</sup>	60/ma
S.G. Sensitivity <sup>(2)</sup>	mv/mr	5	5
Mass Unbalance	deg/hr/g	<1	<1
Anisoelasticity	deg/hr/g <sup>2</sup>	.01	.01
Trimmed Drift Rate	deg/hr	<0.1	<0.1
Wheel Power	watts	1.5	1.5
Wheel Excitation	line-to-line	26v,3φ,400 cps	26v,3φ,400 cps
Torque Linearity	%	0.5	0.01
Size	inches	1.2 x 2.5	1.2 x 2.56
Weight	ounces	6	6

**NOTES:**

(1) Gyros can be supplied for any value of damping constant from 15,000 to 120,000.  
(2) At 400 cps, 50 ma input. This parameter is directly proportional to current and frequency. Range is to 5,000 cps, and 100 ma input. Tuning the output will increase sensitivity by a factor of 5.

Qualified engineers seeking opportunities in these fields are invited to get in touch with us.



**REEVES INSTRUMENT COMPANY**  
Division of Dynamics Corporation of America, Roosevelt Field, Garden City, N. Y.

15RV63

*Simplex Electronic Cables . . .*

**Stabilize Frequency Response**

**Eliminate Radiation**

**Lower Cable Attenuation**

Newest of the Simplex electronic cables, economical Foam-Cel foam-polyethylene insulated coaxial cable, is filled with tiny air cells which provide superior insulating qualities in high frequency transmission. Ideal as community TV antennas, closed circuit TV, EDP signal transmission, and information circuits of all types, Simplex Foam-Cel has a solid aluminum outer sheath which is continuously seam-welded, making the cable impervious to liquids and gases. The resultant product is one which offers superior operating characteristics to those of conventional solid dielectric cables of the same dimensions . . . at substantial savings in cost.

#### **Deep Sea Applications**

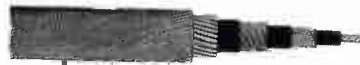

This double-armored High Molecular Weight

Polyethylene insulated Simplex electronic cable has, in addition to power and instrumentation circuits, the required tensile strength for lowering and retrieving complicated electronic equipment in ocean depths of several miles. Balanced-torque double-armored construction minimizes residual torque of the armor wires.

#### **Reduce Low-Level Signal Noise**



Simplex special polyethylene insulated

antimicrophonic designs reduce externally caused noise to a level of 2 millivolts — 96.7% lower than a typical RG 8/U cable subjected to identical severe mechanical abuse. Stocked for immediate delivery are high demand items such as 2 conductor #18 and single conductor #16. Antimicrophonic features may be incorporated in any special cable construction.

In addition to a wide variety of standard electronic cable types, Simplex has the capability to produce specific cables to meet your particular requirements. For complete details write to Department 365, Simplex Wire & Cable Co., Cambridge, Mass.



**Simplex**

**WIRE & CABLE CO.**

EXECUTIVE OFFICES: Cambridge, Mass.

Plants at Cambridge, Mass., Portsmouth, N.H.,

Westbury, L.I., Monrovia, Calif.

CIRCLE 22 ON READER SERVICE CARD

# NOW AVAILABLE FROM STOCK!



## FM-AM SIGNAL GENERATOR

### TYPE 202-H

#### RADIO FREQUENCY CHARACTERISTICS

RF RANGE: 54-216 MC

RF ACCURACY:  $\pm 0.5\%$

RF OUTPUT RANGE:

0.1  $\mu$ v to 0.2 volts\*

\*Across external 50 ohm load at panel jack

ACCURACY:

$\pm 10\%$ , 0.1  $\mu$ v to 50 K  $\mu$ v

$\pm 20\%$ , 50 K  $\mu$ v to 0.2 volts

AUTO LEVEL SET:

Holds RF monitor meter to "red line" over band

IMPEDANCE: 50 ohms

VSWR:  $< 1.2$

#### SPECIFICATIONS

#### AMPLITUDE MODULATION CHARACTERISTICS

AM RANGE:

Internal: 0-50%

External: 0-100%

AM ACCURACY:

$\pm 10\%$  at 30% and 50% AM

AM DISTORTION:

$< 5\%$  at 30%  $< 20\%$  at 100%

$< 8\%$  at 50%

AM FIDELITY:

$\pm 1$  db, 30 cps to 200 KC

#### FREQUENCY MODULATION CHARACTERISTICS

FM RANGE:

Internal: 0-250 KC in 4 ranges

External: 0-250 KC in 4 ranges

FM ACCURACY:  $\pm 5\%$  of full-scale\*

\*For sine-wave

FM DISTORTION:

$< 0.5\%$  at 75 KC (100 MC and 400 cps modulation only)

$< 1\%$  at 75 KC (54-216 MC)

$< 10\%$  at 240 KC (54-216 MC)

FM FIDELITY:

$\pm 1$  db, 5 cps to 200 KC

SIGNAL-TO-NOISE RATIO:

$> 60$  db below 10 KC

#### PULSE MODULATION CHARACTERISTICS

PM SOURCE: External

PM RISE TIME:  $< 0.25$   $\mu$ sec

PM DECAY TIME:  $< 0.8$   $\mu$ sec

#### MODULATING OSCILLATOR CHARACTERISTICS

OSC FREQUENCY:

50 cps 7.5 KC 1000 cps 15 KC

400 cps 10 KC 3000 cps 25 KC

OSC ACCURACY:  $\pm 5\%$

OSC DISTORTION:  $< 0.5\%$

#### PHYSICAL CHARACTERISTICS

MOUNTING: Cabinet for bench use;

readily adaptable for 19" rack

FINISH: Gray engraved panel; green cabinet (other finishes available on special order)

DIMENSIONS:

Height: 10 $\frac{3}{4}$ " Width: 16 $\frac{3}{4}$ " Depth: 18 $\frac{3}{4}$ "

#### POWER REQUIREMENTS

202-H: 105-125/210-250 volts,

50-60 cps, 100 watts

PRICE - 202-H: \$1365.00

F. O. B. Rockaway, N. J.



The Type 202-H FM-AM Signal Generator covers the frequency range from 54 to 216 MC and is designed for the testing and calibration of FM receiving systems in the areas of broadcast FM, VHF-TV, mobile, and general communications. The generator consists of a three-stage RF unit, together with a modulating oscillator and power supply, all housed in a single cabinet which may be adapted for rack mounting.

The RF unit consists of a variable oscillator, a reactance tube modulator, a doubler, and an output stage. The modulator is specially designed for minimum distortion and operated in conjunction with the electronic vernier to provide incremental changes in RF output frequency as small as 1 KC. The RF output is fed through a precision, waveguide-below-cutoff variable attenuator; automatic RF level set is incorporated which maintains "red line" on the RF monitor meter over the entire band. The entire RF unit is shock-mounted for minimum microphonism.

An internal audio oscillator provides a choice of eight frequencies which may be used for either FM or AM modulation. A modulation meter indicates either FM deviation or % AM and is calibrated for sine-wave modulation.

A completely solid-state power supply furnishes all necessary operating voltages and may be switched for inputs of either 105-125 or 210-250 volts, 50-60 cps.

Model 202-J is also available for the 215-260 MC telemetering band.

## BOONTON RADIO COMPANY

A Division of Hewlett-Packard Company



GREEN POND ROAD, ROCKAWAY, NEW JERSEY

Tel, 627-6400 (Area Code 201) TWX: 201-627-3912 Cable Address: BoonracO

# Electronics for the SST—What's Ahead?

Designers will try to lower operating costs, don't want exotic systems

By LAURENCE D. SHERGALIS  
Regional Editor, San Francisco

**SEATTLE** — Supersonic airliners will need more reliable electronics and easier maintenance. Exotic control and guidance systems and microminiature equipment will probably not be seen in the first series of these mach-2 to mach-3 aircraft.

Most airliner equipment development is aimed at lowering operating cost. Easy replacement of faulty equipment and very short turn-around time is vital for profitable operation. Supersonic transport planes (SST) must meet schedules or become too expensive to fly.

**Maintenance**—Two approaches to this problem are to be used. The first is complete redundancy of aircraft systems, including inertial navigation, control, engine moni-

toring, radio and landing. If one of the dual systems should fail, the other will go into operation.

In military operations, no redundancy is provided, but equipment is replaced before the statistical mtbf (mean time before failure). Commercial airline operators wait until equipment fails, then replace it. They feel that redundant systems are less costly.

The second approach to maintainability is the trend toward self-testing. Each equipment will use a built-in test circuit for quick checks of its operation. This is to eliminate the variety of "suitcase" testers needed to check out aircraft systems. The military is trending toward the mobile test van for flight-line testing, but airlines haven't time to wheel out a mobile test van loaded with test equipment. Often, commercial airliner turn-around time is only an hour.

In-flight monitoring is another means of maintaining aircraft. Trans World and Trans Canada airlines have been testing a system called the Airborne Maintenance Re-

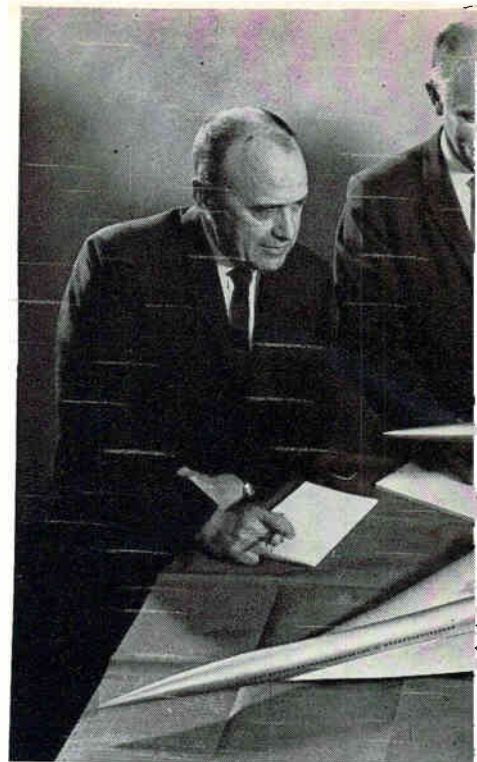

AMONG MANY DESIGNS for the SST are Lower right is Boeing's 733 variable-sweep concept called Scat 16 and behind that is

corder, made by Royston of England. It records on paper tape inputs from engines, electrical and hydraulic systems. Data from these several hundred points show the airplane's performance trend. Objective is to anticipate failure. Preliminary tests indicate engines may not have to be pulled every 2,000 hours. Also, the engineer can crank performance tolerances into the associated computer. For example, TWA reports, a jet flying with an improperly trimmed stabilizer could lose about 2 percent efficiency, raising operating cost \$18,000 a year.

These systems, say the airlines, could be a boon to the SST; performance data could be telemetered ahead to speed necessary repairs.

**Reliability** — Most aircraft electronics equipment is solid-state, reducing weight and heat, but box size has stayed about the same. New military aircraft equipment specifications call for microelectronics, but commercial operators prefer conventional construction with proven reliability.

Boeing's new 727, three-engine jet, is getting equipment considered a new family developed since the 707. Boeing engineers see another new family of solid-state equipment, suitable for the SST, coming on the market in 1964-65 period. Normal development in the industry will

---

## Computer-Radar Systems Hunt Targets

FLAT SIDES of bridge on USS Long Beach, first guided-missile cruiser, are antennas of four Hughes Aircraft Scanfar 3-D radars. Computer-controlled, inertialess rapid electronic scanning finds range, height and bearing of multiple targets. Targets are located by fan beams scanned in azimuth, and are tracked by pencil beams scanned in azimuth and elevation





these being inspected by Boeing officials. model, center is a NASA variable-sweep NASA's delta-wing Scat 17

bring this about, they say.

**Antennas**—Two problems confront the aircraft-antenna engineer—temperature-resistant materials and mounting. In mach-3 aircraft, weight will be critical. A radome material that will withstand up to about 650 F must be found. Glass fiber will probably be used, but a better binder must be found. Present radomes go to about 400 F.

Automatic direction finders require large antennas. Where to put them becomes a problem on the SST. Cavities in an airplane cost money. The answer may be to improve adf performance so that performance will remain the same with lower antenna requirements.

**Control Systems**—Adaptive controls will not be necessary, say Boeing engineers, since programmed systems will probably give the required performance. A probable requirement is a stability-augmentation system (SAS), operating around all three axes because of the SST's low damping factor. The system will be similar to the SAS used in helicopters (ELECTRONICS, p 20, Oct. 5, 1962).

Boeing's SST work has aimed mostly at variable-sweep aircraft using different combinations of surfaces for control. This adds a new dimension to the control problem.

## "WHERE'S THAT TAPE OF 'THE ALLIGATOR GLEE CLUB AT CARNEGIE HALL'?"

*Oh, hello Rip! You got here just in time. Drop that demo on the bench and listen to this tape. It's part of a new batch that Station 16 just sent in — even worse than the ones I was telling you about.*

Worse? I'll say! Sounds like a sped-up playback of "Concerto for Seagulls and Fish Pier"! But I thought you said you were getting groans and burps?

*That's what's rough — the stations NEVER know what kind of interference they'll get next! You told me I don't need two separate filters — how is this one Krohn-Hite black box going to clear up the confusion?*



Because the 315-A is two filters . . . matter of fact, three, on one chassis. As I get it, your radio-telephone transmissions are being loused up by all kinds of noise and interference — above, below, or right in the middle of the intelligence band, and never in the same place twice. Now start that "Screaming Meemy" tape again, while I plug the 315-A into the monitor output and listen through the filter with these earphones. At the stations, they'd do just about the same on live transmission, except that when they had set the filter to maximize the intelligence, they would just switch it right into the line at any convenient a-f stage. . . . I see what you mean — I can barely make out the voice, with a horrible hash above it and below it too. Now let me switch to band-pass, and move in from the ends with both cut-offs independently. I'll spin through that top decade below 200 kc fast, since for this work you'd never hear the difference. But I just dropped out a thump somewhere down around 30 cycles — probably someone chopping liver! Here you are . . . listen to this . . . clear as a bell!

*So far so good. But keep listening. Just about here I think a pig got stuck — skewered real good at about 2 kc. Watch the gain!*

Owwwww — I just found it! Quick — let me find a real DEEP null for my aching ears! We turn to band-reject, sneak in from the sides with both dials, and . . . I think somebody just told that pig "down boy! 60 db down!!" Listen for yourself. That makes both types we've cleaned up!

*I think you've just made yourself a sale. But wait a minute — you said the 315-A is THREE filters. What's the third function?*

High-pass! ALSO tuneable all the way from 20 cps to 200 kc, with the same 24 db per octave attenuation outside the pass band. And if you ever get squawk patterns in the same spots, don't forget — the dials are direct reading and calibrated to 10%. Log 'em and kill 'em fast. Now — how about lunch to celebrate, at a low-decibel restaurant?

*I'm with you!*



**KROHN-HITE  
CORPORATION**

580 Massachusetts Avenue, Cambridge 39, Mass.  
Area Code 617 491-3211

*Pioneering in Quality Electronic Instruments*

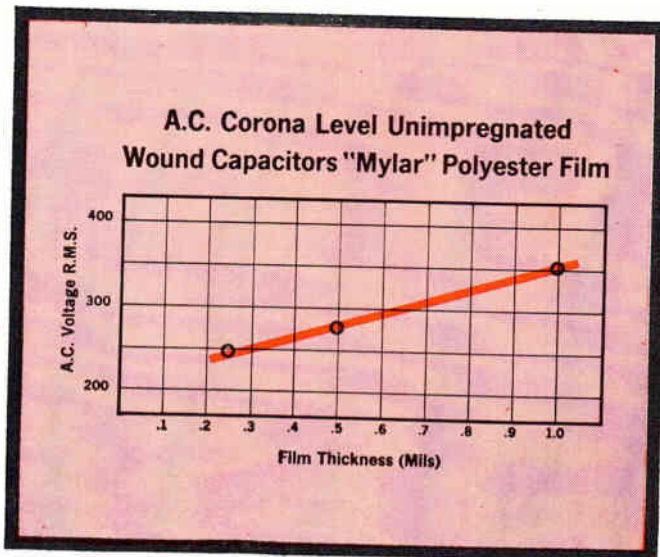

### AC CORONA LEVEL

Corona levels for various gauges of "Mylar"\* in capacitors were determined in life tests and are shown above. AC corona level is defined as the r.m.s. voltage below which corona does not exist.

**Unimpregnated Single Layer 25 Gauge Capacitors of "Mylar"**

D.C. Bias (Volts)	0	100	300
A.C. Volts R.M.S. necessary to produce corona at 25°C	290	290	290
at 125°C	285	285	280

**Unimpregnated Single Layer 50 Gauge Capacitors of "Mylar"**

D.C. Bias (Volts)	0	200	400
A.C. Volts R.M.S. necessary to produce corona at 25°C	345	350	350
at 125°C	315	320	310

### AC/DC CORONA LEVEL

Corona is a function of AC voltage only. Table shows full AC voltage must be applied before corona can exist, whatever the DC bias may be.

# AC/DC Capacitor study... New tests show compatible in

**N**ow designers can apply the high reliability and low cost of capacitors of "Mylar" to AC and AC/DC circuits. Capacitors with "Mylar" polyester film as the dielectric are completely compatible in these circuits in home entertainment equipment and similar circuits in other equipment. Data proving compatibility was developed in Du Pont's test at the Film Department Sales-Service Laboratory and at Inland Testing Laboratory.

Briefly, the tests showed that for a capacitor with a dielectric of dry "Mylar" it does not matter whether the voltage is DC, or AC, or combinations

of these voltages. There are only two limitations: (1) the AC voltage or AC component in an AC/DC situation should not exceed the corona level, and (2) the total of the DC voltage plus the r.m.s. AC should not exceed the rated DC working voltage.

Now that it's assured that these capacitors are completely functional in such circuits, designers can utilize the other advantages of "Mylar"—over-all reliability, high IR, small size, moisture resistance, capacitance stability. Remember, too—capacitors of "Mylar" cost about the same as paper.

\*Du Pont's registered trademark for its polyester film.

**TO APPLY THESE IMPORTANT FINDINGS TO YOUR DESIGN, CLIP AND MAIL THIS COUPON:**





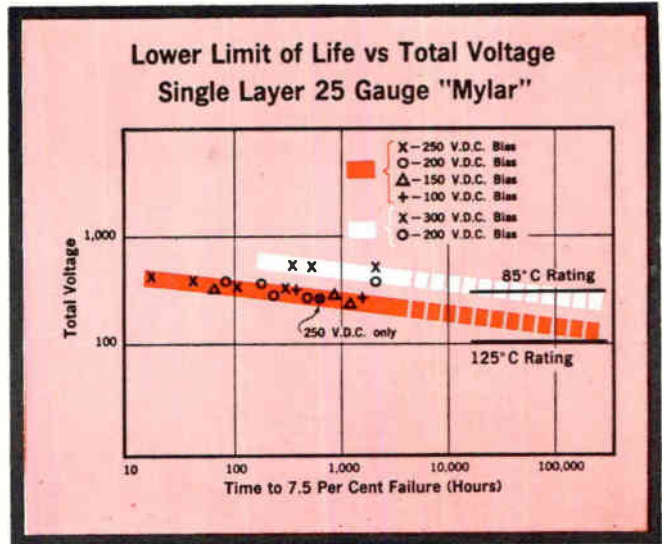
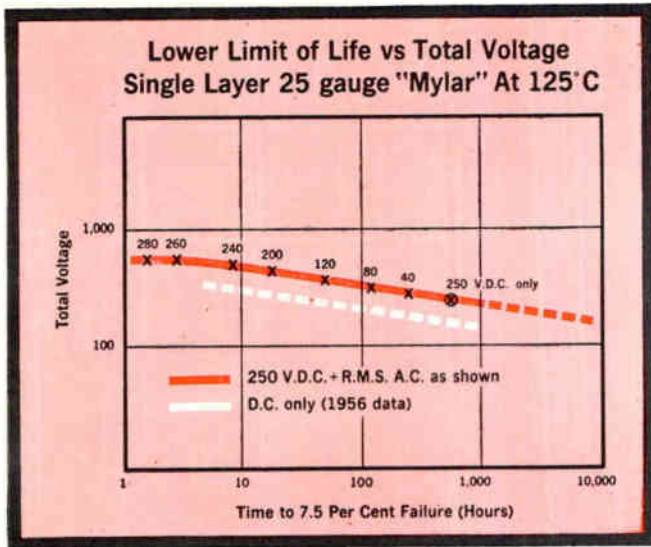

### AC/DC LIFE

Below AC corona level, life is a function of total voltage. AC/DC total voltage life performance is identical to DC life performance.

Regardless of AC/DC combinations, the basic voltage-life law is maintained, and the law applies to various operating temperatures as shown.

# capacitors of **MYLAR**<sup>®</sup> AC/DC circuits

E. I. DU PONT DE NEMOURS & COMPANY (INC.)  
**FILM DEPARTMENT**  
BOX 22B—RM. N10452 WILMINGTON 98, DELAWARE

Rush me your *Pocket Report* on "Mylar" polyester film as a capacitor dielectric for AC and AC/DC voltages.

NAME \_\_\_\_\_ TITLE \_\_\_\_\_

FIRM \_\_\_\_\_ EQUIPMENT \_\_\_\_\_

ADDRESS \_\_\_\_\_

CITY \_\_\_\_\_ STATE \_\_\_\_\_



BETTER THINGS FOR BETTER LIVING  
... THROUGH CHEMISTRY

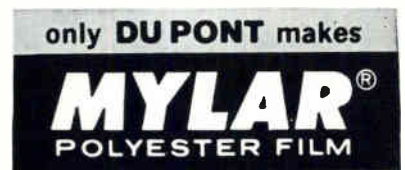

# “What this country needs is a good 5¢ computer diode”

“Psst, General Electric’s got it!”

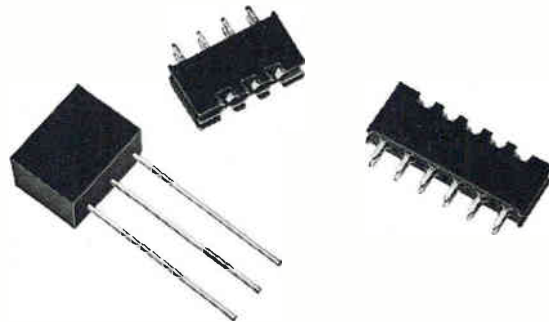

That’s right! Prices go down as low as a nickel (or less) for each diode in large quantity orders. Two different selenium diodes in three different packages give you computer circuit design freedom you never had before! The high current, high capacitance selenium diode is rated at 1 ma at 1 volt; the low current, low capacitance selenium diode is rated at 60  $\mu$ a at 1 volt . . . and both are available in the new 2, 4, and 6 paks. Electrically, they are suitable for 50 KC digital circuits, voltage stabilization, and phase detection circuitry. Parameters are produced by a

*controlled vacuum* system which gives a normal but *narrow* distribution. And the packages have been designed to withstand environmental extremes . . . and tested to *prove* that they do.

Our new selenium diodes are not only reliable and inexpensive, but they offer installation versatility that further reduces your cost. So if you have low-cost computer component specifications that you’d like us to evaluate, just drop a line to Section 16K121, Rectifier Components Department, General Electric Company, Auburn, New York.

GENERAL  ELECTRIC

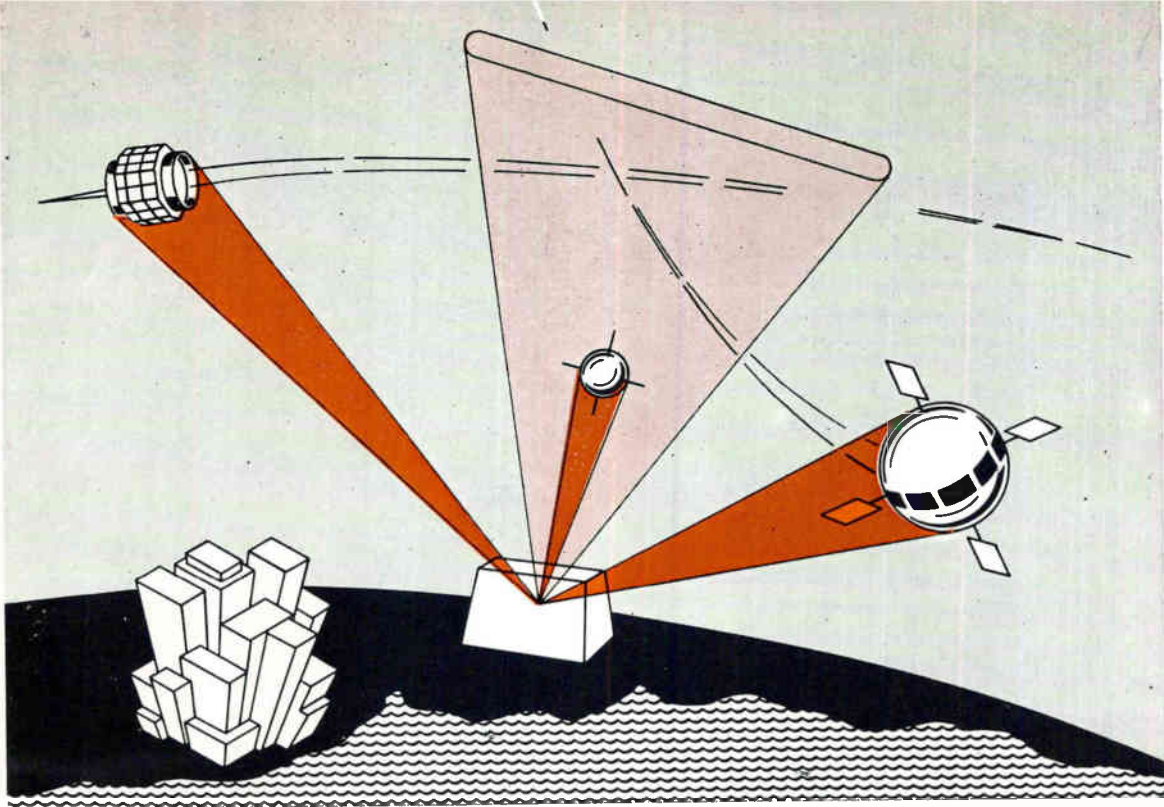

OPERATING MODES of a phased-array radar, in artist's interpretation, showing a search fence detecting a satellite, which would then be tracked as are the other two satellites

## HOW COMPUTERS ALIGN PHASED-ARRAY RADARS

By ARNOLD GUY KRAMER and ALLAN SLOCUM, Sylvania Electronic Systems, Waltham, Mass.

**WITHIN** the past few years the use of phased-array antennas as sensor elements for advanced radar systems has steadily increased. These antennas provide rapid and inertialess electronic-beam steering, using the same physical aperture to form many beams, and to perform many functions. However, from a maintenance point of view, the phased-array antenna system differs markedly from a conventional antenna. A phased-array antenna system is typically made up of a large number of components, both passive and active, interconnected in a multiterminal matrix. These components, both individually and also in particular groups, must have their transfer functions controlled within exacting limits to realize the design performance level of the array—hence the alignment and maintenance problem.

The nature of the phased-array alignment and maintenance problem is illustrated by the following example: The antenna aperture under consideration is a relatively simple one—a ten-by-ten square receiving array of elements from which ten different beams are to be formed with each beam, utilizing the entire aperture. The pattern characteristics of each beam can be related to the phase and amplitude per-

formance of each element channel in the aperture. In our example, the illumination function is assumed to be achieved by placing suitable time delays and attenuation in each signal channel between the individual antenna element and the beam output using parallel r-f beam-forming techniques. Since the output of each element is used in many beams, channels leading from each element must branch. The mini-

---

### CHALLENGE

The optimum selection of a monitoring system for the modern phased array is a carefully considered compromise involving many factors. As array systems grow in size and complexity, methods of fault location and monitoring must also evolve toward automation and system simplification. This will be in many senses an engineering challenge equal to that of the array itself

---

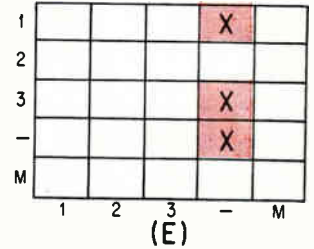
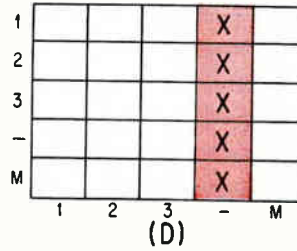
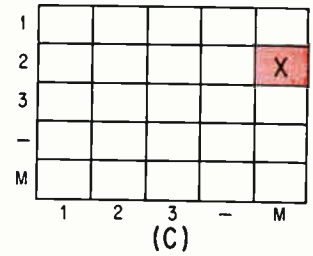
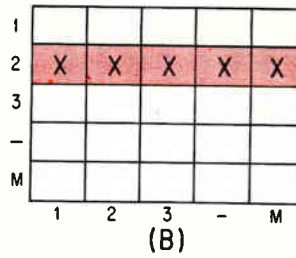
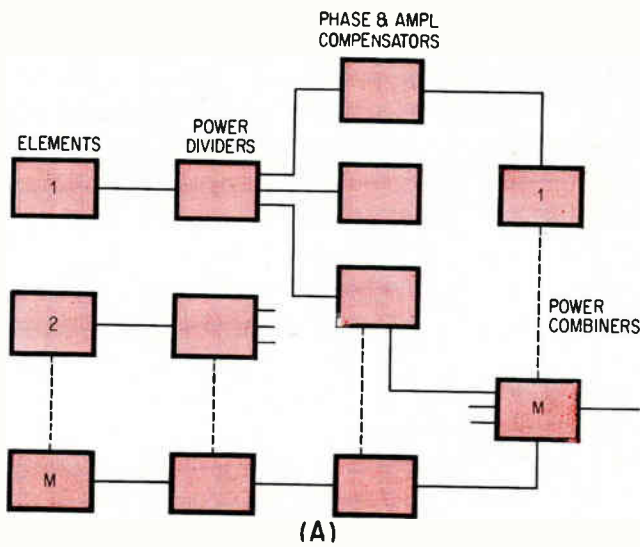

LINEAR ARRAY (A). Failure patterns, with signal channel number in the first column of each, for input (B), channel component (C), beam combiner (D) and for probable beam combiner (E)—Fig. 1

mal number of components in a signal channel consists of an element, power divider, time-delay unit, attenuator, and a beam-power combiner with interconnecting cables. The array, therefore, consists of some 1,000 different signal channels (ports of a single signal channel are an antenna element and a beam output) containing some 5,310 components, many of which are assemblies containing numerous parts. Some components are common to all beams, some to only one beam, and some lie wholly within only one signal channel. Yet all components in the matrix must have their transfer functions aligned and maintained within some specified tolerance of the no-error design value. To measure all of the individual channels is a tedious task. To measure all of the individual components is indeed a formidable task. To identify out-of-tolerance components and to correct or replace them without a carefully designed alignment-and-monitor system is difficult and inefficient, if not impossible. At the present state of the phased-array art, a ten-by-ten array is relatively small and simple. Arrays containing in excess of one hundred thousand signal channels are presently feasible. Problems relating to the design of alignment and monitor systems for the modern phased array are the subject of the following discussion.

#### General Considerations — Certain

general performance criteria for the phased-array antenna maintenance system must be derived from the mission requirements of the overall weapons or reconnaissance system. The following discussing resolves the interrelationship between mission requirements, quantities being measured, measurement techniques, degree of automation, and measurement philosophy. Two examples of working systems will then be described which are illustrative of solutions to the design problem. Briefly, the maintenance system requirements can be summarized as follows: (a) operate without interfering with the operational effectiveness of the basic system; (b) determine the presence of faults within the array matrix and locate these faults; (c) cost—reasonably consistent with the cost of the basic array; (d) use should not require highly skilled maintenance personnel.

The first requirement of noninterference places considerable constraint on the design. If the monitoring function must be performed while the main system is in operation, then measuring techniques which require removal of major components from the array for measurement are unacceptable. Also the measuring signal must pass through the component while it is operationally connected within the system.

The monitoring system basically performs its function by inserting

measurement signals into individual signal channels and measuring their transfer functions. Those which lie outside of prescribed limits with respect to the *average* for each individual beam or function are selected as outages. Allowable channel tolerances are usually based on the work of Ruze<sup>1</sup> and of Rondinelli<sup>2</sup> and others that relate the allowable deviations from a predetermined aperture excitation function to a given performance degradation. The component requiring corrective action is then identified from the pattern of measured channel failures. Figure 1A is a block diagram of a multibeam phased array. To illustrate the logical process of locating component failures from channel measurements, several examples of failure patterns for a linear array are shown in Fig. 1B through 1E. Each signal channel consists of the element, power divider, time-delay unit, attenuator, beam-power combiner, and their associated interconnecting cables. In Fig. 1B, the signal channel of each beam that includes one particular element shows an out-of-tolerance condition; the trouble may be localized to either the element, the power divider, or the cable connecting them. Figure 1C shows the characteristic failure pattern attributable to components common to only one signal channel; that is, the attenuator, time-delay unit, or the interconnecting cables. In Fig. 1D, a catastrophic failure of an entire

beam can usually be traced to difficulties within the beam-power combiner. The type of pattern shown in Fig 1E is more typical of that generally encountered in operating systems. Since some but not all the channels contributing to one beam are faulty, the difficulty cannot be unequivocally attributed to one cause. Diagnosis in these cases must be on a "most probable" basis. In the example, the difficulty probably lies in the beam-power combiner.

The types of failure patterns that will be observed in the signal channels of a two-dimensional switched-delay-type phased array will be more complex. Nevertheless, each type of failure will still involve a characteristic pattern that will permit it to be localized and subsequently corrected.

Figure 2 is a block diagram showing the functional essentials of any monitoring system. It should be noted that some functions need not be performed electronically. The r-f generator supplies a suitable measurement signal at a frequency (or frequencies) within the band of interest at a specific power level and with a required degree of amplitude and phase stability. An input r-f distribution section, typically a matrix of power dividers and switches, supplies a signal of constant phase and amplitude to the input of the channel being measured. An output r-f collection system samples the signal at the output of the channel being measured and routes it to the measurement equipment. The channel measuring and evaluating equipment measures the transfer functions of the channels in the beam under consideration, computes the appropriate phase and amplitude averages, compares individual transfer functions with the average, decides if an out-of-tolerance condition exists, and records the beam number, channel number, and degree of tolerance variation in the faulty channels. The component failure identification unit processes the data associatively to locate the faulty component. The sequencer coordinates the functions of all other blocks.

The degree of automation designed into the operation of each of the various functional blocks shown in Fig. 2 is dependent on such factors as cost, overall complexity of the antenna system, estimated fail-

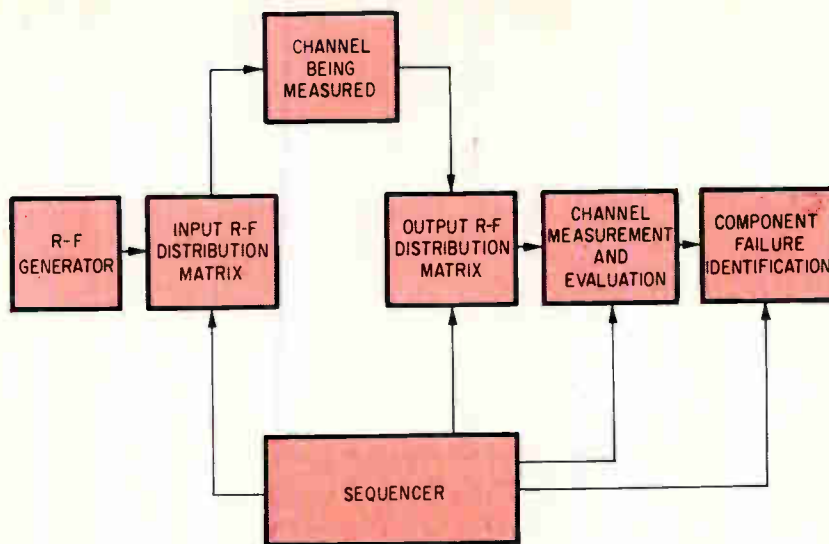

FUNCTIONAL essentials of any monitoring system—Fig. 2

ure rates and mean time between failures of the various components involved, and allowable degree of degradation of performance of the main system. For complex systems, complete automation using a computer may be required.

Complete automation of the system described in Fig. 2 would include automating the sequencer, the channel measuring and evaluating equipment, and the component failure identification equipment. For the beam being measured, the sequencer selects a particular channel input and output and, if real-time channel measuring and evaluation is being performed, synchronizes the measurement and the evaluation. The required minimum speed of measurement sequencing is determined by the probable accumulation of component failures. The fault accumulation depends upon the failure rate, the ease of component adjustment or replacement, and the time required to verify fault correction. Automation of the component failure identification equipment may also be necessary depending on the data volume. The fault-location process must be fast enough to keep up with the average fault occurrence rate; otherwise degradation will be continuous and monotonic. However, if fault location is at least that rapid, the level of operating degradation (steady-state degradation) is not a rapid function of the fault-location rate. The speed of a measurement cycle must also be sufficiently high

to insure that errors due to measurement equipment drift are negligible compared to the channel tolerances.

**Monitoring Systems** — The design principles previously discussed have been successfully applied to phased-array systems now in use. Two such systems will be discussed. The degree of automaticity of function, the speed of sequencing, and the techniques used in the instrumentation of each monitoring system differ in these two examples, showing in some degree the flexibility required to adapt to various systems.

**Semi-automatic** — Following is an example of a semiautomatic monitoring system that was designed and fabricated for a multifunction array antenna. The total number of signal channels involved in this array is less than 10,000; there are comparatively few individual components, the expected mean time between failures is relatively long, hence a fully automatic monitoring system is not required. An automatic sequencer controlled the operation of the input and output r-f matrices. Real-time automatic measurement and channel-error detection controlled by the sequencer shortened the duration of the measurement cycle. Amplifiers used in the array had a much higher failure rate than any other system components. These were monitored separately, as components. Failures among the remainder of the system components could be easily located

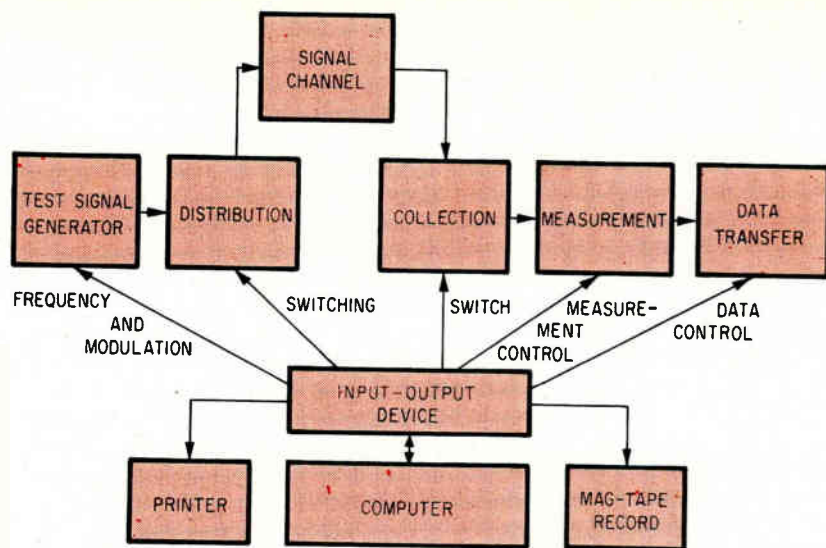

AUTOMATED monitoring system—Fig. 3

by simple associative failure plots performed by the operator. The design rate of sequencing was bounded by two extremes: an upper bound determined by the necessity of minimizing the frequency spectrum occupied by the measuring signal; a lower bound determined by the desire to minimize the effect of long-term drift upon the measurement without the necessity of instrumenting corrective techniques. Since manufacturing tolerances on individual array components were set and controlled at a level consistent with achieving the predicted operational performance, no array-trimming adjustments and consequently no adjustment facility in the monitoring system were required. If a component drifts out of tolerance, it is simply replaced.

The system-design economics justified a method of measurement that reduced the dynamic range linearity requirement upon the transfer function measuring circuits. Prior to measurement, a phase delay and an attenuation complementary to the proper value for each signal channel forming a beam is added to its output. This makes the adjusted output of all signal channels within a particular beam identical. For the limited dynamic range necessary to encompass the allowable phase and amplitude deviations within a beam, a simple phase detector and amplitude detector i-f circuit are accurate and adequate. This method adds some complexity to the required switch sequence and thus to the sequencer.

Other design features of this system are conventional. The required phase and amplitude tracking of the transfer function in input and output matrices is maintained through extremely tight component specifications. Large ensembles of individual components such as switches, power dividers, and directional couplers were in fact successfully produced to transfer-function tracking tolerances significantly tighter than those imposed on the "state of the art" components used in the array. The use of a low-noise dual-channel receiver insures a signal-to-noise ratio in the measurement equipment that is adequate for high-accuracy measurements. The monitoring system has proven itself in the field to be a highly accurate installation and maintenance tool. Operational experience has shown it to be capable of maintaining the antenna array to within its design specifications.

**Larger Array**—As an example of a larger, more complex monitoring system, consider a radar with a 5,000 element receiving array with 50 beam outputs. This array certainly has greater monitoring complexity than the previous example. The number of signal channels is  $50 \times 5000$  or 250,000. The monitoring system cycles through all channels within one hour. One hour allows the measurements to be made on a noninterfering basis with the antenna system and is short enough so that component drift is small. Two hours would have been acceptable from failure or drift-rate con-

siderations, except that this was considered to be too long to wait for a fault correction verification.

The monitoring function must be performed without interfering with the array's operation. In this array, as in most, a small percentage of channel failures, say 5 percent, in any beam, will not appreciably affect the antenna beam performance, hence the design objective of the monitoring system is to prevent the number of channel failures from exceeding this percentage. The monitoring equipment must then repeatedly measure these failures, each time updating the outage list by printing out new information.

Automation is necessary in this system. To check all channels without a completely automated system would be an unacceptably lengthy process. A computer therefore performs a number of functions for the basic system. The monitoring system takes overall direction from the computer, which controls all switching and timing functions involved in each channel measurement process. The computer also receives raw data from the measurement equipment, and processes it, making decisions concerning channel failures, or trim adjustments where these are provided. Associative processing is also performed within the computer, whereby components (such as a power supply) whose failure causes failures in several channels are identified. Outages are printed out with data indicating fault location and the corrective action required.

In the resulting monitoring equipment, the computer directs measurements, receives and corrects data, processes it, and indicates element failures that are beyond design tolerances. Organization of the test sequence along the lines of array network interconnections assists the computer in making the calculations in real time. For example, assume that the column elements are combined directly in any beam. If measurements were made sequentially down the column, this would enable the data to be processed directly, thereby minimizing the amount of raw data storage required within the computer. This type of reasoning, applied extensively, results in the formulation of the complete detailed test sequence. Use of this type of organization is absolutely essential, since computer data storage must

be minimized economically. An unacceptable alternative would be to measure all 250,000 signal channels and then solve 250,000 simultaneous equations, a sizable task for any present-day computer.

Figure 3 shows the basic system of Fig. 2 adapted to computer use for the illustrative system under discussion.

The monitoring signal distribution system is simply a 1-to-5,000 divider with switches in each output branch to enable sequential connections of the signal to one signal channel at a time. Switches use fast-acting, stable diodes. The long-term stability requirement of this switch and distribution system is a small fraction of the signal channel tolerance permitted. Transfer-function tolerances required of the divider network are, as in the previous system, derivable directly from the array channel tolerances.

The collection subsystem samples the signal at a beam output and conveys it to the measuring equipment. Three requirements are of interest in this subsystem; inter-channel isolation, tracking of the transfer function from beam output to measurement equipment, and insertion loss. The isolation between the ON and OFF channels of the collection system must be sufficient to avoid ambiguities in measurement. Beam-to-beam tracking of transfer functions in the collection system is required only where beam outputs are related, as in a monopulse tracking system. Insertion loss in the collection system should not cause excessive deterioration of the signal-to-noise ratio which would degrade the measurement accuracy.

Achieving the required signal-to-noise ratio may be a problem. The signals coming through signal channels are considerably lower in level than the normal array output, and as a result narrow measurement bandwidths are used to reduce the noise. To avoid time interference with the array operation, a pulsed, sampled measurement technique is used. The use of pulsing introduces transients that must decay sufficiently to allow sampling with limited error. This sets a lower bound on the measurement bandwidth.

Measurement equipment performance must be effective. Sufficient monitoring speed and the required resolution must be provided at the

same time. A well-designed limiter is an essential part of the phase monitoring equipment — output phase variation as a function of input amplitude must be controlled.

Amplitude measurement is preferably performed at a frequency where a good rectified i-f output can be obtained, free from ripple uncertainties. Wide dynamic range in the detector is desired so that the linear range of the antenna taper losses can be accurately measured without an expensive and difficult switched taper-loss equalization arrangement.

The choice of a measurement frequency involves a trade-off between the desired phase resolution and the number of cycles in a sample pulse required to provide the desired accuracy. The phase-measurement resolution is the number of degrees at the particular frequency that is contained in the counting interval. The measurement receiver consists of a low-noise preamplifier, a double superheterodyne type of receiver and a device to produce the required i-f frequencies. Mixer errors from spurious cross products in the local oscillator device are minimized and the source should have the required i-f stability.

The data transfer into the computer involves conversion from analog to digital. Gating and storage circuits accomplish the data transfer. The computer requires a real-time input-output device to receive data and to send out properly timed control pulses for all the equipment functions of switching and measurement. A printer and magnetic tape are used for recording the status and outage information of the monitoring system.

Before proceeding further, mention of basic measurement philosophy should be made. The absolute measurement of transfer characteristic does not provide the necessary accuracy for signal channel measurements. Since there is gain and many circuits prior to the measurement equipment that can drift, it is necessary to use comparison switching. Within several milliseconds of any measurement, a standardization path is switched in between the test-signal generator and the measurement equipment to provide a drift-free reference. Thus the changes in the equipment common to the path of both the standardizing and measurement signal are nullified, and the

required measurement accuracy has been achieved without the need for long periods of stability in the measurement equipment.

An obvious remaining engineering problem is the design of the computer program. The test sequence leads directly to program requirements. The details of data storage would be a predominant consideration used in the example under discussion. Computer capacity is assumed to be limited. An "agenda" tape is programmed containing the following information: (a) all constants required for steering correction, calibration data, component location, etc; (b) constants covering the proper switching and measuring sequencing; (c) computational data required as the test sequencing progresses through the monitor cycle.

In this system under discussion a method is presented to assist the maintenance man in making the adjustment or replacement related to a failure. One approach would have been to stop the automatic sequencing and place the channel under adjustment on continuous monitor. Then the element adjustment could be talked in by intercom between a man reading the output of the computer and the man making the adjustment. This method is impractical. The overall failure rate is so high that the monitoring equipment would have to be on repair adjustment much of the time, leaving little time for monitoring.

The workable solution however makes use of the inherent flexibility of the computer. The computer can be addressed directly for each failure and be cycled repeatedly through the channel needing adjustment along with the normal monitor measurements. The results of this measurement can be presented on a portable meter which can be located conveniently near the adjustment. This same device is used to address the computer to measure each failure. Thus the maintenance adjustments, in fact many of them simultaneously, can be made without materially affecting the main monitor function.

## REFERENCES

- (1) J. Ruze, *Supple. al Nuovo Cimento*, **8**, pp 364-380, 1952.
- (2) L. A. Rondinelli, *IRE Nat Conv Record 7*, Part 1, pp 174-187, 1959.

# BI-QUINARY SCALING: Accuracy

Practical 500-Mc counting circuit avoids speed limitation imposed by the feedback required in decade scalars. Both bi-quinary and qui-binary count division are described

By RUDOLPH ENGELMANN, Consultant, Manchester, N. H.

## 500-MC BARRIER BREACHED

Top scaling speeds of practical high-frequency decades are 150 to 200 Mc. Problems inhibiting 500-Mc binary decade counting are feedback, required in binary to decimal conversion for BCD-input readout equipment, and binary drive limitations. The bi-quinary scaler needs no feedback, no differentiated input and counts in excess of 500-Mc

Counting Sequence  
TABLE I

Q<sub>1</sub> on  
Q<sub>3</sub> off  
Q<sub>5</sub> on  
Q<sub>7</sub> off  
Q<sub>9</sub> on

Q<sub>2</sub> off  
Q<sub>4</sub> on  
Q<sub>6</sub> off  
Q<sub>8</sub> on  
Q<sub>10</sub> off

Counting Sequence  
TABLE II

After One Complete Negative  
Going Pulse

Q<sub>1</sub> off  
Q<sub>3</sub> on  
Q<sub>5</sub> on  
Q<sub>7</sub> off  
Q<sub>9</sub> on

Q<sub>2</sub> on  
Q<sub>4</sub> off  
Q<sub>6</sub> off  
Q<sub>8</sub> on  
Q<sub>10</sub> off

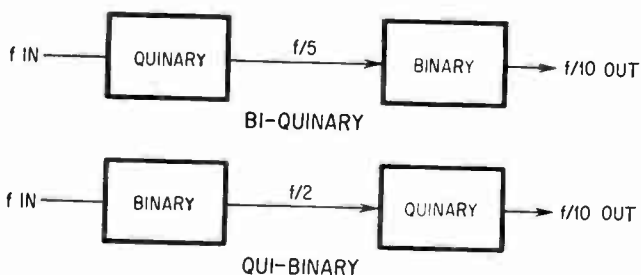

BI-QUINARY DIVISION is fast. Qui-binary converts easily to BCD—Fig. 1

QUINARY DIVIDER is ring-counter of 5 current-mode switches (A), needing no feedback, with undifferentiated input signals. Bias relationships of load resistors (B) during a complete 5-sine wave scaler input cycle—Fig. 2

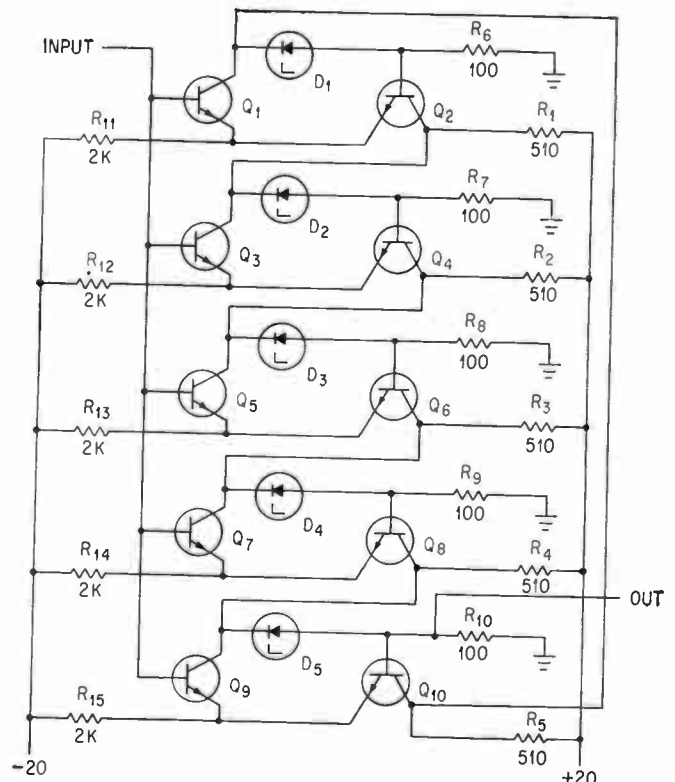

(A)

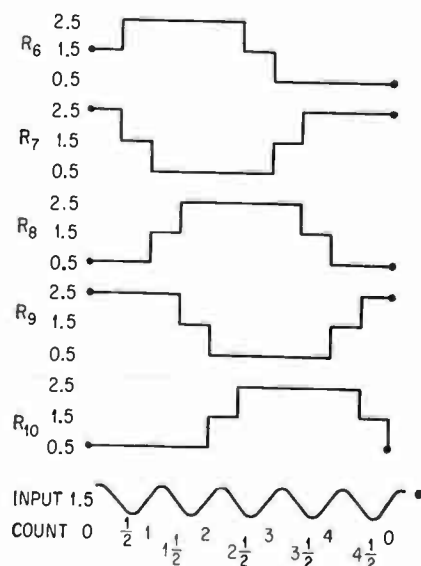

(B)



# and Simplicity at 500 Mc

**INCREASING SPEED** requirements in digital counters has placed a strain on conventional counting techniques, especially in systems requiring decimal presentation. At present, counting rates in excess of 300 megacycles have been achieved in a number of laboratories using binary dividers. However, since binary division does not lend itself readily to decimal conversion, practical systems operating above 100-Mc in decimal mode are scarce and uneconomical.

The following describes a counting circuit (patent pending) which operates in excess of 500-Mc, and is economical of space, components and cost. Other economies, such as power requirements, input drive requirements and peripheral circuits enhance the desirability of this approach to digital measurement, even at low frequencies.

In Figure 1, two forms of count division are shown. The first is bi-quinary division and the second is quinary division. Each has its advantage and disadvantage. In bi-quinary division, the quinary divides the events at the input by five, and the binary divides the number at the quinary output by two, to give a total division by ten. Bi-quinary has the advantage, presently, of high speed, but is more difficult to convert to binary coded decimal (BCD) than quinary, which at a sacrifice in speed, converts readily to BCD. Both methods present decimal information with no difficulty.

**Quinary Divider**—Figure 2A shows a counting ring consisting of five current-mode switches. The input is common to the bases of the switch input transistors. Each switch has emitter current supplied by an individual resistor, from the negative voltage supply to the common emitters of the transistor-pair in the switch. The collector supply resistors ( $R_1$ — $R_5$ ) each connect to: the collector of the output transistor of one switching stage; the collector of the input transistor of a second stage; a zener diode, which leads to the base of the second stage output transistor, and to a load resistor to ground.

**Operation**—Current passing through  $R_1$ , for example, has a choice of three return paths; the collector of  $Q_2$ , the collector of  $Q_3$ , and zener diode  $D_2$ . If 25 milliamperes passes through  $R_1$  at all times and both  $Q_2$  and  $Q_3$  are turned off, then the entire 25 ma passes through zener diode  $D_2$  and load resistor  $R_7$ . The voltage across  $R_7$  is 2.5 volts, which the base of  $Q_4$  sees as a bias. Since  $Q_3$  is turned off,  $Q_4$  must be turned on, and for this to be true the voltage on the base of  $Q_3$  must be less than 2.5 volts. Since the base of  $Q_3$  is common to the bases of  $Q_1$ ,  $Q_5$ ,  $Q_7$  and  $Q_9$ , the bases of these transistors are also biased at some value less than 2.5 volts.

Collector resistor  $R_2$  supplies  $Q_4$  and  $Q_5$ . At this point  $Q_5$  is turned on. Since the values of the emitter

supply resistors ( $R_{11}$ — $R_{15}$ ) provide a current of 10 ma to their respective stages,  $Q_4$  will draw 10 ma from  $R_2$ , as will  $Q_5$ . Only 5 ma is left to flow through  $D_3$  and  $R_8$ . The voltage across  $R_8$  is therefore 0.5 volt, which is the bias on the base of  $Q_6$  which is turned off ( $Q_5$  is on). Therefore, the voltage on the base of  $Q_5$  and the other four input transistors must be greater than 0.5 volt.

It is established that the bias on the bases on the input transistors is greater than 0.5 volt and less than 2.5 volts. Table I shows the order of transistors turned on and off.

With  $Q_{10}$  turned off and  $Q_1$  on, a total of 15 ma flows through zener diode  $D_1$  and load resistor  $R_6$ . The bias on the base of  $Q_2$  is 1.5 volts. So that  $Q_2$  be turned off, the bias on the base of  $Q_1$  must be greater than 1.5 volts. It is now established that the bias on the bases of the input transistors is greater than 1.5 volts and less than 2.5 volts.

**Counting Sequence**—From this point a counting sequence can be established. If the input bias moves to a value less than 1.5 volts,  $Q_1$  will be turned off and  $Q_2$  on. With  $Q_1$  off, a total of 25 ma flows through  $D_1$  and  $R_6$ . The base of  $Q_2$  is now biased at 2.5 volts. With  $Q_2$  turned on, only 15 ma flows through the diode-resistor combination ( $D_2$ ,  $R_7$ ). The bias on the base of  $Q_4$  is 1.5 volts. This set of conditions will be retained until the input bias rises to a value greater than 1.5 volts at which time  $Q_3$  will turn on and  $Q_4$  off as its base bias drops to 0.5 volt. This new order (Table II) of on and off transistors is the condition of the circuit after one complete negative going pulse has been applied to the input. The width of the pulse is of no consequence.

**Prime Advantage**—Herein lies the primary advantage of this scaling technique. It is not necessary to differentiate the input signal. The quinary divider remains stable as long as the input signal does not cross the switching reference, which in this illustration is 1.5 volts. The d-c bias on the input may thus be set either above or below the reference, and pulses of either polarity, or any type of alternating signal will be accepted and correctly counted. However, if the upper and lower bias values of 2.5 and 0.5 volts are exceeded at the input, false triggering will occur. The input levels must be limited in amplitude. This is a minor consideration since a driving amplitude on the order of 200 millivolts is sufficient for error-free counting.

**Components**—For 500-Mc operation this circuit uses 2N2708 transistors. Actually any transistor with  $F_t$  of 2 or 3 times the top frequency expected to be counted can be used (typically  $F_t = 1.2, 1.3, 1.5$ -Gc). The switching current is that value at which the tran-

sistors are specified for maximum performance as amplifiers. The dominant factor in selecting the 2N2708 was cost, as several other types, such as the 2N2809 or 2810, perform as well in the quinary.

The zener diodes are 5.6-volt, 400-milliwatt types (typical is the 1N752A). Circuit sensitivity can be increased by matching the voltage drops of the zeners, and even further increases can be had by matching the resistors, and the base-emitter forward drop of the transistors. As is, 5-percent resistors, and zener matching will accomplish the sensitivity claimed here.

**Output**—Figure 2B demonstrates the bias relationships between the load resistors of each stage during a complete scaler cycle of five complete sine waves applied to the input. In this instance an output may be taken from across  $R_{10}$  to drive a shaper and a binary to complete a bi-quinary decade.

Figures 3A and B demonstrate means for displaying the count contained in bi-quinary and qui-binary decades respectively. The Nixie indicators are driven directly without need of buffers. Figure 3C demonstrates the conversion of qui-binary to BCD.

Bi-quinary to BCD conversion requires the bi-quinary be converted first to ten line code; BCD then is derived by normal 10-to-4 line conversion. A multiple decade counter will use bi-quinary decades in only the first one or two decades to take advantage of their greater speed and ease of driving. The qui-binary decade would be used in the lower-frequency decades to take advantage of the easier conversion to BCD which is required for most hard-copy readout systems.

With better transistors becoming available and with more advanced physical layout of the circuit com-

ponents, scaling speeds in excess of 1-Gc will be obtained in the near future. Under rigid conditions, speeds of 750-Mc have already been obtained in the lab. At this time however, practical instruments which must operate in extremes of environment will be limited to top specified speeds of 500-Mc.

**Low Frequencies**—The lower the frequency a given decade is expected to scale, the lower the switching current required to maintain the operation of the decade. At 50-Mc, a switching current of 3 or 4 ma is sufficient. At frequencies below 1-Mc, switching currents of 200 or 300  $\mu$ a are sufficient to maintain operation and avoid complications due to semiconductor leakage in high-temperature environments.

Below 50-Mc, the zener diode, employed as a low dynamic impedance-coupling device, is unnecessary. A resistor will replace the zener diode. There is no case in which a coupling capacitor will be used. But, at very-low-frequency operation, a bypass capacitor across the load resistor of each stage may be desirable to reduce noise sensitivity when a low-amplitude drive is desired.

As example of the wide range of practical uses for the quinary circuit: a 50-Mc counter; 100-Mc and 200-Mc plug-in decade counting units; a nanosecond time interval meter; and a 500-Mc frequency meter.

With all the advantages of this approach to frequency division, the appearance of a low-cost, battery-operated, coat-pocket counter, paralleling in every respect the performance of present laboratory counters, becomes imminent. Complete low-frequency decades the size of a nickel are being constructed and versions much smaller than this are possible if applications become known.

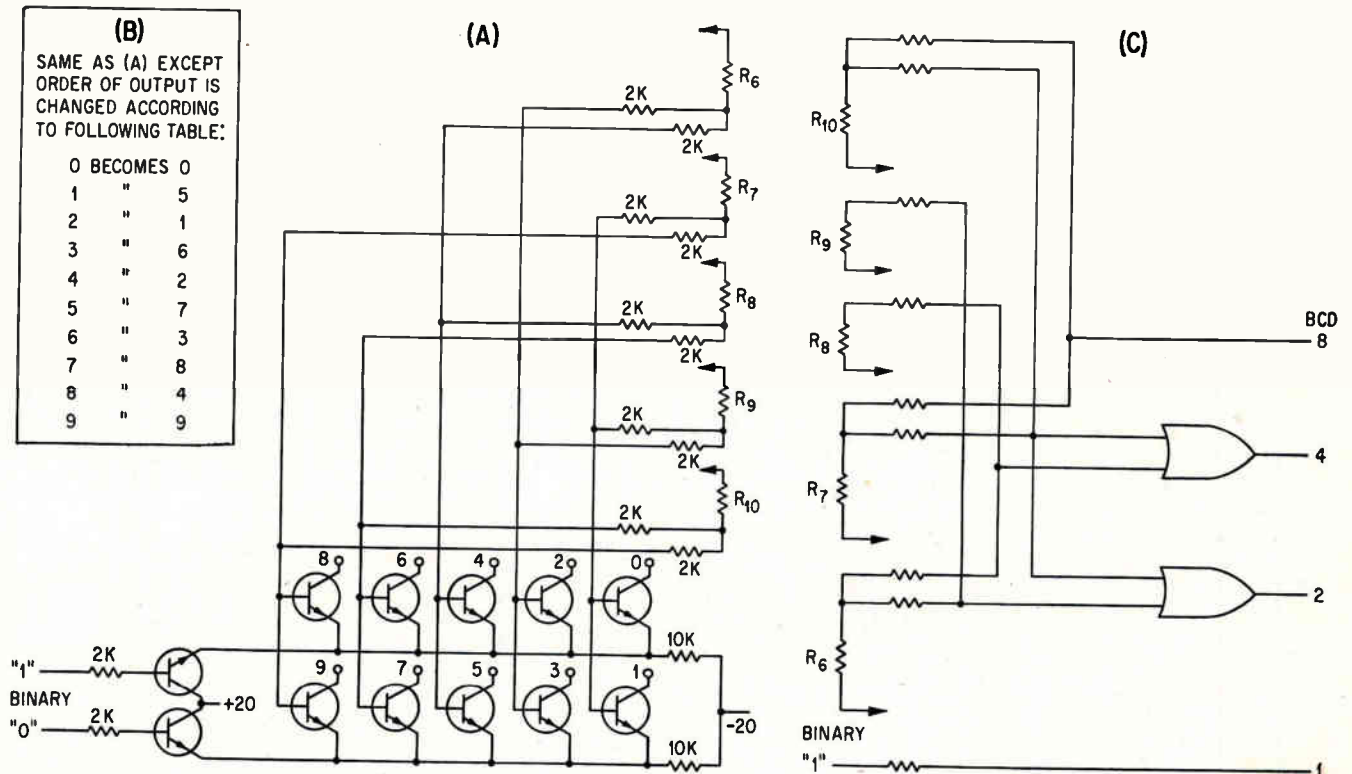

COUNT of bi-quinary decade is displayed by Nixie indicators (small numbered circles) which require no buffers (A). Outputs are reversed for qui-binary decade (B); conversion of qui-binary to BCD (C)—Fig. 3

# CHASSIS WIRING

PRESENT STANDARD	PROPOSED*	
Gray		A-C power lines
Black (K)		Grounded elements and returns
X-N		Grounded heater or fil.
X-R		Grounded B minus
X-Y		Grounded cathode
X-G		Grounded grid
Brown (N)		Heaters or filaments
N-R		Rectifier htr. or fil.
N-Y		Auxiliary htr. or fil.
N-G		Auxiliary htr. or fil.
N-W		Htr. or fil. c.t. (not grounded)
Red		Main stem B plus
R-W		Unfiltered B+ from fil.
R-B		B+ above main stem
R-Y		B+ below main stem
R-G		B+ intermediate
R-K		B+ intermediate
R-B-Y		B+ intermediate
White		B or C minus, main stem
W-R		B- below ground (max)
W-D		C- intermediate, fixed
W-Y		C- intermediate, fixed
W-G		C- (preferred for avc bias)
W-N		C- (intermediate avc bias)
W-K		Alternate ground or off-ground connection
W-B		Internal antenna or to antenna coil
W-R-B		Universal substitute wire
Green		Control grids and diode plates (and first base on transistors*)
GW		Diode plate (if identified from control grid)
G-R		Identified grid (as thyratron grid)
G-Y		Identified grid (as oscillator grid)
Blue		Plates, except diode plates (and transistor collectors*)
B-R		Identified plate
B-Y		Identified plate
Yellow		Cathodes (and transistor emitters*)
Y-R		Identified cathode
Y-G		Identified cathode
Orange		Screen grids (and second base on transistors*)

Detailed differentiation not included in new proposal!

\*EIA proposed new standard: not formally approved as of date of publication

Color	Label	Grid
K	Grounds, grounded elements	
N	Heaters or filament off ground	
Y	Cathode, also heater-cathode lead if common	
R	Collector	
O	Helix 1	A
O-G	Helix 2	W
O-B	Helix 3	G-K
O-A	Helix 4	B-K
G	Grid 1	A-K
B	Grid 2	W-K
A	Grid 3	
W	Grid 4	
G-K	Grid 5	
B-K	Grid 6	
A-K	Grid 7	
W-K	Grid 8	

## TRAVELLING WAVE TUBE

# ELECTRONICS COLOR

## TRANSFORMERS

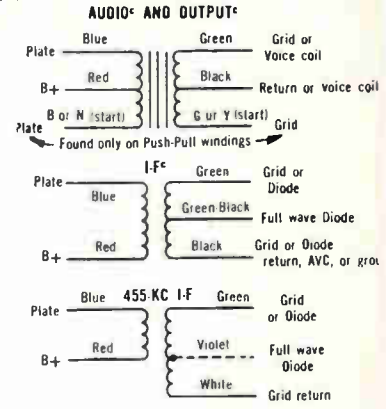
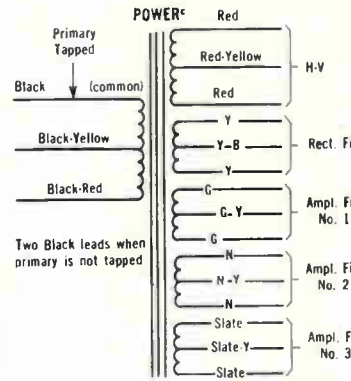

## SERVO AND CAPACITOR MOTORS

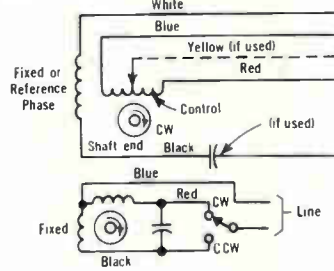

## SELENIUM AND COPPER-OXIDE RECTIFIERS

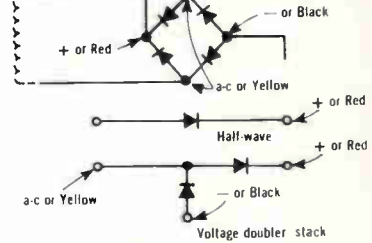

## LOUDSPEAKER

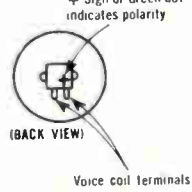
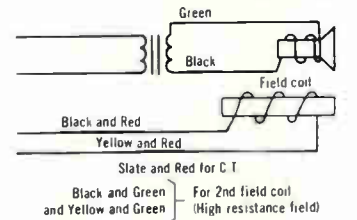

## BROADCAST MICRO

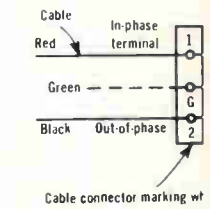

## COLOR KEY

COLOR	Abbreviations	1	2	3
	STO.	Number	Suffix Letter	Standard Multiplier
black	Bik	0		10 <sup>0</sup>
brown	Brn	1	A	10 <sup>1</sup>
Red	Red	2	B	10 <sup>2</sup>
Orange	Orn	3	C	10 <sup>3</sup>
Yellow	Yel	4	D	10 <sup>4</sup>
Green	Grn	5	E	10 <sup>5</sup>
Blue	Blu	6	F	10 <sup>6</sup>
Violet	Vio	7	G	10 <sup>7</sup>
Gray	Gra	8	H	10 <sup>8</sup> (alt.)
White	Wht	9	J	10 <sup>9</sup> (alt.)
Silver	Sil			10 <sup>-2</sup> (preferred)
Gold	Gld			10 <sup>-1</sup> (preferred)
None				

<sup>a</sup> Guaranteed Minimum Value

<sup>b</sup> Optional when metallic pigment is undesirable

<sup>c</sup> Widely used but not a standard

# CODES

COLOR CODES shown here are from the main standards for electronics of EIA and NEMA. Standards for semiconductor devices are formulated by JEDEC committees and are now issued jointly by EIA and NEMA. Neither EIA nor NEMA members are required to follow the color codes shown here but it is industry practice to do so where practical.

## HALL-EFFECT GENERATOR

(MIL Std. 681A)

Black—Negative side, control current  
 Red—Positive side, control current  
 Yellow—Negative side, output voltage  
 Blue—Positive side, output voltage

## PREFERRED SECONDARY COLORS

Light brown—use Tan  
 Light red—use Pink  
 Dark red—use Maroon  
 Light orange—use Peach  
 Dark yellow—use Mustard  
 Light green—use Lime  
 Dark green—use Jade  
 Light blue—use Aqua  
 Dark violet—use Purple  
 Dark gray—use Slate

## INDUSTRIAL CONTROL WIRING

Black or Gray—a-c and d-c power and line  
 Red—a-c control circuits  
 Blue—d-c control circuits  
 Green—(usually equipment grounding)  
 White—(usually grounded neutral)

## STEREO PICKUP

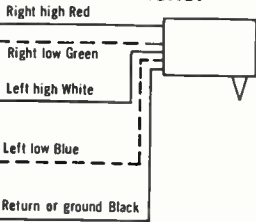

## DIODES

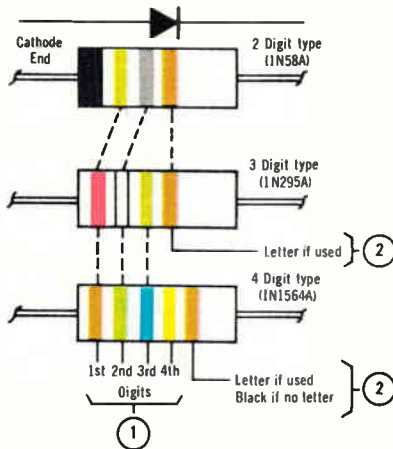

## RESISTORS

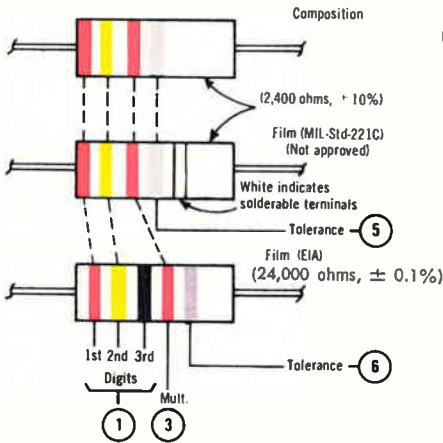

## CERAMIC DIELECTRIC CAPACITORS

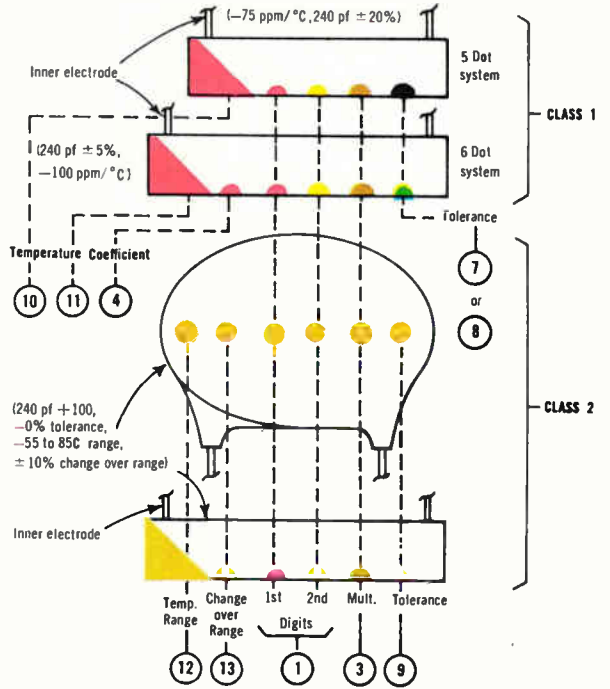

## MOLDED MICA CAPACITORS

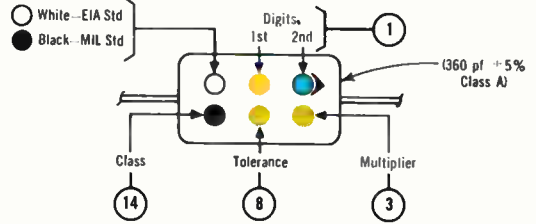

Temp. Coeff. Multiplier	Tolerance in percent film resistor only	Capacitor Tolerance	Temperature Coefficient (Parts per 10 <sup>6</sup> per deg. C)	Temp. Range (deg. C)	Capacitance Change over Range (in percent)	Capacitor Class (molded mica)				
4	5	6	7	8	9	10	11	12	13	14
-1	± 20	-	< 10pf ± 2pf	> 10pf (in percent) ± 20	(in percent) ± 20	(5 dot system) 0	(6 dot system) 0	-	± 2.2	A
-10	± 1	± 1	± 0.1pf	± 1	-	-33	-	+10 to +85	± 3.3	B
-10 <sup>2</sup>	± 2	± 2	-	± 2	-	-75	1	-	± 4.7	C
-10 <sup>3</sup>	± 3	-	-	± 3	-	-150	1.5	-	± 7.5	D
-10 <sup>4</sup>	GMV <sup>a</sup>	-	-	-	+100, -0	-220	2.2	-	± 10	E
+1	± 5 <sup>b</sup>	± 0.5	± 0.5pf	± 5	± 5	-330	3.3	-	± 15	-
+10	± 6	± 0.25	-	-	-	-470	4.7	-	± 22	-
+10 <sup>2</sup>	± 12.5	± 0.1	-	-	-	-750	7.5	-	+22, -33	-
+10 <sup>3</sup>	± 30	± 0.05	± 0.25pf	-	+80, -20	+150 to -1,500	-1,000 to -5,200 <sup>d</sup>	-	+22, -56	-
+10 <sup>4</sup>	± 10 <sup>h</sup>	-	± 1pf	± 10	± 10	+100 to -750	-	-	+22, -82	-
-	± 10	± 10	-	-	-	-	-	-30 to +85	± 1.5	-
-	± 5	± 5	-	-	-	-	-	-55 to +85	± 1	-
-	± 20	-	-	-	-	-	-	-	-	-

<sup>a</sup> Multiplier dot for this coefficient is black

# CHASSIS WIRING

PRESENT STANDARD	PROPOSED*	
Gray		A-C power lines
Black (K)		Grounded elements and returns
K-N		Grounded heater or fil.
K-R		Grounded B minus
K-Y		Grounded cathode
K-G		Grounded grid
Brown (N)		Heaters or filaments
N-R		Rectifier htr. or fil.
N-Y		Auxiliary htr. or fil.
N-G		Auxiliary htr. or fil.
N-W		Htr. or fil. c.t. (not grounded)
Red		Main stem B plus
R-W		Unfiltered B+ from fil.
R-B		B+ above main stem
R-Y		B+ below main stem
R-G		B+ intermediate
R-K		B+ intermediate
R-B-Y		B+ intermediate
White		B or C minus, main stem
W-R		B- below ground (max)
W-O		C- intermediate, fixed
W-Y		C- intermediate, fixed
W-G		C- (preferred for avc bias)
W-N		C- (intermediate avc bias)
W-K		Alternate ground or off-ground connection
W-B		Internal antenna or to antenna coil
W-R-B		Universal substitute wire
Green		Control grids and diode plates (and first base on transistors*)
G-W		Diode plate (if identified from control grid)
G-R		Identified grid (as thyratron grid)
G-Y		Identified grid (as oscillator grid)
Blue		Plates, except diode plates (and transistor collectors*)
B-R		Identified plate
B-Y		Identified plate
Yellow		Cathodes (and transistor emitters*)
Y-R		Identified cathode
Y-G		Identified cathode
Orange		Screen grids (and second base on transistors*)

\*EIA proposed new standard: not formally approved as of date of publication

K	Grounds, grounded elements		
N	Heaters or filament off ground		
Y	Cathode, also heater-cathode lead if common		
R	Collector		
O	Helix 1	A	Grid 3
O-G	Helix 2	W	Grid 4
O-B	Helix 3	G-K	Grid 5
O-A	Helix 4	B-K	Grid 6
G	Grid 1	A-K	Grid 7
B	Grid 2	W-K	Grid 8

# ELECTRONICS COLOR CODES

COLOR CODES shown here are from the main standards for electronics of EIA and NEMA. Standards for semiconductor devices are formulated by JEDEC committees and are now issued jointly by EIA and NEMA. Neither EIA nor NEMA members are required to follow the color codes shown here but it is industry practice to do so where practical.

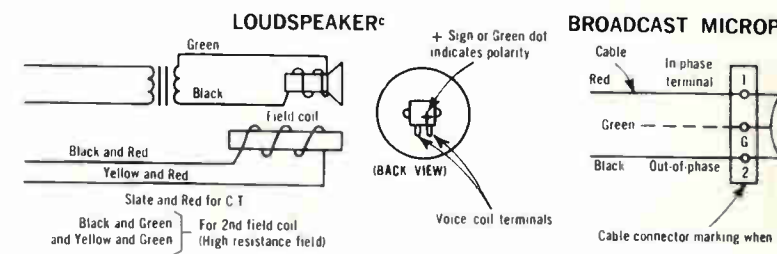
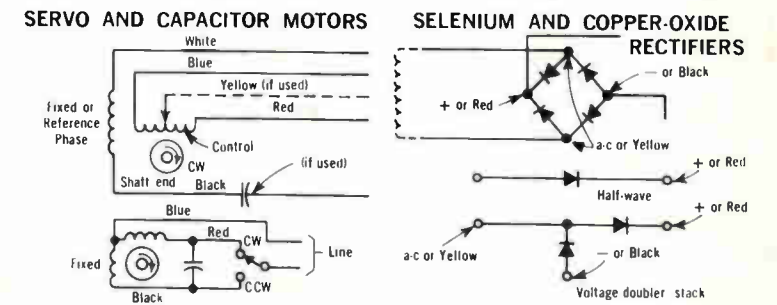
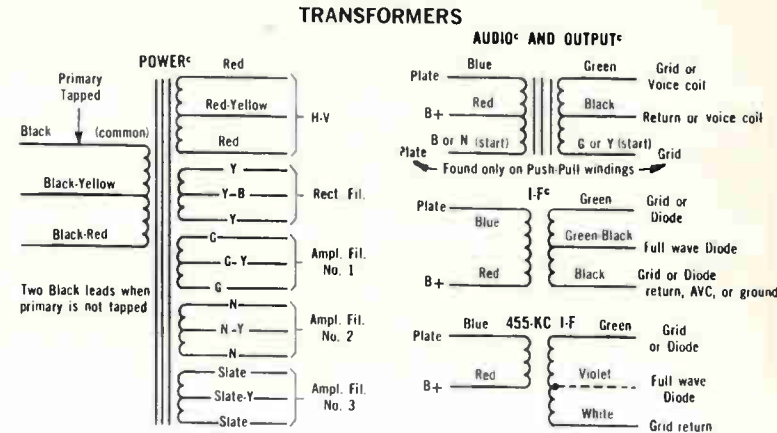

### HALL-EFFECT GENERATOR

(MIL Std. 681A)

Black—Negative side, control current  
Red—Positive side, control current  
Yellow—Negative side, output voltage  
Blue—Positive side, output voltage

### PREFERRED SECONDARY COLORS

Light brown—use Tan  
Light red—use Pink  
Dark red—use Maroon  
Light orange—use Peach  
Dark yellow—use Mustard  
Light green—use Lime  
Dark green—use Jade  
Light blue—use Aqua  
Dark violet—use Purple  
Dark gray—use Slate

### INDUSTRIAL CONTROL WIRING

Black or Gray—a-c and d-c power and line  
Red—a-c control circuits  
Blue—d-c control circuits  
Green—(usually equipment grounding)  
White—(usually grounded neutral)

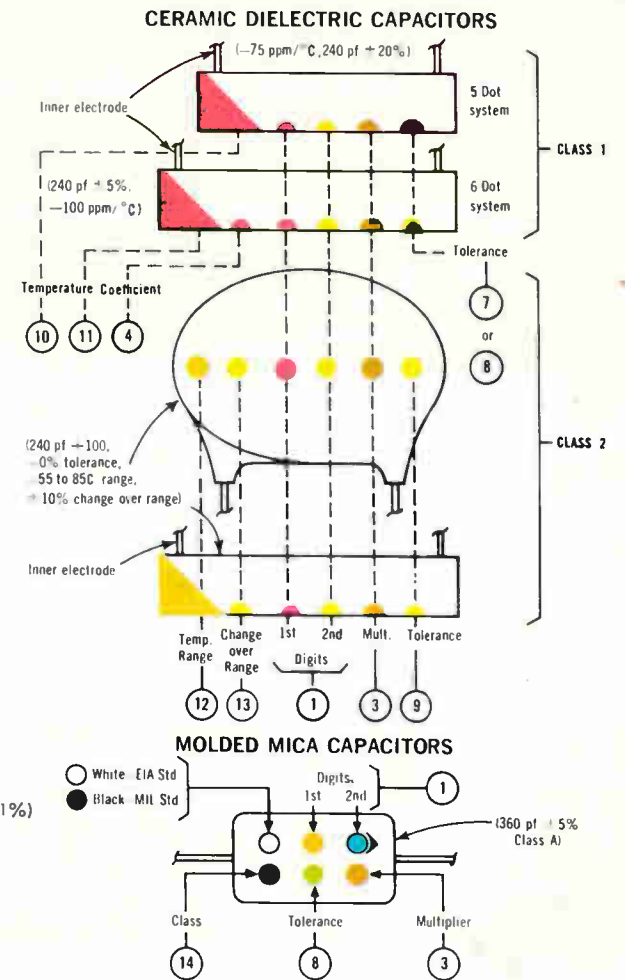
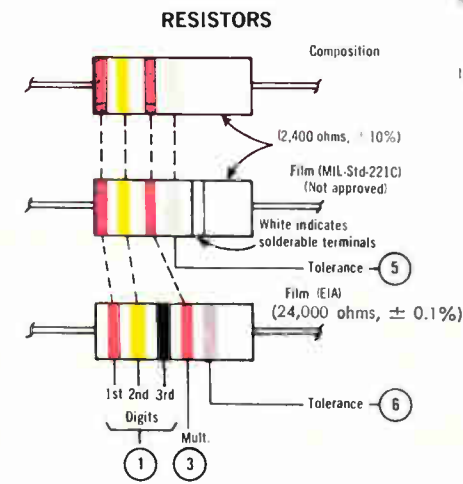
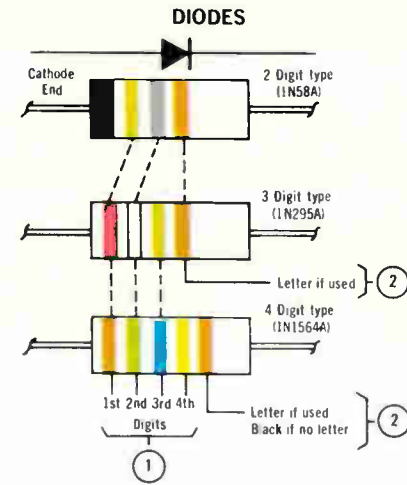

### COLOR KEY

COLOR	Abbreviations	Number	Suffix Letter	Standard Multiplier	Temp. Coeff. Multiplier	Tolerance in percent	Capacitor Tolerance	Temperature Coefficient (Parts per 10 <sup>6</sup> per deg. C)	Temp. Range (deg. C)	Capacitance Change over Range (in percent)	Capacitor Class (molded mica)
	STD.	ALT.						(5 dot system)	(6 dot system)		
black	Blk	K	0	—	10 <sup>0</sup>	-1	±20	—	—	±2.2	A
brown	Brn	N	1	A	10 <sup>1</sup>	-10	±1	±1	±0.1pf	±1	B
Red	Red	R	2	B	10 <sup>2</sup>	-10 <sup>2</sup>	±2	±2	—	±2	C
Orange	Orn	O	3	C	10 <sup>3</sup>	-10 <sup>3</sup>	±3	—	—	±3	D
Yellow	Yel	Y	4	D	10 <sup>4</sup>	-10 <sup>4</sup>	GMV <sup>a</sup>	—	+100, -0	±10	E
Green	Grn	G	5	E	10 <sup>5</sup>	+1	±5 <sup>b</sup>	±0.5	±0.5pf	±5	—
Blue	Blu	B	6	F	10 <sup>6</sup>	+10	±6	±0.25	—	±6	—
Violet	Vio	V	7	G	10 <sup>7</sup>	+10 <sup>7</sup>	±12.5	±0.1	—	±12.5	—
Gray	Gra	A	8	H	10 <sup>8</sup> (alt.)	+10 <sup>8</sup>	±30	±0.05	±0.25pf	±30	—
White	Wht	W	9	J	10 <sup>9</sup> (alt.)	+10 <sup>9</sup>	±10 <sup>6</sup>	—	±1pf	±10	—
Silver	Sil	—	—	—	10 <sup>-2</sup> (preferred)	—	±10	±10	—	±10	—
Gold	Gld	—	—	—	10 <sup>-1</sup> (preferred)	—	±5	±5	—	±5	—
None	—	—	—	—	—	—	±20	—	—	±20	—

<sup>a</sup> Guaranteed Minimum Value <sup>b</sup> Optional when metallic pigment is undesirable <sup>c</sup> Widely used but not a standard <sup>d</sup> Multiplier dot for this coefficient is black



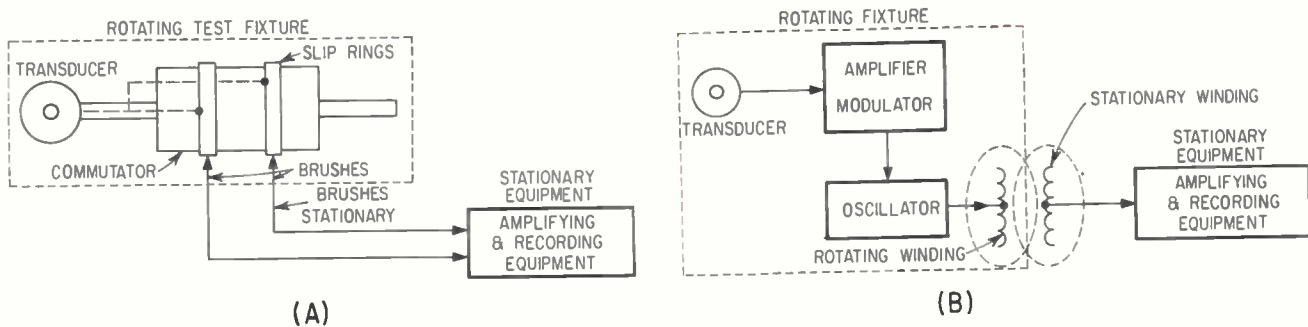

CONVENTIONAL spin-measurement system with mechanical contacts (A), and inductive telemetry scheme (B)—Fig. 1

# INDUCTIVE TELEMETRY Improves Spin-System Measurements

Brush contact pressure and mechanical alignment cause varying amounts of noise in mechanical systems. Here is a technique for transmitting transducer signals to test gear by telemetry

By **H. BAUMANN**  
Instrumentation Section,  
Picatinny Arsenal, Dover, N. J.

**CONVENTIONAL** methods for telemetering data from rotating test fixtures utilize a commutator-slip-ring unit to connect the transducer output signal to indicating and display equipment for analysis as shown in Fig. 1A. While this method may often be satisfactory, it has some objectionable characteristics such as slip-ring-generated noise and the problems associated with mechanical contacts subject to high rpm. Brush contacts on a com-

mutator revolving at 5,000-15,000 rpm will generate some level of contact noise. If the transducer output signal is of low amplitude, the contact noise may completely obscure the transducer signal. Brush contact pressure and mechanical alignment are variable factors that can cause changes in contact noise levels and therefore must be maintained for optimum performance.

Some of the more common types of transducers include microphones, accelerometers, strain gages, photo electric cells, magnetometers and blast gages. Many of the non-electrical signals are generated under conditions of rotating motion, dur-

ing a test. This means that the transducer output signal must be transmitted from the moving device to a stationary system which displays the transducer output signal for observation and analysis as shown in Fig. 1B.

**Inductive Technique**—The purpose of the inductive telemetry technique is to provide a means for transmitting electrical signals from transducers in a rotating test fixture, to measurement and display equipment. This method eliminates slip-ring-generated noises and problems associated with mechanical contacts and alignment when used in con-

## BETTER SPIN-SYSTEM MEASUREMENTS

Conventional spin-measurement techniques require the use of a commutator-slip-ring assembly to couple an output signal to various pieces of laboratory test equipment. The method discussed in this article uses an inductive coupling scheme to do away with physical connections between the spun device under test and the analysis gear. In so doing, the technique eliminates noise problems normally associated with brush-contact devices and increases life by eliminating physical wear and tear

AUTHOR adjusts the spun device prior to a working test at Picatinny Arsenal ▶

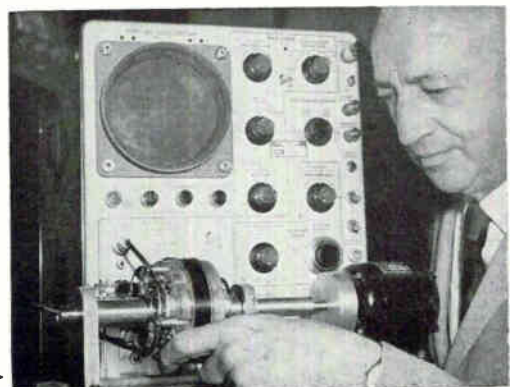

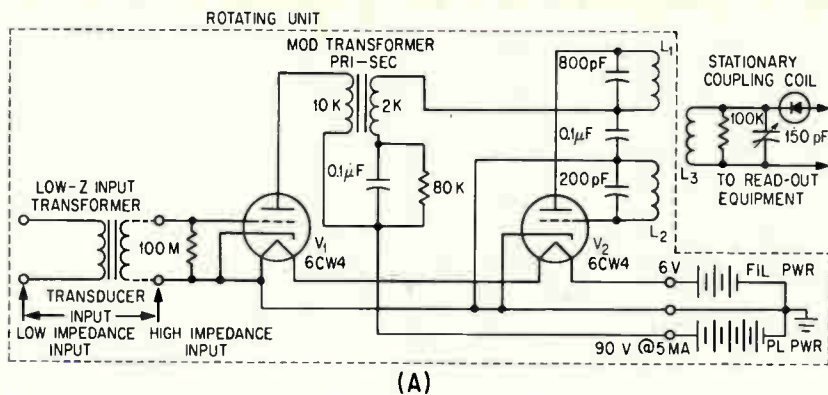

(A)

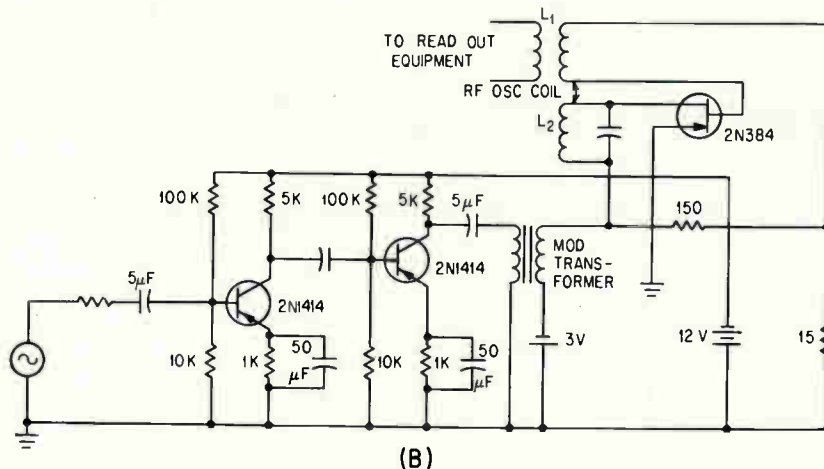

(B)

ROTATING unit and inductive coupling used by the author (A), and suggested circuit for its transistor equivalent (B)—Fig. 2

of a shunt resistor or to use a coupling coil with a degraded Q. There is a limit to the degree of damping which is practical and for bandwidths of several megacycles, simple circuits can not be employed.

Modulation-amplifier gain-bandwidth requirements are governed by transducer sensitivity and the determinable parameters. For most applications, a voltage gain of  $10^3$  and uniform response of 200 to 10,000 cycles will be adequate.

Nuvistors were used initially because of the inherently high input impedance characteristics that make them ideally suited for use in conjunction with high-impedance crystal transducers. For spin measuring systems using strain gages and relatively low-impedance transducers transistor circuits such as that in Fig. 2B can be utilized.

The linearity of the system is such that saturation or nonlinearity occurs beyond the signal level that causes 100-percent modulation of the carrier. The unit must be calibrated with the associated transducer, and some knowledge of the expected level of the input signal to be analyzed is necessary to remain within the limits of linear response.

All components should be mounted symmetrically to maintain dynamic balance with a minimum of counterbalancing.

**Speed Limitations** — Electrically, speed limitations of the system will be governed by the acceleration or g level which the components can withstand.

Tests with nuvistors indicate they can tolerate up to 10,000 g for limited intervals. Transistors, condensers and resistors, have been subjected to accelerations of 20,000 to 30,000 g without apparent damage.

The test unit has been rotated at 6,000 rpm, which is an acceleration level of 2,000 g. Output indications have been observed with inputs in the order of several millivolts over a frequency range of 200 to 10,000 cycles.

The a-m system described transmits only one channel of information. However, by using f-m techniques, multiplexing of a number of channels can be achieved. It is also possible to operate a number of a-m channels simultaneously providing there is adequate frequency separation to eliminate crossover.

junction with a commutator at high revolutions.

A spin-test unit has been developed at Picatinny Arsenal that makes use of radio frequency inductive coupling. Briefly, the system functions as follows: The transducer output signal instead of passing through slip-ring contacts, is connected to the input of a modulation amplifier, which in turn modulates a radio-frequency oscillator. This unit spins with the system to be analyzed. The radio frequency modulated signal from the rotating oscillator coil is then inductively coupled to a tuned circuit consisting of an inductance coil, tuning capacitor and diode. This tuned circuit connected to the input of a wide-band, high-gain oscilloscope. The r-f carrier is eliminated by the diode and the display on the oscilloscope is the electrical analog of the transducer output signal. The transducer, modulator and oscillator are packaged in a cylindrical unit that rotates with the spin system. As long as the spacing between the rotating oscillator coil and the fixed coil connected to the oscilloscope are constant, the behavior is similar

to an r-f transformer with fixed coupling between primary and secondary as illustrated in Fig. 2A.

The prototype unit that has been developed uses nuvistors in conventional circuits. The entire package including battery supply is contained in a cylindrical configuration that is considerably smaller than a slip-ring commutator assembly.

The r-f oscillator frequency for this unit is approximately 1 Mc. Sufficient stability is obtainable in this range without crystal oscillator circuits; however, their use is recommended as they would introduce no additional problems. Output signals are not affected by the coupling factor if the spacing between the rotating and stationary transformer coils is constant.

Design of the oscillator and coupling coil are determined by the carrier frequency selected and the required transmission bandwidth. The carrier frequency should be approximately ten times the required bandwidth of the system to be analyzed. For bandwidths of 10 Kc and greater at the half-power points, it may be necessary to reduce the coupling coil Q by means



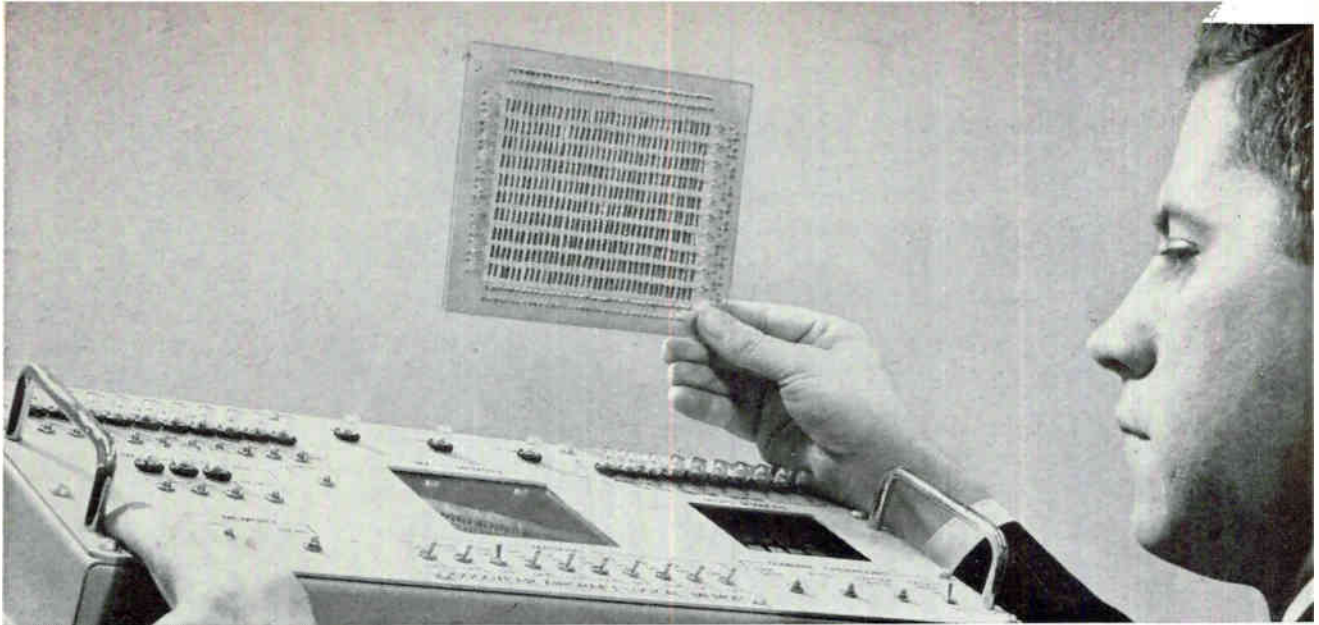

PORTABLE FEASIBILITY MODEL of an associative memory containing a memory plane of eight 10-bit words. Front-panel controls enter information into memory—masking, reading and comparing. Lights are provided for the load-and-compare-word and the compare-location registers

## HOW to Quiz a Whole Memory At Once

Associative memory queries all the memory of a computer in one cycle instead of word by word. Memory read-write operations are random-access, with nondestructive read-out

---

### WHAT IS AN ASSOCIATIVE MEMORY?

Present-day digital computers are word-oriented. Arithmetic and memory operations are sequenced by function and the computer solves all problems word-by-word. However, computation is still relatively fast. Standard logical operations such as encoding-decoding, table look-up, or memory search routine all take time. Such operations are usually performed by sequencing through all or part of the memory until a desired logical operation is achieved. In each case, the data contained in some definite but unknown memory location is desired. With increasingly larger memories, memory searching time becomes prohibitively long. The total time depends upon the logic and memory speeds plus the size of the memory. Frequently the programmer must abandon the luxury of memory-search routines. Unfortunately this cannot always be done.

A solution would be to interrogate all of memory at one time. A logical operation such as a compare function would be accomplished in one memory-cycle time. While reading out an entire digital memory into a logical unit is possible, the equipment required and the resultant cost would be prohibitive. An ideal solution is a logical operation inherent in the memory system itself

By G. T. TUTTLE

Goodyear Aerospace's Computer Systems Dept.,  
Akron, Ohio

**THE MAIN FUNCTION** of an associative memory is to compare a data word to the entire contents of memory. Occasionally, such memories are called search memories or content address memories. Then, for such a memory system to be useful, some method must be provided to handle the responses resulting from the compare operation. An additional feature often desired is the ability to limit the compare operation to certain bit locations in the data word. This is usually accomplished by using a masking word.

**Memory Element**—The basic memory element in Goodyear Aerospace Corporation's associative memory is the Male (Multi-aperture logic element), which has one major and two minor apertures. The major aperture is for storage and the minor apertures provide the exclusive OR logical function, thus combining both memory and logic in a single device. A unique method of wiring is used with the Male,

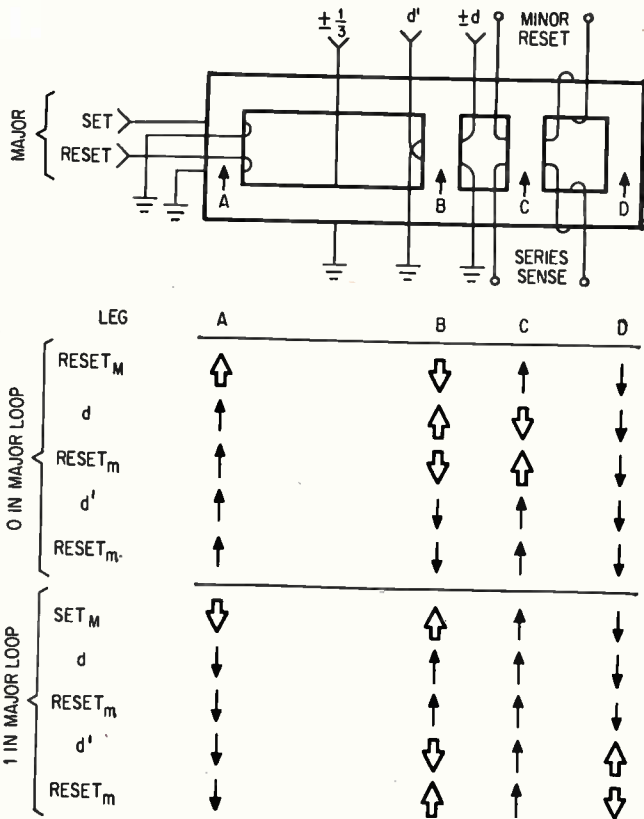

MALE flux-state diagram—Fig. 1

resulting in an extremely high signal-to-noise ratio for ferrite devices. The high signal-to-noise ratio allows the Male to be used in word lengths exceeding one hundred bits.

A wiring and flux-state diagram of the Male is shown in Fig. 1. The large arrows indicate which legs change state. Operation is:

(1) A ONE or a ZERO is set into the major loop by causing a constant current to flow into either the SET or RESET lines. The resulting mmf is just enough to fully switch around legs A and B and not affect legs C or D.

(2) A ONE or a ZERO may then be compared to the information stored in the major loop by causing a constant current to flow into either the  $d$  or  $d'$  lines. In either case, only legs B and C or B and D may change. The current and resulting mmf is limited so that no switching can occur in leg A.

Then by causing a constant current to flow into the minor-reset line, and at this time monitoring the series-sense line, a pulse will be observed if the digital information set into either of the digit lines differs from that set into the major loop. If we let the information stored in the major loop equal  $X$  and the information stored in the minor loops equal

$Y$ , the following relationship is observed: series sense line =  $XY'$  or  $X'Y$  (exclusive OR).

Referring again to Fig. 1, note that if the information stored in the major loop is desired, it can easily be obtained by causing constant current flow into the  $d'$  line and a true indication of the stored bit will be obtained by monitoring the series-sense line when resetting the minor loop. It is this feature that gives the device its nondestructive read operation.

One additional line is required to use the Male in an associative memory system and that is the  $\pm 1/3$  line located in the major loop and shown in Fig. 1. After resetting the major loop, the  $\pm 1/3$  line provides the choice of setting or not setting the major loop to a ONE.

**System Operation**—A typical memory word is shown in Fig. 2, and a block diagram of the associative memory system in Fig. 3.

Writing into memory is done as in a linear select memory with one exception: the basic storage element is now the major aperture of the Male. A certain word is selected by the word-select matrix, and the contents of the input register determine which bits (major apertures) in the selected word are set to a ONE. This is the only memory operation that affects the major aperture.

A nondestructive read operation is performed by interrogating the minor loops in the Male. To read a particular word from memory, the digit-oriented  $d'$  drivers are turned on. Each respective minor loop will switch only if the major loop contained a ONE (Fig. 1). Since parallel (bit-by-bit) sensing is required, the series sense is not used during the read-memory operation. After the  $d'$  lines have been pulsed, the desired word is selected by the word-select matrix and the reset-minor line for that particular word is turned on. There are two reset-minor lines in the system; one is used for the read-memory operation, and the other is used during the associative operation. For readout sensing, the  $d$  wires are used and by appropriate gating via the control circuits are fed to the read amplifiers during the reset-minor pulse. Notice that all of the minor loops in memory may have changed state by turning on the  $d'$  lines, but this is of no consequence, as readout was sensed on a word basis (by turning on only one reset-minor line). Also if succeeding read operations on additional words are required, the  $d'$  drivers need not be turned on again.

**Compare Operation**—The associative function of comparing a word stored in the Input and Compare Register (ICR) (Fig. 3) to all of memory at one time is accomplished as follows:

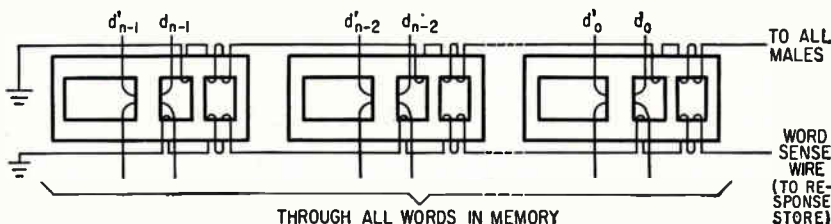

TYPICAL memory word. For clarity, the write wires are omitted and only the wires used for the associative function are shown—Fig. 2

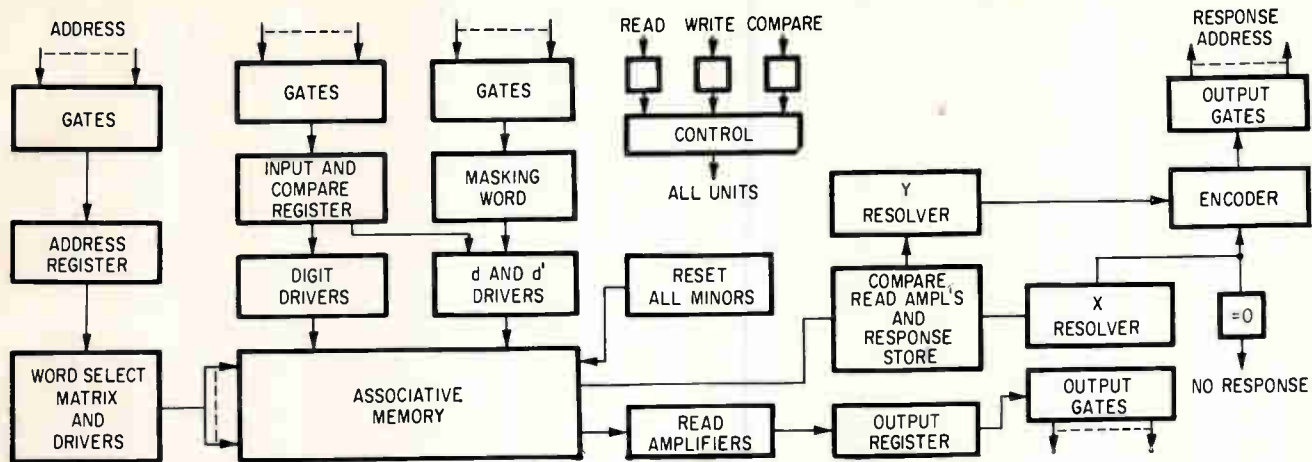

ASSOCIATIVE MEMORY—Fig. 3

The contents of the ICR determine which  $d$  driver is gated ON. For every ZERO in the ICR, the  $d'$  driver is gated on, and for every ONE the  $d$  driver is gated on. Thus for each bit location, either a  $d$  or  $d'$  driver is turned on. Immediately following the  $d$  drivers (gated off) the minor loops of every word in memory are reset to ZERO. At this time each word-sense wire for each word in memory is gated into the compare read amplifiers.

Previously, it was shown that if the digital information set into the minor loops by the  $d$  drivers differs from that stored in the major loop, an output pulse will be observed on the word-sense line upon resetting the minor loops. The word-sense line of all Males making up a memory word are wired in series (Fig. 2), thus providing the means of detecting if one or more of the minor loops changed states during the compare operations. In practice the signal appearing on the word sense line is the complement of what is desired; that is, a signal for non-compare. The compare-read amplifier complements the input signal, which sends the correct logic level to the response store.

**Masking Word**—The power of an associative memory is greatly increased if some method is provided to select certain bits in the ICR for the compare operation. This is particularly true for any encoding or decoding operation. A typical example would be a table look-up operation such as finding the sine of a given angle. Conventional digital computers usually solve this problem by some iterative process such as a power series; that is

$$\sin x = x - \frac{1}{6} x^3 + \frac{1}{120} x^5 - \frac{1}{5040} x^7 + \dots$$

Here a number of add, subtract, multiply and divide operations are required, which is time-consuming. With an associative memory, a  $\sin x = y$  table could be used. Each word in the table would contain the following information

ANGLE		SINE		INTERPOLATION VALUE
-------	--	------	--	---------------------

To obtain the sine value, the compare operation would be performed on the data bits representing the

angle. The sine value and the interpolation values are masked out of the compare operation. Masking is done in the associative memory by simply inhibiting both the  $d$  and the  $d'$  drivers in selected bit positions. The selected bits then appear as don't-care bits in the compare operations. Regardless of the information contained in the major loop, no signal can appear on the series-sense line during the reset-minor pulse unless preceded by a  $d$  or  $d'$  current pulse. Which bits are selected are determined by ONE's in the masking register which has a bit-by-bit correspondence with the ICR.

In the example, suppose the table consisted of 90 words, one for each degree and the sine of 43.17 deg is desired. The input to the system for the compare operation would be 43 deg and the contents of the ICR and the masking register is

4 3 1 7 0 0 0	0 0 0 0 0 0	ICR
---------------	-------------	-----

1 1 0 0 0 0	0 0 0 0 0 0	MASK REGISTER
-------------	-------------	---------------

The resulting search in the associative memory would be on

4 3 X X X X X X X	X X X X X
-------------------	-----------

where the X's indicate don't-care bits. Immediately following the compare operation, a read-memory operation is performed using the address indicated by the response store. Now the sine value and the sine interpolation value are transferred to a standard arithmetic unit for one multiplication and add operation to obtain the sine of 43.17 deg.

**Response Store**—Two methods are currently used to resolve the multiple responses resulting from the compare operation. Both are similar in operation and differ only in the actual storage element used. For small associative memory systems, solid-state devices (flip-flops) are used and for large systems, two-core planes are used. Both methods divide the memory into zones, with each zone containing a number of words. The contents of the zone and word resolver, denoted in Fig. 3 as the  $x$  and  $y$  resolver, are then fed

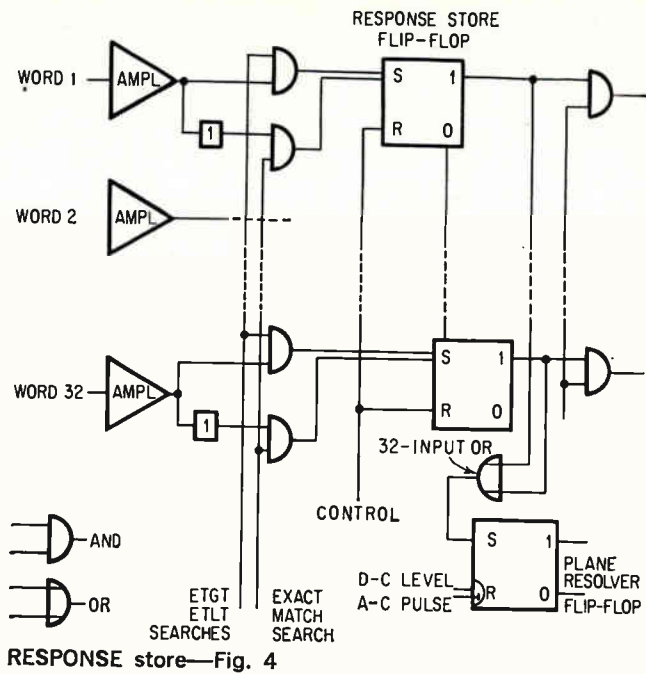

RESPONSE store—Fig. 4

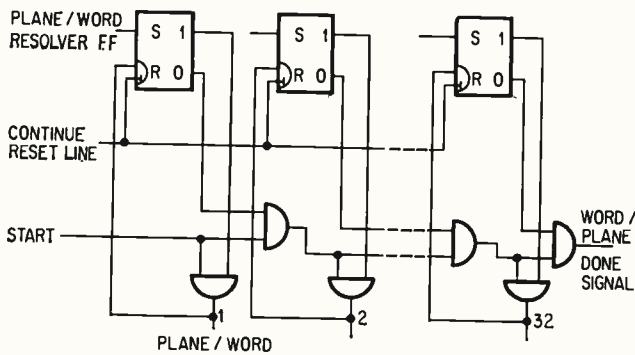

PLANE and word-resolver circuit—Fig. 5

to a diode encoder, which generates a binary number for the first least significant word position that compared to the data word used in the compare operation. The  $x$  and  $y$  resolvers are sequential in operation and generate response addresses at a one-mc rate. The lack of a response to a compare operation is indicated by all zeroes in the  $x$  resolver, which activates the no-response line shown in Fig. 3.

To describe the operation of the response store and associated circuits, a 1,024-word associative memory consisting of 32 planes will be used. Each plane contains 32 words and straightforward noninverting logic circuits are shown instead of the actual circuits developed for the system to better illustrate system operation. Each word in memory has associated with it (see Fig. 4) one amplifier with both the true and an inverted output plus three AND gates and a flip-flop (FF). The AND gates feeding the response-store FF discriminate between the exact match search and the compound searches of Equal to and Greater Than (ETGT), and Equal to and Less Than (ETLT). At this time only the exact match or compare operation will be considered. During the compare operation the control circuitry gates the inverted signal from the word amplifier into the response store FF's. If one or more of the response store FF's are set to a ONE, the plane resolver FF is also set to a ONE

by the 32-input OR gate. The remaining 31 planes are identical and are set or not set during the compare operation. The circuit that determines which words met the search criteria is now activated (Fig. 5). The plane-resolver FF for each plane is shown along with two additional AND gates per stage. To start the plane-resolver circuit, a ONE is applied to the start line at the end of the compare operation and begins to ripple down through the top AND gate structure as long as each plane-resolver FF is reset. If any plane-resolver FF is set to a ONE, the chain is broken, and the lower AND gate associated with that particular FF is turned on. Notice that one, and only one, of the lower AND gates will generate a ONE at any one time. This signal is used to transfer the contents of the response-store FF's associated with the plane-resolver FF into a word-resolver circuit that is identical to the plane-resolver circuit just described. A ONE is now started down the word-resolver circuit and stops at the first word FF that contains a ONE. These are the  $x$  and  $y$  resolvers shown in Fig. 3. At this time there is a signal from one AND gate in both the word resolver and plane resolver. These two signals are then fed into a standard diode-encoding matrix that generates, in binary form, the address of the first word meeting the search criteria in the compare operation. To obtain the additional addresses that may exist (which would indicate that more than one word met the search criteria) the continue-reset line in the word resolver in Fig. 5 is activated with a short-duration pulse. Each FF has a gated a-c reset so that only one of the resolver FF's will be reset at one time, which allows the start signal to continue rippling down the top AND gate structure until stopped by another FF that contains a ONE. This process continues until a completion signal appears in the last AND gate in both the word and the plane resolver, which indicates that no additional responses exist in the system. In practice the rippling process is speeded up by using conventional look-ahead circuits<sup>1</sup>. Worst-case-time timing for the response store, the word and plane resolvers and the diode encoding matrix is one microsecond for a 4,000-word memory so that addresses can be generated at a one-mc rate.

**Additional Functions**—Other useful functions performed by the associative memory are finding all words in memory that are less than, or greater than, some specified value. A between-limits search is obtained by combining a greater-than search with a less-than search.

**System Functional Speed**—The read, write and compare operations are determined by the switching speed of the ferrite material used in constructing the Male. Two different types of materials are used in making the Males. The faster of the two results in a 2.5- $\mu$ sec function time for the read and compare operations and a 5- $\mu$ sec write time. The slower material requires 5  $\mu$ sec for the read and compare operation and 7  $\mu$ sec for the write operation.

#### REFERENCE

(1) O. L. MacSorely, *High Speed Arithmetic in Binary Computers*, Proc IRE, Vol. 49, No. 1, Jan. 1961.

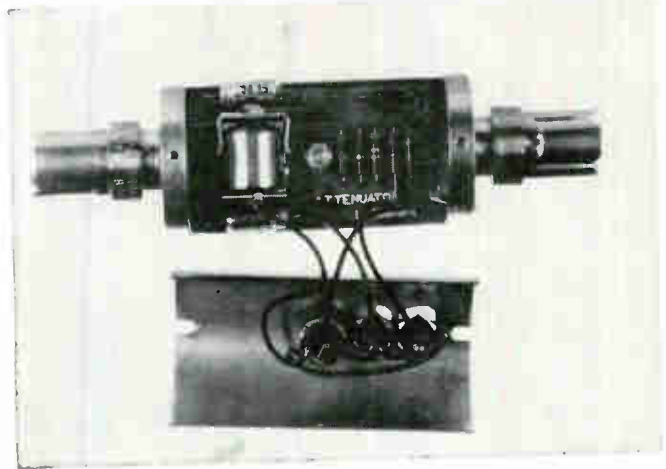
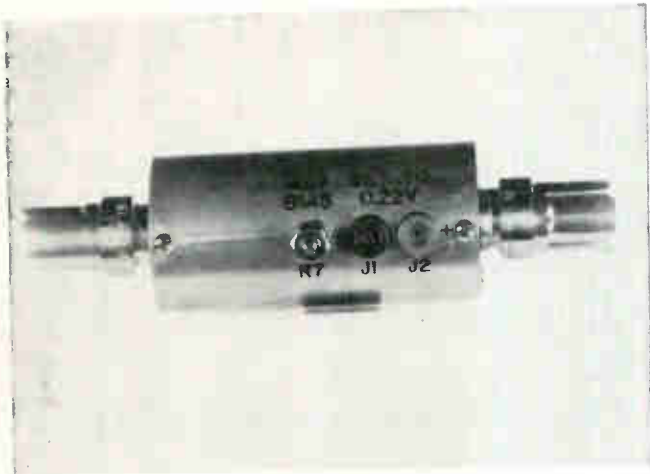

THREE-DECADE attenuator for logarithmic pulse compression

### ATTENUATOR SPECS

This passive attenuator of simple construction will logarithmically compress positive or negative pulses having an amplitude range of three orders of magnitude. The output is proportional to the logarithm of input voltages between 0.1 and 100 volts. The range of the output is between 0.1 and 0.9 volt and the log-linear relationship is achieved with an accuracy of better than  $\pm 4$  percent. The corresponding attenuation varies from 1:1 at an input of 0.1 volt, to 111:1 at 100 volts

# LOGARITHMIC ATTENUATOR SPANS THREE DECADES

Passive circuit attenuates positive or negative pulses, has output proportional to the logarithm of input voltages between 0.1 and 100 volts. Output ranges between 0.1 and 0.9 volt

By C. D. NAIL, Lawrence Radiation Laboratory U. of California, Livermore, Calif.

**IN ANY NONLINEAR** attenuator the apparent rise time, measured by the output waveform resulting from an ideal step input, depends on the amplitude of the step. Best (smallest) rise time is obtained for large input and is progressively greater with decreased input.

When this attenuator was connected to an oscilloscope having an input impedance of 1 megohm shunted by 47 pf, the observed rise time was less than 20 nsec for an input of 10 volts or more (limited by the inherent rise time of the oscilloscope). At an input of 1.0 volt, the rise time was 70 nsec and at 0.1 volt it was about 400 nsec.

Naturally the input and output impedance of the attenuator are also a function of the signal level. At 0.1 volt the input impedance is equal to 1,300 ohms plus the load impedances of the attenuator are ohm). The corresponding output impedance is 1,300 ohms plus the source impedance (nominally between 50 and 100 ohms). At the 100-volt level the input impedance approaches 1,300 ohms and the output impedance is about 10-12 ohms.

**Construction**—The circuit of the completed log-attenuator is shown in Fig. 1. The calibration obtained for 0.5-microsecond pulses from a mercury pulser is shown in Fig. 2. No appreciable differences in the calibration were detected when positive or negative pulses were ap-

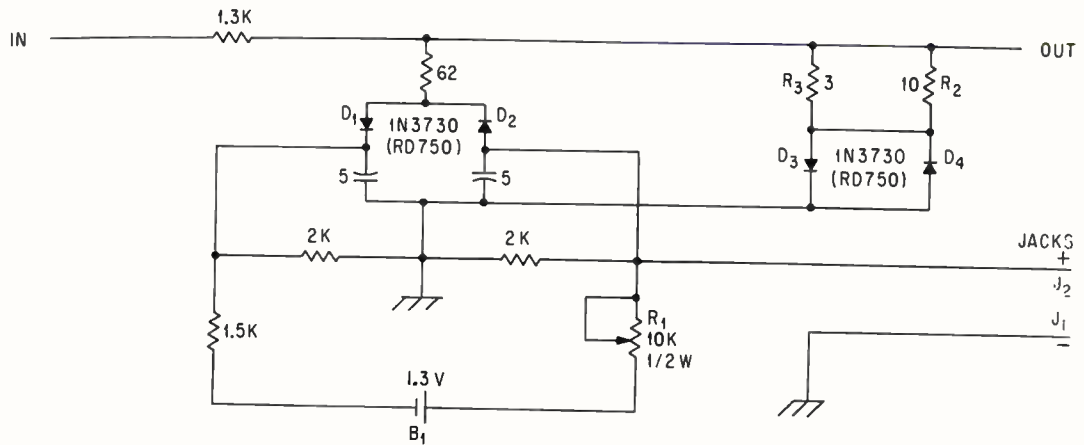

LOG ATTENUATOR for positive or negative pulses, 100 volts maximum input. The capacitors are 6-volt electrolytics—Fig. 1

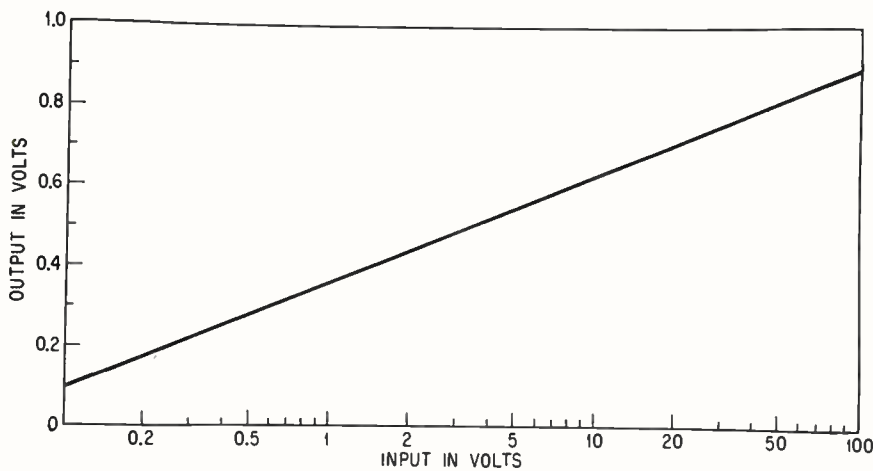

CALIBRATION of three-decade logarithmic attenuator—Fig. 2

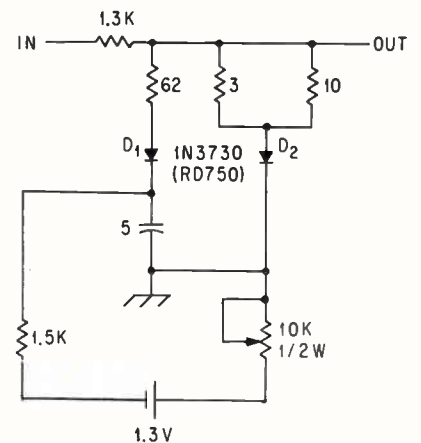

LOG ATTENUATOR for positive polarity only—Fig. 3

plied, although no care was taken to select matched diode pairs.

**Adjustments**—To obtain log-linear characteristics in the 0.1-to-1.0-volt region it is necessary to bias diodes  $D_1$  and  $D_2$  in the forward direction to a point near the knee of the conduction curve. This is done with a small mercury battery  $B_1$  and adjusting rheostat  $R_1$ . Optimum log-linearity is obtained at a setting of about 0.22 volt (between pin jacks  $J_1$  and  $J_2$ ) for the diodes specified. The adjustment is not critical in the range of 0.20 to 0.25 volt.

Above 10 volts input, diodes  $D_3$  and  $D_4$  are primarily responsible for the attenuation, so that changes in bias have little effect upon the output at that level.

The linearity of the log characteristic can be adjusted in the 20-to-100-volt region by varying the  $R_2 - R_3$  combination. Larger values will increase the upward trend of the curve while decreased values will cause the curve to roll off as the input nears 100 volts. The optimum value was found to be about 2.3 ohms and did not vary appreciably with different diodes of the same type and lot.

Calibration was made using a mercury pulser and a number of 50-ohm, fixed attenuators with ratios of 2:1, 5:1 and 10:1.

**Simplification**—The circuit may be simplified nearly 50 percent if pulses of only one polarity are to be compressed. The simpler circuit shown

in Fig. 3 is designed for positive pulses. The transfer characteristics are the same, in the positive direction as for Fig. 1, except that the rise time is slightly better at low levels, due to decreased stray and diode capacitances.

In the negative direction the simplified circuit has little attenuation. Rise time, however, is limited to about 350 nsec by the 1,300-ohm series resistance combined with the shunting capacitances of the diode, output connector and oscilloscope input. For large negative signals (above 80 v) the zener point for the diode is reached and nonlinear characteristics result.

This work was performed under the auspices of the U. S. Atomic Energy Commission.

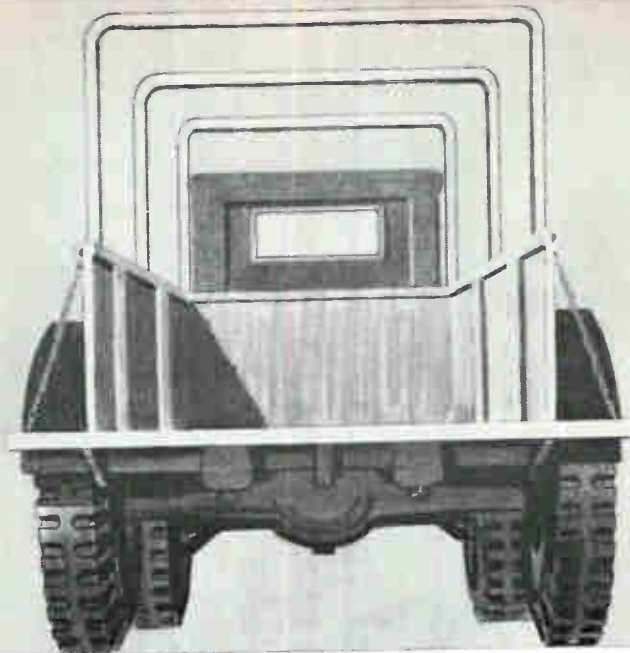

Could you put a 50 kw transmitter in this space?

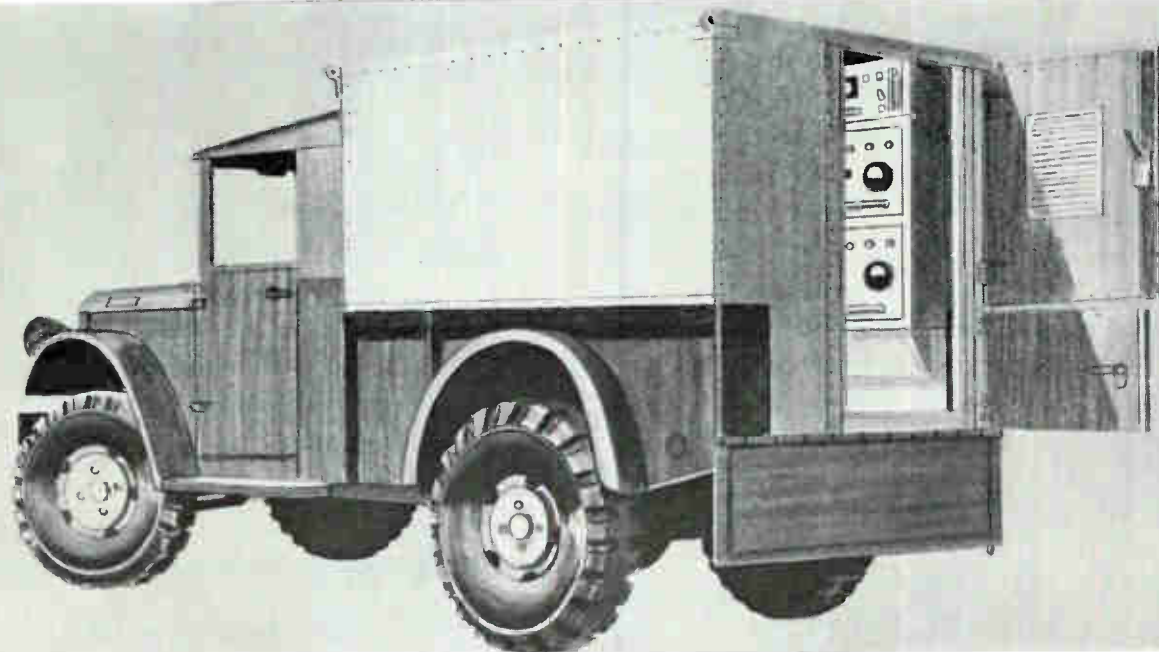

### Westinghouse can

A Westinghouse Solid State Transmitter (Series ST) fits in about one tenth the space you need for conventional designs. It weighs only one third as much, requires far less cooling, operates with 80% efficiency. And it is 10 times more reliable on the basis of MTBF.

Series ST transmitters have made it possible to apply high power communications techniques (up to 150 kw) in many areas where tube-type transmitters are imprac-

tical. Using Westinghouse-developed all-solid-state circuitry, such restricted environments as ships, submarines, aircraft and tactical vehicles can now support advanced high power communications systems.

Other applications include underground and underwater installations, where equipment must operate unattended for long periods.

Westinghouse Surface Division pro-

duces Series ST Solid State Transmitters in a variety of configurations for specialized defense communications systems. These highly versatile systems are but one indication of how the broad capabilities of Westinghouse can answer your most urgent needs in electronics.

Get details by writing to Westinghouse Electric Corporation, P.O. Box 868, Pittsburgh 30, Pennsylvania. You can be sure ... if it's Westinghouse.

J-02354

We never forget how much you rely on Westinghouse



CIRCLE 49 ON READER SERVICE CARD

Designed for



Application



**COUPLINGS**

Illustrated are a few of the stock miniature and standard Millen couplings. Flexible or solid — insulated or non-insulated — normal or high torque. Also available with inverted hubs to reduce length.

**JAMES MILLEN MFG. CO., INC.**

MALDEN  
MASSACHUSETTS

CIRCLE 200 ON READER SERVICE CARD

**NEW!**

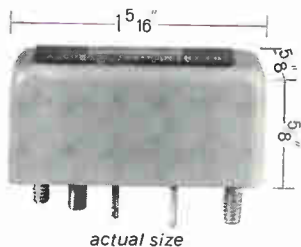

**PICO**  
Miniature  
**FREQUENCY STANDARD**

Smallest size  $\frac{5}{8}$ " x  $1\frac{1}{16}$ " x  $\frac{5}{8}$ ", weighing less than  $\frac{3}{4}$  oz.

Widest range Expanded frequency range is from 2 kc to 50 kc and is available with accuracies from 0.001% to 0.2% over temperature variations from  $-55^{\circ}\text{C}$  to  $+125^{\circ}\text{C}$ .



Designed for shock and vibration applications. Ideal for space and aircraft use.

Write for PM Catalog

**ACCURATE INSTRUMENT CO.**  
P. O. BOX 19426 • HOUSTON 24, TEXAS

Manufacturers of frequency standards and test instruments

**Higher Reliability  
& Greater Stability**  
by Passivation.  
**Lower Price**  
by Resin Molding Process

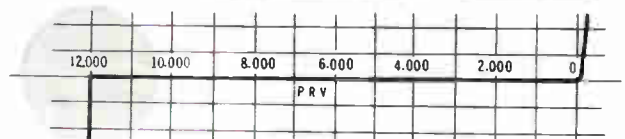

Sharp Reverse Breakdown,  
Unchangeable by Time  
or Environment.

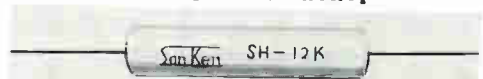

SH-SERIES SILICON RECTIFIER

For Low Power Supplies  
SD-1 Series

For High Power Supplies  
SH-Series

SD-1	400 PRV	500 mA
SD-1A	600 PRV	500 mA
SD-1B	800 PRV	500 mA
SD-1C	1000 PRV	500 mA

SH-6K	6000 PRV	30 mA
SH-8K	8000 PRV	30 mA
SH-10K	10000 PRV	30 mA
SH-12K	12000 PRV	30 mA

**SanKen SANKEN ELECTRIC CO., LTD.**

Daiwa Bldg., 1-11, Ikebukuro-Higashi, Toshima-ku, Tokyo

**Cable: SANKELE TOKYO**

CIRCLE 201 ON READER SERVICE CARD  
November 15, 1963 electronics





## The men you hire tomorrow

## are the kids you help today

Contributions made to United Funds or Community Chests are really an investment. An investment in *your* future. United Fund agencies take the edge off hunger and misery, sure, but they go way beyond that. They do an awful lot for youngsters—providing recreational facilities, finding homes for the homeless, steering puzzled teen-agers onto the right road. So it makes good sense to give the United Way. Your company can make a contribution, and you can make it convenient for your employees to join in through payroll payments. This once-a-year appeal cuts down on the confusion and duplication of separate drives, too. So give United. Could be, the kids you help today will be helping your business tomorrow.

**One gift works many  
wonders/GIVE THE  
UNITED WAY**

PHOTO BY PHIL BATH

Space contributed as a public service by this magazine.

# Introducing the new CEC 5-133 datagraph recording oscillograph

The ultimate achievement of today's recognized leader in oscillography

The 5-133 DATAGRAPH Oscillograph is a rack-mounted or bench-mounted direct-writing instrument producing 36 or 52 channels of data on 12-inch-wide light-sensitive-paper. Superior performance, the maximum in operator convenience, and superb styling have been perfectly blended in an oscillograph that fulfills and surpasses the most critical requirements of modern

technology. For additional information on this outstanding new instrument, call your CEC sales and service office or write for Bulletin CEC 5133-X7.

**CEC**  
Data Recorders Division

**CONSOLIDATED ELECTRODYNAMICS**

A Subsidiary of Bell & Howell • Pasadena, Calif. 91109

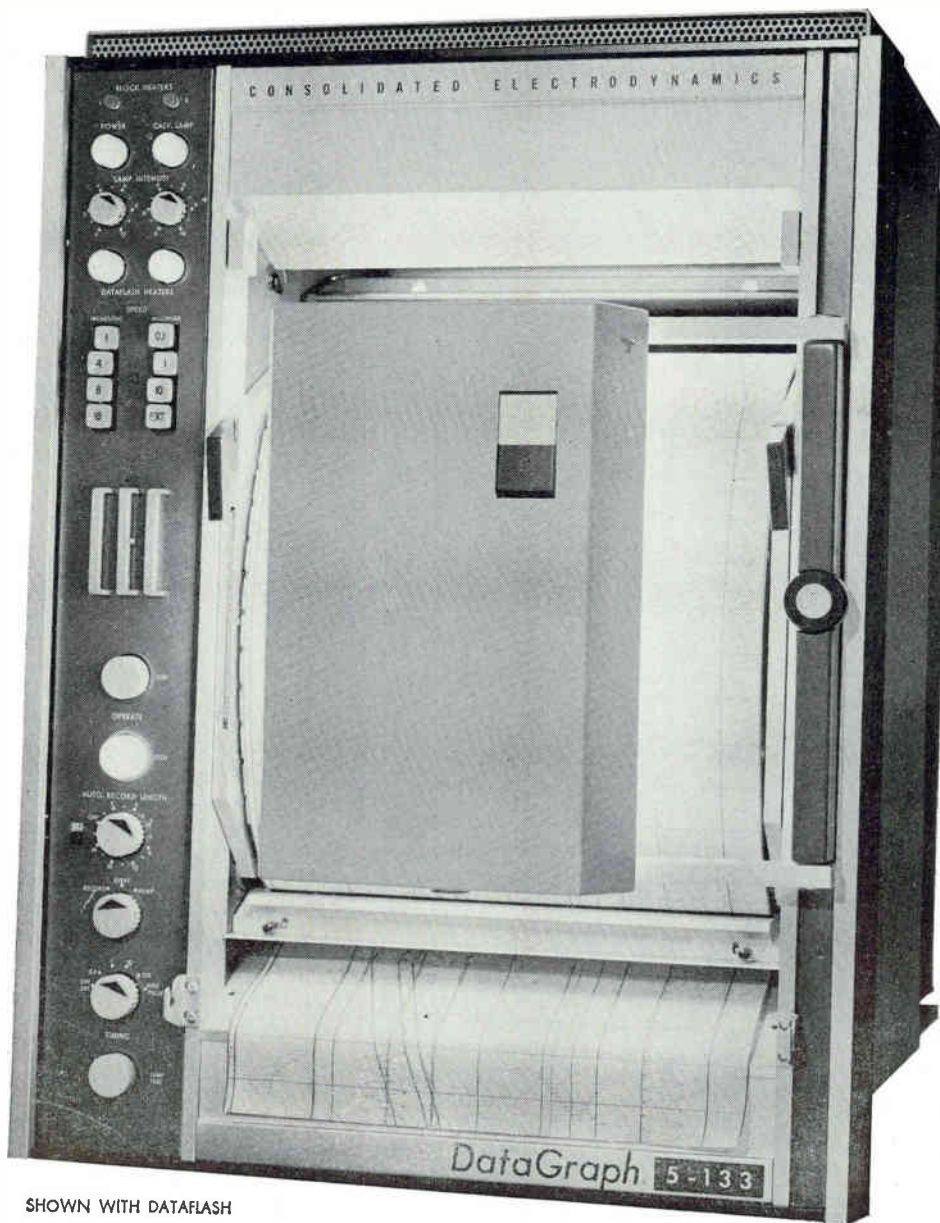

SHOWN WITH DATAFLASH

## Features

**STATIC MAGNETIC REGULATED LAMP POWER SUPPLY** — provides proper power to lamp regardless of input voltage variations, allows start/restart times of less than one second.

**SLOT-EXIT CAPABILITY** — up to 160 inches-per-second.

**ADJUSTABLE GRID LINE INTENSITY** — continuous variable vernier control.

**NEW TIMING LINE GENERATOR** — electronically flashes timing lines at intervals of 10, 1, 1/10, 1/100, and 1/1000 second.

**RECORD/EVENT NUMBERING** — selected by front panel switch.

**AUTOMATIC RECORD LENGTH CONTROL** — continuously variable from 0 to 15 feet; multiplier extends range to 0 to 150 feet.

**TWELVE RECORDING SPEEDS** — pushbutton selectable speeds of .1, .4, .8, 1, 1.6, 4, 8, 10, 16, 40, 80, and 160 inches-per-second.

**TRACE IDENTIFICATION** — trace interruption and trace numbering.

**VIBRATION ISOLATION** — four isolator mounts on recorder and four on the drive motor/transmission assembly.

**GALVO LIGHT INTENSITY CONTROLS** — manual and automatic controls provide optimum trace quality for each block.

**FILTERED AIR COOLING** — cools and pressurizes the optical module for maximum cleanliness.

**MODULE CONSTRUCTION** — all modules removable as single assemblies.

# THREE MORE WAYS

to measure with CEC



CEC's 5-114 DATAGRAPH Recording Oscillograph is available in 18 or 26 trace models; produces 225-ft. records on 7-inch-wide paper. The instrument's DATARITE accessory provides immediate access to records.



CEC's 5-119V DATAGRAPH Recording Oscillograph, the "universal" oscillograph, makes conventional, DATARITE® (Flash Developing Process), or print-out records; 36 or 52 channels, a-c or d-c models with 12" wide oscillograms. Speed: 0.1 to 160 ips.



CEC's 5-124 DATAGRAPH Recording Oscillograph is portable, direct-writing, weighs only 40 pounds. It is low cost and loads easily. Up to 18 traces may be recorded on 7"-wide-paper. Further data? Call or write for Bulletins in CEC Kit #3472-X7.

**CEC**  
Data Recorders Division

**CONSOLIDATED ELECTRODYNAMICS**  
A Subsidiary of Bell & Howell • Pasadena, Calif. 91109

CIRCLE 53 ON READER SERVICE CARD  
electronics November 15, 1963

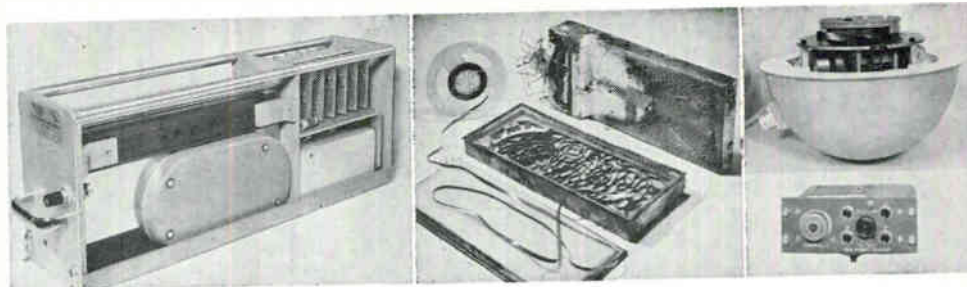

FOUR VERSIONS of cockpit recorder: four-channel amplifier and tape magazine of Lockheed Aircraft Service model (left); United Data Control prototype, showing that liquid ablation preserved tape in bin during fire test (center); Spec Tool will switch from spherical housing (top right) to box; Fairchild's pushbutton control and microphone unit (bottom right) works with fireproof recorder

## Hot Mikes Will Record Air Crew's Conversation

Requirements for airliner cockpit recorders will soon be set by FAA

By **ALEXANDER A. MCKENZIE**  
Associate Editor

**FEDERAL** Aviation Agency will soon tie down its requirements for a four-channel cockpit voice recorder that must run during the flight of every U. S. carrier aircraft. Costing about \$2,000 a unit and upwards of \$1,000 for installation, the tab for some 3,000 aircraft will total at least \$10 million.

The airlines are unhappy about the expense and weight; pilots have demanded a means of wiping the recorder clean upon safe termination of each flight, but all agree they can't fight FAA and the Congress. There have been too many unexplained air accidents. A crash-and fireproof record of the crew's last words could help save lives on other flights.

**Doing the Job**—Coordinating efforts of airlines, manufacturers and FAA is the Airlines Electronic Engineering Committee (AEEC) chaired by W. T. Carnes, of Aeronautical Radio, Inc. (ARINC). After FAA suggested minimum performance standards last June, AEEC members representing a standing committee of the Air Lines Communications Administrative Council began planning the kind and size of equipment necessary to

meet the specs and satisfy the users.

This paper work parallels results of an FAA equipment development contract to United Data Control, Inc. of South El Monte, Calif., whose recorders are already in service on Australian air lines. Other equipments were later ordered from Lockheed, Fairchild and Spec Tool.

**FAA Limits**—The magnetic tape recording system desired by FAA must have characteristics beyond those normally required in connecting a mike to a home recorder. Besides such requirements that the record tape come safely through 1,100-deg C fire for 30 minutes, withstand 100 g in 11 milliseconds and survive immersion in salt water, the system must provide multiple records. Simultaneous recordings will be made of everything spoken into pilot's, copilot's and flight crew's microphones and all audio signals introduced into their headphones. Besides these three channels, all vocal expressions of those flight crew members who are within range of a cockpit-mounted continuously active microphone assembly must be recorded on a fourth channel.

**Recording Standards**—Trickiest audio problem appeared to be attaining as high as 70-percent intelligibility over aircraft noise on first playback of the tape (subsequent repetitive readings could well exceed 90 percent). Fortunately,

# YOU MAY NEVER NEED THIS KIND OF REGULATION ...but YOU'LL BE GLAD YOU HAVE IT .....

Maybe we build our power supplies too good. But, by anticipating the unusual conditions of some installations, we provide a margin of performance that may be necessary to overcome problems in isolated cases. This then assures precise operation in the ordinary installation. Precision control is the key to a high level of performance over a wide range of installation conditions,

If you need power supplies, that are designed and built with a high degree of regulation, like the units shown below — then get in touch with Acme Electric.

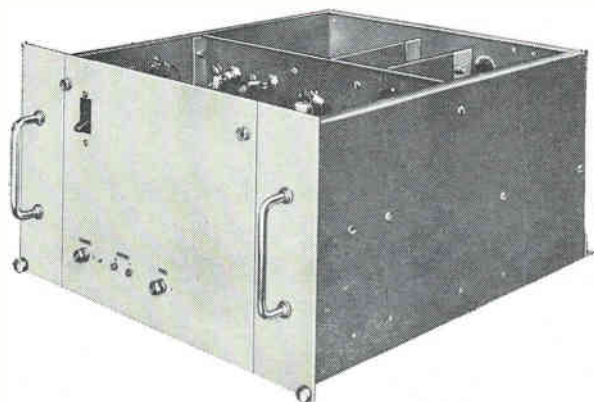

AC Input Volts: 190, 198, 206, 214, 222, 230, 238, 246, 254, 277,  $\pm 15\%$   
 Frequency: 48-62 cps  
 DC Output: 60 volts @ 20 amperes  $\pm 2\%$

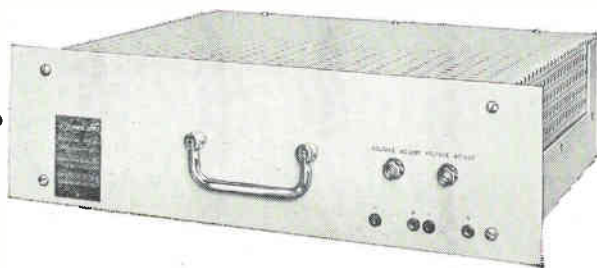

Input: 208V  $\pm 15\%$ ; 60 cps  $\pm \frac{1}{2}$  cps; 3 phase Y  
 240V  $\pm 15\%$ ; 60 cps  $\pm \frac{1}{2}$  cps; 1 phase  
 220V  $\pm 15\%$ ; 50 cps  $\pm 1$  cps; 1 phase  
 Output: 99.98 - 100.02 V. @ .25 amperes,  $\pm .03\%$   
 Ripple: .002%  
 Line Regulation: .001%  
 Load Regulation: .002% (50 - 100%)  
 Drift: .04%

**Acme ACME Electric**

**Engineers and Builders of...**

3111 WATER STREET, CUBA, NEW YORK

In Canada: Acme Electric Corp. Ltd.  
 50 Northline Rd., Toronto, Ont.

REGULATED POWER SUPPLIES  
 STATIC POWER RECTIFIERS  
 VOLTAGE STABILIZERS  
 VOLTAGE REGULATORS

FAA's early studies showed that audio spectral energy patterns for all aircraft were similar in frequency with the predominant noise interference below 400 cycles. Low-frequency roll-off starting at 600 cycles and dropping at a rate of 18 db per octave or greater as frequency decreases towards zero suppresses noise peaks and permits hearing voices over the noise level of even piston engine aircraft. This roll-off can be accomplished either with passive filters or design of the microphone preamplifier.

Recorded sound must not vary more than 6 db from 350 to 3,000 cycles; distortion is limited to 10 percent. A visual monitor giving indication that all four channels are recording properly is required. FAA specifies that the output level of the hot microphone shall not vary more than a total of 12 db from 400 to 3,000 cycles at sound pressure input ranges of 60 to 120 db above 0.0002 dyne per square centimeter.

**Clean Record**—Air Line Pilots' Association (ALPA) initially objected to monitoring normal cockpit conversations, claiming that records from successful flights could contribute nothing to safety. The pilots threatened that if recordings were ever used in any enforcement action flight crews would just stop talking and use hand signals. They also recommended recording throughout the aircraft but agreed that passengers might object to riding in bugged airplanes. The pilots are expected to be satisfied by provision for bulk erase under control of the pilot after the plane has been safely landed and just before all power is turned off.

## Monitors Check Air for Lethal Vapor or Dust

CHICAGO—IIT Research Institute has developed for Edwards Air Force Base devices that monitor air for poisons. One detects vapors from boron compounds, or other toxic gas, by using a multiplier phototube to measure characteristic color when an air sample is fed to a flame. In the other, beryllium-oxide dust is detected by the gamma rays a sample gives off when bombarded with alpha particles.

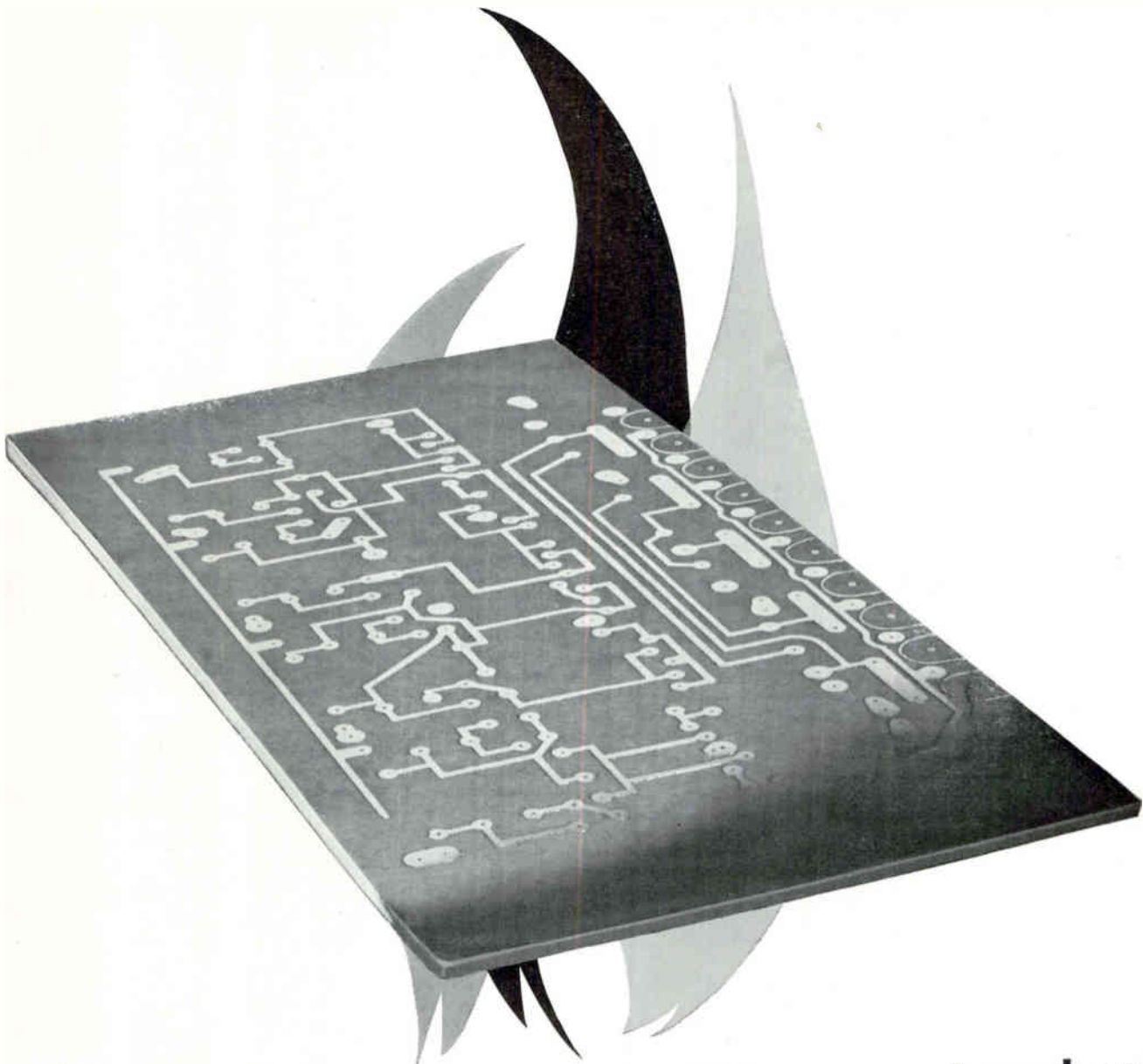

## New Formica® FR-200: Flame retardant

Formica FR-200 paper-phenolic laminate . . . for flame retardant printed circuitry. NEMA grade FR-2. Meets properties of MIL-P-3115C. Burn time: 4 sec. (ASTM D635-65 test modified to show burn time after 1st ignition.) High flexural strength (flatwise average value: 21,500 psi lengthwise, 17,500 psi crosswise.) Excellent insulation resistance. High solder blister resistance . . . in excess of 15 sec. at 500°F. Good solvent resistance: 10 min. in trichloroethylene. Can be punched cold up to and including  $\frac{1}{16}$ " , warm (140° to 180°F) up to and including  $\frac{3}{32}$ ". Available copper clad or unclad.

WRITE FOR DATA ON:

- Electrical/electronic grades
- Copper clad laminates
- Mechanical grades
- Engraving stock

FORMICA CORPORATION  
DEPARTMENT CS-624 CINCINNATI 32, OHIO  
subsidiary of 

  
**FORMICA®**  
industrial plastics

# A MIGHTY BIG STEP

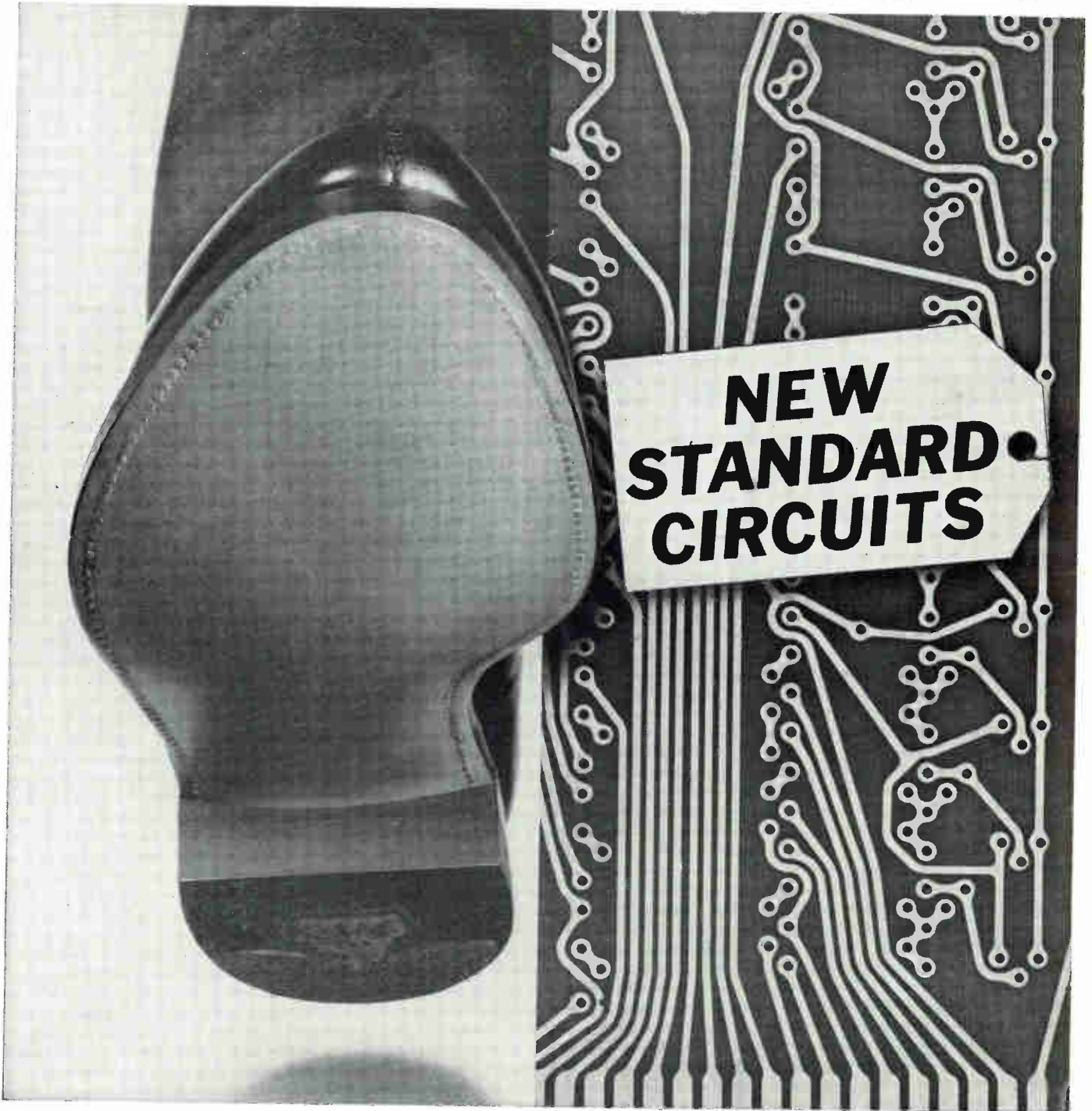

**A MIGHTY IMPORTANT STEP FOR YOU! YOU CAN NOW BUY PRINTED CIRCUITS WITH YOUR CONDUCTOR AND HOLE PATTERN... WITHOUT ARTWORK... WITHOUT QUOTATIONS... WITHOUT TOOL CHARGES, AND IN MOST CASES, AT HALF THE USUAL COST AND IN HALF THE USUAL DELIVERY TIME!** *Our new Standard Circuit Division reduces printed circuit manufacturing overhead to the barest minimum by automation and standardization. Mass production techniques drastically reduce costs, delivery time, and improve quality—yet still give you flexibility in board design. Sound exciting? For complete information write today for our 16 page brochure detailing this major printed circuit breakthrough.*

**Photocircuits**  
CORPORATION • GLEN COVE, N.Y. • ANAHEIM, CALIF.

# Device Powers Go Higher

Gains in both tube and transistor power, and at higher frequencies, cited

By **MICHAEL F. WOLFF**  
Senior Associate Editor

**CIRCUIT AND EQUIPMENT** designers can expect higher-power devices in several areas of the frequency spectrum. This was evident at the IEEE Electron Devices Meeting Oct. 31 to Nov. 1. Significant advances in both tubes and semiconductor devices were reported.

L. F. Eastman, of Cornell University, cited linear accelerators and ohmic heating equipment as a large upcoming market for superpower microwave tubes, adding that a big need continues for them in military and radar astronomy applications. He predicted the single-beam klystron would reach 1-Mw continuous operation at X band in the next year and 5 to 10 Mw by paralleling tens of lower-power beams. Peak power at S band could reach 1,000 Mw by paralleling tens of klystrons, he said. Crossed-field tubes could be paralleled inside a single vacuum envelope to yield 5 to 10-Mw average power at S band, while 50-Mw peak powers could be generated at X band by internally paralleling tens of anode sections.

**High-Power Tubes** — Developments reported in this area include:

- Pulsed bwo that produced 107 kw peak and 324 w average power at 100 Gc, reported by J. W. Sedin, K. W. Slocum and M. V. Purnell, of Watkins-Johnson. Tube uses a discharged waveguide circuit and a perveance  $0.125 \times 10^{-6}$  electron gun having an area convergence ratio of 900 to 1. Beam current density is 1,350 amperes per sq cm. First two authors also reported a 1 kw c-wt amplifier for 35 Gc.

- L-band klystron with a peak power output of 5 Mw and capable of operating at 300 kw average power for extended periods, described by A. J. Prommer, A. J.

Smith and W. H. Watson, of Litton Industries. Tube is a 4-cavity klystron that uses a nonintercepting modulating anode. It is tunable over 130 Mc centered at 1,320 Mc.

- Newly developed high-dissipation cooling technique has helped boost Raytheon's Amplitron tube's c-w power to over 400 kw at 3,000 Mc, W. C. Brown, J. F. Skowron, G. H. MacMaster and J. W. Buckley reported. Efficiency is 70 percent, gain is 9 db.

**UHF Transistors** — Push toward higher transistor power at higher frequencies was emphasized in work reported from three companies.

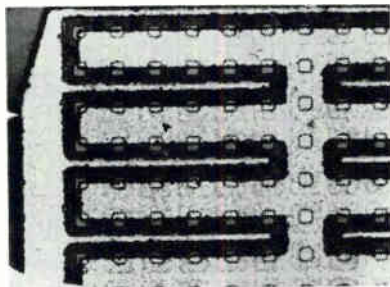

OVERLAY transistor has 156 emitter elements, 1/2-mil square and fabricated to 1-micron tolerance (RCA)

A 500-Mc transistor with power output almost a factor of 10 higher than that previously reported for single-transistor amplifiers was described by D. R. Carley, of RCA. Called an overlay transistor, it uses an array of 156 separate emitter sites paralleled by metallizing and diffusion (see photo). The new geometry allows a ratio of 8 mils of emitter edge per square mil of emitter area. In a class-C common-emitter amplifier, typical units provide 4.5 w out at 400 Mc and 40 v, some deliver 5 w at 500 Mc with 7-db gain.

A 500 Mc transistor described by R. N. Clarke, of TRW Semiconductors, gave 1 w with 10-db gain and 3 w with 5-db gain as an amplifier. H. Wolf, G. Parker and D. Lance, of Fairchild Semiconductor, reported on planar epitaxial silicon transistors that deliver more than 1 w at 1 Gc



## AMERICAN TIME PRODUCTS 10 to 1000 CPS LIGHT CHOPPER

### NO LUBRICATION NEEDED

Unlike motor driven types, American Time optical choppers and modulators function without lubrication — no wear, with reliability multiplied several-fold. Based on the balanced, vibrating members of a tuning fork, the chopper also has the advantage of drastically reduced power requirements. These inherent benefits are obvious for space and other applications. IR, UV and other radiation are controllable.

Operated by an external 2 transistor circuit, signal voltage is available from the fork circuit as a reference. Accuracy of .05% in ranges from -55 to +85°C — higher accuracies can be obtained. Input power is 150 m.w. @ 28 volts into external circuit. Lower powers and lower voltages can be worked out. Operational altitude is up to space vacuum. And physical size is 1" x 3/4" x 3", with a 3/4" diameter window — the unit weighing a maximum of 3 oz.

Applications include spectrophotometers, mass spectrometers, radiometers, bolometers, IR detectors, star trackers, burglar alarm systems, intrusion systems, telemetry systems, colorimeters, and densitometers. Write Bulova, American Time Products, 61-20 Woodside Ave., Woodside 77, New York.

INDUSTRIAL/DEFENSE GROUP

## BULOVA

AMERICAN TIME PRODUCTS





## THERE IS A JENNINGS VACUUM CAPACITOR FOR EVERY HIGH POWER RF APPLICATION

Jennings has been designing and building vacuum capacitors for 21 years. In this time we have designed vacuum capacitors for hundreds of standard and special applications. These designs are now production items—over 450 types. We can deliver from stock a vacuum capacitor to solve practically every specialized application.

But if a new design is necessary consider these resources ready to work for you at Jennings. • 21 years experience designing and building vacuum capacitors.

• Exclusive processing techniques that assure superior performance. • Qualified, experienced engineering staff. • The only complete rf laboratory in existence for proper testing of vacuum capacitors in high power rf circuits through 100 kw that duplicate actual operating conditions.

Jennings offers a complete line of vacuum capacitors for operating in the high frequency range at voltages up to 120 kv and capacities up to 5000 pf. We will be happy to send detailed catalog literature at your request.

 <p><b>UXCF 500</b></p> <p>Capacity Range . . . 20-500 pf Voltage Rating . . . 20 kv pk RF Current Rating . 45 amps rms Length . . . . . 9<sup>7</sup>/<sub>8</sub> inches Width . . . . . 4<sup>3</sup>/<sub>8</sub> inches</p>	 <p><b>MMHC 1000</b></p> <p>Capacity . . . . . 1000 pf Voltage Rating . . . 45 kv pk Current Rating . 150 amps rms Length . . . . . 13 inches Width . . . . . 9<sup>1</sup>/<sub>4</sub> inches</p>	 <p><b>CVHA 650</b></p> <p>Capacity Range . . . 30-650 pf Voltage Rating . . . 55 kv pk Current Rating . 150 amps rms Length . . . . . 11<sup>1</sup>/<sub>2</sub> inches Width . . . . . 7 inches</p>
---	--	---

RELIABILITY MEANS VACUUM / VACUUM MEANS

**Jennings**

JENNINGS RADIO MFG. CORP., 970 McLAUGHLIN AVE., SAN JOSE 8, CALIF., PHONE CYpress 2-4025

with 30-percent efficiency as oscillators.

In other transistor and tube developments:

• Transistors using a *p-n* GaAs-Ge heterojunction as the emitting junction and an *n-p* Ge homojunction as the collecting junction were described by H. N. Yu, of IBM. The

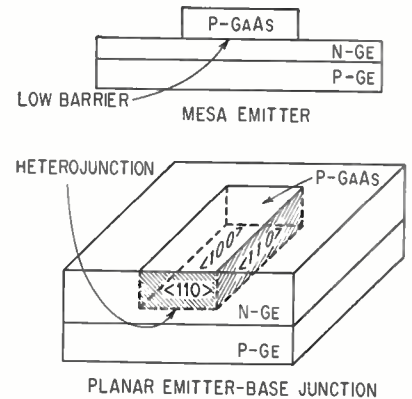

HETEROJUNCTION transistor is made at IBM by new process called post-epitaxial diffusion

experimental transistors (see illustration) are expected to operate at combinations of higher current and frequency than homojunction transistors.

• IBM reported two new experimental silicon *npn* transistors for solid-state memories. The first, described by P. P. Castrucci, J. P. Martin and R. M. Folsom, can operate at nearly twice the speed of presently available units rated for the same voltage, current and gain. It switches 600 ma through a 90-v swing in less than 25 nsec with a circuit beta of 10. Collector-base breakdown voltage is 180.

R. L. Ruggles, W. A. Pieczonka and R. M. Folsom described a low-voltage ultra-fast transistor that will operate at twice the current of presently available units rated for the same speed and voltage. It can switch 1 amp through a 25-v swing in less than 8 nsec with circuit beta of 10.

• Experimental cyclotron-wave microwave amplifier that achieves an excess noise temperature of about 100 K without a pump was reported by G. Hrbek and R. Adler, of Zenith Radio. New tube is called Diftron because the electron beam is launched in a divergent magnetic field. Noise figures of 3 db at S band and less than 2 db at L band are predicted.



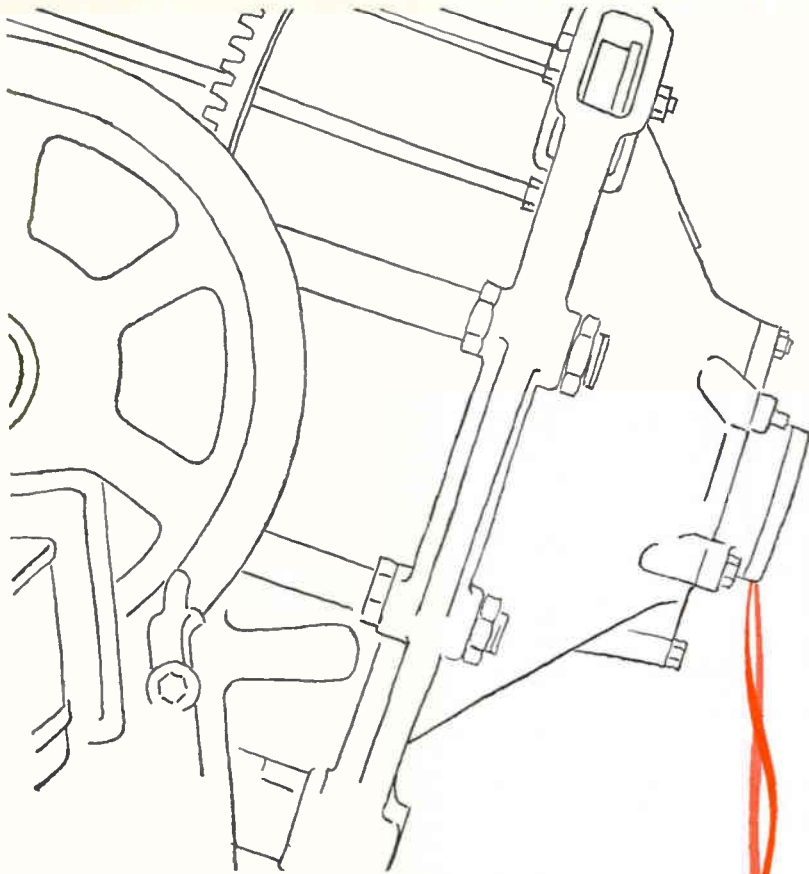

there are 1001  
types of  
industrial glass.

*Why does FUSITE  
make their own?*

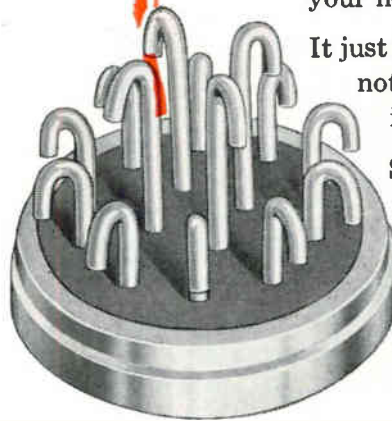

We could "make do" with glasses from commercial sources. Most other glass-to-metal seal manufacturers find them adequate.

Here's our reason.

All the glass used in our entire industry wouldn't add up to the tonnage of a few trailer loads of beer bottles. But the properties of the several kinds we *do* use in small quantities determine the performance of a given terminal in your whole assembly of component parts.

The coefficient of expansion, firing range, insulation resistance, mechanical strength, surface properties, chemical resistance, thermal sensitivity and bubble structure, etc., are engineered for your specific application of the terminals.

We just refuse to compromise for the sake of expediency.

Fusite Terminals start with your intended use and your production procedures. We then recommend the best possible combination of design and metal type, and only then do we select a glass that our extensive research has proven well suited to your needs.

It just happens that more often than not the exact glass you need isn't being made.

So we make it.



THE **FUSITE** CORPORATION  
6000 FERNVIEW AVENUE • CINCINNATI 12, OHIO

Fusite Corporation, Cincinnati, O.

Woodford Mfg. Co., Versailles, Ky.

Fusite N. V., Konigweg 16, Almelo, Holland

Fusite GmbH, Dieselstrasse 5 Karlsruhe, W. Germany

Fusite-Japan, Gotemba, Japan

# GERTSCH STANDARDS RECEIVERS



PCR-1 Phase Comparison Receiver

VLF



RHF-1 High-Frequency Standards Receiver

WWV

— provide rapid calibration checks on frequency and time standards... frequency comparisons against carrier-stabilized frequency transmissions — with high accuracy.

**VLF Phase Comparison Receiver**—an all solid-state receiver incorporating a built-in servo-driven, strip-chart recorder. Instrument features front-panel frequency selection, permitting rapid switching of up to 4 plug-in frequencies within the range of 10 to 100 kc. Frequencies are easily changed or added as they are needed. PCR-1 is for use with local frequency standards accurate to 1 part in  $10^6$  or better. Unit utilizes the propagation stability of low-frequency waves, allowing comparisons to an accuracy of 5 parts in  $10^{10}$  to be made in one hour. Send for Bulletin PCR-1.

**WWV High-Frequency Standards Receiver.** Instrument is an all-transistorized superheterodyne unit designed for receiving WWV and other high-frequency standard transmissions. Ideal in precision time measurements, reception of standard audio frequencies, pulse code modulation, and radio propagation notices transmitted at these frequencies. Local frequency standards comparisons accurate to 1 part in  $10^7$ . Operates from either a 115/230-volt power line, or a 12-volt battery. Send for Bulletin RHF-1.

*Gertsch*

GERTSCH PRODUCTS, INC.

3211 S. La Cienega Blvd., Los Angeles 16, Calif. • Upton 0-2761 • Vermont 9-2201

therefore the resolution, varies with the accelerating potential of the electron beam, because of lateral electron scattering in the emulsion.

According to Evans, there is no apparent lower limit to the spot size that can be produced on the new electron recording film.

**Applications**—The new electron recording technique and film is likely to find practical use wherever a high-density, wide-bandwidth optical memory can be used. Suggested applications include pre-detection recording of telemetry data in the form of i-f signals and high-resolution tv recording.

## Screen Mesh Factors Affect Electron Beam

ELECTRON-BEAM mode discharge in hollow cathodes is affected by the size of the screen mesh of the cathode. This was reported at NEC by E. C. Muly and H. L. L. van Paassen of the Martin Company, Baltimore. The experimental Martin hollow cathode with perforated walls is shown in action on the cover.

The perforated-wall hollow-cathode electron beam mode discharge (EBMD) is a high-impedance cold-cathode discharge. A cathode operating in this mode (see cover) pro-

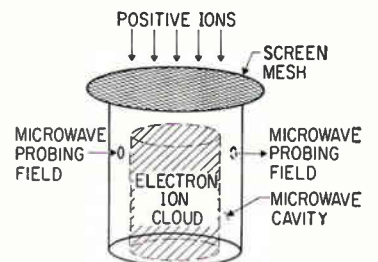
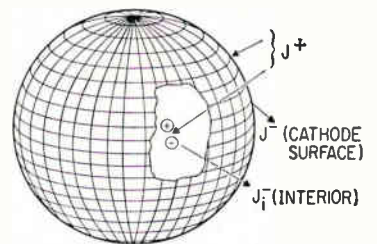

DISCHARGE mechanisms taking place in the spherical screen mesh hollow cathode, top; test cavity used in Martin investigation, of solid copper with one screen mesh face, bottom

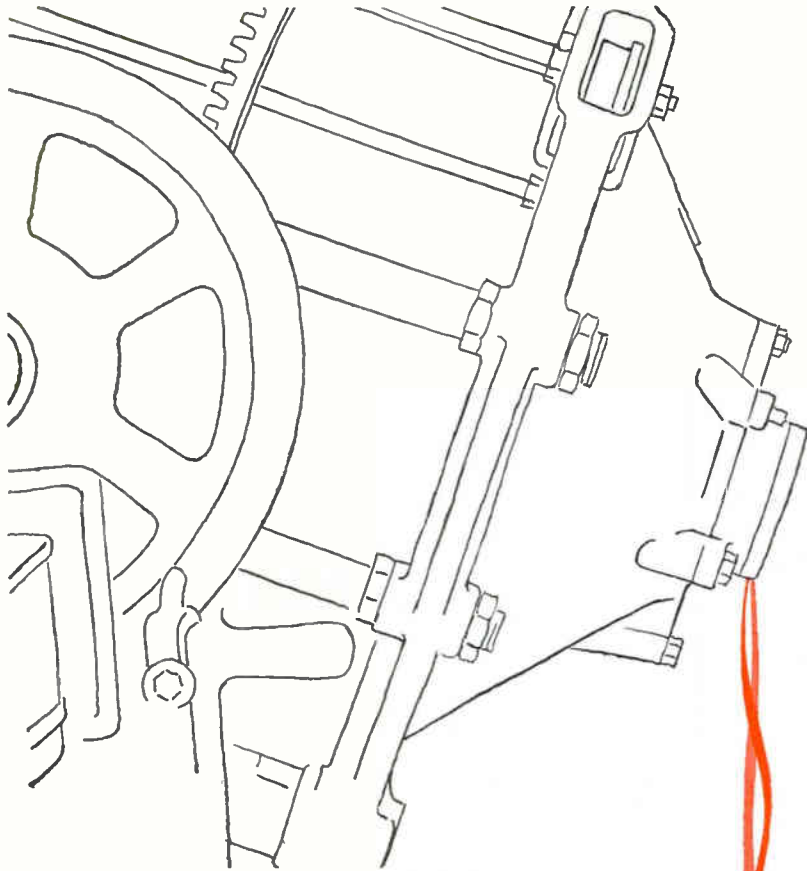

there are 1001  
types of  
industrial glass.

*Why does FUSITE  
make their own?*

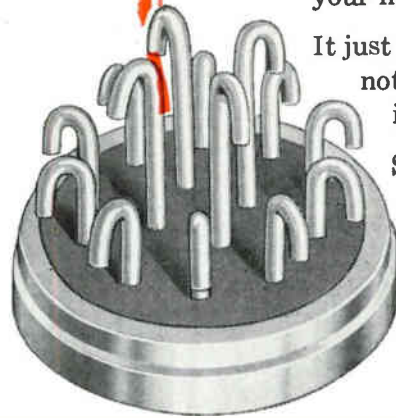

We could "make do" with glasses from commercial sources. Most other glass-to-metal seal manufacturers find them adequate.

Here's our reason.

All the glass used in our entire industry wouldn't add up to the tonnage of a few trailer loads of beer bottles. But the properties of the several kinds we *do* use in small quantities determine the performance of a given terminal in your whole assembly of component parts.

The coefficient of expansion, firing range, insulation resistance, mechanical strength, surface properties, chemical resistance, thermal sensitivity and bubble structure, etc., are engineered for your specific application of the terminals.

We just refuse to compromise for the sake of expediency.

Fusite Terminals start with your intended use and your production procedures. We then recommend the best possible combination of design and metal type, and only then do we select a glass that our extensive research has proven well suited to your needs.

It just happens that more often than not the exact glass you need isn't being made.

So we make it.



**THE FUSITE CORPORATION**

**6000 FERNVIEW AVENUE • CINCINNATI 12, OHIO**

Fusite Corporation, Cincinnati, O.

Woodford Mfg. Co., Versailles, Ky.

Fusite N. V., Konigweg 16, Almelo, Holland

Fusite GmbH, Dieselstrasse 5 Karlsruhe, W. Germany

Fusite-Japan, Gotemba, Japan

# CRT Recording Has Wide Bandwidth

Placing the camera inside the cathode-ray tube cuts losses, raises resolution

**CONVENTIONALLY**, electronic information or images are first displayed on the faceplate of a cathode-ray tube, and photographed by means of a camera focussed on the crt face. This process, however, is singularly inefficient in terms of energy; using a P11 phosphor and an electron beam accelerated with 27 kilovolts, typical efficiency from cathode to film is a few tenths of one percent. In addition, the resolution of the system is limited by optical dispersion and by faceplate phosphor thickness.

A new recording process under development in the Kodak Research Laboratories in Rochester eliminates these losses by placing the film directly inside the cathode-ray tube. This does away with both the phosphor faceplate and the optical focussing system; the electron beam strikes the film emulsion directly, producing an image whose sharpness is determined only by the beam focus.

Kodak Research Laboratories has



TELEVISION film recording made on 16-mm film by direct electron exposure. Lines are clearly resolved as shown in inset, top left

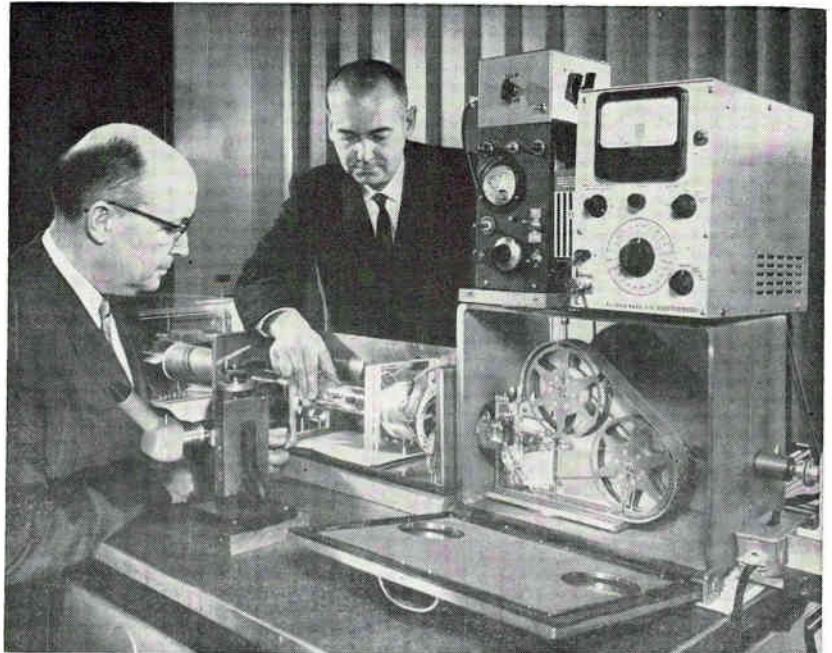

EXPERIMENTAL UNIT has camera chamber, lower right, attached to tube containing electron gun, left, with external deflection system; entire system is evacuated to  $2 \times 10^{-6}$  Torr

developed a new type of film for electron recording. While responding to a direct electron beam it is relatively insensitive to light, and has extremely fine grain. The experimental combination of the new film and a special cathode-ray apparatus has shown a resolution of better than 5 microns.

**Better Than Tape**—When recording a television image from a standard 525-line scan onto 16-mm film, the resolution of the new technique corresponds to a frequency bandwidth of nearly 65 megacycles. C. H. Evans of Kodak told *ELECTRONICS* that a bandwidth of 100 megacycles is practicable, exceeding that of present-day tv magnetic tape by a factor of ten. The very high information packing density of the electron recording film is said to exceed that of magnetic tape by a factor of 100.

The experimental electron re-

ording setup, shown in the photograph, consists of a chamber containing a 16-mm camera with up to 200 feet of film, without lens, and an electron gun in a glass tube. The entire unit is evacuated; pumping down with a fresh film supply takes 1 to 2 hours before a good vacuum of about  $2 \times 10^{-5}$  Torr is achieved. A special film base (Estar) is used to minimize outgassing in the vacuum. By operating the anode of the electron gun at ground potential, the vacuum chamber, camera and film can also be grounded. This requires that the cathode and control grid be operated at a high negative potential. A thoriated-tungsten filament is used rather than an oxide-coated cathode to prevent cathode poisoning during pump-down and activation. Acceleration potentials are in the 14-to-20-kv range, with electron-beam currents of the order of 0.5 microampere. The size of the trace produced, and

# 12 'ABC' POWER SUPPLIES

FLEXIBILITY • HIGH QUALITY • LOW COST

**CHECK  
KEPCO**



**GROUP**  
from 0-2V/1A to  
0-2500V/2ma

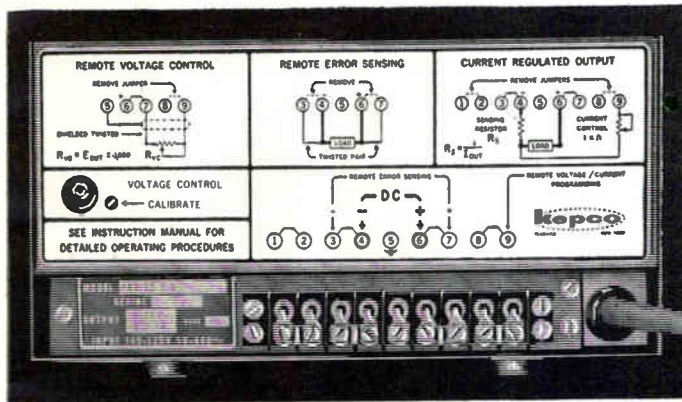
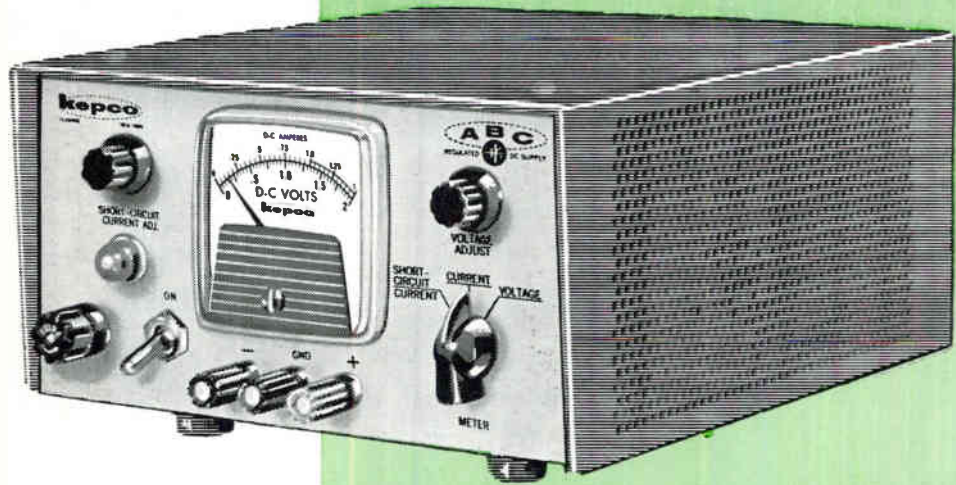

## VOLTAGE/CURRENT REGULATED

Connections provide for:

- REMOTE PROGRAMMING OF VOLTAGE OR CURRENT BY RESISTANCE OR VOLTAGE
- REMOTE ERROR SENSING
- PARALLEL AND SERIES CONNECTION

**PROMPT DELIVERY  
MOST MODELS FROM STOCK**

## 0.05% REGULATION and STABILITY ALL-TRANSISTOR MODELS

DC OUTPUT		RIPPLE RMS MV	PRICE	*METERED MODEL
VOLTS	AMPS			
0-2	0-1	0.25	\$ 179.00	ABC 2-1M
0-7.5	0-2	0.25	159.00	ABC 7.5-2M
0-10	0-0.75	0.25	119.00	ABC 10-0.75M
0-15	0-1	0.25	159.00	ABC 15-1M
0-18	0-0.5	0.25	119.00	ABC 18-0.5M
0-30	0-0.3	0.25	119.00	ABC 30-0.3M
0-40	0-0.5	0.25	159.00	ABC 40-0.5M

### HYBRID MODELS

0-200	0-0.1	0.5	199.00	ABC 200M
0-425	0-0.05	0.5	199.00	ABC 425M
0-1000	0-0.02	1.0	274.00	ABC 1000M
0-1500	0-0.005	1.0	274.00	ABC 1500M
0-2500	0-0.002	1.0	334.00	ABC 2500M

INPUT REQUIREMENTS: 105-125V AC, 50-440 cycles.

All-Transistor Circuit is illustrated below. The Hybrid Circuit is a unique design which achieves high efficiency and reliability through the use of Transistorized Reference and Amplifiers combined with a Vacuum Tube series pass element for reliable high voltage operation.

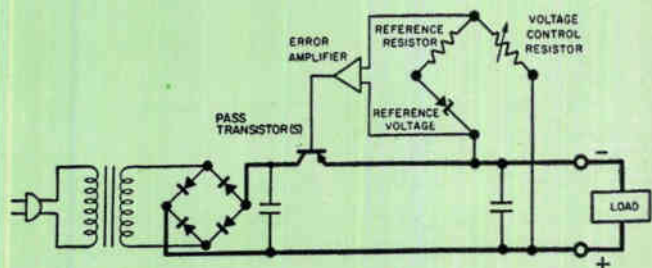

All models are designed for continuous operation without de-rating under all specified line, load and temperature conditions.

\* UNITS are available without volt/amp meter; delete suffix "M" from model number and deduct \$20.00 from price (ABC 2500M, ABC 1500M, ABC 1000M voltmeter only; deduct \$15.00).

**RACK MOUNTING ADAPTER (5-1/4" H x 19" W):**

Model RA-4: for mounting 2 units .....\$15.00  
Model RA-5: for single unit .....\$15.00



For complete specifications on more than 230 standard model Power Supplies, send for NEW Catalog B-631.

131-38 SANFORD AVENUE • FLUSHING 52, N.Y., U.S.A. • Phone (212) IN 1-7000 • TWX# (212) 539-6623 • Cable Address: KEPCOPOWER, NEW YORK

# GERTSCH STANDARDS RECEIVERS



PCR-1 Phase Comparison Receiver

VLF



RHF-1 High-Frequency Standards Receiver

WWV

— provide rapid calibration checks on frequency and time standards ... frequency comparisons against carrier-stabilized frequency transmissions — with high accuracy.

**VLF Phase Comparison Receiver**—an all solid-state receiver incorporating a built-in servo-driven, strip-chart recorder. Instrument features front-panel frequency selection, permitting rapid switching of up to 4 plug-in frequencies within the range of 10 to 100 kc. Frequencies are easily changed or added as they are needed. PCR-1 is for use with local frequency standards accurate to 1 part in  $10^6$  or better. Unit utilizes the propagation stability of low-frequency waves, allowing comparisons to an accuracy of 5 parts in  $10^{10}$  to be made in one hour. Send for Bulletin PCR-1.

**WWV High-Frequency Standards Receiver.** Instrument is an all-transistorized superheterodyne unit designed for receiving WWV and other high-frequency standard transmissions. Ideal in precision time measurements, reception of standard audio frequencies, pulse code modulation, and radio propagation notices transmitted at these frequencies. Local frequency standards comparisons accurate to 1 part in  $10^7$ . Operates from either a 115/230-volt power line, or a 12-volt battery. Send for Bulletin RHF-1.

**Gertsch**

GERTSCH PRODUCTS, INC.

3211 S. La Cienega Blvd., Los Angeles 16, Calif. • UPTon 0-2761 • VErmont 9-2201

therefore the resolution, varies with the accelerating potential of the electron beam, because of lateral electron scattering in the emulsion.

According to Evans, there is no apparent lower limit to the spot size that can be produced on the new electron recording film.

**Applications**—The new electron recording technique and film is likely to find practical use wherever a high-density, wide-bandwidth optical memory can be used. Suggested applications include pre-detection recording of telemetry data in the form of i-f signals and high-resolution tv recording.

## Screen Mesh Factors Affect Electron Beam

ELECTRON-BEAM mode discharge in hollow cathodes is affected by the size of the screen mesh of the cathode. This was reported at NEC by E. C. Muly and H. L. L. van Paassen of the Martin Company, Baltimore. The experimental Martin hollow cathode with perforated walls is shown in action on the cover.

The perforated-wall hollow-cathode electron beam mode discharge (EBMD) is a high-impedance cold-cathode discharge. A cathode operating in this mode (see cover) pro-

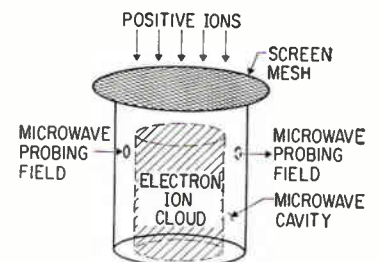
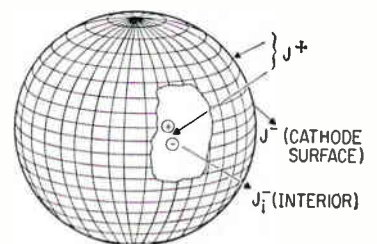

DISCHARGE mechanisms taking place in the spherical screen mesh hollow cathode, top; test cavity used in Martin investigation, of solid copper with one screen mesh face, bottom

duces a well-collimated electron beam, when an excess of electrons within the cathode cavity leak out through an aperture in the cathode. This aperture is generally at least three times the diameter of the screen mesh hole size. Electrons produced inside the cathode interact, after effusing from the interior, with gas molecules external to the cathode, and produce positive ions. These positive ions then increase the current by producing more electrons inside the cathode.

The total discharge currents were found at Martin to be a function of the screen mesh characteristics; the mesh hollow cathode was analyzed by microwave techniques, and the results give an indication of the basic mechanisms of EBMD production.

Spherical cathodes have been designed to defocus the positive ions streaming toward the cathode. Use of a concave area surrounding the aperture has been found to increase the range of operation of EBMD.

## Infrared Telescope Finds Invisible But Hot Stars

SAN FERNANDO—Using a highly sensitive infrared telescope, scientists at ITT's Industrial Products Laboratory here have detected stars that are too faint in the visual spectrum to be seen. These relatively cool stars emit enough infrared radiation to be sensed by modern techniques.

The discovery makes possible the detection of silent or nonbroadcasting satellites by the heat they emit. Success in this area will be heightened after all other interfering celestial heat sources have been mapped. In this connection, the laboratory has completed 20 percent of a sky-mapping program for the Air Force.

The infrared telescope is so sensitive that work is sometimes interrupted by heat from bodies of insects flying nearby, and air currents from a cigarette 50 feet away.

## Fiber Optics IR Tracker

UNUSUAL optical head for tracking with an infrared vidicon tube has been developed at GE's Advanced

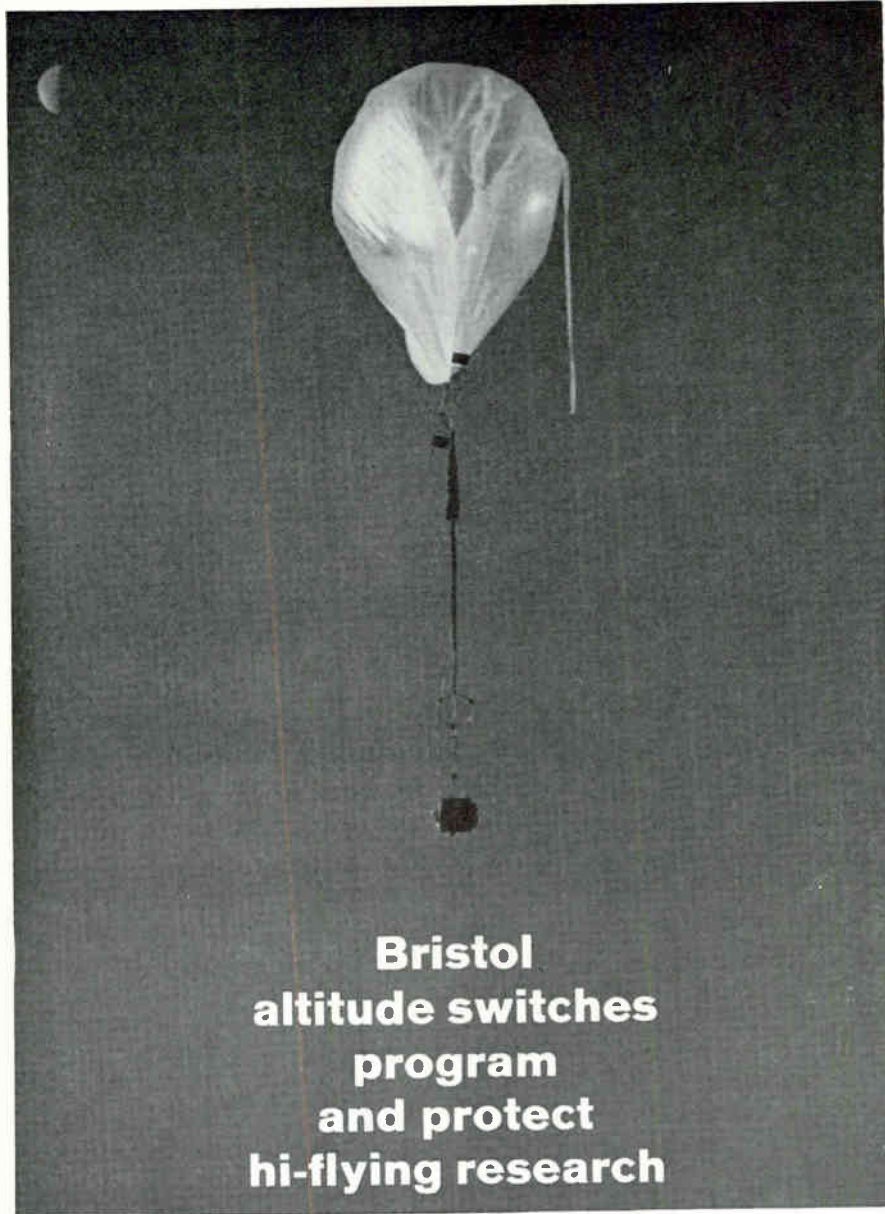

**Bristol  
altitude switches  
program  
and protect  
hi-flying research**



Bristol Miniature Altitude Switches are solving critical switching problems encountered during high-altitude balloon flights conducted by General Mills Aerospace Research Department — under NASA contract to investigate the presence and identity of micro-organisms in the stratosphere.

These miniature altitude switches trigger the operation of air sampling equipment at several predetermined altitudes as the balloon descends from flights that may go as high as 90,000 feet. In addition, an altitude switch activates a safety device that aborts the flight if the balloon is ascending so slowly as to be an aviation hazard.

### **Bristol Altitude Switches feature:**

**Sensitivity**—Providing accurate switching action even at the low barometric pressures encountered at extremely high altitudes.

**High Reliability**—Dependable performance at any altitude.

**Mil Specs**—Meeting requirements of MIL-E-5272A.

Bristol offers a wide variety of altitude and pressure switches for practically every type of application. It's possible we have an off-the-shelf switch that meets your requirements. Write for engineering data. **The Bristol Company, Aircraft Equipment Division, 152 Bristol Rd., Waterbury 20, Conn.** A Subsidiary of American Chain & Cable Company, Inc. In Canada: The Bristol Company of Canada Ltd. 71-79 Duchess Street, Toronto 2, Ont.



3.24

**BRISTOL** . . . engineers for precision, builds for reliability



## OFFERS THE WIDEST RANGE OF RESISTANCE VALUES

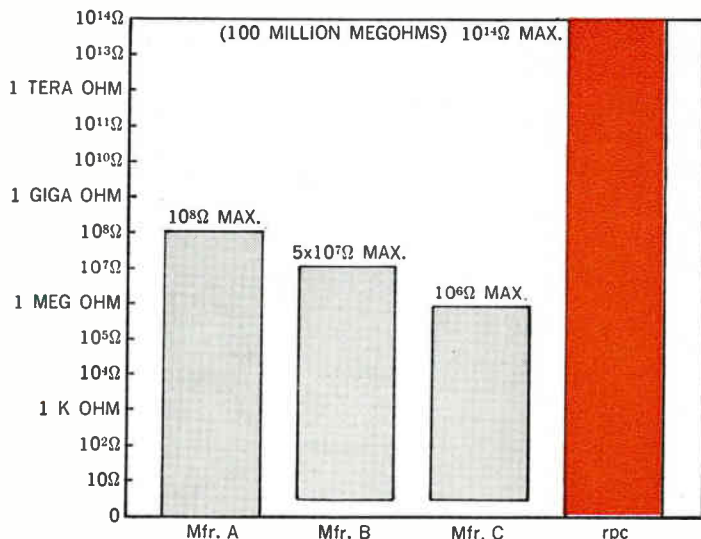

Manufacturers' ohmic ranges based on highest and lowest ohm single resistor.



## WIREWOUND RESISTORS DRIFT ONLY 25 PPM IN 3 YEARS

(If applicable to your needs)

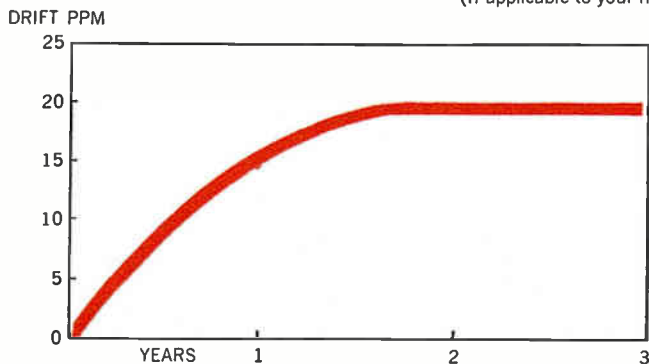

Drift in PPM. Resistors stored and measured at room temperature without the use of controlled atmosphere.

In addition to brilliant performance and outstanding reliability, RPC offers you a wide choice of quality resistors and a highly competent engineering department that can help you solve sticky problems involving resistance.

- PRECISION WIRE WOUND
- PRECISION METAL FILM,
- CARBON FILM
- RESISTANCE NETWORKS



# Resistance Products Co.

914 S. 13th Street, Harrisburg, Pa.

Electronics Center in Ithaca, N. Y.

Designed to cut the required space and the optical transmission losses inherent in conventional tracking systems, the unit has three special fiber optics elements: a rotating fiber ball and two fitting lens-like parts, one to deliver the image to the ball and one to transfer it to the vidicon. These three parts replace a complex system of rotating prisms, derotating prisms, bearings and correcting lenses. The glass fibers used are 10 microns in diameter, have nominal aperture of 0.66. The fiber optic parts were made by Mosaic Fabrications, Inc., Southbridge, Mass.

K. W. Harper of GE told ELECTRONICS that the present model of the system can scan through up to 45 degrees in any direction; the fiber ball itself, moved by a spring differential drive, rotates half the amount of the total deflection. Resolution in the range of 275 lines per inch is said to be adequate for most tracking systems.

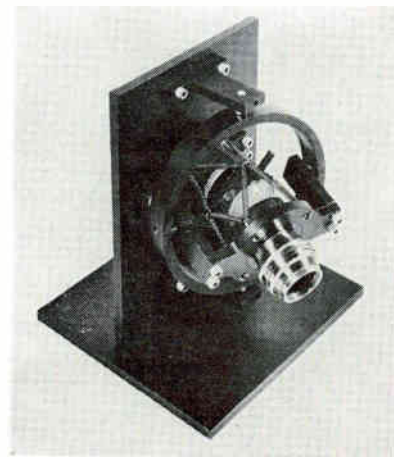

ROTATING fiber optics assembly is mounted in gimbals, with springs moving the ball (center) through half the deflection angle

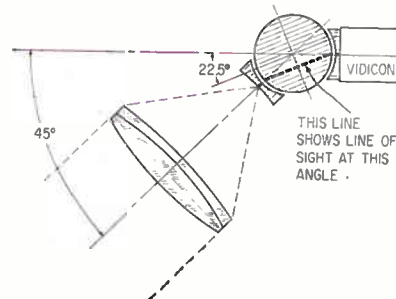

GEOMETRY of system shows how image is transmitted through fiber optics ball. Narrow spaces between ball and fitting parts are filled with silicone lubricant whose index of refraction is the same as that of the glass fibers



What can a power supply contribute to circuit design?

PLENTY... if it's an \*ISOPLY®

SPECIFY ELCOR FOR:

**Servo design** . . . ISOPLY substantially eliminates ground loop problems and zero errors.

**Bridge design** . . . ISOPLY eliminates common-mode signal . . . no differential amplifier needed. Ground referenced Bridge output available.

**Digital design** . . . ISOPLY allows DE-coupled DIRECT coupled circuits.

**Amplifier design** . . . ISOPLY is ideal for bootstrap cathode or emitter follower and related circuits.

**Nuclear design** . . . ISOPLY changes polarity from the detectors to suit the instrument.

**RFI design** . . . ISOPLY can meet MIL-I-16910 or other appropriate specifications.

**Bio-medical design** . . . ISOPLY provides the isolation required for neuro-physiological stimulation experiments.

**Special designs** . . . ISOPLY construction lends itself to design flexibility and variation capable of meeting many special requirements.

**Multiple output design** . . . ISOPLYS with as many as four outputs are available.

\***Highly isolated power sources** . . . ISOPLYS . . . offer a completely new dimension in circuit design flexibility by removing the constraint imposed by dependence upon ground referenced power.

**Other Elcor Products** . . . ISOFORMERS® (Isolated Transformers) up to 1 KW . . . ISOREX® (Isolated Transformer-Rectifier) units and unregulated but isolated power packs . . . Current Indicators and Integrators and related measurement instruments . . . specify Elcor.

for further information, write, wire or phone:



**ELCOR, Incorporated**  
 Subsidiary of Welx Electronics Corporation  
 1225 West Broad Street, Falls Church, Va.  
 Telephone Code 703—JE 2-8850  
 (FAX No.-RFJ, Falls Church, Va.)  
 Some areas still open for representation

CIRCLE 202 ON READER SERVICE CARD

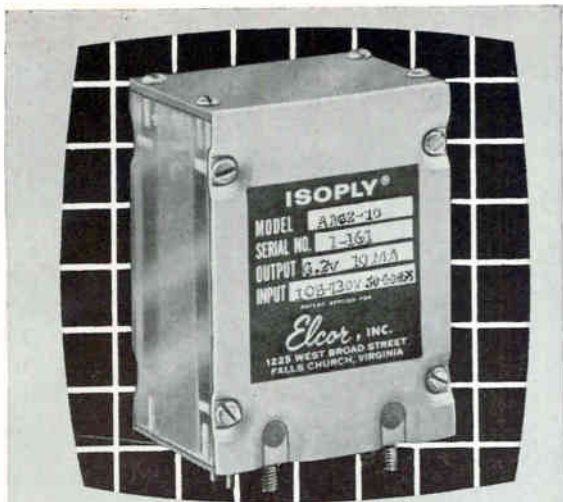

**TYPICAL A4R SERIES ISOPLY SPECIFICATIONS—MODEL ARE 2-10**

Input	105-130 vac 50-60 cps
Output	6.2 vdc ± 5% fixed at 10 ma constant load
Output ripple	1 mv p-p
Stability	
a Line stability	.01% over 105-130 vac input (less than .001% per volt of input change)
b Load stability	.01% per-ohm of load change
c Temperature coefficient	.01% /°C from 0°C to 60°C
d Long term stability after 15 minutes warm-up	.01% per day (with line load and ambient temperature held constant)
Isolation	
a Intercircuit capacitance from dc output to primary winding	1 pf
b Shunt capacitance from dc output to ground	20 pf
c Insulation voltage	1000 vdc
d Leakage resistance to ground	greater than 100,000 megohms
*Hum and noise induced in external circuit with power supply ungrounded (neither output terminal grounded)	less than 10 uv 0-p per kilohm impedance to ground
Dimensions	1 1/2" x 2 1/4" x 3-1/16"
Weight	.75 lb.

Elcor Isoply Circuitry Handbook (60 pages) Available.. Price \$1.00

**AROUND THE WORLD IT'S KEW**

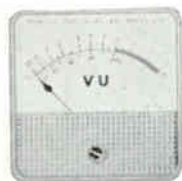

MODEL P-25



MODEL P-40



MODEL PV-202



MODEL TK-90A



MODEL KHE-505



MODEL EW-8



MODEL EW-16

**KYORITSU ELECTRICAL INST. WORKS, LTD.**

NO. 120, NAKANE-CHO, MEGURO-KU, TOKYO, JAPAN  
 CABLE ADDRESS: "KYORITSUKEIKI TOKYO"  
 TEL (717) 0131-5 · 0151-3

**FAST DELIVERY ANYWHERE**

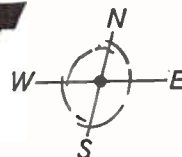

MIDWEC INSTRUMENT GRADE MYLAR\* DIELECTRIC

**Ca-pac-i-tor's**

Best Shipping Interval In The Industry—3 Weeks Standard  
 High Reliability and Quality  
 Competitively Priced

Specialists In Low Tolerance Units

Approved for use in Talos, Minute Man, Titan, Typhon, Telephone Companies ■ 100% Test for dielectric strength, capacitance, insulation resistance and dissipation factor

See the EBG Page 55



write for data sheets and prices

SALES OFFICE: 601 So. Jason St., Denver 23, Colo.  
 TWX: 292-3891—Telephone SH 4-3481—DDD 303

\* DuPont TM for Polyester Film.

CIRCLE 203 ON READER SERVICE CARD

CIRCLE 65 ON READER SERVICE CARD

25°C load life test. Stackpole COLDITE 70+ Resistors selected at random from production lines are clipped to control boards and operated at full load under 25°C ambient for 1000 hours. Equipment can apply power to over 600 resistors at a time, permitting a comprehensive quality control check of all Stackpole production runs.

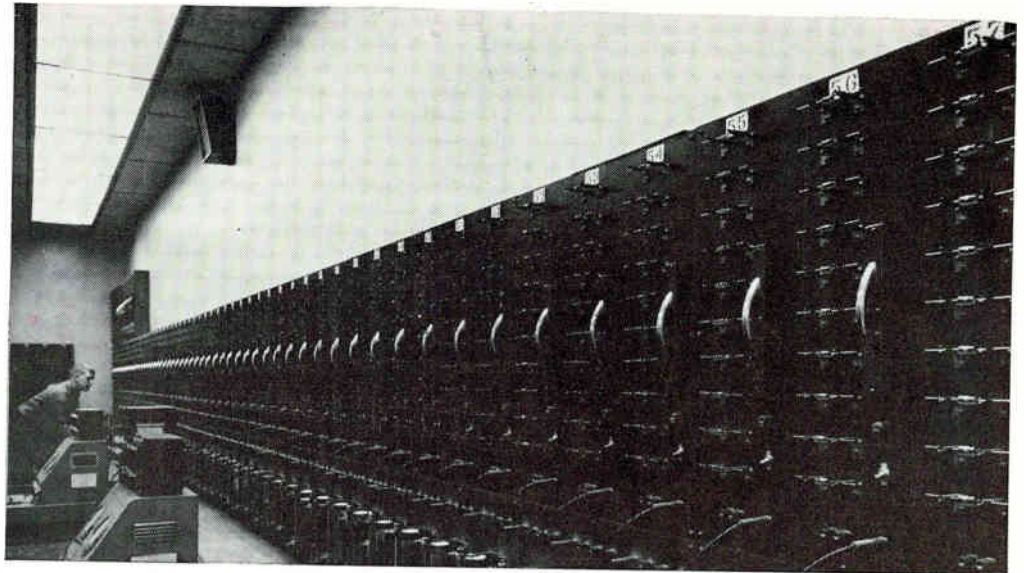

## Some Stackpole resistors aren't for sale!

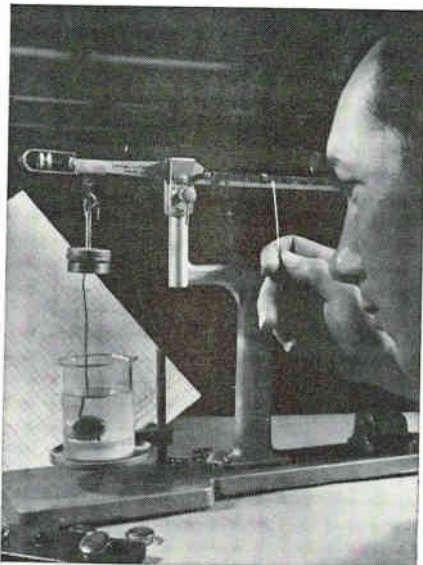

Solder-quality test. Stackpole COLDITE 70+ Resistors are the only resistors you can buy with solder dipped leads. To help guarantee their high quality, constant laboratory control checks are made on samples of solder actually being used in our daily production. Solder alloy composition is held to exact requirements.

Stackpole customers buy millions and millions of our COLDITE 70+® Fixed Composition Resistors in the course of a year . . . for thousands of critical applications where resistors must not fail!

That's precisely why there are also some Stackpole resistors that money can't buy. These are the handful in each of our huge production runs that don't meet every Stackpole standard for performance, quality, dependability . . . or even appearance!

We spot them through one of the severest, most comprehensive quality control programs in the industry . . . which even includes tests of sample resistors made from each batch of blended carbon powders before production starts! Two other critical Stackpole tests are shown above and at left.

Wouldn't you welcome this extra edge of assurance in the resistors you specify? And appreciate knowing that the solderability, load life, humidity and temperature characteristics are there . . . and that your resistors exceed every important MIL-R-11 requirement?

All you have to do is call your Stackpole representative, or write to Electronic Components Division, Stackpole Carbon Company, St. Marys, Pennsylvania.

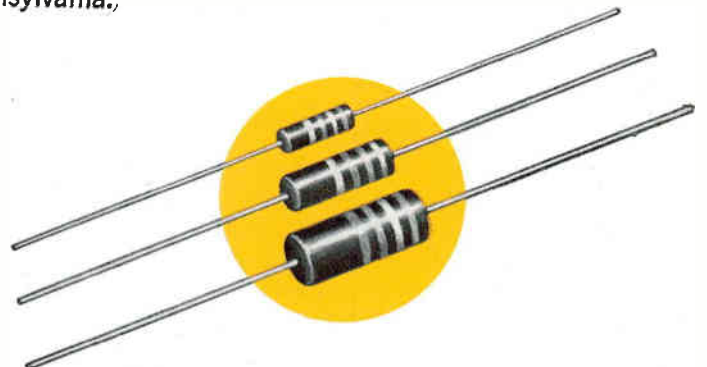

# STACKPOLE

CARBON COMPANY, *Electronic Components Division*  
St. Marys, Pennsylvania

# How Rare Earth Chelate Lasers Work

Although presently limited, rare earth chelates promise better overall performance

By **MAX METLAY**

Advanced Technology Laboratories,  
General Electric Company,  
Schenectady, New York

**ADVANTAGES** of the rare earth chelates for laser applications include their solubility in a variety of organic solvents and in various plastics. Plastic based lasers allow special shapes for special purposes; liquids are useful for high power lasers because excess heat can be rapidly disposed of. In addition, chemical tuning—that is, producing lasers with slightly different wavelengths by making small variations in the structure of the chelates—should be possible.

**Characteristics**—Chelates are molecules in which a central inorganic ion is covalently bonded to one or more organic molecules, and there are at least two bonds to each molecule. The compound shown in Figure 1, europium trisbenzoylacetonate or  $\text{EuB}_3$ , is that upon which one of the first successful rare earth chelate lasers was based.

The rare earth chelates combine, in an intricate way, some of the advantages, and the liabilities, of the inorganic ions used in lasers, and of organic molecular systems. The fluorescence spectra produced by many rare earth chelates is characteristic of the central rare earth ion, showing the discrete, sharp emission lines necessary for laser action. The absorption spectra, however, are characteristic of the organic part of the molecule, that is a broad absorption through most of the ultraviolet region, and sometimes extending well into the visible

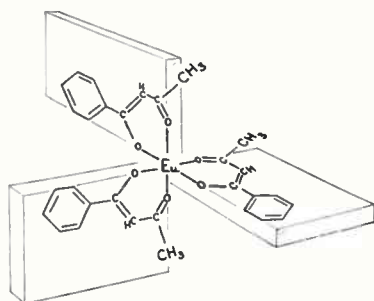

STRUCTURE of europium trisbenzoylacetonate, a typical rare earth chelate—Figure 1

region. This broad absorption is much more efficient in utilizing the broad band pumping light produced by the usual flash lamp than is the narrow line absorption of the inorganic rare earths.

**Energy Levels**—The current thinking on the reasons for the spectral properties of the rare earth chelates is schematically described in Figure 2, an energy level diagram for an europium chelate. The molecule in its ground state absorbs pumping energy, and is raised to an excited singlet state. A singlet state is one in which the spins of all electrons are paired. The curve in this section of the diagram represents the absorption curve of the chelate. It indicates that there is a band of excited singlet states, extending over the energy range corresponding to the wavelengths indicated. The height of the curve at a particular wavelength (that is, energy) is proportional to the density of states at that energy. From the excited singlet state, the molecule goes over to a triplet state in a very rapid process of  $10^{-8}$  seconds duration or less. A triplet is a state in which the spins of two electrons are unpaired. The triplet state also consists of a band of excited states, but no detailed knowledge of the distribution of states in the band exists. After the absorption of a given photon,

the molecule arrives at the lowest triplet state with an excess of energy, that is, the difference between the original energy of the photon and that of the triplet state. This excess energy is dissipated by the production of heat, or photon radiation. If the lowest triplet state is higher in energy than the resonance level of the central ion (that is, the level from which fluorescence originates in the free ion), then the energy will be fed into the resonance level, and the central ion will emit its characteristic fluorescence radiation. The fluorescence spectrum is indicated at the right of the figure, as is the relationship of the spectral peaks to the energy level transitions responsible for them. The most prominent fluorescence line— $613 \text{ m}\mu$ —corresponds to a transition ending at the  ${}^7\text{F}_2$  level, which lies about 0.12 eV above the ground state. This energy is sufficiently large so that the equilibrium population of the terminal state is about 1% of the ground state at room temperature, and much less at lower temperatures. The chelates, therefore, act as four-level laser materials.

**Measurements** — Observations reported on two europium chelate

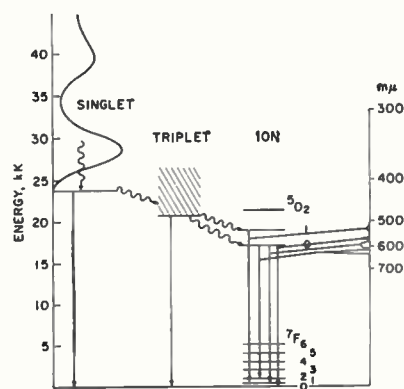

ENERGY LEVEL diagram for a typical europium chelate—Figure 2

Model SR-121  
Size: 3¼" x 4" x 5½"  
price: \$165.00

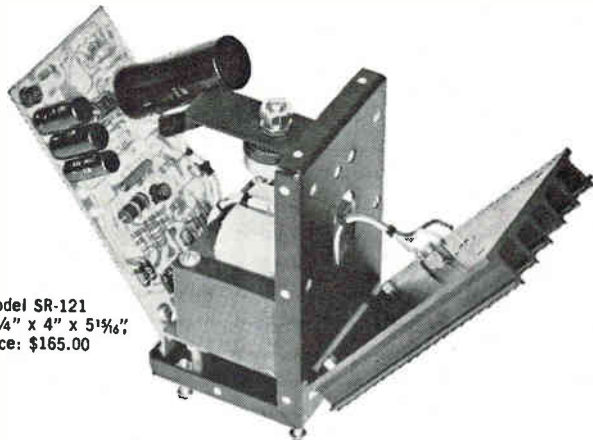

## Low cost Silicon DC power in space-saving Transpac® modules 200 ma to 8 amps



Typical of the ERA Silicon Transpac Series is the compact SR-121, 1 amp, 11 to 13 volt dc power module that is ultra-stable and fully repairable. It will operate continuously, full load, at temperatures up to 71°C with no heat sink or air blow. This model is just one of the 42 High Current Silicon Transpacs available from stock.

### SPECIFICATIONS COMMON TO ALL MODELS

Input: 105-125 VAC, 50-400 cps  
Line Regulation: Less than  $\pm 0.01\%$  or 5 mv for full input change  
Load Regulation: Less than 0.05% or 8 mv for 0-100% load change  
Ripple: Less than 800 microvolts RMS  
Long Term Stability: Less than 5 mv  
Transient Response: Less than 50 microseconds for step line or load change  
Maximum Operating Temperature: 71°C, free air, full ratings, convection-cooled  
Temperature Coefficient: Less than 0.01% per degree C or 3 mv

Short Circuit Protection: Automatic, with automatic recovery

Remote Sensing: Remote sensing facilities available

Interconnection: Series or parallel operation permissible

Remote Voltage Control: Provision for external control of output voltage

Output Connection: Ungrounded outputs, either positive or negative terminals may be grounded

### 42 HIGH CURRENT MODELS FROM STOCK

200 MA Series	0-5 VDC
500 MA Series	0-61 VDC
1 Amp Series	0-61 VDC
2 Amp Series	0-46 VDC
4 Amp Series	0-45 VDC
8 Amp Series	0-32 VDC

Check the full range of solid-state TRANSPAC DC Power Modules, Converters, Inverters and Frequency Changers. Send for your ERA catalog today!



**ELECTRONIC RESEARCH ASSOCIATES, INC.**

Dept. E-11, 67 Factory Place • Cedar Grove, N. J. • CEnter 9-3000

SUBSIDIARIES: ERA Electric Co. • Advanced Acoustics Co. • ERA Dynamics Corp. • ERA Pacific, Inc.

lasers, one plastic and the other liquid,<sup>1,2</sup> include spikes of laser light, a "ringing" phenomenon, lifetime shortening and wavelength narrowing. The 6129 Å line decreased from a half-width of 8 Å to less than 0.3 Å during lasing.<sup>(1)</sup> No measurements on beam divergence have been reported. The plastic laser was in the form of thin filaments, and parallel polished ends were not attempted. The liquid laser was incorporated in a quartz tube, with polished quartz pistons at the ends forming a Fabry-Perot cavity. Concentration of active material was about  $3 \times 10^{18}$  molecules/cm<sup>3</sup>.

The present materials are limited in efficiency and power output because the absorption coefficient in the ultraviolet is very high. This means that the pumping light does not penetrate very far into the cavity. A small tail on the visible end of the absorption curve allows an inefficient pumping in the visible. The pumping threshold reported for one solution of EuB<sub>3</sub> was about twice that for ruby.<sup>(2)</sup>

**Possibilities**—Several groups are investigating the rare earth chelates with a view toward improving laser performance, decreasing pumping power, increasing stability, achieving new wavelength capabilities, and so forth. These, of course, are problems which must be solved before rare earth chelates can compete successfully with the materials currently in use in lasers. Examples of these investigations include a study of the effect of the interaction of chelates with other molecules such as some complex forming species on the intensity and lifetime of fluorescence in our laboratory,<sup>(3)</sup> and by M. Kleinerman and co-workers at American Optical Company.<sup>(4)</sup> F. Ohlmann and co-workers at Westinghouse are investigating a variety of liquid systems.<sup>(5)</sup> Fundamental aspects of energy transfer in rare earth chelates are being studied by G. A. Crosby and co-workers at the University of New Mexico.<sup>(6)</sup> Other groups in the field include those at Space Technology Laboratories,<sup>(7)</sup> Electro-Optical Systems,<sup>(8)</sup> and Melpar.<sup>(9)</sup>

It is not yet possible to predict how soon the problems limiting the usefulness of rare earth chelate

lasers will be overcome. It does seem likely, however, that the present first generation materials will be succeeded by others of increasing utility. These materials, having improved pumping characteristics and greater stability, will provide a family of laser materials having high power capabilities, and a new and useful range of wavelengths.

#### REFERENCES

- (1) A. Lempicki and H. Samelson, Phys. Lett. 4 133 (1963).
- (2) N. E. Wolff and R. J. Pressley, App. Phys. Lett. 2 152 (1963).
- (3) M. Metlay, paper presented at Electrochemical Society Meeting, Pittsburgh, April 1963.
- (4) M. Kleinerman, et al, paper presented at Electromechanical Society Meeting, Pittsburgh, April 1963.
- (5) R. C. Ohlmann, et al, paper presented at Third International Congress on Quantum Electronics, Paris, February 1963.
- (6) G. A. Crosby, et al, J. Chem. Phys. 34 743 (1961), J. Mol. Spectroscopy, 8 315 (1962), J. Phys. Chem. 66 2493 (1962).
- (7) N. W. Windsor, paper presented at American Chemical Society Meeting, Los Angeles, April 1963.
- (8) H. Lyons and M. L. Bhaumik, paper presented at Third International Congress on Quantum Electronics, Paris, February 1963.
- (9) N. Filipescu, et al, Nature, 196 467 (1962).

### Solid-State Thyatron Simplifies Control

A NEW class of silicon power semiconductor has been developed by General Electric. This family of bilateral triode switches is expected to simplify the fullwave a-c phase control circuits that now use two-terminal silicon symmetrical switches and three-terminal silicon-controlled rectifiers.

The units are modified *pnpn* structures, essentially solid-state thyratrons, which work in both directions. Company spokesmen say they have found a practical way to gate the devices, eliminating associated gate circuits. Gate trigger requires less than 100 milliamperes and less than 5 volts to control current bilaterally.

Developmental units have just come out of F. E. Gentry's Advanced Engineering Rectifier Components Group, and have been turned over to GE's Applications Group for followthrough. F. W. Gutzwiller says the high control power gain of the new component is expected to eliminate the sophisticated pulse transformer presently required for triggering two-terminal silicon symmetrical switches.

Two multilayer semiconductor

## THE ONLY HIGH RESISTIVITY ALLOY USED AS A RESISTANCE STANDARD

# EVANOHM<sup>®</sup>

- High Resistivity
- Low TC of Resistance
- Low Thermal EMF to Copper
- High Reliability

**SPECIFICATIONS**

Nominal composition  
75% Nickel  
20% Chromium  
2.5% Aluminum  
2.5% Copper

Specific resistance 20°C  
800 ohms/cm  
134 microhm cm

Temperature Coefficient of Resistance  
-65°C to +150°C  
± .000005/°C

Coefficient of linear expansion  
20° to 100°C  
.000014/°C

Magnetic permeability  
1.0005

Average tensile strength  
180,000 psi

Mean thermal EMF vs copper -65°C to +150°C  
.2µV/°C

### Maintains Highest Stability Over Long Periods of Time and Wide Ranges of Temperature!

EVANOHM, the time-tested standard of the precision wire-wound resistor industry, features the lowest thermal EMF versus copper of all resistance alloys . . . with stability within a few parts per million per year. EVANOHM is recommended for all precision requirements where highest reliability is essential, and is well suited for analog computers and guidance equipment for space applications. EVANOHM, in .0004 and heavier gauges, can be supplied from stock, either bare or enameled, for immediate delivery. The Wilbur B. Driver Company's engineering "know how" is available to help solve your problems. Call or write WBD for recommendations on your requirements, or request EVANOHM brochure!

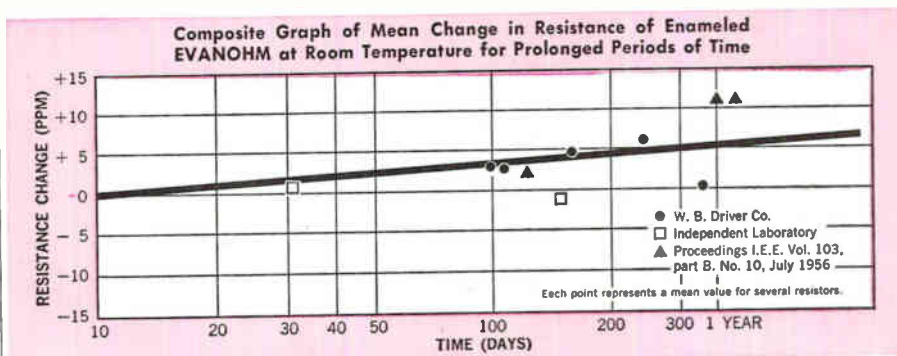

### WILBUR B. DRIVER COMPANY

Newark 4, New Jersey—Tel. HUmboldt 2-5550 (Area Code 201)

MFG. PLANTS—1875 McCarter Highway, Newark 4, New Jersey; 50 Ronson Drive, Rexdale (Toronto), Ontario, Canada  
BRANCH OFFICES—Chicago\*, Philadelphia, Los Angeles\*, Minneapolis, Cleveland\*, Hartford (\*Indicates Warehouse)

Melters and Manufacturers of Custom Electrical, Electronic, Mechanical and Chemical Alloys for all industries.

# NEW 4-WAY WIRE MARKERS



- IDENTIFY
- INSULATE
- STRENGTHEN
- PROTECT

**ALPHLEX®**

## SHRINKABLE FIT-Markers!

FIT-Markers are pre-printed lengths of abrasion-resistant, irradiated polyolefin tubing designed as a simple, convenient method for permanently identifying multi-wire or cable circuits.

Supplied in expanded form, the markers may be applied over terminations or connectors and shrunk down to form a tight, moisture-resistant, permanent bond even over irregular shapes. The shrinkage process guarantees a tight, slip-proof marker, without the use of insulation-damaging adhesives.

When a temperature of approximately 275°F (125°C) is applied with the Alpha Heat Gun, or other heat sources, the markers immediately return to the predetermined size (approximately 50% smaller).

FIT-Markers are available pre-printed in numbers or letters, in white type on black tubing, and are available at your local electronics distributor. Write for your FREE Alphlex Catalog AT-63 describing the industry's most complete line of tubing products.



### ALPHA WIRE CORPORATION

Subsidiary of LORAL Electronics Corporation  
200 Varick Street, New York 14, N. Y.  
PACIFIC DIVISION:  
11844 Mississippi Ave., Los Angeles 25, Calif.

structures were described by Gentry at the IEEE Electron Devices meeting, Oct. 31, in Washington, D. C. Both structures can be triggered into a highly conductive state in either direction by applying a low voltage, low current pulse between the signal control terminal and one of the main load terminals. Hence, both halves of an alternating current waveform can be controlled from a simple low-power trigger source.

### Passivation of Germanium Now Commercially Possible

LONDON—Commercial quantities of tetragonal germanium dioxide—a rare and highly stable modification of germanium dioxide that can be used in passivating germanium—will soon be available, according to researchers at the British Post Office Research Station, Dollis Hill, London. A practical new method of producing the tetragonal germanium dioxide has been evolved that uses a water/hydrogen atmosphere to control the minute quantities of oxygen required for the reaction.

Germanium devices, claim GPO scientists, have previously been difficult to protect. Silicon devices can easily be protected by a film of highly-stable and easily produced silica, but normal germanium dioxide is unsuitable because it is highly soluble. The tetragonal form of germanium dioxide is extremely stable, even to hydrofluoric acid solutions, but previously it was difficult to produce.

### Silicon Crystals Grown On Insulating Bases

H. M. MANASEVIT and W. I. Simpson of Autonetics have grown single crystals of silicon on sapphire substrates. The crystals were grown using a chemical vapor deposition process in which the deposits are obtained through the hydrogen reduction of silicon tetrachloride at high temperatures. After etching for configuration, the sapphire substrates provide "built-in" insulation replacing the various doping processes now used to eliminate electrical interference from non-insulating silicon substrates.



John A. Rovegno, manager of special products at General Electric's Home Care & Comfort Products Department, Bridgeport, Conn., shows heater frame.

## Di-Acro adjustable punch and die sets cut over ¾ from this tooling cost

Now you can beat the short-run profit squeeze with Di-Acro Adjustable Punch and Die Sets that reset quickly and easily with a minimum of down time. A department of General Electric's Housewares & Commercial Equipment Division, for example, reduced tooling costs on one product line, the GE built-in wall heater, by more than three-fourths.

Department Manager John A. Rovegno says, "We have found that adjustable punch and die sets give us versatility and flexibility in our manufacturing methods. In addition, they have afforded us significant savings in tooling costs."

After making the number of parts needed, you can reset this adjustable punch and die for any minor change or for a completely new part. No more extensive and costly stockpiling—any part "repeats" quickly.

All Di-Acro Adjustable Punch and Die Set components are fully reusable. Die set sizes range up to 18" x 36" for punch presses and up to 5 1/4" x 96" for press brakes with a wide range of standard and "electrical" die shapes available—also made-to-order specials. See your nearest Di-Acro distributor or write for information—ask about savings on the special starter set.



"Modular" setup proceeds rapidly with these reusable components.



Simple standard operation—note multiple punching setup.



### DI-ACRO CORPORATION

4311 Eighth Street  
Lake City, Minnesota

WHEN SPECS REQUIRE  
LACING CORDS & TAPES WITH  
**GREATER STABILITY**  
UNDER HIGH HEAT

specify **HEMINWAY  
& BARTLETT**

**NYLON**  
or  
**DACRON**  
FLAT BRAIDED  
TAPES or CORDS

Also  
Teflon-  
Coated  
Fiberglas  
Tapes

Tie tighter, faster, easier. Knots won't slip!

Available in wax-coated, wax-free or "G.E." finish

Write for free samples and specification book  
**THE HEMINWAY & BARTLETT MFG. CO.**  
Electronics Division: 500 Fifth Avenue, New York 36

CIRCLE 205 ON READER SERVICE CARD

**New! MINIATURE  
AXIAL FANS**  
with  
up to 4 times  
greater cooling efficiency!



FULLY GUARANTEED FOR 10,000 HRS. UNDER NORMAL OPERATING CONDITIONS

Characteristic	PAMOTOR Model 1000	Conventional Fan
Type of Motor	induction (capacitor-type squirrel cage)	shaded-pole
Housing	die cast warp-free Zymec	plastic
Output @ 60 cps (0 back pressure) (.25" back pressure) (.3" back pressure)	125 cfm 75 cfm 50 cfm	100 cfm 20 cfm 0
Output @ 50 cps (0 back pressure) (.25" back pressure)	100 cfm 62.5 cfm	75 cfm 5 cfm
Operating Temp. Range	-55°C to +85°C	-18°C to +44°C

The PAMOTOR Model 1000 Miniature Fan is completely interchangeable with conventional units now in use (4 1/8" center-to-center mounting holes). But the similarity ends there.

check this comparison chart!

Model 1000 meets MIL-T-5422E (Class 2), and MIL-STD-202 Environmental specs. Inside-outside rotating motor design gives fly-wheel effect, resulting in constant, quiet fan speed. Large surface sleeve bearings mean minimum maintenance, maximum reliability.

For complete specifications and name of nearest stocking distributor, write to:

**PAMOTOR, Inc.**  
312 Seventh Street • San Francisco 3, Calif.

CIRCLE 207 ON READER SERVICE CARD

electronics November 15, 1963

Type SC torques  
to 300 oz. in.  
1.07" dia.



Type MC torques  
to 1000 oz. in.  
1.25" dia.

## MINIATURE A.C. GEARMOTORS

Globe Type SC and MC motors with planetary or spur gearheads provide more than 101 standard ratios, even and odd. Custom winding and gearing provide all in-between speeds for the exact speed-torque you need—up to 1000 inch ounces. SC and MC motors are hysteresis-synchronous or induction types, 115 to 208 v.a.c., 60 or 400 cycle or variable frequency, weigh 2 1/2 and 6 1/2 oz. respectively; gearheads add 1 3/4 to 6 oz. depending on type and ratio of gearing. MIL specs are routine. Ask about commercial versions and check us if you need larger or smaller gearmotors. Please specify your speed; many prototypes shipped in one day, larger quantities soon after. Bulletin SMG. Globe Industries, Inc., 1784 Stanley Avenue, Dayton 4, Ohio.

GLOBE

GLOBE  
INDUSTRIES,  
INC.

CIRCLE 206 ON READER SERVICE CARD

# NEW ULTRA HIGH SPEED



## SOLID STATE SWITCH

Switching faster than 10 nanoseconds • Broadband — DC to 200 MC • Isolation greater than 70 db • Insertion loss less than 1 db • Weighs only 6 ounces • Ideal for switching in receivers, multiplexers, antenna systems • Price only \$145.00 from stock (priced less in quantity).

**CREATING NEW DIRECTIONS IN ELECTRONICS**  
**SANDERS TRI-PLATE® STRIP TRANSMISSION LINE**

Sanders Associates, Inc.  
Electronic Components Dept.  
Canal Street,  
Nashua, N. H.



Rush me details on Model DS11 SPDT solid state switch.

Name..... Title.....  
Company..... Department.....  
City..... Zone..... State.....

® Reg. T.M.; Extensive Patent Coverage. Sanders Associates, Inc.

CIRCLE 71 ON READER SERVICE CARD

71

# Electrons Work Tiny Ferrites

Drill smaller apertures,  
but need better control  
for interconnections

**ELECTRON-BEAM** machining of ferrite wafers reduces size limits of memory elements for digital computers, thus increasing operational speed, R. A. Shahbender, of RCA Laboratories, reported at the National Electronic Conference last month.

At the present 0.02 mil is the smallest obtainable aperture radius for conductors used with memory toroids. This is considerably smaller than the radius obtainable by conventional techniques, but within capabilities of electron-beam drilling.

**Aperture Drilling**—Blank wafers of dry-pressed, sintered ferrite are electron-beam drilled with a pulsed beam to provide microapertures.

To drill an aperture pattern, the beam is sequentially deflected by energizing deflection coils. A high degree of beam focus drills these small diameter apertures. A drilling rate of only 6 wafers per minute is mainly attributed to mechanical factors rather than the time required for actual drilling.

Optimum drilling conditions are typically; 80 to 100 kilovolts, 150 to 200 microamperes, 10-microsecond pulse width and repetition rate of 100 pps, Shahbender said. For the selected ferrite the melting point is close to the sublimation point. Thus recrystallization at point of impact of the focused beam is not excessive.

**Depositing Connections**—Selective electron-beam evaporation of copper on the ferrite surface to form interconnections between filled apertures is another operation. Only

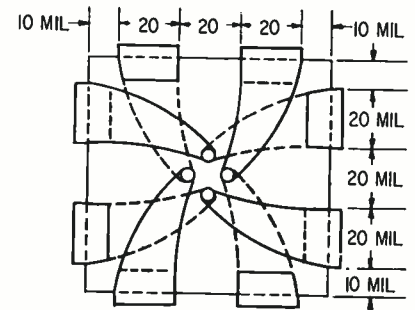
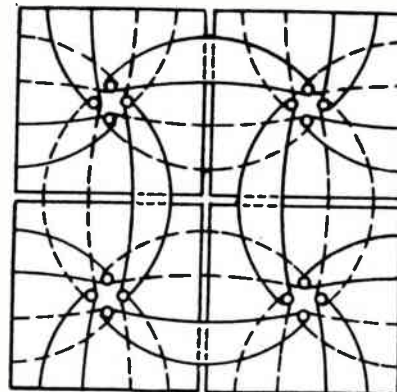
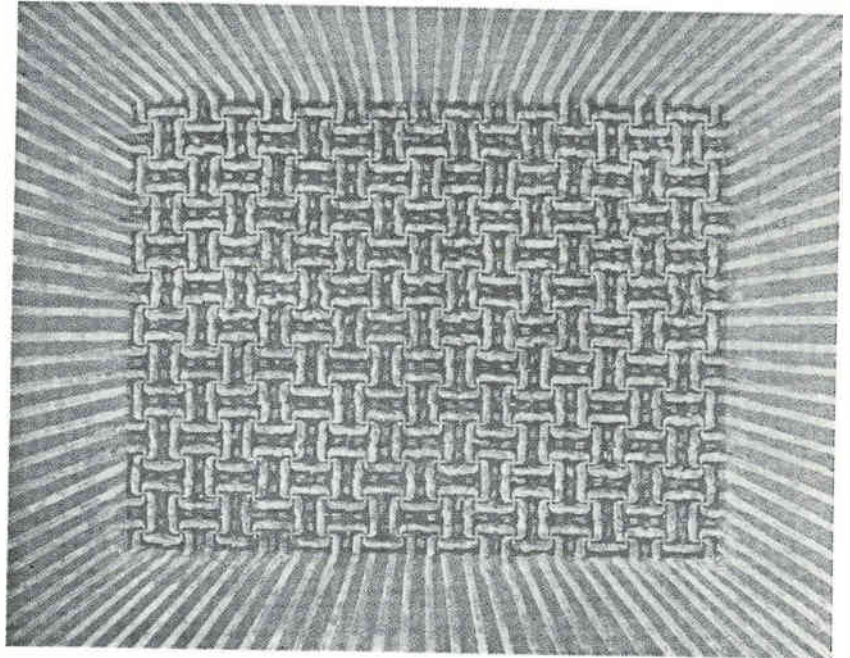

**MICROAPERTURE MEMORY** is a mosaic of  $12 \times 16$  interconnected wafers drilled by electron-beam technique. Each wafer (right)  $80 \times 80 \times 10$  mils has 4 apertures of 1-mil diameter each and center spacing of 2 mils. Four separate windings each linking an aperture in the pattern shown (left) are fabricated by photoetching techniques. Interconnections are formed by conventional mass production techniques

very thin layers of about 1 micron thick are feasible. Beam power level must be minimized to prevent damage to the ferrite. Thicker layers require higher power and this undesirably grooves the ferrite surface.

The use of this technique for interconnections is severely hampered in available machines, but im-

proved control of position and beam power level of individual electron pulses will accomplish this operation and may be highly successful for miniaturized electronic equipment, Shahbender said.

**Machine Shapes**—Flexibility provided by the electron beam process



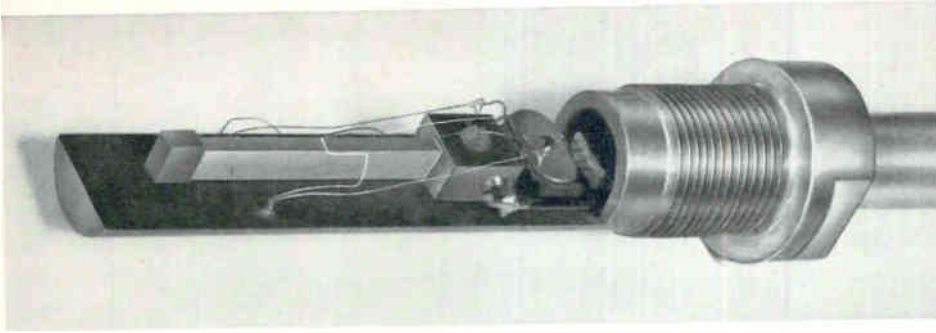

An elegant, but tiny refrigerator, utilizing the Nernst-Ettingshausen effect, has been demonstrated in the Solid State Physics Laboratories at Lockheed Missiles & Space Company. This type of cooling is applicable below 200° Kelvin, where thermoelectric cooling is no longer efficient. It shows particular promise for space application because of the reliability inherent in its all-solid state construction.

In the Nernst-Ettingshausen effect, heat is pumped as a result of an electrical current flowing in a magnetic field. The heart of the present device is a bismuth antimony single crystal. Other crystal systems are also being investigated.

This thermomagnetic cooling device is one of the results of the Lockheed research program in transport phenomena in solids.

Another investigation concerns the quantum theory of the electronic structure of crystals. An ingenious computer program has been devised for determining the essential features of the energy band structure of a wide variety of crystals. Results for a given case can be obtained in an hour or less. Conclusions drawn from the theoretical solution elucidate many of the electronic properties of crystals, and have widespread significance.

Lockheed scientists and engineers are also studying: Electron spin echo phenomena; the interaction of electrons with microwave phonons; coupled traveling waves in crystals; semiconductor lasers; antiferromagnetic resonance; various theoretical and experimental aspects of superconductivity.

### **LOOK AT LOCKHEED...AS A CAREER**

Consider Lockheed's leadership in space technology. Evaluate its accomplishments—such as the Polaris missile, the Agena vehicle's superb record of space missions. Examine its outstanding advantages—location, advancement policies, creative climate, opportunity for recognition.

Then write for a brochure that gives you a more complete Look at Lockheed. Address: Research & Development Staff, Dept. M-45D, P.O. Box 504, Sunnyvale, California. Lockheed is an equal opportunity employer.

**SCIENTISTS & ENGINEERS:** In addition to solid state physicists and chemists, other important openings exist for specialists in: Inertial guidance • Orbit thermodynamics • Electromagnetics • Mission & trajectory analysis • Gas dynamics • Chemical & nuclear propulsion • Systems engineering • Computer research

**LOCKHEED**  
**MISSILES & SPACE COMPANY**  
A GROUP DIVISION OF LOCKHEED AIRCRAFT CORPORATION

Sunnyvale, Palo Alto, Van Nuys, Santa Cruz, Santa Maria, California • Cape Canaveral, Florida • Huntsville, Alabama • Hawaii

## **LOOK AT LOCKHEED IN SOLID STATE PHYSICS:**

*Basic and applied research on the properties of solids*

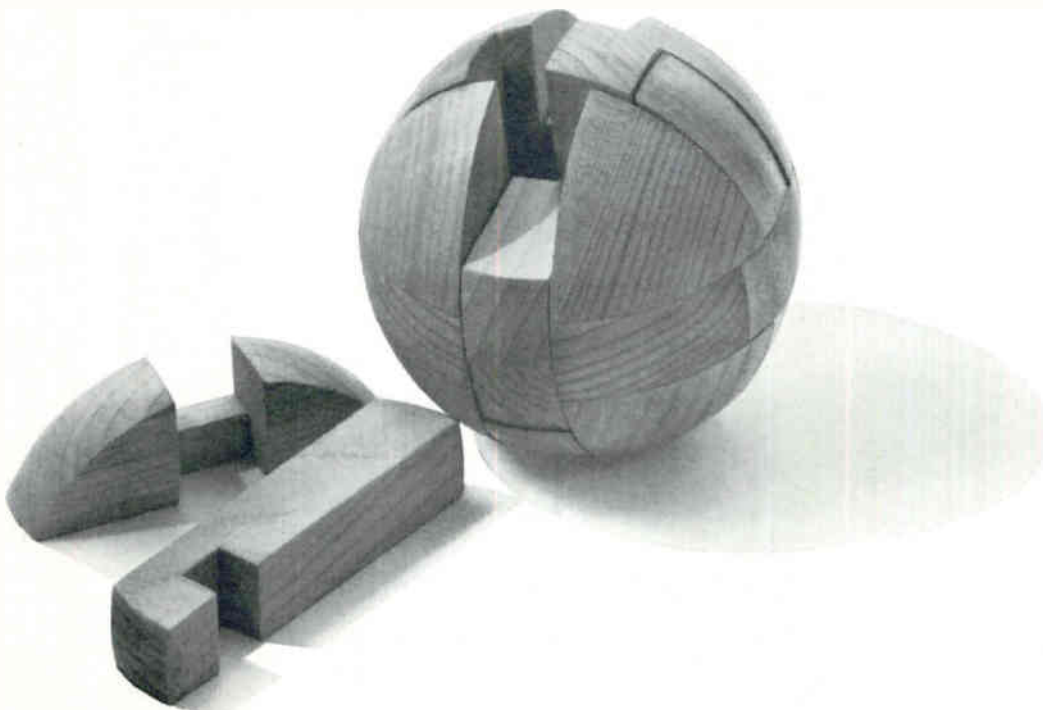

# 700 turns

No. 37 Single Enamel Wire  
Insulation on Both Leads Stripped  
Finished Coil Taped

# 800 coils per hour

Leesona No. 116 Automatic  
Bachi Bobbin Winder  
*automatically:*

- Closes the tail stock.
- Insulates starting lead with tape.
- Winds coil.
- Stops winding at  $\pm 2$  turns.
- Strips insulation from start and finish leads.
- Tapes finished coil.
- Waxes finished coil.
- Indexes wire guide.
- Cuts wire.
- Ejects finished coil.
- Sorts coils of two different specifications.
- Counts number of coils produced.



At 7250 turns, No. 39 single formex wire, 585 coils per hour is a typical production rate reported by prominent manufacturers who use the No. 116. Operator merely loads bobbin on arbor of individual head as table rotates, and clips starting lead. Production can be cycled to operator's loading time by controlling clockwise table rotation from  $\frac{1}{4}$  to 2 rpm. Winding speed of each head can be set according to number of turns desired. Write Leesona Corporation, Warwick, Rhode Island.

Or call Leesona at 5700 W. Diversey Ave., Chicago 39, TU 9-5735; 1500 Walnut St., Phila. 2, K1 6-1720, or A. R. Campman & Co., 1762 W. Vernon Ave., Los Angeles, AX 3-6265.

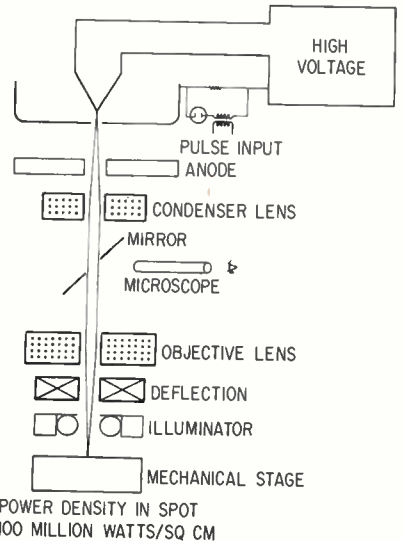

DRILLING MACHINE uses sharply focused pulsed beam to drill micro-miniature holes in ferrites without excessive recrystallization

is used to great advantage to fabricate a variety of miniaturized multi-apertured transfluxors, he reported. These devices are operated at moderate and high speed with low power. Geometrical shapes, difficult or impossible to attain by conventional dry-pressing techniques are easily achieved in miniaturized form by electron-beam machining, he added.

Miniature toroids with 3-mil internal diameter and 9 mil external diameter are fabricated by this technique. To rotate the beam and make a circular cut, 60-cps current is applied to the deflection coils. The internal aperture is first formed, then the external diameter is cut. Optimum beam operating conditions are 80 to 100 kv at 150 micro-amperes.

## Iron or Machine Can Solder Printed Cables

EXTENSIVE use of flexible printed wiring since its introduction several years ago has demonstrated that this type of wiring is compatible with both hand and mechanized soldering methods, according to Sanders Associates, of Nashua, N. H.

The company points out that its Flexprint wiring depends on thermoplastic insulation to position the con-

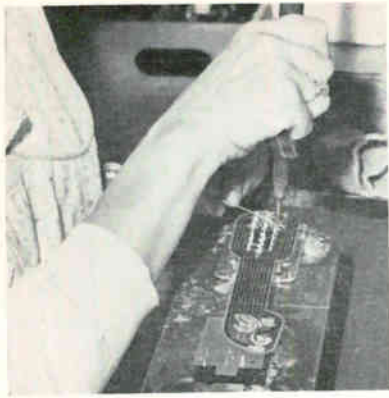

TYPICAL production setup for soldering Flexprint cable to assembly's fixed terminals



OPERATOR uses tweezers to press solder pads down over terminal pads



LAYERS of printed cable are stacked to save space and weight

ductors. Soldering techniques must be selected for minimum detrimental effects on the thermoplastic.

For hand soldering, the recommended iron is a 23-watt pencil iron with a 1/8-inch-diameter bit. For mechanized soldering, dip or fountain-type soldering can be used.

In dip soldering, eutectic solder temperature should be kept within 5 deg C of 200 C and the solder should be covered with Shell Peblum

# -260° C. to +500° C. Industrial temperature sensors

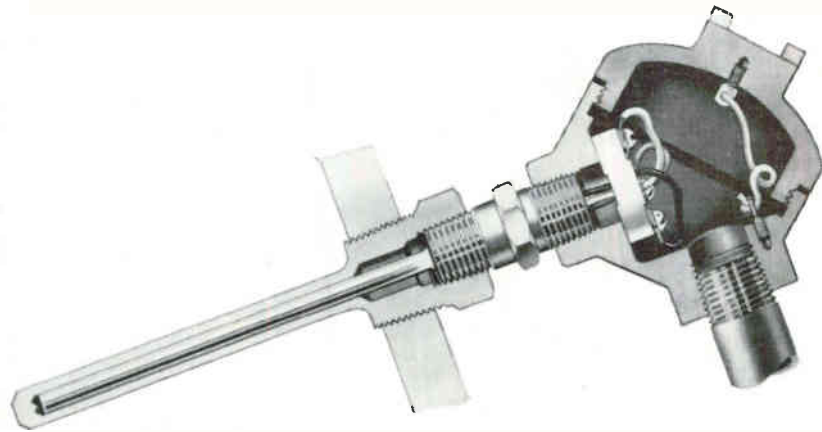

## REC's 104 series platinum resistance temperature sensors

Models for direct immersion, thermowell, or surface applications. Designed for high pressure and a wide temperature range, this new line of rugged, platinum resistance temperature sensors is competitively priced. Check these features of the Model 104 series:

- Wide range: -260° C. to +500° C.
- Stability: repeats within 0.05° C. at 0° C. when used over above range.
- Fast Response: Models available with time constant less than one second.
- Interchangeability: within 0.1% of master resistance curve at 0° C (or within 0.250° C.)
- Versatility: Mount in thermowells, directly into pipes or pressure vessels, or on surfaces.
- High Pressure Rating: 3000 psi on all models.

The REC Model 104 element is made of highly pure platinum wire mounted strain-free in a ceramic rod, and hermetically sealed into a stainless steel sheath. Sensors are available with diameters as small as .084". Many options in mountings, lead wires, and connectors.

### A complete line

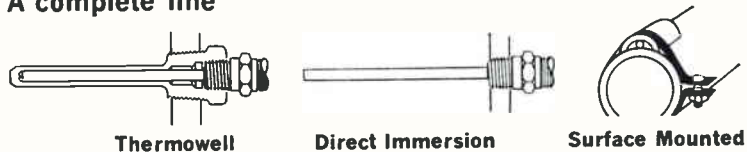

Thermowell

Direct Immersion

Surface Mounted

For further details on how the new REC Model 104 sensors will fit your application, write for Bulletin 8622 on Industrial Applications of platinum resistance temperature sensors. This 32-page bulletin gives a variety of fundamental engineering data on platinum thermometry and provides detailed performance specifications.



**ROSEMOUNT  
ENGINEERING  
COMPANY**

4900 West 78th Street • Minneapolis 24, Minn.

**SPECIALISTS IN TEMPERATURE & PRESSURE MEASUREMENT**

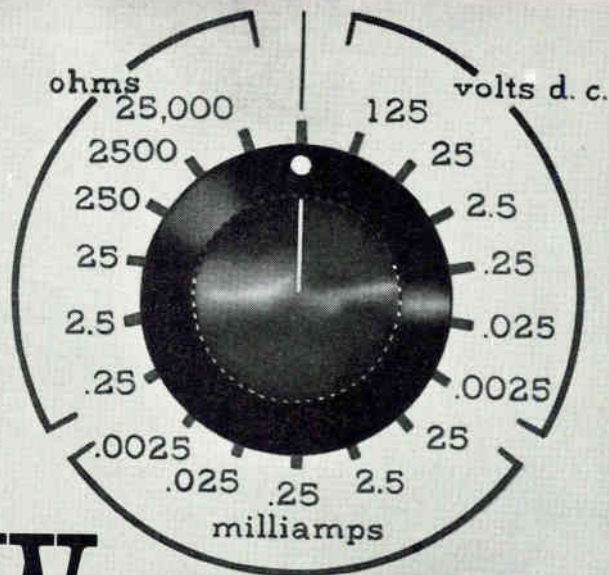

# New

FULL SCALE  
VALUES

## HIGHER SENSITIVITY RECORDER

# V.O.M.-6

by Bausch & Lomb

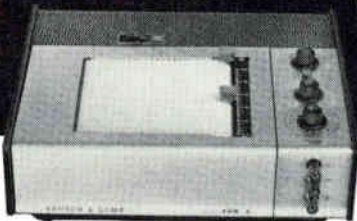

*Records Signals of 2.5  
Millivolts Full Scale Accurately!*

... a self-balancing, complete 5-inch strip-chart recorder ... brings you complete versatility ... without costly extras ... at one low price. Its higher sensitivity extends its usefulness in a great number of applications ... with the B&L Opacimeter—determine and record opacity of paper ... with the B&L Data Acquisition System—it extends the range of the Spectronic-20 to 340 $\mu$  ... many transducers can be used directly with the V.O.M.-6, no further amplification is normally required in gas chromatography applications.

ONLY  
**\$700**  
COMPLETE  
(Suggested Retail)

### COMPARE THESE EXCLUSIVE ADVANTAGES:

- Six voltage ranges, 2.5 millivolts to 125 volts
- Six linear ohms scales, 0.25 ohms-to-25,000 ohms full scale, with zener diode D.C. supply
- 5 D.C. current ranges, 2.5 micro-amperes to 25 milliamperes
- Off balance input impedance—over 10 megohms
- Five chart speeds, 400-to-1 range
- Event marker, with solenoid operated marking pens
- Function switch with mechanical pen letdown
- Operates in flat, 30° tilt, or wall-mounted position
- Compact, only 4 $\frac{3}{4}$ " x 14 $\frac{1}{2}$ " x 11 $\frac{3}{4}$ "
- Portable, only 18 lbs.

For further information, write for Brochure D-2054. Bausch & Lomb Incorporated, 61447 Bausch St., Rochester, N. Y. 14602

**BAUSCH & LOMB**



In Canada, write Bausch & Lomb Optical Co., Ltd., Dept. 614 Scientific Instrument Division, 18 Grosvenor St., Toronto 5, Canada

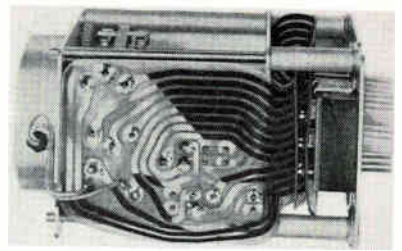

SOLDER fillets are bright and smooth

oil A. An epoxy-fiberglass fixture that exposes only the joints is used.

Fountain soldering is similar to dip soldering, except that molten solder is pumped through tubes to selected areas of the assembly. Tubes protrude through the oil-covered solder and the pump is immersed in the solder pot. Solder flow through a tube is controlled by a gate valve so it overflows smoothly without dross.

### Fused Terminals Provide Secure P-C Connections

PROMISING new technique is being widely applied by Bendix in new product assembly. Called the bifurcated fused terminal, it is used instead of plated-through holes for terminals on printed circuit boards.

A tinned terminal is inserted in the terminal hole of a printed circuit board. The terminal is turned down on two sides to create a slot and fused to the board by a special mechanism. This fusing means that soldering later either to insert a component or to remove one will not release the post from the board.

Components are inserted in the slots and the printed board goes through a flow-soldering unit. Capillary action draws molten solder up through the terminal to insure an electrically sound, rugged bond.

If it is necessary to remove a component, the soldering iron need contact only the fused terminal. Thus the component and p-c board conductor are exposed to a minimum of destructive heat.

Bifurcated fused terminals have the advantages of both point-to-point wiring and printed wiring with improved reliability in the finished product, says Bendix.

# HOW TO USE YOUR ELECTRONICS BUYERS' GUIDE\*

## The Two-Way Product Locator

\* \* \*

Most products advertised in the ELECTRONICS BUYERS' GUIDE are listed twice for your convenience. After the Product Heading, advertising page numbers appear where appropriate (when advertisements of one kind are grouped together in the book). Next to the individual product listing, the page number of associated advertising material is cited. Thus you can locate all of the advertisements for a particular product category, or any specific advertisement, quickly, accurately, and conveniently. Keep your ELECTRONICS BUYERS' GUIDE close to your work area at all times.

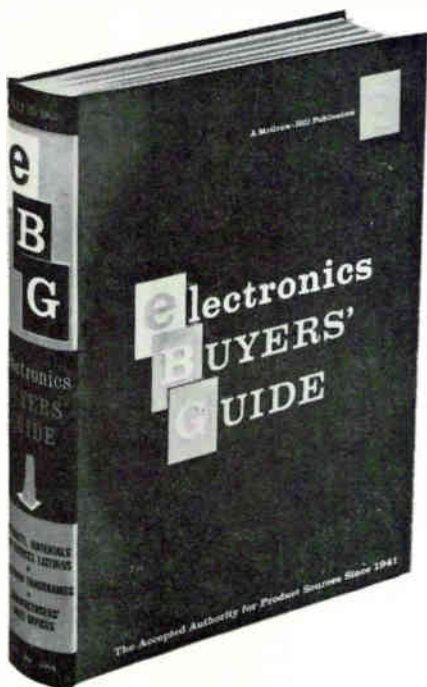

## NEW! Weld on top of p.c. boards...thin films... and inside transistors with the MINI-WELDER!

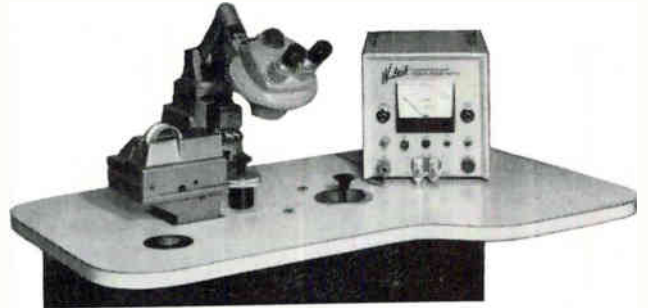

New Model 500 "Mini-Welder" welds wire from .0003" up to .030" or ribbon from .000125" up to .020" on top of thin films (down to 1000 Å), copper p.c. boards, many kinds of depositions, laminates, and etched circuits. Console is equipped with: Power supply, parallel gap or "one-sided" weld head, X Y micropositioner, fine wire feeder, product holder, B&L StereoZoom optics, Formica topped table and actuating system. Welds many different materials. For lab or production use. Write for details.

### FREE WELD SAMPLE SERVICE!

We'll help you with your welding problems. Send sample materials to Weltek Sales Mgr.

*Weltek*

### Precision Welders

by WELLS ELECTRONICS, INC.

1701 S. Main Street, South Bend, Indiana, U.S.A.  
CIRCLE 208 ON READER SERVICE CARD

## YOUR INSTANT SOURCE FOR

# TEFLON\*

## WIRE AND CABLE IS BRAND-REX

YOU GET IMMEDIATE SHIPMENT OF YOUR REQUIREMENTS, BIG OR SMALL, FROM ONE OF THE COUNTRY'S LARGEST TEFLON STOCKS.

BRAND-REX TURBOTEMP® TEFLON® WIRE AND CABLE			
MILITARY TYPES			
MIL - W - 168780	MIL - W - 22759	NAS - 703	COAXIAL CABLE
Types E, EE, ET (TFE Insulation)	Type 1 MS - 21985 MS - 21986 (TFE Insulation)	Types U, S, SJ Classes A & C (TFE Insulation)	MIL - C - 17C and MIL - C - 8721
Types K, KK, KT (FEP Insulation)	Type 1 MS - 17411 MS - 17412 MS - 18000 MS - 18001 (Filled TFE Insulation)		
U. L. TYPES			
Appliance Wire		Business Machine Wires	
200 °C, 300V & 600V 1/64" & 1/32" TFE Insulation	105 °C, No voltage rating .006" FEP Insulation with nylon jacket	105 °C, No voltage rating .010" TFE or FEP Insulation	
MULTICONDUCTOR CABLES			
Made to order for your military or commercial applications.			

Send for new 20-page catalog: "Brand-Rex TEFLON Wire and Cable, Section 6207"



DIVISION AMERICAN ENKA CORPORATION

31 Sudbury Road, Concord, Massachusetts

\*DuPont Trademark



## 15 Standard Coil and Transformer Lines with Proven Reliability for all Circuit Applications

Delevan's successful performance in the manufacture of precision coil and transformer products results from a unique blending of engineering and manufacturing experience in the field of micro-miniature precision-made components.

From Delevan's inception, its product philosophy called for an extremely high degree of precision manufacturing to meet exacting performance levels required by all quality-minded manufacturers of electronic systems.

This led to the creation of Delevan's in-plant certified test laboratory... with great consideration given to the design and processing techniques which resulted in the products' repeated reliability under extensive environmental testing.

In addition to Delevan's standard line of coil and transformer products, a specialized group of engineers are available for the sole purpose of designing custom coils of any variation to your specifications.

All Delevan products meet the requirements of U. S. Government Specification MIL-C-15305 Grade & Class 4 for RF and IF Coils and Transformers, and are manufactured to the rigid Quality Control Procedures as established by MIL-Q-9858.

### MOLDED FIXED

- Miniature sizes down to .095 inches dia. x .250 inches length
- Available in 10 standard series
- Inductances from .15 microhenries to 220 millihenries
- Excellent Q values for all circuit applications

### MOLDED TUNABLE

- A remarkable break-thru for design engineers
- Reliable high-quality molded tunable coil
- Maximum Q values
- Guaranteed L values .18 uh to 70,000 uh
- Tuning ranges as high as three to one
- Chassis or printed circuit applications

### FIXED SHIELDED

- Finest industry advancement in molded shielded coils
- Size .157 inches dia. x .375 inches length
- Inductance range from .10 microhenries thru 120 millihenries
- Epoxy molded for reliability

### MOLDED TUNABLE SHIELDED

- Model DSV (vertical mount) and DSH (horizontal mount) units for printed circuit boards
- Electrostatically and electromagnetically shielded
- Maintainable tuning core torque with repeated core cycling
- Foolproof encapsulation eliminates possibility of improper fills or cures which allow entry of moisture
- Minimum coil form thickness assures highest Q and L values
- Compatibility between coil form and potting materials provide maximum moisture resistance
- A unique, patented vibration and shockproof tuning feature requires no extra space for core in extended position
- Only .50 inches maximum over tuning length

### DELEFORMS

- Ceramic forms centerless ground for reproducible windings
- All purpose terminals for connection of external wiring
- Nickel plated metallic parts to prevent corrosion
- Internal teflon washer creates vibration proof unit
- Various powdered iron and ferrite cores available

**Delevan Electronics Corporation**

A SUBSIDIARY OF AMERICAN PRECISION INDUSTRIES INC.

270 QUAKER ROAD

EAST AURORA, NEW YORK 14052

# Magnetic-Core Module Resists Shock

Miniature device has no moving parts and infinite storage life

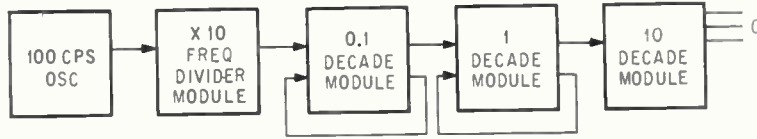

**TYPE 25900** magnetic-core module is designed for use in a variety of timing and programming applications where reliability is a major consideration. Unit contains no moving parts and all switches are solid state rather than mechanical. Advantages include greater shock and acceleration resistance, greater temperature operating range, smaller size, infinite storage life and lack of lubrication requirement.

The module requires no standby power. It can be programmed, left idle for any time period and at the time of use, will start timing from the pre-programmed position. In the decade ring-counter configuration, outputs will occur at the pre-

set time and the module will continue counting with a period of ten times the input period. In the non-ring counter configuration, outputs will occur at the pre-set time and the module will become inoperative until it is programmed or set again. Outputs from the cores are used directly to gate scr's that in turn can actuate relays, steppers and other electromechanical devices.

Device is a one core-per-bit counter composed of magnetic tape wound on stainless-steel bobbin cores with integral drivers. Each decade module contains 12 cores and two solid-state switches plus associated passive components. Applications include binary to decimal

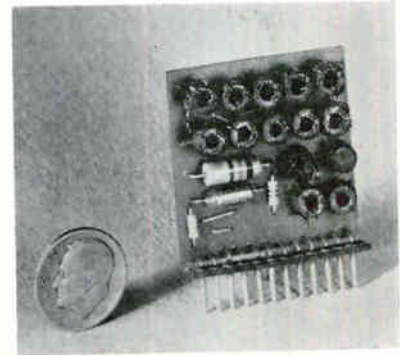

decoder, electronic counter, electronic programmer, intervalometer and frequency divider. Hamilton Watch Co., Lancaster, Pa.

CIRCLE 301, READER SERVICE CARD

# Data-Insertion Converter Handles 20 Inputs

**TWENTY** external signals in the range 0 to 5,000 cps with between 0.5 and 20 volts peak to peak can be accommodated by model DIC-1 data insertion converter. Unit consists of twenty IRIG subcarrier voltage-controlled oscillators, three mixer amplifiers, four precision power supplies and a metering circuit as shown in the diagram.

Incoming signals modulate the

subcarrier oscillators whose outputs can be independently and linearly summed into 1, 2 or 3 composite outputs. The signal from each vco may be included in, or excluded from any or all of the composite outputs. Individual control of the signal level from each vco to each mixing amplifier is provided. Metering of the three outputs from the mixing amplifiers permits establish-

ing pre-emphasis schedules and desired over-all output level. Power is furnished by precision positive and negative 10-volt supplies and by zener-regulated, positive and negative 20-volt supplies. Defense Electronics, Inc., 5455 Randolph Rd., Rockville, Md. (302)

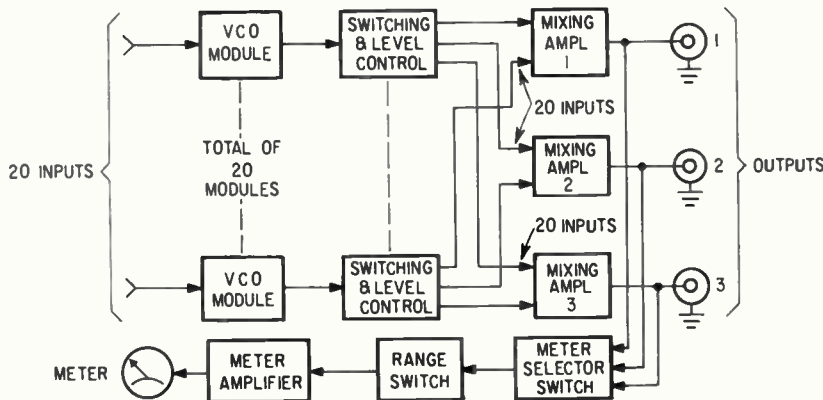

## Diodes Demodulate Laser Outputs

OPTICAL-detecting, photomixing diodes are capable of demodulating laser outputs in optical communication systems operating between 0.4 and 5.7 microns. Called the L4500 series, the four units have typical cutoff frequencies of 40, 10, 0.5 and 0.8 Gc for an output power decrease of 6 db per octave. Ratio of the number of hole-electron pairs generated by incident photons to the number of incident photons (typical

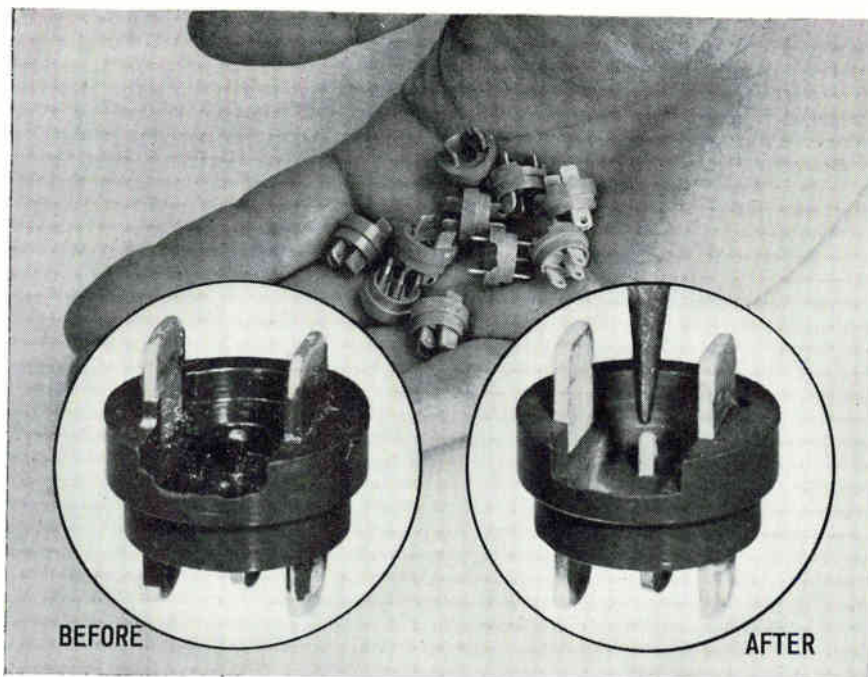

## Airbrasive® deflashing... reduced cost of this product 60%

It used to take nine weary-eyed girls a total of 72 hours of picking and scraping with hand tools to deflash and clean these tiny switch bases, according to Molded Insulation Company, Philadelphia, Pa. Now, with the S. S. White Airbrasive, *three* girls deflash the same number in only 24 hours!

What's more, the reject rate dropped from a burdensome 300% to practically nil. Result: the Airbrasive reduced the cost of producing the product by 60%.

Deflashing isn't the only use for this amazing industrial tool. It also cuts, scores, abrades, shapes, wire-strips... in fact, it has a real talent for solving all kinds of seemingly impossible production bottlenecks.

The secret is in the Airbrasive's precise, gas-propelled stream of microscopic particles that cut hard, brittle materials without heat, shock or vibration. Use it in the laboratory or in automated production. Glass, tungsten, ferrites, ceramics, germanium, and other fragile materials. For under \$1,000 you can set up your own Airbrasive cutting unit.

Send us samples of your "impossible" jobs  
and let us test them for you at no cost.

SEND FOR  
BULLETIN 6006  
... complete information

S. S. WHITE INDUSTRIAL DIVISION  
DEPT. EU, 10 East 40th St., N. Y. 16, N. Y.  
Telephone MU 3-3015 collect



for superfine cutting • deburring • cleaning

hard brittle materials

**S.S. White** INDUSTRIAL AIRBRASIVE®

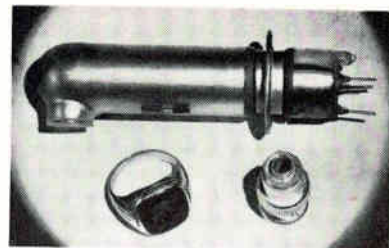

photon efficiency) ranges from 50 percent for silicon units to 25 percent for intermetallic diodes. Current efficiency is 85 percent for the four models, while light-sensitive areas for the series are 5, 20, 200 and 300 square mils. Units are packaged in a UG-88 U coaxial connector to provide transmission of output frequencies that cover the entire operational bandwidth of the particular diode. Coherent detection techniques improves the directivity of infrared photodiodes by many orders of magnitude. Moreover, calculations demonstrate that photo-mixing of coherent infrared radiation can increase detector sensitivities by 4 orders of magnitude. A maximum improvement of six to seven orders of magnitude appears possible. Prices range between \$100 and \$390. Philco Corp., Lansdale Div., Lansdale, Pa.

CIRCLE 303, READER SERVICE CARD

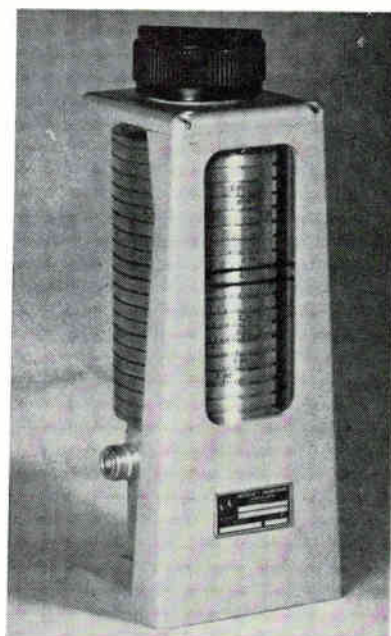

### Broadband Wavemeters Have High Accuracy

SERIES of broadband wavemeters provide frequency coverage over the range 1.0 Gc to 18.0 Gc with an



absolute accuracy of  $\pm 0.05$  percent. Units are suited for use as frequency markers in conjunction with broadband sweep generators and spectrum analyzers or in tuning a transmitter, receiver local oscillator or signal generator. Spurious signals are a minimum of 20 db down, absorption dip is  $1.5 \pm 1$  db and power capacity is 20 watts. Wavemeter retains its accuracy over a temperature range of  $22\text{ C} \pm 10\text{ C}$ . Available frequency ranges are 1.0 Gc to 2.0 Gc, 2.0 to 4.0 Gc, 4.0 Gc to 8.0 Gc, 8.2 Gc to 12.4 Gc and 12.0 Gc to 18.0 Gc. Frequency Engineering Laboratories, Farmingdale, N. J. (304)

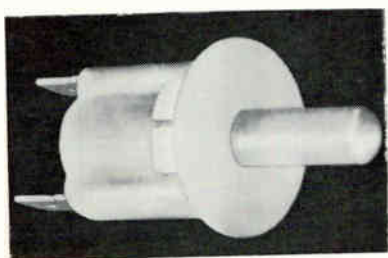

### Door Switch Is Rugged Device

Low-cost door switch rated at 3 amperes, 125 v a-c has been developed. It can be used wherever door movement must make or break a circuit. It can also serve as an economical industrial limit switch. Made of unitized Nylon, Zytel 101, the switch snaps into position and needs no screws due to its pressure fit design. Fits a  $\frac{3}{4}$  in. diameter hole and has  $\frac{1}{4}$  or  $\frac{3}{16}$  in. tab terminals for quick connection. It has been tested to over 500,000 operations. Normally open, makes within  $\frac{3}{4}$  in. stroke; normally closed, breaks within  $\frac{1}{4}$  in. stroke. Oak Mfg. Co., Crystal Lake, Ill. (305)

### TWT Supply Features Low Noise

MODEL MWA-5A is a low-noise traveling wave tube preamplifier power-supply unit designed to improve the sensitivity of reconnaissance or communication receivers. The basic device may be used with a variety of existing ppm and pm TWT's by simply changing a plug-in circuit board with each tube type. Unit is sufficiently versatile to ac-

## PUSH TO TEST

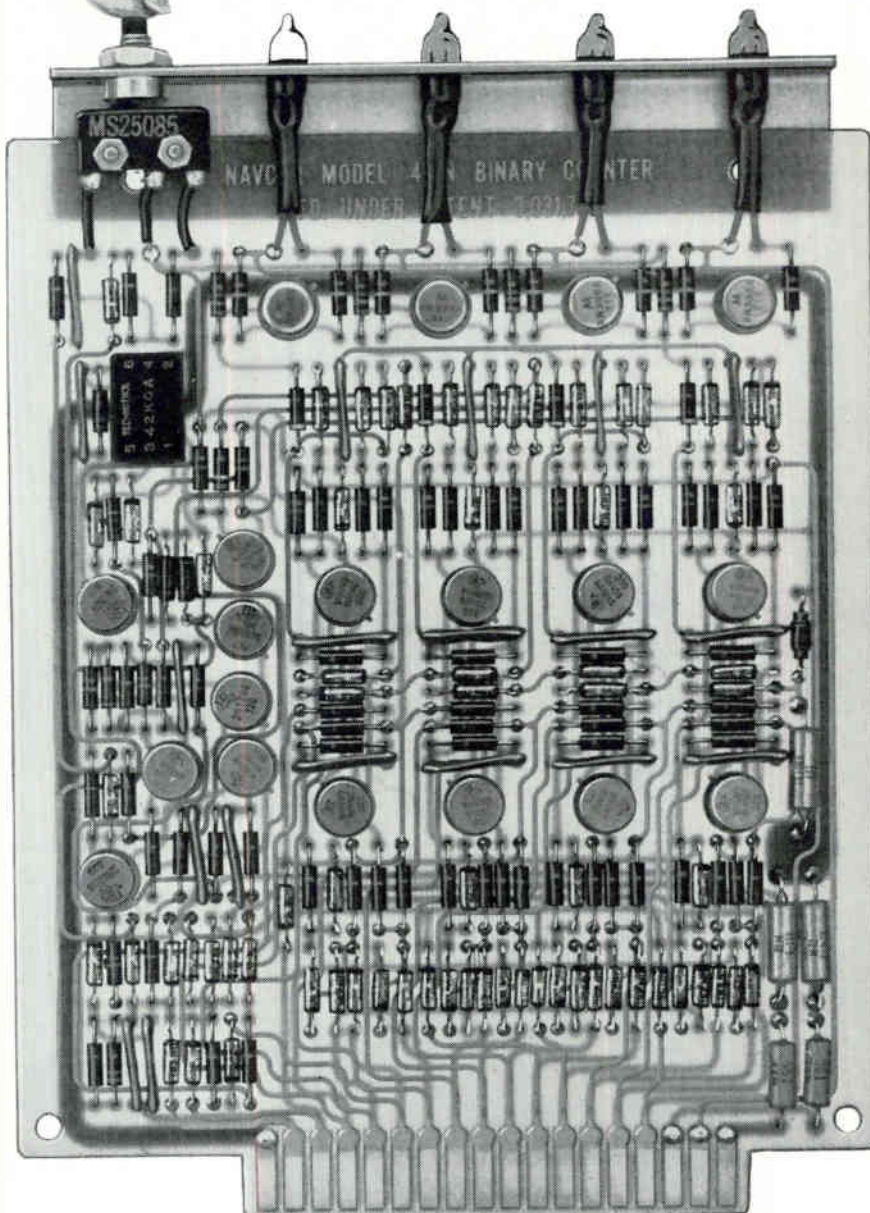

Push a button . . . follow the operation of a Navcor 400 Series system function module one logical step at a time on the neon indicator lights. Each module is a complete system function, grouping many logic elements. Push button and lights permit positive checkout in a fraction of the time required with less sophisticated flip-flops. Write for data on complete MIL Standard line of

**Transistorized Digital System Function Modules**

# NAVCOR

VALLEY FORGE INDUSTRIAL PARK  
930 RITTENHOUSE ROAD, NORRISTOWN, PA. • GL 2-6531

There's a standard  
**BURR-BROWN**  
**OPERATIONAL**  
**AMPLIFIER**

for nearly every  
design requirement

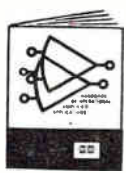
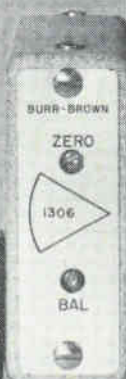
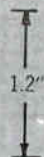

**NEW HANDBOOK of OPERATIONAL AMPLIFIER APPLICATIONS** contains valuable theory and typical circuits . . . the result of Burr-Brown's long experience in the application of operational amplifiers. Send \$1 for your copy, today.

Burr-Brown offers the industry's widest selection of solid state operational amplifier packages and performance ratings . . . priced from only \$55, they enable you to select the proper unit for your specific application. And, Burr-Brown provides competent technical assistance in the application of these versatile components.



Phone: (602) 623-0328 / TWX: (602) 792-2681 / Box 6444 Tucson, Arizona

**CIRCLE 209 ON READER SERVICE CARD**

commodate other proposed TWT's, and is capable of covering 1 Gc to 11 Gc in a series of bands dictated by the tube bandwidths with typical noise figures between 9 and 12 db.



Replacement of the tube to cover L, S, C or X band operations can be accomplished in minutes through disconnect power plugs. Front panel metering is provided for the tube voltages and currents to permit analysis of operating conditions. The TWT may be remotely located up to 200 feet from the power supply without degradation of performance. Applied Technology Corp., 930 Industrial Ave., Palo Alto, Calif.

**CIRCLE 306, READER SERVICE CARD**

**Data Transmission Test Set**

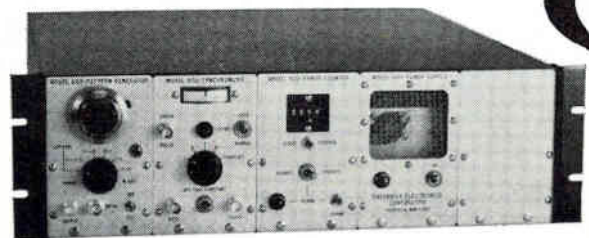

for  
**Wire Line,  
Radio and  
Recorded Systems**

The Model 600 generates a pseudo-random test pattern signal, 2047 bits in length, at a rate from 10-100,000 bits per second using its own oscillator or an external clock source. In either instance, the Test Set can be slaved to the time base of the system under test. The Model 600 receives the system output test pattern, synchronizes to it, and compares it with a locally generated "perfect" pattern. Errors in the received test pattern are counted and registered on a front panel indicator.

The Model 600 is of solid state design with modular construction; the Pattern Generator and Power Supply are available separately for only pattern generation. Interface adapters may be supplied to match the Model 600 to various systems.

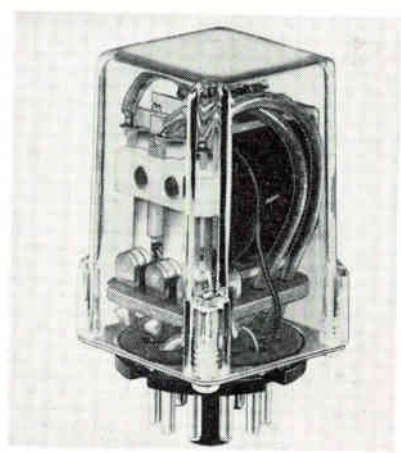

**Relay Provides  
High Versatility**

DESIGNED for maximum versatility, series U general purpose relay is available with single, double or triple pole double throw contact arrangements in either a 5-amp or 10-amp rating. Standard coil voltages 6, 12, 24, 48, 115 and 230 v a-c; and 6, 12, 24, 48 and 110 v d-c. The relay can be obtained in an open type with solder terminals or with a plastic dust cover. The single and double pole enclosed versions have 8 pin; the triple pole has 11 pin terminals for quick plug-in to octal sockets. Hart Mfg. Co., Hartford 1, Conn. (307)

**F E C** **FREDERICK ELECTRONICS CORP.**  
414 Pine Avenue, Frederick, Maryland Phone: 301-662-5901 TWX: FRED 419

**82 CIRCLE 82 ON READER SERVICE CARD**

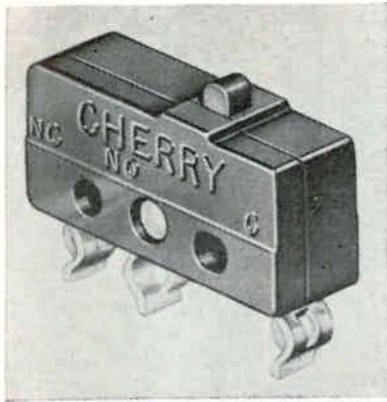

### Subminiature Switch Has Target Terminals

DEEP-WELL target-type solder terminals are featured on the E62 and E61 series subminiature snap-action switches. Having greater soldering area because of the cylindrical shape, the new terminal type permits easier wire insertion, faster installation and greater anchorage with better solder adherence. The switch pictured, E62-13A, has a rating of 10.1 amperes 125/250 v a-c,  $\frac{1}{4}$  h-p 125 v a-c. Cherry Electrical Products Corp., P. O. Box 439, Highland Park, Ill. (308)



### Resistance Calibrators Save Time and Space

NOW AVAILABLE is a resistance calibrator that covers 1 ohm through 100 megohms and has a shorted and an open position for zeroing meters. Unit is useful for speedy checkout and calibration of ohmmeters or ohmmeter sections of multimeters

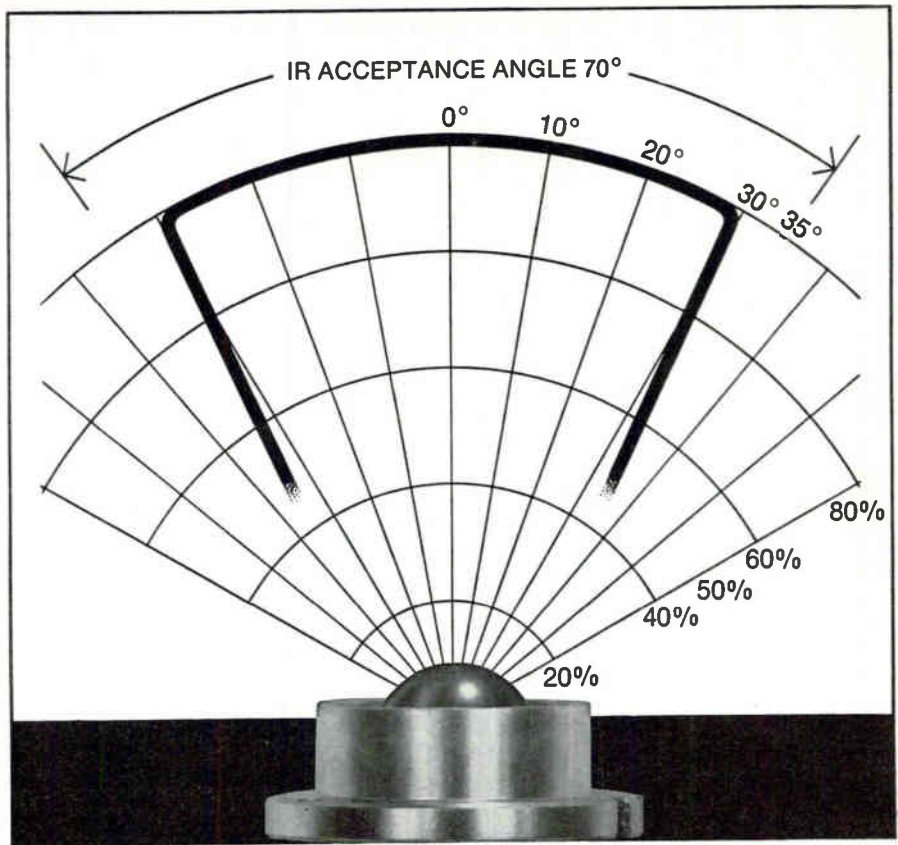

## INFRARED WIDE ANGLE GERMANIUM IMMERSSED THERMISTOR DETECTOR

### DESIGNED FOR SPACE ENVIRONMENT...

Servo Corporation's new wide-angle thermistor detector features an acceptance angle of up to 70° nominal, with wider angles on special order. Operation is stable and reliable even at temperatures in excess of 100° C. The detector is coated to peak at 13 microns and may be peaked at any wavelength in the 9-15 micron region.

This is but one of the many infrared products from Servo. The company is presently engaged in advanced studies involving IR materials, detectors, and instrumentation. Facilities include a complete IR optics department.

*For literature describing the wide-angle detector, write to:*



## SERVO CORPORATION OF AMERICA

111 New South Road, Hicksville, L. I., New York

(516) WELLS 8-9700

# BLOCKS for BUSS FUSES

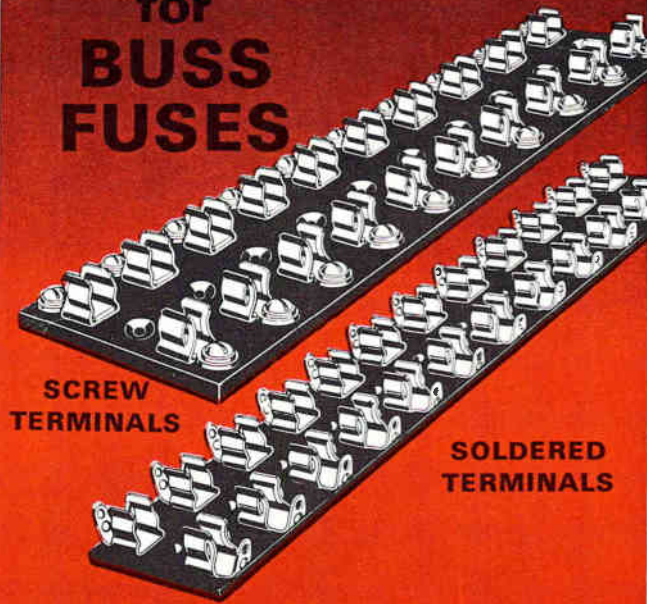

Standard type — 1 to 12 pole.

## BUSS

Write for BUSS  
Bulletin SFB.

BUSSMANN MFG. DIVISION, McGraw-Edison Co., St. Louis 7, Mo.

# BUSS FUSEHOLDERS

● LAMP INDICATING SERIES HG

Made To  
Military  
Specifications

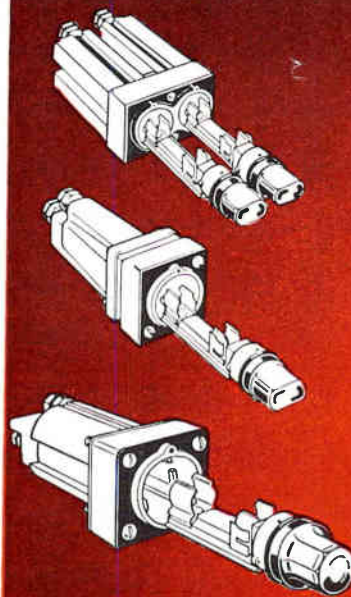

Provides quick, positive, visual identification of faulted circuit. Transparent knob permits indicating light to be readily seen.

Fuses are held in clips on a fuse carrier.

Fuse carrier slides into holder and is locked in place with bayonet type knob.

Holder designed for panels up to 1/4 inch thick.

Holder is inserted in panel from rear. Mounting screws can be conveniently tightened from front of panel.

## BUSS

Write for BUSS  
Bulletin SFB.

BUSSMANN MFG. DIVISION, McGraw-Edison Co., St. Louis 7, Mo.

## BUSS : the complete line of fuses

CIRCLE 85 ON READER SERVICE CARD

in industrial calibration laboratories. Accuracies available are: 1 percent, 0.1 percent and 0.05 percent. The 1 percent calibrators use carbon resistors, the 0.1 percent and 0.05 percent units have wirewound resistors. Dimensions are 3 3/4 by 6 1/4 by 3. Panco Electronic Enterprises, 2112 Pontius Ave., West L. A. 25, Calif. CIRCLE 309, READER SERVICE CARD



### Coax Attenuators Cover from 2 to 10 Gc

SERIES 3650 coaxial attenuators are general purpose devices covering the frequency range from 2 to 10 Gc (20 db covers 2.5 to 10 Gc). They are designed to satisfy the need for an economical attenuator for systems and laboratory applications where a high degree of precision is

not required. The devices are ruggedly constructed and are negligibly affected by temperature or humidity changes. They are supplied with type N connectors in any arrangement desired. Maury Microwave Corp., 10373 Mills Ave., Montclair, Calif. 91763. (310)

### Pulse Generator Operates in 6 Modes

ON THE MARKET is model 155 pulse generator, which provides, without the use of external synchronization or control systems, high versatility. It provides operation in six modes: single pulse, single pairs of pulses,

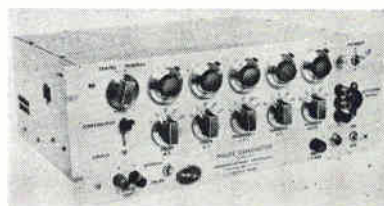

single trains of pulses, repetitive pulses, repetitive pairs of pulses, repetitive trains of pulses. Maximum power is 25 w at 250 v, providing energy for use of a pulse isolator, strobe light, relays and solenoids. An accessory output plug is provided on the front panel. All frequencies, durations, delays, and the like, are calibrated to within 5 percent; are stable to 1 percent or better over long periods. Resetability accuracies are in the order of 0.1 percent. American Electronic Laboratories, Inc., Richardson Road, Colmar, Pa. (311)

### Ga-As IR Light Source Has High Power

GALLIUM-ARSENIDE infrared light source, the SNX-110, is typically capable of a continuous optical output of 20 mw at 25 C package temperature with a forward bias of 2 amperes. Peak optical outputs ex-



## X-ray to be sure

Now, here's true quality control on transistors and other electronic components. X-ray is an economic and efficient non destructive testing method that assures reliability and provides a film record to prove it. Send samples for free test report or request literature.

*X-ray Problem? Ask Balteau About It!*



**BALTEAU ELECTRIC CORPORATION**  
10-14 MEADOW ST. • STAMFORD, CONNECTICUT

CIRCLE 210 ON READER SERVICE CARD

# NEW! FREE!

## CAMBION® DIGITAL MODULES CATALOG

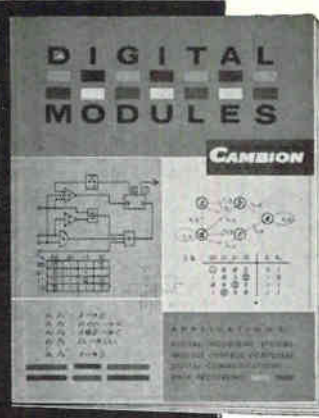

New 48-page catalog contains circuit diagrams and operating characteristics on the complete line of CAMBION 12-pin digital modules — 19 families, 43 modules in all. They are designed specifically for military, industrial control, communications and data processing applications where switching speed is secondary to considerations of economy, simplified circuitry, easy mounting and straightforward interconnections. The line is complete in itself and each module is compatible, one with another. Modules are designed for worst combination of loading and environmental conditions and conservatively rated to a speed of 100 KC. Encapsulated in epoxy, each module measures 29/32" x 13/32" x 5/8".

For complete details write for a copy of our new catalog. Cambridge Thermionic Corporation, 437 Concord Ave., Cambridge 38, Mass.

## CAMBION®

Standardize on CAMBION...The Guaranteed Electronic Components

CIRCLE 211 ON READER SERVICE CARD

..... of unquestioned high quality

## BUSS FUSEHOLDERS



- LAMP INDICATING
- SIGNAL ACTIVATING
- SERIES HKA

For 1/4 x 1 1/4 inch BUSS GLD Fuses, 1/4 to 5 amps.

Where a visible or audible signal or both is desired to indicate trouble on a circuit, the BUSS HKA fuseholder with BUSS GLD fuses presents a practical answer.

When fuse opens, an indicating pin completes a circuit that lights knob indicating lamp and makes electrical contact on external signal circuit. The external signal can be an audible alarm, or another lamp mounted at a distance, or it can operate a relay.

# BUSS

Write for BUSS  
Bulletin SFB.

BUSSMANN MFG. DIVISION, McGraw-Edison Co., St. Louis 7, Mo.

CIRCLE 85 ON READER SERVICE CARD



If you should have a  
special problem  
in electrical  
protection...

... we welcome your request either to quote or to help in selecting the type of fuse or fuse mounting best suited to your particular conditions.

Submit description or sketch, showing type of fuse to be used, number of circuits, type of terminal, etc. If your protection problem is still in the engineering state, tell us current, voltage, load characteristics, etc. Be sure to get the latest information BEFORE final design is crystallized.

At any time our staff of fuse engineers is at your service to help solve your problems in electrical protection and save you engineering time.

# BUSS

Just call  
or write:

BUSSMANN MFG. DIVISION, McGraw-Edison Co., St. Louis 7, Mo.

CIRCLE 85 ON READER SERVICE CARD

# New way to "bend" light to your needs

Now there's a way to control light and place it precisely where you want it. To illuminate an inaccessible spot, for example . . . or to pick up a light signal, carry light through complex mechanisms, even transmit it from a single source to several places. The answer lies in AO Fiber Optics.

When beamed on the end of a glass fiber, much of the light that enters will be caught inside, unable to escape out the sides because of total internal reflection within the clad, glass fibers. It will be reflected a number of times from the fiber walls till it finally escapes from the far end.

As many as 6,000 finely-drawn, 75-micron glass fibers may be bound into a ¼-inch diameter tube. This light guide gives an efficient, easy, economical way to transmit light over a curved or flexible path.

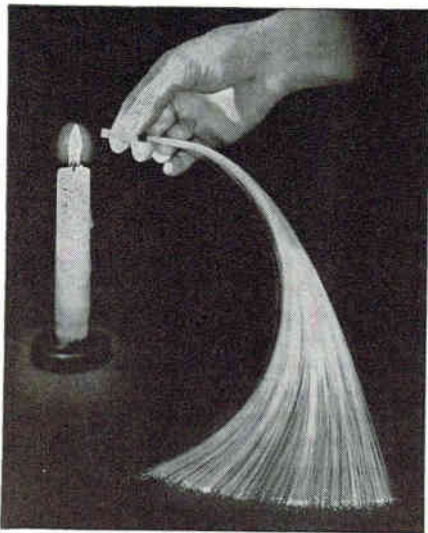

Candle demonstrates AO Fiber Optics in action. In a 50-micron fiber, a ray of light may be reflected 3,000 to 4,000 times per foot.

AO Fiber Optics uses only precision optical glass fibers; they transmit approximately five times as much light as clear plastic rods. For flexible light guides, continuous fiber bundles up to ¼-inch in diameter are bound into tubing as long as 22 feet. Now available and relatively inexpensive, these light guides have found many industrial and scientific uses. In addition to fibers that will transmit through the visible light range, light guides are also available with infra-red transmission beyond 6 microns. For further information, write or call:

Space Defense Division  
Fiber Optics Department 1E

**American Optical**  
COMPANY

Southbridge, Mass.

Telephone Southbridge 764-3211, Ext. 323

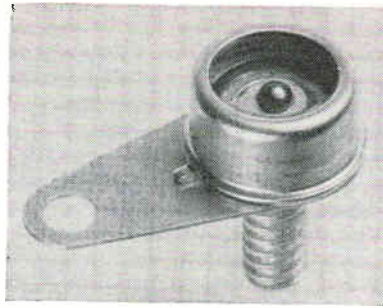

ceeding ¼ w have been achieved at package temperatures of  $-195^{\circ}\text{C}$ . Specially designed package features a concentrically mounted threaded copper stud which, when attached to a properly designed heat sink, provides efficient dissipation of the heat generated during diode operation. Texas Instruments Inc., 13500 North Central Expressway, Dallas, Texas.

CIRCLE 312, READER SERVICE CARD

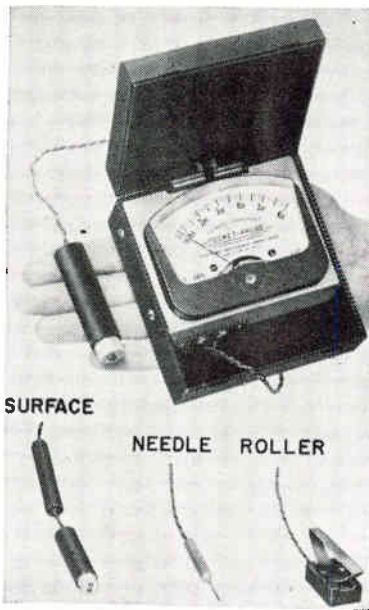

## Portable Pyrometer Has Versatility

POCKET-SIZED pyrometer measures 4 in. by 4½ in. by 2 in. The Pocket-Probe features a large scale, automatic temperature compensation, red pointer, fast acting thermocouple, 2-ft long wire cable from pyrometer to probe, and replaceable thermocouples. Connections are brazed or welded to guarantee constant accuracy. Readings are very fast. Pocket-Probe is available in any temperature range with either surface probe, needle probe or roller contact type. Standard accuracy is

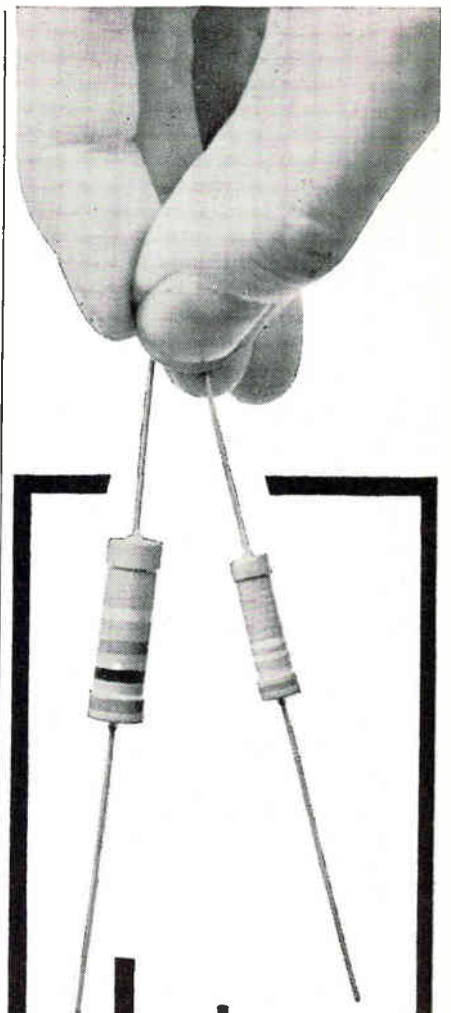

# Let us help you cut costs!

CARBON FILM RESISTOR

# Rohm

TOYO  
ELECTRONICS  
INDUSTRY  
CORPORATION

P, O, BOX 103 CENTRAL  
KYOTO JAPAN

CIRCLE 212 ON READER SERVICE CARD

November 15, 1963 electronics

**What BLOWERS**  
*GUARANTEE*  
**20,000**  
 HOURS OF  
 CONTINUOUS  
 SERVICE LIFE ?  
 2½ Years ... 27 Months  
 833½ Days

**McLEAN  
 BLOWERS DO!**

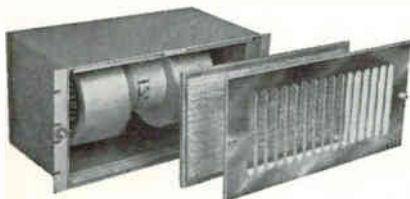

MIL-SPEC MODEL NO.  
 M2EB512A

*How's THAT FOR  
 RELIABILITY?*

**RFI SHIELDED  
 MIL-SPEC  
 COMMERCIAL**

Packaged Blowers,  
 Ring Fans, Panel  
 Fans, Centrifugal  
 Blowers. Over 100  
 models in various  
 panel heights,  
 widths, CFM's

*Any  
 Questions?*  
 SEND FOR CATALOG



**McLEAN ENGINEERING  
 LABORATORIES**

World Leader in Packaged Cooling  
 P.O. Box 228, Princeton, New Jersey

Phone Area Code 609 WALnut 4-4440  
 TWX 609-799-0245

**CIRCLE 213 ON READER SERVICE CARD**  
 electronics November 15, 1963

2 percent. Accuracy of 1 percent can be easily supplied. Price is \$44.90. Electronic Development Laboratories, 29 John St., New York 38, N. Y. (313)

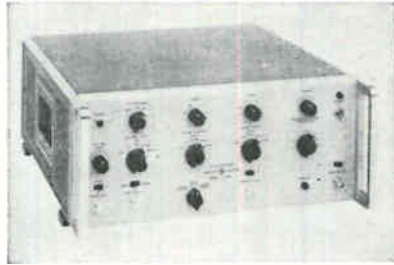

**Pulse Generator Offers  
 High Peak Power**

VERSATILE pulse generator offers high peak power pulses of known shape. Model 214A can provide positive or negative 100-v, 2-amp pulses into 50 ohms. Source impedance is 50 ohms on all but the highest output range to minimize errors caused by re-reflections when operating into unmatched loads — a feature which permits the output pulse characteristics to be accurately specified. At maximum output, pulse rise and fall times are typically 15 nsec; on all other ranges, less than 13 nsec. Internal triggering extends to 1 Mc, and oscilloscope-type controls make it possible to trigger from the positive or negative slope of almost any d-c to 1 Mc external signal from -40 to +40 v. Other features include single pulse, double pulse, and pulse burst capabilities. Hewlett-Packard Co., 1501 Page Mill Road, Palo Alto, Calif. (314)

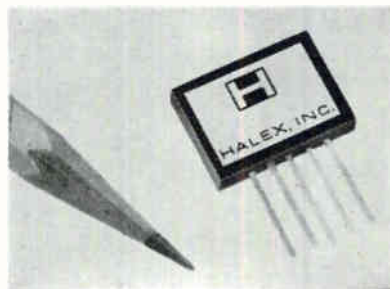

**D-C Amplifier  
 Features Low Drift**

MODEL 1030 is a general-purpose thin-film d-c amplifier with preset gain up to 100, bandwidth of 100

**NEW**



**CATALOG**

**VITREOSIL®  
 PURE FUSED  
 QUARTZ**

**LABORATORY WARE  
 INDUSTRIAL WARE  
 TUBING AND ROD  
 SPECIAL APPARATUS**

**IF YOU DON'T HAVE THIS NEW  
 30 PAGER, WHICH INCLUDES  
 THE UNUSUAL PHYSICAL  
 PROPERTIES OF VITREOSIL,  
 WRITE TODAY, IT'S FREE.**



How many ways  
can the all-electric  
**ELECTROTABLE**  
increase your  
production?

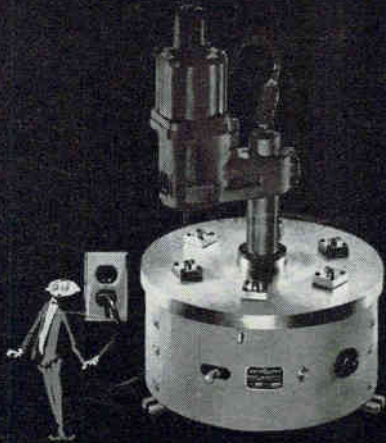

**BLACK & WEBSTER**  
INC.  
570 PLEASANT STREET,  
WATERTOWN 72, MASS.

Gentlemen:

Please send me information about the Series 3 Black & Webster all-electric indexing table which:

1. automatically positions work within  $\pm .001$ "
2. triggers other tools to swage, stake, rivet, punch, etc. as desired
3. accommodates as many as 12 stations at speeds to 48 indices per minute
4. plugs into any 115V outlet
5. has no complicated connections or piping of any kind
6. adapts easily to automatic feeds
7. cuts costs, time, and labor

NAME \_\_\_\_\_

COMPANY \_\_\_\_\_

STREET \_\_\_\_\_

CITY \_\_\_\_\_

ZONE \_\_\_\_\_

STATE \_\_\_\_\_

DEPT. E \_\_\_\_\_

kc, and drift of less than 100  $\mu\text{V}/\text{deg C}$ . It utilizes vacuum deposited resistors, terminals and interconnections on a 0.75 in. by 0.55 in. encapsulated substrate. Thickness of the module is 0.10 in. Active components consist of micro size silicon diodes and transistors. Flat ribbon leads can be welded or soldered. Output amplitude into a 1,000-ohm load is 1 v rms at an output impedance of less than 100 ohms. Power requirement is +12 and -12 v. Amplifier will operate over a temperature range of -40 to +100 C. Price is \$250 in quantities of 1 to 9. Halex, Inc., 139 Maryland St., El Segundo, Calif.

CIRCLE 315, READER SERVICE CARD



### Sweeping Oscillator Is Solid-State Unit

MODEL 100 Marka-Sweep is an all solid-state sweeping oscillator providing extremely flat sweeps up to 100 Mc wide. It provides at least 1 v rms metered output for all modes of operation—line-locked, variable, manual or c-w. Fixed, pip-type frequency markers and variable birdie-type markers are available simultaneously. Additional features of the unit include a built-in detector, precision step-attenuator, and provision for external modulation of the sweep oscillator. These features are provided in a sweeping oscillator and marker generator measuring only 8 by 19.5 by 13.5 in. overall. Kay Electric Co., Maple Ave., Pine Brook, N. J. (316)

### D-C Servo Amplifier Has 3 Summing Inputs

MODEL A457 is designed to drive d-c servo motors and torquers up to 28 v d-c and 4½ amp. The basic model A480 has 3 summing inputs with independent gain adjustment.

**McGRAW-HILL**  
**BOOKS**

#### FIELD ANALYSIS AND ELECTROMAGNETICS

*Just Out.* Presents electromagnetic theory, developed logically in general form, with examples of its various facets. Covers applications in statics, boundary value problems, waveguides, etc. By M. Javid & P. M. Brown, City Coll. of N. Y. 544 pp., illus., \$12.75

#### ELECTROHYDRAULIC SERVOMECHANISMS

*Just Out.* Shows how to get peak performance from fluid systems through combined use of electronics and hydraulics. Treats control valve fundamentals and complete range of components. Includes servo valve design. By A. Morse, No. Amer. Aviation, Inc. 246 pp., illus., \$11.50

#### LINEAR SYSTEM THEORY

*Just Out.* Presents unified theory of linear systems from "state space" point of view. Concepts of state, system equivalence, linearity, etc., are developed systematically and tied to properties of linear systems. By L. Zadeh & C. Desoer, both of Univ. of Calif., Berkeley, 640 pp., illus., \$15.00

#### 1963 McGRAW-HILL YEARBOOK OF SCIENCE AND TECHNOLOGY

*Just Out.* The latest scientific breakthroughs, and the most significant technological achievements are described in this stimulating yearbook. Eminent authorities treat their special fields. 608 pp., over 650 maps, photographs, and illustrations, \$19.50

#### MATHEMATICAL METHODS IN PHYSICS AND ENGINEERING

Bridges the gap for the engineer and physicist between fundamental mathematics books and advanced monographs. Covers the general area of boundary value and eigenvalue problems. By J. W. Dettman, Case Inst. of Tech. 320 pp., 16 illus., \$9.75

#### GUIDANCE AND CONTROL OF AEROSPACE VEHICLES

*Just Out.* Covers broad range of topics in guidance and control in terrestrial, satellite, and extraterrestrial systems. Includes quantitative evaluation of relative merits of various guidance and control systems and techniques. By C. T. Leondes, UCLA. 678 pp., illus., \$19.50

#### 10 DAYS' FREE EXAMINATION DIRECT FROM PUBLISHER

McGraw-Hill Book Co., Dept. L-11-15  
327 W. 41st St., N.Y.C. 10036

Send me book(s) checked below for 10 days' examination on approval. In 10 days I will remit for book(s) I keep plus few cents for delivery costs, and return unwanted book(s) postpaid. (We pay delivery costs if you remit with this coupon—same return privilege.)

- Javid & Brown—Field Anal. & Electromag., \$12.75
- Morse—Electrohydraulic Servomech., \$11.50
- Zadeh & Desoer—Linear Sys. Theory., \$15.00
- McGraw-Hill Yearbook of Sci. & Tech., \$19.50
- Dettman—Math. Meth. in Physics & Eng., \$9.75
- Leondes—Guidance & Cont. of Aerosp. Vehicles, \$19.50

(PRINT)

Name \_\_\_\_\_  
Address \_\_\_\_\_  
City \_\_\_\_\_ State \_\_\_\_\_ Zip Code \_\_\_\_\_  
Company \_\_\_\_\_  
Position \_\_\_\_\_  
For price and terms outside U.S.  
write McGraw-Hill Intl., N. Y. 10036 L-11-15





Special features are d-c isolation of the signal inputs from the output and the 28 v d-c supply, and a-c carrier type amplifier with built-in carrier frequency generator. West-amp, Inc., 11529 Pico Blvd., Los Angeles 64, Calif. (317)

### Pulse Transformers for High-Frequency Use

SMALL, molded pulse transformers, encased in standard, low-silhouette packages, are available for high-frequency coupling applications and use on small, solid-state pulse circuits in the nanosecond range. Designed for operation in both commercial and military environments, these transformers have an o-d of 5/16 in., and a height of only 1/8 in.



Leads are composed of wire 10 to 12 mils in diameter, suitable for either soldering or welding. Available in inductances as high as 500 microhenries per winding, units contain 4 leads mounted on 0.2-in. centers, or 6 leads mounted on 0.28-in. diameter circle. Price: under \$20

**Thomas A. Edison Industries**  
INSTRUMENT DIVISION



miniature  
meter  
recorder

**EDISON**

# OMNICORDER



## ELIMINATES METER WATCHING

- A PERMANENT RECORD OF CONTINUOUS MEASUREMENT WITHOUT METER-WATCHING
- ACCURATE MEASUREMENT WITH THE RELIABILITY OF AN ELECTRIC CLOCK
- ELIMINATION OF HUMAN ERROR IN DATA RECORDING
- DIRECT PANEL MOUNT IN NO MORE SPACE THAN A METER ALONE (3 3/4" SQUARE)
- THREE CHART SPEEDS VARIABLE BY SIMPLE SWITCHING
- INKLESS — NO LOSS OF RECORD DURING OPERATION
- FOR FURTHER INFORMATION WRITE FOR FREE CATALOG.

Measures and records AC and DC current, voltage and temperature

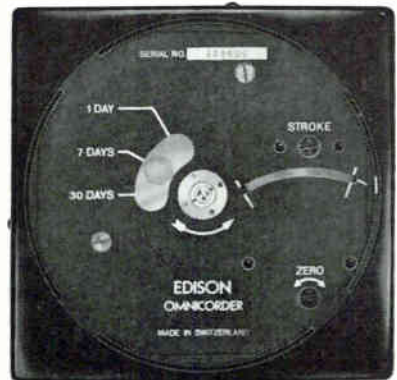
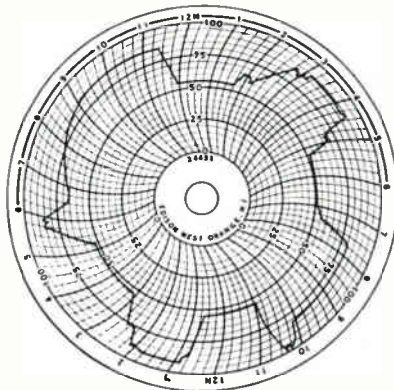

SIMPLE EXTERNAL ADJUSTMENT  
WITHOUT INTERNAL TAMPERING

# ARCO electronics inc.

Community Drive, Great Neck, N.Y. ■ 516 HUnter 7-0500 ■ TWX 516-466-0235  
EXCLUSIVE SUPPLIER TO THE ELECTRONIC INDUSTRY IN U.S.A.

BRANCHES

Los Angeles: ARCO CAPACITORS, INC.  
1548 So. Robertson Blvd., Los Angeles 35, Calif. ■ 213 CRestview 1-1151 ■ TWX 213-273-4092  
Dallas: ARCO ELECTRONICS, INC.  
2523 Farrington St., Dallas 7, Texas ■ 214 MEIrose 1-0270 ■ TWX 214-631-5910

# NOW AVAILABLE

FOR ENGINEERS  
WORKING IN  
VERY LOW  
FREQUENCIES



## Type 301 VLF RECEIVER



Frequency coverage.....	3-30 kc in three bands
Bandwidth.....	200 cps
Audio output.....	1 volt RMS into 2k $\Omega$ , approx. for 50% modulation
Audio response.....	0 cps to 100 cps
Power input.....	115 volts, 50/60 cps
Power consumption.....	2 watts, approx.

**Communication Electronic Incorporated**

4908 HAMPDEN LANE, BETHESDA 14, MARYLAND

CIRCLE 214 ON READER SERVICE CARD

# DYNAMICS INSTRUMENTATION AMPLIFIERS



—high input impedance  
AC amplifiers  
permit use with  
a wide variety of  
piezoelectric  
transducers

**MODEL 6083**—wideband, AC amplifier solves system amplification problems with one instrument. Provides 300 megohms input impedance—won't load down the source. Drives long output lines. Excellent signal-to-noise ratio. Input filter eliminates high-voltage peaks resulting from high "Q" piezoelectric transducers.

Voltage gain: 1.0 through 30.0 in 4 steps, continuously variable between steps.

Wide Bandwidth:  $\pm 3$  db at 0.6 cps and 200,000 cps (without filter).

Noise: 30 microvolts rms or less, with shorted input.

Input filter: low-pass, 12 db/octave. Customer can specify cutoff frequency.

Output Capability: 20 volts peak to peak into 0.05 mfd capacitive load from 1 cps to 25,000 cps.

Instrument is compatible with many other Dynamics amplifiers and signal conditioners for use in standard 6-channel, rack mounting module. Write for literature on Model 6083, or on the entire line.

**DYNAMICS INSTRUMENTATION COMPANY**

583 Monterey Pass Rd., Monterey Park, Calif.—Phone: CUMberland 3-7773

90 CIRCLE 90 ON READER SERVICE CARD

each. PCA Electronics, Inc., 16799 Schoenborn St., Sepulveda, Calif. CIRCLE 318, READER SERVICE CARD

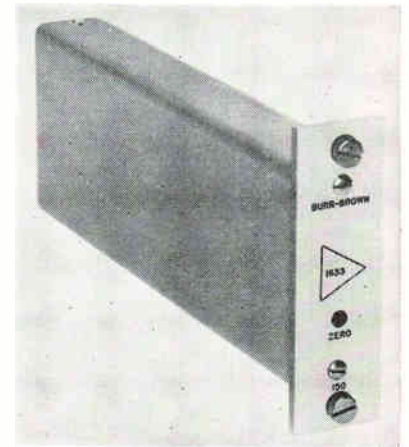

## D-C Power Amplifiers With Choice of Output

FEATURED in the models 1633 and 1635 are 5 to 15 w peak output, 500 ma output current capability, voltage gain of 10,  $\pm 0.5$  db response from d-c to 10 kc, and a choice of single-ended or differential output. Useful in driving low impedance loads, the units are also general laboratory tools. An output circuit is designed to draw minimum idle current from external power supply. Model 1633 is designed to deliver  $\pm 10$  v at 500 ma, and model 1635 is designed to deliver 60 v peak-to-peak at 500 ma. Burr-Brown Research Corp., Box 6444, Tucson, Ariz. (319)

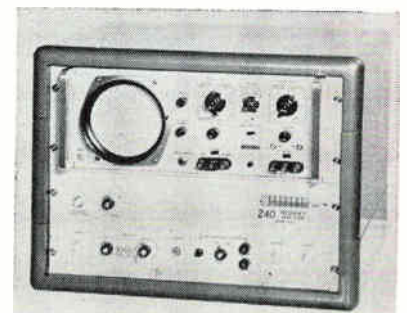

## Spectrum Analyzer Offers Fast Sampling

REAL-TIME multiple-filter spectrum analyzer, model 240, employs a bank of 240 magnetostrictive rod filters sampled 240 times per sec with a rotating capacity-coupled commutator. A new rotor config-

November 15, 1963 electronics

## Acoustical Components of Superior Quality

JAPAN PIEZO supplies 80% of Japan's crystal product requirements.

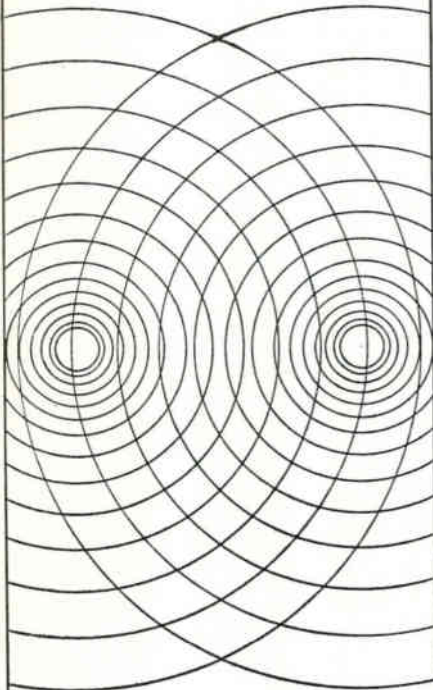

### STEREO CARTRIDGE

Crystal — "PIEZO" Y-130

#### X'TAL STEREO CARTRIDGE

At 20°C, response: 50 to 10,000 c/s with a separation of 16.5 db. 0.6 V output at 50 mm/sec. Tracking force:  $6 \pm 1$  gm. Compliance:  $1.5 \times 10^{-6}$  cm/dyne. Termination:  $1M\Omega + 150$  pF.

Write for detailed catalog on our complete line of acoustical products including pickups, microphones, record players, phonograph motors and many associated products.



**JAPAN PIEZO  
ELECTRIC CO., LTD.**

Komi-renjoku, Mitoko, Tokyo, Japan

uration provides two sweeps per revolution; the rotor speed is 7200 rpm. The filter element bandwidth of 100 cps is standard, giving a 20-kc analysis band. Other element bandwidths, including 3, 10 and 25 cps, are also available. Model 240 with scope is \$9,740. It is available without scope for \$8,950. Spectran Electronics Corp., 146 Main St., Maynard, Mass. (320)

### Cleaner & Deoxidizer For Circuit Boards

THIS PRODUCT (Fremont 238A) is designed for cleaning and deoxidizing copper on epoxy or polyethylene boards prior to applying solder plate. Its chief advantages are: removal of all oxidation and stain with minimum effort; inhibition of copper tarnishing, and an economical overall cleaning job. Fremont Industries, Inc., 219 West 90th St., Minneapolis 20, Minn. (321)

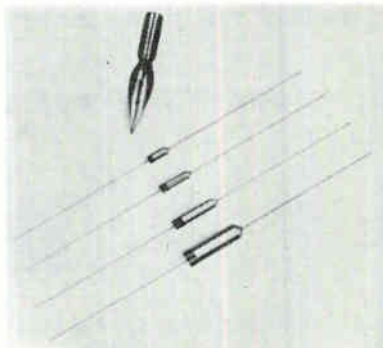

### Tantalum Capacitors Come in 4 Case Sizes

LINE of subminiature straight-wall tantalum capacitors with liquid electrolyte and highly reliable seals is announced. They feature 85 C capability with high capacitance in a subminiature package. The electrolyte is thixotropic. Package is insulated and leads can be welded or soldered. Line includes four case sizes ranging between 0.312 in. long by 0.115 in. in diameter to 0.875 in. long by 0.225 in. in diameter. There are 28 standard units with capacitances between 2 and 330  $\mu$ f at 85 C and at working voltages between 6 and 60 v. International Telephone and Telegraph Corp., Palo Alto, Calif. (322)

# WORLD'S FASTEST SWITCHING DIODES with HIGH FORWARD CONDUCTANCE

With All these features:

Reverse Recovery Time in Nanosecond and picosecond ranges with forward conductance of 100 ma to 500 ma @ +1V.

Our devices include such industry-tested diodes as: Q6-100, Q5-100, Q3-90, Q7-250, ID5-050, ID3-050, ID1-050, ID10-050, ID6-050, 1N3146 etc. For more information see electronics October 18, 1963 issue, pages 42-45 and REVIEW OF SCIENTIFIC INSTRUMENTS April 1962, pages 423-428 and April 1963, pages 412-413.

For T Series diodes (add "T" to the above numbers) Minimum  $I_r = 200$  ma. @ +1V.

Prices from \$1.25 up. Delivery: from stock.

Super-fast switching transistors in the development stage.

**INTERNATIONAL DIODE  
CORPORATION**

90 Forrest Street  
Jersey City 4, New Jersey  
Tel: 201-432-7151

*the most reliable PANEL METERS  
on earth... or in space!*

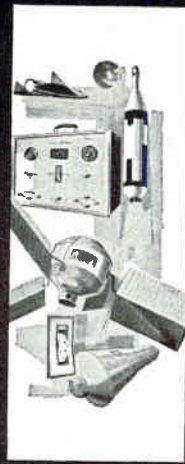
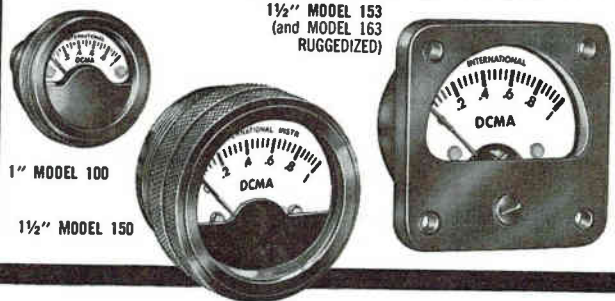

Rugged, accurate, super-reliable miniature meters in a wide variety of ranges and sizes, with zero at center, left or right.

Also special scales, ranges, sensitivities, resistances, cases and other modifications to your exact requirements, as DCUA, DCMA, DCA, DCMV, DCV, ACV, VU, Db.

International has pioneered in the development of miniature and sub-miniature meters ideally suited for industrial, military, aero-space and geophysical devices, and other high-demand applications.

WRITE FOR ENGINEERING DATA SHEETS.



**international instruments inc.**

88 Marsh Hill Road, Orange, Connecticut, Cable: "INTERINST"

CIRCLE 216 ON READER SERVICE CARD

## You Get Things Done With Boardmaster Visual Control

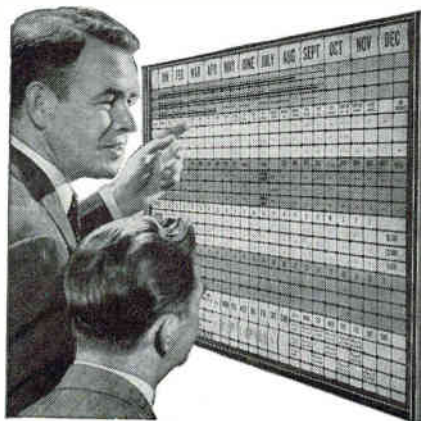

- ☆ Gives Graphic Picture of Your Operations—Spotlighted by Color
- ☆ Facts at a glance—Saves Time, Saves Money, Prevents Errors
- ☆ Simple to operate—Type or Write on Cards, Snap in Grooves
- ☆ Ideal for Production, Traffic, Inventory, Scheduling, Sales, Etc.
- ☆ Made of Metal, Compact and Attractive. Over 750,000 in Use

Full price **\$4950** with cards

**FREE**

24-PAGE BOOKLET NO. C-30  
Without Obligation

Write for Your Copy Today  
**GRAPHIC SYSTEMS**  
Yonceyville, North Carolina

92 CIRCLE 92 ON READER SERVICE CARD

## AM-FM Tuner Unit



AM SEC. CAPACITY: MAX. 377PF  
MIN. 12PF  
TUBE: 6AQ8, 12DT8, 17EW8

PLASTIC  
VARIABLE CONDENSER

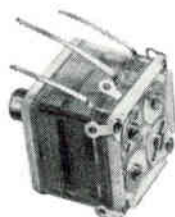

Square Size :  
15mm., 17mm.,  
20mm., 21mm.,  
Single band :  
2 band, 3 band  
and for FM only.



**SAN ESU  
ELECTRONICS  
CO., LTD.**

Cable address: SANESVARICON TOKYO ;  
1425, 4-chome, Higashinakanobu,  
Shinagawa-ku, Tokyo, Japan.

CIRCLE 217 ON READER SERVICE CARD

## —LITERATURE OF

WIRE STRIPPER Artos Engineering Co., 2757 S. 28th St., Milwaukee 46, Wisc. Bulletin 563A describes an all-electric, hand-fed wire measuring cutting and stripping machine.  
CIRCLE 360, READER SERVICE CARD

PERFORATED TAPE READER Cook Electric Co., Data-stor Division, 8100 Monticello Ave., Skokie, Ill., Specifications and operation information on the model 56 perforated tape reader are contained in a 4-page brochure. (361)

INPUT SCANNER Cohu Electronics, Inc., Kin Tel Division, Box 623, San Diego 12, Calif. Data sheet 19-72 covers the 453M input scanner which simplifies design of complete data acquisition systems. (362)

MINIATURE RECORDERS Rustrak Instrument Co., Inc., 130 Silver St., Manchester, N.H. Condensed catalog covers a line of miniature galvanometer chart recorders. (363)

HIGH-SPEED SWITCHING James Electronics Inc., 4050 North Rockwell St., Chicago, Ill. Catalog F-5174 details typical circuit applications and specifications of new relays to aid equipment, application and system engineers with their switching circuit problems. (364)

DIGITAL VOLTMETER Epsco Inc., 275 Massachusetts Ave., Cambridge, Mass., has available literature on the new, all-silicon model SI-500 DVM. (365)

STANDARDS AND COMPONENTS General Radio Co., West Concord, Mass. An illustrated booklet describes an extensive line of standard resistors, inductors, and capacitors. (366)

FACILITIES BOOKLET Maser Optics, Inc., 89 Brighton Ave., Boston 34, Mass., has printed a new short-form brochure describing its products, capabilities and facilities in the field of laser devices and systems. (367)

R-F JACK Sealectro Corp., 139 Hoyt St., Mamaroneck, N. Y. A new subminiature recessed bulkhead r-f jack is described in data sheet CK-4. (368)

SLIDE CHARTS Perrygraf Corp., 150 So. Barrington Ave., Los Angeles 49, Calif., has published a folder telling how the electronic industry uses slide charts to increase sales. (369)

OSCILLOSCOPES AND CAMERAS Scientific Instruments, 750 Bloomfield Ave., Clifton, N. J. Short form catalog No. 129 illustrates and describes high, medium and low-frequency oscilloscopes and scope cameras. (370)

TRIMMER POTENTIOMETER Minelco Miniature Electronic Components Corp., 600 South St., Holbrook, Mass. Supplement No. 1 to bulletin P-62 describes model MP2 low-cost sealed miniature trimmer potentiometer. (371)

T-Y RECORDER Houston Instrument Corp., 4950 Terminal Ave., Bellaire 101, Texas. A new concept in recording a variable as a function of time is described in a 4-page T-Y recorder brochure. (372)

November 15, 1963 electronics

## THE WEEK

**XENON POWER SUPPLIES** Sola Electric Co., Elk Grove Village, Ill. Catalog XE-108 covers a complete line of power supplies for xenon and mercury arc lamps. (373)

**POWER MODULES** Technipower Inc., 18 Marshall St., South Norwalk, Conn. Catalog No. 634A contains technical data on a wide line of solid state power modules. (374)

**POWER TRANSISTORS** Bendix Semiconductor Division, Holmdel, N. J., offers data sheet on 16 germanium *pnp* alloy power transistors designated 2N2552-2N2567. (375)

**SIGNAL CONDITIONING AMPLIFIER** Spaceonics Div., Portable Electric Tools, Inc., 1200 E. State St., Geneva, Ill. Sheet S-2001 covers a signal conditioning amplifier for telemetry. (376)

**PRINTED-CIRCUIT PRODUCTION** Industrial Circuits Co., East Paterson, N. J., offers a revised edition of a technical booklet describing printed-circuit design and manufacturing techniques. (377)

**C-W KLYSTRONS** Raytheon Co., Waltham, Mass. 02154. A 4-page information bulletin covers a line of low-noise X-band c-w klystrons. (378)

**PRECISION POTENTIOMETER** Litton Precision Products, Mt. Vernon, N. Y. Details of the model MDU20-10 ultra-short potentiometer are contained in a specification sheet. (379)

**SWITCHING COMPONENTS** Electronic specialty Co., 5121 San Fernando Road, Los Angeles 39, Calif., has available a catalog giving complete technical data on switching components. (380)

**ALUMINUM WIRE** Hudson Wire Co., Ossining, N. Y., has prepared a paper titled, "Technical Analysis, Silver Plated Aluminum Wire." (381)

**ELECTRONIC COMPARATOR** Carter-Princeton, 178 Alexander St., Princeton, N. J. 08540, offers a data sheet on its electronic comparator that can detect 1 nanoampere of current. (382)

**HYBRID JUNCTIONS** Anzac Electronics, Inc., Moody's Lane, Norwalk, Conn. 06851. A preliminary data sheet on models H and HD uhf broadband hybrid junctions is available. (383)

**CENTER SCREWLOCK CONNECTORS** Continental Connector Corp., 34-63 56th St., Woodside 77, N. Y., has released a 6-page brochure covering center screwlock miniature rectangular plug and socket connectors. (384)

**SOLID-STATE CHOPPER** Solid State Electronics Co., 15321 Rayen St., Sepulveda, Calif. A catalog sheet describes model 5 electrostatically shielded Microchopper. (385)

**GLASS-CERAMIC SPHERES** Emerson & Cuming, Inc., Canton, Mass. Brochure covers Eccospheres—hollow micron sized spheres of glass-ceramic composition which are used in foams, casting resins, light weight ceramics, and deep water floats. (386)

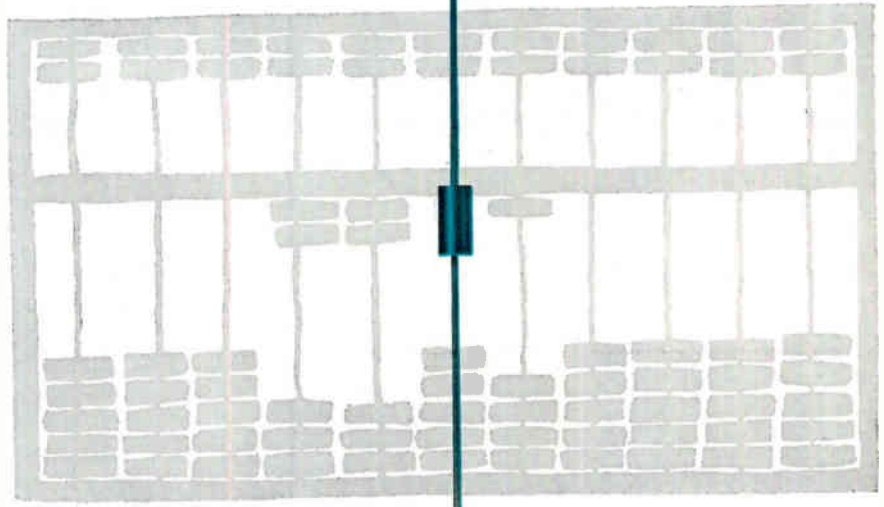

## a new addition . . .

to the Paktron® family of molded miniature Mylar® capacitors—the MA-375

Egyptians, Greeks, Romans and Chinese used various forms of movable counters. Quite a difference when you consider today's modern digital and analog computers. Quite a difference, too, between the components of earlier computers. Today's computers demand the small size, high reliability of capacitors such as the Paktron® molded MA-375.

The extended values of the MA-375 are from 220mmf to .01mf at 100v. It's adaptable for printed boards, cordwood techniques and automatic inserting. Size: L—.375 O.D.—.200. Delivery fast. Quality outstanding. Priced competitively.

For complete technical data on the MA-375 axial lead capacitor write:

<sup>®</sup> DuPont

**PAKTRON**  
DIVISION ILLINOIS TOOL WORKS INC.  
1321 LESLIE AVENUE • ALEXANDRIA, VIRGINIA



L. J. McLaughlin



G. J. Shomphe



L. E. St. Jean



N. R. Wild

## Sanders Adds Four Directors

**SANDERS ASSOCIATES, Inc.**, Nashua, N.H., voted at its annual meeting of shareholders to increase its board of directors from 8 to 12, and elected four new directors in addition to members of the previous year.

"The increase in the number of directors," president Royden C. Sanders, Jr., told the meeting, "has been prompted by the tripling in the last three years of our sales, the multi-plant operations and the increased diversity and complexity of our products."

The four newly elected directors, all of them executives of the company, are:

Leo J. McLaughlin, manager of contracts, in charge of corporate contract negotiations. He joined the company in 1954.

George J. Shomphe, manager of manufacturing, was one of the founders of the company in 1951.

Lloyd E. St. Jean, manager, Geospace Electronics division, has been the manager of the Plainview facility since its inception and was previously chief engineer of equipment design in the Nashua plant. He joined the company in 1954.

Norman R. Wild is corporate scientist, and one of the founders of the company. He was elected and served as a director in 1958.

### Hewlett-Packard Revamps Corporate Setup

**HEWLETT-PACKARD Company**, Palo Alto, Calif., has announced a corporate reorganization whereby its largest subsidiary, the Sanborn Company of Waltham, Mass., will become a division of the parent firm.

David Packard, H-P president, said Sanborn's transition to divisional status, "should be achieved within a few months, pending completion of necessary legal arrangements."

Packard also announced that W. Bruce Wholey has been named general manager of Sanborn.

Wholey, for the past three years, has served as general manager of H-P's Microwave division.

John A. Young, formerly sales manager of the Microwave division, has been appointed general manager, succeeding Wholey.

### TRW Announces Name Changes

**SUBSIDIARY companies and divisions** comprising the TRW Electronics units of Thompson Ramo Wooldrige Inc. now have new names.

Pacific Semiconductors, Inc.,

Lawndale, Calif. is now TRW Semiconductors Inc.; Good-All Capacitor Division becomes TRW Capacitor Division; and the former Radio Condenser Company and Radio Industries, Inc. become TRW Electronic Components Division.

Milam Electric Mfg. Co., a TRW subsidiary, and TRW Microwave Division names remain unchanged.



### General Precision Appoints Lee

**APPOINTMENT** of R. W. Lee as president of the Information Systems Group, General Precision, Inc., Glendale, Calif., is announced. He had been executive vice president and general manager of the group.

The Information Systems Group comprises the Librascope division, Commercial Computer division and a Research and Systems Center with plants in Glendale, San Marcos, Burbank, and Sunnyvale, Calif. It produces digital computers, ship-board weapons fire-control systems, and command and control systems.

### Aden Accepts Key EOS Post

**ARTHUR L. ADEN** has joined the staff of Electro-Optical Systems, Inc., as a corporate vice president and associate technical director. In this capacity, he will assist John M. Teem, vice president and technical director, in overall direction of the technical activities of the corporation.

Aden was formerly a vice presi-

## OPPORTUNITIES IN MELPAR'S RAPIDLY EXPANDING ELECTRONICS DIVISION

Melpar's Electronics Division has an immediate need for Engineers to fill these important positions:

### MICROWAVE RECEIVER DESIGN

Specific problems include parametric amplifiers, varactor techniques, microwave filters, ultra-stable programmable oscillators, and dual and triple channel balanced receivers for monopulse and guard antenna gating.

### DATA PROCESSING SYSTEMS DESIGN

Perform the logic design of digital equipment to process real time flight data. Problems include specifying necessary digital/analog interface equipment and the design of computer systems for a variety of applications.

### COMPUTER PROGRAMMING

Generate programs for fixed point real time computers to be used with special purpose digital and analog equipment.

### COMMUNICATIONS

Perform design studies of terminal equipments for time frequency dodging, matched filters, adaptive highly reliable communications throughout the electromagnetic spectrum. Techniques of interest include spread spectrum circuitry, error detection and correction coding, and privacy and security circuitry.

For Further Details,  
write in confidence to:

**John A. Haverfield**

Manager—Professional Placement

**MELPAR INC.**

(A Subsidiary of Westinghouse  
Air Brake Co.)

3436 ARLINGTON BLVD.  
FALLS CHURCH, VA.

(A Suburb of Washington, D.C.)

an equal opportunity employer

dent of Motorola Instrumentation and Control, Inc., in Phoenix, Ariz., where he served as manager of operations for the Solid State Systems division and associate director of research and development in the Military Electronics division.



**General Radio  
Elects Sinclair**

DONALD B. SINCLAIR, executive vice president of General Radio Company, West Concord, Mass., has been elected president of the firm, succeeding Charles C. Carey, deceased.

Sinclair joined GR in 1936 and subsequently became chief engineer. In 1955 he was appointed vice president for engineering and in 1956 was elected a director. For the past two years he has held the post of executive vice president and technical director.



**Newly Formed Company  
Names Fisher**

GEORGE F. FISHER, former vice president and general manager of Midland and Wright divisions, Pacific

## SOLVE YOUR TESTING AND PRODUCTION PROBLEMS

with  
**BELL**  
HALL EFFECT DEVICES  
AND MAGNETIC FIELD  
INSTRUMENTATION!



Model 240 **GAUSSMETER**

Incremental • Measures One part out of 10,000 resolution • .1 gauss to 30,000 gauss, full scale • Single sensing device • Custom probes.



Model 350 **A-C GAUSSMETER**

First in direct scale reading to 30,000 cps • For time-varying fields from 10 to 30,000 cps • .1 to 3000 Gauss F.S. • Accuracy  $\pm 2\%$  • Magna-probe provides 100 Gamma F.S. sensitivity • Selectable high and low pass filters • Provision for spectrum analysis.

**PLUS: 5 other gaussmeter models • 10 standard "HALL-PAK" Hall effect devices • Hall Multipliers and Power Transducers • Calibration Magnets**

Many of our most enthusiastic customers are men who "didn't need" Magnetic Field Measurement or Hall Effect circuitry. Let us show you, too, how profitable these instruments and devices can be! Circle inquiry card for full data.

**BELL INC.**  
1356 Norton Avenue  
Columbus, Ohio, 43212  
Phone (614) 294-4906

Representatives in All principal cities

EXPORT: JOSEPH PLASENCIA, INC.  
401 Broadway, New York 13, N. Y.

CANADA: MEGATRONIX, LTD.  
1800 Avenue Rd., Toronto 12, Ont.

# NARROW - CAPS

## Subminiature CERAMIC CAPACITORS

For 1/10" modular spacing. Intermediate values obtainable. W.E.P.A. Spec. nickel leads available for welding.



### 35 STOCK VALUES

Part No.	Capac. mmf.	Tol.	W.V. D.C.	Max. Body Lgth.
NC-5	5	±15%	50	1/4"
NC-7.5	7.5	±15%	50	1/4"
NC-10	10	±15%	50	1/4"
NC-15	15	±15%	50	1/4"
NC-22	22	±15%	50	1/4"
NC-33	33	±15%	50	1/4"
NC-47	47	±15%	50	1/4"
NC-68	68	±15%	50	1/4"
NC-82	82	±15%	50	1/4"
NC-100	100	±20%	50	1/4"
NC-150	150	±20%	50	1/4"
NC-220	220	±20%	50	1/4"
NC-250	250	±20%	50	1/4"
NC-330	330	±20%	50	1/4"
NC-470	470	±20%	50	1/4"
NC-500	500	±20%	50	1/4"
NC-680	680	±20%	50	1/4"
NC-750	750	±20%	50	1/4"
NC-1000	1000	±20%	50	5/16"
NC-1500	1500	±25%	25	5/16"
NC-1500B	1500	±20%	25	5/16"
NC-2000	2000	±25%	25	5/16"
NC-2000B	2000	±20%	25	5/16"
NC-3000	3000	±30%	25	5/16"
NC-3000B	3000	±20%	25	5/16"
NC-3000C	3000	±25%	25	5/16"
NC-4000	4000	±30%	25	5/16"
NC-4000B	4000	±20%	25	5/16"
NC-4000C	4000	±25%	25	5/16"
NC-5000B	5000	±20%	25	5/16"
NC-6500	6500	±20%	25	5/16"
NC-6500B	6500	±20%	25	5/16"
NC-7500B	7500	±20%	25	5/16"
NC-01	10000	±30%	10	5/16"
NC-01B	10000	±20%	25	5/16"

# SLIM - CAPS

.060" wide max. x .060" thick max. Working voltage 25 VDC. W.E.P.A. Spec. nickel leads available for welding.



### 23 STOCK VALUES

Part No.	Capac. mmf.	Tol.	Max. Body Length
SC-1	1.0	±25%	.100"
SC-2.5	2.5	±25%	.100"
SC-5	5.0	±25%	.100"
SC-7.5	7.5	±25%	.100"
SC-10	10	±25%	.100"
SC-15	15	±25%	.100"
SC-22	22	±25%	.100"
SC-33	33	±25%	.100"
SC-47	47	±25%	.100"
SC-68	68	±25%	.100"
SC-82	82	±25%	.100"
SC-100	100	±25%	.100"
SC-150	150	±25%	.100"
SC-220	220	±25%	.200"
SC-330	330	±25%	.200"
SC-470	470	±25%	.200"
SC-680	680	±25%	.200"
SC-820	820	±25%	.200"
SC-1000	1000	±25%	.200"
SC-1500	1500	±25%	.200"
SC-2500	2500	±25%	.250"
SC-3300	3300	±25%	.250"
SC-4000	4000	±25%	.250"

# MUCON CORPORATION

9 ST. FRANCIS ST., NEWARK 5, N. J.  
201 Mitchell 2-1476-7-8

Industries, has been named president of the newly formed Valpey-Fisher Corp., Holliston, Mass. The new company is a result of a reorganization of Valpey Crystal Corp. This permits significant expansion of technologies, production facilities, and product lines.

Valpey-Fisher Corporation will develop and manufacture packaged piezoelectric crystal-controlled oscillators and quartz filter and oscillator crystals used in commercial and military applications.

### PEOPLE IN BRIEF

**Thurman L. Sipp** promoted to director of technical services at C. P. Clare & Co. **Eric D. Daniel** moves up to director of research at Memorex Corp. **J. E. McEvoy** advances to chief engineer of Bailey Meter Co. **Robert W. Carr** raised to mgr. of the Professional Products div. of Shure Brothers, Inc. **Walter P. Davison**, ex-Collins Radio Corp., appointed a senior scientist at ITT Federal Laboratories California Operations. **Parker L. Folsom**, Capt. USN Ret., named mgr., system analysis and planning, at the Univac div. of Sperry Rand Corp. **Walter Morton**, formerly a consulting engineer, now technical director of Dynamics Instrumentation Co. **David W. Lang**, previously with United Electrodynamics, Inc., joins Nortronics div. of Northrop Corp. as exec advisor for special projects in the Systems Support dept. **James F. Borst** leaves Crydom Laboratories to become product mgr. for d-c laboratory and test stand instrumentation at Endeveco Corp. **Bernard Kessler** elevated to marketing v-p of The Mica Corp. **Andersen Laboratories, Inc.**, promotes **Walter M. A. Andersen** to chairman of the board; and hires **Charles S. Fama**, ex-Melpar, Inc., as chief engineer for electronics. **Warren R. Yuenger**, recently with Ling-Temco Vought, named senior project engineer at Electrac, Inc. **Louis M. Palamara**, formerly with Erie Technical Ceramics, now mgr. of the ceramic plant of Hi-Q div. of Aerovox Corp. **George Weinman** leaves Electronics Fitting Corp. to head the new Gorn Connector div., Waltham Precision Instrument Co., Inc.

# FREE TO COMPANY OFFICIALS LOOKING FOR A NEW PLANT SITE

WE WILL PREPARE FOR YOU A  
**CONFIDENTIAL SURVEY**  
OF SELECTED LOCATIONS  
FOR YOUR NEW PLANT IN  
**NEW YORK STATE**



### TABLE OF CONTENTS

SUBJECT	PAGES
Introduction .....	1
Growth Trends .....	2-3
Climate .....	4-6
Public Utilities .....	7-22
Financial .....	23
Government Services .....	24-44
Taxes	
Protective Services	
Water Supply & Sewerage	
Community Facilities .....	45-73
Housing	
Education	
Recreation & Culture	
Industrial History .....	74-79
Labor .....	80-92
Natural Resources .....	93-94
Transportation & Markets ..	95-104
Sites .....	105-133

**TAILOR-MADE.** This confidential report is not taken off the shelf. It will be prepared specifically for you, based on the requirements for your new plant as you give them to us. Send these requirements on your business letterhead to Commissioner Keith S. McHugh, N.Y. State Dept. of Commerce, Room 254R, 112 State St., Albany 7, N.Y.

Keith S. McHugh, Commissioner  
New York State Department of Commerce



**DON'T CUT CORNER  
ON VITAL PARTS!**

## SHIZUKI CAPACITORS

Using metallized paper and metallized mylar film produced by itself.

- \* Lacquer Film Capacitors
- \* Polystyrene Capacitors
- \* Mylar Capacitors
- \* Metallized Paper Capacitors for motor running, fluorescent ballasts
- \* Noise Suppression Capacitors
- \* Ignition Capacitors



Lacquer Film Capacitors  
D.C. working 30 volts  
0.2—2 MFD available

**SHIZUKI ELECTRIC WORKS CO., LTD.**

HEAD OFFICE: 1, TAISHA-CHO, NISHINOMIYA, JAPAN  
CABLE ADDRESS: "CAPACITOR" NISHINOMIYA  
TOKYO FACTORY: 10-7, ARAIYUKU, OTA-KU, TOKYO

CIRCLE 218 ON READER SERVICE CARD

# GRC tiny parts



die cast  
ZINC ALLOY



molded  
PLASTICS



Coil Bobbins  
Gears & Pinions



### GEAR & PINION GUIDE BOOK

Gives full specs for hundreds of stock combinations of small 1-pc. die cast zinc alloy gears integral with pinions, shafts, spacers, etc. also combination to specs. GRC's exclusive techniques give you high quality in small parts of diecast zinc alloy, and engineering thermo-plastics at low cost! Write for samples and literature. Send prints for quotation.

No Minimum Size! Max: Zinc Alloy-2" long. 1/4 oz. Plastic-1 1/2" long. .05 oz.



**GRIES REPRODUCER CORP.**

World's Foremost Producer of Small Die Castings  
151 Beechwood Ave. • New Rochelle, N. Y.  
phone: (914) New Rochelle 3-8600

CIRCLE 219 ON READER SERVICE CARD

### EMPLOYMENT OPPORTUNITIES

The advertisements in this section include all employment opportunities — executive, management, technical, selling, office, skilled, manual, etc. Look in the forward section of the magazine for additional Employment Opportunities advertising.

## ELECTRONIC CIRCUIT DESIGNERS

## ELECTRONIC ENGINEERS

# Bausch & Lomb

has openings for EXPERIENCED ENGINEERS IN R & D AND PRODUCT DESIGN SECTIONS.

Products are Scientific Instruments (Bio-Medical, Analytical, measuring, recording instruments, etc.) Mechanical-Electrical Optical in nature. Ability to take electronic design responsibility from concept to saleable product, Engineering Degree (BS or MSEE) required, experience desirable.

Positions entail circuit design and testing, co-ordination of customer requirements with Mechanical and Optical Engineers, supervision of detail draftsmen and technicians, assistance to Production Engineers on factory problems and follow up on special customer designs.

Those who can qualify and are interested in real design responsibility are invited to send resume with salary requirements to E. P. Faro, Professional Employment, Bausch and Lomb, Inc., 17 Bousch Street, Rochester, New York.

AN EQUAL OPPORTUNITY EMPLOYER

## TO ORDER REPRINTS

Fill in, cut out coupon below

insert in envelope and mail to:

electronics Reprint Dept.

330 W. 42nd Street, New York, N. Y. 10036

## REPRINT ORDER FORM

For Listings of Reprints Available Turn To Reader Service Card

(To help expedite mailing of your reprints please send cash, check or money order with your order.)

For Reprints of the latest Special Report:

Materials for Space Age Electronics

Send me.....Reprints of Key No. R-42 of 50¢ each.

For Reprints of previous Special Reports or Feature Articles fill in below:

Send me.....Reprints of Key No.(s).....@.....¢ each.

(For prices, see Reader Service Card.)

\*For orders of Bulk Reprints of other editorial articles in this issue or past issues:

Send me.....Reprints of page No.(s).....of issue date.....

of article entitled.....

\*Minimum bulk order 100 copies. You will be advised of costs by return mail.

Name.....

Number of Street.....

City, Zone No., State.....

**E. E.'s**  
for FEE-PAID Positions  
**WRITE US FIRST!**

Use our confidential application for professional, individualized service... a complete national technical employment agency.

**ATOMIC PERSONNEL, INC.**  
Suite 1207L, 1518 Walnut St., Phila. 2, Pa.

## SEARCHLIGHT SECTION

**THIS WEEK** 2K2S Klystron Mount. PRD type w/ var att. & full-shielding. \$45.00 ea.

RADAR AUTO-TRACK & TELEMETRY ANTENNA FEDESTALS 3 & 10 CM. SCR 554 AUTO-TRACK RADARS. M-33 RADAR TPS-10 SEARCH. APS-45 TPS-100 HT-FINDERS. WX RADARS. FPN-320CA. APS-10 APS-15R APS-27 (AMTI) SEARCH. ■ ■ ■ APN-102 DOPPLER. DOZENS MORE CARCINOGENS. PWS-25-5-1-3-5 MEGAWATT PULSE MODULATORS. CAVITIES. PULSE TRANSFORMERS. IF STRIPS. WAVEGUIDE BENDS 200 MC. 1 KMC. 3 KMC. 6 KMC. 9 KMC. 24 KMC. RF PKGS.

**RADIO RESEARCH INSTRUMENT CO.**  
550 5TH AVE., NEW YORK 36, N. Y. JU 6-4691

CIRCLE 951 ON READER SERVICE CARD

## Professional Services

**GIBBS & HILL, Inc.**  
Consulting Engineers

Systems Engineering  
Operations Research • Development  
Field Studies • Design • Procurement  
Power • Transportation • Communications  
Water Supply • Waste Treatment

393 Seventh Avenue New York 1, N. Y.

# INDEX TO ADVERTISERS

• AMP Incorporated	7	Heminway & Bartlet Mfg. Co., The	71	SAAB Motors Inc.	16
• Accurate Instrument Co.	50	• Hewlett-Packard Company	inside front cover	• Sanborn Company	4
• Acme Electric Corp.	54	inside front cover		Sanders Associates, Inc.	71
Allen-Bradley Co.	15	Huntington Alloy Products		San Esu Electronics Co., Ltd.	92
• Alpha Wire Corp.	70	Div. of International Nickel		Sanken Electric Co., Ltd.	50
American Optical Co.	86	Co., Inc.	12	Servo Corporation of America	83
• American Time Products Div. of Bulova Watch Com- pany, Inc.,	57	International Diode Corp.	91	Shizuki Electric Works Co., Ltd.	97
• Arco Electronics Inc.	89	International Instruments, Inc.	92	Simplex Wire & Cable Co.	22
				Sprague Electric Co.	3, 6
				Stackpole Carbon Co.	66
Balteau Electric Corp.	85	Japan Piezo Electric Co., Ltd.	91	Thermal American Fused Quartz Co., Inc.	87
Bausch & Lomb, Inc.	76	• Jennings Radio Manufacturing Corp.	58	• Toyo Electronic Ind. Corp.	86
Bell Inc., F. W.	95	• Kepco Inc.	61	Virginia Electric & Power Co.	14
Black & Webster, Inc.	88	Kin Tel		Wells Electronics Inc.	77
• Boonton Radio Co. Div. of Hewlett-Packard Co.	23	A Division of Cohu Electronics Inc.	3rd cover	Westinghouse Electric Corp.	49
Brand Rex Div. of American Enka Corp.	77	• Krohn-Hite Corp.	25	White S. S.	80
Bristol Company, The	63	• Kyoritsu Electrical Instruments Works, Ltd.	65		
Burr-Brown Research Corp.	82	Leeson Corp.	74		
• Bussmann Mfg. Co. Div. of McGraw Edison Co.	84, 85	Lockheed Missiles & Space Co.	73		
		McGraw-Hill Book Co.	88		
• CTS Corp.	8-9	• McLean Engineering Labora- tories	87		
Cambridge Thermionic Corp.	85	• Melpar Inc.	95		
Communication Electronics Inc.	90	• Midwec	65		
Consolidated Electrodynamics Corp.	52, 53	Millen Mfg. Co., Inc., James	50		
		Minnesota Mining & Mfg. Co. Mincom Division	13		
Delavan Electronics Corp.	78	Mucon Corp.	96		
Di Acro Corp.	70	• NAVCOR	81		
• Driver Co., Wilbur B.	69	New York State Dept. of Commerce	96		
duPont de Nemours & Co., Inc. E. I.	26, 27	Paktron			
Dynamics Instrumentation Co.	90	Div. of Illinois Tool Works	93		
		Pamotor Inc.	71		
Elcor, Inc.	65	Photocircuits Corp.	56		
Electronic Research Associates, Inc.	68	Radio Corporation of America	4th cover		
		Reeves Instrument Corp. Div. of Dynamics Corp. of America	21		
Formica Corp.	55	Resistance Products Co.	64		
Frederick Electronics Corp.	82	• Rosemount Engineering Co.	75		
• Fusite Corp., The	59				
General Electric Co. Rectifier Components Dept.	28				
Gertsch Products, Inc.	62				
• Globe Industries Inc.	71				
Graphic Systems, Inc.	92				
Gries Reproducer Corp.	97				

## CLASSIFIED ADVERTISING

F. J. Eberle, Business Mgr. (2557)

EMPLOYMENT OPPORTUNITIES... 97

## EQUIPMENT

(Used or Surplus New)

For Sale... 97

## CLASSIFIED ADVERTISERS INDEX

Atomic Personnel, Inc. 97  
Bausch & Lomb, Inc. 97  
• Radio Research Instrument Co. 97

• See advertisement in the July 25, 1963 issue of electronics Buyers' Guide for complete line of products or services.

This Index and our Reader Service Numbers are published as a service. Every precaution is taken to make them accurate, but electronics assumes no responsibilities for errors or omissions.

## electronics



Audit Bureau  
of Circulation



Associated Business  
Publications

AUDITED PAID CIRCULATION

JAMES T. HAUPTLI (2210)  
Advertising Sales Manager

HENRY M. SHAW (3485)  
Market Research Manager

DAVID M. TEMPEST (3139)  
Promotion Manager

### electronics Buyers' Guide

R. S. QUINT (2335)  
General Manager

RICHARD J. TOMLINSON (3191)  
Business Manager

THEODORE R. GEIPEL (2044)  
Production Manager

NEW YORK TELEPHONE: Dial Direct:  
971 plus number in parenthesis,  
Area Code 212

## ADVERTISING REPRESENTATIVES

ATLANTA, GA. 30309  
Michael H. Miller, Robert C. Johnson  
1375 Peachtree St. N.E.,  
Trinity 5-0523 (area code 404)

BOSTON, MASS. 02116  
William S. Hodgkinson  
McGraw-Hill Building, Copley Square,  
Congress 2-1160 (area code 617)

CHICAGO, ILL. 60611  
Harvey W. Wernecke,  
Robert M. Denmead  
645 North Michigan Avenue,  
Mohawk 4-5800 (area code 312)

CLEVELAND, OHIO 44113  
Paul T. Fegley  
55 Public Square, Superior 1-7000  
(area code 216)

DALLAS, TEXAS 75201  
Frank Le Beau  
The Vaughn Bldg.,  
1712 Commerce St.  
Riverside 7-9721 (area code 214)

DENVER, COLO. 80202  
John W. Patten  
Tower Bldg., 1700 Broadway,  
Alpine 5-2981 (area code 303)

HOUSTON, TEXAS 77025  
Kenneth George  
Prudential Bldg., Halcombe Blvd.,  
Riverside 8-1280 (area code 713)

LOS ANGELES, CALIF. 90017  
Ashley P. Hartman, John G. Zisch,  
1125 W. 6th St., Huntley 2-5450  
(area code 213)

NEW YORK, N. Y. 10036  
Donald H. Miller (212) 971 3615  
George F. Werner (212) 971 3617  
Donald R. Furth (212) 971 3616  
500 Fifth Avenue

PHILADELPHIA, PA. 19103  
Warren H. Gardner, William J. Boyle  
6 Penn Center Plaza,  
LOcust 8-4330 (area code 215)

SAN FRANCISCO, CALIF. 94111  
Richard C. Alcorn  
255 California Street,  
Douglas 2-4600 (area code 415)

LONDON W1:  
Edwin S. Murphy Jr.  
34 Dover St.

FRANKFURT/Main:  
Mathee Herfurth  
85 Westendstrasse

GENEVA:  
Michael R. Zeynel  
2 Place du Port

TOKYO:  
George Olcott,  
1, Kotohiracho, Shiba, Minato-ku



NEW  
KIN TEL TV CAMERAS  
LET YOU

send  
direct,  
visual  
reports  
from  
just about  
anywhere!

And under just about any kind of condition. In deep space. In explosive environments. In temperatures ranging from  $-17^{\circ}\text{C}$  to  $+70^{\circ}\text{C}$ . In water. In pipelines, deep wells, boilers (its 3-inch diameter barrel permits operation in restricted areas).

In addition, KIN TEL'S new 2000 series cameras are available with a built-in 4-1 zoom lens; provide the clearest pictures available anywhere—up to 700 lines of horizontal resolution; and—thanks to all solid state circuits—are as trouble-free as you can buy.

Send us your RFQ. The 2000 series cameras are the newest addition to one of the industry's largest lines of television equipment. With KIN TEL'S three basic TV systems and 207 separate in-stock components, KIN TEL can help you custom build a completely checked-out TV system to fit your exact needs. And do it faster and less expensively than you thought possible. Contact us or the KIN TEL representative near you.

5725 Kearny Villa Road,  
San Diego 12, California  
Phone 277-6700  
(Area Code 714)

**COHU**  
ELECTRONICS, INC  
KIN TEL DIVISION

CIRCLE 901 ON READER SERVICE CARD

# SEE HOW RCA RECEIVING TUBES KEEP GETTING BETTER

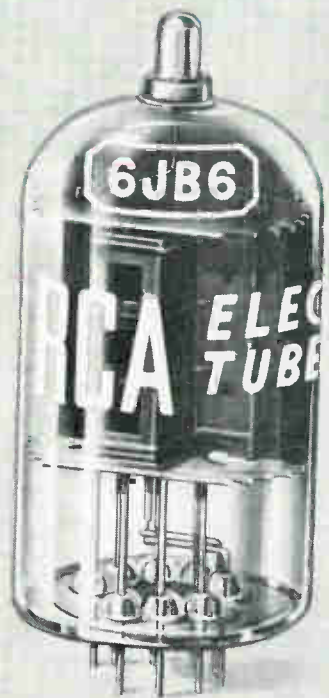

**1959-N-132 Cathode Base Material**

**1960-S-311 Plate Material**

*Virtually ideal black-body characteristics for most effective heat dissipation*

**1961-Dark Heater**

*Produces required cathode temperature at a heater temperature 200°K to 350°K below that of conventional heaters*

**AND NOW 1963...**

## THE BONDED CATHODE

Ends cathode peeling, even after long periods of high-temperature, high-voltage tube operation.

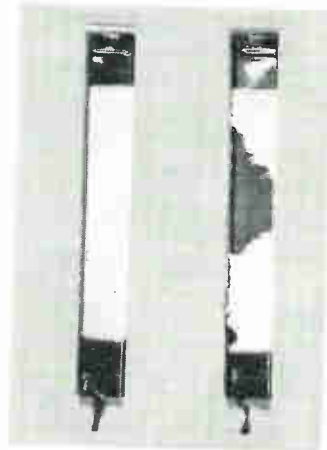

Picture on right is an example of peeling which may occur in nonbonded cathode of a horizontal-deflection-amplifier tube after several hundred hours of operation in a TV receiver.

From RCA research, another major contribution to electron-tube performance and reliability: the bonded cathode. Its emissive-oxide coating will not peel even after extended service under high-voltage, high-temperature conditions encountered in TV horizontal-deflection-amplifier tubes and damper diodes. Permanent adhesion of the emissive-oxide coating of the RCA bonded cathode improves over-all tube performance and reliability...with resultant extension of tube life. Here's why!

### THE NEW RCA BONDED CATHODE:

- virtually eliminates peeling of emissive oxide coating
- reduces cathode interface-type impedance effects during life
- reduces grid-to-cathode shorts during life

- improves stability of cathode-to-grid spacing
- improves anode-voltage-per-mil-spacing safety factor in damper diodes
- transmits heat more efficiently and uniformly—thereby, providing more uniform cathode-current density

The RCA bonded cathode was first applied with outstanding success in beam power tube types 6DQ6-B and 6JB6, and half-wave vacuum rectifier types 6AU4-GTA and 6AY3. This new development is now being incorporated in a growing number of types where service conditions indicate the need. Call your RCA Field Representative for details.

**RCA ELECTRONIC COMPONENTS AND DEVICES, HARRISON, N. J.**

**RCA FIELD OFFICES**—EAST: 32-36 Green Street, Newark 2, N. J., (201) 485-3900 • MIDWEST: Suite 1154, Merchandise Mart Plaza, Chicago 54, Ill., (312) 527-2900 • WEST: 6801 E. Washington Blvd., Los Angeles 22, Calif., (213) RA 3-8361 • 1838 El Camino Real, Burlingame, Calif., (415) 697-1620



The Most Trusted Name in Electronics