

# electronics®

A MCGRAW-HILL WEEKLY

75 CENTS

SEPTEMBER 20, 1963

## IMAGE INTENSIFIER

Control grid can  
reverse image

(photo below)



## NEW TRENDS IN RADAR

Processing data  
automatically

## FAST-PULSING SOLID LASER

Uses Gatling-  
gun principle



R D SKINNER  
1020 GOVINGTON RD  
LOS ALTOS CALIF  
C 3-9  
L

# INSTRUMENTATION

## 8.2 to 12.4 GC

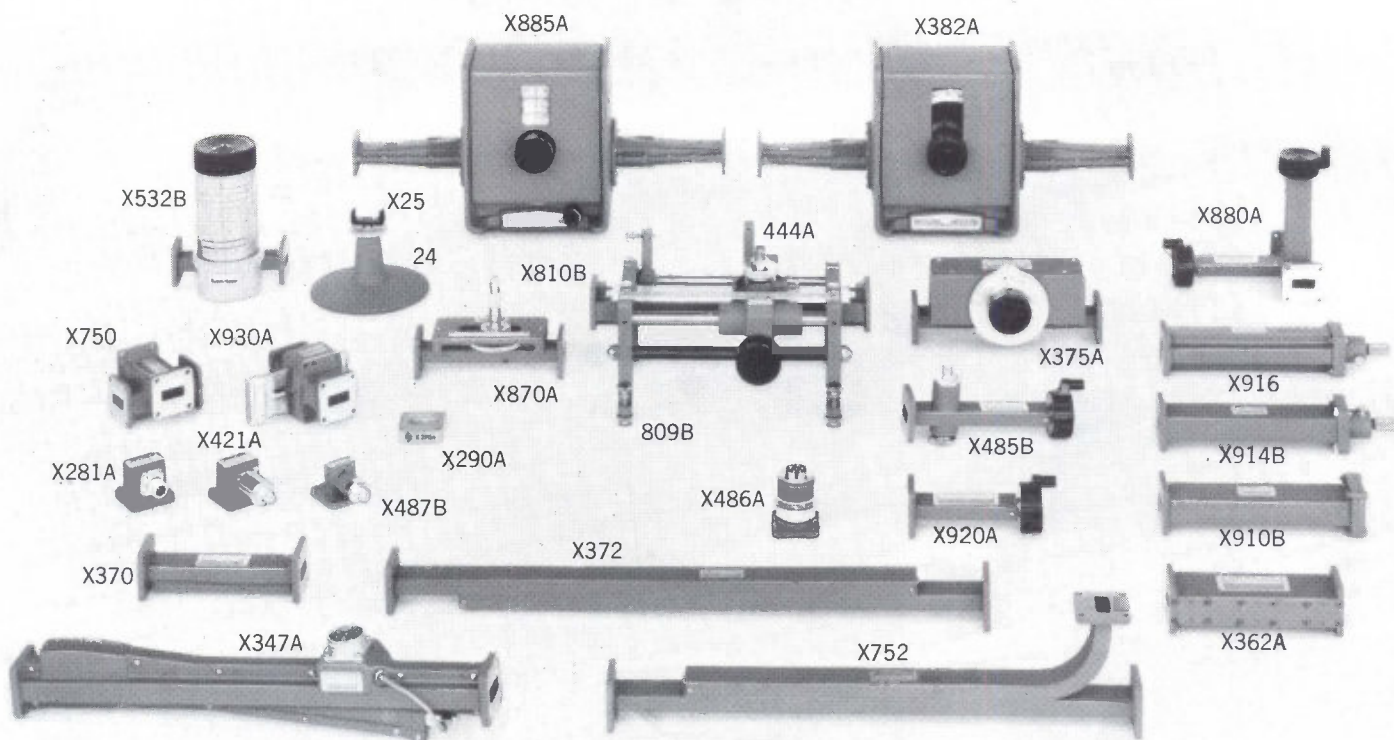

Instrument	Frequency Range	Characteristics	Price
620A Signal Generator	7 to 11 gc	Output 0.1 $\mu$ v to 0.223 v into 50 ohm load; cw, pulse, FM or square wave modulation; direct calibration	\$2250 \$2270 (R)
626A Signal Generator	10 to 15.5 gc	Output +10 dbm to -90 dbm, cw, pulse, FM or square wave modulation; direct calibration	\$3400 \$3420 (R)
686C Sweep Oscillator	8.2 to 12.4 gc	Electronically swept; variable sweep rate and width; output 10 mw, swr 2 or less; pulse, square wave, FM, amplitude modulation; leveled output	\$2900 \$2885 (R)
494A Microwave Amplifier	7 to 12.4 gc	30 db gain; AM, helix input; 20 mw output	\$2000
495A Microwave Amplifier	7 to 12.4 gc	30 db gain; AM input; 1 watt output	\$2900

(R) Rackmount

Data subject to change without notice. Prices f.o.b. factory.

**HEWLETT  
PACKARD  
COMPANY**

1501 Page Mill Rd., Palo Alto, California 94304, (415) 326-7000. Sales and service in all principal areas. Europe, Hewlett-Packard S.A., 54 Route des Acacias, Geneva, Switzerland; Canada, Hewlett-Packard (Canada) Ltd., 8270 Mayrand St., Montreal, Quebec.



2564

CIRCLE 900 ON READER SERVICE CARD

# FULL-RANGE TESTED X-BAND

Typical of microwave instrumentation offered by Hewlett-Packard up to 40 gc is the X-band equipment described here, along with hp signal generators, oscillators, and amplifiers useful in work in the X-band range. Using swept frequency techniques, hp tests each instrument over its entire frequency range, not

just at random points. All hp instruments are warranted to conform with, or exceed, published specifications. Full details on the complete hp line of microwave instrumentation is available from your hp field sales office, as is information on microwave measuring techniques.

Model	Description	Accuracy	Range	SWR (max.)	Power (watts)	Length (inches)	Price
X281A	Adapter, waveguide-to-coax			1.25		1 $\frac{3}{8}$	\$25
X290A	Adapter, cover-to-choke flange					$\frac{1}{2}$	\$20
X347A	Noise Source, waveguide	$\pm 0.5$ db	15.2 db	1.2		14 $\frac{3}{4}$	\$200
X362	Low Pass Filter	Insertion Loss, Passband: <1 db Stopband: >40 db	Passband: 8.2 to 12.4 gc Stopband: 16 to 37.5 gc	Passband 1.5		5 $\frac{1}{32}$	\$325
X370	Attenuators, fixed	$\pm 20\%$	3, 6, 10, 20 db	1.15	1	5 $\frac{1}{4}$	\$65
X372	Attenuators, precision fixed	$\pm 0.5$ db	10, 20 db	1.05	1	19 $\frac{1}{8}$	\$110
X375A	Attenuator, flap	$\pm 1$ db at <10 db $\pm 2$ db at >10 db	0 to 20 db	1.15	2	7 $\frac{3}{16}$	\$100
X382A	Attenuator, precision variable	$\pm 2\%$ of reading or 0.1 db, whichever is greater	0 to 50 db	1.15	10	15 $\frac{5}{8}$	\$275
X421A	Detector Mount (with crystal)	Freq. Resp.: $\pm 2$ db Sens.: 0.05 v dc/mw cw		1.5			\$75 \$170 (matched pair)
X485B	Detector Mount (less detector)			with barretter 1.25		6	\$75
X486A	Thermistor Mount, compensated		0.001 to 10 mw	1.5		2 $\frac{1}{8}$	\$145
X487B	Thermistor Mount, broadband		0.01 to 10 mw	1.5		1 $\frac{3}{16}$	\$75
X532B	Frequency Meter, direct reading	$\pm 0.05\%$ at 23°C $\pm 0.08\%$ overall				4 $\frac{1}{2}$	\$200
X750	Directional Couplers, cross-guide	$\pm 1.7$ db	20, 30 db			3 x 3	\$60
X752	Directional Couplers, multi-hole	Mean: $\pm 0.4$ db Variation: $\pm 0.5$ db	3, 10, 20 db	1.1 1.05 1.05	1	16 $\frac{11}{16}$ 15 $\frac{11}{16}$ 15 $\frac{11}{16}$	\$110
X810B (809B) (444A)	Slotted Section, waveguide (Carriage for 810B) (Detector Probe for 809B)			1.01		10 $\frac{1}{4}$	\$90 (\$175) (\$55)
X870A	Tuner, slide screw	Insertion Loss: <2 db at 20:1 swr	Corrects swr of 20			5 $\frac{1}{2}$	\$130
X880A	E-H Tuner	Insertion Loss: 3 db at 20:1 swr	Corrects swr of 20			3 $\frac{1}{2}$	\$130
X885A	Waveguide Phase Shifter	<2° at 8.2 to 10 gc or 10% <3° at 10 to 12.4 gc or 10%	-360° to +360°	1.35		15 $\frac{5}{8}$	\$425
X910B	Termination, low power			1.02	1	6 $\frac{7}{8}$	\$35
X913A	Termination, high power			1.05	500	9 $\frac{1}{2}$	\$100
X914B	Moving Load	Load Reflection: <0.5%	> $\frac{1}{2}$ wavelength	1.01	1	10	\$60
X916B	Standard Reflection	Coefficient: $\pm 0.0025$	Nom. Reflect. Coeff.: 0.05			10 $\frac{1}{4}$	\$125
X916C	Standard Reflection	Coefficient: $\pm 0.0035$	Nom. Reflect. Coeff.: 0.1			10 $\frac{1}{4}$	\$125
X916D	Standard Reflection	Coefficient: $\pm 0.0045$	Nom. Reflect. Coeff.: 0.15			10 $\frac{1}{4}$	\$125
X916E	Standard Reflection	Coefficient: $\pm 0.007$	Nom. Reflect. Coeff.: 0.2			10 $\frac{1}{4}$	\$125
X920A	Adjustable Short		> $\frac{1}{2}$ wavelength			4 $\frac{7}{8}$	\$75
X930A	Waveguide Shorting Switch	Insertion Loss "Open": <0.05 db		Open: 1.02 "Shorted": >125		3 $\frac{11}{16}$	\$160
X25	Waveguide Clamp						\$2.50
24	Waveguide Stand						\$3

Complete coverage of microwave frequencies to 40 gc is provided in precision hp instrumentation, with every instrument tested over its full range, assuring that it will meet or exceed specifications.

Full-range  
tested

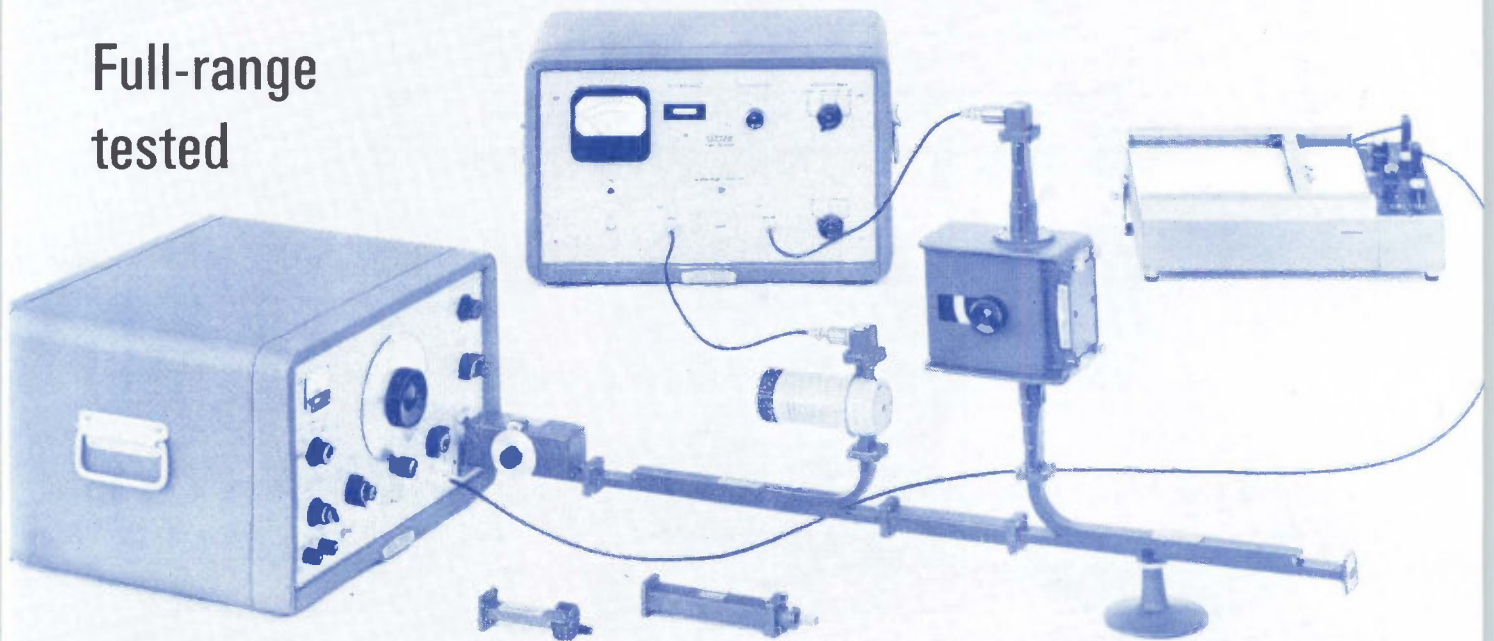

# MICROWAVE INSTRUMENTATION

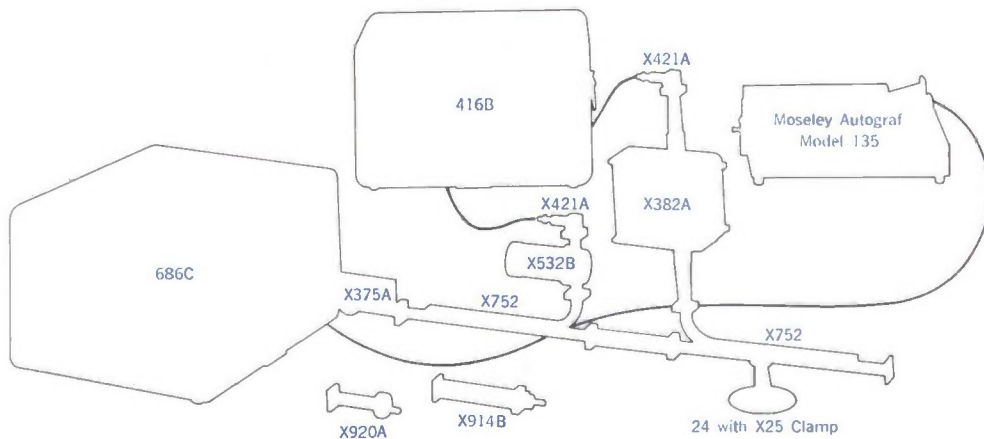

from 

This reflectometer system, made up of hp X-band instruments, will measure either the swr of an unknown load or the directivity of the coupler on the right.

Turn the page for the details on X-band instrumentation, then call your hp representative for information on the complete line.

**W. W. MacDONALD, Editor**  
Telephone Area Code 212 (971-2645)

**J. M. CARROLL, Managing Editor (2293)**

**SENIOR EDITORS**  
Samuel Weber (2371)  
George W. Slderis (3444)

**SENIOR ASSOCIATE EDITORS**  
Michael F. Wolff (2600)  
John F. Mason (2666)

**ASSOCIATE EDITORS**  
Michael F. Tomaino (2071)  
William P. O'Brien (2297)  
George J. Flynn (2188)  
George V. Novotny (3151)  
Leon H. Dulberger (3446)  
Alexander A. McKenzie (2685)

**ASSISTANT EDITORS**  
Stephen B. Gray (2245)  
Barry A. Briskman (2306)  
Dan Smith (2472)  
Joel A. Strasser (2127)

**REGIONAL EDITORS**  
**Harold C. Hood,**  
1125 W. 6th St., Los Angeles 90017, Calif.  
(213-482-5450)  
**Laurence D. Shergalis,**  
John Hancock Bldg., 255 California St.,  
San Francisco 94111, Calif. (415-362-4600)  
**Thomas Maguire**  
McGraw-Hill Bldg., 607 Boylston St.,  
Boston 02116, Mass. (617-262-1160)  
**Cletus M. Wiley,**  
Blair Bldg., 645 N. Michigan Ave.,  
Chicago 60611, Ill. (312-664-5800)

**ART DIRECTOR**  
Howard R. Berry (2430)

**ASSISTANT ART DIRECTOR**  
John C. Wright, Jr. (3430)

**EDITORIAL ASSISTANTS**  
Lorraine Rossi, Virginia T. Bastian,  
Lynn Emery, Ann Mella, Lorraine Werner,  
Alice M. O'Brien, Sharon Parks,  
Claire Benell, Kay Fontana

**FOREIGN NEWS BUREAU**  
**DIRECTOR, John Wilhelm, (2532);**  
Lawrence Mihlon (2997), Alyne Elias  
(2998)

**LONDON—John Shinn, Derek Barlow,**  
Nicholas Landon, 34 Dover St., London  
W.1, England

**BONN—Bruce Bendow, Richard Mikton,**  
Silke McQueen, Mittelstrasse 39, Bad  
Godesberg, Germany

**BRUSSELS—27 Rue Ducarle, Brussels,**  
Belgium

**PARIS—Robert Farrell, Arthur Erikson,**  
17 Ave. Matignon, 3rd Fl., Paris 8,  
France

**MILAN—Marc A. Messina, Via Manzoni**  
No. 12, Milan, Italy

**MEXICO CITY—Wesley Perry, Jr.,**  
Lafragua 4-314, Mexico 1 D.F. Mexico

**RIO DE JANEIRO—Leslie Warren, Rua**  
Mexico 3-S/1507 1509, Rio de Janeiro,  
Brazil

**MOSCOW—Stewart Ramsey,**  
Kutuzovskiy Prospekt 19, Apt. 28-29,  
Moscow, USSR

**TOKYO—Richard Halloran, Charles Cohen,**  
John Yamaguchi, Toranomon Sangyo  
Bldg., 1 Kotohiracho Shiba, Minato-Ku,  
Tokyo, Japan

**CIRCULATION MANAGER**  
Hugh J. Quinn (2310)

**W. W. GAREY, Publisher (2016)**

# electronics

A MCGRAW-HILL WEEKLY 75 CENTS

**LIGHT AMPLIFIER.** Portrait of young Japanese lady shows versatility of Matsushita solid-state light amplifier with control grid embedded in photoconductive layer. Input image was negative and is shown intensified at upper left. Positive-intensified image is at right. Lower left-hand photo shows effect of a V-shaped gamma characteristic. *The way it provides improved detail in selected portions of the image may be important in medical applications. See p 30* COVER

**RADAR AT MIL-E-CON.** Reports at last week's convention included several demonstrating improved versatility for radar systems. An f-m/c-w set shares space tasks; a new four-frequency system can also probe propagation paths; a pulse system proposed for 1970 would have a frequency range of 10 to 14 Gc. *Simple, pocket-sized, bistatic system warns of intruders* 10

**MUSCLE-POWER TELEMETRY.** That's one solid-state prospect. A researcher has obtained 0.25 ma, for implanted transmitters, from rat muscle. Others are working on thin-film telemetry systems. *Two additional reports at instrumentation conference last week discuss tunnel diodes as strain switches and transducers* 14

**GATLING-GUN LASER.** Novel approach to optical radar resembles design of a nineteenth-century machine gun. To achieve high laser pulse repetition frequencies, a Fabry plate rotating at 15,000 rpm controls firing of six laser crystals. *Possible applications are in optical radar and pulse communications.* 25  
By M. F. Wolff

**BREAKTHROUGH IN LIGHT AMPLIFIERS.** Light-amplifying panel consists of a thin photoconductive slab sandwiched between an electroluminescent layer and a transparent dielectric layer backed with a transparent electrode. *A control grid of tungsten-wire embedded in photoconductor permits image intensification with ability to select a negative or positive image.* 30  
By T. Kohashi and K. Miyaji,  
Matsushita Research Institute, Tokyo

**NANOSECOND SWITCHING.** This report on circuit-design trends for high-speed switching points up a reason for the renaissance of the tunnel diode. Its fast-switching characteristics have been exploited by circuit designers seeking even faster logic circuits. Tunnel-diode circuits, transistor-tunnel diode circuits and tunnel diode-storage circuits all have unique advantages and disadvantages. *You have to trade off speed, tolerance and gain.* 35  
By P. Meyers, Martin Company

Contents continued

Published weekly, with Electronics Buyers' Guide as part of the subscription, by McGraw-Hill Publishing Company, Inc. Founder: James H. McGraw (1860-1948).

Title ® registered U.S. Patent Office; © copyright 1963 by McGraw-Hill Publishing Co., Inc. All rights reserved, including the right to reproduce the contents of this publication, in whole or in part.

Executive, editorial, circulation and advertising offices: McGraw-Hill Building, 330 West 42nd Street, New York, N. Y., 10036. Telephone Area Code 212 971-3333. Teletype TWX N. Y. 212-640-4646. Cable McGrawhill, N. Y. PRINTED IN ALBANY, N. Y.; second class postage paid at Albany, N. Y.

OFFICERS OF THE PUBLICATIONS DIVISION: Shelton Fisher, President; Vice Presidents: Joseph H. Allen, Operations; John R. Callahan, Editorial; Ervin E. DeGraff, Circulation; Donald C. McGraw, Jr., Advertising Sales; Angelo R. Venezian, Marketing.

OFFICERS OF THE CORPORATION: Donald C. McGraw, President; Hugh J. Kelly, Harry L. Waddell, L. Keith Goodrich, Executive Vice Presidents; John L. McGraw, Treasurer; John J. Cooke, Vice President and Secretary.

Subscriptions are solicited only from those actively engaged in the field of the publication. Position and company connection must be indicated on orders. Subscription rates: United States and Possessions and Canada, \$6.00 one year, \$9.00 two years, \$12.00 three years. All other countries \$20.00 one year. Single copies, United States and Possessions and Canada 75¢. Single copies all other countries \$1.50.

THE PUBLISHER, UPON WRITTEN REQUEST TO OUR NEW YORK OFFICE FROM ANY SUBSCRIBER, AGREES TO REFUND THAT PART OF THE SUBSCRIPTION PRICE APPLYING TO COPIES NOT YET MAILED.

Subscribers: Please send change of address notices, subscription orders or complaints to Fulfillment Manager, Electronics, at the address below. Change of address notices should provide old as well as new address, including postal zone number if any. If possible, attach address label from recent issue. Allow one month for change to become effective.

Postmaster: Please send Form 3579 to Fulfillment Manager, Electronics, P. O. Box 430, Hightstown, New Jersey, 08520.



Audited Paid Circulation

Contents continued

HYBRID VOLTMETER. New transistor-tube circuit overcomes aging errors. The vtvm is still a stronghold of the vacuum tube where its high input impedance minimizes the effect of the meter on the circuit under test. But vtvm's drift in calibration as tube transconductance changes with age. This hybrid circuit uses transistors to reduce tube output impedances and avoid need for recalibration. By J. J. Faran, Jr., General Radio 41

TACTICAL DATA SYSTEMS. Navy is now readying an Airborne Tactical Data System and a Marine Tactical Data System. Both will be integrated with the Naval Tactical Data System to cover air and amphibious battles as well as surface actions. This report contains details that were heretofore classified. 43

FRENCH TV. Now that France will have a second tv network, set sales are heading toward a new record. One company is now producing a 23-inch transistor tv set that can receive any program on the continent, including second-network offerings 47

DEPARTMENTS

Crosstalk. More Chicken Wars? 5
Comment. Eclipse. Industrial Morality 6
Electronics Newsletter. Rise-Time Control Multiplies SCR Peak Current 17
Meetings Ahead. PTG-MTT International Symposium 18
Washington This Week. Across-the-Board Probe of Federal Research Is On 20
Research and Development. Multi-Quantum Conversion 50
Components and Materials. Gas Laser Aimed for Optical Radar 59
Production Techniques. Welding Improves Grid Construction 62
New Products. Instrument Generates Currents From 1 ma to 10^-13 Ampere 67
Literature of the Week 74
People and Plants. Antenna Lab Goes Up 76
Index to Advertisers 80

# All from Sprague... for "cordwood" packaging!

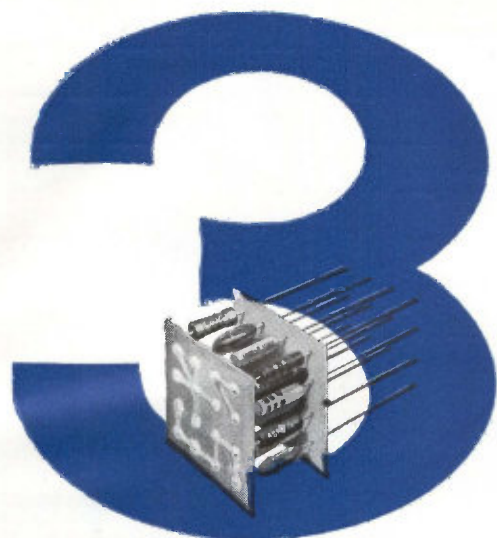

## ULTRA-MINIATURE SOLID TANTALUM CAPACITORS











...PLUS...



**Type 172D** in glass-to-metal hermetically-sealed cases. Performance characteristics identical to Sprague's famous Type 150D capacitors... including superior high frequency performance, lower leakage current values, lower dissipation factor limits, and higher permissible ripple currents as compared to customary industry specifications. **Engineering Bulletin 3523**

**Type 154D** in molded cases. Another Sprague innovation to cut your costs. Offers nearly all the high performance characteristics of metal-clad capacitors. For selected applications in digital computing equipment and other commercial and industrial electronic gear where you do not need the humidity protection of higher-priced, hermetically-sealed types. **Engineering Bulletin 3530**

**Type 165D** in polyester-film tubes. Sealed with epoxy resin. Because of thin wall of tube casing, Type 165D gives you the highest capacitance of any solid tantalum capacitor anywhere! Recommended for use in encapsulated blocks or hermetically-sealed metal-encased sub-assemblies to assure protection from moisture. **Engineering Bulletin 3535**

 <p><b>TYPE 206P</b> Epoxy-Coated <b>PACER®</b> polyester film <b>CAPACITORS</b> Engineering Bulletin 2067</p>	 <p><b>TYPE 252C</b> Molded-Case <b>CERA-MITE®</b> ceramic <b>CAPACITORS</b> Engineering Bulletin 6151</p>	 <p><b>TYPE 262C, 263C</b> Molded-Case <b>MONOLYTHIC®</b> layer-built ceramic <b>CAPACITORS</b> Engineering Bulletin 6250</p>	 <p><b>TYPE 903Z</b> Epoxy-Coated <b>INDISTOR®</b> induction-resistance <b>DELAY NETWORKS</b> Engineering Bulletin 45,001 <small>*Trademark</small></p>	 <p><b>TYPE 416E, 418E</b> Molded-Case <b>FILMISTOR®</b> metal film <b>RESISTORS</b> Engineering Bulletin 7025B</p>
 <p><b>TYPE 405E, 411E</b> Molded-Case <b>FILMISTOR®</b> deposited-carbon <b>RESISTORS</b> Engineering Bulletin 7000B</p>	 <p><b>TYPE 239E</b> Vitreous-Enamel <b>BLUE JACKET®</b> power wirewound <b>RESISTORS</b> Engineering Bulletin 7410D</p>	 <p><b>TYPE 219E</b> Silicone-Encapsulated <b>ACRASIL®</b> precision power wirewound <b>RESISTORS</b> Engineering Bulletin 7450</p>	 <p><b>TYPE 5000Z</b> <b>CONNECTORS</b> and <b>ISOLATORS</b> ("shorts and opens") Engineering Bulletin 94,000</p>	 <p><b>TYPE 7000Z</b> Shielded Radio Frequency <b>INDUCTORS</b> Engineering Bulletin 41,800</p>

The Sprague components shown here are available in the two basic sizes (.090"D. x .250"L. and .138"D. x .390"L.) you need for the accepted high-density technique known as "cordwood" packaging. If you wish, they can be furnished on lead tape for automatic insertion on printed wiring boards. And with standardized sizes, these components can be installed with the same machines, permitting more efficient use of insertion equipment.

For complete technical data, write for Engineering Bulletins listed above. Address: Technical Literature Service, Sprague Electric Company, 35 Marshall Street, North Adams, Massachusetts.

### SPRAGUE COMPONENTS

CAPACITORS  
TRANSISTORS  
RESISTORS  
MICROCIRCUITS  
INTERFERENCE FILTERS

PULSE TRANSFORMERS  
PIEZOELECTRIC CERAMICS  
PULSE-FORMING NETWORKS  
TOROIDAL INDUCTORS  
ELECTRIC WAVE FILTERS

CERAMIC-BASE PRINTED NETWORKS  
PACKAGED COMPONENT ASSEMBLIES  
BOBBIN and TAPE WOUND MAGNETIC CORES  
SILICON RECTIFIER GATE CONTROLS  
FUNCTIONAL DIGITAL CIRCUITS

**SPRAGUE®**  
THE MARK OF RELIABILITY

\*Sprague and ® are registered trademarks of the Sprague Electric Co.

***Allen-Bradley's Type J is the  
only hot molded Potentiometer  
with a 25-year record of  
unfailing service***

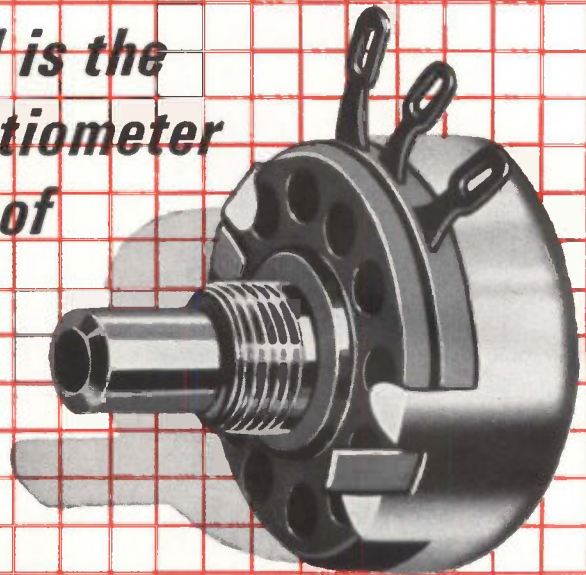

(Shown twice actual size)

Type J controls are rated 2.25 watts at 70°C and are available in special as well as standard tapers . . . and in standard total resistance values up to 5 megohms. Higher resistance values and various mechanical variations can also be furnished to fit your special requirements.

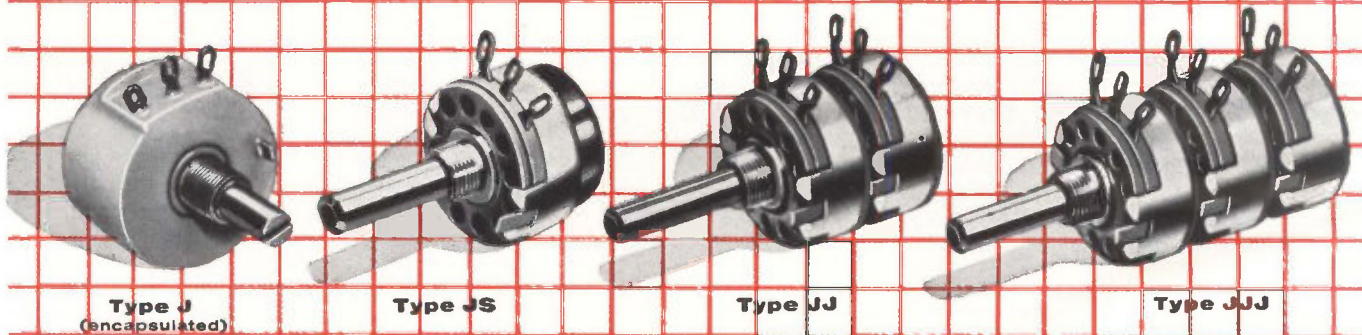

■ Over "25 years" much can go wrong—but no A-B hot molded potentiometer has failed in service to date. And, the A-B potentiometers of today are superior to those built 25 years ago, because continuing improvements have been made over the years to make sure the Type J has no equal for performance.

Today, the Type J hot molded potentiometers can claim: Longest life, yet high wattage rating in a compact structure; stability under the most demanding conditions; extremely low noise level; smooth, stepless control.

And here are the reasons: Type J solid resistance element made by A-B's exclusive hot molding process; and

A-B's production control of resistance-rotation characteristics. These reasons account for the fact that the Type J potentiometer provides consistently uniform characteristics . . . that the Type J assures complete freedom from catastrophic failures . . . that the Type J eliminates the incremental steps of wire-wound units, and provides the freedom from inductance which insures excellent high frequency response.

For full details on Type J potentiometers, write for Publication 5200, please: Allen-Bradley Co., 110 West Greenfield Avenue, Milwaukee, Wisconsin 53204. In Canada: Allen-Bradley Canada Ltd., Galt, Ontario.

QUALITY ELECTRONIC COMPONENTS

**ALLEN - BRADLEY**



## More Chicken Wars?

**THE NEWSPAPERS** have been having fun with the controversy over Europe's high tariff on American poultry.

The dispute is not comical. It is brought into focus for us by the "massive effort" the Electronics Industries Association is planning "to prevent the destruction of the U.S. electronics industry by increasing imports from low-wage countries."

EIA proposes to gather statistics on the impact of imports on the industry "in preparation for a variety of actions before government agencies." No fair-minded person could quarrel with that.

But the EIA announcement seems to imply a campaign to get protective overall tariffs, as well as to avoid cuts in any existing tariffs.

Protective tariffs across the board, we think, are unwise. If the U.S. imposes such tariffs then other governments can justify retaliatory tariffs on U.S. firms successfully competing abroad.

The Trade Expansion Act authorizes the President to adjust tariffs. But the intent of the Act is to stimulate U.S. trade overseas by mutual tariff cuts, not to touch off new chicken wars.

A better course would be for our industry to hew to the intent of the Act and to seek aid when needed under its escape clause. This clause does permit protective overall tariffs if an entire industry is hurt, but calls for domestic remedies when only segments of an industry are harmed by excessive imports.

**ARE WE AHEAD?** Last week, Westinghouse dedicated a new molecular electronics plant in Maryland.

During the dedication, a number of statements were made about the prospects for products constructed in this manner. One we found particularly encouraging concerns the consumer market. We quote:

"American manufacturers have, with moderate success, withstood stiff competition from abroad. One area, which has been successfully captured by the Japanese, for example, is the portable transistor radio. So far, solid state electronics, such as the transistor or molecular electronics, has not found its way to any significant extent into the large phonograph and television markets. Therefore the Japanese and Europeans have not had a chance to impress with their technology in these areas.

"Some industry leaders feel that molecular electronics, with its advanced technology, and with the substantial lead that certain American manufacturers have in the field, can impair foreign ability to sell into the United States in the area of solid state consumer markets. The lead that the United States now has in molecular electronics may further supply the cost advantage that American manufacturers need to sell successfully in Europe and Asia.

"Consumer products that lend themselves to this new

technology are radio and television receivers, hi-fi equipment, and the automotive industry."

The statement is a provocative footnote to our August 2 *Crosstalk* on feverish overseas activities in microelectronics.

**TOWARDS FLAT-PLATE TV.** Visionaries have for many years predicted that television sets would one day hang on the wall, like pictures, or even be carried in the pocket, like wallets. With each new phase in the development of electronics, the prediction becomes less far-fetched.

This week's cover shows a picture formed by an electroluminescent panel developed in Japan. On p 33 and below, you'll see the panel reproducing a tv test pattern. However, as the developers point out on p 30, they can't show a television program on the panel—yet. The materials used don't have a response time fast enough to form rapidly moving pictures. But that doesn't sound like an unsolvable problem.

Circuits? The active elements of the panel, only 200 microns thick, are sandwiched between glass plates. It should be possible to mount integrated circuits, or even deposit thin-film circuits, right on the back plate. That, too, should pose no unsolvable problems to an industry that has been able to come up with computers the size of a breadbox. Added up, the thickness of the panel and the circuits shouldn't be much more than an inch.

Though the panel's developers confine their discussion in this week's article to the panel's operating principles and presently feasible applications, it was the potential for flat-screen tv that excited us most when we first heard of the panel last spring.

Just before we obtained a news article on the panel (*ELECTRONICS*, p 20, May 24) we had printed a series of three articles on consumer electronics. In our surveys of present tv design (p 49, May 3) and electroluminescence applications (p 52, May 10), no marriage of the two appeared. Therefore, we set the wheels in motion for Charles Cohen, the McGraw-Hill World News staffer in Tokyo, to have Matsushita Research Institute prepare this week's article.



# When You Need ELECTRIC WAVE FILTERS

Depend on Sprague for

- ✓ SERVICE
- ✓ DELIVERY
- ✓ RELIABILITY





Sprague Electric Wave Filters for use in telemetry, telephony, and various types of communications systems and laboratory equipment which require selection and/or rejection of specific frequencies are now being designed by *Modern Network Synthesis*, which assures exact matching of wave filter characteristics to application requirements for Low Pass, High Pass, Band Pass, and Band Rejection filters.



Drawing on Sprague's long experience in component manufacture, wave filter engineers are able to employ capacitor, inductor and resistor production facilities for particular sizes, shapes, and materials best suited for specific filter applications. Unlike most filter manufacturers, Sprague is not dependent upon other component suppliers, therefore faster deliveries can be provided.



To further Sprague capabilities, wave filter design and field engineering offices as well as pilot production facilities are maintained in North Adams, Mass.; Vandalia, Ohio; and Los Angeles, Calif. Specialized mass production facilities are located at Visalia, Calif. and North Adams.

For additional information on Sprague Electric Wave Filters, write for Engineering Bulletin 46000 to Technical Literature Section, Sprague Electric Company, 35 Marshall Street, North Adams, Massachusetts.



93-444

6 CIRCLE 6 ON READER SERVICE CARD

## COMMENT

### ECLIPSE

Just read your July 26 article, *Racing the Solar Eclipse* (p 37).

Enclosed is an autograph which the eclipse wrote in my backyard. The equipment was completely automatic and consisted of a recorder driven by a barrier-layer photocell.

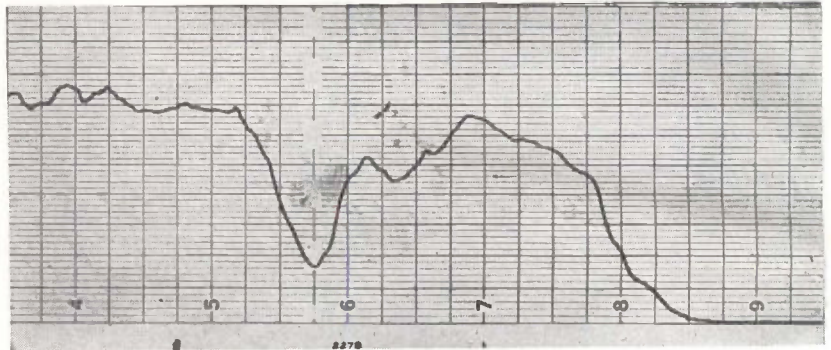

The recorder chart shows "total sky radiation." This is mostly white light, plus some infrared and ultraviolet. It is not direct sunlight. It is "daylight."

The sensitivity of the recorder was adjusted to 100 (top of scale) on a perfectly clear day. This day (July 20) was cloudy, so the recorder averaged around 80. During the eclipse, the value decreased to around 8. After the eclipse there was a rain shower, which accounts for the dip as the eclipse waned.

ANTHONY H. LAMB

Atlantic Instruments & Electronics, Inc.  
Boston, Massachusetts

### INDUSTRIAL MORALITY

I read with interest your articles on industrial spying (p 22, July 12, and p 32, July 19). I believe the ultimate solution is, as was suggested, in the morality of the employees.

This is difficult to achieve, however, in the atmosphere of modern companies where every element of the company's operation is subject only to the dictum, "Thou shalt make money." A more "immoral" atmosphere is hard to imagine. I agree that such a philosophy is eminently practical—but let's not call it moral or delude ourselves into thinking that such a perspective promotes individual morality. The employee who sells out is being eminently practical—an attitude that was fostered by the parent company's sole objective of making money.

I suggest as an alternative that the making of money is a *necessary* but *not sufficient* condition for corporate survival. What is necessary and sufficient? Strong production capability *and* basic research might be a good example. Or production capability and basic research and company loyalty to the individual employee and a return to the community of some of the profits extracted from it.

A. E. LARSON

Los Altos, California

### CERAMIC BENDERS

In my article, *How Ceramic Benders Control Light Rays* (p 80, July 19), the thickness of the bender (column 1, line 11) is 0.021 inch rather than 0.0021 inch. The abstract should read "Past attempts to construct *low-energy* relays . . ."; the choice previously was between comparatively high stored energy, with a piezoelectric driving a rugged mechanical snap-action switch, and low stored energy with contact problems. Lastly, the surface at which total internal reflection occurs was omitted from Fig. C.

I find *ELECTRONICS* of great value in both planning and pursuing my work; the editorial policy of seeking out and quickly publishing new work, particularly in rapidly changing fields, helps all of us to avoid duplication of effort.

FREDERICK W. KANTOR

Silver Spring, Maryland

### MULTIFUNCTION RADAR

I was startled to see the Nike X radar system, pictured on p 14 of your Sept. 13 issue, called a "malfunction array radar." Isn't it a *multifunction* array radar that Sylvania is developing?

DONALD ROBERTS

Albany, New York

• Of course it should be multifunction; our printer goofed.

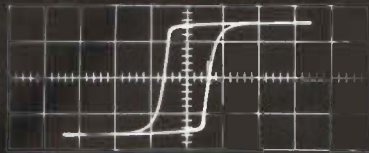

**DISPLAY OF INTEGRATED WAVEFORM**—transformer secondary voltage integrated and plotted against the transformer primary current—for enabling study of B-H loops of transformer cores.

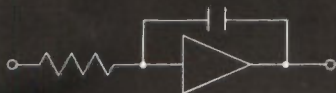

INTEGRATOR

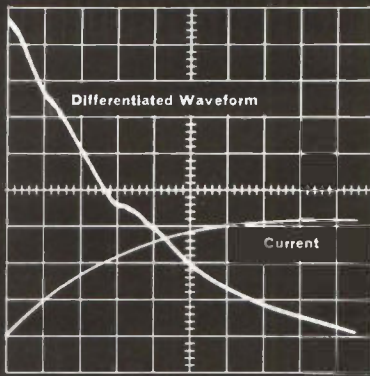

**DISPLAY OF DIFFERENTIATED WAVEFORM**—tunnel diode in liquid helium—for enabling detection of quantum phenomena at low temperature.



DIFFERENTIATOR

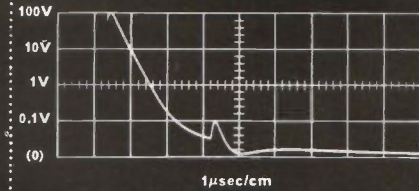

**DISPLAY OF LOGARITHMIC RESPONSE**—two pulses of widely varying amplitudes—for enabling observation of 100-volt pulse and 0.1-volt pulse in the same viewing area (simplified schematic shown below).

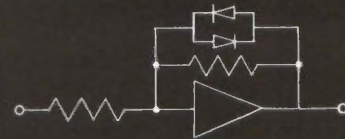

NON-LINEAR AMPLIFIER

## Operational Amplifier Plug-In Unit Permits Oscilloscope Measurements Under Dynamic Conditions

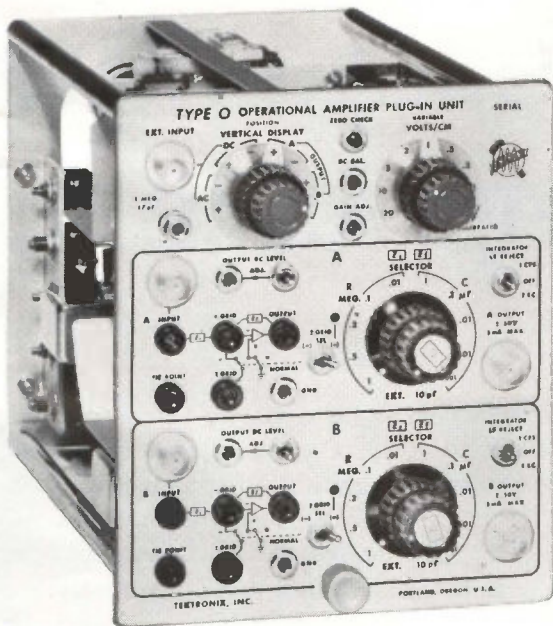

Type O Unit . . . . . \$525  
 Accessory Log Adapter . . . . . \$75  
 U. S. Sales Prices, f.o.b. Beaverton, Oregon

**For a demonstration—  
 please call your Tektronix Field Engineer.**



**TYPE O UNIT**—for Tektronix Oscilloscopes that accept letter-series plug-in units.

Using this new Operational Amplifier Unit in your Tektronix Oscilloscope, you can perform precise operations of integration, differentiation, function generation, linear and non-linear amplification. You can accomplish many of these operations by simply manipulating the front-panel controls—for the Type O Unit features convenient selection of precision input and feedback components.

You can use the Type O Unit as a gated integrator . . . as a high-input-impedance amplifier . . . as a bandpass amplifier . . . as a constant-current-drive amplifier . . . as a peak-memory amplifier . . . as a function generator . . . as a capacitance-measuring device . . . as a low-current measuring device . . . and for many and varied other specialized operations—some performed *with* external circuitry and some *without*.

### CHARACTERISTICS

The Type O Unit contains two complete operational amplifiers and one complete vertical preamplifier.

Each operational amplifier features 15 mc open-loop gain-bandwidth product, open-loop dc-gain of 2500, selectable input and feedback impedances, drift rejection for ac integration. The output of one operational amplifier can be applied to the input of the other for combined operations.

The vertical preamplifier can be used independently or to monitor the output of either operational amplifier. In a Tektronix Type 540-Series Oscilloscope, the passband is dc-to-25 mc, the risetime is 14 nsec, and the maximum calibrated sensitivity is 50 mv/cm.

**Tektronix, Inc.** / P. O. BOX 500 • BEAVERTON, OREGON 97005 / Phone (Area Code 503) Mitchell 4-0161 • Telex: 036-691 • TWX: 503-291-6805 • Cable: TEKTRONIX • OVERSEAS DISTRIBUTORS IN 27 COUNTRIES

Tektronix Field Offices: in principal cities in the United States. Consult Telephone Directory • Tektronix Limited, Guernsey, Channel Islands  
 Tektronix Canada Ltd.: Montreal, Quebec • Toronto (Willowdale), Ontario • Tektronix Australia Pty. Limited, Sydney, New South Wales

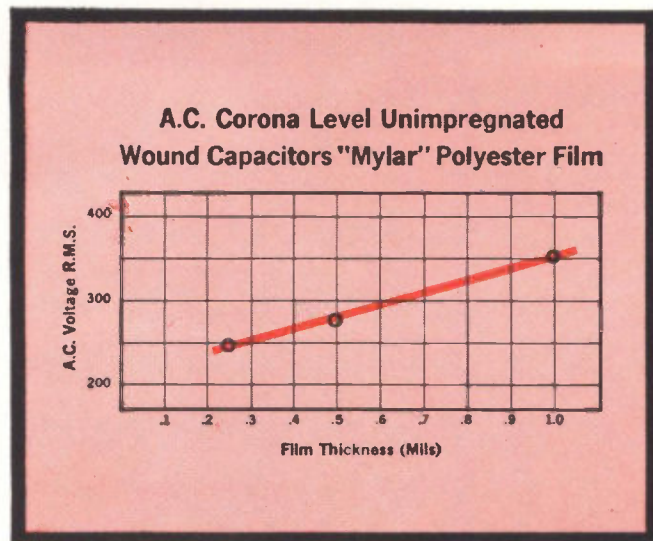

## AC CORONA LEVEL

Corona levels for various gauges of "Mylar"\* in capacitors were determined in life tests and are shown above. AC corona level is defined as the r.m.s. voltage below which corona does not exist.

**Unimpregnated Single Layer 25 Gauge Capacitors of "Mylar"**

D.C. Bias (Volts)	0	100	300
A.C. Volts R.M.S. necessary to produce corona at 25°C	290	290	290
at 125°C	285	285	280

**Unimpregnated Single Layer 50 Gauge Capacitors of "Mylar"**

D.C. Bias (Volts)	0	200	400
A.C. Volts R.M.S. necessary to produce corona at 25°C	345	350	350
at 125°C	315	320	310

## AC/DC CORONA LEVEL

Corona is a function of AC voltage only. Table shows full AC voltage must be applied before corona can exist, whatever the DC bias may be.

# AC/DC Capacitor study... New tests show compatible in

**N**ow designers can apply the high reliability and low cost of capacitors of "Mylar" to AC and AC/DC circuits. Capacitors with "Mylar"\* polyester film as the dielectric are completely compatible in these circuits in home entertainment equipment and similar circuits in other equipment. Data proving compatibility was developed in Du Pont's test at the Film Department Sales-Service Laboratory and at Inland Testing Laboratory.

Briefly, the tests showed that for a capacitor with a dielectric of dry "Mylar" it does not matter whether the voltage is DC, or AC, or combinations

of these voltages. There are only two limitations: (1) the AC voltage or AC component in an AC/DC situation should not exceed the corona level, and (2) the total of the DC voltage plus the r.m.s. AC should not exceed the rated DC working voltage.

Now that it's assured that these capacitors are completely functional in such circuits, designers can utilize the other advantages of "Mylar"—over-all reliability, high IR, small size, moisture resistance, capacitance stability. Remember, too—capacitors of "Mylar" cost about the same as paper.

\*Du Pont's registered trademark for its polyester film.

TO APPLY THESE IMPORTANT FINDINGS TO YOUR DESIGN, CLIP AND MAIL THIS COUPON:

Lower Limit of Life vs Total Voltage  
Single Layer 25 gauge "Mylar" At 125°C

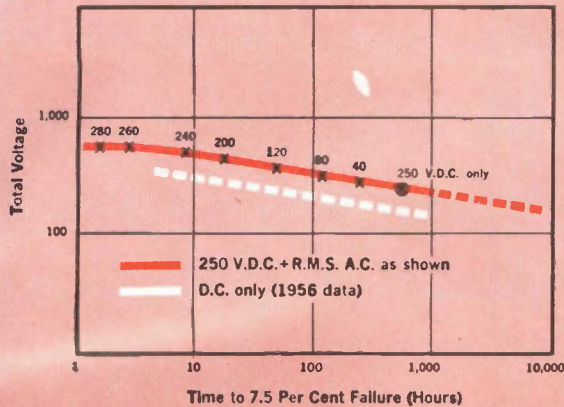

Lower Limit of Life vs Total Voltage  
Single Layer 25 Gauge "Mylar"

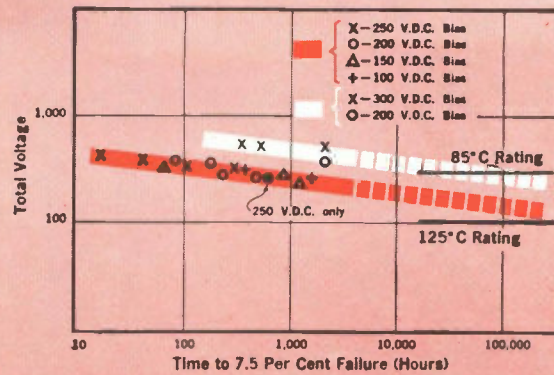

## AC/DC LIFE

Below AC corona level, life is a function of total voltage. AC/DC total voltage life performance is identical to DC life performance.

Regardless of AC/DC combinations, the basic volt-age-life law is maintained, and the law applies to various operating temperatures as shown,

# capacitors of **MYLAR**<sup>®</sup> AC/DC circuits

E. I. DU PONT DE NEMOURS & COMPANY (INC.)

### FILM DEPARTMENT

BOX 22B-RM. N10452 WILMINGTON 98, DELAWARE

Rush me your *Pocket Report* on "Mylar" polyester film as a capacitor dielectric for AC and AC/DC voltages.

NAME \_\_\_\_\_ TITLE \_\_\_\_\_

FIRM \_\_\_\_\_ EQUIPMENT \_\_\_\_\_

ADDRESS \_\_\_\_\_

CITY \_\_\_\_\_ STATE \_\_\_\_\_



BETTER THINGS FOR BETTER LIVING  
... THROUGH CHEMISTRY

only **DUPONT** makes

**MYLAR**<sup>®</sup>  
POLYESTER FILM

# RADAR DESIGNS Acquiring New

One set will share space tasks; small bistatic unit guards against intruders

By JOHN F. MASON  
Senior Associate Editor

**WASHINGTON**—New techniques in radar design—including an f-m/c-w system for rendezvous, a wideband pulse system, and another that operates in four frequency bands—got the MIL-E-CON convention off to a flying start last week.

More than 4,000 representatives from industry, government and universities attended the sessions and exhibition sponsored by the IEEE'S PTG on Military Electronics. General theme of the convention was the national information and command control systems.

**Satellite Radar**—An f-m/c-w radar system for orbital rendezvous and landing from orbit was reported by Jack Hooper and Harold Sullivan, of Emerson Electric. One 2-ft diam-

eter antenna, placed to accommodate look angles for both operations, is used. System is in development as a lightweight sensor (28 lb). Frequency is 16 Gc; radar primary power, 75 w.

In the rendezvous mode, the transmitter is a voltage-controlled r-f oscillator modulated by a multi-tone modulator. A circulator duplexes the common antenna for transmission and reception. Output from a cooperative beacon is translated in frequency by the radar intermediate frequency. A sample of the transmitted waveform is coupled to the receiver and is used as the local-oscillator signal.

In the landing mode, the same modulator, transmitter, duplexer, and antenna are used. An ssb modulator offsets a sample of the transmitted signal for use as the local-oscillator signal. Transmitter feedthrough appears as a narrow-band signal in the i-f amplifier, the delayed f-m signal occupies a wider spectrum. The feedthrough cancellor circuits use the i-f reference oscillator signal to null out the un-

desired feedthrough signal.

The ssb modulator is of the phase-shift type and uses a balanced crystal mixer for each balanced modulator to provide the required carrier suppression.

**Wideband Radar**—Another satellite-based radar system, to rendezvous with noncooperative satellites—either hostile craft or malfunctioning friendly ones—was described by S. K. Kamen and M. S. Tanenbaum, of Sperry Gyroscope. Proposed for the 1964-1970 period, radar was selected as the sensor rather than optical laser due to radar's more advanced state of the art.

Type of radar selected is a non-coherent, pulsed system, using a single antenna with no added circuits to reduce interference. Parameters chosen are: frequency, 10 Gc to 24 Gc; pulsewidth, 1  $\mu$ sec; repetition rate, maximum value to yield unambiguous range, approximately 200 to 2,000 pps; number of pulses integrated, 1, 10, 100; antenna diameter, 0.3, 0.6, 1 and 3 meters; system losses, 6 db.

The system consists of a magnetron transmitter and two types of mechanically scanned antenna reflectors—rigid and inflatable—and signal-processing and data-handling equipment. The antenna includes a reflector, feed, gimbals, drive, synchro, and counterweight.

Radar parameters were calculated for different circumstances using existing equipment and improvements expected through 1970. For example: a 100-lb, 2-cu-ft radar at present could acquire a noncooperative target with a 5-mile uncertainty radius at 300 miles.

**Airborne Radar**—A four-frequency, frequency-stabilized, coherent radar system jointly developed by Naval Research Lab and RCA, will begin flight tests this month in a WV-2 aircraft. Tests will check out its capabilities for target signature work on point targets, area extensive targets—such as sea clutter and terrain—and as one terminal of a one-way

## Titan III Guidance Nearly Ready

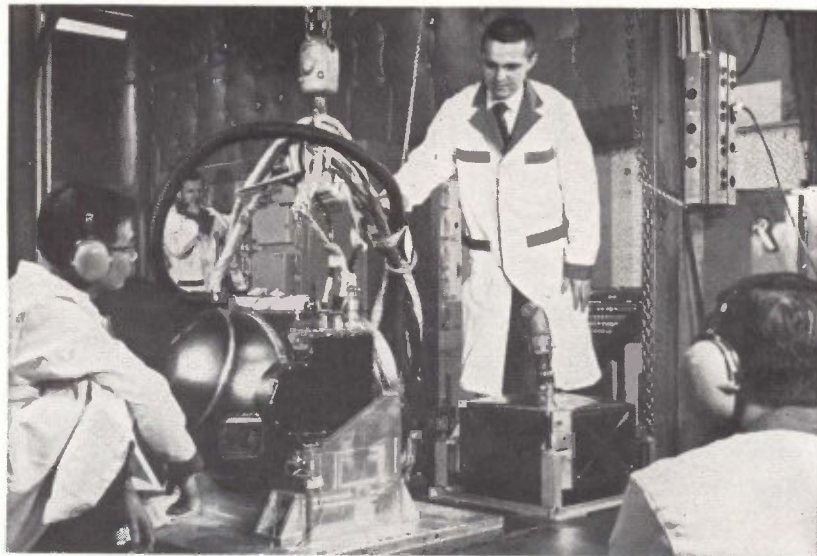

DELIVERIES of Titan III guidance systems to Air Force will start in December, AC Spark Plug said last week. System is same as that in Titan II, except for modifications to handle longer flight times. Above, a Titan II guidance is vibration tested

# Versatility

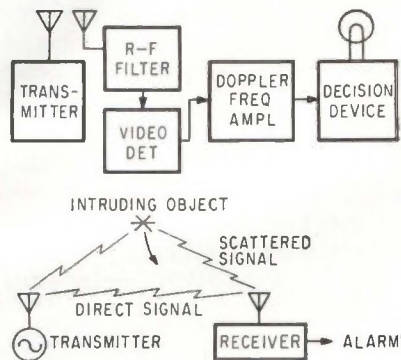

BISTATIC radar radiates intruder detection "fence"

transmission link in anomalous-duct propagation investigations.

The four frequencies (P, L, C, and X bands) can be transmitted singly or in rapid succession to provide a total of eight different vertically and horizontally polarized transmissions for subsequent target-data correlation.

For data-gathering versatility, the radar provides dual-polarization transmission and reception, and separate amplitude and phase channels for processing repetition rate, receiver bandwidth, transmitted pulse width, and range-gate width—all can vary widely and are independently adjustable in steps.

System features and components include:

- Wideband (10 Mc) and large dynamic range (70 db) limiting i-f amplifier with almost negligible phase error over the range
- Lin-log i-f amplifier, 12-Mc bandwidth, and transfer characteristic linear within 0.5 db over 45-db dynamic range
- X-band transmitter with phase stability on the order of 3 degrees
- All-solid-state coherent signal source with frequency stability of 5 parts in  $10^9$  short term and 1 part in  $10^6$  long term
- Microwave reentrant test mode for in-flight calibration and performance checks
- Phase comparator able to handle pulses as short as 0.1  $\mu$ sec with full 360-degree operation

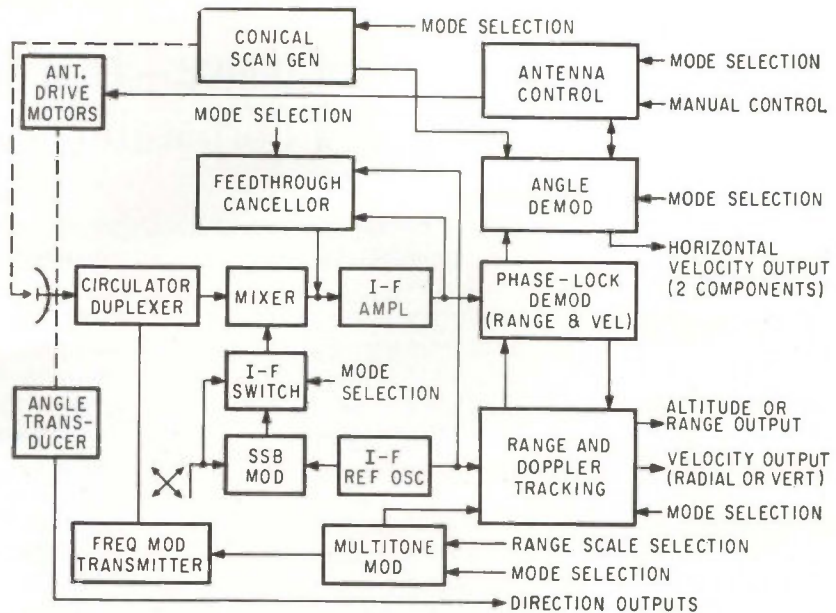

IN DEVELOPMENT at Emerson Electric, this f-m/c-w system would provide lightweight sensor for orbital rendezvous and landing from orbit

The system was reported by N. G. Hamm and E. G. McCall, of RCA, and F. C. Macdonald and J. T. Ransone, Jr., of NRL.

**Watchdog Radar**—Bistatic vhf, c-w radar that sets off an alarm when personnel intrude on area was described by W. A. Visser, J. O. Wedel and M. I. Skolnik, of Electronic Communications, Inc. The units are the size of a transistor radio, easy to operate, lightweight, low power, and inexpensive enough to be abandoned in military operations where mobility is important.

The radar's coverage is more like a fence than the conventional hemispheric coverage of a typical monostatic radar. When a moving object approaches the base line connecting transmitter and receiver, an interference signal is generated, resulting in an alarm.

The transmitter is an antenna driven by a battery-operated transistor oscillator. The receiver is an antenna, r-f filter and crystal video receiver. The doppler frequency components in the receiver signal set off an alarm when they exceed a preset amplitude.

## ARMY LIKES MINICOMPUTER

WASHINGTON—Army's efforts to get tactical automatic data processing (ADP) systems in the field during 1965-70 is moving according to plan.

One in-house system that satisfies Army Electronics R&D Lab at Fort Monmouth is the Minipac—a small-scale advanced Fielddata command and control computer. Army says the Minipac project has demonstrated that high-speed, low-cost, battery-operated military computers are feasible.

Contributing heavily to Minipac's success is the use of magnetostriction delay lines as the main memory system. These, says Army, are more modular and faster than magnetic drums or disks and cheaper—though slower—than magnetic core systems. Also delay lines use less power than others.

In the immediate future, the Minipac concept extended to glass or quartz delay-line memories, could yield 20-Mc serial-operation speeds. A machine using this type of organization may have all the advantages of Minipac while operating at 10 times its present speed.

While the trend in military computer circuits is to silicon semiconductor devices, for higher-temperature performance, high-speed germanium transistors are used in Minipac for lower-power operation. Little internal heat is generated in Minipac

# Product Reliability Performance—To MIL-Q-9858 Requirements by Mycalex Corporation of America

Our key to successful service has always been: 1) search for the best design, 2) make efficient and trouble-free tooling, and 3) produce high quality components.

The need for a uniform measure of quality control to meet today's extraordinary requirements for reliable performance dictates that all responsible companies accept the specifications spelled out in the MIL-Q-9858 Quality Assurance Program.

Mycalex Corporation of America is therefore proud to announce that we have committed ourselves to meet this exceptionally high level of quality that must be achieved to meet the requirements of the MIL-Q-9858 specifications.

Sound planning has created a Quality Control Department with clearly defined responsibilities for establishing and enforcing the procedures and necessary documents to assure that all materials and services meet the standards in our specifications and contracts. Our Quality Control System includes procedures exactly designed by ourselves to meet requirements unique to our products; and, of course, our entire system is applied to all Government and commercial contracts equally.

We are never satisfied that our Quality Control is perfect; this new system is a firm basis for continued improvements.

## Precision-molded materials

SUPRAMICA® 620 "BB" ceramoplastic	SUPRAMICA 560 ceramoplastic	SUPRAMICA 555 ceramoplastic
MYCALEX® 410 glass-bonded mica	MYCALEX KM glass-bonded mica	MYCALEX 410X glass-bonded mica

## Precision-fabricated materials

SUPRAMICA 620 ceramoplastic	SUPRAMICA 500 ceramoplastic	MYCALEX 400 glass-bonded mica
MYCALEX K glass-bonded mica	MYCALEX 385 glass-bonded mica	

If you are interested in the complete details of our accuracy program, we will be glad to mail you a copy of

our Quality Assurance Procedure manual on request. Please send this request on company letterhead.

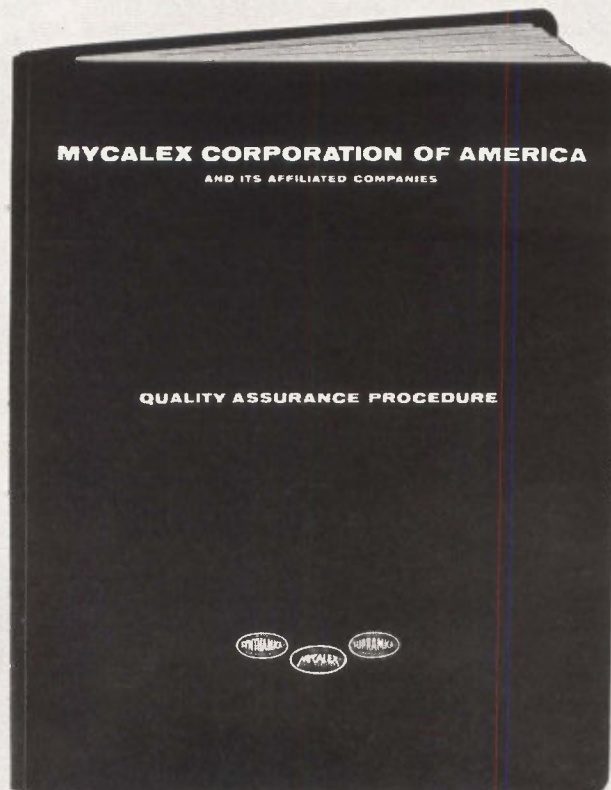

Dept. AJ, 125 Clifton Boulevard, Clifton, N. J.



# From 6 volts to 100 volts— get Mallory quality in all solid tantalum capacitors

Available ratings  
for Mallory type  
TAS solid  
tantalum capacitors

With the addition of new 75 and 100 volt ratings, the Mallory TAS line of solid tantalum capacitors now gives you a complete range of ratings . . . including all standard MIL ratings. The new 75 volt units come in values from 0.47 to 3.3 mfd. The 100

volt series ranges from .47 to 2.7 mfd. Temperature rating is  $-80^{\circ}\text{C}$  to  $+125^{\circ}\text{C}$ . Both are in two case sizes: MIL size A, .125" dia. by .250"; and size B, .175" dia. by .438". Tinned nickel leads are standard; untinned or Dumet leads on special order.

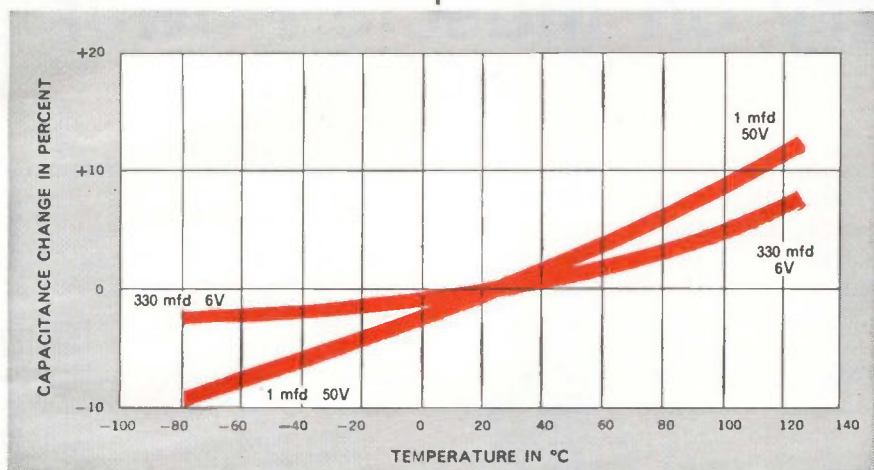

Typical temperature stability curve for type TAS; other ratings show comparable performance.

Proved by over 14 million piece-hours of reliability testing, with only 4 catastrophic failures in all this period, Mallory TAS capacitors are made with the consistently high quality that comes from over 12 years of experience in tantalum capacitor manufacturing. Many ratings are

available on immediate delivery. All are designed and tested to meet or exceed requirements of MIL-C-26655A and MIL-C-26655/2C. For a copy of our new Bulletin 4-40J, write to Mallory Capacitor Company, Indianapolis 6, Indiana, a division of P. R. Mallory & Co. Inc.

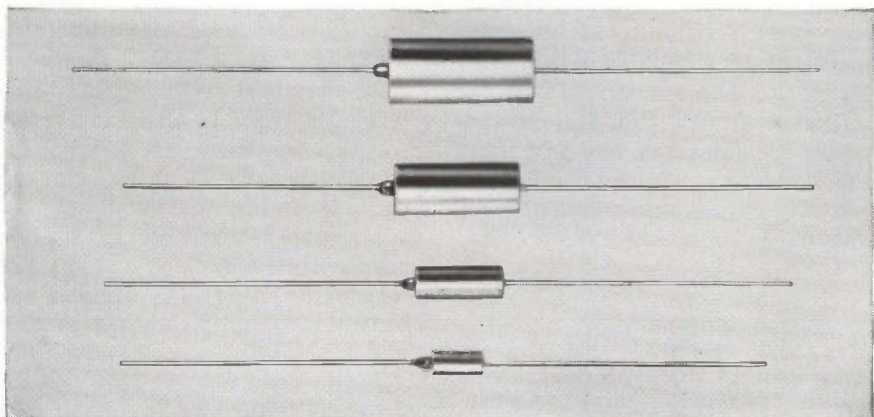

## WET SLUG, FOIL AND SOLID TANTALUM CAPACITORS

VOLTAGE	MAXIMUM MFD.	MINIMUM MFD.
100	2.7	.47
75	3.3	.47
50	22	.47
35	47	.0047
20	100	.0047
15	150	.0047
10	220	.0047
6	330	.0047



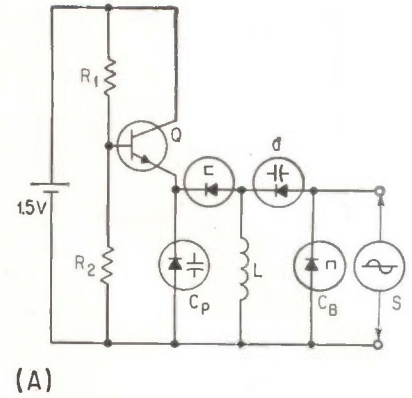
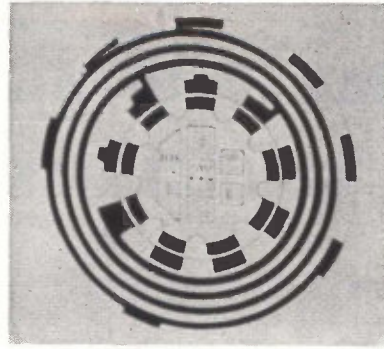
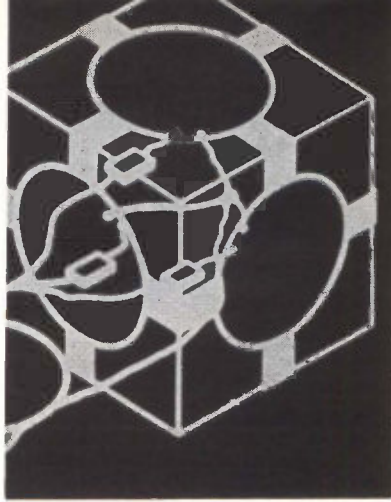

QUARTER-INCH circles are integrated circuits used to telemeter physiological data from animals. Schematics (A)

# Telemetry on Muscle Power

That's one solid-state prospect; another is strain-switching diodes

**CHICAGO** — Muscle power as source for implanted transmitters has been tapped at the 0.25-ma level in rats—bringing closer the day body movements can power implanted telemetry, Wen Ko, of Case Institute of Technology reported in the biotelemetry session at the ISA Instrument Automation Conference last week.

Wen Ko demonstrated ¼-in.-diameter integrated-circuit chips (see figures) developed at Bell Telephone Labs for implant-monitoring of elec-

trocardiogram, electroencephalograph and other functions in animals and eventually hospital patients. The cubic detector picks up radio energy telemetered from a transmitter weighing 0.4 gram and 22 mm thick.

**Thin Film Telemetry**—Complete thin-film telemetry systems were forecast for near future during a discussion of a new thin film family of voltage-controlled oscillators.

Deposition of all passive circuit elements on a surface area little less than a square inch fits cost and reliability trend toward combining more elements on a single substrate, said Everett Eberhard and William Whitworth, of Motorola Solid State Systems.

Thin-film inductances have already been fabricated to several microhenry values and methods have also been developed to integrate small toroidal coils into thin film packages. The company is now experimenting with thin-film power-supply regulators, mixing amplifiers and calibrators. A signal conditioner — to fit between sensor and the oscillator — is under investigation,

along with high-quality differential amplifiers.

**Strain Switching**—Biasing of tunnel diodes at fixed levels to make strain-sensitive switches was discussed by Anthony Kurtz, of Julite-Bytrex Corp., in the Monday evening forum. Current setting determines switching at various strain levels, he said. Binary output suggests a line of digital transducing devices, especially for the biomedical field.

Uniaxial strain transducer applications of Esaki diodes in conventional strain-gage circuitry, and in novel applications using negative-resistance characteristics as uniaxial strain transducer were discussed in the technical session by Terence Kiggins and Arthur Milnes, of Carnegie Institute of Technology. Strain-sensing limit-switch application of a tunnel diode exploits its tendency to switch to higher voltages, they said. Diode will switch if biased from a constant current source and then the junction is strained until peak-current value under compression is less than current value under no strain. Voltage across diode increases and remains high until the strain is removed and biasing current is returned to zero and reapplied.

Strain level of operation may be varied by shifting the bias point. The closer bias current is to peak current, the smaller will be the strain

**TELEMETRY COLLAR** in search of a grizzly bear. This one is used at Yellowstone Park to study the inhabitants. System, described by Frank Craighead, of the National Geographic, transmits 20-mw pulses, with prf varied from bear to bear to tell them apart

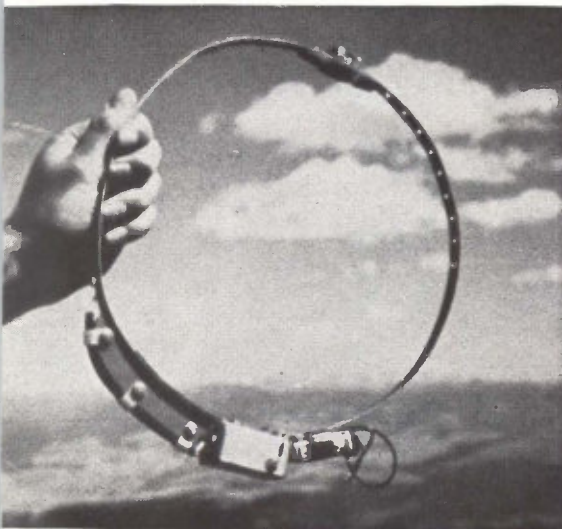

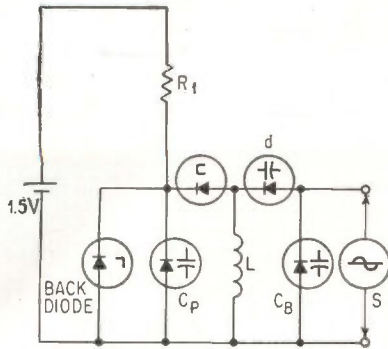

(B)

show type of circuits used

By **CLETUS M. WILEY**  
Regional Editor, Chicago

required to switch the diode. Tunnel diode may also be used as a strain-sensitive oscillator, but parameters which make it strain sensitive also make it susceptible to temperature and bias variations, requiring an extremely stable biasing source.

**Thermistors**—Positive-temperature-coefficient (ptc) thermistors offer a powerful new tool for overtemperature protection of motors, bearings and other processing components, reported Arthur Aden, of Motorola Instrumentation and Control. Aden described a circuit in which thermistors mounted in the motor winding actuate a solid-state motor-switching circuit in less than a second.

The ptc thermistors employ substitution of trivalent lanthanum in a barium titanate crystal lattice to provide excess electrons in an energy level near the conduction band, Aden explained. Base resistance depends on degree of doping and geometrical configuration. The thermistors show a sharp increase in resistivity over a relatively narrow temperature range.

Ratio of titanates is the determining factor in position of transition temperatures, which can occur from below zero to approximately 120 C. Other materials indicate feasible switching temperatures up to 400 C, Aden said. Specially fabricated thermistors change resistance as much as 75 to 80 percent per deg C.

## "WHERE'S THAT TAPE OF 'THE ALLIGATOR GLEE CLUB AT CARNEGIE HALL'?"

*Oh, hello Rip! You got here just in time. Drop that demo on the bench and listen to this tape. It's part of a new batch that Station 16 just sent in — even worse than the ones I was telling you about.*

Worse? I'll say! Sounds like a sped-up playback of "Concerto for Seagulls and Fish Pier"! But I thought you said you were getting groans and burps?

*That's what's rough — the stations NEVER know what kind of interference they'll get next! You told me I don't need two separate filters — how is this one Krohn-Hite black box going to clear up the confusion?*



Because the 315-A is two filters . . . matter of fact, three, on one chassis. As I get it, your radio-telephone transmissions are being loused up by all kinds of noise and interference — above, below, or right in the middle of the intelligence band, and never in the same place twice. Now start that "Screaming Meemy" tape again, while I plug the 315-A into the monitor output and listen through the filter with these earphones. At the stations, they'd do just about the same on live transmission, except that when they had set the filter to maximize the intelligence, they would just switch it right into the line at any convenient a-f stage. . . . I see what you mean — I can barely make out the voice, with a horrible hash above it and below it too. Now let me switch to band-pass, and move in from the ends with both cut-offs independently. I'll spin through that top decade below 200 kc fast, since for this work you'd never hear the difference. But I just dropped out a thump somewhere down around 30 cycles — probably someone chopping liver! Here you are . . . listen to this . . . clear as a bell!

*So far so good. But keep listening. Just about here I think a pig got stuck — skewered real good at about 2 kc. Watch the gain!*

Owwwww — I just found it! Quick — let me find a real DEEP null for my aching ears! We turn to band-reject, sneak in from the sides with both dials, and . . . I think somebody just told that pig "down boy! 60 db down!!" Listen for yourself. That makes both types we've cleaned up!

*I think you've just made yourself a sale. But wait a minute — you said the 315-A is THREE filters. What's the third function?*

High-pass! ALSO tuneable all the way from 20 cps to 200 kc, with the same 24 db per octave attenuation outside the pass band. And if you ever get squawk patterns in the same spots, don't forget — the dials are direct reading and calibrated to 10%. Log 'em and kill 'em fast. Now — how about lunch to celebrate, at a low-decibel restaurant?

*I'm with you!*



**KROHN-HITE  
CORPORATION**

580 Massachusetts Avenue, Cambridge 39, Mass.  
Area Code 617 491-3211

*Pioneering in Quality Electronic Instruments*

# 1-KW/ft.<sup>3</sup>

The CAPITRON\* power supply packs it in . . . power to spare in minimum space—500 watts per half cubic foot . . . a kilowatt per cubic foot . . . closely regulated and reliable!

This specially designed transistorized computer power supply goes a long way toward solving packaging density problems in new, miniaturized design requirements and it's built to go for a long time.

For absolute minimum cube, close regulation to help maintain computer accuracy . . . for long life and extreme reliability . . . check these features . . . see how easily they fit your design plans:

**DESIGN FEATURES:** ● High power in small space  
● Protected against short circuits ● Close regulation over full load range ● Integral pancake type fan cooled ● Output adjustable to  $\pm 1.5$  volts tolerance  
● Protected against input overvoltage ● Easily accessible electrical connections ● Fast recovery from load surges over full load range Remote sensing to control output at the load Output volt,

age and current can be varied over a range of 200% within the same size package if output power is held constant.

#### PERFORMANCE SPECIFICATIONS:

- Input—95 to 130 V AC, 1  $\phi$ , 60  $\pm$  3 cps
- Outputs—
  - +20 V DC at 10 amperes, 1% Ripple P to P
  - 20 V DC at 20 amperes, 1% Ripple P to P
  - +17½ V DC at 5 amperes, 5% Ripple P to P
- Regulation—Better than 1% from 0 to 100% load variation and 95 to 130 V input ● Ambient Temperature—15°C min. to 38°C max. ● Size—7½" H x 7½" W x 14" L ● Duty Cycle—Continuous

**AMP** | **CAPITRON**  
**INCORPORATED** | **DIVISION**  
155 PARK STREET, ELIZABETHTOWN, PA.

\*Trademark of AMP INCORPORATED



CAPITRON\* POWER SUPPLY

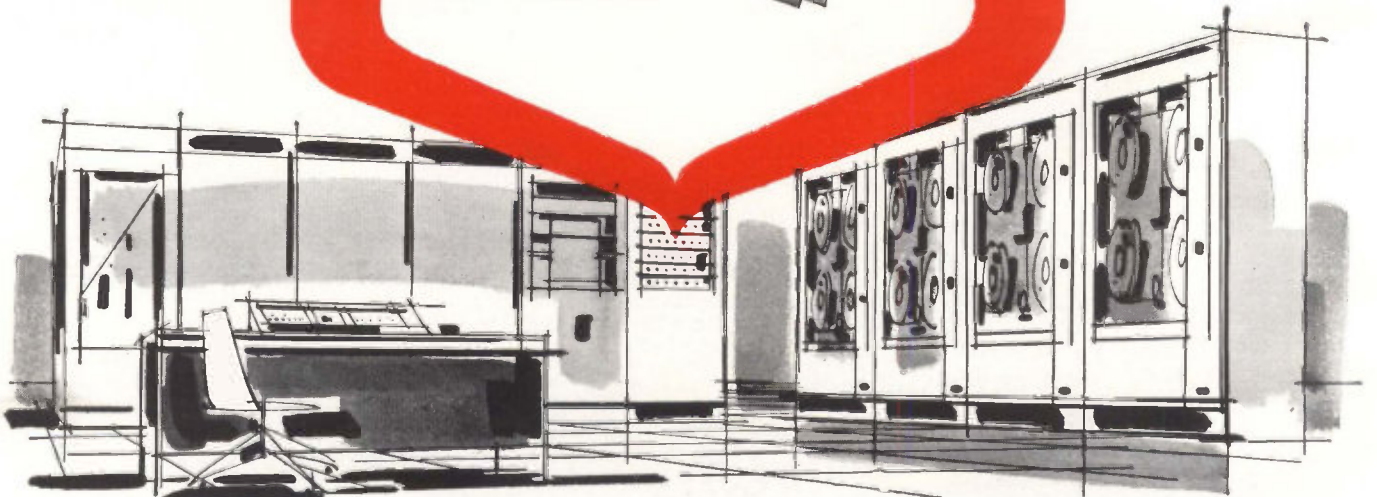

AMP products and engineering assistance are available through subsidiary companies in: Australia • Canada • England • France • Holland • Italy • Japan • Mexico • West Germany

# Soaking Multiplies SCR Peaks

## EIA Backs Drive on Imports

NEW YORK—EIA last week gave its official support to a "constant and intensive" drive aiming to protect domestic electronics manufacturers from growing foreign competition. The drive was started by the EIA's Electronics Imports Committee, headed by Robert C. Sprague, board chairman of Sprague Electric Co. (p 20, Sept. 13 and p 20, Sept. 6).

Endorsement by the board of directors and the various divisions of the EIA, gathered here for their annual fall conference, means two things: the Imports Committee will be enlarged to represent every segment of the industry, and more money will be earmarked for the program. How much, no one was saying.

Sprague said imports of radio receivers have nearly doubled in two years, radio-tube imports have gone up 90 percent and tv-receiver imports are running about 10 times the 1961 level. Although Charles F. Horne, EIA president, said the drive won't concentrate on any one geographic area, Sprague stressed the activities of Japanese manufacturers.

His comparisons of Japanese exports to the U.S. from 1961 to 1962 show the following: tv receivers, almost a six-fold increase; capacitors, more than a 100 percent increase; transistors, almost a 100 percent increase

LIVERMORE, CALIF.—Discovery of a new parameter that may enable silicon-controlled rectifiers to carry from 10 to 100 times their rated peak pulse current was disclosed to **ELECTRONICS** last week by Kristian Aaland, of Lawrence Radiation Lab. He has isolated the problem of scr failure and defined a new parameter that he calls soaking time. This is the safe rate at which current is applied.

It has been recognized that scr's fail, even at rated currents, if the rise time of applied pulses is too short (p 50, Aug. 17, 1962). Aaland predicts that with more study it may be possible to adjust soaking time to get up to 1,000 times the rated currents. Secret is in controlling rise time of applied pulse.

A typical scr rated at 150 amp d-c carried 32,000 amp after proper soaking. A 250-amp d-c rated unit carried 40,000 amp without failure. Manufacturers publish high ratings for 60 cps applications, but Aaland points out that rise time is too slow for switching circuit use.

## Orbital Dipole Belt Declining as Predicted

BOSTON—Project West Ford belt of orbiting dipoles is being modified by solar radiation pressure and earth's gravity field, indicating that predictions of a three-year life were correct (p 12, July 5). This report was made to URSI in Tokyo this week by W. E. Morrow, Jr., of MIT Lincoln Laboratory.

Morrow said only about half the payload became useful x-band dipole scatterers due to uneven dispenser heating, that perigee height continues to decrease, and that the belt's orbital-plane thickness has increased. In the week after the May 9 launch, teletypewriter and voice messages and digital data at speeds to 50,000 bits per second were transmitted. The data rate has dropped to about 1,000 bps, enough for multichannel teletypewriter, but

## New Material Improves Polarization of Light

IBM SAYS it has developed a new material, europium orthosilicate, that more effectively rotates the plane of polarization of light when subjected to a magnetic field. This may point the way toward the practical use of magnetic fields to control light, including laser beams, according to IBM.

IBM scientists M. W. Shafer, T. R. McGuire and J. C. Suits measured the material's Verdet constant—the rotation per unit of thickness per unit of magnetic field—at 2.5 minutes per oersted per centimeter at room temperature. This is nearly 10 times larger than previously reported values, IBM says.

Europium orthosilicate is highly transparent to red and yellow light and is ferromagnetic at low temperatures. It is easy to handle and chemically stable in normal use, IBM says. The Air Force helped support the research leading to its discovery.

## Metal Strip Shows Thin-Film Potential

LONDON—Nickel-iron alloys cold-rolled down to a thickness of 1.5 microns show properties akin to evaporated films for electronic applications, according to researchers of Britain's General Post Office.

Theory says a rolled metal strip should not show anisotropic characteristics at thicknesses much above 0.5 micron, but the 1.5-micron strip is definitely anisotropic, although rapidity of switching is not comparable to that of evaporated film devices.

not for good voice communication.

During the belt's maximum density in the first few weeks, photoelectric observations were made. No photographic observations or radio-telescope detection have been reported. Three U.S. observatories have reported no interference with ground-based optical astronomy. Apparently only the special equipment and 60-foot dishes at Westford, Mass., and Camp Parks, Calif., have detected the completed belt.

## High-Frequency Lighting Lowers Operating Costs

NEW YORK—Costs of operating large fluorescent lighting systems can be cut by installing inverters with silicon-controlled rectifiers (p 30, July 19), R. W. Lewis, general manager of GE's Low Voltage Switchgear division, said last week. The 3,000-cycle inverters boosted light output 6 percent and reduced operating

costs 10 percent in a typical office building, an independent engineering firm found. GE's new solid-state converter, the heart of the system, statically rectifies conventional 60-cycle power and then inverts it to the more efficient 3,000-cycle level.

## Insulated Integrated Circuits?

LOS ANGELES—Autonetics division of North American Aviation has epitaxially grown silicon single crystals on sapphire crystals by a vapor-deposition process—high-temperature hydrogen reduction of SiCl<sub>4</sub>. Arnold Miller, research director, reports that since sapphire insulates, while silicon substrates do not, the technique may reduce silicon integrated-circuit processing while improving reliability and design flexibility. Diodes have been fabricated by planar techniques from silicon grown on sapphire

## New Gun Intensifies Electron-Beam Power

LIVERMORE, CALIF.—An extremely high-power electron gun, able to generate a beam with a current density of 50,000 Mw/sq in., has been developed by Ronald Hill, of Lawrence Radiation Laboratory. Hill reports the gun generates a 1-mil-diameter beam in a 1-msec pulse and has been pulsed at rep rates to 500 pulses per second.

Four features make the device unique: oxide-cathode contamination problems are reduced by using a barium-strontium oxide cathode that is large, 1 inch in diameter; no focusing magnets are needed with the stainless-steel Pierce-type lens system; operating voltage is below the x-ray level to avoid operator hazards; filament voltage is gated to keep the filament's magnetic field from defocusing the beam.

The gun, an offshoot of plasma studies, is now being used for welding, machining and drilling holes in stainless steel, tantalum and aluminum.

## MEETINGS AHEAD

NATIONAL POWER CONFERENCE, IEEE, ASME; Netherland-Hilton Hotel, Cincinnati, Ohio, Sept. 22-25.

INTERNATIONAL TELEMETERING CONFERENCE, IEE, IEEE, ISA, ARS, IAS; London, England, Sept. 24-27.

PHYSICS OF FAILURE IN ELECTRONICS SYMPOSIUM, Armour Research Foundation and Rome Air Development Center, Illinois Institute of Technology, Chicago, Sept. 25-26.

ELECTROCHEMICAL SOCIETY FALL MEETING, ECS; New Yorker Hotel, New York, Sept. 29-Oct. 30.

CANADIAN ELECTRONICS CONFERENCE, IEE REGION 7; Automotive Bldg., Toronto, Ont., Canada, Sept. 30-Oct. 2.

SPACE ELECTRONICS NATIONAL SYMPOSIUM, IEEE-PTG-SET; Fontainebleu Hotel, Miami Beach, Fla., Oct. 1-3.

ELECTROMAGNETIC RELAYS INTERNATIONAL CONFERENCE, IEEE, ICER, IEE, Tohoku University, Science Council of Japan; Sendai, Japan, Oct. 8-11.

ELECTRICAL-ELECTRONICS CONFERENCE, Aerospace Electrical Society; Pan Pacific Auditorium, Los Angeles, Calif., Oct. 9-11.

NATIONAL AEROSPACE CONFERENCE, National Society of Professional Engineers; Lafayette Hotel, Long Beach, Calif., Oct. 10-11.

SOCIETY OF MOTION PICTURE-TELEVISION ENGINEERS CONVENTION, SMPTE; Somerset Hotel, Boston, Mass., Oct. 13-18.

AUDIO ENGINEERING SOCIETY FALL CONVENTION—EXHIBIT, AES; Barbizon-Plaza Hotel, New York, Oct. 14-18.

NATIONAL ELECTRICAL MANUFACTURERS ASSOCIATION ANNUAL MEETING, NEMA; Edgewater Beach Hotel, Chicago, Ill., Oct. 21-24.

NATIONAL ELECTRONICS CONFERENCE, IEEE, IIT, Northwestern University, University of Illinois; McCormick Place, Chicago, Ill., Oct. 28-30.

ELECTRON DEVICES MEETING, IEEE; Sheraton Park Hotel, Washington, D. C., Oct. 31-Nov. 1.

17TH NORTHEAST ELECTRONICS RESEARCH-ENGINEERING MEETING, New England Sections IEEE; Commonwealth Armory and Somerset Hotel, Boston, Mass., Nov. 4-6.

## ADVANCE REPORT

PTG-MTT INTERNATIONAL SYMPOSIUM, IEEE; International Hotel, Idlewild Airport, New York, May 19-21, 1964; Dec. 13 is deadline for 50 to 100-word abstracts, 500 to 1,000-word summaries with up to 6 figures. Submit to Leonard Swern, Chairman, Technical Program Committee, 1964 PTG-MTT International Symposium, Sperry Gyroscope Co., Great Neck, Long Island, N. Y. Topics include all areas of microwave research, development, application; also, microwave-analog aspects of lasers, high-power techniques, millimeter and submillimeter wave techniques and components.

## Computer Runs Studies Of Crystal Structures

IBM IS USING a computer-controlled x-ray diffractometer system to study semiconductors and ferrites. The company reported last week that the system, sponsored in part by Air Force, reduces manual operations and experiment errors in x-ray crystallography. The system operates in a closed-loop decision-making manner to determine atomic or chemical configurations.

## Where the Boom Is

SOME DIMENSIONS for the boom anticipated in integrated circuits were put forth last week by Westinghouse Electric. C. Harry Knowles, general manager of the firm's Molecular Electronics division, set this year's market at \$20 million to \$25 million, predicted \$40 million for 1964, \$70 million for 1965, \$100 million for 1966 and saw sales of several hundred million a year by 1970

## Radar Will Set FAA Standards

## IN BRIEF

TRACKING RADAR intended to set accuracy standards for checking new electronic devices and air navigation systems will be installed at the FAA's National Aviation Facilities Experimental Center next spring under a \$1-million contract awarded Reeves Instrument division of Dynamics Corp. of America.

With 20-yard accuracy at 100 miles, the radar will operate in C-band with power of 250 kw and prf of 410 at a pulse width of 0.8  $\mu$ sec. Antenna gain will be 45 db, receiver has 104 dbm sensitivity and is capable of simultaneous skin and beacon tracking. Noise figure, employing a tunnel-diode r-f amplifier, is 5 db. Automatic tracking rate is up to 5,000 yards per sec.

Computers will extract digital range, azimuth, elevation from radar and supply an additional accumulated time-data word. Equipment formats this data on digital tape and feeds a 3-kc telephone line simultaneously to a remote IBM 7090 computer

### Germanium Dioxide Gets Some Protection

LONDON — Tetragonal germanium dioxide, a rare and highly stable modification of germanium dioxide, will soon be available to extend the use of germanium transistors and other devices, according to researchers at the British Post Office.

Germanium devices have previously been difficult to protect because normal germanium dioxide is highly soluble. The tetragonal form is extremely stable, even to hydrofluoric acid solutions, but its production has been difficult. With the new method, a water/hydrogen atmosphere controls the minute quantities of oxygen required for the reaction and this promises to have commercial applications.

### Virtual-Image Optics— Help for Astronauts?

VIRTUAL-IMAGE system of reflecting optics was suggested last week as the "most realistic out-of-the-window display for space rendezvous training." Its advantage over a two-dimensional pictorial is perspective: space vehicles, planets and stars could be cast in apparent size at depth to infinity.

Thomas P. Neuberger, ACF Electronics, said that celestial images could be created by television monitor, rear-projection screen, transparency, or by scale model.

Different images would be viewed in composite in front of the astronaut-trainee.

### Helium-Neon Laser Averages 1-w Output

SAN FRANCISCO—Energy Systems Inc. has succeeded in achieving an average power output of 1 w and a peak power of 100 w from a helium-neon gas pulsed laser. Technique used produces inversion to produce nonthermal equilibrium by pulsing the gas with a high-voltage pulse with short rise time.

Peak-power output is approximately 25 w per line, or peak power averaged over all strong lines about 100 w peak. The four lines are in the near infrared; frequencies are 11,177, 11,523, 11,614 and 12,066 A.

Cold cathode d-c discharge is used. Second harmonic conversion techniques can be used to get lines in red, yellow, green and orange visible to naked eye. They think that they have output out to 3 or 4 microns but can't see because of limitation in glass windows. Next they expect to use a prism to concentrate all the power in one line with selective frequencies.

Energy Systems Inc., of Palo Alto, was formerly called Radiation at Stanford. The company bought themselves away from Radiation Inc., of Melbourne, Fla. to become an independent private corporation again.

NASA HAS ADOPTED uniform, general guidelines to help contractors boost reliability of space system hardware. They will apply to contracts estimated at more than \$1,000,000.

WESTINGHOUSE has built a 27-ounce tv camera that draws only 1 w. It uses integrated circuits and a 1-inch vidicon. Company says it's for aerospace use, not for commercial sales. In orbit, slow-scan capability would minimize telemetry bandwidth.

MAGNETIC-INK check sorting in the new IBM 1240 bank data processing system is controlled by programmed instructions, reducing the number of electronic circuits. The 1240 reads as many as 1,200 documents a minute.

NORWAY, Sweden and Denmark have agreed to provide a ground station to receive multichannel telephone or telegraph signals transmitted from the U. S. via NASA's experimental communications satellites.

EXPLORER XVI, after 7½ months satisfactory performance, has stopped transmitting data.

ARMY ENGINEERS will get portable northseeking gyros from Lear Siegler Inc., Calif., under a \$339,000 Army contract.

THIRD TIROS command and data acquisition station is now operational at Fairbanks, Alaska.

ELECTRONIC gage inspects Bethlehem Steel Co.'s railroad car wheels at 100 per hour. It measures 10 dimensions to AAR standards.

EIA'S Distributor Products Division, established in June, has elected Norman A. Triplett its chairman.

FAIRCHILD'S new switching diode has a 50-picosecond recovery time, the firm said. It leads off a family of 15 high-speed switching devices.

NASA will launch five photo spacecraft in three years to gain close-range lunar topographic data.

FAA has named Boeing, North American, and Lockheed as competitors for prime contracts to build a supersonic commercial airliner.

LITTON has reached agreements to acquire Adler Electronics and Clifton Precision Products.

EXPERIMENTAL electroluminescent lighting system for NASA's Apollo-Gemini environmental simulator will be supplied by Madigan Electronic.

## Probe of Federal Research Is On, But Betting Is Against Results

Congress's select committee on research programs is organizing for a year's study of the sprawling federal research effort, following last week's unanimous endorsement by the House. Smart Washington money is already being bet against its ability to match glowing promises with hard results. The study group is the latest in a series of congressional efforts to impose on federal science and technology programs a neatness and order understandable in Congress but incomprehensible in the research agencies. One such effort—in oceanography—met with a presidential pocket veto last year.

What the new study has going for it is its origin in the Rules Committee. This is an attempt to bypass the Science, Military, Nuclear and other committees which have areas of research staked out as their own jurisdictions. But the chief blocks to the new group's efforts to coordinate federal research will still be jurisdictional. Chairmen of the subject committees have accepted seats on the new panel—partly to contribute and partly to guard against invasion of their bailiwicks. And government officials attempting information coordination on research programs necessary to a score of government agencies forecast dire consequences for any attempt to force-feed more formal coordinating procedures.

## ComSat Design Bidding Soon

Within the Next Two Months, the Communications Satellite Corp. (CSC) hopes to call for industry proposals for engineering design work on its first satellite communications system. CSC is now deciding what elements of the system the requests will spell out in detail and what parts will be left to contractor ingenuity. A key part of the proposal will be how companies or teams will guarantee a three-year system life.

CSC's present thinking is to place one or more six-month engineering, production and cost studies. System design and some breadboard work would be completed during the six months, then CSC would move into production of the system by mid-1964.

## FCC Told Its Satellite Rules Too Detailed

Critical Comments have been filed with the Federal Communications Commission over its proposed rules on Communications Satellite Corp. (CSC) procurement. Replies are to be filed by September 23 and FCC is expected to rule on final regulations by year-end or sooner.

Complaints on the rules were filed by CSC, AT&T, General Telephone & Electronics, Electronic Industries Association, and Aerospace Industries Association. Generally, they criticized FCC for the detailed way FCC would be involved in CSC operations.

Under the proposed rules, for example, CSC could not award a contract over \$2,500 without first notifying FCC. Comments filed want this raised to \$100,000 or higher. Other similar comments want FCC removed from minor operations of CSC, but in overall control of procurement practices.

## Unlicensed CRO Exporter Fined

B. W. Trading Corp., a New York export-import company, and its president, Benjamin Winkler, were fined \$6,000 by a federal district court for attempting to export strategic equipment (four oscilloscopes with accessories) without an export license. The \$8,800 shipment was seized at Idlewild Airport, New York, after Winkler had delivered it to an airliner for export to Austria. Winkler had applied for an export license for these and 13 other oscilloscopes, but the license had not yet been approved. Customs officials discovered the shipment.



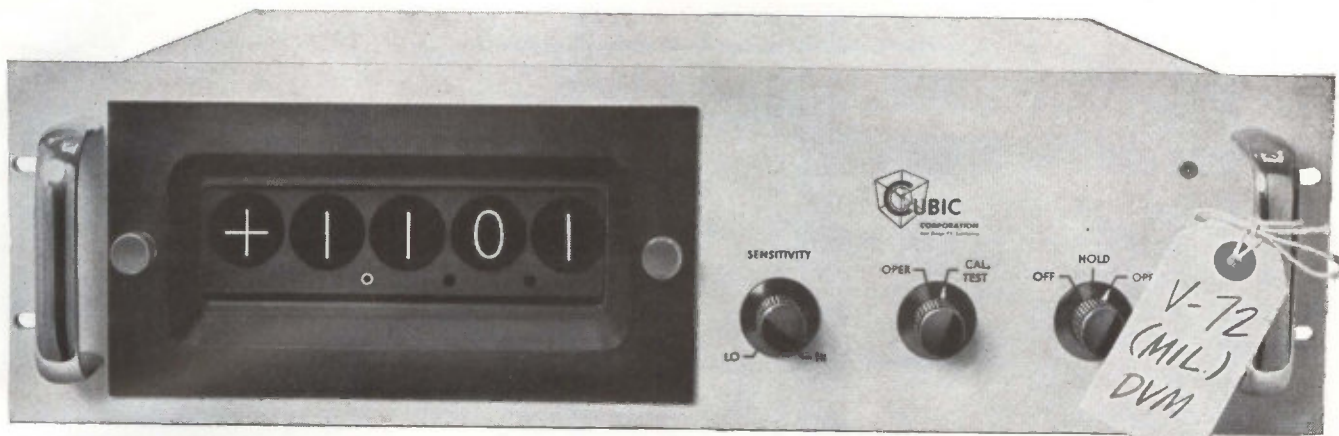

## TWO OF A KIND!

Cubic's commercial V-72 is essentially the same DVM as the militarized instrument Cubic built for the Polaris program, where it is part of the calibration console for the inertial navigation system. Cubic now offers this model at a price to meet commercial re-

quirements. If you need a 1-mv, 4-digit DVM with automatic ranging and polarity, that meets or exceeds Specification MIL-E-16400, here it is. For additional information about the V-72, write to Dept. B-182 or get in touch with your nearest Cubic representative.

### SPECIFICATIONS

**Absolute Accuracy:** .01% of reading,  $\pm 1$  digit

**Sensitivity:** 1 mv

**Reference Stability:** .005% for 1 month; .01%, 1 year

**Bridge Linearity:** .003%

**Temperature Range—**

Non-operational:  $-50^{\circ}\text{C}$  to  $+72^{\circ}\text{C}$   
Operational:  $0^{\circ}\text{C}$  to  $+55^{\circ}\text{C}$

**Input Specs (Floating)—**  
Z = 10 megs at balance  
CMR AC: 80 db @ 400 cps  
100 db @ 60 cps  
DC: 120 db

**Range & Polarity:** 0.001 VDC to 999.9 VDC, completely automatic

**Average Balance Time:** 400 msec; worst case, 800 msec

**Calibration Cycle:** 6 months

Also meets MIL-E-16400 (Electronic Equipment, Naval Ship and Shore, General Specification)



**CUBIC**  
CORPORATION  
SAN DIEGO, CALIF. 92123

INDUSTRIAL DIVISION



## What new data recorder can be simple — or sophisticated? **AMPEX FR-1200**

Here's the newest recorder from Ampex—the FR-1200. It's a medium-priced, basic data recorder that's modular in design and built for long-term reliable operation. With the FR-1200, you're offered various types of electronics and accessories, and with these you can tailor a recorder as simple or as sophisticated as you want—one that meets your needs and budget now, and can be expanded as you grow. You can start at the simplest level—a one-speed, record-only recorder—and build all the way to a 14-track, record/reproduce system with six-

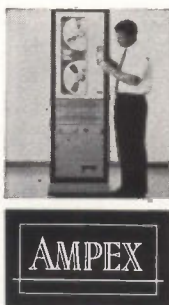

speed (1½ ips to 60 ips) electrically switchable electronics and transport. Ampex ES-100 solid state electronics offer Direct recording to 300 KC, FM recording to 20 KC, or IRIG compatible PDM. The FR-1200 also features a new tape transport. Rugged and reliable, it offers low flutter, prevents tape stress during fast starts, provides constant tape tension on both reels and has new tape braking and guidance systems. For details write: Ampex Corporation, Redwood City, California. Sales and service engineers throughout the world.

**“Will the most sensitive,  
most stable,  
most reliable  
low current SCR  
please stand up!”**

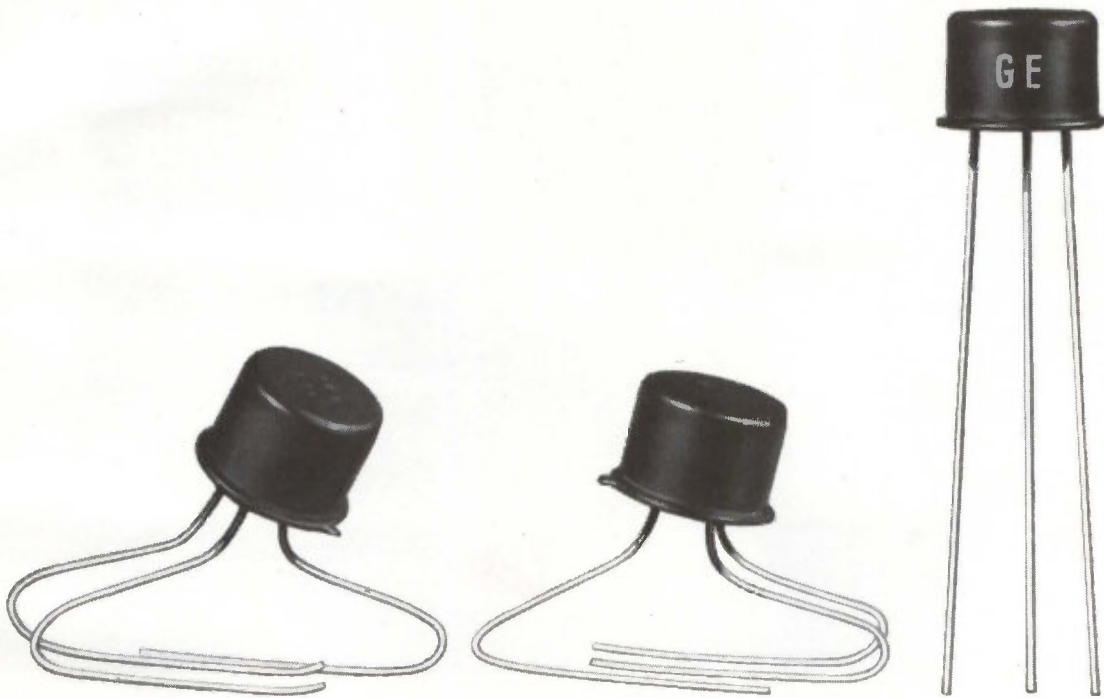

Now you can eliminate the possibility of premature firing... turn on the SCR when you want it in lower power switching and control applications. The G-E C5 SCR requires no more than 200  $\mu$ A trigger current at 25°C. The C7 requires only 20  $\mu$ A. Both devices have guaranteed upper and lower limits on gate voltage to trigger. The narrow spread in gate triggering requirements permits the design of simple, yet reliable, triggering circuits. The long term stability of blocking voltage, leakage current and, most important, the sensitive gate characteristics are well documented by extensive life test data.

For applications that do not require the sensitivity or low blocking currents of the C5 and C7, G. E. also offers the 2N1595 series. For complete details, including spec sheets, see your G-E Semiconductor District Sales Manager. Or write Section 161118, Rectifier Components Department, General Electric Company, Auburn, New York.

**MAXIMUM ALLOWABLE RATINGS**

	C5	C7	2N1595-2N1599 (2N2344-2N2348)
PRV/V <sub>BO</sub>	25-400	25-200	50-400 volts
RMS Forward Current	1.6	1.6	1.6 amperes
Peak One Cycle Surge Current ( <i>i</i> <sub>surge</sub> )	18	15	15 amperes
Storage Temperature	← -65°C to +150°C →		
Operating Temperature	-65°C to +125°C	-65°C to +100°C	-65°C to +150°C

**GENERAL  ELECTRIC**



The new name came after we realized how many *other* changes have been made recently in our company.

**Item:** expansion of our markets and our plans for developing them.

**Item:** management's decision to intensify planning of new products and materials.

**Item:** a three-fold expansion of our research and development facilities, highlighting microelectronics.

**Item:** addition of several internationally famous scientists to our already strong research staff.

**Item:** modernization of all production facilities through our mechanical automation program.

**Item:** even greater emphasis than before on space age quality, reliability and product performance repeatability.

Reason enough to change our name to one more descriptive of the advanced thinking within our 35-year-old company, don't you agree?

ERIE

TECHNOLOGICAL

PRODUCTS, INC.

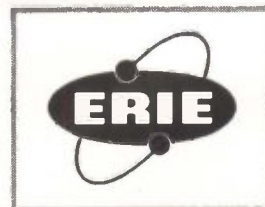

644 West 12th Street  
Erie, Pennsylvania

FORMERLY ERIE RESISTOR CORPORATION

WHERE IMAGINATION CREATES VALUE IN ELECTRONICS

# GATLING-GUN LASER

## NOVEL APPROACH TO OPTICAL RADAR

Array of laser crystals is sequentially Q-switched to achieve high repetition rates. New technique may be useful in optical radar and communications

By MICHAEL F. WOLFF, Senior Associate Editor

**DETAILS** of a new technique for achieving high laser pulse repetition frequencies were revealed this week by the Orlando division of Martin-Marietta. Method involves sequentially Q-switching an array of lasers by a rotating Fabry plate—much in the fashion of the old-time Gatling gun (ELECTRONICS, p 17, May 24.)

Result is to combine the prfs of several laser beams along identical paths, thus achieving higher prfs than can be obtained with a single

GATLING-GUN laser inventor J. H. Burkhalter examines one of the six laser cavities. Currently, Burkhalter, a research physicist at Martin-Orlando, heads a group studying laser effects on humans for the Army Surgeon General's office



## ORDNANCE TO OPTICS

The Gatling gun was an early type of machine gun. It consisted of a revolving cluster of barrels around a central axis. Each barrel was automatically loaded and fired during each rotation of the cluster. The multiple barrels compensated for the time it took to load.

In similar manner this Gatling-gun laser increases laser firing rates by using multiple laser crystals to compensate for the time it takes for a pulse to build up in a crystal.

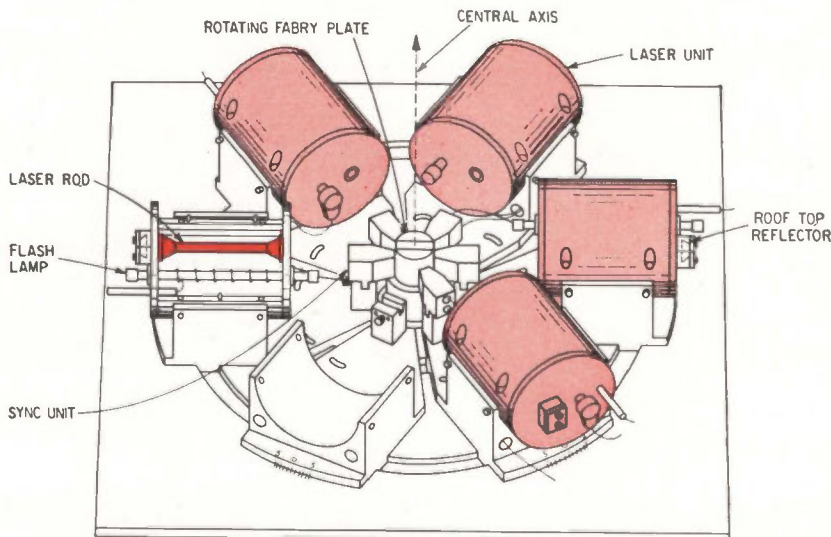

GATLING-GUN SEQUENCER has six lasers arrayed about a central axis—Fig. 1

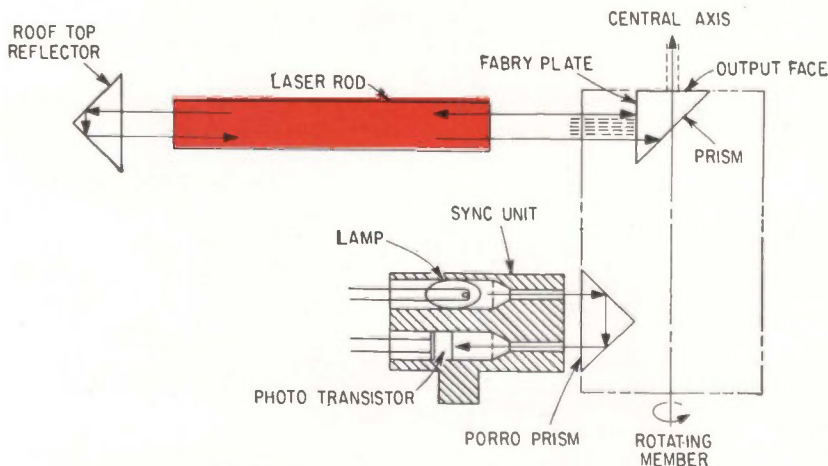

SECTIONAL VIEW of Gatling-gun laser optics—Fig. 2



SCHEME FOR a nonrotating Fabry plate—Fig. 3

crystal. Martin envisions that, because of this, the principal application of the Gatling-gun laser will be in optical radar, with target illumination for semiactive homing being a natural extension of this application.

The technique also permits selecting an arbitrary sequence for firing the lasers as well as an adjustable interval between firings. Thus, pulse coding can be achieved and there is a possibility the device could be used for coded communications since the code could be easily varied each day.

**Q-Switching**—In a laser, there exists competition between the pumping source trying to increase the population inversion and laser action trying to decrease it. Thus the population inversion is limited by the laser action itself and power level of the oscillation is restricted.

Q-switching is a process in which the resonance of the Fabry-Perot cavity is controlled in such a way that this competition is largely eliminated. In Q-switching, the system is made nonresonant (low Q) during the pumping period when the population inversion is increasing, thus enabling the degree of population inversion to be increased far beyond that for an ordinary resonant system. Population inversion goes through a maximum (optimum) value even in the absence of resonance.

If the system represented by the cavity can be made suddenly resonant, that is, with a high Q at or near the time of this maximum population inversion, the energy stored in excited levels is stimulated to emit an intense beam of light. The time required for this energy conversion is the output pulse duration and is determined by the amount of energy present and the suddenness with which resonance is approached, that is, by the rate of change of Q. Obviously, if Q is maximized too slowly, the energy will be dissipated before maximum Q is reached. Peak power is determined by the pulse length since the pulse energy is essentially constant and equal to the stored energy.

Several techniques exist for Q-switching, such as Kerr cell switching, rotating apertures, spin-

ning prisms, and spinning mirrors, but none of these is known to have been used with a laser array capable of being fired in a selected manner at a high prf. The Q-switching technique developed at Martin is that of rotating a Fabry plate at high speed to control Q.

**Six Barrel Laser**—Martin Orlando is constructing a multiple laser sequencer that has a Fabry plate common to six laser units. The plate rotates at 10-15,000 rpm to control the Q and at the same time direct intense output pulses from all or selected units of the array at a high prf along a designated axis.

The six lasers are arrayed about a central axis as shown in Fig. 1. A rotational member carrying two prisms is located on this axis. One surface of the top prism comprises the Fabry plate while the bottom prism is used for synchronization. (See Fig. 2.)

The lasers can be ruby, neodymium-doped calcium tungstate, or other solid materials. In operation each laser is pumped with a xenon flashlamp just before the rotating Fabry plate faces the rod. The order of pumping is selected by a programmer.

The transient alignment of the plate and a rooftop reflector prism furnishes the necessary optical resonance so that the laser can fire. The emitted light beam is transmitted through the Fabry plate and reflected from the hypotenuse surface of the prism along an axis that is the same for all six lasers. By controlling these firings the sequence of output pulses can be varied to achieve pulse time coding, since the interval between all pairs can be made unique.

Future models of the device will have the Fabry surface on a separate piece of transparent material so it will not rotate with the prism. Such a prism is optically within the resonant cavity and light leaving the laser rod enters the near face of the prism (Fig. 3), is reflected toward the Fabry plate and returns along the same path with a small portion being transmitted through the plate. Typical Fabry surfaces are coated to reflect 98 percent of the light and transmit 2 percent.

It is also not essential for the

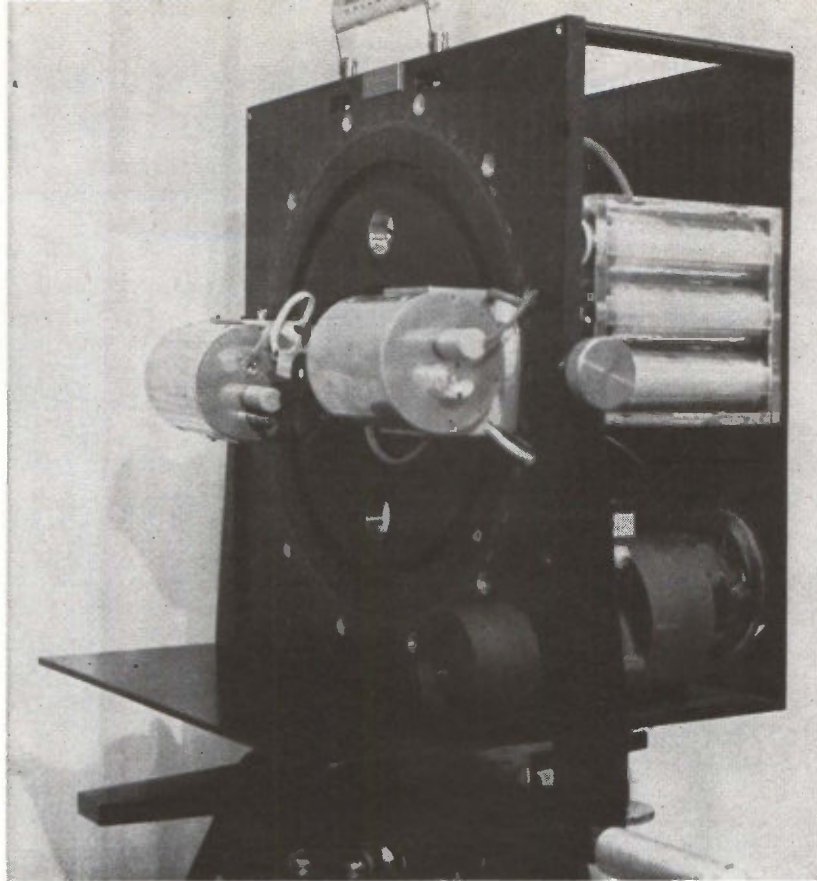

LABORATORY MODEL of laser sequencer with two cavities installed

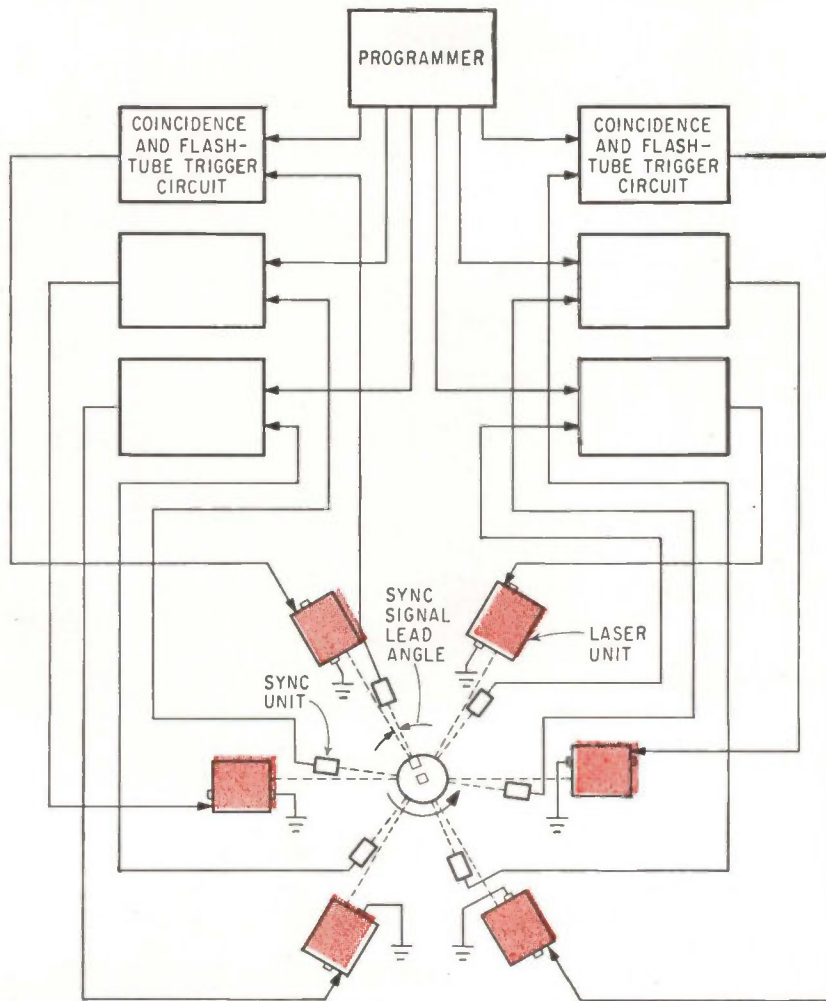

PROGRAMMER and associated circuits for selecting laser to be fired—Fig. 4

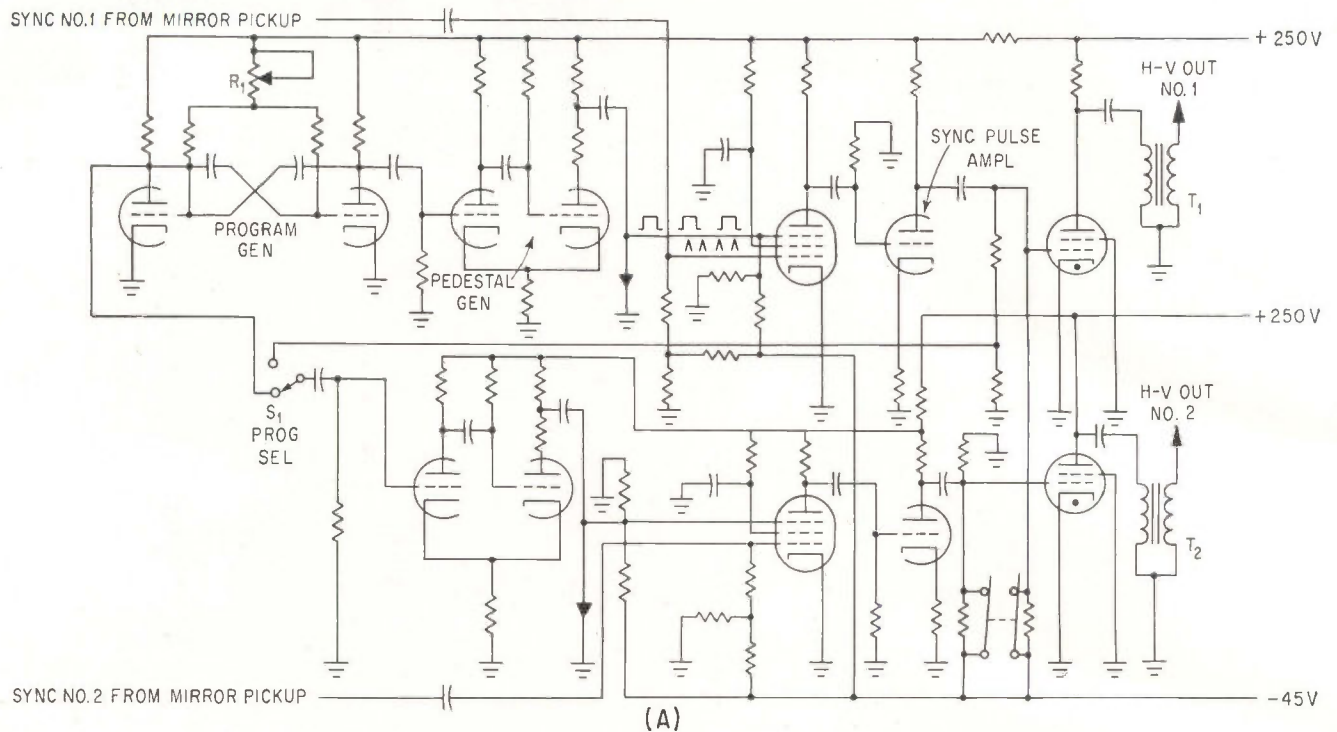

rotating prism to have its axis of rotation through its body—it could rotate about a central axis. In this case, the output beams will not be along a common axis but will be in a common direction, which, at large distances, gives the same effect. This arrangement enables different prisms to rotate about the same axis without interference, with each prism on a different level of a multilevel central rotating member and associated with a different group of lasers. For example, such lasers could be in parallel or, for nonright-angle prisms, in cone shaped tiers with the resulting output then consisting of the outputs of all the lasers of all the tiers. In this manner, many lasers could be combined in their prf and output beam direction.

The sequencer can select a firing sequence for the individual lasers, which may differ in their spacing intervals, polarization, output frequency and other characteristics. In addition, the interval between selected lasers can be adjusted, either by adjusting the speed of the prism drive motor which adjusts all such intervals proportionally, or by adjusting individual prism tilt angles.

Because a particular rotation period can be selected during which one or more of the pump sources is energized, the sequencer output can

be coded with selected numbers of pulses of selected spacings in time, making it useful as a digital communications transmitter, as an illuminator for a coded seeking device such as in a semiactive missile, as a ranging set to gain increased sensitivity by means of pulse correlation techniques, or in any device requiring a high prf of either uniformly or nonuniformly spaced pulses.

**Synchronization**—Sequencer flashtubes are synchronized with the rotating prism through use of the lamp, Porro prism reflector, and phototransistor of Fig. 2, and a coincidence and flash trigger circuit. The reflector rotates with the Fabry plate and reflects the beam from the lamp to the phototransistor just before the Fabry plate is aligned with its image in the rooftop reflector. This establishes a lead angle (Fig. 4) that is adjustable for each laser. In this way a series of pulses is generated to time the high-voltage pulses for the flashtubes.

Figure 5A shows the circuit for flashing two tubes. The program and pedestal generators supply timing pedestals that are fed to the coincidence amplifier along with the train of synchronization pulses from the phototransistor. Timing relation-

ships are shown in Fig. 5B. The amplified sync pulse from the coincidence amplifier goes to a thyatron circuit which generates the high-voltage pulses to trigger the flashtubes. Firing rate is controlled by 500,000-ohm potentiometer  $R_1$  which sets the pulse rate from the pedestal generator.

Switch  $S_1$  enables the operator to select how the lower channel in Fig. 5A will be actuated. In the position shown the flashtube associated with transformer  $T_2$  will fire as a result of coincidence of a pulse from the mirror pickup with a timing pulse pedestal. In the other switch position the flashtube in the second channel will fire after the one in the first channel.

**Selection**—There are a number of ways one can select the order in which the various lasers in the array fire. Referring to Fig. 4, the programmer is connected to each of the six coincidence and flashtube trigger circuits so as to supply the equivalent of the timing pulse pedestals discussed previously.

The six synchronization units generate, as before, a series of closely spaced synchronization pulses. When one of these pulses is in coincidence in a trigger circuit with a pulse from the programmer, a high-



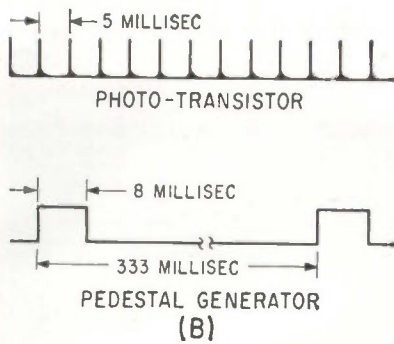

PAIR OF LASERS can be selectively triggered with circuit of (A). Synchronization timing diagram is shown in (B)—Fig. 5

voltage signal will be produced that causes the respective laser to fire when the Fabry plate faces it. The manner and order in which timing pulses are generated by the programmer is flexible and a variety of programmers can be used to make selection of laser firing order dependent upon the form of the information to be coded.

Figure 6 is a functional diagram of a sequencer that allows selecting two sequential operations by de-

pressing one of thirty buttons. As shown in this figure, the trigger circuit comprises an AND gate with inputs from the phototransistor and a separately generated gate source. When the enabling pulse is present on input 2 the pulse from the phototransistor will trigger a thyatron which operates the flashtube, thus firing the associated laser. The thyatron output pulse simultaneously triggers a gate generator. This produces an enabling gate pulse on output line 3 whose duration is equal to the time of one revolution of the Fabry plate, and which then can be used to trigger the other laser.

The switching scheme may be explained by assuming that key  $K_{12}$  is depressed in order to fire lasers 1 and 2 in sequence. Depressing this key puts a steady enabling bias on input 2 of the first trigger circuit. Thus, the first incoming pulse from photodetector 1 initiates the firing of the flashtube and laser. Depressing key  $K_{12}$  also connects the gate generator to the second trigger circuit. Thus, the gating pulse generated when trigger circuit 1 fires appears as an enabling gate for trigger circuit 2, which will then fire at the next incoming pulse from photodetector 2, completing the desired sequence.

Utilizing the same trigger circuits it is also possible to arrange the switching so that all six lasers can be selectively fired or any of the six fired in any desired sequence merely

by punching individual buttons.

The operation of this switching method is similar to that described for Fig. 6 but results in all 6 of the trigger circuits being connected effectively in tandem such that each one is sequentially enabled by the gate generator in its immediately preceding trigger circuit only for the time of one revolution of the Fabry plate. This allows each unit to fire in sequence and in the selected order. Since the gate pulse generated by the various trigger circuits has a duration equal only to the time of one revolution of the Fabry plate, each laser will fire only once even though several revolutions may be necessary for the complete firing sequence.

**Experimental Results**—The crystal used for testing the first sequencer model was an optically imperfect  $2 \times \frac{1}{4}$ -inch calcium tungstate crystal which gave an output of about one kilowatt (peak) with ten joules input. On this program the prf goal would have been 20-30 cps with a six-barrel configuration (five pps for a single crystal). Actually, a pulse repetition rate of 6 pps was obtained for a running period of about 60 seconds in each barrel, or 36 pps for all six barrels. For shorter periods of time (on the order of three to four seconds) a pulse rate of 50 pps was achieved for a single crystal.

Using optically better and larger  $3 \times \frac{1}{4}$ -inch crystals, 10 kilowatts out were obtained with 100 joules input. It is felt that glass-doped neodymium would have provided nominally 250 kw using 1,100 joules input. Expectations are that a megawatt can be achieved soon. (The prf of a single crystal is reduced to about 1 every 10 seconds in the high kilowatt or low megawatt region.) Pulswidth in all cases was on the order of 50 nanoseconds. These energy and power numbers are considered typical and do not represent either optimum or maximum values; for example, no cooling was employed in this model.

The Gatling-gun concept is expected to increase the prf by a factor corresponding to the number of barrels. Any further increase in prf would have to come through better heat transfer methods for removing heat in the crystals.

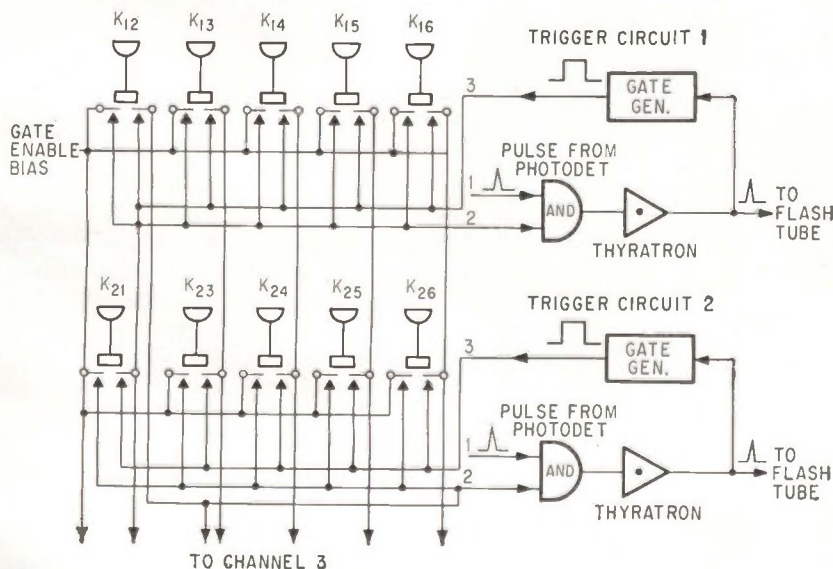

ANY TWO LASERS may be fired in sequence by pushing one button—Fig. 6

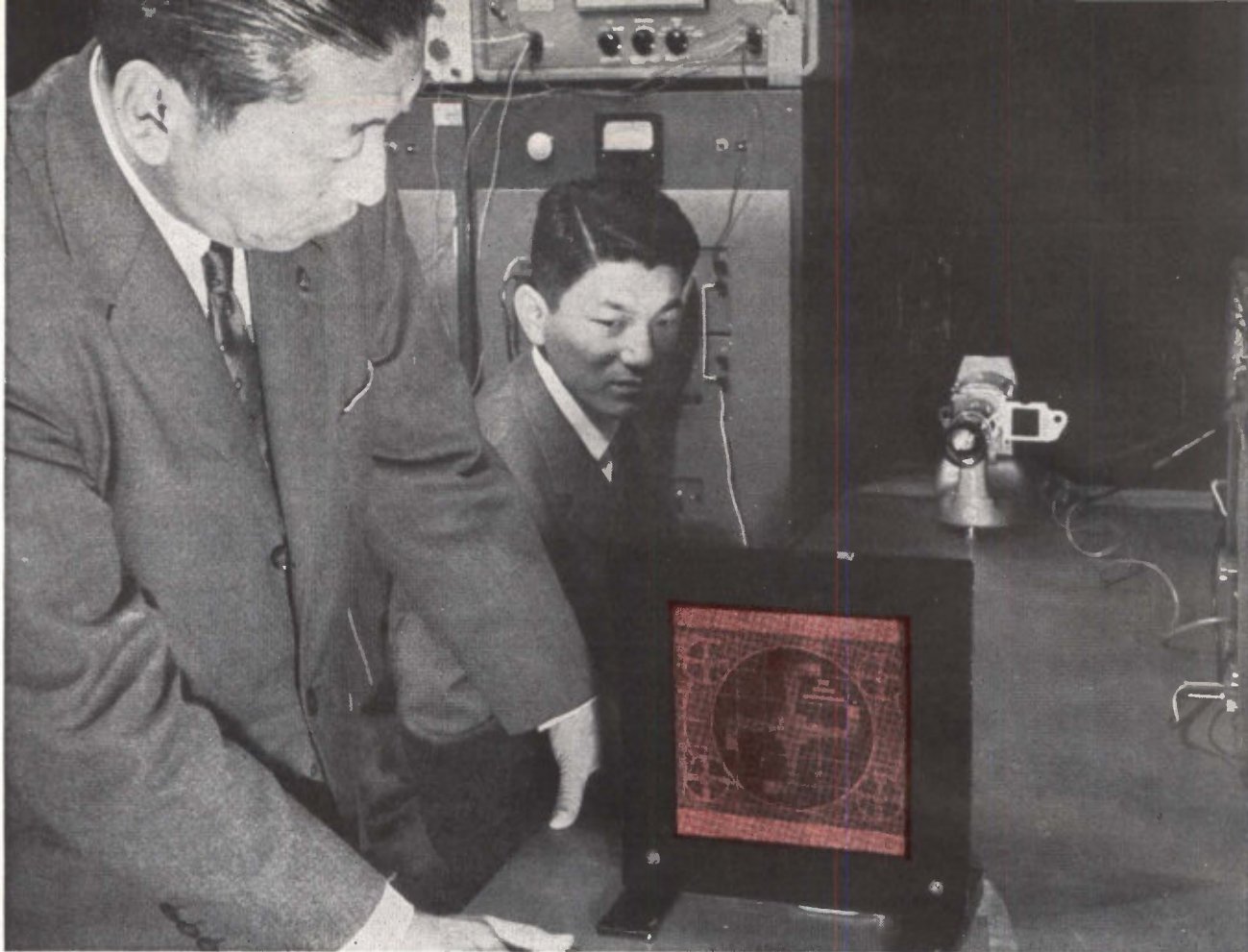

AUTHORS Tadao Kohashi (right) and Koh-ichi Miyaji test resolution and grey scale on a 17-cm electroluminescent photoconductor light amplifier

## BREAKTHROUGH IN LIGHT AMPLIFIERS

# EL-PC IMAGE INTENSIFIER

By **TADAO KOHASHI** and **KOH-ICHI MIYAJI**  
Matsushita Research Institute, Tokyo, Inc.,  
Ikuta, Kawasaki, Japan

**THIS LIGHT AMPLIFYING PANEL**, a sandwich of photoconductive and electroluminescent layers, operates as either a positive or negative image intensifier, depending on amplitude and phase of its two power supply voltages. The panel amplifies visible light, infrared, or x-ray images.

Amplified output image is continuously variable from a positive-intensified reproduction of the original to its negative image similarly intensified. Control of gamma and brightness over a wide range is possible at the same time.

Numerous applications for this panel are foreseen. In photography it can be used to convert a negative image into a positive one. Image intensification and ability to choose a negative or positive image at will

make it unusually useful as a fluoroscope screen.

A V-shaped gamma characteristic is also available. As input radiation is continuously increased light output decreases, reaches a minimum, and increases again. This characteristic gives an unnatural rendition of the input image, but provides better detail and control of characteristics in selected portions of the image. Further investigation of medical applications in cooperation with a university hospital is planned.

If photoconductive material with rapid response time can be developed, this panel might lead to picture-on-the-wall tv. Its application in radar, where rapid response is not imperative, will probably come first.

**Schematics**—A cross section line drawing of the experimental light amplifying panel and its power supply connections is shown in Fig. 1. This structure, with photoconductive layer sandwiched between electroluminescent layer and transparent dielectric layer, is

## LIGHT AMPLIFIER HAS BRIGHT FUTURE

Early electroluminescent-photoconductive (el-pc) light amplifiers relied on two basic phenomena—a photoconductive layer to receive the incoming picture and convert it to electrical signals, and an electroluminescent layer to convert the electrical signals back into visible (and brighter) light. Overall gain depended on electroluminescent efficiency and photoconductor sensitivity; higher gain could be produced at the expense of resolution by connecting individual amplifiers in cascade.

This new light amplifier draws on the same fundamental principles but represents a radical improvement over early designs, much as a triode is more versatile than a diode.

Besides straightforward amplification of images projected onto its photoconductive layer, the amplifier can turn negative pictures into positive ones (and conversely), and also emphasize chosen sections of an image by displaying it as a mixed positive and negative picture. This last feature is especially promising for industrial x-ray

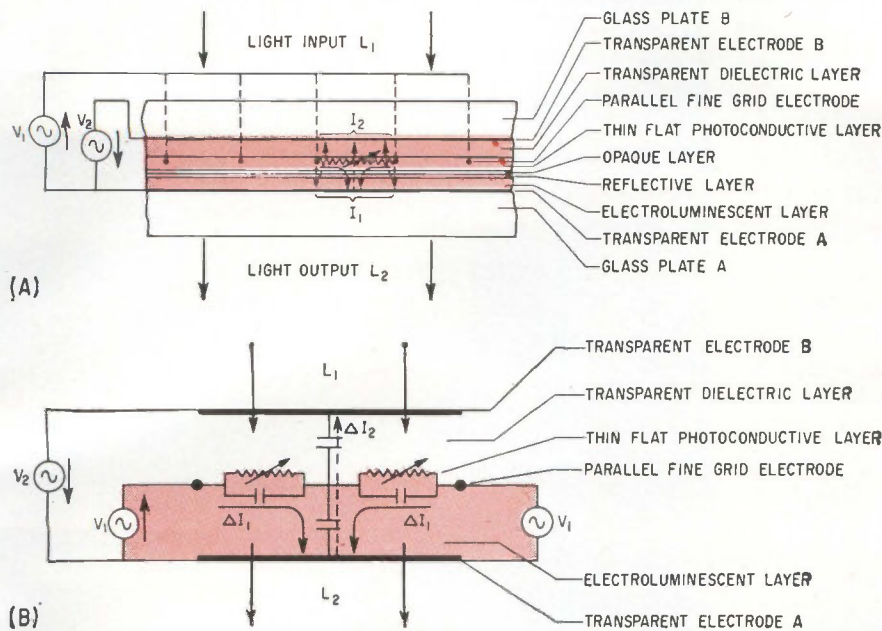

NEWEST el-pc light amplifier dispenses with earlier complicated structures and uses control grid and twin phase-adjustable supplies to select positive or negative image intensification. Schematic (A) shows physical layout, equivalent circuit (B) represents the amplifier's operation—Fig. 1

Two phase-adjustable power supplies plus control grid embedded in photoconductive layer give choice of positive or negative image amplification.

Special V-shaped gamma characteristic may be selected to emphasize parts of a picture

## USES CONTROL-GRID

similar to a dielectric planer triode. Because of its construction and the analogy of field (current) control to the grid action of the vacuum triode, the panel is called a triode or electrostatic image converter.

Operating power comes from two a-c driving voltages of the same frequency but adjustable phase. Voltage  $V_1$  is applied between transparent electrode A and the grid electrode, voltage  $V_2$  is applied between transparent electrodes A and B. The photoconductive layer is excited by the light input  $L_1$  that passes through the glass plate and transparent electrode A.

Light output  $L_2$  is proportional to the current flowing through the electroluminescent layer. A distinguished feature of this panel is that electroluminescent layer current intensity and distribution is controlled by light input  $L_1$  impinging on the photoconductive layer. Lateral photoconductive current through the photoconductive layer from the grid electrode is dependent on light input  $L_1$ . Lateral photoconductivity is the photoconductivity in the plane

in a direction perpendicular to the light input.

Use of lateral photoconductivity results in low concentration of photoconductive currents. Resolution higher than that expected from the pitch of the fine parallel grid electrode is achieved. The current diffusing layer used in the grooved-photoconductor type light amplifying panel<sup>1</sup> is unnecessary.

Light output is proportional to the amplitude of the vector current  $I_3 = I_1 \pm I_2$ , as shown in Fig. 1. Current  $I_1$  is the lateral photoconductive current varied by light input  $L_1$ ;  $I_2$  is the vertical capacitive current through the photoconductive layer. Amplitude of  $I_3$  can be made to increase, decrease, or exhibit a V shaped characteristic with increase in light input  $L_1$ , by adjustment of amplitude and phase relationship between  $V_1$  and  $V_2$ . Light output  $L_2$  varies in a like manner.

Input image can be intensified and converted to positive image, negative image, or mixed output image with negative and positive parts. Characteristics can

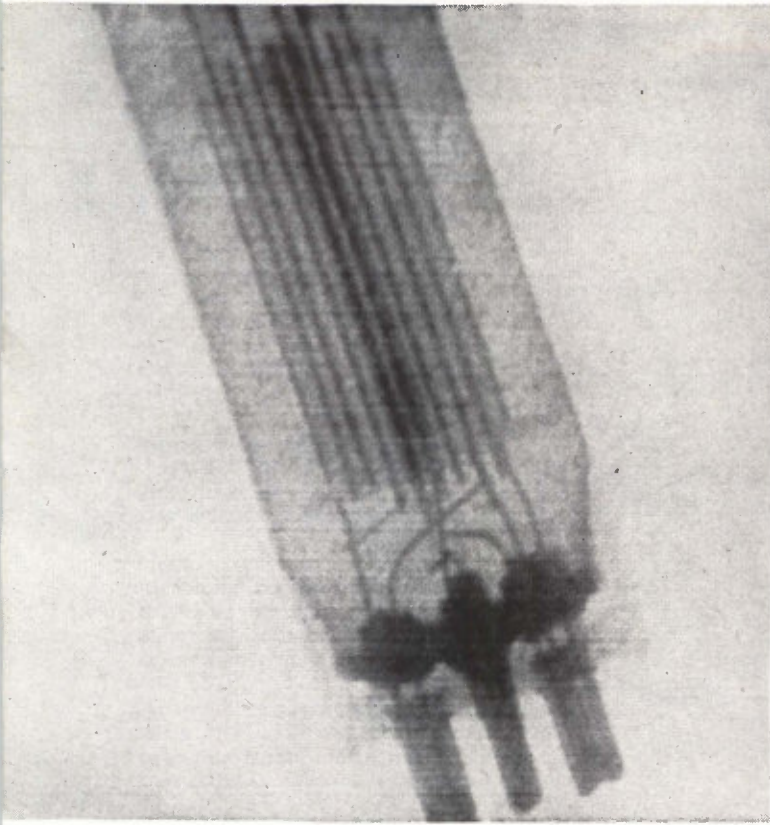

X-RAY image of 6CA7 vacuum tube projected onto light amplifier yields either a positive (left) or negative (right) output image according to the phase and magnitude of the supply voltages

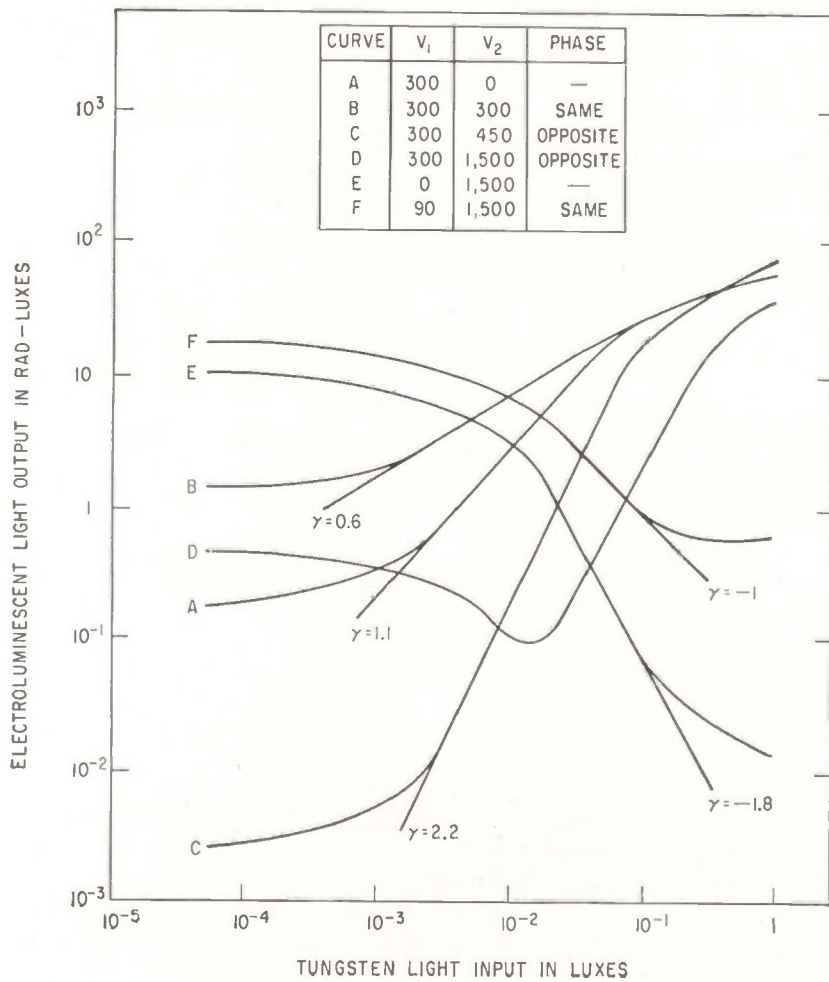

VARIATIONS in phase and voltage of the separate supplies have noticeable effects on light-amplifier's characteristics as analyzed in the text and illustrated in Fig. 3—Fig. 2

be changed continuously by adjustment of  $V_1$  and  $V_2$ . This enables complete control of type of image, gamma and brightness over a wide range.

**Construction**—The light panel is fabricated using a rear glass plate with transparent electrode as substrate. Over this is coated an electroluminescent layer of 50- $\mu$  thick  $BaTiO_3$  powder reflective layer with plastic binder that improves the brightness of the output image. Next is a 5 to 10- $\mu$  thick opaque layer that prevents light feedback to the photoconductive layer. Following is the photoconductive layer with the imbedded tungsten-wire control grid. For low space factor and desirable dispersion of electric flux the grid consists of parallel strands of 10- $\mu$  tungsten wire with pitch of 250 to 500  $\mu$ . The grid is easily fabricated by winding wire directly over the coated rear glass plate. Grid covering is an 80- $\mu$  thick photoconductive layer of powder with a plastic binder. Silver paint makes contact to the grid along the edge of the glass plate, and the unneeded portion of the grid on the back of the glass plate is cut off and discarded.

Transparent dielectric layer is 50- $\mu$  thick polyester film. It is sandwiched between transparent electrode  $B$  and the photoconductive layer. Silicon oil or plastic adhesive is used to fill in air spaces between film and photoconductive layer or transparent electrode, preventing corona discharge.

Total thickness of all elements of the panel, excluding the glass plates, is about 200  $\mu$ . This panel does not require difficult machining like that in the grooved photoconductor structure. Since fabrication consists merely of coating thin flat layers onto the rear glass plate, large panels are easily fabricated.

**Characteristics**—Equivalent circuit diagrams of the light amplifying panel are complicated because they must account for the grid effect of the added lateral photoconductivity. For even an approximation a distributed circuit is necessary.

Figure 1B shows the most simple equivalent circuit. This equivalent aids greatly in understanding the experimental performance characteristics shown in Fig. 2.

Performance characteristics in Fig. 2 are for a typical experimental panel having a 10- $\mu$  diameter tungsten-wire grid wound with a 300- $\mu$  pitch. The electroluminescent layer is green ZnS, the photoconductive layer is CdS. Curves show light output  $L_2$  as a fraction of light input  $L_1$  with amplitude and phase of power-supply voltages  $V_1$  and  $V_2$  as parameters. Constant operating frequency of 800 cycles is used.

Curves  $A$  through  $D$  are experimental curves for four values of  $V_2$ , with  $V_1$  held constant at 300 volts. Curves  $E$  and  $F$  are similar experimental curves for two values of  $V_1$ , with  $V_2$  held constant at 1,500 volts.

Curve  $A$  is for  $V_2 = 0$ . The photoconductive layer and electroluminescent layer are then effectively in a series across the  $V_1$  power supply. The electroluminescent layer is excited with lateral photoconductive current  $I_1 (= I_3)$ , which increases with intensity of light input  $L_1$ . Thus panel light output is a positive intensified reproduction of the input image.

Curve  $B$  is for  $V_2$  in phase with  $V_1$ . Lateral photo-

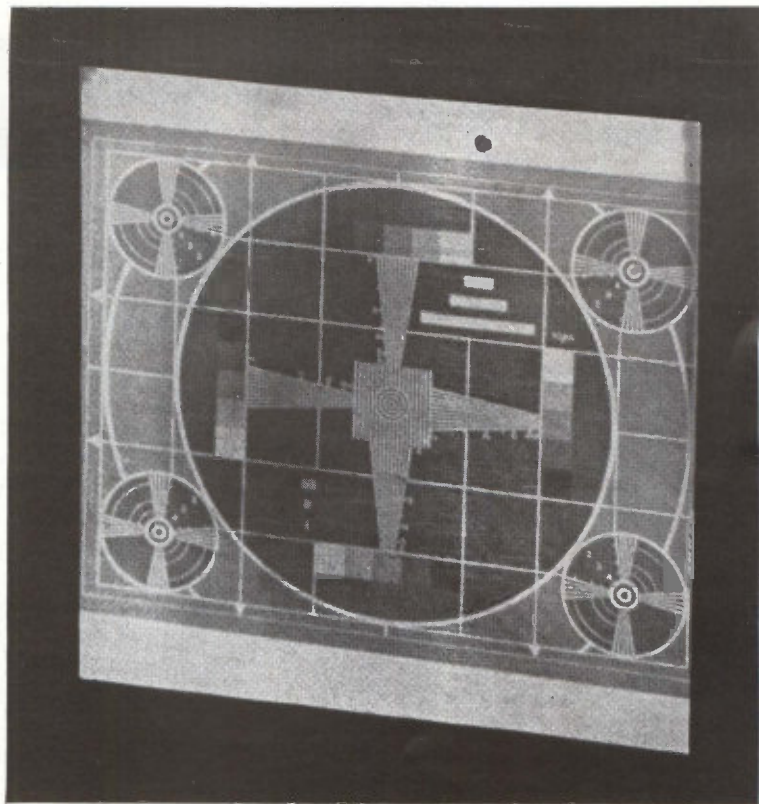

RESOLUTION test of a 17-cm panel shows that the fine-mesh grid has virtually no distorting influence on the light-amplifier's output image

conductive current  $I_1$  and vertical capacitive current  $I_2$  are nearly in phase. The amplitude of total luminescent-layer current ( $I_3 = I_1 \pm I_2$ ) increases. Gamma and brightness range decrease because part of the increased  $I_3$  is not under the control of the incident radiation (input light  $L_1$ ).

Curve  $C$  is for  $V_2$  slightly more than and 180 degrees out of phase with  $V_1$ . Lateral dark current  $I_1$  is opposite in phase to vertical capacitive current  $I_2$ . The structural form of the equivalent circuit in Fig. 1B is similar to that of a bridge circuit. Vertical capacitive dark current compensates the lateral capacitive dark current  $I_2$ , and the dark value of  $I_3$  is greatly decreased.

When light input  $L_1$  is applied,  $I_1$  changes from lateral capacitive dark current to lateral resistive photoconductive current. Its amplitude also increases. This causes a sharp increase in the amplitude of the luminescent layer current,  $I_3 = I_1 \pm I_2$ . The result is positive image intensification with high gamma and large brightness range.

Curve  $D$  is for a much larger  $V_2$ , applied 180 degrees out of phase with  $V_1$ . In the region where the input light  $L_1$  is low,  $I_1$  is overcompensated by the excess  $L_2$ . In this region, increase in light input  $L_1$  increases  $I_1$  which tends to cancel the excess  $I_2$ . Amplitude of  $I_3$  decreases. Panel light output in this region is a negative intensified reproduction of the input image.

As input light  $L_1$  is further increased a point is reached where  $I_1$  exceeds the excess  $I_2$ . Still further increase in input light  $L_1$  causes the amplitude of  $I_3$

to increase. In this region where the input light is high, panel light output is a positive intensified reproduction of the input image.

The curve of  $L_2$  as a function of  $L_1$  is V shaped. If the input image is relatively dark the output image is a negative reproduction of it. If the input image is adequately bright the output image will be a mixed negative and positive reproduction.

Curve  $E$  is for high  $V_2$  and zero  $V_1$ . The electroluminescent layer is effectively in parallel with the photoconductive layer, and in series with the transparent dielectric layer. The el layer is excited by the vertical capacitive current  $L_2 (= I_3)$  that penetrates through the photoconductive layer.

As the intensity of the light input  $L_1$  increases, the lateral photoconductivity of the photoconductive layer increases and acts like an electrostatic shield. Current  $I_2$  is bypassed to the parallel grid electrode. With increasing light input, electroluminescent layer current  $I_3 (= I_2)$  decreases monotonically. Light output decreases similarly. The output image is an intensified negative reproduction of the input image throughout the entire  $L_1$  region. Gamma is negative.

Curve  $F$  is for high  $V_2$  and much smaller in-phase  $V_1$ . When light input is low, the electroluminescent layer is excited mainly by the vertical capacitive current that penetrates through the photoconductive layer. This current decreases with increasing light input. Current  $L_1$  from the photoconductive layer is in phase with current  $I_2$ . It adds to  $I_2$  and tends to reduce the rate of decrease of total  $I_3$  with increase in light input  $L_1$ . The output image is a negative intensified reproduction of the input image, but gamma is lower and brightness range smaller than when  $V_1$  is zero.

These examples describe performance with  $V_1$  and  $V_2$  of the same or opposite phase. Performance characteristics can also be varied by continuous phase control, and interesting characteristics can be obtained.<sup>2</sup> Moreover, performance characteristics can be varied and sensitivity improved by direct-current control of the lateral conductivity.<sup>3</sup>

**Results**—Figure 3 features three electroluminescent output images obtained by projecting the same negative image on an experimental 6-cm square panel. The parallel-grid electrodes of the panel used a 10- $\mu$  tungsten-wire grid with a 300- $\mu$  pitch. The upper negative image is obtained by positive intensification of negative input image. The center image is mixed positive and negative. The lower positive image is obtained by negative intensification of negative input image.

Resolution of these intensified images is excellent. It is higher than that expected from the pitch of the parallel grid electrode because lateral photoconductivity is used and photoconductive current is not converged.

Experiments were made with a resolution chart to check the resolution of the panels. When the incident pattern is perpendicular to the grid the resolution is almost independent of the grid pitch if the grid pitch is reasonably small. Resolution is mainly dependent on the uniformity of the photoconductive and electroluminescent layers, and the size of their powder grains. Resolution of over 10 lines/mm is obtained.

When the incident pattern is parallel to the grid the benefits of lateral conductivity are limited by the grid pitch. Variations also occur with the location of the pattern. Resolution is still higher than expected, and falls between the limits of one line/pitch-length minimum and three lines/pitch-length maximum. Isotropy of the resolution can be improved by using a mesh grid electrode instead of a parallel wire electrode.

#### REFERENCES

- (1) B. Kazan and F. H. Nicoll, An Electroluminescent Light-Amplifying Picture Panel, *Proc. IRE*, 43, p 1888, Dec. 1955
- (2) T. Kohashi, The Continuous Phase Control Operation of an Electrostatic Type Image Converter, *The 1962 National Convention Record of the I.E.C.E. of Japan*, 612, Nov. 1962
- (3) T. Kohashi, The Experimental Performance Characteristics of a Shielding Type Image Reversing Intensifier and its Improvements, *The 1960 National Convention Record of the I.E.C.E. of Japan*, 284, Nov. 1960
- (4) T. Kohashi, The resolution of an Electrostatic Type Image Converter, *Transaction of the 1963 Joint Convention of the Four Electrical Institutes of Japan*, 1552, April 1963



PHOTOGRAPHS are produced by projecting the same negative onto the light-amplifier screen. Left photo is intensified negative image and comes from curves A through C of Fig. 2; center photo is a mixed image formed by the V characteristic, D; right photo is produced by curves E and F, making an intensified positive image—Fig. 3

## CIRCUIT TRENDS IN

# Nanosecond Switching

Tunnel diodes and storage diodes permit design of fast switching circuits essential in gigacycle computers. Now circuit size and interconnections are the limiting factors, not device capabilities

By **PETER MEYERS**, Electronic Systems and Products Div., Martin Co., Baltimore, Maryland

**HIGH SPEED** switching techniques have been developed significantly during the past year. More suitable semiconductor devices plus circuits combining transistors, tunnel diodes and storage diodes have made possible the higher speeds. Particularly noticeable are tunnel diode hybrid circuits, which have renewed interest in the tunnel diode as a switching device. Tunnel-diode/storage-diode logic and tunnel-diode/transistor logic have moved into the forefront as practical general-purpose computer circuits. Circuits available today actually have such high switching speeds that the size and location of circuits and interconnections are becoming more of a problem than speed, particularly in general-purpose computer systems.

Of the various approaches<sup>1</sup> to high-speed switching for new generation computers, transistor circuits, tunnel-diode circuits, transistor/tunnel-diode circuits and storage-diode/tunnel-diode circuits are the main contenders.

**Transistor Circuits**—Transistors are close to ideal for many uses up to 100 Mc. They are the most widely used components for switching circuits because they provide gain, signal inversion and a wide range of design trade-offs. Transistor logic

---

### NEW DRIVE TOWARDS MICROMIN

Time was when radio and light waves traveling at 186,000 mps were thought to be fast moving. They still seem so to most people, the exceptions being some advanced computer designers, who ask to be included out.

The speed of light can also be expressed as 0.98 feet per nanosecond. If you need to build a computer that will be so complex and so fast that only one nanosecond delay can be allowed from one stage to some other randomly located stage, you are going to have to keep things cozy.

Thus the drive towards microminiaturization, first started by the armed services to save power and weight, pushed further by the rocket booster limitations of our space program, is now being pushed in an even more fundamental sense—there isn't any other way to solve the computer's speed-complexity problem

---

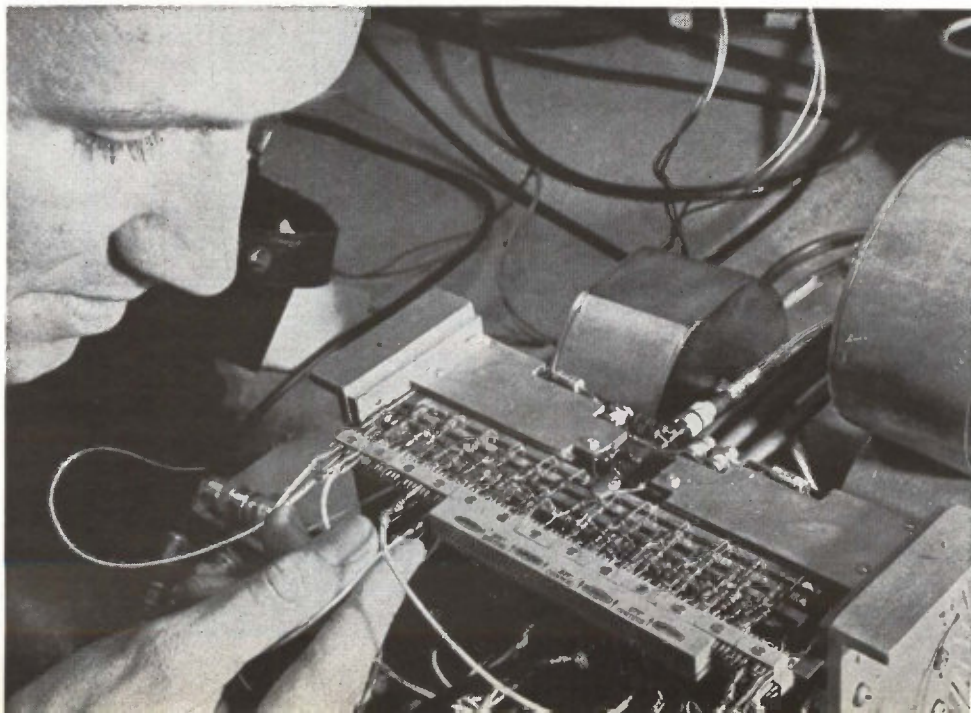

CHECKING the speed, fan-out and tolerance limits of a modified tunnel-diode logic system

building blocks are presently limited to the 100-Mc region in practical circuits by a gain-bandwidth product of about 1 Gc. Although minor increases in this limit may be made, it is unlikely that semiconductor technology will have an order of

magnitude improvement in the next few years.

By virtue of the inherent input-output isolation and inversion properties of the transistor it is possible to design complete asynchronous systems.<sup>2</sup> Asynchronous systems need no high-power high-frequency clock supply, have logical flexibility, and have relatively simple interface circuit problems. Disadvantages include slower operating speed (based on worst-case propagation delay), low information rates, and program timing problems.

A device that cannot be left out of consideration in nanosecond switching, although it has as yet

out. One of its important uses is driving transmission lines at up to 5 Gc, an application made possible by its low-impedance and current-drive capability.

But tunnel-diode tolerances create severe problems in making reliable switching circuits. Some of the arrangements that have been investigated<sup>3, 4, 5, 6, 7, 8, 9, 10</sup> in an attempt to overcome tolerance problems include: resistor tunnel-diode threshold logic; resistor tunnel-diode majority logic; diode tunnel-diode threshold logic; monostable threshold logic; constant-current-operated threshold logic; locked-pair tunnel-diode logic; voltage-mode tunnel-diode logic.

Unfortunately, all the above schemes fall in the same category of having lower gain tolerances than have normally been used in computer systems.

**Transistor-Tunnel Diode**—One important attempt to overcome the gain-tolerance situation in tunnel-diode circuits is the transistor tunnel-diode hybrid. Although giving interstage current gain, the circuit is limited in gain speed by the gain bandwidth of the transistor. Superficially these circuits have no advantage over the transistor configuration; however, the transistor circuits are enhanced by using the tunnel diode as a low-impedance driver for transmission-line coupling, and tunnel-diode circuits are improved in gain tolerance by using the transistor as a coupling isolator.<sup>11, 12, 13, 14, 15</sup> The circuits are useful up to 500 Mc.

The design philosophy of this hybrid scheme is that the advantages of the transistor logic are combined with the advantages of the tunnel diode. Unfortunately, the hybrid cannot realize the tunnel diode's potential of operating in the Gc region.

**TDCT**—A unique approach to tunnel-diode circuits is to use a storage diode or charge transformer as an interstage current amplifier.<sup>16, 17</sup> This results in tunnel-diode charge-transformer logic (TDCT). Because the gain bandwidth of the storage diode or diode amplifier can be on the order of 10Gc for recently available retarded-field diodes, the combination of tunnel diode and storage diode has a 10 to 1 improvement over previously discussed nanosec-

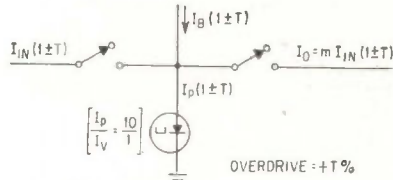

$$I_B(1+T) \leq I_D(1-T) \quad (1)$$

$$I_B(1-T) + I_{IN}(1-T) \geq I_D(1+T) \quad (2)$$

$$I_B(1-T) - I_{V,MAX} \geq m I_{IN}(1+T) \quad (3)$$

(A) SINGLE STAGE TUNNEL DIODE LOGIC

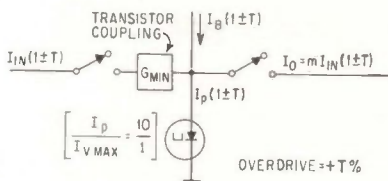

$$I_B(1+T) \leq I_D(1-T) \quad (1)$$

$$I_B(1-T) + G_{MIN} I_{IN}(1-T) \geq I_D(1+T) \quad (2)$$

$$I_B(1-T) - I_{V,MAX} \geq m I_{IN}(1+T) \quad (3)$$

(B) TRANSISTOR COUPLED LOGIC

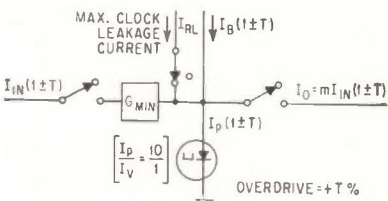

$$I_B(1+T) + I_{RL,MAX} \leq I_D(1-T) \quad (1)$$

$$I_B(1-T) + G_{MIN} I_{IN}(1-T) \geq I_D(1+T) \quad (2)$$

$$I_B(1-T) - I_{V,MAX} \geq m I_{IN}(1+T) \quad (3)$$

(C) TDCT NOR LOGIC

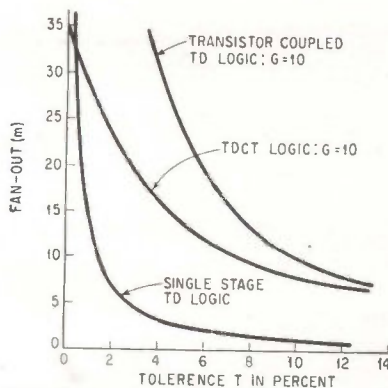

(D) GAIN TOLERANCE CURVES

EQUIVALENT circuits with worst-case equations for three tunnel-diode logic schemes (A), (B), (C). Gain-tolerance comparisons (D) show that modified circuits are much less sensitive to changes in circuit current than straight tunnel-diode stages—Fig. 1

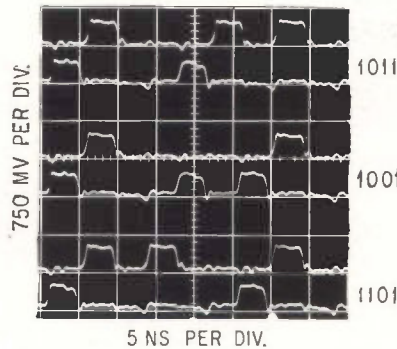

WAVEFORMS recirculating in a 10-bit memory loop at 250-Mc phase rate

found little or no use in logic systems, is the avalanche transistor. It can switch watts of power in fractions of a nanosecond but unfortunately requires too long a time to return the junction to its off state. Because avalanche mechanisms are not fully understood analytically, device manufacturers have had great difficulty in obtaining reasonable yields without allowing a wide spread in the breakdown voltage.

**Tunnel Diode Circuits**—Tunneling type diodes were received initially with great enthusiasm, but this was followed by a period of disillusion over tolerance limitations. Recently there is renewed interest based on improved components and circuit complementing techniques. Improved devices are now being used in computer-switching logic in the 100 to 200-Mc range. Even so, because of its gain-tolerance characteristics, the tunnel diode is severely limited in fan-in and fan-



# FIRST SILICON POWER SUPPLY UNDER \$100

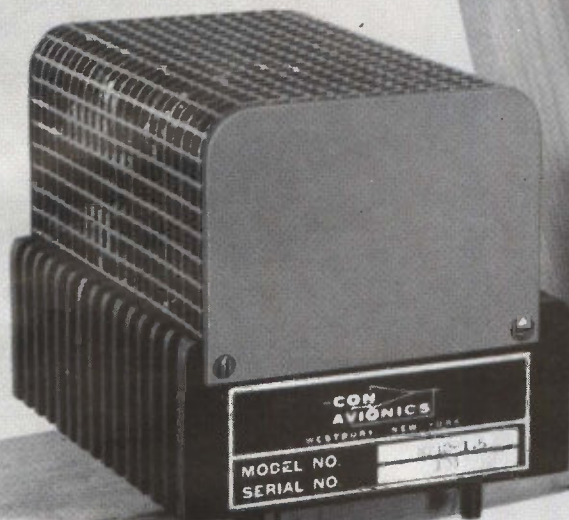

**\$89<sup>00</sup>**

**Guaranteed by  
"Worst Case"  
Analysis**

## A Big New Price Step—35% Below Germanium Units

**New Development.** Here is a unique combination of low cost and high reliability. Featuring all silicon semiconductors throughout, these supplies are priced as much as 35% lower than comparable germanium supplies.

Designed to operate in ambient temperatures up to 50°C without an external heat sink, they may be used up to 75° with a comparatively small

external heat sink or with forced air.

"Worst Case" Analysis designed, these supplies are capable of operating under the worst possible conditions with a "Mean Time Between Failure" that rivals many supplies costing two or three times as much.

For the full money-saving details on Con Avionics new HT Series Silicon Power Supplies, send for literature today.

### SPECIFICATIONS

Regulation Accuracy.....	±0.5%
Ripple.....	10 mv RMS Max.
Max. Operating Ambient.....	75°C
Automatic Short Circuit Protection.	
Models available from 6V @ 1.5A to 32V @ 600 ma	
Dimensions.....	4½" H, 4½" W, 5½" D

**CONSOLIDATED AVIONICS CORPORATION**

800 SHAMES DRIVE, WESTBURY, L. I., NEW YORK

CIRCLE 37 ON READER SERVICE CARD



**CON  
AVIONICS**

ond circuits. Other advantages are simple circuits, availability of several logical functions, wide tolerances and low cost.

The technique allows practical circuits with current gains of 14 at 250 Mc and 7 at 500 Mc, which shows that the tunnel-diode gain-bandwidth capability has been utilized without limiting the gain to less than two for tolerance requirements. The gain represents high fan-in and fan-out capability. Additional advantages of this approach are greater resistance to nuclear radiation, and ultimate low cost. Increasing use of tunnel-diode charge-transformer (TDCT) logic seems probable in the near future. Developmental systems utilizing 250-Mc phase rate synchronous logic are already appearing. By 1965 both military and commercial systems operating at these speeds should appear in quantity.

**Circuit Comparisons**—It is difficult to compare the various design approaches on an absolute basis since such factors as cost, size, flexibility, fan-out, reliability and professional egos are involved. However, it is possible to place a conservative upper bound on the gain tolerance characteristics by using a simplified worst-case analysis. From the equivalent circuits in Fig. 1 the fan-out tolerance relationships are derived. Fan-out is  $m$  and  $T$  is tolerance, with  $T$  expressed as a decimal: 1-percent tolerance is 0.01.

For single stage tunnel-diode threshold logic

$$m = \frac{0.8 - 3T + 3.2T^2}{5T + 6T^2}$$

For transistor tunnel-diode hybrids with interstage gain  $G$

$$m = \left[ \frac{0.8 - 3T + 3.2T^2}{5T + 6T^2} \right] \times G$$

## REFERENCES

- (1) Douglas L. Hogan, Ronald L. Wigginton, Raymond W. Sears, Jr., Nano-second Computing, *Science and Technology*, Oct. 1962.
- (2) F. K. Buelow, Improvements to Current Switching, *International Solid States Circuits Conference*, p 30, Feb. 1960.
- (3) H. K. Gummel and F. M. Smits, Margin Considerations for an Esaki Diode-Resistor OR Gate, *Bell Sys. Tech. J.*, 30, p 213, Jan. 1961.
- (4) R. H. Bergman, Tunnel Diode Logic Circuits, *IRE Trans Electronic Computers*, EC-9, p 430, Dec. 1960.
- (5) G. W. Neff, S. A. Butler and D. L. Critchlow, Esaki Diode Logic Circuits, *IRE*

Tunnel-diode charge-transformer logic with interstage gain  $G$

$$m = G \times \left[ \frac{0.7 - 1.9T + T^2}{0.2 + 4.8T + T^2} \right]$$

The relationships are plotted in Fig. 1D and show the superiority of both approaches that have an interstage current gain. The final consideration in assessing the merits and demerits of the various approaches must be based on gain tolerance and speed, as shown in Fig.

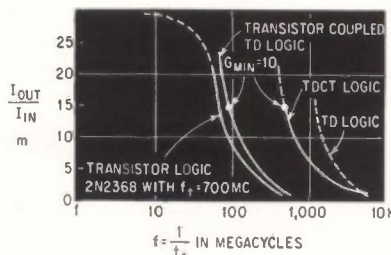

GAIN-BANDWIDTH comparisons, with practical operating regions indicated by solid lines—Fig. 2

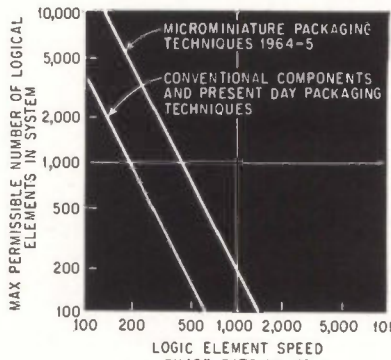

CIRCUIT DELAYS through interconnections place a limit on circuit speed, with speed decreasing as complexity increases. Smaller circuits offer some hope for the immediate future—Fig. 3

- Trans Elec Comp*, EC-9, p 423, Dec. 1960.
- (6) H. S. Yourke, S. A. Butler and W. G. Strohm, Esaki Diode NOR-OR Logic Circuits, *IRE Trans Elec Comp*, EC-10, p 183, June 1961.
  - (7) B. E. Sear, Kilomegacycle Tunnel-Diode Logic Circuits, *Proc Int S S Cir Conf*, p 50, 1962.
  - (8) B. E. Sear, Constant Current Design of Tunnel Diode Logic Circuits, *IEEE Trans Circuit Theory*, CT-10, March 1963.
  - (9) J. J. Gibson, G. B. Herzog, H. S. Miller and R. H. Powlus, Tunnel Diode Balanced Pair Switching Characteristics, *Proc Int S S Cir Conf*, 1962.
  - (10) G. B. Chaplin, Voltage Mode Tunnel Diode Circuits, *Proc Int S S Cir Conf*, Feb. 1961.
  - (11) D. W. Murphy, High-Speed Non-saturating Switching Circuits Using a

2. Tunnel-diode charge-transformer logic has a definite gain-bandwidth advantage.

**Interconnections** — Interconnecting high-speed switching circuits is a problem for both system and circuit designers. A simple example of a high-speed logic system will be used to illustrate the nature of present and future problems. Based on recent nanosecond circuit developments a tolerable delay for a 250-Mc phase rate system (synchronous logic) would require that the maximum allowable coaxial lead length be approximately 9 inches. Working from this point of reference, a plane of logical elements could tolerate a diagonal interconnection cube leaving one side open for access to interconnections. Any one side of the cube would then be limited to  $9\sqrt{3}$  inches, to keep the longest interconnection (diagonal)  $\leq 9$  inches. This geometry is brute force and can be improved by a clever system layout of logical elements, but the improvement would be less than two in most cases. With present-day NAND, and NOR logic (250 Mc), the area required in the interconnection plane for one logical element with 5 input and 5 output connections is approximately 0.22 sq in. Since the area per element is fixed by packaging and interconnections, the number of elements will vary with the frequency of operation. A simple plot of phase frequency versus number of logic elements (Fig. 3) shows the limitations on high-speed computer design. Microminiaturization should provide a factor of 5 improvement in interconnection area per logic element during the next year or two, and this is included in Fig. 3.

Thus the size of the circuits rather than device speed or circuit design is becoming the predominant limitation on speed of operation.

Novel Coupling Technique, *Proc Int S S Cir Conf*, p 48, 1962.

- (12) W. Pell and R. Marolf, Computer Circuitry for 500 Mc, *Proc Int S S Cir Conf*, p 52, 1962.
- (13) R. W. Lade, Directly Coupled Tunnel Diode-Transistor Logic, *Solid State Design*, 3, p 43, Jan. 1962.
- (14) J. R. Turnbull, 100 Mc Nonsynchronous Esaki Diode Computer Circuitry, *Proc Int S S Cir Conf*, 1961.
- (15) J. F. Kruey, High Speed Arithmetic Unit Using Tunnel Diode, *Int S S Cir Conf*, 1962.
- (16) B. E. Sear, Charge Controlled Nanosecond Logic Circuitry, *Proc IEEE*, Aug. 1963.
- (17) B. E. Sear, J. S. Cubert and W. F. Chow, The Enhanced Tunnel Diode Logic Circuit, *Proc Int S S Cir Conf*, 1963.

*Simplex Electronic Cables . . .*

## **Stabilize Frequency Response**

## **Eliminate Radiation**

## **Lower Cable Attenuation**

Newest of the Simplex electronic cables, economical Foam-Cel foam-polyethylene insulated coaxial cable, is filled with tiny air cells which provide superior insulating qualities in high frequency transmission. Ideal for community TV antennas, closed circuit TV, EDP signal transmission, and information circuits of all types, Simplex Foam-Cel has a solid aluminum outer sheath which is continuously seam-welded by a plasma jet welding process, making the cable impervious to liquids and gases. The resultant product is one which offers superior operating characteristics to those of conventional solid dielectric cables of the same dimensions . . . at substantial savings in cost.

### **Deep Sea Applications**



This double-armored  
High Molecular Weight

Polyethylene insulated Simplex electronic cable has, in addition to power and instrumentation circuits, the required tensile strength for lowering and retrieving complicated electronic equipment in ocean depths of several miles. Balanced-torque double-armored construction minimizes residual torque of the armor wires.

### **Reduce Low-Level Signal Noise**



Simplex special  
polyethylene insulated

antimicrophonic designs reduce externally caused noise to a level of 2 millivolts — 96.7% lower than a typical RG 8/U cable subjected to identical severe mechanical abuse. Stocked for immediate delivery are high demand items such as 2 conductor #18 and single conductor #16. Antimicrophonic features may be incorporated in any special cable construction.

In addition to a wide variety of standard electronic cable types, Simplex has the capability to produce specific cables to meet your particular requirements. For complete details write to Department 365, Simplex Wire & Cable Co., Cambridge, Mass.



**Simplex**  
**WIRE & CABLE CO.**

EXECUTIVE OFFICES: Cambridge, Mass.

Plants at Cambridge, Mass., Portsmouth, N.H.,

Westbury, L.I., Monrovia, Calif.

**CIRCLE 39 ON READER SERVICE CARD**



# MICRO SWITCH Precision Switches

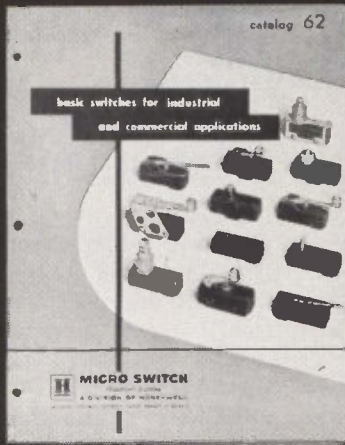

BASIC SWITCHES—Catalog 62.



SMALL BASIC SWITCHES—Catalog 63.

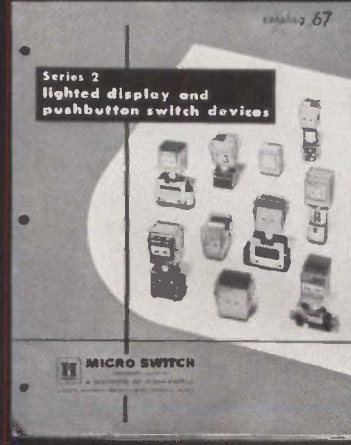

LIGHTED DISPLAY and PUSHBUTTON SWITCH DEVICES—Catalog 67.



SEALED PUSHBUTTON SWITCHES—Catalog 68.



COORDINATED MANUAL CONTROLS combining multiple lighted legends and operator in single compact units—Catalog 69.



TOGGLE SWITCHES and ASSEMBLIES—Catalog 73.

## Answers to thousands of switch problems !

MICRO SWITCH catalogs are widely recognized as standard reference books on switches. Main reasons: Exceptionally broad selection and helpful design assistance. Shown above are six catalogs that provide practical design information on thousands of different switches of special interest in electronics.

For the MICRO SWITCH catalogs that interest you, or for engineering assistance by qualified engineers, call a Branch Office—in principal cities (see Yellow Pages). Or write...



### MICRO SWITCH

FREEMONT, ILLINOIS

A DIVISION OF HONEYWELL

IN CANADA: HONEYWELL CONTROLS LIMITED, TORONTO 17, ONTARIO

HONEYWELL INTERNATIONAL—SALES AND SERVICE OFFICES IN ALL PRINCIPAL CITIES OF THE WORLD. MANUFACTURING IN UNITED STATES, UNITED KINGDOM, CANADA, NETHERLANDS, GERMANY, FRANCE, JAPAN.

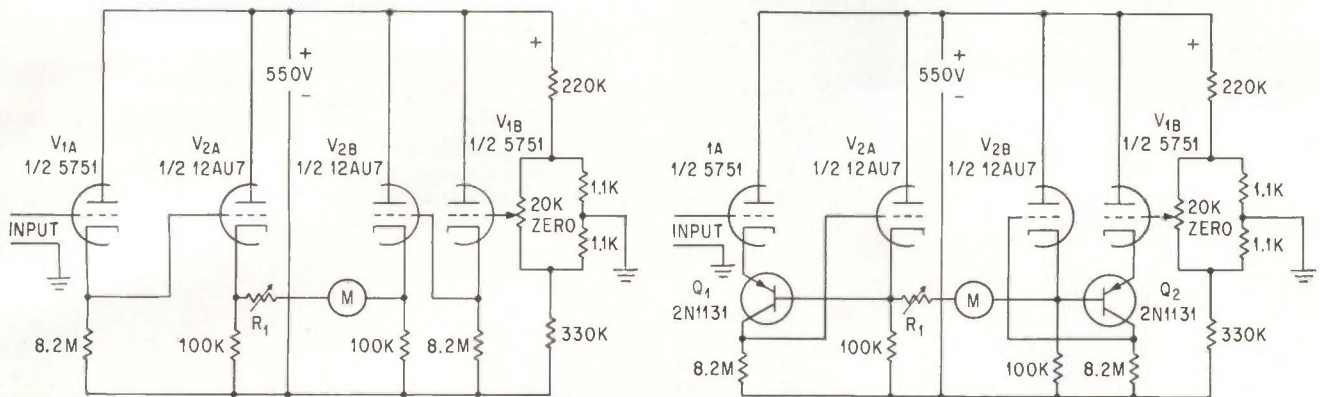

IMPEDANCE of meter drive circuit (left) depends on tube  $g_m$  and is subject to aging; hybrid circuit (right) uses transistors for below-1-ohm drive impedance, achieving independence from  $g_m$  variation

# HYBRID VOLTMETER Avoids Aging Errors

By JAMES J. FARAN Jr., General Radio Corp., West Concord, Mass.

Technique stabilizes drive circuits against changes in tube transconductance

**ONE REASON** why most vacuum-tube voltmeters require calibration at regular intervals is the aging, or change in transconductance, of the vacuum tubes. In this, a balanced vacuum-tube voltmeter uses transistors to bring vacuum-tube output impedances down to a small fraction of an ohm. The resulting performance is virtually independent of changes in tube  $g_m$ , and consequently the vtvm rarely if ever requires recalibration.

The balanced vtvm circuit, before modification, is shown in the left-hand illustration. Tube  $V_1$  operates at low plate current to

keep grid current small;  $V_2$  is operated at normal conditions to drive the meter circuit. Resistor  $R_1$  is switched to different values for various voltage ranges. The long-term stability of this circuit depends on constancy of voltage gain and on the output impedance of each side of the circuit. Voltage gain of  $V_1$  is highly stabilized at  $\mu/(\mu + 1)$  because of the large load resistance (8.2 megohms). The open-circuit voltage gain of  $V_2$  is also stabilized for the same reason, but its output resistance (approximately  $1/g_m$ ) increases steadily with life as  $g_m$  decreases.

**Example**—For a 1.5-volt range and with a 1-ma meter, the total multiplier resistance is a little smaller than 1,500 ohms. This is composed of the output resistance of each half of  $V_2$  (about 360

ohms each), the meter internal resistance, and  $R_1$ . Aging of the tubes to half their original  $g_m$  would double their output resistances and cause the meter to read 30 percent low on that range.

The addition of a transistor in each side of the circuit (right) reduces output impedance to a small fraction of an ohm. A decrease in the  $g_m$  of  $V_2$  to half its original value is now no longer important since the output impedance of each side of the circuit is still less than an ohm. The voltage gain of  $V_1$  is unaffected by the addition of the transistor because the input impedance at the emitter remains substantially unchanged. Voltage gain of the  $Q_1 - V_2$  combination is close to unity, and is highly stable.

Transistor requirements are modest. Base-to-collector voltage is simply the cathode-to-grid bias of  $V_2$ , a maximum of 6 volts. Collector current of  $Q_1$  and plate current of  $V_1$  are equal and quite low. There is no stiff requirement for current gain, so the transistor is used in what is effectively a grounded-base connection.

This hybrid circuit converts a normal good-quality voltmeter into a highly stable instrument, which should not require recalibration even at the normal end of life (half  $g_m$ ) of the vacuum tubes.



Typical Ceramag Ferrite cores available in many sizes and grades . . . from stock at Stackpole. Check us on availability of other types, too!

## ***The Ceramag<sup>®</sup> Ferrite cores you need may be in stock right now at Stackpole!***

***Note, especially, that we are tooled for both 70° & 90° yoke and transformer cores for Color TV.***

Many Stackpole Ceramag ferrite cores have such widespread demand that we are now maintaining fairly substantial stocks on these items. *This means you can get a 5-day delivery or better on receipt of order!*

Stocked items include many types of cup cores, as well as insert and threaded cores for IF, RF, permeability tuning, TV width and linearity coils. Also: horizontal output transformer cores (including cores made from Stackpole's Ceramag 24A), 110° deflection yoke cores, toroidal yoke cores, and threaded cores of Ceramag 26.

### ***Fast delivery on all other cores!***

If we do not stock the core you need, chances are no other supplier does either. You can still depend on Stackpole for faster production and delivery of your item.

Stackpole got a head start as the first commercial supplier of ferrite cores in this country. We've never lost the lead . . . in production, research and design facilities, in quality, knowledge or service. Make it a point always to check Stackpole first on any ferrite core requirement. Call or write today.

**STACKPOLE**  
CARBON COMPANY

*Electronic Components Division*  
St. Marys, Pennsylvania



BIG ROTODOME gives E-2A Airborne Tactical Data System aircraft distinctive look. Plane carries 5-man crew. Grumman is prime contractor for the system



## Navy Readies Airborne Data System

Here are the first declassified details of new tactical systems

**WASHINGTON**—Navy and Marine Corps last week disclosed heretofore classified information on their three integrated information gathering and processing systems: the Naval Tactical Data System (NTDS) (*ELECTRONICS*, p 30, Sept. 16, 1960); Marine Tactical Data System (MTDS) and the airborne extension of the overwater surveillance capability of both, the Airborne Tactical Data System (ATDS).

The airborne system is scheduled for first trials early next year and will probably be operational soon after that.

The E-2A, carrier-based, airborne, tactical data system, is the first such system built as an integrated package—both aircraft and electronic systems. It is also the first Navy early warning plane able to operate at high altitudes (30,000 feet and higher). Besides detecting enemy aircraft it will also give direction for waging air battles.

Main ATDS subsystems include: radar rotodome antenna, search and height-finding radar, Mark X iff

(identification friend or foe), automatic detector, data processor (computer indicator), multipurpose communications, high-frequency data communication link, USC-2 uhf data link, and navigation subsystem (inertial, doppler radar, and air-data computer).

Grumman is prime contractor with subcontractors that include GE, Litton Industries, and Dalmo Victor, Navy said.

ATDS automatically or semiautomatically performs target detection, acquisition, tracking, identification, threat evaluation and weapon assignment, and intercept control. Target position, velocity, and identity are continuously displayed as symbols on a cathode ray tube. On demand, supplementary data for a selected target are displayed on auxiliary status board readouts.

Track and decision data are transmitted to surface ships and fed into the NTDS for action.

**Airborne Radar**—The AN/APA-143 antenna system uses a retarded-wave principle that cuts antenna height 50 percent. The rotodome is 24 feet by 30 inches, weighs 2,200 pounds, rotates at 6 rpm. The iff antenna is integrated into the radar antenna structure. Beam shapes are

4 by 30 degrees for the iff and 6.8 by 21 deg for the radar. No antenna stabilization is required because of the large beam size and the aircraft stability at high altitudes.

The AN/APS-96 search and height-finding radar uses the pulse-compression technique—a narrow pulse is expanded in transmission and recompressed in reception. The net effect is equivalent to multiplying transmitted power by compression ratio.

Very short effective pulse length permits height finding by time-difference method. Direct target return and sea reflections are received as separate echos. Together with known information, target altitude is computed. Airborne-target-indication circuits cancel unwanted clutter, especially sea-surface return. Noise figure is minimized by a parametric amplifier.

**Computer-Detector**—the CP-413/ASA-27 receives raw radar video, iff video, and other navigational and antenna-bearing data and detects targets and determines target location and height.

Target height is determined by evaluating successive radar echoes from the target during the same radar interpulse period. Normally,



**AMERICAN  
TIME  
PRODUCTS**  
240 to  
20,000 cps  
**FREQUENCY  
STANDARD**

Whatever the frequency, 240 to 20,000 cps, the type 32 American Time Products standard assures an uncompromising balance between stability and reliability.

A compact, lightweight and highly reliable audio range unit, the 32 employs a temperature compensated tuning fork and its associated oscillator circuit. Hermetically sealed, this all silicon semi-conductor oscillator provides stability up to  $\pm 0.02\%$  from  $-65^{\circ}\text{C}$  to  $+125^{\circ}\text{C}$ . In narrower temperature ranges, such as  $15^{\circ}\text{C}$  to  $35^{\circ}\text{C}$ ,  $\pm 0.002\%$  is possible.

Other specifications include: Power — 28v at approx. 6 m.a. or calibrated for any other available voltage; Output — 5v r.m.s.; Wave — limited Sine; Loading — up to 20K; Mounting — 4 studs; Termination — 7 pin header.

For more information on American Time Products' type 32 standard, line of fork standards or oscillators, filters, inverters, power supplies, timers or light choppers, write Bulova, American Time Products, 61-20 Woodside Avenue, Woodside 77, New York. Area Code 212 NE 9-5700.

INDUSTRIAL/DEFENSE GROUP

**BULOVA**

AMERICAN TIME PRODUCTS

three echoes may be expected from one target per radar interrogation. The first echo is direct reflection from the target; the second is target reflection that has bounced off the water on the way back to the plane, or vice-versa; the third echo bounces off the water both ways. These three echos arrive back at the plane at successively later intervals. Target height is derived from height of transmitting plane, range of target and the spacing between echoes.

Beam-splitting techniques provide azimuthal accuracies over a wide dynamic range of radar and iff return.

**Communication Link**—The E-2A ATDS is tied to the NTDS for target reporting and tactical data exchange by the multipurpose communication data link, the AN/ASQ-52. The digital data-communication control set is a uhf data link used to control combat air patrol interceptors.

**Marine System**—MTDS is fully integrated with the NTDS and ATDS. Primary objective of MTDS is shore-based control of combat air operations in air amphibious assault. The system consists of special and general purpose computers, display consoles and large screen presentations, surveillance height-finding and 3-D radars and digital teletypewriter and voice communications. For mobility, the system is housed in helicopter-transportable

huts or sections. MTDS will use microwave, uhf, h-f, scatter and wire communications.

**Ship System**—Both MTDS and ATDS are primarily concerned with enemy aircraft and therefore rely heavily on radar for sensors. NTDS, however, is concerned with aircraft, ships, submarines and missiles, requiring a variety of sensors and control of a variety of weapons. Because of this multitude of functions, NTDS is designed around a general purpose computer that can communicate with many peripheral equipments.

The AN/USQ-20 computer is solid-state with a capacity of 32,-768 30-bit words. It can execute some 75,000 instructions a second and includes an internal real-time millisecond clock with a modulus of six days. Besides a 62-instruction repertoire, it has a 16-word wired auxiliary memory for critical instructions and constants, providing automatic recovery of program failure and automatic initial loading of programs. There are 14 input-output channels for rapid data exchange with sensors and equipment without program attention. Two channels permit a direct intercomputer data transfer and connection of additional computers.

The computer housing is 33 inches deep, 37 inches wide, and 65 inches high. The Univac-developed CS-1 compiler programs the computer.

## Computer Analyzes Sound

**BUFFALO**—Complex information problems are being attacked at Cornell Aeronautical Laboratory through a pattern recognition program. Novel input and output devices enable a digital computer to store and analyze sounds as well as graphic information. Acoustic digitizing techniques that convert sounds to numbers result in more accurate and stable spectral analysis of speech, sonar and radar returns than can be obtained with other types of special purpose equipment. Improvements to previous gear (ELECTRONICS p 26, March 23, 1962) allow hundreds of pictures or x-rays to be analyzed automatically in a few hours

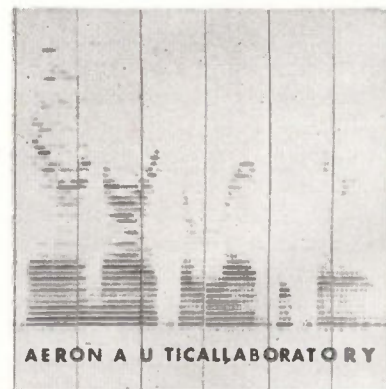

WORDS "aeronautical laboratory" pictorially reproduced by digital computer. Frequency bands are vertical and time is horizontal. Greatest energy is shown by the darker bands



# HOW PRODUCTION RATED soldering tools reduce assembly rejects

## Close control of heat essential to reliability

"Pop" goes the transistor, down goes production and up go costs . . . all victims of a too-hot soldering tool. Unregulated soldering heats impose additional penalties on industrial production lines and laboratories too. Among the faults caused by too-hot or too-cold irons are: precision components driven out of tolerance, cold joints, burned insulation, distorted parts, operator fatigue and work slowdown.

Each year as circuits get smaller and more critical, industry becomes more aware of the costs of slow production and rejects caused by uncontrolled soldering heat. OEM's supplying military electronics are especially cognizant of the problem because of the need to meet the MIL-spec soldering standards.

It is now apparent that old-fashioned irons no longer meet industry needs. If the irons are small and light enough to get in tight places, they cool off when the work load gets heavy. If high-wattage irons are used, they are heavy and bulky. They overheat both the work and the operator's hand during light usage.

Fittingly, the same scientific advances that created the problems have been harnessed to remedy them, in the form of production rated Weller Magnastat® temperature-controlled soldering irons. Without relying on manual selector switches, complex controls or auxiliary ballasts, Magnastat irons maintain their tip temperatures within  $\pm 3\%$  of an average value. They do this by utilizing the Curie point, the characteristic temperature at which an iron-nickel alloy loses its magnetism, to switch power off and on within the iron.

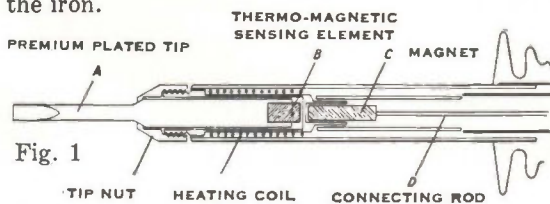

As indicated in Fig. 1, permanent magnet C is attracted to sensing element B when the iron is,

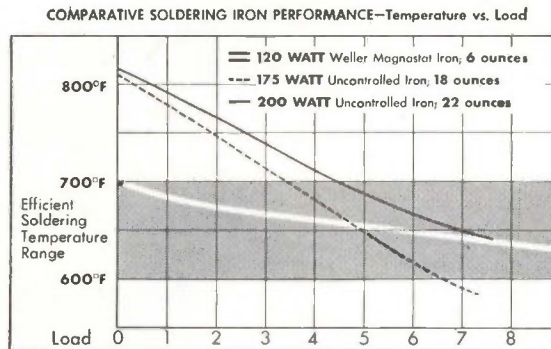

Fig. 2

cold. This pulls on the power switch in the handle through connecting rod D. As the tip reaches its Curie point, which is the selected operating temperature, element B is no longer able to hold the magnet and a spring retracts it, pushing the switch off. When the tip cools slightly, it again attracts the magnet to resume heating.

The Curie principle keeps the Magnastat tip safely within the efficient soldering temperature range under all conditions from no load to continuous hard duty (see Fig. 2). Uncontrolled irons, though of higher wattage, fall into the efficient range for only a fraction of the possible loadings. Also note that the Magnastat does a better job than irons weighing three times as much. Choice of tip styles and control temperatures let each Magnastat iron be matched to its production assignment.

Weller Magnastat irons give other production advantages. Their light weight and cool handles reduce operator fatigue. There are four styles—pencil to heavy duty. Nineteen sizes and shapes of tips are added evidence of a tool that can be exactly matched to its job.

Magnastat soldering irons were developed and introduced by Weller, who also originated the soldering gun, its dual-heat feature and other soldering advances. Write today for further information and descriptive catalogs covering all of these tools.

**Weller Electric Corp.**  
601 Stone's Crossing Road, Easton, Pa.

# MONEL alloy 404

## What is it?

## What does it offer?

## How is it used?

## Can you use it?

MONEL\* nickel-copper alloy 404 was especially designed for applications where you need multiple brazings in wet hydrogen. It offers non-magnetic properties, good strength, excellent corrosion resistance, low thermal expansion. And it may be the answer to your electronic design problem.

Here's what you should know about it.

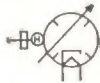

**Physical Properties:** At 78°F the electrical resistivity of MONEL alloy 404 is about 300 ohms per circular mil foot; thermal conductivity is 146 BTU/sq. ft./hr./F/in. (calculated); tensile modulus is  $24.5 \times 10^6$  inches/inch/°F.



**Mechanical Properties:**† Hot rolled, annealed rod has a tensile strength of 67,000 psi, yield strength of 25,000 psi and 46.5% elongation. Rod, cold drawn and stress relieved, has a tensile strength of 77,000 psi, a yield

strength of 63,900 psi and 28.5% elongation.



**Permeability and Magnetic Properties:** The permeability of MONEL alloy 404 in any of the commercial forms will not exceed a value of 1.1 at 27°F, when measured using a field strength of 0.5 oersteds. It is virtually non-magnetic at or above room temperature. These non-magnetic properties are not appreciably influenced by working or heat treatment.



**Corrosion Resistance:** MONEL alloy 404 is inherently corrosion-resistant. It is resistant to practically all alkalis, to most acids and salts, as well as to organic substances.



**Fabrication:** MONEL alloy 404 can be readily hot worked, cold worked,

welded, brazed, soldered, machined, ground, and polished. It can be triple brazed in wet hydrogen with a dew-point of about +80°F. It is available in plate, sheet, strip, rod, bar, wire, pipe and tube.



**Uses:** MONEL alloy 404 is being used in structural parts for power tubes, traveling wave tubes and klystrons. Also for magnetron components, wave guides and cathode supports.

Is this the alloy you're looking for? For further information write for your free copy of "Basic Data—MONEL alloy 404."

\*Registered Trademark

†Nominal

HUNTINGTON ALLOY PRODUCTS DIVISION  
The International Nickel Company, Inc.  
Huntington 17 West Virginia



# HUNTINGTON ALLOYS

# New Stations Spur French Tv

Already in production  
is 23-inch, transistor  
television receiver

**PARIS**—With the heady prospect of an in-the-offing second tv network to stimulate tv sales, French manufacturers reeked optimism as they kicked off their fall sales season this month at the annual Paris Radio-Tv Salon. The show went international for the first time this year.

**Transistor Tv** — Even though a large contingent of foreign manufacturers, most of them German, turned up at the salon, there was no marked speedup in the evolution of set technology. Wide-angle crt screens prevail and the French-developed explosion-proof tube (ELECTRONICS, p 40, March 16, 1962) is starting to catch hold solidly.

Celard of Grenoble, however, established itself as a tv front-runner by showing an all-transistor 23-inch set now in production. It can re-

## That's Entertainment!



**HOME VIDEOTAPE** system introduced by Ampex last week at New York's Hi-Fi Music Show really opened eyes. So did the price: \$30,000. Recorder can be preset to tape a show while owner's away, or tape one program while owner watches another. Components include tv camera, stereo radio and record player



## Interchange-ability with plug-in oscillo/riter\* recorder amplifiers

TI offers amplifiers to fit any medium frequency application . . . all types simply plug in the front panel. Choose from an impedance matching buffer amplifier, a high gain d-c unit, a high performance carrier amplifier, a medium gain differential amplifier, and other special purpose types.

Oscillo/riter recorders offer interchange-ability in chart paper, too. For convenience and ease of ready

reference, choose Z-fold charts, they read like a book, stack out of the way; or get economy with the standard roll chart furnished with each recorder.

Oscillo/riter recorders offer more pushbutton convenience than any other medium frequency recorder. Basic price with buffer amplifiers is \$1195.

Write for complete information.

\*trademark of Texas Instruments Incorporated

INDUSTRIAL  
PRODUCTS  
GROUP



**TEXAS INSTRUMENTS  
INCORPORATED**  
P. O. BOX 66027 HOUSTON 6, TEXAS

SENSING • RECORDING • TESTING • DIGITIZING INSTRUMENTS  
THE INSTRUMENTS OF TEXAS INSTRUMENTS

613

CIRCLE 47 ON READER SERVICE CARD

**HELP YOUR POST OFFICE  
TO SERVE YOU BETTER  
BY  
MAILING EARLY IN THE DAY  
NATIONWIDE IMPROVED MAIL SERVICE  
PROGRAM**

### 2-COIL "MEMORY" RELAY

Mechanical latch, electrical reset, Frame 255, with DP-DT; TP-DT; or 2 N. O. and 2 N. C. contacts.

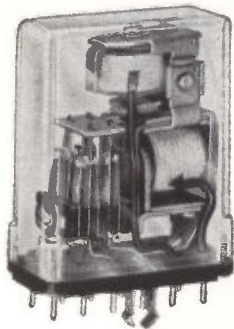

### GENERAL PURPOSE CONTROL RELAY

Frame 219—Available in 3 standard contact arrangements.

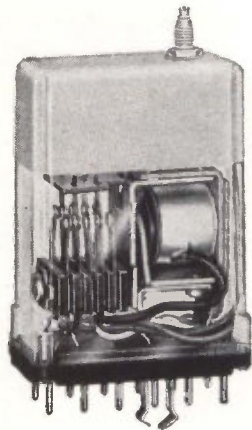

### TIME DELAY CONTROL RELAY

Frame 235—Combines a solid state adjustable timing element with a Frame 219 relay unit. Timing ranges: 0.2 to 18 seconds; 2.0 to 180 seconds.

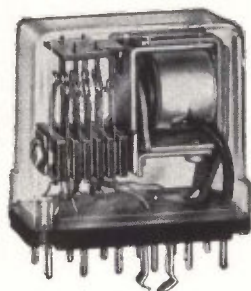

### SINGLE COIL SEQUENCE RELAY

Frame 211—Provides thousands of control sequences, permits simplified, low cost sequence control.



# RELAYS

for better, more compact,  
sensibly priced

# INDUSTRIAL CONTROL

These compact Dunco relays in matching plug-in designs are causing a quiet revolution in simplifying and economizing modern control of many kinds. Four moderately priced types provide practically any operational circuitry feature. Life, dependability, insulation and other characteristics meet the most critical industrial control specifications.

Write for engineering data bulletin on any type to:  
STRUTHERS-DUNN, Inc., Pitman, N. J.

## STRUTHERS-DUNN

5,348 RELAY TYPES



Sales Engineering Offices in: Atlanta • Boston • Buffalo • Charlotte • Chicago • Cincinnati • Cleveland • Dallas • Dayton • Denver • Detroit • Houston • Kansas City • Las Vegas • Los Angeles • Memphis • New York • Orlando • Pittsburgh • St. Louis • Salt Lake City • San Antonio • San Diego • San Francisco • Scottsdale • Seattle • Wichita. Canadian Licensee: Renfrew Electric Co., Toronto, Ontario, Canada. Export Department: 1505 Race St., Philadelphia 2, Pa., U.S.A.

ceive any line standard in use on the continent. The set has such extras as a built-in voltage regulator for the line supply and an automatic circuit that keeps contrast at optimum for the ambient light conditions, determined by a photocell near the crt.

The set lists for \$440 and Celard says 20,000 units will come off the production line during the next 12 months. All transistors are French-made, except in the sweep circuits.

**Second Network**—Manufacturers showed sets ready for the second network, which in January starts weekend broadcasting in the Paris and Lyons areas. By April, the government-owned Radiodiffusion Television Francaise will be airing a full program for those two areas and by 1965 most of the country will be covered.

**Prices**—Prices this year have moved upward—largely, claim the set manufacturers, because of the uhf tuner needed to receive the band-IV second-network broadcasts. Last year's sets generally had 625-line sweep circuits needed for band IV, but not the uhf tuner. The first network, bands I and III, use the 819-line standard.

A representative list price for a 19-inch set without frills this year is \$245. But about 60 percent of sets sold in France have 21-inch screens and they usually list somewhere between \$350 and \$400.

A record sales year is in sight. Tv production is running 12 percent ahead of 1962 and radios 6 percent. In 1962, a record 987,000 tv sets and 2.7 million radios brought total sales up to \$325 million.

### ARPA Orders Booster For Anti-ICBM System

WASHINGTON—Advanced Research Projects Agency has selected Boeing to develop and build a new booster rocket for anti-ICBM point defense. The project is called "Hibex"—high-G boost experiment. Initial funding runs to \$6 million. Radar and guidance subsystems are not yet involved. Test firings of Hibex, described as a "step beyond Sprint in performance," will be conducted within a year.

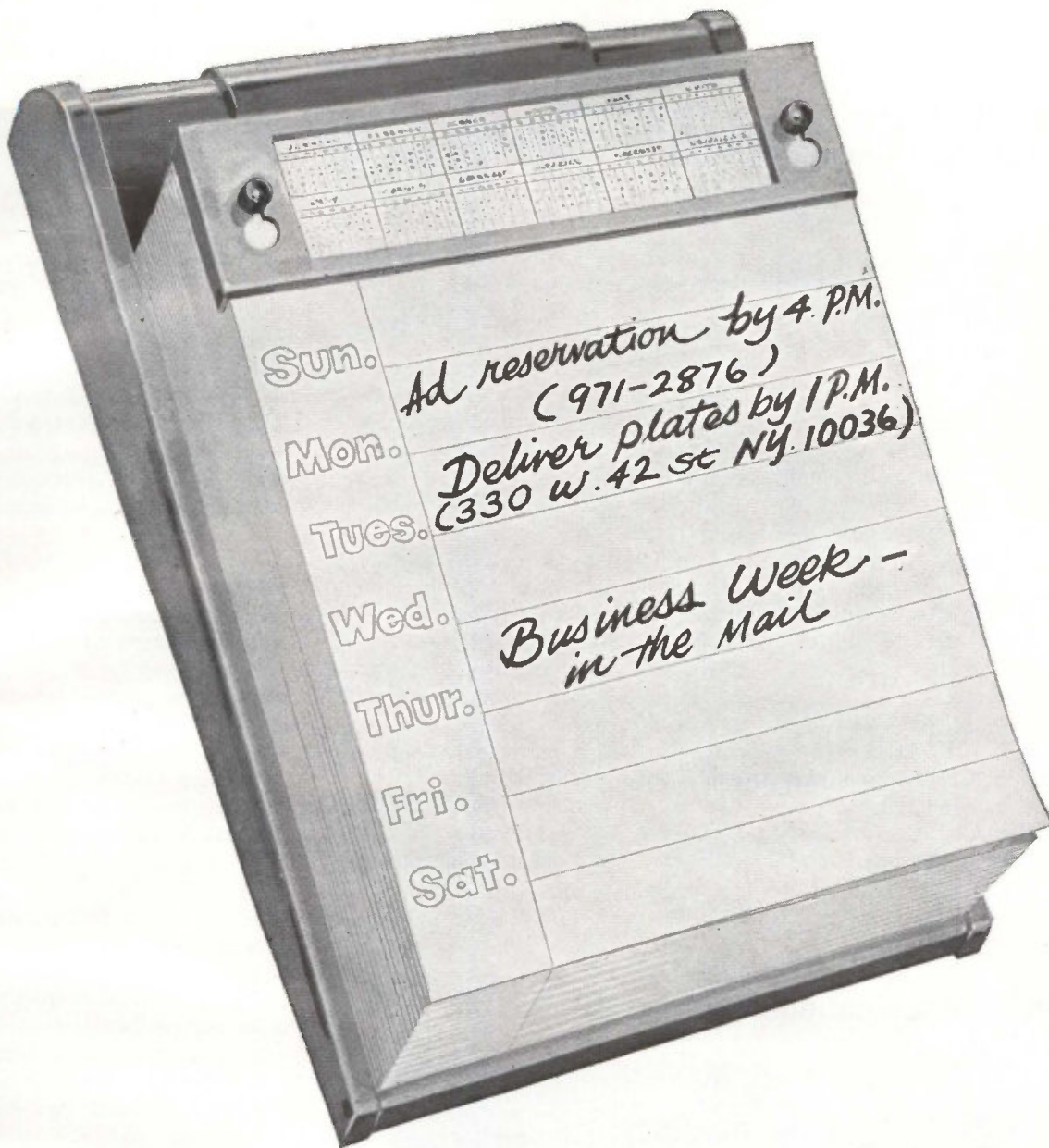

This could be *your* calendar—any week in 1963.

We believe that BUSINESS WEEK's "Short-Notice Closing" is the *fastest* ad closing of any major national magazine. It gives you last-minute, same-week insertion for one or two pages of advertising in any issue.

BUSINESS WEEK is read by the most important people in America for business advertisers—*management men*. With "Short-Notice Closing," you reach these important decision-makers *fast*, with up-to-the-minute information they need for quick decisions.

Here are the details:

**Deadline for Reservations: Monday at 4 p.m.** Our Business Department in New York must have your reservation, *at the latest*, by 4 p.m. on Monday of week-of-

issue. For quickest service, wire (TWX 212-640-4646) or phone K. D. Reynolds, Production Manager, BUSINESS WEEK, 971-2876 (Dial New York City Area Code 212).

**Deadline for Plates: Tuesday at 1 p.m.** To meet our "Short-Notice Closing," your plates must be in the hands of our Production Manager, in our New York office (330 West 42nd Street, New York, N.Y. 10036), by 1 p.m. on Tuesday of week-of-issue, *at the latest*. (Sorry, no extensions possible.)

**Size of Units: Black-and-white Page or Spread.** Either one or two single black-and-white, non-bleed full pages, or one black-and-white two-page spread (gutter bleed only) per issue. Only complete plates can be accommodated. Corrections, additions, or plate refinements are

not possible on so tight a schedule.

**Price:** A premium of 10% will be charged over and above regular advertising space rates for the "Short-Notice Closing" service. Agency commission applies to premium.

To get *fast* decisions, there's nothing like being in the right place at the right time. The right place is BUSINESS WEEK. Now the right time is any time—with BUSINESS WEEK's "Short-Notice Closing."

You advertise in

**BUSINESS WEEK**

when you want to inform management

A McGraw-Hill Magazine



# Multi-Quantum Conversion Shown

Three- and five- quantum transitions point way to higher frequency bands

**MULTIPLE QUANTUM** conversion, as shown by new experimental and theoretical work, appears to offer a most promising way of extending the useful electromagnetic spectrum into the millimeter, sub-millimeter and infrared bands (see Electronics Newsletter, Sept. 6). Basically, the method converts power at one frequency to a higher, harmonically related, frequency.

Researchers at Kane Laboratories, Palo Alto, California, under support from Continental Electronics, have achieved an advanced theory of multiple quantum effects

and their application to frequency conversion. A. Vassiliadis, R. N. Wilson and D. J. Scalapino have demonstrated triple-quantum transitions using paramagnetic resonance, and a higher-efficiency triple-quantum transition using electric dipole interactions, as well as a five-quantum transition.

Multiple-quantum transitions, whose existence was first pointed out in 1959 by E. T. Jaynes and M. J. Duggan, do not depend on the existence of intermediate energy states but take place between energy levels which are also connected by single-quantum transitions. They can be regarded as taking place by way of two intermediate states, which are states of the total system, that is, molecule plus field. These transitions always involve an odd number of photons of electromag-

netic field. It has been observed that the rate of triple-quantum processes increases with the cube of the energy density of the field, whereas the single-quantum rate varies linearly with the energy density. Thus, at high enough energy densities, the triple-quantum process can be as fast as any other process; consequently, an efficient frequency converter is feasible.

**Converter**—In its most basic form, such a converter would be a molecular system whose molecules have two energy levels. The energy separation between the states is associated with a characteristic line frequency. A strong electromagnetic field applied to molecules at a frequency which is an odd subharmonic of the line frequency results in stimulated radiation at the line frequency.

The theory for multiple quantum effects developed at Kane Engineering Laboratories proceeds from a solution of the equations governing the interaction between an electromagnetic field and a molecular or atomic system. These Bloch-type equations, obtained by Professor E. T. Jaynes in 1958, were first solved on an analog computer. Subsequent analytic solutions have led to a detailed understanding of the process. A recent digital-computer program permits solving the equations in areas where the analytic solutions are not valid.

**Experiment**—The theoretical results were first substantiated using the paramagnetic resonance of DPPH, an organic compound, as the active material. A small sample of DPPH was placed in a coaxial resonant cavity which was also resonant at the pump frequency and the third harmonic. Pump frequency was 425 Mc and the third harmonic output obtained was in agreement with the calculations. A

## Optical Communications Lab

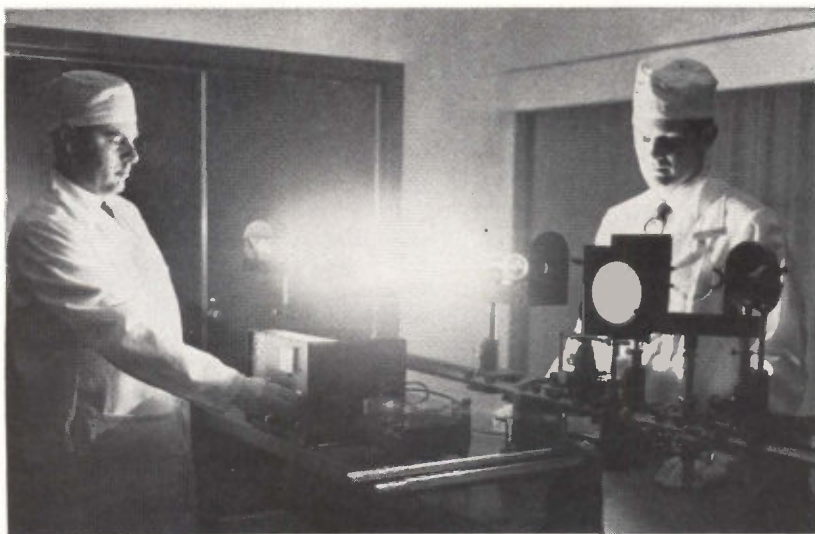

OPTICAL LASER helps study of light as a means of communication, in new optics and solid state research laboratory established at General Dynamics/Fort Worth plant, best known as producer of B-58 Hustler supersonic bombers and F-111 tactical fighters. Labeled IVU, for infrared, visible light and ultraviolet, new lab has facilities for work in space rocket surveillance, target tracking and related fields

# can you use the advantages of Kepco's STATIC MAGNETIC VOLTAGE STABILIZER

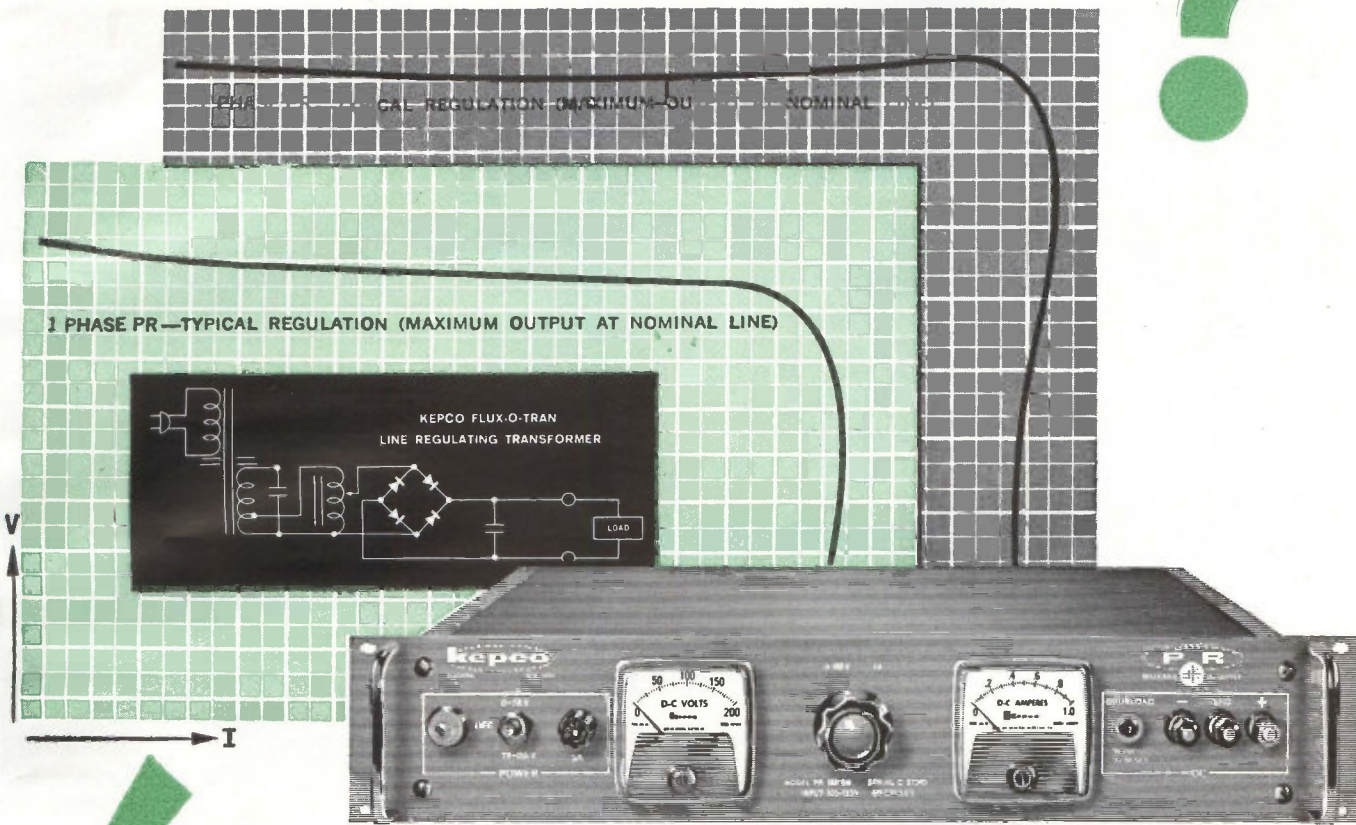

Model PR 155-1M



## KEPCO POWER SUPPLIES

Kepco's **FLUX-O-TRAN** is a ferro-resonant static magnetic voltage stabilizer. Its design characteristics feature:

- output essentially free of line voltage variations
- isolation of line transients
- current limiting protection from current overloads and external short-circuit

The **FLUX-O-TRAN** is the heart of Kepco's PR GROUP of DC Power Supplies. By delivering a squared-wave-form to the rectifier, the **FLUX-O-TRAN** increases rectifier utilization and improves the loading characteristics of the filter capacitors. This characteristic

provides a relatively low intrinsic source impedance, improving load regulation and affording a low ripple content. The result is a simple **FOOL-PROOF**, high efficiency source of regulated DC power in *minimum space* and at *minimum cost*.

The PR GROUP offers a wide choice of *adjustable* output voltage and output ratings with:

- typical ripple values 0.5 to 3%
- overcurrent protection
- no voltage overshoot
- power efficiency typically 50-70%
- reliable, efficient silicon full-wave rectification

± 1% LINE REGULATION — 105-125 V AC, 60 CPS ± 5% — 1 PHASE											± 2% LINE REGULATION 208/230 V AC ± 10% 60 CPS ± 5% — 3 PHASE		
VOLTS	0-7.5-15	0-15	0-19-38	0-38	0-40-80	0-80	0-78-155	0-155	0-165-310	0-310	0-20	0-40	0-50
AMPS	0-10	0-30	0-5	0-15	0-2.5	0-8	0-1	0-4	0-0.6	0-2	0-100	0-50	0-40
MODEL	PR 15-10M	PR 15-30M	PR 38-5M	PR 38-15M	PR 80-2.5M	PR 80-8M	PR 155-1M	PR 155-4M	PR 310-0.6M	PR 310-2M	PR 20-100M	PR 40-50M	PR 50-40
PRICE	\$345	\$495	\$325	\$475	\$325	\$450	\$325	\$430	\$345	\$430	\$1,125	\$950	\$950

for complete specifications on more than 250 standard models, write for NEW Catalog B-631



131-38 SANFORD AVENUE • FLUSHING 52, N.Y., U.S.A.  
Phone (212) IN 1-7000 • TWX# (212) 539-6623  
Cable Address: KEPCOPOWER, NEWYORK

**Fred  
Roberts  
can  
show  
you ...**

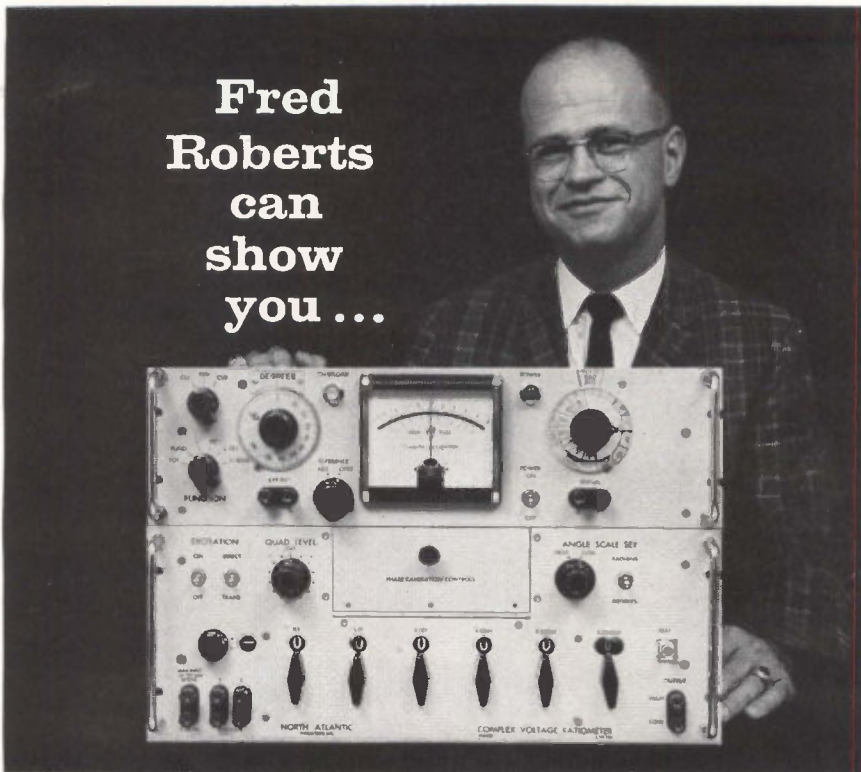

Director of Marketing, North Atlantic Industries

## how to measure ac ratios regardless of quadrature

North Atlantic's Complex Voltage Ratiometer is a completely integrated test set for measuring grounded 3 terminal networks. By providing self-calibrated quadrature injection, the Model CVR-551 permits calibrated meter readings of phase angle up to 30° or 300 milliradians full scale, and, in addition, provides direct readings of in-phase and quadrature voltages. As an added feature, the integral Phase Angle Voltmeter\* and AC Ratio Box can be used independently. Abridged specifications follow:

In-Phase Ratio Range, $R_I$ .....	.000000 to $\pm 1.111110$ with full accuracy
Phase Angle Range, $\alpha$ .....	$\pm 1.0$ to $\pm 300$ milliradians $\pm 0.1$ to $\pm 30^\circ$ (in 6 calibrated ranges)
Frequency .....	Any specified frequency, 50 cps to 3KC
Input Ratio Error, $R_I$ .....	$\pm (.001 + \frac{.0001}{R_I} + \delta \tan \alpha) \%$ of reading
Phase Angle Error, $\alpha$ .....	$\pm .0003$ radians or $\pm .017^\circ$ (low ranges) $\pm 3\%$ full scale (high ranges)
Phase Angle Voltmeter* (independently used) .....	$\pm 2\%$ full scale 1 millivolt to 300 volts (in 12 calibrated ranges)
A.C. Ratio Box (independently used) .....	1 ppm terminal linearity .35f (300 volts max)

North Atlantic's CVR\* line includes 2 and 3 frequency models. All models available with optional 10 ppm Ratio Box control of quadrature injection.

Send for data sheet or contact your local North Atlantic sales representative now for complete information.

\*Trademarks



**NORTH ATLANTIC** industries, inc.  
TERMINAL DRIVE, PLAINVIEW, L. I., NEW YORK • Overbrook 1-8600

maximum conversion output power of about 100 microwatts was obtained with an input power of 8 kilowatts.

Experiments with electric dipole interactions were conducted using ammonia. It was decided to use a continuous-interaction structure rather than a cavity, because it made available a larger volume, resonance problems could be avoided, and a simple theoretical solution to the equations was available for this situation. In the experimental setup, an electromagnetic travelling wave is introduced into a region containing the active material. The third-harmonic converted wave builds up exponentially with distance and eventually reaches a saturation value. The experiment was run first using a strip line to guide TEM waves at both frequencies. With the available pump source, a maximum of 22 milliwatts was obtained at K-band, with an input of about 20 kilowatts at X-band. However, most of the X-band and K-band power is absorbed at the end of one meter length of interaction. The intent was to test the theory and not to build an efficient converter.

Next, a coaxial structure was built, and a low impedance line added to provide a relatively uniform electric field. Using this interaction region, with a length of about 2.8 meters, a converted power of 80 watts was measured for an input power of 160 kilowatts. This indicates a conversion of the order of one watt per cubic centimeter of active material.

A later experiment was conducted with the same coaxial structure, with pump power at C band, attempting a conversion by five. Qualitative results show that a five-quantum process did take place, and conversion of the order of 0.5 watt was obtained with input power of 250 kilowatts.

## Studies Sensing Techniques For Space Vehicle Launch

AERODYNAMIC attitude and dynamic pressure sensing techniques for application during launching of space vehicles will be studied by Nortron-



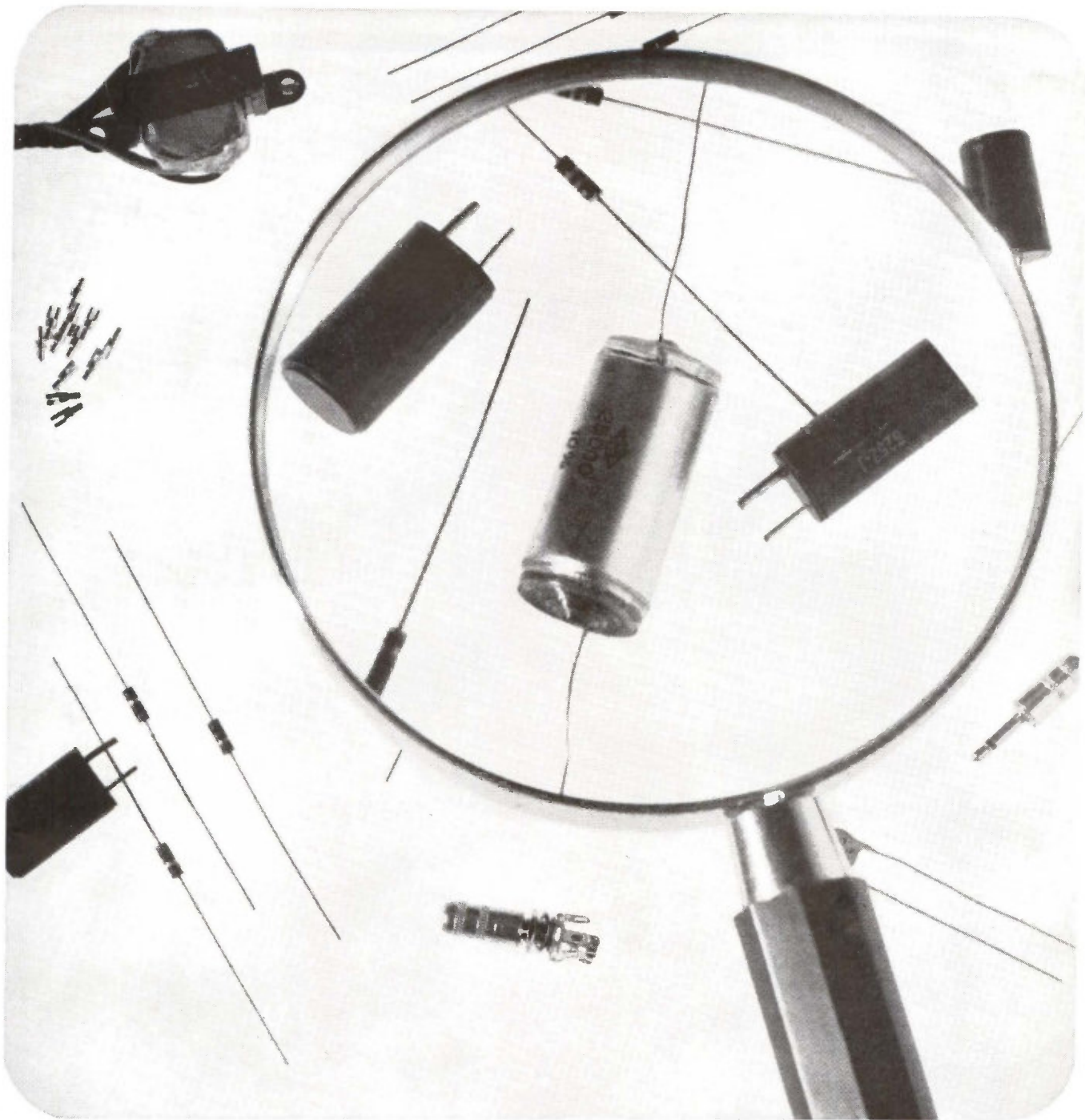

*Let Ansco 'H-D' X-ray film  
give you the ultimate in image sharpness*

For radiography of small objects and the identification of correspondingly minute defects, the critical definition of Ansco Superay 'H-D' X-ray film is a must. The extremely fine grain characteristics of Superay® H-D film provide the utmost in image quality; maintain microscopic definition throughout the entire KvP range. 'H-D' is the first American X-ray film for ultra-

high definition radiography. Ask your Ansco Products Representative for it today.

 **Ansco**  
PHOTO PRODUCTS OF  
GENERAL ANILINE & FILM CORPORATION  
BINGHAMTON, NEW YORK

# Be fussy

Two things determine whether or not a particular printed circuit connector is "right" for your application:

1. How the printed circuit board mates with the connector, and
2. How the connector connects to the rest of the system.

Take mating, for example. Besides having the correct number of contacts, a printed circuit connector must hold the board securely whether the board happens to fall at the high or low end of thickness tolerances.

#### IT TAKES THREE

These considerations convinced Amphenol engineers that no single contact design could satisfy the requirements of a wide range of applications. So they designed three contacts that will.

One, used in Prin-Cir\* connectors, looks a lot like a tuning fork with lips. The circle lip design makes contact overstressing or "setting" impossible—even after repeated insertions. The contact's long spring base also enables it to accommodate boards that range in thickness from .055" to .073", while doing an excellent "wiping" job.

#### EASY DOES IT

But not every application requires the Prin-Cir "bite." For this reason, Amphenol engineers designed connectors with ribbon contacts that mate with a gradual wedge-like force. In

blind mating applications, gradual mating makes the feeling of *correct* mating unmistakable. (Just the thing when your equipment may eventually be maintained by less-skilled and less-concerned personnel.) Ribbon contact wedge action also makes it possible for connectors using these contacts to accept the same wide range (.055" to .073") of board thicknesses as do Prin-Cir connectors.

Finally, advances in micro-miniaturization (like Amphenol-Borg's Intercon® pre-fabricated circuitry) meant that tinier-than-ever-before connectors were needed. Amphenol's answer was the Micro-Min® receptacle and printed circuit board adapter. Micro-Min contacts are actually tiny springs of beryllium copper wire, formed in a precisely designed arc to assure firm circuit board retention. This unique design makes it possible to space contacts on .050" centers and crowd 19 connections into a little more than an inch of space.

#### TERMINATIONS COUNT, TOO

"How to connect connectors to the rest of the system" also merits a good deal of consideration. In some cases, hand soldered terminations will do just fine. In others, higher volume requirements call for high production rate methods like dip soldering and wire-wrapping. Some engineers prefer taper pin terminations.

Our printed circuit connectors are available with contact tails designed for each of these termination methods. In addition, adapters are available for use in connecting printed circuit boards at right angles to each other or in modular arrangements. We make printed circuit connectors with hermetically sealed contacts — still others with coaxial contacts.

Take your choice.

Any Amphenol Sales Engineer or authorized Amphenol Industrial Distributor will be happy to discuss printed circuit connectors (ours) with you. Or, if you prefer, write directly to Dick Hall, Vice President, Marketing, Amphenol Connector Division, 1830 S. 54th Avenue, Chicago 50, Illinois.

\*T.M. Amphenol-Borg Electronics Corp.

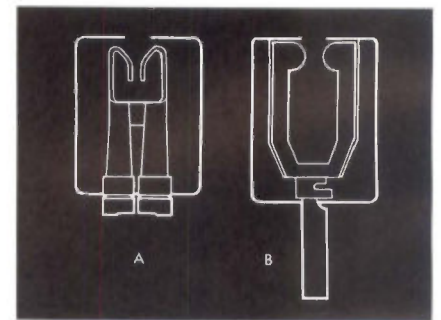

Wedging action of Amphenol ribbon-type (A) and long spring base of Amphenol Prin-Cir connectors (B) assure firm printed circuit board retention, whether board happens to fall at low (.055") or high (.073") end of thickness tolerance.



Connector Division / Amphenol-Borg Electronics Corporation

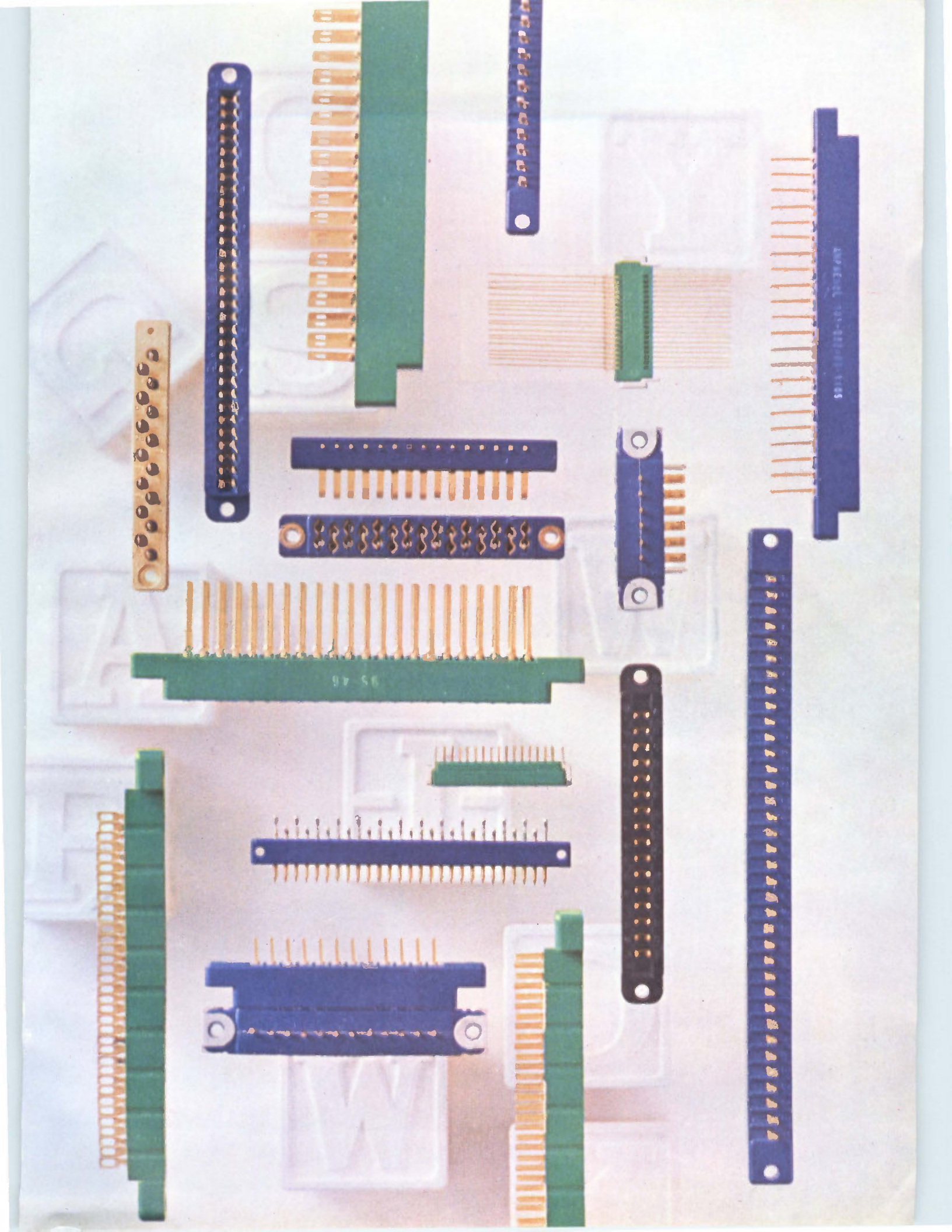

# population -



Even in the most remote areas, wings aloft are guided on their way by AeroCom's new medium range N.D. Beacon Transmitter. This transmitter was designed and built to provide long, trouble-free service with no attendants...even where the total population is Zero.

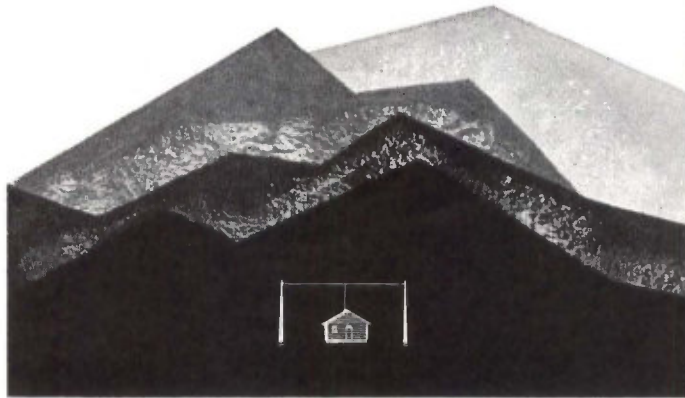

NOW — FCC type accepted — single or dual automatic—for carrier powers of 10, 12, 15, 20, 25, 50 and 100 watts.



## **AEROCOM'S Dual Automatic Package-Type Radio Beacon**

for completely unattended service. This N.D. Beacon (illustrated) consists of two 100 watt (or 50 watt) transmitters with 2 keyers, automatic transfer and antenna tuner. (Power needed 110 or 220 volts 50/60 cycles, 465 V.A. for 50 watt, 675 V.A. for 100 watt.)

Frequency range 200-500 kcs.: available with either crystal or self excited oscillator coil. High level plate modulation of final amplifier is used, giving 97% tone modulation. Microphone P-T switch interrupts tone, permitting voice operation.

The "stand-by" transmitter is selected when the carrier or modulation level of main transmitter drops 3 db or more, in case of failure to transmit the identification signal or if carrier frequency changes 5 kcs. or more. Audible indication in monitoring receiver tells which transmitter is in operation.

Unit is ruggedly constructed and conservatively rated, providing low operating and maintenance costs.

Also available in 400 watt, 1 K.W. and 4 K.W. Models, 200-415 kcs.

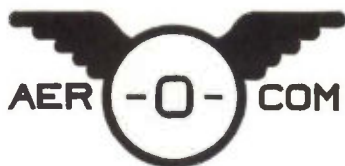

**3090 S. W. 37th AVENUE • MIAMI 33, FLORIDA**

ics Division of Northrop Corp, Beverly Hills, Calif., under NASA contract.

Called the Alpha-Q sensor study, the work includes a survey of present techniques, including Nortronics' Q-Ball concept, for measuring the angle of attack in ascent trajectories of liquid-fuel rockets. Projected studies aim to extend these techniques to heights of 300,000 feet.

The original Q-Ball sensor, using a hydraulically actuated sphere that always points into the relative wind, was developed by Nortronics Division to measure angle of attack and sideslip of the NASA X-15 manned research vehicle during the critical ascent and re-entry phases of supersonic flight. It has been modified for use on Apollo vehicles, and will be used in the upcoming tests of Apollo's abort tower, an emergency rocket designed to get the capsule and its three astronauts out of the way of harm in case the missile malfunctions.

## Solar Research Station Established in Arctic

DOUGLAS AIRCRAFT and National Science Foundation report they've established their second solar research outpost—this one at Shepherd Bay, Canada.

The station, operated by Douglas, joins its Antarctic counterpart in two major studies: the nature and properties of solar emission, and possible periodic variation in its absorption. Data will help schedule manned space launches at times of least solar flareup, permitting less shielding on short missions.

Equipment includes 30 and 50-Mc riometers to measure absorption of ionospheric cosmic radio noise, a dopplometer to measure ionosphere's height and shape changes, and a 27-kc receiver to detect atmospheric radio noise reflected by ionosphere.

Arctic and Antarctic stations are "twins" due to their location near opposite ends of a magnetic force line between north and south poles, where solar flare proton radiation is most intense, are part of U. S. contribution to the International Years of the quiet sun.

## New ac-dc laboratory standard



True RMS  
Indication

## Speed voltmeter calibration Simplify supply voltage monitoring

**±0.03% accuracy of indication.** Engelhard's new Differential Thermocouple Voltmeter provides features never before available in a single instrument. Model 35700 DTVM is designed for rapid, high-precision voltmeter calibration, monitoring of supply voltages, and is ideal for critical ac and dc measurements as well. The instrument offers an accuracy of ±0.03% at any voltage from 1 to 1011.1v—either dc or 5cps to 1kc. Accuracy is rated as percent of *actual* reading rather than full-scale deflection.

Model 35700 indicates results directly, without multiplying factors or calculations, and requires only one operation per calibration reading. In addition, all measurements are performed without accessory equipment.

Circuitry is based on a similar design developed by Griffin and Hermach for the National Bureau of Standards. Calibration of the instrument is traceable to NBS, and the DTVM is acceptable for certification by the Bureau.

**Exceptional stability** permits uninterrupted observation of voltage changes as small as 0.02% over a period of several hours. Zener diodes establish a precise basic reference voltage, while a balanced thermal-converter circuit cancels effects of ambient temperature variations.

**Simplified operation** speeds measurement and helps eliminate error.

Calibration and monitoring results are indicated directly in *percent* on the DTVM. Voltage readings appear directly in *volts* on the instrument.

### SPECIFICATIONS

Range (ac-dc):  
Accuracy (±0.03%):  
Accuracy (±0.05%):

1 to 1011.1, with overranging  
dc and ac from 5 cps to 1 kc,  
any voltage rating.

1.0 to 600v (1kc to 30kc)  
600 to 800v (1kc to 20kc)  
800 to 1011.1v (1kc to 10kc)

Size (inches):  
Power requirement:

19 x 19 x 9  
105/125v, 60cps, 10w

*Write Engelhard for details on Model 35700 DTVM. We'll send a technical data sheet with full information and specifications.*



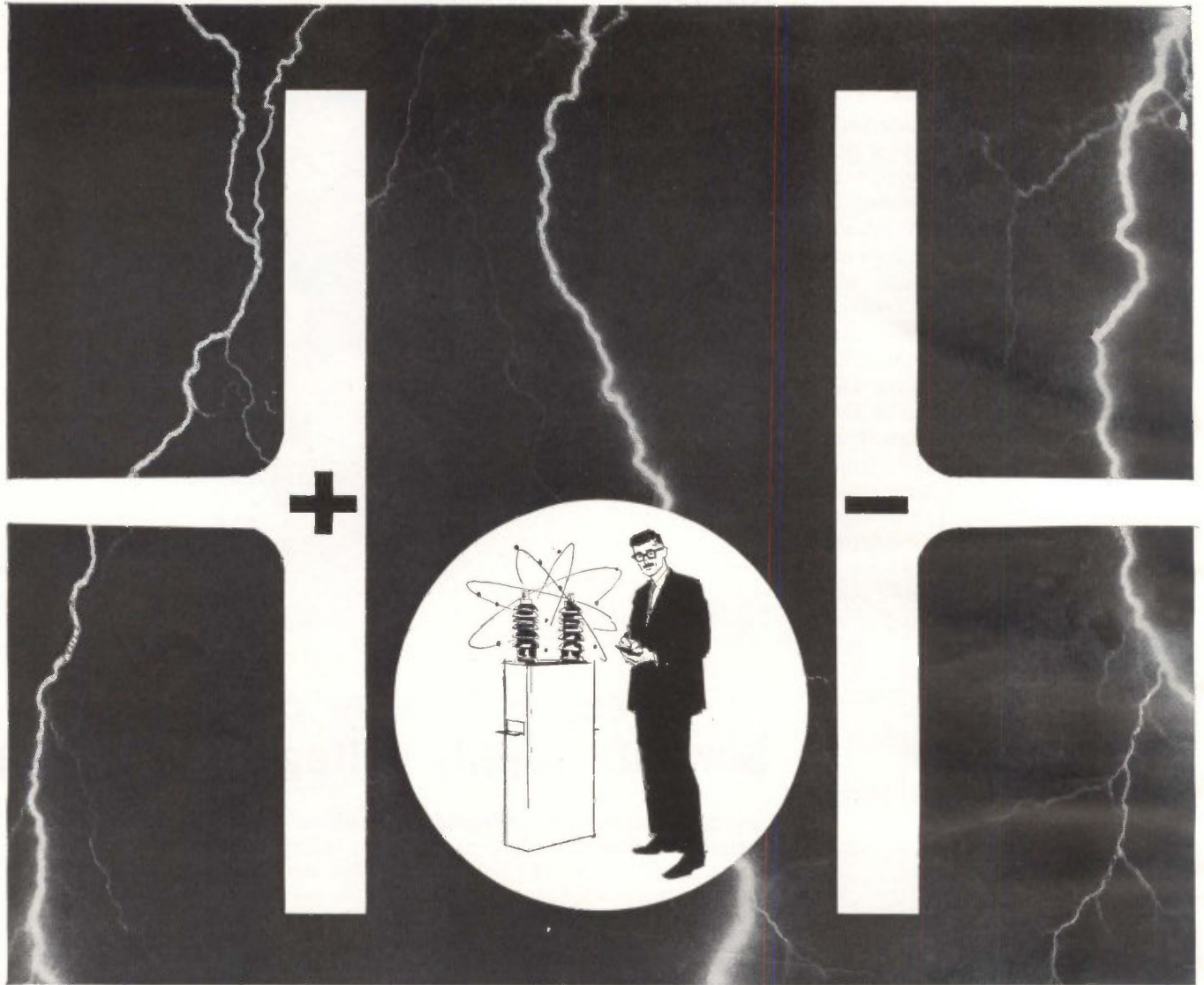

## To Help You In Your Search for Controlled Energy Systems Draw on L-M's 15 Years of Capacitor Experience

### LIKELY L-M CAPACITOR APPLICATIONS

Propulsion Devices / High Pressure Research / Block and Graft Polymer Production / Liquid & Gas Sterilization / Acoustic Wave Generators / Nuclear Triggering Devices / High Intensity Light Source / Imploding & Cylindrical Shock Wave Generators / Free Radical Generators / Food Preservation / Heatless Pasteurizing / Lasers / Filters / Surge Generators / Metal Forming / Precision Drilling / Organic Synthesis / Water Fractioning for Nitrogen Fertilizer / Crushing and Drilling Ore / Sonar Interference Devices / X-Ray Generators / Shock Wave Study / Plasma Generators / Space Tools / Metallurgical Research / Lubricant Impregnation of Metal / Flash Photography / Radar Power Supplies / Hyper-Velocity Guns / Plasma Propulsion

**CONTROLLED ENERGY** capacitor systems have proved to be valuable technological tools. They are the key to much advance research; they are the prime mover in some sophisticated production machinery. In many cases getting the correct capacitor has required the utmost from the supplier.

**RELIABLE SOURCES FOR CAPACITORS** in this relatively new industry must be developed. Selecting one with the broadness of scope like Line Material insures reliability. Fifteen years of high voltage capacitor experience has given us know-how in the design, test, manufacture and application of capacitors. This capacitor know-how is being put to work in the energy storage-discharge field. We supply capacitors to government, university and industrial customers for a whole range of applications.

**MAY WE HELP YOU?** We have the knowledge, ability and manufacturing facility to build capacitors to meet your needs. You can have

our entire engineering staff focus their experience and ingenuity on your problem, if you wish. We'd be happy to be of assistance. Let us help you in your search.

### SEND COUPON FOR COMPLETE DETAILS

**LINE MATERIAL Industries** E-93  
MILWAUKEE 1, WISCONSIN

Please send me complete details on L-M Energy Storage Capacitors.

Name \_\_\_\_\_

Title \_\_\_\_\_

Company Name \_\_\_\_\_

Address \_\_\_\_\_

City \_\_\_\_\_ State \_\_\_\_\_

**LINE MATERIAL**<sup>®</sup>

**Industries**  McGRAW EDISON COMPANY 625

## Gas Laser for Optical Radar

Operates at much longer wavelengths with reduced loss of transmission

**ATLANTA**—Outputs in the kilowatt range are not far off for helium-neon pulsed gas laser, developed at Martin-Orlando Research Laboratories, workers say.

The unit has demonstrated its high potential as a key component in an optical radar system. Results indicate effective ranges up to 10 km for noncooperative targets, and over 100 km for cooperative targets.

Peak powers of over 50 watts have now been achieved. This brings the gas laser from a low-power device into the intermediate power range. System can be used for auto-tracking optical radars, reconnaissance systems, and missile guidance application. Martin effort is now aimed at the development of an optical radar.

The Martin experimental helium-neon laser is 3 cm in diameter. This is reportedly the largest in present use in this country and larger than the only other one in England producing such power levels.

The system uses a pulse repetition frequency of 2,000 cps and a pump input of 50 kv peak voltage in 0.25-microsecond pulses. Output pulse width is 0.7 microsecond at the half-power point.

Significant results of the laser are attributed to a "rapid inversion" technique developed by Martin scientists. This technique enables gas lasers to be built with different design parameters than those previously used.

In a continuous-wave gas laser, power output is limited by the time necessary for the neon atoms to return to ground state after being

pumped to the high-energy level where emission occurs. The energy levels through which the atoms must pass on the way back down tend to be metastable and, consequently, become heavily populated, inhibiting inversion.

**Sequential Buildup**—The pulsed-gas laser, on the other hand, takes advantage of the fact that the buildup of the population of the different energy levels is sequential. This allows inversion of the laser levels before the population of the terminal level of the laser transition has built up to its equilibrium level.

Laser action is thus achieved during the period when the population of the neon is 1s (one-S) levels are low compared to those existing during cw operation.

The new laser uses helium and neon in a 50 to 1 mixture.

The highest peak power output with the present pulse equipment was obtained with pressures with pressure of 100 torr helium and 2 torr neon.

The laser tube is 130 cm long and has an inside diameter of 3 cm. The ends of the tube are Brewster angle windows, flat to 1/20 wavelength. The external Fabry-Perot resonators used are flat to 1/50 wavelength and coated for maximum reflectivity at the 1.5 micron operating wavelength. Output is uniform over the 3 cm aperture.

Pulse rate can be varied from zero to 5,000 cps. Peak power output is uniform over repetition rates up to 2,000 cps, but falls to one-half peak value at 3,800 cps.

As peak power outputs continue to increase and higher-power tubes and more sophisticated detection

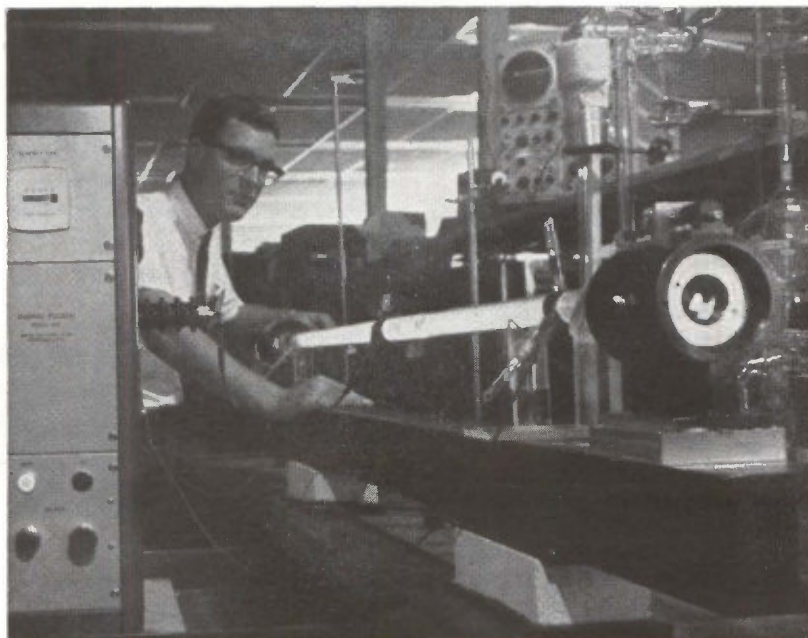

**PULSED** helium-neon gas laser provides pulse power more than three orders of magnitude above the average power afforded by c-w operation. Greater increases are expected

# ULTRA HIGH RELIABILITY tubular capacitors

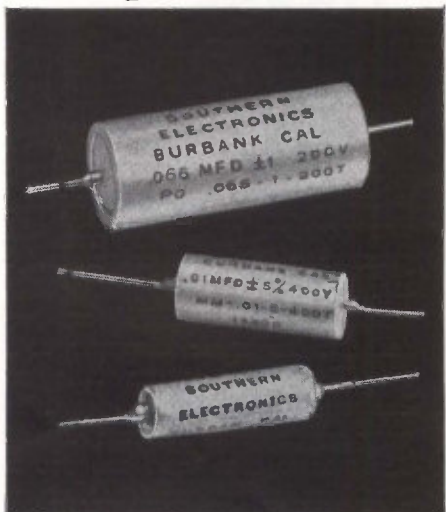

**WITH  
A NEW DEGREE OF  
PRECISION**

SOUTHERN ELECTRONICS CORP. has long been a leader in the design and manufacture of high-precision tubular capacitors, and has pioneered in supplying them for critical applications in computers, missiles, communications and other high-grade military and commercial equipment. They are made to the same standards as our high precision polystyrene capacitors so widely accepted for military applications.

SEC tubular capacitors are manufactured under unusually critical quality control standards, resulting in tolerances as low as 0.5% in most values, and hermetic sealing guarantees accuracy over wide environmental changes.

SEC tubulars are available in a wide range of tolerances to meet your needs, from 100 mmfd. to any higher value, in polystyrene, mylar, metallized mylar, teflon and dual-dielectrics.

All SEC tubular capacitors meet or exceed the most rigid MIL-SPECS.

In addition, we manufacture a complete line of tubular capacitors for commercial applications. Let us know your requirements.



Write today for detailed technical data and general catalog.

**SOUTHERN  
ELECTRONICS**  
*Corporation*

150 West Cypress Ave., Burbank, California

techniques appear, ranges of 1,000 km and more can be expected.

The ultimate accuracy of an optical radar system can far exceed that of its microwave counterpart for the same size and weight.

## Plastic Pot Takes Cryogenic Temperatures

CONDUCTIVE PLASTIC potentiometers have been subjected to  $-320$  F with no loss in performance. Fairchild Controls has subjected its standard Type 757P Farite units to these temperatures without any degradation in the 0.1 percent linearity accuracy built into the unit.

In addition, temperature shocks of subjecting the units to 212 F for two hours and then suddenly freezing it at  $-320$  F produced no deleterious effects. The unit was dropped from a height of 8 feet while at the  $-320$  F temperature, and performed without loss of accuracy. Fairchild Controls' Gordon Glau, who ran the tests said "I estimated the height that was necessary to attain a force of 100 G's at about 8 feet—taking into account the concrete floor on which the unit was dropped had a thin linoleum covering which added about 10 to 20 milliseconds for stopping. Frankly, I was really surprised that I didn't have to sweep up the remains."

## New Control Offered For Plant Processing

A NEW solid-state variable-frequency variable voltage control is now in service for the U. S. Office of Civil Defense. Unit was developed by Allis-Chalmers. The frequency converter controls a-c motor speed variation.

Company says unit can be applied in processing industries for precise speed control. System can be adapted to applications from 5 to 50 Kv for 7 to 65 hp drives. Speed ranges up to 10:1 can be provided. Output can be regulated to within  $\pm 5$  percent.

The converter produces motor shaft speeds having better than 0.1 percent variation.

Unit is basically a rectifier-inverter set consisting of a 3-phase

bridge-controlled d-c power supply and a 3-phase bridge-circuit power inverter. Silicon-controlled rectifiers are used.

Associated equipment includes an adjustable frequency oscillator, voltage phase control, control power supplies, logic for pulse shaping and gating amplifiers. System incorporates an independent, constant-commutation energy source. A choke condenser supplies commutation and allows sufficient recovery time for the silicon controlled rectifiers.

Company says work is in progress on a direct frequency conversion system requiring no immediate rectification. Converter connects the silicon controlled rectifier directly to a three-phase line.

## Probe Measures High Frequency Vibrations

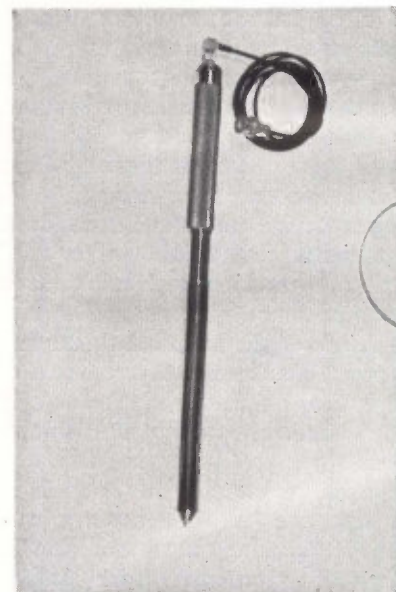

THE AMPLITUDE of ultrasonic or high-frequency vibrations can be measured with a simple probe that requires no connection to the vibrated member, see photo.

The sensing element, developed by Cavitron Ultrasonics, contains a polarized, elongated magnetostrictive rod. Output of the pickup coil of the probe is fed directly to a microammeter. The meter circuit is simplified by providing the pickup coil with a number of turns to match the impedance of the meter. This avoids the need of providing a transformer in the meter circuit.



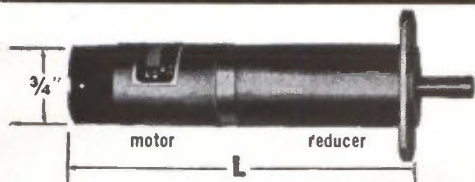

## NEW 3/4" GEARHEAD MOTOR

Now you can get up to 300 oz. in. torque from a precision miniature gearmotor only 3/4" in diameter. Globe's new SD permanent magnet d.c. motor with integral planetary gearhead provides 19 standard ratios, wound for 4 to 50 volts. Armatures can be wound to produce any speed-torque combination within the capacity of the motor. Can meet environmental and other applicable portions of MIL-8609. Request Bulletin SDG from Globe Industries, Inc., 1784 Stanley Ave., Dayton 4, Ohio.

Speed Reduc. Ratio	Max. Cont. Torque In. Oz.	L	Speed Reduc. Ratio	Max. Cont. Torque In. Oz.	L
14.58	3.0		733	100	
22.03	4.5	2 <sup>3</sup> / <sub>4</sub>	1108	150	2 <sup>1</sup> / <sub>4</sub>
33.28	7.0		1853	200	
55.66	10		2799	300	
84.11	14	2 <sup>1</sup> / <sub>2</sub>	4230	300	3 <sup>1</sup> / <sub>4</sub>
127.1	21		6391	300	
192	30		10689	300	
321	45	2 <sup>1</sup> / <sub>2</sub>	16150	300	3 <sup>1</sup> / <sub>4</sub>
485	70		24403	300	
			36873	300	

GLOBE

GLOBE INDUSTRIES, INC.

CIRCLE 201 ON READER SERVICE CARD



**X-ray  
to be  
sure**

Now, here's true quality control on transistors and other electronic components. X-ray is an economic and efficient non destructive testing method that assures reliability and provides a film record to prove it. Send samples for free test report or request literature.

X-ray Problem? Ask Balteau About It!

**Balteau**

BALTEAU ELECTRIC CORPORATION  
10-14 MEADOW ST. • STAMFORD, CONNECTICUT

CIRCLE 202 ON READER SERVICE CARD  
electronics • SEPTEMBER 20, 1963

# AMPERITE

Thermostatic DELAY RELAYS

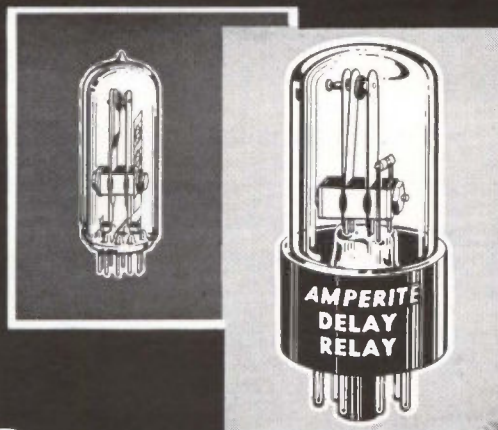

**Only a glass seal  
offers true hermetic sealing  
.. assuring maximum stability and life!**

**Delays: 2 to 180 seconds . . .** Actuated by a heater, they operate on A.C., D.C., or Pulsating Current . . . Being hermetically sealed, they are not affected by altitude, moisture, or climate changes . . . SPST only—normally open or normally closed . . . Compensated for ambient temperature changes from -55° to +80° C. . . Heaters consume approximately 2 W. and may be operated continuously . . . The units are rugged, explosion-proof, long-lived, and—inexpensive!

**TYPES:** Standard Radio Octal, and 9-Pin Miniature . . . List Price, \$4.00. Also — Amperite Differential Relays: Used for automatic overload, under-voltage or under-current protection.

**PROBLEM? Send for Bulletin No. TR-81**

# AMPERITE

BALLAST REGULATORS

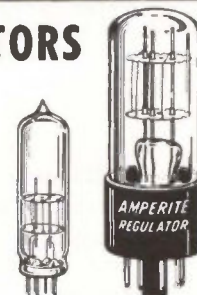
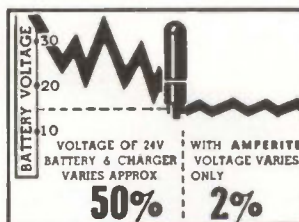

Hermetically sealed, they are not affected by changes in altitude, ambient temperature (-50° to +70° C.), or humidity . . . Rugged, light, compact, most inexpensive . . . List Price, \$3.00.

Write for 4-page Technical Bulletin No. AB-51

# AMPERITE

600 Palisade Ave., Union City, N.J., (201) UN 4-9503  
In Canada: Atlas Radio Corp., Ltd., 50 Wingold Ave., Toronto 10

CIRCLE 61 ON READER SERVICE CARD 61

# Welding Improves Grid Construction

Tighter winding, smaller wire, increases  $g_m$  in vacuum tubes

By E. COMPAGNA and A. OVERSTROM,  
Electron Tube Division,  
Westinghouse Electric Corp,  
Bath, N. Y.

**AUTOMATIC WELDING** technique developed by Westinghouse for vacuum tube grid manufacturing produces a rigid frame grid that greatly improves the amplification factor of tubes used for i-f amplifiers.

Absence of notches—conventionally used to position wire on grids—permits wire to be wound at higher turns-per-inch (tpi) ratios resulting in more transconductance, ( $G_m$ ) per unit plate current in the tube. Also, with a frame grid, the wire is stretched straight across from one siderod to the other. Since diameter of siderods is held to  $\pm 1$  percent, the finished grid configuration held to the same tolerance will be symmetrical. Resulting cathode-to-grid spacing is closer than with conventional grids and provides a higher  $g_m$ .

**Welding Technique** — Frame-grid construction provides support from four relatively heavy pieces of strap material welded across the siderods. These straps not only support siderods but resist the wire-winding tension needed to eliminate notches in siderods.

At Westinghouse, an automatic welder is used to construct frame grid strips  $12\frac{1}{8}$  inches long. This machine makes two-3-ply-sandwich welds in parallel. All materials are molybdenum.

All welds are made simultaneously because weld areas are brittle

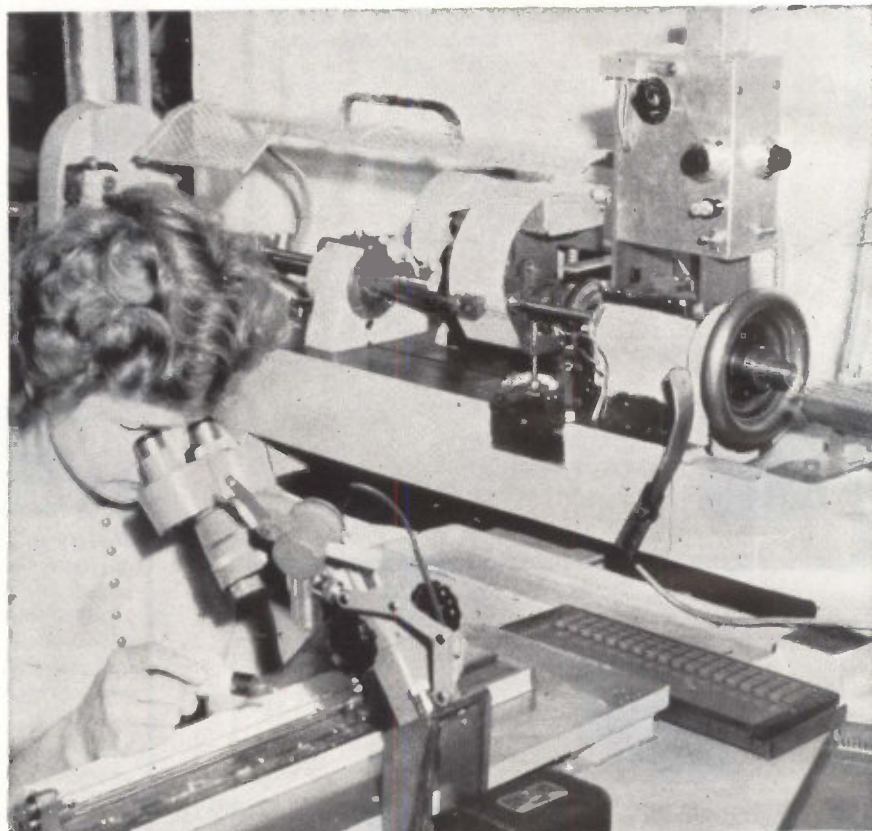

MODIFIED MACHINES produce tube types with sufficient gain to eliminate an entire stage from broadband amplifiers

and may break if there is any deformation after the weld is made. For the same reason, rod spacing and parallelism are best established before or when the weld is made. Rod spacing and parallelism are controlled by rod feed guides supplied to the machine as straightened lengths. Strap contour is controlled by the electrode shape and by a mandrel between the straps and the weld position.

Strap material, generally  $0.008 \times 0.020$  inch, is fed from two spools, located on opposite sides of the weld station. Strap stock is cut off after welding and indexed to a new position for welding the next pair of cross straps.

The machine cycles automatically and shuts off at the end of each

strip. These strips make 15 to 30 grids each, depending on grid length. One operator tends a number of machines.

Electrodes are copper-zirconium alloy and make about 2,500 grids before requiring redressing.

Welder has a synchronous timer and phase-shift heat control. Power rating is 5 kva. Machines are designed with tooling packages for easy change from one grid frame size to another.

**Wire Winding**—A technique adapted from conventional grid-making takes full advantage of frame-grid configuration to wind tungsten wire at much higher turns per inch rate than possible with wound grids. Absence of notches in siderods plus the

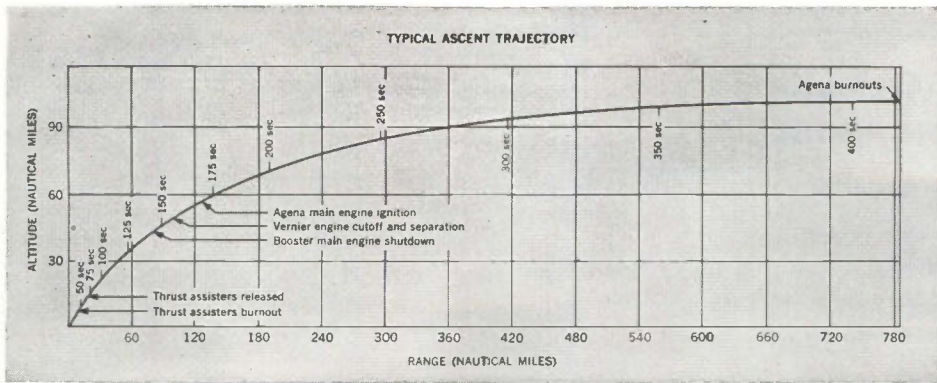

Trajectory analysis, directly affecting payload capability, is vital to any satellite flight. As Lockheed Missiles & Space Company is responsible for the orbiting of over 60% of all U.S. satellites, considerable effort has been given to the study of vehicle dynamics-performance problems.

The result: Many trajectory problems are being solved routinely through the use of automated computer programs. Some of these in use at Lockheed are: Optimal trajectory shaping programs, maximizing payload weight capability for a given set of mission parameters • Targeting programs for specific configurations, which automatically develop ascent trajectories

and orbit ephemerides • Automated trajectory programs for generating dispersion analyses needed to establish propellant margins and expected injection errors • Post-flight analysis programs which establish the actual subsystem flight performance characteristics.

As missions become more complex and demanding in terms of payload capability, accuracy requirements and mission flexibility, the sophistication of ascent and orbital systems increase, demanding greater detail of trajectory and performance analysis. Engineers and scientists at Lockheed are continually expanding their capabilities to meet these needs.

**LOOK AT LOCKHEED...AS A CAREER.**

Consider Lockheed's leadership in space technology. Evaluate its accomplishments—such as the Polaris missile and the Agena vehicle's superb records of space missions. Examine its outstanding advantages—location, advancement policies, creative climate, opportunity for recognition.

Then write for a brochure that gives you a more complete Look at Lockheed. Address: Research & Development Staff, Dept. M-50C, P.O. Box 504, Sunnyvale, California. Lockheed is an equal opportunity employer.

**SCIENTISTS & ENGINEERS:** In addition to positions relating to Trajectory Analysis, such as mathematicians, engineering mechanics, guidance & control and electrical engineers, other important openings exist for specialists in: Laser research • Bio-astronautics • Guidance and control • Operations Research • Trajectory analysis

**LOCKHEED**

**MISSILES & SPACE COMPANY**

A GROUP DIVISION OF LOCKHEED AIRCRAFT CORPORATION  
Sunnyvale, Palo Alto, Van Nuys, Santa Cruz,  
Santa Maria, California • Cape Canaveral,  
Florida • Huntsville, Alabama • Hawaii

**LOOK AT LOCKHEED...IN TRAJECTORY ANALYSIS**

*Automation of highly complex trajectory programs*

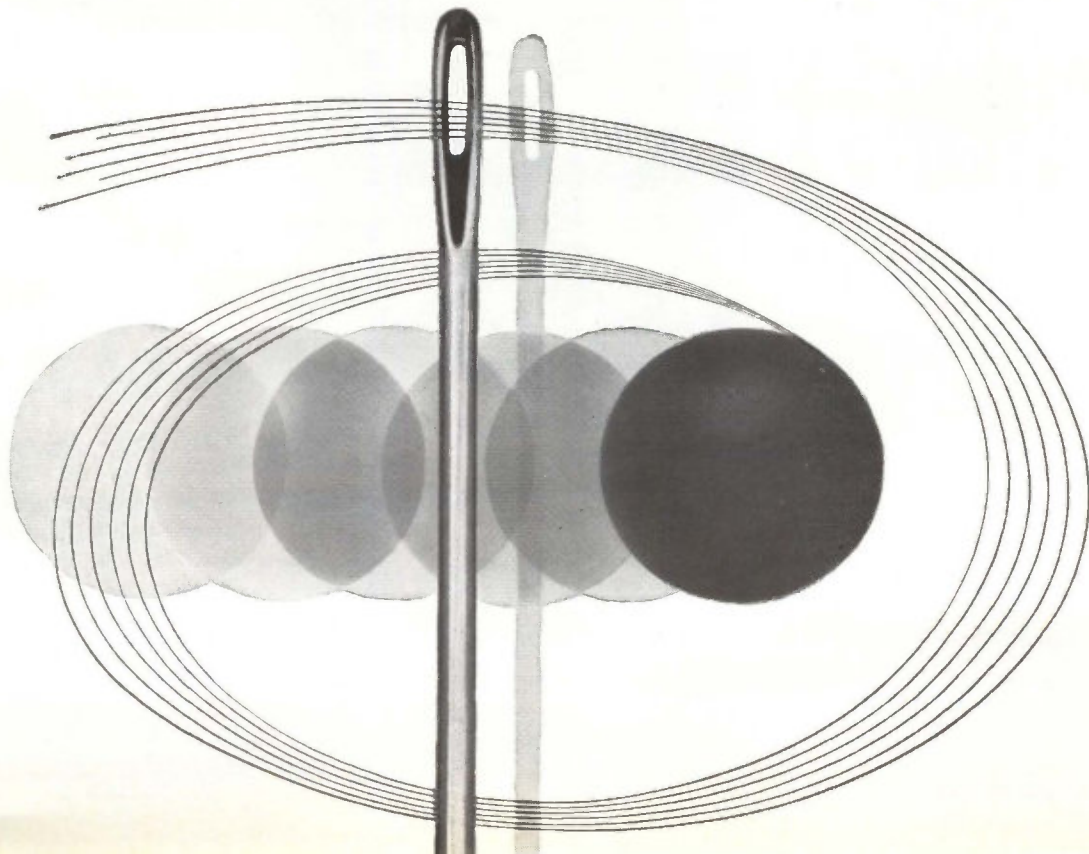

## SHED SOME COHERENT LIGHT ON YOUR RESEARCH PROBLEMS

... use the laser that has set the performance standards.

Whether your laser investigations are directed to basic research or industrial applications, the LSI Laser Systems Center can supply you with complete laser systems, components, and accessories with proven performance and reliability. A skilled Laser Systems Center research and development staff is prepared to give you complete assistance in designing special systems suited to your particular requirements.

The LSI H-130 Laser Head and C-100 Control Console with liquid nitrogen storage Dewar are shown below. This standard system has a maximum output of 3 to 4 joules; is equipped for manual, remote, or automatic firing; has a maximum pump input of 4000 joules; and has a repetition rate of three firings per minute at maximum output.

Write or call for complete information about this system and others with outputs in excess of 20 joules, laser Q-switch attachments, laser calorimeters, and an experimental micro-welding stand.

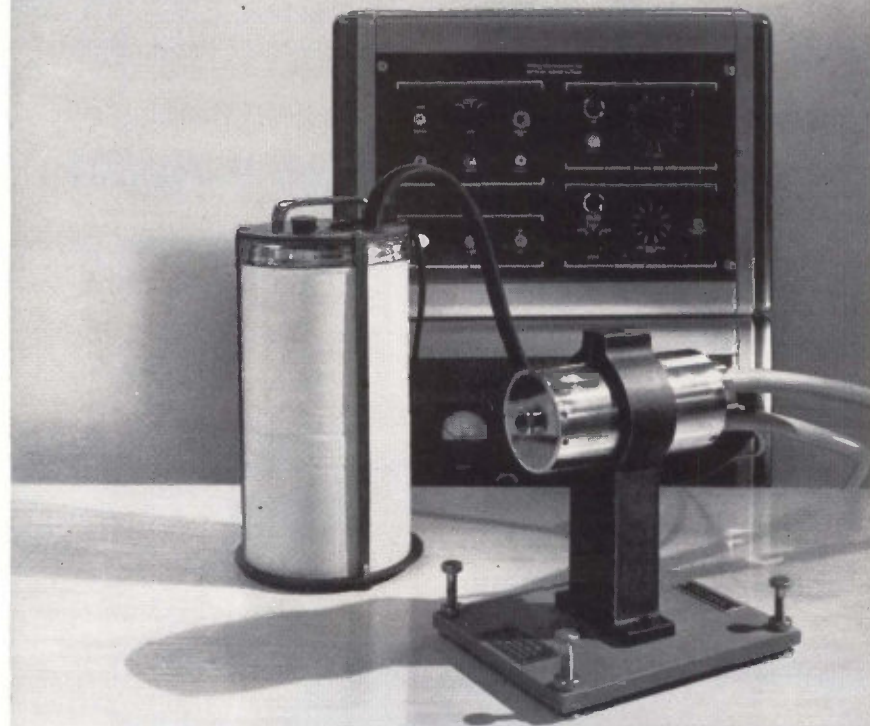

LEAR SIEGLER, INC.



**LASER SYSTEMS CENTER**  
FORMERLY TRION INSTRUMENTS, INC.

2320 WASHTEAW AVENUE  
ANN ARBOR, MICHIGAN  
TELEPHONE 313-665-8844

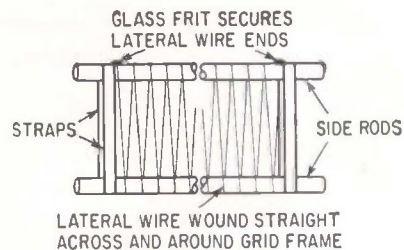

WELDED STRAPS form rigid frames permitting grids to be wound with wire of 0.0003-in. diameter

rigidity provided by the four straps eliminates limitations.

The diameter of wire usable in routine manufacture has decreased to 0.0003 inch. Experimental grids are being made with thinner wire. Tpi's of 500 to 600 and closer result in tubes with higher  $g_m$ .

To wind such fine wire, Westinghouse has modified conventional grid manufacturing equipment. Lateral-wire fastening by notching and peening is conventional in the industry. The mechanism for this operation, and other unneeded machine parts, have been removed.

Machine parts such as bearings and lead screw components are upgraded to provide the greater accuracy required to wind the 500 and higher tpi used on frame grids. A lateral wire tension unit was developed to provide uniform and gentle action at the low values of tension used: 8 to 25 grams, depending on wire size. Current is passed through the lateral wire while it is being wound, hot tungsten winds better than cold. At proper intervals in the winding cycle, the strip is advanced rapidly past the winding station so that there are only  $1\frac{1}{2}$  turns of lateral wire between grids. These turns are removed later.

The lathe operator inserts the welded frame strips for winding, threads up the lateral wire, and removes the completed grid strips. She also rethreads the lateral wire when breaks occur.

**Glass Frit**—The same operator applies glass frit to fasten the end turns on each grid on the wound strip. The wound and fritted strips are fired in hydrogen to fuse the frit to the grid structure. After this firing, the  $1\frac{1}{2}$  turns between grids are removed from the strips. These trimmed strips are cut to make the completed individual frame grids, ready for final inspection.

## Inside-Diameter Saws

### Slice Semiconductors

INSIDE-DIAMETER diamond saws have considerably improved the slicing of silicon semiconductor materials, reports Hoffman Electronics Corp., El Monte, Calif. These saws consist of bronze wheels with an outside diameter of  $8\frac{1}{8}$  inches and an inside cutting edge  $3\frac{3}{4}$  inches in diameter. The cutting edge is made of natural diamond grit, metal-bonded to the wheel to a depth of  $\frac{1}{16}$  inch. The wheels are accurately pretensioned at their outer periphery by circular ring clamps. The entire unit is then mounted horizontally on a spindle, which revolves the saw at an average speed of 4,300 rpm.

The silicon ingot to be cut is vertically mounted with wax on a billet which automatically passes against the diamond saw blade at a rate controlled to 0.0002 inch. When cut, the silicon wafers, from 0.005 to 0.025 inch thick, are separated by melting the wax bond.

Pretensioning the diamond blades eliminates downtime caused by tensioning and adjusting of the blades when they are on the machine. It also permits the use of blades 0.008 inch thick, thus reducing material waste. Outside-diameter cutting wheels are generally thicker.

The Hamco Dia-Saw slicing machine, made by Hamco Machine & Electronics Corporation, is air-powered. The inside-diameter diamond blades are made by Navan Products, El Segundo, Calif.

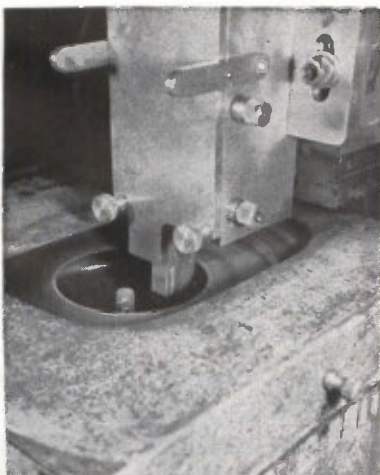

SILICON INGOT is positioned inside diamond saw during slicing

# ultra-pure hydrogen

at lowest cost ever

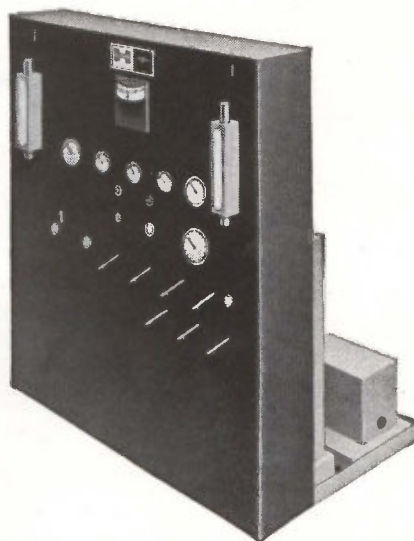

## SAVE UP TO 75%

### on your hydrogen costs!

New Hayes H<sub>2</sub> Generator puts more profits into your process . . . produces hydrogen in what may be the purest form of any known element . . . amortizes equipment cost in one year or less!

Strong claims . . . but this combination hydrogen generator and high pressure dissociator backs these claims with actual production-proved figures:

- 1.) Pick out your hydrogen cost per 1000 cu. ft. on base line.
- 2.) Draw vertical line until it intersects your NH<sub>3</sub> cost line.
- 3.) At point of intersection draw horizontal line to ordinate.

Reading gives daily savings in dollars when using hydrogen at a rate of 1600 SCF for 8 hour day.

Example: With ammonia cost 10¢/lb; H<sub>2</sub> cost \$20.00/1000 SCF; and electricity 2¢/KWH, savings amount to \$25.00/8 hour day. Savings are big . . . equipment small! Hayes H<sub>2</sub> Generator is the most compact, fail-safe, efficient unit available. For details, request Data Sheet H<sub>2</sub> G-1. Write: C. I. Hayes, Inc., 845 Wellington Avenue, Cranston 10, Rhode Island.

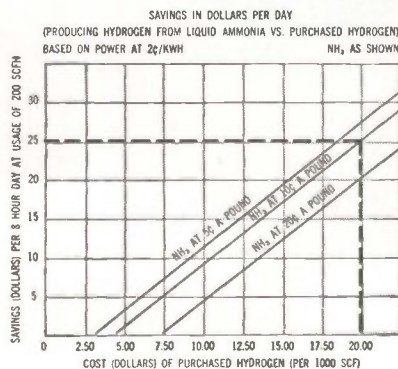

## C.I. HAYES

SLIMLINE...the first standard line of lower cost precision potentiometers with all the exclusive advantages of

# Markite conductive plastics!\*



(8-gang unit, actual size)

**Delivered in 3 weeks!** Sizes: 1-1/16" to 3" diameter. Standard Linearities:  $\pm 0.2\%$  and  $\pm 0.5\%$ . Fully Gangable...additional cups only 0.200" thin. Write for SLIMLINE Technical Data Sheet SL-639.

\* Infinite resolution • Long useful life (many millions of cycles) • No catastrophic failure • Stability in extreme environments • Consistently low noise in system use...and many more

**MARKITE**<sup>®</sup>

Markite Corporation, 155 Waverly Place  
New York 14, New York • ORegon 5-1384  
TWX: 212-640-5534

# Instrument Provides Calibration Down to 0.1 Picoamperes

Ammeter and current source measures d-c to 1 picoampere

**MODEL 124** wide-range ammeter and current source is a one-package instrument that permits rapid and convenient calibration of picoammeters with less than 1-percent scale error. Unit can also be used to measure leakage currents on advanced semiconductor devices where currents in the picoampere range are realized. Using the company's model 120 wide-range ammeter as its basic indicating component, this device also includes a current source that generates calibrating currents from 1 ma through  $10^{-13}$  amperes and a single visible figure indicates the full-scale range in use without the confusion of multiple-scale markings. The instrument contains calibration circuits for self standardization and internal controls for

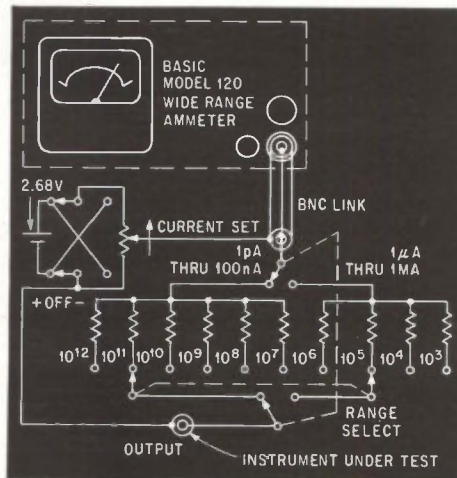

calibration adjustment.

Current source in the device provides a range of calibrating currents of reversible polarity to loads requiring up to 1-volt drop. Moreover, calibrating currents are monitored by the wide-range ammeter and the current source has an accuracy of 0.5 percent, 1 ma through

1  $\mu$ a, decreasing progressively to 1 percent on the picoampere range with full-scale indication.

Model 124 is battery powered for portability and noise-free operation and sells for \$1,425. Hexem, Inc., P. O. Box 636, Los Gatos, Calif.

CIRCLE 301, READER SERVICE CARD

## Printed-Circuit Array Uses Spiral Elements

**BUTLER ARRAY** model 02-40 operates between 2 and 4 Gc using eight printed-circuit spiral elements

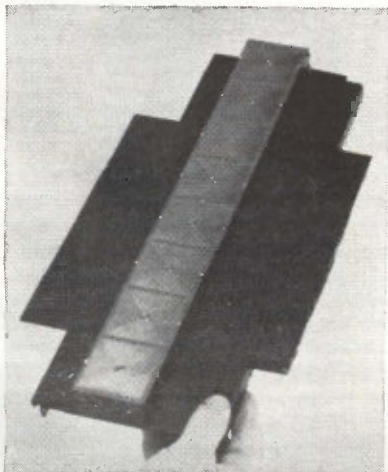

in linear-array form to provide circular polarization. A total of eight, simultaneously-overlapping independent beams are available from a single array. In addition to the eight beams with uniform taper that provide  $\sin x/x$  beams, seven beams are available with cosine taper and six beams with cosine-squared taper by the addition of beam-combining networks.

Antenna is composed of a model 02-35 octave-bandwidth matrix fabricated in strip transmission line and eight model 02-39 printed-circuit square spiral elements. Zero-length feed throughs are used between the layers of strip transmission line and between the antenna elements and phasing circuits. Connectors have been employed only on

the beam supports.

Typical applications include phased-array radar systems, electronic warfare systems and steerable communications. Unit weighs 4½ pounds. Advanced Development Laboratories, Inc., 24 Simon St., Nashua, N.H. (302)

### Frequency Converter Furnishes Two Outputs

**FREQUENCY-UP** converter changes two uhf frequencies to L-band signals and may be used at the input of a receiver for frequency conversion, or for operation as an amplifier of low-level signals. Two outputs are provided in the ranges 1.27 Gc to 1.41 Gc and 1.24 Gc

New! Low-cost  
Instrumentation Head  
tooled for high volume  
... fast prototype delivery!

## "BQQ" 4-CHANNELS ON 1/4" TAPE

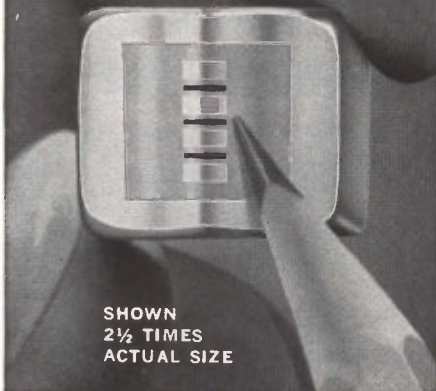

SHOWN  
2 1/2 TIMES  
ACTUAL SIZE

**Deposited quartz gaps down to 50-millionths. Gap is extra-hard with precision edges—eliminates smear!**

Multiple channels for less — with Nortronic's new, compact "BQQ" heads. Designed for digital, instrumentation, analog and audio recording or reproduction, "BQQ" heads are readily available in production quantities — will fit existing 4-track systems. Types include Record only and Record/Reproduce heads in no-mount, base-mount, rear-mount and side-mount styles.

**TYPICAL APPLICATIONS** — Used for instrumentation recording including carrier modulated types such as: AM, FM or Pulse; as straight Digital and Analog recording. Ideal for Audio Duplication, Background Music and 4-Channel "in-line" Stereo. In multiple staggered channel use, the "BQQ" accommodates 14 channels on 1" tape and 7 channels on 1/2" tape.

**"BQQ" SERIES**—Laminated core; flush or relieved metal face; hyperbolic contour; pin terminals. Impedances to 360 millihenrys. Wide range of gap lengths.

**NEED MAGNETIC HEADS?**  
Cut specification time—check Nortronic's first! Industry's widest line of "standards" plus specialized "know-how".

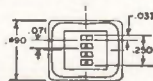
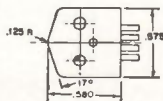

**Nortronics**

8121 -B 10th Ave. No., Minneapolis 27, Minn.

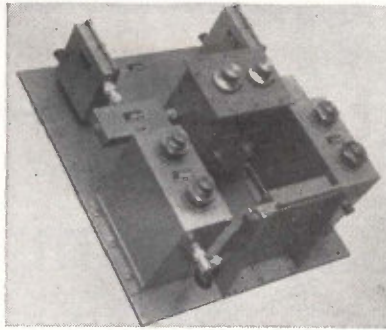

to 1.38 Gc with conversion efficiencies of 9 db and 6 db respectively. Spurious signals in the output are suppressed a minimum of 50 db.

Converter utilizes tunable filters and varactor multipliers to achieve conversion and minimize spurious outputs. Special broadband matching techniques meet required impedance characteristics at the respective termination points. Frequency Engineering Laboratories, P. O. Box 527, Farmingdale, N.J. CIRCLE 303, READER SERVICE CARD

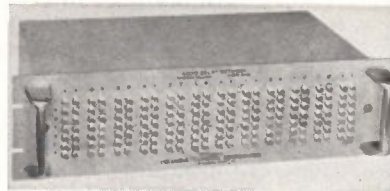

### Audio Delay Line Has 166 Taps

DELAY unit CTC-1504 is rated at 16.666 millisecc. Incorporating 166 taps, this audio delay line operates as a 360-deg phase converter at 60 cps. Tap delay is 100  $\mu$ sec  $\pm$  1 percent; phase linearity,  $\pm$  0.2 percent to 1,000 cps; amplitude linearity,  $\pm$  1 percent; amplitude response, -3 db at 1,000 cps; attenuation, -2 db max; impedance, 500 ohms  $\pm$  10 percent; dynamic range, 0.02 to 20 v peak; temperature stability, 50 ppm/deg C. Columbia Technical Corp., Woodside 77, N. Y. (304)

### Frequency Changers Yield 1 to 30 kw

LIGHTWEIGHT static frequency converters use cyclo-conversion to change one a-c frequency to another frequency without a d-c link. Di-

rect-conversion approach eliminates energy-storage elements like capacitors and reactors and thus achieves a significant weight reduction. For example, a 5-kw unit weighs only 125 lbs. and a 30-kw converter weighs 315 lbs. According to the manufacturer, the lightweight feature makes these solid-state changers ideal for airborne applications where a conventional 400 cps source is available and 60 cps power is required. Ground-support applications include communications, microwave systems or gas-turbine generator sets. Units are self protected against short circuits and use a novel try-again circuit that permits them to recycle and restart in the event of short-time, high-current surges. General Electric, Schenectady 5, New York. (305)

### Power Supply Offers High Stability

ALL-TRANSISTOR power supply has an output voltage continuously variable from 0.5 to 150 v in one range. Current output is 1 amp for any voltage rating. Stability for line voltage variations of  $\pm$  10 percent and from no-load to full-load is better than  $\pm$  5  $\times$  10<sup>-4</sup>. The supply is better than 2 mv rms. Weight of the unit is 19 lb. S.O.D.I.L.E.C., 11, Rue Leon-Morane, Paris. (306)



### D-C/A-C Inverter Powers Small Synchros

NOMINAL 7-w inverter can deliver up to 20 w of power for a period of 2 seconds. It is suitable for powering small-size synchronous motors, where extra power is required for increased stall torque during starting. Input is 24 to 32 v d-c; output, 26 v rms, 400 cps. Frequency stability is  $\pm$  1 percent; temperature range, -5 F to +140 F. Crane



Electronics Corp., 1401 Firestone Road, Santa Barbara Airport, Goleta, Calif. (307)

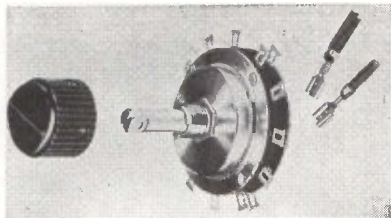

### Rotary Switches Operate Smoothly

ADVANCES in rotary switches are offered through flexible tooling that provides countless contact arrangements without special tooling. This creates a sturdy, dependable method of construction with smooth operating and precise switching as distinct advantages. Features are: (1) Inherently a dust-free or hermetically sealed enclosure utilizing the assembly itself to produce a clean switch. (2) Double break and make for high voltage and high current applications. (3) Up to 24 positions per hole available in a SRO1 type. (4) Available in an oil-filled configuration for high-current, high-voltage, and high-altitude operation. (5) Passive and active circuitry can be installed in the switch enclosure using point-to-point or p-c boards for reliability and compactness. Standard Switch Corp., 115 Moonachie Road, Moonachie, N. J. (308)

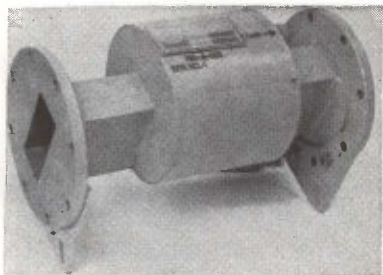

### Ferrite Isolator For Broad Band Use

Now available is a 350-kw broad band ferrite isolator that meets MIL-945-A and MIL-STD-167, and is capable of withstanding extreme temperature variations. Model

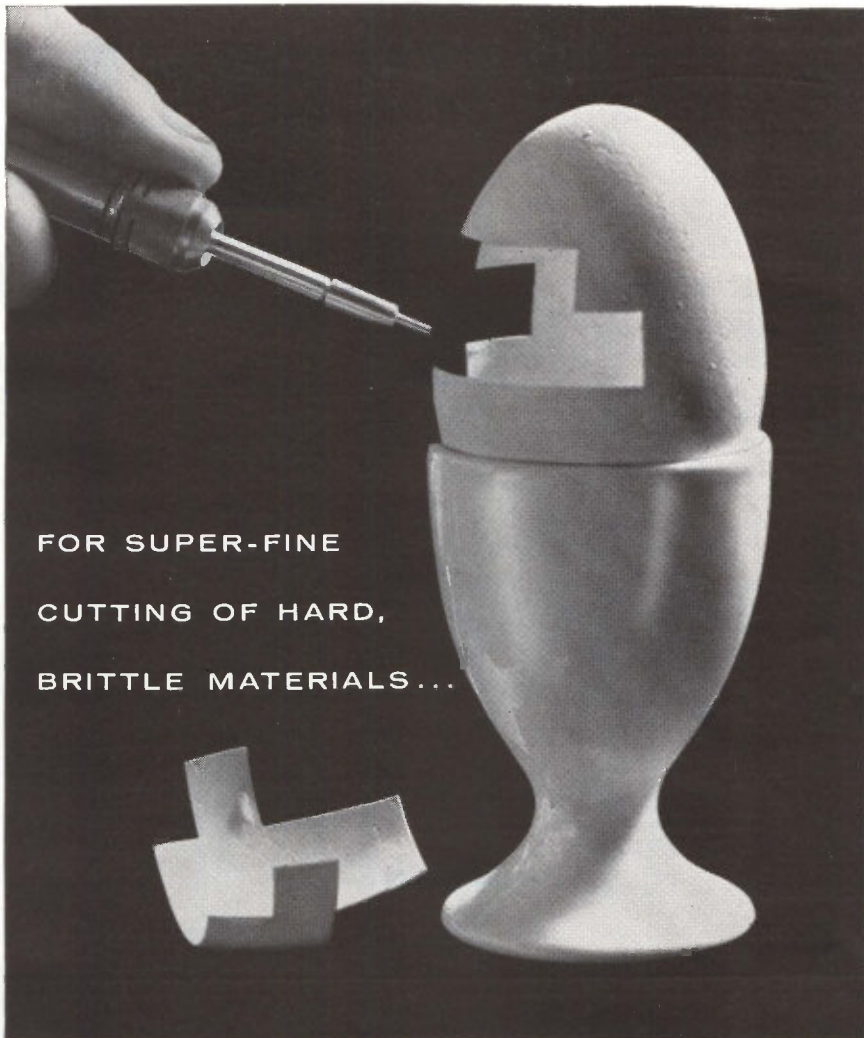

FOR SUPER-FINE  
CUTTING OF HARD,  
BRITTLE MATERIALS...

## THE *S.S. White* Airbrasive® Unit

The Airbrasive is *not* the way to open your breakfast egg. But it is often the *only* way to cut many extremely hard, fragile materials.

It would pay you to look around your production line or laboratory to see where you can use the Airbrasive. Any tool that can make tricky cuts like these in such a fragile object as an empty egg-shell can surely do jobs for you that you previously thought were impossible.

The secret of its unique ability lies in a finely controlled stream of microscopic abrasive particles gas-propelled through a precise nozzle. This stream cuts or abrades or cleans *without shock, heat, or vibration*.

Use it to make cuts as fine as 0.005" . . . remove surface coatings . . . adjust microminiature circuits . . . debur tiny parts . . . and many more delicate tasks. The cost is low. For under \$1,000 you can set up your own Airbrasive cutting unit.

Send us samples of your "impossible" jobs and let us test them for you at no cost.

WRITE FOR  
BULLETIN  
6006.



S. S. WHITE INDUSTRIAL DIVISION

Dept. EU, 10 East 40th St., New York 16, N. Y. • Telephone 212 MU 3-3015 collect.

## *S.S. White* INDUSTRIAL AIRBRASIVE®

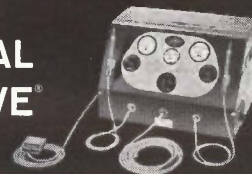

**FREDDY**

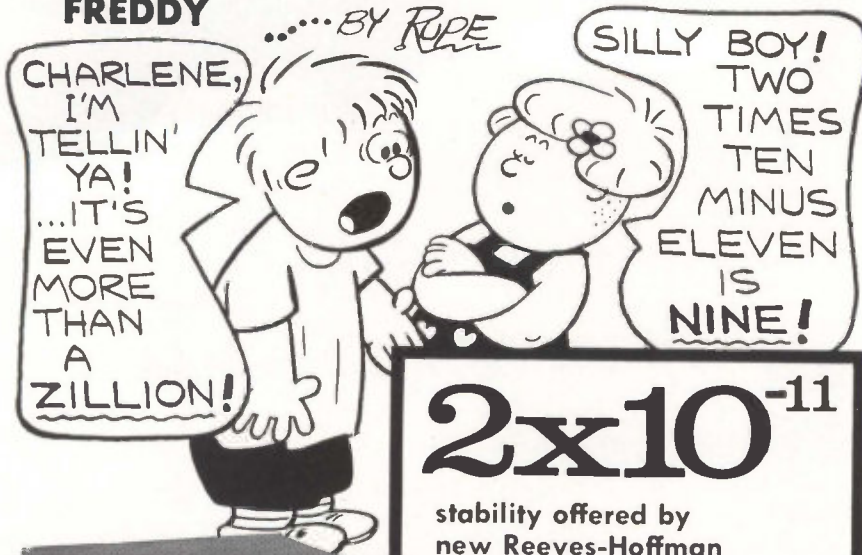

**REEVES-HOFFMAN**

CARLISLE, PENNSYLVANIA  
DIVISION OF  
DYNAMICS CORPORATION OF AMERICA

**$2 \times 10^{-11}$**

stability offered by  
new Reeves-Hoffman  
2.5 mc Frequency Standard

You're wrong, Charlene, it's a bit more than nine! Stability is 2 parts in 100,000,000,000 for model S2075 ultra-precise 2.5 mc Frequency Standard. It utilizes an AT-cut, 5th overtone crystal of our own manufacture, double proportional control oven, and is transistorized throughout. Phase stability is  $7 \times 10^{-3}$  degrees peak to peak during a 20 millisecond period. Output frequencies are 100 kc, 1 mc and 5 mc simultaneously. Unit fits into 5 1/4-inch rack panel. Request bulletin S2075.

CIRCLE 203 ON READER SERVICE CARD

# DYNAMICS

## SIGNAL CONDITIONING EQUIPMENT

- 12-channel, galvanometer control panel provides continuous control of sensitivity over million-to-one current range
- compatible with low- and high-sensitivity galvanometers

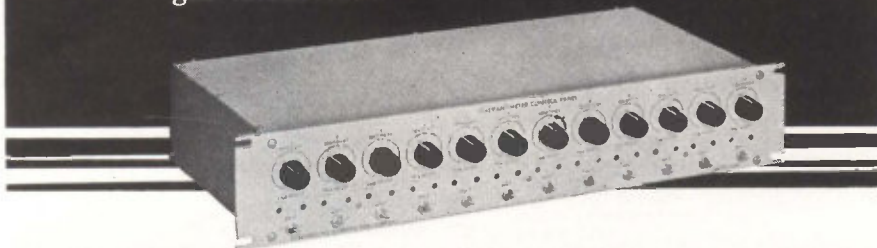

Model 6065 provides an 11-position attenuator for each channel, complete with screwdriver adjust, multi-turn potentiometers for fine control. Every channel features its own 6-position damping resistor selector switch, galvo reversing switch, and galvo disconnect switch. Inputs and outputs on rear panel.

Maximum input voltage: 300 volts dc, or peak ac.  
Maximum galvanometer current: limited to 100 milliamperes dc, or peak ac—protects galvanometer against excessive current. Higher current ranges available on request.

Size: 3 1/2" high RETMA panel x 19" wide x 10" deep.  
Write for literature on Model 6065, or the complete line of Dynamics signal conditioning equipment.

**DYNAMICS INSTRUMENTATION COMPANY**  
583 Monterey Pass Rd., Monterey Park, Calif. • Phone: CU 3-7773

70 CIRCLE 70 ON READER SERVICE CARD

784 provides greater than 13 db of isolation at an insertion loss of less than 0.4 db over the frequency range of 5.4 to 5.9 Gc. Its unpressurized power rating is over 350 kw peak power at average powers to 350 w. VSWR is 1.06 maximum. Portchester Instrument Corp., 114 Wilkins Ave., Port Chester, N. Y. CIRCLE 309, READER SERVICE CARD

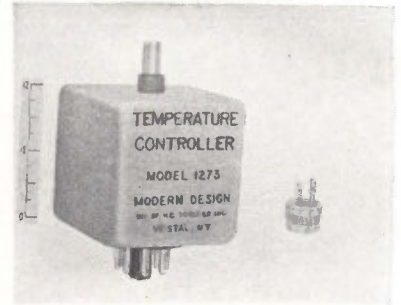

### Temperature Controller Is Self-Contained

THIS self-contained plug-in controller with high system gain provides extreme accuracy for a broad range of temperature control with 600-w resistive loads. Unit utilizes the new GE C22 Press-fit silicon controlled rectifier and associated circuit for complete feedback temperature control. The modular 2 by 2 by 2 in. unit shown was developed for an industrial process control application requiring precise multi-zone spot temperature control. Other applications of similar modules include control of certain induction motors and temperature control of ovens and furnaces with high-wattage loads. Modern Design, Div. of H. C. Schloer, Inc., Vestal, N. Y. (310)



### Controlled Switches In TO-5 Outline

CONTROLLED switches 2N2322 through 2N2326 are announced. With blocking voltage ratings in the

SEPTEMBER 20, 1963 • electronics

## Acoustical Components of Superior Quality

JAPAN PIEZO supplies 80% of Japan's crystal product requirements.

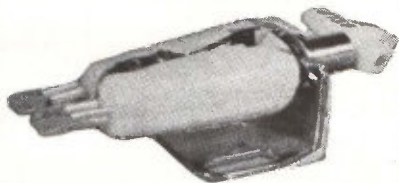
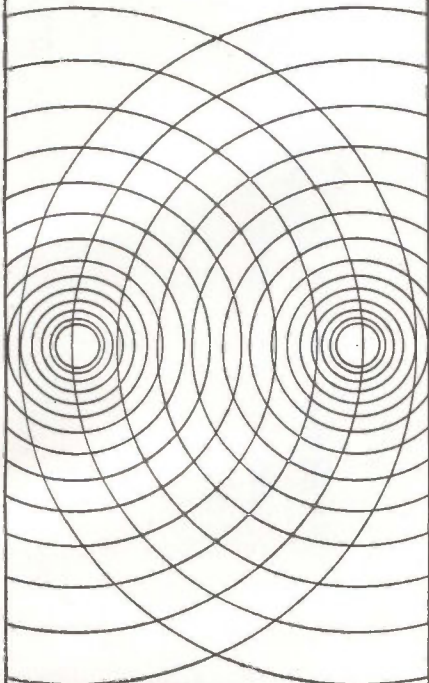

### STEREO CARTRIDGE

Crystal — "PIEZO" Y-130

#### X'TAL STEREO CARTRIDGE

At 20°C, response: 50 to 10,000 c/s with a separation of 16.5 db. 0.6 V output at 50 mm/sec. Tracking force:  $6 \pm 1$  gm. Compliance:  $1.5 \times 10^{-6}$  cm/dyne. Termination:  $1M\Omega + 150$  pF.

Write for detailed catalog on our complete line of acoustical products including pickups, microphones, record players, phonograph motors and many associated products.



**JAPAN PIEZO  
ELECTRIC CO., LTD.**

Kami-renjaku, Mitaka, Tokyo, Japan

CIRCLE 204 ON READER SERVICE CARD

electronics • SEPTEMBER 20, 1963

25 to 200-v range, these units will carry continuous forward current of 1 amp. At room temperature they trigger with 200  $\mu$ a and 0.8 v, and are completely specified for operation over the temperature range of -65 C to +125 C. Solid State Products, Inc., One Pingree St., Salem, Mass. (311)

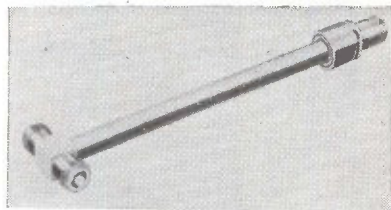

### Power Divider for Coaxial Cables

POWER DIVIDER for coaxial cables is designed to provide an equal power division through each arm at 240 Mc. Mating ends are type N female and will mate with any type N 50-ohm plug, either brass or aluminum. The divider itself is aluminum, finished with clear Alodine 1200. The vswr is less than 1.5:1 at 240 Mc, and max insertion loss is 0.5 db. Power division at both output arms is equal, exhibiting a 50-ohm impedance at each of the arms. Cannon Electric Co., 3208 Humboldt St., Los Angeles 31, Calif. (312)

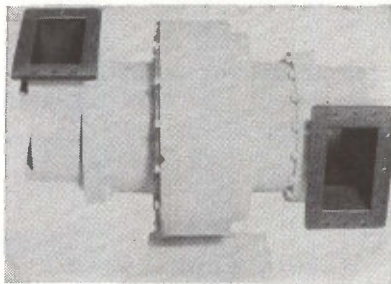

### L-Band Rotary Joint Handles 30 Mw Peak

A ROTARY joint capable of handling 30 Mw peak and 30 kw average power in the 1.2 to 1.3 Gc band has been developed. It is 23.9 in. long, 15.5 in. in diameter and incorporates UG-418/U flat-faced flanges. Unit was designed to be used as an axis of low-speed paraboloid antennas. It is weatherproofed and can

# FREE TO COMPANY OFFICIALS LOOKING FOR A NEW PLANT SITE

WE WILL PREPARE FOR YOU A  
**CONFIDENTIAL SURVEY**  
OF SELECTED LOCATIONS  
FOR YOUR NEW PLANT IN  
**NEW YORK STATE**



#### TABLE OF CONTENTS

● SUBJECT	PAGES
Introduction .....	1
Growth Trends .....	2-3
Climate .....	4-6
Public Utilities .....	7-22
Financial .....	23
Government Services.....	24-44
Taxes	
Protective Services	
Water Supply & Sewerage	
Community Facilities .....	45-73
Housing	
Education	
Recreation & Culture	
Industrial History .....	74-79
Labor .....	80-92
Natural Resources .....	93-94
Transportation & Markets..	95-104
Sites .....	105-133

**TAILOR-MADE.** This confidential report is not taken off the shelf. It will be prepared specifically for you, based on the requirements for your new plant as you give them to us. Send these requirements on your business letterhead to Commissioner Keith S. McHugh, N.Y. State Dept. of Commerce, Room 251R, 112 State St., Albany 7, N.Y.

*Keith S. McHugh*

Keith S. McHugh, Commissioner  
New York State Department of Commerce

WHY SETTLE FOR LESS?

**0.01%**

**ACCURATE**

SIZE 23 RESOLVER



Type 23RV4a1

**Here's a top rated resolver that's priced surprisingly low. So why settle for less than Ford Instrument's highly accurate Size 23 Resolver...the resolver that exceeds MIL-E-5272A.**

**SPECIFICATIONS:**

- Maximum Functional Error (over 360° of shaft rotation)...0.01% of input voltage at maximum coupling
  - Maximum Total Null Voltage... 1 mv/volt input maximum
  - Maximum Interaxis Error (rotor) ... 1.5 minutes
  - Maximum Interaxis Error (stator) ... 1.5 minutes
  - Maximum Variation of Transformation Ratio (with input voltage from 6-18 volts with 12 volts input as reference) ... 0.03%
  - Maximum Variation of Transformation Ratio (with input voltage from 0.3 to 6 volts) ... 0.02% of 6 volts
- 0.025% accuracy available in size 15  
Bulletin FR 62-1 gives full specifications. It's yours for the asking. Write:

**FORD INSTRUMENT CO.**  
Division of Sperry Rand Corporation  
31-10 Thomson Ave., Long Island City 1, N. Y.

be pressurized to 5 psig. Kennedy Antenna Division of Electronic Specialty Co., 155 King St., Cohasset, Mass.

CIRCLE 313, READER SERVICE CARD



**Diode Laser Pulser  
Designed for Lab Use**

MODEL A diode laser pulser was designed for use with diode lasers requiring very high current pulses (0 to 180 amp) of short duration (1.75  $\mu$ sec). A maximum operational current is dependent on load impedance, varying from over 140 amp into 1.0 ohm to over 200 amp into 0.1 ohm. A very low impedance, noninductive series resistance permits continuous monitoring of the output current and wave shape (terminal sensitivity of 10 mv per 10 amp). The delay impedance is one ohm and the square pulse is produced with a rise time less than 0.2  $\mu$ sec and a fall time of approximately 0.5  $\mu$ sec. Unit operates at 60 pulses per sec but it is provided with an external connection applicable to audio oscillators with frequencies up to 200 cps. Seed Electronics Corp., 258 East St., Lexington 73, Mass. (314)

**RFI Filter Is  
Simple to Install**

TYPE RF1070 was developed for use in telephone and intercommunication lines feeding shielded rooms, and provides a nominal insertion loss of 100 db throughout the frequency range of 14 kc to 10 Gc. The filter is designed to be installed in a 2-wire, 600-ohm line. The pass-band attenuation is less than 1 db from 0 to 3,500 cps. The filter comes complete with a single hole

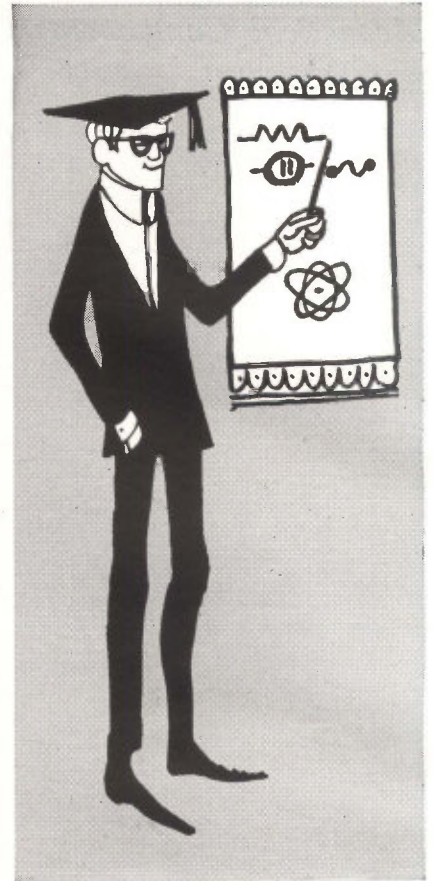

**workability**

(pre-production training)

WESTern PENNSylvania has a time-tested and proved-in-use plan by which employees—adaptable, productive people with a variety of industrial aptitudes—will be trained in advance for whatever skills are needed for YOUR particular operation at no cost to you. For details on this ability... and for complete information on 100% financing of plant space at low, low interest rates... and WESTern PENNSylvania's favorable tax climate, mail coupon, wire or call collect.

**WEST PENN POWER**

an operating unit of ALLEGHENY POWER SYSTEM



INDUSTRIAL SHELL BUILDINGS available at \$2.95 to \$3.25 a sq. ft. completed to your specs in 60-90 days.

WEST PENN POWER Phone: TEmple 7-3000  
Area Development Department (Area Code 412)  
Greensburg, Pennsylvania E 3-8-9

Please send me information on:  Pre-production Training  
 Favorable Tax Climate  100% Industrial Plant Financing  Industrial Properties

Name \_\_\_\_\_  
Title \_\_\_\_\_  
Company \_\_\_\_\_  
Address \_\_\_\_\_  
City \_\_\_\_\_ Zone \_\_\_\_\_  
State \_\_\_\_\_ Phone \_\_\_\_\_

mounting waveguide fitting to simplify installation. Filter size is  $9\frac{1}{2}$  by  $3\frac{1}{2}$  by 2 in. RF Interionics, Inc., 15 Neil Court, Oceanside, L. I., N. Y. (315)

### Subminiature Pentode Features Dual Control

A SHARP-CUTOFF, heater-cathode subminiature pentode, the CK5636 is a dual-control tube for use in such applications as a converter, modulator, phantastron, or gating service. In single control operation it can also be used as a general purpose amplifier or mixer. The eight-pin tube is packaged in a standard JEDEC(3-1) subminiature glass envelope. Designed for reliable use under extreme environmental conditions of shock, vibration, temperature, and altitude, the tubes comply with MIL-E-1 reliability specifications. Raytheon Co., 55 Chapel St., Newton 58, Mass. (316)



### Slide Rule Analyzes Reliability Problems

CIRCULAR slide rule, 4 in. in diameter, has two independent faces for the calculation of different reliability parameters. Side A calculates (1) mean time to failure, given reliability and hours of operation, (2) reliability, given mean time to failure and time, and (3) hours of operation, given mean time to failure and reliability. Side B calculates (1) mean time between failure lower bound (or the upper bound of failure rate) for selected confidence levels, given total hours of operation and observed number of failures, and (2) total hours of test for various confidence levels, given lower bound for mean time between failure and observed number of failures. Price is \$9.50, complete with instruction manual. Aero Geo Astro Corp., Edsall and Lincolnia Roads, Alexandria, Va. (317)

# NOW... GERTSCH HIGH-ACCURACY, INDUCTIVE VOLTAGE DIVIDERS -AT LOW COST



Model 1011R AC Ratio Standard with terminal linearity better than .0001% (1ppm)

**\$550.00**

including point-by-point data\*



Model RT-60 general-purpose Ratio-Tran®, accurate to 0.001%

**\$275.00**

including half-rack mounting brackets

You get more than low price tags with these instruments — you get typical Gertsch quality and performance.

**Model 1011R** — a precision AC ratio standard providing minimum ratios as low as  $-.0111111$ , accurate to 0.0001%. Instrument features transient suppression, and 7-place resolution. Gertsch 1011R is ideal for standards and calibration laboratories requiring maximum accuracy.

*Write for Bulletin 1000 Series.*

**Model RT-60.** This voltage divider features high input impedance, low effective series impedance, and very low phase shift. Unit has 5 decades of transformer switching — excellent for checking servos and resolvers . . . for voltmeter calibration, computer testing, and transformer turns ratio measurements. Size: 7" x  $7\frac{1}{2}$ " x  $3\frac{1}{2}$ " high — designed for bench, or half-rack mounting.

*Write for Bulletin RT-60 Series.*

\*Point-by-point data is provided in terms of a Gertsch standard traceable to the National Bureau of Standards.

# —Gertsch—

GERTSCH PRODUCTS, Inc.

3211 South La Cienega Boulevard, Los Angeles 16, California/Upton 0-2761 - VERmont 9-2201

# NEW → 40 MC PULSE GENERATORS

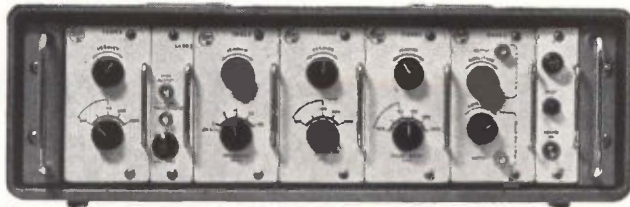

## Feature Modular Expandability, Rise / Fall to 5 ns

The new SERVOPULSE® 9000 Series offers general-purpose pulse generators conveniently modularized to provide special capabilities. Among their outstanding features are very high clock rates, rise times to 5 ns and expandability which defies obsolescence. They deliver clean, sharp waveforms, and permit multi-pulse functions. Several Modules are available for each function of time delay, pulse width, frequency, and amplification. The units are packaged for either rack-mount or benchwork, with integral power supply. A wide spectrum of special functions is possible at prices you would expect for standard generators. Detailed information on request.

	MODEL 9350	MODEL 9450	MODEL 9455	MODEL 9550
Frequency Range	.2 cps - 5 kc	100 cps - 2 mc	100 cps - 10 mc	2 mc - 40 mc
Delay	.1 ms - 1 sec.	0 - 1 millisec.	0 - 1 microsec.	0 - 1 microsec.
Pulse Width	.1 ms - 1 sec.	.1 $\mu$ s - 1 ms.	25 ns - 1 $\mu$ s	25 ns - 1 $\mu$ s*
Simultaneous Pos & Neg Outputs	10V open circuit 7V into 93 ohms	10V open circuit 7V into 93 ohms	10V open circuit 7V into 93 ohms	10V open circuit 7V into 93 ohms
Rise & Fall Time	Under 5 nanosec.	Under 5 nanosec.	Under 5 nanosec.	Under 5 nanosec.
Max Duty Cycle At Full Amplitude	70%	70%-40% at 2 mc	90%	90% - 60% at 40 mc
One Shot/Sync & External Trigger	Yes	Yes	Yes	Yes
Price	\$660.00	\$835.00	\$975.00	\$1,390.00

FLAT TOP FOR ALL INSTRUMENTS LESS THAN  $\pm 2\%$  AT MAX. PULSE WIDTH.

\* 15 ns at 40 mc



**SERVO CORPORATION OF AMERICA** SERVOPULSE® PRODUCTS  
111 New South Road • Hicksville, L. I., New York • Wells 8-9700

CIRCLE 206 ON READER SERVICE CARD

Do you solder ...THIN FILMS  
... DOT MODULES  
... MICROELECTRONICS ?



MODEL H10  
12 Watts  
115 Volts AC-DC

## HEXAACON HORNET - is your iron!

- SMALLEST IRON - ONLY 5 7/8"
- SMALLEST TIP DIAMETER - 1/32"
- SHORTEST DISTANCE FROM WORK - 1 15/16"
- LOWEST WATTAGE - 12 WATTS
- HOT TIP GETS IN AND OUT FAST
- NO DAMAGE TO INSULATION
- FASTEST WORKING TEMPERATURE
- LIGHTWEIGHT

DUROTHERM Non-Freezing Long-Life Tips  
1/32", 1/16", 1/8"

Gets into tight places. Plastic handle, cooled thru ventilated design and concave stainless steel which reflects heat away from hand.

**HEXAACON ELECTRIC COMPANY**  
130 West Clay Avenue, Roselle Park, New Jersey



SERVING INDUSTRY AND CRAFTSMEN FOR OVER THIRTY YEARS

## LITERATURE OF

**VOLTAGE DIVIDERS** Electro Scientific Industries, 13900 N.W. Sunset Science Park Drive, Portland, Ore. Catalog sheet C-44 covers Dekatran voltage dividers—six, five and three-decade units providing accuracies to 1 part-per-million. CIRCLE 318, READER SERVICE CARD

**ACCELEROMETERS** Columbia Research Laboratories, Inc., MacDade Blvd. & Bullens Lane, Woodlyn, Pa. Data sheet T-134 covers an advanced line of high-performance, hermetically-sealed accelerometers. (319)

**CERAMIC LADDER FILTERS** Cle vite Corp., 232 Forbes Road, Bedford, O. Bulletin 94-33 covers vibration test results on ceramic ladder filters. (320)

**TRAVELING-WAVE TUBE** Watkins-Johnson Co., 3333 Hillview Ave., Palo Alto, Calif. Technical bulletin describes the WJ-268-2, a 1.0 to 2.6 Gc low-noise permanent magnet twt with integral power supply. (321)

**R-F TEST EQUIPMENT** Telonic Industries, Inc., 60 N. First Ave., Beech Grove, Ind. Catalog 63-S describes a line of sweep generators and allied equipment for r-f testing applications. (322)

**F-M/F-M TELEMETERING SYSTEM** Solid State Electronics Co., 15321 Rayen St., Sepulveda, Calif., has available literature describing model 5000 silicon transistorized, ultraminiature f-m/f-m telemetering system. (323)

**BIDIRECTIONAL TAPE TRANSPORT** S-I Electronics, Inc., 103 Park Ave., Nutley 10, N. J. Technical bulletin describes model DT-03A tape recorder/reproducer. (324)

**PHOTOELECTRIC CONTROL CELL** Solar Systems, Inc., 8241 Kimball Ave., Skokie, Ill. A photoelectric control cell that can be used in the photovoltaic mode or photoresistive mode is described in a 4-page brochure. (325)

**D-C VOLTAGE STANDARD** Cohu Electronics, Inc., Kin Tel division, 5725 Kearny Villa Road, San Diego 12, Calif., has issued a 4-page brochure on the model 321 d-c voltage standard. (326)

**THERMAL STRIPPERS** Western Electronic Products Co., 107 Los Molinos, San Clemente, Calif. A 4-page folder illustrates and describes a line of thermal wire strippers. (327)

**CAPACITORS** Electron Products, division of Marshall Industries, 1960 Walker Ave., Monrovia, Calif. A 4-page condensed catalog of precision capacitors is now available. (328)

**NUMERIC READOUT** Dialight Corp., 60 Stewart Ave., Brooklyn, N. Y. Catalog L-171A describes series R-100 single plane numeric readout. (329)

**CONNECTORS** National Connector Corp., Science Industry Center, Minneapolis 28, Minn. A full line of electronic connectors is described in a 20-page, 4-color catalog. (330)

## THE WEEK

**TEMPERATURE CONTROL** Assembly Products, Inc., Chesterland, O. Bulletin 37 covers a temperature control designed for easy adaptation into process circuits and OEM applications. (331)

**PROGRAMMING SWITCH** Sealectro Corp., 139 Hoyt St., Mamaroneck, N. Y., has released a data sheet describing the series AP miniature programming switch. (332)

**CABINET COOLING PANEL** Rotron Mfg. Co., Inc., Woodstock, N. Y. Complete technical specifications for the model RF cabinet cooling panel are provided in data sheet D-2500. (333)

**DIGITAL CIRCUIT COMPONENTS** Control Logic, Inc., 11 Mercer Road, Natick, Mass. Brochure describes a family of 0- to 20-kc digital circuit components for industrial control and low-speed data processing. (334)

**DIGITAL VOLTMETER** Houston Instrument Corp., 4950 Terminal Ave., Bellaire 101, Texas. Bulletin describes model 2660 digital voltmeter with 1  $\mu$ v/digit sensitivity and five-digit readout. (335)

**H-F AMPLIFIER** Continental Electronics Mfg. Co., P. O. Box 5024, Dallas 22, Texas, offers a brochure on type 621A 600-kw peak envelope power high-frequency electronic amplifier. (336)

**DIGITAL COUNTER PRINTER** Texas Instruments Inc., 3609 Buffalo Speedway, Houston 6, Texas, offers a bulletin with full description and specifications on a solenoid-operated digital counter printer. (337)

**RFI SHIELD-AIR COOLING PANEL** Technical Wire Products, Inc., 129 Dermody St., Cranford, N. J. A 4-page brochure describes Teckcell, metal honeycomb panels, with integral rfi gasket, for cooling and shielding enclosures. (338)

**TUNABLE CAVITY OSCILLATOR** Microlab, 570 West Mt. Pleasant Ave., Livingston, N. J. A 2-page catalog describing series EC tunable cavity oscillator is available. (339)

**CERAMIC CAPACITORS** The Scionics Corp., 8900 Winnetka Ave., Northridge, Calif. Data sheet describes high reliability hermetic-seal ceramic capacitors. (340)

**R-F INDUCTORS** Nytronics, Inc., 550 Springfield Ave., Berkeley Heights, N. J., offers a catalog sheet on ultra-reliable shielded subminiature r-f inductors with inductances from 0.1  $\mu$ h to 180,000  $\mu$ h in 76 values. (341)

**ELECTRICAL MEASURING INSTRUMENTS** Yokogawa Electric Works, Inc., 40 Worth St., New York 13, N. Y. Short form catalog No. C9-03 describes a line of electrical measuring instruments. (342)

**SERVOS** Vernitron Corp., 52 Gazza Blvd., Farmingdale, N. Y. Catalog digest provides a master file to precision synchros, resolvers and servo motors. (343)

## ARGUMENT(?) ON THERMO- ELECTRICS

**Design Engineer:** "Thermoelectrics is here to stay. It's by far the best way to temperature-stabilize critical electronic components in the entire range of operating ambients."

**Management:** "Best—why?"

**Design Engineer:** "There's no maintenance problem with TE enclosures...less space...less weight...and better system performance."

**Management:** "Explain 'better performance'."

**Design Engineer:** "With TE temperature stabilization we gain higher operating efficiency, lower noise levels, greater frequency stability, longer component life."

**Management:** "But what about reliability?"

**Design Engineer:** "Thermoelectric enclosures have been and are now functioning without failure in commercial, industrial and military applications."

**Management:** "Aren't TE units expensive?"

**Design Engineer:** "Not when you consider the money we can save by simplifying system design. What's more, thermoelectrics can do an efficient stabilizing job in places where it would be impossible, or too costly, to use other equipment."

**Management:** "Good! How do we get these devices?"

**Design Engineer:** "Carter-Princeton is the leading manufacturer of TE products especially designed to solve cooling, heating and stabilization problems."

Carter-Princeton is the electronics division of Carter Products, Inc., established in 1880 and one of the world's leading manufacturers.

**FREE!** "When to Specify Thermoelectric Temperature Stabilization"...

...is the title of a new, authoritative, 12-page, fact-filled study just completed by Carter-Princeton's technical staff. Write for your free copy today: Carter-Princeton, 178-F Alexander Street, Princeton, N. J. 08450, Phone (609) 921-2880.

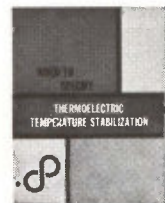

**CARTER-PRINCETON**



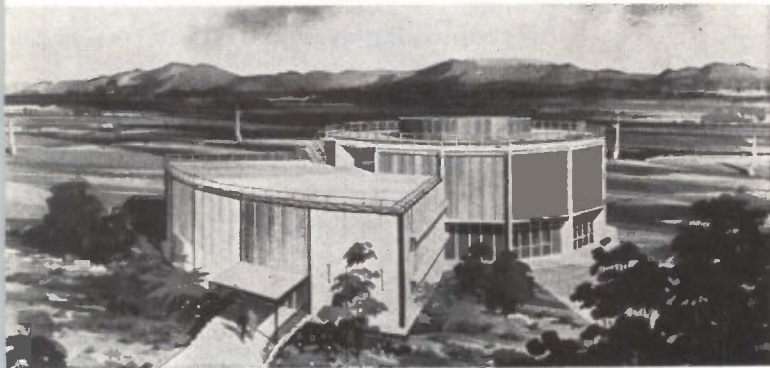

## Antenna Lab Goes Up

**LOCKHEED-CALIFORNIA** Company announces that a new 25,000-square foot electromagnetic laboratory to develop antennas and components for advanced space and aircraft communication-detection systems will be in operation by December. Construction is well under way on the two-story building in Lockheed's Rye Canyon Research Center near Saugus, 26 miles north of the company's main Burbank plant.

Lockheed engineers note the \$750,000 laboratory and attached open radiating ranges will save thousands of flight hours that would be otherwise necessary in

evaluating new radio, radar, countermeasure, navigation, and telemetry antenna systems.

The electromagnetic laboratory will continue to broaden its capabilities to meet future space-age requirements, according to J. B. Wassall, company director of engineering.

Extending spoke-like from the cylindrical section of the building will be four antenna ranges—150 feet to a quarter-mile long—equipped with rails and movable towers. Four more outdoor ranges and an indoor anechoic (radiation-absorbing) range are scheduled in the future.

Aircraft and space vehicle models will be mounted on the 25-foot-tall towers that will travel the length of the range tracks. Engineers in the building will be able to rotate the tower and position the model via remote control during tests. Radio waves will be beamed from the transmitting antenna in the building to the receiving model. The signals will return to recording and data processing consoles in the laboratory for radiation pattern analysis and "echo area" measurements.

In addition to testing and range control equipment, the 45-foot-tall building will contain experimental laboratories and a shop for design and building of antennas, radomes, and other components. Staff will include 30 to 50 engineers, technicians, and other personnel.

The facility will be available to other companies, research organizations, and governmental agencies.



### Milgo Electronic Appoints Rose

**WILLIAM L. ROSE** has been appointed to the newly created position of executive vice president of Milgo Electronic Corp., Miami, Fla. He joined Milgo as general manager in 1955 when the company was organized.

Milgo supplies the government and industry with electronic systems and equipment such as data converters, transmitters, receivers, timers, and programmers.

### EMR Division Moving To Larger Plant

**ADVANCED SCIENTIFIC INSTRUMENTS**, Minneapolis, Minn., a division of Electro-Mechanical Research, Inc., Sarasota, Fla., will move this month into a newer, larger plant in suburban Minneapolis.

Advanced Scientific Instruments designs and manufactures digital computer systems for the scientific and engineering fields. The new facility will provide approximately 47,000 sq ft. The expansion will also provide space for staff increases in the engineering, programming, and marketing support groups.

### RCA Realigns Defense Divisions

**REALIGNMENT** of RCA's Defense Electronic Products divisions "to bring related or similar projects and

activities into closer coordination and to extend the use of skills in these areas", is announced.

The Data Systems division situated at Van Nuys, Calif., has been merged with the Aerospace Communications and Controls division, to form a new division known as the Aerospace Systems division, with headquarters at Burlington, Mass. Both divisions have been engaged in data processing systems, checkout and related programs, and this merger will bring much of RCA's defense activity in these areas under one jurisdiction. Irving K. Kessler, heretofore division vice president and general manager of ACCD, will remain in that position in the new Aerospace Systems division.

The communications portion of the Aerospace Communications and Controls division, at Camden, N. J., is being merged with the Surface Communications division, also at Camden, to form the Communications Systems division. This merger



# AROUND THE WORLD IT'S KEW

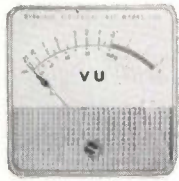

MODEL P-25



MODEL P-40

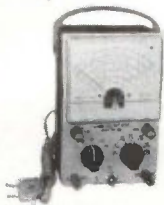

MODEL PV-202



MODEL TK-90A



MODEL KHE-505



MODEL EW-8



MODEL EW-16

## KYORITSU ELECTRICAL INST. WORKS, LTD.

NO. 120, NAKANE-CHO, MEGURO-KU, TOKYO, JAPAN  
CABLE ADDRESS: "KYORITSUKEIKI TOKYO"  
TEL: (717) 0131-5 · 0151-3

CIRCLE 207 ON READER SERVICE CARD

1  
Tie faster,  
easier,  
tighter!

2  
Form knots  
that  
don't slip!

3  
Greater  
stability  
under  
high heat!

WHAT DO YOU WANT  
LACING CORDS and TAPES  
TO DO FOR YOU?

**HEMINWAY  
& BARTLETT**

NYLON and DACRON CORDS  
FLAT BRAIDED TAPES  
and TEFLON COATED  
FIBERGLAS TAPES

GIVE YOU  
ALL THESE ADVANTAGES

Available in wax-coated, wax-free or "G.E." finish  
Write for free samples and specification book.

**THE HEMINWAY & BARTLETT MFG. CO.**

Electronics Division: 500 Fifth Avenue, New York 36, N.Y.

CIRCLE 208 ON READER SERVICE CARD

- SCAN CONVERSION
- FLICKERLESS  
DISPLAY STORE
- VIDEO STORAGE

### RECORDING STORAGE TUBE SYSTEMS

Single-gun, dual-gun, multi-tube systems to convert scan for radar, sonar, television, and to perform analog processing, data analysis, contract or expand time scale, auto correlation.

- SLOWED TELEVISION  
TRANSMISSION

by telephone line or other narrow-band systems.

- IMAGE ENGINEERING

OPTICAL CHART READERS, FLYING SPOT SCANNERS, LOW-LIGHT-LEVEL CAMERAS, and IMAGE RECTIFICATION. Automatic inspection and recognition of size, shape, color, and texture.



Write or call for complete information:

INSTRUMENTS, Inc.

2300 Washington Street  
Newton 62, Massachusetts  
617 WOODWARD 9-8440

CIRCLE 209 ON READER SERVICE CARD  
electronics • SEPTEMBER 20, 1963

*Magneline*<sup>®</sup>  
THE INDICATOR WITH INHERENT MEMORY

Two new series for digital readout,  
ideal for multiplex applications

#### SERIES 14000—FOR SOLID STATE LOGIC

Character Size..... $\frac{9}{32}$ " x  $\frac{1}{4}$ "  
No. of Characters.....Up to 11  
Leads.....11 plus a common  
Watts.....2.4

#### SERIES 15000—FOR RELAY LOGIC

Character Size..... $\frac{5}{16}$ " x  $\frac{1}{4}$ "  
No. of Characters.....Up to 10  
Leads.....5 plus a common\*  
Watts.....1.3-1.7

\*Requires switching of lead in combination with reversal of polarity to change indicator.

Units hold last reading without power. Totally enclosed, self-stacking housing for front or rear mounting. Jewel bearings, only one moving part. Standard voltages 6, 12, 24, or 28 V.D.C. Readability 12 feet at normal room lighting. Options include special voltage, special characters, and internal lighting for dark room applications.

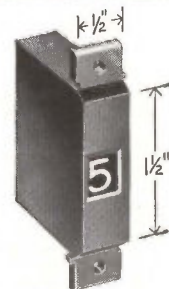

External appearance of  
14000 or 15000 series

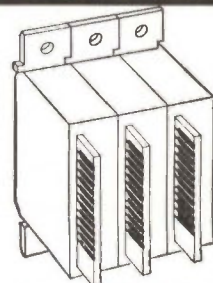

Rear view of units  
showing stacking and  
plug-in connectors

Write or teletype  
(203-753-9341)  
for free literature

**PATWIN<sup>®</sup> ELECTRONICS**

A DIVISION OF THE PATENT BUTTON COMPANY  
WATERBURY 20, CONNECTICUT

CIRCLE 77 ON READER SERVICE CARD 77

YOUR INSTANT SOURCE FOR

# TEFLON\*

WIRE AND CABLE IS  
BRAND-REX



YOU GET IMMEDIATE SHIPMENT OF YOUR REQUIREMENTS, BIG OR SMALL, FROM ONE OF THE COUNTRY'S LARGEST TEFLON STOCKS.

BRAND-REX TURBOTEMP® TEFLON* WIRE AND CABLE			
<b>MILITARY TYPES</b>			
MIL - W - 16878D	MIL - W - 22759	NAS - 703	COAXIAL CABLE
Types E, EE, ET (TFE Insulation)	Type 1, MS - 21985 MS - 21986 (TFE Insulation)	Types U, S, SJ Classes A & C (TFE Insulation)	MIL - C - 17C and MIL - C - 8721
Types K, KK, KT (FEP Insulation)	Type 1 MS - 17411 MS - 17412 MS - 18000 MS - 18001 (Filled TFE Insulation)		
<b>U. L. TYPES</b>			
<b>Appliance Wire</b>		<b>Business Machine Wires</b>	
200°C, 300V & 600V	105°C, No voltage rating	105°C, No voltage rating	
1/64" & 1/32" TFE Insulation	.006" FEP Insulation with nylon jacket	.010" TFE or FEP Insulation	
<b>MULTICONDUCTOR CABLES</b>			
Made to order for your military or commercial applications.			

Send for new 20-page catalog: "Brand-Rex TEFLON Wire and Cable, Section 6207"



DIVISION AMERICAN ENKA CORPORATION  
31 Sudbury Road, Concord, Massachusetts

\*DuPont Trademark

combines most of RCA's defense communications activities in one stronger consolidated division. Stanley W. Cochran, formerly division vice president and general manager of the Surface Communications division, will hold the same post in the new division.

## PEOPLE IN BRIEF

**Orion L. Hoch** promoted to asst. g-m of Litton Industries Electron Tube div. **Harry S. Malutich** advances to mgr. of mfg. for the Electronics div., Erie Resistor Corp. **Charles Bissegger** transfers from the New York facility of LEL, Inc., to LEL West as mgr. **Orville D. Page** leaves General Electronic Laboratories to join Vitro Electronics as product mgr.-telemetry and surveillance equipment. **Michael Hirsh**, formerly with Librascope div. of General Precision Corp., appointed v-p, marketing, for Benson-Lehner Corp. **Edward Galuska** moves up to mgr. of engineering in the Industrial Products div. of Adler Electronics, Inc. **Salvatore Savarese**, previously with Airtron Corp., named production mgr. of International Ultrasonics, Inc. **M. C. Hegdal** raised to g-m of the 3M Company's Magnetic Products div. **James H. Carpenter**, ex-Havag Industries, now mfg. engineering mgr. of the Panelyte Industrial div. of Thiokol Chemical Corp. **Isotopes, Inc.** ups **Samuel Fine** to mgr. of the Engineering div. **F. E. Shashoua** advances to mgr., electro-optics and thermoelectrics, at RCA Defense Electronic Products. **C. Louis Cuccia** leaves RCA to join Microwave Electronics Corp. as co-director of engineering. **John H. Cover, Jr.**, promoted to director of advanced programs at Aeronutronic div. of Philco Corp. **J. T. Underhill**, from Lockheed Missiles and Space Co. to Packard Bell Electronics as director of engineering, Space and Systems div. **Harold M. Gordy**, formerly with Litton Industries, named corporate mgr. of reliability and quality control at Giannini Controls Corp.

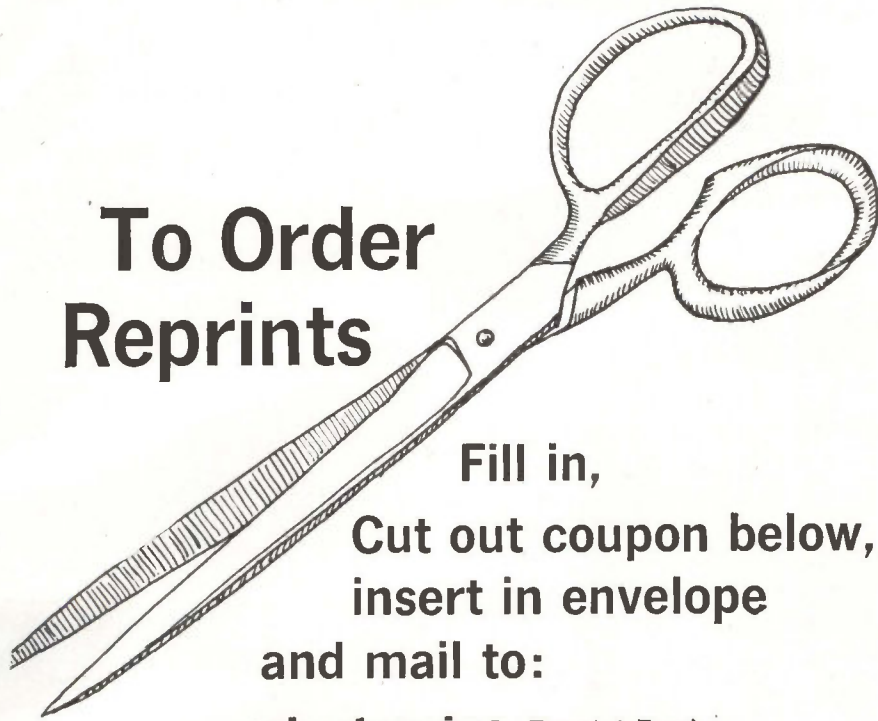

# To Order Reprints

Fill in,  
Cut out coupon below,  
insert in envelope

and mail to:  
**electronics** Reprint Dept.  
330 West 42nd Street,  
New York, N. Y.—10036

## REPRINT ORDER FORM

For Listing of Reprints Available See Reader Service Card

(To help expedite mailing of your reprints please send cash, check or money order with your order.)

For Reprints of the latest Special Report:

**Radio Frequency Interference**

Send me . . . . . Reprints of Key No. R-39. I—10 copies 75¢ each, II—24 copies 60¢ each, 25 or more 50¢ each.

For Reprints of previous **Special Reports** or **Feature Articles** fill in below:

Send me . . . . . Reprints of Key No.(s) . . . . . @ . . . . . ¢ each.

(For prices, see Reader Service Card.)

\*For orders of **Bulk Reprints** of other editorial articles in this issue or past issues:

Send me . . . . . Reprints of page no.(s) . . . . . of issue date . . . . .

of article entitled . . . . .

\*Minimum bulk order 100 copies. You will be advised of costs by return mail.

Name . . . . .

Number and Street . . . . .

City, Zone No., State . . . . .

## EMPLOYMENT

### Electronic Instrument Technicians

The Oak Ridge National Laboratory  
operated by  
**UNION CARBIDE NUCLEAR COMPANY**

at  
Oak Ridge, Tennessee  
Has Openings for  
Highly skilled electronic instrument technicians to work with electronic engineers in the development, installation and maintenance of electronic systems. Digital data handling, transistorized pulse height analyzers, analog and digital computer systems are only a few examples.

Minimum high school education, with additional training in electronics and at least three years' experience in installation and maintenance of complex electronic systems. Entrance rate \$3.19 per hour; \$3.25 per hour after six months. Reasonable interview and relocation expenses paid by Company.

**Excellent Working Conditions**  
and  
**Employee Benefit Plans**  
An Equal Opportunity Employer  
Send detailed resume to:  
Central Employment Office

**UNION CARBIDE NUCLEAR COMPANY**  
A Division of Union Carbide Corporation  
Post Office Box M Oak Ridge, Tennessee



**E. E.'s**  
for FEE-PAID Positions  
**WRITE US FIRST!**  
Use our confidential application for professional, individualized service . . . a complete national technical employment agency.  
**ATOMIC PERSONNEL, INC.**  
Suite 1207L, 1518 Walnut St., Phila. 2, Pa.

**SALES REPRESENTATIVE**  
Company engaged in development and manufacture of electronic communication equipment desires aggressive representation in Washington area. Please send resume, references and compensation requirement to:  
**MAXWELL ELECTRONICS CORPORATION**  
229 Garvon Garland, Texas  
An Equal Opportunity Employer

**NORWEGIAN ENGINEERS**  
Are you considering a return to Norway? Electronics is rapidly expanding. We have openings in Project Management Electronic Data Handling  
**A/S TELE-PLAN E**  
Consulting Engineers  
P. O. Box 69 — Lysaker — Oslo — Norway

## SEARCHLIGHT

**RADIO RESEARCH INSTRUMENT CO.**  
AUTO-TRACK & TELEMETRY ANTENNA PEDESTALS  
3 & 10 CM. SEA 504 AUTOTRACK RADARS  
AN TPS-10 SEARCH AN TPS-10 HT. FINDERS  
AN FPN-32GCA AN APS-10 NAVIG. & WEATHER  
AN APS-15B PRECISION AN APS-35B PRECISION  
AN APS-31A SEARCH DOZENS MORE  
5-1.2 MEGAWATT HIGH POWER PULSERS.  
RADIO RESEARCH INSTRUMENT CO.  
550 Fifth Ave., New York Judson 6-4691  
**RADAR SYSTEMS & COMPONENTS/ IMMEDIATE DELIVERY**  
**CIRCLE 951 ON READER SERVICE CARD**

## PROFESSIONAL SERVICES

**GIBBS & HILL, Inc.**  
Consulting Engineers  
Systems Engineering  
Operations Research • Development  
Field Studies • Design • Procurement  
Power • Transportation • Communications  
Water Supply • Waste Treatment  
393 Seventh Avenue New York 1, N. Y.

# INDEX TO ADVERTISERS

• AMP Incorporated Capitron Div. . . . .	16	Image Instruments Inc. . . . .	77	• Weller Electric Corp. . . . .	45
Aerocom . . . . .	56	Japan Piezo Electric Co., Ltd. . . . .	71	West Penn Power . . . . .	72
Allen-Bradley Co. . . . .	4	• Kepco, Inc. . . . .	51	White S. S. . . . .	69
• American Time Products Div. of Bulova Watch Company, Inc. . . . .	44	Kin Tel A Division of Cohu Electronics Inc. . . . .	3rd cover		
Amperite . . . . .	61	Krohn-Hite Corp. . . . .	15		
Ampex Corporation . . . . .	22	• Kyoritsu Electrical Instruments Works, Ltd. . . . .	77		
Amphenol-Borg Electronics Corp. Connector Division . . . . .	55				
Anasco . . . . .	53				
Balteau Electric Corp. . . . .	61	Lear Siegler, Inc. . . . .	64		
Brand Rex Division of American Enka Corp. . . . .	78	• Line Material Ind. . . . .	58		
Business Week . . . . .	49	Lockheed Missiles & Space Co. . . . .	63		
• Carter-Princeton . . . . .	75	Mallory and Co., Inc., P. R. . . . .	13		
Consolidated Avionics Corp. . . . .	37	Markite Corp. . . . .	66		
Cubic Corp. . . . .	21	• Microswitch Division of Honeywell . . . . .	40		
		• Mycalex Corp. of America . . . . .	12		
duPont de Nemours & Co., E. I. . . . .	8 9	New York State Dept. of Com- merce . . . . .	71		
Dynamics Instrumentation Co. . . . .	70	• North Atlantic Industries, Inc. . . . .	52		
		• Nortronics . . . . .	68		
Englehard Industries, Inc. . . . .	57	Patwin Electronics . . . . .	77		
• Erie Technological Products Inc. . . . .	24				
• Ford Instrument Co. Div. of Sperry Rand Corp. . . . .	72	Radio Corporation of America 4th cover . . . . .			
		• Reeves Hoffman Div. of Dynamics Corp. of America . . . . .	70		
General Electric Co. Rectifier Components Dept. . . . .	23				
Gertsch Products, Inc. . . . .	73	Servo Corporation of America . . . . .	74		
• Globe Ind. Inc. . . . .	61	Simplex Wire & Cable Co. . . . .	39		
		• Southern Electronics Corp. . . . .	60		
Hayes, Inc. C. I. . . . .	65	Sprague Electric Co. . . . .	3, 6		
Hemingway & Bartlett Mfg. Co., The . . . . .	77	Stackpole Carbon Co. . . . .	42		
• Hewlett-Packard Company inside front cover . . . . .		Struthers-Dunn Inc. . . . .	48		
Hexacon Electric Co. . . . .	74				
Huntington Alloy Products Div. The International Nickel Co., Inc. . . . .	46	• Tektronix, Inc. . . . .	7		
		Texas Instruments Incorporated Industrial Products Group . . . . .	47		

**CLASSIFIED ADVERTISING**  
F. J. Eberle, Business Mgr. (2557)

**PROFESSIONAL SERVICES . . . . .** 79

**EMPLOYMENT OPPORTUNITIES . . . . .** 79

**EQUIPMENT**  
(Used or Surplus New)  
For Sale . . . . . 79

**CLASSIFIED ADVERTISERS INDEX**

A/S Tele-Plan Consulting Engi-  
neers . . . . . 79

Atomic Personnel Inc. . . . . 79

Maxwell Electronics Corporation . . . . . 79

• Radio Research Instrument Co. . . . . 79

Union Carbide Nuclear Company . . . . . 79

• See advertisement in the July 25, 1963 issue of electronics Buyers' Guide for complete line of products or services.

This Index and our Reader Service Numbers are published as a service. Every precaution is taken to make them accurate, but electronics assumes no responsibilities for errors or omissions.

## electronics



AUDITED PAID CIRCULATION

**JAMES T. HAUPTLI (2210)**  
Advertising Sales Manager

**DAVID CUNNIFF (3139)**  
Promotion Manager

**HENRY M. SHAW (3485)**  
Market Research Manager

### electronics Buyers' Guide

**R. S. QUINT (2335)**  
General Manager

**RICHARD J. TOMLINSON (3191)**  
Business Manager

**THEODORE R. GEIPEL (2044)**  
Production Manager

NEW YORK TELEPHONE: Dial Direct:  
971 plus number in parenthesis,  
Area Code 212

### ADVERTISING REPRESENTATIVES

ATLANTA, GA. 30009  
Michael H. Miller, Robert C. Johnson  
1375 Peachtree St. N.E.,  
Trinity 5-0523 (area code 404)

BOSTON, MASS. 02116  
William S. Hodgkinson  
McGraw-Hill Building, Copley Square,  
Congress 2-1160 (area code 617)

CHICAGO, ILL. 60611  
Harvey W. Wernecke,  
Robert M. Denmead  
645 North Michigan Avenue,  
Mohawk 4-5800 (area code 312)

CLEVELAND, OHIO 44113  
Paul T. Fegley  
55 Public Square, Superior 1-7000  
(area code 216)

DALLAS, TEXAS 75201  
Frank Le Beau  
The Vaughn Bldg.,  
1712 Commerce St.  
Riverside 7-9721 (area code 214)

DENVER, COLO. 80202  
John W. Patten  
Tower Bldg., 1700 Broadway,  
Alpine 5-2981 (area code 303)

HOUSTON, TEXAS 77025  
Kenneth George  
Prudential Bldg., Halcombe Blvd.,  
Riverside 8-1280 (area code 713)

LOS ANGELES, CALIF. 90017  
Ashley P. Hartman, John G. Zisch,  
1125 W. 6th St., Huntley 2-5450  
(area code 213)

NEW YORK, N. Y. 10036  
Donald H. Miller (212) 971 3615  
George F. Werner (212) 971 3617  
Donald R. Furth (212) 971 3616  
500 Fifth Avenue

PHILADELPHIA, PA. 19103  
Warren H. Gardner, William J. Boyle  
6 Penn Center Plaza,  
LOcust 8-4330 (area code 215)

SAN FRANCISCO, CALIF. 94111  
Richard C. Alcorn  
255 California Street,  
Douglas 2-4600 (area code 415)

LONDON W1:  
Edwin S. Murphy Jr.  
34 Dover St.

FRANKFURT/Main:  
Mathee Herfurth  
85 Westendstrasse

GENEVA:  
Michael R. Zeynel  
2 Place du Port

TOKYO:  
George Olcott,  
1, Kotohiracho, Shiba, Minato-ku

**Only one  
electronics manufacturer\*  
in the world  
can make this statement:**

"We deliver the following quality products *from stock*: bench instruments; closed-circuit television systems (environmental, miniaturized, industrial); DC data amplifiers (wideband, narrowband, differential, solid state); DC preamplifiers; digital comparators; digital programers, digital translators; digital voltmeters (solid state, mercury-wetted, Zener reference, stepping switch); meter calibrators; power supplies; ratiometers; thermal transfer standards, and voltage standards (AC, DC, DC programable)."

**FOR TECHNICAL INFORMATION, CALL US AT:**

**NORTH AMERICA**

Ala., Birmingham ..... 205-534-1648  
 Ala., Huntsville ..... 205-534-1648  
 Ariz., Phoenix ..... 602-258-2693  
 Ariz., Tucson ..... 602-327-6288  
 Calif., Beverly Hills ... 213-655-5200  
 Calif., Los Angeles ... 213-655-5200  
 Calif., Palo Alto ..... 415-323-2466  
 Calif., San Diego ..... 714-277-6700  
 Calif., San Francisco ... 415-323-2466  
 Canada, Montreal ..... 514-684-3000  
 Canada, Ottawa ..... 613-722-7658  
 Canada, Toronto ..... 416-293-3161  
 Colo., Denver ..... 303-388-4391  
 Conn., Bridgeport ..... 203-368-4582  
 Fla., Orlando ..... 305-241-1091  
 Ida., Idaho Falls ..... 206-725-7727  
 Ill., Chicago ..... 312-676-1100  
 Ind., Indianapolis ..... 317-356-4249  
 La., New Orleans ..... 504-943-5617  
 Md., Baltimore ..... 301-656-3061

Md., Bethesda ..... 301-656-3061  
 Mass., Boston ..... 617-658-9171  
 Mass., Wilmington ... 617-944-3930  
 Mich., Detroit ..... 313-357-3700  
 Minn., Minneapolis ... 612-545-4481  
 Mo., St. Louis ..... 314-966-3646  
 Nev., Las Vegas ..... 702-384-1000  
 N. C., Greensboro .... 919-273-1918  
 N. J., Clifton ..... 201-773-6160  
 N. M., Albuquerque ... 505-255-9632  
 N. Y., Baldwin ..... 516-223-8000  
 N. Y., New York City ... 516-223-8000  
 N. Y., Syracuse ..... 315-446-1771  
 Ohio, Cleveland ..... 216-442-8080  
 Ohio, Dayton ..... 513-298-7573  
 Okla., Tulsa ..... 918-627-1515  
 Ore., Portland ..... 206-725-7727  
 Penn., Philadelphia ... 215-877-7071  
 Penn., Pittsburgh ..... 412-884-5515  
 Tex., Dallas ..... 214-235-4541  
 Tex., Houston ..... 713-529-5292

Utah, Salt Lake City .. 801-328-3101  
 Wash., Seattle ..... 206-725-7727

**THE WORLD**

Argentina, Buenos Aires ... 33-7770  
 Australia, Melbourne ..... 42-1216  
 Austria, Vienna ..... 54-7585 Serie  
 Belgium, Brussels ..... 37-31-30  
 Denmark, Copenhagen ... ASTA 1575  
 England, Farnborough ... HANTS 3000  
 Finland, Helsinki ..... 13505  
 France, Paris ..... PYR 48-40  
 Germany, Munich ..... 59-51-09  
 Holland, Rotterdam ..... 35380  
 India, New Delhi ..... 57131  
 Italy, Milan ..... 321-544  
 Japan, Tokyo ..... 281-6811  
 New Zealand, Christchurch .. 62-254  
 Norway, Oslo ..... 42-99-93  
 Portugal, Lisbon ..... 672161-5  
 Sweden, Stockholm ..... 65-28-55  
 Switzerland, Bern ..... (031) 37866

\* COHU ELECTRONICS, INC., Kin Tel Division, 5725 Kearny Villa Road, San Diego, California 92112, Phone: 714-277-6700

1956—First Commercial Low-Noise Traveling-Wave Tube Announced

1955-57—First Practical PPM Traveling-Wave Tubes for Airborne Applications

1958—First Ruggedized PPM Traveling-Wave Tubes for Military Airborne Systems

1959—PPM Traveling-Wave Tubes with Temperature Compensation

1959—First PPM Traveling-Wave Tubes for Commercial Service

1962—First PPM Traveling-Wave Tubes Operating in a Memory Storage Loop Over a Full Octave Frequency

1962—First Reliable, Long-Life PPM Traveling-Wave Tube in an Orbiting Communications Satellite

1963—First Use of a High-Sensitivity Photocathode with a Helix Structure in a Traveling-Wave Tube

Since 1956, RCA has paced the progress of Traveling-Wave Tube development from laboratory to commercial device.

Consult your RCA Industrial Tube representative, or bring your special problem to the attention of: Manager, Microwave Marketing, RCA Electronic Components and Devices, Harrison, N. J.

**RCA FIELD OFFICES—OEM SALES:** Newark 2, N. J., 32-36 Green St., (201) 485-3900 • Chicago 54, Ill., Suite 1154, Merchandise Mart Plaza, (312) 527-2900 • Los Angeles 22, Calif., 6801 E. Washington Blvd., (213) RA 3-8361 • **GOVERNMENT SALES:** Harrison, N. J., 415 South Fifth St., (201) 485-3900 • Dayton 2, Ohio, 224 N. Wilkinson St., (513) BA 6-2366 • Washington 6, D. C., 1725 "K" St., N.W., (202) FE 7-8500 • **INTERNATIONAL SALES:** RCA International Div., Clark, N. J., (201) 382-1000. **ALSO AVAILABLE FROM YOUR AUTHORIZED RCA INDUSTRIAL TUBE DISTRIBUTOR**



**The Most Trusted Name in Electronics**