

electronics

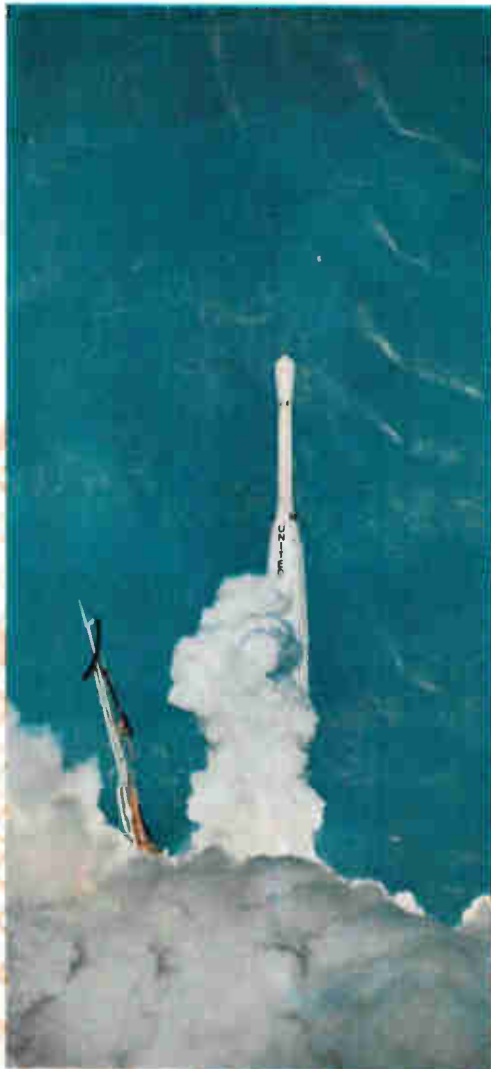

WHAT'S NEW IN MATERIALS?

Laser and semiconductor crystals command attention

RELIABILITY SLIDERULE

Cut out and paste this versatile design aid

TUNNEL DIODES READOUT CORES

These circuits mean better analog-digital converters

SPECIAL

TELEMETRY TODAY

Here's a chance to catch up with a fast-moving art that spells big business in our industry and there's no cutback in sight



C 10
MOSES LAKE WASH
BOX 956
ROLAND KISSLER

CLAMP AROUND THE LEAD:

and measure dc current 0.1 ma to 10 amps, without breaking circuit leads, without loading the circuit.

Pull back the probe flange, the probe opens. Aim it at a lead and let loose. The probe closes. Now you can measure dc current, on a bare or insulated wire . . . and you can read it directly, even in the presence of equally strong ac on the same wire, without breaking a lead and without loading the circuit.

The hp 428B Clip-on DC Ammeter reads dc current directly in 9 ranges by sensing the magnetic flux induced by the dc current. To measure the sum or difference of currents flowing through two separate wires, you simply clamp the probe around them both . . . and read. The standard 428B has a range of 0.1 ma to 10 amps and lets you read dc currents on wires up to $\frac{3}{8}$ " in diameter. A recorder, oscilloscope output is provided on the 428B.

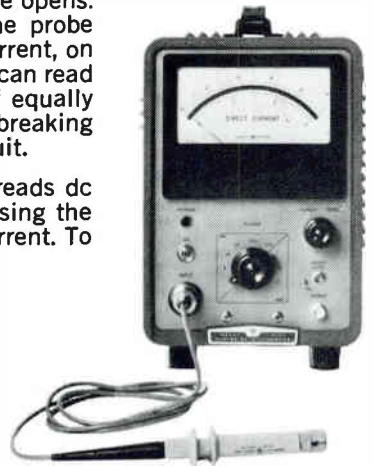

CHOMP!

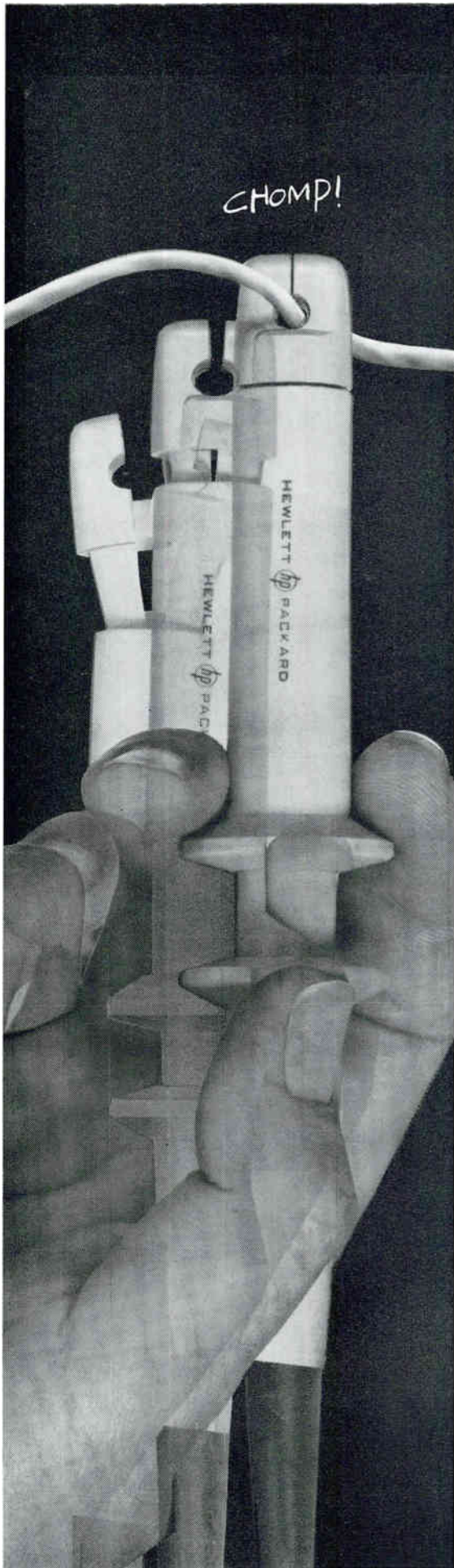

hp 3528A Current Probe

hp 3529A Magnetometer Probe

The hp 3528A Current Probe (\$450 with degausser) lets you measure dc current in conductors up to $2\frac{1}{2}$ " in their maximum dimensions . . . even pipes, multiconductor cables, lead-sheathed cables, microwave waveguide.

The hp 3529A Magnetometer Probe (\$75) is useful in applications ranging from acoustical transducer design to study of the Zeeman effect; it measures the direction or magnitude of any magnetic field with 1 milligauss sensitivity.

Look at the 428B specs, then call your hp field engineer or write direct for a single data sheet which describes all its capabilities.

428B SPECIFICATIONS

- Current Range:** 1 ma to 10 a full scale in 9 ranges
 - Accuracy:** $\pm 3\%$, ± 0.1 ma
 - Probe Inductance:** $< 0.5 \mu\text{h}$ introduced into measured circuit
 - Probe Induced-Voltage:** < 15 mv peak into measured circuit
 - AC Rejection:** ac with peak value less than full scale affects meter accuracy less than 2% at frequencies above 5 cps and different from carrier (40 kc) and its harmonics; (on 10 range, ac is limited to 4 a peak)
 - Recorder/Oscilloscope Output:** app. 1.4 v across 1400 ohms full scale; frequency response dc to 400 cps
 - Probe Insulation:** 300 v maximum
 - Price:** hp 428B, \$600 (cabinet); hp 428BR, \$605 (rack mount) (428A also available; same as 428B except range: 3 ma to 1 ampere full scale; no recorder output, \$500)
- Data subject to change without notice. Prices f.o.b. factory.

8595

**HEWLETT
PACKARD
COMPANY**



1501 Page Mill Rd., Palo Alto, Calif., (415) 326-7000. Sales and service representatives in principal areas. Europe, Hewlett-Packard S.A., 54 Route des Acacias, Geneva, Switzerland; Canada, Hewlett-Packard (Canada) Ltd., 8270 Mayrand St., Montreal, Que.

electronics

A MCGRAW-HILL WEEKLY 75 CENTS

W. W. MacDONALD, Editor (2645)

J. M. CARROLL, Managing Editor (2293)

SENIOR EDITORS

Samuel Weber (2371)
George W. Sideris (3444)

SENIOR ASSOCIATE EDITORS

Michael F. Wolff (2600)
John F. Mason (2666)

ASSOCIATE EDITORS

Michael F. Tomaino (2071)
William P. O'Brien (2297)
Sy Vogel (2467)
George J. Flynn (2188)
George V. Novotny (3151)
Leon H. Dulberger (3446)
Alexander A. McKenzie (2685)

ASSISTANT EDITORS

Stephen B. Gray (2245)
Barry A. Briskman (2306)
Dan Smith (2472)
Joel A. Strasser (2127)

REGIONAL EDITORS

Harold C. Hood,
1125 W. 6th St., Los Angeles 90017, Calif.
(213-482-5450)
Laurence D. Shergalis,
John Hancock Bldg., 255 California St.,
San Francisco 94111, Calif. (415-362-4600)
Thomas Maquire,
McGraw-Hill Bldg., 607 Boylston St.,
Boston 02116, Mass. (617-262-1160)
Cletus M. Wiley,
Blair Bldg., 645 N. Michigan Ave.,
Chicago 60611, Ill. (312-664-5800)

ART DIRECTOR

Howard R. Berry (2430)

ASSISTANT ART DIRECTOR

John C. Wright, Jr. (3430)

EDITORIAL ASSISTANTS

Lorraine Rossi, Virginia T. Bastian,
Lynn Emery, Ann Mella, Lorraine Werner,
Alice M. O'Brien, Sharon Parks, Patricia
Mitchell, Claire Benelli, Kay Fontana

FOREIGN NEWS BUREAU

DIRECTOR, John Wilhelm, (2532);
Lawrence Mihlon (2997), Alyne Elias
(2998)LONDON—John Shinn, Derek Barlow,
Nicholas Landon, 34 Dover St., London
W.1, EnglandBONN—Bruce Bendow, Richard Mikton,
Silke McQueen, Mittelstrasse 39, Bad
Godesberg, GermanyBRUSSELS—27 Rue Ducarle, Brussels,
BelgiumPARIS—Robert Farrell, Arthur Erikson,
17 Ave. Matignon, 3rd Fl., Paris 8,
FranceMILAN—Marc A. Messina, Via Manzoni
No. 12, Milan, ItalyMEXICO CITY—Wesley Perry, Jr.,
Lafragua 4-314, Mexico 1 D.F. MexicoRIO DE JANEIRO—Leslie Warren, Rua
Mexico 3-S/1507 1509, Rio de Janeiro,
BrazilMOSCOW—Stewart Ramsey,
Kutuzovsky Prospekt 19, Apt. 28-29,
Moscow, USSRTOKYO—Richard Halloran, Charles Cohen,
John Yamaguchi, Toranomon Sangyo
Bldg., 1 Kotohiracho Shiba, Minato-Ku

CIRCULATION MANAGER

Hugh J. Quinn (2310)

W. W. GAREY, Publisher (2016)

NEW YORK TELEPHONE:

Dial Direct: 971 plus extensions shown
above in parentheses. Area Code 212

THE WORLD OF TELEMETRY—Superimposed on our artist's conception of a modern telemetering antenna, Bell Labs' Telstar II blasts skyward from Cape Canaveral in the nose of a NASA Thor-Delta rocket while a Bell Labs engineer at Andover, Maine, manipulates the telemetry panels of the Telstar control console. *For a fast rundown on what else is new in telemetry today, see p 31*

COVER

ASW SURVEILLANCE GAINS Threaten Submarine Invulnerability. Multiplication of sensor techniques may leave subs no place to hide. *Potentially important techniques: infrared, nuclear, temperature-difference, galvanic, biological, optical*

10

AFTER ECHO II: What and Why? Passive communications satellites offer multiple access, are jam-proof and durable. *Echo II is a balloon, but more exotic designs are proposed*

24

SPECIAL—TELEMETRY TODAY. An essential part of every space exploration project, telemetering is also enjoying unprecedented expansion in down-to-earth industrial applications. This report covers proposed IRIG subcarrier frequencies, compares modulation methods including new hybrid pulse schemes and orthogonal coding to correct errors. *Many new techniques aim at increasing bandwidth: vestigial sideband modulation, predetection recording and off-line data processing as well as the coming shift of telemetry channels to uhf.* By B. A. Briskman

31

TUNNEL DIODES SAVE PARTS: Continuous Readout of Magnetic Cores. A tunnel diode biased in its bistable mode can give continuous indication of the flux-state of any closed magnetic path. Circuits like this have been used in an analog-to-digital converter using five-aperture cores. *The application resulted in a saving of 80 percent in parts and 40 percent in solder joints.*

By W. G. Trabold, GM Research Labs

38

NEW TELECASTING TECHNIQUE—Special-Effect Amplifier Combines Scenes Without Sharp Transition Edge. This tv dissolve wiper shapes the transition-region video scenes and overlaps them to give an indistinct border needed in drama and musical shows. *The key factor is a gating signal consisting of a ramp connecting two constant voltages. It is obtained by clipping the top and bottom of a sawtooth waveform.*

By K. Kazama, T. Ishino, K. Shudo and K. Kumakura,
Japan Broadcasting Corp., Tokyo

40

Contents continued

Published weekly, with Electronics Buyers' Guide as part of the subscription, by McGraw-Hill Publishing Company, Inc. Founder: James H. McGraw (1860-1948).

Title ® registered U.S. Patent Office; © copyright 1963 by McGraw-Hill Publishing Co., Inc. All rights reserved, including the right to reproduce the contents of this publication, in whole or in part.

Executive, editorial, circulation and advertising offices: McGraw-Hill Building, 330 West 42nd Street, New York, N. Y., 10036. Telephone Area Code 212 971-3333. Teletype TWX N. Y. 212-640-4646. Cable McGrawhill, N. Y. PRINTED IN ALBANY, N. Y.; second class postage paid at Albany, N. Y.

OFFICERS OF THE PUBLICATIONS DIVISION: Shelton Fisher, President; Vice Presidents: Joseph H. Allen, Operations; John R. Callahan, Editorial; Ervin E. DeGraff, Circulation; Donald C. McGraw, Jr., Advertising Sales; Angelo R. Venezian, Marketing.

OFFICERS OF THE CORPORATION: Donald C. McGraw, President; Hugh J. Kelly, Harry L. Waddell, L. Keith Goodrich, Executive Vice Presidents; John L. McGraw, Treasurer; John J. Cooke, Vice President and Secretary.

Subscriptions are solicited only from those actively engaged in the field of the publication. Position and company connection must be indicated on orders. Subscription rates: United States and Possessions and Canada, \$6.00 one year, \$9.00 two years, \$12.00 three years. All other countries \$20.00 one year. Single copies, United States and Possessions and Canada 75¢. Single copies all other countries \$1.50.

THE PUBLISHER, UPON WRITTEN REQUEST TO OUR NEW YORK OFFICE FROM ANY SUBSCRIBER AGREES TO REFUND THAT PART OF THE SUBSCRIPTION PRICE APPLYING TO COPIES NOT YET MAILED.

Subscribers: Please send change of address notices, subscription orders or complaints to Fulfillment Manager, Electronics, at the address below. Change of address notices should provide old as well as new address, including postal zone number if any. If possible, attach address label from recent issue. Allow one month for change to become effective.

Postmaster: Please send Form 3579 to Fulfillment Manager, Electronics, P. O. Box 430, Hightstown, New Jersey, 08520.



Audited Paid Circulation

CONTENTS continued

REFERENCE SHEET: Cut Out Your Own Reliability Slide Rule. If you know the required system reliability and percent of total system failures assigned to a subsystem, this rule will give required subsystem reliability directly. Also, knowing the total number of failures, tests and the required confidence, you can find system reliability. Just cut out p 46 for body of rule and p 48 for the slide then mount on stiff cardboard and assemble. By G. F. Allen, General Dynamics/Pomona 44
DISARMAMENT—What Chance? What Impact? Washington sees no realistic timetable for disarmament. But if it should come, arms-control, space, civilian electronics would help offset defense electronics cuts 56
TV BRIEFS Air Force. Pentagon spends \$1/2 million on closed-circuit system. World-wide network may be next 58
MATERIALS CONTROL Key to New Devices. That was the dominant theme at last week's conference on advanced electronic materials. Among the advances: epitaxial lasers, semiconductor ultrasonic amplifiers 66
NEW TECNETRONS Switch 15 Amp. Today, a high-power version of the French field-effect device was introduced for a-c and d-c switching. Devices to switch 50 amp are being planned 75
HELICOPTERS Try L-F Navigator. FAA certification for instrument flight sought. Decca is used to avoid line-of-sight problems 77

DEPARTMENTS

Crosstalk. Telemetry Tomorrow. Our New Look 5
Comment. Keeping Abreast. Transistor Symbol 6
Electronics Newsletter. Overseas Investment by Electrical-Electronics Companies Rises 17
Meetings Ahead. Electronics Components Conference 19
Washington This Week. Congress Trims NASA's New Budget 20
Research and Development. New Cooler Uses Thermoelectric Effect 84
Components and Materials. Thin-Film Photocells Get Brighter Faster 99
Production Techniques. Etched Molds Form P-C Boards 108
New Products. High-Speed Solid-State Printer 119
Literature of the Week 143
People and Plants. Sanders Enters New Facility 144
Index to Advertisers 153

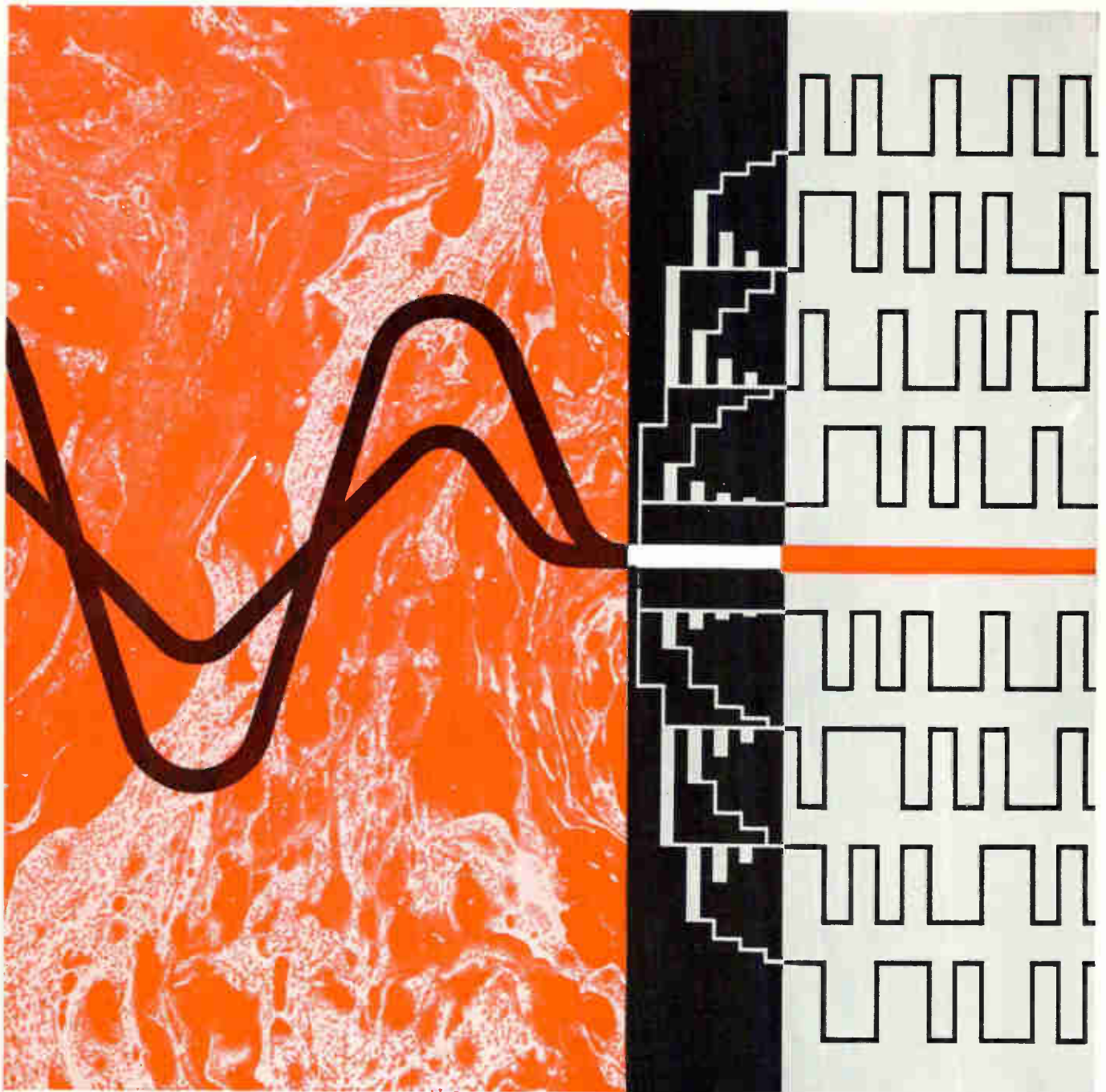

HIGH-SPEED ANALOG TO DIGITAL AND DIGITAL TO ANALOG CONVERTERS

5 million bits per second
1 watt power consumption

High-speed Telemetry Signals
High-speed Data Processing
High-speed Signal Digitizing
Digital Television
Speech Digitizing/Voice Communications
Computerizing Wide-Band Data

SPECIFICATIONS / SERIES 1042-1046

- From 4 to 8 bits including parity
- Sampling aperture 300 nanoseconds
- Serial and Parallel outputs
- NRZ, M and C code formats
- Even or odd parity-bit
- Size—5 x 4 x 4 inches
- Weight—less than 3 lbs.



Vector Manufacturing Company, Inc., Southampton, Pa.

Telemetry Components & Systems / ELmwood 7-7600 TWX 215 357 1276

Vg SWITCHING MODULE



this tiny "bounce-free" switch eliminated the need for

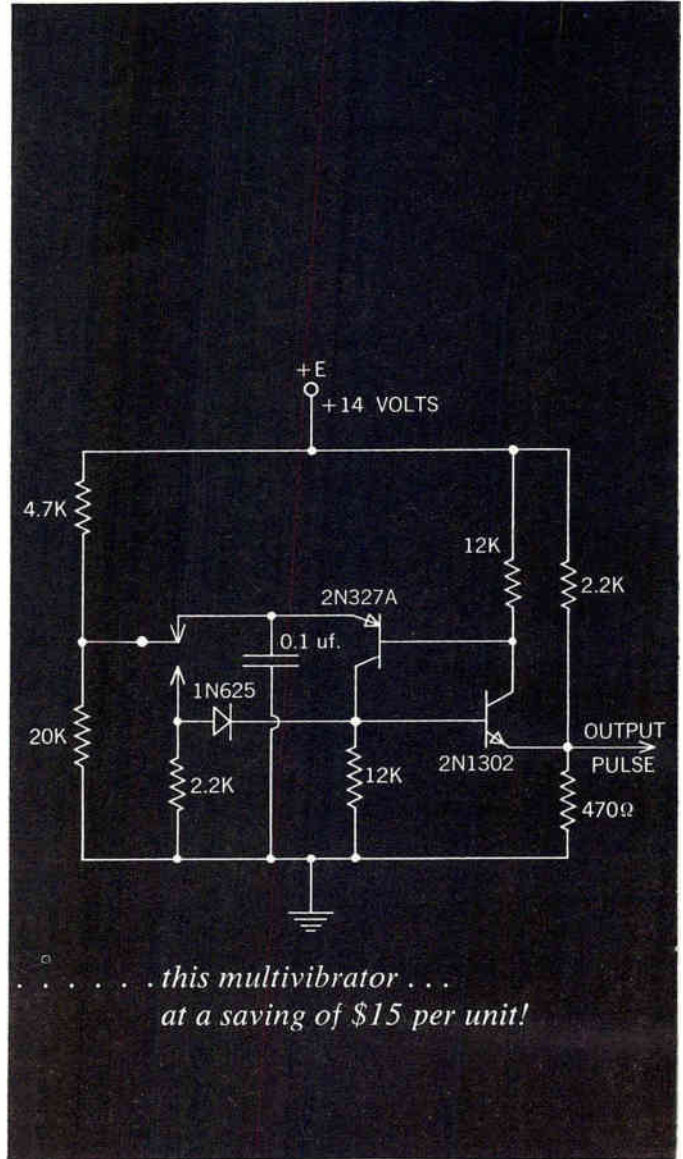

. this multivibrator
at a saving of \$15 per unit!

The multivibrator was used to obtain a square pulse from a pushbutton switch installed in digital equipment developed by a leading systems manufacturer. *Note that "Form C" had to be used to produce a satisfactory signal.*

Substituting a "VG" Pushbutton Switch, the design engineer obtained the clean signal he needed — *without the multivibrator* — and saved the company \$15 on every unit produced! The no-bounce, no-noise operation of "VG" Switches, coupled with extreme reliability in the "micro-dry" circuit switching region (and even as high as ¼ ampere), have made possible dramatic simplification of circuitry, including the elimination of filters and associated components.

Write for complete information on the "VG" Pushbutton Switch, and the mechanically actuated "VG" Switching Module designed for precision contacting at rates up to 1000 closure cycles per second.

© Vitramon, Inc. 1963



Vitramon

INCORPORATED

VITRAMON, INC. • BOX 544 • BRIDGEPORT 1, CONNECTICUT

Telemetry Tomorrow

THIS WEEK'S feature on telemetry (p 31) points up advances the art has made in meeting today's complex aerospace and civilian demands. A good portion of present techniques, however, will become history by 1970, the year when most telemetry users will have had to swing over from the present 215 to 260-Mc vhf band to new uhf assignments between 1.435 and 1.535 Gc or 2.2 to 2.3 Gc.

The coming of the uhf telemetry allocations has important technical and financial implications.

One aim of the switchover, ordered by FCC and the Interdepartmental Radio Advisory Committee (IRAC) of the Office of Emergency Planning, is to improve telemetry. For example, a broader telemetry spectrum will permit a greater number of experiments in a given space shot, since more data channels can be employed. This adds up to more data with fewer space vehicles, plus an added bonus of increased reliability. Moreover, such requirements as obtaining positional data will become easier to meet. At uhf, tracking data may be obtained from telemetry alone, reducing the need for radar beacons.

Uhf equipment is markedly different than vhf gear. In transmitters, for example, output circuits will employ cavities rather than simple LC circuits or tuned lines. Receivers will require lower-noise front ends, additional frequency conversion and perhaps remote preamplification to do away with losses incurred between the antenna and receiver. The r-f

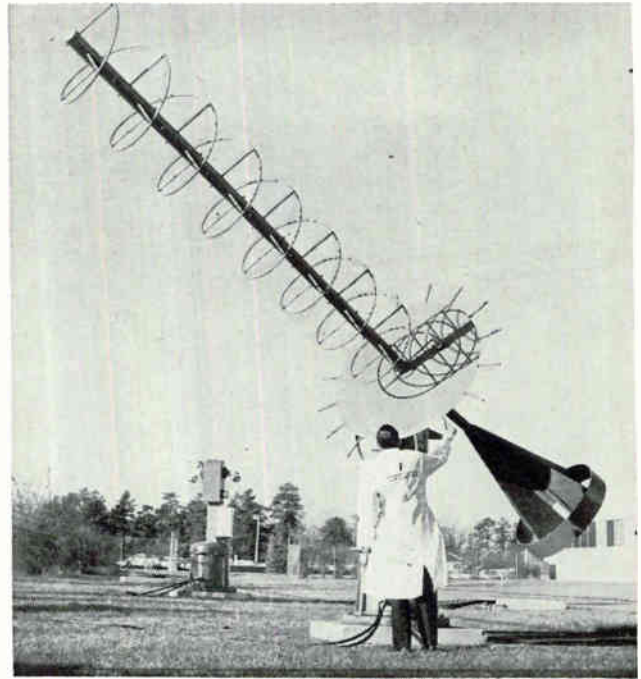

portions of the telemetry link will require the greatest amounts of new thinking and redesign since they exhibit little similarity at 200 Mc and at 2 Gc.

Reinstrumentation of r-f equipment will undoubtedly require modification or replacement of large amounts of vhf equipment. Doing the technical job is not a major stumbling block since the problems from both operational and equipment viewpoints are well understood. Ingenuity and practical operational analysis will probably dictate the changeover designs.

While many in the telemetry business agree that the frequency shift will be a good one, there is some concern as to where the money is coming from and when. If, as some suggest, funding does not appear until 1969 or 1970, a crash program may be forced upon both suppliers and users.

This prospect is one that should be countered, while there is still plenty of time, by more substantial government funding of redevelopment in the next few years. The government military and space programs are, after all, the largest users of radio telemetry, and have the most vital interest in making the changeover with a minimum of debugging at the last moment.

QUESTIONNAIRE—On page 89 of this issue of **electronics**, you will find a form similar to our reader service card. We ask you to fill in the form and mail it to us. The more we know about your needs the better we can serve you.

OUR NEW LOOK

We've restyled **electronics** and hope you like it.

Don't want to bore you with shoptalk, but here are the most important changes:

- New type is larger and easier to read; because of its design we get the same number of words on a page
- Our Newsletter has been increased by one page and, together with the Washington report, is printed in an easy-to-find insert
- Meetings will be regularly listed within the insert
- Important technical articles have been moved well forward
- Important news is carried throughout the magazine

Other improvements will, we hope, be apparent to you

SPRAGUE[®]

MODEL 500

INTERFERENCE LOCATOR



This versatile instrument is a highly sensitive interference locator—with the widest frequency range of any standard available unit! Model 500 tunes across the entire standard and FM broadcast, shortwave, and VHF-TV spectrums from 550 kc. to 220 mc. in 6 bands.

It's a compact, portable, rugged, versatile instrument—engineered and designed for most efficient operation in practical field use. It features a transistorized power supply, meter indications proportional to carrier strength as well as sensitivity of 5 microvolts minimum for 5% meter deflection over entire tuning range.

For full details, send for brochure IL-106.

SPRAGUE ELECTRIC COMPANY
35 Marshall Street, North Adams, Mass.



COMMENT

KEEPING ABREAST

The May 24 issue contained an article, Can Synthetic Sleep Save Time? (p 20), which aroused my interest...

As a Canadian Air Defense Command Advisor, I find your magazine to be the only way to keep abreast of new developments and techniques. I've been a subscriber for almost two years now, and I look forward to each week's issue.

LOUIS G. ESPOSITO

Ville LeMoynes, Quebec
Canada

TRANSISTOR SYMBOL

The recent Crosstalk article entitled Defeat in Venice (p 3, July 12), expressed an interesting, but distressing viewpoint. The symbol controversy should be given thought by all electrical engineers, not just by our committee members.

The Swedish symbol seemed to be a radical idea when I was introduced to it several years ago. It has proven itself to me in practice, and I now use it almost exclusively.

The Swedish symbol is not, as you have stated, "a giant step backwards" to a symbol resembling a vacuum tube, but a step forward. The classical symbol was derived from the physical configuration of the now obsolete point-contact transistor, whereas the Swedish symbol does in fact more closely resemble the modern junction transistor.

This alone would be far from sufficient to justify the new Swedish symbol. The circuit diagram itself is the best justification. Below I have drawn two diagrams of a simple flip-flop, one with the conventional symbol, and the other with the Swedish symbol. Which diagram appears neater, easier to draw and easier to read?

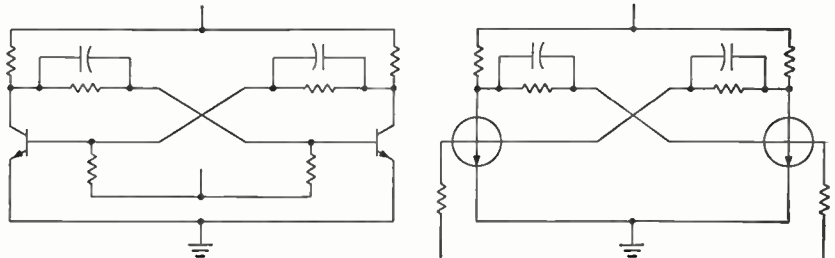

I encourage you to try this test on any circuit you wish.

I fear that much of the support the classical symbol receives is due to lack of knowledge of the new symbol, rather than a true preference. I was surprised to find that a majority of the engineers I have shown the symbol to, had never seen it before.

Are we right and are all the Europeans who have jumped on the bandwagon wrong? Are they merely being impulsive? Perhaps the European trend should be given more serious thought, not only by our committees, but by each and every engineer who will be using the symbols.

ROBERT L. HERRMANN

West Lafayette, Indiana

NEGATIVE RESISTANCE VIII

Since the interpretation of the expression "negative resistance" is a repeatedly discussed subject in Comment, I want to point out that the negative resistance is not a recently introduced concept. To prove this point, I enclose photocopy extracts from my patent 1,920,569, filed in the United States on November 11, 1929.

L. L. KOROS

Cherry Hill, New Jersey

• The patent is on a "Device for Keeping Constant the Terminal Voltage of Sources of Current," and reads, in part:

If in a coordinate system the terminal voltage e is changed in dependency on the intensity of current i , there follows for a glow cathode discharging tube the inclining curve E negative, a characteristic which is known as negative resistance characteristic.

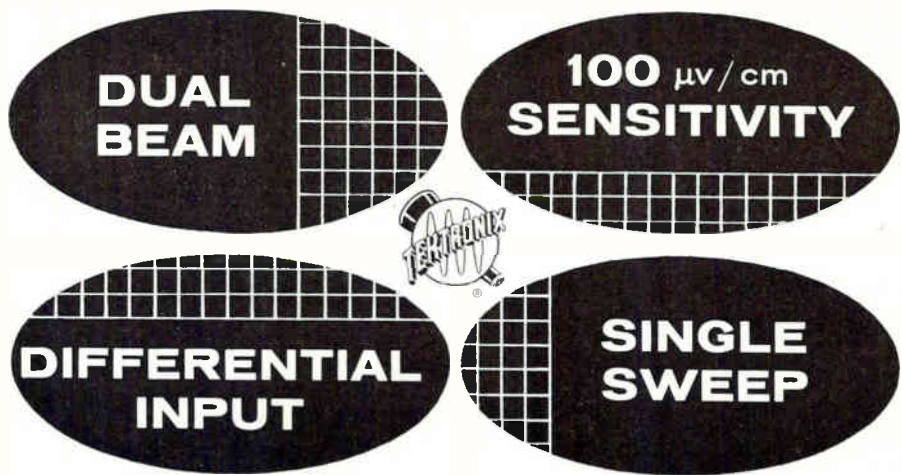

to simplify waveform-comparison applications . . . Type 502A

- . . . To measure stimulus and reaction on the same time base.
- . . . To measure transducer outputs, such as pressure vs. volume.
- . . . To measure phase angles and frequency differences.
- . . . To measure plots of X-Y curve-tracing presentations.
- . . . To measure other characteristics of low-level displays.

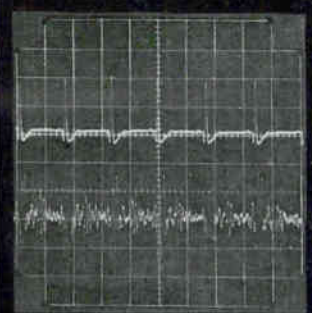

BIO-MEDICAL APPLICATION
 Typical dual-beam display shows presentation of ECG (upper beam) vs. heart sounds (lower beam) of patient.

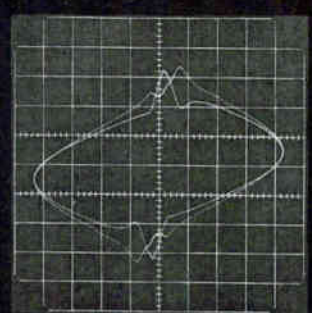

QUALITY-CONTROL APPLICATION
 Typical dual-beam X-Y display shows comparison of E/I loops of two transformers in a production run.

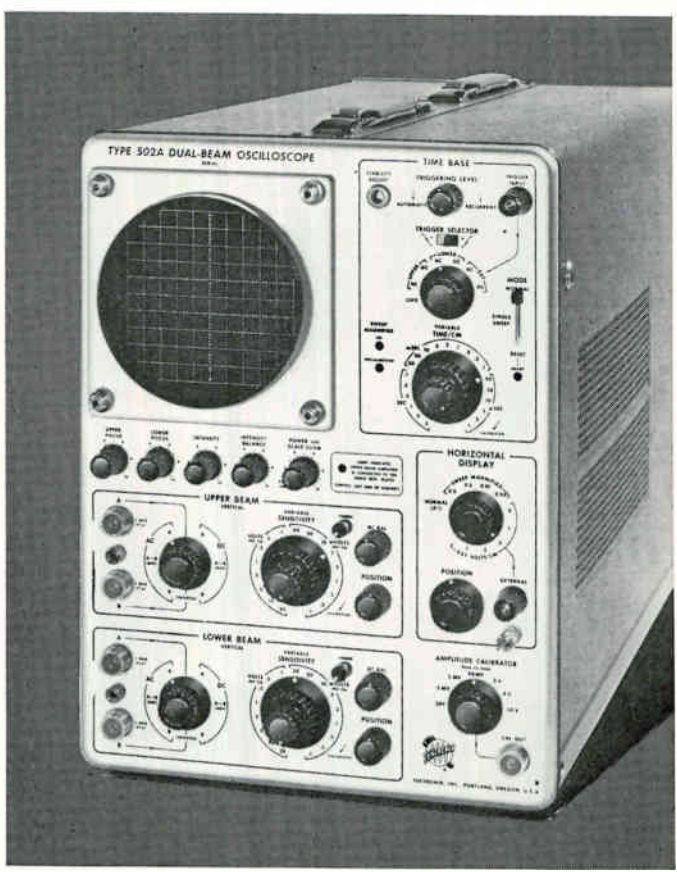

FEATURES

- 2 identical vertical amplifiers
- 17 calibrated steps of sensitivity
- 21 calibrated sweep rates
- 4 steps of sweep magnification
- Continuously adjustable sweep and sensitivity controls
- Push-button beam finders
- Intensity-balance control

FOR A DEMONSTRATION, PLEASE CALL YOUR TEKTRONIX FIELD ENGINEER

MAIN PERFORMANCE CHARACTERISTICS

- Passbands from dc-to-50 kc, minimum, to dc-to-1 Mc maximum
- Calibrated Vertical Sensitivity in 17 steps from 100 $\mu\text{v/cm}$ to 20 v/cm , both amplifiers
- Calibrated Sweep Range in 21 rates from 1 $\mu\text{sec/cm}$ to 5 sec/cm
- Variable, Uncalibrated, Sensitivity and Sweep Range Controls • 2X, 5X, 10X, or 20X Sweep Magnification
- Flexible Trigger Facilities
- Amplitude Calibrator
- Electronically-Regulated Power Supplies

Type 502A Oscilloscope \$1050
 U. S. Sales Price f.o.b. Beaverton, Oregon

Tektronix, Inc. / P. O. BOX 500 • BEAVERTON, OREGON 97005 / Phone (Area Code 503) Mitchell 4-0161 • Telex: 036-691 • TWX: 503-291-6805 • Cable: TEKTRONIX • OVERSEAS DISTRIBUTORS IN 27 COUNTRIES

Tektronix Field Offices: in principal cities in the United States. Consult Telephone Directory • Tektronix Limited, Guernsey, Channel Islands
 Tektronix Canada Ltd.: Montreal, Quebec • Toronto (Willowdale), Ontario • Tektronix Australia Pty. Limited, Sydney, New South Wales

How much do you know about today's high-frequency scopes?

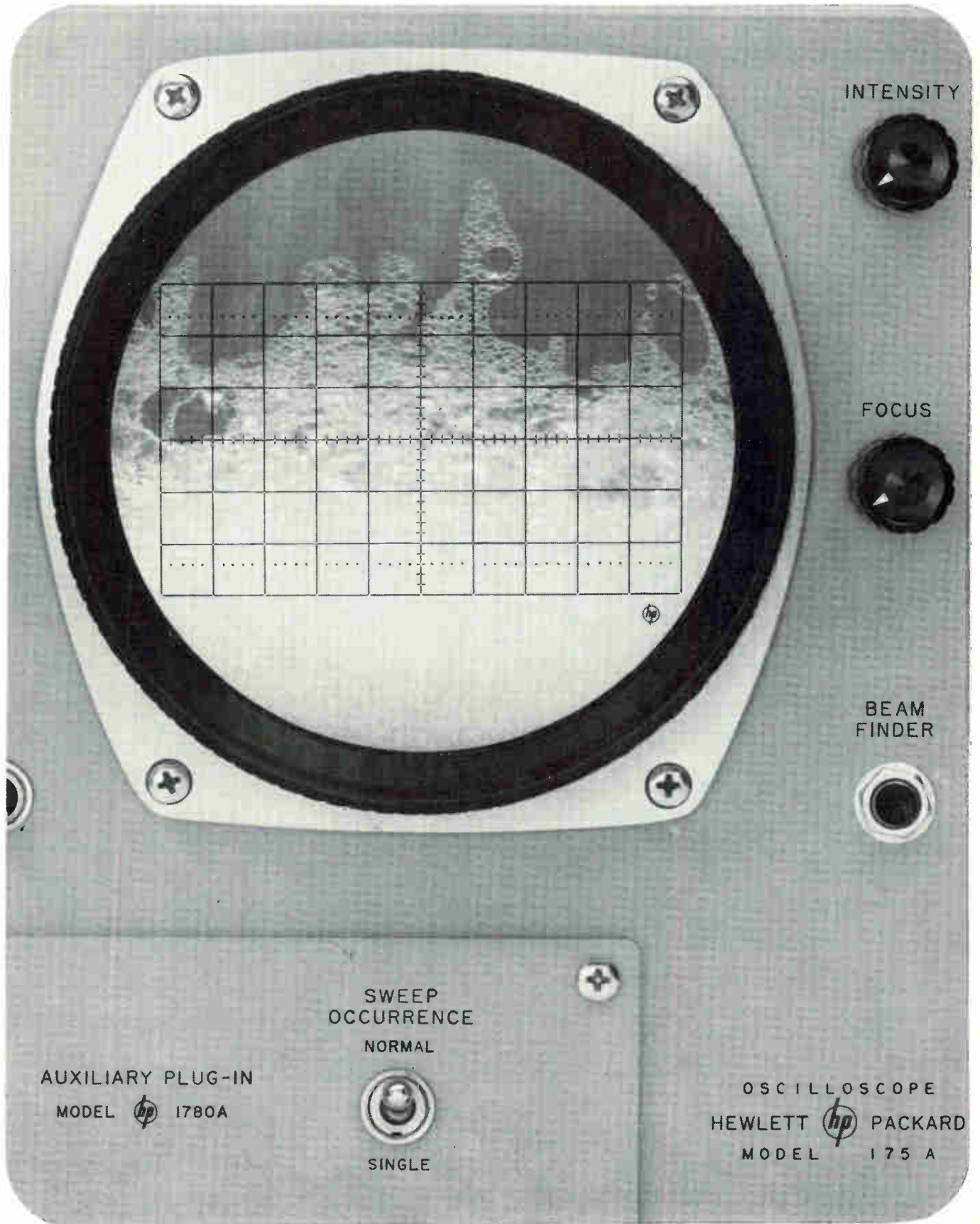

Easy as ABC

Easy as ABC

Clean operation... As familiar as you are with your present high-frequency scope, it doesn't seem like much of a chore to operate it. But then the wife didn't think she was working too hard on Mondays before the washer-drier came into being. But here's a real test on just how easy your scope operation is:

Take a novice, someone who hasn't used your kind of high-frequency scope. Give him the instruction manual and ask him to get a signal on the crt. Time him. Then do the same with the hp 175A Oscilloscope. (You can try the 175A *first*, if you like... the results will be the same.)

Try getting a spot. With many scopes you have to put one hand on the horizontal position control, the other on the vertical position control... and play. If the intensity control happens to be turned down, you won't find anything. On the 175A you push a button... the beam finder... and there's the spot. You can see where it comes from; you know immediately which way to turn the position controls—no fiddling here.



So you have a spot. Try focusing. With the conventional scope you focus, you set intensity and then, when you try a sweep, you find that astigmatism hinders the measurement. You adjust the astigmatism control, then focus, then astigmatism, then...

Not so with the 175A, which has no front-panel astigmatism knob — because it doesn't need one. (Our 12 kv crt is so sensitive that deflection defocusing is history — no more jockeying between focus and astigmatism control to get a meaningful picture of the important trace.)

Now the controls. The 175A uses concentric controls... fewer, at that, than the conventional scope. They're concentric for a *reason* (they relate to related functions), and they are color-coded to front panel legends, so you can't miss. What's more, they're logically arranged — you don't spend half the time looking for an engraved or silk-screened legend that isn't where it *really* belongs.

Next (and you don't have to check your novice for this one), look at the triggering controls. How many modes are indicated on the triggering switch of your present high frequency scope? Then check this:

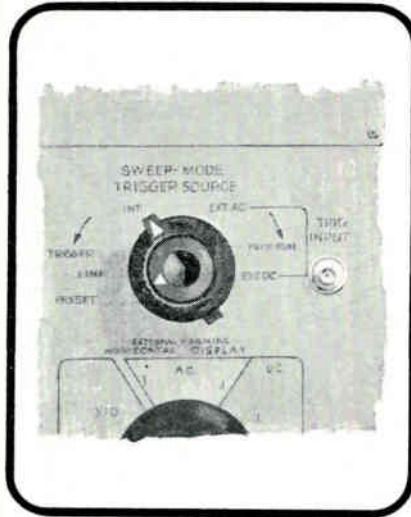

We've incorporated tunnel diode triggering circuitry, more sensitive, vastly easier to set — and the 175A is the only scope in its price range to offer this feature. We have fewer bandwidth-limited, and trigger slope and level are a snap to set. Your check-out will prove it.

And speaking of bandwidth limited, surely one of your problems when you buy a 50 mc oscilloscope is to find that it will operate only to, say, 30 mc on the precise function you need. With the 175A, using a particular trigger mode or other function control doesn't limit the specified performance of the scope. It's a 50 mc scope that does what it says it will—in every way you want it to.

Add to all this the fact that the 175A gives you a 6x10 cm picture (as opposed to the 4x10 cm picture you're used to), a crt that eliminates parallax error with an internal graticule and a non-glare faceplate, the greatest viewing accuracy *ever*.

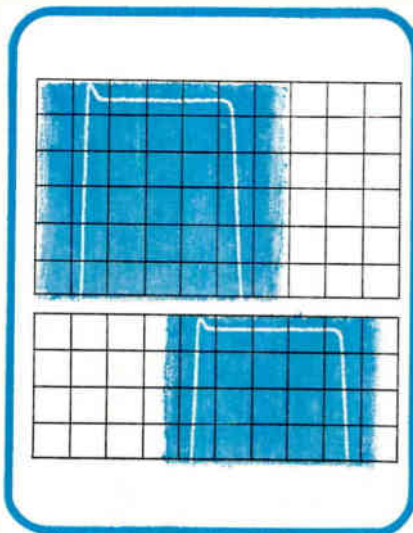

With the 175A, too, we deliver the utmost in both horizontal and vertical plug-in flexibility — dual- and four-trace and high sensitivity vertical viewing, sweep delay and x-y recording capabilities... when, but not unless you need them. They're all available as 175A plug-ins.

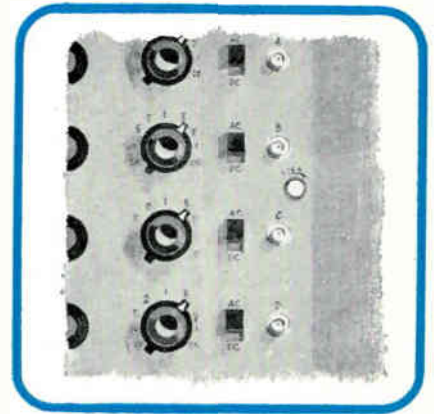

Easy maintenance, too. No distributed amplifiers to adjust (the sensitive 12 kv crt doesn't need them); no delay adjustments (a built-in cable delay line requires no adjustment); the fewest possible number of adjustments (i.e., only five simple, independent adjustments for the main vertical amplifier); use of only 7 tube types and 5 transistor types (none of them "selected"), to reduce your spare parts inventory and make component replacement easier.

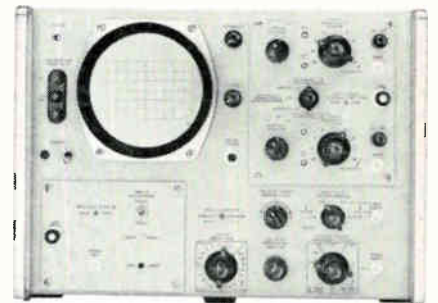

The 175A is big in performance with a big story that we can tell you on your bench. One thing small about it is the price. If two words can describe the 175A, they're "performance" and "value." It takes *three* words to describe other high-frequency scopes alongside the 175A: "Not nearly comparable." hp 175A, \$1325 (without plug-ins).

Data subject to change without notice. Price f.o.b. factory.

**HEWLETT
PACKARD
COMPANY**



1501 Page Mill Rd., Palo Alto, Calif., (415) 326-7000. Sales and service representatives in principal areas. Europe, Hewlett-Packard S.A., 54 Route des Acacias, Geneva, Switzerland; Canada, Hewlett-Packard (Canada) Ltd., 8270 Mayrand St., Montreal, Quebec.

Gains in ASW Surveillance

Multiplication of sensor techniques may leave subs no place to hide

By **LEON H. DULBERGER**
Associate Editor

THE MUCH-SOUGHT antisubmarine-warfare (ASW) sensor breakthrough is still unrealized. Until it is, surveillance undersea will not be as easy as radar penetration of the skies. However, gains in sonar and magnetic anomaly detectors (MAD) plus promising new sensing methods are making it increasingly difficult for enemy submarines to remain undetected.

Latest sensor techniques in use or possibly under study include: detection of heat in a submarine's wake with airborne infrared scanners, ultraviolet inspection of dead microbiological life trailing a sub, inspection of snorkel exhaust traces in the atmosphere with a nuclei detector, check of nuclear radiation imparted to water by passage of an atomic submarine, possible use of detection gear to measure voltage caused by dissimilar metals in water, and possible exploitation of lightning-generated radio waves that penetrate water.

SONAR'S LIABILITIES—So far, sonar remains the chief technique for long-range penetration of water because sound travels readily through the medium. But bending of sonar

rays at temperature interfaces in water—thermoclines—may shield submarines from detection or distort surveillance patterns preventing accurate location of targets. Additionally, active sonar, which is used to fix target location gives away the searcher's location.

Radar, useful against surfaced or snorkeling submarines, has limited usefulness against modern nuclear subs that remain submerged for extended periods. The Communist bloc has roughly 450 submarines in service, some of them atomic-powered. Our military experts point out that the submarine's ability to rain missiles on American mainland targets while submerged, or when surfacing briefly off our coast lines, represents one of the gravest threats to our security.

Sonar advances include ability to operate beneath thermoclines through use of deep-dipping sonar operated from helicopters or surface ships. Also called variable-depth sonar, it is finding extensive ASW application.

Project Artemis, an extremely high-power, long-range active sonar system under test in the Atlantic uses a transducer ship, and hydrophones to pick up echoes that are sent to data-processing gear on an island laboratory. The system may lead to an active sonar early warning net. Project Caesar, now being expanded, uses many hydrophones in a listening network off America's shores.

Sonobouys, deployed from air-

craft or ships, are a mainstay of Navy's ASW and are being improved.

Presently they lower a transducer beneath thermoclines and radio back data by a transmitter operating on the surface. A chemical explosive charge set off underwater near a pattern of several passive sonobouys provides location information on submarines hidden in the area. Development work on a sonodiver which records sound, temperature and other data while hovering beneath the surface may possibly find ASW applications.

MAD ADVANCES — Magnetic anomaly detectors used for years by the Navy, are undergoing improvements to increase range. MAD is helpful in identifying targets discovered by sonar through recording of variations in the earth's magnetism. Submarines and sea creatures are readily differentiated. It also provides an accurate fix on targets. MAD systems may presently be using proton free-precession magnetometers for increased sensitivity. This is thought possible as such devices are finding extensive use in oceanography and treasure hunting, and in the *Thresher* search in the Atlantic. Proton magnetometers respond to minute distortions in the earth's magnetic field.

INFRARED—Temperature measurement of water by airborne infrared scanners, and also by *in situ* sensors drawn through the water, may be

DESTROYERS drop depth charges during ASW exercises



Threaten Subs' Invulnerability

designed to reveal the 0.5 to 1-degree change in temperature caused by a submarine's passage. Airborne equipment using infrared radiometers, some with low-noise maser amplifier inputs, are finding growing application in hydrographic work. Infrared scanners able to measure sea surface temperature with an accuracy of ± 0.2 degree C over a range of -2 to $+35$ degrees C are being tested in hydrographic research from airborne platforms and may find ASW applications. Thermistors spaced along chains towed behind surface vessels have been used in oceanographic work for charting thermal currents with high accuracy. If used in ASW surveillance, thermistor chains may allow penetration to depths where today's deep-running submarines lurk.

SIDE-LOOKING RADAR—Radar using high resolution side-looking techniques could be operated from aircraft to detect submarine snorkels from the background clutter of waves with a minimum of signal-processing circuits. Side-looking airborne radar produces a readily definable target against random motion waves and spray when recording the steady motion of submarine snorkels. It may also prove possible to detect the rise in the ocean's surface caused by passage of a submarine beneath it, using radar techniques.

Condensation nuclei detectors are used to track conventional snorkeling or surfaced submarines

from the air by inspecting the nuclear structure of the atmosphere, which is affected by engine exhaust.

Radioactivity imparted to water by the passage of a nuclear-powered submarine presents another possible means of locating submerged submarines.

MARINE ORGANISMS—Microbiological life present in water is affected by the movement of submarines, and techniques to discover the dead organisms are under study. These may possibly include ultraviolet inspection of the water with airborne sensors to detect the bioluminescence of marine organisms, and also *in situ* tests by taking samples in bottles at extended depths for study.

Dissimilar metals immersed in seawater produce a voltage, and may possibly form the basis for an ASW sensor. The technique is being used in the search for the sunken *Thresher* lost in the Atlantic. It may prove important in locating enemy subs at rest.

LASERS—Optical techniques underwater continue to receive attention. They include the possibility of a laser-operated, three-dimensional scanning system for positive target identification at short ranges. A 3-D system might use a scanning technique, and an intense blue-green coherent, narrow-band laser as a light source, when it is developed. Synchronized scanning of the target would reduce backscatter due to

suspended particle matter in the water. Only a small portion of the target and water adjacent to the beam would be illuminated, with the optical receiver designed for narrow band pickup.

Low-frequency radio signals are known to be transmittable through water and presently provide communication to submerged submarines on ulf bands. Because worldwide, lightning-generated, long-wave signals occur many times a second, it may be that they will form the basis for an ASW surveillance technique in the future.

Other surveillance techniques under consideration include a magnetically operated device that locks onto passing submarines and transmits a beacon signal to implement tracking.

SEA FORECASTING—The high complex. Signal processing and data processing systems are being developed to process and display sensor information in a manner that permits rapid target identification and deployment of attack weapons.

Another factor in the use of future ASW surveillance systems is the operation of an oceanographic, sea-condition forecasting net, Asweps, to tell ASW commanders what to expect from their equipment at a given time, in various theaters of operation. It would also allow routing convoys around areas of bad ASW-operating conditions, to allow best ocean environment for defense and attack by ASW commanders.



ASW PATROL PLANE, Orion, helped Navy track and flush Soviet submarines during the Cuban crisis. Extending from tail is magnetic anomaly detector



TORCH IT! Withstands temperatures of 1500°F without a sign of deformation. No other vitreous-enamelled resistor will stand 1500°F without burning, softening, or dripping away. There's absolutely no effect on markings either . . . they are vitreous in nature . . . a ceramic marking fired right into the coating. Markings on all other resistors burn off immediately, or rapidly become illegible.



ABRADE IT! Try it yourself. Use a glass fiber eraser, for example, on the markings. Rub them hard. Nothing happens. Do it again. Still the markings don't come off, because they are vitreous ceramic, fired into the molded vitreous coating. You can't remove them except with a grinding wheel. With any other resistor, the markings disappear with the first couple of rubs.

DON'T try all these tests

OHMITE Series 99 Wire-Wound Resistor

"molded" in vitreous enamel
...for highest quality protection!



Enlarged 2½ times

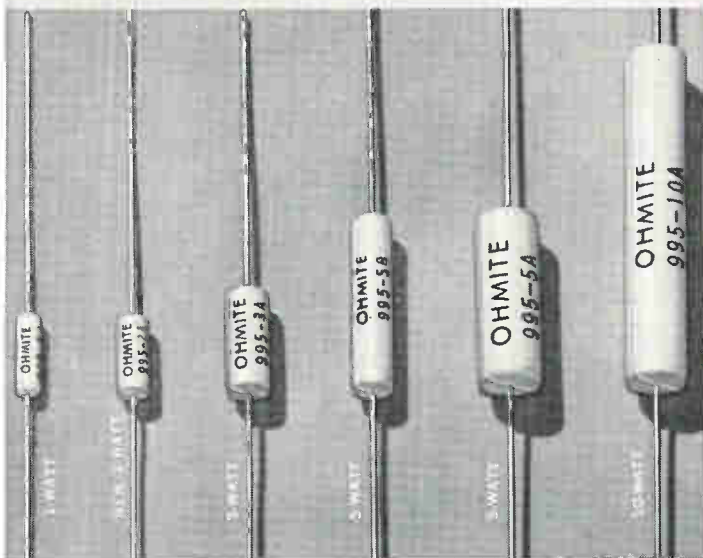

■ Series 99 resistors represent a completely new approach—a breakthrough in the science of protective coatings. The result is an *insulated* (1000 V to ground) axial-lead resistor of the highest quality.

The molded vitreous coating of Series 99 resistors involves an entirely new process of vitreous enameling (patent applied for) which creates an entirely new product (patent applied for). It endures the red heat of manufacture, yet retains its precise molded shape and dimensions with a uniformity that varies only in thousandths of an inch. This new process locks the uniformly wound resistance wire in place which eliminates hotspots during operation.



Uniform, Controlled Coating on Series 99 Molded Resistors



Variable Coating on Conventional Dipped Resistors

Series 99 resistors, constructed in accordance with the requirements of MIL-R-26C will pass the famous and

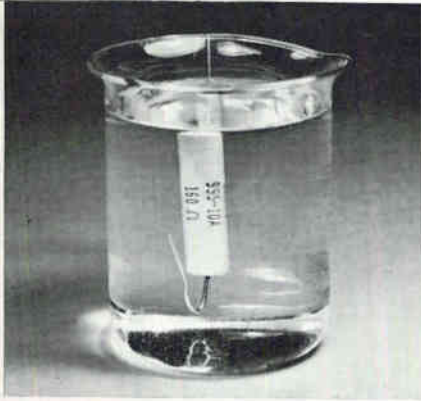

SOAK IT IN SOLVENT! Here's another test you can run quickly. Fill a beaker with the most active of organic solvents used in degreasing and flux removal. Drop in a Series 99 molded resistor. Let it soak. Then try to rub off the markings. They're bright as new, because they're *part* of the ceramic coating. Try this on any other resistor . . . the markings dissolve and can be rubbed off.



BEND THE LEAD where it emerges from the resistor body! You can bend the lead repeatedly at this point without damage. Conventional axial-lead, vitreous-enamelled resistors have a dipped coating which forms a meniscus around the lead where it joins the body of the resistor. Bending the lead ruptures the meniscus and damages the coating. Series 99 resistors are molded and there is no meniscus.

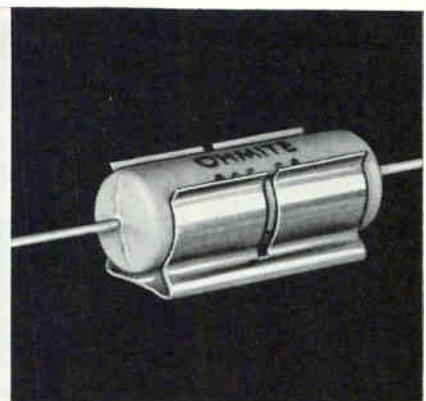

CLIP IT! Insert a molded Series 99 resistor into a metal clip. Don't baby it; ram it in. There's no danger of cutting, chipping, or scratching the hard coating which provides 1000 VAC insulation. Notice the snug fit, too. The clip mounting shown is resistant to high shock and vibration. When mounted on a metal chassis, it provides a heat sink which may increase the wattage rating as much as 100%.

on any other resistor!

10,964,000 UNIT-HOURS OF TESTING! This new molded construction has been proven in extensive load-life tests shown in the accompanying table.

These test results have been obtained from many experimental lots of resistors representing different constructional materials and manufacturing processes. These resistors were produced, tested, and evaluated for developmental purposes which ultimately determined our present production practices. Hence, the $\% \Delta R$ values given should not be specified as design or performance limits.

More typical ΔR data is presently being collected as part of another test program in which samples are being taken from standard production lots. Data will be available after sufficient time has elapsed.

CYCLIC LOAD-LIFE TEST SUMMARY ON TYPE 995 RESISTORS AT RATED WATTAGE (GROUPS STARTED AT DIFFERENT TIMES)

TYPE	TOTAL NUMBER OF UNITS	TOTAL UNIT-HOURS "ON-TIME" AS OF 6/4/63	ALL GROUPS 2000 HRS. "ON-TIME"		ATTAINED "ON-TIME" OF DIFFERENT SUBGROUPS AS OF JUNE 4, 1963					
					3000 HRS.		4000 HRS.		5000 HRS.	
					NO. OF UNITS	AV. $\% \Delta R$	NO. OF UNITS	AV. $\% \Delta R$	NO. OF UNITS	AV. $\% \Delta R$
995-1A	409	1,304,000	409	0.447	284	0.536	101	1.051		
995-3A	768	3,055,000	768	0.868	155	0.999	373	1.397	206	0.876
995-5A	346	1,131,000	346	0.633	89	0.687	175	0.662		
995-5B	281	1,124,000	281	2.109			281	2.740		
995-10A	438	1,609,000	438	0.733	146	0.780	238	0.891	37	0.974
ALL	2242	8,223,000*	2242	0.712	674	0.715	1168	1.455	243	0.891

*Equal to 10,964,000 total unit-hours of test (cyclic: 1½ hours on, ½ hour off).

"fatal" characteristic F (salt water immersion test) of former MIL-R-26B.

SPECIFICATIONS

Series 99 molded vitreous resistors meet all requirements of MIL-R-26C for insulated units RW69, RW67, and RW68, characteristics V (350° C max hotspot) or G (275° C).

They can also be supplied as RW59, RW57, and RW58 resistors, characteristics G or V.

Standard tolerance is $\pm 5\%$. Tolerances down to $\pm 0.25\%$ supplied to order.

Low temperature-coefficient requirements of 0 ± 30 ppm/°C for resistances of 10 ohms and greater, and 0 ± 50 ppm/°C for resistances under 10 ohms (up to 350°C) are available on order.

Standard leads are solder-dip coated for soldering; furnished bare for welding, or gold plated on order.

OHMITE STYLE	RATED WATTS AT 25° C	DIMENSIONS (INCHES)		OHMS RANGE (COMM'L)
		OIAM. $+0.031 - 0.000$	LENGTH ± 0.015	
995-1A	1	0.125‡	0.422‡	1 to 3,000
995-2A	2	0.188	0.375	1 to 3,000
995-3A*	3	0.203	0.547	1 to 10,000
995-5A§	5	0.313	0.922	1 to 30,000
995-5B	5	0.203	0.938	1 to 25,000
995-10A†	10	0.313	1.781	1 to 51,000

NOTE: Standard lead length is 1½". *Also in MIL style RW69V (991-3). §Also in MIL style RW67V (991-6.5). †Also in MIL style RW68V (991-11). ‡Tolerance, $\pm 0.015 - 0.005$.

Write for Bulletin 103



OHMITE
MANUFACTURING COMPANY
3610 Howard Street, Skokie, Illinois
Phone: (312) ORchard 5-2600

RHEOSTATS • POWER RESISTORS • PRECISION RESISTORS • VARIABLE TRANSFORMERS
TANTALUM CAPACITORS • TAP SWITCHES • RELAYS • R. F. CHOKES • SEMICONDUCTOR DIODES

MIL-T-55164 TERMINAL BOARDS

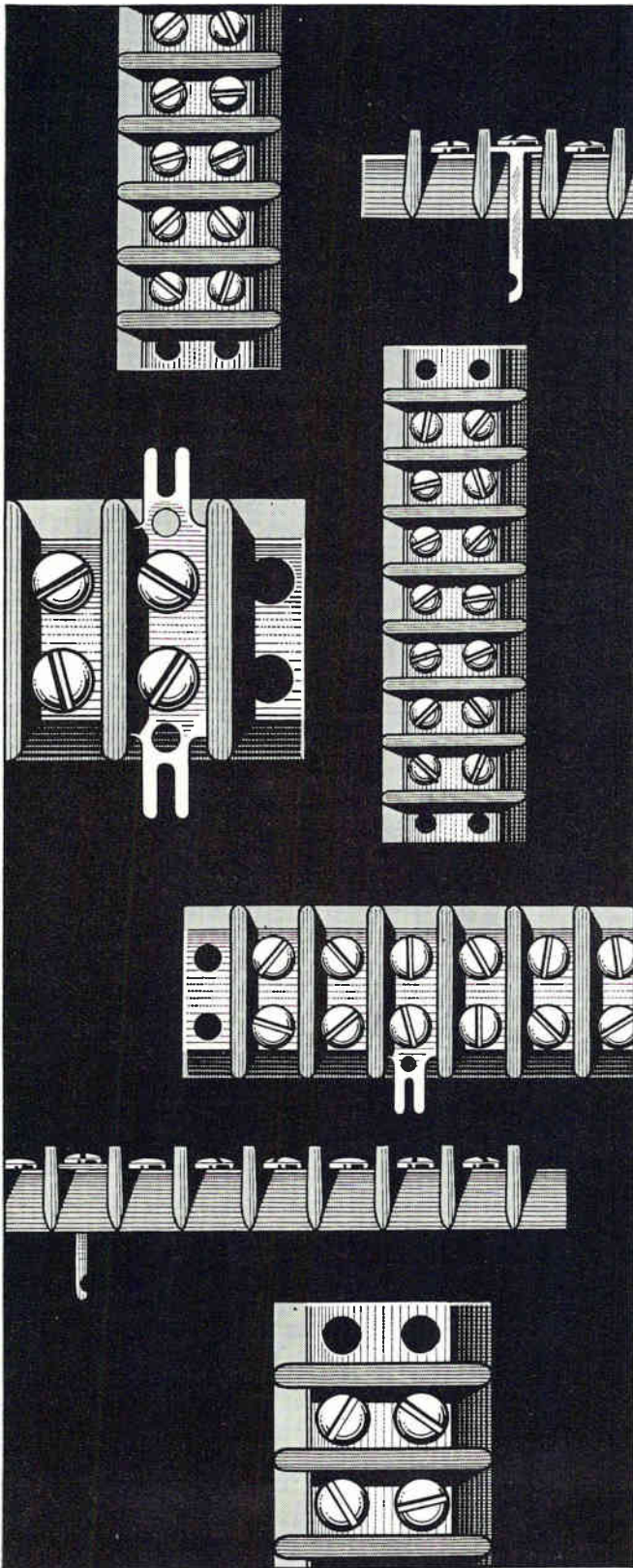

**Immediate delivery
from industry's
largest stocks**

The first coordinated military specification on terminal boards for use in all electrical and electronic equipment manufactured for the Department of Defense, Gen-Pro boards are produced in full accordance with MIL-T-55164 and are available for immediate delivery.

The Gen-Pro military blocks feature solid, insulated backs with completely smooth surface; molded-in conductors to assure positive, contamination-proof terminals; molded-in saddle plates around mounting holes for greater strength and easier handling. They are molded of Compound GDI-30F per MIL-M-19833.

Gen-Pro maintains full inventories at all times. TBLS and TBLD hardware is also available for immediate delivery. Gen-Pro, the originator of solid-back blocks, can meet your production schedules with complete service . . . no need to worry about slow shipments or back orders.

**For descriptive literature, write to
Military Products Manager**

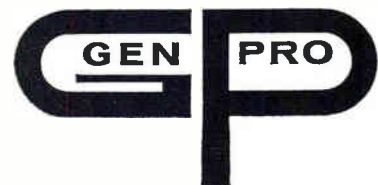

**GENERAL PRODUCTS CORPORATION
UNION SPRINGS, N.Y.**

Phone: (area code 315) TT9-7367 • TWX: 315-999-1455

The Nation's Leading Producer of Military Terminal Boards

FLUKE

offers the most complete line of differential voltmeters on the market

Features common to all models are infinite input resistance at null; in-line readout with automatic lighted decimal; front panel DC polarity switch; standard cell reference (zener diode optional); taut band suspension meter and flow-soldered glass epoxy printed circuit boards.



Choose the degree of accuracy that meets your need...

DC ACCURACY ±% of input voltage	0.05%		0.02%		0.01%		0.1% 0.01% 0.1%	
	DC	DC	DC	DC	DC	AC	DC	AC
AC ACCURACY ±% of input voltage					0.05% 0.2%		0.02%	
Models	801B	825A	821A	803B	803D	823A		
INPUT RANGE	0-500V	0-500V	0-500V	0-500V	0-500V	0-500V		
FREQUENCY RANGE	20 cps-10 kc	5 cps-100 kc	5 cps-100 kc		
MAXIMUM FULL SCALE SENSITIVITY	10 mv	1 mv	1 mv	10 mv DC 1 mv AC	1 mv	1 mv		
MAXIMUM METER RESOLUTION	50 uv	5 uv	5 uv	50 uv DC 5 uv AC	5 uv	5 uv		
REFERENCE	Std. cell (zener diode optional)	Std. cell (zener diode optional)	Standard cell	Std. cell (zener diode optional)	Std. cell (zener diode optional)	Standard cell		
PRICE Cabinet model	\$485.00	\$590.00	\$795.00	\$875.00	\$1,100.00	\$1,300.00		
Rack model	\$505.00	\$610.00	\$815.00	\$895.00	\$1,120.00	\$1,320.00		

Prices and data subject to change without notice. Prices f.o.b. factory.

MILITARIZED — DC DIFF. VOLTMETER

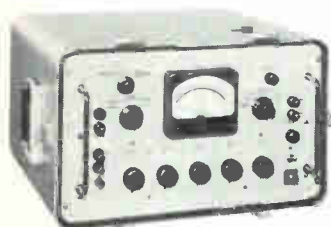

Meets all environmental requirements of Mil-T-945A. Provides accurate voltage measurements (0 to 500V) under adverse environmental conditions.

MODEL 8011A
PRICE: \$1745.00
Complete technical data on all FLUKE voltmeters available upon request.

PARTIAL 8011A SPECIFICATIONS

ACCURACY: ±0.05% of input from 0.1 to 500V
±0.1% of input or 0.5 mv, whichever is greater, below 0.1V
NULL RANGES: ±10, ±1, ±0.1, ±0.01V
INPUT IMPEDANCE: Infinite at null from 0 to 500V
MAXIMUM METER RESOLUTION: 50 uv
REFERENCE: Temperature controlled Zener diode

John Fluke Mfg.
Co., Inc., Box 7428
Seattle 33, Wash.



PR 6-1171 TWX 206-879-1864 TLX 852 Cable: FLUKE

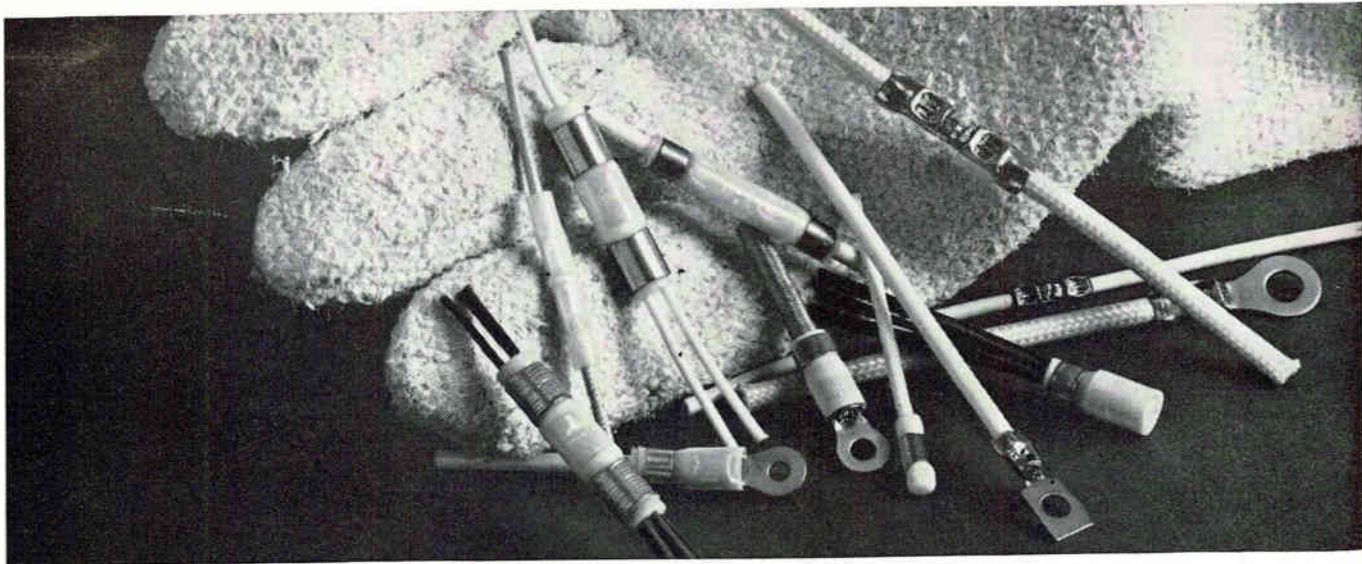

Some . . .

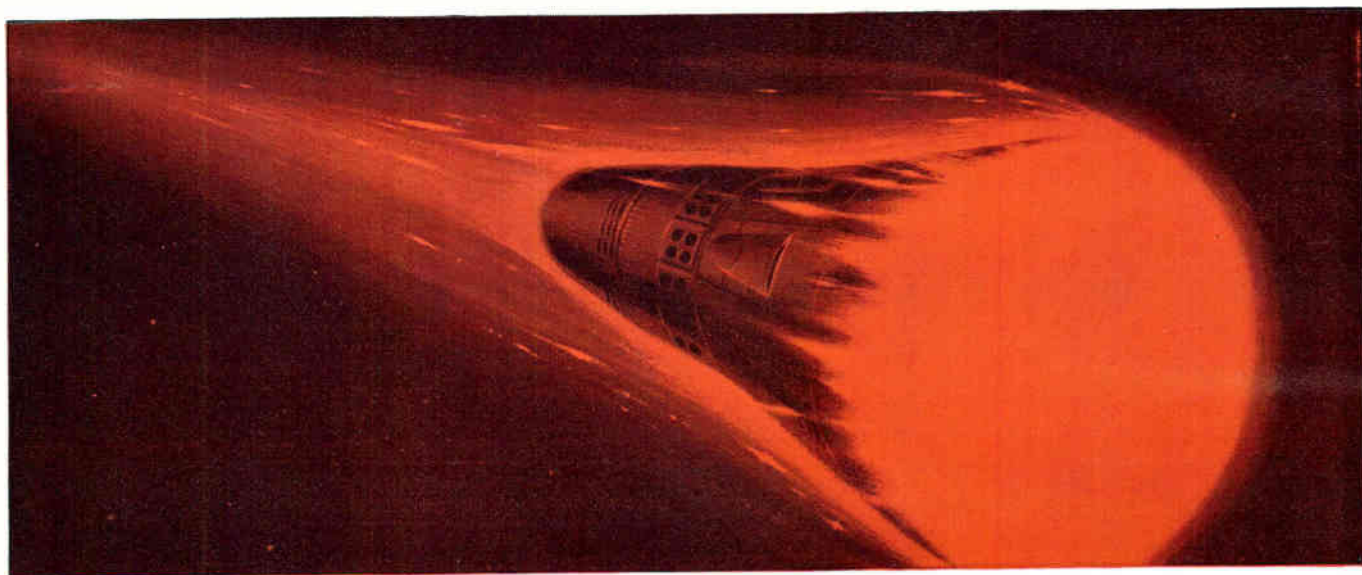

like it hot!

Go as high as you want and as hot as 1200° F. and our STRATOTHERM* terminals and splices perform with utmost reliability . . . all the way! In a vapor-trailed jet at 35,000 feet or a cherry-nosed missile braked by earth's atmosphere, STRATOTHERM brand products easily ride out vibration, corrosion, heat, cold and other extremes that go with pushing beyond sound or into space.

You can choose from three basic, temperature-oriented types: uninsulated (650° F. or 1200° F.), pre-insulated (550°F.) and post-insulated (500° F.). Splices (sealed or unsealed) for single or multiple wire applications. Caps for pigtail splices and spare wire caps . . . all part of the largest line of high-temperature, high-altitude connection devices available anywhere.

Quite by design, our STRATOTHERM terminal and splice line offers many other advantages including:

- choice of plating predicated on temperature requirements
- color coding of sleeve or crimping rings
- precision controlled crimping with matching A-MP* tools—hand or automatic
- wire size range—AWG 26-2/0
- TEFLON® insulation used throughout

There's more to tell; all of it convincing, if your needs are in high-temperature, high-altitude connections. So, send now for complete information on AMP STRATOTHERM terminals and splices.

*Trademark of AMP INCORPORATED.

TEFLON® Trademark of E. I. Du Pont



AMP products and engineering assistance are available through subsidiary companies in: Australia • Canada • England • France • Holland • Italy • Japan • Mexico • West Germany

Investment Abroad Rising

NEW YORK—Electrical-electronics firms plan to invest \$60.9 million this year to begin operations in Europe's Common Market—about \$9 million more than last year and \$57 million more than five years ago. To that they'll add \$39 million for plants, property equipment elsewhere in Europe, reports McGraw-Hill's fifth annual survey of overseas capital investment.

In two years, electrical and electronic companies expect to spend \$76.8 million just in the Common Market.

In other European nations the 1962 figure was \$44.1 million, the poll says, and this year's seems \$39.1 million. Next year they anticipate pumping in \$30.7 million; in 1965, \$23 million. Will it diminish? Eighty percent of firms responding said "no." Those saying "yes," like other businesses, gave one major reason: projects abroad are now or would soon be completed.

The report also disclosed that gains felt in Europe take their toll elsewhere—mainly Latin America, until now a prime area for outside-U.S. investing. Countries there garnered a quarter of all overseas outlays five years ago. This year, electrical-electronics people are sinking only \$2.9 million into Latin America, forecast only \$6.4 million in 1965.

Finally, the survey predicts that subsidiary sales will continue outstripping exports, at least for two years, as firms forecasted in all four earlier studies. While electrical-electronics exports might rise 5 percent during 1963-64, subsidiary sales should show a gain three times that.

Japanese Tv-Price Floor Near Approval

TOKYO—Last week the Japanese Television Exporters Council officially applied to the Ministry of International Trade and Industry (MITI) for approval of their agreement to fix floor prices for tv sets destined for U.S. markets (p 8, Aug. 30; p 7, Aug. 2).

Nippon Electric Company is the only major manufacturer abstaining. A spokesman stated the company's first task was to settle the lawsuit brought by Symphonic Electronic Corp.

(Symphonic contracted to buy receivers from NEC. A Symphonic

customer, the Spieged mail-order house, advertised the sets at \$30 below the going market. Upon request, Spiegel agreed to readjust prices in their next catalog. According to the lawsuit, NEC and the Japanese tv industry then refused to sell tv sets to Symphonic.)

There has been some concern that the price-fixing agreement is illegal under the U.S. antitrust law. Both the council of tv manufacturers and MITI pointed out, however, that if tv price agreement violates U.S. laws, so do 126 other similar agreements now in existence.

Silicon-Carbide Laser Emits Blue Light

LOW-POWER c-w injection laser that emits blue light at room temperature has been developed by Tyco Laboratories in Waltham, Mass. The device is a silicon-carbide structure with molybdenum electrodes; it is fabricated by a crystal-growing technique known as the traveling solvent method.

Use of silicon carbide has allowed achieving very low threshold current densities (120 amp per sq cm) at room temperature. Thus, the device is considered particularly promising for applications requiring ruggedness.

Emission is at 4,560 angstroms—in the visible blue-region of the spectrum. Tyco Laboratories' president Arthur J. Rosenberg told ELECTRONICS that this emission exhibits constructive interference and that the spacing of the interference lines implies that the emitted radiation comes from an aperture that agrees precisely with the actual physical dimensions of the diode *i-n* junction.

Coinventors are L. B. Griffiths and A. I. Mlavsky. They were assisted by G. Rupprecht, P. H. Smakula and M. A. Wright. The Norton Co. is licensed to manufacture and sell the device.

Big Advances Predicted in Computer Technology

FUTURE ADVANCES in computers as significant as the transition from the vacuum-tube to the solid-state type were predicted last week by William C. Norris, president of Control Data Corp. They would include new concepts of machine organization and new wiring and packaging schemes. Norris was keynote speaker at the 18th annual conference of the Association for Computing Machinery in Denver.

Norris predicted development of a "second generation of input-output equipment" within the next 10 years. These would include cathode ray tube "visual techniques" for real-time problems, wider use of film to store information and the develop-

IN BRIEF

JAPANESE plan two industrial trade fairs in Communist China this fall. Some \$400,000 in equipment, including electronics, will be shown in Peiping during October and Shanghai in December. The British are also planning an industrial show in Peiping, in November.

ECONOMICAL production capability for cesium-beam tubes (time and frequency standard) is goal of \$262,500 Army contract awarded National Company.

MICROWAVE altimeter for unmanned helicopters has been developed for Navy by Sylvania. It will permit helicopters like the Dash ASW system (p 18, April 19) to maintain present altitudes to 1,000 ft.

VIDEO tape recorders, made by Precision Instrument, will be sold as accessories to Westinghouse x-ray and fluoroscope systems. Recordings will provide alternative to x-ray movies.

JOSEPH H. McCONNELL, of Reynolds metal, formerly with RCA and NBC, will head U. S. delegation to Extraordinary Administrative Radio Conference of ITU Oct. 7 to Nov. 8. He will have the rank of ambassador.

UNDERSEA CABLE link between Guam and Philippines will permit all-cable communications between U. S. and Philippines in late 1964. AT&T will lay the cable, a joint project with overseas companies.

SWEDISH Army demonstrated a new 15-lb manpack transistor radio transceiver with range of 15 miles. It will replace sets now used.

GENERAL PRECISION is denying reports it will merge with Magnavox. Reports were heard last week after Frank Freimann, Magnavox president, said his company was considering a "sizable" acquisition.

CLEVITE and Kokusan-Denki, of Japan, are jointly developing a piezoelectric ignition system for internal combustion engines.

NASA is now hoping to flight-test in late 1965 or early 1966 a passively oriented, passive-communications satellite (for earlier story, see p 24).

MAGNAVOX's \$12.4-million award for solid-state, f-m, vehicular communications systems brings total to \$34.4-million.

BACHE & CO. has installed first of Ultronic Systems' Lectrascan system. It displays stock ticker tape reports on alphanumeric tubes.

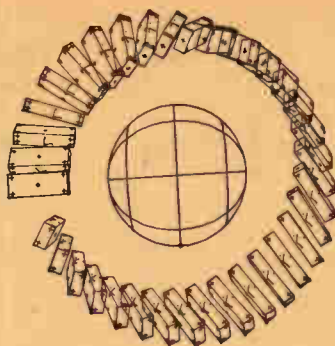

TECHNIQUE for drawing perspective movies frame-by-frame on a crt was among several programming methods described last week at the ACM meeting. Example above, from Bell Telephone Labs, simulates motion of satellite orbiting earth

ment of audio communication equipment for both input and output. He also called the use of standard languages such as Cobol, Algol and Fortran as "absolute necessity."

At the conference, ACM announced a special education program to train the blind as computer programmers. ACM said computers can be programmed to print out data in a special kind of braille.

Negative-Resistance May Improve Lasers

DAYTON, OHIO—Upgraded lasers may result from negative-resistance experiments with cadmium sulfide reported last Wednesday by Donald Reynolds, aerospace research labs, Wright Patterson Air Force Base.

Negative resistance in semiconductors is important because of its apparent connection with junction-laser action, Reynolds said. He also suggested applications to light integration and other monitoring or measuring devices of light quanta and particle emission.

Resistivity of CdS crystals has been changed up to 10 orders of magnitude and kept at any level within a chosen range, after crystals were cooled to liquid nitrogen temperatures.

Red light beyond the 6,900 —A wavelength or 1.75-ev photon threshold appears to excite electrons up to a conduction band, while trapping holes.

Negative resistance seems to result from double-carrier injection of electrons at an indium electrode and of holes at a silver electrode, Reynolds reported. Crystals apparently pump themselves up to a higher level of stimulation by absorption of their own recombination radiation.

Infrared radiation destimulates the crystal, by exciting trapped holes to valence bands, where recombination with trapped electrons radiates green light.

Quantum Transitions Multiply Frequencies

SAN FRANCISCO—Kane Engineering Labs (KEL) are using multiple quantum transition techniques in frequency-conversion devices to multiply X-band frequencies to obtain K-band frequencies. Outputs up to 80 watts have been obtained with 250-kilowatt inputs. KEL has also achieved fifth harmonic conversion—from C-band to K-band frequencies. They are also researching the adaptation of optical techniques for creating millimeter and submillimeter waves via multiple quantum transitions. KEL is looking for suitable materials to provide the proper atomic or molecular conversion system.

Are the Russians Using Laser Space Speedometer?

VIENNA—Design for a laser doppler system that can measure relative velocities of two rendezvousing spacecraft is described in the Russian journal, *Znaniesila*, according to the Czech publication, *Priroda a Spolocnost*.

(The report did not make clear whether the system is actually being used. Similar systems have been proposed in the U. S.)

Output from the transmitting laser is split into two beams by a semitransparent mirror. One beam is projected onto a photocell in the

first spacecraft and serves as a frequency reference. The other beam is reflected from a mirror on the second spacecraft.

Doppler shift in the returning beam is directly indicated as relative velocity of the two craft, according to the report. The system is said to be able to measure velocities of 8 km/sec to 0.03 mm/sec (4.97 mi/sec to 0.0118 in./sec).

UK Urged to Adopt NTSC Color-Tv System

LONDON—In choosing a common color system for European tv, it would be “folly” if any other than the U. S. National Television System Committee (NTSC) method were adopted—according to Dudley Saward, managing director of the Rank-Bush Murphy Group. He went on to urge that Britain should take the lead in color tv as it did in black-and-white since one person in four in the UK has a tv set as compared to one in ten in the Common Market countries. He pointed out that the NTSC method has been operating in the U. S. for 10 years and for 8 years in Britain, while transmitting and receiving experience with the French SECAM and the West German PAL (p 22, Aug. 2) is less than a year.

AFCLR Drops IR Detectors Through Titan II Plumes

CAMBRIDGE, MASS.—Two separate infrared instrument packages were dropped through ballistic missile tail plumes on August 21 in an experiment by Air Force Cambridge Research Laboratory. The experiment, revealed last week, is reportedly the first of its kind. It was designed to examine missile thrust and fuel efficiency and to study the characteristic signature of exhaust plumes as an aid to missile identification.

The instruments, designed and built by Block Engineering, Inc.,

were injected into the exhaust stream of a Titan II rocket; one at 300,000 feet, the other at 600,000 feet. The 13 instruments, including complementary devices on the missile, reportedly all operated successfully. The packages telemetered the data to earth.

Magnetic Tape Market Gets Two New Entries

PHILADELPHIA—Eastman Kodak's Durol magnetic sound-recording tape will be marketed by International Resistance Co. starting this month. The cellulose triacetate tape is reported to have—in addition to professional quality—low-stretch characteristics that prevent curling if the tape is broken. There are to

be two types of tapes, a low-print tape with an output comparable to a good general-purpose tape, and a high-output tape with low print-through characteristics.

How Do You Find Water on the Moon?

DALLAS—Texas Instruments will evaluate geophysical methods for finding water on the moon under a \$105,926 Air Force Cambridge Research Laboratories contract. Theoretical studies to identify the best techniques and equipment will be made. Techniques which, at present, appear to hold particular promise include infrared measurement, electrical resistivity methods, nuclear logging, and seismic profiling.

MEETINGS AHEAD

MILITARY ELECTRONICS NATIONAL CONFERENCE, IEEE-PTGMIL; Shoreham Hotel, Washington, D. C., Sept. 9-11.

ANNUAL ISA INSTRUMENT-AUTOMATION CONFERENCE-EXHIBIT, ISA; McCormick Place, Chicago, Ill., Sept. 9-12.

ELECTRICAL INSULATION CONFERENCE, IEEE, NEMA; Conrad-Hilton Hotel, Chicago, Sept. 10-14.

JOINT ENGINEERING MANAGEMENT CONFERENCE, IEEE, ASME; Biltmore Hotel, Los Angeles, Sept. 12-13.

INTERNATIONAL ASSOCIATION FOR ANALOG COMPUTING, AICA; Brighton College of Technology, Lewes Rd., Brighton, England, Sept. 14-18.

INDUSTRIAL ELECTRONICS ANNUAL CONFERENCE, IEEE, ISA; Michigan State University, East Lansing, Mich., Sept. 18-19.

NATIONAL POWER CONFERENCE, IEEE, ASME; Netherland-Hilton Hotel, Cincinnati, Ohio, Sept. 22-25.

INTERNATIONAL TELEMETERING CONFERENCE, IEE, IEEE, ISA, ARS, IAS; London, England, Sept. 24-27.

PHYSICS OF FAILURE IN ELECTRONICS SYMPOSIUM, Armour Research Foundation and Rome Air Development Center, Illinois Institute of Technology, Chicago, Sept. 25-26.

ELECTROCHEMICAL SOCIETY FALL MEETING, ECS; New Yorker Hotel, New York, Sept. 29-Oct. 30.

CANADIAN ELECTRONICS CONFERENCE, IEE REGION 7; Automotive Bldg., Toronto, Ont., Canada, Sept. 30-Oct. 2.

SPACE ELECTRONICS NATIONAL SYMPOSIUM, IEEE-PTG-SET; Fontainebleu Hotel, Miami Beach, Fla., Oct. 1-3.

ELECTROMAGNETIC RELAYS INTERNATIONAL CONFERENCE, IEEE, ICER, IEE, Tohoku University, Science Council of Japan; Sendai, Japan, Oct. 8-11.

ELECTRICAL - ELECTRONICS CONFERENCE, Aerospace Electrical Society; Pan Pacific Auditorium, Los Angeles, Calif., Oct. 9-11.

NATIONAL AEROSPACE CONFERENCE, National Society of Professional Engineers; Lafayette Hotel, Long Beach, Calif., Oct. 10-11.

ADVANCE REPORT

ELECTRONICS COMPONENTS CONFERENCE, EIA, IEEE; Marriott Twin Bridges Motor Hotel, Washington, D. C., May 5-7, 1964; Nov. 1 is deadline for submitting 500-word abstract, 3 copies, to Dr. John J. Bohrer, Technical Program Chairman, International Resistance Co., 401 North Broad St., Philadelphia 8, Pa. Some invited topics: fixed and variable resistors, capacitors, printed wiring, thin film devices, micro-miniaturization (excluding silicon integrated devices), reliability and testing techniques, conductors and cables.

Congress Cuts NASA Budget \$362 Million

CONGRESS has slashed \$362 million from NASA's \$5,712-million authorization request for fiscal 1964—a compromise between a \$509-million cut by the House and a \$201-million cut by the Senate. The trimming amounts more to a congressional admonishment to the space agency to present better-justified budgets in the future than a roll back of the space program. By and large, reductions made are for long-lead-time items and for requests not adequately supported with details on just how and when money would be spent.

There were few specific cuts in electronics. Those made include: \$13.2 million from the \$231.5-million request for tracking and data acquisition; \$6.7 million from a \$90-million request to equip three new instrumentation ships; and \$28 million out of \$153 million requested for integration and checkout programs. Congress pared \$1.1 million from the \$5 million for a new electronics center in Boston. NASA must submit new site selection surveys to Congress before it can proceed with the facility. Virtually no one expects NASA to shift the center's location.

Tariff Break Sought by EIA

ROBERT C. SPRAGUE, chairman of the Electronic Industries Association's Electronic Imports Committee, has asked the President's special representative, Christian A. Herter, to separate electronic equipment from electrical machinery in lists prepared for 1964 tariff negotiations under the Trade Expansion Act. Electronic products are distinguished from electrical machinery by high skilled-labor content—and, therefore, high value-to-mass ratio, Sprague said. He added that the rise in electronic imports indicates an accelerating invasion of the domestic electronic product market.

Probe to Weigh Buying Changes

ECONOMIC implications of shifts in defense spending are being studied in Washington these days with unusual seriousness. There is considerable disagreement among government and other economists over the urgency of the problem, reflecting opposing opinions on the effects of military spending on the economy: whether it is a "drag" or a stimulus.

The focal point of this controversy will probably be a series of hearings by the Senate Subcommittee on Manpower and Employment, scheduled for October or November. The inquiry, headed by Sen. Joseph Clark (D.-Pa.) will be a far-reaching look at what would happen to the economy if defense spending is reduced and at proposals for easing the adjustment.

TFX Electronics Off-the-Shelf

AIR FORCE will supply the IFF transponder, instrument landing system, uhf radio, intercommunication system, TACAN and omni-range navigation equipment as "government-furnished" equipment to the prime contractor on the F-111 (TFX) tactical fighter aircraft. Air Force Secretary Zuckert says, "to a large extent, these will be off-the-shelf items". First flight test for the F-111 has been scheduled for January, 1965.

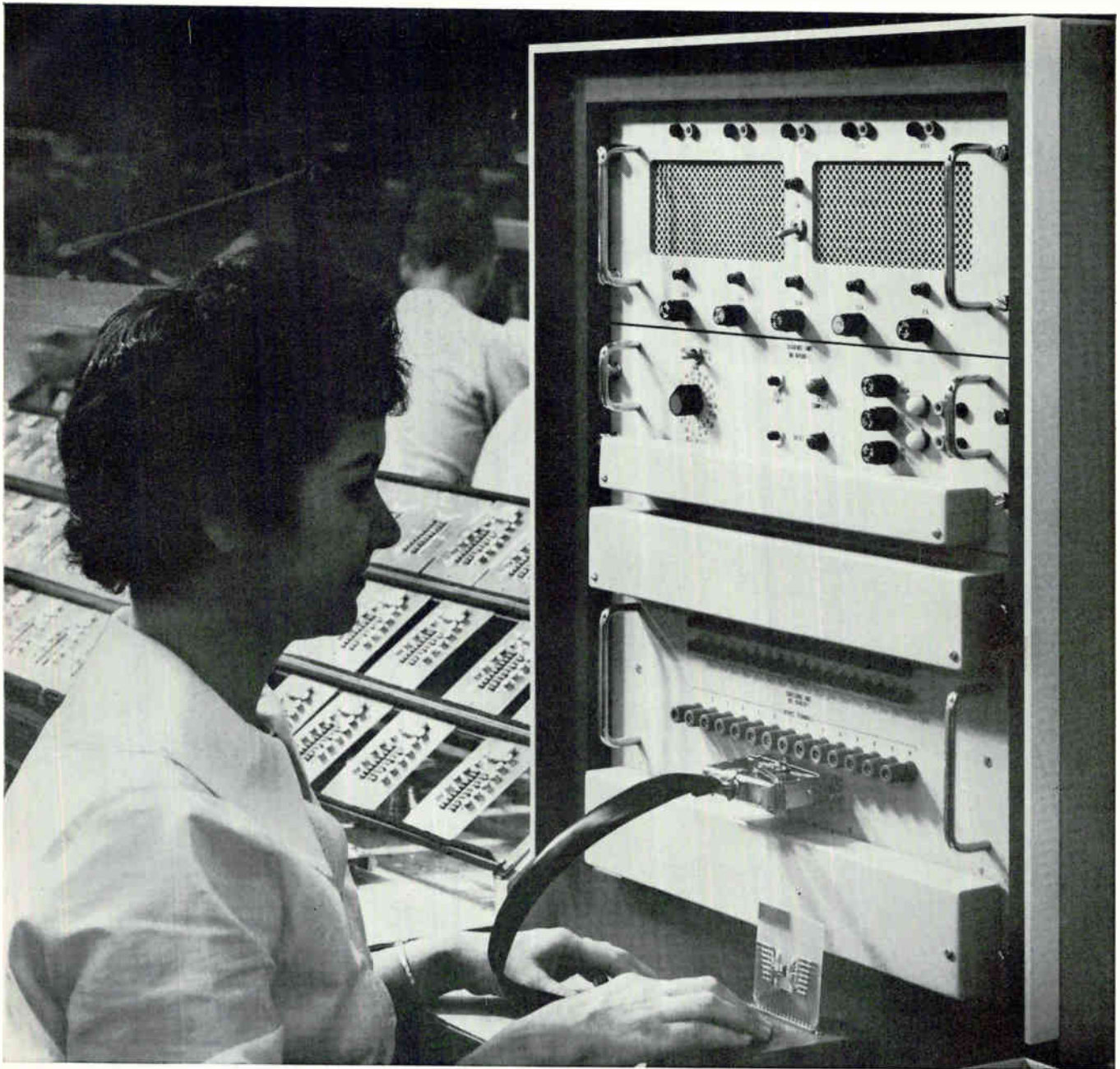

Testing Integrated Circuits?

reduce test time and cost

With TI's new Integrated Circuit Tester, the 659A, you can make 36 d-c or logic function tests on integral circuit packages in less than 2 seconds. Two-terminal (Kelvin) connections are made to 14 active leads. You can stack two units—operate them in series—for a 72 test sequence. You can program the 659A easily using printed circuit boards for bias conditions, tim-

ing, limits, and sorting logic. Integral circuit packages, no matter their size or shape, mount on device holders which plug into the test socket. To operate, simply press the start button. Four solid-state power supplies provide test bias voltages. Internal logic determines classification to 15 categories for use with a companion sorter. Failures are indicated on front

panel lights. The 659A is compact, yet designed for ease of maintenance. Test points are accessible on the front panel, printed circuit boards are easily removable . . . and the basic unit is priced at \$16,500 f.o.b. plant. Let a TI representative show you the advantages of 659A integrated circuit testing.

Write for complete information.

INDUSTRIAL
PRODUCTS
GROUP



TEXAS INSTRUMENTS

INCORPORATED

P. O. BOX 66027 HOUSTON 6, TEXAS

606

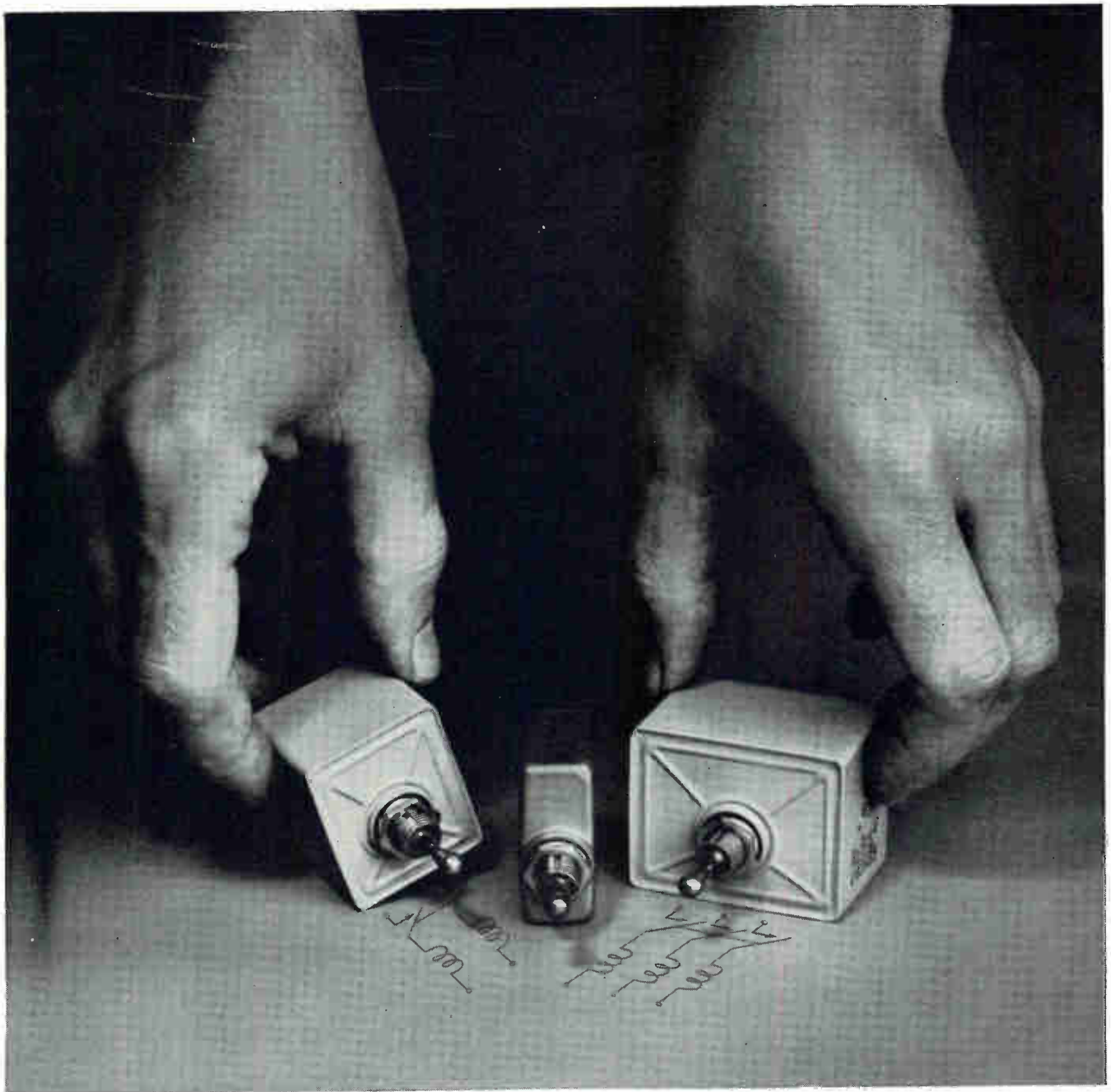

If you are designing for severe-environment service and need polyphase or multiple-circuit protection, these new subminiature two- and three-pole SM breakers can probably help you out.

Built to take rough going, they are designed to meet stringent specs for operation under conditions of shock, vibration, high humidity, sand and dust atmosphere, and salt-sea atmosphere. In addition, they will comply with requirements for explosion-proofing, fungus resistance, and high-altitude operation.

That's not all. The breakers are also temperature-stable (thanks to hydraulic-magnetic actuation). You don't have to derate them for high-ambient service. They will maintain nominal load capacity and calibrated trip points

**Now available
in multi-pole models:
Heinemann's
rugged, Mil-type
SM circuit breaker**

at any temperature from -40° to 100°C .

And, nicely enough, you don't have to pay a weight or space penalty to get these capabilities. The two-pole SM weighs only $3\frac{1}{4}$ ounces, and measures just $1.5 \times 1.25 \times 1.9$ inches (excluding handle). The three-pole model weighs $4\frac{1}{2}$ ounces, measures $1.5 \times 1.9 \times 1.9$ inches.

You can have both models in any integral or fractional current rating you need, from 0.050 to 20 amps, with either a "fast" or "slow" inverse time delay, or instantaneous trip. Both can be furnished in voltage ratings of 230V AC (max.), 60 or 400 cycles, or 50V DC (max.).

Our Bulletins 3502 and 3503 will give you complete technical information. A word from you will put them in the mail.

HEINEMANN ELECTRIC COMPANY  **2600 BRUNSWICK PIKE, TRENTON 2, N. J.**

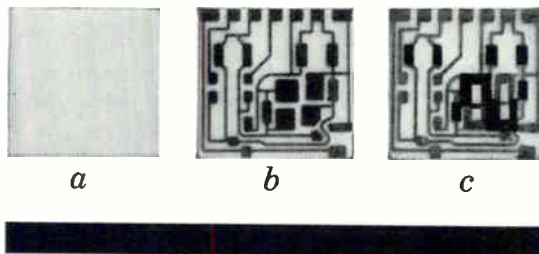

If you could
make your own,
wouldn't you make
microcircuits like this?

a We start with an alumina ceramic that we make ourselves, that we know is free of impurities. It's glazed with glass that we make ourselves and that we formulate so that its electrical properties match precisely those of the films we add later. Surface smoothness is controlled to less than one micro-inch.

b We add the basic circuit pattern with our own tin-oxide film which bonds *molecularly*—not just mechanically—with the substrate. This is the same film used in our high-reliability discrete resistors which have run more than 135,000,000 mostly *overstressed* unit test hours without a single failure. You can forget environmental prob-

lems because the film is already an oxide. Our tin-oxide patterning process lets us match your proprietary designs with surprising economy.

c Depending on your requirements, we add copper, gold, or aluminum circuitry where needed. Here we have silicon monoxide capacitors coupled with resistors and conductors. Mount your transistors and diodes—the holes are there—and you've got a flip-flop circuit.

All this adds up to the *total control* that we exercise over all the materials and processes that go into the making of CORNING microcircuits.

To total control, you can add the proven reliability of tin-oxide resistive

film, the proven technology of our long experience with substrates and metallizing, and the economical flexibility we can bring to bear on *your* custom design.

One more point: every custom microcircuit we've made so far has outperformed our promises for it.

For more information on our capabilities in superior microcircuitry, write Corning Glass Works, 3901 Electronics Drive, Raleigh, N. C.

**CORNING
ELECTRONICS**

A DIVISION OF CORNING GLASS WORKS

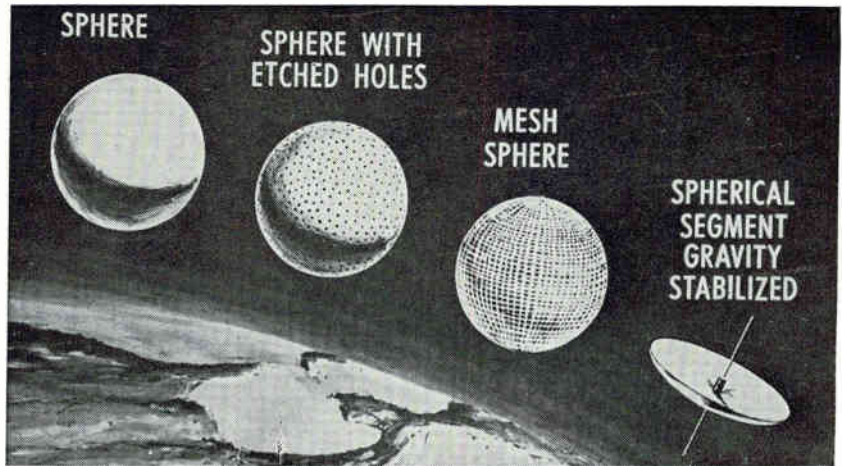
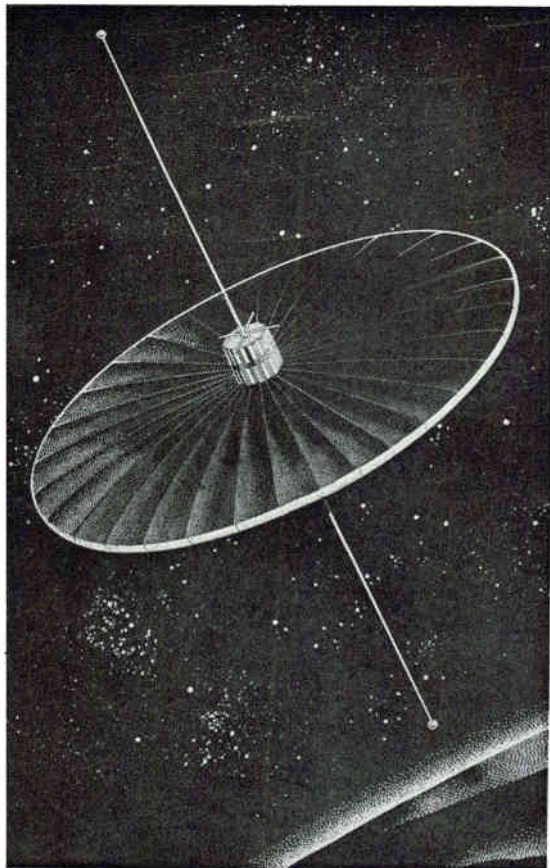

VARIETY OF CONFIGURATIONS of passive communications satellites have been proposed. Goal is larger reflective surface, lighter weight

PASSIVE ORIENTATION Lenticular Satellite (Poles) designed by General Electric uses two-axis gravity-gradient stabilization

Passive comsats offer multiple access, are jam-proof and durable

By JOEL STRASSER, Assistant Editor

WASHINGTON—Although active communications satellites are in the limelight now, much thought is being devoted to advanced types of passive satellites, Donald P. Rogers, Echo project director for NASA, told *ELECTRONICS* last week.

Passive satellites can have advantages over active; they are not frequency sensitive, are ideally adaptable for multiple access by using different frequencies and can have extremely long lifetimes. Significantly, the fact that they are difficult to jam makes them particularly attractive to the military.

Passive comsats can be made to do almost anything their active counterparts can do. Depending on the balloon diameter, antenna diameters, altitude and power required, passive satellites can even transmit television. For example,

one tv channel can be accommodated on a passive satellite balloon 427 feet in diameter at a 2,000-mile altitude using 100-kw ground transmitter with an 85-foot diameter antenna. Frequency would be 6 Gc and receiver noise temperature, 100 K. Ground stations would need twenty times more power than if a comparable active satellite were used, but it can be done.

NEW CONFIGURATIONS—Beyond Echo II, the two most attractive configurations being examined by NASA are a larger, lightweight spherical balloon, and a lenticular (lentil-shaped) type using gravity-gradient stabilization (*ELECTRONICS*, p 16, Aug. 23). Both types would provide a larger diameter, thus greater r-f reflectivity.

Passive satellites made of wire mesh have been proposed to reduce the force of solar radiation pressure upon them. The spacings of the mesh are directly proportional to the wavelength. For a smaller wavelength, the mesh wires are closer together; a coarse mesh is used for long wavelengths. Fine mesh would be used for high frequencies. For the passive wire mesh satellite, re-

flection factor equals

$$\frac{1}{1 + 4s^2/\lambda^2 \log^2 (s/\pi a)}$$

where a is diameter of the wire in the mesh, s is spacing of the wires and λ is wavelength.

To make a wire mesh satellite erectable in space, the balloon is made gas-tight with a plastic film. Special plastic film, called a photolizable film, has been proposed which would disintegrate and evaporate under the influence of radiation leaving only the wire mesh.

Another proposal is to construct the mesh of plastic fibers coated with vapor-deposited metal to make them radio reflective. The fibers would have a "memory effect" so that mechanical energy stored in them would be released by the heat of the sun after injection into orbit, thus erecting the satellite.

Spherical segments, apart from complete spheres, are also receiving considerable attention. These range from an orbiting reflector plate to a lenticular satellite. In both cases, they would have to be stabilized to keep the reflecting surface facing the earth.

After Echo II: What

Did you know Sprague makes...?

MAGNETIC LOGIC DEVICES



Core-diode and core transistor magnetic shift registers and magnetic counters for switching and storage applications in computer and logic circuitry.

CIRCLE 277 ON READER SERVICE CARD

MOLDED PULSE TRANSFORMERS

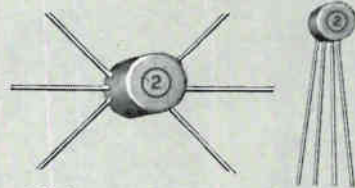

Miniature Pulse Transformers with tough molded cases for increased protection against physical damage and severe atmospheric conditions.

CIRCLE 278 ON READER SERVICE CARD

NANOSECOND PULSE TRANSFORMERS IN TO-5 TRANSISTOR CASES

Special design offers distinct advantages: (1) Mini-fied size. (2) Welded hermetic seal. (3) Increased reliability. (4) Compatibility with transistor mounting techniques.



CIRCLE 279 ON READER SERVICE CARD

SOMETHING NEW IN COUNTING TECHNIQUES

Simple yet versatile, low-cost yet reliable counters available for predetermined (2 to 11) or selectable (5 through 10) counting cycles.



CIRCLE 280 ON READER SERVICE CARD

DYNACOR[®] BOBBIN CORES



Series "300" Cores with logical flux values in popular physical sizes are stocked in production quantities for fast delivery. They're value engineered for quality with economy!

CIRCLE 282 ON READER SERVICE CARD

HERMETICALLY-SEALED TO-5 ENCASED SWITCH CORES

Designed especially for high-speed, low-power switching up to 100 kc, adaptability with conventional transistor packaging techniques, and performance under MIL-S-21038 environmental conditions.



CIRCLE 281 ON READER SERVICE CARD

ELECTRONIC MODULES TO CUSTOMER REQUIREMENTS



Custom packaging is no novelty at Sprague's Special Products Division, where "specials" are continually being developed and produced with countless variations in electrical characteristics and mechanical configurations.

CIRCLE 283 ON READER SERVICE CARD

For application engineering assistance (without obligation, of course) on any of the above products, write or call the Special Products Division, Sprague Electric Company, 35 Union Street, North Adams, Massachusetts.

455P-111-63 R4

SPRAGUE[®]
THE MARK OF RELIABILITY

*Sprague' and '®' are registered trademarks of the Sprague Electric Co.

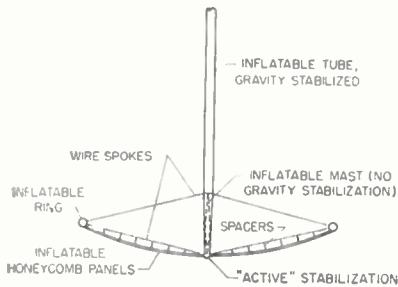

ORIENTED REFLECTOR could use either active or passive stabilization. William J. O'Sullivan, Jr. described this and other configurations at the Conference on Artificial Satellites at Blacksburg, Va. in August

and Why?

TWO PROPOSALS—According to Rogers, a flight program for passive satellites will begin when planners develop a configuration that is better than Echo II by a factor of 10. To do this, designers are seeking either a spherical design 427 feet in diameter weighing the same as Echo II, or a good design for a gravity-stabilized lenticular satellite.

In the late sixties, NASA plans to test a 1,000-foot balloon at the first manned orbiting space laboratory.

Goodyear Aircraft now has a study contract for the lenticular satellite. They are working with Philco to develop a gravity-gradient stabilization system to orient the satellite toward earth.

In a parallel study, General Electric's Passive Attitude Control Group headed by Richard J. Kattucki, has a \$29,000 study contract with Goddard Space Flight Center due next week for a three-axis completely passive damper approach. It would be used in the two-axis Passive Orientation Lenticular Satellite (Poles).

A final decision on which system NASA will use is expected this month.

Honeywell data acquisition system records stresses on ships at sea

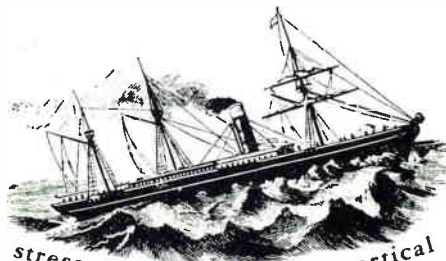

The extremely low recording speed capability of a Honeywell Magnetic Tape System and the versatility of a Honeywell Visicorder Oscillograph have teamed up to report a new story of the punishment ships take at sea. Lessells and Associates, Inc., Boston, used the Honeywell system to measure the vertical longitudinal stresses induced in the hull each time a ship is pounded by a wave.

A Honeywell LAR 7460 Magnetic Tape Recording system was installed aboard the S.S. Hoosier State, and later aboard a sister ship, the S.S. Wolverine State. Both are 520-foot, 15,000 ton freighters operated by States Marine Lines of New York. Strain gages were attached to the port and starboard gunwales amidships to sense stresses produced by waves encountered over the turbulent trade routes of the North Atlantic. The outputs of the gages were combined in a manner which would cancel the horizontal and transverse

stresses and permit only vertical bending stresses to be measured. Data from the strain gages were then recorded at .3 inches per second on the 14-track LAR 7460 tape system. The extremely low speed capability of the recorder permitted 40 hours of data to be recorded on a single pass of a 10½-inch reel of tape. During the voyage, the ship's officers rewound the tape every 40 hours, permitting 160 hours of data to be recorded on a single reel of tape.

After the voyage, the tape was taken to Lessells' laboratory and played back from a Honeywell reproducing and amplifying system at 60 inches per second, or a speed ratio of 200 to 1. From the playback system, the data were recorded on a Honeywell Model 906 Visicorder oscillograph, operating at a paper speed of one inch per second.

The data were also fed through a probability distribution analyzer and this processed output was fed into the

Visicorder to permit simultaneous observation of original and processed data. By being able to control both the recording speed and the playback speed, as well as the paper speed of the Visicorder, Lessells could obtain a permanent record of the data with any desired trace resolution.

Whatever your data acquisition requirements may be, Honeywell systems can meet your needs. Visicorder oscillographs are available with channel capacities from 1 to 36 and paper speeds from 1 inch per hour to 160 inches per second. Honeywell Magnetic Tape Systems range from the economical Honeywell 8100 portable recorder/reproducer to complete laboratory systems, with capabilities including FM, direct, digital, and incremental recording.

For complete information, call your local Honeywell representative. Or write or call Honeywell, Denver Division, Industrial Products Group, Denver 10, Colo. (303-794-4311)

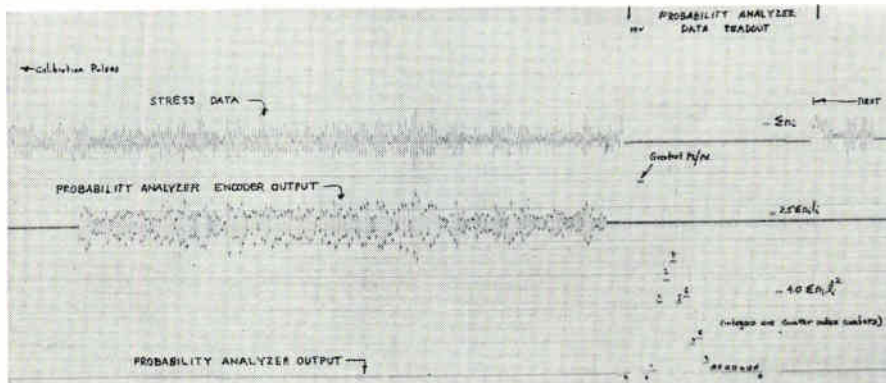

Top trace: Stress data as recorded on ship. Middle trace: Probability distribution analyzer encoder output. Bottom trace: Probability distribution analyzer output. Work performed under NOBS Contracts: #88349, Ships Structures Committee; #88451, Office Chief of Transportation, Dept. of Army.

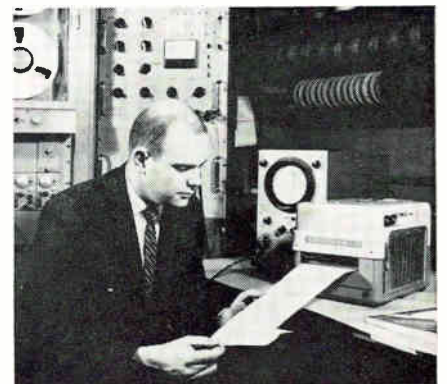

The Honeywell reproducing and amplifying tape system and the Model 906 Visicorder Oscillograph in Lessells' Boston laboratory.

DATA HANDLING SYSTEMS

Honeywell

HONEYWELL INTERNATIONAL Sales and Service offices in all principal cities of the world. Manufacturing in United States, United Kingdom, Canada, Netherlands, Germany, France, Japan.

What's new
behind the
compact-TV
camera lens?

3 New G-E Vidicons

High sensitivity, low lag, and more uniform photoconductive surfaces give broadcast-quality pictures in *any* television pickup function. New "Snow White" manufacturing facilities assure uniformity.



The GL-7038 vidicon is designed for televising live scenes and film pickup applications. Highly uniform photoconductive surface provides a uniform, high-quality picture across the scanned area. The GL-7038 will replace the 6198 and 6198A vidicons. Over-all length: 6¼".



The GL-7325's high sensitivity is ideal for televising live scenes, at lower light levels. The photoconductive surface provides low lag (20-30%) at these light levels. Over-all length: 6¼".



The GL-7226 is designed for transistorized camera chains. Featuring a low heater power cathode which operates at 90 ma, performance characteristics of the tube are the same as the GL-7325. Over-all length: 5½".

For specifications and data on the complete line of G-E vidicons and image orthicons, write to: General Electric Company, Room 8006A, Owensboro, Kentucky, or call your nearest G-E Industrial Tube Distributor, today!

Dedicated to Broadcast Quality in Industrial Applications

Progress Is Our Most Important Product

GENERAL  ELECTRIC

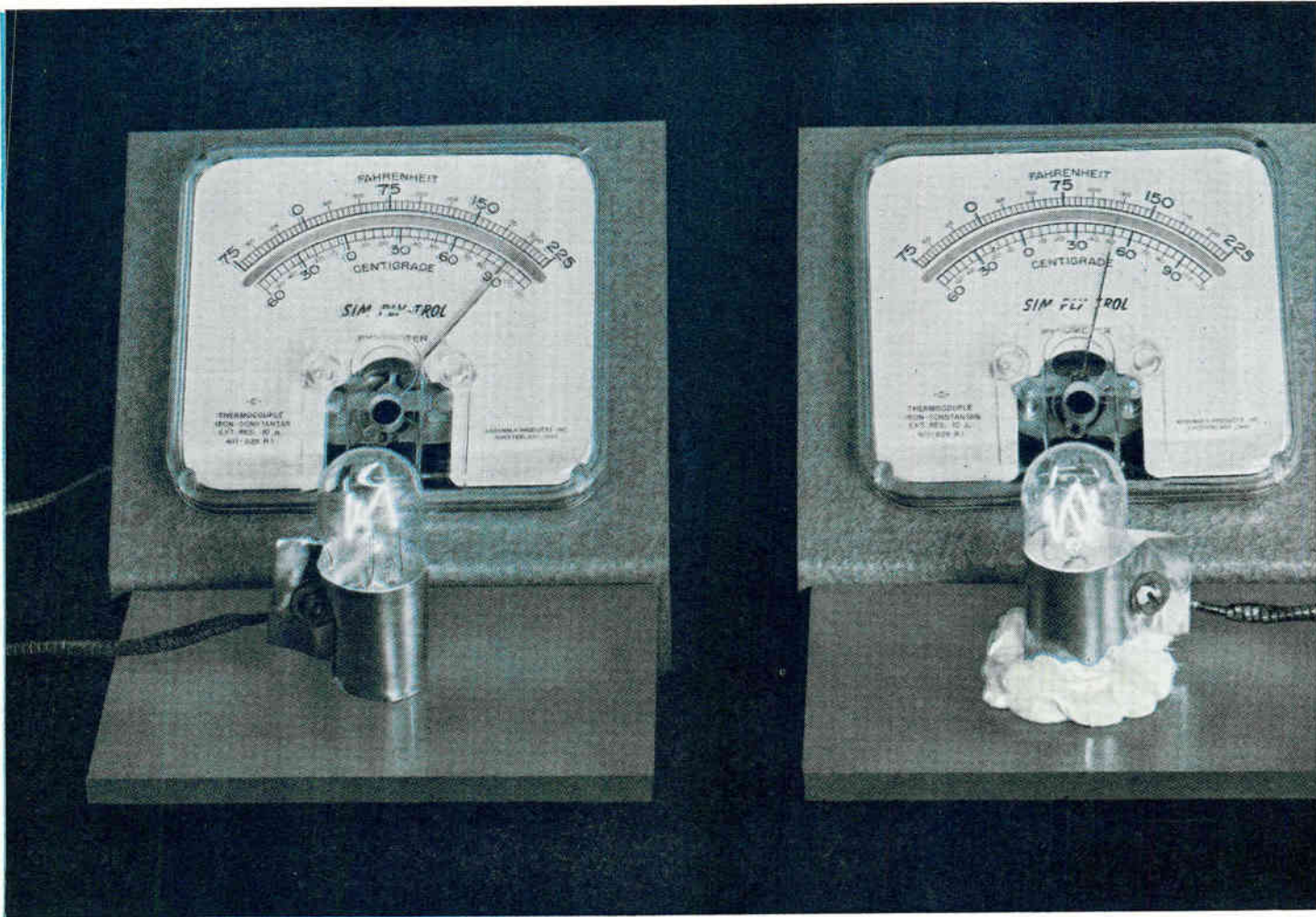

News Briefs



New compound for transistor potting

Dow Corning® 18 semiconductor potting compound keeps junction temperatures at a minimum, cushions against shock, acts as a moisture getter to absorb moisture from within the cap. These advantages — plus high centrifuge stability — assure uniform properties and reliability of transistors, diodes . . . other solid state devices.

CIRCLE 290 ON READER-SERVICE CARD

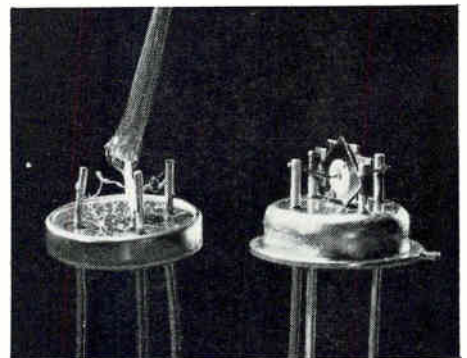

New resins protect device junctions

Exceptionally high purity standards characterize three new Dow Corning transistor junction coating resins. Applied with a dropper or brush, these resins cure to form a tough protective film that seals out contaminants; assures junction integrity. Cure time is adjustable from 30 minutes at 250 C to 16 hours at 150 C.

CIRCLE 291 ON READER-SERVICE CARD

Speed heat dissipation, extend device life with new compound

Why is one bulb base 75 degrees cooler than its mate? Simply because this new Dow Corning® 340 silicone heat sink compound is carrying heat to the heat sink faster. Having three times the thermal conductivity of other materials, this new compound assures cooler operation, longer life and greater reliability for diodes, transistors, rectifiers and other devices.

Dow Corning 340 silicone heat sink compound fills all air spaces; maintains a positive seal between component and heat sink or chassis; provides a uniform heat transfer path. It will not dry out, harden, gum or melt, even after prolonged exposure to

200 C. Dow Corning 340 is chemically inert, has low loss factor, low power factor, excellent arc resistance.



CIRCLE 289 ON READER-SERVICE CARD

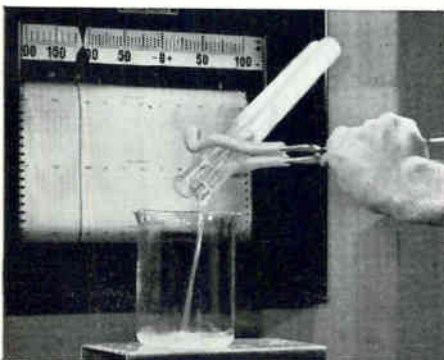

New fluid non-congealing at -110 F

Higher pumping rates, rapid heat transfer, and smaller, lighter weight pumps are among the design advantages made practical with Dow Corning® 331 fluid coolant. This low viscosity silicone fluid flows freely when other coolants are frozen solid, features high flash point and an operating temperature range from -130 F to 400 F, -90 C to 201 C.

CIRCLE 292 ON READER-SERVICE CARD

We'll be pleased to forward full information on these and other materials that aid reliability and performance. Just write Dept. 3921, Electronic Products Division, Dow Corning, Midland, Michigan.

Dow Corning

NEWS from DEI

SHOWCASE FOR PRE-DETECTION TELEMETRY AT ATLANTIC MISSILE RANGE

At the Atlantic Missile Range, the U.S. Air Force will install over the next several years the most advanced telemetry complex yet available . . . employing throughout pre-detection receiving and recording systems designed and built by Defense Electronics, Inc.

This SHOWCASE OF PRE-DETECTION TELEMETRY will be used to monitor, record and playback all telemetry data from existing as well as all future missile and space programs . . . with assured reliability, flexibility and economy . . . and with minimum effort.

It will be the first large-scale application of the "pre-d" concept, for which DEI is the recognized industry leader.

The many telemetry pre-detection receiver/recorder systems to be installed by DEI will allow the Atlantic Missile Range complex to record the original space data before it is detected and demodulated. Later, other sophisticated electronic components can make **repeated** use of the "assured data" for varied scientific applications.

Defense Electronics, Inc., one of the largest producers of ground station telemetry receiving equipment in the country, has enjoyed unprecedented growth in the past three years. As a result, there is a broad range of opportunity and responsibility for qualified electronic engineers who are seeking career positions in the dynamic field of telemetry/space communications equipment and systems.

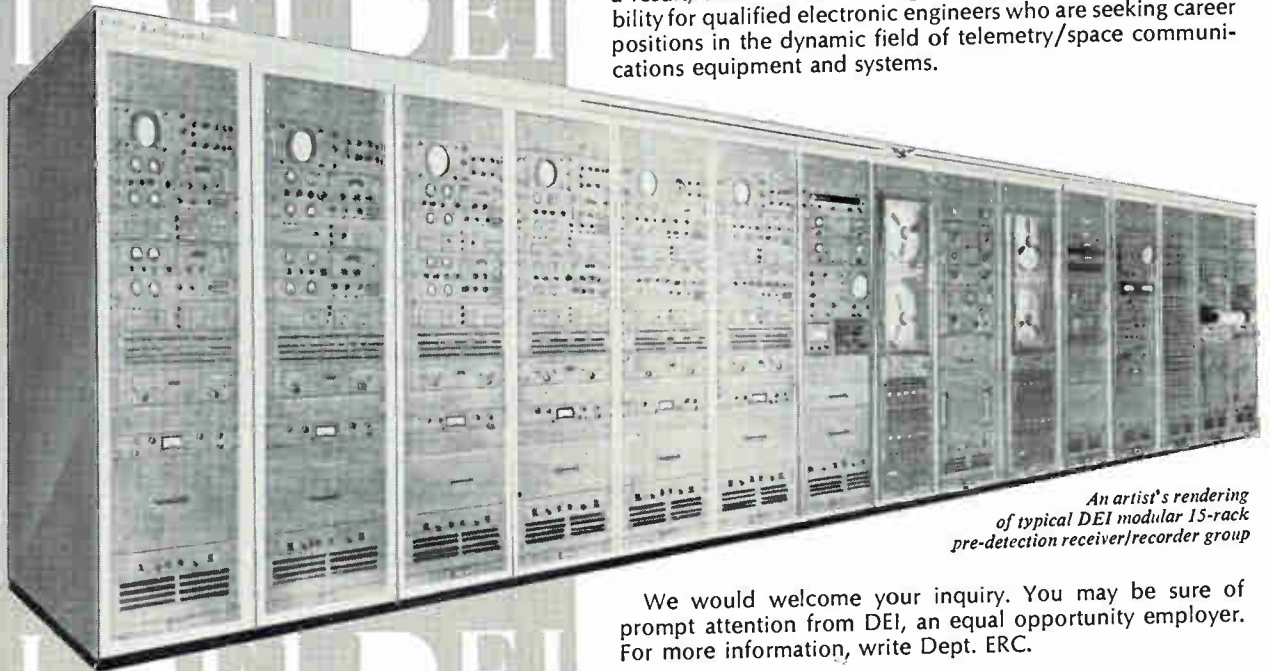

*An artist's rendering
of typical DEI modular 15-rack
pre-detection receiver/recorder group*

We would welcome your inquiry. You may be sure of prompt attention from DEI, an equal opportunity employer. For more information, write Dept. ERC.



DEI
SERVING
GOVERNMENT
AND INDUSTRY

Defense Electronics, Inc.

Rockville, Maryland

TWX: 301-949-6788 Phone: 301-946-2600

Sherman Oaks, California, Phone: 873-4322

CIRCLE 30 ON READER SERVICE CARD

TELEMETRY TODAY

More and better methods have been developed to permit faster handling and processing of telemetry data. Here is how tried-and-true techniques and late ideas meet modern demands

By **BARRY A. BRISKMAN**, Assistant Editor

TELEMETRY fulfills one of man's basic scientific needs by transmitting information derived in a hostile environment or remote location. Dating back to the late 1800s in concept, practical use of telemetering techniques appeared in elementary form in public utilities around 1912. While growth of the field had been slow until about 1950, the advent of space vehicles, satellites and high-altitude manned flights has moved telemetry forward at a rate comparable to most aerospace endeavors.

Today, telemetry is considered a prime, if not the only means of returning scientific information from distances that range from near to astronomical. It has found wide use in commerce and industry for performing remote power measurements, securing data on weather conditions and water pressure, keeping tabs on off-shore oil facilities

MOUSE MOBILE is actually an attempt to telemeter medical data. This experiment and others have led the way to expanding biomedical telemetry applications

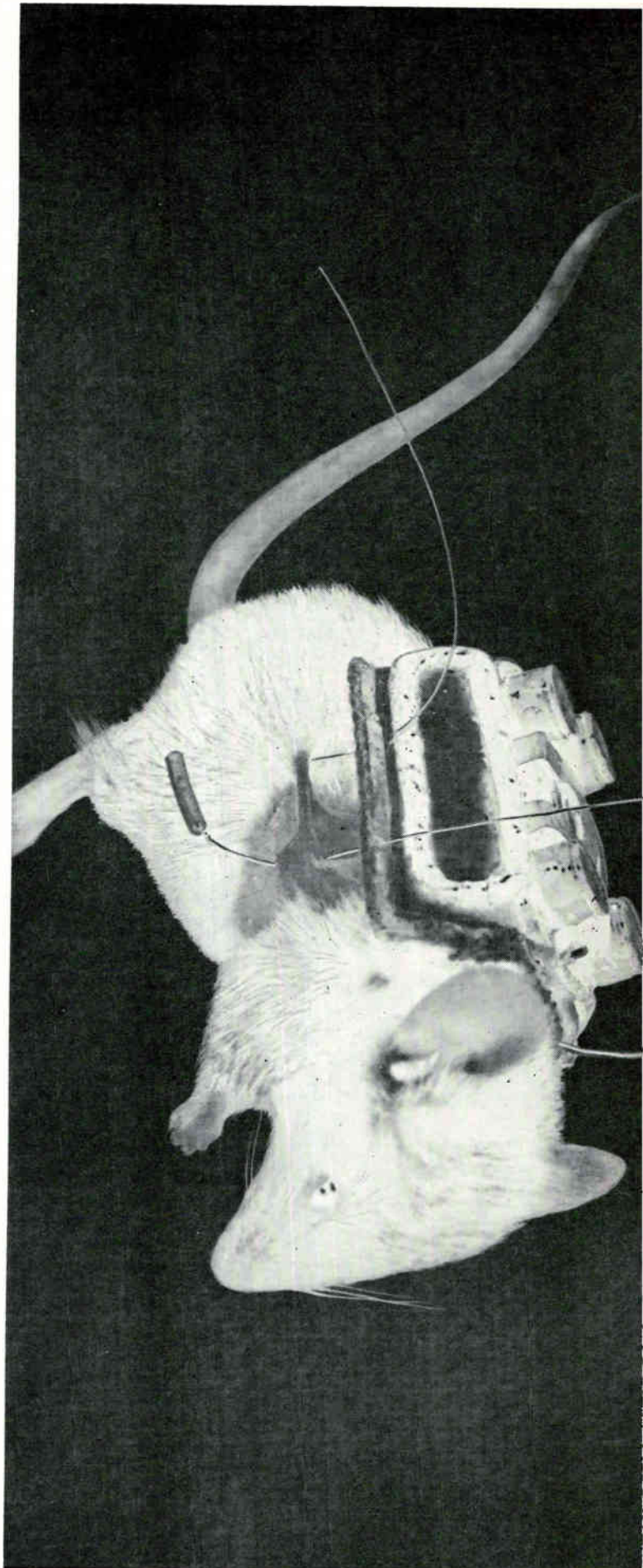

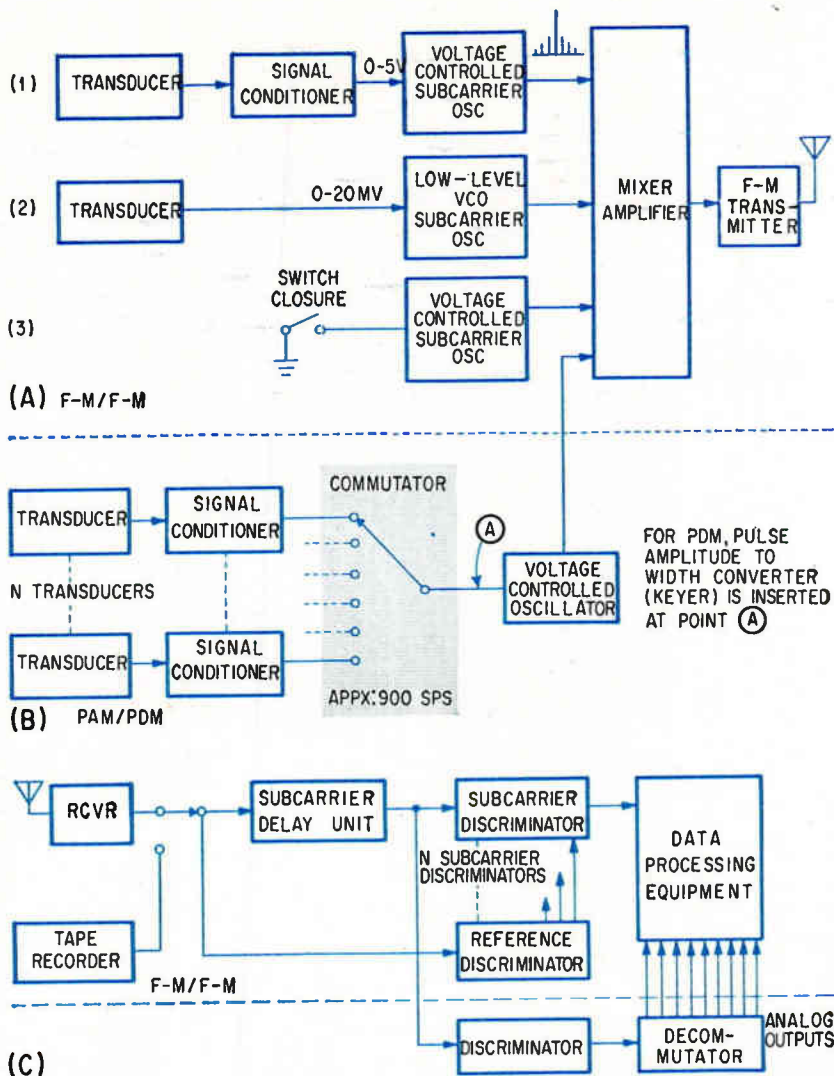

(A) F-M/F-M SYSTEMS are still widely used as they are simple and reliable (A); pam and pdm, however, permit larger amounts of data to be transmitted (B). Similar basic ground equipment is used with all three techniques (C)—Fig. 1

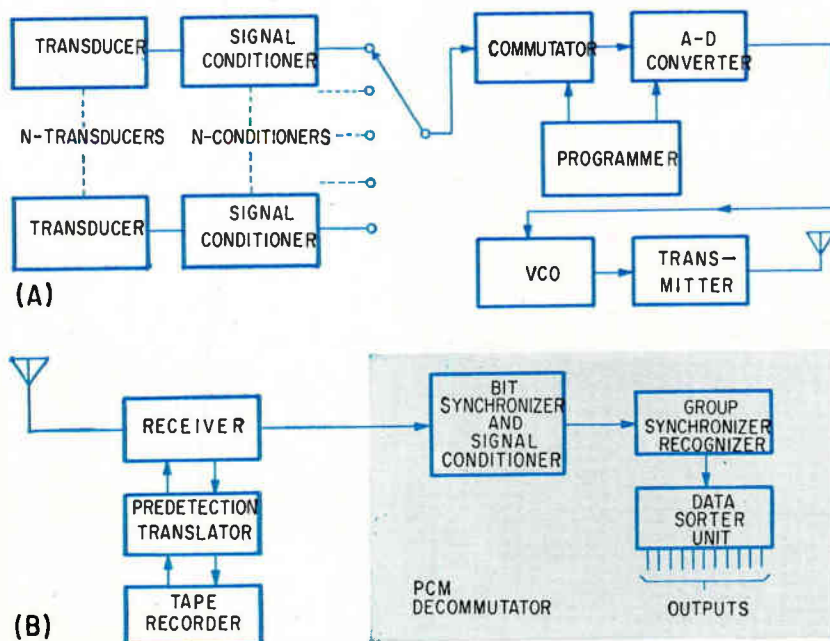

FLEXIBILITY and high-data capacity are achieved with pcm airborne equipment (A). Fixed facilities often include predetection recording for data storage (B)—Fig. 2

and a host of other interests. Moreover, our Mariner II Venus probe has proven that the secrets of other planets may be unlocked and the data successfully returned to earth through multimeasurement telemetering systems.

Being primarily electronic, telemetry has been responsible for considerable expansion in our industry as evidenced by the increasing number of companies in the telemetry field and growing research and development funding. While aerospace telemetry represents the major portion of the industry, nonspace applications have also seen unprecedented expansion.

One survey predicts that as much as \$65 million a year will be spent for industrial telemetering by the end of 1963. Last year's figure exceeded \$55 million.

METHODS—The basic differences between aerospace telemetry systems lie mainly in data capacity, range of transmission and the environments in which they operate. Of these differences, capacity presents the greatest problem. The large number of measurements required and extremely high cost of r&d for high-altitude and space flight, demands that telemetry systems be capable of handling as much data as possible to obtain the greatest value from each flight. High accuracy, reduced spectrum usage, decreased weight and size and increased capacity have been the basis of intensified research.

The main telemetry techniques now in use include f-m/f-m (frequency modulation on frequency modulation), pam (pulse amplitude modulation), pdm (pulse duration modulation) and pcm (pulse code modulation). There are also numerous other schemes such as pfm, (pulse frequency modulation), ppm (pulse position modulation) and psk (phase-shift keying).

F-M/F-M—In f-m/f-m telemetry, a transmitter is frequency modulated by the output of one or more subcarrier, voltage-controlled oscillators that have been frequency modulated by data signals from a transducer and signal conditioner as shown in Fig. 1A. The number of subcarrier oscillators used is dependent upon the desired data-handling capacity of the system. Subcarrier frequen-

cies¹ have been adopted for standardized use by the Inter-Range Instrumentation Group of the Range Commanders' Conference (IRIG). Proposed expansions to the present standards are shown in Table I. Figure 1C illustrates the ground equipment required to receive and process f-m/f-m telemetry signals.

Of all telemetry systems, f-m/f-m enjoys widest use. Called the workhorse of the field, it can provide accuracies of 2 to 3 percent and handle as many as 18 IRIG channels.

PULSE AMPLITUDE—Data handling capacity is increased by pam. Here, a commutator (switch) can rapidly sample portions of the outputs of a large number of additional transducers delivering quasistatic (slowly-varying) data. Since quasistatic signals usually vary at less than 1 cps, continuous transmission is not necessary. Hence, portions of each cycle may be selected to adequately supply data-signal definition. A multitude of sequentially sampled channels can be used with one commutator and only one sub-carrier oscillator.

PULSE DURATION—This technique is similar to pam except that a keyer (pulse-amplitude-to-width converter) is inserted between the commutator and the vco as shown in Fig. 1B. Amplitude-to-width conversion results in a substantial improvement in noise figure and better accuracy of received data. The commutator required for pdm differs slightly from that used in pam systems because it must provide trigger pulses to both start the keyer and provide synchronization and timing.² Both pam and pdm techniques are widely used where multichannel time sharing is desirable. Moreover, they can provide an increase or decrease in data-frequency response by super or sub-commutation.

PULSE CODE—Pulse code modulation has gained wide recognition. Though under consideration for many years, reliable and practical pcm equipment has been in existence for only a short time. In pcm, a series of coded pulses is transmitted that represents a finite number of possible values of the desired data. The code may be transmitted as the presence or absence

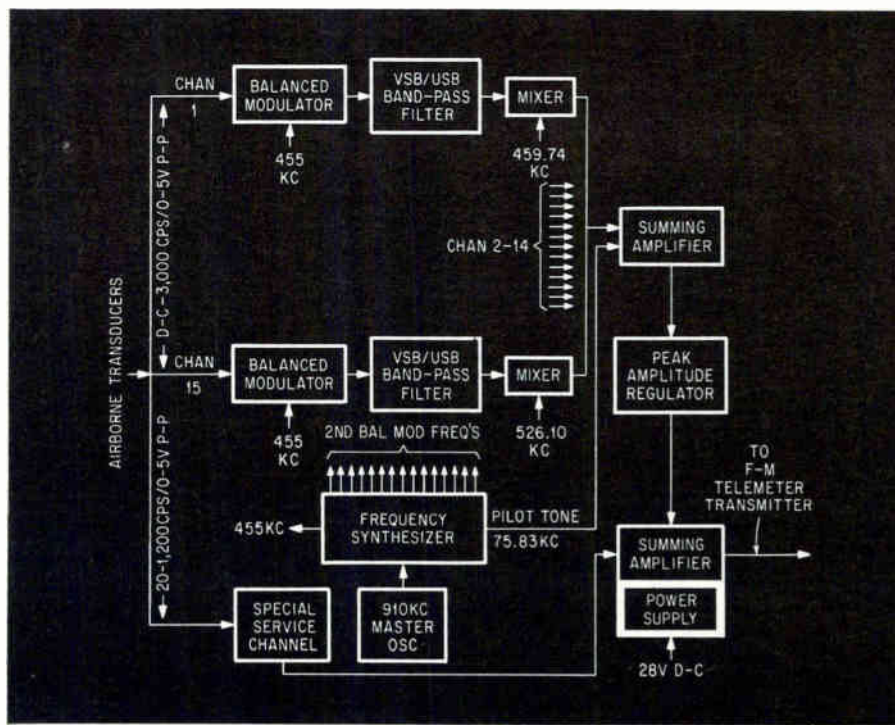

VESTIGIAL sideband telemetry is a recent technique that shows promise. This system also can be used for voice communications—Fig. 3.

of a pulse, or a sequence of pulses. The output of the multiplexer or high-speed commutator is a series of pulses that is sent to a high-speed analog-to-digital converter where the pulses are changed to binary digits representing the magnitude of the data from which the pulse is derived. Encoding or conversion is accomplished by comparing the magnitude of the input pulse with a number of accurate reference voltages within the A-D converter and sending a group of coded pulses representing the input pulse magnitude.²

The serial train of output pulses is fed to a radio transmitter where a ONE causes the center frequency to shift in a positive direction and a ZERO causes a negative shift. With this type of transmission, near perfect reproduction of the signal is maintained as long as the amplitude of the code group is greater than the noise. When received on the ground, digital words are tape-recorded or changed in format and fed into digital computers in real time.³ Block diagrams of a typical pcm airborne and ground facility appear in Fig. 2A and 2B. The bit synchronizer and signal conditioner shown in the pcm decommutator group in Fig. 2B acquires bit synchronization, generates a clock signal and determines

whether a bit is a ONE or a ZERO. One modern pcm system is shown in Fig. 9.

Other digital and analog telemetry systems have also found use. The binary pulse code modulation waveform for example, may be used to amplitude or phase modulate a primary carrier rather than to frequency modulate it. A system of this type might be designated pcm/a-m or pcm/p-m. A pcm waveform can also be used to modulate a sub-carrier that will in turn modulate a primary carrier.

In pulse frequency modulation or pfm, information is contained within the frequency of a sequential series of pulses or bursts separated by blanks or intervals. Data is electronically commutated and encoded into a series of time-multiplexed pfm bursts and blanks where the burst frequency contains the intelligence of one analog parameter or three binary bits; and the location of the burst within the telemetry sequence identifies the parameter being measured. This type of system is suited for small satellite systems because it makes efficient use of transmitter power as a function of bit rate. A practical form of a pfm system was used in the Explorer XII satellite.

Pulse position modulation, ppm,

**Proposed Additions To Inter-Range Instrumentation Group
(IRIG) Subcarrier Bands—TABLE I**

BAND	CENTER FREQ (cps)	LOWER LIMIT (cps)	UPPER LIMIT (cps)	MAX. DEVIATION (percent)	FREQUENCY RESP. (cps)
19	93,000	—	—	7.5	1,400
20	124,000	—	—	7.5	1,900
21	165,000	—	—	7.5	2,500
F	93,000	—	—	15	2,800
G	124,000	—	—	15	3,700
H	165,000	—	—	15	5,000

NOTE: The entire IRIG chart as revised in 1962 can be found in IRIG Document No. 106-60

though similar to pdm, is not widely used. With ppm, the desired information is contained in the time separation between successive pulse pairs. The initial pulse in each pair corresponds to sampling time and the separation between pulses varies with modulation amplitude. Position pulses directly modulate the transmitter by amplitude modulating the r-f carrier.

Phase shift keying or psk techniques have been used in space probes such as Mariner II and Explorer VI. Permitting only all-or-none modulation of the carrier, psk is compatible with digitized data and permits continuous peak power. With psk, the carrier is shifted between 0 and 180 degrees depending upon binary data.

There are many different codes other than the binary code that may be used to describe data and transmit it by radio. One popular technique is called orthogonal. Here,

data is encoded so that only a few out of many possible codes are used and many errors, not just one, must occur before one of the applied values is changed to another value. In this way, errors due to the transmission process can often be corrected.

Orthogonal systems require wider r-f spectrums than conventional pcm but will operate satisfactorily with a lower-level signal.

VESTIGIAL SIDEBAND—One recent ssb system is shown in Fig. 3. Called vestigial sideband frequency modulation instrumentation, it is an outgrowth of a technique in use on the Saturn program. It has 16 input channels of which 15 handle data with input frequencies ranging from d-c to 3,000 cps plus one special channel that accommodates frequencies from 50 to 3,000 cps. The sixteen data inputs are combined into one complex signal by frequency multiplexing that modulates a fre-

quency modulation transmitter.

In operation, any type of data can be fed to the airborne vestigial ssb multiplexer. After reception on the ground by conventional f-m receivers, the output can be recorded or fed directly to a demodulator. The transmission of almost 48 kc of data in 75 kc of baseband spectrum on one r-f link makes this system about 13 times as efficient as f-m systems that usually handle 4 kc of data in a 75 kc baseband.

TRANSDUCERS—Quantities such as gas pressure, acceleration, temperature, vibration, fuel flow, and many others may be measured by transducers and applied to the telemetry system for transmission from a vehicle fixed remote location.

A large number of transducers have outputs that range between 0 and 50 mv.⁴ In addition, transducer outputs can take many different forms such as low-level d-c signals from thermocouples, pulses from flowmeters, low-level low-frequency signals from strain gages, and low-level a-c signals from vibration pickups.

For aerospace applications, transducer size, weight and reliability are of major importance. Latest developments include a growing family of solid-state transducers that meet these specifications and have reduced power consumption.

COMMUTATORS—A commutator sequentially samples a number of different data sources and generates



TYPICAL of trends toward compact transmitters, this unit manufactured by Conic produces 5 watts between 215 and 260 Mc—Fig. 4

MODERN telemetry receivers are a system in themselves. Modular construction as in this solid-state unit by Vitro is typical—Fig. 5

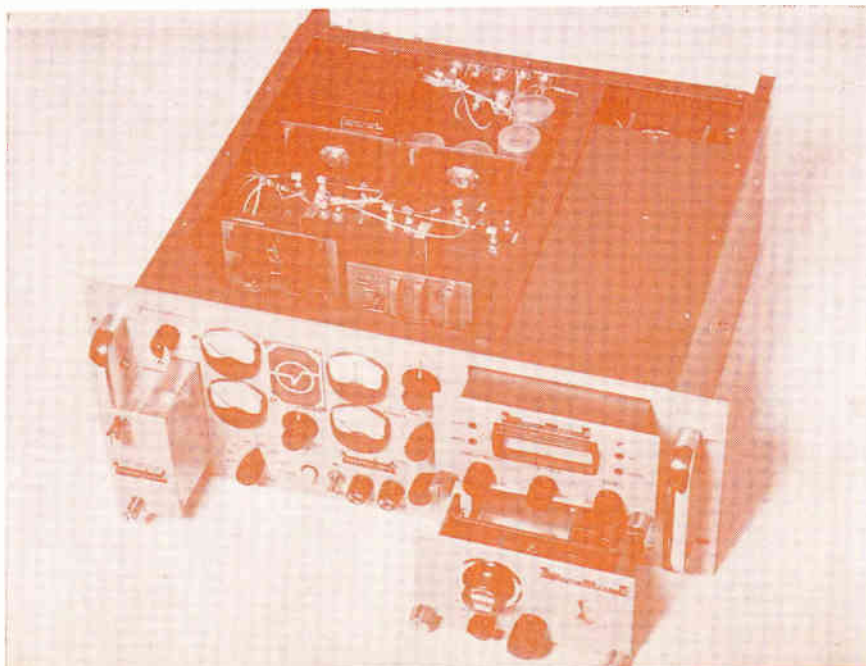

a serial train of amplitude-modulated pulses at its output. The amplitude of each pulse is equal to the amplitude of the signal on its respective data source. This process is known as time multiplexing. The advantage of time multiplexing is that it provides the capability of evenly distributing the bandwidth of the communication medium throughout a large number of data channels.

Commutators are generally classed by the level of signals they are designed to accommodate and the design differences between low and high-level devices can vary substantially. Also, low-level units² are generally more difficult to construct.

TRANSMITTERS—A telemetry transmitter is responsible for transmitting the data from the remote location or vehicle. Frequencies employed by U. S. aerospace facilities fall between 216 and 260 Mc; however, additional telemetry bands and frequencies are available as illustrated in Table II.

A major design problem is securing greatest output power with minimum weight and size and high reliability. Both vacuum tubes and semiconductors have been used in units with power outputs varying between 5 milliwatts and 150 watts.

Heat dissipation also poses a substantial problem to designers of telemetry r-f links. As transmitter output power goes higher, final stages with efficiencies between 35 and 75 percent generate additional heat that must be removed to protect circuits

within the r-f equipment package.

A typical 5-watt transmitter using solid-state techniques is shown in Fig. 4. Having high reliability, this unit can be used anywhere in the 215 to 260 Mc range. Units of this type are typical of latest solid-state designs and are small and lightweight. Manufacturer also produces models with 2 and 10-watt outputs.

Present telemetry systems use many different power sources. Among these, solar cells, chemical batteries and mechanical generators powered by hydrogen-peroxide turbines or other prime sources find wide use. Atomic energy conversion devices will very likely be the power sources of the future.

RECEIVERS—The flexibility of telemetry receivers has been vastly increased to meet the growing complexity and sophistication of telemetry signals. For example, receivers now have plug-in r-f tuners to ac-

commodate the seven authorized frequency ranges. In addition, front panel plug-in modules readily provide the various bandwidths required for differing modulation formats. Bandwidths are determined by filter configurations and receivers include demodulators with matched characteristics to optimize linearity, sensitivity and capture capabilities. Demodulators are available incorporating latest demodulation techniques including phase lock, frequency feedback and synchronous a-m and p-m. True phase demodulators can be obtained that linearly accommodate phase deviations approaching ± 180 degrees. These synchronous techniques eliminate the threshold phenomena normally associated with wide-band demodulators.

Receivers such as the solid-state unit shown in Fig. 5 minimize size, weight and power consumption while simultaneously offering improved re-

Aerospace Telemetry Bands—TABLE II

FREQUENCY (Mc)	USAGE
20*	U. S. and USSR Ionospheric experimentation
40	USSR satellites
108	IGY satellites; minitrack beacons through 1960
136-137*	U. S. minitrack beacons since 1960
183	USSR satellites and space probes
216-260	U. S. flight tests, missiles
378	U. S. satellites and space probes
960	U. S. satellites and space probes
1,435-1,535	U. S. govt & civilian flight test & space
2,200-2,300*	U. S. flight tests & space vehicles

* Asterisks denote frequencies allocated by ITU on July 1, 1961

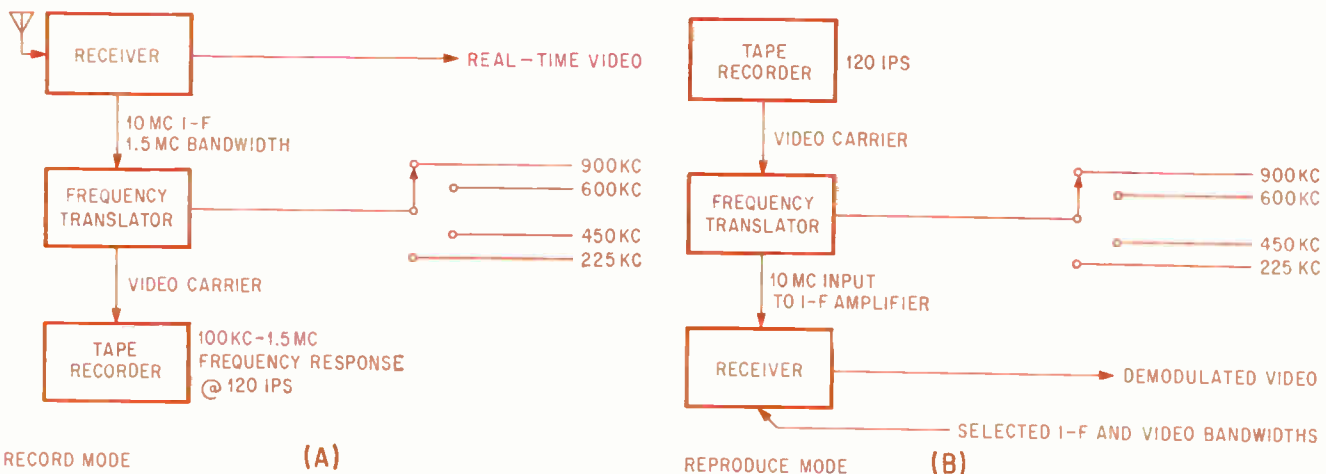

PREDETECTION systems are being used more and more since wide-bandwidth tape recording became practical. Record mode is shown in (A), and reproduce mode in (B)—Fig. 6

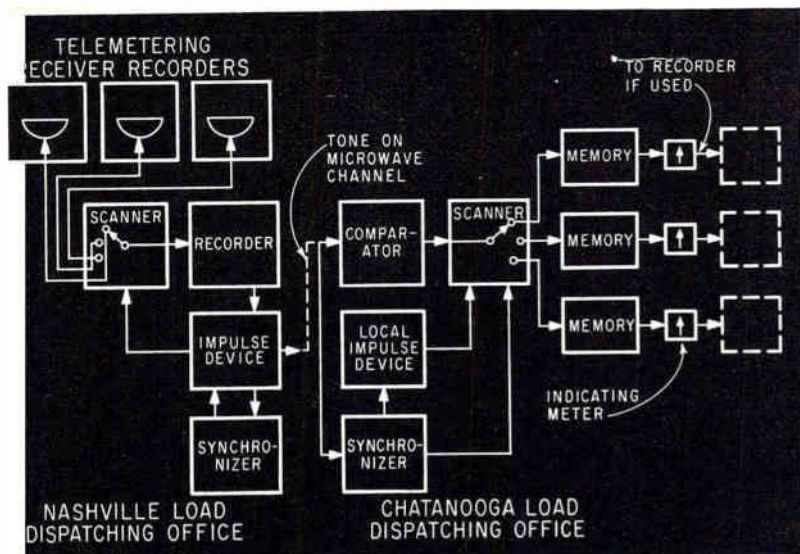

TENNESSEE VALLEY AUTHORITY uses this system for teletyping electrical-load data from facility to facility and central office—Fig. 7

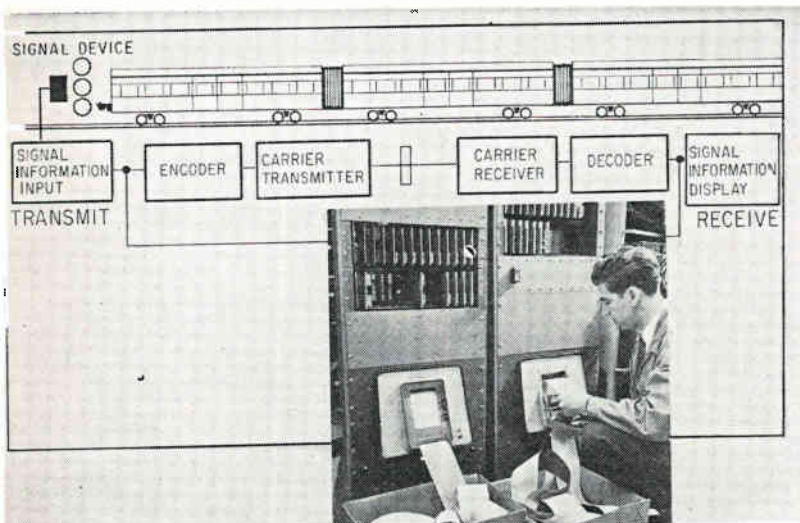

TRANSPORTATION was one of the first industries to employ teletyping back in 1912. This modern system has been successfully tested in New York subways—Fig. 8

liability. Flexibility is achieved through complete modular construction of etched, solid-state circuits. Due to reduction in size and power consumption, additional features such as spectrum-display units or predetection up and down converters are now available as integral portions of a receiver.

RECORDERS-COMPUTERS—Until recently, most telemetry data was recorded on either a galvanometer or cathode-ray oscilloscope. With the advent of magnetic tape in the early 50s, this data could be

tape recorded to preserve the signal in an electrical form that could be fed to various reduction processes and computers.

With the advent of digital systems, recorders were developed for saturation-pulse recording where serial bits from a pcm system were converted into parallel format, with each bit of a coded group recorded on a different head.

Latest and most flexible methods of telemetry recording make use of the intermediate frequency of the receiver prior to detection. Called predetection recording (preD), this

technique is possible because recent advances have expanded the bandwidth of tape units. PreD has highest value since it may be used with almost all types of incoming telemetry data without banks of separate equipment for each change of incoming format.

Both record and reproduce modes of predetection recording are shown in Fig. 6A and 6B. In the record mode, the widest predetection-bandwidth capability of the system is used so that optimum bandwidth selection is accomplished during reproduction. During playback, the recorded spectrum is reconverted or translated back up to the original i-f frequency and reinserted into the receiver i-f amplifier where it is demodulated as if it were the original r-f signal.

Computers speed up evaluation of data and simplify analysis. However, various types of interface equipment must be employed to convert received data into a form suitable for computer insertion and handling.

With recent successes in videotape recording and the development of automatic data-processing equipment, data processing now includes the handling of all data after it leaves the receiver. Thus, data processing may often be considered automatic data reduction and it is the speedy performing of this and other functions that makes the use of computers so vital to modern telemetry.

INDUSTRIAL TELEMETRY—

There are numerous teletyping methods used today by industry that are concerned with converting information into suitable form for data-link transmission, receiving at supervisory points and converting data into a usable form. Basic systems may be either analog or digital and may use f-m/f-m, pdm, pam, or pcm techniques; each has specific advantages for a given job.

A time-division multiplex system in use by the Tennessee Valley Authority provides power-system dispatchers with data formerly obtainable only by telephone. It transmits load readings of five hydroelectric plants and their total from TVA's Nashville dispatching office to their Chattanooga facility. Numerous in-channels. The load readings of interconnecting companies are totaled in Chattanooga and compared with

a schedule; any deviation from the schedule is transmitted to the appropriate generating station, which automatically adjusts its output to compensate. Figure 7 shows a block diagram of the TVA system.

A solid-state digital telemetry link has been successfully used by the New York City Transit Authority in its subway system. Using wire-link coding with high-speed binary logic, it is used for both switch and signal controls and also to indicate high-density data such as track indications, switch positions and signal aspects to a central control point. The technique used appears in Fig. 8.

In medicine, and particularly aerospace medicine, the telemetry field has seen great expansion. One paper⁵ recently described a microwatt telemetry system for implantation in small animals. Operating around 130 Mc, the transmitter package for animal use contained an f-m oscillator, a battery and a small magnetic microphone, and was excellent for the transmit end of a simple animal-borne f-m/f-m telemetry system. The complete unit mounted on a mouse is shown in the lead photograph.

PROGNOSTICATION — Probably the most significant change coming is the shift to the uhf range between 1.435 to 1.535 and 2.2 to 2.3 Gc. Directives have been issued that will require most telemetry application to be so instrumented by 1970. The change will undoubtedly render obsolete large amounts of present-day equipment that will require modification or replacement. Problems from both operational and equipment viewpoints are well understood. While present-day equipment evolved with experience, present knowledge will provide a basis for a more systematic development program for the future.

There are many technological problems associated with the shift to uhf. In transmitters, for example, design criteria vary drastically between 200 Mc and 2,000 Mc. Final tanks for the higher range will probably be cavities similar to those shown in the photo on the right. The capabilities and limitations of new equipment must be well understood. Ingenuity and practical operational analysis will dictate designs to provide versatility in most areas. More-

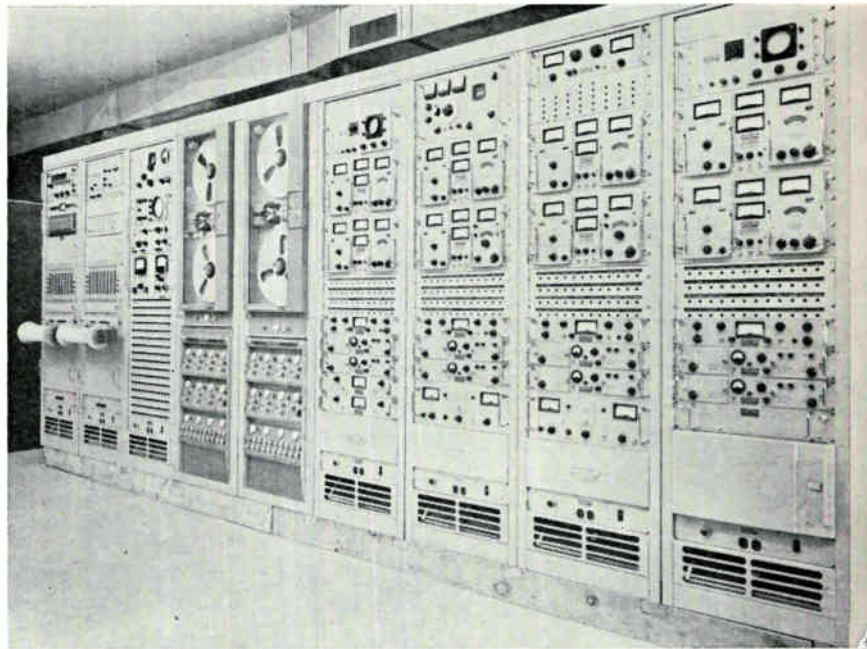

GROUND equipment can handle a variety of formats with increased speed and reliability. Systems like this TPRS-5 manufactured by Defense Electronics exemplify today's trends—Fig. 9

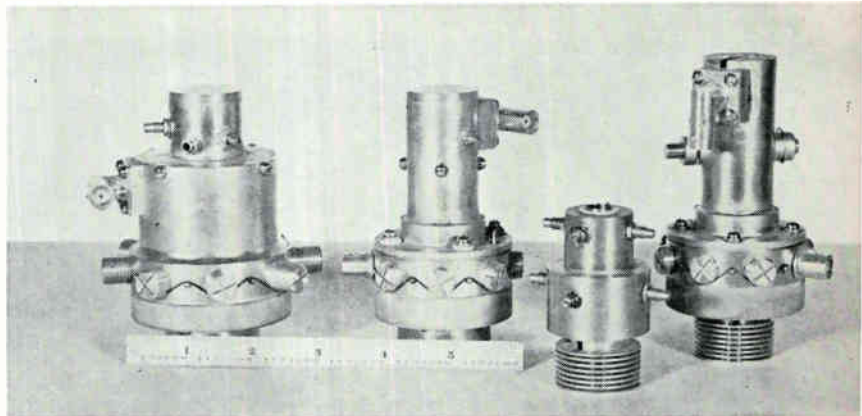

IMPENDING switch to the uhf range has given rise to new techniques. The cavities above are earmarked for use in new transmitters

over, the requirement for obtaining positional information from tracking systems will become easier to meet.

The author thanks Victor Ratner, Bob Blanchard, Elton Sherman and

Mort Cohen of Defense Electronics, Don Allison, Jr. and Mort Salkind of Vitro Corp. of American and Ted Rybicki of Ortronix for their cooperation in the preparation of this article.

REFERENCES

- (1) IRIG Telemetry Standards, Armed Services Technical Information Agency, Arlington Hall Station, Va., Document No. 106-60 Revised June 1962.
- (2) Stiltz, H. L., "Aerospace Telemetry", Prentice-Hall Inc., Englewood, N. J., 1961.
- (3) Gardenhire, L. W., Internal Paper, Radiation, Inc., Melbourne, Fla., 1962.
- (4) Moody, W. N., A Comparison of Low-Level Commutators, p 2-4, *Proc 1963 National Telemetry Conference*, Washington, D. C.

- (5) Adams, R. M., Fromme, G. L., Dizon, D., and Anstadt, C. L., A Microwatt VHF Telemetry System For Implantation In Small Animals, p 52, *Proc 1963 National Telemetry Conference*, Washington, D. C.
- (6) Dickstein, H. D., The New UHF Telemetry Bands: Systems Considerations and Hardware Solutions, p 112, *Proc 1963 National Telemetry Conference*, Washington, D. C.

WHY THIS CIRCUIT?

Application of magnetic switching circuits has been deterred by the problem of obtaining continuous indication of the flux state in the magnetic path. Since the path is closed, a flux meter or Hall effect device is unusable. An additional winding around the magnetic path yields only transient information that must be fed through a bistable device like a flip-flop to obtain continuous indication of flux state. R-f transformers can be used to sense flux state in minor apertures of a multiaperture device. If the aperture is in the blocked state, the transformer is effectively decoupled from the primary. But other ancillary equipment is required. The tunnel-diode circuit is simple and it saves parts

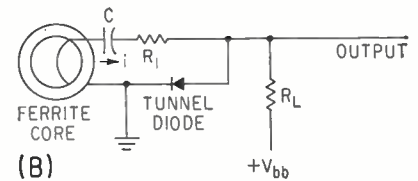
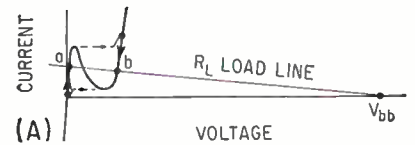

TUNNEL DIODE operating in its bistable mode (A) is shunt fed by a ferrite core (B) to give continuous indication of flux state—Fig. 1

TUNNEL DIODES SAVE PARTS Continuous

Devices operating in the bistable mode save 80 percent on components and 40 percent on soldering in an analog-digital converter

CONTINUOUS indication of the flux-state of any closed reversible magnetic path can be shown by a tunnel diode biased in its bistable mode. Both shunt fed and series fed circuits are described.

The shunt fed circuit is given in Fig. 1. Figure 1A shows the tunnel diode voltage-current characteristic and the load line forming two stable intercepts. The load line is chosen so the low-voltage state *a* and the high-voltage state *b* are removed as far as practical from the tunnel diode peak and valley current points. This condition yields the maximum circuit stability and noise tolerance.

Figure 1B indicates the method of shunt feeding the core signal into the tunnel diode. Initially the core is in its ccw flux state and the tunnel diode is in its low-voltage state. When the core switches to cw flux state, a positive voltage with respect to ground is induced in the core winding. The induced voltage causes a transient current *i* to flow through capacitor *C* and series resistor *R*₁ into the tunnel diode. This current pulse is sufficient to raise the tunnel diode current from the low-voltage point beyond its peak current value, thereby switching the tunnel diode to the high-voltage state. Since the high-voltage point is stable, the tunnel diode will remain in that state

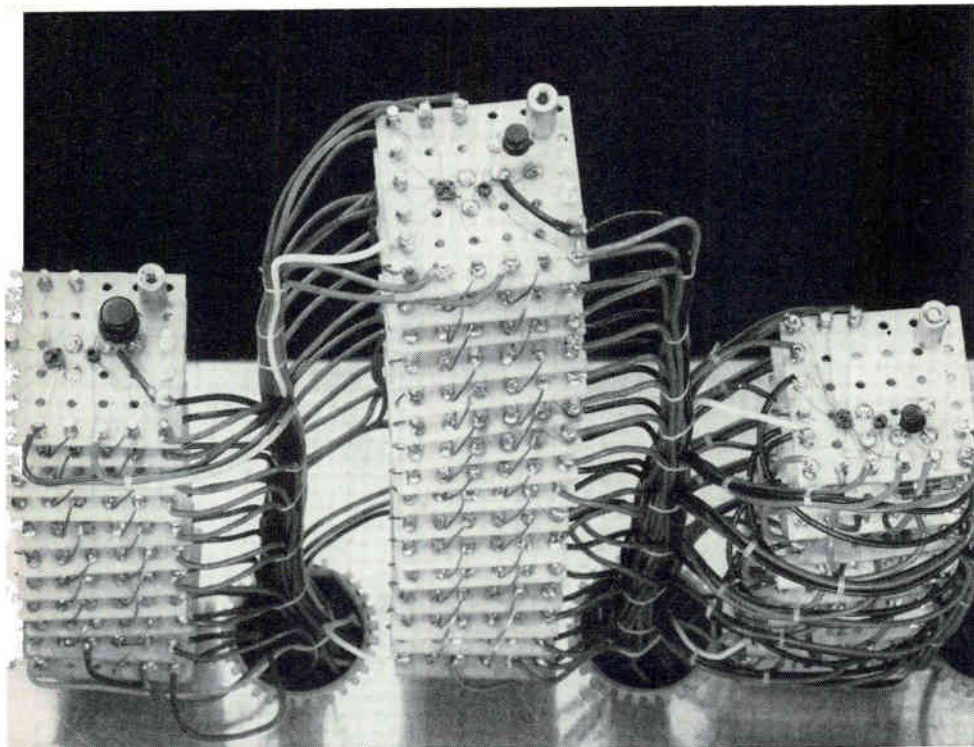

LOGIC STACKS that perform the analog-digital conversion in equipment employing tunnel diodes for continuous flux sensing

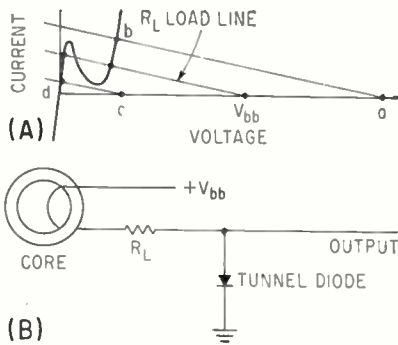

LOAD LINE of tunnel diode (A) is shifted by a series feed from ferrite core (B) to give continuous flux-status indication—Fig. 2

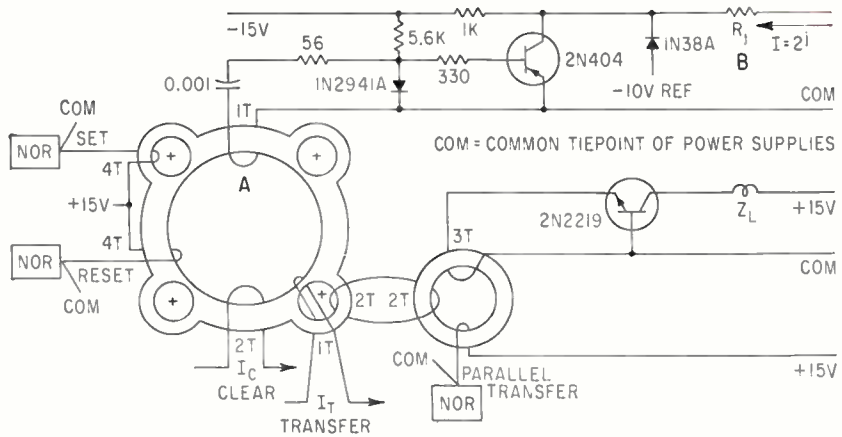

ANALOG-DIGITAL converter module employs tunnel diode to sense change in state of core (point A) and switch binarily weighted current generator on and off (point B)—Fig. 3

Readout of Magnetic Cores

By WILLIAM G. TRABOLD, Electronics and Instrumentation Dept., G.M. Research Laboratories, Warren, Michigan

pending the core-flux reversal.

NEGATIVE SWITCH — When flux is switched from the cw to the ccw direction in the core, a negative voltage is induced in the winding. This voltage causes the tunnel diode current to decrease from the high-voltage point to a value less than its valley current and the tunnel diode switches to the low-voltage state. It remains in that state until the flux is again switched to a clockwise direction.

The tunnel diode may also be series fed by the magnetic path. If the circuit shown in Fig. 2 is used, the series capacitor and resistor can be eliminated. However, this circuit has the disadvantage of requiring a larger number of turns on the core, or the use of a lower bias voltage V_{bb} or both. The use of a lower bias voltage will generally yield a lower circuit stability.

In the series fed circuit the core is initially in the ccw flux state and the tunnel diode in the low-voltage state. When the core is switched to its cw flux state, a transient voltage induced in the core winding adds to the bias voltage V_{bb} . The induced voltage pulse shifts the load line from V_{bb} to a , thereby shifting the tunnel diode current to point b . As the induced voltage decays to zero

the load line returns to V_{bb} and the tunnel diode is left in its stable high-voltage state.

When the core is switched to its ccw flux state, a transient voltage is induced in the winding such as to subtract from the bias voltage V_{bb} . This voltage pulse shifts the load line to point c and the tunnel diode current is shifted to point d . As the induced voltage decays to zero, the load line returns to V_{bb} and the tunnel diode is left in its stable low-voltage state.

OUTPUT POLARITY — Any polarity combination of core winding and tunnel diode and bias polarity may be used to obtain the output signal polarity and state desired. For example, the cw flux state can produce a positive or negative output signal with the tunnel diode in either the high or low voltage state as required by other circuit considerations.

If a germanium tunnel diode is used, it may be coupled directly to the base of a germanium transistor. When the tunnel diode is driven to the low-voltage state, the transistor is cut off. When it is in the high-voltage state, the transistor is saturated.

The core-tunnel diode circuit has been used successfully in the design

of an analog-to-digital converter. All switching functions of the a-d converter are implemented using NOR, OR logic functions. The NOR, OR logic functions were generated using multiaperture ferrite devices. Transistors are used on the output of the modules to facilitate fan-out and conventional wiring harness.

The core-tunnel diode circuit was used to read out the flux state of a five aperture core and control the switching of binarily weighted current generators, shown in Fig. 3. Multiaperture ferrite logic effected a parts saving of 80 percent and a solder-joint saving of 40 percent over conventional diode-transistor logic circuitry.

Resistor R_j is a binarily weighted resistor used to generate a reference current. Five such current generators are used in the circuit:

$$\begin{aligned} I_1 &= 1 \text{ ma}; & R_{j1} &= 10K \\ I_2 &= 1/2 \text{ ma}; & R_{j2} &= 20K \\ I_3 &= 1/4 \text{ ma}; & R_{j3} &= 40K \\ I_4 &= 1/8 \text{ ma}; & R_{j4} &= 80K \\ I_5 &= 1/16 \text{ ma}; & R_{j5} &= 160K \end{aligned}$$

BIBLIOGRAPHY

- H. D. Crane and E. K. Van De Riet, Design of an All-Magnetic Computing System, Part I—Circuit Design, *IRE Transactions on Electronic Computers*, p. 207, June, 1960.
 "General Electric Tunnel Diode Manual", 1st ed., General Electric Co., p. 44, 1961.

TV

Special-effect



TV PROGRAM photographed from monitor screen showing result of dissolve wipe used with an iris shape. Transition from camera output showing girl to floral background from another video source is gradual and more artistic than sharp-edge newscast type of box wipe

By **KOMEI KAZAMA, TAKAYOSHI ISHINO, KATSURO SHUDO,** and
KUNIKATSU KUMAKURA, Japan Broadcasting Corp. (NHK), Tokyo, Japan

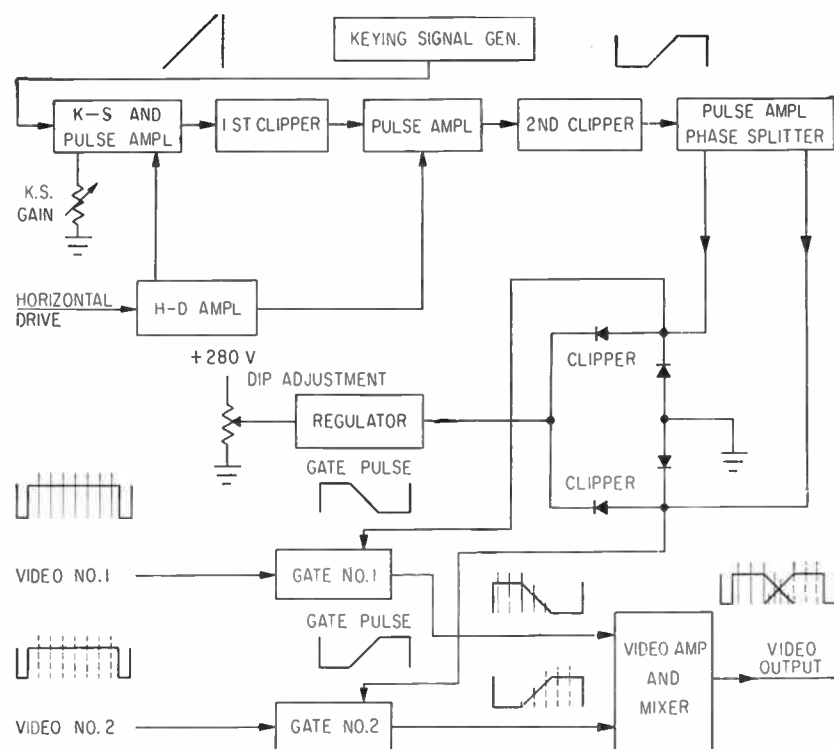

GATING PULSES, necessary for controlling video sources before they enter mixer, are derived from keying signal generator and processed through clippers and pulse amplifiers. Waveforms shown are for simple horizontal dissolve wipe—Fig. 1

GRADUAL TRANSITION is produced in the tv dissolve wiper by shaping the transition region video signals of the two scenes and then overlapping them. No camera modifications are required. With the exception of operating controls on the studio console it is completely housed in a rack panel. Both the width and brightness of the transition region can be adjusted as directed by the producer.

CIRCUITS—The block diagram in Fig. 1 shows how the two video signals are shaped and mixed. Only a simple wipe across the scene is described for simplicity.

Heart of the tv dissolve wiper is the keying signal generator. It is similar to that of the RCA montage amplifier. The timing of the sawtooth waves from this source determines the pattern of the dissolve. For simple horizontal dissolves the output of the keying signal generator comprises sawtooth waves that start at the beginning of each horizontal sweep and rise linearly to the end of the horizontal line.

The sawtooth voltage from the keying signal generator passes through two amplifiers and two clippers that shape it into a gating signal. The first clipper removes the upper portion of the sawtooth, the second clipper the lower portion. The resultant gating signal consists of two constant voltages at different levels connected by a ramp voltage.

The circuits are so designed that the difference between the voltages at which the two clippers operate is a constant. Thus the height of the signal ramp remains constant. But the absolute value of both clipper voltages can be changed in equal increments simultaneously. As the clipper voltages are varied the ramp portion of the gating signal appears earlier or later in the horizontal line.

The gating signal is passed through a phase splitter to obtain two signals opposite in phase. The upper levels of these two signals are clipped again by transition region brightness clippers. The sig-

DISSOLVE WIPER

amplifier combines scenes without sharp transition edge

A WIPE IS RASTER DIVISION

In television broadcasting terminology, the word wipe defines the next production step beyond fading one camera off and fading a second camera on. In elementary form, as one picture was wiped sharply off the screen, another followed immediately after it. A split screen is a stationary wipe. The wipes described in this article involve even more complex forms, such as the diamond, diagonal, wedge and iris. But far from being sharp-edged, they are deliberately blurred for artistic effect. The technique is relatively simple and can be applied to any system

nals are then coupled into the gate circuits, which they control. Video signals from the two scenes are shaped in the gate circuits, as shown in Fig. 2, mixed and amplified.

The video dissolve occurs during the interval Δt in Fig. 2. The dissolve interval is variable from zero to H , the horizontal period, by controlling the gain of the keying signal amplifier. The higher the gain the steeper the slope of the ramp portion of the keying voltage and the shorter the dissolve interval.

Control of the transition region brightness clipper is adjustable over the dissolve interval Δt . It can be adjusted at will for a dissolve that is the same or either darker or lighter than the two scenes it divides.

Brightness in the dissolved portion of the picture is proportional to the sum of the two video signals. By varying the overlap of the two signals it is possible to make total video signal amplitude in the transition region greater or less than in the undissolved portions.

Gating voltage for each video channel in the prototype equipment is a-c coupled through a capacitor to the gate circuit. A germanium diode clamp prevents the voltage at the gating circuit from rising above zero volts. Gain of the gate circuit varies almost linearly with gating voltage between zero at its cutoff voltage and maximum at zero volts. Available gating voltage is larger than necessary to cut off the

gate. Under these conditions, overlap of the two video signals is small, as shown in Fig. 3A.

The transition region brightness clippers eliminate the positive portions of the two gating voltages from the phase inverter. After passing through the coupling capacitors to the gate circuits the positive levels are clamped at zero volts.

As gating signal clipping is increased, overlap of the two signals and thus total video signal amplitude in the transition region is increased. As shown in Fig. 3B and 3C brightness in the transition region can be increased until it is equal to, or greater than, brightness in the undissolved portions.

Waveforms of total video signal in Fig. 3 are only approximate. Nonlinearities in gate-circuit characteristics will cause slight variations. Variation of the transition region brightness may cause a small change in the transition region width, but not the reverse effect.

D-C LEVEL—Capacitor coupling is also used between stages of the tv dissolve wiper in which the gating signal is generated to insure

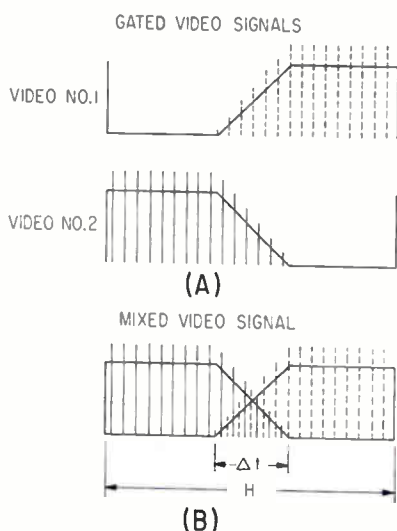

WAVEFORMS of gated video signals from first and second video sources (A) and the composite mixed video signal (B)—Fig. 2

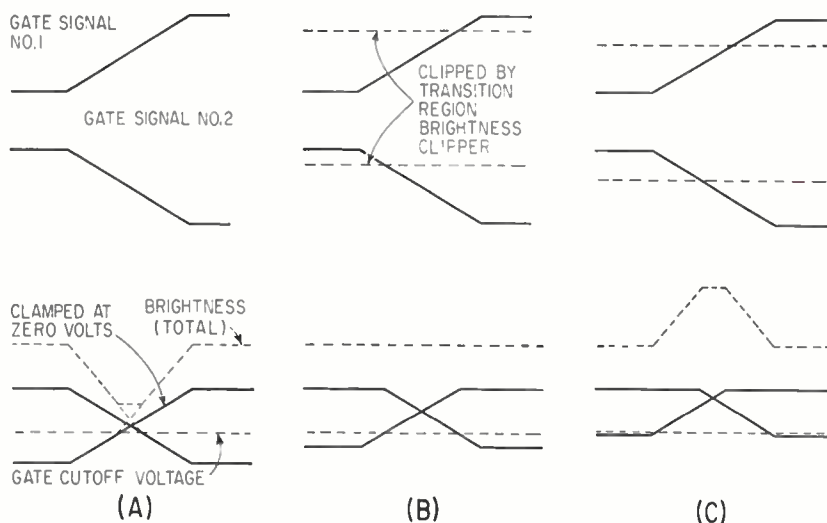

TRANSITION REGION brightness clipper, with full amplitude gating (A) moderately clipped gating (B), further clipped gating when overlap is increased and brightness in the transition region is greater than in undissolved regions—Fig. 3

simplicity and increased stability. Diode clamps provide reinsertion, where necessary, of the d-c level lost through capacitor a-c coupling.

No problems are caused by the use of a-c coupling except when the transition region is at the extreme left or right. This situation occurs when it is necessary to have one of the two scenes occupy the entire screen. If the producer desires to have the scene from video 1 occupy the entire screen, then the aperture between the clippers, shown in Fig. 4, will be below the negative tips.

This defect is remedied, while retaining the advantages of a-c coupling, by adding pulses from the horizontal driving pulse generator to the horizontal sawtooth from the keying signal generator. The horizontal driving pulses are the source from which the horizontal sawtooth is derived. They occur during the retrace period. Horizontal driving pulses are added to the sawtooth wave as shown in Fig. 1. When the transition region falls in the center of the screen these added pulses fall outside of the range passed by the two clippers and do not affect operation. The waveforms illustrating this action are shown in Fig. 5.

The horizontal driving pulses added in the second pulse amplifier

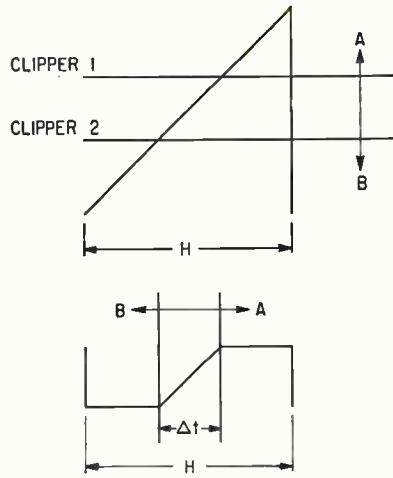

RAMP PORTION of the gating signal shifts to right or left with variation in height of aperture between two clipping levels—Fig. 4

cause rectangular pips during the retract period that extend below the negative tips of the sawtooth. Thus, when the transition region is at the extreme left, the output of the two clippers is a series of rectangular pulses. These pulses, together with their inverse generated in the phase splitter, keep video 1 on and video 2 off during the entire field. This generation of the rectangular pulses is shown in Fig. 5B.

The horizontal driving pulses applied to the first pulse amplifier

cause rectangular pips during the retrace period that extend above the positive tips of the sawtooth. These serve to produce a series of rectangular pulses when the transition period is at the extreme right or left.

With the aperture below the tips of the sawtooth, no portion of the sawtooth will appear at the output of the second clipper. No gating signal will be generated and both gates will be biased for maximum gain. Signal to both gates, video 1 and video 2, will overlap across the entire width of the screen.

It might be thought that the horizontal driving pulses applied to the first two pulse amplifiers would cancel each other out. They do not. When the transition region is at the extreme left the horizontal driving pulse inserted in the first pulse amplifier, together with the entire sawtooth, is removed by the first clipper.

When the transition region is at the extreme right cancellation is prevented by properly proportioning gain and inserted pulse amplitude. Horizontal driving pulse inserted into the second pulse amplifier is much smaller than the opposite polarity pulse from the preceding stage. Slight cancellation occurs but pulse height still remains adequate.

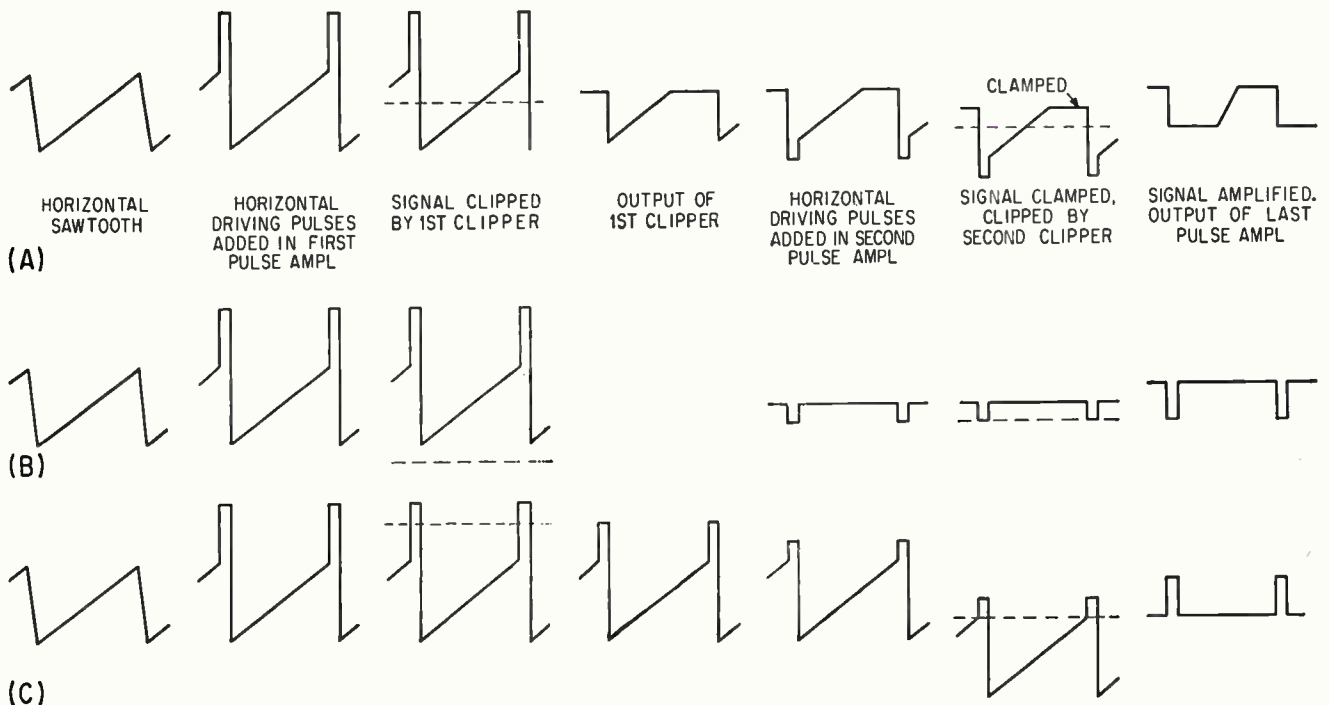

HORIZONTAL driving pulse added to horizontal sawtooth with transition region in center of screen, addition of horizontal driving pulse has no effect on gating waveform (A). At extreme left transition there would be no gating waveform without horizontal driving pulses (B). Same condition when the transition region is at the extreme right (C). Gating waveform is a series of rectangular pulses—Fig. 5

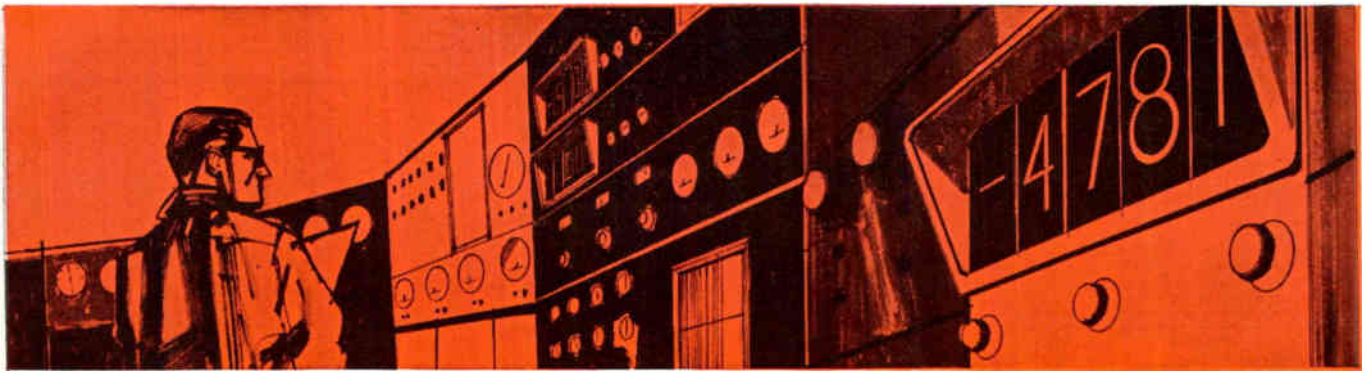

Burroughs Corporation uses Allen-Bradley hot molded resistors in their Beam-X counter modules because... **time and experience have eliminated all questions about their reliability***

■ Burroughs* simplified counter modules feature greatly increased reliability. Where individual component reliability is paramount—as in this application—Allen-Bradley hot molded resistors are a “natural” choice . . . and for the best of reasons.

Allen-Bradley’s exclusive hot molding process results in such amazingly uniform properties from resistor to resistor—and from year to year—that they have become the only “choice” in critical circuits, where strictly commercial resistors can be used. The billions of A-B resistors produced over the years have proven that in the combination of conservative ratings and consistently stable

characteristics, these resistors have no equal. It also makes possible the accurate prediction of the resistor performance in apparatus in which the A-B resistors are used. It is also well to remember that there is no instance on record where an A-B hot molded resistor has failed catastrophically.

So far as resistors are concerned, only by specifying Allen-Bradley hot molded resistors can you be certain you’re building the full measure of reliability into your electronic equipment. For complete resistor data, please send for Technical Bulletin 5050: Allen-Bradley Co., 110 W. Greenfield Ave., Milwaukee 4, Wis. In Canada: Allen-Bradley Canada Ltd., Galt, Ont.

**Trademark of Burroughs Corporation*

ALLEN-BRADLEY HOT MOLDED FIXED RESISTORS are available in all standard EIA and MIL-R-11 resistance values and tolerances.

TYPE TR 1/10 WATT		MIL TYPE RC 06
TYPE CB 1/4 WATT		MIL TYPE RC 07
TYPE EB 1/2 WATT		MIL TYPE RC 20
TYPE GB 1 WATT		MIL TYPE RC 32
TYPE HB 2 WATTS		MIL TYPE RC 42

Burroughs Corporation's Model DC-114 transistORIZED decade counter with Nixie* tube readout, showing use of Allen-Bradley hot molded resistors.



ALLEN-BRADLEY
QUALITY ELECTRONIC COMPONENTS

CUT OUT
YOUR OWN

Reliability Slide Rule

By GERALD F. ALLEN, General Dynamics/Pomona, Pomona, California

RELIABILITY calculations for both systems and subsystems can be made quickly with the slide rule to be assembled from the accompanying illustrations. The number of tests that must be made to prove out a system or component to a given confidence and reliability is found from one set of scales. Failure rates allowable to subsystems to meet system specifications are determined from a second set of scales.

With the data obtained, estimates of project costs and ultimate capabilities can be made more realistically.¹ Before reading the following discussion, it may be desirable to assemble the rule (see Slide Rule Assembly). Detailed analysis of the slide rule mathematics will not be made.

BACKGROUND—An accepted working definition of reliability is the probability that a device will perform as intended under design conditions for a specified period of time.² After all design work is completed and prototypes of an item are produced, then—and not before—reliability must be proved. The only legitimate question becomes—how many items will work under the specified conditions?

The only applicable variables are the number of tests and the number of failures. In preliminary planning stages, the question takes another form—how many items will have to be allocated for tests to demonstrate required reliability? A basic application of the so-called binominal distribution gives the required answers. Although frequently overlooked, the theorem yields demonstrated reliability in exact accord with the preceding definition.

Scales *D*, *E*, *F* and *G* on the slide rule are based on this distribution. The statistical formulations governing these scales stem from probability laws concerning the occurrence of one of any two possible outcomes. The outcome of any event (or test) is constrained to one of two values: acceptable or unacceptable. Once the boundary segregating these alternatives has been established, there can be no question about the outcome of any test; whatever its value, it falls in one of two discrete categories. The outcomes of such realistic tests follow the binominal distribution. (The popular normal, or Gaussian distribution, incidentally, serves as an approximation to the binominal for a large number of tests or items.)

To demonstrate the use of the reliability slide rule, consider a large bag with an unknown mixture of black and white marbles. From a handful of marbles, the mixture within the bag is to be inferred.

Intuitively, if we draw only two marbles from the bag and both turn out to be white, we would not be

justified in saying that 100 percent of the marbles in the bag are white; but if we drew 100 marbles and all were white, we would feel more certain that there were at least a large percentage of white marbles.

What, then, is the probability that the examined handful of marbles is representative of the remainder in the bag? The larger the handful the surer we can be that it is a meaningful indicator. The term confidence is used to indicate the rigorous arithmetic analysis of the size of the handful or sample on the ability to predict the characteristics of the remainder. From the handful of 100 white marbles we can predict that any group of marbles removed from the bag will be at least 98 percent white. We can have 90 percent confidence that the prediction is correct; stated another way, the prediction will be correct at least 90 times out of 100.

Using the slide rule, the number of black marbles drawn is zero and is set up in the window of scale *F* for the desired confidence of scale *G*. In this case 90 percent; under the total number of marbles drawn, 100, on scale *E*, we read a reliability of about 0.977 on scale *D*. This means that based on our sample set of 100 tests (marbles), there would be a 90 percent chance of drawing a handful of 100 marbles with 98 or more white marbles in it. To put it another way, if we replaced each handful after it was drawn and counted, so as not to upset the ratio, 90 percent of an infinite number of handfuls should contain 98 or more white marbles.

Note that each white marble has been considered a success and each black marble a failure. Since reliability is the probability of success, we can read the white-marble probability on the reliability scale.

Logically, the likelihood of drawing 99 or more white marbles in any one handful is less than the likelihood of drawing 98, while the likelihood of drawing 96 or more is greater. A reliability schedule can readily be developed using the slide rule. Using the example of a 100-marble handful containing no black marbles, we can infer the following.

The lower-limit white-marble probability is	With this confidence (in percent)
0.991	60
0.977	90
0.957	99

The same reasoning applies to missile testing and other events. First a performance boundary (such as miss distance for missiles) is established. When tested, missiles falling within the boundary are counted as successes, those outside as failures. Suppose 17

continued on p 48

FOR HIGH RF POWER OUTPUT IN TRANSISTORIZED TRANSMITTER EQUIPMENT

2 WATTS @ 170 MC

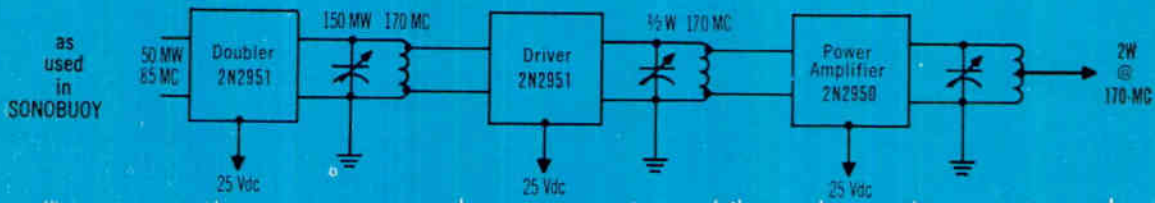

ideal for
CITIZENS'
BAND

2.5 WATTS @ 28 MC

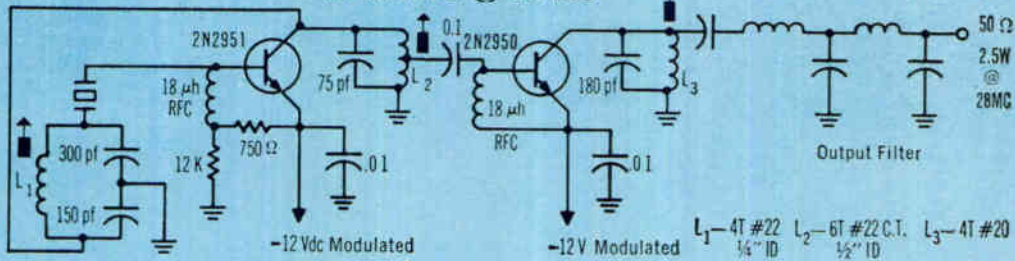

Oscillator and
Multipliers
2N2951

DESIGNED and BUILT TO WORK TOGETHER

SSB • FM • AM



Motorola's New Silicon RF Power Transistors Offer up to 20 Watts Output @ 50mc

Motorola's new team of silicon high-power, high-frequency RF power transistors are immediately available from your local Motorola District Office or Distributor . . . available at production prices.

Designed to operate at low supply voltages (12 to 25 volts), these devices are ideal for portable equipment in spacecraft . . . in the military . . . in the field.

For additional application or pricing information on these new Motorola RF Amplifier transistors, contact your Motorola Semiconductor Distributor or District Office or write: Technical Information Center, Motorola Semiconductor Products Inc., Box 955, Phoenix 1, Arizona.

the RF Amplifier Line

Type	Package	TYPICAL PERFORMANCE DATA ($V_{CC} = 25 V @ 50mc$)			MAXIMUM RATINGS @ 25°C ($T_{j, max} = 175°C$)			
		Power Output in Watts (cw)	Power Gain @ Power Output (db)	Collector Efficiency (%)	Pulse Breakdown* V_{CES} (V)	V_{CB} (Vdc)	$I_{C, max}$ (Adc)	P_o 25°C Case
2N2947	TO-3	17	8.5	70	90	60	1.5	25
2N2948	TO-3	10	7	60	80	40	1.5	25
2N2950	STUD	3.5	12	50	85	60	0.75	6.0
2N2951	TO-5	0.7	7.5	40	—	60	0.50	2.0

*Minimum specification limit measured in pulse condition at 250 mA.



"new leader in Total Silicon Technology"

MOTOROLA Semiconductor Products Inc.

BOX 955 • PHOENIX 1, ARIZONA • A SUBSIDIARY OF MOTOROLA INC.

D-63-046

SLIDE RULE ASSEMBLY

Before committing the templates to use, experiment with available backing material, glue, and parts of pages from this issue.

1. Cut out templates and paste or glue to thin cardboard or plastic.
2. Cut out areas marked XX. If

transparent plastic is used as stiffener, cutouts need be made only through the templates and not through stiffener.

3. Cut two long thin strips (approximately $7\frac{1}{4} \times \frac{3}{16}$ in.) of backing or thin metal to use as spacers.

4. Match slide to one face of rule and put spacers in place. Lock spacers in place with glue or paste.

5. Set other face in place and bind to spacers.

6. Once rule is aligned, small rivets can be added to increase strength.

A clear plastic spray over the templates will help preserve readability. Since the scales do not fold over from front to back, alignment in this respect is not critical

(Continued)

INSTRUCTIONS

To determine the subsystem reliability when the total system reliability is specified, use scales A, B, C.

1. Set the total system reliability on scale A, under the arrow.
2. Locate the percentage of total system failures assigned to the subsystem, on scale B. This value may be thought of as being the assigned percentage of system unreliability.
3. Read the required subsystem reliability on scale C below the desired value on scale B.

To determine reliability-confidence relationships, use scales D, E, F, G.

1. Set the total number of failures in the window of scale F, opposite the required confidence on scale G.
2. Locate the total number of tests on scale E.
3. Read the system reliability (minimum) on scale D below the desired value on scale E.

TEMPLATE for body of rule should be cut along indicated line. Cutouts can be made with razor blade

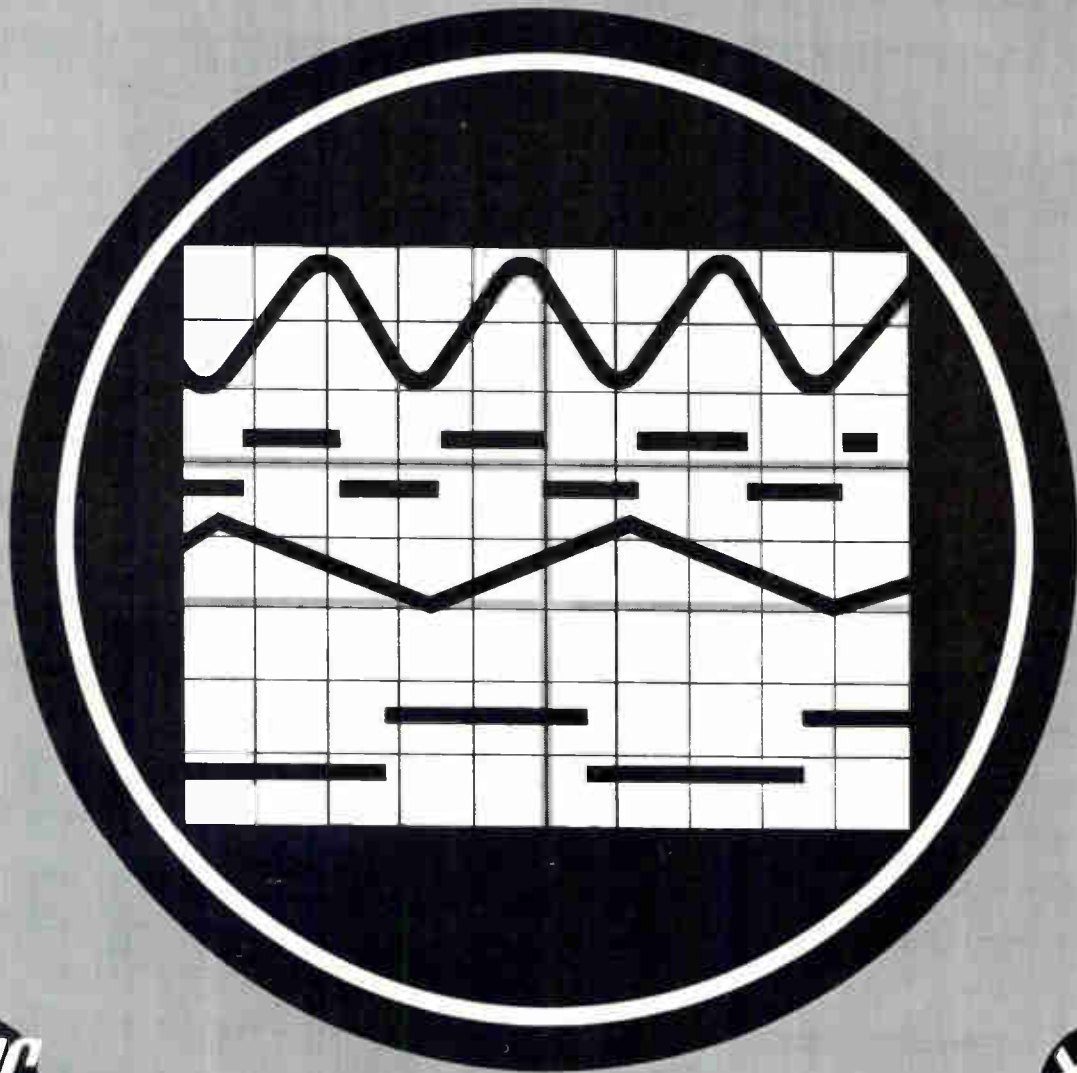

ANOTHER FIRST FROM GENERAL ATRONICS . . .

TRANSISTORIZED DUAL-BEAM OSCILLOSCOPE

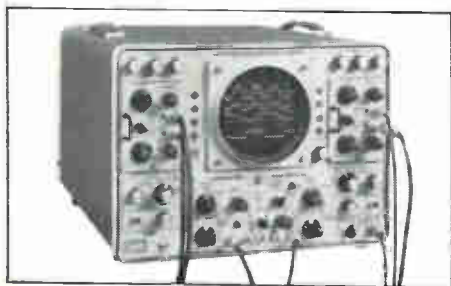

The new General Atronics model GA-255 oscilloscope puts dual-beam versatility and 15 mc bandwidth in a compact 48-pound package. Transistorization, the secret of its relatively small size, also yields cool operation, ruggedness, and a low power requirement — only 165 watts. Its total dimensions: 12" height, 16" width, 19¾" depth.

You'll like its high light output (with 10 KV accelerating potential). You'll like its big dual-beam display (5" round CRT has a flat face that eliminates parallax). And you'll like General Atronics' plug-in preamplifiers and sweep generator accessories — including a dual trace plug-in for 4-trace capability. Send for complete data on model GA-255. Write Dept. E9963.



GENERAL ATRONICS

ELECTRONIC TUBE AND INSTRUMENT DIVISION, PHILA. 18, PA.

CATHODE RAY TUBES • OSCILLOSCOPES • OSCILLOSCOPE RECORDING CAMERAS

CIRCLE 47 ON READER SERVICE CARD