

electronics

McGraw-Hill Weekly

75 Cents

July 19, 1963

(photos illustrate)

ACID TEST

Passivated micro-circuit resists hot dichromic acid, p 47

HOT CARRIER DIODES

Faster switching than ever, p 53

TOMORROW'S ECLIPSE

What will we learn from it, p 26

TRANSISTOR GAIN CONTROL

New agc circuit is a servo, p 60

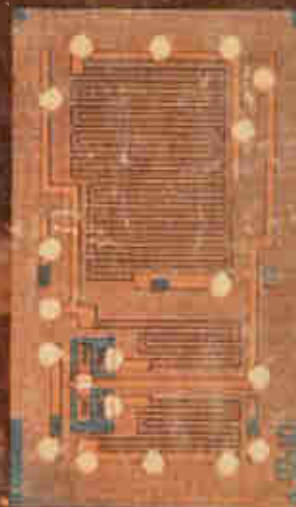



**PIONEERS IN
MINIATURIZATION**

NEW PIP SERIES

ULTRAMINIATURE TRANSISTOR PULSE TRANSFORMERS

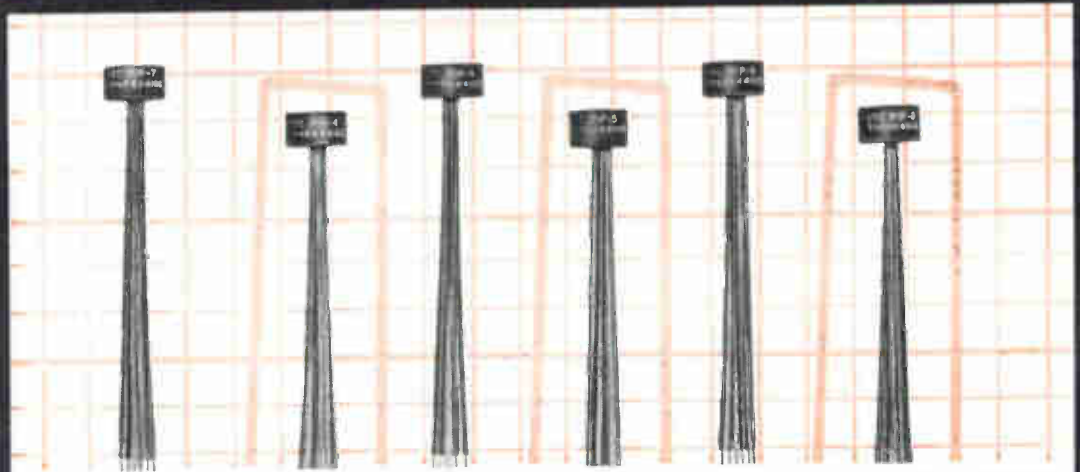

UNITS SHOWN ACTUAL SIZE—IMMEDIATE DELIVERY FROM STOCK

TRANSISTOR TEST CIRCUIT

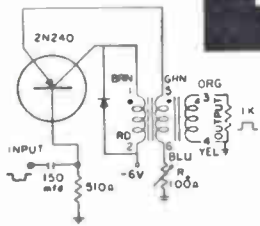

All units individually checked and adjusted, in transistor circuit illustrated, to parameters in table.

DEFINITIONS

Amplitude: Intersection of leading pulse edge with smooth curve approximating top of pulse.
Pulse width: Microseconds between 50% amplitude points on leading and trailing pulse edges.
Rise Time: Microseconds required to increase from 10% to 90% amplitude.
Overshoot: Percentage by which first excursion of pulse exceeds 100% amplitude.
Droop: Percentage reduction from 100% amplitude a specified time after 100% amplitude point.
Backswing: Negative swing after trailing edge as percentage of 100% amplitude.

- **RUGGED—COMPLETELY METAL CASED**
- **Manufactured & Guaranteed to MIL-T-21038B**
- **5/16" Dia. x 3/16" Ht.; Wt. 1/20 oz.**
- **Ratios—4:4:1 and 5:3:1**
- **Anchored leads, withstands 10 lb. pull test**
- **Printed circuit use, plastic insulated leads**
- **Can be suspended by leads or clip mounted**

Type No.	APPROX. DCR, OHMS			BLOCKING OSCILLATOR PULSE					COUPLING CIRCUIT CHARACTERISTICS						
	1-Brn 2-Rd	3-Grn 4-Yel	5-Grn 6-Blu	Width μ Sec.	Rise Time	% Over Shoot	Droop %	% Back Swing	P Width μ Sec.	Volt Out	Rise Time	% Over Shoot	Droop %	Back Swing	Imp. in/out*
RATIO 4:4:1 MIL TYPE TP6RX4410CZ															
PIP-1	.18	.20	.07	.05	.02	0	0	37	.05	9	.018	0	0	12	50
PIP-2	.47	.56	.17	.1	.025	0	0	25	.1	8	.02	0	0	5	50
PIP-3	1.01	1.25	.37	.2	.03	2	0	15	.2	7	.035	0	0	5	100
PIP-4	1.5	1.85	.54	.5	.05	0	0	15	.5	7	.06	0	0	0	100
PIP-5	2.45	3.1	.9	1	.08	0	0	14	1	6.8	.15	0	0	5	100
PIP-6	3.0	3.7	1.1	2	.10	0	0	15	2	6.6	.18	0	2	10	100
PIP-7	4.9	6.05	1.8	3	.20	0	0	14	3	6.8	.20	0	2	10	100
PIP-8	8.0	9.7	2.9	5	.30	0	0	3	5	7.9	.22	0	13	25	200
PIP-9	13.1	15.9	4.7	10	.35	0	5	12	10	6.5	.4	0	15	20	200
PIP-100	Transistor pulse transformer kit, consisting of PIP-1 thru PIP-9 in plastic case.														
RATIO 5:3:1 MIL TYPE TP6RX5310CZ															
PIP-10	.55	.41	.15	.1	.01	0	0	20	.1	8	.01	0	0	5	140/50
PIP-11	2.9	2.2	.82	1	.02	4	4	6	1	6.6	.05	0	6	12	280/100
PIP-12	9.4	7.1	2.6	5	.05	0	12	12	5	8	.09	2	12	25	560/200

* Input winding leads Brn-Rd (1-2); output winding leads Org-Yel (3-4); leads Grn-Blu (5-6) open.

**AND CUSTOM BUILT
UNITS TO YOUR SPECS.**

Write for catalog for full details on these and 1000 other stock items



UNITED TRANSFORMER CORP.

150 VARICK STREET, NEW YORK 13, N. Y.

PACIFIC MFG. DIVISION: 3630 EASTHAM DRIVE, CULVER CITY, CALIF.
 EXPORT DIVISION: 13 EAST 40th STREET, NEW YORK 16, N. Y. CABLES: "ARLAB"

CIRCLE 900 ON READER SERVICE CARD

electronics

A McGraw-Hill Weekly 75 Cents

W. W. MacDONALD, Editor (2645)

J. M. CARROLL, Managing Editor (2293)

SENIOR EDITORS

Samuel Weber (2371)
George W. Sideris (3444)

SENIOR ASSOCIATE EDITORS

Michael F. Wolff (2600)
John F. Mason (2666)

ASSOCIATE EDITORS

Michael F. Tomaino (2071)
William P. O'Brien (2297)
Sy Vogel (2467)
George J. Flynn (2188)
George V. Novotny (3151)
Leon H. Dulberger (3446)
Alexander A. McKenzie (2685)

ASSISTANT EDITORS

Stanley Froud (2710)
Stephen B. Groy (2245)
Roy J. Bruun (3495)
Barry A. Briskman (2306)
Dan Smith (2472)
Joel A. Strasser (2127)

REGIONAL EDITORS

Harold C. Hood
(Pacific Coast, Los Angeles)
Laurence D. Shergalis
(Pacific Coast, San Francisco)
Thomas Maguire
(New England, Boston)
Cletus M. Wiley
(Midwest, Chicago)

ART DIRECTOR

Howard R. Berry (2430)

ASSISTANT ART DIRECTOR

John C. Wright, Jr. (3430)

EDITORIAL ASSISTANTS

Lorraine Rossi, Virginio T. Bastian,
Lynn Emery, Ann Mello, Lorraine
Werner, Alice M. O'Brien, Sharon
Porks, Patricia Mitchell, Claire
Benell, Kay Fontana

FOREIGN NEWS BUREAU

DIRECTOR, John Wilhelm;
Alyne Elias, Laurence Mihlon
LONDON—John Shinn, Derek
Barlow, Nicholas London
BONN—Bruce Bendow,
Richard Mikton, Silke McQueen
BRUSSELS—Peter Forbath
PARIS—Robert Forrell,
Arthur Erikson
MILAN—Marc A. Messina
MEXICO CITY—Wesley Perry, Jr
RIO DE JANEIRO—Leslie Warren
MOSCOW—Stewart Romsey
TOKYO—Richard Halloran,
Charles Cohen, John Yomaguchi

CIRCULATION MANAGER

Hugh J. Quinn (2310)

W. W. GAREY, Publisher (2016)

NEW YORK TELEPHONE:

Area Code 212. Locally, 971 plus
extensions shown above in parenthesis

THIN GOLD WIRE suspends a combined thin-film and semiconductor microcircuit in hot dichromic acid. Thus CBS Labs demonstrates successful surface passivation of thin-film components on the same silicon wafer that contains planar passivated transistors. *Technique adds several degrees of freedom to microelectronics technology.* See p 47

COVER

NEW LOOK in This Year's Comsats. Starting with Syncom II, to be launched next week, the second round of active and passive communications satellites will incorporate significant design improvements over their earlier counterparts. *Designers of Relay II have taken steps to prevent any repeat mishaps and Echo II has a completely new balloon to improve r-f reflectivity*

18

LEM ELECTRONICS Faces New Design Challenges. High reliability in all flight model components and subsystems, as well as specially designed gear for the long lunar flight, are a prime requirement of designers of the lunar excursion module (LEM). *But, say the experts, none of the electronics going aboard LEM is beyond the present state-of-the-art*

22

ECLIPSE TO BARE IONOSPHERE'S Secrets. Late tomorrow afternoon, astronomers and engineers from all over the world will take up observation posts between Maine and Alaska to make detailed solar and atmospheric measurements during the total solar eclipse. *The long list of participants includes government agencies, scientific organizations, the military, universities, and private companies*

26

PROTOTYPE ELECTRON-BEAM welding system for in-space fabrication operations will be built for the Air Force by Hamilton Standard. System will weigh about 350 lb, use an 80-Kv gun. *Main use of welding equipment in space will probably be to seal manned spacecraft structures in order to cut air supply losses*

30

INDUSTRIAL SPY—Aristocrat of Thieves. Is there a common element in situations where company secrets are stolen and then sold to other firms? Some experts blame a lot of these cases on lax management practices. Tightening security measures will undoubtedly help, but in the last analysis it is the moral atmosphere in which the employee works that matters. *Ethical behavior must start with management*

32

MICROPOWER CIRCUITS: New Frontier in Solid State. When you start packing $\frac{1}{2}$ million components or more into a cubic inch of space, power consumption of individual circuits must be reduced to microwatts. But as you reduce you magnify problems. *Now a pioneer in microelectronics helps iron out many of the kinks.* By W. W. Gaertner and M. Schuller, CBS Labs

47

Contents Continued

Published weekly, with Electronics Buyers' Guide as part of the subscription, by McGraw-Hill Publishing Company, Inc. Founder: James H. McGraw (1860-1948).

Title ® registered U.S. Patent Office; © copyright 1963 by McGraw-Hill Publishing Co., Inc. All rights reserved, including the right to reproduce the contents of this publication, in whole or in part.

Executive, editorial, circulation and advertising offices: McGraw-Hill Building, 330 West 42nd Street, New York, N. Y., 10036. Telephone Area Code 212 971-3333. Teletype TWX N. Y. 212-640-4646. Cable McGrawhill, N. Y. PRINTED IN ALBANY, N. Y.; second class postage paid at Albany, N. Y.

OFFICERS OF THE PUBLICATIONS DIVISION: Shelton Fisher, President; Vice Presidents: Joseph H. Allen, Operations; John R. Callahan, Editorial; Ervin E. DeGraff, Circulation; Donald C. McGraw, Jr., Advertising Sales; Angelo R. Venezian, Marketing.

OFFICERS OF THE CORPORATION: Donald C. McGraw, President; Hugh J. Kelly, Harry L. Waddell, L. Keith Goodrich, Executive Vice Presidents; John L. McGraw, Treasurer; John J. Cooke, Vice President and Secretary.

Subscriptions are solicited only from those actively engaged in the field of the publication. Position and company connection must be indicated on orders. Subscription rates: United States and Possessions and Canada, \$6.00 one year, \$9.00 two years, \$12.00 three years. All other countries \$20.00 one year. Single copies, United States and Possessions and Canada 75¢. Single copies all other countries \$1.50.

THE PUBLISHER, UPON WRITTEN REQUEST TO OUR NEW YORK OFFICE FROM ANY SUBSCRIBER AGREES TO REFUND THAT PART OF THE SUBSCRIPTION PRICE APPLYING TO COPIES NOT YET MAILED.

Subscribers: Please send change of address notices, subscription orders or complaints to Fulfillment Manager, Electronics, at the address below. Change of address notices should provide old as well as new address, including postal zone number if any. If possible, attach address label from recent issue. Allow one month for change to become effective.

Postmaster: Please send Form 3579 to Fulfillment Manager, Electronics, P. O. Box 430, Hightstown, New Jersey, 08520.



Audited Paid Circulation

CONTENTS continued

HOT-CARRIER DIODES Switch in Picoseconds. New metal-semiconductor-interface diodes are removing speed limitations formerly imposed by minority-carrier storage in *p-n* junction diodes. *Making the new diodes requires very pure semiconductors and special methods for epitaxial growth and surface cleansing.* By S. M. Krakauer and R. W. Soshea, Hp Associates 53

LEADLESS TRANSISTOR PROBE WORKS UNDERWATER. Probe contains 7-Mc tunnel-diode oscillator that is frequency modulated by signal to be measured. It can measure the near-field pattern of a dipole immersed in sea water. *The same principles are useful in designing medical devices like the radio pill.* By K. Iizuka, Harvard University 56

TRANSISTOR AGC: Novel Solution to a Dilemma. Automatic gain control of transistor i-f stages has never been easy because of changes in transistor parameters with operating point. Here a transistor amplifier is used as an attenuator in a servo system. *Rectified output from feedback amplifier sets attenuator impedance.* By F. Susi, Sylvania 60

DEPARTMENTS

Crosstalk. <i>The Fragmented Engineer</i>	3
Comment. <i>Negative Resistance VI. Metric System II</i>	4
Electronics Newsletter. <i>DOD Awards Zoom</i>	7
Washington This Week. <i>Project Forecast Gets Underway</i>	12
Meetings Ahead. <i>Aerospace Electro-Technology International Conference</i>	40
Research and Development. <i>What Happens to Dielectrics in Space</i>	68
Components and Materials. <i>How Ceramic Benders Control Light Rays</i>	80
Production Techniques. <i>Module Production-Quality Assured by Thermal Cycling and Life Testing</i>	92
New Products. <i>Synchronizer Accepts PCM at Rates to 1 Mc</i>	104
Literature of the Week	120
People and Plants. <i>Airpax Completes \$1 Million Plant</i>	122
Index to Advertisers	129

The Fragmented Engineer

THE TITLE "fragmented engineer" does not mean some new engineering discipline; rather it means, in some cases, the absence of engineering discipline. It represents, unfortunately, what happens today to many of our most competent and creative engineers.

Once an engineer is recognized as being knowledgeable and dependable, it is not long before more and more people begin calling upon his time and talent for any number of worthwhile causes. And he soon becomes not an electronics engineer but a fragmented engineer.

Where he once spent most of his time planning and carrying forward his own research and development work with perhaps some time out to confer with colleagues about mutual problems or help a younger engineer over a rough spot, he now finds his professional life slowly being carved up into little bits and pieces.

Within his own company he becomes a member of a papers review committee, design review committee, reliability review committee, and maybe more. Within his professional society he may be asked to serve on a section committee, professional group committee or technical committee. He may even, God forbid, become its chairman or secretary.

He may represent his company on any number of trade association committees, or joint groups for this or that.

Then, when he has really arrived, professionally speaking, he may become a member of one or more of the many committees and panels that are forming all the time, it seems, to advise the government about things technical and scientific.

Meanwhile, he will also be delivering speeches to professional and trade association meetings, writing technical papers and articles, and possibly even testifying before various committees of the Congress.

There is no doubt that all these activities are of great value to the engineer, his company, the country and the profession. But when does the engineer now find the time to do any engineering?



It is a potentially dangerous trend that siphons off our best engineering talent and often leaves the actual research and development work either to immature or noncreative individuals.

It well may be time to examine the cost of meetings in terms of lost hours of engineering creativity and question whether we are not in danger of cross fertilizing ourselves to death in the process of creating a giant, interdisciplinary nothing.

If the engineer who feels himself becoming fragmented would look into the mirror every morning and as a minor rite repeat: "I am an engineer. *I am an engineer.* I AM AN ENGINEER, DAMMIT!" he might be better able to fend off the blandishments of those who would turn him into some kind of amateur statesman.

Likewise, men in public life and directing the activities of professional groups or societies should consider carefully the cost in lost engineering time and talent of every new technical or scientific committee they propose. In this day of the race to the moon and other manifestations of the technological cold war, engineering creativity is indeed a national resource to be used only where it can do the most good.

Let's ask ourselves whether we are out to create hot circuits and devices or just hot air.

now
available
for
immediate
delivery:

**JERROLD
RF SWEEP
EQUIPMENT
...the industry's
finest!**



**Model 900B
Super Sweep Generator**

Wide plus narrow band in one versatile instrument. Handles all 1F, VHF, UHF sweep requirements. Sweep widths from 10kc to 400mc. Frequency range from 500kc to 1,200mc. Built-in crystal-controlled harmonic markers, dc or ac scope preamplifier, precision attenuator. **\$1,980.00**



**Model LA-5100
rf Log Amplifier**

Accurate within ± 1 db over 80db dynamic range. Frequency range 500kc to 100mc. Lets you make exact measurements of attenuation in networks, filters, amplifiers with dynamic ranges down to 85 db. Total rf response displayed in precise log ratio on standard dc-coupled scope. **\$795.00**

Model 900A Wide-Band Sweeper

Sweep widths from 100kc to 400mc. Frequency range from 500kc to 1,200mc. **\$1,260.00**

Model 707 Ultra-Flat Sweeper

Flatness of ± 0.05 db in highest single octave. Plug-in oscillator heads. **\$840.00**

All for immediate delivery. Prices f.o.b. Philadelphia. Write for complete technical data on these and other Jerrold rf test instruments.



Industrial Products
Division,
Philadelphia 32, Pa.



A subsidiary of THE JERROLD CORPORATION

COMMENT

Negative Resistance VI

Concerning Mr. Lyon's letter in the May 24 issue (*Comment*, p 4), he points out correctly that negative resistance is a perplexing concept. Many of us, however, will object strenuously to using *conductance* to mean *negative resistance*. The definitions of these two terms are not the same.

Conductance, in mhos, is of course the inverse of resistance, in ohms. One is equal to I/E ; the other to E/I , providing we deal with pure resistance, and in either the d-c or a-c case.

Negative resistance is a term used, generally, in the case of varying currents, rather than steady ones. Restricting ourselves to the case where we have a varying current and a varying voltage, we may define negative resistance as follows: Consider the voltage applied to, and the current through, an element. If the change in current is proportional to the change in voltage *but in the opposite direction*, that element is said to have negative resistance.

To make the concept quite graphic, imagine a black box to which we apply a voltage, this time a *direct steady voltage*. If we apply various voltages and find to our surprise that each time we get a proportional current, but in exactly the opposite direction from that we expect with a resistive element, then we say we have a negative resistance, d-c variety.

In either the case of the d-c or a-c negative resistance, there must be power generated within the element (d-c or a-c power). This power is furnished to the circuit. The element acts like a generator as far as direction of power flow is concerned. Perhaps the term *power donor* is helpful in contrast to the *power absorber*, or resistor.

Formulae for negative resistance would use a minus sign to indicate that the current and power flow in the negative direction. For example, watts consumed equals I^2 times a negative R ; power is produced, not consumed.

OTIS N. MINOT

Minot Informativ Devices
Lexington, Massachusetts

Metric System II

When I read Mr. Poulsen's letter in the June 7 *Comment* column (p 4), I found myself in complete accord with one small exception. I would like to see you give all measurements and dimensions in the metric system (with the English equivalent following in parenthesis) immediately.

In the past few years, I have been actively engaged in metrical photogrammetry and nucleonics mensuration. Both use the metric system and, through my associations with these fields, I have already started my reorientation in which systems to use. While I still think in the English system, I find it increasingly easy to do my engineering solely in metric units. My greatest trouble, now, is communicating with my colleagues.

Any of your readers that are interested in helping with this vital change might do as I have just done: write The Metric Association, 502 Albee Building, 1426 G Street N.W., Washington 5, D.C. I haven't received their answer yet, but I feel better knowing that others feel as I do.

As Mr. Poulsen mentions in his P.S., your range of articles and coverage make *ELECTRONICS* a most desirable journal, one that I look forward to each week.

CLAUDE W. ASHBURN
Albany, California

Amplifier Gain

Your very excellent article on consumer electronics in the May 17 issue had a small error that might mislead someone. You indicate (p 49) that the amplifier of the Acousticon hearing aid has an average gain of 93 db. As a matter of fact, we do not publish the gain of the amplifier itself. The HAIC gain (average of 500, 1,000 and 2,000 cps sound pressure gain as standardized by the Hearing Aid Industry Committee) is 39 db. Could it be possible that the typesetter transposed the numbers?

HAROLD H. BEIZER
Dictograph Products Inc.
Danbury, Connecticut

It was the author, not the typesetter.

ONLY 7 INCHES OF RACK HEIGHT for this Tektronix Oscilloscope THAT ACCEPTS 12 PLUG-IN UNITS

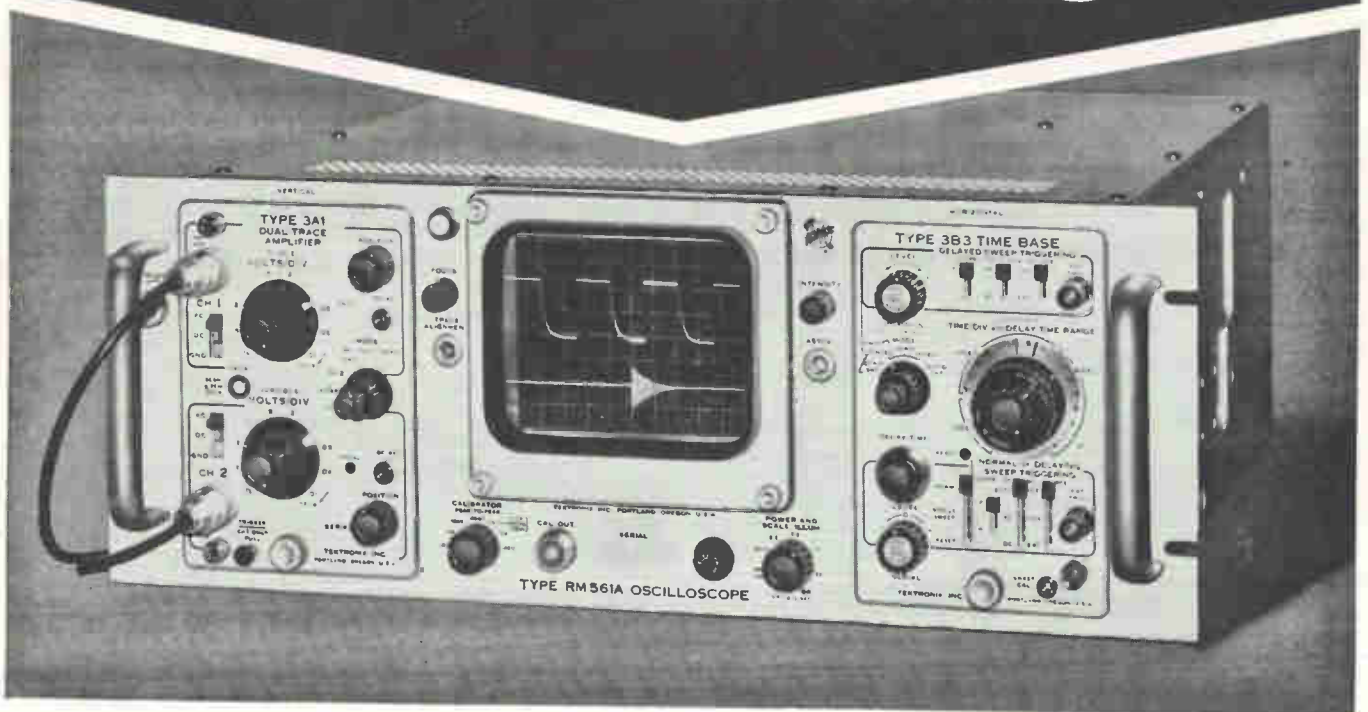

Type RM561A Oscilloscope—with Type 3A1 Dual-Trace Amplifier Unit and Type 3B3 Time-Base Unit—provides high sensitivity, wide-band, dual-trace operation combined with calibrated sweep delay in a compact, moderately priced package.

You can use any of 10 other amplifier and time-base units for differential, multi-trace, sampling, other applications, including matched X-Y displays using the same type amplifier units in both channels.

Also, you can observe no-parallax displays and sharp trace photography. For the new rectangular ceramic crt has an internal graticule with controllable edge lighting.

TYPE RM561A OSCILLOSCOPE
(without plug-ins) \$525

TYPE 3A1 DUAL-TRACE AMPLIFIER
UNIT \$410

Passband from dc-to-10 Mc for each channel • Sensitivity from 10 mv/cm to 10 v/cm in 10 calibrated steps, 1-2-5 sequence, with variable control • 6-cm linear scan • No signal delay

TYPE 3B3 TIME-BASE UNIT \$525

Normal and Delayed Sweeps from 0.1 μ sec/cm to 1 sec/cm in calibrated steps, 1-2-5 sequence, with variable control • 5X Magnifier • Single Sweep for Normal Sweep • Delay Interval from 0.5 μ sec to 10 sec • Flexible Triggering Facilities with triggered operation to above 10 Mc.

U. S. Sales Prices, f.o.b. Beaverton, Oregon

FOR A DEMONSTRATION, PLEASE CALL YOUR TEKTRONIX FIELD ENGINEER

Tektronix, Inc. / P. O. BOX 500 • BEAVERTON, OREGON 1 (Area Code 503) Mitchell 4-0161 • TWX: 503-291-6805 •
Telex: 036-691 • Cable: TEKTRONIX • OVERSEAS DISTRIBUTORS IN 27 COUNTRIES

Tektronix Field Offices are located in principal cities throughout the United States. Please consult your Telephone Directory.
Tektronix Canada Ltd: Montreal, Quebec • Toronto (Willowdale) Ontario • Tektronix Ltd., Guernsey, Channel Islands



"made-to-measure precision"

Never be casual with a complex wave

Be militant! Tackle it with a Sierra 125B, the brisk, businesslike Frequency Selective Voltmeter that never lets you stray more than a db away from the readings you ought to be getting.

Poised on the brink of a wave, the 125B literally ripples with diverse capabilities. It's a tunable voltmeter with one continuous tuning range from 3 to 620 kc and dual selectivity bandwidths. Or, as the occasion demands, it can serve you as a broadband a-c voltmeter with essentially flat response from 1 to 620 kc. Its sensitivity varies from $24.5 \mu\text{v}$ to 30 v in eleven attenuator steps.

The 125B costs a brisk, businesslike \$895 — a touch more for models with carrier reinsertion or multiple input switching. Memo us in singlicate for a brochure that communicates on your wavelength. Or you might try waving at your Sierra sales representative for a response that'll be anything but flat.

SIERRA ELECTRONIC DIV.

OF
PHILCO.

A SUBSIDIARY OF *Ford Motor Company.*

Sierra Electronic Division / 3885 Bohannon Drive / Menlo Park 1, California

DOD Awards Zoom as Fiscal Year Ends

WASHINGTON—The Pentagon has had good news lately for the electronics industry. Although the volume of prime contracts is still behind the amount scheduled for the fiscal year which ended June 30 (p 7, June 28), a spurt in awards during the last days of the year has done much to correct the imbalance.

The awards are just now being announced and include several in the \$20-million-and-up category and many others that total less than \$1 million. The Pentagon has no statistical data yet on the contracting zoom. Such figures aren't normally available for at least two months after the fact.

Pentagon spokesmen say there is no great mystery about the rise. The last couple of weeks of a fiscal year are traditionally a period in which formal contract awards pour out at a spectacular rate. This is because the procurement agencies must commit the funds before June 30 or risk going through lots of red tape to get authority to contract out the money again in the next fiscal year.

Ship's Engines Get Automatic Controls

AN AUTOMATIC control system for a marine propulsion unit has been developed by Allgemeine Elektrizitäts-Gesellschaft (AEG). The system is now being demonstrated on a test stand in which the AEG remote-control system has been combined with a 5500-horsepower, five-cylinder diesel engine commonly used for shipboard installations.

The system eliminates the human intermediary link between the bridge command and the engine room. The commands are still generated on an engine-room telegraph, but the new system automatically checks the acceptability of the command, and initiates whatever commands are necessary to

control the diesel engine. The programming of the control system is designed to prevent damage caused by improper commands.

Laser Gives Hope For Cancer Cure

BOSTON — Researchers at Tufts-New England Medical Center here have cautiously reported that a method for destroying cancerous tissue may result from studies now being conducted with the laser. The scientists, using a device supplied by Raytheon, say they will also investigate the laser's effect on occlusive lesions of the arterial system.

The experiments were begun in October, 1962, by Dr. Paul E. McGuff of the center and David Bushnell of Raytheon. "Since that time, an intensive series of experiments has been carried on using hamsters and human biopsy and autopsy specimens," the center announced. "The major emphasis to date has been in the study of 14 types of malignant tumors, with well over 200 tissue specimens or hamsters with transplanted human tumors having been exposed to laser energy."

PRESIDENT ELECTED

On Monday afternoon, Donald C. Burnham was elected president and chief executive of Westinghouse Electric Corp. He also became a member of the board of directors. Former president, Mark Cresap, Jr. resigned for reasons of health. Burnham was formerly vice president in charge of the company's Industrial Group.

"It has been observed that the laser has a maximal effect on certain malignant tumor tissues and a minimal effect on normal tissues," center explained. "The extensive early destructive effect of the laser on certain types of transplanted human malignant tumors lends some encouragement to the belief that this energy may have an ultimate medical use. However, until the lasting effects can be determined and the restricting factors relating to the application of the laser to humans have been determined, it is premature to draw any firm conclusions at this time."

Energy densities ranging from 17 to 12,000 joules per square cen-

400-Kilogauss Magnet Predicted

A MAGNET capable of producing fields in excess of 400 kilogauss will hopefully be built and operated within the coming year, it was reported at Oxford, England last week by staff members of the National Magnet Laboratory at MIT. Speaking at the second International Conference on High Magnetic Fields at Oxford University, MIT professor and magnet pioneer Francis Bitter reported that the plan is to make full use of the new magnet lab's four generators with flywheel energy storage, harnessing 32 megawatts for a few seconds of 400 Kg operation (p 56, May 17). This would be the world's most powerful magnet yet.

The strength problem, though severe, appears to be soluble in terms of techniques already developed for the NML's 250 Kg magnet, Bitter told the international conference, adding that the main problem is to provide adequate cooling. The NML scientists are planning to use a pulsed cooling technique

timer were applied to the surface of the tissue samples through a double convex lens. A 360-joule Raytheon laser of the same design as used in these tests has blasted holes in 3/8-inch thick girders.

Capacitors Would Store Solar Energy for Rockets

HUNTSVILLE, ALA.—A NASA man at Marshall Space Flight Center here says he has invented a new electrical power system for space rockets. The system would gather solar energy and store it in capacitors, which would also serve as part of rocket's bulkhead structure.

Robert J. Schwinghammer, the inventor, is section chief of one of the MSFC methods research and development branches. He says the stored energy could be used to energize on-board components, such as lasers, radar, and electric engines, and for vehicle coupling activities where short bursts of power are needed for fabrication-assembly operation. The inventor says the capacitors would have no moving parts, no hydraulics and no pneumatics and would not be subject to the lubrication, sealing and vapor-pressure problems present when conventional power systems are used in space.

Lower-Cost Computer Offered for Typesetting

NEW YORK—IBM moved into the automatic typesetting field in a big way last week, announcing that five daily newspapers, a book printer and a job printer have ordered its new system, built around the IBM 1620 computer. The IBM system sells for as little as \$82,650, depending on attachments, but does not punch tape until all editorial corrections have been made. The system introduced last winter by RCA, priced about \$300,000, punches tape directly from reporter's typewriter.

Other computer companies are expected to introduce typesetting systems in the near future, ELECTRONICS learned. The potential market is huge. There are more than 1,700 daily newspapers in the U.S. Significantly, the IBM announcement mentions orders from news-

papers, notably The New York Daily News and The Washington Evening Star, that have agreements with unionized typographers. Papers ordering the RCA system last winter employed non-union printers.

Bertram Powers, president of the New York Typographical Union, Local 6 told ELECTRONICS his union has yet to come to an agreement with The Daily News on the new system but he "hopes this thing can be faced with reason." He said the system might result in fewer jobs but that his union would not oppose it so long as those printers currently employed are protected.

Titan III First Stage Static Fired Tomorrow

FIRST STAGE of the Titan III-C will be static fired for the first time tomorrow. The 85-foot high, 120-inch-in-diameter booster is the largest solid fuel motor to be developed and static fired in the U.S. It will be fired upside down, exerting a million pounds of thrust into a concrete thrust block, 30 feet square and 20 feet thick. Launch site will be United Aircraft's Development and Test Center, Coyote, Calif.

In an operational mission, two of these boosters will be "strapped-on" to the Titan III-A (thus converting it into a Titan III-C) and fired simultaneously. The Titan III-A consists of a modified Titan II "core" with a new upper stage and control module mounted on top.

Titan III will be capable of putting payloads of 5,000 to 25,000 pounds into relatively low orbits, accommodating payloads ranging from ten tons in a 100-nautical-mile orbit to 13,000 pounds in a 1,000-mile orbit.

Developed specifically for space work, Titan III will be able to handle a variety of manned and unmanned missions. First manned mission will be Dynasoar.

Associate contractors include: Martin-Marietta—airframe, assembly, test and systems integration; Aerojet General—liquid propulsion system for the first and second stages of the core in the transtage; United Technology Center—120-inch segmented solid rocket motors; AC Spark Plug—inertial guidance.

In Brief . . .

ATOMIC ENERGY Commission has extended its contract with Edgerton Germeshausen and Grier through 1968. The contract for fiscal year 1964 totals \$32 million.

COMMUNICATIONS Satellite Corp. is requesting proposals for study of multiple access systems for communications satellites, to replace the single-channel system in use today. Requests went to RCA, ITT, Bell Telephone Laboratories, General Telephone and Hughes.

NASA has given Lear Siegler a \$3.5-million contract to build data acquisition systems at Marshall Space Flight Center. Lear Siegler had previously received contracts totaling \$6.5 million for this program.

NATIONAL INSTITUTES of Health and NASA are supporting a major center for computer technology and biomedical research. The center will be managed by 12 New England universities and will be located in Cambridge, Mass.

ITT PLANS to buy Cannon Electric Co.

THE COMMON MARKET, in an attempt to close the five-year gap between Europe and the USA, is planning to expand computer installations tenfold by 1970. This will represent an investment of \$600 to \$700 million.

RADIATION INC. was awarded a \$1.2 million contract from AC Spark Plug for telemetry systems to be used in the Titan III.

EMI ELECTRONICS in Great Britain is demonstrating a separate-luminescence color tv technique using a four-tube camera operating in NTSC, SECAM and PAL systems but requiring only enough light for a monochrome studio.

MARTIN received an Air Force contract for \$100,000 to develop a new type of direct-energy conversion device. The device would be used in space missions where long-term reliability is important.

New Bridge Design For Safe, Accurate, Easy Measurement of 'Lytic Capacitors



The Sprague Model 1W2A Capacitance Bridge introduces new, improved technical refinements as well as restyling for added attractiveness and ease of operation. Built by capacitor engineers for capacitor users, it incorporates the best features of bridges used for many years in Sprague laboratories and production facilities.

Precision Measurements over Entire Range from 0 to 120,000 μ F

The internal generator of the 1W2A Bridge is a line-driven frequency converter, and detection is obtained from an internal tuned transistor amplifier-null detector, whose sensitivity increases as the balance point is approached. It has provision for 2-terminal, 3-terminal, and 4-terminal capacitance measurements, which are essential for accurate measurement... $\pm 1\%$ of reading + 10 μ F... of medium, low, and high capacitance values, respectively.

No Damage to Capacitors

The model 1W2A Capacitance Bridge will not cause degradation or failure in electrolytic or low-voltage ceramic capacitors during test, as is the case in many conventional bridges and test circuits. The 120 cycle A-C voltage, applied to capacitors under test from a built-in source, never exceeds 0.5 volt! It is usually unnecessary to apply d-c polarizing voltage to electrolytic capacitors because of this safe, low voltage.

Complete Specifications Available

For complete technical data on this precision instrument, write for Engineering Bulletin 90,010A to Technical Literature Service, Sprague Electric Company, 35 Marshall Street, North Adams, Massachusetts.

485P-120-63

Did you know Sprague makes...?

MAGNETIC LOGIC DEVICES



Core-diode and core transistor magnetic shift registers and magnetic counters for switching and storage applications in computer and logic circuitry.

CIRCLE 277 ON READER SERVICE CARD

MOLDED PULSE TRANSFORMERS

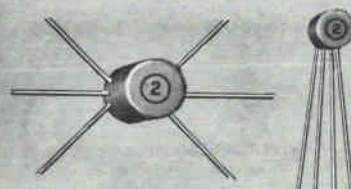

Miniature Pulse Transformers with tough molded cases for increased protection against physical damage and severe atmospheric conditions.

CIRCLE 278 ON READER SERVICE CARD

NANOSECOND PULSE TRANSFORMERS IN TO-5 TRANSISTOR CASES

Special design offers distinct advantages: (1) Mini-fied size. (2) Welded hermetic seal. (3) Increased reliability. (4) Compatibility with transistor mounting techniques.



CIRCLE 279 ON READER SERVICE CARD

SOMETHING NEW IN COUNTING TECHNIQUES

Simple yet versatile, low-cost yet reliable counters available for predetermined (2 to 11) or selectable (5 through 10) counting cycles.



CIRCLE 280 ON READER SERVICE CARD

DYNACOR[®] BOBBIN CORES



Series "300" Cores with logical flux values in popular physical sizes are stocked in production quantities for fast delivery. They're value engineered for quality with economy!

CIRCLE 282 ON READER SERVICE CARD

HERMETICALLY-SEALED TO-5 ENCASED SWITCH CORES

Designed especially for high-speed, low-power switching up to 100 kc, adaptability with conventional transistor packaging techniques, and performance under MIL-S-21038 environmental conditions.



CIRCLE 281 ON READER SERVICE CARD

ELECTRONIC MODULES TO CUSTOMER REQUIREMENTS



Custom packaging is no novelty at Sprague's Special Products Division, where "specials" are continually being developed and produced with countless variations in electrical characteristics and mechanical configurations.

CIRCLE 283 ON READER SERVICE CARD

For application engineering assistance (without obligation, of course) on any of the above products, write or call the Special Products Division, Sprague Electric Company, 35 Union Street, North Adams, Massachusetts.

485P-111-63

SPRAGUE[®]
THE MARK OF RELIABILITY

"Sprague" and "S" are registered trademarks of the Sprague Electric Co.

How much do you know about today's high-frequency scopes?

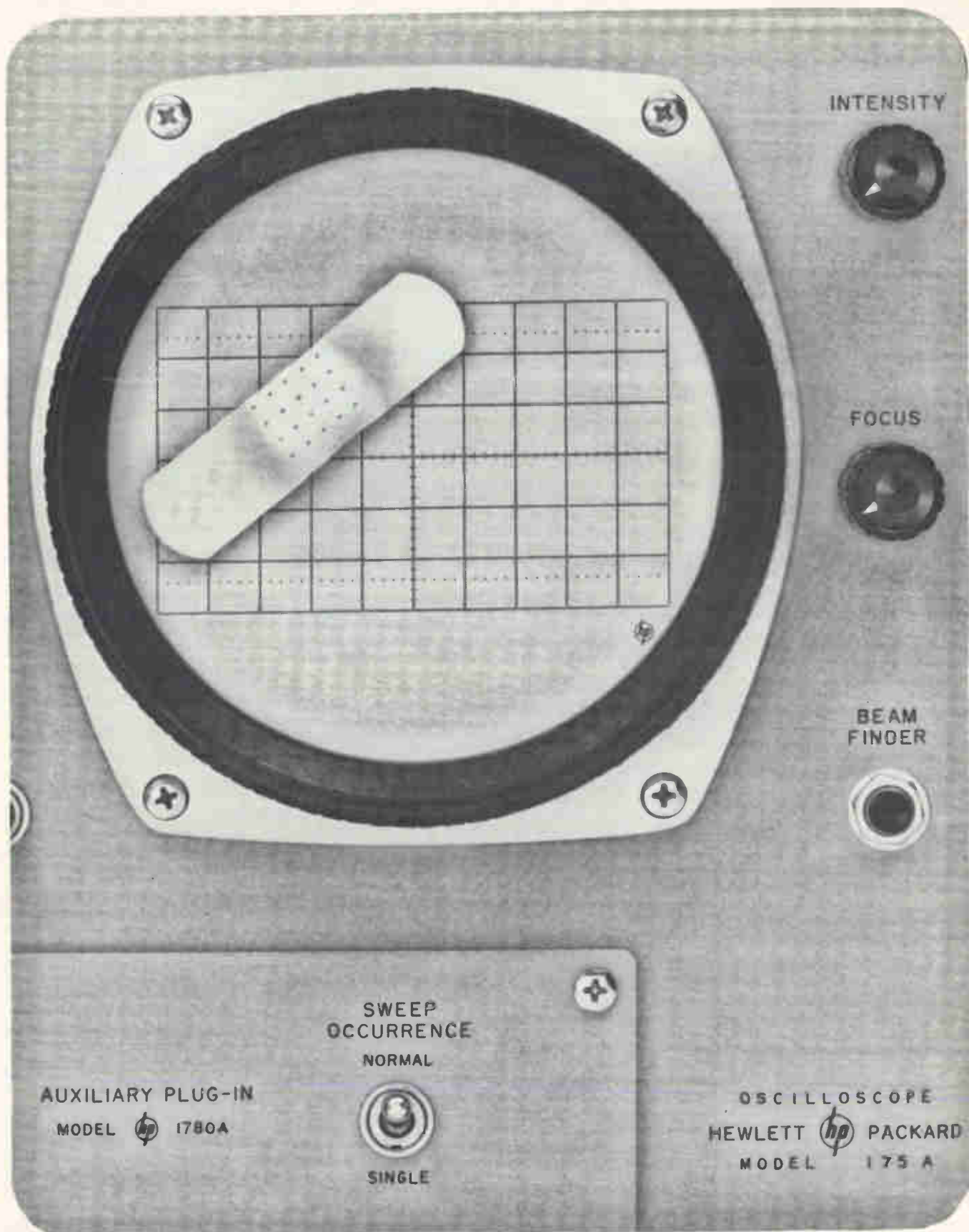

First aid?

First aid?

Internal medicine... Even if you're not the chief maintenance man on your oscilloscope, alignment, calibration and adjustment can be real problems for scope users, as well. Add to that the down time required by routine maintenance, and you see the true importance of having a scope that's both reliable and easy to keep on the air.

It's pretty basic that the simpler the circuitry, the easier the alignment and maintenance, and when you can have simplified circuitry *plus* the best performance, it's well worth investigating. Our 175A Oscilloscope uses simple circuitry, as witness the total output amplifier of its main vertical amplifier:

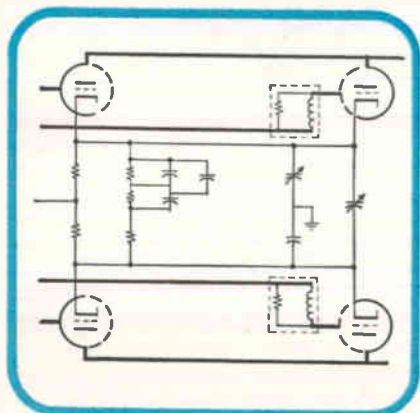

If you've ever calibrated and aligned a high-frequency scope — even if you've made the periodic routine adjustments — you know it's no easy matter. Even changing a tube can require quite a bit of readjustment of circuit components.

Consider, then, the problem: Conventional high-frequency scopes employ complicated distributed amplifiers in the vertical deflection system. These amplifiers produce the large voltages needed to drive conventional high-frequency crt's. They require inductance coils and trimmer capacitors which need to be delicately tuned because they're interdependent. Next time you attempt this task, time yourself.

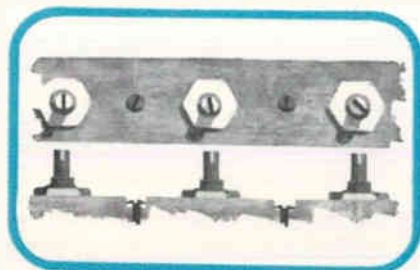

For the 175A 50 MC Oscilloscope, we developed a new 12 kv cathode ray tube, a tube so sensitive that deflection circuitry can be simplified at no sacrifice in performance. Gone are distributed amplifiers and their tedious adjustments. Alignment time is vastly reduced from that required for conventional scopes.

What's more, the 12 kv crt in the 175A provides a picture 6x10 cm, larger than the 4x10 cm picture on the conventional high-frequency scope. An internal graticule eliminates parallax error, and a specially etched glass produces a non-glare faceplate. There you've got unprecedented accuracy.

Next, check your present scope instruction manual for adjustments required on your vertical delay circuitry . . . another time-consuming procedure. For the 175A we developed a high-frequency balanced cable delay line which has no adjustments — it's sealed. Altogether, the main vertical amplifier in the 175A Oscilloscope requires only five simple, independent adjustments.

You're familiar with the number of components you have to keep on hand to maintain the conventional scope . . . and you're familiar with the term "selected" components. Most scopes use many tube types, for example, including some "selected" tubes . . . components that can only be replaced with tubes of identical characteristics or with considerable realignment.

The 175A uses only 7 tube types and 5 transistor types . . . and none of them are "selected." Each can be replaced with any tube or transistor of the same type. See what that fact does to your parts inventory . . . and use your valuable shelf space for something else.

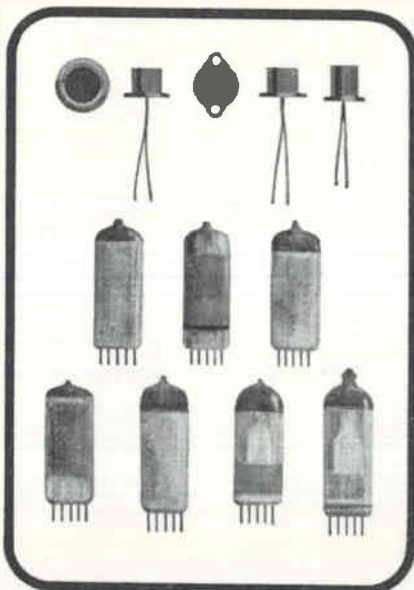

Now consider the mechanical convenience (or inconvenience) of maintenance on your present high-frequency scope . . . inaccessible circuits and components, solder joints that are hard to get at. With some scopes maintenance is practically like factory assembly.

The 175A is packaged in our modular cabinet, sides, top and bottom of which are easily removed for access to all components. Circuit boards with plated-through holes are connected to their circuits with

"edge-on" connectors, greatly simplifying removal and replacement.

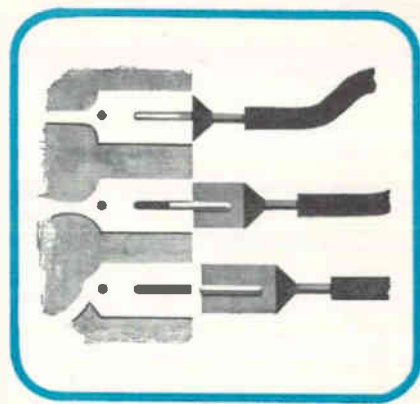

Other virtues of the 175A: Horizontal and vertical plug-ins . . . such as dual- and four-trace and high sensitivity vertical viewing, sweep delay and x-y recording capabilities . . . when, but not unless you need them. They're all available with the 175A — as plug-ins.

Positive preset syncing over the entire bandwidth, the easiest triggering and the most dependable triggering you can find. Fewer controls, easier to use. A novice can learn to use the 175A in half the time it'll take him to learn the intricacies of other scopes.

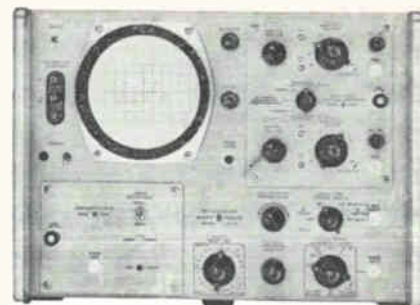

We're not just "demonstrating" the 175A these days. We're actually letting you *use* it, stack it up alongside any high-frequency scope you can find, compare them feature by feature. And feature by feature you'll say to yourself, "This is great." Feature by feature our competitors will ask, "Why didn't we think of that?" hp 175A, \$1325 (without plug-ins).

Data subject to change without notice. Price f.o.b. factory.

HEWLETT PACKARD COMPANY



1501 Page Mill Rd., Palo Alto, Calif., (415) 326-7000. Sales and service representatives in principal areas. Europe, Hewlett-Packard S.A., 54 Route des Acacias, Geneva, Switzerland; Canada, Hewlett-Packard (Canada) Ltd., 8270 Mayrand St., Montreal, Quebec.

WASHINGTON THIS WEEK

USAF TO FORECAST 1970's REQUIREMENTS

THE AIR FORCE has launched a major study on what its mission and weapons systems will be through the 1970's. Operating under the name of Project Forecast, more than 300 top level military, industry and scientific experts are working on the project under General Bernard A. Schriever, commander, Air Force Systems Command.

The group is projecting the probable military missions for this time period, then appraising technology to determine what weapons can be developed to meet the mission requirements. It will be several months before the study is completed, with the recommendations certain to be highly classified.

The Air Force will undoubtedly recommend development of military space weapons. Meanwhile, Air Force is optimistic that Defense Secretary McNamara will allow it to continue development of the manned Dynasoar spacecraft. A decision on Dynasoar's future is due soon.

COMPETITIVE BUYING SAID TO SAVE \$40 MILLION

PENTAGON ESTIMATES savings of \$40-million during first 10 months of fiscal year 1963 by shifting from noncompetitive to price competitive buying of electronic and communications equipment.

Examples: price of the R-442 radio receiver was trimmed from a non-competitive quote of \$1,519 to \$1,034 in competition (total gross savings \$908,890); RT-246 receiver/transmitter was cut from \$3,976 to \$2,692, with total savings of \$927,048; price of the RT-524 receiver/transmitter was reduced from \$3,074 to \$2,036, resulting in \$7.4-million total savings; and the AN/PRC-25 man pack radio (see p 36) was trimmed from \$2,278 to \$843, saving \$10.5 million. The original sole-source supplier for the PRC-25 was RCA's Military Products division. In the follow-on competition, the firm's Commercial Products division came in with a bid price some 60 percent lower, McNamara said.

DOD SAYS USE OF EXCESS INVENTORIES SAVES BILLION

MCNAMARA REPORTED supply savings of \$1 billion in the past year and set a target of almost 4-billion annual cost reductions over the next three years.

The savings, McNamara said, result from increased use of excess inventories, "refining requirements calculations," eliminating "gold-plating" from specifications (one example involved use of an ordinary women's hair wave clip, cut to size, instead of a heat sink, to prevent soldering heat from damaging transistors; this reduced the unit cost from \$1.35 to 2 cents); shifting from noncompetitive to competitive procurement; and shifting from cost-plus to fixed price and incentive contracts.

BIGGER FIRMS ARE NOW "SMALL BUSINESS"

THE GOVERNMENT has revised its official definition of electronics small business. Up to now, firms with no more than 500 employees were so classified, and thus qualified for whatever preference was granted to small firms in government procurement.

The work force maximum has now been lifted to 750 for manufacturers of radio and tv receiving sets (except communications); radio and tv transmitting, signaling, and detection equipment; cathode-ray picture tubes; and transmitting, industrial, and special-purpose electron tubes. The limit is now raised to 1,000 workers for producers of radio and tv receiving-type electron tubes, except cathode ray.

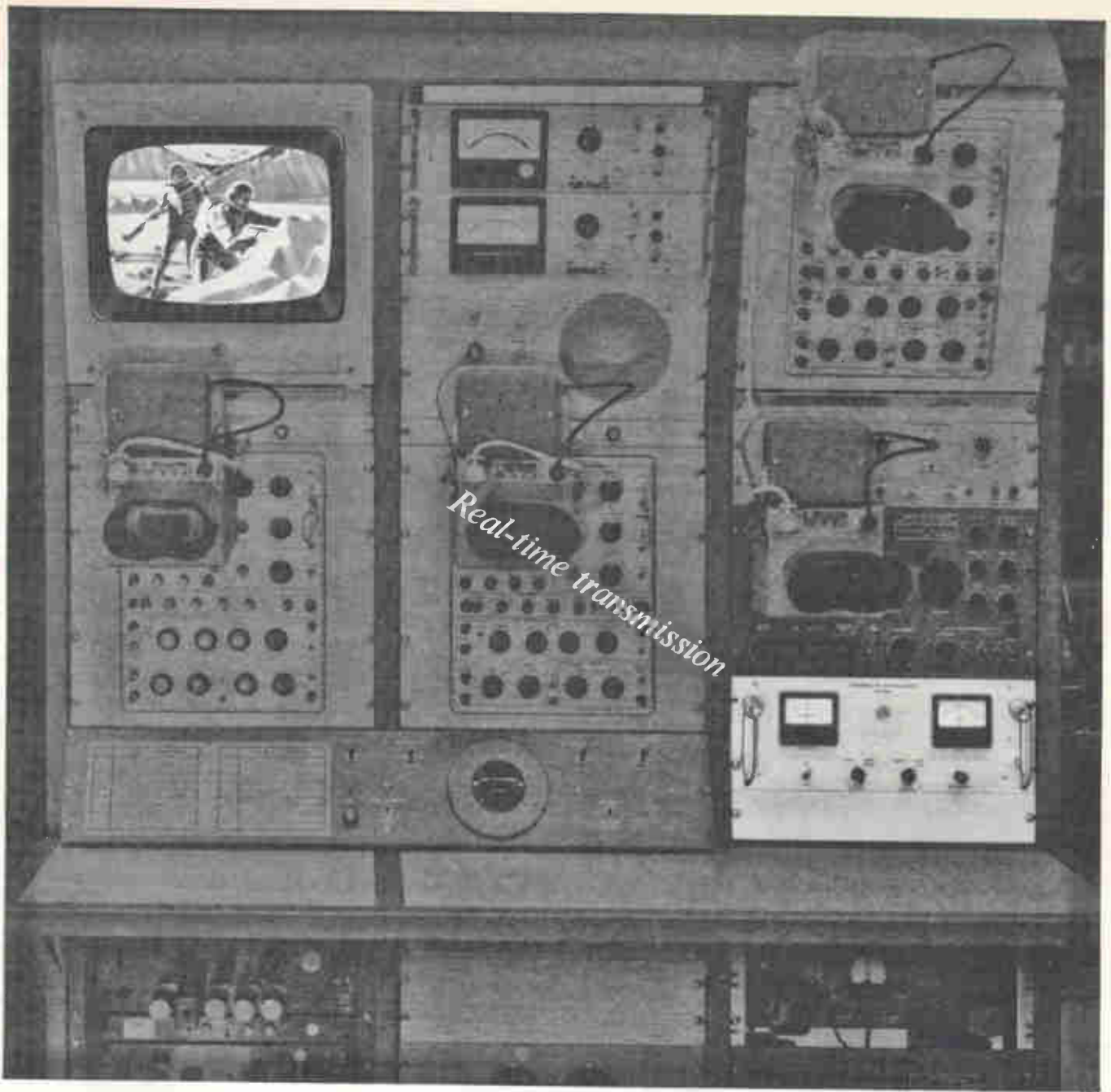

If a TV signal were beamed earthward from the surface of the moon tomorrow, a wideband phase-lock demodulator built by STL could pick it up and faithfully reproduce it. The new demodulator is already aboard Project Relay. Two important advances in FM design distinguish the STL demodulator. First, it allows reduction of spacecraft transmitter power by a factor of four. Second, its loop 3 db bandwidth of 7.5 megacycles is wide enough for real-time transmission of full bandwidth television or multichannel telephony. Scientists and engineers interested in advancing the art of space communications will find STL an active place. STL builds spacecraft for NASA and Air Force-

ARPA, and continues Systems Management for the Air Force's Atlas, Titan and Minuteman programs. These activities create immediate openings for Space Physics, Radar Systems, Applied Mathematics, Space Communications, Antennas and Microwaves, Analog Computers, Computer Design, Digital Computers, Guidance and Navigation, Electromechanical Devices, Engineering Mechanics, Propulsion Systems, Materials Research. For Southern California or Cape Canaveral positions, write Dr. R. C. Potter, One Space Park, Redondo Beach, California, Department G-7, or Post Office Box 4277, Patrick Air Force Base, Florida. STL is an equal opportunity employer.



SPACE TECHNOLOGY LABORATORIES, INC.
a subsidiary of Thompson Ramo Wooldridge Inc.

Los Angeles • Vandenberg AFB • Norton AFB, San Bernardino • Cape Canaveral • Washington, D.C. • Boston • Huntsville • Dayton • Houston
Those attending the Aerospace Conference in Washington August 4-9 are cordially invited to visit STL Booth 93



TIPS (Technical Information and Product Service)

7 NEW G-E DEVELOPMENTS

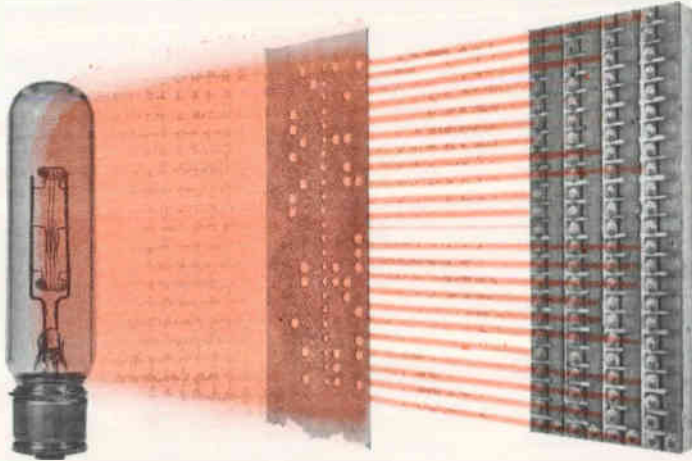

3 new G-E photoconductive devices offer a host of new uses

Photoconductive Arrays: Newly developed photoconductor arrays (illustrated) offer many promising applications, especially for data processing, industrial automation, telephony, photocopying, proportional control devices, and alarm systems of all sorts.

The cadmium sulfide or cadmium selenide cells in the arrays can provide a wide range of electrical characteristics to meet specific needs: *spectral response* 5,500-7,300 angstroms; *light resistance* 100-125 K ohms @ 1-5 ft-c; *dark resistance* 15-100 megohms; *power dissipation* 50-400 mw.

Tightly compact 20-, 40-, 90-cell and even more complex G-E photoconductor arrays are now under development. Pinpoint photosensitive areas can be tailored to almost any design configuration.

Photosensitive "Siamese twins." Double-cell G-E photoconductors, in two sizes, also are now available. Each highly sensitive, hermetically sealed unit has three flexible leads, one interconnecting both photosensitive areas. Electrical characteristics can be varied considerably to meet special needs.

New PC-L devices make noiseless controls and rugged low-level switches. G.E.'s new PC-L (photoconductor-lamp combination devices) are light-tight packages which enclose a photoconductive cell and a variable illumination source. Photoconduction is controlled by varying the voltage to the light source. Circuit isolation, noiseless potentiometry, and reliable low-level switching are just a few of the new product possibilities that G-E PC-L devices open up. Here are typical characteristics:

Developmental Types:	Y 1079	Y 1128	Y 1138	Y 1248
Lamp rating	5v 60ma	5v 60ma	5v 60ma	28v 40ma
Max. photoconductor voltage	60v	30v	60v	60v
Power dissipation	150 mw	75 mw	250 mw	100 mw
Photoconductor resistance (ohms) for various lamp input voltages	45 @ 4v 3K @ 1v	150 @ 4v 17K @ 1v	45 @ 4v 3K @ 1v	50 @ 20v 1700 @ 6v

Free booklet gives application data and specifications on the complete line of "standard" G-E photocells—get yours today!

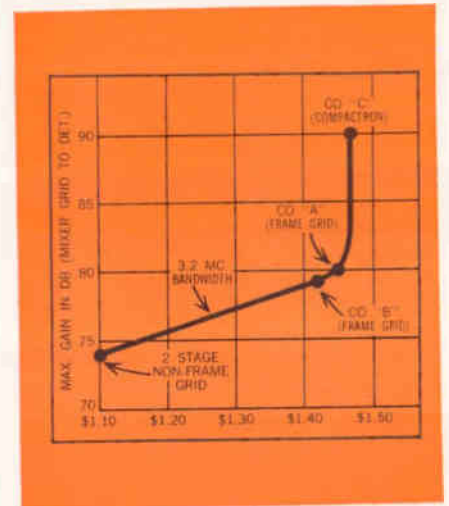

Compactron IF amplifier gives 15% higher gain than comparably priced frame-grid types

Value IF amplifier cost-and-performance figures were determined for TV sets of three manufacturers:

Two manufacturers, Co. "A" and Co. "B," used the popular 6EH7 and 6EJ7 frame grid tubes plus a frame grid mixer. The third, Co. "C," used a 3-stage IF amplifier consisting of a 6AR11 compactron plus a non-frame grid 6JN8 pentode and a less expensive non-frame grid mixer.

The results showed that *all three* amplifiers fell in the cost range of \$1.40-\$1.49.* However, the compactron version gave 90 db maximum gain as compared to only 78 db for the frame grid types. In all cases, gain was measured from mixer grid to detector; bandwidth was 3.2 mc.

To increase gain, Co. "A" and Co. "B" have chosen to allow IF "pole shifting" to occur so that at maximum gain (fringe area signal) the bandwidth reduces to about 1.5 mc. This yields about 6 db more gain—still 6 db less than the compactron version.

*Includes price of IF tubes, plus component and socket cost differences and tuner cost difference for frame grid mixer required by Co. "A" and Co. "B."

CIRCLE 200 ON READER SERVICE CARD
July 19, 1963 • electronics

FEATURE THE "ACCENT ON VALUE"



More G-E compactrons in tomorrow's radio, TV, hi-fi, and industrial equipment

 Over 40 of today's major equipment manufacturers have joined the move to compactrons. Many of the 65 compactron types now available have been designed into equipment such as: portable and console TV sets, electronic organs, telemetering units, sweep generators, mobile and fixed communication equipment, stereo tuners, multiplex adapters, microwave amplifiers, halogen leak detectors, and precision power sources.

Major reasons for this mushrooming growth of G-E compactrons are: (1) performance, (2) lower costs. Compactrons overcome the limitations of tubes and transistors and deliver more watts per cubic inch than any other component. They have a lower initial cost per function and offer savings in labor and materials.

By combining several functions into one low-profile envelope requiring fewer pins, stems, sockets, welds, and handling, compactrons provide increased reliability and more compact circuitry, when compared to present-day components.

They cost less than tubes or transistors and use up to 35% less power to perform the same function. Compactrons reduce hardware, wiring, and soldering connections and lower assembly time. Heat dissipation is up to 35% better than with conventional tubes, increasing life and reliability. Multifunction design provides more compact circuits, allowing use of a smaller chassis and cabinet with resultant savings in materials.

CIRCLE 201 ON READER SERVICE CARD
electronics • July 19, 1963



New areas of design opened up by highly sensitive subminiature magnetron

 Two curves, illustrated above, emphasize the Z-2935's ability to produce large changes in frequency with slight changes in plate voltage and magnetic field strength. Typical sensitivities: for voltage, 1CPS/mv, or for magnetic field strength, 100 CPS/gauss. Specifications of the Z-2935 are:

Heater Voltage, AC or DC+	6.3±0.3 Volts
Heater Current	0.15 Amperes
Plate Voltage	25 Volts
Internal Shield Voltage	
Positive	5 Volts
Negative	5 Volts
Cathode Current	6.0 Milliampers
Heater-Cathode Voltage	
Heater Positive with Respect to Cathode	25 Volts
Heater Negative with Respect to Cathode	25 Volts

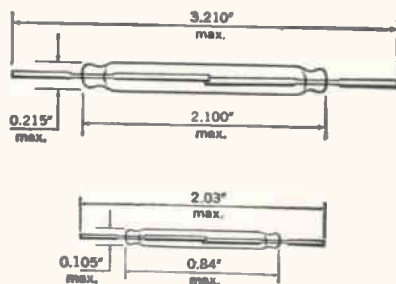
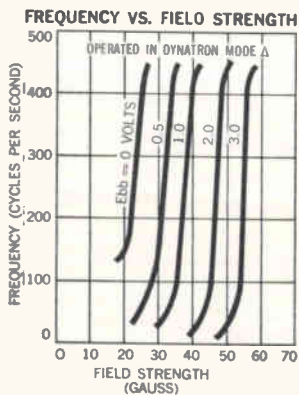
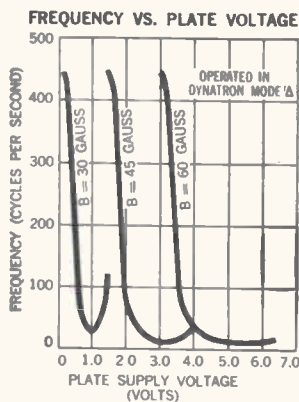

Versatile G-E reed switches outlive, outspeed, outswitch any other mechanical switching device

 G-E dry reed switches are designed to work perfectly, with milliwatt sensitivity, up to 100 million cycles or more. They're small, simple, rugged, and fast acting. All types are magnetically actuated. Contacts are pure gold, silver, or rhodium.

Dry reed switches appeal especially to the designer who can't let well enough alone. Appliances, alarm systems, telephony and data processing gear, and virtually all other electro-mechanical equipment can be improved with economical dry reed switches.

Some typical performance characteristics:

SWITCH TYPE:	ZDR15	ZDR50	Y1027	Y1136
Life expectancy (at half load)	100 million operations	100 million operations	15 million operations	100 million operations
Ampere turns Pull-in	90 ± 15	90 ± 15	43 ± 7	90 ± 15
Release	35 ± 10	40 ± 10	25 ± 6	65 ± 10
Max. contact rating (DC resistive)	15 watts 250 volts 1 amp	50 watts 250 volts 3 amps	4 watts 250 volts 250 mA	15 watts 250 volts 1 amp
Max. contact resistance	50 milli-ohms	150 milli-ohms	150 milli-ohms	50 milli-ohms
Length (excluding leads)	2.10"	2.10"	0.84"	2.10"

Progress Is Our Most Important Product

GENERAL  ELECTRIC

For more information: Write G-E Receiving Tube Dept., Technical Information and Product Service (TIPS), Room 7013-C, Owensboro, Ky. Please specify product(s).

CIRCLE 202 ON READER SERVICE CARD

CIRCLE 15 ON READER SERVICE CARD



NEW

FM STEREO MODULATOR

TYPE 219-A



- Direct (L) & (R) Inputs
- SCA Input
- Internal Preemphasis
- Internal 1 KC Modulating Oscillator
- Peak Reading Output Meter
- Self-Checking Switchable Matrix

INPUT CHARACTERISTICS

LEFT (L) & RIGHT (R) INPUTS

Frequency Range: 50 cps — 15 KC

Level: 1.7 + 0.3 volts rms*

*For 45% peak multiplex output; simultaneous (L) and (R) inputs yield 90% peak multiplex output

Preemphasis: 75 μ sec preemphasis switchable in or out of circuit

SUBSIDIARY COMMUNICATIONS (SCA) INPUT

Frequency range: 20 — 75 KC

Level: 1.0 volt rms*

*For approx. 10% peak multiplex output

MODULATING OSCILLATOR CHARACTERISTICS

Osc Frequency: 1 KC

Osc Output: Switchable into either (L) or (R) input

SPECIFICATIONS:

The FM Stereo Modulator Type 219-A is designed to provide a multiplex output signal in accordance with FCC Docket 13506 when fed with Left (L) and Right (R) audio stereo channel inputs and/or subsidiary communications FM sub-carriers (SCA). The output of the modulator may be switched to provide either (L + R), (L - R), 19 KC pilot carrier, 38 KC residual carrier or the complete multiplex signal which can then be used to modulate a suitable FM Signal Generator. When used with the BRC Type 202-E, no external audio oscillator or other equipment is required.

A peak reading metering system, calibrated in % of system deviation, is provided for setting and monitoring the levels of the individual sub-carriers. The internal matrix may be switched from the normal condition to provide either (L + R) or (L - R) null for checking the matrix in the receiver under test. The modulator is completely self-contained and housed in a single cabinet which may be adapted for standard rack mounting.

BOONTON RADIO COMPANY

A Division of Hewlett-Packard Company



GREEN POND ROAD, ROCKAWAY, NEW JERSEY

Tel. 627-6400 (Area Code 201) TWX: 201-627-3912 Cable Address: Boonraco

OUTPUT CHARACTERISTICS

Level: 0 — 7.5 volts peak*

*Multiplex output

Residual Hum & Noise: > 60 db below 100% output

Crosstalk*: > 40 db below 100% output

*(L - R) into (L + R)

METERING

Range: 0 — 10%* (19 KC and 38 KC only); 0 — 100%*

*Multiplex output; output adjustable 0 — 7.5 volts peak for 100%

Output Modes: Switchable for (L + R), (L - R), 19 KC pilot carrier, 38 KC residual carrier, or multiplex signal

PILOT CARRIER

Frequency: 19 KC

Accuracy: \pm 0.01%

MONAURAL (L + R)

Fidelity: 50 cps — 15 KC \pm 1 db*

* \pm 0.2 db and \pm 1.5° relative to (L - R)

DOUBLE SIDEBAND SUPPRESSED CARRIER (L - R)

Frequency: 38 KC

Fidelity: 50 cps — 15 KC \pm 1 db*

* \pm 0.2 db and \pm 1.5° relative to (L + R)

SUBSIDIARY COMMUNICATIONS (SCA)

Fidelity: 20 — 75 KC \pm 0.5 db

OSCILLOSCOPE SYNC SIGNAL

Frequency: 19 KC

Output Level: 0.5 volts rms

Price: \$975.00 F.O.B. Rockaway, N. J.

silicon planar

reliability in

2N1722

and

2N1724

power transistors



New from Transistron

The most recent achievement of Transistron's Total Reliability Program, these new planar versions of the highly popular 2N1722 and 2N1724 NPN silicon power transistors have the greater inherent reliability associated with advanced surface passivation techniques. They readily replace mesa versions in existing circuitry. Both offer lower leakage current, lower saturation voltage, better power dissipation and improved beta linearity. The 2N1722 is packaged in a flange type mounting, the 2N1724 is an 11/16" hex base, stud-mounted package. Both are available through your Transistron Distributor. For complete information, write to Transistron, Wakefield, Massachusetts.

Type	DC Current Gain (@ $I_c=2$ Amps (β))	Typical Collector Saturation Voltage (@ $I_c=2$ Amps (Volts))	Minimum Sustaining Voltage (@ $I_c=200$ mA (Volts))	Typical Cut-Off Frequency (@ $I_c=100$ mA (Mc))	Power Dissipation Rating (@ 100°C Case (Watts))
2N1722 } 2N1724 }	20-90	0.3	80	20	50

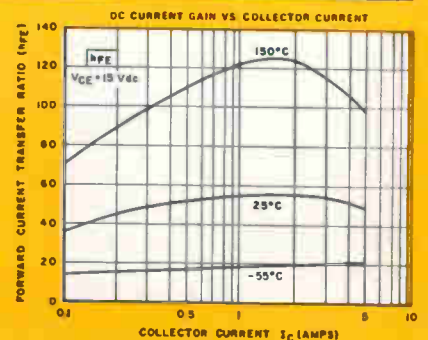
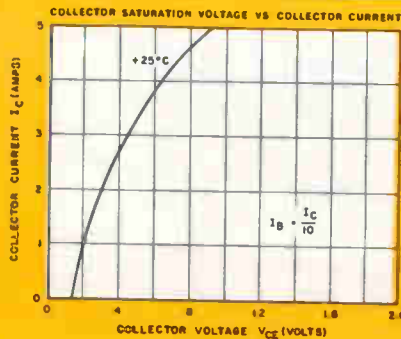

Transistron

electronic corporation
wakefield, melrose, boston, mass.

SALES OFFICES IN PRINCIPAL CITIES THROUGHOUT THE U. S. A. AND EUROPE • CABLE ADDRESS TRELCO

CIRCLE 17 ON READER SERVICE CARD

New Look in

Next week it's Syncom; design changes set for new Relay and Echo, too

By JOEL STRASSER
Assistant Editor

DESIGN IMPROVEMENTS will be incorporated into the second round of communications satellites to be launched next week and later this year using lessons learned from their predecessors. A beefed-up Syncom II will make another attempt into orbit no earlier than Tuesday, while both Relay II and Echo II will probably go up during the last few days in December.

SYNCOM II—To prevent repetition of Syncom I's failure, the second Syncom, now being readied on the launch pad at Cape Canaveral, has been modified. Originally, it was thought that a defect in the power supply may have caused the failure. The prevailing theory now, however, is that one of the titanium tanks that store nitrogen used for vernier attitude control and period control may have ruptured in Syncom I, blowing the satellite apart. In tests conducted within the last several weeks, a tank was punctured causing an explosion that ejected a weight similar to that displaced by the apogee kick on Syncom I. In the second Syncom, clearance between the tanks was increased.

As a precautionary measure against power failure, as indicated earlier (**ELECTRONICS**, p 25, May 17) all wires to power-consuming subsystems are being fully duplicated. Another set of batteries in the beacon will give 10 to 15 extra minutes of telemetry for location purposes, if the spacecraft gets lost again.

While these improvements will add several pounds to the overall weight of Syncom II, a higher-powered apogee kick motor, built by Jet Propulsion Laboratory, will be used instead of the Thiokol motor used in Syncom I. Hughes Aircraft built the satellite.

RELAY II—To avoid the problems that plagued Relay I with a faulty

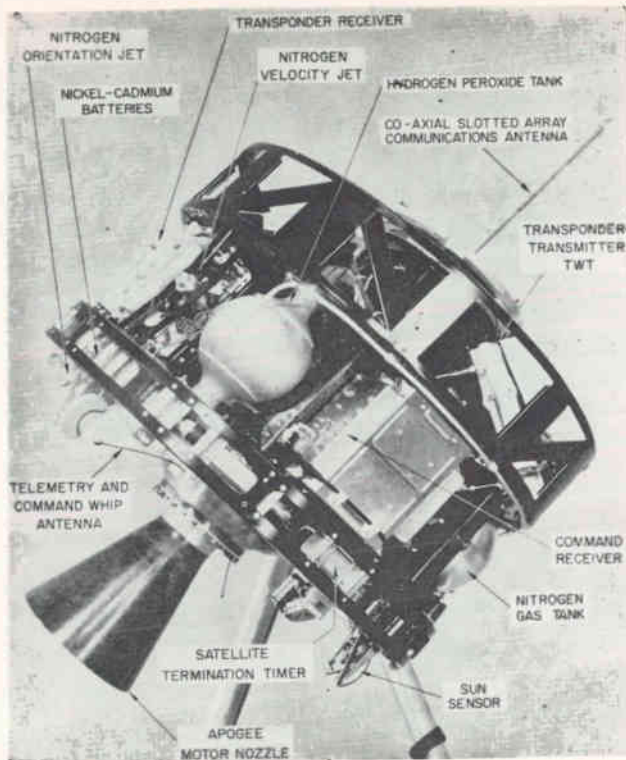

PROBABLE CAUSE of Syncom I's failure, it is now believed, was explosion of nitrogen tanks. Clearance between tanks (one is shown at lower right of picture) has been increased)

EXTERNAL CONFIGURATION of Relay II will be the same as Relay I, although internal electronics will be improved. New Relay is now being built at RCA's Astro-Electronics Division for the December launch

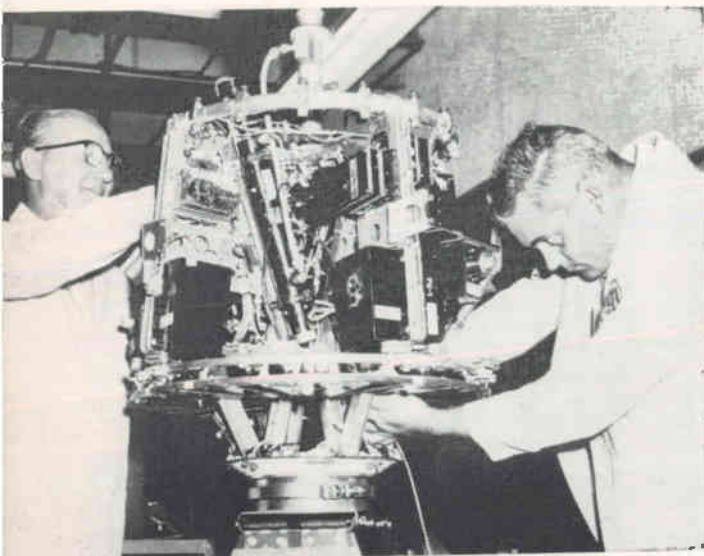

DURING INFLATION TEST of Echo II at Lakehurst, N. J., smaller, 30-ft balloons, filled with helium, carry engineers aloft to check Echo's r-f reflectivity characteristics

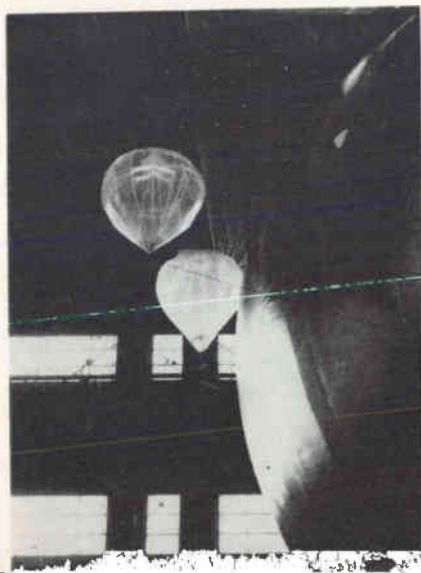

This Year's Comsats

switching transistor in the transponder, changes are being made in the voltage regulator switching circuits. A different transistor, less sensitive to temperature variation, is being incorporated into this circuit. An electromagnetic relay is being placed in series with the voltage regulator switch to provide a second means of turning the satellite off.

N-on-p solar cells, which offer much greater radiation resistance than Relay I's p-on-n units, are being incorporated into the satellite. They will have a 60-mil glass shielding. Radiation experiments conducted by Bell Telephone Laboratories and State University of Iowa will be the same, but a minor change will be made on the radiation damage experiment conducted by Goddard Space Flight Center. For redundancy, three gallium-arsenide cells will be used instead of one, and unlike Relay I's, these will have 6- to 10-mil glass shields. The tests, which were to be conducted with high-energy radiation, were voided by low-energy protons, which the glass shield is designed to protect against.

More r-f shielding will be used in the wide-band system because of command anomalies. It was determined that Relay I's command circuit was particularly susceptible to rock and roll music. Command receiver characteristics are being changed—more shielding, the operating squelch level will be less sensitive to spurious transmissions, and a new filter will be placed in the antenna feed system.

An extra cell will be added in each of the satellite's three batteries to achieve greater ampere-hour capacity. This will provide 23 v, rather than the former 22 v, at the end of the operating discharge cycle.

Unpressurized traveling wave tubes may be used in the wideband system. Pressurized twt's were used in Relay I because there was no conductive or convective heat transfer. The redesigned twt would have the same electrical characteristics, but physical changes in the pitch angle of the helix and an outer glass coating would eliminate the

heat problem. Pressurized tubes would then be unnecessary.

Changes in the charge-controller circuit, which were affected by radiation damage in Relay I, will give longer periods of operation.

Telemetry sensors are being relocated in some instances. A thermistor that could have picked up the failure of the 2N174 transistor immediately in Relay I is being moved to the satellite's base ring.

When the satellite gets hot, a thermal controller activates a hydraulic system to let the heat radiate out through vanes in the spacecraft. A sensing device is being added to the vane system. Total added weight to the spacecraft for all these changes is about one pound.

ECHO II—Biggest change in the Echo II balloon satellite will be a new inflation system that uses higher pressure acetamide as the inflating material in a specially designed compartmented balloon (*ELECTRONICS*, p 7, Feb. 15). Previous plans called for using lower pressure benzoic acid in a regular balloon. In a recent test, it was determined that the increased pressure is better for r-f. The balloon, which underwent its third static inflation test last week at Lakehurst, N. J., will be 135 feet in diameter compared to Echo I's 100 feet.

Tv system to monitor the deployment of the balloon for five minutes following the launch is being incorporated into the second (Agena) stage of the Thor-Agena booster. Readout will be at Johannesburg, South Africa. The initial trajectory will be changed somewhat, but this will not affect orbit or period.

Collins Radio is now using the old Echo I balloon for voice communications between Cedar Rapids, Iowa and Dallas, Texas. Under test is a new station at Dallas with a 60-foot parabolic dish and phase-lock loop receivers to aid in tracking. Collins reports that Echo I has shrunk from 100 feet to 60 feet in diameter but is still very much alive. MIT Lincoln Laboratory and the Naval Research Laboratory facility at Stump Neck, Md. are also using it successfully.

the
Last Word in

HIGH SPEED

printer systems

from



POTTER

the
LP-1200 SYSTEM
provides:

- **LOW COST BUFFER STORAGE...**
Computer proven Magnetostrictive Delay Lines are compatible with the fastest computer systems.
- **NEW DELAY LINE AMPLIFIER...**
Peak Detection circuit improves reliability at higher frequencies.
- **QUALITY HIGH SPEED PRINT-OUT**
Vacuum Paper control, coupled with high speed paper feed produces clean, sharp impressions.
- **HUMAN ENGINEERING provides...**
quick, front paper loading, ease of ribbon change, access to drum and hammers, convenient operating controls.
- **ADDITIONAL FEATURES...**
non-wearing Elastomeric torsion bearings assure long hammer life; low inertia drive belts minimize clutch and brake wear.

To learn how the Potter LP-1200 Printer System can reduce the cost of your computer time, write to the General Manager, Printer Division, today.



POTTER INSTRUMENT CO., INC.
PRINTER DIVISION
East Bethpage Road • Plainview, New York

You can take your work to the HONEYWELL 8100 TAPE RECORDER

or
you can
take
the
8100
to
your
work!

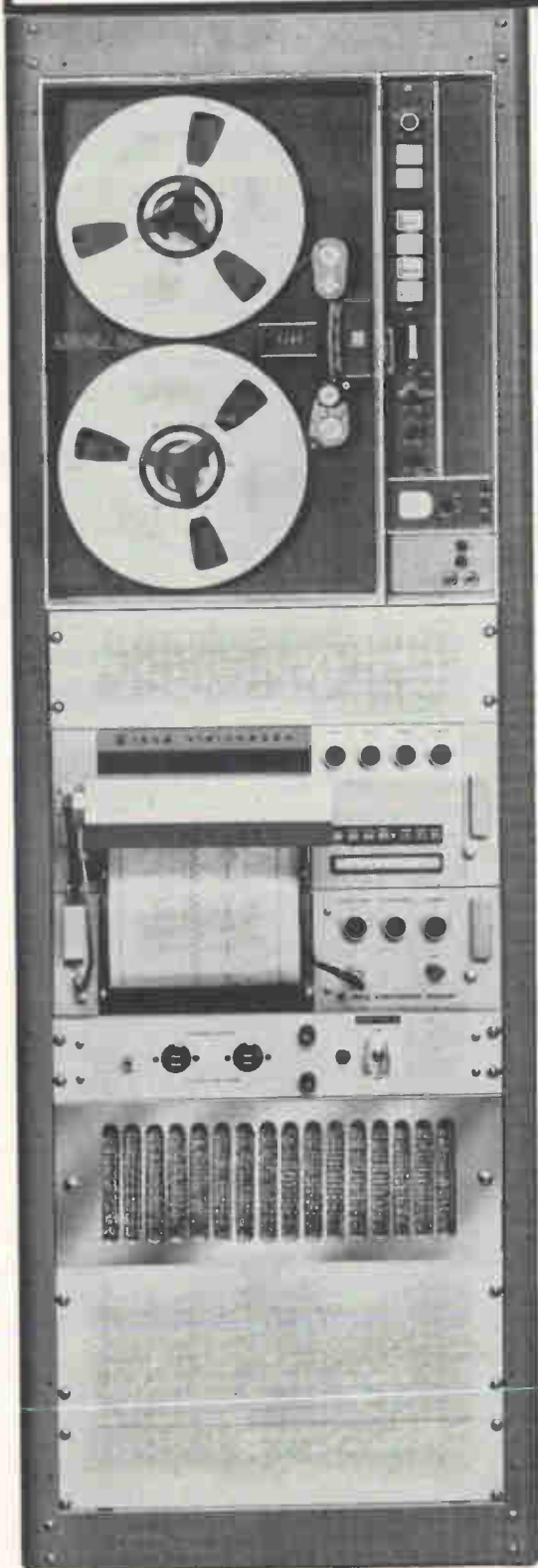

Completely portable, completely self-contained, the new Honeywell 8100 recorder/reproducer offers instrumentation quality in a package you can carry from test to test with one hand. Or you can rack-mount the 8100, as shown at left with a Honeywell Model 1508 Visicorder Oscillograph. The 8100 contains all its own electronics, plus such convenience features as a built-in calibration panel and automatic switching of center frequencies. You can record analog data from DC to 10,000 cps on up to 8 data channels. And there's an optional built-in scope for monitoring data while you record. Available with either $\frac{1}{4}$ or $\frac{1}{2}$ inch tape. Weight only 85 pounds. Price from \$5900 to \$11,300. Write for brochure #2038 to Honeywell, Denver Division, Denver 10, Colorado.

Honeywell

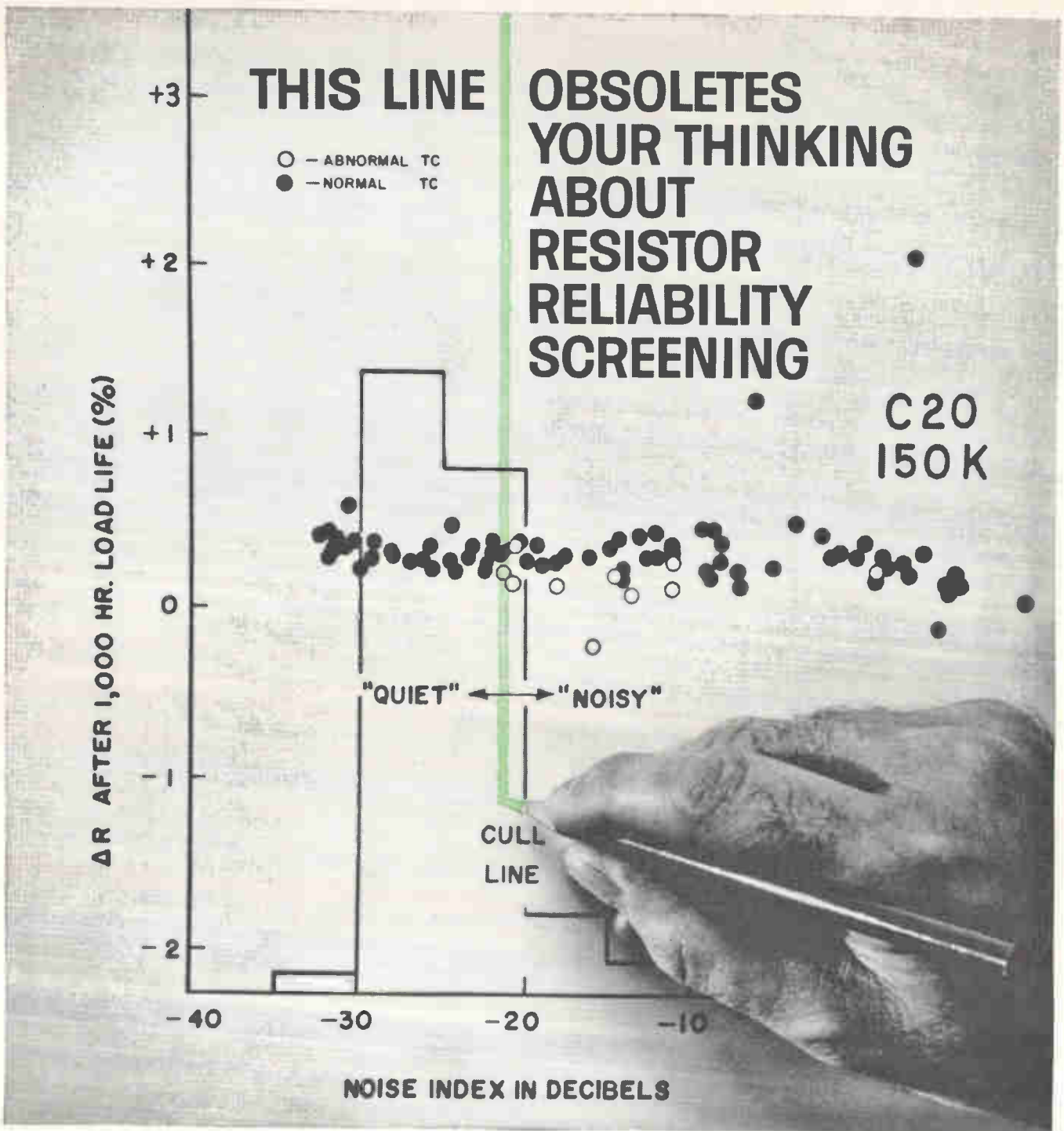

It's the reliability CULL* line we can draw on the basis of *current noise level* for any lot of Corning metal-oxide film resistors.

The good guys are on the left. Test them at 2½ times rated power and 25°C. We've been doing it for 23,000,-000 part hours without one failure.

If one had failed, you'd have a failure rate of 0.01001%/1000 hours at 90% confidence, 0.00398 at 60%, and 0.00022 at 5%. But none have!

The CULL line falls at different db levels for different styles and sizes of Corning resistors. But we can draw one for any of them that is practical in cost and unsmirched to date for reliability.

Resistors to the right of the line may be OK, but our

findings indicate that all mavericks in TC and load life will be on the noisy side of the line.

Read all about this new, *non-destructive* reliability screening tool, and how we'll put it to work for you at modest cost. Write for our new folder, "Current Noise Level: New Reliability Screening Technique for Corning Metal-Oxide Resistors," to Corning Glass Works, 3901 Electronics Drive, Raleigh, N. C.

*Corning Uniformity Limit Level

CORNING
Electronic Components

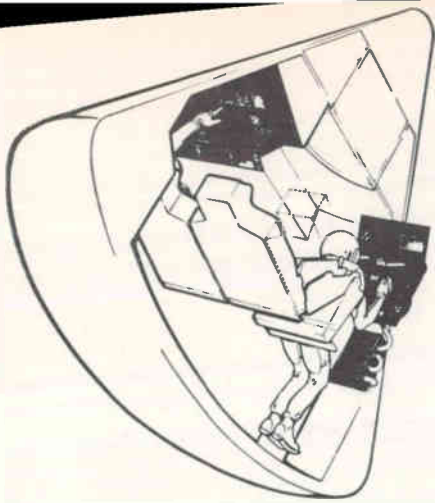

DRAWING shows location of guidance and navigation electronics aboard LEM. RCA's \$50-million sub-contract includes work on these systems

EXTERNAL CONFIGURATION of LEM. Base portion of vehicle will be used for touchdown on moon. Upper portion of vehicle has its own propulsion system for lunar lift-off, permitting the lower portion to remain on the moon. Grumman is prime contractor

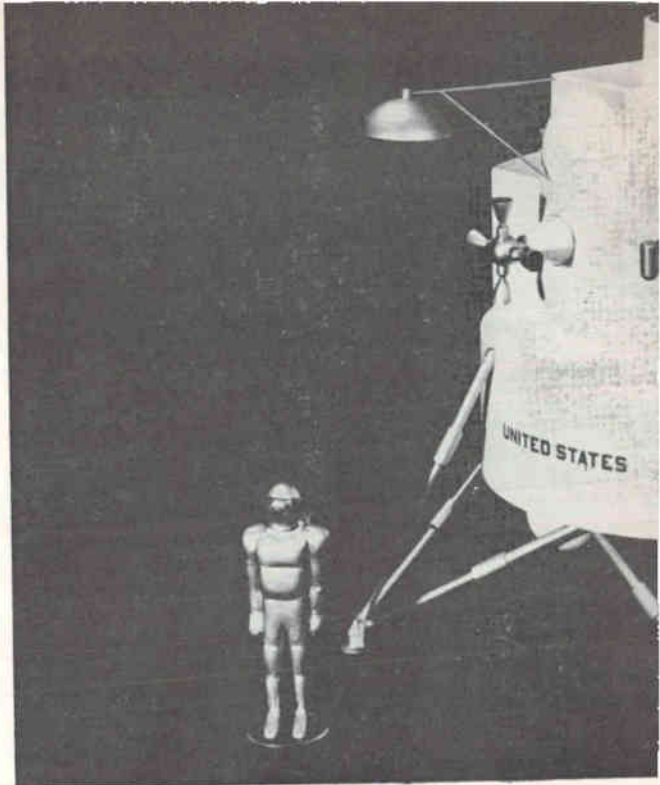

LEM Electronics Faces New

Lunar Excursion Module will require reliable custom-made gear

By MARVIN REID
McGraw-Hill World News

HOUSTON—A minor roadblock in the procurement of electronic components has arisen in the National Aeronautics and Space Administration's Apollo project, ELECTRONICS learned this week. It is not serious enough, however, to cause any delay in NASA's overall goal of putting Americans on the moon this decade.

Some component manufacturers are having difficulty meeting NASA's rigid quality control specifications. This is causing some delay in getting 'type A' components for the guidance and control systems, David Gilbert, manager of Apollo spacecraft systems office of guidance and control, reports.

Gilbert says the problem is not serious, at least not at this stage. "We are going ahead and releas-

ing initial systems designs," he said, "based on 'type B' components. These can be used in early test units. We will need 'type A' for the flight vehicles, however," Gilbert said.

In the Apollo program, NASA requirements call for minute tracing of quality control steps by parts manufacturers. The degree of control, Gilbert reports, "has proved annoying to some manufacturers" leading to "negotiations and renegotiations."

"The parts problem has been a surprise to us. We didn't expect it. We are working around it, however, and since we don't have to have all 'type A' components for the first few systems, we see no reason for any delay in the overall program," Gilbert said.

SUBSYSTEMS — The electronic systems concept and basic designs of both the command and lunar excursion modules have been "pretty well completed" now, Gilbert said.

LEM's electronic systems, which duplicate where possible those in the command module, will for the most part be handled by RCA un-

der subcontract with Grumman Aircraft. Five areas that RCA, under a \$50-million plus contract, will be responsible for include systems engineering, communications, radar, in-flight systems, and ground test out. RCA will also handle certain other undefined jobs.

- Communication system includes: S-band transponder, S-band power amplifier (20 watts), S-band diplexer, S-band erectible antenna (lunar surface) 10-ft diameter, S-band high-gain antenna (spacecraft) 2-ft diameter, S-band omnidirectional antenna, vhf transceiver, vhf lunar stay antenna, vhf omnidirectional antenna, pcm telemetry equipment, tv equipment, intercom equipment, and miscellaneous microwave components.

- Instrumentation system consists of data storage equipment, central timing equipment, signal conditioning equipment, sensor/transducer equipment, and in-flight test systems.

- Navigation and guidance includes rendezvous radar, radar altimeter, computer, and signal conditioning equipment.

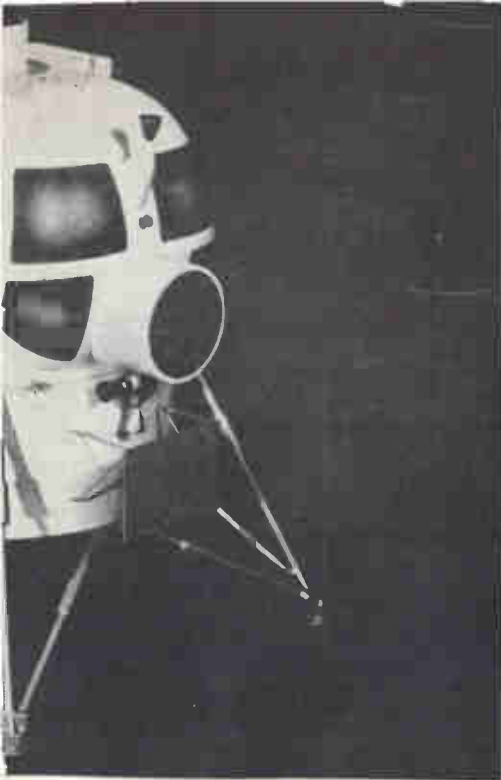

Challenges

CUSTOM-MADE GEAR—Of the communications and instrumentation systems, “almost nothing is off the shelf hardware for LEM except transducers and microwave switches,” Owen Maynard, acting manager of spacecraft systems for LEM reports. However, he and Douglas Broone, Jr., of his staff, report that virtually all systems now called for are “within the state-of-the-art.”

For example, LEM will require some exacting antenna systems, but the main task facing designers is to match present systems to LEM's configuration. An exception may be the vhf lunar-stay antenna which will have to scan from 80 to 100 miles when the command module's orbit is directly above it, and up to 232 miles away as command module begins making its pass.

Broone reports NASA is now looking at a turnstile-type antenna used on one of the Goddard earth orbital satellites. “Patterns to date indicate it is what we want. Basically, it will be a spiral antenna with two crosses in it.” Although the adaptation of antennas to LEM's configuration is causing

UHF

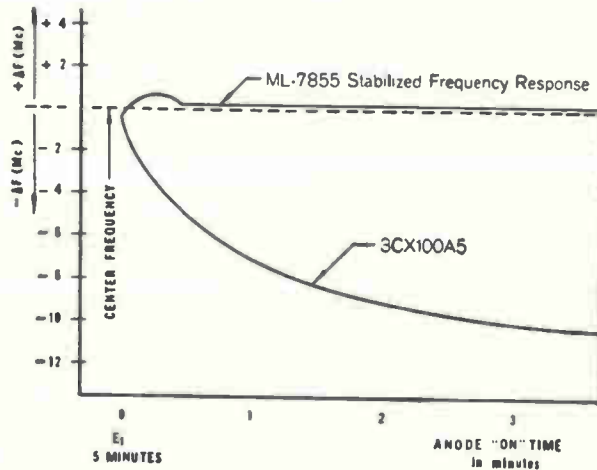

Frequency stable performance . . . 100 times faster than normal

Frequency stable performance is achieved upon application of high voltage nearly 100 times faster with the ML-7855 than with conventional planar triodes. Even with an unregulated plate supply the ML-7855 will provide this same frequency stability within 2 seconds. High-voltage, arc-suppressed, operation is provided by the Phormat (matrix) cathode. . . . Plate-pulse to 3000 Mc, with 3000 v eb, 3.0 a ib, t 3 usec at 0.0025 Du. For complete

write The Machlett Laboratories, Inc., Springdale, Conn. An affiliate of Raytheon Company.



Now from Sprague!



TO-5
CASE

WIDE SELECTION
OF

Silicon Chopper Transistors

NOW IN
VOLUME PRODUCTION

Specifically designed for use as low-level choppers, Sprague Silicon Precision Alloy Transistors are inherently stable. Every Sprague chopper transistor undergoes a rigid production conditioning of 40 temperature cycles from -55 C to $+140\text{ C}$, a 200-hour bake at $+140\text{ C}$, and a 2-hour 125mW operational burn-in!

2N2162 2N2165	Guaranteed 30 volt rating. Typical f_T of 20 Mc and low offset voltage make these transistors ideal where high voltage is required
2N2163 2N2166	Have 15 volt rating and same high frequency performance and low offset voltage as 2N2162
2N2164 2N2167	Highest frequency P-N-P Silicon Choppers available as standard types
2N2185	Extremely low leakage current of 1 nano-ampere at 10 volts. Has 30 volt rating
2N2274	Similar to 2N2185 but has lower inverted dynamic saturation resistance
2N2276	Low-cost version of 2N2274
2N2278	Very low offset voltage of 1.75 mV at $I_B = 1\text{ mA}$
2N2187	Matched pair of 2N2185 with $\Delta V_{off} = 50\mu\text{V}$ max. from $+25\text{ C}$ to $+85\text{ C}$
2N2275	Matched pair of 2N2274 with $\Delta V_{off} = 100\mu\text{V}$ max. from $+25\text{ C}$ to $+65\text{ C}$
2N2277	Matched pair of 2N2276 with $\Delta V_{off} = 100\mu\text{V}$ max. from $+25\text{ C}$ to $+65\text{ C}$
2N2279	Matched pair of 2N2278 with $\Delta V_{off} = 50\mu\text{V}$ max. from $+25\text{ C}$ to $+85\text{ C}$



TO-5
CASE

For additional information, write Technical Literature Service, Sprague Electric Co., 35 Marshall Street, North Adams, Mass., indicating the types in which you are interested.

SPRAGUE
MARK OF RELIABILITY

CALL 24 ON READER SERVICE CARD

design headaches, "the technology for what we need exists," Broone says.

One state-of-the-art system will be the S-band power amplifier, according to Broone. There are tubes on the market—traveling wave, klystron and amplatron—but he says they haven't been adapted for airborne use.

MORE SENSITIVE TUBES—Another system problem includes the tv equipment, which is to be used to transmit lunar pictures back to earth in real time at rates "just a little slower than commercial rates."

The trouble here revolves around the small amount of "earthshine" on the lunar surface. The maximum sensitivity of lenses now available is just equal to the amount of maximum earthshine, so, Maynard says, "we must either carry extra light or get more sensitive tubes." He thinks more sensitive tubes will be available.

In LEM's instrumentation, Maynard says, there is nothing particularly "exotic" in any of the equipment. He points out, however, that virtually all of LEM's equipment will be custom-made for the vehicle.

Broone says rendezvous radar, which has not yet been defined, in the navigation and guidance system may be "state-of-the-art." Design data will probably be released by October. The big problem here is "finding a place to put the antenna."

The special radar altimeter, a 2-position, 3-beam doppler, is a "special case" Broone says, but he believes "there is enough intelligence around industry to build what we want." He also adds that the computer "is a big operation."

COMPUTER—Gilbert reports the computer in LEM will be similar to the one planned for the command module. In fact, "all electronic portions will be as identical as we can make them."

The design of the LEM computer, "now pretty well along," uses Fairchild's micro-logic circuits. Circuits contain three transducers and one resistor. It is a parallel machine packaged so it will have removable module trays.

It will have a keyboard to allow the astronauts to insert information from the ground, and a digital display readout. Computers used in the command module and LEM will be original designs, with accuracy the primary factor.

"Speed will not be a big factor" on the computers, says Gilbert. "Its critical portions will be during entry and landing. It has to solve problems in real time."

One big question still under debate is whether to provide extensive back-up electronic systems on LEM. On the command module, NASA officials have generally favored in-flight maintenance rather than heavy redundancy of equipment. "It is quite possible we will favor this approach on LEM, which, compared to airplane missions, will be a long flight. It will have about six minutes of powered flight, although its overall mission may range from 10 to 48 hours. It makes sense, considering this, to consider in-flight maintenance."

One exception may be the navigation-guidance systems. This will be one of the "very crucial" areas, as far as systems is concerned, and "you can bet it will be very refined and backed up where it has to be," Maynard says.

PLANS—Although Project Gemini will be responsible for the nation's next manned space flight, Project Apollo is being pursued separately and "we can't wait for hardware" tested by Gemini, Gilbert says.

NASA has officially said it hopes to land men on the moon by 1970. Nobody talks of "official schedules here, but there is hope that the big shot—sending the three-module Apollo to the moon for a two-man landing and return—can come as early as the end of 1967. To meet any kind of schedule such as this, Gilbert says, several Apollo earth orbital shots will be required within the next two to three years.

Approximately 80 percent of the money spent for LEM and the command module will be for equipment common to both. Only 20 percent will be spent on specialized gear peculiar to the needs of one or the other.

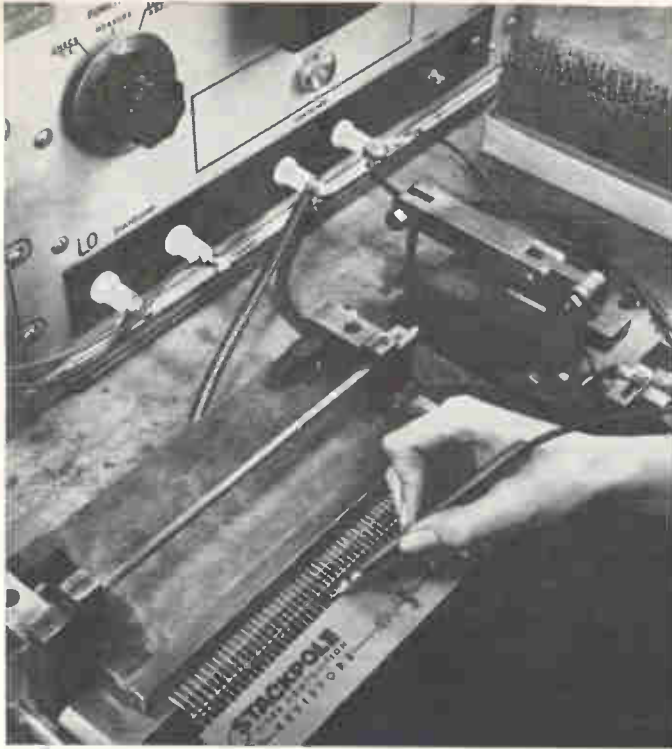

Tested 200% plus! Production line machines automatically classify every Stackpole resistor to insure that specified resistance and tolerance are unerringly met. Then, just before packaging, resistors are again tested individually as the final step in a series of critical inspections that start even before production begins.

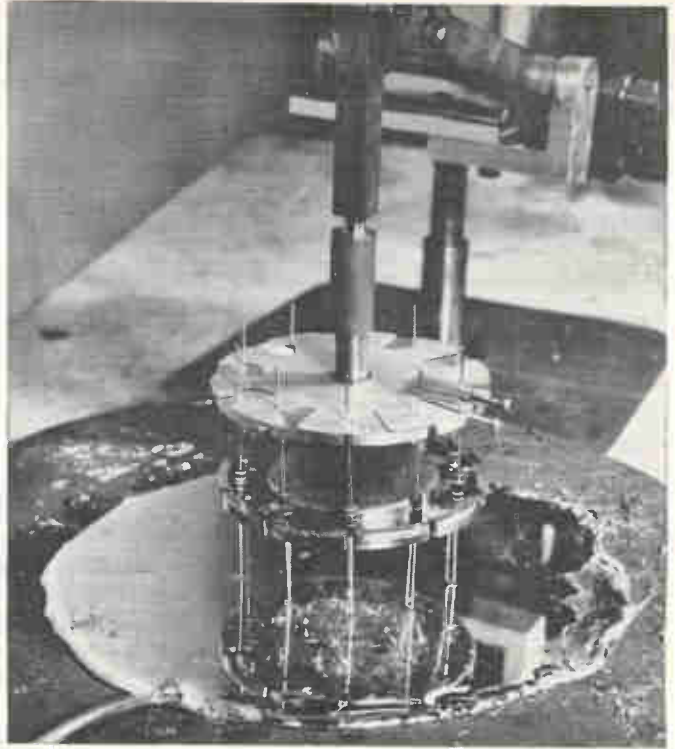

Effect-of-soldering test! Samples from Stackpole resistor runs are laboratory tested regularly to make certain that soldering heat will have negligible effect on performance. Equally rigid tests at every important stage of production assure quality second to none in every Stackpole COLDITE 70+ resistor you specify.

Some Stackpole resistors are not for you

Stackpole COLDITE 70+® Fixed Composition Resistors roll down our line, and out to customers, by the tens of thousands every day.

But does this mean sheer volume at the sacrifice of quality?

On the contrary!

It calls for one of the most rigid, comprehensive testing and quality control programs in the resistor industry . . . just to spot the one Stackpole resistor that is not for you (or any other Stackpole customer). Two of the tests are shown above.

This is why you can specify COLDITE 70+ resistors without a second thought about their solder-

ability, load life, humidity and temperature characteristics. And why they exceed every important MIL-R-11 requirement.

If you're ever in our area, drop in and say, "Hello!" We'll be glad to chat about your design problem. Meantime, buzz your Stackpole distributor and prove our point: you get more out of Stackpole resistors because we put more in them. Or write: Electronic Components Division, Stackpole Carbon Company, St. Marys, Pennsylvania.

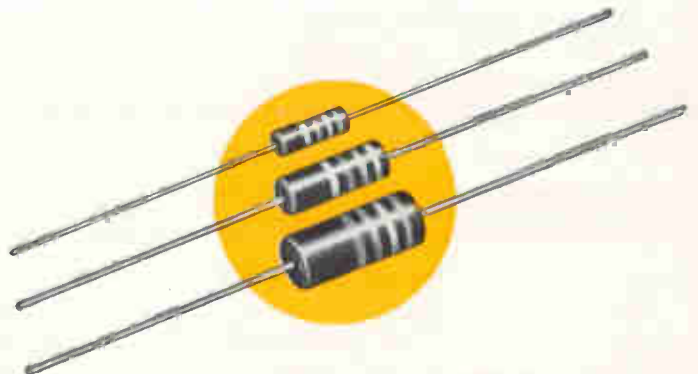

STACKPOLE

CARBON COMPANY, *Electronic Components Division*

St. Marys, Pennsylvania

ECLIPSE

TO BARE IONOSPHERE'S SECRETS

*Experimenters converge
on path of totality
from Alaska to Maine*

By THOMAS MAGUIRE
New England Editor

ELECTRONIC INSTRUMENTATION on the ground, in jet aircraft and aboard rockets will be probing the ionosphere and "listening in" on the sun and moon tomorrow (July 20) during one of nature's rare spectacles—a total eclipse of the sun.

Besides information on the structure and processes of the ionosphere, the eclipse is expected to yield data on the solar corona

and chromosphere, airglow, sky brightness, and the exact size and shape of the moon. Some scientists will be using radiometric techniques in an attempt to get a millimeter-wave "picture" of the solar limb; and others will be checking once again Einstein's prediction that light waves passing near the sun are bent by its gravitational pull.

In all parts of the North American continent, a partial eclipse will be observable. The total eclipse will be seen in a path from Alaska through Canada and central Maine. An estimated half-million professional scientists, amateurs and tourists will crowd into the most heavily populated section of the path of totality—a 55-mile-wide strip across Maine from Jackman to Bar Harbor. In this path, the totality will last about one minute.

This eclipse has attracted unusual attention because of accessibility of the path of totality and its nearness to existing stations, approach of the International Quiet Sun Year, and relatively high angle of elevation of the sun and moon to stations on the North American continent.

AIR FORCE — Cambridge Research Laboratories in Bedford, Mass., will concentrate heavily on this eclipse because of the proximity of the path to several of its highly instrumented field sites. Additional equipment has been set up in the Bangor, Me. area.

At AFCRL's Sagamore Hill Radio Astronomy Observatory in Hamilton, Mass., the 84-foot radio telescope will be used in a moon-bounce program in cooperation with the Army Signal Corps, the University of Illinois and Stanford University. Signals at 25, 50 and 150 Mc will be bounced off the moon before, during and after the eclipse. Receiving stations will measure Faraday rotation of electrons in the ionosphere and also total electron density changes. Measurements of ionospheric changes during a period of chang-

ing solar radiation constitute one of the most important observations to be made tomorrow.

The new 150-foot dish at Sagamore Hill will be trained on the radio star Cassiopeia for scintillation studies as the ionosphere changes during the eclipse.

CANADIAN ROCKET — From Fort Churchill, Canada, AFCRL will fire a Black Brant rocket carrying instrumentation for measuring variations in the D and E layers of the ionosphere during the eclipse.

To measure changes in the D-layer, broad-band riometers located in Maine will receive Loran-C signals transmitted from a Coast Guard station on Nantucket Island.

Effects on the D layer will also be measured by an instrumented KC-135 aircraft which will meet the eclipse over Fort Churchill, Canada.

Also racing the moon's shadow will be Charles H. Smiley of Brown University, who will be observing from an F-104 jet plane which may be able to keep him in the shadow for five or six minutes as the dark image races eastward at about 3,300 mph. National Geographic Society and Douglas Aircraft are sponsoring a jet flight over the Canadian Northwest.

NASA PARTICIPATION—Rocket firings will be made from Fort Churchill to probe the ionosphere as part of a NASA contract. The experiments, conducted by Geophysics Corp. of America, will simultaneously measure electron density and u-v and x-ray radiation under conditions of varying solar radiation. Hopefully, the experiments will provide a new insight into the precise effects of solar radiation on molecular particles and the temperature in the upper regions of the atmosphere. It is also hoped they will prove or disprove theories concerning the role of the sun's corona in generating the ionizing radiation that creates the atmosphere.



NIKE-APACHE sounding rockets, to be fired into the ionosphere from Fort Churchill, tomorrow, surround Leslie G. Smith of Geophysics Corp. of America, project director. He holds X-ray Geiger counter (top) and Lyman-Alpha proton counter instruments to be used on the rockets

... IN HIGH-EFFICIENCY 15Kc POWER INVERTERS

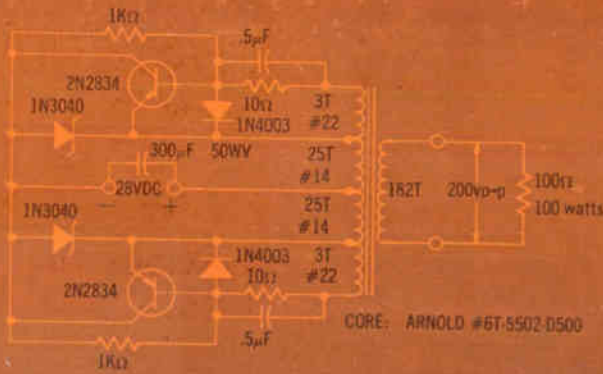

EFFICIENCY CURVE FOR 15Kc INVERTER

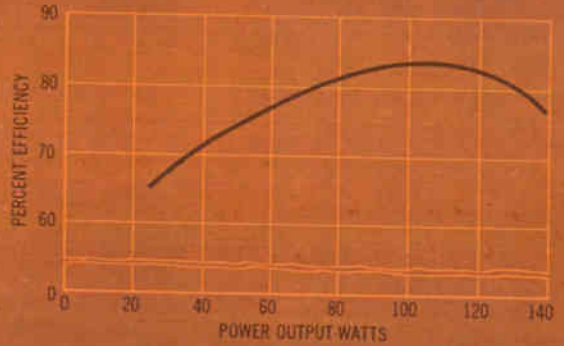

SPEED + POWER = MOTOROLA'S 2N2832-34

... IN CATHODE RAY DEFLECTION CIRCUITS

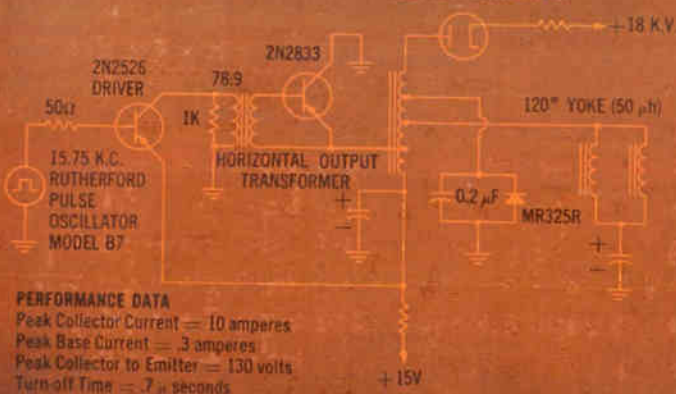

PERFORMANCE DATA
 Peak Collector Current = 10 amperes
 Peak Base Current = 3 amperes
 Peak Collector to Emitter = 130 volts
 Turn-off Time = .7 µ seconds

2N2833 VOLTAGE AND CURRENT VS HORIZONTAL SWEEP TURNOFF TIME

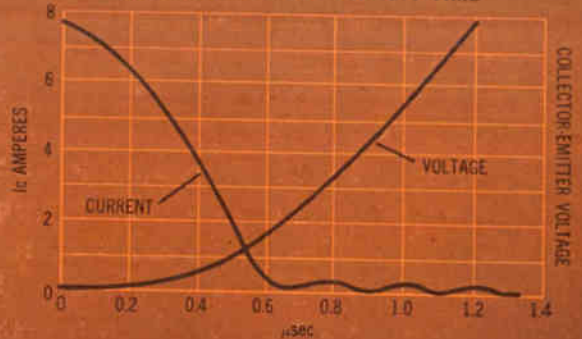

NOW... Motorola Engineers Have Broken the Barrier Between Transistor Speed and Transistor Power!

For the first time, the epitaxial concept has been applied to a power transistor to improve switching characteristics, to lower saturation voltage, and to increase gain. The result is the new Motorola high-frequency, high-current 2N2832-34 series germanium PNP device with collector-emitter voltage ratings of up to 160 volts, and 0.5 volt $V_{CE(sat)}$ at 20 amps. This TO-3 packaged transistor will fill applications in television flyback circuits, inverters and converters, class C power amplifiers, ultrasonic generator circuits, and core drivers.

Industrial and military designers of cathode ray tube deflection circuits will find that this new transistor excels in frequency, saturation voltage, transconductance, power, and switching time characteristics. For television flyback applications, a fall time of 0.7 µsec at 8 amperes of collector current is typical with this new device.

The ring-emitter construction, very narrow base width, and conservative 20-ampere maximum current rating suggest applications in high-frequency inverter and converter circuits where there is a need to reduce transformer size and weight.

ELECTRICAL CHARACTERISTICS					
Type Number	BV_{CEO}	BV_{EBO}	I_C	f_{AE} (Typical) @ 1 Adc	I_{CES}
2N2832	50V	2V	20A	100	@ $V_{CE} = 100V \dots 20 mA$
2N2833	75V	2V	20A	100	@ $V_{CE} = 140V \dots 20 mA$
2N2834	100V	2V	20A	100	@ $V_{CE} = 160V \dots 20 mA$

The 2N2832-34 power transistors are *immediately* available from your local Motorola Semiconductor Distributor or District Office. For complete technical information, write: Technical Information Center, Motorola Semiconductor Products Inc., P. O. Box 955, Phoenix 1, Arizona.



"your most complete power transistor source"

MOTOROLA Semiconductor Products Inc.

BOX 955 • PHOENIX 1, ARIZONA

A SUBSIDIARY OF MOTOROLA INC.

D-63-043

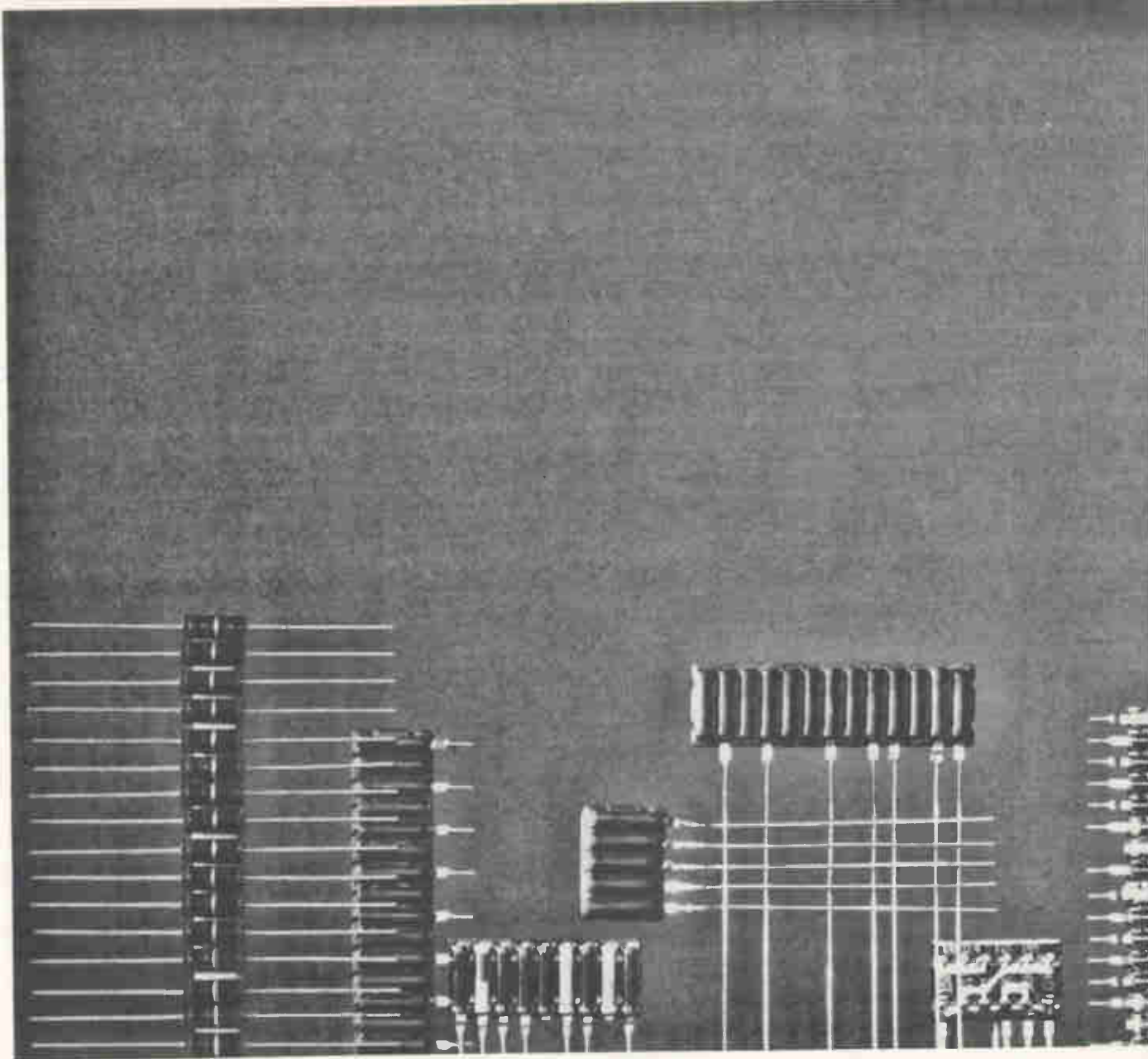

One good electronic component...

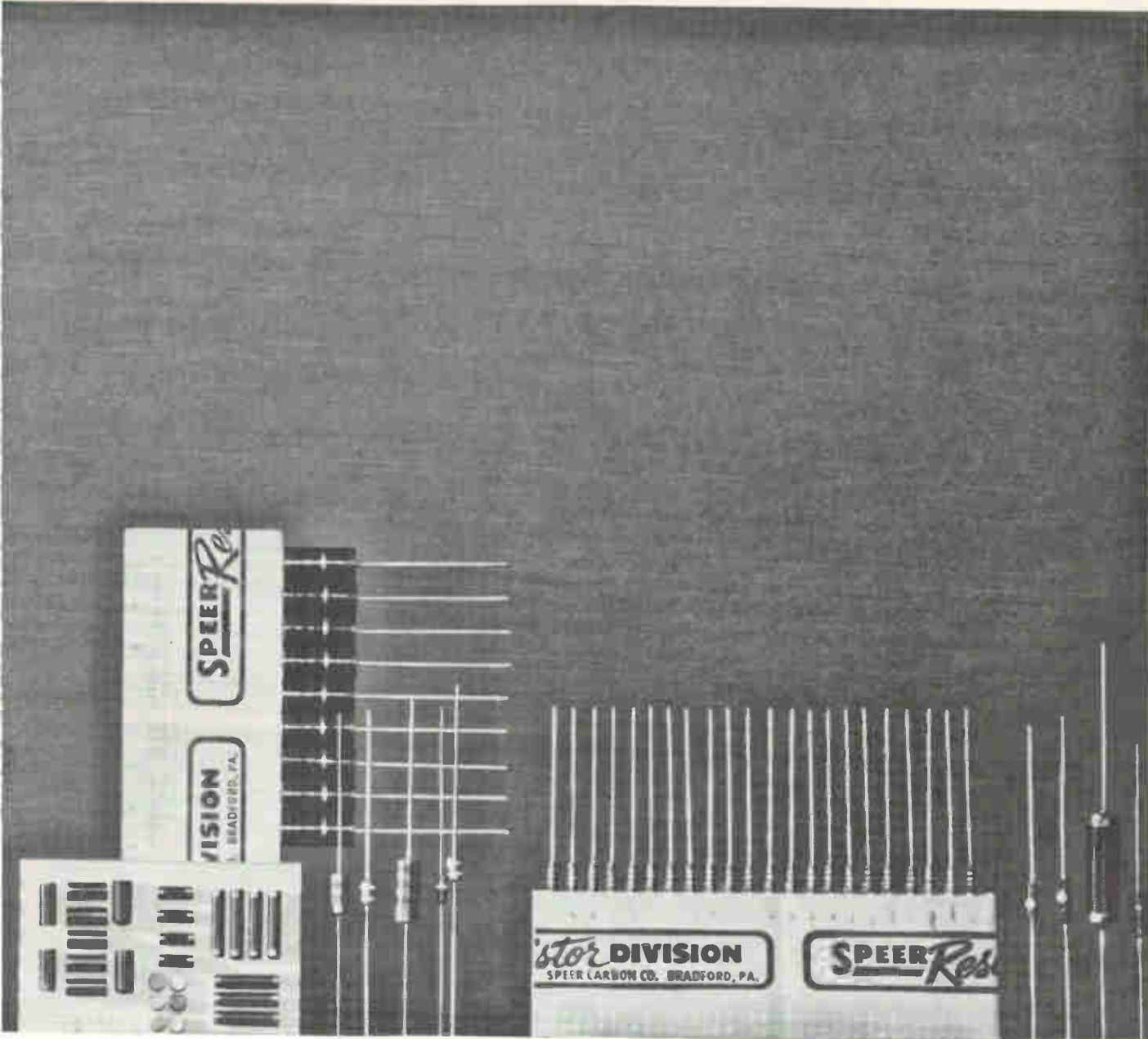

leads to another at Speer

(Thanks to a Multi-Million Dollar Research and Development Program)

At our R&D Center in Niagara Falls we are constantly developing new types of electronic components and improving the performance characteristics of our present types. We are also continually improving our production and quality control facilities throughout our various divisions. If you have a circuit design problem and want the cooperation of a modern, progressive company employing over 2000 people in the design and production of high quality components, call on a Speer representative. The broad line of electronic components manufactured by Jeffers Electronics and Speer Resistor Divisions includes: 1. Speer 1 Watt body tape-packaged resistors; 2. Jeffers phenolic coated PAC's; 3. Jeffers clear-coated PAC's; 4. Speer special leadless resistors; 5. Speer 2 Watt carbon composition resistors; 6. Jeffers Types 09, 15, 19, 22, 24, 28 and 30 molded inductors; 7. Speer 1/4 Watt carbon composition resistors; 8. Jeffers special coils; 9. Jeffers JM 110 and 160 capacitors.



Dept. 427, St. Marys, Pennsylvania
Speer Carbon Co. Is A Division Of Air Reduction Company, Inc.

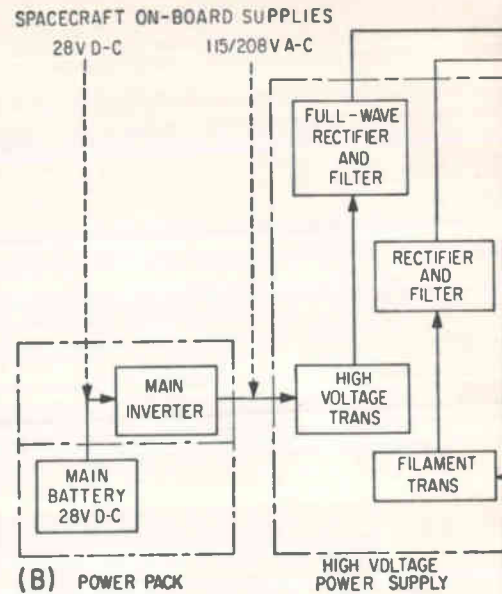
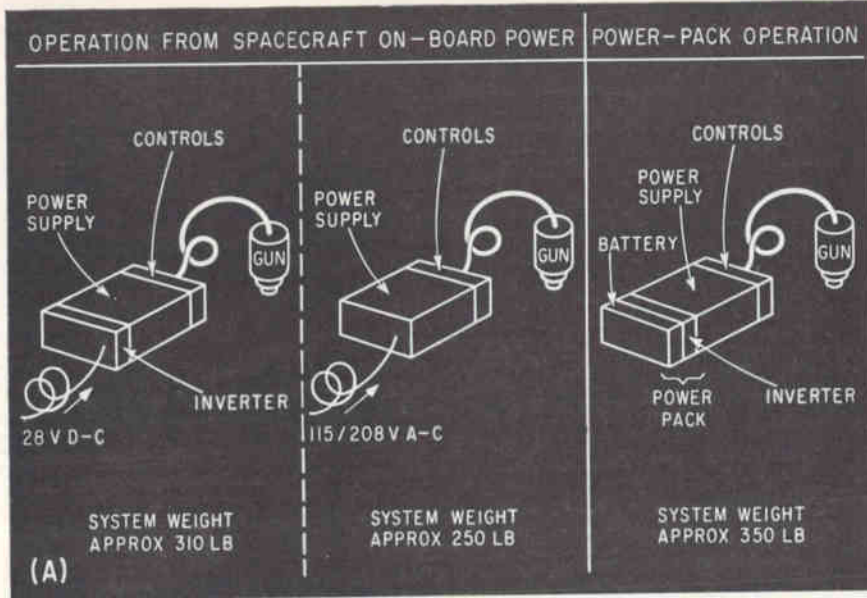

OPERATIONAL MODES (A) of prototype electron-beam welding system (B)

Construction of Electron-Beam Space

Prototype tests in simulated environment to begin next summer

PHASE II of a three-phase Air Force program to investigate joining materials in space by electron-beam welding techniques is now underway. Sponsored by the Aeronautical Systems Division Manufacturing Technology Division at Wright-Patterson AFB, the work

is being carried out by Hamilton Standard div. of United Aircraft Corp. Objective of this phase of the program is to develop a prototype welding system—a project that will probably take a year to complete (ELECTRONICS, p 12, May 31). After that, in Phase III, the prototype system will undergo a series of operational tests in a simulated space vacuum environment.

Initial phase of the program, which has just been completed, was

aimed at defining the nature of the electron-beam system to be developed. The joining tasks that would be required in space were defined, the methods for using electron-beam welding in those tasks and the means of obtaining operating power were studied.

APPLICATIONS—The Phase I study indicated that the main use of welding equipment in space will be to seal manned spacecraft structures to reduce losses of the vital on-board air supply (particularly on large, self-erecting space stations).

Besides this, a fabrication and repair capability will also be needed in space for such things as meteoroid damages, docking and landing mishaps, station alterations, and rendezvous assembly operations.

To handle such eventualities, the system was designed for mobility within the spacecraft while still being accessible to the power supply.

Heart of the welder is a compact high-voltage welding gun column approximately 9 inches in diameter and 18 inches long. Power is fed to the welding gun through a flexible length of shielded high-voltage cable from a modular power supply and control package. Depending upon the nature of the power

Lighting Systems To Use Inverters

SILICON-CONTROLLED rectifiers, already cutting a wide swath in industrial applications such as motor control and switchgear, may soon move into factories and offices.

Static solid-state inverters using these components may make possible a radical departure from conventional 60-cycle lighting systems. The units generate 3,000-cps power although frequencies from 400 to 10,000 cps could be used. According to J. L. Fink of GE's Switchgear and Control division, this development could set

off a new trend in low-voltage power distribution.

The lighting systems are useful in office buildings, convention halls, airplane hangars and factories. They would use silicon rectifiers to produce d-c power from a-c mains and electronic switches using silicon-controlled rectifiers to convert this d-c power to high-frequency a-c for lighting use.

The advantages include economy due to smaller, lighter ballasts in simpler, less expensive fixtures. Also, there is a big reduction in air-conditioning requirements.

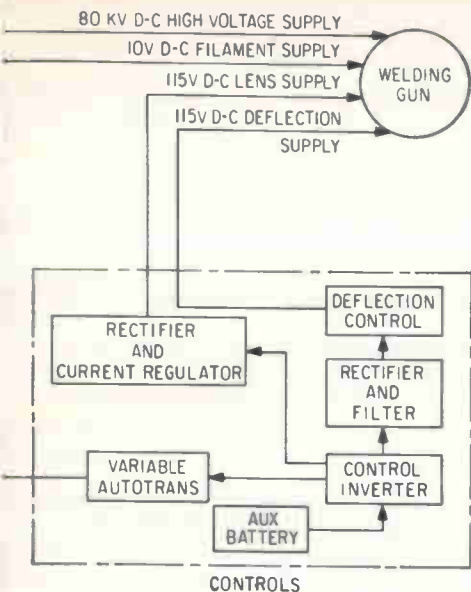

Welder Begins

source, the system is designed to operate in several modes, as shown in Fig. A. Complete independence from spacecraft power is possible for short durations by use of a rechargeable storage battery when operated in the "power pack" mode.

SYSTEM SPECS—The welding system concept is shown schematically in Fig. B. In addition to the welding gun and its cable, the packaged power system (when operated in the power pack mode) will consist of a controls module, a high-voltage power supply module and a power pack which contains battery and inverter modules that can be removed to convert the system to other operational modes. The power system ultimately will fit into a package approximately $1 \times 2 \times 3$ ft, and the entire system will weigh about 350 lb.

The electron-beam gun will normally be operated at 80 Kv and draw around 500 watts. But to provide adequate power for the variety of welding tasks that may be encountered in space, the system is being designed to operate at 80 Kv and 12.5 ma. The peak accelerating potential of 80 Kv results from a compromise among gun column size (and weight), weld penetration requirements, and the efficiency of the use of available power.

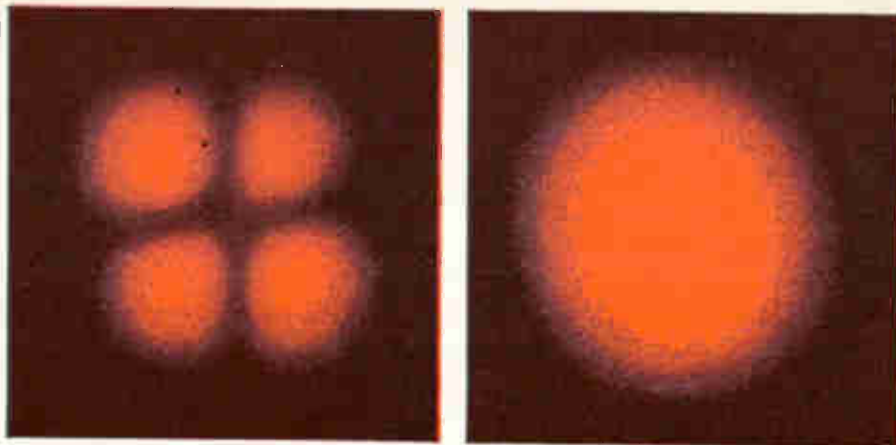

Spectra-Physics LASERS

within a millionth of an inch of perfection

The difference between an ordinary monochromatic gas laser beam (left, above) and one with complete spatial coherence in a single phase wavefront (right) is very largely in the precision of the optics. The reflectors and Brewster's-angle windows in a continuous-wave gas laser, to qualify it as a precision laboratory instrument, require an optical finish of a very small fraction of a wavelength.

You will find this precision in all Spectra-Physics CW gas lasers, a result not only of meticulous care in the preparation of the optics, but also of the practiced skill with which they are integrated into the instrument.

The quality of a Spectra-Physics laser becomes immediately apparent when you turn on the power and observe the uniphase, truly coherent quality of its output. All its power is thus available for insertion into the diffraction limit of an optical system, with the important benefits of better collimation, greater intensity, and sharper focus.

An impressive proportion of all significant laser work now underway is being conducted with equipment produced by Spectra-Physics. Among the many advantages now offered is complete assurance of reliability of operation, backed by a full year's warranty which includes even the plasma tube.

Write for information on our Model 115, the higher-powered Model 112, and related accessories. We will also send you Laser Technical Bulletin #2, "Properties of laser resonators giving uniphase wave fronts." Address your inquiry to 1255 Terra Bella Avenue, Mountain View 3, California (or call collect (415) 968-4467).



Spectra-Physics

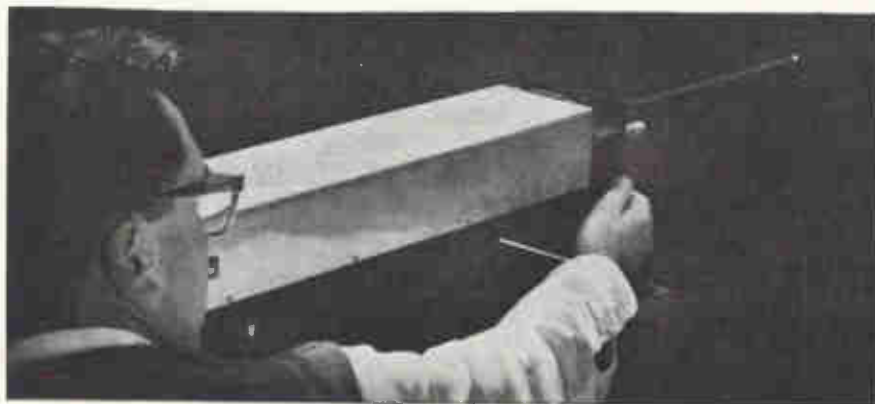

INDUSTRIAL SPY

ARISTOCRAT OF THIEVES

PART II

*He trades in ideas
but is less clever
than you would expect*

By DAN SMITH, Assistant Editor

AS WE LEARNED from talking to experts at Norman Jaspan Associates, a management engineering firm that uses undercover agents to investigate the operations of client companies, the amount of industrial espionage in the electronics field should be a cause for alarm. In the past year, Norman Jaspan itself filed \$1 million in claims to cover losses incurred by electronics firms from the theft of company secrets, and the total for the industry is undoubtedly much higher. How much, no one knows.

Neither is it known how fast industrial spying is spreading—there simply aren't any reliable overall figures on the subject—but more general statistics indicate the activity is on the increase. So-called white-collar thievery was once a rarity; now it is the most common crime in the United States.

"Compared to dishonest employees, the professional criminal is an amateur," the Jaspan firm says. "Recent Federal Bureau of Investigation figures indicate that the nation's armed robbers, burglars and auto thieves manage to steal about \$500 million each year. White collar employees—rank and file, supervisory and executive—are stealing more than \$4 million each working day in cash and

property from their employers."

The industrial spy is undoubtedly the aristocrat of white collar thieves, dealing as he does with the most esoteric material—ideas—and it is surprising to find how little ingenuity his modern brand of piracy requires. As with the research director who simply shipped out his company's secrets under the label of "Reprints," other wrongdoers described by Norman Jaspan seemingly needed little more to commit their larcenies than the desire to be dishonest.

HIS OWN BOSS—One case involved a man who tried to destroy a company in revenge for what he considered a damaged ego. As added retaliation he walked off with the profits. Mr. X, principal of an electronics firm, sold the company to a larger organization with the stipulation that he would be appointed vice president in charge of electronics research. In time, however, he became disenchanted with the arrangement. He wanted to be his own boss, and he resented having to report to a professional manager who had no electronics background.

To "get even" with his new associates for the situation he himself had arranged, he injected a critical modification into the prototype of an electromechanical item after it had proved out satisfactorily in the lab. The item, which had large market potential, was scuttled. Mr. X resigned, obtained financial backing, and on his own produced a commercial version of the item. It took the

Have you evaluated
**OHMITE?
DIODES!**



SILICON **Gold Bonded GERMANIUM**
(Subminiature Glass Envelopes Enlarged)

OHMITE MFG. CO.
3610 HOWARD ST.
SKOKIE, ILL.

You may be in for a surprise!
Users report considerably lower reject rates. The reason? Close control over manufacturing, typical of all Ohmite components. Price and delivery? Competitive! Why not try these superior diodes? Available from factory stock and electronic distributors.

**BRING YOUR DIODE
DATA UP TO DATE**

Germanium:
Catalog (No. 801)
Stock Price List (No. SR819)
Interchangeability Tables
(No. 803)

Silicon:
Catalog (No. 804)

OHMITE

MANUFACTURING COMPANY
3610 Howard Street, Skokie, Illinois
Phone: (312) ORchard 5-2600

CIRCLE 32 ON READER SERVICE CARD
July 19, 1963 • electronics



*at your fingertips
in Catalog 700...*

All These Relays and Hundreds More From Ohmite's 12 Basic Models

USED THROUGHOUT INDUSTRY: General purpose, industrial controls, mobile equipment, aircraft systems, commercial devices, and military equipment requiring 1 to 25-amp contacts.

MANY CHOICES: High quality types, good economy units, unenclosed, plug-in, transparent enclosures, removable enclosures, dust-tight enclosures, hermetically sealed, miniature, sensitive, latching, indicator (light), U.L. approved, thyatron plate circuit models, and many special designs.

FULL SELECTION OF TERMINALS: Quick-connect (push on), octal plug, screw type, solder, binding post, Jones plug, and banana plug.

338 TYPES CARRIED IN STOCK: Units stocked fall in the 5 to 25-amp contact range, and include latching types with transparent enclosures, U.L. approved models, hermetically sealed units, and thyatron plate circuit relays.

Be sure to get a copy of relay Catalog 700

RHEOSTATS • POWER RESISTORS • PRECISION RESISTORS • VARIABLE TRANSFORMERS
TANTALUM CAPACITORS • TAP SWITCHES • RELAYS • R.F. CHOKES • SEMICONDUCTOR DIODES



OHMITE
MANUFACTURING COMPANY
3610 Howard Street, Skokie, Illinois
Phone: (312) ORchard 5-2600



this is the new ZJ227 light activated controlled rectifier (it offers optional gate triggering—from either an isolated light source or direct electrical supply)



this is a Controlled Avalanche Rectifier (it protects itself against destructive voltage transients... we have four different current ratings)

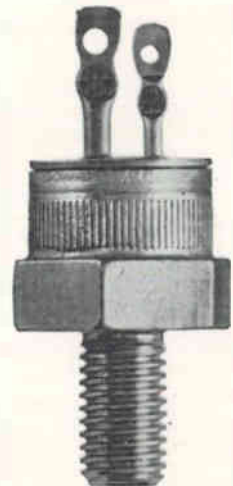

this 200 volt C20B is the industry's first \$2.00 Silicon Controlled Rectifier for low-cost, high volume applications (press fit C22B sells for even less)

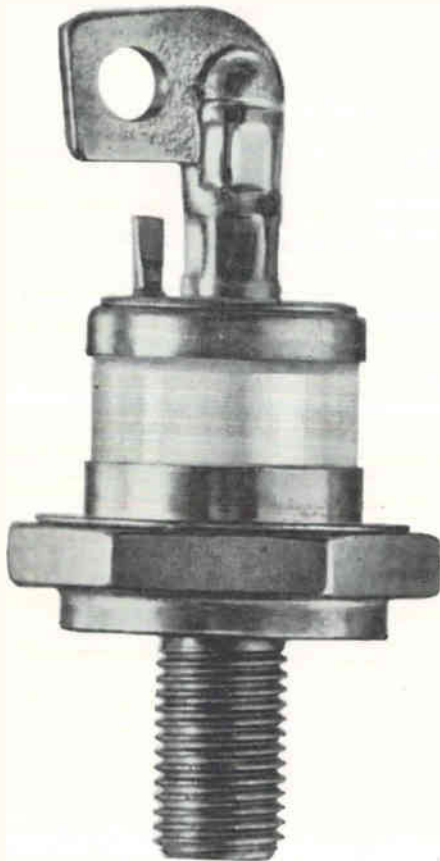

this is the double-diffused 100 amp 1200 volt flag type A70 (IN3289-IN3296 series) high current rectifier (it can replace three 400 volt diodes with a 35% cost saving)



this is the versatile 20 amp 50 volt A40F medium current rectifier that sells for 79c (we also have a press fit version that sells for less)

What do these five rectifiers have in common?

Each of these G-E developed devices can significantly improve existing circuit designs, or can open entirely new application areas.

Our Application Engineering Center is always ready to show you how they can be used in your circuits. Just call your G-E Semiconductor Products District Sales Manager, or write Section 16G112, Rectifier Components Department, General Electric Company, Auburn, New York. In Canada: Canadian General Electric, 189 Dufferin Street, Toronto, Ont. Export: International General Electric, 159 Madison Ave., N.Y. 16, N.Y. AVAILABLE THROUGH YOUR G-E SEMICONDUCTOR DISTRIBUTOR

GENERAL  **ELECTRIC**

ULTRA HIGH RELIABILITY tubular capacitors



WITH A NEW DEGREE OF PRECISION

SOUTHERN ELECTRONICS CORP. has long been a leader in the design and manufacture of high-precision tubular capacitors, and has pioneered in supplying them for critical applications in computers, missiles, communications and other high-grade military and commercial equipment. They are made to the same standards as our high precision polystyrene capacitors so widely accepted for military applications.

SEC tubular capacitors are manufactured under unusually critical quality control standards, resulting in tolerances as low as 0.5% in most values, and hermetic sealing guarantees accuracy over wide environmental changes.

SEC tubulars are available in a wide range of tolerances to meet your needs, from 100 mmfd. to any higher value, in polystyrene, mylar, metallized mylar, teflon and dual-dielectrics.

All **SEC tubular capacitors** meet or exceed the most rigid **MIL-SPECS.**

In addition, we manufacture a complete line of tubular capacitors for commercial applications. Let us know your requirements.



Write today for detailed technical data and general catalog.

**SOUTHERN
ELECTRONICS**
Corporation

150 West Cypress Ave., Burbank, California

company more than 18 months to unravel the cause of the prototype's failure.

A BOYHOOD FRIEND—A European scientist who had helped his firm develop an electronic measuring instrument bumped into a boyhood friend at a trade show where a rudimentary model of the instrument was on display. The friend, whom the scientist had not seen in years, was now an executive of a competitive firm. The two men reminisced about their youth and eventually the executive made an offer to the scientist. If the scientist would join forces with the executive, bringing along the secrets needed to manufacture the new instrument, he would be given a 50 percent interest in the executive's company. The scientist was receiving a substantial salary at his present company, in which he had previously been awarded a 10 percent interest. He, nevertheless, accepted his friend's offer. Within a short time, he and his new associates were giving his old firm considerable competition on the new instrument.

MAINTENANCE COSTS — An East Coast electronics firm concentrated on turning out products

that were the outgrowth of scientific breakthroughs, enjoying lead times of several months to a year over most of its rivals. There was one competitor, however, that consistently reduced these leads—so sharply that the firm became suspicious. It investigated and found that the head of its maintenance department was selling to the competitor the plans for production machinery, most of which had been specially designed and built by the firm's engineers.

COMMON ELEMENT—Is there a common element in these cases? The Norman Jaspan organization thinks so. "This is basically a good management problem," we were told. "The best way for a company to prevent espionage is to run a good ship."

Partly, this means laying down rules which will tell employees clearly what they can and can't do and adopting policies and techniques that will keep temptations to the minimum. But rules, locks, guards and classified files—which most firms have anyhow—don't go far. Norman Jaspan says: "In the final analysis, effective control hinges upon management's knowledge of what is actually taking place within the organization. It is a problem in communication, and



TWO-WAY RADIOS FOR ARMY

ARMY ELECTRONIC Material Agency is buying 10,944 portable two-way transceivers from **RCA** under a \$9 million contract. Known as **PRC-25**, the unit weighs 17 lb. and has a five-mile range under combat conditions. It operates in 920 crystal-controlled channels of 50-Kc separation in the 30- to 76-Mc range

proven techniques are available to alert executives who understand the need for them."

The Jaspán people also stress the importance of a company's attitude toward engineers and scientists, criticizing many firms for coddling them as "creative, highly emotional types" who shouldn't be subjected to the usual employee regulations. Jaspán also blasts firms on the opposite end of the spectrum: those that do not have the proper respect for the engineer and scientist and saddle him with make-work and other endeavors that rob him of his status as a professional.

ULTIMATE PREVENTATIVE—

Eventually even the shrewd, hard-headed men who run Norman Jaspán must talk more abstractly, and it is then, of course, that the trouble begins. No matter what safeguards are taken, no security program will succeed without the cooperation of the employees, and more than anything else, the moral atmosphere exuded by a corporation will influence the amount of cooperation received. Some people will be honest or dishonest no matter what, but the largest number will be affected by what they see going on around them. If management winks at executives who pad their expense accounts or juggle their inventories and efficiency ratings to make themselves look better, then it should not act surprised when workmen walk off with some of the tools and materials they handle or engineers and scientists sell to the highest bidder their knowhow.

Ethical conduct will for the most part beget ethical conduct, although when it doesn't, the experience is likely to be a bitter one. It is up to individual managements to make sure companies are run on a high moral plane and, while help may be obtained from the outside, no outside conscience can ensure this. We would have to get even more airy if we were to pursue this subject much further. A discussion of the imperfectibility of the human race would probably come next—and that lies outside our scope here.

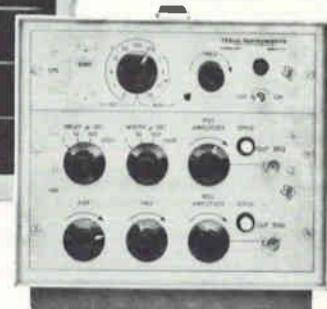
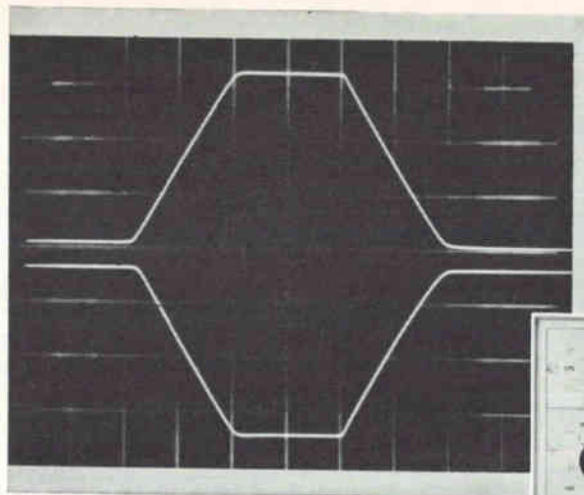

Clean waveforms with TI Model 7505 variable rise/fall time pulse unit

Clean waveforms are characteristic of TI pulse generators. The Model 7505 provides coincident positive and negative 10 volt pulses into 50 ohms with unlimited duty cycle . . . and both pulses can be simultaneously controlled in width, rise time, fall time and delay. Amplitudes are independently variable and outputs are short-proof, with overload indicators and reset buttons. Specifications, briefly . . . rise/fall times from less than 20 to 500 nanoseconds; width 40 nanoseconds to 1 millisecond; delay 90 nanoseconds to 1 millisecond; repetition rates to 25 megacycles. Like all Texas Instruments pulse generators, the Model 7505 is compact, lightweight and portable, extremely convenient to use. Circuitry is all solid-state.

Write for complete information.

INDUSTRIAL
PRODUCTS
GROUP



TEXAS INSTRUMENTS
INCORPORATED
P. O. BOX 66027 HOUSTON 6, TEXAS

SENSING • RECORDING • TESTING • DIGITIZING INSTRUMENTS
THE INSTRUMENTS OF TEXAS INSTRUMENTS

CIRCLE 37 ON READER SERVICE CARD ⁶⁰²



Your electronics BUYERS' GUIDE should be kept in your office at all times—as accessible as your telephone book.

New silicone dielectrics

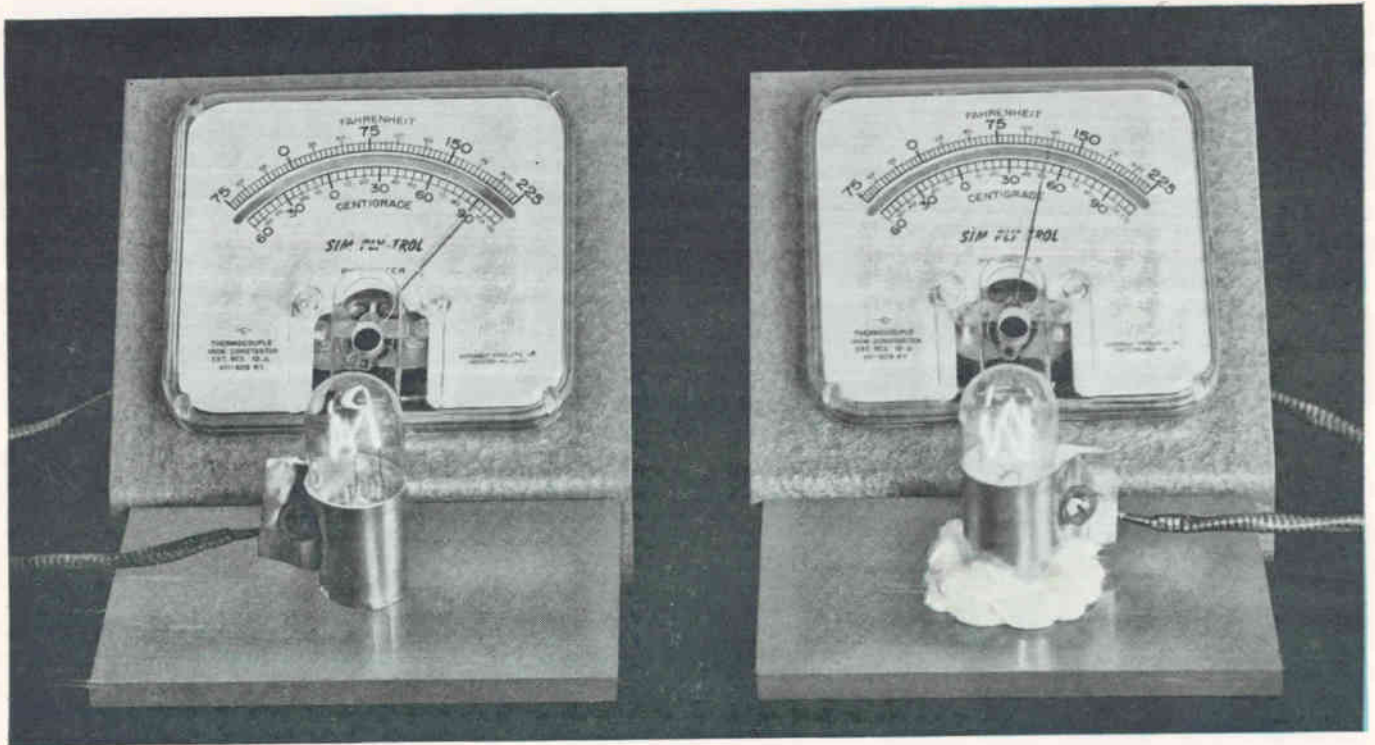

New heat sink compound dissipates heat faster; improves performance, reliability

Diodes, transistors, rectifiers . . . and light bulbs, too . . . operate cooler when Dow Corning 340 silicone heat sink compound is used. With triple the thermal conductivity of other materials, this new compound carries heat to the heat sink faster . . . devices operate longer, more efficiently, and with increased reliability.

Formulated of heat stable silicones and thermally conductive fillers, this heat sink compound lowers equilibrium temperatures and assures reliable device performance.

Dow Corning 340 silicone heat sink compound is a grease-like material that fills all tiny air spaces, maintaining a positive seal between component and heat sink or chassis. This total contact means faster heat transfer, a uniform heat transfer path.

Increased reliability is assured because this new silicone heat sink compound does not dry out, harden, gum or melt, even after long exposure to temperatures up to 200 C. Milk-white in color, it is chemically inert, won't attack or react with other materials, has low loss factor, low power factor, and excellent arc resistance.

Optimum conductivity of the compound is demonstrated above. Dow Corning 340 silicone heat sink compound carries heat from base of bulb at right to heat sink faster . . . bulb base is 75 F cooler than bulb without heat sink compound.



TYPICAL PROPERTIES

Dow Corning 340 silicone heat sink compound	
Color	White, opaque
Consistency	
Penetration, worked and measured within one minute after working (ASTM D 217)	290
Bleed, percent after 24 hours at 200 C	0.6
Evaporation, percent after 24 hours at 200 C	1.0
Specific Gravity	2.85
Thermal Conductivity, K Factor	0.0015gm/cal/sec/cm ² /degrees C/cm

CIRCLE 289 ON READER SERVICE CARD

Dow Corning

preserve design integrity

New compound for transistor potting

Dow Corning 18 semiconductor potting compound keeps junction temperatures at a minimum, cushions against shock, and absorbs moisture from within the cap to act as a moisture getter. These advantages . . . plus high centrifuge stability . . . combine to assure consistency and reliability of transistors, diodes, rectifiers, and other solid state devices.

Supplied in sealed containers, this silicone-based, grease-like material combines high purity, low moisture content, high thermal conductivity, good dielectric properties, oxidation and evaporation resistance. These capabilities are maintained from -40 C to 400 C .

CIRCLE 290 ON READER SERVICE CARD

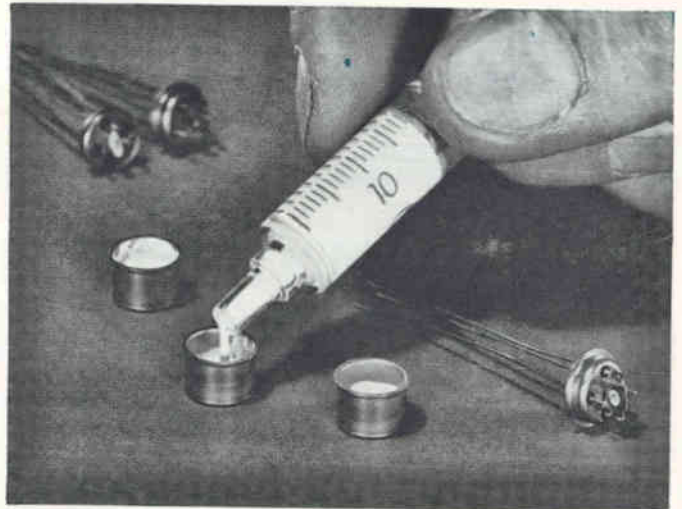

New resins protect device junctions

Exceptionally high purity standards characterize three new Dow Corning transistor junction coating resins. Applied with a dropper or brush, they cure to form a tough protective film that seals out contaminants; assure junction integrity. Cure time is adjustable from 30 minutes at 250 C to 16 hours at 150 C , depending upon processing requirements and device heat limitations. Typical properties: viscosity, from 75 to 80 centistokes; specific gravity, 1.008; dielectric constant at 25 C , 10^2 cycles per second, 2.23 to 3.22; dielectric strength, 2225 to 2380 volts per mil; volume resistivity, 1.0×10^{15} to 5.27×10^{15} ; surface resistivity, 1.38×10^{13} to 9.33×10^{13} .

CIRCLE 291 ON READER SERVICE CARD

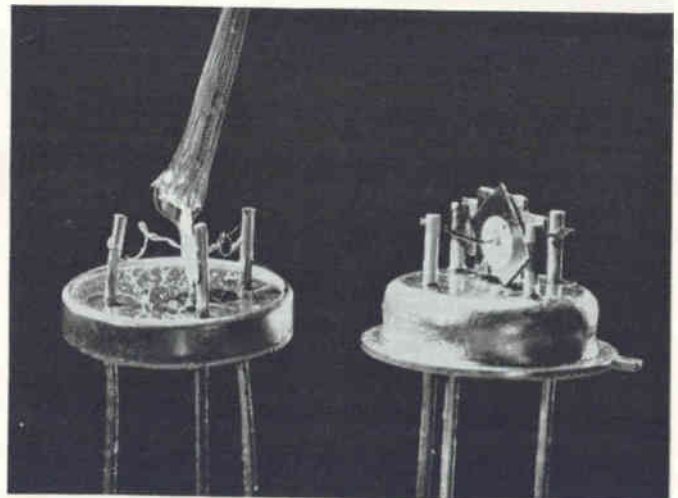

New fluid non-congealing at -110 F .

Higher pumping rates, rapid heat transfer, and smaller, lighter pumps are among the design advantages made practical with Dow Corning 331 fluid coolant. This silicone fluid flows freely when other coolants are frozen solid, features an operating temperature range of from -130 F to 400 F , -90 C to 204 C . Other features: viscosity of 10 centistokes; low volatility; flash point of 420 F , 216 C , in a closed cup. Designed to meet MIL-S-27875, this new fluid also provides high dielectric strength, stable electric properties, high specific heat, hydrolytic stability, inertness, excellent thermal stability and oxidation resistance.

CIRCLE 292 ON READER SERVICE CARD

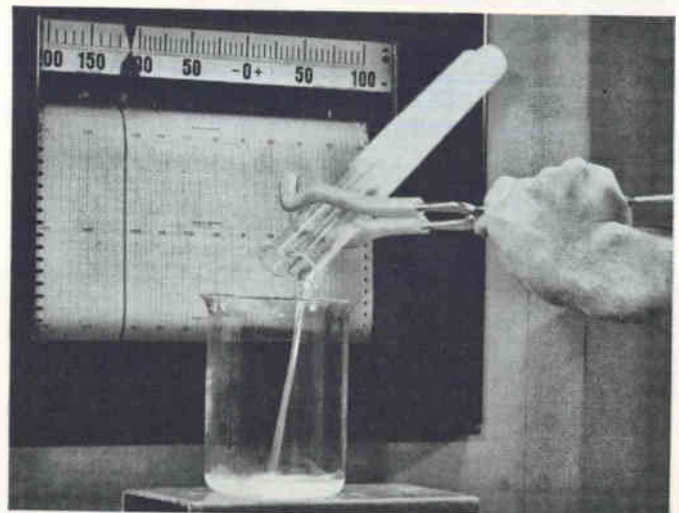

For information on these and other silicone materials, write Dept. 3931, Electronic Products Division, Dow Corning Corporation, Midland, Michigan.

HOW WE SHRUNK TEFLON*

Why Gudebrod's Common Sense Approach to Lacing Problems Pays Dividends for Customers!

Some years ago motor manufacturers had a problem! They required a high temperature lacing tape that would not deteriorate during the baking process of motor manufacture and would be practical in its application.

Teflon offered the most practical solution to the problem since it provides a temperature range from -100°F to 500°F . We took teflon and flat braided it—we originated the process—but what about shrinkage? When teflon is baked it shrinks . . . it would cut thru fine motor wires!

To meet this problem, we developed an exclusive pre-shrunk process for teflon. This patented process pre-shrinks teflon so that the maximum shrinkage is less than 3% after 16 hours at 425°F . We call this lacing tape Pre-Shrunk TEMP-LACE. Motor manufacturers use it in great quantities.

Pre-shrinking teflon is but one of the many processes we have developed to meet the needs of customers. Whatever your lacing needs—nylon, glass, dacron, fungus proofing, color coding—Gudebrod's common sense approach to the problem will pay dividends for you because

1. *Gudebrod lacing tape increases production!*
2. *Gudebrod lacing tape reduces labor costs!*
3. *Gudebrod lacing tape means minimal maintenance after installation!*
4. *Gudebrod is quality—our standards for lacing tape are more exacting than those required for compliance with MIL-T!*

Write today for our Technical Products Data Book which explains the many advantages of Gudebrod lacing tape for both civilian and military use.

*Du Pont registered trademark for its TFE-fluorocarbon fiber.

†Du Pont trade name for its polyester fiber.



GUDEBROD BROS. SILK CO., INC.

FOUNDED IN 1870

Electronics Division

12 SOUTH 12th STREET, PHILADELPHIA 7, PENNA.

Visit Gudebrod Booth #921 at the Wescon Show

MEETINGS AHEAD

MEDICAL ELECTRONICS INTERNATIONAL CONFERENCE, IFME, University of Liege, Liege, Belgium, July 22-26.

ELECTROMAGNETIC MEASUREMENTS & STANDARDS SEMINAR, National Bureau of Standards; NBS Laboratory, Boulder, Colo., July 22-Aug. 9.

AEROSPACE SUPPORT INTERNATIONAL CONFERENCE & EXHIBIT, IEEE, ASME; Sheraton-Park Hotel, Washington, D. C., Aug. 4-9.

INTERNATIONAL ELECTRONICS CIRCUIT PACKING SYMPOSIUM, University of Colorado, et al; at the University, Boulder, Colo., Aug. 14-16.

WESTERN ELECTRONICS SHOW AND CONFERENCE, WEMA, IEEE; Cow Palace San Francisco, Calif., August 20-23.

DATA PROCESSING NATIONAL CONFERENCE & EXHIBITION, Association for Computing Machinery; Denver Hilton Hotel, Denver, Colo., Aug. 27-30.

AUTOMATIC CONTROL INTERNATIONAL CONGRESS, International Federation of Automatic Control; Basle, Switzerland, Aug. 27-Sept. 4.

MILITARY ELECTRONICS NATIONAL CONFERENCE, IEEE-PTGMIL; Shoreham Hotel, Washington, D. C., Sept. 9-11.

ELECTRICAL INSULATION CONFERENCE, IEEE, NEMA; Conrad-Hilton Hotel, Chicago, Sept. 10-14.

JOINT ENGINEERING MANAGEMENT CONFERENCE, IEEE, ASME, et al; Biltmore Hotel, Los Angeles, Sept. 12-13.

INTERNATIONAL ASSOCIATION FOR ANALOG COMPUTING, AICA; Brighton College of Technology, Lewes Rd., Brighton, England, Sept. 14-18.

INDUSTRIAL ELECTRONICS ANNUAL CONFERENCE, IEEE, ISA; Michigan State University, East Lansing, Mich., Sept. 18-19.

PHYSICS OF FAILURE IN ELECTRONICS SYMPOSIUM, Armour Research Foundation and Rome Air Development Center, Illinois Institute of Technology, Chicago, Sept. 25-26.

ADVANCE REPORT

AEROSPACE ELECTRO-TECHNOLOGY INTERNATIONAL CONFERENCE, IEEE, et al; Phoenix, Ariz., April 19-25, 1964. Aug. 19 is the deadline for submitting a 250-word abstract to: Arnold A. Sorensen, Technical Program Chairman, Mail 3016, The Martin Company, Baltimore 3, Md. Papers representing original contributions in the following fields of aerospace technology are invited: electrical systems (including mechanical and packaging design); electronics systems (including integrated electronics); energy conversion (including cryogenics and superconductivity); thermoelectricity (including device construction and performance).

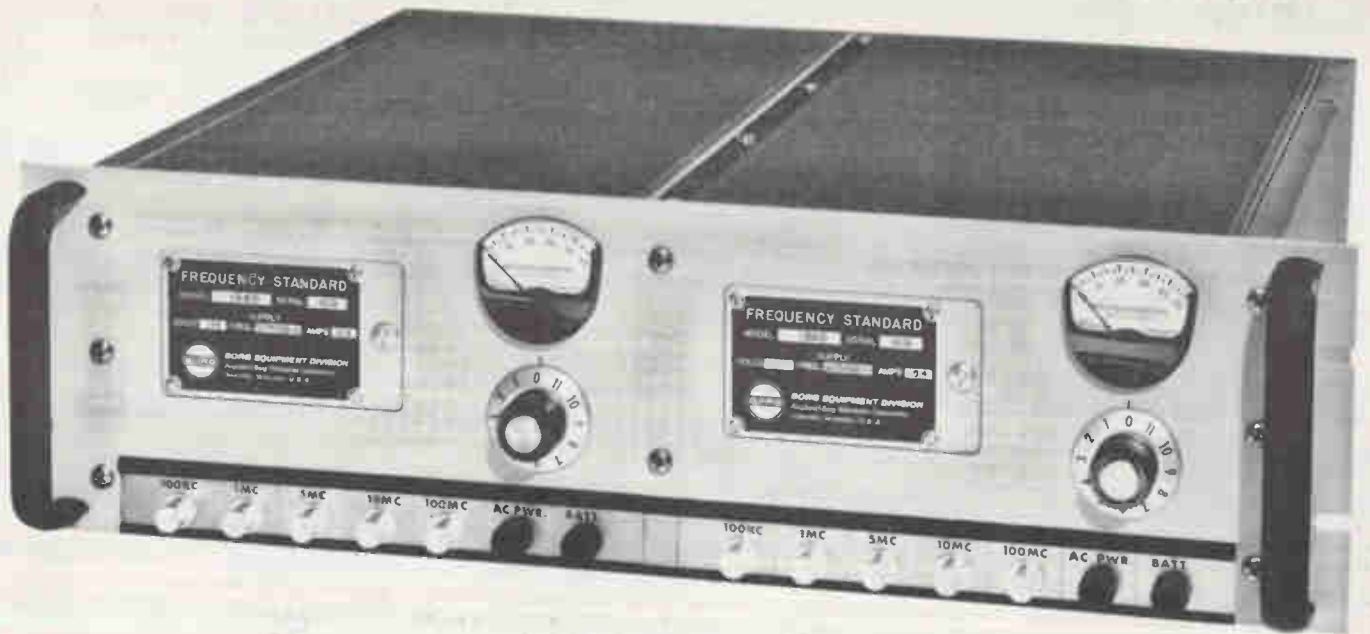

MTBF > 10,000 Hours

That's the kind of reliability you can expect from this new Borg Frequency Standard. What's more . . . **IT'S MODULAR**—You can easily plug in extra modules, multipliers up to 100 mc or dividers down to 1 pulse per second*.

IT'S COMPACT—2 units fit 5¼" panel space.

IT'S STABLE—Down to 5×10^{-12} for short term (see specs below for long and short term stability).

And it is designed to meet MIL-E-16400D.

Fully transistorized, 1560 Series offers the highest demonstrated reliability of any commercial available frequency standard. Stability? Dual ovens hold the 5mc overtone crystal temperature to within $\pm 0.005^\circ\text{C}$. All semiconductors are silicon or tetrode type.

Rechargeable standby battery (good for +10 hrs) lets you carry

unit to remote project sites or airship it anywhere without shutdown.

Oven and oscillator available as a separate module for your system.

If you need precision timing—for communications or weapons systems, navigation, radar, laboratory, or commercial use—you're a postage stamp away from the best source. Borg Equipment is the world's largest manufacturer of precision frequency standards.



BORG EQUIPMENT DIVISION

Amphenol-Borg Electronics Corporation,
Janesville, Wisconsin

SPECIFICATIONS: Transistorized Frequency Standard, Borg 1560 Series

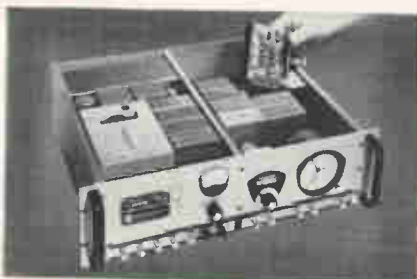

FREQUENCY STABILITY

Long Term: 5×10^{-10} per day after 21 days operation

Short Term: 5×10^{-12} rms average of 1 second counts

OUTPUT FREQUENCY

5mc plus options (1 pps to 100mc)

HARMONIC DISTORTION

—40db

FREQUENCY ADJUSTMENT

Fine 1×10^{-7} digital dial, 1 count equals 1×10^{-10} Coarse 1×10^{-4}

METERING

12 selected circuits

TEMPERATURE RANGE

—20°C to +50°C (—4°F to 122°F)

POWER CONSUMPTION

14 watts from 60 volt line

DELIVERY in 30-60 days

*Some budget-minded project engineers, finding a gap in their appropriations, have ordered Borg Frequency Standards, knowing that they can get plug-in multipliers, dividers, power supplies, and battery packs later.

CIRCLE 41 ON READER SERVICE CARD



Print top and side together at 3200/hour

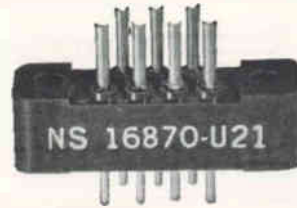

Identify products with inks that meet government specs



Print 1500 hard-to-hold items per hour with complete uniformity — change to new imprint in seconds

cut your identification costs with modern methods like these



Color-band and/or print economically by machine — in sample lots or up to 6000/hour



Save purchase, inventory and obsolescence costs by making your own labels exactly as needed



Get sharp, durable imprints on extremely irregular shapes or rough surfaces

Looking for faster identification . . . imprints that meet government specs . . . flexibility to meet changing requirements . . . a practical way to mark prototype or sample lots? Would direct printing or making your own labels cut costs, give higher print quality? Ask Markem to analyze your identifica-

tion needs now — without obligation — and show you *how* and *where* you can save money. Frequently, a Markem in-plant identification system pays for itself in a few months. Contact the Markem Technical Representative near you, or write Markem Machine Co., Keene 5, New Hampshire.



New 12-page Catalog describes Electrical/Electronic Identification Methods and Equipment. Copy on request.

MARKEM

TECHNICAL ASSISTANCE AND INDUSTRY-PROVEN EQUIPMENT
WORLDWIDE . . . TO HELP YOUR PRODUCT SPEAK FOR ITSELF

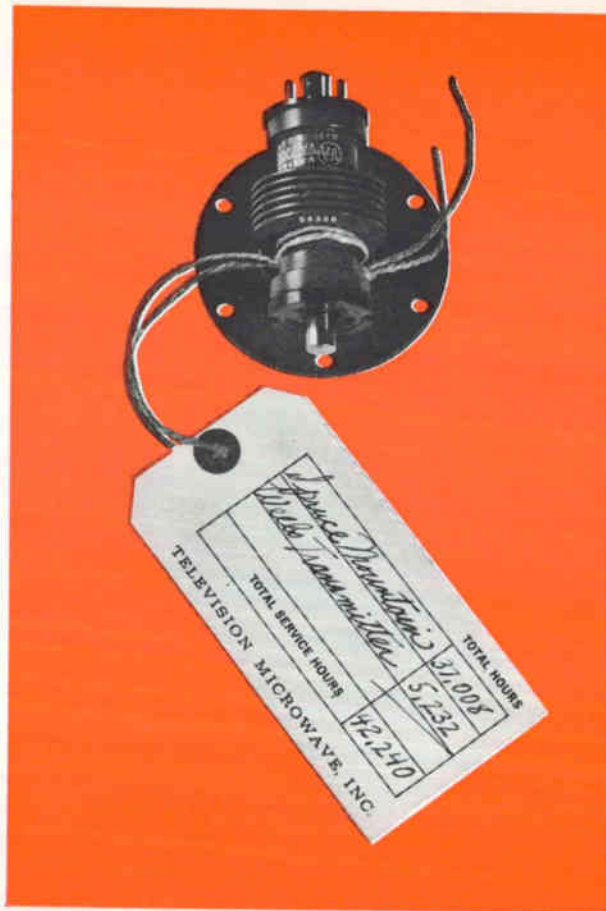

VARIAN KLYSTRON LOGS 42,000 HOURS SERVICE

A Varian VA-220E klystron, Serial No. 59366, was installed in August, 1957, in a television repeater transmitter on Spruce Mountain near Wells, Nevada. Still operating after 37,000 hours, the tube was removed from service in November, 1961. Television Microwave, Inc., operators of the four-channel, three-repeater TV relay system, later installed this tube in its Wells transmitter, and obtained 5,000 more hours of unattended service. The tube is still good. ■ Long-life performance is quite usual for Varian tubes; Television Microwave, Inc., reports that its Varian tubes are seldom replaced before 30,000 hours of operation. ■ For assured long tube life, you can depend on Varian.



VARIAN

ASSOCIATES
TUBE DIVISION
Palo Alto 1, Calif.

MICROWAVE TUBE GROUP: PALO ALTO TUBE DIVISION • BOMAC
DIVISION • S.F.D LABORATORIES, INC. • SEMICON OF CALIFORNIA, INC.
VARIAN ASSOCIATES OF CANADA, LTD. • SEMICON ASSOCIATES, INC.

EUROPEAN SALES HEADQUARTERS: VARIAN A.G., ZUG, SWITZERLAND

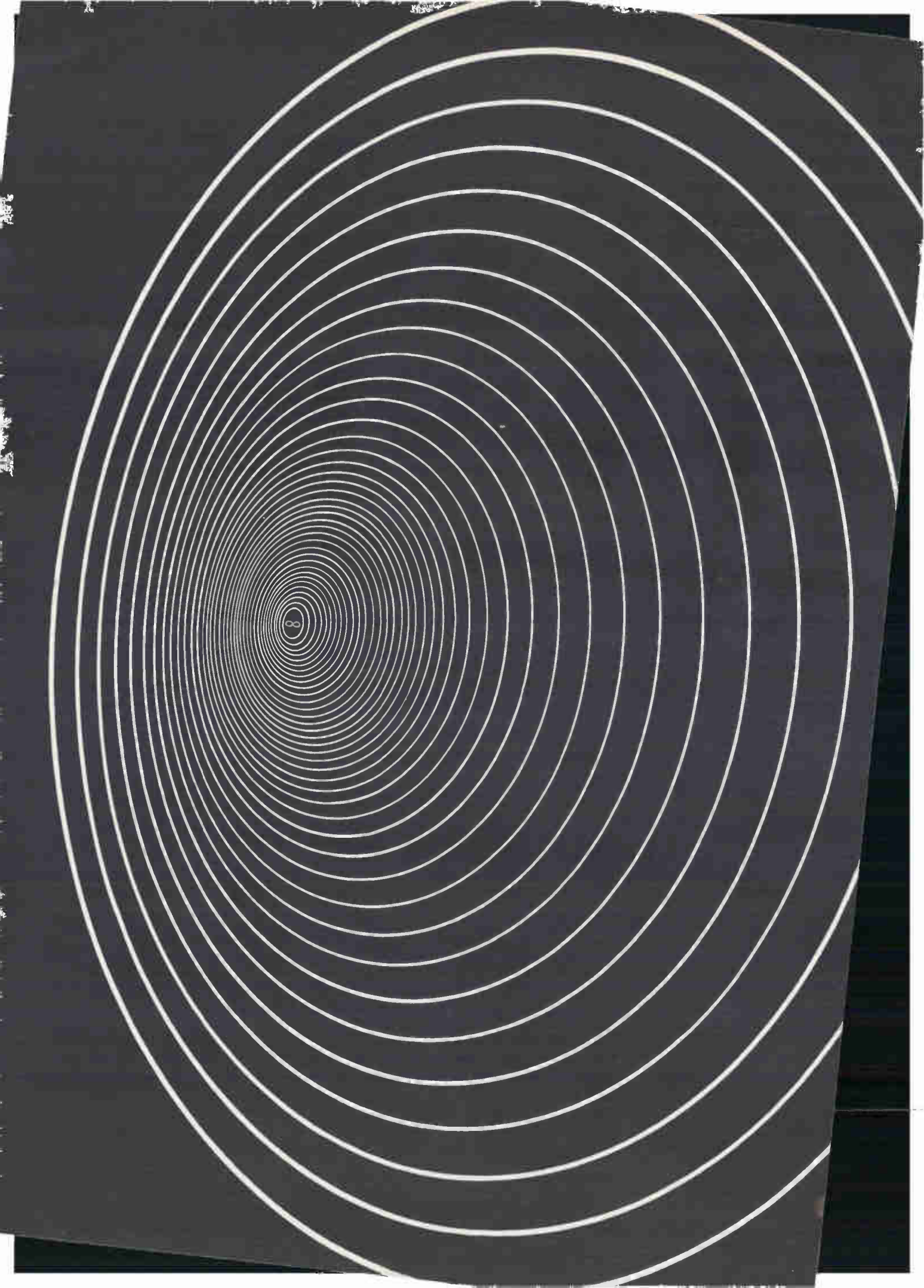

SCIENTISTS AND ENGINEERS:

From undersea navigation equipment for test on the research vessel Trieste to the development of non-inertial systems for deep space rendezvous, Motorola performance spans the broad spectrum of environments in advanced systems.

In the area between, current programs include: advanced random access communications and side looking radar surveillance systems for the Army... air-to-air missile guidance and digital command systems for the Navy... data transfer and high speed teleprinting systems for the Air Force... satellite tracking, telemetry and instrumentation for NASA and extensive company funded R & D projects. Scientists and engineers interested in joining an electronics company with versatile interests unbounded by narrow specialization write today describing your background and training in:

ZERO TO INFINITY

Systems Design • operational and functional mission analysis, optimum time-bandwidth utilization, redundant system organization for reliability, phased arrays, digital and voice communications, and A-J secure communications.

Equipment Design • solid state receivers, transmitters and transponders, distributed parameter microwave equipment, digital Modems, controls and displays, low-level switching circuits, and digital data processing circuitry.

Familiarity with State-of-the-Art • spread spectrum techniques, visual spectrum intelligence transmission, statistical theory of communication, integrated circuit applications, multiple logic element techniques, organization of digital data handling systems, correlation and phase-lock techniques, and coding and modulation.

We are particularly interested in programs on which your experience was obtained and the extent of your technical responsibility. Please address this information to our Manager of Engineering for immediate and confidential attention.



MOTOROLA
An equal opportunity employer

Military Electronics Division

Motorola Building, 6500 E. McDowell Road, Phoenix, Arizona 85006

Leach Balanced Armature Relays are the smallest relays on the market today that solve your really **difficult** application problems. For example, this relay (actually only 1.8 inches high) withstands 2000 foot lbs. of shock loading and vibration of 30 G's to 2000 cps to meet Mil-S-901B for equipment-mounted components.

Maximum benefits in minimum packaging! No smaller relays answer all these demands: radiation resistance, perfect performance at extreme altitudes, reliable contact switching, three phase rating, minimum voltage spike generation, high terminal strength, minimum current capability, no maintaining power required, grounded AC ratings or gold alloy contacts for dry circuit applications. Whatever your specifications, there's a Leach Balanced Armature Relay to meet your requirements. If size is **really** the problem, ask about our subminiature relays.

That's why we urge you to look to Leach. You name your problem. We'll take it from there.

LEACH CORPORATION

405 Huntington Drive, San Marino, California • Export: Leach International S. A.

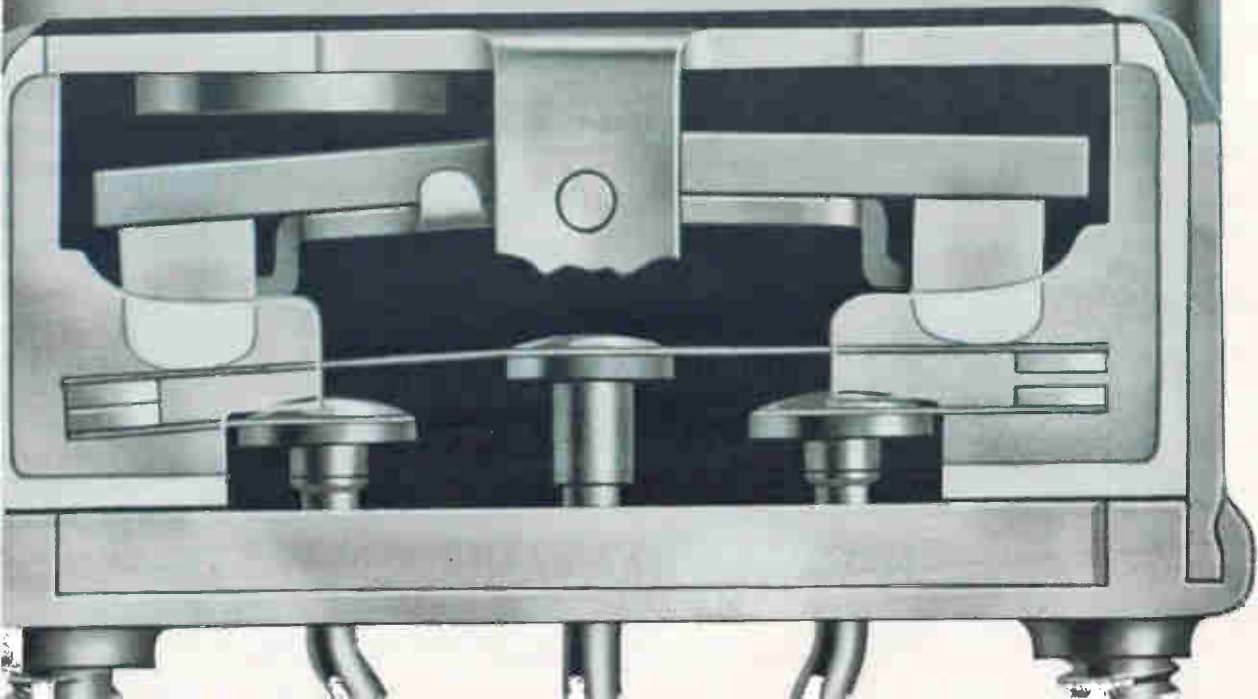

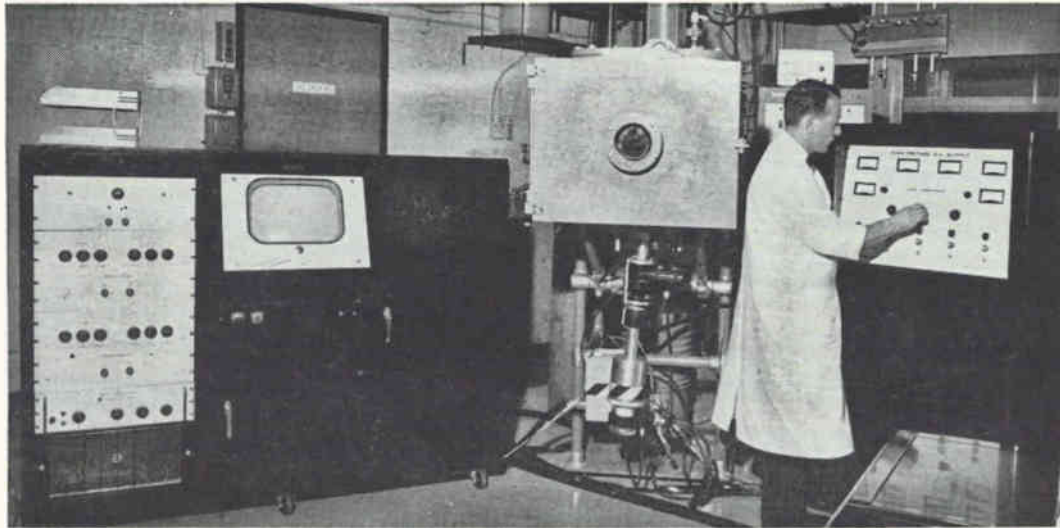

ELECTRON-BEAM gun—extending below vacuum chamber—is part of equipment used in micropower technology. Equipment at left has pattern monitoring screen

MICROPOWER CIRCUITS

NEW FRONTIER IN SOLID STATE

Micropower circuits combining thin-film and diffusion technology are now limited to operating below 1-Mc, but higher speeds appear feasible with further size reduction. Circuit design for micropower—both analog and digital—promises to be on a par with conventional design

By W. W. GAERTNER and M. SCHULLER, CBS Laboratories, Stamford, Conn.

BY BRINGING power consumption of individual circuit components down to microwatts, packaging densities of one million components per cubic inch become feasible since the heat generated is small and the circuits operate nearly at ambient temperature. Space electronics with a density of $\frac{1}{2}$ million components per cubic foot have already been delivered to

NASA and much greater size reduction is possible.

The technique developed to produce microwatt circuits integrates planar diffusion technology and deposited thin-film technology on the same silicon wafer. Microwatt power does not represent a lower limit for the process and even nanowatt power appears feasible. Nanowatt operation would bring micro-

electronic circuits into the range of power of biological systems.

TECHNOLOGY — Integration of planar diffused technology and deposited thin-film technology on the same silicon wafer is indicated in Fig. 1. All the conventional processes of epitaxial growth, diffusion and alloying are performed first and then the grown silicon oxide on

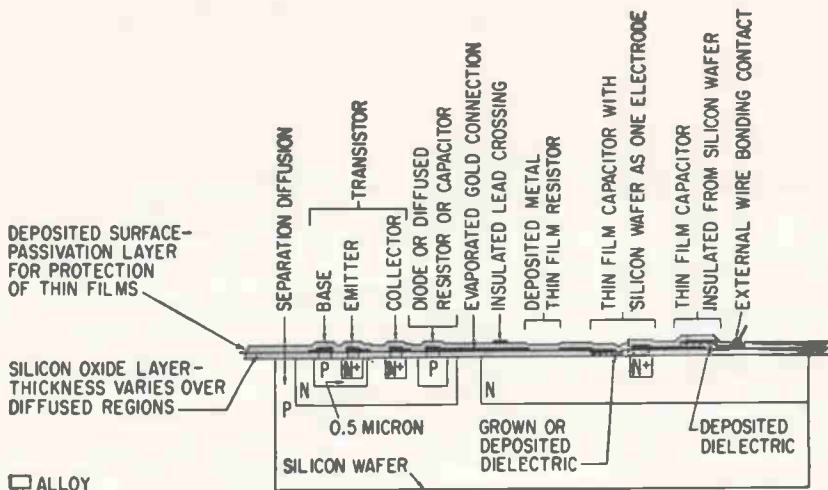

PLANAR DIFFUSED technology is combined with thin-film techniques to give microwatt circuits. The deposited surface-passivation layer allows a large reduction in volume—Fig. 1

the wafer surface is used as a substrate for depositing thin-film components. Finally, an inert passivation layer is deposited over the thin-film components to protect them from mechanical and chemical damage. The result is a fully passivated function block, as in conventional microelectronics, but with thin-film components included.

The photograph on the cover of this issue shows such a surface-passivated thin-film semiconductor circuit wafer being subjected to a hot dichromic acid test. The circuit is unaffected. Thus the surface-passivation technique is an important step towards eliminating the present bulky package around the small semiconductor wafer. This increase in allowable packing density is not accompanied by a destructive temperature rise.

The new technology brings several additional degrees of freedom to the microelectronics field and offers some distinct advantages.

• **High Resistor Values**—Micro-power operation requires resistances of the order of megohms.

With a sheet resistance of only 400 ohms per square and a line width of 1 mil, a 1-megohm resistor covers an area of approximately 70×70 mils. A diffused 1-megohm resistor would take up twice this area.

• **Low RC Time Constants**—All microelectronics is plagued by stray capacitance between the closely spaced circuit elements and the bulk of the wafer, resulting in undesirable coupling, spurious oscillations and R-C time delays that slow down the circuit significantly at all power and impedance levels. It is particularly noticeable, however, in low power, high resistance circuits. The capacitance of silicon *p-n* junctions, which separate diffused resistors from the bulk and from other circuit elements, is typically about 0.2 pf per sq mil. But the capacitance across a 1-micron thick layer of grown silicon oxide that separates a deposited metal-film resistor from the substrate is only 0.024 pf per sq mil. Thus the time constant associated with a thin-film resistor of the same value and size as a diffused resistor

is almost 10 times lower.

In addition, the size of the deposited resistor itself will usually be at least 50 percent smaller. Furthermore, the silicon-oxide layer can still be made substantially thicker whereas there is a natural limitation to the thickness of a *p-n* junction depletion layer. Therefore the combination thin-film semiconductor technology can produce faster microcircuits at all power-levels and not only in the microwatt range. Thin film resistors deposited on silicon oxide over silicon compare even favorably in response time with those deposited on ceramic substrates because the latter often have high dielectric constants which lead to high coupling capacitance between the closely spaced resistor lines.

• **Component Independence**—Since the fabrication of transistors and resistors—and sometimes of capacitors—occurs at different times, their characteristics are largely independent and each can be changed and optimized without affecting the others.

• **Versatility**—A direct result of the complete independence of transistor and resistor characteristics is design versatility. A number of universally useful transistors can be diffused into a silicon wafer and then various resistor and interconnection patterns can be added to produce a variety of different circuits for different speed and power ranges. When the transistors are fabricated it is not necessary to know whether a digital or analog circuit is to be built, or which package leads will be used for which purpose. Figure 2 shows six different resistor and interconnection patterns added to a basic transistor pair to form a variety of medium-power analog and digital circuits.

Another example is given in Fig.

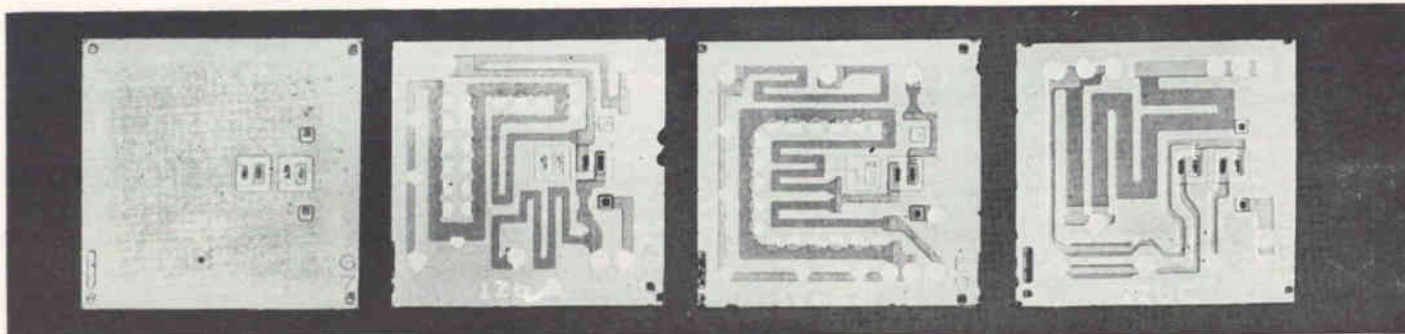

3, where several different NOR gates and a pair of emitter-followers have been evaporated onto the same transistor pattern. This not only aids efficient production but also allows quick reaction during circuit development. If a fast mask-making facility is available, a new circuit design can be ready for testing in microelectronic form in one day. New resistor and interconnection patterns are evaporated onto an existing universal transistor wafer, then tested after being scribed, mounted and bonded.

• *Tight Tolerances*—In some applications tight tolerances on components must be achieved. Resistor tolerances are a function of line width and sheet resistance. Tight tolerances are achieved by monitoring the sheet resistance of a thin-film resistor during deposition and stopping the evaporation as close as possible to the desired value, as well as by being able to predict the small resistance changes which occur during high-temperature stabilization. Readily achievable tolerances range at the present time from ± 5 percent with a line width of 1.5 mils and a sheet resistance of 400 ohms per square to fractions of 1 percent with a line width of 5 mils and a sheet resistance of 100 ohms per square. These tolerances are continuously being improved. Since there is a direct relationship between component tolerances and speed and power consumption of a system, performance superior to systems produced with diffused components alone is expected. The accuracy of resistors evaporated on the same substrate is within a few tenths of one percent. Figure 4 shows a high precision resistor ladder network for microelectronic analog-to-digital converters.

• *Temperature Stability*—In applications such as f-m telemetry,

temperature stability of components is an absolute necessity. In other applications it is desirable because it increases the speed and decreases the power consumption of the entire system. Figure 5 shows the temperature variation of a passivated thin-film resistor deposited on silicon oxide over silicon. Its temperature coefficient is 10 to 100 times better than diffused semiconductor resistors.

• *Resistor Materials*—Any resistor material that can be evaporated or sputtered can be used in the thin-film semiconductor technology: the choice depends on sheet resistance, temperature coefficient or other property desired. Nichrome, chrome and tantalum are useful for many applications.

• *Scaling*—Many circuits depend on the ratios of resistances rather than on their absolute values. The speed, power consumption and fan-out capabilities of a thin-film semiconductor microcircuit can be changed over wide ranges by depositing different amounts of resistor materials onto the same pattern.

• *No High-Temperature Leakage*—Unlike diffused semiconductor resistors, thin-film resistors on silicon oxide over silicon show no leakage currents between the resistor and the bulk of the wafer even at high temperatures and with large resistor areas.

• *Heat Conduction of Substrate*—The high heat conductivity of the silicon substrate as compared to ceramic substrates equalizes hot spots in the microcircuit much better, so permissible power dissipation for a resistor covering a given area is much higher. Figure 6 shows the long term stability of these resistors under loading at elevated temperatures.

• *Extremely Pure Substrate*—

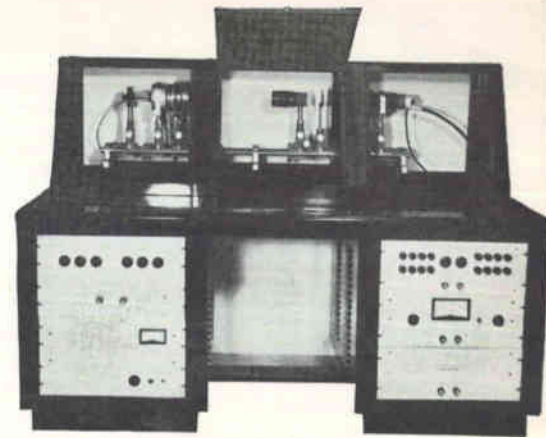

CONTROL DESK with optical bench in which pattern slide is sensed by a flying-spot scanner

The extreme chemical purity of the grown silicon oxide substrate is considered a favorable factor for the long-range high-temperature stability of the thin film resistors.

• *Low Operating Temperature*—In microwatt operation and at packing densities dictated by present packaging and interconnection schemes, the microelectronic function block remains at ambient temperature rather than experiencing the significant temperature rise typical in systems consisting of uncooled tightly packed conventional microelectronic packages. This low operating temperature is expected to contribute greatly to reliability.

• *Packing Density*—Since one million transistor stages operating at one microwatt each will dissipate only 1 watt, micropower circuits alone will allow the size reductions previously predicted on the basis of size alone. Already delivered to NASA is microelectronic space hardware with a packing density of $\frac{1}{2}$ million components per cubic foot, and an increase of many orders of magnitude is still feasible.

• *Secondary Advantages*—Indirect benefits derive from micro-

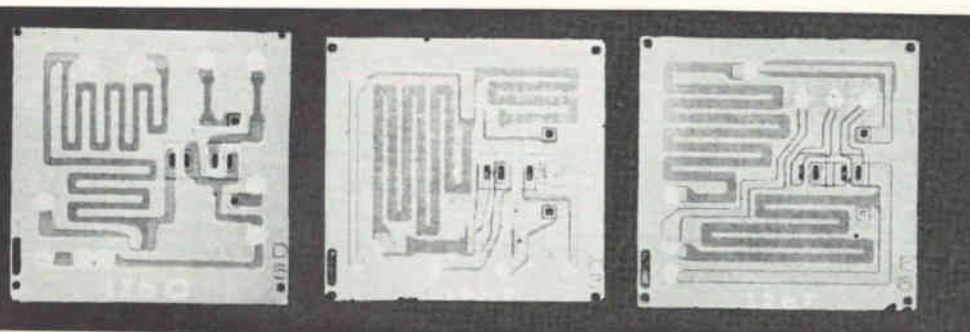

WAFER with two transistors (far left) can be made into a variety of circuits by depositing different thin-film patterns. Circuit development can be rapid if mask-making equipment is available—Fig. 2

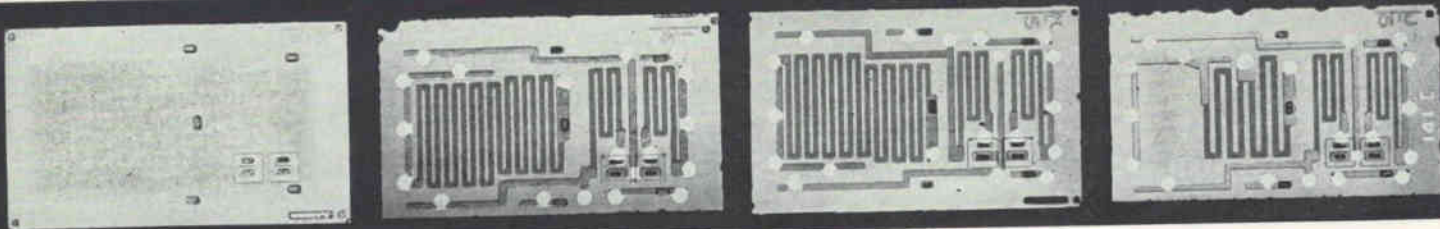

BASIC transistor wafer applied to various circuit designs. A few basic transistor chips can be applied to many circuits

APPLYING MICROPOWER

Microwatt and nanowatt circuits should go a long way toward freeing the circuit designer from the problems of heat dissipation and circuit volume, at least so far as the signal processing and computing part of the circuit is concerned. One result is that highly sophisticated techniques can be developed for military and space applications—and eventually for more prosaic uses

power operation of systems. The cost, size and weight of the power supply—storage batteries, solar panels—can be reduced sometimes by as much as 100. In air and spaceborne systems this results in a saving in transportation costs or in greatly improved capability for a given transportation cost.

PROBLEMS—Whereas the desirability of very low power operation and of complete integration of thin-film and semiconductor techniques is almost self-evident, the technological problems in the practical realization of these concepts have not been trivial.

• *Transistor Quality*—To achieve microwatt operation the microelectronic function block must contain transistors with high current gain at an emitter current of 1 microampere and a collector voltage of less than 1 volt. Such transistors, with high capacitances, are now

commercially available but are not necessary for and are not used in conventional milliwatt microelectronics.

Since high-quality performance is required of adjacent transistors on the same function block, the overall yield of the microwatt transistor production process must be high. Furthermore, in the interest of speed the high gain at low current must be combined with low junction capacitance. Since decreasing size increases the surface-to-volume ratio of the junctions, resulting usually in lower current gain at low currents because of surface recombination at the junction, high precision in mask line-up and photoresist processing is required. The transistors shown in Fig. 2 and 3 have betas as high as 80 at one microampere collector current and junction capacitance of 5 pf at zero volts.

• *Substrate and Resistor Quality*—In ordinary planar and microelectronic technology occasional pinholes and oxide flaws are not immediately harmful except near the junctions and may only later result in poor reliability. In the thin-film semiconductor technology, however, the oxide layer covering the silicon wafer is the substrate for the thin-film components and must be perfect and uniform over large areas, especially for resistors with long narrow lines closely spaced and for large capacitors. For resistors an irregularity may cause an im-

mediate break in a line, or a weak spot which opens up under high load and temperature. Or, the resistor may have leakage or a short to the substrate. In capacitors, imperfections cause leakage and low breakdown voltage.

Equally important to the quality of the silicon substrate are the controls on thin-film deposition. Since the substrate wafer contains transistors and diodes worth thousands of dollars, the yield of the deposition process must be near 100 percent. Subsequent trimming of resistors by abrasion, customary with some conventional thin-film resistors, is impossible and all components must be deposited within tolerances, and subsequent accelerated aging must not bring them outside tolerance.

• *Compatibility of Technologies*—Thin-film deposition requires cleaning the substrate with highly reactive chemicals and heating it to high temperature for a prolonged time. Cleaning, however, must have no ill effects on the transistors and diodes in the substrate. For micropower operation the transistors must maintain their high current gain throughout the treatment. Thin-film components must withstand thermocompression bonding temperature. Both these steps present difficulties.

• *Effect on Cost*—Several factors contribute to the present high cost of micropower microelectronics: the quality of the components required; the extra fabrication steps required by the addition of the thin films; the size of the megohm-range resistors which allows only a relatively small number of circuits on one wafer. With improved understanding and automation of all processes, however, and control of higher and higher sheet resistances, the cost of micropower microelectronics will come down close to that of conventional milliwatt

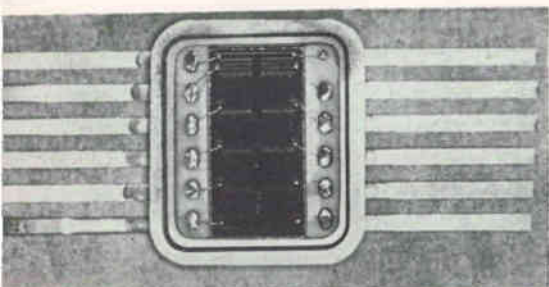

HIGH PRECISION ladder network has 19 thin-film resistors accurate to 0.3 percent—Fig. 4

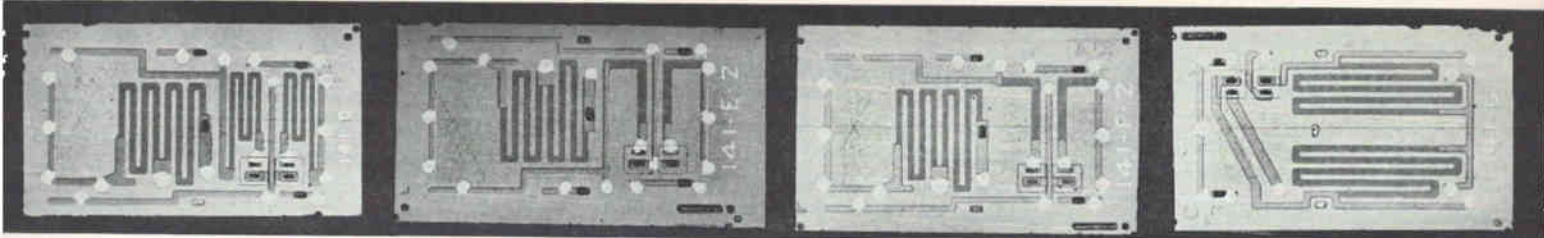

because of component independence—Fig. 3

electronic circuits.

• **Reliability**—This is one of the main reasons for using microelectronic building blocks. Thin-film semiconductor microelectronic technology is at this point too new for extensive reliability data and the technology itself still changes rapidly to take advantage of possible improvements. An unusually high degree of reliability is expected, however. It is well established that an increase in operating temperature causes a decrease in reliability, and since micropower microelectronic blocks operate virtually at ambient, they should eventually have the highest reliability possible at a given ambient—higher than any type of circuit that raises its operating temperature significantly due to heat dissipation.

The main source of reliability is in the fabrication processes. Although these are proprietary a few general rules can be mentioned. All work must be performed in white rooms with humidity, dust and temperature control; all fabrication should be carried out at the highest possible temperature to eliminate subsequent changes of component values in the operating range; the entire circuit is covered by a tough passivation layer such as silicon oxide, which allows the circuit to be submerged in hot dichromic acid ($H_2SO_4 + H_2O + Na_2Cr_2O_7$) for almost an hour without damage to the thin-film components (see cover); each circuit chip can be monitored through all fabrication steps into final packaging. The letters and numbers on the circuit chips in Fig. 2 and 3 identify the location of the chip on a wafer, which may contain 40 to 1,000 circuits. These tight controls lead to high yield, which is another prerequisite for high reliability.

NANOWATTS—Microwatt operation is not a limit dictated by

semiconductor physics and a reduction of supply power by several orders of magnitude into the nanowatt range appears feasible. This would bring microelectronics down into the biological-supply power range. Several research projects are presently underway to penetrate the nanowatt range, with emphasis on the following.

- Improved control on diffusion processes to achieve a high yield of transistors with sufficient current gain at emitter currents of 1 na

- The exploration of stable thin-film resistors with a sheet resistance of many thousands of ohms per square

- The replacement of visible light by electron and ion beams as the major technological tools to produce the minute geometries necessary for high speed at very low power. Transistors with a maximum area of 3×3 microns are forecast whose details could not even be observed under an optical microscope. Experimental electron and ion beam systems for such purposes are shown in the photographs.

SYSTEMS — Micropower microelectronics has been applied to several subsystems of moderate complexity, some already delivered for operational systems use; one application involves over 300 transistors and 600 resistors and capacitors, all on micropower function blocks. The applications have led to some general design rules and procedures.

- Micropower microelectronics lends itself to all types of analog and digital circuits. Transformers and inductances must be designed out of the circuits. Field-effect transistors and active R-C filters may sometimes be used.

- The large resistance values required, together with the $p-n$ junction and stray capacitances in the circuit, limit the operating frequency to below 1 Mc. This limitation will be lifted as the size of the microcircuits decreases. Higher power circuits close to the frequency response of the transistors can be built.

- Interfaces between micropower microelectronics and conventional-

MONO-ENERGETIC ion beam emerges from slit in top plate. Oven for generating neutral atomic beams is at lower right; evaporation well is under screw cap on top of oven

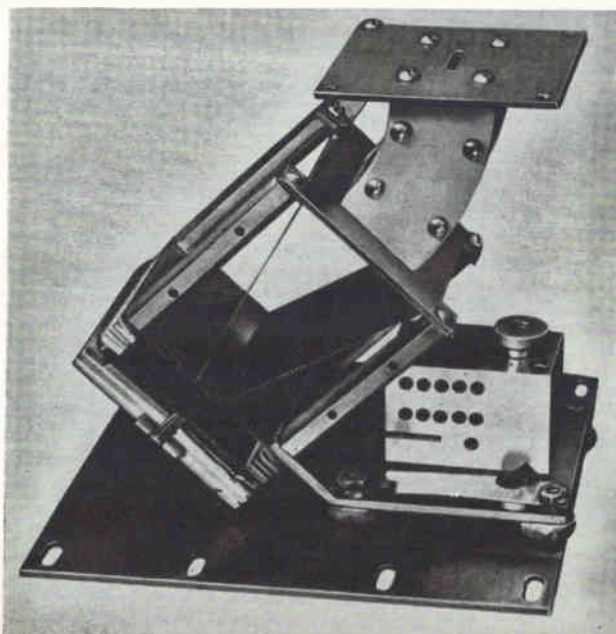

component or microelectronic circuits operating at milliwatt level present no problem. Micropower function blocks can readily be driven by milliwatt circuitry and interface amplifiers (emitter-followers, see Fig. 3) can be provided wherever a micropower circuit must drive a milliwatt circuit. These amplifiers typically consume more power than all the microwatt circuits preceding; thus it is desirable to use microwatt circuits in as much of the system as possible.

- Power consumption in each circuit of a system should be minimized to provide only the speed and fan-out required and not more. Thus in a typical system the resistance values and power consumption of circuit blocks of the same type may vary by more than a factor of ten. In a binary counter chain, for example, the power consumption of each successive stage can be reduced by 2 because less speed is required. In many systems most circuits require only a fan-out of about 4 and these circuits can be designed for much lower power consumption than the few high fan-out circuits. By changing the amount of metal deposited on the resistor pattern, and thus changing the sheet resistance and the resistance value, or by adding a different resistor pattern to the basic transistor pattern, speed, fan-out and power consumption can be varied continuously over 4 orders of magnitude. The exact minimum power circuit desired can thus be realized.

- Micropower circuits can be used today where the reduced power and increased reliability justify present high prices.

At the present time, with micropower components not yet gener-

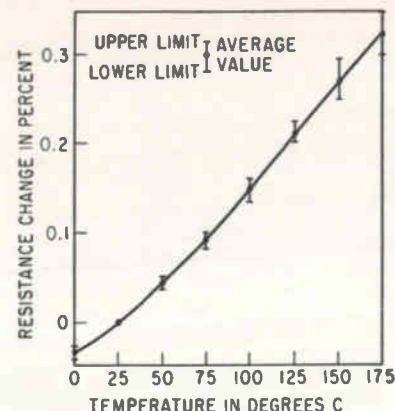

THIN-FILM resistor (nichrome on silicon dioxide) with average value of 240,000 ohms is highly stable with temperature—Fig. 5

ally available, circuit design should be done in collaboration with a fabricator of micropower circuits. The first step is to build a systems breadboard with conventional components but using the identical transistors that will later be used in the microelectronic function block, thus avoiding discrepancies in temperature, voltage and bias-current dependence of parameters. Next, the conventional resistors and capacitors are replaced by individual diffused and thin-film resistors and capacitors on a silicon substrate. This is the first step towards taking stray capacitance into account.

Adjustments are made in the breadboard using conventional components for trimming. Then partial integration is accomplished by putting five to ten active and passive elements on the same silicon chip. Taps are provided on the resistors and capacitors and test points are brought outside the package in addition to the input, output, power supply and ground

connections. Again conventional components or individual microelectronic components on silicon chips can be used for trimming. When the circuit design is frozen the circuit is fully integrated on a single silicon chip.

Engineering samples of various micropower logic and analog stages will soon be available for systems design and will provide short cuts in circuit development.

Experience in designing micropower systems accumulates rapidly; within a year circuit design will probably be no more difficult than with conventional components.

C. Heizman, J. Kostelec, C. Levy, E. Littau, W. Meyer and M. Urban have been instrumental in the design and fabrication of the microwatt function blocks.

The electron-beam system and the ion gun have been designed and constructed by A. Andrews and F. Cook respectively, under sponsorship of the U.S. Naval Avionics Facility in Indianapolis and the U.S. Army Research and Development Laboratory, Fort Monmouth, New Jersey.

Most of the other work has been sponsored by the National Aeronautics and Space Administration and the U.S. Air Force.

BIBLIOGRAPHY

- (1) W. W. Gaertner, M. Schuller, C. Heizman, C. Levy, Microwatt-Microelectronics, paper presented at the 1961 Northeast Electronics Research and Engineering meeting, Boston, Mass., Nov. 1961.
- (2) W. W. Gaertner, M. Schuller, C. Heizman, C. Levy, Microwatt-Microelectronics, lecture to Washington Chapter of P(ED), Washington, D. C., Nov. 27, 1961.
- (3) W. W. Gaertner, M. Schuller, C. Heizman, C. Levy, Microwatt-Microelectronics, lecture to Merrimack Valley Subsection of the IRE, North Andover, Mass., Jan. 15, 1962.
- (4) W. W. Gaertner, M. Schuller, C. Heizman, C. Levy, Microwatt-Microelectronics, *Electro-Technology*, Feb. 1962.
- (5) W. W. Gaertner, C. Heizman, M. Schuller, C. Levy, Microelectronics, Micropower Analog and Digital Circuit-Function Blocks for Space Applications, paper presented at 1962 National Symposium on Space Electronics and Telemetry, Miami Beach, Fla., Oct. 1962.
- (6) W. W. Gaertner, C. Heizman, C. Levy, M. Schuller, Microelectronic, Micropower Digital and Low Level Amplifiers for Space Applications, *Spaceborne Computer Engineering Conference Proc.*, p 151, Anaheim, Calif., Oct. 1962.
- (7) W. W. Gaertner, Nanowatt Devices, paper presented at the 1962 Electron Devices Meeting of the IRE Professional Group on Electron Devices, Wash., D. C., Oct. 1962.
- (8) Descriptions of the CBS technology have also been given in the following Journals: Giants Jump Into Race for Tinier Electronics, *Business Week*, Aug. 25, 1962; Microwatt Computer Block, *Electronic News*, Oct. 1, 1962; Micromin, Communication Strive to Meet Space Needs, *Electronic Design*, Oct. 25, 1962; Nanowatt Range Devices Developed by CBS Labs, *Electronic News*, Oct. 29, 1962; Recipe for Stringbean Transistors, *Electronic Design*, Nov. 22, 1962; And Now—A Nanowatt Circuit Design, *Electronic Design*, Nov. 22, 1962; Nanowatt Power: How Low is Low?, *Electronic Design*, Feb. 15, 1963; Advances in Microminiaturization, *Electronics*, Feb. 15, 1963.

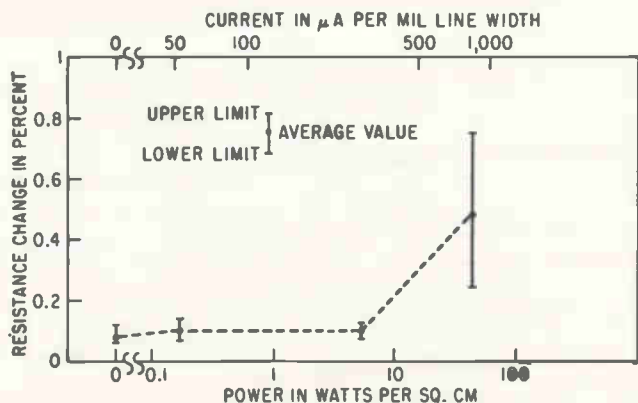

PERMANENT CHANGES in thin-film resistors after 1,000 hours at 125 C—Fig. 6

ANOTHER NEW
COMPONENT

HOT CARRIER DIODES Switch

in Picoseconds

Metal-semiconductor diodes increase switching speed now limited in p-n junctions by minority-carrier storage. Devices need very pure materials and improved epitaxy

By S. M. KRAKAUER, Applications Engineer
S. W. SOSHEA, Project Leader
HP Associates, Palo Alto, California

EPITAXIAL SILICON hot carrier diodes were introduced by HP Associates only recently, but many of the principles of rectifying metal contacts have been known for decades. The great advances in germanium and silicon $p-n$ junction devices in the last 15 years have tended to obscure the potential of metal-semiconductor contacts. The $p-n$ junction diodes are, however, approaching the limit of their

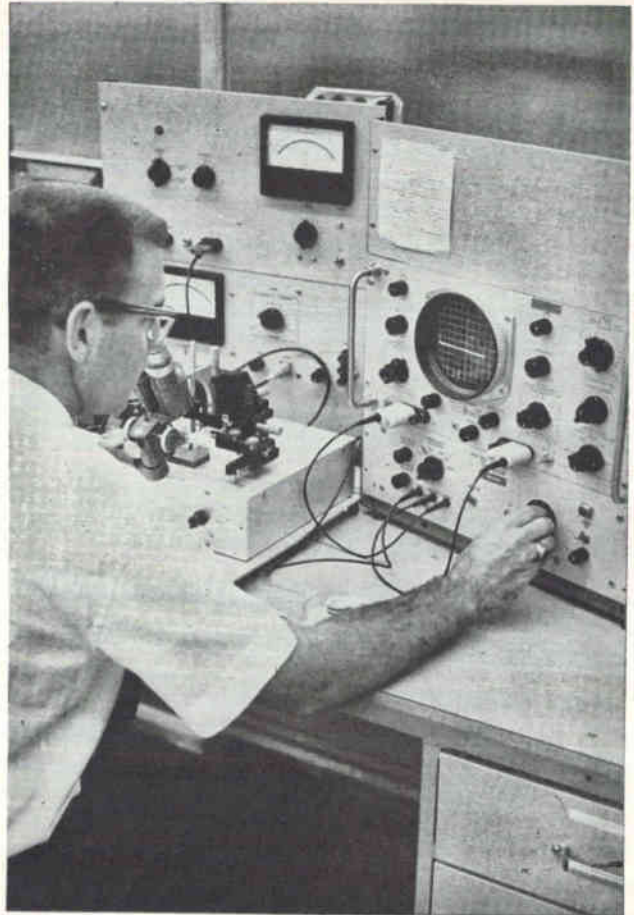

HOT CARRIER DIODE WAFER undergoing evaluation of leakage current by project engineer Bill Baker

high-frequency performance, because of storage of minority carriers. Since minority carrier storage is virtually eliminated, metal-semiconductor diodes show renewed usefulness. The development of the modern hot carrier diode was made possible by the availability of very pure semiconductors, by improved techniques of surface cleaning and passivation, and by the epitaxial construction method.

A hot carrier diode can be made in a variety of ways. A typical epitaxial type is shown in Fig. 1. Experimental models have been made on silicon using evaporated gold, platinum, palladium, silver and many other metals. Both hot electron (on n -type silicon) and hot hole (on p -type silicon) forms are possible, but the hot electron type is generally preferable because the higher electron mobility gives better high frequency performance.

OPERATION—Hot carrier diode operation and the distinction between it and a $p-n$ junction can be understood most clearly by means of the appropriate electron energy diagrams. Figure 2A shows the electron energy diagram of a hot electron diode with a Schottky-type barrier, and Fig. 2B shows the corresponding diagram for an abrupt $p-n$ junction diode with the n -type region more heavily doped than the p -type region. When the hot carrier diode is forward biased, the electrons in the n -type semiconductor

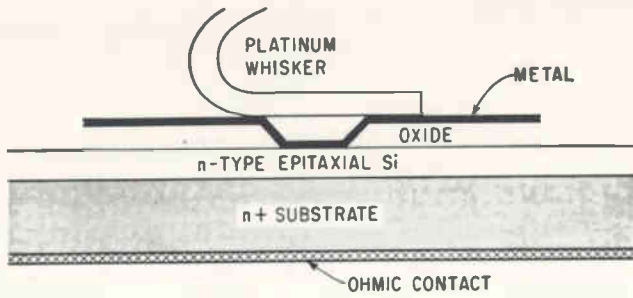

HOT ELECTRON DIODE construction differs from that of hot hole where substrate would be p-plus material and epitaxial layer p-type silicon—Fig. 1

diffuse over the barrier and are injected into the metal.

The injected hot electrons interact with the lattice and the electrons of the metal and when the diode is reverse biased, these hot electrons are unable to surmount the barrier, so they do not contribute to the stored charge. When, however, the $p-n$ junction is forward biased, the electrons diffuse into the p -type region and build up to a concentration that is limited by the rate of carrier recombination, as depicted in Fig. 2B. When the $p-n$ junction is reverse biased, the stored electrons (minority carriers) flow back into the n -type region, thus lowering the rectification efficiency if the diode is used as a detector, or increasing the reverse recovery time if it is used as a switching diode.

The current-voltage characteristics of hot carrier diodes can be described very closely by the ideal diode equation

$$I_r = I_s [\exp(qV/kT) - 1]$$

in which the saturation current I_s is proportional to $\exp(-qV_i/kT)$. The type of metal can be conveniently selected to have an internal barrier V_i , from 0.3 to 0.8 volt, corresponding to a saturation current, for a typical diode size (about 6×10^{-6} cm²), from 10^{-11} to 10^{-8} amp. The junction capacitance of the hot carrier diode varies as the inverse square root of voltage and is only slightly dependent on V_i . This combination of characteristics is analogous to a family of $p-n$ junctions of incrementally varying energy band gap and provides the circuit designer with an added degree of freedom that was not previously available. The reverse characteristics of hot carrier diodes appear very similar to those of $p-n$ junction diodes. The

WHAT'S A HOT CARRIER?

Nothing radioactive! In rectifying metal-semiconductor contacts, current flow is predominantly by majority carriers. When such a diode is forward biased, these majority carriers are injected into the metal and have much greater velocity than the thermal electrons—hence the name hot-carrier diodes. With minority carrier storage virtually eliminated, these diodes surpass conventional $p-n$ junction types at high frequencies

CHARACTERISTICS OF HOT-CARRIER DIODES

	HPA-2001			HPA-2101		
	Min	Typ	Max	Min	Typ	Max
Forward Current I_F in ma (at $V_F = 1$ v)	20	30		20	30	
Forward Current I_F in μ a (at $V_F = 0.4$ v)	0.5	1.0		2,000	4,000	
Capacitance C_o in pf (at $V_B = 0$)		0.85	1.0		0.95	1.1
Breakdown Voltage V_B in v (at $I_R = 10 \mu$ a)	15	25		15	25	
Leakage Current I_r in na (at $V_R = 3$ v)		1	10		30	100

reverse leakage current increases with reverse voltage gradually, owing to the internal Schottky effect, until the avalanche multiplication voltage is reached.

Hot carrier diodes are similar in concept and in operation to the ideal point-contact diode in which the contact is neither formed, alloyed nor bonded. Both the hot carrier diode and the ideal point contact diode employ a Schottky barrier, but there are many notable differences. Being of much larger area, the hot carrier diode has larger capacitance than the point contact, but it can handle greater power and is less sensitive to current transients than is the ideal point contact. The hot carrier diode, furthermore, is more stable mechanically and has more nearly ideal and reproducible electrical characteristics.

PERFORMANCE—Recovery time as a function of minority carrier lifetime for these diodes is difficult to measure. The lifetime is so low that its influence is readily obscured by diode and circuit impedances and by transient response anomalies in the associated instrumentation. It has been found best to characterize the recovery time for these diodes relative to a sinusoidal excitation¹. The circuit is shown in Fig. 3, the resulting oscilloscope patterns in Fig. 4.

The effective minority carrier storage can be related to the amplitude of the negative spike. Diode capacitance causes the baseline to tilt, and so capacitive conduction can be separated from storage conduction by measuring the spike amplitude from this tilted reference line, as shown in upper Fig. 4.

Measurement using this technique is not completely quantitative, but it gives a convenient index of the diode recovery that corresponds to most applications. If, for example, the signal generator and amplifier are adjusted to 53 mc with sufficient output to produce a peak forward current flow of 20 ma and scope gain set to give a 5-cm deflection for the positive peak, then the amplitude of the negative spike (read as shown) will be related to lifetime as $\tau = 500$ ps/per cm for deflections less than 1.5 cm. This value is an effective rather than a true minority carrier lifetime. It is essentially the product of true minority carrier lifetime by the ratio of minority to majority carriers that is associated with forward conduction. This ratio is made smaller with reduced barrier height and reduced substrate resistivity. Currently available diodes have effective lifetimes below the resolution capability of this measurement (<50

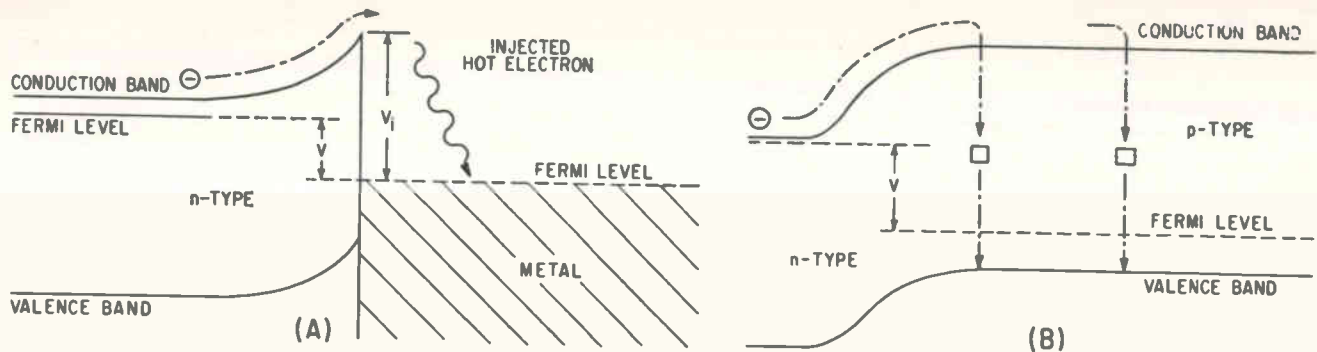

ENERGY LEVELS in metal-semiconductor junction (A) and p-n junction of normal silicon diode (B)—Fig. 2

ps). Sufficiently high values of forward current can cause minority carrier injection, and storage.

Hot carrier diodes now available are listed in the table. The static characteristics of these diodes, both in forward and reverse, are similar to conventional p-n junction diodes. The type 2001 resembles a conventional silicon p-n junction diode, and the type 2101 resembles germanium, as shown in Fig. 5.

To take full advantage of their fast response capability, care is necessary in mounting these diodes. Minimum possible lead length will reduce to a minimum performance degradation owing to shunt capacitance and series inductance. The self-inductance of the present package is approximately 3 nh. A lower inductance package is under development.

In general the same considerations that apply to the application of conventional p-n junction diodes will apply to the hot carrier diode. The differences between them is confined to the lower storage and wider choice of barrier height that is associated with the hot carrier diode. Accordingly, hot carrier diodes might be substituted in many existing circuits without design modifications being required, and with a substantial gain in performance.

NO DELAYS—Minority carrier storage in the hot carrier diode is so low that the turn-on and turn-off delays that are present in conventional p-n junction diodes will be essentially eliminated. Accordingly, hot carrier diodes can be used effectively in those pulse and high frequency applications where lag-free response is required, such as detection, mixing and limiting at microwave and high frequencies. Within fractional nanosecond limits they can be used for clamping and gating rapidly.

Freedom of choice in barrier height leads to applications that may or may not also require low storage. Low barrier, low storage diodes permit an approach to ideality for detection sensitivity, mixing efficiency, and harmonic generating capability because of the improved impedance matches. Also, tunnel diode logic circuits which require very low turn-on voltage for the associated diode may become possible.

REFERENCE

(1) S. M. Krakauer, Harmonic Generation, Rectification, and Lifetime Evaluation with the Step Recovery Diode, *Proc. IRE*, p 1665, July 1962.

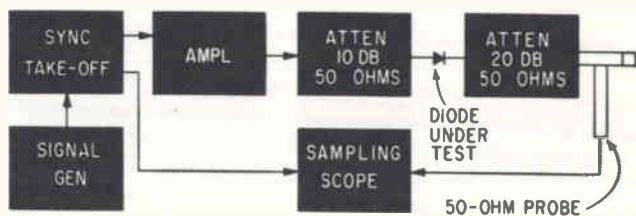

EFFECTIVE LIFETIME MEASUREMENT of diode is made with this equipment setup—Fig. 3

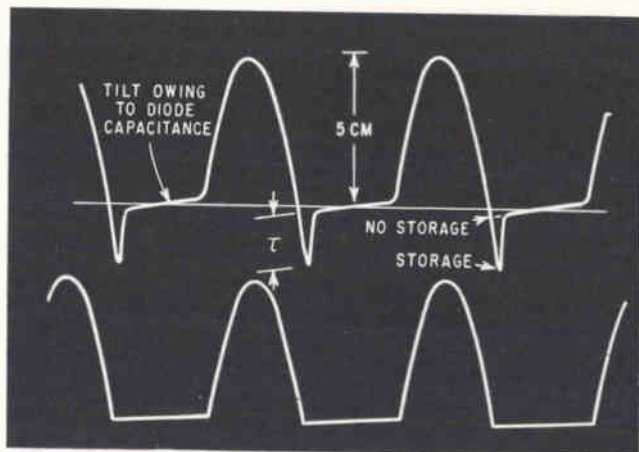

HIGH-SPEED SWITCHING DIODE (top) compared with hot carrier diode. Sweep speed is 10 nsec per cm, vertical sensitivity is 20 ma per cm. Applied signal is a 30-Mc sine wave—Fig. 4

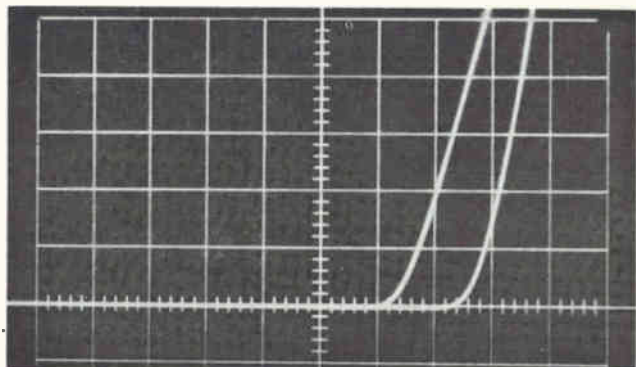

STATIC CHARACTERISTICS of type 2101 (left) and type 2001 show that the former starts conduction at about 0.3 v and latter around 0.5 v. Vertical calibration is 2 ma per division and horizontal is 0.2 v per division—Fig. 5

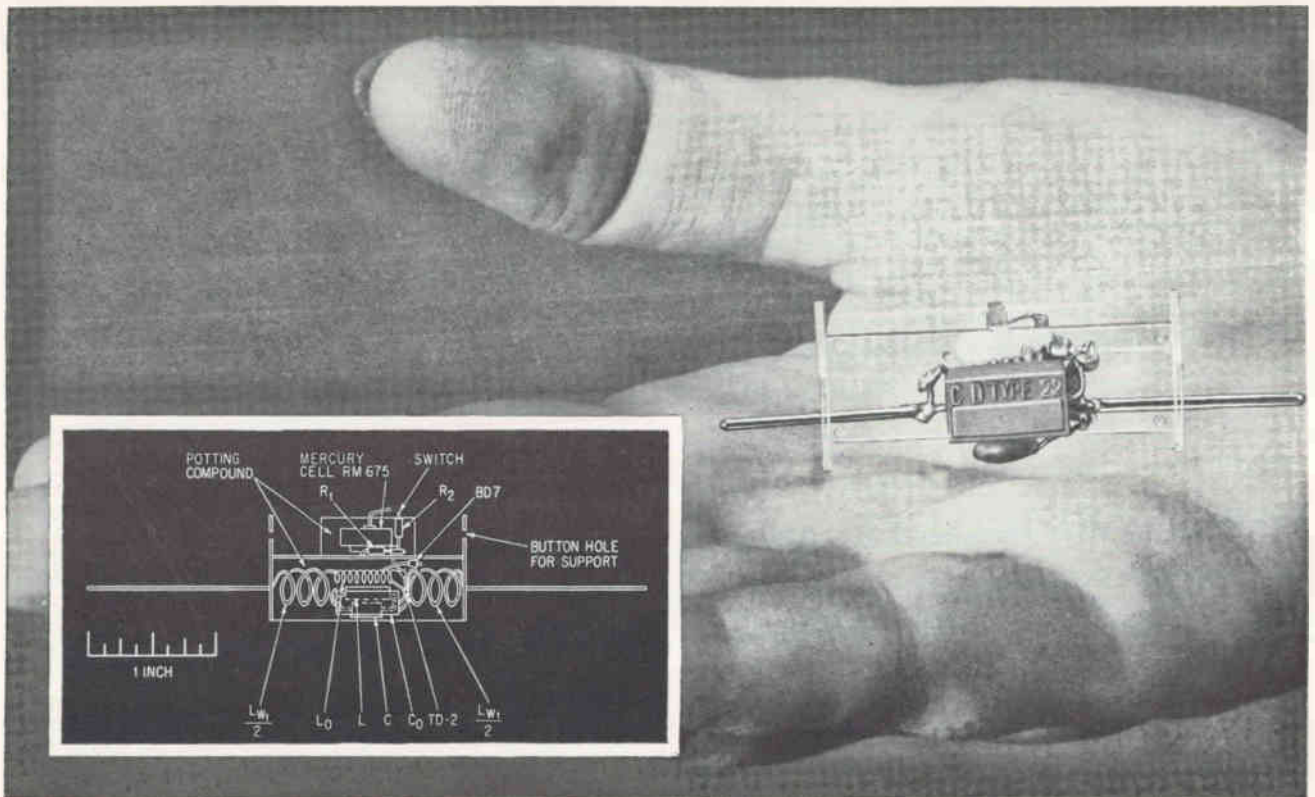

FIELD-STRENGTH-PROBE uses tunnel-diode frequency-modulated oscillator. Underwater testing requires the probe be potted. Antenna and coils occupy the most space

LATEST FIELD-MAPPING IMPROVEMENT

Leadless Transceiver

MEASURING the field pattern of an antenna is often difficult because the field-mapping probe disturbs the field being measured. Even if the probe is small, its connecting leads may upset field distribution. The problem is especially difficult in measuring the field distribution of parabolic disk antennas, microwave lenses, and many other fields that do not permit image-plane measuring methods.

The need for lead wires to a probe for measuring the electromagnetic field may be eliminated with a

miniature f-m wireless probe that has been built with readily available components. It can be used under water as well as in free space. Despite simple construction, the operation was satisfactory.

Figure 1 shows the test setup, with the antenna operating at 114 Mc and using 1,000-cycle amplitude modulation. The probe detects the 114-Mc energy and uses it to frequency-modulate a 7-Mc tunnel-diode oscillator. Rebroadcast energy from the probe is picked up by the telemetering antenna and fed through a lock-in amplifier. Subsequent instrumentation extracts field intensity values from the frequency-deviation of the 7-Mc signal.

BUILDING BETTER ANTENNAS

Communications is an ever-expanding industry involving greater precision in circuit design and more efficient techniques for getting the transmitted energy exactly where it is needed. Fundamental laws for some radiating bodies are not fully understood and techniques for verifying theories often lack accuracy because the process of measuring disturbs the field being measured. This new field mapping technique gets close to using no instrumentation at all

TRANSCEIVER DESIGN — Overall size of the transceiver must be small to prevent the probe disturbing the original field, yet it should be stable and temperature insensitive. Figure 2 shows a circuit diagram of the transceiver tuned for a 114-Mc a-m input signal and a 7-Mc f-m output. A TD-2 tunnel diode (subminiature axial package) provided dual functions of 7-Mc r-f oscillator and frequency modulator, while a BD-7 backward diode detected the 114-Mc a-m signal. Tunnel diodes were selected because they are small, compact and relatively insensi-

By KEIGO IIZUKA
Harvard University,
Cambridge, Mass.

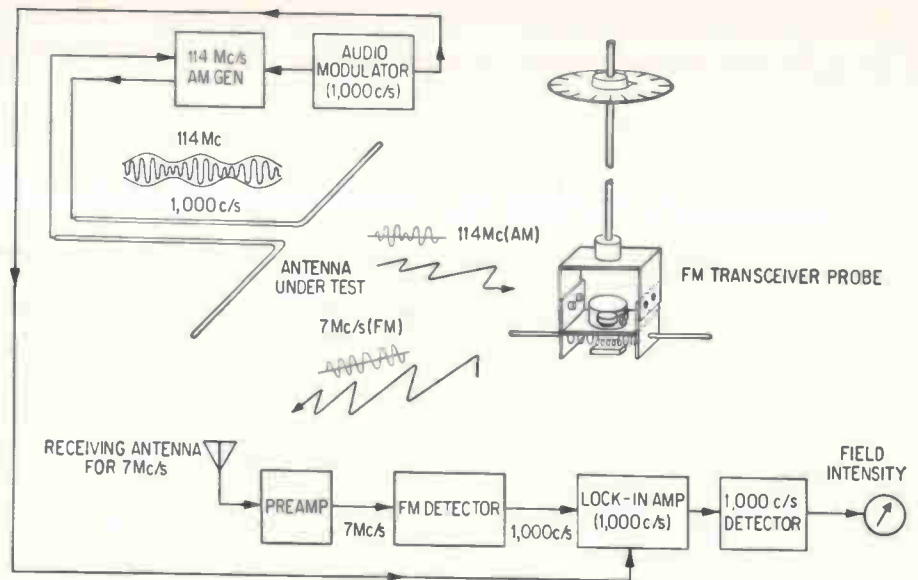

AMPLITUDE-MODULATED 114-Mc field is detected by probe, converted to frequency-modulated 7-Mc signal by tunnel-diode oscillator, then rebroadcast to receiver for extracting field-intensity values—Fig. 1

Miniature probe senses field intensity, converts it to reradiated 7-Mc f-m signal. Frequency-deviation of reradiated signal gives strength of field; method eliminates leads, preventing interference with field pattern

Probe Works Underwater

tive to the adverse effects of temperature changes.

The upper part of Fig. 2 is a detector stage for the 114-Mc a-m signal from the short dipole antenna. The tank circuit tuned at 114-Mc consists of 8 turns of No. 18 tinned copper wire with a length of $\frac{3}{4}$ in. and diameter of $\frac{3}{8}$ in. (50 nh) and a 39 pf mica capacitor. The mica capacitor was preferred for its low loss tangent and temperature insensitivity, even though it is much larger than the smallest ceramic capacitors available. A backward diode BD-7 (having the advantage of low forward voltage drop and low stray capacitance) was connected to the tap at $1\frac{1}{4}$ turns of the coil, L_o . The detected 1,000 cycle signal was then fed to the bias point of TD-2 oscillator through a 67-ohm coupling resistor. The resistor was used as a coupler instead of a capacitor because of the limited space, but a 25- μ f capacitor would be preferable if space were available. The tank circuit, C, L , in the lower part (tuned to 7 Mc) is effectively a short circuit at 114 Mc, and, conversely, the tank circuit, C_o, L_o , in the upper part (which is tuned to 114 Mc) is effectively a short circuit at 7 Mc. Thus, the two-tank circuit staggered and loaded with a short dipole antenna form a duplexer for receiving 114 Mc and transmitting 7 Mc.

The lower part of the circuit diagram in Fig. 2 is the 7-Mc tunnel-diode series-parallel sinewave oscillator.³ Choice of tunnel diode is important if satisfactory results are to be obtained. Maximum power available from the tunnel diode can be estimated by

$$P_{\max} = \frac{(I_p - I_v)^2}{8} \frac{1}{g_d} \approx \frac{(I_p)^2}{8g_d} \quad (1)$$

where I_p and I_v are the peak and valley point currents, and g_d is the magnitude of the tunnel diode's negative conductance. As a rough approximation, the relation

$$I_p = V_v g_d \quad (2)$$

where V_v is the valley point voltage, may be used. Introducing Eq. (2), Eq. (1) becomes

$$P_{\max} = \frac{V_v^2 g_d}{8} \quad (3)$$

The value of V_v is nearly the same for all types of tunnel diode, lying in the range 200 to 350 mv. From the viewpoint of available power, it is preferable to choose a tunnel diode with a large negative conductance, but g_d must not be too large because the max-

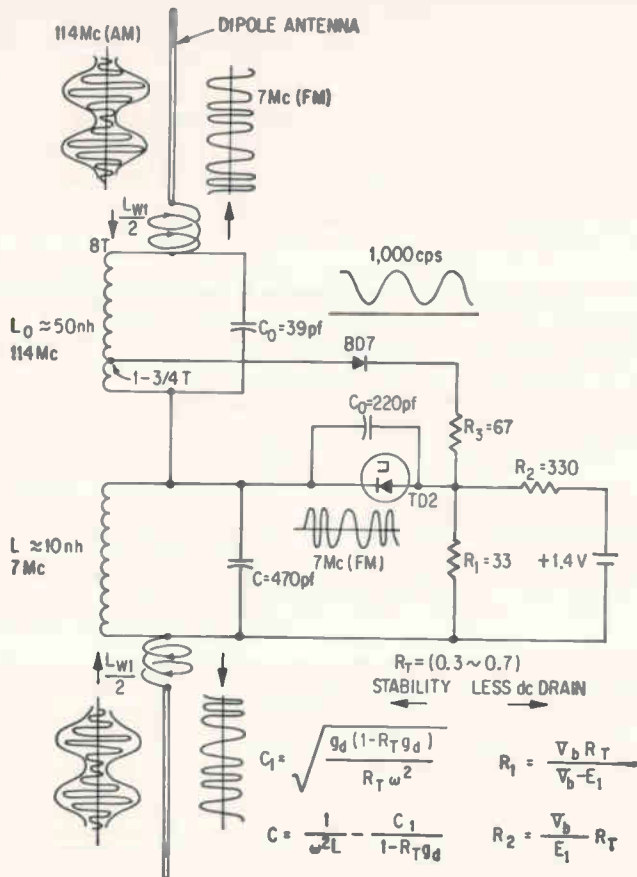

LOADING COILS enable dipole antenna to receive at 114 Mc and reradiate at 7 Mc; backward diode makes a low-loss demodulator for low-level incoming signal—Fig. 2

imum frequency of oscillation, f_{oo} , is related by g_d by

$$f_{oo} = \frac{g_d}{2\pi C_1} \sqrt{\frac{1}{R_T g_d} - 1} \quad (4)$$

For f_{oo} to be real, it is necessary that

$$R_T g_d < 1 \quad (5)$$

The smaller $R_T g_d$ the greater the oscillator stability. The value of g_d must not be chosen too large, or the value of R_T will become too small for the restricted d-c power drain from an RM675 miniature mercury cell. Hence, it is necessary to choose a diode with g_d near a middle value that satisfies both requirements. The TD-2 tunnel diode with the parameters $g_d = 16$ millimho and $V_b = 350$ mv was selected and gave about 250 microwatts r-f power. Efforts were made to reduce the number of elements as much as possible. Frequency modulation was accomplished by the 1,000-cycle signal through R_3 , Fig. 2, which varied the operating point of the diode and modulated the value of g_d , which in turn modulated the oscillator frequency f_{oo} .

$$f_{oo} = \frac{1}{2\pi} \sqrt{\frac{1}{L(C + C_1)} - \frac{g_d^2}{C_1(C + C_1)}} \quad (6)$$

The value of R_3 is critical. When it is too large, the waveform of the 7-Mc signal is distorted and the output is decreased; when it is too small, the deviation of the frequency modulation is not enough. A compromise has to be found by cut-and-try methods. The d-c current drain during the operation was about

4 to 5 ma and the lifetime of the stable operation of the probe with an RM675 mercury cell was about 15 to 20 hours.

PROBE LENGTH—Since limited r-f power is available from the transceiver and one short dipole probe antenna is to be used both for receiving 114-Mc and sending 7-Mc, a careful design of the probe antenna is necessary. The driving-point impedance of such a short dipole is predominantly capacitive and its radiation resistance is small. The driving-point impedance Z_o of a short antenna⁴ is

$$Z_o \sqrt{\epsilon_r} = 18.3 \beta^2 h^2 - j \frac{396.0}{\beta h} [1 - 0.383 \beta^2 h^2] \quad (7)$$

where $\beta = \sqrt{\epsilon_r} (2\pi/\lambda)$, λ = the wavelength in free space, h = the half-length of the dipole = 3.5 cm, and ϵ_r = the relative dielectric constant = 1.

$$\text{Equation 7 gives } Z_o = 0.485 \times 10^{-3} - j 7.71 \times 10^2 \text{ (for 7 Mc)} \quad (8)$$

$$Z_o = 128 \times 10^{-3} - j 0.473 \times 10^2 \text{ (for 114 Mc)} \quad (9)$$

To achieve better matching to the antenna circuit, this large capacitive component has to be neutralized with a series inductor $L_1 = 175 \mu\text{h}$ for the 7-Mc signal, and by $L_1 = 0.66 \mu\text{h}$ for the 114-Mc signal. These values give the same positive reactance. When the probe is to be operated in water of low loss tangent ($\epsilon_r = 78$), the reactive component is reduced by $1/\sqrt{\epsilon_r}$ (from Eq. 7). The values of the inductors needed then become $L_{w1} = 254 \text{ nh}$ for 7 Mc and $L_{w1} = 0.957 \text{ nh}$ for 114 Mc.

The value of the loading inductor was chosen to meet the matching condition of the antenna for 7 Mc in water, rather than for 114 Mc, since the radiation resistance of the dipole increases with the square of the frequency, Eq. 7. The loading coil $L_{w1}/2$ was made of 4 turns of No. 18 tinned copper wire with the length of $\frac{1}{2}$ in. and diameter of $\frac{1}{8}$ in.

The 7 Mc was chosen as the frequency of the oscillator because the matching condition of the short dipole for 7 Mc was not extremely different from that for 114 Mc, yet the two frequencies were separated far enough to ensure proper functioning of the duplexer.

COMPONENT LAYOUT—Special care has to be taken with the layout of the components, since at vhf their physical positions are important. Components are mounted on a $\frac{1}{2}$ -in. thick polystyrene H-shaped panel of $1\frac{1}{2}$ -in. long, $\frac{3}{4}$ -in. high, and $\frac{1}{2}$ -in. wide; they are self-supported by their own short-cut leads which pass through holes in the panel. The mercury cell and the biasing circuits were grouped above the panel; the oscillator and modulator circuits under the panel.

Interaction between the H-field and the two loading coils located at the upper and lower parts of Fig. 2 may introduce errors in the measurement of the E-field. This can be suppressed by winding the two loading coils in opposite sense. The two coils were placed symmetrically about the center of the probe and separated to avoid coupling between them. Absence of interaction was checked by measuring the same field first with the probe's panel wrapped in a thin sheet of aluminum foil, then with it unwrapped.

This arrangement reduced the interaction.

MEASURED RESULTS—A near-zone field polarization pattern of a half-wave dipole immersed in a water solution of sodium chloride was measured with the wireless probe. The electric field in the immediate vicinity of the dipole is elliptically polarized. The measurement of the polarization pattern was performed by rotating the probe 360 degrees in the plane of the dipole at the position of $k_r = 2.0$, $k_a = 0.7$ in the conducting solution with the properties of $\epsilon_r = 78$, $\tan \delta = 0.71$. Coordinates k_r , k_a specify location with respect to dipole position.

Agreement between the results measured with the wireless probe and with a conventional thin electrically short dipole antenna supported by $\frac{1}{4}$ inch brass tubing is excellent. In a highly conducting solution the reflection of electromagnetic waves from the brass tubing which supports it is minimized, and the conventional dipole probe behaves like an isolated dipole. Consequently a comparison of the results measured by the wireless probe and by a conventional dipole probe was made with a conducting medium. No explanation is given for differences between measured and theoretical values near the minor axis.

To demonstrate the superior characteristics of the wireless probe as compared with the conventional probe, the outside of the hollow polystyrene tubing support of the wireless probe was covered by an aluminum cylinder of various diameters to simulate a conventional dipole probe with a metal support (or lead wire). The polarization pattern set up by an electrically short dipole antenna in air was measured by the wireless probe with and without this aluminum cylinder. The results and the related electrical parameters are shown in Fig. 3. The waves scattered from the cylinder create a pair of extra ears in the direction of the minor axis as well as a distortion of the shape of the polarization pattern. When the cylinder becomes large in diameter, the antisymmetry of the pattern with respect to the center of the probe becomes more prominent. This is due to the scattered field components E_s^1 and E_s^2 , which are associated with the induced circulating current i_s on the surface of the aluminum cylinder and are antisymmetric with respect to probe center.

In free space the probe was operated up to 30 feet from the receiver. Underwater range is shorter.

The author thanks Professor R. W. P. King at Harvard University and Stephane Prévot.

REFERENCES

- (1) K. Iizuka, A New Technique for Measuring an Electromagnetic Field by a Coil Spring, *IRE Trans PTG-MTT* (to be published).
- (2) U. Davidsohn, Y. Hwang, and G. Ober, Designing with Tunnel Diodes, *Electronic Design*, Feb. 3 and 17, 1960.
- (3) "Tunnel Diode Manual," General Electric, p. 33, 1961.
- (4) R. W. P. King, Theory of Electrically Short Transmitting and Receiving Antennas, *J. Appl. Phys.*, 23, No. 10, p. 1174, Oct. 1952.
- (5) K. Iizuka, How to Measure Field Patterns with Photo-sensitive Probes, *Electronics*, p. 39, Jan. 25, 1963.
- (6) R. W. P. King and K. Iizuka, The Complete Electromagnetic Field of a Half-Wave Dipole in a Dissipative Medium, *Trans. IRE*, PGAP-11, May 1963

ALUMINUM cylinders around probe (A) produce different degrees of field disturbance depending on cylinder size (B)—Fig. 3

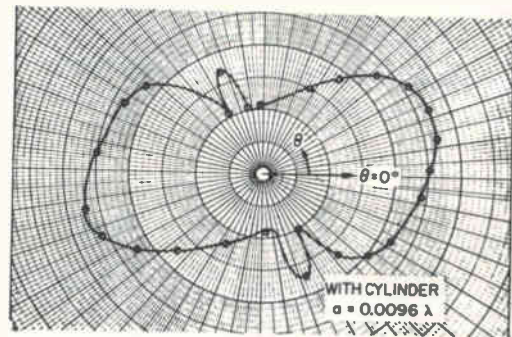
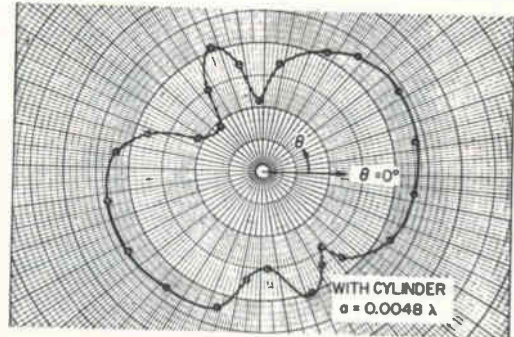
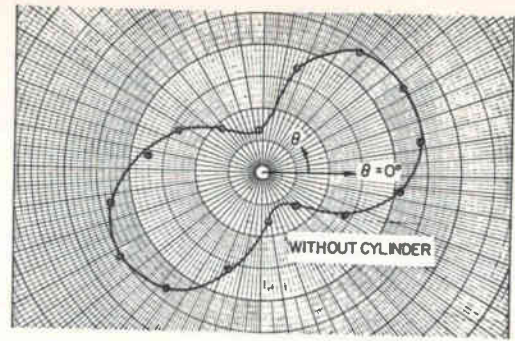

(A)

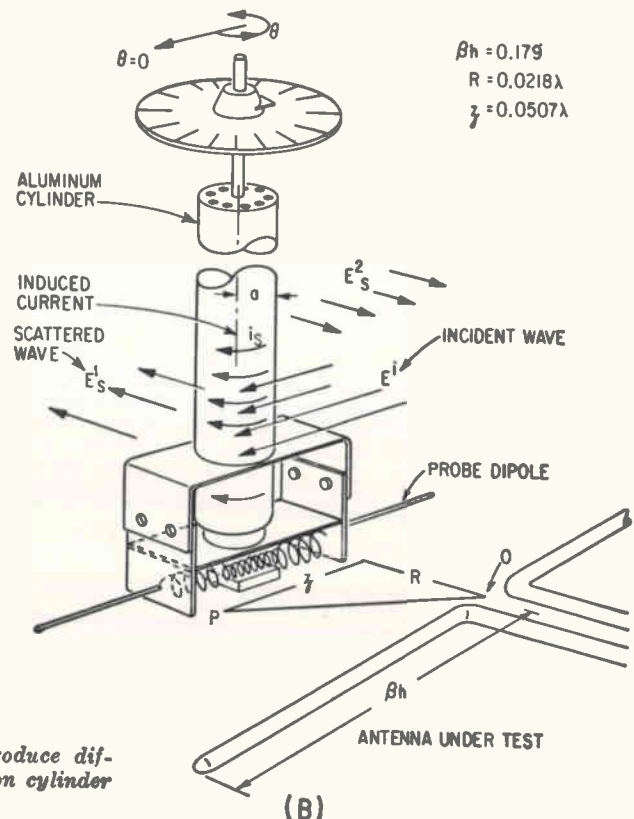

Solving the AGC Dilemma

SERVO SYSTEM USES ATTENUATOR

Transistor fed with d-c control signal operates as attenuator in input circuit of amplifier. Technique is useful up to 150 Mc

By FRED SUSI, Sylvania Electric Products, Inc., Sylvania Electronic Systems, Needham, Mass.

AUTOMATIC GAIN CONTROL is extensively used in receivers to prevent variations in the audio output signal amplitude with changes in r-f input signal strength. To compensate for these fluctuations in signal strength, the gain of the i-f stages is usually varied either by continuously varying the collector voltage or emitter current, or both, of the transistors used in the i-f stages. In these forward and reverse agc methods, serious concessions in bandwidth, and shifts in center frequency of the i-f stages are usually made, owing to significant fluctuations in the transistor parameters with changes in quiescent conditions.¹ One solution is to use buffering between the transistors and the tuned output, as in the cascode configuration.^{2,3} Another agc technique is the servo type system shown in Fig. 1A. This system uses an attenuator stage, an N stage amplifier in the transmission loop, and a feedback loop. This servo method, with emphasis on the attenuator stage, is described here.

In the system of Fig. 1A, consider a sudden error signal ΔE developing at the input terminal, where ΔE is expressed in db above

E_{in} . Since the attenuation stage (a) at this time is not activated by any new level of control current, the same ΔE appears at the input of the transmission amplifier, A_T . Assuming linear amplification in the transmission amplifier, $A_{Tab} + \Delta E_{ab}$ appears at the system's output and, therefore, at the input of the feedback amplifier B . Again, assuming linear amplification in B , $\Delta E_{ab} + A_{Tab} + B_{ab}$ will be impressed at the input of the detecting circuit. If the proportional direct control current produced at the output of the detector is sufficient to cause an attenuation of almost ΔE_{ab} , that is $(\Delta E_{ab} - \delta_{ab})$, then δ_{ab} of error signal will be seen at the system's output at steady state conditions. A change in input signal of ΔE_{ab} , therefore, causes a δ_{ab} change in output signal. This reasoning is also applicable when input error ΔE is below E_{in} .

The compression or flatness factor m' is defined as the ratio of change in input signal in db to a corresponding change in output signal in db at steady state; that is, $m' = \Delta E/\delta$ for a final error δ appearing at the system's output for a corresponding ΔE at the in-

put. The amount of error presented to the transmission amplifier for a given change in input signal determines the compression ratio of the system. If an m value of 40 is specified for a 40 db change in signal at the system's input, then only 1 db change can be presented finally at the input of the amplifier.

ATTENUATOR STAGE — Diode attenuators have been discussed extensively in current literature,⁴ and depending upon the application, have been successfully used up to frequencies of 70 mc. These attenuators, however, have serious limitations which can make the closed-loop system unwieldy. Such limitations include relatively low signal handling capabilities, large changes in attenuation with small fluctuations in control current, and high sensitivity to changes in temperature. A transistor attenuator, which overcomes these disadvantages, will be discussed in some detail.

The transistor attenuator used in Fig. 1A is a grounded emitter stage whose collector is d-c isolated as shown in Fig. 1B. Figure 1C depicts the equivalent circuit of this attenuator, where the isolating capacitors C_1 and C_2 are made large enough to be disregarded at the operating frequencies. Also, from Fig. 1C, note that at relatively low frequencies ($f < 2Mc$) the transistor's collector-to-emitter voltage is $V_{ce} = R_{sp} E_c / (R_c + R_{sp})$, where R_{sp} is the shunt resistance of the attenuator for a given I_{ce} , R_c is a series dropping resistor, and C_2 is the shunt capacitance over the entire operating frequency range. C_1

GAINING GROUND

Automatic gain control using vacuum tubes is relatively easy to accomplish because with variable- μ tubes you merely make the grid negative and the stage-gain is reduced.

It's not so simple with transistors. Although changing the bias level does alter the stage gain, the conditions under which this occurs are not always beneficial and the result is often instability, reduced bandwidth, or increased distortion

is approximately constant at 5pf in the high frequency units.

Typically, R_{sp} changes exponentially from approximately 4,000 to 20 ohms for a 1.0-ma change in control current, or for a 200 μ w change in control power. At relatively low frequencies, where the reactance of the shunt capacitance C_p is negligible, this change in R_{sp} represents a 45-db range of useful control. For higher frequencies where $f > 2Mc$, the reactance of C_p in quadrature with R_{sp} governs the upper end (where R_{sp} is large) of the control range. Consequently, at frequencies above 150 Mc, the high frequency transistors tested lost their usefulness as attenuators.

Figure 2A is a plot of attenuation, α versus control voltage V_{d-c} , and control current, I_{d-c} , for the type 2N94 germanium alloy *npm* transistor. The α versus V_{d-c} curve is linear in the operating range, while the α versus I_{d-c} or P_{d-c} is logarithmic in nature (see Fig. 2B) and follows the form $\alpha = K_1 \log P_{d-c} + K_2$ where K_1 , and K_2 , are constants.

Solving for these constants from the plot of α versus P_{d-c} on semilog paper (Fig. 2B), the following relationship is obtained

$$\alpha = - \left[\frac{\alpha_1 - \alpha_2}{\log(P_{max}/P_{min})} \right] \log \left(\frac{P_{d-c}}{P_{min}} \right) + (\alpha_1 - \alpha_2)$$

where α_1 = the α intercept (insertion loss of the attenuator in db), α_2 = the P_{d-c} intercept, α = attenuation in db as a function of control power using α_2 as the reference, P_{d-c} = control power, P_{max} = control power at P_{d-c} intercept, and P_{min} = control power at the α intercept.

The left hand curves inset in Fig. 2A represent the V - I characteristics of a typical transistor used in the attenuator stage of Fig. 1A. The family of constant I_b or constant I_{d-c} curves crowd together at the high values of base drive and spreads at the low values. The end result of this phenomenon is shown in the graph of α versus I_{d-c} in Fig. 2A. That is, the maximum rate of change of R_{sp} with I_{d-c} occurs at the lower base drives. In this range, however, the greatest distortion is found. This distortion can be attributed mainly to the relatively large non-linearity of the constant I_b curves in this range. Also the constant I_b curves are not coincident

at the origin, but meet at a relatively small offset voltage and current.⁹ At different base drives, a corresponding V - I characteristic curve is traversed resulting in a marked change in collector - to - emitter impedance. Since the collector of the transistor attenuator is d-c isolated, its quiescent point shifts as indicated in the left-hand curves inset in Fig. 2A.

In the attenuation stage for Fig. 2C, an R_s of 10,000 ohm was used as the series dropping resistor. Inputs of 100 mw or less caused only slight distortion at near zero control currents. The distortion is mainly in the form of a large second harmonic, 90 degrees out of phase with the fundamental. A plot

of the total harmonic content of the output signal versus control current is shown in Fig. 2C. As one might expect, the total harmonic distortion increases with decreasing I_b and increasing V_{in} . Therefore, the distortion problem can be circumvented by increasing the quiescent control current slightly or by increasing the series dropping resistor, R_s . However, a trade is made between insertion loss and increasing R_s . For the transistors used in the attenuator stage, where α versus I_{d-c} curves are shown in Fig. 2B, between 8 and 11 db insertion loss was realized.

TEMPERATURE EFFECT—The curve of attenuation versus control

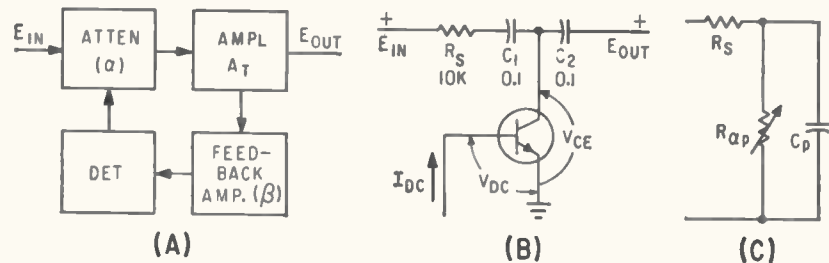

SEPARATE attenuator controlled by feedback signal adjusts amplitude of amplifier input (A). Rectified output from feedback amplifier sets attenuator impedance (B), attenuator equivalent circuit (C)—Fig. 1

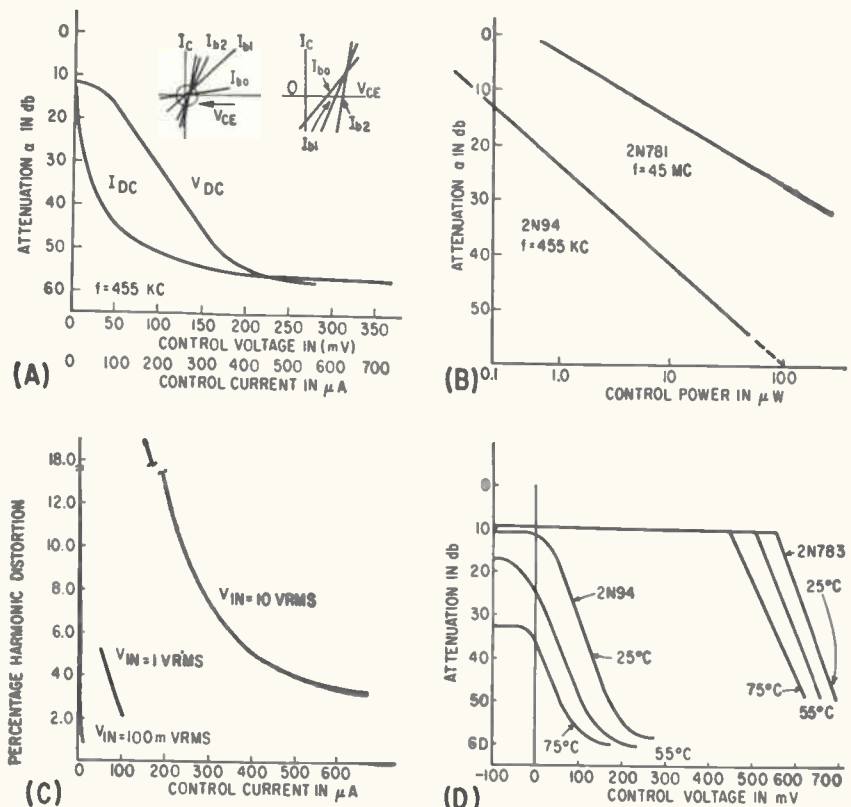

ATTENUATOR control characteristics with transistor V - I characteristics inset (A), power control characteristics (B), harmonic distortion (C), and temperature characteristics for two different transistors (D)—Fig. 2

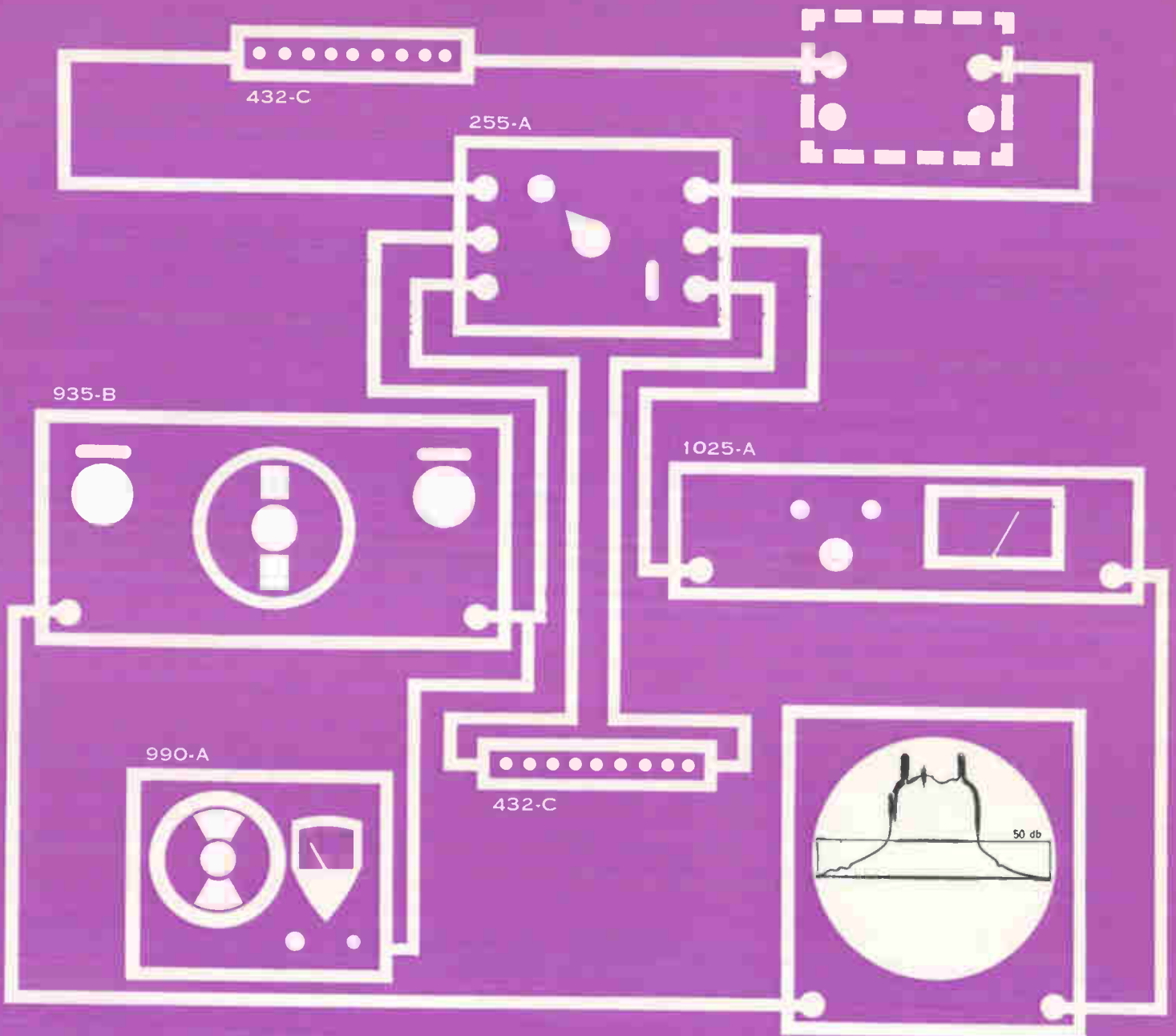

Swept, Marked, Logged, Calibrated... by **KAY**

A sharp filter, swept and marked in frequency (fixed and variable) by 935-B and 990-A on the log amplitude display of the 1025-A, with calibrated level line set by the 432-C, switched in by the 255-A.

935-B Sweeping Oscillator

50 cps to 220 mc
Audio Video, VHF

Price: \$1295.00

990-A CW Oscillator

4.5 to 220 mc
1.0V rms, AGC'd

Price: \$373.00

1025-A Log Amplifier

200 kc to 220 mc
80 db Dynamic Range

Price: \$795.00

432-C Attenuator

DC to 500 mc
0 to 101 db in 1-db steps

Price: \$110.00

Write for complete catalog information

KAY
ELECTRIC COMPANY

Maple Ave, Pine Brook, Morris County, New Jersey

Dept. E-7 • Capital 6-4000

255-A Coaxial Electronic Switch

DC to 500 mc
70 db "off" at 200 mc

Price: \$295.00

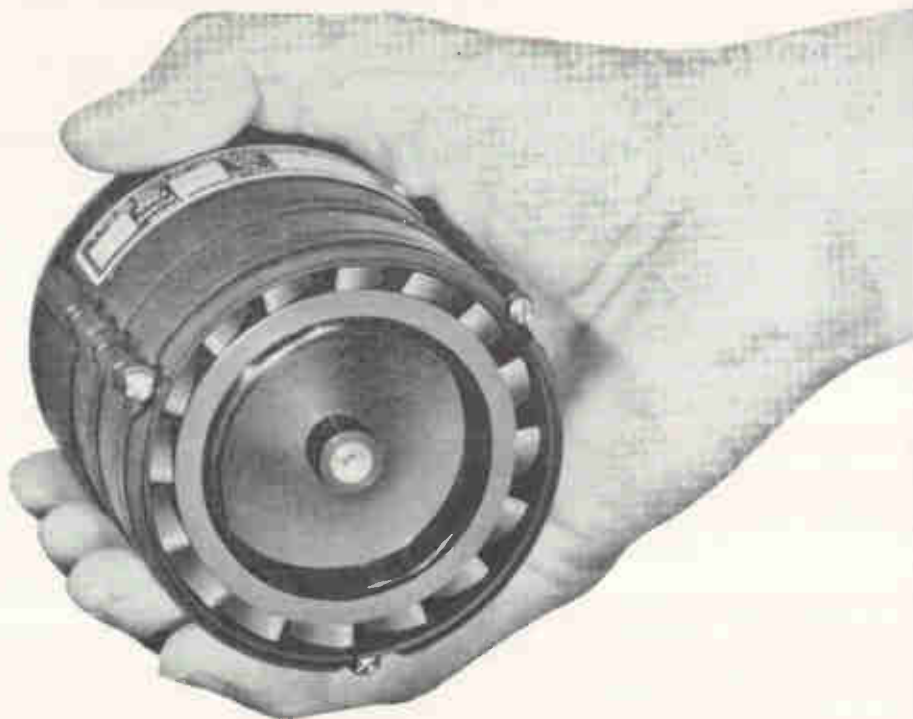

MULTI-STAGE BLOWER THIS SMALL?

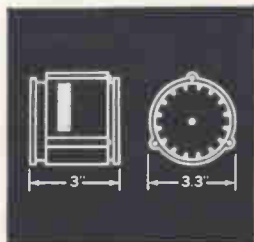
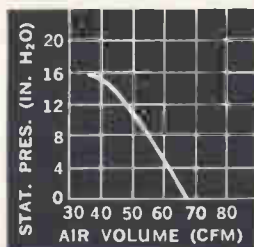

New Globe multi-stage blowers drive cooling air against the extreme pressure resistance you encounter in heat exchangers, tightly packed black boxes, and crammed transistor circuitry. They deliver 45 cfm against 14" H₂O back pressure! (65 cfm free air.) With STAX-3-FC blowers you can design right past costly devices and heavy centrifugal air "pumps" (that use ¼ hp or more for comparable volume/pressure). And you can keep the whole package small.

With a low specific speed ($N_s = 15,000$) STAX blowers perform far past the stall regions of other axial blowers. Unique dynamically balanced rotor design permits the use of one, two or three stages in the same size package. Motor operates on 200 v.a.c., or 115 v.a.c., 400 cycle, one or three phase power. Can also be designed for d.c. operation. Units are designed to meet applicable MIL specs; nominal continuous life is 1000 hours. Weight: 29 oz. (3-stage). Production tooling keeps the price within reason. If you need more performance, different power, etc., Globe will design the exact multi-stage blower you require.

The powerful STAX is one of hundreds of miniature blowers made by Globe and engineered for your application. Request Bulletin STX, or call direct: Area Code 513 222-3741.

Globe Industries, Inc., 1784 Stanley Avenue, Dayton 4, Ohio.

GLOBE

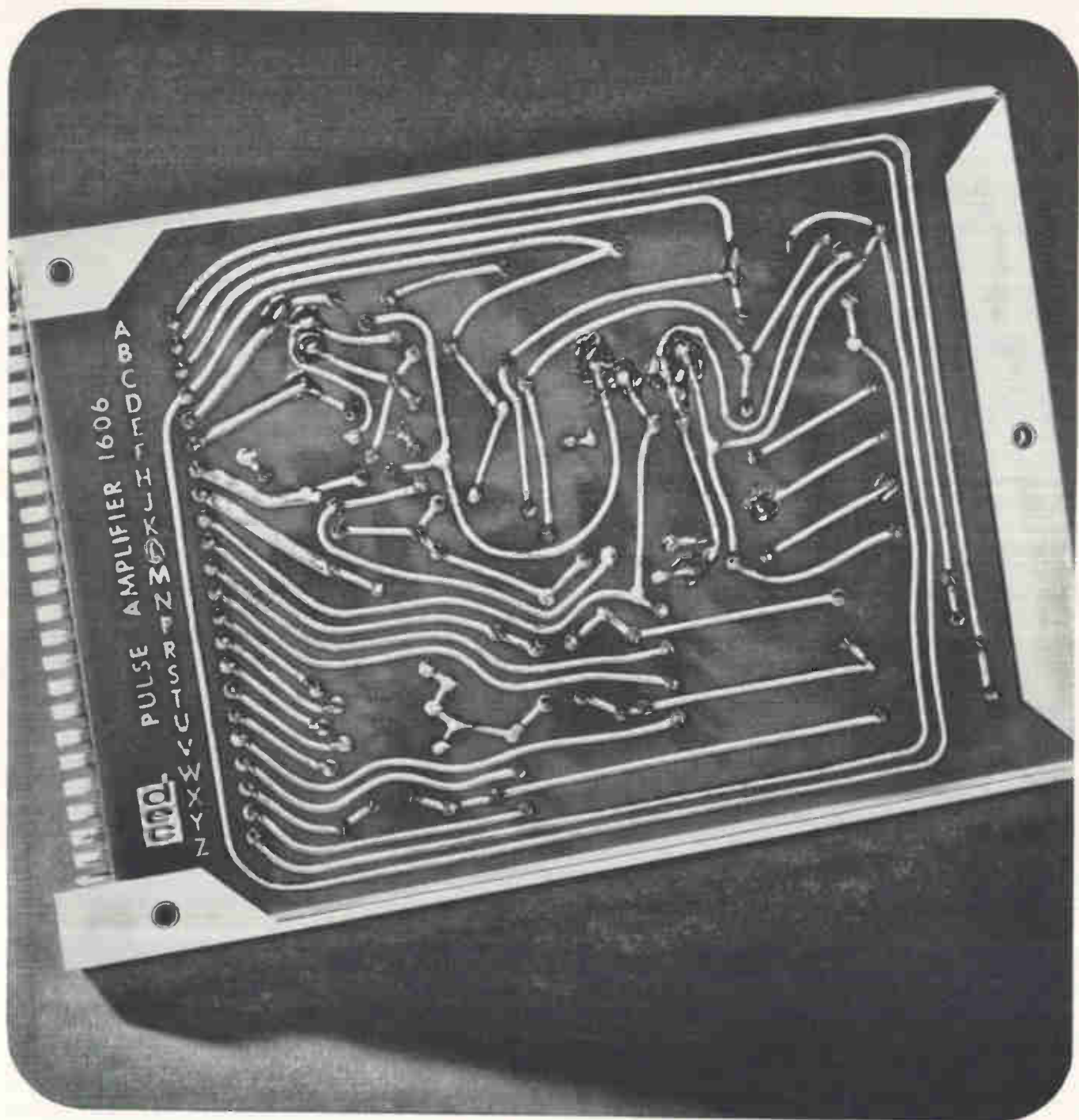

Checking your components in braille?

While other methods of non-destructive testing may indicate discontinuity or tiny imperfections, nothing brings proof to your eyes like a radiograph on Ansco Superay® 'H-D' Industrial X-ray film.

This ultra fine grain Class I film makes you Ansco-sure of sending only faultless components to customers.

For the ultimate in image sharpness and high contrast throughout the widest range

of X-radiation, use Ansco Superay 'H-D'. Available in economical bulk packaging. Ask your Ansco Representative for technical literature, or write Ansco X-ray Sales, General Aniline & Film Corp., Binghamton, N. Y.

gaf **Ansco**
X-RAY PRODUCTS
GENERAL ANILINE & FILM CORPORATION
BINGHAMTON, NEW YORK

NEW MODEL 430A POWER SUPPLY

—a "first" for FLUKE in the high voltage field!

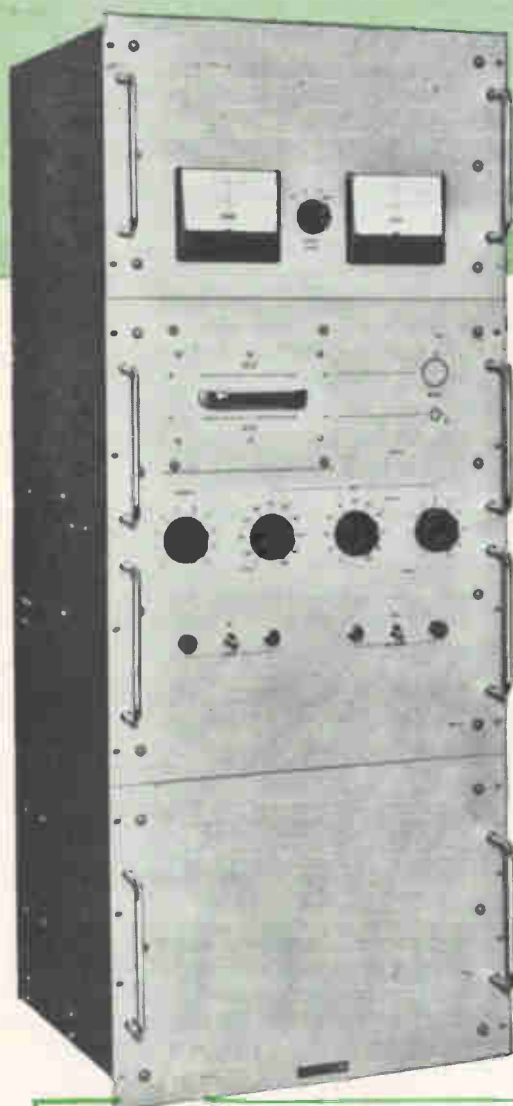

10.00-30.22KV
Line regulation, 0.005%
Load regulation, 0.01%
Stability, 0.005%
Precision calibrated



Model 430A fulfills exacting requirements for

Electrostatic focusing in mass spectrometry
Acceleration and focusing in high resolution cathode ray tubes
Calibration of electrostatic voltmeters and high voltage dividers
Pressurized ionization chamber experimentation
High voltage research
Charging high voltage capacitor banks

Model 430A delivers calibrated DC from 10 kilovolts through 30.22 kilovolts, with an output current capability from 0 to 10 milliamperes. The supply may be operated with either a positive or negative output, with one side always grounded to the chassis. Polarity is easily changed by reversing a front panel polarity plug, which is interlocked for safety.

No oil-filled tanks and associated heaters and thermostats are used. The sampling string features stress-free encapsulation, reed relay switching and 100 millivolt resolution at any output voltage.

The high voltage output is developed from a conventional 50-60 cycle voltage doubler, free of interference associated with RF type supplies. Approximately 60 seconds after line power is switched on, the high voltage circuitry is armed, and the 430A is ready for use.

BRIEF SPECIFICATIONS

	MODEL 430A	MODELS 413C, 413D
OUTPUT VOLTAGE	10 KV-30.22 KV	0-3111 VDC
OUTPUT CURRENT	0-10 ma	0-20 ma
LINE REGULATION, for 10% line change	0.005%	0.001% + 1 mv
LOAD REGULATION, for full load change	0.01%	0.001% + 2 mv
STABILITY		
Per hour	±0.005%	±0.005%
Per day after warmup	±0.03%	±0.03%
RESOLUTION, full range	100 mv	2 mv
RIPPLE	5 mv RMS	150 uv RMS
CALIBRATION ACCURACY	±0.25%	±0.25%
SIZE	48" high x 19" wide x 18" deep	19" wide x 5 1/4" high x 16" deep
WEIGHT	260 lbs.	50 lbs.
PRICE	\$3900.00	\$695.00—413C \$595.00—413D

Models 430A, 413C and 413D may be used over a wide range of environmental conditions

OPERATING TEMPERATURE RANGE	0°C to 50°C
TEMPERATURE COEFFICIENT, 10°C to 40°C	±0.002%/°C
STORAGE TEMPERATURE RANGE	-20°C to +60°C
HUMIDITY	0 to 80%
ALTITUDE	0 to 10,000 feet

Other new Fluke power supplies:

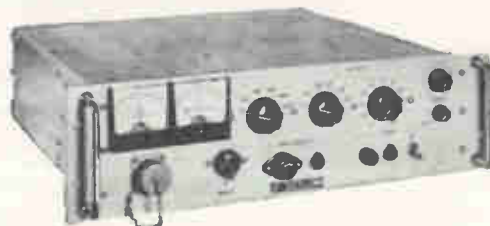

MODEL 413C, shown above, offers 0-3111 VDC; ±0.001% line and load regulation; front panel polarity switch; virtually complete absence of noise; low ripple; no voltage overshoot, and high resistance to mechanical shock and vibration. Same specifications apply to Model 413D (with front panel polarity plug; without meters).

Before specifying any type of power supply, check the full range of Fluke models. Write for new Catalog Digest 3-63 showing complete line of Fluke test and measurement instruments, or ask your Fluke sales representative for complete technical data or demonstration.



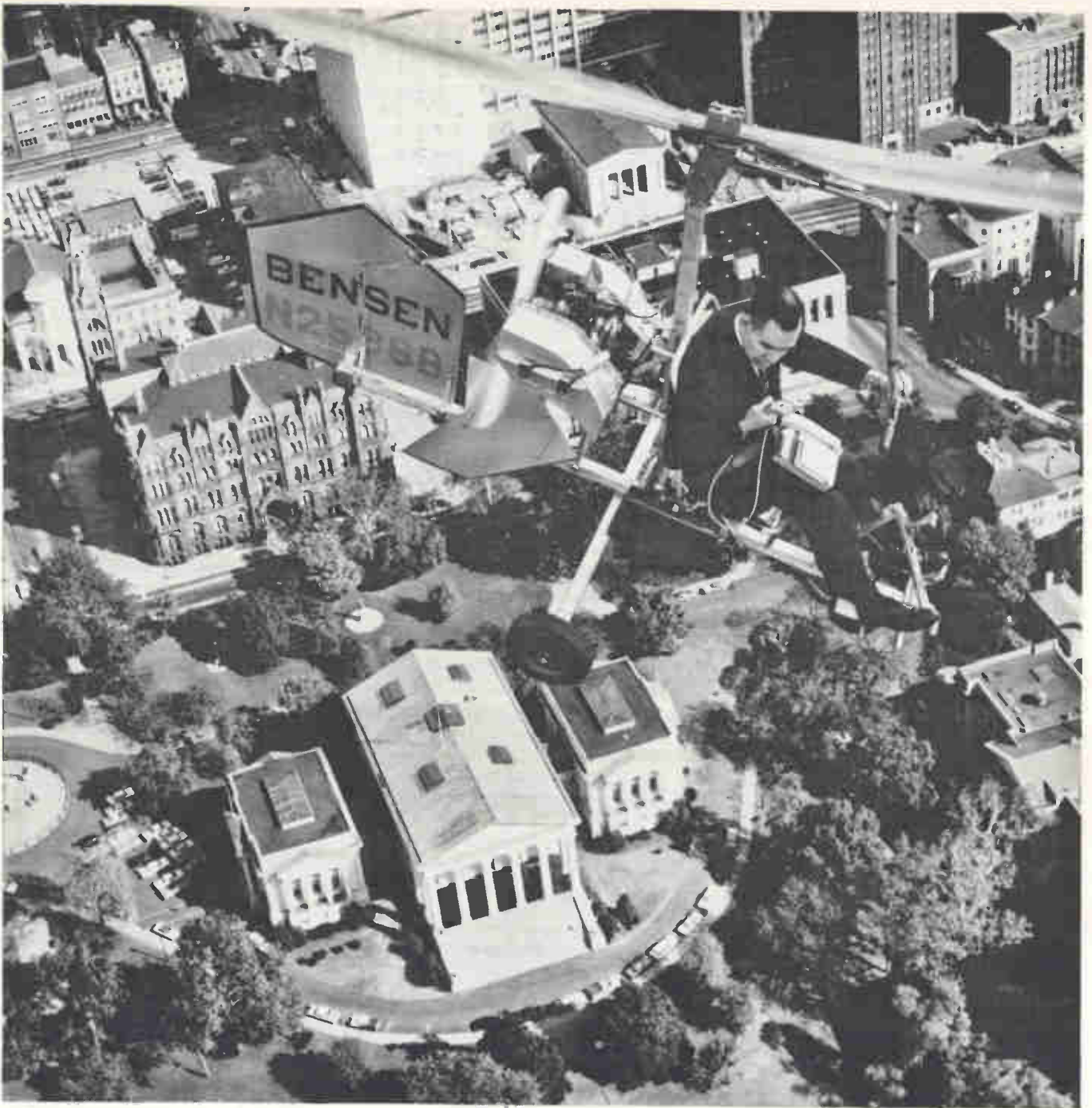

Single Place Gyrocopter by Bensen Aircraft Corp.

From industry's viewpoint,
 sound, thrifty government
 is a capital asset in
 Virginia's Capital Area.

The Richmond-Petersburg-Hopewell-Colonial Heights area of Virginia is much more than a strategic rail, highway, air and deep-water transportation center. It is also the seat of one of the nation's soundest state governments.

From industry's viewpoint, this represents long-range advantages that far outweigh any temporary plant location "gimmicks." They're enduring advantages such as freedom from state debt, freedom from overlapping taxes, outstand-

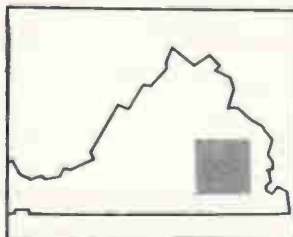

ing labor legislation, and clean-cut, central administration of industrial water use and waste disposal privileges.

For available site data, and a complete economic study of this key area, write, wire or phone.

VIRGINIA ELECTRIC and POWER COMPANY 
 J. Randolph Perrow, Manager—Area Development
 Electric Building, Richmond 9, Virginia • Milton 9-1411
 Serving the Top-of-the-South with 2,540,000 kilowatts—due to reach 3,500,000 kilowatts by 1965.

What Happens to Dielectrics in Space?

New power systems, radiation resistances point way to space

USE OF DIELECTRICS in space, a growing field of research in laboratories across the country, was discussed at the Dielectrics in Space symposium held in Pittsburgh under joint sponsorship of Westinghouse and NASA.

New information about the behavior of existing dielectrics in space environments of temperature, vacuum and radiation extremes points the way to development of new power systems, improved equipment operation and better space-vehicle propulsion systems—such was the consensus of the meeting.

The behavior of plasma as a dielectric, studied by Boeing Research Lab, was reported on by M. J. Kofoid. The study, connected with project Dynasoar, attempts to determine possible hazards during reentry due to abrupt changes in dielectric properties of the low-

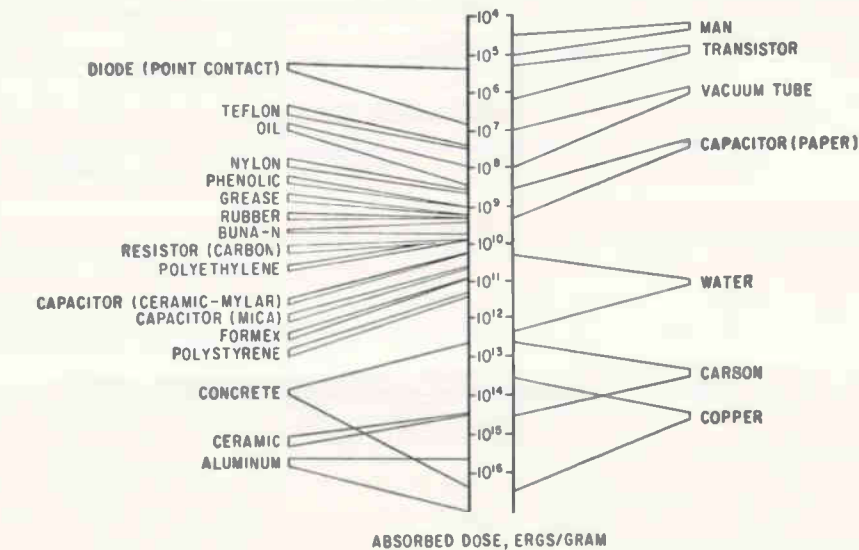

RADIATION DOSE thresholds for different types of materials show the amount of radiation absorbed before functional impairment. From paper by K. H. Sun, Westinghouse Research Laboratories

pressure plasma surrounding a space vehicle. For example, the Dynasoar vehicle may have exposed electric terminals on its skin where it was separated from its booster; in a reentry plasma a breakdown might occur between an exposed terminal and the

vehicle skin. The study determined that breakdown is much less likely to occur if the exposed terminal has negative polarity with respect to the vehicle skin; also determined the optimum amount of recessing for the terminal as one diameter.

A study of the effects of a simulated space environment on a large variety of dielectrics was summarized by L. J. Frisco of Johns Hopkins University. The NASA-sponsored project determined the properties of materials when subjected to vacuums of 10^{-6} Torr, 50-Kv X-ray radiation, and ultraviolet irradiation, with respect to flashover, a-c and d-c losses, dielectric strength, at a variety of frequencies to 18 megacycles.

NEW POWER SYSTEM—A new type of power system suitable for space applications was described by B. H. Beam of NASA's Moffett Field, California. The system (ELECTRONICS Newsletter, July 5) is based on building a series of thin-film capacitors into the skin of a satellite. The capacitors are charged by radiation, and dis-

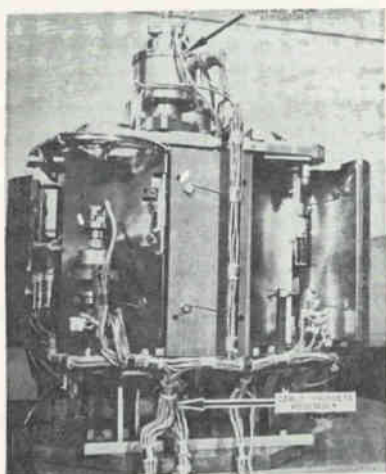

REACTOR ASSEMBLY can test space components' resistance to cumulative dosage of 10^{18} neutrons per square cm, built by Atomics International. Control actuators are directly on reactor, top—Fig. 1

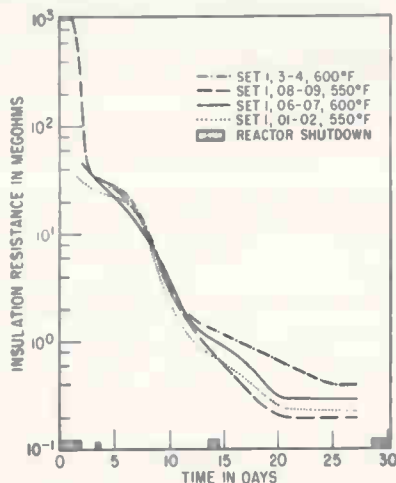

RESISTANCE VS IRRADIATION in a 30-day test by Atomics International on a Westinghouse aircraft motor, shows gradual insulation failure as accumulated dosage increases—Fig. 2

SANBORN® DC DATA AMPLIFIERS



For precise control of low level signals from thermocouples, strain gages and resistance bridges, other millivolt-output transducers

Low noise and drift, high linearity and freedom from ground loop problems are a few of many distinct advantages these stable, all-solid-state Sanborn amplifiers offer your low-level DC signal instrumentation. Typical inputs include millivolt signals from thermocouples and strain gages. Amplifier outputs can be connected to scopes, meters, magnetic tape, oscil-

lographs, computers, and for high current output models, high frequency optical galvanometers. This choice from Sanborn lets you select the performance characteristics you need in your data acquisition system — you pay for only what you need. *And the specs hold true in practice as well as on paper.*

■ Consult Sanborn on your instrumentation requirements — your local Sanborn Sales-Engineering Representative will be glad to work out the details with you . . . and a phone call will get immediate action. Offices throughout the U.S., Canada and foreign countries.

	"FIFO" 860-4000	WIDEBAND 860-4200	NARROW BAND 860-4300
Bandwidth	DC — 10 KC within 3 db	DC — 50 KC within 3 db	DC — 100 cps within 3 db
Linearity	±0.1% of 10 V f.s. at DC	±0.01% of 10 V f.s. at DC	±0.03% of 5 V f.s. at DC
Gain	1000, 500, 200, 100, 50. Smooth gain control covers intermediate ranges	1000, 500, 200, 100, 50, 20, 10. Does not phase invert	1000, 500, 200, 100, 50, 20, 10. (Gain of 10 to 20,000 in 12 fixed steps available on special order)
Overload Recovery	For 20 V, 1 ms to 1% of f.s. output		For ±10 v, 200 ms to within 25 mv of original output
Drift	±2 uv ref. to input. ±0.01% of f.s. at output at constant ambient for 40 hours	±0.02% of f.s. at constant ambient for 40 hours	±2 uv ref. to input. ±0.1 mv. ref. to output for constant ambient for 40 hours
Noise	5 uv rms, DC-10 KC (ref. to input at gain of 1000)	7 uv rms, DC-50 KC (ref. to input)	1 uv p-p, DC-20 cps (ref. to input, at gain of 1000)
Input	Isolated from gnd. and output. Impedance 100 meg. min. at DC in parallel with 0.001 mfd.	Impedance 100 meg. at DC in parallel with 0.001 mfd.	Isolated from gnd. and output. Impedance 500K
Output	Isolated from input and ground. ±10 V at 10 ma. (—4000P has grounded output, ±10 V at 100 ma.)	±10 V at ±100 ma. Sustained short across output will not cause damage to amplifier.	Isolated from input and ground ±5V at ±2.5 ma. Part or all of internal 2K in parallel with 25 mfd. may be removed, connected externally.
Common Mode Characteristics	120 db rejection at 60 cps, 160 db rejection at DC (1000 ohms in either input lead). Tolerance ±300 V DC or peak AC.	Amplifier floats with respect to chassis. Isolation impedance is greater than 3000 megohms in parallel with 5 pfd.	130 db rejection at 60 cps, 160 db rejection at DC (1000 ohms in either input lead). Tolerance ±300 V DC or peak AC
Price (F.O.B. Waltham, Mass.)	\$825 (860-4000P: \$900)	\$650 (including internal power supply)	\$425

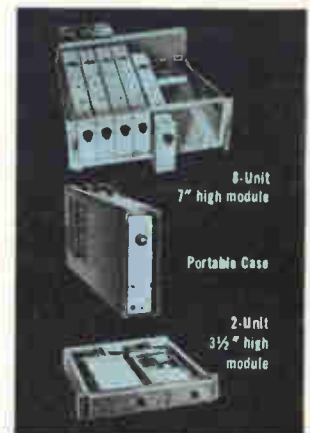

INDUSTRIAL DIVISION
SANBORN COMPANY
 WALTHAM 54, MASS.
 A Subsidiary of Hewlett-Packard Co.

Trapped by

PW Assembly Cost Factors?

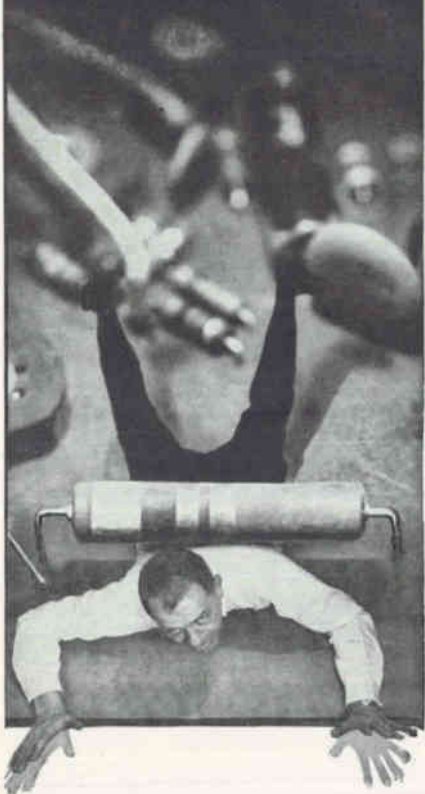

Then **DYNASERT** component inserting machine may be your way out. This is automated, high-speed inserting at its best: up to 10 times faster than costly hand methods. And savings add up and up: users find that their savings in direct labor costs and production time easily pay for a Dynasert installation in less than a year. Dynasert delivers product uniformity. Greater efficiency. Superior quality. It automatically feeds, cuts and bends leads, inserts and clinches all types of axial lead components. Virtually no operator training required. Changes made from one board or component type in seconds. Interested? Send for a free copy of: Dynasert — Production Equipment for Electronics. Dynasert Dept., United Shoe Machinery Corporation, Boston, Massachusetts.



United Shoe Machinery
BOSTON, MASSACHUSETTS

mental dielectric solar conversion system is a cylindrical power supply using a polyethylene terephthalate dielectric film, has an area of 200 square feet. Designed to rotate in space at 2 revolutions per second, the system will develop a continuous 30 watts. Weight of the $\frac{1}{2}$ -mil dielectric film is $\frac{1}{2}$ lb, of the entire power system 7 lbs. While the overall efficiency is low (0.63 percent) the system is not easily damaged by dust and meteorites as are solar-cell conversion units.

B. H. Beam said the system effi-

raised; he indicated that the solution of the problem of lighter, sturdier power systems for space probably lies in the dielectric film field.

RADIATION SIMULATION — A reactor assembly to simulate the radiation conditions encountered in space was described by O. P. Steele of Atomics International, as part of a program of space-testing inorganic insulation. Shown in Fig. 1, the reactor assembly enables neutron fluxes of 10^{19} to 10^{20} neu-

Fresnel Reflector to Orbit This Year

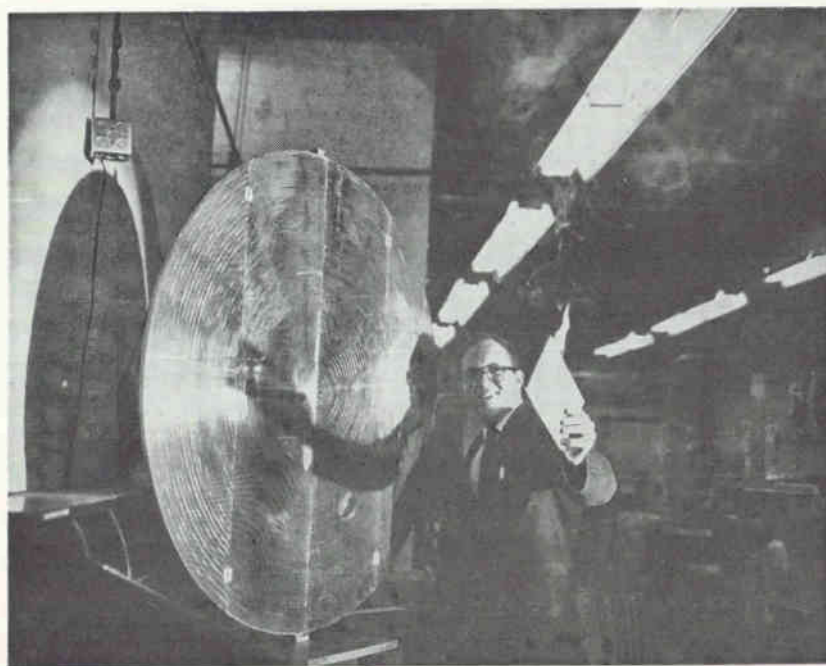

AT WRIGHT-PATTERSON AFB, experimental reflector sets wooden board afire by light from a three-kilowatt searchlight in demonstration of project EROS' capability

FOUR-FOOT diameter Fresnel solar reflector will orbit the earth later this year in project EROS (Experimental Reflector Orbital Shot) to prove feasibility of using focussed sun's rays to run space equipment.

The reflector has been delivered to Air Force's System Command, Aeronautical Systems Division. It was developed and built under \$500,000-contract by GM's Allison Division.

The flat-plate electroformed nickel reflector with aluminized

surface will unfold in orbit to focus sunlight into a radiometer for measurement. It will orbit for thirty days, aligning with sun for about one minute each orbit. Energy conversion will not be tried, but officials predict the mirror could produce 100 to 500 watts.

Larger reflector projects ranging up to 30 kilowatts are under study. Additional ASD solar energy collection programs are being established to simultaneously place two ten-foot reflectors in orbit for more than 90 days.

trons per square cm over a one-year testing period. The results of a 2,500-hour test on an aircraft motor winding are plotted in Fig. 2.

New Types of Learning Machines Proposed

NO COMPREHENSIVE theory of the learning machine has been developed to date, analogous to the von Neumann theory of the digital computer, pointed out Dr. Julius T. Tou at the Computer and Information Sciences Symposium at Evanston, Ill. "This is a new science, and it has a real literature problem; we don't even have a textbook", Tou said and indicated that most of the available literature is in the collated papers of the COINS symposia,

There are many schools of thought on the basis of adaptive systems. Some scientists still favor the conversion of conventional computers to pattern recognition tasks by increasing their capacity and coming up with more sophisticated programming. Others, and increasing majority, believe that an entirely fresh approach is needed.

"A primitive, elementary adaptive system is still at least three to five years away," stated Dr. Tou, who intimated that it would be many years after that before a usable "next generation" computer would be on the market. He agreed that Stanford's Madaline and Cornell's Perceptron, both capable of primitive, single-parameter recognition, are probably on the right track toward development of an adaptive system.

ASSOCIATIVE—So-called learning machines would differ from computers in that they would possess purely associative-type memories and would be continually programmed on the basis of human or environmental feedback. An associative memory would permit a learning machine equipped with photo-input, for instance, to recognize a given letter of the alphabet even though it had never seen the letter in precisely that form before—as handwritten or scrawled as opposed to printed.

By continually correcting the ma-

**Mort
Mann
can
show
you...**

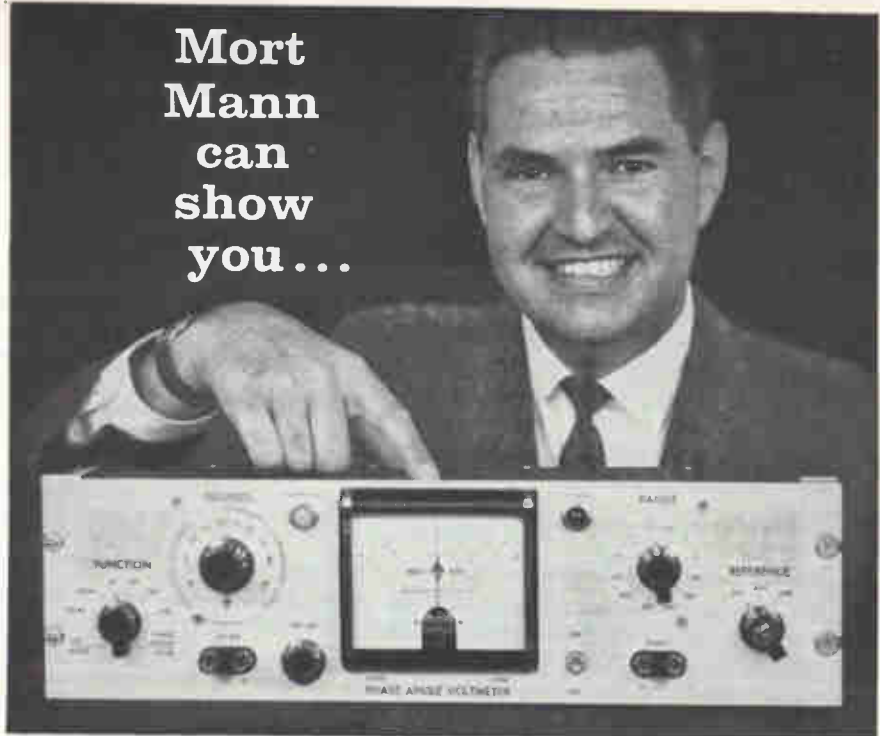

Sales Engineer, North Atlantic Industries

how North Atlantic's Phase Angle Voltmeters* solve tough ac measurement problems ... in the lab or in the field.

Designed for critical tasks in circuit development, production and testing, North Atlantic's Phase Angle Voltmeters provide direct reading of phase angle, nulls, total, quadrature and in-phase voltages—with proven dependability even under field conditions. Your North Atlantic engineering representative can quickly demonstrate how they simplify ac measurement jobs from missile checkout to alignment of analog computers—from phasing servo motors to zeroing precision synchros and transducers.

Shown below are condensed specifications for single-frequency Model VM-202. Other models include high sensitivity, three-frequency and broadband types.

Voltage Range.....	1 mv to 300 v f.s., 12 ranges
Voltage Accuracy.....	±2% f.s.
Phase Accuracy.....	dial: ±1°; meter: ±3% of F.S. degrees
Signal Frequency.....	1 Freq., 30 cps—10 kc
Input Impedance.....	10 megohms
Reference Input.....	100 K, 0.25 v min.
Meter scale.....	3-0-3, 10-0-10 linear
Phase Angle Dial.....	4 scales, 90° (elec.) apart
Nulling Sensitivity.....	2 microvolts (phase sensitive)
Harmonic Rejection.....	55db (with filters)
Dimensions.....	5¼" h. x 19" w. x 7⅞" d.

The North Atlantic man in your area has full data on standard and special models for laboratory, production and ground support. Call today for his name, or request Bulletin VM-202.

**Trademark*

NORTH ATLANTIC industries, inc.
TERMINAL DRIVE, PLAINVIEW, L. I., NEW YORK • OVERbrook 1-8600



NOW from DEI

Versatile . . . Proven . . . Modular

VHF/UHF Telemetry Receiver

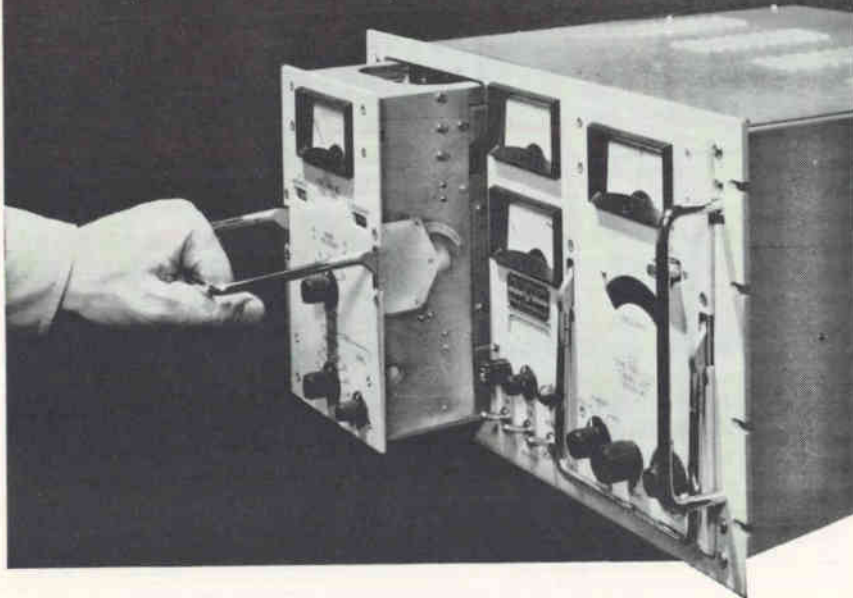

- Video Amplifier Response DC to 1 mc with Impedences Selectable 75 or 600 ohms
- AFC Optional on all RF Heads
- Multiple Bandwidth Front Panel Switchable IF Amplifiers
- Multi-Range Deviation Meter Calibrated Directly in KC

Immediately available from Defense Electronics, Inc. is the versatile, field-proven, completely-modular TMR-5A telemetry receiver.

This reliable unit will currently accept 14 plug-in tuning heads . . . 14 plug-in IF strips and six demodulators . . . any one of which can be easily removed from the receiver in seconds. Additional heads, demodulators and IF amplifiers are available upon request.

Plug-in RF heads can be instantly installed or removed from the receiver to provide the required frequency range by merely using the "single-action" pull out handle.

The video drawer also can be speedily converted by the various plug-in IF strips, ranging from 3 KC to 2.4 MC, and plug-in demodulators for FM, AM, PM and FM phase-lock applications.

This unit is particularly suitable for conical scan antenna tracking, dual diversity combining and predetection record/playback applications.

Write for DEI bulletin TMR-5A . . . or call:



DEI
SERVING
GOVERNMENT
AND INDUSTRY

Defense Electronics, Inc.

Main Office:

5455 Randolph Rd.
Rockville, Md.

Phone: WH 6-2600
TWX: 301-949-6788

Regional Office: Sherman Oaks, Calif. Phone: 873-4322

chine a human operator could, in effect, cause it to learn when to produce a desired response from input; technically the machine's response under such conditions would be based on probability rather than certainty that the suspected input was received, since each input would be somewhat different from all previous ones. In this way, the machine's learning process would approach man's.

Hungarians Develop 3-D X-ray Equipment

VIENNA—Use of two X-ray tubes arranged to penetrate a human body from two different directions and thus produce a "plastic image" on a screen has been reported by Dr. Sandor Dekany, in Budapest. Special equipment senses differences between the two projections and locates targets exactly in three-dimensional manner, according to the inventor.

Reported exposure time is one-fifth of a second; clear pictures can be obtained even of moving objects. The system is the subject of a patent application in several countries.

High Intensity Gun Simulates Nuclear Blast



PHYSICIST checks alignment as x-ray gun is fitted to specimen-chamber porthole

HIGH-INTENSITY X-RAY GUN simulates the gamma-ray emission given off by a one-megaton nuclear blast 2 miles away, to test effects of nuclear explosion radiation on electronics equipment for 0.1 μ sec.

The unit, installed in General Precision's new Aerospace Research Center in Little Falls, New

NEWS

Thermistors?—Nobody makes a wider variety than Carborundum.

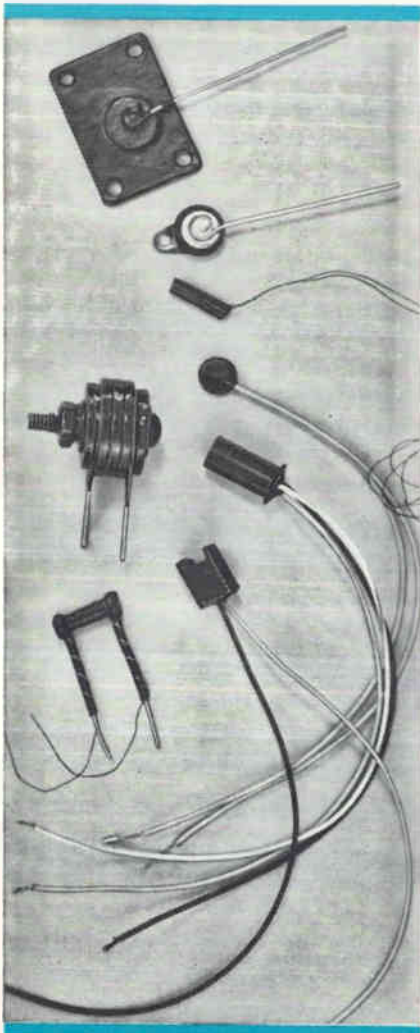

Carborundum is turning out thermistors in varieties undreamed of a short time ago—from sub miniature discs to complete assemblies.

Special assemblies can be manufactured to fit chassis and operating requirements. You can specify your electrical and dimensional needs and we'll design the assemblies to meet

them. They meet precise tolerances for temperature coefficient, dissipation constant and resistance at reference temperature. Can be potted in epoxy. Provide long-term stability.

Discs and washers are available in sizes from 1/10" to 1" in diameter. We supply them soldered to mounting plates or with special terminals to solve assembly problems. They're made of high-stability compositions. Beta values range from 2700 to 4800.

Rods can be purchased from Carborundum in the widest range of body sizes and temperature coefficients available to industry—in lengths from 1/4" to 12" and diameters from .05" to 1". Beta values from 1100 to 4600.

PTC Thermistors are new, positive-temperature-coefficient units with high sensitivity. Sensitivities as high as 12 percent per °C can be achieved. Use PTC's in combination with NTC's (negative coefficient units) and with linear resistors to construct an astonishing variety of temperature compensation curves for your circuits. We also manufacture PTC assemblies and probes for special needs.

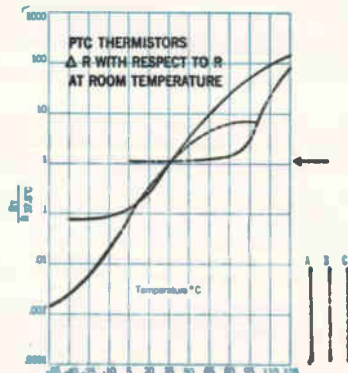

The graph shows resistance of three different PTC thermistors over a range of temperatures as a multiple of resistance at room temperature.

For more information on this complete thermistor line, write to: Electronics Division, Globar Plant, Dept. ED-6T, Niagara Falls, N. Y.

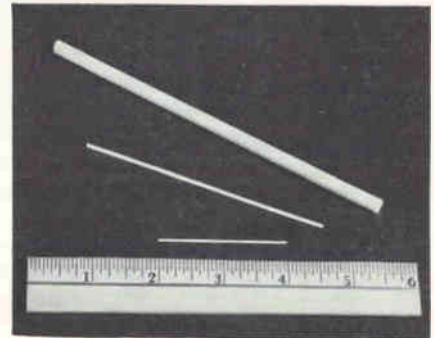

Magnesium oxide crushable preforms now in longer lengths

High-purity (99.4%) MgO tubing is now available in lengths up to six inches. This is double the previous size available. Now you can produce swaged, high-precision thermocouple assemblies faster. Cut costs at the same time.

These ceramic preforms are available in 2", 4" and 6" lengths depending upon O. D. size. In addition, O. D., hole size, and camber tolerances have been tightened. They have an AQL (acceptable quality level) of 2.5% for O. D., hole size and camber. Using the longer lengths, you can produce thermocouples with fewer air gaps, better resistivity and lower fatigue factor. They're just what you need wherever rigidity, resistance to vibration and high reliability are a must. For our new literature on ceramic insulating tubing, write to: Electronics Division, Latrobe Plant, Dept. EL-7, Latrobe, Pa.

CARBORUNDUM®



NOW-PRECISION VOLTAGE AND PHASE COMPARISONS AUTOMATICALLY-WITH A GERTSCH COMPLEX RATIO BRIDGE

This self-nulling AC bridge displays both in-phase and quadrature ratios on a 5-place Nixie readout. You get fast, accurate measurements without the need for a skilled operator. In-phase ratio accuracy is better than .005% of range—quadrature accuracy: better than .05% of range, plus calibration. Average nulling time is less than 10 seconds. Instrument is ideal for production testing of transformers, tachometers, rate gyros, all types of transducers, AC amplifiers, AC networks, and AC systems.

Measures step-up ratios as high as 1:6 to 3-, 4-, or 5-place resolution.

Automatic quadrant selection and indication.

Choice of operating frequencies. Either 400 or 800 cps models available. Other frequencies furnished on request.

Completely self-contained—requires no external calibration sources. Output provided for printer. Both cabinet and rack-mounted models are available.

Write for complete literature. Bulletin CRB-3.

Gertsch

GERTSCH PRODUCTS, INC.

3211 S. La Cienega Blvd., Los Angeles 16, Calif. • Upton 0-2761 • VErmont 9-2201

Jersey, generates x-rays with a 600,000-volt, 1,500-ampere tube, producing an intense gamma-ray pulse 0.1 microseconds in duration, directed at a radiation and r-f shielded specimen chamber. Effect on circuits is observed by high-speed oscilloscope and camera.

Purpose is to study the temporary effects of blasts on military electronic equipment in space and at high altitudes. At sea level, the gamma radiation is not harmful because of atmosphere absorption.

Control of Ionosphere To Be Probed by Rocket

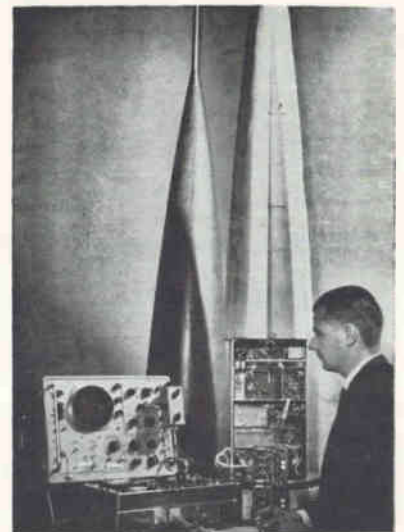

INSTRUMENTED NOSE CONE
will go 100 miles into ionosphere.
Cone has two loop antennas and a 4-foot probe at tip

IONOSPHERE STUDIES, with a view to eventual control of ionosphere for long-distance radio communication, are being conducted by University of Illinois with an instrumented Aerobee 150 rocket.

The rocket's transmitter will heat the electrons of the upper atmosphere; the resulting glow will be observed by photocells in the rocket. The effect of this on polarization or direction of radio wave propagation through the ionosphere will be then determined.

Special interest is the cross-modulation effect of the heated ionosphere; this causes intermodulation between radio signals of different frequencies.



Want to talk to a salesman who says,
"My Company Makes it Better--to Save You Money" ?

The woods are full of hermetic terminal manufacturers selling price. Exactly how many no one knows. They come and go too fast to keep track of.

We won't pretend that Fusite is invulnerable against their allure for some of our customers.

But nearly always, a manufacturer learns the hard way that the most expensive terminal he can use is a cheap one that fails on the job. The very best Fusite Terminal you can use is

a small fraction of the total cost of your assembled product.

In the 20 years since Fusite pioneered in its field we've watched the "price sellers" come and go, while we continued to make the best terminals we know how.

If you want the least expensive terminals you can buy we'd like to do business with you now. If you're looking for the cheapest price—we'll still be around later. We hope you will.



THE FUSITE CORPORATION
DEPT. J2, 6000 FERNVIEW AVE., CINCINNATI 12, OHIO

Gentlemen: Please send me, without obligation, the items checked below.

- | | |
|---|--|
| <input type="checkbox"/> An enlargement of this cartoon, without advertising, suitable for framing, | <input type="checkbox"/> A sample terminal of _____ type |
| <input type="checkbox"/> The Fusite catalog | <input type="checkbox"/> A sales representative |

Name _____ Title _____

Company _____

Address _____

STC LOW NOISE TRAVELLING WAVE TUBES EXTEND RADAR RANGE!

STC offers two tubes of eminently suitable design for use in /S band

TYPE W9/2E FOR BROADBAND COVERAGE

with a gain of 40 dB and noise factor of about 8.5 dB. It is intended for operation over the whole frequency range 2.5 to 4.1 Gc/s with fixed voltages. An aluminium foil mount is available with coaxial r.f. connectors.

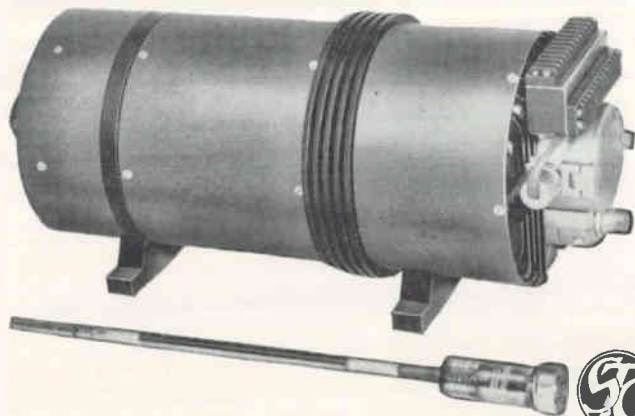
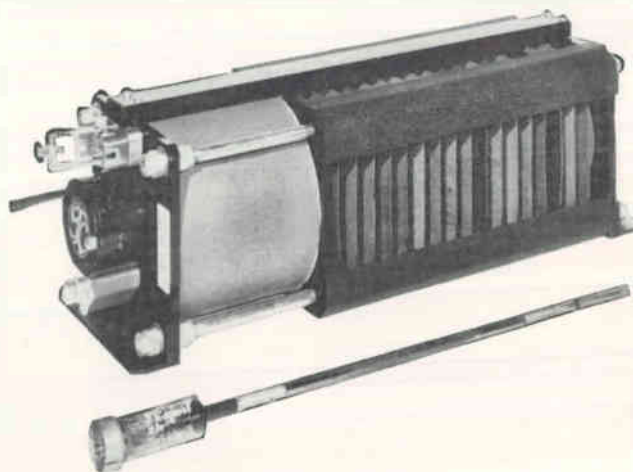

TYPE W10/3E FOR NARROW BAND OPERATION

with about 23 dB gain and 6.5 dB noise factor with the grid voltages set for optimum noise factor at the appropriate centre frequency. ■ W10/3E has a frequency range 2.7 to 3.3 Gc/s in solenoid circuit 495—LVA—003 with waveguide r.f. connectors or frequency range 2.8 to 3.8 Gc/s in solenoid circuit 495—LVA—006 with coaxial r.f. connectors.

COMPONENTS GROUP VALVE DIVISION

Standard Telephones and Cables Limited

FOOTSCRAY SIDCUP KENT

USA enquiries to
ITT COMPONENTS DIVISION · P.O. BOX 412 · CLIFTON N.J.



now
there
are



*WITH MIRROR SCALE
Series 4M
\$50.95

2 new 260[®] VOMs

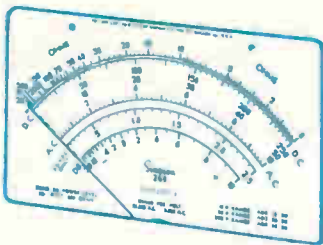

WITH STANDARD 260
SCALE Series 4... Still Only
\$48.95



with 6 new features

Now the world-famous 260[®] volt-ohm-milliammeter is a better buy than ever before. Call your distributor now for immediate delivery on either of these two new 260's, or on any of the other 50 Simpson testers—the world's largest selection.

- New Self-Shielded Movement
- New Higher Accuracy: 2% DC, 3% AC
- New Ruggedness From Spring-Backed Jewels
- Greater Repeatability
- Increased Linearity and Stability
- *Mirror Scale (260, Series 4M)

S I M P S O N I N S T R U M E N T S S T A Y A C C U R A T E

Both new 260's can be used with Simpson's popular "Add-A-Tester" adapters. Write for Revised Stock Catalog 2064A.

Simpson

SIMPSON ELECTRIC COMPANY 5203 West Kinzie Street, Chicago 44, Ill.

Representatives in Principal Cities ... See Telephone Yellow Pages

Phone: (312) Estebrook 9-1121
In Canada: Bach-Simpson Ltd.,
London, Ontario

WHAT MAKES AN INSTRUMENTATION CABLE FAIL?

It can pass inspection perfectly one minute and fail miserably the next. Simply manufacturing it to spec isn't good enough. Insurance against failure must be built into the cable at every step from diagram to installation.

Where can it go wrong? At almost any point not adequately safeguarded. Here are four of the most common trouble spots:

- (1) Incompatible Plasticizers
- (2) Filler Material
- (3) Component lay-factors
- (4) Shielding

INCOMPATIBLE PLASTICIZERS A unique form of chemical warfare within cable materials has fouled more than one missile program. Plasticizer materials have to be added to compounds to obtain the required flexibility. These additives are seldom compatible with each other. Incompatible plasticizers used in systems in contact with each other without control may attack each other with disastrous effects. (As a prime example, additives in low temperature neoprene jackets are not always compatible with the insulating materials.)

Manufacturers can control plasticizer migration problems by selecting proper materials and by using suitable barriers between components. Many specifications make the use of barrier material optional and a manufacturer whose only concern is price will leave it out.

Rome-Alcoa, as a result of its wide experience with materials, always uses barriers where migration could be a problem.

FILLER MATERIALS When spurious signals arrive at your display, recording or control panel, the fault could be in the improper selection of filler material. Compatibility between insulations and filler materials is of prime importance.

In the case of some plastics or rubbers, the material's "memory" can cause it to shrink disproportionately, creating undue stresses internally in the cable. This can cause kinking of the insulated conductors; electrical failures follow.

Only experience can tell a cable manufacturer how to compensate for "memory" and how to control compatibility in filler materials. Experience in areas such as this has given Rome-Alcoa its remarkable record of instrumentation cable reliability.

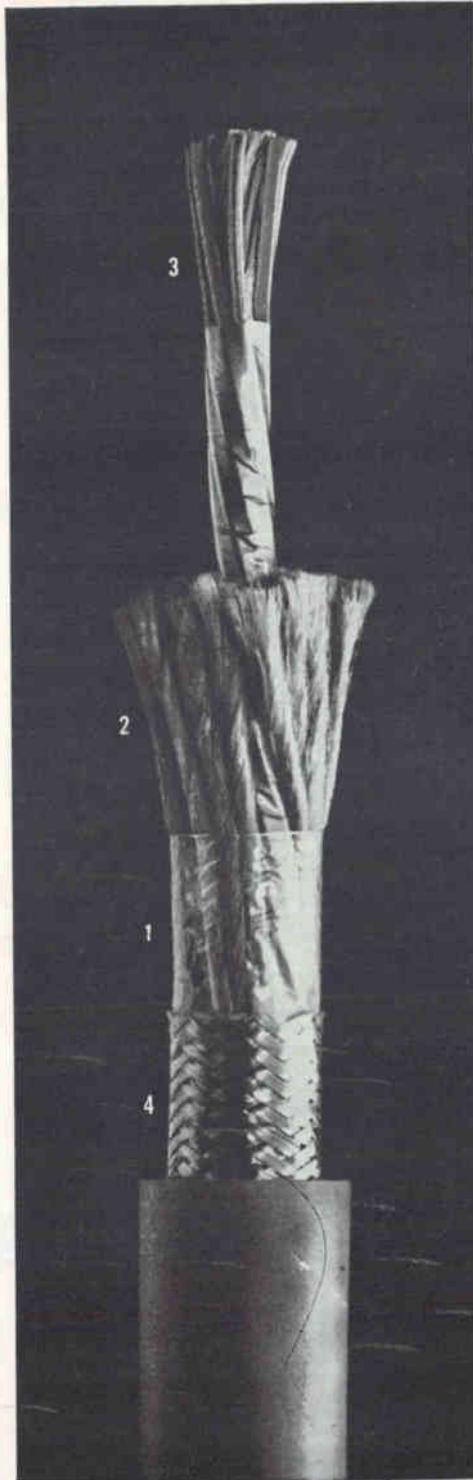

COMPONENT LAY-FACTORS Conductor kinking can also be a result of mistakes in the twisting of component conductors. Inconsistent tensions and improper sequence of lay-up can create uneven tensions in the assembled conductors.

In such cases, individual conductors may actually push through their insulations, causing electrical failures.

Obviously, these mistakes should be avoided during cabling. At this stage in cable construction careful, experienced workmanship can provide safeguards against possible trouble later on. Such careful craftsmanship sometimes costs a little more, but it can make the difference between success and failure.

SHIELDING Constructed of many ends of fine strands, shielding braids are prone to having broken and loose ends. These can break through insulations and short out component conductors. Improperly treated, they are the most common cause of shielding failures.

It's cheaper to let such loose ends remain in the braid—but it can also be disastrous. Experience on thousands of such shieldings has taught Rome-Alcoa the exact tensions which must be maintained, as well as methods of protecting and treating loose ends.

HOW TO AVOID FAILURES No manufacturer can promise you 100% reliability at every development stage. But it's only logical that the one way to be sure of maximum reliability is to have your cable planned and manufactured by a company with depth of experience and a record of reliability in the field.

Rome-Alcoa is, frankly, one of the few companies that qualify. We've been designing and constructing these cables since their first conception—long enough to know what can cause a cable failure, and how to avoid it. If you're planning to design or install instrumentation cable soon, call us.

As a starter, send for our 24-page booklet titled "Instrumentation Cables, Cable Assemblies and Hook-up Wires." In it, we describe instrumentation cable constructions, production, military specifications and our qualifications. For your copy, write Rome Cable Division of Alcoa, Dept. 27-73, Rome, N.Y.



NEW!



volt-pac[®]

variable transformers

10.0 Amperes

DOLLAR SAVINGS—

19 Basic Ratings—
Wider Selection

Industry's Most
Complete Line

LONGER LIFE—

30-100% Greater
Overload Capability

SPACE SAVINGS—

Up to 33% Greater
Over-all Capacity
in Same
Physical Size



You benefit three big ways with General Electric's new volt-pac variable transformer line.

First, G.E.'s wider selection offers big dollar savings. You can choose from nineteen basic G-E 120- and 240-volt, single-core ratings—more than ever before—to more precisely meet your applications. By making smaller jumps between ratings, you save the difference in dollars. And G.E.'s 2-65 amp single-core current range, 15 amps more than previously available, means one volt-pac unit can replace two stacked units in these higher ratings. You lower costs and space requirements too!

Second, you get longer life—the result of three exclu-

sive volt-pac features. General Electric's ① new unique heat-sink ring* located beneath the gold-plated brush track quickly dissipates heat from the hot spot. The ② solid-carbon, grain-oriented brush and the ③ quick-transfer current collector* provide more reliable operation. Total effect: up to 100% greater overload capability than previously available.

Third, you get up to 33% more over-all capacity—in existing core sizes. And in the popular sizes through 10 amps, G-E units are directly interchangeable with your present mounting arrangements.

For the full story on G.E.'s manual and motor-operated volt-pac lines, and the automatic line with solid-state SCR control, see your G-E Sales Engineer or authorized G-E Electronics Distributor. Or write for Bulletin GEA-7751 to Section M458-02, General Electric Company, Schenectady 5, New York.

*Patent Pending



Progress Is Our Most Important Product

GENERAL ELECTRIC

CIRCLE 79 ON READER SERVICE CARD

How Ceramic Benders Control Light Rays

Here's piezoelectricity with a new twist. Ceramic acts as light shutter

By F. W. KANTOR,
Consultant
Silver Spring, Maryland

WHEN VOLTAGE is applied to two different thin strips of piezoelectric materials, bonded together, one strip increases in length and the other becomes shorter. The composite element curls, according to the polarity of the applied voltage. Considerable mechanical travel can be produced. For example, the Clevite bimorph bender 1.75-in. long \times 0.125-in. wide \times 0.0021-in. thick bends about 0.07-in. at 150 v.

This curling motion can control the passage of light from light source(s) to photoconductor(s). With the ceramic element deflected in an open position, relays can be constructed, driven by 10 to 100 nanowatts and capable of controlling several watts.

If the bender is initially mounted in the open position, and bent closed, normally-closed switching operation is obtained. Figure 1A shows a possible arrangement for a single-pole single-throw normally-open relay.

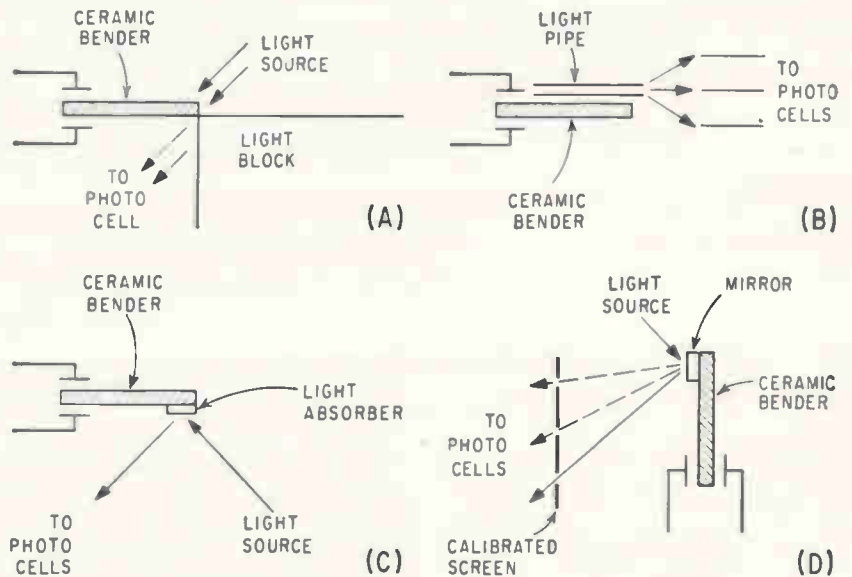

CURL of ceramic reed controls light. Author suggests four ways of doing this. Ceramic blocks light (A); bender moves light pipe to different photoconductors (B); bender lifts light-absorber pad from total internal reflecting surface (C); and optical lever works with mirror on bender element (D)

The input resistance of the ceramic bender element is greater than 10^{11} ohms. Capacitance is less than $0.005 \mu\text{F}$. Benders operate with stored energy less than 50 microjoules.

The output characteristics depend mostly on the photoconductor. This permits construction of relays with widely-varying contact characteristics in the same unit.

Photoconductive switching provides very low noise operation for

small-signal switching, and does not require spark suppression when handling moderate loads. With present photoconductors, maximum output can be as high as 25 w, but is more typically 0.25 to 2 watts. The operating time depends primarily on the rise and fall time of the photoconductors, and is in the order of 10 to 20 ms, depending on the design. With any design, the lamp serves as a control element, providing two isolated inputs.

PIEZOELECTRIC WITHOUT SPARK

Past attempts to construct relays with piezoelectric drives have foundered because, with no snap action available, there has been prolonged sparking, with heating and oxidation.

Author now suggests piezoelectric principle for a new family of switches. Mechanical curl of ceramic element controls the transfer of light from an internal light source to a photoconductor. The photoconductor, in the load circuit, takes the place of mechanical contacts. Uses are legion: general switching, signaling voltages of low-current power supplies, radiation monitors, simple timers, polarity sensors, and small motor controls

THE DESIGNS—Bender elements can be arranged to move a fiber light pipe to different photoconductors, Fig. 1B. Such a device makes a small, low-output multiple-throw switch for polarity sensing.

In another design, light from the lamp is reflected on a surface—to the photoconductor, Fig. 1C. The bender carries a light absorber which conforms to the reflecting surface. When voltage is applied to the bender, the total internal reflection is destroyed. When the absorber moves a few wavelengths of

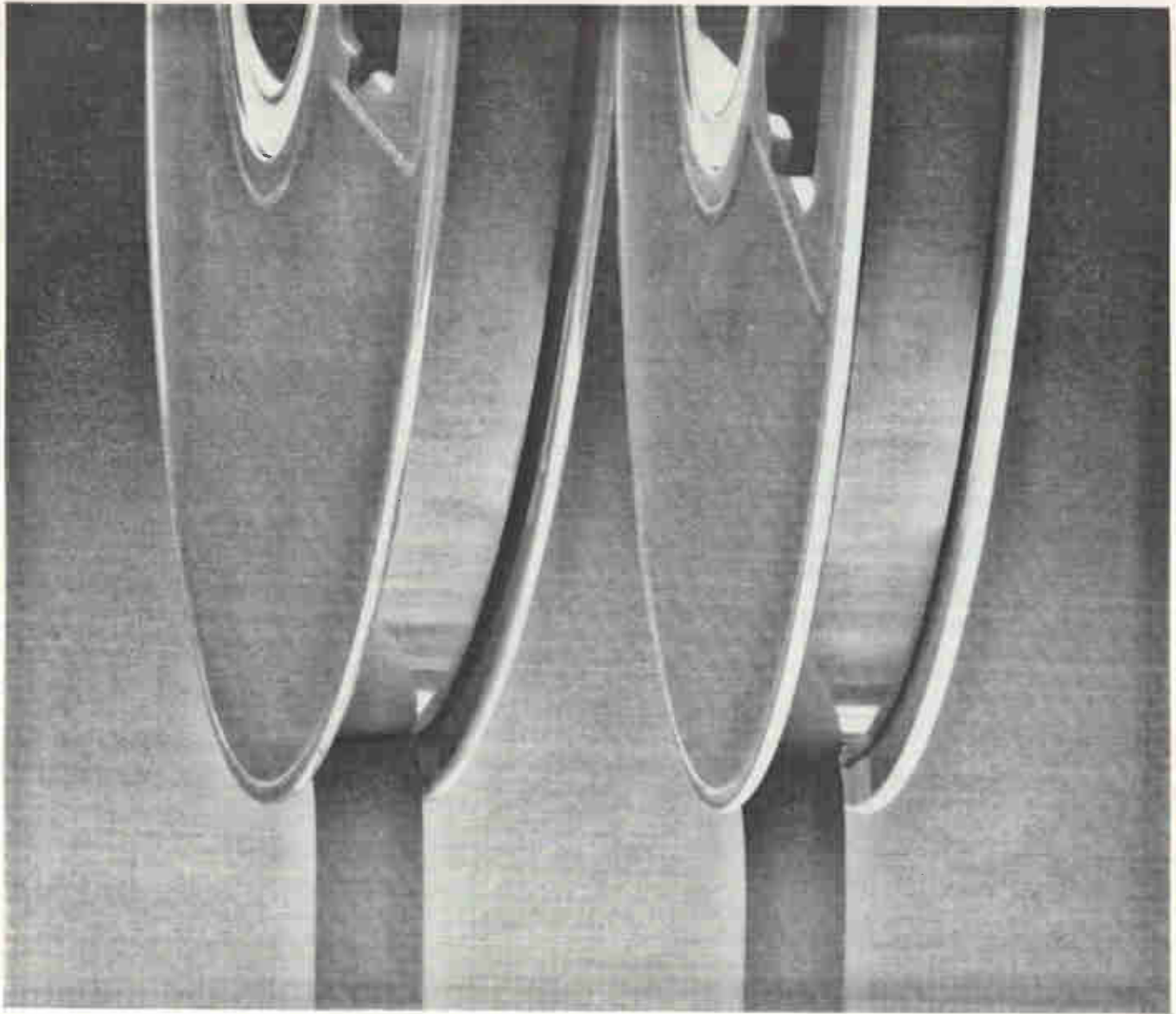

BOTH THESE MAGNETIC TAPES HAVE A POLYESTER BASE ...BUT ONLY ONE IS MYLAR® (8 YEARS PROVEN)

Eight years ago instrumentation tape of Du Pont MYLAR® polyester film appeared on the scene and set new standards of reliability. Naturally enough, people whose needs called for a magnetic tape of highest performance couldn't risk a tape other than MYLAR. ■ Now, other polyester films are beginning to appear. They are not all the same: MYLAR is a polyester film, but other polyester films are

not MYLAR. In the past you could safely assume you were getting MYLAR when you specified "polyester base". *Today you cannot.* ■ There's only one way to be sure you're getting the MYLAR you've used and trusted for magnetic tapes of proven reliability: specify MYLAR by name. E. I. du Pont de Nemours & Co. (Inc.), 10452 Nemours Bldg., Wilmington 98, Delaware.

*Du Pont's registered trademark for its polyester film.



BETTER THINGS FOR BETTER LIVING ... THROUGH CHEMISTRY

electronics • July 19, 1963

only DU PONT makes

MYLAR®
POLYESTER FILM

CIRCLE 81 ON READER SERVICE CARD

81

INSTANT INSULATION

for

- development
- production line
- maintenance



- Pot connectors
- Secure wiring against vibration
- Insulate wiring and terminals
- Laminate sheet insulation
- Repair damaged insulation
- Fill voids
- Bond silicone rubber tapes
- Assemble insulating components
- And 1,001 other uses

Ready-to-use liquid silicone rubber for potting, encapsulating, sealing, bonding and void-filling. No pre-mixing or priming. RTV-102 silicone rubber adheres to almost anything—glass, metal, plastics, most insulating materials, silicone rubber. Sets in minutes, cures in a few hours, forms a resilient rubber that never dries out, cakes or cracks. Has excellent electrical properties. Resists moisture, weathering, and temperatures from -75° to $+500^{\circ}$ F.

For free evaluation samples plus technical data, write on your letterhead describing your application to Section N792, Silicone Products Department, General Electric Co., Waterford, N. Y.

GENERAL ELECTRIC

light away from the surface, reflection is restored. The short travel gives great sensitivity. The on state is sensitive to mechanical shock and vibration, and the off state does not have a high resistance, due to slight surface irregularities in the absorber.

The large area available for reflection permits great efficiency in transferring light from the lamp to the photoconductor, and makes uniform illumination easier. The increased capacity of recent photoconductors (ELECTRONICS, Apr. 12, p 100) can control small lamps, motors, and heavy relays.

OPTICAL LEVER—A mirror, mounted on the end of the bender, can be made for 10-v spacing between photoconductors, Fig. 1D. Photoconductors, facing a calibrated screen, act as an relay with adjustable trip points.

In principle, it is possible to mount a resistor-photoconductor-conductor sandwich in place of discrete photoconductors. Thus, continuous output can operate as an electrometer amplifier.

With all designs, the output photoconductor can be removed and light can be used as a visual readout for human consumption.

CIVIL DEFENSE—High input resistance of this proposed family of

photoconductive switches can make them useful in RC time-delay circuits, for monitoring inputs which are integrated by a capacitor, as short-term radiation-dosage meters and controls, or in RC running integral circuits used in radiation-level monitors. One configuration could greatly simplify mass-produced radiation monitors, because it can operate without amplification from the output of a geiger tube.

When combined with a small rectifier to prolong discharge of their internal capacitance, such relays can be operated by a single pulse in the microsecond range in a type of latching mode, freeing control-switching circuits. Relays can be held closed for up to 15 minutes.

The high power gain and small differential make feedback operation attractive: 70 to 90 db overall gain can be obtained.

Aging effects occur in the lamp, the photoconductor, and the bender elements. Lamps with life of one million hours are available. Photoconductor aging does not particularly affect the performance. Of more significance is the aging of the bender, which requires 10 to 15 percent more voltage for the same travel after 2 to 3 years. This effect is well behaved, however, and as such does not effect reliability. Pre-aging of bender elements can reduce the voltage effect considerably.

Easy Way to Test Accelerometers

Flapper circuits are simple. Just energize and monitor system

By **H. W. HOSSFELD**,
McDonnell Aircraft Corp.
St. Louis, Mo.

A DESIGN modification has been developed to provide a self-test feature for accelerometers. The circuit allows the accelerometer to be tested for proper operation without removal from its mount and was developed for accelerometers used in the autopilot for F4B and F4C aircraft.

Two basic types of accelerometers are used in the aircraft autopilot. The G limit and trim cutout accelerometers are essentially G sensitive switches. Switch action occurs at the limit acceleration values. The lateral accelerometer includes an inductive pickoff and provides an output signal proportional to applied acceleration.

The self test assembly can be applied to both the switch types and proportional type. Construction of the accelerometers is very similar, the only difference being in the type of output pickoff.

In the trim cut out accelerometers, the sensing mass rotates about a pivot point just under the mounting flange. Movement of the

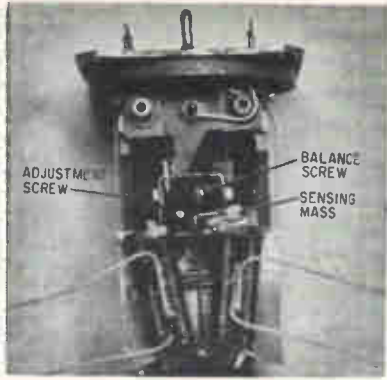

BIDIRECTIONAL flapper is shown mounted on G-limit accelerometer—Fig. 1

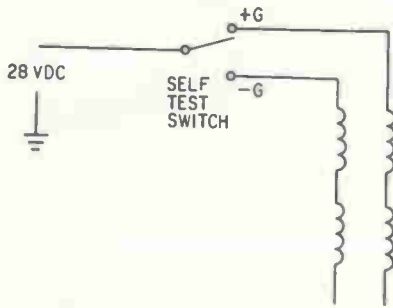

SIMPLE hookup deflects sensing mass when coils are deenergized—Fig. 2

mass carries the extension arm which supports the switch wiper. The switch is designed for a G range of $\pm \frac{1}{2}$ G. Beyond this range, the wiper moves off the conductive material and the circuit is broken. Operation of the limit accelerometer is similar, except that the circuit is maintained for a range from -1 to 4 G.

The lateral accelerometer has an E core pickoff to give a proportional output. The center coil is excited with a 400 cycle voltage and the signal is taken from the series-connected outside coils.

FLAPPER—The self-test mechanism is a bidirectional flapper. Energizing either set of coils will develop a magnetic field through their iron cores, an end cap, and one side of the armature. The force developed by the action of the magnetic field on the armature will rotate it and the attached yoke about the pivot. A compression spring mounted in a hole in the armature and working against a flat on the pivot shaft returns the yoke to a center position on removal of power from the coils.

Figure 1 shows the self test as-

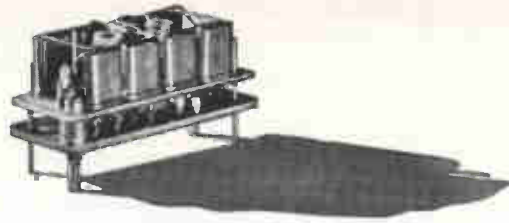

new ILo[®] crystal filters
obsolete narrow band image parameter designs

Obsolete is a very strong word. We wouldn't use it lightly.

But compared with conventional image parameter crystal filters, new ILo[®] crystal filters by Midland have much lower insertion losses, better symmetry, tighter phase control, better approximations of Chebishev or Butter-

worth responses, tighter control over passband characteristics, better spurious control, and are far more easily reproduced in quantity.

What word would you use?

ILo[®] crystal filters are no more expensive than conventional designs, and there are no technical tradeoffs. They are equal or superior to image parameter designs in every other characteristic.

New ILo[®] crystal filters are designed by a technique radically different from conventional filters, and may represent the most important advance in filter design in the past five years.

Write for facts from world's largest producer of crystals and crystal filters.

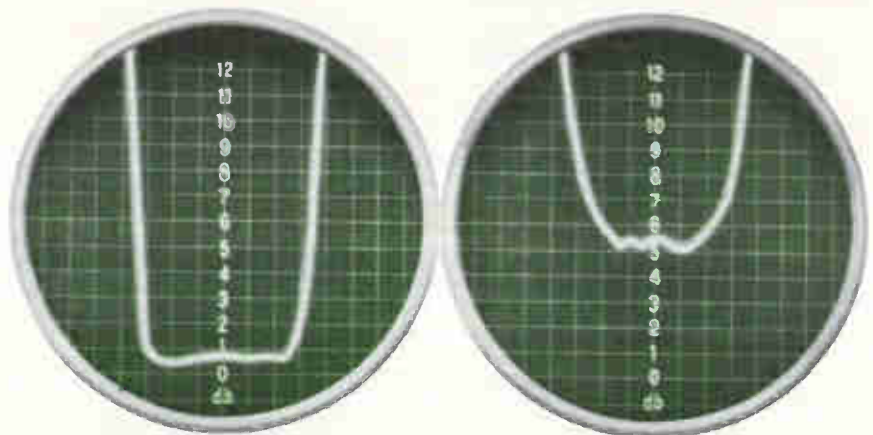

MIDLAND MANUFACTURING COMPANY

3155 FIBERGLAS ROAD

KANSAS CITY 15, KANSAS

An electronics division of Pacific Industries, Inc.



all sizes
for all jobs

Waugh

FREQUENCY TO DC
CONVERTERS

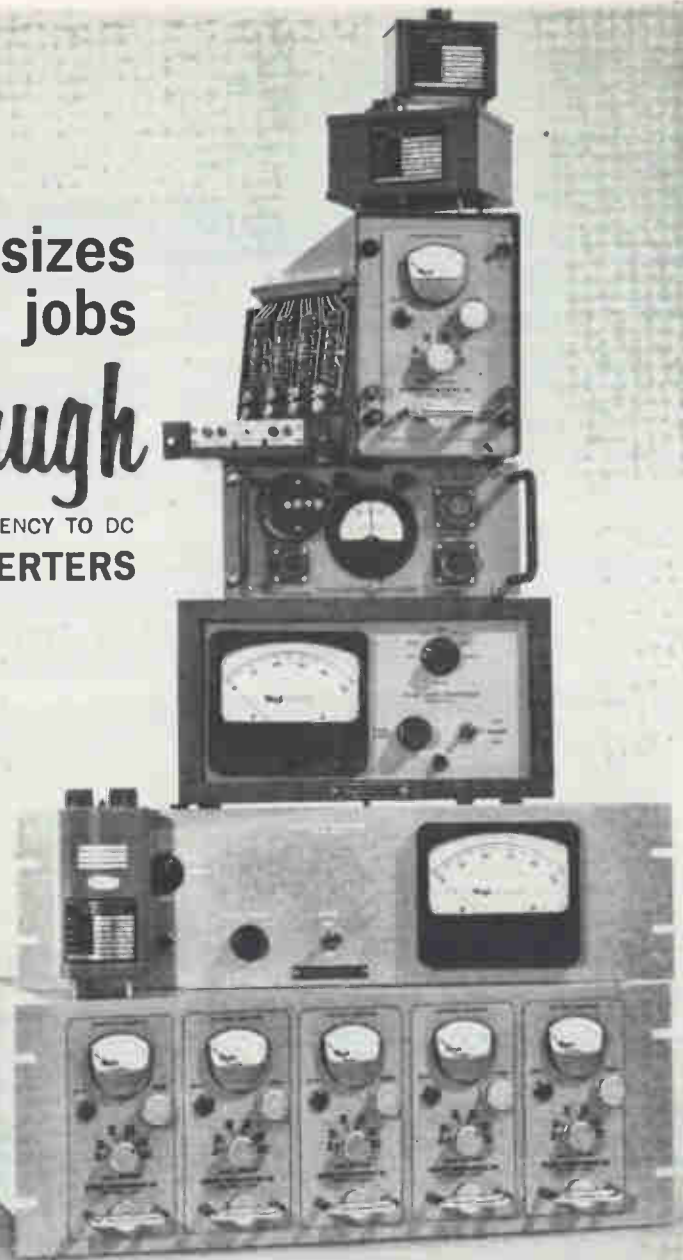

One Frequency-to-DC Converter (handling input frequencies from 5 to 10 Kc) is a printed circuit card measuring three by four inches. Our solid state FR-500 series features modular construction for multi-channel operation in your instrument control room. In addition, a variety of Frequency-to-DC Converters are available that have been shaped, sized and engineered for virtually every type of application or environment—airborne, shipboard, field, plant or laboratory.

Typical applications include Frequency-to-DC conversion of symmetrical pulse trains from turbine flowmeters, tachometer generators, electro-magnetic coils, photocells and nuclear detection devices. Wherever incoming AC signals must be converted to a triggering or recording DC output with exceptional linearity, sensitivity and reliability, specify FOXBORO.

FOXBORO
REGISTERED TRADEMARK

WAUGH ENGINEERING DIVISION
7740 LEMONA AVENUE, VAN NUYS, CALIFORNIA • STATE 2-1710

Call or write regarding your current projects

sembly mounted on the limit accelerometer. The adjustment screws are set such that they pick up the balance screw and deflect the sensing mass when a set of coils is energized, but allows normal movement of the sensing mass when the self-test circuits are de-energized. Energizing one set of coils deflects the accelerometer in one direction and vice versa when the other set is energized. The self-test circuit diagram is shown in Fig. 2.

Where and How to Use Gallium Arsenide

THE POTENTIAL of gallium arsenide devices to surpass either silicon or germanium devices for certain applications has been outlined by Texas Instruments.

Company has demonstrated the potential for gallium arsenide for higher power and increased frequency response. Before this potential can be realized, however, advances in GaAs materials and device technology will have to be

Selects Zig-Zag Antenna To Meet UHF Changeover



MODIFIED cardioid pattern of new GE antenna teams with GE's newly designed 25 Kw uhf transmitter to provide KERO-TV Bakersfield California with coverage for the rich southern San Joaquin Valley. Television station changes over from vhf Channel 10 to uhf Channel 23 under FCC deintermixture order. Transmitter-antenna site is 22 miles east of Bakersfield, on Mt. Brekenridge

LEVIN HIGH PRECISION CABINET MOUNTED INSTRUMENT LATHES



INSTRUMENT
LATHE

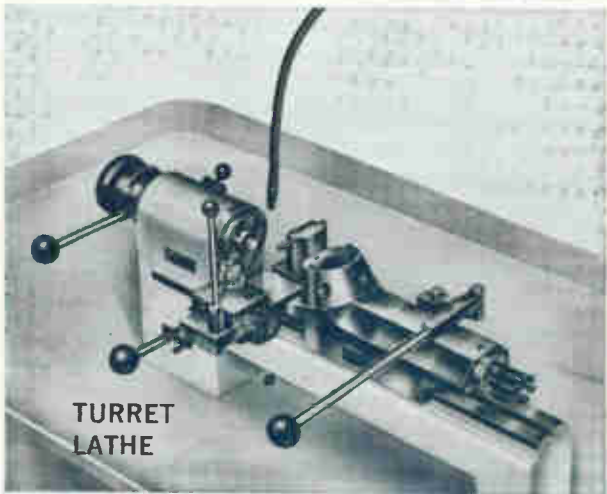

TURRET
LATHE



MICRO-DRILLING
MACHINE



LEVIN now offers a complete line of Instrument Lathes mounted on a welded steel cabinet. These machines have the advantages of greater rigidity, higher spindle speeds, increased operator efficiency due to cabinet design, multi-vee belt drive, and for the first time, operating and alignment tolerances heretofore available only on specially built lathes.

Your *LEVIN* dealer or the factory will be glad to furnish complete details. These machines are on display in dealer showrooms in New York and Los Angeles. Send for complete catalog.

LEVIN®

LOUIS LEVIN & SON, INC., 3573 HAYDEN AVENUE
CULVER CITY, CALIFORNIA

DEALERS:

RUSSELL HOLBROOK & HENDERSON, INC.
NEW YORK and LOS ANGELES
INDUSTRIAL TOOL & SUPPLY COMPANY — SAN JOSE
MARSHALL TOOL & SUPPLY CORPORATION — LOS ANGELES
ROYAL TUCHANTRE — BALTIMORE

BRISTOL sub-miniature chopper 0.1 CU. IN.

(shown actual size)

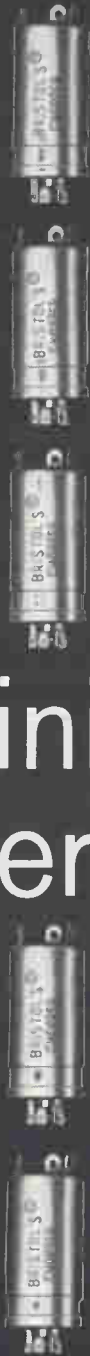

Featuring □ airborne environmental ratings and complete shielding for military applications. □ Unmatched noise level for low level instrument applications. Write for detailed spec sheet.

The Bristol Company, Aircraft Equipment Division, 152 Bristol Road, Waterbury 20, Conn. A Subsidiary of American Chain & Cable Company, Inc. In Canada: The Bristol Company of Canada Ltd. 71-79 Duchess Street, Toronto 2, Ontario.



3.4

BRISTOL

...engineers for precision, builds for reliability.

comparable with present technology attained for silicon and germanium, company says.

Fabrication feasibility of high-temperature medium-power and low-power gallium arsenide transistors were only partially fulfilled because no satisfactory high-temperature and high-injection efficiency emitter has been found.

Principal objectives of the TI program were to carry out studies for the Navy which would lead to the development of gallium arsenide transistors.

Using Microcircuits In Micromodules

SEVERAL recommendations were made by Servomechanisms for microelectronic circuits in micromodules. Where required, larger substrates containing more riser notches will not only permit more circuits per wafer, but will also permit more wafers per module. Multiples such as 0.310-in. × 0.620-in., and 0.620-in. square would be compatible with present dimensions. Servomechanism says glass is preferred over alumina as a substrate material when vacuum-deposited components are to be made, because of superior surface quality.

Peripheral terminals, formed simultaneously with the vacuum-deposition of conductors, would save the expense of an extra process and eliminate a possible source of contamination. The gold terminals should have an undercoat of copper so that the terminals will not dissolve during soldering, company says.

Other recommendations include protection of thin-film capacitors against shock if they are soldered, company says. Conductive epoxy serves well for attaching riser wires, according to findings. Servomechanisms says semiconductor manufacturers should supply transistors and diodes with 0.002-in., or 0.003-in. diameter gold leads which can be thermocompression bonded directly to thin films.

Recommendations were submitted to the government as part of a program that investigated possible problem areas of micromodule circuits.



Ravenous Tiger

It's late evening. All the Tiger pickup trucks are empty. In five minutes, the last shipment will be fed into the huge cargo hold of the Swingtail-44 and the dock will be clear. Three minutes later, everybody's shipment will be on its way. Everybody's.

That's the beauty of the Swingtail-44. It has a big appetite—33 tons. It carries off every package on the dock. Nothing

waits to go out. Nothing gets left behind.

And when you've got a whole fleet of 44's . . . and a fleet of trucks for door-to-door service . . . and a gang of detail-minded people to expedite your shipment all along the way . . . then you've really got airfreight service. The fast kind. The kind you can depend on.

The Flying Tiger kind.

first in airfreight with airfreight first **FLYING TIGER LINE**



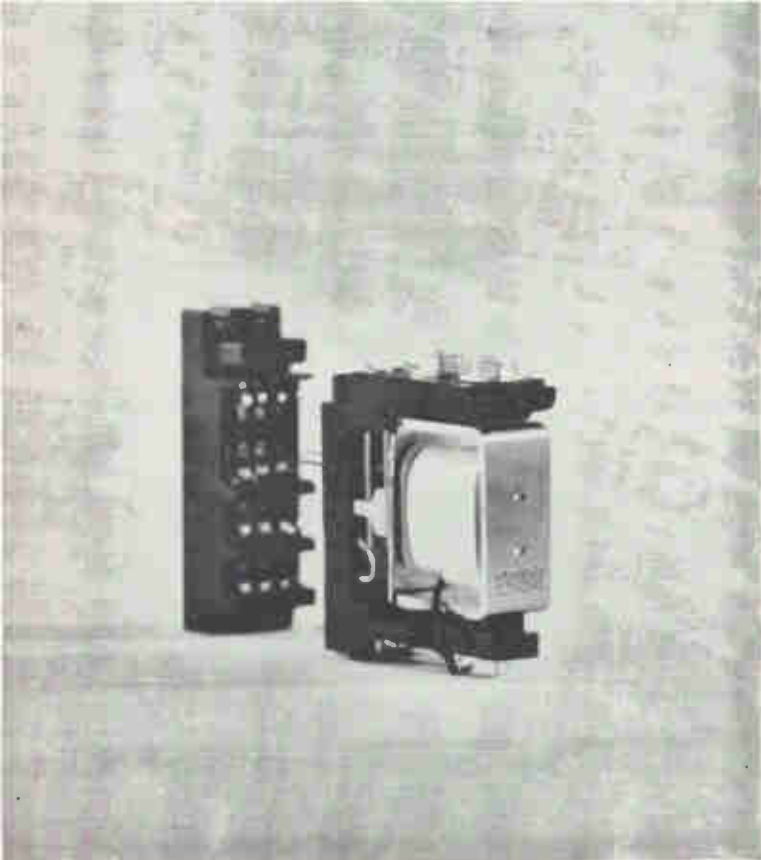

New low price is a big reason to use IBM Wire Contact Relays

Compare IBM relay price/performance with the relay you are now using. Four PDT IBM relays start at a new low of \$2.90, 12 PDT start as low as \$5.40. And IBM latch relays start at \$8.45. Add all this to the performance shown above and they can't be beat.

Delivery is un-beatable, too. Production shipments within 24 hours if requested.

Design-in or plug-in an IBM relay. Here's what you get:
Life: Up to 200 million operations.

Operate Speed: As fast as 4 ms.

Release: 5 ms.

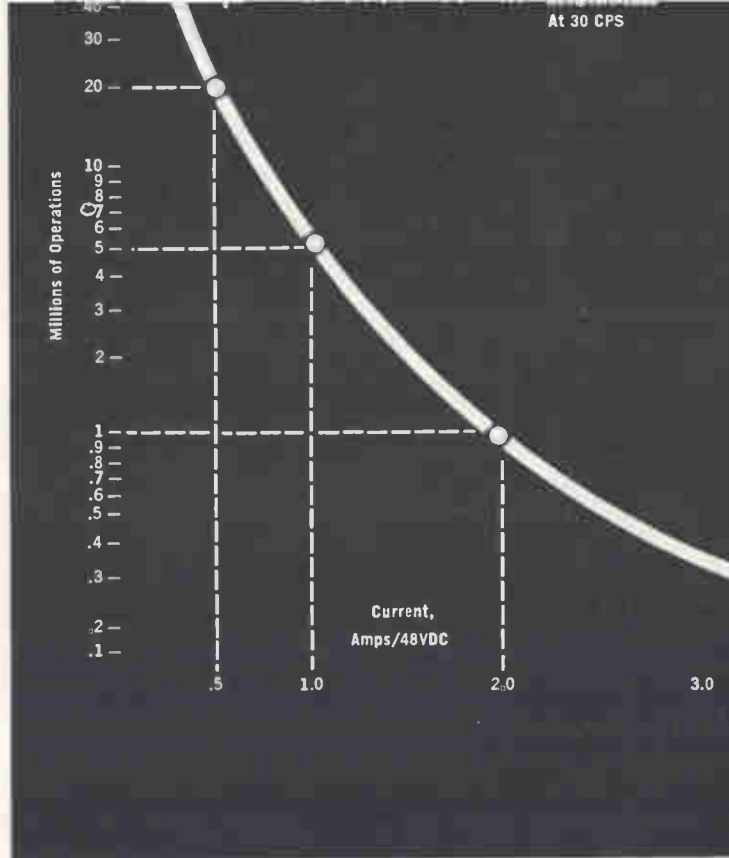

Performance is an even bigger reason to use IBM Wire Contact Relays

at 48 VDC attainable with these relays.

Coil Voltages: Up to 100 VDC.

Integrated Package: Solderless connections, multiple coils, compactness and standardized mountings give you *manufacturing savings and lower product costs.*

Applications. Wire contact relays are ideal for counting, logic switching, shift registers, flip-flop and timing circuits in numerical control, communications, test equipment, process control, data processing, supervisory control systems, and many other applications.

Send for Catalog that tells you the relay story—perform-

NEW HIGH-AVERAGE-POWER LASER FLASH TUBES

FX-65



Water-cooled tube designed to handle 8 kw average power input with water flow of 1 gpm. Capable of flash rates up to 50 fps. Arc length is $6\frac{1}{2}$ ", overall length $12\frac{7}{8}$ ", O.D. 15 mm overall, discharge bore 7 mm. A shorter tube with 3" arc length and 4 kw rating will soon be available. EG&G is in a position to quote on a power supply capable of driving the FX-65.

FX-52



Air-cooled flashtube rated at 600 watts average power input with a minimum air velocity of 40 linear ft/sec. Electrical ratings are similar to those for EG&G FX-42. Arc length is 3", overall length $6\frac{13}{16}$ ", O.D. 0.945" overall, discharge bore 7 mm.

FX-55

Similar configuration to FX-52 but with 6" arc length, conservatively rated at 1000 watts average power input.

FX-56



Very high energy flashtube designed for operation at up to 3000 joules per inch of arc length with pulse duration of 3 milliseconds. Arc length $6\frac{1}{2}$ ", overall length $12\frac{7}{8}$ ", O.D. 31 mm, discharge bore 28 mm. Also available on order in arc lengths from 3" to 36".

FX-57



A higher rated version of the popular FX-47. Rating: 13,000 joules @ 3 millisecond pulse duration. Arc length $6\frac{1}{2}$ ", overall length $12\frac{7}{8}$ ", O.D. 15 mm overall, discharge bore 12 mm. Available on order in any arc length to 36".

EG&G has the widest range of standardized Xenon flashtubes available, plus an unequaled capability for development and manufacture of special tubes. Write or phone Marketing Department for detailed information. Edgerton, Germeshausen & Grier, Inc., 176 Brookline Avenue, Boston 15, Massachusetts.



EDGERTON, GERMESHAUSEN & GRIER, INC.

BOSTON • LAS VEGAS • SANTA BARBARA

ANTI-BACKLASH GEARING

assures
smooth
drive...



HANSEN SYNCHRON® GIVES "DIMENSIONAL STABILITY"

for those tricky fourth-dimension design areas

Sometimes it takes more than a quality motor to solve drive problems. That's why Hansen has teamed its reliable SYNCHRON motor with anti-backlash gearing for a chart drive application. Two identical gears are spring-loaded in opposing directions, both meshed with the same pinion. One gear holds in one direction while the other gear holds in the opposite direction. This allows minimum movement or "pickup" of the output shaft during rotation, insuring $1/2^\circ$ maximum backlash at most speeds. And this is only one gearing adaptation — Hansen engineers design many special applications.

ON ALL HANSEN SYNCHRON® MOTORS, pinions are machined from one piece of steel, carefully tested with "go"—"no go" gauges. Other gears may be of steel, brass, or special materials. They're double-staked for permanence and operate reliably with minimum noise. Outputs are 8, 20, or 30 inch ounces at 1 RPM. 90 inch ounces of static torque may be applied to output shafts without damaging the motor or stripping gears.

If you have a special requirement, particularly one demanding precision, call on Hansen — today.

APPROXIMATE SPACE REQUIREMENTS

Round Mount — 2" diameter, $1\frac{1}{8}$ " deep

Pear Shape — 2" wide, $2\frac{1}{2}$ " high, $1\frac{1}{8}$ " deep

OUTPUT DRIVES

Pinion drives, flatted, threaded, cross-drilled, knurled, or slatted shafts; adapters, or crank assemblies. OR HANSEN WILL INTEGRATE PINIONS, GEARS, OR SPECIAL DRIVE ASSEMBLIES OF YOUR OWN MANUFACTURE.

Information on D.C. motors available on request.



Sweet's Product
Design File

HANSEN REPRESENTATIVES:

R. S. HOPKINS COMPANY
Sherman Oaks, Calif.

EICHORN & MELCHIOR, INC.
San Carlos, Calif.

THE FROMM COMPANY, Chicago, Ill.

H. C. JOHNSON AGENCY, INC.
Binghamton, N.Y., Fayetteville, N.Y.,
Rochester, N.Y., Schenectady, N.Y.,
Williamsville, N.Y.

WINSLOW ELECTRIC COMPANY
Essex, Connecticut, New York City,
Philadelphia, Pa.

EXPORT DEPARTMENT
15 Moore Street, New York City



HANSEN
MANUFACTURING
COMPANY, INC.
PRINCETON, INDIANA

Handled exclusively in Canada by Sperry Gyroscope Ottawa Ltd., Ottawa, Canada

90 CIRCLE 90 ON READER SERVICE CARD

DURANT

DIGITAL READ-OUT COUNTERS

Model "D" SERIES



Model "Y" SERIES

for MISSILE TRACKING, RADAR CONTROLS,
COMPUTERS, NAVIGATION INSTRUMENTS, GAUGING
INSTRUMENTS, and ANY other indicator applications.

- Meets military specifications.
- High speeds, lower torque, lower moment of inertia for long life.
- Nylon wheels with legible figures, nylon pinions.
- Single, $1\frac{1}{2}$, or double wheels.
- Right or left hand drive, clockwise or anti-clockwise rotation.
- One-piece aluminum die cast frame.
- Base mounting. Threaded mounting holes may be placed in frame top or ends.
- "Y" Series, single or dual bank.
- Component parts can be purchased separately to meet design requirements.

Your answer to an infinite number of variable
demands for PRECISION CONTROLS.

Send for Catalog No. 400

DURANT
MANUFACTURING COMPANY

1912 N. Buffum St., Milwaukee 1, Wis. • 12 Thurbers Ave., Providence 5, R. I.

REPRESENTATIVES IN ALL PRINCIPAL CITIES

CIRCLE 203 ON READER SERVICE CARD



the finest
precision
coaxial
connectors*



*TM®

(miniaturized TNC)

General RF Fittings, Inc.

702 BEACON STREET, BOSTON 15, MASSACHUSETTS
Telephone: 617 267-5120

CIRCLE 204 ON READER SERVICE CARD

July 19, 1963 • electronics

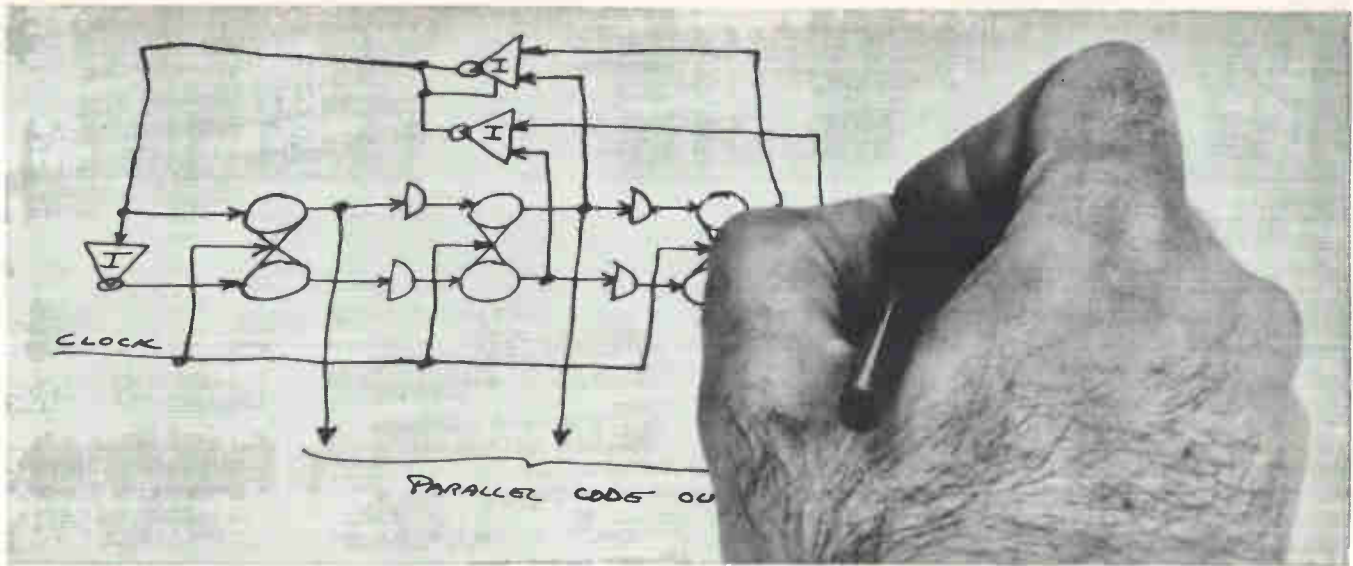

WILL IT WORK AT 10 MC?

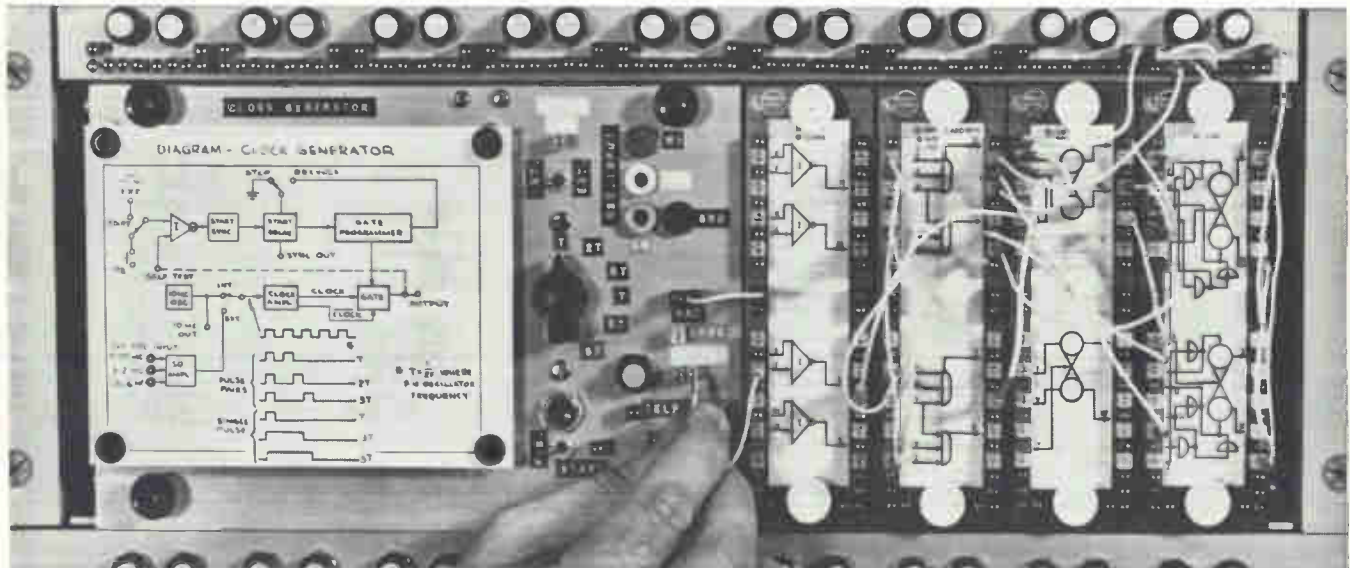

FIND OUT FAST WITH AN EECo HIGH-SPEED DIGITAL SYSTEM BREADBOARD

It looks good on paper. Now—what will be the effect of clock duty cycle? Wiring? Propagation delay?

You can get the answers *fast* with EECo system breadboard equipment—an exceptionally simple means of formulating and testing digital electronic circuits at clock speeds to 10 Mpps.

This versatile transistor equipment lets you patch up trial circuit combinations with the same catalog modules that go into the final system, perform tests at operating frequencies by pushing a button on the control panel, and get a “stop-action” look at the over-all logic flow.

The built-in clock generator permits fast set-up of a wide range of test conditions, and indicators give you an immediate reading on any part of the circuit. Plastic symbol cards

further speed your work by giving you a road map of the system as you put it together.

You may operate the system slowly to check individual operations or at end-system speeds, introducing high-speed pulses either singly or in pairs. If you want to try an alternative design idea, a few minutes of patching will make your brainstorm a reality.

Discover for yourself this speedy route from paper to prototype. Write for our new breadboard brochure today.



ENGINEERED ELECTRONICS Company

1441 East Chestnut Avenue, Santa Ana, California
Telephone: 547-5651 Cable Address: ENGELEX

Module Production Quality Assured by Thermal Cycling and Life Testing

Checks stringently on flow soldering and special construction techniques

By **T. V. GORE,**
W. V. LANE
U. S. Army Electronics R & D Lab.
Fort Monmouth, N. J.

THERMAL CYCLING tests give a close and immediate check on reliability levels of cordwood printed circuit modules manufactured by Republic Aviation Corp. (Farmingdale, N. Y.). Operating under a program sponsored by the Army's Electronic Research & Development Laboratory, Republic employed the tests as an integral part of production process.

Tests testified to the effectiveness of special techniques in manufacturing modules: lead compliance configuration, pre-tinning leads for reliable soldering, two-stage packaging (coating and encapsulation). It was definitely shown that component failure rates are less than that estimated for military parts in units assembled by conventional means.

ASSEMBLY—The disciplined layout of subminiature parts in cordwood modules with packaging densities as high as 100,000 parts/cu. ft. demands use of sophisticated assembly techniques. These, in turn, demand close checking to weed out any production flaws occurring during the making of the complex module structure: axial-lead parts are stacked between two parallel printed wiring end plates (boards), while multi-lead parts such as transistors are nested one-over-the-other with leads attached to the appropriate plate.

When assembled modules are

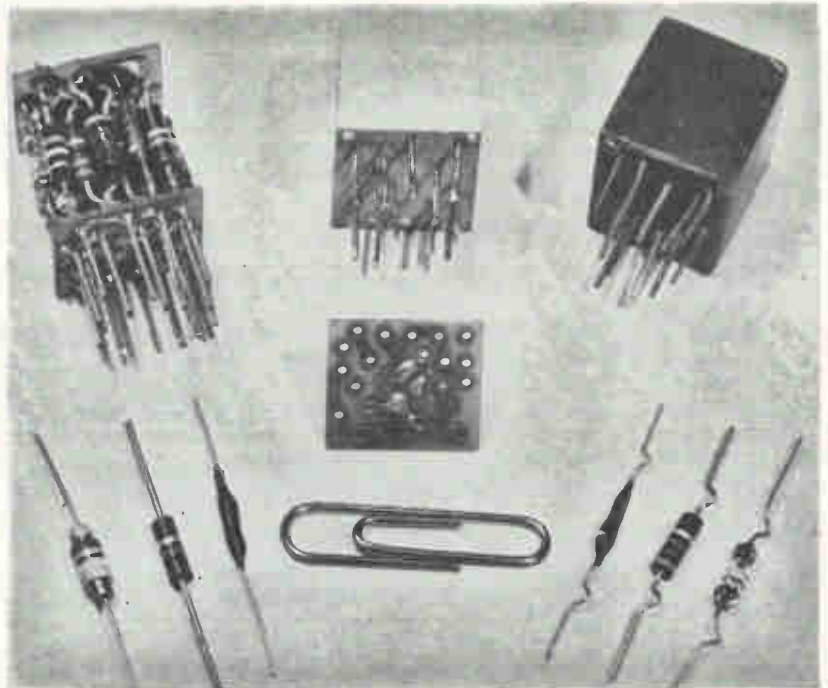

MODULES and module components are surrounded with a compliant coating that prevents adherence of epoxy potting material thus relieving stress on leads. Bell-shaped kinks in leads also absorb stresses

subsequently loaded with a silica-filled epoxy, stresses are introduced to soldered joints at both lead-part interfaces and lead-printed wiring interfaces. These stresses are sufficient not only to cause

failures of soldered joints but can also result in the failure of components.

SOLDERED JOINTS — To obtain maximum strength in the soldered joint, plates having plated-through holes were used, giving a large soldering surface area. Also, pre-tinning of all part leads provided optimum surface conditions.

Following the above requirements, excellent joint uniformity has been obtained with hand soldering. However, even further improvement is expected with a flow soldering (wave soldering) process developed by Republic for large production runs.

FLOW SOLDERING—Flow soldering is also expected to minimize soldering-heat effect on parts. Re-

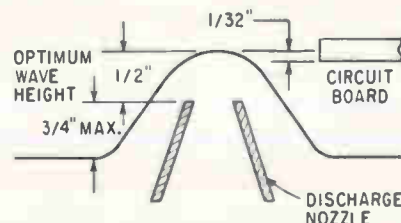

JIGGING TECHNIQUE was developed to limit solder-depth exposure of assembled modules during mass production. High temperatures are used in solder bath to maintain high fluidity but the modules are sent through bath at speeds sufficient to minimize solder heat effect



In our photocell, too—the **Blue Dot** says it works

Sylvania photocells and flashbulbs have one obvious thing in common: Blue Dot insurance against a common enemy, moisture.

Reliable protection for the cadmium sulfide in Sylvania photocells comes from hermetic sealing in a one-piece, glass enclosure. For extra safety, the moisture-sensitive Blue Dot is put there. If the hermetic seal is ever

broken and moisture enters from any cause whatsoever, the Blue Dot turns pink. As little as .02% water vapor triggers this warning, enabling you to spot the defective cell, in most cases, days or weeks before it actually becomes inoperative.

If you're in the market for photoconductors, consider the Sylvania T-4 line. Rated at 400 volts and featuring

300 mW dissipation, the selection ranges from 750 ohms to 16,000—widest in the industry. One of them is probably right for your streetlighting, furnace alarm, remote control or other application.

See your Sylvania sales engineer or write to Electronic Tube Division, Sylvania Electric Products Inc., Box 87, Buffalo, New York.

SYLVANIA
SUBSIDIARY OF
GENERAL TELEPHONE & ELECTRONICS



AT WESCON: BOOTHS
 2901-06 AND 2917-22



222 Steps to the first plateau

INDUSTRY'S MOST COMPLETE TANTALUM CAPACITOR LINE



Wet slug types rated up to 200°C, solid electrolyte types up to 50 volts, plain and etched foil types. All in many MIL sizes. Write for data.

Tantalum powder travels a long road until it assumes final form in a solid or wet slug capacitor. A minimum of 222 individual steps are required for complete electrical, chemical and physical evaluation of the powder before it is transformed into its usable capacitor form, the pellet. Someone is watching, measuring or testing . . . before, during and after each operation. When the powder is pressed into pellets only the first plateau has been reached.

Throughout the entire manufacturing process, inspections and tests are conducted and recorded on every production lot of tantalum capacitors. If we seem fanatical about testing, it's because we know from over twelve years experience in making tantalum capacitors that this is essential to consistently high quality. And that's what you're always sure of getting in Mallory tantalum capacitors. They're the product of the most modern tantalum capacitor facility in the world. Visit us and see for yourself. Mallory Capacitor Company, Indianapolis 6, Indiana—a division of P. R. Mallory & Co. Inc.

SOLID, WET SLUG AND FOIL TANTALUM CAPACITORS

CIRCLE 94 ON READER SERVICE CARD

P. R. MALLORY & CO. Inc.
MALLORY

Mallory tantalum capacitors delivered from stock at factory prices by these distributors:

- Baltimore, Md.
Radio Electric Service
- Binghamton, N.Y.
Wehle Electronics
- Birmingham, Ala.
MG Electronics & Equipment Co.
- Boston, Mass.
Cramer Electronics
DeMambro Radio Supply Co.
Lafayette Radio
QPL House, Inc.
- Buffalo, N.Y.
Summit Distributors, Inc.
- Chicago, Ill.
Allied Electronics Corp.
Newark Electronics Corp.
- Cincinnati, Ohio
United Radio
- Cleveland, Ohio
Pioneer Electronics
- Dallas, Texas
Engineering Supply Co.
Hall-Mark Electronic Corp.
- Dayton, Ohio
Stotts-Friedman Co.
- Denver, Colo.
Newark Denver Electronic Supply
- Houston, Texas
Harrison Equipment Co., Inc.
Lenert Company
- Indianapolis, Ind.
Graham Electronics
- Kansas City, Mo.
Radio Lab
- Los Angeles, Calif.
California Electronics
Kierulff Electronics, Inc.
Lynch Electronics
Radio Product Sales
- Minneapolis, Minn.
Northwest Electronics Corp.
- Montreal, Que.
Canadian Electrical Supply Co.
- Muskegon, Mich.
Fitzpatrick Electric Co.
- Nashville, Tenn.
Electra Dist. Co.
- Newark, N.J.
Lafayette Radio
- New York, N.Y.
Harrison Electronics Corp.
Harvey Radio Co., Inc.
Lafayette Radio
Milo Electronics
Terminal Hudson Electronics.
- Oakland, Calif.
Elmar Electronics, Inc.
- Oklahoma City, Okla.
Radio, Inc.
- Orlando, Fla.
Hammond Electronics, Inc.
- Ottawa, Ont.
Wackid Radio-TV Lab.
- Palo Alto, Calif.
Zack Electronics
- Perth Amboy, N.J.
Atlas Electronics
- Philadelphia, Pa.
Herbach & Rademan
Philadelphia Electronics
- Phoenix, Ariz.
Kierulff Electronics, Inc.
- Pittsburgh, Pa.
Radio Parts Co.
- Salt Lake City, Utah
Kimball Electronics
- San Antonio, Texas
Perry Shankle
- San Francisco, Calif.
Kierulff Electronics, Inc.
- St. Louis, Mo.
Olive Electronics
- Seattle, Wash.
F. B. Connelly Co.
- Springfield, N.J.
Federated Purchaser, Inc.
- Toronto, Ont.
Alpha Aracon Radio Co.
Electro Sonic Supply
Wholesale Radio & Electronics
- Tulsa, Okla.
Engineering Supply Co.
- Washington, O.C.
Capitol Radio Wholesalers
Electronic Industrial Sales
- White Plains, N.Y.
Westchester Electronic Supply Co., Inc.
- Winston-Salem, N.C.
Electronic Wholesalers Inc.

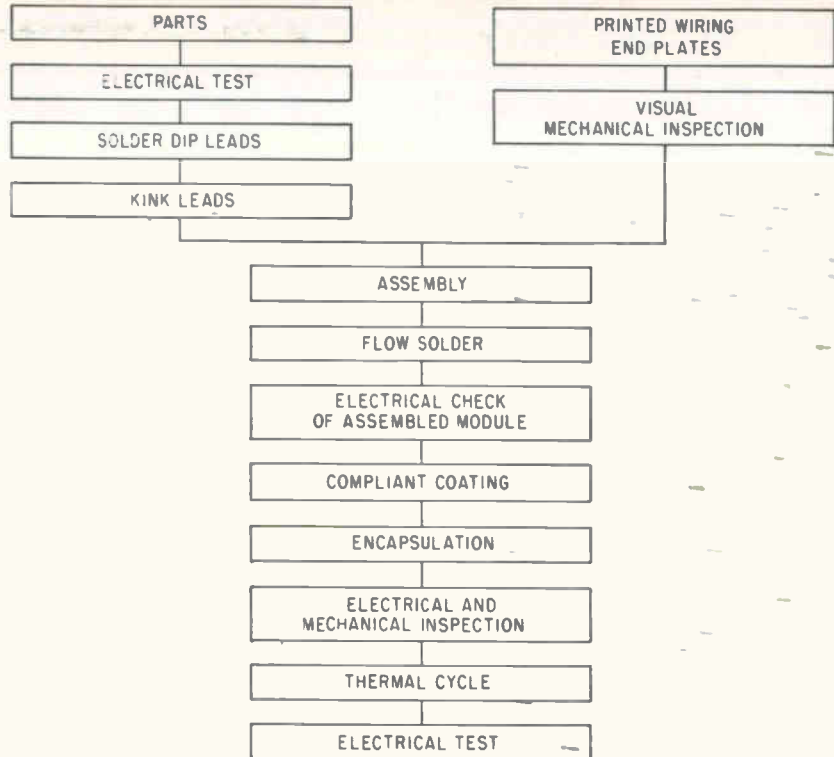

MANUFACTURING FLOW DIAGRAM indicates use of tests during and after production of modules

public set up the following process specifications:

Solder used conforms to QQ-S-571, having a composition of Sn, 60. Solder bath temperature is maintained between 500 degrees F (260 degrees C) and 520 degrees F (272 degrees C). Pump speed is set so that the wave is approximately 1/8-inch above the level at underside of board: traversing track carrying board is arranged so that this does not require a wave height above 1/2 inch over discharge nozzle level (see accompanying diagram) unless there are projections on underside of circuit which must have higher wave to clear nozzle.

In order that no portion of assembly be in tangential contact with solder bath (having above-indicated temperatures) no longer than 5 seconds, the transfer mechanism is made to carry assemblies through solder at speeds of from 2 to 4 feet per minute.

LEAD COMPLIANCE—Linear displacement of the two end plates can be as much as 0.006 inch when modules encounter military equipment temperature changes ranging from -55 to 85 degrees C. To offset resulting lead stresses, bell-shaped kinks with dimensions of

approximately 0.03 by 0.06 inch are included in part leads of all diodes, jumpers and 1/2-watt resistors. This has proven an adequate substitute for finding an encapsulant having an expansion coefficient matching the accumulative coefficient of the various part materials.

ENCAPSULATION — After assembly and soldering, parts and leads are surrounded with a compliant coating that prevents later adherence of epoxy potting compound to permit lead movement when axial forces are applied at lead terminal joints. Dow Corning DC-271, for example, prevents adherence because of its resilient silicon base material.

After coating, the assembly is placed in an open mold and cast in a silica-filled epoxy (HYSOL 6020 or equal). Casting is then cured, and excess resin trimmed off.

THERMAL CYCLES—As part of the production process, all completed modules were subjected to 5 thermal cycles. Each cycle was sequenced as follows:

- A temperature reduction to -55 degrees C from room tempera-

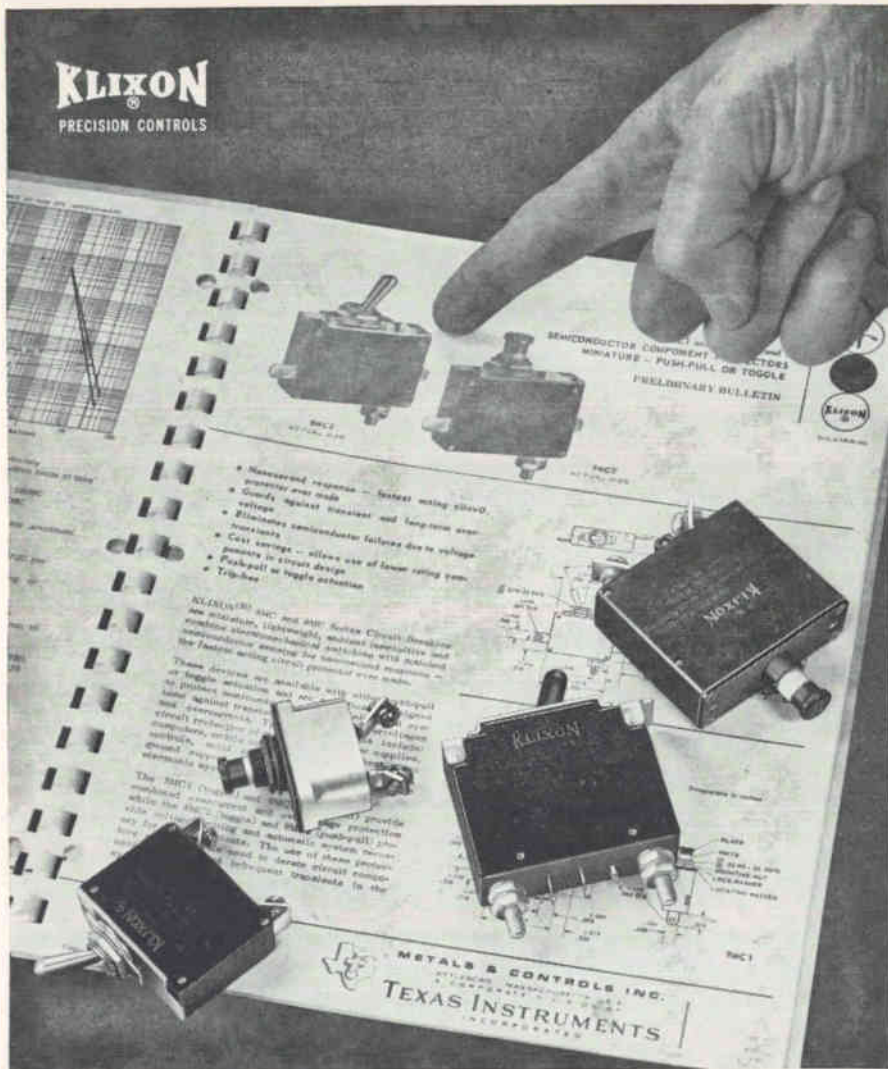

Circuit breaker selection made easier!

New fact file describes distinctive advantages of all four types of KLIXON circuit breakers

For the first time, you can get all the data you need to evaluate thermal, thermal-magnetic, magnetic and magnetic-electronic types of circuit breakers . . . in one convenient package.

Only TI makes all four . . . and favors no particular type. So, you get unbiased help in selecting the type that best protects your circuits and/or systems from faults due to overcurrent or overvoltage.

Compare! Our SP-40 fact file shows that New KLIXON Magnetic-Electronic Circuit Breakers, with nanosecond response, are the fastest acting devices ever made for protecting transistorized equipment circuitry against transient and prolonged overloads.

You'll also find that New KLIXON Magnetic Circuit Breakers combine trip-free protection, fast response time and more design options than comparable units. As for KLIXON Thermal and Thermal-Magnetic Circuit Breakers, you'll see that their high rupture capacity and resistance to shock and vibration have no equals for protecting wire and cable in airborne applications.

Write today for our new SP-40 fact file . . . the quickest, easiest means of selecting the right circuit breaker from all four types.



METALS & CONTROLS INC.
5007 FOREST ST., ATTLEBORO, MASS.
A CORPORATE DIVISION OF
TEXAS INSTRUMENTS
INCORPORATED

ture for a period of 30 minutes

- Back up to 25 degrees C for 10-15 minutes

- Up to 85 degrees C for 30 minutes

- Back down to 25 degrees C

In performing above cycles, one test chamber was maintained at -55 and another at +85 degrees C. Temperature in each of these stabilized 2 minutes after introduction of modules.

Of 485 modules subjected to test there were two rejects:

- One write-amplifier failed due to an intermittent solder joint

- One read-amplifier failed because of a burned-out base connection in the transistor (this was thought to be due to a polarity-reversed tantalum capacitor).

LIFE TESTS—Modules surviving thermal tests were subjected to various environmental tests without any failures: shock, vibration, moisture resistance, altitude. These demonstrated that military-quality resistors, capacitors, transistors and diodes could be packaged in the printed circuit cordwood module without degrading their electrical performance. Storage life tests exposing modules to 71 degrees C for 2,600 hours gave the same answer.

The biggest process hurdle for modules was an operational life test. Modules numbering 274 were test-circuit operated in an oven ambient temperature of 85 degrees for a total of 3,750 hours. Six capacitors failed. But 5 of these were in read-amplifiers, in which as mentioned previously an assembly process error resulted in capacitors being installed with reverse polarity. Since only very low voltage was applied to capacitors, this indicated effectiveness of life test in checking-out production.

In view of above, only one valid component failure occurred after the 3,750 hours. This duration together with the exposure of 274 modules each containing at least 539 components, established a confidence level of 75 percent. At the end of that time, an additional 2,750 hours was accumulated for a total of 6,500 hours to provide 1.78 million unit hours for modules as a group. Unit hours for parts ranged from 3.1 million (capacitors) to 76.7 million (solder

To Order Reprints

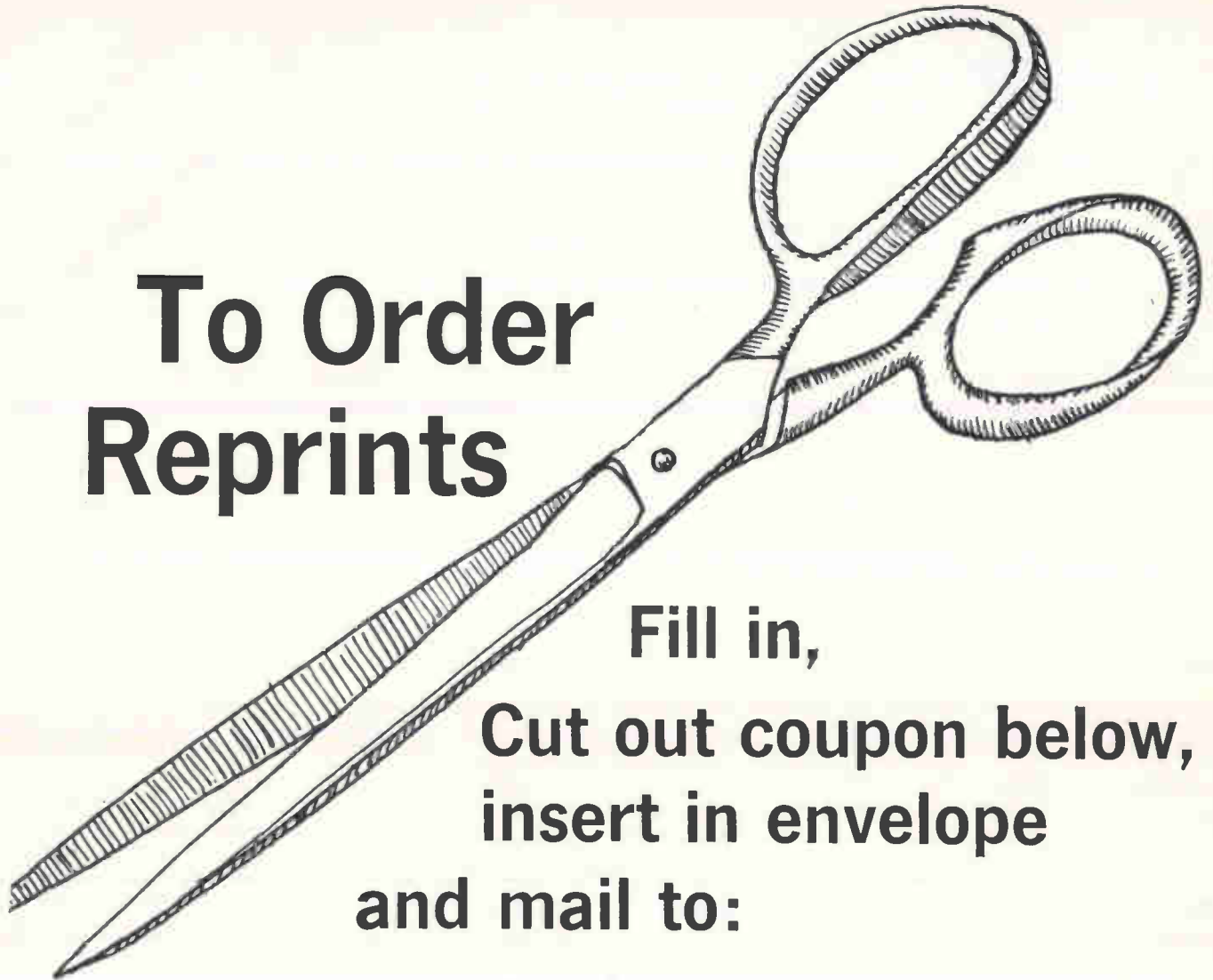

Fill in,
Cut out coupon below,
insert in envelope
and mail to:

electronics Reprint Dept.
330 West 42nd Street,
New York, N. Y.—10036

REPRINT ORDER FORM

For Listing of Reprints Available See Reader Service Card

(To help expedite mailing of your reprints please send cash, check or money order with your order.)

For Reprints of the latest Special Report:

Radio Frequency Interference

Send me Reprints of Key No. R-39

1-10 copies 75¢ each, 11-24 copies 60¢ each, 25 or more 50¢ each.

For Reprints of previous Special Reports or Feature Articles fill in below:

Send me Reprints of Key No.(s) @ ¢ each. (For prices, see chart above.)

*For orders of Bulk Reprints of other editorial articles in this issue or past issues:

Send me Reprints of page (no.(s)) of issue

of article entitled

*Minimum bulk order 100 copies. You will be advised of costs by return mail.

Name

Number and Street

City, Zone No., State

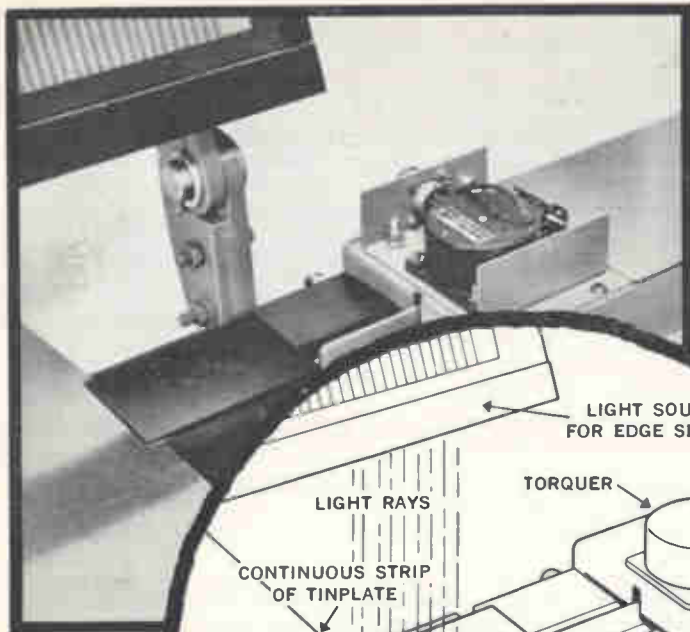

Pinhole detector for continuous inspection of tinplate has an automatic edge shield system developed by Bethlehem Steel Co.

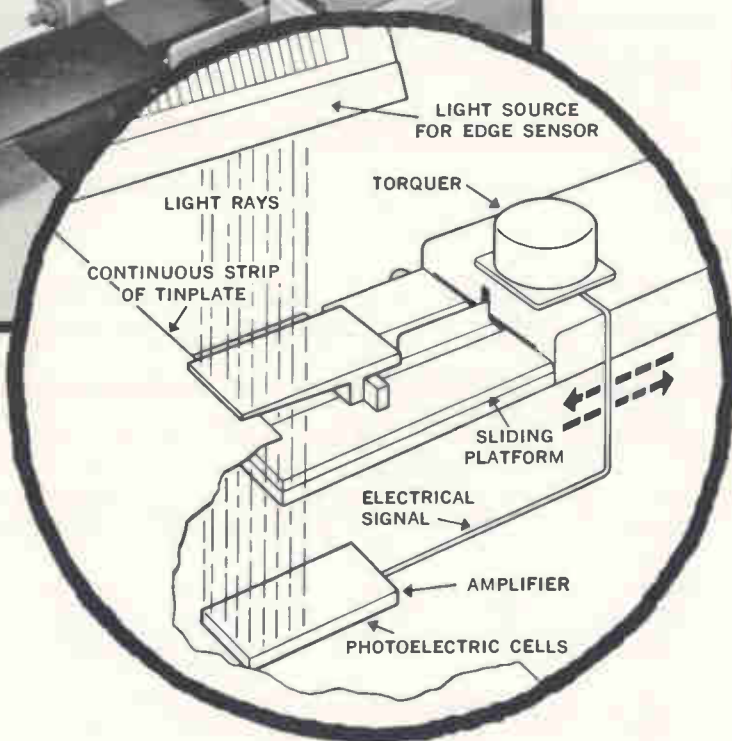

Inland Gearless Torquers help make pinhole detection fool-proof!

Bethlehem Steel Company runs tinplate at high speed through a photo inspection device. Purpose is to detect pinholes. Side-to-side movement of the continuous strip creates a problem. The least light entering at the edges of the strip can cause false pinhole indications.

Fast-response positioning of edge guides by two Inland Gearless Torquers on signal from photoelectric sensors blocks out "false-alarm" light. These direct-drive d-c torque motors have peak torque of 60 ounce-inches.

Rapid, high-resolution response to servo-position error signal has earned for Inland Gearless Torquers a place in all major missile and space programs to date, as well as in an increasing number of industrial applications. Their superior performance comes from torque-to-inertia ratios 10 times higher than equivalent gear-train servo motors. Moreover, their compact, pancake configuration overcomes space and weight limitations.

What's your problem? If you're currently planning a servo system calling for output torque between 20 ounce-inches and 3000 pound-feet*, compare Inland Gearless Torquers with any alternative. Write for all the facts today, 347 King Street, Northampton, Mass.

*Higher torque output levels can be provided on special order.

 **INLAND MOTOR**
CORPORATION
SUBSIDIARY OF **KOLLMORGEN**

Calculated on basis of established 75 percent confidence level mean time to failure for parts was as follows:

- Transistors—1.9 million hours
- Diodes—7.3 million hours
- Resistors—6.6 million hours
- Capacitors—1.2 million hours
- All parts—9.3 million hours
- Solder joints—55.5 million hours

hours

Translating above meantime to failure data to failure rate per 1,000 hours at a 75 percent confidence level, we have:

- Transistors—0.052 percent per 1,000 hours
- Diodes—0.013 percent per 1,000 hours
- Resistors—0.015 percent per 1,000 hours
- Capacitors—0.087 percent per 1,000 hours
- All parts—0.01 percent per 1,000 hours
- Solder joints—0.002 percent per 1,000 hours

Thus, tests indicate and provide assurance that the printed circuit modular configuration manufactured with techniques described, can result in component reliability levels equal to or greater than levels reported for similar components in a "free-air" (non-encapsulated) environment.

Heliac Cable Goes to Five Inches

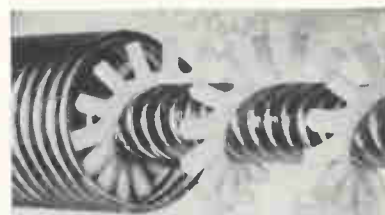

COMMUNICATION CABLE
measuring 5-inches in diameter has convoluted inner and outer copper tube conductors and air dielectric to permit easy bending

ADDITION of a 5-inch diameter cable to its heliac line is being made by Andrew Corp. of Chicago. For use in high power 2-way communications, the cables are manufactured from oxygen-free high conductivity copper. Newest addition to the flexible-cable line, uses

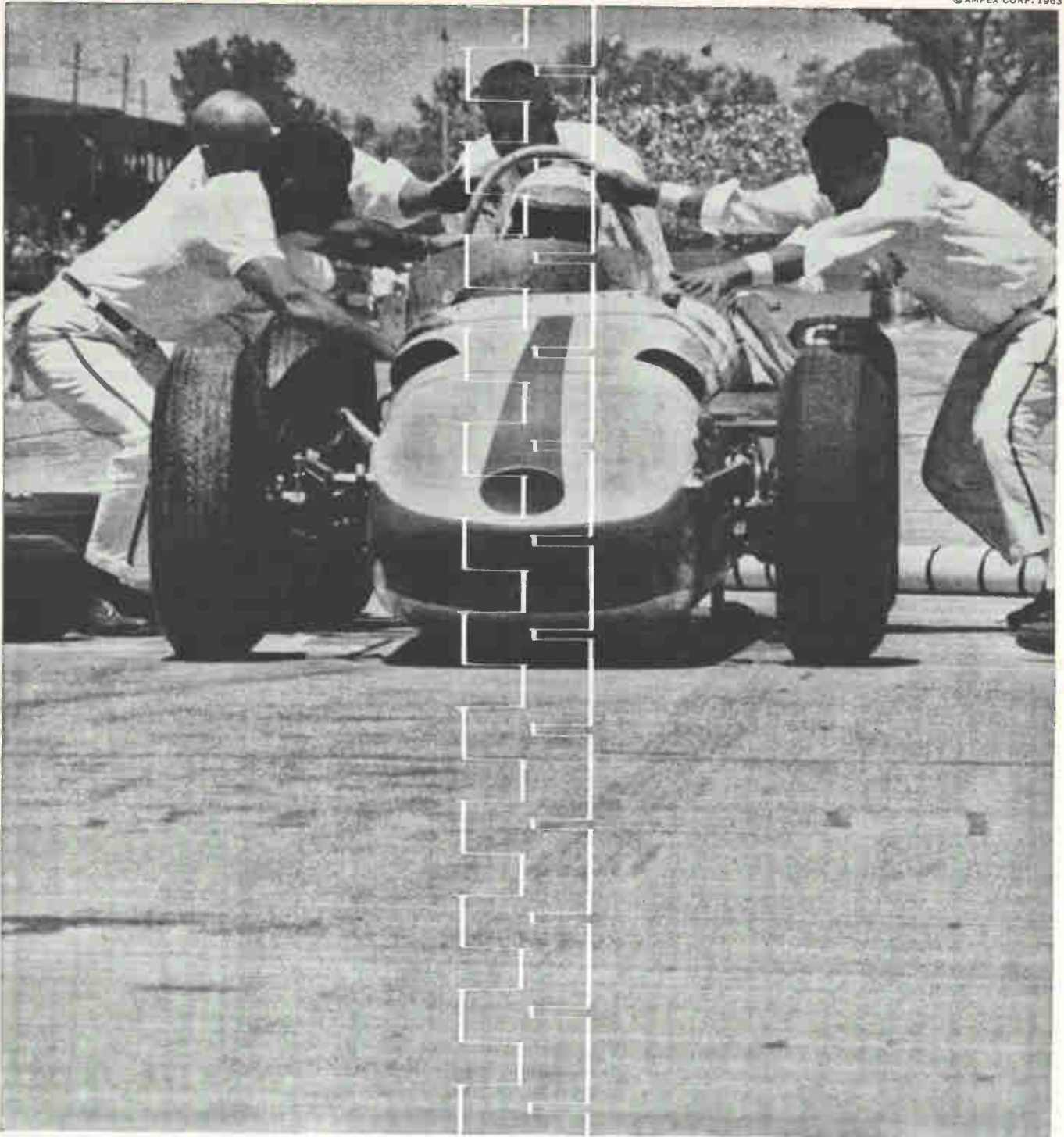

What new high speed tape transport means less down time?

AMPEX TM-5

Here's how it's done. The highly stable, solid state servo requires less adjustment. Capstan rollers are quickly changed. Settings are quickly made. The head assembly is isolated. (This makes the tape path highly stable. In fact, dynamic skew at start time is less than dynamic skew continuous.) And precision practices reduce static skew. There's no tape flap; an erase head isn't needed. Positive safety interlocks eliminate tape damage. Instantaneous speed



variation has been reduced. Plus: up to 150 ips tape speeds; 2 ms maximum start time; 1.5 ms maximum stop time; 800 bpi capability with or without clock track; available as a complete tape memory system with transfer rates up to 240 kc. And above all, there's Ampex reliability and ruggedness throughout. The TM-5 is made by the Ampex Computer Products Co., Culver City, Calif. For information write Ampex Corp., Redwood City, Calif. Worldwide sales, service.

U T I C A[®]

UTICA

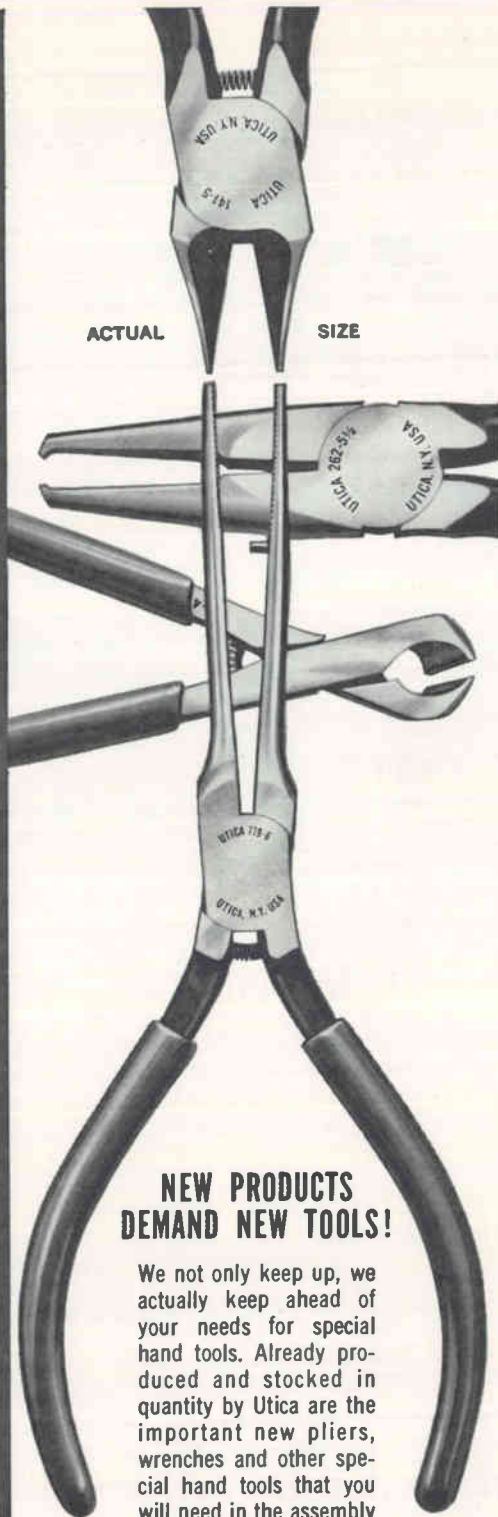

NEW PRODUCTS DEMAND NEW TOOLS!

We not only keep up, we actually keep ahead of your needs for special hand tools. Already produced and stocked in quantity by Utica are the important new pliers, wrenches and other special hand tools that you will need in the assembly of your new designs. All have been proved through application. All are backed by famous full guarantee.

Get the full story. Talk to your Utica distributor or write for our latest hand tool catalog.

**Utica Drop Forge & Herbrand
Tool Division, Kelsey-Hayes Co.
Orangeburg, S. C.**

tools the experts use!

an air dielectric between convoluted tubes used as inner and outer conductors. Produced in continuous lengths up to 1,000 feet, cables are of a splice-free construction. Reportedly, this results in low VSWR up through 950 Mc. Designated the type H9, the cable has flanged-end fittings that mate with 6½-inch EIA standard flanges and inner conductors. Seam welding is used to form tubes that are then convoluted by a turning fixture.

Hall Device Built for Production Line

PRODUCTION LINE permanent magnet testers using a Hall-effect probe is being introduced by Indiana General Corp. of Valparaiso, Indiana. Testers are claimed to be ideal for on-line use, quality control, and incoming inspection because of a better than 1-percent repeatability. Colored panel lights give visual indication of whether magnets in a given run are in either of two magnetic-quality categories. A readout meter checks precise quality level values. Provision is made for attachment of external bells, buzzers, switches, gating circuits which can be set to operate in conjunction with the quality-indicating lights. Constant-current supply provided for probe has a voltage stabilizer.

Cleaner Than Clean



WALL of absolute filters (rear) draws air into clean room at General Dynamics/Pomona. Air is drawn-out through a facing wall of return air registers. Reportedly, room is 200 times cleaner than hospital operating rooms and exceeds maximum military standards for clean rooms

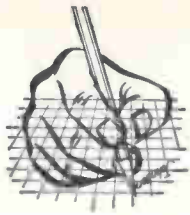

Time after time engineers specify Johnson sockets!

Whatever the choice . . . a miniature 7-pin steatite wafer or a low-loss Kel-F socket for high power transmitting tubes . . . time and time again design and development engineers specify Johnson tube sockets! All sockets have been categorized under a socket standardization program, reducing the number of variations in each socket type. Standardization and immediately available stock shortens delivery cycles—permits fast selection of a Johnson socket for almost any application!

Standard: Commercial grade for general requirements. Bases are glazed porcelain or steatite. Etched aluminum shields or bayonet shells.

Industrial: Superior in quality to "Standard" Grade. Glazed steatite bases, DC-200 treated. Phosphor bronze or beryllium copper contacts .0005 silver-plated. Aluminum shells and shields are iridite No. 14 treated. Fungus resistant cushion washers under contacts.

Military: Top quality to meet military requirements. Glazed L-4 steatite bases, DC-200 treated. Phosphor bronze or beryllium copper contacts heavily silver-plated. Hot tin dipped solder terminals. Brass bayonet shells .0003 nickel-plated. Aluminum shells and shields are iridite No. 14 treated. Fungus resistant cushion washers under contacts. Wafer sockets protected for 200 hour salt spray test.



E. F. JOHNSON COMPANY
2821 TENTH AVENUE S.W. • WASECA, MINNESOTA

KEL-F SERIES—Molded of low dielectric loss-factor Kel-F plastic—designed for use with a wide selection of high power transmitting tubes such as: 4X150A; 4X150D; 4X250B; 4CX250B; 4X250F, 7034; 7035. Basic sockets are available in several designs—with or without screen grid by-pass capacitors, mounting saddles, or steatite chimney to direct air flow through tube cooling fins. Control grid contact "guide" is machined for greater alignment accuracy, and tapped for 6-32 machine screw. All contacts are low resistance silver-plated beryllium copper. Tube pin contacts are heat treated to provide positive contact pressure as well as extended life. Annealed soldering tabs may be easily bent or formed.

BAYONET TYPES—Includes Medium and Heavy Duty Medium, Jumbo and Super Jumbo 4-pin types. For use with tubes such as: 866A or 811A, E.I.A. Base No. A4-10; 872A, 211, and others with E.I.A. Base No. A4-29; and tubes such as: 800B, 5C22, FG104, GL146 and others with E.I.A. Base No. A4-18.

STEATITE WAFER TYPES—Available in 4, 5, 6, 7, and 8-pin standard socket types, as well as Super Jumbo 4-pin for tubes with E.I.A. Base Nos. A4-15, A4-16, and A4-18. Giant 5 and 7-pin models for tubes with E.I.A. Base Nos. A5-19 and A7-17. Septar Sockets for tubes such as the 7094 with E.I.A. Base No. E7-2; and VHF Septar Sockets for tubes such as: 5894, 6524, 6252 with E.I.A. Base No. E7-20; and 826, 832, 4D32 with E.I.A. Base No. E7-2.

MINIATURE TYPES—All steatite, available in Standard Wafer Type or Shield Base Type for 7-pin miniatures such as the: 1RS, 1S5, 6CB6, etc., with E.I.A. Base No. E7-1.

SPECIAL PURPOSE TYPES—Includes sockets for special purpose tubes such as the: 204A and 849; the 833 and 833A; 152TL; 304TL; 750TL; 1500T; 2-2000A; 5D21, 705A and others.

NOTE: Detailed specifications on all Johnson tube sockets have been prepared for engineering department use in Socket Standardization Booklet 536. Should you wish a copy—please make your request on company letterhead.

STANDARD, INDUSTRIAL, MILITARY TUBE SOCKETS

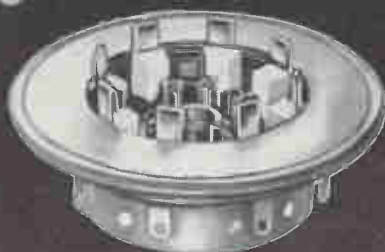

DETAILED COMPONENTS CATALOG AVAILABLE—Write today on company letterhead

• CAPACITORS • TUBE SOCKETS • CONNECTORS • PILOT LIGHTS • INSULATORS • KNOBS AND DIALS • INDUCTORS • HARDWARE

Synchronizer Accepts PCM At Rates To 1 Mc

Signal conditioner will operate over a 40 db dynamic range

MODULATION bit synchronizer and signal conditioner manufactured by Defense Electronics, Inc., 5455 Randolph Road, Rockville, Md., is designed for use in shipboard, aircraft and ground station telemetry systems. Called the model BRS-1, the unit will accept a serial pcm signal at rates up to 1 Mc and will operate over a 40 db dynamic range, allowing the signal to originate from the output of a telemetry receiver, tape recorder or other source. Moreover, the BRS-1 will generate a stable clock that is

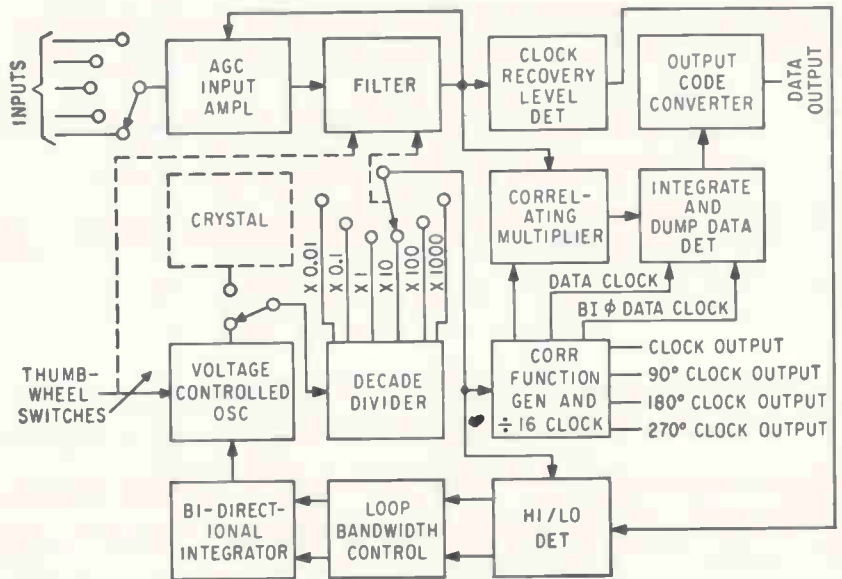

phase-coherent with data output.

The synchronizer also accomplishes functions of data reconstitution and format conversion. Its output is a reshaped, noise-free, serial pcm signal plus a clock signal that is phase-coherent with output data. Bit rate/clock frequency is accurately established by means of thumbwheel switches and push-button range selectors so that a known bit rate can be established within 0.1 percent prior to actual reception. This feature permits the

unit to be operated without the bevy of test equipment usually required for setup.

A completely digital loop filter automatically establishes a loop bandwidth that is proportional to bit rate at all frequencies. According to the manufacturer, the integrate-and-dump-bit-detection circuit uses a unique correlating function generator that causes the bit detection performance to approach that of a perfectly matched filter.

CIRCLE 301, READER SERVICE CARD



Unique Bridge Measures RF Operating Impedance

MODEL OIB2 high-frequency operating impedance bridge can be inserted directly into any part of a 2-30 Mc antenna system to measure the operating impedance of individual radiators, network inputs or transmission line terminals under r-f conditions. According to the manufacturer, Delta Electronics, 4206 Wheeler Ave., Alexandria, Va., the OIB-2 will handle powers up to 1,000 watts and can be excited either directly from the operating r-f power or a high-power signal generator. Moreover, they point out that the device is particularly use-

ful in the adjustment of multi-element high-frequency antenna systems, where the insertion of conventional units might upset the circuit.

Insertion effect of the bridge approximates that of 5 inches of 150-ohm transmission line. An external detector jack permits the unit to be used with a low-power signal generator and sensitive communications receiver as a normal impedance bridge for antenna or laboratory r-f measurements. The OIB-2 has a resistance range of ± 500 ohms and a reactance range





OLD FAITHFUL



MINCOM SERIES CM-100 RECORDER / REPRODUCER

Built-in reliability inspires confidence everywhere in this Mincom Wideband Instrumentation Recorder/Reproducer. CM-100's reputation for minimum downtime stems from its rugged simplicity—only twelve moving parts, four easy adjustments, dynamic braking. Plus, of course, overall electronic craftsmanship and the extreme precision achieved by Mincom's longitudinal recording with fixed heads. Versatile, too: 1.5 megacycles at 120 ips for analog data storage or simultaneous post- and predetection capabilities in FM/FM modulation, PCM, PCM/FM and other FM-type carrier systems. Seven or fourteen tracks. Write today for complete specifications.

Mincom Division **3M**
COMPANY

2049 South Barrington Avenue, Los Angeles 25
425 13th Street N. W., Washington 4, D. C.

BUSS Sub-Miniature FUSE-HOLDER COMBINATION



A light weight, protective device for space-tight applications in multiple circuit apparatus. Fuse has transparent window for visual inspection of element. Fuse may be mounted alone or used in holder on printed circuit boards.

HWA holder can also be panel mounted with or without use of knob. Knob makes holder water proof for front of panel.

BUSS

For full details
write for BUSS
Bulletin 5FB

BUSSMANN MFG. DIVISION, McGraw-Edison Co., St. Louis 7, Mo.

CIRCLE 205 ON READER SERVICE CARD

BUSS MINIATURE FUSES Made To Foreign Standards

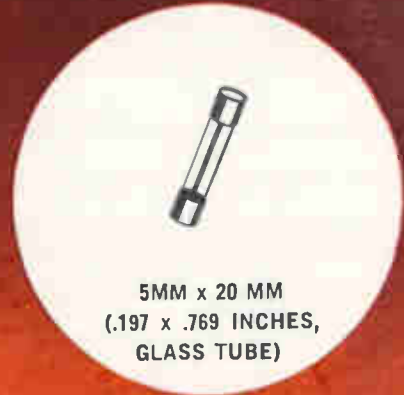

5MM x 20 MM
(.197 x .769 INCHES,
GLASS TUBE)

Designed for protection of miniaturized circuits or equipment. Commonly used in equipment of foreign make.

BUSS

Write for BUSS
Bulletin 5FB.

BUSSMANN MFG. DIVISION, McGraw-Edison Co., St. Louis 7, Mo.

CIRCLE 206 ON READER SERVICE CARD

BUSS : the complete line of fuses .

AROUND THE WORLD IT'S KEW



MODEL P-25



MODEL P-40



MODEL PV-202



MODEL TK-90A



MODEL KHE-505



MODEL EW-8



MODEL EW-16

KYORITSU ELECTRICAL INST. WORKS, LTD.

NO. 120, NAKANE-CHO, MEGURO-KU, TOKYO, JAPAN
CABLE ADDRESS: "KYORITSUKEIKI TOKYO"
TEL (717) 0131-5 - 0151-3

CIRCLE 106 ON READER SERVICE CARD

FAST DELIVERY ANYWHERE

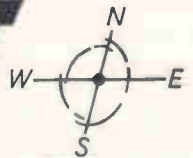

MIDWEC INSTRUMENT GRADE MYLAR* DIELECTRIC

Ca-pac-i-tors

Best Shipping Interval In The Industry—3 Weeks Standard
High Reliability and Quality
Competitively Priced

Specialists In Low Tolerance Units

Approved for use in Talos, Minute Man, Titan, Typhon,
Telephone Companies ■ 100% Test for dielectric strength,
capacitance, insulation resistance and dissipation factor

MIDWEC
OSHKOSH, NEBRASKA

write for
data sheets
and prices

SALES OFFICE: 601 So. Jason St., Denver 23, Colo.
TWX: 292-3891—Telephone SH 4-3481—DDD 303

*DuPont TM for Polyester Film.

CIRCLE 222 ON READER SERVICE CARD

of ± 500 ohms and is contained in a heavy deep-drawn aluminum instrument case with detachable cover and carrying handle. The unit sells for \$695 and is constructed to ensure dependable performance under rugged field conditions.

CIRCLE 302, READER SERVICE CARD

Regulated Supplies Have Mode Indication

MANUFACTURED by Kepco, Inc., 131-38 Sanford Avenue, Flushing, New York, Model VIX indicators provide visual evidence of power supply mode and exact point of crossover from constant voltage to constant current regulation. According to the company's engineers, VIX indication greatly simplifies testing and provides substantial savings in time and engineering. Supplies using the mode indicators use two control bridge circuits, one for voltage and one for current. Between these and a control pass device, an exclusive-OR circuit acts

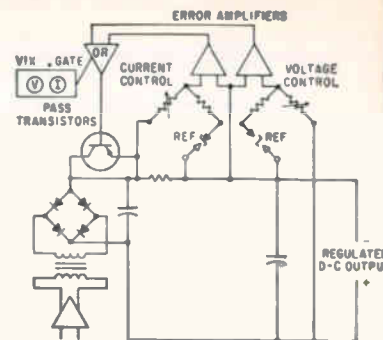
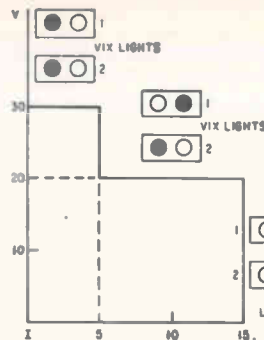
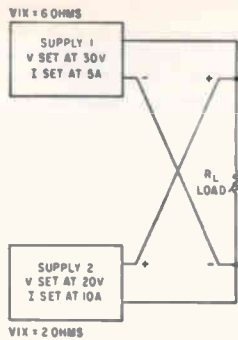

as a trigger or switch without ambiguity or back-lash. The OR circuit both selects the current or voltage bridge and switches the lights that provide visual indication of operating state. Aside from the external indicators, Kepco supplies, embodying VIX, feature front-panel pilots for the same purpose. Moreover, VIX supplies can be stacked in either series or parallel configurations without auxiliary or slaving connections. In this way, the mode of the individual units is readily shown along with the added versatility available with stacked

units. The parallel configuration along with operational characteristics is shown in the diagram along with a schematic of the basic system. (303)

Tiny Frequency Meter Has 1/4% Accuracy

CRYDOM LABORATORIES, Inc., 12850 Western Ave., Garden Grove, Calif., has just announced the availability of a new precise frequency meter that achieves an accuracy of $\pm 1/4$

..... of unquestioned high quality

BUSS Sub-Miniature PIGTAIL TRON FUSES

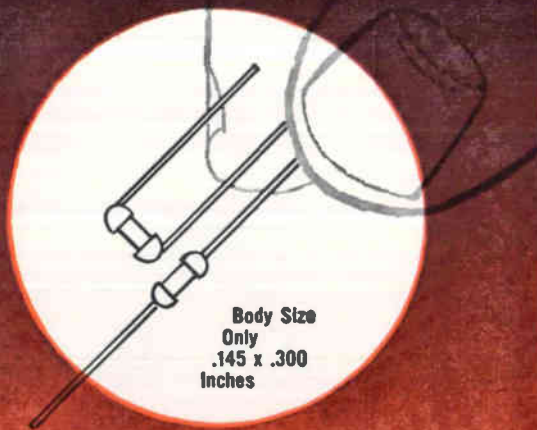

Body Size
Only
.145 x .300
Inches

Tron fuses are so small they can be used as an integral part of circuit—to protect miniaturized devices—or gigantic multi-circuit electronic devices, without sacrifice of space.

They are hermetically sealed for potting without danger of sealing material affecting operation and have high resistance to shock or vibration. Operate without exterior venting. May be teamed with other components in replaceable unit.

BUSS Write for BUSS Bulletin 5FB.

BUSSMANN MFG. DIVISION, McGraw-Edison Co., St. Louis 7, Mo.

CIRCLE 207 ON READER SERVICE CARD



If you should have a special problem in electrical protection...

... we welcome your request either to quote or to help in designing or selecting the special type of fuse or fuse mounting best suited to your particular conditions.

Submit description or sketch, showing type of fuse to be used, number of circuits, type of terminal, etc. If your protection problem is still in the engineering state, tell us current, voltage, load characteristics, etc. Be sure to get the latest information BEFORE final design is crystallized.

At any time our staff of fuse engineers is at your service to help solve your problems in electrical protection.

BUSS

Just call or write:

BUSSMANN MFG. DIVISION, McGraw-Edison Co., St. Louis 7, Mo.

CIRCLE 107 ON READER SERVICE CARD

NOW!

RECORD VOLTS, OHMS, MILLIAMPS

with ONE RECORDER

... NO EXTRAS!



ONLY
\$595
 COMPLETE

New Bausch & Lomb V.O.M.-5 RECORDER

... an all-new, complete 5-inch strip-chart recorder that breaks all precedent in the field ... brings you the finest features of potentiometric recorders for one low price. Compare these exclusive advantages, all these "extras" at no extra cost, with any other recorder in its class.

- Five voltage ranges, 10 millivolts to 500 volts D.C.—full scale deflection.
- Six linear ohms scales, 1-to-100,000 ohms full scale, with zener diode D.C. supply.
- Four D.C. current ranges—10 microamperes to 100 milliamperes.
- Off balance input impedance—over 10 megohms.
- Five chart speeds, 400-to-1 range.
- Event marker, with interchangeable pens.
- Function switch with mechanical pen letdown.
- Operates in flat, 30° tilt, or wall-mounted position.
- Compact—only 4¾" x 14½" x 11¾".
- Portable—only 16 lbs.

And more. Lots more! Mail the coupon now for the whole story on this new 5-speed recorder with versatility-plus!

BAUSCH & LOMB

BAUSCH & LOMB INCORPORATED
 61443 Bausch Street
 Rochester 2, N. Y.

Please demonstrate the V.O.M.-5 Recorder at my convenience.
 Send Recorder Catalog D-2032.

Name Title

Company

Address

City Zone State

percent between 388 and 412 cps.

According to the manufacturer, the accuracy and balance of the device is dependent upon extremely stable operation of the internal frequency to voltage discriminator circuits where frequency is converted to a proportional d-c voltage by saturable-core techniques. The



d-c voltage obtained is then compared to a precise zener diode reference in a bridge configuration and the error signal used to provide meter deflection. Meter zero is set by bridge component selection.

Unlike conventional devices using temperature-sensitive LC circuits, this unit can go from sine wave to square wave with less than 0.1 percent error. The meter achieves voltage and harmonic distortion limits better than 0.2 cps and temperature limits of 1 cps.

CIRCLE 304, READER SERVICE CARD



Kilovoltmeter Is Fully Transistorized

DUAL INSTRUMENT has 0 to 5 Kv/10Kv/50 Kv and 100 Kv d-c and 60 cycle a-c ranges, large 6 in. precision mirror scale meter. Completely transistorized with virtually zero drift amplification, results in

NEW RIBBON CABLE!



Teflon Insulated Wires Woven Together With Unsintered Teflon Tape

Here's a valuable new find in your endless quest for significant design advantages — Hitemp's "TWR" Ribbon Cable. Lighter than round conductor cable, "TWR" separation of individual conductors is controlled to 15-20 mils spacing, with its flat configuration offering unlimited design possibilities in terms of the number of conductors, types and sizes of wires and cables, and color coding, among other specifications.

In such difficult applications, for example, as situations where lateral movement is unavoidable, "TWR" Ribbon Cable has exceptional durability because the unsintered Teflon tape covers 90% or more of the outer surface — reducing wear to an absolute minimum.

And Hitemp also makes other ribbon cables with Teflon insulated wires — one where individual insulated conductors are heat bonded together, Type "ER", another where individual insulated conductors are woven with either Dacron, Rayon, Nylon, or Teflon yarn, Type "TR". TWR, ER, and TR ribbon configurations are perfectly suited to miniaturized components, restricted packaging, and point-to-point contact for

hook-up of control, signal, and power circuits.

So, now you can relax whenever size, weight, abrasion resistance, flexibility, and reliability are critical — because Hitemp's Teflon insulated Ribbon Cables provide *the* safe, sound solution.

SEND FOR NEW BULLETIN No. 100 for the full details on HITEMP Ribbon Cables. Or, send along a piece of what you're currently using — we'll evaluate it carefully and advise you of any savings you might be able to achieve with Hitemp's Teflon insulated Ribbon Cables. Take advantage of either or both offers right now.

HITEMP WIRES CO.

a Division of Simplex Wire & Cable Co.

1200 SHAMES DRIVE, WESTBURY, NEW YORK
1532 S. CALIFORNIA AVE., MONROVIA, CALIF.



CHESTER

MULTI- CONDUCTOR CABLES

Custom constructions to meet your exact requirements. Any combination of conductors, Plastico® insulations, shields, jackets, color coding, etc.

Send for brochure, today!

**CHESTER
CABLE CORP.,
CHESTER, NEW YORK**
a subsidiary of
TENNESSEE CORPORATION



only a few microamperes drain on voltage being measured. Features a novel compensator which automatically provides for voltage coefficient correction of multiplier resistors. Model 50 has special spike bypass circuitry to make it insensitive to overloads up to 100 percent. Kalpa Scientific Laboratories, Inc., P. O. Box 172, Flemington, N. J.

CIRCLE 305, READER SERVICE CARD

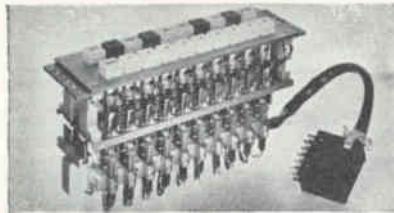

Switch Assemblies Wired to Customer Order

NEW FEATURES in the series L7700 illuminated push button switch include alternate action stations (push-lock, push-release), lock-out, or "no-two operate" feature between rows as well as within each row of a two row interlocking assembly, and square plexiglas buttons, white or a choice of several colors. Single or double row assemblies are available with from 2 to 20 stations in each row. An escutcheon plate simplifies mounting since only one panel opening is required. Donald P. Mossman, Inc., Box 265, Brewster, N. Y. (306)



D-C Supplies Use Silicon Transistors

REGULATED d-c power supplies are built with silicon transistors, have a 75 C ambient temperature range and sell for \$89. Mean time between failure is over 25,000 hours. Models are available with output voltages from 6 to 31 v d-c and current capacities from 600 ma to 1.5 amp. Input is 105-125 v a-c, 47 to

Compact View of Hart Relays



**SERIES R&S Miniature,
Hermetically Sealed.**

4PDT. Contact ratings from microamperes to 10 amps. Meet or exceed MIL-R-5757D. A-c coil version available.



**SERIES P High Speed Polarized.
SPDT. Operating response to 200
microseconds. No contact bounce.**



**SERIES W General Purpose.
DPDT, double break, a-c, d-c relays.
Plug-in type or quick-disconnect terminals. Rated up to 25 amps, yet more compact than most 10 amp relays. Holding contact available.**

For complete information write to:



HART

MANUFACTURING CO.
202 BARTHOLOMEW AVENUE
HARTFORD 1, CONNECTICUT
Telephone: Area Code 203 525-3491
A SUBSIDIARY OF OAK MANUFACTURING CO.

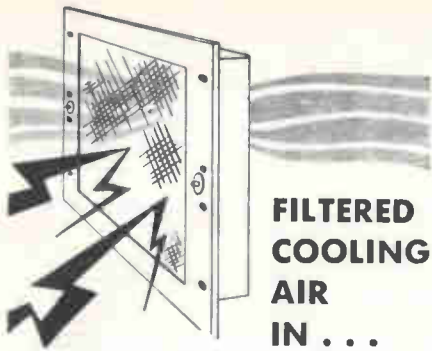

**FILTERED
COOLING
AIR
IN . . .**

RFI *OUT!*

**WITH NEW
McLEAN
RFI
SHIELDED
BLOWERS**

and Filter-Grille Assemblies



mclean Cross Section of McLean RFI Blower

Now you can pressurize radio-shielded electronic cabinets with cool, filtered air without opening the "envelope" to RF interference.

McLean RFI-shielded blowers and filter-grille assemblies have been designed and built for RFI performance in accordance with MIL-I-6181D — meeting or exceeding all requirements including susceptibility, generation and shieldability. **WRITE TODAY** for details.

SEND FOR
NEW 44-PAGE
CATALOG



McLEAN ENGINEERING LABORATORIES

World Leader in Packaged Cooling
P.O. Box 228, Princeton, New Jersey
Phone Area Code 609 WALnut 4-4440
TWX 609-799-0245

CIRCLE 209 ON READER SERVICE CARD

440 cps. Consolidated Avionics Corp., 800 Shames Drive, Westbury, L. I., N. Y. (307)



Digital Voltmeter Is Highly Stable

MODEL 600 series Decameters are precision 5 digit differential instruments designed for measurement of a-c and d-c voltages and resistance. They offer 0.01 percent accuracy for a-c voltage measurements. Extremely high input resistance on all ranges, Zener references, complete overload protection and transistorized circuitry provide an extremely reliable instrument. A recorder output is optionally provided to drive any conventional T-Y, strip-chart or X-Y recorder or digital voltmeter equipped with automatic printout. The Decameter output is a conventional 100 mv for a deviation as low as $\pm 100 \mu\text{v}$ or ± 10 milliohms. Houston Instrument Corp., Auto Data Sales Div., 4950 Terminal Ave., Bellaire, Texas. (308)

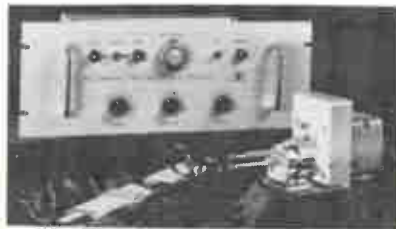

Pressure Controller Works Automatically

INSTRUMENT controls pressure or partial pressures from 10^{-11} mm Hg up to one atmosphere and is bakeable to 450 C for minimum contamination. The throughput of a single unit is large enough to swamp a 50,000 liter/sec pump at 10^{-3} mm Hg and small enough to control laboratory systems operated at the lowest pressures attainable. Applications are in ion sources of mass spectrometers and high energy particle accelerators, in space

COAXIAL CABLES



Accepted by industry as the quality line of Coaxial cables.

Conform to Military Specifications including MIL-C-17C—or your own special requirements.

Send for complete Coaxial Cable catalog.

**CHESTER
CABLE CORP.,
CHESTER, NEW YORK**

a subsidiary of
TENNESSEE CORPORATION



DYNAMICS

VARIABLE ELECTRONIC FILTERS

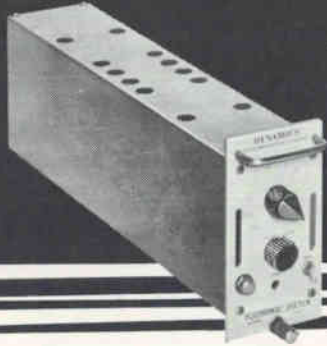

— 3rd to 6th order
Tchebysheff
Butterworth
Linear Phase

- Up to 36 db/octave slope
- Low-pass or high-pass
- Low dc drift
- Source or load independent
- Drive long lines
- No insertion loss
- Variable frequency — 4-decade range

Noise and ripple: below 1 millivolt peak-to-peak, at the output
Linearity: 0.1%
Output voltage and current: ± 10 volts; ± 100 ma

Drift: ± 2 millivolts at output
Output impedance: below 1 ohm
Input resistance: 10 megohms
10th decade steps over a 4-decade range

Model 6370-L6 (illustrated) is a linear phase, low-pass, 6th order filter. Phase is linear in the range dc to $2\frac{1}{2}$ times the cut-off frequency. All Dynamics filters are compatible with other Dynamics signal conditioning equipment. *Write for literature on this model, or on the entire line of electronic filters.*

DYNAMICS INSTRUMENTATION COMPANY
583 Monterey Pass Rd., Monterey Park, Calif. • Phone: CU. 3-7773

CIRCLE 210 ON READER SERVICE CARD

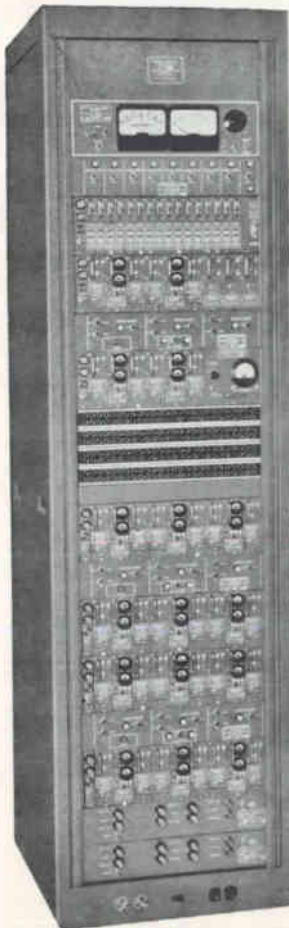

NEW BETTER-THAN-EVER
RELIABILITY
for long-distance point-to-point communications



NEW 16-CHANNEL TRANSISTORIZED
VOICE FREQUENCY DIVERSITY CARRIER
TELEGRAPH TERMINAL TYPE 235 MODEL 3
MIL DESIGNATION AN/FGC-61A

- ... All units militarized: components and design approved by U.S. Military.
- ... Converters have equalized gain and adjustable time delay in each channel for better diversity performance and interchangeability.
- ... Switching Panels provide "local" or "remote" selection of 2-channel or 4-channel diversity modes.
- ... Combiners have adjustable gains in each channel, for complete switching flexibility, and the combining follows an ideally modified square law function for both 2-channel space or frequency and 4-channel space plus frequency diversity.
- ... Keyers have adjustable "threshold" sensitivity control and simplified input circuit selection.
- ... Dotter and Delay Indicator provides test keying signal source for keyers and delay equalizers in all channels.

Write for complete literature.

Pace-Setters in Quality Communication Equipment

NORTHERN RADIO COMPANY, inc.
147 WEST 22nd ST., NEW YORK 11, NEW YORK

In Canada: Northern Radio Mfg. Co., Ltd., 1930 Bank St., Billings Bridge, Ottawa, Ontario.

112 CIRCLE 112 ON READER SERVICE CARD

simulators, backfilling, process control or wherever manual control of pressure is now used. Granville-Phillips Co., 5675 East Arapahoe, Boulder, Colo.

CIRCLE 309, READER SERVICE CARD



Volt-Ohm-Milliammeter
In Two New Types

MODEL 260 vom is now available in two new types—series 4 with standard scale and series 4M with mirror scale. They feature self-shielded movement; higher accuracy (2 percent d-c, 3 percent a-c); ruggedness from spring-backed jewels; greater repeatability; and increased linearity and stability. Price of the series 4 is \$48.95; series 4M, \$50.95. Simpson Electric Co., 5205 West Kinzie St., Chicago 44, Ill. (310)



SPDT Diode Switch
Spans 100-2,500 Mc

DEVELOPMENT of model 7762 spdt solid state microwave switch is announced. It covers from 100 to 2,500 Mc and accomplishes high speed channel switching while having a high isolation and low insertion loss. Termination of a third port allows the unit to be used as an absorptive type voltage controlled attenuator, r-f modulator, or an

July 19, 1963 • electronics

**Electronic Systems Engineers
INTERESTED IN**

broad-gauge projects

These are rare opportunities for youngish, aggressive EE's in that the work is both interesting and important, the future very much up to you, and the locale delightful. You will be responsible for the systems design—in terms of adaptation and compatibility—the installation, test, and maintenance of ALL the Navy's shore-based electronics systems in several Middle-Atlantic states, Iceland, Bermuda, and the Azores. Most of your work will involve the Naval Tactical Data and Communications System in the Norfolk-Portsmouth-Virginia Beach area, and include contact with contractors and engineers of other Navy activities.

Specific staff openings include:

- **COMMUNICATIONS ENGINEER**, for all Naval shore-based radio systems

- **SYSTEMS ENGINEER**, to concentrate on the NTDS facility at the Fleet Programming Center

(Both of the above positions start at \$9,475, plus the benefits of Career Civil Service, and will be increased to \$9,980 on January 1st)

- **GENERAL ELECTRONICS ENGINEERS** to work on special projects such as Command Control Centers, AIRNAVAIDS, Radar, Communications, etc.

(These positions start at \$8,575—\$8,970 after January 1st—and include the complete benefits of Career Civil Service.)

If you have your BS degree, plus three or more years' experience, and are capable of working independently on electronics systems... from concept to conclusion... get in touch with:

INDUSTRIAL MANAGER FIFTH Naval District

P. O. Box 215, Portsmouth, Virginia

An equal opportunity employer

THE DECI-CAP

New Subminiature Ceramic Capacitor—0.100" Diameter by
0.250" Molded Envelope—24 Hour Delivery

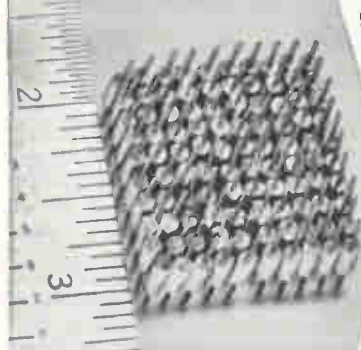

10 PER LINEAR INCH,
100 PER SQUARE INCH

5 pf to 470 pf in 19
values, 200 WVDC

Epoxy molded for high-
est reliability and perform-
ance—less than 7½%
capacitance change from
-55°C to +125°C

FEATURES:

Standardized size
for high density
cordwood packaging

Designed to meet
all the require-
ments of MIL-C-11015

The DECI-CAP is the latest addition to Nytronics' DECI Series—a series that does consist of inductors, capacitors and resistors in a uniform envelope to facilitate point-to-point assembly in cordwood, printed circuit and other high density module assemblies.

For complete engineering data, write Dept. WL-55, or phone 201-464-9300.

NYTRONICS, INC.

550 Springfield Ave., Berkeley Heights, N. J.

Design Leaders STANDARD components to meet CUSTOM requirements

CIRCLE 211 ON READER SERVICE CARD

New! MINIATURE AXIAL FANS

with
**up to 4 times
greater cooling efficiency!**



FULLY GUARANTEED FOR 10,000 HRS. UNDER NORMAL OPERATING CONDITIONS

Characteristic	PAMOTOR Model 1000	Conventional Fan
Type of Motor	induction (capacitor-type squirrel cage)	shaded-pole
Housing	die cast warp-free Zymec	plastic
Output @ 60 cps (0 back pressure) (.25" back pressure) (.3" back pressure)	125 cfm 75 cfm 50 cfm	100 cfm 20 cfm 0
Output @ 50 cps (0 back pressure) (.25" back pressure)	100 cfm 62.5 cfm	75 cfm 5 cfm
Operating Temp. Range	-55°C to +85°C	-18°C to +44°C

The PAMOTOR Model 1000 Miniature Fan is completely interchangeable with conventional units now in use (4 1/8" center-to-center mounting holes). But the similarity ends there.

check this comparison chart!

Model 1000 meets MIL-T-5422E (Class 2), and MIL-STD-202 Environmental specs. Inside-outside rotating motor design gives fly-wheel effect, resulting in constant, quiet fan speed. Large surface sleeve bearings mean minimum maintenance, maximum reliability.

For complete specifications and name of nearest stocking distributor, write to:

PAMOTOR, Inc.

312 Seventh Street • San Francisco 3, Calif.

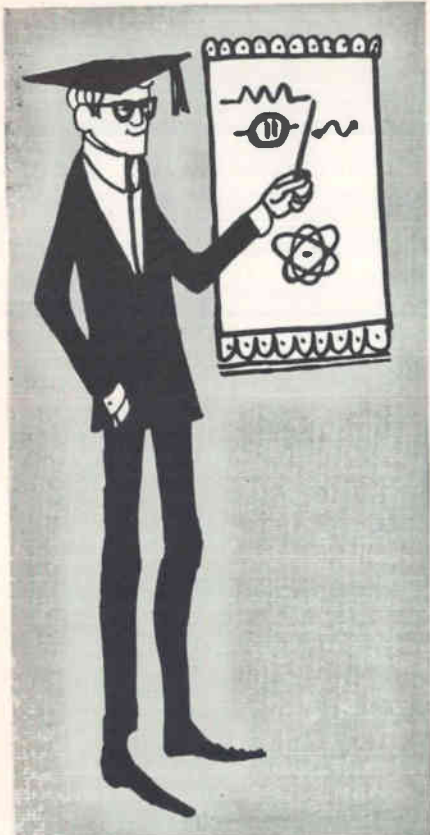

adaptability

(of a triple-A work force)

Electronics firms locate and expand in WESTern PENNSylvania because of a triple-A work force: Available . . . Adaptable . . . and with a good Attitude. For example—one company, as a result of only one help-wanted ad, obtained 500 job applicants; another firm traveled 20,000 miles before it found its needs satisfied in WESTern PENNSylvania. This triple-A work force has the ability to be readily trained in the skills YOU need and at no cost to you through Pennsylvania's unique pre-production training program. This adaptability . . . plus a favorable tax climate . . . plus 100% financing of industrial plant space gives WESTern PENNSylvania a top combination of plant location values. Learn more—write, wire or call collect.

WEST PENN POWER

an operating unit of ALLEGHENY POWER SYSTEM



INDUSTRIAL SHELL BUILDINGS available at \$2.95 to \$3.25 a sq. ft. can be completed to your specs in 60-90 days.

WEST PENN POWER Phone: TEmple 7-3000
Area Development Department (Area Code 412)
Greensburg, Pennsylvania E 3-10-7

Please send me data on: Labor Availability Pre-production Training Favorable Tax Climate 100% Industrial Plant Financing Industrial Properties

Name _____

Title _____

Company _____

Address _____

City _____ Zone _____

State _____ Phone _____

spst switch. Blocking capacitors are provided in the enclosed transmission line to isolate the biasing or modulation circuitry from the microwave network. Temperature range is -55 C to $+90\text{ C}$. Unit cost is \$365. Antenna and Radome Research Associates, 27 Bond St., Waterbury, N. Y.

CIRCLE 311, READER SERVICE CARD



Flow Monitor Has Simplified Design

SOLID-STATE, completely-integrated flow monitor is designed for use in oil and gas pipeline applications to provide high-accuracy remote flow totalizing, meter proving and flow rate read-out. Only the controls and displays used for flow monitoring appear on the front panel, thus eliminating the selector switches, adjustment knobs and interconnections of several instruments previously necessary with such equipment. Input power requirements: 115 v a-c ± 10 percent; power, 30 w. Input signal requirements: 20 mv rms minimum; 15 v rms max; 2500 cps max. Operating temperature range: 0-50 C. 3 M Co. Instrument Dept., 12909 So. Cerise Ave., Hawthorne, Calif. (312)

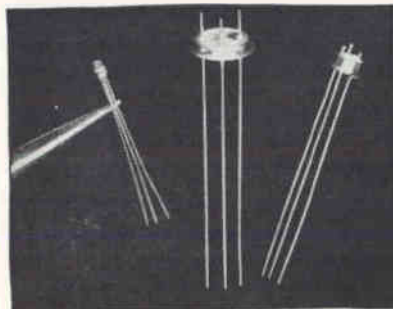

Transistor Headers of Metalized Ceramic

METALIZED ceramic transistor headers are offered to high reliability semiconductor manufacturers. They provide improved physical strength, high and low temperature characteristics and

POWER SUPPLIES AND LIGHT PUMPS FOR LASERS

Standard model Power Supplies, Light Pumps and Special Devices are available for prompt delivery. They are designed and built to be readily adaptable to the requirements of almost every type of solid state laser material. New equipments with enlarged capabilities and new features (including the CW solid state laser) are under development. The models listed below merely indicate the variety of units now in production.

POWER SUPPLIES

All models with continuously variable voltages from 0 to maximum rating. Fast recycling.



Console Models

325 - 5,000 volt with output to 20,000 joules.
330 - 10,000 volt with output to 20,000 joules.

Modular Units

Model 265 - 5,000 volt with output to 20,000 joules.

Model 320 - 10,000 volt with output to 20,000 joules.



PORTABLE LASER POWER SUPPLY

with self-contained energy storage.

Model 322—Complete, self-contained Power Supply and Energy Storage. Voltage continuously variable 0 to 3,000. Output to 800 joules.

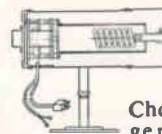

SOLID STATE LASER MOUNTS

6 models available.

Choice of air or liquid (nitrogen) cooling for helix or straight arc flash tubes. Maximum powers, 2,000 to 20,000 joules.

ENERGY STORAGE BANKS...

available in units of 1,000 joules for use with the Power Supplies listed above.

SPECIAL DEVICES...

Model 3C-4000 Rotary Arc Quench for fast quenching.

Model 3C-4039 External Reflector

Model 3C-4040 Rotary Disc and Mirror Assembly for "Q" spoiling or "Q" dumping.

Write for further information

ELECTRO POWERPACS, INC.

A subsidiary of Hydra-Power Corp.



16 Hadley Street
Cambridge 40, Mass.

resistance to thermal shock. Standard packages are presently inventoried for TO-5, TO-18-46 transistors. The ceramic is 94 per cent alumina with flanges available in Kovar or OFHC copper. Leads are supplied in either Kovar or copper cored No. 52 alloy material. Metalized pads are finished for soldering in sizes and shapes to meet customer requirements. Metalized Ceramics Corp., 25 Acorn St., Providence 3, R. I. (313)

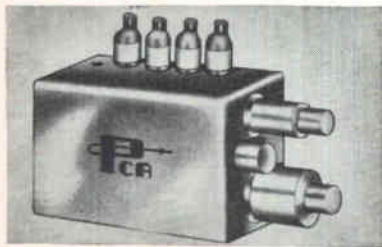

Pulse Transformer Fits in Small Space

MINIATURE, ceramic-fitted, high voltage modulation pulse transformer is designed for use in airborne equipment which must meet critical space limitations. The custom designed unit delivers an output pulse of 2,000 v from a 90 v scr source. It operates in altitudes up to 55,000 ft through temperatures from +170 C to -55 C. PCA Electronics, Inc., 16799 Schoenborn St., Sepulveda, Calif. (314)



Solid State Pulser Is Overload Protected

MODEL 522 can be used to provide fast-rise pulses from input waveforms of any type. It can also act as a frequency divider or a pulse shaper. With no input signal a single pulse can be generated by pushing the button on the front panel. Output pulse width may be varied from less than 0.5 μ sec to greater than 0.1 sec. Rise time is less than 50 nsec for a negative pulse and 200

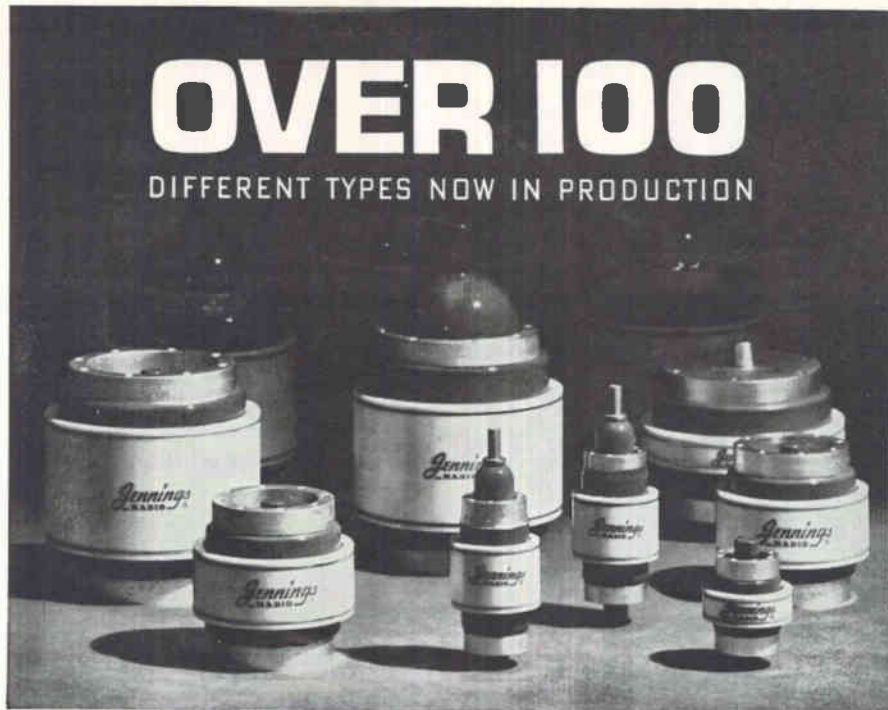





OVER 100

DIFFERENT TYPES NOW IN PRODUCTION

JENNINGS CERAMIC VACUUM CAPACITORS

... have been accorded an enthusiastic vote of approval from users for their superior performance in the field. Now we've added many new styles to accommodate the demand for these capacitors in an even wider variety of size, capacitance, voltage and current levels.

Ceramic vacuum capacitors combine the inherent advantages of vacuum with a high strength ceramic envelope to form the most advanced high voltage capacitor ever devised. The low loss ceramic allows operation in excess of 400 megacycles. It also provides better vibration characteristics, greater shock resistance, higher current ratings, and smaller size. A few of the many ceramic vacuum capacitors available from Jennings are illustrated below.

<p>Type CVFA-450</p> <p>Capacity Range 25-450 PF Voltage Rating 40 kv pk RF Current Rating 100 amps rms Length 9 1/2 inches Width 5 1/2 inches</p> 	<p>Type CVA-7</p> <p>Capacity Range 3.5-7 PF Voltage Rating 35 kv pk RF Current Rating 60 amps rms Length 4 1/2 inches Width 3 1/4 inches</p> 
<p>Type CFHA-1000</p> <p>Capacity 1000 PF Voltage Rating 50 kv pk RF Current Rating 200 amps rms Length 6 1/2 inches Width 7 inches</p> 	<p>Type CVHA-650</p> <p>Capacity Range 30-650 PF Voltage Rating 55 kv pk RF Current Rating 150 amps rms Length 10 2 1/2 inches Width 7 inches</p> 

Our radio frequency laboratory with 12 functioning transmitters ranging from 17 kc to 600 mc and up to 100 kw cw power is at your service to test our products under your particular circuit conditions.

Write for more detailed information regarding these capacitors.

RELIABILITY MEANS VACUUM / VACUUM MEANS

Jennings

JENNINGS RADIO MFG. CORP., 970 McLAUGHLIN AVE., SAN JOSE 8, CALIF., PHONE CYPRESS 2-4025

specify the new Bendix Products

AVNET

contact Avnet for best service

Pygmy types PT, SP; Pygmy crimp types PTCE, PTSE; MS, MS-E, MS-R, QWLD, SR rack and panel

on-time delivery of emergency

BENDIX

and prototype connector needs

Reg. U.S. Pat. & Tm. Office



call your Local Avnet Headquarters

AVNET

The Avnet System, coast to coast

CIRCLE 213 ON READER SERVICE CARD

DIGIAC

High Quality

Compact Low-Cost

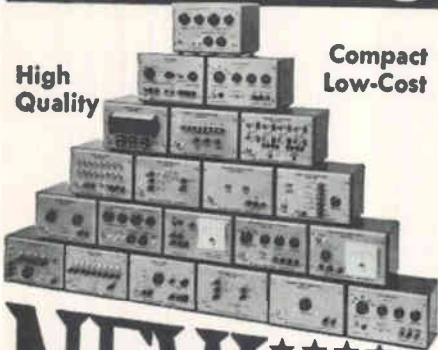

NEW

★★★★ CONCEPT in Laboratory Test Instrumentation &

★★★★ Digital Components

PULSE GENERATOR • PULSER • DECIMAL DISPLAY • DIGITAL TO ANALOG CONVERTER • COUNTER & REGISTER • WORD GENERATOR • HIGH GAIN AMPLIFIER • REGULATED VOLTAGE SINK • CLOCK PHASE GENERATOR • CRYSTAL CALIBRATOR • POWER SUPPLY • LOW FREQUENCY PULSE GENERATOR • HIGH VOLTAGE POWER SUPPLY • ANALOG TO DIGITAL CONVERTER • BINARY DISPLAY • RELAY DRIVER • DIFFERENCE AMPLIFIER • RANDOM NOISE GENERATOR • AND MANY OTHERS • NEW CATALOGUE NOW AVAILABLE



DIGITAL ELECTRONICS
2200 Shames Drive
Westbury, New York

nsec for a positive pulse. Fall times are the same. Amplitude of the output may be varied from 0 to 15 v and is 5 v into a load of 100 ohms. Digital Electronics, Inc., 2200 Shames Drive, Westbury, N. Y.

CIRCLE 315, READER SERVICE CARD

Water Soluble Fluxes Save Labor Costs

SERIES of water soluble fluxes that can be easily removed by water rinse have been developed. Company claims that these fluxes are weakly acidic or slightly basic, stable compounds with no toxic agents. Their salts have resistivities on the order of 10^7 ohms. Nearly all of the fluxes have temperatures of evaporation low enough so that with proper temperature control, residues can be eliminated even without water rinse. Company says basic theories of acids, bases, reductants, and carbon linkages were analyzed and more than a hundred possibilities were tried before their present family of fluxes was created. Connecticut Valley Chemicals, Inc., 178 Prince St., New York 12, N. Y. (316)



Transient Detector Aids Test Engineers

PORTABLE precision instrument for monitoring h-f transients in electronic/electrical systems is now in production. Model 2601 is designed to aid test engineers in detecting and eliminating transient impulses which create rfi and reliability problems with transistor electronics. Impulses as short as $0.1 \mu\text{sec}$ in duration can be detected. Adjustable detection levels measure the voltage amplitude of positive or negative transients occurring up to 3,000 per sec. High input impedance (9.0 megohms at 2.5 pf) pre-

Commercially Available FOR THE FIRST TIME

X-BAND TRIODE Oscillator

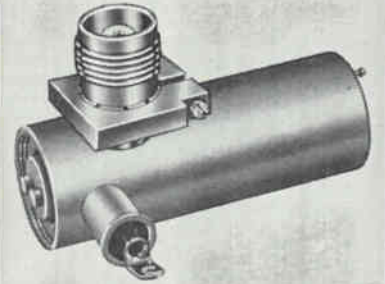

Trak Type 9170—Diameter $\frac{1}{4}$ in., length $2\frac{1}{4}$ in. including projections. Weight 2 ounces.

COMPARE ITS PERFORMANCE

... with any other type of local X-Band oscillator.

- It is tuneable over 500 Mc in the range from 8.0 to 9.6 Gc. (Compare this with solid state crystal oscillator-multiplier chains which are fixed frequency.)
- Power output is greater than 3 milliwatts, CW.
- Low voltage requirements—150 volts B+ and 6.3 volt heater supply. (Compare this with a Klystron.)
- Cleaner spectrum—residual AM and FM noise is far below reflex Klystrons.
- Frequency stable—5 ppm/ $^{\circ}\text{C}$ from -55°C to $+125^{\circ}\text{C}$.
- Smaller and lighter—than any other X-Band local oscillator that we know of on the market today.
- Replacement cost is low. You almost get a second oscillator free because the tube is replaceable.
- It's much more rugged—meets the toughest environmental tests for shock and vibration.
- Delivery now—small quantities are immediately available. On large orders, Trak Microwave has production facilities to meet your requirements.

TRAK STOCK OSCILLATORS COVER 400 Mc to 10 Gc.

Trak offers a complete line of microwave oscillators, 400 Mc. to 10 Gc., harmonic generators and amplifiers.

You can get immediate delivery of stock items and quick delivery of modified devices or prototypes.

Send for full information, or, if you are in a hurry, PHONE COLLECT—TAMPA 877-6735.

TRAK Microwave

TRAK MICROWAVE CORPORATION

5006 N. Coolidge Ave.
Tampa 3, Florida

Specialists In Miniature Microwave Energy Sources

PULSE POINTERS

Twin Pulse Feature
Now Standard On General
Purpose Pulse Generator



Model 3450D Pulse Generator

Modules expand capability of basic test instrument—Need a variety of special purpose design/test instrumentation? Investigate modular flexibility of Servo Corporation's SERVOPULSE™ Model 3450D. With twin pulse feature now standard, it can readily be modified to perform the function of six special purpose instruments. Rep rate is 2 mc-2 cps; rise time is 15 nanosec-0.5 μsec, continuously variable.

Modular Concept Applied To Test Instrumentation

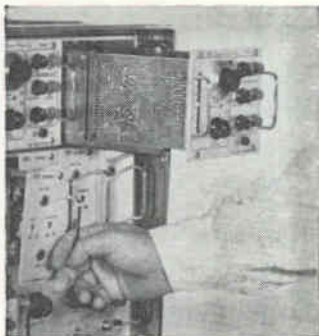

Plug-in module extended for service

Standard sub-assemblies reduce cost of special purpose equipment—

Plug-in modular construction is the basis for low-cost diversification in Servo Corporation's SERVOPULSE™ instruments line. Thirty-three cataloged instruments and 200 standard pulse and digital circuit modules afford unmatched instrument flexibility. Their advanced pulse techniques and circuitry are proved on major missile programs.

For complete details, write:

SERVOPULSE™ PRODUCTS
SERVO CORPORATION OF AMERICA



111 New South Road
Hicksville, L. I., N. Y.
WElls 8-9700

500 v. Keying rate is in excess of 1,000 baud. Ortronix, Inc., P.O. Drawer 8217, Orlando, Fla.

CIRCLE 319, READER SERVICE CARD



Pulse Generator Has Fast Rise Time

PULSE GENERATOR features a rise time of 400 picoseconds. Model 126 uses transistorized circuitry and a high speed coaxially mounted mercury switch to produce its fast rise times. The output waveform is very clean with negligible overshoot and ringing. Frequency is variable from 40 to 300 cps. The pulser will be useful in nuclear applications and for checking transient response of wide band systems, fast solid state switching circuitry and computer devices. Price is \$370. E-H Research Laboratories, Inc., 163 Adeline St., Oakland 20, Calif. (320)

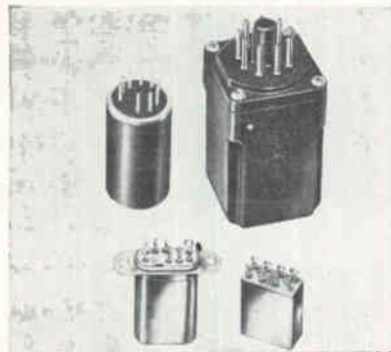

Reed Relays for High Speed Switching

THIRTEEN different models of reed relays are suited for use in computers, telemetry, automatic controls and similar sophisticated circuitry. The switching mechanism consists of magnetic reeds hermetically sealed in a glass capsule filled with an inert gas that inhibits oxidation. Life expectancies extend into the millions of cycles at maximum rating and into the hundreds of millions at low load conditions.

WHEATSTONE BRIDGE



±0.1%
ACCURACY

Model L-3C

Range:	.001Ω to 11.11MΩ
Rheostat Arm:	10x10+100x10+100Ω x10+1000Ωx10 (4 dials)
Ratio Arm:	x0.001, x0.01, x0.1, x1 x10, x100, x1000
Overall Accuracy:	100Ω to 100kΩ ±0.1% 10Ω to 1MΩ ±0.3% 1Ω to 10MΩ ±0.6%

Accurate resistance measurement achieved with a single unit. No accessories, no power source required. Operates on three type D, 1.5V dry cells, YEW's new, rugged galvanometer, Model G-2(B) incorporated. All 5 dials make no-rubbing contact and are dust-proofed, housed in individual plastic case. The L-3C has elastic mold unbreakable housing. Size: 7¼" x 9" x 5" Weight: 5 lbs. shipping weight: 10 lbs. Available for immediate delivery.

Cat No. 52402 \$156.00

CONFIDENCE BEGINS WITH

YEW

YOKOGAWA ELECTRIC WORKS, INC.

40 WORTH STREET NEW YORK 13, N. Y.
Area Code 212 Telephone: BEekman 3-6720

See YEW—WESCON Show—Booth 4533
CIRCLE 217 ON READER SERVICE CARD

AM-FM Tuner Unit



AM SEC. CAPACITY: MAX. 377PF
MIN. 12PF
TUBE: 6AQ8, 12DT8, 17EW8

PLASTIC
VARIABLE CONDENSER

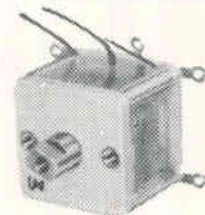

Square Size:
15mm., 17mm.,
20mm., 21mm.,
Single band:
2 band, 3 band
and for FM only.



SANKAISHA CO., LTD.

Cable address: SANESVARICON TOKYO
1425, 4-chome, Higashinakanobu,
Shinagawa-ku, Tokyo, Japan.

CIRCLE 218 ON READER SERVICE CARD

Several styles are available with a variety of contact arrangements from spst to 4pdt and in octal, plug-in and subminiature models. Dormeyer Industries, 3418 Milwaukee Ave., Chicago 41, Ill. (321)

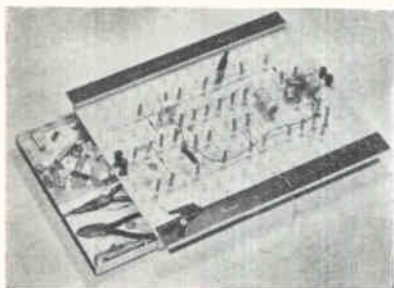

Breadboard Solves Workbench Problem

NEW Mark V breadboard is a solution to the electronic engineers' workbench problem. Circuit diagrams can either be drawn or placed on the schematic transferal board and seen from the work surface above. There is no need for soldering components for the spring connectors are very sturdy and gold plated to assure good electrical contact. The Mark V measures 14 by 17 in., weighs 4½ lb and costs \$29.95 net. Phillips Control Co., 59 West Washington, Joliet, Ill. (322)



Miniature Capacitors Encapsulated in Epoxy

CERAMIC capacitor in model EA-4 case measures 0.125 diameter by 0.250 long. Type 2042 capacitors are encapsulated in machined epoxy cases, and are designed to operate over a temperature range of -55 C to +125 C at full working voltage (100 v d-c). Capacitance values range from 10 pf to 56,000 pf, with standard capacity tolerance of ±10 percent. Total capacitance drift over the temperature range is guaranteed less than ±15 percent. The Potter Co., 7351 North Lawndale, Skokie, Ill. (323)

MIL-C-19978B
MIL-C-19978B
MIL-C-19978B
MIL-C-19978B
MIL-C-19978B
MIL-C-19978B
MIL-C-19978B
MIL-C-19978B
MIL-C-19978B
MIL-C-19978B
MIL-C-19978B
MIL-C-19978B
MIL-C-19978B
MIL-C-19978B

Certifying data with respect to test qualifications available. All data compiled by a government approved testing laboratory.

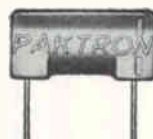

MR-700



MR-330

Paktron MOLDED MINIATURE MYLAR* CAPACITORS—MR330 and MR700—provide the widest possible capacitance range and most useful voltage ratings in the smallest physical size consistent with HIGH PERFORMANCE AND RELIABILITY.

For specific information regarding performance characteristics, write today.

*Dupont Polyester Film

it **PAKTRON**
W DIVISION ILLINOIS TOOL WORKS INC.
1321 LESLIE AVENUE • ALEXANDRIA, VIRGINIA

**"WHERE'S THAT TAPE
OF 'THE ALLIGATOR GLEE CLUB
AT CARNEGIE HALL'?"**

Oh, hello Rip! You got here just in time. Drop that demo on the bench and listen to this tape. It's part of a new batch that Station 16 just sent in — even worse than the ones I was telling you about.

Worse? I'll say! Sounds like a sped-up playback of "Concerto for Seagulls and Fish Pier"! But I thought you said you were getting groans and burps?

That's what's rough — the stations NEVER know what kind of interference they'll get next! You told me I don't need two separate filters — how is this one Krohn-Hite black box going to clear up the confusion?



Because the 315-A is two filters . . . matter of fact, three, on one chassis. As I get it, your radio-telephone transmissions are being loused up by all kinds of noise and interference — above, below, or right in the middle of the intelligence band, and never in the same place twice. Now start that "Screaming Meemy" tape again, while I plug the 315-A into the monitor output and listen through the filter with these earphones. At the stations, they'd do just about the same on live transmission, except that when they had set the filter to maximize the intelligence, they would just switch it right into the line at any convenient a-f stage. . . . I see what you mean — I can barely make out the voice, with a horrible hash above it and below it too. Now let me switch to band-pass, and move in from the ends with both cut-offs independently. I'll spin through that top decade below 200 kc fast, since for this work you'd never hear the difference. But I just dropped out a thump somewhere down around 30 cycles — probably someone chopping liver! Here you are . . . listen to this . . . clear as a bell!

So far so good. But keep listening. Just about here I think a pig got stuck — skewered real good at about 2 kc. Watch the gain!

Owwwww — I just found it! Quick — let me find a real DEEP null for my aching ears! We turn to band-reject, sneak in from the sides with both dials, and . . . I think somebody just told that pig "down boy! 60 db down!!" Listen for yourself. That makes both types we've cleaned up!

I think you've just made yourself a sale. But wait a minute — you said the 315-A is THREE filters. What's the third function?

High-pass! ALSO tuneable all the way from 20 cps to 200 kc, with the same 24 db per octave attenuation outside the pass band. And if you ever get squawk patterns in the same spots, don't forget — the dials are direct reading and calibrated to 10%. Log 'em and kill 'em fast. Now — how about lunch to celebrate, at a low-decibel restaurant?

I'm with you!



**KROHN-HITE
CORPORATION**

580 Massachusetts Avenue, Cambridge 39, Mass.
Area Code 617 491-3211

Pioneering in Quality Electronic Instruments

Literature of the Week

MILLIMETER TUBES Amperex Electronic Corp., 230 Duffy Ave., Hicksville, L. I., N. Y., has published a bulletin covering millimeter tubes and components for industry and research.

CIRCLE 324, READER SERVICE CARD

D-C POWER SUPPLIES Power Devices, Inc., 9760 Cozycroft, Chatsworth, Calif. Double regulated d-c power supplies for bench or system use are described in a two-page catalog sheet. (325)

WIRE & CABLE Belden Mfg. Co., 415 S. Kilpatrick Ave., Chicago 44, Ill., announces availability of its 1963 Electronic Wire Catalog. (326)

POWER-AGING EQUIPMENT Wyle Manufacturing, 133 Center St., El Segundo, Calif. A 12-page booklet describes various types of power-aging equipment for semiconductors and other small components. (327)

INSTRUMENT TRANSFORMERS James Electronics, Inc., 4050 N. Rockwell St., Chicago 18, Ill., offers a catalog covering 68 different instrument transformers for use in analog acquisition, d-c amplifiers, a-c instrumentation and geophysical and medical fields. (328)

AIR-MOVING DEVICE Rotron Mfg. Co., Inc., Woodstock, N. Y. Complete technical information on the new Feather Fan is available in a 6-page catalog. (329)

VIDEO VOLTMETER Ballantine Laboratories, Boonton, N. J., has published a technical bulletin that describes model 314A sensitive video voltmeter. (330)

LOGIC MODULES Raytheon Co., Norwood, Mass. A 60-page logic module handbook provides input and output loading data, performance characteristics, and new low price schedules. (331)

R-F INSTRUMENTS Ferris Instrument Co., Boonton, N. J., has published a six-page catalog illustrating and describing a complete line of precision r-f instruments. (332)

AUTOMATIC DATA PROCESSING General Electric Co., Computer Department, Phoenix, Ariz. Brochure CPB-257F, entitled "Assembly Line Balancing On the GE-225 Computer—For Sound Manpower Planning", is available. (333)

PCM TELEMETRY EQUIPMENT Monitor Systems, Inc., Fort Washington, Pa. Comprehensive series of five brochures, in attractive folder, describes pcm telemetry equipment currently in production. (334)

BOBBIN WINDER Gorman Machine Corp., 480 South Main St., Randolph, Mass. Bulletin describes the Spin Winder, a versatile dual head bobbin winder that can be set up

easily for any size bobbin up to 3 in. diameter and 2½ in. long with minimum tooling. (335)

ZENER DIODES National Transistor, a subsidiary of International Telephone and Telegraph Corp., 500 Broadway, Lawrence, Mass., has released B-106, a new Zener diode cross reference chart. (336)

ULTRASONIC SOLDER POTS The Redford Corp., Schenectady 3, N. Y., has released two bulletins containing information on two types of ultrasonic solder pot. (337)

CROSS-LINKED POLYSTYRENE The Polymer Corp., 2120 Fairmont Ave., Reading, Pa. Bulletin describes the properties and uses of Polypenco cross-linked polystyrene, a rigid, clear, transparent insulating material. (338)

DAC CALIBRATOR Telemetry, Inc., 12927 So. Budlong Ave., Gardena, Calif. Data sheet 9 describes model 6206 calibrator, which powers, displays and calibrates up to 50 digital-to-analog converters. (339)

BALANCED ARMATURE RELAYS C. P. Clare & Co., 3101 W. Pratt Blvd., Chicago 45, Ill. Three high reliability balanced armature relays are described in detail in data sheet No. 753. (340)

H-F POWER AMPLIFIER Collins Radio Co., Cedar Rapids, Iowa. Six-page folder is devoted to a 10-Kw h-f linear power amplifier. (341)

SUPERCONDUCTING WIRE Westinghouse Materials Mfg. Division, Blairsville, Pa., has published a bulletin that tells the current availability and price of niobium-zirconium superconducting wire. (342)

D/A CONVERTER Scientific Data Systems, 1649 Seventeenth St., Santa Monica, Calif. Information bulletin describes a low cost digital-to-analog converter. (343)

INDUCTIVE POT CORES Ferroxcube Corp. of America, Saugerties, N. Y. A new design and selection chart for inductive pot cores is now available (344)

COMPUTER PRODUCTS Ampex Corp., 934 Charter St., Redwood City, Calif., has released an 8-page catalog on its complete line of computer products. (345)

SILVER-ZINC BATTERIES Epic Inc., 150 Nassau St., New York 38, N. Y. Two-page bulletin illustrates and describes miniature silver-zinc chargeable batteries. (346)

TRANSFORMERS Central Transformer Co., 900 W. Jackson Blvd., Chicago 7, Ill. Bulletin G100A contains practical data for estimating and specifying transformers. (347)

SCOPE CAMERA SYSTEMS Analab Instrument Corp., Cedar Grove, N. J. Catalog AN-TDS-505 describes a line of oscilloscope camera systems and accessories for Polaroid, and the new continuous motion 35-mm fast developing film. (348)

PUSH TO TEST

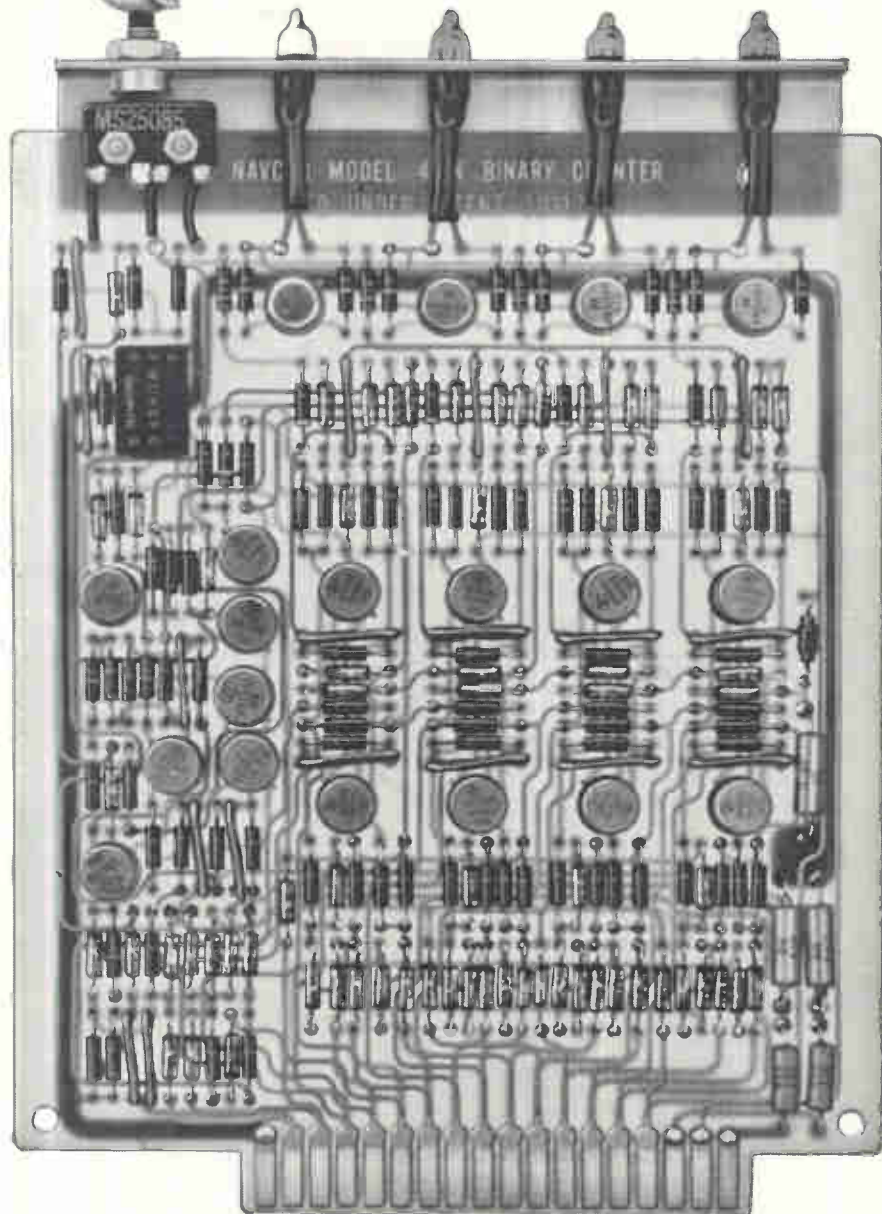

Push a button . . . follow the operation of a Navcor 400 Series system function module one logical step at a time on the neon indicator lights. Each module is a complete system function, grouping many logic elements. Push button and lights permit positive checkout in a fraction of the time required with less sophisticated flip-flops. Write for data on complete MIL Standard line of

Transistorized Digital System Function Modules

NAVCOR

VALLEY FORGE INDUSTRIAL PARK

930 RITTENHOUSE ROAD, NORRISTOWN, PA. • GL 2-6531

Airpax Completes \$1 Million Plant



AIRPAX ELECTRONICS Incorporated has announced the completion of its new \$1 million air-conditioned, fire-proof plant in Cambridge, Md. The facility is devoted entirely to the manufacture of miniature choppers and circuit breakers. Interior design is such as to permit efficient "flow through" of materials and parts to finished products for stock or immediate shipment.

The new plant has an area of 94,000 square feet and is designed to permit future expansion. The production area is over 13,000 square feet and features special "clean" assembly lines equipped with modern filtering facilities.



Elect Bartholomew Vice President

JOSEPH F. BARTHOLOMEW has been elected vice president of Epsco, Inc. and appointed marketing department manager of the newly formed Cambridge division of the Cam-

Other areas, completely isolated from the production area, house a centralized machine shop, impregnating, plating, paint, shipping, receiving, and maintenance departments.

Engineering, model shop, drafting and environmental testing facilities are so integrated as to permit new design, prototypes, and complete testing to be efficiently done in a single area.

The new plant replaces the one destroyed by fire in July, 1962. Airpax also has a plant in Fort Lauderdale, Florida, which specializes in the manufacture of telemetry equipment, discriminators and transformers.

bridge, Mass., analog and digital electronics manufacturer.

Bartholomew has been elevated to this position after several years with Epsco in varied marketing positions.

Wabash Magnetics Promotes Executives

WABASH MAGNETICS, Inc., Wabash, Ind., has announced three executive promotions.

Bernard F. Forrest, vice president of manufacturing, has been appointed vice president and assistant to the president. The newly created position of vice president of operations will be filled by

Shethar Davis, presently director of marketing. Robert O. Jefferson, assistant vice president of manufacturing, has been promoted to vice president and general manager of the company's Deluxe Coils and Hi-Voltage divisions.



Thornton Accepts Elgin Position

RICHARD P. THORNTON has been appointed general manager of Elgin Laboratories, Waterford, Pa., a subsidiary of Erie Resistor Corp.

Prior to joining Elgin, Thornton was with the Armour Research Foundation as a management consultant.



Elect Thomas Nast To Top Post

THE BOARD of directors of Robinson Technical Products, Inc., Teterboro, N. J., has announced the election of Thomas Nast as president and chief executive officer of the corporation. He had been executive vice president of the corporation and president of the Kensico Tube division, Mt. Kisco, N. Y.

Nast replaces C. S. Robinson, founder, who becomes chairman of



DON'T OVERLOOK THE VARIETY OF CIRCUITRY

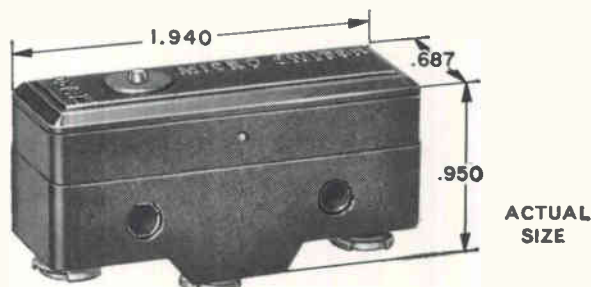

AVAILABLE IN SMALL SWITCHES

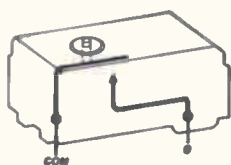

Single-pole single-throw normally open.

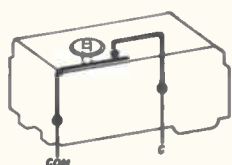

Single-pole single-throw normally closed.

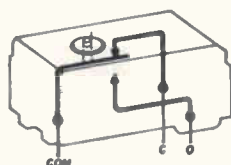

Single-pole double-throw.

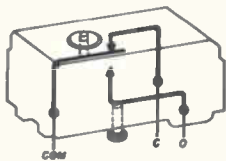

SPDT reset switches, either "trip-free" (non-recycling) or recycling type.

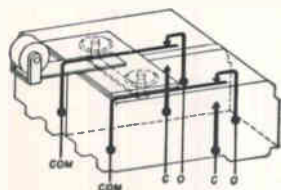

Two SPDT circuits with a single actuator.

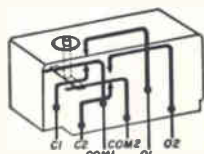

Double-pole double-throw.

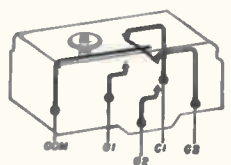

Split-contact double throw.

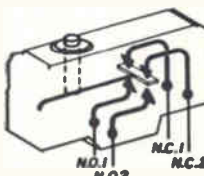

Double-break.

Small switches are providing simple answers to an increasing variety of design problems. These space savers are available in a wide variety of contact arrangements—often eliminating the need for complicated wiring and extra components—greatly simplifying system design. And, all are quickly available from stock.

This broad MICRO SWITCH line of small switches also offers many different actuator and terminal types.

For complete application information, contact our Branch Office (see Yellow Pages), or write for Catalog 62.

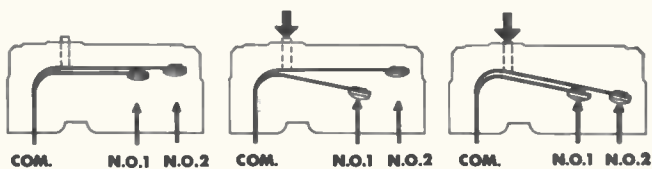

*Make-before-make action closes one circuit before closing the second circuit.

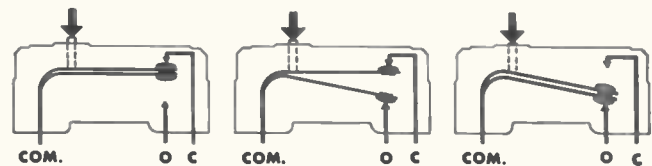

*Make-before-break action transfers circuit without interruption.

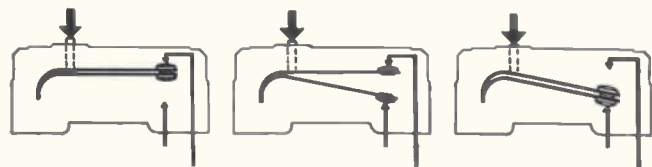

*Two moving contacts provide single electrical pulse.

*Drawings indicate action.



MICRO SWITCH

FREEMONT, ILLINOIS

A DIVISION OF HONEYWELL

IN CANADA: HONEYWELL CONTROLS LIMITED, TORONTO 17, ONTARIO

HONEYWELL INTERNATIONAL—SALES AND SERVICE OFFICES IN ALL PRINCIPAL CITIES OF THE WORLD. MANUFACTURING IN UNITED STATES, UNITED KINGDOM, CANADA, NETHERLANDS, GERMANY, FRANCE, JAPAN.

**Immediate
delivery!**

**ELMENCO
CAPACITORS**

in quantities up to
500 Per Item

CONTACT THESE AUTHORIZED

ELMENCO INDUSTRIAL DISTRIBUTORS

ALABAMA, Huntsville: Electronic Wholesalers, Inc.
ARIZONA, Phoenix: Kierulff Electronics, Inc.,
Midland Specialty Co.

CALIFORNIA, Glendale: R. V. Weatherford Co.,
Inglewood: Newark Electronics Co. Inc., Los
Angeles: Federated Purchaser, Inc., Hollywood
Radio & Electronics Inc., Kierulff Electronics,
Inc., Shelley Radio Co., Inc., Mountain View:
Kierulff Electronics, Inc., Oakland: Brill
Electronics, Palo Alto: R. V. Weatherford Co., Zack
Electronics, Riverside: Electronic Supply of
Riverside, San Diego: Shanks & Wright, San
Francisco: Pacific Wholesale Co., San Jose: Pen-
insula Electronic Supply Inc.

COLORADO, Denver: Denver Electronic Supply Co.
DISTRICT OF COLUMBIA, Capitol Radio Whole-
salers, Inc., Electronic Wholesalers, Inc.

FLORIDA, Melbourne: Electronic Wholesalers
Inc., Miami: Electronic Wholesalers Inc. Dr-
lando: Hammond Electronics Inc.

ILLINOIS, Chicago: Allied Electronics Corp.,
Newark Electronics Corp.

MARYLAND, Baltimore: D & H Distributing Co.,
Electronic Enterprises, Inc., Kann-Ellert El-
ectronics Inc., Wholesale Radio Parts Co., Inc.

MASSACHUSETTS, Newton: Cramer Electronics,
Inc. Cambridge: Electrical Supply Corp.

NEW JERSEY, Camden: General Radio Supply
Co., Radio Electric Service Co. of N. J. Inc.,
Mountainside: Federated Purchaser, Inc.

NEW MEXICO, Alamogordo: Radio Specialties Co.,
Inc., Albuquerque: Electronic Parts Co., Inc.

NEW YORK, Binghamton: Stack Industrial El-
ectronics Inc., Mineola: Arrow Electronics Inc.,
N. Y. C.: Electronics Center, Inc., Harvey Radio
Co., Inc., Lafayette Radio Electronics Corp., Milo
Electronics Corp., Terminal-Hudson Electronics
Co., Inc., Woodside: Boro Electronics, Inc.

NORTH CAROLINA, Winston-Salem: Electronic
Wholesalers Inc.

PENNSYLVANIA, Harrisburg: D & H Distributing
Co., Inc., Philadelphia: Almo Radio Co., Phila.
Electronics Inc., Radio Electric Service Co. of
Penna., Inc., Reading: George D. Barbay Co.,
Inc., York: Wholesale Radio Parts Co., Inc.

TENNESSEE, Nashville: Electra Distributing Co.
Inc.

TEXAS, Dallas: All-State Electronics Inc., Engi-
neering Supply Co., El Paso: Midland Specialty
Co., Houston: Busacker Electronic Equipment
Co., Inc.

UTAH, Salt Lake City: Standard Supply Co.

WASHINGTON, Seattle: C & G Electronics Co.

CANADA, Montreal, Quebec: Atlas Wholesale
Radio, Inc., Toronto, Ontario: Electro Sonic Sup-
ply Co. Ltd.

**ARCO
electronics inc.**

Community Drive, Great Neck, New York

NEW YORK • DALLAS • LOS ANGELES
Exclusive Supplier of ELMENCO Capacitors to
Distributors and Jobbers in U.S.A. and Canada

the board. Robinson will continue as president of the Robinson Vibra-shock division.



EOS Advances Sigoloff

SANFORD C. SIGOLOFF has been elected a vice president of Electro-Optical Systems, Inc., Pasadena, Calif. He also continues in his present position as corporate manager of operations, according to A. M. Zarem, president.

Prior to joining EOS, Sigoloff was manager of operations for the Santa Barbara division of Edger-ton, Germeshausen and Grier, Inc.

ITT Elects Luke Vice President

ELECTION of Stanley Luke as a vice president of International Tele- phone and Telegraph Corporation has been announced by Harold S. Geneen, president.

Luke was also named director of business development for the North American Area of ITT, which is headed by vice president John J. Graham.

Formerly an assistant vice presi- dent, Luke has been associated with ITT in various executive capacities both in the United States and abroad for the past 18 years.

Bendix-Red Bank Names Palmer

JAMES L. PALMER has been named manager of the electron tube sec-

tion of The Bendix Corporation's Red Bank division, Eatontown, N.J. He succeeds John H. Wyman who will continue with the division in a staff position.

Since 1961, Palmer has been man- ager of research and development for the Huggins Company, Sunny- dale, Calif.



Torrington Appoints Petricone

WILLIAM R. PETRICONE has been ap- pointed general manager of the Western division of The Tor- rington Manufacturing Company in Van Nuys, Calif. He will be in charge of manufacturing and all staff fuctions in the production of Torrington's fans, blowers and specialty blower units in the west- ern states.

Petricone joined Torrington Manufacturing in 1958.



Askanas Accepts New Fairchild Post

FAIRCHILD SEMICONDUCTOR has ap- pointed Charles Askanas to the position of plant manager, Instru-

Here is MEASURED RELIABILITY!

DUR-MICA CAPACITORS TYPE M2DM

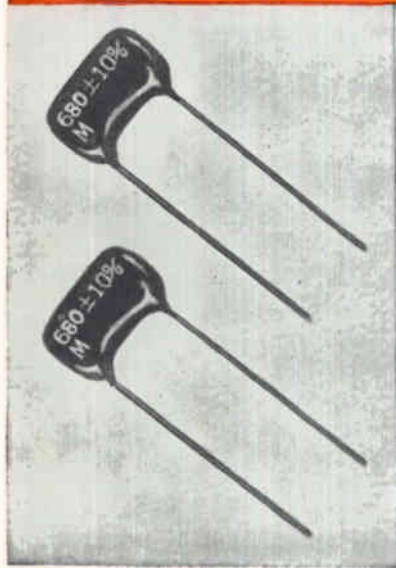

Ten thousand EL-MENGO high reliability dipped mica capacitors were put on life test at 85°C with 225% of the rated DC voltage applied—After 26,500,000 actual test unit-hours no failures of any type occurred.

The accumulated 26.5×10^6 test unit-hours without any failures can be used to calculate many different failure rates depending upon the confidence level desired. However, we shall explore the meaning of the results at a 90% confidence level.

Assuming no acceleration factor for either temperature or voltage, we have verified a failure rate of less than 0.01% per 1000 hours. (Actually, there is a temperature effect and it has been found that, with the DC voltage stress remaining constant, the life decreases approximately 50% for every 10°C rise in temperature. There is also a voltage effect such that, with the temperature stress remaining constant, the life is inversely proportional to the 8th power of the applied DC voltage.)

Assuming no temperature acceleration factor and assuming the voltage acceleration exponent is such as to yield an acceleration factor as low as 100, we have nevertheless verified a failure rate of less than 0.0001% per 1000 hours.

Assuming no temperature acceleration factor and assuming the voltage acceleration factor is on the order of 250 (test results are available to confirm this) we have accumulated sufficient unit-hours to verify a failure rate of less than 0.00004% per 1000 hours!

Note that all the above failure rates are calculated at a 90% confidence level!

Only 1 Failure in 14,336,000 Unit-Hours for 0.1 MFD Capacitors

Life tests have proved that El-Menco Mylar-Paper Dipped Capacitors — tested at 105°C with rated voltage applied — have yielded a failure rate of only 1 per 14,336,000 unit-hours for 1.0 MFD. Since the number of unit-hours of these capacitors is inversely proportional to the capacitance, 0.1 MFD El-Menco Mylar-Paper Dipped Capacitors will yield ONLY 1 FAILURE IN 14,336,000 UNIT-HOURS.

MINIMUM LIFE EXPECTANCY FOR 1.0 MFD** MYLAR-PAPER DIPPED CAPACITORS AS A FUNCTION OF VOLTAGE & TEMPERATURE

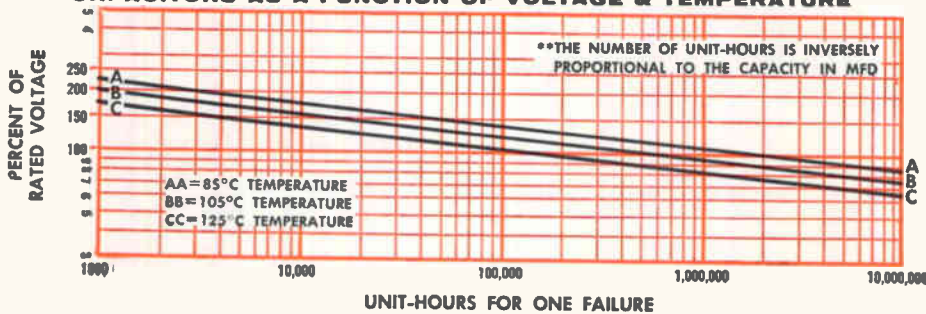

* Registered Trade Mark of DuPont Co.

Write for Reliability Study and technical brochures.

MYLAR-PAPER DIPPED CAPACITORS TYPE MPD

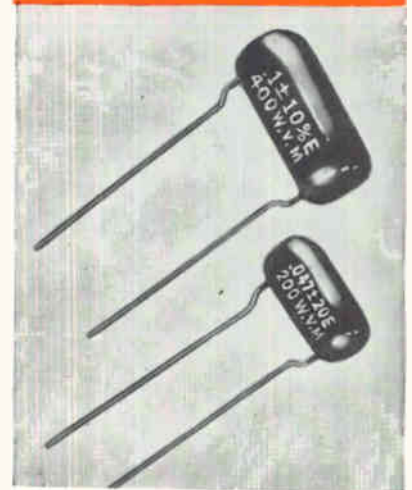

THE ELECTRO MOTIVE MFG. CO., INC.

WILLIMANTIC, CONNECTICUT

*Dipped Mica • Molded Mica • Silvered Mica Films • Mica Trimmers & Padders
Mylar-Paper Dipped • Paper Dipped • Mylar Dipped • Tubular Paper*

ARCO ELECTRONICS, INC., Community Drive,
Great Neck, L. I., New York
Exclusive Supplier to Jobbers and Distributors
in the U. S. and Canada

West Coast Manufacturers Contact:
COLLINS & HYDE CO., 535 Middlefield Road,
Palo Alto, California
3380 Whittier Blvd., Los Angeles, Calif.

MANUFACTURERS OF
El-Menco
Capacitors

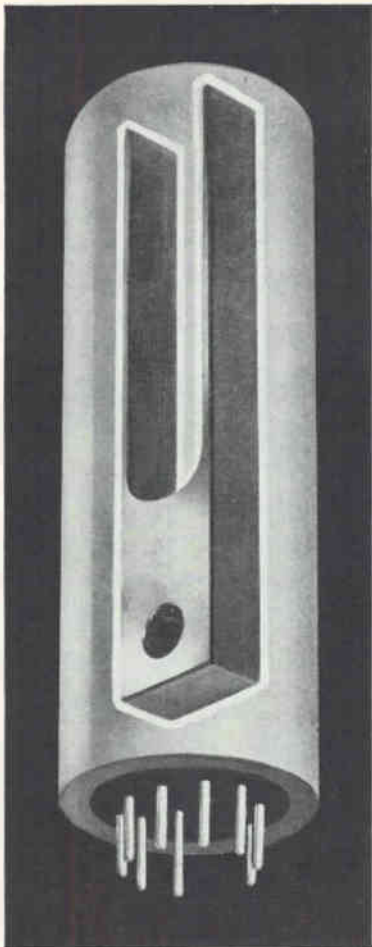

achieve

STABLE FREQUENCY

with Varo
miniature tuning forks
and transistorized
fork oscillators

- Computer Clock Pulses
- Rotary and Static Power Supplies
- Tape Recorders
- Narrow Bandwidth Filters
- Facsimile Equipment
- Lab Frequency Standards

Frequency stability .1% to .01% in a temperature range from —65 C. to 125 C. Frequencies up to 4kc. Missile Environment.

For additional information write:

VARO INC

ELECTROKINETICS DIV.

P.O. Box 1500, Santa Barbara, Calif.
Area Code 805 966-3116

CIRCLE 219 ON READER SERVICE CARD

HERE IS THE WORLD'S SMALLEST MOTOR YET IT'S SO POWERFUL . . .

MITSUMI MICRO MOTOR



MODEL MI-100

Less than 20mm in diameter, the new Mitsumi Micromotor provides a startling efficiency of over 50%, the barrier which miniature motors are not allowed to pass.

A novel construction principle helped to make this accomplishment possible. The form is more simplified by setting all the terminals at one position. Because the entire mechanism is given full protection against irregular revolution and above all, electrical noise is entirely eliminated, you may call this the most perfect micromotor yet devised. Please write for complete information on Mitsumi Micromotor, and we will send you specifications and data.



MITSUMI PARTS

MITSUMI ELECTRIC CO., LTD.

TOKYO • OSAKA • NEW YORK

mentation Facility, in Palo Alto, Calif. In this newly created position, he will be responsible for engineering and production of the firm's product line of component test and measuring equipment.

Previously, Askanas was a project manager for automatic instrumentation with Lumatron Electronics, and most recently, he was eastern regional staff engineer for Fairchild Semiconductor (Instrumentation).

PEOPLE IN BRIEF

Daniel A. Worsham leaves Fairchild Semiconductor Corp. to join Siliconix Inc. as mfg. mgr. Ira Zames, formerly with Polarad Electronics Corp., named administrative coordinator at Pilot Radio Corp. William E. Baird promoted by GE to mgr. of mfg. for the Process Computer Section. John J. McKenna advances to mgr. of service engineering for the Aero-Space div. of Walter Kidde & Co., Inc. Burroughs Corp. ups F. R. Caudle, Jr., to g-m of its new Norwegian subsidiary, Burroughs S/A. Frank L. Weston, previously with Acme Steel Co., appointed director of industrial engineering for Oak Mfg. Co. Joseph F. Fischer moves up to chief engineer of Genistron, Inc. Eugene J. Bourque promoted to works mgr. of the Diode and Rectifier dept. of Motorola's Semiconductor Products div. Henry N. Bowes, ex-General Dynamics Corp., named mgr., training devices project, at Lockheed Electronics Co. General Technology Corp. upgrades three staff members to the positions of v-p: George A. Bronson, Stuart L. Ridgway, and Donald J. Farmer. E. Robert Keibbon, from Curtiss-Wright to Elizabeth div. of Elastic Stop Nut Corp. of America as AGASTAT chief engineer. Billy M. McCormac, formerly with the Defense Atomic Support Agency, named scientific advisor to the Physics div. at IIT Research Institute. Floyd D. Shipley advances to chief engineer at Decibel Products, Inc.

electronics

WEEKLY QUALIFICATION FORM FOR POSITIONS AVAILABLE

ATTENTION: ENGINEERS, SCIENTISTS, PHYSICISTS

This Qualification Form is designed to help you advance in the electronics industry. It is unique and compact. Designed with the assistance of professional personnel management, it isolates specific experience in electronics and deals only in essential background information.

The advertisers listed here are seeking professional experience. Fill in the Qualification Form below.

STRICTLY CONFIDENTIAL

Your Qualification form will be handled as "Strictly Confidential" by ELECTRONICS. Our processing system is such that your form will be forwarded within 24 hours to the proper executives in the companies you select. You will be contacted at your home by the interested companies.

WHAT TO DO

1. Review the positions in the advertisements.
2. Select those for which you qualify.
3. Notice the key numbers.
4. Circle the corresponding key number below the Qualification Form.
5. Fill out the form completely. Please print clearly.
6. Mail to: Classified Advertising Div., ELECTRONICS, Box 12, New York 36, N. Y. (No charge, of course).

COMPANY	SEE PAGE	KEY #
ATOMIC PERSONNEL INC. Philadelphia, Pa.	72*	1
BUREAU OF SHIPS Department of the Navy Washington, D. C.	70*	2
5th NAVAL DISTRICT Dept. of the Navy Portsmouth, Virginia	113	3
HEWLETT-PACKARD CO. 1501 Page Mill Rd. Palo Alto, Calif.	128	4
INTERNATIONAL BUSINESS MACHINES CORP. Space Guidance Center Owego, New York	72*	5
SOCONY MOBILE OIL CO. INC. Dallas 21, Texas	72*	6
SPACE & INFORMATION SYSTEMS Div. of North American Aviation, Inc. Downey, Calif.	66*	7
SPACE TECHNOLOGY LABORATORIES, INC. Sub. of Thompson Ramo Wooldrige Inc. Redondo Beach, California	13	8
UNITED AIRLINES San Francisco 28, California	128	9

* These advertisements appeared in the July 12, issue.

(cut here)

electronics WEEKLY QUALIFICATION FORM FOR POSITIONS AVAILABLE

(cut here)

(Please type or print clearly. Necessary for reproduction.)

Personal Background

NAME

HOME ADDRESS

CITYZONE.....STATE.....

HOME TELEPHONE

Education

PROFESSIONAL DEGREE(S)

MAJOR(S)

UNIVERSITY

DATE(S)

FIELDS OF EXPERIENCE (Please Check)

71963

- | | | |
|--|--|---------------------------------------|
| <input type="checkbox"/> Aerospace | <input type="checkbox"/> Fire Control | <input type="checkbox"/> Radar |
| <input type="checkbox"/> Antennas | <input type="checkbox"/> Human Factors | <input type="checkbox"/> Radio-TV |
| <input type="checkbox"/> ASW | <input type="checkbox"/> Infrared | <input type="checkbox"/> Simulators |
| <input type="checkbox"/> Circuits | <input type="checkbox"/> Instrumentation | <input type="checkbox"/> Solid State |
| <input type="checkbox"/> Communications | <input type="checkbox"/> Medicine | <input type="checkbox"/> Telemetry |
| <input type="checkbox"/> Components | <input type="checkbox"/> Microwave | <input type="checkbox"/> Transformers |
| <input type="checkbox"/> Computers | <input type="checkbox"/> Navigation | <input type="checkbox"/> Other |
| <input type="checkbox"/> ECM | <input type="checkbox"/> Operations Research | <input type="checkbox"/> |
| <input type="checkbox"/> Electron Tubes | <input type="checkbox"/> Optics | <input type="checkbox"/> |
| <input type="checkbox"/> Engineering Writing | <input type="checkbox"/> Packaging | <input type="checkbox"/> |

CATEGORY OF SPECIALIZATION

Please indicate number of months experience on proper lines.

	Technical Experience (Months)	Supervisor Experience (Months)
RESEARCH (pure, fundamental, basic)
RESEARCH (Applied)
SYSTEMS (New Concepts)
DEVELOPMENT (Model)
DESIGN (Product)
MANUFACTURING (Product)
FIELD (Service)
SALES (Proposals & Products)

CIRCLE KEY NUMBERS OF ABOVE COMPANIES' POSITIONS THAT INTEREST YOU

1 2 3 4 5 6 7 8 9 10 11 12 13 14 15

1
Tie faster,
easier,
tighter!

2
Form knots
that
don't slip!

3
Greater
stability
under
high heat!

WHAT DO YOU WANT
LACING CORDS and TAPES
TO DO FOR YOU?



NYLON and DACRON CORDS
FLAT BRAIDED TAPES
and TEFLON COATED
FIBERGLAS TAPES

GIVE YOU
ALL THESE ADVANTAGES

Available in wax-coated, wax-free or "G.E." finish
Write for free samples and specification book.

THE HEMINWAY & BARTLETT MFG. CO.
Electronics Division: 500 Fifth Avenue, New York 36, N.Y.

CIRCLE 220 ON READER SERVICE CARD

DIRECT
VACUUM
READINGS
to less than

10⁻¹³
torr

with NRC'S
REDHEAD
MAGNETRON
GAUGE

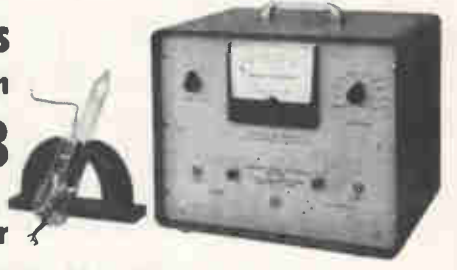

The Model 752 has several unique advantages - High Sensitivity of 4.5 amperes per millimeter of mercury - 50 times that of hot wire ionization gauges - Cold Cathode Operation which keeps the vapor pressure of gauge elements below operation pressures - eliminates contamination by metallic vapors... No Out-gassing Circuit required which simplifies operation... Self Regulating Emission which keeps X-ray background current always much lower than the ionization current.

Write today for data sheet and prices for the Model 752.



A Subsidiary of National Research Corp.
160 Charlemont Street,
Newton 61, Massachusetts

MANUFACTURING PLANTS IN NEWTON, MASS., AND PALO ALTO, CALIF.
CIRCLE 221 ON READER SERVICE CARD

CLASSIFIED

SEARCHLIGHT SECTION

ADVERTISING

EMPLOYMENT • BUSINESS • OPPORTUNITIES • EQUIPMENT—USED or RESALE

ELECTRONIC MARKETING MANAGER—FRANCE

French manager wanted to assume complete responsibility of new Hewlett-Packard sales office in Paris. Applicant must be French National who desires to live permanently in Paris. Technical background in electronics, plus sales engineering or sales management experience essential. Salary & benefits commensurate with French industry. Starting salary between N.F. 50,000 and 60,000. Growth opportunity unlimited. Write in confidence to: Mr. N. O. Williams, Professional Employment Supervisor.

Hewlett-Packard Company

1501 Page Mill Road, Palo Alto, California

An equal opportunity employer.

ENGINEERS

Electrical, Aeronautical, Mechanical Engineers wanted in San Francisco to conduct the technical engineering required to provide safety, reliability, and efficiency of all aircraft operations. Airline engineers develop basic standards, specifications, and procedures for the installation, operation, maintenance, inspection, and testing of aircraft and allied equipment. They evaluate service performance and develop and design modifications, working closely with component manufacturers.

Experience desired but not required in Structures, Hydraulics, Pneumatics, Mechanical Systems, Radio, Electric Power, Servo Controls, Autopilots, Instrumentation, Turbine Power Plants, and Airplane Performance.

Salary commensurate with experience. Permanent career with excellent company benefits including family travel privileges here and abroad. Write today, enclosing resumes and salary history to: Mr. R. W. Lackey, Regional Employment Manager, Dept. E, United Air Lines, San Francisco International Airport, San Francisco 28, California.

UNITED AIR LINES

An Equal Opportunity Employer

RADIO RESEARCH INSTRUMENT CO.

AUTO-TRACK & TELEMETRY ANTENNA PEDESTALS
3 & 10 CM. SCR. 584 AUTOTRACK RADARS.
AN/TPS-10 SEARCH. AN/TPS-10 HY. FINDERS.
AN/FPN-32GCA. AN/APS-10 NAVIG. & WEATHER.
AN/APS-15B PRECISION. AN/APG-35B PRECISION.
AN APS-31A SEARCH. OZENS MORE.
5-1-2 MEGAWATT HIGH POWER PULSERS.

RADIO RESEARCH INSTRUMENT CO.
550 Fifth Ave., New York Judson 6-4691

RADAR SYSTEMS & COMPONENTS/
IMMEDIATE DELIVERY

CIRCLE 950 ON READER SERVICE CARD

Antique

TELEPHONES

As is complete, decorative purpose \$12.00. Working order, inter-comm. \$15.00 Ext. on dial \$17.50. talking circuit only. Write for complete list. All shipments FOB, Simpson, Pa.

TELEPHONE ENGINEERING CO.
Dept. E-7193, Simpson, Pa.



CIRCLE 951 ON READER SERVICE CARD

TO SEARCHLIGHT ADVERTISERS Your Inquiries Mean OPPORTUNITY!

... not only for the advertiser, or the publisher, but FOR YOU! When you mention this publication in inquiries to advertisers, you enable them to value the evidence of your readership... This advertisers' 'satisfaction' means we have an easier time securing more SEARCHLIGHT advertisements - meaning MORE information, MORE choice of products, MORE value—FOR YOU!

INDEX TO ADVERTISERS

Ampex Corporation	101	• Inland Motor Corp. Sub. of Kollmorgen.....	100	Speer Carbon Co.....	28, 29
Anso, General Aniline & Film Corp.	65	• Jennings Radio Manufacturing Corp.	115	Sprague Electric Co.....	9, 24
• Arco Electronics, Inc.....	124	Jerrold Electronics Corp.....	4	Stackpole Carbon Co.....	25
• Avnet Electronics Corp.....	116, 117	Johnson Company, E. F.....	103	Standard Telephone & Cables, Ltd.	76
Bausch & Lomb, Inc.....	108	• Kay Electric Co.	63	Sylvania Electric Products, Inc. Electron Tube Div.	93
• Boonton Radio Co.....	16	Krohn-Hite Corp.	120	Tektronix, Inc.	5
• Borg Equipment Division, Amphenol-Borg Electronics Corp.	41	• Kyoritsu Electrical Instruments Works, Ltd.	106	Texas Instruments Incorporated Industrial Products Group.....	37
Bristol Company, The	86	Leach Corporation	46	Texas Instruments Incorporated Metals & Controls Division.....	96
• Bussmann Mfg. Co., Div. of McGraw Edison Co..	106, 107	Levin and Son, Inc., Louis.....	85	Trak Microwave Corp.....	116
Carborundum Company, The....	73	Machlett Laboratories Inc., The..	23	• Transitron Electronic Corp.....	17
• Chester Cable Corp.....	110, 111	Mallory and Co., Inc., P. R....	94, 95	• United Shue Machinery Corp....	70
• Corning Electronic Components...	21	Markem Machine Co.....	42	• United Transformer Corp....	2nd cover
• Defense Electronics, Inc.....	72	• McLean Engineering Laboratories.	111	• Utica Drop Forge & Herbrand Tool Division, Kelsey-Hayes Co....	102
Digital Electronics	116	• Microswitch, Division of Honeywell	123	Varian Associates	43
Dow Corning Corp.....	38, 39	Midland Mfg. Co.....	83	• Varo Inc.	126
• Du Pont de Nemours & Co., Inc., E. I.	81	Midwec	106	Virginia Electric & Power Co....	67
• Durant Manufacturing Co.....	90	Minnesota Mining & Mfg. Co., Mincom Division	105	Waugh Engineering Div.	84
Dynamics Instrumentation Co....	112	Mitsumi Electric Co., Ltd.....	126	West Penn Power	114
• Edgerton, Germeshausen & Grier, Inc.	89	Motorola Semiconductor Products Inc.	27	• Yellow Springs Instrument Co., Inc.	117
• Electro Mative Mfg. Co., Inc....	125	Motorola, Military Electronics Div.	44, 45	Yokogawa Electric Works Inc....	118
• Electro Powerpacs, Inc.....	114	NRC Equipment Corp.	128		
• Engineered Electronics Co.....	91	NAVCOR	121	■	
• Fairchild Semiconductor Corp....	130	• North Atlantic Industries, Inc....	71	CLASSIFIED ADVERTISING	
Fifth Naval District	113	• Northern Radio Co., Inc.....	112	F. J. Eberle, Business Mgr. (2557)	
Fluke Mfg. Co., Inc., John.....	66	Nytronics Inc.	113	EMPLOYMENT OPPORTUNITIES	
Flving Tiger Line.....	87	• Ohmite Mfg. Co.....	32, 33	EQUIPMENT	
• Fusite Corp., The	75	Paktron, Div. of Illinois Tool Works, Inc.	119	(Used or Surplus New)	
General Electric Co.....	79	Pamotor Inc.	113	For Sale	
Receiving Tube Dept.....	14, 15	• Potter Instrument Co., Inc.....	19	CLASSIFIED ADVERTISERS INDEX	
Silicone Products Dept.....	82	• Radio Corporation of America	4th cover	Hewlett-Packard Co.....	
Rectifier Components Dept..	34, 35	Rome Cable Div. of Alcoa.....	78	• Radio Research Instrument Co....	
• General R F Fittings, Inc.....	90	• Sanborn Company	69	Telephone Engineering Co.....	
Gertsch Products, Inc.....	74	Sankaisha Co., Ltd.....	118	United Airlines	
Globe Industries, Inc.....	64	• Servo Corporation of America...	118	■	
Gudebrod Bros. Silk Co., Inc....	40	• Shizuki Electric Works Co., Ltd..	117	• See advertisement in the July 25, 1962 issue	
Hansen Mfg. Co., Inc.....	90	• Sierra Electronics Div. of Philco..	6	of Electronics Buyers' Guide for complete line of	
• Hart Manufacturing Co.....	110	Simpson Electric Company.....	77	products or services.	
Heminway & Bartlett Mfg. Co., The	128	• Southern Electronics Corp.....	36	■	
• Hewlett-Packard Company.....	10, 11	Space Technology Laboratories, Inc.	13	This index and our Reader Service Numbers are pub-	
• Hitemp Wires Inc.....	109	Spectra-Physics	31	lished as a service. Every precaution is taken to make	
Honeywell, Denver Division.....	20			them accurate, but electronics assumes no responsi-	
IBM Corp.	88			bilities for errors or omissions.	

electronics



Audit Bureau
of Circulation



Associated Business
Publications

Audited Paid Circulation

JAMES T. HAUPTLI (2210)

Advertising Sales Manager

DAVID CUNNIFF (3139)

Promotion Manager

HENRY M. SHAW (2751)

Market Research Manager

Electronics Buyers' Guide

R. S. QUINT (2335)

General Manager

RICHARD J. TOMLINSON (3191)

Business Manager

THEODORE R. GEIPEL (2044)

Production Manager

NEW YORK TELEPHONE: Dial Direct:
971 plus number in parenthesis, Area Code 212

ADVERTISING REPRESENTATIVES

ATLANTA (9):
Michael H. Miller, Robert C. Johnson
1375 Peachtree St. N.E., Trinity 3-0523
(area code 404)

BOSTON (16):
William S. Hodgkinson
McGraw-Hill Building, Copley Square,
Congress 2-1160 (area code 617)

CHICAGO (11):
Harvey W. Wernecke, Robert M. Denmead
645 North Michigan Avenue, Mahawk 4-5800
(area code 312)

CLEVELAND (13):
Paul T. Fegley
55 Public Square, Superior 1-7000
(area code 216)

DALLAS (1):
Frank Le Beau
The Vaughn Bldg., 1712 Commerce St.
Riverside 7-9721 (area code 214)

DENVER (2):
John W. Patten
Tower Bldg., 1700 Broadway,
Alpine 5-2981 (area code 303)

HOUSTON (25):
Kenneth George
Prudential Bldg., Halcombe Blvd.,
Riverside 8-1280 (area code 713)

LOS ANGELES (17):
Ashley P. Hartman, John G. Zisch,
William C. Gries
1125 W. 6th St., Huntley 2-5450
(area code 213)

NEW YORK (36):
Donald H. Miller (212) 971 3615
George F. Werner (212) 971 3617
Donald R. Furth (212) 971 3616
500 Fifth Avenue

PHILADELPHIA (3):
Warren H. Gardner, William J. Boyle
6 Penn Center Plaza, LOcust 8-4330
(area code 215)

SAN FRANCISCO (11):
Richard C. Alcorn
255 California Street, Douglas 2-4600
(area code 415)

LONDON W1:
Edwin S. Murphy Jr.
34 Dover St.

FRANKFURT/Main:
Matthée Herfurth
85 Westendstrasse

GENEVA:
Michael R. Zeynel
2 Place du Port

TOKYO:
George Olcott,
1, Kotahiracho, Shiba, Minato-ku

A Fairchild First: 2N2884

HIGH FREQUENCY POWER AMPLIFIER / OSCILLATOR

.75 W min P_o @ 500 mc ● 1.75 W min amplifier output @ 200 mc ● 5.5 db min power gain @ 200 mc

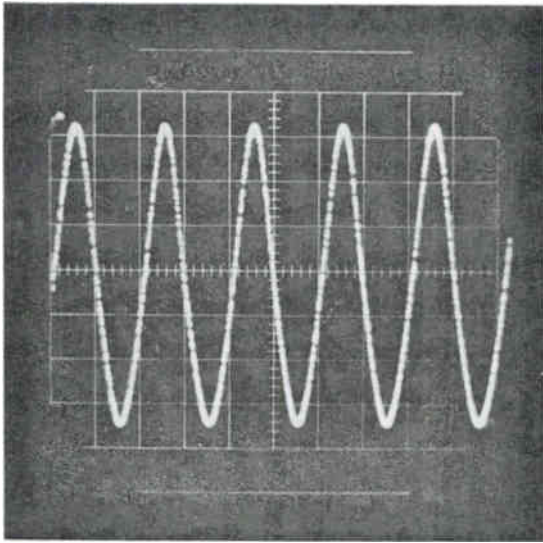

COMMON BASE OSCILLATOR OUTPUT
 RF Power = 1.0 W at 500 mc
 Scale: Vertical = 200 millivolts division
 Horizontal = 1 nanosecond division

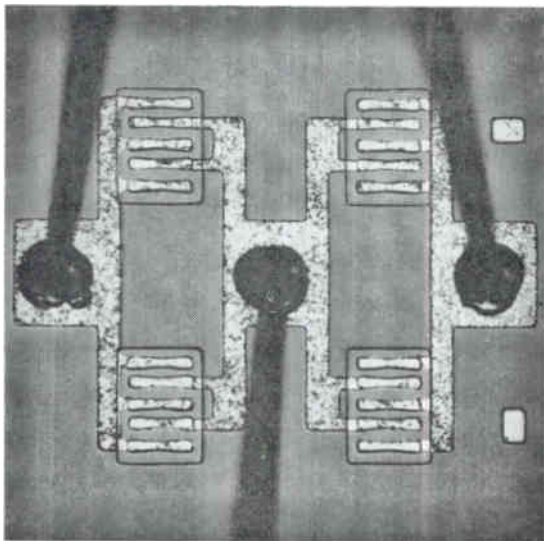

AVAILABLE DIRECTLY FROM DISTRIBUTOR STOCKS

FAIRCHILD
 SEMICONDUCTOR

The new striped structure of Fairchild's 2N2884 is divided into multiple areas interconnected by thin film metallization. This configuration — made possible by advanced Planar* epitaxial techniques — has two major advantages: it allows rapid dissipation of generated heat, and reduces parasitic lead inductance to a minimum. As a result, the 2N2884 has high power capacity at high frequency. In just one frequency doubling step, starting at 500 mc, it is possible to generate 0.5 watt at one kilomegacycle. Used as an oscillator, the 2N2884 has a minimum output of .75 watt at 500 mc. Typical amplifier output is two watts with a 6 decibel gain at 200 mc. Intended primarily for use in VHF and UHF bands, the 2N2884 has excellent characteristics for microwave applications.

*Planar: a patented Fairchild process

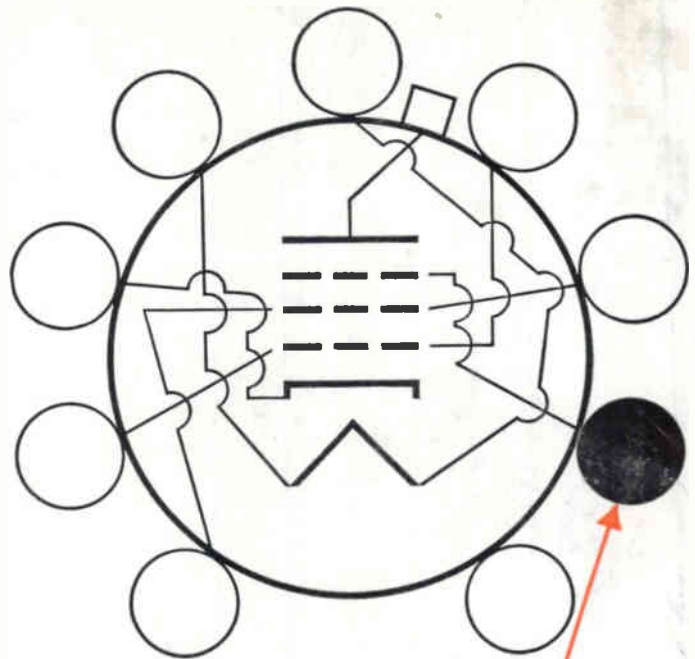
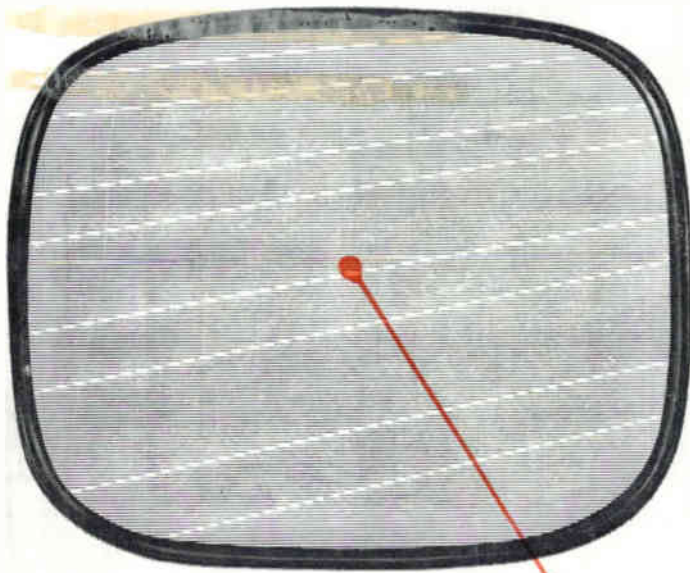

THE PICTURE IS CLEAR! CURB "SNIVETS" HERE



RCA-6JB6 NOVAR
for B-&-W TV

RCA-22JG6 NOVAR
for low-B+ B-&-W TV

RCA-6JE6 NOVAR
for color TV

WITH RCA NOVAR TUBES

New RCA NOVAR Beam Power Tubes Minimize the Picture-Spoiling Effects of TV "Snivets"

New FCC Regulations require that television sets, manufactured after April 30, 1964, and shipped in interstate commerce, shall be capable of adequately receiving all channels allocated by the FCC to the television broadcast service, including UHF channels.

Since "snivets" are most likely to occur in UHF TV receivers, the set designer must, more than ever, be prepared for this problem.

There is a simple solution. The 9-pin construction of RCA NOVAR tubes provides a separate base-pin connection for grid-No. 3. This basing arrangement permits application of positive voltage to grid No. 3 to minimize "snivet"-type interference originating in the horizontal-deflection-amplifier circuit.

Three new families of RCA NOVAR beam power tubes are specifically designed to curb "snivets" in both UHF and VHF TV receivers, color and black-and-white:

RCA-6JB6, -12JB6 and -17JB6 NOVAR tubes for black-and-white TV

RCA-22JG6 NOVAR tubes for low-B+ black-and-white TV receivers

RCA-6JE6 NOVAR tubes for color TV

These new beam power tubes provide the established NOVAR benefits of:

- Large pin circle, long pins, rugged cage structure, integral-based all-glass envelope to assure firm socket seating and very effective heat dissipation.
- Wide pin spacing (0.172") to guard against high-voltage breakdown and interelectrode leakage.
- Low initial cost.
- Plus RCA's highly-efficient "Dark Heater" for cooler heater operation, longer tube life and more stable performance.

Specify applicable RCA NOVAR tubes for your horizontal-deflection-amplifier stages. And for added dependability, there are NOVAR types for TV damper service, audio-output stages and low voltage rectifier use. Ask your RCA Field Representative about them, or write: Commercial Engineering, Section G-19-DE-3, RCA Electronic Components and Devices, Harrison, N. J.



The Most Trusted Name in Electronics