

electronics®

SHORT PULSE,
SHARP RETURN

*New radar resolves
three-inch range, p 36
(photo below)*

INTRODUCING
THE NRE

*Details on a new
circuit component, p 21*

FIXING CIRCUITS
IN OUTER SPACE

*Future satellites need
not stay dead, p 12*

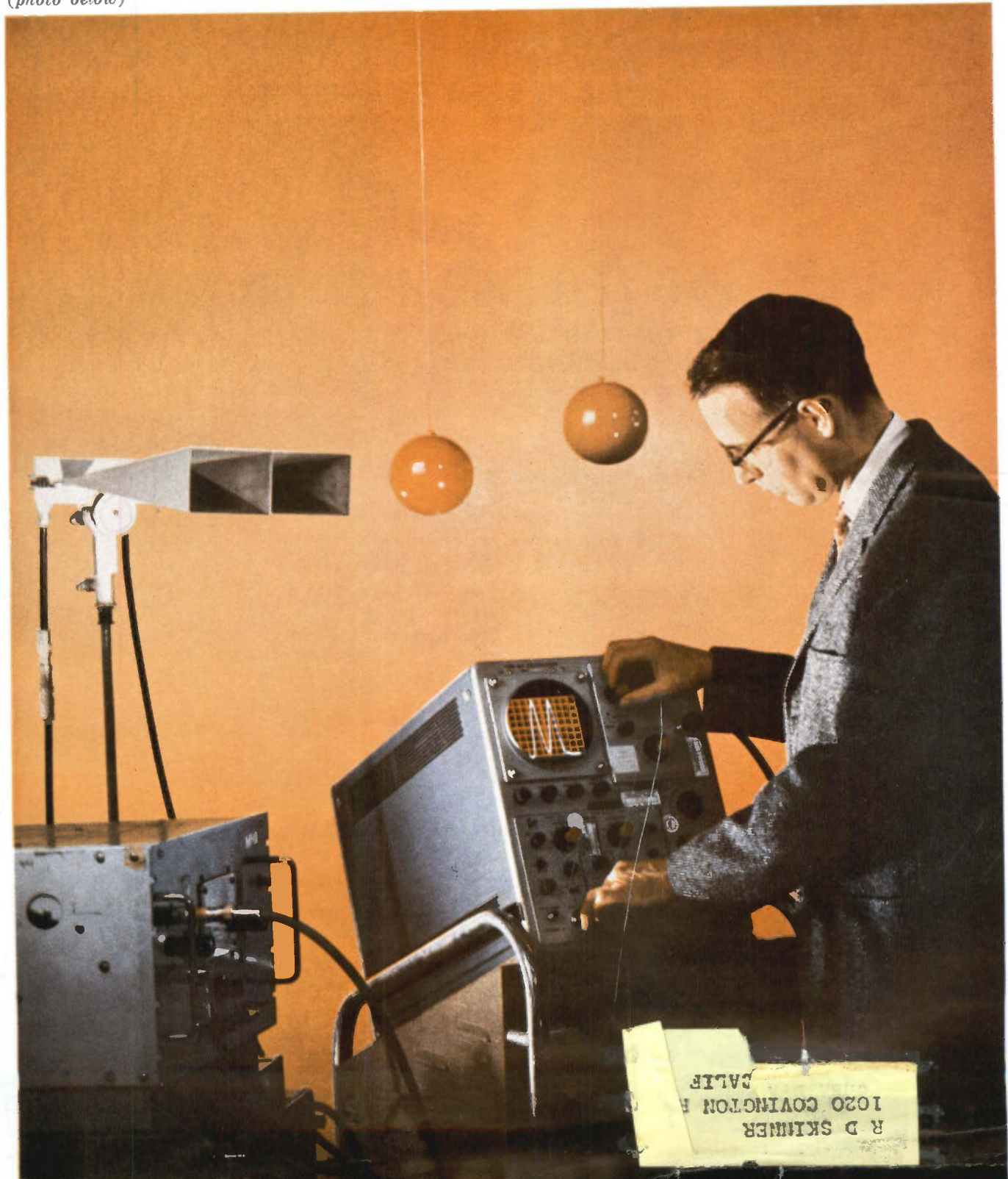

SPECIFICATIONS

| | |
|-------------------------------------|---|
| Source Impedance: | 50 ohms on 50 v range and below |
| Pulse Shape: | RISE AND FALL TIME—Less than 13 nsec on 50 v range and below; typically less than 10 nsec for maximum vernier attenuation; typically 15 nsec on 100 v range PULSE AMPLITUDE—100 v into 50 ohms; calibrated attenuator to 0.2 v plus vernier POLARITY—Positive or negative LEADING AND TRAILING EDGE OVERSHOOT—Less than 5% PULSE TOP VARIATIONS—Less than 4% PULSE DROOP—Less than 5% PRESHOOT—Less than 2% |
| Rep Rate Trigger and Timing: | PULSE WIDTH—0.05 μ sec to 10 msec, continuously adjustable INTERNAL—Repetition Rate: 10 cps to 1 mc, continuously adjustable; pushbutton for single pulse EXTERNAL—Repetition Rate: dc to 1 mc, controls allow selection of level and slope; sensitivity: greater than 1 v TRIGGER OUTPUT PULSE—Continuously adjustable 0 to 10 msec in advance or delay of output pulse; amplitude, 10 v into 1000 ohms; jitter less than 0.05% MAXIMUM DUTY CYCLE—100 v and 50 v range, 10%; 20 v range, 25%; 10 v range and below, 50% |
| Power: | 115 or 230 v \pm 10%, 50 to 60 cps, 325 watts |
| Dimensions: | 16 $\frac{3}{4}$ " wide, 7 $\frac{1}{4}$ " high, 18 $\frac{3}{8}$ " deep; hardware furnished for quick conversion to 7" x 19" rack mount, 16 $\frac{3}{8}$ " deep behind panel |
| Weight: | Net 35 lbs. |
| Price: | \$875 |

Data subject to change without notice. Price f.o.b. factory.

PULSE POWER (100 v, 2 a into 50 ohms)

- 50-ohm source impedance
- Less than 15 nsec rise and fall times
- Positive and negative pulses, dc coupled
- Double pulse feature
- Pulse burst capability

This new Hewlett-Packard pulse generator delivers positive or negative 100 volt 2 amp pulses into 50 ohms with rise times of 10 to 15 nanoseconds. What's more, it offers controlled pulse shape, external trigger slope and level selection and a 50-ohm source impedance for elimination of errors arising from reflections.

The high power output of the 214A is four times the power available from previous pulse generators. At output levels below 50 volts, the 214A has a matched source impedance of 50 ohms, eliminating error-producing reflections. Reflections from the circuit under test are absorbed in the 50-ohm source impedance, and the output pulse is always clean, even though the impedance of the circuit under test may be complex. At reduced output levels the duty cycle may be as high as 50%, ideal for square wave testing.

Pulse repetition rate is continuously adjustable to 1 mc, and pulse charac-

teristics are carefully controlled. Pulse rate, width and delay jitter are kept to a minimum to assure accurate, dependable test results.

The 214A offers an extremely wide range of trigger syncing for triggering on external signals. It will trigger on external signals as small as 1 volt peak, either polarity, and slope and level may be selected so that triggering occurs at a given point on the trigger waveform. The instrument also provides a trigger output for use in synchronizing external equipment.

The pulse generator may be gated on, to provide bursts of pulses, and a double pulse feature is provided for pulse resolution tests of amplifiers and memory cores.

Ask your Hewlett-Packard representative for a demonstration on your bench.

B437

**HEWLETT
PACKARD
COMPANY**



1501 Page Mill Rd., Palo Alto, Calif., (415) 326-7000. Sales and service representatives in principal areas. Europe, Hewlett-Packard S.A., 54 Route des Acacias, Geneva, Switzerland; Canada, Hewlett-Packard (Canada) Ltd., 8270 Mayrand Street, Montreal, Quebec.

CIRCLE 900 ON READER SERVICE CARD

POWER PACKED PULSES 200 WATT

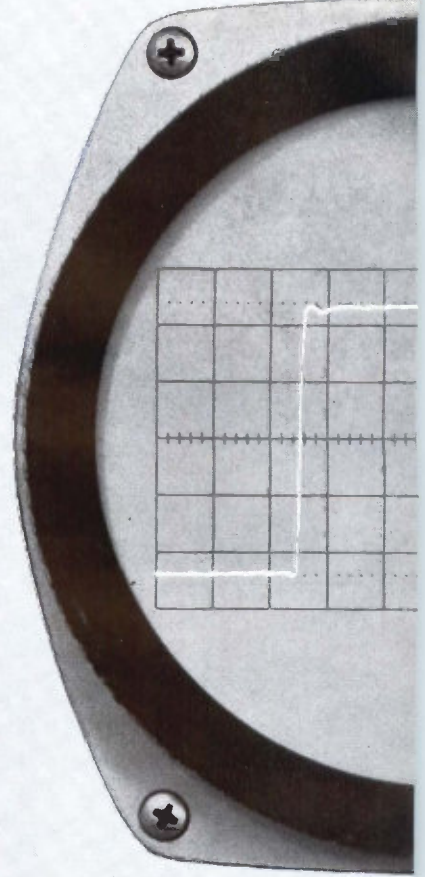

PULSE POWER from the new *hp* 214A!

VERNIER



PULSE POSITION
(μ SEC)

1-10 10-100 100-1K
0-1 1K-10K



VERNIER



PULSE WIDTH
(μ SEC)

1-10 10-100 100-1K
.05-1 1K-10K



VERNIER



PULSE AMPLITUDE
(VOLTS INTO 50 Ω)

2 5 10
1 20
.5 50
.2 100 (Hz)



PULSE ADVANCE **PULSE DELAY** **DOUBLE PULSE**



PULSE GENERATOR
HEWLETT  PACKARD
MODEL 214 A

hp 214A
PULSE
GENERATOR
DELIVERS
200 WATTS

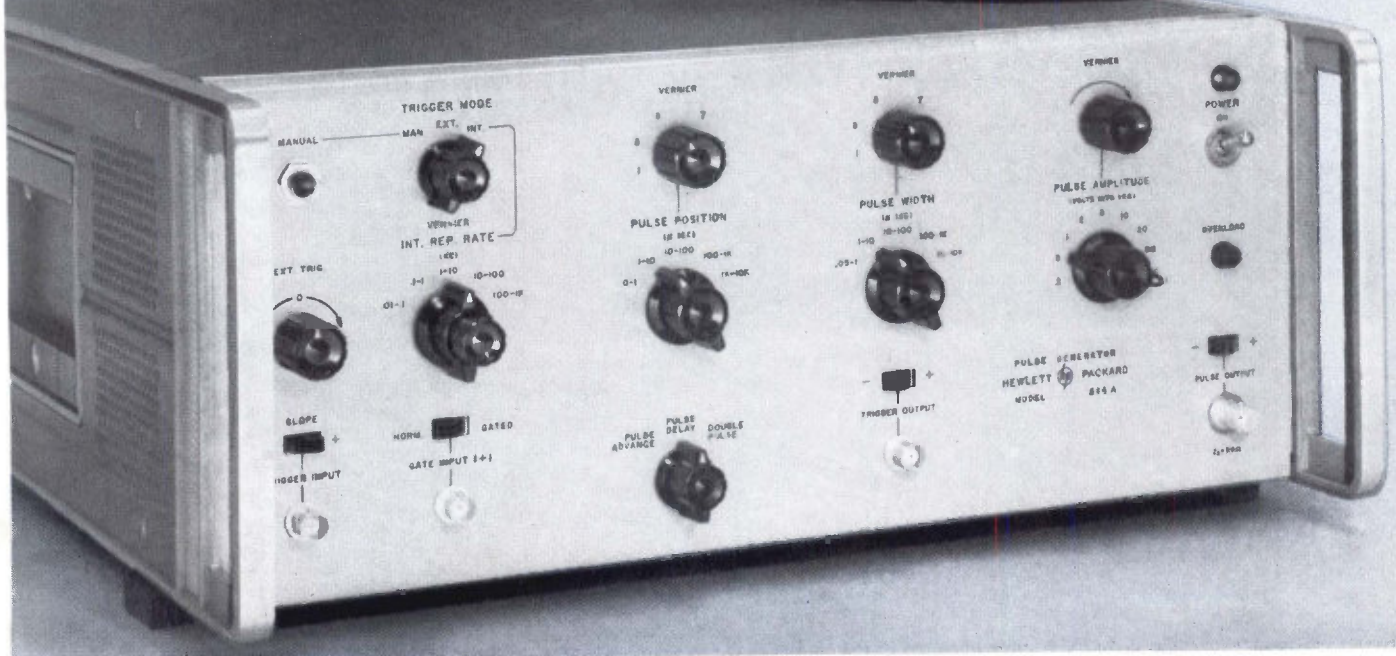
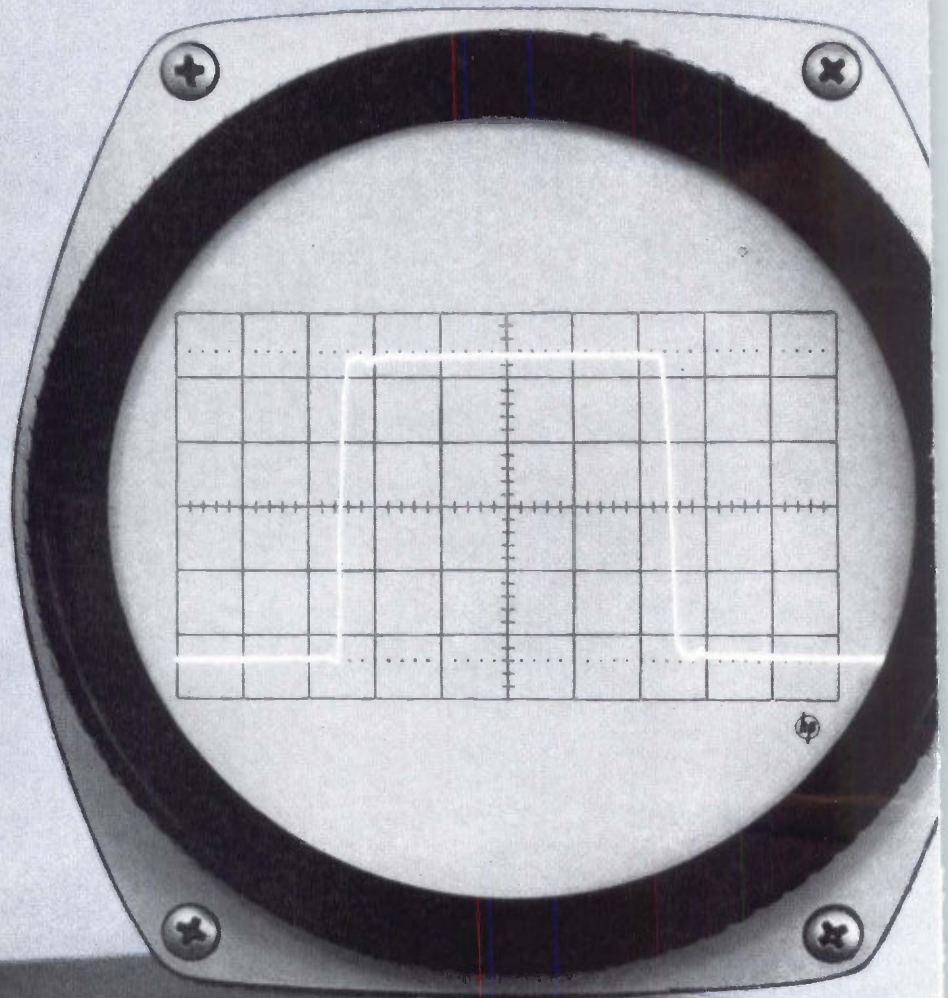

May 31, 1963

electronics

A McGraw-Hill Weekly 75 Cents



W. W. MacDONALD, Editor

J. M. CARROLL, Managing Editor

SENIOR EDITORS

Samuel Weber, George W. Sideris

SENIOR ASSOCIATE EDITORS

Michael F. Wolff, John F. Mason

ASSOCIATE EDITORS

Michael F. Tomaino, William P. O'Brien, Sy Vogel, George J. Flynn, Laurence D. Shergalis, George V. Novotny, Leon H. Dulberger, Alexander A. McKenzie

ASSISTANT EDITORS

Stanley Froud, Stephen B. Gray, Roy J. Bruun, Barry A. Briskman, Dan Smith, Joel A. Strasser

REGIONAL EDITORS

Harold C. Hood (Pacific Coast, Los Angeles), Thomas Maguire (New England, Boston), Cletus M. Wiley (Midwest, Chicago)

ART DIRECTOR

Howard R. Berry

ASSISTANT ART DIRECTOR

John C. Wright, Jr

EDITORIAL ASSISTANTS

Lorraine Rossi, Virginia T. Bastian, Lynn Emery, Ann Mella, Lorraine Werner, Alice M. O'Brien, Sharon Parks, Patricia Mitchell, Claire Benell

FOREIGN NEWS BUREAU

DIRECTOR, John Wilhelm;
Alyne Elias, Charles Obertance

LONDON—John Shinn, Derek Barlow, Nicholas Landon

BONN—Bruce Bendow,
Richard Mikton, Silke McQueen

BRUSSELS—Peter Forbath

PARIS—Robert Farrell,
Arthur Erikson

MILAN—Marc A. Messina

MEXICO CITY—Wesley Perry, Jr

RIO DE JANEIRO—Leslie Warren

MOSCOW—Stewart Ramsey

TOKYO—Richard Halloran,
Charles Cohen, John Yamaguchi

CIRCULATION MANAGER

Hugh J. Quinn

W. W. GAREY, Publisher

SHORT-PULSE RADAR has range resolution less than three inches. Solid-state circuit generates and shapes subnanosecond pulses. A chain of traveling-wave tubes amplifies them to three kilowatts, peak. *General Dynamics/Electronics equipment may be used in a battlefield surveillance system. See p 36* **COVER**

IF A SATELLITE FAILS, How Do You Fix It? You can send up a man or a robot repairman to make the repairs in orbit. If that's too expensive, the satellite can be built with self-repair features and redundancy. *Ingenuity has gotten several ailing satellites working again, but government and its contractors are now working on space-repair techniques* **12**

ORBITING DIPOLES Given New Chore. Air Force will test feasibility of using a dipole belt for extended-range air-to-ground and ground-to-air communications. *Special digital technique is expected to overcome doppler and frequency-smearing of signals* **14**

TELEPHONE-WIRE TV. German closed-circuit system transmits over 3,300 ft of telephone wire. *Special amplifier corrects signal distortion* **14**

ALL-CHANNEL Log-Periodic Tv Antenna in Development. Company already has a vhf model on the market. *It can pull in a tv signal from up to 175 miles* **15**

DIODE LASER TRANSMITS AUDIO. Internal modulation technique promises early use of semiconductor lasers in communications. *Modulation circuit is relatively simple: the a-f signal is built up to a preset voltage, then discharged through the gallium-arsenide laser* **16**

MEET THE NRE: Latest Member of the Solid-State Clan. Packaged negative-resistance element (NRE) consists of two transistor amplifiers and has S-shaped characteristic curve similar to that of a four-layer diode. *Applications include d-c switch, Q multiplier and monostable multivibrator.*
By C. D. Todd, Hughes Aircraft **21**

INTEGRATED-AMPLIFIER DESIGN: A New Approach. First select a closed-loop response satisfying circuit specifications, then calculate open-loop response using feedback to correct errors. *Experimental units include three-stage amplifiers using conventional, cordwood and chip-mounted transistor designs.*
By F. D. Waldhauer, Bell Telephone Labs **24**

Contents Continued

electronics

May 31, 1963

Volume 36 No. 22

Published weekly, with Electronics Buyers' Guide as part of the subscription, by McGraw-Hill Publishing Company, Inc. Founder: James H. McGraw (1860-1948).

Title ® registered U.S. Patent Office; © copyright 1963 by McGraw-Hill Publishing Co., Inc. All rights reserved, including the right to reproduce the contents of this publication, in whole or in part.

Executive, editorial, circulation and advertising offices: McGraw-Hill Building, 330 West 42nd Street, New York 36, N. Y. Telephone Longacre 4-3000. Teletype TWX N.Y. 212-640-4646. Cable McGrawhill, N. Y. PRINTED IN ALBANY, N. Y.; second class postage paid at Albany, N. Y.

OFFICERS OF THE PUBLICATIONS DIVISION: Shelton Fisher, President; Vice Presidents: Joseph H. Allen, Operations; John R. Callahan, Editorial; Ervin E. DeGraff, Circulation; Donald C. McGraw, Jr., Advertising Sales; Angelo R. Venezian, Marketing.

OFFICERS OF THE CORPORATION: Donald C. McGraw, President; Hugh J. Kelly, Harry L. Waddell, L. Keith Goodrich, Executive Vice Presidents; John L. McGraw, Treasurer; John J. Cooke, Vice President and Secretary.

Subscriptions are solicited only from those actively engaged in the field of the publication. Position and company connection must be indicated on orders. Subscription rates: United States and Possessions, \$6.00 one year, \$9.00 two years, \$12.00 three years. Canada: \$10.00 one year. All other countries \$20.00 one year. Single copies, United States and Possessions and Canada 75¢. Single copies all other countries \$1.50.

THE PUBLISHER, UPON WRITTEN REQUEST FROM ANY SUBSCRIBER TO OUR NEW YORK OFFICE AGREES TO REFUND THAT PART OF THE SUBSCRIPTION PRICE APPLYING TO COPIES NOT YET MAILED.

Subscribers: Please send change of address notices, subscription orders or complaints to Fulfillment Manager, Electronics, at the address below. Change of address notices should provide old as well as new address, including postal zone number if any. If possible, attach address label from recent issue. Allow one month for change to become effective.

Pastmaster: Please send Form 3579 to Fulfillment Manager, Electronics, P. O. Box 430, Hightstown, New Jersey.



Audited Paid Circulation

CONTENTS Continued

- COMMUNICATING WITH FUTURE DEEP-SPACE PROBES.**
The Mariner II Venus probe demonstrated the validity of deep-space telemetry by sending data clearly over 36 million miles. *This detailed description of its communications package shows how even more demanding jobs will be carried out.*
By W. E. Dahl, Motorola 28
- REFERENCE SHEET—RLC Values for Critical Damping.** Chart gives values of resistance, capacitance and inductance that make a ringing circuit critically damped when pulsed by an input of a specified duration. *Percent scale relates pulse width to pulse amplitude.*
By A. B. Moulton, Livermore, Calif. 34

DEPARTMENTS

- Crosstalk. *Information: The Whole Picture* 3
- Comment. *Outer Coupling Capacitor* 4
- Electronics Newsletter. *Missile-Detecting Satellite Doing Fine* 7
- Washington This Week. *RS-70 Aircraft Project Moves Closer to Cancellation* 10
- Meetings Ahead. *Communications National Symposium. Aerospace and Navigational Electronics East Coast Conference* 18
- Research and Development. *Subnanosecond Radar Shows High Resolution* 36
- Components and Materials. *Window Materials for High-Power Microwave Tubes* 40
- Production Techniques. *Hot-Air Machine Speeds Soldering* 44
- New Products. *Recirculating Analog Data for Long Delays* 48
- Literature of the Week. 51
- People and Plants. *ITT Erecting Laboratories Addition* 52
- Index to Advertisers 56

Information: The Whole Picture

A WELCOME CONTRIBUTION to better understanding of scientific and technical communications problems—both in and out of government—and of steps that can be taken to meet those problems — —

That's what President Kennedy says in his foreword to the so-called Weinburg report, "Science, Government and Information," by the President's Science Advisory Committee.

However, the report concentrates on only three phases of the technical information transfer: professional society journals, abstract services and information centers. In these areas, the report makes some good suggestions.

But the report fails to present the whole picture. Worse, it almost ignores a prime mover of fresh technical information—the commercial technical magazine.

Information centers, abstract services and professional journals are essential, but they are most useful if you know, in general, what you are looking for. The scientist or engineer must frame his questions to the information center. When he subscribes to a specialized abstract service, or when he joins a professional society or group he has in effect zeroed in on a field of interest.

The user must know what he wants. And this is where these services fall short. They do not create the desire to know and they tend to confine the mind of the scientist or engineer within the range of his specialty.

What is missing is the cross fertilization of knowledge that has so often been responsible for scientific and technical innovation.

We submit that the commercial technical publication is an essential vehicle. A good commercial technical magazine creates broad interest by continually stressing the novel and useful, and by reporting on new technical needs. It invites interest and readership by its varied contents, layout and presentation. Thus, it brings important related scientific and engineering work to the attention of many who might otherwise have missed that work.

Commercial magazines form an essential link



in the chain of information transfer—as indeed also do hard-cover textbooks at the other end of the spectrum.

Unlike the professional journal, abstract service or information center, the commercial technical magazine does not require direct or indirect monetary support from government, as the Weinburg report recommends for those three classes of information services.

However, the government and the scientific community should acknowledge formally and constructively the value of good commercial technical magazines as an essential and perhaps the first step in the information-transfer chain and do everything possible to encourage the flow of technical information to such publications.

Specifically, when the technical magazine editor requests information on new developments from a government or industry source, unnecessary military or proprietary secrecy should be removed. Engineers and scientists should be encouraged to disclose the results and significance of their work to qualified technical reporters without fear of reprisals such as being denied publication of their full article in a professional journal.

The transfer of information is a many-faceted process. Let's not concentrate so much attention on so few parts that we interrupt the smooth functioning of the whole system.

Thin-film Microcircuits Now Being Made By Sprague Electric Co.

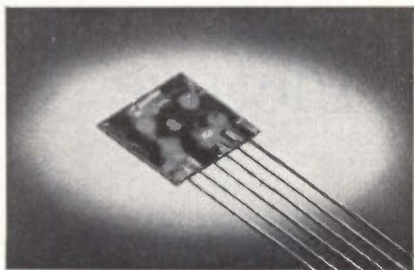

This typical Ceracircuit, shown in actual size, is a two-stage oscillator and gated amplifier.

THIN-FILM Ceracircuits, following a long period of research and development, are now in volume production, it was announced by the Sprague Electric Company.

These revolutionary linear and digital microcircuits allow great flexibility in choice of components and types of circuits. Chopping size, weight, and cost, while boosting reliability and power utilization, Ceracircuits are being used by alert design engineers in ever-increasing numbers.

Their ease of usability is remarkable. Containing familiar circuit elements such as capacitors, inductors, resistors, diodes, and transistors, Ceracircuits offer precision components with a wider choice of tighter parameters, assuring greater design freedom.

Custom Ceracircuits incorporate customers' own circuits, transforming present circuit methods to the reliable, space-saving thin-film technique.

Standard Ceracircuits, such as linear amplifiers, oscillators, NOR gates and drivers, indicators, binary counters, and clocks are immediately available for evaluation of ceramic-base Ceracircuits in customers' own equipment.

Sprague microcircuit specialists are available to discuss the transition of customers' circuits to thin-film. For complete information, write to Technical Literature Service, Sprague Electric Company, 35 Marshall Street, North Adams, Massachusetts.

451M-116-63

COMMENT

Outer Coupling Capacitor

In *Components and Materials* for Jan. 18 (p 62), J. M. Rollett describes a crude but effective means for providing d-c isolation in the outer of coaxial line circuits. This suffers from a serious resonance due to lead length which occurs at 50-100 Mc.

A useful technique for overcoming this has been tried in these laboratories. It consists of lapping the flanges and separating them by a thin PTFE film. Using the size of flange mentioned in the article (1.125 inches diameter with 0.625-inch diameter hole in the middle) and $\frac{1}{4}$ thou. film, the capacitance so formed is 1,500 pf. Low-frequency performance is as in Rollett's article, except the frequency scale is multiplied by 10. If the size of the flanges is not limited by other equipment, an increase by a factor of 3.16 would produce a capacitance of 0.015 μ f, this giving the same low-frequency performance as in the article.

High-frequency limitation is when the radial length of the flange is longer than $\frac{1}{4} \lambda$; at this dimension it looks like a short circuit giving perfect coupling. The device certainly operates at frequencies in excess of this; that is, greater than 6.8 Gc for the 1.125-inch flange or 2 Gc for the 3.5-inch flange.

S. S. HARTLEY

M. K. MCPHUN

Central Electricity Research
Laboratories
Leatherhead, Surrey
England

Author Rollett replies:

Mr. Hartley and Mr. McPhun describe two components, one of small diameter (1.125 in.) for higher frequencies, and one of large diameter (3.6 in.) for lower frequencies.

For higher frequencies, outer coupling capacitors are available commercially, for example Microlab type HR 51, with vswr 1.2 maximum between 500 Mc and 10 Gc; it therefore seems pointless to construct them.

For lower frequencies, the component described by the readers suffers from these disadvantages: (a) large diameter (3.6 in.) would make it extremely cumbersome in normal work, and impossible to use in the situation described in the fifth paragraph of my article; (b) the difficulties of construction using a large area of $\frac{1}{4}$ thou. PTFE are considerable, if not prohibitive; (c) the fragility of the film would make the component unlikely to stand up to normal laboratory usage—useful components should withstand being plugged together and unplugged many thousands of times without mishap.

Thus, the readers' low-frequency component is too large, too hard to make and too fragile to be practical. In contrast, the component described in my article is small, easy to make and very robust; moreover, such components have been in use for over two years in three different research establishments!

J. M. ROLLETT

Government Post Office
London, England

Readers Hartley and McPhun comment:

The conflict between Mr. Rollett and ourselves appears to lie in the difference of application. We are using tunnel diodes at about 500 Mc and require low vswr over a wide bandwidth. This is of course just at the changeover frequency from Mr. Rollett's coupler to the Microlab version, and necessitates a different design.

Obviously we agree that for Mr. Rollett's specialized application, our device is too large, but we take issue with him when he says it is "too hard to make and too fragile to handle." We arranged for our workshops to make one of a mechanical form suitable for Mr. Rollett's work using ordinary workshop techniques, but putting the PTFE film in place in the laboratory away from steel dust, etc. The unit was complete within an afternoon and has stood up to deliberate rough handling.

The coupler should be at its best at 10 Gc and at its worst at 20 Gc.

S. S. HARTLEY
M. K. MCPHUN

REVERSE POWER RATED

25 AMPERE CONTROLLED AVALANCHE SILICON RECTIFIERS ADDED RELIABILITY AT LOWER COST

- Especially designed to operate in the avalanche region. Conservatively rated for extra protection against surges and avalanche breakdown. Built-in transient protection for inductive switching applications.
- Reliability demonstrated by exposure to periodic surges exceeding 3,000 amperes in 100KV clipper service.
- Even at a case temperature of 150°C, Tung-Sol PZ140's can handle current overloads as great as 400 amperes.
- Sharply defined reverse breakdown characteristics and reverse power handling capac-



ity make PZ140 rectifiers ideal for high-voltage series stringing. Individual R-C balancing networks are not required.

- Priced in the range of 12 ampere types and lower than conventional 25 ampere rectifiers without reverse power rating.
- Pressure fit construction provides added savings in assembly costs. Available in both polarities—one heat sink can carry two rectifiers.
- Write for Bulletin CT22. Tung-Sol Electric Inc., Newark 4, N. J. TWX:201-621-7977.

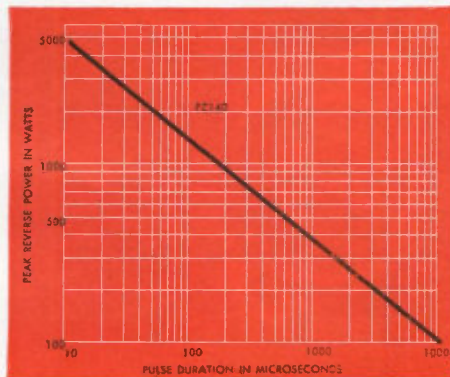

RANGES OF REVERSE CHARACTERISTICS OVER ENTIRE OPERATING TEMPERATURE RANGE

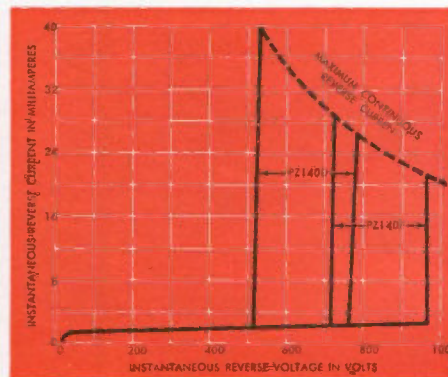

RATINGS AND CHARACTERISTICS
(60 cps, Inductive or Resistive Load, Single Phase Half Wave)

| | PZ140D | PZ140F | UNIT |
|--|--------|-------------|---------|
| Maximum Working Peak Reverse Voltage | 400 | 600 | Volts |
| Maximum Working RMS Voltage | 280 | 420 | Volts |
| Minimum Avalanche Breakdown Voltage | 500 | 700 | Volts |
| Maximum Avalanche Breakdown Voltage | 750 | 950 | Volts |
| Maximum Continuous Power Dissipation in Avalanche Region | 10.0 | 10.0 | Watts |
| Maximum Peak (square wave) Power Dissipation in Avalanche Region 10 Microsec. duration | 5000 | 5000 | Watts |
| Maximum Average Forward Rectifier Current at 100°C Case | 30 | 30 | Amperes |
| at 140°C Case | 25 | 25 | Amperes |
| Maximum Peak One-Cycle Surge Overload Current (Superimposed on Full Load) | 400 | 400 | Amperes |
| Operating Temperature Range | -50°C | -175°C Case | |



TUNG-SOL

Sales Offices: Atlanta, Ga.; Columbus, Ohio; Culver City, Calif.; Dallas, Tex.; Denver, Colo.; Detroit, Mich.; Melrose Park, Ill.; Newark, N.J.; Seattle, Wash. In Canada: Abbey Electronics, Toronto, Ont., Canadian Electronics Ltd., Edmonton, Alta.

are the power transistors you're using as good as this one?

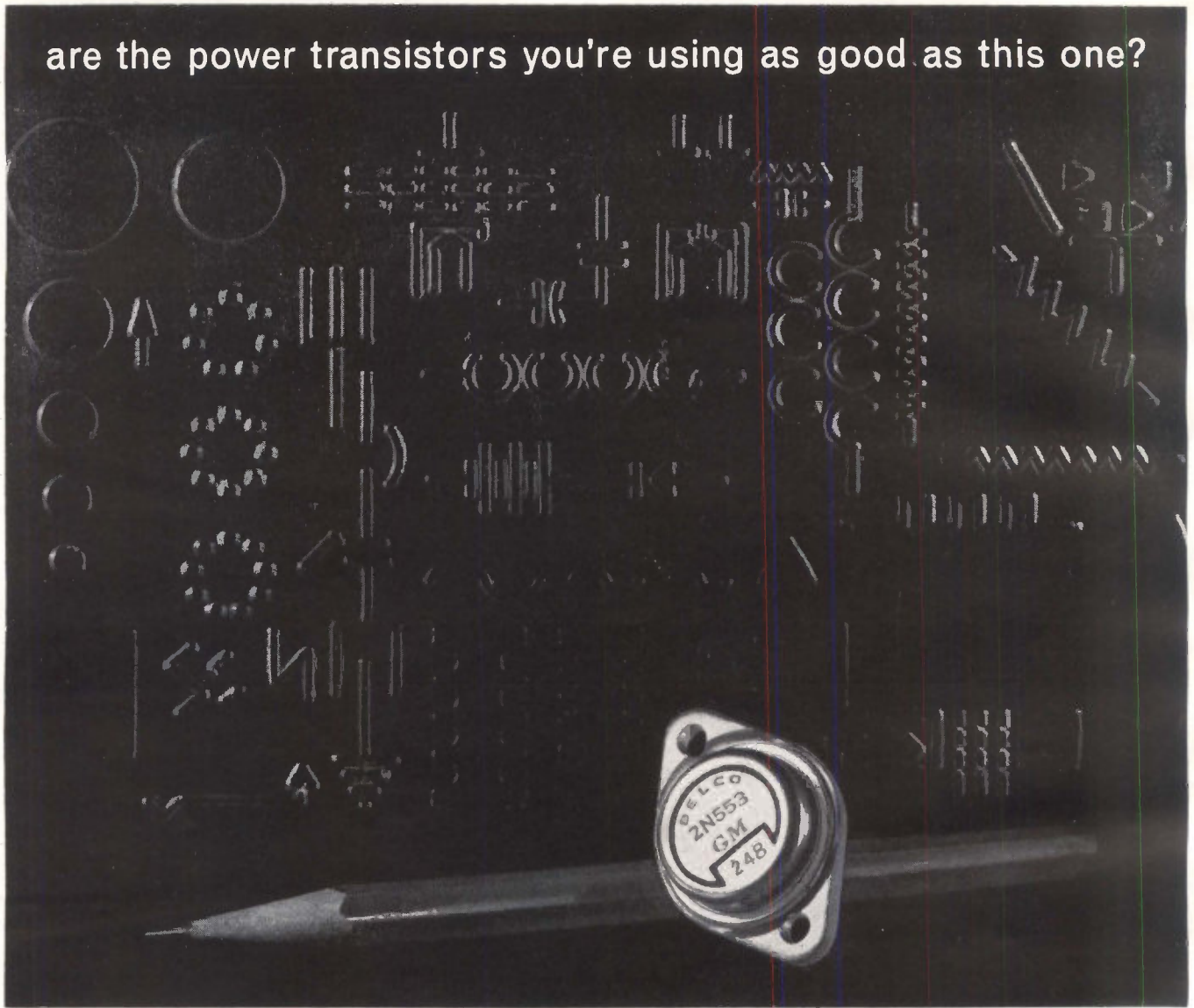

Meet the Delco Radio family of 2N553 high power transistors. This group gives you a wide selection of highly reliable 4-5 amp. power transistors. The perfect choice for direct coupled circuits because of their extremely low collector diode bulk leakage current. Regulator applications? None better than Delco's 2N553. These units have unique thermal stability. Order a handful or a carload and you get uniform high quality. Prove it to yourself and improve your product as a bonus. Contact one of our Sales Offices listed below or your nearby Delco Radio Semiconductor Distributor.

| Type | Ic Max Amps | VCE0 @ Ic Volts @ Amps | VCBO @ IcBO Volts @ ma | hFE @ Ic Amps | VEBO @ IEBO Volts @ ma | VCE (sat) @ Ic Volts @ Amps | VBE Volts | f _{ae} kc | Thermal Resistance |
|--------------|-------------------|---------------------------------------|------------------------------|------------------|------------------------------|--------------------------------|--------------|-----------------------|-----------------------|
| 2N553 | 4 | 40 .300 | 60 2 | 40/80 .500 | 40 2 | 0.9 3.0 | 1.5 | 25 | 1.5° C/watt |
| 2N663 | 4 | 25 .300 | 50 12 ⁽³⁾ | 25/75 .500 | 20 4 | 1.0 3.0 | 1.5 | 15 | 2.0° C/watt |
| 2N665 | 5 | 40 .300 | 80 10 | 40/80 .500 | 40 2 | 0.9 3.0 | 1.5 | 20 | 2.0° C/watt |
| 2N665 Sig C | 5 | 40 .300 | 80 10 | 40/80 .500 | 40 2 | 0.9 3.0 | 1.5 | 20 | 2.0° C/watt |
| 2N297A | 4 | 40 .300 | 60 3 | 40/100 .500 | 40 3 | 1.0 2.0 | 1.5 | 2 | 1.5° C/watt |
| 2N297A Sig C | 4 | 40 .300 | 60 3 | 40/100 .500 | 40 3 | 1.0 2.0 | 1.5 | 2 | 1.5° C/watt |
| 2N1971 | 4 | 40 .300 | 60 2 | 25/60 .500 | 40 2 | 0.9 3.0 | 1.5 | 25 ⁽⁴⁾ | 1.5° C/watt |
| 2N256 | 3 | 30 ⁽¹⁾ .003 ⁽²⁾ | 30 3 ⁽⁴⁾ | 15 .500 | 30 8 | 1.0 1.0 | | 100 ⁽⁵⁾ | 2.0° C/watt |
| 2N307 | 3 | 35 ⁽¹⁾ .015 ⁽²⁾ | 35 5 ⁽⁴⁾ | 20 .200 | 10 2 | 1.0 .200 | | 3 | 2.0° C/watt |

① V_{CE}R ② I_{CE}R ③ @ 85°C ④ Typical ⑤ fab

Union, New Jersey
324 Chestnut Street
MURdock 7-3770
AREA CODE 201

Detroit, Michigan
57 Harper Avenue
TRinity 3-6560
AREA CODE 313

Palo Alto, California
201 Town & Country Village
DAvenport 6-0365
AREA CODE 415

Santa Monica, California
726 Santa Monica Blvd.
UPTon 0-8807
AREA CODE 213

Syracuse, New York
1054 James Street
GRanite 2-2688
AREA CODE 315

Chicago, Illinois
5151 N. Harlem Ave.
775-5411
AREA CODE 312

DELCO
DEPENDABILITY
RADIO
RELIABILITY

General Sales Office: 700 E. Firmin, Kokomo, Ind., Gladstone 2-8211—Ext. 500 • Area Code 317

Division of General Motors, Kokomo, Indiana

Is Midas Making a Comeback?

ALTHOUGH STILL unannounced by the Defense Department, a missile-detecting satellite was sent up by the Air Force on the same vehicle that put up the West Ford dipole belt a few weeks ago. Presumably this was Midas, the Missile Defense Alarm System satellite that was in trouble back in January due to difficulties with the infrared sensors (p 7, Jan. 18; p 7 and 10, Feb. 1, and p 7, Feb. 8). The program was cut back at that time, and work on one of the ground stations (The Naval Air Station at Ottumwa, Iowa) for the system was stopped. The new satellite is said to be operating well, picking up hot spots in a satisfactory manner and relaying the data to the ground.

Any speedup of the Midas program would probably hang more on political than technical considerations. Whatever decision is made, it is a good bet it will be made quietly. Since the U-2 incident, the government has been hypersensitive about this area. Lockheed is prime contractor for Midas.

3-D Radar Finds 3 Targets for 3 Missiles

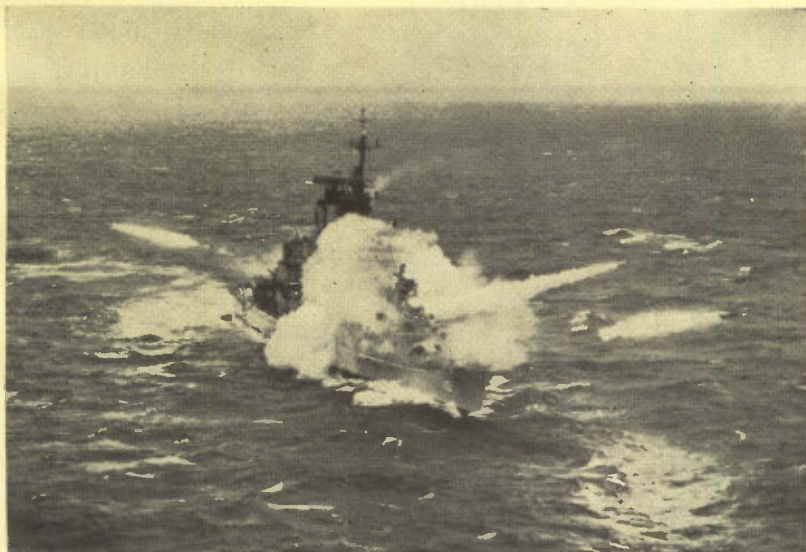

USS ALBANY fires two Talos and a Tartar missile simultaneously. Multiple firing was assisted by Frescan 3-D radar. Radar, developed by Hughes Aircraft, uses electronic scanning to locate many targets with a single antenna

Industrial Accounts Lure Distributors

CHICAGO—More and more electronic distributors are handling industrial accounts and finding it takes more technical know-how to do so. That was the consensus at executive conferences of the Electronic Parts Distributors Show here last week.

Less than half the distributors surveyed two years ago had industrial accounts. Now, 7 out of 10 do. More than 90 percent of these added new industrial accounts last year. Nearly 40 percent reported industrial sales of components running more than half of their total sales.

Key Changes Studied For Future Tiros

TIROS weather satellites may be modified to take continuous cloud cover pictures of the entire planet every three days, where the first satellites permitted observation of only 12 to 25 percent of the earth. Possibly beginning with Tiros 9, the satellites would have two tv cameras mounted 180 degrees apart pointed outward from the base and would be launched into a 400-mile

polar orbit spinning sidewise like a wheel. To optimize photography, a magnetic attitude control system using a coil of 250 turns of fine wire, 12 resistors and a switch, and consuming 30 mw, will manipulate the spin-axis. NASA awarded a \$100,000 evaluation contract to RCA Wednesday.

Thermo-Photovoltaic Power Generated

ATLANTIC CITY, N. J.—Germanium and silicon photocells powered by a propane-fueled silicon-carbide radiator have been used by General Motors to generate a usable quantity of thermo-photovoltaic power. A dozen radio receivers were operated simultaneously and with ease, even under conditions of gross spectral mismatch, reported J. Werth, of GM, at the Power Sources Conference here last week.

With the radiator temperature reduced to 1,200 C, and the germanium cells replaced by silicon, adequate power for the receivers could be derived from less than 3 cm² of effective cell area, Werth said. The investigations also showed that selective reflection as a method of matching germanium cells to a gray body radiation operating at a surface temperature of 1,400 C or less, has a potential relative spectral efficiency of 70 percent.

In a panel discussion, G. C. Szego, of the Institute for Defense Analy-

DUMMIES WITH BRAINS

Life-size robot figures that talk and move realistically will be featured in GE's exhibit at the 1964-65 World's Fair in New York. The figures will be animated by a preprogrammed seven-track tape utilizing techniques and components developed for sequencing the Polaris missile, according to Walt Disney Enterprises, which designed the display. The GE exhibit will also feature an actual demonstration of thermonuclear fusion.

sis, suggested using fuel cells in vehicles, particularly in Army trucks and tanks. Separate electric motors in each wheel would be driven from the power cell.

Laser-Sharp Tolerances May Boost Quality

CHICAGO — Lasers and associated circuitry may drastically tighten industry's production tolerances, Harry Kiefaber, of the Sheffield Corp., predicted last week at a meeting here of the American Society for Quality Control.

Using light energies expected from lasers or equivalent devices, "one will be able to focus and measure from a point with a surface area of 10^{-10} ," he said. Future improvements in optical and electro-mechanical gratings will provide resolutions of 0.0001, or an accuracy of 1 light band, Kiefaber said.

Cargo Glider Augurs Boom in Radio Items

LARGE MARKET for beacon and radio guidance equipment may result from an air-cargo delivery system being developed for the Army by Ryan Aeronautical Co. Intended for combat conditions, the system employs an aluminum container suspended below kite-like flexible wings.

The glider will be towed to the

delivery area by helicopter and then released. A homing beacon or radio control system operated by a ground or helicopter-borne soldier, will guide the throw-away craft to the target location on the ground. A system of cables connected to cams provides longitudinal and fore-and-aft control. The work by Ryan is part of a \$2-million contract awarded to the firm for flex-wing developments, including a flex-wing manned utility vehicle. The glider has been tested successfully at Yuma, Ariz., the Army said.

New Hawk Missile Slated for Army

BOSTON—A multi-million dollar new Hawk missile program for the Army is in the works. Raytheon, prime contractor for the original missile, will also produce the ATBM Hawk (Anti-Tactical Ballistic Missile). Original Hawk is a mobile ground-air weapons system for protection of field armies against aircraft, particularly low-flying aircraft, but in field tests it has knocked down missiles, including the Honest John, Little John and Corporal. ATBM Hawk will be designed specially as an anti-missile weapons system.

Raytheon, RCA and Hughes Aircraft have each received \$500,000 for separate studies on the technical feasibility of new field Army air defense system for 1970's (AADS-70). Studies will stress defense against tactical missile threat in 1970's.

Australians Blast U. S. Radio-Base Deal

MELBOURNE—The Labor Party here has sharply criticized the treaty with the U. S. providing for the establishment of a U. S. Naval vlf radio base at North-West Cape in western Australia (p 20, Jan. 4). The Laborite attack came after the Government revealed the U. S. insists on sole control of the station, to be used for communicating with atomic submarines.

In Brief . . .

AGREEMENT for a cooperative program in nuclear studies has been signed by the U. S. and the Soviet Union.

TV OF THE FUTURE will be able to bypass the human eye and send electronic impulses directly to the brain, enabling the blind to "see", predicts Allen B. Du Mont of Fairchild Camera.

AEC FLIGHT-TESTED a space reactor mockup from Wallops Island, Va. last week to see if it would break up and disintegrate upon reentry into the atmosphere. Preliminary data indicated that it did, AEC reported, but the vehicle will have to be recovered before this can be confirmed.

VARO is receiving an \$8,542,950 contract from the Army for 1,500 infrared searchlight sets for use on tanks.

RUSSIA has launched Cosmos 17, an earth satellite carrying unidentified scientific apparatus.

14 OF 15 West European nations attending a telecommunications conference in Paris last week favored joining the U. S. in a worldwide satellite communications system. France was the lone dissenter.

\$19-MILLION contract for decoy subsystems to be carried by ICBM's has been granted Ford Motor Co. by the Air Force.

WEST FORD'S orbiting dipole belt has been used to transmit voice messages "of telephone quality" from California to Boston, the Air Force reports.

STARTING IN JULY, Motorola will offer a course in integrated circuits at its Semiconductor Products Division in Phoenix.

MERGER of Emerson Electric Co. and Rantec Corp. has been approved by the directors of both companies.

CBS IS BUYING 44 image-orthicon tv cameras from Marconi.

CONGRESS will complete action any day now on an "equal pay for women" bill, which President Kennedy is considered certain to sign.

New from Sprague!

2 x μ F

Get nearly twice the capacitance of older designs in Sprague's new high-gain etched-foil TANTALEX[®] Capacitors

IMPROVE FILTERING EFFICIENCY WITH NO SACRIFICE IN RELIABILITY, SIZE, OR WEIGHT!

HIGH CAPACITANCE Tubular Tantalex Capacitors with almost double the capacitance of standard etched-foil tantalum capacitors have been developed by the Sprague Electric Company to meet the needs of design engineers.

A new etching technique, the result of an intensive research program, gives considerably higher effective surface area to the capacitor electrodes *without sacrifice in reliability or in any of the electrical parameters* by which foil tantalum capacitors are usually judged.

Unlike other "high capacitance" foil tantalums, Sprague Tantalex Capacitors continue to maintain their rigid standards for shelf and service life under severe environmental conditions. Certain performance characteristics have actually been tightened. For example, allowable leakage current has now been halved, making the use of these capacitors possible in many new applications.

Etched-foil Tantalex Capacitors are available in two operating temperature ranges—polarized Type 112D and non-polarized Type 113D for -55 C to +85 C operation, as well as polarized Type 122D and non-polarized Type 123D for -55 C to +125 C operation.

The Foil-type Tantalex Capacitor Line also includes conventional low-gain etched-foil and plain-foil capacitors in both polarized and non-polarized construction, providing a foil tantalum capacitor for every application.



For complete technical data on 85 C capacitors, request Engineering Bulletin 3601B. For the full story on capacitors for 125 C operation, write for Engineering Bulletin 3602B. Address Technical Literature Section, Sprague Electric Company, 35 Marshall Street, North Adams, Massachusetts.

SPRAGUE COMPONENTS

CAPACITORS
TRANSISTORS
MAGNETIC COMPONENTS
RESISTORS
MICRO CIRCUITS

INTERFERENCE FILTERS
PULSE TRANSFORMERS
PIEZOELECTRIC CERAMICS
PULSE-FORMING NETWORKS
TOROIDAL INDUCTORS

HIGH TEMPERATURE MAGNET WIRE
CERAMIC-BASE PRINTED NETWORKS
PACKAGED COMPONENT ASSEMBLIES
FUNCTIONAL DIGITAL CIRCUITS
ELECTRIC WAVE FILTERS



'Sprague' and '®' are registered trademarks of the Sprague Electric Co.

WASHINGTON THIS WEEK

RS-70 MOVES CLOSER TO CANCELLATION

EVEN IF THE RS-70 aircraft's radar system can be developed before 1970, the outlook is that Defense Secretary McNamara intends to cancel the project as soon as the political climate will allow it.

A high-level Air Force source claims Air Force has demonstrated to McNamara's office that the RS-70's high-data-rate, sharp-resolution radar system (**ELECTRONICS**, p 18, Feb. 1) could be developed well before 1970. McNamara and the Office of the Director of Defense Research and Engineering have contended that "we could not have such a system early enough to produce an operational RS-70 force capable of useful reconnaissance strike before 1970."

His position now boils down to, the Air Force source says, "there is no requirement for the RS-70."

SBA HEEDS DISTRIBUTOR PROTESTS

SMALL BUSINESS ADMINISTRATION'S proposed new dollar definition for small businesses is likely to be revised upward to satisfy vehement protests from distributors of electronics, electrical equipment and machine tools. For federal procurement purposes, SBA wants to set aside the 500-employee standard and call a small business one whose three-year average of annual gross sales or receipts does not exceed \$2 million. Distributors contend the figure is too low, would eliminate many of them from the small business set-aside program.

NEW FCC RULES TO LIFT A-M STATION FREEZE

FCC HAS TAKEN a first step in its effort to get a grip on the population explosion in a-m radio. It proposes putting a ceiling on the number of a-m and f-m stations in each community and to ween f-m and a-m programming. The commission will receive comments on its plans through July 17. When it makes its proposals, or some form of them, final, it will lift the freeze on new a-m assignments that was slapped on a year ago. The proposals reflect a growing opinion that f-m is reaching a point where it can be self-sustaining.

Initially, this policy will only affect the largest markets — those over 100,000 — when there are no longer any more f-m frequencies available in these cities. F-m stations owned by a-m stations can duplicate no more than 50 percent of the a-m programming, beginning a year after adoption of the proposal. In addition, FCC aims to bring a-m radio service to new areas without it, to save spectrum space for new communities, and to prevent new assignments encroaching on existing stations. It proposes a table of quotas for a-m and f-m stations in each community, based on population.

BATTLEFIELD MISSILE GETS MONEY BOOST

CONGRESS HAS APPROVED a Defense Department plan to increase this year's funding for the Army's Lance battlefield support missile (formerly Missile B) by 40 percent, to \$17.4 million.

Lance is approved for full system development. Ling-Temco-Vought is prime contractor. Major electronic subcontractors are Telecomputing's Whittaker Controls division, boost-guidance control gyro, and Systron-Donner, velocity control and checkout set.

The House Appropriations Committee had delayed project expansion approval. At issue were claims that project costs would be substantially increased by Army's insistence that LTV, a Texas-based firm, use a government plant in Detroit. The Army pooh-poohed the claim.

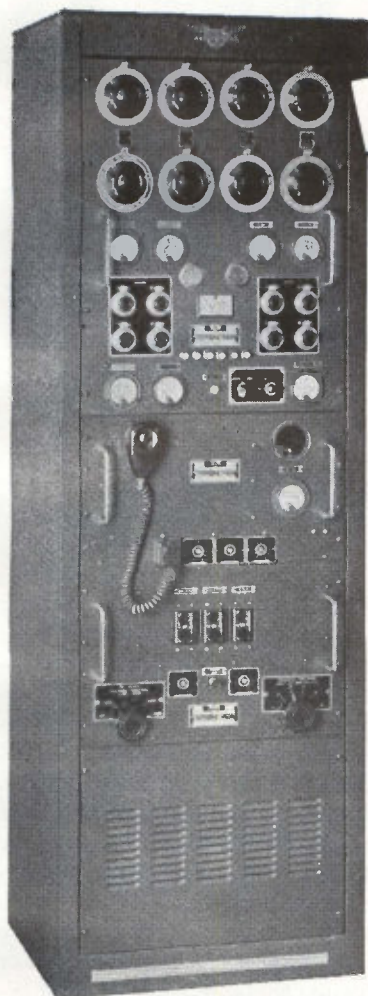

FCC-ACCEPTED
TYPE AVAILABLE

The world-famous **AEROCOM 1046** **TRANSMITTER**

1000 W CARRIER POWER WITH HIGH STABILITY

The Aerocom 1046 Transmitter is designed to give superior performance for all point-to-point and ground-to-air communications. It is now in use throughout the world in climates ranging from frigid to tropical (operates efficiently at -35° to $+55^{\circ}$ Centigrade).

As a general purpose High Frequency transmitter, the 1046 supplies 1000 watts of carrier power with high stability (above -10° Centigrade: $\pm .003\%$ for telegraph and telephone. Temperature controlled oven for FSK). Multi-channel operation is provided on

telegraph A1, telephone A3 and FSK (Radio Teletype). It can be remotely controlled using one pair of telephone lines plus ground return with Aerocom Remote Control Equipment. Front panel switches and microphone are included for local control.

Four crystal-controlled frequencies (plus 2 closely-spaced frequencies) in the 2.0 - 24.0 megacycle range can be used one at a time, with channeling time only two seconds. Operates into either balanced or unbalanced loads. The power supply required is nominal 230 volts, 50 ; 60 cycles, single phase.

The housing is a fully enclosed rack cabinet of welded steel, force-ventilated through electrostatic filter on rear door.

Telegraph keying (A1): Up to 100 words per minute. Model 1000 M Modulator (mounts in trans-

mitter cabinet) is used for telephone transmission; a compression circuit permits the use of high average modulation without over-modulation. Model 400 4 Channel exciter is used for FSK.

Output connections consist of 4 insulated terminals (for Marconi antenna) and 4 coaxial fittings Type SO-239, which can be used separately or in parallel in any combination. For 600 ohm balanced load, Model TLM matching network is used, one for each transmitter channel.

As in all Aerocom products, the quality and workmanship of Model 1046 are of the highest. All components are conservatively rated. Replacement parts are always available for all Aerocom equipment.

Complete technical data on Aerocom Model 1046 available on request.

Also available—Aerocom Model 446 with 350 watts nominal carrier power and Model 100TFA—100 watts



3090 S. W. 37th AVENUE

MIAMI 33, FLORIDA

ZERO-GRAVITY space tools are designed to move components, not the repairman. Above, AMF "astronauts" in simulated weightless environment use conventional hand tool (left) and special space tool (right)



If a Satellite Fails—Go Up and Fix It

Alternatives: use a robot repairman, or build in self-repair and redundancy

By **JOEL STRASSER**
Assistant Editor

IN-ORBIT REPAIR of ailing satellites by men or machines that actually rendezvous with the satellite and fix its circuits looks like the ultimate solution of spacecraft failure problems, say space officials and scientists interviewed by **ELECTRONICS**.

But when a rendezvous would cost more than launching a new

DEMONSTRATION of squeeze wrench at Martin



satellite, remote repair will be attempted. Self-healing circuits is one approach, carefully planned redundancy is another.

And then, there are various ways of manipulating equipment operation from the ground to get the system working again. This has been successful in several cases, notably Telstar I, Pioneer V, Relay I and several Tiros satellites. But these stopgap measures provide no specific technique applicable to all future satellites.

RENDEZVOUS REPAIR—One approach to rendezvous repair involves development of tools and methods that men can use in a weightless environment so they can move the tools and parts without being moved themselves by the reaction force.

The other approach is to use remotely controlled tools like the ones that manipulate atomic reactor controls and materials.

Early in June, Grumman is expected to report findings of a study, for NASA, of structural design considerations to make the Orbiting Astronomical Observatory suitable for in-orbit repair. The repairman would carry tools and plug-in replacement modules.

There are also proposals for an orbiting station to maintain manned vehicles as well as satellites. Lockheed has described a 15-man station that would send shuttle craft to repair other spacecraft.

ZERO-GRAVITY TOOLS — Many aerospace companies are working

on tools for fastening and drilling in a weightless environment.

Among Martin Company's "first-generation" tools is a wrench operated by squeezing. First-generation hand tools require spacecraft equipped with clips and hooks. Martin's second-generation tools are battery operated and produce a minimum reaction while requiring some restraint of the man. Third-generation tools will be smaller, lighter, longer lasting. For restraint, portable hooks will be applied to the spacecraft by an epoxy adhesive that does not require oxygen. Crimp connections and plug-ins will be required for electronic repairs, says Martin B. Goldman, of Martin. Surface bonding will eliminate much soldering.

Other companies designing hand tools include Hughes, AMF and Chance-Vought. Backup work is being done on space simulators and spacesuit design. Boeing, GE and others are studying the effects of weightlessness on how a man can work.

Hamilton-Standard is investigating electron-beam welding, which can make use of the natural vacuum in space, and the possible use of solar, nuclear and fuel-cell power supplies for the welder. Air Force has just authorized the company to build a prototype welder.

ROBOT TOOLS—Goal of a NASA study contract at MIT is a general-purpose, remotely controlled "hand" that could use simple, special-purpose tools and be sensitive enough to replace a transistor. It would be

RELIABILITY FIRST

Reliability, rather than repairability, is the prime goal of all spacecraft designers. Efforts to make spacecraft repairable won't relax electronic equipment specifications or the pressure on government and contractor personnel to do better in component selection, circuit design and system assembly and test. But since an imperfection or an accident are always possible, repairability picks up where reliability leaves off

guided from the ground by tv.

One problem, says Prof. Thomas Sheridan, is the time delay produced by the distance to the spacecraft. Humans are accustomed to a rapid step-by-step procedure, but it would take 2.6 seconds for a command to be given a robot near the moon and for the reaction to be observed on earth.

ELECTRONIC SELF-REPAIR — Self-repairing components and the already well-established redundancy method are two ways to build self-repair capability into space equipment. More advanced solutions may well come out of present work on adaptive systems, bionics and other research areas (ELECTRONICS, p 96, Jan. 4).

A description of how to repair transistors by regenerating the critical material was given at this year's IEEE Convention by D. H. Kramer. For example, when a short circuit is detected between collector and base, a regenerative agent is released near the junction and the temperature raised to the point needed for self repair. Similar methods can be used to regenerate resistors, capacitors and printed-

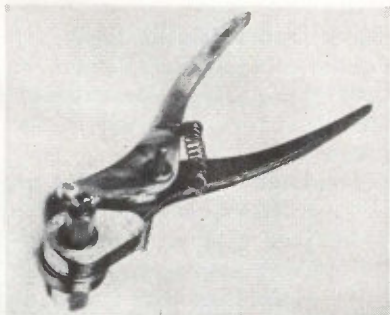

PLENCH, a Chance-Vought combination plier and wrench, is squeezed to rotate a ratchet and socket without moving the user

circuit substrates, he said.

Air Force is sponsoring research at Honeywell into two methods of self repair. In one, printed circuits are coated with an alloy; a small temperature rise melts the alloy and it flows into a break. Also, metallic whisker growth can be controlled to repair a circuit break, Honeywell says. Air Force is also sponsoring work at Adaptronics.

Redundancy is necessary for deep space and lunar probes, a Jet Propulsion Lab spokesman says. In the Ranger series, JPL relies on automatic control sequencing and radio-command capability for many functions, so if there is a malfunction another channel can be used.

The next step is design redundancy rather than system redundancy. The object is to provide alternate internal paths to accomplish a function. The final step is to make a system that can decide which of several potential circuit paths can be used to work around a malfunction.

INGENUITY — Several satellite failures in the past few years have been overcome by the ingenuity of ground personnel.

For example, when ionizing radiation caused Telstar I's decoder to fail, a trick code, worked out in the lab, got it working again. In 1960, while Pioneer V was 5.5 million miles from earth, a new translation code got around a defective diode. Relay was given a rest to close an open transistor that was causing a power drain.

Overloading Tiros II vibrated the vehicle and loosened a foreign particle between the points of a clock timer. On Tiros III and IV, when direct readout failed, it was regained by overriding stored readout.

ELECTRONIC COUNTERS, INC. MODEL 960 DIGITAL RECORDER



**provides permanent measurement records
... INSTANTLY!**

Do you require high speed permanent recording of binary coded information? Do you require both intermittent and continuous operation capabilities? If these are your requirements, the Potter Model 960 Digital Recorder is your answer.

This highly reliable instrument uses the Potter developed 1-2-4-8 coding format to provide an easily read permanent record of measurement data involving micro-second phenomena. Up to 150 eight-digit numbers per second can be permanently recorded—and the visible record is available instantly. No processing is required.

For additional information and detailed specifications write today...



ELECTRONIC COUNTERS, INC.

Subsidiary of

POTTER INSTRUMENT CO., INC.

151 Sunnyside Boulevard • Plainview, New York

New Chore for ORBITING

Air Force will test long-range, air-ground digital communications

DAYTON, OHIO—Next year, Air Force plans to test the feasibility of a new way to get extended range air-to-ground and ground-to-air microwave communications: reflecting the signals from an orbiting belt of resonant dipoles.

Air Force Systems Command's Aeronautical Systems Division (ASD) is now building the special digital modulation and detection equipment. The airborne complex will consist of a 10-Kw, X-band transmitter and a liquid-helium-cooled maser receiver.

SIGNAL SMEAR—The communications link will be analogous to bistatic radar. The reflected signal energy will be perturbed in time, amplitude and frequency, Charles Gauder, of ASD, reported this month at the National Aerospace Electronics Conference.

In addition to normal doppler shift, the carrier frequency will be smeared over a discrete fre-

quency range (perhaps 2 Kc) because of differential velocity vectors of the randomly oriented dipoles at the intersection of the transmitting and receiving beams. The new digital equipment is expected to overcome this.

Narrow pulses will be used to minimize smearing and envelope

incoherence. Doppler smear of long pulses could be offset by using post-detection integration to improve the signal-to-noise ratio. But the degradation caused by frequency smearing won't permit coherent pulse integration because pulse envelope coherency is destroyed.

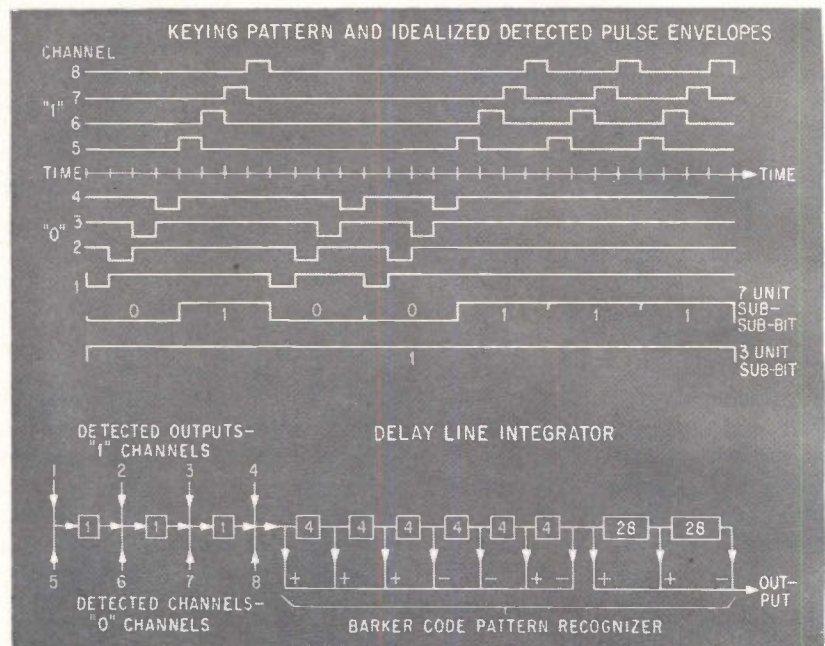

SIGNAL PROCESSING for narrow pulse widths

German Closed-Circuit Tv Needs No Coax

BONN—A new system for transmitting tv signals over telephone wire has been demonstrated by Grundig. Applications are expected in banks and industrial installations where the transmission distance is too long to justify coaxial

TELEPHONE-WIRE tv transmission demonstration by Grundig

cable, but too short for directional transmission.

The line is an unprotected, 3-, 300-ft-long, 2-wire, Y-form (2x0.6-mm). The system is based on a corrective amplifier that suppresses line distortion and compensates for signal losses so the 5-Mc bandwidth signal corresponds to the European picture standard.

The system was demonstrated at West Germany's huge Hanover Fair, which ended this month. Other electronic exhibits highlights included:

- Seimens' tv picture reproducer. Ten full-size pictures up to 16-in. diameter are recorded on magnetic foil for storage and reproduction. The disk carrying the foil rotates at 300 rpm to give 10-Mc recording

and reproduction.

- Telefunken's new compatible vhf-stereo broadcast transmitter. German manufacturers are going along with the U. S. FCC system since it meets pertinent CCIR recommendations

- Lowe Opta's 16.5-lb, 10-in., tv/f-m radio combination. Battery or a-c powered, it uses 31 transistors. Mesa transistors are used in the vhf and uhf tuners

- Transistor radiation detector, shown by Kirem, is essentially a large-surface silicon diode. Particles striking the diode result in positive and negative charges flowing to diode electrodes to produce a proportional pulse. Device is sensitive, and it requires little power.

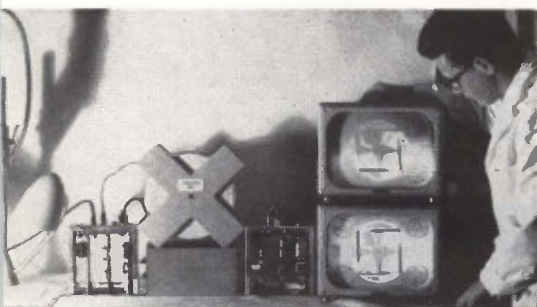

DIPOLES

MODULATION — Gauder told **ELECTRONICS** that a frequency-time dispersed keying pattern—originally developed by Air Force for h-f, air-ground, long-range, digital communications—will be used.

A number of subcarrier oscillators are keyed in a frequency-time manner according to a 7-unit Barker-code pattern (see diagram). Dual-symbol operation is used: two distinct pulses represent the binary 1 or 0; one frequency is keyed for a 1 and another for a 0.

To demodulate: after translation to a suitable i-f, each subchannel is separated, detected, combined, summed through delay lines and applied to a threshold decision circuit. A unique feature of the delay line integrator is the output's excellent peak-to-stray amplitude ratio. This matched-filter characteristic automatically establishes sub-bit timing at coincidence of the incoming Barker code pattern.

All-Channel Tv Array Readied

CHICAGO—JFD Electronics revealed at the Electronic Parts Distributor Show last week that it hopes to have its all-channel, log-periodic tv antenna ready for production by fall.

Now under development at JFD R&D Labs, the antenna uses smaller resonant-V dipole elements at the front end for uhf and larger spaced elements at the back end for vhf (see photo, p 16). It will receive channels 2 through 83.

Feature of the log-periodic design is its ability to pull signals in over long distances. JFD's present antenna, for regular tv/f-m reception, receives from 50 miles, for a 4-element array, and up to 175 miles for an 18-element array. Design is based on work done at the University of Illinois (**ELECTRONICS**, p 10, Dec. 8, 1961, and p 58, June 17, 1960).

Other antenna news at the show included:

- Comment by John Winegard, president of Winegard Co., that

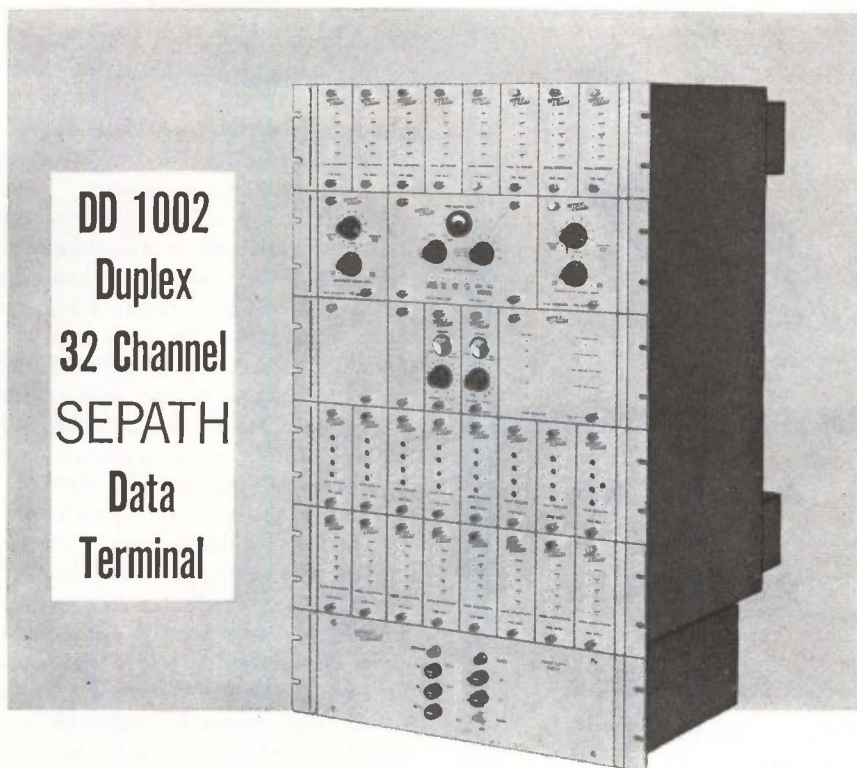

From the DD Line of data transmission equipment

“SEPATH”

Rixon DD 1002 SEPATH data terminals, operating in conjunction with existing frequency division multiplexing equipment, provide an excellent means for transmitting high-speed digital data via hf radio circuits. Serial binary data is converted into parallel low-speed data streams at the transmit terminal to permit propagation through multipath conditions. These are simultaneously transmitted on TTY channels. At the receive station, the parallel information is regenerated and reassembled into the original serial format.

Other systems available which use the SEPATH principle are the SEPATH/Teletype system [SEP 589-1(A)] for bulk encryption, and the DD 3005 30 Channel time division multiplexer for 60 and 100 wpm TTY signals. For further information, contact . . .

RIXON ELECTRONICS, INC.

2121 INDUSTRIAL PARKWAY—MONTGOMERY INDUSTRIAL PARK—SILVER SPRING, MARYLAND
TELEPHONE: 622-2121 TWX: 301 622-2292

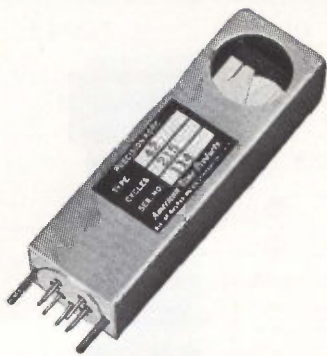

AMERICAN TIME PRODUCTS 10 to 1000 CPS LIGHT CHOPPER

NO LUBRICATION NEEDED

Unlike motor driven types, American Time optical choppers and modulators function without lubrication — no wear, with reliability multiplied several-fold. Based on the balanced, vibrating members of a tuning fork, the chopper also has the advantage of drastically reduced power requirements. These inherent benefits are obvious for space and other applications. IR, UV and other radiation are controllable.

Operated by an external 2 transistor circuit, signal voltage is available from the fork circuit as a reference. Accuracy of .05% in ranges from -55 to +85°C — higher accuracies can be obtained. Input power is 150 m.w. @ 28 volts into external circuit. Lower powers and lower voltages can be worked out. Operational altitude is up to space vacuum. And physical size is 1" x 3/4" x 3", with a 3/4" diameter window — the unit weighing a maximum of 3 oz.

Applications include spectrophotometers, mass spectrometers, radiometers, bolometers, IR detectors, star trackers, burglar alarm systems, intrusion systems, telemetry systems, calorimeters, and densitometers. Write Bulova, American Time Products, 61-20 Woodside Ave., Woodside 77, New York.

INDUSTRIAL/DEFENSE GROUP

BULOVA

AMERICAN TIME PRODUCTS

color tv and f-m stereo are creating sales of good outdoor antennas in cities where indoor types were bought almost exclusively. Winegard introduced a transistorized antenna amplifier for uhf tv, color couplers and other devices

• Jerrold's paralog. It has wheel-shaped insulators to transpose interconnections without crossing transmission-line conductors, to keep impedance constant and reflected line losses negligible. Added parasitic elements are said to improve gain while retaining broadband and impedance-match advantages of log-periodic design.

Among the new sets was a prototype five-loudspeaker a-m/f-m stereo portable, previewed by ITT Distributor Products. It has 23 transistors, operates on eight flashlight batteries. A stereo earphone set, by Superex Electronics, has a miniature crossover network and tweeter controls for each ear and reportedly gives 20-cps to 20-Kc response.

Components introduced included



TEST MODEL of all-channel log-periodic antenna

a 500-cps magnetic reed switch, by RCA. It weighs 0.3 gram, is expected to find applications in computer and switching equipment. Raytheon offered a silicon planar epitaxial transistor said to offer 20-db power gain at 200 Mc. It can be used as an r-f amplifier to 500 Mc and as an oscillator to 1.6 Gc.

Diode Laser Transmits Audio

AUDIO MODULATION of an injection laser at IBM's Federal Systems Division last week clearly demonstrates that the device, announced only 7 months ago (ELECTRONICS, p 7, Nov. 2, 1962) may go into communications systems sooner than anticipated.

Outstanding feature of the IBM experimental communications setup is its simplicity. Little or no optics is required to transmit and receive acceptable-quality voice and music signals over a short distance using pulse-frequency modulation.

Unlike the gas laser, which has transmitted video and audio (ELEC-

TRONICS, p 28, Feb. 22), the injection laser is modulated by d-c pulses which are converted directly into coherent light. In the gas laser, the beam is modulated after it leaves the laser, greatly reducing system efficiency.

The gallium-arsenide diode used by IBM has a lasing threshold of 2.25 amps. Five-amp, 0.2- μ sec pulses are generated by the modulator circuit (see figure). The experimental pfm system transmits audio from 300 to 3,000 cps, but IBM engineers feel circuit and device refinements could extend the pulse repetition rate beyond 100 Kc.

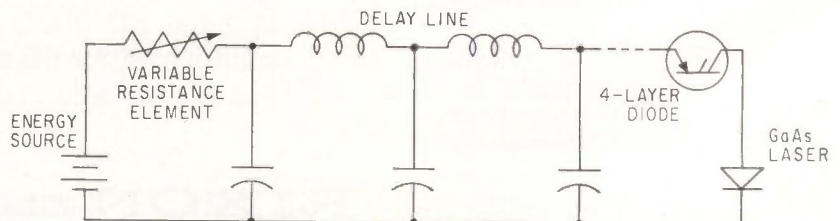

AUDIO SIGNALS through variable-resistance element (in practice, a transistor) control modulation circuit frequency. When the delay line charges to a preset voltage, the 4-layer diode breaks down, discharging the delay line through the laser



PRINCETON APPLIED RESEARCH CORP., Box 565, Princeton, N. J., 799-1222, code 609

- automatic ranging
 - automatic polarity
 - 10 meg input impedance
 - >100 db common mode rejection
 - truly floating differential input
 - 0.1% absolute accuracy
 - 1 millivolt sensitivity
 - solid state / reed relay design
 - rugged printed circuit construction
 - no stepping switches
 - price: \$995.00
 - measures only 6½" wide, 5" high, 8" deep. Weighs 9 lbs.
- Model CS-3.1

Write for Bulletin No. 107

world's smallest digital voltmeter with all of these features



Pulse magnetrons, used in commercial all-weather radar systems, are part of the extensive line of Litton microwave tubes and display devices. For information write to San Carlos, California. In Europe, Box 110, Zurich 50, Switzerland.

LITTON INDUSTRIES
ELECTRON TUBE DIVISION

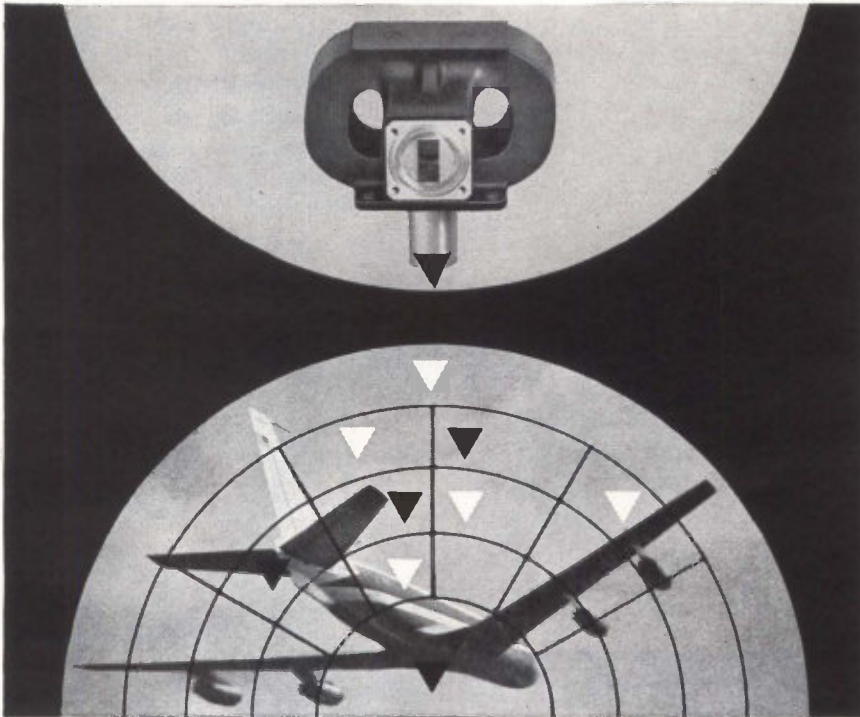

CIRCLE 201 ON READER SERVICE CARD

NOW...ON-LINE!

New Correlation Computer System permits on-line auto- and crosscorrelation studies



MNEOTRON's Correlation Computer System (CC-1) consists of the COR-256 combined with the Computer of Average Transients (CAT 400B). This system performs real time auto- and crosscorrelation computations, thereby permitting the study of statistical properties of repetitive signals buried in random noise.

The Correlation Computer generates up to 256 points of the auto- or crosscorrelation functions. On-line

operation eliminates the need for time consuming and costly data analysis. Results computed by the system are immediately available as an oscilloscope pattern. Accessory units make results available as an analog plot or a printed or punched digital readout.



Executive Sales Offices: 202 Mamaroneck Ave., White Plains, N. Y.

MEETINGS AHEAD

RADIO FREQUENCY INTERFERENCE NATIONAL SYMPOSIUM, IEEE-PTGRFI; Bellevue Stratford Hotel, Philadelphia, Pa., June 4-5.

ARMED FORCES COMMUNICATIONS & ELECTRONICS ASSOCIATION CONVENTION, AFCEA; Sheraton-Park Hotel, Washington, D. C., June 4-6.

INTERNATIONAL TELECOMMUNICATION UNION PANEL OF EXPERTS MEETING, IEEE, et al; Geneva, Switzerland, June 4-23.

RELIABILITY TRAINING CONFERENCE, IEEE-PTGR, ASQC; Bishop's Lodge, Santa Fe, N. M., June 10-14.

BIO-ENGINEERING SYMPOSIUM, ISA; Union Oil Co. Bldg., Los Angeles, June 14-16.

SUMMER GENERAL MEETING, IEEE; Royal York Hotel, Toronto, Canada, June 16-21.

BROADCAST & TV RECEIVERS CONFERENCE, IEEE-PTGTR; O'Hare Inn, Chicago, June 17-18.

JOINT AUTOMATIC CONTROL CONFERENCE, IEEE, ISA, et al; University of Minnesota, Minneapolis, Minn., June 19-21.

X-RAY AND ELECTRON PROBE ANALYSIS SYMPOSIUM, American Society for Testing and Materials; Chalfonte-Haddon Hall, Atlantic City, N. J., June 23-28.

IMPACT OF MICROELECTRONICS CONFERENCE, Armour Research Foundation and ELECTRONICS Magazine; Illinois Institute of Technology, Chicago, Ill., June 26-27.

INFORMATION THEORY IN SCIENCE & ENGINEERING SEMINAR, Dartmouth College; at Dartmouth, Hanover, New Hampshire, July 1-12.

WESTERN ELECTRONIC SHOW AND CONFERENCE, WEMA, IEEE; Cow Palace, San Francisco, Calif., Aug. 20-23.

ADVANCE REPORT

COMMUNICATIONS NATIONAL SYMPOSIUM, IEEE-PTGCS, Utica, N. Y., Oct. 7-9. June 17 is the deadline for submitting 5 copies of a 100-word abstract and a 500-word summary to: Joseph L. Ryerson, Technical Program Chairman, Director of Communications (RAU), Rome Air Development Center, Griffiss Air Force Base, N. Y. Areas of interest include: space and satellite communications; tropospheric scatter; hardened communications; data processing and transmission; communications theory; communications antennas; infrared and light communications.

AEROSPACE & NAVIGATIONAL ELECTRONICS EAST COAST CONFERENCE, IEEE-PTGANE; Emerson Hotel, Baltimore, Md., Oct. 21-23. June 17 is the deadline for submitting 5 copies of a 500-word abstract and a brief author's professional record to: Richard J. Allen, Research & Advanced Technology Dept., Martin Co., Baltimore 3, Md. Areas of interest include: microelectronics; space vehicle guidance & control; design for space environment; space system support equipment.

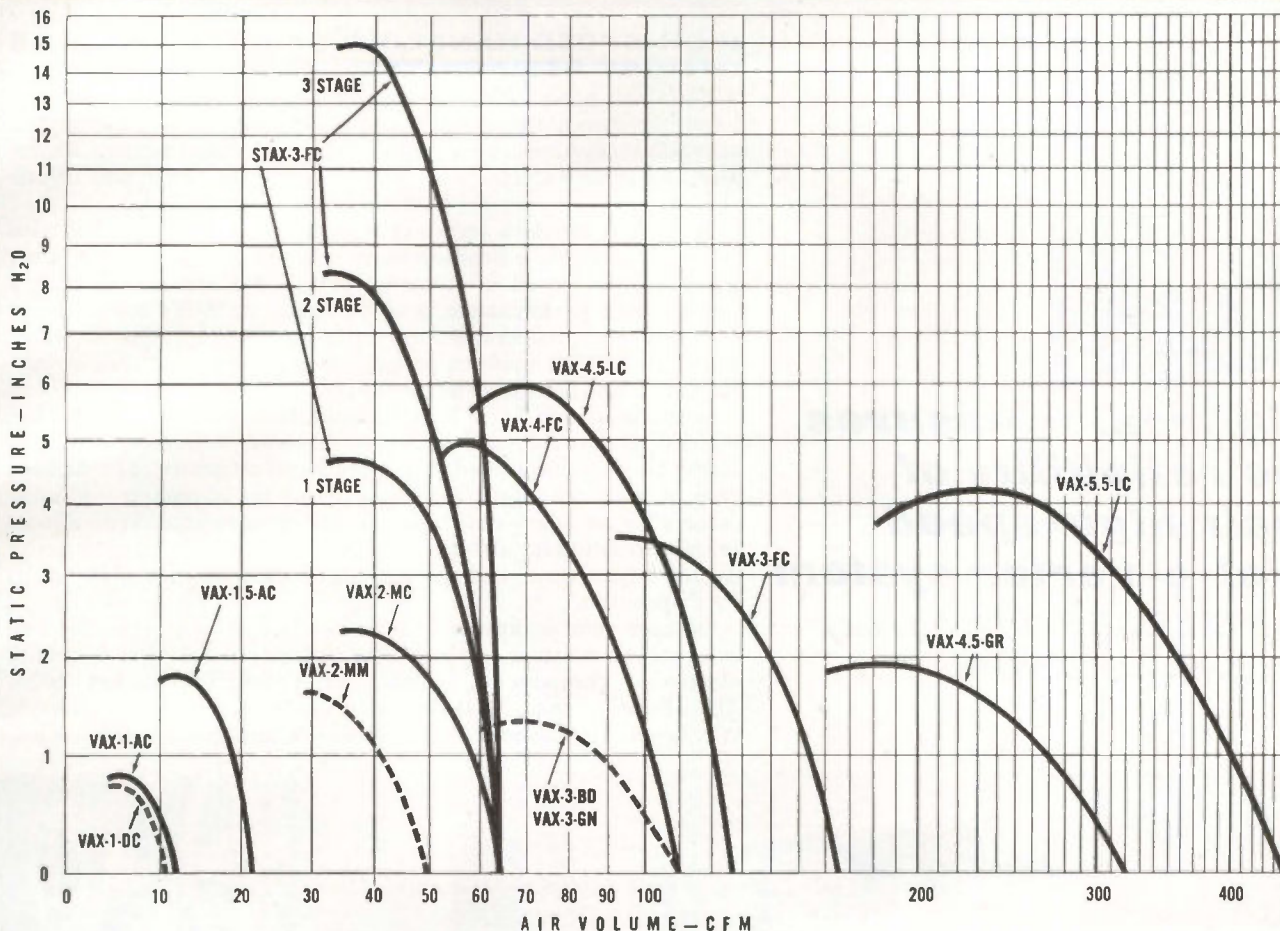

VAX-1-DC D.C. VANEAXIAL BLOWER. 1½" dia. 26 v.d.c. Rugged sub-miniature unit with good performance. 1.4 oz. Ideal for spot cooling. MIL specs.

VAX-1-AC A.C. VANEAXIAL BLOWER. 1½" dia. Operates on 26 v.a.c., 400 cycle, 1 phase. 1.5 ounces. Smallest vaneaxial blower available. MIL specs.



VAX-1.5-AC A.C. VANEAXIAL BLOWER. 1¾" dia. Uses 115 v.a.c., 400 cycle, 1 phase. 4.0 ounces. Can be supplied variable speed for high altitude use.



VAX-2-MM D.C. VANEAXIAL BLOWER. 2" dia. Operates on 26 v.d.c., other versions available up to 50 v.d.c. Designed for MIL specs., weighs 5 oz.



VAX-2-MC A.C. VANEAXIAL BLOWER. 2" dia. Operates on 115 or 200 v.a.c., 1 or 3 phase. Weighs 5 oz. MIL specs.



STAX-3-FC A.C. MULTI-STAGE BLOWER. 3" dia. Compressor staging in a miniature unit, ideal for heat exchangers, compact "black boxes," etc., 29 oz.



VAX-3-BD D.C. VANEAXIAL BLOWER. 3" dia. Operates on 28 v.d.c., other versions may be wound to 115 v.d.c. Designed for MIL specs., 16 oz.

VAX-3-GN A.C./D.C. VANEAXIAL BLOWER. 115 v.a.c., 60 cycle single phase, and 115 v.d.c. Other voltages available. MIL specs., 16 oz.

VAX-3-FC A.C. VANEAXIAL BLOWER. 3" dia. 115 or 200 v.a.c., 400 cycle, 3-phase. Variable speed high altitude units available. 14 oz. MIL specs.



VAX-4-FC A.C. VANEAXIAL BLOWER. 4" dia. High performance, high altitude unit operates on 115 or 200 v.a.c., 400 cycle. Weighs 2 lbs. MIL specs.



VAX-4.5-LC A.C. VANEAXIAL BLOWER. 4½" dia. 200 v.a.c., 400 cycle. MIL specs., weighs 5½ lbs.

VAX-4.5-GR A.C./D.C. VANEAXIAL BLOWER. 4¾" dia. Universal unit. 115 v.a.c., 60 cycles or 115 v.d.c. Exceptionally quiet.



VAX-5.5-LC A.C. VANEAXIAL BLOWER. 5½" dia. 200 v.a.c., 400 cycle. Large volume delivery against high system resistance.



IF YOUR BLOWER SPECS ARE HERE, YOU JUST SAVED TIME AND MONEY

Charted above are representative curves of standard Globe vaneaxial blowers, a.c. and d.c. Telephone us; we stock many of these for 24-hour delivery. Globe also meets most special blower requirements promptly, often by modification of one of our standard blowers. And because Globe is the largest manufacturer of precision a.c. and d.c. miniature motors, we can deliver completely custom prototypes in a few weeks. Let us help you solve your electronic cooling problem with a highly efficient, reliable Globe blower. We also make centrifugals, tube-axials, and axial fans. Request Bulletin V-2 from Globe Industries, Inc., 1784 Stanley Avenue, Dayton 4, Ohio. Tel. Area Code 513 222-3741.





DIGITRONICS DIAL-O-VERTER D520
MAGNETIC TAPE TERMINAL WITH
DOOR OPEN SHOWING CIRCUIT CARDS

**Digitronics assures
the reliability of
their high-speed
Dial-o-verter system**
with ALLEN-BRADLEY quality
electronic components

HIGH-SPEED HANDLING OF DATA DEMANDS UTMOST RELIABILITY!

■ You don't need a Ph.D. to understand that the higher the data handling speed, the greater is the necessity for uninterrupted operation—even short delays lose volumes of information. Therefore, Digitronics Corporation uses Allen-Bradley fixed and adjustable hot molded resistors in their Dial-o-verter system.

A-B fixed resistors are so thoroughly reliable that even with the *billions* of Allen-Bradley fixed resistors in use, there's never been a *single* record of catastrophic failure! The key to such a phenomenal performance is to be found in A-B's hot molding technique—a process developed and used *only* by Allen-Bradley. It results in such uniform properties that long term resistor performance can be accurately predicted.

Allen-Bradley's Type R adjustable fixed resistors are also hot molded so that the solid resistance element, terminals, and insulating body are produced in a rugged unit structure. The molded case is both dust-tight and watertight—it is completely satisfactory for use where entire circuits are encapsulated. With almost infinite resolution, abrupt changes in resistance cannot occur during adjustment, and the moving element is self-locking in its "set" position.

Be sure your equipment has the reliability *only* Allen-Bradley hot molded resistors can give. For full details on all A-B quality electronic components, please write for Publication 6024. Allen-Bradley Co., 110 W. Greenfield Ave., Milwaukee 4, Wisconsin. In Canada: Allen-Bradley Canada Ltd., Galt, Ont.

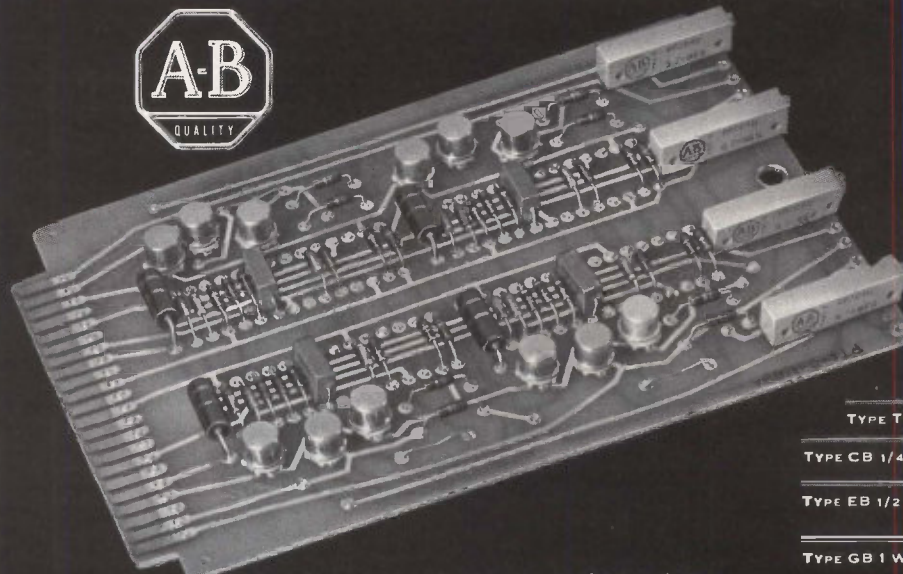

One of the circuit cards showing use of A-B resistors.
Allen-Bradley hot molded fixed resistors are available in all
EIA and MIL-R-11 standard resistance values and tolerances.

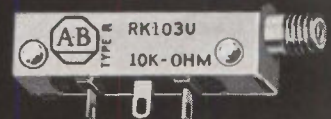

A-B Type R adjustable fixed resistors, rated ¼ watt at 70°C, available in total resistance values from 100 ohms to 2.5 meg.

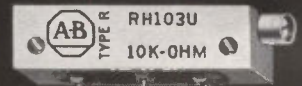

TYPE TR 1/10 WATT

MIL TYPE RC 06

TYPE CB 1/4 WATT

MIL TYPE RC 07

TYPE EB 1/2 WATT

MIL TYPE RC 20

TYPE GB 1 WATT

MIL TYPE RC 32

TYPE HB 2 WATTS

MIL TYPE RC 42

ALLEN-BRADLEY

QUALITY ELECTRONIC COMPONENTS



FAMILY of negative resistance elements are checked on a plotter to determine characteristic curves

The Negative Resistance Element (NRE)

A New Circuit Component

The family of electronics circuit components is continuing to grow as modern techniques generate new and versatile devices. This new series of components exhibits a-c negative resistance and has a variety of applications

By CARL D. TODD, Hughes Aircraft Co., Newport Beach, Calif.

INCREASE in voltage applied to the usual resistor will cause a proportional increase in the terminal current. Certain electronic devices have regions where an increase in applied voltage produces a decrease in terminal current. This represents an a-c negative resistance.

The four-layer diode, silicon-uni-junction transistor and the gaseous discharge tube have a terminal characteristic curve of the general form shown in Fig. 1A. Here, a given value of terminal voltage between V_r and V_p may produce one of three possible terminal currents; however, any set current yields one and only one possible voltage. Thus, a device of this type is referred to as having a current-stable or N-type negative resistance.

The terminal characteristic curve shown in Fig. 1B is exhibited by devices like the tunnel diode, vacuum tube tetrode as used in the dynatron oscillator, and the common-emitter input of a point contact transistor. This characteristic is referred to as voltage-stable or

S-type, since any one voltage will control the terminal current and any current between I_r and I_p may have three possible values of terminal voltage.

Negative resistance devices may be used to construct oscillators and Q-multipliers and perform many switching functions; their usefulness, however, is sometimes limited by nonlinearity or unpredictability of their electrical characteristics.

It is possible to design composite circuits with fairly linear negative resistances. Several configurations have been described,^{1, 2, 3} but these have a certain amount of dependence on the device parameters of the semiconductors used, are temperature sensitive and lack carefully-controlled characteristics.

A patented⁴ composite circuit is currently available that overcomes many of the previous limitations of negative resistance devices or circuits. Negative resistance elements (NRE) have predictability and

THE POSITIVE NEGATIVE

The high predictability of the negative resistance element (NRE) characteristic curve makes the device a natural as a d-c switch, circuit breaker, monostable multivibrator and a relaxation oscillator. It is also useful in threshold and comparator circuits.

In linear applications, the excellent linearity and temperature stability of the NRE gives the circuit designer a usable negative resistor for use in Q-multipliers, two-terminal oscillators and filters.

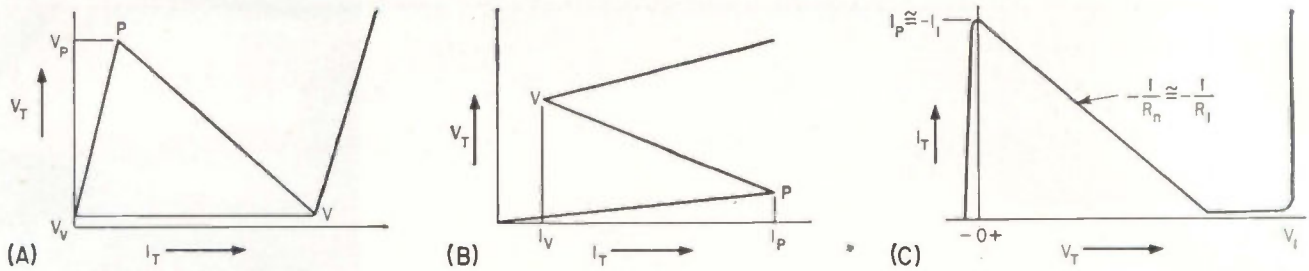

NEGATIVE characteristics of N-type (A) and S-type (B) materials and the terminal characteristics produced by the circuit of Fig. 2B (C)—Fig. 1

stability that yield performances and permit versatile applications not previously possible; thus, a new component is made available to the circuit designer.

BASIC OPERATION—The circuit arrangement shown in Fig. 2A, has two ideal power amplifiers connected together in a loop. Amplifier 1 is assumed to have unity voltage gain and infinite current gain; amplifier 2 assumes an infinite voltage gain and a current gain of minus one.

An a-c voltage, V_i , applied to the output terminals will produce a voltage at the output of amplifier 1 that is also equal to V_i . This will cause a current to flow in R_1 that is equal to V_i/R_1 . This, in turn, is the input current of amplifier 2.

The output current of amplifier 2 will be equal then to $-V_i/R_1$. The terminal current, I_T , is also equal to $-V_i/R_1$, since the current supplied to the input of amplifier 1 is zero. The resulting terminal resistance R_T will be: $R_T = V_i/I_T = V_i/(-V_i/R_1) = -R_1$, or $V_i/(-V_i/R_1)$.

The amplifier circuit of Fig. 2A would yield a negative slope without any boundaries, thus implying an infinite power source. A modified equivalent circuit that is realized to a very close approximation in

the NRE is illustrated in Fig. 2B.

The resulting characteristic curve seen at the output terminals is shown in Fig. 1C. Boundaries on the negative resistance are established by clamping diodes D_1 and D_2 . Voltage V_1 establishes the clamping level for higher values of V_T and D_2 prevents the terminal voltage from going appreciably negative.

The current bias source I_1 provides a terminal current for a zero value of V_T that will be approximately equal to $-I_1$. As V_T is increased in a positive direction, a current I_n is produced that will add algebraically. For the actual case, the magnitudes will subtract, thus reducing the terminal current linearly and producing a negative terminal resistance.

Diode D_3 aids in simulating the actual input conditions to amplifier 2 as seen from the bias terminal. This indicates a slight temperature dependence of the input voltage of roughly 2 mv per-degree C, that must be considered in designing stable bias conditions.

Diode D_1 prevents a negative voltage from producing a current in R_1 and also compensates for the voltage drop across D_3 . The magnitude of the a-c output resistance, R_n , in the negative resistance region, will

be somewhat different from that indicated by the first equation because of the finite dynamic resistance R_{d3} and R_{d1} of diodes D_3 and D_1 , respectively as $R_n = R_1 + R_{d3} + R_{d1}$.

The values of R_{d3} and R_{d1} may roughly be approximated by the usual equation, $R_d = KT/qI_f = 0.026/I_f$ ohm at room temperature, where I_f is the value of forward current in the individual diode.

The equivalent circuit as shown, represents the NRE closely in most applications, although it is not an exact circuit.

GENERAL CHARACTERISTICS

—Negative resistance elements are composite circuits similar to the equivalent circuit of Fig. 2B, and possess an S-type or voltage-stable output terminal characteristic curve. Two main families are available depending upon the polarity desired for the terminal voltage.

Typical output terminal characteristics for the family of NRE designed for use with negative terminal voltage supplies are given in Fig. 3A. Curves for an NRE with $R_n = 1,000$ ohms are shown for several different values of bias current I_1 , and for two values of supply voltage V_1 .

The magnitude of the peak current will be nearly equal to that of the bias current I_1 , and the high-voltage clamping point is about 0.7 volt higher than V_1 . By varying V_1 , and I_1 , the characteristic curve may be considerably modified.

Fig. 3B shows the many possible values of R_n represented as R_1 , an

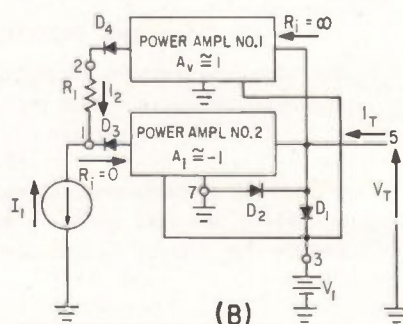
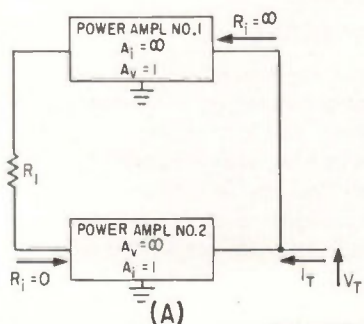

BASIC method of producing a negative resistance (A) and equivalent circuit of an NRE (B)—Fig. 2

external variable resistor connected across the terminals provided. For this curve, biases V_i and I_i were held constant at -30V and 10 ma , respectively.

The excellent linearity of R_n for the NRE is illustrated by the typical performance curve shown in Fig. 3C. With the terminal voltage restricted between 1 and 30 volts, linearity is better than 2%. With V_T restricted to the 4.5 to 29.5 volt-
age range, the linearity is about 0.5 percent.

The temperature coefficient of R_n is a function of the value of R_n . It is possible to achieve a stability of 5 ppm per-degree C over a temperature range of -20 C to $+100\text{ C}$ for values of R_n approximately equal to 700 ohms. For optimum temperature stability, wire-wound resistors must be used for the reference resistor R_1 .

Maximum operating frequency is limited to around 1 Mc for the present negative supply NRE. Higher frequency devices will probably become available later.

The characteristic curves for NRE designed for positive terminal voltages are very similar to those given in Fig. 3 except that the polarities are all inverted; that is, V_T and V_i will be positive, but I_i will be negative. The maximum operating frequency for the positive supply NRE family is about 20 Mc.

In non-linear applications, the excellent predictability of the device's characteristic curve is excellent for an efficient d-c switch, a circuit breaker, monostable multivibrator or a relaxation oscillator. Moreover, the linearity and temperature stability of R_n gives the designer a usable negative resistor for use in Q-multipliers, two-terminal oscillators and filters. Some typical applications are shown in Fig. 4.

REFERENCES

- (1) C. D. Todd, Transistor-Tunnel Diode Combination, *Electronic Design*, Vol. 9, pps. 48-51, April 26, 1961.
- (2) C. D. Todd, Transistor-Tunnel Diode Produces an N-type Negative Resistance, *AIEE Communication and Electronics*, No. 26, pps. 284-290, Sept. 1962.
- (3) C. D. Todd, A Composite Circuit Exhibiting S-type Negative Resistance, *Semiconductor Products*, Vol. 5, pps. 24-28, Oct. 1962.
- (4) H. J. Pfiffner, U. S. Patent No. 2,943,282.

D-C SWITCH application of the NRE (A); the device applied to a Q-multiplier circuit (B) and monostable vibrator circuit and operating characteristics (C)—Fig. 4

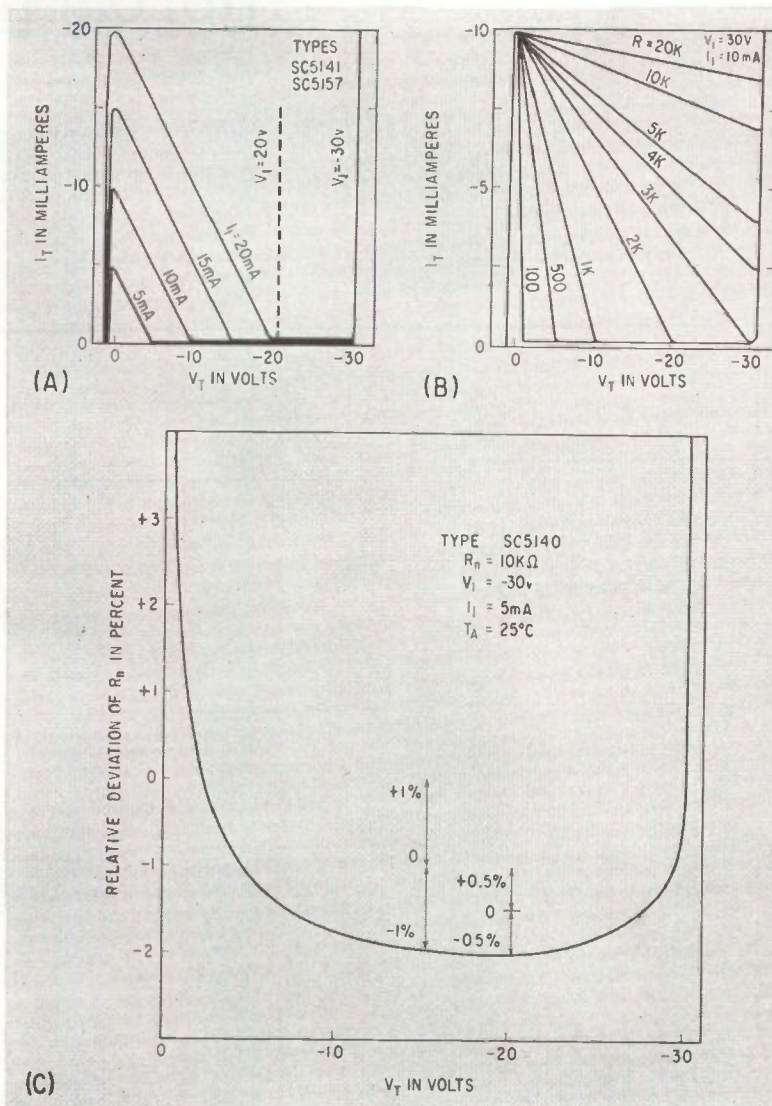

OUTPUT curves for Hughes SC5141 and SC5157 devices for $R_n=1,000$ ohms (A); characteristics for SC5140 and SC5156 for several values of R_i (B) and typical resistance linearity curves (C)—Fig. 3

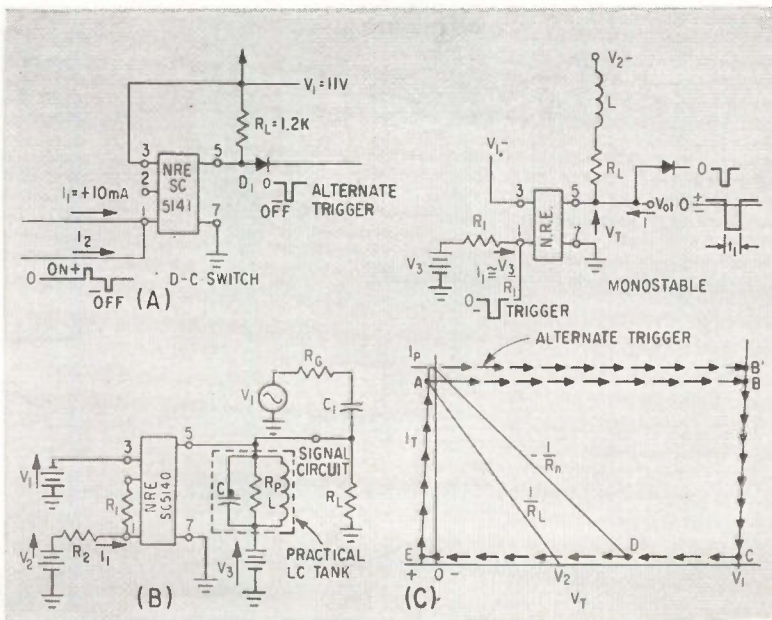

Latest Approach to Integrated

First a closed loop response satisfying circuit specifications is selected, then the open loop response is calculated and errors are considered

By F. D. Waldhauer, Bell Telephone Laboratories, Inc., Murray Hill, N.J.

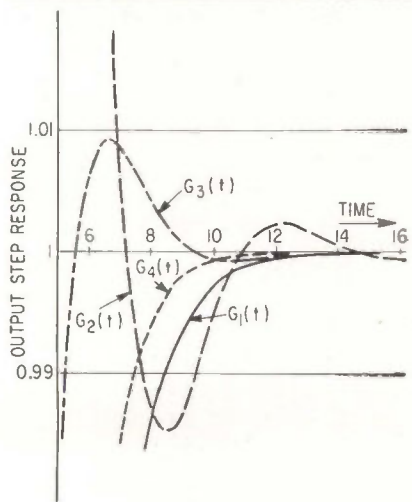

STEP RESPONSES of the third order functions given in the table—Fig. 1

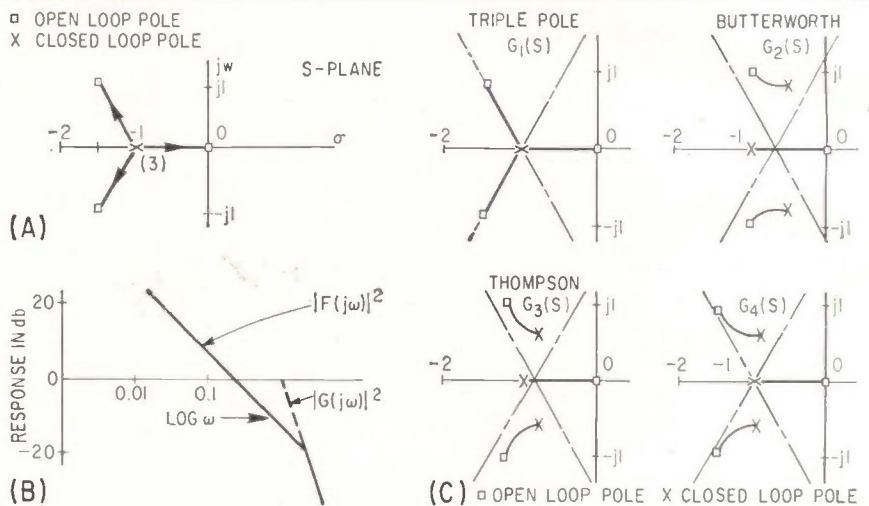

OPEN AND closed loop poles (A) for the triple pole function given in the table and its Bode plot (B). Root loci (curved lines) for functions in the table (C)—Fig. 2

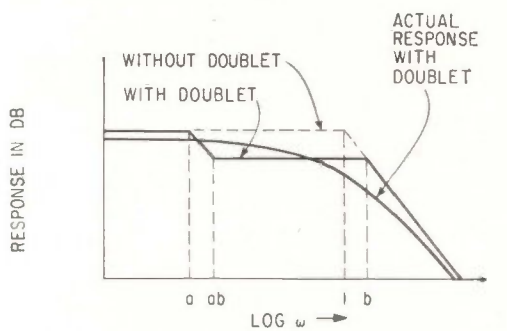

(A) ASYMPTOTIC FREQUENCY RESPONSE INCLUDING DOUBLET WITH POLE AT FREQUENCY A AND ZERO AT AB.

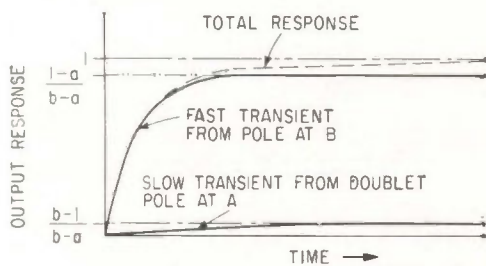

(B) TIME RESPONSE TO A STEP

SPURIOUS pole-zero pairs, or doublets, affect amplifier frequency (A) and transient (B) responses—Fig. 3

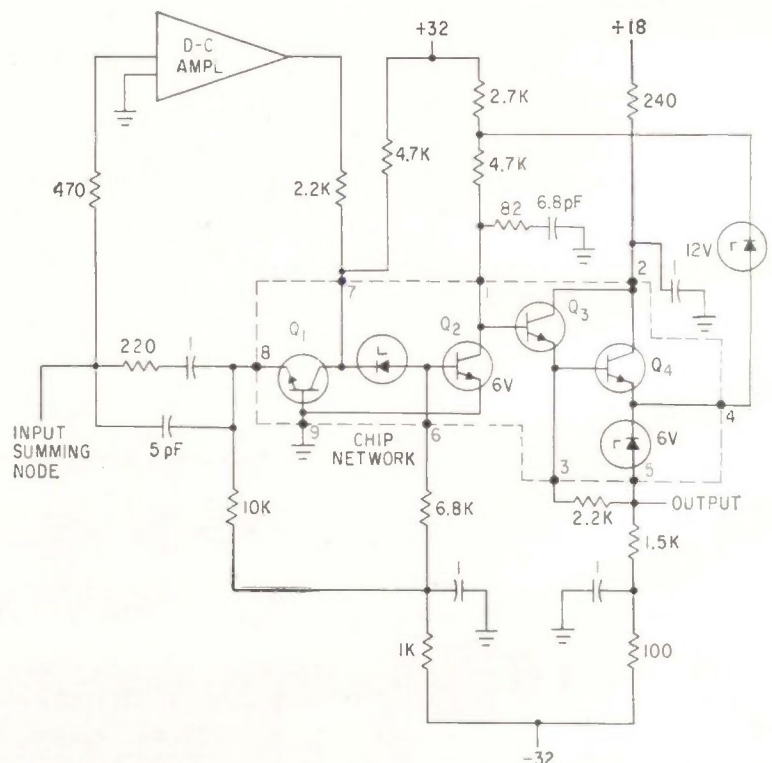

ALL TRANSISTORS of the wideband amplifier are in the integrated circuit package, thereby reducing the signal path and signal delay and improving response—Fig. 4

Amplifier Design

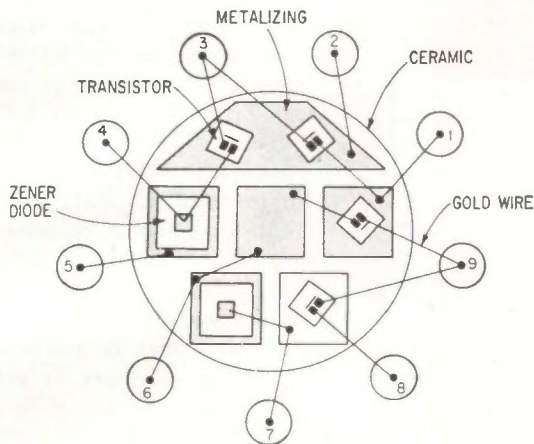

LAYOUT of TO-5 header showing interconnections—Fig. 5

TO-5 header holds four transistors and two zener diodes

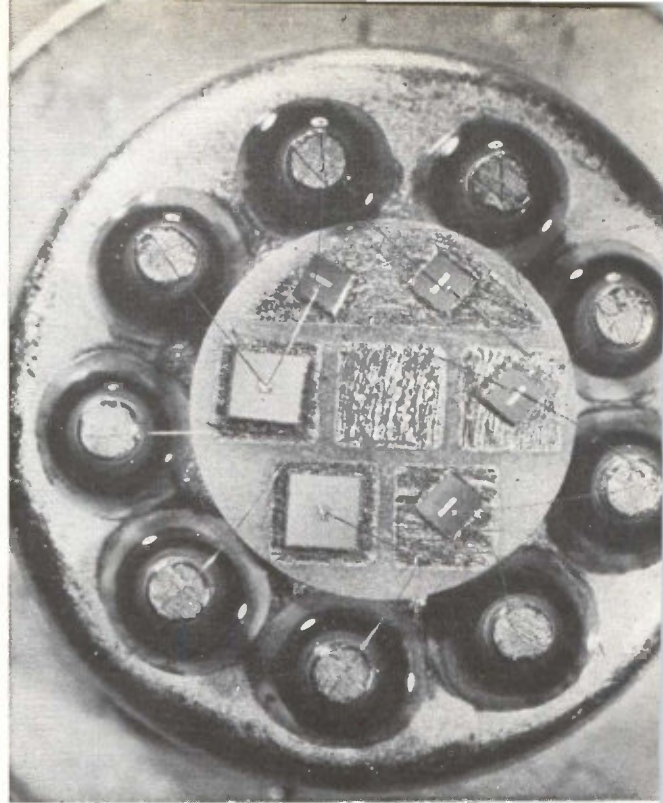

IN THE ANALOG portion of analog digital systems, amplification with critical tolerances on time domain performance is often required. The requirements can sometimes be reduced to stating maximum output error for a step input after a stated settling time. For accuracy of 0.1 to 0.01 percent, feedback techniques are mandatory. But to obtain these accuracies in tens of nanoseconds, the bandwidth of the feedback amplifier must be large, which can produce loop delay and parasitics with conventional assemblies. By integrating the circuit using separate chips, critical signal paths are made small compared with a wavelength and parasitics and delay are greatly reduced.

But the amplifier must be designed to realize the potentials of circuit integration. Ordinary design using pole-zero cancellation introduces pole-zero pairs or doublets, which cause transients in the response. The new procedure avoids this to a great degree, thereby achieving accurate step and unusually flat frequency response.

First the step responses of various well-known filter functions are examined and a suitable closed-loop pole configuration is selected. From this closed loop function, an open loop function is derived. Allowable error in the open loop in terms of spurious pole-zero pairs due to either parasitics or faulty design is

then considered. Then the circuit is put together by integrated circuit techniques.

CLOSED LOOP RESPONSE—To determine the closed loop response necessary to realize time domain specifications, the time response of several common filter functions having the same final (normalized) asymptotic frequency response are compared. Step responses of four such functions in the region of one percent accuracy are shown in Fig. 1. The order has been chosen as three, corresponding to three transistor stages of comparable final asymptotic response.

The table gives the pole locations and settling times for each of the functions of Fig. 1, and shows that the exact function is not particularly critical, as long as the poles maintain sufficient distance ($\frac{1}{2}$ or 1) from the $j\omega$ axis.

The problem therefore is to synthesize an amplifier having the pole configuration of one of these functions for its closed loop gain. Exact pole locations are not important but for accurate response there must be no other spurious poles in the s plane nearer to the origin than the main cutoff poles.

OPEN LOOP RESPONSE — The function having the selected pole configuration represents the closed loop gain $G(s)$ of the equivalent unity gain amplifier; the feedback network is included in the open loop gain function $F(s)$. Thus, $G(0)$ is equal to unity. Open loop gain in terms of the closed loop is given by



$$F(s) = \frac{G(s)}{1 - G(s)} \quad (1)$$

When $G(s)$ includes no zeros (as in the functions in the table)

WHY USE INTEGRATEDS?

Now that integrated circuits are starting to come on strong, circuit designers have to learn how to take advantage of the opportunities they present. By keeping the signal path in a feedback amplifier short, for example, propagation delay is minimized and bandwidth is increased. F. D. Waldhauer points out that each linear inch of signal path contributes about 0.1 nanosecond delay. By keeping most of the amplifier's signal path inside the TO-5 header package, he keeps loop delay to a little less than 0.1 nanosecond

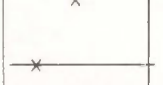
Table - Step input setting times for four third-order functions

| | $G_1(s)$ | $G_2(s)$ | $G_3(s)$ | $G_4(s)$ |
|------------------|---|---|---|---|
| Function | Triple pole | Butterworth | Thomson | |
| Pole locations |  |  |  |  |
| $G(s)$ | $\frac{1}{s^3 + 3s^2 + 3s + 1}$ | $\frac{1}{s^3 + 2s^2 + 2s + 1}$ | $\frac{1}{s^3 + 2.4s^2 + 2.4s + 1}$ | $\frac{1}{s^3 + 2.82s^2 + 2.83s + 1}$ |
| Error in percent | | Settling Time in Seconds | | |
| 0.1 | 8.4 11.2 | 9.4 13.5 | 5.6 8.5 | 7.5 9.6 |
| Overshoot | 0 | 8.1% | 0.94% | 0 |

$$G(s) = \frac{1}{s^n + \alpha_{n-1}s^{n-1} + \dots + \alpha_1s + 1} \quad (2)$$

and

$$F(s) = \frac{1}{s(s^{n-1} + \alpha_{n-1}s^{n-2} + \dots + \alpha_1)} \quad (3)$$

Equation 3 reduces to $1/s$ over most of its range as a result of the restriction on closed loop gain that the poles maintain a sufficient distance from the $j\omega$ axis.

Thus, $F(s)$ has a pole at the origin and $|F(j\omega)|^2$ has a unit (6 db per octave) cutoff slope over its entire range from frequencies near 0 to a frequency near the final asymptote cutoff, considering the restrictions on the closed loop gain.

As an example, consider the closed-loop response

$$G(s) = \frac{1}{(s + 1)^3} \quad (4)$$

The closed-loop poles are all at $s = -1 + j0$, as shown in Fig. 2A. The open loop poles can be found by following along the root loci; one pole moves into the origin, supplying the unit cutoff slope, while the other two become complex, as shown. The corresponding Bode plot is shown in Fig. 2B. The root loci for the other functions in the Table are shown in Fig. 2C. All have a single open loop pole at $s = 0$.

OTHER ERRORS — The finite speed of the transistors produces

an error in step response which is minimized by the selection of the cutoff shape for the closed loop response, which is then translated into open-loop gain requirements. Errors due to the finite transistor speed are not the only ones. Inaccuracy of the feedback resistor will produce a gain error, and drift, in a d-c amplifier, will produce an offset error, but these will not be discussed further here.

Another step response error of importance arises from transients produced by spurious pole-zero pairs, or doublets, which are caused by parasitic reactive elements or by incomplete pole-zero cancellation in pole-zero design. Doublets produce departures from exact flatness in the closed-loop frequency response, and relatively larger departures

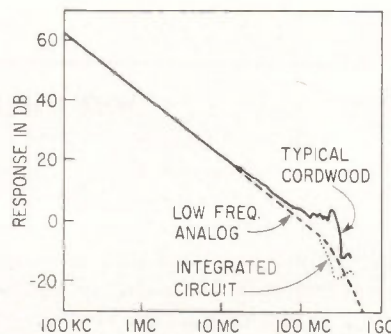

OPEN LOOP gain of typical cordwood amplifier shows high frequency instability—Fig. 6

from exact unit slope cutoff in the corresponding open-loop response.

The effect of a real doublet on the asymptotic frequency response and the time response is shown in Fig. 3. The error transient produced by the doublet will have an initial value equal to the variation in frequency response that it produces. Thus, for a step response accuracy of 0.1 percent, the net effect of all doublets must not vary the closed-loop response by more than 0.1 percent. At sufficiently high frequencies, the doublet transient will die out quickly, so larger doublets may be tolerated.

When feedback is removed, the open-loop response falls at 6 db per octave, and doublets express themselves as departures from this cutoff slope. Feedback reduces doublet size (that is, flattens the response) by roughly the magnitude of the return ratio, so open-loop doublets will be larger than their closed-loop counterparts. Thus, since the return ratio varies inversely with frequency, the allowable open-loop doublet size becomes relatively greater at low frequencies.

ACTUAL CIRCUITS—If frequency doublets are to be minimized, it is undesirable to use pole-zero cancellation techniques to synthesize the unit slope cutoff function. Of the four forward transfer functions of a common emitter transistor amplifier, one, namely the forward transimpedance, z_{21} , has a unit slope cutoff over a wide range of frequencies. The forward transimpedance may be made to control the response in the cutoff region by providing open circuit source and load impedances. This can be accomplished by providing a unity voltage gain amplifier at the output, such as one or several tandem common collector stages as shown in Fig. 4 (Q_3 and Q_4). Bootstrapping the d-c bias resistors of these stages keeps the input impedance high.

The basic unit slope cutoff comes about because the output voltage, V_o , appears (slightly increased) at the collector of Q_3 , where it creates a base current $V_o C_{c23}$ through the collector capacity of Q_3 . This base current is the input current for the amplifier multiplied by the α of an input common base stage; this α is nearly unity.

This amplifier was designed as a

d-c operational amplifier. A parallel path arrangement was developed in which d-c signals at the input summing mode are amplified in a low drift d-c amplifier and reinserted into the amplifier signal path at the input to the common emitter stage. The common base stage isolates the input from the output of the d-c amplifier and provides a high impedance source for the common emitter stage. A resistor in series with the input of the common base stage provides d-c signal voltage for the d-c amplifier and broadens the bandwidth of the common base stage so that it does not add significant slope to the final asymptote in the cutoff region.

The response of the d-c amplifier in parallel with the common base stage is complementary to the high frequency amplifier comprising Q_2 , Q_3 , and Q_4 , and maintains the unit slope down to about one Kc, where the gain is over 100 db. The junction of the two responses produces a small frequency doublet but at a low enough frequency to avoid excessive time response errors.

FREQUENCY RESPONSE — The transfer function of the whole amplifier is of eight order in the frequency variable, but a reasonably good approximation is obtained from

$$G(s) = \frac{1}{s^3 + a_2s^2 + a_1s + 1} \quad (5)$$

or

$$F(s) = \frac{1}{s(s^2 + a_2s + a_1)} \quad (6)$$

The coefficient of the s^3 term, normalized to unity here, is set by the final asymptotic transistor response. Coefficients a_2 and a_1 establish how the unit slope cutoff joins the final asymptote (the smaller a_2 and a_1 , the more lively the response). The last coefficient in the denominator of $G(s)$ (taken as unity) comes about from the feedback, and is accordingly absent from the open loop gain of Eq. 6.

Coefficient a_1 controls the magnitude of the unit slope cutoff. Its value may be increased by increasing the collector capacity of Q_2 . Coefficient a_2 will also increase slightly when this is done, as will a_1 . The effect on a_2 can be reduced by placing a resistor and perhaps inductance in series with the added ca-

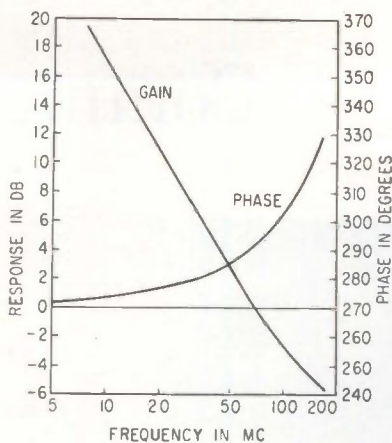

(A) OPEN LOOP

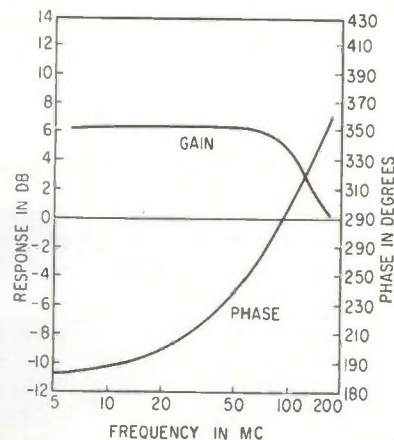

(B) CLOSED LOOP

OPEN and closed loop responses of the integrated amplifier—Fig. 7

capacity. In the amplifiers which have been constructed, the collector capacity of Q_2 was adequate, so that none was added.

Coefficient a_2 may be increased without significant effect on a_1 by adding capacity from the base of Q_3 to ground, again through a resistor to avoid reducing the final asymptotic response. If a_2 is too small, the open-loop gain will have a peak at the asymptotic cutoff frequency.

With these two adjustments, the desired closed-loop filter function of the table can be approximated. Exact analysis is difficult because of both circuit complexity and propagation delay, so experimental work is important.

DELAY — Propagation delay has an unstabilizing effect on performance, and since it adds phase proportional to frequency, ultimately limits the bandwidth of the feedback amplifier. Delay comes from two sources: first is excess phase in the transistors (about 0.1 nanosecond in high frequency silicon transistors) and mainly comes about through the lattice-scattering limited drift velocity in the collector depletion region; the second is transport delay around the feedback loop. In a cordwood version in which particular attention was paid to minimizing the distance around the feedback loop, the loop distance measured three inches, representing roughly 0.3 nanosecond of delay. This was reduced to less than 0.1 nanosecond in the integrated circuit version.

Delay modifies the values of the

coefficients of s in the open-loop gain, but the general effects of increasing a_1 and a_2 remain.

EXPERIMENTAL WORK — High-speed measurements in the time domain are difficult to perform with sufficient accuracy, so frequency domain measurements were performed on three different amplifiers. First, a low frequency analog was built and tested to check the theory without the complications caused by parasitic reactive elements; second, a full speed cordwood model was constructed, with signal path and ground lead lengths minimized; third, integrated circuit was built using separate chip mounting of the four transistors and three zener diodes.

The structure of the integrated circuit is a gold deposited ceramic substrate on a TO-5 header. Silicon planar transistors and diodes and bulk silicon resistors in chip form are bonded to the substrate, as shown in Fig. 5.

Open loop gain of the three amplifiers is shown in Fig. 6. The separate chip approach helps keep parasitic elements to a minimum. Open and closed-loop gain and phase are shown in Fig. 7.

The fabrication of the integrated circuit was performed by Richard Lindner and Karl Martersteck whose help, along with that of James Goldey, is gratefully acknowledged.

REFERENCES

- (1) B. T. Howard and R. Lindner, "The Influence of Evolving Technology on Integrated Circuits," Report No. 8 on Transistors, Contract DA 360-39 SC-88931, Chapter 4, March 31, 1962.

Communicating With



STRICT inspection and quality control must be exercised for space-vehicle equipment to assure successful operation under changing environment

The Mariner II Venus probe has shown the validity of deep-space telemetry. Longer flights are planned in the near future. Here is how Mariners communications system functioned to receive commands and transmit telemetry data during the 109-day flight

By WARREN E. DAHL, Motorola Inc.,
Military Electronics Div., Scottsdale, Ariz.

OUR MARINER II spacecraft recently passed Venus at a miss distance of 21,648 miles, marking the most successful interplanetary space probe ever attempted. At the climax of its 109-day, 181-million-mile journey, it was telemetering information clearly across the 36-million miles to earth, setting a new all-time record for long distance communication. Tracking continued until the spacecraft was more than 53 million miles from earth.

Mariner II's spaceborne communications package has been described as one of the most sophisticated and efficient electronic systems ever devised. Integrating the functions of command, telemetry and tracking, and working in conjunction with the DSIF ground stations, the communications package aboard the probe was built around an L-band transponder. On the spacecraft, an omnidirectional array was used for command and tracking-signal reception, and a directive parabolic antenna for telemetry and tracking signal transmission. Transmissions up to the spacecraft were on 890 Mc and transmissions down to the earth were on 960 Mc.

The 10.5-lb transponder was designed to provide the functions of a command receiver, a phase-coherent doppler transponder and a telemetry transmitter. It consumed about 7 watts of power and had a carrier threshold of -147 dbm. Commands received by the transponder were detected and relayed to the spacecraft command decoder; scientific and spacecraft engineering data were processed by the flight-data encoder and applied to the transponder-modulator. In addition to the six scientific experiments, a total of fifty spacecraft operating parameters were reported, including voltages, temperatures, antenna-pointing information and transponder age voltage.

CONSTRUCTION — The transponder configuration bore a striking resemblance to two six-packs of beer; it weighed about 10 pounds,

Future Deep-Space Probes

occupied less than a $\frac{1}{4}$ cubic foot and was gold plated. Individual modules had tee-section construction to provide a rugged unit and to guard against internally-generated coherent signals. Solid state circuits were employed throughout and transistors and other electrical components were screened in a Minuteman type testing program to reduce the possibility of failure. Moreover, the transponder was subjected to at least 500 hours of testing in all anticipated environments prior to launch. No redundant elements appear in the communications system; however, individual modules were designed to accept a ± 3 -db change in input signal level without performance degradation.

TRANSMITTER AND RECEIVER

—The L-band transponder consists of a double-conversion heterodyne, phase-coherent receiver and a c-w transmitter integrally related in both frequency and phase. The sensitivity of the transponder at threshold is -147 dbm. This is a function of both the receiver noise figure with maximum value of 14 db, and the loop r-f noise bandwidth designed to be 20 cps at threshold.

The phase coherent circuit shown in Fig. 1A is extremely versatile. It can be designed to exhibit a wide variety of characteristics, and the characteristics themselves can be combined in numerous ways to

achieve the objectives of specific applications. Effectiveness is contingent upon the amount of prior information designed into the circuit, which is a product of component values and configurations.

The design of the Mariner transponder was based on estimates of the nature of the received signal. This built-in intelligence includes a history of what these signals have been known to do in the past, plus all frequency and phase permutations that could be exhibited in the future.

The r-f phase-lock loop was designed to follow doppler-frequency

shifts, ground-transmitter frequency changes and long-term oscillator instabilities. The loop filter exhibits the very narrow information passband characteristics required by the doppler modulations, and can thus use a very narrow passband to reject unwanted noise. The phase-lock loop recognizes the carrier-signal components by comparing them with a locally generated description (a process called correlation) that is designed into the circuit. The portion of the signal which is predicted and tracked by the phase-lock loop is used similarly to provide the basis for dop-

EARTH TO VENUS AND BACK AGAIN

Even when high-power transmitters and large antennas are used, signals received from deep space are very weak. Undaunted, Motorola and JPL engineers designed the equipment aboard our Mariner II vehicle to receive command signals from the Goldstone DSIF tracking station at a distance greater than 36 million miles. Moreover, telemetry data sent back from the low-power transmitter aboard the probe reached Earth without a hitch.

| | |
|--|-----------------|
| Goldstone transmitter power | 10 Kw (+70 dbm) |
| Goldstone antenna gain | + 43 db |
| Free-space loss (L_{FS}) | - 247 db |
| $(L_{FS} = -36.6 - 20 \log_{10} 36 \times 10^6 \text{ miles} - 20 \log_{10} 890 \text{ Mc})$ | |
| Spacecraft omni antenna gain (best look angle) | +1.50 db |
| Losses between antenna and transponder | -1.50 db |
| Signal level at transponder | - 134 dbm |

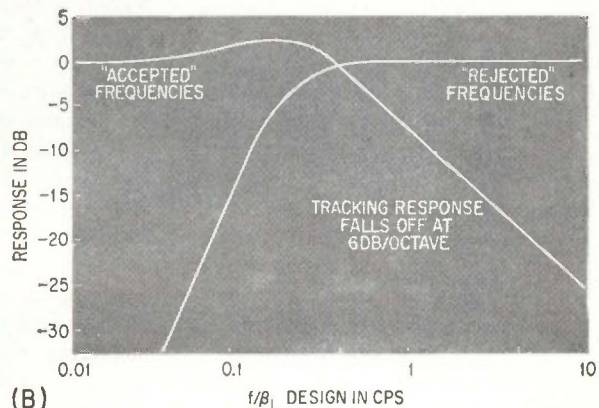
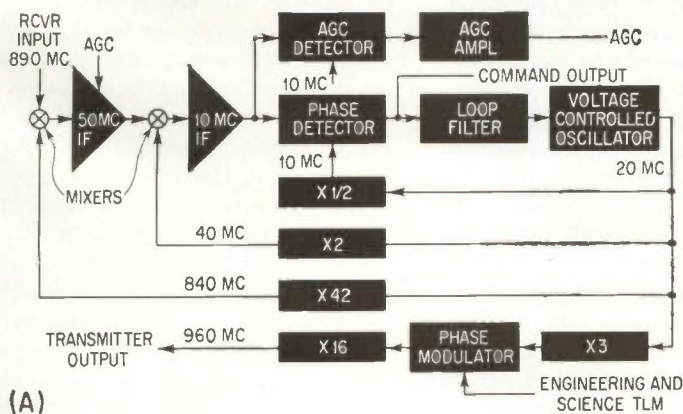

PHASE-COHERENT circuit and frequency-multiplication system comprise the L-band transponder (A) and phase-lock loop response vs receiver modulation bandwidth (B)—Fig. 1

INSIDE



AND OUT...



The all-new CUBIC V-85 is your best buy in a 5-digit voltmeter!

The new V-85 five-digit reed relay voltmeter has more unique quality features inside and out than any other instrument. New lifetime, encapsulated, sub-miniature reed relays in the bridge switching circuit are good for more than a billion cycles of maintenance-free operation. These reed relays are virtually noiseless! The precision Julie Research Lab resistors in the bridge circuit are the best and most expensive obtainable—and they yield unparalleled accuracy.

MILITARY GRADE CIRCUIT BOARDS: Cubic uses extra thick epoxy-glass circuit boards of military grade. All etched circuits are on one side of the boards and all components on the other to simplify maintenance. For rapid repairs, a new board may be slipped into place within seconds. Boards fit into molded connectors mounted on the mother board. This construction technique is much more substantial and eliminates the mis-alignment problems common to many plug-in board designs. Extender boards are furnished to bring circuit boards out into the open to provide external test points for checking.

WITHSTANDS RUGGED ENVIRONMENTS: The V-85 offers military reliability. An independent laboratory put this new DVM through all applicable MIL SPEC environmental tests, and it passed with flying colors. If you're looking for a digital voltmeter that not only looks good on the *outside* but also gives you far superior construction on the *inside*, see the Cubic V-85 before you buy. Write for more information to Department B-151.

GUARANTEED SPECIFICATIONS

Speed: three readings a second
Sensitivity: 100 microvolt
Accuracy: .01% ± 1 digit (of reading)
Reference Stability: .005% per month;
.01% 1 year; temperature coefficient
.002%, 15°C to 45°C
Input: front and rear. Full-floating,
10 megohms at balance, 1 megohm
minimum, 1000 megohms on ratio
and low range
Balance Time: 300 msec average,
600 msec maximum
CMR: 80 db at 60 cps
Power: 40 VA, 50-400 cps, 115-230 V
Ranges: DC Volts ± 0.0001 to ± 9.9999 ,
 ± 10.000 to ± 99.999 ,
 ± 100.00 to ± 999.99 ; DC-DC Ratio
.00000 to .99999
Functions: AC, DC, Ratio, Remote
Automatic Features: Range, Polarity



CUBIC
CORPORATION
SAN DIEGO 23, CALIFORNIA
INDUSTRIAL DIVISION

OTHER OFFICES AND REPRESENTATIVES IN PRINCIPAL U. S. AND CANADIAN CITIES

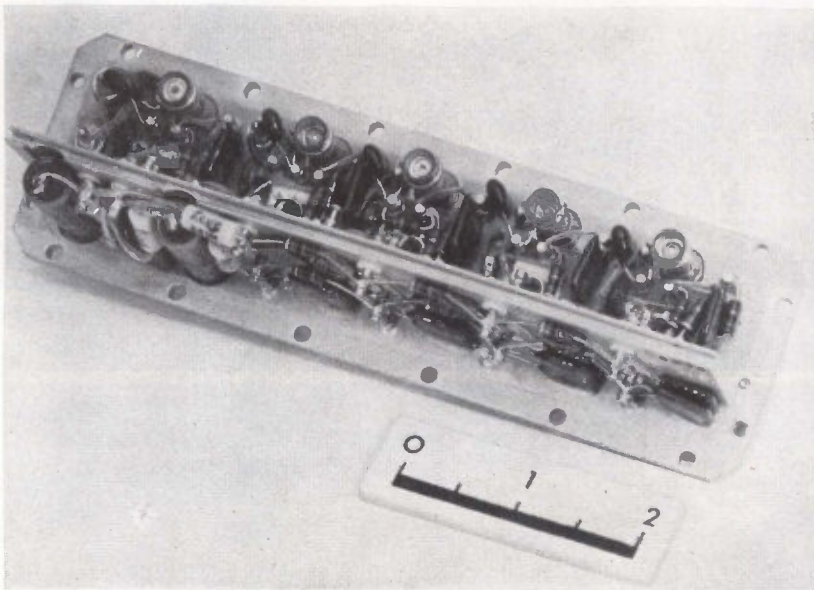

T-SECTION design is used to reduce signal levels at module surface to less than 10 watts—Fig. 3

source to lock the ground receiver.

Telemetry information is applied to the transponder transmitter in a series-phase modulator operating at 60 Mc. Modulation is accomplished by varying the tuning of a series-resonant circuit containing silicon voltage-variable capacitors. The capacitance of the circuit is controlled by the amplitude of the modulating signal. The 60 Mc modulated signal is multiplied by a factor of sixteen to provide the transponder-transmitter output.

MULTIPLIER—The X16 frequency multiplier shown in Fig. 2 provides the 960 Mc r-f output signal by frequency multiplying the 60 Mc input signal from the phase-modulator module. The frequency multiplier consists of four stages. The first stage amplifies the 60 Mc signal; the second multiplies it from 60 Mc to 120 Mc; the third multiplies from 120 Mc to 240 Mc and the final stage multiplies from 240 to the required 960 Mc output signal.

The 60 Mc input is applied to amplifier stage Q1 at a nominal power of 10 mw. The output is split into two out-of-phase signals of 30 mw each and applied to the first frequency multiplier stage Q2-Q3. This stage is composed of two transistors in a push-push, Class C combination in a common-base configuration. The inputs are fixed-tuned to

60 Mc and the output, which is split into two out-of-phase signals, is parallel-tuned to 120 Mc. The stage gain is about unity and the transistors are driven into saturation.

The second frequency multiplier stage Q4-Q5 is also composed of two transistors operating in push-push and class C. The inputs are fixed-tuned to 120 Mc and the output is parallel-tuned to 240 Mc. The stage gain is about unity and the transistors are driven into saturation. The 65 mw, 240 Mc output from multiplier Q4-Q5 is applied to varactor and cavity assembly Z. Varactor D₁, by its inherent harmonic generating characteristics, multiplies the signal from 240 to 960 Mc. A fixed reverse bias of 1.4 volts d-c is applied to the varactor for temperature stability. The output of the varactor is inductively coupled to a quarter-wave, series-resonant coaxial cavity tuned to pass the 960 Mc signal. The 960 Mc output is capacitively coupled and is nominally 10 mw. The 10 mw, 60 Mc drive power at the input to the multiplier module can degrade to about 1.5 mw before the output power is affected. This margin is provided by the saturation designed into each stage of the multiplier. Temperature stability is also increased since stage gain changes are ignored.

SPURIOUS SIGNALS—Much of the overall transponder design ef-

fort was devoted to the elimination of spurious signal paths. If, for example, the 10 Mc output of the frequency divider is permitted to modulate the first or second mixer local-oscillator signals, a coherent output will be obtained. The presence of this output will certainly prevent the desired signal from being tracked by the transponder.

The T-section module design shown in Fig. 3 is used to reduce all signal levels at the surface of the module to less than 10 microvolts. All hot r-f circuitry is located on one side of the leg of the T-section. Supply lines are decoupled once in going through the leg and at least once more in going through the top of the T. All r-f signals are transmitted through double-shielded 50 ohm subminiature cable and all connectors are threaded to ensure a positive ground. The economical extruded T-section is machined to achieve an r-f seal where it mates with supporting sections of the main housing.

RELIABILITY—The general tenets of the reliability program, as carefully followed in the Mariner transponders, emphasize conservative circuit design and repeated inspection and testing of parts, modules and transponders. The specific approach includes: microscopic inspection of all parts that are later sealed into containers; heat soak of all semiconductors for 200 hours at 150 degrees centigrade; temperature cycle of all passive components; vibration test of electromechanical devices; continuous in-process microscopic inspection on all modules; complete transponder testing over required temperature range; disassembly of transponder for microscopic inspection, and re-assembly and complete acceptance tests.

This approach has resulted in a stable transponder whose final reliability figure has been greatly increased by careful attention to manufacturing processes and repeated testing to eliminate weak parts. Since each electrical part is identified and carries an IBM card tabulation of test history, all failures are easily correlated with inspection data, manufacturing lots, and other controls.

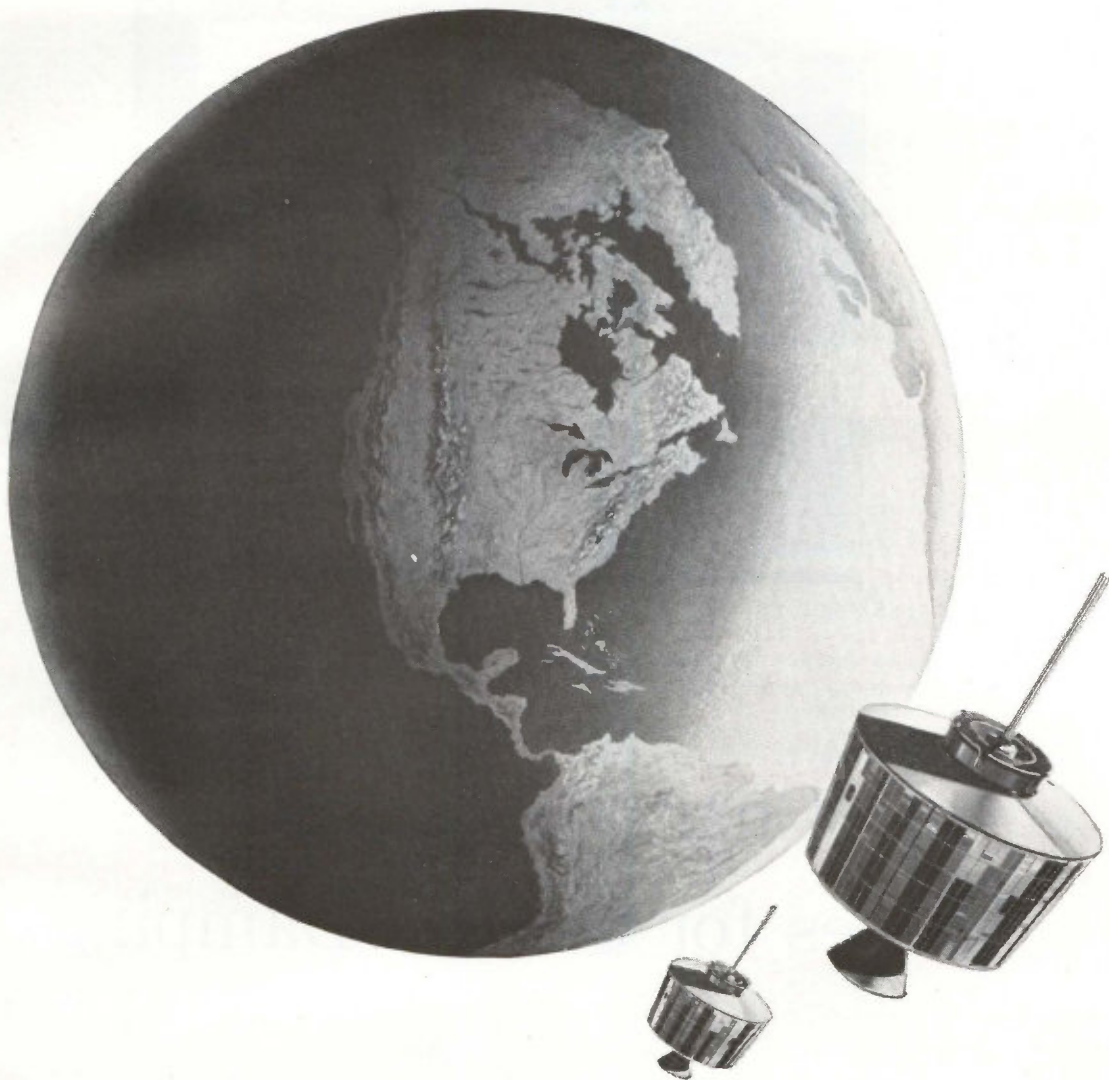

circuit designers...is your appointment in space with Hughes?

Today, Hughes is one of the nation's most active space/electronics firms. Projects include: MMRBM Integration, Assembly & Checkout, TFX(N) Guided Missile System, VATE, TOW Anti-Tank Missile, SURVEYOR, SYNCOM, ARPAT, POLARIS and others.

This vigor promises the qualified engineer or scientist more and bigger opportunities for both professional and personal growth.

Many immediate openings exist. The engineers selected for these positions will be assigned to the following design tasks: the development of high power airborne radar transmitters, the design of which involves use

of the most advanced components; the design of low noise radar receivers using parametric amplifiers; solid state masers and other advanced microwave components; radar data processing circuit design, including range and speed trackers, crystal filter circuitry and a variety of display circuits; high efficiency power supplies for airborne and space electronic systems; telemetering and command circuits for space vehicles, timing, control and display circuits for the Hughes COLIDAR* (Coherent Light Detection and Ranging).

If you are interested and believe that you can contribute, make your appointment today.

Please airmail your resume to:
Mr. Robert A. Martin
Head of Employment
Hughes Aerospace Divisions
11940 W. Jefferson Blvd.
Culver City 5, California

We promise you a reply within one week.

Creating a new world with electronics

HUGHES

HUGHES AIRCRAFT COMPANY
AEROSPACE DIVISIONS
An equal opportunity employer.

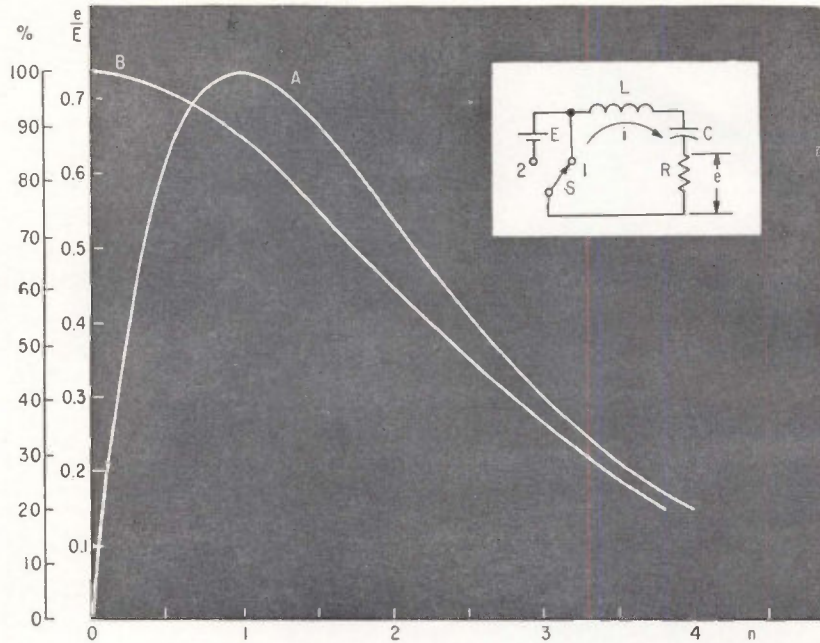

FOR the critically damped circuit shown, curve A gives the ratio e/E versus n . Curve B shows the ratio e/E versus pulse width in terms of n . The percent scale refers to the percent of maximum pulse amplitude for either curve

Chart Gives RLC Values for Critical Damping

By ARTHUR B. MOULTON,
P.O. Box 24, Livermore, California

SELECTING component values for generating a critically damped transient in a simple RLC circuit is a cut-and-try process under conditions frequently encountered in practice. The selection of components for a circuit such as that shown is facilitated by the normalized graphs. When the switch transfers from contact 1 to contact 2, a transient is generated as described by E. A. Guillemin in "Communication Networks," volume 1, page 55. Variations of this circuit may be used to generate pulses for resetting counters in pulse-operated equipment either manually or by remote control.

If $R/4L = 1/RC$, the circuit will be critically damped. The voltage across resistance R will be a pulse described by Eq. 1

$$e = \frac{REt}{L} e^{-Rt/2L} \quad (1)$$

The pulse will have a maximum of $e = 2E\epsilon^{-1}$ when $t = 2L/R$. This cannot be solved explicitly for t , consequently the pulse width can not be determined. If the substitution $t = 2L/R$. This cannot be solved explicitly pulse may be described by the normalized Eq. 2

$$\frac{e}{E} = 2n\epsilon^{-n} \quad (2)$$

Curve A represents Eq. 2. Curve B, obtained graphically from curve A, shows the amplitude of the normalized pulse as a function of the normalized

pulse width in n units. Consider the simplification of calculations resulting from the use of these curves in the following example.

Given: $R = 25$ ohms; desired pulse amplitude = 8 v maximum; desired pulse width at 6 v = 1.5 μ sec; Find E , L , and C .

The maximum pulse height is 0.736 E , therefore $E = 8/0.736$ or $E = 10.9$ volts. Six volts is 75 percent of the maximum pulse height. Referring to curve B, the pulse width in n units is 1.5.

$$L = \frac{tR}{2n} = \frac{(1.5)(25)(10^{-6})}{(1.5)(2)} = 12.5 \mu\text{h}$$

$$C = \frac{4L}{R^2} = \frac{(4)(12.5)(10^{-6})}{625} = 0.08 \mu\text{f}$$

To determine any other characteristics of the pulse from the normalized curve A, simply multiply the ordinate by E and the abscissa by $2L/R$.

So shake it!

New low-cost reflex klystrons designed to meet the severest environments of vibration and shock are now available from Sperry Electronic Tube Division.

An example is Sperry's SRU-4192. It offers 250 mW minimum output at any frequency you specify between 15.5 and 17.5 Gc. It's trim tunable across a 100 Mc range. It operates at an unusually low voltage. It's available within 30 days from receipt of your order, but with all these advantages it's priced far below comparable tubes.

Sperry has similar capabilities in other areas of the spectrum. If you need a ruggedized reflex klystron anywhere in X, U, K, or V band (8.2 to 40 Gc), Sperry has the answer.

To avail yourself of the outstanding performance of one of Sperry's rugged new reflex klystrons, place your order now. Contact your Cain & Co. representative or write Sperry, Gainesville, Florida. In Europe, contact Sperry Europe Continental, Paris.

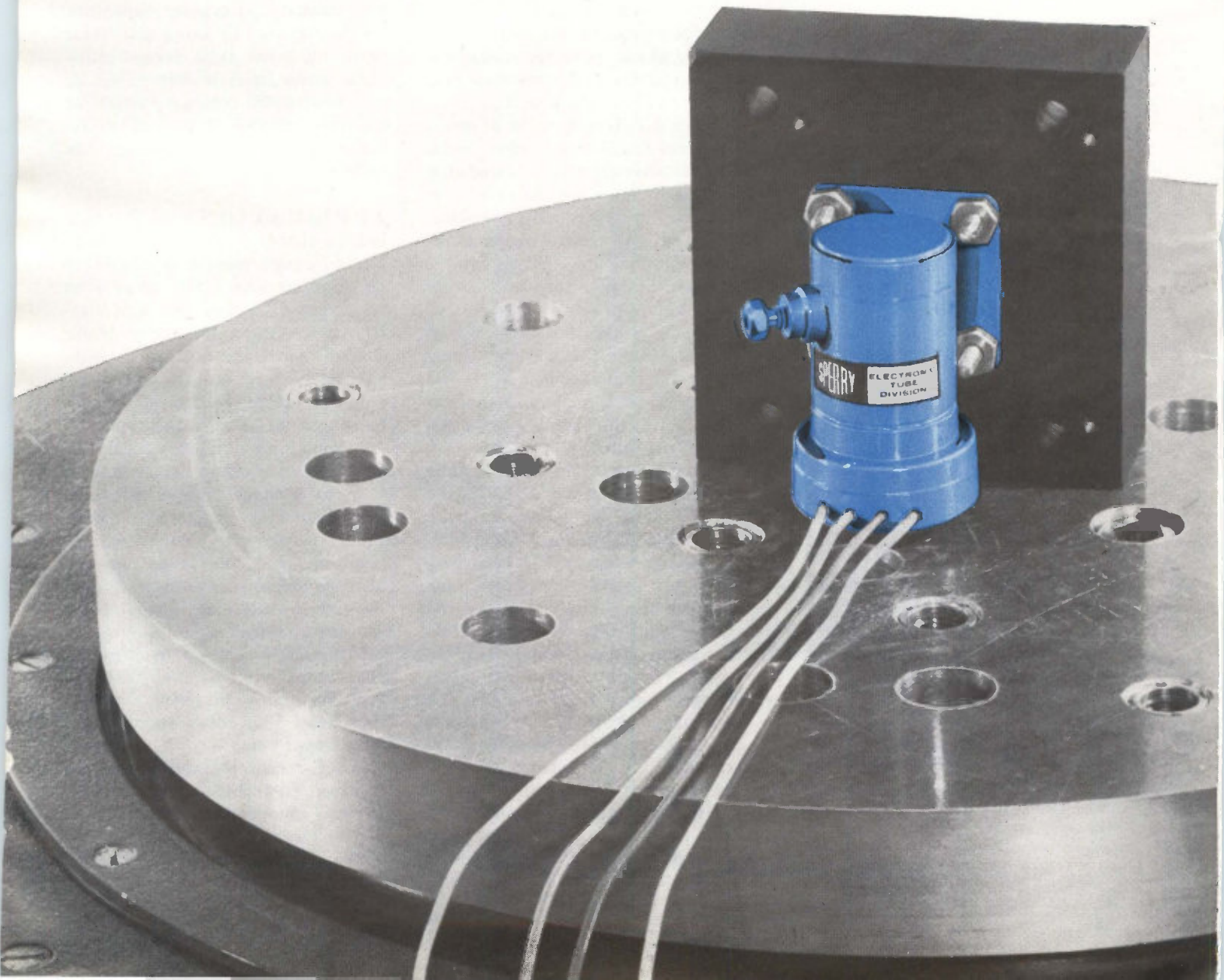

TWT CHAIN completes General Dynamics/Electronics' new system. Frequency is 8 Gc to 9.6 Gc, pulse duration 0.6 nanoseconds, peak power 1.8 kilowatts—Fig. 2

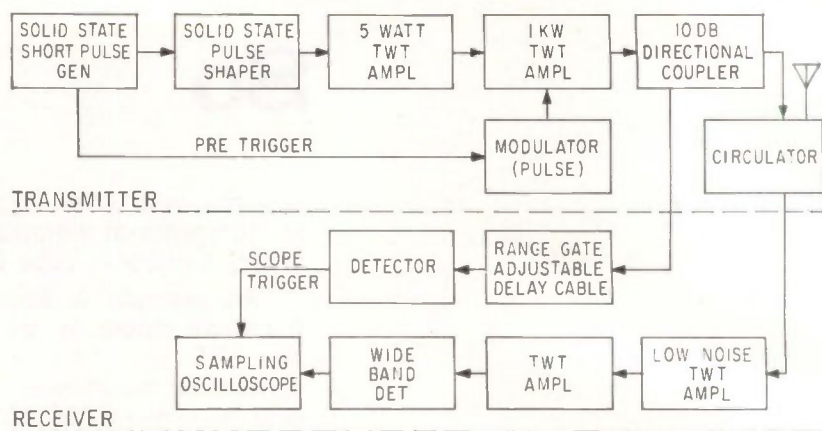

Subnanosecond Radar Shows High Resolution

Novel technique yields unprecedented detail from target returns

NEW RADAR SYSTEM that operates with very short pulses, having a duration of less than one nanosecond, has been developed by

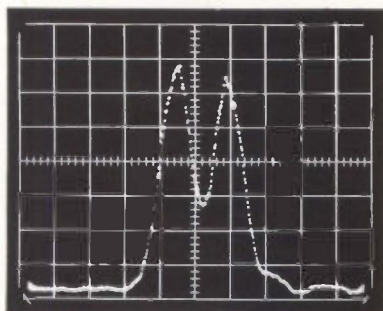

RESOLUTION TEST shows that new radar can distinguish between closely spaced plastic rods, top. Rods were about 4 inches apart for return reading shown at bottom—Fig. 1

General Dynamics/Electronics. Effective range resolution of the new equipment is less than three inches, which provides radar-return detail from targets not previously possible, see Fig. 1.

The radar developed as a result of several feasibility studies, some of them government sponsored, for radar techniques for ice and snow thickness measurement, measurement and analysis of surface reflection coefficients and signal attenuation of sea water, and so on.

Techniques presently used for r-f short pulse generation have evolved from a series of techniques (previously used but not included in the present system) including investigation of diode switches, modulation of travelling wave tubes, impulse data generation, and TR tube leakage. Until recently, the TR tube spike leakage technique was the most successful known for short-pulse work; however, it is relatively inefficient. In the new technique used, the basic pulse is generated by a solid-state subnanosecond pulse generator and shaped by pulse shaping circuits. A chain of travelling-wave tubes then amplifies the subnanosecond pulses to the required power level. The system arrangement is illustrated by the block diagram in Fig. 2.

In the system shown on the cover, about one-half watt of generated r-f power was used. When the final output stages are added, the sys-

tem has a peak output power of 2 kilowatts, and greater capability can be obtained by using additional travelling-wave tube stages. Ultimate power limit is determined by the breakdown characteristics of the transmission lines and subsequent equipment following the transmitter.

APPLICATIONS — The new radar's simple approach and demonstrated range resolution capability make it attractive for areas such as target discrimination and classification, airport and harbor traffic control and surveillance, antisubmarine-warfare studies and periscope detection, battlefield surveillance and target identification.

A short-duration-pulse radar can be used to advantage in the laboratory to conduct remote thickness measurements, evaluate recovery times, breakdown phenomena, relaxation times and other time-dependent microwave effects; to determine locations of imperfections in waveguides and microwave tubes, and to explore propagation phenomena such as multipath reflections and atmospheric indirect time delays due to weather, clouds, temperature etc.

Basic research applications are expected to include the evaluation of radar cross-sections of individual scattering points on complex geometric shapes such as cone tip and base, edges and base of a wedge or

can you use the advantages of Kepco's STATIC MAGNETIC VOLTAGE STABILIZER

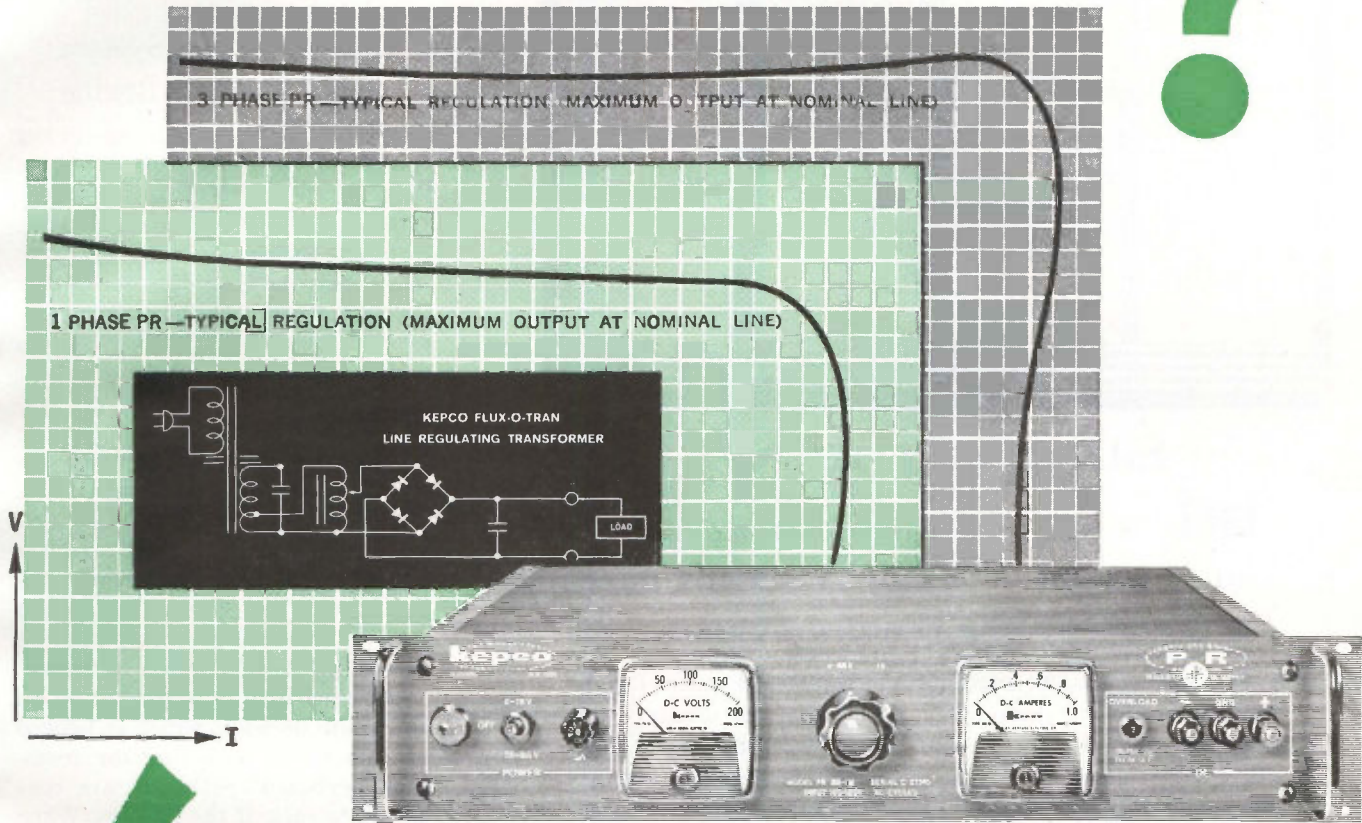

Model PR 155-1M



KEPCO POWER SUPPLIES

Kepco's **FLUX-O-TRAN** is a ferro-resonant static magnetic voltage stabilizer. Its design characteristics feature:

- output essentially free of line voltage variations
- isolation of line transients
- current limiting protection from current overloads and external short-circuit

The **FLUX-O-TRAN** is the heart of Kepco's PR GROUP of DC Power Supplies. By delivering a squared-waveform to the rectifier, the **FLUX-O-TRAN** increases rectifier utilization and improves the loading characteristics of the filter capacitors. This characteristic

provides a relatively low intrinsic source impedance, improving load regulation and affording a low ripple content. The result is a simple FOOL-PROOF, high efficiency source of regulated DC power in *minimum space* and at *minimum cost*.

The PR GROUP offers a wide choice of *adjustable* output voltage and output ratings with:

- typical ripple values 0.5 to 3%
- overcurrent protection
- no voltage overshoot
- power efficiency typically 50-70%
- reliable, efficient silicon full-wave rectification

| ± 1% LINE REGULATION — 105-125 V AC, 60 CPS ± 5% — 1 PHASE | | | | | | | | | | | ± 2% LINE REGULATION 208/230 V AC ± 10% 60 CPS ± 5% — 3 PHASE | | |
|--|-----------|-----------|----------|-----------|------------|----------|-----------|-----------|-------------|-----------|---|-----------|----------|
| VOLTS | 0-7.5-15 | 0-15 | 0-19-38 | 0-38 | 0-40-80 | 0-80 | 0-78-155 | 0-155 | 0-165-310 | 0-310 | 0-20 | 0-40 | 0-50 |
| AMPS | 0-10 | 0-30 | 0-5 | 0-15 | 0-2.5 | 0-8 | 0-1 | 0-4 | 0-0.6 | 0-? | 0-100 | 0-50 | 0-40 |
| MODEL | PR 15-10M | PR 15-30M | PR 38-5M | PR 38-15M | PR 80-2.5M | PR 80-8M | PR 155-1M | PR 155-4M | PR 310-0.6M | PR 310-2M | PR 20-100M | PR 40-50M | PR 50-40 |
| PRICE | \$345 | \$495 | \$325 | \$475 | \$325 | \$450 | \$325 | \$430 | \$345 | \$430 | \$1,125 | \$950 | \$950 |

for complete specifications
on more than 250 standard models,
write for NEW Catalog B-631

See our Catalog in  Sec. 4000



131-38 SANFORD AVENUE • FLUSHING 52, N.Y., U.S.A.
Phone (212) IN 1-7000 • TWX# (212) 539-6623
Cable Address: KEPCOPOWER, NEW YORK

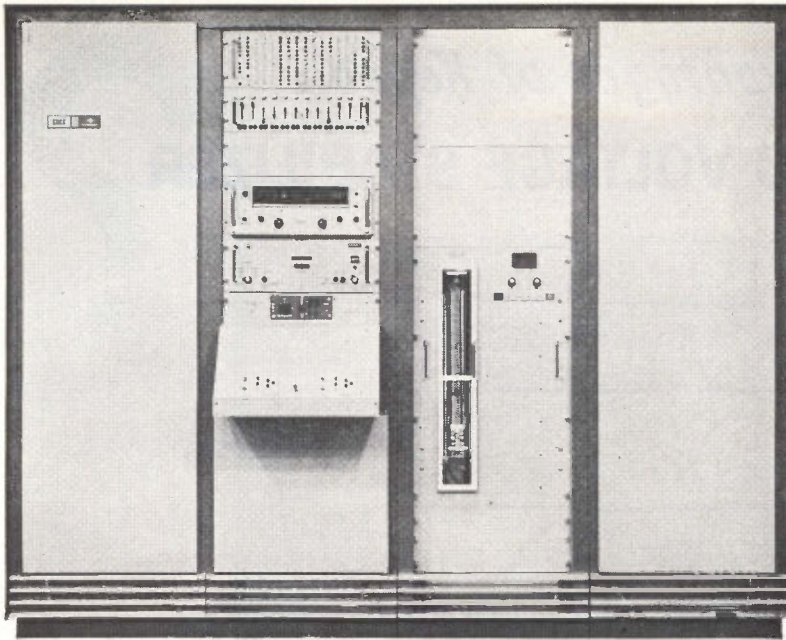

State of the Art

tact, Texas Instruments Transistor
And Component Tester . . . keeps pace
with testing requirements

A universally applicable transistor and component tester, TACT has been proved on every major missile program to date . . . is keeping pace with the newest testing concepts. The TACT system design incorporates anti-obsolescence features that provide unlimited testing flexibility for future expansion and component development.

Versatile, expandable TACT now offers: duty cycle pulse testing to 500 volts or 25 amperes; switching time measurements from 1 nanosecond to 1 microsecond; low current measurements from 1 picoampere automatic ranging — all in one system. Additional plug-in module capacity and system accessories such as environmental chambers and scanners for various component mounting boards are available.

The basic TACT system provides sequentially controlled reliability testing of transistors, diodes, capacitors, resistors, relays and other components. Digital control of analog functions with punched card pre-programming on each device assures absolute repeatability — eliminates operator variation.

Only TACT can fulfill both your present and future testing requirements. Write for information.

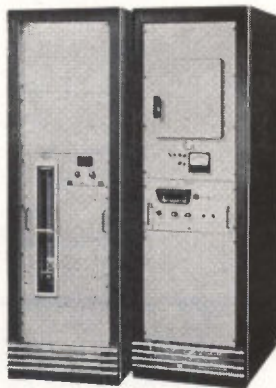

INDUSTRIAL
PRODUCTS
GROUP



TEXAS INSTRUMENTS
INCORPORATED
P. O. BOX 66027 HOUSTON 6, TEXAS

SENSING . RECORDING . TESTING . DIGITIZING INSTRUMENTS
THE INSTRUMENTS OF TEXAS INSTRUMENTS

571

corner reflector, Fresnel and shadow region of a sphere, and to investigate the properties of sea and land clutter targets, and for general radar cross-section measurements.

Punched-Tape System Could Replace Braille

CAMBRIDGE—A new reading aid for the blind, being developed as a thesis project at MIT, uses a stenotype machine working backwards. Punched tape containing words in the stenotype phonetic code is fed through a special mechanism which depresses corresponding keys on the stenotype machine.

By learning the stenotype system, a blind person would be able to read the information with his fingers as he feels the keys move up and down. Air Force Lt. Col. Cheadle, who is developing the technique, says a blind person who became proficient might be able to read at the ordinary prose-reading speed, 300 to 400 words a minute.

Punched tape is processed by an electronic decoder, which is hooked up to a device operating the stenotype keyboard. Solenoids are connected to each of the 22 keys. When triggered by a signal from the decoder, the solenoid pulls down the corresponding key.

Radar Master and Slave Pinpoint Their Target

ROME Air Development Center is putting together in-house a dual-radar, air-surveillance system that will pinpoint target locations by trigonometric techniques. Called the Active Swept Frequency Interferometer Radar (ASFIR), it is designed to obtain extremely high-precision angle and range information.

A master radar transmits and receives signals. A slave radar receives and reflects back to the master. The time it takes the master's signal to reflect to the slave and back to the master is converted into distance for an accurate triangulation. Adding a second slave would give both range and altitude. RADC hopes to have the radar operating by the end of summer.

Conference on
**THE IMPACT OF
MICROELECTRONICS**

Wednesday and Thursday
June 26 and 27, 1963

GROVER M. HERMANN HALL
Illinois Institute of Technology
Chicago, Illinois

Co-Sponsored by
ARMOUR RESEARCH FOUNDATION
of Illinois Institute of Technology
and ELECTRONICS
A McGraw-Hill Publication

Keynote address by

*James M. Bridges, Director,
Office of Electronics,
Department of Defense:*

*"Government Needs and Policies in
the Age of Microelectronics."*

Comprehensive discussions will be presented
by eminent authorities such as:

*R. Galvin of Motorola, Inc.
R. C. Sprague of Sprague Electric Co.
Dr. P. B. Myers of Martin-Marietta Co.
F. J. Van Poppelen, Jr. of Signetics Corp.
Dr. J. T. Wallmark of RCA Labs, and
Dr. E. R. Jervis of ARINC Research Corp.
Dr. J. Bardeen of U. of Illinois*

Sessions will cover the Impact of
Microelectronics on:

*The Changing Technical and Financial
Structure in the Component Industry
Product Status and Forecasts
Changing Vendor-User Relationships
Education and the Changing Role of the
Engineer
Future Trends
Recent Technological Advances*

For detailed program and registration
information write to:

*James J. Hill
Electronics Research Division
Armour Research Foundation
Chicago 16, Illinois*

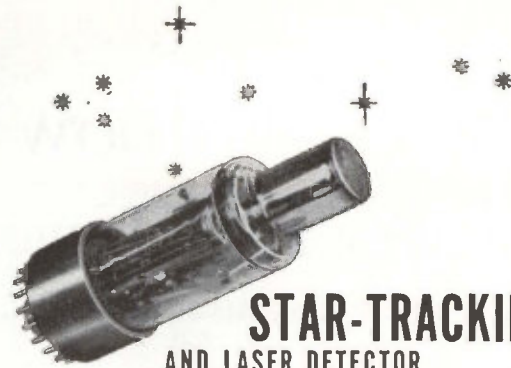

**STAR-TRACKING
AND LASER DETECTOR
Multiplier Phototubes**

- Low ENI (10^{-12} , typical)
- High Sensitivity (20 to 100 μ a, typical)
- Maximum photocathode collection capacity
- Three types: S-1, S-11, S-20 spectral responses
- Ruggedized versions available

ITT Industrial Laboratories 16-stage multiplier phototubes are specifically designed for star tracking, photon counting and field laser applications, where low noise and high sensitivity are vital requirements. When used in tracking, guidance or reference systems, they employ magnetic deflection coils, supplied with the tubes when specified. Types described are representative. Modifications or new types can be developed to specifications.

**ITT INDUSTRIAL
LABORATORIES**

A DIVISION OF INTERNATIONAL TELEPHONE AND TELEGRAPH CORPORATION
3700 East Pontiac Street • Fort Wayne, Indiana

- COMPLETE TECHNICAL SPECIFICATIONS ON REQUEST •
CIRCLE 39 ON READER SERVICE CARD



**Are you a
COMPLETELY
INFORMED
electronics
engineer?**

Today you may be working in microwaves. But on what project will you be working tomorrow? You *could* have read electronics this past year and kept abreast of, say, microwave technology. *There were 96 individual microwave articles between July, 1961 and June, 1962!*

But suppose tomorrow you work in some area of standard electronic components, in semiconductors, in systems? Would you be up-to-date in these technologies? Did you read the more than 3,000 editorial pages that electronics' 28-man editorial staff prepared last year?

electronics is edited to keep you current *wherever* you work in the industry, *whatever* your job function(s). If you do not have your own copy of electronics, subscribe today via the Reader Service Card in this issue. Only 7½ cents a copy at the 3 year rate.

electronics

WINDOW MATERIALS

For High-Power Microwave Tubes

By R. J. BONDLEY, Power Tube Dept., General Electric Co., Schenectady, N. Y.

Guide helps select ceramics for proper window design

REGARDLESS of the amount of power generated within the vacuum envelope of a device by electron interaction, this power must be extracted through the sealed barrier commonly called the window.

To be effective, the window must be transparent to microwave energy, thus should neither reflect nor absorb energy.

When selecting the window material, and arriving at a suitable design, the physical properties of the barrier material must be evaluated and bartered against conditions imposed by the environment and by the mechanical design of the frame.

MATERIALS — Dielectric materials that have the most suit-

able physical properties for windows include the fused oxides of aluminum, beryllium and silicon. As the purity of these materials has improved, their loss factor has decreased accordingly. However, the type of the impurity, even though present in very small amount, may greatly affect the loss factor of the body.

The published values of the physical properties of various ceramic bodies at X-band are given in the table.

It appears that fused quartz (quartz glass or fused silica) would be the outstanding choice for microwave windows. Its extremely low expansion makes it immune to thermal fractures. In addition, its low dielectric constant and loss tangent are desirable electrical properties.

In evaluating all of the physical properties of fused quartz, it is apparent that its poor thermal conductivity can contribute to very high temperatures in the center of a disc, particularly if the only cooling is via the outer periphery and frame. The low thermal expansion which makes quartz particularly immune to cracking also makes it difficult to seal to metals in true concentric joints free from electrical discontinuities. Thus the precise perspective on just where quartz can be used most advantageously has not been entirely determined. Perhaps high Q-circuit requirements where the seal is enclosed by a cavity may eventually dictate the use of quartz of these or similar applications.

Beryllium oxide is unique in that it has a very high thermal conductivity. However, the beryllia now obtainable is more lossy than the best alumina bodies, and it is not as strong mechanically. Thus

TABLE—CHARACTERISTICS OF MICROWAVE WINDOW MATERIALS

| | Dielectric Constant | Tan δ | Therm | Therm Conduct Cal/Sec/Cm ² /°C | Tensile Str $\times 10^3$ | Young's Modulus $\times 10^6$ | Dielec V Str Per Mil | Vol Resist |
|-------------------------|---------------------|-----------------------|---|---|---------------------------|-------------------------------|----------------------|---------------------------------|
| | | | Coef of Linear Expan- Per °C $\times 10^{-6}$ | | | | | |
| Alumina Wesgo AL-300 | 9.04 | 0.00015 | 8.5 | 0.064 | 26 | 39 | 1,100 | $>10^{14}$ |
| | 9.32 ^a | 0.0001 ^a | | | | | | 1×10^{12} ^a |
| Wesgo AL-995 | 9.37 | 0.00009 | 6.9 | 0.070 | 30 | | 800 | $>10^{14}$ |
| | 9.61 ^a | 0.00011 ^a | 8.5 | | | | | 2×10^{11} ^a |
| Coors AD- 94 | 8.75 | 0.0011 | 6.7 | | 25 | 40.2 | 330 | $>10^{14}$ |
| | 9.05 ^a | 0.0016 ^a | 7.6 | | | | | 9×10^{11} ^a |
| Coors AD-995 | 9.44 | 0.00008 | 6.8 | | | 50 | 330 | |
| | 9.88 ^a | 0.00028 ^a | 8.3 | | | | | |
| Lucalox | 9.9 | 0.000025 | 6.8 | 0.085 | | 56.1 | 1,700 | $>10^{14}$ |
| | | | 6.9 ^a | 0.003 ^a | | | | 2×10^{14} ^a |
| Sapphire ⊥ to C Axis | 11 | 0.000026 | 5 | 0.065 | >20 | 55 | 1,200 | |
| | | 0.000065 ^a | 7.7 ^a | | | | | |
| Beryllia Coors BD-96 | 6.7 | 0.00011 | 9.23 ^b | 0.52 | 16 | 46 | | 10^{13} |
| | BD-98 | 6.6 | 0.00056 | 9.23 ^b | 0.52 | 18 | 46 | |
| Quartz | 3.8 | 0.00005 | 0.57 | 0.0035 | >7 | 10 | | 10^{18} |

^a—300 deg C, ^b—500 deg C.

\$.25

TYPICAL UNIT COST

Capacitors of "Mylar"® polyester film cost about the same as paper!

\$.00

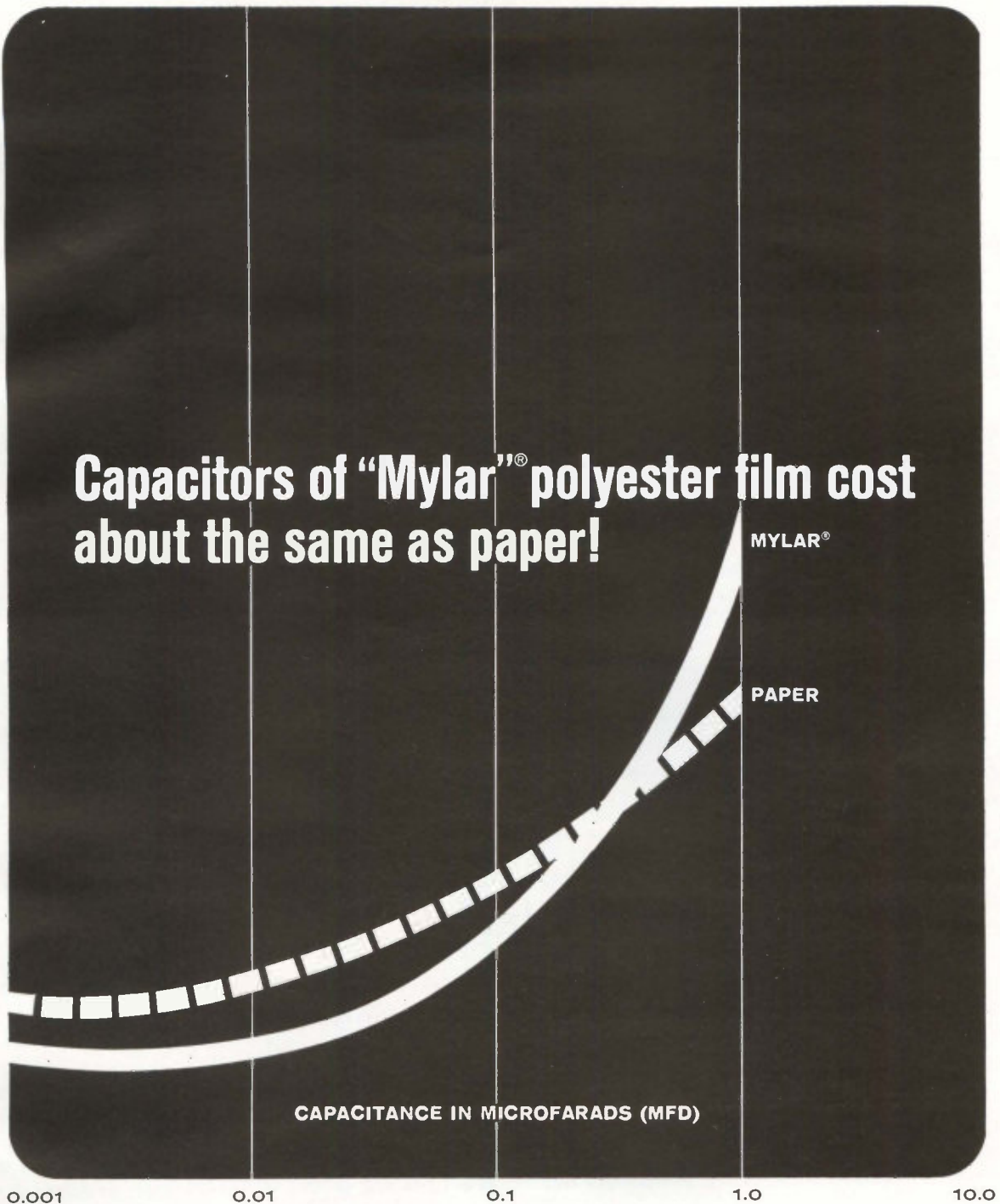

CAPACITANCE IN MICROFARADS (MFD)

0.001

0.01

0.1

1.0

10.0

For capacitors, specify the extra performance of "Mylar"

Studies of manufacturers' average prices show that capacitors of "Mylar"* are comparable in cost with paper units, over a range of capacitances and voltages. At comparable cost, the higher reliability you get makes capacitors of "Mylar" a better value by far.

Only "Mylar" gives you the extra performance of higher dielectric strength, wider temperature range and higher moisture resistance—at about the same price! Also, capacitors of "Mylar" are smaller than paper units with the same capacitance. In circuits for home-entertainment radio and TV they're perfectly compatible with AC voltages imposed on a DC circuit as long as total voltage doesn't exceed the rated voltage of the capacitor,

and the AC component does not exceed the AC corona level. Remember, within the range from .001 to 1 mfd under 600 volts DC, you can get the added reliability of "Mylar"—at costs similar to paper.

For the full story, write for our detailed booklet comparing performance and prices of various insulation systems. Du Pont Co., Film Department, N-10452, Wilmington 98, Delaware.

*Du Pont's registered trademark



BETTER THINGS FOR BETTER LIVING
... THROUGH CHEMISTRY

only DU PONT makes

MYLAR®
POLYESTER FILM

NEW
FROM WESTON

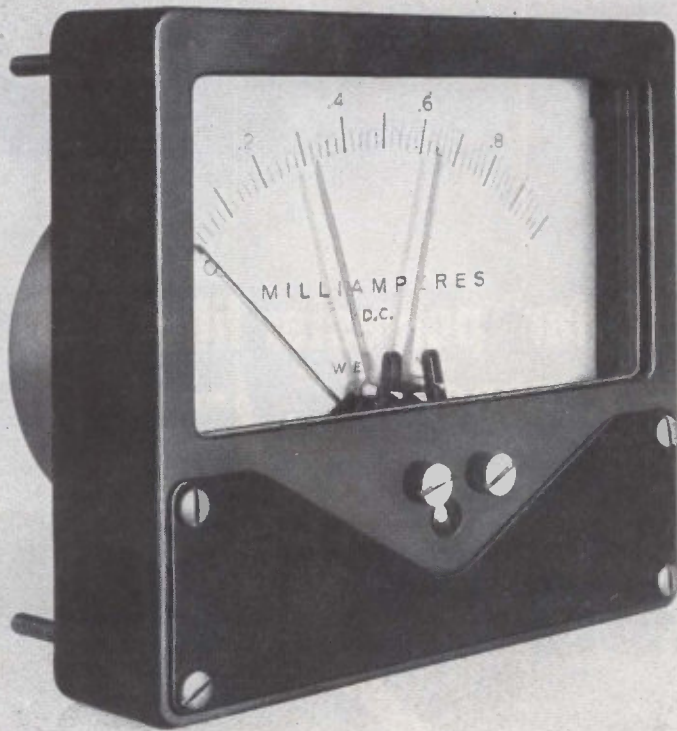

Eliminate contact failure!

Pyromillivoltmeter controller is first meter relay with no physical contacts. The Weston Model 1075 Meter Relay eliminates contact failure by using no physical contacts. Thus pitting, arcing, chatter and contamination are no longer a problem.

Model 1075 is a continuous-reading meter relay with built-in automatic reset. Non-physical contacting is achieved through the use of light beams and photoresistive cells. When the pointer reaches a set point, it blocks a tiny beam of light shining on the cell and actuates the instrument's internal transistorized switching circuit. This outstanding Weston design allows a set-point separation of only 5 degrees. Contact repeatability is $\pm 1\%$.

Increased sensitivity is provided by a Weston taut-band suspension mechanism. Fail-safe circuitry and illuminated dial are added features.

The new $4\frac{1}{2}$ " relay has an accuracy of $\pm 2\%$, full scale, and is available with single or double index arms in a variety of d-c ranges. Available for use as pyromillivoltmeter controller with thermocouples in five ranges up to 2500 F. Switching capacity with load relay: 5 amperes ac non-inductive load. Operating temperature: -20 to $+50$ C. ambient. Operating voltage: 105/125v, 60 cps. Write for details.

WESTON 
Instruments & Electronics
614 FRELINGHUYSEN AVENUE, NEWARK 14, NEW JERSEY

Division of
Daystrom,
Incorporated

increased conductivity is largely offset by the dielectric loss. The one notable exception is a situation where large additional heating is caused by external effects such as particle bombardment rather than internal dielectric heating.

High-purity alumina appears to be the best window choice at this time. Its high strength, ease of fabrication and sealing, and its low loss factors are favorable properties. Its high dielectric constant can lead to difficulties from modes and broad bandwidth requirements.

POWER CAPABILITIES — The maximum power capability of an X-band disc window, a half centimeter thick and $1\frac{1}{2}$ in. diameter, as limited by tensile strength shows that for a high purity alumina, such as 995, operation at a level near 300 Kw should be possible.

A lower-loss alumina, such as sapphire or General Electric's Lucalox, should just about double this value. How close to those values the window can be used in practice can only be determined by experiment.

A similar estimate for a Coors BD-96 Beryllia disc, $1\frac{1}{2}$ in. dia. indicates a maximum power level of 367 Kw at X-band. In the future, if the dielectric loss for beryllia decreases as the purity of the body is increased, beryllia windows may ultimately surpass alumina in power handling capability.

Since quartz will not crack with thermal gradients, the question arises as to what a safe operating temperature might be since 900 deg C is often taken as the temperature at which quartz deteriorates. If this value is taken as an upper limit and 0.00038 as the loss factor, quartz should transmit a power of 66 Kw. However, at 900 deg C, considerable energy would be radiated, so that the 66 Kw figure is conservative.

These calculated power levels are not absolute, but they serve to point out the relative merit of the three ceramic bodies, when edge cooling only is the heat sink for the absorbed power.

Growing Ruby With Strain-Free Crystals

FLUX-GROWN ruby crystals that can be cut 1½-in. long and ½-in. in diameter have been made to lase.

Growth process was reported by J. W. Nielson of Litton's Airtron Div., N. J.

Crystals are said to be remarkably strain free, and have low etch pit density.

Flux-grown crystals have a compositional gradient, but this is said to be uniform.

Firm to Market Strain Gage Elements

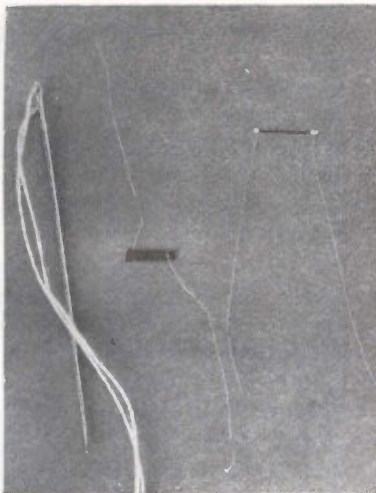

SEMICONDUCTOR strain sensor elements that use an epitaxially-grown silicon will be offered by General Electric's Semiconductor Products Department.

In announcing G. E.'s entry to the strain gage field, J. H. Sweeney, manager of marketing said that new semiconductor strain elements were developed for space age equipment. Use of an epitaxial layer on a high-resistance silicon material allows the strain sensor to be soldered or alloyed directly to the stress member. Sweeney said that the new semiconductor strain elements are 60 times more sensitive than conventional wire strain gages.

Sensor element in photo on the right is a conventional semiconductor strain gage. Device on the left is an epitaxial element strain sensor.

THE OLDEST MANUFACTURER OF CADMIUM SULPHIDE AND CADMIUM SELENIDE PHOTOCONDUCTIVE CELLS

WE'VE HELPED OUR CUSTOMERS*

SHED A LITTLE LIGHT**

ON LOTS OF PROBLEMS***

- Daylight Switches
- Automatic Door Controls
- Burglar Alarms
- Counting - Sorting Devices
- Medical Pulse Counters
- Oil Burner Flame Detector
- Conveyor Routing Controls
- Analogue - Digital Converters
- Furnace Temperature Controllers
- Camera Automatic Exposure Controls
- TV Receiver Automatic Brightness - Contrast Controls
- Reading Machines for Blind
- Space Vehicle Sun Sensors for Attitude Control and Telemetry
- Metal Working Automatic Line Followers
- Boat Automatic Pilots
- Computer Punched Tape - Card Readers
- Fire Detectors
- Head-Light Automatic Dimmers
- Rear View Mirror Automatic Flippers
- Computer Magnetic Tape Controls
- Oxygen Measuring Instruments
- Collimators for High Precision Angular Alignment
- Space Particle Detectors
- Flame Photometers
- Exposure Light Meters
- Choppers for D.C. - A.C. Converters
- In-Line Electronic Counter Read Outs
- Contactless Control with Meter Movement
- Photoelectric Targets for "Light Guns"
- Lamp-Photocells in Logic Circuitry
- Watt-hour Meter Testers

*Clairex Photoconductive Cells, in their capacity as reliable, light-controlled variable resistors, have assisted thousands of systems design engineers; (most of the leading electronics manufacturers have depended on Clairex for years as a key source of supply).

**Clairex Photoconductive Cells don't require much!

***Clairex Photoconductive Cells are now operating as essential components in hundreds of applications, both simple and complex, (the list at left is just a sample).

You too may benefit from this wealth of experience. Clairex offers the industry's most complete line in a wide variety of glass or metal packages (special units also developed). Write today for technical information; become familiar with "The Light Touch In Automation And Control."

CLAIREX CORPORATION 8 West 30th Street, N. Y. 1, N. Y.

NEW 16 PAGE PHOTOCONDUCTIVE CELL DESIGN MANUAL FREE ON REQUEST

Hot-Air Machine Speeds Soldering

Metal bonding, modular packaging, breadboards are other meeting topics

COLISEUM in New York City will be the scene next week (June 4-6) of the first National Electronic Packaging and Production Conference. Sponsored by the Industrial and Scientific Conference Management, Inc. of Chicago, the meeting "is designed solely for the men who build and produce electronic equipment," says ISCM president, Milton S. Kiver.

HOT-AIR SOLDERING — Terminal pin connections in printed circuit boards have been soldered in place by a hot-air technique to be described by E. J. Wooldridge of Bendix's Computer Division. Technique is carried out by a machine that:

- Positions solder preforms at the joints
 - Transports board assembly under a hot-air blast (temperature of which is closely controlled) so that blast is directed onto joints to complete soldering operation.
- Machine was developed to fulfill following requirements:
- Strict localization of solder at joint—neither printed circuitry nor terminal pin are to have any solder coating beyond joint area
 - Minimize heat effect of temperature-sensitive components on opposite side of board
 - Yield solder joints as good or better than with hand soldering and at less cost.

Cost is a particularly important item since an average of 300 joints per board had to be soldered.

WELDING & HONEYCOMB—Welded-honeycomb module technique will be presented by S. Konsowski and C. Johnson of Sperry Gyroscope. The technique uses the Sperry honeycomb: a molded thermosetting shell with holes in it to

NEW CONFERENCE FOR PRODUCTION ENGINEERS

The conference previewed here is devoted entirely to production people. The nine sessions include: thermal design of equipment for military service; the connector as a factor in production design; miniaturization I: structures and assemblies; miniaturization II: intercomponent connection in manufacturing; advances in fabrication and assembly of electronic equipment; applications of materials and processes to electronic assemblies and structures; airborne and spaceborne packages; structural design of electronic equipment; modular packaging—design and manufacture

accept components; holes are undercut to support component bodies to eliminate loading problems of board modules and to provide component accessibility before, during and after welding of component interconnections. Authors will describe the use of printed circuitry with removable substrates in conjunction with honeycomb configuration to improve module reliability and reduce costs; there are a few disadvantages of this approach with respect to point-to-point wiring: loss of component accessibility for repairs and interference with flow of potting resins (this is lessened by use of removable substrate).

Removable substrates were developed jointly by Sperry Gyroscope and Intercon Division of Amphenol.

DIP BRAZING—Advantages of dip brazing of aluminum in the manufacture of electronic equipment chassis will be extolled by John Turnwall of Collins Radio. Essentially, the process is one in which parts are first assembled, then chemically cleaned; this is followed by addition of filler aluminum material before dipping assembly into a molten salt bath. The bath provides both heat (for melting filler material) and flux (for oxide removal). Filler materials are available as: brazing clad sheet, sheet, preforms, wire, powder.

Advantages of process are said to include:

- Brazing of all joints in a single operation
- Minimum distortion in brazed assembly
- Uniform heating of thin and thick sections
- Use of joints that would be inaccessible to brazing by other processes
- Protection of parts against hot atmosphere corrosive effects
- Reduction of material weight and cost

After being chemically cleaned

Lathe Crystal Rounder

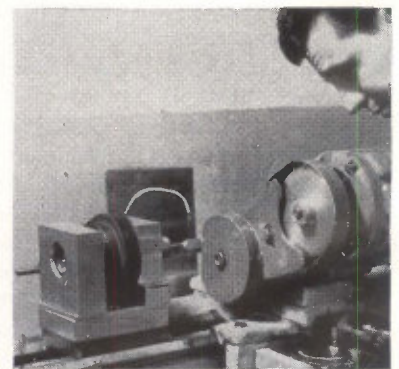

ONE HUNDRED crystal blanks are cemented and stacked together before being fed into and across a diamond wheel by a lathe. Resulting high-precision crystals are reported to be formed in 3 to 5 percent of time for diamond-core drilling. Technique was developed by Itek-Electro Products

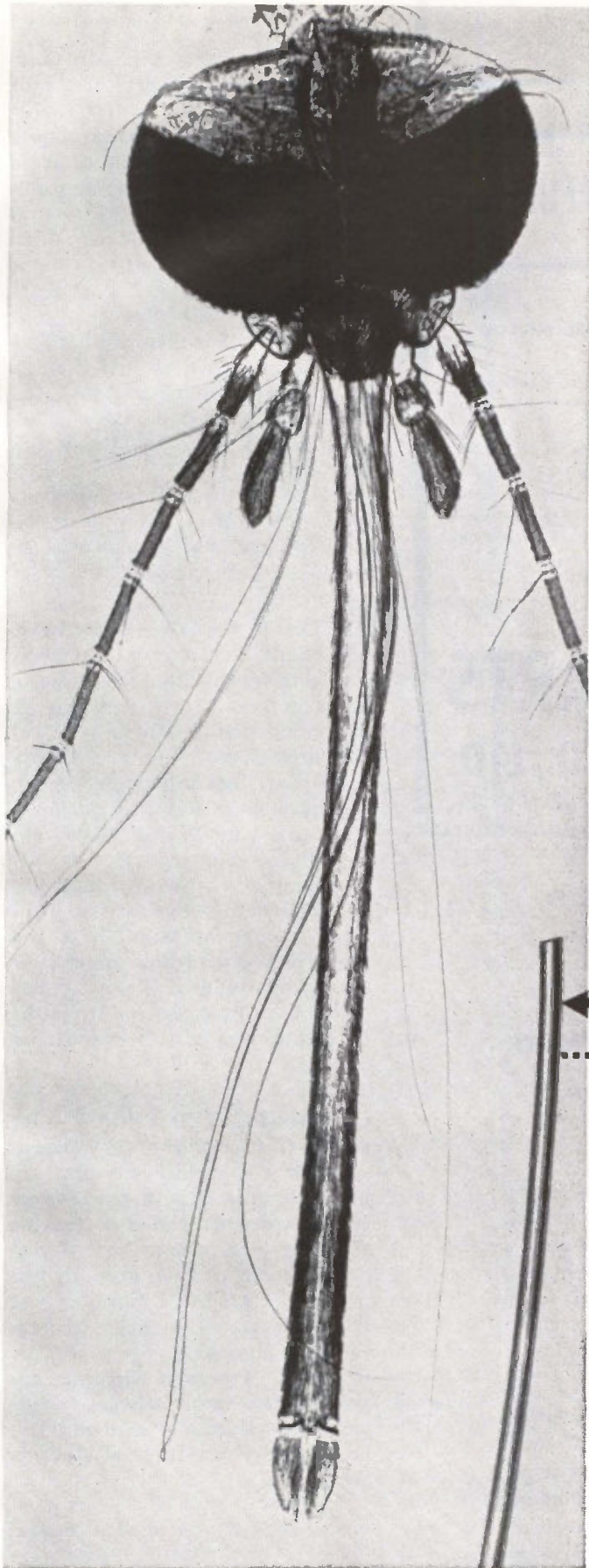

Nature has given the mosquito a proboscis that measures 0.0031 of an inch at its widest point. Nickel makes it possible to produce tubing that's much finer.

How fine? The tubing pictured here—drawn by the Superior Tube Co.—has an outside diameter of 0.0019 of an inch, and an inside diameter of 0.0004 of an inch!

But the smallest tube ever made is still much finer. The fact is, that nickel tubing has been drawn down to 0.00061 outside diameter and 0.000036 inside diameter. *That's really fine!*

SMALL WONDER

...that tubing finer than a mosquito's stinger calls for a Huntington Alloy!

Tiny tubing like this is just one example of how you can get Huntington Alloys in any form or size you may want, right down to the fine sizes produced by specialists in strip wire and tubing. In commercial production, Huntington high-nickel alloys are made in tube forms from 0.010 inch outside diameter to the giant welded cylinders used in paper-making machinery. They're also available in wire and strip forms. And in all the other various shapes and sizes needed for electronic applications.

Perhaps a Huntington high-nickel alloy can help you solve one of your electronic problems? Write for the informative booklet, "Huntington Alloys for Electronic Uses." It will give you a convenient reference on the properties, available forms and typical applications of these alloys.

HUNTINGTON ALLOYS



HUNTINGTON ALLOY PRODUCTS DIVISION
THE INTERNATIONAL NICKEL COMPANY, INC.
HUNTINGTON 17 • WEST VIRGINIA

HERE IS THE WORLD'S SMALLEST MOTOR YET IT'S SO POWERFUL . . .

MITSUMI MICRO MOTOR



MODEL MI-100

Less than 20mm in diameter, the new Mitsumi Micromotor provides a startling efficiency of over 50%, the barrier which miniature motors are not allowed to pass.

A novel construction principle helped to make this accomplishment possible. The form is more simplified by setting all the terminals at one position. Because the entire mechanism is given full protection against irregular revolution and above all, electrical noise is entirely eliminated, you may call this the most perfect micromotor yet devised. Please write for complete information on Mitsumi Micromotor, and we will send you specifications and data.



MITSUMI PARTS

MITSUMI ELECTRIC CO., LTD.

TOKYO • OSAKA • NEW YORK

CIRCLE 202 ON READER SERVICE CARD

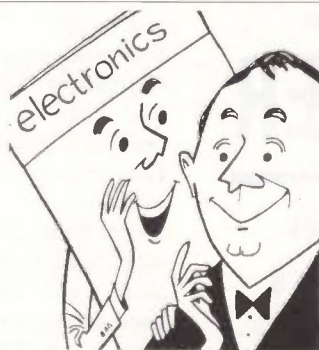

electronics
IS EDITED
TO KEEP YOU
FULLY INFORMED
— a "well-rounded"
engineer

What's your *present* job in electronics? Do you work on computers? (*electronics* ran 158 articles on computers between July, 1961 and June, 1962!) Are you in semi-conductors? (For the same period, *electronics* had 99 articles, not including transistors, solid-state physics, diodes, crystals, etc.) Are you in military electronics? (*electronics* had 179 articles, not including those on aircraft, missiles, radar, etc.)

In all, *electronics'* 28-man editorial staff provided more than 3,000 editorial pages to keep you abreast of all the technical developments in the industry. No matter where you work today or in which job function(s), *electronics* will keep you fully informed. Subscribe today via the Reader Service Card in this issue. Only 7½ cents a copy at the 3 year rate.

electronics

and before being put in bath, parts are preheated till dry and near brazing temperature. On being transferred to the salt bath, precautions have to be made to avoid entrapping air, excessive drag out, shocks or bumping. After removal from bath, parts are allowed to cool sufficiently to prevent distortion before going into a hot water bath to remove solidified flux.

Buoyancy of molten salt bath requires that parts be self-aligning or external fixturing be used. Recommended techniques: tab and slot construction, spot welding, tack welding.

Of two basic joints commonly used, the butt joint is preferred over the lap joint because of considerable space savings.

OPTIMUM WELDS—R. A. Geshner of RCA's Defense Electronic Products organization will describe methods for accurately defining an "acceptable weld" joint in terms of "optimum weld" joints. He will point out that although certain combinations of welded materials—copper, Kovar, Dumet, nickel, etc.—produce comparatively weaker tensile-torsion strengths, they may be exposed to comparatively little stress during operation in a system. He will show how to arrive at optimum strength of weld joints on the basis of stress (or strength) of joints versus joint population density.

COPPER-PLATED EPOXY — R-f and i-f submodules in Transit satellite command receivers are pre-encapsulated in a hard epoxy and then copper plated to provide shielding at Sippican Corp. Incorporating circuits designed by the Applied Physics Laboratory at Johns Hopkins University, the receivers, according to paper by Charles C. Pierce of Sippican, are one of the most complex single pieces of welded and hard-encapsulated electronics in production to date.

Assembled submodules are connected by a welded-wire matrix prior to an initial encapsulation that leaves voids. Gain and band-pass components selected during temperature cycling tests are installed in voids. Encapsulation of

assembly is then completed prior to copper plating. Each submodule includes 200 components in a 8.4 × 3.5 × 1.3-inch package weighing 1.66 pounds. Receivers have a 5-year life expectancy.

RESONANT PROBLEMS—Harold B. Nichols of General Dynamics/Astronautics will describe a construction solution to a present-day mounting problem in aerospace systems: Conventional mounting methods use beams and diaphragms in various shapes to support and restrain components. Resonant frequencies of these mountings are so low that they are easily excited with components suffering accordingly.

Solution proposed by Nichols is obtained with following technique that produces a "solid-block" assembly having a resonant frequency above limit of forcing frequency:

Encapsulated modules having all terminals on one face are positioned on an assembly plate with terminals protruding into plate. Entire assembly is then placed in a case having block configuration giving desired high-frequency response, with assembly plate at open side of case. A rigid-cell foam (polyurethane, epoxy, etc.) is poured into voids surrounding modules. After curing of foam, assembly plate is removed. Exposed terminals are interconnection wired. Case cover is secured and a clear silicon or epoxy gel is poured through small holes therein, completely sealing interconnections. A solid mounting block for circuitry thus results with shock forces attenuated by the foam and gel. Modules can be placed as close together as 0.020 inch.

In addition to shock and vibration reduction, technique eliminates need for cable clamps, facilitates wiring and testing by placing all wiring on one plane. Testing by probing self-sealing gel can be done without destroying contaminant-and-moisture-proof seal.

BREADBOARD INTEGRITY—In breadboards, mechanical integrity, good workmanship and pleasing appearance are closely related. This is theme of paper by Richard S. Moeller of GE's Advanced Elec-

tronics Center. He will examine breadboard construction needed to achieve such characteristics with respect to: assembly and component-change techniques, standardization of mechanical hardware, standardization of electrical accessories, marking control panel production and finishing; these are discussed in relation to cost and schedule. Examples include a mixture of digital and r-f circuits.

Says Moeller: A breadboard is built to prove a circuit. Unfortunately, it often leaves the laboratory looking somewhat less than professional. It is delivered to a customer or taken for sales purposes. Since most people will have only visual contact with the breadboard, its appearance does much to register an impression.

It is generally assumed, he says, that the breadboard works electrically. Equally important, however, is that it can withstand the rigors of handling and shipment and still continue to function.

He maintains that such breadboards can be built within existing costs and schedules.

RAIL CONCEPTION—Three authors from Ling-Temco-Vought will describe a rail-construction concept for ease of breadboarding and modular standardization that fulfills following requirements: self-jigging capability, encapsulation ease, automation capability, heat-sink capability, ease of external connections.

Plastic rails hold individual components at each end by their leads. Component spacing is fixed. Heat sinks can be inserted in place of components on an as-required basis. Each rail-pair unit slips into a holder that provides a dense cordwood module ready for production to eliminate redesign at completion of breadboard phase.

The authors—K. W. Allen, H. D. Roberts, A. J. Lephakis—claim that simplicity and flexibility of design greatly reduce complexity of fabrication and tooling in both limited and mass production of modules.

WORKSHOPS—Six workshop sessions will be held including: commercial electronic production, miniature packaging, large electronic structures.

True TORQUE CONTROL

REJECTS REDUCED



NEW YORK ELECTRONICS
FIRM CHOOSES
CLECOMATIC* BECAUSE ...

- (1) Precise torque start/stop feature reduces rejects drastically.
- (2) Adjustable exhaust keeps air from blowing on fragile components.
- (3) No ratcheting reduces operator fatigue among female employees.
- (4) Automatic start/stop increases bit life and improves quality control.

This manufacturer finds the Model 6RSA-10 the best tool for his particular problem. Your nearest CLECO Representative will be glad to discuss your production problem. He can help you.

**Fully warranted for one year by the GOLDEN CIRCLE guarantee*



A DIVISION OF
REED ROLLER BIT COMPANY
P. O. Box 2541 • Houston, Texas

IN CANADA:
Cleco Pneumatic Tool Company of Canada
927 Millwood Road, Toronto 17, Canada

Recirculating Analog Data for Long Delays

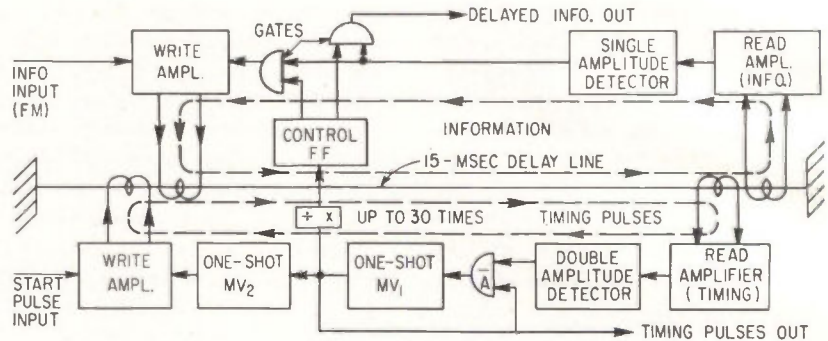
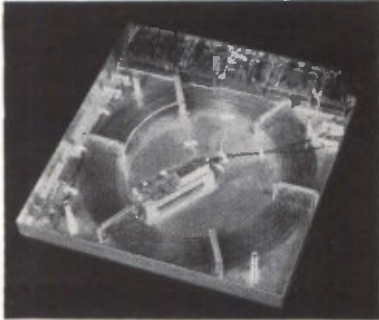

Built-in control circuits decide number of round trips, initiate readout

MAGNETOSTRICTIVE delay line recirculates analog information to produce time delays that are multiples of the length of the line. Built-in circuits control data handling, readout-out, and timing functions.

The line accepts the analog in-

formation in f-m form, with incoming information presented as sharp edged pulses representing crossovers of the f-m data. For a bandwidth of 1 Mc the delay line provides 15 msec delay; greater delays for short bursts of data are achieved by recirculating the information for a predetermined number of counts.

The block-diagram illustrates the processes involved. Two channels are used for simplicity, one handling analog information, the

other keeping track of timing. The timing pulses travel down the line with the analog information. A counter X determines the number of recirculations, and trips the control flip-flop when the correct number of recirculations have been attained. The delay line, plus additional custom accessories to increase its versatility, are available from Digital Devices Inc., 212 Michael Drive, Syosset, Long Island, N. Y.

CIRCLE 301, READER SERVICE CARD

Transistor Puts Out 1 Watt at 500 Mc

THIS planar epitaxial transistor, besides operating as an amplifier or oscillator at 500 Mc, will deliver 1 watt of r-f power at 1 gigacycle using 2 frequency-doubling steps, beginning with a fundamental frequency of 500 Mc. The new device will have a minimum gain-bandwidth product of 400 Mc at 10 volts and 50 ma. Used



from a 15 volt supply as a 200 Mc class-C amplifier, the unit yields a typical output of 2 watts at 6 db gain and collector efficiency of 70 percent. These transistors designated 2N2884 and 2N2883 by the manufacturer, Fairchild Semiconductor Division of Fairchild Camera & Instrument Corporation, 545 Whisman Road, Mountain View, California, will become available June 3, 1963. (302)

Xtal Filters Give Amplifier 0.02-Percent Bandwidth

FOUR-POLE version of this filter-amplifier-detector, which uses the piezoelectric effect for stability,

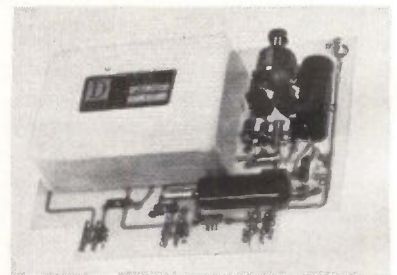

selectivity, and a wide, linear, dynamic range, has a -3 db bandwidth of 20 ± 3 cycles/second in the 20-Kc model; -50 db bandwidth is less than 130 cycles for a shape-factor of 6.5/1. Units can be obtained singly, or in matched comb-filter sets covering the range 10 Kc to 30 Mc.

Advantages of using crystals as the filter-elements, according to the manufacturers, Damon Engineering, Inc., 240 Highland Avenue, Needham Heights 94, Massachu-

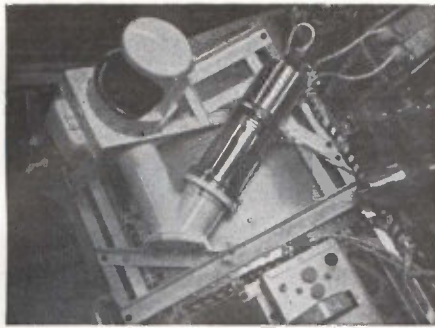

Here, in Lockheed Missiles & Space Company's Physical Sciences Laboratories, scientists are engaged in a comprehensive space physics research program embracing experimental and theoretical work in space radiation, aurora, atmospheric structure, geomagnetic micropulsations, x-ray astronomy, and the propagation of electromagnetic waves in space. Experimental programs include the measurements of geophysical and space properties, both in space and in the laboratory.

Currently, measurements of variations on the earth's magnetic field are being made at remote islands in the Pacific Ocean, providing clues to the effect of solar activity on its shape and stability. The influence of solar wind on the geo-

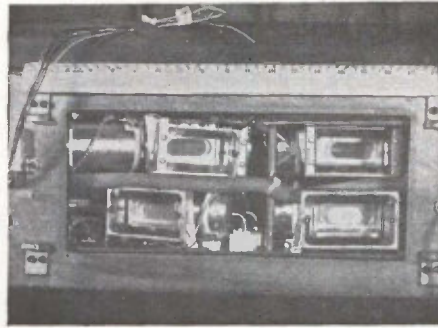

magnetic field is also being investigated in laboratory experiments, by bombarding magnetic fields with clouds of highly ionized gases.

Scientists at Lockheed are engaged in a continuing program of designing and placing density gages, mass spectrometers, ion traps, and similar instruments on space vehicles to measure the density, composition, and temperature of matter in space. These experiments lead to a better understanding of the chemical reactions occurring in the atmosphere high above the earth.

Important investigations of the low energy x-rays emitted by stars are being carried out and interpreted to give information on the structure of stellar coronas.

LOOK AT LOCKHEED...AS A CAREER

Consider Lockheed's leadership in space technology. Evaluate its accomplishments —such as the Polaris missile, the Agena vehicle's superb record of space missions. Examine its outstanding advantages —location, advancement policies, creative climate, opportunity for recognition.

Then write for a brochure that gives you a more complete Look at Lockheed. Address: Research & Development Staff, Dept. M-44B, P.O. Box 504, Sunnyvale, California. Lockheed is an equal opportunity employer.

SCIENTISTS & ENGINEERS: In addition to positions in the physical sciences, other important openings exist for specialists in: Trajectory analysis • Gas dynamics • Orbit thermodynamics • Electromagnetics • Chemical & nuclear propulsion • Systems engineering • Electronic engineering • Communications & optics research

LOCKHEED **MISSILES & SPACE COMPANY**

A GROUP DIVISION OF LOCKHEED AIRCRAFT CORPORATION

Sunnyvale, Palo Alto, Van Nuys, Santa Cruz, Santa Maria, California • Cape Canaveral, Florida • Huntsville, Alabama • Hawaii

LOOK AT LOCKHEED IN SPACE PHYSICS:

Continuing investigation of matter and forces in space

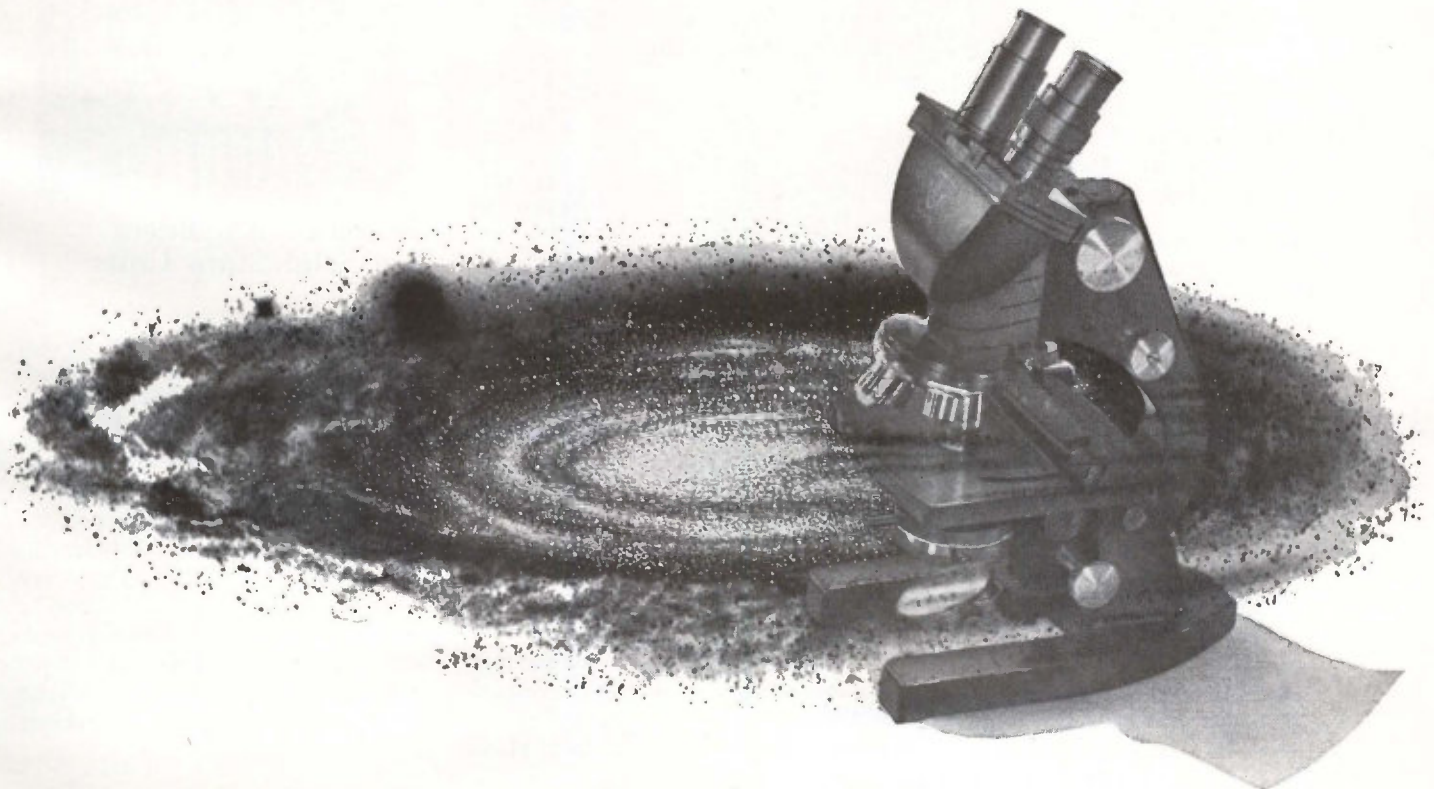

computer power



COMPUTER POWER SUPPLIES FOR 465-L

465-L Strategic Air Command Control computer system power supplies are designed and built by ITT.

These units can regulate from poor quality input and maintain MTBF of 8000 hours to 90% confidence.

ITT power for high reliability.

For further information write Power Equipment and Space Systems Department for Data File E-1858-3.

ITT

Industrial Products Division
International Telephone and Telegraph Corporation
15191 Bledsoe Street • San Fernando, Calif. • EMpire 7-6161

sets, lie in their inherently linear characteristics, hence the wide dynamic range that they afford. They are, additionally, very stable, and offer low insertion losses, permitting operation with low-power amplifiers.

CIRCLE 303, READER SERVICE CARD

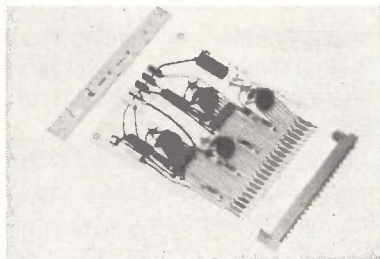

Magnetic Logic On Plug-In Card

UNIVERSAL CTL magnetic core-transistor-logic circuits mounted on a low-cost plug-in card are announced. Each CTLA-4 card carries 4 independent magnetic core-transistor-logic circuits. By appropriate backboard interconnection, each CTL can perform any logical function such as AND, OR, INHIBIT, or COMPLEMENT—making available to the designer a complete logic system capability through the use of a single card type. A single card can be a decade scaler or one bit's worth of parallel arithmetic. No additional components are required. DI/AN Controls, Inc., 944 Dorchester Ave., Boston, Mass. (304)

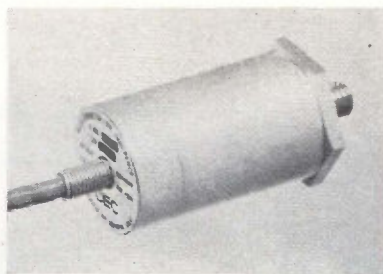

Integral Emitter Follower Mates Transducer to Line

CONNECTING CABLES used with various forms of electrical transducer are often a major bugbear because line capacitance as high as 30 pf/ft seriously degrades transducer performance. Moreover, the transducer often has to be recalibrated whenever it is given a new lead. These

problems are overcome, as in this piezoelectric accelerometer, by building an amplifier right into the transducer head, thereby matching transducer and line impedances.

The Type 4-280 accelerometer can be used with cables up to 100 feet length without serious loss of performance. The accelerometer, manufactured by Consolidated Electrodynamics, Inc., 360 Sierra Madre Villa, Pasadena, California, provides a 6 to 6,000 cps response, operating to 250 peak-g, and covering temperatures within the -65 F to 200 F range. Voltage sensitivity is said to be 20 peak mv/peak-g at 77 F while operating at 100 cps into a 50,000 load. Response to cross-axis motion is limited to 5 percent, amplitude linearity is 1 percent and the unit operates from a 28 volt supply. (305)

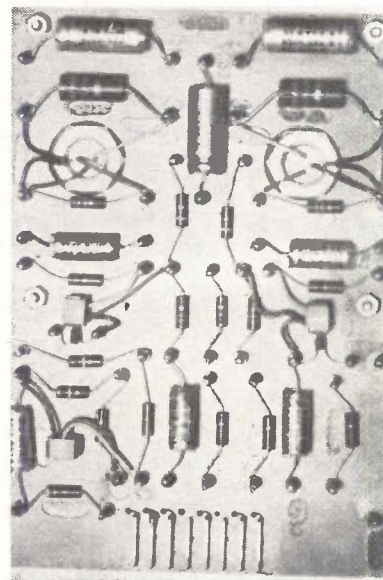

Computer Amplifiers Are Solid State Units

A COMPLETE range of 60/400 cps solid state amplifiers for analog computer use has been developed. All types are assembled on $\frac{1}{16}$ in. plug-in cards, measuring 6 $\frac{1}{2}$ in. by 4 $\frac{1}{2}$ in., designed to fit standard card boxes. Types include: transformerless summing servo-amplifiers, summing amplifier, resolver amplifier and relay amplifier. Units are packaged in a typical installation in 17 in. by 10 $\frac{1}{2}$ in. card boxes, each box housing up to 34 modules. Price range: \$165 to \$195. Transdyne Corp., 43 Albertson Ave., Albertson, L. I., N. Y. (306)

Literature of the Week

static inverters

INSTRUMENTS Keithley Instruments, Inc., 12415 Euclid Ave., Cleveland 6, O., has available a 44-page catalog describing its full line of sensitive electronic instruments for research and industry. (307)

GLASS-ENCASED R-F CAPACITORS Captronics, Inc., 9 Cricket Terrace, Ardmore, Pa. Technical bulletin 402 lists low loss silicon oil impregnated r-f capacitors with voltage ratings from 2.5 Kv to 30 Kv. (308)

ENERGY DISCHARGE CAPACITORS Sangamo Electric Co., Springfield, Ill. Technical bulletin contains reference data for electrical and mechanical design criteria covering energy discharge capacitors. (309)

SILICON ZENER DIODES Transistron Electronic Corp., 168 Albion St., Wakefield, Mass., has published an alpha-numerical guide to its silicon zener diodes. (310)

SPACE SIMULATION Ilikon Corp., Natick Industrial Centre, Natick, Mass., has a two-color brochure describing and illustrating its advanced space simulation facilities. It also contains space data charts. (311)

BERYLLIUM-COPPER TUBING Uniform Tubes, Inc., Collegetown, Pa. Data sheet covers beryllium-copper tubing and fabrications. (312)

ION BEAM GENERATOR CBS Laboratories, High Ridge Road, Stamford, Conn. Bulletin IBG-1 describes a new ion beam generator for the production of steady, controllable beams of metal ions. (313)

SEMICONDUCTORS Bendix Semiconductor Division, South St., Holmdel, N. J., has published a guide listing a wide range of semiconductor products by type number with information on pertinent electrical characteristics and case type. (314)

TIN OXIDE RESISTORS Corning Electronic Components, Raleigh, N. C. Methods of manufacturing, selecting and proving performance of high-reliability tin oxide resistors are given in a bulletin. (315)

DELAY LINE SERIAL MEMORY SYSTEMS Computer Control Co., Inc., Old Connecticut Path, Framingham, Mass., offers an 8-page brochure featuring applications of delay line serial memories to 3 C digital systems. (316)

CHOPPER Solid State Electronics Co., 15321 Rayen St., Sepulveda, Calif. Catalog sheet describes model 75 silicon transistorized chopper with isolated transformer drive. (317)

NANOSECOND DELAY LINE Lumatron Electronics, Inc., 116 County Courthouse Road, New Hyde Park, N. Y. Mailing piece illustrates and describes model 1202AR variable step delay line. (318)

COMPUTING SCIENCE Electronic Associates, Inc., Long Branch, N. J. A 20-page illustrated brochure describes the activities and facilities of the EAI Research and Computation division. (319)

ROTARY POTENTIOMETERS Weston-Instruments & Electronics division, 614 Frelinghuysen Ave., Newark 14, N. J. Data sheet covers the 349 series rotary Multipots. (320)

TOUCH CONTROL SWITCH Tung-Sol Electric Inc., 1 Summer Ave., Newark 4, N. J. Brochure discusses various possible applications of the Dynquad touch control module. (321)

SPECTROMETERS Strand Labs, Inc., 294 Centre St., Newton 58, Mass. A 24-page technical brochure describes a full line of electron-paramagnetic-resonance spectrometers. (322)

TRIMMING POTENTIOMETERS Techno-Components Corp., 18232 Parthenia St., Northridge, Calif. Catalog covers line of $\frac{3}{8}$ in. square precision and commercial trimming potentiometers with resistance values to 50,000 ohms. (323)

RELAY SOCKET PUNCH Greenlee Tool Co., Rockford, Ill. Bulletin E-324 pictures and describes a punch that makes clean, accurate, finished holes for miniature relay sockets. (324)

RECEIVING TUBES Raytheon Co., 55 Chapel St., Newton 58, Mass. A full line of industrial, military, and special purpose receiving tubes is detailed in a 16-page condensed data brochure. (325)

QUARTZ CRYSTAL UNITS Connolly & Co. Inc., 914 Rengstorff Ave., Mountain View, Calif. An illustrated 24-page booklet covers Genalex low frequency quartz crystal units. (326)

FERRITE CORE Electronic Memories Inc., 9430 Bellanca Ave., Los Angeles 45, Calif., offers an 8-page technical bulletin on the two-aperture Transfluxor ferrite core. (327)

SILICON POWER TRANSISTORS Westinghouse Semiconductor Division, Youngwood, Pa. Procurement specifications are available as a series of five booklets for the company's entire line of silicon power-transistors. Request on company letterhead.

POWER SUPPLIES Behlman-Invar Electronics Corp., 1723 Cloverfield Blvd., Santa Monica, Calif., has issued a catalog on a line of solid state d-c power supplies, a-c Invertrons and plug-in oscillators. (328)

SEMICONDUCTOR PRODUCTS Motorola Semiconductor Products Inc., P.O. Box 955, Phoenix 1, Ariz. A 22-page condensed catalog covers a complete line of standard industrial and MIL-type semiconductor products. (329)



HIGH EFFICIENCY SOLID STATE INVERTERS

Transistorized 750 VA static inverter power supply from ITT is designed for maximum reliability and efficiency. Harmonic interchange techniques generate stepped waveforms into the filters. Regulation and phase control are maintained by phase shift techniques.

This 400 cps solid state power supply achieves up to 85% efficiency at full load and nominal line, and maintains low total harmonic distortion at the output.

Other Features:

- Input Voltage /swing: 22-34 VDC
- Output Voltage: 115 V phase to neutral 3 ϕ 4 wire -WYE
Adjustable and regulated $\pm 1\%$
- Distortion: Less than 2%
- Response time: Less than 50 ms.
- Short circuit protection: Automatic current limiting (recoverable)

For further information write Power Equipment and Space Systems Department for Data File E-1869-2.

ITT

Industrial Products Division
International Telephone and Telegraph Corporation
15191 Bledsoe Street • San Fernando, Calif. • Empire 7-6162

ITT Erecting Laboratories Addition



INTERNATIONAL Telephone and Telegraph Corporation is building a 53,000-square-foot addition to the ITT Federal Laboratories plant in San Fernando, Calif.

Norman E. Friedmann, vice president of ITTFL and general manager of its California operations, said the additional building and plant equipment will represent an investment in excess of \$1 million. The expanded plant will be ready for occupancy by the end of August. The addition will provide a threefold increase in size of the present ITTFL California facility and will employ approximately 350 persons.

The California operations of ITT Federal Laboratories are engaged in research and development of electronic, electro-optical, and electromechanical equipment

to meet advanced aerospace applications. Specific activities include the development of optical communications, tracking and navigation systems, self-organizing and adaptive machines, physiometric data systems, inertial navigators and components, attitude reference sensors, and electronic surveillance systems, in addition to a basic research program in these areas.

The addition will allow consolidation of research, engineering, and fabrication facilities in one integrated plant, and will be equipped with the latest in scientific equipment and laboratory facilities.

Friedmann indicated that the new facility is part of a continued program of expansion of the ITT Federal Laboratories activity in California.



Sprague Electric Hires Vogel

F. LINCOLN VOGEL, Jr. has been named head of the Semiconductor Research department of the Sprague Electric Co., North Adams, Mass.

Before joining Sprague, Vogel was manager of advanced materials at the Semiconductor division of Radio Corp. of America, Somerville, N. J.

TIC of California Names Moore President

MILFORD B. MOORE has been appointed president and general manager of Technology Instrument Corp. of California, a subsidiary of Bowmar Instrument Corp., Fort Wayne, Ind.

Moore was director of manufacturing of Bowmar's Fort Wayne division.

Hildebrand Joins Silicon Transistor

APPOINTMENT of G. A. Hildebrand to the post of director of marketing at Silicon Transistor Corp., Carle Place, N. Y., has been announced by Randolph Bronson, executive vice president of the

semiconductor manufacturing firm.

"Bud" Hildebrand comes to STC after 14 years with RCA where he served in numerous executive capacities.

According to Bronson, Hildebrand's responsibilities at Silicon Transistor will include military, OEM and distributor sales, plus applications engineering. He will also be wholly responsible for other phases of marketing such as product planning and market development.



Weiner Accepts New Position

SHERMAN B. WEINER has joined United States Instrument Corp., Charlottesville, Va., as vice president in charge of engineering.

He comes to the new post from the Stromberg-Carlson Telecommunication division of General Dynamics in Rochester, N. Y., where he was chief engineer-electronic engineering.

Houston Fearless Shifts Executives

HOUSTON FEARLESS Corporation's board of directors has named former president George E. Johnson as chairman, replacing Noah Dietrich. At the same time the board elected Fred C. Mehner president and chief executive officer of the Los Angeles based company.

Mehner joined the company in early 1961 and has most recently been corporate vice president. He was formerly vice president, general manager, and a board member of Acoustica Associates.



electronics IS EDITED TO KEEP YOU FULLY INFORMED — a "well-rounded" engineer

What's your *present* job in electronics? Do you work on computers? (electronics ran 158 articles on computers between July, 1961 and June, 1962!) Are you in semi-conductors? (For the same period, electronics had 99 articles, not including transistors, solid-state physics, diodes, crystals, etc.) Are you in military electronics? (electronics had 179 articles, not including those on aircraft, missiles, radar, etc.)

In all, electronics' 28-man editorial staff provided more than 3,000 editorial pages to keep you abreast of all the technical developments in the industry. No matter where you work today or in which job function(s), electronics will keep you fully informed. Subscribe today via the Reader Service Card in this issue. Only 7½ cents a copy at the 3 year rate.

electronics

electronics • May 31, 1963

PROFESSIONAL SERVICES

GIBBS & HILL, Inc.
Consulting Engineers
 Systems Engineering
 Operations Research • Development
 Field Studies • Design • Procurement
 Power • Transportation • Communications
 Water Supply • Waste Treatment
 393 Seventh Avenue New York 1, N. Y.

EMPLOYMENT OPPORTUNITIES

(Additional Employment opportunity Advertisement on page 55)



E. E.'s
 for FEE-PAID Positions
WRITE US FIRST!
 Use our confidential application for professional, individualized service . . . a complete national technical employment agency.
ATOMIC PERSONNEL, INC.
 Suite 1207L, 1518 Walnut St., Phila. 2, Pa.

SEARCHLIGHT SECTION

(Classified Advertising)

BUSINESS OPPORTUNITIES

EQUIPMENT - USED or RESALE

ELECTRONIC AND RELATED INDUSTRIAL PLANTS AND SITES

CHOICE ORANGE COUNTY, CALIFORNIA, LOCATION

Attractive proposal to the firms who can meet standards of quality and appearance and start construction in 1963 to comply with building commitments. Close to major freeway, trackage available, excellent topography. Will sell or lease land; will build to your specifications.

BO-2324, Electronics
 645 N. Michigan Ave., Chicago 11, Ill.

U. S. MICROWAVE

AMERICA'S LEADING DISTRIBUTOR OF ELECTRONIC TUBES

Klystrons, Transmitting, Magnetrons, Amplitrons, Rectifiers, Thyratrons, BWO, TWT, Exotic Types, XFA, MBK, COAX Mag, Image converters, Orthicon, Photomultiplier, Transistor, Zener, Cathode-Ray, Storage.

Distributors of Specialized Electronic Equipment—Nuclear, Geophysical

EXPORT INQUIRIES INVITED—ALL LANGUAGES

U. S. MICROWAVE

P. O. Box "G"

Collingswood, New Jersey

Call Collect, Area Code 609 - WO 6-2929

CIRCLE 950 ON READER SERVICE CARD

RADIO RESEARCH INSTRUMENT CO.

AUTO-TRACK & TELEMETRY ANTENNA PEOESTALS
 3 & 10 CM. SCR. 584 AUTOTRACK RADARS.
 AN/TPS-10 SEARCH, AN/TPS-10 HT. FINDERS.
 AN/FPN-32GCA. AN/APS-10 NAVIG. & WEATHER.
 AN/APS-15B PRECISION. AN/APQ-35B PRECISION.
 AN/APS-31A SEARCH. DOZENS MORE.
 S-1-2 MEGAWATT HIGH POWER PULSERS.

RADIO RESEARCH INSTRUMENT CO.
 550 Fifth Ave., New York Judson 6-4691

RADAR SYSTEMS & COMPONENTS/ IMMEDIATE DELIVERY

CIRCLE 951 ON READER SERVICE CARD

LOOKING FOR USED/SURPLUS ELECTRONIC EQUIPMENT/COMPONENTS?

For an up-to-date listing of such equipment see Searchlight Section of May 10th.

SAVE! BIG MONEY on GENERATOR SETS



MOTOR-GENERATOR, AC TO DC

Motor: 5 H.P. 3510 RPM, 220/440 volts, 60 cycles, 3 phase. Type OGX, Frame 225, Class G, Form B. Generator: 28 volts, 100 amperes

D.C. Model No. 60. Made by Motoresearch Co. Equipped with motor starter box and generator control panel. Complete assembly mounted in tubular frame for portability. Shpg. wt. 250 lbs. F.O.B. Chicago No. AS-G764 ONLY \$175.00

50 KW, 400 CYCLE MOTOR GENERATOR SET

Ideal Type F-1. Rated 62.5 KVA, 50 KW, 120/208 volts, 3 phase, 400 cycles, 0.8 P.F. Powered by 60 cycle, 3 phase, 220/440 volt motor. Complete with instrument and control panel. Overall dimensions: 85" L, 34" W, 41" H. Shpg. wt. 2100 lbs. F.O.B. Chicago. No. AS-G964 ONLY \$1,250.00

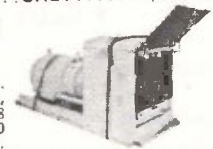

FREE CATALOG!

Write today for Groban's NEW 72 page Equipment Catalog and Hydraulic Reference Manual. Tremendous Savings on hundreds of items.



GROBAN SUPPLY COMPANY, INC.

1139 So. Wabash Ave., Dept. AS-5, Chicago 5, Ill. WEBster 9-3793 • Cable: GROBANCO — CHICAGO

CIRCLE 952 ON READER SERVICE CARD

electronics

WEEKLY QUALIFICATION FORM FOR POSITIONS AVAILABLE

ATTENTION: ENGINEERS, SCIENTISTS, PHYSICISTS

This Qualification Form is designed to help you advance in the electronics industry. It is unique and compact. Designed with the assistance of professional personnel management, it isolates specific experience in electronics and deals only in essential background information.

The advertisers listed here are seeking professional experience. Fill in the Qualification Form below.

STRICTLY CONFIDENTIAL

Your Qualification form will be handled as "Strictly Confidential" by ELECTRONICS. Our processing system is such that your form will be forwarded within 24 hours to the proper executives in the companies you select. You will be contacted at your home by the interested companies.

WHAT TO DO

1. Review the positions in the advertisements.
2. Select those for which you qualify.
3. Notice the key numbers.
4. Circle the corresponding key number below the Qualification Form.
5. Fill out the form completely. Please print clearly.
6. Mail to: Classified Advertising Div., ELECTRONICS, Box 12, New York 36, N. Y. (No charge, of course).

| COMPANY | SEE PAGE | KEY # |
|--|----------|-------|
| ATOMIC PERSONNEL INC. Philadelphia, Penna. | 53 | 1 |
| EXECU-SEARCH Division of Davies-Shea Inc., Chicago, Ill. | 76*** | 2 |
| HIGH VOLTAGE ENGINEERING CORPORATION Burlington, Mass. | 79** | 3 |
| HONEYWELL St. Petersburg, Florida | 58* | 4 |
| LOCKHEED MISSILES & SPACE CO. Div. of Lockheed Aircraft Corp. Sunnyvale, California | 49 | 5 |
| NORDEN Div. of United Aircraft Corporation Norwalk, Conn. | 89* | 6 |
| PAN AMERICAN WORLD AIRWAYS INC. Guided Missiles Range Div. Patrick AFB, Fla. | 55 | 7 |
| UNION CARBIDE NUCLEAR COMPANY A Div. of Union Carbide Corporation Oak Ridge, Tennessee | 88* | 8 |

* These advertisements appeared in the May 10th issue.

** This advertisement appeared in the May 17th issue.

*** This advertisement appeared in the May 24th issue.

(cut here)

electronics WEEKLY QUALIFICATION FORM FOR POSITIONS AVAILABLE

(cut here)

(Please type or print clearly. Necessary for reproduction.)

Personal Background

NAME

HOME ADDRESS

CITY ZONE STATE

HOME TELEPHONE

Education

PROFESSIONAL DEGREE(S)

MAJOR(S)

UNIVERSITY

DATE(S)

FIELDS OF EXPERIENCE (Please Check)

53163

- | | | |
|--|--|---------------------------------------|
| <input type="checkbox"/> Aerospace | <input type="checkbox"/> Fire Control | <input type="checkbox"/> Radar |
| <input type="checkbox"/> Antennas | <input type="checkbox"/> Human Factors | <input type="checkbox"/> Radio-TV |
| <input type="checkbox"/> ASW | <input type="checkbox"/> Infrared | <input type="checkbox"/> Simulators |
| <input type="checkbox"/> Circuits | <input type="checkbox"/> Instrumentation | <input type="checkbox"/> Solid State |
| <input type="checkbox"/> Communications | <input type="checkbox"/> Medicine | <input type="checkbox"/> Telemetry |
| <input type="checkbox"/> Components | <input type="checkbox"/> Microwave | <input type="checkbox"/> Transformers |
| <input type="checkbox"/> Computers | <input type="checkbox"/> Navigation | <input type="checkbox"/> Other |
| <input type="checkbox"/> ECM | <input type="checkbox"/> Operations Research | <input type="checkbox"/> |
| <input type="checkbox"/> Electron Tubes | <input type="checkbox"/> Optics | <input type="checkbox"/> |
| <input type="checkbox"/> Engineering Writing | <input type="checkbox"/> Packaging | <input type="checkbox"/> |

CATEGORY OF SPECIALIZATION

Please indicate number of months experience on proper lines.

| | Technical Experience (Months) | Supervisory Experience (Months) |
|-------------------------------------|-------------------------------|---------------------------------|
| RESEARCH (pure, fundamental, basic) | | |
| RESEARCH (Applied) | | |
| SYSTEMS (New Concepts) | | |
| DEVELOPMENT (Model) | | |
| DESIGN (Product) | | |
| MANUFACTURING (Product) | | |
| FIELD (Service) | | |
| SALES (Proposals & Products) | | |

CIRCLE KEY NUMBERS OF ABOVE COMPANIES' POSITIONS THAT INTEREST YOU

1 2 3 4 5 6 7 8 9 10 11 12 13 14 15 16 17 18 19 20 21 22 23 24 25

ENGINEERS • SCIENTISTS



One big systems field known only to a handful of engineers

(...outside of PAN AM's Guided Missiles Range Division)

We're referring to the new technology—advanced range systems engineering—as developed and practiced by GMRD.

From the systems viewpoint, a striking metamorphosis has taken place since 1953 when GMRD undertook range engineering, operation and development at Cape Canaveral for the Air Force.

A comparatively simple set-up existed in the early '50's (to monitor missile flights up to 500 miles). Today this has been transformed into a vast, integrated systems complex of new generation tracking, monitoring, data handling, data support and communications sub-systems.

Present range capabilities can support the launch of global flights; lunar and interplanetary space probes. New capabilities are under development now—to meet the unprecedented requirements of the Apollo Program. And GMRD's Advance Planning Group is engaged in projecting range needs as far ahead as the late '70's.

In fact the giant range system at Cape Canaveral and down-range is always a **system-in-transition**, calling for the highest technical contributions from engineers and scientists of many disciplines,

to keep pace with the needs of the nation's new missile systems and space vehicles.

YOU ARE INVITED TO INQUIRE ABOUT CAREER OPPORTUNITIES FOR:
Systems Engineers—EE's, Physicists capable of assuming complete project responsibility for new range systems.

Instrumentation Planning Engineers—EE's, Physicists to be responsible for specific global range instrumentation concepts.

Advance Planning Engineers—EE's, Physicists to evaluate and project the state-of-the-art in all applications of range instrumentation.

Experience in one or more of these areas: Pulse radar, CW techniques, telemetry, infrared, data handling, communications, closed circuit TV, frequency analysis, command control, underwater sound, timing, shipboard instrumentation.

Why not write us today, describing your interests and qualifications in any of the areas above. Address Dr. Charles Carroll, Dept. 28E-5.



GUIDED MISSILES RANGE DIVISION

PAN AMERICAN WORLD AIRWAYS, INC.
P. O. BOX 4465, PATRICK AIR FORCE BASE, FLORIDA

An Equal Opportunity Employer

Only the PRICE IS DIFFERENT

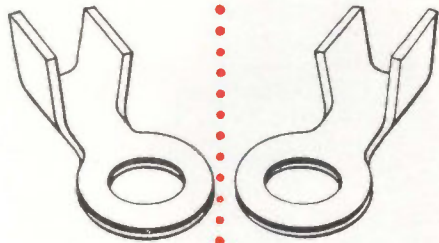

THIS
TERMINAL
SELLS FOR
\$10.50
PER M

THIS
ELECTRIX TERMINAL
SELLS FOR
\$7.50
PER M

BOTH THESE TERMINALS ARE HEAVY DUTY
.030 THICK TIN PLATED BRASS

HOW MANY DO YOU USE?

In our extensive line, there are probably Electrix terminals that are identical to types you are using right now — identical in every way but price. — Our price is lower! This price differential can be as important to you as the quantity of terminals you use.

IT'S EASY TO FIGURE YOUR SAVINGS

The quality is as good or better than more expensive terminals—so is the holding power — so are the electrical and physical characteristics, so is our service! You give up nothing. Your savings are absolute "velvet." Ask us for prices — then see how easy it is to figure your savings.

Electrix Division

NORTH AMERICAN
PHILIPS CO., INC.

ASHTON • RHODE ISLAND

INDEX TO ADVERTISERS

| | |
|---|--------------------|
| Aerocom | 11 |
| Allen-Bradley Co. | 20 |
| • Bulova | 16 |
| • Clairex Corp. | 43 |
| Cleco | 47 |
| Division of Reed Roller Bit Co. | 31 |
| Cubic Corp. | 6 |
| Delco Radio | 41 |
| duPont de Nemours & Co., Inc. E. I. | 6 |
| Electrix Div. | 56 |
| North American Philips Co., Inc. | 19 |
| • Globe Industries Inc. | 19 |
| • Hewlett-Packard Company | inside front cover |
| Hughes Aircraft Co. | 33 |
| Aerospace Divisions | 45 |
| • International Nickel Company, Inc. | 51 |
| • International Telephone and Telegraph Corp. | 50, 51 |
| Industrial Products Div. | 39 |
| Industrial Laboratories | 37 |
| • Kepco, Inc. | 37 |
| Kintel | 3rd cover |
| A Division of Cohu Electronics Inc. | 18 |
| • Litton Industries | 49 |
| Lockheed Missiles & Space Co. | 46 |
| Mitsumi Electric Co., Ltd. | 18 |
| Mnemotron | 13 |
| • Potter Instrument Co., Inc. | 17 |
| Princeton Applied Research Corp. | 15 |
| • Radio Corporation of America. | 4th cover |
| Rixon Electronics, Inc. | 35 |
| Sperry Electronic Tube Div. Sperry Rand Corp. | 4, 9 |
| Sprague Electric Co. | 38 |
| Texas Instruments Incorporated Industrial Products Group. | 5 |
| • Tung-Sol Electric, Inc. | 42 |
| Weston Instruments A Division of Daystrom Inc. | |

PROFESSIONAL SERVICES

CLASSIFIED ADVERTISING

F. J. Eberle, Business Mgr.

EMPLOYMENT OPPORTUNITIES. 53, 55

EQUIPMENT

(Used or Surplus New)

For Sale

ADVERTISERS INDEX

| | |
|---|----|
| Atomic Personnel Inc. | 53 |
| Groban Supply Company Inc. | 53 |
| Pan American World Airways Inc., Guided Missiles Range Div. | 55 |
| • Radio Research Instrument Co. | 53 |
| U. S. Microwave | 53 |

• See advertisement in the July 25, 1962 issue of Electronics Buyers' Guide for complete line of products or services.

This Index and our Reader Service Numbers are published as a service. Every precaution is taken to make them accurate, but electronics assumes no responsibilities for errors or omissions.

electronics



Audit Bureau
of Circulation



Associated Business
Publications

Audited Paid Circulation

JAMES T. HAUPTLI

Advertising Sales Manager

DAVID CUNNIFF

Promotion Manager

Electronics Buyers' Guide

R. S. QUINT

General Manager

RICHARD J. TOMLINSON

Business Manager

THEODORE R. GEIPEL

Production Manager

ADVERTISING REPRESENTATIVES

ATLANTA (9):

Michael H. Miller, Robert C. Johnson
1375 Peachtree St. N.E., Trinity 5-0523
(area code 404)

BOSTON (16):

William S. Hodgkinson, Donald R. Furth
McGraw-Hill Building, Copley Square,
Congress 2-1160 (area code 617)

CHICAGO (11):

Harvey W. Wernecke, Robert M. Denmead
645 North Michigan Avenue, Mohawk 4-5800
(area code 312)

CLEVELAND (13):

Paul T. Fegley
55 Public Square, Superior 1-7000
(area code 216)

DALLAS (1):

Frank Le Beau
The Vaughn Bldg., 1712 Commerce St.
Riverside 7-9721 (area code 214)

DENVER (2):

John W. Patten
Tower Bldg., 1700 Broadway,
Alpine 5-29B1 (area code 303)

HOUSTON (25):

Joseph C. Page, Jr.
Prudential Bldg., Halcombe Blvd.,
Riverside 8-1280 (area code 713)

LOS ANGELES (17):

Ashley P. Hartman, John G. Zisch,
William C. Gries
1125 W. 6th St., Huntley 2-5450
(area code 213)

NEW YORK (36):

Donald H. Miller, Henry M. Shaw,
George F. Werner
500 Fifth Avenue, LO-4-3000
(area code 212)

PHILADELPHIA (3):

Warren H. Gardner, William J. Boyle
6 Penn Center Plaza, LOcust 8-4330
(area code 215)

SAN FRANCISCO (11):

Richard C. Alcorn
255 California Street, Douglas 2-4600
(area code 415)

LONDON W1:

Edwin S. Murphy Jr.
34 Dover St.

FRANKFURT/Main:

Matthée Herfurth
85 Westendstrasse

GENEVA:

Michael R. Zeynel
2 Place du Port

TOKYO:

George Olcott,
1, Kotohiracho, Shiba, Minato-ku

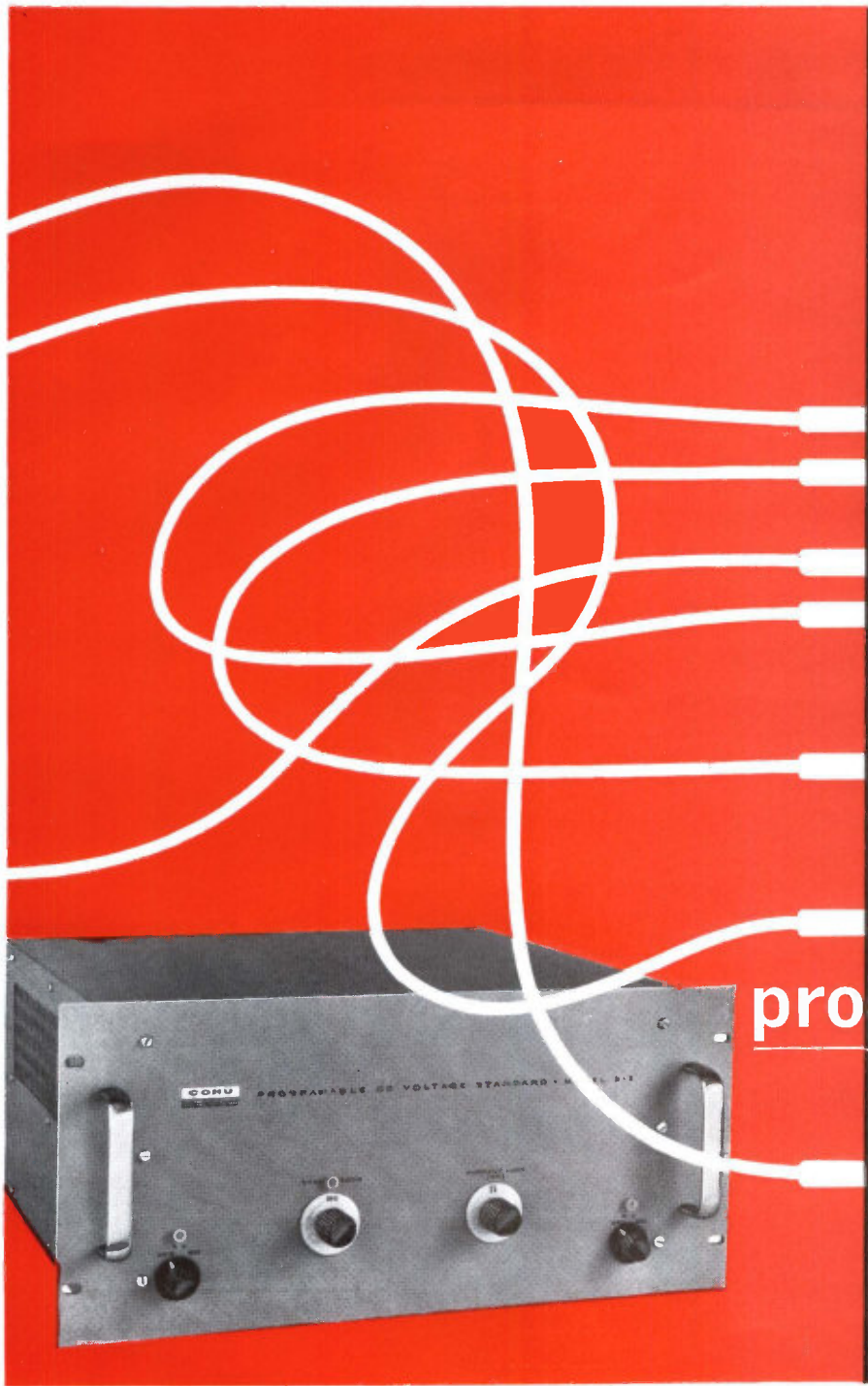

world's
first
programmable
DC voltage
standard!

With KIN TEL's new Model 313 DC standard, you can select voltages — *automatically, and in any sequence* — from 0 to 1111.1110 volts, with an accuracy of 0.01% having either polarity, and in steps as small as 1 μ v. It responds to any program applied to it in the form of parallel entry, 28 volts @ 25 ma per relay, 1-2-4-4 binary-coded-decimal signals. Switching is done internally with mercury-wetted relays.

The Model 313 is ideal for such applications as automated quality control, missile checkout and missile system test, semi-conductor production test and evaluation, and computer reference. It can be driven by punched cards, paper tapes or by remote manual switching.

OTHER IMPORTANT SPECIFICATIONS include a stability of 0.005% over a 30-day period, output current 0 to 25 ma in 4 ranges (with overload protection), 0.001 ohm source impedance, remote sampling terminals, and a floating guarded circuit.

PRICE: \$3995. All prices FOB, San Diego, Calif. (additional export charge)
WRITE TODAY for detailed information or a demonstration. Representatives in all major cities.

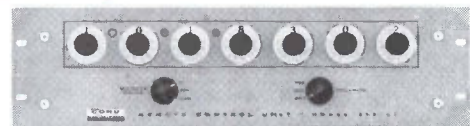

REMOTE CONTROL, TOO. (Illust.) A manual remote control unit is available at \$500. unit price. This unit (Model 313-51) is also helpful in checkout and calibration of the basic 313 standard.

5725 Kearny Villa Road, San Diego 12, California
Phone 277-6700 (Area Code 714)



CIRCLE 901 ON READER SERVICE CARD

New "Sharktooth" Geometry
of RCA 2N2476 and 2N2477.



The Revolutionary New RCA 2N2476 & 2N2477

Switch 500 Milliamperes in 50 Nanoseconds

Unique "SHARKSTOOTH" geometry of RCA's new Silicon NPN 2N2476 and 2N2477 provides new levels of performance as core or line drivers in high-speed memory circuits, and in other high-frequency, high-current applications.

The unique internal geometry of RCA's new 2N2476 and 2N2477 achieves a much larger emitter periphery AND a substantially reduced emitter area, providing high beta over a wide range of collector currents AND excellent switching speeds at high currents. For example, these new types have more than adequate speed and current capabilities for driving RCA's new Micro-ferrite Memory Stacks. Check these outstanding performance features:

- Excellent high-current beta... 20 typ. at $I_c = 1$ amp. for the 2N2476; 40 typ. for the 2N2477 (pulsed condition).
- Low $V_{CE}(\text{Sat})$ at High Currents... $V_{CE}(\text{Sat}) = 0.75\text{V}$ max. for the 2N2476, 0.65V max. for the 2N2477 at $I_c = 500$ ma, $I_B = 50$ ma.
- Low Collector Capacitance... 10pf max.
- Short Turn-On Time... 25nsec. max., $I_c = 150\text{ma}$, $I_B = I_{B_2} = 15\text{ma}$.
- Short Turn-Off Time... 45nsec. max., $I_c = 150\text{ma}$, $I_B = I_{B_2} = 15\text{ma}$.
- Dissipation... 0.6 watt max. free-air temp. up to 25°C (in TO-5 case).
- Gain-Bandwidth Product... 250 Mc min.

Call your RCA Representative today for complete information or write RCA Semiconductor and Materials Division, Commercial Engineering, Section CN5-4, Somerville, N. J.

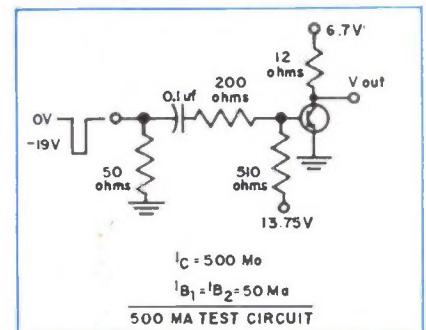

AVAILABLE THROUGH
YOUR RCA DISTRIBUTOR



THE MOST TRUSTED NAME IN ELECTRONICS

RCA SEMICONDUCTOR AND MATERIALS DIVISION FIELD OFFICES—EAST: 32 Green St., Newark 2, N. J., 485-3900 • 731 James St., Room 402, Syracuse 3, N. Y., GR 4-5591 • 605 Marlton Pike, Erlton, N. J., HA 8-4802 • Greater Baltimore Area, 1725 "K" St., N.W., Washington 6, D.C., FE 7-8500 • NORTHEAST: 64 "A" St., Needham Heights 94, Mass., HI 4-7200 • SOUTHEAST: 200 East Marks St., Orlando, Fla., 425-5563 • CENTRAL: Suite 1154, Merchandise Mart Plaza, Chicago 54, Ill., 527-2900 • 2132 East 52nd St., Indianapolis 5, Ind., CL 1-1405 • 5805 Excelsior Blvd., Minneapolis 15, Minn., WE 9-0676 • 714 New Center Bldg., Detroit 2, Mich., TR 5-5600 • 7905 Carpenter Freeway, Dallas 7, Tex., ME 1-9720 • Continental Terrace Bldg., 2785 North Speer Blvd., Room 346, Denver 11, Colo., 477-1688 • WEST: 6801 E. Washington Blvd., Los Angeles 22, Calif., RA 3-8361 • 1838 El Comino Real, Burlingame, Calif., OX 7-1620 • 2250 First Avenue, S., Seattle 4, Wash., MA 2-8816 • GOVERNMENT: 224 N. Wilkinson St., Dayton 2, Ohio, BA 6-2366 • 1725 "K" St., N.W., Washington 6, D.C., FE 7-8500 • RCA INTERNATIONAL DIVISION, 30 Rockefeller Plaza, New York 20, New York, Cable Address: RADIOINTER, N. Y.

CIRCLE 902 ON READER SERVICE CARD