

electronics

FIRST COLOR RADIOPHOTO SENT BY SATELLITE

Color inset was sent from New York to London by Relay satellite and returned over Atlantic cable, p 51

New micromodule (inset below) incorporates thin-film and integrated circuits. Welded ribbon matrix (background) interconnects wafers, p 78

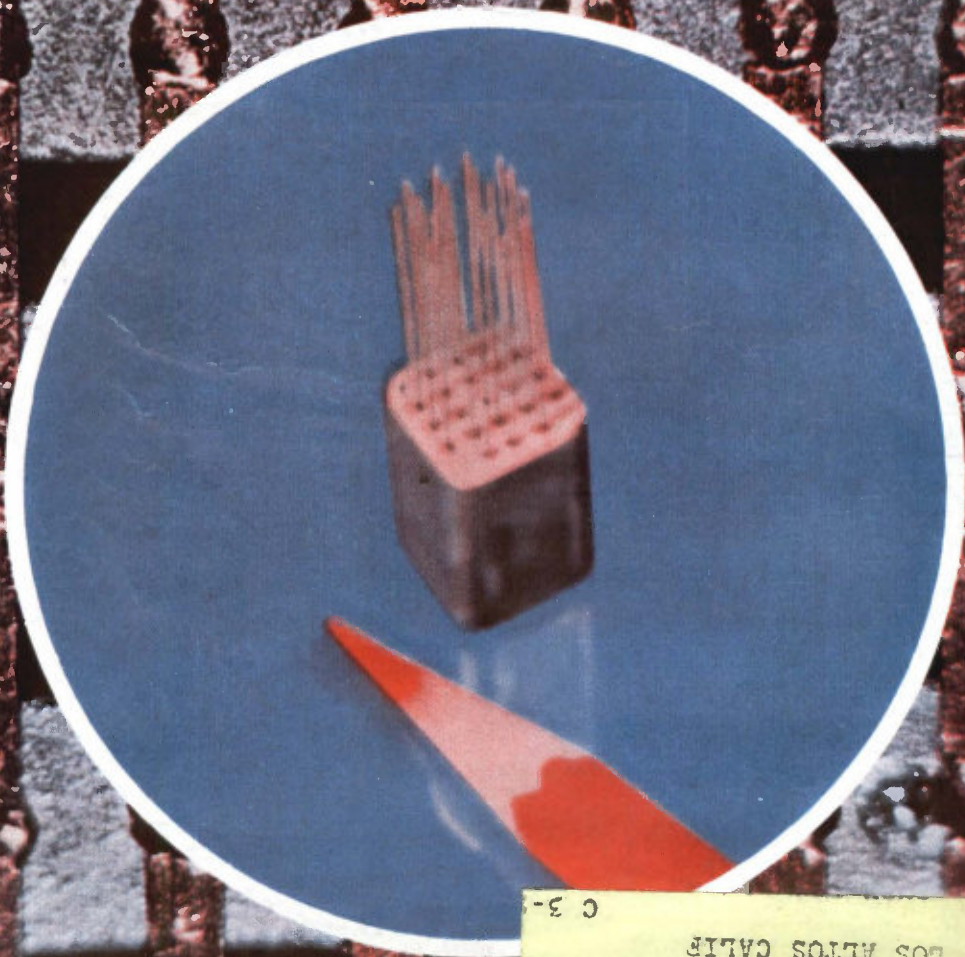

C 3-
R D SKINNER
1020 GOVINGTON RD
LOS ALTOS CALIF

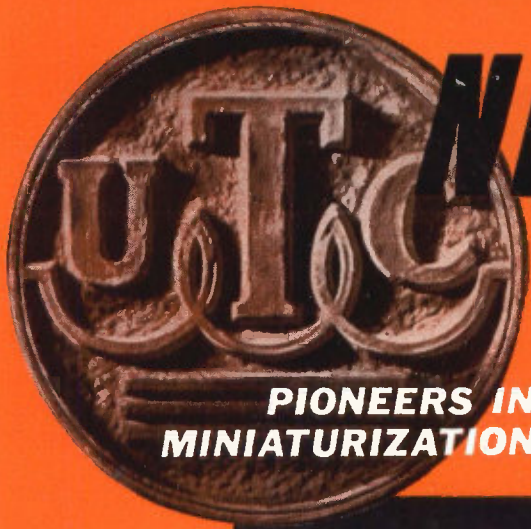

NEW PIP SERIES

ULTRAMINIATURE TRANSISTOR PULSE TRANSFORMERS

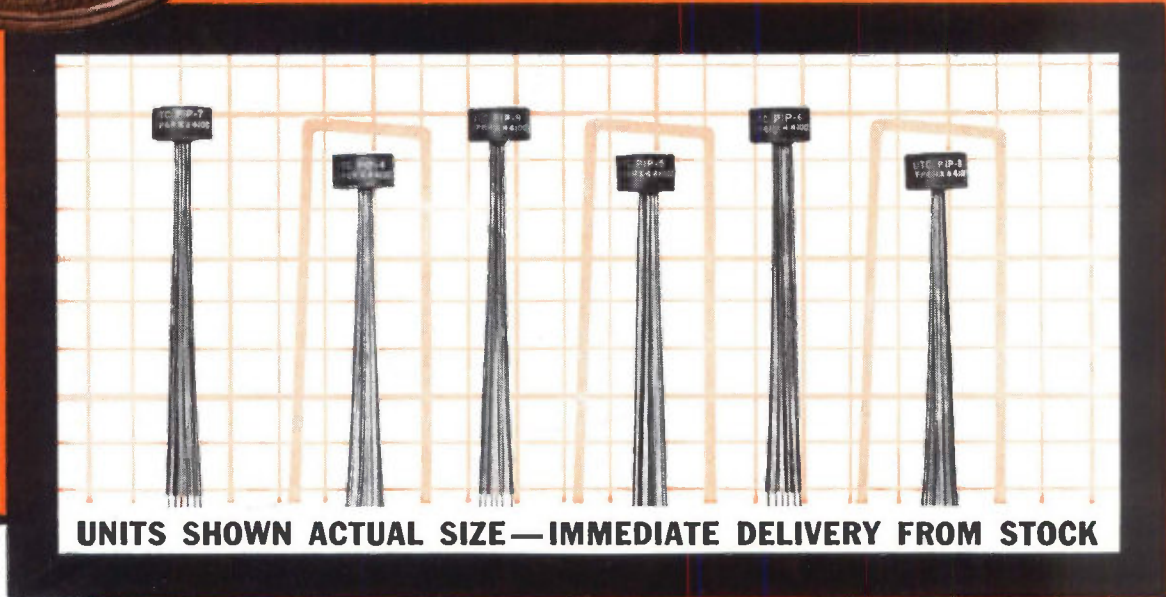

UNITS SHOWN ACTUAL SIZE—IMMEDIATE DELIVERY FROM STOCK

TRANSISTOR TEST CIRCUIT

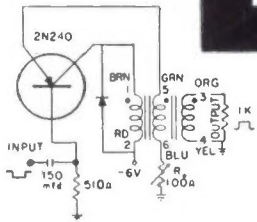

All units individually checked and adjusted, in transistor circuit illustrated, to parameters in table.

DEFINITIONS

Amplitude: Intersection of leading pulse edge with smooth curve approximating top of pulse.
Pulse width: Microseconds between 50% amplitude points on leading and trailing pulse edges.
Rise Time: Microseconds required to increase from 10% to 90% amplitude.
Overshoot: Percentage by which first excursion of pulse exceeds 100% amplitude.
Droop: Percentage reduction from 100% amplitude a specified time after 100% amplitude point.
Backswing: Negative swing after trailing edge as percentage of 100% amplitude.

- RUGGED—COMPLETELY METAL CASED
- Manufactured & Guaranteed to MIL-T-21038B
- 5/16" Dia. x 3/16" Ht.; Wt. 1/20 oz.
- Ratios—4:4:1 and 5:3:1
- Anchored leads, withstands 10 lb. pull test
- Printed circuit use, plastic insulated leads
- Can be suspended by leads or clip mounted

Type No.	APPROX. DCR, OHMS			BLOCKING OSCILLATOR PULSE				COUPLING CIRCUIT CHARACTERISTICS							
	1-Brn 2-Rd	3-Grn 4-Yel	5-Grn 6-Blu	Width μ Sec.	Rise Time	% Over Shoot	Droop %	% Back Swing	P Width μ Sec.	Volt Out	Rise Time	% Over Shoot	Droop %	Back Swing	Imp. in/out*
RATIO 4:4:1 MIL TYPE TP6RX4410CZ															
PIP-1	.18	.20	.07	.05	.02	0	0	37	.05	9	.018	0	0	12	50
PIP-2	.47	.56	.17	.1	.025	0	0	25	.1	8	.02	0	0	5	50
PIP-3	1.01	1.25	.37	.2	.03	2	0	15	.2	7	.035	0	0	5	100
PIP-4	1.5	1.85	.54	.5	.05	0	0	15	.5	7	.06	0	0	0	100
PIP-5	2.45	3.1	.9	1	.08	0	0	14	1	6.8	.15	0	0	5	100
PIP-6	3.0	3.7	1.1	2	.10	0	0	15	2	6.6	.18	0	2	10	100
PIP-7	4.9	6.05	1.8	3	.20	0	0	14	3	6.8	.20	0	2	10	100
PIP-8	8.0	9.7	2.9	5	.30	0	0	3	5	7.9	.22	0	13	25	200
PIP-9	13.1	15.9	4.7	10	.35	0	5	12	10	6.5	.4	0	15	20	200
PIP-100	Transistor pulse transformer kit, consisting of PIP-1 thru PIP-9 in plastic case.														
RATIO 5:3:1 MIL TYPE TP6RX5310CZ															
PIP-10	.55	.41	.15	.1	.01	0	0	20	.1	8	.01	0	0	5	140/50
PIP-11	2.9	2.2	.82	1	.02	4	4	6	1	6.6	.05	0	6	12	280/100
PIP-12	9.4	7.1	2.6	5	.05	0	12	12	5	8	.09	2	12	25	560/200

* Input winding leads Brn-Rd (1-2); output winding leads Org-Yel (3-4); leads Grn-Blu (5-6) open.

AND CUSTOM BUILT UNITS TO YOUR SPECS.

Write for catalog for full details on these and 1000 other stock items



UNITED TRANSFORMER CORP.

150 VARICK STREET, NEW YORK 13, N. Y.

PACIFIC MFG. DIVISION: 3630 EASTHAM DRIVE, CULVER CITY, CALIF.

EXPORT DIVISION: 13 EAST 40th STREET, NEW YORK 16, N. Y.

CABLES: "ARLAB"

CIRCLE 900 ON READER SERVICE CARD

electronics

A McGraw-Hill Weekly 75 Cents



W. W. MacDONALD, Editor

J. M. CARROLL, Managing Editor

SENIOR EDITORS

Samuel Weber, George W. Sideris

SENIOR ASSOCIATE EDITORS

Michael F. Wolff, John F. Mason

ASSOCIATE EDITORS

Michael F. Tomaino, William P. O'Brien, Sy Vogel, George J. Flynn, Laurence D. Shergalis, George V. Novotny, Leon H. Dulberger

ASSISTANT EDITORS

Stanley Froud, Stephen B. Gray, Roy J. Bruun, Barry A. Briskman, Dan Smith, Joel A. Strasser

REGIONAL EDITORS

Harold C. Hood (Pacific Coast, Los Angeles), Thomas Maguire (New England, Boston), Cletus M. Wiley (Midwest, Chicago)

ART DIRECTOR

Howard R. Berry

ASSISTANT ART DIRECTOR

John C. Wright, Jr

EDITORIAL ASSISTANTS

Lorraine Rossi, Virginia T. Bastian, Lynn Emery, Ann Mella, Lorraine Werner, Alice M. O'Brien, Sharon Parks, Patricia Mitchell, Claire Benell

FOREIGN NEWS BUREAU

DIRECTOR, John Wilhelm;
Alyne Elias, Charles Obertance

LONDON—John Shinn, Derek Barlow, Nicholas Landon

BONN—Bruce Bendow,
Richard Mikton, Silke McQueen

BRUSSELS—Peter Forbath

PARIS—Robert Farrell,
Arthur Erikson

MILAN—Marc A. Messina

MEXICO CITY—Wesley Perry, Jr

RIO DE JANEIRO—Leslie Warren

MOSCOW—Stewart Ramsey

TOKYO—Richard Halloran,
Charles Cohen, John Yamaguchi

CIRCULATION MANAGER

Hugh J. Quinn

W. W. GAREY, Publisher

OUR FRONT COVER has really been around. It is the first color radio photo sent by satellite across the Atlantic Ocean. It came back by cable. *For details on how our staff worked with NASA to develop this new communications principle, see p 51*

THE COVER SHOWS a new type of Army micromodule that can incorporate both thin-film circuits and semiconductor networks. Background is a welded matrix of copper ribbons to interconnect wafers. *Technique permits 64,000 interconnections per cubic inch; see p 78*

COVER

AIR FORCE R&D. Plans and objectives outlined at NAECON last week include work in such key areas as electromagnetic wave techniques and bionics, as well as the old standbys like devices and communications. *News bonuses at equipment displays included improved digital gear and lasers*

16

SYNTHETIC SLEEP: Can It Save Time? Some medicos think a few hours of instrument-induced sleep will substitute for a full night. Air Force and NASA are interested. *Here's the story on how and why a new sleep instrument works*

20

NEW LIGHT AMPLIFIER. A solid-state electroluminescent panel developed in Japan provides a negative or positive image. *Its resolution is reported to be better than a tv receiver.*

20

600,000-WPM PRINTER Races Computer. It pounds out copy at the rate of 30,000 lines a minute. But it does the job with electrical styli and logic, not hammers. *Question: what do you do with all that paper?*

26

IR DETECTOR Needs No Chopping. Array of thermocouples deposited on solid backing generates usable signal without moving parts. *Smaller, longer-lasting space infrared systems result*

28

NEXT NEW LASER May Be a Triode. Experimenters hope new technique will lead to silicon and germanium lasers. *The trick is to use tunneling to intensify recombination radiation. This has already been demonstrated in a transistor*

32

POWER PLANTS Can Be Made Fail-Safe. So says speaker at last week's ISA conference. *Cost of a really safe control system would be negligible*

38

NEW COMMUNICATIONS TECHNIQUE: Facsimile Sends First Color Photo by Satellite. How members of ELECTRONICS editorial staff and NASA engineers perfected the facsimile transmission of color photos by communications satellite. *Our front cover is the result of their work.* By J. A. Strasser

51

GETTING RELIABILITY AND ECONOMY in Power-Transistor Circuits. It isn't always necessary to go to expensive silicon transistors to get reliable high-temperature performance. Well-designed germanium units in well-designed circuits can do the job. *But you must understand both your components and your circuits.* By R. Greenburg, Motorola

54

Published weekly, with Electronics Buyers' Guide as part of the subscription, by McGraw-Hill Publishing Company, Inc. Founder: James H. McGraw (1860-1948).

Title ® registered U.S. Patent Office; © copyright 1963 by McGraw-Hill Publishing Co., Inc. All rights reserved, including the right to reproduce the contents of this publication, in whole or in part.

Executive, editorial, circulation and advertising offices: McGraw-Hill Building, 330 West 42nd Street, New York 36, N. Y. Telephone Longacre 4-3000. Teletype TWX N.Y. 212-640-4646. Cable McGrawhill, N. Y. PRINTED IN ALBANY, N. Y.; second class postage paid at Albany, N. Y.

OFFICERS OF THE PUBLICATIONS DIVISION: Shelton Fisher, President; Vice Presidents: Joseph H. Allen, Operations; John R. Callahan, Editorial; Ervin E. DeGraff, Circulation; Donald C. McGraw, Jr., Advertising Sales; Angelo R. Venezian, Marketing.

OFFICERS OF THE CORPORATION: Donald C. McGraw, President; Hugh J. Kelly, Harry L. Waddell, L. Keith Goodrich, Executive Vice Presidents; John L. McGraw, Treasurer; John J. Cooke, Vice President and Secretary.

Subscriptions are solicited only from those actively engaged in the field of the publication. Position and company connection must be indicated on orders. Subscription rates: United States and Possessions, \$6.00 one year, \$9.00 two years, \$12.00 three years. Canada: \$10.00 one year. All other countries \$20.00 one year. Single copies, United States and Possessions and Canada 75¢. Single copies all other countries \$1.50.

THE PUBLISHER, UPON WRITTEN REQUEST FROM ANY SUBSCRIBER TO OUR NEW YORK OFFICE AGREES TO REFUND THAT PART OF THE SUBSCRIPTION PRICE APPLYING TO COPIES NOT YET MAILED.

Subscribers: Please send change of address notices, subscription orders or complaints to Fulfillment Manager, Electronics, at the address below. Change of address notices should provide old as well as new address, including postal zone number if any. If possible, attach address label from recent issue. Allow one month for change to become effective.

Postmaster: Please send Form 3579 to Fulfillment Manager, Electronics, P. O. Box 430, Hightstown, New Jersey.



Audited Paid Circulation

CONTENTS Continued

TRUE SOLID-STATE ALTERNATORS. The static alternator differs fundamentally from the static inverter. It gives sinusoidal output without filtering and simple means of generating polyphase power. *This new technique uses silicon controlled rectifiers in a ring-counter circuit.*
By R. H. Murphy, Transitron Electronic, Ltd., England 58

LATEST USE FOR SATURABLE REACTORS: Stabilizing High-Power Rectifiers. Square-loop transducers are the key components that help this power supply resist 20-amp step changes in line current. *It can handle enough power to feed a small computer while keeping output voltage swings within one percent.*
By T. Kurimura and K. Yamamura, Kokusai Denshin Denwa Co., Ltd., Japan 62

DEPARTMENTS

Crosstalk. <i>Give ComSat a Chance</i>	3
Comment. <i>Imported Components. Tv Projection Tubes and X-Rays</i>	4
Electronics Newsletter. <i>After Cooper's Flight, What?</i>	7
Washington This Week. <i>Pentagon Considers Loosening Contract Management Controls</i>	12
Meetings Ahead. <i>National Vacuum Symposium, Reliability in Space Vehicles Seminar</i>	42
Research and Development. <i>Special Computer Integrates Rainfall</i>	70
Components and Materials. <i>Modules Incorporate Integrated Circuits</i>	78
Production Techniques. <i>Ultrasonic Waves Clean Circuit Boards</i>	86
New Products. <i>Bistable Semiconductor Easily Turned Off</i>	94
Literature of the Week	104
People and Plants. <i>Philips Erecting Research Laboratory</i>	108
Index to Advertisers	113

Give ComSat a Chance

WE MAY never understand lawyers and legislators. Just when we think they have a problem nicely ironed out, they sometimes manage to introduce fresh complications.

Take the new Communications Satellite Corporation. We thought that once the government set it up, the government would let it make its own way in the world as a private corporation.

But some Washingtonians are now chewing over the possibility that the government won't sever the umbilical cord, that it will effectively run the corporation by directing its choice of system, equipment suppliers, and so on.

Proponents of government control fear that unless the government does mother the corporation, one or two companies represented on the corporation's board could use their position and their experience in space communications to monopolize the space communications equipment business. Opponents fear that unless the government keeps out of the corporation's internal affairs it will lead the U.S. further towards socialism.

Talking is part of the Washington way of life. From it, all laws flow. But we do hope that the talk now going on about the Communications Satellite Corporation doesn't lead to premature changes in the law or to application of strong government control early in the corporation's life.

The law setting up the corporation was passed after a lengthy debate that supposedly settled basic issues. The free-enterprise and antimonopoly provisions in the existing law should be given at least a few years to prove their worth. All the government should do for now is concern itself with the rate, service and profit structures of the corporation as they affect the using public—the same as any other utility—and let the corporation and its stockholders worry about the details.

If the government takes too vigorous an interest in the corporation's affairs, it might as well run it like a "Space TVA." This would be contrary to Congress' decision last year.



If, on the other hand, the corporation or its personnel should use their positions in a manner contrary to the public interest, the government can quickly put a stop to such practices by exercising its present regulatory powers.

By leaning as far as possible towards a hands-off policy, the government will give free enterprise a chance to demonstrate whether it can adapt to the space age.

WHAT A FIELD TRIP! Telemetry's fascination has just been multiplied by some promotional literature on the International Telemetry Conference. After the sessions end in London on September 27, the conferees have the option of returning home or of taking "an extended tour of European telemetry facilities" lasting a dozen days. The tour brochure mentions facilities several times. And it also mentions about 50 or 60 such advances in the state of the art as the Paris Opera House, Rembrandt's house in Amsterdam, the Eiffel Tower, Schloss Heidelberg, Capri, the Vatican Gallery and the Palace of the League of Nations. We were ready to leap at this opportunity to see the latest in European techniques, when we were reminded that McGraw-Hill World News staffers in Europe have already inspected these facilities and that there was no point in repeating all their legwork.

Coming In Our May 31 Issue

NEW DEVICE, NEW CIRCUITS. Something new in the solid-state showcase is the nonlinear-resistance element. This isn't a single component—it's a couple of transistor amplifiers put together into one neat, versatile package. Among its applications are monostable multivibrator, d-c switch, Q multiplier.

The details on the NRE and its uses are just one of the circuit-design topics next week. Others are:

- New approach to wideband integrated-amplifier design, using closed-loop, open-loop analysis. This technique isn't confined to any one packaging style. It's been used for conventional, miniature and micro-miniature three-stage amplifiers.

- Reference sheet, with chart that gives RLC values for critical damping.

- The communications system that sent Mariner II data back from Venus will be thoroughly detailed in another article, pointing up what is in store for future long-range space communications systems.

Analab 1120/700 the industry's finest dual-trace oscilloscope

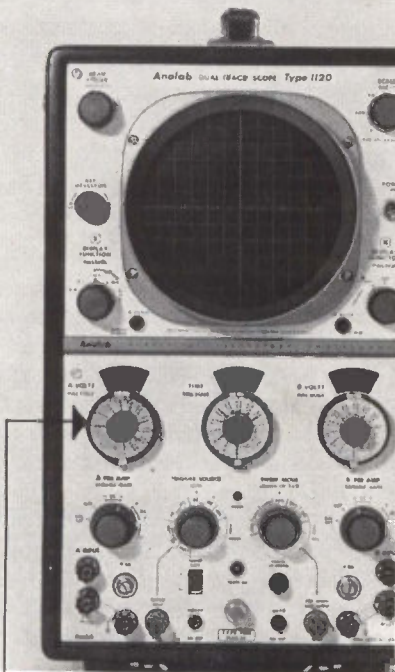

the only oscilloscope
on which you can make
PRECISE QUANTITATIVE
MEASUREMENTS!
USE AS PRECISION
AC & DC VOLTMETER,
PHASE METER,
TIME-INTERVAL METER.

- Superior triggering and over-all stability
- Highest sensitivity (100 μ v/cm)
- Both single-ended and differential amplifier inputs, AC or DC-coupled
- No interpolation needed with direct-reading Null-Balance dials
- "Instantaneous" beam finder
- Delayed trigger output from 1 μ sec to 50,000,000 μ sec
- Bandwidth from DC to 150 kc

Call or write for specifications on the 1120/700 and on the full line of Analab scopes, scope camera systems, and accessories.

Analab Instrument Corporation
Cedar Grove, New Jersey

Analab 

A subsidiary of THE JERROLD CORPORATION

COMMENT

Negative Resistance

I have read Mr. Sproull's *Comment* (p 4, April 26) on negative resistance, and I would like to suggest that the subject gets more and more involved, and the term more ambiguous, as time goes on.

I suggest that the term "negative resistance" be relegated to the wastebasket and the old standby, "conductance", be used in its place.

One of the confusions commonplace in electronics articles is the misuse of the term "resistance." It is not uncommon to find it stated that this or that happens when there is resistance in a circuit.

Since resistance, if carried to infinity, becomes a close relation to nothing, it can be conclusive that any amount of resistance in a circuit is a degree of nothingness determined by the value of the resistance.

In all correctness, current flows in a circuit due to a degree or value of conductance, and not to a degree or value of resistance. In addition, some interesting observations are derived experimentally by making current measurements in terms of conductance.

HARRY ALDEN LYON

Lyonart Industries
Taos, New Mexico

Rabbit's Foot Communication

[Regarding the April 5 *Crosstalk* item (p 3) about the following week's article, New Transducers For Communicating By Seismic Waves, by K. Ikrath and W. Schneider], every country-boy rabbit hunter is familiar with that animal's earth-thumping signal system, although its code is something else again, akin to crow language.

If brain-to-brain signaling, as some would have us believe again, is real, then its transmission speed is inordinately slow. Some five or more years ago, in response to, as I recall, the head of the Rome, New York, laboratories' request for new ideas in communication, I suggested the resurrection of Tesla's old idea for setting the earth into electrical oscillation at its own natural fre-

quency as one such; another involved use of deep, abandoned or dry oil wells with a closely-coupled, impedance - matching, powerful vibration-excited and a remote receiver well, as an R&D starter for a seismological system, either by discrete pulses, or by resonating a laterally boundaried, diametrical, solid layer. This is done now undersea by SOFAR, and it might work in earth layers too.

B. F. MIESSNER

Miessner Inventions, Inc.
Miami Shores, Florida

Seismic-Wave Communication

In the article, New Transducers For Communicating By Seismic Waves (p 51, April 12), an error was made in the sign in Eq. 1 (p 52).

The negative sign preceding the numerator of Eq. 1 and in Fig. 2A should be a plus. Figure 2A should also be altered:

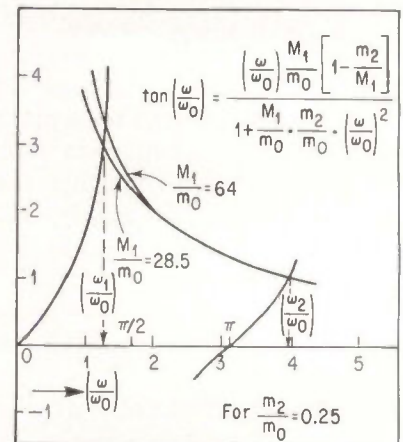

On p 52, the next-to-last sentence before Eq. 1 should read, "We then determined the dynamic stiffness, indirectly by experiment, with approximately *four percent off* the static stiffness."

On p 53, the first sentence should be, "Equation 1 also reveals that by extreme reduction of the drive-coil mass m_2 , a *higher* resonance frequency will be obtained." In the third paragraph, the last three sentences should read, "In this case $\omega_1/\omega_0 = 1.28 \dots$ so that $\omega_0 = 500/1.28 = 390 \dots$ This yields $\dots 0.64 \times 15 \times 10^4 = 0.96 \times 10^6 \dots$ This is *four percent off* the static stiffness \dots "

KURT IKRATH

U.S. Army Electronics R&D Lab.
Fort Monmouth, New Jersey

New SANBORN 30-channel EVENT RECORDER

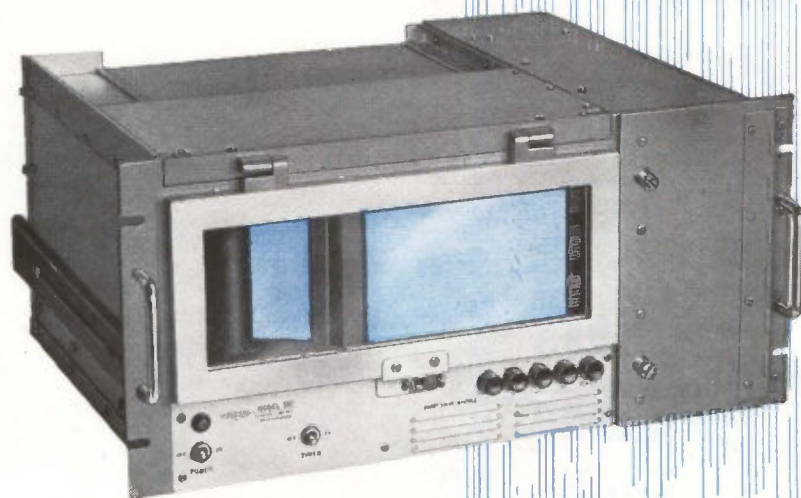

only 8 $\frac{3}{4}$ " high, with solid-state plug-in writing control: \$2050 complete

- Compact portable case or rack mounts in 8 $\frac{3}{4}$ " of panel space
- Meets MIL-I-26600/2 Class 1B RFI Spec.
- Choice of 6 solid-state plug-in Writing Controls
- Simple front-loading of 4.07" wide, 300-foot charts, built-in paper take-up
- Solid-state pulse generator and power supply
- Confidence: under worst combination of low line voltage and short duration signals, probability of marking exceeds 99%
- Response to events as short as 1.3 ms
- Constant trace intensity at all speeds
- Self-cleaning, reversible styli replaceable individually or in groups of 30; stylus pressure automatically maintained
- 4 pushbutton-selected chart speeds, 1 to 100 mm/sec.; remote controlled chart speeds available on special order
- Signal return isolated from chassis (1 megohm min.)

This economical new 30-channel operations monitor provides immediate, permanent recording of on-off events on dry, electro-sensitive charts — using "pulsed writing" for maximum clarity, stylus life and economy of power. Six different interchangeable, plug-in 10-channel solid-state Writing Control cards are available to match your signal voltage and recording requirements. Included are types which operate with logic levels between +6 and +40 volts or -6 and -40 volts. Also, "precision types" for monitoring low level signals are available with adjustable threshold or balanced input (with respect to signal return). Model 361 system, for rack mounting or portable case, is 8 $\frac{3}{4}$ " x 19" wide x 14 $\frac{1}{2}$ " deep, weighs approx. 50 lbs. Complete 30-channel system, with either +6 v to +40 v or -6 v to -40 v Writing Control, is \$2050 F.O.B. Waltham, Mass. Prices with other Writing Controls on request.

FOR UP TO 120 CHANNELS of on-off recording, Model 360 uses 16" wide, 450-foot charts; has 9 standard and 9 optional additional speeds; takes only 14" of panel space complete with integral cooling system. Solid-state plug-in Writing Control cards described above are optional. Model 360 120-channel Recorder alone, \$3900; prices with various Writing Controls on request.

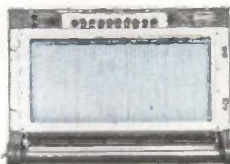

Call your nearby Sanborn Sales-Engineering Representative for complete specifications and application assistance. Offices throughout the U.S., Canada and foreign countries.

INDUSTRIAL DIVISION
SANBORN COMPANY

WALTHAM 54, MASSACHUSETTS
A Subsidiary of Hewlett-Packard Company

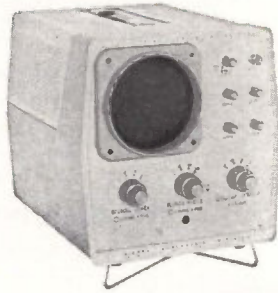

"made-to-measure precision"

Always Finding Fault

Only way to keep a Sierra 370A Cable Fault Locator peaceable is to show it a clean cable. Let it get wind of an open, short, or impedance variation, and its scope starts quivering like a setter's nostrils filled with duck scent.

Model 370A goes to extraordinary lengths to find a fault. From 0 to 30 miles, as a matter of fact. Restless pulse echoes from the cable parade on the radar-type scope, flushing hidden rifts from their hideaways, telling you what they are, and where they lie. Even small deviations get "scoped" with 370A's high gain receiver.

A Model 370A, equipped with four measuring ranges, variable output pulse lengths and pulse amplitudes, and a built-in affinity for faults on a cable, costs \$1,350. Our new bulletin, which finds nary a fault with the 370A, tells you more. So will your Sierra sales representative, who'll also be happy to give you a pulse-throbbing demonstration.

SIERRA ELECTRONIC DIV.

**OF
PHILCO.**

A SUBSIDIARY OF *Ford Motor Company*

Sierra Electronic Division / 3885 Bohannon Drive / Menlo Park 1, California

After Cooper's Flight, What?

CAPE CANAVERAL—With the success of Astronaut Gordon Cooper's 22-orbit MA-9 shot resounding in their ears, NASA officials were this week trying to decide if a MA-10 launch is called for. An announcement is expected shortly.

Conflicting viewpoints on the MA-10 were evident at Cooper's news conference Sunday. Cooper himself backed a MA-10 flight, saying that it would gather much valuable data. But NASA's associate director, Robert Seamans, said the MA-10 is "unlikely" as additional manpower is needed to speed up the Gemini program.

The electronic failures which made millions of persons hold their breaths for Cooper's safety are sure to play a big part in the MA-10 decision, even though Cooper and Astronaut John Glenn denied there was any serious danger from them. A latching relay which locked when it shouldn't have caused the by-now-famous "05G" light to come on late in the flight, officials said, also preventing the attitude gyros from operating. More trouble ensued in the last orbit when the inverter used to change d-c to a-c for the whole autopilot system broke down.

Cooper's flight checked out two electronic systems developed for Gemini. They were a direct communications line to Hawaii permitting the Cape capsule communicator to talk directly to Cooper while he flew above the Hawaii area, and a remote operation capability of the electrocardiogram receiving equipment at three range stations.

The direct-talk line used a phase-shift-keying technique with a special notch tone filter at both ends of a standard communications circuit. It worked perfectly, it was reported. The ekg operation worked well and a remote set-up around the world for this and other data is feasible, NASA said. A dual tv-telemetry channel (p 18, March 22) also worked well, Astronaut Cooper said.

Japanese Firm Selling Know-How to Rumania

TOKYO—Hokushin Electric Works says that the government will allow it to extend technical assistance to Rumania for the production of electronic controls. Hokushin has signed a \$1.33-million contract with Masinimport of Bucharest, the state machine import corporation.

The agreement covers the company's automatic control apparatus, self balancing recorders, and data processing equipment. It gives Masinimport exclusive production and sales rights in Rumania and provides for use of patent rights and delivery of know-how and technical information necessary to construct plants to make the equipment. Hokushin will also supply technicians and the necessary parts and instruments.

Hokushin has a 25-year cross-licensing agreement with Fischer and Porter, an American firm, but Hokushin says the Rumanian agreement covers only instruments in-

dependently developed by Hokushin. Because Hokushin's relations with F&P are very close, Hokushin obtained a gentlemen's agreement with F&P for export of Hokushin's technology to Rumania.

West Ford Going Strong —So Are Its Critics

CAMBRIDGE—Propagation measurements and communications experiments conducted with the partially formed West Ford dipole belt are proving successful as "construction" of the passive-repeater belt in space continues at the rate of about 1,000 miles a day (p 8, May 17, and p 7, May 10).

The West Ford transceiver terminals manned by MIT Lincoln Laboratory researchers at Millstone Hill, Mass., and Camp Parks, Calif., are daily measuring such propagation characteristics as signal distortion in time delay and frequency. Experiments are believed to include both digital data and voice trans-

Disarmament Agency Pushing for Status

ARMS CONTROL and Disarmament Agency is seeking status equal to that of other government agencies. First change would be elimination of the \$10-million authorization ceiling to "such sums as may be necessary and appropriate." The request for 1964 amounts to \$15 million, of which \$11 million would be spent for contracts outside the agency. Industry contractors thus far include Bendix, Raytheon, Hudson Institute, Sylvania, and Aerospace Corp. The agency also wants to relax security requirements for contractor personnel.

Contracts in fiscal 1964 will include studies on integration of techniques in inspection systems; elements in an inspection system (aerial inspection, satellite inspection techniques, specific sensors of aerial or satellite inspection, analysis of records and finance data, training requirements); verification of specific armaments and activities such as nuclear tests, clandestine activities, space exploration, R & D activity, production of strategic delivery vehicles, and retained levels of conventional and tactical nuclear weapons; inspection of field test program; computer services, and methodological studies

How About Smith?

STOCKHOLM—IBM 1401 and 7070 data processing machines have been put to use to create almost a million new family names for Swedes. Hundreds of thousands of Andersons, Carlsons, Pettersons, Svensons and Johansons cause no end of confusion and the government is encouraging persons with such common names to choose new ones. A committee, after winnowing the million names by hand, is expected to authorize about 50,000 of them for adoption

mission similar to those conducted by moon bounce by Lincoln Lab while waiting for a dipole belt.

Commenting on West Ford, Prof. Fred T. Haddock, director of the University of Michigan Radio Astronomy Observatory, said:

"The test belt itself isn't damaging to radio astronomy but radio astronomers are still mighty concerned about the precedent established and about the possibility of future growth of experiments of this type—when a large number of objects are put into orbit."

Medium-Altitude System Seen ComSat's 1st Goal

CONSENSUS among space experts queried by ELECTRONICS is that the Communications Satellite Corp. will probably go for a medium-altitude satellite system initially, and gradually phase into a Syncom-type synchronous system as the latter technique is perfected.

A corporation spokesman confirmed that this is its thinking, but a formal announcement won't be made for many months.

Meanwhile, the Air Force has selected GE and a Philco-Space Technology labs team to compete in a "program definition" study of a medium-altitude, random-orbit military communications satellite system. After two months, each contractor will make a technical and cost proposal.

Voice System Lowers Power, Bandwidth Needs

NEW YORK—A voice communication system that would decrease the bandwidth and power requirements of some types of voice channels was described by Louis Focht of Philco at last week's meeting of the Acoustical Society of America.

Incoming speech would be analyzed for: pitch or frequency, envelope shape, whether voiced (vocal cords in motion) or unvoiced (a whisper is unvoiced), and for dominant or recessive formant (determines vowels). A digital equivalent for each factor is derived and the combined signal transmitted at about 500 bits per second.

The synthetic speech signal is reconstructed at the receiver.

Injection Laser Transmits Audio Data

IBM DEMONSTRATED Tuesday transmission of audio information signals over a light beam generated by a gallium arsenide injection laser. When the voltage of the delay line in the modulation circuitry reaches a preset level, a 4-layer diode at the end of the line breaks down, discharging a 0.2- μ sec, 5-amp pulse through the laser. The charge time of the delay line, and therefore the frequency of the laser pulse train, is controlled by the amplitude of the information signal through a variable resistance element. Average prr is 12 Kc.

British IRE Assails Electronics Industry

LONDON—The British Institution of Radio Engineers has criticized this country's radio and electronics industry for lack of direction, no coordination in research endeavors, too much emphasis on "fashionable" subjects and too much security. The BIRE wants to set up a Radio and Electronic Research Council to remedy these defects. Fields being neglected include radio propagation, ultrasonics, network color tv, automation and satellites.

In Brief . . .

SOVIET UNION says it has lost radio contact with its Mars-1 automatic interplanetary station. The last regular radio transmission was sent on March 21 when the probe was 106 million kilometers from earth.

U. S., BRITISH and Bahamian officials have finally reached agreement for the construction of a giant \$100-million underwater submarine warfare testing range to be built by the Navy in the Bahamas near Andros Island (p 12, April 26).

RCA IS WORKING on a "metal sheet memory with extreme temperature tolerance" that is completely different from thin film and conventional memories. RCA would not elaborate on this.

TWO of every fifteen tv sets produced in Japan during March had a screen size of 12 inches or less, says EIA-Japan.

INSERTION into polar and elliptical orbits and other mission variations will be incorporated into future Tiros launches. One will carry Nimbus subsystems including an infrared recorder and automatic cameras.

RCA EXPECTS to receive \$100-million in contracts for the Lunar Excursion Module. It is understood this will include power supplies and telemetry equipment, plus items mentioned earlier (p 8, May 17).

PERKIN-ELMER will build a miniature infrared carbon-dioxide sensor for monitoring manned space vehicle cabin atmospheres.

ELECTRO-OPTICAL Systems, Inc. won a \$2.2-million contract for electrical power systems for the Ranger 6 through 9 lunar spacecraft.

AIR FORCE gave Geotech a \$1,479,775 contract under the Vela-Uniform program to improve the detection of underground nuclear explosions, using its new borehole seismometer that can operate two miles below ground.

SPRAGUE LOGIC TRANSISTORS GIVE SUPERIOR LATCH-UP PROTECTION!

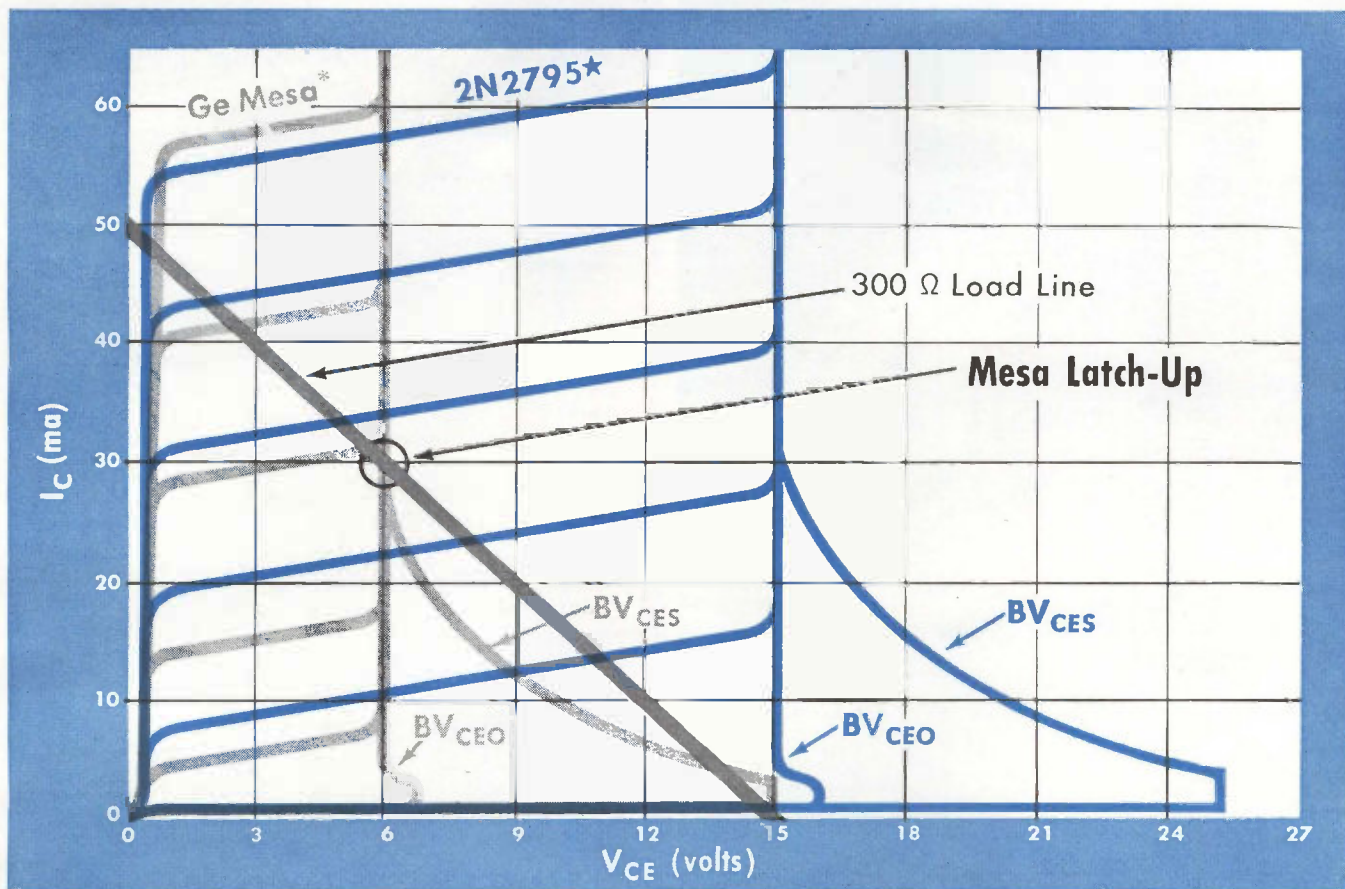

*ratings for most prime germanium mesa types. ★based on guaranteed ratings!

For Guaranteed High Voltage Operation at High Speeds, Investigate Sprague ECDC[®] and MADT[®] Transistors

Type No.	f _T (typical)	BV _{CES} (minimum)	BV _{CEO} (minimum)
2N2795	450 mc	25 volts	15 volts
2N2796	450 mc	20 volts	12 volts
2N984	350 mc	15 volts	10 volts
2N979	150 mc	20 volts	15 volts
2N980	150 mc	20 volts	12 volts
2N2048†	250 mc	20 volts	15 volts

(†TQ-9 Case)

● For additional information on Sprague High Voltage Logic Transistors, write to the Technical Literature Service, Sprague Electric Company, 35 Marshall Street, North Adams, Massachusetts.

© Trademark, Philco Corp.

SPRAGUE COMPONENTS

TRANSISTORS
CAPACITORS
MAGNETIC COMPONENTS
RESISTORS
MICROCIRCUITS

INTERFERENCE FILTERS
PULSE TRANSFORMERS
PIEZOELECTRIC CERAMICS
PULSE-FORMING NETWORKS
TOROIDAL INDUCTORS

HIGH TEMPERATURE MAGNET WIRE
CERAMIC-BASE PRINTED NETWORKS
PACKAGED COMPONENT ASSEMBLIES
FUNCTIONAL DIGITAL CIRCUITS
ELECTRIC WAVE FILTERS

SPRAGUE[®]
THE MARK OF RELIABILITY

'Sprague' and '®' are registered trademarks of the Sprague Electric Co.

For protection of value

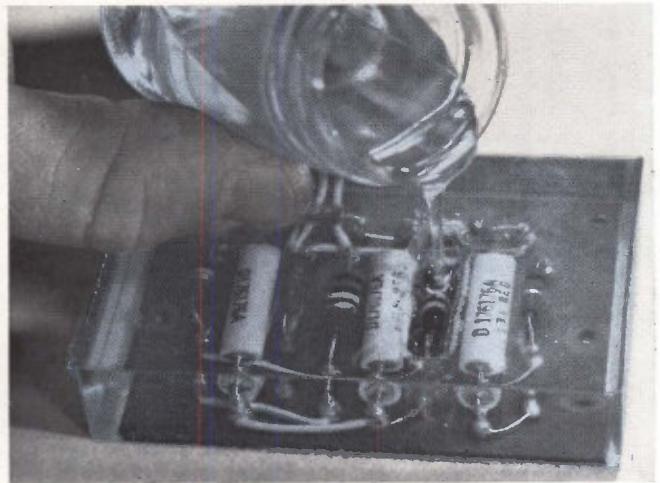
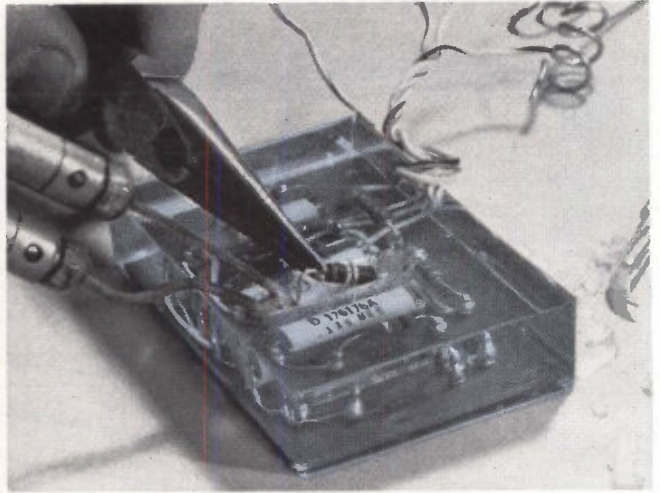
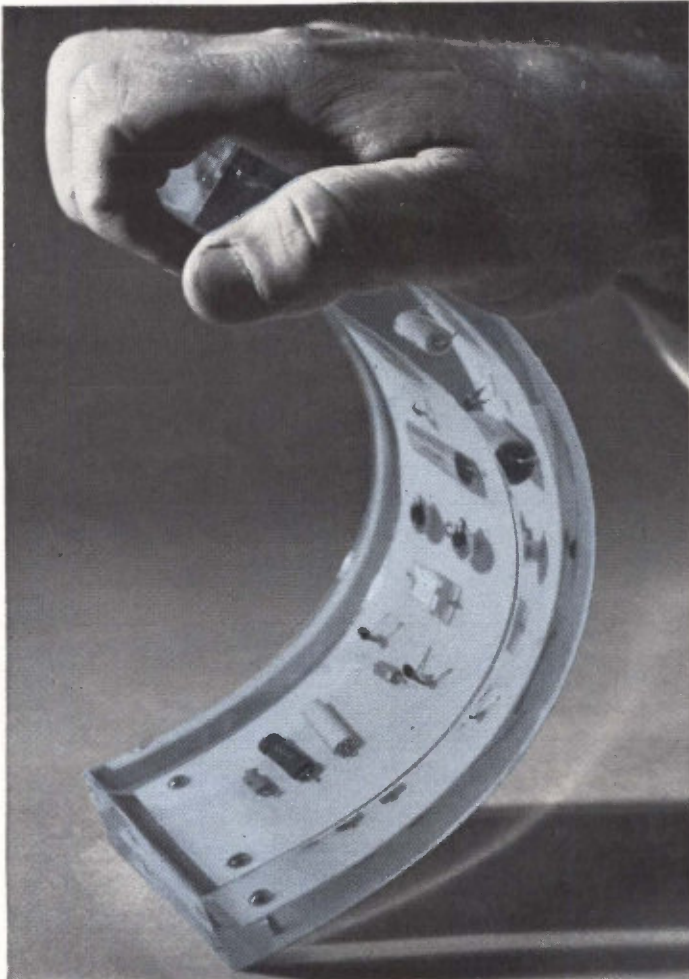

New casting resin - Sylgard® 182 - is tough, flexible and repairable

Visual inspection . . . environmental protection . . . ease of processing . . . simplicity of repairs — these and other features make Sylgard 182 an important new tool when engineering for value.

Tough yet flexible, this solventless silicone casting resin cushions against shock and vibration from -70 to 225 C . . . assures constant dielectric strength in any environment . . . resists the effects of ozone, voltage stress, heat aging and thermal cycling.

Processing is simplified since Sylgard 182 and its curing agent are not toxic to the skin . . . nor do they give off toxic fumes or heat during blending or curing. Curing time can be controlled by the external heat applied — from as little as 15 minutes at 150 C to four hours at 65 C .

Deep sections cure thoroughly. There are no solvent fumes to be trapped . . . and visibility is excellent. Applied as a fluid, Sylgard 182 resin flows readily around intricate shapes . . . cures even in deep sections without damage from internal stresses or exothermic heating.

Repairability is assured when circuits are embedded in Sylgard 182. Defective components can be removed and replaced after cutting away the cured resin with a sharp knife. New resin, poured over the repaired area, adheres to the existing encapsulant restoring the entire unit to its original condition.

CIRCLE 289 ON READER SERVICE CARD

Dow Corning is your best source for a broad line of silicone fluids, gels, elastomers and rigid forms for potting, filling, embedding and encapsulating.



Dow Corning

-- specify these silicones

Visually inspect... instrument check and replace faulty parts with ease

Dielectric Gel permits both visual and instrument inspection of potted circuits and components. Poured as a liquid, Dielectric Gel fills all voids, then sets up as a transparent, heat-stable, resilient mass. No significant stresses or exothermic heating develops during cure. Even the most delicate electronic components are safe. Instrument probes can be inserted and withdrawn repeatedly without damaging the outstanding dielectric properties of this Dow Corning silicone potting material.

Circuit Repair is easy to accomplish. Simply cut away the gel surrounding a defective component with knife or scissors. After the circuit is repaired, simply pour new gel into the repaired area to restore original high quality protection.

CIRCLE 290 ON READER SERVICE CARD

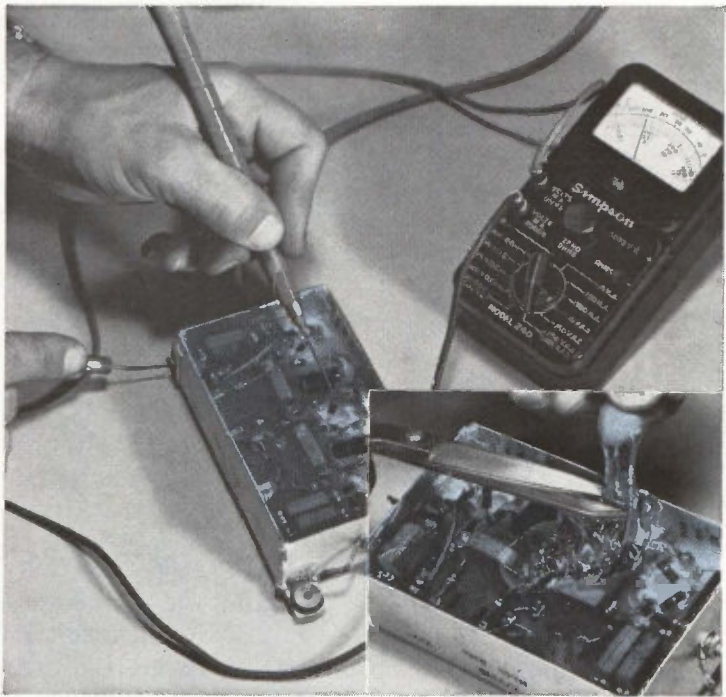

Deep section... rugged protection with repairable Silastic® RTV

Silastic RTV, Dow Corning's fluid silicone rubber that vulcanizes at room temperature, is available in several variations. Select the best one suited for your application or processing requirements. All have excellent dielectric properties, low water absorption, stability under extreme temperatures, resistance to thermal cycling and aging. The newest Silastic RTV cures in thick sections in 24 hours at 77 F. Variations in thickness have no significant effect on curing rate or material uniformity.

Vulcanized Patch. Defective parts embedded or encapsulated in Silastic RTV... even where thick sections are used... can be replaced. The cured Silastic RTV is cut away with a knife, the component replaced, and new Silastic RTV applied to the repair area. The fresh material bonds to the original, restoring the encapsulant's integrity.

CIRCLE 291 ON READER SERVICE CARD

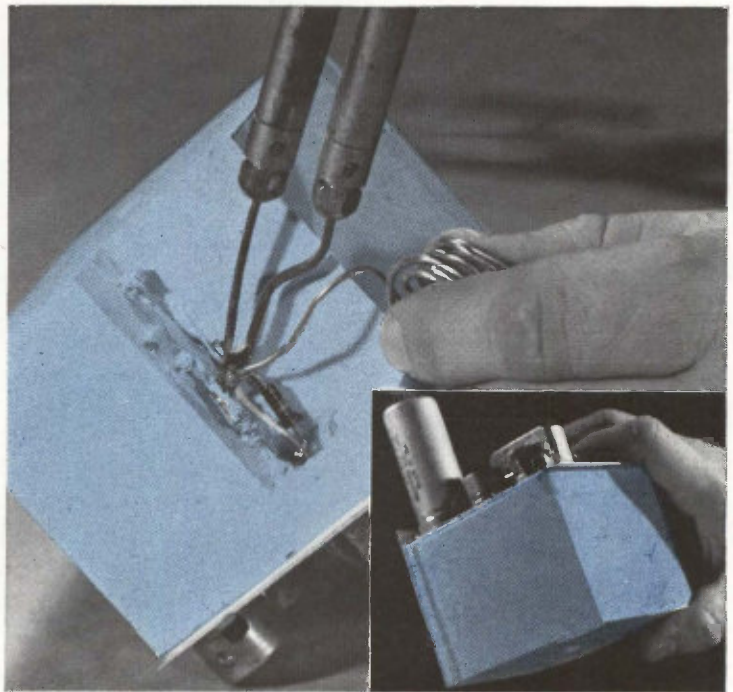

Free 12-page manual, "Silicones for the Electronic Engineer". Write Dept. 3917, Electronic Products Division, Dow Corning Corporation, Midland, Michigan.

WASHINGTON THIS WEEK

PENTAGON SHARPENS RED-TAPE SCISSORS

DEFENSE DEPARTMENT is considering lifting or relaxing some of its management controls on military development and production projects. Included are requirements that contractors obtain approval on whether to subcontract, subcontract prices, changes in "make-or-buy" schedules, payment of overtime to employees, and the like.

These controls developed when cost-plus fixed-fee (CPFF) type contracts dominated defense contracting. The Pentagon viewed CPFF contractors as, in effect, agents for the use of government funds, and wanted tight controls to restrict contractors' expenditures.

However, the controls have since been routinely carried over even to incentive-type contracts where contractors assume costs at their own risk. The shift to incentive contracting and assumption of risks by many contractors have induced Pentagon officials to take a new—and more sympathetic—look at management controls that irk defense producers. An industry-Pentagon study is identifying the specific controls contractors want relaxed. But an official decision is still a long way off.

WHO'S WHO ON FCC NOW?

OUTLOOK IS that FCC's new chairman, E. William Henry, will be tougher on broadcasters than Newton H. Minow has been. Henry thinks FCC should not be just a neutral arbiter, but should look after the public interest aggressively. Lee Loevinger, now head of the Justice Department's Antitrust Division, will fill the vacancy left by Minow's resignation. His influence is expected to be felt as FCC moves more deeply into the communications satellite program—in fact, this is why he got moved to FCC, said Attorney General Kennedy. Loevinger was active as an administration spokesman during the bitter Congressional debate on the satellite program last year.

SENATE TUNES UP FOR PATENT LAW DEBATE

PRESSURE IS BUILDING in the Senate for another debate on government patent policy. Chief vehicle will be a bill proposed by Sen. John L. McClellan (D-Ark). Except for specified areas of acute national interest, contractors would get patents they develop. Views of industry and government agencies are being sought preparatory to a Judiciary Committee recommendation to the Senate. Other legislation, particularly that of Sen. Russell B. Long (D-La.), for greater government ownership rights, will probably be reflected in amendments tightening the McClellan bill.

In balance, the measure will meet White House suggestions for an effort to protect public rights to public-financed inventions, while not being over-restrictive about ownership.

The House, where similar opposing proposals have been made, approved a loose policy for NASA two years ago, but last year decided to await Senate initiative on a broader, government-wide measure.

FAA MAKES RTCA UNHAPPY

FEDERAL AVIATION AGENCY is preparing to defend itself against charges that its air traffic control system is a patchwork, growing excessively costly for its effectiveness. That report will be made in June by the unofficial government-industry Radio Technical Commission for Aeronautics. After that, Senate Hearings are expected to explore the broad range of criticisms the group levels against FAA.

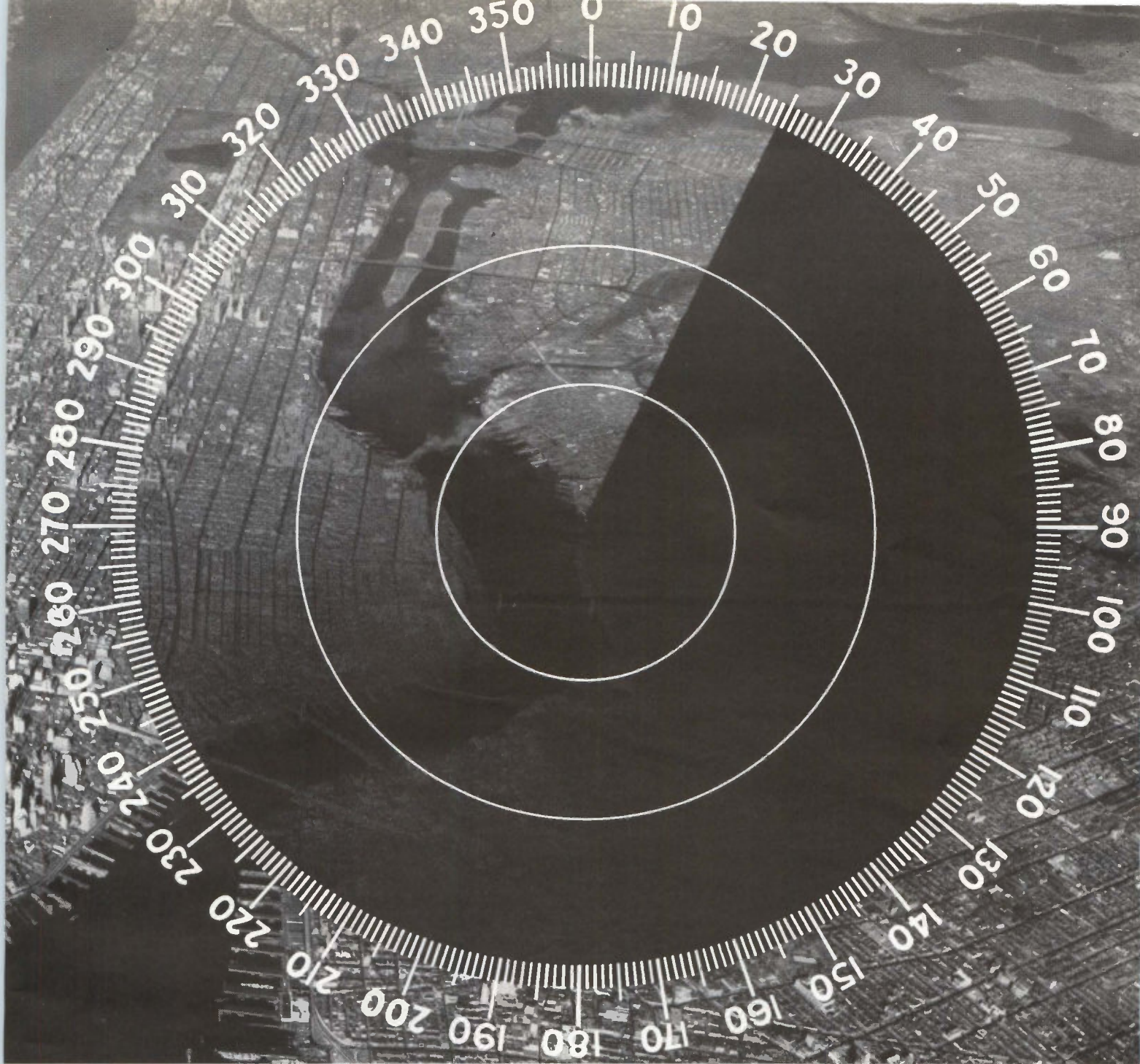

Raytheon storage tube puts realism into Marquardt's radar trainer

The AN/APQ-T10 Radar Trainer, produced by the Marquardt Corporation, Pomona, California, trains USAF crews in navigation and bombing procedures. Raytheon two-gun storage tube, CK1383, operates as a scan converter to provide realistic PPI simulation of airborne radar. By converting video signals to a real time base, the CK1383 provides such realistic effects as shadows and slant range and eliminates the need for stereo picture projection. Thanks to the Raytheon CK1383, the AN/APQ-T10 has higher resolution, faster writing and erasing capabilities than similar equipment.

Raytheon storage tubes are serving in many other advanced applications such as FAA air traffic con-

trol systems and the Coast Guard RATAN radar-to-tv scan conversion display of lower New York harbor. Interested in the development of equipment and systems utilizing stop motion, integration for signal-to-noise improvement, information storage for data processing, slow-down video, time delay or phase shift? Call on the unmatched capabilities and vast experience offered by Raytheon's storage and display devices department.

For more complete technical information or application assistance, write today to: Raytheon Company, Industrial Components Division, 55 Chapel Street, Newton 58, Massachusetts.

RAYTHEON

WHERE THE SKYLINE IS SUBJECT TO CHANGE

You swing into things when you build a plant in the Baltimore area — an area growing far faster than the nation. Old buildings coming down, new ones going up fast! Factories, warehouses, suburban developments. New office towers, the huge \$127,000,000 Charles Center and new Civic Center. New expressways and beltways that shorten travel time.

Move into an area that's obviously on the move . . . gives the competitive advantages of a world port, superb transportation, ready sources of labor and materials, easy access to half the U.S. buying public and just minutes driving time from the Nation's capital. **Plant sites aplenty** . . . 2,500 zoned acres in 30 industrial parks — more being planned. When you think big, think BALTIMORE.

PUT YOUR PLANT IN

BALTIMORE

For confidential information, write Robert J. George, BALTIMORE GAS AND ELECTRIC COMPANY, Baltimore 3, Maryland. Or call him at 301-539-8000.

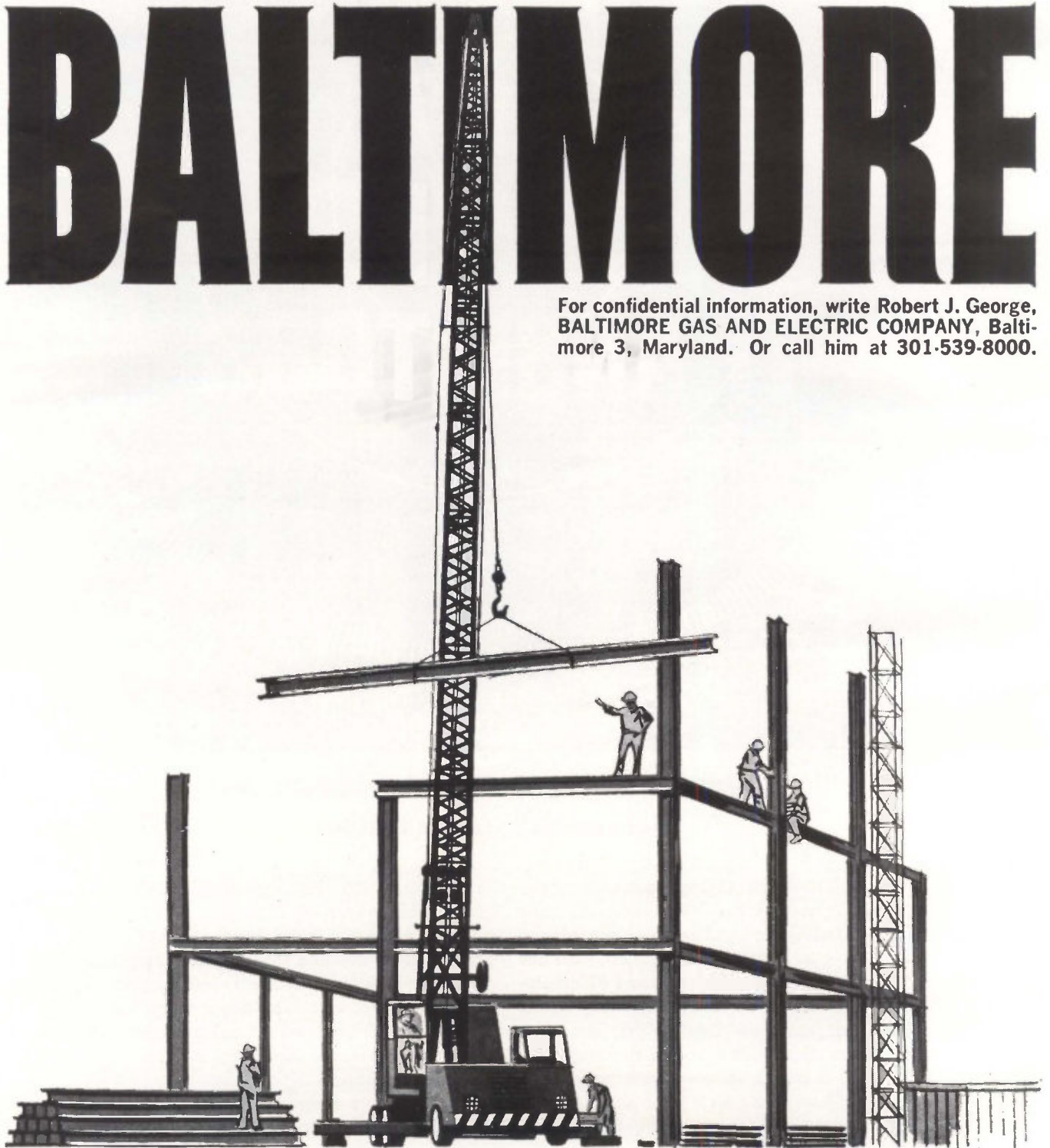

SILICON PLANAR POWER TRANSISTORS

PNP 2N2875

Features remarkably high beta linearity over wide range of collector currents. Dissipates up to 15 Watts of power at 100°C case.

Type	DC Current Gain @ $I_c = 500\text{mA}$ (β)	Typical Collector Saturation Voltage @ $I_c = 500\text{mA}$ (Volts)	Minimum Sustaining Voltage @ $I_c = 50\text{mA}$ (Volts)	Typical Cut-Off Frequency @ $I_c = 100\text{mA}$ (Mc)	Power Dissipation Rating @ 100°C Case (Watts)
2N2875	20-60	1.0	50	30	15

IN A
 $\frac{1}{16}$ " STUD-
MOUNTED
PACKAGE

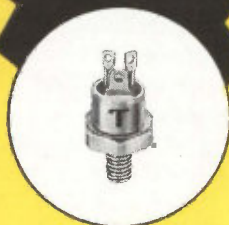

NPN 2N2866-7

Features extremely low RCS of 0.75 Ohms Max. Dissipates up to 20 Watts of power at 100°C case. High beta linearity.

Type	DC Current Gain @ $I_c = 500\text{mA}$ (β)	Typical Collector Saturation Voltage @ $I_c = 1\text{Amp}$ (Volts)	Minimum Sustaining Voltage @ $I_c = 50\text{mA}$ (Volts)	Typical Cut-Off Frequency @ $I_c = 100\text{mA}$ (Mc)	Power Dissipation Rating @ 100°C Case (Watts)
2N2866	20-60	0.4	80	15	20
2N2867	40-120	0.4	80	15	20

TRANSITRON'S NEW STATE-OF-THE-ART SILICON PLANAR TRANSISTORS FEATURE GREATER RELIABILITY, LOWER RCS, AND PERMIT FURTHER CIRCUIT SIMPLIFICATION IN DEMANDING POWER CATEGORIES.

Drawing heavily upon its broad experience in silicon power transistor development and stud-mounted packaging, Transitron introduces its new PNP 2N2875 and NPN 2N2866-7 intermediate power silicon transistors. They combine all the recognized advantages of planar construction with the efficiency of $\frac{1}{16}$ " hex base stud-mounted packaging, which solves a variety of annoying mounting problems. And, because they complement each other, extensive circuit simplification is now practical within power applications.

These highly reliable silicon planar power transistors are the product of the

same intensive Transitron Total Reliability Program that produced the popular $\frac{1}{16}$ " NPN 2N1647-50 and 2N2018-21 series for modern military ICBM systems. Continuous lot control from ingot stage, thorough product improvement documentation, and comprehensive failure analysis have enabled Transitron Product Engineering to develop units which will satisfy the strictest requirements.

The 2N2875 and the 2N2866-7, and other complementing PNP and NPN silicon power transistors, are available through your Transitron Distributor.

For complete information, write Transitron's Wakefield, Mass. installation.

Transitron 
electronic corporation
wakefield, melrose, boston, mass.

SALES OFFICES IN PRINCIPAL CITIES THROUGHOUT THE U. S. A. AND EUROPE • CABLE ADDRESS TRELCO

CIRCLE 15 ON READER SERVICE CARD

JAMES DENNIS, NAECON president; Ferdinand Hamburger, Johns Hopkins U.; Ernst Weber, IEEE president, and Alexander Bereskin, U. of Cincinnati, at conference.



Air Force Outlines Latest R&D Plans

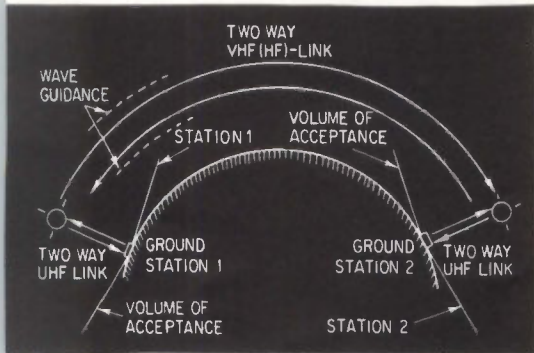

CONCEIVABLE *h-f vhf* link for communicating via ionospheric ducts described in paper by J. I. Barker, of ASD, and M. D. Grossi, of Raytheon, would have nondirective antennas and low-power transmitters

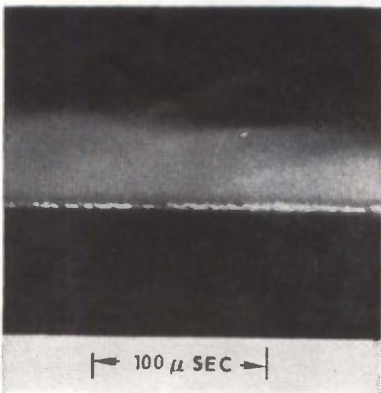

RUBY LASER beam passing through simulated reentry plasma with no measurable attenuation shown in smear photo by R. C. Sykes of Douglas

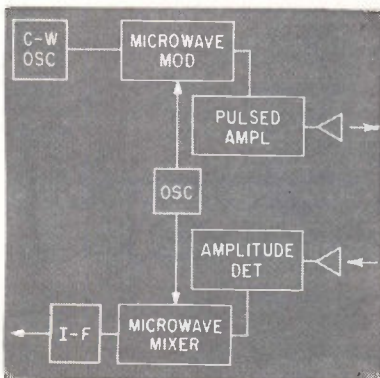

OPTICAL HOMING might be accomplished with subcarrier system in which transmitter c-w laser output is microwave-modulated (Raytheon)

In-house research and evaluation programs will be expanded

By MICHAEL F. WOLFF
Senior Associate Editor

DAYTON — Air Force research plans in key areas of electronics were outlined by Aeronautical Systems Division spokesmen at the 15th annual National Aerospace Electronics Conference last week. Here are the highlights:

AEROSPACE INTERCEPT — Complex technical requirements for aerospace fire control were cited in a paper by J. Pasek as:

- Long-range detection and tracking of hot and cold targets at closing speeds up to tens of thousands ft/sec under severe external e-m interference
- Guidance subsystem accuracy consistent with performance of other interceptor system components
- Vastly improved life, reliability.

The paper said considerable effort is being expended on microwave and optical radar techniques

and a variety of passive optical sensors for guidance parameters. An e-m sensor equipment using molecular electronics to the greatest extent possible is in the final stages of development.

BIONICS—Extensive program for the next three to four years that will hopefully lead to “playing the games” identified by present *L* and ballistic space systems was outlined by Lt. Col L. M. Butsch. Some of the work in progress includes ear and cellular analogs, visilog, artificial muscle, booster for the arm under high-g conditions, tactile sensors, neurotron nets, and systems able to form their own components and circuits. More than 20 other tasks are planned.

COMMUNICATIONS — Pointing out that demands will continue to increase, particularly for anti-jam systems, G. H. Scheer called for:

- Systems that can automatically adapt to conditions of the link
- Elimination of doppler shift by methods not subject to jamming, interception and decoding
- Emphasis on message synchronization
- Microminiature, reliable equipment.

E-M WAVE TECHNIQUES — Though millions of dollars and

many man-years have been expended on efficient ways to transmit through reentry plasma, P. W. Springer said only limited solutions exist, such as transmitting above 10 Gc. Spike antennas protected by ablative or gas cooling, plasma seeding or strong magnetic fields look promising on paper and in shock-tunnel experiments.

Use of solid-state devices integrated into antenna structures shows great promise for rapid scan and omnipolarization antennas. For satellite-to-satellite communications ionospheric ducts, magnetic-field aligned scatter propagation and other new modes promise extreme efficiency and long range.

E-M VULNERABILITY — R. G. Stimmel said emphasis is shifting radically to concern with man-made interference. Areas of current major interest for vehicular electronics include quantitative measurements between 10 and 100 Mc, and above 20 Gc, computer and simulation techniques, and noise and other reentry effects.

DEVICES TECHNOLOGY — Air Force will expand its in-house applied research and evaluation programs in order to enhance its internal technical capability, reported A. H. Dicke.

In other developments at the meeting:

- ASD experiment next year to determine feasibility of microwave communications from an aircraft by way of an orbiting belt of resonant dipoles was announced by Charles Gauder.

- Anticipated improvements will allow using lasers in future acquisi-

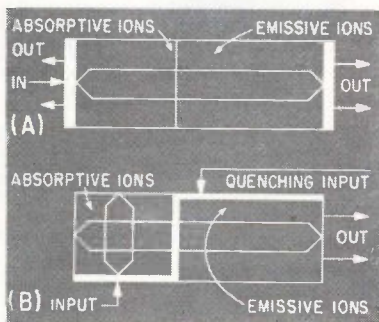

NEURISTOR LASER computer concepts described by W. F. Kosonocky, of RCA Labs, include slow-wave neuristor line obtained by cascading optical resonator (A) and bistable circuit by using resonator as in (B)

tion, tracking and homing systems, said Irving Goldstein, of Raytheon. He cited the subcarrier scheme illustrated as a promising homing system if conversion losses in twt photocathode amplitude detectors could be improved.

- Reports from six companies on liquid laser research showed that materials are still the big problem, with more fundamental studies needed so that energy transfer, chemical purity, homogeneity, stability, temperature gradients and other factors can be controlled.

- Several sessions on transitioning to the supersonic transport plane brought out that electronic systems can probably develop in an evolutionary way except perhaps in reliability where major improvement was called for. Some also felt a central electronic management may be needed, either of the central computer type, or for sampling.

- Forty-pound laser ranging unit with a Q-switched ruby and maximum range of 9,990 meters was demonstrated by Martin/Orlando. Martin said it has demonstrated feasibility of a similar device as an illuminator to direct a beam at a target so semiautonomous missiles could home on the reflected light. This illuminator would be a Q-spoiled device with a prism centered between several laser cavities. As the prism rotates it sequentially triggers each cavity in Gatling-gun fashion.

- Wideband (7 to 13-Gc) laser demodulators employing microwave phototubes announced by Douglas.

- Hoffman Electronics' prototype digital frequency synthesizer derives frequencies in 10-cps steps between 1.4 and 7 Mc and in 50-cps steps between 7 and 35 Mc. It's built around a variable frequency oscillator and digital frequency dividers, fits into 3½ inches of space.

- Nanosecond pulse power switch by Martin/Baltimore handles 2½ w of r-f power for pulses with 0.2-nsec risetimes and 1-nsec width. Switch was developed for hard-to-jam secure communications systems with 1-Gc pseudo-random codes of several thousand bits. It has also been tried out in radar with 6-inch range resolution.

- Westinghouse Electric is starting to make n-on-p web silicon solar cells 1 ft long, 1 cm wide. Efficiency is 9 to 10 percent.

POTTER
announces



printer
division

As part of our continuing effort to serve the needs of the rapidly expanding Electronic Data Processing field we take great pleasure in announcing the fact that our new printer facility is now fully operational.

The new Printer Division building increases our plant and production capacity by more than 65%, enabling us to provide you with faster delivery and better service. For example, we can now deliver our standard tape transports in 4 weeks and standard printers in 12 weeks from receipt of order. If you require fast delivery—with no sacrifice in performance or reliability—write us today.



POTTER INSTRUMENT CO., INC.
PRINTER DIVISION
East Bethpage Road • Plainview, New York
TAPE TRANSPORT DIVISION
151 Sunnyside Boulevard • Plainview, New York

For radiography — it's Ansco best by definition

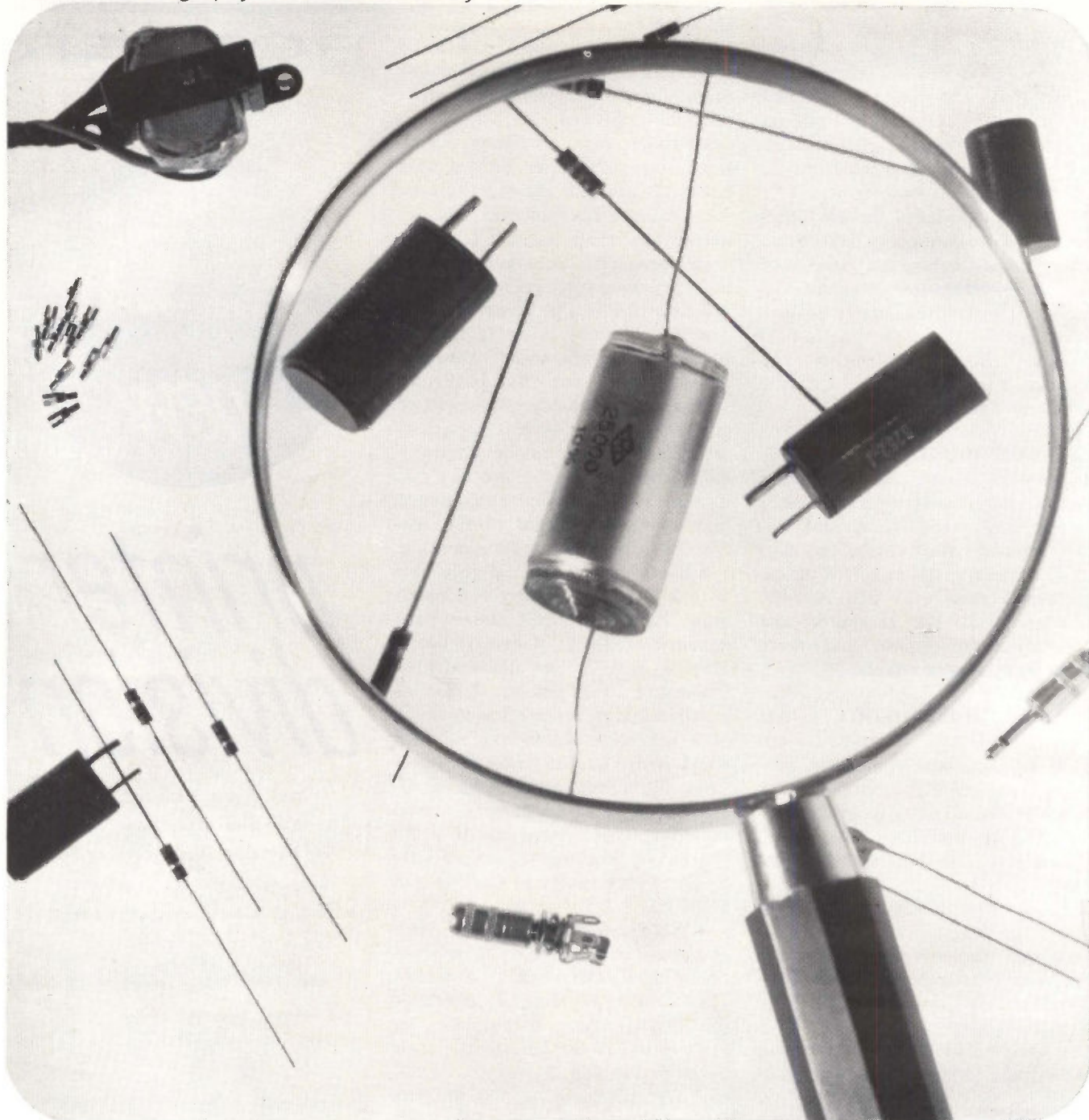

*Let Ansco 'H-D' X-ray film
give you the ultimate in image sharpness*

For radiography of small objects and the identification of correspondingly minute defects, the critical definition of Ansco Superay 'H-D' X-ray Film is a must. The extremely fine grain characteristics of Superay® H-D film provide the utmost in image quality; maintain microscopic definition throughout the entire KVP range. 'H-D' is the first American X-ray film for ultra-

high definition radiography. Ask your Ansco Products Representative for it today.

gaf Ansco
PHOTO PRODUCTS OF
GENERAL ANILINE & FILM CORPORATION
BINGHAMTON, NEW YORK

America's first manufacturer of photographic materials . . . since 1842

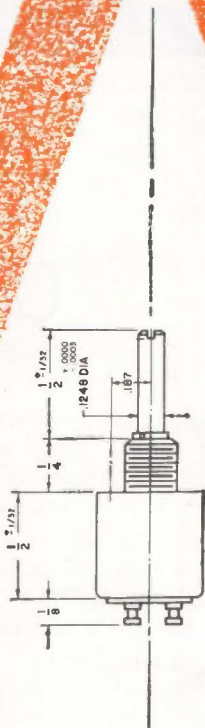
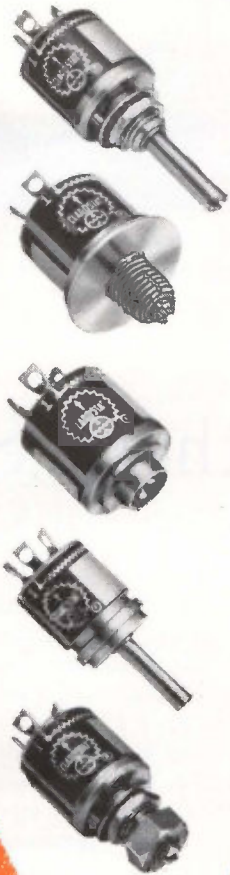
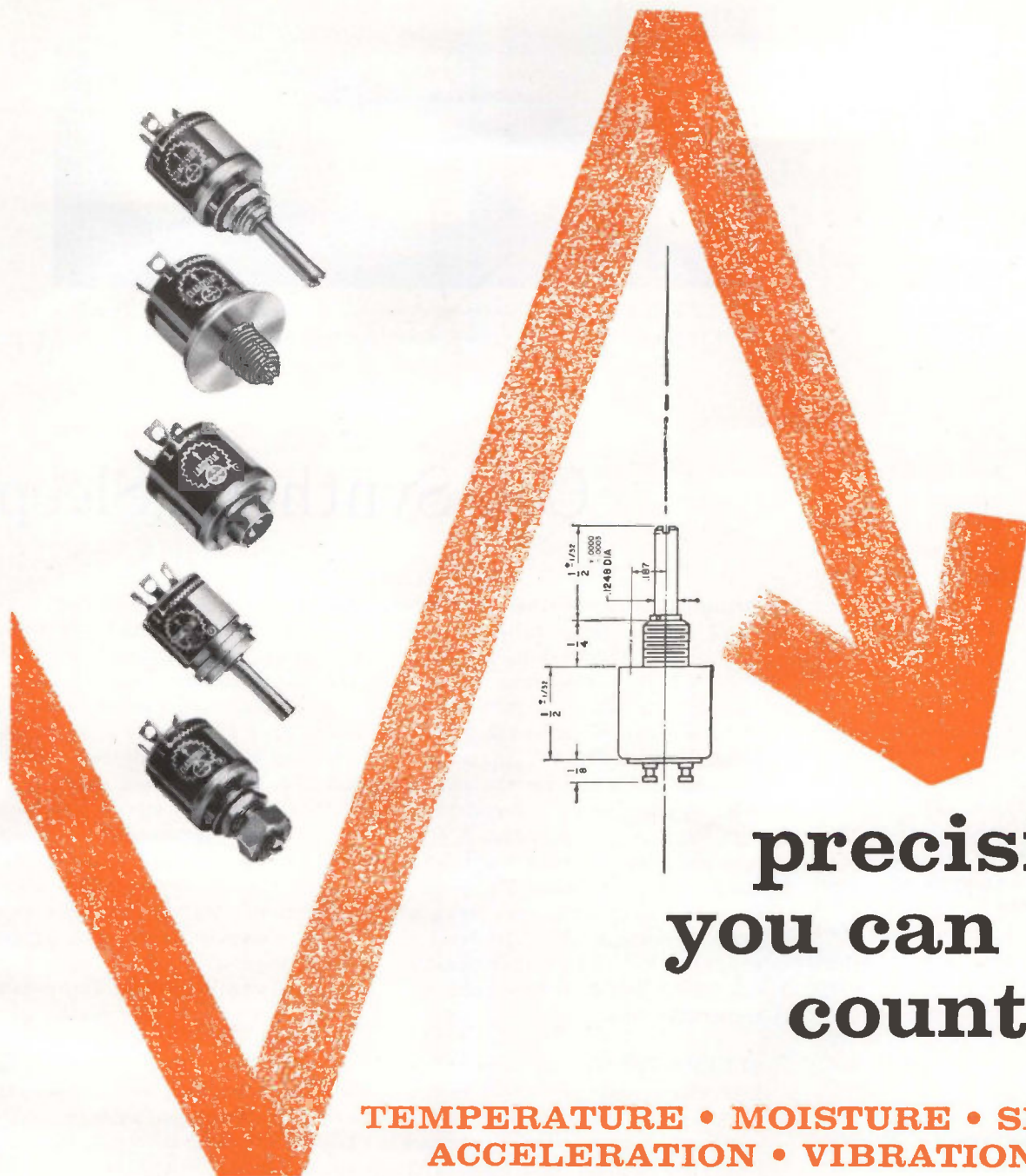

**precision
you can
count on**

**TEMPERATURE • MOISTURE • SHOCK
ACCELERATION • VIBRATION...**

in extreme degrees do not affect the inherent reliable precision of the 1/2" diameter Series 57M and 57EM potentiometers. (57EM is high-temperature version utilizing glass sealed terminals.) Resistance ranges to 100K ohms. Resistance tolerance to $\pm 3\%$. Linear functional output. Standard power rating, up to 2 watts at 70°C, specials even higher. An outstanding performer and space saver at a relatively low cost. Write for complete data on all Clarostat fixed and variable resistance components...

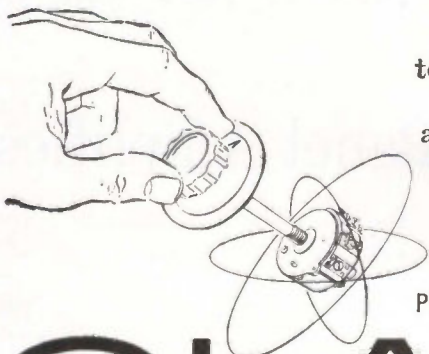

PRECISION POTENTIOMETER DIVISION

CLAROSTAT

CLAROSTAT MFG. CO., INC. DOVER, NEW HAMPSHIRE

*Pulse-induced slumber
appears deeper, also
has therapeutic value*

By **LEON H. DULBERGER**
Associate Editor

NEW YORK—An electronic instrument that induces "sleep" in humans and animals by slowly applying an electrical pulse to the subject's head is now being clinically tested at several hospitals.

The instrument produces sleep in most persons. Indications are that the induced sleep is deeper than normal slumber and may also be of value in the treatment of certain mental and physical diseases.

The possibility that a few hours of instrument-induced sleep may be substituted for eight hours of normal sleep has aroused the interest of the Air Force and NASA. Air Force has inquired about possible applications, such as helping SAC pilots perform on limited sleep. NASA reportedly is considering using sleep instruments for its astronauts, possibly in the Gemini program.

RUSSIAN DESIGN—Now being tested in the U. S. is a transistor version of a vacuum-tube design developed and being used in the USSR. Russian doctors have experimented with the instrument for four years and use it for medical treatment in hospitals. The Russians are reported to be producing 5,000 of the instruments a year, including one model that has multiple output jacks for simultaneous treatment of several patients.

National Patent Development Corp., of New York, which has a licensing arrangement with the USSR, funded the design of the transistor version by Prof. Omar Wing, of Columbia University. NPDC expects to produce the in-

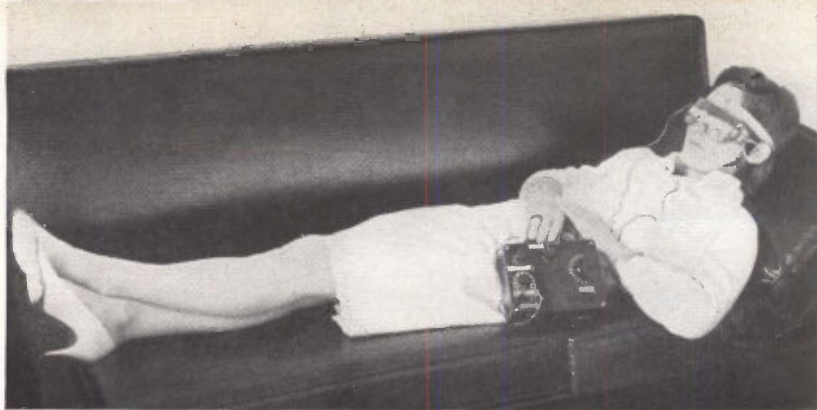

SLEEP-PRODUCING instrument developed by National Patent Development Corp. from Russian design is being tested by U.S. physicians

Can Synthetic Sleep

strument, now in the prototype stage, within six months.

The NPDC version measures 6 x 3 x 5 inches, weighs about 4 pounds and uses a rechargeable battery. Connection to the subject is made by a head harness with eye pads and a pad for the rear of the skull. For low-resistance coupling, cotton moistened with salt water or a conducting jelly is used with the pads. Pulses are 0.1-msec long and are repeated every 3 seconds. Voltage level is roughly 20 v and current passage 0.5 ma. A built-in timer controls treatment time.

SLEEP EFFECT—In humans, the instrument may produce a restful sleep, comparable to the second or third hours of slumber experienced by persons who sleep eight hours.

Since these hours of sleep are the most efficacious, some doctors

believe instrument-produced slumber may reduce human sleep needs to a few hours. Russian work on this is reportedly very encouraging. So far, instrument-produced sleep does not appear to be habit-forming like barbiturates and no side effects have been reported.

While it is not known precisely how the instrument produces sleep, one concept is that a sleep-inhibitory center in the brain is probably paralyzed by electric currents. However, there is disagreement about this.

Dr. Bernard Post, of Downstate Medical Center, New York, who has been working with sleep instruments for more than two and a half years, still has not proven to his satisfaction that the electric currents actually pass through the brain.

He thinks that a field of electrical potential set up in the brain's casing may produce sleep. He

Solid Panel Amplifies

*Resolution is reported
as better than tv set,
and it's easy to make*

TOKYO — Matsushita Research Institute Tokyo, Inc., reports it has developed an easily fabricated,

high-resolution, electrostatic-type light-amplifying panel that will operate as either a positive or negative image intensifier. The panel consists of a solid sandwich between two plates of glass whose inside surfaces are coated with SnO to form transparent conductive electrodes (see diagram on

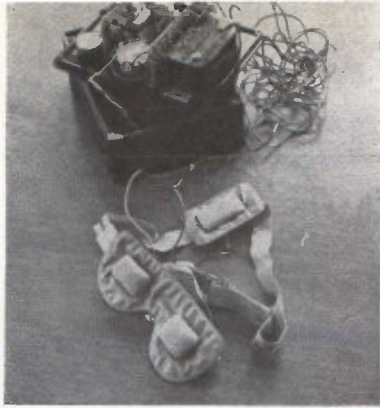

EYE AND SKULL PADS couple pulse source to subject

Save Time?

plans an experiment, using pulse-staggering techniques, in which a subject's brain waves are recorded by an electroencephalograph while the instrument is also coupled to the patient. So-called "spindles" that usually precede slumber have been observed on EEG traces. Dr. Post will look for these and other EEG indications of sleep.

TREATING DISEASES — Treatment of various illnesses with sleep instruments has been reported here and in the USSR. These include certain aspects of paraplegia, cerebral palsy and multiple sclerosis. High blood pressure has been successfully treated and indications are the instrument can be used to treat insomnia, ulcers and other conditions.

Dr. Post is now using NPDC's transistor version in experiments such as relaxing spastic patients before physical therapy.

Images

p 22). Total thickness of experimental panels is 3.2 mm; all but 0.2 mm of this is taken up by the glass plates. Two a-c power supplies are used: one connected between the two transparent conductive layers and one connected between the rear transparent conductive layer and the photocon-

UHF



NEW

Approximate Power Output CW
ML-8403 vs ML-7289

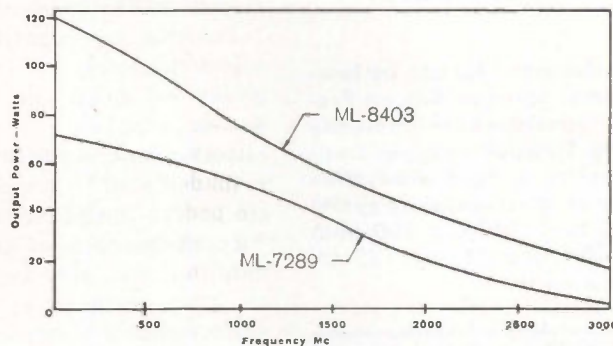

50% more cathode current... & Frequency stable performance

50% more cathode current (190 vs 125 ma) from the Phormat (matrix) cathode of the new ML-8403 planar triode allows higher powered performance—to nearly 120 watts CW—at normal plate voltages. A frequency stable anode permits variable duty cycle without noticeable shift in frequency. For ML-8403 ratings write The Machlett Laboratories, Inc., Springdale, Conn. An affiliate of Raytheon Company.



Now from Sprague!



WIDE SELECTION
OF

Silicon Chopper Transistors

NOW IN
VOLUME PRODUCTION

Specifically designed for use as low-level choppers, Sprague Silicon Precision Alloy Transistors are inherently stable. Every Sprague chopper transistor undergoes a rigid production conditioning of 40 temperature cycles from -55 C to $+140\text{ C}$, a 200-hour bake at $+140\text{ C}$, and a 2-hour 125mW operational burn-in!

2N2162 2N2165	Guaranteed 30 volt rating. Typical f_T of 20 Mc and low offset voltage make these transistors ideal where high voltage is required
2N2163 2N2166	Have 15 volt rating and same high frequency performance and low offset voltage as 2N2162
2N2164 2N2167	Highest frequency P-N-P Silicon Choppers available as standard types
2N2185	Extremely low leakage current of 1 nanoampere at 10 volts. Has 30 volt rating
2N2274	Similar to 2N2185 but has lower inverted dynamic saturation resistance
2N2276	Low-cost version of 2N2274
2N2278	Very low offset voltage of 1.75 mV at $I_B = 1\text{ mA}$
2N2187	Matched pair of 2N2185 with $\Delta V_{off} = 50\mu\text{V}$ max. from $+25\text{ C}$ to $+85\text{ C}$
2N2275	Matched pair of 2N2274 with $\Delta V_{off} = 100\mu\text{V}$ max. from $+25\text{ C}$ to $+65\text{ C}$
2N2277	Matched pair of 2N2276 with $\Delta V_{off} = 100\mu\text{V}$ max. from $+25\text{ C}$ to $+65\text{ C}$
2N2279	Matched pair of 2N2278 with $\Delta V_{off} = 50\mu\text{V}$ max. from $+25\text{ C}$ to $+85\text{ C}$



For additional information, write Technical Literature Service, Sprague Electric Co., 35 Marshall Street, North Adams, Mass., indicating the types in which you are interested.



4ST-102-63

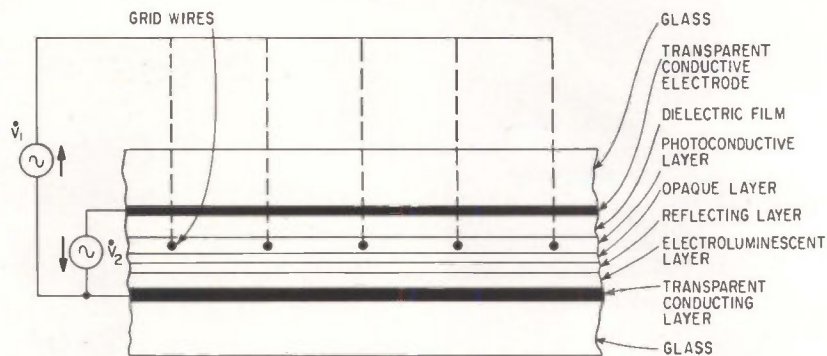

CROSS SECTION of electrostatic light-amplifying panel indicates arrangement of layers, location of grid wires and power inputs

ductive layer. In the lab, power supplies used were signal generators and amplifiers, with frequencies of 50 to 5,000 cps. The higher frequencies give better efficiency. Voltage was approximately 200 to 1,000 volts.

Positive or negative image is selected merely by changing the phase or amplitude of the two power supplies. Image contrast can also be controlled. Matsushita calls the panel a triode or electrostatic type image converter.

Input image need not be visible light but can also be infrared or an x-ray image. It can be used to show either a positive or negative image from a projected film negative. It can also be used as a solid-state amplifying fluoroscope screen that will directly convert a negative image to a positive image—something not done before, the company says.

EASY TO MAKE—In addition to its other advantages the new light amplifier is extremely simple to fabricate. No difficult machining operations are required.

Electroluminescent, light reflecting and opaque layers are coated on the rear transparent conductive layer in that order. A tungsten wire grid is wound over this coated glass plate and then covered with CdS photoconductive material on top of the insulating layer side. Silver paint is used to make contact to the grid along the edge of the glass plate, and the unneeded portion of the grid on the back surface of the glass plate is cut off and discarded. Over this are cemented Mylar film and the front electrode. The panel looks like an oversize film slide.

RESOLUTION—Resolution of prototype panels is limited by spacing of grid wires, which are 10-micron tungsten wires with center-to-center spacing of 300 microns. Measured resolution is about 10 lines per millimeter, or better than tv. Ultimate resolution is limited by the granular nature of the electroluminescent layer, which consists of ZnS particles approximately 20 to 30 microns in diameter.

RADAR SEES CLEAR-AIR TURBULENCE

RCA reports consistent detection of clear-air wind shear with a C-band precision tracking radar that has a peak power of 3 Mw.

The wind shear was seen as backscatter from refractive areas—a limitation in tracking radar, but of interest to weather radar. The returns correlated with readings obtained by Army rawinsonde balloons.

RCA's Surface Radar division is now developing clear-air radar techniques that could be used for forecasting or to warn aircraft pilots of turbulent air

NEWS

Thermistors?—Nobody makes a wider variety than Carborundum.

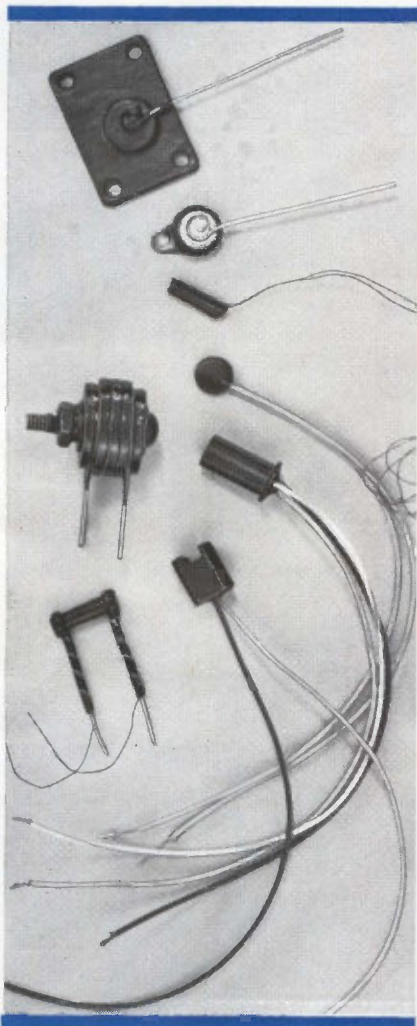

Carborundum is turning out thermistors in varieties undreamed of a short time ago—from sub miniature discs to complete assemblies.

Special assemblies can be manufactured to fit chassis and operating requirements. You can specify your electrical and dimensional needs and we'll design the assemblies to meet

them. They meet precise tolerances for temperature coefficient, dissipation constant and resistance at reference temperature. Can be potted in epoxy. Provide long-term stability.

Discs and washers are available in sizes from 1/10" to 1" in diameter. We supply them soldered to mounting plates or with special terminals to solve assembly problems. They're made of high-stability compositions. Beta values range from 2700 to 4800.

Rods can be purchased from Carborundum in the widest range of body sizes and temperature coefficients available to industry—in lengths from 1/4" to 12" and diameters from .05" to 1". Beta values from 1100 to 4600.

PTC Thermistors are new, positive-temperature-coefficient units with high sensitivity. Sensitivities as high as 12 percent per °C can be achieved. Use PTC's in combination with NTC's (negative coefficient units) and with linear resistors to construct an astonishing variety of temperature compensation curves for your circuits. We also manufacture PTC assemblies and probes for special needs.

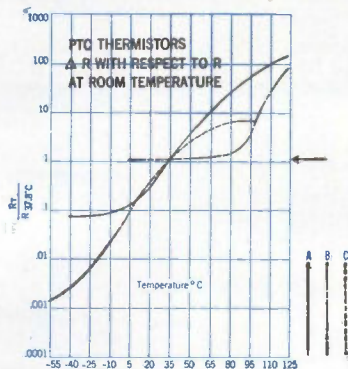

The graph shows resistance of three different PTC thermistors over a range of temperatures as a multiple of resistance at room temperature.

For more information on this complete thermistor line, write to: Electronics Division, Globar Plant, Dept. ED-6T, Niagara Falls, N. Y.

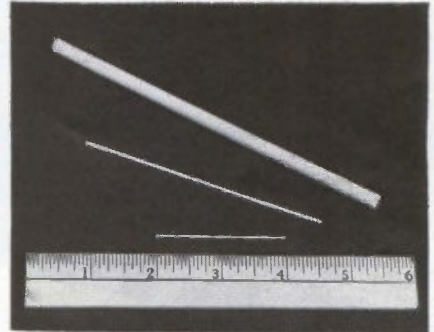

Magnesium oxide crushable preforms now in longer lengths

High-purity (99.4%) MgO tubing is now available in lengths up to six inches. This is double the previous size available. Now you can produce swaged, high-precision thermocouple assemblies faster. Cut costs at the same time.

These ceramic preforms are available in 2", 4" and 6" lengths depending upon O. D. size. In addition, O. D., hole size, and camber tolerances have been tightened. They have an AQL (acceptable quality level) of 2.5% for O. D., hole size and camber. Using the longer lengths, you can produce thermocouples with fewer air gaps, better resistivity and lower fatigue factor. They're just what you need wherever rigidity, resistance to vibration and high reliability are a must. For our new literature on ceramic insulating tubing, write to: Electronics Division, Latrobe Plant, Dept. EL-5, Latrobe, Pa.

CARBORUNDUM®



WE USE BOTH ENDS OF THE PENCIL...

to solve advanced systems research problems



Out beyond the State-of-the-Art, original solutions to the formidable new problems of today's advanced electronic systems depend on the effective application of three important tools... the pencil, the eraser and man's brain. At Motorola, these factors have been successfully applied to the design and development of such major electronic systems as the NASA/Goddard Range & Range Rate Satellite Tracking System... the Air Force data acquisition and relaying system at the Edwards AFB high speed flight corridor... and the RADAS random access, discrete address system.

If you are interested in participating in these stimulating areas of systems research, write today describing your background and training in:

Applied Systems Research • conceptual design and equipment development, communications theory, coding theory, logic systems design, systems and analysis, and operations research as applied to both military and non-military systems.

Systems and Sub-Systems Design • antenna and microwave design, integrated circuit applications, stress analysis and heat transfer, digital and voice communications, command and control, telemetry and tracking systems design, data processing and display, ultrareliability design techniques, radar and guidance equipment.

We are particularly interested in programs on which this experience was obtained, and the extent of your technical responsibility. Address information to our Manager of Engineering at the location of your choice for immediate attention.

MOTOROLA
An equal opportunity employer



Military Electronics Division

CHICAGO 51, Illinois, 1450 N. Cicero Ave. / SCOTTSDALE, Arizona, 8201 E. McDowell Rd. / RIVERSIDE, California, 8330 Indiana Ave.

600,000 WPM Printer Races Computer

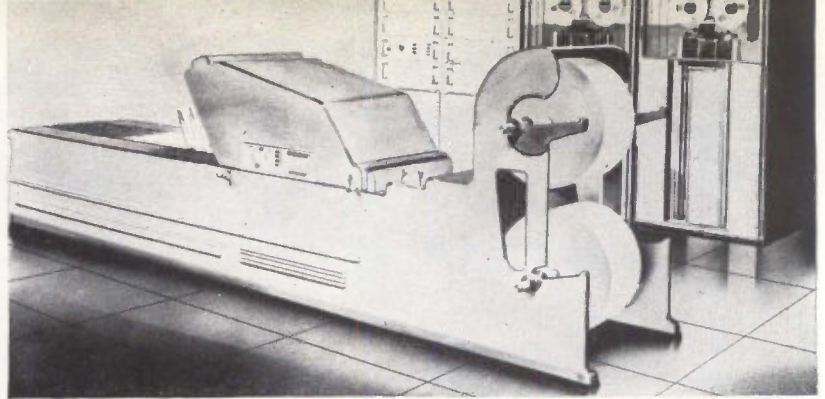

SUPERSPEED alphanumeric page printer produces a printed record at paper speeds up to 3½ feet per second

But what do you do with all that paper?

By **LAURENCE D. SHERGALIS**
Associate Editor

MELBOURNE, FLA. — Printer capable of keeping pace with high-speed computers—with an output of more than 60,000 characters per second—has been developed by Radiation, Inc. for Lawrence Radiation Laboratory.

The rate of 30,000 lines of type per minute, each line containing 120 letters and numbers, breaks all records for printing speed, Radiations says. First public demonstration was held yesterday.

Secret of the printer's high speed

operation is a printing method that eliminates mechanical motion. Electronic control of a series of electrical styli permits fast line-at-a-time recording on Teledeltos paper.

Input to the printer is 6-bit data from a pair of IBM 729V magnetic tape units. Two tape transports permit continuous printing with automatic switching between the tape units.

OPERATION—Seven input data lines are combined in an OR gate that provides a character clock pulse train for routing to a buffer control unit and a counter. The data is also fed to an AND gate and to a parity check circuit. After parity checking, input data is directed, by the buffer control unit, to one of two recirculating buffers capable of storing a complete line of data in 6-bit binary form. If a parity error

is detected, the gates will be inhibited by the parity check unit and an error code will be loaded into the buffer.

When one recirculating buffer has been filled, input data is transferred to the second, and printout of data in the first buffer is started. Each 6-bit binary code is translated sequentially into a 35-bit matrix code to operate character generators that drive 600 recording styli. Styli are arranged in 120 sets of five each, with a decommutator selecting the appropriate five.

CHARACTERS — Characters, 0.1-inch high by 0.06-inch wide are formed from 5 × 7 matrix of dots, and printed one horizontal row of dots at a time. Five of the 35 matrix code bits are printed for each circulation and the data is circulated through the buffer seven times to

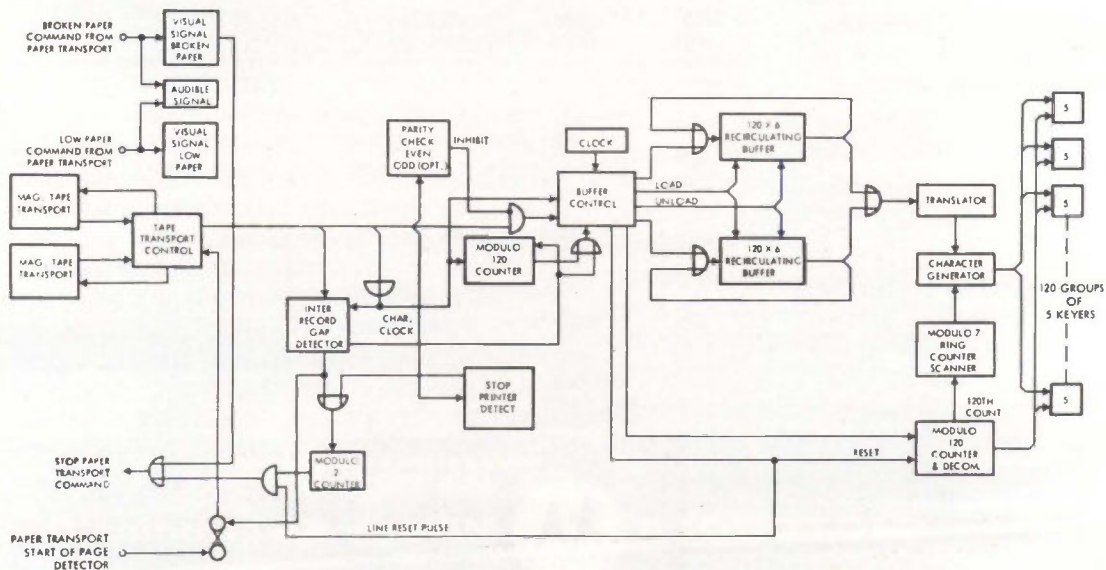

TWO TAPE INPUTS enable continuous operation of the system

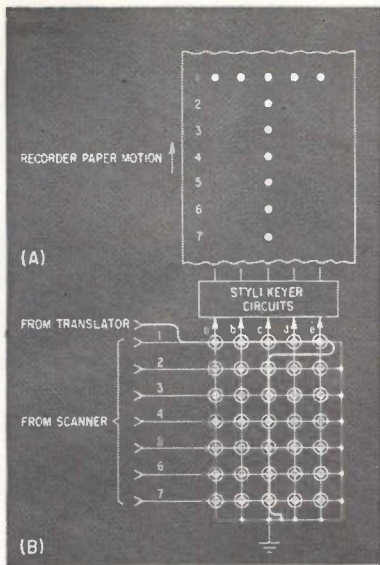

PRINTING OUT of the letter T is accomplished a line at a time (A), with dots printed by energizing the styli with a magnetic-core character generator (B)

complete printing of one line of characters.

Four 5×7 magnetic core generators are used. Cores are arranged in rows of five horizontally and seven vertically. Character set windings are connected in a physical pattern representing each of the 64 characters or symbols. When an input pulse is decoded by the translator as a specific letter, a pulse sets each of the appropriate cores to positive magnetization. To print the character, the readout windings on all cores in the top horizontal row are pulsed and shifted back to a negative state. Output sense windings on each core produce an output pulse to a stylus keyer. Thus, the top row of dots for one character are printed. The translator goes to the next character and repeats the process until the top row of dots for all characters in that line are printed.

Next, the core readout windings in the second horizontal row are pulsed and the second row of dots is printed. The process is repeated until all seven horizontal rows are read out and the entire line of type printed.

Preprogramming the input data controls the format of the output. Automatic stopping, partial page format, program identification and other control functions are accomplished by recognition of certain input data codes.



LAPP ENTRANCE INSULATORS

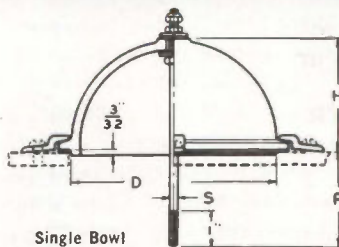

...in all these standard sizes to save you time and money

DIMENSIONS IN INCHES AND RATINGS									
Single Bowl	Double Bowl	Material	D*	H	P	S	Dry Flashover 60 μ s kv eff.	Radio Rating kv eff.	
9164 26846	7185 26841	Porcelain Steatite	3	1 $\frac{1}{8}$	1 $\frac{1}{2}$	$\frac{1}{4}$	22	9 17	
9165 26847	7181 26843	Porcelain Steatite	4 $\frac{3}{4}$	2 $\frac{1}{8}$	2	$\frac{1}{4}$	31	10 $\frac{1}{2}$ 20	
9166 26004	9167 26845	Porcelain Steatite	6 $\frac{1}{2}$	4 $\frac{1}{8}$	3	$\frac{1}{2}$	38	12 $\frac{1}{2}$ 24	

*D is mounting hole diameter.

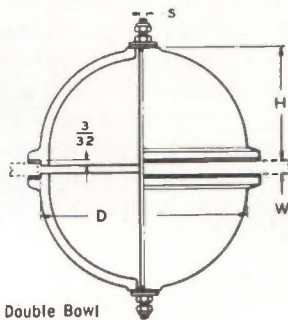

When you design, keep our *standard* sizes in mind. They really cut down on costs and delay. Lots of other standard sizes for heavy duty, low voltage and apparatus applications. And, of course, if you need specials, we'll meet your specs as fast as possible, at a price you'll agree is fair.



WRITE for Bulletin 301-R.
Lapp Insulator Co., Inc.,
205 Sumner Street,
LeRoy, New York.

PULSE POINTERS

Double Pulse Generator
Recommended For
Semi-Automatic
Checkout Systems

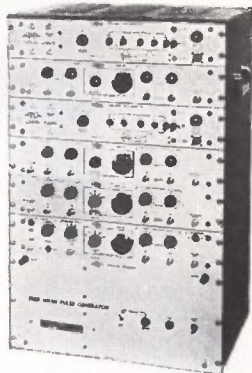

Model 2140A Precision Double Pulse Generator

Fast rise time, calibrated controls, separate or mixed signals—Pulse simulation and control problems are easily resolved over a broad range by the multiple capabilities of SERVO-PULSE™ Model 2140A Precision Double Pulse Generator. Reliable output parameters allow immediate use of the equipment without calibration and monitoring instruments. Model 2140A offers wide-range adaptability to special purpose applications through the use of standard pulse and digital circuit modules.

Compact, Medium-Power Pulse Generator Features Modular Adaptability

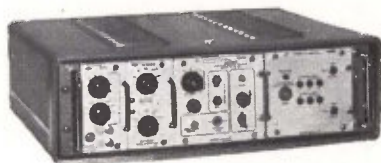

Model 3350A Pulse Generator

Fast rise time pulses are fully controllable in a variety of parameters—Model 3350A Pulse Generator offers broad performance range in a unit designed for console mounting. Uses include pulse circuit design and testing of RADAR, navigational systems, digital computers, and control systems. It may be operated from the internal oscillator, slaved to an external trigger, or used single shot by pushbutton for transient testing. SERVO-PULSE™ Model 3350A has 2 mc-2 cps rep rate and 10 nanosecond rise time.

For complete details, write:

SERVO-PULSE™ PRODUCTS
SERVO CORPORATION OF AMERICA



111 New South Road
Hicksville, L. I., N. Y.
WElls 8-9700

No-Chop IR Detector Cuts Size

*Evaporated thermopiles
for space systems don't
require beam modulation*

STAMFORD, CONN.—Barnes Engineering Company unveiled a new type of infrared detector last week—a thermopile—that doesn't require ir beam modulation.

The company says the device will provide for infrared space systems without moving parts, generally halving size and weight, reducing power requirements to a third, and raising life expectancy to three years or better.

The radiation thermopile consists of bismuth-antimony junctions vacuum-deposited on a Mylar insulating strip mounted on an anodized aluminum heat sink. The single-junction thermocouples are combined to form thermopiles.

THE DIFFERENCE—In bolometer detectors, the microvolt signals due to infrared radiation must be separated from random variations in the large d-c polarizing voltage; the infrared is coded by optical chopping.

The thermopile itself generates an emf directly proportional to the small temperature differential generated by the infrared radiation on the active junction. The signal can be detected and amplified without polarizing or bias voltage. Solid-state photoconductive modulators, using neon-bulb relaxation oscillators, convert the submicrovolt d-c signal to an a-c signal for further amplification without adding noise.

Another advantage is the detectors sensitivity to long wavelengths

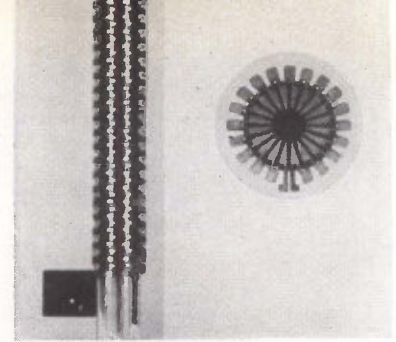

Thermopile configurations include 120 elements in a 1x8-mm active area and 20-element radial with a 2.5-mm-diameter active area

without liquid-helium cooling.

Barnes says the longest life of moving-part space instruments was one year for the Barnes 5-channel radiometer in Tiros. With the new device, systems under development are expected to last three years, and longer with improved or redundant circuits.

APPLICATIONS—The thermopiles will complement and not displace ir detectors such as thermistor bolometers, according to Eric Wormser, Barnes vice president, and will present new applications in space vehicles.

At present, immersed thermistor bolometers are more sensitive for an equivalent time constant and therefore are better suited for systems using radiation chopping or optical-mechanical chopping.

Principal space applications for thermopiles are expected to be horizon-sensing and scientific and meteorological radiometric measurements. A radiometric comparison-type horizon scanner for a classified low-altitude space vehicle is now in limited production. Horizon sensors are being developed for the Fairchild Micrometeoroid Measurement Satellite, and for Jet Propulsion Laboratory's lunar and planetary orbiting vehicles.

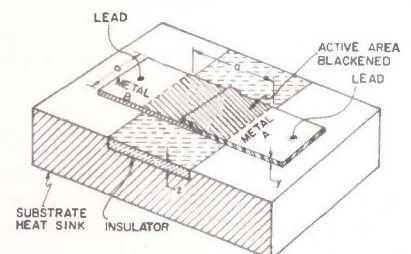

Thermocouple detector is evaporated on solid backing

FOR

HIGH INSULATION RESISTANCE

LOW DISSIPATION FACTOR



NEGATIVE TEMPERATURE COEFFICIENT

EXCELLENT CAPACITANCE STABILITY



LONG LIFE



SAN FERNANDO

USES NATVAR

Styroflex® Film

West-Cap Capacitors are available in a wide range of capacities—in glass-to-metal, hermetically sealed, tubular and bathtub types, made to MIL Specs such as MIL-C-19978 (Ships) and MIL-C-26086/3 (USAF). Natvar Styroflex is used as the dielectric.

San Fernando Electric Manufacturing Co., San Fernando, California and

their subsidiary, Caribe Capacitors, Inc., Cataño, Puerto Rico, manufacture West-Cap capacitors for use in timing circuits, filter network components, test equipment and secondary standards of capacitance, and other critical circuits for computers and certain weapons programs where stability and close tolerances are essential.

Natvar Styroflex is used as the dielectric, first because of its excellent dielectric properties, and second, because its complete flexibility makes it easy to handle, and its consistent uniformity makes it possible to manufacture to extremely close tolerances.

Natvar Styroflex Film is made in thicknesses from 0.00025" to .0060", and in widths from 1/8" to 10" depending on thicknesses and manufacturing requirements.

Styroflex is the registered trade name for Natvar's biaxially oriented flexible polystyrene film.



Natvar Products

- Varnished cambric—sheet and tape
- Varnished canvas and duck — sheet and tape
- Varnished silk and special rayon—sheet and tape
- Varnished papers—rope and kraft—sheet and tape
- Varnished, silicone varnished and silicone rubber coated Fiberglas*—sheet and tape
- Slot cell combinations, Aboglas[®] Isoplex[®]
- Teraglas[®]
- Acryliglas** sheets, rolls, tapes
- Isoteraglas** sheets, rolls, tapes
- Epoxy coated glass sheets, rolls, tapes
- Isoglas[®] sheet and tape
- Isolastane[®] sheet, tape, tubing and sleeving
- Vinyl coated and silicone rubber coated Fiberglas tubing and sleeving
- Extruded vinyl tubing and tape
- Styroflex[®] flexible polystyrene tape

*TM (Reg. U.S. Pat. Off.) OCF Corp. **TM Reg. Applied for

We will be very happy to supply information on any of our products on request.

NATVAR CORPORATION

FORMERLY THE NATIONAL VARNISHED PRODUCTS CORPORATION

Telephone TWX Cable Address
 Code 201 FULTON 8-8800 201-381-8056 NATVAR: RAHWAY, N. J.
 RANDOLPH AVENUE • WOODBRIDGE, NEW JERSEY

Speer Jeffers

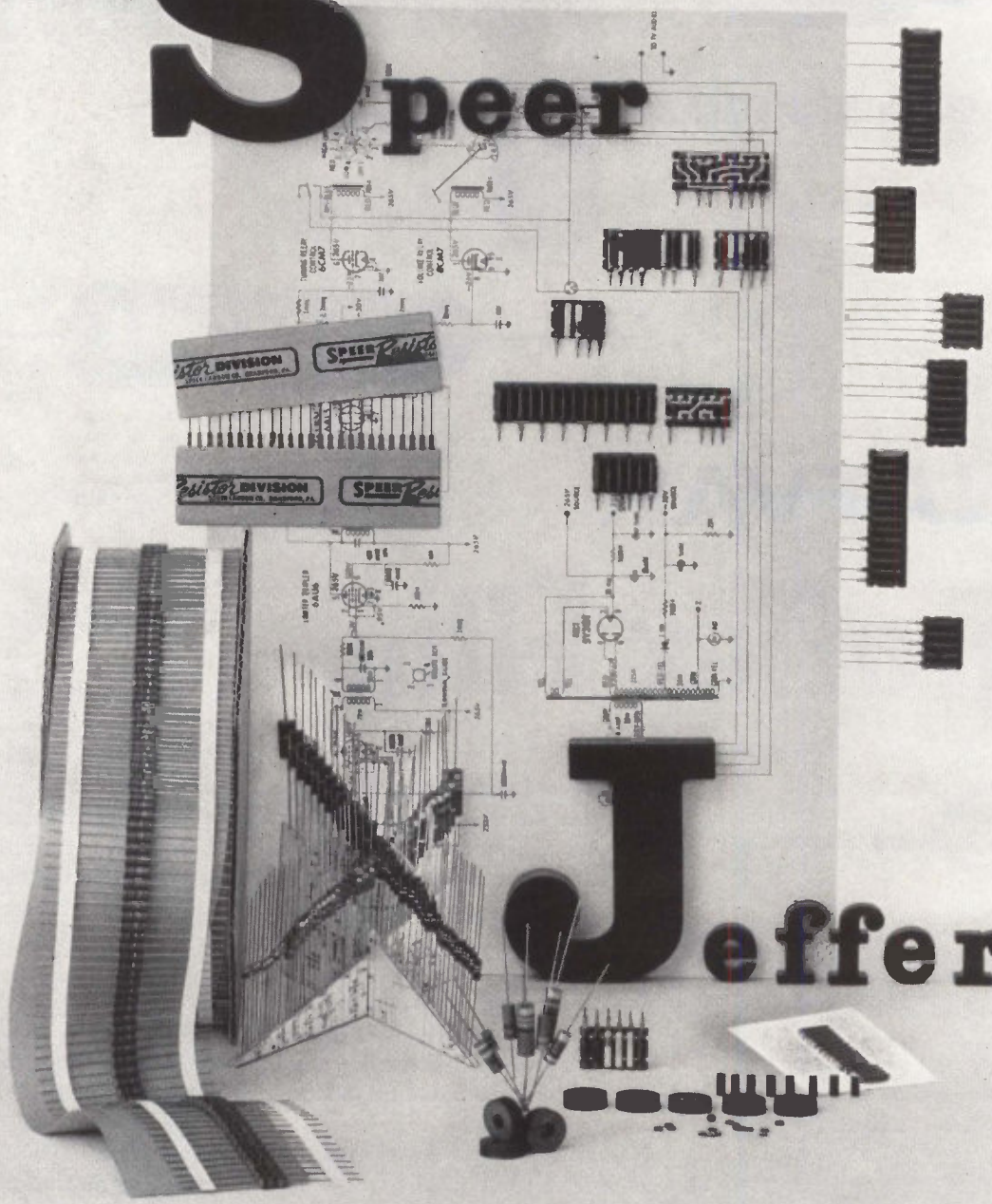

What 5 things do these Speer electronic components have in common?

that will increase your equipment reliability)

All components shown here are made by electronics divisions of Speer Carbon Company. In addition to research facilities at each division, Speer maintains a centralized research and development center in Niagara Falls. There, a staff of scientists is engaged exclusively in improving performance characteristics of present products and developing new types of electronic components. Each division shares Speer's multi-million dollar investment in research and development, in-plant reliability and quality control testing facilities. At Speer Resistor, for example, reliability is backed up by over 100 million hours annual capacity for life testing. When you discuss your circuit design problems with a representative from any Speer division, you can count on the technical support of a company that employs more than 2,000 people to design and manufacture the highest quality products you can buy.

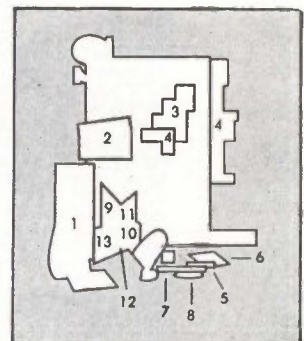

SPEER Carbon Co.



How many of the above electronic components can you identify? They're all manufactured by divisions of Speer Carbon Company: 1. Jeffers Type 19 molded inductors; 2. Speer 1/4W fixed composition resistors; 3. Jeffers clear-coated PAC's; 4. Jeffers phenolic-coated PAC's; 5. Speer 680Ω leadless resistors; 6. Speer 68Ω leadless resistors; 7. Speer 5.6Ω leadless resistors; 8. Speer 5000Ω leadless resistors; 9. Speer coil forms; 10. Speer 2W, 1W & 1/2W resistors; 11. Jeffers Type 09, 15, 19, 22, 24, 28, and 30 molded inductors; 12. Jeffers JM 110 & JM 160 capacitors; 13. Jeffers special inductors.

Dept. 425, St. Marys, Pennsylvania

Speer Carbon Co. Is A Division Of Air Reduction Company, Inc.

RELOCATING OR EXPANDING
YOUR BUSINESS?

EXPAND WESTWARD..



A wonderful welcome awaits you in Washington State, and a remarkable opportunity, too! For, although it may not be suited to every business, Washington has a surprising lot to offer the company with relocation or expansion ideas. Here are 11 topics most asked about by executives considering our advantages. Check them over. Then write and ask us specifically about the ones pertaining to your business.

Art E. Brown

Director, Washington
State Department
of Commerce &
Economic Development

W. M. Paulsen

Governor
State of Washington

POWER • Abundant hydroelectric power, lowest industrial rates in nation. Natural gas, coal.

INDUSTRIAL WATER • More fresh, cool, pure water than any other state in the nation!

LIVING • Unlimited variety of cultural and recreational facilities in a mild climate, surrounded by magnificent natural splendor.

RAW MATERIALS • Timber, agriculture, 71 founded minerals (15 in production).

LABOR SKILLS • Washington's workers 15% more productive than the national average!

SITES • Developed sites for both basic and service industries.

MARKETS • Already second largest market in entire West, growing and permanent!

TRANSPORTATION • Four transcontinental rail lines, more than 15 major deepwater ports, inland barge lines from sea to eastern border, international airports.

TAXES • Competitive with all western states, and no state personal income tax!

RESEARCH FACILITIES • Ever expanding industrial research facilities available.

WELCOME ATTITUDE • Citizens, government officials at all levels, highly receptive to new industry.

Write on your company letterhead or have your secretary fill out and mail this coupon.

THE
Surprising
STATE

WASHINGTON

Washington State Department of Commerce and
Economic Development—Industrial Division,
General Admin. Bldg., Olympia, Washington

Name

Firm

Position

Address

City..... Zone..... State.....

W-1

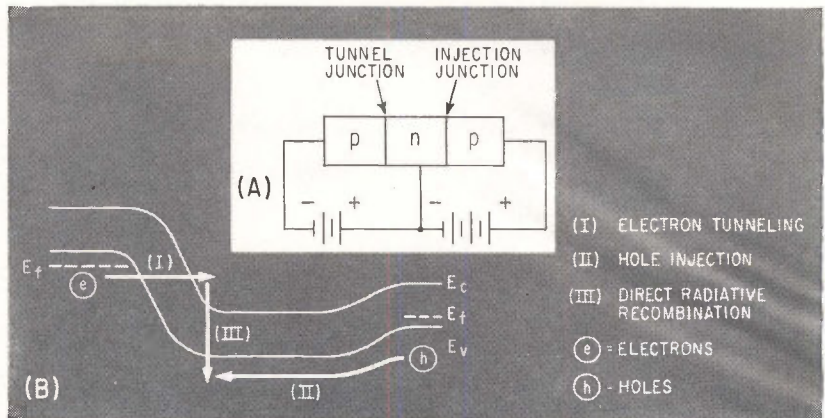

EMITTER JUNCTION of transistor is biased as the injection junction (A). Electrons tunneling from the left side and holes injected from the right side recombine (B)

Try for Triode Lasers

*Tunneling expected to
give intense output
from germanium, silicon*

SAN FRANCISCO—Attempts are now being made at the University of California, in Berkeley, to build a semiconductor triode laser that would employ the tunneling effect to achieve an intense output.

If the experiments are successful, they could lead to a new, transistor-like configuration for solid-state lasers and enable lasers to be fabricated from materials not yet usable, including germanium, silicon and aluminum antimonide.

The work is being done by S. Wang, associate professor of electrical engineering, and associates. The team has already used the tunneling effect to obtain radiation from a high-frequency germanium mesa transistor (2N700).

Wang told *ELECTRONICS* last week that he is optimistic about achieving coherent output from the new devices. He feels the proposed two-stage scheme for laser action is "quite feasible." Anticipated wavelength is 1.5 microns, in the infrared.

Preliminary experiments with the 2N700 transistors were performed at liquid-nitrogen temperature (77 K) with direct current and the transistors quickly burned out.

Wang expects pulse operation to be very difficult to achieve in the new devices at room temperature. Attempts will also be made to control frequency and amplitude of operation.

LASING PROCESS—In gallium arsenide, commonly used for diode lasers, excess electrons and holes can rapidly recombine with each other, giving out intense electromagnetic radiation. Semiconductors like germanium do not have this property. The required transitions are slow and recombination radiation is much weaker.

An efficient way of speeding up the recombination process, Wang says, is to supply electrons into the conduction band by tunneling. Electrons are tunneled into the base region from the left-hand tunnel junction while holes are injected into the same base region from the right-hand injection junction (see figure). This permits rapid recombination.

In the experimental devices, impurity concentrations will be designed to enhance radiative recombinations. A resonant structure will also be attempted. In the mesa transistors, the emitter junction was biased as the injection junction. The preliminary reports on that work appeared in *Applied Physics Letters*, April 15, and *Transactions on Electron Devices*, May.

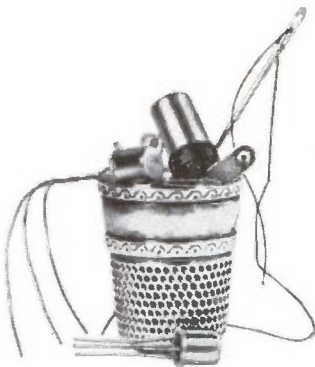

**This could be
all the
inventory
you need**

Because Air Express delivers overnight—anywhere in the USA

Why stock 10,000 parts when 1,000 might be enough? Duplicate parts inventories drain away profits...and they're no longer always necessary. Air Express shipments let one do the job of many.

Air Express distribution works as simply as this: Salesmen or customers phone in their orders. You call Air Express. Then we pick up your shipments...put them on the first flight out...and our trucks deliver them to your customers the next day...anywhere in the U.S.A.

Cost? Less than you think. For example, 20 lbs. travels 649 miles for only \$5.56.

Air Express alone can offer this service, because only Air Express has scheduled service between 2,500 airport cities... plus scheduled surface express connections with another 21,000 off-airline cities. And Air Express shipments have official priority with all 38 scheduled airlines—first cargo aboard after air mail.

To reduce expense and speed shipments, specify Air Express. Call your REA Express office for Air Express service.

AIR EXPRESS
DIVISION



CIRCLE 33 ON READER SERVICE CARD

Why so many?

We admit it.

Amphenol, more than any other connector manufacturer, accepts responsibility for confronting you with a seemingly endless selection of rack and panel connectors.

There's a good reason.

For some uses, a ten-contact connector the size of an Idaho potato will do just fine. In others, ten connections must be squeezed into a space no bigger than a jelly bean. Still other applications have unique requirements that relate to environment or mating force—even the technical skill of the operator.

WHY WE DO IT

We make a lot of different rack and panel connectors because it takes a lot to satisfy the wide range of applications.

For example: the Amphenol Blue Ribbon® rack and panel connector is widely used in "blind" mating applications. Part of Blue Ribbons' popularity is due to the fact that they mate with a smooth and gradual wedge-like force. Because they mate so smoothly, the "feeling" of correct alignment is unmistakable.

Another advantage of the Blue Ribbon design is the wiping action that occurs as connectors mate. Each time Blue Ribbons are mated, contact surfaces are wiped clean. Combine wiping action with high mated contact pressure, and the result is an extremely low-resistance connection.

THINKING SMALL?

As fine a connector as we know the Blue Ribbon is — it's just not right for the real tiny stuff. Thus, as miniaturized

electronic equipment became popular, Amphenol engineers developed the Micro Ribbon® — a rack and panel connector utilizing the ribbon contact principle, but in as little as one-half the space. Further development produced a circular Blue Ribbon connector which crammed 50 contacts into a diameter just under 3 inches.

Also, there's the question of terminating rack and panel connectors. Often, confined quarters or complex wired harnesses can tax the dexterity of even the most skilled worker

To solve this problem, Amphenol engineers developed rack and panel connectors with Poke-Home® contacts. Poke-Home contacts make it possible to terminate conductors independent of the connector. Contacts are crimped, soldered, or even welded to conductors, then inserted into the connector. Besides simplifying assembly, Poke-Home contacts can be easily removed *after* assembly should circuit changes or repairs later become necessary. Needless to say, Amphenol rack and panel connectors with Poke-Home contacts (Min-Rac 17®, 93 and 94 Series, for example) are popular items with engineers who are forced to think small, spacewise.

BEATING THE ELEMENTS

There's a need for environmentally resistant rack and panel connectors, too. High performance aircraft, missiles and space craft led to the development of Amphenol 126 and 217 Series environmentally sealed rack and panel connectors. (The 217 offers the added feature of Poke-Home contacts.) Other Amphenol rack and panel connectors

can accommodate coaxial connectors; many can be supplied with hermetically sealed contacts. There are rack-to-cable connectors available in every series. There are super-economy types and super-reliable types.

So, when you have a rack and panel connector problem, contact an Amphenol Sales Engineer (or an authorized Amphenol Industrial Distributor). With the broadest line of rack and panels in the industry—if he can't solve it, no one can. If you prefer, write directly to Dick Hall, Vice President, Marketing, Amphenol Connector Division, 1830 South 54th Avenue, Chicago 50, Illinois.

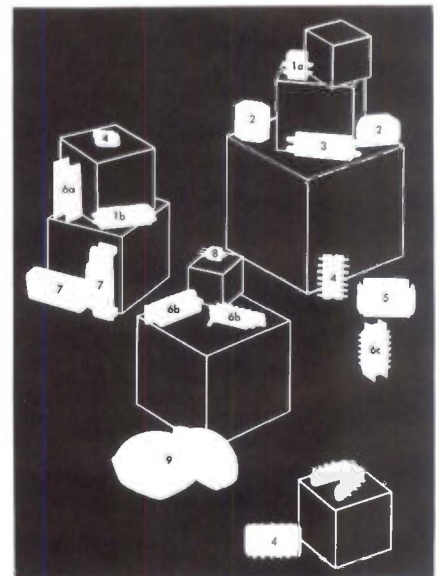

Amphenol connectors shown on the opposite page are: 1—Min-Rac 17 with (a) crimp-type contacts and (b) solder-type contacts 2—94 Series 3—Micro-Ribbon 4—126 Series Rectangular 5—93 Series 6—Blue Ribbon with (a) barrier polarization, (b) pin polarization and (c) keyed shell and barrier polarization 7—126 Series "CNI" 8—126 Series Hexagonal 9—Circular Blue Ribbon



Connector Division / Amphenol-Borg Electronics Corporation





Shown above are the
CORNING resistors which have failed
in more than 135,000,000 (MOSTLY
OVERSTRESSED) unit test hours.

We may have a failure any year now.

In the meantime, we have calculated statistical failure rates which may change your thinking about high-reliability resistors . . . whether you are working with MIL-R-22684 (NAVY), MIL-R-10509D or MIL-R-55182. The rates look like this:

Less than 0.0015%/1000 hours. CORNING has failure rate data based on continuous life testing for periods up to 50,000 hours; nearly six years. This test is for 1800 resistors that have been on continuous life test for

60,000,000 unit hours at powers up to 140% of rated. The confidence level is 60%.

Less than 0.0012%/1000 hours. This one is based on 75,000,000 unit hours at 250% of rated power and 25°C.

CORNING resistors live through high-stress reliability programs like these because of the inherent reliability of the tin oxide and glass that go into them. They demonstrate *flat* load-life characteristics for the same reason.

High-reliability CORNING resistors are available in general purpose C-style, precision RN-type, and hermetically sealed precision NF-type. A bulletin on CORNING "Resistor Reliability" is now available. Write for your copy.

**CORNING
ELECTRONICS**

A DIVISION OF CORNING GLASS WORKS
3901 ELECTRONICS DR., RALEIGH, N. C.

ANCIENT HISTORY



Μικροί έν εκατομμύριον
πεντακόσιοι χίλιοι

OPERATIONAL
PREDETECTION
RECORDING AT
1.5 MEGACYCLES
INTRODUCED
WESCON 1961

MINCOM CM-100 1.5 MC RECORDER / REPRODUCER

Only the Mincom CM-100 has a field-proven record of predetection performance. Mincom's leadership in this highly complex telemetry technique stems from the CM-100's long-standing and reliable 1.5-mc response. CM-100's versatility and extreme wideband capability have made it the industry's instrumentation standard: 1, 1.2 or 1.5 mc at 120 ips in analog recording/reproducing, or simultaneous post- and pre-detection recording in FM/FM mod, PCM, PCM/FM, PAM/FM, PACM/FM and other FM-type carrier systems. Superior fixed heads and phase-compensating electronics produce better rise time, correcting for phase shift and overshoot. Write today for specifications.

Mincom Division **3M**
COMPANY

2049 South Barrington Avenue, Los Angeles 25
425 13th Street N.W., Washington 4, D.C.

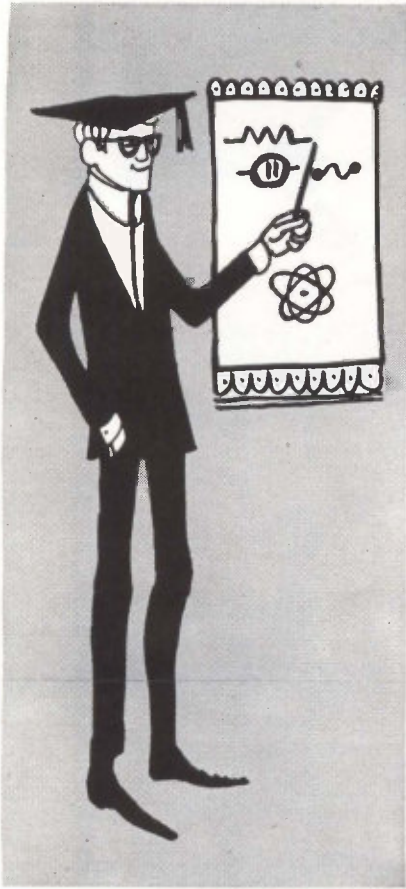

workability

(pre-production training)

WESTern PENNSylvania has a time-tested and proved-in-use plan by which employees—adaptable, productive people with a variety of industrial aptitudes—will be trained in advance for whatever skills are needed for YOUR particular operation at no cost to you. For details on this ability . . . and for complete information on 100% financing of plant space at low, low interest rates . . . and WESTern PENNSylvania's favorable tax climate, mail coupon, wire or call collect.

WEST PENN POWER

an operating unit of ALLEGHENY POWER SYSTEM



INDUSTRIAL SHELL BUILDINGS available at \$2.95 to \$3.25 a sq. ft. completed to your specs in 60-90 days.

WEST PENN POWER Phone: TEmple 7-3000
Area Development Department (Area Code 412)
Greensburg, Pennsylvania E-3-8-5

Please send me information on: Pre-production Training
 Favorable Tax Climate 100% Industrial Plant Financing Industrial Properties

Name _____
Title _____
Company _____
Address _____
City _____ Zone _____
State _____ Phone _____

Safer Power Plants:

They can be fail-safe with relatively cheap analog systems, ISA told

By JOHN GRUENBERG
McGraw-Hill World News

PHILADELPHIA — Although solid-state analog controls have moved into a dominant position in the control of large-steam-electric generating units in the last three years, most installations are not sufficiently fail-safe nor operator-safe, declared Thomas M. Nourse, marketing manager of Daystrom's Control Systems division, at ISA's Power Instrumentation Symposium last week.

He said that a fail-safe analog control would add only 0.1 to 0.5 percent to the cost of a new generating unit—a "bargain." Nourse and R. R. Ruett presented designs improved by such features as redundancy, automatic balancing, and logic networks for monitoring and preventing unsafe conditions.

Nourse told **ELECTRONICS** after presenting his paper that "until industry reevaluates what it will invest . . . in analog controls—and lets safety precede price—the number of truly safe systems will remain in the minority." Nourse added that "a reevaluation of what industry will invest (in safe operation controls) is coming," and saw greater awareness of such a need now.

DIGITAL COMPUTERS—R. A. Russell, of Black & Veatch, Kansas City, Mo., predicted that 1963 will be "by far" the biggest year for installations of on-line digital computers in steam-electric generating stations. But 1964 and 1965 will be slow years.

An ISA-sponsored survey of 42

generating stations with capacities over 50 Mw showed that from 1958 through 1962, 20 computers were installed for data service and 9 for data and control.

For 1963, 15 data and 11 data-control installations are reported—representing 63.5 percent of the stations. In 1964 and 1965, a total of only 19 installations are anticipated. However, Russell said, the number may swing up again in the late 1960's.

Russell said that increased safety and fuel savings were the primary reasons why computers were purchased. Input transducer equipment is generally standard power plant instrumentation equipment, and "should be improved or replaced with other equipment designed to take advantage of computer capabilities," he added.

BOILER CONTROL—Control of steam generation, a basic power process, was called increasingly difficult. Control system demands for boilers have not changed funda-

Who Needs a Laser?



FRYING PAN made of 39-mil steel is burned through in Westinghouse Electric demonstration of intense, but incoherent, plasma-jet light source. Light is focused by elliptical mirror through quartz lens. Input is 50 Kw, radiant output 15 Kw

Why Not?

mentally through the years, but the speed and magnitude of load changes make it difficult to meet requirements today, said R. E. Van Derway, of Commonwealth Edison, Chicago.

Better-coordinated control systems, coupled with computers and other modern equipment, is the "key to successful boiler operation in the future," since control systems now have more functions.

Commonwealth Edison's automatic dispatching equipment and other computer and control facilities enable it to handle twice as much boiler load with half as many boilers as 10 years ago, he said.

Solid-State Controls To Boost Appliance Sales

CHICAGO — Will home appliances make wholesale use of semiconductor-device controls? Yes, if the innovations excite and intrigue the customer. The appliance industry is seeking a cure for recent sales declines.

Among promising items discussed last week at the 14th Annual Appliance Technical conference were: continuous speed controls, proximity switches, and switches that couple temperature, water, pressure, humidity and light sensors directly to inexpensive power-switching modules.

One point made by F. P. Stearns, of Texas Instruments, is that circuits should be packaged as modules that can be pulled and replaced for \$5.

John Mungenast, of GE, cited a number of uses for silicon controlled rectifiers. In one, an inexpensive miniature scr amplifies a thermistor signal and timing function. Another is a light-activated scr for a home laundry's static programmer. A universal control can be used by a number of appliances, spreading the cost and making the unit price more attractive.

But only if the decal on the filter reads ILo® ■ New ILo® crystal filters by Midland are designed by a technique radically different from conventional crystal filters, and the biggest advantages show up in the passband. Compare. ■ A narrow band ILo® crystal filter has a typical insertion loss of one-half db; a conventional image parameter crystal filter loses 3, 4 or 5 db. From the "no loss" zero db point to 5 db, the conventional filter provides loss; the ILo® filter provides selectivity! ■ And sharp selectivity.

ILo® crystal filters can be made with extremely sharp corners, flat passbands, quick rise time. Even a good image parameter filter, when it gets going, has rounded corners, falls off unsymmetrically, exhibits comparatively poor characteristics near the passband. And prices are comparable. ■ Midland believes the development of ILo® filters to be the most important advance in filter design in five years. Wouldn't you like the facts? Write the world's largest manufacturer of crystals and crystal filters.

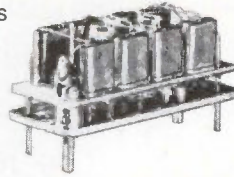

**selectivity
starts
in
the
passband**

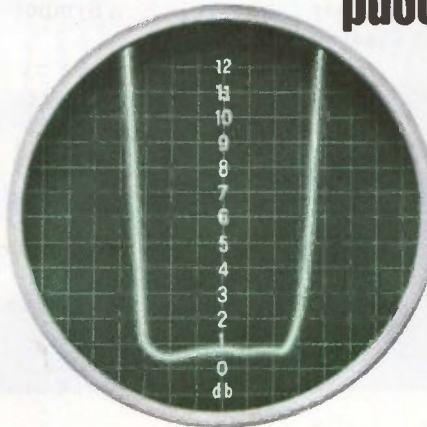

this is an ILo® filter

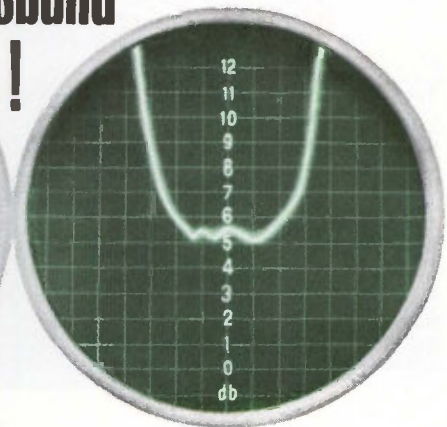

this is not



MIDLAND MANUFACTURING COMPANY

3155 FIBERGLAS ROAD

KANSAS CITY 15, KANSAS

An electronics division

of Pacific Industries, Inc.



NEW COAX!



MINIATURE THIN WALL 100% SHIELDED TEFLON COAXIAL CABLE

Inner-space, outer-space, or lack of space — wherever size, weight, and shielding of coax is a criteria, Hitemp's new cables provide design advantages not previously available!

Engineering, production, and Q.C. techniques advanced by Hitemp make it possible to hold shielding to a wall thickness of 1.5 mils, or less. For example, on a RG-196A/U teflon insulated coax cable, Hitemp holds the O.D. to .040" or half the O.D. of conventional wire braid construction (.080"). Subsequently, there's a weight savings of 21%. And this miniaturized cable can be wrapped around a $\frac{3}{8}$ " mandrel.

Naturally, the 100% shielded construction improves attenuation characteristics, reduces cross-talk to a minimum, stabilizes capacitance, and lowers VSWR.

100% shielding offers you assembly economies, too. It eliminates many termination problems associated with braided shields, and increases the reliability of the terminations, themselves.

Wherever your circuitry requires lower attenuation, improved VSWR, and so forth — wherever shielding, weight, size, flexibility, and reliability are critical, that's where it will pay you to use Hitemp's new miniature 100% shielded.

SEND FOR A SAMPLE if you'd like to run some checks on it yourself. Or, send us a piece of what you're currently using. We'll evaluate it and advise you of the savings you can make with Hitemp's new miniature coax. Why not take advantage of *either* offer today!

HITEMP WIRES CO.

a Division of Simplex Wire & Cable Co.



1200 SHAMES DRIVE, WESTBURY, NEW YORK
1532 S. CALIFORNIA AVE., MONROVIA, CALIF.

I HEAR **GENERAL ELECTRIC TWT'S**
 ARE NOW **COMMERCIALY AVAILABLE FOR**
MULTIPLE SOCKET TRANSMITTERS
AT LARGE COST SAVINGS!
WHAT'S THE SECRET ?

NO SECRET, SIMPLY THE USE OF A

IN THEIR



C'MON-TALK WORDS

O.K! THESE NEW G-E TWT'S HAVE A
HIGH POWER RING-BAR R.F. CIRCUIT
THAT MAKES POSSIBLE
SAVINGS UP TO 50 %
IN VOLUME LOTS.

IT'S USE permits automated manufacture not possible with conventional designs. Results: Manufacturing savings, plus improved tube uniformity that means more savings in test and alignment—all passed along to the customer.

Available in designs from L to C-band with typical 20% bandwidth, all tubes feature PPM focusing to eliminate bulky solenoids, and are sufficiently light and compact to be ideal for phased-array radar and other multi-socket applications.

Here's data on typical C-band types . . .

Min. Peak Power	Saturation Gain Min.	Max. Duty Cycle	Cooling	Size	Wt.
12 KW	40db	0.028	water	24" x 2.79"	13 lb
5 KW	51db	0.002 0.01	air water	21.5" x 2.79"	13 lb
1 KW	40db	0.01	air	13.25" x 2.38"	6 lb

Inquiries on scaling these parameters will be welcomed at any G-E sales office listed here.

NOW YOU'RE
TALKING MY
LANGUAGE!



ELECTRONICS

PROGRESS IN MICROWAVE TECHNOLOGY

INCLUDING IGNITRONS, HYDROGEN THYRATRONS, MAGNETRONS, METAL-CERAMIC TETRODES, HIGH-POWER DUPLEXERS, HIGH-POWER WAVEGUIDE FILTERS, KLYSTRONS AND THERMIONIC CONVERTERS. FOR INFORMATION ON THESE PRODUCTS, WRITE SECTION 265-26, POWER TUBE DEPT., GENERAL ELECTRIC CO., SCHENECTADY, N. Y. OR TELEPHONE

TODAY: **SCHENECTADY, N. Y.** FRanklin 4-2211 (Ext. 5-3433) • **WASHINGTON, D. C.** EExecutive 3-3600 • **DAYTON, OHIO.** BAlwin 3-7151 • **LOS ANGELES, CALIF.** BRadshaw 2-8566
SYRACUSE, N. Y. 652-5102 • **CHICAGO, ILL.** SPring 7-1600 • **CLIFTON, N. J.** GRegory 2-8100 • **NEW YORK, N. Y.** Wlconsin 7-4065 • **ORLANDO, FLA.** GArden 4-6280

GENERAL ELECTRIC

POWER TUBE DEPARTMENT

265-26

HOW WE SHRUNK TEFLON*

Why Gudebrod's Common Sense Approach to Lacing Problems Pays Dividends for Customers!

Some years ago motor manufacturers had a problem! They required a high temperature lacing tape that would not deteriorate during the baking process of motor manufacture and would be practical in its application.

Teflon offered the most practical solution to the problem since it provides a temperature range from -100°F to 500°F . We took teflon and flat braided it—we originated the process—but what about shrinkage? When teflon is baked it shrinks . . . it would cut thru fine motor wires!

To meet this problem, we developed an exclusive pre-shrunk process for teflon. This patented process pre-shrinks teflon so that the maximum shrinkage is less than 3% after 16 hours at 425°F . We call this lacing tape Pre-Shrunk TEMP-LACE. Motor manufacturers use it in great quantities.

Pre-shrinking teflon is but one of the many processes we have developed to meet the needs of customers. Whatever your lacing needs—nylon, glass, dacron†, fungus proofing, color coding—Gudebrod's common sense approach to the problem will pay dividends for you because

1. Gudebrod lacing tape increases production!
2. Gudebrod lacing tape reduces labor costs!
3. Gudebrod lacing tape means minimal maintenance after installation!
4. Gudebrod is quality—our standards for lacing tape are more exacting than those required for compliance with MIL-T!

Write today for our Technical Products Data Book which explains the many advantages of Gudebrod lacing tape for both civilian and military use.

*Du Pont registered trademark for its TFE-fluorocarbon fiber.

†Du Pont trade name for its polyester fiber.



GUDEBROD BROS. SILK CO., INC.

FOUNDED IN 1870

Electronics Division

12 SOUTH 12th STREET, PHILADELPHIA 7, PENNA.

MEETINGS AHEAD

PRODUCT ENGINEERING & PRODUCTION NATIONAL CONFERENCE, IEEE-PTGPEP; Continental Hotel, Cambridge, Mass., May 27-28.

FREQUENCY CONTROL ANNUAL SYMPOSIUM, U. S. Army Electronics Research and Development Laboratory; Shelbourne Hotel, Atlantic City, N. J., May 27-29.

RADIO FREQUENCY INTERFERENCE NATIONAL SYMPOSIUM, IEEE-PTGRFI; Bellevue Stratford Hotel, Philadelphia, Pa., June 4-5.

ARMED FORCES COMMUNICATIONS & ELECTRONICS ASSOCIATION CONVENTION, AFCEA; Sheraton-Park Hotel, Washington, D. C., June 4-6.

INTERNATIONAL TELECOMMUNICATION UNION, PANEL OF EXPERTS MEETING, IEEE, et al; Geneva, Switzerland, June 4-23.

BIO-ENGINEERING SYMPOSIUM, ISA; Union Oil Co. Bldg., Los Angeles, June 14-16.

JOINT AUTOMATIC CONTROL CONFERENCE, IEEE, ISA, et al; University of Minnesota, Minneapolis, Minn., June 19-21.

X-RAY AND ELECTRON PROBE ANALYSIS SYMPOSIUM, American Society for Testing and Materials; Chalfonte-Haddon Hall, Atlantic City, N. J., June 23-28.

IMPACT OF MICROELECTRONICS CONFERENCE, Armour Research Foundation and ELECTRONICS Magazine; Illinois Institute of Technology, Chicago, Ill., June 26-27.

WESTERN ELECTRONIC SHOW AND CONFERENCE, WEMA, IEEE; Cow Palace, San Francisco, Calif., Aug. 20-23.

ADVANCE REPORT

NATIONAL VACUUM SYMPOSIUM, American Vacuum Society; Statler Hilton Hotel, Boston, Mass., Oct. 16-18. June 15 is the deadline for submitting 100-word abstracts in triplicate to: G. H. Bancroft, Program Committee Chairman, 398 Kilbourn Road, Rochester 18, New York. Subjects of interest include: structure and properties of thin films as related to their conditions of formation by evaporation and sputtering at low pressures; production and measurement of high and ultrahigh vacuum; surface phenomena at low pressures including friction, lubrication, sorption and permeation processes; vacuum techniques related to space simulation, freeze drying and other vacuum processes.

RELIABILITY IN SPACE VEHICLES SEMINAR, IEEE-PTGR & PTGED; Los Angeles, Calif., Dec. 6. July 1 is the deadline for submitting a 500-word summary to: W. H. Bleuss, Jr., Reliability Engineer, c/o Endevco Corp., 801 S. Arroyo Parkway, Pasadena, Calif. Topics of interest encompass areas of system and component reliability with regard to space vehicle operation.

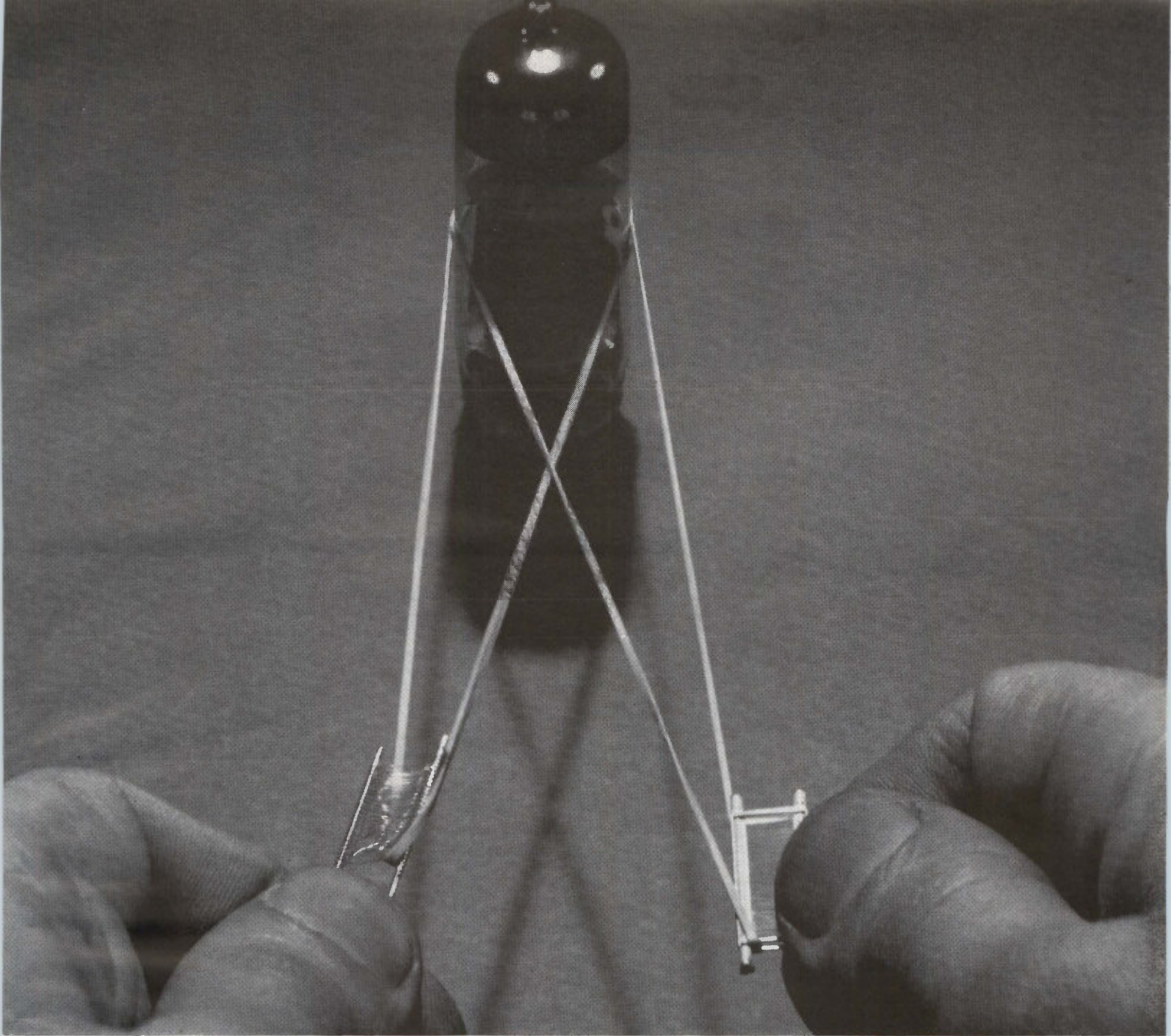

How the strength of Sylvania's Strap Frame Grid improves tube performance

Tube grids in service never get the exact rack torture shown here, but it illustrates a point.

The conventional grid, on the left, depends on its winding for rigidity (which automatically imposes a minimum size limit on the wire). With any rough treatment of the sort encountered in missiles and planes, distances can easily change between the winding and the cathode it surrounds.

By putting metal braces across the back-

bones, the Strap Frame Grid is formed, which is rigid with or without the winding. With no physical support requirement, the wire can be smaller (allowing more turns per inch) and placed a short, precise distance from the cathode—permanently. This closeness greatly improves transconductance, Gm-to-Ib ratio, gain, bandwidth and noise figure. And physical stability translates into electrical stability, even with jarring or environmental changes.

Sylvania was several years ahead of other U. S. tube manufacturers putting Strap Frame Grids in subminiature tubes. And industrial and commercial versions in miniature size have been star performers for even longer.

Another example of how Sylvania advances electronics by introducing—ahead of the field—better-performing, more reliable components. Electronic Tube Division, Sylvania Electric Products Inc., Box 87, Buffalo, New York.

SYLVANIA

SUBSIDIARY OF

GENERAL TELEPHONE & ELECTRONICS



NEW CAPABILITIES IN: ELECTRONIC TUBES • SEMICONDUCTORS • MICROWAVE DEVICES • SPECIAL COMPONENTS • DISPLAY DEVICES

**TRW
Electronics**



PSI

How to design transistorized communications equipment

**MEDIUM POWER
VHF TRANSISTORS**

2N1506A

• 1 watt • 70mc @ 28V • 10db gain

Ideal transistors for application in drivers and final amplifiers of telemetry transmitters to 2W, final amplifiers for mobile radio applications in the 140mc range, and as multipliers from 40 to 200mc.

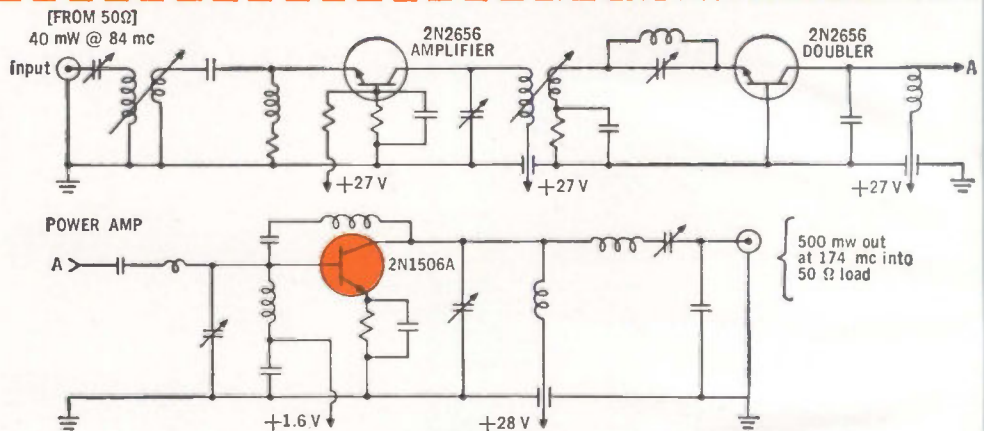

1/2 Watt - 174mc Sonobuoy Circuit

This circuit employs PSI 2N2656 and 2N1506A transistors to achieve high power for Sonobuoy applications. Outputs to 2 watts can be obtained by adding additional stages; the oscillator circuit is at the designer's discretion. This circuit is indicative of the increased design flexibility offered by PSI 2N2656 and 2N1506A silicon RF transistors.

**HIGH POWER
VHF TRANSISTORS**

2N2781

• 5 watts • 30mc @ 28V • 12db gain

Use this series as final amplifiers in communications equipment, 2 to 5W telemetry equipment and mobile radio designs.

CIRCLE 44 ON READER SERVICE CARD

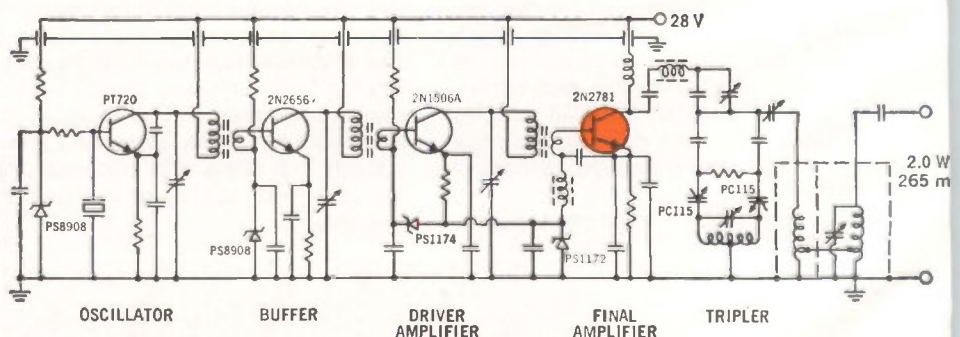

2 Watt - 265mc Telemetry Circuit

Originally designed and engineered at PSI, this circuit applies a PSI PT720 as an oscillator, 2N2656 as a buffer, 2N1506A for the driver stage and a 2N2781 for the final, to deliver a conservative 2 watts at 265mc. This application is one of the first telemetry designs available using low cost, off-the-shelf units instead of state-of-the-art devices.

PSI SERVES THE COMPLETE COMMUNICATIONS SPECTRUM . . . From low-level, low-noise oscillators and amplifiers to advanced high-power, high-frequency devices, PSI has the communications transistor your designs require.

For the past five years, PSI has dedicated the major part of its transistor development and engineering efforts towards optimizing capabilities of silicon transistors in all communications equipment. Today PSI is a leading producer of RF transistors for high reliability space communications equipment in such projects as Mariner, OAO, Ranger, Relay, and Explorer. Realizing that component cost is a major factor in communications equipment design, PSI has had, as an early objective, the pricing of high performance RF devices at levels which will hasten the era of all-transistorized communications systems in many new fields.

Call PSI today to discuss your particular communications equipment design problems. Let PSI application engineering show you how you can design transistorized communications equipment on a vacuum tube budget through lower overall component costs due to lower voltage operation, lack of heater equipment, smaller power supplies, and greater efficiencies.

on a vacuum tube budget!

**HIGH POWER
HF TRANSISTORS**

2N1900

- 100 watts • 10mc @ 60V
- 10db gain

The PSI 2N1900 series is ideal for commercial, marine, and military PRC and VRC designs from 2 to 12mc, as 10 amp switchers in power conversion applications, and amplifiers in VLF transmitters up to 5KW.

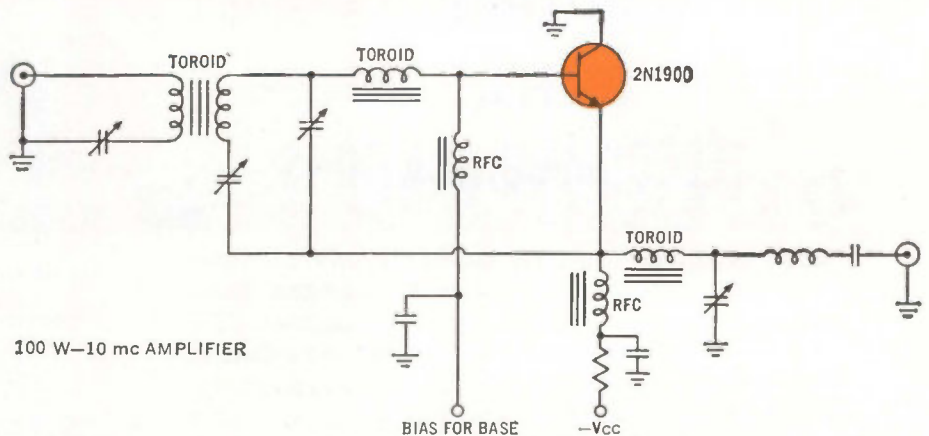

100 W—10 mc AMPLIFIER

100 Watt—10mc Amplifier for PRC, VRC and Marine Radio

This economical design employs optimum heat sinking to provide a substantial reduction in size over 100 watt tube amplifiers. This design employs a PSI 2N1900 in a reliable, cold-welded package to deliver 100 watts out at 10mc with greater than 10db gain.

**LOW POWER/LOW NOISE
UHF TRANSISTORS**

2N2656

- 50mW • 100mc @ 10V
- 10db gain

Apply these low noise figure units to your oscillator designs up to 50mW. These transistors also provide optimum performance in low to medium-level class A and B buffer amplifiers by delivering up to 200mW RF power with over 50% efficiency.



Pacific Semiconductors, Inc.
TRW Electronics

THOMPSON RAMO WOOLDRIDGE INC.

14520 AVIATION BLVD., LAWNSDALE, CALIF. • OS 9-4561, OR 8-0561
TWX: 213 647-5113 • Cable Address: PSISOCAL

CIRCLE 47 ON READER SERVICE CARD

MITSUBISHI MICROWAVE ANTENNAS FOR TELECOMMUNICATIONS



Japan today has the second largest microwave network in the world. Mitsubishi Electric, with the longest microwave antenna experience in Japan, has supplied 90% of the antennas used in the trunk lines of this extensive network. Mitsubishi antenna systems include parabolic, scatter, horn reflector and radar types, as well as a complete line of waveguide components and accessories. Frequencies from 900 Mc. to 24 KMc. are covered. The IU-61, shown above and specified at the right, is typical of the outstanding performance of Mitsubishi microwave antennas. Full technical information on any of these types of antennas is available at your request.

IU-61 6000 Mc. Band Parabolic Antenna

Diameter : 4 meters
 Frequency Range : 5925~6175 Mc/s or 6175~6425M c/s
 Feed System : Dual circularly polarized wave
 Gain : 45 db
 Beam Width : 0.98 degrees (half power)
 First Side Lobe : -23 db
 Wide Angle Radiation : -60 db
 (over 60 degrees)
 Front-to-Back Ratio : 65~70 db
 VSWR : 1.02
 Ellipticity Ratio : 1.1 (power axial ratio)
 Discrimination of anti-circularly polarized wave : -30 db
 Coupling of Both Arms : -35 db
 Guaranteed for
 Wind Velocity of : 60 meters/second
 Weight : 800 kilograms



MITSUBISHI ELECTRIC MANUFACTURING COMPANY

Head Office: Mitsubishi Denki Bldg., Marounouchi, Tokyo Cable Address: MELCO TOKYO

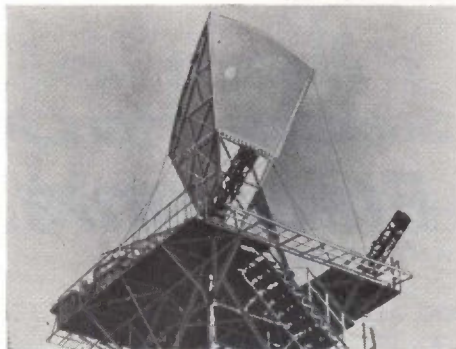

■ Horn reflector antenna



■ Air inflated parabolic antenna

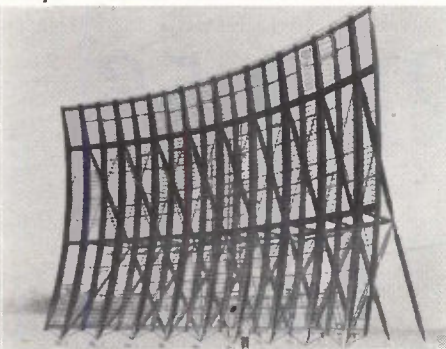

■ 25×16 meter scatter antenna

Quite a package!

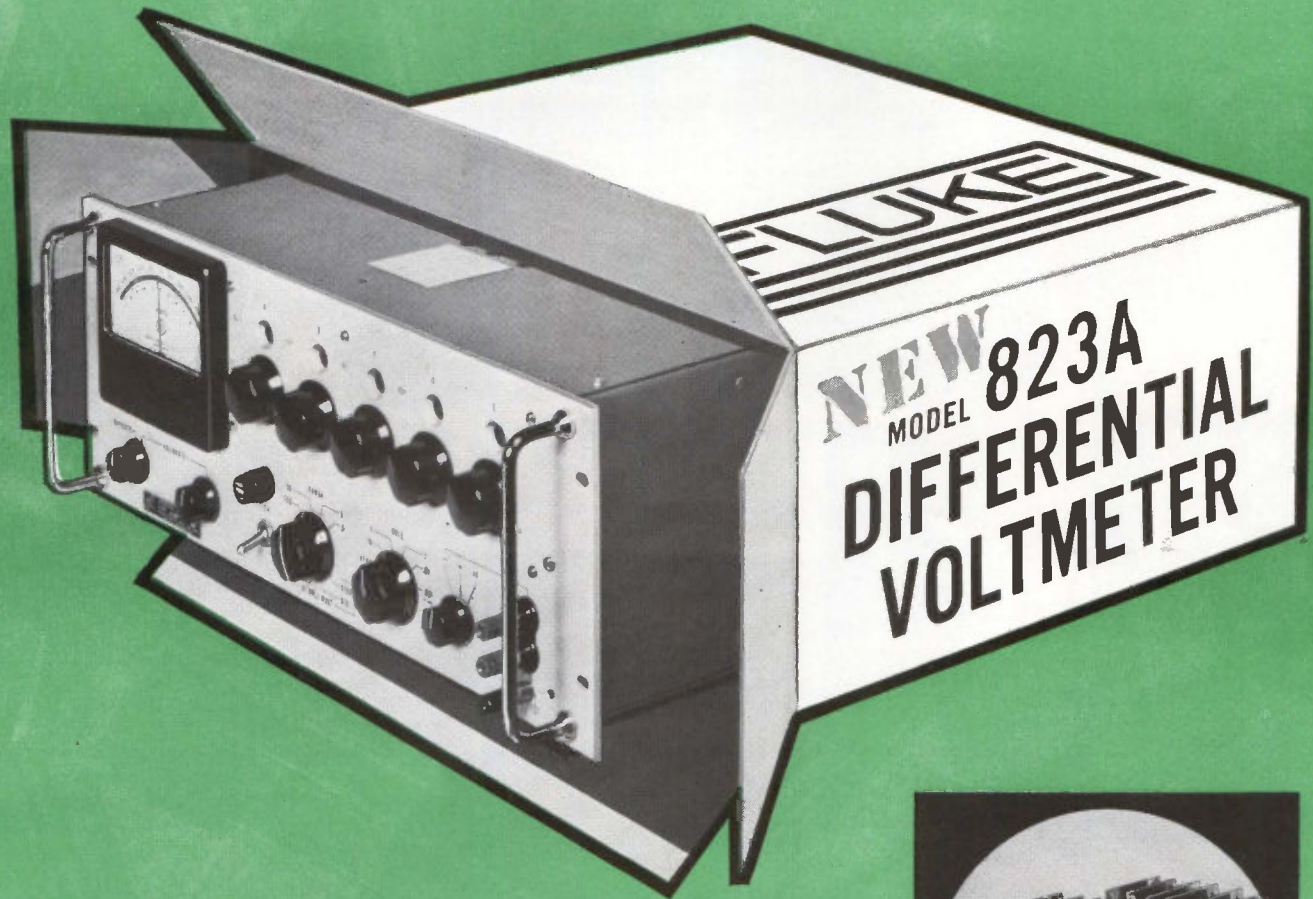

Fluke-manufactured, precision wirewound resistors, aged and matched both for resistance and temperature coefficient, guarantee the long term DC accuracy of the voltmeter to be better than 0.01%. Resistors used in critical portions of the Kelvin-Varley divider have temperature coefficients of less than one part per million per degree Centigrade.



Accuracy of 0.01% DC, 0.1% AC *a uniquely useful measuring instrument*

The new Fluke Model 823A differential voltmeter provides the highest accuracy obtainable in a portable instrument. In addition, it provides infinite DC input resistance at null (0-500V), divider terminal linearity of 2-20 ppm, DC polarity switch, recorder output, and no zero controls.

Model 823A is designed to perform under severe environmental conditions. It is guaranteed to withstand the shock and vibration requirements of Mil-T-945A. It is guaranteed to perform within specifications from 0-80% humidity and from 55° to 95°F. It's quite a package.

Ask your Fluke representative for a demonstration, or request complete data from John Fluke Mfg. Company, Inc., P.O. Box 7428, Seattle 33, Wash. Tel. PR 6-1171; TWX 206-879-1864, TLX 852.



Brief Specifications:

MODEL 823A

DC ACCURACY

± 0.01% from 0.5V to 500V
± (0.01%+10 uv) below 0.5V

AC ACCURACY

± 0.1% from 30 cps to 5 KC
± 0.15% from 20 cps to 10 KC
overall frequency range 5 cps - 100 KC

CALIBRATION

500V internal reference supply calibrated to better than 20 ppm against built-in standard cell

INPUT POWER

115/230V AC ± 10%, 50-400 cps, 80 watts

CABINET RACK

SIZE: 13" high x 9¼" wide x 16" deep 7" high x 19" wide x 15½" deep

WT.: 28 pounds 26 pounds

PRICE: \$1300.00 \$1320.00

MODEL 803D

New Model 803D, available in either rack or cabinet configuration, offers many of the features of Model 823A. Accuracy—AC, 0.1%; DC, 0.02%. Price—cabinet, \$1100.00; rack, \$1120.00.

CIRCLE 49 ON READER SERVICE CARD

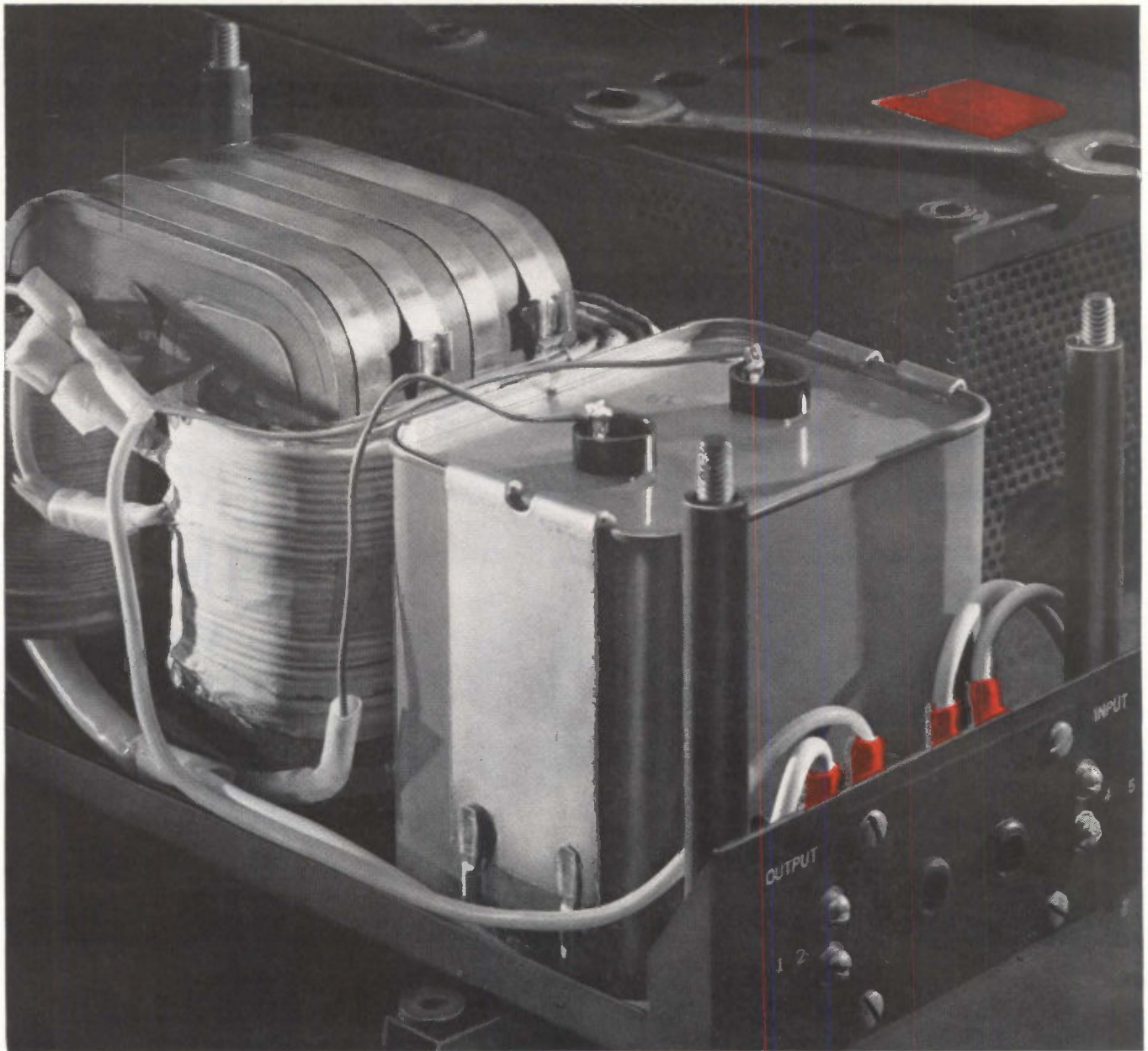

See the wrench?

The wrench is on the black box. It is an ordinary wrench.

The black box is an ordinary box. Commonplace. Everybody has one. That's why we used the wrench. We took the black box off.

Now you can see our new constant voltage transformer. See. It is small ($13\frac{1}{8}'' \times 5\frac{7}{8}'' \times 6''$). It is sturdy (Note construction). It is efficient ($\pm 1\%$ line regulation). It is reliable (we never put the trademark CAPITRON on anything that isn't).

You can't buy a better constant voltage transformer anywhere. It's so good, you'll probably never have to take it out of the black box. That's why you won't get a wrench when you order but you *will* get:

- all solid state components (no moving parts)
- input voltage—95—135 VAC

*Trademark of AMP INCORPORATED

- outpower —1450 VA
- Current limiting to 20 amps under short circuit conditions
- output current—12 amps
- line regulation— $\pm 1\%$ /load regulation— $\pm 2\%$
- input frequency—60 CPS
- output voltage—120 VAC

We'll take the wraps off additional information, test data and other pertinent facts when you send for full details on the CAPITRON* Constant Voltage Transformer. Send today!

AMP | **CAPITRON**
INCORPORATED | **DIVISION**
 155 PARK STREET, ELIZABETHTOWN, PA.

AMP products and engineering assistance are available through subsidiary companies in: Australia • Canada • England • France • Holland • Italy • Japan • Mexico • West Germany



ARTIST'S CONCEPTION shows route taken in transmission of first color facsimile photograph by Relay satellite from Nutley, N. J. to England and return. RCA built the satellite

ON OUR COVER:

First Color Facsimile Transmitted by Satellite

*Successful color transmission opens new field for communication
satellites in world-wide distribution of visual information*

By **JOEL STRASSER**,
Assistant Editor

FIRST FULL-COLOR facsimile photograph to be successfully sent by satellite was transmitted by **ELECTRONICS** magazine on April 25 to the Goonhilly Downs station in England using NASA's Relay satellite (**ELECTRONICS**, Oct. 5, 1962, p 46). The color separations from which the plates for the front cover of this issue of the magazine were made constitute the first set suc-

cessfully received. This experiment lays the groundwork for possible regular color photo transmission by satellite.

Transmission of the first set of color separations was accomplished on satellite pass 1035 between 4:40 and 5:09 p.m. EST, when the photos, showing an enhanced micro-module designed by the U. S. Army Electronic Research and Development Laboratory at Fort Monmouth, N. J., were sent from the facilities of RCA Communications, Inc. in New York to the Relay satel-

lite, and received at the Fleet Building in London through the Goonhilly Downs station. Domestically, ground lines carried the signals from RCA Communications through American Cable and Radio's patch to the satellite communications station on the grounds of ITT Federal Laboratories at Nutley, N. J.

At the same time, black and white 10-sec photographs of the experiment in progress were taken and placed on the facsimile drum for transmission to Europe. Five days later, the pictures were retransmit-



ACTUAL COLOR SEPARATIONS received from the Relay satellite transmission. Photo mislabeled "yellow" was really printed in red.

ted by satellite from England and successfully received in the United States.

The experiment was devised to test the feasibility of using a communications satellite with limited

usable time. As far as possible, the experiments were conducted with existing equipment using internationally acceptable specifications. Out of these experiments has developed a number of criteria for transmitting color separations by satellite.

METHODS—Of the two major methods for transmitting a color photograph by satellite—color television or facsimile—the latter was selected because color television involves costly equipment that effectively limits the number of prospective users. To reproduce a tv image on the printed page, photographs have to be taken of the tv screen and color separations made. (Color television broadcast transmission by satellite has been accomplished previously.)

For facsimile transmission, color separations were made in the conventional manner from a color transparency of the subject. In general, this is accomplished by rephotographing the picture using complementary filters for the color separation desired. To obtain a black separation, a yellow filter is used; for blue, a red filter; for red, a green filter and for yellow, a blue filter. The results are prints emphasizing only the color for which the separations have been made. For example, the red separation shows as darkest those parts that are to be predominantly red in the finished photograph. (Our cover uses three separations: black, blue and red.)

If more than 24 minutes of satellite time had been available, we

would have employed a "serial" transmission method, consisting of sending each of the three 8 × 10-inch separation prints through in sequence. The three separations could have been sent in "parallel," but this would have required three separate channels both on the ground and in space. As a compromise a "simultaneous" method of transmission was developed.

The photographs were reduced in size and reproduced vertically on one 8 × 10-inch glossy print. With this technique, maximum time conservation was achieved at some sacrifice of resolution. The 10-inch dimension was filled to capacity, while only 3 inches of the 8-inch width were utilized. The scanning rate was 100 lines per inch; thus, at 60 rpm the entire set of three separations was scanned simultaneously and transmitted in 5 minutes. Although during the 24 minutes allotted to the experiment on each satellite pass, four composite sets of separations could have been scanned, we actually scanned the one composite set twice and used the remainder of the pass to send the two black-and-white 10-sec photos of the experiment.

STANDARDS—The most popular and internationally acceptable standard for facsimile requires an index of cooperation of 352 and a speed of 60 rpm. The index is the product of the diameter of the cylinder (3.52 inches or 88 mm) and the scanning density in lines per inch (100), or the cylinder diameter divided by the line advance. These specifications have been pub-

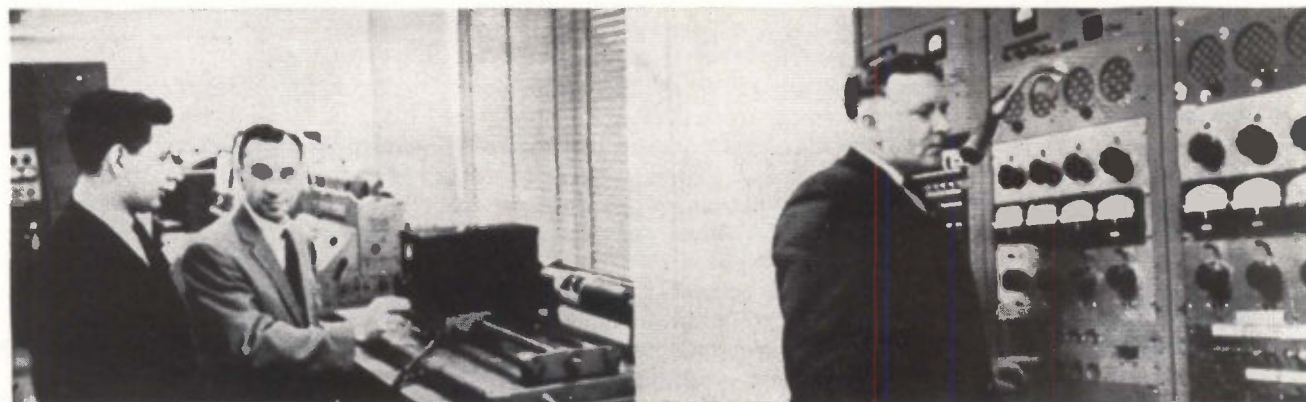

EXPERIMENT IN PROGRESS. In photo at left, author (left), and Ben DeMeo, RCA Communications technician, discuss the transmission as the first photos rotate on the facsimile transmitter. Facility Supervisor Joseph K. Unger, in photo at right, is in voice contact with London as the transmission begins. These 10-second photos were transmitted during the latter part of the satellite pass

TABLE I—Transmission Requirements for 8 × 10-In. Photos
(Based on International Std: index 352, speed 60 rpm)

Transmission Method	2 Colors	3 Colors	4 Colors
SIMULTANEOUS Vertical mounting to 10-in. max.	See note a, 1 channel	See note a, 1 channel	See note a, 1 channel
SERIAL Scan 8-in. width	26.6 minutes plus 2 min. adjustment time, ^b 1 channel	39.9 minutes plus 4 min. adjustment time, ^b 1 channel	53.2 minutes plus 6 min. adjustment time, ^b 1 channel
PARALLEL Scan 8-in. width	13.3 minutes, 2 channels ^c	13.3 minutes, 3 channels ^c	13.3 minutes, 4 channels ^c

^a Given width of pictures, *W* (inches);

$$t \text{ (transmission time, minutes)} = W \times \frac{100 \text{ lines}}{\text{in.}} \div 60 \text{ rpm}$$

^b Allowing 2 minutes adjustment time between pictures for changing photos on drum and transmitting phasing pulse

^c Requires additional facsimile machines and leased ground lines to transmitter

lished by the International Consultative Committee on Telegraphy and Telephony (CCITT). The transmission requirements for the various methods, including the times and numbers of channels, using this standard are summarized in Table I. Transmission speeds and other specifications for several facsimile methods are summarized in Table II. Using this table, transmission requirements, similar to those in Table I can be computed. Some time should be allowed to adjust the f-m limits at the beginning of the transmission, to change pictures on the drum and to transmit a phasing pulse for each separation. The last two operations require about two minutes between photographs.

The experiment was provided with backups to guard against failure. The photos were retransmitted by Atlantic cable to New York, and prints received in London were sent to *ELECTRONICS* by mail. At the same time, the signals were recorded on magnetic tape on a specially designed facsimile tape recorder acquired by the British for this occasion.

On pass 1073, on April 30 between 2:41 and 2:57 p.m. EDT, the tape recorded signals were successfully retransmitted from England by Relay satellite through Nutley, N. J. to RCA Communications in New York. The front cover photo however, was made from the separations returned by Atlantic

cable to meet production schedules.

As a backup at the Nutley station, a modified Ampex FR-100B seven-track facsimile tape recorder was used. One channel carries a corrective frequency tone to monitor the speed. Three channels are used for f-m recording and the remaining three are used for direct recording from 20 cps to 50 Kc.

Output of the transmitter at the Nutley station is 10 Kw. A Cassegrainian antenna feed system is used with a 40-ft parabolic dish to pick up the signal. Transmitting frequency is 1,723.33 Mc. Dual-channel f-m receivers capable of receiving signals at 4,165 and 4,175 Mc are used at the station.

The facsimile transmitter at RCA Communications in New York is an RCA-built machine with an 88-mm diameter cylinder. A Westrex machine was on hand as a backup. The machines use a speed of 60 rpm and an index of cooperation of 352. The facsimile signals are originally a-m and are converted to f-m from 1,500 to 2,300 cps. White is transmitted at the 1,500-cps frequency; black at the higher frequency.

Transmitting frequency of the Goonhilly Downs station in Southwestern Cornwall, England is

GOONHILLY DOWNS station in England uses an 85-ft steerable parabolic antenna

TABLE II—Typical Facsimile Specifications
(With time requirements for 8-inch scans)

Method	Index of Cooperation	Scanning Density (lines/in.)	Speed (rpm)	Time Per 8-Inch Scan (minutes)
CCITT International Standard	352	100	60	13.3
CCITT International Standard	352	100	120	6.7
Alternate CCITT International Standard	264	96	90	8.5
Associated Press	382	100	100	8
United Press International	440	150	120	10
CCITT—Weather Fax Standard	576	96	120	6.4

1,726.67 Mc. The station has an 85-ft steerable parabolic antenna and a maser amplifier.

ELECTRONICS gratefully acknowledges the assistance and cooperation of NASA Headquarters, Washington, D. C., Goddard Space Flight Center, Greenbelt, Md., RCA Communications, Inc., Radio Corp. of America, International Telephone and Telegraph Corp. and American Cable and Radio Corp.



GETTING BOTH RELIABILITY AND ECONOMY IN

Power-Transistor Circuits

Well-designed germanium power transistors are highly reliable even in high-temperature circuits. Failures at elevated temperatures can be reduced when the basic and inherent properties of germanium are known and circuits designed to take advantage of this performance

By RALPH GREENBURG, Section Manager Power Supply Operations, Motorola Inc., Phoenix, Arizona

POWER transistors are being made of either germanium or silicon semiconductor material. Germanium devices have maximum temperature ratings around 125 C and silicon transistors can operate at temperatures as high as 200 C.

The difference in temperature ratings tempts reliability-conscious circuit designers to specify silicon transistors for equipment where, with proper design, germanium is more than adequate to meet the requirements. This causes unwarranted increases in equipment cost.

Well-designed germanium power transistors are highly reliable even in high-temperature applications. Device failures and improper circuit performance at elevated temperatures are normally due to circuit designs that neglect to consider the inherent properties of germanium. The following discussion provides reliability data, based on more than 21,000,000 device hours of life test information for germanium transistors, and describes circuit design areas that influence high-temperature performance.

GERMANIUM RELIABILITY — There are three factors influencing germanium power transistors reliability; surface condition of the germanium, temperature of the collector-base junction, and secondary breakdown of the collector.

Of these, only the last two items are under control of the circuit engineer, but a brief description of

failures that can be caused by improper manufacturing controls and processes will help provide an insight for possible failure analysis.

Instability in germanium power transistors can be caused by contamination of the semiconductor surface during the manufacturing process. This may be due to exposure of the surface to oxidations in soldering and alloying furnaces. To reconstitute the surface, a cleaning process is normally employed just before encapsulation of the device. This usually consists of an etching, washing and drying cycle, followed immediately by encapsulation. When such a process is correctly carried out, neither storage nor operating temperatures have any pronounced effect on the transistor surface, and excellent stability is obtained.

Final assembly and encapsulation of power transistors is normally achieved by soldering the transistor junction assembly to a copper base having the lowest possible thermal resistance and enclosing this assembly in an air tight housing. In a single-ended package, as shown in Fig. 1, the base and emitter leads are inserted and solder-sealed through openings in the package and the structure is capped with a shell both to prevent mechanical damage to the semiconductor device and to guard against the entrance of contaminating gas or moisture.

Either hot-weld or cold-weld processes can be used for sealing

the shell to the copper base. The assembly in Fig. 1A depicts hot-weld encapsulation while that of Fig. 1B illustrates the simpler cold-weld technique. Here, the copper cap is attached to the copper base under high pressure so that the cap and base fuse to become a single piece of metal. All measurements were made on cold-weld-sealed devices.

To neutralize any ambient gas or moisture trapped inside the sealed cap, absorbent materials known as desiccants, molecular sieves or getters are placed inside the device prior to encapsulation.² This keeps the internal moisture in equilibrium, thereby causing surface recombination of charges to be almost independent of temperature and age.

Faulty hermetic seals between cap and base can result in a relatively high transistor failure rate. Even a small leak can admit enough external gas to cause a device to breathe when exposed to alternately hot and cold temperatures in a humid environment. This results in the deposition of water vapor on the semiconductor surface which, if beyond the control capability of the desiccant, can cause variations in transistor characteristics.

The reliability of properly constructed transistors, however, is virtually unaffected by temperature—at least, until the temperature reaches a point near the melting threshold of indium (about 150 C). Verification for this contention

GERMANIUM OR SILICON?

When given a choice, most electronics engineers will specify silicon transistors in a circuit involving high temperatures. The usual thinking is—well, silicon takes the temperature better. After an analysis based on 21,000,000 device hours, Motorola has arrived at some answers that may change a lot of present thinking about the silicon-germanium problem

is shown in Fig. 2A and 2B where the results of a quality-control program are plotted. Both of these graphs show the low failure rate (although it does increase slightly) up to temperatures near the melting point of indium, after which failures increase drastically as the liquefied indium causes open and short circuits within the device.

The electrical characteristics of transistors vary with temperature. Reverse leakage current, for example, increases as temperature rises and current gain varies to some extent as temperature is varied. Reliable transistor circuit performance under widely varying temperature conditions, therefore, demands the utilization of worst-case-design procedures in which maximum and minimum characteristics are taken into consideration at the highest and lowest temperatures to be encountered. With such procedures, the design engineer can expect highly-reliable performance even at temperatures that were once considered to be destructive to germanium alloy devices.

DESIGN FOR CIRCUIT RELIABILITY — Though temperature alone is no deterrent to reliability, other factors may inadvertently raise the temperature of the semiconductor device beyond the maximum limit to cause device damage and improper circuit performance. In a study of device and circuit failures it was found that such

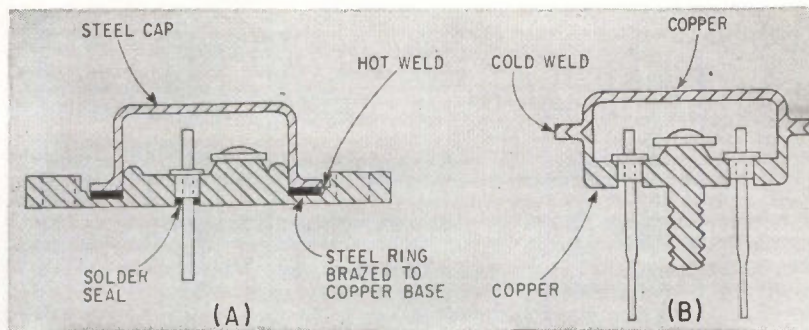

ENCAPSULATION of a power transistor can be in the hot-weld diamond package (A) or the cold-weld doorknob package (B)—Fig. 1

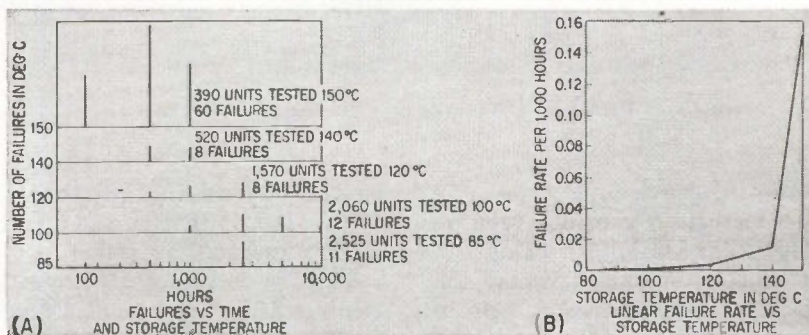

FAILURES plotted against time and storage temperatures (A) and linear failure rate plotted against storage temperature (B)—Fig. 2

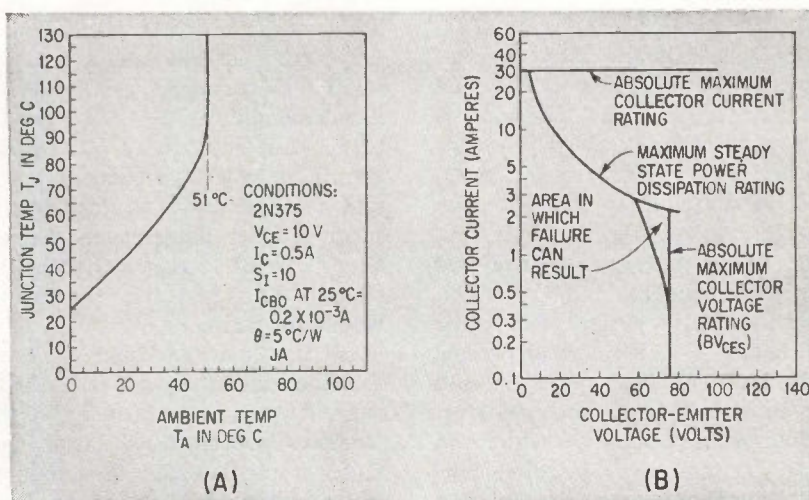

TYPICAL conditions for thermal runaway (A) maximum limits for a 2N2158 transistor (B)—Fig. 3

failures were due principally to application of over-voltage to the transistor and to thermal runaway.

THERMAL RUNAWAY — The phenomenon of thermal runaway has been thoroughly covered in the literature.² It is the result of the temperature effects on collector leakage current I_{co} . Since I_{co} increases with temperature, any increase in junction temperature at a given value of collector current will cause a corresponding increase in collector power dissipation. This

in turn causes a further increase in temperature and an additional increase in I_{co} . If the heat sink is not capable of dissipating the heat fast enough, that is, if no equilibrium between heat generation and heat radiation is reached, thermal runaway will occur. This can result not only in improper circuit performance, but in permanent transistor damage.

The precautions for preventing thermal runaway are generally known, but not always practiced and a typical condition for thermal

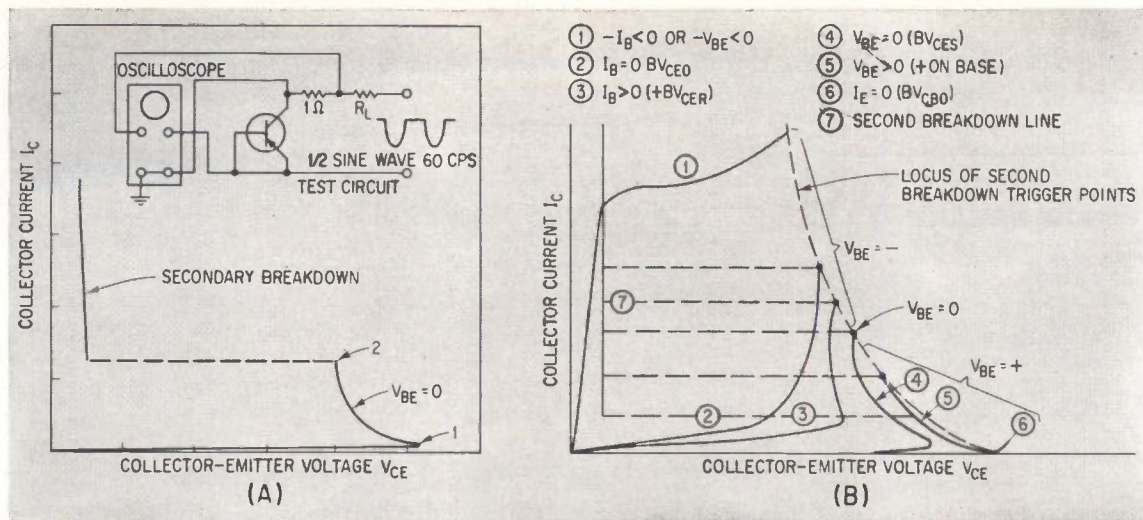

SECOND BREAKDOWN and test circuit (A) with locus of second breakdown trigger points (B)—Fig. 4

runaway is shown in Fig. 3A.

The methods commonly used to achieve bias stability, using an emitter resistor and keeping the base-return resistance low, help to prevent thermal runaway. However, current stability factor S_I is only one of four factors which multiply together to form a thermal stability criteria. Germanium transistors will not go into thermal runaway at or below 110 C if $\theta_{JA} S_I I_{CBO} V_{CE} < 16.5C$ where θ_{JA} is junction-to-ambient thermal resistance expressed in degrees C/watt, S_I is circuit current stability factor ($S_I = \Delta I / \Delta I_{CBO}$), I_{CBO} is the collector cutoff current at the hot junction in amperes and V_{CE} is collector to emitter potential in volts.

Although V_{CE} is generally fixed by design conditions and I_{CBO} is an inherent property of the transistor, there are still two factors which the circuit designer can control to prevent thermal runaway. The stability criteria can be checked to a good approximation from $S_I = 1 / [(R_E / R_B) + (1/h_{FE})]$ where R_E is external emitter resistance, R_B is external equivalent base resistance and h_{FE} is common-emitter d-c current gain.

One way of reducing the chances of thermal runaway is to minimize this expression by making R_E / R_B as large as possible. This can cause a sacrifice in efficiency and performance of many circuits.

The second method involves a reduction of thermal resistance by increasing the heat sink area, causing air flow, etc., but the benefits of this procedure are limited

by the internal thermal resistance of the device; that is, the junction-to-case thermal resistance.

Usually, S_I values of 5 to 10 are easily achieved and θ_{JA} of 4 degrees C/W is readily obtainable with almost any power transistor and a finned heat sink. Thus, a product ($S_I \times \theta_{JA}$) of 20 to 40 is common practice. This means that the $I_{CBO} V_{CE}$ product cannot exceed about 0.4 watt without causing thermal runaway. For example, an $S_I \times \theta_{JA}$ product of 40, coupled with an I_{CBO} value of 20 ma at 100 C (a common value) and a V_{CE} of 20 v would bring the total product dangerously close to the thermal runaway point, although at 12 volts, the system would be stable.

If the mathematical threshold for thermal runaway is exceeded, several solutions to reduce the problem are practical. A larger heat sink or air flow can be considered to lower θ_{JA} and the use of the thermistors or larger emitter resistors to lower S_I may be practical. In certain cases, both methods may prove necessary, and in extreme instances, paralleling of systems may be required.

SAFE AREA OPERATION — Probably the major reason for damaged germanium power transistors or unreliable circuit performance results from a misinterpretation of data-sheet specifications by the engineer, and in some cases, insufficient data-sheet information from the transistor manufacturer. Paradoxically, unless the maximum ratings given on the conventional

data sheet are tempered with a familiarity of device characteristics, one design can cause unreliable performance while in another results in overdesign and decreased circuit efficiency.

As an example, the maximum limits of a 2N2158 power transistor are plotted in Fig. 3B. The maximum-power-dissipation curve has been so drawn that the maximum rated power dissipation of 170 watts is never exceeded for any voltage-current product. This represents a steady-state power dissipation limit which, if the transistor case can be held to a temperature of 25 C (infinite heat sink), will result in reliable circuit performance.

On the same graph, specified limits for maximum collector-emitter voltage (V_{CE}) and collector current (I_C) are indicated. The implication is that if either the maximum-power curve or the maximum voltage or current limits are exceeded, damage to the transistor will result.

What most data sheets fail to make clear is that the maximum voltage specification applies primarily to low collector-current applications on the assumption that high collector current and high voltage do not exist simultaneously. While this assumption is normally true for resistive loads, it does not apply to complex and reactive loads. As a result, the design of circuits using the specified high-voltage limit can lead to improper circuit performance and in some instances to device damage.

The reason for this is second breakdown, which is illustrated in Fig. 4A. Here, the collector current of a typical power transistor is plotted as a function of collector-emitter voltage, with the base externally shorted to the emitter. Under this condition, an increase in applied voltage causes only a slight increase in I_c until the V_{ce} reaches point 1 where the collector junction begins to break down giving rise to an avalanche condition. Any increase in applied voltage beyond point 1 actually reduces V_{ce} and the difference between the applied voltage and V_{ce} will appear across the external load resistor.

At point 2 of the graph, at a specific value of collector current, a second breakdown occurs causing V_{ce} to switch back to a very-low value. This phenomenon is accompanied by an instantaneous rise in current, sufficient to melt the transistor base and causing permanent damage to the transistor.

Normally, the maximum voltage rating of a transistor is specified at an amount of collector current that restricts the operation to the area between points 1 and 2 of the curve. Thus, at higher collector currents, circuit malfunctioning and device damage can result. More important is the effect of base current on the first and second breakdown points.

The curve of Fig. 4A applies for only the shorted-base condition. Under more normal conditions where forward bias is applied to the base-emitter junction and collector current increased, the primary and secondary breakdown points both shift to the left as shown in Fig. 4B. Thus, the maximum collector voltage that may be safely applied to a transistor is a function of circuit conditions and collector current. Second breakdown can be triggered in many transistors at a current value substantially below that value which gives rise to the calculated maximum power dissipation rating of the device at the maximum rated V_{ce} . To avoid second breakdown, it may be necessary to restrict V_{ce} to a lower-than-specified value at higher currents.

Determination of the characteristics that avoid the second breakdown point under any condition for a particular series of transistors can be accomplished only through extensive testing of a large number of devices. It is the responsibility of the semiconductor manufacturer to provide safe-area data that eliminates the inadvertent design errors that can lead to device failures. In the absence of such data, analysis of a circuit that appears to damage transistors for no apparent reason may reveal operation too close to the second breakdown region.

While tests did confirm the dependence of maximum excursion on pulse width, no correlation was found as to duty cycle for pulse widths less than 5 milliseconds. In fact, the destructive testing of large quantities of power transistors revealed that for a given pulse width (100 μ s) there was no apparent change in the failure zone for duty-cycle variations ranging from 50-1 to 10-1. For pulse widths larger than 5 milliseconds, duty cycle will affect junction temperature through thermal time constant effects. This leads to the conclusion that the safe operating areas for pulse applications cannot be calculated from a maximum power dissipation curve, but must be obtained through actual destructive tests on a large enough sampling of devices to yield usable results. The results of a representative test of this nature are shown in Fig. 5, coupled with the worst-case failure loci for pulse widths from 25 μ s to 5 ms for 2N2158 transistors.

Tests such as these have been made on Motorola's entire line of germanium power transistors and the results are being incorporated in data sheets (with an added safety factor) to characterize safe-area operation for both steady-state and pulse circuit applications.

CONCLUSION — Of the power transistor failures that have been brought to the attention of the applications engineering department, the majority by far were caused by over-voltage applications because safe operating areas were either ignored or not clearly defined. The second most frequently encountered cause was improperly designed bias circuits, resulting in thermal runaway. Thus, the final achievement of high-reliability circuits involving well-built germanium power transistors lies in improved circuit design based on more completely specified device characteristics provided by transistor manufacturers. The publication of safe-area curves for both steady-state and pulse conditions on data sheets is a major step in this direction.

OPTIMIZING EFFICIENCY — While reliance on the maximum power dissipation curve can cause power transistor failures under certain conditions, it can lead to inefficient circuit operation under other circumstances. In pulse circuits it is permissible to exceed the maximum power curve, often by a considerable margin, provided that the excursions into the excess power region have relatively short duration.

Although it could be assumed intuitively that the maximum power dissipation curve could be exceeded for pulse applications, since this curve represents a steady-state condition, such intuition would lead to the conclusion that both pulse width and duty cycle would influence the maximum excursion. This, according to extensive tests, is not necessarily true.

REFERENCES

- (1) Gnaedinger, Flaschen, Hall and Richey, Selection of Germanium Transistor Parameters by Control of Moisture, Journ Electrochemical Soc, 109, 7, July 1962.
- (2) Motorola Power Transistor Handbook.

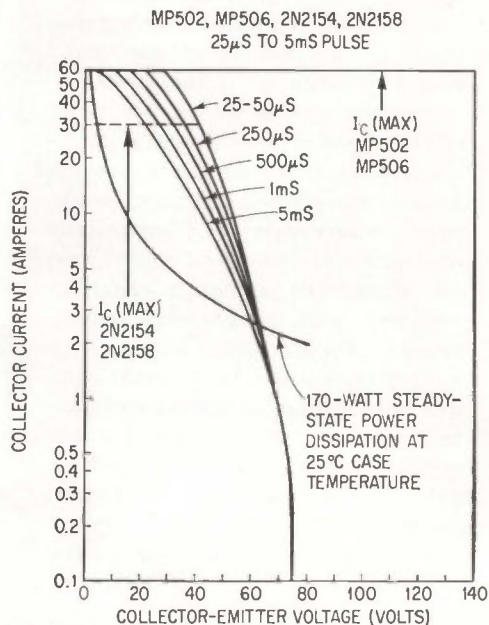

WORST-CASE failure loci for pulse operation of a series of typical power transistors—Fig. 5

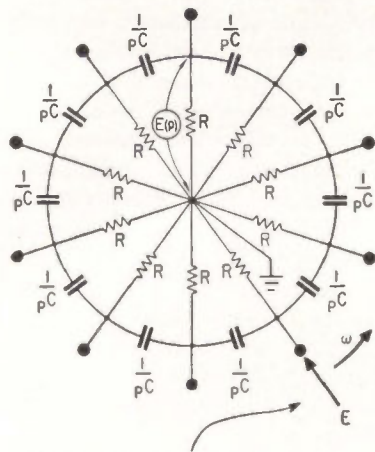

ROTATING CONTACT CONNECTS SUCCESSIVE R-C STAGES TO THE SUPPLY IN MECHANICAL ANALOG OF RING COUNTER

(A)

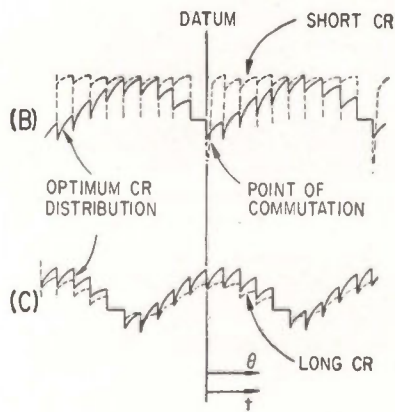

(D)

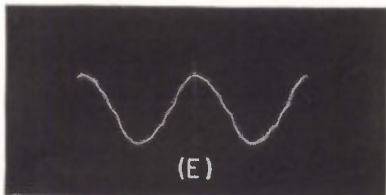

(E)

MECHANICAL switching systems represent ring counter laid out in circular form (A), waveforms across diametrically opposite contacts (B) and (C) show effect of different time constant on harmonic content of waveform. Oscilloscope (D) shows waveform appearing at one contact of ten-stage ring; approximately sinusoidal waveform is derived from two diametrically opposite contacts on ring (E)—Fig. 1

Basic principles of the static alternator differ fundamentally from the more familiar static inverter. Advantages of the new technique include sinusoidal output without filtering and a simple technique for generating polyphase power

By ROBERT H. MURPHY

Chief Engineer, Transatron Electronic Limited, Uxbridge, England

Developing True

THE CONVENTIONAL METHOD of converting d-c into sinusoidal 3-phase a-c involves three separate parallel inverter circuits accurately triggered to give the correct 120 degree phase shift. Apart from the problem of introducing correct relative time delays to the trigger pulses, the parallel inverters have to be followed by complex high-level filters to minimize the harmonic content of the output waveforms. In addition to insertion losses, the filters modify the load presented to the inverters and can introduce severe operating problems, particularly when wide variations of load are encountered.

A new technique of using counters in ring-counting circuits for polyphase sine-wave synthesis overcomes many of these problems. The system is based on an electronic analog of the conventional rotary alternator in which the current-inducing magnetic field is sequentially switched rather than mechanically rotated. Any rotary sequential switch, electronic or mechanical, can produce, across diametrically opposite contacts, polyphase repetitive waveforms that closely approximate the sinusoidal.

THEORY OF OPERATION—The circuit associated with the switch requires the special network geom-

etry illustrated in Fig. 1A. This can be viewed as a ring of RC differentiating networks on which the point of step function excitation is moved progressively around at a constant switching speed. The effect of varying the component values R or C in Fig. 1A is illustrated by Figs. 1B and 1C, which show that there is an optimum time constant (CR) which causes the waveform on one contact to just reach the supply voltage E by the time its diametrically opposite number has come to the end of its excitation period or point of commutation.

Conversely, for any given value of CR there is an optimum triggering frequency f_T which causes the kind of waveforms described to appear on any pair of diametrically opposite contacts in the ring. These waveforms are periodic (period T_0) and are most conveniently represented in polar form, Fig. 2, with datum chosen at the point-of-commutation of one of the pair of contacts under consideration and the time axis expressed in terms of the polar coordinate angle θ . Hence, these polar diagrams correspond to one revolution of the count at the optimum frequency (f_0) given by

$$f_0 = 1/T_0 = f_T/N \quad (1)$$

where N = number of contacts in ring, or $T_0 = Nt_T$ (2)

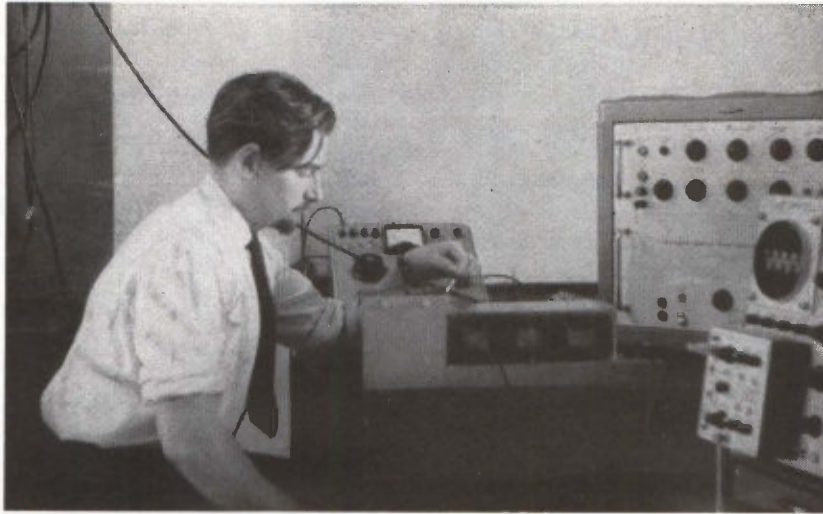

AUTHOR observes static alternator output on oscilloscope while making circuit adjustments

Solid-State Static Alternators

where t_r is the optimum trigger period.

It may be shown that the boundaries of these optimum distributions closely approximate $E \cos^2 \theta/2$ and $E(\cos^2 \theta/2 + K)$ for Fig. 1B, and $E \sin^2 \theta/2$ and $E(\sin^2 \theta/2 + K)$ for Fig. 1C. The constant K represents the abrupt voltage transition (expressed as a fraction of E) when the count moves from one stage to the next.

All steps are equal because of the continuous coupling between stages, and in fact K depends only on the number of stages in the ring.

From the following identities

$$E \cos^2 \theta/2 - E \sin^2 \theta/2 = E \cos \theta \quad (3)$$

$$E(\cos^2 \theta/2 + K) - E(\sin^2 \theta/2 + K) = E \cos \theta \quad (4)$$

the algebraic sum of the voltages across diametrically opposite contacts conveniently cancels the abrupt transitions, yielding a quasi-sinusoidal waveform of half-cycle peak magnitude E and frequency f_o .

However the polar diagrams of Fig. 2 not only represent the time variation of voltage during one cycle on a pair of opposite contacts, but also sets of voltage-variations-with-time during one triggering period, on sets of diametrically opposite contacts. Hence the argument also describes the production of $N/2$ sinusoidal waveforms

having relative phase relationships determined solely by the geometrical relationship of the pairs of opposed stages, that is, the sinusoids are distributed at phase angles of $360 \div N/2$ to each other and represent a set of $N/2$ phases. Here the analogy with the mechanical alternator is apparent since the phase relationship in the switched mechanism depends on a network geometry analogous to the spacial geometry in the rotating machine.

Although the abrupt transitions in the individual contact waveforms are cancelled by taking the output from diametrically opposed stages, the relative magnitude, K , of these steps is extremely important, both in the analysis to determine the optimum circuit parameters, and because of its relationship to distortion in the output sine-waves. Figure 3 shows the effect of number of stages on output waveforms.

THIS ALTERNATOR DOESN'T MOVE

Conventional single-phase static inverters are rugged and efficient even if they do get into trouble when delivering sinusoidal output and operating over a wide load range. Three phase static inverters can become a major headache—their design often becomes complex enough to make it debatable whether they offer any improvement over rotary converters or motor generators. Need variable frequency plus reasonable power and the solid state project grinds to a halt. However the static alternator technique offers a solution—its near-sinusoidal output needs no elaborate filtering, and polyphase output comes without elaborately phased triggers for controlling individual phases

SCR RING COUNTERS—The network geometry is ideally suited to scr's as the switching elements since unidirectional current is involved and the capacitors can be used for commutation. In fact the circuit was developed from an scr ring counter switching numerical indicator unit: it was realized that circuits of this kind could switch currents of 20 amp. or more

at frequencies in the kilocycle region and thus cover the power and frequency range desirable for static inverters.

If the transformer primaries in Fig. 4A are replaced by purely resistive loads the result is a 6-stage scr ring counter. The principle of operation, applicable to any number of stages, is as follows. Assume that one stage is conducting. In the absence of a trigger pulse the reverse voltage across the succeeding diode will be equal to the forward conducting voltage of the scr (about 1-2v). Further, since all other stages are off, the remaining diodes will be reverse biased to a much greater extent (of order E_v volts). A positive trigger pulse, as shown in Fig. 4A, will thus bias only this one diode into conduction and will trigger the succeeding scr through the coupling capacitor. The commutating capacitor will then switch the originally conducting stage off.

An interesting and useful feature of the circuit is that assuming identical scr's in all stages, the upper frequency limit increases with the number of stages since each commutating capacitor may then take longer to recharge after performing its commutating function before its operation is required again. This is responsible for the

vastly increased frequency range of a multistage counter over that of a simple scr bistable circuit. For example, a 50-Kc count-rate for a decade counter as opposed to 10-Kc for the bistable assuming identical low current switches. There is, of course, no lower frequency limit because the almost perfect switching quality of the scr allows it to remain in either of its two stable states indefinitely.

ALTERNATOR PROTOTYPE —

The design of the prototype static alternator was based on an scr ring counter with output produced across any two diametrically opposite resistive loads. During development it was convenient to consider only balanced resistive loads reflected through an ideal polyphase output transformer or group of ideal single phase transformers with center tapped primaries, Fig. 4B.

An analysis for the optimum value of C and R in the resistive load ring counter yields

$$1/CR = 4f_0 \quad (5)$$

Replacing the resistive loads with loads reflected by the output transformer makes it necessary to evaluate the equivalent value of CR for given secondary load resistors (R_L) and commutating capacitors (C_c).

The values of both components are modified by transformer action. In addition, graphical analysis to obtain the half-cycle peak value of the synthesized primary waveform showed that this was not of the expected magnitude ($2E$) that would be obtained by the doubling action of a center tapped primary. In fact, the relationships for all three parameters were found to be

$$C = 4C_c \quad (6)$$

$$R = R_L/n^2 \quad (7)$$

(transformer ratio 1 + 1 : n)

The rms primary voltage becomes

$$1.5E/1.41 \approx E \quad (8)$$

Equation 8 conveniently allows the use of standard $E : E_{ph}$ transformers (E_{ph} being the desired output voltage per phase.) In the prototype the approximation expressed in Eq. 8 was almost completely eliminated by losses incurred by the inherent forward voltage drop of the scr's when conducting.

The prototype illustrated in Fig. 4, together with its oscillogram, was designed for inversion from 30 v d-c to 240 v, 60 w, per phase at 400 cycles a-c, corresponding to a triggering frequency of 2.4 Kc. It employed three standard 240-v, 50-cycle, 75-wa transformers with center tapped 30 v primary windings. A production model using a specifically designed 400-cycle, 3-

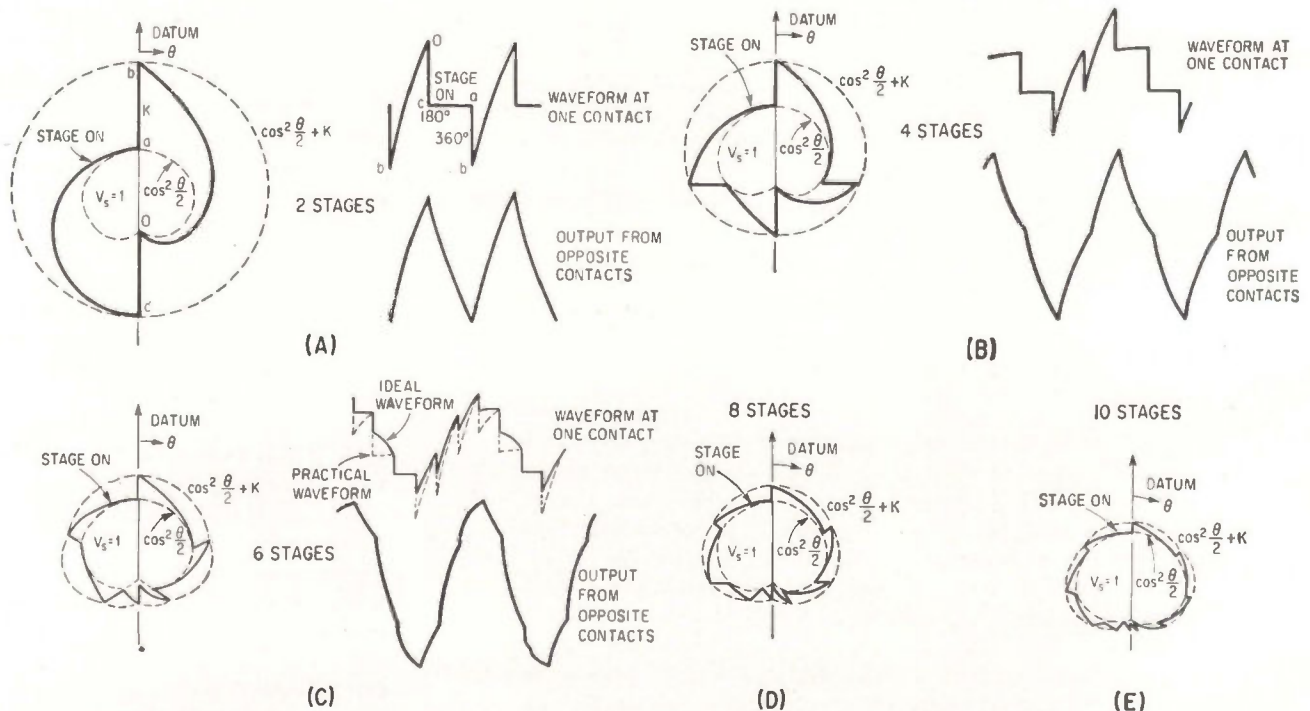

POLAR DIAGRAMS of potentials shows how the harmonic content diminishes as the number of stages in the ring increases from two (A) to ten (E)—Fig. 2

phase transformer would result in a very significant space and weight reduction.

RESULTS—In general performance at constant frequency the prototype was found to be extremely rugged and reliable and in fact more versatile than the simple single phase scr inverter. When using this ring-counter inverter, an increase in the value of the balanced load power (decrease in R_L) merely increases the harmonic content of the output waveform because of the increased value of f_o relative to the operating frequency (Eq. 5). A characteristic of the circuit is that it appears to be less critical of abrupt frequency switching (a factor of 10 can be readily introduced within the operating frequency range) and abrupt open-circuiting of one or two phases. Wide frequency range is not possible in the conventional inverter, but follows naturally in this circuit from the ring-counter's ability to operate over a wide counting-speed range.

Although not yet as rugged as a rotary inverter in its ability to accept wide variations and unbalance of loads, the static alternator can be operated into open circuit loads in all phases by employing over-swing diodes whereby reactive energy can be returned to the supply.

A significant advantage over most contemporary 3-phase scr inverter designs is the need for only one set of trigger pulses by virtue of the simple ring-counter gating system employed. Also the transient operating conditions applied to the scrs do not deviate excessively from the average conditions as they do for inverters which use resonant circuits to generate the sinewaves. This is especially true for reverse voltage conditions to which scrs are particularly susceptible. Here the ratio of peak reverse voltage to supply voltage is 0.5 as compared with 2-3 for the simple parallel inverter with resonant turn-off. Thus the utilization factor is considerably improved.

USES—One of the most important applications of semiconductor devices in the power supply field is the design of electronic inverters to replace the rotary systems which

NO. OF STAGES	IDEAL K	PRACTICAL K
2	1	1
4	0.5	0.5
6	0.25	0.5
8	0.15	0.35
10	0.1	0.31
12	0.06	0.25
24	0.02	0.13

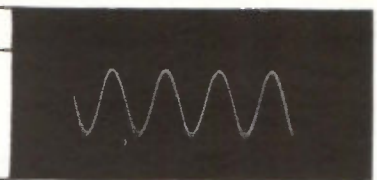
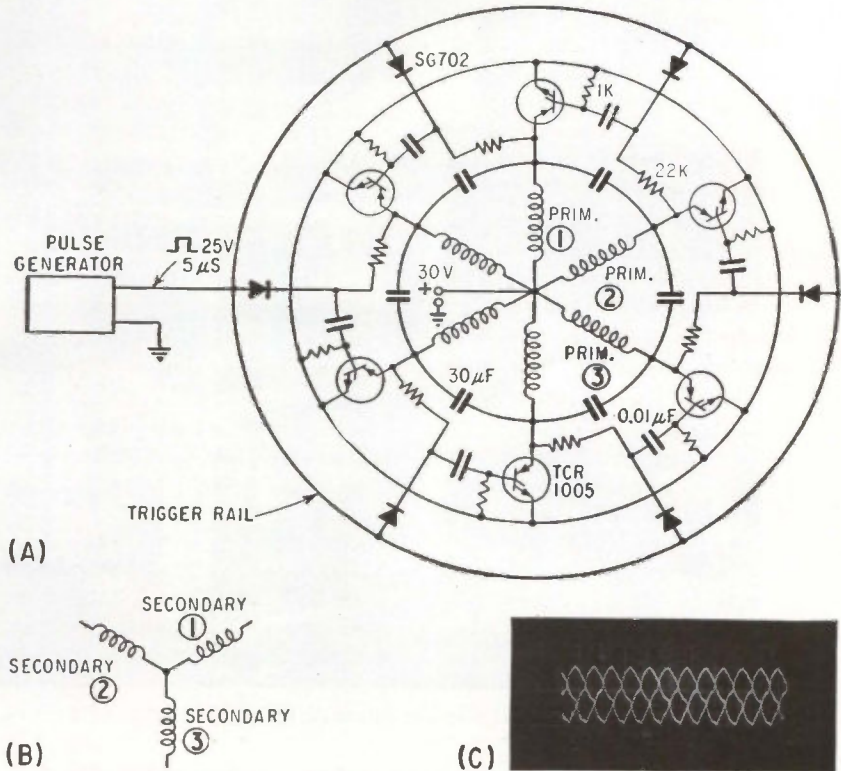

TABLE shows voltage transition, K , falling to relatively insignificant values as the number of stages rises; oscillogram compares the output from a 24-stage ring with the sinusoidal output from a commercial audio generator—Fig. 3



PROTOTYPE solid state static alternator uses scr's as current switching elements (A); connecting transformer secondaries in star yields three-phase output (B), actual output waveform is reasonably sinusoidal considering that no filtering is used (C)—Fig. 4

have long been used to transform low voltage d-c into single and three phase sinusoidal a-c supplies. Typical applications lie in mobile equipment such as aircraft, motor vehicles, boats, and so on.

With regard to potentialities in motor control, here the static alternator principle would appear particularly compatible with center-tapped windings on a three phase induction motor, which would then replace the output transformer of Fig. 4 circuit. However, certain problems, such as the need to increase the output voltage with frequency and motor speed, and an ability to cope with starting and stalled conditions have yet to be solved.

The author acknowledges the guidance of K. P. P. Nambiar (until recently chief engineer of Transistron Electronic Ltd.) during the investigation of the problem.

REFERENCES

- (1) R. H. Murphy and K. P. P. Nambiar, A Novel Method of Polyphase Sinewave Generation Using Silicon Controlled Rectifiers. Digest of Technical Papers. I.S.S.C.C. Feb. 1963.
- (2) A. E. Jackets and K. Wilson: Sinusoidal Inverter Circuits using Silicon Controlled Rectifiers. Colloque International sur les Dispositifs à Semiconducteurs. II. Emploi et Fiabilité. Paris 1961.
- (3) Transistron Applications Laboratory Technical Memo. No. 3. Controlled Rectifier Ring Counters.
- (4) R. H. Murphy and K. P. P. Nambiar: A Design Basis for Silicon Controlled Rectifier Parallel Inverters. Proc. I.E.E. Paper 3642E, Sept. 1961.
- (5) W. McMurray and D. P. Shattuck: A Silicon Controlled Rectifier Inverter with Improved Commutation, A.I.E.E. Paper 60-1346.

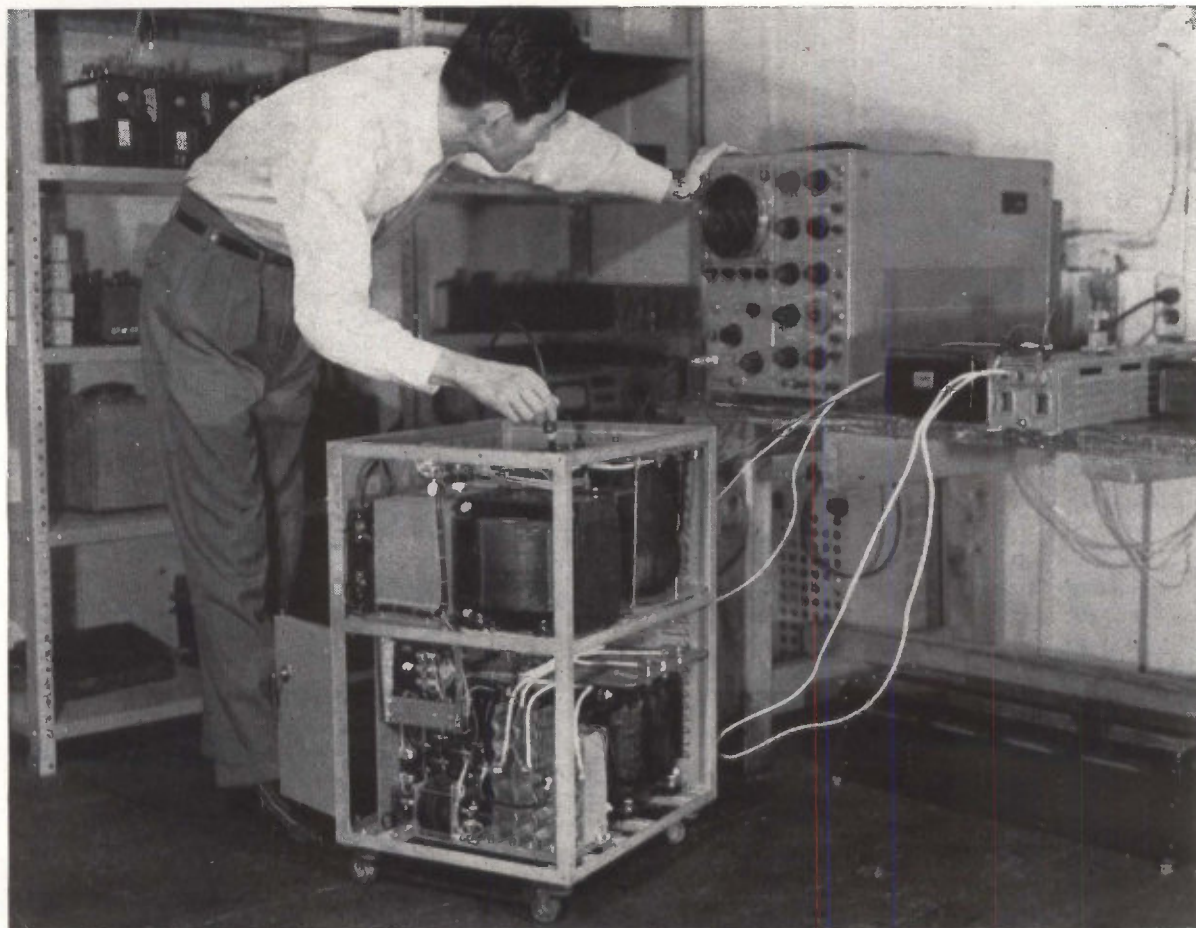

CONSTANT VOLTAGE rectifier has a single-phase rating of 1.2 kva. Output is 58 volts d-c with regulation of 0.2 percent from 5 to 20 amperes load

New Way to Use Saturable Reactors:

VOLTAGE STABILIZED power sources using series regulator tubes, saturable reactors or silicon-controlled rectifiers are usually inefficient and not suitable for high power. A new constant voltage rectifier, taking advantage of properties of a saturable reactor with rectangular-loop core material, is a reset-type transductor regulator. The method of resetting or demagnetizing the transductors requires no transistors, vacuum tubes or magnetic amplifiers. Instead, demagnetization of the transductor is accomplished by using part of the line voltage to increase the degree of the demagnetization automatically with changes of line voltage.

Output voltage is maintained constant against variations in load current, frequency and wave shape of the input line voltage, or the effectiveness of the smoothing circuit. For example, output voltage is constant even when load current becomes too small for normal operation of a choke-input smoothing circuit.

Impedance of a transductor varies according to the magnetic state of the core, e.g. in a case of a transductor have a sendelta core (50 percent Ni permalloy), the ratio of magnetization current to allowable load current for its winding is a few thousandths. Thus, a transductor of this type can be used for switching. Power consumption for controlling or

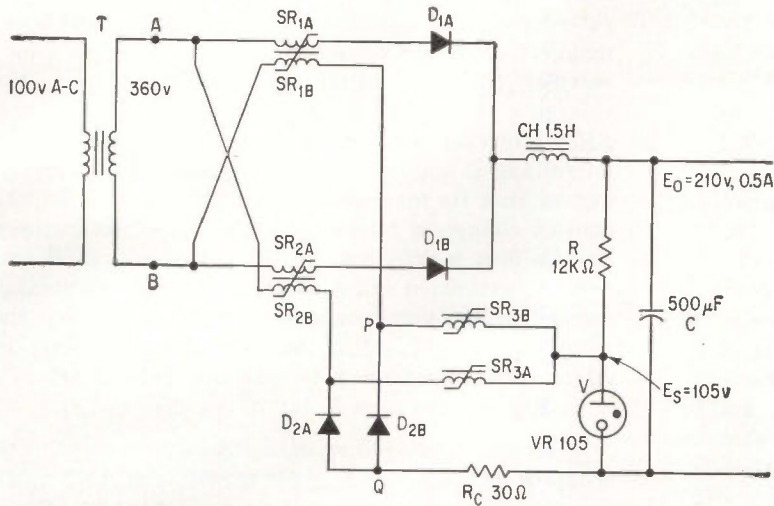

BASIC CIRCUIT of a single-phase constant voltage rectifier using saturable reactors with a rectangular loop characteristic—Fig. 1

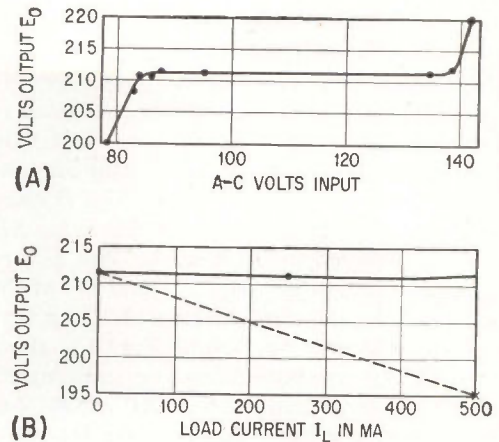

OUTPUT VOLTAGE variation with input line voltage changes (A) and with load current (B)—Fig. 2

Transducers with a rectangular hysteresis loop characteristic are key components in new power supply design that resists step changes in line voltage

By **TOSHIO KURIMURA** and **KAZUOMI YAMAMURA**
Kokusai Denshin Denwa Co. Ltd.,
Research Laboratory, Tokyo, Japan

SMOOTHING THE RUFFLED CURRENT

When load current swings from zero to 20 amps, keeping the voltage constant within 1 percent is a neat trick. And if line voltage varies, the problem becomes worse. Now, the Japanese have come up with a scheme to solve this problem in which they take advantage of the unique magnetic characteristics of the transductor. First major application of the device will be to power a large computer

Stabilizing High-Power Rectifiers

magnetizing a transductor is small compared with the regulator. Efficiency of the regulator can be 80 percent or more. The circuit is simple, the device is easy to construct, and ability to handle overload and temperature variations is good.

Rectifiers of several watts to several thousands watts or more may be built around this system. There is no limit in designing to a wide range of line voltage variation and load current.

CIRCUIT—In the single-phase full-wave rectifier, Fig. 1, transducers SR_1 and SR_2 each have a pair of windings A and B in series with rectifiers to form a

bridge full-wave rectifier. SR_1 and SR_2 are called the main transducers. Auxiliary transducers SR_{3A} and SR_{3B} , connected in series with a reference voltage E_s , or a constant voltage device, are in parallel with rectifiers D_{1B} and D_{2A} . Output voltage E_o is kept nearly twice that of E_s . Current capacity of the reference voltage source is roughly several thousandths of the maximum output current of the regulator, and the demagnetization current of SR_1 and SR_2 tends to charge the source.

In Fig. 2A, output voltage E_o is substantially constant while the line voltage changes nearly 50 percent. The lower break of the curve is caused by too low

line voltage, and the upper break is due to loss of control of the transducers. In Fig. 2B, the dotted line shows the characteristic of load current I_L vs. E_o without using compensating resistor R_c . The improved characteristics by using R_c , is indicated by the solid line.

A three-phase, high-power full wave rectifier, Fig. 3, has six main transducers with windings, SR_{1A} , SR_{1B} and SR_{1C} and SR_{2A} , SR_{2B} and SR_{2C} , in series with rectifiers D_{1A} , D_{1B} and D_{1C} and D_{2A} , D_{2B} and D_{2C} respectively. Auxiliary transducers SR_{3A} , SR_{3B} and SR_{3C} are connected as in Fig. 1. The difference is that auxiliary rectifiers D_{3A} , D_{3B} and D_{3C} are used to reset SR_{1A} , SR_{1B} and SR_{1C} instead of using transducers.

An improved version of Fig. 3 is shown in Fig. 4. Auxiliary windings with the same number of turns as the main transducers SR_{2A} , SR_{2B} and SR_{2C} , and auxiliary rectifiers D_{4A} , D_{4B} and D_{4C} are added. Current in the auxiliary circuits is only several thousandths of the main circuit current.

Characteristics of these two units are shown in Fig. 5. Dotted lines in Fig. 5A and Fig. 5C indicate E_o vs line voltage and E_o vs I_L respectively for the basic circuitry. Solid lines are the improved characteristics of the modified circuit. Figure 5B shows transient response of E_o vs a step change in line voltage for the modified circuit. The ratio of the variation rate of E_o to that of line voltage is lowered to nearly a tenth.

OPERATION—Voltage and current waveforms, Fig. 6A, B and C, are those of the single-phase full-wave rectifier of Fig. 1. It is assumed that the transformer, the transducers and the choke coil have no ohmic resistance and the individual rectifiers have ideal characteristics, besides the reservoir condenser is very large and the ripple in output voltage is negligible, moreover the resistor R_c is zero.

In Fig. 6A, the dotted lines e_{nb} and e_{ba} indicate output voltage of transformer T of Fig. 1, measured from point B to A and vice versa. Line e_{cb} is the voltage waveform of the choke coil using the potential at point Q as reference. In an ordinary rectifier, the voltage e_{cb} does not take a negative value, but here, e_{cb} becomes negative for the period t_2 to t_3 , t_5 to t_6 , etc., because the rectified current or the choke-coil current i_{cb} , Fig. 6C, cannot shift immediately from D_{1A} circuit to D_{2B} circuit at t_2 nor from D_{2B} to D_{1A} at t_5 because of choking action of main transducers. The main transducers reach saturation at t_3 or t_6 and lose the choking action. Then the current i_{cb} shifts abruptly.

The area s_1 is the magnitude of the choking action of SR_{1A} and SR_{1B} for t_2 to t_3 , (of course the same action is performed by SR_{2A} and SR_{2B} for t_5 to t_6).

Since a choke-input type smoothing circuit averages the input voltage e_{cb} , the output voltage E_o is given as the mean value of e_{cb} . The following equation is valid from the period t_2 to t_3 :

$$E_o = (K - 2S_1)/(T/2) \quad (1)$$

where K is an area of e_{ba} for t_2 to t_3 , a part of which, for t_2 to t_6 , is the same area of S_1 , T is a period of e_{cb} .

Figure 6B shows how main transducers SR_{1A} and

SR_{1B} are demagnetized and shows operation of the auxiliary transducer SR_{3B} . The heavy line indicates the voltage waveform at point P taking point Q as a reference. SR_{3B} is in a saturated state at t_1 , and is demagnetized by the volt-secs area G for t_1 to t_6 . Since rectifier D_{1B} is in cutoff condition for t_6 to t_8 , the voltage e_{cb} is applied to the series circuit of SR_{1B} and SR_{3B} . However, while SR_{3B} is in an unsaturated state, no voltage is induced on SR_{1B} because SR_{3B} is so designed that its magnetizing current is insufficient to cause a change in magnetic flux of SR_{1B} . Accordingly SR_{3B} is first magnetized by the volt-secs area H and reaches saturated state at t_7 . Then SR_{1B} is demagnetized by the volt-secs area S_2 up to t_8 . Having the same core as SR_{1B} , SR_{1A} is simultaneously reset in effect. The time from t_1 to t_7 is one-cycle of SR_{3B} .

In Fig. 6B the area S_2 is:

$$S_2 = K - (H + J + S_1) \quad (2)$$

where K is the area of e_{cb} for t_2 to t_6 , a part of which for t_2 to t_6 , is the same area as S_1 in Fig. 6A. Since the area G and H , and S_1 and S_2 are equal, Eq. 2 becomes:

$$K - 2S_1 = H + J = E_o T \quad (3)$$

From Eq. 1 and 3, $E_o = 2E_o$.

Therefore, constant output voltage is maintained without amplifiers regardless of line variation:

RESISTANCE—Resistance components cause E_o to decrease in accordance with the increment of I_L . This is shown by the dotted line in Fig. 2B. Output resistance is about 30 ohms. However the output resistance can be reduced to almost zero by using R_c which has a value of 30 ohms, and the resultant characteristic is shown by solid line in Fig. 2B. The reason is that the voltage drop across R_c , i.e. $\Delta I_L \cdot R_c$, is added to reference voltage E_o , then a voltage $2E_o + 2\Delta I_L \cdot R_c$ or $E_o + 2 \cdot \Delta I_L \cdot R_c$ is induced inside the device, and increment $2 \cdot \Delta I_L \cdot R_c$ is canceled by voltage drops across R_c and the output resistance.

The output resistance is a sum of the choke-coil resistance and part of the resistance of the main transducers. However, the resistance component of the transformer does not have any influence because E_o is not affected by a change in input a-c voltage. Moreover the effect of the main transducer resistance to the output resistance can be diminished to nearly zero by introducing an auxiliary winding for controlling the transducer. Thus, modified transduc-

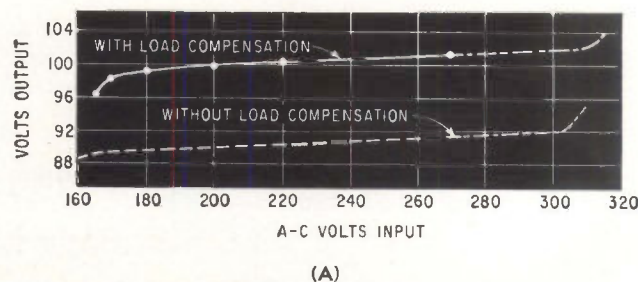

OUTPUT CHARACTERISTICS with and without load current on output with and without compensation (C)

THREE-PHASE
full wave rectifier
basic circuit—
Fig. 3

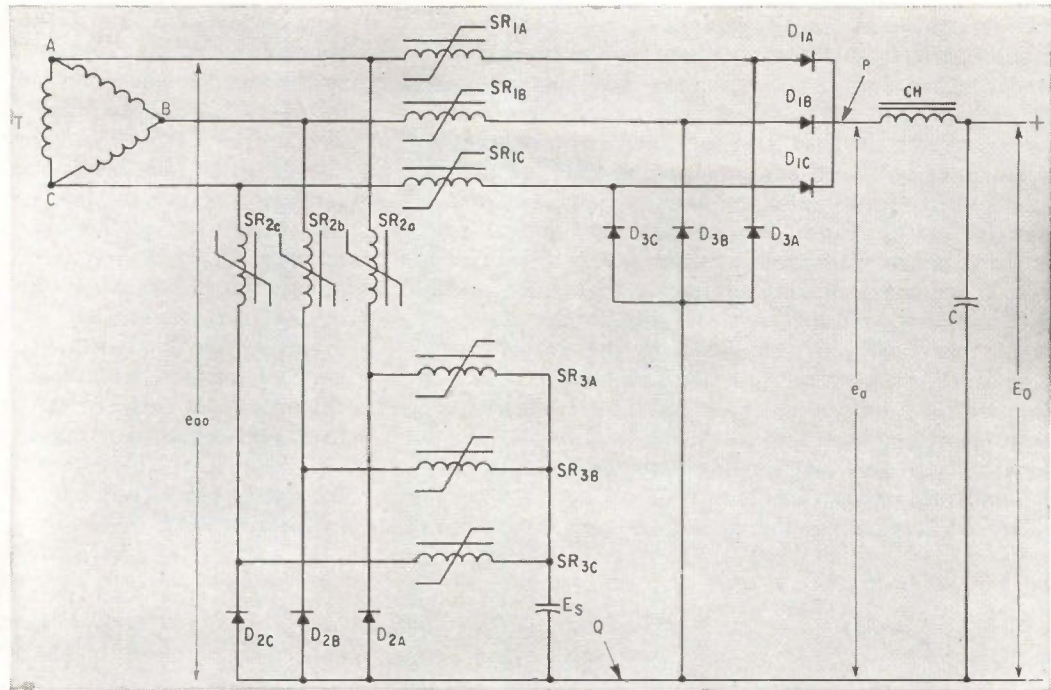

LOAD CUR-
RENT compensation
added to the
basic three-phase,
full wave recti-
fier circuit of
Fig. 3 for im-
proved regulation
—Fig. 4

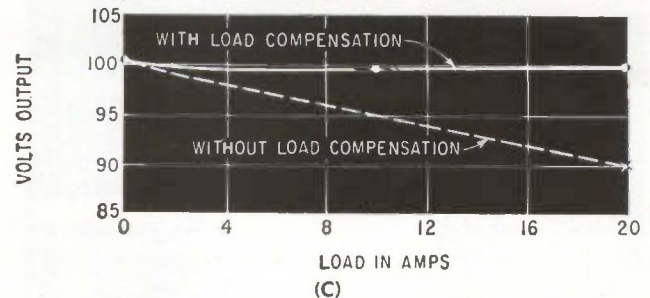
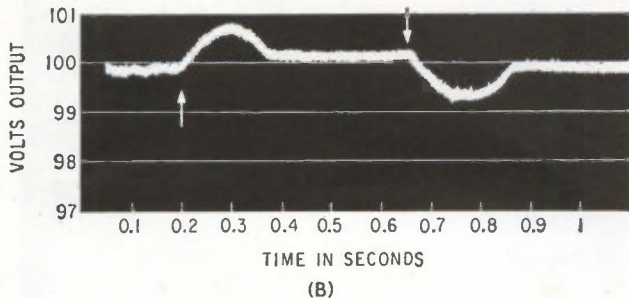
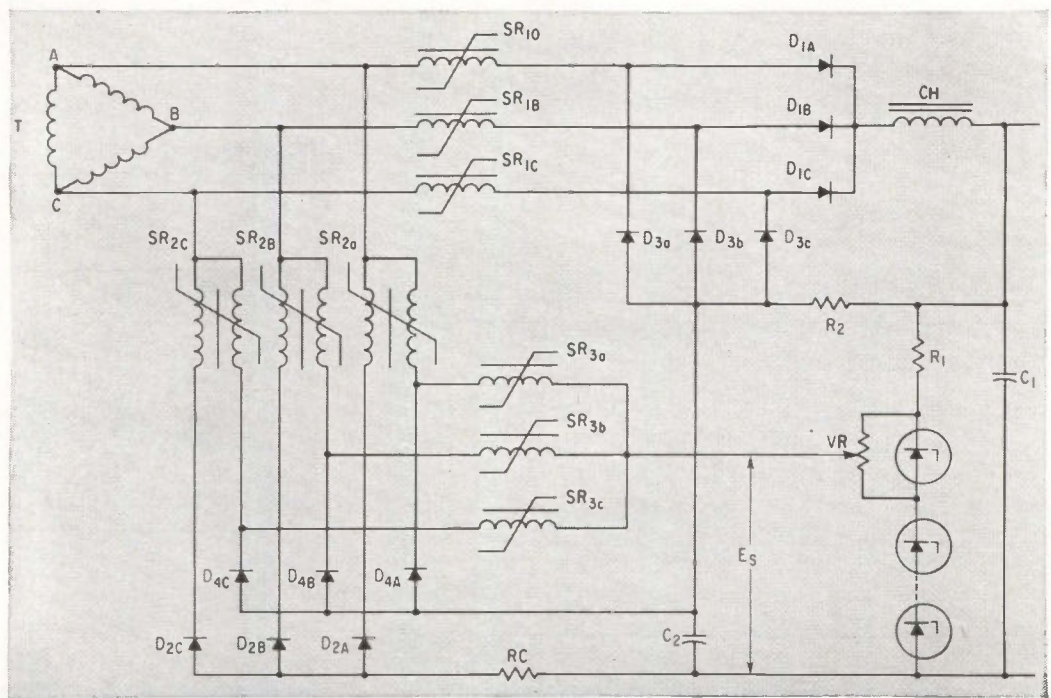

compensation (A), transient response to step changes of 10 volts from a line voltage of 200 volts (B) and effect of load —Fig. 5

tors are shown in Fig. 4, and the power consumption in R_c (0.1×20^2 watts) is reduced to only 2 percent of the output power.

Figures 7A, B and C shows the voltage waveform for the circuit of Fig. 3. Light lines indicate the waveform of e_a , e_b and e_c at the points A, B and C in Fig. 3. Heavy lines show e_{en} and e_n , the voltage at points P and Q respectively, taking the neutral of the three phase voltage as a reference or zero line. Area S_1 indicates choking action of SR_{3A} , SR_{2B} and SR_{3C} , and this volt-secs area is simultaneously applied to one of SR_{1A} , SR_{1B} and SR_{1C} by the way of D_{3A} , D_{3B} and D_{3C} respectively to demagnetize the SR_{1A} , SR_{1B} and SR_{1C} . This operation is different from single phase operation where the demagnetization of SR_{1A} and SR_{2B} is performed by using a common core with SR_{1B} and SR_{2A} respectively.

Figure 7B is similar to Fig. 7A taking e_n as refer-

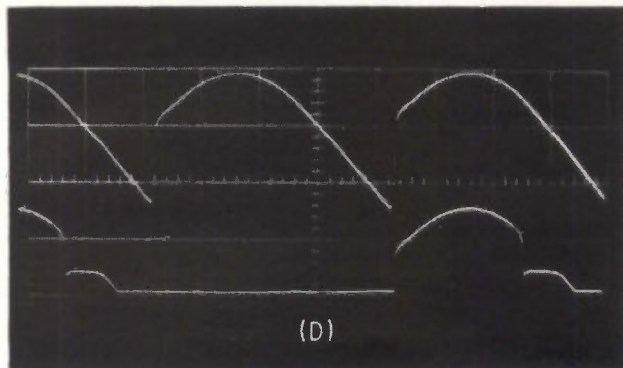
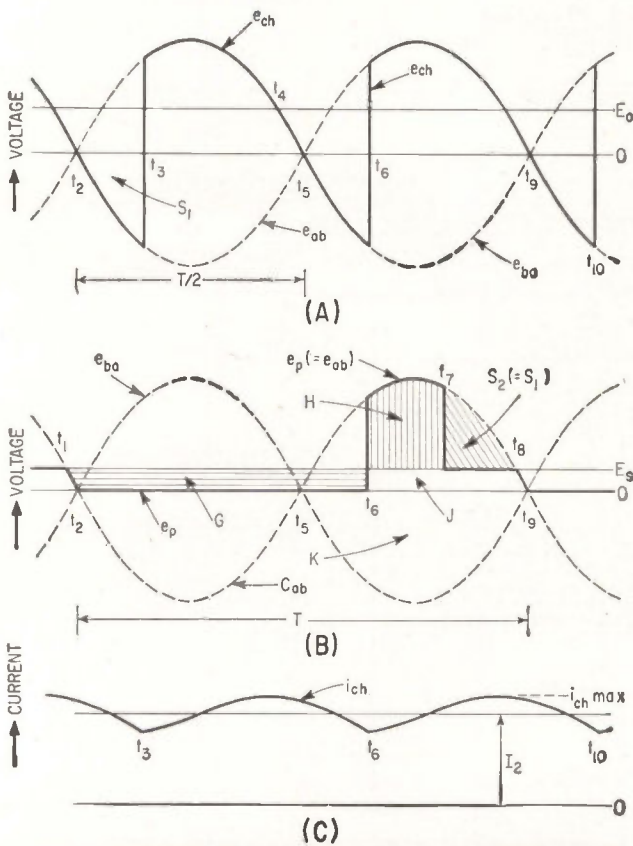

SINGLE-PHASE rectifier waveforms for circuit analysis (A), (B) and (C), and actual oscillogram (D)—Fig. 6

ence. The heavy line shows the voltage difference e_o between e_{en} and e_n . Output voltage E_o must be equal to the mean value of e_o , then E_o can be expressed as $6(M - S_1)/T$, where M is the area shown in Fig. 7B, T is a cycle of the line voltage.

In Fig. 7C, the heavy line shows the voltage difference e_{ao} and e_n to show how auxiliary transductors SR_{3A} , SR_{3B} and SR_{3C} operate and how the main transductors SR_{2A} , SR_{2B} and SR_{2C} are reset. From this figure, the volt-secs area S_2 by which the main transductor is reset, is $(3M - 2S_1) - T \cdot E_o$. Note that areas B_1 and B_2 are equal because the difference between e_{no} and e_{ba} is nothing but e_{ao} itself, and that the area N_2 is equal to the area N_1 . Since S_2 is equal to S_1 for single phase operation, then: $3(M - S_1) = T E_o$, and $E_o = 2E_s$. Output voltage E_o depends upon E_s and is not affected by a-c line voltage as single-phase operation.

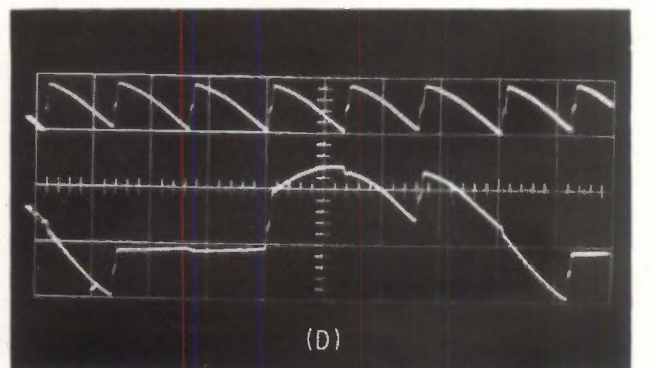
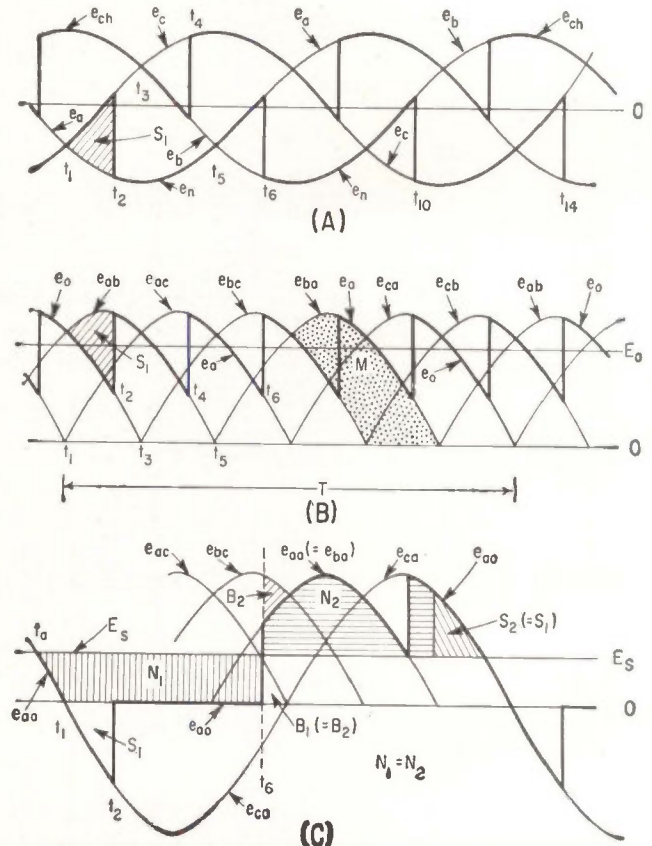

THREE-PHASE waveforms illustrate operation (A), (B), (C) along with actual oscillogram (D)—Fig. 7

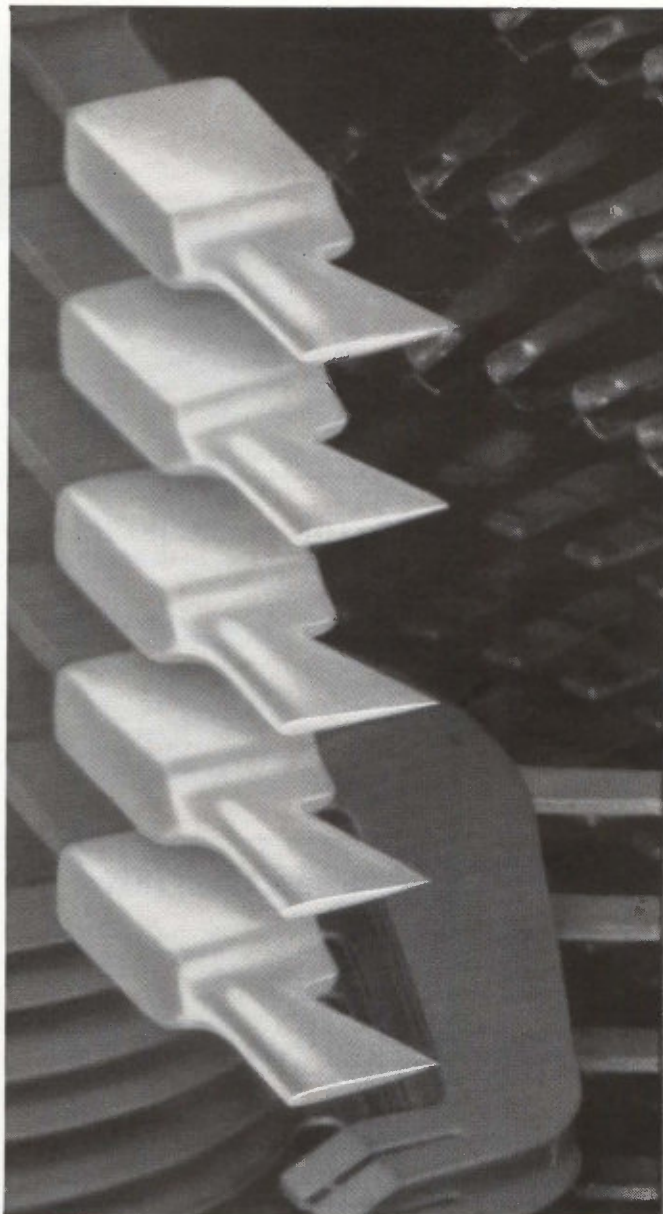
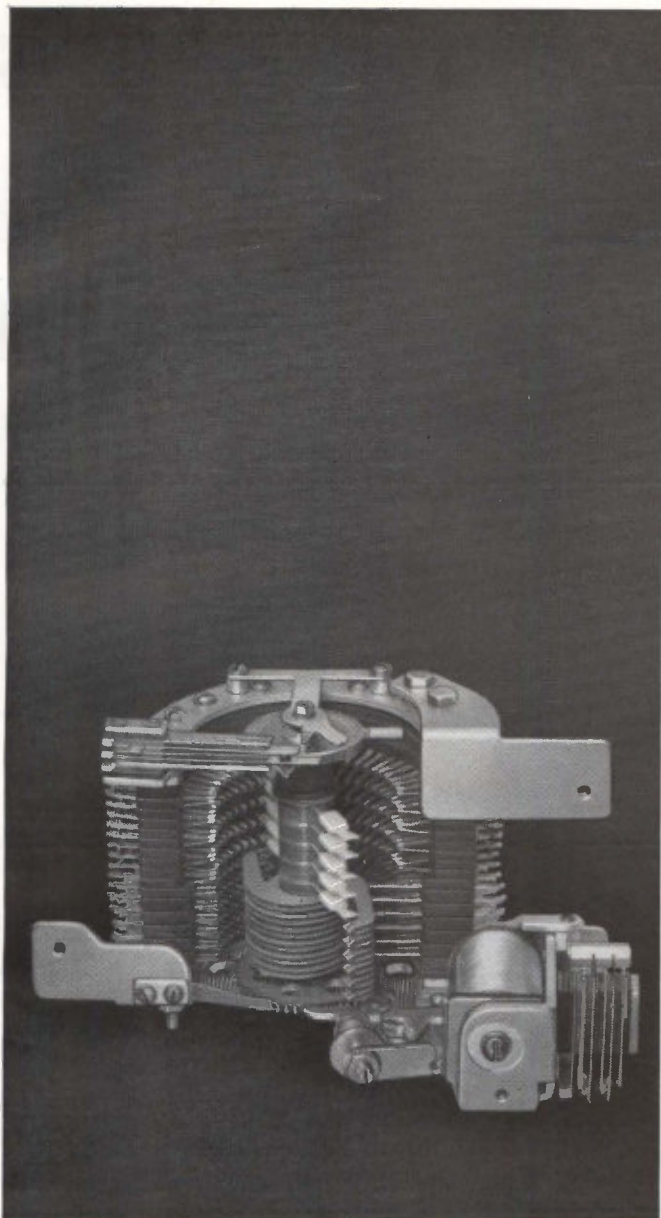

so, what's new?

This is AE's new Type 45NC Rotary Stepping Switch. Each bank is made up of two standard levels tensioned together so that each set of bank contacts forms a closed circuit. The wiper assembly, tipped with a molded Delrin insulator, opens the contacts one at a time as it rotates. Normally open and normally closed banks may be specified on the same switch. ■ Contacts are gold-plated phosphor

normally closed contacts, that's what

bronze, providing contact resistances of only 10 to 20 milliohms measured at 6 volts, 100 milliamperes. ■ The 45NC is ideal for self-interrupted hunting or testing circuits. In either case, no auxiliary relays are needed to initiate operation. For full information, ask for our "Product News: 45NC." Write Director, Control Equipment Sales, Automatic Electric, Northlake, Illinois.

AUTOMATIC ELECTRIC

Subsidiary of

GENERAL TELEPHONE & ELECTRONICS



The Proven Line of Servo Components

MOTORS—Daystrom Transicoil offers a wide line of servo motors, in sizes 5, 8, 9, 11, 15, and 18. These are available in many configurations, with gear trains supplied in standard ratios as part of the unit where desired. Special ratios are supplied on request. In addition to standard and short-housing type motors, Daystrom Transicoil produces high-torque units, acceleration-damped units, and velocity-damped units. ■ Some of the special features of these motors include stainless steel ball bearings, completely encapsulated motor windings, corrosion resistant alloy laminations, stainless steel housings, precision machined stainless shafts, 12" Teflon insulated leads, and precision pinions (Class II per AGMA 236.04 or better).



SIZE 5
MOTOR



SIZE 8
SHORT
MOTOR

MOTOR GENERATORS & TACHOMETERS

—Among the precision rotating components from Daystrom Transicoil is a full complement of motor damping generators and rate generators and integrating tachometer generators. These are available in standard configuration or in short-housing; as temperature-compensated units and as high-performance units. All units are offered with both standard and high torque ratings. ■ Transicoil standard motor tachometers feature low inertia with outputs up to 3.5 v / 1000 rpm. Temperature-compensated motor tachometers will maintain an output voltage per 1000 rpm within $\pm 0.5\%$ over an extended range from -55°C to 125°C . Phase shift is held to within $\pm 0.5^{\circ}$. ■ Special features of the motor tachometers and generators are similar to those listed under motors above.



SIZE 5
MOTOR
GENERATOR



SIZE 8
MOTOR
GENERATOR

SYNCHROS, RESOLVERS, INDUCTION

POTENTIOMETERS—Daystrom Transicoil produces control transformers, differentials, resolvers, transmitters, and inductive potentiometers in a variety of standard sizes from Size 5 through Size 11. These units are designed for high accuracy and reliability; most types offer maximum error from electrical zero of ± 7 minutes. Corrosion-resistant materials are utilized throughout, and all units are designed to meet the rigid requirements commonly encountered in airborne and aerospace applications. ■ Transicoil pancake synchros have been designed into many aerospace systems where precision performance and high density packaging are critical. Our engineering group has extensive experience in pancake applications, and can design units to meet the most stringent specifications.



(GIMBAL
MOUNTED)
SIZE 25
PANCAKE SYNCHRO



(BEARING
MOUNTED)
SIZE 25
ENCASED
PANCAKE SYNCHRO

AMPLIFIERS & SPECIAL UNITS

—Transistorized servo amplifiers from Daystrom Transicoil are designed to provide high linearity signal amplification for driving motors up to Size 18. They are virtually insensitive to temperature variations. Both silicon and germanium types are offered. ■ Other servo units produced by Transicoil include integrated servo follow-ups, in-line servo assemblies, mechanical filters, etc. Information on these is available on request.



MINIATURIZED
TRANSISTOR
AMPLIFIER



GEAR TRAINS
SIZE 5, 8,
11, 15, 18

COMPLETE PACKAGES

—Complete servo assemblies and sub-assemblies have been designed by Daystrom Transicoil for numerous applications. Among these are azimuth indicators, height indicators, synch drives, gain changers, TACAN couplers and sub-assemblies, base-line indicators, and many other systems. As a contributor to various aircraft and missile programs, the company has proven its ability to design highly reliable servo packages to the most demanding requirements.

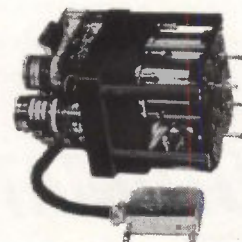

LORAN "C"
INDICATOR



SYNCHRONOUS
DRIVE
ASSEMBLY

and Assemblies from Daystrom Transicoil



SIZE 9
MOTOR



SIZE 11
MOTOR



SIZE 15
MOTOR



SIZE 18
MOTOR



SIZE 9
MOTOR
GENERATOR

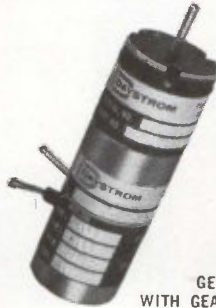

SIZE 11
MOTOR
GENERATOR
WITH GEAR TRAIN



SIZE 15
MOTOR
GENERATOR



SIZE 18
MOTOR
GENERATOR
WITH GEAR TRAIN



SIZE 25
20 SEC ACCURACY
ENCASED RESOLVER



SIZE 8
TEMPERATURE
STABLE
CONTROL
TRANSFORMER



SIZE 8
CONTROL
TRANSFORMER
WITH SOLDER
TERMINALS



SIZE 11
CONTROL
TRANSFORMER



INTEGRATED
SERVO ASSEMBLY:
THREE SIZE 5
COMPONENTS
IN 1" HOUSING



MECHANICAL
FILTERS



SIZE 8
STEPPER MOTOR

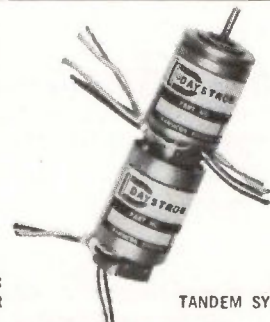

SIZE 8
TANDEM SYNCHRO

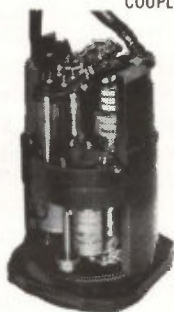

ANTENNA
COUPLER

In its newly enlarged modern plant, Daystrom Transicoil possesses the facilities and capability to manufacture its servo systems and components from wire, bar stock, and other raw materials to finished precision units. Virtually all machining and other operations are performed on the premises, under the supervision of the production engineering group. Clean rooms, white rooms, and other facilities permit a high level of quality control, and result in an unusually low reject rate.

DAYSTROM, INCORPORATED
TRANSICOIL DIVISION
 WORCESTER, PENNSYLVANIA
 TELEPHONE (215) BR 7-1300

Special Computer Integrates Rainfall

U.S. Weather Bureau experiments with new electronic integrator

By RONALD T. H. COLLIS

Stanford Research Institute, Menlo Park, Calif.

THE INTEGRATOR is a simple special-purpose relay computer, which automatically samples the output of a standard WSR-57 weather radar. The data are processed in digital form and displayed on a series of electromechanical counters arranged in a grid set on a map showing the area covered (Fig. 1). The counters show in inches the rainfall accrued at each point since time of reset.

The main display of the prototype has 141 counters uniformly distributed over a circle 200 nautical miles in diameter to a scale of 1:250,000. A subsidiary display (to a scale of 1:125,000) shows a special trial watershed for the Norman installation and employs 17 counters.

The display can be located near the main radar display, or may be remoted to any distance. The remote facility is possible because the system employs a 5-channel punched-tape link to the displays. This link can readily be extended by standard teletypewriter.

AUTOMATIC OPERATION—Five incremental readings are obtained per hour, leaving the radar free



COMPLETE SYSTEM including a subsidiary display at upper left. Photo code wheel is in control unit; author Collis is standing—Fig. 1

for other use in the meantime. Every 12 minutes, after a warning, the integrator takes over the radar and ensures that the radar is operating in the correct manner. (An operator at the console still has full control over the linear receiver and the displays, but unless he overrides the integrator control, the antenna scans in PPI fashion at a predetermined rate and elevation.)

DATA ACQUISITION — Range-corrected video from the logarithmic receiver, together with trigger and antenna position data, is processed as follows: The location of each of the address points of the grid at which rainfall is to be integrated is so arranged that only

one point lies on any one radial from the radar site (for block diagram see Fig. 2). It has been found that quite regular rectilinear grids can be set up on this basis, and provided that the range of each address can be established, the address can then be identified solely by reference to the azimuth of the antenna. In this way it is possible to scan in sequence, identifying each address by counting consecutively from a reference heading. The azimuth of each address is identified by a photo electric trigger system operating on a code drum, driven in synchronism with the antenna. The drum, produced photographically on a standard film base (see Fig. 3), has transparent slots at positions corresponding to the addresses in azimuth. An identical trigger system is derived from a single slot corresponding to the reference heading. Coinciding with each address position, the drum also carries a 7-bit binary-code word which reports the range of each address. This information is read by a photodiode array and used to control the opening of the address gate in range, by reference

HOW MUCH RAIN FELL AND WHERE?

Although weather radar provides valuable information on the intensity of rain falling over a large area, it gives no direct data on the accrued rainfall. A special-purpose computer described here was developed for this purpose by the Stanford Research Institute under sponsorship of the U.S. Weather Bureau, and is now undergoing evaluation and trials at the Weather Bureau's Weather Radar Laboratory at Norman, Oklahoma



Really
"half size"
... any way
you look at it.

NEW LEACH HALF-SIZE CRYSTAL CAN RELAY

NOW IN PRODUCTION QUANTITIES

It's only .400 inches high, .400 wide and .800 in length. This smallest of the Leach relay family is also the lightest — only .25 ounces. □ Most important is its performance. It gives full-size results in low level to 2 amp. switching and is completely interchangeable (including internal terminal connec-

tions) with standard crystal can relays. A wide variety of mountings and terminals are available. □ Which reminds us, Leach has a complete line of standard size subminiature crystal can relays, too. Yes, when it comes to relays, any way you look at it, you should

LOOK TO LEACH CORPORATION
18435 SUSANA ROAD, COMPTON, CALIFORNIA

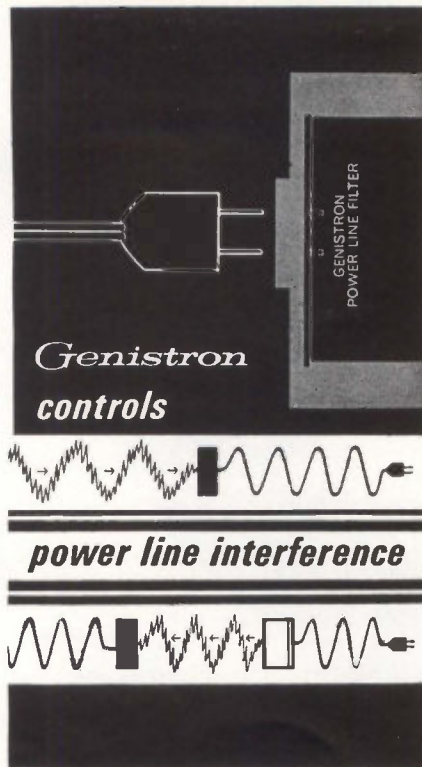

Ideally suited for use with electronic instruments, business machines, computers and related process equipment...Genistrion provides power line RF filters with field proven reliability. This unmatched performance in the suppression of power line RFI, both radiated and conducted, extends to filtering of basic power distribution systems for such critical operations as missile launching sites.

A complete product line of 2 and 3 circuit, single phase 115 V and/or 230 VAC, as well as 3 and 4 circuit, 3 phase power system filters, are designed and manufactured in accordance with UL shock and 900 VAC dielectric testing when necessary.

Whether your RFI problem requires highly qualified applications engineering, assistance during system or installation design, or the proper filter to answer a known RFI problem, ask for data file E-2022-1.

Genistrion
INCORPORATED

6320 West Arizona Circle, Los Angeles 45, Calif.
SP 6-1411

111 Gateway Road, Bensenville, Illinois
NA 5-1570

subsidiary of

Genisco
INCORPORATED

ACQUISITION

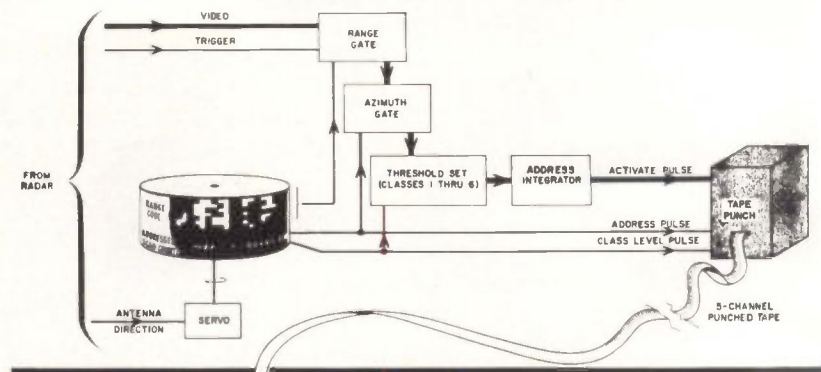

PRESENTATION

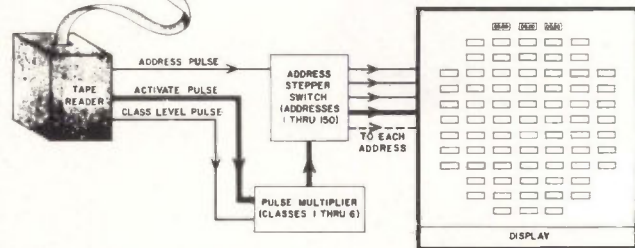

BLOCK DIAGRAM of complete radar precipitation integrator, showing the acquisition system at top, presentation system at bottom—Fig. 2

to the radar trigger. The length and width of the range gate can be varied by adjustment, but in the initial arrangement they are, respectively, equivalent to 4 nautical miles and 1 degree.

The rotation of the code drum in synchronism with the antenna thus yields the following: One reference heading pulse for each complete scan, a series of address pulses, counting off each address in turn from the reference heading, and a gate which, when applied to the radar video, enables echoes relating to a discrete area, corresponding to each address point, to be considered as a unit. The echo intensity, and hence the rainfall rate at each address is

evaluated by making six scans with the antenna. At each scan, a threshold in the gated video circuit is set up at successively higher values. The video signal is processed in an address integrator and has a value in excess of the threshold value for that scan, a "yes" pulse is generated. Thus the intensity of an echo at any address is reported as a series of up to six pulses, representing six classes of rainfall intensity. These activate pulses are passed on to the storage and display units of the integrator in synchronism with

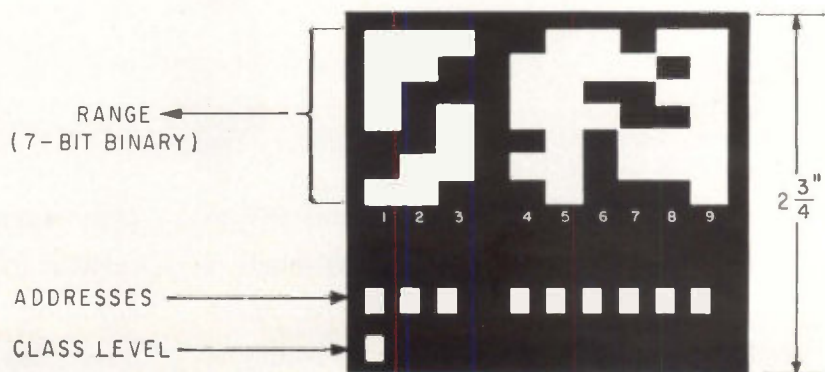

CODE DRUM section illustrates how one address is stored in each vertical column—Fig. 3

COM

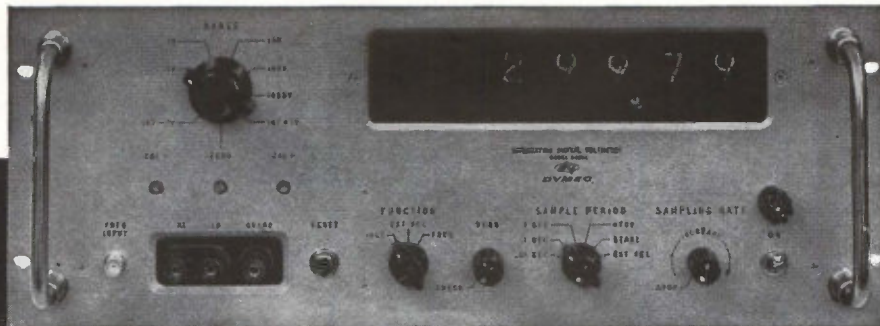

PARE!

Measure microvolt signals accurately... in the presence of high common mode noise!

The bench-proved and system-proved DY-2401A Integrating Digital Voltmeter from Dymec is today's most accurate instrument of its kind for measuring low-level signals in the presence of high common mode noise. It's today's best digital voltmeter buy!

Ten volts of common mode noise on the signal results in a mere one microvolt error. No other digital voltmeter can match that performance. Dymec accomplishes this remarkable performance in the DY-2401A with two techniques: Guarding of the entire measuring circuit, which physically breaks the ground loop currents that circulate in systems with more than one ground; and true averaging of the signal over the sample period, which solves the problem of noise superimposed on the signal. Averaging alone provides virtually infinite rejection of 60 cps and 400 cps noise. The DY-2401A is not dependent on passive input filtering responsible for slower measuring speed.

Low-level measurement . . . High sensitivity of the DY-2401A, even in the presence of noise, offers a 5-digit range of 100 mv full scale. Add the DY-2411A Guarded Data Amplifier and you have an unequalled ± 10 mv full scale 5-digit range. Compare this with any other digital voltmeter . . . and consider your applications in measuring the outputs of thermocouples, strain gage bridge transducers or other millivolt level dc voltages.



For 10 mv full scale sensitivity DY-2411A Guarded Data Amplifier adds the ± 10 mv full scale 5-digit range to the DY-2401A Voltmeter,

with overranging to 30 millivolts and constant 10,000 megohm input resistance. It preserves the guarded measurement features of the 2401A, providing 134 db effective CMR. Gain settings of +1, +10 and bypass are programmed by simple ground closures, with no effect on common mode rejection.

DY-2410A AC/Ohms Converter . . . provides floated and guarded broadband ac voltage and resistance measurements, with full programmability. AC measurements 50 cps to 100 kc, five ranges including 0.1 v rms full scale, 300% overranging on four most sensitive ranges, 110 db common mode rejection at 60 cps when used with the 2401A. Resistance measurement, 100 ohms to 10 megohms full scale in six ranges, with 300% overranging.*

COMPARE: DY-2401A, \$3950
DY-2411A, \$1150
DY-2410A, \$2250*

Data subject to change without notice. Prices f.o.b. factory.

* Available also in ac-only, ohms-only models.

DYMEC

A Division of Hewlett-Packard Company



**John
Brogan
can
show
you...**



Brogan Associates, Inc.

how to match a PAV to tough GSE specs

From its all solid state circuitry to its MIL-type hermetically sealed meter and plug-in amplifiers, every design feature of the Model VM-235 Phase Angle Voltmeter has been selected for rigorous service in Aerospace Ground Equipment.

Your North Atlantic man can quickly demonstrate how this rugged, miniaturized version of North Atlantic's famous PAV provides direct, accurate reading of phase angle, nulls, total, fundamental, quadrature and in-phase voltages—even under the roughest of military field conditions.

The VM-235's ability to meet tough system specs is demonstrated daily in operational and support equipment for USAF and Navy aircraft and missile programs. Its capabilities for complex measurements are shown in the abridged specifications below:

Voltage Range.....	1 mv to 300 v f.s., 12 ranges
Voltage Accuracy.....	±2% f.s.
Phase Accuracy.....	dial: ±1°; meter: ±3% of F.S. degrees
Signal Frequency.....	400 cps
Input Impedance.....	1 megohm
Reference Input.....	26 v or 115 v
Meter scale.....	3-0-3, 10-0-10 linear
Phase Angle Dial.....	2 scales, 90° (elec.) apart
Nulling Sensitivity.....	2 microvolts (phase sensitive)
Harmonic Rejection.....	55db (with filters)
Dimensions.....	8 ¹ / ₁₆ " h. x 8 ¹ / ₂ " w. x 6 ³ / ₈ " d.

North Atlantic's field engineering representative in your area has full data on the VM-235, as well as modified versions for specific systems requirements. For his name, call or write today, or request Bulletin VM-235.



NORTH ATLANTIC industries, inc.
TERMINAL DRIVE, PLAINVIEW, L. I., NEW YORK • Overbrook 1-8600

the address and reference heading pulses. The latter, used to identify (and generate) the threshold changes, are known as class level pulses.

A complete incremental observation is thus reported in the form of a series of pulses in three channels. The series consists of six cycles of observations, each made with a different threshold level. The start of each cycle is marked by a class-level pulse. Each cycle consists of a series of address pulses, marking each address in turn. At each address at which there is a positive report of rainfall, an activate pulse coincides with the address pulse in question.

To enable the data to be processed more slowly than it is acquired, a punch-tape buffer stage is used. This makes it possible for the relatively slow display and storage techniques to keep up with the acquisition stage by taking advantage of the 10-minute intervals between each observation cycle.

PRESENTATION STAGE — A punched-tape reader converts the observation report back to pulsed form at a speed determined by the operation of the display unit. The series of address pulses actuates a stepper switch. This brings each electromechanical counter of the display unit into circuit in sequence. If an activate pulse is present at the address, it is fed to the corresponding counter by way of the pulse-multiplier unit. The function of this unit is to convert the single activate pulse into a train of pulses, which represents the increment to be added to the counter for the class level in question. In this way, class levels may have a nonlinear relationship, since any reasonable weighting factors can be applied by the pulse-multiplier unit. These factors are selected, in turn, by the successive class-level pulses marking the intensity classes in which the data were evaluated in the acquisition stage.

The counters, operating in unit increments, show directly the depth of accrued rainfall.

A buzzer may be set to sound if an echo is reported in the most intense class. This could provide timely warning of rainfall likely to cause floods.

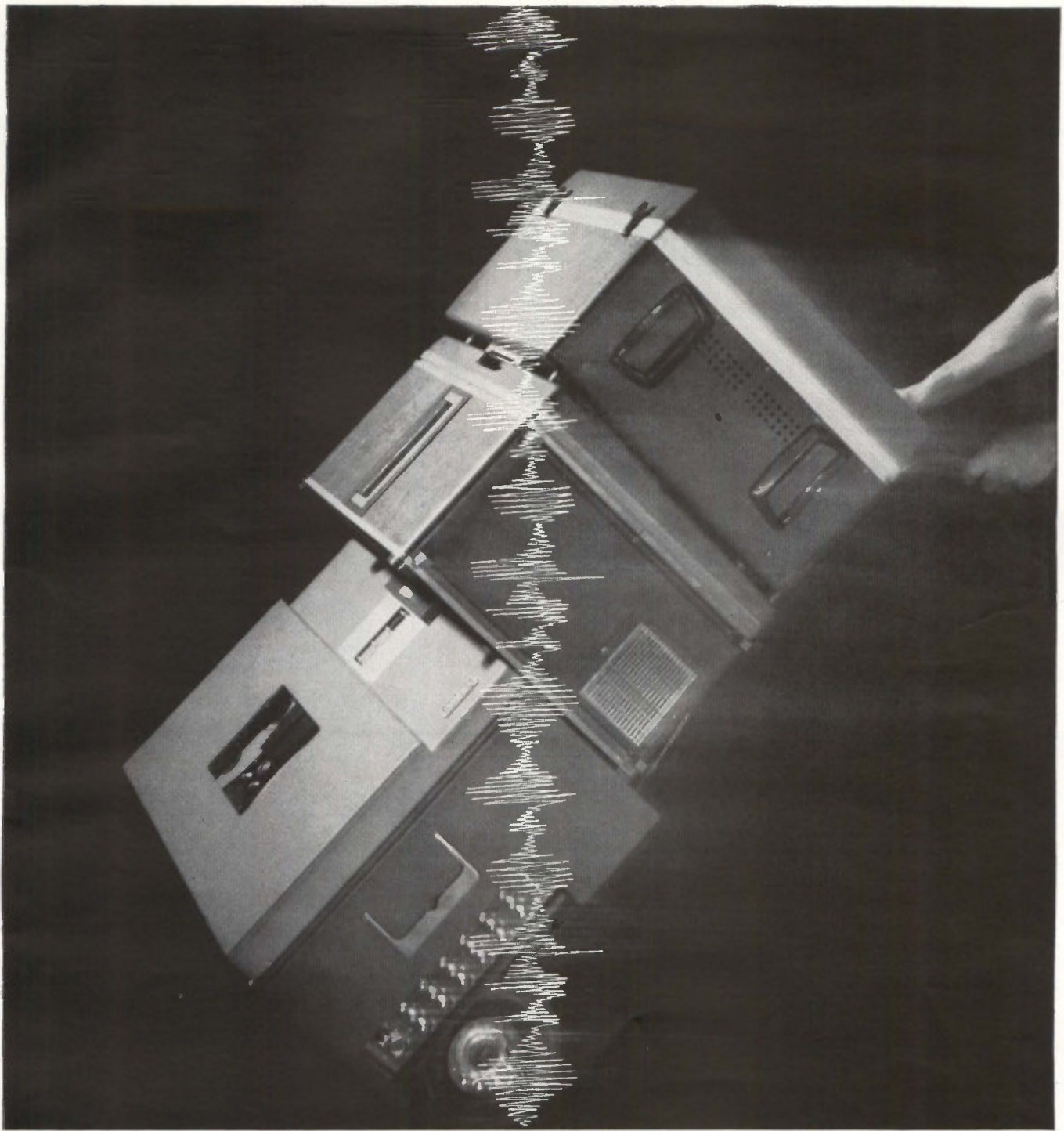

Who can deliver the most complete line of portable instrumentation recorders?

AMPEX

And what a line it is. There's a portable for medical, for industrial, for research applications, for rugged applications—for almost every data acquisition need. And there's a price to fit almost every budget. Behind each recorder stands the name of Ampex—to assure you true instrumentation performance all the time. On the top, above: the low-cost SP-300. It has four speeds, four tracks, push-button selection for FM or Direct recording, plus built-in attenuation, monitoring, calibration and erase. In the middle is the FR-1300. It offers 14 tracks, 300 cps to 300 KC capability on Direct, DC to 20 KC on FM and six speeds precisely controlled by a unique servo-driven capstan. On the



bottom: the rugged CP-100. It records Direct, FM-Carrier and PDM. Has a closed loop drive, six standard speeds, 14 tracks, a frequency response of up to 250 KC on Direct, down to DC on FM. And it operates on almost any source of power—including batteries. In other words, Ampex has a portable line so complete you can pick a recorder to fit your needs instead of having to modify your requirements to fit the recorder. For more information write the only company providing recorders, tapes and core memory devices for every application: Ampex Corp., 934 Charter St., Redwood City, Calif. Term financing and leasing available. **AMPEX**

SILENT POWER
for the hands of time...



SYNCHRON[®]

CLOCK MOVEMENTS

Cut production and assembly costs with Hansen SYNCHRON Clock Movements — simply mount and attach hands. Precision-built, self-starting synchronous movements meet the most rigid requirements of clock manufacture . . . whether you're producing the daintiest bedroom or desk models, wall units for home and office, large display clocks, or programming systems. All moving parts constantly bathed in a sealed, lifetime oil supply. Perfect balance and coordination assure accuracy. (Covers or dust bands available for most models.)

Design assistance by Hansen readily available on your construction or design problems. Special action no problem with Hansen movements for pendulum clocks, oscillating clocks, etc.

Sustained accuracy for all clocks
... up to 26" diameter under glass
... front, rear, or bottom set
... 24, 110, or 220 volts
... 25, 50, or 60 cycles

SEND TODAY for Data Sheet No. 1200, featuring new D-Type Movements as well as C-Type.



HANSEN REPRESENTATIVES:
THE FROMM COMPANY
Chicago, Illinois
H. C. JOHNSON AGENCIES, INC.
Binghamton, N.Y.
Fayetteville, N.Y.
Rochester, N.Y.
Schenectady, N.Y.
Williamsville, N.Y.
WINSLOW ELECTRIC COMPANY
Essex, Connecticut
New York, N.Y.
Philadelphia, Pa.
EXPORT DEPARTMENT
15 Moore Street, New York, N.Y.

HANSEN
MANUFACTURING
COMPANY, INC.
PRINCETON, INDIANA

FAST DELIVERY

ANYWHERE

MIDWEC INSTRUMENT GRADE MYLAR* DIELECTRIC

Ca-pac-i-tors

Best Shipping Interval In The Industry—3 Weeks Standard
High Reliability and Quality
Competitively Priced

Specialists In Low Tolerance Units
Approved for use in Talos, Minute Man, Titan, Typhon,
Telephone Companies ■ 100% Test for dielectric strength,
capacitance, insulation resistance and dissipation factor

MIDWEC
OSHKOSH, NEBRASKA

write for
data sheets
and prices

SALES OFFICE: 601 So. Jason St., Denver 23, Colo.
TWX: 292-3891—Telephone SH 4-3481—DDD 303

* DuPont TM for Polyester Film.

CIRCLE 201 ON READER SERVICE CARD

Systems Manager

to \$30,000

EXPANSION of leading Midwest Research and Development organization has resulted in creation of executive position of Systems Manager. Duties entail technical direction and leadership of several well-established, highly competent subsections, including: Control Systems, Systems Analysis, and Psychological Sciences. Candidate employed will be expected to build present group of approximately 60 to Department status.

POSITION requires Ph.D. Degree in Physics or Electrical Engineering with good knowledge of electronics and microwaves plus proven capabilities in conceptual design of systems.

PERSONAL traits must enable successful candidate to solicit, receive, and maintain cooperative, harmonious relationships with heterogeneous technical groups, individuals, and customers. Preferred age range—35 to 45.

If you are interested in knowing more about this exceptional opportunity but do not have a prepared resume, jot your home address and phone number on the back of your business card and mail with full assurance that all activity will be on a confidential basis and all expenses paid by employer.

EUGENE B. SHEA, PRESIDENT



Execu-Search

A DIVISION OF DAVIES-SHEA, INC.

332 SOUTH MICHIGAN CHICAGO 4, ILL., WEBSTER 9-3838

Serving the Electronics Industry exclusively—with Integrity

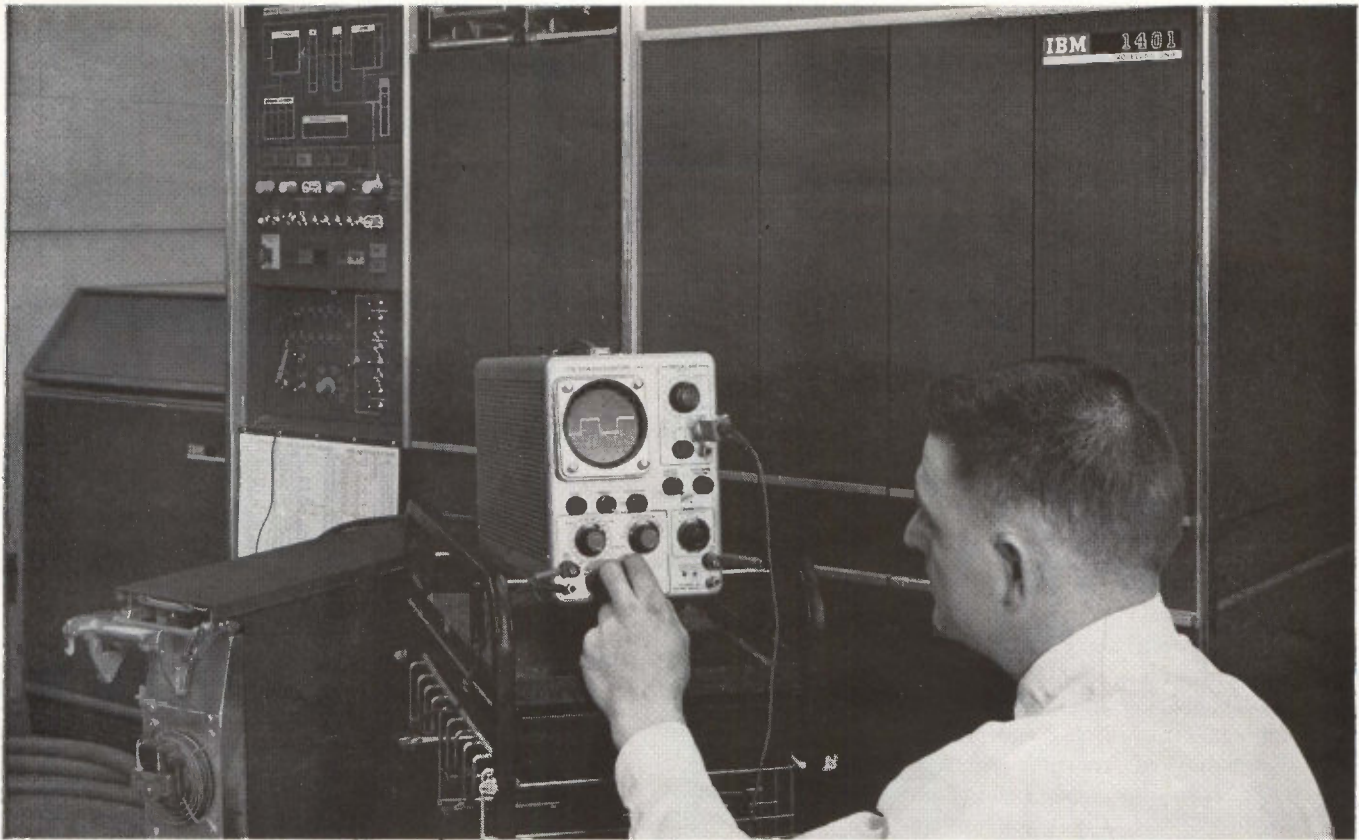

Preventive Maintenance

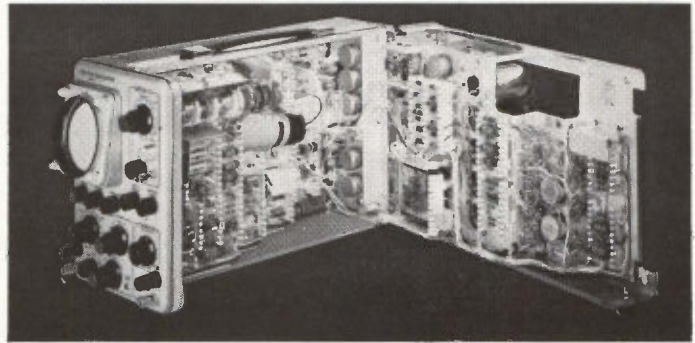

Hinged chassis affords easy accessibility to all tubes and components. Size is 10³/₈" high by 7" wide by 17³/₈" deep. Weight is 23 pounds.



*with Tektronix portable
Type 310A Oscilloscope*

Here a computer technician uses a Tektronix Type 310A Oscilloscope for preventive maintenance on a data processing unit.

Periodic checks—such as this one on the noise level of pulses in the main timing circuit—aid the technician in keeping the unit operating to its fullest capability.

Perhaps the Type 310A can help you in your own preventive-maintenance program . . . in your own point-of-use tests on complex electronic equipment.

It's a precision-measurement tool that operates almost anywhere from 50-to-800 cps line frequency—a compact, portable instrument that presents high-resolution displays of dc-to-4 Mc applications.

Main Characteristics

Frequency Response: DC-to-4 Mc—100 mv/div to 125 v/div, 2 cps-to-3.5 Mc—10 mv/div to 100 mv/div. **Risetime:** less than 90 nanoseconds. **Sweep Range:** 0.1 μ sec/div to 0.6 sec/div, 18 calibrated sweep rates. **Triggering:** internal, external, or line frequency, ac-coupled or dc-coupled, or automatic facility. **Amplitude Calibrator:** 11 square-wave voltages, 50 mv to 100 v, peak-to-peak.

Type 310A Oscilloscope \$675

U.S. Sales Price f.o.b. Beaverton, Oregon

**FOR A DEMONSTRATION, CALL YOUR
TEKTRONIX FIELD ENGINEER**

Tektronix, Inc. / P.O. BOX 500 • BEAVERTON, OREGON / (Area Code 503) Mitchell 4-0161 • TWX: 503-291-6805 •
Telex: 036-691 • Cable: TEKTRONIX • OVERSEAS DISTRIBUTORS IN 27 COUNTRIES

Tektronix Field Offices are located in principal cities throughout the United States. Please consult your Telephone Directory.
Tektronix Canada Ltd: Montreal, Quebec • Toronto (Willowdale) Ontario • Tektronix Ltd., Guernsey, Channel Islands

Modules Incorporate Integrated Circuits

Army program exploits thin-film and integrated block technology

By R. A. GERHOLD,
D. S. ELDERS,
U. S. Army Electronic Research
and Development Laboratory
Fort Monmouth, New Jersey

A NEW generation of micromodules will provide a reliable approach for incorporating advanced circuit technology into military equipment.

The enhanced micromodule will include thin-film and integrated semiconductor circuit technology in its stacked-wafer structure. Application of new interconnection techniques will allow significant gains in performance and reliability.

The new micromodule structure, Fig. 1, provides uniform and economical interconnections within a single hermetic can and header assembly.

CONDUCTORS—A stack of microcircuit wafers, containing thin-film and integrated circuit elements, is connected by welding copper-ribbon conductors to metallized terminal areas around the edges of notchless wafers.

Resistance values for these

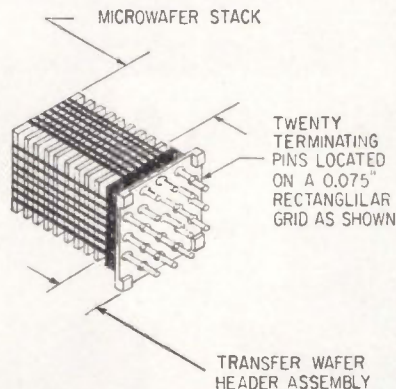

INTERCONNECTIONS for thin-film and semiconductor integrated circuits in micromodules are provided by ribbon conductors welded on each side of notchless wafers (left). Photo, right, shows close-up of these connections in developmental model—Fig. 1

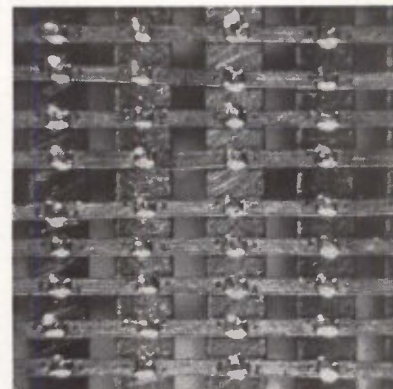

microconnections are in the order of 0.01 milliohm and are more stable than thermocompression bonds. Newly-developed modifications of resistance welding also may prove to be adequately reliable for these microminiature joints.

Interconnections on a 25-mil grid yields a potential termination density of 1,600 terminations per square inch. On a volume basis, 64,000 microconnections could be contained in one cubic inch. This is one-tenth of the volume occupied by the same number of soldered riser wire connections of the micro-module.

Up to 9 ribbon conductors may be

used on each side of the notchless microelement wafers of the standard 0.310-in. size. This provides for 36 interconnecting ribbon conductors in place of the 12 riser wires of the conventional micromodule.

The bottom transfer wafer connects twenty of these ribbon conductors to the pins of a hermetic header. The twenty header pins are located on a 75-mil grid to permit use of relatively noncritical multilayer printed wiring for interconnections between modules.

The can is hermetically sealed to the enhanced micromodule by electron-beam welding, and no flange is necessary. Leakage rates of less than 10^{-9} cc/sec have been demonstrated for such sealed modules. The package is suitable for extreme thermal environments.

Originally, the micromodule was planned with full awareness of the anticipated strides in the thin-film and semiconductor integrated circuit areas.

Back in 1961, a program was explored with Servomechanisms, Inc. to apply multilayer thin-film integrated circuits to the micromodule. Integrated circuit microelements in hermetic flat-packs were assembled into micromodules by Texas Instruments.

A 0.225-in. sq flat-pack is now under development with Westing-

MICROMODULES BY THE MILLION

Since the micromodule program started five years ago, an estimated \$18 million has been spent on this method of miniaturizing military circuits.

More than 50 companies have been involved in various phases of manufacture. Over 675 different circuits, both digital and linear, have been reduced to micromodule design. Reliability of the modules has been confirmed by over 57 million element-hours of life tests, the authors say.

This program keeps pace with new circuit technology, presently scheduling premium applications which can most readily support initial cost differentials between modern techniques and conventional circuits.

Army now has over a score of equipments under consideration. These would require over a million micromodules

LOW C...

(-55°C)

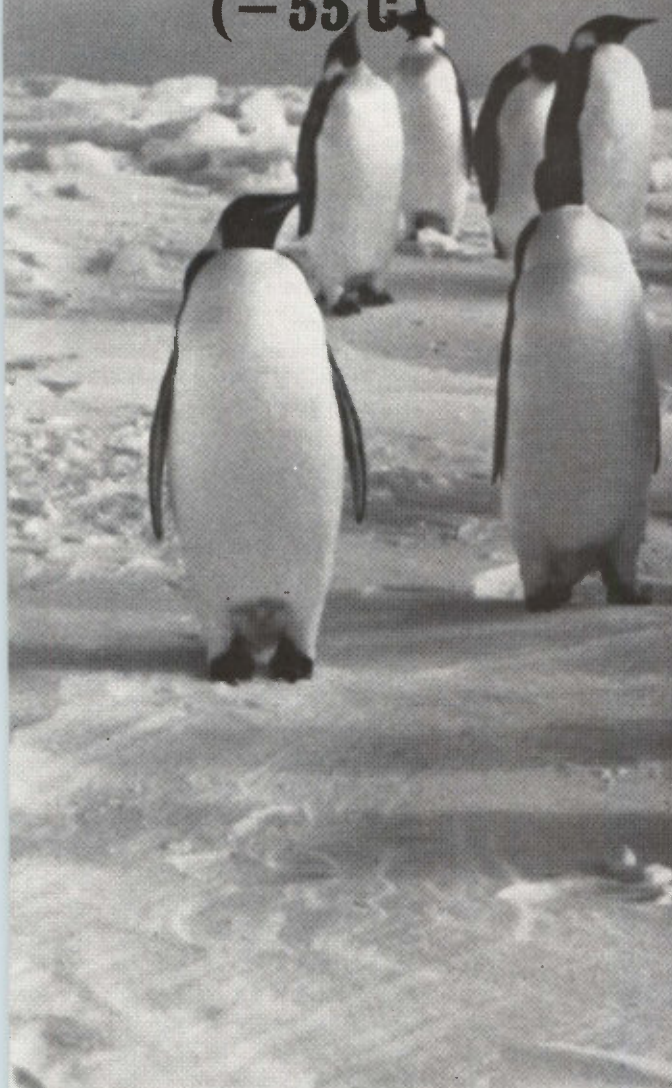

...HIGH C

(+125°C)



thermal breakthrough in aluminum electrolytics

TYPICAL PERFORMANCE DATA—TYPE HTA

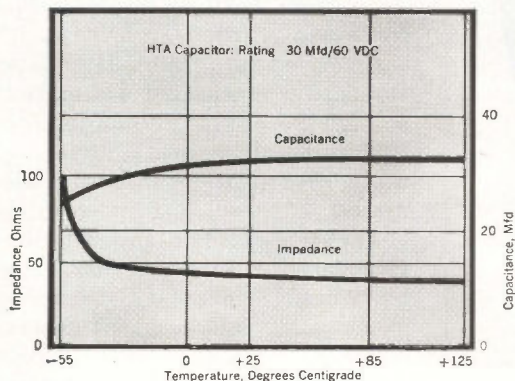

Typical stability of capacitance at low and high temperatures.

Compared to ordinary aluminum capacitors normally rated -30°C to $+85^{\circ}\text{C}$, new Mallory Type HTA capacitors can work over a far greater ambient range, from -55°C to $+125^{\circ}\text{C}$. At the top end . . . plenty of life and reliability. At the low end . . . plenty of capacitance stability.

The Mallory HTA is a new kind of aluminum electrolytic capacitor. For the first time, designers of industrial and commercial electronic circuits can apply the economy of aluminum capacitors to applications in high and low temperature ranges—and still have performance characteristics approaching those of tantalum units.

Take a close look at the HTA's temperature performance: you may find a lot of spots where you figure nothing but tantalum would do. HTA's are supplied in ratings of 8 to 300 mfd, 60 to 3 volts. Standard diameter is $\frac{3}{8}$ -inch. Case length is $1\frac{1}{16}$ to $1\frac{5}{8}$ inches. Tubular aluminum case, with axial leads. Supplied with Mylar* sleeve if desired.

Call or write today for technical data. Mallory Capacitor Company, Indianapolis 6, Indiana—a division of P. R. Mallory & Co. Inc.

*Du Pont trademark



CIRCLE 79 ON READER SERVICE CARD

U T I C A[®]

UTICA

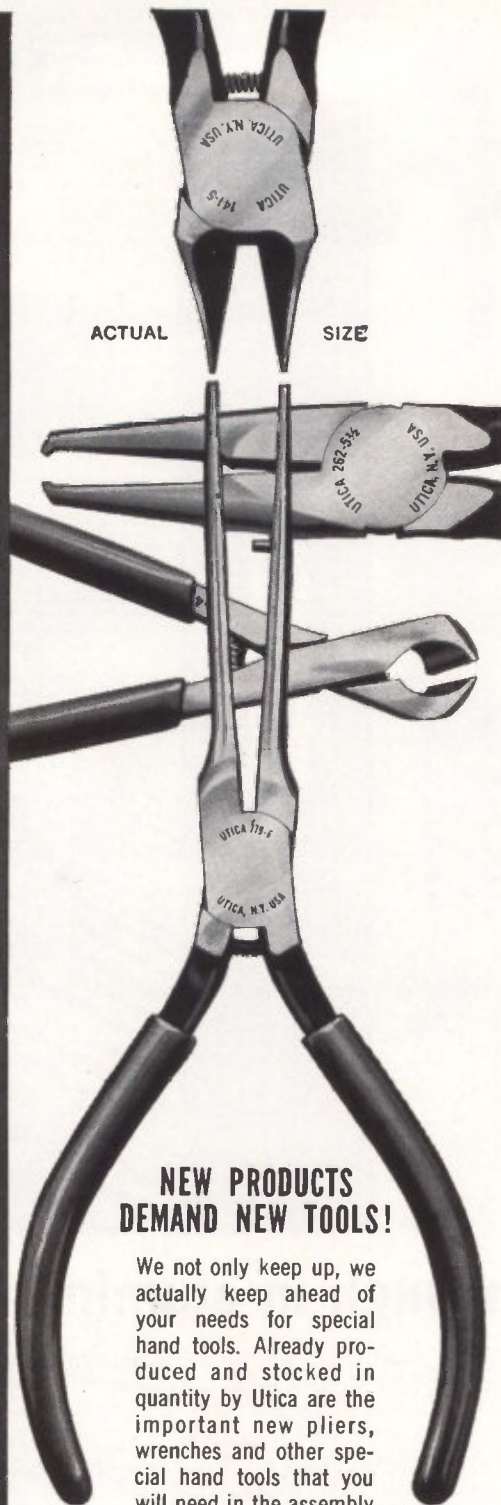

ACTUAL SIZE

NEW PRODUCTS DEMAND NEW TOOLS!

We not only keep up, we actually keep ahead of your needs for special hand tools. Already produced and stocked in quantity by Utica are the important new pliers, wrenches and other special hand tools that you will need in the assembly of your new designs. All have been proved through application. All are backed by famous full guarantee.

Get the full story. Talk to your Utica distributor or write for our latest hand tool catalog.

**Utico Drop Forge & Herbrand
Tool Division, Kelsey-Hayes Co.
Orangeburg, S. C.**

tools the experts use!

house. This will provide useful circuit area equivalent to that of the much larger TO-5 can.

SINGLE CAN—Since no polymeric materials are incorporated within the enhanced micromodule assembly, the package is suitable for temperature extremes. An aggregate of uncased semiconductor devices and integrated circuits can be sealed within a single enclosure.

Interconnections of the semiconductor devices are accomplished in a contamination-free environment. Design eliminates the need for much of the printed wiring now used between individual integrated circuit packages.

With two uncased integrated circuit flip-flops on each of the ten microcircuit wafer, an entire flip-flop shift register could be contained in a single 0.8-in.-high enhanced micromodule. The single overall hermetic seal replaces 20 relatively expensive flat-packs.

From a point of view of efficiency of microminiaturization, 21 parts per flip-flop would result in a total of 420 parts. This results in a packing density of some 9 million parts per cubic foot at the module level. The micromodule program has shown that possibly one-third of this figure could then be realized in extensive logic arrays in practical equipment.

The limiting factors as to reliability are the circuits on the wafers. Full reliability of the integrated circuits are realized by the microwelded connections to the ribbon conductors. Lead lengths between circuits may be greatly shortened and capacitance of the many metal parts of the individual cases minimized.

Retention of the 0.310-in. sq standard microelement will make it possible for the equipment designer to incorporate a broad catalog of established high-performance elements.

The micromodule program has established a broad vendor capability commensurate with the range of available microelement characteristics. Vendors will supply microelements to any equipment manufacturer desiring to assemble micromodules.

Mechanized module assembly facilities have been established at P. R. Mallory, Paktron, and RCA

Semiconductor Division to ensure initial production capability adequate for broad military commitments.

Thermal Shroud Cycles Orbital Temperatures

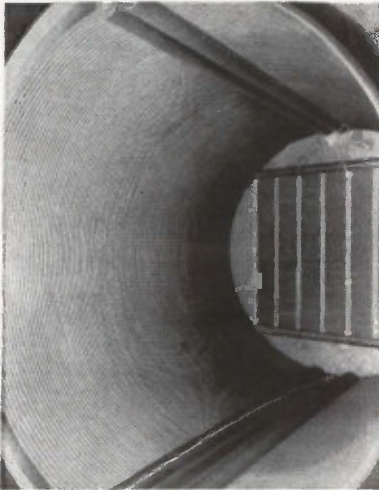

AUTOMATIC programming capabilities of thermal chamber, developed by Bethlehem Corp., permits cycling to orbital thermal environments without any surplus equipment to add to vacuum pumping load. Chamber simulates temperatures from -320 F to 500 F, is in use at RCA's Space Center, Princeton, N. J.

Switching Cores Developed For Molecular Circuits

SIGNIFICANT reduction of drive-current requirements for magnetic thin-film memory elements is claimed by Univac Div. of Sperry Rand Corp.

New magnetic elements have been deposited that operate at drive currents of between 20 to 30 milliamperes. This has been accomplished by altering the chemical composition of the magnetic material and reducing the size of the drive wire to 5 mils. The film thickness was reduced to 200 Angstroms to decrease demagnetization effects.

NEW LOW—Tests of the new film indicated an anisotropy field of about one oersted. This is said to be 3 or 4 times less than films now in use.

The new magnetic memory has a

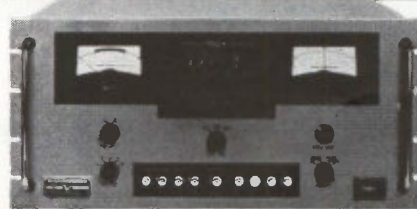
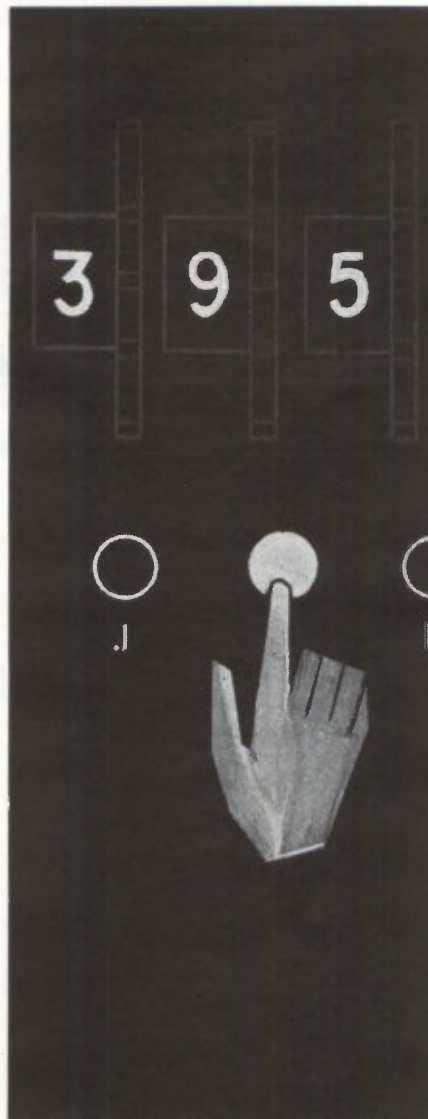

*Visit DEI at
the NTC Show
Booth 65-66*



DEI
SERVING
GOVERNMENT
AND INDUSTRY

NEW from DEI PUSH-BUTTON PCM SYNCHRONIZER

- Exceptional Stability and Calibration Accuracy
- Correlating Bit Detection
- All Digital Loop Filter
- Wide Dynamic Input Range

NOW—for the first time, push-button bit rate selection is possible!

From Defense Electronics, Inc. comes the latest in a line of PCM Digital Products.

The solid state BRS-1 Bit Synchronizer/Conditioner has been designed for PCM telemetry applications and features accurate setting (within 0.1 per cent) for a known bit rate prior to actual signal reception.

This exceptionally stable and highly accurate synchronizer accepts a serial PCM signal at rates up to 1 mc, automatically conditions the incoming data and generates a stable clock signal.

Automatic circuitry adjusts to input signals over a 40 db dynamic range. The unit incorporates a unique digital loop filter that maintains bandwidth proportional to bit rate at all frequencies. Output of the synchronizer is a reshaped, noise-free, serial PCM signal and a set of clock signals phase coherent with the output data.

The BRS-1—which can be remotely-controlled—performs the functions of data regeneration, format conversion and serves as the "front-end" for any digital telemetry system.

Write for DEI bulletin BRS-1 . . . or call:

Defense Electronics, Inc.

Main Office:

5455 Randolph Rd. Phone: WH 6-2600
Rockville, Md. TWX: 301-949-6788

Regional Office: Sherman Oaks, Calif. Phone: 873-4322

EXPANDO DOES IT!

Now - a complete, electronic measurement laboratory in one portable case

EXPANDO UNIVERSAL PORTABLE STANDARD

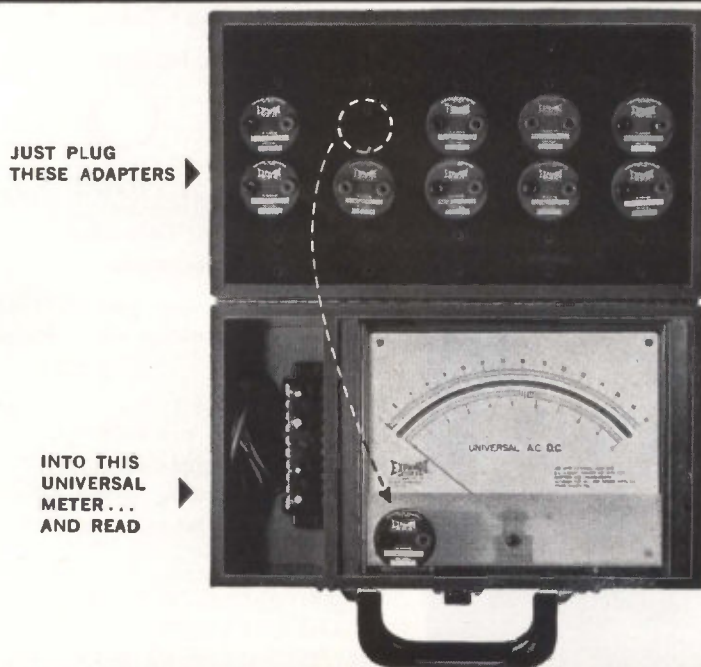

EXPANDED SCALE AND FULL SCALE, AC AND DC, 0.1% TO 1% ACCURACY
VOLTMETER • AMMETER • MILLIAMMETER • FREQUENCY METER • TRUE RMS

You are looking at the first instrument of its kind. There is nothing else like it - it's one standard, five standards, twenty *precision* standards or more - all in one compact case.

Want a 0.1% expanded scale voltmeter? Just plug in Expando Adapter 'A' . . . Want a 1% full scale milliammeter? Just plug in Expando Adapter 'L' . . . and so on.

You start with just the Adapters you need most, and buy others as you require them. Choose your range and the desired accuracy (from 0.1%), plug in the appropriate Adapter, and read easily on the full 7-inch scales.

The unique Expando Adapter made this new plug-in concept possible. Here is unprecedented versatility and precision in portable instrumentation - and you can acquire it for a mere \$75.

Hard to believe, isn't it? So write for the full details about this multi-function precision instrument. It's quite a story!

A & M INSTRUMENT, INC. / SUBSIDIARY OF LORAL ELECTRONICS CORP.
48-01 31ST AVE., LONG ISLAND CITY 3, NEW YORK / TWX NY 4-323

flux of about 0.2 millimaxwells and generates an output voltage of a few tenths of a millivolt when switched in 10 nanoseconds.

The film has been used in operational memory circuits in which signal-to-noise ratios of 10 to 1 have been demonstrated. Outputs of 40 millivolts have been achieved with amplifier gains of 40 decibels.

The magnetic film is a ternary alloy of nickel, iron and phosphorus.

Most existing magnetic thin-film structures require several hundred milliamperes for current drive. Bringing down power requirements to 20 or 30 milliamps make magnetic memory switching elements compatible with molecular integrated circuits.

Univac spokesmen say that this thin-film breakthrough makes possible the future development of 256-word memories, complete with selection circuits, drivers and amplifiers, in a volume of about one-half cubic inch. This development assumes use of evaporated circuit components and conductors with miniaturized diodes and transistors. Full use of evaporated circuits that include active elements would permit even smaller volumes.

Laser, Electron Beam Machining Compared

WESTINGHOUSE ELECTRIC scientists estimate the cost of electron beam devices for machining applications at \$50,000 to \$75,000 and for lasers at \$25,000. The laser systems they consider, however, do not have the average power capabilities of electron beam devices, but can deliver the same power densities.

C. H. Church, W. J. Smith and G. R. Feaster say that repair costs to laser systems would be relatively high in large capacitor machines because of the need for capacitor replacement. Lasers, though, would not require the vacuum systems necessary in electron beam work. For welding, they considered power densities from 10 to 15 Mw per square inch and working areas of 0.01 to 0.03 inch in diameter, with average power of 1 to 10 Kw. For drilling and cutting, they considered power densities over 100 times larger covering smaller areas, such as 0.001 inch in diameter.

In breadboarding, packaging and quantity production, what the concept of strip transmission line promised, TRI-PLATE techniques deliver — they've made the concept a practical reality! □ The multi-component airborne package shown below is produced in volume and is a good example of how TRI-PLATE techniques cut size, weight, and costs. This circuit produced in conventional coaxial line measured 160 cu. in., weighed 6.25

lbs. and cost \$1369.63. By comparison, the same assembly produced as an integrated TRI-PLATE line package measures only 108 cu. in., weighs less than 2.5 lbs., and costs just \$306.05. □ In addition, TRI-PLATE Line minimized the interface problem by at least 60%. This was accomplished by combining six components — two 3 db couplers, one 6 db coupler, two 10 db couplers, two crystal detectors, two crystals, and a ter-

mination — into an integrated assembly. By eliminating multiple connectors, VSWR was also improved. And this Integrated TRI-PLATE Package, the design of which was proved feasible through the use of TRI-PLATE Modules before quantity production was initiated, exceeds environmental Mil Specs for airborne equipment. □ Microwave, semiconductor and fast switching circuits with high density packaging, that hereto-

**77.7% cost reduction
achieved with this
mass-produced**

**Tri-Plate[®]
Package**

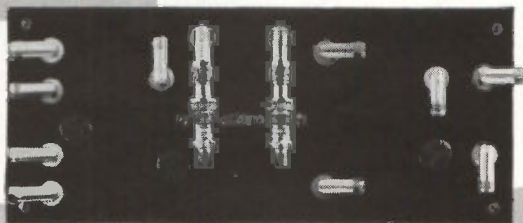

fore have been thought impractical or impossible to build because of their bulk or complexity, are successfully produced in TRI-PLATE Strip Transmission Line. □ To help speed the time from design to breadboard to prototype to production, there are more than 600 TRI-PLATE Modules — plus over 150 TRI-PLATE Mounts for standard and advanced semiconductor devices — available from Sanders. They let you test new circuit ideas — no matter how different or daring — with speed, ease and

economy. You can go from paper schematics to functioning circuits in just minutes to evaluate new design concepts. □ And a system designed with TRI-PLATE Modules can be produced in quantity as an Integrated TRI-PLATE Package, with performance equal to or better than that of the modular prototype, and with great savings in size

and weight. □ For more information about Strip Transmission Line and how TRI-PLATE Products have made it a practical reality, for the latest literature — including specifications and prices — or for consultation regarding your specific requirements, write to Sanders Associates, Inc., Microwave Products Dept., Nashua, New Hampshire.

®REG. T.M.J. EXTENSIVE PATENT COVERAGE, SANDERS ASSOCIATES, INC.

CREATING NEW DIRECTIONS IN ELECTRONICS 
SANDERS TRI-PLATE[®] STRIP TRANSMISSION LINE

20-YEAR HITCH IN DAVY JONES' LOCKER

(Mycalex components are built to work on over 4,000 miles of ocean floor until at least 1983)

These amplifiers will be spaced at 20-mile intervals along a single cable on the ocean floor to help the Bell System handle the growing number of inter-continental telephone calls—well over 4,000,000 last year alone.

In designing these new amplifiers the Bell System engineers aimed at developing a device that would stand up for at least 20 years under the extreme pressure. For failure of any of the complex components could interrupt vital transoceanic circuits.

They looked to Mycalex Corporation of America for 11 key parts—resistors, inductors and transformers—because Western Electric knows from over 20 years of materials testing and experience that our SUPRAMICA® 555 ceramoplastic is one of the most nearly perfect insulating materials. It can be precision molded for reliable operation. It is extremely stable. It has a thermal expansion coefficient close to that of stainless steel. It permits easy soldering of imbedded inserts.

SUPRAMICA (we make three kinds, 555, 560, and 620 "BB") is only one of the products we produce as the world's leading specialists in high-temperature, high-reliability ceramic insulation materials and components. If you'd like a sample of SUPRAMICA 555 plus our newest literature on this amazingly versatile engineering material, please fill out the coupon below.

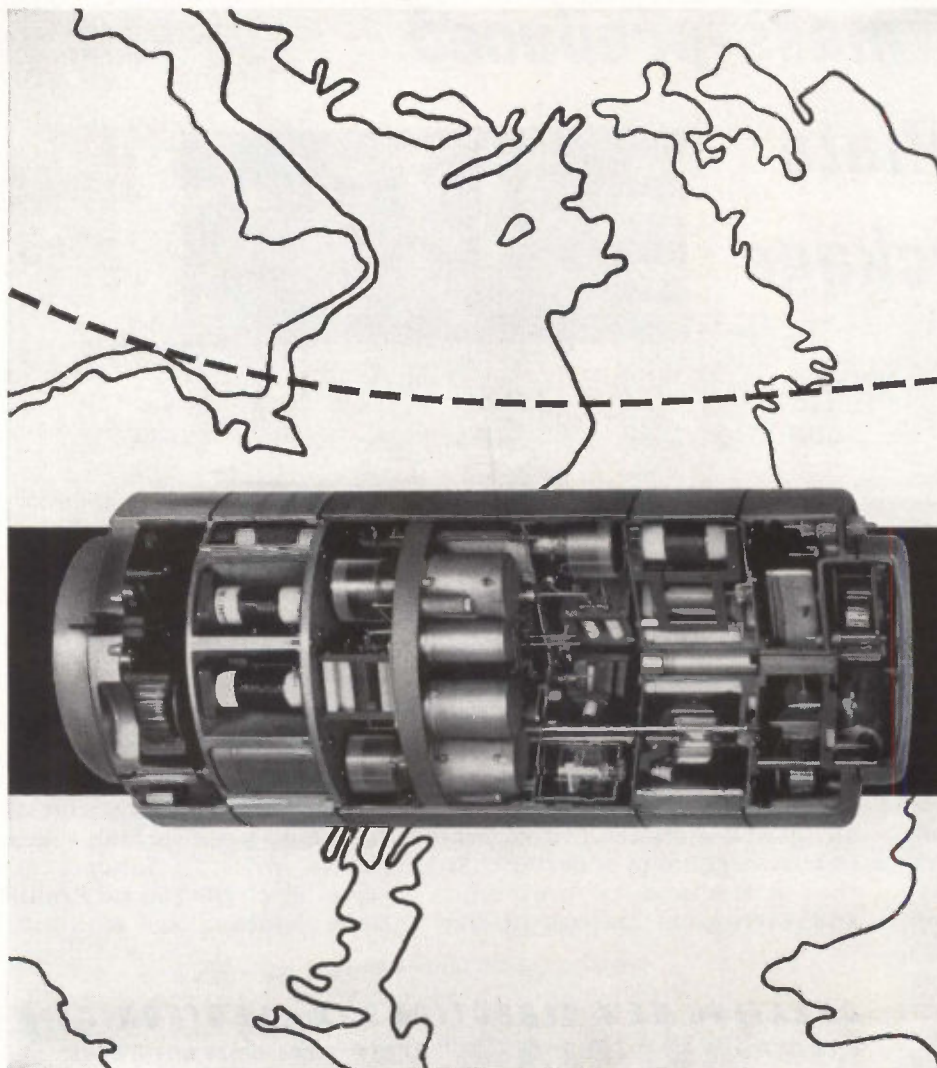
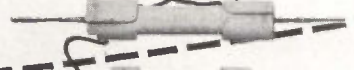

MYCALEX

World's largest manufacturer of ceramoplastics, glass-bonded mica and synthetic mica products.

Mycalex Corporation of America
Dept. S, Clifton Blvd.
Clifton, New Jersey

Please send me information on SUPRAMICA 555 ceramoplastic and other Mycalex products. My specific

interest is _____

Name _____

Title _____

Company _____

City _____ State _____

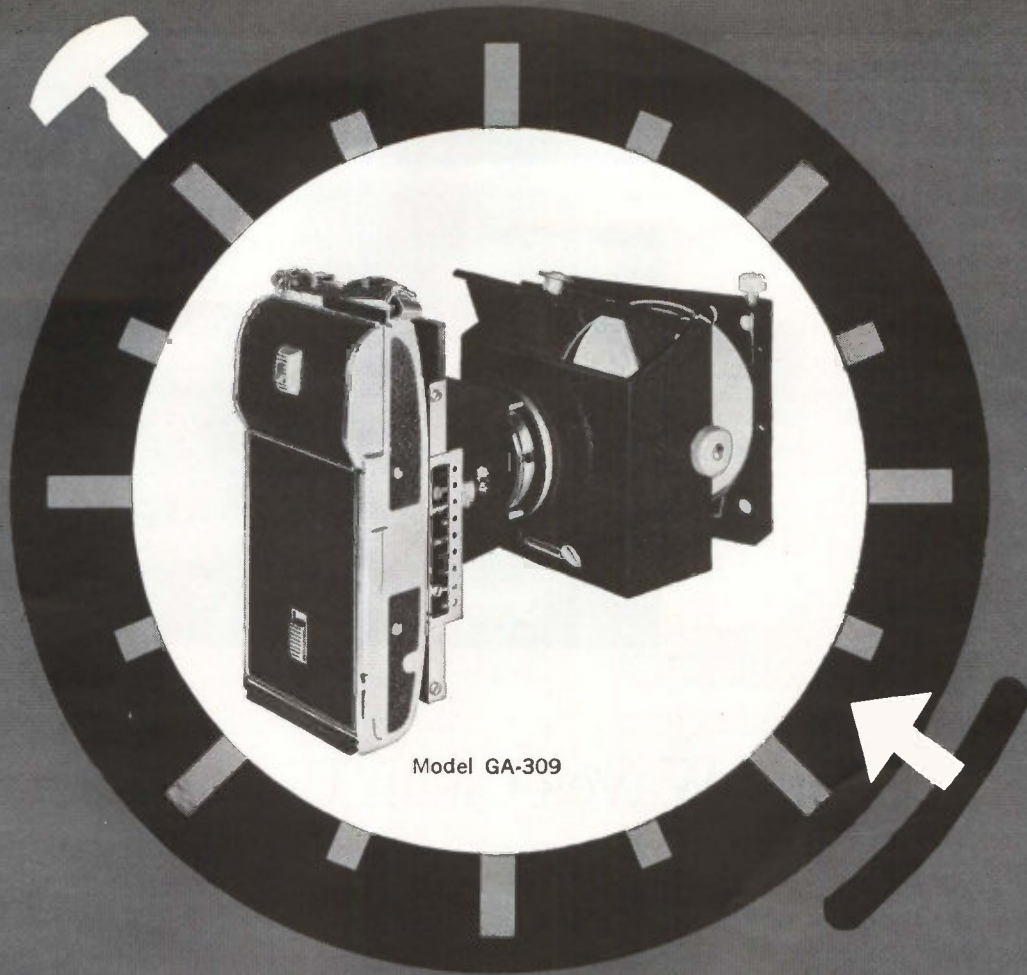

Model GA-309

NEW "UNIVERSAL" OSCILLOSCOPE CAMERAS

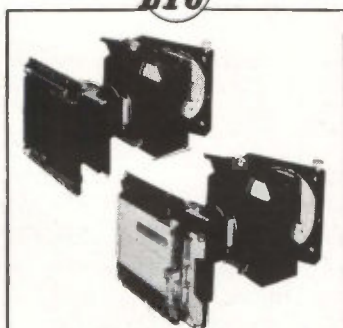

INTERCHANGEABLE-BACK. USE POLAROID OR GRAFLEX. Standardize on one camera, change backs. Use Polaroid film, film negatives, or glass negatives—single or multiple exposure.

COMPARE THESE TYPICAL PRICES:

Model GA-300A* f/2.8 lens \$345
 Model GA-300* f/1.9 lens \$375
 Model GA-309* f/1.9 lens,
 multiple exposure \$390

*Features front-hinged, swing-away, and lift-off mount.

ONE GENERAL ATRONICS INTERCHANGEABLE-BACK CAMERA MEETS ALL YOUR 'SCOPE RECORDING NEEDS. New General Atronics GA-300 series oscilloscope recording cameras present the versatility of interchangeable-back design (models GA-301,A, and GA-309,A). Convert from multiple exposure to single exposure, or from Polaroid film to Graflex film. You can standardize on one high quality camera—add adaptors and backs at nominal accessory cost.

Complementing adaptability, General Atronics standardizes front-hinged, swing-away and lift-off mounting on all GA-300 series cameras. All attach to standard 5" bezels, or directly to scope panels. And so it goes—feature for feature, General Atronics is your best camera buy.

Check the 3-fold combination of General Atronics quality, application-adaptability, and more features per camera dollar. Send for complete data—write Dept. E52463.

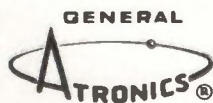

GENERAL ATRONICS

ELECTRONIC TUBE AND INSTRUMENT DIVISION, PHILA. 18, PA.

CATHODE RAY TUBES • OSCILLOSCOPES • OSCILLOSCOPE RECORDING CAMERAS

New technique keeps boards moving in-line on soldering conveyor

By PAUL J. BUD
Electrovert, Inc.
New York, N. Y.



Ultrasonic Waves Clean Circuit Boards

CLEANING of circuit-board assemblies is an extremely critical factor in pre- and post-soldering phases of in-line production. To get away from present dipping in ultrasonic cleaning tanks that disrupt in-line character of wave soldering, Electrovert has developed the near-surface ultrasonic-transducer configuration shown in an accompanying illustration. Called the Ultrasonic Wave Applicator, the patent-applied-for device is believed to be the first equipment allowing straight-line (or in-line) ultrasonic cleaning.

PRINCIPLE — Heretofore, ultrasonic cleaning tanks were provided with transducers placed either at the bottom or on side walls of tank. Both configurations required stop-and-go operations and deep dipping of part to be cleaned. A great deal of ultrasonic energy is wasted due to large volume of cleaning solvent between transducer and part.

L. V. Tardoskegyi, chief industrial engineer at Electrovert, took a new tack by designing the Ultrasonic Wave Applicator so as to avoid both dipping (out-of-line) and energy-dissipation problems: transducer is positioned only 1 to 1½ inches below solvent surface, which itself has a wave configuration that enhances cleaning through

washing-action on board bottom. Solvent is circulated at the high rate of 1,000 gals per hour.

EQUIPMENT — The Ultrasonic Wave Applicator includes a stainless steel double-walled tank which is filled with the proper cleaning solvent (to be discussed). A certain solvent level is maintained in tank by an automatic gravity-flow feeding system. In addition, solvent inside double walls is pump-circulated over the large flat metallic mirror surface of transducers located just below normal level of cleaning solution. Thus, a flat continuously flowing, smooth laminar wave 12 by 12 inches in area is

produced in, or on, which ride circuit boards propelled by solder-process conveyor belt. Height of wave is controllable, averaging about ½ inch.

With topside of transducers no more than 1½ inches below wave surface maximum effect is realized from ultrasonically-induced cavitation effect in cleaning exposed printed-circuit board surface. Energy supplied by transducers is 5 watts per sq. inch.

PRECLEANING — Because of the combined wave and cavitation effect, printed circuit assemblies can be made absolutely clean in precleaning operations including re-

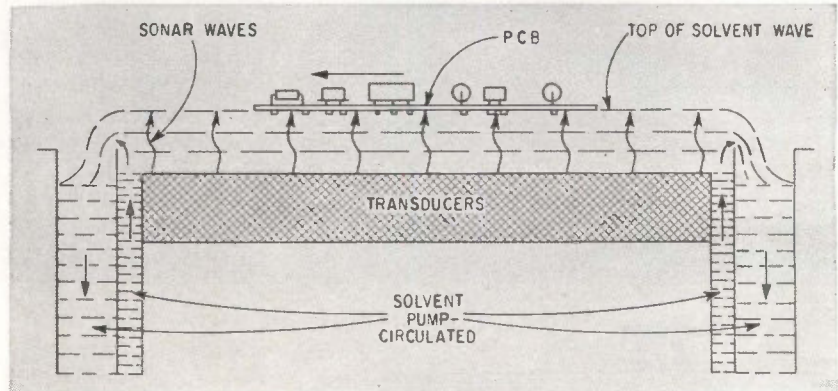

CARRIER holding printed circuit is positioned on solder-process conveyor belt just ahead of ultrasonic-wave cleaner (top). Cleaner uses a near-to-surface ultrasonic-transducer configuration (bottom)

SA-84WA
10-63,680 mc

This instrument was the microwave "hit" last August at WESCON. They were standing three deep to see it in October, at N.E.C. At NEREM, in November, we were demonstrating it **continuously**. At IEEE, eight months after its introduction, it was a **standout** attraction!

Why? Because it **stands alone**. No other manufacturer offers, in a single standard instrument, the complete complement of performance characteristics placed at your command by this **fully-equipped, truly quantitative** spectrum analyzer.

truly **Q**uantitative Universal Microwave Spectrum Analyzer

This exclusive combination of features is not merely desirable — it is **essential**, if you are to make **full use** of the enormous range of measurement capabilities inherent in spectrum analyzer techniques. As a minimum, for **truly quantitative** measurements, you must have:

- **ACCURATE CRYSTAL MARKERS** . . . $\pm 0.01\%$ in the SA-84WA!
- **ACCURATE IF ATTENUATION** . . . ± 0.05 db/db accuracy in the SA-84WA!
- **WIDE FREQUENCY RANGE** . . . 10-63,680 mc in the SA-84WA!
- **HIGH MAXIMUM SENSITIVITY** . . . to -115 dbm in the SA-84WA! (defined in the only **meaningful** way: $S + N = 2 \times N$)
- **CALIBRATED WIDE-RANGE DISPERSION** . . . over 80 mc in the SA-84WA!
- **WIDE-RANGE VARIABLE RESOLUTION** . . . 1-80 KC in the SA-84WA!
- **LOG/LINEAR AMPLITUDE SCALES** . . . to 36 db log display in the SA-84WA!
- **WIDE-RANGE VARIABLE-FREQUENCY MARKERS** . . . ± 40 mc in the SA-84WA!

We can only touch the high spots here — but our brand-new 40-page Spectrum Analyzer Bulletin A63 gives the complete specifications. Use this card—we'll send your copy by return mail!

Incidentally, we make seven classes of spectrum analyzers, in 35 standard versions, hundreds of standard variations. Turn the page for a brief summary.

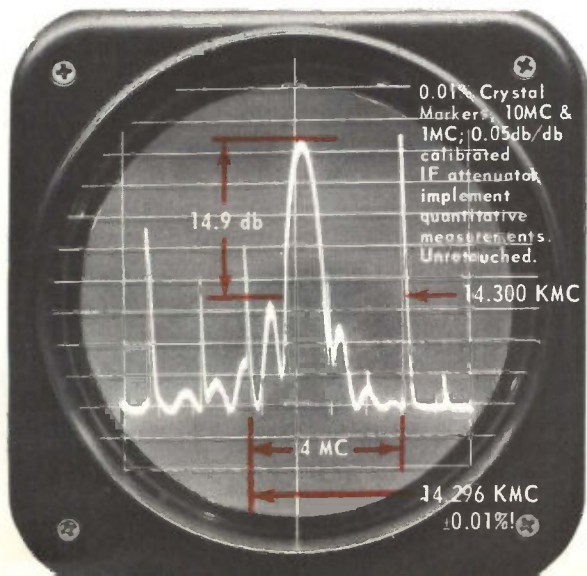

Polarad Electronic Instruments • A Division of Polarad Electronics Corporation
34-02 Queens Blvd. • Long Island City 1, New York

- Please send me your new 40-page Engineering Bulletin A63 on Microwave Spectrum Analyzers.
- I may have an immediate requirement—have my local Polarad field engineer get in touch with me. (My telephone extension is _____.)

My application is _____

Name _____

Title _____ Dept. _____

Company _____

Address _____

City _____ Zone _____ State _____

1234567890

Choose from the industry's largest, most complete line of microwave spectrum analyzers. Choose the exact price/performance combination to meet your needs, without compromise, without excessive cost. Remember, only Polarad makes them all — because Polarad originated and pioneered the microwave spectrum analyzer . . . and Polarad has consistently led the way in extending the range, the versatility, and the scope of applications of spectrum analysis. Experience really counts, too, when you must have reliable, accurate, "bug-free" measuring capability . . . and there are more Polarad microwave spectrum analyzers in service than all other types combined!



MODEL	PRICE	Configuration	Freq. Range	Resolution	Dispersion	Display	Additional Features	Max. & Min. Sensitivity (S+N=2×N)	REMARKS
TSA	\$3,990.*	Multiple PLUG-IN HEADS	10 mc to 40 gc	1 kc to 80 kc	100 kc to 25 mc	LIN-LOG	Video Filter	-115 dbm to -50 dbm	Lowest cost analyzer for specific frequency application.
TSA-W	\$4,335.*	Multiple PLUG-IN HEADS	10 mc to 44 gc	1 kc to 80 kc	25 kc to 80 mc (25 mc on STU-1 band)	LIN-LOG	Sweep and Video Outputs. Video Filter	-115 dbm to -50 dbm	Lowest cost analyzer for specific frequency application requiring wide dispersion.
TSA-S	\$4,635.*	Multiple PLUG-IN HEADS	10 mc to 44 gc	Spect. Anal. 5 kc to 50 kc Syn-500 kc chro. 5 mc	400 kc to 25 mc	LIN	Sweep and Video Outputs. Trigger Output	-105 dbm to -50 dbm	Combined spectrum analyzer & synchroscope for frequency & time domain displays.
SA-84	\$5,000.	Universal MULTI-BAND	10 mc to 40.88 gc	25 kc	500 kc to 25 mc	LIN	Military Standard UPM-84	-90 dbm to -40 dbm	Lowest cost analyzer for wide frequency coverage
SA-84T	\$5,650.	Universal MULTI-BAND	10 mc to 40.88 gc	20 kc	500 kc to 25 mc	LIN	41 DB Calibrated IF Attenuator	-105 dbm to -55 dbm	Transistorized, portable, battery or line operated, wide frequency coverage.
SA-84W	\$6,290.	Universal MULTI-BAND	10 mc to 40.88 gc	1 kc to 80 kc	25 kc to 80 mc (25 kc to 100 mc on special order \$100 add'l)	LIN-LOG	20 DB Calibrated IF Attenuators IF & RF Crystal Markers, Video Filter	-105 dbm to -55 dbm	Wide frequency coverage with wide dispersion.
SA-84WA	\$6,490.	Universal MULTI-BAND	10 mc to 63.68 gc	1 kc to 80 kc	25 kc to 80 mc (25 kc to 100 mc on special order — \$100. add'l)	LIN-LOG	20 DB Calibrated IF Attenuator IF & RF Crystal Markers, Video Filter	-115 dbm to -45 dbm	Widest frequency coverage with wide dispersion.

Buy only the head you need — expand range later!

Single unit covers all bands

* With One Head

STANDARD OPTIONS

- OPTIONS
- 100 mc Dispersion
 - Phase Lock Capability
 - AM Marker Modulation Input
 - XY Recorder Output & Slow Scan Rate
 - 50 DB on Screen Log Display
 - 63 DB Calibrated IF Attenuator
 - Choice of CRT Phosphor

- UNIT
- TSA-W, SA-84W, SA-84WA
 - All Units
 - All Units
 - TSA, TSA-W, SA-84W, SA-84WA
 - TSA, TSA-W, SA-84W, SA-84WA
 - SA-84T
 - All Units

Postage Will be Paid by Addressee

No Postage Stamp Necessary If Mailed in the United States

BUSINESS REPLY MAIL
First Class Permit No. 18, Long Island City 1, N. Y.

POLARAD ELECTRONIC INSTRUMENTS
A Division of Polarad Electronics Corporation
34-02 Queens Blvd.
Long Island City 1, N. Y.



This 40-page engineering bulletin contains an excellent "State of the Art" summary and a review of many new and unusual applications, as well as complete specifications on the industry's largest line. Use the card — get your copy by return mail!

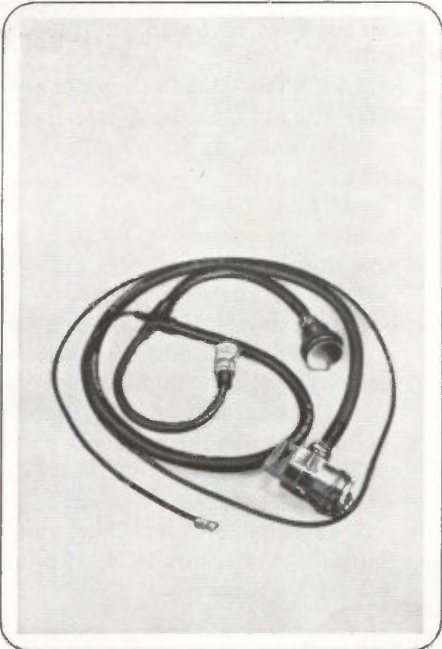
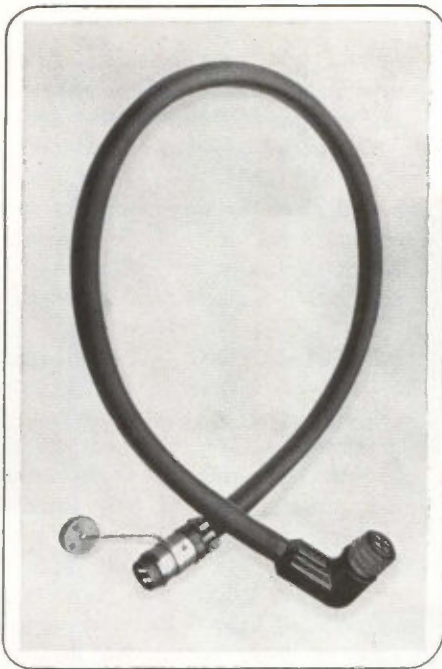
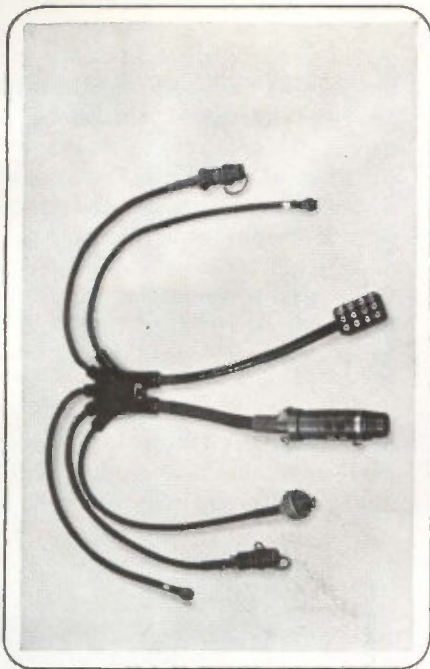

**Now
let us
solve
your
cable
problem
!**

You'll probably never need any of these five cables.

But somebody did. And the same versatility and reliability-control which fit these special cables to special needs are now available to solve your cable problems.

These are products of Rome's Special Products Facility, where unique cable constructions are everyday products.

Cables like these can't afford to fail—there often isn't a second chance. So Rome insures reliability with a quality control program second to none. It tests each cable construction continuously throughout construction and inspection.

The program has been so successful that we recently won the first aerospace reliability contract ever awarded to a cable manufacturer. Its goal is to prevent cable assembly malfunctions in the Minuteman missile.

Other cable constructions from Rome's Special Products Facility have proved themselves reliable on such projects as Hound Dog, Atlas, Mercury, and Sergeant.

Our Special Products Facility brochure explains how you can fit Rome's unique experience, skills and equipment to your specific problems. Just send the coupon.



Special Products Facility
Rome Cable Division of Alcoa
2937 South Tanager Avenue
Los Angeles 22, California

Please send my copy of your brochure describing how I can benefit from Rome's Special Products Facility.

NAME _____

COMPANY _____

ADDRESS _____

CITY _____ ZONE _____ STATE _____

**Immediate
delivery!**

**ELMENCO
CAPACITORS**

in quantities up to
500 Per Item

CONTACT THESE AUTHORIZED

ELMENCO INDUSTRIAL DISTRIBUTORS

ALABAMA, Huntsville: Electronic Wholesalers, Inc.
ARIZONA, Phoenix: Kieruff Electronics, Inc.,
Midland Specialty Co.

CALIFORNIA, Glendale: R. V. Weatherford Co.,
Inglewood: Newark Electronics Co. Inc., Los
Angeles: Federated Purchaser, Inc., Hollywood
Radio & Electronics Inc., Kieruff Electronics,
Inc., Shelley Radio Co., Inc., Mountain View:
Kieruff Electronics, Inc., Oakland: Brill Elec-
tronics, Palo Alto: R. V. Weatherford Co., Zack
Electronics, Riverside: Electronic Supply of
Riverside, San Diego: Shanks & Wright, San
Francisco: Pacific Wholesale Co., San Jose: Pen-
insula Electronic Supply Inc.

COLORADO, Denver: Denver Electronic Supply Co.

DISTRICT OF COLUMBIA, Capitol Radio Whole-
salers, Inc., Electronic Wholesalers, Inc.

FLORIDA, Melbourne: Electronic Wholesalers
Inc., Miami: Electronic Wholesalers Inc. Or-
lando: Hammond Electronics Inc.

ILLINOIS, Chicago: Allied Electronics Corp.,
Newark Electronics Corp.

MARYLAND, Baltimore: D & H Distributing Co.,
Electronic Enterprises, Inc., Kann-Ellert Elec-
tronics Inc., Wholesale Radio Parts Co., Inc.

MASSACHUSETTS, Newton: Cramer Electronics,
Inc. Cambridge: Electrical Supply Corp.

NEW JERSEY, Camden: General Radio Supply
Co., Radio Electric Service Co. of N. J. Inc.,
Mountainside: Federated Purchaser, Inc.

NEW MEXICO, Alamogordo: Radio Specialties Co.,
Inc., Albuquerque: Electronic Parts Co., Inc.

NEW YORK, Binghamton: Stack Industrial Elec-
tronics Inc., Mineola: Arrow Electronics Inc.,
N. Y. C.: Electronics Center, Inc., Harvey Radio
Co., Inc., Lafayette Radio Electronics Corp., Milo
Electronics Corp., Terminal-Hudson Electronics
Co., Inc., Woodside: Boro Electronics, Inc.

NORTH CAROLINA, Winston-Salem: Electronic
Wholesalers Inc.

PENNSYLVANIA, Harrisburg: D & H Distributing
Co., Inc., Philadelphia: Armo Radio Co., Phila.
Electronics Inc., Radio Electric Service Co. of
Penna., Inc., Reading: George D. Barbey Co.,
Inc., York: Wholesale Radio Parts Co., Inc.

TENNESSEE, Nashville: Electra Distributing Co.
Inc.

TEXAS, Dallas: All-State Electronics Inc., Engi-
neering Supply Co., El Paso: Midland Specialty
Co., Houston: Busacker Electronic Equipment
Co., Inc.

UTAH, Salt Lake City: Standard Supply Co.

WASHINGTON, Seattle: C & G Electronics Co.

CANADA, Montreal, Quebec: Atlas Wholesale
Radio, Inc., Toronto, Ontario: Electro Sonic Sup-
ply Co. Ltd.

ARCO
electronics inc.

Community Drive, Great Neck, New York

NEW YORK • DALLAS • LOS ANGELES
Exclusive Supplier of ELMENCO Capacitors to
Distributors and Jobbers in U.S.A. and Canada

removal of perspiration, fumes, grease and oil. Frequently, removing of some of these hard-to-remove substances has required mechanical cleaning (solid-particle sprays, brushes) or thorough submersion in conventional ultrasonic cleaning tanks. Actually, cavitation may be considered a mechanical process.

POSTCLEANING — Postcleaning operations largely resemble pre-cleaning operations. However, in many cases circuit boards do not have to be submerged in wave during precleaning but only have to contact energized surface of wave. Postcleaning, on the other hand, in most cases requires a slight submersion of boards below wave surface in order to remove flux and flux residues from both bottom and top surfaces of board.

SOLVENTS—Depending on characteristics of flux used, two choices can be made as to cleaning solutions:

- If flux is rosin-based, excellent results are possible by using a proper chemical solvent (e.g. "Chlorothene Nu" or equivalent).

- If water-soluble fluxes are used, a properly conditioned aqueous solution produces excellent cleaning.

If a chemical solvent is used in cleaning, it should be easily recoverable by distillation. This will increase operational efficiency and give excellent results. The unit is equipped with outlets for connection with a recovery still.

OIL—The use of oil—by either mixing it in solder or by applying it by spray or wave to the board after passing the solder wave—is a quite controversial procedure. Oil provides a protective layer that keeps air from solder, preventing oxidation. Oil also changes surface and interfacial tension conditions prevailing during soldering operation, thus influencing soldering results.

With properly designed assemblies and prepared board and lead surfaces, excellent soldering results can be achieved without oil, if proper attention is given to pre-solder cleanliness.

While oil's use may thus be justified only in special cases, its use

might make preconditioning and precleaning less critical. However, oil residues should always be removed. This, of course, makes post-cleaning a complicated job: some materials used in printed circuit boards are porous or might pick up oil by capillary action. We feel that there is no better means for removing these oil residues (as required by government regulations) than the ultrasonic-wave method.

SEMICONDUCTORS — Semiconductors on printed circuit boards might be directly exposed to the ef-

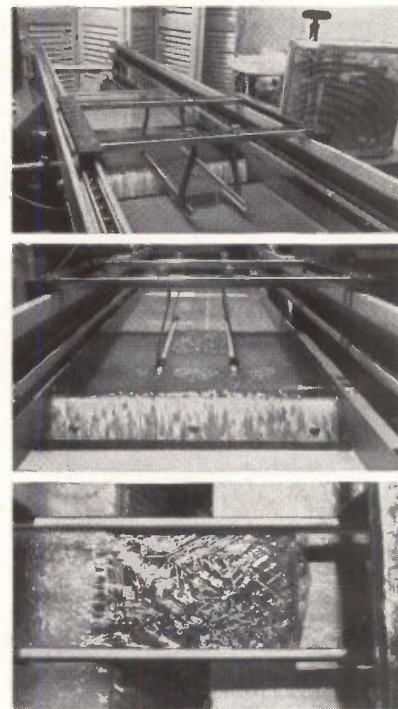

PRINTED circuit board moves into ultrasonic wave and is exposed to wave's mechanical cleaning action which is a combination of ultrasonic cavitation and wave-washing effects. Top view shows board moving away from camera into wave; middle view shows it approaching transducer area of wave (towards camera); bottom view shows close-up of board's topside as it enters wave (on left)

fect of supersonic waves if immersed vertically into ultrasonic tanks having transducers on side-walls of tank; or they might be exposed to waves reflected from side-walls of tanks equipped with bottom transducers. Such exposure can develop a damaging resonance effect.

With the surface exposure, or the

**SELECTED BY
RCA
FOR
A HIGH
RELIABILITY
PROJECT**

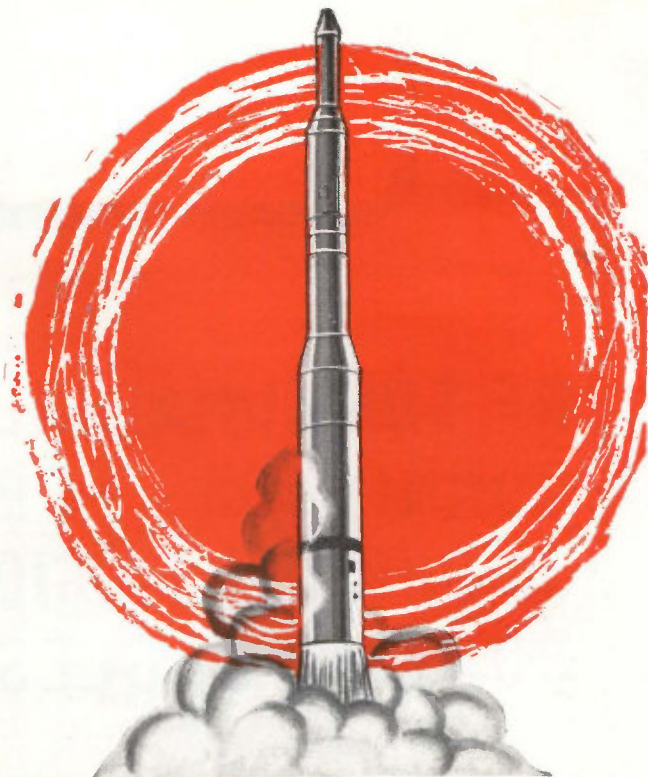
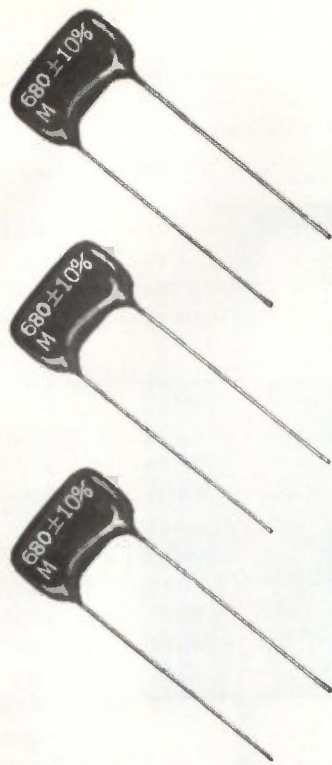

Here is MEASURED RELIABILITY!

**DUR-MICA
CAPACITORS
TYPE M2DM**

Ten thousand EL-MENCO high reliability dipped mica capacitors were put on life test at 85°C with 225% of the rated DC voltage applied—After 26,500,000 actual test unit-hours no failures of any type occurred.

The accumulated 26.5×10^6 test unit-hours without any failures can be used to calculate many different failure rates depending upon the confidence level desired. However, we shall explore the meaning of the results at a 90% confidence level.

Assuming no acceleration factor for either temperature or voltage, we have verified a failure rate of less than 0.01% per 1000 hours. (Actually, there is a temperature effect and it has been found that, with the DC voltage stress remaining constant, the life decreases approximately 50% for every 10°C rise in temperature. There is also a voltage effect such that, with the temperature stress remaining constant, the life is inversely proportional to the 8th power of the applied DC voltage.)

Assuming no temperature acceleration factor and assuming the voltage acceleration exponent is such as to yield an acceleration factor as low as 100, we have nevertheless verified a failure rate of less than 0.0001% per 1000 hours.

Assuming no temperature acceleration factor and assuming the voltage acceleration factor is on the order of 250 (test results are available to confirm this) we have accumulated sufficient unit-hours to verify a failure rate of less than 0.00004% per 1000 hours!

Note that all the above failure rates are calculated at a 90% confidence level!

THE ELECTRO MOTIVE MFG. CO., INC.
WILLIMANTIC, CONNECTICUT

MANUFACTURERS OF
EL-Menco
Capacitors

***Dipped Mica • Molded Mica • Silvered Mica Films • Mica Trimmers & Padders
Mylar-Paper Dipped • Paper Dipped • Mylar Dipped • Tubular Paper***

ARCO ELECTRONICS, INC., Community Drive,
Great Neck, L. I., New York
*Exclusive Supplier to Jobbers and Distributors
in the U. S. and Canada*

West Coast Manufacturers Contact:
COLLINS & HYOE CO., 535 Middlefield Road,
Palo Alto, California
5380 Whittier Boulevard, Los Angeles, California 9

RF SUBMINIATURE CONNECTORS FOR 50-OHM SEMI-RIGID COAXIAL CABLES



SUBMINIATURE RF CONNECTORS

Featuring exclusive "collet-type" clamping action, which when finger tightened will not permit the cable to be pulled out, these subminiature rf connectors have been designed specifically for use with semi-rigid coaxial cables. 50-ohm semi-rigid coaxial cable is constructed with a solid copper shield and a Teflon dielectric. Electrically similar to RG 188/U, semi-rigid cable has a diameter of .082"

Conhex connectors for use with semi-rigid cables in high frequency applications are available in screw-on types that eliminate all soldering operations other than that of attaching the contact to the center conductor. Conhex connectors also feature captivated contacts to insure proper engagement of the mating parts. Types available now include cable jacks, cable plugs and right-angle plugs.

Write today for detailed information on these radically new connectors to . . .



Sealectro CORPORATION

139 HOYT STREET, MAMARONECK, NEW YORK
PHONE: OWENS 8-5600 TWX: MAMARONECK NY 5120

"Press-Fit" Teflon Terminals • "Conhex" Subminiature RF Connectors
"Sealectoboard" Program Boards • "Delttime" Magnetostrictive Delay Lines

slightly-submerged exposure, experienced in the ultrasonic wave process, semiconductor components are shielded from most such resonant effects.

FLUXES—Besides its present use in cleaning, the ultrasonic wave technique might be applied to fluxing. In this way, a cleaning phase can be imparted to fluxing operations. Thus, preliminary cleaning can be eliminated in obtaining cleaned and fluxed boards with flux solution providing the medium for ultrasonic-cavitation effect.

OTHER APPLICATIONS — The new wave applicator can be used for other applications that can take advantage of the ultrasonic vibration and liquid wave combination. There are many industrial processes, particularly those involving extremely careful cleaning, coating and general surface applications and processing, that will benefit from this new device.

Tally Packaging Prevents Spilling

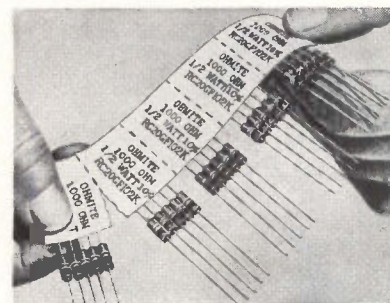

RESISTORS are torn off in groups of 5 with perforated tape

RESISTORS in four wattage sizes ($\frac{1}{4}$, $\frac{1}{2}$, 1 and 2 watts) are packaged with perforated tape, 5 resistors to each perforated segment. The Tally Tape technique used by Ohmite permits a rapid count of resistors because of the 5-in-a-group arrangement with a standard number of groups being used in each perforated tape. Tape prevents resistors from spilling and tangling, and printing on tape spells out resistance value, size, tolerance, and MIL type designation.

MEASURE *PEAK POWER*

INDEPENDENT OF DUTY CYCLE

150-1500 MC

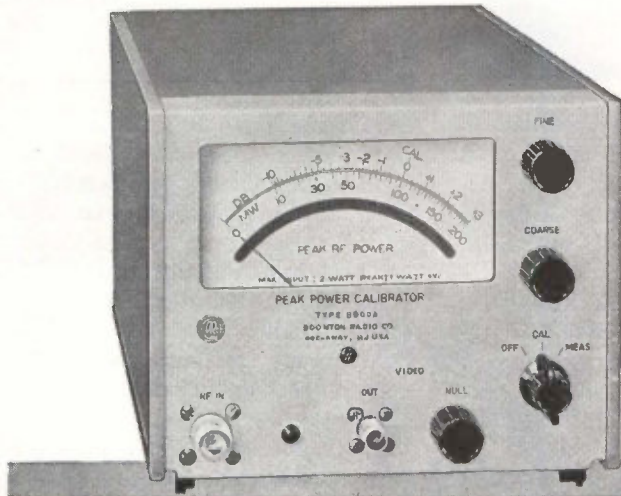

- ± 0.6 db ABSOLUTE ACCURACY
- 0.1 db PRECISION
- READILY STANDARDIZED WITH EXTERNAL BOLOMETER

The Type 8900-A Peak Power Calibrator provides a convenient means for measuring the peak RF power of pulses in the range from 150 to 1500 MC. The power level is read out directly on the panel meter and is completely independent of repetition rate and pulse width ($>0.25 \mu\text{sec}$). The instrument consists of a precision terminated input circuit, diode detector, DC reference supply, meter and a chopped video output system.

In operation, the RF signal is applied to the input circuit, which, through a power splitter, feeds the diode detector. The demodulated diode output and the output of the DC reference supply are simultaneously fed to the video output through a mechanical chopper.

In making a measurement, a suitable external oscilloscope is connected to the video output and the DC reference voltage is adjusted so that it is exactly equal to the peak value of the demodulated pulse. The level of the required DC reference voltage is then indicated on the panel meter, calibrated to read peak RF power. The diode is operated in a biased condition for maximum stability of calibration. Provision is made, however, for readily standardizing the instrument against an external bolometer or calorimeter by simply connecting to the input circuit in place of a standard termination.

The Peak Power Calibrator is completely self-contained and housed in a modular cabinet which may be readily rack mounted.

SPECIFICATIONS

RADIO FREQUENCY MEASUREMENT CHARACTERISTICS:

RF RANGE: 150 to 1500 MC
 RF POWER RANGE: 200mw* peak f.s.
 *May be readily increased through use of external attenuators or directional couplers.
 RF POWER ACCURACY: ± 1.5 db*
 * ± 0.6 db with custom calibration curve.
 RF POWER PRECISION: 0.1 db
 RF PULSE WIDTH: $>0.25 \mu\text{sec}$
 RF REPETITION RATE: 1.5 MC max.
 RF IMPEDANCE: 50 ohms
 RF VSWR: <1.25

PHYSICAL CHARACTERISTICS:

MOUNTING: Cabinet for bench use; readily adaptable for 19" rack mounting.
 FINISH: Gray engraved panel; green cabinet (Other finishes available on special order).

DIMENSIONS: Height: $6\frac{1}{8}$ " , Width: $7\frac{3}{4}$ " ,
 Depth: 11"

WEIGHT: Net: 10 lbs.

POWER REQUIREMENTS:

8900-A: 105-125/210-250 volts,
 50-60 cps

PRICE:

8900-A: \$485.00 — F.O.B. Rockaway, N. J.
 Custom Calibration Curve: \$75.00

BOONTON RADIO COMPANY



A Division of Hewlett-Packard Company



GREEN POND ROAD, ROCKAWAY, NEW JERSEY

Tel. 627-6400 (Area Code 201) TWX: 201-627-3912 Cable Address: Boonraco

Bistable Semiconductor Easily Turned Off

New unit combines merits of transistor and scr, simplifies switching problems

THE SILICON gate-controlled-switch, a descendant of the scr, is among the newest of semiconductors to hit the market. This new unit offers considerable advantage over the scr since it can be turned on and off by low power trigger pulses. The scr is easy to turn on, but it usually has to be disconnected from the supply or fed from a-c before it goes off. The gate-controlled-switch works equally satisfactorily from either a-c or d-c supplies. Unlike the transistor, the gate-controlled-switch needs no continuous input to hold it in one or

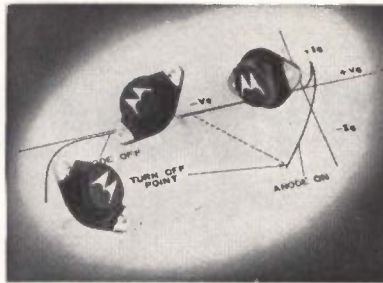

the other of its bistable conditions. The switch, photo, from Motorola Semiconductor Division, East McDowell Road, Phoenix 8, Arizona, is packaged in the TO-41 and TO-3 configurations, and is rated 25 through 400 volts, spanning models MGCS 821-1—MGCS 821-6. Current capacity is up to 5 amperes; minimum turn-on current-gain for the series is 50 at 25 Centigrade, minimum turn-off current-gain is

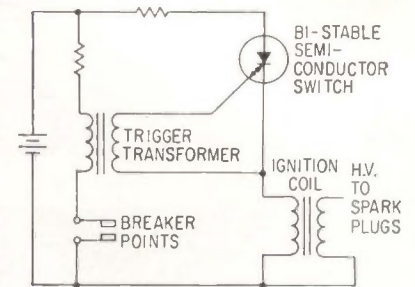

10 for the 25 to 200 volt units and 5 for the higher-voltage models. In the automobile ignition system (see illustration) the breaker points carry only the current necessary to fire, and turn-off, the switch. Since this current is at least five times smaller than the ignition-coil current, considerable saving in contact erosion is achieved.

CIRCLE 301, READER SERVICE CARD

Meter Monitors 4 Types of Radiation

SEMI-PORTABLE radiation survey unit type NF02 is transistorized throughout except that the high voltage supply for the radiation detector uses a corona regulator. Besides giving a visual indication of count rate, the unit is equipped with a 1,000 cps oscillator, whose output is gated to a loudspeaker by detected radiation pulses, thereby giving an audible indication of count rate.

Different probes for measuring alpha, beta, gamma and neutron radiation are available as optional extras. The transistors are mounted on printed circuit cards, and are designed for easy interchange during maintenance. The unit, manufactured by General Electric's Nuclear Electronic Products Section, 175 Curtner Avenue, San Jose, Calif., occupies $14 \times 9 \times 9$ inches volume, gives 10 percent overall accuracy, and a zero-to-1,000 count-



per-minute rate, in three ranges. Input is 115 volts a-c, 50 or 60 cps, power rating is 40. (302)

Analog Integrator Based On Sensitive Motor

MANY of the disadvantages of electronic integrating systems may be overcome by using this sensitive integrating motor, capable of responding to 600 microamperes in-

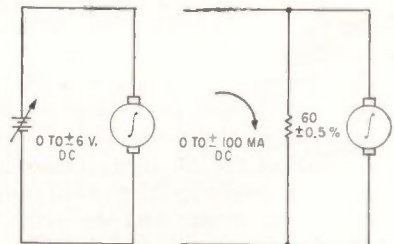

put current, to integrate the variable under consideration. Added flexibility is provided, since the motor revolutions, which are proportional to time-integral of input, can be read out from a digital or analog rotation counter. The unit also retains its reading when the supply is interrupted.

Secret of the integrator's efficiency, which lies in reducing frictional and electrical losses in motor, is the use of jeweled armature bearings, a p-m field system, plus a noble-alloy commutator used in conjunction with wire brushes. At full speed, when operating from a six-volt supply, the motor absorbs less than 4 milliwatts driving power. The units, which come in several

-10db/decade

LOG VOLTMETER - CONVERTER

70 db RANGE 0.2 db ACCURACY

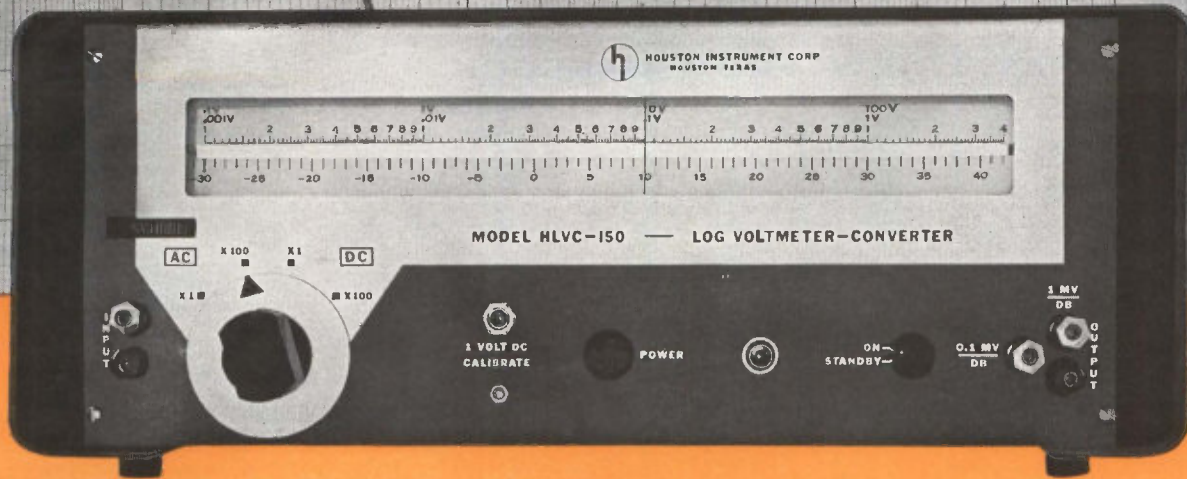

NEW DESIGN PRINCIPLE PERMITS MEASUREMENTS ACCURATE TO 0.2 db OF AC OR DC VOLTAGES OR VOLTAGE RATIOS ON TRUE LOGARITHMIC SCALE OVER 3160:1 OR 70 db CONTINUOUS RANGE

DC OUTPUT FOR RECORDING 60 db/sec SLEWING SPEED MODEL HLVC150 \$1450



houston instrument corporation

4950 Terminal Avenue / Bellaire 101, Texas

Write for 8-page Brochure

MOhawk 7-7403 / Cable HOINCO

TWX 713-571-2063

CIRCLE 202 ON READER SERVICE CARD



Are you a COMPLETELY INFORMED electronics engineer?

Today you may be working in microwaves. But on what project will you be working tomorrow? You *could* have read **electronics** this past year

and kept abreast of, say, microwave technology. *There were 96 individual microwave articles between July, 1961 and June, 1962!*

But suppose tomorrow you work in some area of standard electronic components, in semiconductors, in systems? Would you be up-to-date in these technologies? Did you read the more than 3,000 editorial pages that **electronics'** 28-man editorial staff prepared last year?

electronics is edited to keep you current *wherever* you work in the industry, *whatever* your job function(s). If you do not have your own copy of **electronics**, subscribe today via the Reader Service Card in this issue. Only 7½ cents a copy at the 3 year rate.

electronics

electronics • May 24, 1963

- SCAN CONVERSION
- FLICKERLESS DISPLAY STORE
- VIDEO STORAGE

RECORDING STORAGE TUBE SYSTEMS

Single-gun, dual-gun, multi-tube systems to convert scan for radar, sonar, television, and to perform analog processing, data analysis, contract or expand time scale, auto correlation.

- SLOWED TELEVISION TRANSMISSION

by telephone line or other narrow-band systems.

- IMAGE ENGINEERING

OPTICAL CHART READERS, FLYING SPOT SCANNERS, LOW-LIGHT-LEVEL CAMERAS, and IMAGE RECTIFICATION. Automatic inspection and recognition of size, shape, color, and texture.



Write or call for complete information:



INSTRUMENTS, Inc.

2300 Washington Street
Newton 62, Massachusetts
617 WOODWARD 9-8440

CIRCLE 95 ON READER SERVICE CARD 95



WHAT'S NEW FROM GARLOCK Electronic Products

CHEMELEC® Copper Clad TFE . . . the ideal printed circuit material for today's electronic and aircraft industries. Extensively used in high-frequency circuits and micro-wave systems, it exhibits a dielectric constant of 2.05 and a dissipation factor of .002 Max. (1 Mc). Maximum Continuous Operating Temperature of 150°C (dip solder resistance is +500° F). Offers exceptional insulating characteristics. Water absorption .02%. Specific dielectric properties can be achieved by integrating various filler materials with the TFE. Available from local stock in standard sheet size 18"x36". Larger sizes on request. Write for AD-169.

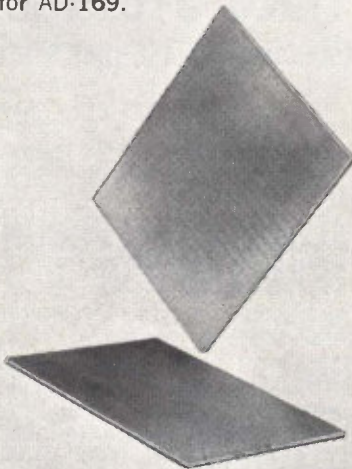

CHEMELEC Test Points offer unmatched pin retention. The reason? Beryllium copper pins, silver plated and gold flashed (now increased to .00005 thickness to prevent tarnishing) for maximum retention life. And, the TFE insulating material has exceptional dielectric properties, resists temperatures from -110° to +500° F., is chemically inert. Flashover (Short time, sea level): Standard and Miniature Models — 3000 VRMS; High Voltage Model—5000 VRMS. Best of all, current high production enables us to offer these high quality test points at new low prices. Write for AD-169.



STANDARD MODEL



HIGH VOLTAGE MODEL



MINIATURE MODEL

For full information, contact your Garlock Electronic Products distributor or representative. Or, write GARLOCK ELECTRONIC PRODUCTS, GARLOCK INC., Camden, New Jersey.

GARLOCK

models, are available from Acromag, Inc., 15360 Telegraph Road, Detroit 39, Michigan.

In the illustrations, the voltage integrator (left) shows how simple the technique is, since no auxiliary equipment is needed. Current integration is achieved (right) by addition of a parallel resistor to provide a "stiff" voltage source.

CIRCLE 303, READER SERVICE CARD



Thermocouple References Stable From -40 to 212 F

DESPITE their environmental temperature changing at 10 degrees F per minute, these thermocouple reference elements don't deviate from their calibration by more than $\frac{1}{4}$ degree F. The units, designated JR130, enable a low level d-c measuring system to be converted to an accurate temperature indicator that retains its calibration under severe operating conditions.

An advantage of the new unit is the ease with which it can replace such elaborate thermocouple references as ice baths, liquid hydrogen, or liquid nitrogen baths, and at the same time eliminate auxiliary equipment that keeps these references in working order. The manufacturer, Consolidated Ohmic Devices, Inc., 900 Third Avenue, New Hyde Park, N. Y., states that their reference elements will meet MIL-E-5272 and that the life of the units under continuous use is at least 10,000 hours. The references weigh 25 grams, they are epoxy encapsulated and size to $4\frac{1}{4}$ -in long by 1-in diameter; their output impedance is 200 ohms. (304)

D-C Amplifier for Wideband Use

SOLID-STATE wideband potentiometric d-c amplifier, model 260, has been introduced. Bandwidth: down 3 db at 200 Kc minimum; settling time, full-scale step input, 10 μ sec to within 0.01 percent of final value; gain accuracy, ± 0.002 per-

cent at d-c; input impedance, 1000 megohms minimum at d-c. Redcor Corp., 7760 Deering Ave., Canoga Park, Calif. (305)

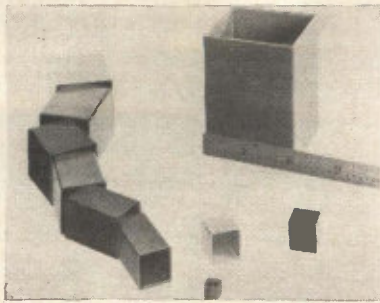

Encapsulating Shells Come in Many Sizes

EXPANDED line of square encapsulating shells come in sizes every sixteenth of an inch, from $\frac{1}{8}$ in. to $2\frac{1}{8}$ in. square, and in heights up to $2\frac{1}{2}$ in. from $\frac{1}{8}$ in. square. Featuring a recessed shoulder in order to accept a firm mating header, the unit can be filled with an encapsulant. When the encapsulant cures, the component is ready for use. High volume resistivity is achieved in both alkyd or diallyl phthalate, both affording continuous high operating temperatures. The Milton Ross Co., Box 274, Southampton, Pa. (306)



H-V Power Supply In 7 to 75 Kv Range

HIGH VOLTAGE regulated supply, model MR.75R, has been designed for use in laboratories and for a wide range of industrial applications such as crt supplies, component testing, particle acceleration, image intensification and numerous other electrostatic processes. Operation is by power tube oscillators, working at approximately 8 Kc,

PUSH TO TEST

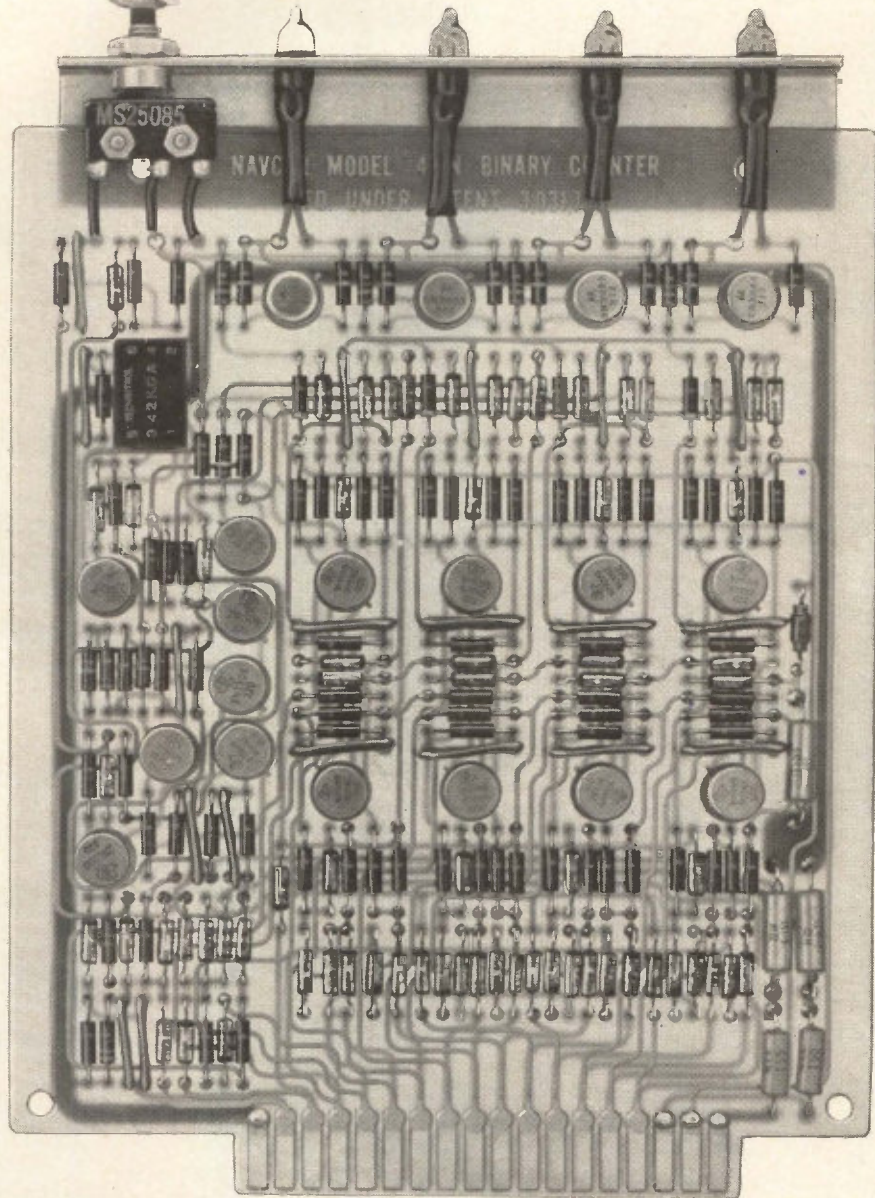

Push a button . . . follow the operation of a Navcor 400 Series system function module one logical step at a time on the neon indicator lights. Each module is a complete system function, grouping many logic elements. Push button and lights permit positive checkout in a fraction of the time required with less sophisticated flip-flops. Write for data on complete MIL Standard line of

Transistorized Digital System Function Modules

NAVCOR

VALLEY FORGE INDUSTRIAL PARK

930 RITTENHOUSE ROAD, NORRISTOWN, PA. • GL 2-6531
CIRCLE 97 ON READER SERVICE CARD

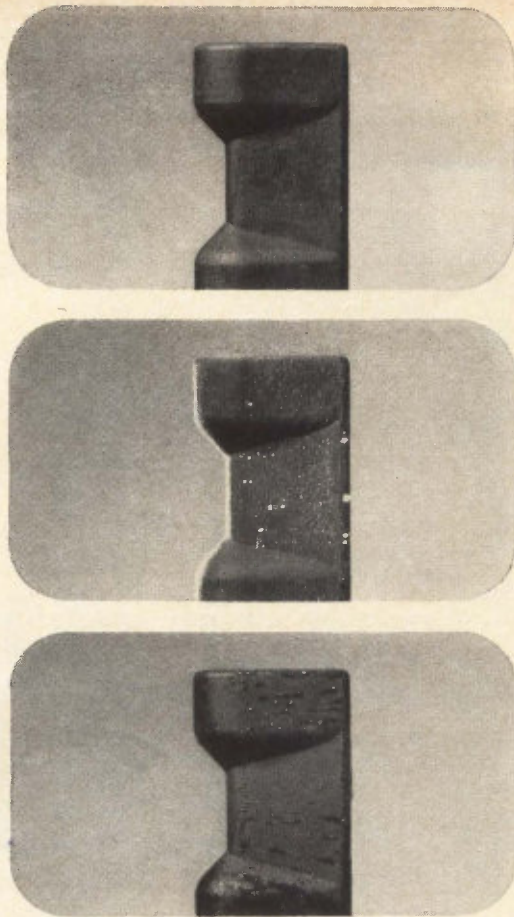

We threw away the "book" and built a better ice detector!

At United Control, we threw out the established design methods and found a fresh, simple solution to ice detection waiting to be discovered. This solution makes United Control's new Ice Detection System the only fast, truly reliable icing sensor ever designed. The solid-state, completely encased probe has no holes to clog, no delicate parts exposed, and needs only an occasional wipe-down to sustain accurate operation. It utilizes a radioactive source (safer than the dial of your wristwatch), an aerodynamically-ideal sensing surface, and a Geiger-Mueller tube. As little as 0.015 inches of ice interrupts a narrow beam of "beta" particles, closing the control circuit and energizing the de-icing system and ice warning light. The probe is then quickly de-iced to provide continuous icing rate signals.

This system has proved itself on several fixed- and rotary-wing production aircraft. If ice detection and control are your problems, United Control will be happy to arrange a screening of its special film showing the system in action. For more details on ice detectors or the family of temperature, environmental, flight and propulsion controls, or accessory systems and components, call United Control: serving the aerospace industry—where reliability counts.



UNITED CONTROL CORPORATION

Overlake Industrial Park, Redmond, Washington • Phone: 206-885-3711, TWX: 206-999-1874 • Palomar Scientific Corporation and United Data Control, Inc.—Subsidiaries

used with an encapsulated ferrite cored transformer to provide the output which is fed to a selenium type rectifier system, arranged as a voltage multiplier. The d-c output is monitored with a 100 μ a movement and a high stability series resistor, which also provides the feedback to the stabilizer. Output voltage range is from 7 Kv to 75 Kv with an output current range of from 0 to 0.5 ma. Brandenburg, Ltd., 139 Sanderstead Rd., South Croydon, Surrey, England.

CIRCLE 307, READER SERVICE CARD

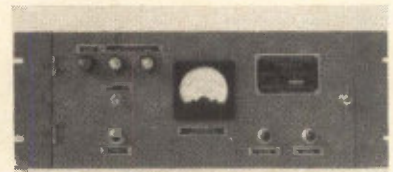

Monitor Measures Frequency Difference

PURPOSE of the frequency difference monitor is to visually indicate the resulting beam frequency of 8 Kc, plus or minus an allowable 5 Kc deviation that could be obtained when two h-f signals in the range of 108 to 112 Mc are applied to the unit. Operation is such that it is independent of the nature of the incoming signal within and exceeding that of predetermined conditions. One of the uses to which the equipment can be put is detecting variations in process heat, as in a chemical reaction, and controlling the heat to within a small tolerance. More than one point can be monitored for temperature with the same unit using separate sensors at the input. Marine View Electronics Inc., 88-06 Van Wyck Expsrwy, Jamaica, N. Y. (308)



Liquid Level Sensor Is Tiny and Accurate

SERIES 200 Liquilite is a liquid level sensing, indication and control sys-

tem, complete in one unit. Its self-contained alarm lamp permits one to "see through" the tank wall, while providing remote indication and control many miles from the tank. All-transistor design results in the tiny and accurate (0.01 in.) device. Made of stainless steel, it mounts in a standard 1 in. pipe threaded hole. When liquid reaches the sensing level, the self-contained transistor circuit lights an integral alarm lamp. Simultaneously, a transistor output signal operates remote alarm lamp, relay, etc., up to miles from tank. Controlotron Corp., 7 Commercial St., Hicksville, N. Y. (309)

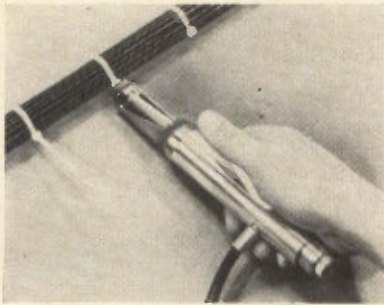

Installation Tool for Production Cabling

PNEUMATIC-POWERED Sta-Strap installation tool for production cabling applications is completely automatic. It sets correct strap tension and cuts strap flush with head. No twisting of strap or operator labor required. The tool, designated ATS-2, features in-line feed and is actuated by a single lever. No air regulator is required because strap tension is precisely controlled by means of an internal spring mechanism. Panduit Corp., 17301 Ridgeland Ave., Tinley Park, Ill. (310)

Semiconductor Tester Is Easily Programmed

GO/NO-GO multiparameter tester, series 250, is capable of conducting tests at the rate of 900 units per hour. It features 16 variable go/no-go tests per unit. Series 250 is easily programmed with decade cards or fixed resistor cards. Accuracy at 1 μ a is \pm 0.5 percent (\pm 1 percent at 100 μ a). A system for priority sorting is optional. Fairchild Semiconductor, a division

OVER 100

DIFFERENT TYPES NOW IN PRODUCTION



JENNINGS CERAMIC VACUUM CAPACITORS

... have been accorded an enthusiastic vote of approval from users for their superior performance in the field. Now we've added many new styles to accommodate the demand for these capacitors in an even wider variety of size, capacitance, voltage and current levels.

Ceramic vacuum capacitors combine the inherent advantages of vacuum with a high strength ceramic envelope to form the most advanced high voltage capacitor ever devised. The low loss ceramic allows operation in excess of 400 megacycles. It also provides better vibration characteristics, greater shock resistance, higher current ratings, and smaller size. A few of the many ceramic vacuum capacitors available from Jennings are illustrated below.

Type CVFA-450

Capacity Range 25-450 PF
Voltage Rating 40 kv pk
RF Current Rating 100 amps rms
Length 9 $\frac{3}{8}$ inches
Width 5 $\frac{1}{2}$ inches



Type CVA-7

Capacity Range 3.5-7 PF
Voltage Rating 35 kv pk
RF Current Rating 60 amps rms
Length 4 $\frac{1}{8}$ inches
Width 3 $\frac{1}{4}$ inches

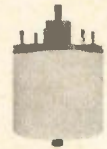

Type CFHA-1000

Capacity 1000 PF
Voltage Rating 50 kv pk
RF Current Rating 200 amps rms
Length 6 $\frac{1}{2}$ inches
Width 7 inches



Type CVHA-650

Capacity Range 30-650 PF
Voltage Rating 55 kv pk
RF Current Rating 150 amps rms
Length 10 $\frac{2}{32}$ inches
Width 7 inches



Our radio frequency laboratory with 12 functioning transmitters ranging from 17 kc to 600 mc and up to 100 kw cw power is at your service to test our products under your particular circuit conditions.

Write for more detailed information regarding these capacitors.

RELIABILITY MEANS VACUUM | VACUUM MEANS

Jennings[®]

JENNINGS RADIO MFG. CORP., 970 McLAUGHLIN AVE., SAN JOSE 8, CALIF., PHONE Cypress 2-4025

now...

controlled diffusion

with longer flat zones!



Insure high yields of top-quality doped silicon or germanium wafers . . . continuously . . . with multi-chamber, four-on-one Hayes Model 4-DHS0330 Diffusion Furnace. Thermal flat zones (16" to 18" \pm 1°C) plus zirconia outer muffle dampen temperature "ripples" in depositing chambers . . . assure positive control of temperature and predictable quality of furnace output.

Furnace features removable diffusion units, each independent of the other three so others need not be shut off to service one . . . three-zone movable source chambers . . . and recessed, modular panels which can be removed for servicing outside "clean room". Furnace is available with iron-chrome, molybdenum, or platinum elements.

Single and double unit models available. Also many other furnaces for continuous, cycling and/or programmed diffusion processes. Flat zones to 24".

Request Data Sheet F-11 for complete details. C. I. Hayes, Inc., 845 Wellington Ave., Cranston 10, R. I. Ph.: 401-461-3400

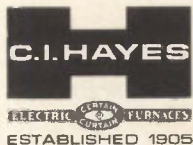

Acoustical Components of Superior Quality

JAPAN PIEZO supplies 80% of Japan's crystal product requirements.

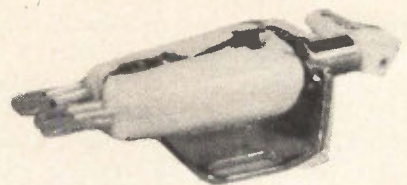
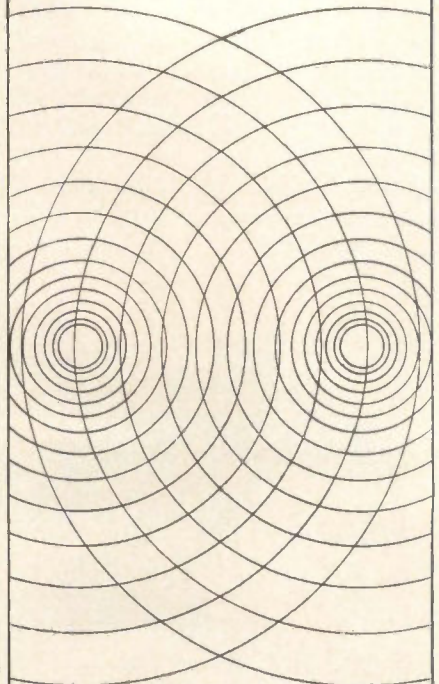

STEREO CARTRIDGE

Crystal — "PIEZO" Y-130

X'TAL STEREO CARTRIDGE

At 20°C, response: 50 to 10,000 c/s with a separation of 16.5 db. 0.6 V output at 50 mm/sec. Tracking force: 6 ± 1 gm. Compliance: 1.5×10^{-6} cm/dyne. Termination: $1M\Omega + 150$ pF.

Write for detailed catalog on our complete line of acoustical products including pickups, microphones, record players, phonograph motors and many associated products.



**JAPAN PIEZO
ELECTRIC CO., LTD.**

Kami-renjaku, Mitaka, Tokyo, Japan

Fairchild Camera and Instrument Corp., 545 Whisman Road, Mountain View, Calif.
 CIRCLE 311, READER SERVICE CARD



N-P Meter for Semiconductor Material

THIS INSTRUMENT determines whether a semiconductor material is *n* or *p* by measuring the magnitude and polarity of the Seebeck voltage generated by a hot probe. It can be used as a quality control or inspection instrument in thermoelectric module production or as a laboratory instrument. In the lab, it is useful in determining the exact location of an *n-p* junction in a material sample. Unit consists of a standard meter probe, a heated probe (approximate temperature of 330 C) and a 50-0-50 microammeter. Instrument is priced at \$49.50. Scientific Columbus, Inc., 840 Kinnear Road, Columbus 12, Ohio. (312)



Thermal Shock Chamber Comes in Varied Sizes

COMPACT environmental test chamber designed for automatically performing the thermal shock portions of MIL-202B, Methods 102A and 107A is available. It tests within the -100 F to + 300 F range; can

KLIXON
 PRECISION CONTROLS

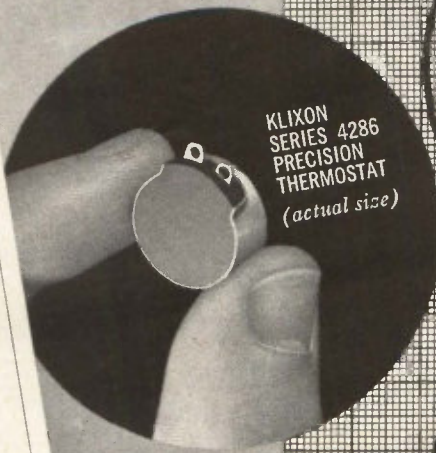

KLIXON SERIES 4286 PRECISION THERMOSTAT (actual size)

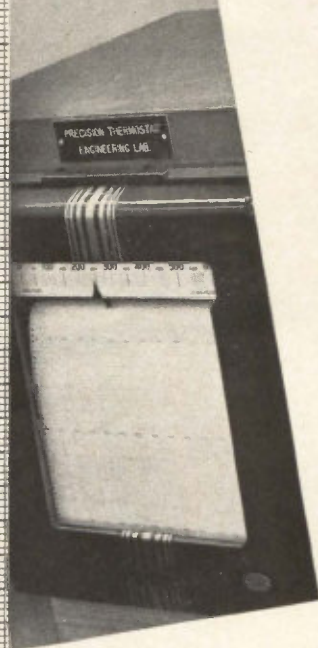
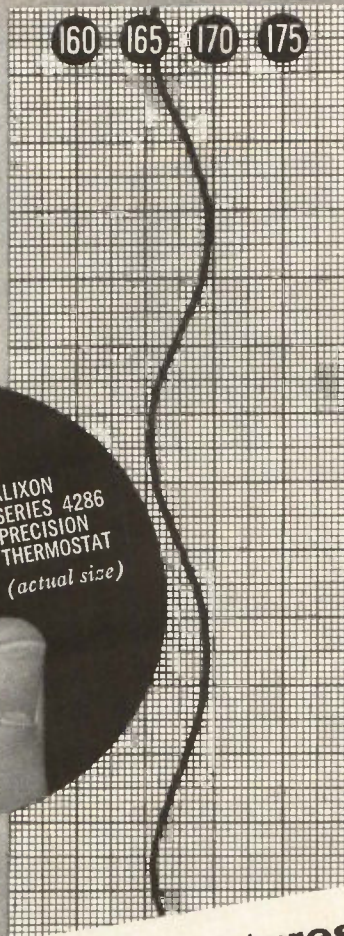

When temperatures must be controlled within 5°F limits . . .

this KLIXON® Precision Thermostat will meet your specifications at minimum cost!

KLIXON 4286 Series epoxy-sealed, snap-acting thermostats match most performance characteristics of all-welded, narrow-differential thermostats costing twice as much. Same MIL-E-5272C immersion test. Same contact life of 250,000 cycles at 2 amp, 115V-ac. Same 60G shock and acceleration resistance. Same SPST switch action of opening or closing on temperature rise.

If your temperature control application . . . between 0°F and 270°F . . . does not involve exposure to extreme hostile environments, KLIXON Series 4286 Thermostats give you all the reliability you need. Proof? These 3.5-gram thermostats are already widely specified as temperature control and warning devices in crystal ovens, heater blankets, parametric amplifiers and other microwave components, computers and "black box" circuits.

Bulletin PRET-7 gives you all the data required for evaluating KLIXON Series 4286 Sealed, Narrow Differential Thermostats. Write for your copy today.



METALS & CONTROLS INC.
 5005 FOREST ST., ATTLEBORO, MASS.
 A CORPORATE DIVISION OF
TEXAS INSTRUMENTS
 INCORPORATED

CIRCLE 101 ON READER SERVICE CARD

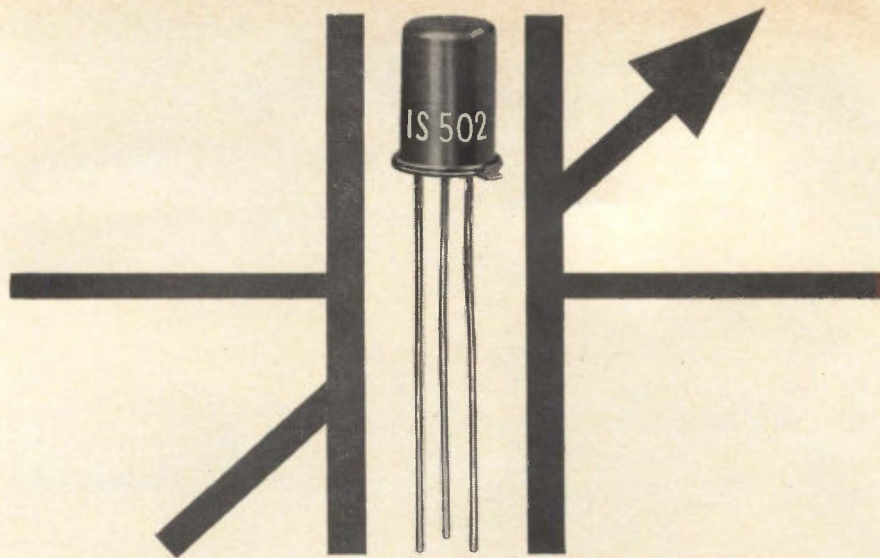

WIDE-RANGE, HIGHLY-SENSITIVE VARIABLE CAPACITANCE DIODE

(Brand: Varipico)

Fujitsu Varipico is a new diode designed to serve especially as a variable capacitor. Having a "hyper-abrupt" junction, a wide range of capacitance variation is made possible by simply varying a small negative bias voltage. The relationship of capacitance to bias voltage is: $C \propto \frac{1}{\sqrt{V}}$. Since n can be set anywhere between 1 and 5, the capacitance range is very large. This makes the Varipico extremely useful in many applications such as frequency modulators, sweep generators, signal generators, frequency meters, phase shifters, converters and multipliers, and parametric amplifiers. The Varipico, hermetically sealed in a metal case, measures only 5.7 mm in diameter and 8mm in length, exclusive of leads. For full technical data and application information write to our representative shown below.



FUJITSU LIMITED

Communications and Electronics
Tokyo, Japan

Represented by: U.S.A. HAR-WELL ASSOCIATES, INC.: Southbury, Connecticut, Phone: 264-8222 THE NISSHO PACIFIC CORP. 120 Montgomery St., San Francisco 4, California, Phone: YUkon 2-7901, 7906 Canada: NISSHO (CANADA) LTD. 100. University Avenue, Toronto, Phone: EMpire 2-4794 United Kingdom: WALMORE ELECTRONICS LIMITED 11-15 Betterton Street, Drury Lane, London W.C. 2, Phone: TEMplebar 0201-5 Germany: NEUMÜLLER & CO. GMBH 8 München 13, Schraudolphstr, 2a, Phone: 29 97 24

CIRCLE 102 ON READER SERVICE CARD

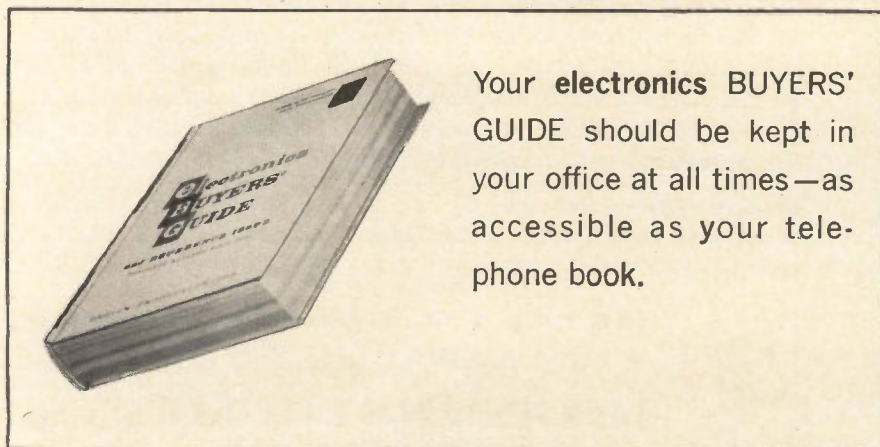

Your **electronics BUYERS' GUIDE** should be kept in your office at all times—as accessible as your telephone book.

also be supplied for operating in a range of -300 F to $+1,000$ F. Operation is completely automatic with cycling timers for each test phase. Heating system is a series of electric heaters located behind baffling. Cooling for the unit is supplied by liquid CO_2 . Conrad, Inc., Holland, Mich.

CIRCLE 313, READER SERVICE CARD

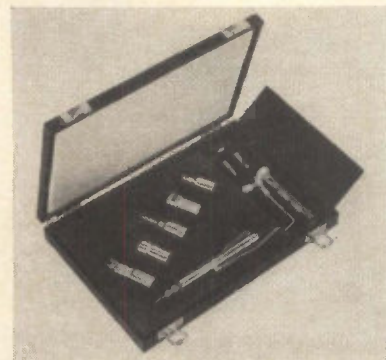

Universal Lab Set Fits in a Briefcase

MODEL PHD-100 universal laboratory set contains the high gain Stethotracer signal tracer with six Stethotracer accessories: vibration pickup, miniature magnetic microphone, magnetic tape head, r-f microwave demodulator, input adapter, and output adapter. It may be used for fast analyzing, assisting in designing, and for testing in the laboratory, on the production line, quality control, and in the field. The set with its transducer probes can reach into tight spots of miniature products. The OEM price is \$149.95. Don Bosco Electronics, Inc., 16 Littell Road, Hanover, N. J. (314)

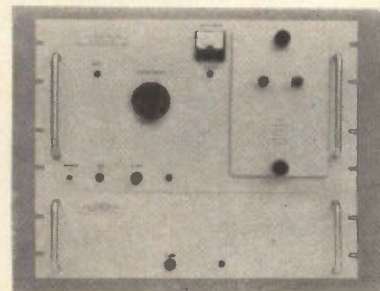

Pulse Power Amplifier Has 300-W Output

GENERAL PURPOSE pulse power amplifier is designed for flexibility in driving a variety of loads. Model

330 provides a negative output pulse, continuously variable from 0 to 12,000 v, which is amplified from a driving source. Unit is normally supplied with plug-in output transformers to match twt's, magnetrons, klystrons, h-f triodes, and other h-v pulsed devices. Average output power is 300 w, with rise-and-fall time capability faster than 70 nsec. Unit weighs 61 lb, costs \$2,490. Velonex Division of Pulse Engineering, Inc., 560 Robert Ave., Santa Clara, Calif. (315)

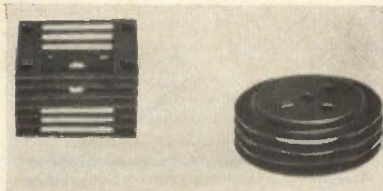

Heat Sinks for Circuit Board Use

SERIES 2900 heat sinks were designed to be used either as natural convection heat dissipators or with forced air in very compact assemblies. Units are easily mounted and well suited for very high packing densities. In particular, they are suited for circuit board applications. They are manufactured of copper with a black ebanol surface finish. Astro Dynamics, Inc., Second Ave., Northwest Industrial Park, Burlington, Mass. (316)

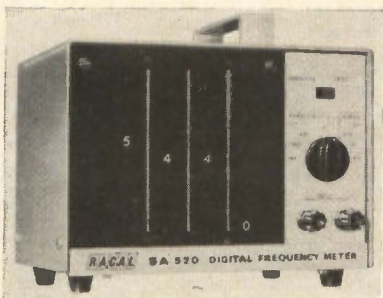

Frequency Counters Are Solid-State Units

NOW being marketed are a new range of Racal frequency counters. Available are 300 Kc, 1 Mc and 10 Mc versions, together with a full range of transducers. The SA520 pictured weighs only 7 lb, and can be operated either from 117 v line or from dry cells. Price is \$495. Avnet Instrument Corp., 91 Commercial St., Engineers Hill, Plainview, L. I., N. Y. (317)

GET THE POINT

- FOR LESS

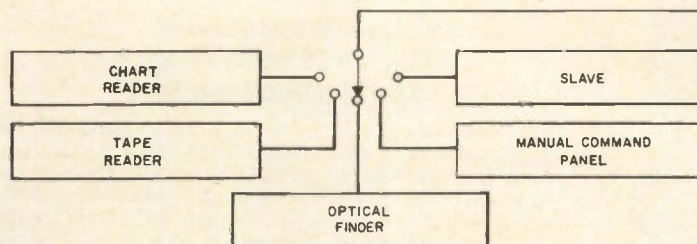
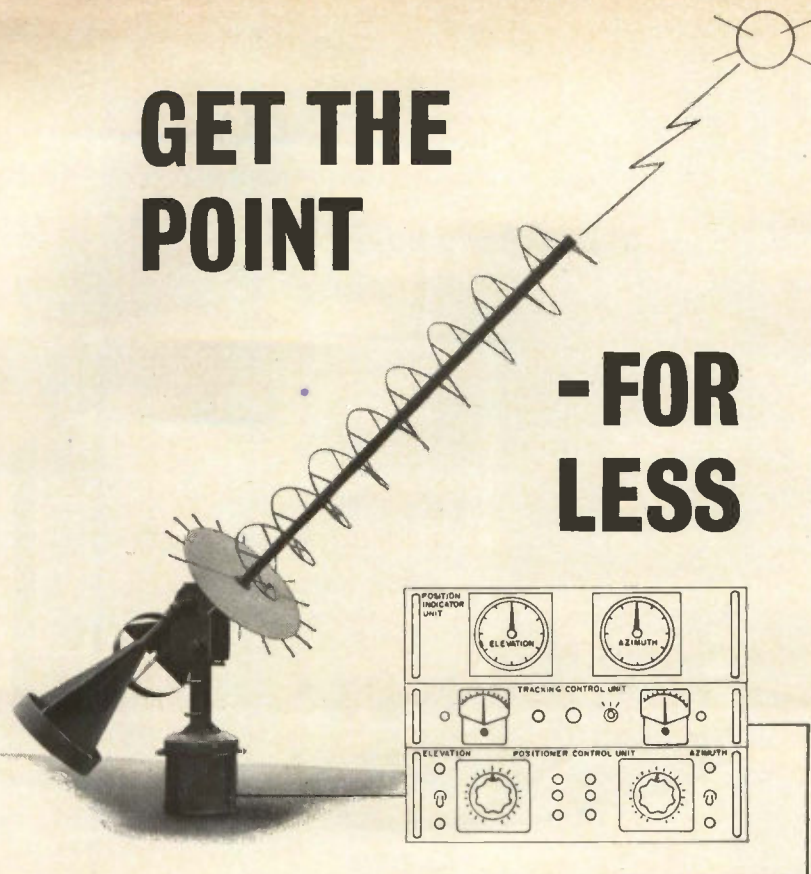

Scientific-Atlanta telemetry antenna position systems offer a unique, economical answer to the problem of following satellites, missiles, aircraft or astronomical targets with medium gain antennas. Such systems provide tracking rates of 6 degrees per second or higher and pointing errors of no more than 3 degrees. Yet, these systems are modestly priced at less than \$10,000.

The two-axis antenna pedestals are "militarized" versions of standard Scientific-Atlanta antenna pattern range positioners, giving an extra margin of reliability even beyond the proven performance of these mounts. Control is provided by Scientific-Atlanta's augmented manual tracking equipment.

Features include two-axis tracking from programmed or slaved sources as well as manual control and continuous position indication; accessories such as optical finders, tape readers, chart readers, manual position command panel, and other input devices; use of solid state units for reliability and compactness (complete control/indication systems in 14" of rack space) and integration of standard Scientific-Atlanta instrumentation wherever possible throughout the system.

Rugged and reliable, these systems meet the environmental requirements of MIL-E-4158 and the RFI shielding requirement of MIL-I-26600.

We invite your request for more information. Please address Scientific-Atlanta, Inc., P. O. Box 13654, Atlanta 24, Georgia. Phone: (404) 938-2930.



SCIENTIFIC-ATLANTA, INC.

AC-DC Precision Power Supply

Model
2120

PROVIDES

Variable Voltage,
Current &
Frequency

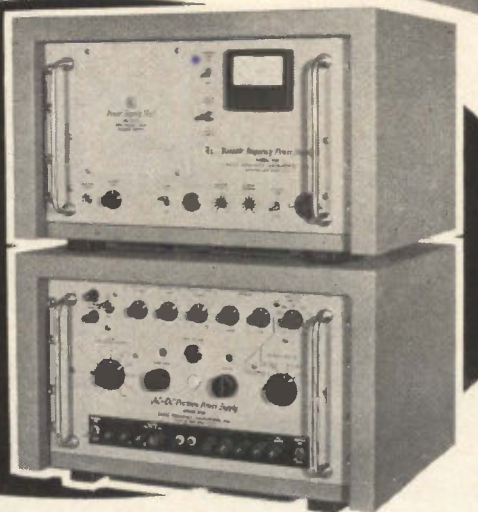

RANGES

VOLTAGE: 0 to 1500 Volts AC and DC

CURRENT: 0 to 30 Amperes AC and DC

FREQUENCY: 50 C/S to 20 Kc/S

Rated output varies from 30 to 100 VA depending on output frequency selected. In addition to continuous coverage, fixed settings of 50, 60, 400, 800, 1000, 1600 and 2400 c/s are provided. Regulation is $\pm 0.1\%$ for 5% line or 25% load change; short term stability is better than $\pm .03\%$. Resolution of output adjustment is $\pm .01\%$ for voltage and current. Housed in two cabinets for maximum utility, the Model 2120 is priced at \$2950.



INSTRUMENT CALIBRATION

The Model 2120 is particularly suited for use with a separate monitoring system to standardize and calibrate high accuracy digital, indicating and recording instruments. Its distortion levels meet the most critical instrument calibration requirements.

A typical, highly accurate calibration set-up using an RFL Model 1605A AC-DC transfer standard with the Model 2120 mounted on a wheeled carrier is illustrated. Protective circuits safeguard both the transfer standard and instrument being calibrated.

Performance is rigidly guaranteed. Price is net, f.o.b. Boonton, N.J. and subject to change without notice.

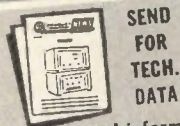

For additional information, including application data, write or phone DE 4-3100. Demonstrations available by local representatives.



Radio Frequency
LABORATORIES, INC.
Boonton, New Jersey, U. S. A.

Literature of the Week

TEES Microwave Development Laboratories, Inc., Needham, Mass. Catalog TH62 describes in detail more than 70 E plane, H plane and magic tees covering EIA waveguide sizes from WR10 to WR2100.

CIRCLE 318, READER SERVICE CARD

PRECISION COMPONENTS Mechatrol, a division of Servomechanisms, Inc., 1200 Prospect Ave., Westbury, L. I., N. Y., has available its 130-page 1963 precision components catalog RC 630. (319)

DRAFTING METHOD Chart-Pak, Inc., 1 River Road, Leeds, Mass. Bulletin describes Trans-Pak, a new method that gives a choice of using a dull crepe paper or ruby red transparent die cut for the making of printed circuit master drawings. (320)

DIGITAL INDICATORS Patwin Electronics, Waterbury 20, Conn. Two-page bulletin illustrates and describes series 15000 digital indicators for relay logic. (321)

PRECISION POWER SUPPLIES Power Designs Inc., 1700 Shames Drive, Westbury, N. Y. Specifications of a complete line of semiconductorized, precision power supplies are given in a short form catalog. (322)

MICROMINIATURE RELAYS General Electric Co., Schenectady 5, N. Y., announces bulletin GEA-7241A on a line of all-welded relays magnetically latched for short power pulse operation. (323)

ATOMIC FREQUENCY STANDARD STL Products, 139 Illinois St., El Segundo, Calif. Product data sheet No. 70 covers a solid-state rubidium frequency standard. (324)

SURFACE ACTIVE AGENT Medical and Pharmaceutical Developments Ltd., 2 Erringham Road, Shoreham By Sea, Sussex, England. RBS25 concentrate, for the cleansing and removal of a wide range of materials such as silicones, various polymers, tars, organic materials and radioactive contamination, is described in a leaflet. (325)

DIRECT WRITING RECORDERS American Optical Co., Instrument Division, Buffalo 15, N. Y. Short form catalog describes a complete line of direct writing recorders. (326)

CIRCUIT-BOARD DAMPER Barry Controls Division of Barry Wright Corp., 700 Pleasant St., Watertown 72, Mass., offers an illustrated bulletin describing type 19010-1 circuit-board damper for reducing vibration in circuit boards and similar plate-type structures. (327)

ISOLATED POWER SUPPLY Elcor, Inc., 1225 West Broad St., Falls Church, Va. Data sheet describes model 124-EI Isoply designed to provide the necessary outputs for powering a

chopper stabilized differential amplifier. (328)

TRIMMING POTENTIOMETERS Weston Instruments & Electronics Division, Daystrom, Inc., 614 Frelinghuysen Ave., Newark 14, N. J., offers a technical data sheet on the 510 series Transitrtrim trimming potentiometers. (329)

TUNNEL DIODE MEASUREMENTS Sylvania Electric Products Inc., 1100 Main St., Buffalo 9, N. Y., is offering a brochure, "Technical Report on Tunnel Diode Measurements." (330)

DIRECT-WRITING RECORDER Brush Instruments, division of Clevite Corp., 37th and Perkins, Cleveland 14, O. Folder contains six catalog sheets on Mark 200 direct-writing recording systems. (331)

TUBE PINCH-OFF PRESS W. A. Whitney Mfg. Co., 636 Race St., Rockford, Ill. Two-page bulletin illustrates and describes model 704 pinch-off press that cuts off and seals copper tubing simultaneously. (332)

COIL WINDING MACHINES Geo. Stevens Mfg. Co., Inc., Pulaski Road at Peterson, Chicago 46, Ill. Condensed 2-page data sheet gives primary specifications on six representative types of high production and laboratory coil winding machines. (333)

TRANSISTOR MOUNTING PADS The Milton Ross Co., 511 Second Street Pike, Southampton, Pa. Dimensional drawings and samples of the complete line of Transipads are available in a 75-page unit, catalog 28. (334)

VACUUM TWEEZER Scientific Columbus, Inc., 840 Kinnear Road, Columbus 12, O. Single-page bulletin describes a positive vacuum pickup tool for handling miniature metal, ceramic and fragile semiconductor parts and elements. (335)

COAXIAL TRANSMISSION LINES The Mecron Co., 5 Jackson Ave., North Plainfield, N. J., offers a 12-page catalog No. 300A, covering 50 ohm rigid coaxial transmission lines and fittings. (336)

SOLID STATE RECTIFIERS Diodes, Inc., 9261 Independence Ave., Chatsworth, Calif. Data bulletin covers a line of high voltage stacked silicon rectifiers. (337)

DIGITAL VOLTMETER Industrial Instruments Inc., 89 Commerce Road, Cedar Grove, N. J. Catalog sheet describes model DVM-2 high-reliability digital voltmeter. (338)

PLUG AND SOCKET CONNECTOR Continental Connector Corp., Woodside 77, N. Y. Catalog sheet illustrates and describes series 683-40 and 683-41 right angle plug and socket connector. (339)

METALIZED CERAMIC TRANSISTOR PACKAGES Metalized Ceramics Corp., 25 Acorn St., Providence 3, R. I. Brochure describes and illustrates the MetCeramic process for making metalized ceramic packages for high-reliability semiconductors. (340)

MINIATURE BRISTOL SYNCROVERTER CHOPPERS

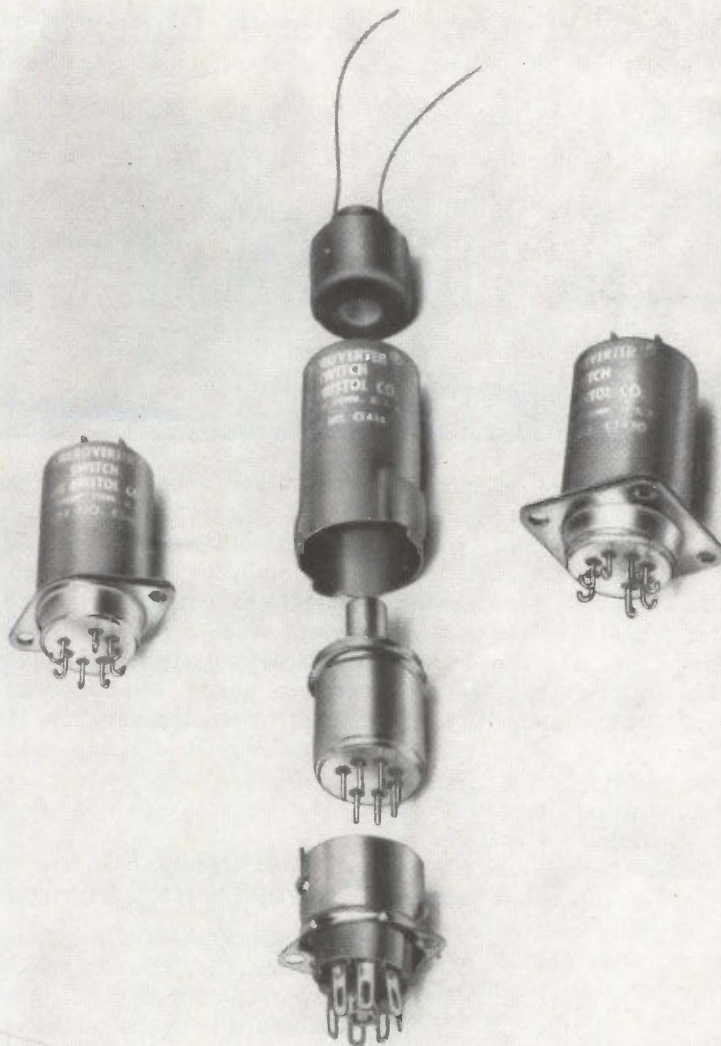

BRISTOL'S LOW-NOISE CHOPPERS

for unmatched **RELIABILITY** in low-level instrumentation

Low-Noise Syncroverter* choppers are used in the finest, most accurate d-c amplifiers, microvolt-ammeters and null-balance systems where the best is required. Write for full specifications:

The Bristol Company, Aircraft Equipment Division, 152 Bristol Road, Waterbury 20, Connecticut. A Subsidiary of American Chain &

ACCO
Cable Company, Inc. In Canada: The Bristol Company of Canada Ltd., 71-79
Duchess Street, Toronto 2, Ontario 3.5 *T. M. Reg. U. S. Pat. Off.



BRISTOL . . . engineers for precision, builds for reliability

Philips Erecting Research Laboratory

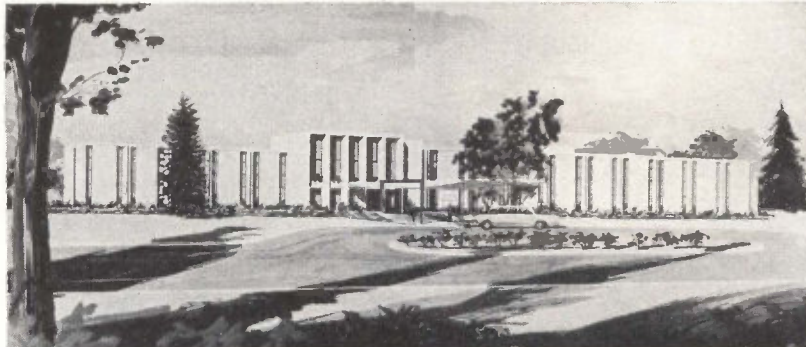

GROUNDBREAKING ceremonies have been held on a 74-acre site in Briarcliff Manor, N. Y., where North American Philips Co., Inc., will build a laboratory for research and development in electronics, physics and chemistry. Since 1944, Philips Laboratories has been located in Irvington-on-Hudson, N. Y.

The new building, with approximately 80,000 square feet of work space, is scheduled for completion in 1964. In addition to areas for research and development, space will be provided for executive, administrative and patent offices, and for engineering, maintenance and employee dining. Approximately 175 persons will be employed initially.

Specific research investigations will involve magnetic and ceramic materials, thermionics, x-ray instrumentation and crystallography, semiconductors, electronic circuits, plasma physics and cryogenics. In addition, Philips Laboratories scientists conduct investigations in theoretical and solid state physics, physical chemistry and metallurgy.

Philips Laboratories also serves additional enterprises associated with North American Philips: Consolidated Electronics Industries Corp., and Philips Electronics and Pharmaceutical Industries Corp. The enlarged laboratory facilities will be an important factor in expansion plans for the two corporations.

Recent projects in which Philips Laboratories has played an active role include an x-ray diffracto-

meter for lunar explorations, and development of a miniature refrigerator that weighs only 12 pounds and produces a temperature of below 30 K. This unit is said to hold great promise for scientific investigations and electronic applications where small, light-weight equipment to produce very low temperatures is critically important.

McBurney Joins The Deutsch Company

HOWARD MCBURNEY has joined The Deutsch Co., Los Angeles, Calif., corporate staff as a vice president concerned with the solution of pro-

duction and distribution problems encountered by each of the company's five operating divisions.

McBurney spent more than 15 years with National Screw and Mfg. Co. of California where he was vice president.

Establish New Corporation

A NEW CORPORATION named Action Labs, Inc., has been formed in Minneapolis, Minn., to manufacture assemblies for builders of electronic and electromechanical equipment.

Founders are Richard Jensen, D. R. Thompson and W. R. Thurston, all of whom have held manufacturing positions with local electronics companies.

Appoint Jacques Operations Manager

GEORGE E. JACQUES has been named operations manager for the Thompson Ramo Wooldridge Microwave division at Canoga Park, Calif.

Formerly the division's engineering manager, Jacques assumes responsibility for all production, purchasing, product engineering and

Geotech Opens Data-Processing Center



SCIENTIFIC data-processing center at The Geotechnical Corporation, Garland, Texas, will aid Project Vela-Uniform, the Department of Defense program for research into the detection and identification of underground nuclear explosions

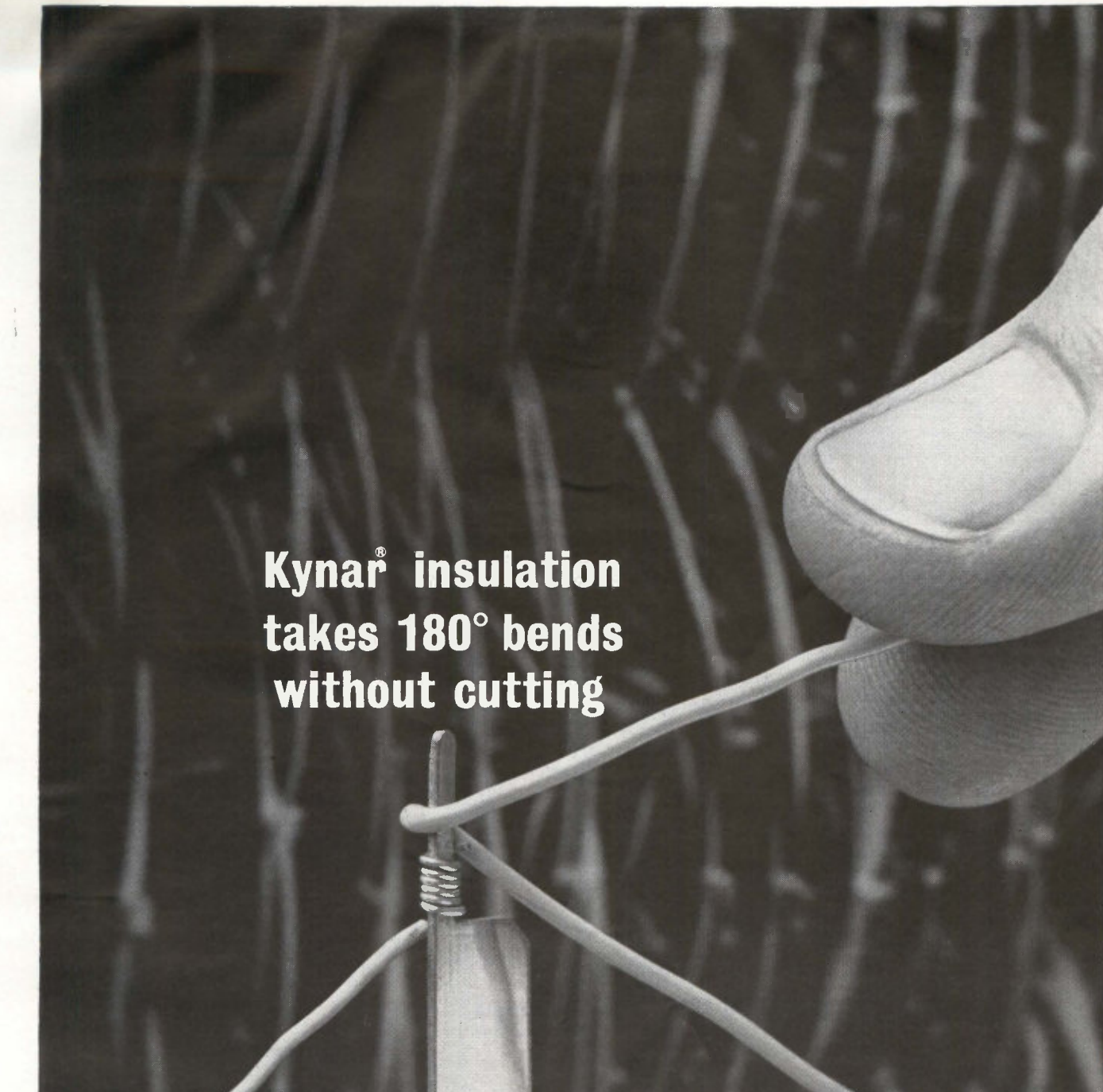

**Kynar[®] insulation
takes 180° bends
without cutting**

Now you can pull computer hookup wire around tight corners—even stretch it over sharp edges—without danger of insulation cutting through. The secret: Kynar, Pennsalt's vinylidene fluoride resin, a new high-performance fluoroplastic that's *tough!* □ Wire insulation of Kynar offers unmatched mechanical strength and toughness, even in 5-mil sections you may need for miniaturization. It cuts cleanly, strips readily,

won't burn or melt. Dimensionally stable, Kynar doesn't stretch when wires are pulled. Wire insulated with Kynar has ample stiffness yet stays in place when harness is bent to shape. □ Write for our brochure and the names of leading manufacturers who supply wire insulated with Kynar. Plastics Department, PENNSALT CHEMICALS CORPORATION, 3 Penn Center, Philadelphia 2, Pa.

Kynar...a fluoroplastic that's tough!

Kynar is a Registered Trademark of Pennsalt Chemicals Corp.



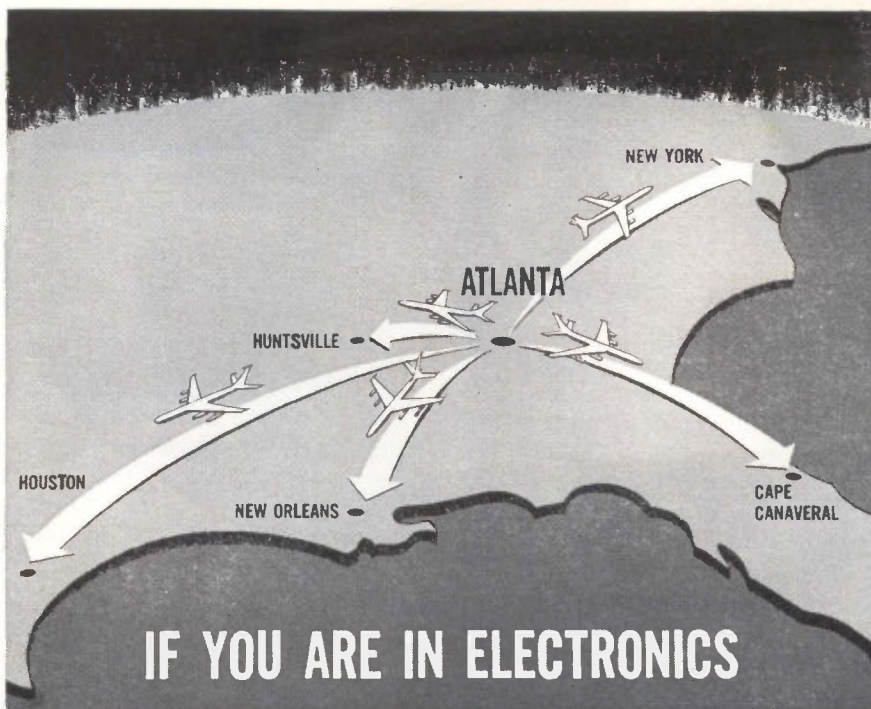

YOU SHOULD HAVE A PLANT IN ATLANTA

HERE'S WHY: Atlanta is the distribution hub of the booming southeast and is within two hours' flight of all major electronics centers east of California. It's the home of Georgia Tech which graduates a constant supply of competent engineers and offers working engineers opportunities for advanced study. Southern Technical Institute produces graduate technicians, and well-trained labor comes from the several trade schools... Besides which, Atlanta is just a great place to live. The weather is all the Chamber of Commerce claims for it. The schools and the recreation and cultural facilities are better than most. Let us tell you more about this exceptional town.

THREE USEFUL BROCHURES

ELECTRONICS — A MANUFACTURING OPPORTUNITY IN GEORGIA

A comprehensive study of local economic factors of special interest to electronics manufacturers of all types.

EDUCATIONAL AND TRAINING FACILITIES IN ATLANTA A detailed account of the secondary and post-high-school educational institutions in the metropolitan area.

COST DATA ON INDUSTRIAL BUILDINGS Atlanta's building costs are among the lowest in the nation. This brochure contains photographs and complete specifications of many recently constructed plants, together with cost information.

We'll gladly send you any or all of these brochures without cost or obligation.

E. A. Yates, Jr., Vice President

GEORGIA POWER COMPANY

INDUSTRIAL DEVELOPMENT DIVISION

Box 4545 N Atlanta 2, Georgia Phone: 521-3400

A COMPLETE, CONFIDENTIAL SITE-SELECTION SERVICE FOR INDUSTRY

quality control in the newly created post.

The TRW Microwave division manufactures and markets a broad line of r-f components for military applications.

GI Rectifier Division Hires Borneman

APPOINTMENT of Edmond H. Borneman as technical director of engineering of the General Instrument Corp., Rectifier division has been announced.

Borneman was formerly with Westinghouse Electric's Semiconductor division.

The General Instrument Rectifier division, with plants at Newark, N. J., and Brooklyn, N. Y., manufactures silicon and selenium devices.



EOS Elects Cook Vice President

LESLIE J. COOK has been elected a vice president of Electro-Optical Systems, Inc., Pasadena, Calif. He also continues in his present position as manager of the EOS Electric Propulsion Flight Test Program.

Cook was manager of West Coast operations for the Perkin-Elmer Corp., Norwalk, Conn., before joining EOS.

Lear Siegler Names Cohen

ABRAHAM L. COHEN has been named vice president in charge of engineering for the Data & Controls division of Lear Siegler, Inc., Long Island City, N. Y.

Cohen joined the Military and In-

the finest precision
coaxial connectors*

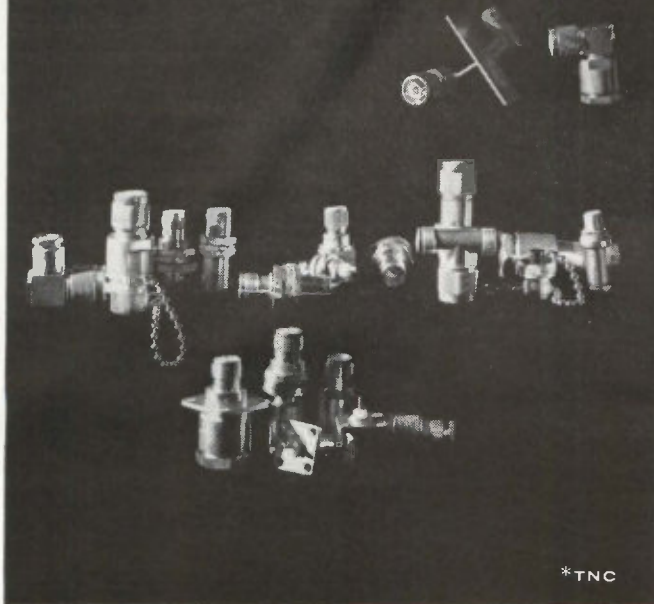

*TNC

General RF Fittings, Inc.

702 BEACON STREET, BOSTON 15, MASSACHUSETTS
Telephone: 617 267-5120

CIRCLE 204 ON READER SERVICE CARD

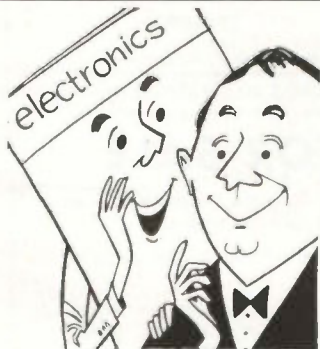

electronics
IS EDITED
TO KEEP YOU
FULLY INFORMED
— a "well-rounded"
engineer

What's your *present* job in electronics? Do you work on computers? (*electronics* ran 158 articles on computers between July, 1961 and June, 1962!) Are you in semi-conductors? (For the same period, *electronics* had 99 articles, not including transistors, solid-state physics, diodes, crystals, etc.) Are you in military electronics? (*electronics* had 179 articles, not including those on aircraft, missiles, radar, etc.)

In all, *electronics'* 28-man editorial staff provided more than 3,000 editorial pages to keep you abreast of all the technical developments in the industry. No matter where you work today or in which job function(s), *electronics* will keep you fully informed. Subscribe today via the Reader Service Card in this issue. Only 7½ cents a copy at the 3 year rate.

electronics

electronics • May 24, 1963

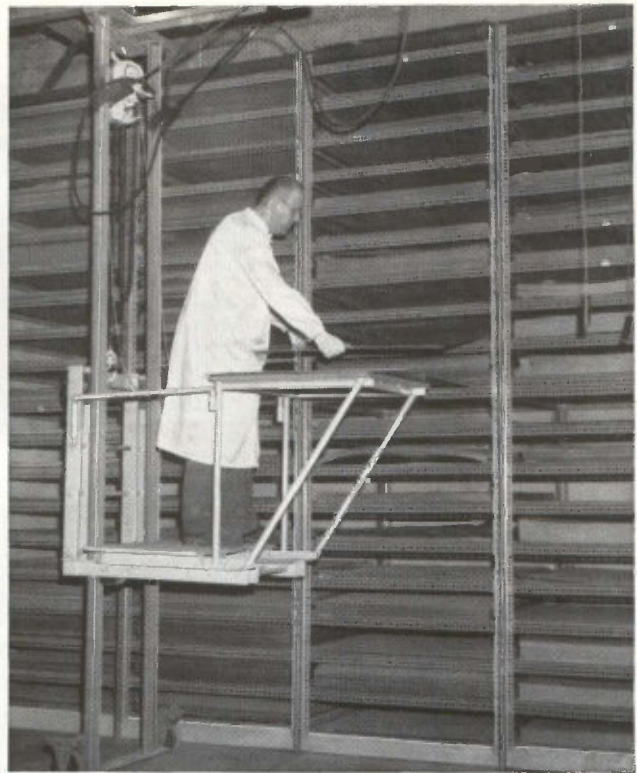

20,000 pounds of COPPER-CLAD Laminates NOW in STOCK

We have systematically increased our stock of Synthane copper-clad laminated plastics. We now have 20,000 lbs. of copper-clad sheets, made under clean room conditions, ready to ship or fabricate immediately.

Our stock includes both paper phenolic and glass epoxy grades in a wide variety of laminate and foil thicknesses.

Standard sheet sizes stocked are 36" x 36", 36" x 42" and 36" x 48". Panels cut to your size are available.

Write for complete information about Synthane metal-clad laminates, using the coupon below.

SYNTHANE

CORPORATION **S** OAKS, PENNA.

Glendale 2-2211 (Area Code 215) TWX 215-666-0589

Synthane-Pacific, 518 W. Garfield Ave., Glendale 4, Calif. TWX 213-240-21040

Synthane Corporation, 36 River Rd., Oaks, Pa.

Gentlemen:

Please send me information about Synthane metal-clad laminates.

Name _____

Address _____

City _____ Zone _____ State _____

CIRCLE 111 ON READER SERVICE CARD

111

Squeezed by PW Assembly Headaches?



Look into **DYNASERT**[®] automatic inserting equipment for the fast, efficient, economical remedy. This is modern, automated, high-speed component inserting: up to 10 times faster than costly hand methods. Examples: a single machine can average 800 insertions per hour. A fully automatic system up to 1200 boards an hour with just two operators. Dynasert delivers product uniformity. Greater efficiency. Superior quality. Greater circuit design flexibility. It automatically feeds, cuts, and bends leads, inserts and clinches all types of axial lead components. Little operator training required. Changes made from one board or component type in seconds. Savings can pay for a Dynasert installation in less than a year. Want more facts? Send for a free copy of: Dynasert — Production Equipment for Electronics. Dynasert Dept. 2, United Shoe Machinery Corp., Boston, Massachusetts.



United Shoe Machinery
BOSTON, MASSACHUSETTS

dustrial Products Group of Olympic Radio & Television division in 1956 as systems engineering manager. He was named director of engineering in August, 1962 when the Group was merged into the new Data & Controls division.

PEOPLE IN BRIEF

Bernard M. Oliver, v-p of R&D at Hewlett-Packard, and a v-p of the IEEE, elected to board of directors of Spectra-Physics, Inc. Lester L. Kilpatrick resigns as president of California Computer Products, Inc., and is named chairman of the board. Donald W. Gade, senior v-p, is the company's chief exec officer pending election of a new president. H. Dickinson moves up to exec v-p and g-m of Varec, Inc., and Dynel, Inc., subsidiaries of Microdot Inc. Norman Zachary, formerly with General Telephone Co. of California, named a senior scientist at Operations Research Inc. Promotions at Neptune Meter Co.: Edgar A. Gaudette to exec v-p, and Paul S. Wells to v-p. Mois Gerson appointed v-p of United ElectroDynamics, Inc., continuing as g-m of the company's United AeroSpace div. William H. Keppel advances to mgr., engineering and mfg., for the Videosonic Systems div., ground systems group, Hughes Aircraft Co. Richard W. Ehrhorn, previously with Cal-Tech's Jet Propulsion Lab, named supervisor of advanced development for Electronic Communications, Inc. John J. Foley, ex-Sola Electric, now materials mgr. of the Relay div. of Leach Corp. William A. Raatz moves up to supervisor of the process systems section in California Research Corp.'s Richmond lab. Gerald L. Sandberg from Ampex Data Products Inc., to Halex, Inc., as director of thin-film microminiaturization programs. William C. Anderson, director of engineering, elected v-p, engineering, of Jefferson Electric Co. Terry R. Savage leaves IBM to join Documentation Inc. as mgr. of systems and programming.

EMPLOYMENT OPPORTUNITIES

SELLING OPPORTUNITY WANTED

Mfr' Export Reps with exc world-wide connect., on their toes around the clock, are eager to boost your sales. Aacor International, 198 Broadway, N. Y. 8, BA 7-0482.

SEARCHLIGHT SECTION

(Classified Advertising)
BUSINESS OPPORTUNITIES
EQUIPMENT - USED or RESALE

WANTED:

AN/TRC-24 RADIO SET COMPONENTS

AM-912/TRC
AM-913/TRC
AM-914/TRC
AM-915/TRC
PP-685/TRC
R-417/TRC
T-302/TRC

W-2147, Electronics
Class. Adv. Div., P.O. Box 12, N.Y. 36, N.Y.

CIRCLE 950 ON READER SERVICE CARD

WANTED

Two Used No. 331 Dumont CATHODE RAY OSCILLOGRAPHS In Good Condition

W. DENTON
P. O. Box 293, Church Street Station
New York 7, New York

CIRCLE 951 ON READER SERVICE CARD

FOR SALE

Standard 3-channel open-wire Carrier
Terminals and Repeaters.

Standard v-f carrier-telegraph terminals.

Standard v-f ringers, v-f repeaters,
repeating coils, condensers, filters, re-
tard coils, polar relays.

Complete list on request

FS-2148, Electronics
Class. Adv. Div., P.O. Box 12, N.Y. 36, N.Y.

CIRCLE 952 ON READER SERVICE CARD

OVER 2,000,000

RELAYS

IN STOCK!

Send for Catalog \$5
Universal RELAY CORP.
42 WHITE ST., N. Y. 13, N. Y. • WALKER 5-6900

CIRCLE 953 ON READER SERVICE CARD

RADIO RESEARCH INSTRUMENT CO.

AUTO-TRACK & TELEMETRY ANTENNA PEDESTALS
3 & 10 CM. SCR. 584 AUTOTRACK RADARS.
AN/TPS-1D SEARCH. AN/TPS-10 HT. FINDERS.
AN/FPS-320CA. AN/APS-10 NAVIG. & WEATHER.
AN/APS-15B PRECISION. AN/APS-35B PRECISION.
AN/APS-31A SEARCH. DOZENS MORE.
5-1-2 MEGAWATT HIGH POWER PULSERS.

RADIO RESEARCH INSTRUMENT CO.
550 Fifth Ave., New York Judson 6-4691

RADAR SYSTEMS & COMPONENTS/ IMMEDIATE
DELIVERY

CIRCLE 954 ON READER SERVICE CARD

INDEX TO ADVERTISERS

A & M Instruments, Inc.	82	• Japan Piezo Electric Co., Ltd.	100	United Control Corp.	98
• AMP Incorporated	50	• Jennings Radio Manufacturing Corp.	99	• United Shoe Machinery Corp.	112
Air Express	33			• United Transformer Corp. ... 2nd cover	
Ampex Corporation	75	• Lapp Insulator Co., Inc.	27	• Utica Drop Forge & Herbrand Division, Kelsey-Hayes Co.	80
• Amphmol-Borg Electronics Corp. Connector Division	34, 35	Leach Corporation	71		
Analab Sub. of Jerrold Corp.	4			Washington, State of	32
Ansoco	18	Machlett Laboratories, Inc.	21	West Penn Power	38
• Arco Electronics Inc.	90	Mallory and Co., Inc., P. R.	79		
Automatic Electric	67	Midland Mfg. Co.	39		
		Midwec	76		
		Mincom	37		
Baltimore Gas and Electric Co.	14	Mitsubishi Electric Mfg. Co.	48		
• Boonton Radio Corp.	93	Motorola Military Electronics Div.	24, 25		
Bristol Company, The.	107	• Mycalex Corp. of America	84		
Carborundum	23	• Natvar Corporation	29		
• Clarostat Mfg. Co., Inc.	19	• Navcor	97		
• Corning Electronics	36	• North Atlantic Industries, Inc.	74		
• Daystrom Incorporated Transicoil Div.	68, 69				
• Defense Electronics, Inc.	81	Pacific Semiconductors, Inc.	44, 45, 46, 47		
Dow Corning Corp.	10, 11	Pennsalt Chemicals Corp.	109		
Dymec A Division of Hewlett Packard Co.	73	• Polarad Electronic Instruments, Div. of Polarad Electronics Corp.	87, 88		
		• Potter Instrument Co., Inc.	17		
• Electro Motive Mfg. Co., Inc.	91	• Radio Corporation of America. 4th cover			
Execu-Search	76	• Radio Frequency Laboratories, Inc.	104		
		• Raytheon Company	13		
		Rome Cable Div. of Alcoa	89		
• Fairchild Semiconductor. .114, 3rd cover					
Fluke Mfg. Co., Inc., John	49	• Sanborn Company	5		
• Fujitsu Ltd.	102	Sanders Associates, Inc.	83		
		Scientific Atlanta Inc.	103		
• Garlock Electronics Products	96	• Sealstro Corp.	92		
General Atronics	85	• Servo Corporation of America	28		
• General Electric Co. Power Tube Dept.	41	• Sierra Electronic Div. of Philco	6		
• General RF Fittings Inc.	111	Speer Carbon Co.	30, 31		
Genistron Inc.	72	Sprague Electric Co.	9, 22		
Georgia Power Co.	110	Sylvania Electronic Products, Inc. Electron Tube Div.	43		
Gudebrod Bros. Silk Co., Inc.	42	Synthane Corp.	111		
Hansen Mfg. Co., Inc.	76				
• Hayes, Inc., C. I.	100	Tektronix, Inc.	77		
• Hitemp Wires Co.	40	Texas Instruments Incorporated Metals & Controls Division.	101		
Houston Instrument Corp.	95	• Transatron Electronic Corp.	15		
• Image Instruments Inc.	95				

CLASSIFIED ADVERTISING

F. J. Eberle, Business Mgr.

EMPLOYMENT OPPORTUNITIES .. 112

EQUIPMENT

(Used or Surplus New)

For Sale

112

WANTED

Equipment

112

ADVERTISERS INDEX

Denton W.

112

• Radio Research Instrument Co.

112

• Universal Relay Corp.

112

• See advertisement in the July 25, 1962 issue of Electronics Buyers' Guide for complete line of products or services.

This Index and our Reader Service Numbers are published as a service. Every precaution is taken to make them accurate, but electronics assumes no responsibilities for errors or omissions.

electronics



Audit Bureau
of Circulation



Associated Business
Publications

Audited Paid Circulation

JAMES T. HAUPTLI

Advertising Sales Manager

DAVID CUNNIFF

Promotion Manager

Electronics Buyers' Guide

R. S. QUINT

General Manager

RICHARD J. TOMLINSON

Business Manager

THEODORE R. GEIPEL

Production Manager

ADVERTISING REPRESENTATIVES

ATLANTA (9):

Michael H. Miller, Robert C. Johnson
1375 Peachtree St. N.E., Trinity 5-0523
(area code 404)

BOSTON (16):

William S. Hodgkinson, Donald R. Furth
McGraw-Hill Building, Copley Square,
Congress 2-1160 (area code 617)

CHICAGO (11):

Harvey W. Wernecke, Robert M. Denmead
645 North Michigan Avenue, Mohawk 4-5800
(area code 312)

CLEVELAND (13):

Paul T. Fegley
55 Public Square, Superior 1-7000
(area code 216)

DALLAS (1):

Frank Le Beau
The Vaughn Bldg., 1712 Commerce St.
Riverside 7-9721 (area code 214)

DENVER (2):

John W. Patten
Tower Bldg., 1700 Broadway,
Alpine 5-2981 (area code 303)

HOUSTON (25):

Joseph C. Page, Jr.
Prudential Bldg., Halcombe Blvd.,
Riverside 8-1280 (area code 713)

LOS ANGELES (17):

Ashley P. Hartman, John G. Zisch,
William C. Gries
1125 W. 6th St., Huntley 2-5450
(area code 213)

NEW YORK (36):

Donald H. Miller, Henry M. Shaw,
George F. Werner
500 Fifth Avenue, LO-4-3000
(area code 212)

PHILADELPHIA (3):

Warren H. Gardner, William J. Boyle
6 Penn Center Plaza, LOcust 8-4330
(area code 215)

SAN FRANCISCO (11):

Richard C. Alcorn
255 California Street, Douglas 2-4600
(area code 415)

LONDON W1:

Edwin S. Murphy Jr.
34 Dover St.

FRANKFURT/Main:

Matthée Herfurth
85 Westendstrasse

GENEVA:

Michael R. Zeynel
2 Place du Port

TOKYO:

George Olcott,
1, Kotohiracho, Shiba, Minato-ku

HIGH SPEED

From Fairchild—for economical volume testing

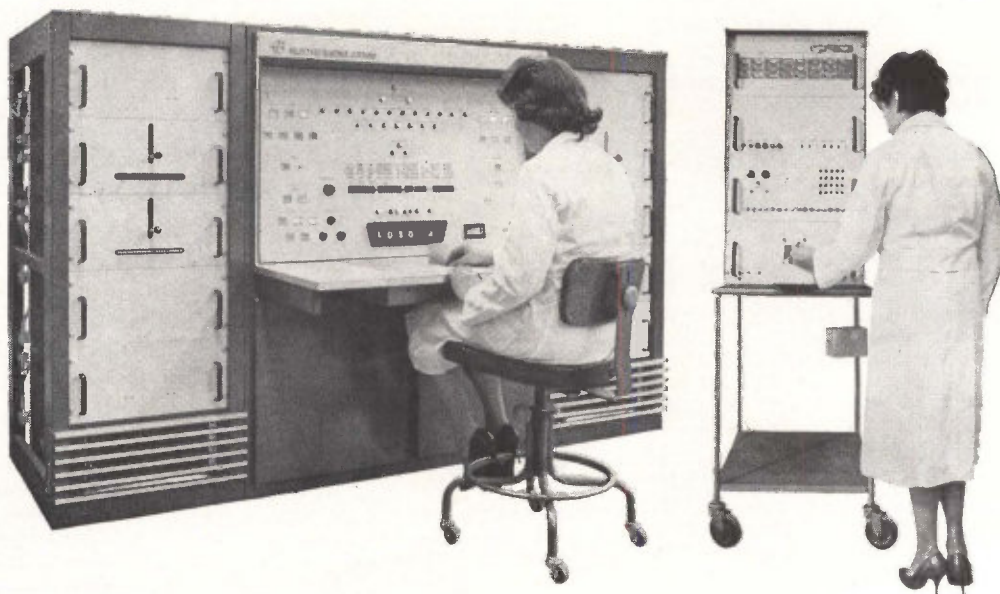

SERIES 900 Card Programmed Data Logger. All digital from test socket to readout. Performs up to 24 tests per device in any order. Completely programmed by four plastic punched cards. Self checking. Pulse testing eliminates junction heating effects to insure accuracy of high current tests. Data logger adaptable to drive recorders including typewriters, printers and tape punch systems.

SERIES 250 Go/No-go Multiparameter Tester. Tests 900 units per hour—16 variable go/no-go tests per unit. Features pulse testing. Like all Fairchild test equipment, the Series 250 can be operated by non-technical personnel after a few hours of training. Easily programmed with decade cards or fixed resistor cards. Test accuracy at $1\mu\text{A}$: $\pm 0.5\%$ ($\pm 1\%$ at 100nA). Optional priority sorting.

TESTERS

of transistors and diodes



SERIES 500 Multiparameter Tester. Quickly and easily programmed. Automatic direct digital readout with optional data logging capabilities. Readout test results are accurate to $\pm 1\%$. Rugged modular construction easily adaptable to special needs and the entire system can be expanded to incorporate future tests as a safeguard against obsolescence. Features pulse testing methods.

SERIES 200 Transistor Tester/Sorter and Series 100 Diode Tester/Sorter. Automatic priority sorting. Series 200 handles 1500 transistors and Series 100 handles 3600 diodes per hour. 24 tests per device—or one test repeated 24 times. Completely programmed by four plastic punched cards. Features pulse testing. Self checks for incorrect programming and also during each test sequence.

MODEL 50 Beta Tester. Tests all types of NPN and PNP transistors to an accuracy of ± 1 digit or $\pm 2\%$. Features pulse testing. A closed loop feedback system provides extreme circuit calibration stability and a built-in short detector protects both equipment and test units. Maximum time per unit tested: 2 seconds. Readout range: from 2 to 999, read directly. Also has data logging output cable.

FAIRCHILD
SEMICONDUCTOR
(INSTRUMENTATION)

Write for data sheets on the above models, or on others not shown. Fairchild has the widest selection of testers in the industry.



1,600,000 Hours of Nuvistor Life Tests DEMONSTRATE:

**99.53%
RELIABILITY**

per 1,000 hours over first 10,000 hours of operation at a

95% CONFIDENCE LEVEL

New data, from continuing tests, substantiate these exceptional reliability figures for RCA nuvistors.

1,600,000 tube hours of actual life tests on the RCA-7586 nuvistor triode have established a failure rate of only 0.47% or less per 1,000 hours—for the first 10,000 hours of operation—at a confidence level of 95%.

Furthermore, during the tests, involving 532 nuvistors, only one tube showed a reduction in transconductance to 50 percent or less of the initial value. The tests also revealed no sustained downward trend in transconductance distribution. Based on these findings, wear-out type failures should be virtually non-existent during the first 10,000 hours of nuvistor tube life.

These facts give you 95% assurance that:

- Of every 200 RCA-7586 type nuvistors in your sockets, 199 will satisfactorily complete each 1,000 hours during the first 10,000 hours of operation.
- Nuvistor characteristics are exceptionally uniform from tube to tube, and remain exceptionally stable throughout tube life.

This outstanding reliability is one more reason why you should specify nuvistors for all applicable circuitry. For technical data on specific types, see your RCA Field Representative or write: Commercial Engineering, RCA Electron Tube Division, Harrison, New Jersey.

Nuvistor Life Test Conditions

	Test Conditions = 1	Test Conditions = 2
Heater volts	6.3	6.3
Heater-cathode volts	100	0
Plate volts	100	—
Plate-supply volts	—	75
Grid volts	-1.85	—
Cathode resistor—ohms	—	100
Grid-circuit resistance—megohm	0.5	0.5
Metal-shell temperature—°C	150	150
Plate dissipation—watts	1	0.75

FIELD OFFICES—EAST: 32-36 Green St., Newark 2, N. J., (201) 485-3900 • MIDWEST: Suite 1154, Merchandise Mart Plaza, Chicago 54, Ill., (312) 527-2900 • WEST: 6801 E. Washington Blvd., Los Angeles 22, Calif., (213) RAYmond 3-8361 • 1838 El Camino Real, Burlingame, Calif., (415) 697-1620



The Most Trusted Name in Electronics