

electronics®

INTEGRATED CIRCUITS

How soon in consumer electronics? p 22

NEW SUPERHETS FOR SIDEBAND

Design criteria for modern receivers, p 39

TUNNEL DIODES SPEED UP LOGIC

Reduce propagation delays, p 50

SECOND-HARMONIC GENERATOR *converts red laser light to blue, p 60*

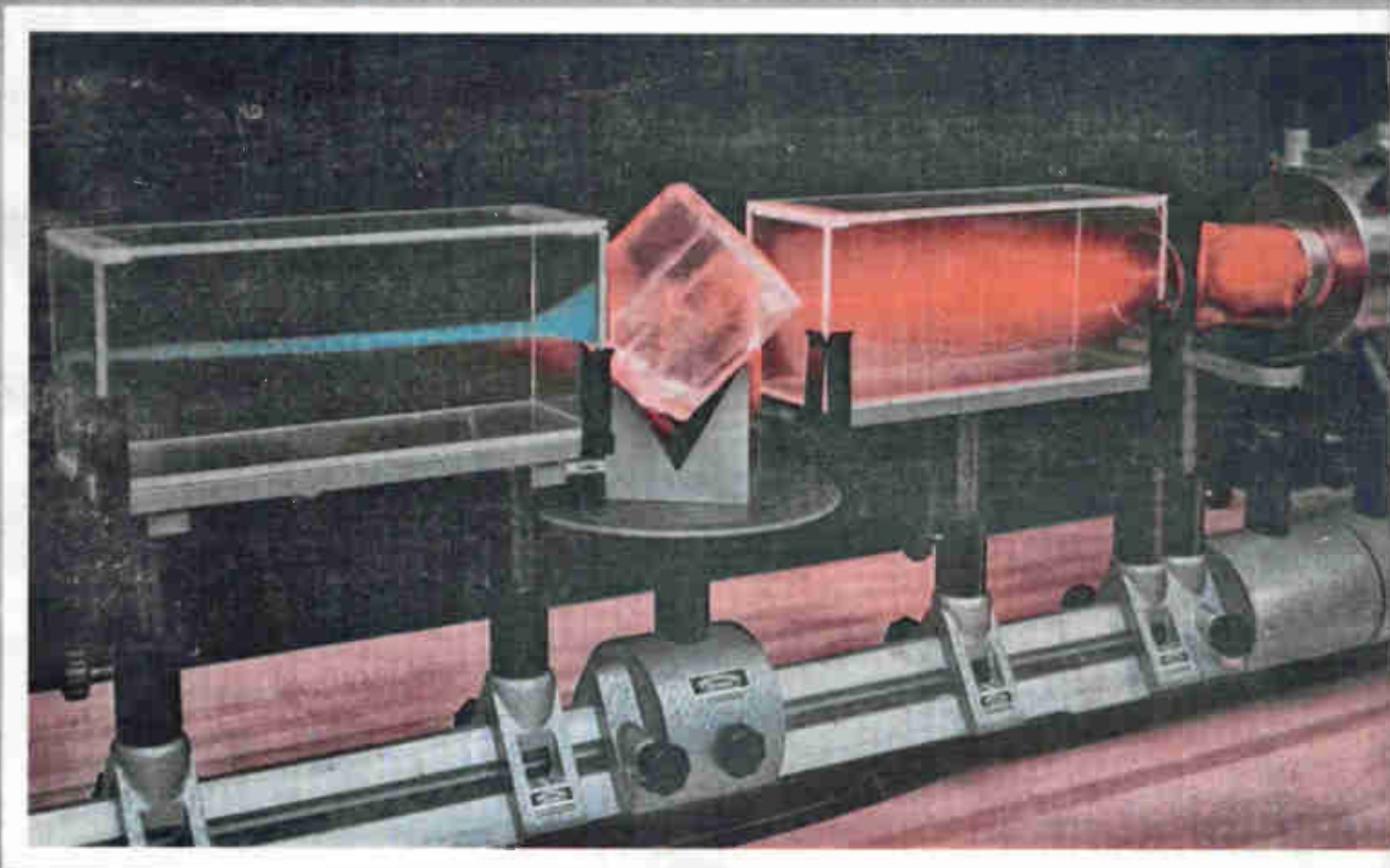

C 10

MOSES LAKE WASH

BOX 956

L 28-

ROLAND KISSLER



Check Components

the semiautomatic way

Make Bridge Measurements at Rates up to One a second

No manual balancing is necessary with the Type 1605-A Impedance Comparator. Once set up, the Comparator instantly measures both impedance-magnitude and phase-angle differences between an unknown R, L, or C component and a standard. The differences are indicated directly on two panel meters. Ranges of measurement are: ΔZ , from $\pm 0.01\%$ to $\pm 10\%$; $\Delta\theta$, from ± 0.0001 to ± 0.1 radian. Or, in other terms: R, from 2 ohms to 20 megohms; L, from 20 μh to 10,000 h; and C, from 40 pf to 800 μf . Measure-

ing accuracy is 3% of full scale. Hence, on the $\pm 0.3\%$ ΔZ range, accuracy is 0.009% of the value being measured. Four internal test frequencies are provided: 100 cps, 1 kc, 10 kc, and 100 kc. DC voltages proportional to percentage deviation are available at the back of the instrument for automatic tabulation of data and control of sorting systems. An excellent guard circuit is provided to permit remote measurements (ideal for environmental chambers).

Price of the 1605-A is \$875 in the U.S.A.

For those desiring higher sensitivity for difference measurements to 0.003%, the 1605-AH is available at \$925 (in U. S. A.). Write for complete information.

GENERAL RADIO COMPANY
WEST CONCORD, MASSACHUSETTS

In EUROPE
General Radio
Overseas
Zurich, Switzerland

NEW YORK, N. Y., 964-2722
Ridgefield, N. J., 943-3140

CHICAGO
(Oak Park) 848-9400

PHILADELPHIA, 424-7419
Abington, 887-8486

WASHINGTON, D.C.
(Rockville, Md.) 946-1600

SYRACUSE
454-9323

DALLAS
FL 7-4031

SAN FRANCISCO
(Los Altos) 948-8233

LOS ANGELES
469-6201

ORLANDO, FLA.
425-4671

IN CANADA
(Toronto) 247-2171

CIRCLE 900 ON READER SERVICE CARD

electronics

A McGraw-Hill Weekly 75 Cents



W. W. MacDONALD, Editor

J. M. CARROLL, Managing Editor

SENIOR EDITORS

Samuel Weber, George W. Sideris

SENIOR ASSOCIATE EDITORS

Michael F. Wolff, John F. Mason

ASSOCIATE EDITORS

Michael F. Tomaino, William P. O'Brien, Sy Vogel, George J. Flynn, Laurence D. Shergalis, George V. Novotny, Leon H. Dulberger.

ASSISTANT EDITORS

Stanley Froud, Stephen B. Gray, Roy J. Bruun, Barry A. Briskman, Dan Smith, Joel A. Strasser

REGIONAL EDITORS

Harold C. Hood (Pacific Coast, Los Angeles), Thomas Maguire (New England, Boston), Cletus M. Wiley (Midwest, Chicago)

ART DIRECTOR

Howard R. Berry

ASSISTANT ART DIRECTOR

John C. Wright, Jr

EDITORIAL ASSISTANTS

Lorraine Rossi, Virginia T. Bastian, Lynn Emery, Ann Mella, Lorraine Werner, Alice M. O'Brien, Sharon Parks, Patricia Mitchell, Claire Benell

FOREIGN NEWS BUREAU

DIRECTOR, John Wilhelm; Alyne Elias, Charles Obertance

LONDON—John Shinn, Derek Barlow, Nicholas Landon

BONN—Bruce Bendow, Richard Mikton, Silke McQueen

BRUSSELS—Peter Forbath

PARIS—Robert Farrell, Arthur Erikson

MILAN—Marc A. Messina

MEXICO CITY—Wesley Perry, Jr

RIO DE JANEIRO—Leslie Warren

MOSCOW—Stewart Ramsey

TOKYO—Richard Halloran, Charles Cohen, John Yamaguchi

CIRCULATION MANAGER

Hugh J. Quinn

W. W. GAREY, Publisher

HIGH-EFFICIENCY conversion of ruby light into blue is achieved by weakly focusing the beam of a giant-pulse laser into an ADP crystal in its phased-matched condition. Smoke-filled chambers on each side of crystal scatter the beams; a filter after second chamber removes red beam. *Conversion efficiency exceeds 20 percent (Ford Motor Co.). See p 60* **COVER**

MISSILE DEFENSE CLUES Sought by Long-Range Spectrometer. Big telescope systems, slaved to tracking radars, analyzes reentry vehicle glow. *One object of this program, and programs at White Sands, is to improve ICBM-decoy discrimination methods* **16**

HOW TO SUCCEED IN USAF Contract Work. Air Force survey turns up deficiencies in contractor management practices. *Tip from Air Force: don't do the same* **17**

INTEGRATED CIRCUITS: When Will They Go Civilian? Best guess is that significant applications will start to show up in consumer and industrial electronics about 1965. *As military volume grows, price cuts will help spur commercial use* **22**

EARTH-SPACE LASER LINKS. NASA figures it can build cooperative space communications and tracking systems. *In one conceptual plan, modulated beams from two earth stations are electro-optically coupled by a satellite and redirected to earth* **22**

DATA COMMUNICATIONS Boom Gathers Steam. Installations multiply despite limited speed of available land lines. *Few systems really need extremely high transmission rates* **26**

TELSTAR II More Wary of Radiation. Decoder transistors are evacuated to avoid ionization that affected Telstar I. *Another change: microwave telemetry after two years* **29**

BETTER SUPERHETS FOR SIDEBAND RECEPTION. Superheterodyne receivers for single-sideband work must have high oscillator stability, low noise, high sensitivity front ends and wide dynamic range with low cross-modulation and intermodulation distortion. *Here's how these objectives are achieved in modern ssb receivers.*
By W. Bruene and E. Schoenike, Collins Radio, and E. Pappenfus, Granger Associates **39**

NEON-PHOTOCONDUCTORS VS RELAYS in Low-Speed Logic. Electromechanical devices used in low-speed digital logic are often more costly and less reliable than solid-state logic devices. A neon bulb combined with a photoconductor may offer reduced cost and improved reliability. *It is also a built-in visual display.*
By J. L. Patterson, IBM **46**

Published weekly, with Electronics Buyers' Guide as part of the subscription, by McGraw-Hill Publishing Company, Inc. Founder: James H. McGraw (1860-1948).

Title ® registered U.S. Patent Office; © copyright 1963 by McGraw-Hill Publishing Co., Inc. All rights reserved, including the right to reproduce the contents of this publication, in whole or in part.

Executive, editorial, circulation and advertising offices: McGraw-Hill Building, 330 West 42nd Street, New York 36, N. Y. Telephone Longacre 4-3000. Teletype TWX N.Y. 212-640-4646. Cable McGrawhill, N. Y. PRINTED IN ALBANY, N. Y.; second class postage paid at Albany, N. Y.

OFFICERS OF THE PUBLICATIONS DIVISION: Shelton Fisher, President; Vice Presidents: Joseph H. Allen, Operations; John R. Callahan, Editorial; Ervin E. DeGraff, Circulation; Donald C. McGraw, Jr., Advertising Sales; Angelo R. Venezian, Marketing.

OFFICERS OF THE CORPORATION: Donald C. McGraw, President; Hugh J. Kelly, Harry L. Waddell, Executive Vice Presidents; L. Keith Goodrich, Executive Vice President and Treasurer; John J. Cooke, Vice President and Secretary.

Subscriptions are solicited only from those actively engaged in the field of the publication. Position and company connection must be indicated on orders. Subscription rates: United States and Possessions, \$6.00 one year, \$9.00 two years, \$12.00 three years. Canada: \$10.00 one year. All other countries \$20.00 one year. Single copies, United States and Possessions and Canada 75¢. Single copies all other countries \$1.50.

THE PUBLISHER, UPON WRITTEN REQUEST FROM ANY SUBSCRIBER TO OUR NEW YORK OFFICE AGREES TO REFUND THAT PART OF THE SUBSCRIPTION PRICE APPLYING TO COPIES NOT YET MAILED.

Subscribers: Please send change of address notices, subscription orders or complaints to Fulfillment Manager, Electronics, at the address below. Change of address notices should provide old as well as new address, including postal zone number if any. If possible, attach address label from recent issue. Allow one month for change to become effective.

Postmaster: Please send Form 3579 to Fulfillment Manager, Electronics, P. O. Box 430, Hightstown, New Jersey.



Audited Paid Circulation

CONTENTS continued

TUNNEL DIODES BOOST TRL SPEED. Transistor-resistor logic circuits are not usually as fast as diode-transistor logic. Adding tunnel diodes as switches reduces TRL propagation delay. *Both NAND and NOR circuits are realizable.*
By P. J. Langlois, Standard Telephones & Cables, Ltd., London 50

CONSUMER ELECTRONICS: Home and Auto Controls. Part II of a series. New nonentertainment uses of electronics include electroluminescent panels, light dimmers, capacitance switches, controlled home machine tools and transistor auto-ignition. *A radar speed-meter detector provides ecm for the family car.*
By S. B. Gray 52

DEPARTMENTS

Crosstalk. <i>Academy of Engineering. Consumer Countermeasures</i>	3
Comment. <i>Square Tangerine. ESP</i>	4
Electronics Newsletter. <i>Air Force Trying Orbital Dipole Belt Again</i>	7
Washington This Week. <i>Wall Between R&D Program Management and Performance Contracting Grows Higher</i>	12
Meetings Ahead. <i>Fall Joint Computer Conference</i>	32
Research and Development. <i>Giant Ruby Laser Produces Harmonics</i>	60
Components and Materials. <i>Will Solid State Nip Relay Markets?</i>	66
Production Techniques. <i>Better Techniques Toughen Connections on P-C Boards</i>	70
New Products. <i>Spike Analyzer Gives Transient Duration</i>	74
Literature of the Week	80
People and Plants. <i>Lab's Patio Plans Fosters Discussion</i>	82
Index to Advertisers	92

Academy of Engineering

THE DECISION that a National Academy of Engineering is to be formed is received with mixed feelings.

The new academy will be affiliated with the National Academy of Sciences but, under present thinking, will not be an integral part of that body.

The Engineers Joint Council, which has been asked by NAS to set up the framework for the NAE, says that the opinion of the EJC and NAS committees that made the recommendation was that:

"Existing organizations and conditions preclude effective participation of engineers in matters related to national technical problems and policies;

"The National Academy of Sciences has to a large extent neglected its membership in the areas concerned with application of science;

"A mechanism must be provided for broader representation of the engineering community, to provide for participation of engineers in the advisory functions in partnership with scientists and that the organization should be evolved in cooperation with and be closely associated with the National Academy of Sciences."

This outlines the problem clearly, but we do not see how two separate academies, however closely they are affiliated, will completely solve it.

As we said here last fall (ELECTRONICS, p. 3, Oct. 5, 1962), if engineers are to effectively participate in national affairs there should be just one national academy, of science and engineering.

We welcome this or any other recognition of the importance of engineers, but wonder if science won't still unduly dominate.

INTEGRATED CIRCUITS. Some of the recent price cuts in integrated circuits prompted queries by us to manufacturers on whether a price war would hit microelectronics. The check proved this assumption false—the prices have been dropping for the same reason that the print of a painting costs less than the original. Manufacturers are moving away from samples and into full-scale production.

The real story, it turned out, was about the new op-

portunities that price reduction will bring to integrated circuits in consumer and industrial electronics. So that's the way the story was written. You'll find the report this week on p 22.

CONSUMER COUNTERMEASURES. Did you know that you could go out and buy a detector that will tell you if a police patrol car is trying to detect your speed by radar? Well you can, and they are selling like hot-cakes—production is reported to be 1,000 a week. But police forces are striking back. The detector is now banned in several areas. How it works is one of the many descriptions of consumer electronics equipment printed this week in the article beginning on p 52.

Coming In Our May 17 Issue

HOUSEWARES. In the last of our staff-written series on consumer electronics, the subject is appliances and housewares: electronic ranges, ultrasonic dishwashers, thermoelectric air conditioners, and the like. We are including something for the parent-engineer, too—a section on electronic toys. Other topics next week:

- Since practically every electronic engineer is concerned about power supplies, if not constantly then occasionally, we expect our lead technical feature next week will prove popular. It is a detailed report by T. P. Sylvan, of GE, on a new device that simplifies power supply design. An integrated transistor-zener diode structure, it provides both voltage reference and error voltage amplification. As a bonus, Sylvan gives a new definition of temperature coefficient for reference devices, and test circuits.

- If you've been waiting to see some practical data-processing applications of the new gallium-arsenide infrared diodes, wait no longer. R. F. Broom and C. Hilsum, of the Services Electronics Research Lab, tell how to use the diode as a light source in optoelectronic tape readers for computers. It gives better efficiency than lamps and potentially higher speeds.

- One vital requirement of military radar is that it perform well despite surrounding radio-frequency interference. Another is that the set be difficult to jam. A checklist of steps that designers can take to eliminate rfi effects and make the radar less susceptible to jamming is contained in another of next week's feature articles. The author is J. C. Galenian, of the U.S. Army Electronics R&D Lab.

A MOST
UNUSUAL OFFER
BEHIND THIS
MOST UNUSUAL
PRODUCT

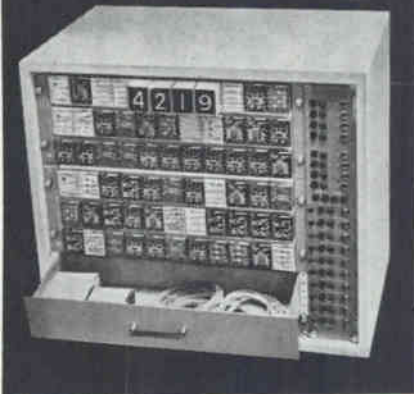

**HARMAN-KARDON SHIPS A
\$1500 DIGITAL SYSTEMS
BREADBOARD FREE TO YOUR
COMPANY UPON REQUEST!**

New! The H-K Facilog Module Kit with all required power and accessories to permit you to immediately breadboard your projects! H-K ships a 33-module kit to you FREE for one-month upon receipt of a purchase order from your company, authorizing your loan and shipping costs. A limited number of these kits have been set aside for this program. First come, first served. Call!

- Simplifies breadboarding! Builds test equipment! Trains personnel!
- Built-in indicator lights show "logical state of circuit"
- Front and Back plug connections.
- MIL SPEC symbols and simplified loading rules on front of each module
- Power supply and wires provided
- Available for purchase or exclusive lease arrangement

WIRE! Prompt attention to your telegram.

PHONE! Dial 516/OV 1-4000; Mr. R. Schramm.

WRITE! Mail in the coupon below for full details of loan program.

Data Systems Division, Desk E-5
HARMAN-KARDON, INC.
Plainview, L.I., N.Y.

Please send me full details on the new
Digital Systems Breadboarding Kit.

Name _____

Company _____

Address _____

City _____ State _____

harman kardon

HK-88 R

A subsidiary of THE JERROLD CORPORATION

COMMENT

Square Tangerine

In *ELECTRONICS*, p 42, March 29, the top photo legend reads: "... resemble a square tangerine in size."

Please—more on this biological hybrid. Citrus growers can appreciate high-density packing.

G. F. BROCKMAN, M. D.
Greenville, Kentucky

The square tangerine, which is still in R&D, has also the advantage that it can be easily peeled with six quick flicks of a little snickersnee. No details available: the project is Top Citrus.

ESP

I read with interest your news item on some current work in ESP (ESP: Is Biological Radio Communication Possible?, p 14, March 29).

Readers may find interesting some earlier correspondence on the subject by R. J. Bibbero, *Proc IRE*, Vol. 39, p 290, March 1951, and H. E. Hollman, *Proc IRE*, Vol. 39, p 841, July 1951, both of which include references.

HEBERT SINOFSKY
Defense Electronic Products
Radio Corporation of America
New York, New York

Patent Rights Law

In *Washington This Week* for Mar. 15 (p 12), *ELECTRONICS* reports briefly on Rep. Herman Toll's (R.-Pa.) proposal requiring government contractors to set up an awards system for employed inventors, now totally ignored in the present controversy over "who gets the patents."

Corporate R&D industry has long confiscated employee patent rights, governed formerly by common law, by requiring employees to assign such rights as a condition of their employment, in a master-slave relationship. Because about 70 percent of our annual patent output now goes unrewarded, via that route into corporate portfolios, U. S. invention productivity, in terms of that output compared with over a hundred-fold increase in techni-

cally competent, potential inventors, and a like increase in our annual expenditures for R&D, has drastically declined during the past twenty to forty years. In European countries, however, where reasonable compensation has been made compulsory, the patent output per million of population has risen to from four to ten or more times that of the U. S.

Contrary to your statement that "In the U. S., employed inventors are protected by commercial law and legal precedents," there is in reality no such protection whatsoever, because common law has been nullified by the employed inventor's compulsory patent-assignment contracts. Common law gives to the employer only a non-revokable, non-exclusive, royalty-free "shop right" to make use and/or sell his employee's invention's product. The employee retains all other rights.

BENJAMIN F. MEISSNER
Miami Shores, Florida

Direct-Coupled Amplifier

Thank you for the excellent work your staff has done on my article, Direct Coupling Shrinks Amplifier Size and Cost (p 66, March 22).

In Fig. 1C, transistors Q_2 to Q_4 are Philco 2N2401 MADT transistors, not 2N401.

Also, I should have said a few words about circuits using multiple supplies: The circuits described are designed for a single voltage supply. If two supplies of opposite polarity are available, feedback stabilization technique is considerably simplified. The basic circuit, illustrated in Fig. 1A, for example, can be improved to provide a high degree of stability by injecting a d-c current of opposite polarity into the base of Q_1 . This essentially fixes the value of current that has to be provided by the feedback path from the collector of Q_2 . A small change in the operating point of Q_2 will then cause large degenerative variations in the base current of Q_1 .

The price that has to be paid for the increased stability is, of course, an increase in the size of C_1 , as R_1 and R_2 have to be decreased to supply the additional current.

PETER LAAKMANN
American District Telegraph Co.
New York, New York

Lambda announces 3 new LE models

Environment-
Engineered at
competitive prices

LE 106 0-18VDC 15 AMP • LE 107 0-18VDC 22 AMP • LE 110 0-9VDC 20 AMP

Note these quality design features

CONVECTION COOLED

No blowers or filters; maintenance free.

WIDE INPUT RANGE

Wide input voltage and frequency range—105-135 VAC, 45-66 CPS and 320-480 CPS in two bands selected by switch.

COMPLETELY PROTECTED

against—short circuit and electrical overload; input line voltage transients; excessive ambient temperatures. No voltage spikes due to "turn-on, turn-off" or power failure.

9 models available

CONSTANT VOLTAGE CONSTANT CURRENT

by automatic switchover.

REMOTELY PROGRAMMABLE AND CONTINUOUSLY VARIABLE

Voltage continuously variable over entire range. Programmable over voltage and current range.

OTHER FEATURES

- All solid state.
- Adjustable automatic current limiting.
- 0°C to + 50°C ambient.
- Grey ripple finish.
- Ruggedized voltmeters and ammeters per MIL-M-10304B on metered models.



LE SERIES CONDENSED DATA

DC OUTPUT (VOLTAGE REGULATED FOR LINE AND LOAD)⁽¹⁾

Model	Voltage Range	Current Range	Price ⁽²⁾
LE101	0-36 VDC	0- 5 Amp	\$420
LE102	0-36 VDC	0-10 Amp	525
LE103	0-36 VDC	0-15 Amp	595
LE104	0-36 VDC	0-25 Amp	775
LE105	0-18 VDC	0- 8 Amp	425
LE106	0-18 VDC	0-15 Amp	590
LE107	0-18 VDC	0-22 Amp	695
LE109	0- 9 VDC	0-10 Amp	430
LE110	0- 9 VDC	0-20 Amp	675

⁽¹⁾ Current rating applies over entire voltage range.

⁽²⁾ Prices are for nonmetered models. For models with ruggedized MIL meters add suffix "M" to model number and add \$40 to the non-metered price. For metered models and front panel control add suffix "FM" and add \$50 to the nonmetered price.

REGULATED VOLTAGE:

Regulation

(line and load) Less than .05 per cent or 8 millivolts (whichever is greater). For input variations from 105-135 VAC and for load variations from 0 to full load.

Remote Programming 50 ohms/volt constant over entire voltage range.

Ripple and Noise Less than 0.5 millivolt rms.

Temperature Coefficient Less than 0.015%/°C.

AC INPUT: 105-135 VAC; 45-66 CPS and 320-480 CPS in two bands selected by switch.

PHYSICAL DATA:

Mounting Standard 19" rack mounting.

Size LE 101, LE 105, LE 109 3½" H x 19" W x 16" D
LE 102, LE 106, LE 110 5¼" H x 19" W x 16" D
LE 103, LE 107 7" H x 19" W x 16½" D
LE 104 10½" H x 19" W x 16½" D

SEND FOR LAMBDA CATALOG.



LAMBDA ELECTRONICS CORP.

515 BROAD HOLLOW ROAD • MELVILLE, L. I., NEW YORK • 516 MYRTLE 4-4200

SALES OFFICES AND REPRESENTATIVES CONVENIENTLY LOCATED IN MAJOR CITIES

CIRCLE 5 ON READER SERVICE CARD



COUNT the features on the new hp 5233L 2.0 MC Universal Counter

1. Measures frequency, 0 to 2.0 MC dc coupled, 10 cps to 2.0 MC ac coupled
2. Measures time interval, 10 μ sec to 10⁶ sec
3. Measures period, 0 to 100 KC
4. Measures period average to 10⁷ periods
5. Measures ratio, multiples of ratio
6. Refined A and B trigger level controls for precise positioning of trigger points
7. Six digit resolution, rectangular close-spaced Nixies
8. Input impedance of 1 megohm, sensitivity of 0.1 v rms
9. Time base stability \pm 2 parts in 10⁷ per month
10. High sampling rates (0.2 to 5 sec, variable), independent of gate time
11. Display storage, continuous display
12. Automatic measurement unit, decimal display
13. BCD code output for systems, digital recorders
14. Self check in all function and multiplier positions
15. Operates -20° to $+65^{\circ}$ C
16. Small, compact, 3 1/2" high, 16 3/4" wide, 11 1/2" deep, only 19 lbs
17. Solid state construction, low power consumption, high reliability
18. Plug-in module construction for easy maintenance
19. Costs only \$1,850.00 complete

Contact your Hewlett-Packard representative today for a demonstration of this versatile counter! *Data subject to change without notice. Price f.o.b. factory.*

**HEWLETT
PACKARD
COMPANY**

1501 Page Mill Road, Palo Alto, California, Area Code 415, DA 6-7000. Sales and service representatives in all principal areas; Europe, Hewlett-Packard S. A., 54-54bis Route des Acacias, Geneva; Canada, Hewlett-Packard (Canada) Ltd., 8270 Mayrand Street, Montreal



5063

West Ford Going Up "In Near Future"

AIR FORCE put the world scientific community on the alert Monday for the second attempt to launch the controversial Project West Ford payload—400 million copper dipoles each 0.007 inch in diameter that hopefully will form an orbital ring 40,000 miles in circumference 2,000 miles above the earth to test the feasibility of orbital scatter as a highly reliable, long range, virtually invulnerable method of microwave communication (p 7, Feb. 1 and p 7, April 26). MIT's Lincoln Lab says an approximately polar orbit at an altitude of 2,000 miles will limit the lifetime of the belt to "about five years at most".

The data of the new launch was not disclosed, although AF said it would be "in the near future". The launch itself will not be announced until it is verified that the required orbit has been reached and the fibers are being released. About 60 days after launch, the tuned dipoles—0.7 inch long for maximum reflecting strength at 8 Gc—should be uniformly distributed in an orbital belt five miles wide and 25 miles thick. A radio command circuit ejects the package only if a suitable, lifetime-limiting orbit is achieved.

Navy Eyes Development Of Gamma-Ray Laser

BOSTON—Allied Research Associates here will push development of a gamma-ray laser if it wins expected support from the Office of Naval Research. Such a device would have an extremely high energy density, important in weapons applications, and would be able to penetrate wood, many other non-magnetic materials and the atmosphere, even heavy cloud cover. It would also provide an improved means of analyzing spectral distribution—of beams bounced off distant planets, for example. Boeing conceived device in 1960, when ARA was a Boeing subsidiary.

NASA Will Investigate Pneumatic Computers

WASHINGTON — NASA's Marshall Space Flight Center is expected to award a contract within the next few weeks to study pneumatic computer techniques. The contractor will study concepts for computing with multiple controlled jets and for improving the basic binary flip-flop based on the single switchable jet.

H. H. Lowell, manager of data processing for NASA's Office of Advanced Research and Technology, told ELECTRONICS that if high reliability is proven for pneumatic computers, they may find the following space applications:

- Diagnostic and monitoring control units, should increased reliability be worth the attendant weight, speed and power penalties. Examples here are checking two units in a modular redundancy system and performing real-time rapid switching during reentry.

- Satellites and probes where lifetimes on the order of years are

a major requirement.

- Systems in hostile environments of high temperature and radiation such as probes near Jupiter and the sun. Lowell saw no reason why computers using an inert or non-interacting gas with a material like ceramic or tungsten could not operate at temperatures of 1,000 or 2,000 F.

New Diode Lasers Operate in Infrared

OPERATING RANGE of semiconductor lasers has been extended further into the infrared by two research groups. MIT's Lincoln Laboratory reports coherent emission at 3.1 microns from zinc-diffused indium arsenide diodes. IBM scientists say they have operated an indium phosphide laser at 0.903 micron.

"By demonstrating coherent emission in indium arsenide we believe that the ground has been laid for the fabrication of coherent infrared sources, by using suitably proportioned gallium-indium arse-

Thresher Search Using Latest Gear

THE NAVY has added Loran C and Decca navigation equipment to four vessels being used in the search for the nuclear submarine *Thresher*, lost 220 miles off Boston in 8,400 feet of water. Navy says this will permit accurate survey of the area of interest.

The British-built Decca system operates in the vlf range at roughly 85 Kc. It uses an unmodulated carrier and phase comparison techniques. It operates on signals from New York and Nova Scotia and can be used out to roughly 300 miles.

Sperry Gyroscope's Loran C, used at distances of roughly 1,000 miles with experimental reports of fixes to 2,300 miles at night, will also be employed. Bouncing of signals off the ionosphere permitted the longest range fixes. Loran C uses lower frequency transmission than standard Loran.

Other equipment includes cameras by Edgerton, Germeshausen & Grier designed for underwater service and at least one underwater tv system designed and built by Naval Research Laboratory, carrying its own lights. Another instrument being used is a deep magnetometer built by Varian Associates. A proton free-precession magnetometer was tested by Varian off the Florida coast last summer, proving that magnetic anomaly techniques can be used to locate underwater ship-wrecks.

A Bucket of Sound



ORDINARY, TWO-GALLON scrub bucket is being used at Wright-Patterson Air Force Base as a resonator to condition weak signals from Tiros V and Tiros VI. The signals were inaudible until a loud-speaker "spilled" them into the bucket. They then became audible throughout the test facility, which is studying suitable—and presumably more sophisticated—receiving systems for the satellites

nide compounds, to cover the entire wavelength range between 0.84 and 3.1 μ ," I. Melngailis, of Lincoln Lab, said.

Lincoln Lab observed coherent emission at temperatures of 4.2 K and 77 K. IBM achieved pulsed laser action by putting current densities of about 6,000 amp per square centimeter through the indium phosphide diode at 77 K. At 4.2 K, the threshold current was reduced by a factor of about five. The laser operates c-w at very low temperatures.

Melngailis also said that since his group had previously observed a large shift in the radiation spectrum of incoherent indium arsenide diodes to shorter wavelengths in a magnetic field, it may now be possible to make a tunable laser in which the emission wavelength can be changed by selecting the cavity mode by a magnetic field.

Japanese Cut Prices Of Transistor Tv Sets

TOKYO—Japanese companies have started announcing the lower prices they will charge for their transistor tv sets now that they no longer have to pay a commodity tax (p 7, May 3). In many cases the price reductions are greater than the tax saving because companies expect sales to increase sufficiently to warrant

large increases in production.

Sony reduced the price of one set from \$180.56 to \$144.44. Mitsubishi cut the price of one model from \$156.56 to \$138.33, and Hayakawa cut one price from \$161.11 to \$144.44.

Company Head Scores DOD on Procurement

SAN FRANCISCO—Eitel-McCullough president W. W. Eitel last week blasted DOD procurement practices as "missing the original goal by a considerable margin." Disclosure of cost information and proprietary technical data to the government and competitors, besides tending to discourage companies from continuing their own research and development, will eventually reduce competition rather than stimulate it, he said.

West German Firms Protest Radio Award

BONN—Electronics firms here are upset about a \$16.75-million order for radio communications equipment, given to Britain's Standard Telephones and Cables by the West German government (p 8, April 12). The contract is said to be STC's biggest yet. The government says the order was placed because NATO procurement policies favor centralized purchasing throughout all NATO countries.

How to Keep Track Of Rail Shipments

CHICAGO—A method for keeping track of every railroad freight car and freight shipment in the country has been proposed by the Association of American Railroads. Scanners stationed at tracksides would record the cars' identification numbers which could be correlated with shipment data previously stored in computer memories. AAR is now evaluating identification systems made by Sylvania (p 7, April 19), Union Switch & Signal, GE and Transdata.

In Brief . . .

TELSTAR II was launched successfully Tuesday from Cape Canaveral. Bell Labs reported everything "on schedule" during the first few hours of flight.

AIR FORCE denies that Minuteman is in "serious difficulties" but admits that the cut of a year in its development schedule has reduced certain performance capabilities (p 7, April 26).

FIELD of 75 kilogauss was attained last week by Magnion in an air core superconducting magnet augmented with specially designed iron pole pieces and end plates. The previous high was 68 kilogauss (p 18, March 1).

GROUND WAS BROKEN last week for the University of Chicago's Laboratory for Astrophysics and Space Research, for which it received a \$1,775,000 grant from NASA.

BRAZIL will conduct studies of the equatorial ionosphere by monitoring satellite radio transmissions in cooperation with NASA from three stations it is building along the geomagnetic equator.

MATSUSHITA will export 15,000 19-inch tv chassis to Rumania.

TWO AUTOMATED telemetry data processing systems will be built by Radiation Inc. for the Apollo project and the Saturn III program. The contracts total \$3.5 million.

HOFFMAN won a \$1,356,515 Air Force contract for procurement of components for Tacan navigation sets for the T-38 aircraft.

ARIS-1, first of the Air Force's Advanced Range Instrumentation Ships, was commissioned last week (p 31, Nov. 30, 1962; p 22, July 28, 1961).

EIA HAS DEVISED a new name for the microelectronics industry—the "Integral Circuit Package Industry."

SYLVANIA was awarded a \$3.5 million contract for development of optical and electronic equipment for the Orbiting Astronomical Observatory satellite program.

our stock answer is

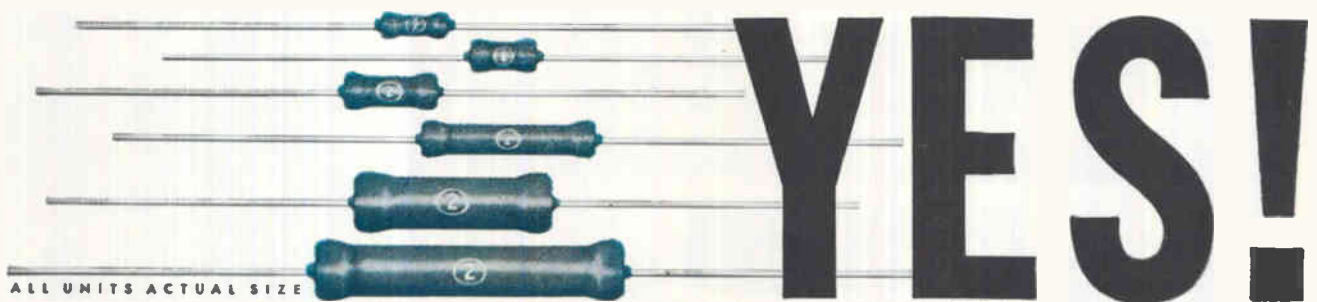

ALL AXIAL LEAD BLUE JACKET RESISTORS

*in 1, 2, 3, 5, 7 and 10-watt power ratings are carried in
factory stock for immediate delivery. Place your order now with your
nearest Sprague District Office or Sales Representative.*

Key Sprague Industrial Distributors carry most popular ratings in local stocks.

S P R A G U E S A L E S O F F I C E S

Ariz. Phoenix, Sprague Electric Co., 3550 N. Central Ave., 279-5435
Cal. Los Angeles, Sprague Electric Co., 12870 Panama St., UP 0-7531 or EX 8-2791
San Francisco, W. J. Purdy of Calif., 312 7th St., UN 3-3300
Colo. Denver, R. G. Bowen Co., Inc., 721 S. Broadway, RA 2-4641
D.C. Washington, Sprague Electric Co., 2321 Wisconsin Ave., N.W., 338-7911
Fla. Clearwater, Sprague Electric Co., 1152 Cleveland St., 446-3119
Ill. Chicago, Sprague Electric Co., 5942 W. Montrose Ave., MU 5-6400
Mass. North Adams, Sprague Electric Co., Marshall St., 664-4411
Newton, Sprague Electric Co., 313 Washington St., WO 9-7640
Mich. Detroit, ABM Sales Co., 10116 Puritan Ave., UN 2-1300
Minn. Minneapolis, H. M. Richardson & Co., Inc., 9 E. 22nd St., FE 6-4078

Mo. St. Louis, Sprague Electric Co., 3910 Lindell Blvd., JE 5-7239
N. J. Camden, Sprague Electric Co., 545 Cooper St., WO 6-1776
N. M. Albuquerque, Bowen & Carberg Co., 2228A San Mateo Blvd., N.E., AM 5-1579
N. Y. New York, Sprague Electric Co., 50 E. 41st St., OR 9-1195
Great Neck, William Rutt, Inc., 123 Middle Neck Rd., HU 2-8160
Winston-Salem, Sprague Electric Co., 928 Burke St., 722-5151
N. C. Chagrin Falls, Sprague Electric Co., 24 N. Main St., CH 7-6488
Ohio Dayton, Sprague Electric Co., 224 Leo St., BA 3-9187
Tex. Dallas, Sprague Electric Co., 3603 Lemmon Ave., La 1-9971
Utah Salt Lake City, R. G. Bowen Co., Inc., 463 E. 3rd St., S., EM 3-4520
Wash. Seattle, Sprague Electric Co., 4601 Aurora Ave., ME 2-7761

*For application engineering assistance write:
Marketing Dept., Resistor Division, Sprague Electric Co., Nashua, New Hampshire.*

SPRAGUE COMPONENTS

RESISTORS
CAPACITORS
MAGNETIC COMPONENTS
TRANSISTORS
MICRO-CIRCUITS

INTERFERENCE FILTERS
PULSE TRANSFORMERS
PIEZOELECTRIC CERAMICS
PULSE-FORMING NETWORKS
TOROIDAL INDUCTORS

HIGH TEMPERATURE MAGNET WIRE
CERAMIC-BASE PRINTED NETWORKS
PACKAGED COMPONENT ASSEMBLIES
FUNCTIONAL DIGITAL CIRCUITS
ELECTRIC WAVE FILTERS



'Sprague' and '®' are registered trademarks of the Sprague Electric Co.

time related measurements

with

9



5211B



5512A



5212A



5532A



5237A



5233L

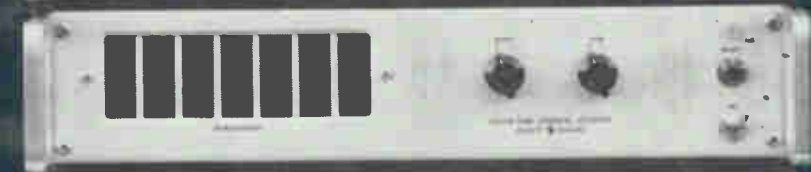

5275A



5245L



5243L

4 8 1

solid state counters!

From precision high speed measurements to economical production testing, one of these counters is right for your job. You can measure frequency, period, multiple period average, ratio, multiple ratio, and time interval.

The advanced line of Hewlett-Packard solid state counters incorporates as standard such features as display storage (continuous display of the most recent measurement until the count actually shifts), higher sampling rates (the time between counts is independent of gate time), -20 to $+65^{\circ}$ C operating range, and BCD output for recorders, systems.

Hewlett-Packard modular construction introduces counters that are bench and rack mount models in a single instrument, front panels are only $3\frac{1}{2}$ " or $5\frac{1}{4}$ " high. Operation is simple, straightforward, making every human-engineered instrument in the line easy to use, even by untrained personnel.

Check the brief description of individual models here. Then check your nearest representative or contact Hewlett-Packard direct for full information and demonstration of the instrument designed specifically for your job:

⊕ 5245L — Makes more measurements with greater accuracy than any other counter available today: Measures frequency, time interval, period, multiple period average, ratio, multiple ratio, scales by decades. Measures to 50 mc directly, 100 mc and 512 mc with plug-in converters. Additional plug-in permits time interval measurements. Time base stability, 3 parts in 10^7 /day. 8-digit resolution in rectangular, close-spaced numeric indicator tubes. Remote programmability of time base and function controls. ⊕ 5245L 50 MC Counter, \$3,250.00. ⊕ 5251A Frequency Converter, to extend counter frequency to 100 mc, \$300.00; ⊕ 5253A Frequency Converter, to extend counter frequency from 100 to 512 mc, \$500.00; ⊕ 5262A Time Interval Unit, 0.1 μ sec resolution, \$300.00.

⊕ 5243L — Identical to ⊕ 5245L, but measures directly to 20 mc, \$2,950.00.

⊕ 5233L — This 2 mc counter measures time interval, frequency, period, multiple period, ratio, and multiples of ratio. Featuring 6-digit resolution in an in-line display of rectangular digital in-line tubes and superior trigger, level controls. Price, \$1,850.00.

⊕ 5232A, 5532A — These 1.2 mc counters measure frequency, period, multiple period average and ratio. Offering 6-digit resolution, they are identical except for readout. The 5232A provides display in improved neon columns, while

the 5532A provides display in long-life numeric indicator tubes. Operating temperature range, as with the other ⊕ solid state counters, is -20 to $+65^{\circ}$ C. ⊕ 5232A, \$1,300.00; ⊕ 5532A, \$1,550.00.

⊕ 5212A, 5512A — Five-digit resolution is provided by these counters, which have a maximum counting rate of 300 kc. They measure frequency, period, multiple period average and ratio. The two instruments differ only in display, the 5212A presenting neon columnar readout, and the 5512A offering digital in-line tube readout. ⊕ 5212A, \$975.00; ⊕ 5512A, \$1,175.00.

⊕ 5211A, B — These counters use line frequency as a time base and measure frequency directly to a maximum counting rate of 300 kc, and they also measure ratio. They furnish 4-digit resolution with neon columnar display. The 5211A offers gate times of 0.1 second, 1 second, and manual. The 5211B offers an additional gate time of 10 seconds. Otherwise, the instruments are identical. ⊕ 5211A, \$750.00; ⊕ 5211B, \$825.00.

⊕ 5275A — This counter measures time interval 10 nsec to 0.1 sec., with 10 nanosecond resolution. The instrument counts 100 mc by a 100-to-1 multiplying circuit. Seven-digit display is in neon columns. Separate 1 mc time base, such as ⊕ 101A required. ⊕ 5275A, \$3,250.00; ⊕ 101A, \$500.00.

Data subject to change without notice. Prices f.o.b. factory.

**HEWLETT
PACKARD
COMPANY**

1501 Page Mill Road, Palo Alto, California, Area Code 415, DA 6-7000
Sales and service representatives in all principal areas; Europe, Hewlett-Packard S.A., 54-54bis Route des Acacias, Geneva; Canada, Hewlett-Packard (Canada) Ltd., 8270 Mayrand Street, Montreal



8130

WASHINGTON THIS WEEK

WALL BETWEEN R&D MANAGERS AND SUPPLIERS GROWS HIGHER

STIFFER CONFLICT-OF-INTEREST regulations will start coming out of government soon. The administration is seeking to avoid all possible conflict of interest situations in R&D management. The White House is issuing new rules for individual advisers and consultants. The Pentagon is now circulating in industry proposed regulations formalizing the barrier between managers and performers.

The Budget Bureau is particularly troubled by the necessity to tap the limited pool of potential R&D contributors for management talent and capability. To avoid giving managers an inside track on the performance contract, managing organizations will be kept out of the performance business, at least for a time. However, the bureau foresees growing industrial reluctance to accept performance-limiting management contracts and consequently more problems in contract research management.

NASA and other agencies using management contracts are expected to adopt defense regulations and may ultimately require a "cooling off" period between any firm's participation in a project as a manager and then as a performer.

McNAMARA SAYS USSR DOESN'T HAVE ANTI-ICBM

DEFENSE SECRETARY McNAMARA has gone out of his way to knock down press reports of Soviet anti-ICBM installations at Lenin-grad. He told the Senate Appropriations Committee that "contrary to some newspaper reports . . . the Soviet Union (does) not have any significant ability to intercept the missiles once they are launched." McNamara was explaining his decision not to produce Nike Zeus. He said he "cannot (soon) foresee a sufficient increase in our (anti-ICBM) capabilities."

WHO GETS TV CHANNEL 37— ASTRONOMERS OR STATIONS?

RADIO ASTRONOMERS are grappling with FCC over uhf-tv channel 37. Scientists using a radio telescope on this band at Danville, Ill., claim it should be reserved for scientific use world-wide. This runs head on into FCC's efforts to promote uhf-tv. Four applicants want channel 37 for tv broadcasting from Paterson, N. J.

As a temporary compromise, FCC offers to protect the Danville telescope from other assignments within 600 miles, and to limit use of channel 37 elsewhere to 7 a.m. to midnight. Unless the scientists can show interference with their work, they will probably have to accept it while FCC works out a permanent way to give radio astronomers the spectrum space they require.

NASA SEEKS FASTER USE OF SPACE R&D

BYPRODUCT SPILLOVER from missile-space industries is keeping pace with that expected from advanced technologies, according to a forthcoming report from NASA. The year-long study by the University of Denver Research Institute cites "expected" barriers and stimuli to transfer of technology into commerce. But NASA officials say the time lag is not peculiar to missiles and space R&D. Rather, missiles and space reflect time lags intrinsic in translating new technology into broad productive capacity.

Researchers, who studied some 1,000 industrial firms, concluded that a more rapid byproduct development is not to be expected without stimulus. The NASA Applications Division says it is attempting to provide that stimulus and "eat into the time lag" where ever possible.

1963 SAAB . . . built so well that it has a 24,000-mile/24-month written warranty*

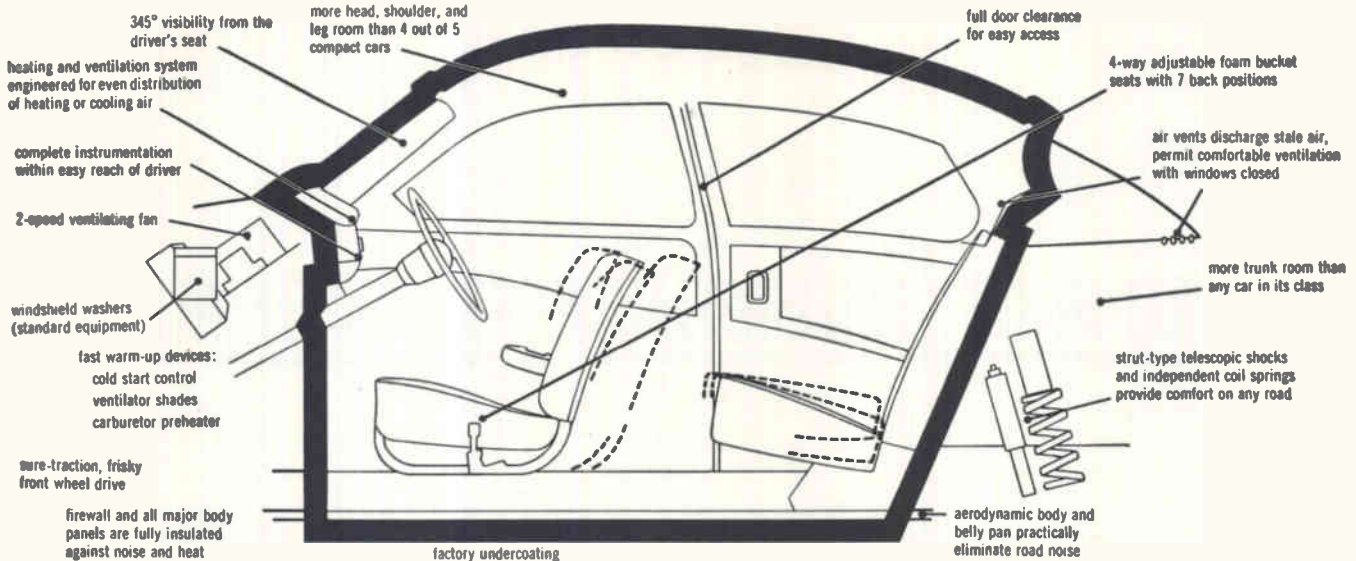

Take a critical look at SAAB comfort and convenience

Aircraft reliability and performance standards are blended with an entirely new approach to over-all automotive design in the Swedish SAAB 96. This car was built to be better and more comfortable, not different . . . built by one of Europe's leading aircraft man-

ufacturers . . . built for those who enjoy mechanical excellence, technical uniqueness, and extraordinary craftsmanship.

A critical look at *all* the facts and specifications will prove that SAAB is unquestionably one of the world's best engineered cars.

*Engine, transmission (3- or 4-speed gear box available), and differential have a written warranty for 2 years or 24,000 miles.



SAAB STANDARD EXTRAS place complete comfort and convenience within easy reach of its driver. At no extra cost, SAAB provides: electric clock, temperature and fuel gauges, ammeter, on easy-to-read instrument panel; heater and defroster to warm or cool car interior as required and keep all windows fog-free; dual padded sun visors; cold start control, ventilator shades, and carburetor preheater for instant starts in any weather; windshield washers, lockable glove compartment; safety belt fittings; factory undercoating—all *standard* equipment!



SAAB RIDING COMFORT is based on front wheel drive, which eliminates driveshaft, makes all floor space flat and usable, permits quick conversion of SAAB interior to a bedroom big enough for two. Front wheel drive, combined with carefully calculated understeering, low center of gravity, and advanced suspension design, provides swayless directional stability for relaxed driving. The sure-footed traction of front wheel drive pulls the rest of the car firmly and easily around sharp curves and corners, through mud, ice, and snow.

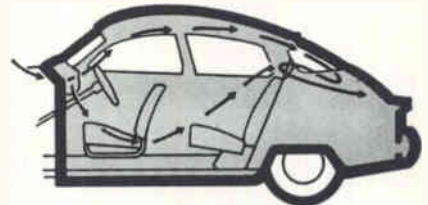

SAAB HEATING AND VENTILATION provides draft-free, year-round comfort. Fresh air is circulated and discharged through ducts below the rear window and vents behind the side windows. Removable ventilation lids help keep engine compartment and car interior cool in summer, warm in winter. New ultra-efficient hot water heating system eliminates hot spots and danger of exhaust fumes . . . provides even heat to front and back seats. Strategically-positioned air jet holes keep front and side windows clear and defrosted for fog-free vision.



1ST OVERALL WINNER—MONTE CARLO RALLY, 1962-1963

Arrange a test drive at your nearest SAAB dealer. Or write for more information—and the SAAB North American Road Atlas, a 64-page comprehensive travel guide valued at \$1.00, but yours for only 25¢ to cover postage and handling. SAAB Motors, Inc., Dept. 305, 405 Park Avenue, New York, New York.

\$1895 P.O.E. (little enough for one of the world's best engineered cars)



SAAB MOTORS, INC.—NEW YORK • NEW HAVEN • JACKSONVILLE • ST. LOUIS

FOR INFORMATION OTHER THAN ROAD ATLAS CIRCLE 299 ON READER SERVICE CARD

WHAT MAKES "INSTRUMENTATION CABLE" DIFFERENT?

It is no more like power or control cable than a Ferrari is like the old family sedan. Not knowing this can cause you a lot of grief: project delays, costly replacements, malfunctions.

THE THIN BLACK LINE On your schematics, instrumentation cable is a black line from launching pad to blockhouse or from one part of a computer to another. In the broadest sense, it connects data or signal sources with display or recording or control devices. Its function is to carry those signals unfailingly and with the required reliability. In this day and age, it's no easy job.

WHAT CAN GO WRONG The improperly designed cable can simply fail. This has happened and at important sites. An untried saturant, lacquer or compound ingredient used in the cable may destroy the electrical integrity of this primary insulation. This sort of deterioration need not be sudden; only experts know which impregnants will migrate in a week or a month or more.

Or a relative lack of art in manufacture may create problems for the future. Under certain circumstances in use, variations in insulation thickness, conductor placement, or conductor unbalance in the cable lay-up may cause spurious or ambiguous signals to arrive at the display, recording or control panel. Your sharp, precise pulses become displaced in time, are a little too fuzzy, or are joined by other unwanted signals from another line.

DESIGN IS HALF THE STORY Configuration of conductors within the cable is important, for physical as well as for electrical reasons. For example, positioning of coaxial components within the cable is critical in order to assure maintenance of minimum standards of concentricity between the inner and outer conductors when the cables may be subjected to bending operations during installation work.

Selection of insulating, filler and

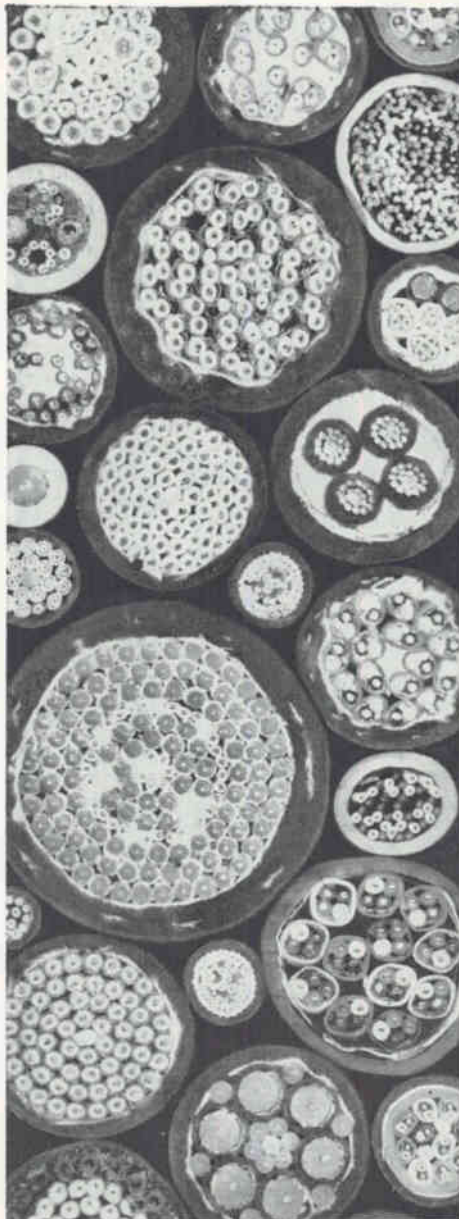

jacketing materials requires expert knowledge and judgment. Some materials, as mentioned above, tend to migrate. Others harden or soften with cold or heat. Some change their electrical characteristics in time. These are not fundamentally new problems in cable design, *but in instrumentation cable the standards are far more severe than ever before.*

MANUFACTURE IS THE OTHER HALF Even a properly designed cable may well become unacceptable sooner or later if it is not manufactured to new standards of precision. This requires stranding machines that reduce circular eccentricity to remarkably low figures and help assure insulation uniformity, insulating machines of considerable precision, and highly precise cabling equipment. It also requires, as is so often the case in precision manufacture, an indefinable skill on the part of machine operators.

ASK THE EXPERTS To protect the functioning of your system, there's only one way to make sure the thin black lines on your schematics become cables with the requisite dependability: have them designed by experts, in consultation with you, and constructed by experts.

Rome-Alcoa is, frankly, one of the very few companies that qualify. We've been designing and constructing these cables since their first conception. If you're going to need instrumentation cable soon, call us, the sooner the better.

We now have a 24-page booklet titled "Instrumentation Cables, Cable Assemblies and Hook-up Wires." In it, we describe instrumentation cable constructions, production, military specifications and our qualifications. For your copy, write Rome Cable Division of Alcoa, Dept. 27-53, Rome, N. Y.

ALCOA
ROME CABLE
DIVISION



SOLID STATE IN Electronics

Men of vision thrive here. And it takes men of vision to cope with today's electronics and space problems. Space in more ways than just up. Space problems of a different nature plague the manufacturer who must expand, but hasn't the land to expand on.

Here in Florida we have the space, the climate, the work force. Florida has more to offer electronics firms than any other area on earth. Men think better where life is pleasant, where off hours can be devoted to just plain *living*—and to just plain *thinking*.

Yes, Florida is a Solid State in Electronics. Already the sun, Mother of Life, shines on over sixty thriving electronics firms in our busy state.

Cape Canaveral is here, too, with its massive, awesome missiles blasting off to make space history. Electronics makes possible every thrust into the universe. Every hope of getting to the moon depends upon electronics—and the first American to the moon will definitely soar to history from Florida.

Engineers and their families dream of living here in Florida. Give them this dream by moving your plant here. Nurture the brains that will give your business a greater and greater stature in this, the Electronics Age.

For complete details of the many advantages Florida offers the Electronics Industry, write us. Let us tell you why some of the greatest names in electronics have impressive plants here in Florida.

FLORIDA'S ASSURANCE POLICY

"You have my personal assurance of a sunny business climate here in Florida. You have positive assurance of every aid and assistance possible from our Florida Development Commission and from the overwhelming majority of our businessmen, industrialists, and financiers. We have everything to make your large or small enterprise healthy and successful. Write, wire, or phone us TODAY. The only thing better than a FLORIDA vacation is having your plant here."



FARRIS BRYANT
Governor

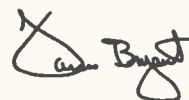

Investigate

Florida

... NOW AN 11 BILLION DOLLAR MARKET

Ask about free film "Profile of Progress"
FLORIDA FOR CONVENTIONS—
Write for free information on Florida's wonderful facilities for your group meeting.



Mr. Wendell Jarrard, Chairman
FLORIDA DEVELOPMENT COMMISSION
Box 4247F, Tallahassee, Florida

Please send me brochure, "Why Your New Plant Should Be Located In Florida," containing the facts about FLORIDA's opportunities for New Industry, the 11 BILLION DOLLAR CONSUMER MARKET, Labor, Climate, Schools, Natural Resources, Favorable Tax Structure.

Name.....

Firm Name.....

Address.....

City.....Zone.....State.....

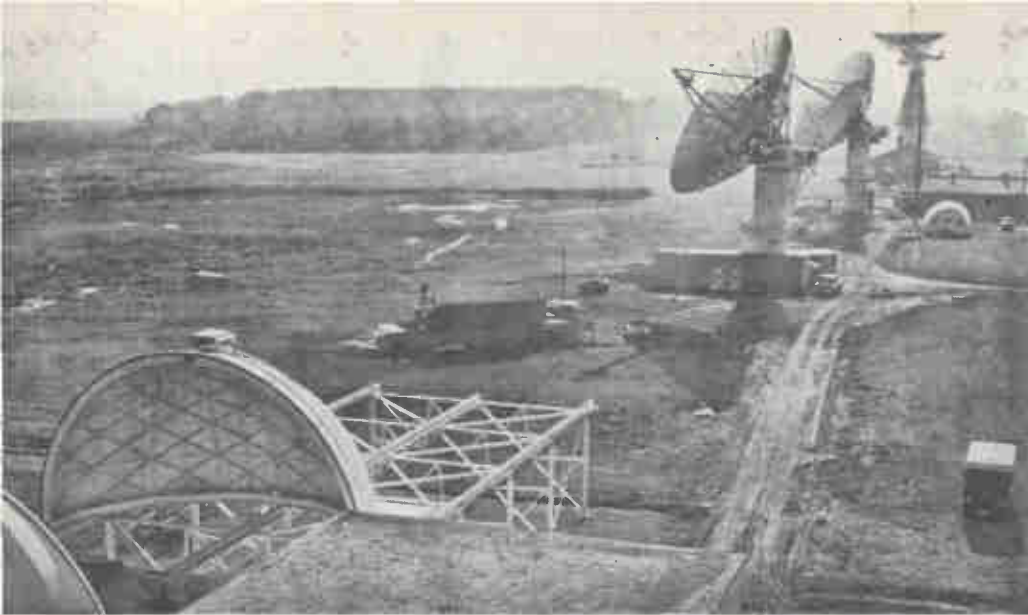

ARBUCKLE NECK site includes, from left, houses for the telescope and meteor cameras, S-band tracking radar, combined uhf and X-band radars, and a trajectory and range safety radar. Trailblazer reentry rockets are fired from nearby Wallops Station.

MAIN TELESCOPE. Mounted beneath it are 12-inch tracking telescope (left) and radiometer



Long-Range Spectrometer Seeks Missile Defense Clues

Radiation from reentry vehicles is analyzed with 48-inch telescope

By **SETH PAYNE**
McGraw-Hill World News

ARBUCKLE NECK, VA.—MIT's Lincoln Laboratory has officially unveiled the big high-speed automatic tracking telescope it uses for antimissile and other reentry studies.



The 48-inch spectrometric telescope measures the visible, infrared, and ultraviolet radiation from a vehicle reentering the atmosphere at velocities to 20,000 mph at a range of 100 to 200 miles. It is unique in its size and ability to make a detailed analysis of the reentry glow during the few seconds that it exists.

The telescope is the same one used a year ago, when it was only partially completed, to detect a laser beam reflected back from the moon (*ELECTRONICS*, p 7, May 18, 1962). Later this year, the telescope is to be shipped to White Sands, N. M., for a program in reentry physics there.

So far, Lincoln Lab has only used the telescope on two reentry experiments with only moderate success. The problem has been getting it to slave properly with tracking radar. Eight more experiments are sched-

uled before the program at Arbuckle Neck is completed in November.

ANTIMISSILE WORK — Lincoln Lab has been working on reentry here since 1959 under an Advanced Research Projects Agency (ARPA) Project Defender contract. The program aims at solving the discrimination aspect of antimissile defense—sorting out dummies from the real incoming warheads. Inability to do this is a major reason why Nike-Zeus production was held back.

Reentry tracking starts at altitudes of around 300,000 to 400,000 feet. Discrimination systems built in the first antimissile weapon system are likely to cover the area from 250,000 feet and down, according to an ARPA spokesman. Within the next three years, he predicts, we will know about 95 percent of what is to be learned in this area.

EXPERIMENTS—Work performed by Lincoln Lab at Arbuckle Neck falls into three general areas:

- Detecting and tracking 5-inch to 8-inch-diameter conical and spherical metal objects lofted by

MOUNTED atop the telescope are the 30-channel spectrometer covering visible spectra from 0.3 to 0.6 micron, and the 10-channel one for 0.6 and 4 micron

Trailblazer rockets to around 200-mile altitudes, then forced back into the atmosphere at speeds of 14,500 feet per second to 22,000 fps.

- Understanding the interaction of the flow field surrounding the object as it reenters and its effect on tracking radars. Radiation, for example, varies with location—front, side or wake.

- Exploring the electron sheath that surrounds a reentry object, making communications difficult. This is directly applicable to NASA's problem of communicating with astronauts.

To gain this data, Lincoln Lab uses three radars, the telescope and a pair of Super-Schmidt meteor cameras loaned by Harvard University. Cross sections of reentry vehicles with their ionization environment are measured at uhf, S-band and X-band, at approximately a 45-degree reentry angle to the radars. The radars operate at 400 Mc, 2.8 Gc and 9 Gc.

Lincoln Lab's reentry work has not been 100 percent successful. Out of 20 Trailblazer shots fired to date, radar data has been collected on 7 or 8. But the task is not easy—tracking time on reentry is limited to about 40 seconds. ARPA says Lincoln Lab has averaged one shot every three months. ARPA would like a shot per month.

Data gained, although limited, has been extremely valuable. It served as design basis for ARPA's new, Advanced Measurement Radars (AMRAD). These will be used at White Sands when the program shifts there later this year.

AT WHITE SANDS—Three programs will be conducted at the White Sands Proving Grounds:

- Air Force experiments on its Advanced Ballistic Reentry System (ABRES) to develop decoys for use on U.S. rockets.

- Radar tests on equipment to be installed on Kwajalein Island for

ARPA's Project Press (Pacific Range Electromagnetic Signature Studies) using full scale missiles as test vehicles.

- Continuance of the Lincoln Lab reentry physics work using the new Amrad radars and the 48-inch telescope. Launchings for the experiments will be done at Green River, Utah, some 300 to 400 miles away.

TELESCOPE DESIGN—The 48-inch telescope performs a complete, 40-channel spectrum analysis of reentry glow 10 times a second.

Optical configuration is cassegrainian. An f/15 telescope with a focal length of 720 inches focuses light from a 48-inch mirror down to an area just over 0.07 inch square.

The entire instrument tracks at rates up to 5 deg per second, with a jitter of less than 2 sec of arc.

The S-band radar tracks the target before reentry and positions the main assembly to within $\frac{1}{4}$ degree of the target area, bringing the target within the field of view of the tracking telescope. Target light falls on a photoelectric tracking system consisting of two rotating reticles and a sensitive multiplier phototube. Electrical signals generated by the tracking system automatically keep a 12-inch auxiliary telescope on target by positioning its secondary mirror closely coupled to the 16-inch secondary mirror of the main telescope.

Collected light is split and analyzed by two electronic spectrophotometers mounted on the telescope's moving frame. Infrared light is dispersed by a lithium fluoride prism and measured in 10 contiguous channels by lead sulphide cells. Cell outputs are sampled and tape recorded. Visible and ultraviolet light is reflected into a second spectrograph, and dispersed by a diffraction grating. An array of lenses direct the energy into a helical array of 30 multiplier phototubes, covering from 3,000 to 6,000 Å.

Air Force Scores Suppliers

RESULTS OF surveys made by Air Force for the past two years provide tips on good management to firms doing business with the government.

Details were presented yesterday by Brig. Gen. G. F. Keeling, Deputy Chief of Staff for Procurement and Production of Air Force Systems Command (AFSC), American Ord-

WHAT ARE YOUR DELIVERY REQUIREMENTS?



STANDARD
TAPE TRANSPORTS
4 WEEKS



STANDARD
PRINTERS
12 WEEKS



NEW PRINTER DIVISION

Broad acceptance of our product line coupled with the fact that so many Potter "specials" are now industry standards has resulted in such dramatic growth that we have increased our plant and production capacity by more than 65%. This new production capability can directly benefit you through faster delivery.

For example, we can deliver our standard transports in 4 weeks, and standard printers in 12 weeks from receipt of order.

If you require fast delivery — with no sacrifice in performance or reliability, write us today.



POTTER INSTRUMENT CO., INC.
TAPE TRANSPORT DIVISION
151 Sunnyside Boulevard • Plainview, New York
PRINTER DIVISION
East Bethpage Road • Plainview, New York

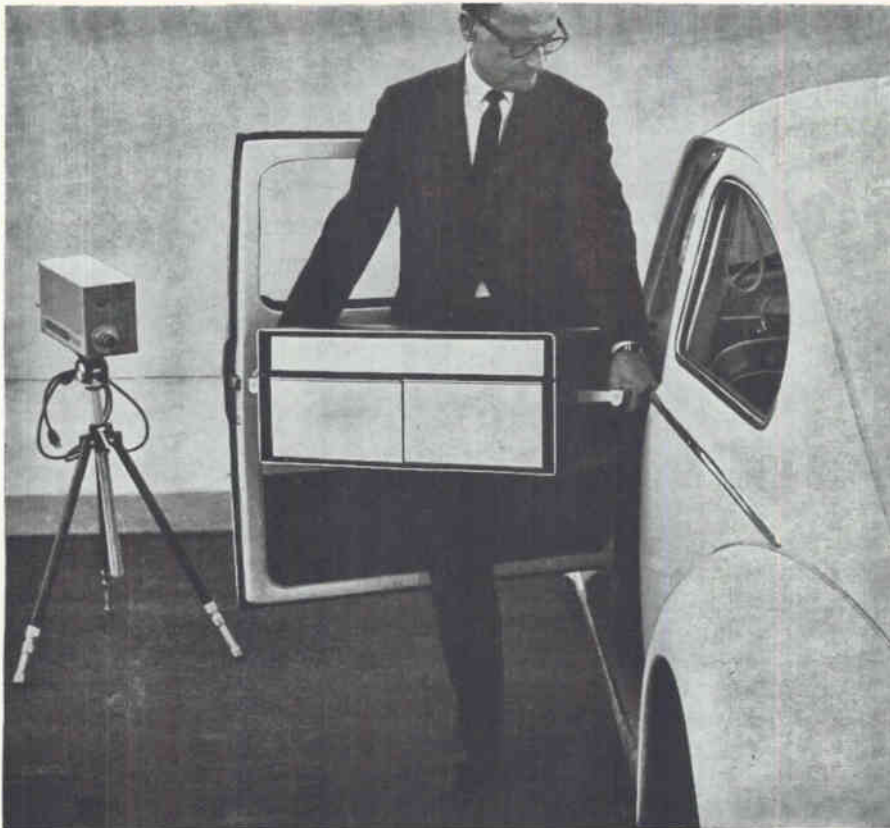

NEW LOW-COST PORTABLE TELEVISION RECORDER puts sight and sound on magnetic tape

Now at a small fraction of the size, weight, and cost of studio-type television recorders, the Precision Instrument Model PI-3V puts over an hour and a half of sight and sound on a single reel of 1" wide magnetic tape.

It operates almost as easily as a home audio tape recorder. Thread the tape, pick your scene, push the "start" button and the rest is history. You can play it back then and there, or days or years later, as many as 100 times or more, with all the "live" quality of the original action.

For existing or new closed-circuit TV systems For educational, medical, military, or industrial use, the PI-3V enables you to record valuable training material, demonstrations, and one-time-only events, and re-create them at will, any number of times, before any number of audiences, any place in the world. The recorder is compatible with existing CCTV systems, EIA standard or industrial sync, and will operate with one or any number of TV monitors. For new closed-circuit systems, all that is required is the PI-3V, an image orthicon or vidicon camera, a TV monitor, and a place to plug in the 110v power cord. And the complete system will fit in the rear seat of a compact car!

Uses 1" tape — pays for itself in tape savings alone Because the PI-3V uses 25% less magnetic tape than any other TV recorder, an amount equal to its entire purchase price can be saved by the time 438 reels (700 hours recording time) of permanent recordings have been made. When the tapes have outlived their usefulness, they may be erased and re-recorded with new program material.

Other savings are made possible by the economy of size and weight (only 1/2 that of the next smallest TV recorder), the low power requirements, the extreme reliability, and the portability (one man can carry the PI-3V aboard an airplane and take it anywhere in the world in 24 hours). May we carry one around to your office for a demonstration? For a copy of the PI-3V brochure, address us at

Stanford Industrial Park,
Palo Alto 20, California.

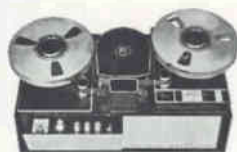

**PRECISION
INSTRUMENT**



Inquiries invited from qualified CCTV Dealers and Distributors

nance Association meeting in Washington, D. C.

AFSC will buy \$8 billion worth of weapon systems, supplies, and services this fiscal year and will administer approximately 70,000 contracts, Keeling said.

Almost all contractors lacked adequate methods for developing valid cost data, or else did not use available data to prepare estimates, Keeling said. Also:

- Inadequate correlation between cost proposals and records of actual cost experience creates lack of confidence and prolonged negotiation.

- Technical work statements used in placing major subcontracts are neither well-written nor comprehensive and lack adequate engineering support for purchasing agents.

- Too many subcontracts are awarded noncompetitively to a single source and without adequate price evaluation. There is a serious lack of direct management of major subs by prime contractors.

- Program managers (directors) were found who "didn't really manage or direct anything outside of a few people assigned to their offices." A program manager should control allocation of contract and company resources on his programs.

- Almost all contractors had no valid system for relating expenditures to task completion and were unable to estimate cost to completion.

Findings were the result of the Industrial Management Assistance Survey and the Systems Program Management Survey.

Dropsondes Speed Air Weather Data Gathering

BENDIX'S Friez Instrument division will supply dropsondes for USAF's Air Weather Service B-47 jet aircraft. Sensors on the plane and the sounding instruments will gather data conditions along the flight path and below the aircraft.

The ejected dropsonde falls on a parachute. Meteorological information transmitted to the plane is put into digital form and combined with the data recorded in the aircraft. Data is automatically briefed into a short digital message and transmitted to ground stations for rapid computer processing.

NEW FROM DIEHL

10 WATT TRANSISTORIZED SERVO AMPLIFIER SERIES

- MIL SPECS
- REPAIRABLE
- SILICON
- 50, 60 OR 100 CPS MOTORS

DIEHL Manufacturing Company now offers a complete silicon transistor amplifier series. This series incorporates a large number of interrelated servo amplifiers designed to operate in nearly any servo system where a 50, 60 or 400 cps motor requires about 10 watts or less.

The new series is made up of two types of amplifiers. The "120" series units are housed in 2-inch round cans. The "500" series units are the same as the "120" series but have integral power supplies and are housed in 4 $\frac{3}{8}$ " x 2 $\frac{1}{4}$ " x 2 $\frac{1}{2}$ " rectangular cans (see lower photo). Both types use wafer construction, are repairable and are filled with aluminum oxide particles for maximum heat transfer. Both types also mount on their base through 14-pin miniature headers as an electrical connection and an extended screw as a mechanical connection.

All units are available with an additional pre-amplifier wafer, increasing the gain by a factor of 7.5, and/or with a modulator wafer permitting d-c inputs.

Although both types are designed for Mil E 16400 environments, non-military standard transistors are normally used for low cost, high performance.

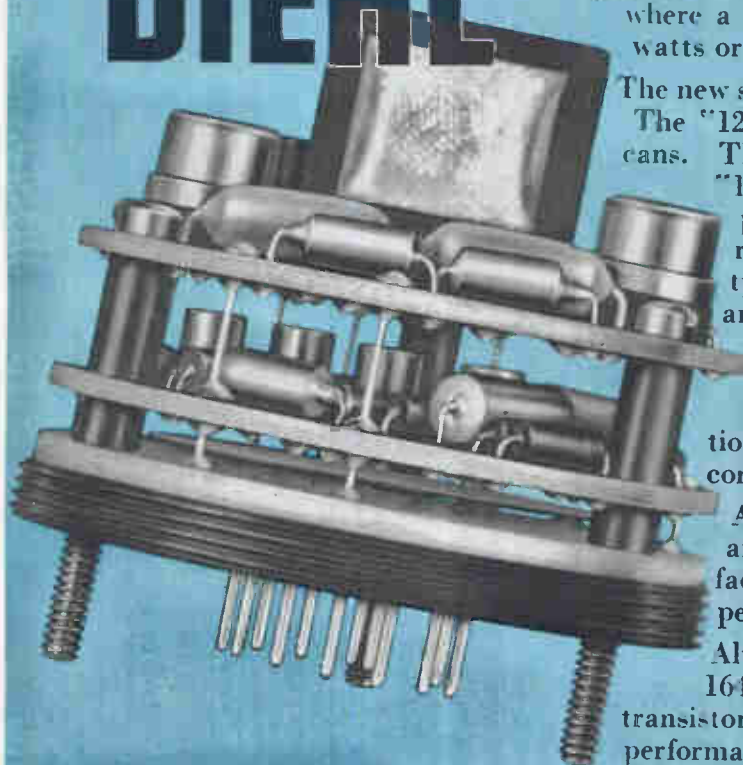

DIEHL COMPONENTS + DIEHL CAPABILITY = MAXIMUM PERFORMANCE

NOMINAL CHARACTERISTICS

	TA010-OA-120	TA010-OA-121	TA010-OD-122	TA010-OD-123	TA010-OA-500	TA010-OA-501	TA010-OD-502	TA010-OD-503
GAIN								
INPUT #1	1000 $\frac{V_{rms}}$	7000 $\frac{V_{rms}}$	1000 $\frac{V_{rms}}$	7000 $\frac{V_{rms}}$	1000 $\frac{V_{rms}}$	7000 $\frac{V_{rms}}$	1000 $\frac{V_{rms}}$	7000 $\frac{V_{rms}}$
INPUT IMPEDANCE OHMS								
INPUT #1	40 K	40 K	12 K	12 K	40 K	40 K	12 K	12 K
OUTPUT IMPEDANCE	25 OHMS							
PHASE SHIFT	Max 15° at 60 cps				5° at 400 cps			
BANDWIDTH	no measurable shift over 20 cps passband 400 cycles - 10° phase shift over 100 cps passband							
OUTPUT PROTECTION	Output can be shorted for short periods of time without damage to amplifier							

For complete information and specifications, write to address below.



DIEHL MANUFACTURING COMPANY

A Subsidiary of THE SINGER MANUFACTURING COMPANY

Finderne Plain, SOMERVILLE, NEW JERSEY

Telephone: Randolph 5-2200

* A Trademark of THE DIEHL MANUFACTURING COMPANY

In **FIXED COMPOSITION RESISTORS**

if it's news, expect it first from IRC

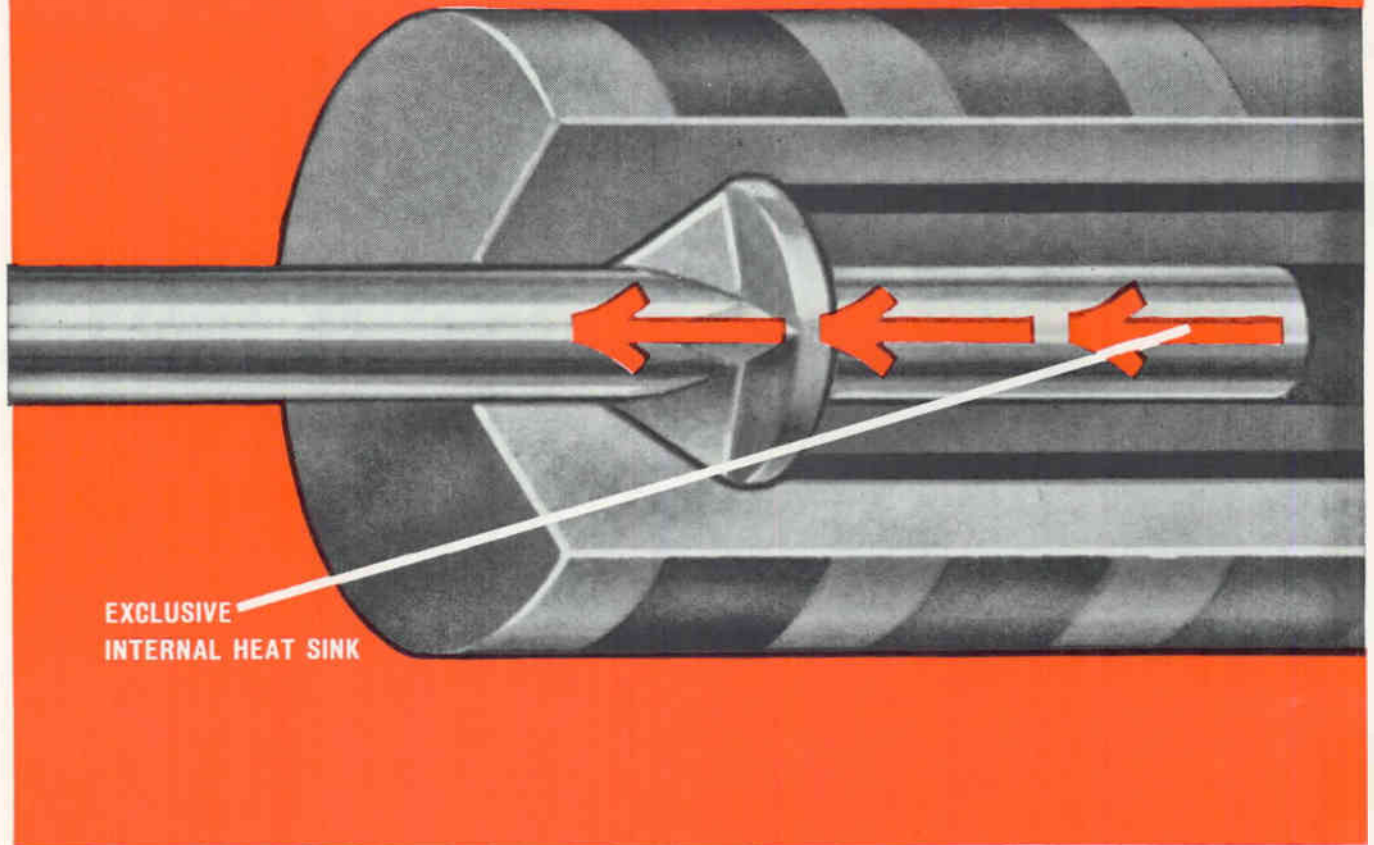

EXCLUSIVE
INTERNAL HEAT SINK

IRC Fixed Composition Resistors **RUN COOLER**

HERE'S WHY . . . IRC's resistance element is a film of carbon composition thermally bonded to a glass body. Exclusive talon leads extend far into the body and act as heat sinks to conduct heat away from the "hot spot" and out of the resistor.

60% of the heat generated in an IRC resistor is removed by this metallic conduction. 35% is carried off by convection, and 5% by radiation.

Other Fixed Composition Resistors use a solid carbon slug element. Without metallic conduction from the center of the resistor, their typical operating temperatures range from 6 to 14% higher than IRC's.

For better load life and long term stability, specify IRC MIL-R-11 resistors. Write for GBT Bulletin. International Resistance Co., Philadelphia 8, Pa.

PERFORMANCE ADVANTAGES

IRC Type GBT's also provide

- Stronger termination
- Weldable leads
- Outstanding load life
- Greater moisture protection
- Better resistance-temperature characteristics
- Superior high frequency characteristics
- Ranges to 100,000 megohms



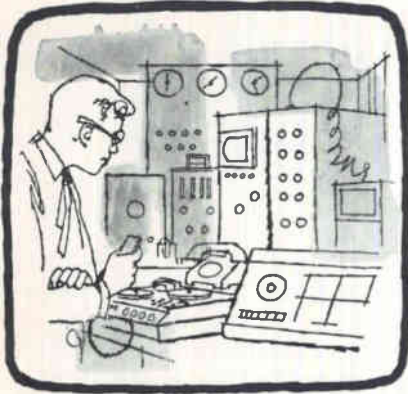

IF YOU ARE RECORDING IN THE LAB...



OR IN THE FIELD, YOU CAN NOW...

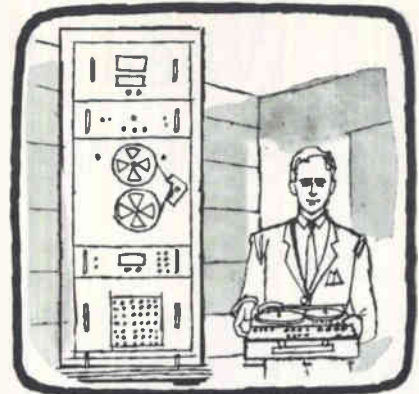

GET PRECISION PERFORMANCE...

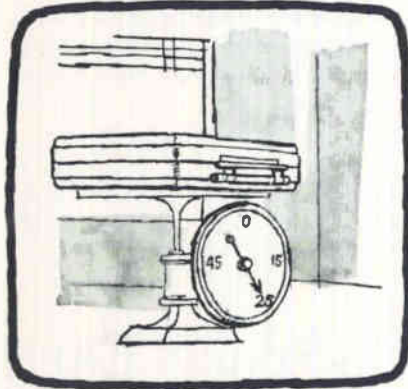

IN A 25-POUND RECORDER/REPRODUCER

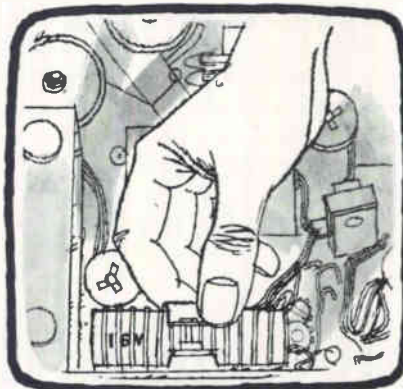

THAT IS COMPLETELY SELF-POWERED.



CAN BE HAND-CARRIED ANYWHERE.

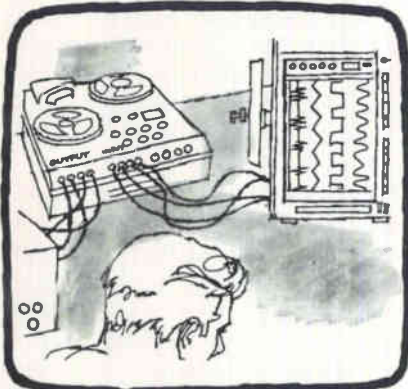

CAN SIMULTANEOUSLY RECORD/REPRODUCE 4 TRACKS.

DIRECT SYSTEM

*Tape Speed	Frequency Response ± 3 db
1 1/2	50-5,000
3 3/4	50-10,000
7 1/2	50-20,000

FM SYSTEM

Tape Speed	Frequency Response $\pm 1/2$ db
3 3/4	0-1,000
7 1/2	0-2,000

**optional speeds available*

FM OR DIRECT,

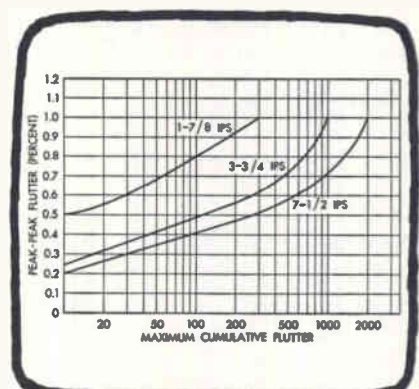

WITH EXTREMELY LOW FLUTTER.

THE NEW LOCKHEED 411 INSTRUMENTATION RECORDER

MAIL COUPON TODAY FOR FULL INFORMATION

LOCKHEED ELECTRONICS COMPANY/TAPE PRODUCTS DEPT.,
INDUSTRIAL TECHNOLOGY GROUP, Metuchen, New Jersey
Mr. Bernard Mayer: Send me free product specification folders
on the Lockheed 411 instrumentation recorder/reproducer.

NAME

TITLE

COMPANY

ADDRESS

CITY..... STATE

LOCKHEED ELECTRONICS COMPANY
A Division of Lockheed Aircraft Corporation/Metuchen, N. J.

E-5



When Will Integrated Circuits Go Civilian? Good Guess: 1965

As military volume grows, lower prices will help commercial use

By MICHAEL F. WOLFF
Senior Associate Editor

HOW SOON will integrated circuits be commercially competitive? The market is now primarily a military one, but price drops over the past few months have aroused speculation about the timetable for

industrial and consumer applications. Best guess is that significant commercial applications are still a few years off.

Evaluation of integrated circuits for consumer applications is underway at several companies. For example, Delco Radio is studying silicon integrated circuits for car radios. Westinghouse Electric is looking at a citizen's band receiver kit with silicon circuits.

Robert Thalner, chief engineer of Sylvania's Home and Commercial Electronics division, feels some in-

tegrated circuits will probably show up in the 1966 line of home electronics, which normally would be introduced in spring 1965.

He cites reliability and space savings as inherent advantages of integrated circuits and sees high-fidelity tuners, power output stages and pickups as among possible early applications. However, integrated circuits will have to be competitively priced for wide acceptance.

PROCESS CONTROL—High-reliability potentialities of microcir-

NASA Studies Earth-Space-Earth

First step towards actual cooperative systems is S-66 tracking experiment

WASHINGTON—NASA's special requirement for completely cooperative space communications and tracking systems is making agency scientists optimistic about using lasers in these applications.

Because NASA assumes that communication between, say, earth and Gemini would always be completely cooperative they are not faced with such difficult problems as unfriendly target acquisition and bad-weather attenuation. Atmos-

pheric attenuation is not considered a serious problem because the time and place of communication and tracking can be selected.

Freedom from these concerns allows the Communications and Tracking division of the Office of Advanced Research and Technology to pursue several promising techniques that are expected to lead to flight experiments in a year or two.

ACQUISITION—Problem here is simplified initially because spacecraft position is known to better than 30 minutes of arc and a corner reflector or light source can be placed on the vehicle. If the light source is a laser, a complete communications and tracking loop closed by human operators and/or servomechanisms can be feasible.

Roland Chase, responsible for laser development in the NASA division, said that if putting a laser in the spacecraft proves impractical, special corner reflectors being developed could be used instead. These reflectors can be modulated by a human voice; that is, their surfaces can be varied mechanically,

modulating any reflected energy. An astronaut could talk into the reflector and his voice would be impressed on the returning ground-based-laser beam.

This is an elementary mechanical version of a device that is the goal of a NASA R&D program called Miros (Modulation Inducing Retrodirective Optical System). Aim here is to develop techniques for transferring intelligence between two or more laser beams without consuming auxiliary energy.

Concept is illustrated for a potential communications satellite system. Transmitter A illuminates a retrodirective optical system B with an intelligence-modulated beam that returns to receiver A. Transmitter C illuminates B with a c-w optical beam that would be electro-optically coupled to the modulated signal from A so that a modulated c-w beam returns to receiver C. Modulation on the returned beam is read out at C, thus accomplishing communication between A and C. A large number of electro-optical phenomena can be employed for this type of coupling, Chase said.

CONCEPTUAL plan for a laser communications satellite system

FIRST STEPS—Upcoming laser tracking experiments with the S-66

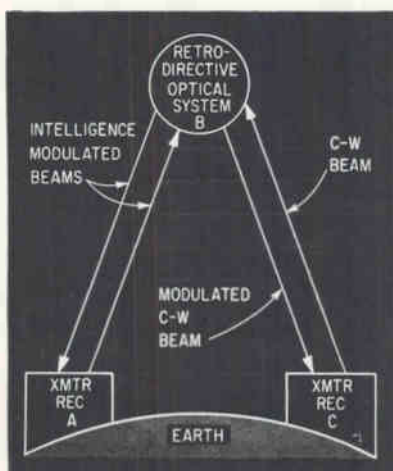

cuits are also important to process control manufacturers. The high input impedance attainable with field-effect devices makes them look attractive for amplifiers that could be used universally throughout industrial process-control systems—perhaps in 3 to 4 years. Integrated circuits are too expensive now, but the main reason they are not used in linear systems is that circuit design is not yet perfected, one company spokesman says.

Spokesman for the same company's digital systems division said he was considerably interested but is waiting for better performance and costs of roughly \$10 a flip-flop in small quantities (1-10). He expects this when a big computer manufacturer requires volume production, possibly in 2 to 3 years.

(continued on p 24)

Laser Links

satellite (ELECTRONICS, p 14, Nov. 23 and p 20 Sept. 7, 1962) marks NASA's first step toward operational laser communications systems. Other experiments presently planned involve:

- Advanced tracking systems with improved lasers and tv read-out systems to get tracking data and possibly give position relative to a star background.

- Manned Space Flight Center's research program for astronaut optical communications. This is significant because it would encompass many features of a real system—tying a man into the loop with acquisition, tracking and communications functions.

BEAM STEERING—A program just starting at NASA is the development of electro-optical methods of steering laser beams. The beam steering device would be controlled from suitable laser beam tracking systems. Calling the need for direct control of laser beams "one of our severe problems," Chase said it arises because desired laser beam-widths are less than 20 seconds of arc while a tracking platform can be oriented only to approximately 30 seconds of arc.



these are the **12**
main
reasons

why you will

choose WESTON-ROCHAR COUNTERS

- All solid state
 - High crystal stability
 - High input sensitivity
 - Maximum count capacity
 - Low consumption
 - AC or DC power supply
 - Cabinet or standard rack mounting
 - Direct reading on the counter
 - Direct recording from the counter
 - Wide temperature range
 - Shock and vibration tests
 - A great number of additional accessories (plug-in, transducers,...) extending the range of applications of the instruments.
- even when connected to H.F. converters operating at any frequency.

For complete specifications, ask :

manufactured by **Rochar**
electronique

Distributed in U.S.A. and Canada by :

WESTON - Newark (N.J.)

for complete information on our line of products and address of our agency in your country please apply to **ROCHAR-ELECTRONIQUE**, 51, rue Racine MONTROUGE (Seine) FRANCE.



Mech-tronics Corporation, Melrose Park, Illinois found the Di-Acro 12 Ton Press Brake fast, safe and easy to set-up. In production of small aluminum electronic components a tolerance of .010" is maintained.

ACCURATE, HIGH SPEED FORMING PRODUCTION

di-acro
PRECISION METALWORKING EQUIPMENT

12 TON HYDRAULIC PRESS BRAKE

The Di-Acro 12 Ton Press Brake is designed for high speed, economical forming and fabricating of precision parts. Less than 15 seconds is required to pre-set the length of stroke for most efficient operation and maximum safety. The operator can easily "inch" the ram or reverse it at any point in the stroke. The 12 Ton series uses standard press brake dies and is available with 3 or 4 foot bed.

25 AND 35 TON SERIES

The rapid, dual speed work cycle provides fast approach, slow work and fast return—or a stroke as slow as 6 operations per minute. Dangerous sheet whipping with resultant costly kinking is virtually eliminated. This dependable hydraulic press brake is available in 6 and 8 foot bed sizes.



A complete selection of press brake dies for bending, blanking, box forming, corrugating, curling, hemming, punching and flattening. Fits all standard press brakes.



Di-Acro Rol-Form Dies eliminate work marking of highly polished or painted materials. Saves time and reduces die costs—one die does the job of many.



Consult the Yellow Pages of your telephone book under Machinery—Machine Tools for the name of your nearest Di-Acro distributor or write us.

Please send complete information on . . .

- 12 Ton Hydraulic Press Brake
- 25 Ton Hydraulic Press Brake
- Standard Press Brake Dies
- Rol-Form Dies

DI-ACRO CORPORATION
435 Eighth Avenue
Lake City, Minnesota

NAME _____

COMPANY _____

ADDRESS _____

CITY _____ STATE _____

PRICE WAR COMING?

Tumbling silicon integrated circuit prices appear to be the natural result of producers moving out of the sample into the production stage. Industry sources do not think it presages a price war of the type the transistor industry ran into a while back. They hasten to add, however, that this is how it looks now—a year from now the situation could change.

One salesman says no company has a large enough inventory to launch a price war. Also there is no direct price competition since no two companies make exactly the same device, he adds.

Queried about the possibility of a future price war, one company spokesman said "Depends upon how hungry we get. I hope the industry has learned its lesson from the price war of the semiconductor industry, but I'm not sure that it has."

COMPUTERS—Several commercial computer manufacturers are looking at integrated circuits. IBM has bought some and is evaluating them but doesn't plan commercial production now.

Univac has no commercial machines in the works, but is building military machines. They estimate it may be 3 to 5 years before integrated circuits are cheap enough for commercial applications.

Another manufacturer told ELECTRONICS that "It's pretty hard (for integrated circuit costs) to meet the conventional approaches because you're shooting at a moving target—standard discrete components are getting cheaper too."

Europe may push integrated-circuit computers. "Tremendous" interest in applying integrated circuits to industrial data processing and controls is reported. Olivetti is reportedly designing a prototype commercial calculator using integrated circuits.

COSTS—Integrated circuit prices are coming down. The crossover point could be this year or next.

Users seem to feel that integrated circuits are still generally more expensive than comparable printed circuit boards with discrete components. Direct price comparisons are difficult—much of the market is custom military work, circuits vary from 4 to 50 components.

Large manufacturers of integrated circuits say that, taking the whole procurement cycle into account and talking in terms of large volume and military performance requirements, digital silicon integrated circuits are cheaper now.

A comparison by Fairchild Semiconductor shows that where discrete component logic circuits of commercial grade cost about \$6 to \$8 in large quantities, integrated circuits average about \$25 in quantities of a couple of hundred. The same circuits for high-reliability military programs would cost \$30 to \$50 when made up of discrete components and \$16 to \$66 in integrated form.

Westinghouse predicts that a master wafer with 150 circuits that presently costs \$150 will in a few years carry 500 circuits for \$12. Pacific Semiconductors projects that an integrated circuit flip-flop it introduced last year at \$125 will cost \$4 to \$6 in 1965. Signetics feels integrated circuits will offer distinct cost advantages for the commercial computer industry by 1965 or 1966.

Cost estimates for the Apollo guidance computer show integrated part costs higher than discrete components. But lower production costs are expected to make overall cost a tossup. Increased reliability due to simpler assembly methods is also expected to give the integrated version an overall edge.

Patrick Haggerty, president of Texas Instruments Incorporated, estimates that high-volume integrated circuits would cost half as much as conventional circuits, for an overall savings of around 10 percent in government electronic equipment. He cited studies indicating that integrated circuits can now perform one-third of the circuit functions in such equipment and will be capable of handling 75 percent by 1968.

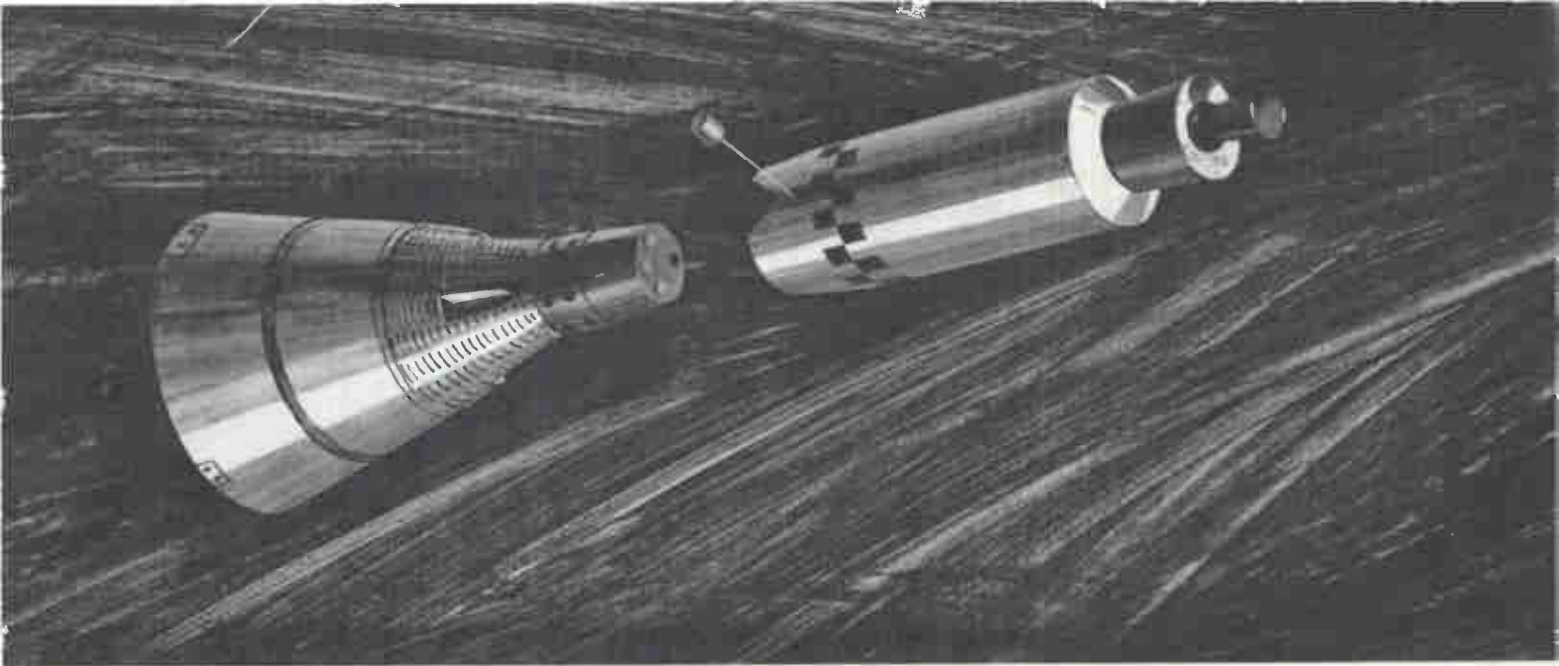

Westinghouse radar will guide the first orbital rendezvous



Westinghouse is working on advanced radar systems for deep space missions

When the Gemini two-man spacecraft first performs rendezvous and docking maneuvers in earth orbit, a new Westinghouse radar system will help assure the success of the mission.

The Gemini spacecraft itself, one important mission of which is the perfection of rendezvous techniques, is being built by McDonnell, prime contractor for the Gemini project, under the technical direction of

NASA's Manned Spacecraft Center.

Using a unique interferometer system developed by Westinghouse's Air Arm Division, the spacecraft interrogator will transmit a series of pulses to the target transponder. Reply pulses received by the spacecraft will be used to measure range and azimuth and elevation angles.

The first of its kind in space, the Westinghouse radar system for Gemini is the be-

ginning of a new generation of advanced radars for deep space missions, lunar landings, planet exploration and space station logistic support.

For more information on Westinghouse Air Arm Division space programs, write for new brochure, "Into Space," to Westinghouse Electric Corporation, P.O. Box 868, Three Gateway Center, Pittsburgh 30, Pa. You can be sure...if it's Westinghouse.

J-02340

We never forget how much you rely on Westinghouse



CIRCLE 25 ON READER SERVICE CARD

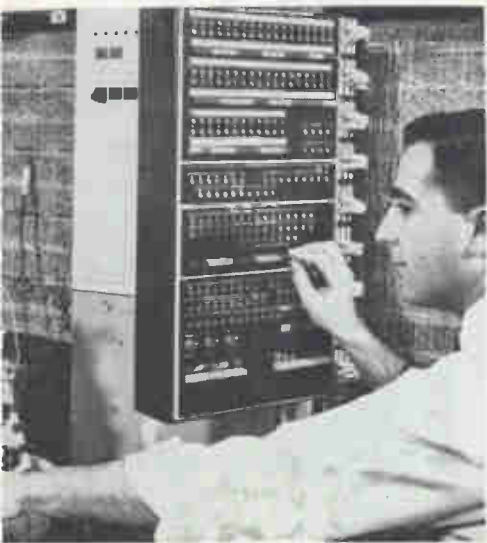

DATA COMMUNICATIONS center installed by Western Union at Tinker AFB, world-wide system with a capacity of 100 million words daily

PROGRAMMED transmission control—IBM's 7750—translates information to and from computer language, can handle up to 112 low-speed or 6 voice-grade lines. MIT engineers use it to communicate from their desk with a central computer. Here, memory is tested with built-in checking panel (left)

Data Communications Boom Gathers

Installations multiply despite limited speed of available land lines

By **GEORGE J. FLYNN**
Associate Editor

THIS SUMMER, U.S. Steel will link up about 25 of its computers into one giant computing and data-processing network. While this will be one of the first true computer networks, it is only one more system in a flood of such data communications developments as:

- The Martin Company institutes computer-to-computer load sharing between Baltimore and Denver
- DOD announces opening of Autodin, world-wide data-process-

ing system for the armed services

- Computer at University of Pennsylvania is linked to similar computer at N. Y. University for medical research projects

- Feasibility of generating voice output from computer using digital data input—with application in air traffic control—demonstrated by Teleregister

- Information from bank teller machine sent to central data processor and back through Telstar

- IBM sends computer data at 20-million bits per second over a tv channel

- ITT Kellogg system, for widely dispersed companies, transmits graphic, written, punched, voice and computer communications by a variety of techniques at up to 4 million bits a second.

As long ago as 1958 the president of AT&T, F. Kappel, predicted that the volume of data traffic would exceed voice by 1970. Some 5,000 Bell System's Data-Phone subsets, which convert data pulses into tone-modulated signals for transmission over voice circuits, have been installed since 1960 and 35,000 are expected in 10 years.

Western Union's Telex system for data transmission over telegraph lines is now in 3,000 locations, will soon be in 5,000. The subsets match the communications channel to the data signals; the data originates in computers, card and paper tape readers, and other peripheral equipment.

DATA CHANNELS—While microwave links for data communications are starting to come into use, the bulk of data traffic for years to come will be over existing common-carrier land lines. But the lines now being pressed into service were originally designed for voice or telegraphy, not for high-speed digital data.

A typical 3-Kc voice channel, for example, can handle about 1,200 bits per second (bps) routinely, and 2,400 bps using Bell's 4-phase transmission scheme. Higher rates are possible but at increased terminal equipment costs (graph A) and one bps per cycle of channel band-

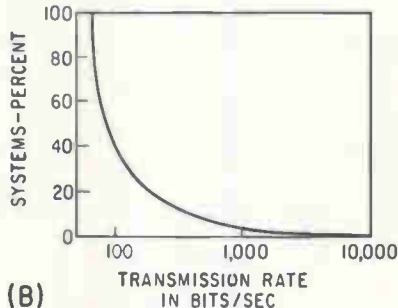
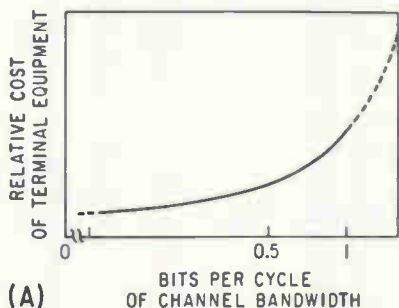

TERMINAL EQUIPMENT costs start to rise steeply when data transmission rate approaches 1 bit per cycle of channel bandwidth (A). Few of today's systems use high speed (B). These are Bell System estimates



Okla. (above), is one of five in a

Steam

width is usually the practical limit. But since costs can be reduced if more data can be sent with a given bandwidth, various techniques to increase capacity have been proposed, one of the latest being a duobinary system (ELECTRONICS, p 61, March 22, 1963).

Simplest way to increase data transmission rates is to increase channel bandwidth. AT&T lumps 12 voice channels into a single channel called Telpak. Combining Telpak channels makes possible rates to 500,000 bps.

Few systems today require data handling at such speed or generate enough data to make such systems economically feasible (graph B). System designers have therefore concentrated on solving today's applications with transmission rates of 1,500 to 1,600 bps on voice channels, and 75 bps on telegraph lines.

ERROR RATES—Errors generated in transmitting data long distances have been cut by an estimated order of magnitude during the past few years. General Electric's Computer division, in a test at 1,500 bps, measured an error rate of 1 in 1.6×10^9 . This is much better than the error rate in data generated manually—as in card-punching—estimated at about 1 in 10^6 . Computer-generated errors are es-

UHF

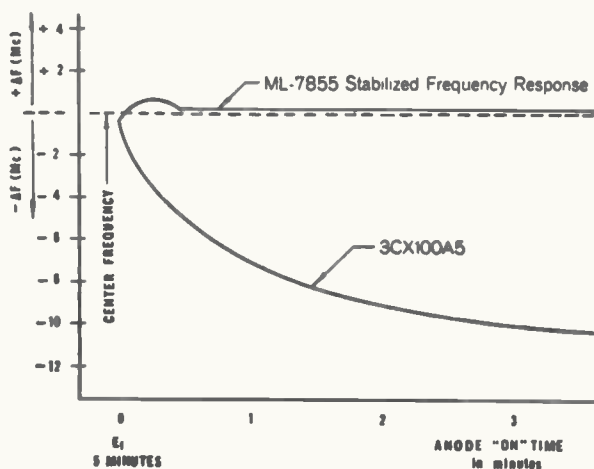

Frequency stable performance . . . 100 times faster than normal

Frequency stable performance is achieved upon application of high voltage nearly 100 times faster with the ML-7855 than with conventional planar triodes. Even with an unregulated plate supply the ML-7855 will provide this same frequency stability within 2 seconds. High-voltage, arc-suppressed, operation is provided by the Phormat (matrix) cathode. . . . Plate-pulsed to 3000 Mc, with 3000 v eb, 3.0 a ib, tp of 3 usec at 0.0025 Du. For complete ratings write The Machlett Laboratories, Inc., Springdale, Conn. An affiliate of Raytheon Company.

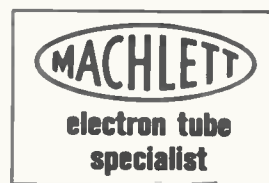



This is Venus

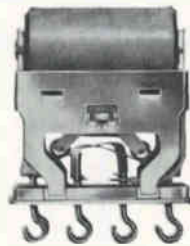

**85 of these
Sigma Relays went
there on Mariner II**

Sigma Relays were specified for Mariner II because the designers knew they'd have no second chance. What had to be done, had to be done right the first time. Opening the solar panels, for example. Switching on the scanning devices as Venus was approached. Initiating timing sequences. Sampling data for telemetry. The designers of Mariner II needed assured reliability in spite of adverse operating conditions—both predictable and unpredictable. And they came to Sigma to get it. □ Working together, Sigma Application Engineers and

Mariner's designers specified the Sigma Series 32's and 33's which performed so reliably on the Venus probe.

Come to Sigma when you have switching or controlling problems. The same Sigma reliability and Application Engineering is available to you, whether you're building space vehicles or commercial equipment. Sigma Application Engineers will work with you in selecting the right standard from over 100,000 available. Or, if a standard won't do, we'll create a special for you.

SIGMA DIVISION  **SIGMA INSTRUMENTS INC**
Braintree 85 Mass



ENGINEERING changes are transmitted by Martin Co. to missile base using Digitronics' Dial-o-verter terminal



DIRECT communication with Honeywell computer is obtained over Western Union's Telex system for data transmission

timated at 1 in 10^4 to 1 in 10^4 .

Transmission errors can probably never be completely eliminated, but errorless data can be obtained by retransmitting data blocks and comparing, and by redundancy. One of the most common error-detecting techniques is parity checking. Digitronics' Dial-o-verter system, for instance, can apply both horizontal and longitudinal parity checking—parity checks on the columns and rows of paper tape as an example—and will automatically call for up to three retransmissions of message groups if parity does not check.

ECONOMICS—The fastest but most expensive way to send data is

by a wideband data channel. Requirements must be studied carefully to determine acceptable trade offs between speed and cost.

One of the big urges to data communications is unused time—90 percent or more in some installations—on existing computers. Banks, in particular, are beginning to use common carrier lines to sell computer time to other local businesses.

The day of mass use of data communications—when a housewife can dial a central file and receive a recipe for beef stroganoff—will come when terminal equipment costing from \$50 to \$250 is available, thinks Joseph Halina, of ITT

Telstar II More Wary of Radiation

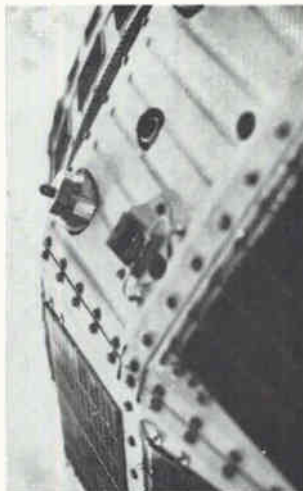
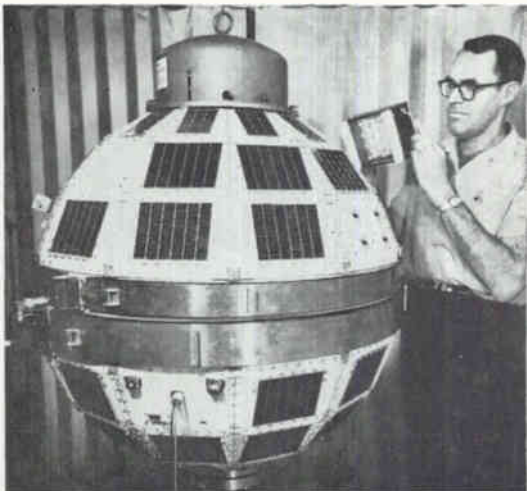

TO AVOID radiation effects that plagued Telstar I (see p 30, Jan. 11), Telstar II uses non-ionizing, evacuated transistors in decoder and will fly higher—8,500-mile orbit apogee. Electron detector range is 0.75 to 2 Mev, twice as high as Telstar I's. Another change: telemetry will be sent by microwave when vhf is turned off after two years. Photos show solar cell illumination test at Bell Telephone Labs, Cape Canaveral, and gold scatter dome over detector

for maximum reliability

BIRTCHEP PCB-TAINERS®



**1-PIECE SPRING
CLIPS RETAIN
PRINTED CIRCUIT
BOARDS SAVE
TIME & MONEY
PROVIDE MAXIMUM
RETENTION &
QUICK ACCESS**

Birtcher PCB-Tainers® simplify design and production, provide important cost savings. Tested and certified to retain printed circuit boards under more than 30Gs shock, vibration to 2,000 cps. Available in more than 70 sizes and types from 1½" to 10" long. Permits boards to be mounted on 17/32" centers for maximum density packaging.

**PROVIDES EXCELLENT
ELECTRICAL GROUND
AND THERMAL PATH**

Available from authorized distributors



Send for new catalog—
just off the press

THE BIRTCHEP CORPORATION

INDUSTRIAL DIVISION
745 S. Monterey Pass Rd.

Mailing Address: P. O. Box D, Monterey Park, Calif.
Angelus 8-8584, Area Code 213, TWX 213-266-6814

**TUBE/TRANSISTOR/COMPONENT
RETENTION AND COOLING DEVICES
SEMICONDUCTOR TEST SETS**

ReCap

The latest
technical information on Fansteel
Rectifiers, Capacitors, and Semiconductors

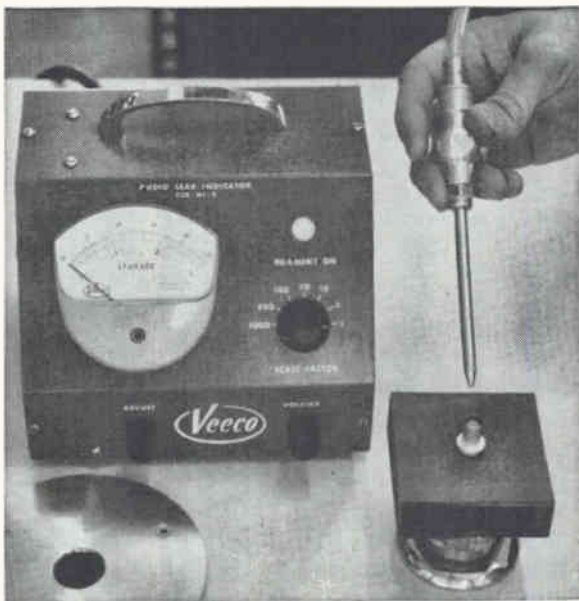

Tests show Fansteel tantalum capacitors ideal for low pressure applications

Leak rate less than 2.8×10^{-10} cc/sec.

Fansteel shoulder type capacitors were recently tested at Fansteel laboratories for seal leak rate with a helium mass spectrometer. Results indicate that these Fansteel capacitors are equivalent in hermetic seal characteristics to glass-to-metal seal encapsulation.

Before testing, randomly selected Fansteel capacitors were prepared by removing the bottom of the case, washing out the electrolyte and drying. The capacitor was then placed over the vacuum aperture of the leak rate tester, creating in effect a positive internal pressure.

While under vacuum, a stream of helium was directed into the opening at the bottom end of the capacitor. Any seal leakage would allow helium to penetrate into the vacuum, causing the mass spectrometer to respond.

The instrument indicated no leakage on the capacitors. In fact, it registered no indication of leakage on the lowest scale multiplier where each scale division of the meter is equivalent to 2.8×10^{-10} cc/second.

These tests show that Fansteel capacitors keep electrolyte in and impurities out, assuring you of highest reliability in performance. See your Fansteel representative for complete details, or write Fansteel direct.

FANSTEEL

METALLURGICAL CORPORATION

RECTIFIER-CAPACITOR DIVISION

North Chicago, Illinois.

Federal. Before that happens, long-distance data transmission for medical diagnosis and consultation will be in wide use. Electrocardiogram transmission (ELECTRONICS, p 20, Jan. 19, 1962) is nearly ready for general use.

American Computer System Will Be Made in Japan

TOKYO—IBM Japan Ltd., a subsidiary of IBM, will make 1440 system computers in Japan. First domestic computers will be finished during first quarter of 1964. IBM says initially it will assemble computers here from U.S. components, but will gradually increase the percentage of Japanese components.

Rental and sales prices of domestic computers will be the same as those of imported computers, but customers will save transportation costs from the U.S. and 15-percent customs duty. IBM expects this to improve its competitive position here.

Units to be made in Japan are the 1441 central computing apparatus, 1442 card reading and punching machine, and 1447 control device. It does not plan to build the 1443 printer and 1311 disk memory in Japan. IBM has until now built only punched card systems here.

Electronic Nurse



HOSPITAL patient-monitoring system developed by ITT Federal Labs can watch over 25 patients, sound alarm if pulse or any of five other parameters reaches dangerous level. First installation is in St. Joseph's Hospital, Denver.

How long have you been looking for component quality ?

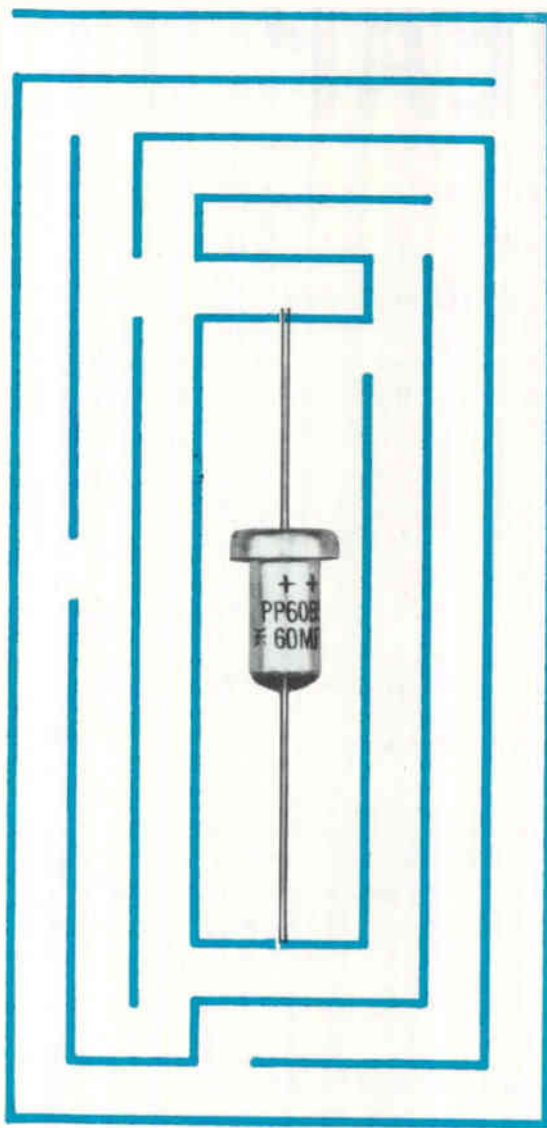

Do you break out in a cold sweat every time a new rocket is tested at the Cape? Do you have the feeling that you're groping your way through a maze of unsubstantiated claims and vague specifications in order to find reliable components? We may be able to offer you ease.

We don't make flashy stuff. Sometimes we're the last manufacturer to introduce a new product. But when our engineers finally get around to releasing something—whether it's technical information, tantalum capacitors, zener diodes, or silicon controlled rectifiers—you can believe it, you can depend on it.

We know what you're going through.

We have the same trouble trying to find suppliers who can make materials to our specifications—who can offer us something more than a hearty handshake and a warm promise.

Fortunately, the metallurgical know-how of Fansteel means that we can depend on the best quality of basic tantalum anodes, leads, and other refractory metal parts that go into our products. All materials, however, whether from Fansteel or other sources, have to meet the standards of our Quality Assurance Center.

We think we have an advantage over other component manufacturers. Our customers agree with us.

FANSTEEL

METALLURGICAL CORPORATION

RECTIFIER-CAPACITOR DIVISION

North Chicago, Illinois.

HOW CHEAP IS "CHEAP"?

"Why should we buy from you when we can get the 'same thing' from other suppliers at a lower price?"

In selecting a supplier of lacing tape (or any component), price and compliance with specifications are not the only criteria. But too often, manufacturers ignore the other factors involved and consequently lose money.

For example, in a \$15,000 piece of equipment there may be only 15 cents worth of Gudebrod lacing tape. It costs \$75 to work this tape. It may be possible to buy the same amount of tape from other suppliers for 2 or 3 cents less . . . it "will meet the specs" according to these suppliers. But one of our customers recently pointed out why he still specifies only Gudebrod lacing tape in such cases.

"We tried buying some cheaper tape that 'met the specs.' Within a few months our production was off by 50% . . . boy, did the production people really scream about that tape. And our labor costs doubled . . . our costing people really flipped!

"Another thing, why should we risk the possible loss of thousands of dollars when the original material cost difference is only a few cents. Once you put cheaper tape on and something goes wrong after the equipment is finished . . . you've had it. No, thank you! We learned our lesson! We buy Gudebrod lacing tape!"

Whether your firm uses one spool of lacing tape or thousands, there are four advantages in specifying Gudebrod for all your lacing requirements:

1. *Gudebrod lacing tape guarantees increased production!*
2. *Gudebrod lacing tape guarantees reduced labor costs!*
3. *Gudebrod lacing tape guarantees minimal maintenance after installation!*
4. *Gudebrod guarantees quality!* On every spool is a lot number and seal which guarantees that all Gudebrod lacing tape is produced under strict quality control. Our standards are more exacting than those required for compliance with Mil-T.

Our Technical Products Data Book explains in detail the complete line of Gudebrod lacing tapes for both civilian and military use. For your copy write to Electronics Division



GUDEBROD BROS. SILK CO., INC.

FOUNDED IN 1870

Electronics Division

12 SOUTH 12th STREET, PHILADELPHIA 7, PENNA.

MEETINGS AHEAD

NATIONAL AEROSPACE ELECTRONICS CONFERENCE, IEEE, AIAA; Biltmore Hotel, Dayton, Ohio, May 13-15.

NATIONAL POWER INSTRUMENTATION SYMPOSIUM, ISA; Bellevue Stratford Hotel, Philadelphia, May 13-15.

NORTHEASTERN DISTRICT MEETING, IEEE; Wentworth By-The-Sea, Portsmouth, N. H., May 20-22.

ELECTRONIC PARTS DISTRIBUTORS SHOW, Electronic Industry Show Corporation; Conrad Hilton Hotel, Chicago, May 20-22.

AMERICAN SOCIETY FOR QUALITY CONTROL ANNUAL CONVENTION; ASQC; Sherman House, Chicago, May 20-22.

MICROWAVE THEORY & TECHNIQUES NATIONAL SYMPOSIUM, IEEE-PTGTT; Miramar Hotel, Santa Monica, Calif., May 20-22.

NATIONAL TELEMETERING CONFERENCE, IEEE, AIAA, ISA; Hilton Hotel, Albuquerque, N. M., May 20-23.

INTERNATIONAL TELEVISION SYMPOSIUM, IEEE, et al; Montreaux, Switzerland, May 20-25.

STANDARDS ENGINEERS SOCIETY SEMINAR—EXHIBIT, SES; Carnegie International Endowment Center, New York City, May 21-22.

SPRING JOINT COMPUTER CONFERENCE, IEEE and ACM; Cobo Hall, Detroit, Mich., May 21-23.

PRODUCT ENGINEERING & PRODUCTION NATIONAL CONFERENCE, IEEE-PTGPEP; Continental Hotel, Cambridge, Mass., May 27-28.

IMPACT OF MICROELECTRONICS CONFERENCE, Armour Research Foundation and ELECTRONICS Magazine; Illinois Institute of Technology, Chicago, Ill., June 26-27.

WESTERN ELECTRONIC SHOW AND CONFERENCE, WEMA, IEEE; Cow Palace, San Francisco, Calif., Aug. 20-23.

ADVANCE REPORT

FALL JOINT COMPUTER CONFERENCE, AFIP (IEEE and ACM); Las Vegas Convention Center, Las Vegas, Nev., Nov. 12-14. June 3 is deadline for submitting a 300-word abstract and a complete manuscript in triplicate to: Paul M. Davies, Technical Program Chairman, Abacus Inc., 1718 21st Street, Santa Monica, Calif. Papers in following areas, and emphasizing new developments which promise to have great impact on the computer field, are of interest: novel computer organizations; information retrieval; computer memories; computer devices; modern trends in programming; analog computers; hybrid systems. Papers cannot have been given at other national conferences.

COM



PARE!

Measure microvolt signals accurately... in the presence of high common mode noise!

The bench-proved and system-proved DY-2401A Integrating Digital Voltmeter from Dymec is today's most accurate instrument of its kind for measuring low-level signals in the presence of high common mode noise. It's today's best digital voltmeter buy!

Ten volts of common mode noise on the signal results in a mere one microvolt error. No other digital voltmeter can match that performance. Dymec accomplishes this remarkable performance in the DY-2401A with two techniques: Guarding of the entire measuring circuit, which physically breaks the ground loop currents that circulate in systems with more than one ground; and true averaging of the signal over the sample period, which solves the problem of noise superimposed on the signal. Averaging alone provides virtually infinite rejection of 60 cps and 400 cps noise. The DY-2401A is not dependent on passive input filtering responsible for slower measuring speed.

Low-level measurement . . . High sensitivity of the DY-2401A, even in the presence of noise, offers a 5-digit range of 100 mv full scale. Add the DY-2411A Guarded Data Amplifier and you have an unequalled ± 10 mv full scale 5-digit range. Compare this with any other digital voltmeter . . . and consider your applications in measuring the outputs of thermocouples, strain gage bridge transducers or other millivolt level dc voltages.

with overranging to 30 millivolts and constant 10,000 megohm input resistance. It preserves the guarded measurement features of the 2401A, providing 134 db effective CMR. Gain settings of +1, +10 and bypass are programmed by simple ground closures, with no effect on common mode rejection.

DY-2410A AC/Ohms Converter . . . provides floated and guarded broadband ac voltage and resistance measurements, with full programmability. AC measurements 50 cps to 100 kc, five ranges including 0.1 v rms full scale, 300% overranging on four most sensitive ranges, 110 db common mode rejection at 60 cps when used with the 2401A. Resistance measurement, 100 ohms to 10 megohms full scale in six ranges, with 300% overranging.*

COMPARE: DY-2401A, \$3950
DY-2411A, \$1150
DY-2410A, \$2250*

Data subject to change without notice. Prices f.o.b. factory.

* Available also in ac-only, ohms-only models.

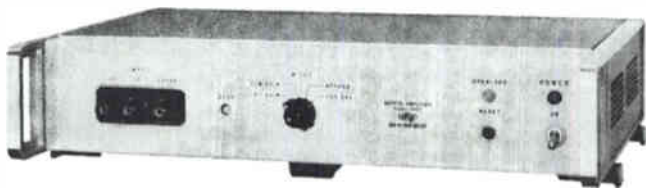

For 10 mv full scale sensitivity DY-2411A Guarded Data Amplifier adds the ± 10 mv full scale 5-digit range to the DY-2401A Voltmeter,

DYMEC

A Division of Hewlett-Packard Company



Help yourself

You have probably become conditioned to sacrificing one feature to gain another in your selection of micro-miniature connectors. The part that's small enough may be relatively unreliable or nearly impossible to work with. Often you must choose between size, electrical characteristics, or performance reliability.

Not so with the Amphenol Wire-Form Group.

NO COMPROMISE

The Wire-Form Contact is an interconnection device that combines small size with easy handling in assembly . . . high reliability with low cost. Most important of all, though, is the application versatility of the Wire-Form.

The Wire-Form Group conforms effortlessly to your packaging requirements, whatever they may be. From single contacts on component leads through Strip Connectors or Tiny Tim[®] Connectors on modules to Micro-Rac[®] or Mighty-Mite[®] Connectors for system input-output lines . . . the Wire-Form family can provide the best answer to your design needs. No more "round hole-square peg" problems!

FOR EXAMPLE

The Wire-Form Contact is extremely small, permitting high-density packaging. Depending on the connector insert used, you can have contact centers on 0.100", 0.085", or even down to 0.075". Yet connectors are easy to assemble . . . because you terminate *before* contacts are inserted, while there's still room to maneuver. Later, if you want to change circuitry or replace a component, contacts can be removed, repositioned, or replaced without discarding the connector.

Wire-Form Contacts can be termi-

nated by crimping, soldering, welding, or wire-wrapping. For single-contact terminations we have eyelet type female contacts that can be potted in modules or soldered into circuit boards.

PRICED RIGHT

The Wire-Form family will help keep costs down. High volume manufacturing methods let Amphenol market Wire-Forms at unusually low purchase prices. For example, our circular Wire-Form Connector (the Mighty-Mite) meets or exceeds the performance characteristics of other micro-miniature connectors selling for ten times its price. But initial cost is only half the battle . . . What about installed cost? Well, it's rock-bottom too. The Poke-Home feature means that most all of the assembly can be done out in the open, with plenty of room, and no fiddling with tweezers or magnifying glass. In short, it can be done quickly. And quickly means inexpensively, as labor costs go.

Wire-Forms give top reliability. Equalized, multi-point contact pressure results in exceptionally stable and low contact resistance. Contact resistance

varies less than half a milliohm through a thousand cycles of engagement-disengagement. (See chart below.)

FAMILY PLAN

One of the more important things to remember about the Wire-Form Group is the way it works as a team. No matter what kind of challenge comes up, at least one member of the Wire-Form team can handle it. This means you only need to stock one basic component, the Wire-Form Contact, to meet virtually all your micro-miniature connection needs. The savings in inventory investment, in stock control, and in uniform manufacturing methods can be substantial.

FACTS AND FIGURES

The new 24-page catalog on Amphenol Micro-Miniature Connectors (Catalog MM-1) has the facts, figures, drawings, and detailed performance characteristics you'll need to "help yourself." You can get a copy by contacting your local Amphenol Sales Engineer or by writing to Dick Hall, Vice President, Marketing, Amphenol Connector Division, 1830 S. 54th Avenue, Chicago 50, Illinois.

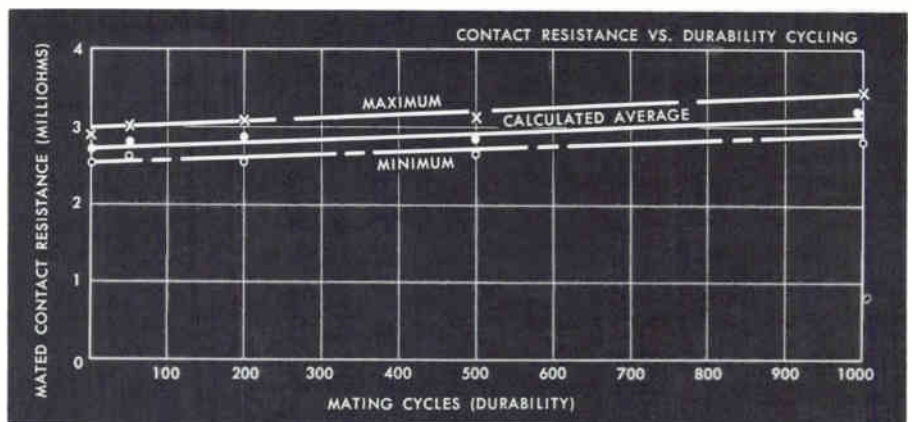

Tested male contacts were Amphenol cat. number 22-692, formed from gold-clad, nickel-interlined beryllium copper wire. The females (cat. number 220-502 short) are copper bodies with electroless gold over nickel plating. Each pair was subjected to 1000 mating cycles.



Connector Division / Amphenol-Borg Electronics Corporation



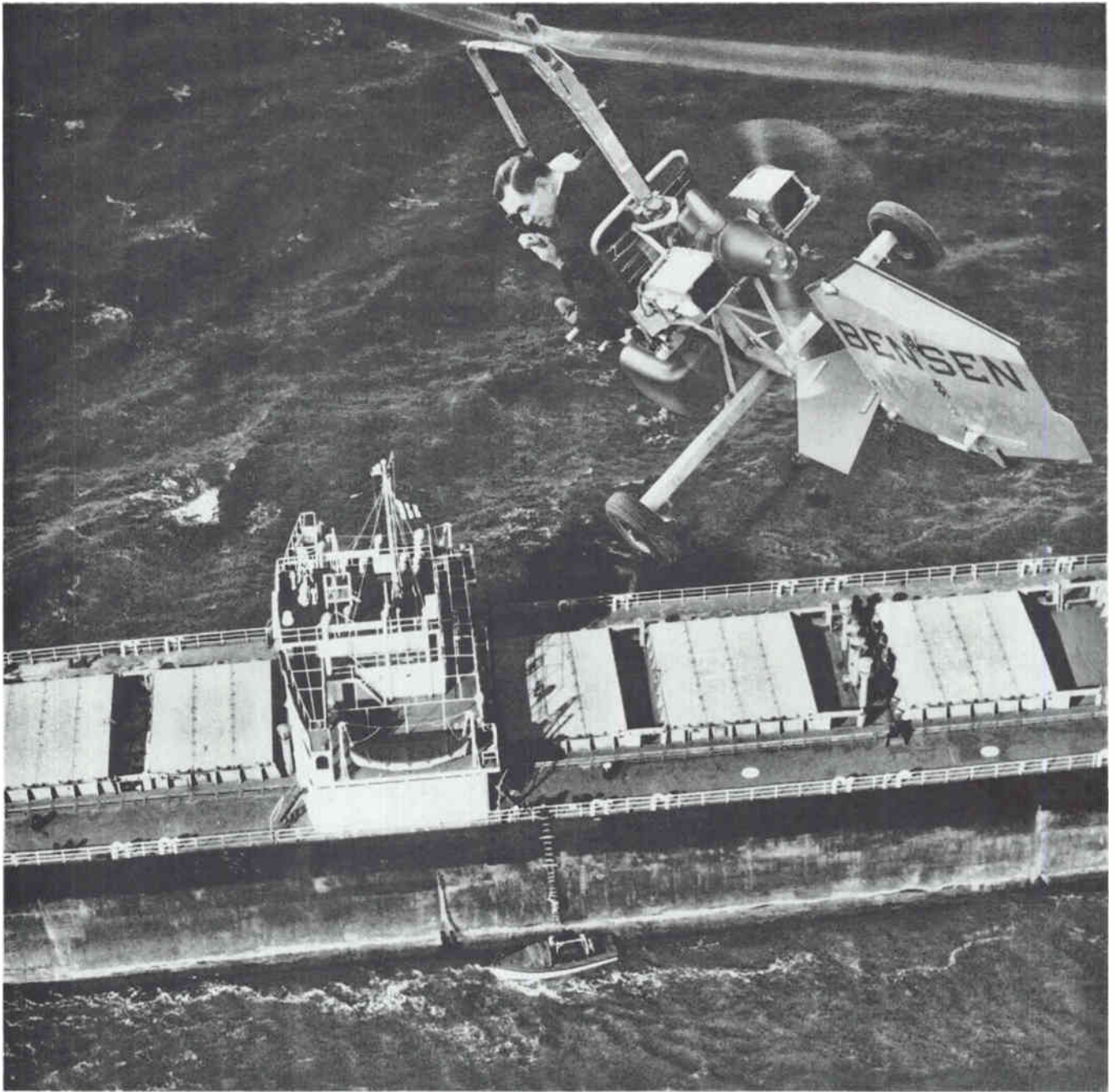

Single Place Gyrocopter by Bensen Aircraft Corp.

From industry's viewpoint,
the Common Market is
uncommonly close to
Virginia's Hampton Roads.

Is yours a port-oriented industry with an eye on Europe's Common Market? Then from your viewpoint, the Virginia industrial area around Hampton Roads rates top consideration.

It offers Southern production savings that can help make your product competitive abroad. The harbor has an outstanding record of freedom from natural or human tie-ups. And the hundred ship lines serving it offer frequent sailings to and from Common Market ports.

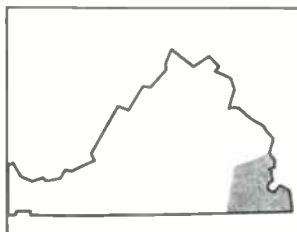

Ask VEPCO for available plant site data and economic studies on the pleasant, hospitable communities in this key port-industrial area. Write, wire or phone, in complete confidence, without cost or obligation.

VIRGINIA ELECTRIC and POWER COMPANY 
J. Randolph Perrow, Manager—Area Development
Electric Building, Richmond 9, Virginia • Milton 9-1411
Serving the Top-of-the-South with 2,540,000 kilowatts—due to reach 3,500,000 kilowatts by 1965.

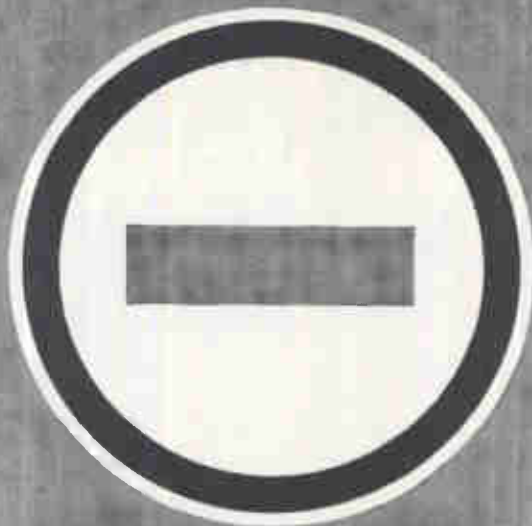

THIS \$9,000 CRT

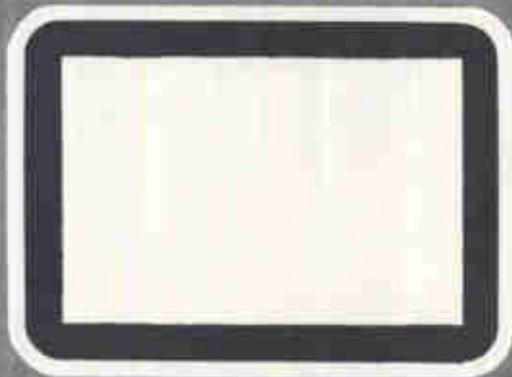

MAKES THIS \$15 CRT BETTER

ETC MAKES BOTH...AND MOST OF THE IN-BETWEENS



ETC fiber optics CTR—available in 1" to 6" dia., resolutions of 1,000 by 1,000 dots per inch.

You'll see more display per dollar in every ETC industrial or military Cathode Ray Tube. That's because the same know-how, precision, and process controls that go into an ETC ten-gun CRT show us how to make a single-gun tube more precise. Other ETC CRT innovations, such as fiber optics, transparent phosphor multicolor, and extremely high-resolution, also contribute to the overall quality of even the lowest-price CRT. ETC Cathode Ray Tubes have in common some uncommonly high quality standards. Variations lie only in application features.

Consult ETC for both your common and custom CRT requirements. For specific application assistance, or facts on standardized types, write ETC, Dept. E51063.



GENERAL ATRONICS

ELECTRONIC TUBE AND INSTRUMENT DIVISION, PHILA. 18, PA.

CATHODE RAY TUBES • OSCILLOSCOPES • OSCILLOSCOPE RECORDING CAMERAS
CIRCLE 37 ON READER SERVICE CARD

SWEEP DELAY AND PLUG-IN VERSATILITY

with a new Tektronix dual-beam oscilloscope

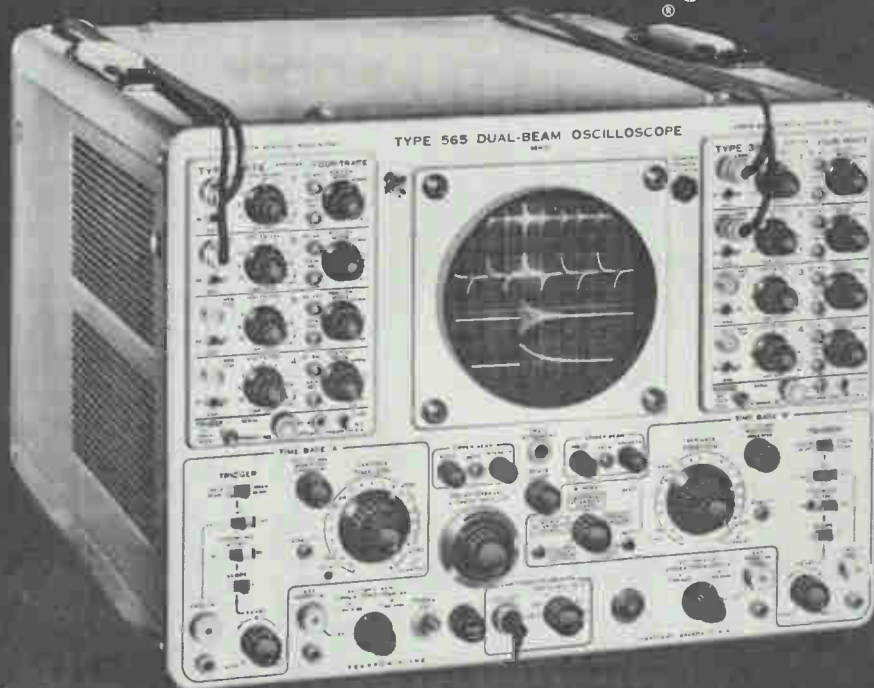

- 2 Completely Independent Beams
- 2 Vertical Amplifier Compartments
- 2 Identical Independent Sweep Systems
- Single-Sweep Operation
- Rear-Panel Output Connectors
- Cabinet Model or Rack-Mount Model

The waveform display represents four time-related functions—two trace-intensified by use of delayed sweep and two expanded presentations of these intensified portions.

Four additional traces are available from this oscilloscope/plug-in combination.

Sweep-delay characteristics include delay interval range of 1 μ sec to 50 sec, calibrated and continuously adjustable—with 0.5% incremental accuracy and wide-range, jitter-free magnification.

Cabinet Model, illustrated.

Dimensions—13 $\frac{1}{2}$ " high, 17" wide, 23 $\frac{3}{8}$ " deep. Weight—62 pounds.
TYPE 565 OSCILLOSCOPE (without plug-ins) \$1400

Rack-Mount Model

(Mounts on tilt-lock, slide-out tracks to standard 19" rack.)
Dimensions—12 $\frac{1}{4}$ " high, 19" wide, 22" deep. Weight—67 pounds.
TYPE RM565 OSCILLOSCOPE (without plug-ins) \$1500

U. S. Sales Price®, f.o.b. Beaverton, Oregon

AMPLIFIER PLUG-IN UNITS

TYPE	PASSBAND (3-db down)	SENSITIVITY	PRICE
2A60	dc—1 Mc.	50 mv/cm—50 v/cm 4 decade steps with variable control	\$105
2A61 Low Level Differential	.06 cps—300 kc.	10 μ v/cm—20 mv/cm 1-2-5 sequence with variable control.	\$385
2A63—Differential (50:1 rejection ratio)	dc—300 kc.	1 mv/cm—20 v/cm 1-2-5 sequence with variable control	\$130
3A1—Dual Trace (Identical Channels)	dc—10 Mc. (each channel) 6-cm linear scan.	10 mv/cm—10 v/cm 1-2-5 sequence with variable control.	\$410
3A72—Dual Trace (Identical Channels)	dc—650 kc. (each channel)	10 mv/cm—20 v/cm 1-2-5 sequence with variable control.	\$250
3A74—Four Trace (Identical Channels)	dc—2 Mc. (each channel)	20 mv/cm—10 v/cm 1-2-5 sequence with variable control.	\$550
3A75	dc—4 Mc.	50 mv/cm—20 v/cm 1-2-5 sequence with variable control.	\$175

**FOR A DEMONSTRATION—PLEASE CALL YOUR
TEKTRONIX FIELD ENGINEER.**

Tektronix, Inc. / P. O. BOX 500 • BEAVERTON, OREGON / (Area Code 503) Mitchell 4-0161 • TWX: 503-291-6805 •
Telex: 036-691 • Cable: TEKTRONIX • OVERSEAS DISTRIBUTORS IN 27 COUNTRIES

Tektronix Field Offices are located in principal cities throughout the United States. Please consult your Telephone Directory.

Tektronix Canada Ltd: Montreal, Quebec • Toronto (Willowdale) Ontario • Tektronix Ltd., Guernsey, Channel Islands

BETTER SUPERHETS FOR SIDE BAND RECEPTION

Strict design criteria and new circuits for single-sideband receivers are improving high-frequency communications

By **W. BRUENE**
E. SCHOENIKE
Collins Radio Co.,
E. PAPPENFUS
Granger Associates

SUPERHET RECEIVERS for single sideband reception must meet stricter performance criteria than conventional a-m receivers. Oscillator stability must be higher, because of the necessity of keeping the ssb signal in the proper relation to the reinserted carrier. Errors of more than 100 cps are seldom tolerable.

The lack of carrier in a ssb signal places a different light on agc circuit design. Fast attack—slow release circuits are required to handle small to large signal levels with minimum distortion and thumping.

Use of concentrated-selectivity, sharp-skirt filters in the i-f amplifiers of ssb receivers results in a substantial reduction of unwanted adjacent channel spillover and noise, and helps reduce splatter from strong signals in the proximity of the desired receiver pass-band.

Product detectors are designed for lower distortion and a wider dynamic range than conventional a-m diode detectors with bfo injection.

SENSITIVITY—The first stage in the front-end of a superhet re-

TWO of the authors, Edgar Schoenike (left) and Warren Bruene, discuss a new SSB receiver

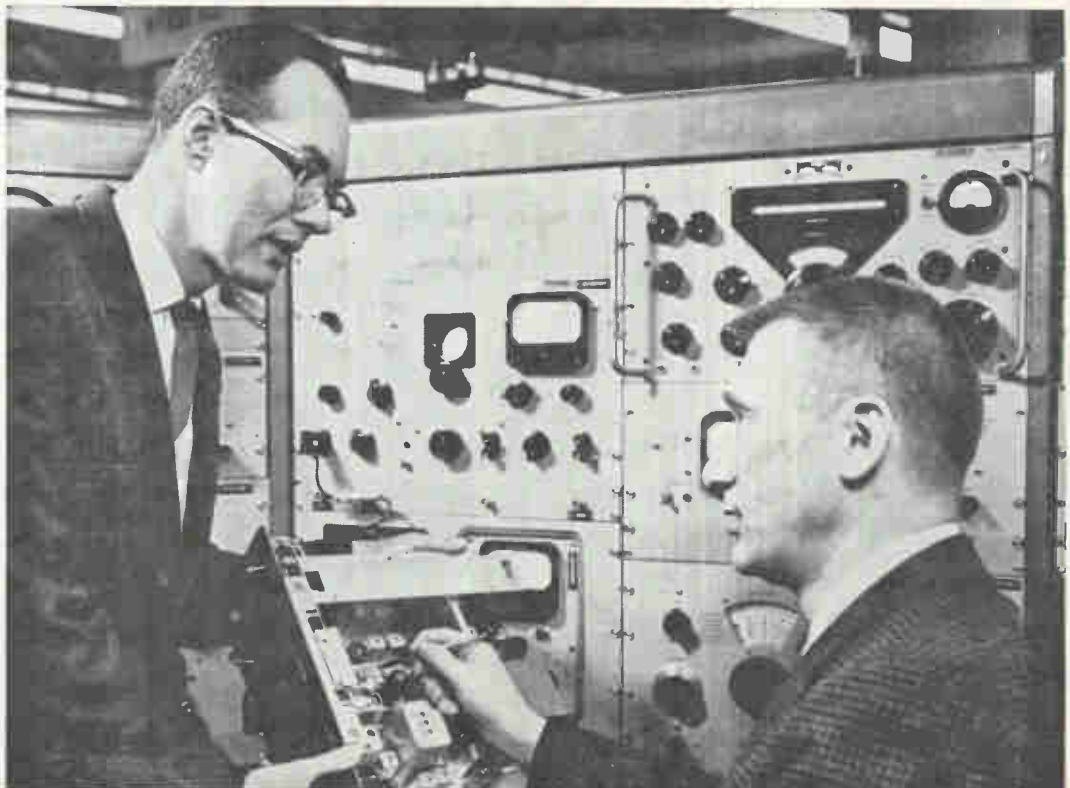

ceiver requires careful design attention. Here, the small signals from the antenna are amplified to a level sufficient to drive a second r-f amplifier or first mixer. Since the first stage deals with small signals, it must be designed for low-noise operation. At the same time, it must be insensitive to strong adjacent-channel signals that can result in cross-modulation and blocking. The first r-f amplifier has a limited selectivity as compared to later stages in the superhet and cannot discriminate as widely against undesired signals.

As the signal level at the receiver input decreases, internally generated noise tends to mask it. These noise sources include thermal agitation (Johnson) noise and shot-effect noise. External noise sources, while limiting achievable sensitivity, cannot be controlled by receiver design. However, at frequencies below 30 MC, this external noise often places a practical limit on r-f amplifier performance and permits the design engineer to concentrate on other important considerations.

Typical values of noise resistance for the first r-f amplifier stage of a receiver are shown in Fig. 1A. Here, R_a is the transformed resistance of the antenna, R is the tuned circuit QX_1 , R_e is the electronic input resistance and R_{eq} is the equivalent shot-noise resistance referred to the grid circuit. This figure illustrates the method of solution for the noise-voltage problem in a receiver input-stage operating at 30 Mc. The total rms noise-voltage between cathode and grid is $0.57 \mu\text{v}$. To reduce calculation, the graph of Fig. 2 may be used to find the noise-voltage for any value of resistance, and for various bandwidths, assuming operation at room temperature. In Fig. 1A, a cw signal voltage of $4.1 \mu\text{v}$ (referred to an impedance level of 5,000 ohms) is required to produce a 10-db signal-to-noise ratio.

NOISE FACTOR—Noise voltage is proportional to the square root of resistance and bandwidth; thus a wide-band or high-input impedance receiver requires a larger c-w input signal level for a given signal-to-

noise ratio, than a narrow-band or low-input impedance device.

Thus it is impossible to compare weak-signal reception capabilities of receiver quality, without specifying input-impedance and bandwidth, as well as required signal. To establish a figure of merit for receiver sensitivity, a ratio is defined that is independent of input impedance and bandwidth, called noise factor^{1, 2}. Noise factor is a measure of the degradation of signal-to-noise ratio of a received signal as it is processed by the receiver, and is expressed by noise factor = $(s/n \text{ at input}) / (s/n \text{ at output})$; s/n is expressed as a power ratio, or since both signal and noise operate into the same resistance, as the squared voltage ratio. A perfect receiver, considering only sensitivity, is one that adds no noise to the signal, but preserves the s/n ratio available at the antenna. In a perfect receiver, the noise factor is equal to 1, or 0 db. In the example of Fig. 1, the noise factor is $[(4.1/.5) / (1.82/0.57)]^2 = 6.9$ or 8.4 db.

When the noise factor of two stages is known, the overall factor can be found $NF = NF_1 + (NF_2 - 1)/G_1$, where NF_1 is the noise factor of the first stage, NF_2 is that of the second, and G_1 is the available power gain of the first stage.

NEW LOOK FOR AN OLD STANDBY

The superhet circuit has been around for many a year, and has provided a strong foundation for communications receiver design. However, for single-sideband reception, design parameters are stricter. The old standby has to meet new specifications of stability, i-f bandwidth, noise figure and physical characteristics.

This discussion is based on a forthcoming book "Single Sideband Principles and Circuits," by W. Bruene, E. Schoenike, Collins Radio Co., and E. Pappenfus, Granger Associates to be published by the McGraw-Hill Book Co.

BLOCKING AND CROSS-MODULATION — When a receiver is tuned to a weak signal, with a strong signal close to the same frequency, an apparent decrease in receiver gain may be encountered. This loss of gain and consequent reduction of desired signal is called blocking. It commonly occurs when the voltage from the unwanted signal is just sufficient to exceed bias and drive a mixer or amplifier into the positive-voltage region. Rectified grid current may be coupled back into the automatic gain control loop, to reduce receiver gain. Even when no coupling exists between the conducting grid and the age circuit, the conducting grid drives the mixer or amplifier into a condition under which gain is reduced and distortion is increased.

Another effect produced by a strong signal close to the receiver frequency, is cross-modulation. Here, the modulation of the unwanted signal is transferred to the

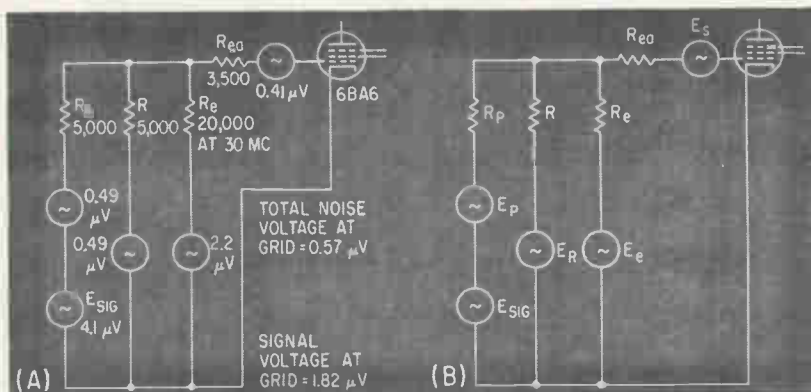

TYPICAL values of noise resistance for a 6BA6 r-f stage; E_{sig} is the value needed for a 10 db s/n ratio in a 3-Kc bandwidth (A) and equivalent circuit for noise sources in a vacuum-tube mixer (B)—Fig. 1

desired signal. Both undesired conditions are controlled by receiver selectivity, especially in the early stages. Lack of selectivity allows an undesired signal to pass through the front-end circuits without sufficient attenuation, driving an amplifier or mixer into a nonlinear region. Figure 2 illustrates the progressive selecting action that takes place in the first tuned circuits of a receiver. Curves represent the accumulated signal level and off-frequency response of the receiver. At point (1), the same amplitude signal is applied to the first r-f amplifier and the first mixer. At point (2), the same amplitude signal is applied to the first and second mixer and at point (3), the first r-f amplifier and second mixer have the same amplitude signal applied. The amplification from antenna input to second mixer grid is given at each stage in the simplified receiver schematic of Fig. 2. From the composite selectivity curves of Fig. 2, the effects of strong signal amplitude versus frequency difference can be analyzed. With strong interfering signals, the first r-f amplifier overloads at a large frequency difference. At some lower level and small frequency difference, the second stage overloads, and at a still smaller level and reduced frequency difference, the second mixer overloads. The plot of frequency versus undesired signal amplitude for a chosen degree of cross-modulation is shown in Fig. 3. With a knowledge of

cross-modulation characteristics and stage-by-stage gain and selectivity, it would be possible to calculate the cross-modulation curve of Fig. 3. However, it is common to use laboratory measurement because the data is more easily obtained in this manner. Blocking curves are similar to cross-modulation curves, but generally occur at slightly greater values of undesired signal amplitude. Undesired effects of cross-modulation and blocking can be minimized by optimum selection of amplifier and mixer type, and by choice of signal level and operating voltages. Cross-modulation is substantially independent of desired signal level, assuming no overload, if the d-c operating conditions of the stage remain unchanged. In general, the application of agc not only changes the d-c operating point, but also reduces the gain. This provides better protection to all stages beyond the first agc controlled stage and considerably improves the cross-modulation near resonance.

CHOOSING AN R-F AMPLIFIER

—Low receiver-noise factor is opposed to optimum cross-modulation performance in the first r-f stage. Remote cut-off tubes are advantageous for reducing cross-modulation with strong out-of-band signals particularly with agc voltage applied, but for best noise factor, the sharp cutoff tubes seem, as a class, to be superior.

Probably the best characteristic

to use in selecting a tube or transistor for r-f amplifier use, is dynamic range, defined as the ratio of the signal input for a certain distortion level, to the input for a certain signal-to-noise plus noise ratio.

Radio-frequency distortion is generally of two types, cross-modulation and intermodulation distortion. For test purposes, intermodulation distortion is measured with a two-tone signal whose frequencies differ by perhaps 500 cps to 1 Kc. Odd order curvature in the tube or transistor transfer characteristic produces additional tones, spaced at intervals from each of the two test tones equal to the frequency difference between them.

The dynamic range of a tube is a function of its grid bias. If agc voltage is applied, the dynamic range of greatest interest with respect to intermodulation distortion is the ratio of input for a specified distortion level with the bias at its maximum agc voltage, to the input for a specified $(s+n)/n$ ratio without agc. A typical curve of grid-input voltage against gain control for a remote-cutoff tube is shown in Fig. 4. When used as a receiver r-f amplifier, the point where the gain has been reduced by a specified number of db from its normal bias value is the point of maximum intermodulation (IM) distortion, since the input to the r-f amplifier increases much faster than the input dynamic range, with increasing agc.

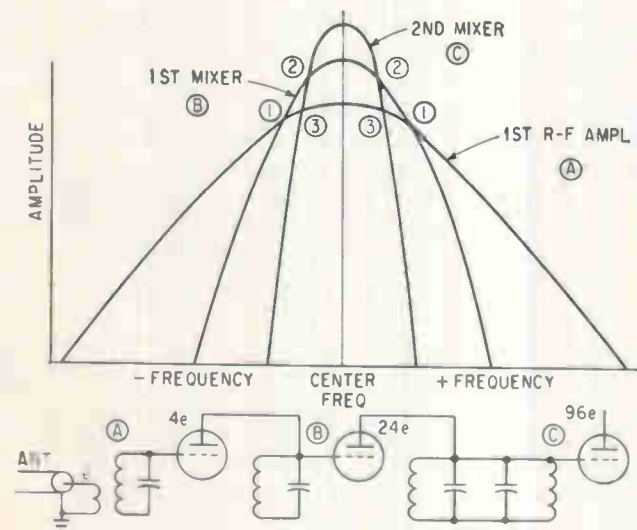

FRONT-END receiver selectivity curves considering stage-by-stage amplification—Fig. 2

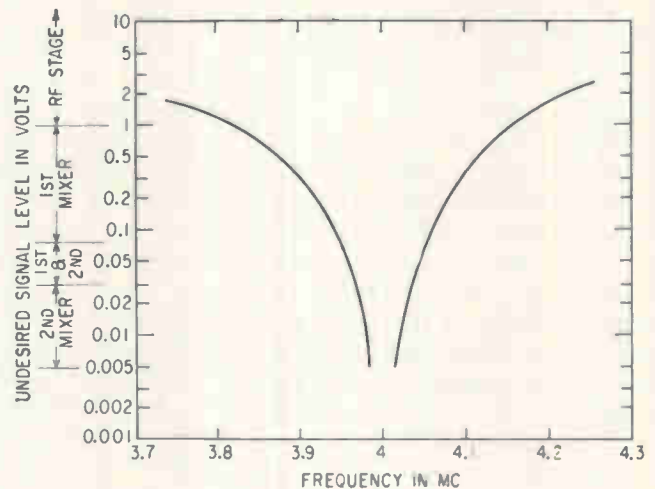

CROSS MODULATION characteristics of a double conversion receiver showing stage contributions at various levels of undesired signal—Fig. 3

For cross-modulation (CM) the dynamic range is defined in a slightly different manner. Here, it is the ratio of the minimum input for a specified distortion-level over the entire agc range, to the input for a certain $(s + n)/n$ ratio without agc voltage. In this case, the distortion is produced by a signal outside the passband and maximum cross-modulation distortion occurs at a grid-bias level where the distortion-gain curve reaches its lowest level over the agc range. The point of maximum cross-modulation for a typical tube is also shown in Fig. 4.

Table I shows the dynamic range of some receiver r-f amplifier tubes. The lower limit for dynamic range is the signal required for 10 db $(s + n)/n$ in a 3-kc band without agc. The upper limit is the signal level (per tone) for 40 db third-order IM distortion. Since the IM dynamic range is dependent upon the amount of gain control, the data for all tubes is given for a 30-db gain reduction. Specifying the cross-modulation dynamic range in terms of IM distortion is not quantitatively correct, but the relative comparison among tubes is valid.

At present, transistors have a dynamic range that is 20 to 40 db less than vacuum tubes. Application of agc to transistors reduces their dynamic range still further; however, field-effect transistors show some promise of increased dynamic-range.

MIXERS—In an ssb receiver, mixers have five characteristics that are important: (1) signal-to-noise ratio; (2) gain; (3) intermodulation; (4) cross-modulation; and (5) crossovers or birdies (spurious outputs).

Receiver mixers have only one or two r-f stages preceding them. Under weak signal conditions, only a small signal voltage is applied to the mixer input, typically between 5 and 100 μv . Because this signal level is so small, it is important to secure the lowest possible noise level. Table II shows typical gain, sensitivity and distortion data for triode, pentode and pentagrid mixers. The gain column in Table II shows the increase in signal amplitude from mixer input to output at the i-f frequency. The minimum signal shown is that at which a 10

db signal-to-noise ratio exists. At the other end of the signal-amplitude scale, the maximum signal is given as that at which a 40 db signal-to-intermodulation ratio occurs.

Triodes may be expected to produce low-noise mixers. This is demonstrated by the performance of the 12AT7, where only 4.1 μv of signal is required in a 3-Kc bandwidth, to give a 10-db signal-to-noise ratio.

Signal-to-noise ratio in an improperly designed receiver may be determined by the magnitude of mixer noise when a weak input signal is present. By selection of mixer circuit and r-f amplifier gain, reduction of receiver sensitivity due to mixer noise can be avoided. Multigrid mixers are prolific sources of fluctuation noise, with a high noise output. Mixer noise sources are similar to those present in an amplifier as shown in the equivalent circuit of Fig. 1B. The preceding amplifier-plate resistance is represented by R_p , thermal noise resistance due to the interstage network by R and electronic input resistance by R_i . The equivalent shot-noise resistance of a mixer can be found from $R_{eq} = 4/g_c$ or approximately $15/g_m$ for a triode mixer; $I_b(2.5/g_c + 19 I_{cs}/g_c^2)/I_b + I_{cs}$ for a pentode mixer; and $R_{eq} = (20I_b(I_c - I_b))/I_k g_c^2$ for a pentagrid mixer, where g_c = conversion transconductance, I_b = average plate current in amperes, I_{cs} = average screen current in amperes, I_k = average cathode current in amperes and g_m = peak value of transconductance over the oscillator cycle in mhos.

The sum of the local injection oscillator and the input signal frequency or the difference between these two r-f frequencies is the desired output product from a receiver mixer. Ordinarily, the difference frequency product is used in a receiver mixer, because it is more convenient to beat the signal down to a lower variable or fixed intermediate frequency. Any other combination of desired or undesired signals, or combination of signal and oscillator multiplies that result in the i-f frequency, are mixer-spurious responses, also referred to as crossovers or birdies. Low order (fifth or below) crossover frequencies are serious if they fall within the receiver r-f passband, even

though the crossover itself may not fall within the i-f passband. The frequency scheme for a receiver can be analyzed with the aid of Fig. 5, and Tables III and IV, which list the spurious crossovers which exist for both sum and difference mixing. To use Fig. 5, plot the signal bands versus oscillator frequencies on the chart. Where these lines intersect the lines of the chart a spurious crossover occurs. Tables III and IV show the nature of the crossover. As an example, assume a signal at 4 Mc is mixed with a 6 Mc oscillator to produce a 2 Mc i-f. This point intersects the 2:3 ratio line of Fig. 5. Reference to Table IV shows that a third and seventh-order spurious crossover exists.

I-F AMPLIFIERS—The i-f amplifier of a superhet ssb receiver provides the bulk of receiver amplification, selectivity and gain control. In addition to these functions, the i-f amplifier usually furnishes agc voltages.

The gain of an i-f amplifier for ssb usually lies between 60 and 100 db. In conventional i-f amplifier design, selectivity is distributed, that is, instead of being provided for in one filter, it is obtained by a number of single or double-tuned circuits isolated by tubes or transistors. The overall selectivity characteristic is then the resultant of all the individual stages. If the selectivity curve of each stage is plotted in db versus frequency, the overall selectivity curve is obtained by adding the attenuation of each of the contributing stages at each frequency. By a combination of tuned circuits, it is possible to design an overall selectivity curve having a flat response in the passband.

A second type of i-f amplifier utilizes concentrated selectivity. This type obtains most of its selectivity from a single filter, often placed at the input of the i-f. This type provides the receiver selectivity ahead of the i-f amplifier and all the i-f stages are protected against strong off-resonance signals. The only signals they have to contend with are those in the receiver passband. Thus the i-f no longer is subject to blocking and cross-modulation. Since interstage coupling is not required to furnish selectivity, simpler coup-

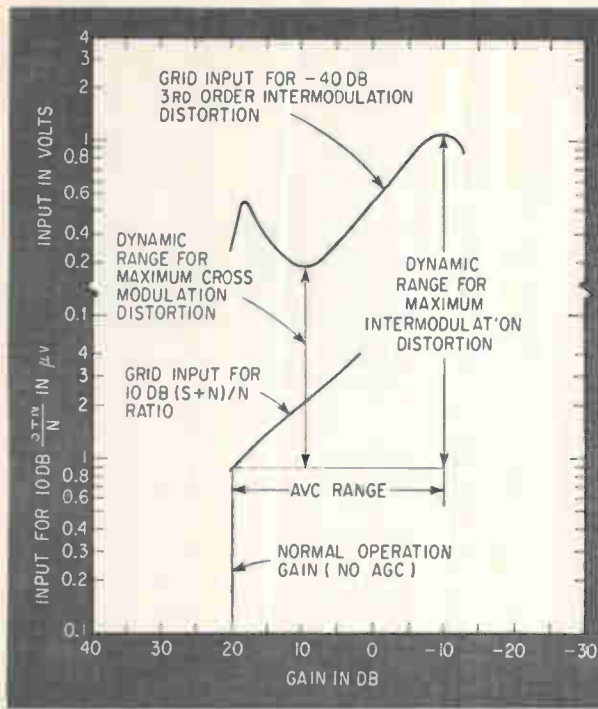

DYNAMIC range of r-f amplifiers for cross-modulation and intermodulation distortion—Fig. 4

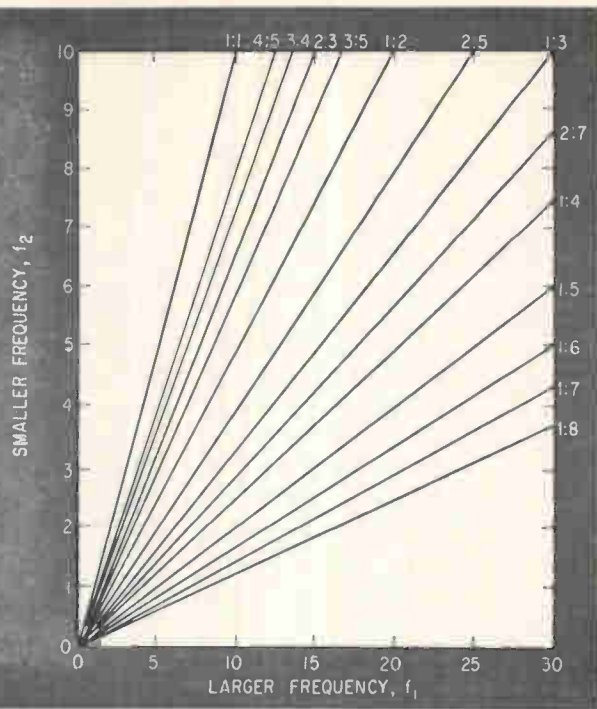

MIXER spurious products must be carefully considered in an ssb receiver—Fig. 5

TABLE I—DYNAMIC RANGE OF RECEIVER R-F AMPLIFIER TUBES

Tube Type	IM Dynamic Range	CM Dynamic Range
6BA6 Pentode.....	124 db	112 db
6BZ6 Pentode.....	122 db	108 db
5899 Pentode.....	117 db	116 db
6BZ8 Cascode.....	118 db	112 db
6ES8 Cascode.....	118 db	114 db
6306 Cascode.....	132 db	114 db

TABLE II—GAIN, SENSITIVITY & DISTORTION OF MIXERS

Tube Type	Gain	Min. Signal	Max. Signal
1/2 12AU7 Low Mu triode.....	3	9.0 uv	2.1 v
1/2 12AT7 High Mu triode.....	14	4.1 uv	.7 v
6AU6 Pentode.....	16	8.0	.36 v
6BA7 Pentagrid.....	8	20.0	.41 v
6BE6 Pentagrid.....	4.5	22.0	.44 v

TABLE III—SPURIOUS CROSSOVERS FOR MIXING ($f_1 + f_2$)

$f_2:f_1$	Table III—Spurious Crossovers
1:1	$2f_1, 2f_2, 3f_1-1f_2, 3f_2-1f_1, 4f_1-2f_2, 4f_2-2f_1, 5f_1-3f_2, 5f_2-3f_1$
4:5	$5f_1-4f_2, 6f_2-3f_1$
3:4	$4f_1-3f_2, 5f_2-2f_1$
2:3	$3f_1-2f_2, 4f_2-1f_1$
3:5	$4f_1-4f_2, 6f_2-2f_1$
1:2	$2f_1-1f_2, 3f_2, 3f_1-3f_2, 5f_2-1f_1, 4f_1-5f_2, 7f_2-2f_1$
2:5	$3f_1-4f_2, 5f_2-1f_1$
1:3	$2f_1-2f_2, 4f_2, 3f_1-5f_2, 7f_2-1f_1$
2:7	$3f_1-6f_2, 8f_2-1f_1$
1:4	$2f_1-3f_2, 5f_2$
1:5	$2f_1-4f_2, 6f_2$
1:6	$2f_1-5f_2, 7f_2$
1:7	$2f_1-6f_2, 8f_2$
1:8	$2f_1-7f_2, 9f_2$

TABLE IV—SPURIOUS CROSSOVERS FOR MIXING ($f_1 - f_2$)

$f_2:f_1$	Spurious Crossovers
4:5	$4f_1-2f_2$
3:4	$3f_2-2f_1$
2:8	$2f_2-1f_1, 3f_1-4f_2$
3:5	$4f_2-2f_1$
1:2	$1f_2, 3f_2-1f_1, 2f_1-3f_2, 5f_2-2f_1$
2:5	$4f_2-1f_1$
1:3	$2f_2, 2f_1-4f_2, 5f_2-1f_1$
2:7	$6f_2-1f_1$
1:4	$3f_2, 2f_1-5f_2$
1:5	$4f_2$
1:6	$5f_2$
1:7	$6f_2$
1:8	$7f_2$

ling circuits may be employed.

Although some tubes and transistors can provide up to 40 db control of gain without excessive r-f distortion, there are considerable variations in gain-control characteristics among each type, and it is preferable to operate each stage with no more than 20 to 30 db of control. With tubes capable of 40-db control, however, three

controlled stages would be sufficient to give 120 db of agc range. This corresponds to control of inputs from 1 μ v to 1 v, which is usually sufficient. With 30 db per stage, four stages are required, and for 20 db per stage, six stages are necessary to give a 120-db range.

SELECTIVITY—The required receiver selectivity is determined

by the width of the ssb signal plus whatever allowance for frequency instability may be desirable. With modern high stability continuously-tuned receivers, oscillator drift seldom exceeds several hundred cycles and little or no increase in bandwidth is needed. For ssb voice, the i-f nose bandwidth usually lies between 2 and 3.5 Kc. If the receiver is to be used exclusively with a

companion transmitter, it is desirable to use the same bandwidth for both; 2.5 to 3 Kc is perhaps optimum for voice. A general-purpose receiver may sacrifice some of the higher audio frequencies to reduce noise and interference, and may use an i-f passband as narrow as 2 Kc. Intermediate-frequency shape factors (6 to 60 db) are commonly in the range 1.5 to 3. The closer the shape factor to unity, the better the adjacent channel selectivity. However, for certain types of data transmission, linear phase response is important, and this precludes the use of ordinary minimum-phase filters that have a rapid transition from passband to stopband, unless only the linear-phase center portion of the passband is used.

A number of conflicting factors enter into the selection of the intermediate frequency. A low frequency is desirable because high gain-per-stage is possible with little danger of instability. Low-frequency i-f filters having a given shape factor are also easier to design, particularly with limited-Q, L-C circuits. Low-order crossover responses are easily avoided by keeping the i-f frequency low compared to the signal frequency. But, a low frequency i-f requires more r-f selectivity for a given amount of image rejection. At high r-f frequencies, it may be impractical to obtain the necessary selectivity. Dual conversion receivers overcome this problem by using two i-f frequencies. The first i-f is placed high enough to obtain the required image response at the uppermost receiver frequency. It has enough selectivity to obtain the required image response of the second, low-frequency i-f.

A widely used circuit element for coupling between i-f stages is the double-tuned transformer, especially in vacuum-tube i-f amplifiers of the distributed-selectivity type. If the receiver utilizes a band-pass filter to establish the basic selectivity, then the design requirements for i-f coupling become relaxed. It is merely required that the passband of the coupling circuit be sufficiently flat over the filter passband to preserve the shape of the filter nose. Some skirt selectivity may be required to reduce the spurious responses of electromechanical or crystal filters, if they

are used. Care must be taken to insure that wideband noise produced by stages following the i-f filter, does not become objectionable; this may require a low-noise amplifier stage following the filter or an increase in gain before the filter.

AUTOMATIC GAIN CONTROL—

In most ssb receivers, a control loop is included to automatically adjust the r-f and i-f gain. This control of receiver gain holds the output relatively constant despite changes in input level. In ssb receivers, a d-c control voltage is derived from the composite signal or from a pilot carrier. By application of this d-c control to variable gain elements, the desired degree of gain adjustment is realized.

In the suppressed carrier ssb receiver, the control voltage must be generated rapidly to avoid transient overload at the beginning of each portion of a transmission. The gain adjusting action must take place rapidly to avoid a thump at the start of the first syllable in speech signals. The syllabic envelope of the ssb speech signal is similar to that of the original audio signal; that is it fluctuates in amplitude at a low frequency rate (about five per second) in a manner similar to the input wave. The automatic gain control (agc) voltage must rise rapidly with the start of the syllable and then maintain the level of control voltage for a longer time. To avoid rapid fluctuation in receiver gain, the agc control is usually held at a value corresponding to the average of several syllabic undulations of the signal. Excessive variation of the agc voltage with syllabic peaks brings up background noise between syllables, a phenomenon referred to as pumping. Thus, for ssb speech, a fast attack-slow decay agc time constant circuit is desirable.

SIDEBAND SELECTION— Selection of sidebands must be considered. It seems likely that for commercial communications, a standard may be set up using only upper sideband. For military and amateur receivers, provisions should be made for the selection of either upper or lower sideband. In a receiver, the problem is to reinsert the carrier on the proper side of

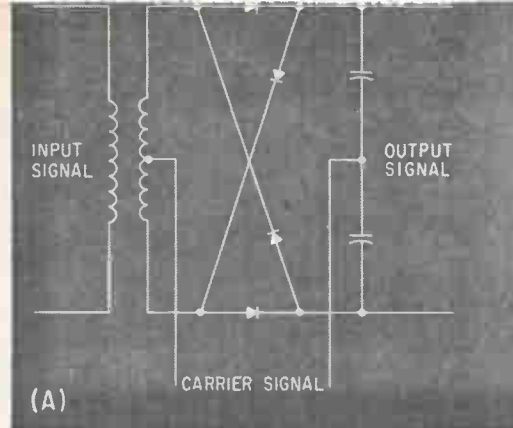

RING (A), dual-control pentode (B)

the signal. In stabilized step-tuned systems, it is usually easier to move the passband to the proper side of the inserted carrier by switching i-f selectivity. This is especially easy if the i-f selectivity is of the concentrated type. However, if the local carrier is tunable, as with a simple bfo, it could be easier and more economical to move the carrier to the opposite side of the passband. Another unique method of selecting sidebands in a receiver is referred to as passband tuning. In this system, the bfo is mechanically coupled to the main-tuning oscillator so they track together, moving cycle for cycle. A c-w beat note will not change as the bfo is tuned, but will move across the passband of the receiver. This allows the bfo to be set on the carrier frequency of a station and either sideband to be received by simply tuning the passband control from one side of the passband to the other. This is also useful for orienting the ssb signal to a position in the passband with minimum interference.

NOISE REDUCTION— Although there is no general method of reducing the effect of random noise in communication systems other than by using higher transmitting power, more sensitive receivers and complex modulation schemes, much interference is caused by impulse noise, such as that produced by automobile-ignition systems and switch-clicks. This type of noise must have high amplitude to contain enough average energy to cause interference. It is therefore possible to discriminate between noise and signal on the basis of amplitude. The greater the amplitude, and the shorter the pulse, the easier it is to reduce or eliminate it without affecting the signal.

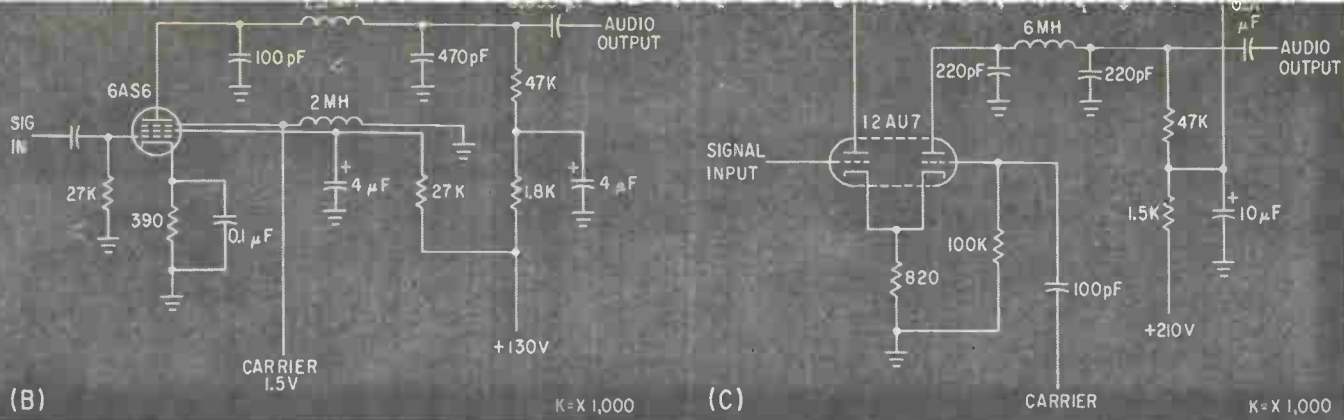

and dual triode (C) demodulators make good product detectors—Fig. 6

Successful ssb reception requires a fast agc attack and slow decay. From the standpoint of impulse noise interference, this may be unfortunate, because the agc becomes quite susceptible to loading up in the presence of noise and reduces receiver sensitivity. An agc detector noise limiting circuit offers some help. The narrower bandwidth, however, and the steeper selectivity-skirts usually employed in ssb, reduce the amplitude of the noise pulses and stretch them out in time, so that it is difficult for the agc noise limiter to discriminate on the basis of amplitude. Moreover, there is no carrier to automatically set the clipping level. In addition to causing agc line loading, impulse noise also reduces the receiver signal-to-noise ratio. Attempts to use conventional noise limiters at the input or output of demodulator meet the same objection as the agc limiter, because the impulse noise is reduced in amplitude and stretched out in time. In both cases, it is desirable to reduce or eliminate the noise before the bulk of the receiver selectivity. This, in a filter-selectivity receiver, is just before the i-f filter. There are two principal methods of impulse noise reduction. These are silencing or blanking and limiting or clipping.

A silencer or blanker interrupts the signal for the duration of the noise pulse, removing both signal and noise for a short period of time. In the presence of an a-m carrier, this constitutes downward modulation and produces a spectrum of sidebands, some of which pass through the i-f, are detected and cause a residual audio noise output. In suppressed carrier ssb, there is no carrier to modulate, so the only effect of blanking is to remove small portions of the signal. If

the blanking periods are short, these small holes in the signal are imperceptible.

The second method of reducing noise in the i-f amplifier is by limiting or clipping. Ideally, the clipper would have no effect on the desired signal, but would simply chop off noise-peaks which were higher in amplitude than the signal. In designing a clipper, a choice must be made as to the location of the clipper in the circuit. It is desirable to have sufficient selectivity before the clipper so that it does not chop adjacent-channel signals and produce IM products in the desired signal channel. Clipping should be done before the bulk of the selectivity for much the same reason as blanking. This is particularly important for receivers employing an i-f filter with a flat top and steep sides.

SSB DEMODULATORS—To demodulate an ssb signal, it is necessary to have a local carrier bearing the same frequency relationship to the ssb signal as the original carrier in the transmitter bore to its generated sideband signal. Perhaps the simplest method of ssb signal demodulation consists of adding the local carrier to the ssb signal and using a simple diode envelope detector for audio recovery.

Despite its simplicity, the simple envelope ssb detector requires a high ratio of carrier to sideband voltage for low output distortion and is seldom used in new receiver design.

An ideal ssb detector would produce no audio distortion or IM products. These characteristics can be realized by a product detector that produces an output that is the product of the carrier and sideband voltages. A detecting device which

has a square law transfer characteristic behaves much like a true product detector if the carrier is strong compared to the sidebands. Various circuits have been devised to approximate the performance of a product detector, two of which are shown in Fig. 6B and 6C. Balanced diode demodulators also perform well as ssb detectors. Assuming perfect balance, the diode circuit shown in Fig. 6A produces output frequencies of $n_c C \pm m_s S$ where n_c and m_s are odd order integers, 1, 3, 5, etc. C is the carrier and S is the signal. For ssb demodulation, $n_c = m_s = 1$ and only the difference frequency is utilized. Higher orders of n_c and m_s , which produce distortion are minimized by making the carrier at least 10 times as large as the signal.

If a receiver is to be used for ssb reception only, it is desirable to use a fixed frequency oscillator for the local carrier that is placed in the correct relationship to the i-f passband. The oscillator output voltage required depends on the demodulator circuit used, together with the signal input level to the demodulator. To reduce hum and noise products, detector levels are often in the range 0.05 to 0.5 volt. Carrier levels at least 20 db higher than this are preferable to reduce distortion, requiring a minimum of 0.5 to 5 volts. Care should be taken to shield and filter oscillator circuits to prevent coupling to any part of the receiver other than that required.

REFERENCES

- (1) D. D. North, The Absolute Sensitivity of Radio Receivers, *RCA Review*, Vol. 6, p 332-343, Jan 1942.
- (2) H. T. Frills, Noise Figures of Radio Receivers, *Proc. IRE*, 7 p 419-422, July 1944.

Will Neon Photoconductors Replace

Solid-state devices are generally desirable for logic circuits. But relays are still photoconductors are being developed to implement low-speed logic at reduced cost

By J. L. PATTERSON
IBM General Products Div.,
San Jose, Calif.

LOW-SPEED digital logic is often performed with electromechanical devices. These devices need significant improvement in cost and reliability to bring them to a level that is comparable to solid-state logic products.

The neon-photoconductor (NePC) is being developed as a possible means of implementing low-speed logic circuits at reduced cost with solid-state reliability. In addition to lower cost and higher reliability, NePC devices have smaller physical size, lower power consumption, silent operation and built-in visual displays that make them attractive replacements for electromechanical relays.

Basically, the NePC is a normally open relay, where the neon is equivalent to the relay coil and the photoconductors are equivalent to the relay contacts. With no input to the neon, the photoconductors are

in their dark or high-resistance state. When an input is applied, it is optically coupled to the photoconductors associated with it, driving them to their light or low-resistance state. However, unlike the contacts of an electromechanical relay, the photoconductors cannot be considered as a short circuit when the neon is on. This point is significant in the application of NePC devices.

NePC DEVICE—The photoconductor (PC) is the most critical component of the NePC. The low cost potential of the technology is dependent to a large degree on the ability to produce a large number of PC's on one substrate with a high degree of uniformity and low cost.

Reliability, performance and versatility of the NePC are also determined principally by the characteristics of the photoconductors.

There are a large variety of PC materials that can be used for the NePC device. Selection of the PC material is based primarily on four

considerations, including fabrication techniques that produce the device, sensitivity or ratio of dark resistance R_d , to light resistance R_l , speed of response and spectral response. From these considerations, the field of possible materials is narrowed to cadmium sulfide (CdS) and cadmium selenide (CdSe). A comparison of these materials shows that cadmium selenide PC's are 5 to 10 times faster than those using cadmium sulfide; CdSe is a better spectral match to the neon lights; CdS is more adversely affected by moisture; and CdSe is highly dependent on temperature.

The final choice between these two materials will depend largely upon application. However, since speed is a critical factor, cadmium selenide PC's will probably get widest use.

CADMIUM SELENIDE—Polycrystalline cadmium selenide photoconductors can be batch-produced by silk-screening an electrode pattern and then an overlay of the CdSe material on a ceramic or glass sub-

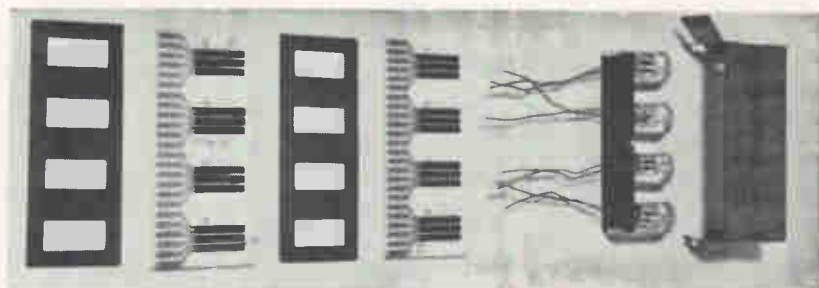

MODULAR assembly includes neons and photoconductive substrates. These may be used as building blocks for complex assemblies—Fig 1

PRINTED circuits permit compact packaging of the modules—Fig. 2

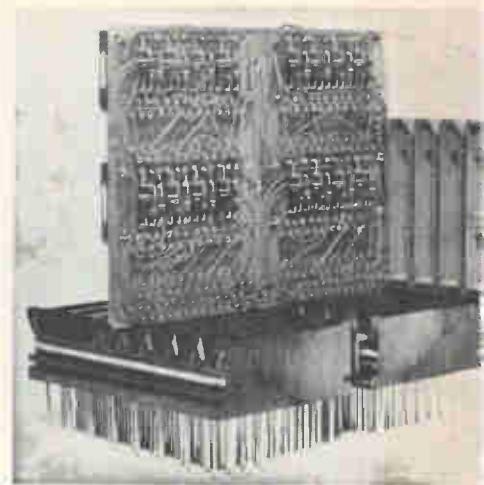

Relays in Low-Speed Logic?

used in low-speed circuits for economy. Here is how neon and with higher efficiency

strate. An overcoating of some material such as silicon varnish or acrylic is then applied to the substrate to protect the cells from moisture and handling. In this way, the photoconductors can be produced at low cost. A typical substrate is shown in Fig. 1.

Because the characteristics of cadmium selenide photoconductors are temperature dependent, sensitivity decreases and speed increases when temperature increases. This occurs so that the product of sensitivity and response time remains approximately equal over a wide temperature range. Quantitatively, R_i increases approximately 5 percent while R_p decreases about 1 percent per degree C. rise. Manufacturing tolerances and variations introduced by temperature set a basic limit on the performance of NePC circuits.

The neons used in the NePC device are miniature indicator lamps such as the General Electric Ne-2H neon, where the firing voltage, (V_f) is 80-120 volts; the maintaining voltage, (V_m) is 60-100 volts; and the maximum operating current is 2.5 ma.

The firing time of neons increases when they have been in a dark environment for a long period of time. Also, firing time is much lower in a light environment, where electrons emitted from the slightly photoemissive electrodes maintain a low level of ionization in the lamp, permitting the lamp to arc 10 to 20 microseconds after the application of a voltage pulse.

Without this ionization, firing

times are increased to milliseconds. If the neon is placed in a high-voltage a-c field, the ionization level in the lamp can be maintained so that the firing times are independent of external illumination. A 350-volt, 60-cps field applied between one electrode of the neon and an

external electrode close to the neon will maintain the ionization level.

PACKAGING — The complete NePC device is made by combining the neons and photoconductors in a functional package. One possible packaging scheme is shown in Fig.

THE VERSATILE NEON

Neon lamps are available in a variety of configurations and specifications. While widely used for pilot lamps and other indicators, their use in logic circuits has been limited mainly to readout devices.

Work now being done indicates that a marriage between the neon lamp and photoconductive circuits can successfully implement low-speed logic to achieve reliability beyond the capabilities of a relay and on a par with solid-state devices.

Several problems still remain to be solved before the NePC finds wholesale use. These lie mainly in photoconductor economy. However, the author believes this device represents a substantial improvement over electromechanical switching systems

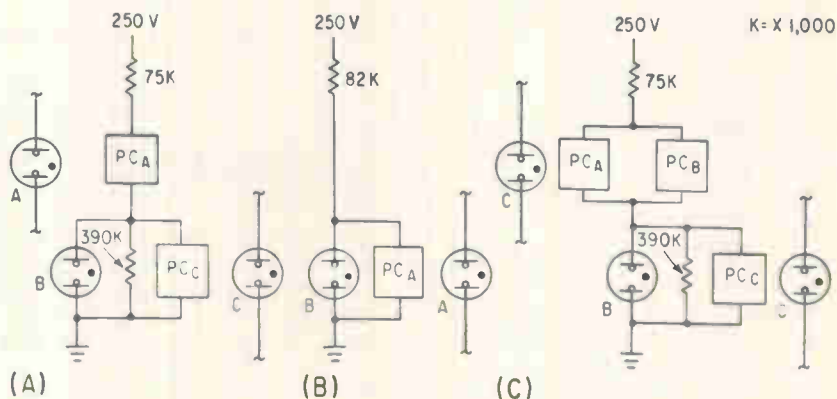

NEON photoconductor gate (A), inverter (B) and latch circuit (C)—Fig. 3

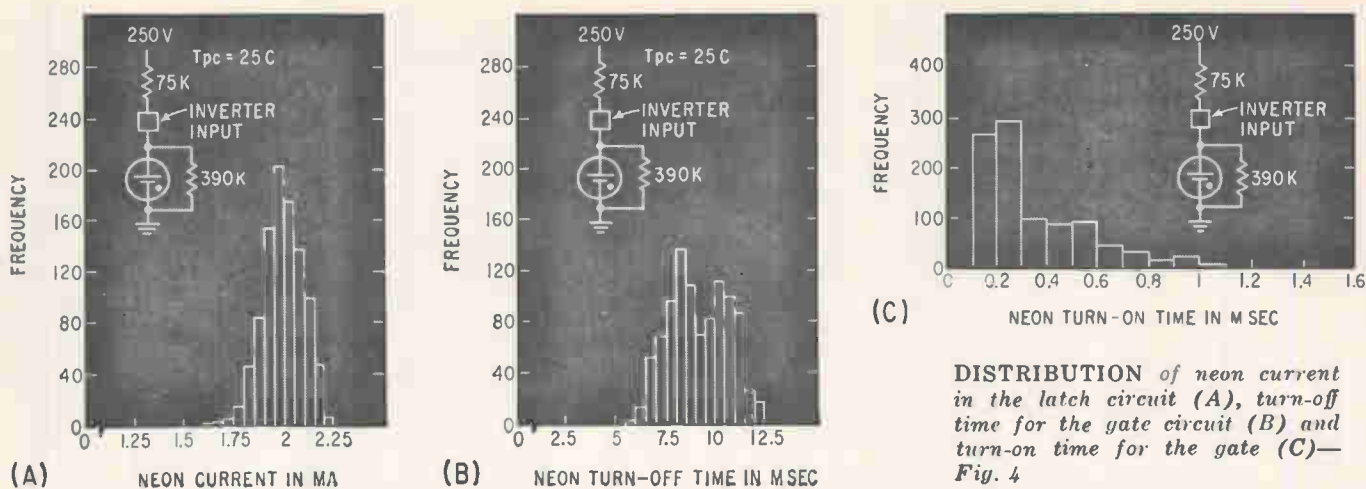

2, where four modules are mounted on a pluggable circuit board. Each module consists of four neons and 24 PC's (six PC's are associated with each neon). An aluminum light divider and rubber gaskets optically isolate the four NePC devices in each module. The a-c field used to eliminate the dark effects in the neon is applied between one electrode of each neon and the light divider. Small holes are provided around each of the neon leads so that the state of each circuit can be seen. The resistor associated with each circuit is mounted on the opposite side of the printed circuit board from the modules. The complete package is equivalent to 16 six-pole relays.

The NePC characteristic can be summarized in relay specifications, where pick-up time is 0.25-1.0 millisecond, drop time is 2-12 milliseconds, and open resistance is in excess of 10^9 ohms. Also, contact resistance is 2-30 kilohms, drive voltage is 200-500 volts, current rating of the contacts is 2.25 ma, and power consumption is from 0.4 to 1 watt.

NePC CIRCUITS—Three NePC logic circuits are shown in Fig. 3. In the gate circuit in Fig. 3A, an input from neon A is applied to PC_A , driving it to its low-resistance state. The voltage across neon B increases until the firing voltage is exceeded; neon B fires and drives its photoconductors to their low-resistance states. When the input A is removed, the resistance of PC_A

increases, reducing the current in neon B until B is extinguished. Neon B may also be turned off by providing an input to PC_r , thus shunting out the neon current. This turn-off method is preferred where speed is critical, because the rise time of the photoconductor is much faster than its decay. However, this speed advantage is limited because neon B cannot be fired again until PC_r has recovered.

In the inverter circuit shown in Fig. 3B, neon B is on when there is no input. An input to PC_A turns neon B off. The time required to turn neon B on after an input has been applied and then removed from PC_A is dependent on the slow recovery time of PC_A . There is no way of eliminating this dependence as there is in the gate circuit.

When neon B is turned on as a result of an input to PC_A in the latch circuit of Fig. 3C, it will remain on, independent of input A, due to the feedback from neon B to PC_r . The latch is reset with an input to PC_r .

For all the NePC circuits there

are three parameters that describe circuit performance: turn-on time, turn-off time and the steady-state current through the neon when it is on. Looking at the last condition first, the current through the neon must be held within a specific range for all circuits. The lower limit of this current range is that current below which the light output of the neon is not adequate to drive other NePC circuits. The upper limit of the current range is fixed by the power dissipation of the photoconductors and the life of the neon. For the Ne-2H neon and the PC's and package shown in Fig. 2, the neon must operate in a current range from 1.25 to 2.25 ma.

The degree of uniformity in the neon current that can be obtained for a group of NePC circuits is determined by the variation in the characteristics of the neon and photoconductors, including variations resulting from temperature changes. Adverse effects due to component variations can be reduced by using a large power supply voltage and limiting the current in the neon with a large series resistor. The maximum power supply voltage that can be used is determined by the breakdown voltage of the photoconductors. For practical sized photoconductors, this limit is between 300 and 500 volts. Also, an increase in the power-supply voltage requires that the PC's transverse a wider range of resistance to turn the neon on or off. Thus, the response time of the circuits are adversely affected by this

ELECTRICAL CHARACTERISTICS OF CADMIUM SELENIDE PHOTOCONDUCTORS

Dark Resistance— 10^9 ohms at 55 C
 Light Resistance—30,000 ohms at 55 C
 Fall (RL to 100 RL)—8-12 ms at 55 C
 Rise Time

(RD to 2RL)—0.5-1.0 ms at 55 C

Light Source:

GE Ne-2H neon, 2 ma conduction

N-WAY AND circuit has limitations on number of series photoconductors that may be applied—
Fig. 5

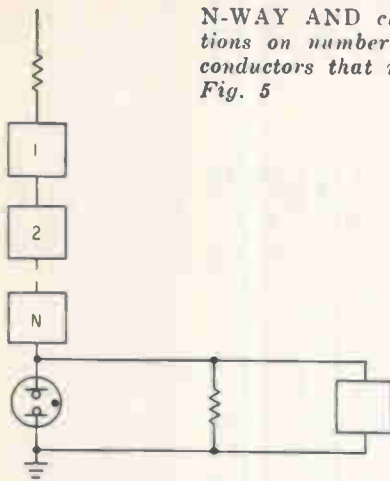

method of stabilizing the neon current and the trade-off must be evaluated in selecting the power supply.

The distribution of neon turn-on and turn-off time and of steady-state neon current predicted from a computer simulation of a large number of NePC gate circuits, are shown in Fig. 4.

When a number of PC's are added in series as in the *N*-way AND circuit shown in Fig. 5, the problem of maintaining neon current in specified range becomes more severe. The number of PC's that may be put in series in the AND circuit is limited to two, or possibly three. Thus, an AND circuit with more than three inputs requires additional devices, decreasing the cost advantage of NePC circuits.

APPLICATION—When low-voltage, coded information is being received over a low-impedance transmission line at 10 characters per second (assuming 7 bits per character, each bit requires 14.3 milliseconds), it is desired to store each character in an NePC register, and to read out of this register in parallel during the succeeding character time. The first problem is to provide an interface between the low-voltage, low-impedance input and high-voltage, high-impedance NePC circuits. One way of accomplishing this is to transmit a start bit preceding the transmission of each character. The start bit triggers a free-running, high-voltage multivibrator that generates 14.3-milli-

second, 300-volt pulses. Each multivibrator output advances the NePC ring circuit one position. Each input character drives an amplifier circuit that produces a 300-volt output pulse for each bit received. The amplifier output supplies the voltage to line 1 of input register 1. When a bit is received, a coincidence occurs between the voltage on line 1 of the input register 1 and the neon in the ring that corresponds to the bit received. This coincidence results in a turn-on of the corresponding neon in register 1, that becomes latched through a photoconductor back to line 2. An additional stage in the ring stops the multivibrator, allows the information in register 1 to be transferred to register 2, and clears register 1. The NePC circuits are required to recover in one bit time or 14.3 milliseconds. If the input circuit is altered so that adjacent bits of input information are separated and applied to two separate lines on input register 1, the time allowed for the circuits to recover will be twice the bit time. Thus 20 characters per second could be received with no increase required in the performance of the NePC circuits.

This application points out another condition that must be exam-

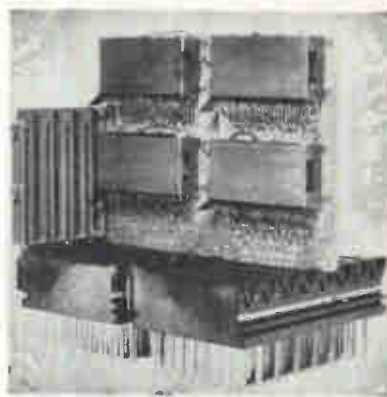

REVERSE SIDE of the modular assembly shown in Fig. 2. Printed wiring appears on both sides of the main board—Fig. 6

ined in determining possible applications for NePC circuits: the cost of combining low-voltage circuits with high-voltage NePC circuits. For this application, a number of expensive transistors are required to provide the interface between the two levels of logic. In addition, at least one other supply voltage is required to combine the two types of circuits.

The interface required to go from NePC logic to transistor logic is less of a problem. A small resistor (about 1K), between one of the neon electrodes and ground, provides a low-impedance input to transistor logic.

Because of added costs, the use of NePC technology will be an advantage only for applications where the number of NePC devices used is sufficient to more than balance the costs of combining the two technologies.

CONCLUSION—There are several major problems that remain to be solved before the full potential of NePC devices can be realized. These are primarily involved with producing low-cost PC's that meet all the requirements of this application. When solutions are found, the NePC will represent a considerable improvement over electromechanical devices in logic applications.

The NePC device must be considered just the first step in the development of the ultimate optoelectronic relay. The next step will probably be the replacement of the neon with electroluminescent light sources, which at present are too short-lived for this application. This, together with silk-screened wiring and resistors, would allow whole logic blocks to be manufactured at extremely low cost.

Further development should be directed toward improving the performance and versatility of the device.

The development of a fast photoconductor or the development of low-voltage light sources will greatly increase the number of applications for this family of devices and present the logic designer with another high-reliability, low-cost component.

Tunnel diodes raise operating speed of transistor resistor logic circuits to level of diode transistor logic

TUNNEL DIODES Boost

TRANSISTOR-RESISTOR LOGIC (TRL) circuits shown in Fig. 1A have been the subject of a considerable amount of work. One limitation is their relatively low operating speeds. Logic units using transistors with $f_t = 300$ Mc give useful propagation delays of about 100 ns; using tunnel diode transistor-resistor logic (TDTRL) with similar transistors, the propagation delay is about 10 ns, which is about the delay expected from diode-transistor logic.

In this article, two types of TDTRL are discussed. The first is a simple circuit with a large hysteresis effect and preferably requiring low-current tunnel diodes. The second circuit uses delayed feedback to minimize the hysteresis effect and allow the use of higher current tunnel diodes.

COMPONENTS — Commercially available tunnel diodes are made of silicon, gallium arsenide or germanium. In the present application, the important characteristics of each type can be roughly summarized by the useful voltage swing expected ($V_f - V_r$), and the peak-to-valley current ratio (I_p/I_r).

A higher voltage swing on the tunnel diode eases the requirements for switching. However, in the general logic elements, to keep the loading on the tunnel diode at the correct level, collector voltage and current swings must be proportionately increased.

The current ratio (I_p/I_r) is a measure of the current gain in the tunnel diode circuit, and should be as high as possible. For lower power transistors where a low voltage swing on the tunnel diode is desirable, the germanium tunnel diode should be used.

TRANSISTOR CHARACTERISTICS—In the following circuits, there must be high voltage and current gains in the active elements. The transistors are therefore used in the common emitter configuration. To switch such a transistor, a finite voltage change corresponding to a change in base current must appear

A WORKING TOOL

Tunnel diodes have passed the stage of being glamorous new semiconductor elements with great potentiality. They've arrived! They are now just another element that the engineer can choose from to build faster, more reliable or more sensitive circuits

on the base. The tunnel diode voltage swing is relatively small, so that the spreads on the transistor base-emitter characteristic must be kept to a minimum.

The silicon planar transistor has a smaller spread and a sharper elbow than the germanium transistor so that its switching voltage swing is about 200 mv compared with about 400 mv for the germanium transistor. In addition, the effect of I_{co} is negligible, compared with its effect in a germanium transistor.

CIRCUITS—Figure 1B shows the ideal equivalent circuit for a TRL element. In practice the current input I is the sum of several high voltage high resistance sources as shown in Fig. 1A. Figure 1C shows a tunnel diode connected across the base-emitter junction of a transistor. Using germanium tunnel diodes and *npn* silicon transistors, the junction must be forward-biased by about $1/2v$ to make the tunnel diode straddle the elbow of the input characteristic. Figure 1D shows the V_{be} , I_b loadline on the tunnel diode characteristic. Assuming that the input current I , Fig. 1C, increases from zero, the tunnel diode operating point is on the low voltage part of the characteristic having slope x . When the current exceeds I_{cr} , the tunnel diode switches to the high voltage state, slope y . This causes a current I_c to flow in the base circuit switching the transistor on. The output is switched in about

BASIC TDTRL circuit (A), TDTRL circuit with feedback (B), characteristics of feedback circuit (C), bistable NAND circuits (D), monostable and bistable NAND circuits and characteristics (E)—Fig. 2

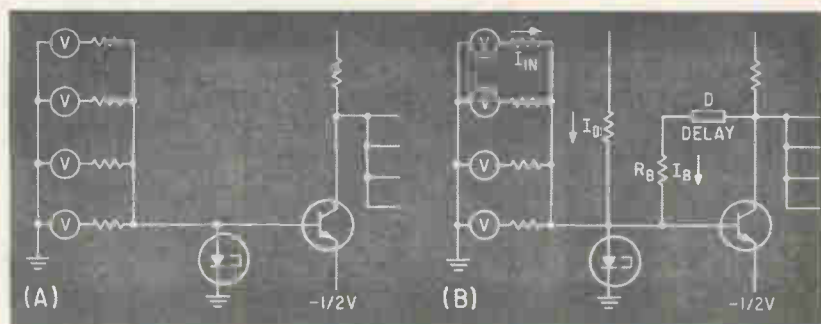

TRL Speed

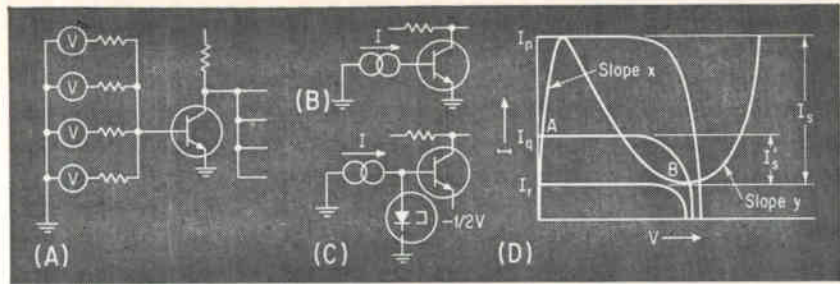

TYPICAL TRL NOR circuit (A), TRL equivalent circuit (B), TDTRL equivalent circuit (C), and loading on T-D characteristic (D),—Fig. 1

5 to 25 ns using a 300 Mc transistor and depending on the type of loading.

If the current I is now reduced to some intermediate value between I_p and I_n , Fig. 1D, the tunnel diode remains in the high voltage state. In this region, it has two stable states, A and B. The minimum current drive that will keep the transistor fully on is I_n , when I_n' is the minimum base current required. If I is reduced below I_n , the transistor starts to switch off; below I_r , the tunnel diode switches to the low resistance condition.

From this ideal circuit, Fig. 1C, the practical NOR bit is developed. As in TRL, the current generator is replaced by several high voltage high resistance inputs, each of which can switch the tunnel diode. The circuit performs in the same way as TRL NOR logic elements, except for large hysteresis effects.

TDTRL—FEEDBACK CIRCUIT—In the simple circuit, Fig. 2A, the current from each input must exceed the peak current I_p of the tunnel diode. An alternative circuit can be designed that requires substantially less input current than the tunnel diode peak current, and which minimises the hysteresis effect. The circuit uses feedback as shown in Fig. 2B; the appropriate load lines on the tunnel diode characteristic are shown in Fig. 2C.

Suppose the transistor is off and the tunnel diode is in the low voltage condition. Current I_n flows through the feedback resistor R_n and biases the tunnel diode to the point A in Fig. 2C. The device now requires only a small current I_n to trigger the tunnel diode and switch the transistor on. By inserting a delay component D in the feedback circuit, the tunnel diode will complete its switching before there is any change in the current I_n . The delay required is about the same as the switching time of the (loaded) tunnel diode. For the slower transistors, the inherent delay in the transistor collector circuit

is sufficient, needing no auxiliary delay devices.

After the delay, bias current I_n is reduced to zero. By choosing an appropriate value for I_n (using one input only) the tunnel diode will be biased to point C in Fig. 2C. The transistor will remain on if the value of I_n is high enough to cause adequate current I_r to flow into the base of the transistor. In practice, when several inputs are required, a small d-c bias I_D can be injected into the base circuit to assist in keeping the transistor on. When the current I_n is removed, the tunnel diode drops to the low voltage condition and switches off the transistor.

OTHER APPLICATIONS—Various NAND circuits can be made using the techniques employed with the NOR elements, but the inputs allowed are restricted severely by tolerance limits. These circuits are usually faster than NOR circuits.

With a little modification, the feedback circuit can be designed as a bistable, monostable or astable device. A bistable device can be made by biasing the tunnel diode so that there are two stable states (A, B and A, C) as shown on the loadline characteristics in Fig. 2D, for the simple and feedback circuits, respectively.

Using the feedback circuit, a monostable circuit can be made by biasing the tunnel diode with the feedback current to just below the peak current as in Fig. 2E. A triggering pulse switches the tunnel diode and transistor on. The transistor remains on for the duration of the delay in the feedback circuit. When the bias current collapses the transistor switches off. After the delay in the feedback circuit I_n reappears to bias the tunnel diode to just below its peak current.

The astable circuit Fig. 2E is the same as the monostable circuit except that the feedback current I_n is arranged to exceed the peak current of the tunnel diode.

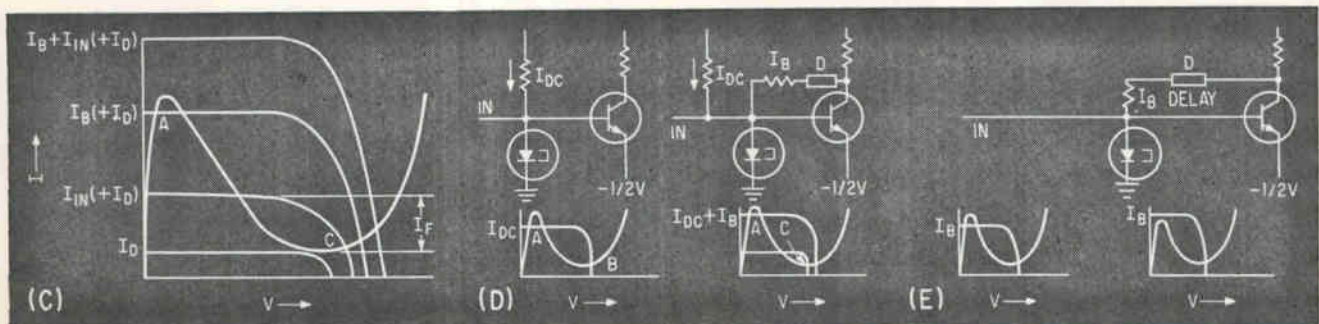

CONSUMER ELECTRONICS

PART II: HOME AND AUTO CONTROLS

Here are recent innovations in electroluminescence, appliance controls, light dimmers, capacitance switches, radar speed detectors and transistor ignition

By **STEPHEN B. GRAY**, Assistant Editor

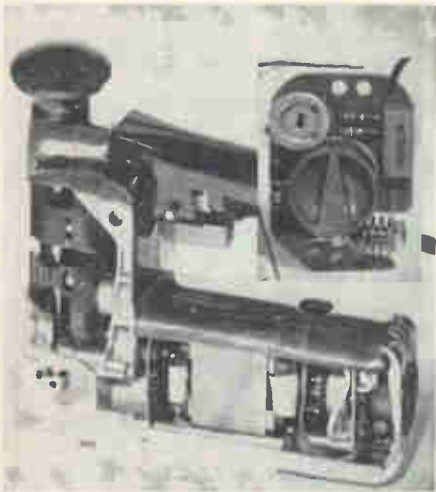

SABRE SA W cutaway view shows scr circuit board at right end, inset shows scr heat sink, cooled by motor air. By Diehl for Sears, Roebuck.

ELECTROLUMINESCENCE—A French discovery, electroluminescence was first marketed by Sylvania, in 1951. For five years Sylvania was the only producer, and then others began marketing EL: General Electric, Westinghouse and RCA. According to one ex-EL man, the feeling was, "It's a natural for consumers—we should sell a million." All four companies made night-lights, plus EL panels for commercial and military uses.

But the consumer wanted enough light from an EL device to be able to do something with it, and 5 lumens per watt from a green panel wasn't enough for him. Even as a night-light, EL wasn't bright enough for many. The eye needs time to accommodate to a dim night-light after coming from a brightly lit room, but most people didn't know about that, and didn't care. Dealers demonstrated night-lights in stores brilliant with 75-lumens-per-watt fluorescent lamps.

Now Sylvania is again the only producer of consumer EL. The others are keeping up research, and a rebirth is expected, perhaps when a more efficient panel can be made. At present there is no useful light output at less than 120 volts, 60 cycles. A true hermetic seal is needed, because the biggest problem is moisture, which deactivates EL powders. There is a natural straight-line decay, anyway, with a knee around several hundred hours, and then an asymptotic decline out to thousands of hours.

In addition to night-lights, Sylvania makes EL items such as wall switchplates, a panel bearing the names of the controls on an Argus slide projector, the front panel of a Sears, Roebuck electric blanket control, a channel-number indicator on an Admiral tv tuner, and dials for several makes of electric clocks.

A standby emergency light using a Sylvania EL panel is made by Gulton Industries (see photo). Powered by nickel-cadmium batteries, the light is kept plugged into an outlet so that it is always fully charged. In this mode it is a night-light, with the EL panel lit. If power fails, the EL panel turns off and the incandescent lamp illuminates the room. The unit can be removed from the wall and used as a conventional flashlight.

An illuminated house-number device by Madigan Electronic Corporation (see photo) incorporates a Sylvania EL panel and a step-up transformer that operates from the 6 to 10, 16 or 24-volt doorbell transformer. The unit includes a bell pushbutton, and

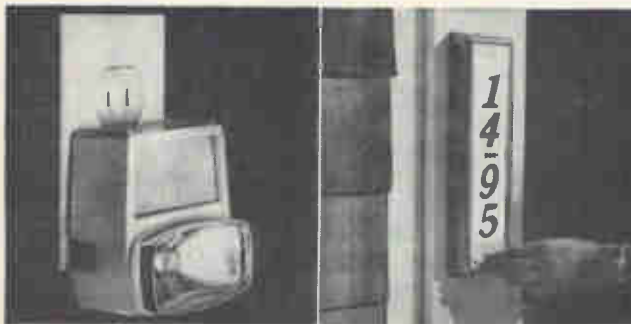

ELECTROLUMINESCENT panel in standby emergency light by Gulton Industries (left) and illuminated house-number device by Madigan Electronic Corp.

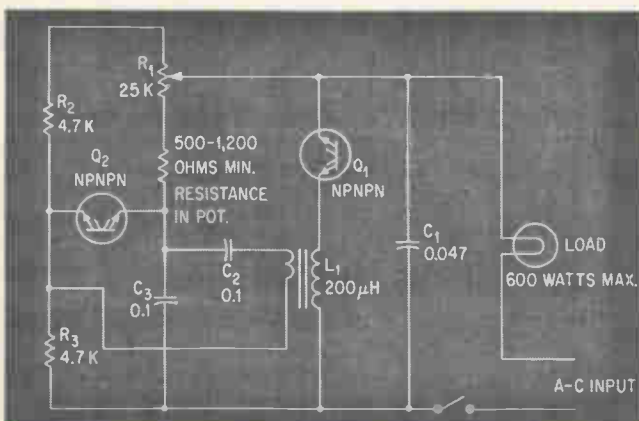

LIGHT DIMMER for fluorescent or incandescent lamps, by Hunt Electronics—Fig. 1

FIELD-STRENGTH
meter version of
Radar Sentry
microwave receiver,
by
Radartron

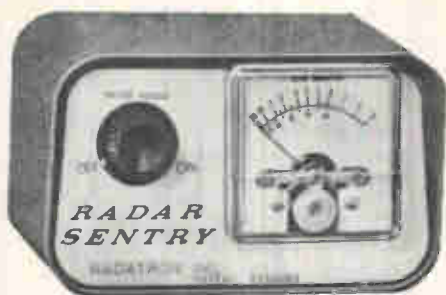

an auxiliary pushbutton is supplied if the light unit is to be some distance from the button. The house-owner applies the adhesive-backed numbers to the inside of the transparent plastic cover.

SILICON CONTROLLED RECTIFIERS—The scr is a fast-rising star in the semiconductor skies, and new uses are springing up everywhere. The scr already has a good foothold in the consumer field, as shown by the current Sears, Roebuck catalog, which lists at least three scr items: an electronic fence shocker, a light-dimmer switch and a multi-speed sabre saw.

The sabre saw, made for Sears by Diehl (see photo), provides full-load blade speeds of 1,950, 1,625 and 800 strokes a minute, depending on the switch settings. The speed is controlled with a feedback signal produced by the universal motor. This signal is a voltage induced in the motor armature by the motor residual field. In a universal motor, the field is in series with the armature. When the motor armature is not moving, no voltage is induced in the armature by the residual field, and the scr fires early in the cycle, providing ample armature voltage to accelerate the motor. The motor residual field produces an emf on the armature, prior to firing the scr, which bucks the flow of gate current, requiring that the gate voltage reach a higher value before firing the scr. This technique automatically establishes an equilibrium running speed. As load is applied to the motor, its speed starts to decrease, reducing the armature residual induced voltage, which will automatically fire the scr early in the cycle. This provides more voltage to the armature, increasing motor speed to handle the increased load and to prevent loss of motor speed or power. Therefore, the built-in feedback signal guarantees constant speed at any load.

The light-dimmer switch, made by Leviton, is available at Sears in a two-way switch, with high (100-percent) and low (30-percent) settings, and in a full-range switch, from off to full on. These dimmers are designed for incandescent lamps only.

Both fluorescent and incandescent lamps can be dimmed with a continuously variable control made by Hunt Electronics. The basic component of the Hunt dimmer is a silicon symmetrical switch (sss), which, according to the company, was designed for direct application to the dimming of light.

The sss is a five-layer *npnpn* switch, similar to a pair of scr's back-to-back, which permits proportional

HIGH COST OF PROGRESS

An electroluminescent instrument panel was used in the 1961 and 1962 models of the Chrysler New Yorker, but was discontinued because of the expense. Cost for the special-shape panel and installation was \$5 per car; the alternative is half a dozen lamps that cost a few cents each

control of a-c power by controlling the phase angle at which load current flows.

One of the *npnpn* switches, Q_1 , is the power-handling device for the system (Fig. 1). Although similar in many respects to an scr, it differs in that it will break over in both directions, and will therefore conduct current in either direction. Also, it has no gate lead. Switch Q_1 is designed for a breakover voltage between 200 and 290 volts, so that when Q_1 is in series with an incandescent load, the line voltage is insufficient to cause the power device to conduct. In series with Q_1 is inductor L_1 , used for two reasons: one, to slow the current rate of rise, and, with capacitor C_1 , to minimize radio interference generated by the fast switching of Q_1 ; two, to receive a current pulse from the *RC* network and transform it into high voltage that adds to the line voltage across Q_1 , to turn on Q_1 .

The *RC* network consists of R_1 , R_2 , R_3 and C_3 . The voltage produced by this network appears across Q_2 , shunted by the primary of L_1 in series with C_2 . The setting of R_1 determines the point in the cycle at which Q_2 will fire. A second *npnpn* switch, Q_2 , is used as a symmetrical relaxation oscillator, with a period determined by the setting of R_1 (C_2 and C_3 being fixed). At the beginning of a half cycle, with R_2 set at about the half-power point, C_2 and C_3 are discharged. As the voltage increases, C_3 charges through R_1 , and C_2 charges through R_1 and R_3 . When the voltage crosses the breakover voltage of Q_2 , Q_2 will then switch on and the total voltage of C_2 will be impressed across the primary of L_1 . This voltage is transformed into a high voltage across L_1 , so that about 200 volts are in series with whatever voltage is then across Q_1 , driving Q_1 into its avalanche breakover and turning it on. Since the system is symmetrical, this happens 120 times a second with a 60-cps power supply.

Since power device Q_1 is symmetrical, it cannot be damaged by line surges, since it will only be switched to its ON state. Also Q_1 is independent of transients that may appear on the line, either from motors or other dimmers nearby. The symmetrical oscillator is not susceptible to line transients because of the cascaded *RC* filtering, which includes the *RC* phase-shift system and the filter component of C_2 and R_3 .

CAPACITANCE SWITCH—A touch-control lamp kit, made by Tung-Sol, features the Tung-Sol Dyna-

quad four-layer *pnpn* germanium alloy transistor. The lamp turns on when the metal portion of the base is touched, and off when the center flange of the stem is touched. The touch-control module is also available as a separate unit.

The normal electrical capacitance of the human body is about 30 to 100 pf, which is enough to activate the module. Body capacitance is coupled into the circuit by antennas that are normally connected to metal touch points.

The touch-switch module operates on half-wave d-c obtained from rectification of the 105 to 125-v a-c source. Neon-bulb oscillators fire the Dynaquad and also regulate the bias supply. When the ON antenna is touched, the high-impedance network is loaded with body capacitance, reducing the oscillator voltage below a level to keep the Dynaquad fired. The relay operates, because current that was shunted to ground is now available to operate the relay, turning on the load. The Dynaquad is now in the OFF state. When the OFF antenna is touched, the capacitance change increases the oscillator signal to again fire the Dynaquad, reducing the voltage necessary to hold the relay.

Trimmer capacitors permit adjusting the switch sensitivity when long antenna wires are used for remote antenna locations.

RADAR SPEED DETECTOR—The "Radar Sentry," made by Radartron, appeared on the market some six years ago, and is now available in a new model. The original detected only the S-band police radar. Basically a receiver using eight transistors and two diodes, the first Sentry had a resonant-slot antenna, which was the back panel of the case, tuned to the S band, 2,455 Mc. The latest model detects both S and X-band (10,525 Mc) radar, monitoring both frequencies simultaneously. The X-band antenna is detachable, and must be inserted in the back panel of the unit. Current production of the new model is 1,000 a week.

Because the speed-meter signal is unmodulated, an audio oscillator signal (actually a flip-flop square wave) is fed to a diode mixer along with the incoming radar signal, so that the radar signal is chopped at an audio rate. The mixer output goes through a diode detector, is amplified and fed to a p-m loudspeaker. When triggered by a radar signal, the Sentry emits an 800-cycle tone.

Another model has a calibrated meter instead of a loudspeaker, and is marketed as a microwave field-strength meter (see p 53), for frequencies from 1,000 Mc in the L band up through 1,000 Mc in the X band, with a sensitivity to signal levels as low as -65 dbm, according to the manufacturer.

Tests by New York State police show that the detector is effective within 300 feet or less of the radar. Radar speed detectors are banned in Chicago by local ordinance, in Connecticut by executive order of the Motor Vehicle Commissioner, and in the District of Columbia by law. Similar laws are under way in New York and other states.

TRANSISTORIZED IGNITION—By 1956, the downward trend in the cost of germanium power

transistors permitted their practical use in ignition systems. Transistor switching was of interest because contact life could be greatly extended, and because the newer ignition systems needed much higher voltages and energies.

The transistor takes over the role of distributor breaker points, which tend to deteriorate under high currents. The breaker points handle only the current that switches the transistor on and off, and the transistor handles the ignition coil current. The uniform accurate switching of the transistor eliminates the timing variables and the arc-robbing energy variables that show up as non-uniform secondary voltage pulses. Transistor ignition eliminates excessive arcing on low-spark starts, excessive arcing due to contact contamination, and the "blued points" problem of tungsten oxide formation on contacts. By using the contacts only for transmitting a small transistor base-triggering current, contact tungsten erosion is greatly reduced.

The Prestolite division of Electric Autolite has a transistor-switched ignition system, the Transigniter 201 (Fig. 3A), which, according to its maker, gains not only the advantages of extended contact life, but also a longer life for such secondary components as distributor rotor and cap, spark-plug harness and sparkplugs.

The contact current is about 0.25 ampere, while transistor current is about 9 amperes peak. A relatively flat output voltage (Fig. 3B) is obtained because of the fast rise of current to design value, due to the relatively low primary inductance.

Diode D_1 reverse-biases the emitter-to-base junction when the distributor contacts are open, to insure transistor cut-off, even at high temperatures. Resistor R_1 allows a small current to flow continuously through D_1 , so that there is a drop of 0.5 to 0.75 volt across D_1 . Since the base is connected to the positive side of D_1 through R_2 , and the emitter is connected directly to the negative side of the diode when the contacts are open, the base is at a potential of 0.5 to 0.75 volt positive with respect to the emitter, to guarantee cut-off. This action is enhanced by keeping

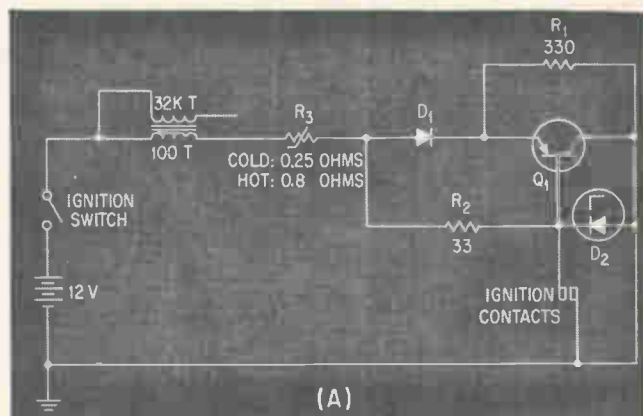

TRANSISTORIZED IGNITION by Prestolite (A); comparative region that creates excess spark trailing and

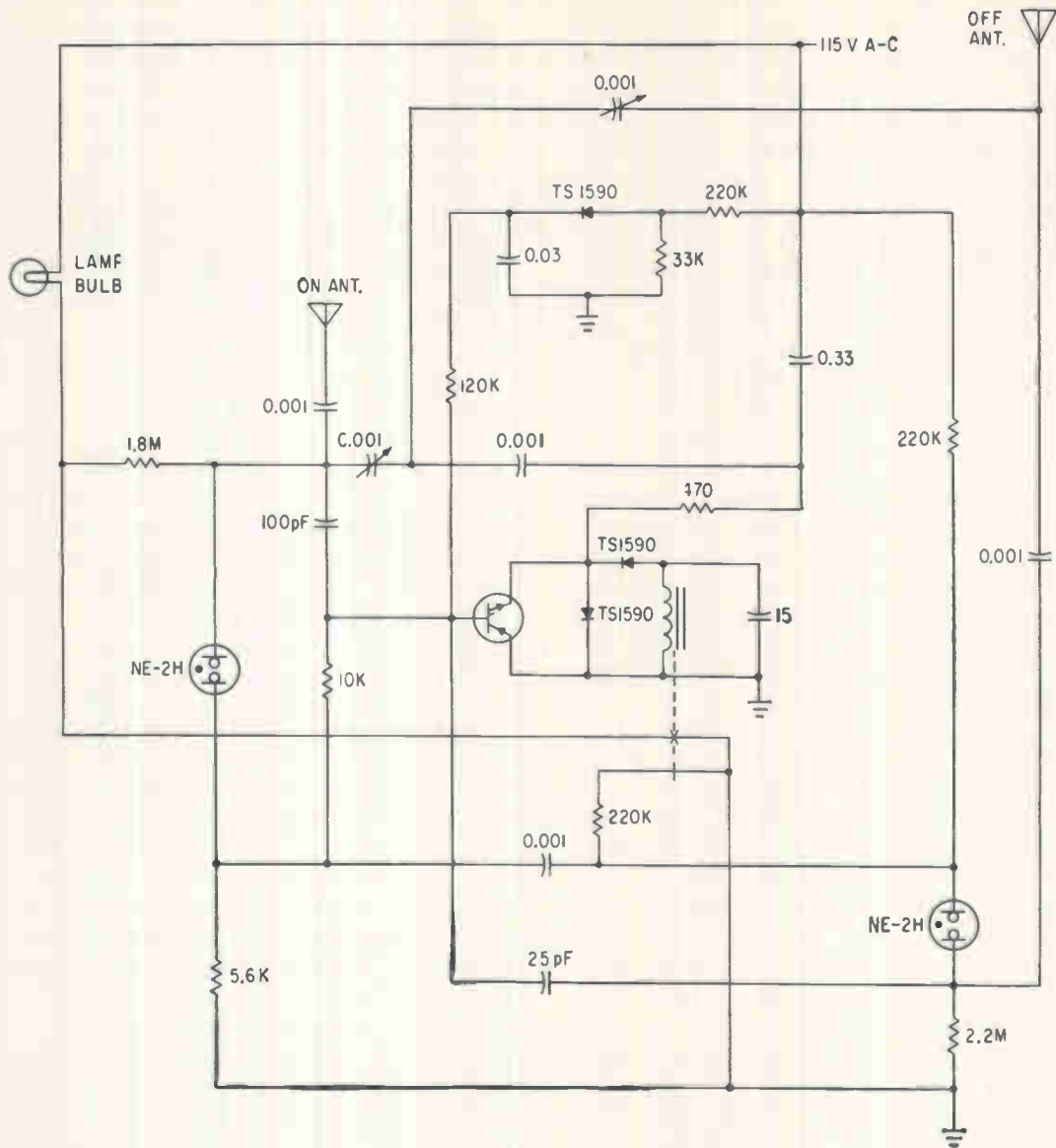

CAPACITANCE SWITCHES operate lamp in kit by Tung-Sol—Fig. 2

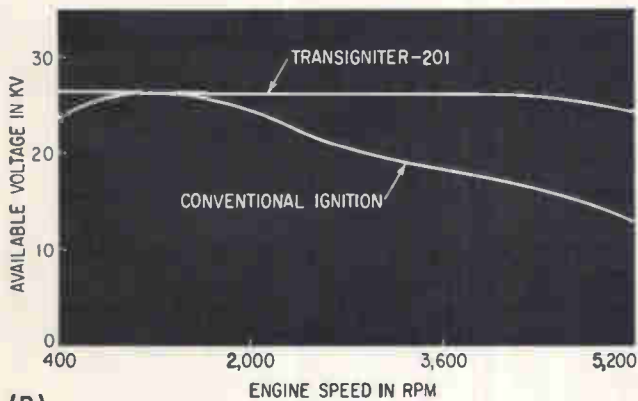

(B)

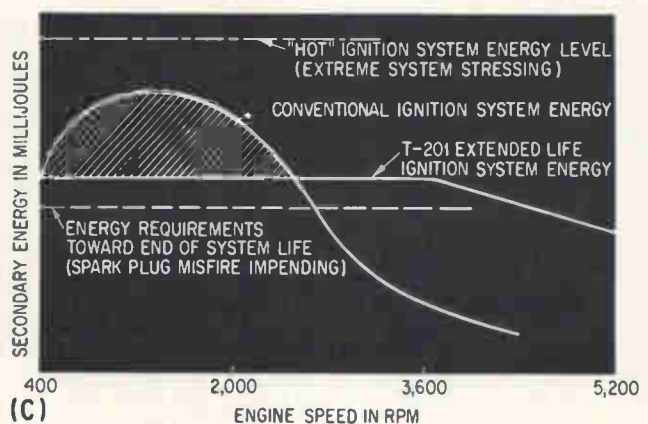

(C)

son of available voltages (B); secondary energy versus engine speed (C), with shaded area indicating the excess restrikes, which contribute to accelerated aging of the ignition system—Fig. 3

R_2 as low as possible, but R_2 cannot be too low or it would allow too much current to flow through the contacts on make.

Zener diode D_1 is a protective device. If the induced back voltages or a transient voltage is higher than the voltage rating of D_1 , then D_1 will clip this voltage pulse below the minimum emitter-to-collector rating. Diode D_1 will always be of less value than the transistor voltage; therefore, the voltage across the emitter-collector junction will never be more than the value of D_1 .

During the dwell period when the contacts are closed, the transistor base is connected directly to the collector, allowing maximum current to flow. Transistor impedance when full on is about 0.1 ohm. Initial current is limited by the resistance of the high-voltage transformer primary, but finally by ballast resistor R_2 . The traditional capacitor across the ignition contacts has been eliminated.

The excess energies of the conventional system (Fig. 3C), although never used, will decrease sparkplug life, according to Prestolite. With the clean arc-less switching of the contacts in the transistor system, a precise secondary voltage is realized. In a conventional system, contact arcing causes a large scatter band of voltages with maximum peaks of 32 Kv, which decreases sparkplug life.

The flat output voltage curve (Fig. 3B) means that sparkplugs with larger gaps can be used longer, since the required increased voltages are available.

A special design feature of the Transigniter is that the inductively wound ballast resistor (R_2 , Fig. 3A) is located between the coil and heat-sink assembly, to help protect the transistor by allowing for a low return-loop impedance.

Prestolite has begun production of a positive-ground transistor system, which is basically the same as the negative-ground unit except for the transistor, which is an *npn* silicon type. This transistor withstands temperatures up to 400 F, and has a collector current rating of about 30 amperes. The *pnp* germanium transistor in the negative-ground system has a temperature maximum of 200 F and a collector

current of 15 amperes.

The first approach to a positive-ground system was to use a small *nnp* type to drive the germanium *pnp* transistor. But not enough base drive was available to drive the *pnp* transistor into complete saturation. A high junction temperature developed and caused transistor failure. The solution was an *nnp* power transistor, although the penalty for this is a more expensive device.

One possible trend is that contact triggered systems will eventually be replaced with contactless versions. Another is toward a more complete electronic ignition system that would make the distributor itself obsolete.

MAGNETIC-PULSE IGNITION—The Delcotronic magnetic-pulse ignition system, made by the Delco-Remy division of General Motors, eliminates contact points. Timing in this three-transistor system is achieved by a voltage pulse generator consisting of an iron pole-piece that rotates within a permanent magnet and a winding assembly inside the distributor. The timed pulses from the distributor are passed to an ignition pulse amplifier, which controls primary current to the ignition coil.

In the circuit, (Fig. 4), Q_1 is the trigger transistor, Q_2 the driver and Q_3 is the output transistor; all three are special types. The current through the ignition coil is controlled by Q_3 ; the rest of the circuit controls Q_1 . The pulse generator and Q_1 turn off the coil current at the proper time, and C_1 and R_1 turn it on again.

When the ignition switch is on and the distributor is stationary, Q_2 and Q_3 turn on, allowing current to flow through the primary of the ignition coil and C_1 to charge. When the distributor turns, a pulse is generated in the pickup coil, which applies a forward bias to C_1 and turns it on, connecting C_1 from the base of C_2 to its emitter. With the charge that is on C_1 , the base of Q_2 is now more positive than the emitter, which turns off Q_2 and Q_3 . Turning off Q_3 interrupts the coil primary current, causing the magnetic field to collapse in the ignition coil, and the coil to send a high-voltage surge to the sparkplug. The charge on C_1 will hold Q_2 off until it is bled to ground through R_1 . Then Q_2 will again conduct and allow Q_3 to turn on, after which current will again flow through the ignition coil. As Q_2 conducts, the voltage rise feedback through R_2 will turn off Q_1 , and the system is now ready for the next pulse.

Zener diode D_1 clips any voltage that would exceed the voltage rating of Q_3 . Capacitors C_2 and C_3 suppress transient voltages, protecting Q_1 .

The Delcotronic ignition system is currently an optional feature on the 1963 Pontiac models.

An electronic ignition system by Motorola also replaces breaker points with a magnetic pickup system. The pulse generator is a small spoked wheel that rotates past a magnet without touching it. This system is available only for original equipment manufacturers. Motorola has a transistor system for installation in present automobiles by using the standard distributor and its breaker points. Four models are available, for 6 or 12 volts, positive or negative ground.

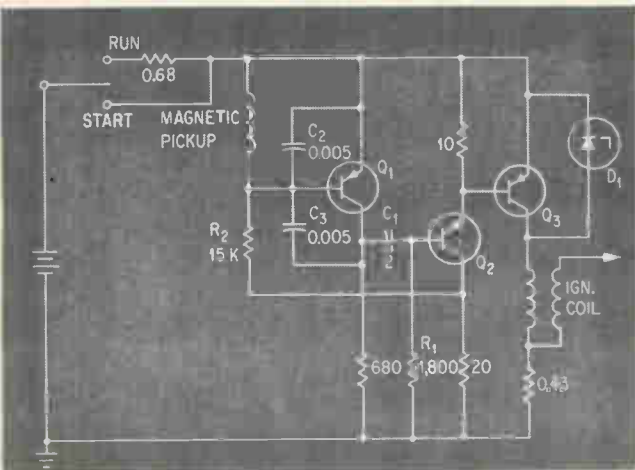

MAGNETIC-PULSE IGNITION by Delco-Remy. The ignition switch, first turned to the start position by hand, is returned to the run position by spring action—Fig. 4

HOW PI TURNS OUT A BETTER TAPE TRANSPORT

—by supporting it on its centerline. The transport is thus freed from one of the most vexing problems besetting users of instrumentation magnetic tape recorders — creeping misalignment. The PI-400 will never suffer from this malady; you can expect it to perform its function superbly, metering tape across the heads, day-in and day-out, with everlastingly precise alignment.

Every moving part concerned with tape motion (and there are fewer than a dozen) is anchored rigidly in place to the same reference plane, and all rotating axes are parallel within less than a minute of arc. The reference plane is shaped into a ribbed, rectilinear box frame casting which is structurally and functionally massive, yet finely balanced and light in weight. The entire transport assembly can be rotated about

its centerline, even during operation, without imposing any unbalance or in any way affecting the precision tape handling function. An important side benefit is the complete accessibility of not only the rear of the transport, but also the slide-out power supply and servo-control chassis.

The turnabout transport is but one of the many advanced-design features which make the PI-400 stand out from its contemporaries. Others are its 7 bi-directional tape speeds; switchable electronics; error-proof, logic-programmed tape motion control circuitry; and complete accessibility during operation of every component of the recorder. May we arrange a demonstration of the PI-400? If you'd like to see the literature first, address us at **Stanford Industrial Park, Palo Alto 20, California.**

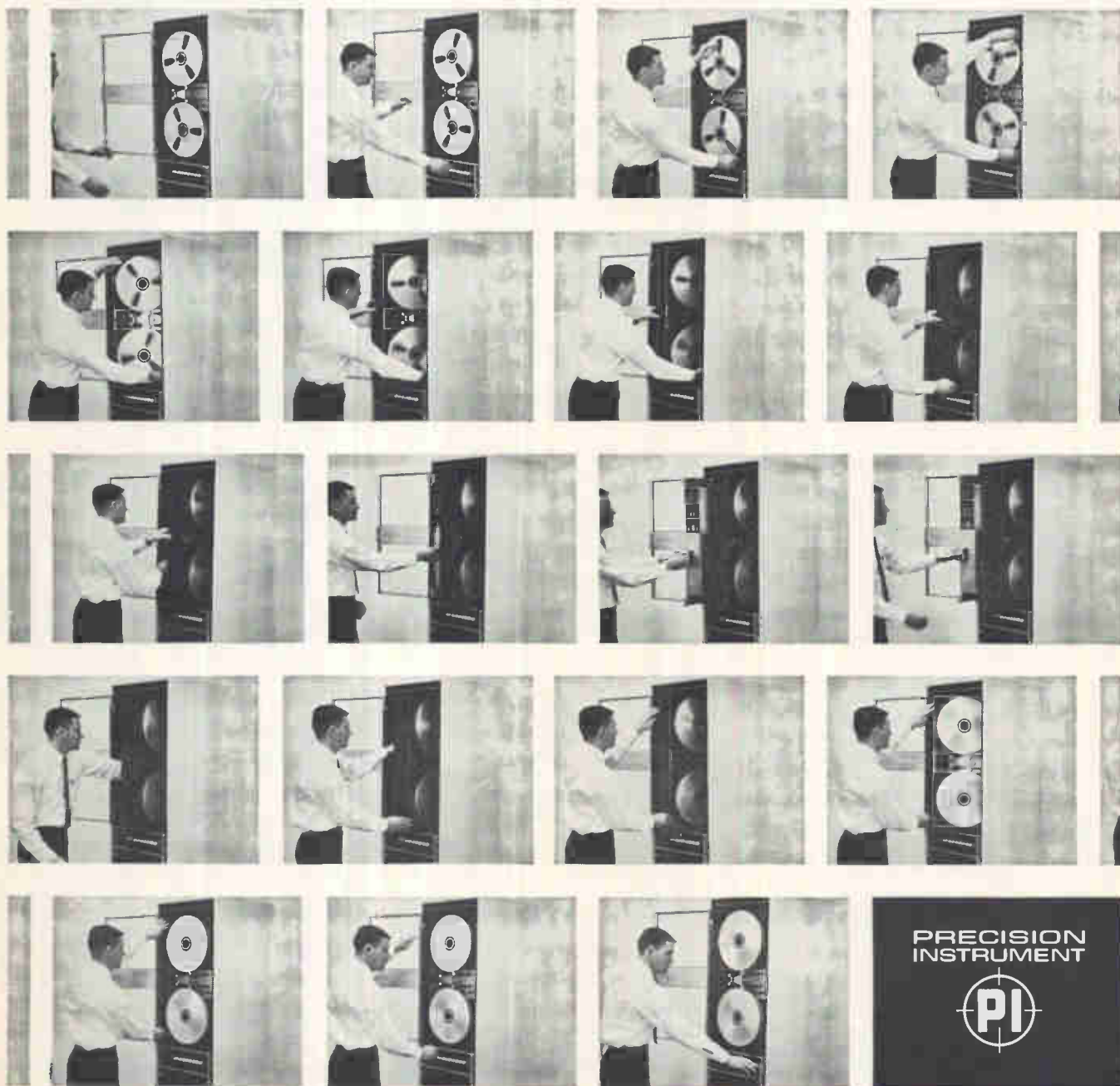

PRECISION
INSTRUMENT



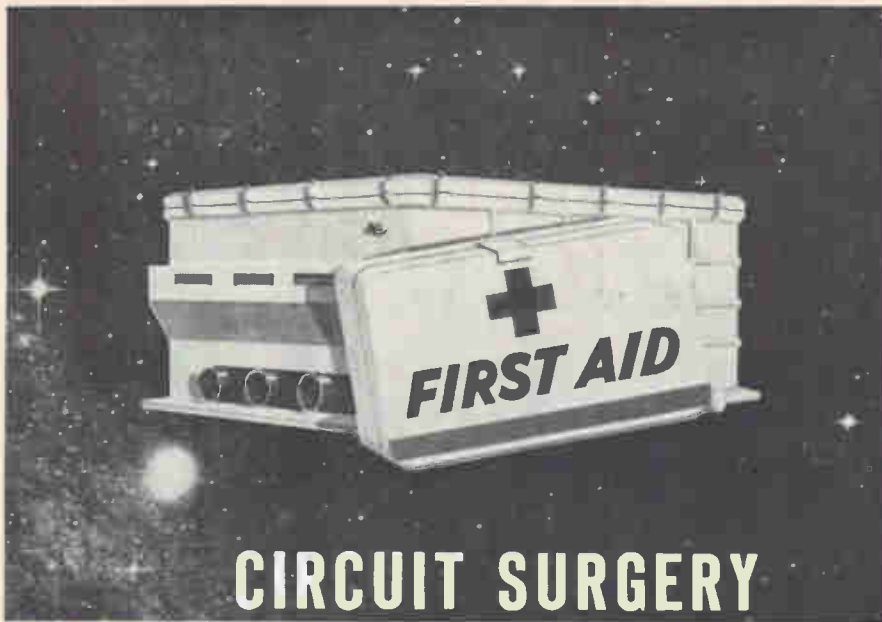

CIRCUIT SURGERY IN SPACE!

The problems associated with translating the self-healing concept into practical, space-applicable devices provide technical challenges of the highest order to Engineers and Scientists at Honeywell in Florida.

Advanced development work on ULTRA-RELIABLE aero space guidance systems include our investigations in the following areas: Multi-Redundancy techniques, Self-Adaptive techniques, including Self-Diagnosis, Self-Repair and modular number systems.

These studies provide FRESH OPPORTUNITY FOR TALENTED ENGINEERS AND SCIENTISTS AT EVERY LEVEL OF EXPERIENCE.

Other studies which may open up new avenues of career advancement for you are:

- Development of fluid components for Computer and Navigation systems.
- Advanced inertial systems design and development, including electrostatic gyros, strapped down systems and fluid inertial components.
- Optical Navigation systems and devices, (Astral Inertial Systems, Star Trackers, etc.)
- Metrology. Continuing development of precise angle measurement devices beyond the capability of our "Dynagon," which accurately measures less than 1 arc second.
- Optical Coordinate Transfer Devices.

Interested in contributing your talents in any of the above areas? Just send a brief note describing your education, experience and specific area of interest to M. L. Ericson, Honeywell, 13350 U. S. Highway 19, St. Petersburg, Florida. We promise a prompt, confidential reply, and, perhaps, an invitation to visit with us, to see our facilities, meet our people and discover for yourself the added attraction of living here on Florida's Suncoast.



Honeywell An Equal Opportunity Employer

"A GOOD PLACE TO WORK... A GOOD PLACE TO LIVE"

To investigate professional openings in other Honeywell facilities, send your resume to H. F. Eckstrom, Honeywell, Minneapolis 8, Minnesota.

HONEYWELL ENGINEERS ARE DOING THINGS IN FLORIDA

WHY SETTLE FOR LESS?

0.01%
ACCURATE
SIZE 23 RESOLVER



Type 23RV4al

Here's a top rated resolver that's priced surprisingly low. So why settle for less than Ford Instrument's highly accurate Size 23 Resolver... the resolver that exceeds MIL-E-5272 A.

SPECIFICATIONS:

- Maximum Functional Error (over 360° of shaft rotation) ... 0.01% of input voltage at maximum coupling
 - Maximum Total Null Voltage ... 1 mv/volt input maximum
 - Maximum Interaxis Error (rotor) ... 1.5 minutes
 - Maximum Interaxis Error (stator) ... 1.5 minutes
 - Maximum Variation of Transformation Ratio (with input voltage from 6-18 volts with 12 volts input as reference) ... 0.03%
 - Maximum Variation of Transformation Ratio (with input voltage from 0.3 to 6 volts) ... 0.02% of 6 volts
- 0.025% accuracy available in size 15
Bulletin FR 62-1 gives full specifications. It's yours for the asking.
Write:

FORD INSTRUMENT CO.

Division of Sperry Rand Corporation
31-10 Thomson Ave., Long Island City 1, N. Y.

CIRCLE 201 ON READER SERVICE CARD

May 10, 1963 • electronics

NIMS

NATIONWIDE IMPROVED
MAIL SERVICE PROGRAM

For Better Service
Your Post Office
Suggests

That You Mail Early
In The Day!

STI-SERIES SUB-MINIATURE

TRANSISTORIZED INDICATOR LIGHTS by DIALCO

Logically Combine Neon Lamps
or Filament Lamps with Transistors
or Other Semiconductor Circuitry

DIALCO'S STI-Series provides the advantages of a single Transistorized Indicator package: Each compact unit contains the light source, switching circuit, and all power circuit and bias voltage connections; eliminates need for separate drivers... There are 2 general classes of transistorized lights: (a) units for connection to power at 90 V or more, and (b) units for low voltage circuits of 6 V or more... The light source: for the higher voltage series, built-in Neon Glow Lamps; for the low voltage series, low current miniature T-1 3/4 Incandescent Lamps.

Assemblies mount from back of panel: The Neon series requires a 3/8" clearance hole; the Incandescent series requires a 15/32" clearance hole... Options include: cylindrical or stovepipe lenses with or without Fresnel rings; 6 lens colors; hot-stamped legends; AMP "53" Series Taper Pins, Double Turret, or "Wire Wrap" terminals.

Problem? Circuitry and other components can be custom-engineered to meet your special requirements—for applications in computers, data-processing equipment, etc.

Plus—Matching Indicator Lights: A companion series to the above—with identical front-of-panel appearance (no resistor or other circuitry built-in). Accommodate T-1 3/4 Incandescent Lamps (1.3 to 28 V), and NE-2D or NE-2J (high brightness) Neon lamps.

For complete data, request Catalog L-166B.



(Illustr. actual size)



Foremost Manufacturer of Pilot Lights

DIALIGHT
CORPORATION

60 STEWART AVE., BROOKLYN 37, N. Y. • (212) HYacinth 7-7600

CIRCLE 202 ON READER SERVICE CARD

BEST MINIATURIZED INDICATOR

VU RADIOATOR



V-403



SB-305



R-201



R-101

- R-101 Tuning indicator and Battery residual capacity indicator
- F-102 FM tuning indicator
- V-103 Audio level indicator
- A-104 AM tuning indicator
- SB-105 Stereo balancing indicator
- B-106 Battery indicator
- R-201 Smaller type tuning and battery indicator
- V-203 Smaller type level indicator
- B-206 Smaller type battery indicator
- R-301 Larger type tuning and battery indicator
- V-303 Larger type level indicator
- SB-305 Larger type stereo balancing indicator
- V-403 VU meter
- V-403B Audio level indicator
- SB-405 Null indication stereo balancing indicator

ACCEPTABLE SPECIAL DIAL UPON YOUR REQUEST

DISTRIBUTOR

ATAKA NEW YORK, INC. ATAKA & CO., LTD.

633 THIRD AVENUE
16TH FLOOR
NEW YORK 17, N.Y., U.S.A.
PHONE: OXFORD 7-7480

OHEMACHI BLDG.
1-CHOME, OHEMACHI
CHIYODA-KU, TOKYO
PHONE: 201-6411

MAKER
TOYO MUSEN CO., LTD.

75, WAKABAYASHI-CHO, SETAGAYA-KU, TOKYO

CIRCLE 203 ON READER SERVICE CARD

TRENT "High Temperature" ELECTRIC JACKETS

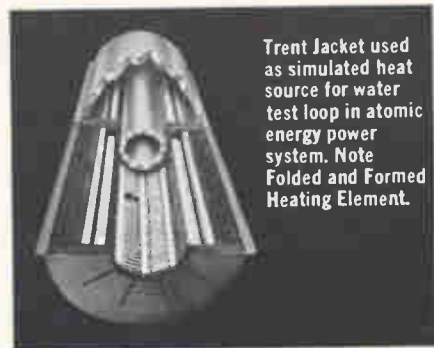

Trent Jacket used as simulated heat source for water test loop in atomic energy power system. Note Folded and Formed Heating Element.

feature TRENT FOLDED AND FORMED HEATING ELEMENT

The result? Jacket heating advantages not possible with steam or liquid heating methods! • Temperature to 1000°C. without Pressure Equipment—Minimum Maintenance • Maximum Heat Input • Chamber Control • Heat Zone Control • Low mass element—quick control response • Maximum Element and Jacket Life • No matter what your process heating problem—Trent can solve it. Discuss your needs with a qualified Trent Engineer, or write for Bulletin J-1.

203R



203 Leverington Ave.
Philadelphia 27, Pa.

Electrically Heated Industrial Equipment
In Canada: Pioneer Electric Eastern Ltd., Toronto

CIRCLE 59 ON READER SERVICE CARD

Giant Ruby Laser Produces Harmonics

Second and third harmonic wavelengths derived from laser beam by crystals

COHERENT BLUE LIGHT has been produced from a ruby laser, using an ADP crystal to convert the primary red light emission into its second harmonic frequency.

The work has been reported by R. W. Terhune, P. D. Maker and C. M. Savage of Ford Motor Company's Scientific Laboratory. They used a giant pulse laser with an output energy of 30 mJ, and a triangular pulse with a width of 60 nsec, focusing its beam weakly on ammonium dihydrogen phosphate crystal, oriented to its phase-matched condition. The combination of high electric field strength and long coherence length gave a saturation of conversion efficiency over 20 percent for a second-harmonic wavelength of 3,470 Å. In the experimental setup shown on the cover, a smoke-filled chamber on each side of the ADP crystal scatters the laser beam for visibility. A filter inserted in front of the second chamber removes the red beam in order to increase the visibility of the blue second harmonic beam.

Second harmonic generation, which involves a 3-photon process, was the first step in a research program aimed at investigating non-linear optical phenomena now observable through the use of giant pulse laser systems. Many non-linear effects have analogous low-frequency counterparts such as Faraday effect and linear and non-linear electro-optic effects. In addition to these, however, certain intensity-dependent phenomena can be predicted which could lead to useful devices such as limiters. Ford plans investigation into all these effects; thus far, third-harmonic generation (4-photon process), electric-field-induced second-

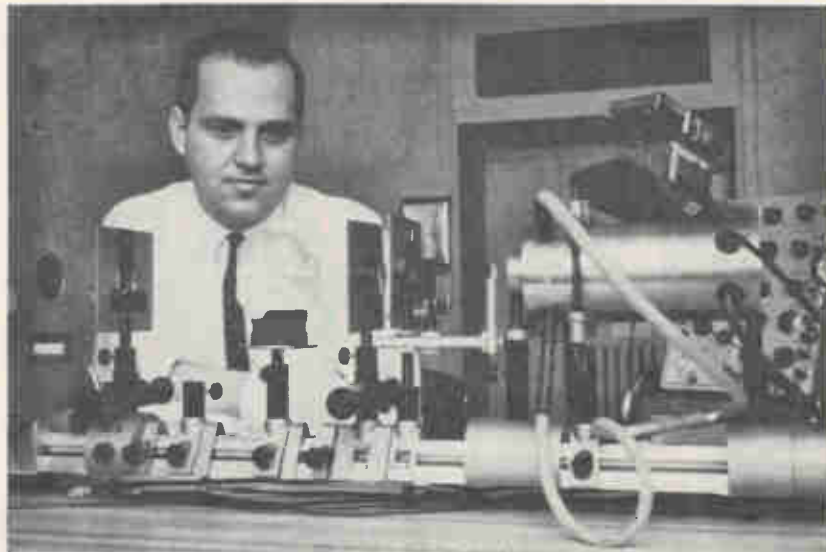

EXPERIMENTAL SETUP, shown with R. W. Terhune, consists of giant pulse ruby laser, right, ammonium dihydrogen phosphate crystal, center, and a grating spectrometer with photomultiplier to analyze the beam

harmonic generation (4-photon), and inverse Faraday effect (3-photon plus one magnetic term) have been studied (see also *ELECTRONICS*, May 3, p. 30).

THIRD HARMONIC—Third-harmonic generation has been observed by Ford Laboratories using calcite crystals; difficulty was encountered due to the powerful primary laser beam breaking down the sample in the 4-photon process. Third harmonic generation, in small amounts, was also observed in iso-

tropic materials and liquids.

The Ford team concluded that harmonic generation is an excellent technique for obtaining laser beams at short wavelengths, especially in the ultraviolet region. The problem is to use very high power lasers for the primary emission so that the higher harmonics will be present in appreciable amounts. Present conversion efficiencies for the third harmonic are in the 0.001 percent range; efficiency apparently increases with the power output of the laser.

New Transducers At Biomedical Meeting

SAN DIEGO—The need for men trained in both biology and mathematics, physics and/or engineering was stressed in a keynote address by Dr. R. F. Rushmer, of the University of Washington, at the Third Annual San Diego Symposium for Biomedical Engineering.

Current efforts of biomedical re-

search, as indicated by the meeting, are focussed on electronic devices for externally sensing parameters which, at present, require internal probes. Disadvantages of the latter are that they require incisions through the skin, frequently interfere with normal functioning of the parameters being measured, and, in



NEW—from ITT Surprenant

TEFLON*

ABRASION-RESISTANT REINFORCEMENT

TEFLON

CONDUCTOR

ITT SURPRENANT SURCODUR** superior new abrasion-resistant Teflon insulated wire—the most nearly perfect hook-up wire for critical conditions of miniaturization, weight and high temperature.

World's most nearly perfect hook-up wire: new SURCODUR in heavy duty abrasion-resistant Teflon

SURCODUR hook-up wire preserves all the exceptional electrical and thermal properties of Teflon TFE and FEP insulation: lowest dielectric constant, lighter weight, higher heat resistance, greater mechanical strength, non-flammability, no shrinkback or insulation damage from soldering, chemical inertness, and flexibility even at low temperatures.

But now ITT Surprenant Laboratories have overcome the previous weakness of TFE resins—low abrasion resistance due to poor cold flow properties. The secret: extrusion of a remarkable triple

insulation of ultra abrasion-resistant material sandwiched between two layers of pure Teflon.

Specify Surprenant Mil Spec MS 17411, MS 17412, MS 18000 and MS 18001 (WEP). Available in all types and sizes, with silver-plated or nickel-plated conductors.

See your ITT Surprenant representative for full details or write for technical information.

Surprenant Mfg. Co., a Subsidiary of International Telephone and Telegraph Corporation, Clinton, Massachusetts.

ITT

Surprenant



To move your delicate equipment faster, better...

BEKINS ENGINEERS TAKE UP WHERE YOURS LEFT OFF!

From start to finish, Bekins Electronics Moving is engineered to specifications as exacting as your own

When it comes to the moving of delicate electronics equipment, Bekins starts with *the man*.

There's good reason, too. We'd be the first to admit that many of our competitors have vans as good as ours. But we just don't believe that anyone in the world can teach a van how to do the job.

That's why we teach our men. They're the real key. And we teach them thoroughly. Only after they're Certified in our special electronics school are they ready to serve you.

No wonder Bekins Certified Electronics Moving is your best bet. You get skilled specialists *at both origin and destination*. And knowledgeable supervisors, too.

It might be worth remembering that Bekins is the largest moving and storage organization in the world. We've been in business since 1891.

Think about it! Isn't that the kind of experience *your* delicate equipment deserves?



CERTIFIED SERVICE WITH BEKINS WORLDWIDE MOVING AND STORAGE

the case of heart and brain probes, can be hazardous to the patient. Existing sensing systems must be refined to better identify and measure relatively weak biological signals in presence of high noise.

NEEDED TRANSDUCERS—

Three badly needed items, suggested by Marquette University's Dr. Saul Larks, are: a foolproof means for accurately determining cardiac output; a small, portable, special-purpose computer for diagnostic work, and a dependable blood pressure sensor which does not require circulation shut-off.

Successful method for injection-molding ultrasonic blood flowmeter transducers was detailed by N. W. Watson of the University of Washington. Reportedly feasible for use in connection with the transit-time pulsed ultrasonic technique, the back-scattered Doppler technique, the phase difference flowmeter, and the transit-time continuous wave flowmeter, the new transducer solves problems of alignment of the acoustic axis, fixed crystal separation, and electrical insulation as well as any device developed to date. One of the molded transducers, which cost about \$2 each, has functioned for over 18 months transplanted in a monkey at the university laboratory.

M. L. Hanson and R. J. Preston, of United Aircraft Corporation's Systems Center, described a recently developed telemetering f-m cardiac monitor, using integrated circuits, and small enough to be af-



PIEZOELECTRIC ultrasonic transducer for monitoring changes in blood flow, from the University of Washington

fixed directly to the skin. An implantable version designed for coupling with an r-f power detector measures $\frac{3}{4} \times \frac{1}{4} \times \frac{1}{8}$ inch. Carrier frequency near 100 Mc was selected as a tradeoff between tissue absorption at high frequencies and large component size at low frequencies, and to use standard f-m receivers. A tunnel diode is used in preference to a transistor oscillator for its higher modulation sensitivity.

A transducer for recording instantaneous blood flow velocity directly from superficial veins through the skin was described by Watson and Dr. Rushmer. The device, shown in the photo, is a modified pulsed ultrasonic flowmeter that is applied to the skin over the jugular by a section bulb. The transducer, the first to sense blood flow through the skin, records variations of flow accompanying each heart beat and motion of the body.

Experimental Tape Deck Records Sideways

LONDON—Packing densities five times normal and the use of $\frac{3}{4}$ -inch magnetic tape are the features of a new magnetic recording system developed by Data Recording Instrument Company Ltd., a subsidiary of International Computers and Tabulators, for the new ICT 1300 computer. The deck, see picture, uses a full tape width longitudinal variation recording system to give a maximum 1,800 flux reversals per inch. A single head magnetizes a strip right across the tape width; the length of the recording along the tape is proportional to the number recorded. No numerical coding is used: numbers are recorded directly as 0-9 as proportional lengths.

To ensure correct operation, when a number is recorded the tape control unit generates an appropriate check digit which is held in temporary storage in the computer. After writing on the tape, the tape advances past two check read heads separated by $\frac{1}{8}$ in. Reading from the first head generates a control digit for comparison with that already held in the computer. If there is agreement, recording continues; otherwise the check is repeated by the second head. Continual disagreement stops the recording.

Other features of the new system

SUPERIOR SUPPLIES CATHODES FOR EVERY ENGINEER'S REQUIREMENTS



I want high-purity nickel



I want round shape



I want square shape



I want king size



I want active



I want passive



I want all-purpose

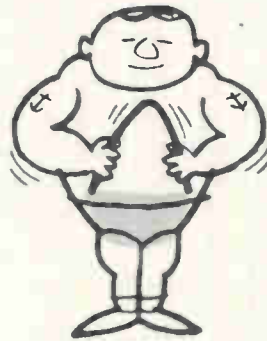

I want high strength

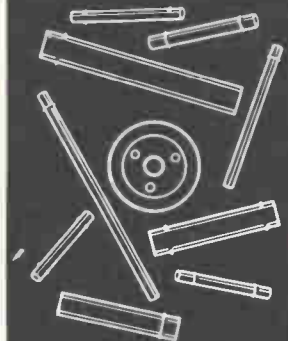

Which kind do you want?

Whatever kind of cathodes you need, Superior can supply them. For all sizes of receiving tubes, transmitting tubes, special purpose tubes. Seamless, WELDRAWN,[®] Lockseam,^{*} lapseam. Choice of over 25 different alloys. Shaped, beaded or tabbed. Disc cathodes in standard, miniature and subminiature sizes. Quality is unmatched. Fast delivery. Write for selector guide. Superior Tube Co., 2500 Germantown Avenue, Norristown, Pa. ^{*}Manufactured under U.S. patents

Superior Tube

The big name in small tubing
NORRISTOWN, PA.

Johnson & Hoffman Mfg. Corp., Mineola, N.Y.

—an affiliated company making precision metal stampings and deep-drawn parts

PROVED

in thousands
of
applications

AIRPAX

MICRO-MIDGET LOW-NOISE CHOPPERS



Model 30A
60 CPS



Model 40A
400 CPS

Introduced in mid-1960 after exhaustive laboratory and application tests, thousands of these tiny electromechanical choppers are performing to complete customer satisfaction in devices such as: RF and DC Voltmeters, ultra low-level DC Amplifiers, Servo Systems in complex aircraft-landing sequences and in similar critical areas. The 60 CPS series will operate at drive frequencies from 0 to 250 CPS; the 400 CPS series, from 0 to 1,000 CPS. Each series is obtainable in a variety of enclosures and header types.

CHARACTERISTICS

Drive: 6.3 volts
Contacts: SPDT BBM
Signal: to 10 volts DC; 2 MA max.
Noise: as low as 0.6 microvolts
Temperature: -65 to +100° C
Vibration: 15G to 2,500 CPS Shock: 100G
Volume: 0.15 cubic inches Weight: 9 grams

Available from Stock



TWX 301-228-3558

PHONE: 228-4600 (301)

AIRPAX ELECTRONICS • CAMBRIDGE DIVISION • CAMBRIDGE, MARYLAND
Incorporated

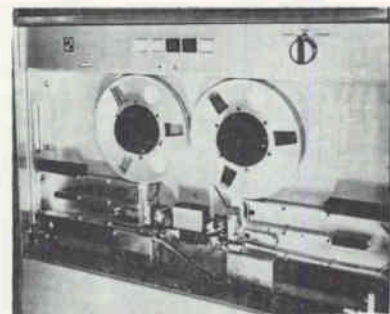

TAPE DECK takes 1,800-foot tape reels, uses a novel system of check digits to ensure recording accuracy

include horizontal tape feed across the reading heads. Tape is held in vacuum chambers left and right of the recording head, suction capstans drive the tape past the heads so that gravity drag and wear are eliminated.

Maximum capacity of a single deck unit is 38 million bits, with an input-output rate of 16,000 digits per second.

High Energy Plasma Lab Started at Berkeley

SAN FRANCISCO—The first facility for graduate student research into high-energy plasmas on a college campus has begun operation at the University of California in Berkeley.

Major experimental apparatus, concerned chiefly with containing hydrogen ions in a magnetic bottle, is a two-stage magnetic mirror machine with a 100-Kilogauss maximum field, provided by 0.25-M joule capacitor bank. It is expected to produce plasma of 10^{18} to $10^{19}/\text{cm}^3$ density, with expected containment of several milliseconds, with electron temperature of 20 Kev and up to 1 Kev ion temperature.

Specific experiments planned are the measurement of plasma density by improved microwave interferometer methods, studies of plasma stability by probing the electric fields in and near the plasma with an electron beam, plasma heating by high-energy electron beams and lasers used as plasma diagnostics, and the effects of variation of the basic configuration of the magnetic field.

If your plant
belongs in
FLORIDA

Plant City

is the most
**STRATEGIC
LOCATION**

LOCATION — In the center of Florida — closer to all Florida markets — served by two railroads, major truck lines; only minutes from deep-water port and international airport.

LAND — Low cost sites in city-owned industrial park. Large acreage also available.

LABOR — Excellent local labor market.

LIVING — Established community with all educational, civic, and cultural advantages.

All correspondence in strict confidence.

SEND FOR INDUSTRIAL SURVEY
Dick Prewitt, General Manager
INDUSTRIAL DEVELOPMENT COMMITTEE
P.O. Box 1509-E
Plant City, Florida

City MOST Convenient to ALL Florida

CIRCLE 204 ON READER SERVICE CARD

Because you've got to SEE it to BELIEVE it
...we will send you a FREE sample!!!!



instant lettering

DRY TRANSFER TITLES

FOR PROTOTYPES AND ELECTRONIC PANELS

NOT A DECAL — NO WATER — NO TAPES — NO SCREENS
GOES ON INSTANTLY — JUST PRESS AND IT'S THERE
MAKES PROTOTYPES LOOK LIKE FINISHED EQUIPMENT!

"Instant Lettering" Electronic Titles transfer DRY to almost any surface — metal, glass, wood, plastic — with just a quick light pressure. Simply try the sample. You'll agree "Instant Lettering" is the easiest quickest way to get professional lettering you've ever seen.

Complete "Instant Lettering" Title Sets contain 24 sheets with thousands of preset words and phrases researched to give you the greatest variety and flexibility.

Nb. 958 — Black \$4.95
Nb. 959 — White 4.95

The complete line of standard "Instant Lettering" sheets is also available. Type sizes range from 8 point to 1½ inch display letters in a wide selection of type faces.

WRITE — WIRE — PHONE FOR FREE SAMPLE!

THE DATAK CORPORATION

63 71st STREET
N. J. 201—UN 4-6555

GUTTENBERG, N. J.
N. Y. 212—LA 4-0346

CIRCLE 205 ON READER SERVICE CARD

electronics • May 10, 1963

TURBO

your
headquarters
for

- ELECTRONIC COMPONENTS
- COMPLETE ASSEMBLIES
- DIP-BRAZING OF ALUMINUM ALLOYS
- COMPLETE SERVICE FROM PRINT TO FINISHED PART
- PACKAGE DELAY LINES



This sophisticated electronic chassis built by Turbo has 67 interlocked parts. Size: 16" x 16" x 8". Dip-brazing permits close tolerances

to be held. Gauge of Material: .040 & .060.



Electronic assemblies such as this mixer are built by Turbo. Size of this assembly is 10" in diameter and 8" high with 37 interlocking parts. Dip-brazing af-

forded best means of meeting design requirements.

Behind Turbo stands more than 20 years of reliability in manufacturing electronic parts and assemblies. Allow us to submit a quotation on your requirements.

TURBO

ORDNANCE AND ELECTRONIC DEPARTMENT
TURBO MACHINE COMPANY
LANSDALE, PA.
Phone: Area Code 215, Ulysses 5-5131

CIRCLE 65 ON READER SERVICE CARD 65

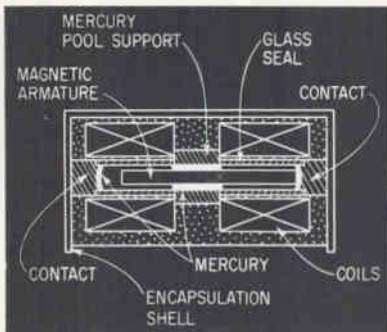

MERCURY needle relay may answer need for small, economical and reliable package (Phillips Control)—Fig. 1

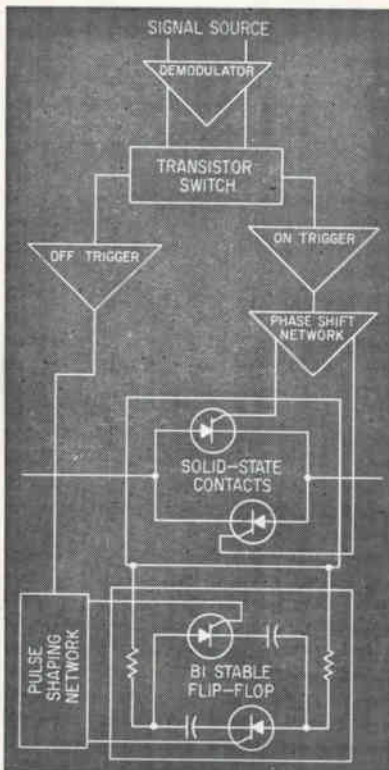

SOLID-STATE relay uses silicon controlled rectifier (Phillips Control)—Fig. 2

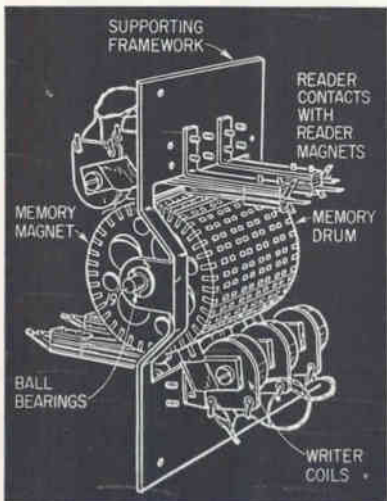

LOW-COST magnetic memory drum is suited for industrial memory systems (ITT Kellogg Telecommunications)—Fig. 3

Will Solid State Nip Relay Markets?

By CLETUS M. WILEY, Midwest Editor

Choice lies in proper evaluation of design for specific application

STILLWATER, OKLA.—Advances in solid state devices may threaten relay markets, according to Winford Crawford of Autonetics. Warning was aired at the 11th relay conference held at Oklahoma State University during week of April 23.

Gains in reliability, and introduction of new components have led many systems engineers to favor semiconductor switching circuits over electromechanical relays, he said.

Crawford cited fact that every switching function for guidance and control of the Minuteman missile is performed by solid-state circuits, although this approach boosted both numbers of components and total cost of the program.

Relays could have performed many of these switching functions much more simply, efficiently and cheaply, Crawford said, had they been available with the required reliability when the system design had begun. Urging relay failure rate reductions by two to three orders of magnitude, Crawford proposed eliminating circuit redundancies, more rigorous testing programs and state of the art advances such as truly leakproof terminal headers.

Relays can contribute much toward reducing the ever-increasing

complexity of electronics systems, he concluded, while also offering substantial cost advantages.

MERCURY NEEDLE—Reliability approaching that of solid state devices was claimed for a new mercury needle relay introduced by Harold Schultz, Phillips Control Co., Joliet, Ill. Minimizing numbers of moving parts, a magnetic armature is wetted with mercury and supported in a mercury pool, see Fig. 1. A center section supports the pool and also conducts current to the armature.

Development and applications of

EVALUATING RELAYS FOR SWITCHING

Role of electromechanical devices and the circuit function was detailed in a special report on Electromechanical Systems for Electronics (ELECTRONICS, Sept. 30, 1960, pgs 58-64). At that time an objective analysis was presented on the switching function, and how to apply relays to modern circuits, both from an economic and engineering standpoint.

Ordinary simple relays of modern design are used in many missile systems today. Solid-state devices can and will be used if they can show operational advantages, as well as economic justification: And this applies to military systems as well.

In many cases, the electromechanical relay cannot be substituted for the solid-state device. And in other cases, certain space requirements recommend a solid-state device.

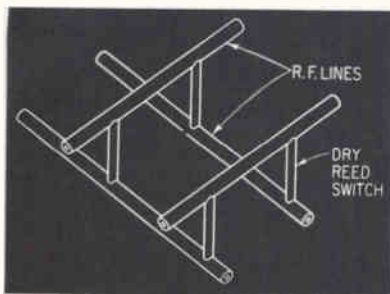

RADIO-FREQUENCY switching matrix uses dry reed relays (Hathaway Instruments)—Fig. 4

The four-layer silicon diode may determine the future of the electronics industry, predicted Wesley Koeffler, also of Phillips.

Superior forward-voltage characteristics, operating temperature range and independence from external power has already obsoleted conventional power transistors in many switching areas, Koeffler said. This diode also offers many advantages as a contactless current interrupter.

With turn-off turn-on several times faster than electromechanical devices, the scr best lends itself to switching, with a minimum of associated electronics (see Fig. 2). A prototype can switch a four to six ampere light bulb load several million cycles without a failure or a miss, Koeffler reported.

Developers are aiming at a service life of more than 100-billion cycles.

DRUM MEMORY—A new magnetic drum memory was introduced at the relay conference by Weichien Chow of ITT Kellogg Telecommunications, Chicago.

Requiring no amplification for input or output of switching or control systems, the new memory device can be used either for general purpose bit storage or as a main storage device in switching control systems, according to Chow.

The nonferrous three-inch diameter drum has bit magnets and associated read and write heads shown in Fig. 3.

Memory bit magnets are mounted circumferentially as a layer on the drum periphery, in five parallel rows fifty magnets each. An external stepping switch, with motor, rotates the drum to read or

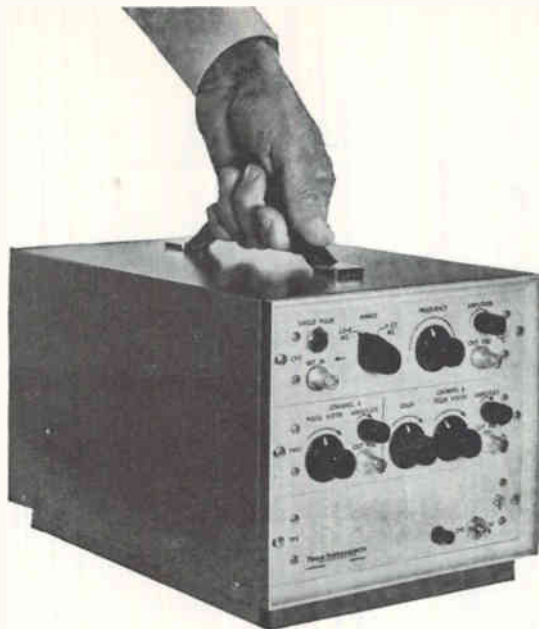

TI has what you need in pulse programming!

Versatility — Custom combination of modules for any desired performance characteristics. **Portability** — Compact, lightweight, easy to carry. **High Rep Rate** — Repetition rates of 100 cycles to 100 megacycles.

Texas Instruments Series 6000 Pulse Generators are the smallest instruments available with the advantages of modular construction plus a wide range of operating features which include variable width and delay, variable rise and fall times, plus and minus outputs, pulse mixing, programmed and random word generation.

TI Pulse Generators combine dependable performance with a high degree of versatility and convenience. Circuitry is all solid state with compact controls. Write for complete information.

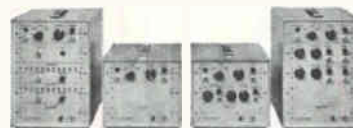

INDUSTRIAL
PRODUCTS
GROUP



TEXAS INSTRUMENTS
INCORPORATED
P. O. BOX 66027 HOUSTON 6, TEXAS

SENSING • RECORDING • TESTING • DIGITIZING INSTRUMENTS
THE INSTRUMENTS OF TEXAS INSTRUMENTS

572
CIRCLE 67 ON READER SERVICE CARD



Your electronics **BUYERS' GUIDE** should be kept in your office at all times—as accessible as your telephone book.



FLEXITE[®]

TUBINGS

for a wide range of temperature requirements...

One of these Markel FLEXITE Extruded Tubings will meet your particular needs with economy and reliability for the lifetime of your equipment.

FLEXITE TFE Teflon[®] Tubing combines superior electricals with exceptional heat stability, chemical resistance, and physical strength. Recommended for continuous use from -55°C to 250°C .

FLEXITE SR-20 Silicone Rubber Tubing is extremely flexible, highly temperature stable, and has excellent corona resistance. It meets MIL-R-5847C, and is recommended for use at -70° to 210°C .

FLEXITE FEP Teflon Tubing has most of the outstanding characteristics of TFE, and is recommended for use where high reliability is required at temperatures from -55° to 200°C .

Ask for data sheets, samples and prices

L. FRANK **MARKEL** & SONS

NORRISTOWN, PA.



SOURCE FOR EXCELLENCE

Insulating Tubings and Sleeveings
High Temperature Wire and Cable

*Du Pont Trademark

write for access to bit storage.

Each unit can store 250 bits, and drums may be connected in series for greater capacity. Record or retrieve speeds are now about 25 bits a second. A 6,000 bit constant speed drum looks practical for the future, Chow said.

Most promising applications are as low-cost industrial memories for production lines, hotels, libraries and supermarkets, where these systems will compete with others using relays, diodes and magnetic tapes.

DRY REEDS—Highly efficient r-f switching matrices are possible using dry-reed relays, reported Dale Ballinger, Hathaway Instruments, Denver.

Centering a conductor in a non-conducting cylinder, the reeds are effective as a 70-ohm section of r-f transmission line, capable of being opened or short-circuited by an externally-applied magnetic field (see Fig. 4).

An application using several reed switches in series processed 2 to 25 Mc signals with standing-wave ratios less than 1.3 and crosstalk held to more than 50 db down, Ballinger said.

New Storage Element Promises Faster Memory

EXPERIMENTAL magnetic film element reported by IBM is said to represent a major departure from other magnetic thin film elements in that it exhibits a third, or intermediate state, between its zero and one information states.

The two current pulses needed to change the information state of the element can now appear at the element sequentially. In previous devices, these pulses had to appear simultaneously and long pulses were required to insure coincidence. With the new elements, the pulse length can be reduced and, therefore, memory speed can be increased.

The new memory was described by E. W. Pugh at the IEEE International Conference on Nonlinear Magnetics, held in Washington last month. The element is made of a biaxial magnetic material—one that exhibits two stable magnetic

NEW JERSEY

"cradle of industrial research"



Many of the scientific developments that will shape tomorrow's world are germinating right now in New Jersey's more than 500 industrial research institutions. The smaller manufacturer who does not have his own research staff can easily find top-notch facilities and personnel available close by to help work out his problems.

Because of its great contributions in such fields as electricity, electronics, chemistry, metallurgy and aviation, New Jersey has been called "the cradle of industrial research". Your executive and technical people will find a stimulating environment here, and ample opportunity for advanced study.

Write For Industrial Information

Department of Conservation and Economic Development
Promotion Section 951-U
520 East State Street, Trenton 25, New Jersey

NEW JERSEY
Bureau of Commerce,

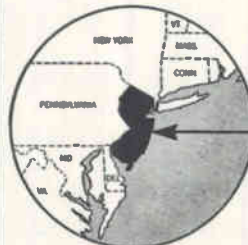

in the geographic center of

the world's richest market

CIRCLE 206 ON READER SERVICE CARD
May 10, 1963 • electronics

Acoustical Components of Superior Quality

JAPAN PIEZO supplies 80% of Japan's crystal product requirements.

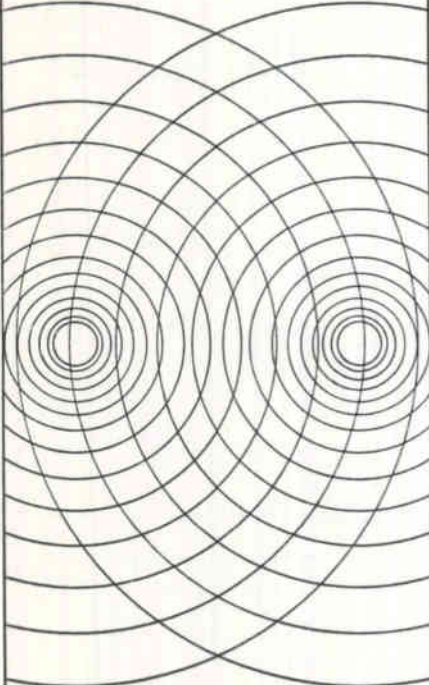

STEREO CARTRIDGE Crystal — "PIEZO" Y-130 X'TAL STEREO CARTRIDGE

At 20°C, response: 50 to 10,000 c/s with a separation of 16.5 db. 0.6 V output at 50 mm/sec. Tracking force: 6 ± 1 gm. Compliance: 1.5×10^{-6} cm/dyne. Termination: 1M Ω + 150 pF.

Write for detailed catalog on our complete line of acoustical products including pickups, microphones, record players, phonograph motors and many associated products.



JAPAN PIEZO ELECTRIC CO., LTD.

Kami-renjaku, Mitaka, Tokyo, Japan

axes. One axis is used for the two information states and the other for the intermediate state. Up to now, thin film magnetic memories have been constructed of uniaxial magnetic materials, which possess only one magnetic axis.

An experimental array of these memory elements resembles previous thin film arrays—a set of parallel word lines which are crossed at right angles by a set of parallel bit lines. Memory elements are located at each point of intersection.

To enter information into such an array, all elements in a particular word line would be set to an intermediate state by a word pulse. Then each element within a word would be set to either a *zero* or *one* state by bit pulses. The polarity of the pulses would determine the final state of the element.

Elements in other word lines would be undisturbed by the bit pulse, since they would be already in either a *zero* or *one* state.

Ways of finding improved techniques for fabricating the biaxial magnetic films are being investigated.

Radiation Shielding Called Major Advance

TEST DATA on x-ray, gamma and neutron shielding properties of Polyshield (see ELECTRONICS, Feb. 15, p 91) was released last week by Raymond G. Osborne Laboratories, Los Angeles, 7.

The new ceramic is said to be a major technological achievement in atomic energy protection, and is claimed to provide a wide spectrum of radiation shielding.

Data has been compiled on radiation shielding properties of Polyshield when used as a filler in Polyurethane foam and Polyethylene plastics.

Materials have been tested to determine x-radiation attenuation, gamma-ray and thermal and fast neutrons, gamma rays from 0.32 mev to 1.33 mev.

Since first announced in ELECTRONICS, several top electronics research laboratories are now investigating applications of new shielding materials to electronic components and instrumentation.

HOW DOES YOUR CIRCUIT SEE A RESISTOR AT 100Mc?

like this



... or this

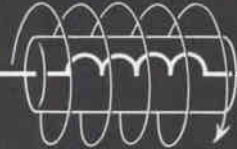

WESTON[®] VAMISTORS

PRECISION METAL FILM RESISTORS

offer superior HF response

Inductance has an important place in high frequency design—but not where your circuit calls for resistance! Weston Vamistors are engineered for critical HF applications. From dc to 100 Mc, inductance remains *virtually unchanged* at 0.007 μ h, and d-c resistance shifts less than 10% in units up to 50K! Distributed capacitance is less than 0.6 pf.

Vamistors offer many other features of importance to design engineers. They're the *most reliable* precision metal film resistors available. Average noise level is -33db (0.023 μ V/V), using NBS measurement techniques. And the current established failure rate is .015% per 1000 hrs @ 60% confidence level (full load @ 125C) based on over 6 million unit hours of testing.

The Vamistor's superior HF response is a result of advanced Weston design and special production techniques:



Alloy is thermally-bonded into internal glaze with patented Weston process.

Weston developed and produced resistance alloy offers uniformity and ideal metallurgical properties for vacuum deposition.

Length of resistance spiral is automatically controlled to minimize heat spots.

Incoming materials inspection, in-process control, testing and quality assurance programs guarantee specifications!

Weston Vamistors are available with highest ratings from $\frac{1}{8}$ to 2 watts. Tolerance: to 0.05%. Temperature coefficient: 0 ± 25 or 50ppm/°C. Stability: exceed all MIL R-10509D specs.

Write for details. We'll include Weston Spec 9800 covering High Reliability Vamistors.

WESTON[®] Instruments & Electronics

Division of Daystrom, Incorporated, Newark 14, N. J.

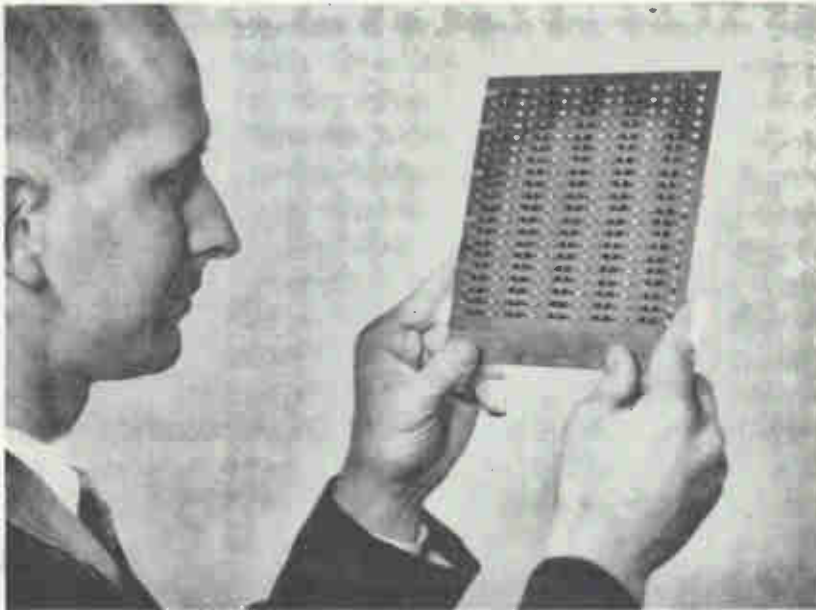

PRINTED CIRCUIT board through-connections were continually improved with help of thermal-destructive testing. Plated through-connections withstood 40 test cycles, while eyelet and rivet through-connections stood up under 12 and 2 cycles, respectively

Better Techniques Toughen Connections on P-C Boards

5-year tests improve design and production of board connections

By **W. G. JEZOWSKI**
Light Military Electronics Dept.
General Electric Company
Utica, N. Y.

PRINTED-CIRCUIT through-connection configurations for double-side boards have been studied for five years at LMED, and it has been found that:

Riveted - through connections, onto which component leads can be welded, do not stand up as well as eyelet and plated-through connection configurations soldered to printed circuit and component leads (see Fig. 1).

Increasingly severe thermal cycling tests were used to "push" improved design of all three configura-

tion types shown in Fig. 1:

- Riveted - through connections are solid with top and bottom ends squeezed against printed copper conductor lands to make a tight physical connection, which was improved by soldering or brazing

- Eyelet connection consists of a hollow tube, two ends of which are flared out into funnel-shaped flanges on both sides of board (one flared end is preformed). The flared ends are soldered to copper printed circuit, while component leads are soldered to inside of tube

- Plated-through connections are simply extensions of electro-plated printed circuit into hole taking component leads. Solder is used to fasten leads inside plated hole. Plated-through connections are either surface plated (in laminated boards) or molded where plated runs are recessed (molded boards). Holes in laminated boards are cylindrical with straight vertical walls. Those

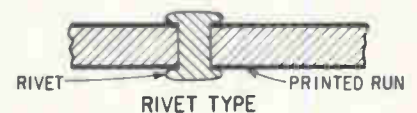
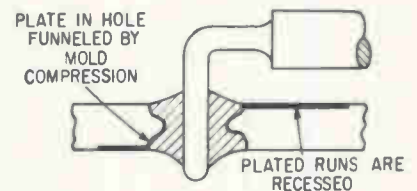
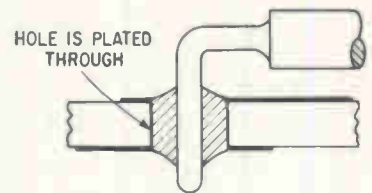
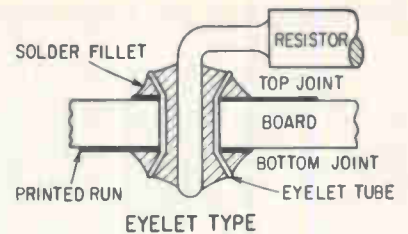

RIVETED through-connection relies on physical-force contact. Other types of connections use solder to secure attachment to printed circuit thus making them more resistant to thermal opening—Fig. 1

in molded boards are funnel shaped because of compression effect during board molding — this makes plating easier than on vertical surfaces.

FABRICATION DISCOVERIES — Certain design and process parameters and reliability data have been established as a result of our development effort:

- With regard to plated-through connections: Minimum before plating hole diameter should be $\frac{3}{8}$ circuit board thickness. This will help achieve uniform plating in hole with a thickness close to board-surface plate thickness. Electroless copper provided optimum conductive path through hole by furnishing a film to take later electroplated copper. However, scrupulous cleanliness must be followed before and after deposition to avoid any voids in this material in attaining high reliability. Deionized water was



**200 KC to 220 MC
LOGARITHMIC AMPLIFIER**

KAY
Logafier
1025-A

**NEW
LOG AMPLIFIER**

- **200 KC to 220 MC**
- **80 DB Dynamic Range**
- **True RF Amplifier with 40 DB Gain**
- **Both Scope and Meter Measurements**
- **Simultaneous "Flat Top" and "Skirts" Magnified Display**

SPECIFICATIONS

FREQUENCY RANGE:
200 KC to 220 MC.

FLATNESS:
0.5 to 100 MC ± 0.5 DB.
200 KC to 220 MC ± 1.0 DB.

LOGARITHMIC ACCURACY:
Better than ± 2.0 DB.

DYNAMIC RANGE:
80 DB. Referenced to 1.0 volt input.

EXPAND CONTROL:
Variable over 0 to 7.0 DB range.

INPUT IMPEDANCE:
50 Ohms.

OUTPUT LOAD:
50 Ohms.

DIMENSIONS:
5½" x 12½" x 19½".

WEIGHT:
23 lbs.

PRICE:
\$795.00 F.O.B. Factory
\$875.00 F.A.S. New York

The 1025-A is a wide range logarithmic amplifier with continuous coverage from 200 KC to 220 MC. It provides 80 DB dynamic range available either as a calibrated display on an oscilloscope or as a precise built-in panel meter indication.

SWEPT FREQUENCY DISPLAY

Over its wide frequency range, it permits accurate viewing of the skirts and sharp slopes of band pass filters, single side-band filters, etc. Used with a sweeping oscillator, it gives overall response, and at the same time gives detailed, easily seen, and accurately (logarithmically) known measurements of the "way down" points on the curve. Three logarithmic ranges are provided — full scale 40 db, 60 db, or 80 db.

TOP AND SKIRTS EXPANSION

An added control varies expansion over the top 7 or 8 DB so as to give an easily read curve of the flat top and critical 1 db, 3 db points simultaneously with the log display. The effect of adjustments on both flat top and skirts can be seen at once, greatly speeding the adjustment of inter-acting controls.

CW MEASUREMENTS (Manual Sweep)

A wide-scale precise panel meter calibrated in three ranges is provided. This gives stable, accurate measurements under CW conditions. When the 1025-A is used with a sweeping oscillator equipped with manual sweep control, the panel meter offers an accurate DB reading that can be easily correlated with frequency counter measurements. The ease of switching from swept "scope" display to manually-controlled meter measurement gives the full advantage of the combined technique.

RF AMPLIFIER

The 1025-A is a true RF amplifier. It provides 40 DB of gain over its entire frequency range (maximum output 0.35 volts rms into a 50 ohm load). The dynamic range at RF is 80 DB in log mode. Linear gain can be varied down to -10 DB.

USE WITH ELECTRONIC SWITCH

The 1025-A can be used advantageously in conjunction with the KMC 255 Kay electronic switch and a Kay 30-0 attenuator to provide reference calibrating displays over its full frequency range.

Write for Complete Catalog

KAY ELECTRIC COMPANY

Dept. E-5 Maple Avenue, Pine Brook, Morris County, N. J. Capital 6-4000

new

35 Mc OSCILLOSCOPE \$1,495

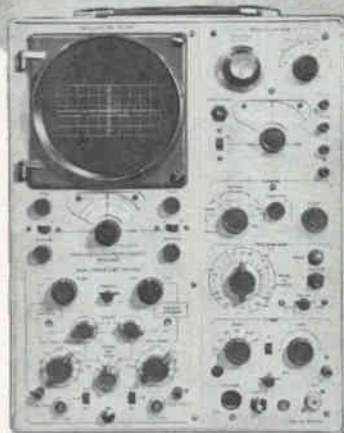

Model 2200

- Switched Transient/Wideband Response
- Voltage and Time measurement to 2%
- No Distributed Amplifier
- Normal, Delayed, Gated and Multi-Trig Timebase
- Stability Controls Eliminated

PLUG-INS

SINGLE TRACE —

DC to 36Mc at 50mV/cm, DC to 30Mc at 10mV/cm.

DUAL TRACE —

DC to 33Mc at 50mV/cm, alternate or chopped (500Kc), sum-and-difference amplifier.

TV - DIFFERENTIAL —

DC to 28Mc at 50mV/cm, 4cps to 1Mc at 1mV/cm. Differential amplifier common mode rejection 40db.

SINGLE TRACE PLUG-IN . . . \$195

DUAL TRACE PLUG-IN . . . \$245

Write for detailed catalog sheet.

MARCONI INSTRUMENTS

DIVISION OF ENGLISH ELECTRIC CORPORATION
111 CEDAR LANE • ENGLEWOOD, NEW JERSEY
Main Plant: St. Albans, England

used in cleaning hole before electroless coating to minimize any contamination of process variables.

• With regard to both eyelet and plated-through configurations: Difference in diameter between inside hole diameter and component lead diameter should be maintained at from 5 to 15 mils to obtain optimum solder connections.

• Plated-through connections appear to be more reliable than eyelet configurations. Reliability was determined by number of thermal cycles connections could withstand. While only two repetitions of severe thermal cycle resulted in disconnection of rivet connection from printed circuit, plated connections survived 40 cycles and eyelets weathered 12 cycles.

THERMAL CYCLING — Connections had to withstand increasing repetitions of following thermal cycle: 6 hours at 100-degrees C and 96 percent humidity; 6 hours at 120 degrees C and ambient humidity; 1 hour at -55 degrees C. As construction improved, more and more cycles were used until destruction of connection. Electrical measurements made between cycles determined degree of degradation. Test objective was establishing a process-improvement yardstick.

Sample through connections were fabricated on test boards having 100 to 600 connections laid-out in series. Electrical checking consists of measuring voltage drop between first and last connections on board. Normal drop is in range of 0.20 to 0.30 millivolts. Increase of 250 times this is significant enough to indicate a problem.

PLATED CONNECTION—As previously mentioned, electroless copper is used to establish base for plating through hole connection. A microphotograph in Fig. 2 shows copper electroless plating on glass epoxy base material. Other photo in Fig. 2 (150 × magnification) shows uniformity of plating through hole and electroplated copper with solder overplate.

Continued fabrication improvement includes use of special carbide drills in a GE Mark II computer-controlled drilling equipment. Strict process controls on time, temperature, plating rate, solution composition, viscosity, and etching

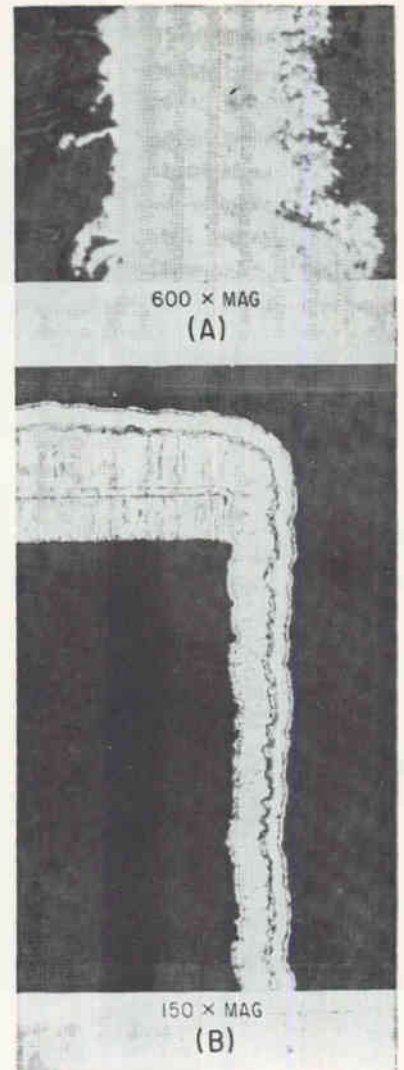

ELECTROLESS plating of copper (shown in A) is used to accept final electrolytic plating of copper. Electroplated copper with solder overplate is shown lying over electroless copper (B)—Fig. 2

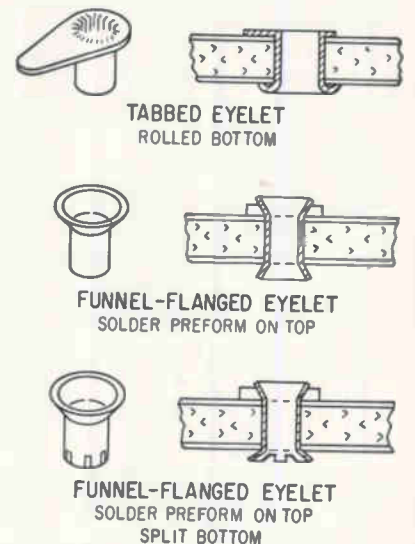

EVOLUTION of improved eyelet through-connections resulted in elimination of solder-cracking problem—Fig. 3

solution also contributed to improvement.

EYELET CONNECTION—Fig. 3 illustrates evolution of improved eyelet connections.

Tabbed eyelets with rolled bottoms were first used. Tabs were hot staked to printed wiring board pads, eyelets and pads were then solder plated. However, tabs and pads separated under test.

Then evolved a gold plated funnel-flanged eyelet having a nickel-silver underplate. This became a double-funnel, flanged through connection when assembled to a printed circuit board. A solder preform was attached to top side of eyelet during eyelet staking and hot staked (with 1/8-inch board) or flowed during dip soldering (with 1/16-inch board) to produce connection.

Fabrication was further improved by a semiautomatic, eyelet-preform staking machine. Also, removal of nickel underplate permitted much more uniform staking.

Final design improvement involved scoring bottom side of eyelet to permit a patterned petal effect on dip solder side (underside) after staking: There had been a problem of circumferential solder cracking on bottom side between eyelet and solder fillet formed during dip solder operation. Scored eyelet reduced stress between solder and eyelet to eliminate cracking.

RIVET CONNECTION—We tried to develop a printed circuit board with weldable rivet connections.

Two approaches were tried: (1) staking a solid rivet and (2) fusing a two-part split rivet. In connecting leads to rivets the following were evaluated: brazing, electroplating, cold welding, resistance welding, mechanical staking. Materials used include copper, aluminum, steel, nickel-glass copper, phosphor-bronze, red brass rivets, nickel-plated copper, gold-plated printed patterns. Board materials were paper phenolic and glass epoxy. Staking with a number of material combinations seemed successful. But only two thermal test cycles were needed to destroy connection. If riveted configurations are to be used, improvements must be made in board material to prevent deformations causing rivet separation while under thermal stress.



People in a hurry to lay hands on a laser now have someplace to turn for *assured deliveries* in less than 3 weeks. The place is Admiral. The laser: the compact, built-to-last, completely self-contained instrument shown in the photograph.



The Admiral gas laser carries its own integral all-solid-state power supply. It weighs less than 20 lbs. Its versatility and modest size make it an ideal teaching tool for universities where square footage goes at a premium.

These data beam some coherent light on its capabilities:

Laser Wavelengths6328 μ (deep red visible)
	1.1530 μ (infrared)
Power Output	1 to 3 mw
RF Exciter	27.120 mc
Beam Divergence	5 min. with collimation
Tube	Helium/Neon
Mirrors	Flat and spherical, interchangeable

You'd expect to pay more than \$2,000 for a laser like this. But not at Admiral. It costs only \$950 — complete with the power supply. Bank the difference toward a second laser.

For the product bulletin and information about a demonstration, write today to Admiral.



Palo Alto Division of Admiral Corporation • Stanford Industrial Park, Palo Alto, California

Spike Analyzer Gives Transient Duration

Spike duration between 1 and 10 μ s displayed on lighted indicators

RANDOM SPIKES, too short for analysis by conventional oscillographic techniques are analyzed by the Model DX-812 analyzer manufactured by Leland Airborne Products Division, Box 128, Vandalia, Ohio. The analyzer, according to the company, permits rapid and accurate determination of spike amplitude and duration, and is particularly useful for trouble shooting in the field. The unit operates from 60 or 400 cycle line current, or from self-contained batteries.



Four digital dials covering 10 to 990 volts in 10 volt increments are set to the probable amplitude of incoming spikes, so that spikes exceeding the set values are trapped in the instrument's 4 x 4 voltage-time matrix (see sketch). By progressively adjusting the digital

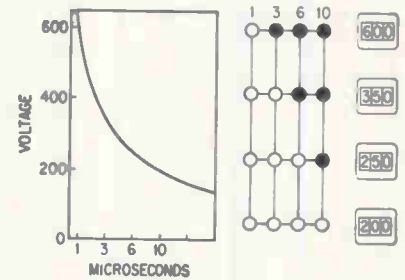

dials, the engineer can accumulate a case history of spike generation for a particular transient-prone system, enabling him to determine whether localized spike suppression will be adequate, or whether overall network filtering is necessary.

CIRCLE 301, READER SERVICE CARD

Generator Makes Variable-Width Pulses

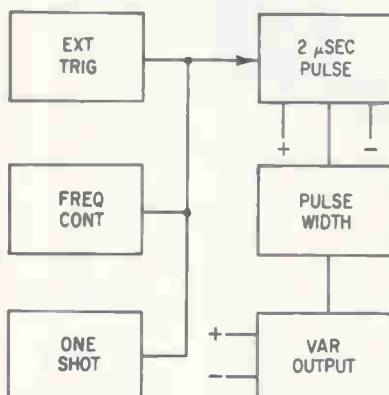

LOW-COST, portable, battery-powered pulse generator producing clean, stable 12-v, variable-width pulses from 1 μ sec to 1 second and a standard 2 μ sec pulse with a rise time of 30 nanoseconds is available from Divelpro Inc., 1367 Connecticut Ave., N.W., Washington 5, D.C. Positive or negative pulses can be selected at repetition rates from 1 cps to 100 Kc and the Divgen unit will respond to a widerange of input triggers. Output pulse frequency with internal oscillator is single step to 100 Kc, and with external trigger is 0 to 200 Kc. Out-

put pulse amplitude is both positive and negative from 0 to 12 v, no load rise time is 30 ns, and with a 1,000-ohm load shunted by 0.001 μ f, rise time is 100 ns. Fall time no load is 100 ns and with 1,000-ohm shunted by 0.001 μ f, is 200 ns. External trigger can be sine, sawtooth or square wave, positive or negative polarity. (302)

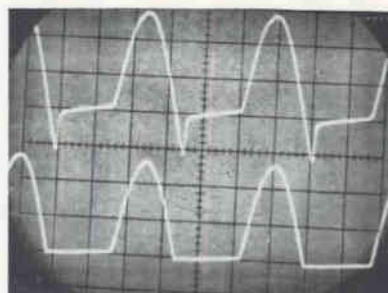

Fast Diode Features Metal-Silicon Junction

THE oscillogram compares the waveforms produced by the new (Hot Carrier) diode, lower trace, with a conventional high speed switching-diode, upper trace, specified to

have a 1 nanosecond recovery period. Sweep speed is 10ns/cm, sensitivity 20 ma/cm; input is a 30 Mc sinewave. The negative spike on the upper trace is due to the diode's charge storage, and is almost eliminated in the new diode. The actual minority carrier lifetime is less than 100 picoseconds; diode capacitance is below one picofarad, and the breakdown voltage exceeds 15 volt for a reverse current of 10 microamperes. Majority carrier conduction, responsible for the virtual absence of charge storage, stems from the use of a metal-silicon junction, according to the diode manufacturers, HP Associates, 2900 Park Boulevard, Palo Alto, California. Turn-on and turn-off times are claimed to be in the picosecond range HP says diode is ideal for very fast computer switching networks, microwave detectors and mixers, and harmonic generators. (303)

SCR Firing Module Has Low Phase Angle Operation

SCR firing module providing zero to 160-degree gate pulse is sufficient

From the World's Largest Supply
of
SINGLE CRYSTALS

GALLIUM ARSENIDE

Tailored for Laser Diodes
and

**SELECTRO OPTIC*
CUPROUS CHLORIDE**

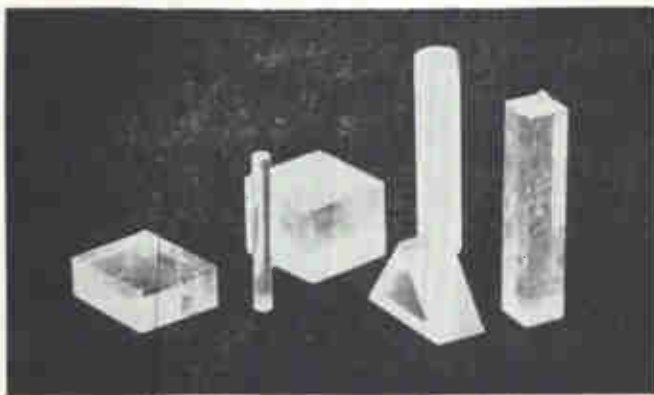

- Electro Optical Use
 - Laser Modulation
 - Optical Studies
 - Exploratory Laser Host Lattice
- AND the All NEW Continuous Wave Gas
Laser—Model MK 1 A Complete at \$995.00

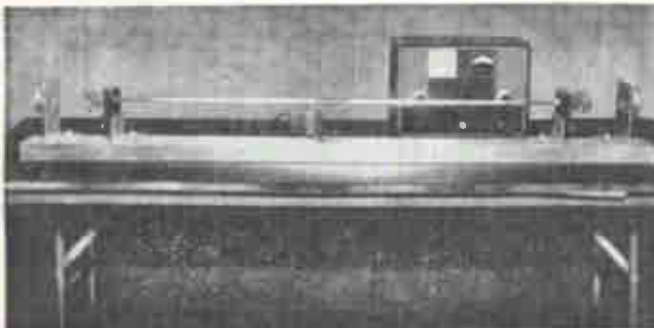

Write for Details on the NEW
SE-SAF SELECTRO*LASER GLASSES

For Eye Safety In
Laser Beam Work

* Trademark



semi-elements, inc.

Saxonburg Boulevard, Saxonburg, Pa.
Phone: 412-352-1548

CIRCLE 208 ON READER SERVICE CARD

electronics • May 10, 1963

**Methode Thru-Connected
Printed Wiring Boards**

HIGH { *Reliability!
Re-usability!*



Fused In Place Eyelets

Solder flowed under flanges by high current electrode set dies using latest equipment improvements — fast, flexible, economical. Special Methode techniques now permit mounting of .016" semi-conductor leads into eyelets which can be supplied with a .021" ± .003" inside diameter.

Plated Thru Holes

Using copper reduction techniques for sensitizing in conjunction with preclad laminates — compact, reliable, excellent component soldering and high component density.

Funnel Tubelets

Funnel shaped tubelets—permit easy component insertion, repeated removal and re-mounting without damage to board or adhesion — maximum re-usability.

**New Three-Dee
Sealed Harness**

Methode's new fully encapsulated multi-layer circuitry — permits unlimited cross-overs and taps, flexible, conformal, light and tough for interconnecting individual circuit cards or black boxes.

*37 to one
micro photographic
cross-section view

Use the Best Prefabricated Wiring Technique
for Your Requirement . . .
ALL ARE AVAILABLE FROM:

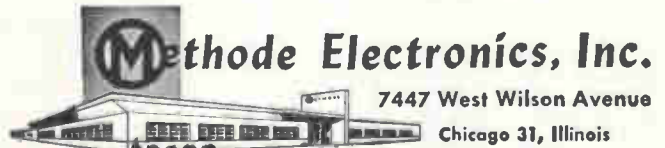

Methode Electronics, Inc.

7447 West Wilson Avenue

Chicago 31, Illinois

CIRCLE 75 ON READER SERVICE CARD

75



General Time digital electronic systems and components sent into space have been 100% reliable and accurate.

- INCREMAG, the precision electronic counting element with a memory
- MU-CHRON, the highly stable magnetic oscillator
- Solid State Delay Switch
- True Rotary Solenoid, free of axial motion
- Digital Control Systems

General Time Systems, sub-systems and components have proven themselves dependable again and again in a wide range of military and space applications. INCREMAG, for example, times, programs and controls the functions of data collection, recording, reporting in TIROS I and II—with total reliability.

Developed to meet the specifications of space use, they represent a high point in the state of the art, and offer these advantages:

- Simplicity in design — dependability
- Low power consumption
- Unfailing memory
- Minimum size and weight
- Rugged construction—missile—space
- Economical to specify

They are available on an off-the-shelf basis, or can be readily modified to meet custom requirements.

GENERAL TIME

CORPORATION
ELECTRONIC SYSTEMS DIVISION
201 Summer Street, Stamford, Conn.

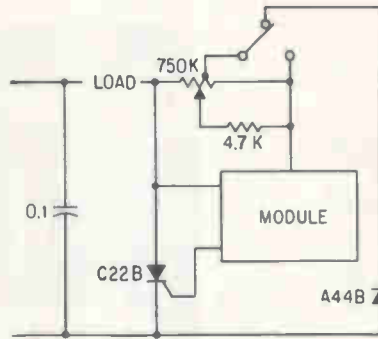

to fire all scr's at a lower phase angle than multilayer devices is available from Seco Electronics Inc., 1201 S. Clover Dr., Minneapolis 20, Minnesota. The firing module is not sensitive to line voltage transients and requires only 6 v to adequately fire the scr. This is accomplished by using an averaging circuit to determine the supply voltage and trigger the scr. Any transients are lost in the averaging circuit. The circuit uses a bootstrap multivibrator with an emitter follower providing isolation so that scr gate current does not effect the firing characteristics. The phase position is varied using a resistance-capacitance network. The capacitor is included in the firing module while the resistor is external. The circuit is reset after each cycle thus providing a reference point for the next cycle. The reset is electronic and assures exact phase position from one cycle to the next.

CIRCLE 304, READER SERVICE CARD



Plugs & Receptacles For Printed Circuits

ELECTRONICS and electromechanical OEM's utilizing printed circuits in product fabrication will find these plugs and receptacles highly practical. Developed for p-c application, they are available in sizes ranging from 3 to 60 circuit connectors and in Nylon from 3 to 15 circuit connectors. When inserted into proper circuit holes in a circuit board, they can be dipped or fountain soldered, eliminating costly hand soldering.

Industrially styled to provide perfect polarity between receptacle and printed circuit, this combination assembly is designed for long life, serviceability and dependability in low voltage connectors. Molex Products Co., 9515 Southview Ave., Brookfield, Ill. (305)



Telemetry Transmitter Is Solid-State Unit

AN ADVANCED space vehicle-to-ground, frequency modulated telemetry transmitter, RT-103A, is said to have an unlimited variety of applications due to both its low voltage and current requirements of 24 to 32 v d-c at 325 ma and its space requirements of less than 22 cu in. It weighs less than 14 oz, will withstand an 11 millisecc shock of 50 g and will operate within specifications in temperatures ranging from -55 C to +71 C. Electronic Specialty Co., 5121 San Fernando Road, Los Angeles 39, Calif. (306)

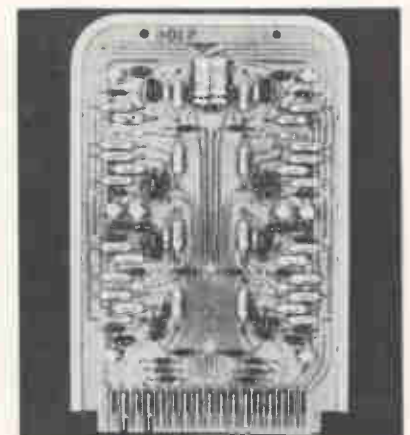

Digital Logic Modules Feature Reliability

INTRODUCTION of 1 Mc silicon S-pac digital logic modules is announced. They function comfortably from -55 C to + 100 C. Units meet a variety of applicable component and equipment Mil specifications, and

will exceed continuous operating temperature requirements of USAF/Mil-E-5400, Cl. 3 and USN/Mil-E-16400, Cl. 1. Emphasis is placed on reliability, with high stability components employed and circuits designed "worst case" conservative. Electrical design is such that all components dissipate less than 50 percent of their ratings at 100 C. Computer Control Co., Inc., Old Connecticut Path, Framingham, Mass. (307)



Voltage Sensors Cover from 1 V to 1 Kv

MODELS ACS and DCS sensors provide 2 percent accuracies on pick-up and drop-out voltage levels, covering the voltage range from 1 v to 1 Kv. Stability and drift-free operation is assured by feedback which attributes to the device's self temperature compensation from -10 F to +165 F. Standard models offer time delay and external adjustment on both sensing levels. Delivery 3-4 weeks. Crane Electronics Corp., 1401 Firestone Road, Santa Barbara Airport, Goleta, Calif. (308)

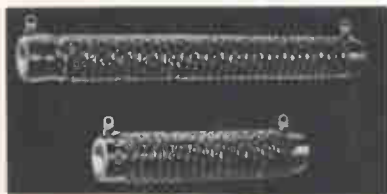

Power Resistors Save Space

HIGH-WATTAGE, low-ohmage, space-saving Greenohm V edge-wound resistors are available in power ratings from 90 to 375 w. Tem-

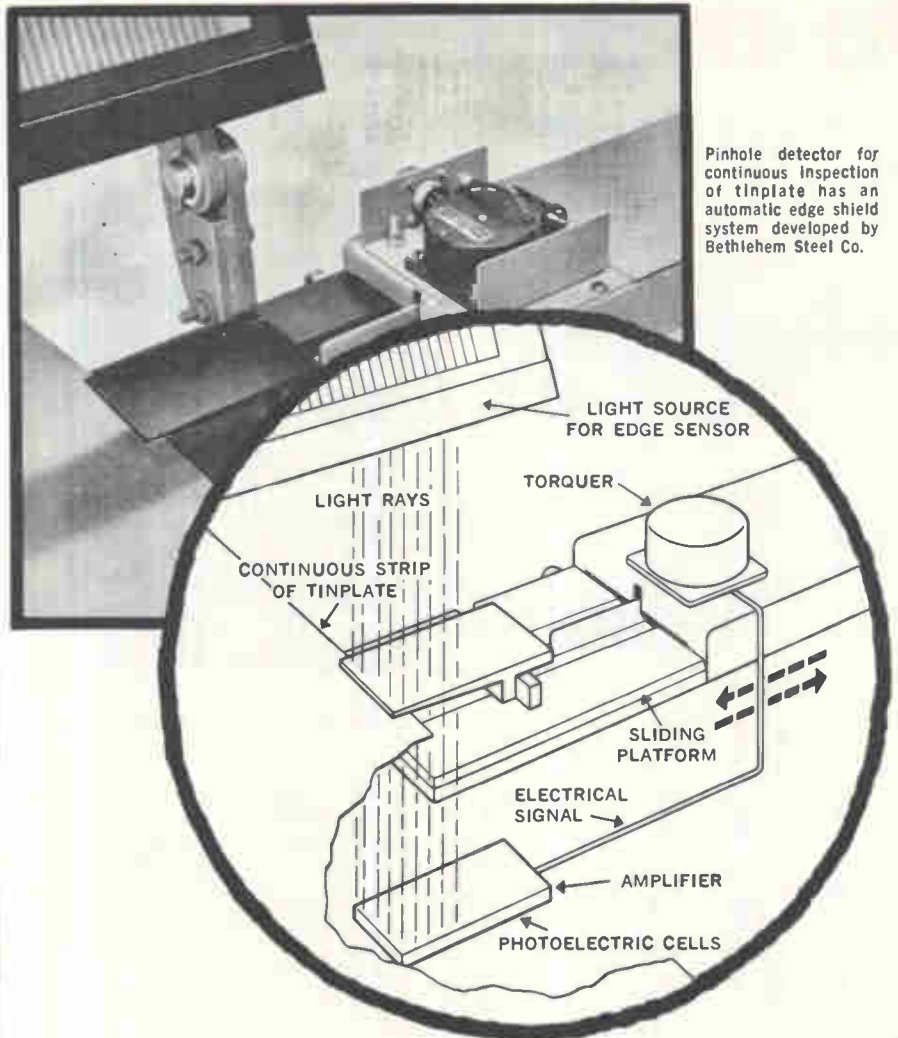

Pinhole detector for continuous inspection of tinplate has an automatic edge shield system developed by Bethlehem Steel Co.

Inland Gearless Torquers help make pinhole detection fool-proof!

Bethlehem Steel Company runs tinplate at high speed through a photo inspection device. Purpose is to detect pinholes. Side-to-side movement of the continuous strip creates a problem. The least light entering at the edges of the strip can cause false pinhole indications.

Fast-response positioning of edge guides by two Inland Gearless Torquers on signal from photoelectric sensors blocks out "false-alarm" light. These direct-drive d-c- torque motors have peak torque of 60 ounce-inches.

Rapid, high-resolution response to servo-position error signal has earned for Inland Gearless Torquers a place in all major missile and space programs to date, as well as in an increasing number of industrial applications. Their superior performance comes from torque-to-inertia ratios 10 times higher than equivalent gear-train servo motors. Moreover, their compact, pancake configuration overcomes space and weight limitations,

What's your problem? If you're currently planning a servo system calling for output torque between 20 ounce-inches and 3000 pound-feet*, compare Inland Gearless Torquers with any alternative. Write for all the facts today, 347 King Street, Northampton, Mass.

*Higher torque output levels can be provided on special order.

 **INLAND MOTOR**
CORPORATION
SUBSIDIARY OF **KOLLMORGEN**

OMARK Gramweld Percussive Stud Welding

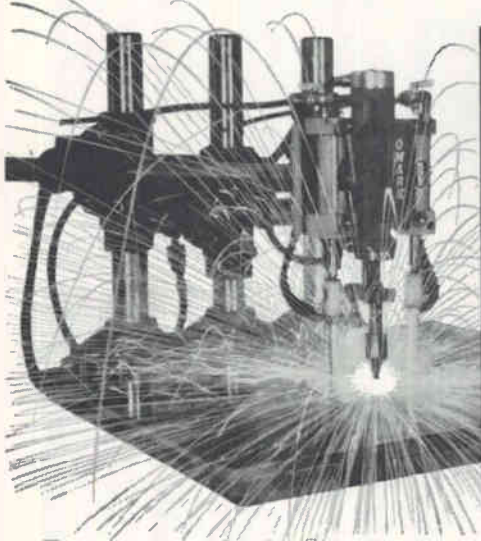

developing
new
concepts
in metal
fastening
for
industry

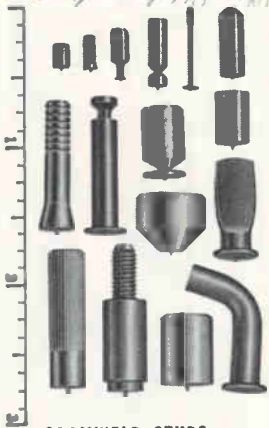

GRAMWELD STUDS may vary widely in size, shape, kind of metal.

In such diverse areas as space vehicle and submarine assembly, electronic equipment and electric appliance manufacture, automotive and aircraft production, and the fabrication of metal cabinets of all description, OMARK Gramweld burn-and-distortion-free percussive stud welding is now providing industry with a new concept in multiple metal fastening.

Utilizing Gramweld stationary and portable machines this patented system has already proved itself in hundreds of applications of studs varying widely in design, and welded to metals of differing kind and thickness. Substantial savings in time, effort and money have resulted.

To meet your requirements for metal fastenings of exacting specifications, consult the nearest of OMARK Industries' 27 factory branches throughout the U. S. A factory trained, technically qualified OMARK Gramweld Percussive Stud Welding representative will help solve your problem immediately.



OMARK
Industries, Inc.

Portland, Oregon
Guelph, Ontario, Canada
Amsterdam, Holland • Varberg, Sweden
Branches in 27 major U.S. cities
Consult the "yellow pages"

CIRCLE 78 ON READER SERVICE CARD

perature rise is 375 C. Units meet or exceed MIL-R-26C for uninsulated resistors. Resistance range is from 0.04 ohm to 25 ohms. Clarostat Mfg. Co., Inc., Dover, N. H.
CIRCLE 309, READER SERVICE CARD

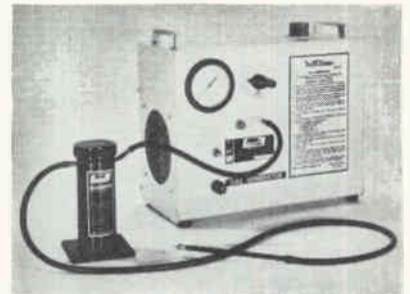

Water Welder Features Flexibility

MODEL V Water Welder instrument has a built-in variable voltage transformer and a gas pressure gage. The variable voltage transformer allows exact adjustment of gas production, which can be readily checked on the precision gage to assure proper operation for each different job. Designed so the operator can dial the size flame he needs, unit is capable of butt welding exotic metal wires from $\frac{1}{16}$ in. in diameter to 0.0003 in. diameter. For welding, brazing, annealing or silver soldering subminiature parts, the flame temperature can be varied up to 6,000 F and gas production may be increased to 2.5 cu ft per hr. Henes Mfg. Co., 4300 E. Madison St., Phoenix 34, Ariz. (310)



Rotary Switch Has 24 Positions

ON THE MARKET are series H rotary selector switches with 24 shorting or 12 non-shorting positions in $1\frac{1}{8}$ in. o-d. They are available with up to 6 poles per deck, up to 10 decks. Series H is designed to meet re-

HELP YOUR POST OFFICE
TO SERVE YOU BETTER

BY

MAILING EARLY IN THE DAY
NATIONWIDE IMPROVED MAIL SERVICE
PROGRAM

quirements of MIL-S-3786A. Contact resistance is 0.010 ohm max; dielectric strength is 1000 v a-c minimum; insulation resistance is 10,000 megohms minimum; contact current interrupting is 0.5 amp at 115 v a-c with a resistive load. Daven Division of General Mills, Inc., Livingston, N. J. (311)

Heat Sink For TO-8 Transistor

FEATHERWEIGHT cooler for the JEDEC TO-8 package is now available with the Delta flexfin design which excels in performance under natural or forced convection conditions. Made of beryllium copper, the units will not fatigue under constant heat. Thus greater reliability is assured to a circuit or component. Cooler's spring action provides rigid contact of large areas insuring repeatable thermal performance. Wakefield Engineering, Inc., 139 Foundry St., Wakefield, Mass. (312)

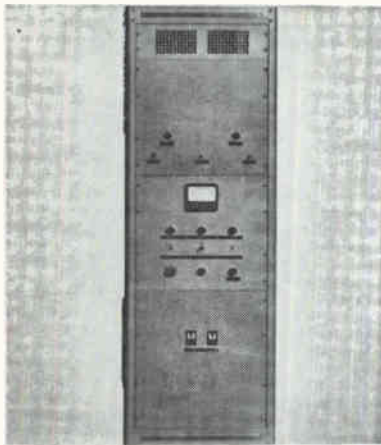

Inverter for Use in Tracking Systems

THIS 2 Kw inverter will start $\frac{1}{2}$ h-p motor from rest. It will also supply 2,000 w at unity power factor. Initial application has been in sidereal and satellite tracking systems. An external 25 v signal will drive this amplifier fully, in the range of 60 cps. Higher frequency capability, 400 cps or 3,200 cps is available. Unit is designed for continuous reliable operation in laboratory environments. Engineering Model Lab., Inc., Ashland, Mass. (313)

20 to 200 D.P.

Send your prints
for quotations

- SPURS
- HELICALS
- WORM AND WORM GEARS
- STRAIGHT BEVELS
- LEAD SCREWS
- RATCHETS
- CLUSTER GEARS
- RACKS
- INTERNALS
- ODD SHAPES

Production of fine-pitch gears of extreme accuracy for all kinds of instruments is a specialty of ours.

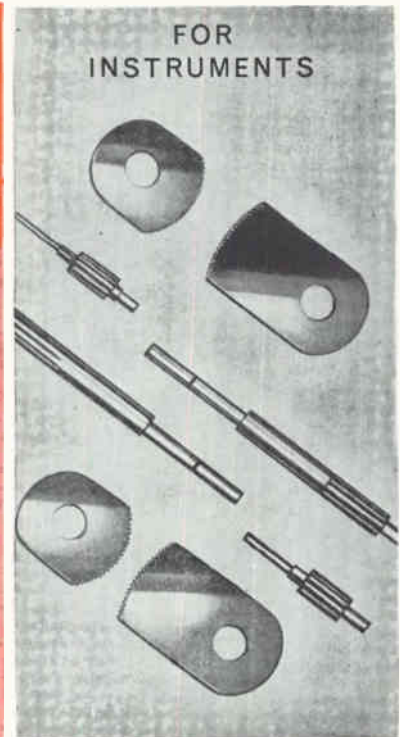

THE *Finest* IN GEARS

Beaver Gear Works Inc.

1021 PARMELE STREET, ROCKFORD, ILLINOIS

CIRCLE 209 ON READER SERVICE CARD

Magneline® THE INDICATOR WITH INHERENT MEMORY

Two new series for digital readout,
ideal for multiplex applications

SERIES 14000—FOR SOLID STATE LOGIC
 Character Size..... $\frac{9}{32}$ " x $\frac{1}{4}$ "
 No. of Characters.....Up to 11
 Leads.....11 plus a common
 Watts.....2.4

SERIES 15000—FOR RELAY LOGIC
 Character Size..... $\frac{5}{16}$ " x $\frac{1}{4}$ "
 No. of Characters.....Up to 10
 Leads.....5 plus a common*
 Watts.....1.3-1.7

*Requires switching of lead in combination with reversal of polarity to change indicator.

Units hold last reading without power. Totally enclosed, self-stacking housing for front or rear mounting. Jewel bearings, only one moving part. Standard voltages 6, 12, 24, or 28 V.D.C. Readability 12 feet at normal room lighting. Options include special voltage, special characters, and internal lighting for dark room applications.

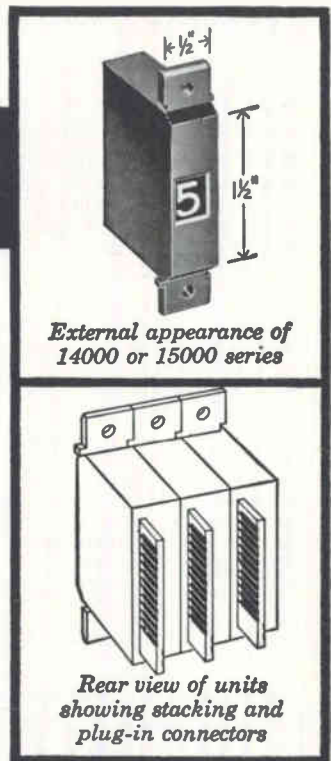

Write or teletype
(203-753-9341)
for free literature

PATWIN® ELECTRONICS

A DIVISION OF THE PATENT BUTTON COMPANY
WATERBURY 20, CONNECTICUT

For laboratory or field
research applications

MODEL 700/1400 SERIES NEW MAGNETIC TAPE RECORDING SYSTEMS



ACCURATE ± 0.2 linearity for analog data

FLEXIBLE as many data channels as you need from 2 to 14

COMPACT a 7-channel system fits in less than 2 ft. of rack space

LOW COST modest initial cost, true operating economy

MNEMOTRON NEW MODEL 700/1400 SERIES MAGNETIC TAPE RECORDING SYSTEMS record any electrical quantity from DC up to 5000 cps. A uniquely simple pulse-frequency modulation technique insures that data signal intelligence is free from non-linearity due to tape coating or other distortions.

Select as many data channels as you need, up to 14. Choose the tape format you want— $\frac{1}{4}$ ", $\frac{1}{2}$ " in-line, or standard IRIG. If standardization is desired, simply specify 7 channels on $\frac{1}{2}$ -inch tape in the standard IRIG configuration.

Record/Reproduce electronics for each channel are integrated in a single plug-in module featuring unity gain. An integral speed switch permits selection of data conversion for 2, 3 or 4 tape speeds — no additional plug-ins needed. For maximum flexibility, each multi-channel input is isolated. Data can be accepted from unbalanced, differential or push-pull outputs — or different DC levels on input signal ground returns can be preserved. Test points allow monitoring of input during recording, output voltage level when reproducing.

Write for the pleasant details.

MNEMOTRON

Division of
TECHNICAL MEASUREMENT
CORPORATION

TMC

Executive Sales Offices:
202 Mamaroneck Ave., White Plains, N.Y.

Literature of the Week

NUCLEAR ELECTRONIC PRODUCTS General Electric Co., Schenectady 5, N. Y., has available brochure GET-3127 describing a complete line of nuclear instrumentation components.

CIRCLE 314, READER SERVICE CARD

ANTENNA SYSTEMS Advanced Structures Division of Telecomputing Corp., 5159 Baltimore Drive, La-Mesa, Calif. Three brochures cover a line of precision antennas for satellite communications, target tracking, decoy discrimination, radio astronomy, telemetry and space research. (315)

RELIABILITY MANUAL Cornell-Dubilier Electronics Division, 50 Paris St., Newark 1, N. J., has available a manual designed for personnel engaged in high-reliability projects. At present it contains data on CDE's general reliability program, and mica capacitor reliability. Each month for the next 9 months additional sections will be published and mailed to manual holders. (316)

PRECISION INSTRUMENT SWITCHES Hi-Q Division, Aerovox Corp., 1100 Chestnut St., Burbank, Calif. A 16-page illustrated catalog of Cinema precision instrument switches is available. (317)

VACUUM CHAMBER Nuclear Diodes, Inc., 1640 Old Deerfield Rd., Highland Park, Ill., offers a 2-page bulletin on the model VC-10 vacuum chamber for testing solid state detectors and radiation sources. (318)

MAGNETIC AMPLIFIERS Electric Products Division, Vickers Inc., 1815 Locust St., St. Louis 3, Mo. Bulletin 1306-1 describes high performance magnetic amplifiers. (319)

HALL EFFECT F. W. Bell, Inc., 1356 Norton Ave., Columbus 12, O. A 23-page pocket-size booklet, entitled "The Hall Effect and Its Applications", is being offered as an aid in experimentation, demonstration and application activities in this phenomenon. (320)

TOROIDAL INDUCTORS Microtran Co., Valley Stream, N. Y. A booklet "Toroidal Inductor Application Guide", is available. (321)

X-RAY INSPECTION SYSTEM Philips Electronic Instruments, 750 S. Fulton Ave., Mt. Vernon, N. Y. A 6-page folder contains complete data on an x-ray inspection system for production control. (322)

VACUUM CAPACITORS Calvert Electronics Inc., 220 E. 23rd St., New York 10, N. Y. Sales Letter No. 14 contains two pages of reliability notes on English Electric vacuum variable capacitors. (323)

AUTOMATIC LEVEL CONTROL CBS Laboratories, High Ridge Road, Stamford, Conn. Technical bulletin 443

Coils for Contact Capsules



1 to 5 Reeds
.095 — .215 dia.

6 to 48 V.D.C.

Lead or Pin Term.

Also Available with Reeds.

Write for Bulletin and Prices

ELECTRICAL COIL WINDINGS

Wire sizes #6 to #56, Classes A, B, F and H. Complete engineering service available.

Coto-Coils

COTO-COIL COMPANY INC.

65 Pavilion Avenue, Providence 5, R. I.

CIRCLE 210 ON READER SERVICE CARD

How To Get Things Done Better And Faster

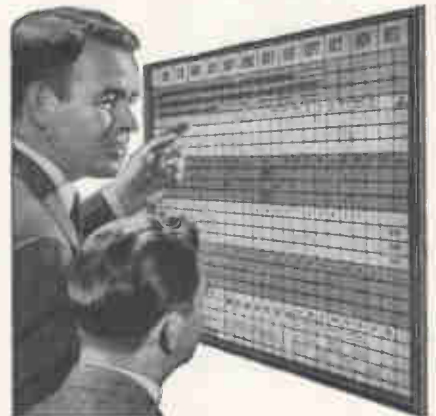

BOARDMASTER VISUAL CONTROL

- ☆ Gives Graphic Picture—Saves Time, Saves Money, Prevents Errors
- ☆ Simple to operate—Type or Write on Cards, Snap in Grooves
- ☆ Ideal for Production, Traffic, Inventory, Scheduling, Sales, Etc.
- ☆ Made of Metal. Compact and Attractive. Over 750,000 in Use.

Full price **\$4950** with cards

FREE 24-PAGE BOOKLET NO. C-50
Without Obligation

Write for Your Copy Today

GRAPHIC SYSTEMS

YANCEYVILLE, NORTH CAROLINA

CIRCLE 211 ON READER SERVICE CARD

May 10, 1963 • electronics

describes the Audimax II RZ automatic level control. (324)

PRECISION POWER BRIDGE Weinschel Engineering, Gaithersburg, Md. Two-page bulletin contains features, specifications and applications of the model PB-1B precision r-f power bridge. (325)

THIN PLATE CAPACITORS Aerovox Corp., New Bedford, Mass., has issued bulletin NPJ-122 on a line of subminiature thin plate capacitors. (326)

CATHODE FOLLOWER Dyna Magnetic Devices, Inc., 110 Duffy Ave., Hicksville, L. I., N. Y. A two-color data sheet describes the D-505 cathode follower and associated power supply. (327)

FREQUENCY CONTROL DEVICES Northern Engineering Laboratories Inc., 357 Beloit St., Burlington, Wisc. Catalog 363 contains specifications and ordering information on a complete line of crystals, ovens and oscillators. (328)

SURFACE ANALYZER CONSOLE Brush Instruments Division of Clevite Corp., 37th and Perkins, Cleveland 14, O. A two-page illustrated data sheet describes a new surface analyzer console now available. (329)

VOLTMETERS Sierra Electronic Division of Philco, 3839A Bohannon Drive, Menlo Park, Calif. Folder surveys a family of frequency selective voltmeters and wave analyzers. (330)

PRINTED CIRCUIT CONNECTORS Amphe-nol-Borg Electronics Corp., 1830 S. 54th Ave., Chicago, Ill. Company's line of p-c connectors is described in a new 20-page catalog. (331)

REFERENCE SOURCE Corning Glass Works, Raleigh, N. C. A solid state stable voltage reference source is described in a data sheet. (332)

REGULATED POWER SUPPLIES Deltron Inc., Fourth and Cambria St., Philadelphia 33, Pa. Bulletin describes the "99" line MP Minipac series of 99 percent solid state regulated power supplies. (333)

VARIABLE ELECTRONIC FILTERS Spencer-Kennedy Laboratories, Inc., 1320 Soldiers Field Road, Boston 35, Mass. Bulletin 717 describes the series 300 electronic filters. (334)

MICROWAVE SPECTRUM ANALYZERS The Singer Mfg. Co., 915 Pembroke St., Bridgeport, Conn. A 20-page brochure covers applications and descriptive information on microwave spectrum analyzers. (335)

SILVER POWDERS American Platinum & Silver division of Engelhard Industries, Inc., 231 New Jersey Railroad Ave., Newark, N. J. Brochure presents a wide variety of high purity silver powders to meet exacting industrial requirements. (336)

POTENTIOMETER OUTPUT SMOOTHNESS Markite Corp., 155 Waverly Place, New York 14, N. Y. Bulletin TD-110 is entitled "Potentiometer Output Smoothness, What It Is and How It's Measured". (337)

From **intellux**
INCORPORATED

PRACTICAL MICROCIRCUIT LOGIC MODULES

Tired of the "Madison Avenue Pitch" on microcircuitry? . . . Take a look at practical logic modules.

The INTELLUX approach is realistic—it's here today—in any volume (2, 3, 4 or 5,000 per week if you want)—and best of all their use can put profit back in your computer-sales.

Drop us a card for the complete story, but here are the brief facts:

- ▶ Available immediately . . . Flip Flops, Double NOR Gates, Gate Buffers and Free-running Multivibrators.
- ▶ They can be mounted physically adjacent to each other . . . and still be interconnected.
- ▶ Standard semiconductors are married to thin film passive components.
- ▶ Stability of resistors guaranteed to 30,000 hours.
- ▶ Outperforms discrete component modules . . . and on a par with the most sophisticated microcircuits.
- ▶ So rugged in construction they need no special handling—just treat them like any ordinary radio component.
- ▶ Unquestioned economic and reliability advantages.

For complete data and specifications write:

intellux
INCORPORATED

P.O. Box 929, Santa Barbara, Calif.

Lab's Patio Plan Fosters Discussion



VARIAN ASSOCIATES is employing an unusual "inward looking" design in the \$1-million Central Research Laboratory the company is building in Palo Alto, Calif.

The laboratory section is designed as an open rectangle with office modules spaced along the inner courtyard. This plan provides scientists easy access to laboratories located on the periphery and to other offices. The design is expected to stimulate the flow of new ideas by the cross-fertilization of knowledge which results from frequent contact between scientists representing different disciplines.

Varian's Central Research activity involves basic research in such fields as electronics, physics, chemistry and psychology. Experiments are concerned with fundamental concepts. Product-oriented research and development is carried on independently in each of Varian's four product divisions.

Facilities in the new building will include chemistry, electronic and physics laboratories, special equipment for radioactive trace studies, a large computer to be used for scientific research, conference rooms with audio-visual equipment, and a library to house technical literature.

The 43,000-square-foot structure and associated parking space will occupy a five-acre site directly across from the firm's administration building. It is expected to be ready for occupancy late this year.

Designed to accommodate approximately 50 scientists and 100 technicians and other support per-

sonnel, the facility will consist of a two-story laboratory wing, a 4,000-square-foot technical library, and an administration and reception area.

Edward W. Herold, vice president, research, said the new laboratory was designed to provide ample room for future expansion of the Central Research staff and activities.

"Research is the foundation upon which a company such as Varian is built," Herold said. "Each year we introduce new products which, a few years earlier, were not even considered as potential products."



Frick Rejoins GD/Convair

CHARLES W. FRICK has resigned as manager of NASA's Project Apollo to rejoin General Dynamics/Convair as vice president-engineering.

Frick, who first joined Convair as chief of applied research in February, 1956, directed and coordinated the division's efforts to obtain new study contracts and to develop new products. He also helped plan and

furnish the technical support for production programs. He assumed the NASA post in February, 1962.

EG&G Promotes James McInnis

APPOINTMENT of James J. McInnis as manager of the Instrument Product Engineering activity for Edgerton, Germeshausen & Grier, Inc., Boston, Mass., is announced. He had been a senior engineer at EG&G since August, 1961.



Herud Takes New Management Post

APPOINTMENT of Eric C. Herud as manager of the newly formed Medical Instrument department of DuMont Laboratories, divisions of Fairchild Camera & Instrument Corp., Clifton, N. J., is reported. He will have responsibility for product evaluation, development and engineering, as well as marketing of medical electronic product lines.

Herud has been a member of the DuMont Divisions and Fairchild organization since 1944.

Announce Formation of New Company

A NEW FIRM, Voltronics Corp., has been established in Hanover, N. J., by Richard J. Newman. The company has purchased the assets of Voltronics, Inc. of Westbury, N. Y.

Newman previously was chief engineer and then manager of component planning and marketing for

the Daven division of General Mills.

Chief engineer and vice president is Martin J. Blickstein who was chief engineer of Voltronics, Inc.

Voltronics Corporation will manufacture electronic components including a broad line of precision trimmer capacitors.



Servonic Instruments Elevates Weiss

DAVID E. WEISS has been appointed a vice president of Servonic Instruments, Inc., Costa Mesa, Calif., in charge of the company's eastern division.

Weiss joined Servonic Instruments in 1962 when Servonic acquired the business and assets of Dynamic Measurements, Inc., Willow Grove, Pa. He had been president of that organization. After acquisition, Dynamic Measurements was liquidated, but continued its operations as the eastern facility of Servonic Instruments with Weiss as general manager.

Servonic's present product line encompasses a wide range of transducers.

General Electric Promotes Hayden

JOHN O. HAYDEN has been appointed telecommunications product planning manager for General Electric's Communication Products department, Lynchburg, Va. He will have responsibility for microwave multiplex-carrier and r-f developmental projects.

Hayden has been a product planner on mobile radio and microwave

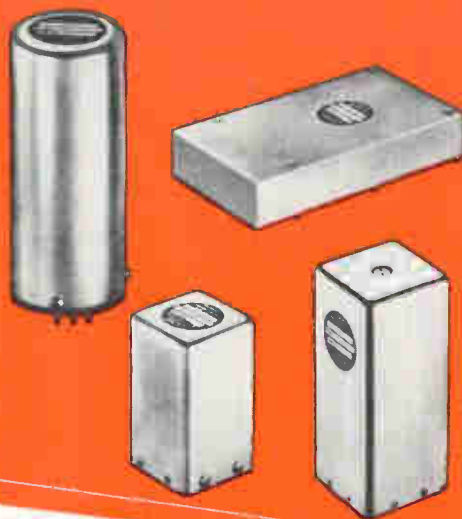

FREQUENCY/TIME CONTROLS

- 30 cps to 100 mc
- Choice of stability (commercial to 1×10^{-8})
- Standardized models for greatest economy
- Completely solid state oven control (no noise-generating thermostats!)
- Modest power demand
- Buffered output (no change in stability on load changes)
- Mount in any position
- Individual test documentation shipped with each unit
- Compact packaging

FRONTIER STAYS AHEAD...

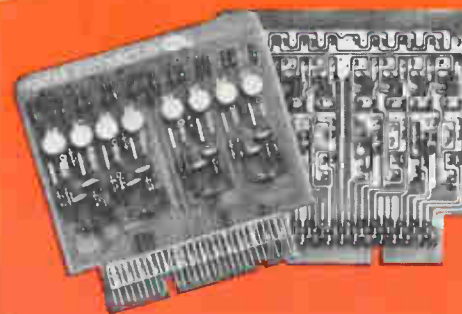

LOGIC BOARDS

- Five series in silicon or germanium: 100 kc, 500 kc, 1 mc, 2 mc, and 5 mc
- Practical, universally-used four-bit logic
- 14 basic functions meet fully any system design requirement
- Standard pin numbering and circuitry for same functions in all series
- Same power supply and pulse voltages for all functions
- Each function compatible with all others
- Sections of system may be high-speed others low for greatest economy
- Two to 9 identical circuits per board

FREQUENCY/TIME CONTROLS*LOGIC BOARDS AVAILABLE...RIGHT NOW!

Frontier's Total Systems Capability provides you with high-quality, proven systems components that meet today's needs today. ■ We offer conservatively-rated standardized units that fill an amazing number of special applications. And we make specials based on those standard units. Our prices might be quite attractive to you considering that all R & D work has been done, and the production line set up and running. You can count on swift delivery, usually off the shelf, though specials may take a little longer. ■ Engineering aid? It's yours for the asking. ■ Write today on your company letterhead for a copy of our catalog.

TIME LOGIC SYSTEMS
TOTAL SYSTEMS CAPABILITY



FRONTIER ELECTRONICS DIVISION
800 MEMPHIS AVENUE • CLEVELAND 9, OHIO

NEW DIMENSIONS IN RELIABILITY...

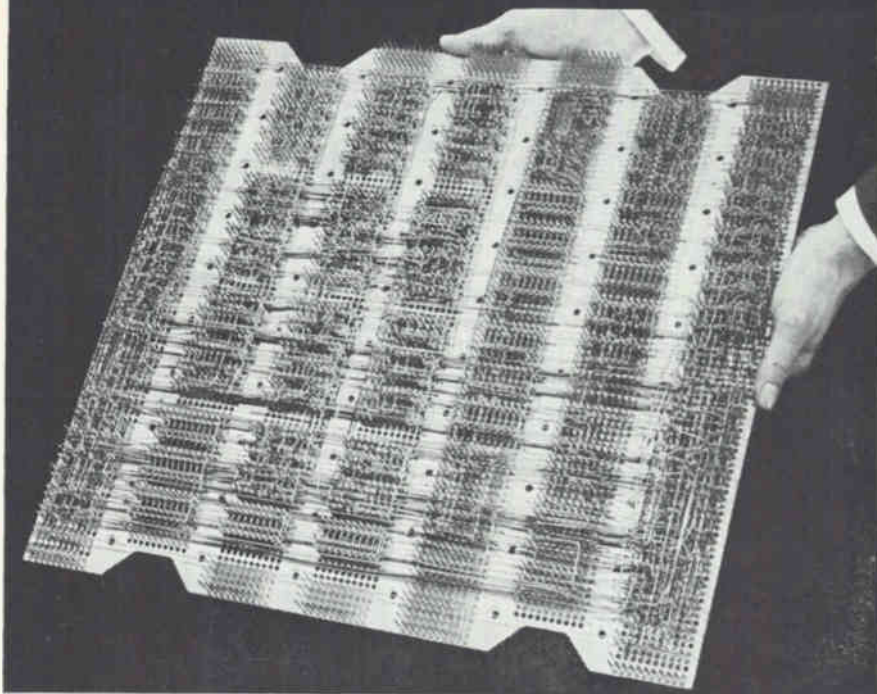

Complex computer boards wired automatically by Wire-Wrap[®] machines

2480 wires and 4960 connections are contained in this complicated back panel—automatically wired by a Gardner-Denver "Wire-Wrap" machine.

This is typical of how Gardner-Denver brings new dimensions to the reliability of complex electrical connections. This machine, with its punched card control system, wires complicated modular panels fast—in just about any conceivable pattern . . . makes literally thousands of connections in a small space.

And these connections are the most reliable in the world—because they're solderless wrapped connections. Just how good are they? Over a billion without reported failure.

If you're looking for ways to make lasting, trouble-free connections, **fast**—consult one of our engineers, or write for bulletin 14-121.



EQUIPMENT TODAY FOR THE CHALLENGE OF TOMORROW

GARDNER - DENVER

Gardner-Denver Company, Gardner Expressway, Quincy, Illinois

In Canada: Gardner-Denver Company (Canada), Ltd., 14 Curity Ave., Toronto 16, Ontario

designs since 1953. He joined General Electric Communications in Syracuse, N.Y., in 1948 as an engineer.

Greenslit Moves Up At Bendix Radio

CHARLES L. GREENSLIT has been appointed manager of government products for the Radio division of The Bendix Corp., Baltimore, Md. He was previously assistant general manager of the operation.

Greenslit joined Bendix in 1948 and has held supervisory positions in design, development, systems engineering, and engineering management.

Canoga Electronics Hires Epps

DOUGLAS EPPS has been appointed manager, Digital Systems department, Canoga Electronics Corp., Van Nuys, Calif. His responsibilities include development of digital radar techniques and equipment, telemetry tie-in equipment for digital acquisition and data handling, logic design and check-out of digital data systems.

Epps was formerly chief engineer, Computer Equipment Corp., Los Angeles, Calif.



Sola Electric Promotes Gislason

RAY S. GISLASON has been named vice president-manufacturing for Sola Electric Co., Elk Grove Village, Ill., a division of Basic Products Corp. He replaces H. H. Velten who has resigned.

Gislason has been assistant to

Velten since joining Sola last November. Previously he had been vice president of Stancor Electronics and had managed plants for that company in Zanesville, O., and Chicago.

Lockheed Sets Up Research Group

LOCKHEED MISSILES & SPACE CO., Sunnyvale, Calif., has formed a physical electronics group to expand its experimental programs in lasers, cesium plasmas, ferroelectricity, non-linear interaction of electromagnetic waves with plasmas, and measurements of low energy electron atom cross sections.

According to E. P. Wheaton, vice president and general manager of the company's Research and Development division at Palo Alto, the new research group will be part of the Electronic Sciences Laboratory.



Schjeldahl Company Names Laegreid

NILS LAEGREID has been named manager of the newly acquired Thin-Film division of the G. T. Schjeldahl Company, Minneapolis, Minn.

The Schjeldahl Company purchased the Thin-Film process and related assets from Electro-Craft Corp. last month.

Laegreid, who had directed the development of Thin-Film at Electro-Craft, will add to his staff and begin immediate work on development of marketable products utilizing the Thin-Film process.

Myron Howe Takes Ortronix Post

MYRON R. HOWE has been named management coordinator for all op-

New ac-dc laboratory standard



Acceptable for certification by the National Bureau of Standards

Speed voltmeter calibration Simplify supply voltage monitoring

±0.03% accuracy of indication. Engelhard's new Differential Thermocouple Voltmeter provides features never before available in a single instrument. Model 35700 DTVM is designed for rapid, high-precision voltmeter calibration, monitoring of supply voltages, and is ideal for critical ac and dc measurements as well. The instrument offers an accuracy of ±0.03% at any voltage from 1 to 1011.1v—either dc or 5cps to 1kc. Accuracy is rated as percent of *actual* reading rather than full-scale deflection.

Model 35700 indicates results directly, without multiplying factors or calculations, and requires only one operation per calibration reading. In addition, all measurements are performed without accessory equipment.

Circuitry is based on a similar design developed by Griffin and Hermach for the National Bureau of Standards. Calibration of the instrument is traceable to NBS, and the DTVM is acceptable for certification by the Bureau.

Exceptional stability permits uninterrupted observation of voltage changes as small as 0.02% over a period of several hours. Zener diodes establish a precise basic reference voltage, while a balanced thermal-converter circuit cancels effects of ambient temperature variations.

Simplified operation speeds measurement and helps eliminate error.

Calibration and monitoring results are indicated directly in *percent* on the DTVM. Voltage readings appear directly in *volts* on the instrument.

SPECIFICATIONS

Range (ac-dc):
Accuracy (±0.03%):
Accuracy (±0.05%):

1 to 1011.1, with overranging
any dc voltage setting ac from 5cps to 1kc
1.0 to 600v (1kc to 30kc)
600 to 800v (1kc to 20kc)
800 to 1011.1v (1kc to 10kc)

Size (inches):
Power requirement:

19 x 19 x 9
105/125v, 60cps, 10w

Write Engelhard for details on Model 35700 DTVM. We'll send a technical data sheet with full information and specifications.



DIGI EC

LOW COST DVM



base price
\$287⁵⁰
portable model
"200" shown

36 models available

featuring:

- CHOICE OF 0.1% or 0.2% FULL SCALE ACCURACY
- DIGITAL READINGS FROM 0.1 MV to 1000 V-DC.
- "4 RANGE" MODELS:
 - 0 to 1,000, 10.00, 100.0 & 1000 volts
 - 0 to 2,000, 20.00, 200.0 & 1000 volts
 - 0 to 4,000, 40.00, 400.0 & 1000 volts
 - "SINGLE RANGE" MODEL -0 to 100.0 MV
- Floating or Grounded Input
- Bi-Directional Tracking Without Flicker
- Reliable Transistorized Circuit
- 1-Year Guarantee
- Individually Calibrated & Certified
- Adaptors for Current Measurement from 0.1 μ A to 2 AMP.
- Specific Variations to Your OEM Requirements

Write or wire for demonstration



UNITED SYSTEMS CORPORATION

Dayton 3, Ohio

Stocking Representatives Throughout the United States and Canada

CIRCLE 212 ON READER SERVICE CARD

alpha >.003924

Precision temperature sensing elements require
Platinum Wire
of highest purity, homogeneity and reproducibility...



Write for latest brochure
Sigmund Cohn Mfg. Co., Inc.
121 South Columbus Ave.
Mount Vernon, N.Y.



SIGMUND COHN CORP. OF CALIFORNIA • 151C NORTH MAPLE STREET, BURBANK, CALIFORNIA

86 CIRCLE 86 ON READER SERVICE CARD

erations in the Electronic and Mechanical divisions at Ortronix Inc., Orlando, Fla. In this newly created position, he will be primarily concerned with both mechanical and electronic engineering, cost control, estimating and scheduling.

Prior to joining Ortronix, Howe was operations manager at Industrial Control Products, Caldwell, N. J.

PEOPLE IN BRIEF

Leonard J. Schwartz, director of field engineering, elected a v-p of Capehart Corp. Laurence E. Jewett promoted to mgr. of the Manufacturing Engineering div. of Leeds & Northrup Co. James Moore leaves Bell & Howell Co. to join Paraplegics Mfg. Co. as chief project engineer. Nicholas Zelinski advances to v-p, engineering, and a director of Corson Electric Mfg. Corp. Joseph H. Schlessel, formerly president of the Engineered Products div. of U.S. Industries, Inc., appointed president of the Automation div. Edwin A. Kreuder moves up to v-p of sales at Syntron Co. Speer Carbon Co. ups I. McKeand to mgr. of resistor development and production technical service of the Resistor div. Farrington Mfg. Co. elevates James L. Gallagher to director of mfg. and Keith G. Huntley to director of engineering for its data processing products. Sherman C. Maple, previously with Litton Systems, Inc., appointed director of operations of American Laboratories, a section of American Electronics, Inc. Frederick R. Cronin, ex-ACF Electronics, named mgr. of the Digital Development dept., Government Products div. of Adler Electronics, Inc. Gaelen L. Felt promoted to chief operating officer and v-p in charge of the Las Vegas laboratories of Edgerton, Germeshausen & Grier, Inc. Stanley Pro, formerly with Behlman-Invar Corp., now chief engineer of Arnold Magnetics Corp. Elton N. Sherman, from Telemetrics, Inc., to Defense Electronics, Inc., as technical consultant. Gene P. Hopkins, ex-Gregory Industries, Inc., elected president of Emtec Inc.

May 10, 1963 • electronics

electronics

WEEKLY QUALIFICATION FORM FOR POSITIONS AVAILABLE

ATTENTION: ENGINEERS, SCIENTISTS, PHYSICISTS

This Qualification Form is designed to help you advance in the electronics industry. It is unique and compact. Designed with the assistance of professional personnel management, it isolates specific experience in electronics and deals only in essential background information.

The advertisers listed here are seeking professional experience. Fill in the Qualification Form below.

STRICTLY CONFIDENTIAL

Your Qualification form will be handled as "Strictly Confidential" by ELECTRONICS. Our processing system is such that your form will be forwarded within 24 hours to the proper executives in the companies you select. You will be contacted at your home by the interested companies.

WHAT TO DO

1. Review the positions in the advertisements.
2. Select those for which you qualify.
3. Notice the key numbers.
4. Circle the corresponding key number below the Qualification Form.
5. Fill out the form completely. Please print clearly.
6. Mail to: Classified Advertising Div., ELECTRONICS, Box 12, New York 36, N. Y. (No charge, of course).

COMPANY	SEE PAGE	KEY #
ATOMIC PERSONNEL INC. Philadelphia, Penna.	130*	1
GENERAL DYNAMICS/ELECTRONICS A Div. of General Dynamics Corp. Rochester, New York	131*	2
HONEYWELL St. Petersburg, Florida	58	3
LOCKHEED MISSILES & SPACE CO. Div. of Lockheed Aircraft Corp. Sunnyvale, California	81*	4
NORDEN Div. of United Aircraft Corporation Norwalk, Conn.	89	5
PAN AMERICAN WORLD AIRWAYS INC. Guided Missiles Range Div. Patrick AFB, Fla.	88	6
SCHLUMBERGER WELL SURVEYING CORP. Ridgefield, Conn.	130*	7
UNION CARBIDE NUCLEAR COMPANY A Div. of Union Carbide Corporation Oak Ridge, Tennessee	88	8

* These advertisements appeared in the May 3rd. issue.

(cut here)

electronics WEEKLY QUALIFICATION FORM FOR POSITIONS AVAILABLE

(cut here)

(Please type or print clearly. Necessary for reproduction.)

Personal Background

NAME

HOME ADDRESS

CITY ZONE STATE

HOME TELEPHONE

Education

PROFESSIONAL DEGREE(S)

MAJOR(S)

UNIVERSITY

DATE(S)

FIELDS OF EXPERIENCE (Please Check)

51063

- | | | |
|--|--|---------------------------------------|
| <input type="checkbox"/> Aerospace | <input type="checkbox"/> Fire Control | <input type="checkbox"/> Radar |
| <input type="checkbox"/> Antennas | <input type="checkbox"/> Human Factors | <input type="checkbox"/> Radio-TV |
| <input type="checkbox"/> ASW | <input type="checkbox"/> Infrared | <input type="checkbox"/> Simulators |
| <input type="checkbox"/> Circuits | <input type="checkbox"/> Instrumentation | <input type="checkbox"/> Solid State |
| <input type="checkbox"/> Communications | <input type="checkbox"/> Medicine | <input type="checkbox"/> Telemetry |
| <input type="checkbox"/> Components | <input type="checkbox"/> Microwave | <input type="checkbox"/> Transformers |
| <input type="checkbox"/> Computers | <input type="checkbox"/> Navigation | <input type="checkbox"/> Other |
| <input type="checkbox"/> ECM | <input type="checkbox"/> Operations Research | <input type="checkbox"/> |
| <input type="checkbox"/> Electron Tubes | <input type="checkbox"/> Optics | <input type="checkbox"/> |
| <input type="checkbox"/> Engineering Writing | <input type="checkbox"/> Packaging | <input type="checkbox"/> |

CATEGORY OF SPECIALIZATION

Please indicate number of months experience on proper lines.

	Technical Experience (Months)	Supervisory Experience (Months)
RESEARCH (pure, fundamental, basic)
RESEARCH (Applied)
SYSTEMS (New Concepts)
DEVELOPMENT (Model)
DESIGN (Product)
MANUFACTURING (Product)
FIELD (Service)
SALES (Proposals & Products)

CIRCLE KEY NUMBERS OF ABOVE COMPANIES' POSITIONS THAT INTEREST YOU

1 2 3 4 5 6 7 8 9 10 11 12 13 14 15 16 17 18 19 20 21 22 23 24 25

RADAR & TELEMETRY ENGINEERS

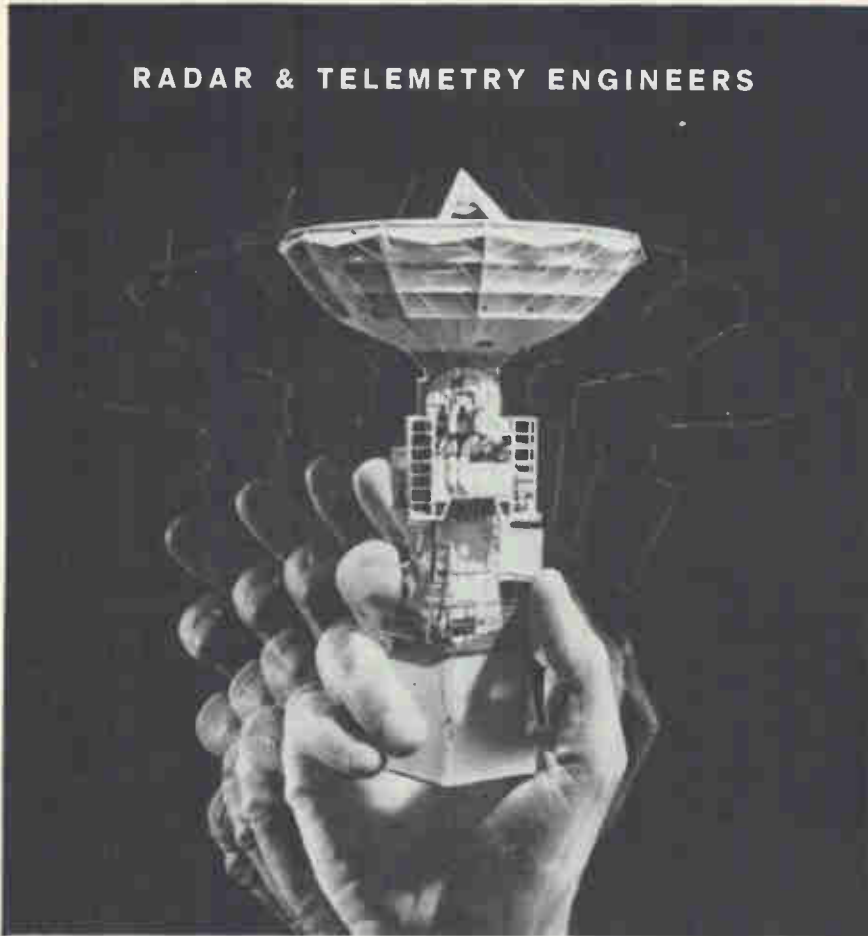

our ears
are "UP"

... to track, monitor,
and measure space-
craft and missile per-
formance of every
launch at the Atlantic
Missile Range.

For instrumentation engineers with Pan Am's Guided Missiles Range Division, this means the planning and design of new sensor systems to meet the demanding radar and telemetry requirements of each new mission—Gemini, Apollo, Satellites, Space Probes. These next generation instrumentation systems will provide greater coverage, accuracy, mobility, reliability and automated real-time data delivery.

Examples of diverse approaches being taken to achieve such systems are:

- a new CW doppler range-rate tracking system that measures missile and spacecraft velocity with accuracy of 0.5 fps.
- pulse doppler radars that measure range rate to 0.1 fps.
- large high-gain (85 ft. diam.) wide-band (130-2300 mc) automatic tracking antenna systems
- advanced, universal pulse code modulation (PCM) ground systems (bit rate from 1 to 1 million bits per second).

Engineers interested in joining in this effort are invited to write in confidence to Dr. Charles Carroll, Dept. 28E-2.



GUIDED MISSILES RANGE DIVISION

PAN AMERICAN WORLD AIRWAYS, INC.
P. O. BOX 4465, PATRICK AIR FORCE BASE, FLORIDA
AN EQUAL OPPORTUNITY EMPLOYER

INSTRUMENT TECHNICIANS THE OAK RIDGE NATIONAL LABORATORY Operated by UNION CARBIDE NUCLEAR COMPANY at Oak Ridge, Tennessee HAS OPENINGS FOR

highly skilled instrument technicians to work with engineers in the installation and maintenance of process control and electronic instrumentation for nuclear reactors and associated experiments. Nuclear reactor control system experience desirable but not essential.

Minimum high school education, with additional training in either the physical sciences, instrumentation, or electronics, and at least 3 years experience in installation and maintenance of complex instrumentation and control systems. Entrance rate \$3.19 per hour; \$3.25 per hour after six months. Reasonable interview and relocation expenses paid by the Company.

Excellent Working Conditions

and
Employee Benefit Plans
An Equal Opportunity Employer

Send detailed resume to:

Central Employment Office
UNION CARBIDE NUCLEAR COMPANY
A Division of Union Carbide Corporation
Post Office Box M Oak Ridge, Tennessee

WANTED

Ingenious and Ambitious Engineers and Scientists

To form the technical nucleus of a new industrial applied research laboratory. Positions are available for Inorganic Chemists, Physical Chemists, Solid-State Physicists, Electrical Engineers. Opportunities and advantages are:

- 1) Freedom to initiate areas of investigation
- 2) Responsibility for technical programs
- 3) Top salaries for qualified people
- 4) Northern New Jersey location

CALL COLLECT

(201)—HU 5-2100, Ask for Dr. Kaufman

EMPLOYMENT OPPORTUNITIES



The Advertisements in this section include all employment opportunities—executive, management, technical, selling, office, skilled, manual, etc. Look in the forward section of the magazine for additional Employment Opportunities advertising.

Positions Vacant	Civil Service Opportunities
Positions Wanted	Selling Opportunities Wanted
Part Time Work	Selling Opportunities Offered

Employment Agencies
Employment Services
Labor Bureaus

— RATES —

DISPLAYED: The advertising rate is \$40.17 per inch for all advertising appearing on other than a contract basis. Contract rates quoted on request.

An advertising inch is measured 7/8" vertically on a column—3 columns—30 inches to a page.

Subject to Agency Commission.

UNDISPLAYED: \$2.70 per line, minimum 3 lines. To figure advance payment count 5 average words as a line.

Box numbers—count as 1 line.

Discount of 10% if full payment is made in advance for 4 consecutive insertions.

Not subject to Agency Commission.

what a location for eclectic* engineers!

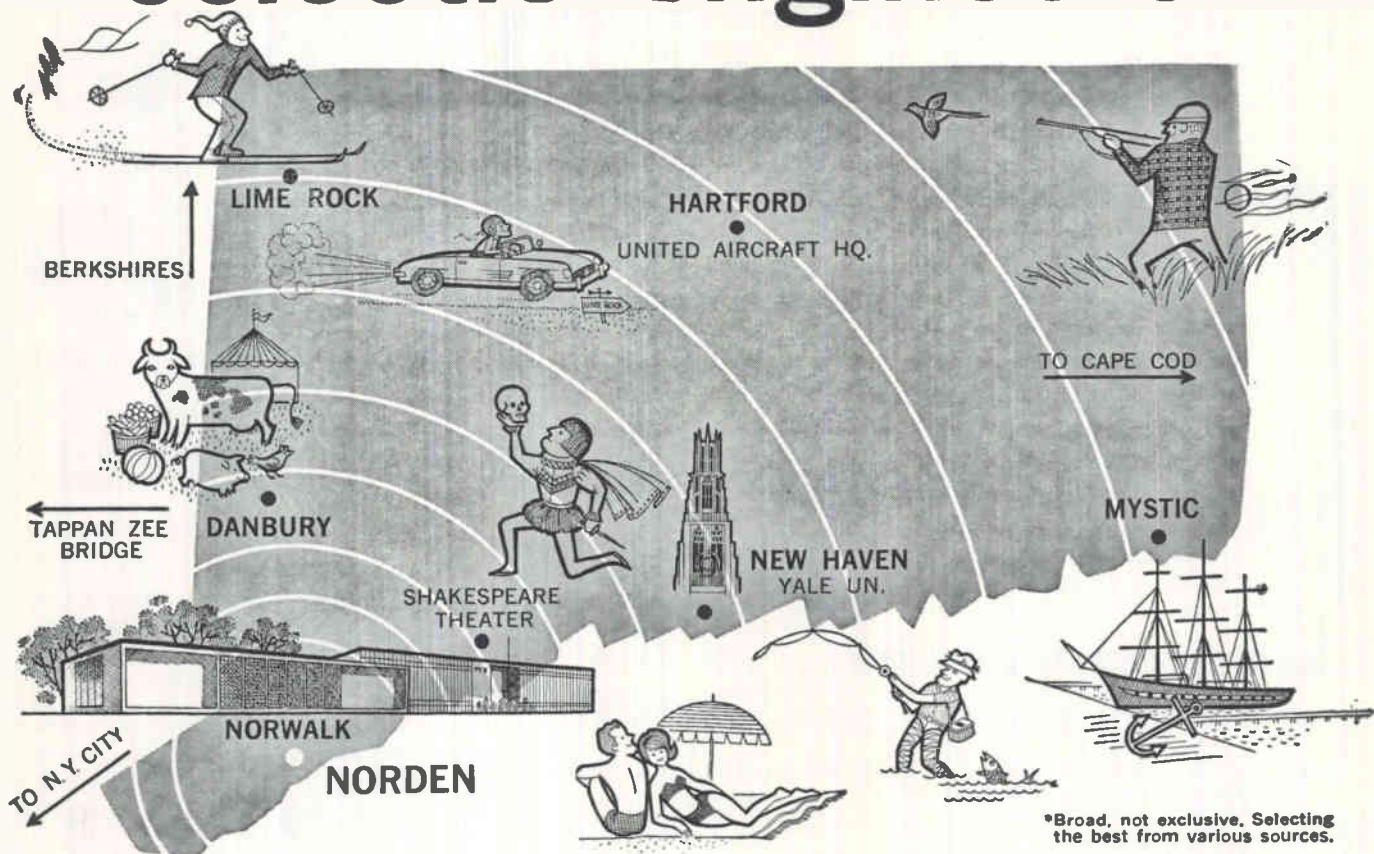

*Broad, not exclusive. Selecting the best from various sources.

Whatever their specialty, most engineers at Norden are eclectic indeed—men of unusually broad interests—both in their work, and in their equally enthusiastic approach to a full personal life.

Which is perhaps one reason why they came here in the first place.

Norden's location in famous Fairfield County, Connecticut, offers a rare combination of cultural and sports activities the year 'round. Close by is Long Island Sound. Hunting country and ski centers are within easy driving distance, as are a number of nationally-known cultural events. And New York City is a short 41 miles away. Opportunities for advanced study at nearby schools such as U. of Connecticut, Brooklyn Poly, Columbia, NYU, CCNY and Stevens, are open to qualified engineers under our company-paid graduate program.

Just as Norden's location offers a wide diversity of things to see and do—so exposure to many technical facets of a project is the keynote of working at Norden. Problem-solving teams work across a wide spectrum of advanced electronics areas. Test and research facilities include a 12,000 sq. ft. Environmental Lab capable of simulating extreme temperatures, pressures and humidity levels; and an extensively equipped Applied Physics Laboratory.

And today's expanding programs offer engineers and scientists of many disciplines highly divergent fields for exploration—military radars, microelectronic circuitry, ground support equipment for missiles and aircraft, data processing systems and equipments, computers, navigation programs and many others.

Assignments are open at all technical levels. A few are described below:

VIDEO PROCESSING & DISPLAY ENGINEERS

BSEE with advanced degree preferred. Experience on video amplifiers, radar displays, scan converters, synthetic video generators and/or high speed function generators. Military TV or radar experience preferred.

SEMICONDUCTOR DEVICE SCIENTISTS & ENGINEERS

R&D of silicon functional electronic blocks. Requires experience with oxide masked multi-diffused structures and knowledge of transistorized circuitry.

SYSTEMS ENGINEERS

Aerospace applications of military ground support equipment; and modern microwave and optical radar systems.

RELIABILITY ENGINEERS

Review system and subsystem tests for design approval. Will recommend design modifications.

EQUIPMENT DESIGN ENGINEERS

Knowledge of stress analysis, heat transfer, high density electronic packaging.

Norden DIVISION OF UNITED AIRCRAFT CORPORATION
U A
 An Equal Opportunity Employer

For further information or to arrange an interview appointment, please forward your resume to Mr. James E. Fitzgerald, at Helen Street, Norwalk, Conn.

ANTENNA PEDESTAL SCR 584-MP 61B

Full azimuth and elevation sweeps 360 degrees in azimuth, 210 degrees in elevation. Accurate to 1 mil. or better over system. Complete for full tracking response. Angle acceleration rate: AZ, 9 degrees per second squared EL, 4 degrees per second squared. Angle slewing rate: AZ 20 degrees per sec. EL 10 degrees per sec. Can mount up to a 20 ft. dish. Angle tracking rate: 10 degrees per sec. Includes pedestal drives, selsyns, potentiometers, drive motors, control amplidyne. New condition. Quantity in stock for immediate shipment. Ideal for missile & satellite tracking, antenna pattern ranges, radar system, radio astronomy, any project requiring accurate response in elevation and azimuth. Complete description in McGraw-Hill Radiation Laboratory Series, Volume 1, page 284 and page 209, and Volume 26, page 233.

MIT MODEL 9 PULSER 1 MEGAWATT—HARD TUBE

Output 25kv 40 amp. Duty cycle .002. Pulse lengths, 25 to 2 microsec. Also .5 to 5 microsec. and 1 to .5 msec. Uses 6C21 Input 115v 60 cycle AC Mfr. GE. Complete with driver and high voltage power supply. Ref: MIT Rad. Lab. Series Vol. 5 pps. 152-160.

500KW THYRATRON PULSER
Output 22kv at 28 amp. Rep. rates: 2.25 microsec. 300 pps., 1.75 msec 550 pps., .4 msec 2500 pps. Uses 5C22 hydrogen thyatron. Complete with driver and high voltage power supply. Input 115v 60 cy AC.

2 MEGAWATT PULSER
Output 30 kv at 70 amp. Duty cycle .001. Rep rates: 1 microsec 600 pps. 1 or 2 msec 300 pps. Uses 5C22 hydrogen thyatron. Complete with driver and high voltage power supply. Input 120/208 VAC 60 cycle. Mfr. GE. Complete with high voltage power supply.

1SKW PULSER—DRIVER
Biased multivibrator type pulse generator using 3E29. Output 3kv at 5 amp. Pulse lgths .5 to 5 microsec. easily adj. to 1 to .5 msec Input 115v 60 cy AC. \$475. Ref: MIT Rad Lab. Series Vol. 5 pp 157-160

CIRCLE 951 ON READER SERVICE CARD

FREE Catalog OF THE WORLD'S FINEST ELECTRONIC GOV'T SURPLUS BARGAINS



HUNDREDS OF TOP QUALITY ITEMS — Receivers, Transmitters, Microphones, Inverters, Power Supplies, Meters, Phones, Antennas, Indicators, Filters, Transformers, Amplifiers, Headsets, Converters, Control Boxes, Dynamotors, Test Equipment, Motors, Blowers, Cable, Keyers, Chokes, Handsets, Switches, etc., etc. Send for Free Catalog—Dept. B-3

FAIR RADIO SALES
2133 ELIDA RD. • Box 1105 • LIMA, OHIO

SMALL AD but BIG STOCK of choice test equipment and surplus electronics

Higher Quality—Lower Costs
Get our advice on your problem
ENGINEERING ASSOCIATES
434 Patterson Road — Dayton 19, Ohio

CIRCLE 952 ON READER SERVICE CARD

FOR SALE

Standard 3-channel open-wire Carrier Terminals and Repeaters.

Standard v-f carrier-telegraph terminals.

Standard v-f ringers, v-f repeaters, repeating coils, condensers, filters, retard coils, polar relays.

Complete list on request

FS-2148, Electronics
Class. Adv. Div., P.O. Box 12, N.Y. 36, N.Y.

CIRCLE 953 ON READER SERVICE CARD

SCR 584 RADAR AUTO-TRACK
3 CM & 10 CM. Our 584s in like new condition, ready to go, and in stock for immediate delivery. Used on Atlantic Missile Range, Pacific Missile Range, NASA Wallaps Island, A.B.M.A. Write us. Fully Desc. MIT Rad. Lab. Series, Vol 1, pps. 207-210, 228, 284-286.

300 TO 2400MC RF PKG.
300 to 2400MC CW. Tuneable, Transmitter 10 to 30 Watts. Output. As new \$475.

AN/TPS—1D RADAR
300 kw. 1220-1359 mcs. 160 nautical mile search range P.P.I. and A. Scopes, MTI, thyatron mod. 5J26 magnetron. Complete system.

AN/TPS 10D HEIGHT FINDER
250 KW X-Band. 60 & 120 mile ranges to 60,000 feet. Complete.

AN/APS—15B 3 CM RADAR
Airborne radar. 40kw output using 725A magnetron. Model 3 pulser. 30 in. parabola stabilized antenna. PPI scope. Complete system \$1200 each. New.

100 KW 3 CM. X BAND RADAR
Complete AN/APS-27 radar system using 4J52 magnetron. PPI antenna 360 degree rotation azimuth, 60 degree elevation apt. Complete installation including gyro & AMTI \$2800.

L BAND RF PKG.
20KW peak 990 to 1040mc. Pulse width .7 to 1.2 micro sec. Rep rate 180 to 420 pps. Input 115 vac. Incl. Receiver \$1200.

CARCINOTRONS
Type CSF CM706A Freq. 3000 to 4000 mcs. Typ. CSF CM710A. Freq. 2400 to 3100 mcs. CW Output 200 Watts minimum. New. Full wty.

AN/CPS-9 WEATHER RADAR
250 kw. 3 cm. 360 deg. az. 90 deg. elev. scan PPI. RHI A scopes

**RADIO RESEARCH
INSTRUMENT CO.**
550 FIFTH AVE., NEW YORK
JUDSON 6-4691

CIRCLE 950 ON READER SERVICE CARD

WANTED: AN/TRC-24 RADIO SET COMPONENTS

AM-912/TRC
AM-913/TRC
AM-914/TRC
AM-915/TRC
PP-685/TRC
R-417/TRC
T-302/TRC

W-2147, Electronics
Class. Adv. Div., P.O. Box 12, N.Y. 36, N.Y.

CIRCLE 957 ON READER SERVICE CARD

**POTTING APPLICATORS
MANUAL AND DISPOSABLE**
6cc 12cc 30cc
FOR POTTING, ENCAPSULATING, AND
SEALING OF MINIATURE COMPONENTS
PHILIP FISHMAN CO.
7 CAMERON ST., WELLESLEY 81, MASS.



CIRCLE 958 ON READER SERVICE CARD

ELECTRON TUBES

KLYSTRONS • ATR & TR • MAGNETRONS
SUBMINIATURES • C.R.T. • T.W.T. • 5000-
6000 SERIES
• SEND FOR NEW CATALOG A2 •
A & A ELECTRONICS CORP.
1063 PERRY ANNEX
WHITTIER, CALIF.
AN 92865 OR 943-2829

CIRCLE 959 ON READER SERVICE CARD

**TUBES & COMPONENT
FREE...CATALOG
BARRY ELECTRONICS**
512 BROADWAY 212-Walker 5-7000
NEW YORK 12, N.Y. TWX-571-0484

CIRCLE 955 ON READER SERVICE CARD

RELAYS?



WHAT ARE YOU WORRIED ABOUT?

UNIVERSAL CAN SOLVE YOUR PROBLEMS
OVER 2,000,000 in STOCK

ALL TYPES • MOST MAKES
PRODUCTION QUANTITIES

DON'T BE A WORRY WART

Write for Catalogue EK

Universal RELAY CORP.

42A White St., New York 13, N. Y., WA 5-6900

CIRCLE 956 ON READER SERVICE CARD

Searchlight Equipment Locating Service

NO COST OR OBLIGATION

This service is aimed at helping you the reader of "SEARCHLIGHT", to locate Surplus new and used Electronic equipment not currently advertised. (This service is for USER-BUYERS only.)

How to use: Check the dealer ads to see if what you want is not currently advertised. If not, send us the specifications of the equipment wanted on the coupon below, or on your own company letterhead to:

Searchlight Equipment Locating Service
c/o ELECTRONICS
P.O. BOX 12, N.Y. 36, N.Y.

Your requirements will be brought promptly to the attention of the equipment dealers advertising in this section. You will receive replies directly from them.

Searchlight Equipment Locating Service
c/o ELECTRONICS,
P.O. Box 12, N.Y. 36, N.Y.

Please help us locate the following equipment components.

.....

.....

.....

.....

.....

NAME

TITLE

COMPANY

STREET

CITY 5/10/63

GET IT FROM GOODHEART!

Please Write Us for Your Specific Needs. Below are SAMPLINGS of our Inventory for Engineers:

UNIDIRECTIONAL D.F. LOOP & PREAMPLIF Navy DL-1: Compact, total only 7 lbs. 1 1/2" loop. 4 1/2" azim. scale. 25K716 tube. 0.2 to 1.0 mc. W Instructions, modify to 3 mc. Takes B- from receiver you use it with. True bearing in \$29.95 3 seconds, no 180-deg. ambiguity. New.

MEASURE R TO 0.1%, E AND I TO 0.01% and with ZERO current drawn! Read 4 digits on 3-dial 20K ohm Kelvin-Variety Voltage Divider for direct-reading potentiometric measurements of E and I. AC and DC. Air Force Spec says 1 part in 10,000. Plus 0.1% standards to measure R in modified Wheatstone Bridge ckt. Plus 100-0-100 uA meter and ckt of 2-transistor amplifier for 3 uA full scale. You get a \$1055.00 Air Force Test Set plus Handbooks, R Standards, and our own simple instructions. BRAND NEW. Ship wt 37 lbs for \$79.50 Springfield, Ohio

GERTSCH "RatioTran" RT-7R BARGAINI Divides voltages 50-10,000 cv with decade dials X.1, X.01, X.001, X.0001 & finally an interpolating slide-wire pot on 6th dial. \$500 MIL model, better potting, etc. new, w/instr. \$179.50 book, mating plug, only.

RECEIVERS AND PANADAPTERS RC-45B: 100-550 kc 6-tube superhet w/85 kc IF's. Best as long-wave receiver, as 2-tube IF & as 2nd convert. W all data CHECKED ELECTRI. \$12.95 CALLY: Grid, OKI 11 lbs. for Los Angeles. Same, in handsome case, w/ pwr sply. spkr. etc., ready to use, is our QX-533, 19 lbs. \$37.50 RIB: Navy's pride 2-20 mc 14-tube superhet has voice filter for low noise, car-sounding AGC, high sense & select. IF is 125K kc. Checked, aligned, w/ supply cords, tech data, ready to use, for \$69.50 Charleston, S.C. or Los Angeles. R-43: ARR-7 brand new, 12-tube superhet .55-43 mc in 6 bands, S-meter, 455 kc IF's, xtl filter, 6 set. positions, etc. Hot and complete. It can be made still better by double-converting into the RC-453 or QX-535. Pwr sply includes DC for the automatic tuning motor. FOB San Antonio, \$179.50. Time Pay Plan: \$17.05 down, 11 x \$16.03

R-54/APR-4 rev is the 11-tube 30 mc IF etc. for its plug-in tuning heads. S-meter, 60 cv pwr sply. Pan, Video & Audio outputs. AM. Checked, aligned, with heads for 38-1000 mc. \$164.00 pwr plug & Handbook, for Los Ang. Add \$30.00 for 60 cv AM/FM instead of AM

TN-19 (975-2200 mc) & TN-54 (2175-4000 mc) P.U.R. R-111/APR-5A receiver 1 to 6 mc & Panadapter ? ? (30 mc +5 mc for both APR-4 and APR-5A) \$199.50 RDP by itself, checked, w/schematic, \$72.50 Panadapter IB-60/AP-10: 3-20 mc, 30 mc inputs; 400 cv pwr sply. W/schematic & \$99.50 instructions for changeover to 60 cv. Panadapter BBV-1: 400 kc input; 60 cv pwr. \$49.50

71% DISCOUNT ON SCINTILLATION COUNTER Famous-Name overstock, new, w/instruct., checked and guaranteed. Sotomura, 2-20 mc. Variable time constant. Use for walking or living surveys. Ultra-sensitive meter. 0.02-20 Mc/hr. Regularly \$340.05. Only \$199.50

FREQUENCY-METER BARGAINS Navy, LM., 125-20 mc w/matching book, \$57.50 xtl, schematic, instruct., 100% grd. MC Pwr for LM. New, new EAO, w/LM plug, all-com diodes, instructions we furnish \$9.95 3M w/Nav. pwr sply & cords, ready to use, \$72.50 TS-173 w/AC pwr sply, 00-450 mc, 0.05% \$150.00 TS-174, 20-280 mc, 0.1% \$150.00 TS-186, 0.1-10 KMC, 0.1%, xtl calib., \$195.00 General Radio Co. \$692.00 \$300.00 \$199.50 xtl calib., 0.1% accur. Reg. \$625.00 only

ESTERLINE-ANGUS & VARIAN RECORDERS Est-Line type AWC, 1" tape dec; 121v 60 cv \$249.50 synch chart drive; for Los Angeles. \$249.50 Same w/spring-wound drive; for Philad. \$249.50 ready to use, 1" tape, complete \$249.50 Above in 60 cv; same in 30 cv, only \$149.50 Varian G-10 0-100 mv less chart drive & pen, servo-system only. Use as meter. \$97.50

PRECISION PHASE METER/MONITOR ME-63/U Meter shows phase-angle difference 0-360 + deg. between any 2 inputs; 2-20 mc, 0.05% \$275.00 peak 20-20,000 cv. \$1420 Gov't cost!

TUNING-FORK FREQ REFERENCE STANDARDS 100 cv + .001%, AM, Time Prod. fork only \$9.95 Complete module, w/tubes, instructions, \$14.95 Same in case w/pwr sply, AF amplifier \$69.50 10,000 cv + .001%, #2001-2H w/multiplier \$49.50 1000 cv + .02%, #2000 plus 4 Walker \$50.00 count-downs to 500, 250, 125, 62 1/2 cv \$37.50

FM MICROVOLTER WITH BUILT-IN SCOPE TS-432A/U, pass-band 0.1-100 mc. You are aligning, 5-108 mc in 6 bands. Movable marker pip is wavemeter, calib. accuracy .33%. Accurate attenuator 1 db, 1 db steps, from min. to 40 db. Scope synched to freq sweep, 500 Gcps. Gov't cost; for Los Ang., checked 100% OK only \$149.50



0.1% SORENSEN Line Voltage Regulator #50008 reg ul. against load changes 0-5 kva & line changes 95-130 v, 1 ph 50/60 cv; set to 110-120 v, holds to 0.1%. Harm. less than 3%. Recovery 1 sec. Regularly \$695.00 less spares. New, w/spares orig. pack, 28 1/2 lbs. for Utica. \$349.50 #10008, 1 kv. for Los Angeles \$179.50 #1500 Special, 150 to 1500 va, 105-125 v 60 cv, +0.3% line & load, 110-120 v. Max. 2000. Part. for \$199.50 Norwalk, Conn. Sold 500 va, 117 v, Los An. \$49.50

STANDARD SIGNAL GENERATOR BARGAINS All modulated, all microvolt-calibrated outputs, all cert 100% OK, Bonton #203B Inverter 1-25 mc, \$130. #804 1X3, 715-330 mc, \$150. Means, Corp. #78FM, 88-108 mc, \$135. #890 or AN equivalent TS-4B7B CUR, 2-400 mc, \$350. #84, .3-1 kmc, \$150. LAE2 new, .52-1.3 kmc, \$90.

R. E. GOODHEART CO. P. O. Box 1220-E Beverly Hills, Calif.

No Catalog. Buy what you want from the ad.

SPECIAL PURPOSE TUBES

Table listing various vacuum tubes with their types and prices. Columns include tube type (e.g., OA2, OA2WA, OA3), quantity, and price (e.g., 80, 1.50, 0.85).

ALL TUBES ARE NEW, INDIVIDUALLY CARTONED, FULLY GUARANTEED

western engineers

TELEX or TWX: 916-681-3061 ELK GROVE, CALIFORNIA Prices FOB Telephone: 916-685-9582 Min order \$10 SUPPLIERS OF ELECTRON TUBES SINCE 1932

CIRCLE 960 ON READER SERVICE CARD

INDEX TO ADVERTISERS

Admiral Corp. Palo Alto Div.	73	• Kay Electric Co.	71	• Westinghouse Electric Corp.	25
Airpax Electronics, Inc.	64	• Lambda Electronics Corp.	5	Weston Instruments A Division of Daystrom Inc.	69
• Amphenol-Borg Electronics Corp. Connector Division	84, 85	• Lockheed Electronics Co.	21		
Beaver Gear Works, Inc.	79	Machlett Laboratories	27		
Bekins Van and Storage Co.	62	Marconi Instruments, Ltd.	72		
Bircher Corporation, The.	29	• Markel & Sons, L. Frank.	68		
• Brush Instruments Div. of Clevite Corp.	3rd Cover	• Methode Electronics, Inc.	75		
		Mnemotron Corp.	20		
• Cohn Corp., Sigmund.	86	New Jersey Bureau of Commerce.	66		
• Coto-Coil Co., Inc.	80	Omark Industries, Inc.	73		
Datak Corp., The.	65	Patwin Electronics	79		
• Dialight Corporation	59	Plant City	65		
Di Acro Corp.	24	• Potter Instrument Co., Inc.	17		
Diehl Mfg. Co.	19	Precision Instrument Co.	18, 57		
Dymec A Division of Hewlett Packard Co.	83	• Radio Corporation of America. 4th Cover			
Engelhard Industries, Inc.	85	• Rochar Electronique	23		
Fansteel Metallurgical Corp.	30, 31	• Rome Cable Div. of Alcoa.	14		
Florida Development Commission.	13	Saab Motors, Inc.	12		
Ford Instrument Co. Div. of Sperry Rand Corp.	54	• Semi-Elements, Inc.	75		
• Frontier Electronics Co.	83	• Sigma Instruments, Inc.	26		
Gardner-Denver Company	84	Sprague Electric Co.	9		
General Atronics	27	• Superior Tube Co.	63		
• General Radio Co.	2nd Cover	Suprenant Mfg. Co.	61		
General Time Corp.	76	Tektronix, Inc.	88		
Graphic Systems, Inc.	80	Texas Instruments Incorporated Industrial Products Group.	67		
Gudebrod Bros. Silk Co., Inc.	32	Toyo Musen Co. Ltd.	59		
Harman Kardou Inc.	4	Trent Inc.	59		
• Hewlett-Packard Company	6, 10, 11	• Turbo Machine Co.	65		
Honeywell	58	United Systems Corp.	86		
• Inland Motor Corp. Div. of Kollmorgen Corp.	77	Virginia Electric & Power Co.	26		
Intellux, Inc.	81				
International Resistance Co.	20				
• Japan Piezo Electric Co., Ltd.	69				

CLASSIFIED ADVERTISING

F. J. Eberle, Business Mgr.

EMPLOYMENT OPPORTUNITIES. 88, 89

EQUIPMENT

(Used or Surplus New)

For Sale 90, 91

WANTED

Equipment 90

INDEX TO CLASSIFIED ADVERTISERS

• A & A Electronics Corp.	90
• Barry Electronics Corp.	90
• Engineering Associates	90
• Fair Radio Sales	90
Fishman Co., Philip.	90
Goodheart Co., Inc., R. E.	91
Kaufman, Dr.	88
Norden, Div. of United Aircraft Corp.	89
Pan American World Airways Inc. Guided Missiles Range Div.	88
• Radio Research Instrument Co.	90
Union Carbide Nuclear Company Div. of Union Carbide Corporation.	88
• Universal Relay Corporation.	69
• Western Engineers	91

• See advertisement in the July 25, 1962 issue of Electronics Buyers' Guide for complete line of products or services.

This Index and our Reader Service Numbers are published as a service. Every precaution is taken to make them accurate, but electronics assumes no responsibilities for errors or omissions.

electronics



Audit Bureau
of Circulation



Associated Business
Publications

Audited Paid Circulation

JAMES T. HAUPTLI

Advertising Sales Manager

DAVID CUNNIFF

Promotion Manager

Electronics Buyers' Guide

R. S. QUINT
General Manager

RICHARD J. TOMLINSON
Business Manager

THEODORE R. GEIPEL
Production Manager

ADVERTISING REPRESENTATIVES

ATLANTA (9):

Michael H. Miller, Robert C. Johnson
1375 Peachtree St. N.E., Trinity 5-0523
(area code 404)

BOSTON (16):

William S. Hodgkinson, Donald R. Furth
McGraw-Hill Building, Copley Square,
Congress 2-1160 (area code 617)

CHICAGO (11):

Harvey W. Wernecke, Robert M. Denmead
645 North Michigan Avenue, Mohawk 4-5800
(area code 312)

CLEVELAND (13):

Paul T. Fegley
55 Public Square, Superior 1-7000
(area code 216)

DALLAS (1):

Frank Le Beau
The Vaughn Bldg., 1712 Commerce St.,
Riverside 7-9721 (area code 214)

DENVER (2):

John W. Patten
Tower Bldg., 1700 Broadway,
Alpine 5-2981 (area code 303)

HOUSTON (25):

Joseph C. Page, Jr.
Prudential Bldg., Halcombe Blvd.,
Riverside 8-1280 (area code 713)

LOS ANGELES (17):

Ashley P. Hartman, John G. Zisch,
William C. Gries
1125 W. 6th St., Huntley 2-5450
(area code 213)

NEW YORK (36):

Donald H. Miller, Henry M. Shaw,
George F. Werner
500 Fifth Avenue, LO-4-3000
(area code 212)

PHILADELPHIA (3):

Warren H. Gardner, William J. Boyle
6 Penn Center Plaza, LOcust 8-4330
(area code 215)

SAN FRANCISCO (11):

Richard C. Alcorn
235 California Street, Douglas 2-4600
(area code 415)

LONDON W1:

Edwin S. Murphy Jr.
34 Dover St.

FRANKFURT/Main:

Matthée Herfurth
85 Westendstrasse

GENEVA:

Michael R. Zeynel
2 Place du Port

TOKYO:

George Olcott,
1, Kotohiracho, Shiba, Minato-ku

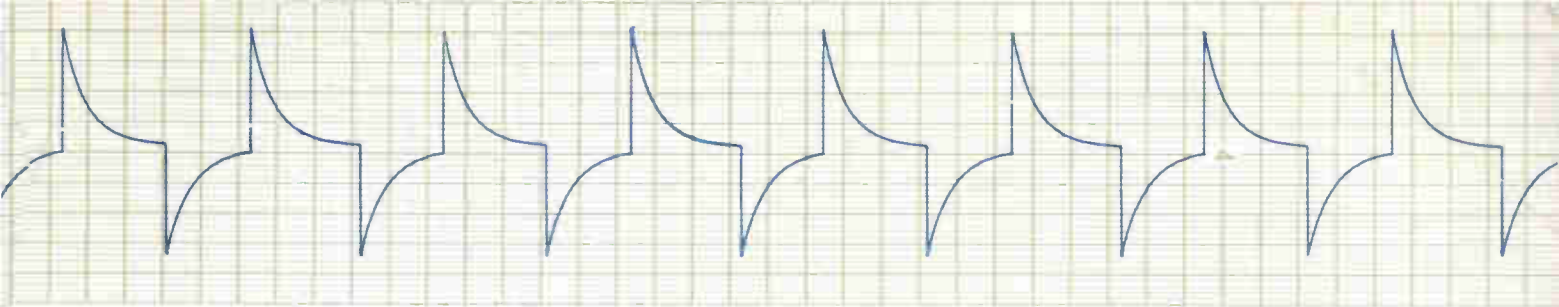

COPYRIGHT 1966

BRUSH INSTRUMENTS

DIVISION OF CLEVELITE CORPORATION

CLEVELAND, OHIO

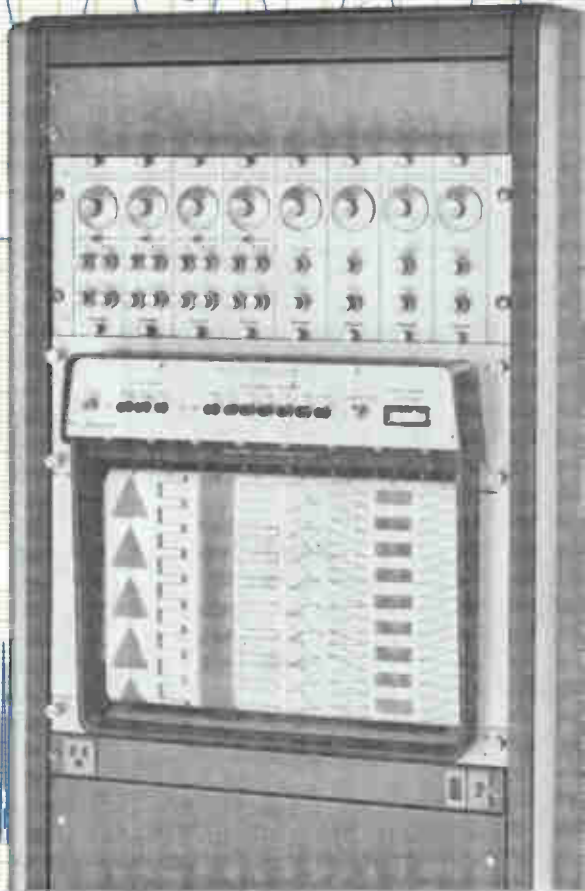
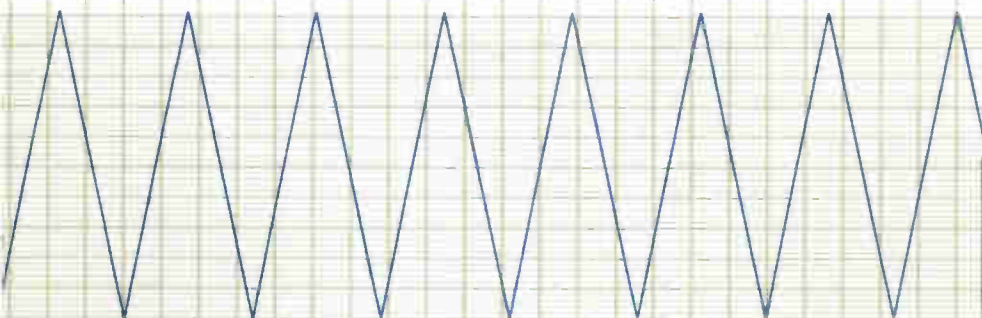
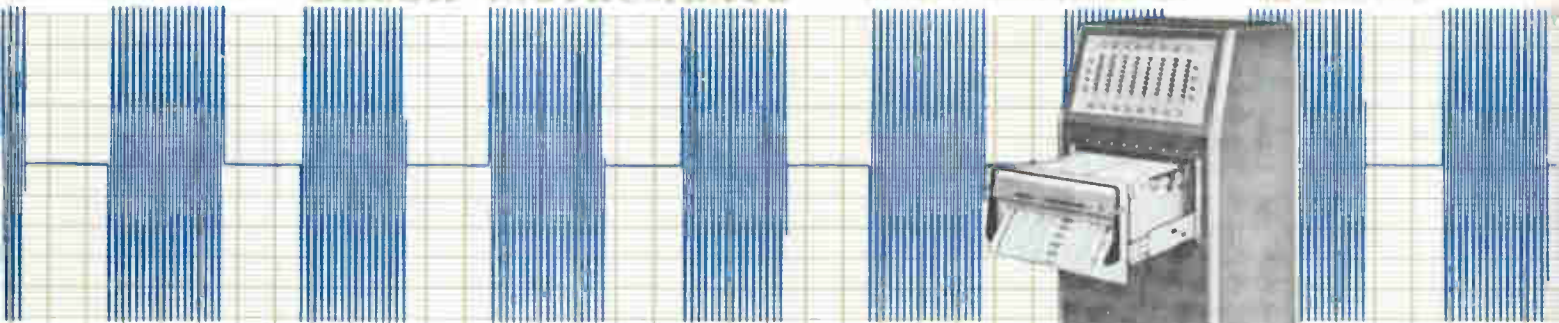

precision and
clarity never
before achieved...

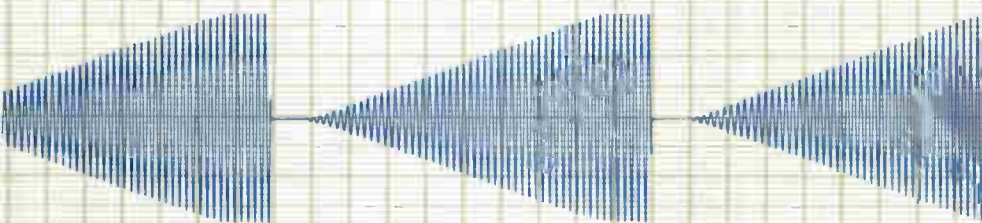

The new Brush Recorder Mark 200 made these incredibly crisp tracings. No other recorder in existence can match them. Note the line width. It never varies . . . regardless of writing velocity, regardless of chart speed. The writing mechanism is electrically signaled by the position-seeking "Metrisite" transducer . . . no parts to wear, infinite resolution, verifiable dynamic $\frac{1}{2}\%$ accuracy. Traces are permanent, high-contrast, reproducible . . . on low cost chart paper. The Mark 200 has but three standard controls . . . attenuator, pen position, chart speed. Such fidelity, simplicity and economy are possible with no other direct writing recorder. Available in both vertical and horizontal models with interchangeable plug-in preamplifiers or signal conditioning push-button controls. Write for details . . . they'll speak for themselves.

CIRCLE 901 ON READER SERVICE CARD

brush INSTRUMENTS
DIVISION OF CLEVELITE 37TH AND PERKINS, CLEVELAND 14, OHIO

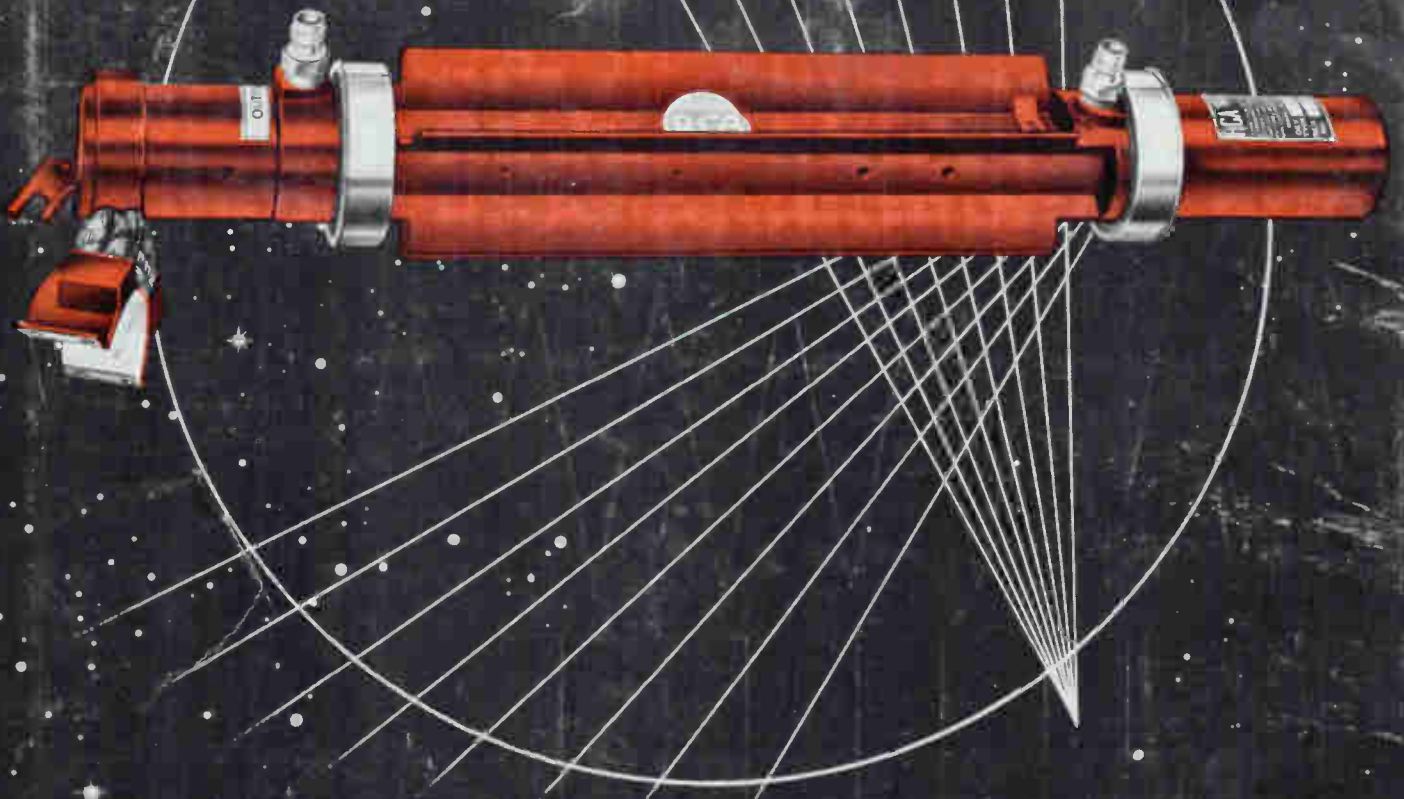

RCA-A1245

The Traveling-Wave Tube Designed for RELAY

Tube Powers History-Making Color Telecast from Satellite

The steady progress of microwave tube development at RCA is marked by RCA-A1245—the Traveling-Wave Tube in RELAY that recently demonstrated its capability in the first public color telecast from space. At 11 watts output, this tube is four times more powerful than any other now available for space communications and telemetry.

Designed especially for satellite use, RCA-A1245's were developed from established technology and proved design. By selecting the optimum combinations of design criteria, RCA was able to provide these Traveling-Wave Tubes with long-life reliability. Esti-

mated mean time before failure, for example, is 58,000 hours—more than six years—with a 95 per cent confidence factor.

RCA-A1245's are assembled in a special manufacturing environment—including a dust-free "white room"—for maximum reliability assurance and uniformity. Tested under thermal-vacuum condition, they are ideal for use in space systems because of their light weight (only 2½ lbs. basic weight), conduction cooling, high CW power output.

For more information on RCA-A1245's write: Manager, Microwave Marketing, RCA Electron Tube Division, Harrison, N. J.



Basic characteristics of RCA-A1245's—used in the National Aeronautics and Space Administration's RELAY satellite—are frequency, 4,050 to 4,250 Mc; gain 33 db minimum at 11 w; over-all efficiency, 21 per cent.

INDUSTRIAL TUBE PRODUCTS FIELD OFFICES

OEM SALES: Newark 2, N. J., 37-36 Green St., (201) 485-3960 • Chicago 51, Ill., Suite 1154, Merchandise Mart Plaza, (312) 527-2900 • Los Angeles 22, Calif., 6801 E. Washington Blvd., (213) RA 3-8361 • GOVERNMENT SALES: Harrison, N. J., 415 South Fifth St., (201) 485-3900 • Dayton 2, Ohio, 224 N. Wilkinson St., (513) BA 6-2366 • Washington 6, D. C., 1725 "K" St., N.W., (202) FE 7-3500 • INTERNATIONAL SALES: RCA International Div., Clark, N. J., (201) 382-1000



The Most Trusted Name in Electronics