

electronics

A McGraw-Hill Weekly

75 Cents

March 13, 1967

FIRST IEEE CONVENTION



HIGHLIGHTS OF TECHNICAL SESSIONS, P 63

PREVIEW OF THE EXHIBITS, P 33

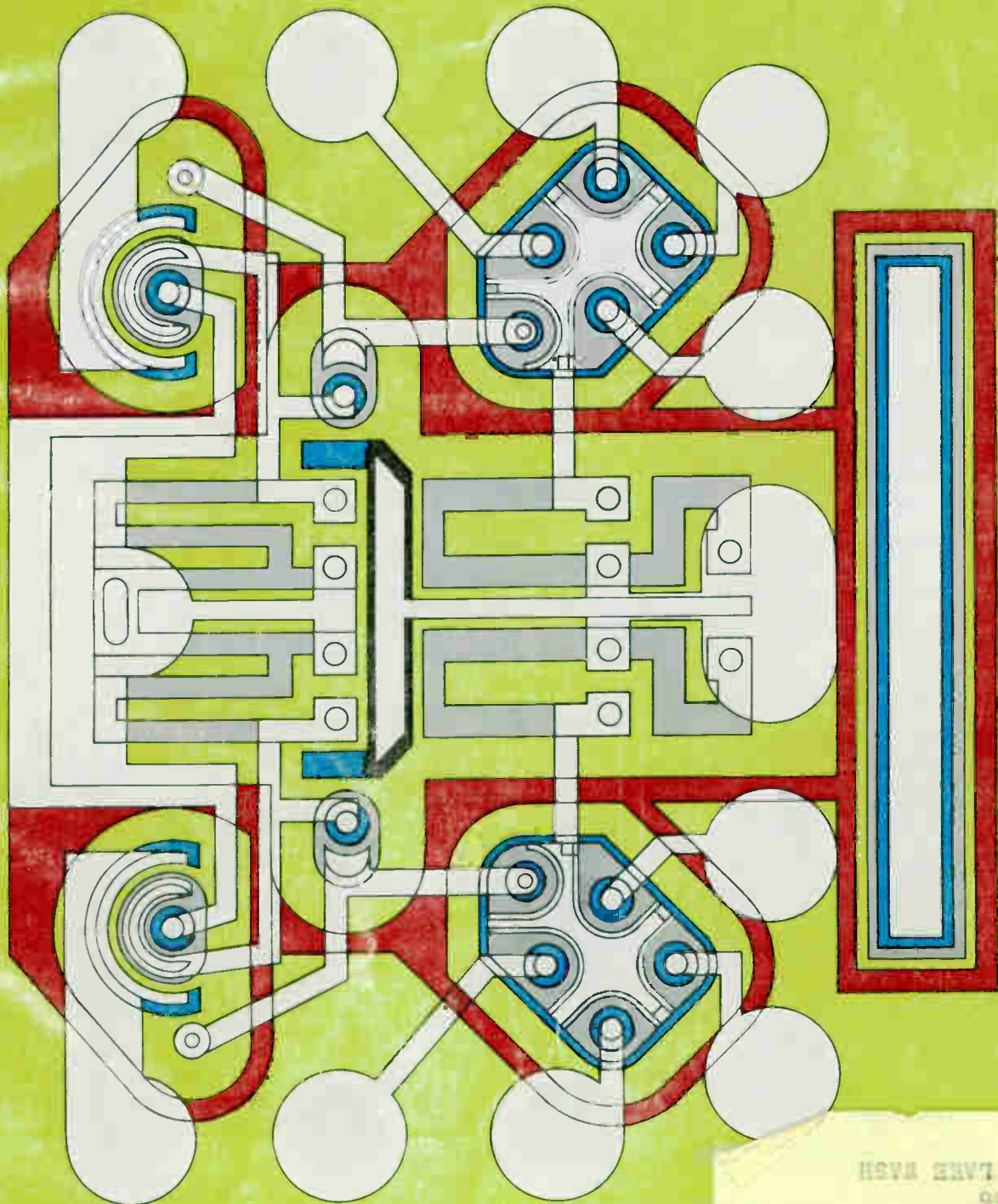

Integrated circuit using lead-compensated transistor-diode logic

HOWARD KISSLER
BOX 956
HOUSTON TEXAS

No BCD*



in this counter



*Binary Coded Decimal

The 1150-A Digital Frequency Meter uses ring counting circuits. The advantages are many. The ring counter can readily be made into a decade device without need of fussy feedback circuits and complex decoding matrices. Furthermore, the ring counter is capable of driving readout devices directly; additional stages of amplification are not needed and circuit voltages are not critical.

Summing it up, the G-R 1150-A Digital Frequency Meter is straightforward and reliable.

You get dependability, in-line Numerik® readout, and a crystal-controlled time base in this low-cost counter.

CONDENSED SPECIFICATIONS

Frequency Range: 10 cps to 220 kc
Accuracy: ± 1 count \pm time-base stability
Time-Base: Internal 100-kc crystal oscillator with $\frac{1}{2}$ ppm stability.
Provision for external 100-kc time base
Sensitivity: Better than 1 volt, peak-to-peak.
For pulses, duty ratio should be between 0.2 and 0.8. Input impedance is 0.5 M Ω shunted by less than 100 pf.
Gate Times: 0.1, 1, and 10 seconds. Also manual start/stop.
Reset: Automatic or manual
Display Time: Adjustable from 0.1 to 5 seconds, or infinite.
Self Check: Has provision for counting own 100-kc frequency.
Small Size: Only 3½" x 19" x 10"
Price: \$915 in U.S.A.

- All solid-state construction.
- Totalizes events or measures frequency to 220 kc.
- Oven-controlled 100-kc crystal oscillator with $\frac{1}{2}$ ppm stability. Temperature stability better than 5 ppm over an ambient range of 0° to 50°C.
- New, brilliant, always in focus, NUMERIK® in-line indicator 120° viewing angle . . . 5000-hour lamp life in counting service.



- **Build NUMERIK® indicators into your equipment.** One-third the volume and uses one-half the power of comparable units. Prices start at \$32.20. Quantity discounts available. Write for complete information.

Write for 1150-A Counter Bulletin

GENERAL RADIO COMPANY

WEST CONCORD, MASSACHUSETTS

SEE THIS INSTRUMENT AT THE IEEE SHOW—Booths 3201-3208

Also on display for the first time — a Sweep Generator with standard-signal generator features . . . another low-cost Counter with Numerik® in-line indicators . . . an accurate, peak-responding Voltmeter that's easy to use . . . precision Invar Capacitor Standard . . . 200va Power Oscillator and Amplifier . . . Microphone Calibrator based on reciprocity techniques . . . 8-ampere Variac® autotransformer . . . new precision vhf-uhf Coaxial Connectors . . . Optical Pickoff and Flash Delay for locking electronic stroboscopes to non-cyclic motion.

CIRCLE 900 ON READER SERVICE CARD

electronics

A McGraw-Hill Weekly 75 Cents



W. W. MacDonald, Editor

J. M. CARROLL, Managing Editor

SENIOR EDITORS

Somuel Weber, George W. Sideris

SENIOR ASSOCIATE EDITORS

Michael F. Wolff, John F. Moson

ASSOCIATE EDITORS

Michael F. Tomoino, Sylvester P. Corter, William P. O'Brien, Sy Vogel, Leslie Solomon, George J. Flynn, Laurence D. Shergolis, George V. Novotny, Leon H. Dulberger

ASSISTANT EDITORS

Nilo Lindgren, Stanley Froud, Stephen B. Groy, Roy J. Bruun, Borry A. Briskmon

REGIONAL EDITORS

Harold C. Hood (Pacific Coast, Los Angeles), Thomas Mogueire (New England, Boston), Cletus M. Wiley (Midwest, Chicago)

ART DIRECTOR

Howard R. Berry

ASSISTANT ART DIRECTOR

John C. Wright, Jr

EDITORIAL ASSISTANTS

Lorraine Rossi, Virginia T. Boston, Lynn Emery, Ann Mello, Lorraine Werner, Alice M. O'Brien

FOREIGN NEWS BUREAU

DIRECTOR, John Wilhelm; Alyne Elios

LONDON—John Shinn, Derek Borlow, Nicholas London

BONN—Bruce Bendow, Richard Mikton, Silke McQueen

BRUSSELS—Peter Forboth

PARIS—Robert Forrell, Arthur Erikson

MILAN—Morc A. Messino

MEXICO CITY—Wesley Perry, Jr

RIO DE JANEIRO—Leslie Warren

MOSCOW—Stewart Romsey

TOKYO—Richard Holloran, Charles Cohen, John Yomoguchi

CIRCULATION MANAGER

Hugh J. Quinn

W. W. GAREY, Publisher



IEEE SPECIAL

INTEGRATED CIRCUIT using load-compensated diode-transistor logic (LCDT) by Siliconix. This modified version of DTL circuit uses a clamping diode. It overcomes some speed and power dissipation problems of other logic circuits. *Our cover was reproduced in natural color from actual diffusion mask negatives. See p 68* **COVER**

IEEE PRESIDENT Talks Candidly. We asked Dr. Ernst Weber to outline problems facing the IEEE. *The biggest problem: the split in AIEE and IRE views* 22

PLANAR TRANSISTORS. More of these popular types will bow at the show. *In one, a plastic header slashes costs* 23

IEEE AWARD WINNERS—What They're Like. The careers of nine winners of top awards are profiled. *Did you know, for example, that one winner's study of water troughs helped develop waveguides in the 1930's?* 26

PREVIEW OF EXHIBITS. Instruments Extend Operating Ranges. New instruments at the show continue the trend toward greater utility, higher accuracy and bolder display. *Design improvements make for easier operation, faster measurements* 33

TUBES PACK MORE PUNCH. Tube designers are cutting size and weight while adding to frequency range and power. *Marriage of klystron and traveling-wave-tube techniques is one new concept* 36

MICROCIRCUITS Graduate Into Hardware. Integrated circuits and thin-film devices pace development of off-the-shelf equipment lines. *This section of our preview of IEEE Show exhibits also surveys new equipment built with more conventional circuits* 38

FIRST IEEE CONVENTION: Engineering Preview. Again this year our staff has combed the 54 technical sessions to select newsworthy papers. Our efforts combined with those of our McGraw-Hill News Bureaus and the cooperation of the authors makes this preview possible. *High on the list are electron devices—both tubes and semiconductors—medical electronics and antennas* 63

HIGH-SPEED INTEGRATED CIRCUITS With Load-Compensated Diode-Transistor Logic. These integrated circuits are constructed within and upon a single sliver of silicon. The article gives details on fabrication and the advantages of a new kind of logic circuit—LCDT. *This may be one of the most informative articles ever published on integrated circuits.* By B. T. Murphy, Siliconix 68

electronics

March 15, 1963 Volume 36 No. 11

Published weekly, with Electronics Buyers' Guide as part of the subscription, by McGraw-Hill Publishing Company, Inc. Founder: James H. McGraw (1860-1948).

Title ® registered U.S. Patent Office; © copyright 1963 by McGraw-Hill Publishing Co., Inc. All rights reserved, including the right to reproduce the contents of this publication, in whole or in part.

Executive, editorial, circulation and advertising offices: McGraw-Hill Building, 330 West 42nd Street, New York 36, N. Y. Telephone Longacre 4-3000. Teletype TWX N.Y. 212-640-4646. Cable McGrawhill, N. Y. PRINTED IN ALBANY, N. Y.; second class postage paid at Albany, N. Y.

OFFICERS OF THE PUBLICATIONS DIVISION: Shelton Fisher, President; Vice Presidents: Joseph H. Allen, Operations; John R. Callahan, Editorial; Ervin E. DeGraff, Circulation; Donald C. McGraw, Jr., Advertising Sales; Angelo R. Venezian, Marketing.

OFFICERS OF THE CORPORATION: Donald C. McGraw, President; Hugh J. Kelly, Harry L. Waddell, Executive Vice Presidents; L. Keith Goodrich, Executive Vice President and Treasurer; John J. Cooke, Vice President and Secretary.

Subscriptions are solicited only from those actively engaged in the field of the publication. Position and company connection must be indicated on orders. Subscription rates: United States and Possessions, \$6.00 one year, \$9.00 two years, \$12.00 three years. Canada: \$10.00 one year. All other countries \$20.00 one year. Single copies, United States and Possessions and Canada 75¢. Single copies all other countries \$1.50.

THE PUBLISHER, UPON WRITTEN REQUEST FROM ANY SUBSCRIBER TO OUR NEW YORK OFFICE AGREES TO REFUND THAT PART OF THE SUBSCRIPTION PRICE APPLYING TO COPIES NOT YET MAILED.

Subscribers: Please address change of address notices, subscription orders or complaints to Fulfillment Manager, Electronics, at above address. Change of address notices should provide old as well as new address, including postal zone number if any. If possible, attach address label from recent issue. Allow one month for change to become effective.

Postmaster: Please send Form 3579 to Fulfillment Manager, Electronics, 330 West 42nd Street, New York 36, New York.



Audited Paid Circulation

CONTENTS continued

INCREASING DIGITAL TRANSMISSION RATES With a Unique Synchronization Method. Synchronization of transmitter and receiver is a major problem in radio digital data transmission. Systems usually sync on the leading or trailing edge of pulses. <i>This system syncs on the middle. Trick is to insert three extra bits centered on the sync pulse.</i>	
By K. Roedl and R. Stoner, General Dynamics/Electronics	75
MEASURING EQUIPMENT PERFORMANCE: New Method Uses Common Instruments. Technique permits precise measurements and immediate display; requires only a generator, attenuator and oscilloscope. <i>Both positive and negative gain can be displayed.</i>	
By J. L. Haynes, Consulting Engineer	78
SEMIPERMANENT MEMORY: Latest Use for Twistors. The twistor is a copper wire on which is wound a helix of square-loop magnetic material. This 7,680-bit memory functions by automatically resetting bits to their original state after each read pulse. <i>Holes punched in removable copper sheet inhibit writing in bit locations desired.</i>	
By K. E. Krylow, J. T. Perry, Jr., and W. A. Reimer, Automatic Electric	80
REALISTIC SONAR TRAINER Generates Ships Wakes. Wakes of ships can lead sonar operators to the ship that produced it or obscure echos on the far side. This new simulator adds realism to sonar training. <i>The digital wake generator can also simulate radar signals from ion trails.</i>	
By M. Kaufman and E. Levine, Applied Science Labs, Inc.	84
DEPARTMENTS	
Crosstalk. <i>Program for IEEE</i>	3
Comment. <i>Millimeter Waves. Recruiting Students</i>	4
Electronics Newsletter. <i>Electroluminescent Diode Has Negative-Resistance Characteristic</i>	7
Washington This Week. <i>UHF Tv Wins Test</i>	12
Meetings Ahead. <i>Instrument Society of America Conference</i>	44
Research and Development. <i>Contest Produces Novel Circuit Designs</i>	96
Components and Materials. <i>Components Meet Sales Challenge</i>	114
Production Techniques. <i>Variety Spices IEEE Production Topics</i>	132
New Products. <i>Generator Tailors Pulses</i>	146
Literature of the Week	188
New Books. <i>Lasers: Generation of Light by Stimulated Emission</i>	190
People and Plants. <i>IEEE Medal of Honor Goes to Inventor</i>	196
Exhibitors at the IEEE Show	203
Reprint Information and Order Form	213
Index to Advertisers	225



IEEE SPECIAL

Program for IEEE

THE International IEEE Convention and Show opening in New York March 25 is a highpoint of the year for the electronics industry. This meeting will be unsurpassed in sheer magnitude by any technical event anywhere in the world during 1963. An estimated 75,000 engineers will view more than 850 exhibits and listen to over 250 technical papers.

Four days of buying and selling products exhibited at the Show will administer a shot in the arm to the electronics industry. And this is good. But the Convention came before the Show. It was the technical papers presented before the two merged groups forming the Institute that attracted engineers in the first place. And it is around this essential technical core that all this highly beneficial economic activity revolves.

Now, this year's announced technical program is disappointing. There are few new revelations and few papers to arouse any real controversy. It cannot be blamed on the program committee because we understand that almost every paper submitted was accepted for presentation. There were just not enough papers submitted so that the committee could be sufficiently selective.

Many engineers have observed, and indeed some IEEE officers admit, that many specialized conferences siphon off the best papers reporting new developments and discoveries in our field. These specialized conferences will continue, and for the good of the industry the International Convention must also continue. This dilemma leaves us with the problem of how to build and sustain an interesting and significant technical program in the face of heavy and increasing competition from specialized conferences.

Here are a few suggestions:

- Let's face up to the fact that new developments cannot always wait until the last week of March for disclosure. Let's have them, by all means, but let's stress panel discussions by renowned engineers treating important and controversial topics of the industry as well as invited papers by specialists summarizing work done in



a particular field during the past year

- Let's get away from the professional-group system of organizing the Convention, wherein a group with little new to say gets equal time with one whose activities can barely be scratched in the time allotted. A paper should stand on its own merits, not on its sponsorship

- Let's put an end to the three-ring and four-ring circus aspect of the convention that often makes it impossible for an engineer to be everywhere he wants to be. The answer: fewer papers, but better papers, of broader interest.

The proper function of the International IEEE Convention as we see it is to cross-fertilize this vast field of electrical-electronics engineering—to be a place where the antenna specialist can learn about new developments in transistor circuits and conversely, or where the computer designer can get up to date on lasers.

A smaller but more selective program of stimulating panel discussions and comprehensive tutorial papers as well as important new developments would be truly worthy of the world's largest engineering society.

SEE US AT THE SHOW. While you are at the IEEE Show, why not stop in at our booth too?

Comments, criticism, suggestions on articles you would like to see us publish, articles you'd like to author, news tips, chit-chat, or just a friendly hello—we'll welcome them all.

ELECTRONICS' booth is 4314-4316, on the fourth floor right near the elevators. There will be an editor at the booth each day from 9:45 a.m. to 8 p.m. (if you want to see a particular editor just leave a message).

McGraw-Hill Book Company will be at booth 4331.

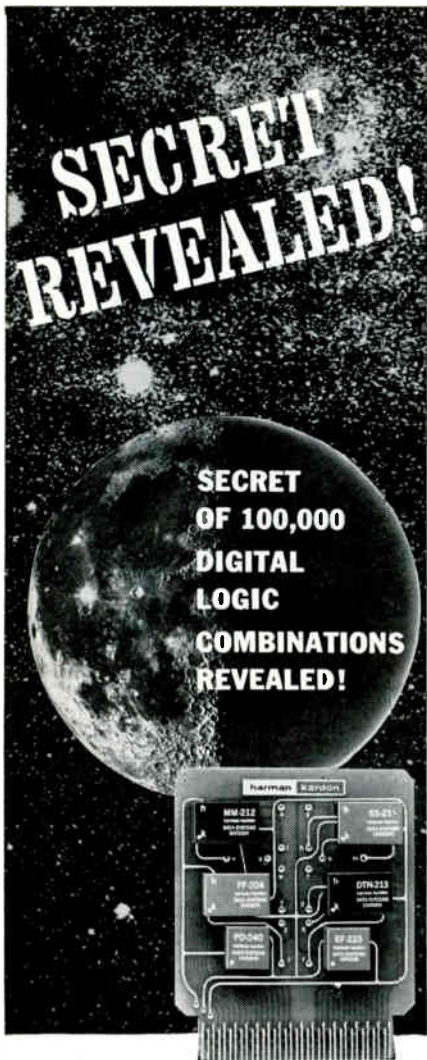

NO BLACK MAGIC HERE!
just simple combinational (or is it per-
mutational?) mathematics.

65 different HARMAN-KARDON Logic
Modules...19 different HARMAN-KARDON
Flexi-Cards...mix and combine to pro-
vide 100,000 functional card combi-
nations, delivered immediately and
economically, assembled to your re-
quirements. 250kc, 125°C, 5/10mc.

DIGITAL LOGIC **FREE!**

Send for complete
64-page DIGITAL
LOGIC catalog with
sections on theory
and application
and a Boolean
algebra guide.

HK-90

Data Systems Division, Desk E-3
HARMAN-KARDON, INC.
55 Ames Court, Plainview, L.I., N.Y.

Please send complete details
on Digital Logic.

Name _____
Company _____
Address _____
City _____ State _____

harman kardon

A subsidiary of THE JERROLD CORPORATION

COMMENT

Millimeter Waves

I should like to extend my con-
gratulations and appreciation to
ELECTRONICS for the excellent cov-
erage of the Orlando IRE Milli-
meter Wave Conference appearing
in your Jan. 18 issue (p 24).

In my opinion, and that of many
others in the industry, you contrib-
ute substantially to the state of the
art by such perceptive efforts.

JACK G. BUTLER
Butler Roberts Associates, Inc.
New York, New York

Recruiting Students

A feature called Who's Minding
the Stockroom? (p 3, Nov. 2), was
recently called to my attention. It
asked what might be done to coun-
teract the alarming decline in the
number of young people entering
the engineering profession.

At the University of Pittsburgh,
we have begun an active campaign
to recruit high-school students to
engineering careers. As part of
this campaign, we wrote a nine-
week series of radio shows based
upon the United States space pro-
gram. We distributed these scripts
to high schools in half a dozen east-
ern states.

DAVID MARTIN
Public Relations Division
University of Pittsburgh
Pittsburgh, Pennsylvania

Dictionaries and Usage

Mr. Julian Loebenstein's letter
(p 4, Dec. 28, 1962) about the use
of the word "obsolete" as a verb,
and the editorial reply, bring out a
very interesting point that most
people overlook.

Because a dictionary says that a
word "means" thus and so, it does
not mean that this is the "correct"
definition or use of the word, but
merely the prevalent one. We forget
that a good dictionary is not a de-
finer of words, but a reporter of
usage. Every good dictionary will
make a point of saying that quite
strongly. It merely reports that this

is how the word is being used; it
does not say that this is how the
word *should* be used.

Indeed, any usage of a word is
correct, if it is made clear that the
word is being used in a special or
obscure sense, if such is the case.
We tend to forget that very often
words are used just that way, or we
assume that, because we know that
our usage is special, everyone else
will know it too.

In this sense, H. L. Mencken's
statement that Dr. Samuel Johnson
was the worst thing that ever hap-
pened to the English language, is
quite correct. Johnson set himself
up as an authority, and said, not
that this is how words are used,
nor even that this is how they
should be used, but that this is how
they *must* be used. A language, in
order to express any subtlety what-
ever, must be allowed to evolve with
the society using it. Johnson tried
to prevent that change. In so do-
ing he almost obsoleted (!) the
language, like a lexicographer
shouldn't.

KIM A. BORISKIN
Burlington, Vermont

New Color TV System

The article on Harries' new color
television system (p 33, Dec. 14,
1962) is quite interesting, but
doesn't the 50 and 100-Kv rating
for the crt place it in the X-ray
class? I believe RCA warns of
X-radiation at 25 Kv. Will shield-
ing be necessary for these tubes?

A. R. ROGERS
Dunbar, West Virginia

Author Harries

The picture tubes are not used
at 100 Kv, and having regard to the
current and much lower voltage at
which they are used, the X-radia-
tion is adequately shielded by the
electrode materials in the tube and
by the metal plates of the chassis.
We went into this very thoroughly
in the early stages with the Na-
tional Physical Laboratory's X-Ray
Protection Division in London, and
this result has been confirmed by
later tests.

J. H. OWEN HARRIES
Harries Electronics Corp., Ltd.
Devonshire, Bermuda

VISIT
LAMBDA
AT
IEEE SHOW
BOOTHS 2318-2320

You pay no more for Lambda environment-engineered LE power supplies

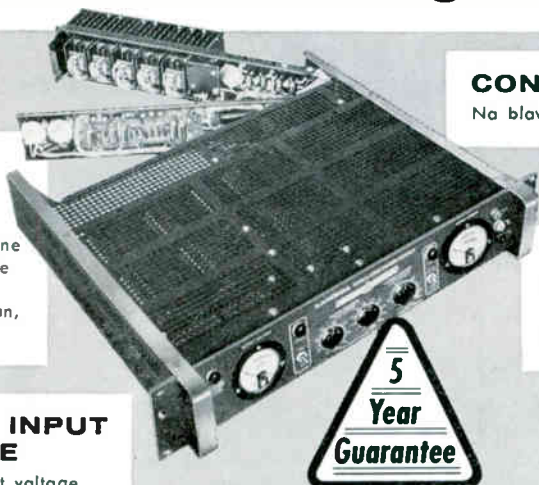

COMPLETELY PROTECTED

against—short circuit and electrical overload; input line voltage transients; excessive ambient temperatures. No voltage spikes due to "turn-on, turn-off" or power failure.

WIDE INPUT RANGE

Wide input voltage and frequency range—105-135 VAC, 45-66 CPS and 320-480 CPS in two bands selected by switch.

CONSTANT VOLTAGE CONSTANT CURRENT

by automatic switchover.

CONVECTION COOLED

No blowers or filters; maintenance free.

**6 MODELS
AVAILABLE**

REMOTELY PROGRAMMABLE AND CONTINUOUSLY VARIABLE

Voltage continuously variable over entire range.
Programmable over voltage and current range.



OTHER FEATURES

- All solid state.
- Adjustable automatic current limiting.
- 0°C to + 50°C ambient.
- Grey ripple finish.
- Ruggedized voltmeters and ammeters per MIL-M-10304B on metered models.

LE SERIES CONDENSED TENTATIVE DATA

DC OUTPUT (VOLTAGE REGULATED FOR LINE AND LOAD)⁽¹⁾

Model	Voltage Range	Current Range	Price ⁽²⁾
LE101	0-36 VDC	0- 5 Amp	\$420
LE102	0-36 VDC	0-10 Amp	525
LE103	0-36 VDC	0-15 Amp	595
LE104	0-36 VDC	0-25 Amp	775
LE105	0-18 VDC	0- 8 Amp	425
LE109	0- 9 VDC	0-10 Amp	430

⁽¹⁾ Current rating applies over entire voltage range.

⁽²⁾ Prices are for nonmetered models. For models with ruggedized MIL meters add suffix "M" to model number and add \$40 to the non-metered price. For metered models and front panel control add suffix "FM" and add \$50 to the nonmetered price.

REGULATED VOLTAGE:

Regulation

(line and load) Less than .05 per cent or 8 millivolts (whichever is greater). For input variations from 105-135 VAC and for load variations from 0 to full load.

Transient Response

(line) Output voltage is constant within regulation specifications for any 15 volt line voltage change within 105-135 VAC.

(load) Output voltage is constant within 25 MV for load change from 0 to full load or full load to 0 within 50 microseconds of application.

Remote Programming 50 ohms/volt constant over entire voltage range.

Ripple and Noise Less than 0.5 millivolt rms.

Temperature Coefficient Less than 0.015%/°C.

AC INPUT: 105-135 VAC; 45-66 CPS and 320-480 CPS in two bands selected by switch.

OVERLOAD PROTECTION:

Thermal Thermostat, reset by power switch, thermal overload indicator light front panel.

Electrical:

External Overload

Protection Adjustable, automatic electronic current limiting.

METERS: Ruggedized voltmeter and ammeter to Mil-M-10304B specifications on metered models.

PHYSICAL DATA:

Mounting Standard 19" rack mounting.

Size LE 101, LE 105, LE 109 3½" H x 19" W x 16" D
LE 102 5¼" H x 19" W x 16" D
LE 103 7" H x 19" W x 16½" D
LE 104 10½" H x 19" W x 16½" D

SEND FOR LAMBDA CATALOG.



LAMBDA ELECTRONICS CORP.

515 BROAD HOLLOW ROAD • HUNTINGTON, L.I., NEW YORK • 516 MYRTLE 4-4200

SALES OFFICES AND REPRESENTATIVES CONVENIENTLY LOCATED IN MAJOR CITIES

Use it
anywhere!

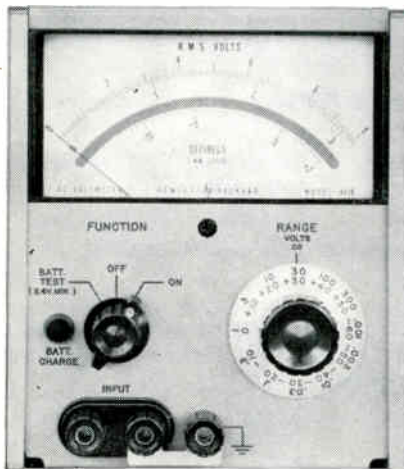
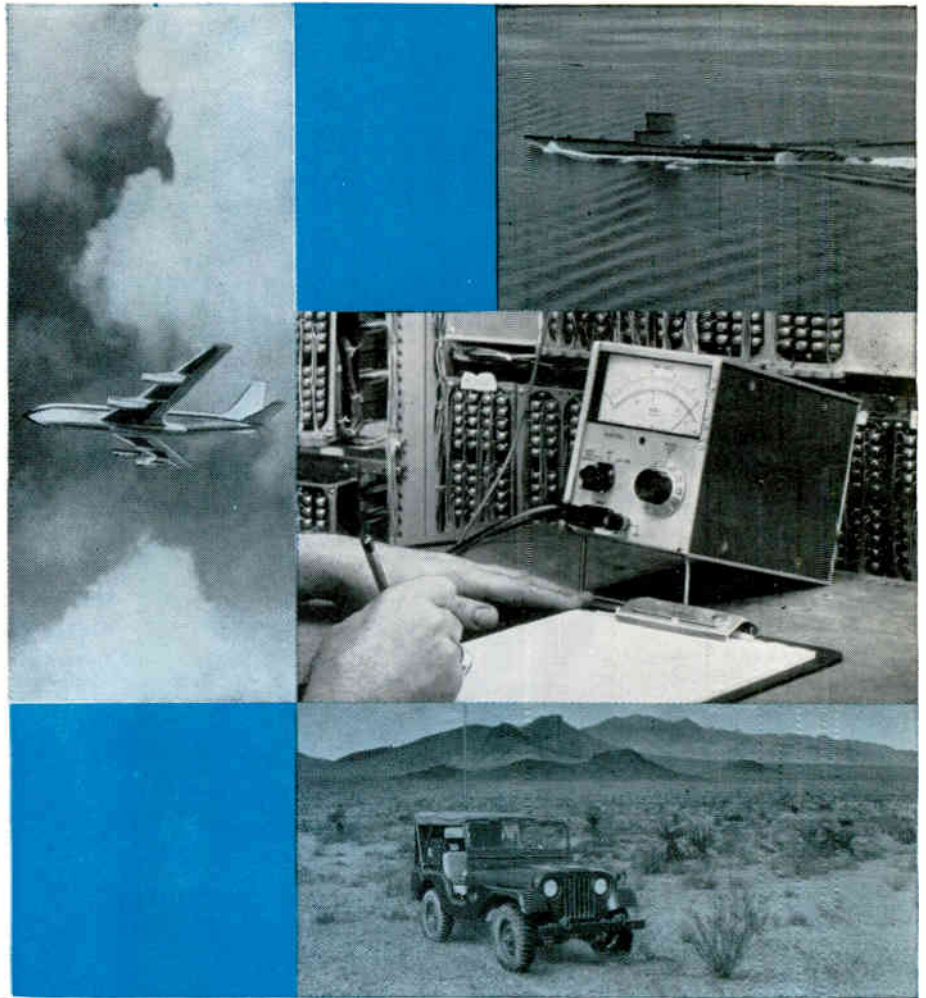

New *hp* portable AC Voltmeter 100 μ v to 300 v • 5 cps to 2 MC

2% accuracy is yours over a major portion of the frequency range with this new battery-operated hp 403B AC Voltmeter. Carry it anywhere and quickly make direct measurements from 100 microvolts to 300 volts, 5 cps to 2 mc.

Battery charge, easily checked with a front-panel switch, is automatically restored while you use the 403B on your bench or from your ac line.

The instrument itself always operates from its battery supply, and the battery operation permits complete isolation of the 403B

from power line and external grounds—eliminating hum and ground loops. Signal ground may be ± 500 v dc from external chassis. The meter responds to the average value of the input, is calibrated in the rms value of a sine wave. The solid state, compact 403B weighs only 6½ lbs.

Call your Hewlett-Packard representative or write direct for a demonstration on your bench.

Data subject to change without notice. Price f.o.b. factory.

Range: 0.001 to 300 v rms full scale, 12 ranges
Frequency: 5 cps to 2 mc

Accuracy:	Frequency		Temperature	
			0°C to +50°C	0°C to -20°C
1 mc				
10 cps to	$\pm 2\%$		$\pm 8\%$	
5 to 10 cps				
1 to 2 mc*	$\pm 5\%$		$\pm 8\%$	
* $\pm 10\%$ on 300 v range				

Nominal Input Impedance: 2 meg-40 pf, 0.001-0.03 v ranges; 20 pf, 0.1-3 v ranges; 15 pf, 10-300 v range
Maximum Input: 600 v peak, 0.3-300 v ranges; 25 v rms, 600 v peak, 0.001-0.1 v range

Power: 4 rechargeable batteries (furnished) 40-hr operation per recharge, up to 500 recharging cycles. Self-contained recharging circuit functions when instrument is operated from ac line

Size: 5½" wide, 6-3/32" high, 8" deep

Price: Φ 403B, \$310.00

8034



HEWLETT-PACKARD COMPANY

1501 Page Mill Road, Palo Alto, California, Area Code 415, DA 6-7000
Sales and service representatives in all principal areas
Europe, Hewlett-Packard S. A., 54 Route des Acacias, Geneva;
Canada, Hewlett-Packard (Canada) Ltd., 8270 Mayrand St., Montreal



New GaAs Diode Is Promising Light Switch

ELECTROLUMINESCENT gallium-arsenide diodes with negative-resistance characteristics have been fabricated by IBM scientists. Diode I-V characteristics exhibit a negative resistance at a forward bias of 3 to 5 volts. There is also a non-linear increase in light intensity that indicates such diodes could make highly efficient light switches.

Diodes are prepared by diffusing manganese and then zinc into *n*-type gallium arsenide. Because manganese is a deep level acceptor, there is a freeze-out of holes on the manganese centers at liquid nitrogen temperatures. This produces a relatively wide high-resistance region (1 mil, several thousand ohms) on the *p* side of the junction that is responsible for the negative resistance.

Below the critical voltage of 3 to 5 v, current is a few milliamperes. Current then jumps through the negative resistance region to typically more than 10 times its pre-breakdown value, depending on load resistance. Scientists feel it might be possible to switch on the order of 1 amp. For a current change by a factor of seven, intensity of the manganese and zinc lines have been observed to change by a factor of 10 and 100, respectively. This contrasts with ordinary electroluminescent diodes where light intensity is roughly linear with current.

The emitted light is incoherent. Possibility of laser action exists but IBM scientists had no comment. Work will be described by K. Weiser, R. S. Levitt, and W. P. Dumke, of IBM Watson Research Center, at the American Physical Society meeting in St. Louis, March 25 to 28.

Temperature-Tunability Features Diode Lasers

BOSTON—Tunability is one of most important features of junction-

diode laser, says Ali Javan, of MIT. Tunability is a corollary of fact that frequency of oscillation is a function of the diode's temperature, and the temperature can be varied. Although Javan did not spell out applications, frequency diversity is an obvious advantage in military uses.

In Boston, IEEE lecture on quantum electronics, Javan said another advantage of semiconductor laser, extremely high power efficiency, makes it important for space applications. It is known that MIT Lincoln Laboratory is exploring possibilities of junction-diode laser radar as a lunar landing aid.

Russians Considering French Color-Tv System

PARIS—Russia, Poland and Czechoslovakia plan to take a serious look at the French "Secam" color tv system (p 57, May 6, 1960), reports Compagnie Francaise de Television, which developed the system. Tests are already underway in six western European countries. At stake is selection of a standard for the Continent and England, and probably the Iron Curtain countries as well.

For western Europe, the decision should come in July, when the European Radio Broadcasting Union releases its comparative study of the two systems still in the running—Secam and the American NTSC

system. Both are compatible for black-and-white. They differ principally in the way the color signals are handled.

Dyna-Soar Project Future Looks Dimmer

IN THE OPINION of some Washington officials, Defense Secretary McNamara's mind was already made up to scrap the X-20 Dyna-Soar program before he left Washington Wednesday to visit prime contractor Boeing in Seattle. Stated purpose of the trip is to study the feasibility of continuing USAF's manned space project (p 8, March 1). Cancellation of the project would fall in line with McNamara's stalemate strategy that he outlined to Congress (p 7, Feb. 8).

Deep-Space Tracker Set for Canberra

MELBOURNE, AUSTRALIA—Canberra has been chosen as site of main Australian tracking station for U. S. space shots. Decision follows visit last year of NASA team. Station will be for deep tracking and will be integrated into existing network of stations at Johannesburg, South Africa, Woomera and Los Angeles.

Main equipment will be parabolic

IEEE Hard Put to Break IRE's Records

IEEE HAS BOOKED some 860 manufacturers' exhibits into a total of 1,256 booths at the Coliseum for the show March 25 through 28. This is just about the same number of exhibits that were packed into the last IRE show in New York. The reason: while IEEE is far bigger than IRE was, the Coliseum is still the same size.

IEEE, however, predicting an attendance of 75,000 at the Show and Convention. That would set a new record. Last year, the IRE predicted 70,000 and drew about 73,500

antenna 85 feet in diameter, antenna control systems and equipment for transmission reception and processing of radio signals to and from spacecraft.

Single-Chip Gate Has 5-nsec Delay

NEW YORK—Single-chip integrated circuits using a modified transistor-transistor logic were introduced here Wednesday by Sylvania's Semiconductor division. The silicon-based epitaxial planar structures include a dual NAND gate, a NAND-OR block and two flip-flops. These circuits simultaneously attain a minimum noise rejection of 0.7 v at 125 C, a typical fan-out of 25 without a buffer amplifier, propagation delay of 11 nsec and dissipate 12 mw per stage. The dual NAND includes two 3-input gates that can be cross coupled to give a 20-Mc set-reset flip-flop. Individual gates have been observed to have propagation delays of 5 nsec and dissipate 7 mw per stage.

Boston Begins Forming Regional Space Firm

BOSTON—Baystate Science Foundation, a non-profit corporation, has been formed in Boston as the initial step in marshalling resources of New England area for bidding on major space contracts (p 7, Oct. 5, and p 24, Nov. 2, 1962). If pledges of capital are sufficient, Advanced Technology Inc., a profit-making operating company wholly owned by the Foundation, will be formed. The planning committee says that at no time would firm intrude into the hardware province of industry.

Soviet Plants Increase Tv Production

VIENNA—Tv assembly plants of 500,000 units annual capacity will be established soon in the USSR, Tass reported last week.

The plant will produce standard types of tv sets, using automation

and mechanization. This move is to boost Soviet tv production far above the 2 million in 1962.

An end will come to Soviet production of "a great number of tv sets," Tass said. Basic model having a 13.6-inch screen is up for approval soon; unified types of 18.3 and 23-inch screens will be presented at the end of 1963.

Electronics Spending Up in British Budget

LONDON—Britain's 1963-64 defense budget shows increased communications and electronics expenditures for the Army and Navy. RAF radio and radar purchases are down by \$3 million, reflecting the Skybolt-Polaris switch.

Army plans to spend \$19 million on signal and radar equipment, a 35-percent rise. Majority of increase will be used to integrate its communication network between the headquarters and man-pack set levels. Computer techniques will be used in communications.

New weapons coming into Navy service include the SS11 wire-guided missile, Bullpup and Sidewinder missiles.

The Investment Business —How Big Is Small?

ELECTRONICS CAPITAL CORP., a small business investment company, played a major role in three recent transactions.

Remanco, Inc. and Micro-Radionics announced plans for merger. ECC said both firms are its clients and that it will have a total investment of \$1,750,000 in the combined firm. This represents an equity of 66.3 percent, ECC said.

Merger of Dynair Electronics, Inc. into Communications Control Corp. was announced by ECC, which will have a 25-percent interest in the surviving firm.

Gulton Industries bought \$1,015,000 of debentures and notes of Electronic Energy Conversion Corp. from ECC. The debentures are convertible into 80 percent of the outstanding stock of Electronic Energy.

In Brief . . .

WEST GERMAN Post Office is buying a transportable space communications station from ITT that will have dual transmitters, one for working with Relay and the other for Telstar.

SPACE FLIGHT operations center costing \$12 to \$15 million is planned by Jet Propulsion Laboratory. It will guide unmanned lunar and planetary probes after launch.

MINIATURE SONOBUOYS will be produced for Navy by Hazeltine Corp.

HIGH-PRESSURE, modular inflation system is being tested for Echo II.

IRC SAYS it will deliver pre-production samples of hybrid circuits this year.

JAPAN MAY IMPOSE quota on battery exports. Rule could go into effect April 1.

HUNGARY has built a semiconductor plant.

KAISER will build \$25 million NASA facility at Sandusky, Ohio, for final ground testing of nuclear-powered spacecraft.

CONTROL DATA CORP. is buying Bendix Computer division. It will continue the line of Bendix G-15 and G-20 computers.

LIGHTWEIGHT tape recorders with large capacity and low power requirements are being developed for Apollo spacecraft by Leach.

MODEL RAILROADING breakthrough has been claimed by GE. Micro-receiver, using two silicon-controlled rectifiers, provides "realistic" operation.

AGREEMENT to make and market TRW-530 computer in Japan has been signed by Thompson Ramo Wooldridge and Mitsubishi.

WATKINS-JOHNSON acquired Stewart Engineering Co. in stock transfer.

HONEYWELL introduced new models of its 800 and 1800 computers, featuring input-output control center.

THIN-FILM MICROCIRCUITS NOW AVAILABLE FROM SPRAGUE!

Smaller than a postage stamp, this typical CERACIRCUIT is a two-stage oscillator and gated amplifier, used as a clock-pulse source in digital systems.

LINEAR and DIGITAL

CERACIRCUITS[★]

FOR GREATER DESIGN FLEXIBILITY... INCREASED RELIABILITY... CIRCUIT ECONOMY!

Thin-film CERACIRCUITS allow great flexibility in the choice of components and types of circuits. Chopping size, weight, and cost, while boosting reliability and power utilization, these revolutionary microcircuits are being used by alert design engineers in ever-increasing numbers. Their ease of usability is remarkable. Containing familiar circuit elements such as capacitors, inductors, resistors, diodes, and transistors, CERACIRCUITS offer precision components with a wider choice of tighter parameters, assuring greater design freedom.

*Trademark

Custom thin-film CERACIRCUITS are here . . . Now! A Sprague microcircuit specialist will be glad to discuss the transition of *your* circuits to thin-film. He can also supply CERACIRCUITS such as linear amplifiers, oscillators, NOR gates and drivers, indicators, binary counters, and clocks for evaluation of Ceramic-base CERACIRCUITS in *your* equipment. For complete information, write to Technical Literature Service, Sprague Electric Company, 35 Marshall Street, North Adams, Massachusetts.

SPRAGUE COMPONENTS

MICROCIRCUITS
CAPACITORS
TRANSISTORS
MAGNETIC COMPONENTS
RESISTORS

INTERFERENCE FILTERS
PULSE TRANSFORMERS
PIEZOELECTRIC CERAMICS
PULSE-FORMING NETWORKS
TOROIDAL INDUCTORS

HIGH TEMPERATURE MAGNET WIRE
CERAMIC-BASE PRINTED NETWORKS
PACKAGED COMPONENT ASSEMBLIES
FUNCTIONAL DIGITAL CIRCUITS
ELECTRIC WAVE FILTERS



*Sprague' and 'Q' are registered trademarks of the Sprague Electric Co.

GET THE FULL STORY AT IEEE BOOTH 2424

CIRCLE 9 ON READER SERVICE CARD

WASHINGTON THIS WEEK

DOOR OPENS FOR UHF TV IN 7 CITIES

UHF TV HAS WON a crucial test. By a four to three vote, FCC vetoed its plan to put new vhf stations in seven cities (ELECTRONICS, p 7, March 1). Now, third-network service to these markets can only be developed at uhf. A vhf station at Enid, Okla., will be permitted to move to Oklahoma City in the only exception to the FCC's ruling against allowing new vhf stations at spacings below usual standards. Commissioner Robert E. Lee succeeded in convincing Chairman Newton N. Minow, the swing-man in the vote, that allowing the vhf stations would set back uhf development.

BAN ON SALES OF KNOWHOW TO REDS STIFFENS

DON'T SELL technical data or processes to Communist countries without checking with the Commerce Department, officials warn. The prohibition on exporting "unpublished" technical information includes the knowhow that enables American technicians to build an efficient facility, even if the principles are well-known.

In the first test case of data export controls, Hydrocarbons Research, Inc., was penalized by a curb on its export privileges because it built a petrochemical facility in Rumania. Congressional critics charge that Commerce acted too little and too late since the Rumanians got U. S. knowhow. Commerce officials promise swifter enforcement, tougher penalties. Maximum penalty is total loss of export privileges.

FAA SETS UP BUYING STAFF

FEDERAL AVIATION AGENCY has established four new contracting branches, each headed by a specialist, to handle procurement. The branches and their newly-named directors are: traffic control and radar, Ray E. Mulari; communications and weather, Harold N. Austin; aircraft and navigation aids, Richard T. Golrick; and facilities and services, Frederick G. Bremer.

PATENT LAW SEEKS AWARDS FOR INVENTORS

PATENT RIGHTS LAW proposed by Rep. Herman Toll (R.-Pa.) includes a requirement that government contractors set up an awards system for employed inventors. Inventor rights are an incidental consideration now in government concern over contractor-government patent interests.

In the Senate last week, a Judiciary Committee report said that in Europe a body of patent law to protect rights of employed inventors is growing. Generally, the laws developing in Germany and other countries protect non-research employees—those not hired to invent. In the U. S., employed inventors are protected by commercial law and legal precedents. One study indicates that the courts more often than not protect employed inventors' interests.

ELECTRONICS STILL OUT OF TFX PROBE

McCLELLAN COMMITTEE PROBE into the TFX contract (ELECTRONICS, p 18, Dec. 14, 1962) has not yet touched seriously on performance or source selection of the aircraft's electronics. The investigation has disclosed that the secretaries of Defense, Air Force and Navy reversed four source-selection board recommendations favoring Boeing. The secretaries saw "no over-riding margin between the competitors," gave General Dynamics-Grumman the edge because the team proposed to standardize 85 percent of parts in Air Force and Navy versions of TFX. Boeing proposed 60 percent.

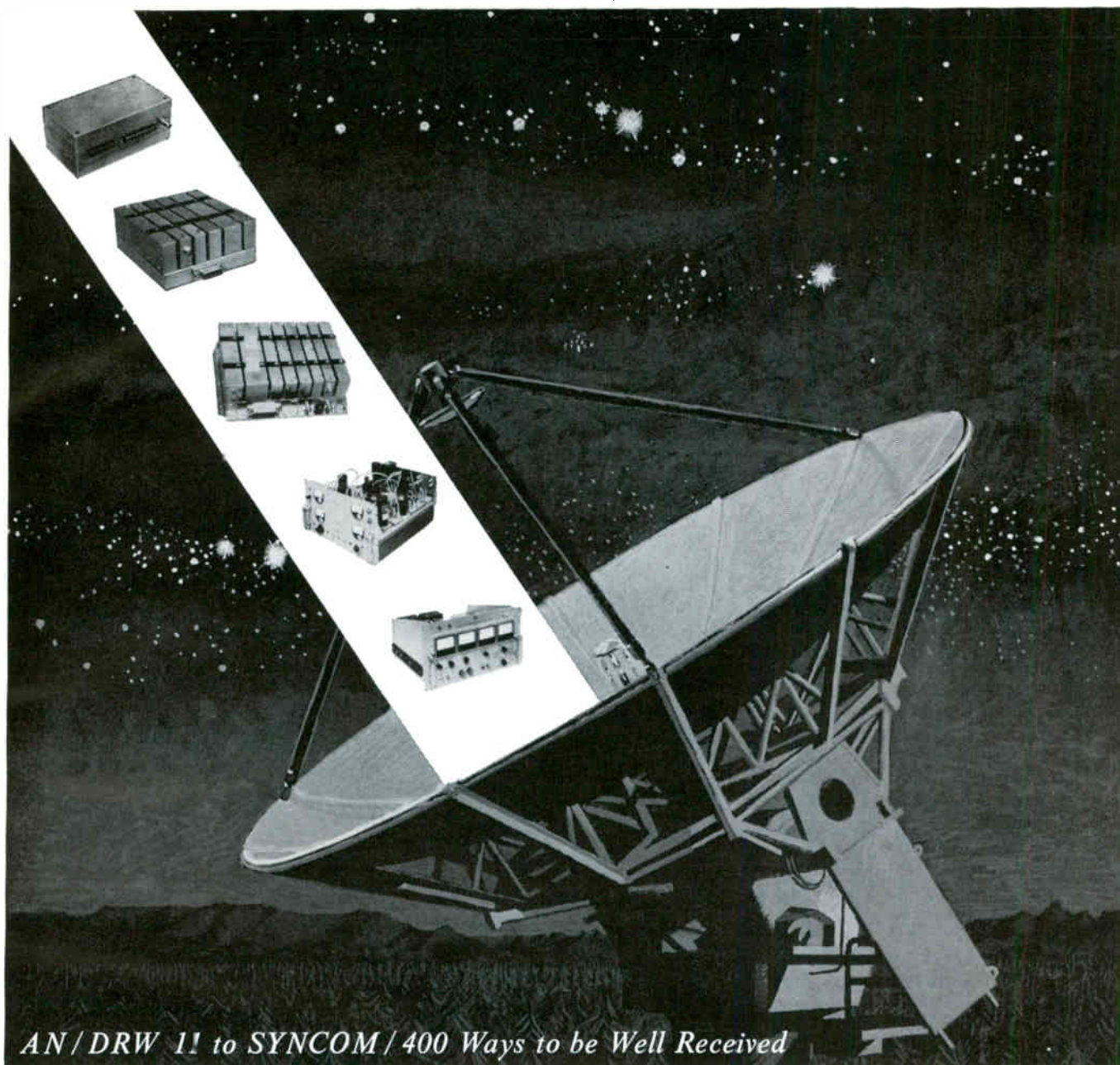

AN/DRW 11 to SYCOM/400 Ways to be Well Received

Since 1958, when it first built the AN/DRW 11 (a receiver whose primary function is to destroy malfunctioning missiles), STL has produced more than 400 space communications receivers of 14 different designs. The Able I receiver, the first phase-locked receiver ever to fly, was built by STL. So were the ground station parametric amplifiers that tracked Pioneer V 22 million miles into space. STL built the receiver now being used at Plermeur-Bodou, France, to track America's first communications satellites. The voice communications receiver for SYCOM and the space command receiver for NASA's OGO are both STL products. Scientists and engineers interested in advancing the art of space communications will find Space Technology Laboratories an active place.

STL builds spacecraft for NASA and Air Force-ARPA, and continues Systems Management for the Air Force's Atlas, Titan and Minuteman programs. These activities create immediate openings in: Space Physics, Radar Systems, Applied Mathematics, Space Communications, Antennas and Microwaves, Analog Computers, Computer Design, Digital Computers, Guidance and Navigation, Electromechanical Devices, Engineering Mechanics, Propulsion Systems, Materials Research. To obtain additional information regarding positions at Southern California or Cape Canaveral, you may contact Dr. R. C. Potter, One Space Park, Dept. G-3-3, Redondo Beach, California, or P.O. Box 4277, Patrick AFB. STL is an equal opportunity employer.



SPACE TECHNOLOGY LABORATORIES, INC.
a subsidiary of Thompson Ramo Wooldridge Inc.

Los Angeles • Vandenberg AFB • Norton AFB, San Bernardino • Cape Canaveral • Washington, D. C. • Boston • Huntsville • Dayton • Houston

IEEE DELEGATES: VISIT STL PRODUCTS BOOTH 3237-3239

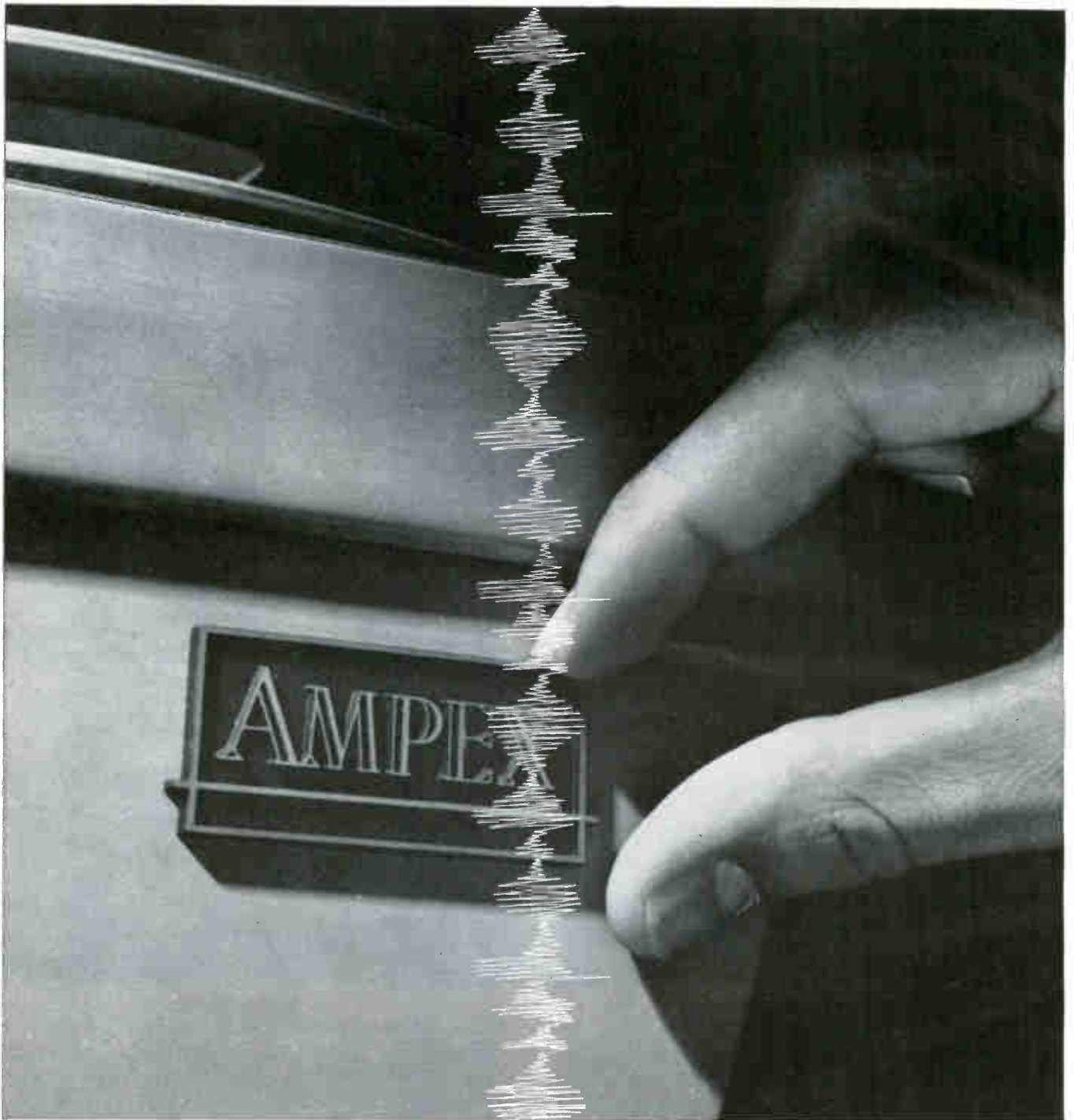

What name is on the first 1.5 Mc recorder?

AMPEX

Here it is: a 1.5 Mc per track, multi-track recorder! And Ampex is the first to have it. It's called the FR-1400. It will give you the broadest bandwidth yet in longitudinal recording. What's more, it utilizes solid state electronics throughout—all in one rack. It has four speeds, each electrically switchable with no adjustments needed. And it comes with tape search and shuttle to provide quick data location and permit any portion of the tape to run repeatedly without operator attention. What about per-



formance? Outstanding! It offers better rise time and minimum ringing on square waves, low intermodulation distortion, and improved flutter. Ampex also brings you a new 1.5 Mc tape. In both you'll find the same engineering precision, the same superior quality, that has made Ampex first in the field of magnetic recording. Write the only company providing recorders and tape for every application: Ampex Corp., 934 Charter St., Redwood City, Calif. Worldwide sales and service. **AMPEX**



Beckman 210 high-speed, solid-state, data processing system shown with cathode ray oscilloscope monitor.

Allen-Bradley Hot Molded Resistors Help Beckman Engineers Achieve Maximum Reliability

■ In designing utmost reliability into their 210 high-speed data processing system, Beckman engineers—from the very start—insisted on components of the highest reliability. Thus, A-B hot molded resistors fitted ideally into this development program.

For more than three decades, A-B resistors—by the *billions*—have been delivering superior performance in high quality equipment of all types. Allen-Bradley has developed and perfected a unique hot molding process which assures such consistent year-in and year-out uniformity that long term performance can be accurately predicted . . . and there is complete freedom from catastrophic failures.

When performance takes priority over all else, be certain to begin the planning of your equipment with the built-in reliability that *only* Allen-Bradley hot molded resistors can deliver. For full details on all Allen-Bradley *quality* electronic components, please write for Publication 6024.

Type TR 1/10 Watt	MIL Type RC 06
Type CB 1/4 Watt	MIL Type RC 07
Type EB 1/2 Watt	MIL Type RC 20
Type GB 1 Watt	MIL Type RC 32
Type HB 2 Watts	MIL Type RC 42

Typical circuit board shows extensive use of A-B resistors in this section of the Beckman 210 system.



ALLEN-BRADLEY

QUALITY ELECTRONIC COMPONENTS

Allen-Bradley Co., 110 West Greenfield Avenue, Milwaukee 4 Wisconsin • In Canada, Allen-Bradley Canada Ltd., Ball, Ont.

for advanced components:

CALL COLLINS

for these five reasons:

1. Simplified purchasing with broad product line including mechanical, crystal and LC filters, toroids, transformers, magnetic amplifiers, magnetostrictive devices.
2. Improved delivery schedules because of newly expanded production facilities.
3. Engineering talent in depth to bring you such developments as low cost mechanical filters, microminiature toroids, printed circuit magnetic components, super-selective crystal filters in thumb-size cases. And even more advanced research programs are in full swing in ferrite development, metallurgy, crystal processing, component packaging.
4. High-reliability qualification facilities are among most well-equipped in industry.
5. Expanded force of experienced engineering sales representatives in principal cities. Call one of those listed today or write for more information. Ask for Data File 205.

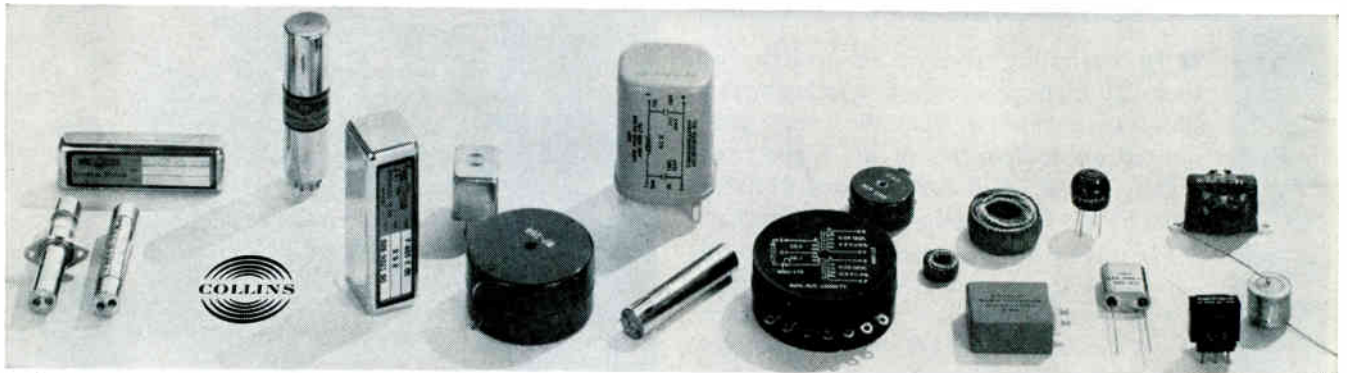

A representative sample of Collins mechanical, crystal and LC filters, toroids, transformers, magnetic amplifiers, magnetostrictive devices.

ARIZONA — NEW MEXICO

AR/TEC, INC.
34 East Stetson Drive
P. O. Box 727 Scottsdale, Arizona
Telephone: 947-6304
TWX: 602-949-0183

CALIFORNIA (SOUTHERN)

Engineering Liaison Associates
3360 Barham Boulevard
Hollywood 28, California
Telephone: HOLlywood 9-2283
TWX: LA 1543

FLORIDA — ALABAMA

William R. Lehmann Company
P. O. Box 1224, 222 Palmetto Avenue
Orlando, Florida
Telephone: GARDen 4-0131
TWX: OR 7207

ILLINOIS

Edward Schmeichel Company
5968 West Chicago Avenue
Chicago 51, Illinois
Telephone: ESTerbrook 8-2070

MARYLAND

Daniel and Company
P. O. Box 124, 36 Margate Road
Lutherville, Maryland
Telephone: VALley 5-3330

MISSOURI — KANSAS

Midland Engineering Sales Assoc.
2210 West 75th Street
Prairie Village, (Kansas City) Kansas
Telephone: ENDicott 2-7327

NEW ENGLAND STATES

R. H. Sturdy Company
103 Morse Street
Newton 58, Massachusetts
Telephone: WALnut 6-0808

NEW JERSEY

Harold Gray Associates
8-10 Highwood Avenue
Tenafly, New Jersey
Telephone: LOWell 7-3585

NEW YORK

Naylor Electric Company
1718 Erie Boulevard, East
Syracuse 3, New York
Telephone: GRANite 2-9183 TWX: SS 166

NORTHERN CALIFORNIA

WASHINGTON — OREGON

Engineering Liaison Associates North
626 Jefferson Street
Redwood City, California
Telephone: EM 9-5515

OHIO

Electro Com
5554 Pearl Road
Cleveland 29, Ohio
Telephone: TUXedo 6-2404

OKLAHOMA — TEXAS — LOUISIANA

Hillman Enterprises, Inc.
3505 Turtle Creek Blvd.
Dallas 19, Texas
Telephone: LAKeside 1-2070
TWX: DL 123

PENNSYLVANIA

Hile and Stitzer Company
17 South Valley Road
Paoli, Pennsylvania
Telephone: NLAGara 4-5500

CANADA

Collins Radio Company
of Canada, Ltd.
11 Bermondsey Road
Toronto 16, Ontario, Canada
Telephone: PLYmouth 7-1101

**Collins Radio Company
Components Division
19700 San Joaquin Road
Newport Beach, California**



Maggs Electronics, 5611 Sheila Street, Los Angeles 22, California, is a Collins distributor for the Collins standard toroidal coil line and is able to provide 24-hour delivery on most types in quantities up through 99 pieces, packaged and marked to customer requirements. Telephone: Code 213, 685-6141. TWX 213-722-6289.

See the complete Collins line at New York IEEE

OHMITE TECHNOLOGICAL BREAKTHROUGH!

MOLDED VITREOUS ENAMELED WIRE-WOUND RESISTORS



A NEW PRODUCT . . . A NEW METHOD

Patent Applied For

Patent Applied For

ADVANTAGES

- ★ Insulated for 1000 V to Ground
- ★ Uniform Shape
- ★ Uniform Sizes
- ★ Permanent "Fired-on" Vitreous Markings, Completely Cleaning-Solvent Resistant
- ★ Plus All The Advantages of Ohmite Time-Proven Vitreous Enamel

The NEW Series 99 Resistors are the result of an outstanding technological development—an exclusive new molding process for applying vitreous enamel to resistors. This "Patent Applied For" molding process is the first radical manufacturing change in the history of vitreous enameled resistors—replacing the traditional "wet dipping" process. The dense uniform vitreous enamel jacket created by molding—fired at high temperature—produces the hard, glossy, moisture-resistant covering proved in years of service, as well as the extra advantages featured above.

Series 99 Resistors meet all requirements of MIL-R-26C, including pertinent V-block insulation tests[▲]. Construction is all ceramic and metal. Ratings are based on a maximum hot spot temperature of 350°C with a 25°C ambient. Standard tolerance is ±5%, other tolerances available.

Standard leads are grade A nickel, tinned for soldering. Also supplied untinned for welding. Other types of lead material are available.

▲For 1-watt size only, V-block not to exceed length of resistor body.

RHEOSTATS • RESISTORS • RELAYS • TAP SWITCHES • R.F. CHOKES
VARIABLE TRANSFORMERS • TANTALUM CAPACITORS • SEMICONDUCTOR DIODES

MILLIONS OF UNIT-HOURS OF TESTING—This new molded vitreous enamel construction has been test-proven in pilot production. Load-life tests are being conducted at full-rated wattage on all sizes and resistance values which represent the approximate minimum and maximum for each size. The total number of resistors in this test group is 1,966, and 2,000 hours of cyclic "on-time" have been exceeded, thereby producing an equivalent total to date (January, 1963) of 5,242,666 unit test hours (cyclic, 1½ hours on, ½ hour off) of successful operation. Testing on all units continues.

OHMITE STYLE	RATED WATTS AT 25° C	DIMENSIONS (INCHES)		OHMS RANGE (COMM'L.)
		DIAM. +.031-.000	LENGTH ±.015	
995-1A	1	0.125‡	0.422‡	1 TO 3,000
995-3A*	3	0.203	0.547	1 TO 8,000
995-5A§	5	0.313	0.922	1 TO 30,000
995-5B	5	0.203	0.938	1 TO 18,000
995-10A†	10	0.313	1.781	1 TO 51,000

NOTE: Standard lead length is 1½" *Also in MIL style RW69V §Also in MIL style RW67V †Also in MIL style RW68V ‡Tolerance, +.015-.005

Write for Bulletin 103



OHMITE
MANUFACTURING COMPANY
3610 Howard Street, Skokie, Illinois
Phone: (312) ORchard 5-2600

SEE ALL OF OHMITE'S NEW PRODUCTS AT BOOTH 2333-35, IEEE (IRE) SHOW
CIRCLE 17 ON READER SERVICE CARD

CIRCLE 18 ON READER SERVICE CARD →



eight component lines...

one standard of excellence

*every OHMITE component reflects the controlled quality which
has made OHMITE products worthy of your confidence*

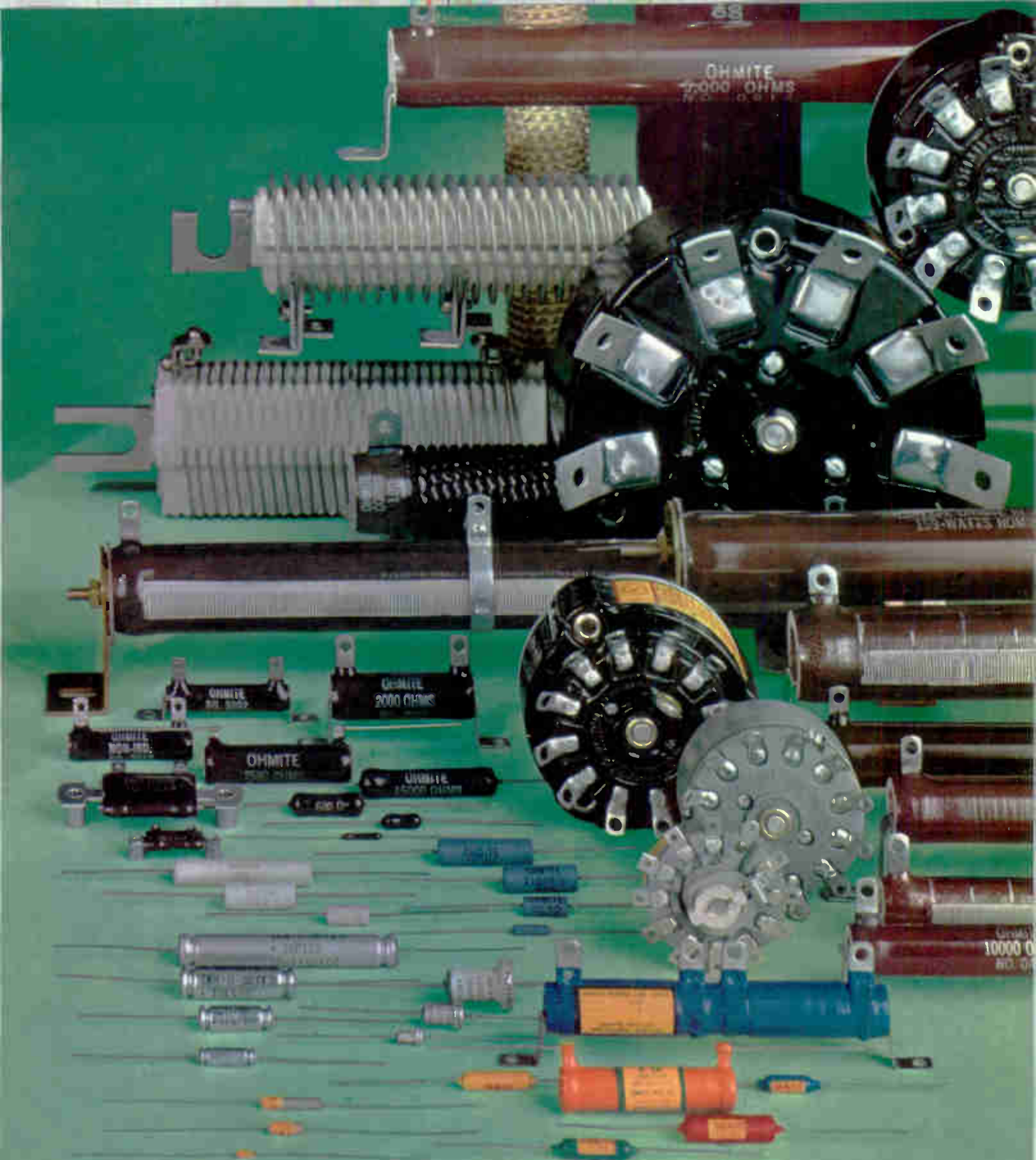

RHEOSTATS
RESISTORS
VARIABLE TRANSFORMERS
RELAYS
TANTALUM CAPACITORS
TAP SWITCHES
R. F. CHOKES
SEMICONDUCTOR DIODES

REQUEST CATALOG FROM

OHMITE

MANUFACTURING COMPANY

3637 HOWARD STREET, SKOKIE, ILLINOIS
PHONE: (312) ORchard 5-2600



Single Place Gyrocopter by Bensen Aircraft Corp.

From industry's viewpoint,
the distance from farm
to plant is shorter in
Virginia's Shenandoah Valley.

How do you measure the distance from farm to plant? In miles? Or in human trainability? On the latter count, the sturdy farmer stock of Virginia's Shenandoah Valley has made a superb record. Industries from textiles to electronics, from furniture to drugs, report Shenandoah men and women learn new jobs faster, show greater stability and productivity than people in older, more congested industrial areas.

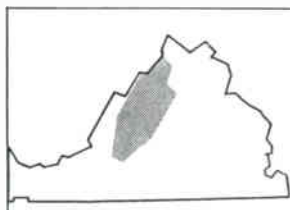

Ask VEPCO for industrial site data and economic studies covering the Shenandoah Valley's warmly hospitable, highly livable communities. Write, wire or phone in confidence.

VIRGINIA ELECTRIC and POWER COMPANY 
J. Randolph Perrow, Manager—Area Development
Electric Building, Richmond 9, Virginia • Milton 9-1411
Serving the Top-of-the-South with 2,540,000 kilowatts—due to reach 3,500,000 kilowatts by 1965.

←CIRCLE 19 ON READER SERVICE CARD

CIRCLE 20 ON READER SERVICE CARD



**1 MC to 300 MC
WIDE-SWEEPING
SWEEPING OSCILLATOR**

ALL SOLID STATE

KAY
Multi-Sweep
**MODEL VIDEO 300
159-A**

The Multi-Sweep Model Video 300 is a wide range video-vhf sweeping oscillator which provides a full 300 mc of swept-frequency output by all-electronic frequency modulating techniques. It provides a linear swept frequency output, AGC'd for constant output over the frequency band. The Multi-Sweep Model Video 300 includes provision for the insertion of external oscillators to generate variable birdie-bypass type markers on all frequencies. A calibrated frequency dial permits the use of the unit as an IF-VHF oscillator with continuously variable center frequency and sweep width.

- 300 mc to less than 1.0 mc in single sweep

Sweep Frequency Range

The Model 300 is a wide-sweeping swept frequency oscillator with high and undistorted output, essentially free of spurious signals. Over the entire sweeping range, it generates a 0.5 volt (rms into load) output which is held constant to within ± 0.25 db by a fast-acting automatic gain control circuit. The RF output is monitored by a calibrated panel meter.

- All electronic

Sweep Rate

The repetition rate of the sweep may be locked to the nominal line frequency or varied around this frequency for hum checks. A manually-controlled swept output provides a means of varying c-w signal in sync with the oscilloscope display. The manual control covers the same frequency range to which the Model 300 is set for electronic sweeping.

- All solid state

Advanced Design

The Multi-Sweep Model 300 employs recently developed techniques in providing a compact and versatile instrument. All elements, including the frequency modulated source and its means of modulation use recently developed solid state circuits. Careful isolation and buffered outputs provide for excellent waveshapes and clean, reliable outputs.

- 0.5 volt rms into load AGC'd to ± 0.25 db

SPECIFICATIONS

- Built-in detector

Frequency Range: Continuously variable 1 mc to 300 mc.

Sweep Width: Linear, continuously variable 200 kc to 300 mc. CW operation.

Sweep Rate: Variable around line frequency, locks to line. Manual control.

RF Output: 0.5 volt rms into nominal 50 ohms (70 ohms on request); flat to within ± 0.25 db over widest sweep — metered.

Markers: Provision for birdie-bypass markers derived from external oscillators. Separate level control and output.

Attenuators: Switched 20,20,20,10,6,3 db plus variable 6 db.

Power Supply: Input approx. 20 watts, 117 volts ($\pm 10\%$), 50-60 cps ac, regulated.

Dimensions: 6 $\frac{3}{4}$ " x 15 $\frac{1}{2}$ " x 13 $\frac{1}{2}$ ".

Weight: 24 lbs.

Price: \$795.00 f.o.b. factory. \$875.00 f.a.s. N. Y.

- Stable narrow sweeps

VISIT KAY AT THE IEEE SHOW: BOOTHS 3512-3518

KAY ELECTRIC COMPANY

Dept. E-3 Maple Avenue, Pine Brook, Morris County, New Jersey • Capital 6-4000



IEEE President Talks Candidly

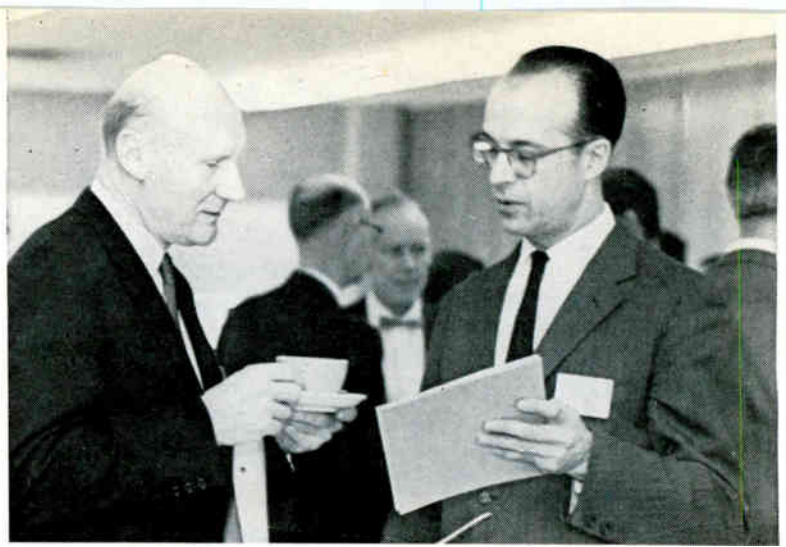

COFFEE TIME is no break for busy Weber and associates

Dr. Ernst Weber says split in AIEE, IRE views is big problem

AS FIRST PRESIDENT of the merged AIEE-IRE, Dr. Ernst Weber is in a unique position to view the problems, the conflicts and the enthusiasms that the new organization, the IEEE, has generated. Recently we went to Polytechnic Institute of Brooklyn, which he heads, to find out what he thinks will be the IEEE's biggest problem:

"The difference in viewpoints of the two memberships," he answered. "The AIEE member is happiest when you tell him just what to do. With the IRE man, it's a case of telling him what *not* to do."

This difference, he says, has a profound effect on IEEE's first order of business: combining AIEE's technical committees with IRE's professional groups. IEEE's top

brass has adopted a hands-off policy toward this issue, encouraging the committees and groups to work out their own plans for merger. But the traditional methods of operation of the AIEE and IRE produce difficulties here.

"For instance, what an AIEE member means by freedom will probably be quite different from what an IRE member means."

The technical committees were organized from the top down, he explained, with members chosen by AIEE higher-ups. IRE groups were most often established by the members' own initiative and staffed by volunteers. Headquarters regulated certain well-defined areas but otherwise only provided a model constitution, which a group might rewrite to suit itself.

COMPANIES' ATTITUDE—What has been the attitude of companies in the industry to the AIEE-IRE merger, we asked.

"They're all for it," he said.

Dr. Weber agreed that in recent years many companies had become more and more reluctant to cooperate with the professional societies. Some of them have balked at giving their men time off and travel money to attend meetings. Dr. Weber holds that the principal reason for this has been the proliferation of such meetings. Because the IEEE will be striving to eliminate overlapping and duplication, every firm he has talked to is enthusiastic about IEEE.

ORIGINAL PAPERS—Concerning the meetings themselves, the trend in the future, as in the recent past, will be to steer original papers to the meetings of the professional and technical groups, where researchers can expect to find a "serious and competent" audience.

The national meeting in March will continue to be a "three ring circus," he said, with much emphasis on socializing. Papers read at national meetings will be "tu-

MEETINGS such as this one take much of Weber's time



WEBER, THE WELL-ROUNDED MAN

Most impressive qualities of Dr. Ernst Weber are his energy and his varied interests. In an interview, the energy asserts itself as a desire to answer questions fully but pithily, candidly but diplomatically. Here is a man, you judge, who is making the fullest use of his resources.

The record bears this out. In college, he doubled up on his studies and won doctorates in engineering and philosophy. He holds three degrees, of Polytechnic Institute of Brooklyn, Polytechnic Research and Development Corp., and IEEE. His contributions to microwave are reflected in 50 American and foreign patents. His nonprofessional interests include music, poetry, mountain climbing—the list stretches on, as we have reported before (*Electronics*, p 268, March 13, 1959)

torial in nature," aimed at bringing members up-to-date on happenings in their specialties.

Being an educator himself, Dr. Weber not surprisingly thinks that when the IEEE has overcome its organizational problems it must become a bigger force in education. It should have two goals in this area, he says.

More engineering colleges should provide courses to keep graduates abreast of advances in their fields. To do this, he thinks it would be best if engineers returned to college every five or six years for refresher courses.

BROADER EDUCATION — Dr. Weber also thinks that the IEEE should push for the broadening of

engineers' education.

It should be recognized, he said, that many engineers will eventually be called on to fill administrative positions. To prepare them for this, they should be taught administrative and social science subjects.

Engineers and scientists have been much criticized in the past for taking too small a part in social and political affairs, a viewpoint Dr. Weber agrees with perfectly. He hopes a broader educational program will help correct this. Maybe someday, he said, engineers will be named regularly to high governmental posts, such as secretary of defense.

A few days after this interview, Dr. Weber himself was named to the Defense Science Board.

More Planar Transistors

Plastic package in one silicon planar type slashes cost

NEW YORK—GE will be luring consumer products designers into its components booth at the IEEE Show with a silicon planar transistor that sells for 40¢. Chief cost-cutter—a plastic package.

Beryllia mounting wafer for collector isolation is the design feature of Pacific Semiconductors' new silicon triple-diffused planar transistors. In a new circuit, one type gives 10-w output at 265 Mc. F-m transmission is among expected applications.

A 250-w silicon power transistor in a double-ended stud package, now in advanced stages of development, will be shown by Silicon Transistor Corp. Beta is 10 at 50 amp.

A 10-amp series of silicon planar triple-diffused power transistors will be shown by Minneapolis-Honeywell. At 10 amp, breakdown voltages are around 80 v. Gains are 20 to 60 or 40 to 120.

Multiple forward voltage regulators with up to 4 units in a DO-7 package are offered by Computer Diode. Electrochemical polishing

and other semiconductor finishing services are being introduced by Semiconductor Specialties.

International Resistance is showing $\frac{1}{8}$ -inch-cube trimmers with ranges of 50 ohms to 20 K. Screw-driver-adjusted, they are designed for higher packing densities.

Among the new products at Spragut Electric's booth are a line of molded solid tantalum capacitors and molded pulse transformers. Buckbee Mears is now making hemispherical grids with up to 1,000 lines an inch in a variety of materials, as well as thin-film memory circuits, masks and other products.

TRIPLE-STRIPE geometry gives this Sylvania silicon epitaxial planar transistor distinctive appearance (see p 154)

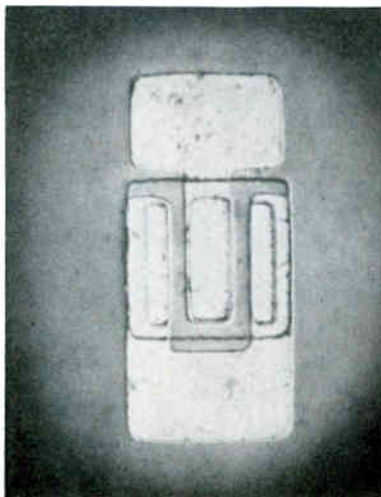

*the
Last Word in*

**HIGH
SPEED**
printer systems

from



POTTER

the
LP-1200 SYSTEM
provides:

- **LOW COST BUFFER STORAGE...**
Computer proven Magnetostrictive Delay Lines are compatible with the fastest computer systems.
- **NEW DELAY LINE AMPLIFIER...**
Peak Detection circuit improves reliability at higher frequencies.
- **QUALITY HIGH SPEED PRINT-OUT**
Vacuum Paper control, coupled with high speed paper feed produces clean, sharp impressions.
- **HUMAN ENGINEERING provides...**
quick, front paper loading, ease of ribbon change, access to drum and hammers, convenient operating controls.
- **ADDITIONAL FEATURES...**
non-wearing Elastomeric torsion bearings assure long hammer life; low inertia drive belts minimize clutch and brake wear.
- **12 WEEK DELIVERY**

To learn how the Potter LP-1200 Printer System can reduce the cost of your computer time, write to the General Manager, Printer Division, today.



POTTER INSTRUMENT CO., INC.
PRINTER DIVISION
East Bethpage Road • Plainview, New York

CIRCLE 23 ON READER SERVICE CARD

Amperex announces
5 new Ruggedized Tetrodes...
direct plug-in replacements
for all standard prototypes,
ruggedized or non-ruggedized,
regardless of brand...and
they are available
at no premium in price.

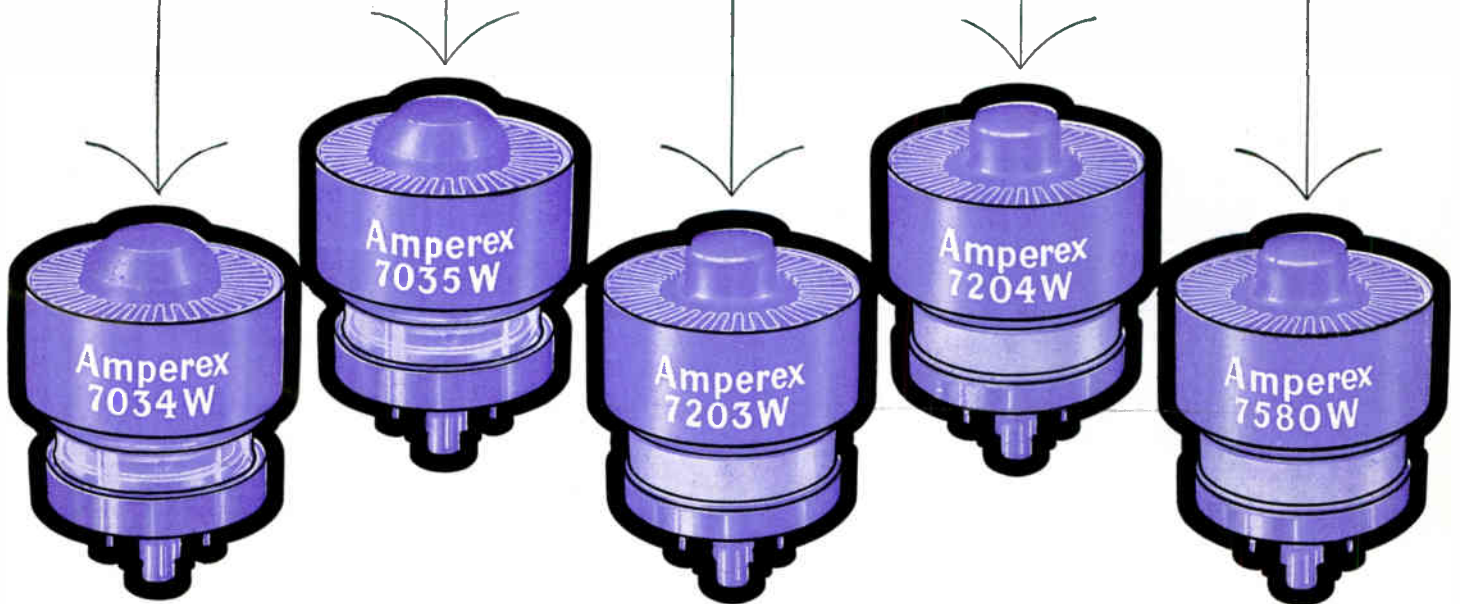

7034W and 7035W are Ruggedized Glass/Metal Power Tetrodes, designed for use as a Wide-band RF Amplifier in class B Television Service; class C RF Oscillator/Am-

plifier; and class AB₁ or 2 AF Amplifier/Modulator. Fil. Ratings: 7034W (6.0V, 2.6A), 7035W (26.5V, 0.56A). (MIL specifications in preparation.)

7203W and 7204W are Ruggedized Ceramic/Metal Power Tetrodes, for high reliability performance as UHF Frequency Multiplier, RF Pulse Amplifier, class C RF Amplifier/

Oscillator or class AB₁ AF Amplifier/Modulator. Fil. Ratings: 7203W (6.0V, 2.6A), 7204W (26.5V, 0.56A). (MIL specifications in preparation.)

7580W is a Ruggedized Ceramic/Metal Power Tetrode, for SSB and other Linear RF Amplifier applications. (Available to specifications MIL-E-1/1385A [Navy].)

These AmpereX Ruggedized Tetrodes are rated for full 250 watts plate dissipation in applications up to 500 Mc...and simultaneously meet the additional AmpereX Ruggedization Specifications of 90 G Shock Test and 10 G Vibration Test (10-1000-10 cycles)!

AmpereX ruggedization has been achieved without alteration of static or dynamic characteristics of the related tube prototypes or of their external physical dimensions. Input and Output capacities and heater ratings remain the same. That is why

these AmpereX Ruggedized Tetrodes are preferred for BOTH new equipment specifications as well as direct plug-in field replacements... and at no premium in price for ruggedization.

These five new ruggedized power tetrodes are now in production at the AmpereX, Hicksville, Long Island plant... where advanced manufacturing techniques assure high reliability transmitting tubes in production supply. Write for detailed data today,

IN CANADA: PHILIPS ELECTRON DEVICES, LTD., TORONTO 17, ONTARIO.



AmpereX Electronic Corporation, Tube Division, Hicksville, Long Island, New York



IEEE SPECIAL

ABSORBING
MATTER—
Frederick E. Terman
explains a point



WHATEVER the 'British Look' is, Leonard Lewin has it. He's shown at his desk

IEEE Award Winners — What

*Profiles of 9 men
who will be honored
at IEEE Convention*



ALLEN H. SCHOOLEY *with model
of sea wave slopes*



A. C. MONTEITH



GEORGE C. SOUTHWORTH



WILLIAM E. EVANS



IAN M. ROSS

FORMER IRE AWARDS will be presented at the IEEE's convention banquet March 27. Winner of one former AIEE prize, the Edison Award, will be "recognized" at the banquet, the award having already been given. Winner of the Lamme Award, who has not yet been named, will also be "recognized." Presentation will be later this year. Next year, IEEE says, all awards will be presented at the same time.

ALEXANDER C. MONTEITH is winner of AIEE's Edison Award for "meritorious achievements in engineering education, management and development of young engineers."

Monteith, a Westinghouse vice president, has long been concerned with "getting better engineers and more of them." Born in 1902, he is former president and director of the recently completed Westinghouse Educational Center. While serving on the Engineers' Council for Professional Development, he spearheaded the development of the well-known report, "The First Five Years of Professional Development."

The profiles that follow are of IRE prize winners. John Hays Hammond, Jr., co-winner of the

Medal of Honor "for pioneering contributions to circuit theory and practice, to the radio control of missiles and to basic communications methods" is profiled on p 196 of this issue.

GEORGE C. SOUTHWORTH, the other co-winner of the Medal of Honor, is one of the grand old men of radio and electronics.

Born in 1890 and brought up on a farm near Little Cooley, Pa., he was seeking out information about the spark-gap transmitter and coherer receiver when he was still in high school. While a graduate student at Yale, he became interested in resonant water troughs. He later pursued these studies while working for the Bell System, accumulating enough data for a demonstration on waveguides before the IRE in 1938. This eventually led to waveguide technique as we know it today. Dr. Southworth retired from Bell recently.

FREDERICK E. TERMAN, winner of the Founders Award, is vice president and provost of Stanford University. He has played a large part in developing Stanford's electronics engineering curriculum into one of the finest in the world. Born in 1900, Dr. Terman still searches every grade card and lab report for evidence of deep analytical talent. Former students include Russell Varian, Robert Hansen, William Hewlett and David Packard. He has written what are now classics in their field, "Radio En-



RESEARCHER RELAXES — *Chih-Tang Sah and wife Linda at recent party*

They're Like

gineering" and "Radio Engineer's Handbook."

IAN M. ROSS, winner of the Morris Liebman Award, has spent his entire career with solid-state devices. At 35, he expects to devote the rest of his working life to that specialty, a prospect that leaves him with no feeling of limitation whatsoever.

"So far as I'm concerned, the opportunities are boundless," he told *ELECTRONICS*. This is not true of transistors and diodes, he thinks. Main advances in these devices will concern quality, reliability, large volume production and low cost.

"This isn't very exciting but I'm afraid that's the state of a mature art," he said. He holds nine patents and has five patents pending on semiconductor devices. He is director of the Semiconductor Device and Electron Tube lab at Bell Telephone.

CHIH-TANG SAH will be given the Browder J. Thompson prize for his paper, "Effect of Surface Recombination and Channel on P-N Junction and Transistor Characteristics," published last year when he was only 29. Until recently he commuted between Fairchild Semiconductor and the University of Illinois, where he was both teacher and researcher. He now works full time as head of Fairchild's solid-state physics department.

ALLEN H. SCHOOLEY, who will receive the Harry Diamond Award,



15 Mw Modulator Power 3.0 Mw R-F Power **ML-7560** Ceramic Triode

Coaxial terminal, thoriated-tungsten cathode ML-7560 provides:

15 Mw Pulsed Modulator Power Capability at 1% duty . . .

DC Plate Voltage Max 50 kv

Pulse Cathode Current Max 550 amps

3.0 Mw R-F Pulsed Power capability at 5% duty . . .

Peak Plate Pulse Supply Voltage Max 40kv

Pulse Cathode Current, Max 550 amps

Send for 74 page brochure, "Hard Pulse Modulator Tubes", containing useful information for Radar Design Engineers and others.



An Affiliate of Raytheon Company

THE MACHLETT LABORATORIES, INC.

SPRINGDALE, CONNECTICUT

NEW!

"BUILDING BLOCK" MULTI-TONE MODULES

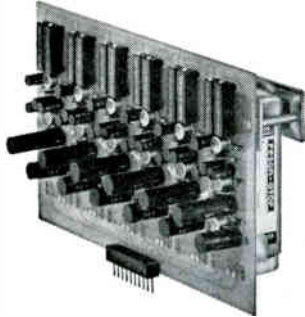

MODULTONE ENCODER

**HIGH Stability LOW Cost
SPACE-Saving**

Standard 6-tone encoder and decoder modules supplied with choice of frequencies from 67 to 1600 cps. Patented, proven RESONATORS assure superior frequency stability. Entire circuit printed . . . rugged, dependable.



MODULTONE DECODER

WRITE for additional information
on MODULTONE encoders
and decoders.

SDI SECURITY
DEVICES
LABORATORY
ELECTRONICS DIVISION OF
SARGENT & GREENLEAF, INC.
17 Seneca Ave.
ROCHESTER 21, N.Y.

**SEE MODULTONE
IN ACTION...**
IEEE SHOW • BOOTH 1625

RESEARCHER
RESEARCHES
—Philip J. Rice
in the lab



thrives on a split life. Daytimes he is associate director of research for electronics at the U.S. Naval Research Laboratory, supervising more than 750 persons and numerous research projects. Nights and weekends he is often back at the lab working on a project of his own. Using inexpensive equipment—a 95-cent motor and paper clips in one case—he has over the years carried out experiments in electronics and oceanography that have led to an impressive list of published papers.

LEONARD LEWIN, winner of the W. R. G. Baker Award, started investigating microwaves while working in the British Admiralty during World War II. He continued this work after joining ITT's Standard Telecommunication Laboratories in 1946, where he is now assistant manager.

By 1949-50 he had originated so many ideas he was able to publish a book, "Advanced Theory of Waveguides." He suspected, though, that many of the apparently independent examples he cited were really special cases of some linking theorem. Eleven years later he verified this in a paper, "On the Resolution of a Class of Waveguide Discontinuity Problems by the Use of Singular Integral Equations," for which he will be given the Baker Award.

PHILIP J. RICE JR. will receive the Vladimir K. Zworykin Award, along with William E. Evans, "for the development of techniques and equipment for fixing televised images on paper." Award-winning project was a joint effort of A. B. Dick Co. and Stanford Research Institute, where Dr. Rice is manager of Physical Electronics Lab.

It resulted in the development of a videograph utilizing crt principles to print data on paper rather than displaying it on a screen. The system is now used by some publications to print address labels. Dr. Rice is 46 years old and is presently trying to develop a solid-state device focusing on a new type of metal-base transistor.

WILLIAM E. EVANS, co-winner of Zworykin Award, already has several special achievements to his credit. He received a War-Navy Dept. citation for ecm work during World War II, co-designed the first successful high-power phase-to-amplitude broadcast transmitter in the U.S. and holds four patents in the field of outphasing tv modulation, color tv systems and the utilization of scanning techniques in industrial tv systems. Born in 1921, he is engineering manager of the R&D labs at A. B. Dick Co.

Glass Display Arrays

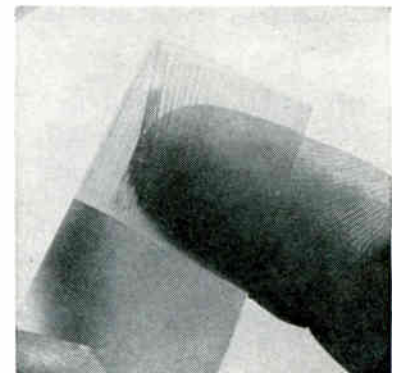

TRANSPARENT wire arrays for electroluminescent X-Y coordinate display panels, being shown by Corning Glass Works, are made of glass strands coated with conductive metal oxide and transparent insulation



For Illustrated Brochure Detailing Melpar's Capabilities, Write to Office of the President, Melpar, Inc., Falls Church, Virginia

EXPERIENCED TRAVELER

Here is Melpar's case for space.

Experience? We've got a bagful—from the first probing start with Snark to the far-advanced Apollo program, from earth to the moon, to Venus and beyond. If you're aiming for a place in space, Melpar's proven capabilities can help you get there—fast.

Thinking small, like circuits ten millionths of an inch thin or refriger-

ators (thermo-electric coolers) half the size of your thumb nail? Melpar makes them.

Thinking big, like data handling complexes (Finder) as large as a basketball court? Melpar produces those, too.

If you're traveling or exploring in the spheres of Advanced Electronics, Aerospace, Physical or Life Sciences, just pack up your space problems and bring them to Melpar.

We make wonderful traveling companions, because we've been there—and that's a mighty strong case anytime.

And, if you're a scientist or engineer who would like to travel along with this fast-moving leader in space and defense, we're ready to reserve your place in space, too. Write: Professional Employment Manager, 3010 Arlington Blvd., Falls Church, Virginia.

Serving Government and Industry

MELPAR  **INC**

A SUBSIDIARY OF WESTINGHOUSE AIR BRAKE COMPANY

3902 Arlington Boulevard, Falls Church, Virginia.

An equal opportunity employer

Subsidiaries: Microwave Physics Corp., Garland, Texas • Television Associates of Indiana, Inc., Michigan City, Indiana • Melpar-Fairmont Corp., Fairmont, West Virginia

A New Galaxy—



New Type IMM 648-1
Shown Actual Size

An entire circuit module compensated for phase, gain and zero drift over entire temperature range.

- 0.1 Cubic Inch Volume
- 0.1 Ounces in Weight
- Infinite Standby and Service Life
- Low Milliwatt Power Consumption
- High Shock and Vibration Resistance
- Electrical zero point and gain, repeatability and stability over entire service life
- Extremely broad bandwidth
- Carrier frequencies as high as 1 megacycle
- Input signal current resolution better than 0.01 μ a
- Absolute reliability



Micro Magnetic Modulator
Type IMM-655-2



Micro Magnetic Modulator
Type IMM-648-1

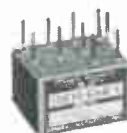

Micro Magnetic Modulator
Type IMM-664-1



Micro Magnetic Modulator
Type IMM-680-1

1952-1962... weight reduced from 5 ounces to 0.1 ounce! The product of 2 years of intensive development work, new completely microminiaturized magnetic modulators feature an essentially drift-free circuit with superior phase and gain stability over wide environmental ranges. All the ruggedness, dependability, wide dynamic range and stability that are characteristic of the larger magnetic modulators are engineered into this new magnetic circuit. "MICRO MAG MODS" are shock and vibration proof, provide the ultimate in reliability and unlimited life.

of "MAG MOD"

MICRO MAGNETIC MODULATORS

— provide repeatable data over years of continuous, unattended operation

"MAG MODS" provide four quadrant operation, extreme stability with negligible change of phase, gain and zero position over a wide temperature range. Design is simple, lightweight, rugged with no vacuum tubes, semiconductors or moving parts to limit life. "MAG MODS" offer infinite design possibilities and impedance levels, and are adaptable for algebraic addition, subtraction, multiplying, dividing, raising to a power and vector summing.

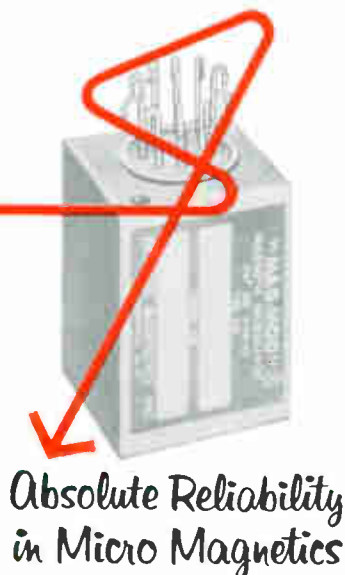

Absolute Reliability
in Micro Magnetics

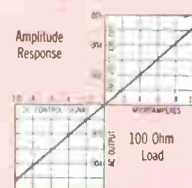
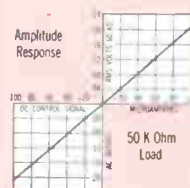
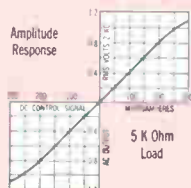
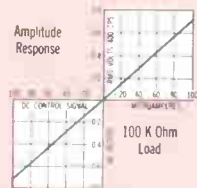

TYPE NUMBER	IMM-655-2	IMM-648-1	IMM-664-1	IMM-680-1
Reference Carrier Voltage and Frequency	3 V @ 400 cps	2 V @ 2 KC	10V @ 60 KC	115 V @ 400 cps
Input Control Signal Range	0 to $\pm 100 \mu\text{A}$ DC	0 to $\pm 300 \mu\text{A}$ DC	0 to $\pm 100 \mu\text{A}$ DC	0 to $\pm 10 \mu\text{A}$ DC
AM Phase Reversing AC Output Range	0 to 0.8 V RMS @ 400 cps	0 to 1.0 V RMS @ 2 KC	0 to 200 mv RMS @ 60 KC	0 to 30 mv RMS @ 400 cps
RMS mv AC Output/ μA DC Signal Input	7 mv/ μA	4 mv/ μA	2 mv/ μA	5 mv/ μA
AC Output Null (Noise Level) RMS	5 mv RMS Max.	5 mv RMS Max.	10 mv RMS Max.	100 μv RMS Max.
Output Impedance	14 K ohms	1000 ohms	11 K ohms	Approx. 150 ohms
External Load	100 K ohms	5 K ohms	50 K ohms	100 ohms
Zero Drift over Temperature Range	$\pm 0.1 \mu\text{A}$ Max.	0.5 μA Max.	—	0.05 μA Max.
Hysteresis in % of Max. Input DC Signal	0.2% Max.	0.2% Max.	0.5% Max.	0.1% Max.
% Harmonic Dist. in Output Product Wave	15%	10% to 15%	5%	20%
Temperature Range	-55°C to $+125^\circ\text{C}$	-55°C to $+125^\circ\text{C}$	-55°C to $+125^\circ\text{C}$	-55°C to $+125^\circ\text{C}$
Frequency Response	5 K Series, 108 cps	Over 200 cps	Over 5 KC	Over 100 cps
Approximate Weight (in Ounces)	0.2	0.1	0.2	0.2

GENERAL MAGNETICS • INC

135 BLOOMFIELD AVENUE
BLOOMFIELD, NEW JERSEY

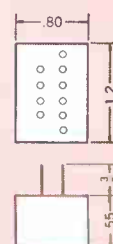
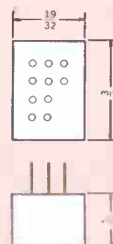
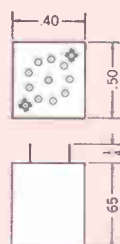

Catalogs are available on Micro Magnetic Modulators, Standard Magnetic Modulators, Miniaturized Multiplying Modulators and Transistor Oscillators. Call or write for your copies, or ask to have a GENERAL MAGNETICS representative contact you for consultation on specific applications.

CIRCLE 31 ON READER SERVICE CARD

There's logic in Delco's line of digital circuits and equipment

Check it yourself. A large variety of standard logic functions are available in three series of Delco circuit modules: the extra low power 100 KC "SM" series for extreme light weight and wide environmental applications; the 200 KC "DM" series for ultra reliability circuits in the low and medium speed range; the high speed "FM" silicon series operates from DC to 10 MC in a wide range of environments. Circuit cards of 200 KC, 5 MC and 10 MC are available where size is less critical. Digital support equipment includes standard and special power supplies, card racks and special circuits. Delco Radio digital cards, modules and support equipment are available now to reduce component and design time costs in your digital systems.

Contact our Military Requirements Department for more data and our new low prices. You'll be convinced of the logic in the Delco line.

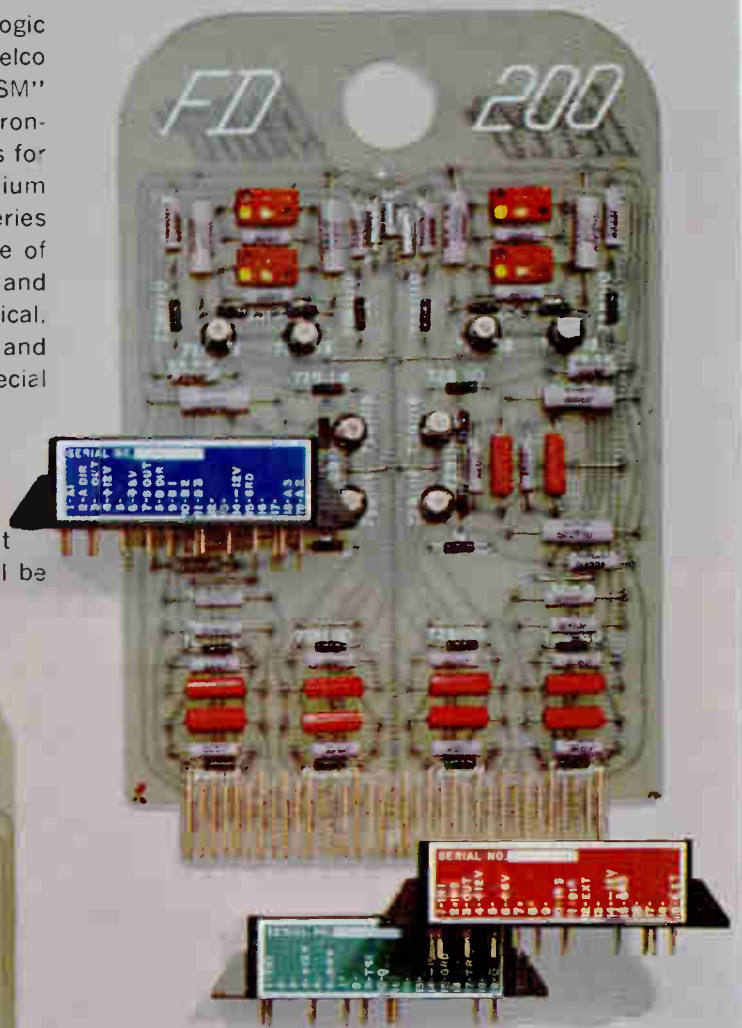
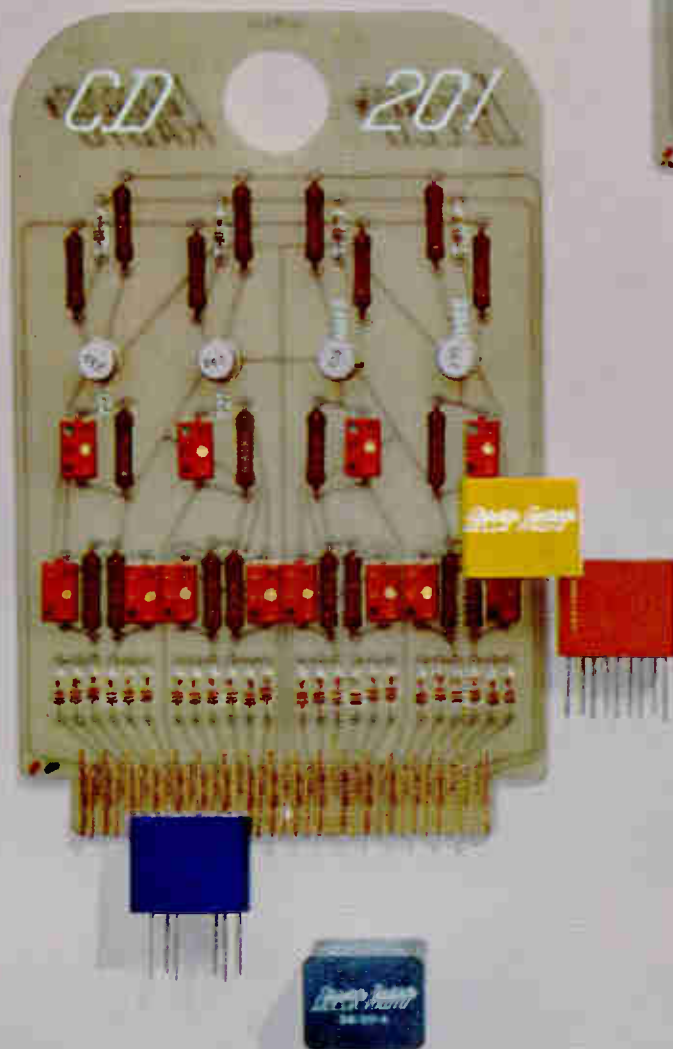

**DELCO
RADIO**

Division of General Motors
700 East Firman Street
Kokomo, Indiana
Phone GL 2-8211 • Area 317

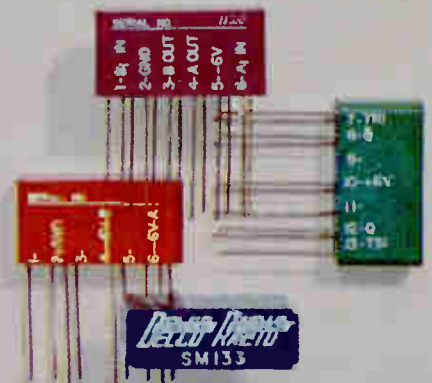

See our display at the IEEE Show—Booth 1423.

PREVIEW OF EXHIBITS



IEEE SPECIAL

Instruments Extend Operating Ranges, Are Easier to Work

Trends toward greater utility, higher accuracy, bolder display continue

NEW YORK—Greater utility, rather than radically new approaches to measuring techniques, characterizes most of the new instruments being exhibited March 25 through 28 at the Coliseum.

Instrument manufacturers—almost to a man—appear to have concentrated during the past year on developing new instruments that extend the capabilities of their bread-and-butter lines.

Wider ranges, greater sensitivity and accuracy, more automatic operation, human engineering in the form of fewer knobs and bolder indication, digital readout, portability—these are some of the continuing trends.

OSCILLOSCOPES—Automatic d-c to 10 Mc oscilloscope will be shown by California Instruments. Vertical sensitivity, horizontal sweep speed and d-c offset are set, positioned and indicated on a digital display of the parameters.

A digital-readout oscilloscope programmer for use with Tektronix' digital dual-trace scope will be introduced by the company. Program cards can be set up to measure such parameters as amplitude, time, start-to-stop time intervals or first or second pulse selection.

Lumatron Electronics is showing an improved version of their modular oscilloscope. The 0.35-nsec scope has a trigger capability to several Gc.

FREQUENCY MEASURING—Designed for antenna measurements, a receiving system with a frequency range from 20 Mc to 100 Gc will be shown by Scientific-

MOBILE EQUIPMENT for spectrum signature collection peers at r-f source from shielded enclosure atop aerial ladder. This is drawing of system. Sperry Microwave will show model at Coliseum

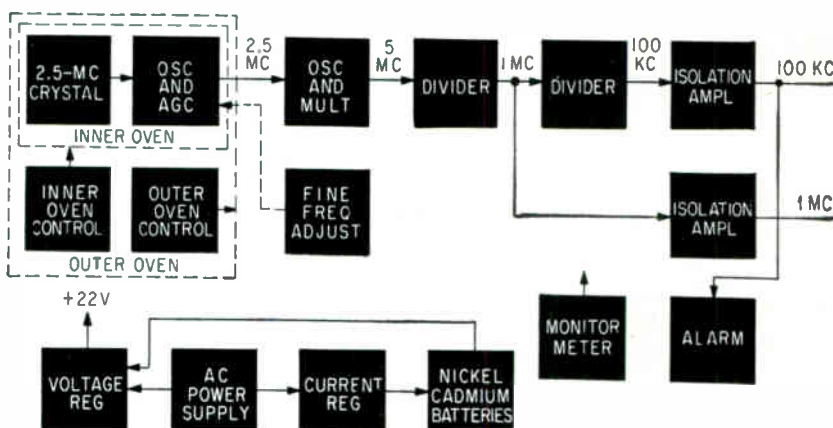
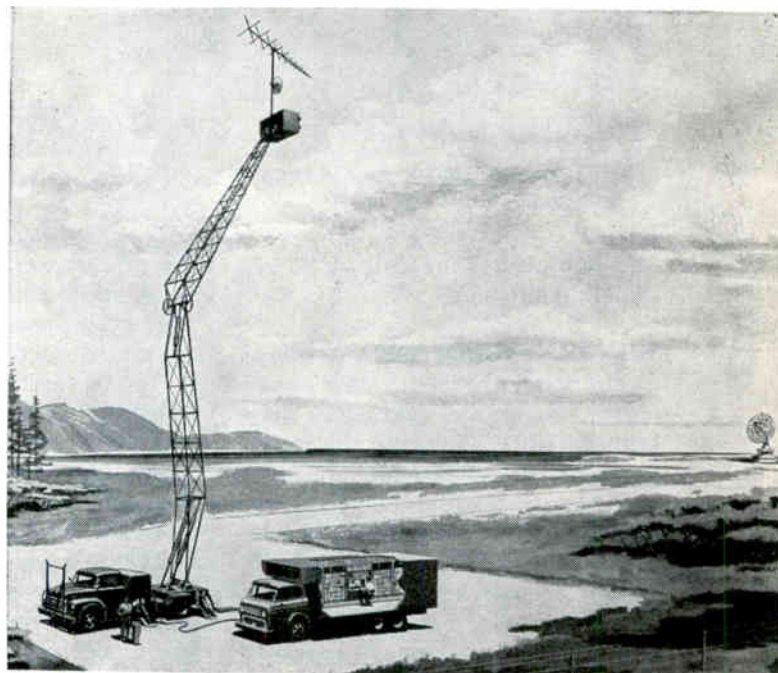

DOUBLE-OVEN DESIGN provides exceptional stability in new frequency standard, reports Motorola. The silicon solid-state instrument has 1-Mc and 100-Kc outputs

Atlanta. Dynamic range is 60 db.

Its new solid-state broadband signal analyzer will speed up spectrum signature measurements, reports PRD Electronics. Frequency range is 45 Mc to 11 Gc. The unit is designed for checking jammers, rfi sources, broadband microwave tubes and frequency diversion radars.

Ssb spectrum analyzer that in-

cludes a built-in frequency synthesizer and self-check features is being introduced by Lavoie Laboratories. Range is 2 to 80 Mc. An accompanying two-tone generator has a range of 20 cps to 20 Kc.

Frequency of unmodulated and modulated signals including a-m, f-m and fsk from 10 cps to 1 Gc can be monitored and measured by a system being exhibited by Rohde

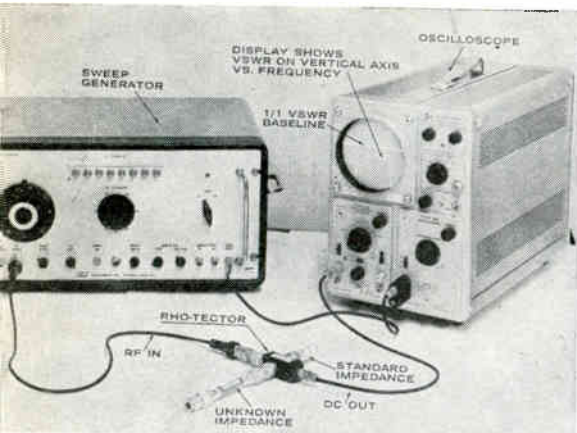

DETECTOR produces vswr measurements directly on an oscilloscope, reports Telonic Engineering

and Schwarz. Signals can be remotely displayed.

SIGNAL GENERATORS—General Radio will introduce a new sweep signal generator featuring very high stability. It covers the range from 700 Kc to 230 Mc plus two lower band spreads—one from 400 to 500 Kc, and one from 10.4 to 11 Mc. The marker system is calibrated in frequency and amplitude.

New series of signal generator modules will be shown by Polarad Electronic Instruments. Signal generators and sources will have ranges of 3.8 to 8.2 Gc and 6.95 to 11 Gc; doublers will provide outputs up to 21 Gc. A modulator is designed to drive the sources.

H. H. Scott will show a self-calibrating, combination f-m generator, audio oscillator and multiplex generator in one package about the same size as one unit of the former models.

E-H Research Labs is announcing a new light-weight microwave swept signal oscillator that gives continuous coverage in octave or greater bandwidths from 1 to 40

DIGITAL logic module breadboarding kit will be exhibited at the show by the Martin Co.

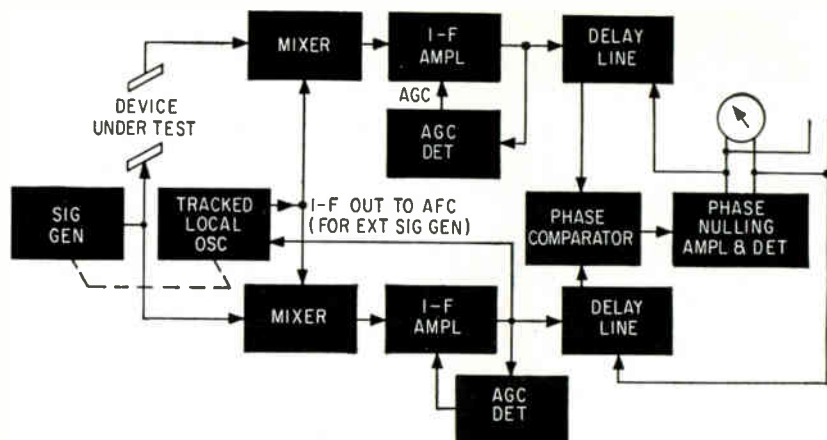
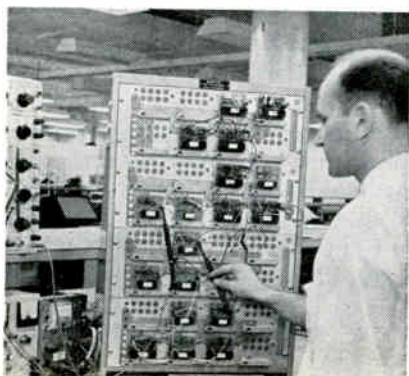

ALL-ELECTRONIC I-F PHASEMETER by Wittron has electrically controlled delay lines. Phase angle can be read digitally by attaching digital voltmeter to outputs. Range is 2 to 100 Mc

Gc. Frequencies may be changed by plug-in heads. Three internal frequency markers, 25 v in amplitude, are continuously adjustable.

Sweep oscillator with sweep widths as wide as 300 Mc and as narrow as 100 Kc is being shown by Kay Electric. Frequency range is 0.5 Mc to 1.1 Gc.

Video sweep generator designed for three modes is being shown by Jerrold. The unit has low residual frequency modulation of 20 cps in narrow band and cw modes and 700 cps in wideband mode. Range is 1 Kc to 15 Mc.

Short-circuit-proof, solid-state pulse generator with a repetition rate of 100 cps to 5 Mc is being shown by Velonix division of Pulse Engineering. Pulse width can vary from 50 nsec to 1 msec.

Function generator that provides simultaneous outputs of sine, square and triangle waveforms over the frequency range of 0.001 cps to 10 Kc will be shown by Exact Electronics.

Random-noise generator that is a serves as a stable, calibrated white noise source for vibration and strain analysis will be exhibited by Quan-Tech Labs. Output is continuously variable from 0.01 to 1,000 μ v per root cycle and is white from d-c to 100 Kc.

SYNTHESIZERS—Frequency synthesizer that generates precise signals to 50 Mc in steps of 0.01 cps will be shown by Hewlett-Packard. It can be remotely programmed, or programmed by computer.

New high-stability frequency-synthesizer by Manson Labs provides over 690,000 discrete fre-

quencies from 2 to 34 Mc in four bands. The synthesizer offers direct digital readout.

Frequency synthesizer producing any stable frequency from 10 to 20 Mc with only one temperature-controlled crystal will be shown by Measurements division of McGraw-Edison. With external multipliers it reaches 1 Gc. One use is ssb-transceiver design.

METERS—A solid-state a-c/d-c digital multimeter is being exhibited by Electronic Associates. Reading speed is 200 a sec.

D-c digital voltmeter to be exhibited by Cimron Corp. features automatic range and polarity with plug-in a-c converters or preamplifiers. Range is 0.1 μ v to 1,000 v.

True rms voltmeter with ranges from 10 μ w to 330 v (reaching 10 Kv rms with optional accessories) is being introduced by Ballantine Labs. The unit features flat amplification from 5 cps to 4 Mc with 90 db gain. Accessories provide for current and rms power measurements.

Phase shift can be read directly with digital readout with Narda Microwave's d-c to 5-Gc coaxial phase shifter.

Portable L, C and R-measuring bridge from Marconi Instruments can also measure electrolytic capacitance and incremental inductance.

Victoreen Instruments will show an electrometer dubbed the Femtometer because it can make measurements in the femto-ampere (10^{-15}) range.

Gaussmeter that measures a magnetic field from d-c to 30 Kc

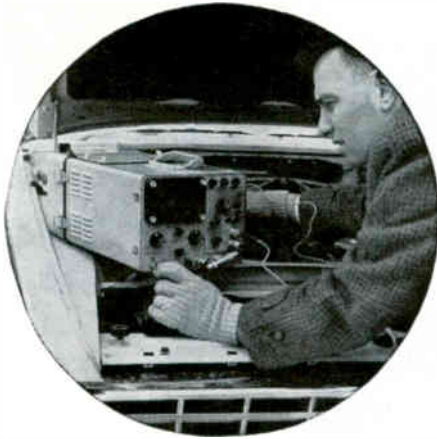

CRT deflection as low as 6 v features General Atronics new line of 15-Mc single and dual-trace transistorized scopes. Company is also introducing 6-gun crt for airborne displays

will be shown by F. W. Bell, Inc.

REFERENCES—Voltage reference source being shown by Corning Glass Works can be used instead of a dry cell. Output is adjustable from 0.900 to 1.070 v d-c.

A-c/d-c thermo voltmeter standard with a range from 1.000 to 1,000.000 v and 6-place digital read-out is being shown by Weston Instruments and Electronics.

Reeves-Hoffman reports its new solid-state 2.5-Mc frequency standard is designed for use as an in-house standard to be continually compared with vlf transmission.

Precision resistance decades being shown by Shallcross feature high d-c accuracy and minimum a-c errors to 10 Kc.

Kelvin Varley voltage divider that will be shown by Electro Scientific Industries uses special circuits and switches to improve performance at low settings.

Calibrator to measure peak power between 150 Mc and 1.5 Gc is being exhibited by Boonton Radio. The power range is 200 mw peak full scale and may be extended to 2 Kw.

COUNTERS AND TIMERS—Solid-state counters and timers for recording and data processing will be featured by Berkeley division of Beckman Instruments. The 25-Mc models accept plug-ins to extend their range directly to 100 Mc and, through heterodyning, to 1 Gc.

Systron-Donner's new 10-Mc counter-timer is all-transistor. It provides front-panel plug-in versatility, a wide range of optional features.

...up to 160
channels in a
5 $\frac{1}{4}$ " panel!

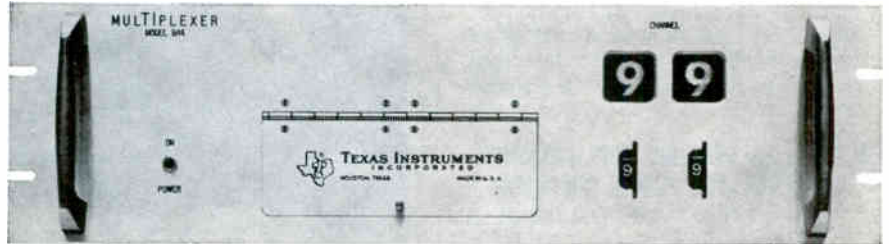
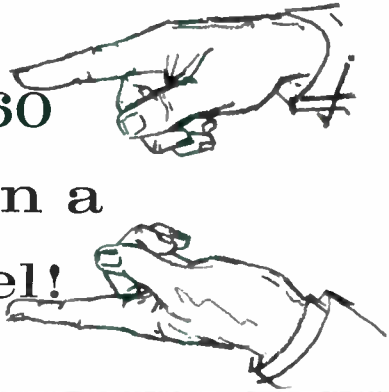

**versatile
addressable or sequential**

Multiplexers

features

- Sampling rate to 50,000 channels/sec
- Variable frame length
- Accuracy $\pm 0.02\%$ full scale
- Input levels to ± 10 V

Texas Instruments Multiplexers are all solid state units providing accurate, high-speed bipolar operation with low dynamic crossfeed, fast settling time, and variable strobe. Manual channel select switches facilitate system set-up and check-out. Frame length is selectable from front panel. Expandable to 160 channels by means of plug-in printed circuit cards. Case size 5 $\frac{1}{4}$ by 19 by 18 inches for standard relay rack mounting.

TI's high speed Model 834 Analog-Digital Converter, ideal companion instrument to the TI Multiplexer.

High speed: 1.5 μ sec per bit
Built-in sample and hold

Accuracy: $\pm 0.05\%$ full scale
Automatic zero stabilization

Ask a TI Application Engineer for further information on digital data handling equipment for your specific needs.

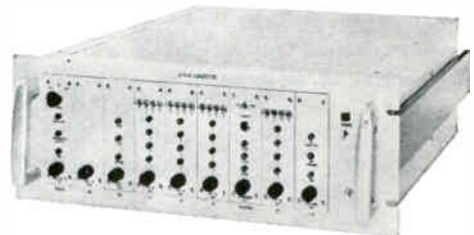

INDUSTRIAL
PRODUCTS
GROUP



**TEXAS INSTRUMENTS
INCORPORATED**
P. O. BOX 66027 HOUSTON 6, TEXAS

SENSING • RECORDING • TESTING • DIGITIZING INSTRUMENTS
THE INSTRUMENTS OF TEXAS INSTRUMENTS

558

POWER SUPPLY TECHNICAL LITERATURE



For the very latest information, Kepco, Inc., offers a wide variety of useful illustrated booklets described below. For your complimentary copies write today.

1 Notes on SYSTEMS APPLICATIONS OF REGULATED POWER SUPPLIES:

40-page REFERENCE HANDBOOK aids the engineer in making full use of the versatility built into many of today's power supplies.

Information ranges from the fundamentals of selecting a power supply, to detailed theoretical discussions on applications for systems use.

2 POWER SUPPLY NEWS:

Newsworthy and pertinent facts related to the use of power supplies in the electronic industry. Feature articles in present issue describe: Significance of Patents in the Electronic Field Today; Design Notes; and Power Supplies in Systems Applications.

3 AN ANALYSIS of COOLING METHODS:

Advantages of forced-air cooling over large-area convection systems are discussed in an effort to analyze overall equipment reliability.

4 UNDERSTANDING POWER SUPPLY TERMINOLOGY and a NOMOGRAPH on WIRE LOSSES:

Comprehensive definitions of the most-commonly used significant terms to assist the engineer in the understanding of Regulated Power Supplies.

The Nomograph supplied enables rapid determination of voltage loss across the load supply leads as a function of wire size and current.

5 Designing a CONSTANT-CURRENT POWER SUPPLY:

This informative material defines a constant-current source. It then describes a method of converting a standard constant-voltage source to a constant-current source.

CLIP AND MAIL TO-DAY

KEPCO, INC. DEPT. E
131-38 SANFORD AVENUE • FLUSHING 52, N.Y.

Please send me the following KEPCO technical literature.

1 2 3 4 5

Name: _____ Title: _____
Company: _____
Address: _____
City: _____ Zone: _____ State: _____

Include catalog B-631, comprehensive specifications and performance features on more than 250 standard models.

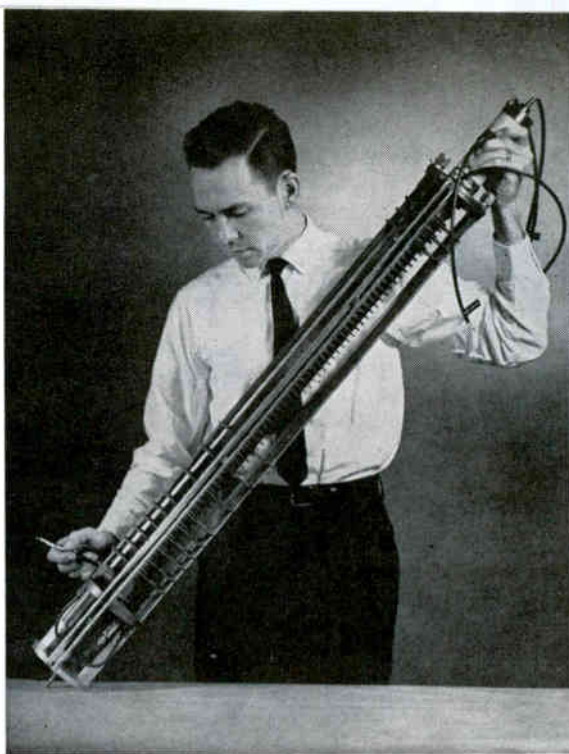

HYBRID SLOW-WAVE structure in Raytheon's 5-Kw twt (left) for phased arrays helps keep power linear over 1.2 to 1.4 Gc range. On tripod is X-band klystron rated at 50 Kw by Varian Associates—it has generated 106 Kw. Typical of Huggins Labs' new permanent-magnet-focused bwo's is 50-mw model for 8.2 to 12.4 Gc

Tubes Pack More Punch



IEEE SPECIAL

NEW YORK—First of the S-band driver klystrons for Stanford's 2-mile-long linear accelerator has just been delivered to the university by Eitel-McCullough. The tube will rate as the newest of the new products at Eimac's IEEE Show display. Development started only six months ago.

Designed for 75 Kw peak output and tested to 100 Kw, it weighs only 35 lbs. Weight was cut 80 percent by periodic permanent-magnet beam-focusing. Company also has new 500 Kw pentodes.

Another tube that borrows twt concepts is GE's traveling-wave multiple-beam klystron (detailed on p 64 of this issue).

Metcom's new X and K_a-band klystrons use an adjustable dielectric tuning rod in the cavity to get flat power response over a 1.5-Gc band. The ½-w tubes are being used

mostly in parametric pumps.

Six new pulsed magnetrons—four mm-range models and two 1-lb types that put out 1 Kw and ½ Kw at 9.3 Gc—are being shown by Litton Industries. There is also a 30 Kw to 10 Mw hollow-beam klystron and a fiber-optic crt with ultraviolet output.

One of CBS Labs' special light-sensing, light-emitting and image-conversion tubes is a multiplier phototube with rubidium-telluride sensing surface and peak quantum efficiency of 25 percent. Another is an image dissector used in deep space probes as a star tracker.

ITT is showing a ceramic power tube that dissipates 100 kw and has an evaporative cooling anode. Writing speed less than 1 ips is achieved by ITT's Iatron direct-viewing storage tube.

Sylvania is showing a 3-inch crt for use in military airborne displays faced by extremely high ambient light. RCA promises a long list of new tubes and microwave devices. One is a developmental Nuvistor for power supplies and small-signal amplification to 350 Mc.

ELECTRONIC PRODUCTS NEWS BY CARBORUNDUM

NEWS



Varsitor helps cut picture interference on latest

Zenith TV—automatically

A development of the patented "Fringe Lock" circuit incorporated in Zenith TV receivers now automatically cuts annoying picture disturbances, whether made by nearby electrical machines or external influences such as passing automobiles.

Function of the circuit is to cut off the twin pentode 6HS8 (see below) when external noise is introduced. Plates of the pentode are connected respectively to the AGC and Sync circuits. Two of the grids are fed by composite video signals. Automatic bias setting, varying with signal level

fluctuations and always safely above the Sync tips, is provided by the voltage-sensitive resistance characteristics of the type BNR-331 Carborundum varistor.

The varistor replaces a potentiometer that required adjustment for maximum noise protection, particularly in fringe areas. The varistor not only provides automatic control and positive, instantaneous cut out, but also costs one-third less than the potentiometer previously used.

New Technical data on varsitors points way to wider applications and production savings

Carborundum offers a new bulletin and technical literature to aid

in the selection and application of silicon carbide non-linear, voltage-sensitive resistors.

A variety of body types and sizes is available, with electrical characteristics suitable for applications requiring microamperes at one volt up to kiloamperes at kilovolts. Typical applications are lightning arrestors; contact arc suppression for relay coils and solenoids; protection for silicon rectifiers, capacitors and other electronic components against high peak inverse voltage; and voltage regulation and control.

The bulletin lists standard stock varistors with pertinent design information. Individual technical sheets provide E/I characteristic curves and specifications on over 100 stock varistors.

For your copies, write Dept. EL-3R, Electronics Division, Carborundum Company, Niagara Falls, New York. Inquiries regarding application to specific problems are invited.

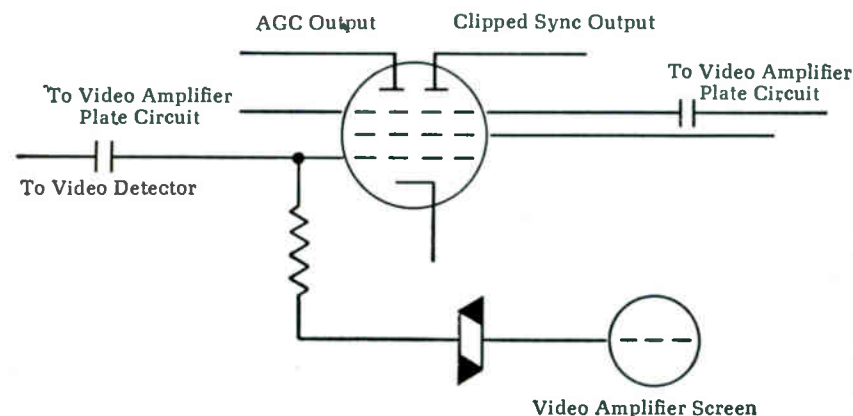

CARBORUNDUM®

Be sure to visit our booth at the IEEE Show.

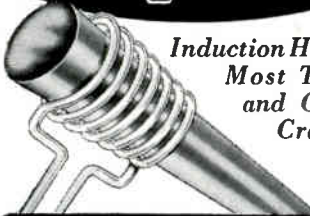

*Induction Heating's
Most Trusted
and Creative
Craftsmen
Since
1926*

**HIGH FREQUENCY
INDUCTION
HEATING UNITS**

- for
- BRAZING ● SOLDERING
 - HEAT TREATING
 - ZONE REFINING
 - CRYSTAL GROWING
 - PLASMA TORCH

Typical Applications
WAVEGUIDE ASSEMBLIES
INDUCTION BRAZED

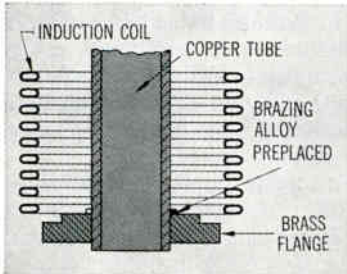

Induction brazing has proved to be an excellent method for production assembly of wave guides. In the diagram, a rectangular copper tube is joined to a brass flange using a pre-placed ring of brazing alloy. Uniform localized heating minimizes distortion. Induction brazing produces consistently sound joints with smooth fillets.

Free Application Engineering Service

GLASS - TO - GLASS SEALS

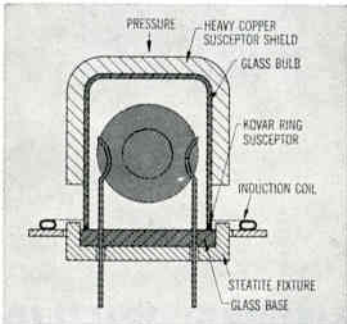

Holders for quartz crystals are sealed by induction heating in an evacuated bell-jar. A glass-coated kovar metal ring is used as a susceptor between bulb and base. Steatite nest, held in plate-type induction coil positions glass base, while spring-loaded copper block locates glass bulb and also provides pressure to cause plastic flow of glass after localized heating. In production, several crystals are sealed at one time.

WRITE FOR LEPEL CATALOG

**Lepel HIGH FREQUENCY
LABORATORIES, INC.**

55th ST. & 37th AVE., WOODSIDE 77, N. Y. C.
CHICAGO OFFICE: 6246 WEST NORTH AVENUE

CAST-IRON HEAD contains gyro-accelerometer system. Fairchild Controls put it in there to test stresses and strains on humans. One use is in the Apollo test program



IEEE SPECIAL

**PREVIEW OF
EXHIBITS**



**Microcircuits Graduate
Into Hardware Products**

*Integrated and thin-film
circuits pace development
of off-the-shelf lines*

least 500 joules. Raytheon's 350-joule unit can blast through 1/4-inch steel.

Meanwhile, the producers of tube and transistor equipment haven't been idle during the past year. They'll be offering a mixed bag of scores of new products, ranging from data-processing gear to production test equipment.

NEW YORK—Predictions that the industry is "going micro" this year (ELECTRONICS, p 45, Feb. 15) will be amply borne out when the IEEE Show opens March 25.

Since the last IRE Show, microcircuit exhibits have multiplied and most of the manufacturers will be offering product lines, rather than production capability.

Another sign of the swift pace of product development will be lasers. In addition to the lower-power types now readily available, there will be at least two super-power ruby lasers. One, from Radiation at Stanford, puts out at

MICROCIRCUITS—Sylvania will be featuring hardware applications for thin films. Among these are a cigarette-pack-sized transceiver-beacon, being built for use by pilots downed at sea, and a tape-control unit—also for Navy.

Linear molecular circuits by Westinghouse Electric include a variety of amplifiers and an oscillator-mixer. Molecular digital circuits will also be shown.

High-speed thin-film, hybrid dif-

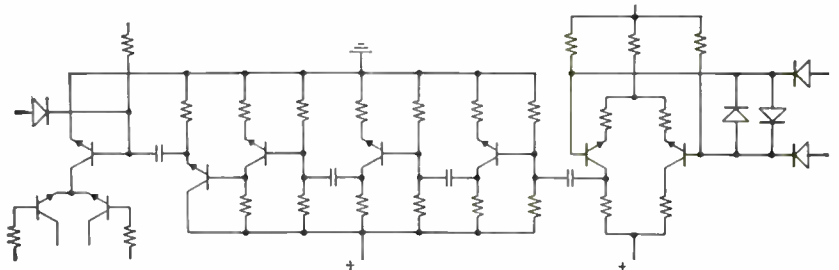

THIS CIRCUIT, reduced to a 3/4-inch-square integrated circuit by Signetics, provides the sense amplifiers in Univac's new aerospace computer

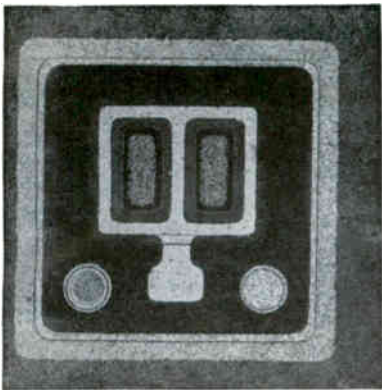

MICROCIRCUIT CHOPPER, developed by Sperry Semiconductor as low-level switch has equivalent of two matched npn silicon planar transistors with common base and collector

fused silicon tantalum logic gates will be introduced by Philco Lansdale. Silicon planar/epitaxial devices being introduced by Amperex Electronic include choppers and 11 types of mil-spec high-speed switches and amplifiers. Transatron is reportedly planning to introduce a new line of integrated circuits. Texas Instruments Incorporated is showing its expanded line of integrated circuits.

LOGIC MODULES — Flip-flops, rated at 50 Mc with some tested as high as 80, will be at Varo's booth. Sanders Associates will introduce parts of its new digital logic module line.

Microcircuit ten-bit 20-Mc shift register by General Instrument is designed for general computer and data system applications.

Micro package of 10 npn diffused silicon transistors is fabricated simultaneously by Burroughs in a common emitter, strip configuration that permits interconnection with diode matrices.

RECORDERS — Sangamo Electric's instrumentation magnetic tape recorder/reproducer reduces speed errors with a new eddy-current drive system that eliminates mechanical coupling between the motor and the capstan.

Seven-channel instrumentation magnetic tape recorder, by American-Concertone, has differential capstan and coaxial reels. Computer tape of 1-mil Mylar T from Audio Devices is compatible with 1.5-mil tapes, but provides more



FRONTIER FREQUENCY / TIME STANDARDS are the best across-the-board

Here are space-tested System Frequency/Time Standards that meet your most exacting requirements for commercial, industrial or military applications. The same engineering capability that supplies Frequency/Time control to major space projects places in your hands advanced crystal control that fulfills any precision timing assignment. ■ Frontier's line features a wide range of frequencies (30 cps to 100 megacycles), stabilities for every need (1×10^{-8} , 20×10^{-6} or whatever you require), solid-state circuitry and oven control (no noise-generating thermostats!). The line has unitized modular construction for best shock and vibration resistance — fast start-up and low power consumption — choice of sizes and mountings — *individual test documentation shipped with each unit* — mounts in any position. Write or call today for complete technical information:

Visit us at the I.E.E.E. Show Booth 3017
March 23 to 28 The Coliseum, New York

Commercial / Military
Systems Capability



FRONTIER ELECTRONICS DIVISION
INTERNATIONAL RESISTANCE COMPANY
4600 Memphis Avenue • Cleveland 9, Ohio • Phone: 216 749-1570



VISUAL PRINTOUT, magnetic keyboard, remote programming ability feature Navigation Computer's tape-puncher for numerical machine control

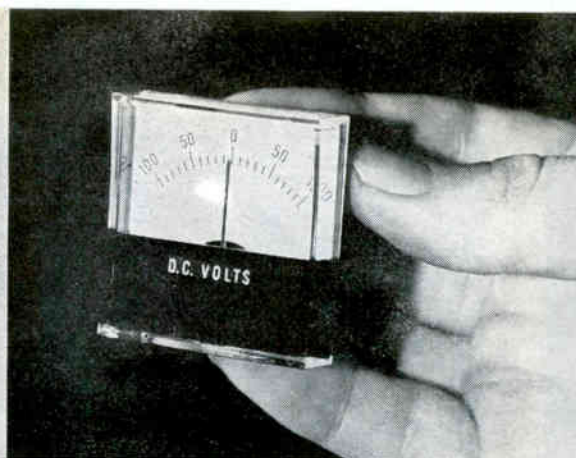

CLEAN LINES improve readability of Honeywell Precision Meter division's new panel meters. Concave plastic forms face



CARTRIDGE-LOADING tape-drive system introduced by IBM has an instantaneous data rate of 170,000 8-bit characters a second

footage on standard-sized reels.

Rheem Electronics' bidirectional punched-tape reader can sense 300 characters/second and stop on character.

Bausch & Lomb's X-Y strip chart recorder records multiple inputs directly, d-c volts, ohms, or milliamps, without external converters. Vertical strip-chart recorders for transcribing telemetry and analog computer readout and other uses are being introduced by American Optical. Two low-cost X-Y recorders being shown by Houston Instrument feature built-in time base, selectable time sweep and electric pen lift.

COMPUTER GEAR — Magnetostrictive delay lines are used for storage in a printer that Potter Instrument reports conserves computer loading time by as much as 20:1. It accepts asynchronous or synchronous data and prints 1,200 alphanumeric lines a minute.

Packard Bell Computer reports its two high-accuracy analog-to-digital converters are fast enough to digitize high-speed transient phenomena and telemetry data on-line. Speeds are 30,000 15-bit conversions a second and 70 Kc.

On-line auto/cross-correlation computer for medical electronics and vibration analysis is being exhibited by Mnemotron. Frequency response is 0.006 to 100 cps.

Transfer functions of servo systems can be derived directly with Wayne Kerr's new computer. Frequency range is 100 cps to 5 Kc.

Solid-state angle position indicator, featuring a 30-sec repeatability, accuracy of 6 min of arc, and digital readout over 360 degrees is being exhibited by North Atlantic Industries.

COMMUNICATIONS—North Electric says its digital-to-voice converter/multiplexer is unique. Airlines reservations and stock quotation systems are applications.

For amateurs, National Radio has a 6-inch-high ssb transceiver that puts out 200 watts. High-frequency crystal-lattice filter for both receiving and transmitting eliminates multiple conversions.

Tv camera that provides 1,000 horizontal lines and 700 vertical lines will be shown by Dage division of Thompson Ramo Wooldrige.

AN/ARW-79 receiver with proportional control decoder for controlling pilotless aircraft and missiles will be featured by RS Electronics. Avco will show its satellite radio-command receiver.

Rixon Electronics will demonstrate a digital-data modem that operates at up to 3,600 bits/sec. Unique feature is carrier exhalting or reinjection.

POWER SUPPLIES—Designed for lab and equipment use, a remotely programmable d-c power supply that delivers 0 to 100 v at up to 30 amp will be shown by Behlman-Invar Electronics. Consolidated Avionics has a series of low-cost silicon power supplies.

Several new amplifiers are being unveiled by M. Ten Bosch, Inc. One has voltage gain of 1 to 40 Mv.; another has gain of 2 to 10 Kv. A third is widely variable for use in laboratory servo setups. Mil-spec, solid-state amplifier by Loral Electronics, with a center frequency of 100 Mc, has gain of 66 db, 20-Mc bandwidth at 3 db.

TESTERS — Magnetic hysteresis loop tracer was designed by

Yokogawa Electric Works for graphical analysis of soft magnetic materials. Medium and high-power semiconductor devices can be tested with a unit from Sierra Electronic division of Philco. SCR gating circuits reduce power dissipation in devices tested.

Bridge to measure temperature coefficients of resistors from 1 ohm to 1 Meg is being introduced by Daven. California Technical Industries has updated its automatic circuit analyzer for programming input and output test data.

ANTENNA DRIVES—Its variable-speed tracking antenna system will be demonstrated by Technical Appliance. Hydraulic operation minimizes rfi.

Microwave Associates will introduce a multiple-bit phase shifter for L-band antenna scanning, expects it to have wide applications in phased-array radar.

Guarded-crossbar 600-channel scanner will be shown by Dymec division of Hewlett-Packard. Low signal-path resistance permits switching of microvolt signals.

Miniature pressure-sensitive cut-off charging devices for use with Yardney Electric's AgZn and AgCd batteries goes into operation as gassing increases within the battery to about 2 psig.

Panel meters only 3/4 inch in diameter will be among Triplett Electrical Instrument's new products. Infra-pack, a modular system for providing infrared instrumentation will be shown by Telewave Labs.

Consumer electronics competition from Japan is typified by a 16-inch color television set, featuring only a hue control for color adjustment, by Toshiba.

NEW FROM
SANGAMO

SANGAMO
SANGAMO
SANGAMO
SANGAMO
SANGAMO
SANGAMO
SANGAMO
SANGAMO
SANGAMO
SANGAMO
SANGAMO
SANGAMO
SANGAMO
SANGAMO
SANGAMO
SANGAMO
SANGAMO
SANGAMO



TOUGHER **TANTALUM** **CAPACITORS**



These solid electrolyte capacitors, Sangamo Type 595, represent a distinct achievement in tantalum capacitors. They utilize Sangamo's exclusive "Innerseal" construction with the terminals mechanically secured to the tubular container and precisely positioned without regard to the capacitor element. The seal is produced with a minimum of solder and flux, and with minimum thermal and mechanical stress on the glass insulator. There is absolutely no reliance on solder for mechanical strength. That's why these *tougher* units give peak performance under the most drastic shock and vibration conditions.

Sangamo tantalum capacitors comply with all the electrical and mechanical requirements of Mil-C-26655A.

Basically, these tantalum capacitors provide the highest capacitance per-cubic-inch in an extremely small and strong, hermetically sealed package.

Sangamo Type 595 capacitors are designed for filter, by-pass, coupling, blocking, and low voltage applications in telemetering devices, airborne systems, computers, missiles, and transistor circuits. They have low dissipation factor, low dc leakage, and excellent shelf life. They are available in capacitance values of 0.22 to 330 mfd, and in voltages from 6 to 35 WVDC. They're suitable for operation at full-rated voltages over a temperature range of -80°C to $+65^{\circ}\text{C}$ and, when properly derated, will operate up to $+125^{\circ}\text{C}$. Complete information is yours for the asking.



SANGAMO ELECTRIC COMPANY
SPRINGFIELD, ILLINOIS



NEW SANGAMO 4700 SERIES

THE MOST ADVANCED CONCEPT
IN MAGNETIC
TAPE INSTRUMENTATION



The new 4700 Series combines accuracy, application flexibility, and operator convenience unmatched in other instrumentation recorders.

ACCURACY Eddy current clutch for smoother tape handling—faster servo response of 50%/sec. over a range of 30% of nominal tape speed. Low-mass drive resulting in 100 times better TDE than conventional high-mass drives. Precision guiding for minimum tape skew. Vacuum tensioning and cleaning producing positive head-to-tape contact. Phase-equalized electronics.

FLEXIBILITY ¼-inch through 2-inch tape-handling capacity with no changes other than heads and guides. Reel-to-reel or continuous loop operation with no mechanical changes. Modular construction for system expansion. Four speeds of either FM or direct record and reproduce at the flip of a switch. Direct galvo drive capability plus squelch. Full IRIG compatibility.

CONVENIENCE 8 speeds (15/16 ips through 120 ips) controlled by a single switch—no belt changing. Attractive control panel designed for the operator. Eye-level electronics modules for quick, easy setup. No mechanical brake to adjust with linear DC reel drive servos.

There's much more to tell about the new 4700 Series . . . write, wire, or phone us for the complete story.

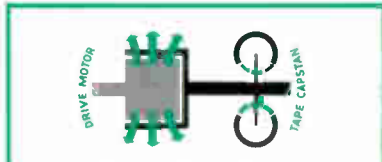

Unique capstan drive with no mechanical coupling isolates motor from capstan—an eddy current clutch is the secret. This vibration-free coupling system is combined with Sangamo's proven eddy current speed control in the only light-mass tape drive—another "first" for your instrumentation needs from Sangamo.

SANGAMO ELECTRIC COMPANY
SPRINGFIELD, ILLINOIS

MORE VERSATILE THAN EVER

"SPEEDIVAC"

MULTIPLE VAPOR SOURCE

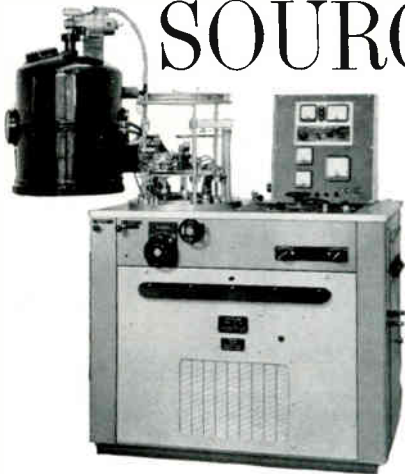

VACUUM COATING UNIT

Following are listed some of the special features supplied as standard fittings in the EDWARDS 19E6 evaporator.

Stainless Steel Bell Jar, Viton Gasketing, Six Position Vapor Source, Substrate Heater, Motor Driven Rotary Substrate Holder, Glow Discharge Cleaning, Ultimate Vacuum with LN² trap 2 x 10⁻⁷ Torr.

Fast reliable pump downs are, of course, a feature of all EDWARDS evaporators.

Write for your free technical reprints, written by members of our research staff on "Thin Films and Ultra High Vacuum Techniques."



MICRO-CIRCUIT JIG AND MASK CHANGER

The micro-circuit jig is complete with a six-position vapor source, enabling six 2" square substrates to be coated with six different materials using six different masks.

The jig is also provided with two substrate heaters, one to preheat the substrate to 150°C. and the second to raise the temperature of the substrate in the evaporation position to 300°C. Resistance monitor pick-up points are provided and separate resistance monitor and automatic source shutter can be provided.

Standard EDWARDS patented glow discharge cleaning rings are supplied with the jig, along with the rotating six-position vapor source.

The accuracy of registration of each successive mask in contact with a given substrate is within $\pm 0.001"$.



ELECTRON BOMBARDED VAPOR SOURCE

Designed as an inexpensive vapor source for depositing thick films of material containing Ni, Fe or Co. The source is complete with a wire feed mechanism and handwheel assembly for continuous controlled evaporation by feeding wire to the vapor source from the handwheel mounted externally on the coating unit. A complete power supply to operate the source is also available complete with interlocks to the vacuum system.



MARK II MODULATED BEAM PHOTOMETER

The "Speedivac" Modulated Beam Photometer provides a method of controlling the optical thickness of films deposited by evaporation or sputtering by indicating the changing optical characteristics of the films as their thickness increases. The instrument measures the reflection from or the transmission through coated glass surfaces as a function of wavelength. Both these quantities can be measured alternately if two light sensing elements are used.



OMEGATRON-MASS SPECTROMETER

The "Speedivac" Omegatron Mass Spectrometer analyzer delivers quantitative and qualitative data of minute quantities of residual gases and vapors in vacuum systems. The unit provides the following characteristics: High Sensitivity • Extended Range • Excellent Resolving Power • Rapid Response, Linear Scan • Pressure Measurement Independent of Gas Composition • High Sensitivity Leak Detection • Simple Construction.

GENERAL SPECIFICATIONS INCLUDE: Range—Mass 2-200; Resolution—Complete separation of adjacent peaks to mass 32 and very good separation to mass 60; Sensitivity—The unit's high sensitivity enables the analysis of residual gases in the range of 10⁻⁶ to 10⁻¹¹ Torr.

EDWARDS HIGH VACUUM INC. / 3279 GRAND ISLAND BLVD., GRAND ISLAND, N.Y.
MANUFACTURERS OF THE MOST COMPLETE LINE OF HIGH VACUUM COMPONENTS AND SYSTEMS

HOW CHEAP IS "CHEAP"?

"Why should we buy from you when we can get the 'same thing' from other suppliers at a lower price?"

In selecting a supplier of lacing tape (or any component), price and compliance with specifications are not the only criteria. But too often, manufacturers ignore the other factors involved and consequently lose money.

For example, in a \$15,000 piece of equipment there may be only 15 cents worth of Gudebrod lacing tape. It costs \$75 to work this tape. It may be possible to buy the same amount of tape from other suppliers for 2 or 3 cents less . . . it "will meet the specs" according to these suppliers. But one of our customers recently pointed out why he still specifies only Gudebrod lacing tape in such cases.

"We tried buying some cheaper tape that 'met the specs.' Within a few months our production was off by 50% . . . boy, did the production people really scream about that tape. And our labor costs doubled . . . our costing people really flipped!

"Another thing, why should we risk the possible loss of thousands of dollars when the original material cost difference is only a few cents. Once you put cheaper tape on and something goes wrong after the equipment is finished . . . you've had it. No, thank you! We learned our lesson! We buy Gudebrod lacing tape!"

Whether your firm uses one spool of lacing tape or thousands, there are four advantages in specifying Gudebrod for all your lacing requirements:

- 1. Gudebrod lacing tape guarantees increased production!*
- 2. Gudebrod lacing tape guarantees reduced labor costs!*
- 3. Gudebrod lacing tape guarantees minimal maintenance after installation!*
- 4. Gudebrod guarantees quality!* On every spool is a lot number and seal which guarantees that all Gudebrod lacing tape is produced under strict quality control. Our standards are more exacting than those required for compliance with Mil-T.

Our Technical Products Data Book explains in detail the complete line of Gudebrod lacing tapes for both civilian and military use. For your copy write to Electronics Division



UDEBROD BROS. SILK CO., INC.

FOUNDED IN 1870

Electronics Division

12 SOUTH 12th STREET, PHILADELPHIA 7, PENNA.
VISIT GUDEBROD BOOTH #4032 AT THE IEEE SHOW

MEETINGS AHEAD

PACIFIC COMPUTER CONFERENCE, IEEE; California Institute of Technology, Pasadena, Calif., March 15-16.

BIONICS SYMPOSIUM, United States Air Force; Biltmore Hotel, Dayton, Ohio, March 18-21.

EUROPEAN ELECTRONICS MARKET, EIA; Statler Hilton, Washington, D. C. March 19-22.

INSTITUTE OF PRINTED CIRCUITS MEETING, IPC; Barbizon-Plaza Hotel, New York City, March 25-27.

IEEE INTERNATIONAL CONVENTION, Institute of Electrical and Electronics Engineers; Coliseum and Waldorf-Astoria Hotel, New York, N. Y. March 25-28.

ELECTRON BEAM SYMPOSIUM, Alloyd Electronics Corp.; Somerset Hotel, Boston, Mass. March 28-29.

ENGINEERING ASPECTS OF MAGNETO-HYDRODYNAMICS SYMPOSIUM, IEEE, IAS, University of California; at UC, Berkeley, Calif., April 10-11.

OHIO VALLEY INSTRUMENT-AUTOMATION SYMPOSIUM, ISA, et al; Cincinnati Gardens, Cincinnati, Ohio, April 16-17.

CLEVELAND ELECTRONICS CONFERENCE, IEEE, Case Institute, Western Reserve University, ISA; Hotel Sheraton, Cleveland, O., April 16-18.

OPTICAL MASERS SYMPOSIUM, IEEE, American Optical Society, Armed Services, et al; Waldorf Astoria Hotel, New York City, April 16-18.

INTERNATIONAL NONLINEAR MAGNETICS CONFERENCE, IEEE; Shoreham Hotel, Washington, D. C., April 17-19.

SOUTHWESTERN IEEE CONFERENCE & ELECTRONICS SHOW, IEEE (Region 5); Dallas Memorial Auditorium, Dallas, Texas, April 17-19.

BIO-MEDICAL ENGINEERING SYMPOSIUM, IEEE, et al; Del Webb's Ocean House, San Diego, Calif., April 22-24.

NATIONAL ELECTROMAGNETIC RELAY CONFERENCE; Oklahoma State University; OSU, Stillwater, Okla., April 23-25.

ADVANCE REPORT

INSTRUMENT SOCIETY OF AMERICA CONFERENCE, ISA; McCormick Place, Chicago, Ill., Sept. 9-12. March 30 is deadline for submitting abstracts to: T. A. Abbot, Conference Program Coordinator, Instrument Society of America, Penn Sheraton Hotel, 530 Wm. Penn Place, Pittsburgh 19, Pennsylvania. Technical sessions to be given include: aerospace instrumentation; analog computation and process control; analysis instrumentation; automatic control systems; computer control and systems engineering; data handling and computation; electronic instrumentation; noise, shock and vibration measurement; radiation methods of analysis; reference voltage devices & techniques; solid state controls & instruments; transducers.

The Siliconix 12 nsec 5 mw Dual NAND Gate

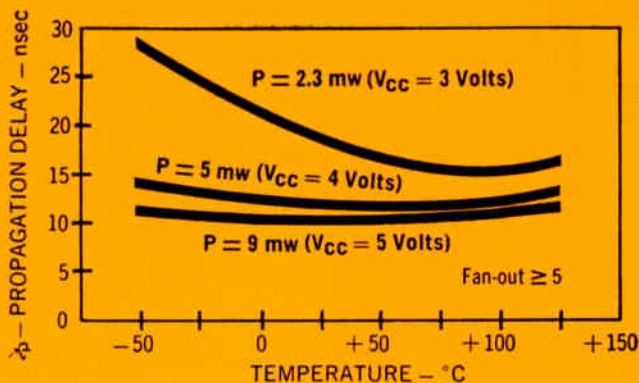
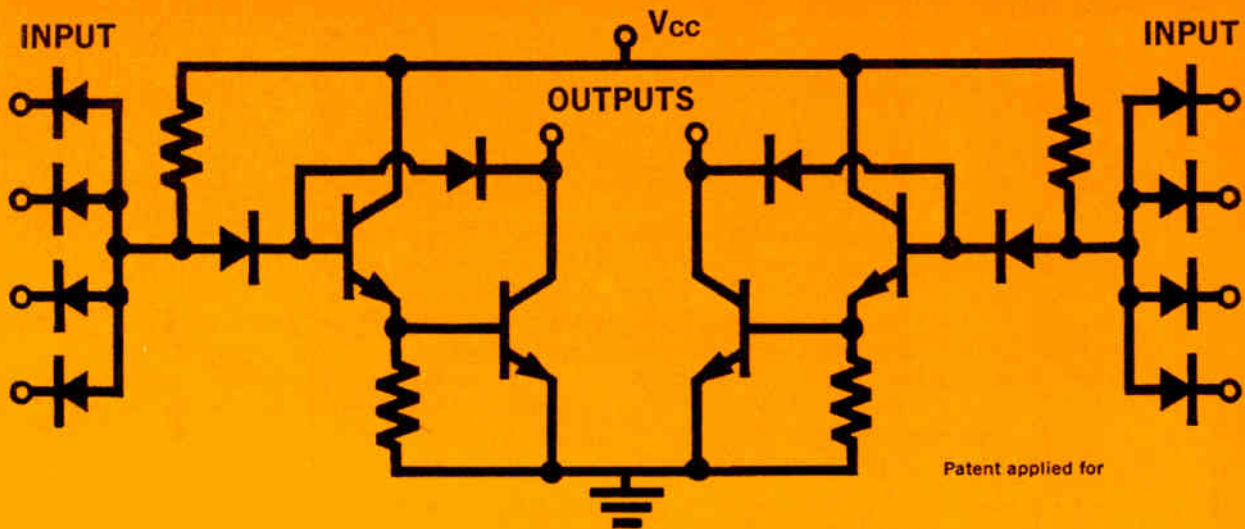

Average Propagation Delay vs. Temperature and Power Dissipation

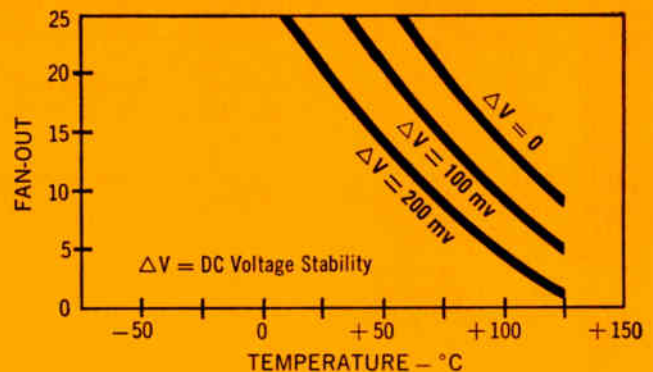

Fan-out as a Function of DC Stability and Temperature

THIS PLANAR SILICON INTEGRATED CIRCUIT HAS A LOWER POWER-SPEED PRODUCT (60 PICOWATT-SECONDS) AT HIGHER FAN-OUT THAN CONVENTIONAL DIODE-COUPLED NAND GATES BECAUSE OF:

- The unique emitter-follower diode-clamp circuit . . .
- Small geometry which minimizes capacitance . . .
- Epitaxially grown collectors.

PROPAGATION DELAY VARIES LESS THAN $\pm 7.5\%$ FROM -55°C TO $+125^{\circ}\text{C}$ WITH V_{CC} 4 TO 5 VOLTS. USE THIS GATE AS A NAND, NOT AND-OR, BISTABLE FLIP-FLOP, OR HALF ADDER. ANOTHER EXAMPLE OF THE WAY SILICONIX COMBINES CIRCUIT AND SEMICONDUCTOR TECHNOLOGIES INTO DIGITAL AND LINEAR INTEGRATED CIRCUITS AND COMPONENTS. WRITE FOR DETAILS.



Siliconix incorporated

1140 West Evelyn Ave. • Sunnyvale 33, California
Telephone 245-1000 • Area Code 408 • TWX 408-737-9948

FOUR YEARS OF PERFORMANCE – FOUR YEARS OF EXPONENTIAL GROWTH

Many test instruments have been shipped thru our doors since we first opened them in 1959 and it leaves us with a feeling of appreciation to our customers—not just because you have bought our products but because you have recognized our pledge to maintain performance, reliability, flexibility and instrument accessibility. We estimate some 20 million charts may have been plotted on our equipment by now. But the chart we're proudest of was not plotted on **one** of our recorders . . . but **by ALL** of them. That is our own growth chart. It's fun looking at a growth curve that just goes up. Of course, we're not getting smug about it . . . we know we're not the biggest in the field. We're just going to keep adding to our line with one thought in mind: our growth can only result by a continuous, successful striving for designed simplicity. May we send you a brochure?

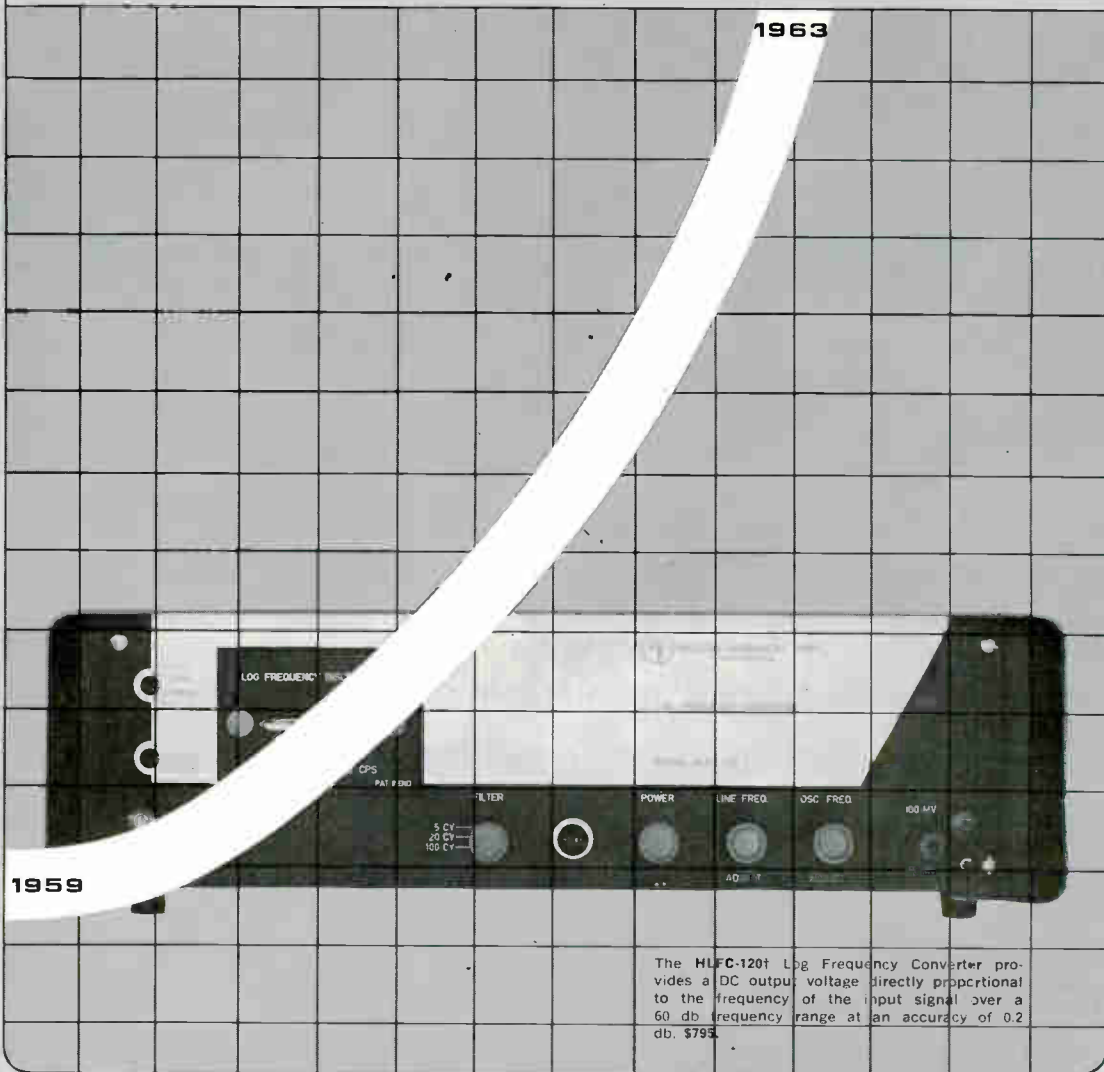

The **HLFC-120t** Log Frequency Converter provides a DC output voltage directly proportional to the frequency of the input signal over a 60 db frequency range at an accuracy of 0.2 db. \$795.

SEE US IN BOOTH 3029 AT 1963 IEEE SHOW MARCH 25-29

16 PAGE SHORT FORM CATALOG AVAILABLE ON REQUEST



HLVC 150 The HLVC-150 log voltmeter-converter's new design principle permits measurements accurate to 0.2 db of voltage or voltage ratios on a true logarithmic scale over a 3160:1 or 70 db continuous range. AC or DC inputs, DC output for recording. \$1450.

EXCLUSIVE
Moveable =
75db scale with
Thumbwheel Adjust



HR 95



The HR-95 Recorder, a high performance 8 1/2 x 11" recorder featuring plug-in modules and dual regulated zener reference supplies. Front recording panel swings open for easy access to all of the electrical and mechanical components. \$1250.

HR 80



The HR 80 T-Y* recorder provides rectangular recording as a function of time on standard graph paper of any variable expressible as DC voltage. \$475.

* TM Houston Instrument Corporation

HR 97



Emphasizing a straightforward design approach, the HR-97 is an 11 x 17" XY recorder with 1 mv/in. basic sensitivity, 0.25% of full scale accuracy, 15 in/sec. pen speed, zener reference voltages, snap-on pen assembly and vacuum paper hold-down. \$1350.

HR 96



The HR 96 is an 8 1/2 x 11" XY recorder with a 1 mv/in basic sensitivity, 0.25% accuracy, 10 in/sec. pen speed, zener reference voltages, snap-on pen assembly and 0.5 to 2 in/sec. time base. \$895.



houston instrument Corporation

4950 TERMINAL AVENUE / BELLAIRE 101, TEXAS / MOhawk 7-7403 / Cable: HOINCO TWX: 713-571-2063 † PATENTS PENDING

PUMPS • VALVES • BAFFLES • GAUGES

VACUUM COMPONENTS

DIFFUSION PUMPS



Only NRC offers a full line of high-speed diffusion pumps with all these important advantages:

- No super-heating... minimizes pump fluid decomposition.
- Fractionating jet assembly... constantly purifies pump fluid... lower pressures can be held longer.

- Patented Cold Cap*... an NRC exclusive... cuts back-streaming 98%.

Available now in 4", 6", 10", 16" and 32" sizes for all your high vacuum testing and production applications, where performance and reliability really count.

*Licensed exclusively from Edwards High Vacuum Limited. U.S. Patent No. 2919061.

SLIDE VALVES



New NRC Slide Valves (HC Series) are *very-high* and *ultra-high* vacuum valves at *conventional* prices. Pressures of 10^{-8} to 10^{-10} torr range have been produced... without baking... in vacuum systems using these valves. 100% clear opening and low height provide highest conductance. Double-pumped stem seal cuts gas bursts 99%. They're available in 4" and 6" sizes, either hand or air operated.

CRYO AND MOLECULAR BAFFLES



Now, your high vacuum system can be operated at lowest pressures for extended periods of time *with no detectable trace of hydrocarbons reaching the chamber!* The reason: NRC's Circular Chevron Cryo Baffle and the all-new NRC Molecular Sorbent Baffle (which utilizes three full trays of zeolite) virtually eliminate back-migration of pump fluid vapors. Yet, they provide exceptionally high conductance for maximum *useful* pumping speed.

VACUUM GAUGES



Get accurate, reproducible direct-readings to 10^{-13} torr with the new NRC Model 752 Red-head Magnetron Gauge! The only really satisfactory gauge commercially available for measurements below 1×10^{-9} torr. Increased current readings provide 50 times the sensitivity of hot-wire ionization gauges. Because there's no hot filament, it's magnitudes less "gassy", can't become contaminated by vaporizing of gauge elements. And the 752 Gauge is not X-ray limited.

NRC's full line of vacuum gauges and controls also includes an improved Bayard-Alpert type gauge, Model 751, for accurate, reliable measurement in the 1×10^{-3} to 10^{-10} torr range.



A Subsidiary of National Research Corporation

160 Charlemont St.
Newton 61, Massachusetts
Area Code 617, DEcatur 2-5800

SEE THESE AND OTHER NEW NRC
VACUUM COMPONENTS AND SYSTEMS
—IEEE SHOW BOOTH #4425-4427

MANUFACTURING PLANTS IN NEWTON, MASSACHUSETTS AND PALO ALTO, CALIFORNIA.

New DPDT TRIMPOT® Relay: 160 mw Sensitivity, Microminiature Size!

This new DPDT is more than just small—it's reliable! Subject it to 150 G shock or 30 G, 3000 cps vibration, and you still get the performance that's on the published data sheet. Model 3101 has single-coil design, rotary balanced armature, hermetically sealed case, and self-cleaning contacts. It's designed to meet or exceed all environmental requirements of MIL-R-5757D.

Every relay goes through a 5000-operation run-in and 100% final inspection, including mass-spectrometer leak testing, for all important characteristics. In addition, monthly samples undergo the punishment of the Bourns Reliability Assurance Program. This program, originally developed for TRIMPOT potentiometers, is one of the most extensive series of electrical and environmental tests in the electronics industry. It underscores the trustworthiness of the name TRIMPOT in relays, too.

Model 3101 relays and their SPDT companion, Model 3100, are available immediately from the factory in a full range of coil-resistances and with voltage or current adjustment. Three terminal types, two mounting-bracket styles. Write for complete technical data.

Size: .2" x .4" x .6"
Maximum operating temperature: 125°C
Contacts: DPDT; Rating: 1.0 amp resistive, 26.5 VDC
Coil resistances: 65Ω to 2000Ω
Pick-up sensitivity: 160 milliwatts
Vibration: 30 G standard, 60 G special
Shock: 150 G



ACTUAL SIZE

Compare its space requirements with those of the usual crystal-can or half-crystal-can types.

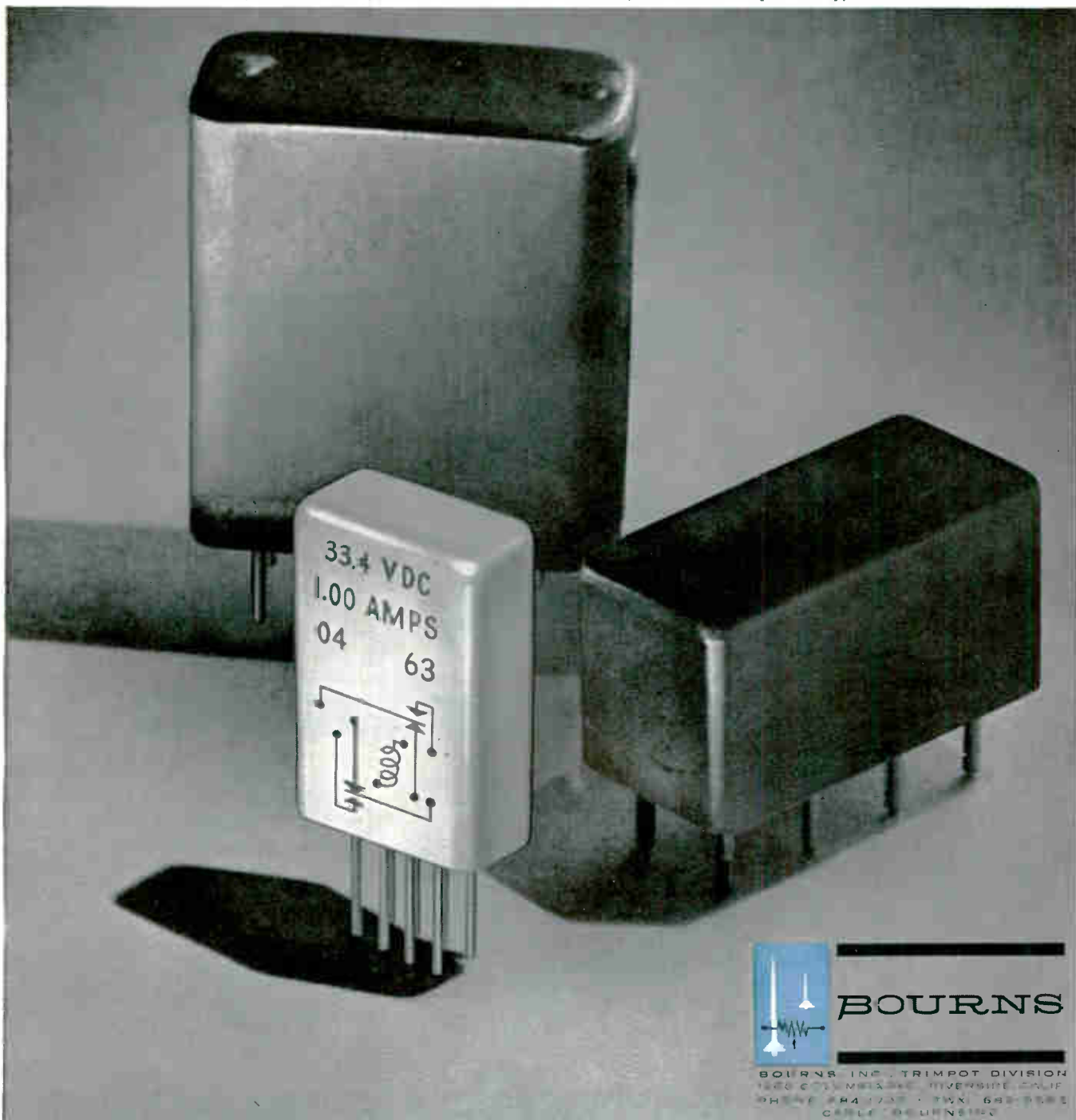

BOURNS

BOURNS INC., TRIMPOT DIVISION
1200 COLLETT DRIVE, RIVERSIDE, CALIF.
PHONE 944-1737 • TWX 680-0001
CABLE BOURNS-2

Manufacturer: TRIMPOT® potentiometers; transducers for position, pressure, acceleration. Plants: Riverside, Calif.; Ames, Iowa; and Toronto, Canada

SEE BOURNS PRODUCTS IN BOOTHS 1429-1431 AT THE IEEE SHOW

CIRCLE 49 ON READER SERVICE CARD

SWITCH TO TECH LABS for Precision Electrical Resistance Instruments

TAP SWITCHES

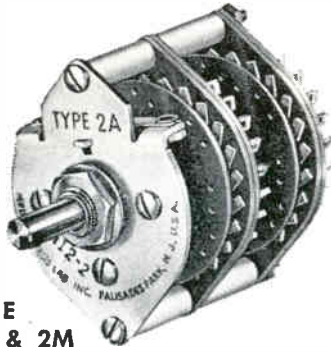

TYPE 2A & 2M

Standard control switch with phenolic or Melamine insulation, 3-5 amp. rating.



**TYPE 3A
MINIATURE
TAP SWITCH**

\$3.00 List (Without Handle) Molded from Diallyl Phthalate

Specifications

Size: 1" diameter, 1 1/4" with terminals. 1 deck, 1 1/4" long, 1/2" for each additional deck.
Weight: 1 deck, 30 grams. 10 grams for each additional deck.
Rating: 1200 volts rms, 2000 VDC, 5 amps. (carrying) 115 V.
Insulating resistance: 100 megohms minimum at 500 volts DC.
Life: 1.5 - 2 million revolutions.
Contact resistance (standard): 6-10 milliohms. (silver): 3-5 milliohms.
Temperature range: -65°C to 100°C.
Mounting: single hole.
Meets MIL-S-3786A.

CAM SWITCHES



**TYPE 8A
CAM
SWITCH**

A new development of great interest. Small size, long life and great flexibility. Have been made with from one to 30 contact springs. Will carry 3 amp. Standard unit has four contact springs and 10 positions, price \$12.50.



**TYPE 10A
TAP SWITCH**

A multi-deck switch of small dimensions, 1 3/8" sq. This is a precision switch designed to meet high requirements in smallest possible space. Up to 24 positions, shorting. Price approx. \$10 per deck, plus frame \$5.

The following standard switches are representative of those produced by Tech Laboratories, all of which meet government specifications. Write or teletype for further information.

The Type 2A is the standard control switch for electronic instruments and high quality equipment. It is made in a number of combinations with as many as four poles per deck and 24 positions. Insulation is phenolic. The Type 2M is identical except for Melamine insulation. In the table, Code No. "S" stands for "shorting" and "N" for "non-shorting".

TYPE	CODE	DIA.	RATING	NO. POS.	NO. DECKS	POLD.	PRICE
2A	A1S24	1 3/4"	3A	24	1	1	\$4.50
2A	A4S5	1 3/4"	3A	4	1	4	\$6.00
2A	A1N10-2	1 3/4"	3A	10	2	1	\$7.00
2M	M1S24	1 3/4"	3A	24	1	4	\$5.50
2M	M4N3	1 3/4"	3A	3	1	4	\$7.00

The new Type 3A molded miniature switch for use in all military and commercial applications in which a superior instrument switch is required, can be furnished with as many as eight decks and up to twelve positions per deck, single pole, or six positions double pole. It has adjustable stops for any lower number of steps.

The switch, 1 1/4" in diameter, carries 5 amp and is furnished "Shorting", with "non-shorting" types available on request. It can be supplied solenoid-operated and hermetically sealed. Write for details and prices.

SQUARE SWITCHES



TYPE 600

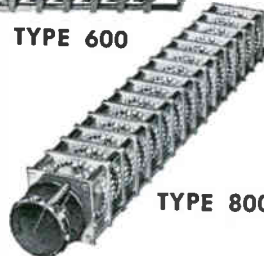

TYPE 800

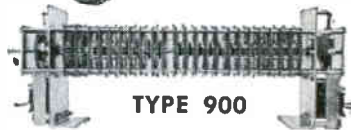

TYPE 900

These standard rugged control switches are the standby for equipment calling for dependable switches in a hurry. Will meet all standard government specs. All parts carried in stock. An infinite number of combinations possible. Teletype your specs.

The price of the basic frame is the same for all, viz. \$4.00 each. The type 600 and 800 are priced at \$8.00 per deck plus frame price, and the type 900 switches are \$9.50 per deck plus frame \$4.00.

Type	Size	Rating	Max. Pos. Short.	Max. Pos. Non-Short.
600	1 3/4" sq.	5A.	24	12
800	2 1/4" sq.	5A.	32	16
900	2 3/4" sq.	10A.	48	24

OTHER TECH LAB SWITCHES



**STEPPING
SWITCHES**

TECH LAB switches are now standard equipment in most missiles as well as in ground controls. Furnished sealed to meet all specs. Write for details. Prices on request.



ATTENUATORS

A complete line of audio and r.f. attenuators with both manual and REMOTE CONTROL. We will design components to meet your specific requirements, if standard units are inadequate. Please write for catalogue and send us your specs for estimate.



WRITE FOR INFORMATION ON NEW DIGITAL BINARY SWITCHES

WRITE FOR NEW BULLETINS ON SWITCHES • DECADE RESISTORS • POTENTIOMETERS
TECH LABORATORIES INC. • Palisades Park, New Jersey

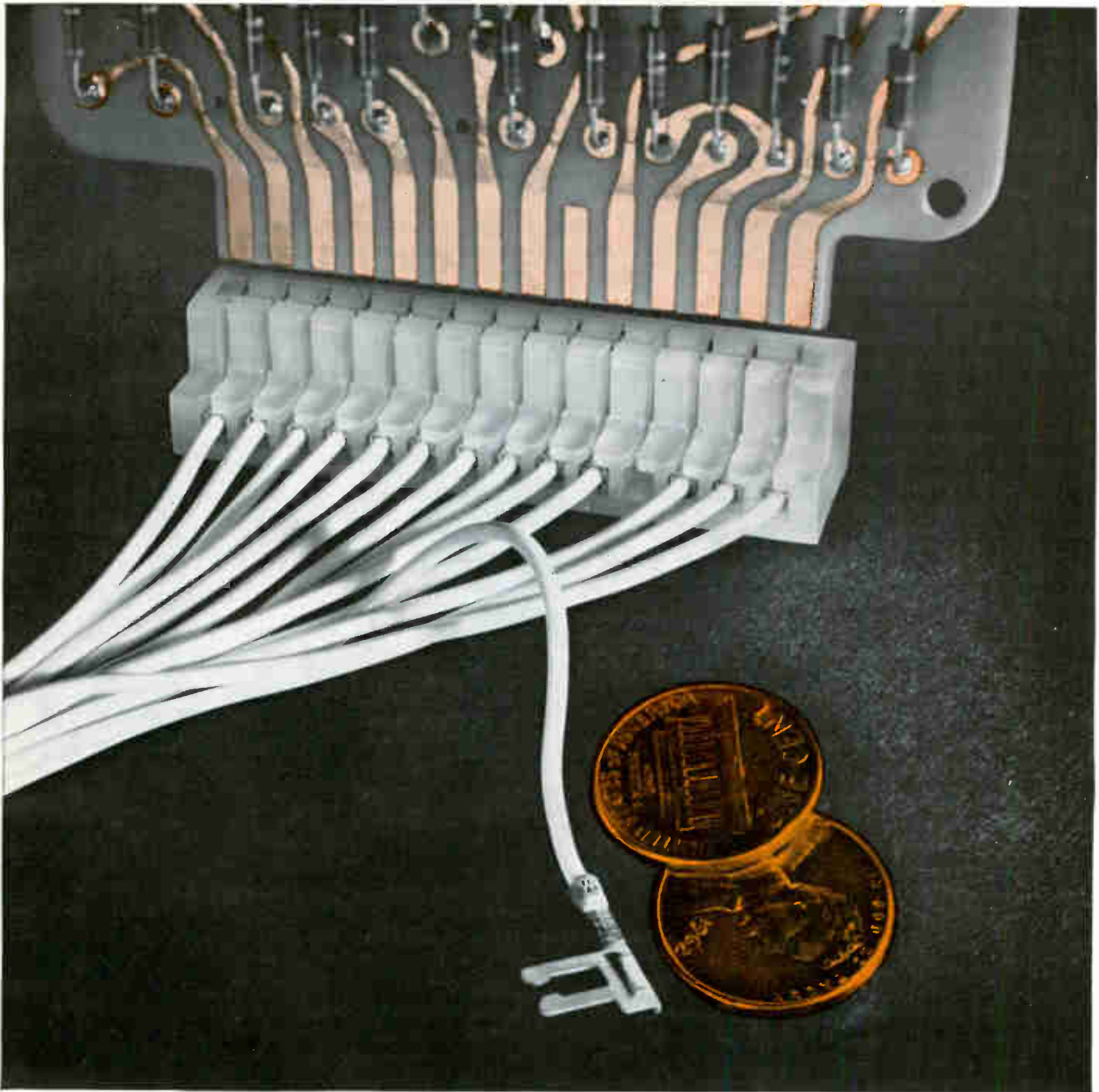

Put our 2¢ worth in!

Think solid state design's too expensive? Not with AMPin-cert* DUO-TYNE* Flag Connectors. Cost approximates **just 2¢ a line!** And performance meets and exceeds all UL requirements. This low cost reliability means that now you can design solid state components into **all** your electrical/electronic products (washers, dryers, power tools, vending machines, organs, etc.).

And there's no worry here that production problems will stifle your design creativity. This connector is right down the production man's alley. Strip-mounted, crimp, manual snap-in contacts make possible automated job lot assembly. This means speedy automatic wire preparation with an A-MP* crimping machine. Separate harness assembly. Swift loading of connector housings. Penny-pinching features that add up to big dollar savings in the form of **lowest installed costs.**

In-use service is no trouble with snap-in snap-out contact design. This allows for simplified field servicing. Every

AMP products and engineering assistance are available through subsidiary companies in: Australia • Canada • England • France • Holland • Italy • Japan • Mexico • West Germany

way you look at it, the AMPin-cert DUO-TYNE Flag Connector is a money-saver—a money-saver that means wider design parameters for you. Learn more about this economical new connector. How it can help you get more design freedom, greater reliability and lowest installed costs.

Extensive product line includes 3 position to 22 position housings . . . with or without mounting ears. Wherever your need, whatever your need, AMP puts an end to every circuit problem! Additional information available on request.

*Trademark of AMP INCORPORATED

AMP
INCORPORATED
Harrisburg, Pennsylvania



Visit us at the IEEE Show, Booths 2527-31 and 2837, March 25-28, 1963

CIRCLE 51 ON READER SERVICE CARD

ANCIENT HISTORY

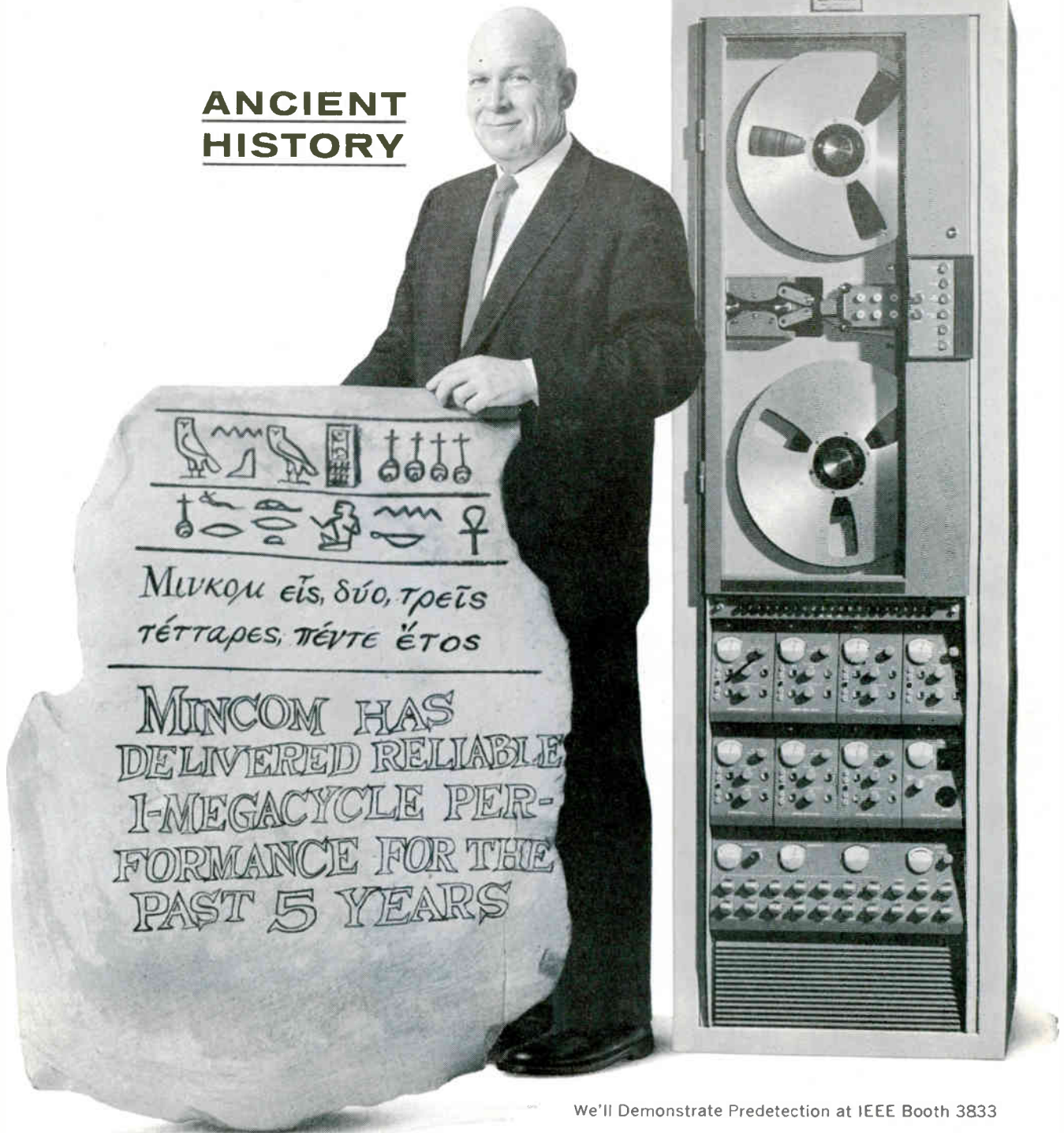

We'll Demonstrate Predetection at IEEE Booth 3833

Reliable wideband performance at Mincom is an old story — and a good one. Mincom systems were recording and reproducing extremely complex signals at 1 mc as far back as 1955. Today Mincom's 1-mc system, the CM-100, is noted as a pioneer in operational predetection. Another system, the CMP-100, is a smaller mobile unit for recording in the field — also with 1 mc at 120 ips. The CM and CMP (as well as the other two basic Mincom systems) provide the simple, reliable data-gathering capability possible only with longitudinal recording on fixed heads. For all the details on Mincom's dependable wideband instrumentation, write us today.

Mincom Division **3M**
COMPANY

2049 South Barrington Avenue, Los Angeles 25
425 13th Street N. W., Washington 4, D. C.

SUBMINIATURE CIRCUIT BREAKERS

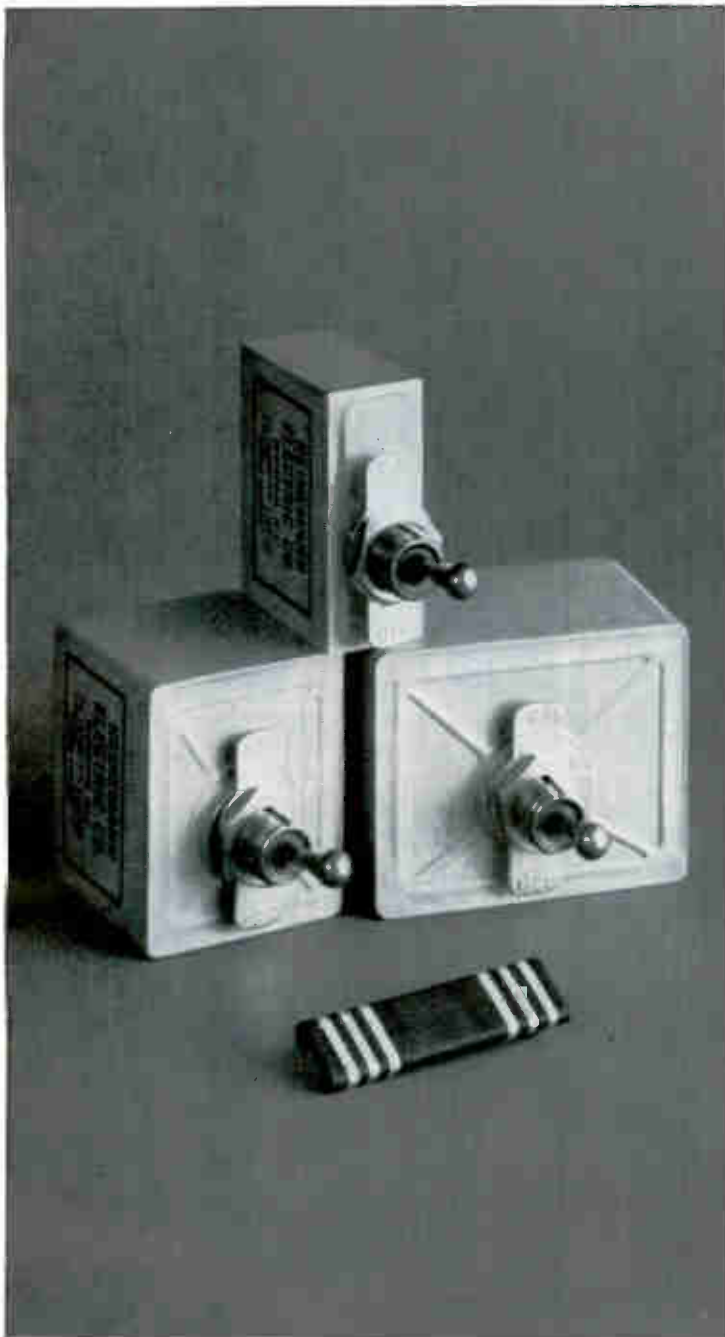

MIL-TYPE

The Heinemann Series SM: hermetically sealed and built to take it under rough environmental conditions. One-, two-, and three-pole models. Available in any integral or fractional current rating you want, from 0.050 to 20 amps. For 230V AC, maximum, 60 or 400 cycles AC; or 50V DC, maximum. Choice of two time-delay responses for each voltage frequency. Hydraulic-magnetic actuation provides temperature-stable performance: nominal load-current capacity and specified trip-points are completely unaffected by ambient temperature. Details: Bulletin 3504.

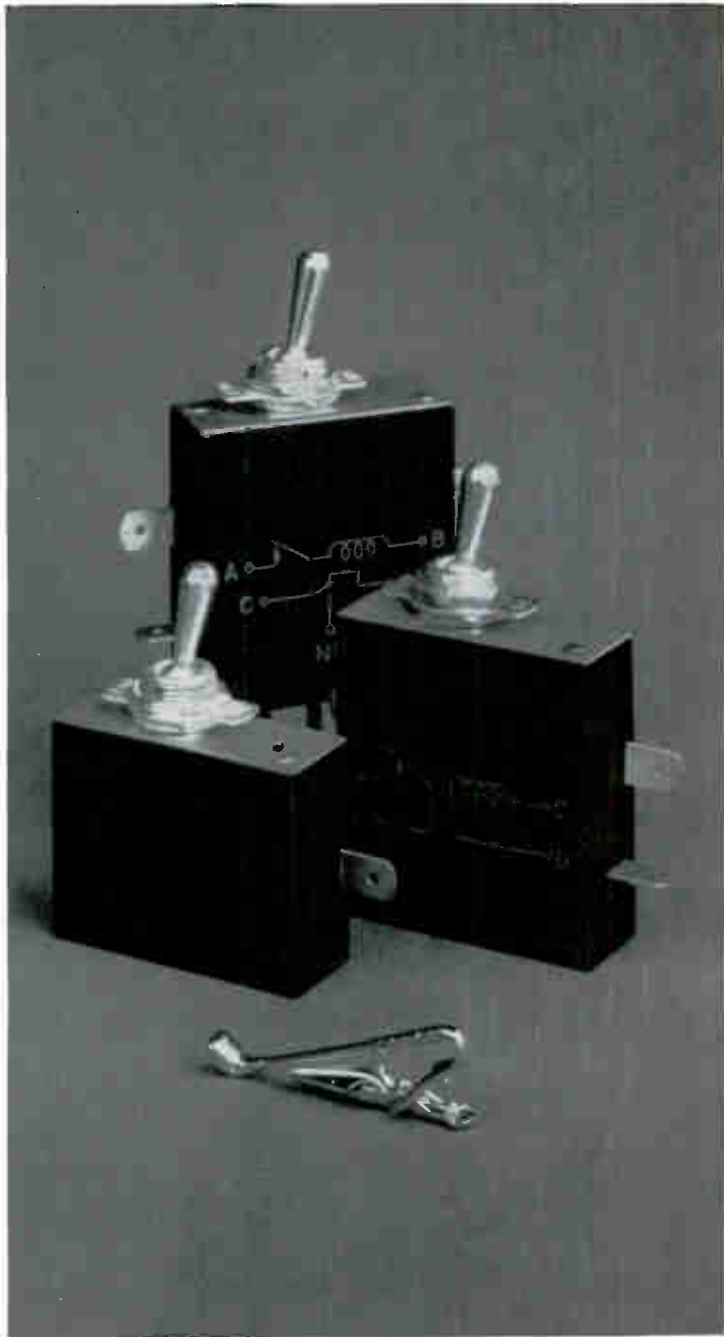

COMMERCIAL

The Heinemann Series VP: low-cost, molded-case, commercial version of the Series SM, opposite. Exceptionally lightweight: only 1.5 ounces. Single-pole only. Can be supplied in our conventional series-trip construction or any of four special-function models (shunt-trip, relay trip, calibrating-tap, auxiliary-contact). Available in the same range of current and voltage ratings as the Series SM, and with a similar choice of time-delay responses. Hydraulic-magnetic actuation, of course—hence, no de-rating for high ambient temperatures. Details: Bulletin VP.

HEINEMANN ELECTRIC COMPANY  2600 Brunswick Pike, Trenton 2, N. J.

CIRCLE 53 ON READER SERVICE CARD

Special Introductory Offer

To new members of the
ELECTRONICS and CONTROL ENGINEERS' Book Club

ANY ONE

FOR
ONLY

\$1.00

YOURS WITH A CHARTER MEMBERSHIP
AND SENT WITH YOUR FIRST SELECTION

VALUES FROM \$7.00 TO \$22.50

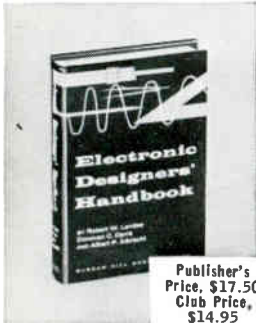

Publisher's
Price, \$17.50
Club Price,
\$14.95

Electronic Designers' Handbook, Edited by R. W. Landee, D. C. Davis, and A. P. Albrecht. Presents detailed, practical design data.

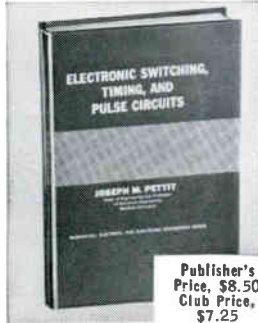

Publisher's
Price, \$8.50
Club Price,
\$7.25

Electronic Switching, Timing, and Pulse Circuits by J. M. Pettit. Provides a practical understanding of complex circuits.

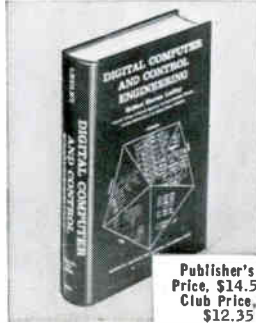

Publisher's
Price, \$14.50
Club Price,
\$12.35

Digital Computer and Control Engineering by R. S. Ledley. Full coverage from basic design to advanced programming techniques.

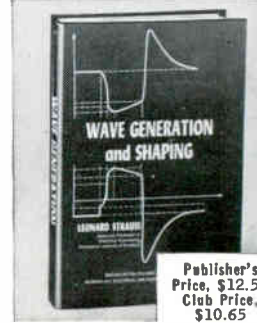

Publisher's
Price, \$12.50
Club Price,
\$10.65

Wave Generation and Shaping by L. Strauss. Essential features and techniques of practical wave-generating and -shaping circuits.

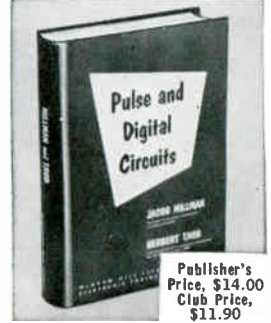

Publisher's
Price, \$14.00
Club Price,
\$11.90

Pulse and Digital Circuits, by J. Millman and H. Taub. Fully explains pulse and digital circuit operation for electronic systems design.

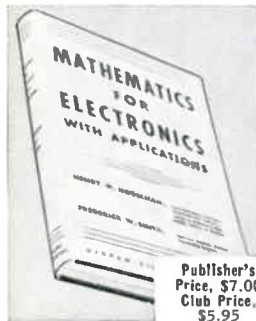

Publisher's
Price, \$7.00
Club Price,
\$5.95

Mathematics for Electronics with Applications by H. M. Nodelman and F. W. Smith, Jr. Methods for solving practical problems.

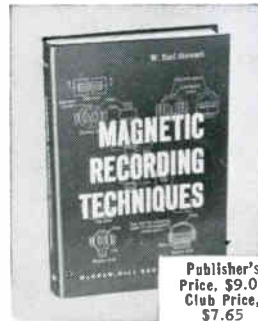

Publisher's
Price, \$9.00
Club Price,
\$7.65

Magnetic Recording Techniques by W. E. Stewart. Full description of magnetic recording methods and devices.



Publisher's
Price, \$22.50
Club Price,
\$19.10

Control Engineers' Handbook by J. C. Truxal. A wealth of practical help on automatic feedback control systems.

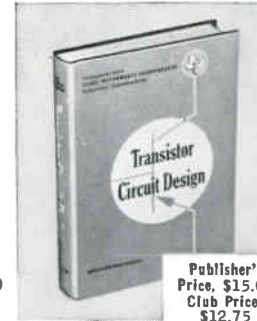

Publisher's
Price, \$15.00
Club Price,
\$12.75

Transistor Circuit Design, prepared by the Engineering Staff of Texas Instruments Inc. Reduces theory to actual practice.

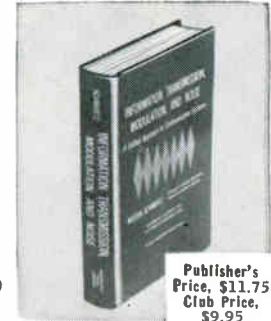

Publisher's
Price, \$11.75
Club Price,
\$9.95

Information Transmission, Modulation, and Noise by M. Schwartz. A unified approach to communication systems.

How many of the books shown here do you wish you had immediately at hand?

Select one for JUST A DOLLAR! Choose from *Electronic Designers' Handbook*, *Magnetic Recording Techniques*, *Wave Generation and Shaping*, and seven other valuable books . . . your introduction to membership in *The Electronic and Control Engineers' Book Club*.

If you're missing out on important technical literature—if today's high cost of reading curbs the growth of your library—here's the solution to your problem. *The Electronic and Control Engineers' Book Club* was organized for you, to provide an economical technical reading program that cannot fail to be of value to you.

All books are chosen by qualified editors and consultants. Their thoroughgoing understanding of the standards and values of the literature in your field guarantees the authoritativeness of the selections.

How the Club operates. Periodically you receive free of charge *The Electronic and Control Engineers' Book Bulletin* (issued eight times a year). This gives complete advance notice of the next main selection, as well as a number of alternate selections. If you want the main selection you do nothing; the book will be mailed to you. If you want an alternate selection . . . or if you want no book at all for that particular period . . . notify the Club by returning the convenient card enclosed with each *Bulletin*.

We ask you to agree only to the purchase of three books in a year. Certainly out of the

large number of books in your field offered in any twelve months there will be at least three you would buy anyway. By joining the Club you save yourself the bother of searching and shopping, and save in cost about 15 per cent from publishers' prices.

Send no money now. Just check any two books you want—one for only \$1.00 and one as your first Club selection—in the coupon below. Take advantage of this offer now, and get two books for less than the regular price of one.

THIS COUPON IS WORTH UP TO \$21.50

The Electronic and Control Engineers' Book Club, Dept. L-3-15
330 West 42nd Street, New York 36, N. Y.

Please enroll me as a member of the Electronic and Control Engineers' Book Club. I am to receive the two books I have indicated at the right. You will bill me for my first selection at the special club price and \$1 for my new membership book, plus a few additional cents for delivery costs. (The Club assumes this charge on prepaid orders.) Forthcoming selections will be described to me in advance and I may decline any book. I need take only 3 selections or alternates in 12 months of membership. (This offer good in U.S. only.)

PLEASE PRINT

Name

Address

City..... Zone..... State.....

Company

NO RISK GUARANTEE If not completely satisfied, you may return your first shipment within 10 days and your membership will be canceled.

Check 2 Books: We will send the higher priced book for only \$1.00, and the other as your Club Selection:

- Electronic Designers' Handbook, \$14.95
- Electronic Switching, Timing, and Pulse Circuits, \$7.25
- Digital Computer and Control Engineering, \$12.35
- Wave Generation and Shaping, \$10.65
- Pulse and Digital Circuits, \$11.90
- Mathematics for Electronics with Applications, \$5.95
- Magnetic Recording Techniques, \$7.65
- Control Engineers' Handbook, \$19.10
- Transistor Circuit Design, \$12.75
- Information Transmission, Modulation, and Noise, \$9.95

SILICON PLANAR EPITAXIAL DIODES

TRANSITRON'S NEW SG5000-5400 SERIES — OUTSTANDING SUCCESSORS TO THE POPULAR SG5000 — PROVIDES THE MOST EFFECTIVE COMBINATION OF HIGH FORWARD CONDUCTANCE, LOW CAPACITANCE AND FAST SWITCHING EVER OFFERED TO THE INDUSTRY.

DEMANDED



Introduced a short time ago, the SG5000 offered a new high in reliability, performance and versatility that quickly made it a popular component for computer circuit design. Fully aware of the need for a complete range of similar devices, Transitron has now developed a series of premium subminiature glass silicon planar epitaxial diodes.

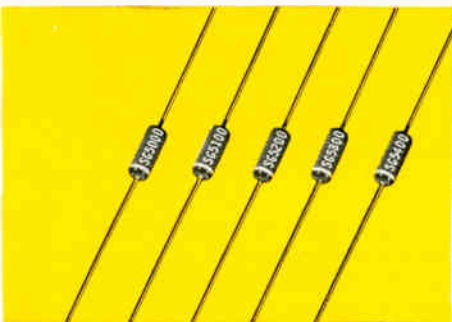

EXPANDED

Transitron's new SG5000-5400 series offers a combination of 3 major characteristics that is superior to any now available: higher forward conductance . . . 200 to 400 mA @ 1 Volt; lower capacitance . . . 2 to 4 pf @ 0 Volts; faster switching . . . down to 2 nsec. All types will fully meet the rigid requirements of military and space exploration high reliability systems.

highly compatible with the critical space limitations of computer memory core systems.

Another important application is logic systems. The SG5000 series provides tightly controlled lower forward voltages at specified low current levels, and more units can be paralleled and still deliver fast switching.

Because these units fulfill maximum diode specifications, it is no longer necessary to use 2 or 3 diode types in a system. Now, only one diode need be evaluated for component procurement.

All SG5000-5400 silicon planar epitaxial diodes are digitally marked for quick diode type identification. And all types are also available through your Transitron Distributor... For further information, write for Transitron's "Silicon Planar Epitaxial Diode" bulletins.

SPECIFICATIONS AT 25°C

Type	Minimum Forward Current @ 1 Volt (mA)	Minimum Breakdown Voltage @ 5 μ A (Volts)	Maximum Capacitance @ 0 Volts (pf)	Maximum Inverse Recovery Time (nsec)
SG5000	200	100	2	2
SG5100	400	50	4	2
SG5200	400	75	4	2
SG5300	300	100	2	2
SG5400	200	150	2	2

A balanced combination of very low capacitance and exceptional high current switching makes the diodes of the new SG5000 series ideal for memory core driving applications. And since all types can be custom-encapsulated as multiple-chip assemblies, they are

Transitron

electronic corporation
wakefield, melrose, boston, mass.

SALES OFFICES IN PRINCIPAL CITIES THROUGHOUT
THE U.S.A. AND EUROPE • CABLE ADDRESS: TRELCO

MEET US AT THE IEEE — BOOTHS 1720-24

CIRCLE 55 ON READER SERVICE CARD

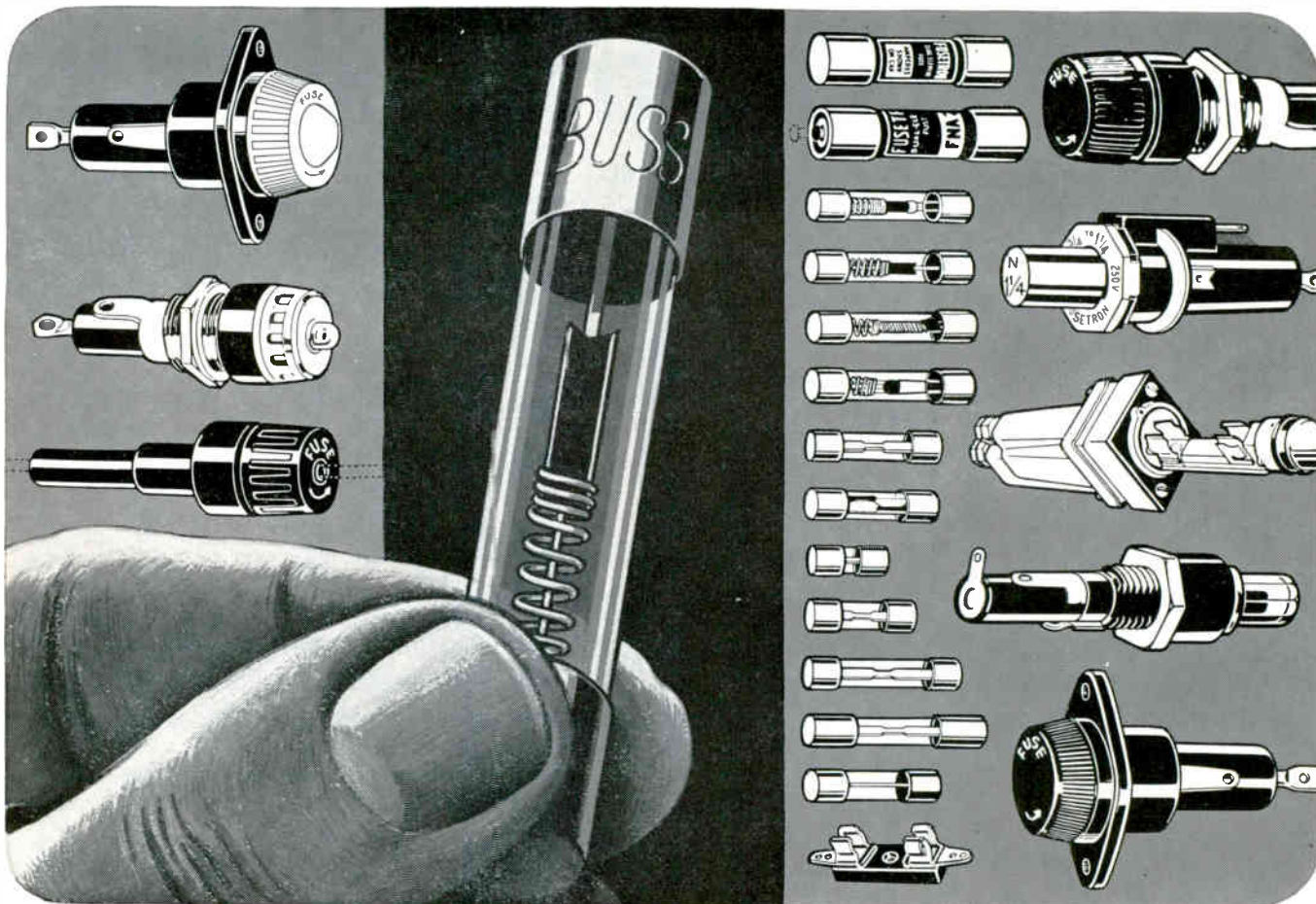

For Every Electrical Protection Need

*there's a safe and
dependable BUSS or
FUSETRON Fuse!*

BUSS fuse engineers have consistently pioneered the development of new fuses to keep pace with the demands of the Electronic industry. Today, the complete line includes:

Single-element fuses for circuits where quick-blowing is needed;—or single-element fuses for normal circuit protection;—or dual-element, "slow-blowing" fuses for circuits where harmless current surges occur;—or indicating fuses for circuits where signals must be given when fuses open. Fuses range in sizes from 1/500 amperes up—and there's a companion line of fuse clips, blocks and holders.

If you have a special protection problem

The world's largest fuse research laboratory, plus the experience gained by solving many, many electrical protection problems is on call to you at all times. Our engineers work with yours and can help you save engineering time and trouble.

For more information, write for BUSS bulletin SFB.

**BUSS: The complete line of fuses and
fuse mountings of unquestioned high quality.**

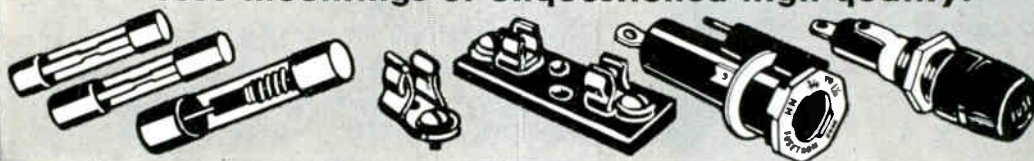

BUSSMANN MFG. DIVISION
McGraw-Edison Co.
St. Louis 7, Mo.

SMALL PART PROBLEMS ?

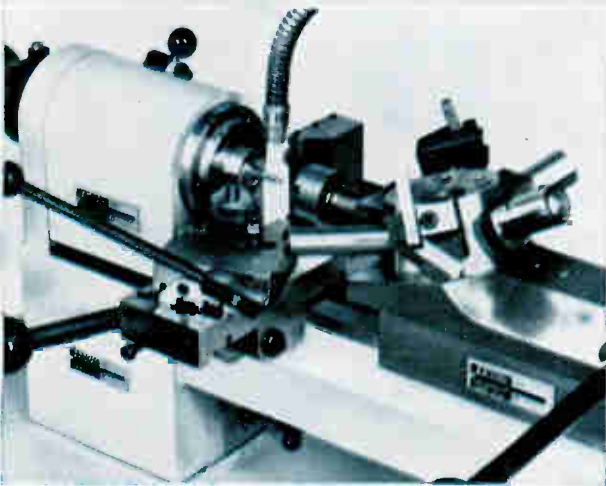

Shown above, an ACAF turret lathe set up to produce the small needle valve, illustrated, with a 0.0118" bleed hole. The self indexing turret is extremely sensitive for fine work. Speed regulation is continuously variable from 0 to 4000 r.p.m. with IR drop compensation.

SEND FOR COMPLETE CATALOG

JEVIN Heavy duty instrument lathes offer the best solution to small part lathe operations. 29 standard models for first and second operation work in 3/16", 5/16", and 1/2" collet capacities.



JEVIN[®]

INSTRUMENT LATHES

LOUIS LEVIN & SON, INC.
3573 Hayden Ave., Dept. E • Culver City, California

New York Representative and Showroom
RUSSELL-HOLBROOK & HENDERSON, INC.
292 Madison Ave., New York 17, N.Y.



PHOTO TUBES

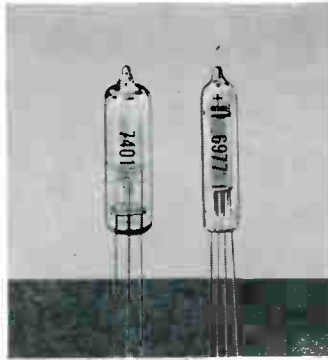

INDICATOR TUBES

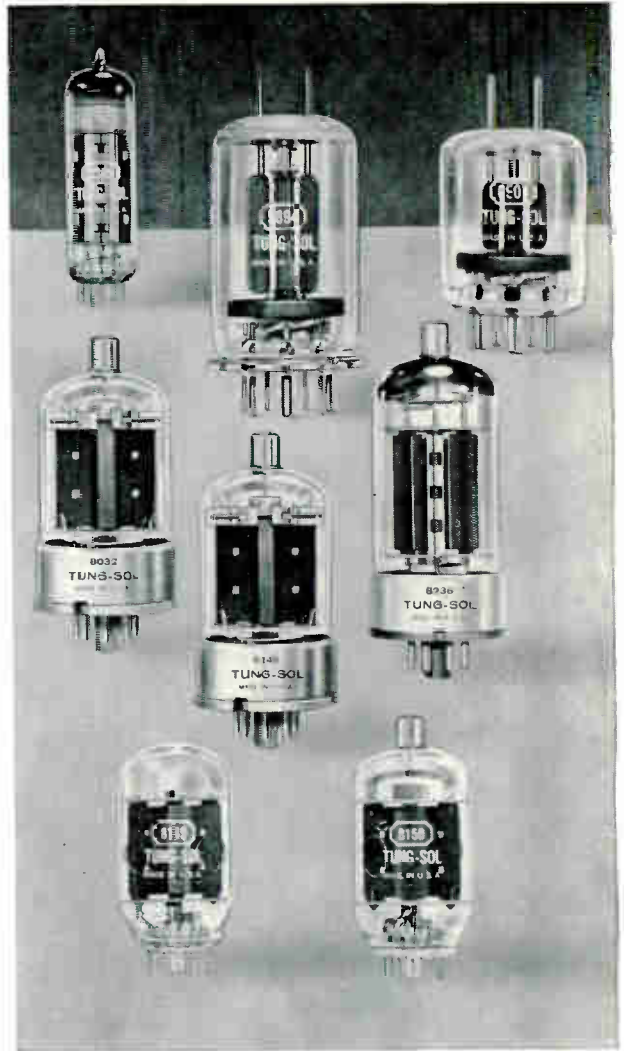

TRANSMITTING TUBES, INCLUDING COMPACTRON TYPES

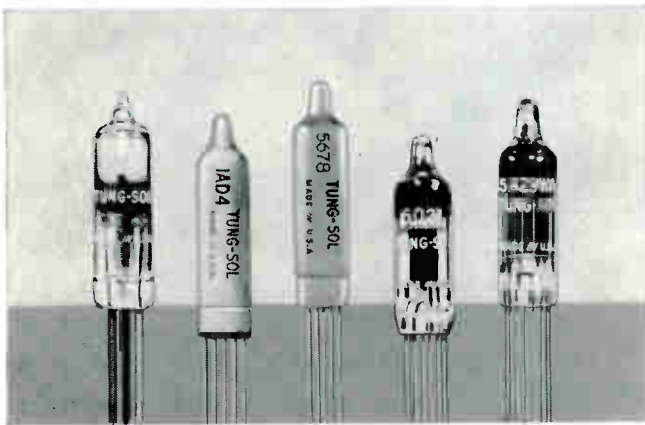

SUBMINIATURE TUBES

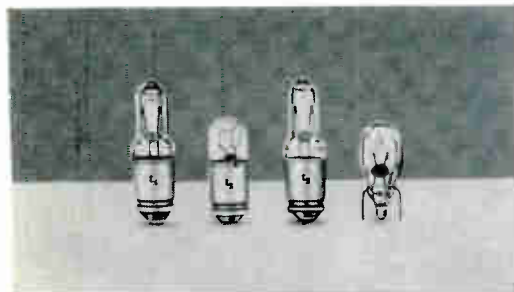

SUBMINIATURE LAMPS



GERMANIUM POWER TRANSISTORS



DYNAQUAD™ TOUCH CONTROL MODULES

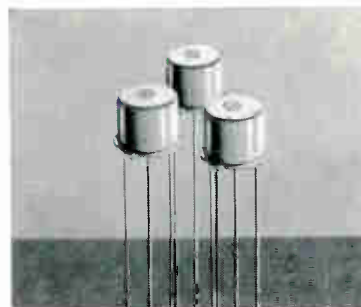

DYNAQUADS

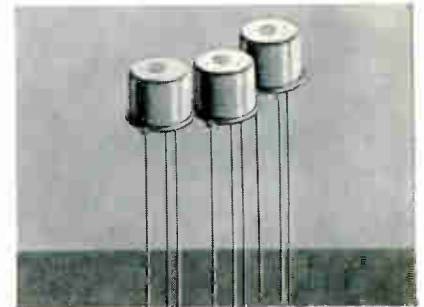

SILICON DIFFUSED AND FIELD EFFECT TRANSISTORS



CERAMIC HYDROGEN DIODES AND THYRATRONS

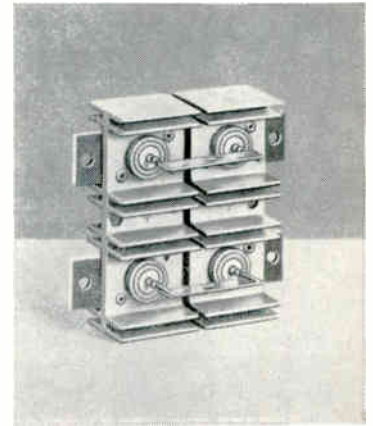

SILICON RECTIFIER STACKS.



GLASS HYDROGEN DIODES AND THYRATRONS



SILICON RECTIFIERS TO 250 AMPS, INCLUDING NEW REVERSE POWER RATED TYPES



REGULATED POWER SUPPLIES.

TUNG-SOL SHOWCASE

Tung-Sol is the one independent domestic manufacturer of vacuum and gas-filled tubes and solid state devices with the capability to supply volume requirements of so many popular-demand types. Tung-Sol components span the whole frequency spectrum. For more than sixty years, Tung-Sol has served America's largest-producing industries. Year after year the confidence of companies of all sizes has been merited by the performance-to-cost ratio of Tung-Sol products, the competence of Tung-Sol engineering and the dependability of Tung-Sol service. You may find it profitable to discuss your component requirements with Tung-Sol, particularly in the design stage. Tung-Sol Electric Inc., Newark 4, New Jersey. TWX: 201-621-7977

CENTER LINE



QUALITY

TUNG-SOL®

Technical assistance is available through: Atlanta, Ga.; Columbus, Ohio; Culver City, Calif.; Dallas, Tex.; Denver, Colo.; Detroit, Mich.; Melrose Park, Ill.; Newark, N. J.; Seattle, Wash. In Canada: Abbey Electronics, Toronto, Ont.

BOOTHS 2733-35-37-39 AT THE IEEE SHOW



New Value Package

You can use the Type 561A Oscilloscope—with Type 3A1 Dual-Trace Amplifier Unit and Type 3B3 Delayed-Sweep Time-Base Unit—for a wide range of DC-to-10 MC laboratory applications.

You can observe no-parallax displays and sharp trace photography. For the new rectangular ceramic crt has an internal graticule with controllable edge lighting.

You can display single or dual-trace presentations or algebraic addition.

You have 10 mv/cm sensitivity with .035 μ sec risetime.

You have highly adaptable time-base features including:

1. Calibrated sweep range—from 0.1 μ sec/cm to 1 sec/cm for normal and delayed-sweep presentations.
2. Calibrated sweep delay—for setting and measuring precise delay intervals from 0.5 microsecond to 10 seconds.
3. Single-sweep control—for simplifying waveform photography of normal-sweep presentations.
4. Flexible triggering facilities—with triggered operation extending to beyond 10 megacycles.

Also, you can use any of 9 other amplifier and time-base units for differential, multi-trace, sampling, other applications, including matched X-Y displays using the same type amplifier units in both channels.

TYPE 561A OSCILLOSCOPE (without plug-ins)	\$470
TYPE 3A1 DUAL-TRACE AMPLIFIER UNIT (6 cm linear scan • no signal delay)	\$410
TYPE 3B3 TIME BASE UNIT	\$525

U. S. Sales Prices f.o.b. Beaverton, Oregon

**For a demonstration, please call
your Tektronix Field Engineer**

Delayed Sweep and Dual-Trace Plug-in Units

with the Tektronix Type 561A Oscilloscope

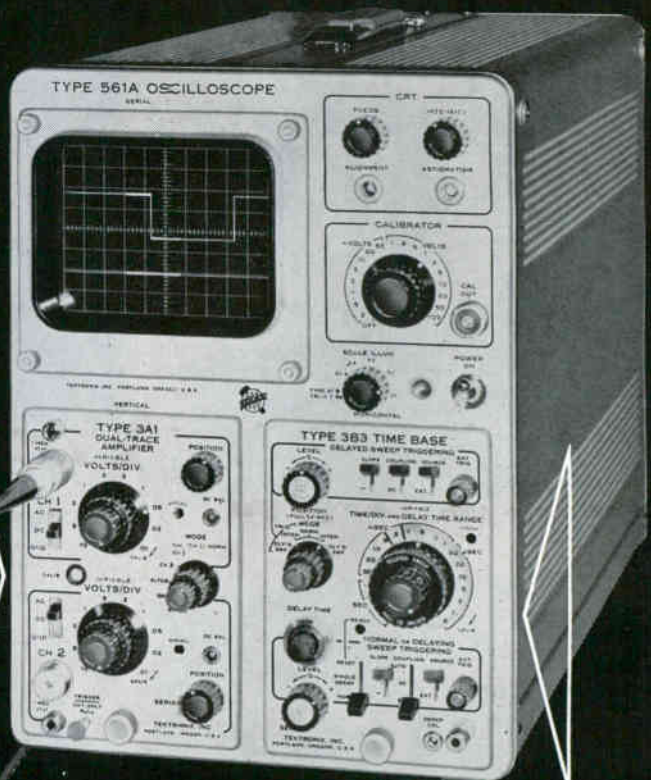

- illuminated internal graticule
- rectangular ceramic crt

Tektronix, Inc. / P. O. BOX 500 • BEAVERTON, OREGON / Mitchell 4-0161 • TWX-503-291-6805 • Cable: TEKTRONIX, OVERSEAS DISTRIBUTORS IN 27 COUNTRIES AND HONOLULU, HAWAII.

Tektronix Field Offices are located in principal cities throughout the United States. Please consult your Telephone Directory, Tektronix Canada Ltd: Montreal, Quebec • Toronto (Willowdale) Ontario • Tektronix International A. G., Terrassenweg 1A, Zug, Switzerland.

In **FIXED COMPOSITION RESISTORS**

if it's news, expect it first from IRC

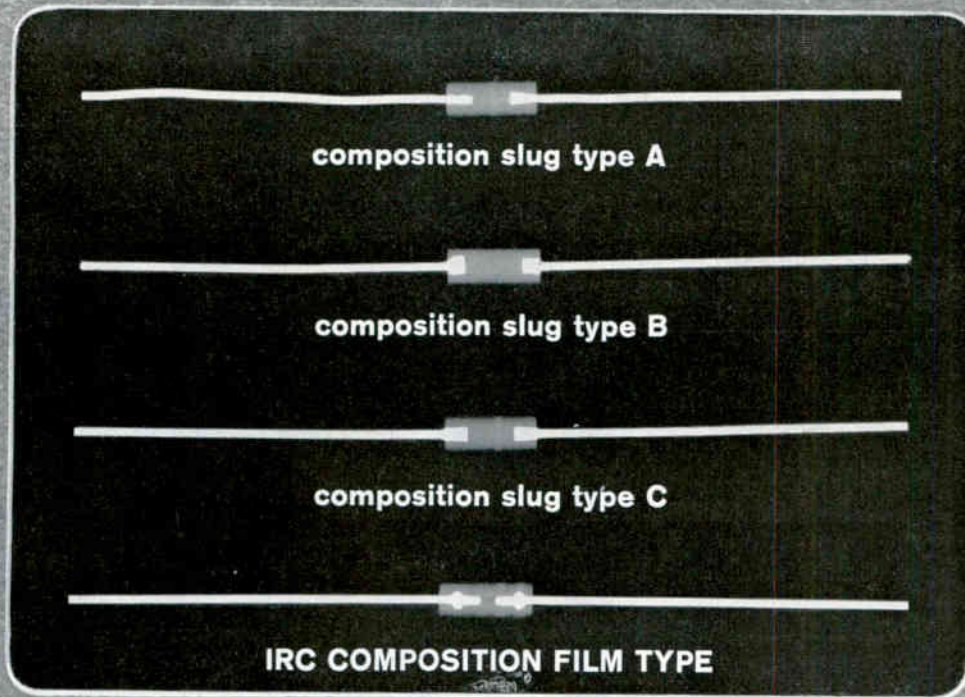

UNRETOUCHED X-RAY PHOTOGRAPH reveals construction features that give IRC resistors stronger terminations.

IRC Fixed Composition Resistors have a **STRONGER LEAD ASSEMBLY**

HERE'S WHY... IRC's resistance element is a film of carbon composition thermally bonded to a glass body. This rugged, compact configuration permits 35% more molding around the lead assembly, and a correspondingly thicker molding at the ends. IRC's exclusive talon lead extends farther into the resistor.

Ribbed shoulders are imbedded in the molding to prevent twisting or pull-out. The lead is bonded to the element so strongly, IRC resistors are failure-free under MIL-R-11 shock, vibration and acceleration tests.

In destructive tensile tests, carbon slug types fail at forces averaging 22, 18 and 28 pounds respectively, for brands shown in the X-Ray.

IRC carbon composition resistors withstand forces averaging 33 pounds. Even at that force, IRC leads do not pull out... the wire breaks outside the body. Write for GBT bulletin. International Resistance Co., Philadelphia 8, Pa.

PERFORMANCE ADVANTAGES

IRC Type GBT's also provide

- Outstanding load life
- Better resistance-temperature characteristics
- Lower operating temperatures
- Greater moisture protection
- Superior high frequency characteristics
- Ranges to 100,000 megohms
- Weldable leads



Analab

1120/700...without a doubt

the INDUSTRY'S FINEST dual-trace OSCILLOSCOPE

FEATURES:

- Superior triggering and over-all stability
- Highest sensitivity (100 $\mu\text{v}/\text{cm}$)
- Brightest traces
- "Instantaneous" beam finder
- Delayed trigger output from 1 μsec to 50,000,000 μsec
- Bandwidth from DC to 150 kc
- Both single-ended and differential amplifier inputs, AC or DC-coupled

PLUS

the only oscilloscope on which you can make **PRECISE QUANTITATIVE MEASUREMENTS!**

In addition to its exceptionally fine qualitative characteristics, the Analab 1120/700 has consistently proved itself for accurate quantitative measuring of signal amplitude, rise time, pulse duration, frequency, and phase. Use it as a precision AC & DC voltmeter, phase meter, time-interval meter, analog wave-form indicator . . . thanks to Analab's exclusive Null-Balance Readout.

Call or write for specifications on the 1120/700 and on the full line of Analab scopes, scope camera systems, and accessories.

Analab Instrument Corporation
Cedar Grove, New Jersey

Analab Model 1120 main frame with Model 700 plug-in.

Analab 

A subsidiary of THE JERROLD CORPORATION

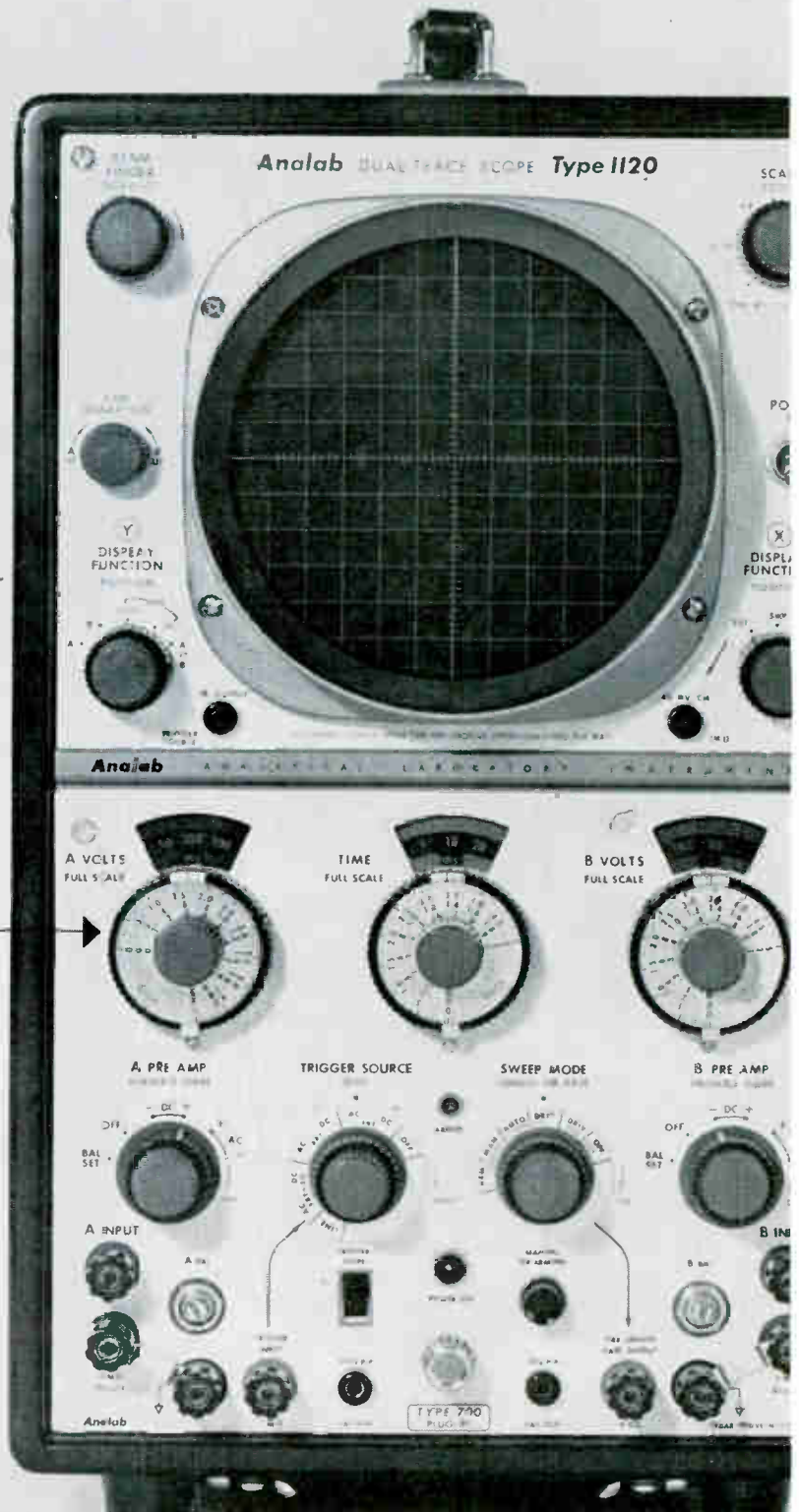

BOOTH 3904-08

CIRCLE 62 ON READER SERVICE CARD

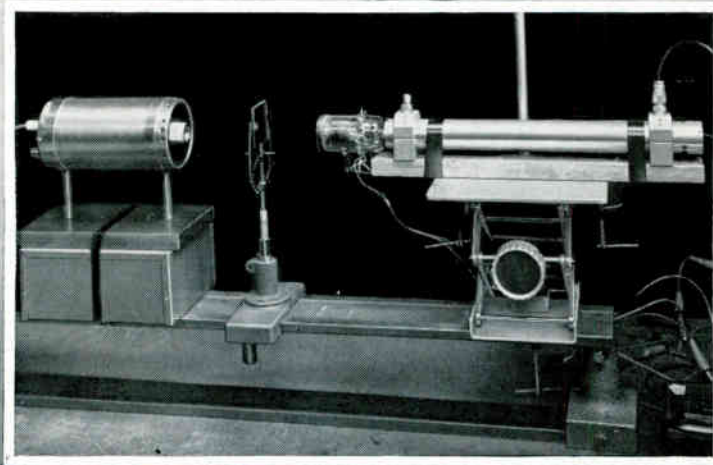

PERFORMING *laser mode-separation measurement with transmission-type microwave phototube. Large photo shows phototube withdrawn from its traveling-wave-like focusing structure*



IEEE SPECIAL

PREVIEW OF FIRST **IEEE** CONVENTION

HIGHLIGHTS of the First International Convention of the Institute of Electrical and Electronics Engineers beginning two weeks from Monday in New York's Coliseum and Waldorf-Astoria Hotel are spread over 54 technical sessions.

They deal with electron devices, self-repairing circuits, antennas, medical electronics and radar, to mention only a small sampling.

MICROWAVE PHOTOTUBE — Discovery of the laser makes pos-

sible optical communications systems having thousands of megacycles of bandwidth. But such systems will require photodetectors having similarly wide bandwidth. One such detector is the microwave phototube shown in the photographs. The large photo shows the tube withdrawn from its focusing structure while the inset shows it performing a laser mode-separation measurement.

Figure 1 is a cross section of the tube. Light to be demodulated

passes through the optical window on the left onto a transmission-type photocathode on a glass disk. The photoelectrons emitted from the cathode are bunched at the modulation frequency of the incident light.

As the electrons are accelerated and pass through a traveling-wave-tube type helix, they excite a traveling wave on the helix. This signal

is taken out at the output coupler. The electron-beam focusing structure which surrounds the helix uses periodic permanent magnets as do modern traveling-wave tubes.

The tube, with its focusing structure, is 18 inches long and weighs five pounds. The photocathode response can be made to match that of any conventional phototube. The tube shown uses an L-band helix

but tubes can be built for S, C or K band.¹

PERMACHON SCAN CONVERTER—The tube shown in the photograph is a special type of scan converter. Scan converters are tubes into which information can be written in one format and extracted at the same or a later time in the same or a different format.

As Fig. 2 shows, there is a writing gun at one end of the tube and a reading gun at the other. The writing gun emits high-velocity electrons; the reading gun emits low-velocity electrons. Between the guns is a target. In the Permachon scan converter this target is made of material that becomes electrically conductive when it is bombarded with electrons.

The tube can be read out many times even after the input illumination has been removed for a long time. It can also add together several scans at a low light level to furnish an enhanced visual output.

Three kinds of target are used. The first two use so-called EBIC (electric bombardment induced conductivity) materials: an aluminum-oxide supported target and an aluminum supported target. The third type of target is fiber-optics coupled. It furnishes complete isolation between input and output. It has received the acronym FOPT (fiber optics photon transfer).

There are two thin transparent and conductive films separated by a fiber optics honeycomb. The film on the writing side is coated with a television-type phosphor while the one on the reading side is a photoconductor. The writing beam excites the phosphor and light travels through the fiber-optics rod and makes the photoconductor conductive.

One of the first applications of the Permachon may be to improve the performance of an Army moving-target-indicator radar.²

MULTIPLE-BEAM TRAVELING-WAVE KLYSTRON—Many modern microwave systems require both high power levels and wide dynamic bandwidth.

One approach to the problem is the multiple-beam klystron (MBK). This not only permits generating high power levels but also allows broadbanding by stagger tuning the

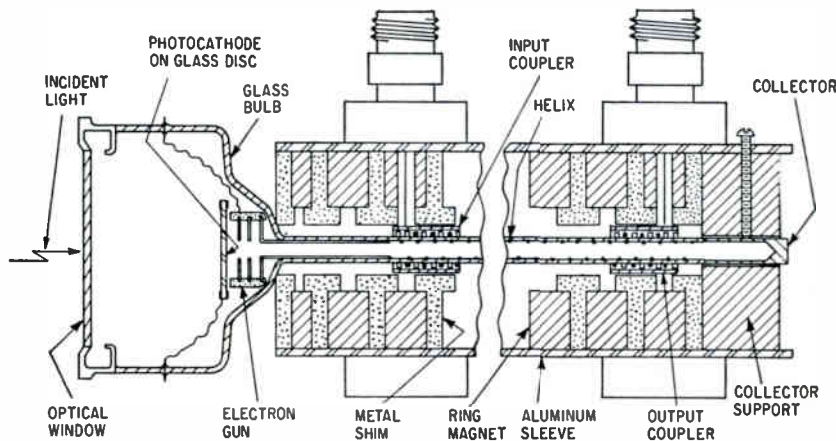

MICROWAVE PHOTOTUBE ASSEMBLY

CROSS SECTION of microwave phototube illustrates its kinship to the traveling-wave tube. Light enters from the left and dislodges electrons from transmission-type photocathode—Fig. 1

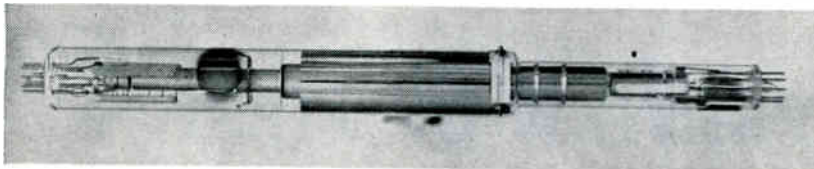

PERMACHON scan converter operates on principle similar to that of vidicon television camera tube

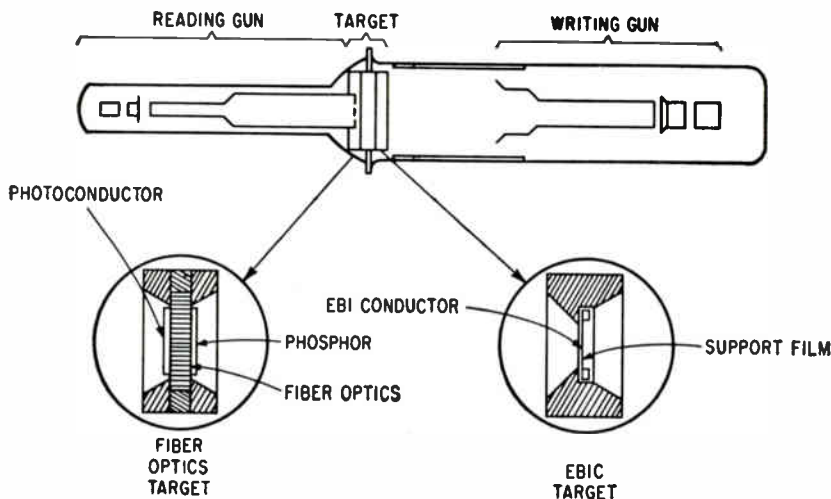

SIMPLIFIED SKETCH of Permachon shows reading and writing guns at either end. Target may be either of electron-bombardment-induced-conductivity (EBIC) type or special fiber-optics configuration—Fig. 2

MULTIPLE-BEAM *traveling-wave klystron combines the best of two possible approaches to obtaining super-power microwave signals with wide bandwidth*

beams. This could yield a 10 or 15 percent bandwidth.

Another approach is the traveling-wave klystron (TWK). It is illustrated in Fig. 3A. An elongated ribbon beam crosses the gap between two ridge-loaded waveguides that comprise the input and output circuits. Figure 3B shows how an r-f voltage that propagates on the lower or input guide will velocity modulate the beam as the input signal travels from left to right. Bunching takes place in the drift distance between the guides and a density-modulated current will induce waves in the upper or output guide.

This idea was good in theory but it never worked out too well. A long build-up distance was required for the waveguide and it was hard to produce a stable sheet beam.

The tube shown in the third photo combines the best features of both the MBK and the TWK. It uses cylindrical instead of sheet beams. Build-up distance is decreased by increasing the impedance of the waveguides by periodic inductive and capacitive loading.

The experimental MBTWK has eight beams. It operates at 725 Mc. Gain is 24 db and efficiency averaged 44 percent over a sample of ten prototype tubes.³

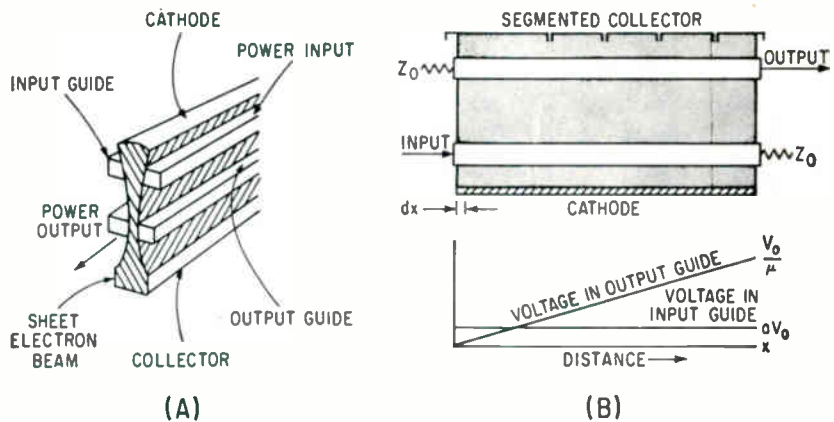
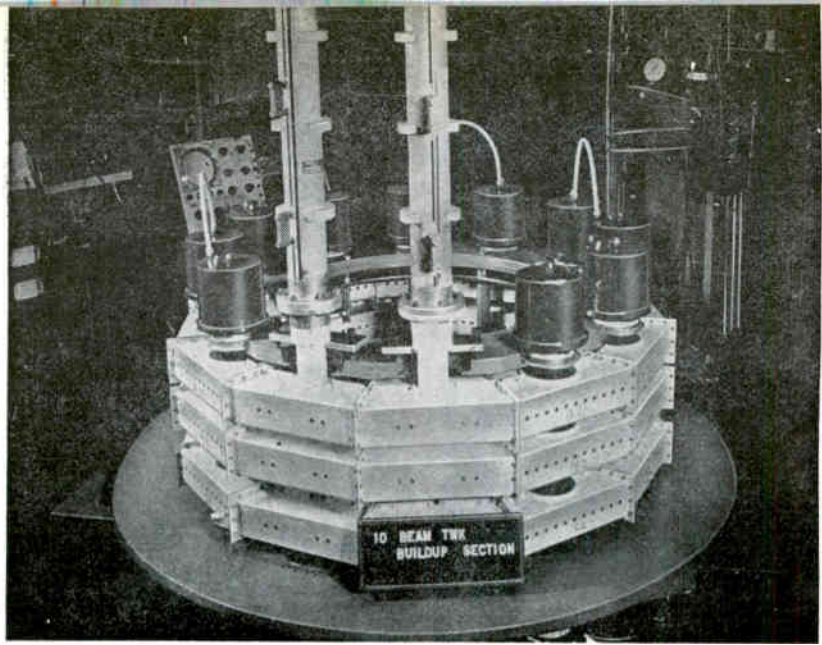

TRAVELING-WAVE KLYSTRON *used sheet beam with input and output signals coupled by ridged waveguide (A). Voltage gradient shows how velocity modulation and subsequent bunching was achieved (B)—Fig. 3*

SELF-REPAIRING CIRCUITS —

As electronic circuits become increasingly complex, especially in computer and control circuits, the problem of reliability increases almost without bound. One approach is to increase component reliability. However, reliability is only the probability of success and no matter how high the reliability there is some finite chance of failure.

Another approach is to use circuits that will repair themselves. In the majority-logic network, redundancy is the key. The so-called voter gives the output called for by the majority of the inputs. Even if some circuits fail, operation can continue as long as most work.

The next step is to replace the simple voter with an adaptive cir-

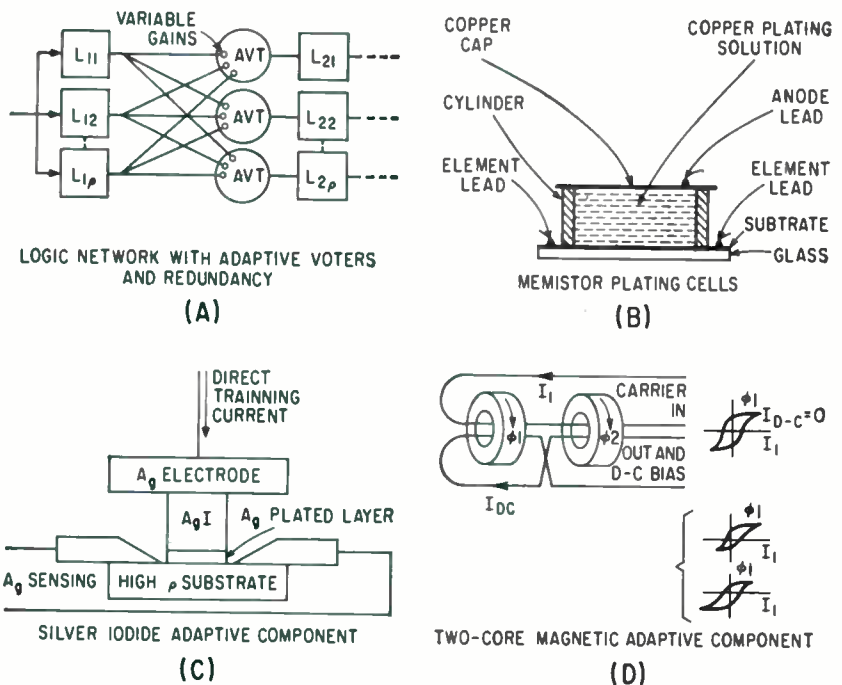

ADAPTIVE *logic network (A) is one key to circuits that repair themselves. Several adaptive circuit elements can apply weights needed: memistor plating cell (B), silver-iodide adaptive component (C) and two-core magnetic adaptive component (D)—Fig. 4*



HIGH-FREQUENCY power transistor has mesa configuration and makes use of interdigitated emitter and base fingers to increase junction area

circuit as shown in Fig. 4A. Here weights are assigned to the inputs to the voter so that a circuit that persists in giving the wrong response is given less and less weight.

Figures 4B, 4C and 4D illustrate mechanisms by which this weighting may be accomplished. Each provides a fixed weight with permanent memory except when a so-called adapt signal is received. The memistor, Fig. 4B uses electroplated copper film for memory; the resistance of the film is the readout. The resistance can be changed smoothly and reversibly by plating or etching.

The same principle is used in the device shown in Fig. 4C. Here the ionic conduction of silver iodide (AgI) affords a sort of solid electrolyte. The device in Fig. 4D is a magnetic component that uses second-harmonic readout to provide nondestructive readout of the flux stored in the cores.

These three devices not only have possible application in self-repair circuits, they also make excellent integrators and can store an integrated value indefinitely. Thus they may even substitute for motor-driven potentiometers in some applications.⁴ For a complete discussion of five types of adaptive components see H. S. Crafts' article *Components That Can Learn and How to Use Them* in next week's issue.

HIGH-FREQUENCY POWER TRANSISTOR—A new silicon transistor has been developed that

has a cutoff frequency of 200 Mc. Power output is about 30 watts and maximum current is five amperes.

The transistor has an interdigitated emitter-base geometry with emitter and base fingers both 75 microns wide and contact strips 25 microns wide. This gives an emitter periphery of about 31 millimeters on an area of four square millimeters. The contacts are evaporated aluminum 0.4 micron thick. Two application procedures were used: evaporating a continuous layer and removing the excess with the photoresist technique or evaporating the aluminum through a metal mask. Both techniques were satisfactory. Four gold bonds along the center of the emitter and one to the base provide the electrical connections. The device is encapsulated in a TO3 can with a moisture getter.

Epitaxial techniques are used to achieve low saturation resistance. Two epitaxial techniques were evaluated: normal and inverse. In the latter, a low resistivity epitaxial layer is grown on a high resistivity substrate. Conventional diffusion and oxide-masking produce a base region 1.4 microns thick. The emitter junction is planar while the collector junction is passivated subsequent to etching a mesa. Passivation is accomplished in a two-step oxidation.⁵

LETTER-RACK ANTENNA—This wideband antenna of log-periodic design can be mounted flush on the surface of an aircraft or missile. Its design evolved from the corrugated surface-wave antenna.

However, the corrugated antenna is not in itself suitable for use as a log-periodic antenna when it is fed in the usual manner with a horn or loop exciter at one end. This letter-rack antenna uses a novel feed system that produces the backfire condition. This gives good coupling of the radiated pattern into space and makes the pattern unidirectional.

The shift into the backfire region is accomplished with a feed system that provides an extra 180-degree phase shift per cell.⁶

ULTRASONIC CARDIAC DIAGNOSIS—Echo ranging with ultrasound permits distinguishing between heart defects that are diffi-

cult to tell apart. One is mitral stenosis or a closing down of the opening around the mitral valve of the heart. The other is mitral insufficiency where the opening is so large that some blood flows backwards when the heart pumps.

Two-megacycle ultrasonic pulses with a peak power of six watts per sq cm and an average power of 12 mw per sq cm are applied to the patient's chest. The echoes are recorded on film as an A-scope display. A moving film camera is used.

Diagnosis takes from five to 10 minutes and replaces difficult and painful catheter procedures. The technique may also be used to diagnose pericardial effusion or a gathering of fluid in the sac around the heart and possibly aortal defects.

In the waveforms, ultrasonic ranging traces are shown with the usual electrocardiograph trace. The normal record (A) is a continuous double-peaked curve of echo presumed to have come from the anterior leaflet of the mitral valve. Record (B) is from a patient suffering from mitral stenosis. His valve velocity is 15 mm per second. The record (C) is from the same patient after a successful heart operation and shows a valve velocity increase to 30 mm per second.⁷

MYOCARDIAL PROSTHETIC SYSTEM—Artificial blood pumping has been achieved in dogs using a myocardial prosthesis and external electronic support unit. It may be that someday human beings suffering from heart impairments will be kept alive by this technique much as respiratory patients are now aided by the so-called iron lung.

The prosthesis consists of an inner flexible liner bonded to a rigid outer shell. It is surgically implanted in the chest and entirely encapsulates the heart.

The support unit is a transistor controller that activates a three-way solenoid valve that regulates the air pressure and suction applied to the stem of the prosthesis.

During the period corresponding to the systole, a pulse of air pressure is supplied between the outer shell and inner lining causing the inner lining and hence the myocardium to contract pumping blood through the cardiovascular system.

AUTHORS *Mittra and Wahl* display their letter-rack antenna that permits log-periodic design of a flush-mounted structure

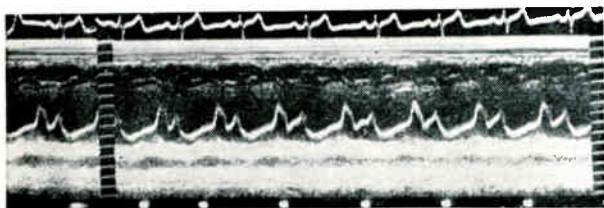

(A)

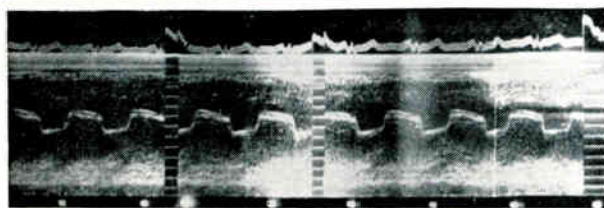

(B)

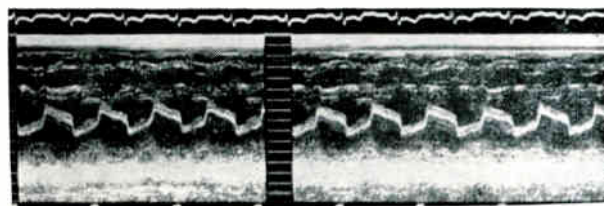

(C)

◀ USE of ultrasound in cardiac diagnosis; A-scope returns are shown with conventional electrocardiograms for normal heart (A), patient suffering from mitral stenosis (B) and same patient after successful operation (C)

During the period corresponding to the diastole, a suction pulse is applied causing the liner to retract and permitting the ventricles to expand and fill.⁶

MILLIMETER-WAVE PARAMP

—Parametric amplification at millimeter wavelengths has been held up by the requirement that the pump frequency had to be at least twice the signal frequency.

In this new device, the signal frequency exceeds that of the pump while the amplifier retains its low-noise and high-gain characteristics. Instead of a single idler tank, the amplifier introduces additional idlers.

Progressively lower sideband frequencies are generated as the signal passes through the multiple idlers. Two sidebands are selected to form the basis of a regenerative system. They create a negative resistance and lead to power amplification.

To date, a 10-Mc paramp using a 7.2-Mc pump and a 13.3-Gc paramp with a 9.6-Gc pump have been

constructed. Work is underway on a 13.3-Gc paramp with a 5.6-Gc pump. This approach offers possibilities of parametric amplification all the way from 10 to 100 Gc.⁹

OBSERVING MULTIPLE RADAR TARGETS

—Watching many radar targets spread out over a wide volume of space presents problems. One solution is to convert all the target tracks to ultrasonic beams in a transparent acoustic medium and examine this model in a beam of well collimated monochromatic light projected at right angles to the direction of propagation of the sonic waves.

The sonic pressure waves phase modulate the light and this phase modulation can be converted to intensity modulation by collecting the light passing through the medium with a converging lens and observing the light intensity in the focal plane of the lens. The target tracks are all now a series of dots on a plane surface.

A multielement array receives

signals continuously from all targets in its volume of coverage. Signals from each antenna element are heterodyned to a common ultrasonic frequency and applied to separate acoustic transducers arranged in an array analogous to the antenna array but propagating into the ultrasonic medium.¹⁰

REFERENCES

- (1) D. Blattner, H. Johnson, J. Ruedy and F. Sterzer, Microwave Phototube With Transmission Photocathodes.
 - (2) R. J. Doyle, Permachon Type Scan-Converters.
 - (3) M. R. Boyd, R. A. Dehn and T. G. Mhuran, The Multiple-Beam Traveling-Wave Klystron.
 - (4) J. B. Angell, The Need and Means for Self-Repairing Circuits.
 - (5) A. Goetzberger, N. Zetterquist and R. M. Scarlett, A New High-Frequency Power Transistor.
 - (6) R. Mittra and M. Wahl, The Letter Rack Antenna—A Flush Mounted Wide Band Antenna of Log Periodic Design.
 - (7) J. M. Reid and C. R. Joyner, Jr., Ultrasonic Echo-Ranging Techniques in Cardiac Diagnosis.
 - (8) J. Kline, A Bio-Medically Engineered Myocardial Prosthetic System.
 - (9) H. B. Henning, New Class of Parametric Amplifiers Enables Below-Signal Pumping.
 - (10) H. L. Groginsky and J. D. Young, A New Technique for Simultaneous Radar Observation of Multiple Targets Within a Broad Surveillance Area.
- All papers to be presented at the First IEEE International Convention, New York, March 25-28, 1963.

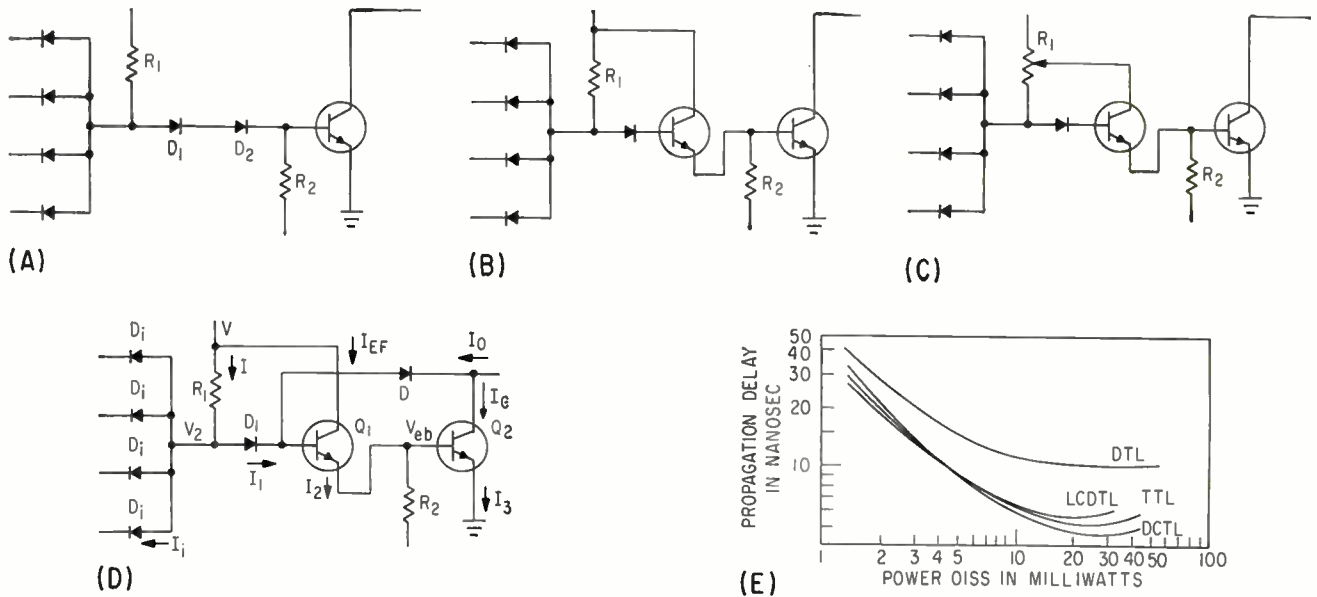

CONVENTIONAL DTL circuit (A); high-gain DTL (B); high-gain, resistor-controlled DTL (C); load-compensated DTL (D); and power-speed curves for the various switching circuits (E)—Fig. 1

For integrated circuits, LCDT logic is shown to offer many advantages—including short propagation delay at low power dissipation, high fan-out levels with loose component tolerances, and minimal crosstalk

High Speed Integrated Circuits With

FOR SEVERAL REASONS integrated logic circuits are usually designed as low-power, high-speed devices. First, of course, these goals are desirable in themselves. Second, since integrated circuits aim at high component packing density, the power dissipation per component must be low. Third, small device size makes it possible to process a large number on a single slice of silicon and to maximize the probability of any given device being good. Since transient delays due to both capacitive and minority carrier effects are related to current densities rather than total currents, small device geometry implies low power operation.

With the trend towards low power levels, it is desirable to use logic circuits that operate satisfactorily with small voltage differences between true and false states. Saturating current-steering circuits satisfy the requirement for small line voltage swings. They can also be used at low voltage levels, which further reduce power consumption. Their disadvantages are minority carrier storage effects and their need for low saturation resistance. The former can be made small in comparison with capacitance effect by gold doping techniques, particularly at low power levels.

But low saturation resistances are difficult to realize in integrated circuits since all contacts are usually at one side of the device—collector currents must therefore flow along increased path lengths. The low power requirement alleviates this problem, but does not eliminate it because of small device geometries. Low saturation resistance can be satisfactorily achieved only with epitaxial growth techniques.

LOGIC CIRCUITS—Diode-transistor logic (DTL), direct-coupled transistor logic (DCTL), and transistor-transistor logic (TTL) have all been scrutinized for their applicability in integrated circuit design. Conventional DTL (Fig. 1A) offers the desired high speed at low power levels. It has a relatively high saturation resistance tolerance but the current available for turning off the inverter transistor must flow either as recovery current in diodes D_1 and D_2 , or through R_2 . A compromise is thus forced between circuit gain and speed, which is particularly severe if R_2 is grounded to avoid a second power supply.

Logic modes DCTL and TTL offer higher speeds at lower operating voltage level than DTL when the

LCDT INTEGRATED CIRCUIT in plan view shows functional areas called out

ARGUMENT FOR LOGIC

In this article author Murphy argues the case for LCDT versus other types of logic such as DTL, DCTL and TTL for applicability to integrated circuit design. By modifying a DTL circuit with a clamping diode—thus forming the load compensated circuit—he shows that certain speed and power dissipation problems of the other circuits are overcome

β_{MIN} FOR FAN-OUT AND RESISTOR TOLERANCES—TABLE I

		3-VOLT SUPPLY			4-VOLT SUPPLY			
		F.O.	5	15	25	5	15	25
TOLERANCES	5%	5	7	9	4	6	7	
	15%	6	8	10	4	6	8	
	25%	6	10	12	5	7	9	

By BERNARD T. MURPHY
Siliconix Inc., Sunnyvale, Calif.

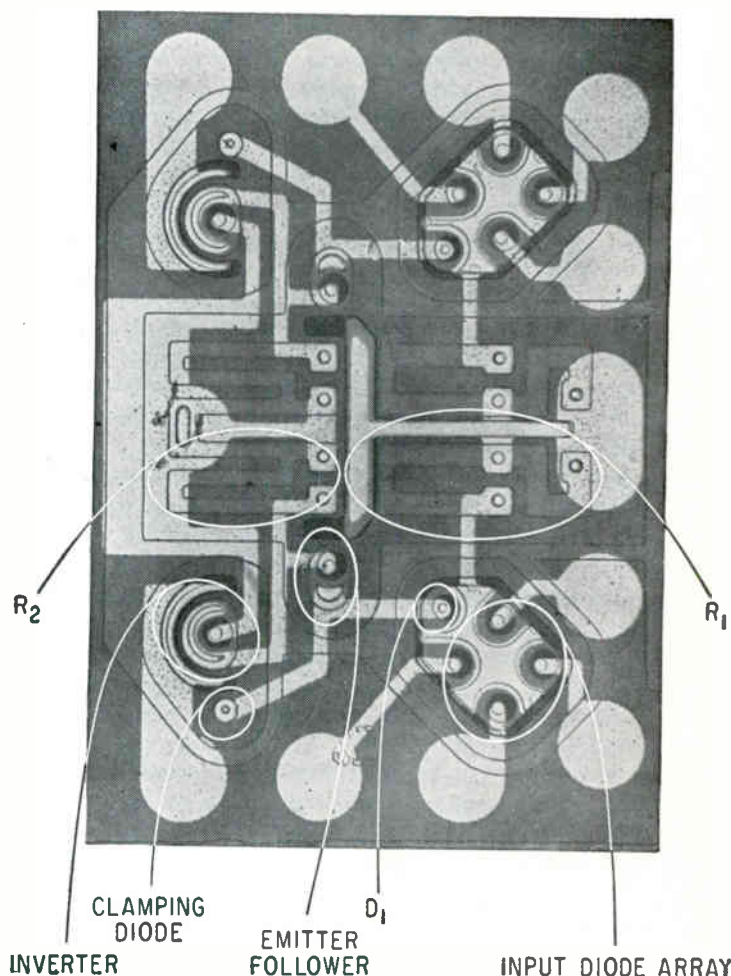

Load-Compensated Diode-Transistor Logic

same inverter is used in all three, primarily because of the smaller voltage difference between their true and false states. However, since they have a lower tolerance to saturation resistance, a slower transistor is generally needed for adequate d-c stability. The d-c stability and logical gain of these circuits is further compromised by cross-talk. Current hogging, which is severe in DCTL, can be reduced to acceptable levels by using resistive coupling, but only by sacrificing switching speed. A similar situation exists in TTL due to inverse gain in the logic transistors, and the requirement of low inverse β conflicts with the requirement of low offset voltages. Thus, a confusing situation exists as to the relative suitability of the foregoing circuits in integrated circuit form.

In an integrated DTL circuit, it is convenient to form one or both of diodes D_1 and D_2 (Fig. 1A) as the emitter-base diode of a transistor. This transistor also can be used to increase the total gain of the circuit to a point at which gain no longer presents a problem. The transistor can be used as an emitter follower (Fig. 1B), or as a quasi emitter follower (Fig. 1C) in which saturation is also pre-

vented. In Fig. 1B, the power dissipation is high and gain dependent; in Fig. 1C, power dissipation is high but resistor controlled, as is the additional gain. In both, the overdrive is excessive at low fan-out values; but the circuit of Fig. 1C could be used as a buffer element to complement the conventional lower fan-out DTL circuit, provided the inverter were redesigned (larger geometry) for low saturation resistance.

Speed and power dissipation problems posed by the above circuits can be overcome by using a clamping diode as a shunt around the amplifying stages, as in Fig. 1D. Here the excess current from R_1 (which causes overdrive in the previous circuits) flows through the clamping diode, while the emitter follower draws just enough current from the power supply to sustain the load current. As load current increases, the driving current also increases and, in this sense, the circuit is load compensated. The current drawn from the power supply by the emitter is

$$I_{EF} = \left\{ \frac{V_{eb}}{R_2} + \frac{I_c}{\beta_1} \right\} / \left\{ 1 + \frac{1}{\beta_2} \right\}$$

The clamping diode considerably improves switching

speed by restricting the line voltage swing. Speed improves also because the lower limit of R_2 is not now set by gain requirements. Minority carrier storage in the transistor collector region is also avoided, but the clamping diode introduces a similar effect, so that gold doping is still needed to control minority carrier lifetime. Transistor coupling could decrease the effect of carriers stored in the diode, but cross-talk problems would be introduced by this mode of coupling.

At first sight, it appears that d-c stability of the load-compensated circuit must always be inferior to that of conventional DTL. This probably will be the case if the best switching speeds are to be attained; however, to obtain the fastest switching speed with DTL, the transistor design should be such that the saturation resistance is close to its maximum permissible limit, which gives minimum permissible d-c stability. Furthermore, the load-compensated version (LCDTL) clamps at an output voltage which can be adjusted by introducing series resistance effects into the diode shunt path (this is easy to do in the integrated circuit). Thus, considerable design freedom is possible in balancing d-c stability and speed requirements, while retaining the load compensation feature of the circuit.

To summarize, the LCDT circuit can be used with line voltage swings similar to those of DCTL and TTL. At the same time, it has the relatively high tolerance to saturation resistance of DTL. Switching speed and d-c stability can be traded by introducing resistance in series with the clamping diode. The number of components used is greater than in any of the single-stage circuits, but their tolerance are considerably looser, which makes the device particularly suitable for integrated circuits. The circuit seems to combine the good features of the more conventional saturating circuits, while eliminating their weaknesses. A detailed description of the circuit and its integrated version follows.

LCDT LOGIC—The most interesting circuit characteristics are d-c stability at various values of fan-out and switching speed. The former can be calculated if the ideal diode equation is assumed. The

latter is dependent on minority carrier storage effects in the diodes and transistors and also on current flow in R_1 and R_2 during the ON-OFF and OFF-OFF transients. Such a transient analysis would be a study in itself; information presented here is based on direct measurements.

Two requirements need to be satisfied for the circuit to operate at a given value of fan-out; namely, the overall gain should be high enough and the output voltage at that fan-out should be low enough to turn off the next stage with an adequate margin of stability ΔV .

The maximum output current from the circuit under worst-case conditions is:

$$I_{o \max} = \beta_1 \beta_2 \left\{ \left(\frac{V - V_{2 \max}}{R_{1 \max}} - I_i \right) - \frac{1}{\beta_1} \cdot \frac{V_{eb \max}}{R_{2 \min}} \right\} \quad (1)$$

where β_1 = current gain of the emitter follower, β_2 = current gain of the inverter, I_i = worst-case input current ON, and V , V_2 and V_{eb} are the voltages indicated in Fig. 1D. Voltage $V_{2 \max}$ is the maximum V_2 ever occurring in the circuit.

The worst-case input current when the circuit is being held OFF is:

$$I_i = \frac{V - V_{2 \min}}{R_{1 \min}} - \frac{V_{eb \min}}{\beta_1 R_{2 \max}} \quad (2)$$

Voltage $V_{2 \min}$ is the lowest V_2 that can occur when the input is at the highest permissible false voltage.

Since both the emitter follower and the inverter are formed simultaneously in proximity on the device, it is a good approximation to assume that they have the same gain. Then, using Eq. 1 and 2, Table I gives the minimum gain values at -55 deg C for various values of fan-out and resistor tolerances. Values for V_2 and V_{eb} were measured on a circuit using silicon diodes and transistors; $R_{2 \text{ nominal}}/R_{1 \text{ nominal}}$ is taken to be 1.5, which was found to give optimum speed power balance. In an integrated circuit, the required β_{\min} values will be lower than those given in Table I, particularly for the looser resistor tolerances, since resistors R_1 and R_2 tend to increase or decrease together in the same circuit.

Assuming that the circuit has sufficient gain, its output voltage when fully loaded is determined by the forward voltages across the emitter-base diodes

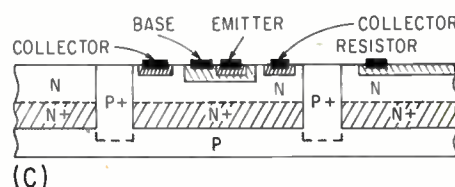
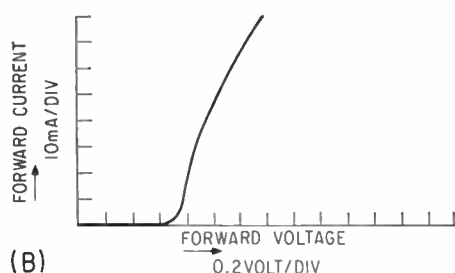
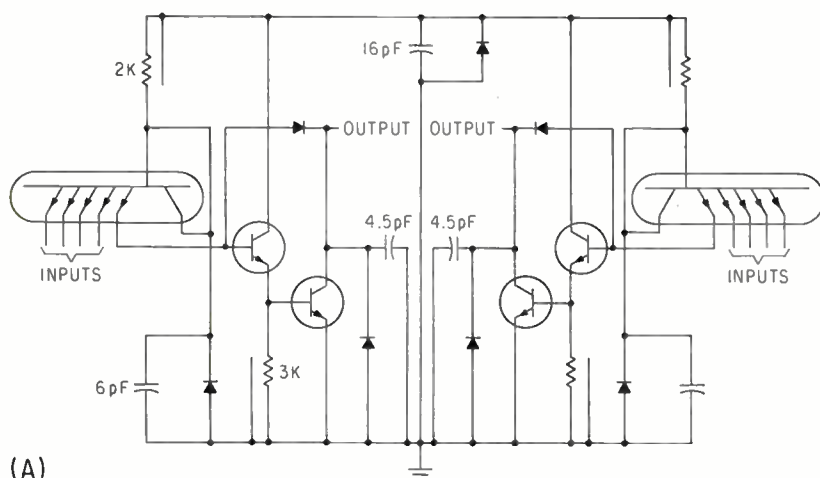

EQUIVALENT CIRCUIT of LCDT logic device (A), and cross-section of the actual device (C); in (B) appears the forward characteristic of transistor used as a diode—Fig. 2

HOR: V OUT 0.2V/DIV
 VERT: I OUT 5mA/DIV
 I IN = 0.1mA/STEP

HOR: 1V/DIV
 VERT: 2mA/DIV

HOR: V IN 0.2V/DIV
 VERT: I OUT 10 μ A/DIV
 ZERO SET ON 4TH DIV
 I IN = 0.2mA/STEP

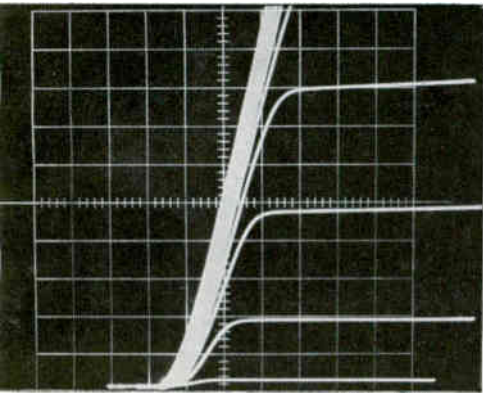

(A)

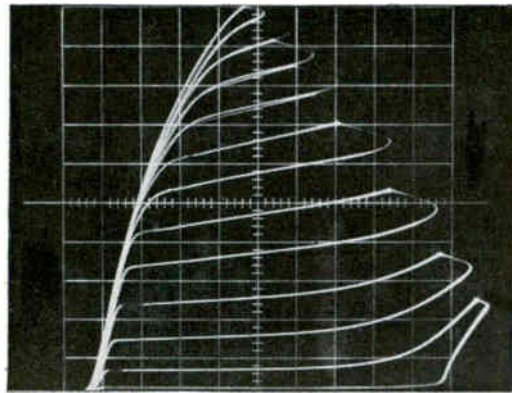

(B)

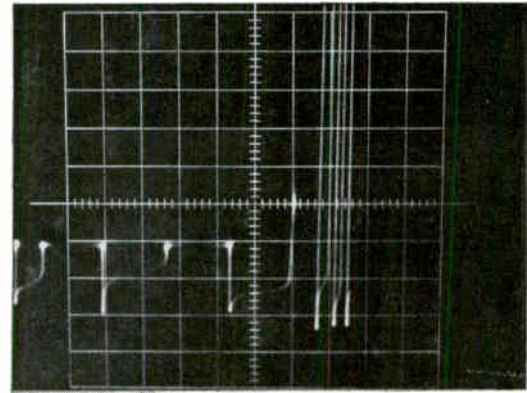

(C)

OUTPUT CHARACTERISTICS of LCDT integrated circuit, 4-v supply (A and B). In (A), max permissible load current at 1.1 v is 37 ma. In (B), saturation effects set in at 100 ma output current, breakover occurs at over 10 v. Input characteristics of LCDT circuit (4-v supply, 4-v output) shown in (C)—Fig. 3

of Q_1 and Q_2 and the clamping diode D .

$$V_o = V_{eb}(Q_1) + V_{eb}(Q_2) - V_D$$

Similarly, the maximum permissible false voltage at the input is

$$V_F = V_{eb}(Q_1) + V_{eb}(Q_2) + V_{Di} - V_{Di}$$

The d-c stability margin ΔV is the difference between the worst-case values of V_F and V_o . Using the ideal diode equation

$$\Delta V = \frac{kT}{q} \left\{ \log \frac{I_3''}{I_{S3}} + \log \frac{I_2''}{I_{S2}} + \log \frac{I_1''}{I_{S1}} - \log \frac{I_i''}{I_{Si}} \right\} - \frac{kT}{q} \left\{ \log \frac{I_3'}{I_{S3}} + \log \frac{I_2'}{I_{S2}} \right\} + V_D$$

where subscripts are as in Fig. 1D. Single primes indicate worst-case ON values, double primes indicate worst-case OFF values; I_S values refer to the saturation current of the various diodes.

Rearranging this expression, and noting that to a good approximation

$$\text{Fan-out (FO)} = I_3'/I_i''$$

then

$$\text{FO} = \left[\frac{I_2'' I_3'' I_1''}{(I_i'')^2 I_3'} \right] \left[\exp \frac{q}{kT} (V_2 - \Delta V - \Delta V') \right]$$

The term $\Delta V'$ accounts for two effects. First, it includes the difference in forward voltage across diodes D_i and D_1 at the same current level. For maximum stability D_i should have a low forward voltage relative to D_1 . Second, it includes the forward voltage tolerances from circuit to circuit on the emitter diodes in Q_1 and Q_2 .

The current level in the emitter of Q_2 varies enough from ON to OFF that the ideal diode equation is unlikely to hold over the whole range; departure from the ideal equation will be in a direction to reduce F.O. However, even if the ideal equation does not hold exactly, it does give some measure of the effects of various circuit parameters on the overall d-c stability.

POWER-SPEED CURVES—Figure 1E shows the power-speed curve for the LCDT gate using a 2N743

inverter, an FD829 clamping diode and a 4-volt supply. Similar curves are shown for DCTL, TTL and DTL, using in each case a 2N743 inverter and a 4-volt supply. These curves cannot be directly related to integrated versions of the four circuits, since the transistor design and optimum power supply voltage would vary from circuit to circuit. The lower supply voltages which are permissible with TTL and DCTL tend to compensate for the higher saturation resistances which are permissible with DTL.

Two further points are worthy of note. First, integrated circuits eliminate the contribution of packaging capacitance to collector-base and clamping-diode capacitance. This is of more significance in DTL and LCDTL than in DCTL and TTL, since turn-off currents are more limited in the former. Second, DCTL requires the use of as many inverters with separate bases and low saturation resistances as there are inputs. These transistors require more layout space and provide more stray capacitance in integrated circuit form than the input transistor-diodes of DTL, TTL and LCDTL. This tends to counter-balance the low component count of DCTL.

TOPOLOGY—In designing an integrated circuit to perform LCDTL, it is important to minimize stray capacitances and to avoid cross-overs. The device was planned as a four-input dual NAND for maximum packing density. An equivalent circuit, including principal stray capacitances, is shown in Fig. 2A. Low isolation capacitances, including 1.3 pf of pin capacitance, were realized with adequately low saturation resistances by use of epitaxial growth techniques and tight masking tolerances.

A plan view of the device (see photo) shows the function of the different areas. In accordance with the principles outlined, the device was designed for minimum junction areas to allow high-speed operation at low power levels, to obtain as many devices per silicon wafer as possible, and to increase the percentage yield. Thus, the total size for the dual gate is 37×28 mils. The inverter transistor has a slightly

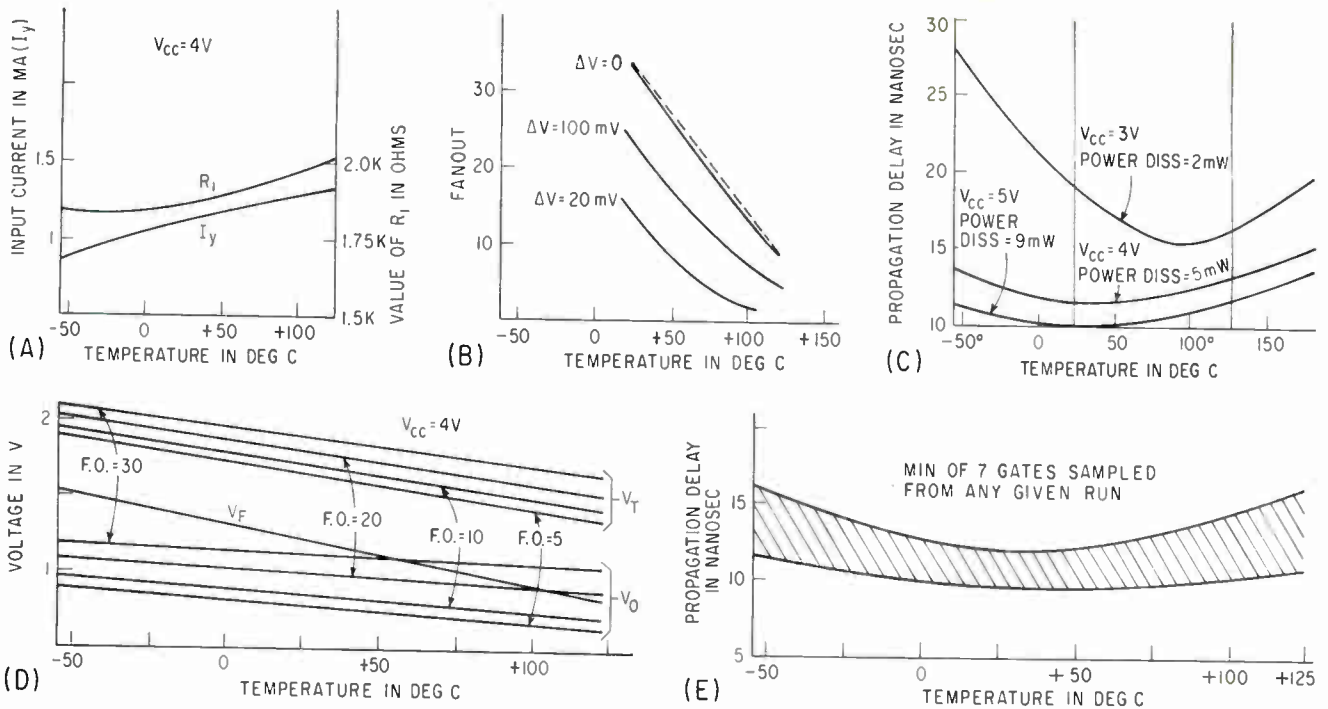

INTEGRATED LCDT PERFORMANCE: resistor and input current variations with temperature (A); worst case F.O. as function of d-c stability and temperature (B); propagation delay as a function of voltage and temperature (C); variation with F.O. and temperature of true and false thresholds and fully loaded output voltage (D); and envelope of all 4-v propagation delay measurements obtained on 6 different runs (E)—Fig. 4

smaller geometry than the 2N709 transistor.

The input diode array was formed as a transistor array with a collector-base short for convenience in fabrication, but the arrangement also has operational advantages. Good diode action is obtained in that the ideal diode equation is obeyed over a wide range of forward-current values. This is because most of the forward current flows by transistor action through the collector until the transistor saturates. At that point, which is well outside the operating range, the diode characteristic shows an inflection, as in Fig. 2B. The collector-base short avoids inverse transistor action.

To obtain maximum d-c stability, the clamping diode and diode D_1 were made as small as was consistent with reproducibility. From this point of view, it would also be desirable to make the input diodes large, but this requirement conflicts with that of minimizing the recovery effects in these diodes and with small total device size; thus a compromise must be made.

The sizes of the emitter follower and inverter are unimportant from the point of view of stability, provided that resistive effects are avoided, since each affects both the output and input voltages.

FABRICATION—Epitaxial techniques have been used to minimize junction capacitance while maintaining an adequately low saturation resistance. There are many ways of using epitaxial growth techniques to fabricate integrated circuits. As is standard practice in transistors, the best ones employ a heavily doped layer beneath the surface for current carrying purposes and a lightly doped surface layer in which p - n junctions can be formed for transistors,

resistors or diodes with minimal capacitance effects. The heavily doped layer can be predeposited either uniformly or selectively, using epitaxial growth or diffusion techniques, or it can be formed as part of a composite layer by proper control of the dopants in the gas stream entering the reaction furnace. Contact can be made to the n^+ layer either through the n layer by a special diffusion through it, or by prearranging the surface so that the n^+ layer appears at certain points.

The substrate will generally be high resistivity p -type silicon, and isolation between component areas can then be obtained by either etching troughs between them or by a p -type diffusion. Etching minimizes capacitance effects but exposes junctions and creates problems in making the desired interconnections between component parts. Isolation by diffusion is simpler, gives planar junctions, and for the purposes of the low-power circuit in hand, gives only marginally more isolation capacitance with adequate values of saturation resistance. The latter technique was used in this design; a cross-section of the device is shown in Fig. 2C.

Sheet resistivity and depth of the boron diffusion affects the circuit in a number of ways. The range of useful values of sheet resistivities is generally confined to 100 to 300 ohms/sq., although for special purposes, the limits of this range can be exceeded. Higher values generally are more suitable for forming resistors with small junction areas and obtaining high gain in the transistors. Lower values are more suitable for minimizing resistive effects in the transistors and diodes. Lower resistivities also maintain high forward voltage drops in the various diodes that determine the threshold voltage V_T and hence indi-

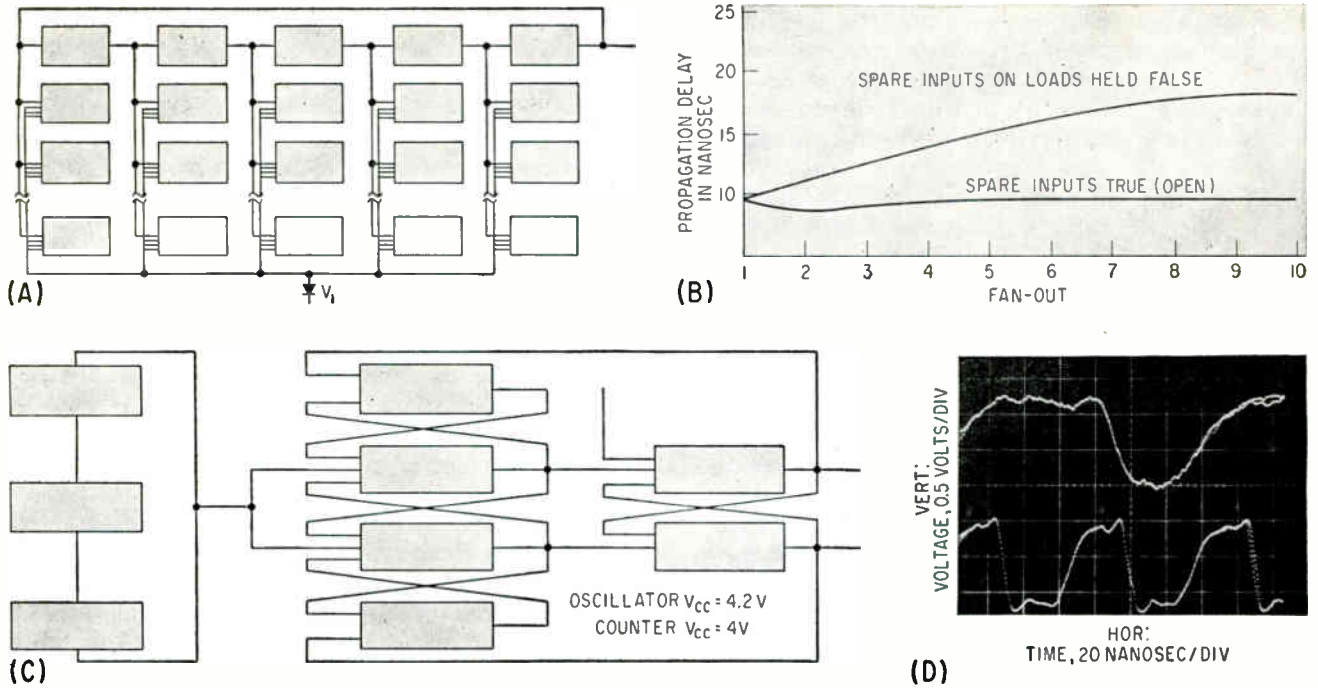

LOADING ARRANGEMENT for propagation delay measurements (A); effect of loading on propagation delay (B); ring oscillator and counter arrangement (C) in which counting proceeds at a 15 Mc rate; input and output waveforms of counter are shown in (D). With better techniques and a better waveform on the clock pulse, a higher counting rate should be achieved—Fig. 5

rectly the maximum permissible saturation resistance in the transistor. Shallow diffusion depths are necessary to obtain fast switching, since the transit time must be kept small both for its own sake and to minimize the effect on gain of the heavy gold doping required for low storage effects. For the LCDT gate, resistor values are small, gain requirements are at minimum, and, at the same time, resistive effects in the various diodes must be minimized. Thus, a relatively low ρ_s value of 140 ohms/sq was chosen. Junction depths of 1.8 to 2.1 microns for the base layer and 1.2 to 1.6 microns for the emitter gave satisfactory gains and switching speeds. Based on all units measured to date, a 15 percent tolerance can be maintained on resistors with 93 percent yield.

Gold doping is necessary to minimize minority carrier storage effects in the transistors and diodes. One of the more fortunate facts about the diode-coupled logic circuit is that capacitance effects are worst at low temperatures, while minority carrier storage effects are worst at high temperatures. If the gold doping is adjusted correctly, switching speeds can be made worst-case at both high and low temperatures with optimum performance near room temperature and with a minimum of overall variation.

INTEGRATED CIRCUIT PERFORMANCE—The d-c characteristics of the LCDT gate can be studied most simply with a transistor curve tracer. The output, one input, and the ground leads are connected to the collector, base, and emitter posts of the curve tracer; the B⁺ lead is connected to an appropriate supply voltage. Displays of output voltage against output current with negatively stepped input cur-

rent, and input voltage against output current for negatively stepped input current are the most informative. These displays give: (a) the worst-case output voltage under full load and worst-case input current, (b) the maximum "false" voltage for worst-case output OFF current, (c) the minimum "true" input voltages for various load currents, (d) the value of resistor R_i , and (e) the worst-case input current. Typical displays are shown in Fig. 3A, 3B and 3C. Figures 4A and 4D show how these parameters as measured on a typical device vary as a function of temperature. One of the desirable features of DTL is that the variation in input current and power dissipation due to variation of R_i with temperature is partially compensated for by variation in the diode forward voltages with temperature.

The LCDT integrated circuit will operate over a minus 55 deg C to plus 125 deg C range at supply voltages between 3 and 6 volts. It seems unlikely, however, that such a wide voltage variation will be experienced by any one device. Preliminary studies indicated that a 4-volt supply was optimum in that

OFF CURRENT CHOSEN FOR OPERATING TEMPERATURES—TABLE II A

$T^{\circ}C$	-55	+25	+70	+100	+125
$I_0' \mu A$	5	10	20	40	40

I_L CHOSEN FOR OPERATING TEMPERATURES—TABLE II B

$T^{\circ}C$	-55	+25	+70	+100	+125
$I_L \mu A$	0.05	0.1	0.3	1	2.5

component tolerances were loose and that speed and power dissipation varied little with temperature at this voltage. Thus the circuit was designed primarily for operation at 4 volts, d-c and dynamic studies on the device were made primarily at this operating voltage.

The following test program was carried out on a large number of units sampled from 20 different production runs. First, an output current level I_o' was chosen for each temperature at or below which the device was defined as being OFF (see Table IIA), and the input voltage V_f at which this current would flow was measured on all units. Second, input currents at various temperatures were measured, and worst-case values set which gave a good yield. Third, a leakage specification I_L (see Table IIB) was set at each temperature for the input diodes, to be measured with the full B^+ voltage applied to the input with the device ON. Fourth, output voltage V_o was measured at various fan-out values and temperatures on all the units with an input current I_i , where

$$I_i = \text{Fan-In} \times \{I_o' + (\text{FO} - 1)I_L\}$$

These results were used to choose values of V_f and V_o at 125 deg C that would guarantee a d-c stability $\Delta V = 100$ mv at a fan-out of 5 with maximum yield. Units were selected which would pass this test and plots drawn of their worst-case V_o vs F.O. at each temperature. From these plots, the values of F.O. were obtained for which

$$V_o = V_{FW} - \Delta V$$

where V_{FW} = lowest value of V_f measured on any unit at each temperature. The curves in Fig. 4B, showing fan-out as a function of temperature and d-c stability level, were obtained in this way.

If the fan-out values given in Fig. 4B are to be realized, saturation resistance of the inverter transistor should be lower than V_o at the maximum fan-out at each temperature. Saturation would have two effects. First, V_o would be increased; such an increase would be detected in the tests already described. Second, the power drain from the supply would be increased, since any increase in V_o above the natural clamping level will divert current from the clamping diode into the emitter follower, even though the increased V_o is within specifications. Power drain at maximum fan-out must be measured to safeguard against this effect.

Specifications for the epitaxial layer were chosen to avoid saturation at all temperatures. The following measurements were made to check this. First, the saturation resistance of the inverters on a large number of gates were measured at room temperature with 20 percent overdrive. Nearly all units fell within the range 0.25 to 0.35 volt at 10 ma collector current. Second, the collector current on a worst-case inverter was measured at a collector voltage of $V_o' = V_{FW} - 200$ mv with 20 percent overdrive at various temperatures; V_o' was chosen in this way so that it would be below the clamped output voltage of any unit. Finally, the fan-out values to which these collector currents corresponded were plotted to give the broken line in Fig. 4B.

Breakdown effects in the device are consistently above the operating voltage range of the device. The

input diodes, being emitter-base junctions, have breakdown voltage of 6.5 to 7 volts at 10 μ a. Isolation and collector-base junctions (including the clamping diode, which is formed at the same time as the collector-base of the transistor) have breakdown voltages typically in excess of 25 volts at 10 μ a, and both the emitter follower and inverter transistor have breakover voltages of 8 to 10 volts.

DYNAMICS—Propagation delays in the device were measured using a five-stage ring oscillator. No significant difference was observed between delays measured across two stages of the ring (average of the delay per stage between 50 percent points) and measurements based on the frequency of oscillation.

The dependence of average propagation delay on voltage, temperature and fan-out are illustrated in Fig. 4C, 4E and 5B. The effect of increasing fan-out depends on whether or not the spare input diodes on the additional loads are connected to other gates which remain ON during the 0 to 1 transient. If such a connection is assumed, recovery effects in the input diodes slow down the propagation. Figure 5A illustrates how this effect was simulated to obtain the results given in Fig. 5B. Care was taken to ensure that voltage V_i was such as to give worst-case effects in these measurements. Grounding V_i produced a situation very close to the worst-case. The rise time (0 to 1 transient) varies from 10 nanosec at 4 volts (with a single load), to 18 nanosec with 10 loads ungrounded or 30 nanosec with 10 loads grounded. The fall time (1 to 0 transient) varies from 5 nanosec at 4 volts with a single load, to 20 nanosec with 10 ungrounded loads and 20 nanosec with 10 grounded loads.

The LCDT gate is shown interconnected as a counter, driven by a ring oscillator and counting at a rate of 15 Mc in Fig. 5C and 5D. The interconnection techniques were poor, which accounts for the poor wave form. With better techniques, and a better wave form on the clock pulse, a higher counting rate should be achieved.

One final point of note concerning the dynamic characteristics of the device is that when overdriven with a low impedance generator, ringing is observed. Although related to the large recovery currents that would flow in the input diodes under such circumstances, the mechanism propagating the ringing is not fully understood. The ringing can be avoided by using a transistor on the generator output.

CONCLUSIONS—LCDT logic offers a way of achieving high-speed propagation delay at low power dissipation, and high fan-out levels with loose component tolerances, particularly at temperatures below 100 deg C. Cross-talk is virtually nonexistent, and the circuit has a relatively high saturation resistance tolerance. Extra d-c stability is achieved by a small resistance in series with the clamping diode to depress the clamped output voltage, at a sacrifice in speed and saturation resistance tolerance.

The author acknowledges the invaluable contributions of W. F. Perrine, H. L. Schoger and W. R. Faleschini in the development of the LCDT integrated circuit.

AUTHOR Stoner sets up message on digital message entry device

Since the pulse center is less affected by noise than pulse edges, three extra bits, centered on the sync pulse, are inserted periodically. Regardless of pulse distortion, the total length of the 3 pulses still equals 3 bits



MILITARY APPLICATION

This synchronization system is used in a target observer's reporting device (see photo). Switches are set to indicate target location, description, quantity, heading and activity, as well as date and time. After the message is checked, the operator presses a transmit button, and the entire message is transmitted over standard field equipment. The device weighs about 4½ pounds

UNIQUE SYNCHRONIZING TECHNIQUE INCREASES Digital Transmission Rates

By K. ROEDL and R. STONER, General Dynamics/Electronics, San Diego, Calif.

A MAJOR PROBLEM in achieving faster and more accurate radio transmission of digital data to remote receiving stations is that of synchronizing the transmitting and receiving systems. With high-stability timing systems, an initial synchronization is usually adequate for the reception of short messages, but for longer messages it becomes necessary to resynchronize periodically on the transmitted data.

Some of the methods developed use the leading or trailing edge of the received pulses for synchronization. In radio transmissions, however, these edges are affected by noise and may shift to such an extent that the timing obtained be-

comes inaccurate and unreliable. A received signal after demodulation may be narrowed or widened as a result of noise (Fig. 1A).

Methods to diminish the detrimental effects of noise have been developed using the center of the received pulse instead of the edges. Since laboratory tests have shown that the center of a modulated signal shifts noticeably less than the edges when affected by noise, more accurate synchronization may be obtained this way. At any signal-to-noise ratio tolerable for reliable communications, the pulse center remains relatively stable. Under conditions that cause the pulse center to shift significantly, the

problem becomes one of communication rather than of synchronization.

This method uses the pulse center for synchronization and determines this center by digital means in a simple but unique manner. Three extra bits, called sync bits, are inserted periodically between equal groups of data bits when synchronization is desired. The logic levels of the extra bits may be either 0-1-0 or 1-0-1. The center bit of the three is called the sync pulse, since the center of this pulse is used to synchronize the system.

PRINCIPLE—The basic principle of the method is shown in Fig. 1B. Time *B* represents the length of

the received sync pulse. As shown in Fig. 1A, this pulse may be shorter or longer than the true bit length, depending upon how the transmission has been affected by noise. Time C is the period from the end of the received sync pulse to the start of the first data bit. If the center of the sync pulse has not shifted (that is, if transmitter and receiver are in sync) time C will equal time A , regardless of the length of B . This leads to the following equation, which forms the

basis for this synchronization method: $B + 2C = 3$ bits.

A binary counter performs the arithmetic operation shown in the equation above. The length of the received sync pulse, time B , is measured by the counter while counting at its normal rate. At the end of time B , the counting rate is doubled and the counter continues at that speed until the count accumulated represents the time of 3 bits. As indicated in Fig. 1B, at this point the counter is synchronized

to the transmitted data, since this count of three bits is reached at the end of the third sync bit. If the center of the sync pulse has not been affected significantly by noise, the accuracy of synchronization will be to within one clock period of the counter. Therefore, the accuracy is a function of the clock rate and the number of counter stages used.

Figure 1C illustrates the application in which the method was first checked. In the system described, 8-bit characters are utilized. The three sync bits are inserted between characters, to provide resynchronization before the start of each new character. The transmission speed is 600 bits per second and the receiving system is controlled by an 8-stage binary timing counter operated by a 9.6-Kc clock (Fig. 2). The timing counter has the triple function of determining when to sample the received data bits for their logical level; of counting these bits to determine when the sync pulse is to be expected; and of finding the center of the sync pulse to reach synchronization at the beginning of the first data bit. Since in this case only eleven bits have to be counted in one cycle, the counter is reset automatically to the count of 01010000 at the end of the eighth data bit.

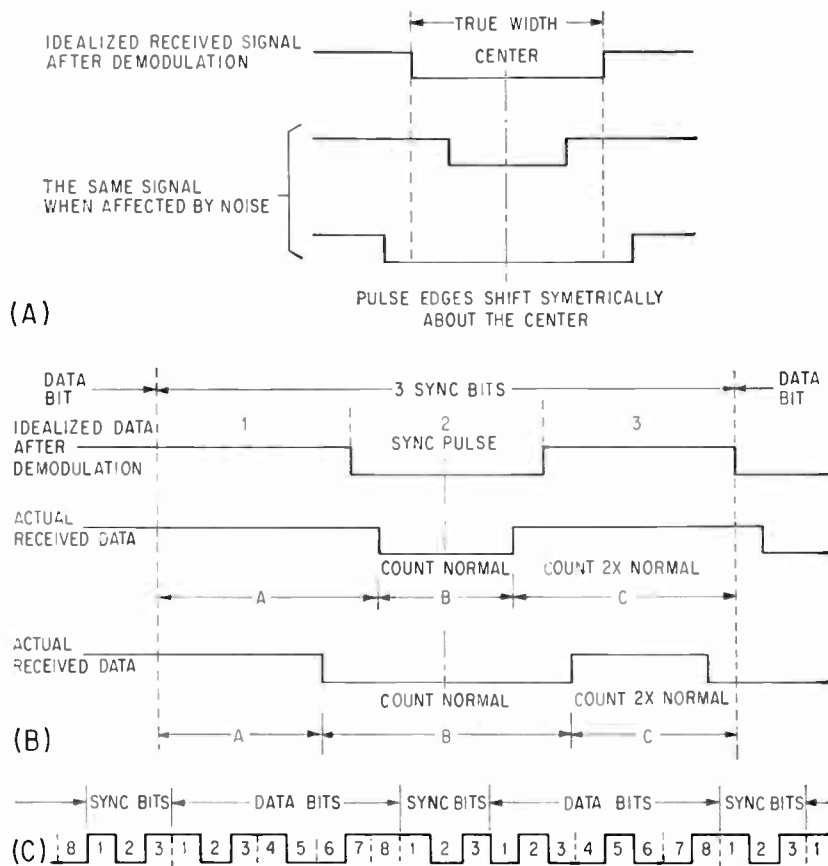

EFFECT OF NOISE on transmitted signals (A); principle of synchronization (B); insertion of three sync bits between each eight-bit character (C)—Fig. 1

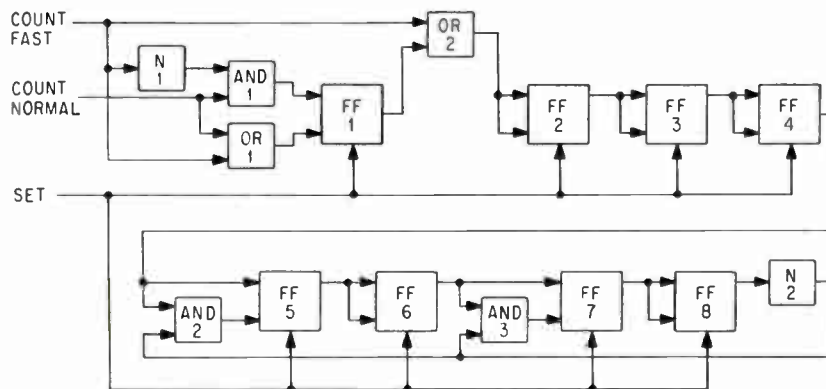

TIMING COUNTER, which uses internally cross-coupled flip-flops—Fig. 2

TIMING COUNTER—The timing counter (Fig. 2) is a typical binary counter with eight stages of internally cross-coupled flip-flops. When the COUNT NORMAL signal is a logical one, the COUNT FAST signal is a logical zero. In this condition, the one and zero inputs to flip-flop 1 are enabled through AND 1 or OR 1 respectively. Since the flip-flop is cross-coupled, the next clock pulse will provide coincidence at one of its inputs and it will change state.

Each time the first stage goes to a one state, flip-flop 2 is enabled through OR 2 and will change state on the next clock pulse. Each of the succeeding stages of the counter is enabled when the stage preceding it is in a one state and will change state on successive clock pulses. Thus the count produced is binary at a speed determined by the clock rate.

When the COUNT FAST signal is a logical one, the COUNT NORMAL signal is a logical zero. In this condition, the first flip-flop stage is dis-

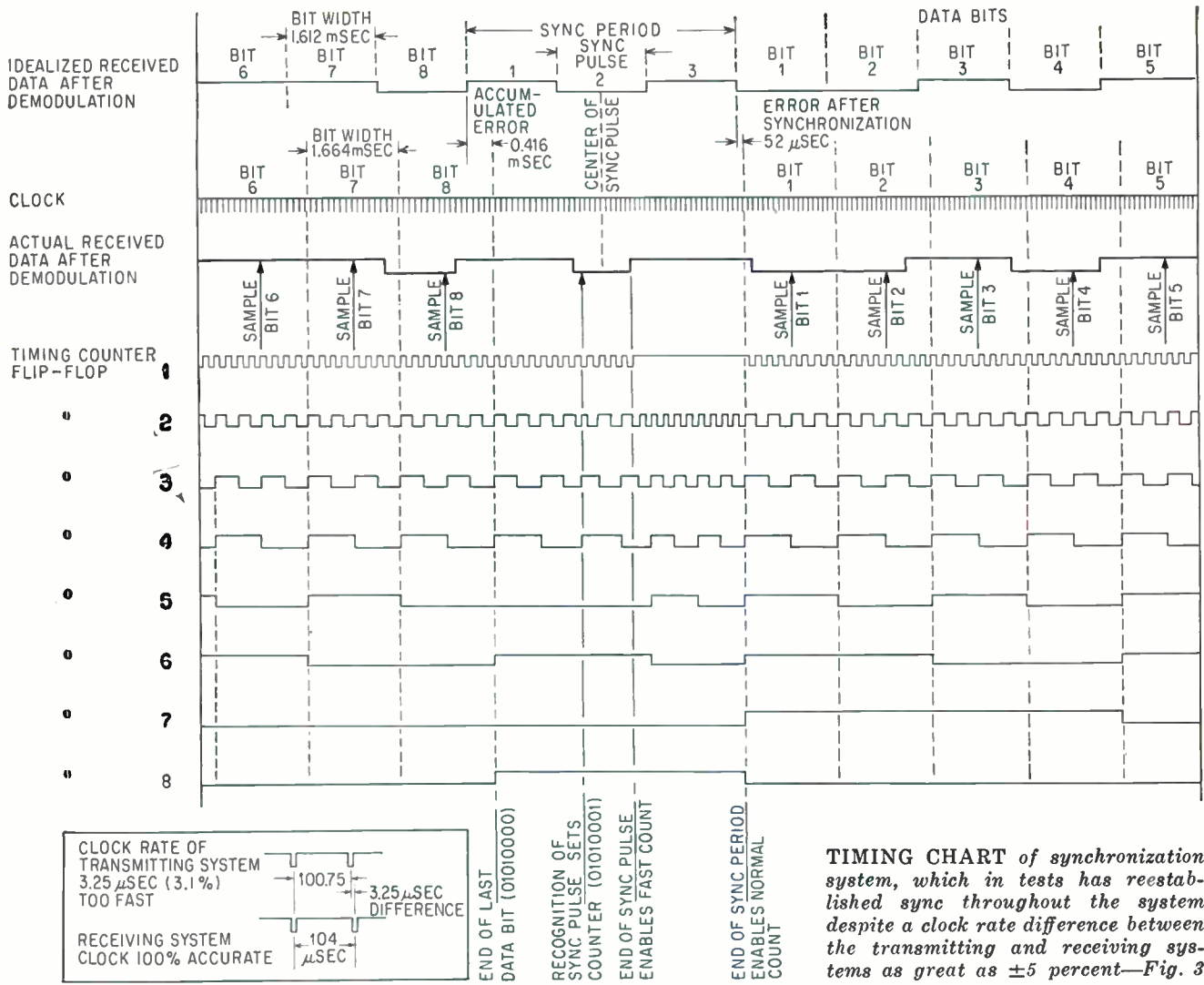

TIMING CHART of synchronization system, which in tests has reestablished sync throughout the system despite a clock rate difference between the transmitting and receiving systems as great as ± 5 percent—Fig. 3

abled through AND 1 and the counter is enabled at its second stage through OR 2. This causes the remaining stages to count at twice the normal rate.

The AND 2 and 3 permit setting the counter at a particular count. As long as final stage flip-flop 8 is in its zero state, its one output is a logical zero and AND gates 2 and 3 are enabled through inverter N2. With these gates enabled, flip flops 5 and 7 change state. When the last stage changes to a one state, its inverted output disables AND gates 2 and 3, and the following clock pulse will set flip-flop stages 5 and 7 to a one state. This provides a count of 01010000 at the end of the eighth data bit. This is the count indicated in the timing chart (Fig. 3) at END OF LAST DATA BIT. The count of 01010001, set in the counter by the recognition of the sync pulse, is also indicated. The status of the various stages of the timing counter at the shift from normal to fast count and return to normal count

are shown in the timing chart at END OF SYNC PULSE and END OF SYNC PERIOD.

EXAMPLE—For illustration, a clock rate difference of 3.1 percent between the transmitting and receiving systems is assumed. If the two systems are in synchronism at the start of the first data bit, the accumulated error at the end of the eighth data bit will be 416 microseconds. This error must be corrected during the following sync period by synchronizing to the center of the sync pulse. With sync bits of zero-one-zero, the incoming data is checked for a logical one level throughout the interval from the center of the first sync bit to the center of the last sync bit. As soon as a logical one level is detected, it is recognized as the start of the sync pulse and the timing counter is set by the following clock to 01010001. This is one count greater than when the counter is reset automatically at the end of the eighth

data bit, to account for the fact that one clock period has passed between the beginning of the received sync pulse and the setting of the counter. For the duration of the sync pulse, the timing counter is counting at normal speed. At the end of the sync pulse, as soon as a zero level is detected on the incoming data, the counter is advanced through its second stage with the first stage disabled. Thus the counter now counts at twice its normal rate. When the clock count equivalent to three bits has been reached (01111111), the timing counter has established synchronization, within one counter clock period, to the transmitted data by using the center of the received sync pulse. In this example, the timing error after synchronization is only 52 microseconds. The first stage of the timing counter is again enabled at the beginning of the first data bit, allowing it to count at normal speed to control the timing for reception of the next character.

DYNAMIC NULL

New Method for Measuring Equipment Performance

With simple laboratory components and an oscilloscope, this method allows precise parameter measurements and immediate display

By JOHN L. HAYNES, Consulting Engineer, Redwood City, Calif.

THIS DYNAMIC NULL method of measuring equipment performance parameters requires only simple laboratory instruments. It is useful for product testing, for calibrating and adjusting d-c or a-c amplifiers, and even for the complete f-m/f-m data links of many instrumentation systems. By this method, the effect of any component or power supply change on almost all equipment characteristics can be immediately displayed on an oscilloscope.

Many modern instrumentation systems offer overall performance accuracies ranging from 0.05 to 1 percent; equipments making up such systems require accuracies two to five times better. An amplifier, for example, may specify gain as $1,000 \pm 0.01$ percent, linearity as 0.05 percent, bandwidth as 100 Kc, output impedance as 0.1 ohm and input impedance as 100,000 ohms.

Measurement of such parameters

by conventional input-output techniques requires highly accurate test equipment. Furthermore, although measurements of d-c transfer characteristics can be made to better than 0.02 percent with a Kelvin bridge or potentiometric voltmeter, the process is tedious. Linearity can be determined by calculating the largest deviation from a plotted or calculated best straight line. If the amplifier is a-c coupled, or for a-c gain and linearity measurements, the difficulty increases, since measurement of a-c signals to 0.01 percent or even 0.1 percent absolute accuracy is virtually impossible with usual laboratory instruments. Measurement of linearity by harmonic analysis would be difficult even if generators with 0.05 percent distortion were available.

DYNAMIC NULL — With this method, an oscilloscope gives a dy-

amic plot of equipment errors in gain or linearity, offset or drift, effects of input and output impedance, phase shifts, all noise and hum, and transient effects such as overshoot, ringing, saturation or slewing errors. Photographs of the oscilloscope display can serve as part of the performance record of individual units.

As with a conventional bridge, the test accuracy is dependent on an attenuator. A resistive attenuator has no offset, has linearity better than 10 parts per million, and can be made with negligible phase shift. An absolute gain error measurement is limited by the tolerances of the attenuator (for f-m/f-m tests, gain is usually one; no attenuator needed). However, precision attenuators are usually available or can be made with precision resistors for each amplifier. The attenuator should have an output impedance equal to the recommended source impedance for the amplifier, which should also be terminated in the proper load.

A dynamic null test requires only an a-c generator, a few resistors and an oscilloscope. Generator output waveform is not critical—it may be sinusoidal, ramp or triangular, and may have poor distortion and amplitude stability (it could even be a signal from the secondary of a filament transformer). Resistors need not be precise for linearity measurements, but should be for accurate gain measurement. The

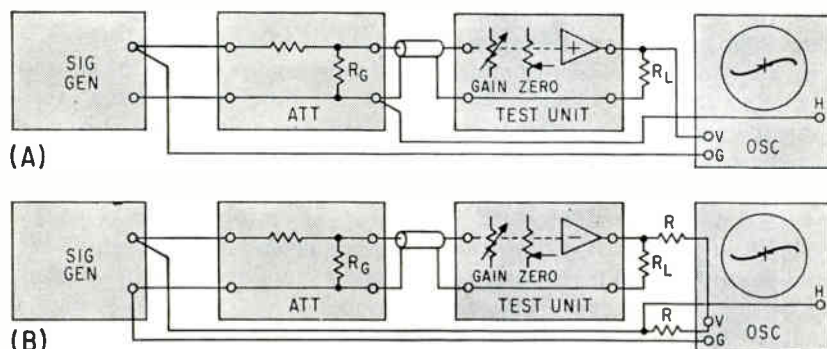

DYNAMIC NULL test setup for positive gain unit (A) and negative gain unit (B)—Fig. 1

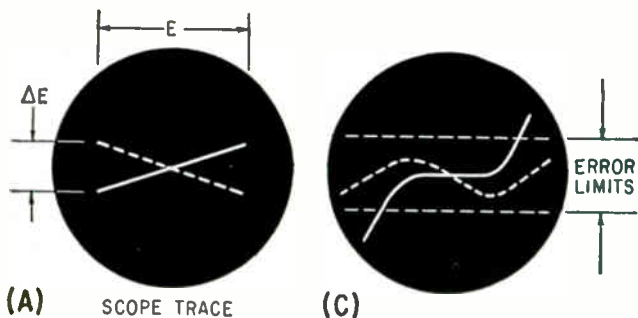

(A) SCOPE TRACE

(C)

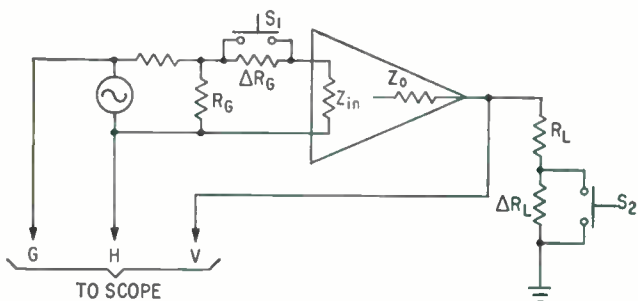

(B)

SETUP for measuring input and output impedances (A and B), and illustration of gain adjustment to reduce linearity error (C)—Fig. 2

SCOPE TRACE



SCOPE TRACE	CONDITION	POSSIBLE SOURCE OF TROUBLE
	Ideal Output	Scope sensitivity too low?
	Positive Offset	Recheck scope zero, then adjust zero control of unit under test.
	Low Gain	Recheck attenuator, then adjust gain control of unit under test.
	Distortion (even harmonics)	Clipping or saturation. Check output stages for correct bias point.
	Distortion (odd harmonics)	Symmetrical clipping. Input signal level high or power supply low.
	Distortion (crossover)	Low gain at small signals. Bias low in output stages.
	Hum (in cycles)	Pickup (60cps) or power supply (120 cps). Hum frequency is 2n times input freq.
	Noise	Input stage probably at fault. Touching-up solder joints may help.
	Phase Shift	Input-Output delay. Input signal is outside bandpass of unit.
	Slowing Error	Inadequate current to drive capacitive loading. Check output bias.
	Load Sensitivity	Inadequate loop gain, or excessive loading.

only oscilloscope requirements are good vertical sensitivity and provision for external horizontal input. Generally, the chassis should be floating from ground potential. The usual isolation provided by the oscilloscope power transformer is adequate.

MAKING TESTS—To test an amplifier with positive gain, the generator is connected to it through the attenuator (Fig. 1A); for negative gain, the connection is as in Fig. 1B. Attenuator loss is adjusted to equal the specified amplifier gain; amplifier output should then equal generator output. The oscilloscope is next connected to the generator output and to the amplifier output, making the vertical deflection proportional to the difference between the attenuator input and amplifier output. This displays any amplifier error. The oscilloscope horizontal input is then connected to make the horizontal deflection proportional to the generator signal (in Fig. 1A, positive voltages will read from left to right since the horizontal trace is inverted). The resulting trace is amplifier error plotted against signal amplitude at the generator frequency. Any transfer error in the system under test shows up at a glance, allowing quick adjustment

of errors. For instance, with the generator adjusted for 3 v rms output (10 v p-p) and the scope vertical sensitivity set at 5 mv/cm, a 0.1 percent gain error will be displayed as a 1-cm vertical deflection.

Two precautions should be noted: (1) the scope should be re-zeroed periodically to eliminate drift; (2) shielded leads should be used on the output of the attenuator, because signal level is normally low and any noise or hum entering the amplifier terminals at this point will show up as an apparent amplifier output

error. A signal ground point should be found which results in the minimum hum and pickup. The ground point may be dictated by an existing ground in the amplifier.

The table shows scope patterns of typical errors, their cause and cure. Figure 2A and 2B show a setup for sensitive measurements of input and output impedance. The impedances can be calculated from these equations: $Z_{in} = R_G + \Delta R_G$, $(E - \Delta E)/\Delta E$ where ΔE is obtained by closing S_1 ; and $Z_o = R_L(\Delta E R_L + \Delta E \Delta R_L)/(E \Delta R_L - R_L \Delta E)$ where ΔE is obtained by closing S_2 .

Trade-offs in system errors for best overall output errors are easily assessed. Figure 2C shows the display for an amplifier with no gain error but with odd harmonic distortion which apparently puts the output out of spec. By increasing the gain slightly the curve is tilted to bring the output within spec; thus a unit which would have been rejected by a simple linearity test is proved satisfactory.

All of the preceding measurements can be made over time, temperature, power supply variations and/or component substitutions, allowing a complete check of the amplifier under rated environment; with one measurement it is possible to display simultaneously all amplifier errors.

QUICK, STRAIGHTFORWARD AND INFORMATIVE

Although most examples given here are for amplifiers, this dynamic null measurement method is equally useful for evaluating transfer gain of many other subsystems — f-m modulator-demodulator units, or other voltage-to-frequency converters, analog-to-digital converters, and so forth. This method, says author Haynes, is quick, straightforward and informative, and can even be used by relatively unskilled lab technicians

Semipermanent Memory: LATEST USE

Experimental twistor memory with 7,680 bits obtains semipermanent information storage by automatically resetting the twistor bits to their original state after each read pulse. Holes punched in removable copper sheet inhibit writing in desired bit location

EXTENSIVE USE of digital storage techniques in recent years has led to investigation of various information storage devices and methods. One of these devices, the twistor¹, is being used as the storage element in an experimental 7,680-bit semipermanent card-changeable memory built to evaluate overall quality and operating characteristics of a moderate quantity of twistor element. The memory also indirectly measures the effectiveness of fabricating apparatus and procedures and establishes a reference point for circuit design requirements and improvement of existing techniques.

BASIC MEMORY—The simplest twistor memory consists of a length of twistor and a solenoid con-

centric with the twistor (Fig. 1A). Because of the helical orientation, the direction of magnetization in the ribbon can be reversed by the magnetic field produced by the current flowing in the twistor core, the current flowing in the solenoid or a combination of the two.

Because of material square-loop properties, the component of the magnetic field along the ribbon must exceed a threshold value before such reversal occurs. Three current pulses are required to operate a twistor memory in the temporary storage mode. Of these, two (I_{sw} and I_{sr}) are used for writing and one (I_{sr}) for reading. A coincidence of write pulses through the core of the twistor and the solenoid is used to write ONES into the memory. The amplitudes

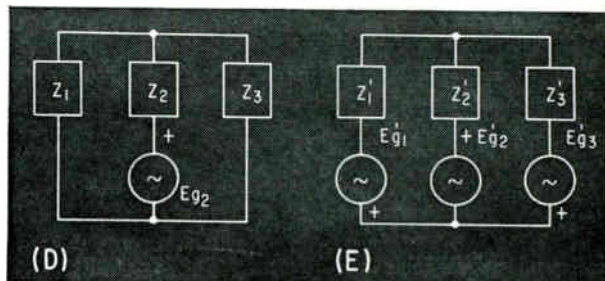
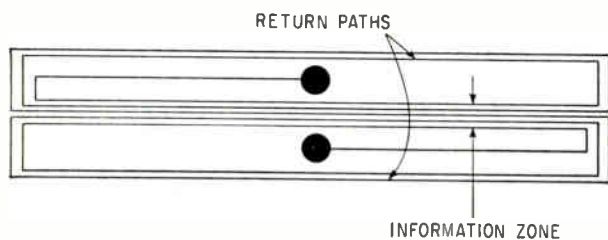
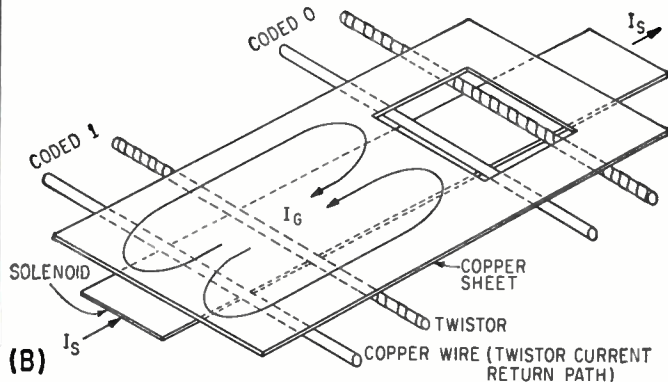
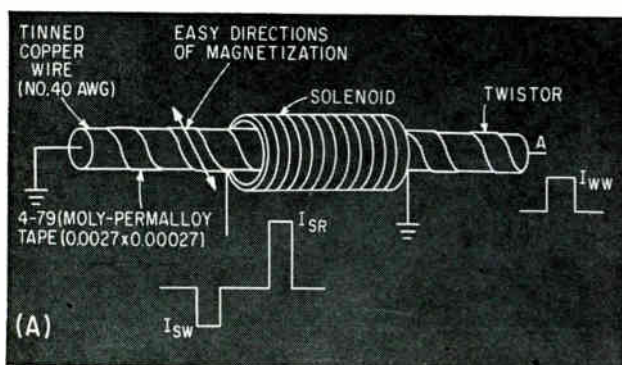

TWISTOR memory (A) uses coincidence of current pulses (I_{sw} and I_{wr}) to set the magnetic material under the solenoid to the 1-state. Readout is by current pulse I_{sr} through the solenoid with readout at point A. Two bits of the memory are shown in (B) while (C) shows a five-turn, printed-wire solenoid. Equivalent circuit (D) shows eddy current return paths far removed from the copper while (E) shows return path near the copper—Fig. 1

FOR TWISTORS

By K. E. KRYLOW, J. T. PERRY, JR.,
and W. A. REIMER,
Staff Engineers,
Automatic Electric Laboratories, Inc.,
Northlake, Illinois

of the write pulses are such that neither pulse is capable of switching the twistor by itself. However, their combined effect during coincidence is sufficient to put the twistor into the ONE state.

Read pulse polarity is opposite to that of the solenoid write pulse and its amplitude is large enough to insure full switching. The read operation sets the bit into the ZERO state and it remains in this state until it is reset to the ONE state, regardless of the number of times it is read out. When a twistor bit in either state is interrogated, a voltage is induced in the twistor core. The voltage induced during the transition of an interrogated bit from the ONE state to the ZERO state is much larger than that induced when the bit is originally in the ZERO state and no change of state occurs. Consequently, the two states are readily distinguishable.

In practice, a number of twistors pass through any solenoid and many solenoids can be placed at intervals along the twistors. Each solenoid represents one address and one twistor represents one bit in every address. Each twistor is paired with a plain copper wire to form a transmission line pair. Properly terminated, this arrangement reduces external noise pick-up and provides uniformity of transmission characteristics.

SEMI-PERMANENT STORAGE—Two approaches to semipermanent information storage are available. One is to find a means by which the twistor bits can be kept in the desired state as long as necessary, and the state of the bits ascertained in some way without changing it. The other is to find a means by which the twistor bits can be automatically reset to their original state after each read pulse. The memory described here is based on the second approach.

Physically, twistor and solenoid are different from that described above. The twistor element is placed outside the solenoid and a thin copper sheet is placed over the twistor (see Fig. 1B). During the rise and fall of solenoid current I_s , eddy currents I_e are induced in the copper sheet by the time-changing flux linkages. At the twistor location, the magnetic field intensity associated with the currents induced during the rise of the solenoid current, aids the field pro-

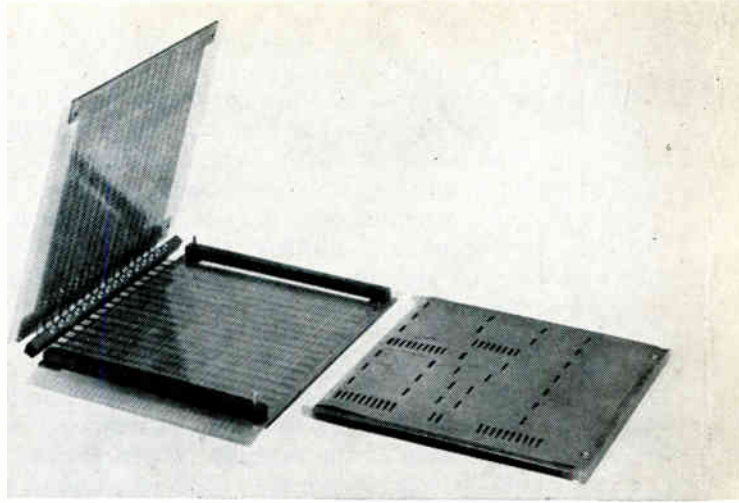

HIGH-PERMEABILITY plates are affixed to both sides of the code card in this partially assembled memory plane

duced by the solenoid. The rate of rise and the final value of the solenoid current can be adjusted so that the magnetic field intensity due to the solenoid and the eddy currents combined is sufficient to switch the twistor, while the magnetic field intensity due to the solenoid current alone is not. Under such conditions, the twistor will switch when the copper sheet is present over the twistor but will not switch when it is absent. In the memory, the presence of copper over the twistor bit codes a ONE while the absence of copper codes a ZERO. This is accomplished by punching holes in the copper sheet over the twistor bits which are to be coded ZERO. If two consecutive solenoid pulses of opposite polarity are used, all twistor bits associated with the selected solenoid which are coded ONE will switch to the ZERO state and then back to the ONE state. Bits which are coded ZERO will remain in this state at all times, since the magnetic field intensity is insufficient to switch them.

SOLENOIDS—A switch core matrix is a convenient way to provide two consecutive pulses of opposite polarity and at the same time supply the means to select a solenoid in the memory. However, no switch core could be found that would give the relatively high currents necessary to switch the twistor with single-turn solenoids. The situation was solved by

WHAT'S A TWISTOR?

It's a magnetic information storage device. The original twistor¹ was a magnetic wire under torsion, hence its name. At present, the twistor consists of a copper wire on which a ribbon of square-loop magnetic material is wound helical fashion. Through selection of materials and processing, the easy direction of ribbon magnetization is made to lie along the ribbon. Information is stored in binary form using the two remanent magnetic states

devising a special five-turn printed-wire solenoid configuration as shown in Fig. 1C. The solenoid is a figure eight in which the section common to the two loops has twice as many conductors as there are in the outer portions of each loop. The central portion of the solenoid is called the information zone, and the outer portions of the solenoid are the return paths. Several variations of this solenoid have been made, including one that provides bipolar outputs—positive ONES and negative ZEROS.

The presence of the return paths near the copper sheet increases the induced current flow over the information zone of the solenoid. The effect can be explained by considering the copper sheet over the solenoid as a two-loop circuit, where the common branch represents the information zone. When the return paths are far removed from the copper, a generator, representing the induced voltage, exists only in the common branch (Fig. 1D). When the return paths are near the copper, additional generators are inserted in the outer branches of the circuit (Fig. 1E) that aid the generator in the center branch. This increase of solenoid efficiency permits the use of lower drive current amplitudes, but imposes an upper limit on the read current. Increasing the read current beyond a certain magnitude will cause the portions of the twistor over the return paths to switch in opposition to the twistor over the information zone, thereby reducing twistor signal output.

A memory based on these principles was built and operated successfully. Only small variations of the solenoid pulse magnitudes could be tolerated because of the spread in twistor characteristics. To increase allowable variation of the solenoid pulses from nominal operating magnitudes, plates of high-permeability magnetic material were placed over the copper sheets. This addition improves the operation of the memory in two ways. It permits the use of higher solenoid currents without switching the bits which are in the ZERO state. Also greater control over the information content of any bit is transferred to the copper sheet; that is, the ratio of the magnetic field intensity due to the eddy currents to the magnetic field intensity due to the solenoid current is larger. These effects can be deduced by considering the distortion of the magnetic field caused by planes of high-permeability materials in the vicinity of the current-bearing conductors.

MEMORY PACKAGE—The memory consists of a number of transmission line pairs passing over a series of solenoids and under a series of copper sheets. There are as many twistors as there are bits per address, and as many solenoids as there are addresses. The card-changeable feature is provided by attaching the copper sheets to removable code cards that can be inserted in slots in the package. The memory coding is changed by punching the required hole pattern in a copper sheet, attaching the sheet to a code card, and inserting it in the memory. A slight bow in the copper sheet and reasonably tight dimensional tolerances on the slots and code cards provide adequate proximity of the copper to the twistor elements.

In designing a package using this coding scheme,

all bits must be located accurately in the memory. The spacing between neighboring twistor elements in one direction, and between adjacent solenoids in the other, has to be kept constant. Twistor element spacing is established by encapsulating the required number of pretested twistor elements between two polyester tapes. In addition to locating the twistor elements accurately with respect to one another, the encapsulation minimizes the possibility of damaging the elements and simplifies the problems of storing and handling.

Uniform solenoid spacing is maintained by printing solenoids on a flexible substrate, using conventional wire-printing techniques. The solenoids are printed in groups to minimize tolerance build-up, provide a convenient subunit within the memory and keep the package to reasonable dimensions. Each group contains eight solenoids of the type shown in Fig. 1C, and constitutes one plane of the memory.

A partially assembled memory plane is shown in the photo. A backing plate and a tape containing the encapsulated twistors are affixed to opposite sides of each half of a solenoid group. Two spacer bars and a solenoid terminal strip are added, and the plane is assembled by folding, keeping the twistor tapes to the inside. The spacer bars and the terminal strip are side guides and back stop for the code card, providing an accurate index of the coded copper sheet to the twistor bit locations. Matching hole patterns are provided in the twistor tapes, solenoid groups and package hardware. All components are held in alignment, both during and after assembly, by pins passing through these holes. To build a memory package, these planes are assembled side-by-side along two lengths of twistor tape. Using the tape between planes as hinges, successive planes are stacked on top of each other. The package is completed by adding corner supports, top and bottom plates, and twistor terminal strips.

ELECTRONICS — The system was constructed solely for evaluating overall performance of twistor elements and techniques used in fabrication, testing and packaging. Consequently, circuits associated with this unit function merely as a memory exerciser. The only design considerations, other than the drive requirements imposed by the memory package, were simplicity of construction and reasonable flexibility of programming. The various circuit blocks, flip-flops, diode gates, drivers, are of conventional design, and no special interconnection techniques are used.

Since the principles of design, interconnection, and operation of the circuit blocks and the switch-core matrix are covered extensively²⁻⁶, only a brief description of overall operation will be given. Referring to Fig. 2, a particular set of logic levels is provided by the seven flip-flops. This set activates one X gate and one Y gate, which in turn place the corresponding X and Y switches in the ready condition. An enabling pulse S from the monostable multivibrator MS closes the switches and simultaneously disconnects the two current shunts from the constant-current-generator drivers. The current pulses sent into the two select lines thus chosen, reverse the state of the ferrite switch core at their intersection, caus-

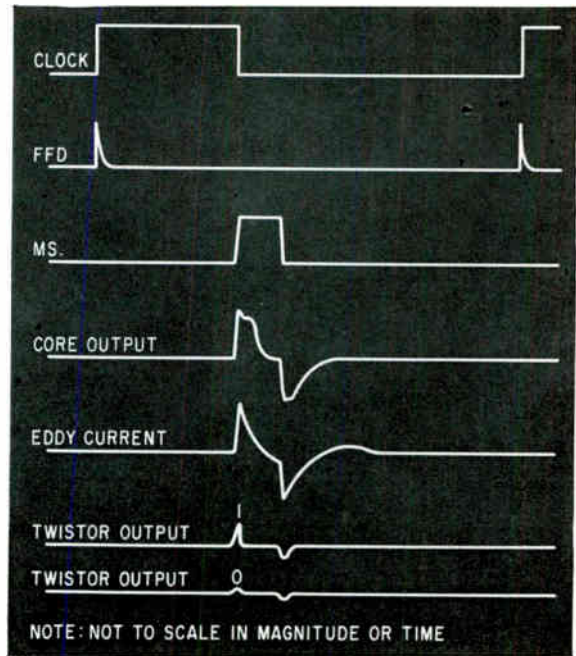
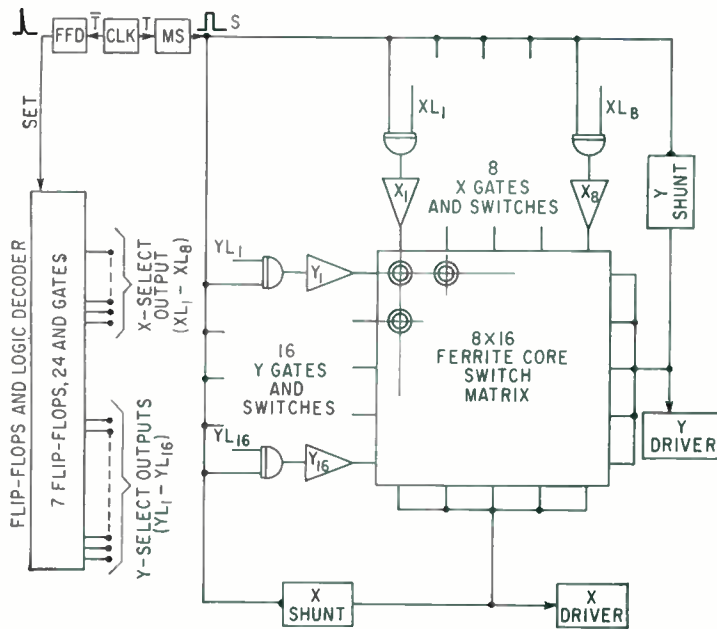

LOGIC generator, core matrix and matrix drivers of the memory (left) and timing sequence and waveforms—Fig. 2

ing a READ current pulse to flow in the solenoid connected to that core. When *S* terminates, the select line switches open, the shunt switches close, and a d-c bias resets the selected core to its original state causing a WRITE current pulse to flow in the solenoid. A new set of logic levels is set by the trigger pulse from the flip-flop driver and the entire process repeated. A wide variety of programs can be set up by altering the flip-flop and gate connections.

The output signals from the twistor are coupled into the sense amplifiers through 1:3 (nominal) ferrite pot-core transformers. The primary is center-tapped to ground, and presents an impedance of about 35 ohms to the twistor. Each sense amplifier consists of the transformer, two class-A voltage amplifiers, an emitter-follower buffer and an output discriminator-amplifier. A voltage gain of 80 is provided by the first four units. The final discriminator stage presents ONE outputs as eight-volt pulses strobed during the interval of switch-enabling pulse *S*.

Memory speed limitation is imposed by the characteristics of the switch core matrix, and not by those of the twistor. The results of another phase of the twistor memory investigation indicate that metallic tape-wound cores would be more suitable as switch matrix elements. Substituted directly for the ferrite core matrix in this system, a tape-wound core matrix would allow a 20-percent reduction in matrix drive requirements and decreased the minimum read-write cycle to 5.0 microseconds.

NOISE—The memory was susceptible to the influence of external magnetic fields and excessive internal noise almost entirely masked the output signals. The first was completely eliminated by enclosing the memory module with magnetic shielding. The second problem required extensive investigative work before the solution was found.

The circuit layout and component placement for

the system were based on the extrapolation of data previously obtained from test arrays. The general trend was to place various components as close as possible to each other to keep lengths of interconnecting leads to a minimum, especially those carrying low-amplitude signals. The switch-core matrix and the first stage of the sense amplifiers were placed directly on the memory module.

Changes were made as the troubleshooting of the system proceeded. Part of the noise was eliminated by removing the switch core matrix from the memory and placing it outside the magnetic shield. The source of the remaining noise was finally traced to capacitive coupling among the relatively long leads between first and second stages of the sense amplifiers. The problem was solved by removing the first stage of amplification from the memory package and moving it closer to the next stages, and replacing interconnecting wiring by a shielded twisted pair.

The memory has been in operation since March, 1962 without any malfunction. The system, built as a feasibility model, has now found application as a 60-channel program generator. Since completion, several new memory packages have been developed. This feature increased information storage density as well as various components designed to facilitate the assembly and wiring. An electrically alterable semipermanent twistor memory is under investigation.

REFERENCES

- (1) A. H. Bobeck, A New Storage Element Suitable for Large-Sized Memory Arrays, Bell System Technical Journal, 36, p 1,319, Nov, 1957.
- (2) J. A. Rajchman, A Myriabit Magnetic Core Matrix Memory, Proc IRE, 41, 10, p 1,407, Oct, 1953.
- (3) A. Ashley, S. Bradspies, E. Cohler, M. Stern, and H. Ullman, Core Memory Systems, Sylvania Technologist, XII, 4, p 140, Oct, 1959.
- (4) R. P. Schneider, G. H. Barnes, High Speed, Word Organized Memory Techniques, Electronic Design, p 40, June 24, 1959.
- (5) L. P. Hunter, Handbook of Semiconductor Electronics, 1st Edition, McGraw-Hill Book Company, Inc., New York, 1956.
- (6) J. Millman and H. Taub, "Pulse and Digital Circuits," McGraw-Hill Book Co., Inc., New York, 1956.

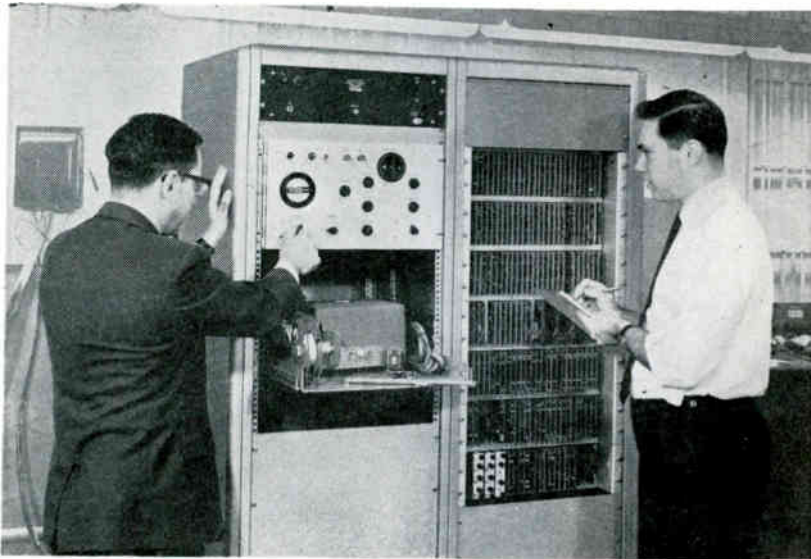

ENGINEER ADJUSTS equipment used for presenting the sonar display and its simulated wake

INTRODUCING REALISM

Many training aids and simulators are unable to reproduce the real-life effects of the equipment they are simulating. A million-dollar aircraft simulator, for example, still can't provide the sustained acceleration and gravitational forces exerted by the simplest airborne maneuver.

This realism-deficit has now been largely corrected, for sonarmen at least, by the equipment described here, which puts an important ingredient—ship's wakes—back into the picture

By M. KAUFMAN and E. LEVINE, General Applied Science Laboratories, Inc., Westbury, L. I., New York

REALISTIC SONAR TRAINER

Digital equipment generates artificial wakes and relates them to target-ship's speed, course and position. Increased realism helps condition classroom trainees to events at sea

THE WAKES OF SHIPS are simultaneously a hindrance and an aid to sonar operators. A wake, which may last 15 minutes and longer, acts as a reflecting sur-

face that returns echoes to active sonars. It is useful because it leads the operator to the ship that produced it, but a hindrance because it obscures echoes that come from

its far side. Methods for simulating ships' wakes for active sonar displays have been considered by several investigators with varying degrees of success. Two basic equations were derived in 1956, based on theoretical and empirical considerations. These relations describe the intensity of a wake echo and the effects of interference produced by other wakes interspersed between the sound (sonar) source and the target.

FUNDAMENTALS — Based on these two equations an attenuation factor, A , can be expressed

$$A = \frac{\text{Interspersed Wake}}{F(S_T) F_1(T)} \times \frac{\text{Reflecting Wake}}{F_2(T) F(\rho)}$$

where $F(S_T)$ is a function of the

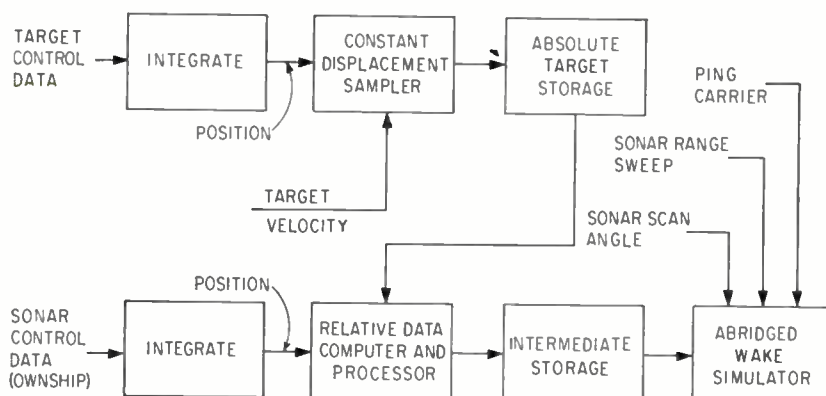

DATA relating to ship's activity is processed for feeding into the wake simulator—Fig. 1

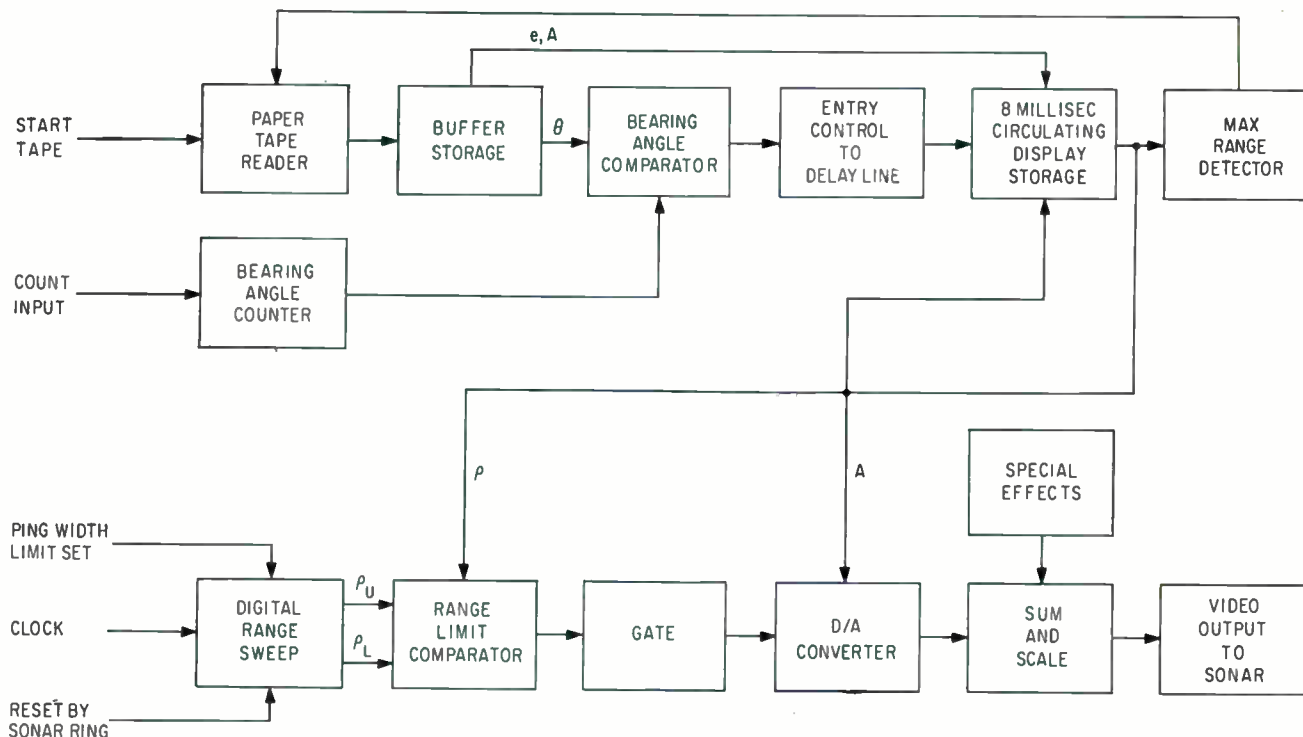

WAKE SIMULATOR keeps up-to-date with target-ship so that wake is modified in accordance with target-ship's speed, course and other parameters. Maximum wake storage is 15 minutes, which conforms to a real-life decay rate of a ship's wake of 6 db/minute—Fig. 2

SIMULATES SHIP'S WAKES

target speed while laying the interspersed wake, $F_1(T)$ is a function of the wake segment age between the reflecting wake and sonar, $F_2(T)$ is a function of the age of the reflecting wake, α is the target aspect (bearing angle θ —heading angle ϕ), and F_ρ is a function of wake range.

This article describes digital equipment for simulating ships' wakes as they affect sonar receivers using multiple hydrophones and ppi displays. The equation does not include the effects of target depth or target accelerations, but these effects may be included.

SIMULATOR DESCRIPTION

Figure 1 is a block diagram of the wake simulator. Control data for both the sonar and the target is supplied in the form of initial position and velocity. The sonar and target tracks are computed by integrating the velocities. The resultant target position is sampled at a rate dependent on the target velocity, rather than at fixed time inter-

vals, providing position information at incremental target displacements to reduce the amount of data storage needed for slow-moving targets.

The sampled target position data is stored in a circulating magnetostrictive delay line together with predetermined functions of target velocity, heading angle and other data.

The resolution of the stored position is 60 yards for a 100-mile-square area. A maximum of 15 minutes of wake information may be stored, which, considering the high rate of age attenuation, (6db/min), is adequate.

The wake position is assumed to be identical (plan view) to the stored past position of the target, thus neglecting effects of currents on the wake position. The latest 15 minutes of target track are held in the absolute target storage and compared to the sonar position to determine the relative wake-sonar position.

Other operations and computations give data for solution of wake

strength as defined by the relative data computer and processor, Fig. 1. The resulting signals are held in the intermediate storage.

The wake range, speed of vessel at the time the wake was laid, wake segment age, and related data, is routed from the intermediate storage (which is constantly up-dated) to the echo amplitude-and-location computer.

Based on the range, age, speed and aspect of the wake, an attenuation factor, A , is derived in the computer. The range number, ρ , and the corresponding A number are rearranged in terms of azimuth angle relative to a line passing stem-to-stern through the sonar carrying "ownship". These two numbers are held in azimuth sequence in the magnetostrictive delay line display storage, which circulates in synchronism with the sonar scanning rate at 120 cycles.

This synchronous circulating display storage is the key to simulation of wake effects for high speed scanning sonar, where both the

sonar and targets may have motion.

Because the information in the display storage is arranged in synchronism with the video scan, only two numbers per wake segment are stored. The display storage is divided into 48 sections, one for each beamwidth (7.5 degrees for the particular sonar of interest). Each section may contain several ρ and A numbers to accommodate target tracks that cross back and forth in the same 7.5 degree sector.

The range data is compared to a range sweep initiated by the sonar ping (in the sonar presentation converter). When a comparison is made, the wake segment attenuation number corresponding to that wake range is converted to an analog voltage for modulating a carrier. This signal is routed to the video amplifiers where, due to synchronism between the display storage and the ppi, it is displayed at the correct angular position.

Figure 1 also depicts an abridged wake simulator. The bulk of the total simulator (track generator, digital integrators, samplers, data processing, relative position computation, intermediate storage) are eliminated. Since the innovation in this simulation technique is the synchronous display storage, only this portion of the simulator was constructed and tested.

The computations described by the equations were handled on a general-purpose computer with the resultant range, bearing angle, and attenuation numbers A , supplied on punched paper tape. The punched tape was used as the input to the abbreviated simulator and entered into the echo amplitude and location computer, as shown. The data was processed and displayed on an operational sonar.

SIMULATOR DETAILS—Figure 2 is a detailed block diagram of the abridged wake simulator. The circulating display storage provided video signals of the sonar display. This digital memory has an access time of nominally 8 ms which is equivalent to the sonar ppi scan rate of 120 cycles. The display storage is divided into 48 slots, each corresponding to a 7.5 degree increment of target bearing angle. Within each 7.5 degree segment, capacity is provided for storing seven

samples of range (ρ) and attenuation factor (A) of a wake, enough to accommodate seven target crossings at the same bearing. The 8-bit ρ number quantizes the range to 60 yards. The attenuation, A , is held as a 14-bit word to provide greater than 80 db dynamic range. Two blank bit spaces are provided for each sample of ρ and A , thereby forming a basic 24-bit word length. Consequently the display storage capacity is 7 words/slot \times 48 slots \times 24 bits/word = 8064 bits. At a 1.024-Mc clock rate, the display storage recirculation time is 7,875 μ s (equivalent to 127 cycles).

To obtain synchronism between the ppi and display storage, the motor that drives the 48-position sonar scanning switch and the sonar sweep generator is disconnected. A computer-synchronized 127-cps signal drives a synchronous motor, which together with a resolver and

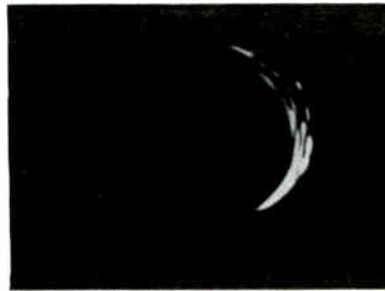

TARGET SHIP in action 5 minutes produced this wake; target ship is on spiral course, sonar range 5,000 yards

ping-synchronized ramp, provides the sonar ppi scan.

Referring to Fig. 2, the ρ , A and θ (bearing angle) information stored on paper tape is converted to serial digital numbers and temporarily stored in the buffer store. A bearing angle counter, which counts from 1 to 48, selects any 7.5 degree slot. Every 168 μ s (7.5 degrees) the counter is stepped. The counter is compared to the temporarily stored number in the bearing angle comparator. The display storage line containing the range and attenuation numbers is synchronized to the bearing angle counter. When the counter is in position 1, it is possible to place information that has a bearing angle between 0 degrees and 7.5 de-

grees into the display storage line. Information related to a bearing between 7.5 degrees to 15 degrees is entered into slot 2 (168 μ s later) and so on, until, when the counter has reached the 48th slot, the 352.5-to-360 degree portion of the delay line is available.

A digital range sweep is initiated by the sonar ping after which a step sweep is generated consisting of 8 ms steps, each having a weight of 7.5 yards. The simulated ping width is added to each range step. The range plus the ping width digital number and the range number alone, represent the upper and lower limits of each range step. Once the input information is entered in the display line, it is repeatedly compared to this simulated radial sweep. When a segment of wake is found to have a range lying between the upper and lower limits of the ping, the gate is activated by the range limit comparator and the A number is routed to the display storage. This attenuation number, which defines the necessary intensity of the video, is converted to an appropriate analog signal and is summed and scaled with special effects and then routed to the sonar video amplifier.

After all the numbers in the display storage line are scanned, compared, and displayed, a maximum range number is detected. At this time, all the information in the delay line has been displayed and a total wake presentation viewed. When the maximum range detection is accomplished, the old information in the delay line is erased and the tape radar up-dates the line with the latest wake information. This process of reading-in, scanning, displaying and reading-in again is repeated every 20.5 seconds (time between pings) for 15 minutes.

The new information is a continuation of the previous information but contains data for an additional 20.5 seconds of movement and aging. Thus a real-time display of the wake is generated.

The authors acknowledge the contribution of Dominick Capuano of The Naval Training Device Center, Port Washington, N.Y., under whose direction this equipment was developed, under Naval Training Device Center's contract N61339-1099.

ANNOUNCING THE VERSATILE NEW **JERROLD** **VIDEO SWEEP GENERATOR** MODEL 1015

for both wide- and narrow-band
response testing from **1 kc to 15 mc**

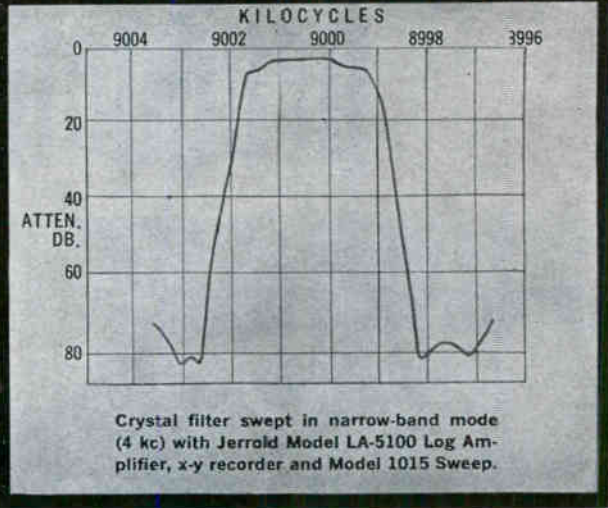
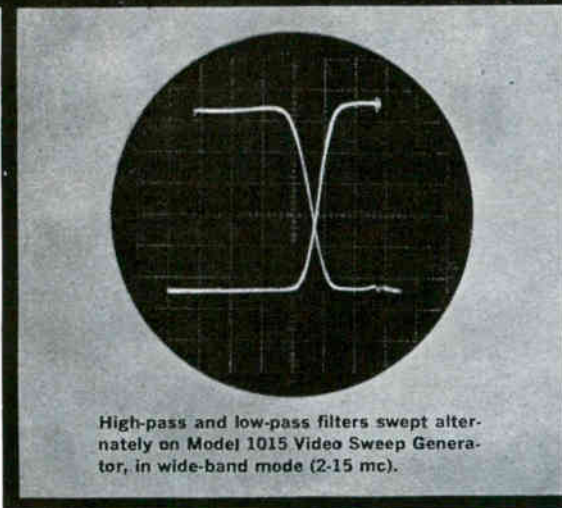

Jerrold is proud to introduce this versatile, highly stable video sweep generator as the latest in its growing line of sophisticated measuring instruments.

Engineered to combine characteristics of a very stable narrow sweep (20 cps residual FM) and a very wide sweep for video applications (10 kc to 15 mc), the Model 1015 provides narrow-band, wide-band, and continuous-wave output modes. Automatic or manual sweeping is provided by a front-panel selector switch. Center frequency is continuously variable from 1 kc to 15 mc in all three modes. In addition to a built-in marker generator on the wide-band range, provision is made for connecting two external marker generators.

For fast quantitative measurements of response that otherwise would involve hours of tedious point-by-point compilation, it will pay you to investigate this stable new video sweep generator. Write for complete specifications. **\$2,540**



FEATURES:

- Wide-band, 0-15 mc; narrow-band, 0-400 kc; CW
- Excellent stability in both narrow and wide modes
- Better than 2v metered output in both modes
- Low residual FM (20 cps on narrow band and CW)
- Continuously variable sweep rate from 60/sec. to 1 per 2½ min.
- Built-in high-output birdie-type marker generator

JERROLD ELECTRONICS CORPORATION
Industrial Products Division Philadelphia 32, Pa.



A subsidiary of THE JERROLD CORPORATION

BOOTH 3904-08

CIRCLE 87 ON READER SERVICE CARD

Why depend on 'selected' transistors for your communications applications?

See how Amperex production-run P.A.D.T.'s

**you need
LOW NOISE AT HIGH FREQUENCY**

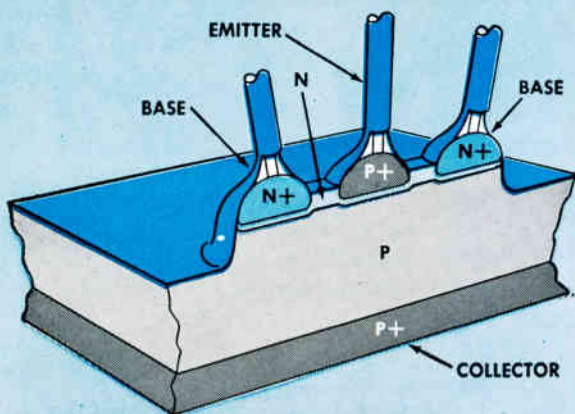

**3-DOT SMALL GEOMETRY
gives you**

Low r_{bb}' · High f_T

as in the P.A.D.T. 2N2495

**you need
STABLE HIGH GAIN**

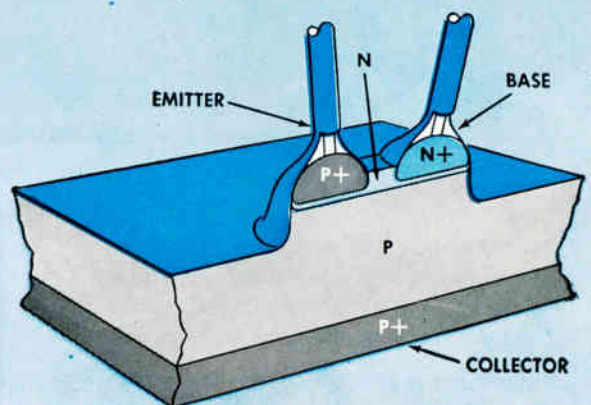

**2-DOT SMALL GEOMETRY
gives you**

**Stable High Gain
Low, low Capacity · High f_T**

as in the P.A.D.T. 2N2654

AMPEREX production-run P.A.D.T. transistors are immediately available from these and other authorized Industrial Electronic Distributors and in volume quantities from our semiconductor plant at Slatersville, Rhode Island

CALIFORNIA

R. V. WEATHERFORD COMPANY
Glendale 1, Calif.
KIERULFF ELECTRONICS
Los Angeles 15, Calif.
BRILL SEMICONDUCTOR CORP.
Oakland 6, Calif.
ELMAR ELECTRONICS INC.
Oakland 7, Calif.

COLORADO

INTERSTATE RADIO & SUPPLY
Denver 4, Colorado

CONNECTICUT

CRAMER ELECTRONICS, INC.
Hamden, Conn.

DISTRICT OF COLUMBIA

ELECTRONIC WHOLESALERS, INC.
Washington 1, D. C.

FLORIDA

THUROW ELECTRONICS, INC.
Cocoa, Fla. • Jacksonville, Fla. • Miami, Fla.
Orlando, Fla. • Pensacola, Fla. • Tampa, Fla.

ILLINOIS

NEWARK ELECTRONICS CORP.
Chicago, Ill.

INDIANA

RADIO DISTRIBUTING COMPANY
Indianapolis 6, Indiana

MASSACHUSETTS

RADIO SHACK CORP.
Boston, Mass.

MICHIGAN

RADIO SPECIALTIES COMPANY
Detroit, Michigan

MINNESOTA

ADMIRAL DISTRIBUTORS, INC.
St. Louis Park 16, Minn.

MISSOURI

BURSTEIN-APPLEBEE COMPANY
Kansas City, Missouri
INTERSTATE INDUSTRIAL ELECTRONICS
St. Louis 32, Missouri

NEW YORK

MILO ELECTRONICS
New York, N. Y.
ROME ELECTRONICS
Rome, N. Y.

OHIO

UNITED RADIO, INC.
Cincinnati, Ohio

OKLAHOMA

OIL CAPITAL INDUSTRIAL ELECTRONIC
DISTRIBUTORS
Tulsa, Oklahoma

OREGON

UNITED RADIO SUPPLY, INC.
Portland 9, Oregon

PENNSYLVANIA

RADIO ELECTRIC SERVICE CO.
Philadelphia, Pa.

TEXAS

BUSACKER ELECTRONIC EQUIPMENT CO., INC.
Houston 19, Texas

WASHINGTON

ROBERT E. PRIEBE COMPANY
Seattle 1, Washington

CIRCLE 88 ON READER SERVICE CARD

designs for specific requirements!

**you need
POWER AT HIGH FREQUENCY**

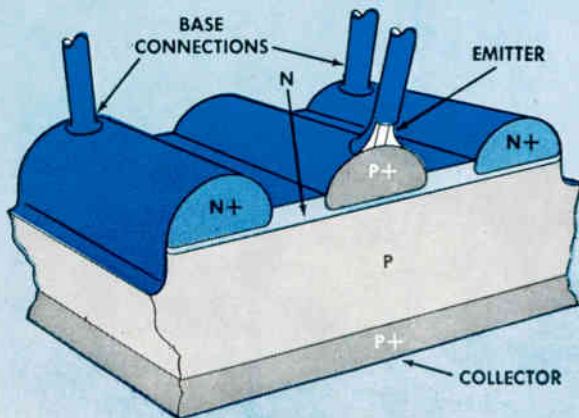

**P.A.D.T. STRIPE GEOMETRY
gives you**

**Lower $r_{bb'}$ · High Dissipation
High f_T · High Beta
as in the P.A.D.T. 2N2786**

**you need
HIGH GAIN, LOW NOISE, LOW COST**

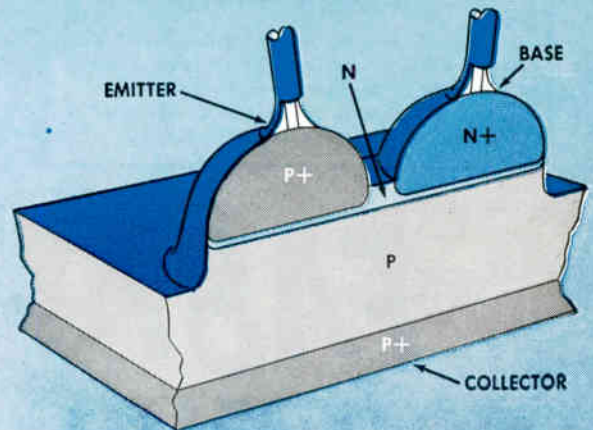

**2-DOT LARGE GEOMETRY
gives you**

**a universal, high performance transistor for a
wide range of frequencies for entertainment,
industrial and military applications.**

**as in the P.A.D.T. 2N2084 (MIL-S-19500/213A NAVY)
P.A.D.T. 2N2089 } for P.A.D.T. 2N2092 } for
P.A.D.T. 2N2671 } VHF P.A.D.T. 2N2672 } RF**

AMPEREX semiconductor specialists have been engaged in a continuing technological program that brings the superior performance and high-level production-benefits of PADT to ever expanding applications in the areas of communications, radar, instrumentation and AM-FM-TV receivers. From this program there have emerged the four distinctive P.A.D.T. transistor geometries illustrated above...each with "DESIGNED-IN" parameters and performance characteristics of significance to specific end-equipment needs — and reproducible, IN MASS PRODUCTION, without selection... at P.A.D.T. production-run prices! As you are undoubtedly aware, P.A.D.T. is the unique AMPEREX Post Alloy Diffusion Technique by which simultaneous diffusion and alloying take place under specified and controlled conditions. This exclusive process makes it possible to mass-produce superior communications type transistors with a base layer of only a few ten thousands of an inch and with extremely high cut-off frequencies... and P.A.D.T. does this with consistently high yields and with unequalled uniformity, stability and reliability. For detailed data and/or applications engineering assistance, write to: AMPEREX Electronic Corporation, Semiconductor and Receiving Tube Division, Hicksville, Long Island, New York.

(IN CANADA: PHILIPS ELECTRON DEVICES, LTD., TORONTO 17, ONTARIO.)



CIRCLE 89 ON READER SERVICE CARD

Designed for



Application



MAGNETIC SHIELDS

Illustrated are a few of the stock mumetal or nicaloy magnetic shields for multiplier photo tubes and cathode ray tubes. Stock shields are available for all popular tubes. Custom designed shields are made for special applications.

JAMES MILLEN MFG. CO., INC.
MALDEN
MASSACHUSETTS

CIRCLE 301 ON READER SERVICE CARD

FAST
DELIVERY
ANYWHERE

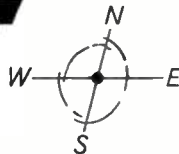

MIDWEC INSTRUMENT GRADE MYLAR* DIELECTRIC

Ca-pac-i-tors

Best Shipping Interval In The Industry—3 Weeks Standard

High Reliability and Quality

Competitively Priced

Specialists In Low Tolerance Units

Approved for use in Talos, Minute Man, Titan, Typhon, Telephone Companies ■ 100% Test for dielectric strength, capacitance, insulation resistance and dissipation factor



write for data sheets and prices

SALES OFFICE: 601 So. Jason St., Denver 23, Colo.
 TWX: 292-3891—Telephone SH 4-3481—DDD 303

*DuPont TM for Polyester Film.

90 CIRCLE 90 ON READER SERVICE CARD

William J. Kennedy
 Sales Manager
 shown 1/25 actual size
 Model 1011 Broadband
 Coaxial Crystal Holder
 shown actual size.



BROADBAND COAXIAL CRYSTAL HOLDERS

■ "Model 1011 Broadband Coaxial Crystal Holder is one of 44 models in our SAGELINE of coax crystal holders. It is designed for mixer and video detector applications using tripolar crystals such as the 1N358A. Its recommended frequency range, without a DC return, is 10-15,000 MC. DC returns are available for five specific frequency ranges. The DC returns are internal and do not increase holder size. Output capacity is 6-7 mmf, minimum. ■ The 1011 input is type N male; the output, BNC female. Maximum dimensions are 2 7/8" in diameter and 2 1/4" in length. ■ The price of the basic 1011 holder is \$20 . . . with any DC return, \$30 . . . FOB Natick. Quantity discounts are available. Delivery is from stock for quantities up to 100. ■ If you have a question or would like to place an order, I hope you will call the number shown below. We'll look forward to talking with you." ■

William J. Kennedy / Sales Manager



SAGE LABORATORIES, INC.
 3 HURON DRIVE • NATICK, MASS. • Tel: 617-653-0844
 TWX: 617-653-6193 • Cable: SAGELABS-NATICK

CIRCLE 302 ON READER SERVICE CARD
 March 15, 1963 • electronics

**Especially Designed for
Rapid, Easy Installation!**

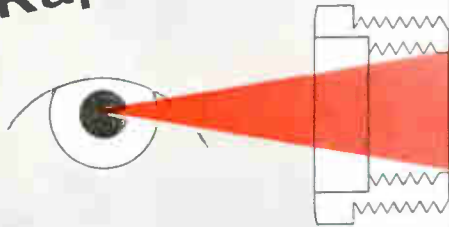

PIPE-THREADED

CLEAR GLASS
HERMETICALLY
SEALED

OBSERVATION WINDOWS

HTW SERIES WINDOWS
ARE AVAILABLE IN A
WIDE RANGE OF SIZES

STANDARD AMERICAN
PIPE THREAD (NPT)
FOR QUICK INSTALLATION

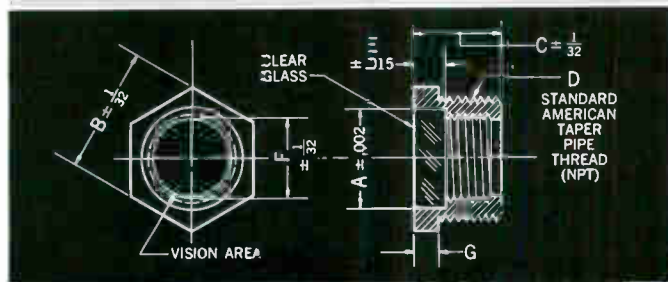

Dimensions for HTW Series Sealed Windows (In Inches)

PART NO.	A	B	C	D	E	F	G
HTW-1	.525	.687	.500	3/8	.125	.410	5/32
HTW-2	.675	.875	.562	1/2	.200	.500	3/16
HTW-3	.825	1.062	.750	3/4	.200	.675	9/32
HTW-4	1.035	1.437	.812	1	.250	.800	1/4
HTW-5	1.300	1.790	.875	1 1/4	.250	1.000	11/32
HTW-6	1.635	2.000	.937	1 1/2	.500	1.300	3/8
HTW-7	1.890	2.500	1.000	2	.500	1.600	7/16

Ruggedly constructed and hermetically sealed for
**AIR CONDITIONING, REFRIGERATION AND HEATING EQUIPMENT
ELECTRICAL AND ELECTRONIC AND PHOTO SENSITIVE DEVICES
CONTROL AND OTHER SEALED OR PRESSURIZED MECHANISMS**

Visit Booths 2526 and 2528
at the IEEE Show



Patented in the U.S.A., No. 3,035,372;
in Canada, No. 523,390;
and in the United Kingdom, No. 734,583.

E-I sealed glass windows are designed for observing internal conditions in hermetically sealed mechanical, electrical and electronic equipment. These windows are precision made to provide "space age" reliability... feature super-rugged E-I compression seals that have been proven for utmost reliability in major missile and space projects. For complete data and recommendations on your particular requirements, call or write E-I, today.

ELECTRICAL INDUSTRIES

A Division of Philips Electronics & Pharmaceutical Industries Corp.

MURRAY HILL, NEW JERSEY—Telephone: 464-3200 (Code 201)

*Backed by
15 years' proof of*
RELIABILITY



1946



1949

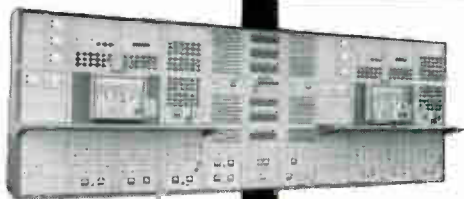

1960



1959

REAC[®] 500
ANALOG COMPUTER



1962

Typical unscheduled downtime LESS THAN 3%

RELIABLE
EXPANDABLE
AAILABLE
COMPETITIVE

REAC 500 is the proud successor to a long line of REAC Analog Computers first produced more than 15 years ago. Most REAC installations are still in operation — many "round-the-clock" — with unscheduled down-time averaging less than 3%.

The same high quality built into our previous models has been maintained in the new REAC 500 series which are now in production. REAC is synonymous with RELIABILITY — safeguarded by our uncompromising standards for performance; construction, and ease of maintenance. Your computer investment is **guaranteed** when you specify REAC 500. For complete information, write for Data File 103.

Qualified engineers who are seeking rewarding opportunities for their talents in this and related fields are invited to get in touch with us.

See our dynamic display at the I.E.E.E. Exhibit—Booths 1305-1307



REEVES INSTRUMENT CORPORATION

A Subsidiary of Dynamics Corporation of America, Roosevelt Field, Garden City, New York

Visit
Sperry Microwave
Electronics Company
Booths 3314 - 3318
**IEEE
SHOW**
New York

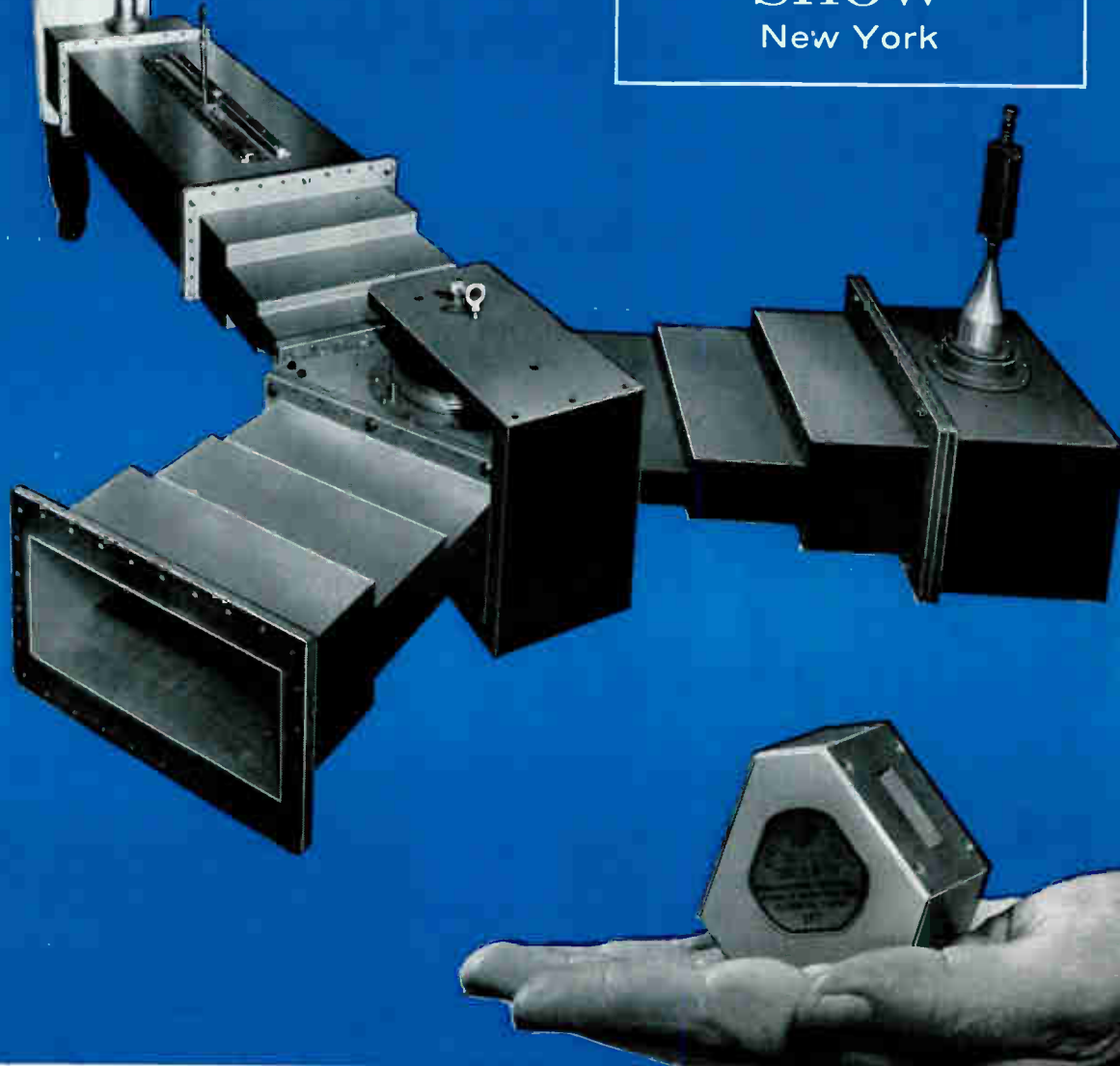

From Bantamweight To Heavyweight. Completion of the world's largest and first high power, low frequency WR 2100 Circulator for Rome Air Development Center, Rome, N. Y., demonstrates Sperry's ability to extend the state of the art. The WR 2100 Circulator as well as Sperry's full range of circulators will be exhibited at the IEEE Show. Another example of Sperry's solid state capability is the development and testing of the first total solid state front end system...also displayed at IEEE.

Sperry's technical competence is represented by the full line of Microline test instruments—now available from stock—and the ability to design complete microwave measurement systems for commercial and military use. Radar Performance Analyzers that provide complete overall performance measurement and monitoring, as well as ground spectral measurement equipment, clearly demonstrate Sperry's engineering ingenuity and technical know-how. You'll be interested in seeing the full importance of Sperry's versatility and capability at IEEE booths 3314 - 3318. **SPERRY MICROWAVE ELECTRONICS COMPANY, Clearwater, Florida.**

SPERRY

DIVISIONS OF
SPERRY RAND
CORPORATION

Need Miniature Ferrite Parts?

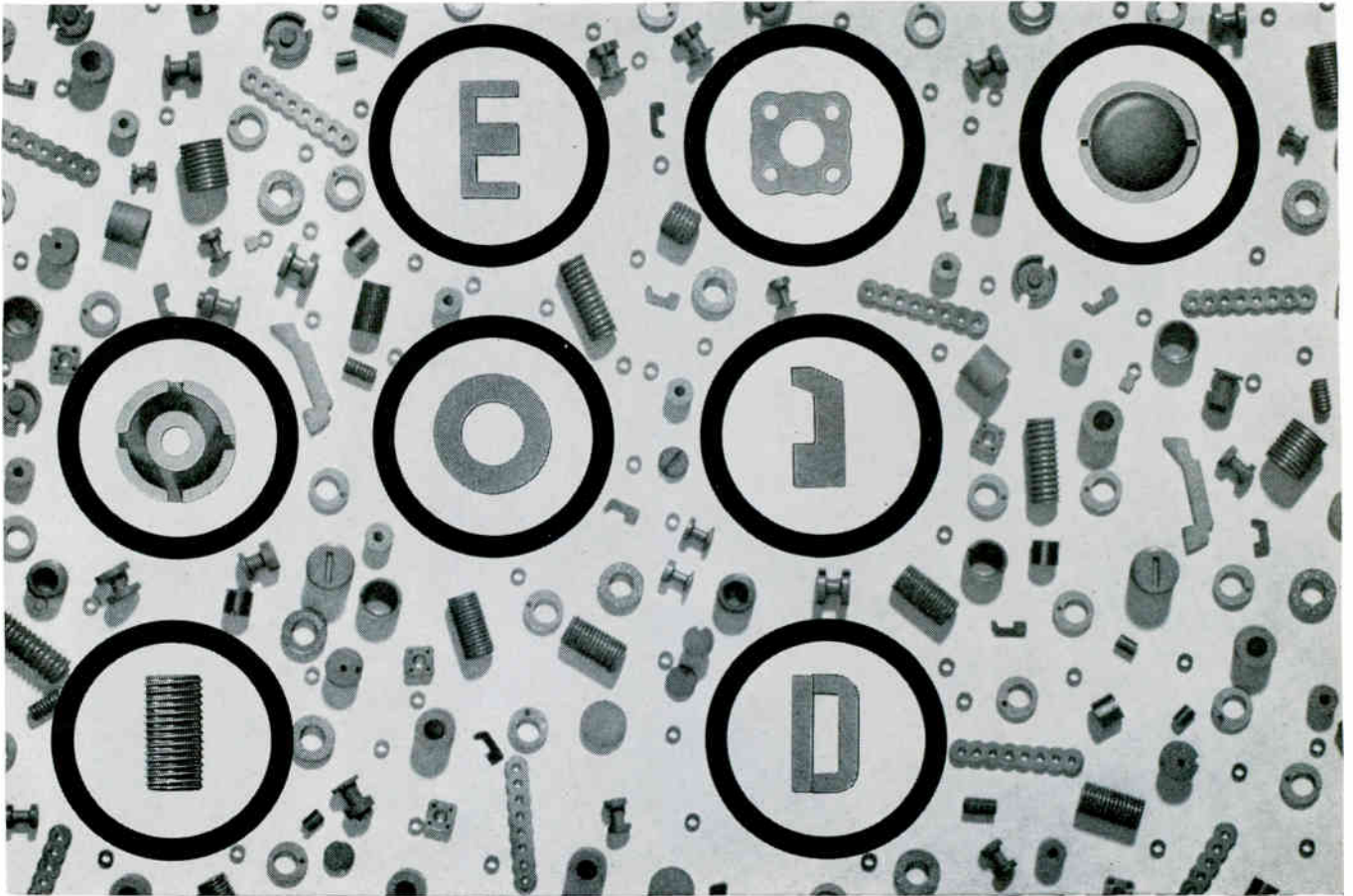

Indiana General offers you..

Wide Range of Materials for frequency bands from 800 cycles to 1 kilo-megacycles. IGC can furnish miniature parts in a material that will meet your most rigid application requirements — high Q, high permeability, high saturation, low loss, linear temperature coefficient, close physical tolerances.

Wide Variety of Configuration — E & I cores, U cores, multi-aperture cores, cup cores, bobbins and sleeves, toroids and recording heads.

Design and Consultation Service — IGC field sales engineers will give you valuable assistance in solving application problems. Write to Indiana General Corporation, Electronics Division, Keasbey, N. J. Ask for bulletin 30K.

INDIANA GENERAL



FIRST SILICON POWER SUPPLY UNDER \$100



\$89⁰⁰
Guaranteed by
"Worst Case"
Analysis

A Big New Price Step—35% Below Germanium Units

New Development. Here is a unique combination of low cost and high reliability. Featuring all silicon semiconductors throughout, these supplies are priced as much as 35% lower than comparable germanium supplies.

Designed to operate in ambient temperatures up to 50°C without an external heat sink, they may be used up to 75° with a comparatively small

external heat sink or with forced air. "Worst Case" Analysis designed, these supplies are capable of operating under the worst possible conditions with a "Mean Time Between Failure" that rivals many supplies costing two or three times as much.

For the full money-saving details on Con Avionics new HT Series Silicon Power Supplies, send for literature today.

SPECIFICATIONS

Regulation Accuracy..... ±0.5%
Ripple..... 10 mv RMS Max.
Max. Operating Ambient..... 75°C
Automatic Short Circuit Protection.
Models available from 6V @ 1.5A to 32 V @ 600 ma
Dimensions..... 4¹/₈" H, 4¹/₁₆" W, 5³/₁₆" D

CONSOLIDATED AVIONICS CORPORATION

800 SHAMES DRIVE, WESTBURY, L. I., NEW YORK

See us at Booth 1324 IEEE Show

CIRCLE 95 ON READER SERVICE CARD



**CON
AVIONICS**

Contest Produces Novel Circuit Designs



IEEE SPECIAL

FOUR ORIGINAL digital circuits were chosen by editors of four electronics publications as winners in the Burroughs Beam-X Switch tube contest, timed for the IEEE Show.

One choice was a sequentially delayed pulse generator circuit, with a frequency-independent preset duty ratio, submitted by designer Gordon E. Nelson of Sperry Products Div., Danbury, Conn. The circuit's output pulses are sequentially delayed relative to a reference pulse, so that on each cycle the pulse is delayed by an amount equal to the pulse width of the generated pulse. Suggested applications include electron-beam cutting control, an ultrasonic inspection instrument with expanded scale display, and a radar with expanded scale display.

The circuit, shown in Fig. 1, produces an output pulse whose pulse width is equal to the period of the input waveform (from an oscillator

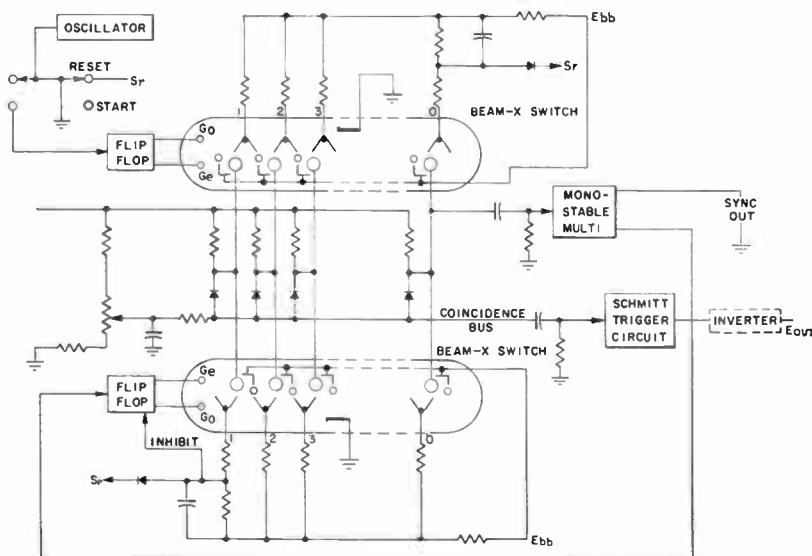

SEQUENTIALLY DELAYED pulse circuit uses two Beam-X tubes and common coincidence bus for output—Fig. 1

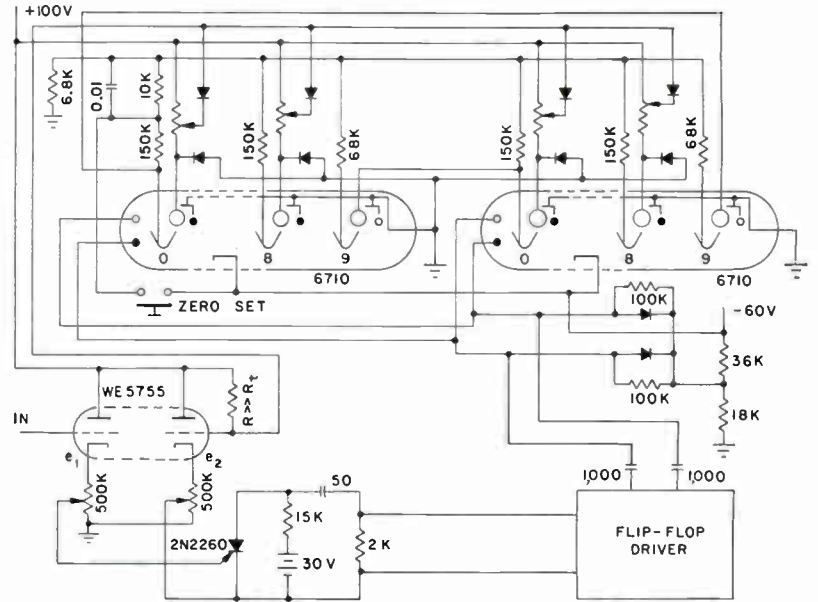

SHOCK SPECTRUM ANALYZER uses several peak voltage memory units, like the one shown above—Fig. 2

or pulse generator) and whose pulse repetition frequency is a fraction, determined by the preset duty cycle, of the input frequency, with each subsequent pulse delayed by a time equal to the period of the input waveform.

A fixed or variable-frequency source drives the input driver for the upper beam-switching tube. The driver is a bistable flip-flop. Duty ratio is established by the scaling-down ratio between the input to the upper beam-switching tube, and the output target. Each time the output target returns to its off state, a sync output pulse is sent to the driver of the lower beam-switching tube.

The upper and lower beam-switching tubes share corresponding target load resistors, so that a coincidence in target currents produces a negative step voltage double that produced by a single target current. A coincidence bus is connected through off-biased diodes, so that a coincidence of target currents is required to deliver a pulse to the bus.

The output of the coincidence bus can be used directly for some applications, but feeding it through a Schmitt trigger produces a fixed-amplitude output pulse with a faster leading and trailing edge, and additional level discrimination. A positive output pulse is obtained

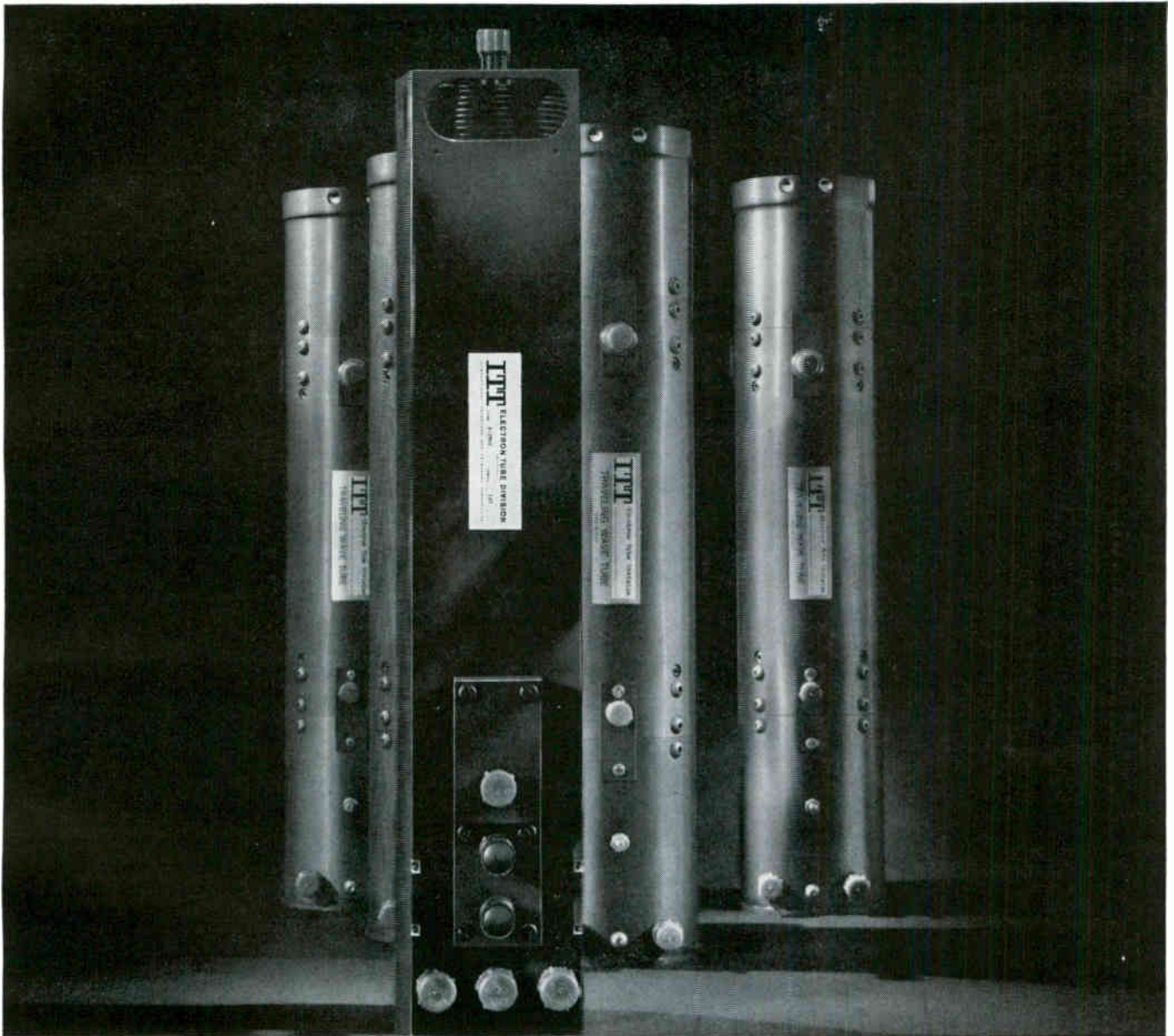

For ECM ITT 1 kw metal-ceramic C-Band TWT weighing in at 7 pounds!

ITT model F-2502 is the smallest, lightest 1 kw TWT available today. This new tube has four other advantages for ECM applications (or when used as a driver for high-power klystrons):

- Highest power—1 to 2 kw peak pulse power
- Full spectrum—4 to 8 Gc at rated power
- Rugged construction—all metal-ceramic
- Longer duty cycle—tested at 2%

In addition to its broad line of TWT's, ITT has recently introduced a line of PM BWO's covering L through X band. Write for more information or applications assistance.

**TYPICAL ITT
PPM METAL-CERAMIC POWER TWT'S**

Type	Frequency Gcs	Power kw	Duty	Control
F-7640	2-4	1	.005	K
F-2500	2-4	1	.01	G
F-2501	2-4	1	.02	K
F-2502	4-8	1	.02	K
F-2503	4-8	1	.01	G



ELECTRON TUBE DIVISION

CLIFTON, NEW JERSEY

INTERNATIONAL TELEPHONE AND TELEGRAPH CORPORATION

BARKER AND WILLIAMSON



HARMONIC (B&W) AND SPURIOUS TOTALIZER

B&W Harmonic and Spurious Totalizer, Model HST, measures total harmonic and spurious radiation from radio transmitters.

Frequency Range:

for transmitters operating from 2-32 mc, measures harmonics and spurious to 90 mc.

Total spurious and harmonic levels as low as 65 db below the carrier can be measured.

A measurement can be made in a matter of minutes.

Ideal for:

Periodic check of spurious emissions at radio transmitting stations.

Development of transmitter equipment.

Production testing of radio transmitters.

Write for Sales Bulletin #106 for description and specification.

BARKER & WILLIAMSON, Inc.
Radio Communication Equipment Since 1932
BRISTOL, PENNSYLVANIA • Stillwell 8-5681

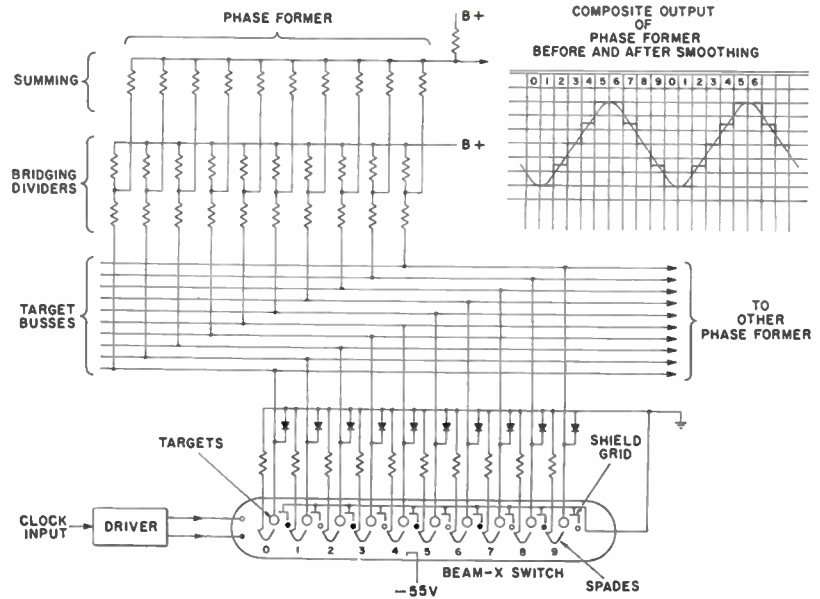

MULTIPHASE GENERATOR uses beam switching tube to allow starting a new phase at any of a number of points in the cycle—Fig. 3

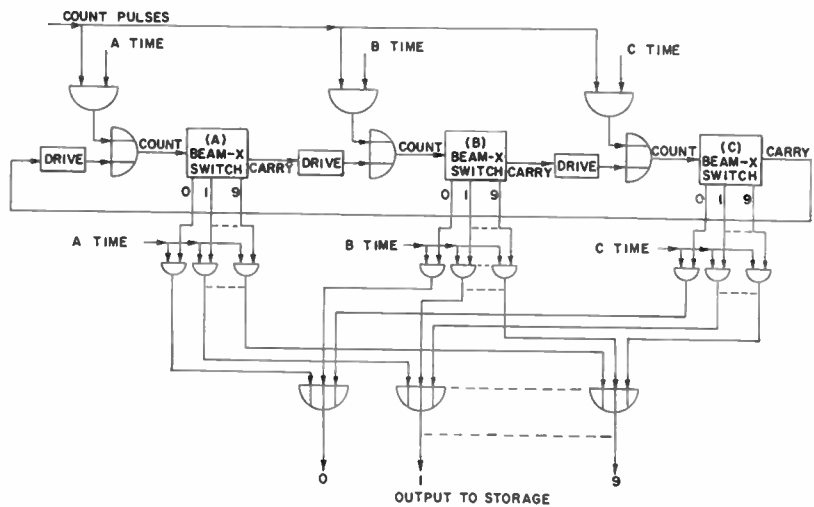

REVOLVING ARITHMETIC UNIT handles addition, subtraction, multiplication, using Beam-X beam switching tubes—Fig. 4

by inserting an inverter between the Schmitt trigger and the output.

Duty cycles of less than 1:10 are obtained by connecting the flip-flop to another target position, to provide the appropriate ratio. The reset circuit is shifted to the same position. An analogous circuit can be built for duty cycles greater than 1:10, such as 1:100.

SHOCK SPECTRUM ANALYZER

—Another of the four prize-winning entries in the Burroughs contest is a fast, simple spectrum analyzer circuit designed by David F. Palmer of Sandia Corp., Albuquerque, N. M.

The shock spectrum analyzer consists of a number of peak voltage memory circuits, connected in parallel, each preceded by an L-C filter that through its resonance frequency determines its frequency channel. The shock spectrum of an input pulse is defined by the peak voltage appearing across each filter capacitor. The analyzer requires the use of peak voltage memories that can retain the information long enough for all channels to be recorded; it is also important that the memory be inexpensive since a large number may be needed.

The peak voltage memory using a Beam-X switching tube is shown in



**NEW
PHILCO
PLANAR
40V_{CBO}, 20V_{CEO}
500 mc f_T
SWITCH**



NEW PHILCO 2N2710
Interdigitated Epitaxial Silicon
Planar NPN Transistor, in
TO-18 Case.

Only Philco gives you so much design margin in so many parameters—with proven planar reliability. The new Philco 2N2710 presents industry's best combination of speed, voltage, and beta. It also is specified for leakage current an order of magnitude lower than I_{CBO} specifications of other 500 mc f_T switches. Every 2N2710 parameter is outstanding. Get samples today from your Philco Industrial Semiconductor Distributor. Write for complete data. Dept. E31563.

PHILCO 2N2710 CHARACTERISTICS

V_{CBO}40v min	V_{CEO}20v min	h_{FE}40 min	t_{ON} ...20 nsec max	t_{OFF} ...35 nsec max
V_{CES}30v min	V_{EBO}5v min	I_{CBO} ...30 na max	t_S ...15 nsec max	f_T ...500 mc min

CONSULT PHILCO SEMICONDUCTOR ENGINEERS AT I.E.E.E. BOOTHS 1302-1308

PHILCO

A SUBSIDIARY OF *Ford Motor Company*

LANSDALE DIVISION, LANSDALE, PA.

CIRCLE 99 ON READER SERVICE CARD



**Fred
Roberts*
can
show
you ...**

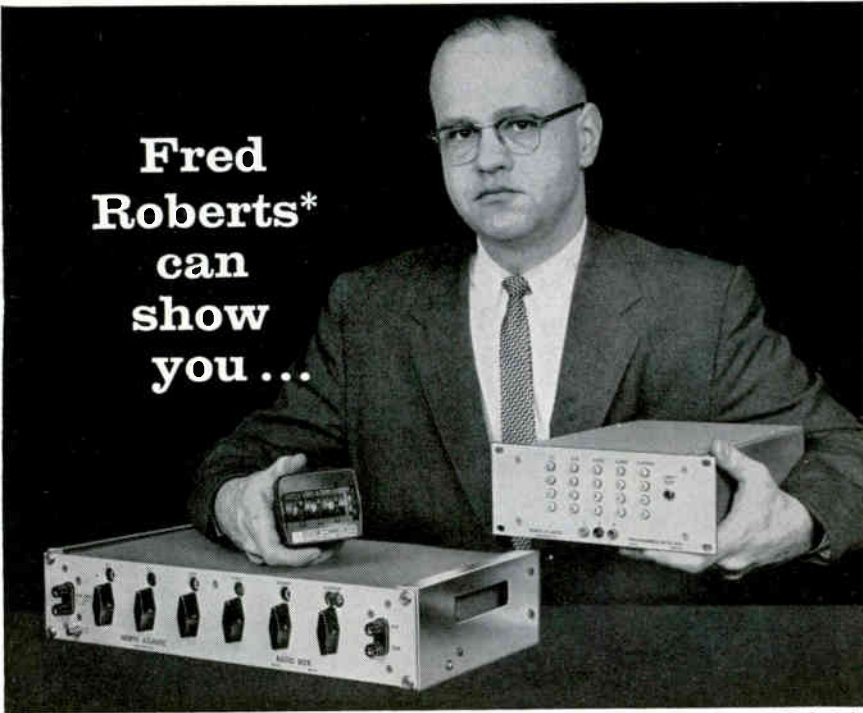

**Director of Marketing, North Atlantic Industries*

how to measure ac ratios to 1.0 ppm ...at a sensible price

In fact, any of North Atlantic's field representatives can quickly demonstrate how NAI's Ratio Boxes will economically meet critical requirements for AC ratio measurements—in the laboratory, or in field and production testing.

These high-precision inductive voltage dividers are available in a complete range of models for particular applications. Standard types include Model RB-503 for bench or rack use, the miniaturized RB-521 for panel mounting in military specification equipment and PRB-506, a versatile system module programmable from punched cards or tape for automatic testing. Abridged specifications of these models are given below.

MODEL	RB-503	RB-504	RB-521	PRB-506
	RACK OR BENCH	RACK OR BENCH	MINIATURE PANEL MTD.	MINIATURE PROGRAMMED
Ratio Range	0.000000 to +1.111110	-0.111110 to +1.111110	0.0000 to +1.1110	0.0000 to +1.111110*
Nominal Accuracy (Term. Linearity)	10 ppm	1 ppm	10 ppm	10 ppm
Freq. Range (Useful)	50 cps-10 Kc	50 cps-3 Kc	50 cps-10 Kc	50 cps-3 Kc
Input Impedance at 400 cps	> 60K	> 200K	> 50K	> 50K
Nominal Input Voltage Ratings (f in cps)	0.5f volts 350v max.	1.0f volts 350v max.	.35f volts 300v max.	.35f volts 300v max.
Maximum Output Series Resistance	3.2Ω	8.0Ω	3.5Ω	3.4-3.9Ω*
Resolution	5 decades plus pot.	5 decades plus pot.	3 decades plus pot.	3, 4, 5 or 6 coded decades
Size	19" x 3½" x 8"d	19" x 3½" x 8"d	2½" x 3¾" x 6¼" L.	9½" x 3½" x 13" d
Price	\$295.00	\$450.00	\$275.00	\$900 to \$1500*

Abridged specification—send for full details

*Depends on number of decades

Also from North Atlantic: Model RB-510 for 2.5ppm precision at 10kc, RB-503T and -504T with ratio ranges from -1.111110 to +1.111110, and PRS-531 Resolver Ratio Simulator.

For complete technical and application data, write for Data File RB, or contact the North Atlantic man in your area.



NORTH ATLANTIC industries, inc.
TERMINAL DRIVE, PLAINVIEW, L. I., NEW YORK • Overbrook 1-8600
See us at IEEE—Bath 3939

the circuit of Fig. 2. When input voltage e_1 becomes greater than voltage e_2 , the driver is triggered. The beam is thus advanced by one position, which increases voltage e_3 by one increment, ready for triggering by the next advance, etc. The last position of the beam corresponds to the peak reached by voltage e_1 .

Output is a d-c voltage level suitable for automatic plotting. Visual output can be obtained by operating a Beam-X tube run by the same driver circuit.

MULTIPHASE GENERATOR

—Another winner from among the contest entries is an unusual multiphase generator by Warren A. Anderson of Raytheon Co., Portsmouth, R. I. Shown in Fig. 3, the circuit produces an output waveform whose phase is locked to the clock-signal driving assembly. A sequence of bridging voltage dividers are connected across the respective target outputs of the Beam-X tube or tubes, making up the basic counter chain. Each voltage divider is so adjusted that its output is appropriate to its angular position in the counting cycle, and the composite output of the voltage dividers is obtained by resistive summing.

Repeating the resistive phase formers with appropriate connections to the Beam-X tube target buses will yield other phases of the basic counting cycle frequency. In the circuit shown, additional phases can be developed at 36-degree increments.

This circuit can be applied in the development of multi-phase carrier voltages appropriate to synchro-resolver-servo computing applications; in developing precise pulse vs sine-wave time relationships, such as are required in navigation and measurement techniques, and in developing stable phase relationships despite variations in clock frequency. Other applications include precise phase shifts, and generation of single or multiple-phase sine-wave signals.

ARITHMETIC ACCUMULATOR

—Fourth contest winner is an arithmetic accumulator circuit with an automatic carry control, submitted by Richard J. Bartek, of the General Motors Defense Research Labs

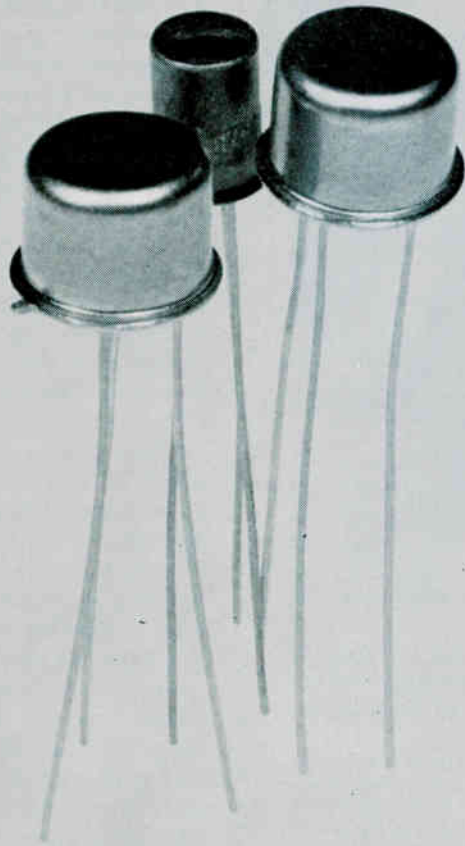

THIS IS A PHOTO AMPLIFIER



SO IS THIS

Raytheon's RM3002 combines a light sensor and high-gain amplifier in one TO-18 package

Now, optical readout is simpler because one component replaces three. Raytheon's new RM3002 photo-Darlington, the third in a series of Darlington configurations, combines a lens window with an integral light-sensing amplifier. The result is extreme sensitivity in a very small package.

Raytheon's other Darlington amplifiers, without lens windows, include the RM3022, and, with an additional base lead for greater design freedom, the 2N998.

RM3002

Dark Current (I_{CE0})	25°C	$V_{CE} = 20\text{ V}$	10 nanoA max.
Dark Current	150°C	$V_{CE} = 20\text{ V}$	100 μA max.
Collector Dark Current (I_{CB0})	25°C	$V_{CB} = 30\text{ V}$	10 nanoA max.
Collector Dark Current	150°C	$V_{CB} = 30\text{ V}$	15 μA max.
Light Current Sensitivity (I_{CE})		$V_{CE} = 12\text{ V}$	25 $\mu\text{A}/\text{ft. candle.}$

For technical data, price and delivery, write Raytheon Company, Semiconductor Division 350 Ellis Street, Mountain View, California.



QUALITY CONTROL

Starts with Calibration



Wide range Model 829D calibrates AC and DC instruments quickly and at modest cost with certificated accuracy traceable to the National Bureau of Standards.

Employing TBS comparison standards with a repeatability of reading within $\pm 0.1\%$, the Model 829D instrument calibration standard has a full scale, direct reading accuracy within $\pm 0.5\%$ and within $\pm 0.25\%$ using correction factors supplied for all ranges from 0.25 mV to 2000 volts and 2 μ A to 20 amperes. Output frequency for AC calibration is same as input frequency; useful range for stated accuracy is 50-1000 c/s.

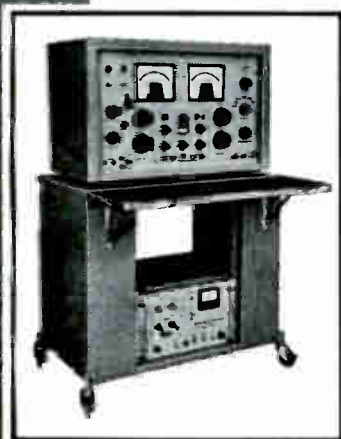

Automatic interlocks and built-in safety features protect the operator and instrument under test. On shock mounts supplied, the Model 829D will maintain long term calibrated accuracy in mobile van service.

Most compact instrument calibration system is also mobile

Photo at left shows the Model 829D mounted on the Model 10 Test Equipment Cart which contains a Model 250 Variable Frequency Power Supply. Latter regulates 115/230-volt line source to $\pm 0.2\%$ for 5% line or 25% load change, with low distortion, and supplies calibration frequencies from 50 to 1000 c/s.

Performance is certified and guaranteed. Price of Model 829D for 115-volt operation is \$2950. f.o.b. Boonton, N.J. subject to change without notice.

SEND FOR TECH. DATA

For complete information write, TWI or phone 201-334-3100. Demonstrations available by local representatives.



Radio Frequency LABORATORIES, INC.
Boonton, New Jersey, U.S.A.

IEEE Show Booths 3115, 3117, 3119

in Goleta, California.

This circuit (see Fig. 4) is useful as the basic element in an arithmetic unit. The following multiply operation illustrates its operation. Assume that it is required to multiply 472 and 893. Clock time A is on. Pulses are applied to the circuit, representing 3 times 2 and the product 6 accumulates in tube A. This is read out through the and-or combination into storage as the least-significant part of the result.

Clock time B is turned on. Pulses are applied to tube B representing 3 times 7 plus 9 times 2, or a total of 39 pulses. The 9 is read out as the second least significant digit, and carry three propagates to tube C.

Clock time C is turned on, and pulses enter tube C, representing 3 times 4 plus 9 times 7 plus 8 times 2, or 91 pulses. Adding the carry of 3 already present, actual total is 94. The 4 is stored as the third least significant digit of the answer, 9 is taken as carry to tube A.

Clock time A now returns, and 8 times 7 plus 9 times 4 plus the carry of 9, or 101, enters tube A. The next answer digit, 1 is stored, and 10 carries to tubes B and C. The final operation is 8 times 4 plus the carry of 10, or 42 during B time. These are both read out in turn as answers. The final result, 421,496 is now in storage. A total of 6 + 39 + 91 + 92 + 32, or 260 pulses were required to complete the operation.

Tester Checks Out Thermocouple Circuits

By SIGMUND MEIERAN
Boeing Company, Seattle, Wash.

INSTRUMENT to check out thermocouple installations for thermal contact, electrical continuity and correct polarity, without causing any temperature change on the thermocouple junction, has been developed by the Boeing Company, Seattle.

Advantage is taken of the resistance difference between the thermocouple wires. The resistance, per 100 feet, of 28-gauge wire at 68 deg F varies from 6.489 ohms for copper to 266 ohms for Chromel-P. Thermocouples are often connected



Take To
Booth 3301-3303,
IEEE

NEW PORTABLE TRANSISTORIZED



SPECTRUM ANALYZER

Completely new from Singer Metrics is the Model TA-2 transistorized portable spectrum analyzer. To be unveiled at the IEEE Show, the TA-2 represents the first of a new series of all-solid-state PANORAMIC units. It is battery operated and easily portable. Its batteries recharge when AC-operated. The compact model TA-2 measures 8 $\frac{3}{4}$ " wide x 11" high x 18" deep. Its carefully designed solid-state modules provide a high order of reliability. ■ The TA-2 with the AR-1 plug-in module is a sonic spectrum analyzer covering the frequency range from 20 cps to 25 kc. Additional modules will be available in the near future

for other frequency ranges. Thus, the one basic instrument will provide incomparable versatility for an extremely wide range of applications. ■ The small size and portability of the new TA-2 with AR-1 module permits on-site analyses of noise and vibration in vehicles and other locations having severe space limitations. A 3 $\frac{1}{2}$ " x 3 $\frac{1}{2}$ " square CRT display provides quick-look capability, and the instrument is designed for high resolution, low drift, and ease of operation. ■ See the all-new TA-2... and many other PANORAMIC instruments... dynamically demonstrated at Booth 3301-3303, IEEE Show. Full engineering attendance at booth.

®A Trademark of THE SINGER MANUFACTURING COMPANY



Manufactured by



SINGER METRICS DIVISION
THE SINGER MANUFACTURING COMPANY
915 PEMBROKE ST. • BRIDGEPORT 8, CONN.

SEE IN OPERATION—COMPREHENSIVE ARRAY OF ANALYZERS AND RELATED INSTRUMENTS—BOOTH 3301-3303—IEEE SHOW

EXPANDO expanded scale meters

achieve 0.1% accuracy with no added depth

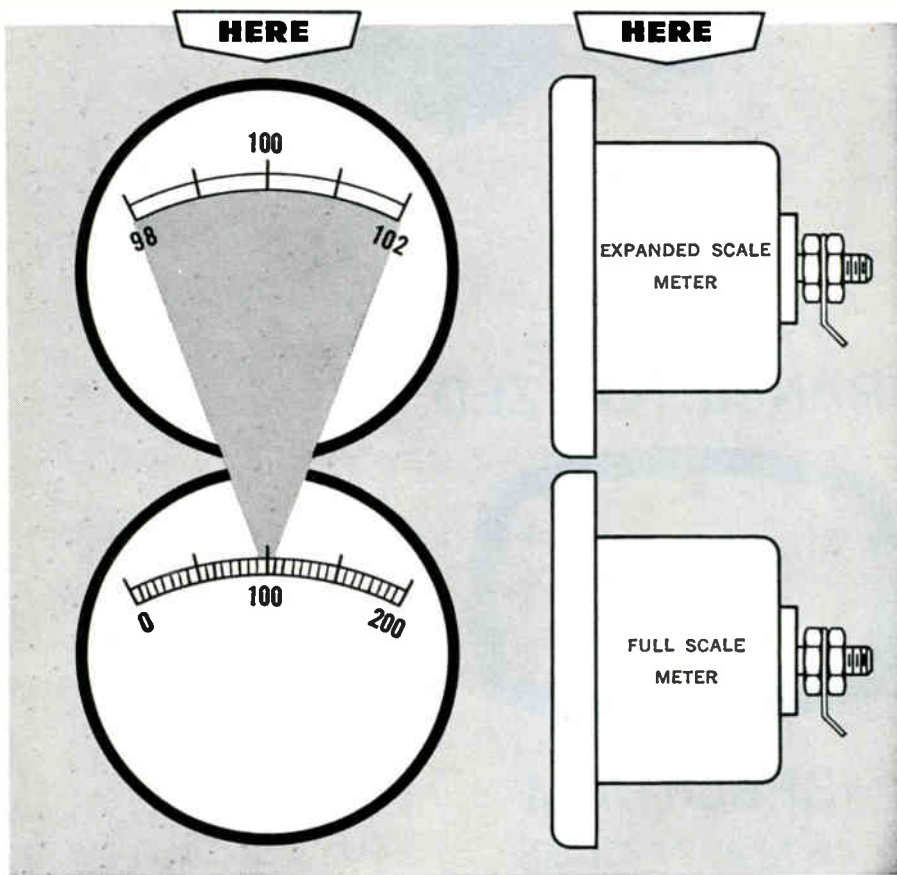

When you want the range of interest on a meter expanded to occupy the full scale for higher resolution and improved readability, do you have to accept enlarged dimensions? No. The advanced Expando technique expands the scale *without back-case extensions*. Expando achieves accuracies as fine as 0.1% in *completely self-contained* meters built into any manufacturer's models. Now you can match meters for a uniform instrument panel. What's more, because Expando's low consumption eliminates costly external circuitry, you get a compact meter with more reliable performance at a lower price. Write for specifications on expanded range AC and DC voltmeters, ammeters, milliammeters, true-RMS, frequency meters, and meter relays.

EXPANDO®

EXPANDO METERS • A & M INSTRUMENT, INCORPORATED
48-01 31ST AVENUE, LONG ISLAND CITY, NEW YORK

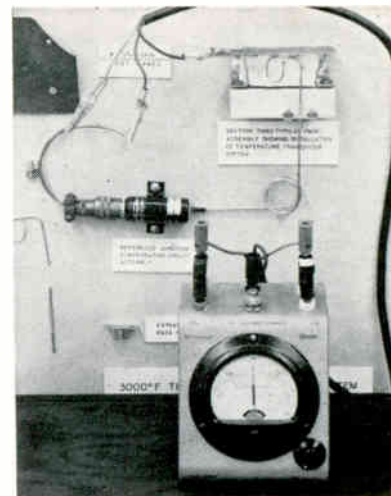

THERMOCOUPLE tester arrangement—Fig. 1

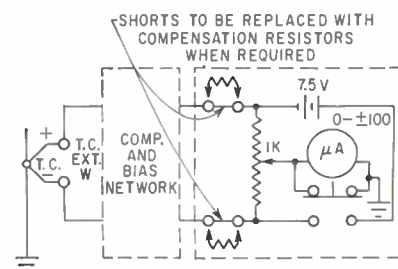

CIRCUIT diagram of thermocouple circuit tester—Fig. 2

to compensating and biasing networks to provide for the reference junction and common mode rejection; as a result, the output terminals have about the same resistance to ground. If the hookup is reversed, this is no longer the case, and an incorrect hookup can be detected by a resistance bridge.

The thermocouple installation tester, see Fig. 1, includes a potentiometer to complete the bridge, a zero-center microammeter connected between the potentiometer wiper and the metal structure on which the thermocouples are installed, a suitable battery for resistance-bridge excitation, and a push button for protection of the microammeter and prevention of unnecessary battery drain. Circuit is shown in Fig. 2.

The potentiometer is adjusted to unbalance the bridge for a clockwise deflection of the microammeter. The magnitude of the deflection should equal that caused by a reversed thermocouple installation in counterclockwise direction. If the thermocouple is not making contact with the metal structure, there will

SANBORN FLEXIBILITY— 7 channels — fm, direct record or any combination/plug-in, all solid-state circuitry/record-reproduce amplifiers on same card/4 speeds — 3¾ to 30 ips; 1⅞ to 15 ips and 7½ to 60 ips optional / 7" high electronics available separately/optional extras include voice channel amplifier, digital input circuit, push-pull input coupler, precision footage indicator, loop adapter and remote control unit. AT AN UNMATCHED \$7200.



This new Sanborn/Ampex Model 2007 system conforms to accepted IRIG instrumentation standards, provides 1% system accuracy and bandwidths to 100,000 cps with direct recording, 10,000 cps with FM amplifiers. Max. error due to non-linearity is only $\pm 0.5\%$ on DC, $\pm 1\%$ on AC.

Basic system features include quickly interchanged, readily accessible printed circuit plug-in modules . . . flutter compensation by using one channel to compensate all others . . . alignment of all FM channels with built-in meter and selector switch, eliminating need for electronic counters . . . automatic squelch circuit . . . entire system in only 31" of rack panel space . . . packaging in either mobile console shown or portable cases for tape transport and electronics.

System price of \$7200 includes 7-channel tape transport, transfer chassis, playback preamplifiers, power supply and 7 channels of FM Record/Reproduce electronics, housed in metal mobile cabinet. All prices F.O.B. Waltham, Mass., and subject to change without notice.

Get the complete specifications on this new Tape System — as well as 3 new types of Sanborn Data Amplifiers, 17" Multi-Trace Scope and other related instrumentation — from your local Sanborn Industrial Sales-Engineering Representative. Ask him for your copy of the complete Industrial Catalog.

SEE SANBORN'S COMPLETE RANGE OF OSCILLOGRAPHIC, TAPE, X-Y AND EVENT RECORDERS — PLUS DATA AMPLIFIERS, TRANSDUCERS AND RELATED INSTRUMENTS — AT BOOTHS 3413-3417, 1963 IEEE SHOW, MARCH 25-28.

INDUSTRIAL DIVISION
SANBORN COMPANY

WALTHAM 54, MASS.

A subsidiary of Hewlett-Packard Company

CIRCLE 105 ON READER SERVICE CARD



"CLAIREXCOR NYC — TELEGRAM

"AT 1201 PST TODAY DEC 14 1962 THE MARINER 11 SPACECRAFT MADE ITS CLOSEST APPROACH TO THE PLANET VENUS WITHIN THE PLANNED MISS CORRIDOR THIS INTERPLANETARY FLIGHT HAS SET MANY WORLD RECORDS INCLUDING COMMUNICATIONS DISTANCE QUANTITY AND SIGNIFICANCE OF DATA RECEIVED THREE AXIS ATTITUDE CONTROL AND INTERPLANETARY SPACE MANEUVER.

"WE ARE PLEASED TO REPORT THAT YOUR CADMIUM SULFIDE PHOTOCONDUCTOR DETECTORS USED IN THE MARINER 11 SUN SENSORS AND SUN ATE HAVE OPERATED SUCCESSFULLY THROUGHOUT THE COMPLETE 109 DAY FLIGHT YOUR DETECTORS HAVE PLAYED A KEY PART IN THE SUCCESS OF THIS HIGHLY SUCCESSFUL MISSION. JET PROP LAB G W MEISENHOLDER SCHMIDT R G FONEY J M WHALEN"

THE EYES OF A MODERN MARINER



CLAIREX PHOTOCONDUCTIVE CELLS recently served as the detectors in the sun-sensing "eyes" of Mariner II, our Venus space vehicle, controlling reference attitude prior to the critical mid-course correction maneuver which reduced the "miss" from 233,000 to 21,000 miles! The sun sensors also served as panel-orientors throughout the flight for maximum power output of the solar cell panels, signalling position errors to the pitch and yaw stabilization jets.

The Clairex cells in Mariner II were the standard CL-605 type now in use in hundreds of other more earth-bound applications. Special single-crystal Clairex components, however, have been utilized in Ranger and other space probe projects as radiation detectors.

MID-COURSE CORRECTION AFFECTS FLIGHT PATH

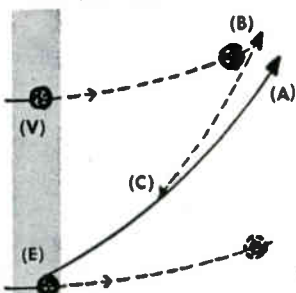

Redirecting vehicle from destination (A) to (B) in vicinity of Venus required flight correction at point (C) by applied jet propulsion of short duration. The vehicle's maneuvers prior to corrective propulsion were based on initial proper sun reference via the photoconductive sun sensors.

SUN SENSING ARRAY ON MARINER VEHICLE

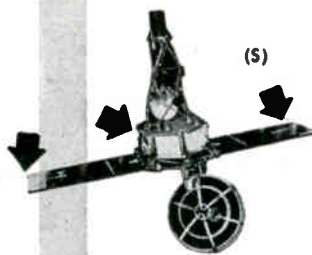

Throughout the life of the craft, prior and subsequent to mid-course correction, the sun sensors (S) signalled error-correcting commands to the stabilization jets for pitch and yaw control, thus keeping the solar cell banks properly oriented for maximum power output.

PHOTOCONDUCTIVE CELL COMPONENTS

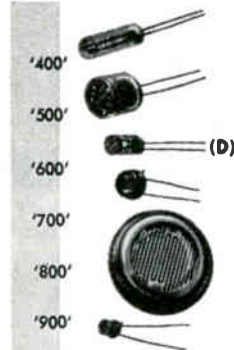

Six Standard Series of photoconductive cells, including the Mariner II type, (D), are manufactured by Clairex Corporation. Illustrated are units of both Cadmium Sulfide and Cadmium Selenide, in glass or metal containers, offering a wide range of response characteristics.

Technical design data available on request.

"The light touch in automation and control"

CLAIREX CORPORATION

8 West 30th Street, New York 1, New York

THE OLDEST MANUFACTURER OF CADMIUM SULPHIDE AND CADMIUM SELENIDE PHOTOCONDUCTIVE CELLS

See us at the I.E.E.E. Show—Booth 1217

be no deflection. A broken thermocouple, or an open circuit with the thermocouple junction still connected to the metal structure, would give an excessive deflection, clockwise with the open circuit in the high-resistance wire and counter-clockwise if the open circuit is in the low-resistance wire. Where thermocouple extension wires are used, the tester can distinguish between reversals of the thermocouples proper and reversals of either or both ends of the extension wires. Uncalled-for shorts or grounds will also give distinctive deflections.

The method lends itself to automatic-checkout or multiple thermocouple installations, and is especially useful for checking thermocouple installations on rocket engines and solid-propellant casings, where stimulation of thermocouples for checkout purposes is prohibited.

Effect of Disarmament on Space R&D to Be Studied

CAN ARMS CONTROL and disarmament agreement be circumvented by R&D activities? This is one of the questions to be studied by Aerospace Corporation under a \$215,000 contract from the U.S. Arms Control and Disarmament Agency. The contract calls for an assessment of the nature and impact of possible controls on RDT&E of ballistic missile and space systems, inspection procedures and related recommendations.

Electron Beam Welder Studied for Space Use

AIR FORCE may supply orbital maintenance spacecraft with electron beam welders. To investigate this possibility it has awarded a \$340,000 contract to Hamilton Standard division of United Aircraft. Experimental welding equipment will be built to perform tests under the high vacuum conditions of space. Narrow heat-affected zones and short cool-down periods would minimize sublimation, or evaporation of metals in space, giving the electron-beam process a major advantage over other welding methods, Hamilton Standard claims.



MODEL 61



MODEL 60



MODEL 40A

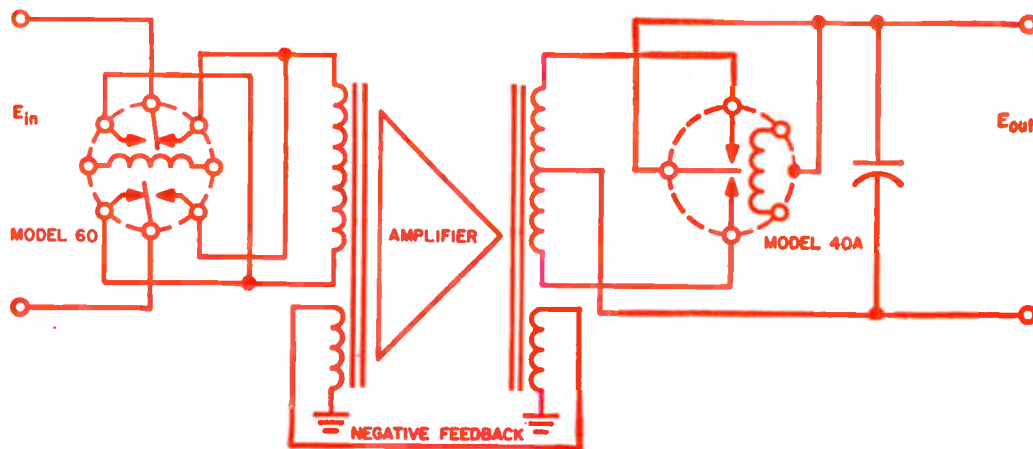

WHAT SHALL WE DO WITH ONE MICROVOLT

PART THREE OF A SERIES ON THE STATE OF THE CHOPPER ART

One microvolt not being much, it is reasonable to be efficient in the interest of the most usable signal. The circuit shown is efficient for several reasons readily apparent to a transformer engineer.

For one thing, the transformer secondary has four times the impedance of the more usual centertapped

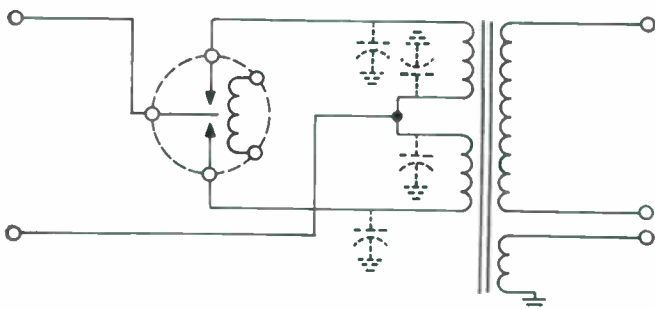

CAPACITIVE BALANCE IS DIFFICULT WITH A CENTER TAP MODULATOR

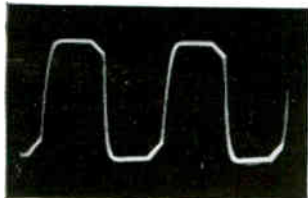

HIGH LEVEL

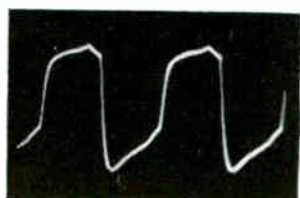

LOW LEVEL

POOR INITIAL PERMEABILITY MAY LIMIT TRANSFORMER PERFORMANCE

modulator circuit, and this is one real good reason for using a DPDT chopper. (Engineers always seem to want higher impedances and lower noise levels.)

Low noise levels are also easier to obtain with DPDT, unless the chopper itself is noisy. It is rather simple to arrange the transformer primary in two identical halves, so that both primary leads are perfectly symmetrical to ground. It is considerably more difficult to provide this precise a balance when the center tap circuit is used. Chopper models 60 and 61, being also perfectly symmetrical as well as low noise, continue the perfect balance out to the input terminals of the amplifier. The net effect is remarkably good common mode rejection. Since the noise in these choppers is virtually non-existent, the recognition and use of signal levels of a few microvolts becomes feasible, even in strong noise fields.

The "initial" permeability of the input transformer core presents a problem. The permeability of some materials falls off seriously as the level approaches zero. The published curves of 80-20 nickel-iron show good permeability even at 0.1 gauss. One assumes hopefully it will still be good at .001 gauss. At impedances of 1,000 ohms the power level, E^2/R , is 10^{-15} watts, and the use of the high permeability alloys is mandatory. It helps to use more turns, too, since impedance varies as the square. Which is now full circle back to where we came in. Use a DPDT chopper.

We have much more information — it's yours for the asking.

AIRPAX ELECTRONICS



CAMBRIDGE DIVISION • CAMBRIDGE, MARYLAND
TELEPHONE: 228-4600 TWX: 301-228-3558



**ANNOUNCING THE BEST PERFORMING,
MOST RELIABLE DIODES EVER BUILT:
HOFFMAN OXIDE-PASSIVATED ZENERS!**



BIG DEAL.

Heard it all before, have you? About better temperature and impedance and leakage characteristics? Well, not like this! The plain fact is that these new zeners, through oxide passivation, come within a whisker of delivering everything semiconductor theory says a zener should. And that *is* a big deal. Because look at what it buys you:

First and foremost, stability. You can put these zeners into your circuit and forget them. Because the elements that cause deterioration are no longer present; they're not there to begin with and oxide passivation literally locks them out—permanently. We've proved it by "Joy-bomb" testing these devices with—and without—the glass case.

And extraordinarily sharp zener knees, a result of leakage rate that's less than 1/100th of the Mil Spec combined with extremely low impedance, provide voltage regulation at microamp current levels—permanently.

Temperature characteristics? The wide ambient range of these devices means you have a temperature confidence level that's probably higher than anything else in the circuit. For example, these zeners can be instantly cycled from -190° to $+250^{\circ}\text{C}$, again and again and again.

There's lots more performance data—including life test data—available either at our **IEEE Booth #1227-9** ...or from your local Hoffman distributor or sales office. We urge you to look it over.

Just one more thing. We do more than talk about Oxide Passivated Zeners. We ship them. Types 1N960A through 1N984A are in stock for immediate delivery. And that's probably the biggest deal of all.

Hoffman / **ELECTRONICS CORPORATION**
Semiconductor Division

4501 N. ARDEN DR., EL MONTE, CALIF. • CUMBERLAND 3-7191 • TWX: 213-442-5633

CIRCLE 109 ON READER SERVICE CARD

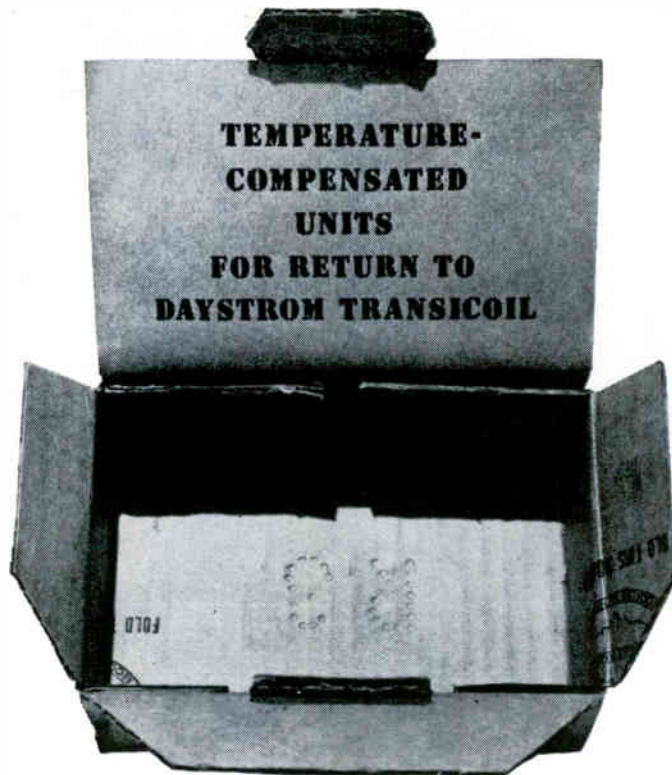

A Month's Rejects

Transicoil delivers highest volume with lowest reject rate on precision temperature-compensated motor tachometers.

Daystrom Transicoil's claims to lowest reject rate rest squarely where such claims are proven: at the customer's incoming inspection. Coupled with this reliability, moreover, is our ability to deliver on schedule in volume. In fact, Daystrom Transicoil is the largest known producer of temperature-compensated motor tachometers.

In recent months, systems requirements have become increasingly stringent for component reliability. Our Size 11's have successfully met this challenge in such systems as the F-104, A3J, Pershing, Hound Dog, Mirage, and a number of other systems as yet not even officially designated by name. Most delivery promises have been met . . . and even bettered. Why don't you check the specs at right, then find out for yourself how our temperature-compensated motor tachometers can meet your own requirements?



DAYSTROM, INCORPORATED
TRANSICOIL DIVISION
 WORCESTER, PENNSYLVANIA
 TELEPHONE 215-584-2421

SIZE 11 TEMPERATURE-COMPENSATED TACHOMETER ELECTRICAL CHARACTERISTICS	
INPUT VOLTAGE (V)	115
INPUT POWER (W)	5.5
INPUT IMPEDANCE (OHMS)	1500
INPUT CURRENT (A)	0.077
OUTPUT IMPEDANCE (OHMS)	5000
OUTPUT VOLTAGE (V/1000RPM)	2.75
MAX. NULL RMS (VOLTS)	0.020
LINEARITY (%)	0.07
SIGNAL TO NOISE	140
PHASE SHIFT AT 25°C (DEG.)	0±0.5°
SCALE FACTOR VAR. W/TEMP.	±0.5% } -55°C
PHASE SHIFT VAR. W/TEMP.	±0.5° } to
	+100°C

See us at Booths 1702-1710, 1801-1809, IEEE Show



VOA

smashing the truth through the iron curtain



■ In the continuing cold war between West and East, one of the more powerful weapons the United States has is the around-the-clock broadcasts of news and commentary by the U. S. Information Agency. Heard in 36 languages, this broadcast operation known as the Voice of America is virtually the only means of getting the truth to millions behind the Iron and Bamboo Curtains. Attesting to the success of the USIA program is the fact that the Communists use some 2,000 transmitters in an effort to block out free world broadcasts.

■ To maintain and strengthen the Voice of America, the world's largest transmitting facility is now beaming programs overseas from Greenville, North Carolina. Building this facility

was a joint effort by Continental Electronics Systems, Inc., and Alpha of Texas Inc., subsidiary of Collins Radio Co., with Continental responsible for the electronic aspects of the project.

■ The Consolidated East Coast Facilities are at three sites totalling 6,000 acres of cleared timber land. Two transmitter sites and the receiving sites are 18 miles apart. Each of the transmitting sites has three 500,000 watt short wave transmitters supplied by Continental Electronics Manufacturing Company. Other transmitters include: Three 250,000 watt transmitters, three 50,000 watt and two 5,000 watt transmitters, for a combined total transmitting power of 4.82 million watts.

Continental Electronics

SYSTEMS, INC. MAILING ADDRESS: BOX 17040 • DALLAS 17, TEXAS • EV 1-7161
4212 SOUTH BUCKNER BLVD. LTV SUBSIDIARY OF LING-TEMCO-VOUGHT, INC.

Designers and Builders of the World's Most Powerful Radio Transmitters



CIRCLE 111 ON READER SERVICE CARD

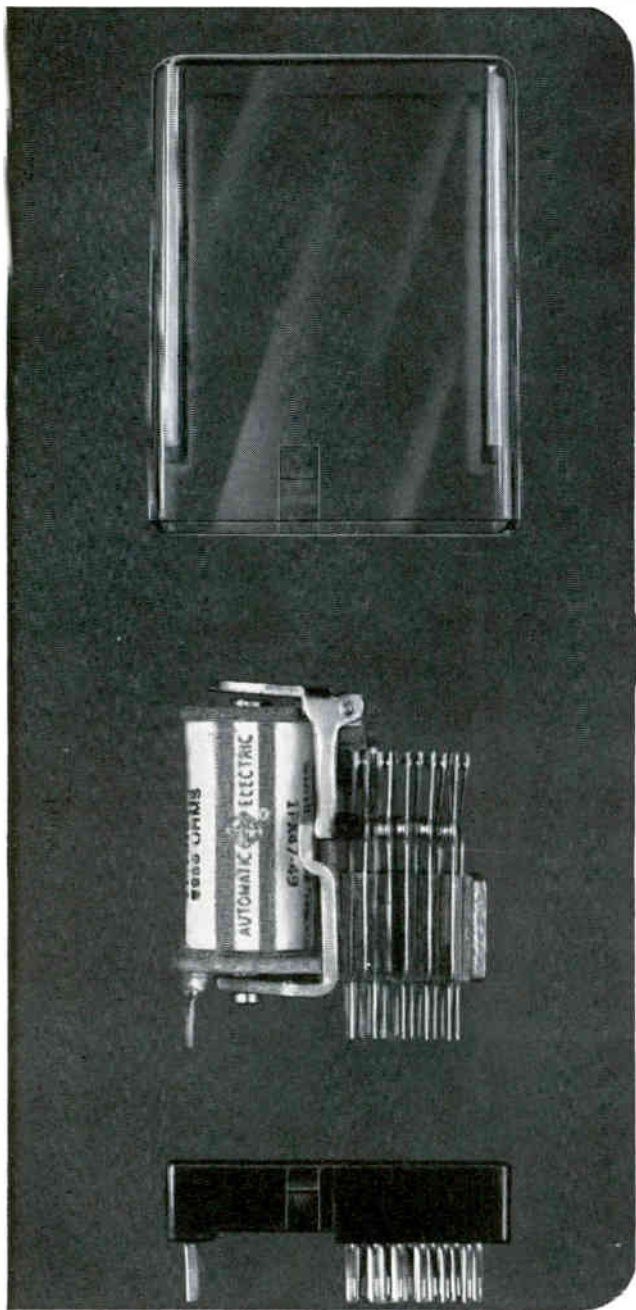

AE
 CLASS E
 RELAY,
 SERIES EIN

NEW!

This plug-in relay brings you remarkable savings in time and money

Now, for the first time, AE's new Series EIN relay assemblies offer you the advantages of true plug-in relays at low cost.

This is made possible through the design of a special integrated socket that accommodates any of AE's standard Class E relays with taper-tab terminals. With Series EIN, you avoid the mounting and wiring charges on relays equipped with octal-type plugs.

The sockets are available separately from AE stock so that you can wire complete chassis, as you would for tubes, then order the Class E relays to meet production schedules.

The relay terminals fit snugly and provide large surface contact, yet the relays are easily removed in the field for repair or replacement.

Series EIN relays are provided with clear plastic cases that protect the mechanism from dust and damage, and allow visual examination of the relays in operation.

• • •

AE circuit engineers will be happy to work with you in applying Series EIN Class E relays to your designs. For full details on Class E relays, Series EIN, write the Director, Control Equipment Sales, Automatic Electric, Northlake, Illinois.

AUTOMATIC ELECTRIC

Subsidiary of
GENERAL TELEPHONE & ELECTRONICS



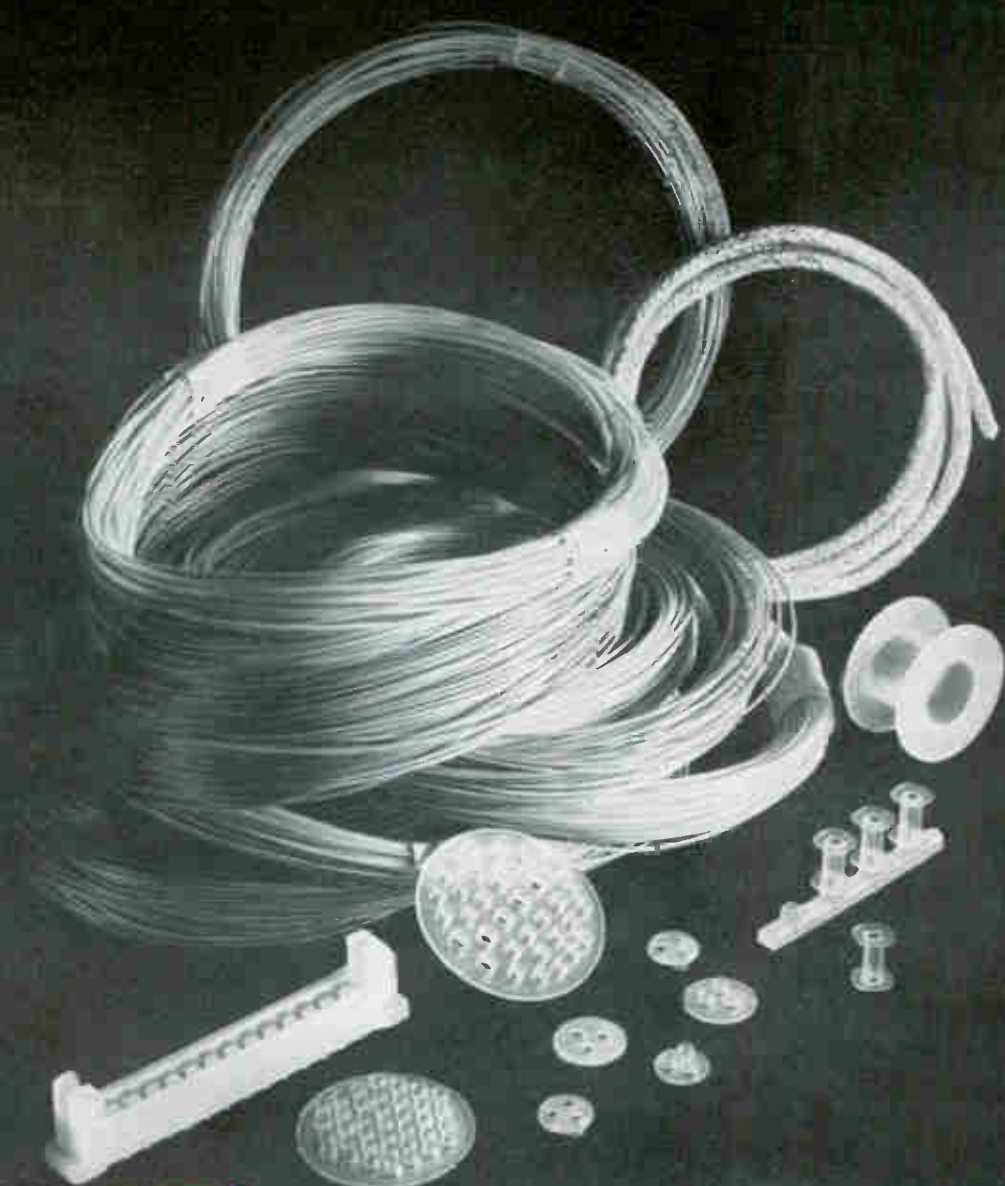

KYNAR[®] vinylidene fluoride resin...

the new high performance insulating material

Kynar, the new fluorocarbon resin from Pennsalt Chemicals, offers an outstanding combination of properties for electronic applications. Coupled with high dielectric strength and resistivity, Kynar offers extreme mechanical strength and toughness, stability to temperatures ranging from -80 to $+300^{\circ}\text{F}$, and resistance to severe environmental stresses caused by weather, radiation and corrosive chemicals. Kynar is readily extruded to form primary wire insulation, abrasion-resistant jackets, and thin wall tubing. And Kynar-insulated hook-up wire withstands the mechanical stresses imposed by high speed automatic wrap and assembly without deterioration.

Typical properties of 10-mil Kynar insulation extruded over AWG 24 solid soft copper conductor:

Dielectric strength, volts.....	10,000
Insulation Resistance, meg-ohm/M.....	> 1,000
Cold bend, $\frac{1}{2}$ " dia., 1 lb. weight at -70°F , volts..	8,000
Abrasion Resistance, Janco Tester grade 400 alumina, inches of tape.....	50
Cut through, anvil at 90° , 350 gm. hours at 270°F	> 500

Soldering test, flare back..... None
 Flammability..... self extinguishing

Write for our new brochure and the names of nearby fabricators who supply Kynar. Plastics Dept., PENNSALT CHEMICALS CORPORATION, 3 Penn Center, Phila. 2, Pa.





IEEE SPECIAL

Components Meet Sales Challenge

Electronics mart bigger, wares get better, and competition fiercer

EMPHASIS at the big electronics market place this year is to offer better devices and better materials in the face of stiff competition.

More electronics firms are scheduled to enter the electronics arena this year in the annual Coliseum contest to win favor for their products.

Many of the same words will be used to influence the electronics market. The particular device or material will claim advantage over adversary by claims of greater reliability, at lower cost, to overcome existing limitations, for more efficient utilization, at more critical operating temperatures, to improve circuit performance.

Familiar words ever. But fact of the matter is that more devices and better materials are now available to meet claims of superiority than in any other period of electronics' history.

Company know-how will be in evidence everywhere. But the same big problem still faces the user: How can he keep intelligently informed on available devices that can fit his needs?

Companies that best know how to keep engineers informed will have decided edge in capturing healthy share of a highly-competitive electronics market. Company selling products must develop more competence in technical sales know-how. Sales engineer will render knock-out blow when he learns not only to sell, but to educate. Two-pronged approach involves much more than merely supplying data-sheet information

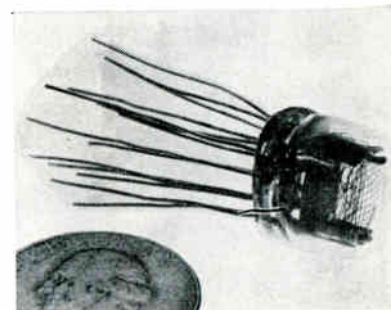

CHARACTERS of new Nixie readout tube are only 0.310-in. high. Circuit can be applied to many common transistors

on his company's product. Sales engineer must trigger user in applications, and "provide user with what he wants, not what his company has to sell" (see *ELECTRONICS*, May 11, 1962, p 57).

Here are some of the devices and materials, that will be shown at this year's I-Triple-E show. Device engineers may want to find out more about these components for their particular applications:

READOUT tubes are smaller this year. Miniature electronic readout tube, shown by Burroughs, displays numeral 0 to 9. Characters are 0.310 inch high. Object of mechanical design of new Nixie tube is to provide minimum readout space when groups of tubes are mounted together. Complete ten-digit display of $\frac{1}{8}$ -in. characters occupies less than five inches of panel width and $\frac{3}{4}$ -in. of behind-panel space when units are connected to the activating circuit.

OPTICAL meter relay, featured by Assembly Products Inc. may be biggest item in their line. Device uses a combination of fiber optics and a reflecting disk. Relay obtains almost instantaneous control action at set point, a dead band of 0.25 percent of full scale or less, and low price. Units can be pro-

Components Engineers:

YOUR GUIDE TO I-TRIPLE-E SESSIONS

Subject	IEEE Session	Date	Where Held
Antennas, (three sessions)	17	Mar 26, pm	a
	25	Mar 27, am	a
	33	Mar 27, pm	a
Audio	46	Mar 28, am	b
Component Fabrication	22	Mar 26, pm	b
Component Horizons	28	Mar 27, am	c
Components, Miniature	12	Mar 26, am	c
Component Reliability	15	Mar 26, am	b
Computer Components	5	Mar 25, pm	d
Electron Devices	20	Mar 26, pm	c
Microelectronics	52	Mar 28, pm	e
Microwaves, (three sessions)	36	Mar 27, pm	c
	43	Mar 28, am	c
	51	Mar 28, pm	c
Semiconductors	11	Mar 26, am	e
Ultrasonics (two sessions)	11	Mar 26, am	f
	19	Mar 26, pm	f

am sessions begin at 10 am; pm sessions begin at 2:30 pm

- (a) Waldorf Astoria, Starlight Roof (d) Waldorf Astoria, Empire Room
 (b) N. Y. Coliseum, Marconi Hall (e) N. Y. Coliseum, Faraday Hall
 (c) Waldorf Astoria, Sert Room (f) Waldorf Astoria, Jade Room

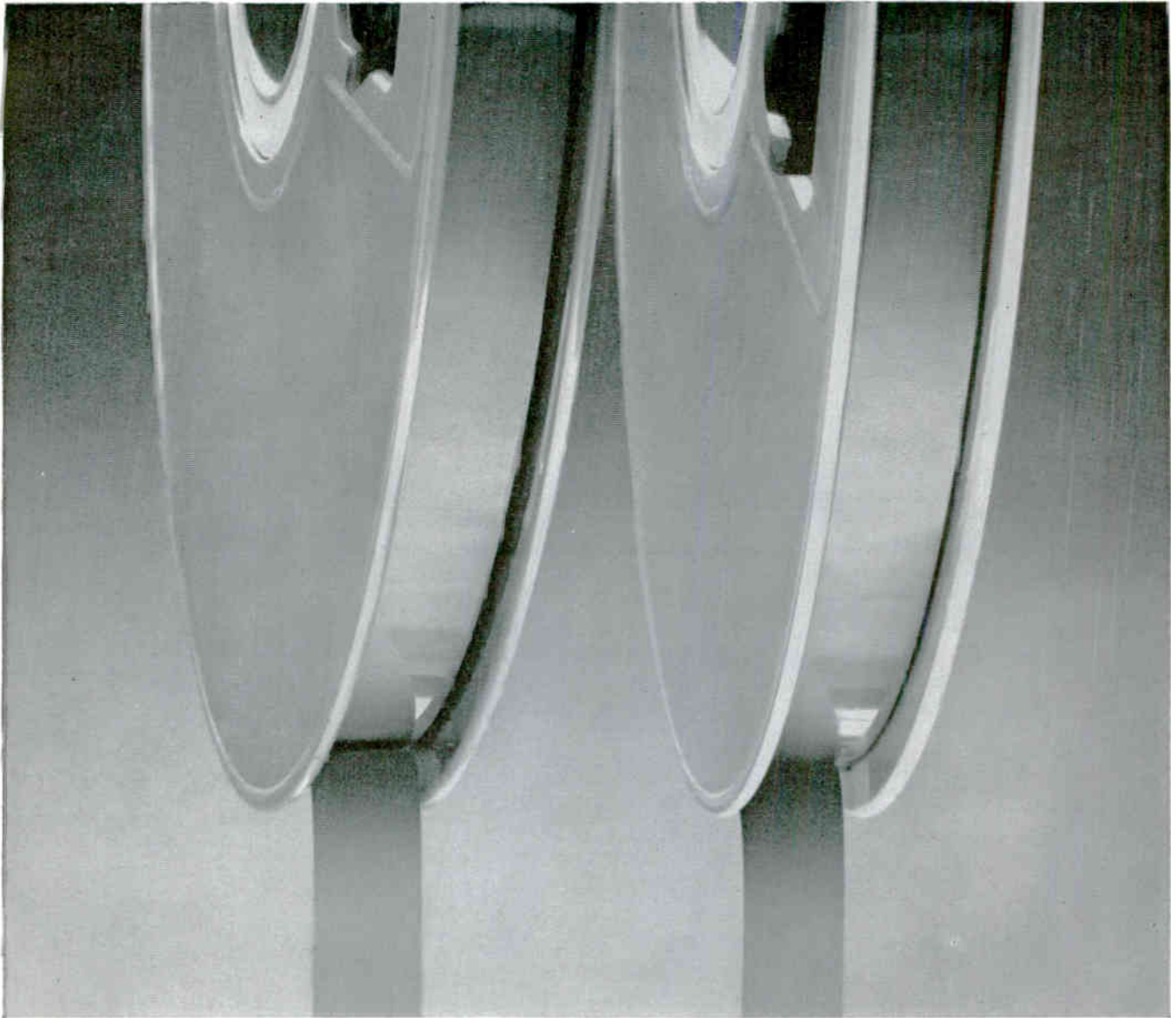

BOTH THESE MAGNETIC TAPES HAVE A POLYESTER BASE ...BUT ONLY ONE IS MYLAR[®] (8 YEARS PROVEN)

Eight years ago instrumentation tape of Du Pont MYLAR* polyester film appeared on the scene and set new standards of reliability. Naturally enough, people whose needs called for a magnetic tape of highest performance couldn't risk a tape other than MYLAR. ■ Now, other polyester films are beginning to appear. They are not all the same: MYLAR is a polyester film, but other polyester films are

not MYLAR. In the past you could safely assume you were getting MYLAR when you specified "polyester base". *Today you cannot.* ■ There's only one way to be sure you're getting the MYLAR you've used and trusted for magnetic tapes of proven reliability: specify MYLAR by name. E. I. du Pont de Nemours & Co. (Inc.), 10452 Nemours Bldg., Wilmington 98, Delaware.

*Du Pont's registered trademark for its polyester film.



BETTER THINGS FOR BETTER LIVING . . . THROUGH CHEMISTRY

electronics • March 15, 1963



CIRCLE 115 ON READER SERVICE CARD

115



Pedigree by the yard

MALLORY WET SLUG TANTALUM CAPACITORS



8 different types, including ratings up to 200°C. Rating for rating, they often have far smaller size and lower cost than other tantalum capacitor types. Reliability and performance backed by 12 years of production experience. Write for data.

This man-size stack is representative of records that are kept five years on every XT tantalum capacitor we produce. There's a point to all of this paper work. This is evidence that every XT capacitor has passed the most critical examination at every phase of production. Our engineers analyze the numbers that go on these log sheets . . . and if characteristics show a trend toward specification limits, they can take immediate action to head off trouble *before* it starts.

Careful testing, both during production and on every finished capacitor, is a key part of the advanced techniques we have engineered into our Greencastle plant . . . the first to be built specifically for tantalum capacitor manufacturing. Typical result: our XT series have performed over 45,000 hours on life test. Mallory Capacitor Company, Indianapolis 6, Indiana—a division of P. R. Mallory & Co. Inc.

WET SLUG, FOIL AND SOLID TANTALUM CAPACITORS

CIRCLE 116 ON READER SERVICE CARD

P. R. MALLORY & CO. Inc.
MALLORY

Mallory tantalum capacitors delivered from stock at factory prices by these distributors:

Baltimore, Md.
Radio Electric Service

Binghamton, N.Y.
Wehle Electronics

Birmingham, Ala.
MG Electronics & Equipment Co.

Boston, Mass.
Cramer Electronics
DeMambro Radio Supply Co.
Lafayette Radio
QPL House, Inc.

Bridgeport, Conn.
Westconn Electronics

Buffalo, N.Y.
Summit Distributors, Inc.

Chicago, Ill.
Allied Electronics Corp.
Newark Electronics Corp.

Cincinnati, Ohio
United Radio

Cleveland, Ohio
Pioneer Electronics

Dallas, Texas
Engineering Supply Co.
Hall-Mark Electronic Corp.

Dayton, Ohio
Stotts-Friedman Co.

Denver, Colo.
Denver Electronics

Houston, Texas
Harrison Equipment Co., Inc.
Lenert Company

Indianapolis, Ind.
Graham Electronics

Los Angeles, Calif.
California Electronics
Kierulff Electronics, Inc.
Lynch Electronics
Radio Product Sales

Minneapolis, Minn.
Northwest Electronics Corp.

Montreal, Que.
Canadian Electrical Supply Co.

Muskegon, Mich.
Fitzpatrick Electric Co.

Nashville, Tenn.
Electra Dist. Co.

Newark, N.J.
Lafayette Radio

New York, N.Y.
Harrison Radio Corp.
Harvey Radio Co., Inc.
Lafayette Radio
Milo Electronics
Terminal Hudson Electronics

Oakland, Calif.
Elmar Electronics, Inc.

Oklahoma City, Okla.
Radio, Inc.

Orlando, Fla.
East Coast Electronics
Hammond Electronics, Inc.

Ottawa, Ont.
Wackid Radio-TV Lab.

Palo Alto, Calif.
Zack Electronics

Perth Amboy, N.J.
Atlas Electronics

Philadelphia, Pa.
Herbach & Rademan
Philadelphia Electronics

Phoenix, Ariz.
Kierulff Electronics, Inc.

Pittsburgh, Pa.
Radio Parts Co.

Salt Lake City, Utah
Kimball Electronics

San Antonio, Texas
Perry Shankle

San Francisco, Calif.
Kierulff Electronics, Inc.

St. Louis, Mo.
Olive Electronics

Seattle, Wash.
F. B. Connelly Co.

Springfield, N.J.
Federated Purchaser, Inc.

Tampa, Florida
Thurrow Electronics, Inc.

Toronto, Ont.
Alpha Aracon Radio Co.
Electro Sonic Supply
Wholesale Radio & Electronics

Tulsa, Okla.
Engineering Supply Co.

Washington, D.C.
Capitol Radio Wholesalers
Electronic Industrial Sales

White Plains, N.Y.
Westchester Electronic Supply Co., Inc.

Winston-Salem, N.C.
Electronic Wholesalers Inc.

CIRCLE 117 ON READER SERVICE CARD

vided with modulating action that makes them particularly suited for precisely controlling industrial processes. Solid-state components give high reliability. Taut-band suspension is used for the meter movement, giving the in-

strument greater ruggedness, resistance to vibration and repeatability of at least 0.2 percent full scale.

HEAVY-DUTY switch will be displayed by Hickock Electric Instru-

New Design for Planar Devices

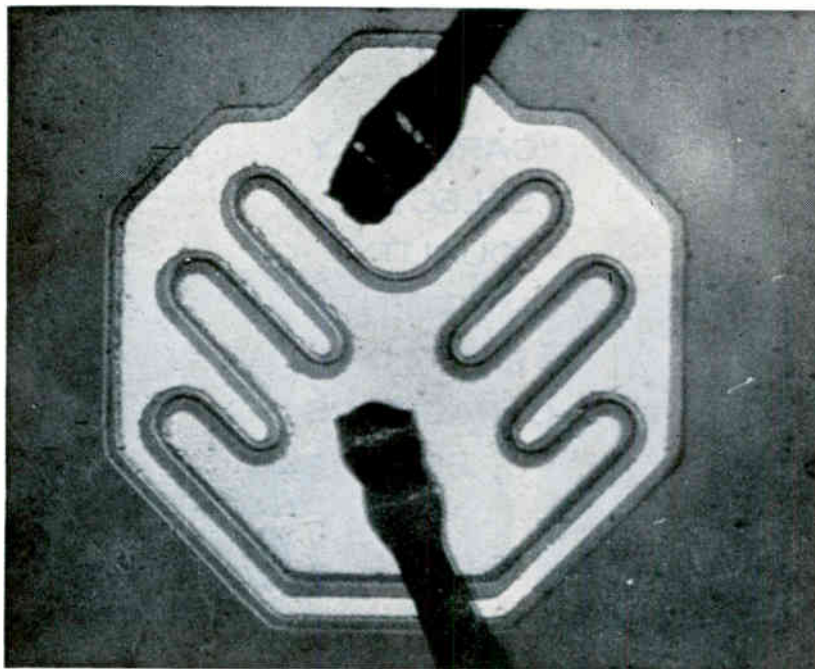

LEAF configuration is claimed to improve performance of planar transistors for medium power, medium frequency range

ANALYSIS of various configurations of existing planar transistors, conducted by Bendix, has resulted in a new surface design of planar devices. Bendix now claims optimum design performance for planar types in medium power, medium frequency range. Company now offers device that is said to be particularly important for amplifiers and switching applications, claims device that can handle heavier current, with improved reliability factors.

Basically what Bendix has done is to design a planar transistor that has a larger emitter area, larger contact area, and say they have improved contacts.

Leaf design, shown above has eliminated sharp corners, which may reduce leakage problems. Circuit design engineer attending IEEE will have an opportunity to

evaluate results of beta gain, saturation voltage, and temperature storage effects that can minimize reliability of contacts.

CONTACTS—Leaf configuration, shown in above photo, was developed by Robert L. Reber and Albert Schrob. Photo shows top contact connected to white emitter contact area; and lower base contact. Grey areas adjacent to emitter and base contact areas are non-conducting layers.

Bendix says leaf design has reduced: collector-base cutoff current, emitter-base cutoff current, collector capacitance, collector saturation voltage, emitter saturation voltage. Company also says gain-band width product is higher and gain at high collector voltage is improved. Company also says breakdown voltages are unchanged.

INTO
DIGITAL
SYSTEMS
DESIGNED
AND
DEVELOPED BY
COMPUTER
CONTROL
COMPANY, INC.

GO
"CAREFULLY
SELECTED
QUALITY
COMPONENTS."

PAKTRON
CAPACITORS

FILL
THE
BILL.

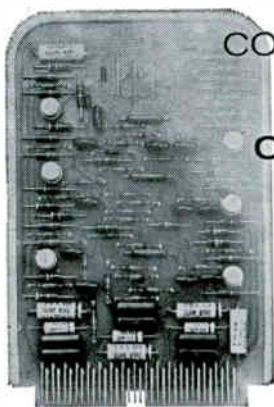

Digital Logic Module



DDP-24 Digital Data Processor

actual
size

For ten years Computer Control Company, Inc. has designed, developed and delivered a broad range of specialized digital systems. Their reputation for high-quality and high-reliability are well known. They insist on reliable components throughout. We at Paktron are well aware of our obligation to meet their exacting requirements of small size, high reliability and economy.

For high quality and outstanding performance, specify Paktron Miniature Molded Mylar* capacitors.

**DUPONT



PAKTRON

DIVISION ILLINOIS TOOL WORKS INC.

1321 LESLIE AVENUE • ALEXANDRIA, VIRGINIA

AREA CODE 703 King 8-4400

ment. Company calls item card-programmed automatic, heavy-duty switch, applicable in traffic control and other heavy-use equipment.

SOLID TANTALUM capacitor is shown by Kemet Co., Div. of Union Carbide. They call it C series of their epoxy-molded solid-tantalum capacitor line. This is in cylindrical form. Component has application in any welded module construction item.

EPOXY GLASS laminates claimed to have higher peel strengths which are consistent in most applications, are being shown by General Electric's Laminated Products Department. Company feels product is significant advance.

BRUSHLESS d-c motor, shown by Globe Industries, Dayton, has inverter mounted integrally right on blower. Unit is one and one-half inches long. Device is claimed to be half the size of anything now on the market.

PRECISION THERMISTORS, now available from Yellow Springs Instrument Co., Ohio, show high degree of sophistication. Most of company's output is directed toward laboratory markets with a substantial portion in the area of temperature measurement and control. Company has aimed at determining basic limitations on operating temperatures. Company cites thermistor that has operated at 1,200 C for six months with no evidence of degradation of characteristics.

CRYSTAL CAN relay, shown by Babcock Electronics, is designed for low-profile mounting. Half-size crystal can features high sensitivity and durability, company says. Coil operation requires only 175-mw pull-in power to switch any load from dry circuit to 2 amps. Unlike conventional relay motor arrangement, armature is located inside the coil, the region of highest flux density.

CONNECTOR called Ultrekon will be displayed by Cinch Manufacturing Co., Chicago. Unit was developed primarily for military and



THE COMPLETE LINE OF HALL EFFECT PRODUCTS

Today's line of ISC HALL*ISTOR products represents over ten years' research, development and application engineering on Hall effect components for a broad range of detection, measurement, computation and control applications. Many of these probes, pick-ups, multipliers, modulators, tape heads, and other devices have been in production and actual service for five years or more.

The HALL*ISTOR line begins where others end. Only from ISC can you get a complete selection of advanced devices and components with the latest developments in Hall effect technology. More than 50 different products, all in stock for immediate delivery, are available as standard catalog types. These include probes of Indium Antimonide, Indium Arsenide, or Indium Arsenide Phosphide — all in a choice of crystalline or deposited thin film construction — on ceramic or ferrite substrates.

ISC's leadership in the field of Hall effect devices results in the lowest available prices of components together with the industry's widest assortment of sizes, shapes, terminations, outputs, linearities, sensitivities, effective air gaps, and other characteristics.

Our applications engineering staff is at your disposal to discuss requirements for complete systems involving processing, automation, material handling, and other automatic controls.

Get complete engineering specifications and application data — send for the new ISC HALL*ISTOR Catalog No. H-20014.

HALLTEST DIVISION 111 Cantiague Road
Westbury, L. I., New York (516) WE 8-8000

instrument systems corporation

isc

Electrically and
mechanically,
ATOHM'S 1"
rectilinear,
wirewound
TRIMMER POT



(SHADED AREA INDICATES RT-12 SIZE)

QUALIFIES to new
MIL-R-27208A

The RT-12, or "thin case" style, as called out by MIL-R-27208A, is the only 1" rectilinear, wirewound trimmer potentiometer that is MIL-approved for future designs.

The popular Atohm Model 120, shown above, meets this new spec mechanically and electrically.* Furthermore, the Model 120 has a 2-watt capability, 20% better resolution, an operating temperature range of -65°C to $+200^{\circ}\text{C}$, a superior mechanical design, and other features which give it exceptional accuracy and reliability.

Atohm has manufactured the Model 120 for $3\frac{1}{2}$ years, and is one of only two manufacturers who have been making this style for an extended period. All other manufacturers must re-tool to meet the new spec.

ATOHM lab approved to qualify to MIL-R-27208A

The Defense Electronics Supply Agency (formerly ASES) has granted approval to the Atohm lab to qualify parts to this long-awaited MIL spec. Since July, 1962, all Atohm MIL-type trimmers have been tested to MIL-R-27208A. Systematic random samples of production units are given complete tests (Group II) including shock, vibration and load life, to determine that production lots continue to meet or exceed the spec.

Specify Atohm for thoroughly tested, field proven trimmers...at no extra cost. When desired, Atohm provides a Certificate of Conformance without charge.

*But not dimensionally. The Model 120 is smaller. So, when preparing house specs and specification control drawings, use maximum dimensions where possible. Write for reproducible transparency with shadow area drawing for RT-12 style.

ATOHM ELECTRONICS
7648 San Fernando Road, Sun Valley, California • TR 7-9873



aerospace applications. Connection is claimed to approach reliability of an uninterrupted conductor, with functional flexibility that doubles its usefulness. Contacts can be bonded for permanent connection in circuit—either by wire-wrapping or welding. Avail-

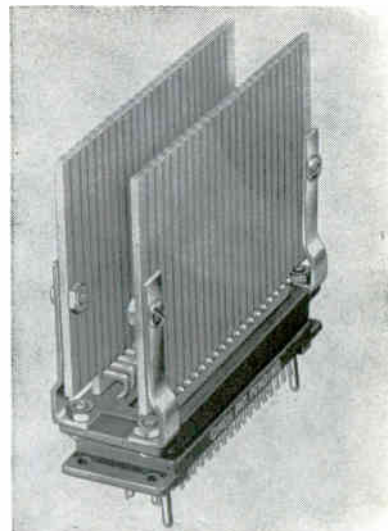

CONNECTOR can be used with single or double-sided printed circuit board, or for direct mounting of welded modules (Cinch Manufacturing)

able for either rack-and-panel or cable-to-chassis installation, Ul-trekon can accommodate solid or stranded wire, or tape cable.

BERYLLIA ceramics will be featured by American Lava, Chattanooga, Tenn. Company will show thin flat substrates for microminiature applications. Beryllia has dielectric constant about three-quarters that of dense alumina and a Te value almost twice that of alumina.

CHOPPER of double-pole, double-throw design, is said to be smallest on market, according to Airpax. Company also claims noise level of new electro-mechanical chopper is lowest available—less than 25 microvolts into a megohm load. Company quotes small-quantity delivery of four to eight weeks, says unit is competitively priced.

VITREOUS ENAMEL resistor with new coating is singled out as best component offered by Ohmite this year. Unit has precise dimensions. **CIRCLE 121 ON READER SERVICE CARD** →

March 15, 1963 • electronics

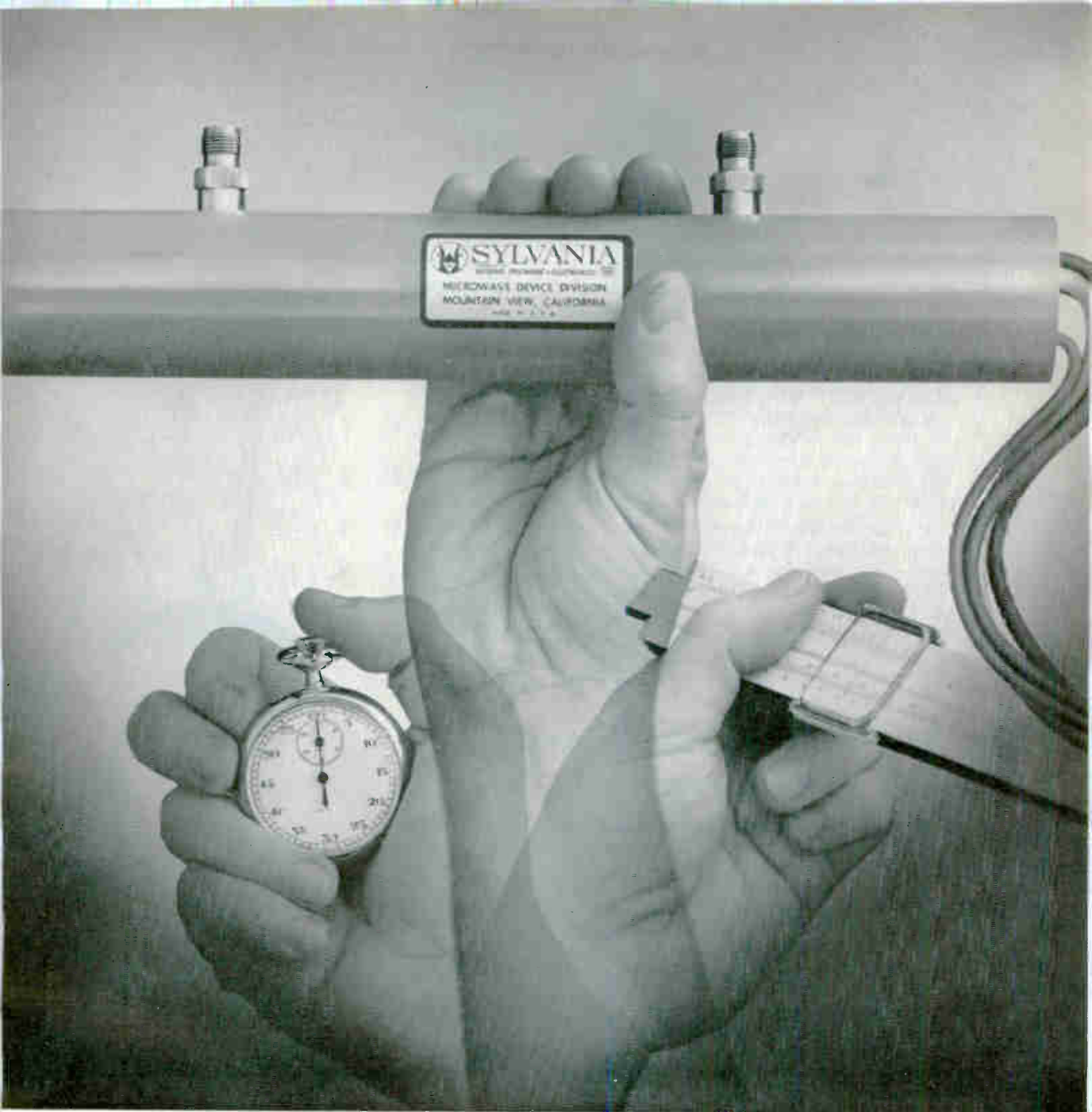

How Sylvania produced a 100-watt TWT in a PPM package...in only 4 months

Our microwave engineers pride themselves on being able to redesign an existing traveling-wave tube in a short time to meet new specifications of a customer. "Quick reaction," they call it.

In the case of our 100-watt CW X-band tube, the reaction took only four months—something of a record for a power increase of such magnitude. They started with a pulsed Sylvania tube of 10 watts average

power, modified the internal structure, and incorporated a new helix design. The result is a whopping 100-watt CW output that system designers have been needing for ECM, long-range space communications, and special equipment for testing high-power components.

"Quick reaction" means being able to come up with fast solutions and render on-the-spot engineering assistance. And it

requires production lines that can handle either long runs of standards or small runs of special-purpose tubes. That's exactly the way we are set up—a result of our work on the B-58 "Hustler" tube program.

Care to give us a try on your traveling-wave tube requirements?

Write to Microwave Device Division, Sylvania Electric Products Inc., P.O. Box 87, Buffalo, New York.

SYLVANIA

SUBSIDIARY OF

GENERAL TELEPHONE & ELECTRONICS



SEE US AT IEEE —
BOOTHS 2322-2332
AND 2415-2425

Dilemma: true RMS-measuring instruments are low-impedance, delicate, and damage-prone devices. Increase their sensitivity and they slow down. VTVMs, conversely, measure true RMS of pure sine waves only.

Resolution: trio/lab's superb combination of high impedance, sensitivity, and overload immunity — the new Model 120 AC Voltmeter. The trick is turned by driving a laboratory-standard electrodynamicometer by an ultra-linear, high-impedance amplifier, gain-stabilized by negative current-feedback to better than 0.1%.

Results: 0.25% true RMS accuracy, 10MV-500V full-scale sensitivity, 50-2,000 CPS frequency range — regardless of time, temperature, or line fluctuations. Convenience and peace of mind for you, too: the Model 120 reads out *directly* from a 7" edge-indicating, mirror-backed scale; it can be overloaded only by malicious mischief.

Put this original concept in instrumentation — derived from trio/lab's 8 pioneering years in producing "build-ins" — to work for you. \$985 ships the portable Model 120-1, or the rack-mounted 120-7, from stock.

Secondary-Standard Accuracy

$\frac{1}{4}$ % true RMS-direct reading

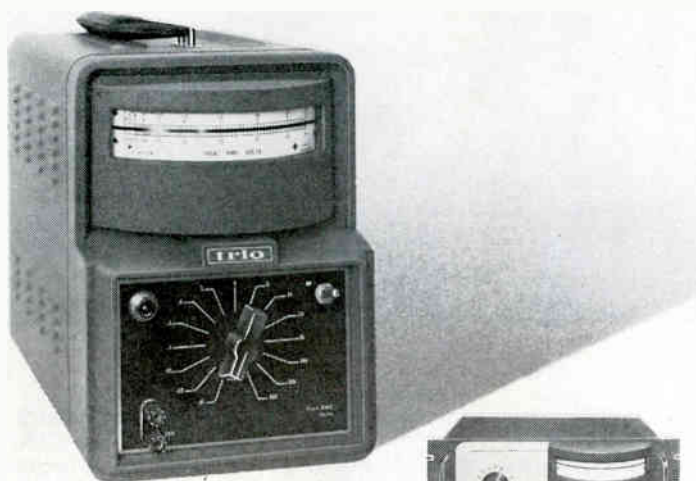

triolab

TRIO LABORATORIES, INC., PLAINVIEW, L.I., NEW YORK
OVERBROOK 1-0400, AREA CODE 516, TWX: 516 433-9573

See us at IEEE, Booth 3222

sional accuracy, maintained over wide heat range. Ohmite says they will display more items this year than they have for a long time.

REED SWITCH, shown by General Electric Receiving Tube Department is $\frac{1}{10}$ in. in diameter, has



SMALL reed switch is only 0.1-in. in diameter, each has switch arms of equal length (General Electric)

glass length about $\frac{3}{4}$ in. long. Switch arms of equal length permit both arms to move under influence of magnet. Switch is normally open, but can be magnet-biased to use normally closed. Firm has started sampling prospective customers.

STEPPER MOTOR, size 8, claimed to increase pulse potential, is featured by Wright Division of Sperry Rand. Motor provides torque at 90 degrees in excess of one ounce inch. Step motor employs magnetic detenting, thus eliminating shock loading and wear on mechanical detent mechanisms.

RELAY shown by Phillips Control Company has special armature for more efficient utilization of the magnetic field. Design includes single diagonally-mounted coil, single stamping for integral return spring and backstop. Company also specializes in telephone and power relays.

IMPROVED Alnico 8 material, featured by General Magnetic Corp., is guaranteed to 1,600 ostededs and a max vh of 5.25 million. Magnetic version of Alnico 5

is not for sale as yet. It will run in the order of 8 to 8.5 million v/h. Crystallized version of Alnico 5 grows in spaghetti-like bunch.

SILICON RECTIFIERS, featured by International Rectifier, are designed to meet NEMA standards and operate with high reliability in electro-chemical processing and general industrial service. Devices have voltage ratings to 900-v repetitive prv, 1200-v transient prv, current ratings to 250 amps continuous, and 4,500 amps peak one cycle surge current capability. Five types cover prv range from 650 to 900 volts and have stable reverse characteristics under alternating and direct voltage over temperature range from -40 to 200 C.

RESONANT RELAY of self-holding type, is recent development of Mallory Timers Co. Contact action is prevented until a critical operating point has been reached as a result of a signal being present on the coil of proper frequency, power and duration. At instant of operation, resonant reed is pulled away from the magnetic fulcrum and held solidly to an operating gap. Associated circuit contacts are closed with a positive snap action.

TRIM CAPACITORS, displayed by JFD Electronics, are fixed capacitors of 5-pf and 6-pf values with variable temperature coefficients. Diffused quartz dielectric units are designed for control of frequency variations due to temperature changes from -55 to 200 C. Capacitance variation is $\pm 1,000$ parts per million per deg C.

TRAVELING WAVE tube mount, shown by Calvert Electronics, eliminates need for external leads. The N4047 mount has an ejector bar and socket built in. The twt is designed for use between 5.8 and 7.2 Gc, and has a nominal gain of 43 db, 5-w output, typical saturation output power of 12 w, noise figure of 30 db, and a gain flatness of 0.01 db per one Mc measured over a 50-Mc range.

MINIATURE ceramic vacuum relay, shown by Jennings Radio, is

Emcor II

ENCLOSURE'S
three dimensional
utility provides
each customer
with product
individuality

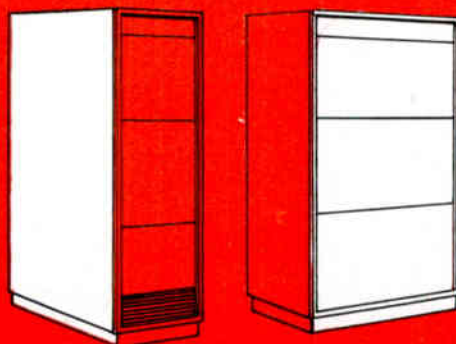
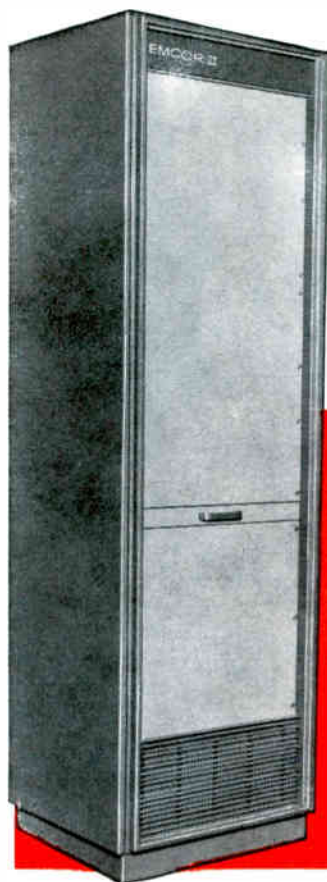

WHEN DEPTH... OR WIDTH IS IMPORTANT

A FEW OF THE
MANY ENCLOSURE
STYLES AVAILABLE



Vertical
Rack



Sloped
Front

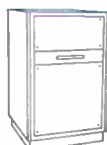

Equipment
Enclosure

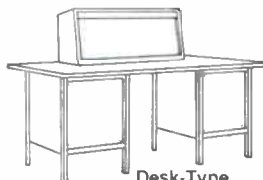

Desk-Type
Console



Extended
Arm



Turret

REQUEST NEW
EMCOR II
LITERATURE



BORG-WARNER

INGERSOLL PRODUCTS SALES ENGINEERS ALSO REPRESENT McLEAN BLOWERS FOR ENCLOSURES
VISIT US AT IEEE BOOTH NOS. 4211-13-15

EMCOR II Modular Enclosures provide a major breakthrough in full functional utilization of available enclosure space. No matter what face—side or front—that you select—each provides the most favorable housing area for your precision instrumentation. A variety of standard component modifications and/or variations offer each customer product individuality. A custom look is achieved through a choice of recessed, flush or extended panel mountings; single or double width frames, pontoon bases and side panels; assorted customer nameplate styles; aluminum trim or grillwork extrusions (customer's own design extrusions or trim can be readily utilized) and externally removable side panels. Stimulate your imagination, request full details today!

EMCOR—The Original Modular Enclosure System By
INGERSOLL PRODUCTS
Division of Borg-Warner Corporation
1000 W. 120th ST. • DEPT. 1242 • CHICAGO 43, ILL.

FOR SUPERFINE
CUTTING OF HARD,
BRITTLE MATERIALS



THE S. S. WHITE
AIRBRASIVE® UNIT

We don't know why anyone would want to slice a light bulb up like an onion. But we do think it is an awfully good demonstration of the Airbrasive's ability to cut hard brittle materials. Imagine, for example, cutting precision slivers like these with a mechanical tool!

This unique industrial tool is doing jobs that were up to now considered impossible. Its secret lies in its superfine jet of gas-propelled abrasive particles that are capable of precision cutting without shock, heat or vibration. Thus the most fragile materials can be shaped, drilled, abraded, or cleaned with complete safety.

Use it to make cuts as fine as 0.008" . . . remove surface coatings . . . debur tiny parts . . . wire-strip potentiometers . . . adjust microminiature circuits . . . cut germanium, silicon, ferrites, glass, ceramics . . . in the laboratory or on the production line.

The cost is low, too. For under \$1000 you can set up an Airbrasive cutting unit in your own shop.

Send us samples of your "impossible" jobs and let us test them for you at no cost.

WRITE FOR
BULLETIN 6006.
Complete information.



S. S. WHITE INDUSTRIAL DIVISION
Dept. EU, 10 East 40th St., New York 16, N. Y. • Telephone MU 3-3015 collect.

S.S. White INDUSTRIAL
AIRBRASIVE®



designed to operate at 2,500 volts. Yet device is only 1 $\frac{3}{8}$ -in. long and weighs only one ounce. At 16 Mc, the relay is rated at 4 amps rms and 2,500 volts withstand voltage. Unit was designed for high-volume production.

NICKEL-CADMIUM batteries, shown by Sonotone, are available in polystyrene and nylon cases. Batteries have vented cells, are made up in more than 100 standard and special configurations. Cells weigh from one pound to 21 pounds.

SENSOR for low-temperature controlled systems, displayed by Electronics Div. of Carborundum, has maximum temperature sensitivity of -55 C to 105 C. Company will also show 24, 115 and 220-v ignitors for the first time. Devices serve as replacements for wire elements, spark plugs and automatic standby pilots. In typical test, an ignitor, operated on a cyclic test 30 sec on, 90 sec off, indicated the following surface temperatures: 2,362 F; and after 240,000 cycles, 2,280 F.

TWO NEW time-delay proximity switch systems and a new two-position multi-pole rotary switch with snap-acting switch elements will be shown by Honeywell's Micro Switch Division. Time-delay systems are especially valuable to show when an object has been in a specified position for a certain length of time, or to indicate when production lines have slowed or stopped, or when parts jam. Both systems respond to ferromagnetic material within the detection range of the sensor without physical contact. Each system is available with three amplifier models that overlap the time delay from 0.1 to 30 seconds.

FOAMED TEFLON FEP, just developed by DuPont, permits dielectric constant below 2.0. Resulting dielectric constant depends upon percent void, can be in order of 1.5 or 1.6. Fluorocarbon resins as a solid material have dielectric constants in range of 2.05 to 2.20. In new foamed FEP, air or an inert gas displaces the solid FEP during the foaming process. Resulting dielectric constant is reduced as the degree of foaming is increased.

Foam was developed by DuPont in cooperation with several of its



TO-18 for logic switching . . . MOTOROLA'S PROVEN 2N964



TO-5

Now for Line and Core Driving . . . MOTOROLA'S NEW 2N2381-82

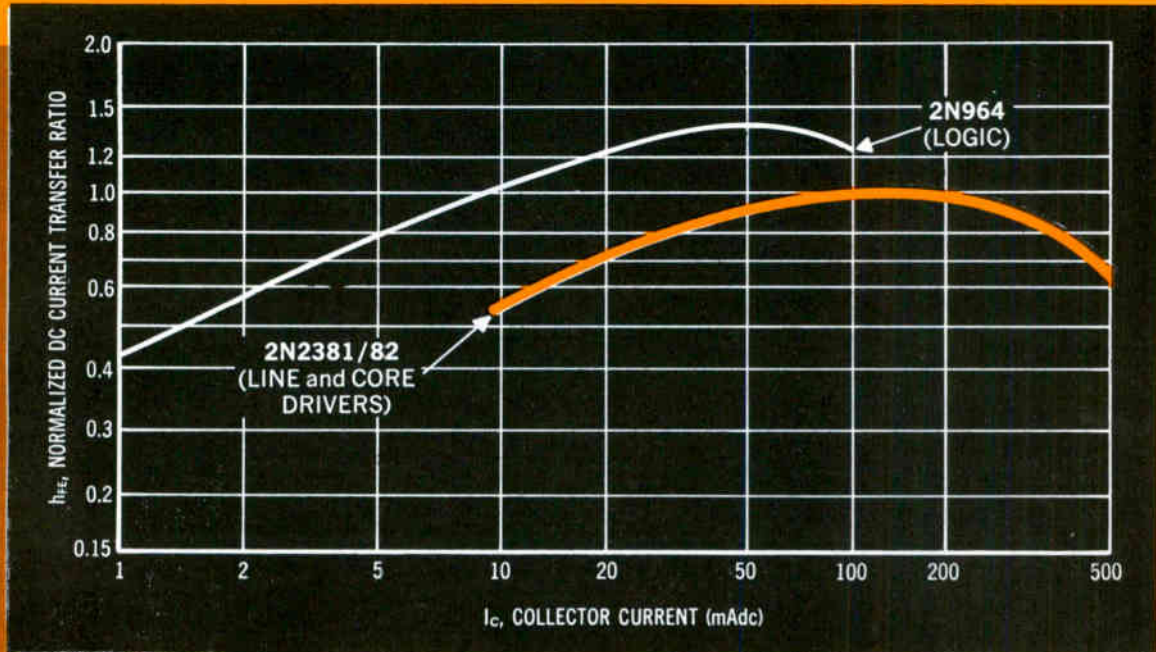

the 2N2381-82

- ✓ WILL SWITCH 200 mA IN 40 NSEC TYP.
- ✓ WILL SWITCH AT CURRENTS AS HIGH AS 1/2 AMP

Motorola has designed two entirely new germanium epitaxial PNP transistors for advanced line and core driver applications . . . for driving pulses on co-axial or resistance lines, or as line drivers for read-out and memory units.

These devices, types 2N2381 and 2N2382, cover a switching current range from 100 mA to 500 mA. They feature a typical 200 mA switching time of only 40 nsec (67 nsec max.).

See for yourself, by comparing specifications and by trying them in your present circuit, how the 2N2381 and 2N2382 compare with the transistors you are now using.

For additional information on these new Motorola high-current transistors, contact your nearest Motorola District Sales Office or Distributor or write: Motorola Semiconductor Products Inc., Technical Information Department, Box 955, Phoenix 1, Arizona.

COMPARE THESE PERFORMANCE CHARACTERISTICS

Type	V_{CE0}	V_{CE0}	V_{CE} (sat) @ I_C / I_B	t_{ON}^*	t_{OFF}^*
2N2381	30	15	.4 @ 200 / 20	10 nsec	20 nsec
2N2382	45	20	.4 @ 200 / 20	10 nsec	20 nsec
2N1204	20	15	.5 @ 200 / 20	15 nsec	25 nsec
2N1495	40	25	.3 @ 200 / 20	15 nsec	30 nsec
2N2099	25	12	.6 @ 200 / 10	16 nsec	50 nsec
2N2100	40	20	.5 @ 200 / 10	16 nsec	50 nsec
2N2173	25	15	.5 @ 200 / 10	16 nsec	40 nsec

*All types measured in the same circuit at 200 mA
($I_{B1} = 40$ mA; $I_{B2} = 40$ mA)



MOTOROLA

Semiconductor Products Inc.
A SUBSIDIARY OF MOTOROLA INC.

5005 EAST McDOWELL ROAD • PHOENIX 8, ARIZONA

U T I C A[®]

**UTICA
STRIPWRIGHT**

a revolutionary
new wire stripper

from

UTICA

Adjustable stop permits stripping of any length up to $\frac{3}{8}$ " per stroke.

Cam action dial adjusts strip diameter to the finest variation.

Plastic handles . . . strong, light, comfortable.

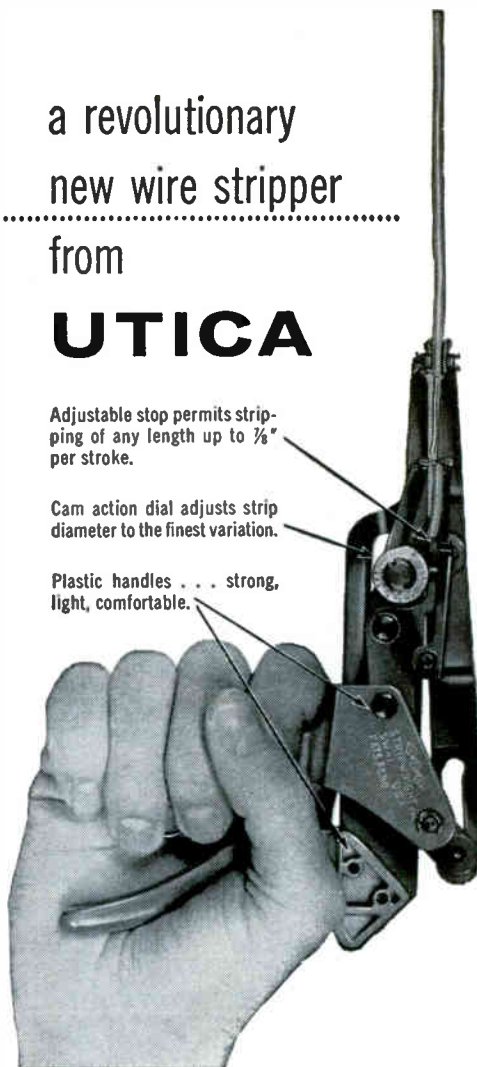

Strip fast and clean! Eliminate nicking! Reduce insulation marking to a minimum! Handle any wire size from #12 to #26 . . . and do it all with Stripwright®. . . Utica's revolutionary new wire stripper. This versatile, lightweight tool with sturdy plastic pistol grips, is engineered for efficiency and speed. And Stripwright is designed to the same high standards of quality as all other Utica tools. Thousands are now in service. Write for complete information.

Utica Drop Forge & Tool Division
Kelsey-Hayes Company, Orangeburg, S. C.

tools the experts use!

wire and cable customers. New material offers two basic advantages over solid materials: the external diameter and cable weight can be significantly reduced for a given conductor size. Also internal conductor can be increased in size and still keep the external diameter the same. Advantage of the larger conductor is added mechanical strength and less electrical copper losses. While a vacuum provides the lowest possible dielectric constant with a value of 1.0, it can be approximated by air and certain other gases. Although the mechanical properties of tensile strength, elongation, and crush resistance are generally lowered, foamed FEP with good balance of mechanical and electrical properties is being produced by several companies. Manufacturers of wire and cable insulated with foamed FEP include: Brand-Rex Div. of American Enka Corp., Surprenant Div. of ITT, Microdot Corp., and Times Wire & Cable Co.

CADMIUM sulphide photoconductor cells, used for industrial control and lighting applications, will be displayed by Sylvania. Units are one-half inch in diam, offer cell resistance, at 2 fc, from 750 through 16,000 ohms.

THREE ELECTRON tubes for the home entertainment market are being introduced by ITT. The tubes are two 9-pin miniature audio amplifiers, ECLL800 (6KH8) and ELL80, and a 9-pin miniature voltage indicator, EM84A. The first tube provides push-pull audio amplification and phase inversion in a single envelope. The second tube is designed for use as a twin-channel audio-frequency output tube in stereo amplifiers, recorders, and radios, as well as for push-pull or single-ended circuits. The last tube, the EM84A, is a miniature, sensitive, voltage indicator.

COLD CATHODE counters, introduced by Baird-Atomic, are two new Dekatron glow transfer types. At same time company will introduce packaged transistor drive circuits for all double-pulse types. One new counting tube is a selector type GS10J with a low striking voltage, 150 v; a low pulse amplitude, 24 v; and a maximum counting rate, 1 Kc.

NEW

Soniline Magnetostrictive Delay Lines

4 TO 20,000 MICROSECONDS

STANDARD SONILINE MODELS

3C Soniline Model	S-33A	S-33A-1	S-44A	S-66A	S-66B	S-77B	S-88A	S-88B	S-99A	S-99B	S-99C	S-99D
Delay Range (μsec)	4-14	4-14	Max. 1000	Max. 1500	Max. 2000	Max. 2200	Max. 3500	Max. 6500	Max. 4500	Max. 9000	Max. 15,000	Max. 20,000
Case Size L x W x H (Inches)	5 x 1 x 7/16	5 x 1 x 7/16	3 1/4 x 3 1/8 x 7/16	4 1/4 x 4 7/8 x 7/16	4 1/4 x 4 7/8 x 3/4	4 1/2 x 5 1/2 x 3/4	6 x 7 x 7/16	6 x 7 x 3/4	9 1/2 x 10 1/2 x 7/16	9 1/2 x 10 1/2 x 3/4	9 1/2 x 10 1/2 x 1	9 1/2 x 10 1/2 x 1 1/2
Maximum Storage Capacity RZ (Binary Bits)	28	28	1000	1500	2000	2200	3500	5000	4500	9000	10,000	10,000
Bit Rate RZ (Megacycles)	0-2	0-2	0-1	0-1	0-1	0-1	0-1	0-0.8	0-1	0-1	0-0.7	0-0.5
INPUT												
V-in (Volts)	15	15	15	15	15	15	15	15	15	15	25	25
I-in (MA)	50	50	50	50	50	50	50	50	50	50	80	80
Z-in (Ω)	300	300	300	300	300	300	300	300	300	300	300	300
L-in (μH)	15	15	30	30	30	30	30	30	30	30	60	60
Pulse Width (μsec)	0.20	0.20	0.4	0.4	0.4	0.4	0.4	0.4	0.4	0.4	0.8	0.8
Rise & Fall Time (μsec)	0.05	0.05	0.1	0.1	0.1	0.1	0.1	0.1	0.1	0.1	0.2	0.2
OUTPUT												
V-out (MV)	70	20	20	20	10	10	10	10	10	5	5	2
Z-out (Ω)	1500	1500	1500	1500	1500	1500	4000	4000	4000	4000	4000	4000
L-out (μH)	80	80	150	150	150	150	150	150	150	150	300	300
(RZ) Pulse Width (μsec)	0.5 ± 0.05	0.5 ± 0.05	1.0 ± 0.1	1.0 ± 0.1	1.0 ± 0.1	1.0 ± 0.1	1.0 ± 0.15	1.25 ± 0.15	1.0 ± 0.15	1.0 ± 0.2	2.0 ± 0.2	2.0 ± 0.2
Signal to Spurious Noise (Static)	10:1	10:1	10:1	10:1	10:1	10:1	10:1	10:1	10:1	10:1	8:1	6:1
Signal to Spurious Noise (Dynamic)	5:1	5:1	5:1	5:1	5:1	5:1	4:1	4:1	5:1	4:1	4:1	3:1
MECHANICAL												
Volume (Cu. In.)	2.2	2.2	5.5	9.4	15.6	18.6	18.4	31.5	43.5	75	100	150
Weight (lbs.)	0.2	0.2	0.4	0.6	1.0	1.2	1.1	1.25	2.7	3.0	3.1	3.4
Mounts*	TS	TS	TBI	TBI	TBI	TBI	TBI	TBI	EMTI	EMTI	EMTI	EMTI
ENVIRONMENTAL												
Opt. Temp. Range (°C)	0-80	0-80	0-55	0-55	0-55	0-55	0-55	0-55	0-55	+10 to +40	+10 to +40	+10 to +40
Max. Delay Change Due to Temperature (μsec)	±0.04	±.005	±0.1	±0.1	±0.1	±0.1	±0.1	±0.15	±0.1	±0.1	±0.2	±0.3
(Non-operating) Shock	50 g, 11 ms	50 g, 11 ms	50 g, 11 ms	50 g, 11 ms	50 g, 11 ms	50 g, 11 ms	50 g, 11 ms	50 g, 11 ms	50 g, 11 ms	50 g, 11 ms	Normal Handling	Normal Handling
(Non-operating) Vibration	20 g, 5-2000 cps	20 g, 5-2000 cps	20 g, 5-2000 cps	20 g, 5-2000 cps	20 g, 5-2000 cps	20 g, 5-2000 cps	20 g, 5-2000 cps	20 g, 5-2000 cps	20 g, 5-2000 cps	20 g, 5-2000 cps	Normal Handling	Normal Handling

* TBI — Threaded Blind Inserts

* TS — Threaded Studs

* EMTI — Edge Mounted Threaded Inserts

Delivery on standard models in 3 to 4 weeks

ON REQUEST — LIBRARY OF INFORMATION ON DELAY LINES

HOW TO USE — An extensive collection of technical notes describes a variety of typical digital applications for magnetostrictive delay lines including storage, sequential buffering, cross-and auto-correlation, signal compression and expansion, and video signal analysis **HOW TO SPECIFY** — 20-Page technical booklet discusses specification of magnetostrictive delay lines for digital applications. Details include: capabilities and limitations, principles of operation, modulation techniques, test patterns and effects of temperature **HOW TO ORDER** — 3C Catalog MDL-1 details complete line of standard Soniline models. Order form included.



COMPUTER CONTROL COMPANY, INC.

OLD CONNECTICUT PATH, FRAMINGHAM, MASS. • 2251 BARRY AVENUE, LOS ANGELES 64, CALIF.

Specify VICTOREEN Special Purpose Components

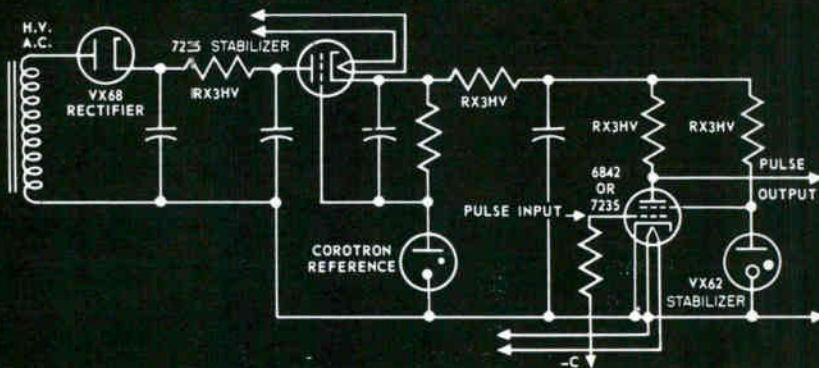

FOR HIGH VOLTAGE, HIGH RESISTANCE, APPLICATIONS WITHIN THE RANGE OF 400 TO 27,000 VOLTS

In the 400 to 27,000 volt range, Victoreen components — Corotrons®, triodes, pentodes and resistors — give your circuits both reliability and outstanding performance. Other advantages are circuit simplification for lighter weight and lower manufacturing costs. Let Victoreen help solve your high voltage stabilization problems.

Condensed specification data on some Victoreen units is listed below:

Glow Tubes:	57 to 150 volts
Corotrons:	400 to 27,000 volts
Vacuum Tubes:	1000 to 10,000 volts
Resistors:	200 ohms to 200 megohms

From the manufacturer of famous Victoreen Hi-Meg Resistors and Electrometer Tubes.

IEEE BOOTH 2301-03



THE VICTOREEN INSTRUMENT COMPANY
5806 HOUGH AVENUE • CLEVELAND 3, OHIO

Victoreen European Office: P. O. Box 654, The Hague

20-YEAR HITCH IN DAVY JONES' LOCKER

(Mycalex components are built to work on over 4,000 miles of ocean floor until at least 1983)

These amplifiers will be spaced at 20-mile intervals along a single cable on the ocean floor to help the Bell System handle the growing number of inter-continental telephone calls—well over 4,000,000 last year alone.

In designing these new amplifiers the Bell System engineers aimed at developing a device that would stand up for at least 20 years under the extreme pressure. For failure of any of the complex components could interrupt vital transoceanic circuits.

They looked to Mycalex Corporation of America for 11 key parts—resistors, inductors and transformers—because Western Electric knows from over 20 years of materials testing and experience that our SUPRAMICA® 555 ceramoplastic is one of the most nearly perfect insulating materials. It can be precision molded for reliable operation. It is extremely stable. It has a thermal expansion coefficient close to that of stainless steel. It permits easy soldering of imbedded inserts.

SUPRAMICA (we make three kinds, 555, 560, and 620 "BB") is only one of the products we produce as the world's leading specialists in high-temperature, high-reliability ceramic insulation materials and components. If you'd like a sample of SUPRAMICA 555 plus our newest literature on this amazingly versatile engineering material, please fill out the coupon below.

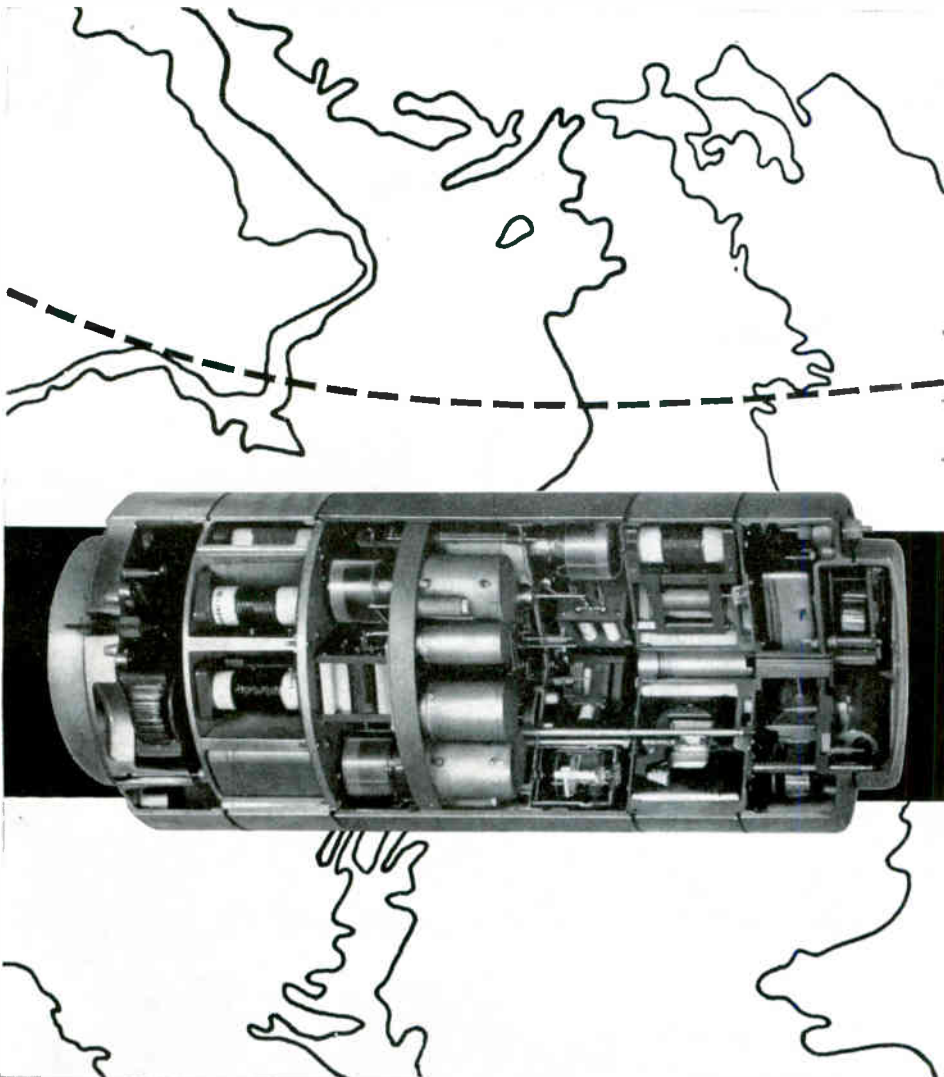

MYCALEX

World's largest manufacturer of ceramoplastics, glass-bonded mica and synthetic mica products.

Mycalex Corporation of America
Dept. L, Clifton Blvd.
Clifton, New Jersey

Please send me information on SUPRAMICA 555 ceramoplastic and other Mycalex products. My specific

interest is _____
Name _____
Title _____
Company _____
City _____ State _____

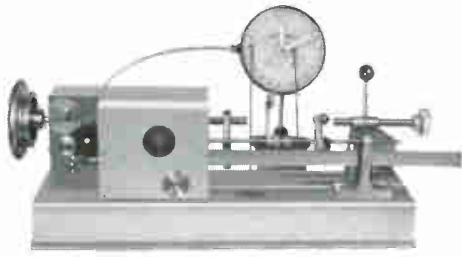

MODEL WX LABORATORY WINDER

The world's most versatile winding machine for all types of radio frequency coils as well as bobbins, transformers, resistors, etc. Features continuous gain or feed adjustment and our exclusive adjustable cam (patented).

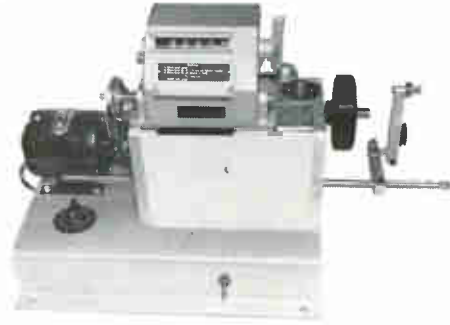

MODEL CS BOBBIN WINDER

Pictured is the current version of our most popular bobbin winder having increased capacities. A complete line of single and multiple units is available.

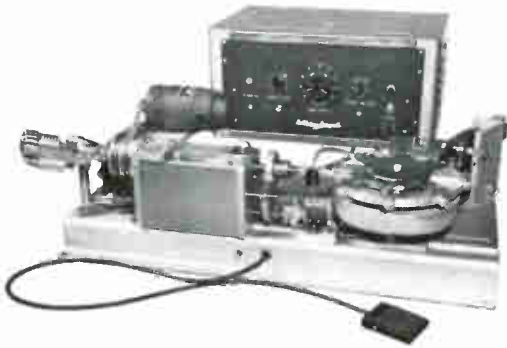

MODEL CK-SL AUTOMATIC WINDER

The machine illustrated produces more than 20 completed coils a minute without operator attention. This is one of a large family of completely automatic machines available.

**The most advanced
Coil Winding
Equipment in the
world today!**

**MODEL MP
HAND WINDER**

Coils with up to 60 turns produced in a single stroke of the lever.

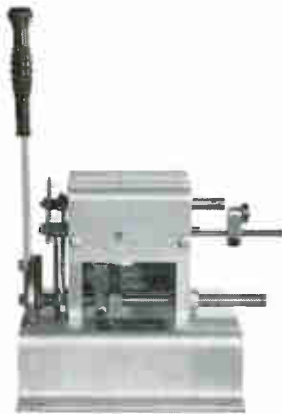

**MODEL BRS
PRECISION STRIP WINDER**

This is one of a group of machines for winding a single layer on continuous or precut strips or mandrels of various shapes.

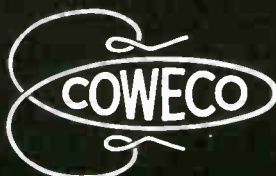

Write today for complete literature

COIL WINDING EQUIPMENT CO.

OYSTER BAY, NEW YORK — WAInut 2-5660 (Area Code 516)

HERE'S EXTREME ACCURACY FROM 5 CPS TO 50 MCS

WITHOUT CORRECTION FIGURES!



MODEL 540A



MODEL A55



MODEL 550A

VOLTAGE MEASUREMENT / CALIBRATION

MODEL 540A THERMAL TRANSFER STANDARD—Extreme accuracy is provided by the new Fluke Model 540A Thermal Transfer Standard over a frequency range of 5 cps to 500 KC. 540A incorporates a built-in Lindeck potentiometer and galvanometer and requires only that the DC standardizing voltage be provided from an external source. Prime advantage offered by the Model 540A is that the AC and DC voltages on any range are always applied to the same portion of the transfer circuitry on a 1:1 basis. This feature completely eliminates the cause of inherent inaccuracy found in other transfer type instruments in which the AC voltage is first divided down to a lower level before comparison with the DC standard voltage. A search circuit minimizes the possibility of thermocouple overload and permits more rapid measurements of unknown voltages. The

frequency range of the 540A can be extended to 50 megacycles by using the Model A55 thermal converters. Current measurements from 2.5 ma to 10A can be made with the 540A by utilizing the Fluke Model A40 current shunts.

MODEL A55 THERMAL CONVERTERS offer frequency specifications to 50MC with complete coverage of the voltage range (from 0.25 to 50 VAC) provided in nine individual converter units.

Great care has been taken in the electrical design and packaging of these units to provide accuracy comparable to NBS standards under less than ideal conditions of temperature, humidity, and vibration enabling them to be used in production areas as well as in the standards or development laboratory.

MODEL 550A TRANSFER STANDARD incorporates: a four dial Lindeck potentiometer, DC reference supply, polarity reversing switch and terminals for external galvanometer. A complete set of accessories is included at no additional cost for convenient interconnection of Models 550A and A55 in any suitable measurement configuration. Price: \$395.00.

CALIBRATION: All accuracy specifications are guaranteed by John Fluke Mfg. Co., Inc., to be within the indicated deviation limits from zero error as defined by the National Bureau of Standards without correction figures! John Fluke Company or NBS test reports on Models 540A or A55 are available at additional cost.

All prices F. O. B. factory, Mountlake Terrace, Washington. Prices and data subject to change without notice.

PARTIAL SPECIFICATIONS—MODEL 540A

VOLTAGE RANGES	TRANSFER ACCURACY				
	5 cps	20KC	50KC	100KC	500KC
0.5V	← ±0.02% →		← ±0.05% →		
1-10V	← ±0.02% →		← ±0.05% →		
20-50V	← ±0.02% →		← ±0.2% →		
100-500V	← ±0.03% →		← ±0.2% →		
1000V	← ±0.05% →				

Voltage Ranges: 0.5, 1, 2, 3, 5, 10, 20, 30, 50, 100, 200, 300, 500, and 1000 V.

(Note: A voltage from 2/3 to 1 1/2 times the voltage specified by the range selector may be accurately measured. The absolute maximum voltage which may be safely applied is 1000 V DC or 1000 V RMS AC). Price: \$795.00.

PARTIAL SPECIFICATIONS—MODEL A55

VOLTAGE RATING	TRANSFER ACCURACY				
	5 cps	1MC	10MC	30MC	50MC
0.5V	±0.01%	±0.01%	+0.5%	+1.50%	
1-10V	±0.01%	±0.03%	±0.10%	±0.10%	
20-50V	±0.01%	±0.05%	±0.10%		

THERMAL CONVERTERS RATED VOLTAGE

RATED VOLTAGE	PRICE
0.5V	\$100.00
1, 2, 3, 5, 10V	\$125.00 each
20, 30, 50V	\$150.00 each

NOTE: Each converter may be used from 1/2 to 1 times voltage rating.



John Fluke Manufacturing Co., Inc.
Box 7428, Seattle 33, Washington
PR 6-1171, TWX—Halls Lake, TLX—852

See the new 821A Voltmeter and other new instruments to be provided at IEEE Show Booth 3229-3231

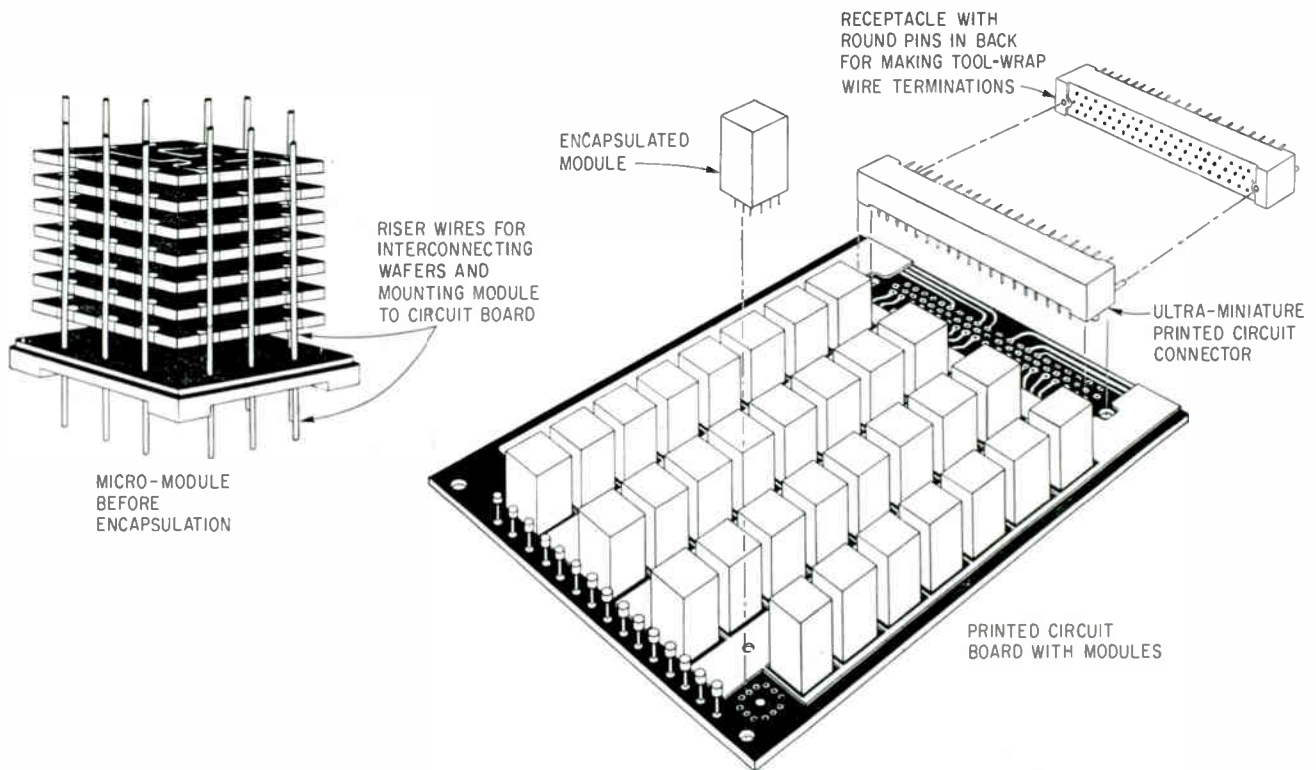

DIP-SOLDERING is used to connect pins of Burndy plug having right-angle configuration to circuit board interconnecting RCA Micro-Modules, also dip-soldered. Packaging scheme facilitates micromin system production and also achieves operational advantages. Further refinements of technique to be discussed at IEEE

IEEE SPECIAL



Variety Spices IEEE Topics

Topics include packaging, quality, welding, thin films

UPWARDS of a dozen papers on production techniques are to be discussed at forthcoming IEEE convention during various techni-

cal sessions. As a result, variety in topics rather than any particular topic trend seems to be the keynote. A panel will discuss assembly of pellet components.

Packaging is of top interest. Development, testing and low-cost production of basic elements used in microelectronic systems appears

to be reaching the point where they can be integrated into reliable, maintainable, low-cost packages.

This is theme of a paper by Michael Lazar of Burndy entitled "Case Histories in the Field of Microelectronic Packaging." He deals with several solutions to problems of package integration concerning: interconnections, power supplies, grounding, shielding, air cooling, mechanical mounting, module polarization and guidance. As indicated by title, Lazar will describe experiences in micro packaging at Burndy and RCA. He says that we are witnessing three microminiature revolutions: (1) microminiaturization of discrete components, (2) thin-film integrated circuitry, (3) semiconductor integrated circuitry. No one now knows, says Lazar, whether any one approach will supplant the other two, whether marriages will take place, or whether each

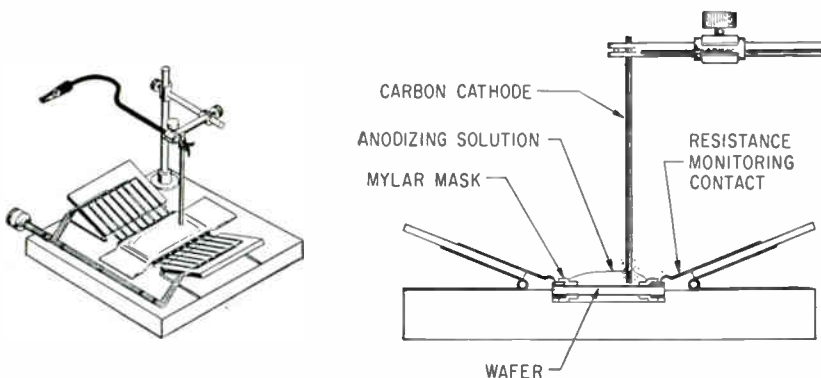

A-C RESISTANCE of deposited resistor is measured by ohmmeter and limit bridge to control process end point



...a TV set
operating under water?

That's not water...that's FREON[®] fluorocarbon solvent

And we'll bet this is the cleanest electronic system at the IEEE show! Because it will play, while completely immersed, for the duration of the show.

This demonstration is possible because "Freon" is an excellent dielectric and a selective cleaning agent. There is no arcing, even in the TV set's high-voltage circuitry. "Freon" thoroughly removes dust, grease, lint and chips from components or entire assemblies—without harm to delicate parts, finishes, elastomers or insulation. "Freon" has a uniquely low surface tension that lets it penetrate minute openings. There it wets and displaces soils other solvents cannot.

And "Freon" is *safe* for production people because it's nonexplosive and virtually nontoxic. It leaves no residue and can easily be recovered for use over and over again for maximum economy.

So don't miss this one at IEEE! If you're not going to the show, write for complete technical information, and, if you wish, the services of a cleaning specialist. Du Pont Co., "Freon" Products Division N-2420 E-3, Wilmington 98, Delaware.

Freon[®] solvents

Better Things for Better Living...through Chemistry



SEE THIS DEMONSTRATION IN BOOTH #4317-4319 AT IEEE!

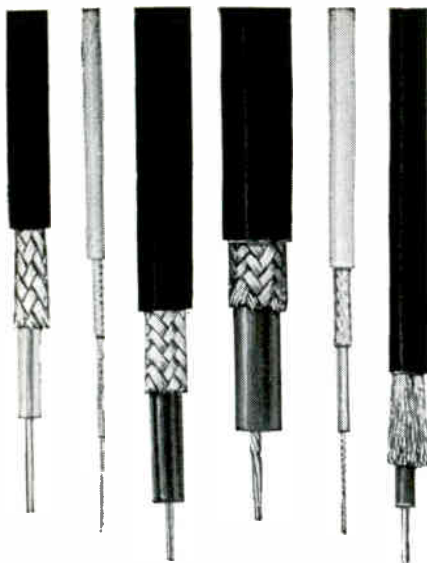

**leave the connectors
to automatic**



Automatic RF Connectors are designed, engineered and manufactured with "built-in" reliability. Don't accept less! *Specify...*



automatic
METAL PRODUCTS CORPORATION

Leaders in the field of radio frequency coaxial connectors and components

323 Berry Street, B'klyn 11, N. Y.
Telephone: EVergreen 8-6057

IEEE (IRE) SHOW



BOOTH 1524

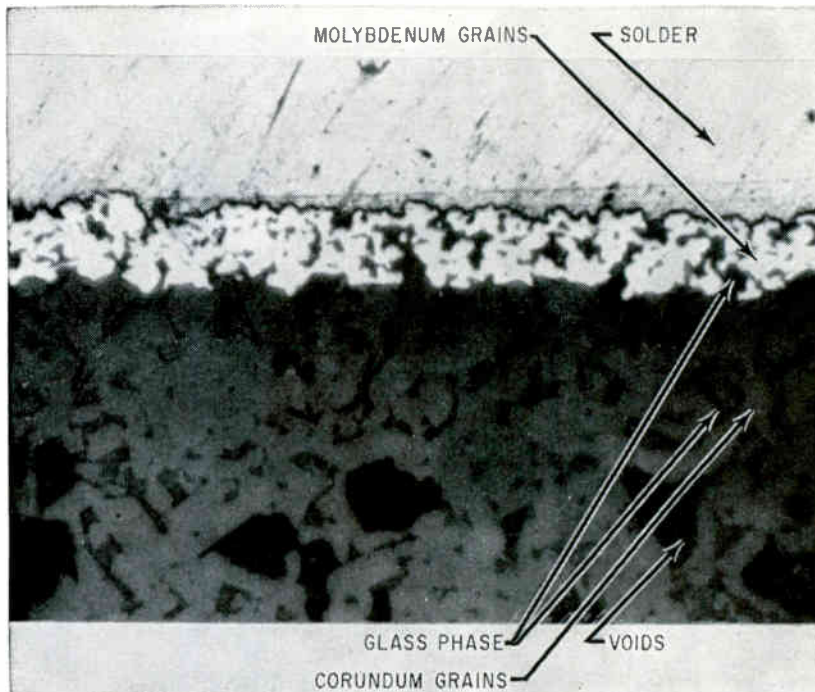

EFFECT of process variables on glass bearing ceramic-to-metal welds must be evaluated on basis of recent discovery that glass migrates from ceramic into porous molybdenum coating

will retain its own place. Right now component standardization does not exist, compounding the problems of mechanical packaging and electrical interconnection of systems. These are not likely to be solved easily by use of standard techniques, he says.

One problem is keeping number of connections to a minimum while maintaining module replaceability and system adaptability to incorporation of new microminiature modules. A packaging technique intended to meet this problem is shown in an accompanying illustration. Modules shown are RCA Micro-Modules developed for U.S. Signal Corps. They consist of wafer-mounted components interconnected with soldered riser wires that protrude from the encapsulated modules for mounting to double-sided printed circuit boards by dip-soldering. Board circuitry interconnects modules and Ultra-Miniature Printed Circuit connector developed by Burndy for U.S. Signal Corps. UPC plug uses three tiers of gold-plated pins of 0.028-inch diameter on 0.100 inch centers, formed in a right-angle configuration and molded in a one-piece plastic body. Plug body is mounted to board with its pins dip-soldered to board circuitry. Large pins at each end

polarize and guide plug into receptacle. Receptacle is also a one-piece molded housing containing gold-plated Beryllium-copper sockets which provide round pins in back for termination to the interconnecting wiring. Wire termination is accomplished by tool-wrapping small gauge solid wires to terminal pins and soldering.

CERAMIC-METAL SEALS—Relative importance of sintering rate, furnace atmosphere, particle size, metal impurities, glassy-phase wetting of metal and peak temperature in making ceramic-to-metal seals will be pointed-out by Sanford S. Cole of Mitronics. In a paper entitled "Basic Mechanisms Affecting Ceramic Seals", he says that different sealing techniques are based on different physical laws. Four techniques provide four categories of seals: (1) glass-bearing ceramics coated with a refractory metal, (2) non-glassy ceramics coated with a refractory metal, (3) seals which adhere as result of chemical formation of molybdenum aluminate compounds, (4) active metal seals.

Since most ceramic-metal seals are in first category, Cole concentrates his discussion on techniques and associated physical laws in making these seals. Adherence of

FALL IN!

New-type recorder assembles slow or random data, spaces it uniformly on tape for computers

If your digital computer is as finicky as most, it won't listen to a magnetic tape that

t a l k s l i k e t h i s

It will insist on characters uniformly spaced on the tape

like this
.....

Which means that life can be difficult for people who have data that is otherwise perfectly reputable, but just doesn't happen to occur at the right time intervals to suit the computer.

Now comes a wonderful device that will gladly accept irregular data — such as the output of a teletypewriter or an analog-to-digital converter — and put it on mag-

netic tape just the way the computer wants it. The secret is incremental tape motion. Our new recorder stands still awaiting each character, records it, then moves the tape a uniform distance to await the next. As a result, whether characters arrive 100 per second or 1 per month, they are recorded in a proper, uniform packing density.

The PI incremental recorder shown here records 200 bits per inch (556 BPI optional), a recording fully compatible with the input requirements of IBM computers. To tell you more, we've put together a brochure fully compatible with the input requirements of discriminating users. Send for bulletin #73; address us at Stanford Industrial Park, **PRECISION INSTRUMENT** Palo Alto 20, California.

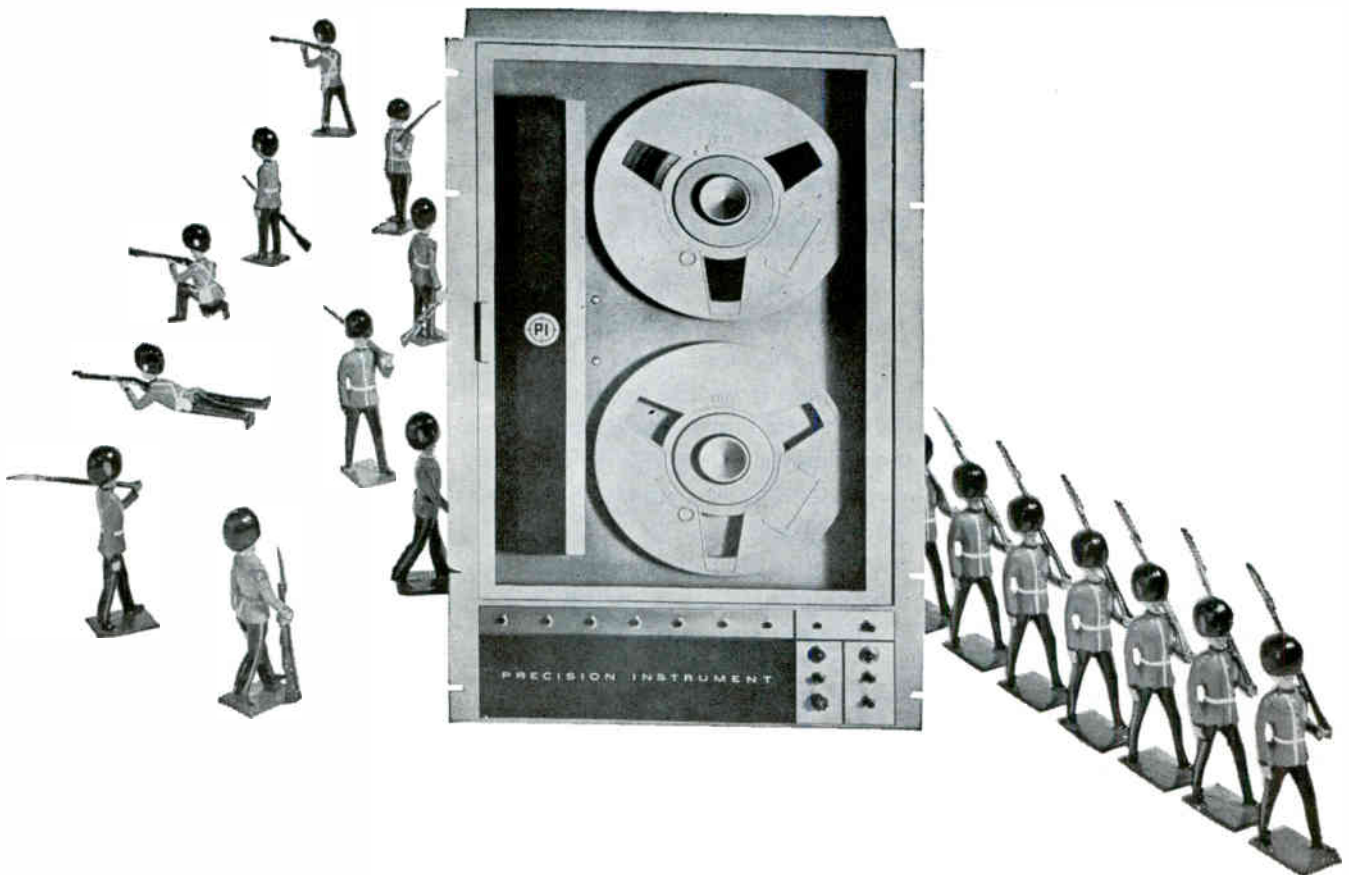



**slash production costs with
new automated coil winder
... fewer operators
... more coils per operator**

Leesona No. 116 will wind 400 to 1,000 bobbin coils per hour... with one operator.

All the operator does, as the rotary table brings the winding heads to her, is load bobbin on arbor, clip start wire.

Automatically the No. 116 closes tailstock, tapes start lead, resets counter, starts winding, stops at ± 2 turns, waxes or tapes finish lead, indexes arbor, cuts wire, ejects and sorts.

It winds two or more different coils up to 3" diameter by $2\frac{3}{8}$ " long... simultaneously. Supports and winds from 100 lb. wire container, and stops when spool or container is empty. Six to twelve two-speed heads wind wire AWG 16 to 50 and finer.

No. 116 is designed by Robert Bachi. We build it to the cus-

tomers' specifications. For details call your nearest Leesona representative.



LEESONA CORPORATION
Warwick, Rhode Island

B.2.2

See us at the IEEE Show, Booths 4325-7

these seals, says Cole, was first believed to be the result of chemical compounds. However, recent work indicates that glass migrates from the ceramic into the porous molybdenum coating. Conclusions on effect of process variables on seal quality must be based on this phenomena. Initial heating of molybdenum-coated glass-bearing ceramic, he says, results in some metal-surface oxidation and with increasing temperature sintering of molybdenum occurs, but when glass migration begins, sintering is arrested.

At this point, laws of surface chemistry and wetting come into play in forming seal. Peak sintering temperature is of importance only insofar as it effects contact angles of ceramic and metal. Once complete wetting by molted glass is achieved further temperature control has limited meaning.

QUALITY WELDING — Developments in high-temperature circuit techniques have made new conductor materials available for interconnecting wiring that make welding of electronic circuit interconnections more feasible. So says F. A. Lally of the Boeing Company in his paper "A Program of Quality Assurance for Welded Electronic Circuitry." This in turn, says Lally, achieves savings in weight and equipment space.

But, despite growing activity in welding of electronic circuitry extremely little reliability data exists. However, says Lally, one study by C. J. Heslin of Raytheon Company shows that while the future goal for mean-time-between-failures of soldered joints is 100,000,000 hours, weld-joint reliability exceeds 552,000,000 hours.

Another study by Heslin indicates a possible 20 to 1 improvement in reliability when using welded rather than soldered joints. However, says Lally, in order to achieve this improvement, welding machines have to be preadjusted to predetermined pressure and energy settings. Operators then only align leads and energize welding circuit, eliminating factor of varying operator skills.

At Boeing, a welded-wire-packaging-technique program evaluates welding machinery on the basis of welding-current discharge

NUMBER ONE IN ELECTRICAL CONNECTORS...



**SOLVE
SPACE AGE
PROBLEMS
BETTER...**

**SPECIFY
CANNON®**

**KV 26500
PLUGS**

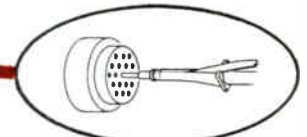
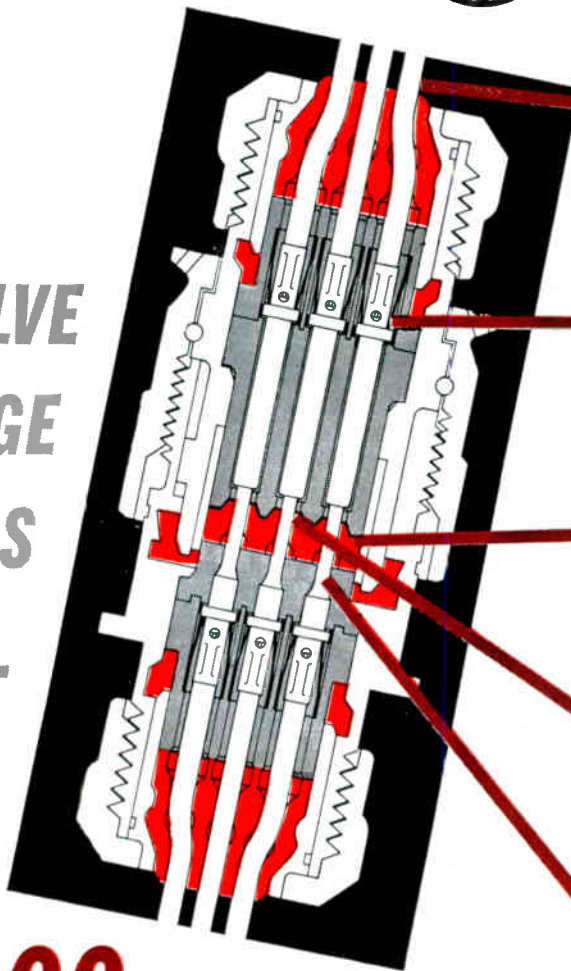

REAR RELEASE SYSTEM

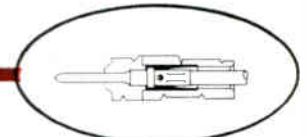

POSITIVE CONTACT RETENTION

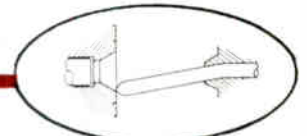

OUTSTANDING MATEABILITY

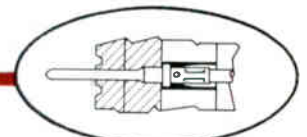

INDIVIDUALLY SEALED CONTACTS

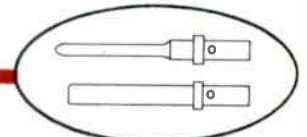

SIMPLER, STRONGER CONTACTS

**SEE CANNON
AT
IEEE BOOTH
2727-2731**

SPECIFICALLY DESIGNED TO EXCEED THE PERFORMANCE REQUIREMENTS OF MIL-C-26500. This new CANNON Series provides high temperature, general purpose plugs with crimp snap in contacts...is designed to exceed the requirements of the MIL-C-26500 specification for meeting the increased environmental demands of missile and space vehicles. The CANNON KV 26500 will help you solve your space age connector problems better with these outstanding new features: LEAD-IN CHAMFER ON HARD CLOSED ENTRY SOCKET INSERT • REAR INSERTION/EX-

TRACTION OF CONTACTS AND TOOL • INTERFACIAL SEAL WITH RAISED BARRIERS AROUND EACH PIN CONTACT • EXPENDABLE PLASTIC TOOL CANNOT DAMAGE INSERT • SIMPLER, STRONGER CONTACTS RESIST BENDING • NEW BUTT-TYPE PERIPHERAL SEAL. Whatever your requirements, whether ground based or outer space, specify CANNON, the world's largest and most experienced manufacturer of electrical connectors. For further information, write to:

® "CANNON" IS A TRADEMARK REGISTERED IN U.S. PAT. OFF. AND FOREIGN COUNTRIES BY CANNON ELECTRIC COMPANY

CANNON ELECTRIC COMPANY

3208 Humboldt Street, Los Angeles 31, California

ADDITIONAL PLANTS IN: SANTA ANA & ANAHEIM, CALIF. • PHOENIX, ARIZ. • SALEM, MASS. • TORONTO • LONDON • PARIS • BORNEM, BELGIUM • TOKYO • MELBOURNE

Sales offices and representatives in principal cities of the world



© 1963 CANNON ELECTRIC COMPANY

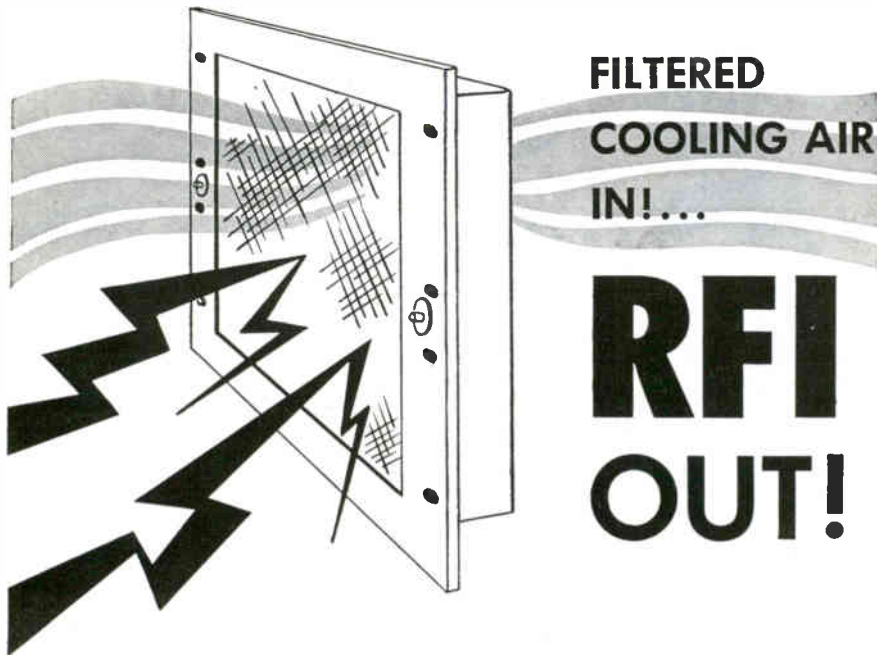

**WITH NEW McLEAN
RFI BLOWERS!
AND FILTER-GRILLE ASSEMBLIES**



McLean RFI Filter-Grille Assembly



Cross Section of McLean RFI Blower

Now McLean makes it possible for you to pressurize radio shielded electronic cabinets with cool, filtered air without opening the "envelope" to RF interference.

These new McLean RFI blowers and filter-grille assemblies have been designed and built for RFI performance in accordance with MIL-1-6181D — meeting or exceeding all requirements including susceptibility, generation and shieldability. This development is one of many by McLean engineers designed to assure reliability of electronic equipment. WRITE TODAY for further information.

**McLEAN
ENGINEERING LABORATORIES**

World Leader in Packaged Cooling

P.O. Box 228, Princeton, New Jersey

Phone: Area Code 609 WALnut 4-4440 TWX 609-799-0245



SEND FOR
NEW 44-PAGE
CATALOG

Or Our
NEW MIL-SPEC
BLOWER
CATALOG

SEE US AT THE NEW YORK IEEE SHOW BOOTH #1624.

curve (magnitude versus time). And also on electrode welding pressure and capability of repetitive consistency.

Testing of welds is performed under the program using torsion-shear testing. Iso-strength diagrams have been developed in which weld strength is plotted as a function of electrode pressure and electrical energy. This was done for each combination of materials used in production welding of wire leads. This plot shows an iso-strength line representing a breaking-strength that 90 percent of welds made at a particular force and energy setting should exceed.

DEVACUATION CONTROL—

New technique for controlled devacuation of television tubes to prevent and contain implosions without using glass or plastic shields will be described by Burton W. Spear and Darryl E. Powell of Owens-Illinois Technical Cen-

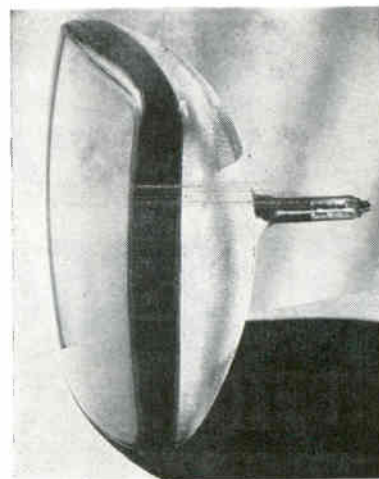

IMPLOSION resistance during devacuation is provided by television tube envelope permanently reinforced with steel bands, resins and glass fiber

ter. Called Kimcode (Kimble Method for Controlled Devacuation) this is a manufacturing approach for building tubes so that tube envelopes are reinforced with steel bands, resins, and glass fibre. The tube is thus made highly-resistant to implosion during devacuation. At the same time, Kimcode technique reportedly permits elimination of safety window in front of tube as in bonded or tempered glass construction. Supposedly, it will simplify pro-

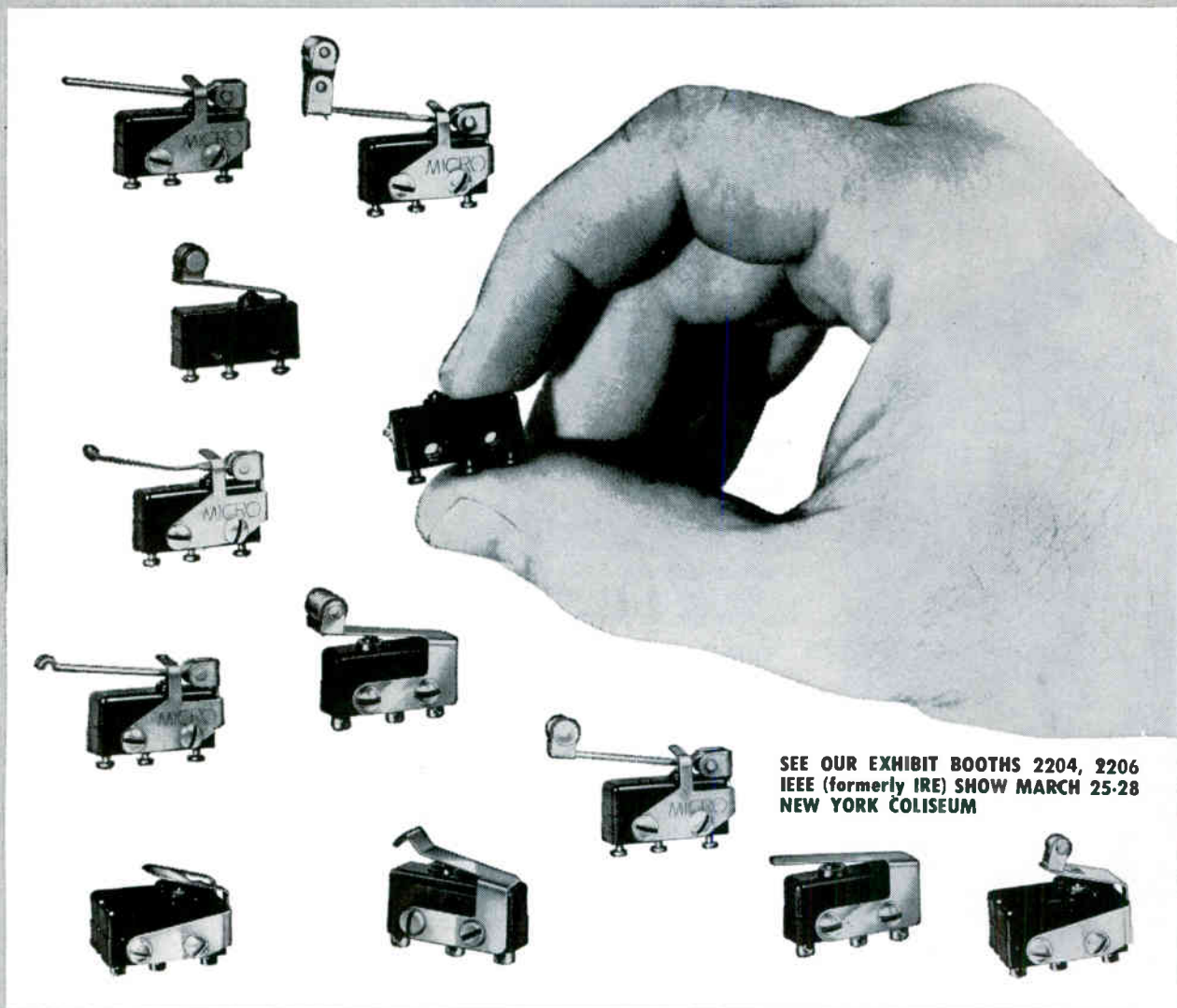

SEE OUR EXHIBIT BOOTHS 2204, 2206
IEEE (formerly IRE) SHOW MARCH 25-28
NEW YORK COLISEUM

PRECISION-MADE SUBMINIATURE SWITCHES hundreds of types and assemblies available

Where space and weight limitations are critical, MICRO SWITCH "SM" subminiature switches bring a combination of compact size, reliable precision operation and broad range of actuators, assemblies and variations to meet a wide variety of design requirements.

Long, reliable life. Wide temperature ranges: -100° to $+180^{\circ}$ F. SPDT contact arrangement. Catalog listings also include types with extra long life and extra high temperature char-

acteristics, gold contacts for low energy circuits, and bifurcated contacts—to name a few.

A field engineer from the nearest MICRO SWITCH Branch (See Yellow Pages) will be happy to show the complete line...or write for Catalog 63 now.



MICRO SWITCH

FREEPORT, ILLINOIS

A DIVISION OF HONEYWELL

IN CANADA: HONEYWELL CONTROLS LIMITED, TORONTO 17, ONTARIO

HONEYWELL INTERNATIONAL SALES AND SERVICE OFFICES IN ALL PRINCIPAL CITIES OF THE WORLD. MANUFACTURING IN UNITED STATES, UNITED KINGDOM, CANADA, NETHERLANDS, GERMANY, FRANCE, JAPAN

NEW 5 KW LOAD



BIRD Model 8890 THERMALINE®
Coaxial RF Load Resistor with
Model BA-88 Blower accessory.

SEE US AT BOOTHS 3217-9
1963 I.E.E.E. SHOW



BIRD Model 8890 RF Load with blower accessory features forced air cooling. No water required!

The BIRD Model 8890 THERMALINE® Coaxial RF Load Resistor is a portable, general purpose 50-ohm coaxial load. It provides an accurate, non-radiating termination for RF transmission lines.

The Model 8890 uses BIRD "QC" Quick-Change Connectors to accommodate any standard series of coaxial line fittings. Female Type LC (illustrated) is normally supplied. Continuous power rating for the Model 8890 utilizing normal air convection cooling is 2500 watts. With accessory blower Model BA-88, this power rating is doubled to 5000 watts continuous duty.

SPECIFICATIONS	BIRD Model 8890 THERMALINE
Resistance:	50 ohms nominal
Power rating:	2.5 KW (air convection cooled) 5 KW with BA-88 Blower accessory
VSWR:	1.1 max. 0-1000 mc
Weight:	33 pounds net (with blower 49 pounds)
Ambient Air Temperature Range:	-40°C to +45°C.
Blower Model BA-88:	115V, 50/60 cy, 27w

NOTE: Other models available in this series are: Model 8891 with 3/8" EIA flanged line connector
Model 8892 with 1/2" EIA flanged line connector

Prices, F.O.B. Factory:

Model 8890	\$410
Model 8891	425
Model 8892	415
Model BA-88	250

Contact BIRD for more information on these and other BIRD products.

ELECTRONIC CORPORATION
30303 Aurora Rd., Cleveland 39 (Solon), Ohio
Churchill 8-1200 TWX 216-248-6458 CABLE: BIRDELEC
Western Representatives: O. H. Brown Co.
P. O. Box 128, Palo Alto, Cal. • Phone 321-8867 (415)
3600 Wilshire Blvd., Los Angeles 43, Cal. • Phone 383-4443 (213)

duction of television sets, which will be lighter and cost less.

HIGH-DENSITY FABRICATION — Aerospace Division of Martin-Marietta will have two authors describing welding and encapsulating techniques for high-density packaging. In their paper, S. Maszy and H. Uglione will discuss economical methods for preparation of molds for encapsulating modules to be used in such packaging. Also they will talk about encapsulating material selection.

THIN-FILM RESISTORS — Vacuum evaporation and desposition of nichrome onto various planar substrates with different surface characteristics to form resistor elements with varying characteristics is topic advanced by H. J. Degenhart and I. H. Pratt of U.S. Army Electronics R & D Laboratory. Among factors measured was effect of substrate surface roughness.

PELLET PANEL — Application and assembly of pellet microcomponents into systems will be discussed at a panel moderated by S. M. Stuhlberg of Mallory. The panel consisting of representatives from a number of both user and supplier companies has been organized because of increasing interest among design and packaging engineers in pellet microcomponents. This interest reportedly has been aroused by advantages such as: design flexibility, reasonable cost, adaptability to mechanized production. Members of panel will discuss applications and assembly techniques which are under investigation at their respective companies. Availability and useability of pellet microcomponents will also be discussed. Suppliers of both active and passive components will be represented.

THIN-FILM CONTROL — Automatic control of thin-film deposition process for resistor elements will be described by R. A. Quinn and H. R. Kaiser of Lockheed. Two instruments—an a-c ohm meter and a-c resistance limit bridge—have been specially developed to terminate process when a predetermined resistance value is attained. In addition to controlling process end-point, units also monitor elec-

McCoy CRYSTALS & CRYSTAL FILTERS

Regardless of its size, type, or frequency any crystal bearing the name



can be relied upon to deliver the ultimate in frequency control despite wide temperature variations and extreme conditions of shock and vibration.



MICRO MODULE CRYSTALS (GLASS)

SHOWN ACTUAL SIZE

This vacuum sealed, hard glass crystal unit was developed and designed for use with the RCA micromodule wafer shown above. Available in frequencies ranging from 10 mc to 200 mc, the type MM crystal provides electronic miniaturization programs with a reliable evacuated crystal enclosure of excellent stability.



M-1 (HC-6/U)

The crystals that made the name of McCoy a synonym for quality. Metal encased, HC-6/U size is available in frequencies from 500.0 kc to 200.00 mc.

METAL ENCASED STANDARD SIZE AND MINIATURE CRYSTAL UNITS

SHOWN ACTUAL SIZE



M-20 (HC-18/U)
M-21 (HC-25/U)

Fills the need for miniature crystals in frequencies from 2.5 mc to 200.0 mc. Meets specs MIL-C-3098C and ARINC No. 401.



G-1 (Military HC-27/U)

ALL GLASS STANDARD SIZE AND MINIATURE CRYSTAL UNITS

SHOWN ACTUAL SIZE

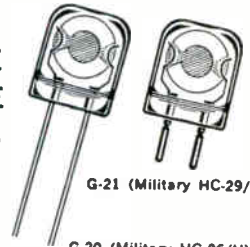

G-21 (Military HC-29/U)
G-20 (Military HC-26/U)

This vacuum sealed, hard glass crystal unit possesses all of the quality features for which the McCoy M-1 is so famous. It has long term frequency stability five times better than the conventional metal types. Available in frequencies from 1000 kc to 200 mc.

This vacuum sealed, hard glass crystal unit meets the new CR-73/U and CR-74/U specifications. It has long term frequency stability five times better than the conventional metal type. Available in frequencies from 5000 kc to 200 mc.

CRYSTAL FILTERS

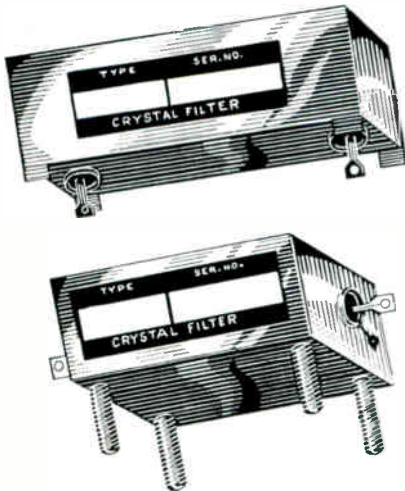

McCoy crystal filter engineering and production capabilities are among the finest in the world and constantly in demand by industry, the military, and everyone searching for quality. A complete technical staff stands ready at all times to discuss your filter requirements. Many standard models are available without costly design and prototype charges.

The following chart shows bandwidths available in specific frequency ranges (expressed as % of center frequency).

Frequency	B.W.
1 mc to 30 mc	.01% to 4.0%
30 mc to 75 mc	.001% to .04%
up to 125 mc	up to .01%

SELECTIVITY CURVES

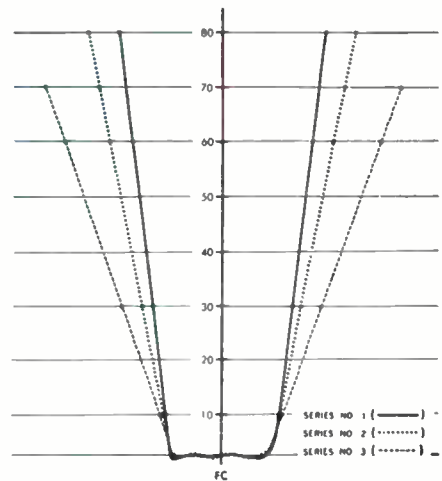

SEE THE NEW McCoy

HIGH-FREQUENCY CRYSTALS AND CRYSTAL FILTERS

AT BOOTH NO. 2214
RADIO ENGINEERING SHOW
NEW YORK COLISEUM
MARCH 25-28

McCoy

ELECTRONICS CO.
Dept. 1363
MT. HOLLY SPRINGS, PA.
Phone: HUnter 6-3411
Area Code: 717

SUBSIDIARY OF OAK MANUFACTURING CO.



Write today for our free illustrated catalogs which include complete listing of MIL-C-3098C military specifications. For specific needs, write, wire or phone. Our research section is anxious to assist you.

A Pump with a History and a Future

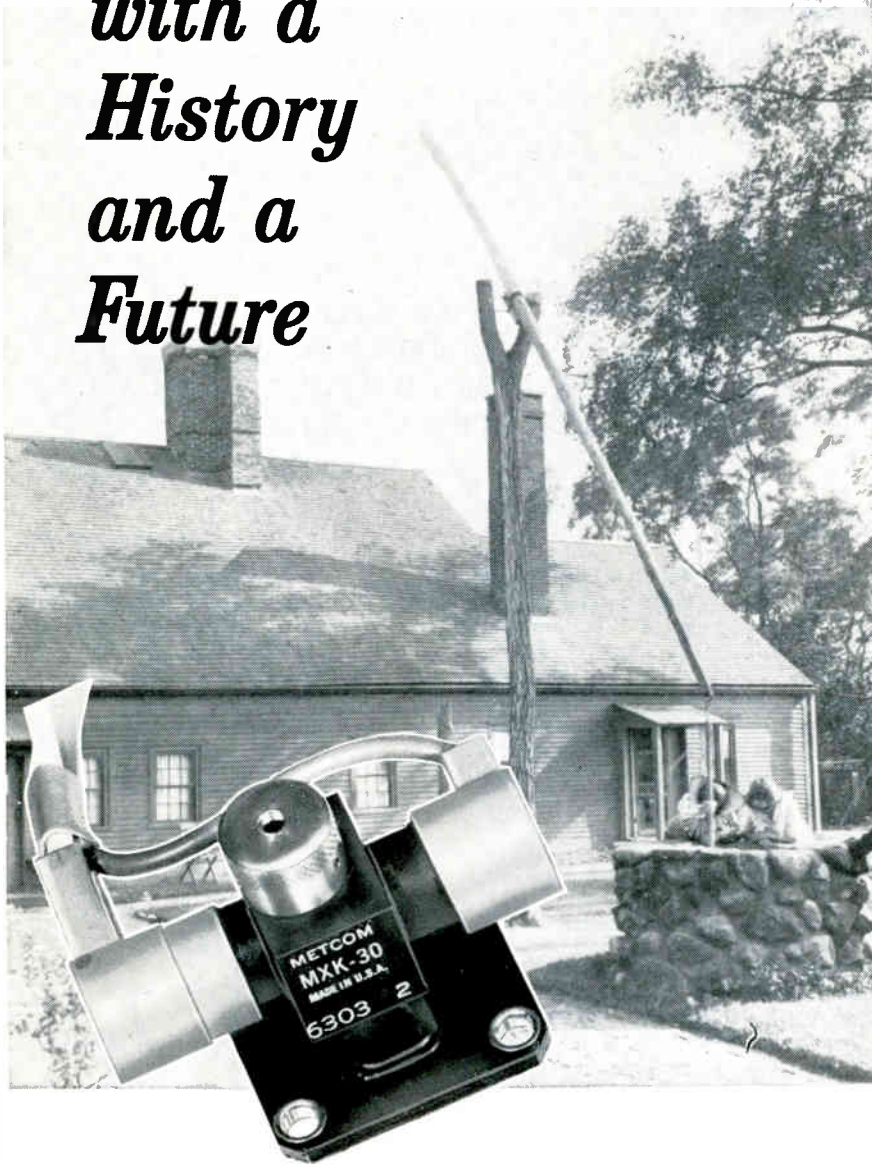

From a 17th Century Well Sweep Pump to a new parametric amplifier pump Klystron, conceived and in production at Metcom. The new Klystron features are: a dielectric tuner, a wider frequency range selection than any other Pump Klystron, a new locking device, and a tuner that can be physically changed to meet different needs and designs. The parametric Pump Klystron is now in production, samples and specifications are available. The Pump Klystron can be adapted or ordered to custom design. Unlike other Klystrons, the user is not limited to specific frequency selections.

trochemical activity of process. Thus, with minor modification, it is expected that these units will provide full control over process variables. A-c measurement rather than d-c is used because of direct current present in resistor elements during fabrication.

ELECTRONIC CABLE SHEATH

—Sheathing of communication and power cable with aluminum performed by a Swedish firm using an electronic method will be described in a paper by C. A. Tudbury of AMF Thermatool Corporation. Aluminum strip is con-

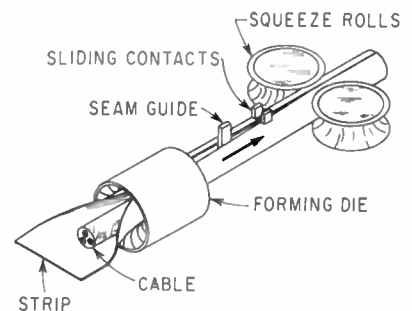

ALUMINUM sheathing of cables is facilitated by skin and proximity effects that concentrate heat along open seam of sheath

tinuously formed into tubing around cable while cable and strip pass through a special mill. Result of a joint effort by Sieverts Kabelverk and Thermatool, the process uses high-frequency seam welding to join strip edges at such a high rate of speed that cable and its insulation are unaffected. Two electrical effects are exploited in welding: skin effect and proximity effect. These make possible very high concentration of heating energy at strip edges without undue heating of other areas. (Skin effect is well known and describes tendency of alternating current to be more concentrated at conductor's surface rather than its center. Proximity effect describes further concentration of current along adjacent sides of two closely-located conductors having pronounced skin effect and comprising a go-and-return circuit).

Current at 450 Kc enters and leaves strip by two sliding contacts. Skin effect and proximity effect cause bulk of current to flow in a thin film along one edge of vee-shaped opening strip to apex of sheath edges and back along other edge.

for better microwave tubes and devices



METCOM INC.
SALEM, MASSACHUSETTS

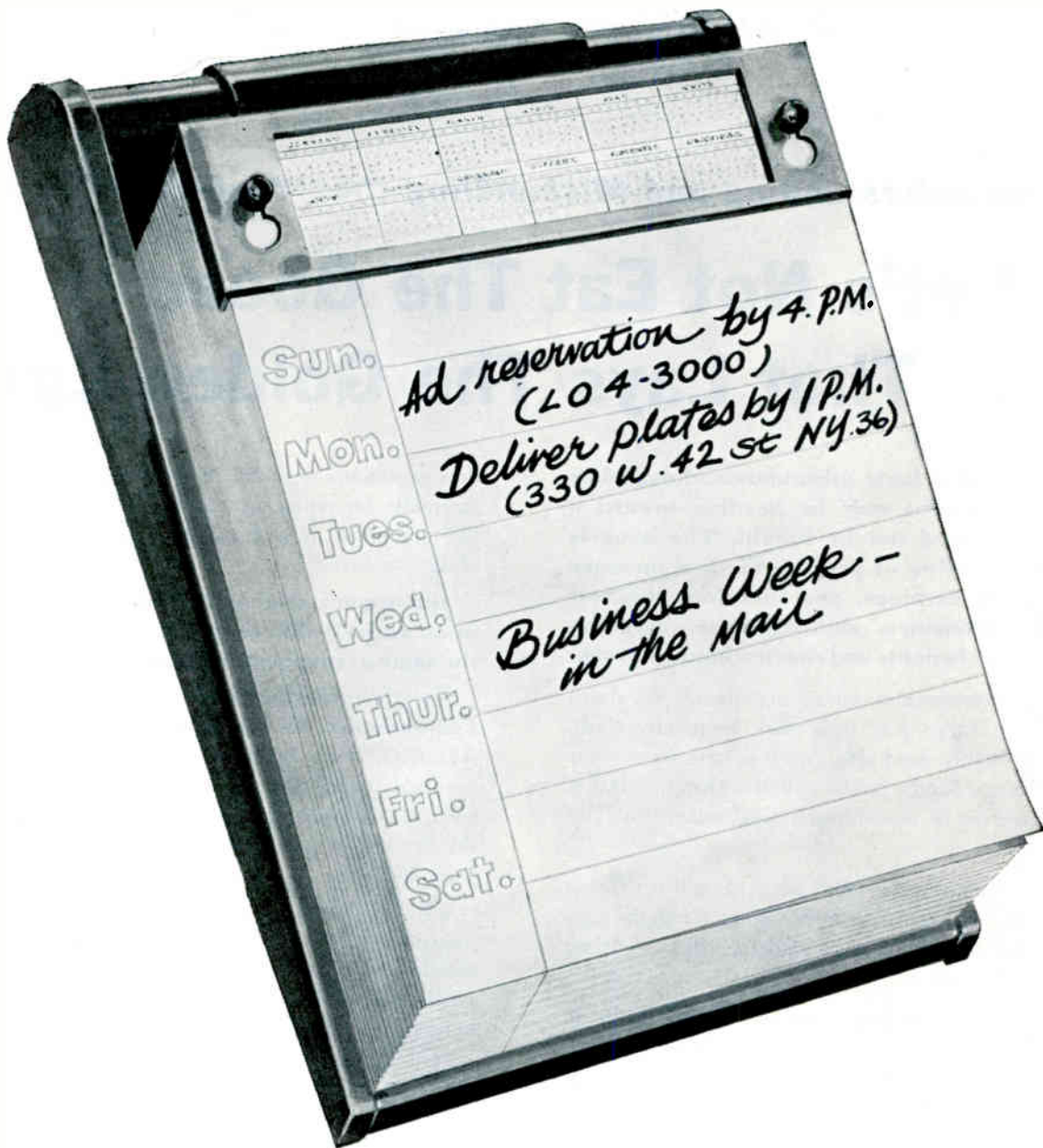

This could be *your* calendar—any week in 1963.

We believe BUSINESS WEEK's "Short-Notice Closing" is the *fastest* ad closing of any major national magazine. It gives you last-minute, same-week insertion for one or two pages of advertising in any issue.

BUSINESS WEEK is read by the most important people in America for business advertisers—*management men*. With "Short-Notice Closing," you reach these important decision-makers *fast*, with up-to-the-minute information they need for quick decisions.

Here are the details:

Deadline for Reservations: Monday at 4 p.m. Our Business Department in New York must have your reservation, *at the latest*, by 4 p.m. on Monday of week-of-

issue. For quickest service, wire (TWX N.Y. 1-1636) or phone K. D. Reynolds, Production Manager, BUSINESS WEEK, LOngacre 4-3000 (Dial New York Area Code 212).

Deadline for Plates: Tuesday at 1 p.m. To meet our "Short-Notice Closing," your plates must be in the hands of our Production Manager, in our New York office (330 West 42nd Street, New York 36, N.Y.), by 1 p.m. on Tuesday of week-of-issue, *at the latest*. (Sorry, no extensions possible.)

Size of Units: Black-and-White Page or Spread. Either one or two single black-and-white, non-bleed full pages, or one black-and-white two-page spread (gutter bleed only) per issue. Only complete plates can be accommodated. Corrections, additions, or plate refinements are

not possible on so tight a schedule.

Price: A premium of 10% will be charged over and above regular advertising space rates for the "Short-Notice Closing" service. Agency commission applies to premium.

To get *fast* decisions, there's nothing like being in the right place at the right time. The right place is BUSINESS WEEK. Now the right time is any time—with BUSINESS WEEK's "Short-Notice Closing."

You advertise in
BUSINESS WEEK

when you want
to inform
management

A McGraw-Hill Magazine



By Misunderstanding and Mishandling the "Cash-Flow" . . .

Let's Not Eat The Goose That Lays The Golden Eggs

Because of a basic misunderstanding, labor and management may be heading toward a battle that need not be fought. The issue is whether cash-flow or profit is the best measure of business earnings, and therefore the best measure of business' ability to raise wages, improve fringe benefits and shorten hours of work.

When business and union negotiators sit down around the bargaining table they frequently clash. This is probably inevitable. But it is pure waste — for both sides and for the public as well — when the clashes are caused by a misunderstanding rather than by realities.

The "cash-flow vs. profits" issue, should it develop as suggested by reports from Washington and the public pronouncements of labor leaders, will be a prime example of such waste.

This editorial, one of a series on business profits, is designed to point this up. It discusses the difference between cash-flow and profits. And it shows how confusion between the two might have disastrous results.

The Meaning Of Cash-Flow

Cash-flow can be calculated in various ways. One way — and the most common one among businessmen — is to add (1) after-tax profits minus dividend payments to stockholders, and (2) depreciation allowances. Another way — the one used by the AFL-CIO — is to add (1) total after-tax profits, and (2) depreciation allowances.

This adding of depreciation allowances (roughly the cost of buildings and machines either worn out in production or rendered obsolete by time) to profits (what is left over after all costs and taxes are met) may seem a clear case of adding apples and pears and coming up with a mixed fruit compote. But the practice does have its uses — as, for instance, in predicting business outlays on plant and equipment. Since cash-

flow represents the total funds corporations generate internally for replacing used-up facilities and acquiring new ones, it is a rough measure of industry's ability to invest.

But organized labor apparently sees cash-flow in an entirely different light, as being virtually the same as corporate earnings.

Here, from the June 1962 issue of *The American Federationist*, the official monthly magazine of the AFL-CIO, is an example: "The cash-flow, which is reported profits plus depreciation allowances, is the accurate measure of a company's returns since it is the amount of money left over after payment of all costs and taxes."

The key phrases in the above are (1) "profits plus depreciation" and (2) "after payment of all costs," which are linked in a way that makes the statement an out-and-out denial that depreciation is a cost. (Nor is this a mere slip of the pen. Virtually the same thing is said, in only slightly different words, four times in the same article.)

Quite clearly, however, depreciation allowances are designed to cover costs, which now and forevermore are the opposite of profits. There are no real profits or net returns to a business enterprise until all costs are recovered, including the cost of buildings and machines either used up in production or made obsolete by time. To argue otherwise is to strip logic from the language of economics, to quash intelligible conversation on the subject of profits. If business spends its depreciation allowances on higher wages or dividends, it is failing to replace its worn out and antiquated productive facilities.

The Measurement Of Profit

Aside from the dispute over the meaning of "cash-flow," "depreciation," and "profit," there is also the question of profit measurement.

Labor points out, and correctly so, that profits as reported by the U.S. Commerce Department's Office of Business Economics have been distorted over the years by revisions in the federal tax laws. Among these are several new ways of calculating depreciation allowances inaugurated in 1954, and the new Internal Revenue Procedure 62-21 introduced in mid-1962. (A recent Department of Commerce study attempts to measure the effect of some of these revisions.)

These changes were designed to enable businesses to charge off their depreciation costs at a rate more closely in line with the rate at which their facilities actually wear out and become out of date. But these more realistic techniques of figuring depreciation allowances in no way disturb this basic fact: depreciation is a cost and not a profit.

Moreover, tax changes have not permitted firms to charge off more than the original cost of their facilities, but only to speed the timing of the charges. As a result, any profit understatement owing to stepped-up depreciation during the years immediately following tax changes is necessarily followed by a profit overstatement in subsequent years.

So it is important to remember that changes in the timing of depreciation allowances work both ways. Some tend to understate current profits relative to those of earlier years. Others do the reverse.

The Correct Measure

As the chart in the box below shows, the corporate cash-flow has not been squeezed during the past several years nearly so much as profits. This alone offers a temptation to suggest that cash-flow — rather than profit — is the best measure of corporate returns or earnings.

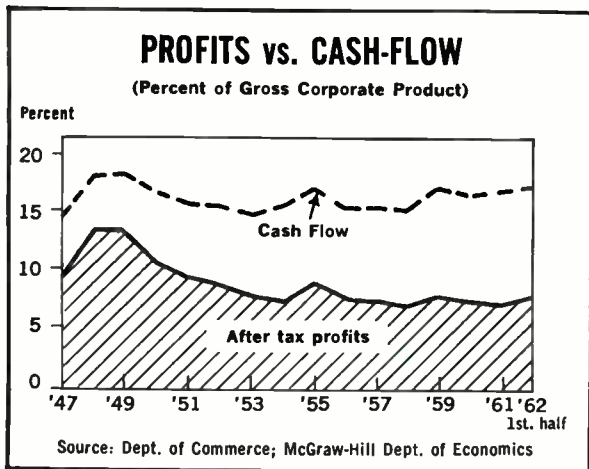

But the temptation must be sternly resisted, for profit — not profit plus depreciation — is the

correct measure of a firm's returns. Those who argue otherwise are treating the language of economics in a cruel and unusual way. They should cease and desist before killing effective conversation altogether.

Eating The Goose

There is not the slightest inclination here to suggest that the profit figures released by the U.S. Office of Business Economics are perfect. Like many statistics, they may not always reveal everything they seem to. But we should remember that they are the most comprehensive and useful measure of over-all corporate profitability we have.

It is even more important for us to remember that depreciation is a cost and not a profit. The funds attributed to depreciation allowances, like any other funds business has, can be paid out in dividends to stockholders or in higher wages to workers — but only if the economy is liquidating; only if it is failing to replace its antiquated and worn out facilities.

The depreciation reform, announced in July by the Treasury, was designed to make depreciation allowances for tax purposes more truly representative of the rate at which machinery actually wears out and becomes obsolete. This, in turn, was intended to speed up machinery and equipment replacement, which will increase productivity, cut costs and give U.S. business a better crack at world markets. It would be ironical, indeed, if this long-needed reform were used to justify wage increases so large that they would actually cut into the funds needed for our program of modernization.

This would be a pure and simple case of eating the goose that lays the golden eggs — a point both labor and management should certainly keep firmly in mind.

This message was prepared by my staff associates as part of our company-wide effort to report on major new developments in American business and industry. Permission is freely extended to newspapers, groups or individuals to quote or reprint all or part of the text.

Donald McGraw
 PRESIDENT
 MCGRAW-HILL PUBLISHING COMPANY



Generator Provides Tailored Pulses

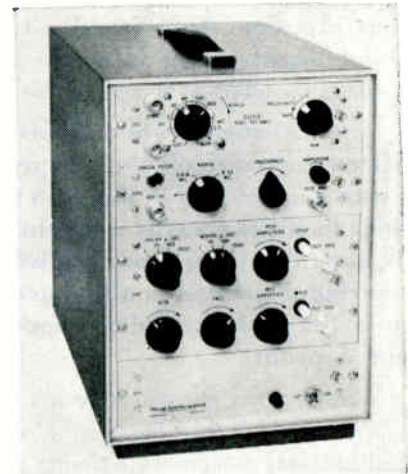
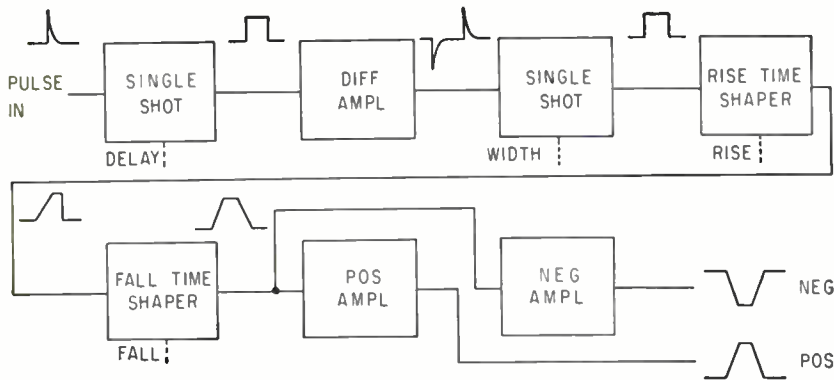

Pulse rise and fall times, width, delay and amplitude are independently variable

ANNOUNCED by the Industrial Products Group of Texas Instruments Inc., 3609 Buffalo Speedway, Houston, Texas, the variable rise and fall (VRF) module extends the flexibility of the Series 6500 pulse generators. The module provides, at 20 Mc repetition rates, independent rise and fall time control from 20 ns to 0.5 μ sec for coincident positive and negative outputs, coincidentally

variable pulse width control from 40 ns to 1 ms, coincident variable pulse delay control from 50 ns to 1 ms and independent variable positive and negative outputs to 10 v into 50 ohms. Short-circuit protection is provided and protection is complete even when reset is attempted with a dead short on the output. Output circuits are designed for 80-percent duty-cycle operation and high duty cycles will not damage the generator. Other devices include an avalanche pulse generator capable of producing up to 1 ampere pulses, 50 v across 50 ohms,

with rise and fall times well under a nanosecond at repetition rates from 100 cps to well into the Mc region. Pulse delay will be adjustable by front-panel controls. A dual mixer module whose output is the algebraic sum of two applied inputs will also be available. The sketch shows operation of the variable rise and fall unit and the model 6563 pulse generator using the VRF with a pulse generator operating between 100 cps and 25 Mc.

CIRCLE 401, READER SERVICE CARD

Preset Counter Performs Many Functions

INTRODUCED by Hewlett-Packard Co., 1501 Page Mill Road, Palo Alto, California, the model 5214L preset counter not only measures frequency, period and totalizes but also measures normalized rate, N, 10N or 100N periods, ratio, normalized ratio, time for N events to occur, counts N, 10N or 100N events giving an output pulse at start and end of count and allows N to be remotely preset. N may be set to any integer from 1 to 100,000. Separate output signals are available to operate external equipment when gate opens or closes. Self-check provisions are incorporated for rate, time, preset at N and ratio functions. The internal time base ag-

ing rate is ± 2 parts in 10^6 per week. Printer output of 4-line BCD (1-2-2-4) at 100,000-ohms per line is also available. Readout is by 5 dis-

play tubes with display storage. The sketch shows setup for rate and ratio measurements. In rate measurements, the gate is controlled by

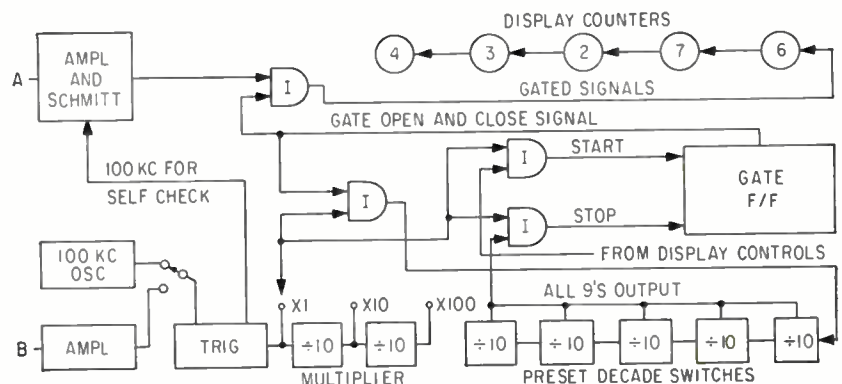

MR. RELAY

by Allied Control

Be sure to see Allied
at IEEE • Booth 2905-7

1. I'D LIKE YOU TO MEET S, THE ONLY RELAY FOR SANDWICH CIRCUIT BOARDS. HE'S WELDED ALL THE WAY AND CONTAMINATION-FREE.



2. HIS CONTACTS ARE BIFURCATED TO INSURE DRY CIRCUIT RELIABILITY AND LESS BOUNCE TOO.



3. SEE, S IS ONLY HALF THE SIZE OF A CRYSTAL CAN RELAY AND INTERCHANGEABLE ... IN EVERY WAY

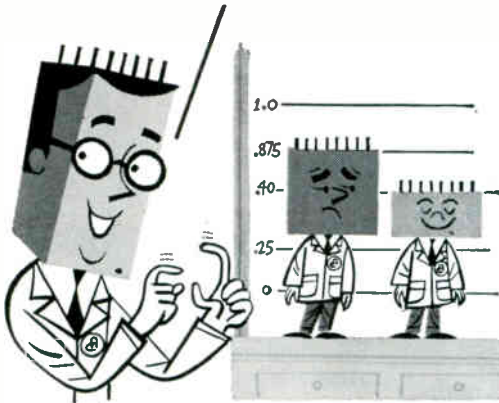

4. AND S IS REALLY A CHAMP WITH HIS PERMANENT MAGNET DESIGN.

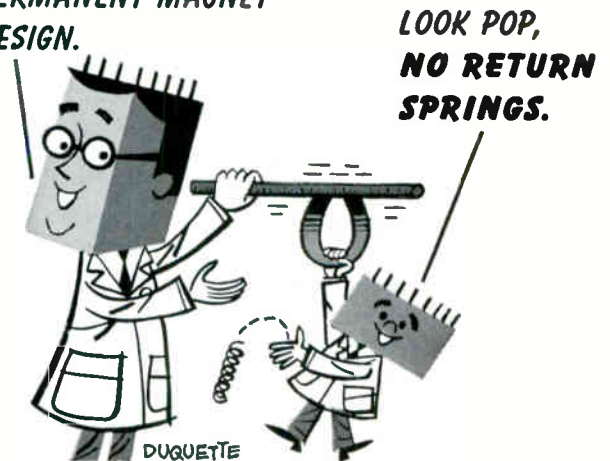

There's more news worth noting about Allied's new S relay. Flux contamination, for example, is a thing of the past. We use the latest heliarc welding techniques to seal the S relay within an inert atmosphere. Since there's no bobbin (the coil is wound directly on the magnetic core), Allied eliminates possible contamination here, too. And talk about immunity to shock and vibration! S is really rugged with its balanced rotary action armature. All S relays are calibrated for contact over-travel of the energized contacts during production, so they stay and stay on the job. Want complete application data? Write for Catalog Sheet S or call your nearest Allied representative.



©1962 BY ALLIED CONTROL COMPANY, INC.

OPERATING CONDITIONS	
Contact Rating: (at nominal coil voltage)	2 amperes resistive at 29 volts d-c Low level contacts available
Contact Arrangement:	Two pole double throw
Shock:	50g operational
Vibration:	5 to 55 cps at 0.125 inch D. A. 55 to 2000 cps at a constant 20g
Operate & Release Time: (at +25°C)	4 milliseconds maximum at nominal coil voltage
Terminals:	Plug-in, printed circuit, hook type solder terminals and 3 inch leads
Weight:	0.3 ounce maximum

ALLIED CONTROL COMPANY, INC.

2 EAST END AVENUE, NEW YORK 21, N. Y.



the time base, preset decades and multiplier. The preset decades may be set to keep the gate open for N cycles of the time base directly or through the multipliers. This enables normalized readings or converting frequency to practical units. For example; if a generator produces 100 pulses per revolution, the gate can be set to 10 ms to measure rps directly or to 600 ms to measure rpm. For ratio, the signal is connected to B and goes through the multiplier and preset decades to control gate time. The signal connected to A goes to the readout decades. Consequently, signal A is counted for (N times multiplier setting) cycles of signal B.

CIRCLE 402, READER SERVICE CARD

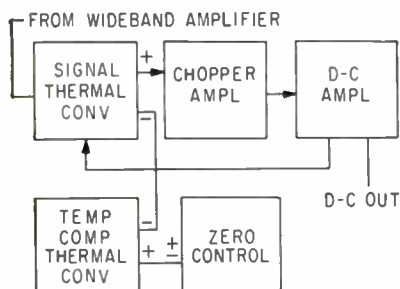

Voltmeter Measures True RMS to 50 Mc

MANUFACTURED by Keithley Instruments, Inc., 12415 Euclid Ave., Cleveland 6, Ohio, the model 121 true rms wideband voltmeter has a frequency range from 15 cps to 50 Mc, voltage range between 1 mv and 300 v full scale, and full-scale accuracy ± 1 percent from 20 cps to 10 Mc, ± 3 percent from 18 cps to 20 Mc and ± 5 percent from 15 cps to 50 Mc. The crest factor is 6/1 at full scale and 60/1 at tenth scale. Input noise is 70 μV rms maximum. The device also has a built-in a-c and d-c amplifier for oscilloscopes and recorders. A-c output is 100 mv/rms with 6 ns risetime and d-c output is 100 mv with less than one second response to input signal. The device uses an a-c to d-c thermal converter with d-c feedback amplification techniques to measure true rms. Thermocouple output of converter is directly proportional to effective heating value of applied a-c signal. The meter and d-c outputs indicate changes in d-c resulting from the applied a-c sig-

nal. A second thermal converter is used to buck-out or null d-c potentials induced by variations in ambient temperature. A quiescent d-c bias is applied to heater of signal thermal converter. When a-c signal is applied, thermocouple output goes up. This increased voltage causes the chopper amplifier to subtract d-c current from the heater. Equilibrium occurs when total a-c and d-c heating equals initial quiescent d-c level. (403)

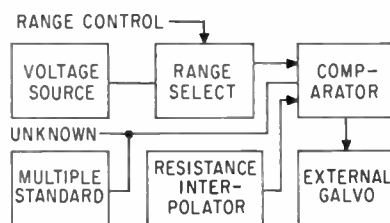

Measuring Resistance to 0.0005 Percent

ANNOUNCED by Julie Research Laboratories, Inc., 211 W. 61 St., New York 23, N. Y., the model PRB-205S primary resistance measuring system makes possible resistance measurement to 0.0005-percent accuracy referred to NBS units. Range is 1,000, 10,000, 100,000, 1 megohm and 10 megohms, accuracy is 0.0001 percent of full scale plus accuracy of standard and resolution is six digits. The system consists of three independently-usable primary standard instruments, a resistance bridge, a multiple resistance standard and a primary standard voltage divider. The primary standard voltage divider and the multiple resistance standard are individually certifiable by NBS. The device requires only the addition of a sensitive null detector. (404)

Semiconductor Chopper Has Two Emitters

MANUFACTURED by Sperry Semiconductor Division of Sperry Rand Corp., Norwalk, Connecticut, the 33K3 multi-element assured tracking chopper (MATCH) is a device having two emitters with common base and collector. Mounted in an 4-lead TO-18 package, the device features offset voltage as low as 50 μV maximum from -25 to $+100$

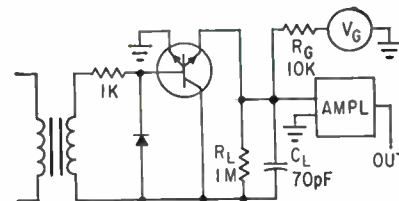

C for I_b of 0.1 to 3 ma, saturation resistance of 15 ohms maximum for I_b of 2 ma, gain-bandwidth product of 100 Mc minimum and off resistance of 1,000 megohms minimum. Emitter-base recovery time is 5 μsec . Since the base and collector are common for both emitters, only one base current limiting resistor is needed. Low transfer resistance allows relaxed drive waveform requirements. A typical shunt chopper is shown in the sketch. Here, R_L is the input resistance of the a-c amplifier in parallel with an external resistor (if used) and R_G is the total resistance in series with the signal source. The maximum d-c error voltage produced in such a circuit (offset voltage plus saturation drop) using a ± 10 mv signal with source resistance R_G equal to 10,000 ohms is 65 μV . Since base-emitter capacitance is low (9 pF at zero volts), an output spike amplitude of less than 1 mv is obtained with R_L equal to one megohm and C_L equal to 70 pF. (405)

Silicon Snap-Off Diodes Turn Off in 0.2 Ns

ANNOUNCED by General Electric Co., Semiconductor Products Dept., Electronics Park, Syracuse, New York, the SSA550 series of silicon snap-off diodes have typical turn-off times of 0.3 ns for one type and 0.2 ns for another. Produced in JEDEC standard DO-7 packages, they are rated at 250 mw power dissipation at case temperatures of 25 C and have 1 μsec peak surge current rating of 2 amperes. For applications requiring high stored charge, one type is rated at 20 picocoulombs per milliampere minimum and 100 pc/ma maximum. Where low stored charge is desired, another type is rated at 1.0 pc/ma minimum to 5.0 pc/ma maximum. When connected in shunt with a load (sketch p151), the snap-off diode produce a fast leading edge for volt-

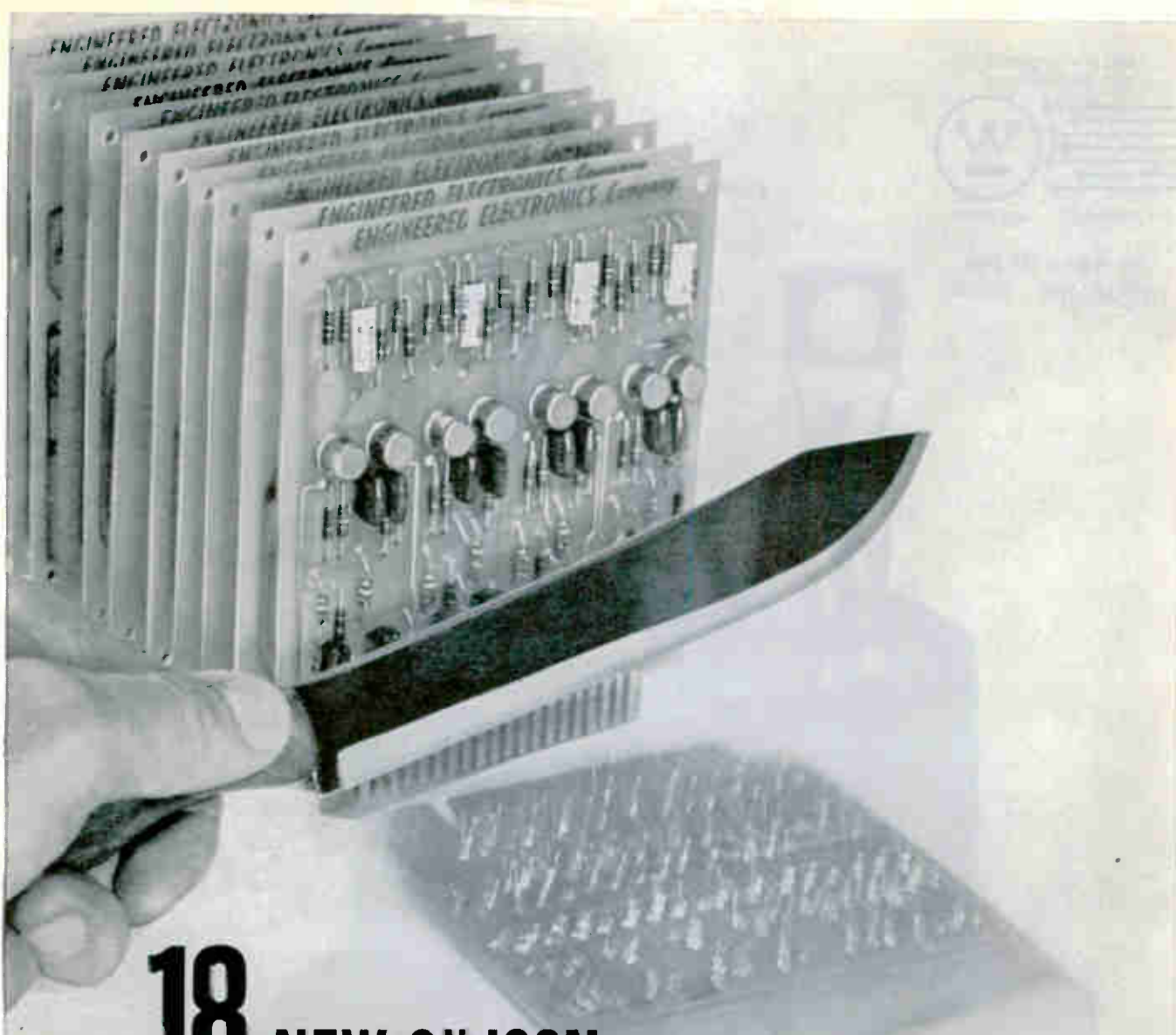

18 NEW SILICON MODULES FROM EECO

125°C circuits in 1 Mc and 10 Mc versions

1 Mc Series	10 Mc Series	Circuits Available
U-501	U-701	Triple 4-input NOR circuit
U-502	U-702	Eight driver circuits
U-503	U-703	Dual flip-flops
U-504	U-704	Multivibrator and three drivers
U-505	U-705	Three one-shots
U-506	U-706	Two exclusive-OR (NAND) circuits
U-507	U-707	Two exclusive-OR (NOR) circuits
U-508	U-708	Full adder
U-509	U-709	Three 4-input-OR circuits

The ability of all 18 modules in this new silicon family to exceed the searing demands of MIL-E-5400F, Class II, for temperature typifies their excellent performance in general.

Superior materials and special packaging techniques make these circuit cards your logical answer to *any* problem in high temperatures or reliability. Designs are based on derated specifications for the components used, and the resulting specifications are then further derated to give you reliability in reserve. Should any module ever fail to perform according to specs under the terms of the company's warranty, it will be repaired or replaced free.

Standard, conservative loading specifications and the availability of compatible hardware make it easy for you to determine your design requirements. Write, wire or phone today for free technical literature or a call from one of our applications engineers.

Power required: +12VDC, -12VDC.

Logic levels: 0 and +6VDC, nominal.

Card dimensions: 4 $\frac{3}{8}$ " x 5" x $\frac{1}{16}$ ".

Contacts: Two sides rhodium-plated with beveled edges for insertion into standard 22-pin etched circuit board connectors. (Special contacts also available.)

Construction: Glass-epoxy etched circuit card with funnel eyelets.



ENGINEERED ELECTRONICS Company

1441 East Chestnut Avenue, Santa Ana, California
Telephone 547-5651 • Cable Address: ENGELEX

See the EECO Line in Booth 1518 at the I.E.E.E. Show

Electronic Components
from Westinghouse

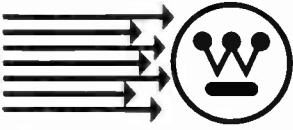

For your needs . one source

See us at the IEEE Show
Booths 1402-1408 1601-1607

THE NEW CASE FOR RELIABILITY

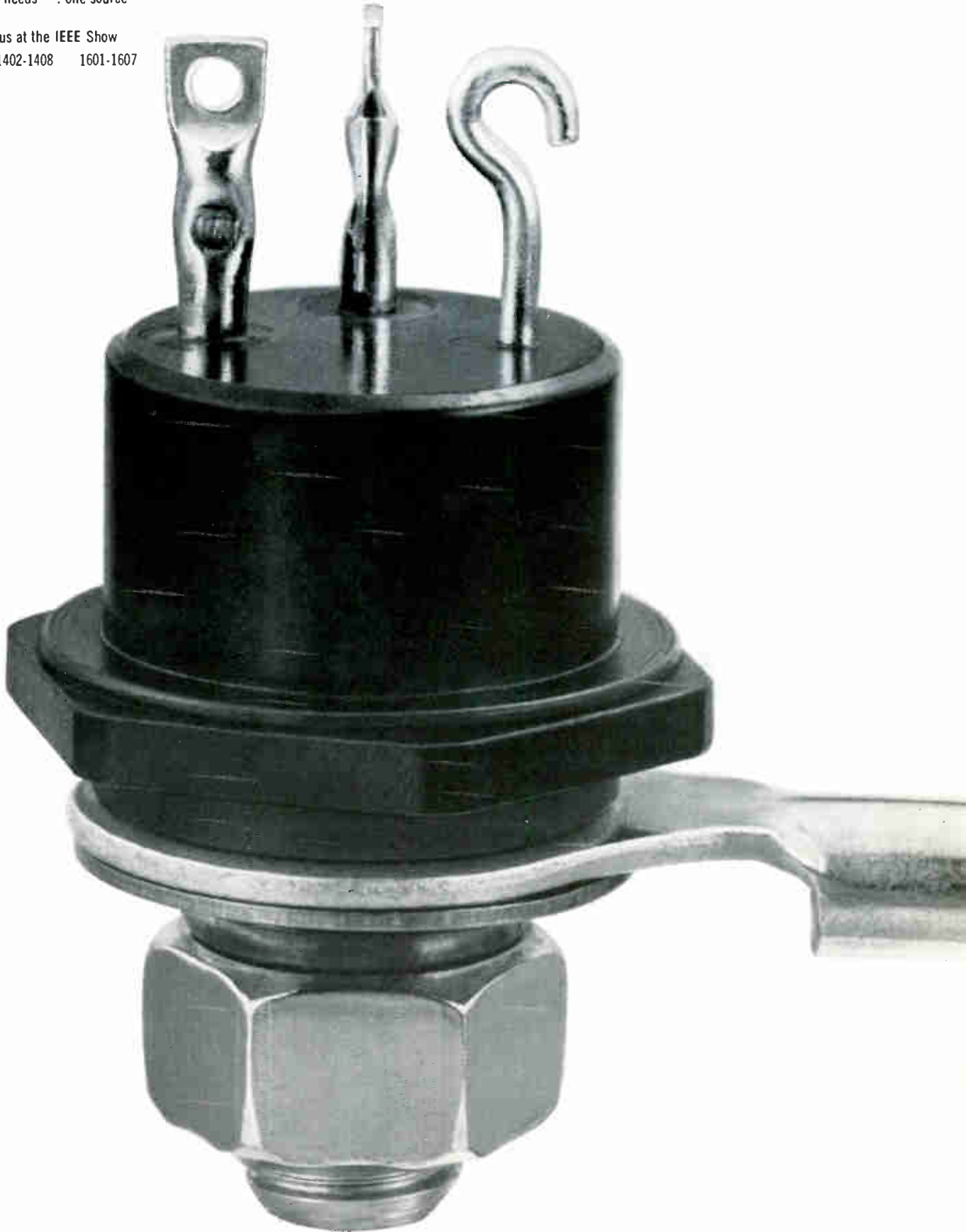

The industry's standard for silicon power transistors—now in a double ended case!

In response to customer demand, Westinghouse now makes available its field-proven silicon power transistor in a new double-ended case. Performance, reliability and construction features are the same as have been successfully used in Westinghouse military type transistors for the last three years. Over 5 megawatts of 30 ampere transistors are now serving in military and industrial applications.

The new double-ended transistor, 2N2757 series, comes in voltage ratings to 250 volts, current ratings to 30 amperes, and a variety of gain classes.



Rock top transistor for highest power ratings

The 250 watt, 300 volt 2N1809-2N2109 series in the rugged "rock top" case features the highest power dissipation ratings available in silicon transistors.



Conventional case for convenient mounting

The 2N2739-2N2754 series (formerly Type 109) offers the convenience of a low mounting profile. Dissipation ratings to 200 watts, currents to 20 amperes.

New procurement specifications

Procurement specifications on each of the above units are available in military format for designers and reliability engineers. These specifications outline electrical and environmental capabilities under standard Mil-spec conditions. Write for a free copy today on your company letterhead: Westinghouse Semiconductor Division, Youngwood, Pa. You can be sure...if it's Westinghouse.

We never forget how much you rely on

Westinghouse

CIRCLE 151 ON READER SERVICE CARD
electronics • March 15, 1963

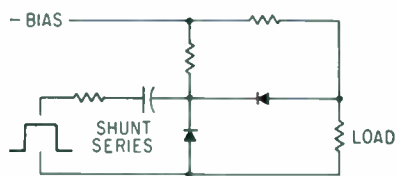
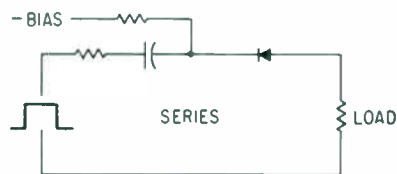
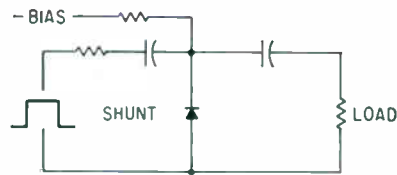

age across the load from a slow-driving waveform. When connected in series with the load, it produces a fast trailing edge for voltage across the load. Two or more diodes can be connected to produce a variety of waveforms. A shunt-series arrangement will produce a narrow pulse with fast rise and fall times. Pulse delay and width can be electronically adjusted by bias currents.

CIRCLE 406, READER SERVICE CARD

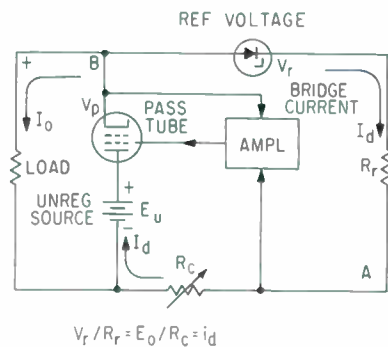

Power Supply has Regulated Output 0 to 2,500 V

ON THE MARKET from Kepco Inc., 131-38 Sanford Ave., Flushing 52, N. Y., New York, the model ABC2500M continuously-adjustable regulated power supply has output from zero to 2,500 v at up to 2 ma, better than 0.05-percent regulation and stability, ripple less than 0.5 ms rms and has less than 50 μ sec recovery time from abrupt line and variations. A ten-position range selector and a ten-turn potentiom-

eter permits resolution of not more than 25 mv. Remote programming by resistance or voltage and constant-current operation is available. The device also has short-circuit protection and no transient overshoot for input power turn on or turn off. As shown in the sketch, output current I_o must pass through plate resistance of V_p , which is controlled by grid bias. This bias is controlled by a transistorized amplifier. Input of the amplifier is connected across null points A and B of a bridge consisting of reference voltage source V_r , reference resistor R_r , and output voltage E_o . The system is phased to balance the bridge and force voltage across A and B to approach zero. With bridge in balance, constant current I_d , determined by ratio of V_r to R_r , circulates. For example: V_r at 6 v and R_r at 6,000 ohms, then I_d is 6/6,000 or 1 ma. This also determines system control ratio, in this case, 1,000 ohms per volt. (407)

35-MM Camera Requires 2 Minutes Developing Time

RELEASED by Analab Instrument Corp., 30 Canfield Rd., Cedar Grove, New Jersey, are the type 3030-C 35-mm electric pulsed film advance camera and the type 100J Rapro-matic process developing unit. The new camera features data chamber that records a 24-hour clock, 4-digit counter and platen data automatically on each frame. *STR* strips of film or the entire 100-f μ l may be removed from camera and developed and fixed in 2 minutes. Process works by placing take-up spool with exposed film in the developing



1/2 size relay does FULL-SIZE job!



Dunco Type FC-1 DC Relays
DP-DT Hermetically sealed,
26.5 volts DC



SAVE SPACE without sacrificing performance and operating capabilities. New Dunco Type FC-1 Relays are only 1/2 the size of conventional crystal cans yet they do every job the standard size units can do. *Example:* they withstand shock at 50G for 11 milliseconds, withstand vibration at 30G to 2,000 cycles. Only .400" high, they're ideal as direct replacements for side terminal crystal can types used in printed circuits.

TESTED IN ACCORDANCE WITH MIL-R-5757D, Type FC-1 Relays are specially designed for missile, ground support equipment, computers, communications, and control systems. They're hermetically sealed in controlled atmospheres. All-welded internal construction prevents solder flux contamination. Only non-gassing materials are used. Parts and components are cleaned repeatedly during assembly. All this assures reliable contact performance at loads ranging from dry circuit conditions to 2 amps resistive. Write for Data Bulletin FC-1. Address: Struthers-Dunn, Inc., Pitman, N. J.

STRUTHERS-DUNN

Member, National Association of Relay Manufacturers



Sales Engineering Offices in: Atlanta • Boston • Buffalo • Charlotte • Chicago • Cincinnati • Cleveland
Dallas • Dayton • Denver • Detroit • Kansas City • Los Angeles • Memphis • New York • Orlando
Pittsburgh • St. Louis • San Diego • San Francisco • Seattle, Canadian Licensee: Renfrew Electric
Co., Toronto, Ontario, Canada, Export Department: 1505 Race St., Philadelphia 2, Pa., U.S.A.
SEE US AT THE I.E.E.E. SHOW—BOOTH M-2

unit. The film and web are threaded through pressure rollers onto another takeup spool. Processor unit is closed and web mated with exposed film in a few seconds by a motor-drive mechanism. Developer and fixing chemicals are carried in a glass fiber saturated web. In 2 minutes, the developing and fixing is complete and the web is peeled from the film producing a negative. In an experimental system, the web is incorporated in the film magazine and a 4- by 6-inch viewer is incorporated. Thus, a negative may be viewed as soon as the film comes from the magazine. The process works with almost all types of presently-used films.

CIRCLE 408, READER SERVICE CARD

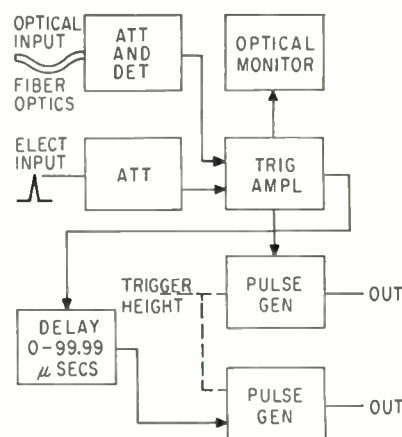

Variable Relay Can Operate From Light Source

RECENTLY ANNOUNCED by STL Products, 139 Illinois St., El Segundo, California, the model 2A trigger delay generator provides accurately controlled delayed pulses for triggering equipment from either optical or electrical inputs. Output pulse can be delayed in four decades from 0 to 99.99 μsecs with reference to the zero delay pulse. Zero delay pulse appears 30 ns after input signal. The five-foot, fiber-optic probe requires 250 μw to produce a pulse. Thirty levels of optical attenuation are available up to 10°, and superimposed timing marks show both the input trigger threshold of the input and delayed output pulse. Repeatability and calibration is within 0.01 percent. Delay setting is digitally displayed on the front panel. When optical input is used, a monitor output permits oscilloscope observation with super-

read this

Now there is a new approach to micro-circuit packaging . . . BIPCO® Diode Matrices and Transistor Strips. They provide the only approach combining:

- Total function logic
- Connection oriented packaging
- Connection oriented batch manufacturing

See how these unique features will benefit you.

see this

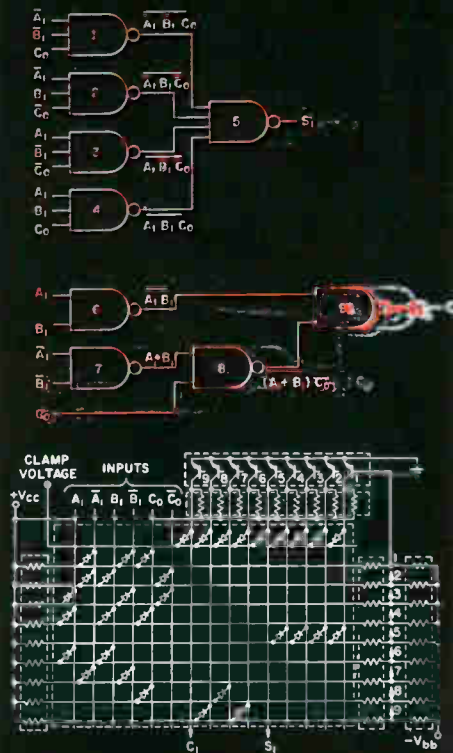

use this

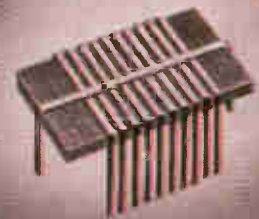
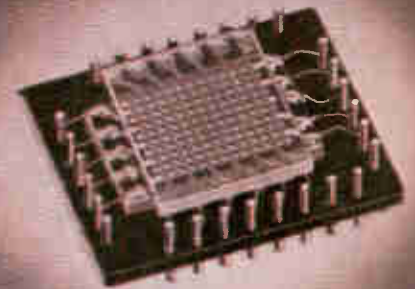

Above is the logic diagram for a full adder and its equivalent BIPCO circuit. Note how "total function" logic is performed with matrices of diodes and strips of transistors and resistors. Since the interconnections are always the same, other functions (counting, decoding, accumulating, etc.) can be performed by simply changing the arrangement of the diodes within the matrix. You can specify parameters, logic levels.

BIPCO devices containing up to 100 silicon diodes and 10 silicon transistors are available as individual packages or as printed circuit assemblies for counting, decoding and code-converting applications. Because the diodes and transistors are manufactured and connected in batches, the cost of these units is competitive with that of conventional components and less than that of other micro-circuit devices.

Write today for our newest brochure . . . "BIPCO Logic | the Total Function Approach".



See us at the I.E.E.E. Show Booths #1211-1215

CIRCLE 153 ON READER SERVICE CARD

CHOOSE YOUR 1 MC TIME BASE



0.01 PPM PER DAY OR 0.1 PPM PER DAY OR 1 PPM PER DAY

PRECISION
GLASS
MOUNTED
QUARTZ
CRYSTALS . . .

TRANSISTORIZED
CIRCUITRY . . .
PLUG-IN
CRYSTAL
OSCILLATORS

Bulletin 533 Available

Bliley ...if you buy quality

BLILEY ELECTRIC COMPANY • ERIE, PENNSYLVANIA
CIRCLE 303 ON READER SERVICE CARD

imposed time markers to indicate trigger threshold of input and delayed output pulse. Both zero delay output pulse and the delayed pulse can be varied from 50 to 500 v. The 10, 1 and 0.1 μ sec delays are generated by discharging an LC circuit into a diode with nanosecond recovery time and detecting the half-cycle point of the oscillation. The 0.01 μ sec delay is generated by varying the amount of stored charge in a diode and driving it off at a constant rate. Delay is diode recovery time. These diodes have a rectangular current recovery time.

CIRCLE 409, READER SERVICE CARD

ALL RESISTORS - 920 Ω TRANSISTORS - 2N2784 DIODES - M0101

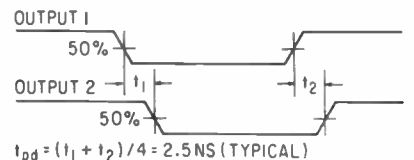
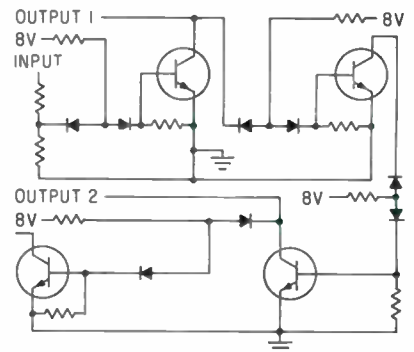

Micropower Transistor Switches in 12 Ns

FROM Sylvania Semiconductor Division, 100 Sylvan Road, Woburn, Massachusetts, the 2N2784 is a silicon epitaxial planar switch having a total switching time of 12 nanoseconds in a saturated circuit. The device is designed for optimum efficiency at the microwatt and milliwatt range. Gain bandwidth product is greater than 1 Gc, typical beta is 70 at 8 ma with gradual falloff at higher IC and aluminum-to-aluminum bonding eliminates catastrophic purple-plague junction deterioration. The transistor is available in the TO-18 package and shortly available in TO-51 and TO-46 packages. Performance results from new geometric configuration, three-stripe design. Two connected base areas, one on each side

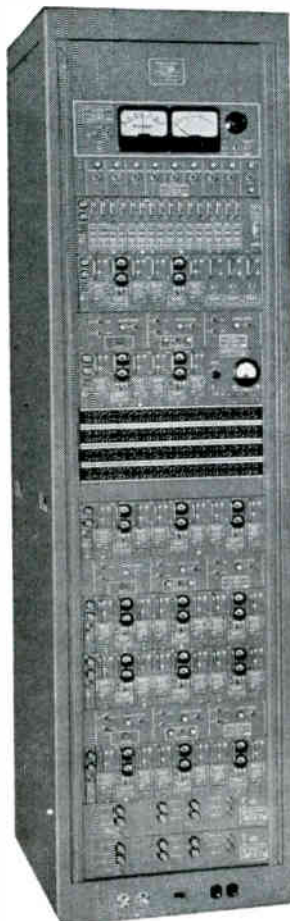

NEW BETTER-THAN-EVER RELIABILITY

for long-distance point-to-point communications



NEW 16-CHANNEL TRANSISTORIZED VOICE FREQUENCY DIVERSITY CARRIER TELEGRAPH TERMINAL TYPE 235 MODEL 3 MIL DESIGNATION AN/FGC-61A

- . . . All units militarized: components and design approved by U.S. Military.
- . . . Converters have equalized gain and adjustable time delay in each channel for better diversity performance and interchangeability.
- . . . Switching Panels provide "local" or "remote" selection of 2-channel or 4-channel diversity modes.
- . . . Combiners have adjustable gains in each channel, for complete switching flexibility, and the combining follows an ideally modified square law function for both 2-channel space or frequency and 4-channel space plus frequency diversity.
- . . . Keyers have adjustable "threshold" sensitivity control and simplified input circuit selection.
- . . . Dotter and Delay Indicator provides test keying signal source for keyers and delay equalizers in all channels.

Write for complete literature.

Pace-Setters in Quality Communication Equipment.

NORTHERN RADIO COMPANY, inc.
147 WEST 22nd ST., NEW YORK 11, NEW YORK

In Canada: Northern Radio Mfg. Co., Ltd., 1950 Bank St., Billings Bridge, Ottawa, Ontario.

**New Reeves-Hoffman
2.5 mc Frequency Standard
offers**

stability

of

2 x 10⁻¹¹

(2 parts in 100,000,000,000)

Reeves-Hoffman's 2.5 mc Frequency Standard, Model S2075, uses an AT-cut 5th overtone crystal of our own manufacture. It provides an ultra-stable, in-house standard that can be compared continually with VLF transmissions.

Other important specifications are: Double proportional control oven construction; phase stability of 7×10^{-3} degrees peak-to-peak during a 20 millisecond period; solid state construction; output frequencies of 100 kc, 1 mc and 5 mc simultaneously; setability to within 1×10^{-11} . Model S2075, which also provides power failure alarm, fits into a 5¼-inch rack panel and will maintain specifications over a temperature range of 0 to 40°C.

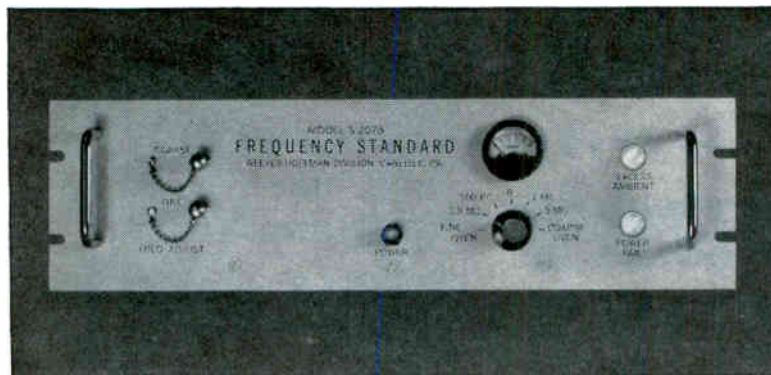

See it at our Booth 1309 at the I.E.E.E. SHOW

... or write for Bulletin S2075 for complete specifications.

PRODUCERS OF PRECISION
FREQUENCY CONTROL DEVICES...
crystals • crystal-controlled
frequency sources, standards,
filters • component ovens.

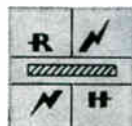

**REEVES-
HOFFMAN**

CARLISLE, PENNSYLVANIA



Data Handling EQUIPMENT

ALL SOLID STATE CONSTRUCTION ASSURING SUPERIOR PERFORMANCE and RELIABILITY

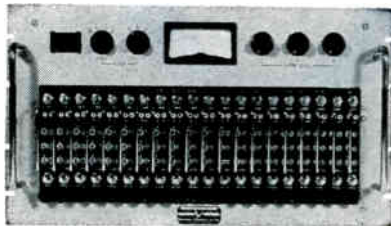

DIC-1

DATA INSERTION CONVERTER

Generates 3 completely independent FM/FM telemetry signals with up to 20 different subcarrier oscillators removable from the front panel. Each subcarrier oscillator module has independent level controls for each of the 3 output mixers. Direct input modules and FSK modules are available.

Input Impedance..... Greater than 500,000 ohms per subcarrier channel
 Linearity..... Less than $\pm 0.2\%$ of bandwidth
 Stability..... Less than $\pm 0.5\%$ of bandwidth



PTS-2 PCM SIMULATOR

A laboratory test instrument or field check-out aid in PCM telemetry systems, the PTS-2 will generate a variety of PCM codes and formats. The simulator generates a periodic frame synchronization word followed by a preset number of identical data words in a continuous serial pulse train, with each bit controlled by a front panel switch.

Bit Rate..... Variable 10 cps to 1 mc
 Output Formats..... RZ, NRZ and split phase



RFT-2

REFERENCE OSCILLATOR/MIXER

Generates a 50 or 100 kc reference signal which is linearly mixed with up to 4 independent telemetry signals for recording on magnetic tape.

Accuracy..... 0.0001%
 Stability..... 5×10^{-7}

Defense Electronics, Inc.

WASHINGTON - ROCKVILLE INDUSTRIAL PARK
 5455 RANDOLPH RD., ROCKVILLE, MARYLAND

Western Regional Office
 84044 Ventura Boulevard, Suite 209
 Sherman Oaks, California



International
 Terminal Radio International Limited
 3 West 61st Street, New York City

of the emitter, capture signal strength ordinarily lost with conventional two-stripe geometry. Epitaxial construction results in extremely low capacitance and higher switching speed. Sketch p 154 shows typical application in a low-level logic circuit with fan in and fan out of one.

CIRCLE 410, READER SERVICE CARD

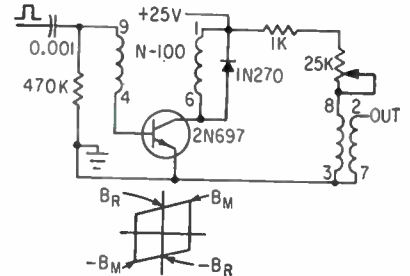

Blocking Oscillator Has Variable Width Output

NEW from Polyphase Instrument Co., East Fourth St., Bridgeport, Pennsylvania, are the series N-100 pulse transformers whose output pulse widths can be continuously controlled between 0.06 and 5 μ sec. Pulse width is controlled by a potentiometer controlling bias current. Repetition rates vary from 100 Kc for the N-100 having a nominal pulse width of 0.06 μ sec to 4 Kc for the N-150 having a nominal pulse width of 5 μ sec. Rise time is less than 40 ns and droop is less than 5 percent for all pulse widths. Conventional blocking oscillators are limited to operation between B_m and B_r on the core BH curve (see sketch), and this allows short pulse widths only. Addition of a bias winding makes it possible to set the core to any desired position between B_r and $-B_m$, resulting in a large ΔB . When bias current is increased so as to reset core to $-B_m$, maximum pulse width is obtained. Reducing bias current brings corresponding reduction in pulse width. Pulse reductions of up to 10 percent for the 0.06 μ sec and up to 70 percent for the 5 μ sec unit are possible. (411)

10-W Swept-Signal Source From 1 to 18 Gc

NEW from Paradyamics, Inc., 10 Stepar Place, Huntington Station,

New York, the series 888C swept-signal source delivers 10 w output power between 1 and 18 Gc. The unit can be used as a stable c-w signal source, a swept source with sweep rates between 0.01 and 100 cps (with external capacitor, sweeps can be up to hours), or it can be pulse modulated. The device

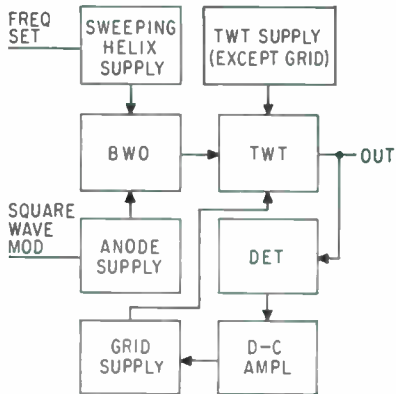

also can be remotely programmed. Output is leveled to 1 db, sweep output voltage is a 100 v peak linear sawtooth, oscilloscope blanking is a 50-v pulse, residual f-m is 0.0025 percent of maximum frequency, residual a-m is 30 db nominal below c-w level and r-f dynamic range is 20 db minimum. Modulation can be by internal square wave between 800 and 1,200 cps, external a-m from d-c to 500 Kc or external pulse. Both the bwo and twt may be pulse modulated separately or simultaneously. As shown in the sketch, a milliwatt signal is amplified to the 10-w level by a twt. A portion of the output is coupled to a detector where it is rectified, amplified and compared with a stable reference source. The difference is applied to the twt a-m input. This system holds output power to 1 db over wide bandwidths. (412)

Coaxial Cables Are Solid Jacketed

MICRODELAY DIVISION of Uniform Tubes, Inc., Collegeville, Pa., offers MicroCoax cables that feature: low loss, total shielding; easy to strip, to connect; no loose frayed ends; solderable; uniform, close-tolerance construction. Characteristic impedance is 50 ohms; outer jacket, solid copper; dielectric, Teflon (TFE);

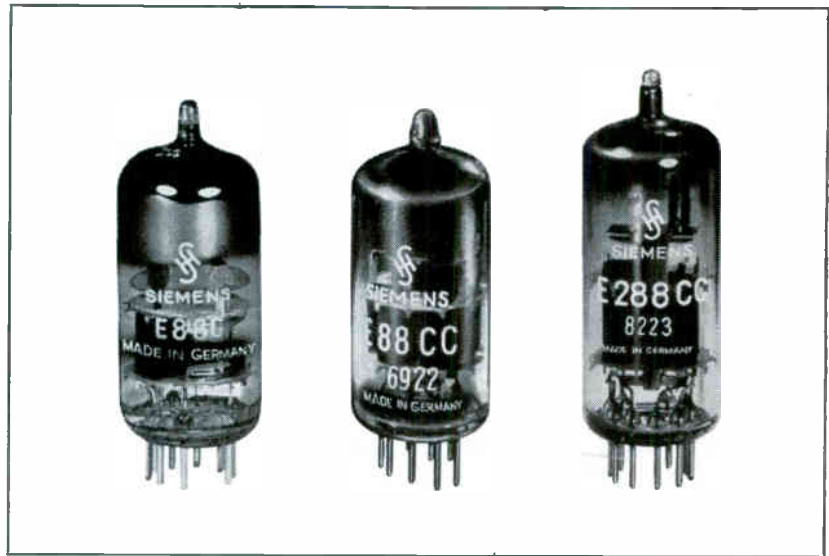

Electron Tubes

Special quality tubes

Frame grid construction with high transconductance to plate current ratio for use in critical industrial and military applications, in which service reliability is of primary importance.

Type	Description	Characteristics			Maximum ratings		
		Plate supply voltage V	Plate current mA	Transconductance μ mhos	Plate voltage V	Plate dissipation Watts	Cathode current mA
E88 C	UHF Triode	160	12,5	13500	200	2.4	15
E88 CC/6922	Twin Triode	100	15	12500	220	1.5	20
E188 CC/7308	Twin Triode	100	15	12500	250	1.65	22
E288 CC/8223	Twin Triode	100	30	18000	250	3.0	40

For further information and application engineering assistance regarding these electron tubes manufactured by Siemens & Halske AG • Germany, please write to their distributor in the U.S.A.:

SIEMENS AMERICA INCORPORATED

350 Fifth Avenue, New York 1, N.Y. • Tel: LOngacre 4-7674, Telex 01-2070, Cable: siemens newyork

in Canada:

SIEMENS HALSKE SIEMENS SCHUCKERT (CANADA) LTD.

407, McGill Street, Montreal 1, P.Q. • Tel: 849-5783, Telex 012800, Cable: siemenscan

NEW FROM ITT

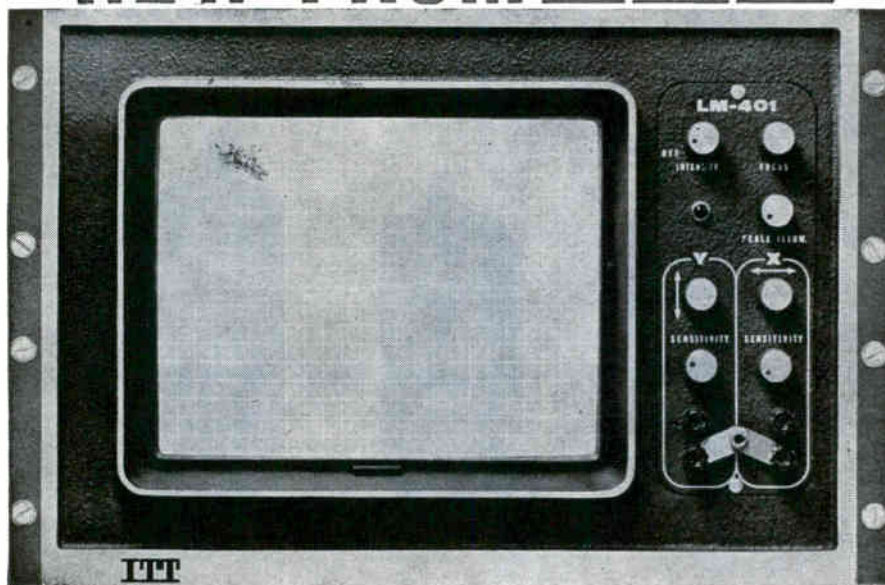

THE MODEL LM-401, HIGH RESOLUTION, MONITOR OSCILLOSCOPE

*provides more data
on 14" screen than 17" scopes*

With a resolution of 25 lines per centimeter (65 lines per inch) the new ITT Model LM-401 Monitor Oscilloscope can present more data with greater precision across the full screen than the old style 17" scopes. This new, low-cost, 14-inch model has a full screen frequency response 5 times greater than previous equipment...to beyond 50 kc. Other important features include: linearity of 1%, stable DC amplifiers, easy conversion to bench or rack mounting, modular design, and high sensitivity in horizontal and vertical axes.

For more information, write for Data File E-1914-2.

ITT

Instruments

Industrial Products Division
International Telephone and Telegraph Corporation
15191 Bledsoe Street • San Fernando, Calif. • EMpire 7-6161

inner conductor, solid copperweld wire, silverplated; temperature range, -60°C to $+85^{\circ}\text{C}$. Company has fabricated coaxial cables as small as 0.010-0.012 in. o-d. Upper size limit preferred for manufacture is 0.250 in., though special needs for larger o-d's can be met.

CIRCLE 413, READER SERVICE CARD

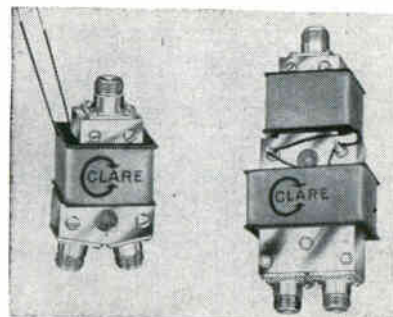

Coaxial Relays Display Very Low VSWR

C. P. CLARE & CO., 3101 Pratt Bldg., Chicago 45, Ill. New coaxial relays assure reliable, high quality switching over r-f ranges to 700 Mc. Among applications are: i-f switching in microwave networks, transmit-receive antenna switching in the uhf range of 100-500 Mc, and switching pcm data in telemetering systems without deterioration of square wave form. Type HGS2C (shown at left) displays a crosstalk isolation of 35 db min, 70-700 Mc and the HGS4C displays a crosstalk isolation of 80 db min. (414)

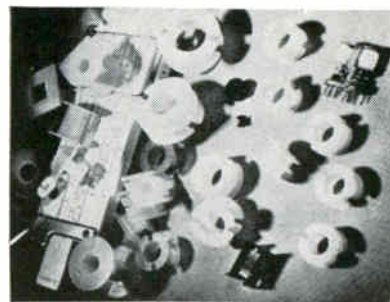

Coil Bobbins Are Precision-Molded

GRIES REPRODUCER CORP., 151 Beechwood St., New Rochelle, N. Y. Designed for ferrite cup core assemblies for telecommunication filter networks and other applications, a complete line of precision-molded coil bobbins for "International Standards Series" cup cores are announced. The bobbins—seven

Another New High Order of Reliability!

El-Menco

* MYLAR-PAPER DIPPED CAPACITORS

TYPE MPD

ASSURE A LOW FAILURE RATE OF Only 1 Failure in 7,168,000 Unit-Hours for 0.1 MFD Capacitors*

14,336,000

Setting A New High Standard Of Performance!

Life tests have proved that El-Menco Mylar-Paper Dipped Capacitors — tested at 105°C with rated voltage applied — have yielded a failure rate of only 1 per 1,433,600 unit-hours for 1.0 MFD. Since the number of unit-hours of these capacitors is inversely proportional to the capacitance, 0.1 MFD El-Menco Mylar-Paper Dipped Capacitors will yield ONLY 1 FAILURE IN 14,336,000 UNIT-HOURS.

CAPACITANCE AND VOLTAGE CHART

• Five case sizes in working voltages and ranges:

200 WVDC —	.018 to .5 MFD
400 WVDC —	.0082 to .33 MFD
600 WVDC —	.0018 to .25 MFD
1000 WVDC —	.001 to .1 MFD
1600 WVDC —	.001 to .05 MFD

SPECIFICATIONS

- **TOLERANCES:** 10% and 20%. Closer tolerances available on request.
- **INSULATION:** Durez phenolic, epoxy vacuum impregnated.
- **LEADS:** No. 20 B & S (.032") annealed copper clad steel wire crimped leads for printed circuit application.
- **DIELECTRIC STRENGTH:** 2 or 2½ times rated voltage, depending upon working voltage.
- **INSULATION RESISTANCE AT 25°C:** For .05MFD or less, 100,000 megohms minimum. Greater than .05MFD, 5000 megohm-microfarads.
- **INSULATION RESISTANCE AT 105°C:** For .05MFD or less, 1400 megohms minimum. Greater than .05MFD, 70 megohm-microfarads.
- **POWER FACTOR AT 25°C:** 1.0% maximum at 1 KC

These capacitors will exceed all the electrical requirements of E. I. A. specification RS-164 and Military specifications MIL-C-91B and MIL-C-25C. Write for Technical Brochure

MINIMUM LIFE EXPECTANCY FOR **1.0 MFD* MYLAR-PAPER DIPPED CAPACITORS AS A FUNCTION OF VOLTAGE & TEMPERATURE

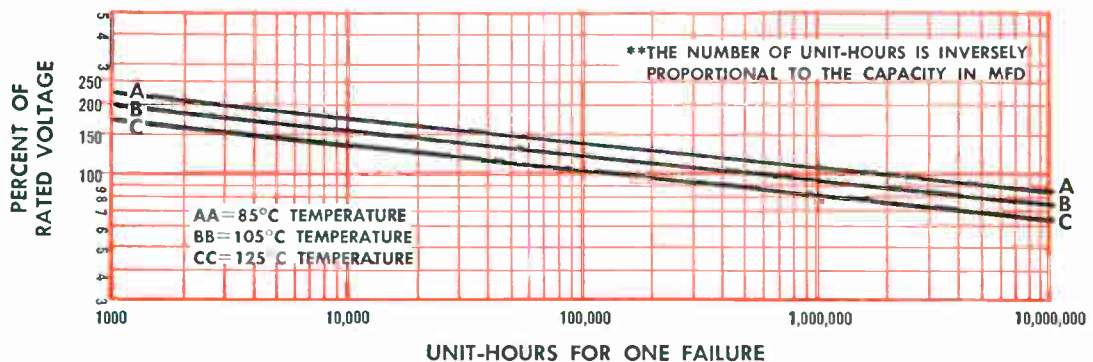

* Registered Trade Mark of DuPont Co.

THE ELECTRO MOTIVE MFG. CO., INC.
WILLIMANTIC, CONNECTICUT

Dipped Mica • Molded Mica • Silvered Mica Films • Mica Trimmers & Padders
Mylar-Paper Dipped • Paper Dipped • Mylar Dipped • Tubular Paper

AMCO ELECTRONICS, INC., Community Drive,
Great Neck, L. I., New York
Exclusive Distributors for the Eastern and Southern
Regions of the U.S. and Canada

West Coast Manufacturing Company
COLLINS & HYDE CO., 525 Mission St.,
San Francisco, California
3205 Wilshire Boulevard, Los Angeles, California

MANUFACTURERS OF

El-Menco
Capacitors

NOW... high accuracy synchro/resolver testing



—GERTSCH STANDARDS AND BRIDGES REPLACE COSTLY ELECTRO-MECHANICAL METHODS

There is a Gertsch synchro or resolver instrument to meet virtually all requirements. Whether testing simple components or complete systems, you get accuracies up to 2 seconds-of-arc — accuracies maintained without constant checking and recalibration. These versatile units employ the same time-proven design techniques as Gertsch RatioTrans,[®] assuring high input impedance, low output impedance, and very low phase shift.

Minimum operator error. Angles are selected with positive detent knob — requires no critical adjustments. Direct-reading digital display reduces readout error.

Simplified circuitry — least susceptible to the effects of stray capacitance, pickup, loading.

Fewer accessories needed, hence less error from associated equipment.

Over 100 synchro/resolver test instruments are available from Gertsch — synchro standards, resolver standards, synchro bridges, resolver bridges. In addition to conventional, manually-operated units, all standards and bridges can be supplied as rotary solenoid, relay (programmable), and decade (.001° resolution) instruments.



Gertsch dividing heads (both manual and automatic), in combination with Gertsch phase angle voltmeters, provide complete checkout capabilities for AC rotating components.



Complete information on all Gertsch synchro/resolver test instruments in catalog #11 — 40 pages of technical information, specifications, theory, application data and engineering bulletins. A valuable reference source for design and test engineers.

Gertsch
GERTSCH PRODUCTS, INC.

3211 S. La Cienega Blvd., Los Angeles 16, Calif. • Upton 0-2761 • Vermont 9-2201

standard sizes with choice of 2, 3 or 4 flanges—are molded in Delrin (duPont's acetal resin) to precise tolerances and exacting specifications in a single automatic operation. Delrin offers high strength and stiffness at elevated temperatures, plus high dielectric strength and low dielectric constant.

CIRCLE 415, READER SERVICE CARD

Deviation Meter

GREIBACH INSTRUMENTS CORP., 315 North Ave., New Rochelle, N. Y., offers a new line of single or multi-range meters capable of measuring current deviation from a pre-established value of as little as 10 parts per million with accuracy as high as 0.0005 percent. (416)

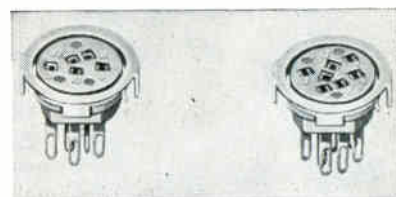

Nuvistor Tube Sockets In 5- and 7-Pin Types

INDUSTRIAL ELECTRONIC HARDWARE CORP., 109 Prince St., New York 12, N. Y., introduces two new Nuvistor tube sockets in both five and seven pin types. The JETEC base numbers are E5-79 and E5-65 for the five-pin types, and E7-83 for the seven-pin type. These sockets are for tube type numbers: 13CW4, 6DS4, 6CW4, 7895, 8058, 8056, 7587, 7586 and 7895. (417)



Digital Voltmeter Uses Reed Relays

INDUSTRIAL INSTRUMENTS INC., 89 Commerce Road, Cedar Grove, N. J., offers the DVM-2 digital voltmeter. Balancing speed is approximately twice that of conventional stepping-switch digital instruments. Long-



READ-WRITE PACKAGE

for INFORMATION RECORDING STORAGE TUBES

YOKES

+

DEFLECTRONS

+

FOCUS COILS

+

DEFLECTION DRIVERS

=

MORE

INFORMATION

PER UNIT AREA

PER UNIT TIME

CELCO Solid State Amplifiers, Deflection Yokes and Focus Coils make a complete Package for your Display applications.

— write or call:

Celco

CONSTANTINE ENGINEERING LABORATORIES COMPANY

Mahwah, N. J.	Miami, Fla.	Upland, Cal.
Area Code: 201	Area Code: 305	Area Code: 714
Davis 7-1123	Plaza 1-1132	YUkon 2-0215
Ed Ryder	Walt Faust	Bob Reese

CIRCLE 304 ON READER SERVICE CARD
electronics • March 15, 1963

life components are used and switching is accomplished by highly reliable sealed reed relays. Plug-in circuits make it a highly flexible instrument. Unit covers d-c voltage from ± 0.001 to 999.9 in ranges of 0.000 to 9.999/99.99/999.9. Accuracy is ± 0.01 percent of full scale $+1$ digit. (418)



Rotary Switch with Positive Positioning

VEMALINE PRODUCTS CO., Box 1, Franklin Lakes, N. J. Series 700 rotary switch features: fully enclosed 1½ in. diameter; a variable detent action; positive positioning; 12 contacts in either nickel silver or coin silver; 5 amp at 115 v a-c res, 3 amp at 28 v d-c res, 2 amp at 28 v d-c ind; available in shorting or nonshorting models; three solder lugs on common ring wafer instead of the usual one lug construction; meets military specifications. (419)

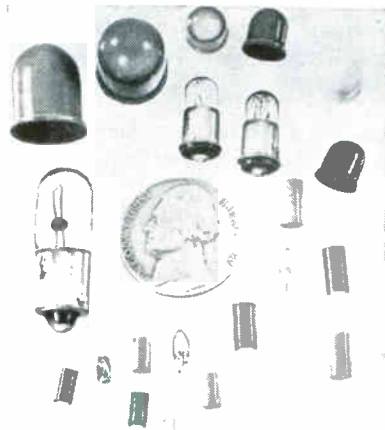

Colored Lamp Filters Are Unbreakable

SILIKROME DIVISION of APM-Hex-seal Corp., 41 Honeck St., Englewood, N. J., introduces a line of elastomeric lamp filters which can be easily slipped over clear incandescent lamps to change their color. Designed for lighting panels, switch

measure dc



100mv to 500v



within 0.02%

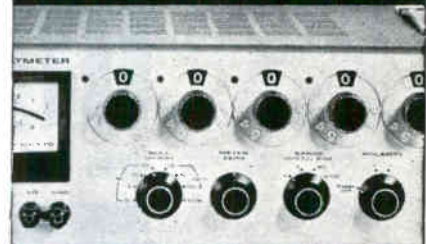

New Differential Voltmeter

Keithley 660 measures dc voltages with the accuracy and stability of a laboratory standard and the ease and low cost of an ordinary VTVM.

Features include:

- 0.02% limit of error
- reference supply stable to 0.005% indefinitely, without periodic re-standardization
- 100 μ v f.s. null range
- 2 μ v resolution
- infinite resistance at null, to 500v
- 0.005% repeatability
- 10mv recorder output
- fully guarded input
- positive, negative or floating

Model 660 Differential Voltmeter . \$575
Model 6501 10:1 Divider Probe . \$175

Send for four page Engineering Note on the Model 660

latest catalog available upon request



KEITHLEY INSTRUMENTS

12415 Euclid Avenue • Cleveland 6, Ohio

CIRCLE 161 ON READER SERVICE CARD 161

now...

controlled diffusion

with longer flat zones!



Insure high yields of top-quality doped silicon or germanium wafers . . . continuously . . . with multi-chamber, four-on-one Hayes Model 4-DHS0330 Diffusion Furnace. Thermal flat zones (16" to 18" \pm 1°C) plus zirconia outer muffle dampen temperature "ripples" in depositing chambers . . . assure positive control of temperature and predictable quality of furnace output.

Furnace features removable diffusion units, each independent of the other three so others need not be shut off to service one . . . three-zone movable source chambers . . . and recessed, modular panels which can be removed for servicing outside "clean room". Furnace is available with iron-chrome, molybdenum, or platinum elements.

Single and double unit models available. Also many other furnaces for continuous, cycling and/or programmed diffusion processes. Flat zones to 24".

Request Data Sheet F-11 for complete details. C. I. Hayes, Inc., 845 Wellington Ave., Cranston 10, R. I. Ph.: 401-461-3400



indicators, instrument lighting, consoles, etc., the filter caps produce colors which conform to the limits as specified in MIL-C-25050 (yellow, red, blue, green, lunar white), MIL-L-25467 (instrument lighting red), and MIL-L-27160A (instrument lighting white). One of the many applications is in the Polaris missile system.

CIRCLE 420, READER SERVICE CARD

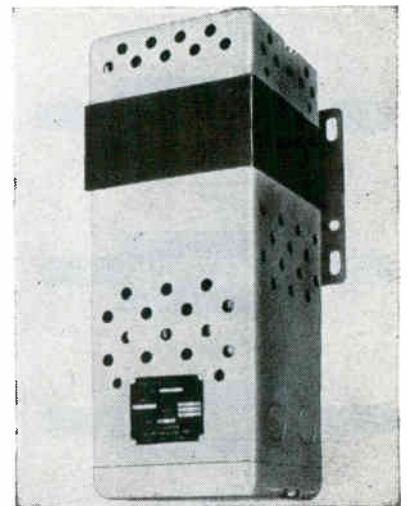

Voltage Stabilizers Have No Moving Parts

STANCOR ELECTRONICS, INC., 3501 Addison St., Chicago 18, Ill., announces the Powerguard group of automatic voltage stabilizers. Initially, 30, 60, 250, 500, 1,000 and 3,000 v-a units are being produced. Units correct line voltage variations of ± 15 percent to within ± 1 percent. Voltage correction time is almost instantaneous. Only 25 milliseconds are required to bring voltage to rated output. Units contain no moving parts, thus providing maintenance free operation, and high resistance to physical and mechanical shock. (421)

Circular Plugs for Space Use

CANNON ELECTRIC CO., 3208 Humboldt St., Los Angeles 31, Calif. The KV series plugs are designed for space and high performance applications. Shell hardware of the plugs conforms to MIL26500B. Improved design concepts and low cost are added advantages. Insulator of the plug incorporates the



HEADED FOR AUTOMATION

...AND DESIGNED TO MEET ALL MIL SPECS. THAT'S THE STORY ON DAYSTROM TRANSITRIM.®

The Daystrom Transitrим potentiometer, in a TO-5 configuration, is designed to facilitate the automatic assembly of PC board circuitry. In addition, it is designed and manufactured to comply with the operational requirements of MIL-R-27208A. The Series 510 wire-wound Transitrим offers 1.25 watts dissipation in still air, resistance ranges from 10 ohms to 30 K, and an operating temperature range from -55°C to $+175^{\circ}\text{C}$.



ACTUAL SIZE

Some features of the Transitrим potentiometer include: a vacuum-tight glass-to-metal seal header with O-ring under compression on the adjustment screw; an all-metal housing free of plastic parts for greatest strength, durability, and heat dissipation; and $1\frac{1}{2}$ inch rigid bare wire leads for automatic assembly. The Transitrим is impervious to humidity, salt spray, sand and dust, etc. No other line offers so much... send for data!

DAYSTROM POTENTIOMETERS ARE ANOTHER PRODUCT OF



WESTON

Instruments & Electronics

Division of Daystrom, Incorporated

614 FRELINGHUYSEN AVENUE, NEWARK 14, NEW JERSEY

See us at BOOTHS 1702-1710, 1801-1809, IEEE SHOW

CIRCLE 163 ON READER SERVICE CARD

PERMACOR[®] Electronic Powdered IRON CORES

for Every Application

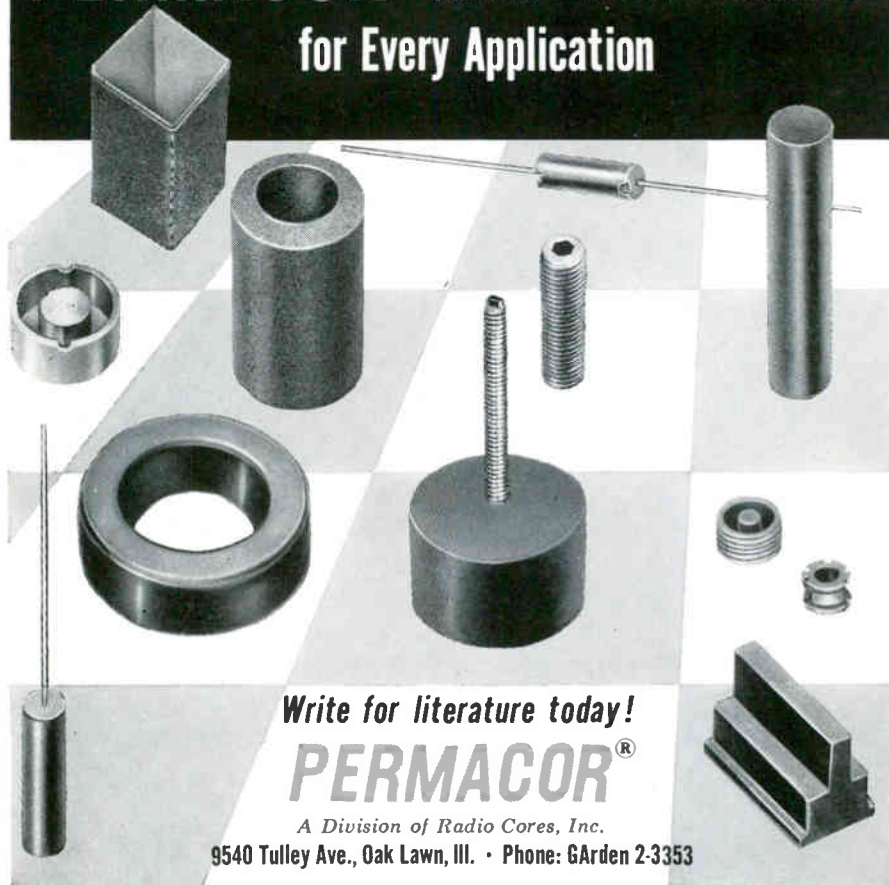

Write for literature today!

PERMACOR[®]

A Division of Radio Cores, Inc.

9540 Tulley Ave., Oak Lawn, Ill. • Phone: GArden 2-3353

CIRCLE 305 ON READER SERVICE CARD

Little Caesar rear release system which provides simple insertion and extraction from the rear and high contact retention. Plugs can withstand temperatures up to 200 C, and all are intermateable with other connectors designed to MIL-C26500.

CIRCLE 422, READER SERVICE CARD

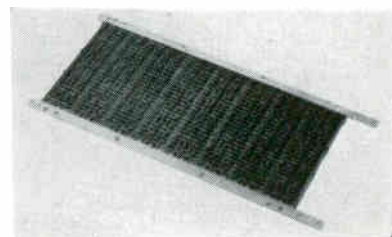

Bus-Line Wiring Speeds Assembly

ELCO CORP., Willow Grove, Pa. Bus-line wiring technique offers contacts on strips which act as wires, furnished in endless reels, thereby eliminating high cost and unreliability of soldering contacts to wires individually. Bus-lines also speed mass assembly wiring of complex circuitry. (423)

CODE FORMAT CONVERTER

TELEGRAPH TERMINAL EQUIPMENT



- For converting 5-level teletype-writer code, 7.0 units or longer character lengths, to any other binary code (Morse, 7 and 8 level teletype-writer, error correcting codes, etc.)
- Step pulse controls character release of sending device.
- Conversion matrix for output code furnished per customer request
- Input is standard 20 ma polar or 60 ma neutral telegraph loop operating at 45.50, 50.0, 56.9, 74.2 or 75 bauds

MODEL 660

- Separate conversion is provided for both upper and lower case
- Output code can be up to 23 bits long per character at any bit rate
- Two character storage permits simultaneous read-in and read-out
- Keyed sidetone enables audio monitoring of output signal
- Modular construction for standard rack mounting

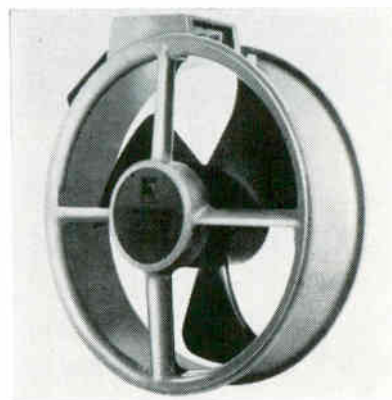

Lightweight Fan for Heavy-Duty Use

ROTRON MFG. CO., INC., Woodstock, N. Y., has available the Feather Fan for cooling electronic packages in computer consoles, relay racks, power supplies, instruments and many other applications. It will deliver 270 cu ft of air per minute at free delivery. Weighing only 1.5 lb, its compact design (7 in. in diameter and only 2 1/8 in. thick) permits simple and easy mounting to any equipment panel. It can be used continuously at any temperature



FREDERICK ELECTRONICS CORP.

414 Pine Avenue, Frederick, Maryland PHONE: 301-662-4156 TWX: 301-553-0466

from -55 C to 65 C; draws only 22 watts; 3,380 rpm; 115 v a-c, 50-60 cps, 1-phase operation. A 2 μ f capacitor can be supplied mounted on the fan. (424)



Cooling Blower Uses Transverse Flow

THE TORRINGTON MFG. CO., 100 Franklin Dr., Torrington, Conn. The 4-in. Crossflo transverse-flow blower is one of three sizes of hand-made models (other two sizes have 2 in. and 3.15 in. impeller diameters) now available. Transverse-flow units are particularly useful in electronic cooling because of their relatively high pressure coefficients, an inherent ability to produce thin bands of air flow, and unusual flexibility in selecting the orientation of air inlet and discharge. (425)

Indicator Lights

DRAKE MFG. CO., 4626 North Olcott Ave., Chicago 31, Ill. Type MF indicator lights with a rectangular lens for midget flange base lamps are used in missile and electronic equipment, as well as commercial applications. (426)



Quartz Crystals Are Glass Mounted

BLILEY ELECTRIC CO., Union Station Building, Erie, Pa. Miniature glass mounted quartz crystals for use in frequency and reference standards have an aging characteristic of less than 0.01 ppm per day and less than 0.03 ppm per week after 24 hours

Vacuum-melted alloys for glass hermetic seals



RODAR[®]
NIRON[®] 52
NIROMET[®] 46

Specified Industry-wide for
PERMANENTLY-BONDED VACUUM-TIGHT SEALS!

Thermal Expansion

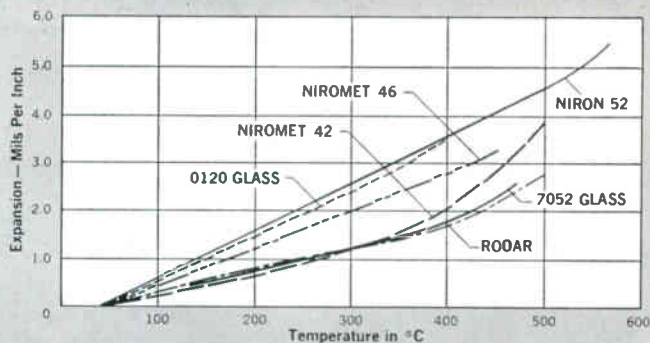

RODAR[®]

NOMINAL ANALYSIS: 29% Nickel, 17% Cobalt, 0.3% Manganese, Balance-Iron

Rodar matches the expansivity of thermal shock resistant glasses, such as Corning 7052 and 7040. Rodar produces a permanent vacuum-tight seal with simple oxidation procedure, and resists attack by mercury. Available in bar, rod, wire, and strip to customers' specifications.

Temperature Range	Average Thermal Expansion $^{\circ}\text{cm}/\text{cm}/^{\circ}\text{C} \times 10^{-7}$
30° To 200°C.	43.3 To 53.0
30 300	44.1 51.7
30 400	45.4 50.8
30 450	50.3 53.7
30 500	57.1 62.1

COEFFICIENT OF LINEAR EXPANSION
*As determined from cooling curves, after annealing in hydrogen for one hour at 900° C. and for 15 minutes at 1100° C.

NIRON[®] 52

NOMINAL ANALYSIS: 51% Nickel, Balance-Iron
For glass-to-metal seals with Corning #0120 glass.

NIROMET[®] 46

NOMINAL ANALYSIS: 46% Nickel, Balance-Iron
For vitreous enameled resistor terminal leads.

NIROMET[®] 42

NOMINAL ANALYSIS: 42% Nickel, Balance-Iron
For glass-to-metal seals with GE #1075 glass.

CERAMVAR

NOMINAL ANALYSIS: 27% Nickel, 25% Cobalt, Balance-Iron
For high alumina ceramic-to-metal seals.

SEE OUR EXHIBIT
AT THE I.E.E.E. SHOW
BOOTHS
4301-A AND 4301-B

Call or write for Sealing Alloy Bulletin

WILBUR B. DRIVER CO.
NEWARK 4, NEW JERSEY, U.S.A.

IN CANADA: Canadian Wilbur B. Driver Company, Ltd.
50 Ronson Drive, Rexdale (Toronto)

Precision Electrical, Electronic, Mechanical and Chemical Alloys for All Requirements

NEW DESIGN

OSCILLOSCOPE

247A GENERAL PURPOSE PORTABLE

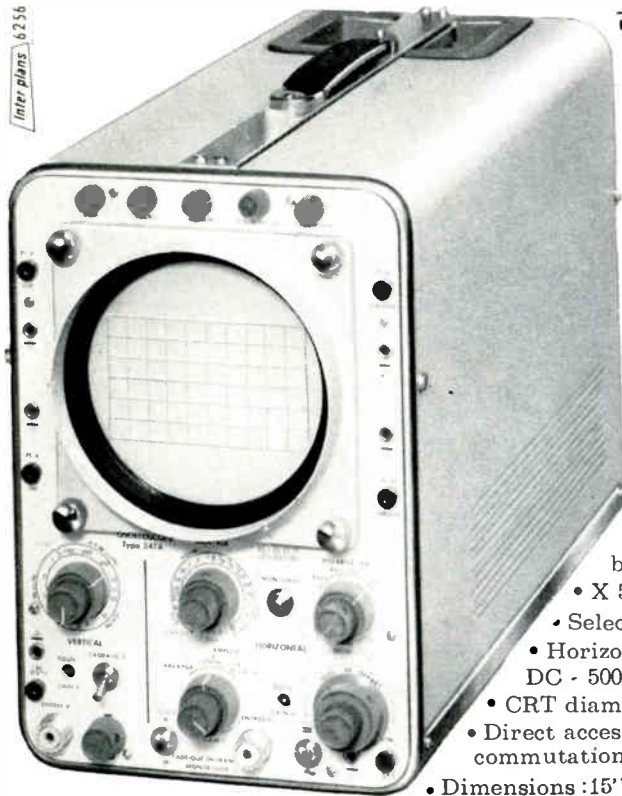

- 1) Band width : DC - 1 MHz
Sensitivity : 50 mV/cm
- 2) Band width : 10 Hz - 200 KHz
Sensitivity : 5 mV/cm
- Direct reading calibration on both axis.
Free running, triggered and single sweep operation.
- Sweep range : 0,5 μ s/cm to 1 s/cm by 20 step attenuator.
- X 5 magnifier
- Selection of triggering level
- Horizontal amplifier : DC - 500 KHz
- CRT diameter : 5"
- Direct access to CRT plates through commutation system
- Dimensions : 15" long, 8" wide, 12" high

TECHNICAL ASSISTANCE IS, AS USUAL, PROVIDED.

RIBET-DESJARDINS

INSTRUMENTS DEPARTMENT: 13-17, rue Périer—MONTROUGE/PARIS FRANCE—Tél: ALEsia 24-40—Cable address: PILACELET MONTROUGE REPRESENTATIVE IN ENGLAND: G. & E. BRADLEY LTD—Electral House—Neasden Lane—LONDON N.W. 10.
CANADIAN BRANCH: RIBET-DESJARDINS (Canada) Ltd. Room 114 5757 Decelles Avenue—MONTREAL.
Other representatives: addresses sent on request.

continuous operation. The design has been optimized for the 1 Mc to 5 Mc range in fundamental mode, with a temperature coefficient of less than 0.15 ppm per deg C at operating temperature in range 74 C to 76 C.

CIRCLE 427, READER SERVICE CARD

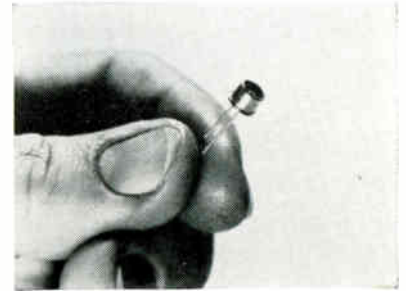

Photoconductive Cells In Compact Case

CLAIREX CORP., 8 W. 30th St., New York 1, N. Y. The 900 series offers 10 distinct types of cells in a compact (0.21 in. diameter by 0.15 in. high), rugged, TO-18 metal case. Types have either a 75 or 250 voltage rating, and a power dissipation rating of 50 mw. (428)

Spectrum Analyzer Features Compactness

PENTRONIX ASSOCIATES, INC., 2037 61st St., Brooklyn 4, N. Y. Model 100 wide band, 100 Mc dispersion, spectrum analyzer has less than 1 Kc of incidental frequency modulation in S band. Extreme compactness (5.25 in. rack panel) is achieved through the use of solid state components combined with high performance circuits. (429)

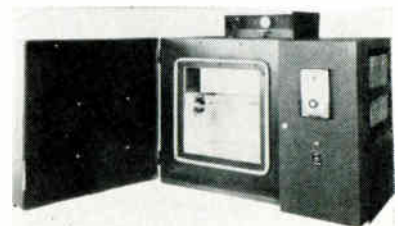

Test Chamber Has Range of - 100 to + 350 F

TENNEY ENGINEERING, INC., 1090 Springfield Road, Union, N. J. The Tenney-Jr. is a compact, mechani-

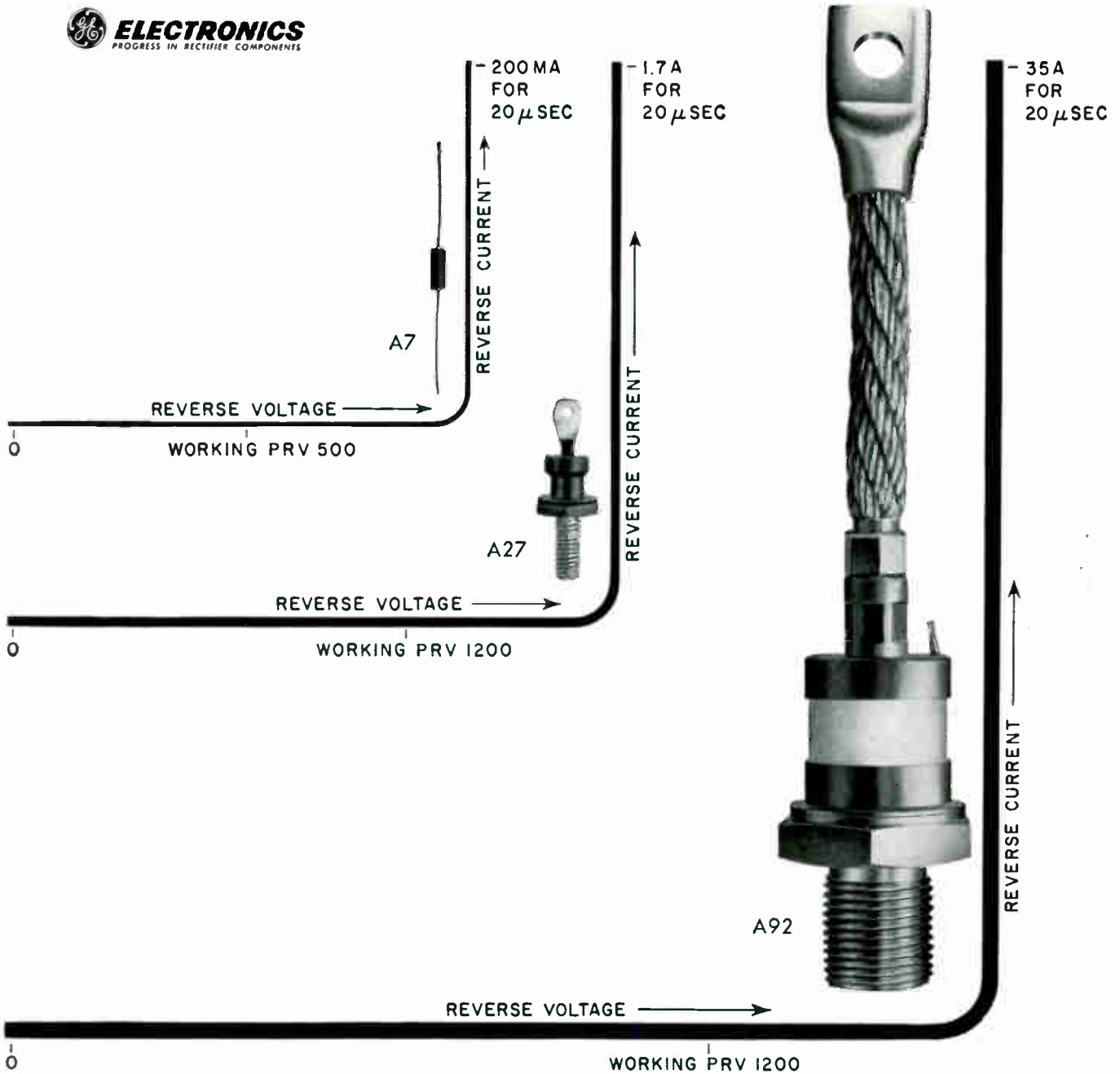

CONTROLLED AVALANCHE RECTIFIERS

1000 times more immune to destructive voltage transients than conventional rectifiers

Because carefully controlled *non-destructive* internal avalanche breakdown occurs *across the entire junction area* . . . the new G-E developed Controlled Avalanche Rectifiers protect themselves and the rest of the circuit against high levels of peak power in the reverse direction. Derating headaches are a thing of the past, your transient voltage problems are solved more efficiently, more economically than ever before. To merit the designation "Controlled Avalanche," G-E silicon rectifier diodes must satisfy these *three important requirements*:

- Have rigidly specified maximum and minimum avalanche voltage characteristics
- Be able to operate steady-state in their avalanche region without damage
- Be able to dissipate momentary power surges in the avalanche region without damage, and have ratings defining this capability

The new 0.5 amp A7 is a subminiature type in 150, 200, 300, 400

and 500 volt working PRV ratings, can dissipate up to 310 watts peak power in the reverse direction. The 12 amp A27 is available in 600, 800, 1000 and 1200 working PRV types, with built-in "zener" diode protection even well beyond 1200 volts, can dissipate up to 3900 watts peak power in the reverse direction. And the A92 is a 250 amp unit in 600, 700, 800, 900, 1000, 1100 and 1200 volt working PRV types, can dissipate up to 80,000 watts peak power in the reverse direction.

For complete details, see your G-E Semiconductor District Sales Manager and ask for bulletin 200.27. Or write Section 16C104, Rectifier Components Department, General Electric Company, Auburn, N.Y. In Canada: Canadian General Electric, 189 Dufferin St., Toronto, Ont. Export: International General Electric, 159 Madison Ave., New York 16, N.Y.

GENERAL  ELECTRIC

NEW



CATALOG



VITREOSIL® PURE FUSED QUARTZ

LABORATORY WARE
INDUSTRIAL WARE
TUBING AND ROD
SPECIAL APPARATUS

IF YOU DON'T HAVE THIS NEW
30 PAGER, WHICH INCLUDES
THE UNUSUAL PHYSICAL
PROPERTIES OF VITREOSIL,
WRITE TODAY, IT'S FREE.



**THERMAL AMERICAN
FUSED QUARTZ CO.**
RT. 202 & CHANGE BRIDGE RD.
MONTVILLE, NEW JERSEY

cally refrigerated bench model high low temperature precision test chamber. It has a temperature range of -100 to $+350$ F in a work space 14 in. wide, 10 in. high and 10 in. deep. It operates on a continuous basis for approximately two cents an hour. Chamber was designed for small batch, small unit testing of semiconductors and other components to military specifications as well as for testing medical and consumer products. Price is \$990.

CIRCLE 430, READER SERVICE CARD

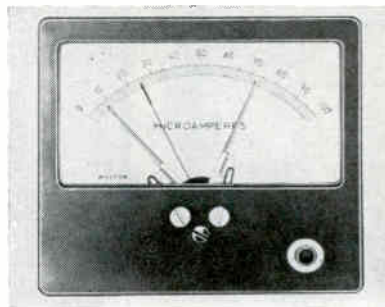

Rugged Meter Relay Features Taut Band

WESTON INSTRUMENTS and Electronics Division, Daystrom, Inc., 614 Frelinghuysen Ave., Newark, N. J. The MagTrak meter relay, which combines magnetic and electromagnetic latching, now incorporates a taut-band suspension mechanism. The double-action principle assures repeated reliability of contact closure. Replacement of the pivot and jewel mechanism with the taut-band suspension mechanism allows full scale deflection at $5 \mu\text{a}$ as compared with the previous $10 \mu\text{a}$. (431)

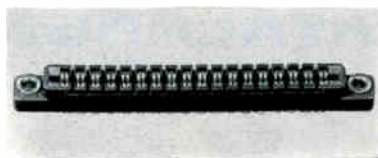

P-C Connectors Have Polarizing Slots

CONTINENTAL CONNECTOR CORP., 34-63 56th St., Woodside 77, N. Y. Series 600-123 feature polarizing slots integral with the molding and accommodate a polarizing key in any desired location. This eliminates the need to sacrifice any contact position for polarization. Eighteen beryllium copper contacts with gold plate over silver plate

have solder lug terminations, and accept a $\frac{1}{8}$ in. p-c board. Molding is glass filled diallyl phthalate per MIL-M-19833, type GDI-30. (432)

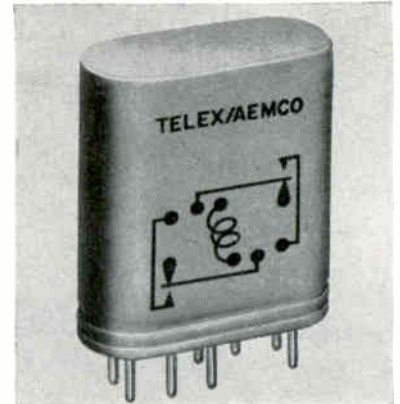

Microminiature Relay Has High Sensitivity

TELEX/AEMCO, 10 state St., Mankato, Minn., announces a 50 mw sensitivity dpdt microminiature relay. Unit will switch 1.0 amp at 30 v d-c resistive. Life of the relay will exceed 100,000 operations at the rated contact load. Meets vibration requirements of MIL-R-5757-D, paragraph 4.7.7.1. Pull-in is 7.1 ma d-c. Also available with 40 mw sensitivity with two form A contacts. (433)

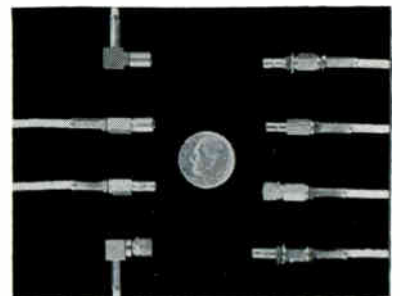

Coaxial Connectors Are 50-Ohm Devices

MICON ELECTRONICS, INC., Roosevelt Field, Garden City, N. Y. Subminiature matched impedance coaxial connectors are available in both straight-through and right angle designs. The connectors whose mating characteristics conform to MIL-C-22557 are the crimp type designed for rapid assembly on cables such as RG174, RG188, and RG196. NEMA voltage rating is 500 v. Flashover at sea level is rated at 2,000 v minimum, and at 70,000 ft 1,000 minimum. They are corona-

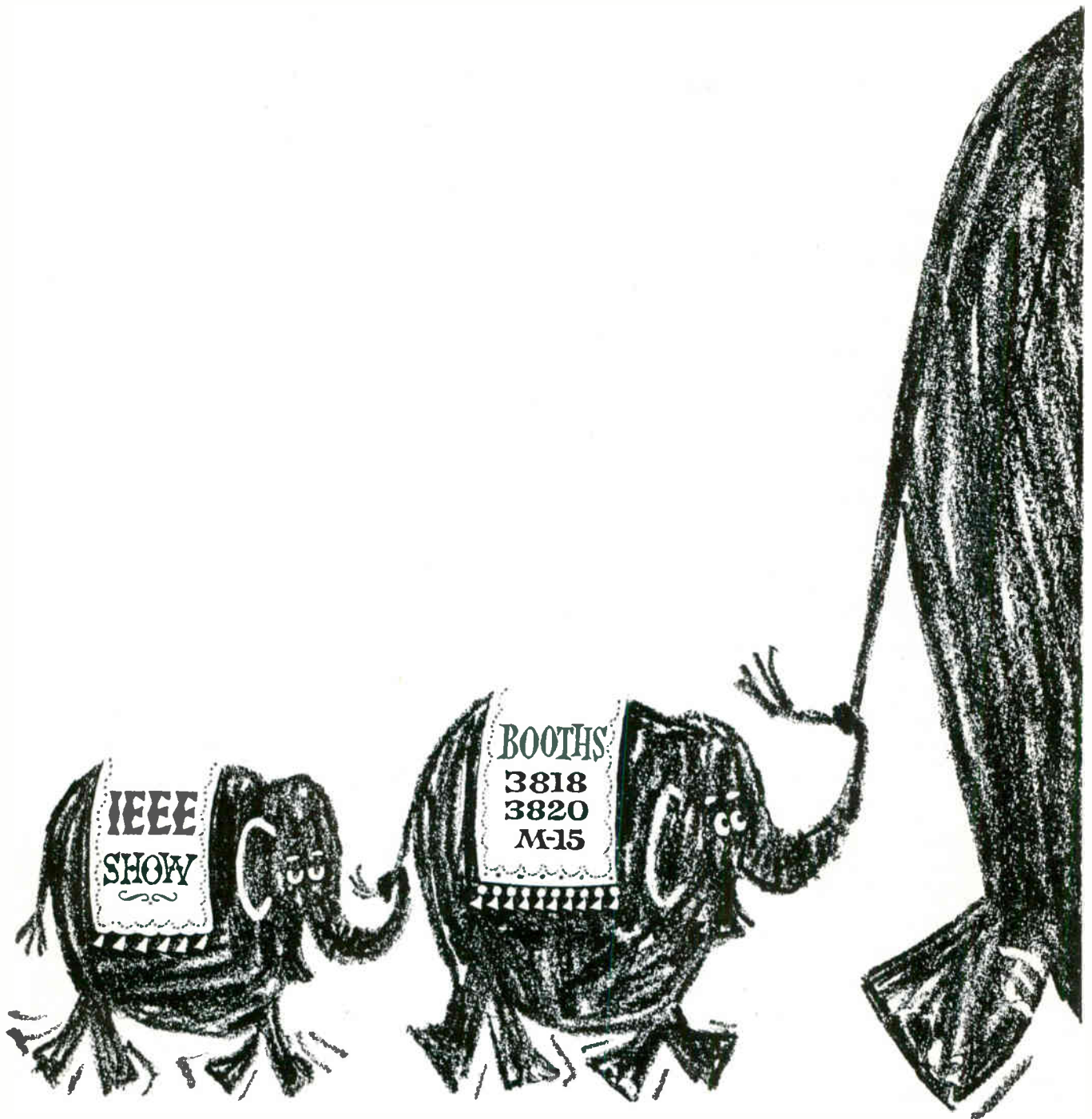

SEE ALL THE NEW PERFORMERS
IN THE **BROADEST BECKMAN LINE EVER!**

NEW YORK CITY...IEEE SHOW...MARCH 25, 26, 27, 28

INTERNATIONAL SUBSIDIARIES: GENEVA, SWITZERLAND; MUNICH, GERMANY; GLENROTHES, SCOTLAND

Beckman[®]

INSTRUMENTS, INC.
BERKELEY DIVISION
Richmond, California

SERIES 1025

This series is the industry's smallest molded coil. Stock values are available from .15 uh through 100 uh (35 values). Available on a custom basis in values up through 1000 uh. Physical size: .100" dia. x .250" lgth. Environmental Conformance: MIL-C-15305 Grade 1 Class B.

SERIES 1330

Similar to Series 1537-700 being a completely shielded coil. It is not molded, but has epoxy end seals. Elimination of the molding achieves some further miniaturization at the expense of environmental protection. Inductance Range: .1 uh through 120,000 uh. Physical Size: .128" dia. x .330" lgth. Environmental Conformance: MIL-C-18305 Grade 2 Class B.

SERIES 1537-700

Features complete electromagnetic shielding — shielding along body and at ends. Completely molded. Inductance Range: 1 uh through 120,000 uh. Physical Size: .156" dia. x .375" lgth. Environmental Conformance: MIL-C-15305 Grade 1 Class B.

SERIES 2531

A semishielded fully molded coil featuring radial leads (at .200" spacing) with inductance values up to 220,000 uh. Physical Size: .250" dia. x .310" lgth. Environmental Conformance: MIL-C-15305 Grade 1 Class B.

Reliability Built into Every Design MICRO-MINIATURE COILS

Through the use of new materials, new designs and new manufacturing methods, Delevan leads the industry in micro-miniaturization offering a line of coils which are superior in every respect. Delevan's precision engineered coil products assure unmatched reliability. Environmental testing of all coil products in Delevan's modern laboratory is continuous to assure conformance to MIL-C-15305C. Design Engineers requiring built in reliability, specify Delevan with confidence. Write for descriptive catalog today.

SEE A REVOLUTIONARY ADVANCEMENT
IN MICRO-MINIATURIZATION AT DELEVAN'S
BOOTH #1437 IEEE SHOW

Delevan 
ELECTRONICS, CORPORATION
A Subsidiary of American Precision Industries, Inc.
270 QUAKER RD. • E3 • EAST AURORA, N. Y.

CIRCLE 170 ON READER SERVICE CARD

**HELP YOUR POST OFFICE
TO SERVE YOU BETTER
BY
MAILING EARLY IN THE DAY
NATIONWIDE IMPROVED MAIL SERVICE
PROGRAM**

free to 1,000 v. Voltage drop does not exceed 5 mv at 1 amp including mating connector.

CIRCLE 434, READER SERVICE CARD

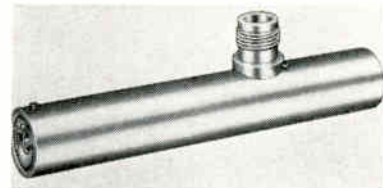

S-Band Oscillator Has 100-W Output

TRAK MICROWAVE CORP., Tampa, Fla., announces an S-band oscillator with a power output of 100 w peak minimum and 150 w typical. Weighing only 3 oz, the type 9186S has a diameter of $\frac{5}{8}$ in. and is 4 in. long excluding projections. Manual tuning range is 2.7 to 3.0 Gc; power input requirements, 1000 v pulse at 0.7 amp peak I_p , 6.3 v at 280 ma. Frequency stability is ± 2 Mc, -20 C to $+70$ C; shock, 100 g, 7 ms, less than 1.0 Mc f-m. Vibration, 15 g, 15-2000 cps, 3 axes, f-m less than ± 1.0 Mc. (435)



Isolators Used With Power Transistors

AUGAT, INC., Attleboro, Mass., announces a line of insulated aluminum isolators for use with TO-3 and TO-36 power transistors. Average thermal resistance values of 0.2C/watt have been attained on an aluminum chassis. Prices run approximately 15 cents each in 1,000 lots. (436)



Miniature Relay Is Shake-Out-Proof

AUTOMATIC ELECTRIC CO., 400 N. Wolf Road, Northlake, Ill. Series EIN will resist normal shock and vibration, yet permit instant re-

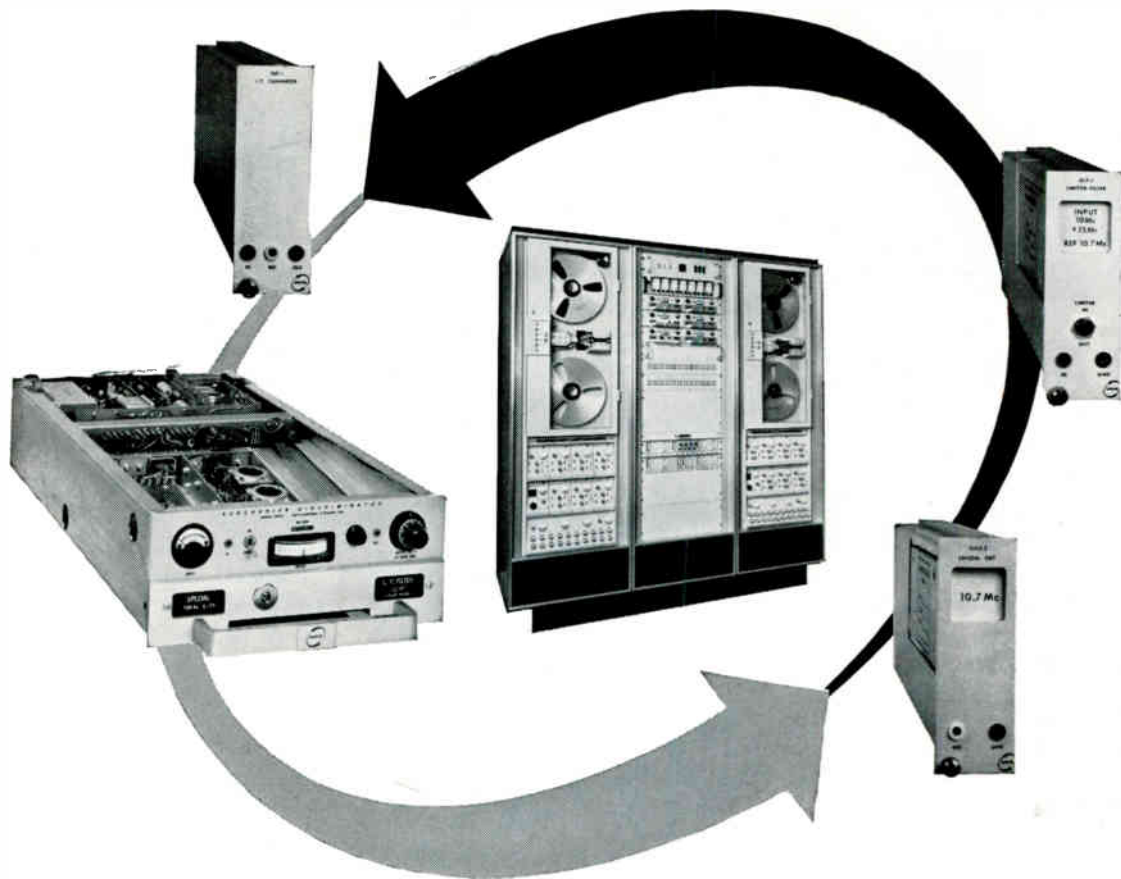

Predetection Recording by DCS gives you these 7 features:

- Best s/n performance • Best transient characteristics
- Up to 800,000 bit/second response • Tape speed compensation
- Off-the-shelf modular flexibility • 100% solid state • Usable with most receivers and recorders

Considering predetection recording? Only DCS can give you *all* these advantages:

First, the phase lock loop design of the GFD-4 Discriminator permits playback at the recorded frequency without incurring the noise and transient degradation typical of up-conversion systems. And in addition, response from DC to beyond that required for 800 Kilo-bit NRZ PCM is provided, for full IRIG requirements.

What's more, DCS has the only system providing tape speed compensation of reproduced data. Components are all solid state . . . modular (just plug 'em in!) . . . and available off the shelf.

Whether you need a complete predetection recording system, or want to build one using your present receiver and recorder (DCS components are compatible with most), DCS can help you.

Write us for complete information. Address: Dept. E-7-2.

DATA-CONTROL SYSTEMS, INC.
Instrumentation for Research

Los Angeles • Santa Clara • Wash., D. C. • Cape Canaveral

Home Office: E. Liberty St., Danbury, Conn. • Pioneer 3-9241



2114 meet accepted IRIG instrumentation standards, have record/reproduce amplifiers on same card, use interchangeable p-c plug-ins for direct and f-m recording, and for seven channels occupy only 31 in. of panel space. System specs include speeds of $\frac{1}{8}$, $\frac{1}{4}$, $\frac{3}{8}$, $\frac{7}{8}$, 15, 30 and 60 ips; nonlinearity less than ± 0.5 percent on d-c, ± 1 percent on a-c; 1 percent system accuracy; 100-100,000 cps direct record bandwidth, d-c to 10,000 cps f-m bandwidth. (442)

Delay Network Housed in Small Case

ESC ELECTRONICS CORP., 534 Bergen Blvd., Palisades Park, N. J. Model 52-77 provides a total delay time of 24.65 μ sec with taps every 1.45 μ sec. The unit, housed in a case only 4.25 in. by 2 in. by 1 in., has a tolerance of ± 0.05 μ sec. Characteristic impedance is 470 ohms. Attenuation is 7.5 db max. Terminating resistance is 470 ohms. (443)

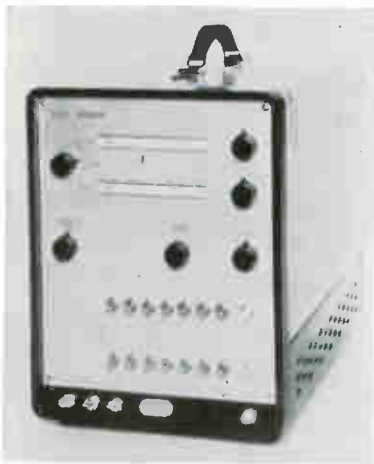

Sweep Generator for F-M System Checkout

TELONIC INDUSTRIES, INC., 60 N. First Ave., Beech Grove, Ind., offers a sweep generator capable of providing complete checkout of signal response of f-m receivers in production and inspection. A switch on the front panel selects oscillators for either the i-f or r-f bands each having separate attenuator systems and output connectors. This allows r-f, local oscillator, and i-f adjustments to be made in a suitably equipped test fixture without re-

Introducing **MICROBOND** THIN FILM WELDER AND MICROPOSITIONER



SPECIFICATION HIGHLIGHTS

Welding Capability

Wire size: .0005 to .005 in. dia.
Ribbon size: .0005 x .0025 to .004 x .020 in.
Film thickness: 500 to 5000 Å.

Electrical

Weld power: 3 sequential cycles, each independently controllable for weld pulse duration and amplitude.
Cycle durations (each): 5-100 milliseconds.
Cycle amplitudes (each): 1.35 to 24C watts.
Total power input to weld: .02 to 72 watt-sec.

For detailed specifications including optional features, price and delivery, write Weldmatic, 950 Royal Oaks Drive, Monrovia, California.

WELDMATIC DIVISION / UNITEK

Rely on **ROHN**

for TOWERS, TOWER SYSTEMS, MICROWAVE PASSIVE REFLECTORS, LIGHTING EQUIPMENT and ACCESSORIES

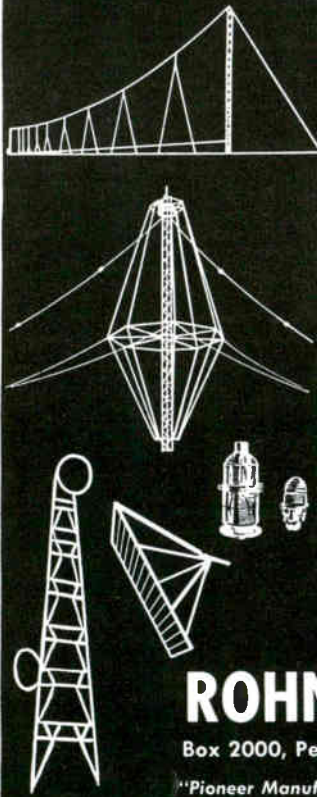

ROHN is the largest company of its kind exclusively manufacturing communication towers and allied equipment. They can supply a wide range of both guyed and self-supporting towers from all heights up to 800'. They have available engineering and manufacturing facilities for special tower systems and complete engineering and design services. Also ROHN makes microwave passive reflectors and complete tower lighting equipment. So whether it's a single tower or a complete communications system, contact ROHN for dependable and reliable equipment and service.

ROHN Manufacturing Company

Box 2000, Peoria, Illinois • Phone 309-637-8416

"Pioneer Manufacturers of towers of all kinds—Representatives world-wide"

CIRCLE 306 ON READER SERVICE CARD

connecting cables or changing input signal levels. Crystal-controlled pulse markers, at customer-specified frequencies, are included as standard equipment. Five markers are provided on the 98 Mc band and three on the 10.7 Mc band. Accuracy is typically 0.01 percent.

CIRCLE 444, READER SERVICE CARD

Amplifiers

INSTRUMENTS FOR INDUSTRY, INC., Hicksville, L. I., N. Y., offers a new 45 Mc phase matched transistorized i-f amplifier, a commercial super-video amplifier a 30 Mc log amplifier, and a portable communications, navigations and interrogations unit which is also suitable for general laboratory and production line testing. (445)



UHF Octave Amplifier Comes in Two Models

COMMUNITY ENGINEERING CORP., 234 E. College Ave., State College, Pa. Models 1033 and 1035 together cover frequencies from 250-1,000 Mc. Model 1033, 250-500 Mc, has a noise figure of 7 db max. Model 1035, 490-1000 Mc, a noise figure of 10 db max. Each is made up of two identical amplifiers each supplied with its own solid state power supply. Each amplifier module has a gain of 18 db nominal. Band flatness is ± 0.5 db for the 1033 and ± 1 db for the 1035. Impedance in and out is 50 ohms with a vswr of 1.75:1 max. (446)

Fasteners Feature Concealed Heads

PENN ENGINEERING & MFG. CORP., Box 311, Doylestown, Pa., offers a new concept in fastener mounting—concealed-head studs and stand-offs which make it possible for the designer to achieve undistorted exterior panel surfaces. Concealed-

for maximum **DEPENDABILITY...**
longest **LIFE...**
highest **STABILITY...**



ALL-CERAMIC KLYSTRONS

Rugged, all-ceramic VELOCITRONS® (reflex klystrons) for CW, FM or pulse operation in an external cavity. Maximum resistance to mechanical shock and vibration, and to thermal stress. Operate to 250°C seal temperature **without cooling**. Add a new margin of reliability to precision instruments, mobile communications, unattended installations. Five types cover 0.5—11.0 KMC. Typical output, 100-250 MW.

Call your POLARAD Field Engineer for prompt, informed assistance!



POLARAD

ELECTRONIC INSTRUMENTS

A Division of Polarad Electronics Corporation

World Leader in Microwave Instrumentation

34-02M Queens Blvd., Long Island City 1, New York

POLARAD

IEEE Booths No. 3205-3211

UNIQUE

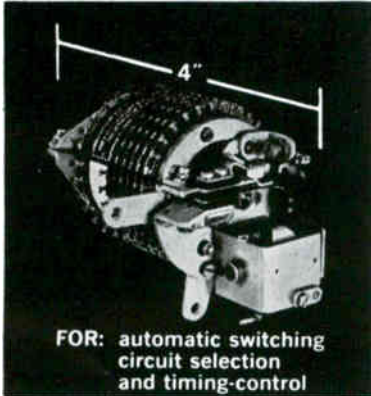

The
Genalex
Miniature
High-Speed
Stepping Switch

FEATURING: 80 steps per second on impulse drive **30** contacts per bank **12** banks maximum **17** oz. light-weight **7** levels sequence switching.

Over 5,000,000 Steps Without Replacements

Write today for complete data — Also, data available on Genalex one-way and two-way stepping switches.



11 UNIVERSITY ROAD, CAMBRIDGE 38, MASS.

U. S. AGENTS FOR THE GENERAL ELECTRIC COMPANY, LTD. OF ENGLAND

CIRCLE 307 ON READER SERVICE CARD

WHAT
do you want
lacing cords and tapes
to do for you?

- Tie faster, easier, tighter!
- Knots that don't slip!
- Greater stability under high heat!

**HEMINWAY
& BARTLETT**

NYLON and DACRON CORDS and FLAT BRAIDED TAPES

give you all these advantages

In addition — they meet Govt. Spec. MIL T-713B.
Available in wax-coated, wax-free or "G. E." Finish.

Write for free samples

THE HEMINWAY & BARTLETT MFG. CO.

Electronics Division: 500 Fifth Avenue, New York 36, N.Y.

CIRCLE 308 ON READER SERVICE CARD

electronics • March 15, 1963

NEW FROM NORTHEASTERN!



Compact 25 MC Solid State Counter

**Features Time
Interval Measurement**

Northeastern's Model 40-81 meets the demand for a low 5¼" panel height, 8 digit in-line presentation, fully solid state 25MC counter which features Time Interval Measurement in the basic unit as well as frequency, period and ratio. Remote operation and programmability are included features.

Specifications:

Frequency Measurement Range...
0 to 25 MCs
Standard Gates Times...
1 μ sec to 10 sec
in decade steps
Period Measurement Range...
(single) 0 to 1MC
(multiple) 0 to 300 KC
Time Interval Range...
1 μ sec to 10⁹ sec
(digit capacity)
Stability... ±7 parts in 10⁹/day
(averaged over 7 days)
Temperature... -20°C to +65°C
Power...
115 VAC ±10%, 50-60 Cps.
Dimensions...

Basic Unit

12" W x 15½" D x 5¼" H

w/rack mount

14" W x 15½" D x 5¼" H

w/plug in

17" W x 15½" D x 5¼" H

w/plug in & rack mount

19" W x 15½" D x 5¼" H

Weight... 28 pounds

w/plug-in hardware... 33 pounds

BOOTH 3226

IEEE SHOW

**NORTHEASTERN
ENGINEERING INCORPORATED**

A SUBSIDIARY OF ATLANTIC RESEARCH CORPORATION
DEPARTMENT 4-A, MANCHESTER, NEW HAMPSHIRE

Employment Opportunities Open At All Levels

CIRCLE 175 ON READER SERVICE CARD

175

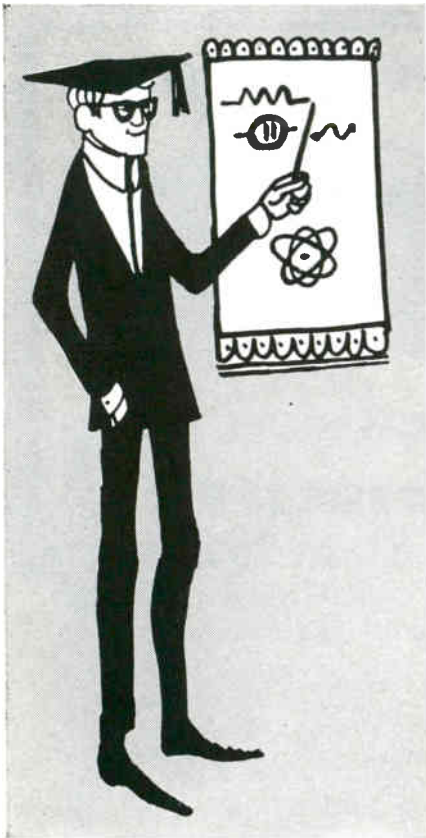

adaptability

(of a triple-A work force)

Electronics firms locate and expand in WESTern PENNSylvania because of a triple-A work force: Available . . . Adaptable . . . and with a good Attitude. For example—one company, as a result of only one help-wanted ad, obtained 500 job applicants; another firm traveled 20,000 miles before it found its needs satisfied in WESTern PENNSylvania. This triple-A work force has the ability to be readily trained in the skills YOU need and at no cost to you through Pennsylvania's unique pre-production training program. This adaptability . . . plus a favorable tax climate . . . plus 100% financing of industrial plant space gives WESTern PENNSylvania a top combination of plant location values. Learn more—write, wire or call collect.

WEST PENN POWER

an operating unit of ALLEGHENY POWER SYSTEM



INDUSTRIAL SHELL BUILDINGS available at \$2.95 to \$3.25 a sq. ft. can be completed to your specs in 60-90 days.

WEST PENN POWER Phone: TEmple 7-3000
Area Development Department (Area Code 412)
Greensburg, Pennsylvania E 3-10-3

Please send me data on: Labor Availability Pre-production Training Favorable Tax Climate 100% Industrial Plant Financing Industrial Properties

Name _____

Title _____

Company _____

Address _____

City _____ Zone _____

State _____ Phone _____

head stud is available in seven thread-diameter choices ranging from 4-40 to $\frac{1}{8}$ -18. Six lengths of stud shanks are from $\frac{3}{8}$ in. to 1 $\frac{1}{4}$ in. Concealed-head standoff is available with range of thread sizes from No. 4-40 to $\frac{1}{4}$ -20, and in eight lengths from $\frac{1}{8}$ in. to 1 in.

CIRCLE 447, READER SERVICE CARD



Solder Pot Heats Rapidly

ORYX CO., 13804 Ventura Blvd., Sherman Oaks, Calif., introduces a miniature quick-heating solder pot. Designed for a variety of production line and laboratory applications, the pot has a capacity of 2 $\frac{1}{2}$ cc. In addition to obvious use in tinning wires and leads of miniature electronic components, the pot may be used to heat waxes, shelsacs, and potting compounds. Pot operates directly from 115 v a-c or d-c. Power consumption is approximately 15 w. Operating temperature is 550-600 F. Heating time is 4 minutes. (448)



Damping Compounds Are Visco-Elastic

LORD MFG. CO., Erie, Pa. DC-322 is a controlled visco-elastic material that may be applied to virtually any structural configuration — hori-

IEEE BOOTH
3701-3-5

new

UNIVERSAL BRIDGE

TRANSISTORIZED PORTABLE

\$375



Model 2700

RANGES:

C: 0.5pF to 1100 μ F

L: 0.3 μ H to 110 H

R: .010 Ω to 11 M Ω

ACCURACY: $\pm 1\%$

FREQUENCY:

Internal 1kc

External 20cps to 20kc

ALSO MEASURES:

Incremental 'L'

Incremental 'R'

'C' with bias

Write
for detailed
catalog sheet.

MARCONI INSTRUMENTS

DIVISION OF ENGLISH ELECTRIC CORPORATION
111 CEDAR LANE • ENGLEWOOD, NEW JERSEY
Main Plant: St. Albans, England

CIRCLE 309 ON READER SERVICE CARD

March 15, 1963 • electronics

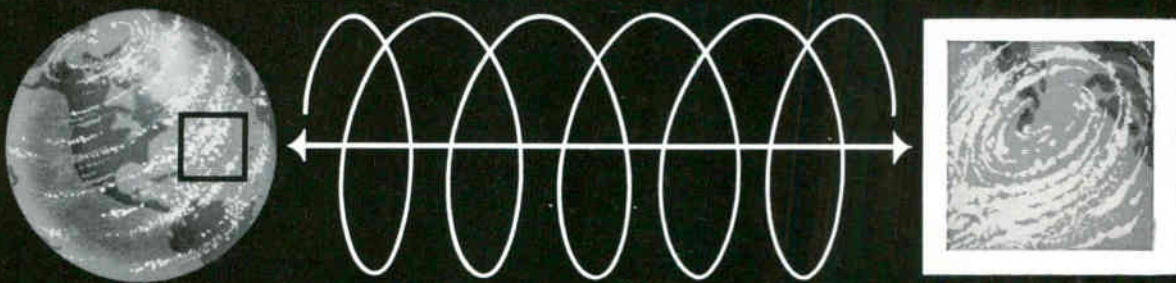

A MILLION MILES OF WEATHER AT A GLANCE

A significant experiment is rapidly drawing to a climax. Soon a weather satellite will go into polar orbit carrying an Automatic Picture Transmission System (APT). As the satellite orbits the Earth it will continually photograph the cloud cover below and transmit pictures to a number of new low-cost ground stations scattered around the world. Through these stations for the first time, local weathermen will see millions of square miles of the Earth's weather at a glance. Remote ocean, desert and mountain areas, oftentimes the breeding ground for the most devas-

tating storms, will be subjected to regular surveillance. This new approach to weather analysis will probably undergo preliminary tests using the Tiros satellite in the middle of the year. Toward the end of the year, the Nimbus satellite for which the system was designed, will be launched. Fairchild Stratos-Electronic Systems Division has developed and is producing APT ground stations under the technical direction of NASA's Goddard Space Flight Center. For more information, on this system, contact our Director of Customer Relations.

When there's a need to know: Fairchild Stratos-Electronic Systems Division capabilities are best reflected in an integrated approach to data requirements. Extensive experience in acquisition, processing, transmission and display has given FS-ESD engineers a particularly sensitive awareness of both final information needs and the many subsystems required to answer them. • For knowledgeable engineers interested in career opportunities in advanced data techniques, may we

suggest a note to our Director of Industrial Relations for the brochure "Grow Your Own Future". FS-ESD, an equal opportunity employer.

FAIRCHILD STRATOS
 ELECTRONIC SYSTEMS DIVISION
 WYANDANCH, LONG ISLAND, NEW YORK

**NOW
YOU CAN BUILD
A FINE
Schober Organ
FOR ONLY
\$550**



You can assemble this new Schober Spinet Organ for \$550 — or half the cost of comparable instruments you have seen in stores. The job is simplicity itself because clear, detailed step-by-step instructions tell you exactly what to do. And you can assemble it in as little as 50 hours.

You will experience the thrill and satisfaction of watching a beautiful musical instrument take shape under your hands. The new Schober Electronic Spinet sounds just like a big concert-size organ — with two keyboards, thirteen pedals and magnificent pipe organ tone. Yet it's small enough (only 38 inches wide) to fit into the most limited living space.

You can learn to play your spinet with astounding ease. From the very first day you will transform simple tunes into deeply satisfying musical experiences. Then, for the rest of your life, you will realize one of life's rarest pleasures — the joy of creating your own music.

For free details on all Schober Organs, mail the coupon now. No salesman will call.

THE *Schober Organ* CORPORATION

43 West 61st Street, New York 23, N. Y.
Also available in Canada and Australia.

MAIL THIS COUPON TODAY

The Schober Organ Corporation
Dept. EL-5
43 West 61st Street
New York 23, New York

- Please send me FREE booklet and other literature on the Schober Organs.
- Please send me the Hi-Fi demonstration record. I enclose \$2 which is refundable when I order my first kit.

Name.....

Address.....

City..... Zone... State.....

zontal, vertical or overhead; flat, curved or irregular—to provide additive damping. Available in cured sheets, bonded structural components or in uncured two-part kits, it makes possible predictable structural response in components and systems. The material affords good damping over a wide frequency range from 50 to 11,000 cps.

CIRCLE 449, READER SERVICE CARD



Metal Foils for R-F Shielding

EMERSON & CUMING, INC., Canton, Mass. Low-cost r-f shielding method provides -100 db enclosures. System centers around the application of specially developed metal foils, Eccoshield WP, in new construction, or for making existing structures into high-performance r-f shielded areas. Conductive adhesive and caulking compounds are used in applying the shielding panels and in rendering all seams and joints r-f tight. Eccoshield WP is installed by stapling and/or bonding to walls, ceiling and floor. Price of the various types of foil ranges from \$1 to \$3 per sq ft in quantities over 100 sq ft. (450)



Four-Terminal Bridge Has Extended Range

ANGSTROHM PRECISION INC., 7341 Greenbush Ave., W. Hollywood, Calif. A direct reading percent deviation principle four terminal extended range Wheatstone-Kelvin bridge covers the ranges from 0.0001 ohm to 10¹¹ ohms with self-contained accuracies of 0.01 per-

**LET US
HELP YOU
CUT COSTS!**

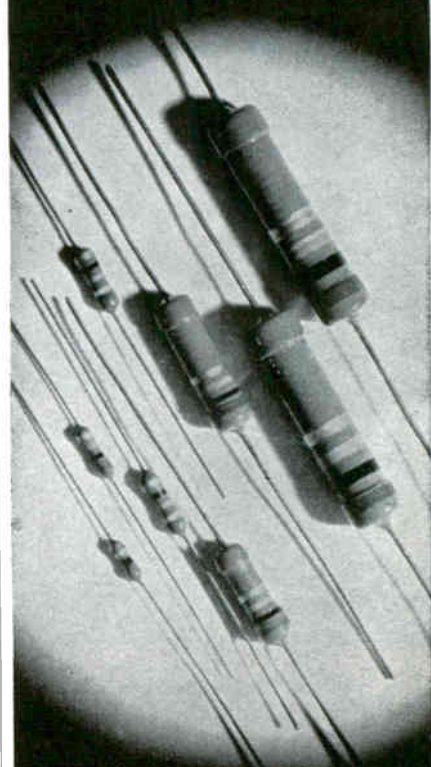

CARBON FILM RESISTOR

Rohm

**TOYO
ELECTRONICS
INDUSTRY
CORPORATION**

P. O. BOX 103 CENTRAL
KYOTO JAPAN

CIRCLE 310 ON READER SERVICE CARD
March 15, 1963 • electronics

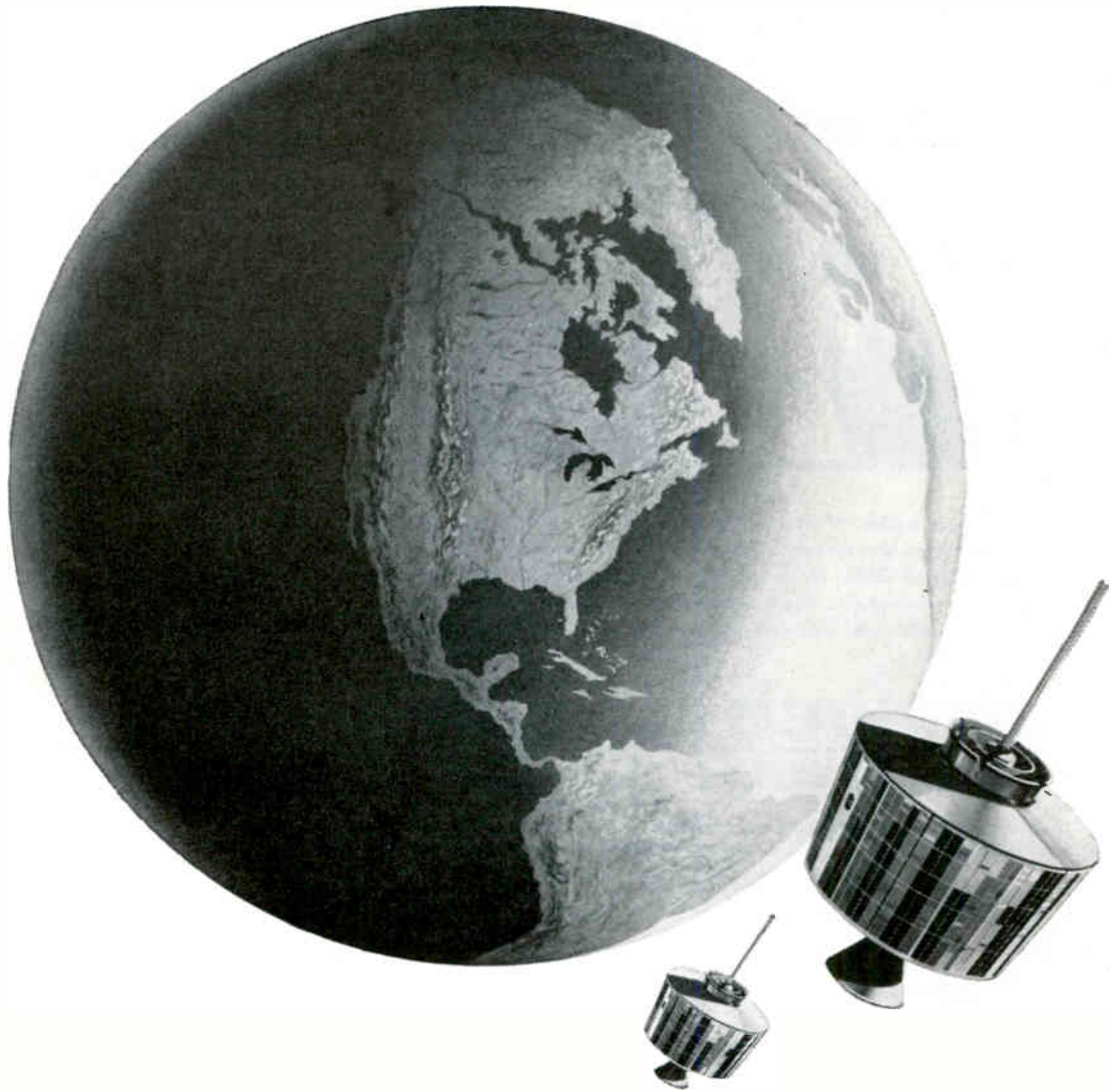

circuit designers...is your appointment in space with Hughes?

Today, Hughes is one of the nation's most active space/electronics firms. Projects include: MMRBM (Mobile Mid-Range Ballistic Missile—Integration, Assembly & Checkout), TFX(N) Electronics, SURVEYOR, SYNCOM, VATE, BAMBI, POLARIS guidance and others.

This vigor promises the qualified engineer or scientist more and bigger opportunities for both professional and personal growth.

Many immediate openings exist. The engineers selected for these positions will be assigned to the following design tasks: the development of high power airborne radar transmitters, the design of which involves use

of the most advanced components; the design of low noise radar receivers using parametric amplifiers; solid state masers and other advanced microwave components; radar data processing circuit design, including range and speed trackers, crystal filter circuitry and a variety of display circuits; high efficiency power supplies for airborne and space electronic systems; telemetering and command circuits for space vehicles, timing, control and display circuits for the Hughes COLIDAR* (Coherent Light Detection and Ranging).

If you are interested and believe that you can contribute, make your appointment today.

Please airmail your resume to:

Mr. Robert A. Martin
Head of Employment
Hughes Aerospace Divisions
11940 W. Jefferson Blvd.
Culver City 11, California

We promise you a reply within one week.

Creating a new world with electronics

HUGHES

HUGHES AIRCRAFT COMPANY

AEROSPACE DIVISIONS

An equal opportunity employer.

FREDDY

by *RUPE*



Don't argue with him, Freddy, he may be right. That's one measurement we've never checked! But that's about the only one we haven't used in assuring the quality of REEVES-HOFFMAN CRYSTALS for standard and precision applications for commercial and military requirements. See for yourself. We've printed specifications concerning both the "milk" and "cream" of our crystal production in bulletin QCI. Write for your copy today.



REEVES-HOFFMAN
CARLISLE, PENNSYLVANIA

DIVISION OF DYNAMICS CORPORATION OF AMERICA

PRODUCERS OF PRECISION
FREQUENCY CONTROL DEVICES...
crystals • crystal-controlled
frequency sources, standards,
filters • component ovens.

CIRCLE 311 ON READER SERVICE CARD

Do you solder ... THIN FILMS ?
... DOT MODULES
... MICROELECTRONICS

HEXAACON HORNET - is your iron!

- SMALLEST IRON - ONLY 5 7/8"
- SMALLEST TIP DIAMETER - 1/32"
- SHORTEST DISTANCE FROM WORK - 1 15/16"
- LOWEST WATTAGE - 12 WATTS
- HOT TIP GETS IN AND OUT FAST
- NO DAMAGE TO INSULATION
- FASTEST WORKING TEMPERATURE
- LIGHTWEIGHT

SEE
BOOTH
4002
I.E.E.E.
SHOW

DUROTHERM Non-Freezing Long-Life Tips
1/32", 1/16", 1/8"

Gets into tight places. Plastic handle, cooled thru ventilated design and concave stainless steel which reflects heat away from hand.

HEXAACON ELECTRIC COMPANY
130 West Clay Avenue, Roselle Park, New Jersey

MODEL H10
12 Watts
115 Volts AC-DC



SERVING INDUSTRY AND CRAFTSMEN FOR OVER THIRTY YEARS

cent and transfer accuracies of 0.0001 percent. Design features include: a 1,000 division deviation range which permits direct reading at options of either 0.01, 0.001 or 0.0001 percent per division; a system for compensation for residual resistance on the rheostat; first step double-wattage (4 w) resistors in all decades.

CIRCLE 451, READER SERVICE CARD

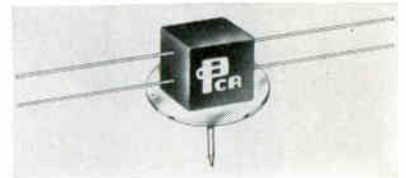

Pulse Transformer Enclosed in Epoxy

PCA ELECTRONICS, INC., 16799 Schoenborn St., Sepulveda, Calif., offers a subminiature RX molded pulse transformer designed in a cube-type configuration. Length of each side: only 0.300 in. Designed for installation in a wide variety of transistorized circuits where space is critical, these compression molded pulse transformers, enclosed in flame-proof epoxy, are all same size. Price is \$3.20 each in lots of 1,000. (452)

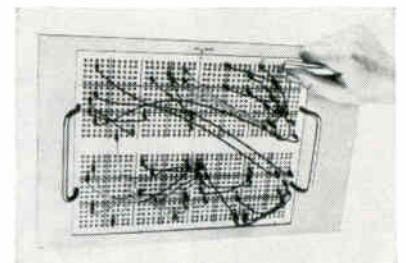

Patchboard Offered in 1200 Contact Size

VECTOR ELECTRONIC CO. INC., 1100 Flower St., Glendale 1, Calif. A 1200 contact size pre-programming patchboard is offered for computer, systems, and test equipment manufacturers. It features a rear contact design that allows solderless slip-on wiring connections. The slip-on contact slides onto the contact pins at the rear of the patchboard, making an extremely low resistance connection which can be readily changed if required. The slip-on contacts can be readily

crimped to leads with a hand pliers, or automatic crimping equipment. The same rear contact can also be soldered if desired. (453)

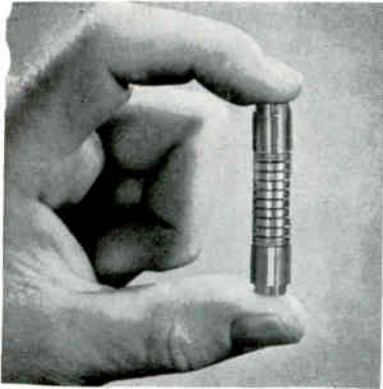

Mechanical Filter for Upper Sideband

COLLINS RADIO CO., 19700 San Joaquin Rd., Newport Beach, Calif., offers an upper sideband mechanical filter built to meet rigid missile telemetry specifications. Composition of the ferrite transducer has been modified, further increasing the mechanical strength of the filter and reducing insertion loss. Another benefit of the new ferrite transducer is a reduction in pass-band ripple. New metallurgical treatment of the nickel-alloy disks which serve as the filter's resonant elements reduce drift to less than 1 part per million per deg C over a temperature range of -25 C to +85 C. (454)



Power Supplies Are Modular Type

HARRISON LABORATORIES, 45 Industrial Road, Berkeley Height, N. J. The 6340 series modular power supplies is designed to meet both the need for a well-regulated, inexpensive chassis-mounting supply and the need for a line of supplies of low power rating capable of being efficiently grouped on rack panels. Both load and line regulation are less than 3 mv or 0.02 percent,

DIGITAL VOLTMETER AT LOWEST COST



base price \$287⁵⁰

portable style - series "200"

36 standard models

FEATURING:

- Choice of 0.1% or 0.2% Full Scale accuracy.
- .025% Resolution and Readability.
- Readings from .0001 to 1000. V-DC.
- Reliable transistorized circuit.
- Bi-Directional Tracking—without flicker.
- Floating or grounded input.
- 1-Year guarantee.
- Individually calibrated and certified.
- Specific variations to your OEM requirements.

Flange Style - Series "220"



Rack Style - Series "210"



Stocking Distributors throughout United States & Canada. Write or Wire for Demonstration.



UNITED SYSTEMS CORPORATION
918 Woodley Road, Dayton 3, Ohio

CIRCLE 181 ON READER SERVICE CARD



Your electronics BUYERS' GUIDE should be kept in your office at all times—as accessible as your telephone book.

NEW DIMENSIONS IN RELIABILITY

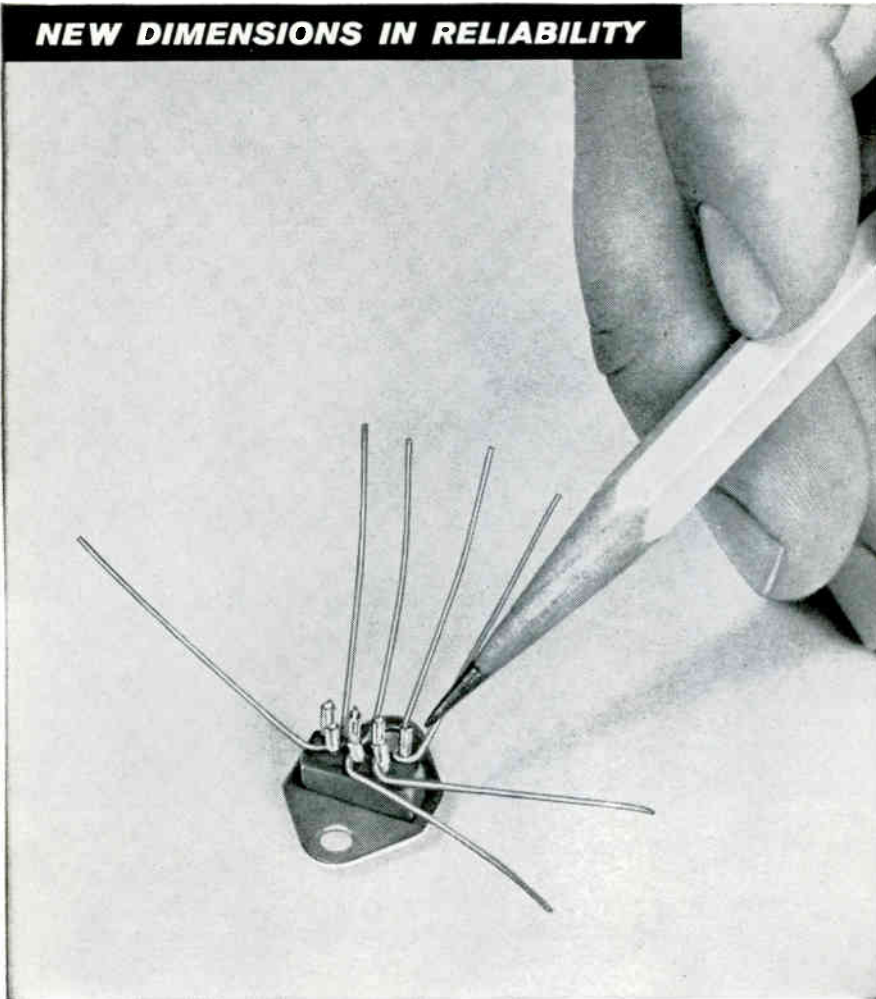

Wire miniaturized components with Wire-Wrap[®] tools

Now you can wire miniaturized components with Gardner-Denver "Wire-Wrap" tools. Use wire as fine as 30 or 32 gauge. Connections with 32-gauge wire are possible on $\frac{1}{10}$ " modular spacings—permitting at least 100 terminals per square inch. All you need is a newly designed bit and nosepiece which fit on present battery-powered or other "Wire-Wrap" tools.

All Gardner-Denver Wire-Wrap tools are simple and easy to use. Permanent connections are made fast—in only 3 seconds to be exact. They end failure headaches. These tools are rapidly—and understandably—replacing less reliable methods.

Proof? Fifteen billion solderless wrapped connections; not one reported failure. Get further proof.

Write for Bulletin 14-1 today.



EQUIPMENT TODAY FOR THE CHALLENGE OF TOMORROW

GARDNER - DENVER

Gardner-Denver Company, Gardner Expressway, Quincy, Ill.—Offices in U.S., Canada, Mexico
In Canada: Gardner-Denver Company (Canada) Ltd., 14 Curity Ave., Toronto 16, Ontario.
International: Gardner-Denver International Division, 233 Broadway, New York 7, N.Y.
Offices: Buenos Aires, Argentina; Artarmon, N.S.W., Australia; Brussels, Belgium; Rio de Janeiro, Brazil; Santiago, Chile; Barranquilla, Colombia; Lima, Peru; Ndola, N. Rhodesia; Salfisbury, S. Rhodesia; Stockholm, Sweden; Johannesburg, Transvaal

whichever is greater, and ripple and noise is less than 1 mv rms for any combination of line voltage, output voltage and load current. Operating temperature range is 0 to 50 C and temperature coefficient is less than 0.033 percent plus 2 mv per deg C. Prices range from \$120 to \$225.

CIRCLE 455, READER SERVICE CARD



Broadband Oscillator Is Highly Stable

LFE ELECTRONICS, 1079 Commonwealth Ave., Boston 15, Mass. Model 831-X-1 is continuously tunable over the 8.2 Gc to 12.4 Gc bandwidth. It achieves long-term stability of one part in 10^6 per hr and short-term stability of two parts in 10^7 over a 20 Kc disturbance band. It features provision for electronic sweeping by an external sawtooth. Start of each sweep is determined by the main dial setting. Sweep width is controlled by a front-panel dial calibrated from 100 Mc to 4.2 Gc. Sawtooth signals from an oscilloscope can be used to synchronize the output of the 831 to provide a calibrated swept signal. (456)

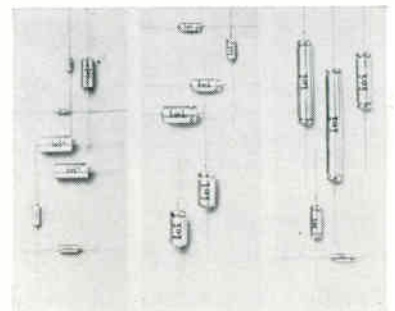

Tantalum Capacitors Offered in 3 Types

INTERNATIONAL ELECTRONIC INDUSTRIES, Box 9036, Melrose, Nashville, Tenn., announces three new miniature tantalum electrolytic capacitor lines. They are comprised of high reliability dry slug tantalum capacitors with advanced perform-

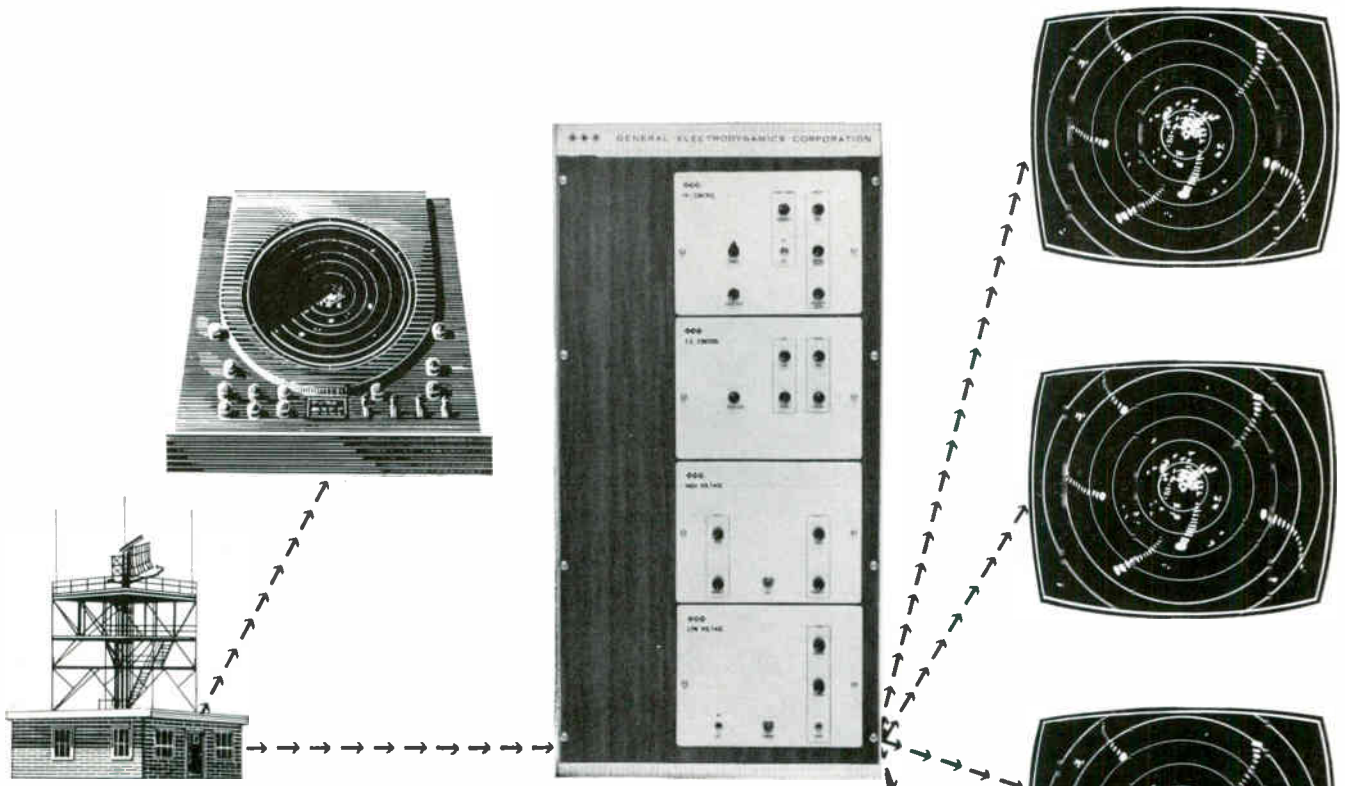

Now Multiple PPI Displays Under High Ambient Light Conditions... With GEC Scan Converter

With GEC's *transistorized* 6021 Scan Converter, it is no longer necessary to look at rapidly decaying PPI displays in dark surroundings. Any number of inexpensive TV monitors can be operated from one PPI source with controlled image storage time affording more reliable evaluation of displayed information.

Readily tailored to your specific requirements through its plug-in functional modules, the 6021 Scan Converter is capable of:

◆◆◆ TRANSLATION of video information from one scanning mode to any other.

◆◆◆ STORAGE and INTEGRATION of video information.

◆◆◆ TIME-COORDINATE TRANSFORMATION for expansion or reduction of bandwidth.

Contact GEC for more information about conversion of radar PPI to TV, TV standards conversion or conversion of slow scan narrow band TV to standard TV or vice versa.

Qualified electronic engineers are needed for work in the field of Scan Conversion. Address inquiries to Professional Placement Manager. An equal opportunity employer.

. . . advanced electronics at work



GENERAL ELECTRODYNAMICS CORPORATION

4430 FOREST LANE • GARLAND, TEXAS • BROADWAY 5-1161

small size...
BIG performance!



**NEW 1/4" round
single turn
MECHATRIM
trimmer potentiometer**

FEATURES:

- infinite resolution
- 200°C temperature performance
- $\pm .015\%$ / ° C temp. coefficient
- 100 megacycle frequency range
- mil spec moisture resistance
- non-wire wound reliability
- limit stops

PHONE OR WRITE FOR DETAILS



**SERVOMECHANISMS/INC.
MECHATROL DIVISION**

NEW YORK - Home Office
1200 Prospect Avenue
Westbury, New York
Area Code 516 - EDgewood 3-6000

CALIF. - (Branch Office) Mechatrol of California
200 North Aviation Boulevard
El Segundo, California
Area Code 213 - ORegon 8-7841

**SEE US AT THE IEEE SHOW
Booth 2316**

ance ratings, a line of wet-slug solid tantalum capacitors and a series of h-v tantalum foil capacitors with rated working voltages to 300 v d-c.

CIRCLE 457, READER SERVICE CARD

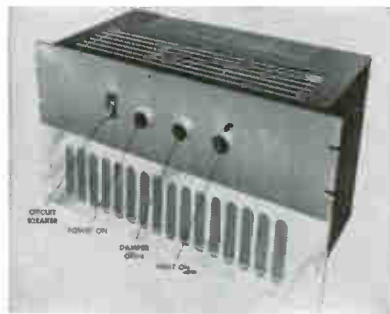

**Heater-Cooler for
Electronic Systems**

MCLEAN ENGINEERING LABORATORIES, P. O. Box 228, Princeton, N. J. This unit will keep an electronic enclosure at an even 65 F with surrounding temperature in still air as low as 10 F. It also will flush and cool electronic cabinets when the remote thermostat indicates that cooling is required. When moderate heating is required, internal dampers are changed to recirculate air within the enclosure without drawing in fresh air. Heat comes from internal electronic units. When substantial heating is required an internal relay energizes a 1,000 w electric heater to maintain a set temperature. The Mil-Spec centrifugal blowers and motors are guaranteed to run continuously for 20,000 hr. (458)



**Round Connectors Have
Grommet Seal Contacts**

WINCHESTER ELECTRONICS, INC., 19 Willard Road, Norwalk, Conn. Series RM-RS connectors meets environmental requirements of MIL-C-26482. They are available in 8, 10, 12, 14, 16, 18, 20, 22 shell sizes.

Preformed
TRADEMARK

**GRID-WIRE
CONNECTORS**

*Fastest to apply...
Lowest installed cost...
No maintenance...
For GRID TYPE ARRAYS*

These unique helically formed connectors are in service on U. S. Government signal installations. For instance, the Tapered Aperture Horn Antenna — TAHA — at LaPlata, Maryland employs over 90,000 PREFORMED Grid-Wire Connectors. They are also used on several Voice of America projects and on rhombic antennas, log periodics, conical monopoles, and horn antennas.

PREFORMED Grid-Wire Connectors are wrapped on by hand; no tools are needed. They provide uniform holding; prevent stress points.

No parts can loosen to create noise. High mechanical strength and electrical conductivity are assured.

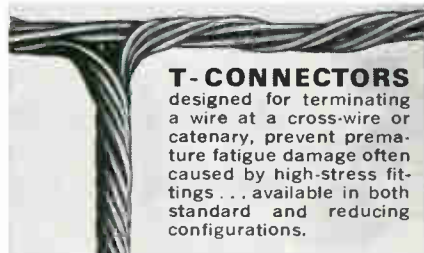

T-CONNECTORS

designed for terminating a wire at a cross-wire or catenary, prevent premature fatigue damage often caused by high-stress fittings... available in both standard and reducing configurations.

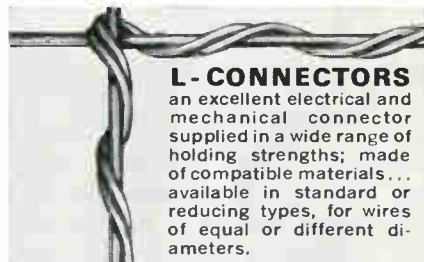

L-CONNECTORS

an excellent electrical and mechanical connector supplied in a wide range of holding strengths; made of compatible materials... available in standard or reducing types, for wires of equal or different diameters.

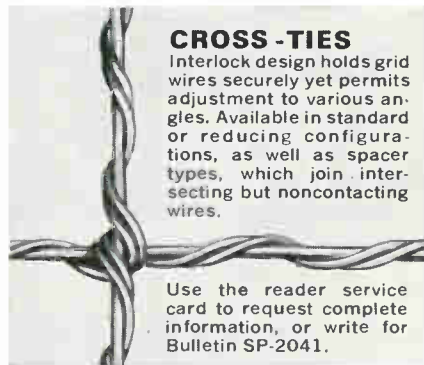

CROSS-TIES

Interlock design holds grid wires securely yet permits adjustment to various angles. Available in standard or reducing configurations, as well as spacer types, which join intersecting but noncontacting wires.

Use the reader service card to request complete information, or write for Bulletin SP-2041.

PREFORMED LINE PRODUCTS CO.



5349 St. Clair Avenue
Cleveland 3, Ohio
881-4900 (DDD 216)
600 Hansen Way
Palo Alto, California
327-0170 (DDD 415)

Made in accordance with U.S. Patent 2,691,865

CIRCLE 312 ON READER SERVICE CARD

March 15, 1963 • electronics

Pin and socket inserts are interchangeable with plug and receptacle shells. Series RM has crimp type contacts; series RS has solder type. Polarization is achieved by shells, with keys and keyways. Contacts are furnished in two sizes: No. 20 Awg, 7.5 amp; and No. 14 Awg, 13 amp. (459)



D-C Power Supplies Feature Compactness

SORENSEN, Richards Ave., S. Norwalk, Conn. Custom specifications have been designed into eight new transistorized d-c power supplies. The low-priced new QB series models provide nominal outputs of 5 to 36 v at 90 or 180 w capacity. They provide regulation of ± 0.01 percent (line and load combined), ripple of only 300 μ v rms and response time of 25 μ sec (typical). (460)

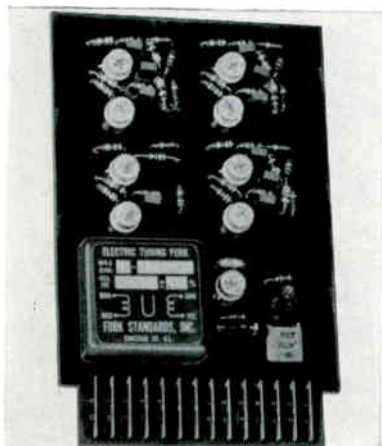

Tuning Fork Oscillator Mounted on P-C Board

FORK STANDARDS, INC., 1915 North Harlem Ave., Chicago 35, Ill., has available a complete tuning fork oscillator built on a printed-circuit board. Accuracy is 0.005 percent at room temperature and 0.010 percent from 0 to 85 C over a frequency range of 60 to 10,000 cps. Output is 3 v rms sine wave or 8 v p/p square



ELECTRONICS

progress in rectifier components

Things You Should See At I Triple E

It's that time of year again. The IEEE (IRE) Show is at the New York Coliseum from March 25 thru 28 (as if you need us to tell you). And this year we're going to continue our tradition of running Application Clinics where you can hear the latest and ask all the questions you want. Etto Von Zastrow will be there, and talking about how one can have equipment failure even with high reliability components. Bill Gutzwiller will speak about phase controlling SCR's in transformer primaries (including three phase trigger circuits). Denis Grafham's subject will be gate circuit design for optimum SCR performance. Keith Howell will give you design tips for the light activated switch, and Neville Mapham will talk about trouble shooting inverters. The place is the Barbizon Plaza. The date is March 27 (Wednesday). The session will run from 9:00 A. M. until noon. You all come.

And while we're talking about Bill G. and his team of imaginative Application Engineers, they've worked out a few new wrinkles to show you at Booth 2902 at the Coliseum. They've put together some operating exhibits to catch your eye, so you ought to see them. They're interesting, entertaining and educational. For example, take a look at this beautifully efficient DC to DC converter. It combines the high efficiency of a switching type regulator with good ripple reduction and the low output impedance of a series transistor regulator.

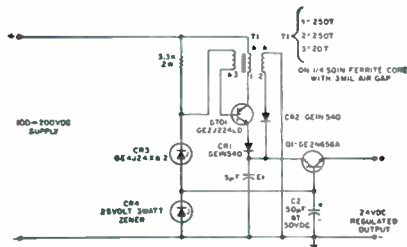

Interesting? The G5 (ZJ224) Gate Turn-Off Switch (GTO) makes it possible, and it converts 100-200 volts DC down to 24 volts of regulated low-ripple direct current. AND, if you drop by the GE Booth at IEEE you can see how it happens. With a twiddle-of-the-knob you can vary raw DC input voltage and load current,

and see how the output voltage remains constant at 24 volts. The points we want to demonstrate, of course, are that the G5 GTO operates directly on a 200 volt line, makes for simple circuitry, has fast switching speed (up to 100 kc) and handles power at least as smoothly as that high megatane rated gasoline you hear so much about on TV. (If you'd like the story on this regulated supply, write us and ask for the note prepared by Denis Grafham. Additional information is available in Application Note 200.23, which gives you a number of circuits ideal for regulated supplies in applications such as computers, test equipment, airborne and missile equipment, and industrial controls, among others.)

Another Thing to See

... at I triple E will be a direct power control with the G-E L7 light activated silicon switch. You'll be able to actuate a motor-driven aperture disc between a miniature incandescent lamp and the L7, trigger a xenon flash tube shining on the same L7, thus directly controlling a 120 volt lamp and an industrial control relay. And with the use of glass fiber to transmit light to the L7, you can trigger the L7, even around corners. If that sounds like a lot, come to Booth 2902 and see. We can prove it. Or if you'd like the whole story about the L7, write us and ask for Application Note 200.29.

A last closing comment: we'll also show you (among other things) how G-E Controlled Avalanche Rectifiers live through reverse voltage transients and also operate in series strings without resistance dividers (whether you like it or not).

Any questions? Write Section 16C102, Rectifier Components Department, General Electric Company, Auburn, New York. In Canada: Canadian General Electric, 189 Dufferin St., Toronto, Ont. Export: International General Electric, 159 Madison Ave., N.Y. 16, N.Y.



GENERAL ELECTRIC

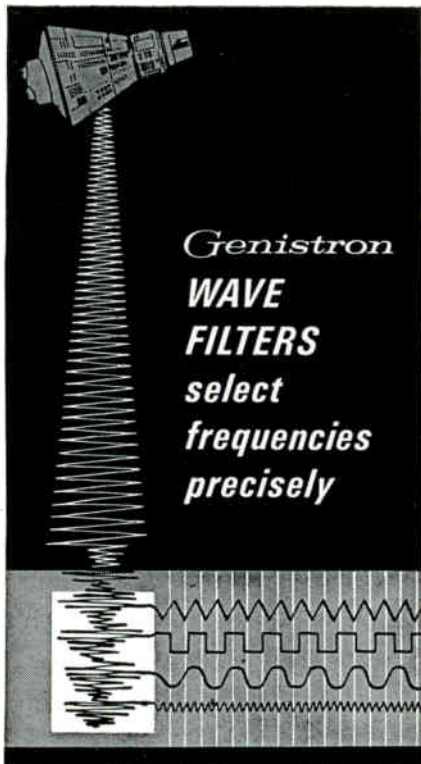

Based upon unparalleled depth of experience in electric wave filter applications across the frequency range of 2 cps to 1 mc... Genistron wave filters are separating and selecting information accurately in the most advanced of today's aerospace instrumentation and communication systems.

Specially designed and manufactured to meet your most exacting requirements, the Genistron wave filter capability extends from low pass, high pass, band pass, band reject and linear phase filters to Gaussian filters for digital type information.

Of particular importance to your equipment design is Genistron's demonstrated ability to miniaturize wave filters yet maintain maximum filtering performance. This is evidenced in wave filters of 1/2 cu. in. as well as those requiring a 120 cu. in. space.

Contact Genistron for an immediate evaluation of your wave filter requirement, or write and ask for data file E-2031-1.

Genistron
INCORPORATED

6320 West Arizona Circle, Los Angeles 45, Calif.
SP 6-1411

111 Gateway Road, Bensenville, Illinois
NA 5-1570

subsidiary of

Genisco
.....

wave with a 10,000 ohm load. Standard board is 3 by 6 by 1/2 in., but the circuit can also be built using the customer's standard sized board and connector.

CIRCLE 461, READER SERVICE CARD

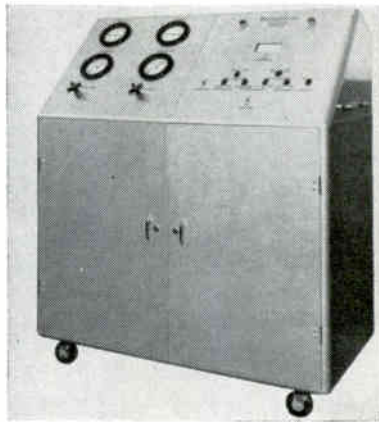

R-F Calorimeter Is Self-Contained

AVNET INSTRUMENT CORP., 91 Commercial St., Plainview, L. I., N. Y. Model HS-12 high power r-f calorimeter, housed in a Widney Dorlec enclosure, is a self-contained portable precision instrument capable of quickly and accurately measuring average, pulsed or c-w, microwave power to 50 Kw. Instrument employs a calibrated constant volume, sealed, distilled water circulating system. (462)

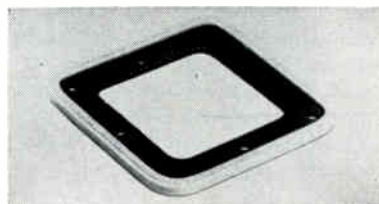

Shielding Material In Three Forms

METEX ELECTRONICS CORP., Walnut Ave., Clark, N. J., offers Polashield, a shielding material that provides both an rfi shield and an integral pressure seal. It is made from thousands of oriented wires that are molded in a matrix of elastomeric material. The wires are aligned perpendicular to the surface of the shield, increasing the insertion loss through the gasket. The material yields an overall sys-

tem attenuation of 125-135 db and has an insertion loss measurement of as much as 100 db. Pressure seals up to 30 psi can be maintained. Polashield is available in three forms: strip, ring and formed gasket. (463)

Programming Switches Are Miniaturized

SEAELECTRO CORP., 139 Hoyt St., Mamaroneck, N. Y., announces miniature programming switches featuring relay-type contacts. These Actan switches are approximately one-third the size of conventional units and utilize a barrel actuator into which activating pins can be inserted to set up the desired sequence of events. A standard switch will offer up to 16-pole, double-throw operation and is also available with as many as 32-poles-double throw. Contact life is claimed to be in excess of 100 million operations. (464)



D-C/A-C Choppers for P-C Board Mounting

STEVENS-ARNOLD, INC., 7 Elkins St., South Boston 27, Mass., offers a-c driven and d-c driven d-c/a-c choppers for printed circuit board mounting. The new models, with twin-contact construction, include all features required for easy mounting, either plug-in or solder-in. For a-c driven applications there are models for 50, 60, 94, and 120 cycles. For d-c applications, company can furnish, for customer convenience, a transistorized driver unit to convert 12 v d-c into 94 cycles square wave a-c to operate the chopper. When user wishes to make a driver unit, company furnishes complete information, circuit diagram, and a parts list. (465)

**PROVEN RELIABILITY—
SOLID-STATE POWER INVERTERS,
over 260,000 logged operational hours—
voltage-regulated, frequency-controlled,
for missile, telemeter, ground support,
135°C all-silicon units available now—**

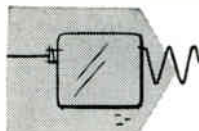
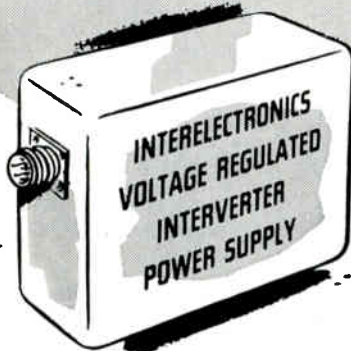

Interelectronics all-silicon thyatron-like gating elements and cubic-grain toroidal magnetic components convert DC to any desired number of AC or DC outputs from 1 to 10,000 watts.

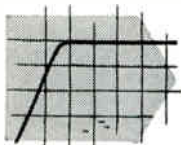

Ultra-reliable in operation (over 260,000 logged hours), no moving parts, unharmed by shorting output or reversing input polarity. High conversion efficiency (to 92%, including voltage regulation by Interelectronics patented reflex high-efficiency magnetic amplifier circuitry.)

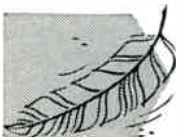

Light weight (to 6 watts/oz.), compact (to 8 watts/cu. in.), low ripple (to 0.01 mv. p-p), excellent voltage regulation (to 0.1%), precise frequency control (to 0.2% with Interelectronics extreme environment magnetostrictive standards or to 0.0001% with fork or piezoelectric standards.)

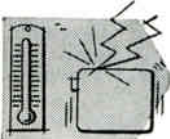

Complies with MIL specs. for shock (100G 11 msec.), acceleration (100G 15 min.), vibration (100G 5 to 5,000 cps.), temperature (to 150 degrees C), RF noise (1-26600).



AC single and polyphase units supply sine waveform output (to 2% harmonics), will deliver up to ten times rated line current into a short circuit or actuate MIL type magnetic circuit breakers or fuses, will start gyros and motors with starting current surges up to ten times normal operating line current.

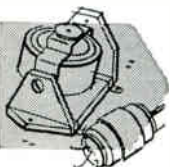

Now in use in major missiles, powering telemeter transmitters, radar beacons, electronic equipment. Single and polyphase units now power airborne and marine missile gyros, synchros, servos, magnetic amplifiers.

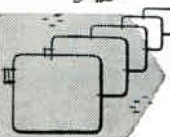

Interelectronics—first and most experienced in the solid-state power supply field produces its own all-silicon solid-state gating elements, all high flux density magnetic components, high temperature ultra-reliable film capacitors and components, has complete facilities and know how—has designed and delivered more working KVA than any other firm!

For complete engineering data, write Inter-electronics today, or call Ludlow 4-6200 in New York.

INTERELECTRONICS CORP.

2432 Gr. Concourse, N. Y. 58, N. Y.

CIRCLE 313 ON READER SERVICE CARD

electronics • March 15, 1963

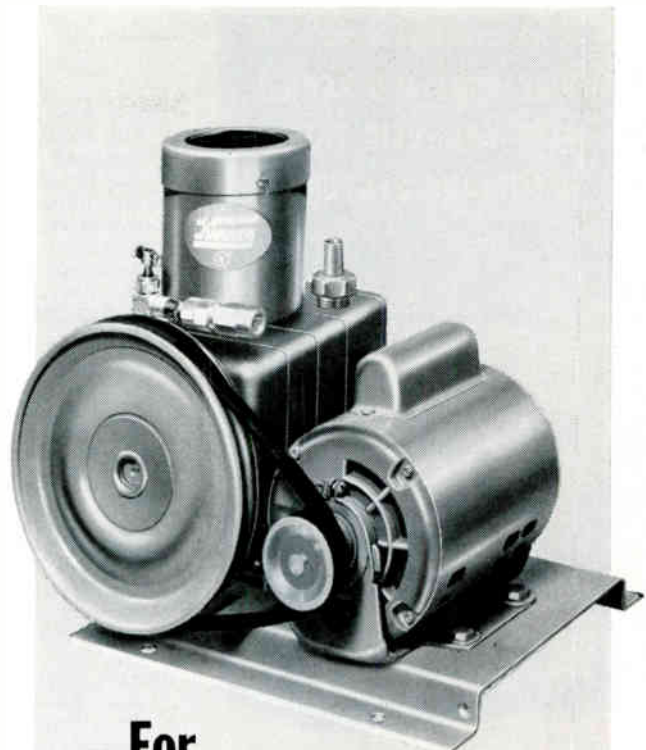

**For
Dependability**

KINNEY COMPOUND HIGH VACUUM VANE PUMPS SERIES KCV

The KCV Series of two-stage, vane-type, compound high vacuum pumps has a range of free air displacements from 2 to 7 cfm and attains ultimate pressures of 0.2 micron. Gas ballasting, a standard feature of all Kinney Pumps, reduces oil contamination and consequent poor vacuum caused by condensable vapors. The series has been developed specifically to provide quiet, vibration-free operation, and includes long-lasting filter elements to eliminate smoke and fumes from the discharge.

KINNEY . . . EVERYTHING IN VACUUM



KINNEY VACUUM DIVISION

The New York Air Brake Company
3529 Washington Street
Boston, Massachusetts

CIRCLE 187 ON READER SERVICE CARD

187

For laboratory or field
research applications

MODEL 700/1400 SERIES NEW MAGNETIC TAPE RECORDING SYSTEMS



ACCURATE ± 0.2 linearity for analog data

FLEXIBLE as many data channels as you need from 2 to 14

COMPACT a 7-channel system fits in less than 2 ft. of rack space

LOW COST modest initial cost, true operating economy

MNEMOTRON NEW MODEL 700/1400 SERIES MAGNETIC TAPE RECORDING SYSTEMS record any electrical quantity from DC up to 5000 cps. A uniquely simple pulse-frequency modulation technique insures that data signal intelligence is free from non-linearity due to tape coating or other distortions.

Select as many data channels as you need, up to 14. Choose the tape format you want— $\frac{1}{4}$ " , $\frac{1}{2}$ " in-line, or standard IRIG. If standardization is desired, simply specify 7 channels on $\frac{1}{2}$ -inch tape in the standard IRIG configuration.

Record/Reproduce electronics for each channel are integrated in a single plug-in module featuring unity gain. An integral speed switch permits selection of data conversion for 2, 3 or 4 tape speeds — no additional plug-ins needed. For maximum flexibility, each multi-channel input is isolated. Data can be accepted from unbalanced, differential or push-pull outputs — or different DC levels on input signal ground returns can be preserved. Test points allow monitoring of input during recording, output voltage level when reproducing.

Write for the pleasant details.

Visit us at Booth 3027 — IEEE Show

MNEMOTRON

Division of
TECHNICAL MEASUREMENT
CORPORATION

Executive Sales Offices:
202 Mamaroneck Ave., White Plains, N.Y.

Literature of the Week

INDUSTRIAL LITERATURE SERVICE McGraw-Hill Book Co., Training Materials & Information Services Div., 330 W. 42nd St., New York 36, N. Y. Brochure describes custom services available, including preparation of technical bulletins, house organs, sales brochures, facility reviews and the like.

CIRCLE 466, READER SERVICE CARD

SSB SPECTRUM ANALYZER Lavoie Laboratories, Inc., Morganville, N. J. A catalog sheet contains advance specifications for the LA-40 single sideband spectrum analyzer with 2-32 Mc range, and the LA-41 two-tone generator. (467)

SOLDERING METHODS Oryx Co., 13804 Ventura Blvd., Sherman Oaks, Calif., has available a technical bulletin on soldering methods and techniques. (468)

DELAY LINES Polyphase Instrument Co., East Fourth St., Bridgeport, Pa. Bulletin 25DL covers nanosecond, microsecond and millisecond delay lines. (469)

PHOTOCONDUCTIVE CELLS Clairex Corp., 8 West 30th St., New York 1, N. Y. A 16-page booklet covers the use of photoconductive cells under various light, circuit and application conditions. (470)

SWITCHING MODULE Vitramon, Inc., P.O. Box 544, Bridgeport 1, Conn. Catalog of 6 pages contains specifications and operating characteristics of VG low level switching module. (471)

MICROWAVE ABSORBERS Emerson & Cuming, Inc., Canton, Mass. Color chart presents performance and physical data on a full line of Eccosorb microwave absorbers designed for "free space" and waveguide applications. (472)

MATERIALS PROCESSING SERVICE Semiconductor Specialties Corp., 252 Garibaldi Ave., Lodi, N. J. Single-page bulletin discusses the company's available service for slicing, lapping, dicing, etching and sizing of materials. (473)

WIRELESS MICROPHONE Bergen Laboratories Inc., 60 Spruce St., Paterson 1, N. J., has published a data sheet describing the Radio-Mike, a professional wireless microphone that requires no trailing cord to the p-a amplifier. (474)

INTEGRATED SERVO ASSEMBLY Daystrom, Inc., Transicoil Division, Worcester, Pa., has published a catalog sheet describing an integrated servo assembly—three components in one housing. (475)

MICROWAVE REFLECTOMETER Parady-namics, Inc., 10 Stepar Place, Huntington Station, L. I., N. Y., has available a comprehensive, illustrated brochure describing the newly developed precision microwave reflectometer. (476)

HIGH-SPEED PRINTER SYSTEM Potter Instrument Co., Inc., East Bethpage Road, Plainview, N. Y. Catalog No. 400-2-1 illustrates and describes the LP-1200, a complete high-speed printer system. (477)

VOLTAGE SURGE PROTECTION International Rectifier Corp., 233 Kansas St., El Segundo, Calif. A 20-page manual, KL-601, provides data on the protection of semiconductors through the use of selenium transient voltage suppressors. (478)

PARAMETRIC AMPLIFIERS Sperry Microwave Electronics Co., P.O. Box 1828, Clearwater, Fla. A 16-page brochure on parametric amplifiers covers design, typical characteristics, structures and systems. (479)

STACK SWITCHES Switchcraft, Inc., 5555 N. Elston Ave., Chicago 30, Ill. Catalog S-308 covers stack switch components and assemblies for the industrial electronic industry. (480)

RESOLVER-AMPLIFIER COMBINATIONS General Precision Aerospace, Little Falls, N. J. Catalog sheet describes size 8 and size 11 winding-compensated resolver-amplifier combinations designed for coordinate chain applications. (481)

CAPACITORS Aerovox Corp., New Bedford, Mass., has issued a bulletin on type V146XR Aerofilm Wrap & Fill Mylar capacitors. (482)

PRECISION POT Giannini Controls Corp., 1600 S. Mountain Ave., Duarte, Calif. A recent two-page bulletin describes the Tempot, a precision potentiometer capable of operating in extreme temperature environments. (483)

FERRITE CORES Electronic Memories, Inc., 9430 Bellanca Ave., Los Angeles 45, Calif., offers specification sheets on two new ferrite memory cores for application in coincident current memories. (484)

IMMITTANCE CHART Avco Corp., Cincinnati 41, O., offers a 17 in. by 22 in. immittance chart which permits direct conversion from impedance to admittance or vice versa. (485)

POWER SUPPLIES Deltron Inc., Fourth and Cambria Sts., Philadelphia 33, Pa. A 32-page catalog, A-631, covers a wide range of solid state and vacuum tube power supplies. (486)

TRUE-RMS VOLTMETER Ballantine Laboratories Inc., Boonton, N. J. Four-page brochure describes model 320A true-rms voltmeter for accurate measurements on a wide range of waveforms. (487)

ELECTRICALLY ISOLATED R-F ROOMS Erik A. Lindgren & Associates, Inc., 4575 N. Ravenswood Ave., Chicago 40, Ill., offers comprehensive catalogs, drawings and specifications covering scientifically designed and constructed double electrically isolated r-f rooms. (488)



**The quality of our IF strips
has been hidden within our systems...**

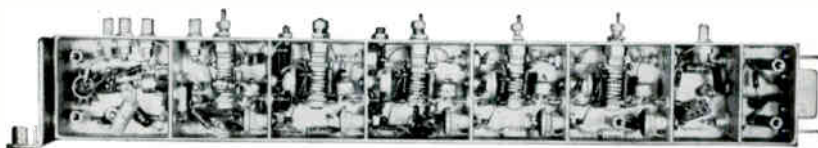

until now.

What's behind Loral's success in meeting—or exceeding—MIL-SPECS in the creation of “black boxes,” both systems and subsystems, for the military for over 15 years?

The quality built into components such as this IF amplifier.

This unit, one of a series of IF amplifiers operating at center frequencies from 30 to 160 megacycles, was developed for a Loral system that meets MIL-E-5400. It is now ready for YOU through our General Products Division.

Such amplifiers are available as virtually “off-the-shelf”

items and are representative of Loral's R & D capacity to create electronic components that are the best possible buy in the smallest, most reliable package—Value Engineered throughout.

We may have, right now, the electronic component that will help YOU do an important defense job while saving YOU the unnecessary time and cost of undertaking your own R & D. For further information on our complete line of amplifiers and other precision microwave products, write: General Products Division, LORAL ELECTRONICS CORPORATION, 825 Bronx River Avenue, The Bronx 72, New York.

MIL SPEC	MIL-E-5400	BANDPASS RIPPLE	0	GAIN CONTROL	Yes	INPUT IMPEDANCE	50 ohms
PART NUMBER	IF-301	WEIGHT	11.5 oz.	AGC	Yes	OUTPUT IMPEDANCE	50 ohms IF 91 ohms video
CENTER FREQUENCY (MCS)	100	TRANSISTOR COMPLEMENT	2N1195	POWER REQUIREMENTS	25v 110 ma		VOLTAGE GAIN
BANDWIDTH AT 3db (MCS)	20	NOISE FIGURE db	7 db	DIMENSIONS	11 x 1¼ x 1		



You are cordially invited to visit our booth at the IEEE Show, March 25-28, 1963.

GREEN

PRINTED CIRCUIT DRILL for versatility at LOW COST



NEW... Spindle feed control provides infinite range of controlled feed rates.

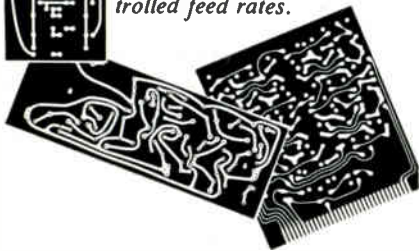

For prototype panels or high production work, drill quickly and easily without specialized labor or expensive tooling. The Green D2 Pantograph Engraver with D2-201 Pneumatic Attachment provides manufacturers with a Printed Circuit Drill having unlimited application flexibility. Check these features:

- Spindle speeds to 26,000 R. P. M.
 - Drill speeds and feeds independently adjustable
 - May be used for profiling and engraving
 - Boards can be stacked 4 deep for fast production
 - Operates on "In Plant" compressed air or tank air (very small volume required)
- drills up to **100** holes/min.

Whatever your requirements, the Model D2-201 is the answer—complete and ready to operate. Write or call today for full details.

**GREEN INSTRUMENT
COMPANY, INC.**

Dept. 63 • 295 Vassar Street
Cambridge, Mass. • ELiot 4-2989

SEE US AT THE IEEE SHOW—BOOTH #4332

NEW BOOKS

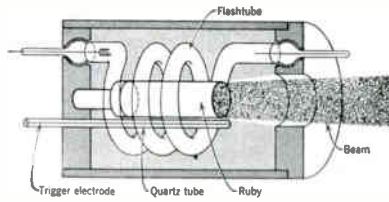

Lasers: Generation of Light by Stimulated Emission

By BELA A. LENGYEL
John Wiley & Sons, Inc., New York,
1962, 125 p, \$6.95.

AT last there is a competent introduction in book-form to lasers, without either the sensationalism and oversimplification of popular press, or the abstruseness of highly specialized journals. The author sets out to bring together the highly scattered literature on lasers, and to present it to technically qualified readers in a unified form. In this he largely succeeds.

There is, of course, probably no less static field today than lasers, and any book on them cannot hope to remain up to date for long. The gallium-arsenide diode laser, for instance, appeared only after this book went to press. Nevertheless, it will serve as an excellent introduction to "classical" laser theory. A good bibliography of laser literature closes the book.—G.V.N.

Electromechanical Energy Conversion

By SAMUEL SEELY
McGraw-Hill Book Co., Inc., New York. 1962, 336 p, \$10.75.

THREE areas in particular are covered by this textbook: energy storage, energy transfer, and energy conversion. The electrical devices that fall within these broad categories are analyzed in a fundamental way, developing and using tools of analysis such as Lagrange's equations and dynamic problem analysis, which will prove useful in other fields as well. From transducers and converters the book progresses to the rotary power converter and generalized machine theory, and the n - m symmetrical

machine. Though its main interest lies in the power engineering field, the fundamentals and methods explained are of importance to electronics engineers as well.

Component Parts Failure Data Compendium

Electronic Industries Association,
New York, 1962, 195 p, \$2.50.

THIS long-awaited work by the EIA Ad Hoc Group on Component Parts Failure Data has arrived. Twenty-eight organizations contributed data to this study and it is the most complete compilation available.

Data is presented in chart form, on 61 different components under various environmental conditions. Failure rates are given in percent per 1,000 hours.

However, as is the case with most failure-rate data, even this compendium should be marked "use with discretion." Some of the data goes back to the early days of reliability work and represents nothing more than someone's "educated" guess. In other cases, conditions of use (mostly in the field) and test hours are carefully documented and these data should prove highly enlightening.—J.M.C.

Reliability: Theory and Practice

By IGOR BAZOVSKY
Prentice-Hall, Inc., Englewood Cliffs, New Jersey, 292 p, \$8.75.

Reliability Principles and Practices

By S. R. CALABRO
McGraw-Hill Book Co., Inc., New York, 1962, 371 p, \$10.50.

IN a field in which university courses are just beginning, the appearance of a usable textbook has been eagerly awaited.

Both these books may find use in reliability courses both in universities and in industry.

Bazovsky's book may be preferred by some university professors who prefer to concentrate on

from the House of Zeners...



a completely New Series



1N 4016B thru 1N 4042B

THE INDUSTRY'S ONLY 5 WATT ZENER

**UNIQUE MINIATURE PACKAGE • 6 YEARS
PRODUCTION EXPERIENCE IN BASIC PACKAGE
DESIGN • SAVE ON WEIGHT, SPACE AND COST
• INCREASE RELIABILITY**

*Solves intermediate power problems for 1 thru 5 watt applications where
you are now using 10 watt 7/16 package (1/3 weight — 20% of volume)*

SEE IT AT IEEE . . . SEMCOR'S DISPLAY SUITE
MEURICE HOTEL • 145 W. 58th ST. • NEW YORK, N.Y.

NEW SCR ANALYZER

NEW **SECO**
INSTRUMENT
ANALYZES
ALL SCR'S
1/2 TO 225
AMPS, 25 TO
600 VOLTS



MODEL 600 • \$46.95
NET

The Model 600 tests performance and characteristics of all types of Silicon Controlled Rectifiers which comply with the manufacturer's published specifications. No scope or charts needed!

- Reveals gate conditions
- Reads anode current and phase angle
- Reads holding current direct
- Varies conduction angle from 0° to 160°
- Shows cathode current at varying gate pulse rates

Sufficient gate pulse amplitude to fire all SCR's and not damage those requiring small gate currents. Special circuit protects Model 600 from shorted SCR and protects SCR if overload of gate current occurs. Unit can be used with scope to see phase angle across load and gate pulse, if desired.

Get full information on this first commercial instrument for testing SCR's. See your electronics supply dealer—or send coupon below.



SECO ELECTRONICS, INC.
1213 S. Clover Drive,
Minneapolis 20, Minn.

Rush me complete information on the new Model 600 SCR Analyzer

NAME _____

COMPANY _____

ADDRESS _____

CITY _____ STATE _____

the basics of the subject and introduce a certain level of rigor in their courses.

Calabro's book is one that no engineer practicing reliability in industry should be without. It is thorough, comprehensive and easily understood. It may also find use as a textbook.—J.M.C.

Textbook on Mechanized Information Retrieval

By ALLEN KENT

Interscience Publishers, div. of John Wiley & Sons, New York, 1962, 268 p, \$9.50.

REVIEW of information retrieval methodology largely from the point of view of the librarian. Includes heavy concentration on special coding techniques used at Western Reserve University. Gives little space to recent advances in machine indexing that appear to hold great promise.—J.M.C.

Electromechanical System Theory

By HERMAN E. KOENIG and WILLIAM A. BLACKWELL

McGraw-Hill Book Co., Inc., New York, 504 p, \$14.50.

ALTHOUGH the subject matter of this book relates to electrical power rather than electronic engineering, the analysis techniques developed are applicable to both fields. A large portion of the book has to do with the formulation of problems, and methods of analysis. Two-terminal and multi-terminal system concepts are dealt with; the second half of the book relates to analysis of d-c and a-c rotating machines and of non-linear systems.

Differential Amplifiers

By R. D. MIDDLEBROOK

John Wiley & Sons, Inc., New York, 1963, 115 p, \$7.95.

THE purpose of this book is to clarify and define the important operating parameters of differential am-

plifiers. It presents methods of analysis for the common-mode (CM) and differential-mode (DM) signals of the balanced symmetrical circuit, and develops a method of analysis also for the unbalanced case. This sequential technique for dealing with a small-percentage unbalance in a circuit in a fairly simple mathematical way is a new contribution.

The analysis technique is illustrated by two practical circuits, a single-stage d-c differential transistor amplifier, and a two-stage d-c differential transistor amplifier with common-mode negative feedback; both of these circuits are commonly encountered in practice. Proof of the sequential analysis method is given in a separate appendix.—G.V.N.

Handbook of Nonparametric Statistics

By JOHN E. WALSH

D. Van Nostrand Company, Inc., Princeton, New York, 1962, 549 p, \$15.

LARGE number of nonparametric tests for randomness, point estimation and confidence regions. Presentation is extremely compact and the book will be of value only to those having a sound foundation both in classical and distribution-free statistics. Some nonparametric tests described will be useful in reliability work.—J.M.C.

Six-Language Dictionary of Electronics, Automation and Scientific Instruments

By A. F. DORIAN

Prentice-Hall, Inc., Englewood Cliffs, N. J., 1963, 732 p, \$16.95

TECHNICAL translations are always impeded by the fact that words have more than one meaning, and a common-usage word will often have a very unexpected connotation when used in a technical sense. Thus, this dictionary will prove very useful to those who deal with foreign technical literature.

The dictionary could have been



**Are you a
COMPLETELY INFORMED
electronics engineer?**

Today you may be working in microwaves. But on what project will you be working tomorrow? You *could* have read **electronics** this past year and kept abreast of, say, microwave technology. *There were 96 individual microwave articles between July, 1961 and June, 1962!*

But suppose tomorrow you work in some area of standard electronic components, in semiconductors, in systems? Would you be up-to-date in these technologies? Did you read the more than 3,000 editorial pages that **electronics'** 28-man editorial staff prepared last year?

electronics is edited to keep you current *wherever* you work in the industry, *whatever* your job function(s). If you do not have your own copy of **electronics**, subscribe today via the Reader Service Card in this issue. Only 7½ cents a copy at the 3 year rate.

electronics

New FILM-THIN Copper-clad Laminates for space-saver or multi- layer printed circuits

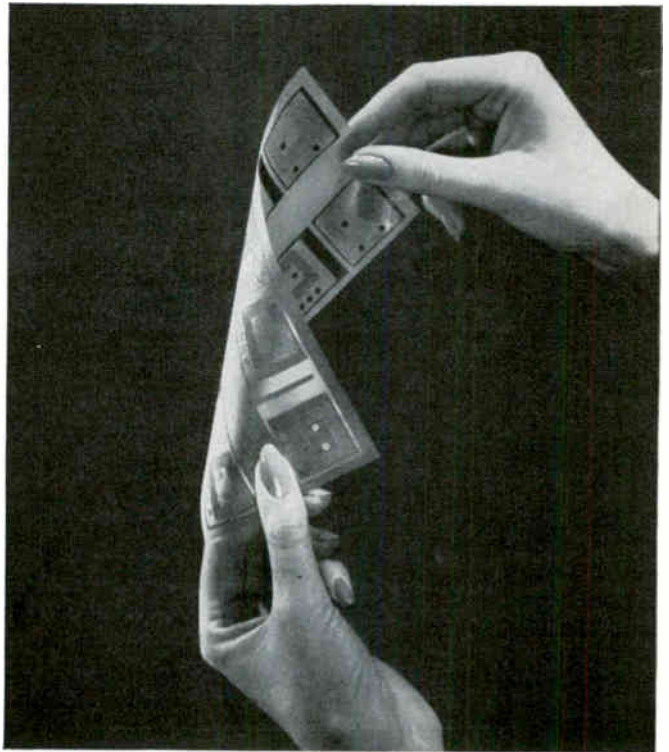

Visit us at I.E.E.E., Booths 4421-23

Synthane copper-clad laminates are now being produced with a base laminate of only .0035" and up—with 1 or 2 oz. cladding available on one or both sides. A pre-impregnated glass cloth with epoxy resin filler is also available for bonding multi-layer circuits. These new materials are produced under clean room conditions. Property values are comparable to military specs for the same materials in standard thicknesses. Write for folder of Synthane metal-clad laminates.

SYNTHANE

CORPORATION **S** OAKS, PENNA.

Glendale 2-2211 (Area Code 215) TWX 215-666-0589
Synthane-Pacific, 518 W. Garfield Ave., Glendale 4, Calif. TWX GLDL 4417U

Synthane Corporation, 36 River Rd., Oaks, Pa.
Gentlemen:
Please send me Synthane metal-clad laminates folder.

Name _____

Address _____

City _____ Zone _____ State _____

SPECIFY Stromberg-Carlson TELEPHONE-TYPE RELAYS

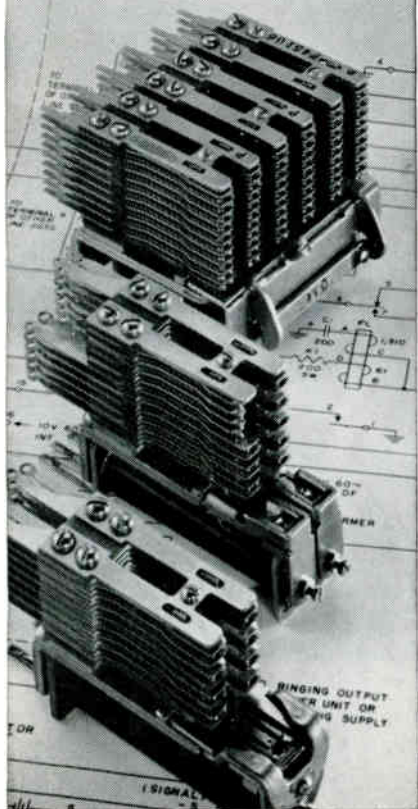

The sound design and long, reliable life of these Stromberg-Carlson relays have been proved by many years of successful use in the exacting field of telecommunication:

Type A: general-purpose relay. Up to 20 Form "A" spring combinations.

Type B: multi-contact relay. Up to 60 Form "A" spring combinations.

Type BB: multi-contact relay. Up to 100 Form "A" springs.

Type C: two relays on one frame; mounts in same space as one Type A.

Type E: general-purpose relay; universal mounting; interchangeable with relays of other manufacturers.

All standard spring combinations are available in these telephone-quality relays. For complete technical data and details on special features, write to Industrial Sales Department.

STROMBERG-CARLSON
A DIVISION OF **GENERAL DYNAMICS**
114 CARLSON ROAD • ROCHESTER 3, N. Y.

improved by adding the definitions of some of the terms which have more than one meaning even within electronics: thus, while P.M. in English can mean photomultiplier as well as permanent magnet, only the latter sense is translated into German.

Languages included are English, Russian, French, German, Spanish and Italian. Entries are listed alphabetically in English, referred to by number from glossaries in the other languages.

Standard Instrumentation Questions and Answers

By STEVE ELONKA and
ALONZO R. PARSONS

McGraw-Hill Book Co., Inc., New York, 1962, 2 vol., 482 p, \$15.95 set.

THIS is a conveniently presented practical guide to control and instrumentation in industry, and gives quick answers to questions on how different instruments work and what they do. The coverage is not deep enough to serve as a process control design handbook, but rather as an introduction to the hardware.

Sections of interest to electronics men include proportional control systems, process computers, information handling systems, and a scattering of electrical and electronic instruments in most of the other sections.

Microwave Engineering

By A. F. HARVEY

Academic Press Inc., New York, 1963, 1312 p, \$35.

THIS large reference volume contains twenty-six comprehensive chapters on various aspects of microwaves. They fall into three main groups: passive components and circuits, electrical behavior of microwave circuits (including microwave tubes), and techniques and devices associated with the applications of microwave, including entire equipment systems.

With its detailed explanations, descriptions of procedures, formula derivations, and extensive bibliog-

raphies, this volume will serve well both as an engineering-level introduction to microwaves, and as a working handbook for the microwave engineer.

Models of Transistors and Diodes

By JOHN G. LINVILL

McGraw-Hill Book Co., Inc., New York, 1963, 190 p, \$7.95.

THE purpose of this book, as stated, is to develop a set of models for transistors and semiconductor diode devices based on their basic internal physics. It makes no reference, in the explanations, to other electronic devices such as vacuum tubes, and thus will be a suitable text for the young engineers who learn about transistors first.

Models are developed, successively, for the semiconductor carrier transport mechanisms, for the $p-n$ junction, and for the $p-n$ diode and the transistor. In the last two cases, lumped models are used that approximate the distributed devices. The book closes with functional models of the transistor and examples of transistor circuits.—G.V.N.

Introduction to Electronics

By WALTER H. EVANS

Prentice-Hall, Inc., Englewood Cliffs, N. J., 1962, 518 p, \$14.65.

AS introductions to electronics go, this one is unusually complete and can probably serve well both the engineering student and the executive or scientist in a related field who wishes to increase his knowledge of electronic circuits.

Not just a popular exposition of the subject, the book contains enough detail and enough mathematics to explain adequately a number of circuit designs, including digital and switching circuits as well as amplifiers and communication circuits. A descriptive chapter is given on microwaves, radar and antennas. Practical exercises give practice in circuit design procedures.—G.V.N.



exhibit at
IEEE show 1963

1

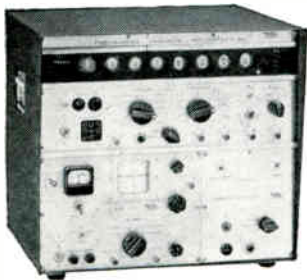

model A-1246

a new 0 to 520 Mc frequency-converter

extending the frequency measuring range of WESTON-ROCHAR 20 Mc frequency-meter A 1149 (Weston ref. model 2052)
Direct reading and recording of complete data from the counter

Complete set including :
1 20 Mc F.T.P. counter model 2052
1 0 to 520 Mc frequency-converter
1 Codeverter (for digital recording)

Input sensitivity :
50 mV from 1 to 60 Mc
20 mV from 60 to 560 Mc
Input impedance : 50 Ω

2



**4 new D.A.V.O. Meters (Digital Amp Volt Ohm Meters)
fully transistorized**

1 nanoampere to 20 mA DC/AC (or more with external shunts)
100 μV to 2,000 V DC/AC
1 Ω to 20 MΩ

0.03 % of reading ± 1 digit

Point and unit displays
Calibration-test : 1.018 V (Weston cell)
Automatic polarity (all models)
Automatic ranging (2 models B)

Rochar
ELECTRONIQUE

Distributed in U.S.A. and Canada by :
WESTON - Newark (N.J.)
for complete information on our line of products and address of
our agency in your country please apply to
ROCHAR-ELECTRONIQUE, 51, rue Racine
MONTRouGE (Seine) FRANCE.





IEEE SPECIAL

IEEE Medal of Honor Goes to Inventor



AMID the massive team efforts that are characteristic of today's electronics, rare indeed is "the inventor."

But that title is a natural appendage to the name of John Hays Hammond Jr. of Gloucester, Mass., who will receive the IEEE Medal of Honor this year. His hundreds of patents underlie much of modern electronic technology. He is cited by the IEEE for "pioneering contributions to circuit theory and practice, to the radio control of missiles and to basic communications methods."

The setting of his work is a medieval castle-museum above the rocky Gloucester coastline not far from the reef of Norman's Woe, the setting of Longfellow's "The Wreck of the Hesperus."

"I love old things," says this inventor of new things for more than a half-century.

In the Great Hall of the castle is the magnificent 10,000-pipe organ designed by Hammond and built over a period of 20 years. The Great Hall has been used for recordings by some of the major record companies, and some of the greatest organists in the world have played there.

Here in this museum, sections of which are open to the public during the Summer, are Hammond's living

quarters, and here is the Hammond Research Corp., whose vice president, Ellison S. Purington, has worked in close association with Hammond since 1920.

The work of Hamond, now 74 years old, spans about the same range of years as the IRE. From 1912 until 1928, the Hammond Laboratory was in a building on the same Gloucester coastline property, and here much pioneering work in radio was accomplished. From 1928 on, the work was done in laboratory areas in the castle.

Hammond did extensive work for the U. S. military services starting in 1912 when the chief of Coast Artillery for the Army witnessed in Gloucester the successful radio control of a boat from shore. During both world wars, the Hammond group developed radio and other remote control systems applicable to waterborne and airborne missiles. Only recently, Hammond Research Corp. completed a communications project for the Navy.

Hammond helped develop some of the stabilization and homing principles used in modern missiles. In communications, the Hammond group contributed to development of the triode for amplification purposes, the i-m principle for selectivity, and of f-m techniques for broadcasting and telephony.

The list of Hammond colleagues, correspondents and consultants over the years reads like a roster of the radio-electronic pioneers: deForest, Alexanderson, Tesla, Lowenstein, G. W. Pierce, Langmuir, David Sarnoff. Harvard's Dr. E. L. Chaffee, now professor emeritus, became a consultant to the Hammond Laboratory as early as 1918, and even now traverses the 40-plus miles from Belmont, Mass., each Wednesday to spend the day at Hammond Research Corp. as a consultant and old friend.

Hammond is a director and a research consultant for RCA, and many of the Hammond and Purington patents are turned over to RCA for development and manufacture.

Son of a millionaire mining engineer, Hammond was graduated from Yale and received a doctorate in science from George Washington University. An early member of the IRE, he has served as treasurer and a director.

Clancy Accepts New Position

WILLIAM E. CLANCY has been appointed vice president and director of sales of John E. Fast & Co., Chicago based capacitor manufacturer.

Prior to this appointment Clancy was vice president and director of sales of Thordarson-Meissner.

Vactek Announces Two Appointments

VACTEK, INC., new wholly owned subsidiary of Geophysics Corp. of America, Bedford, Mass., announces the appointment of Herbert Roth, Jr., as manager, and Bernard Bernstein as technical director.

Roth, formerly a vice president of Nuclear Corp. of America, served previously with Radio Corp. of America.

Bernstein, formerly head of Nu-

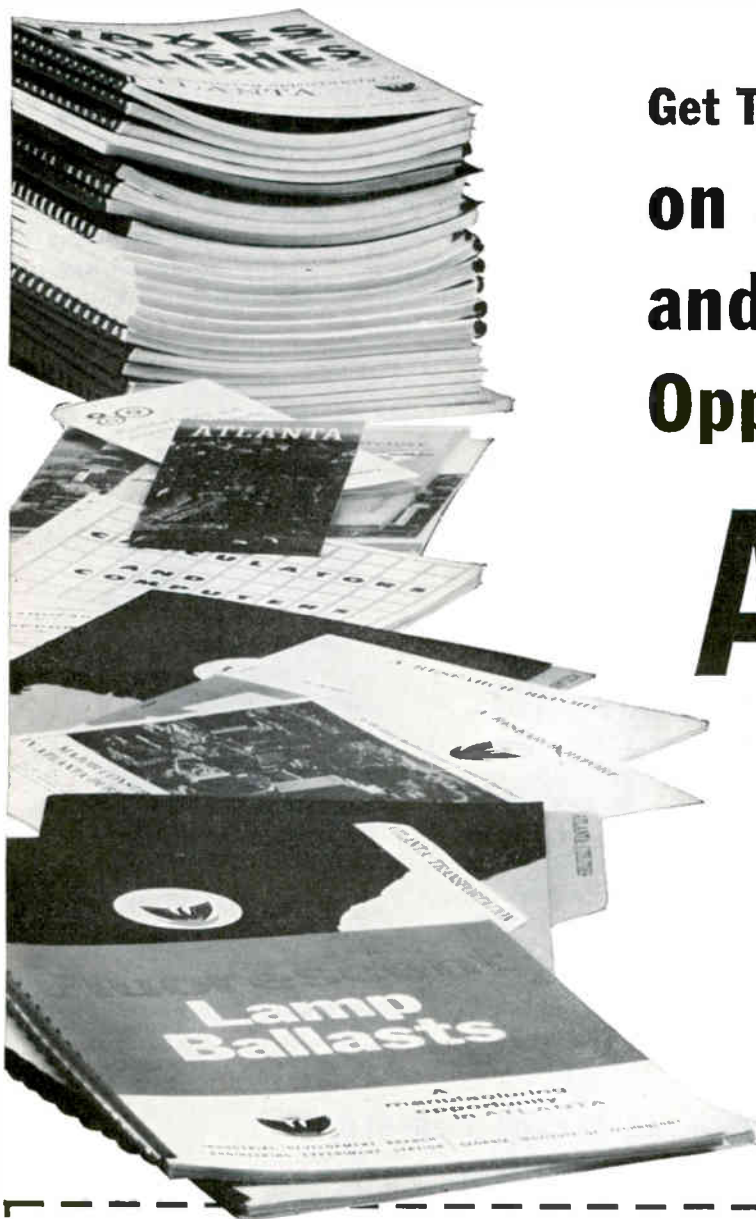

Get These Special Reports on Manufacturing and Marketing Opportunities in Atlanta

Listed below are eleven recently completed reports on specific manufacturing and marketing opportunities in Atlanta. Compiled and written by the Industrial Development Division of Georgia Tech, they are accurate, up-to-date and completely objective. No eye-wash. No glib generalities. Any or all are yours on request. Also available are 17 other studies of various aspects of Atlanta's economic make-up. For the reports you want just check and mail coupon with your company letterhead. There's no cost. No obligation. Inquiries held confidential.

Reports on Manufacturing and Marketing Opportunities in Atlanta for:

- | | |
|---|---|
| <input type="checkbox"/> FLOURESCENT LAMP BALLASTS | <input type="checkbox"/> REFRIGERATION AND AIR CONDITIONING EQUIPMENT |
| <input type="checkbox"/> CURRENT CARRYING DEVICES (FOR BUILDING CONSTRUCTION) | <input type="checkbox"/> ELECTRONIC TESTING AND MEASURING INSTRUMENTS |
| <input type="checkbox"/> PLUMBING FIXTURE FITTINGS | <input type="checkbox"/> DRUGS AND PROPRIETARIES |
| <input type="checkbox"/> HOUSEHOLD WAXES AND POLISHES | <input type="checkbox"/> INDUSTRIAL VALVES AND PIPE FITTINGS |
| <input type="checkbox"/> ANTIBIOTICS | <input type="checkbox"/> PACKAGING |
| <input type="checkbox"/> CALCULATORS AND COMPUTERS | |

General Reports on Atlanta:

- | | |
|--|--|
| <input type="checkbox"/> EDUCATIONAL AND TRAINING FACILITIES IN METROPOLITAN ATLANTA | <input type="checkbox"/> TAXES |
| <input type="checkbox"/> ATLANTA'S METALWORKING INDUSTRY | <input type="checkbox"/> INDUSTRIAL DISTRICTS |
| <input type="checkbox"/> WORLD TRADE | <input type="checkbox"/> MEDICAL COMPLEX |
| <input type="checkbox"/> INSURANCE | <input type="checkbox"/> TRANSPORTATION |
| <input type="checkbox"/> DATA PROCESSING | <input type="checkbox"/> FINANCE |
| <input type="checkbox"/> UTILITIES | <input type="checkbox"/> POPULATION |
| <input type="checkbox"/> COMMUNICATIONS | <input type="checkbox"/> MANUFACTURERS GUIDE |
| | <input type="checkbox"/> GEORGIA DATA |
| | <input type="checkbox"/> ATLANTA FACTS |
| | <input type="checkbox"/> WORLD TRADE DIRECTORY |

"Forward Atlanta,"
Paul Miller, Industrial Manager
Atlanta Chamber of Commerce
1330 Commerce Bldg., Atlanta 3, Ga.
Phone 521-0845



Please send me the special "Forward Atlanta" reports checked. We would be interested primarily in a new: plant warehouse sales office
 other _____

Name _____ Title _____
Product _____
Company _____
Street _____
City _____ Zone _____ State _____

CONFIDENTIAL

NEW from TRU-OHM!

Taped and Reel
Packaging of

**AXIAL
LEAD
RESISTORS**
for AUTOMATION!

Designed to meet the growing demand for printed circuit and other applications requiring automation . . . TRU-OHM'S NEW resistor packaging . . . taped to a reel. Already gaining tremendous acceptance throughout industry, you should investigate this revolutionary packaging method.

Another Tru-Ohm method to better serve you . . . Vitreous Enameled Resistors . . . Power Rheostats . . . Carbon Film Resistors.

The Size is Right! **12½ WATT RHEOSTAT**

Vitreous enameled; miniaturized with longer life; close control, smooth operation . . . packing real power. Any variable of special rheostats is available on this unit.

Write for our latest catalog

TRU-OHM
PRODUCTS

Division of Model Eng. & Mfg., Inc.
3426 West Diversey Blvd.
Chicago 47, Illinois
Factory: Huntington, Indiana

clear Corp. of America's Power Tube division, earlier was with North American Phillips Amperex division.

Vactek's products and capabilities for the laboratory and precision industrial segments of the vacuum industry are expected to complement those of Vacuum Specialties, Inc., another GCA subsidiary.



Illinois Tool Works Appoints Templeton

ILLINOIS TOOL WORKS INC., Chicago, Ill., recently appointed J. Earl Templeton vice president, Electronics divisions.

Templeton was formerly with P. R. Mallory & Co., where he was director, Western operations. He is a vice president and director of Electronics Industry Show Corp. which produces the Electronics Parts Show held annually in Chicago.

GI Rectifier Division Appoints Davis

EMANUEL DAVIS has been appointed to the new post of director of quality control and reliability of the General Instrument Corporation Rectifier division. He was formerly with General Electric Co.

In his new post, Davis will be responsible for all quality control and reliability programs for the division's entire line of silicon and selenium rectifiers. Reporting to him will be a group of approximately 45 engineers and technicians.

General Instrument Rectifier division has plants at Newark, N. J., and Brooklyn, N. Y.



System Development Upgrades Melahn

WESLEY S. MELAHN, Air Defense division manager of System Develop-

Raytheon Promotes Cassevant



ALBERT F. CASSEVANT has been named manager of Raytheon Company's Electronic Services Operation with responsibility for its worldwide support activities. He previously served as corporate special projects manager. Before joining the firm in 1962, he was vice president and general manager for ITT's Kellogg division

SEE US AT BOOTH 4029—I.E.E.E. SHOW



**A *New* ALLOY OFFERING
SUBSTANTIAL SAVINGS**
IN THE MANUFACTURE OF HIGH PERFORMANCE
SLIDING AND WIPING CONTACTS



SEND
FOR
FREE
TECHNICAL
BULLETIN

WHAT IS 239 ALLOY?

Leach & Garner #239 Alloy is a new Gold Palladium Base Alloy developed specifically as an equivalent functional substitute for Leach & Garner #226 Alloy (a Palladium Silver Base Alloy). Unique properties of this new alloy permit it to be clad to base materials and fabricated into a new type, low material cost, potentiometer sliding contact with high reliability and long, low noise life. Immediate use can be made in trimming potentiometer manufacture. Further testing should also validate its high performance in both precision potentiometers and a wide range of other electronic component applications.

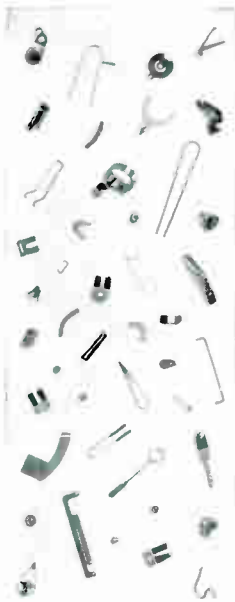

Shown 1/2 actual size

PLEASE DIRECT YOUR INQUIRIES TO
52 PEARL ST., ATTLEBORO, MASS.

LEACH & GARNER FOR ALLOYS AND CLAD METALS

Over 60 years' successful experience has established Leach & Garner as a leader in the production of clad and solid alloys for a wide range of industries. In addition a program, carefully developed by unique owner-management, has created a completely new, clean and separate department where this experience is applied to bonding, rolling and fabrication of clad semiconductor materials.



LEACH & GARNER COMPANY Attleboro, Massachusetts
GENERAL FINDINGS INC. Attleboro, Massachusetts



GENERAL FINDINGS FOR PRECISION PARTS FABRICATION

Specialized experience through production of countless miniature precision parts for the electronic industry is also combined with the most modern facilities to offer semiconductor manufacturers the service needed to meet the most demanding requirements at lost cost with absolute assurance of complete conformity.

A COMPLETE PACKAGE BY PREMIER

Standard

**CONSOLES • RACKS • CHASSIS
PANELS • CABINETS
SLIDES • BLOWERS • FANS**

SEND FOR LATEST ENGINEERING CATALOG

PREMIER METAL PRODUCTS CO., INC.
Subsidiary of Renwell Industries, Inc.
337 Manida Street, Bronx, New York

WESTERN SALES OFFICE:
1667 Laurel St., San Carlos, California
EXPORT DEPARTMENT: EMEC,
127 Grace Street, Plainview, New York
MFD. IN CANADA: PREMIER METAL HOUSINGS, Ltd.,
255 Dunbar Street, Montreal

VISIT BOOTH 4206 IEEE SHOW N.Y.C.
CIRCLE 314 ON READER SERVICE CARD

ment Corp., Santa Monica, Calif., has been appointed a vice president of the firm.

Melahn will continue to direct SDC's efforts in the areas of air defense, air traffic integration, and system training.

System Development Corp. specializes in the design and development of computer-based command control and management systems for military, governmental, scientific and educational applications.



Shelley Named to Stoddart Post

TAMAR ELECTRONICS, INC., Anaheim, Calif., has announced the appointment of Rulon Gene Shelley as vice president and general manager of Stoddart Aircraft Radio, Inc., a wholly owned subsidiary of Tamar.

Shelley was formerly vice president and general manager of the Tamar Electronics division. He has been with the Tamar organization since January of 1962. Prior to that, he spent 12 years with North American Aviation where he was chief engineer of the Armament and Flight Control division of Autometrics.

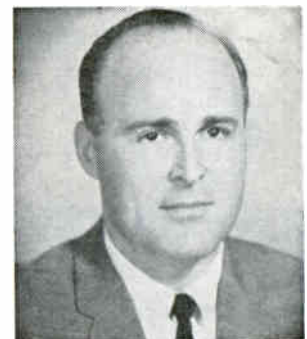

Bell Heads Up Pearce-Simpson

PHILIP BELL, executive vice president of Pearce-Simpson, Inc.,

DYNAMICS INSTRUMENTATION AMPLIFIERS

— with complete galvanometer conditioning controls

Model 6411—transistorized, wideband dc amplifier capable of delivering $\pm 10V$ and ± 100 ma to the load. Unit features continuously variable gain control and variable dc offset adjustment of $\pm 10V$ output range. Front panel galvanometer controls include:

- galvanometer damping switch
- galvanometer simulated load switch
- dc output current meter
- output polarity-reversing switch
- internal/external load switch

Voltage Gain: 0.1 through 1000 in 9 steps, continuously variable between steps.
Linearity: Better than 0.05%
Frequency response: $\pm 2.0\%$ to 10 kc; down 3.0 db at 30 kc
Drift: ± 2.0 μV in 40 hours operation after warm-up, referred to input
Power line isolation: shielded transformer produces less than 5.0 mmf of direct power line capacity to amplifier ground.

The galvanometer conditioning controls are also available on Dynamics gain 10 or gain 100 dc amplifiers. These units feature instantaneous overload recovery time (within rise time of the amplifier).

Write for complete literature on Model 6411, or the entire line.

DYNAMICS INSTRUMENTATION COMPANY
583 Monterey Pass Rd., Monterey Park, Calif. • Phone: CU. 3-7773

TOTAL CAPABILITY-through UTL Services

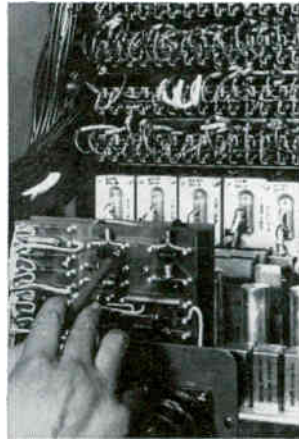

Your Company can attain total capability by utilizing UTL services in Reliability Engineering, Technical Services and Testing.

As an independent and objective organization, the technical assistance rendered by UTL on many major weapon and space programs has provided industry and government with highly valued and advanced developments in the fields of . . .

RELIABILITY ENGINEERING . . . program plans, training instruction, prediction, design review, part selection, quality assurance.

TECHNICAL SERVICES . . . installation, evaluation, logistic support, design, technical documentation.

TESTING . . . simulation of space environments and weapon system mission profiles, electronic ordnance and cryogenic parts and systems testing.

The UTL technical staff, with comprehensive nationwide facilities, can assist you from development through delivery and installation.

➔ Call or write to the address nearest you. Test Facilities • Sunnyvale, Calif. (San Francisco Area), 150 Wolfe Road, RE 9-5900. • Monterey Park, Calif. (Los Angeles Area), 573 Monterey Pass Road, CU 3-4168. • Alexandria, Va. (Washington, D.C. Area), 4416 Wheeler Ave., 836-7200.

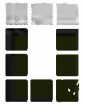

UNITED TESTING LABORATORIES a division of *United ElectroDynamics, Inc.*

CIRCLE 315 ON READER SERVICE CARD

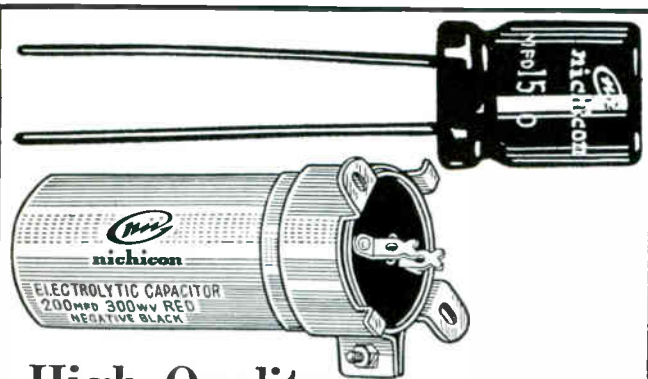

High Quality Nichicon Capacitors

for all electronic equipment

Nichicon research and experience assures remarkable strength and stability in all its capacitors. Nichicon produces a complete line of capacitors designed for every need.

nichicon MAIN PRODUCTS: Oil Paper Capacitor, Electrolytic Capacitor, Tantalum Capacitor, Metallized Paper Capacitor, Ceramic Capacitor, Mica Capacitor and Mylar Capacitor, etc.

Nichicon Capacitor Ltd.

HEAD OFFICE : Uehara Bldg., Oikedori, Karasumahigashi-iru
Nakagyo-ku, Kyoto, Japan
CABLE ADDRESS : CAPACITOR KYOTO

CIRCLE 316 ON READER SERVICE CARD

electronics • March 15, 1963

COSTS DOWN!

WIRE

FORMS

PRECISION UP!

BY ARTWIRE

Art Wire's high speed, automatic machines and production economies mean BIG SAVINGS for you . . . with guaranteed precision from the first to the millionth unit. Widest variety of wire components, made for today's automatic production lines, delivered on schedule to assure uninterrupted work flow.

Send a Sample or Blueprint for Estimates

ART WIRE AND STAMPING CO.

18 Boyden Place, Newark 2, N.J.

CIRCLE 201 ON READER SERVICE CARD

201

CHESTER

MULTI- CONDUCTOR CABLES

Custom constructions to meet your exact requirements. Any combination of conductors, Plastico[®] insulations, shields, jackets, color coding, etc.

Send for brochure, today!

**CHESTER
CABLE CORP.**
CHESTER, NEW YORK
a subsidiary of
TENNESSEE CORPORATION



Miami, Fla., has been named president and chief executive officer. He succeeds William S. Simpson.

The new president has been executive vice president, chief executive officer, and a director since March 1962, after having joined the company as general manager in 1961.

Pearce-Simpson produces marine radio-telephones and Citizens Band radios manufactured by its electronics division.

PEOPLE IN BRIEF

Harold E. Francis leaves Chandler Evans Corp. to take post of v-p in charge of sales for Alloy Nuclear Corp. Electro-Optical Systems, Inc. promotes **John M. Teem** to technical director, and **Henry L. Richter, Jr.**, to mgr., Advanced Systems Development Operations. **Harold E. Watson** (Maj. Gen., USAF, Ret.) has joined GE's Defense Programs Operation as a consultant on aerospace and defense technology. **Sol Sparer** elevated to president and chief executive officer of Pacotronics, Inc. **George J. Tatnall**, formerly of the Naval Air Development Center, now with Corning Glass Works as supervisor of radome engineering. **Ralph F. Woodward**, previously a staff associate at Stanford U., named quality control mgr., mfg. div., of Warnecke Electron Tubes, Inc. IBM Corp. advances **L. R. Bickford, Jr.**, to director of general science at the Thomas J. Watson Research Center. **Gerald deG. Cowan** promoted to director of engineering for Sperry Rail Service. **Hamilton O. Hauck** moves up to director of corporate development, Western region, of Raytheon Co. Motorola ups **Forrest G. Hogg** to mgr. for NASA Programs of the Military Electronics div. **Edmond A. Roelof** leaves Eldon Industries, Inc. to join Midland Mfg. Co. as v-p, mfg. **Larry Kaufman** advances to director of research at Man-Labs, Inc. Consolidated Electrodynamics Corp. ups **C. Kenneth Hines** to g-m of the DeVar-Kinetics div. Directors of the Gudebrod Bros. Silk Co., Inc., have elevated **F. W. Krupp** to president and **W. T. Hooven** to chairman of the board.

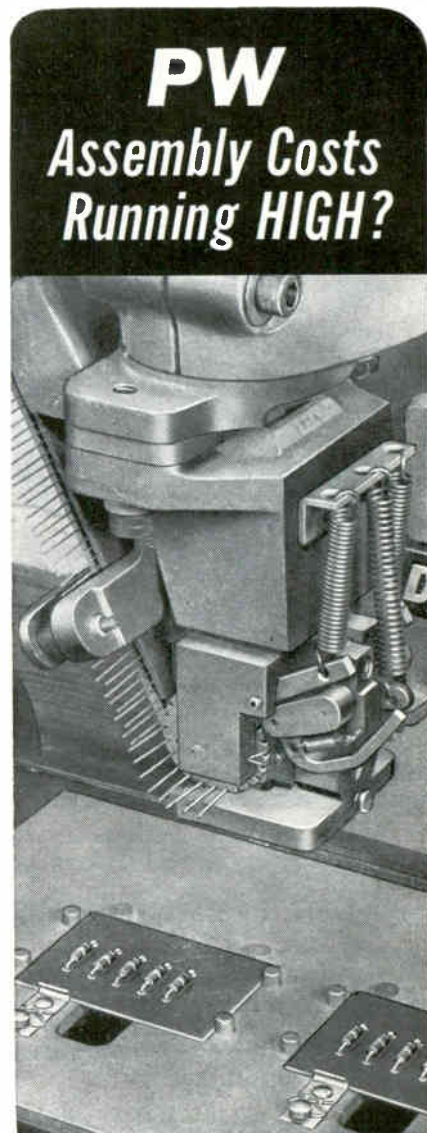

Let DYNASERT[®] CUT COSTS, SAVE TIME!

The Dynasert Component Inserting Machine will pay for itself in a year or less in direct labor savings. It feeds, cuts, forms, inserts and clinches a wide range of axial lead components — up to ten times faster than by hand assembly.

And with the new Pantograph Positioning Table you get even greater economies. For use where multiple components of the same size are to be inserted in parallel positions.

Find out more. Write or call Mr. D. R. Knight, Dynasert, United Shoe Machinery Corporation, Boston 10, Massachusetts. Area Code 617, LI 2-9100.



United Shoe Machinery
BOSTON, MASSACHUSETTS

See us at Booth #4241 at the IRE Show

NEW JERSEY

"cradle of industrial research"



Many of the scientific developments that will shape tomorrow's world are germinating right now in New Jersey's more than 500 industrial research institutions. The smaller manufacturer who does not have his own research staff can easily find top-notch facilities and personnel available close by to help work out his problems.

Because of its great contributions in such fields as electricity, electronics, chemistry, metallurgy and aviation, New Jersey has been called "the cradle of industrial research". Your executive and technical people will find a stimulating environment here, and ample opportunity for advanced study.

Write for our 40-page, "New Jersey Industrial Guide".

Department of Conservation and Economic Development
Promotion Section 951-U,
520 East State Street, Trenton 25, New Jersey

NEW JERSEY
Bureau of Commerce,

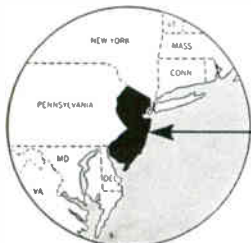

in the geographic center of

the world's richest market



IEEE SPECIAL

Exhibitors at the IEEE Show and their booth numbers are as follows:

A

ADC Products	1623
A.M.E., Inc.	1928
AMP Inc.	2527-2531 & 2837
A & M Instrument, Inc.	3004
A.P.M. Hexseal Corp.	2744
ATR Electronics, Inc.	2822
Ace Electronics Associates, Inc.	1921-1923
Ace Engineering & Machine Co., Inc.	3928
	3930
Acro Products Corp.	4139
Acton Labs., Inc.	3418
Advanced Measurement Instruments, Inc.	3006
Advanced Vacuum Products, Inc.	2607
Ad-Yu Electronics Labs., Inc.	3612
Aeroquip Corp.	4120
Aetna Electronics Corp.	3003
Affiliated Manufacturers, Inc.	4131
AGASTAT Timing Instruments	2343
Ainslie Corp.	1819
Airborne Instruments Lab.	3802-3810
Aircon, Inc.	1108
Airflyte Electronics Co.	1205
Airpax Electronics Inc.	2306
Aladdin Industries, Inc.	1924
Alberox Corp.	M-12
Alden Elect. & Impulse Recording Eq. Co.	1611
Alden Products Co.	1613-1615
Alfax Paper and Engineering Co., Inc.	1609
Alford Manufacturing Co.	1716-1718
Alfred Electronics	3039
Allen-Bradley Co.	2134-2138
Allied Chemical Corp.	4303-4305
Allied Control Co., Inc.	2905-2907
Allison Laboratories, Inc.	3007
Alloys Unlimited Inc.	4045
Alpha Metals, Inc.	4328
Alpha Wire Corp.	1326-1328
Amco Engineering Co.	4502
American Aluminum Co.	4041
American Electrical Heater Co.	4033
American Electronic Laboratories, Inc.	3045
American Enka Corp.	4315
American Lava Corp.	4401
American Molded Products Co.	4235
American Optical Co.	3008-3010
American Silver Co., Inc.	4224-4226
American Smelting and Refining Co.	1005
Amperex Electronic Corp.	2522-2524
Amphenol-Borg Electronics Corp.	1802-1810
	1901-1909
Amulex Electronics, Inc.	M-28
Anchor Alloys Inc.	4021
Andrew Corp.	1502-1504
Anetsberger Brothers, Inc.	4511
Angelica Uniform Co.	4500
ARRA (Antenna & Radome Research Assc.)	1929-1930
Antenna Systems, Inc.	2533 & 2741
Arthur Ansley Manufacturing Co.	1820
ANTLAB Inc.	3233-3235
Applied Research Inc.	1428
The Arnold Engineering Co.	2315-2319
Artes Engineering Co.	4020-4022
Arwood Corp.	4116
Assembly Products, Inc.	3916-3918
Associated American Winding Machinery, Inc.	4410-4412
Associated Testing Laboratories, Inc.	3927-3929
	2521
Audio Devices, Inc.	2521
Augat, Inc.	2229
Automatic Electric Sales Corp.	1908-1910
Automatic Metal Products Corp.	1524
Autofronics Inc.	1103
Avco Corp.	3840-3842
Avnet Electronics Corp.	3803-3807
Axel Electronics, Inc.	1221

B

B & F Instruments, Inc.	3123
B & K Manufacturing Co.	3043
Babcock Electronics Corp.	1105
Baird-Atomic, Inc.	3216-3218
Balco Research Laboratories, Inc.	2338
Ballantine Laboratories, Inc.	3502-3504
Barber-Colman Co.	2242-2244

COAXIAL CABLES



Accepted by industry as the quality line of Coaxial cables.

Conform to Military Specifications including MIL-C-17C—or your own special requirements.

Send for complete Coaxial Cable catalog.

CHESTER
CABLE CORP.,
CHESTER, NEW YORK

a subsidiary of
TENNESSEE CORPORATION



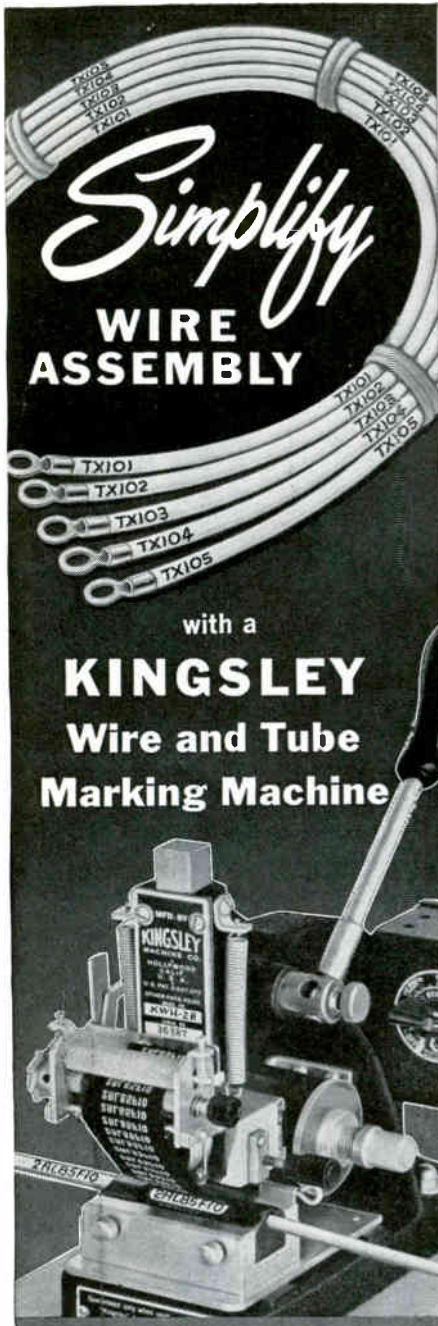

Simplify
**WIRE
ASSEMBLY**

with a
KINGSLEY
Wire and Tube
Marking Machine

Now you can mark each wire or piece of plastic tubing with its own circuit number... quickly...economically, right in your own plant.

You reduce wire inventories because you need only one color of wire for as many circuits as necessary.

Simplify your assembly methods and speed production with the same machine that has proven so successful in the aircraft and missile field. Write for details.

KINGSLEY MACHINES
850 Cahuenga • Hollywood 38, Calif.

See us in Booth 4232—IEEE Show—March 25-28

Barnes Development Co.	1112
Barnes Engineering Co.	3102-3103
Barnstead Still & Sterilizer Co.	4529
Bausch & Lomb Inc.	3845
Beattie-Coleman, Inc.	3914
Beckman Instruments, Inc.	1201-1203 3818-3824
Beemer Engineering Co.	4523
Behlman-Invar Electronic Co.	2824
Belden Manufacturing Co.	4225-4227
F. W. Bell Inc.	3935
The Bendix Corp.	2222-2232 2329-2331
Bergen Laboratories Inc.	2806
Bird Electronics Corp.	3217-3219
Birnbach Radio Co. Inc.	4419
S. Blickman, Inc.	4534
Bliley Electric Co.	1318
BLUE M Electric Co.	3013-3014
Bodnar Products Corp.	4318
Bogart Manufacturing Corp.	1619
Bogue Electric Mfg. Co.	2115-2117
Boonton Electronics Corp.	3114-3116
Boonton Radio Corp.	3401-3403
Borg-Warner Controls	3945
Boston Insulated Wire & Cable Co.	4048
Bourns, Inc.	1429-1431
Bowmar-Technology Instrument Corp.	1508-1514
Bradley Semiconductor Corp.	2227
W. H. Brady Co.	4101-4102
Branson Corp.	2304
H. Braun Tool & Instrument Co. Inc.	4208
The Bristol Co.	1719
Buchanan Electrical Prods. Corp.	2341
Buckbee Mears Co.	4422
Bud Radio, Inc.	4517
Budd-Stanley Co. Inc.	1812
Bulova Watch Co.	1821-1823
Burgess Battery Co.	2812
Burlingame Associates	3814-3816
Burmac Electronics Co. Inc.	1521
Burndy Corp.	1733-1735
Burndy-Esccon, Inc.	1737
Burnell & Co. Inc.	2913-2915
Burr-Brown Research Corp.	3051
Burroughs Corp.	1211-1215

C

CBS Laboratories	3232-3234
C & K Components Inc.	1629
CTS Corp.	1400
CABTRON	4109
Electro Networks	2006
California Technical Industries	3212-3214
Calvert Electronics, Inc.	1926
Cambridge Thermionic Corp.	2219
Cannon Electric Co.	2727-2731
The Capitol Machine & Switch Co. Inc.	2517
The Carborundum Co.	2941-2943
Carpenter Manufacturing Co. Inc.	4520
Carter Manufacturing Corp.	1122
Carter Parts Co.	2808-2810
Ceco, Community Engineering Corp.	1915
CELCO	2534
Ceramaseal, Inc.	1721
Ceramics International Corp.	2922
Cetron Electronic Corp.	M-24
Chassis-Trak, Inc.	4001
Chicago Dynamic Industries, Inc.	2114
Chomerics, Inc.	M-26
Christie Electric Corp.	2911
Cinch Manufacturing Co.	2537-2540
Clare Ceramics, Inc.	1113
Clairex Corp.	1217
S. Paul Sims Co.	1217
C. P. Clare & Co.	2218-2220
Cleveland Metal Specialties Co.	1920
Clevite Corp.	2616-2626
Sigmund Cohn Corp.	4322-4324
Coil Winding Equipment Co.	4426 A & B
Collins Electronics, Inc.	1219
Collins Radio Co.	2221-2223
Columbia Technical Corp.	1116
Columbus Electric Mfg. Co.	1120
Comar Electric Co.	1622
The Combined Book Exhibit, Inc.	4123
Cominco Products, Inc.	4417
Compagnie Generale de Metrologie	3037
Computer Control Co.	3707-3709
Computer Diode Corp.	1337
Computer-Measurements Co.	3711-3713
Computer Systems, Inc.	3926
Conforming Matrix Corp.	4132
Consolidated Avionics Corp.	1324
Consolidated Mining and Smelting Co. of Canada Ltd.	4417
Consolidated Reactive Metals, Inc.	4011
Consolidated Resistance Co. of America, Inc.	1109
Consolidated Systems Corp.	M-4
The Constanta Co. of Canada Ltd.	2113
Continental Connector Corp.	2307-2309
Control Logic, Inc.	3043
Controls Co. of America	1333-1335
Contronics, Inc.	3042
Cool-Fin Electronics Corp.	4509
Coors Porcelain Co.	2233-2235
Cornell-Dubilier Electronics	2721-2725
Corning Glass Works	2619-2625
Cowan Publishing Corp.	4126

Here's how Atlee
spells **RELIABILITY**

**BERYLLIUM COPPER
COMPONENT HOLDERS**

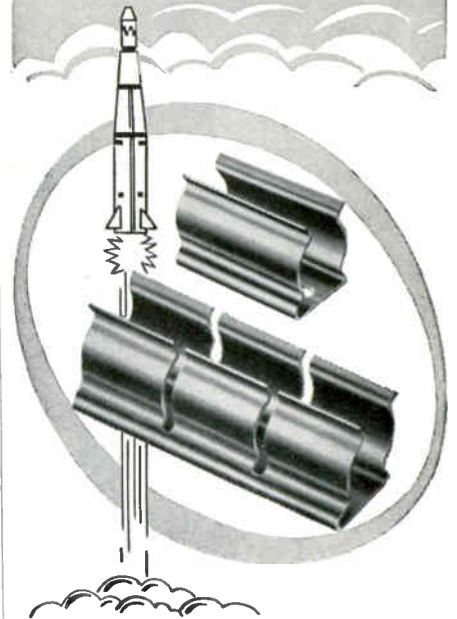

To even the most critical component mounting problems, Atlee's 100-300* series Component Holders bring the added assurance of *functional superiority*. When checked against holders made of conventional materials *Beryllium Copper Component Holders* are . . . *always superior . . . superior all ways.*

- ✓ Tensile Strength
- ✓ Electrical Conductivity
- ✓ Thermal Conductivity
- ✓ Corrosion Resistance
- ✓ Wear Resistance

Atlee component holders and clips are ideal for mounting capacitors, resistors, relays, wires, cables, tubing and related components against shock and vibration; accommodating component diameters from .175" to 3.00". Atlee's *contour design* automatically increases holding power as environmental stress increases.

Finishes Available: Cadmium Dichromate, Silver Dalcoat, Silver, Nickel, Black Matte, Hot Tin Dip, Electro Tin, Dalcoat B (a dielectric), and Natural.

For further information, contact our Engineering Department or request our Application Data Sheet.

*Beryllium Copper



atlee corporation

2 LOWELL AVE. • WINCHESTER, MASS.

CIRCLE 319 ON READER SERVICE CARD

March 15, 1963 • electronics



Boeing has been awarded primary developmental, building and test responsibility for NASA's Saturn S-IC advanced first stage booster. Aero-Space Division's new Saturn Booster Branch has immediate, long-range openings offering professional challenge and rapid advancement to graduate engineers and scientists.

This new Saturn program is expanding rapidly, providing unique advancement advantages and ground-floor opportunities to properly qualified Structural Design, Electronics/Electrical, Propulsion, Aeronautical, Cryogenics, Systems Test, Thermodynamics, Mechanical Design, Industrial and Manufacturing Engineers, as well as to graduate Physicists and Mathematicians.

Salaries are commensurate with all levels of education and experience. Minimum requirements are a B.S. degree in any applicable scientific discipline. Boeing pays travel and moving allowances to newly-hired engineers.

Assignments are in New Orleans as well as in Huntsville, Alabama. Positions with Saturn, and other missile and space programs at Boeing — including the solid-fuel Minuteman ICBM and X-20 Dyna-Soar boost-glide vehicle — are also available at Seattle, Cape Canaveral and Vandenberg AFB, California.

Send your resume to Mr. L. Wendell Hays, The Boeing Company, P. O. Box 26088 · ECR, New Orleans, La. An equal opportunity employer.

BOEING

**OPENINGS
ON
SATURN
S-IC**



BOEING

Divisions: Military Aircraft Systems • Transport • Vertol • **AERO-SPACE** • Industrial Products—Boeing Scientific Research Laboratories

**NEW SATELLITE HEART
LIVES LONGER IN SPACE**

**World's First TRUE Brushless DC Motor
Has Highest Efficiency/Weight Ratio**



■ The new Sperry Farragut self-starting brushless direct current servomotor* offers highest efficiency/weight ratios, longest life and dependable static-free operation. It is the only TRUE brushless direct current motor made for battery operation. Others require inversion units. This solid-state commutator motor lives longer in space because there are no brushes to wear out . . . gone are the friction, arcing and wear of switching commutation necessary for conventional D.C. motors.

*Patent Pending

**Characteristics of Model Being Made
for NASA'S Goddard Space Flight Center**

Efficiency — 50%
Torque — .67 in.-oz. @ 3,000 rpm
Weight — 7.8 oz.

Another Space-Age First From



DIVISION OF SPERRY RAND CORPORATION
BRISTOL, TENNESSEE

**FREE
TECHNICAL
REPORT**

TECHNICAL BULLETIN
SPERRY-FARRAGUT



**SERVOMOTOR
BRUSHLESS DC**

Write today to Dept. EL-3

Crucible Steel Co. of America	2825-2827
Crystallonics, Inc.	2112
Cubic Corp.	3054-3055
James Cunningham Son & Co., Inc.	2237
Curtis Instruments, Inc.	3949
Curtiss-Wright Corp.	1320-1322
Cutler-Hammer, Inc.	1825

D

Dage Electric Co., Inc.	2327
Dahlstrom Mfg. Corp.	4043
Dale Electronics, Inc.	2122-2124
Datapulse Inc.	3946
Daven Div.	2717-2719
Daystrom, Inc.	1702-1710
	1801-1809
Dearborn Electronic Labs, Inc.	2937
DeJur-Amsco Corp.	2310
Del Electronics Corp.	1917-1919
Delevan Electronics Corp.	1437
Delta Coils, Inc.	1922
Deltime, Inc.	2236
DeMornay-Bonardi	3112-3113
Dempa Shimbun, Inc.	2900
Japan Electric Industry	2900
Derivation & Tabulation Associates, Inc.	4122
Dialight Corp.	2518-2520
Diamonite Products Mfg. Co.	4105
DI/AN Controls, Inc.	3120
Diehl Manufacturing Co.	1814-1818
Digital Equipment Corp.	3919-3921
Dodge Fibers Corp.	4012
Don Bosco Electronics, Inc.	3944
Douglas Microwave Co., Inc.	2241-2243
Dow Corning Corp.	4310-4312
Drake Manufacturing Co.	2212
Wilbur B. Driver Co.	4301A-4301B
Driver-Harris Co.	4330
Dymec	3414-3416
Dynage, Inc.	3228
Dynamic Gear Co., Inc.	2918
Dynatron Electronics Corp.	3936
Dytronics Co., Inc.	3121

E

E. I. du Pont de Nemours & Co. (Inc.)	4317-4319
	4333-4335
E.D.I./Columbus Semiconductors, Inc.	1435
EII Research Laboratories, Inc.	3015
ECS Electronics Corp.	2601
Ebauches S. A. Dept. Oscilloquartz	3022
The Watchmakers of Switzerland	3022
Edgerton Germeshausen & Grier, Inc.	3244
Eitel-McCullough, Inc.	2509-2513
ELCO Corp.	1420-1422
Electra Manufacturing Co.	2530-2532
Electralab Printed Electronics Corp.	2132
Electrical Industries	2526-2528
Electro Devices Inc.	4104
Electro Instruments, Inc.	3615-3617
Electro International, Inc.	3025
Electro-Mec Instrument Corp.	2216
Electro-Mechanical Instrument Co.	1231
The Electro Motive Mfg. Co., Inc.	2833
Electro Scientific Industries, Inc.	3016-3020
Electro-Voice, Inc.	1506
Electronic Associates, Inc.	3712-3718
Electronic Controls, Inc.	2004
Electronic Engineers Master-ecm	4424
Electronic Industries	4201-4203
Electronic Instrument Co., Inc. (EICO)	3101
Electronic Measurements Co., Inc.	2410-2411
"Electronic News"	4106-4108
Electronic Representatives Ass'n.	ERA Room 319
Electronic Research Assoc., Inc.	2830-2832
Electronic Sales Marketing Association	Scandinavia Room 416
Electronic Specialty Co.	2927-2929
ELECTRONICS	4314-4316
Elgin National Watch Co.	2519
Ellon Instruments, Inc.	3838
Embree Electronics Corp.	3948
Emerson & Cuming, Inc.	3106
Empire Devices Inc.	3505-3509
Engelhard Industries, Inc.	4403-4411
Engineered Electronics Co.	1518
English Electric Valve Co. Ltd.	1926
Epoxy Products, Inc.	2807
Epoxy Products	M-30
Epsco Inc.	3311-3313
Equipto Electronics Corp.	4240
State Labs., Inc.	2909
L. M. Eriesson Corp.	2909
Eubanks Engineering Co.	4239
Eugene Engineering Co., Inc.	4525
Exact Electronics, Inc.	3059

F

FMC Corp.	4044
Fairchild Camera & Inst. Corp.	2701-2715
Falstrom Co.	4321-4323
Fansteel Metallurgical Corp.	4050-4052
Federal Tool Engineering Co.	4428

Fenwal Electronics, Inc.	1102
Ferris Instrument Co.	3801
Ferrotec Inc.	1114
Ferrocube Corp. of America	2525
Filmohm Corp.	2803
Filters, Inc.	2412
Filtron Co., Inc.	1712-1714
Fitchburg Engineering Corp.	4535
Flotron Industries Inc.	4512
John Fluke Mfg. Co., Inc.	3229-3231
Fork Standards, Inc.	M-20
Bernard Franklin Co., Inc.	4431
Franklin Electronics Inc.	3831
Freed Transformer Co., Inc.	2821-2823
International Resistance Co.	2007

G

G-L Electronics Co., Inc.	1725
G-M Laboratories, Inc.	2105
GPS Instrument Co., Inc.	3060
Gardner-Denver Co.	4524-4526
Garlock, Inc.	2814-2816
Gates Radio Co.	3608-3610
General Applied Science Labs., Inc.	3021
General Atronics Corp.	3315-3317
General Computers, Inc.	3937
General Dynamics Corp.	4025-4027
General Electric Co.	2902-2944
General Findings Inc.	4029
General Instrument Corp.	1311-1323
General Magnetic Corp.	1911
General Motors Corp.	1423
General Plastics Corp.	4236
General Precision, Inc.	1501-1511
General Radio Co.	3201-3208
General Resistance, Inc.	3026
General Thermodynamics Corp.	3934
General Time Corp.	1204-1206
Genisco, Inc.	2002
The Geotechnical Corp.	3837
Gerisch Products, Inc.	3706-3708
Gillroy, Martin & Mills, Inc.	1723
Glass-Tite Industries, Inc.	2607
Glassco Products Co., Inc.	1525
Globe Industries, Inc.	1100-1101
Goe Engineering Co.	4006
Gombos Microwave Inc.	2818-2820
The B. F. Goodrich Co.	3041
Gordos Corp.	1123
W. L. Gore & Associates, Inc.	4121
Gorham Electronics	2308
Gorman Machine Corp.	4046
Grant National Batteries, Inc.	1425-1427
Grand Pulley & Hardware Corp.	4408
Grayhill, Inc.	2302
Great Eastern Metal Products Co.	4117
Green Instrument Co., Inc.	4332
Greenray Industries Inc.	M-23
Grobbach Instruments Corp.	3710
Grenar Manufacturing Co., Inc.	2826
Gries Reproducer Corp.	4054
Guardian Electric Mfg. Co.	2502-2504
Gudelbrod Bros. Silk Co., Inc.	4032

H

H-W Electronics, Inc.	3109
Halliburton Enterprises, Inc.	4506-4508
Hamilton Watch Co.	3050
Hardwick, Hindle, Inc.	2842
Harman-Kardon Inc.	3910
Harrel, Inc.	2103
Harrison Laboratories	3405-3407
The Hart Manufacturing Co.	1527
The Hartwell Corp.	4115
Hastings-Raydist, Inc.	3307
Hayden Publishing Co.	4416-4418
The A. W. Hayden Co.	1405-1407
C. I. Hayes, Inc.	4513
Heinemann Electric Co.	2841-2843
Heli-Coil Corp.	4510
Heller Industries, Inc.	M-33
Hermetic Seal Corp.	1621
Hewlett-Packard Co.	3402-3412
Hexacon Electric Co.	4092
The Hickok Electrical Instrument Co.	3614-3618
Hi-G Inc.	2603
Hill Electronics Inc.	1218
Hitemp Wires Co.	4216
Hoffman Electronics Corp.	1227-1229
Holt Instrument Laboratories	3242
Hotpack Corp.	3846-3848
Houston Instrument Corp.	3029
Hoyt Electrical Instrument Works, Inc.	1331
Hudson Tool & Die Co., Inc.	4309-4311
Huggins Laboratories, Inc.	2434-2438
Hughes Aircraft Co.	2501-2507
Hughes Industries	2009
Hunter Tools	4026
Hull Corp.	4114
Hy-Gain Antenna Products Corp.	2916

I

Illinois Water Treatment Co.	4238
Illinois Tool Works Inc.	1617
Indiana General Corp.	1310-1316
Induction Heating Corp.	4243
Industrial Electronic Engineers, Inc.	M-11

20 to 200 D.P.

Send your prints
for quotations

- SPURS
- HELICALS
- WORM AND WORM GEARS
- STRAIGHT BEVELS
- LEAD SCREWS
- RATCHETS
- CLUSTER GEARS
- RACKS
- INTERNALS
- ODD SHAPES

A few of the many varieties of straight bevels we are regularly producing are shown above. Tell us your needs.

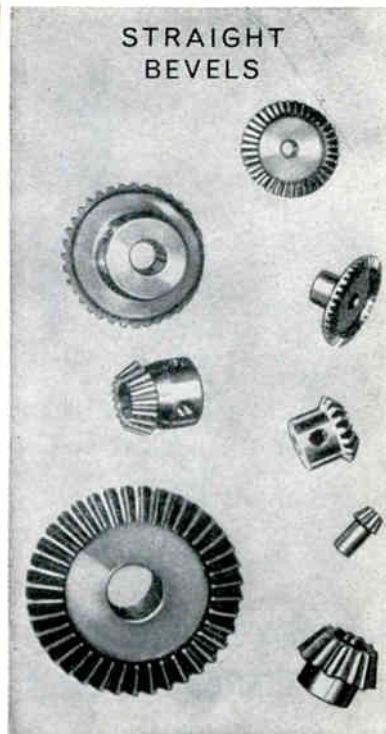

THE *Finest* IN GEARS

Beaver Gear Works Inc.

1021 PARMELE STREET, ROCKFORD, ILLINOIS



CIRCLE 320 ON READER SERVICE CARD

Magneline[®]
THE INDICATOR WITH INHERENT MEMORY

Two new series for digital readout,
ideal for multiplex applications

SERIES 14000—FOR SOLID STATE LOGIC

Character Size $\frac{9}{32}'' \times \frac{1}{4}''$
No. of Characters Up to 11
Leads 11 plus a common
Watts 2.4

SERIES 15000—FOR RELAY LOGIC

Character Size $\frac{5}{16}'' \times \frac{1}{4}''$
No. of Characters Up to 10
Leads 5 plus a common*
Watts 1.3-1.7

*Requires switching of lead in combination with reversal of polarity to change indicator.

Units hold last reading without power. Totally enclosed, self-stacking housing for front or rear mounting. Jewel bearings, only one moving part. Standard voltages 6, 12, 24, or 28 V.D.C. Readability 12 feet at normal room lighting. Options include special voltage, special characters, and internal lighting for dark room applications.

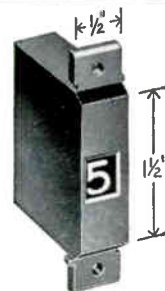

External appearance of
14000 or 15000 series

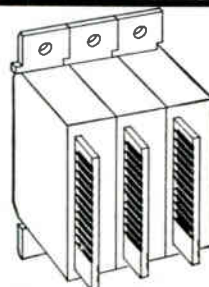

Rear view of units
showing stacking and
plug-in connectors

Write or teletype
(203-753-9341)
for free literature

PATWIN[®] ELECTRONICS

A DIVISION OF THE PATENT BUTTON COMPANY
WATERBURY 20, CONNECTICUT

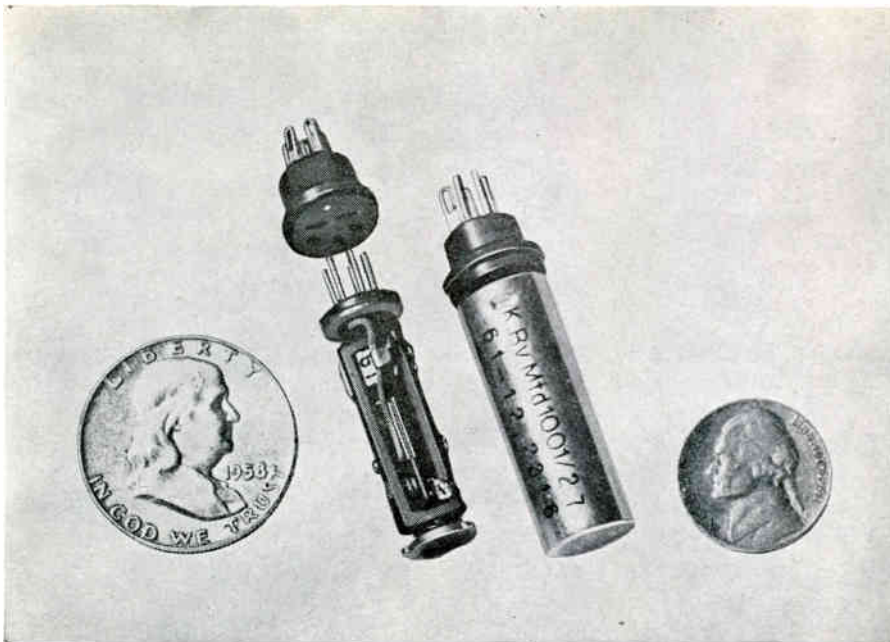

MINIATURE FREQUENCY-ACTUATED REMOTE SELECTOR SWITCHES

These miniaturized resonant reed selectors are designed for remote signaling and control in multiplex telemetry, mobile communications and similar applications. Each selector will respond to one of 40 audio frequencies spaced at 15 cps intervals from 262.5 to 847.5 cps, and actuate signals, counters, controls or other devices. Normal drive current is 2.5 ma. and driving power needed is only 1.8 mW. Selectivity is ± 1.5 cps of calibrated frequency and stability is within ± 0.5 cps of calibrated frequency from -10 to $+50^\circ\text{C}$. Fujitsu resonant reed selectors are particularly useful where space and weight are at a premium. A new electro-mechanical design permits both the reed and driving coil to be sealed in a case only 36mm long and 12.6mm in diameter. For detailed specifications and applications information contact our nearest representative.



FUJITSU LIMITED

Communications and Electronics

Tokyo, Japan

Represented by: U.S.A. HAR-WELL ASSOCIATES, INC. Southbury, Connecticut, Phone: 264-8222 THE NISSHO PACIFIC CORP. 120 Montgomery St., San Francisco 4, California, Phone: YUkon 2-7901, 7906 Canada: NISSHO (CANADA) LTD. 100 University Avenue, Toronto, Phone: EMpire 2-4794 United Kingdom: WALMORE ELECTRONICS LIMITED 11-15 Betterton Street, Drury Lane, London W.C. 2, Phone: TEMplebar 0201-5 Germany: NEUMÜLLER & CO. GMBH. 8 München 13, Schraudolphstr 2a, Phone: 29 97 24

CIRCLE 208 ON READER SERVICE CARD

**HELP YOUR POST OFFICE
TO SERVE YOU BETTER
BY
MAILING EARLY IN THE DAY
NATIONWIDE IMPROVED MAIL SERVICE
PROGRAM**

Industrial Electronic Hardware Corp.	2407
Industrial Instruments, Inc.	3225-3227
Industrial Test Equipment Co.	3310
Industrial Timer Corp.	1212-1214
Ingersoll Products	4211-4215
Inland Motor Corp. of Virginia	1904
Insaco Inc.	M-27
Instrument Specialties Co., Inc.	4313
Instruments for Industry, Inc.	1424
Instruments Publishing Co., Inc.	4307
Intellux Inc.	M-3
International Business Machines Corp.	3605-3609
International Eastern Co.	4034
International Electronic Research Corp.	1522, 3002
International Instruments, Inc.	2811
International Rectifier Corp.	2633-2637
International Resistance Co.	2428-2432
International Telephone & Telegraph Corp.	2510-2516 3302-3304

J

J-B-T Instruments, Inc.	2734
JFD Electronics Corp.	1226
James Electronics, Inc.	2100
Jennings Radio Manufacturing Corp.	1811-1815 3904-3908
Jerrold Corp.	M-10
Jeffron Products, Inc.	4518
Jonathan Mfg. Co.	3238
Julie Research Laboratories, Inc.	3238

K

Kawecki Chemical Co.	4028
Kay Electric Co.	3512-3518
Keithley Instruments, Inc.	3213-3215
Kemtron Electron Products, Inc.	2828
Kepeco, Inc.	2636-2638
Kester Solder Co.	4221
Keuffel & Esser Co.	4504
Kewaunee Scientific Equipment	4016
Kings Electronics Co., Inc.	2334-2336
Kingsley Machine Co.	4232
Kin Tel	3601-3603
Mathias Klein & Sons, Inc.	4430
Knight Electronics Corp.	3825-3827
The James Knights Co.	2706
Krohn-Hite Corp.	3611-3613
Kuhnke Elektrotechnische Fabrik G.m.b.H.	M-6
Kulicke and Soffa Mfg. Co., Inc.	4519
Kulka Electric Corp.	2201
Robinson Technical Products Inc.	1222-1224
Kurman Electric Co.	2135

L

Laboratory for Electronics, Inc.	3715-3717
Lambda Electronics Corp.	2318-2320
Land Air, Inc.	1600
Landis & Gyr, Inc.	3038
LaPointe Industries, Inc.	2102
Larson Instrument Co.	3036-3037
LaVoe Laboratories, Inc.	3835-3837
Leach & Garner Co.	4029
Leach Corp.	1906
Leeds & Northrup Co.	1728
Leesona Corp.	4325-4327
LEL Inc.	2106-2108
Lelanite Corp.	4008
Leonard's Precision Mfg. Co.	1115
Lepel High Frequency Labs, Inc.	4222
Lindberg Engineering Co.	4112
Line Electric Co.	1234
Lionel Electronic Laboratories	1727
Littelfuse, Inc.	2931
Little Falls Alloys, Inc.	4042
Litton Industries, Inc.	1610-1618 1709-1717
Loral Electronics Corp.	1326-1328
Lord Manufacturing Co.	2933-2935
Lumatron Electronics, Inc.	3828

M

MM Electronic Enclosures, Inc.	4103
MRC Manufacturing Corp.	4229
The Machlett Labs, Inc.	2609-2611
MacLeod & Hanopol, Inc.	3309
Mactier Publishing Corp.	4415
Magnecraft Electric Co.	2523
Magnetic Metals Co.	1632
Malaker Laboratories, Inc. & Cryotronics, Inc.	3938

the finest precision
coaxial connectors*



* TM[®]
(miniaturized TNC)

General RF Fittings, Inc.

702 BEACON STREET, BOSTON 15, MASSACHUSETTS
Telephone: 617 267-5120

CIRCLE 321 ON READER SERVICE CARD

DESIGN
IDEAS from EPL

solve speed and control problems

Pickups convert mechanical motion
into AC voltage without contact

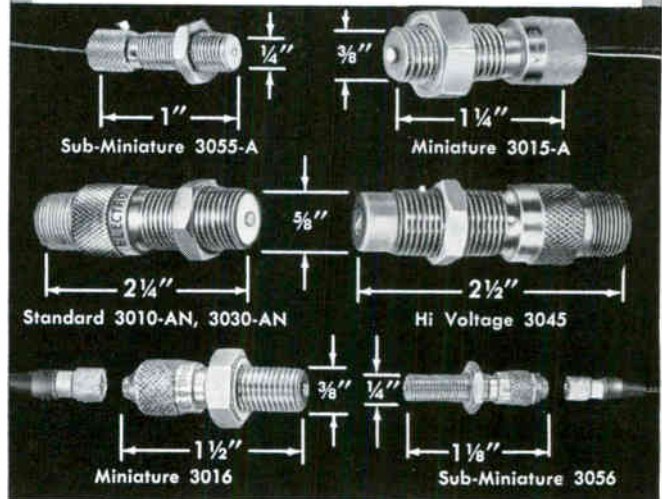
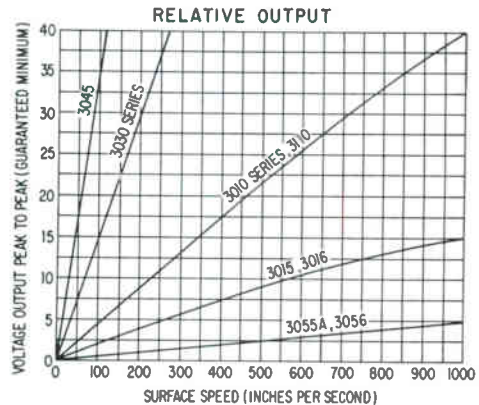

These standard magnetic pickups generate voltage and power without the aid of additional power sources. They actuate electronic or electrical circuitry without amplification in most cases. No extra bearings, mechanical linkages, etc., are required.

A wide variety of stock models are available for immediate delivery, and unlimited variations can be engineered on special order.

CATALOG MP-562 shows varied applications, characteristics and easy selection guide... write today!



ELECTRO PRODUCTS LABORATORIES

6125-F WEST HOWARD, CHICAGO 48
(NILES), ILLINOIS PHONE: 647-6125

Canada: Atlas Instruments Ltd., Toronto

Proximity Switches • Magnetic Pickups • Pres-con Controls • Tachometers
Dynamic Micrometers • DC Power Supplies

2156

CIRCLE 209 ON READER SERVICE CARD

209



Around the world it's **KEW**

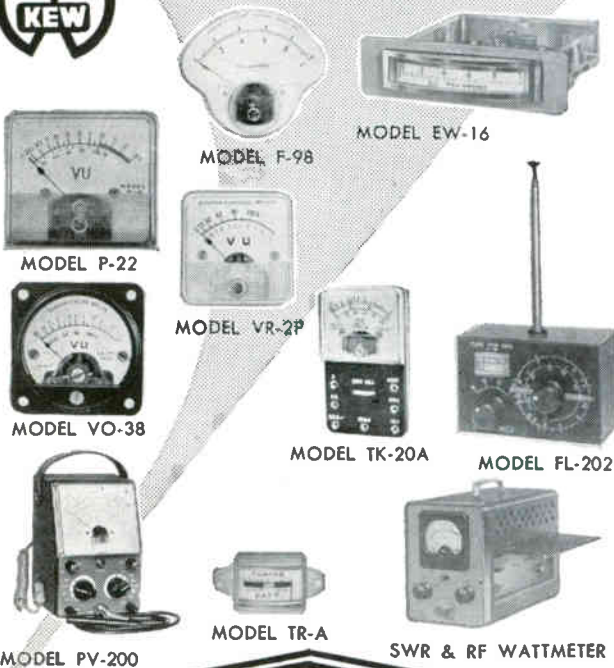

MODEL P-22

MODEL F-98

MODEL EW-16

MODEL VR-2P

MODEL TK-20A

MODEL FL-202

MODEL VO-38

MODEL PV-200

MODEL TR-A

SWR & RF WATTMETER

KYORITSU ELECTRICAL INST. WORKS, LTD.

No. 120, Nakane-cho, Meguro-ku, Tokyo, Japan
Cable Address: "KYORITSUKEIKI TOKYO"

Tel: (717) 0131-5 • 0151-3

CIRCLE 322 ON READER SERVICE CARD

electronics • March 15, 1963

THE PERFECT PACKAGE



FOR HIGH PERFORMANCE APPLICATIONS

KELVIN CUSTOM DESIGNED RESISTANCE NETWORKS

Our experienced engineers will answer your application inquiries accurately and promptly. Send specifications or requirements to:

PRESENT APPLICATIONS:

VOLTAGE DIVIDERS	REFERENCE OR RATIO STANDARDS
COMPUTER APPLICATIONS	LADDER TYPE CONVERTERS
SUMMING NETWORKS	MISSILE CHECKOUT SYSTEMS
DIGITAL TO ANALOG CONVERSION	

Kelvin has specialized for years in the custom design and production of resistance networks to suit individual customer requirements.

Recognized, high quality Kelvin precision wire-wound resistors are used to obtain the ultimate in high accuracy and stability. Units perform in airborne and missile environments involving altitude, shock, vibration, humidity and wide temperature ranges. Networks are packaged in hermetically sealed cases or encapsulated in epoxy resin to meet exact mechanical specifications.

Electrical Characteristics Available:

- Nominal resistance tolerances to $\pm .005\%$.
- Resistance ratio tolerances as close as .002%.
- Long term resistance stability of $\pm .002\%$ per year.
- Low reactances to provide rise times as low as 50 nanoseconds.
- Temperature coefficients of resistors track as close as 1PPM/ $^{\circ}$ C from -55° C to $+125^{\circ}$ C.

Representatives in principal cities



KELVIN ELECTRIC COMPANY

5907 Noble Ave., Van Nuys, Calif., TRIangle 3-3430
New York: Yonkers, 916 McLean Ave., BEverly 7-2500

CIRCLE 323 ON READER SERVICE CARD



PUTS THE BEST IN
CREATIVE ELECTRONICS
INTO YOUR HANDS



Send for
FREE
Catalog

28 pages of professional electronic equipment in kit and wired form—for Lab...Line...Home

EICO, 3300 N. Blvd., L.I.C. 1, N. Y. E-3A
 Send free 32-page catalog & dealer's name.
 Send new 36-page Guidebook to HI-FI for which I enclose 25¢ for postage & handling.

Name _____
Address _____
City _____ Zone _____ State _____

EICO 3300 N. Blvd., L.I.C. 1, N. Y.
Export Dept., Roburn Agencies
431 Greenwich St., N. Y. 13, N. Y.

See us at IEEE Booth 3101

210 CIRCLE 210 ON READER SERVICE CARD

NIMS

NATIONWIDE IMPROVED
MAIL SERVICE PROGRAM

For Better Service
Your Post Office
Suggests

That You Mail Early
In The Day!

P. R. Mallory & Co., Inc.	1410-1414
Mauson Laboratories, Inc.	3104-3105
Marconi Instruments	3701-3705
Markem Machine Co.	4210-4212
Martin Company	3306-3308
Master Specialties Co.	M-17
Maurey Instrument Corp.	1225
Maxson Electronics Corp.	1208-1210
McCoy Electronics Co.	2214
McGraw-Edison Co.	2740
McGraw-Hill Book Co., Inc.	4331
McLean Engineering Labs.	1624
Measurements	3501-3503
Meleor Electronics Corp.	M-9
Adolf Meller Co.	4018
Melpar, Inc.	2101
Mepeco, Inc.	2802-2804
Merek & Co., Inc.	4414
Merrimac Research and Development, Inc.	1106
Meteom, Inc.	2835
Metex Electronic Corp.	4129
Methods Electronics, Inc.	2808-2810
Metronix	3019
Micon Electronics, Inc.	1927
Micro Gee Products, Inc.	3829
Micro State Electronics Corp.	M-19
Mierodot, Inc.	1207-1209
Mierolab	1914
Mieromech Mfg. Corp.	4038
Mierotran Co., Inc.	2215
Microwave Associates, Inc.	2402-2404
Microwave Development Labs., Inc.	2131-2133
James Millen Mfg. Co., Inc.	2515
Miller-Stephenson Chemical Co., Inc.	M-32
Millivac Instruments, Inc.	3305
Minneapolis-Honeywell Regulator Co.	2202-2210
Minnesota Mining & Mfg. Co.	1220
	3833-3835
Mitronics Inc.	1912
Mnemotron Corp.	3027
Molecu-Wire Corp.	4242
Molecular Dielectrics, Inc.	4204A
F. L. Mosley Co.	3409-3411
Donald P. Mossman, Inc.	2239
Motor Generator Corp.	1124
Motorola Communications and Electronics Inc.	3028
Motorola Semiconductor Products, Inc.	1117-1118
Mucon Corp.	2801
Muirhead Instruments Inc.	3230
Murata Mfg. Co. Ltd.	1523
Mycalex Corp. of America	2615-2617

N

N. J. E. Corp.	1626
NR' Equipment Corp.	4425-4427
The Narda Microwave Corp.	3809-3813
National Connector Corp.	M-8
National Beryllia Corp.	4530
National Lead Co.	4501
National Radio Co., Inc.	1401-1403
National Semiconductor Corp.	1723
NAVAN Products Inc.	3032
Navigation Computer Corp.	3812
Needco Frigistors Ltd.	M-25
NEP Instrument Corp.	M-7
Neshaminy Electronic Corp.	M-18
New Departure	2838-2840
New Hermes Engraving Machine Corp.	4124
Nikon, Inc.	1121
	3046
Nippon Electric Co., Ltd.	3241
Non-Linear Systems, Inc.	3047-3049
North American Electronics, Inc.	1520
North Atlantic Industries, Inc.	3939
North Electric Co.	2140-2144
North Hills Electronics, Inc.	2110
Northeast Scientific Corp.	2844
Northeastern Engineering, Inc.	3226
Northern Precision Laboratories, Inc.	M-14
Norton Co.	M-29

O

Ohmite Manufacturing Co.	2333-2335
Optimized Devices, Inc.	3036
Ortho Industries, Inc.	1730-1732
Oryx Co.	4107
John Oster Mfg. Co.	1330-1332

P

PCA Electronics Inc.	1329
PIC Design Corp.	1426
PRD Electronics, Inc.	3602-3606
Packard-Bell Computer Corp.	3911-3913
Panduit Corp.	4030
Panofamic Electronics	3301-3303
Paradynamics, Inc.	3053
Parker Seal Co.	4233

March 15, 1963 • electronics

Par-Metal Products Corp.	4302-4304
Patwin Electronics Div.	3052
Penn Engineering & Mfg. Corp.	4308
Penta Laboratories, Inc.	2834
Perfection Mica Co.	4420
Perkin-Elmer Vernistat	2225
Perkin-Elmer Optical Maser	Japan Room 4267
Perkin Electronics Corp.	1416-1418
Phaotron Instrument & Electronic Co.	1430-1432
Philco Corp.	1302-1308
Phillips Control Co.	2431 & 3012
Photocircuits Corp.	2205-2207
Pickard & Burns, Inc.	3030
Plastic Capacitors, Inc.	2917
Plastoid Corp.	4128
Polyrad Electronics Corp.	3205-3211
Polyphase Instrument Co.	2839
Pomona Electronics Co., Inc.	1627
Popper & Sons, Inc.	4125
H. K. Porter Co., Inc.	4130
Potter & Brumfield, Inc.	2702-2704
Potter Instrument Co., Inc.	3702-3704
Power Designs Inc.	1516
Precision Apparatus Co.	1515
Precision Instrument Co.	3932
Precision Microwave Corp.	M-22
Precision Scientific Co.	3915-3917
Premier Metal Products Co., Inc.	4204-4206
Premier Microwave Corp.	3023
Prentice-Hall, Inc.	4528
Preslin Co., Inc.	3024
Price Electric Corp.	2409
Pritchard Wood Co., Inc.	2615-2617
Probescope Co., Inc.	3832
The Pyle-National Co.	2240
Pyrofilm Resistor Co., Inc.	2104

Q

Quan-Tech Laboratories, Inc.	3243 A
	3243 B

R

REF Dynamics Corp.	4329
RLC Electronics, Inc.	1906
RS Electronics Corp.	2238
Radiation at Stanford	3826
Radio Corp. of America	1602-1608
	1701-1707
Radio Engineering Laboratories, Inc.	1202
	1301-1303
Radio Frequency Laboratories, Inc.	3115-3119
Ramson Electrical Instr. Co.	3210
Raychem Corp.	4505
Rayflex Co.	3912
Raytheon Co.	4056
	2602-2614
Reeves-Hoffman	1309
Reeves Instrument Corp.	1305-1307
Reeves Soundercraft Corp.	1228
Rego Insulated Wire Co.	4127
Ronbrandt, Inc.	1104
Resdel Engineering Corp.	3912
Rheem Electronics Corp.	3905-3907
Riecho Plastic Co.	4532
John F. Rider Publisher, Inc.	4516
Rixon Electronics, Inc.	3034-3035
Robinson Technical Products, Inc.	2506-2508
Rockbestos Wire & Cable Co.	M-31
Rogan Brothers Inc.	4110
Rohde & Schwarz Sales Co. (U.S.A.)	
Inc.	Theater 3000A
	Theater 3000B
Rohr Corp.	M-21
The Milton Ross Co.	4036
Rotek Instrument Corp.	3951
Rotron Manufacturing Co., Inc.	2427-2429
Rowan Controller Co.	2903
Rutherford Electronics Co.	3819
Rye Sound Corp.	2925

S

Sage Electronics Corp.	2217
Sage Laboratories, Inc.	1223
Howard W. Sams & Co., Inc.	4035
Sanborn Co.	3413-3417
San Fernando Electric Mfg. Co.	2736-2738
Sanders Associates, Inc.	2535-2536
Sangamo Electric Co.	2311-2313 & 2130
Sanwa Electric Instrument Works, Ltd.	3941
Sanyo Electric Co. Ltd.	M-2
Sarkes Tarzian, Inc.	1729-1731
Shutter Microwave Corp.	1726
Schwarzer Co.	3952
Scientific-Atlanta, Inc.	3923-3925
H. H. Scott, Inc.	3122



WHAT'S NEW FROM GARLOCK

Electronic Products

CHEMELEC® Printed Circuit Test Points reflect the latest thinking in advanced design and precision manufacture. TFE insulator material provides exceptional dielectric properties, chemical inertness, resistance to temperatures from -110°F to $+500^{\circ}\text{F}$. Beryllium copper contacts and brass brackets are silver plated and gold flashed. Flashover (Short time, sea level) —3000 VRMS. Capacitance (Frequency 1000 KC)—.25 MMFD. Available, in all ten RMA colors, from local stock. Write for AD-169.

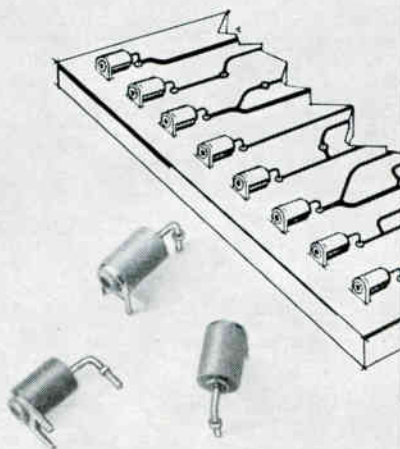

CHEMELEC® Miniature Tube Sockets for high frequency applications, such as radar equipment and wide band oscilloscopes. FEP body insulating material has outstanding impact strength, resists temperatures from -395°F to $+400^{\circ}\text{F}$. Water absorption is zero. All metal parts precision made, and plated to JAN specifications. Furnished in 7 and 9 pin Shield Base Type, 7 and 9 pin Saddle Base Type, and 9 pin Bottom Mounting Type. Available from local stock. Write for AD-169.



Shield Base



Saddle Base Type



Bottom Mounting Type

For full information, contact your Garlock Electronic Products distributor or representative. Or, write GARLOCK ELECTRONIC PRODUCTS, GARLOCK INC., Camden, New Jersey.

GARLOCK

SEE OUR BOOTH 2814-2816 AT THE IEEE SHOW



ANTENNA CAPABILITIES

The advanced design and precision construction of Ainslie antenna systems and associated equipment bear testimony to nearly two decades of microwave communication, detection and identification experience. By virtue of complete design-to-delivery capabilities and facilities, Ainslie Corporation offers its customers not only comprehensive standard lines of mesh, spun and horn antennas, but also the flexibility required to develop custom designed prototypes for on-schedule delivery.

See us at the IEEE Show Booth #1819



Ainslie CORPORATION

531 Pond Street
Braintree 85, Massachusetts

Sealectro Corp.	2234
Secor Metals Corp.	4004
Security Devices Laboratory	1625
Seg Electronics Co., Inc.	1925
Edward Segal, Inc.	4007
Semiconductor Specialties Corp.	4507
Sensitive Research Instrument Corp.	3108-3111
Servomechanisms, Inc.	2316
Shallcross Mfg. Co.	2632-2634
Shieldtron, Inc.	3061-3062
The Sibley Co.	1107
Sierra Electronic	3031-3033
Sigma Instruments, Inc.	2628-2630
Signal-AFCEA	4226B
Signetics Corp.	2005
Silicon Transistor Corp.	1913
Simberkoff Sales Co.	4006
Simpson Electric Co.	2321-2325
Sinclair Radio Laboratories, Inc.	2631
The Sippican Corp.	4135
Skydyne, Inc.	4514-4515
Sliding Mechanisms, Inc.	4113
Slip Ring Co. of America	2939
Herman H. Smith, Inc.	2203
Sola Electric Co.	2815-2819
Solid State Products, Inc.	2742
Solid State Instrument Labs.	3005
Solitron Devices, Inc.	2125
Sonobond Corp.	4133
Sonotone Corp.	1902
Sony Corp.	3107
Sorensen	2602-2604
South Chester Corp.	4533
Southern Electronics Corp.	2901
STL Products	3237-3239
Spaulding Fibre Co., Inc.	4217-4219
Specific Products	3909
Spectrol Electronics Corp.	1822-1824
Sperry Rand Corp.	2627-2629
	3314-3318
	2416-2424
Sprague Electric Co.	4039
Stancor Electronics, Inc.	1216
Standard Electrical Products Co.	2743
Standard Pressed Steel Co.	2829-2831
Star-Tronics, Inc.	M-5
Sterling Instrument	1517
Stevens-Arnold Inc.	2920
George Stevens Mfg. Co., Inc.	4218-4220
Stevens Mfg. Co., Inc.	1325
Stevens-Evans, Inc.	M-15
Stewart Stamping Co.	4031
Herman H. Sticht Co., Inc.	3236
Edwin B. Stimpson Co., Inc.	4013
Stocker & Yale Inc.	3950
Stoddart Aircraft Radio Co., Inc.	3933
Stone & Smith, Inc.	4055
Strand Labs, Inc.	3001
The Superior Electric Co.	2722-2732
Swiss Jewel Co.	4040
Switchcraft, Inc.	2312-2314
Sylvania Electric Products Inc.	2322-2332
	2415-2425
Synthane Corp.	4421-4423
Syntronie Instruments, Inc.	2809
Systron-Donner Corp.	3839-3843

T

TRG, Inc.	2003
TRW Electronics	2340-2344
	2433-2437
The Taylor-Winfield Corp.	4531
Tech Laboratories, Inc.	2120
Tech-Ohm Electronics, Inc.	2119
Technical Appliance Corp.	3912
Technical Devices Co.	4231
The Technical Material Corp.	3901-3903
Technical Wire Products, Inc.	4522
Techni-Rite Electronics, Inc.	3940
Tektronix, Inc.	3511-3517
Telex, Inc.	1628-1630
Telonic Engineering Corp.	3924
Telonic Industries Inc.	3920-3922
Telrex Labs.	1620
M. Ten Bosch, Inc.	1519
Tenney Engineering, Inc.	3118
Test Equipment Corp.	3947
Texas Instruments Inc.	1409-1421
Thomas Electronics, Inc.	2813
The Thomas & Betts Co., Inc.	1327
Thomas & Skinner, Inc.	2919
Thompson Ramo Wooldridge Inc.	3223
Thomson Electric Co., Inc.	2008
Time & Frequency Co., Inc.	2109
Tinnerman Products, Inc.	4205-4209
Todd Electric Co., Inc.	M-13
The Torrington Manufacturing Co.	2836
Toshiba (Tokyo Shibaura Electric Co., Ltd.)	3044
Mitsui & Co., Ltd.	3044
Trans-Sil Corp.	2608-2609
Transistor Devices, Inc.	2126
Transistor Specialties, Inc.	3240
Transitron Electronic Corp.	1720-1724
Traveo Associates, Inc.	1230-1232
Tri Metal Works, Inc.	4047
Trio Laboratories, Inc.	3222-3224

Acoustical Components of Superior Quality

JAPAN PIEZO supplies 80% of Japan's crystal product requirements.

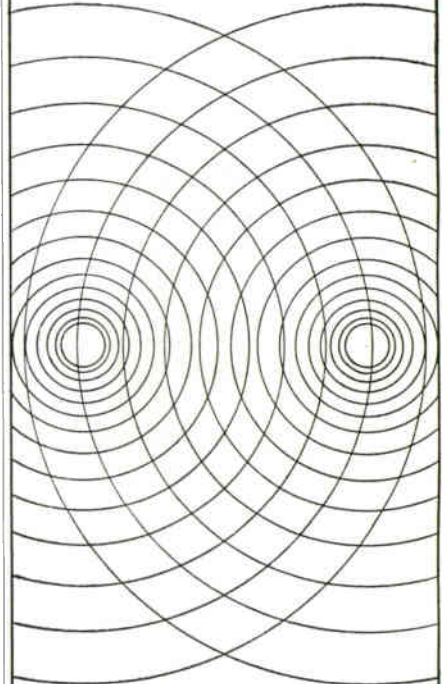

STEREO CARTRIDGE

Crystal — "PIEZO" Y-130

X'TAL STEREO CARTRIDGE

At 20°C, response: 50 to 10,000 c/s with a separation of 16.5 db. 0.6 V output at 50 mm/sec. Tracking force: 6±1 gm. Compliance: 1.5×10⁻⁶ cm/dyne. Termination: 1MΩ + 150 pF.

Write for detailed catalog on our complete line of acoustical products including pickups, microphones, record players, phonograph motors and many associated products.



JAPAN PIEZO ELECTRIC CO., LTD.

Kami-renjaku, Mitaka, Tokyo, Japan

CIRCLE 324 ON READER SERVICE CARD

March 15, 1963 • electronics

electronics REPRINT SERVICE

The electronics Reprint Service Department offers these types of reprints for sale :

1. Reprints of the latest and previously published Special Reports and Feature Articles with definite costs for varying quantities. See the list below for Special Reports and Feature Articles available.
2. Bulk reprints of editorial articles in the current or past issues. (Minimum bulk order is 100 copies. Prices are not quoted because of the unknown number of editorial pages that may be requested.)

Reprints Available on Past Special Reports and Feature Articles

(Order by Key Number. Use the REPRINT ORDER FORM below.)

KEY NO.	TITLE OF REPRINT	NO. OF PAGES	ISSUE DATE	PRICE
	Medical Electronics—			
R-19a	Part I: Diagnostic Measurements	8	Jan. 20, 1961	25¢ ea.
R-19b	Part II: Diagnostic Systems and Visualization	6	Feb. 3, 1961	25¢ ea.
R-19c	Part III: Therapeutic Devices	4	Feb. 24, 1961	25¢ ea.
R-19d	Part IV: Prosthetics—Hearing Aids and Blind Guidance Devices	7	June 23, 1961	25¢ ea.
R-19e	Part V: Prosthetics—Substitute Organs and Limbs	7	July 21, 1961	25¢ ea.
R-19f	Part VI: Observing Life Processes	7	Dec. 15, 1961	25¢ ea.
R-19g	Part VII: Studying Life Processes	3	Jan. 19, 1962	25¢ ea.
	Plasma Engineering—			
R-22a	Part I: Generating and Heating Plasma	7	July 14, 1961	25¢ ea.
R-22b	Part II: Measuring Parameters	7	Aug. 4, 1961	25¢ ea.
R-22c	Part III: Practical Applications of Plasma	7	Sept. 1, 1961	25¢ ea.
R-23	What's New in Semiconductors	32	Sept. 29, 1961	*
	Lasers: Devices & Systems—			
R-26a	Part I: Principles of Functioning and Laser Materials	9	Oct. 27, 1961	25¢ ea.
R-26b	Part II: Communications, Navigation, Ranging and Undersea Applications	5	Nov. 3, 1961	25¢ ea.
R-26c	Part III: Military and Computer Applications	5	Nov. 10, 1961	25¢ ea.
R-26d	Part IV: Scientific and Medical Applications; Laser Optics; Commercial Equipment	4	Nov. 24, 1961	25¢ ea.
	Bionics—			
R-29a	Part I: Electronics and the Life Sciences	6	Feb. 9, 1962	25¢ ea.
R-29b	Part II: Animal Sensors and Electronic Analogs	4	Feb. 16, 1962	25¢ ea.
R-29c	Part III: Brain Models and Neural Nets	5	March 2, 1962	25¢ ea.
R-29d	Part IV: Applications and New Directions	4	March 16, 1962	25¢ ea.
†R-30	Graphical Symbols for Electronics Diagrams	4	March 23, 1962	\$1.00 ea.
†R-31	1962 Electromagnetic Spectrum Chart	8	April 13, 1962	\$1.00 ea.
R-32	Modern Electronics Components	24	May 11, 1962	*
R-33	Information Storage and Retrieval	24	June 29, 1962	*
R-34	Electronics in Canada	24	Sept. 28, 1962	*
R-36	Electronics Markets 1963: What the Future Holds	30	Jan. 4, 1963	*
R-37	Advances in Microminiaturization	16	Feb. 15, 1963	50¢ ea.

* Price: Reprints on items above are 1-10 copies, 75¢ each; 11-24 copies, 60¢ each; 25 copies or more, 50¢ each unless otherwise noted.

† One copy each of the Symbols Chart and Spectrum Chart is available at a combination rate of \$1.75. For prices of bulk orders call or write to electronics reprint department.

Fill in,
Clip Out
coupon,
insert into
envelope and
mail to



REPRINT ORDER FORM

(To help expedite mailing of your reprints please send cash, check or money order with your order.)

For Reprints of the latest Special Report:

Advances In Microminiaturization (Feb. 15, 1963)
Send me Reprints of Key No. R-37 at 50¢ each

For Reprints of previous Special Reports or Feature Articles fill in below:

Send me Reprints of Key No(s). @ ¢ each. (For prices, see chart above.)

* For orders of Bulk Reprints of other editorial articles in this issue or past issues:

Send me Reprints of page no(s). of issue date.
of article entitled.

* Minimum bulk order 100 copies. You will be advised of costs by return mail.

Name _____

Number and Street _____

City, Zone No., State _____

electronics
READER SERVICE
330 W. 42nd Street
New York 36, N. Y.



PHASE METERS

Direct reading in degrees.
Accuracy 0.02° or 2%.
Frequency range 1 cps to 500 mc.

TYPE 202

Phase Range: 0-1°, 0-2°, 0-4°, 0-10°, 0-20° up to 360°
Voltage Range: 0.01v up to 100v in ten ranges.
Frequency Range: 15 cps to 500 mc.
Accuracy: ±0.02° or ±2%.
Price: \$698.

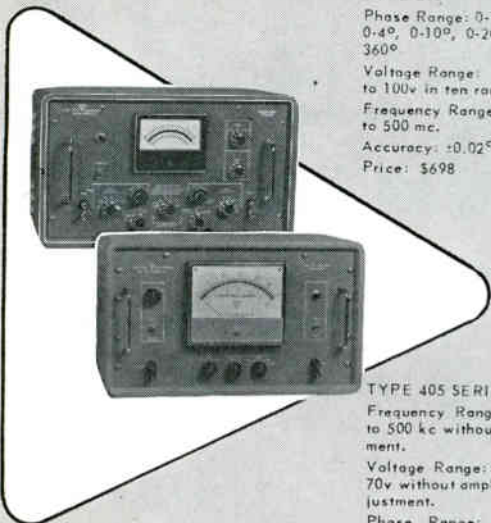

TYPE 405 SERIES

Frequency Range: 1 cps to 500 kc without adjustment.
Voltage Range: 0.3v to 70v without amplitude adjustment.
Phase Range: 0-12°, 0-36°, 0-90° up to 360°.
Accuracy: ±0.25° relative, ±1° or 2% absolute.
Price: \$668 and up.
Write for literature.

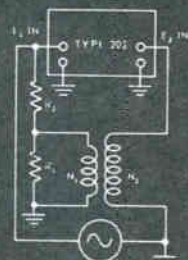

Measure phase shift of step-up transformer with accuracy of 0.02°.

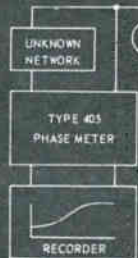

Plotting phase characteristics from 8 cps to 100 kc.

AD-YU ELECTRONICS INC.

249 TERHUNE AVE., PASSAIC, N. J.

Gregory 2-5622 CABLE-AD-YU PASSAIC

Visit Our Booth No. 3612 at the IEEE Show

CIRCLE 325 ON READER SERVICE CARD

MICO

DESK AND DOOR PLATE ENGRAVER

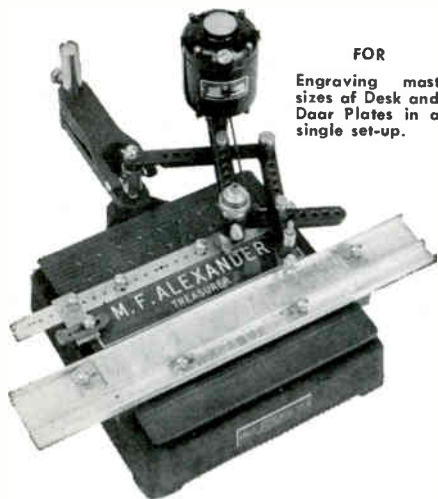

FOR Engraving most sizes of Desk and Door Plates in a single set-up.

FEATURES

1. Six pantograph ratios—from 1.5:1 to 4:1.
2. Spindle has integral micrometer depth control of .250".
3. Uses standard tapered-shank engraving cutters.
4. New 19" Copy carries hold 17" of master copy; Permits engraving about 11" line of characters in one set-up at the 1.5:1 ratio.
5. Three sizes of copy carriers available. Each positioned separately.
6. Work-holding fence speeds set-up and engraving time.

Send for illustrated Catalog

MICO INSTRUMENT CO.

77 Trowbridge St.

Cambridge 38, Mass.

214 CIRCLE 214 ON READER SERVICE CARD

Coils for Contact Capsules



1 to 5 Reeds
.095 — .215 dia.
6 to 48 V.D.C.
Lead or Pin Term.
Also Available with Reeds.

Write for Bulletin and Prices

ELECTRICAL COIL WINDINGS

Wire sizes #6 to #56, Classes A, B, F and H. Complete engineering service available.

Coto-Coils

COTO-COIL COMPANY INC.

65 Pavilion Avenue, Providence 5, R. I.

CIRCLE 326 ON READER SERVICE CARD

The Triplett Electrical Instrument Co. 2426
Tru-Connector Corp. 1110
Tru-Ohm Products 2305
Trygon Electronics Inc. 1916
Tung-Sol Electric Inc. 2733-2739

U

The Unite Co. 2537-2540
Utek Corp. 4053
Ultrasonic Industries, Inc. 4010
Ungar Electric Tools 4234
Unholtz-Dickie Corp. 3931
Uniform Tubes, Inc. 4037
Union Carbide Corp. 2401-2405
United Aircraft Corp. Italy Room 2128
United Mineral & Chemical Corp. 1631
United Shoe Machinery Corp. 4241
Unitrode Transistor Products, Inc. 2001
U. S. Components, Inc. 2805
U. S. Dielectric Inc. 4111
United States Dynamics 4119
U. S. Stoneware Co. 2337-2339
United Transformer Corp. 2413-2414
Unitek Corporation 4527
Universal Electronics Co. 1119
Universal Instruments Corp. 4049 & Room 610
Universal Mfg. Co., Inc. 4017-4019
Utica Drop Forge & Tool 4009

V

Vacuum-Electronics Corp. 3508-3510
Valpey Crystal Corp. 1433
D. Van Nostrand Co., Inc. 4503
Varian Associates 2708-2720
Vari-L Co., Inc. 2209
Varo Inc. 1635-1637
Vector Electronic Co., Inc. 1513
Veeder-Roof Inc. 3506
Vemaline Products Co. 2116
Victor Business Machines Co. 3830
The Victoreen Instrument Co. 2301-2303
Vitamont, Inc. 2406-2408
Vitro Electronics 3821-3823
Vogue Instrument Corp. 2127

W

Wabash Magnetics, Inc. 1529 & 1633
Waber Electronics Inc. 3040
Wales STRIPPIT Inc. 4014-4015
The Walkirt Co. 2605
Waltham Precision Instr. Co., Inc. 2118 4402-4404
Wang Laboratories, Inc. 3221
Ward-Leonard Electric Co. 2231
Waters Manufacturing, Inc. 1233
Waveforms, Inc. 3220
Wayne-George Corp. 3312
Wayne Kerr Corporation 3834-3836
Weckesser Co., Inc. 4003
The Welch Scientific Co. 4214
Weller Electric Corp. 4230
Western Electric Co. M-1
Western Gold & Platinum Co. 4118
Western Semiconductors, Inc. 1111
Western Lithograph Co. 4406
Westinghouse Air Brake Co. 2921-2923
Westinghouse Electric Corp. 1402-1408 1601-1607
John Wiley & Sons, Inc. 4306
A. F. Wilkens Co. 4023
Wiltron Co. 3009
Winchester Electronics, Inc. 2121-2123
Wood Electric Corp. 1918
Wright Div., Sperry Rand. 2129
Wright Metalcoaters, Inc. 4024
Wyreo Projects, Inc. 4521

Y

Yardney Electric Corp. 2211-2213
Yellow Springs Instrument Co., Inc. M-16
Yokogawa Electric Works, Inc. 3844
York Metal Products, Inc. 4228

Z

The Zell Products Corp. 1817
The Zippertubing Co. 4429

ENGINEERS & PHYSICISTS

Unusual Professional Openings Exist At Atomic Energy Research Laboratory

for Engineers and Physicists to participate in the design, development, construction and operation of large particle accelerators and liquid hydrogen bubble chambers/Specific openings include:

- Design and developmental experience and interest in high and low level electronics, RF systems, microwaves and solid state devices for power and control.
- The operation and development of a 3 BEV Synchrotron, a 33 BEV Synchrotron and an 80" liquid hydrogen bubble chamber. These facilities include a wide range of electronic systems, sophisticated high power systems and cryogenic devices. A broad background in electronics as well as a solid understanding of physics fundamentals is necessary.
- Design, development and operation of electrical and electronic instrumentation and control equipment for dynamic devices operating in the Cryogenic region. Experience in both digital and analogue control systems is preferred.
- Design, development and operation of advanced devices for analysis of photographic data, using "ON-LINE" operation of an IBM 7090 or similar computer. Experience with digital circuitry, computer hardware and interface equipment is essential.

NEW YORK CITY INTERVIEWS DURING I. E. E. SHOW AT THE COLISEUM OFFICE BUILDING (MARCH 25 to 28)

For Interview Appointment With Dr. G. K. Green And Staff, Phone COlumbus 5-2090 during the show or send resume to his attention at Building 185

BROOKHAVEN NATIONAL LABORATORY
ASSOCIATED UNIVERSITIES, INC. • UPTON, LONG ISLAND, NEW YORK

An Equal Opportunity Employer



electronics

WEEKLY QUALIFICATION FORM FOR POSITIONS AVAILABLE

ATTENTION: ENGINEERS, SCIENTISTS, PHYSICISTS

This Qualification Form is designed to help you advance in the electronics industry. It is unique and compact. Designed with the assistance of professional personnel management, it isolates specific experience in electronics and deals only in essential background information.

The advertisers listed here are seeking professional experience. Fill in the Qualification Form below.

STRICTLY CONFIDENTIAL

Your Qualification form will be handled as "Strictly Confidential" by ELECTRONICS. Our processing system is such that your form will be forwarded within 24 hours to the proper executives in the companies you select. You will be contacted at your home by the interested companies.

WHAT TO DO

1. Review the positions in the advertisements.
2. Select those for which you qualify.
3. Notice the key numbers.
4. Circle the corresponding key number below the Qualification Form.
5. Fill out the form completely. Please print clearly.
6. Mail to: Classified Advertising Div., ELECTRONICS, Box 12, New York 36, N. Y. (No charge, of course).

COMPANY	SEE PAGE	KEY #
ACF INDUSTRIES INC. Albuquerque Division Albuquerque, New Mexico	223	1
AEROSPACE PLACEMENT CORP. Phila., 3, Penna.	222	2
AFSC-AFLC Joint Professional Placement Office New York, N. Y.	221	3
ATOMIC PERSONNEL INC. Philadelphia, Penna.	93*	4
BELL AEROSYSTEMS CO. Div. of Bell Aerospace Corporation A Textron Company Buffalo, New York	223	5
BENDIX CORPORATION Kansas City Division Kansas City, Missouri	220	6
BOOZ, ALLEN APPLIED RESEARCH INC. Bethesda, Md.	222	7
BROOKHAVEN NATIONAL LABORATORY Upton, New York	215	8
GENERAL DYNAMICS, ELECTRIC BOAT Groton, Conn.	220	9
GENERAL DYNAMICS/ELECTRONICS Rochester 1, N. Y.	217	10
HIGH VOLTAGE ENGINEERING CORPORATION Burlington, Mass.	91*	11
HONEYWELL St. Petersburg, Fla.	84*	12
LOCKHEED MISSILES & SPACE COMPANY Div. of Lockheed Aircraft Corp. Sunnyvale, California	73*	13
NORDEN Div. of United Aircraft Corp. Norwalk, Conn.	219	14
PAN AMERICAN WORLD AIRWAYS INC. Guided Missiles Range Div. Patrick AFB, Fla.	218	15
PERSPECTIVE Needham Heights, Mass.	222	16

(Continued on page 223)

(cut here)

electronics WEEKLY QUALIFICATION FORM FOR POSITIONS AVAILABLE

(cut here)

(Please type or print clearly. Necessary for reproduction.)

Personal Background

NAME

HOME ADDRESS

CITYZONE.....STATE.....

HOME TELEPHONE

Education

PROFESSIONAL DEGREE(S)

MAJOR(S)

UNIVERSITY

DATE(S)

FIELDS OF EXPERIENCE (Please Check)

31563

- | | | |
|--|--|---------------------------------------|
| <input type="checkbox"/> Aerospace | <input type="checkbox"/> Fire Control | <input type="checkbox"/> Radar |
| <input type="checkbox"/> Antennas | <input type="checkbox"/> Human Factors | <input type="checkbox"/> Radio—TV |
| <input type="checkbox"/> ASW | <input type="checkbox"/> Infrared | <input type="checkbox"/> Simulators |
| <input type="checkbox"/> Circuits | <input type="checkbox"/> Instrumentation | <input type="checkbox"/> Solid State |
| <input type="checkbox"/> Communications | <input type="checkbox"/> Medicine | <input type="checkbox"/> Telemetry |
| <input type="checkbox"/> Components | <input type="checkbox"/> Microwave | <input type="checkbox"/> Transformers |
| <input type="checkbox"/> Computers | <input type="checkbox"/> Navigation | <input type="checkbox"/> Other |
| <input type="checkbox"/> ECM | <input type="checkbox"/> Operations Research | <input type="checkbox"/> |
| <input type="checkbox"/> Electron Tubes | <input type="checkbox"/> Optics | <input type="checkbox"/> |
| <input type="checkbox"/> Engineering Writing | <input type="checkbox"/> Packaging | <input type="checkbox"/> |

CATEGORY OF SPECIALIZATION

Please indicate number of months experience on proper lines.

	Technical Experience (Months)	Supervisory Experience (Months)
RESEARCH (pure, fundamental, basic)
RESEARCH (Applied)
SYSTEMS (New Concepts)
DEVELOPMENT (Model)
DESIGN (Product)
MANUFACTURING (Product)
FIELD (Service)
SALES (Proposals & Products)

CIRCLE KEY NUMBERS OF ABOVE COMPANIES' POSITIONS THAT INTEREST YOU

1 2 3 4 5 6 7 8 9 10 11 12 13 14 15 16 17 18 19 20 21 22 23 24 25

IMMEDIATE OPENINGS

WITH

GENERAL DYNAMICS / ELECTRONICS

The large number of diversified development contracts now in the house at General Dynamics/Electronics provide immediate assignments for additional professional personnel in the following disciplines:

SYSTEMS ENGINEERING

SENIOR DESIGN ENGINEER. To assist in evaluation of complex electronic reconnaissance systems. Requires experience in 2 or more of the following: digital, RF, pulse, audio, CRT, photorecorders, magnetic recorders, pulse multiplex and frequency multiplex.

SENIOR ENGINEER. With broad knowledge of Aerospace Ground Electronic design. Will analyze aerospace electronic subsystems for test requirements and determine test equipment needs. Experience in Air Force shop or Naval carrier installations desirable, with emphasis on equipment layout, intercabling, work flow analysis, and operational and calibration procedures.

PROJECT ENGINEERS. To supervise design and integration of test equipments and test stations. Should be familiar with all types of testing equipment and techniques in one or more of the following areas: flight control systems, radar, HF-UHF navigation and communication equipment, microwave equipment, antenna systems and electronic countermeasures.

DIGITAL EQUIPMENT DESIGN

SENIOR ENGINEERS. To supervise and do design work on MODEMS, logic and in-put/out-put devices for data communication equipment used in industrial and military systems. Work includes transistor circuit design, logic design, modulation techniques for radio and wire line data transmission, mechanical design of in-put/out-put devices, packaging design and integration of complete communications systems.

CIRCUIT DESIGN ENGINEERS. With experience in the design of transistorized logic circuits, pulse generators and other digitally controlled circuits such as numerical indicators.

MAINTAINABILITY

Long Range Programs in Development/Test/Evaluation/Production of Aerospace Electronic Equipment for:

PRINCIPAL ENGINEER. To establish and operate elite group — experience with all phases of MIL-M-26512; maintenance engineering analysis; principal practices and techniques in the design, maintenance and use of Aerospace Electronic equipment. — Supervisory Position.

SENIOR ENGINEERS. To implement maintainability tasks — experience with design principles, practices and techniques on Aerospace Electronic hardware; analysis, control and demonstration means; familiar with aerospace ground equipment specifications and Government maintenance procedures.

ENGINEERS. To maximize maintainability on Aerospace Electronic Equipment; perform analysis, monitor, audit and review designs; coordinate demonstration testing, simulations; reporting and documentation responsibilities.

RF EQUIPMENT DESIGN

MICROWAVE ENGINEERS. Experienced in the design of signal generators and receivers in the following frequency bands: L, S, C, T, Ku, Ka. Should also know techniques for remote control of frequency and signal amplitude.

ENGINEERS. Experienced in the design of RF and microwave receivers, digital display circuits, data handling and CRT displays including storage tube circuits.

ENGINEERS. Experienced in the design and development of solid state receivers for reconnaissance telemetry, Doppler and communications equipment. Knowledge of tracking filters, phase lock, and synthesizer circuits desirable.

LOW FREQUENCY DESIGNERS. Experienced in the design of audio and sweep signal generators and servo systems test equipment. Senior engineers are also required with experience in the design of LF receivers and transmitters.

HF-UHF ENGINEERS. With experience in design of signal generators, using both transistorized and vacuum tube circuitry. Knowledge of techniques for digital selection of frequency such as frequency synthesis and remote control of signal amplitude is required.

SENIOR ENGINEERS. Experienced in the design and development of single side band receivers and transmitters.

RELIABILITY

Long Range Programs in Aerospace Electronic Equipment. Positions available in staff functional areas and state-of-the-art systems programs for:

PRINCIPAL ENGINEERS. To provide reliability technical group support and program project task support—experience in reliability activities of the following: Analysis, Design Review, Surveillance, Audit, Sub-Contractor Liaison, Apportionment, Allocation and Assessment. Responsible for the application of techniques on Aerospace Electronic programs and generation of methods and procedures. Staff and program positions available.—Supervision.

SENIOR ENGINEERS. To implement reliability engineering and reliability services group tasks. Experience required in Aerospace Electronic equipment reliability activities. Positions available in all reliability areas including: Analysis, Review, Audit, Surveillance, Monitoring, Sub-Contractor Liaison, Statistical Demonstration Testing Studies, etc. Staff and program positions available.

ENGINEERS. To perform reliability tasks of all kinds on Aerospace Electronic equipment.

Please send your resume to Mr. R. W. Holmes, Dept. 22.

GENERAL DYNAMICS | ELECTRONICS

1400 N. GOODMAN ST., ROCHESTER 1, NEW YORK

An Equal Opportunity Employer

ENGINEERS • SCIENTISTS
measure the **MAGNITUDE** of the
new range technology

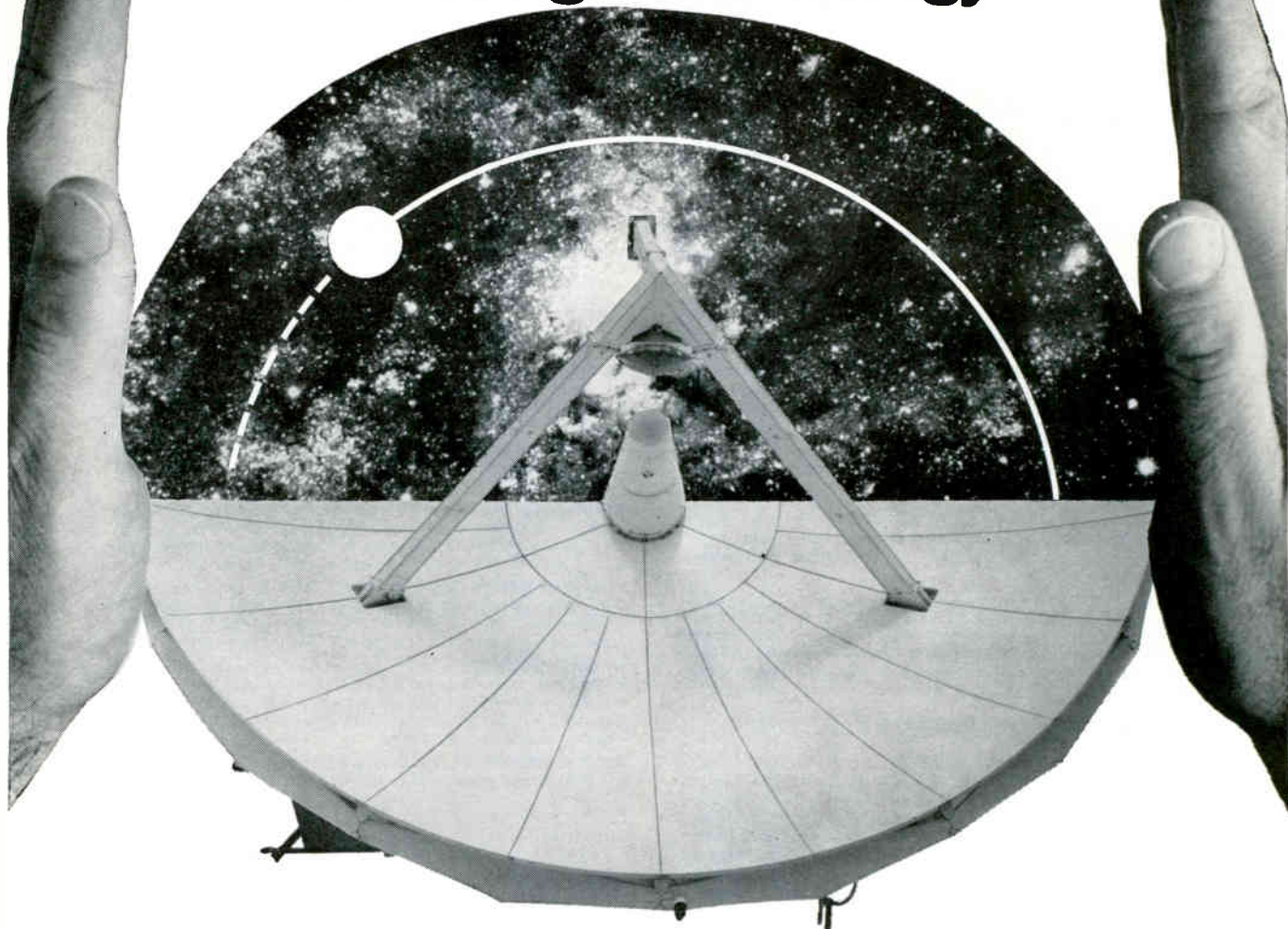

...where a satellite may be just one element in a vast instrumentation system

Using a satellite to assist in monitoring flight performance of a Manned Space Vehicle is only one of the forward-looking projects under study by the Advanced Planning Group of PAN AM's Guided Missiles Range Division at Cape Canaveral.

Since 1953, the need to match range instrumentation systems with the constantly advancing capabilities of new missiles and space vehicles has spurred PAN AM to create a whole new range technology for the Atlantic Missile Range.

TODAY THE EFFORT IS ACCELERATING. PLANNING IS UNDER WAY AT 3 TIME LEVELS. 1. To meet the specific needs of scheduled launchings immediately ahead. 2. To meet the requirements of launch programs of the next 5 years. 3. To prepare for manned lunar flights and work as far into the future as the late 70's projecting range technology for interplanetary vehicles now existing in concept only.

YOU ARE INVITED TO INQUIRE ABOUT THE FOLLOWING OPPORTUNITIES:
Systems Engineers—EE's, Physicists capable of assuming complete project responsibility for new range systems.

Instrumentation Planning Engineers—EE's, Physicists to be responsible for specific global range instrumentation concepts.

Advance Planning Engineers—EE's, Physicists to evaluate and project the state-of-the-art in all applications of range instrumentation.

Experience in one or more of these areas: Pulse radar, CW techniques, telemetry, infrared, data handling, communications, closed circuit TV, frequency analysis, command control, underwater sound, timing, shipboard instrumentation.

Why not write us today, describing your interests and qualifications in any of the areas above. Address Dr. Charles Carroll, Dept. 28C-3 Pan American World Airways, Inc., P.O. Box 4465, Patrick Air Force Base, Florida.



GUIDED MISSILES RANGE DIVISION

PATRICK AIR FORCE BASE, FLORIDA

AN EQUAL OPPORTUNITY EMPLOYER

PAN AM is now creating the range technology for launches of DYNA-SOAR, GEMINI, APOLLO, ADVANCED SATURN BOOSTERS

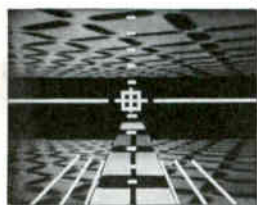
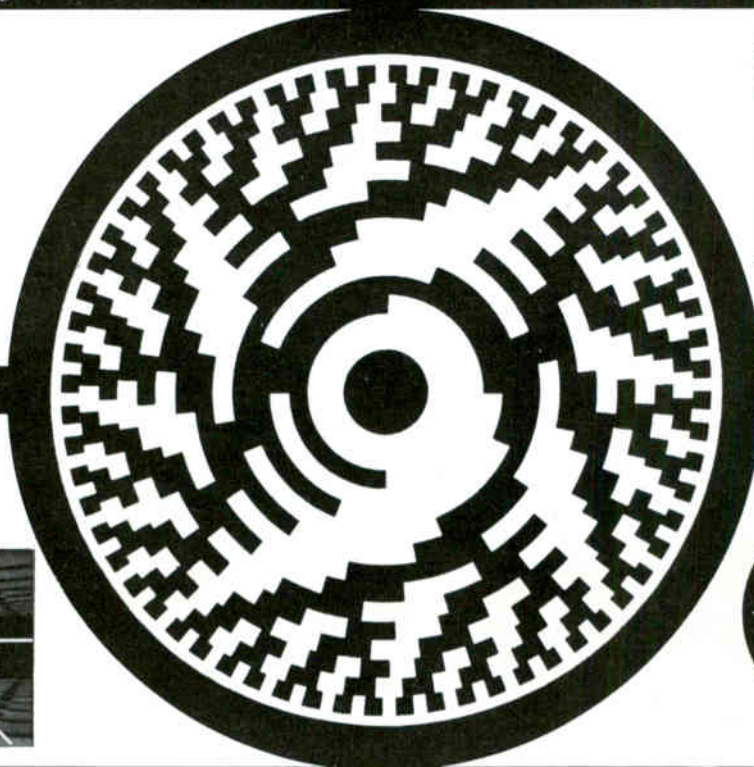
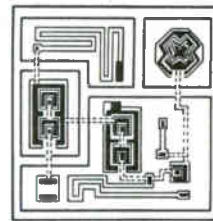

DIVERSIFY YOUR TECHNICAL KNOW-HOW AT NORDEN

We believe in versatile engineers here — men with specialties, yes — but with broad knowledge in many allied areas. Those who have an especially strong interest in diversification are encouraged to grow into creative systems engineering. And the contacts between engineering operations and laboratory research are close. For example, circuit design engineers work hand-in-hand with applied physicists in extending the state of the art in molecular circuitry. An instance of the success of this cooperation: Norden's solid state servo amplifier, which produces a significant power level of 1.5 watts. (Work to obtain even higher outputs is underway.)

Interviews During IEEE Convention
For appointment, phone in New York City (March 25-27)
Mr. James E. Fitzgerald at PLaza 5-5673

Plan also to visit Norden's displays at the Coliseum . . . the Italy Room and Booth 2128

Climate for Achievement at Norden. Engineers and scientists find a working atmosphere at Norden that encourages continued learning and growth. Here, staff members work on problem-solving teams, gaining broad exposure to many technical aspects of a project. Opportunities for advanced study at nearby academic institutions are open to qualified engineers under our graduate program. Unsurpassed test and research facilities are available. And Norden's location near Long Island Sound is outstandingly attractive and convenient, easily reached from Northern New Jersey, Westchester, New York City, Long Island, and of course, all of Connecticut.

Opportunities at all technical levels on programs in the areas of submarine, helicopter, fixed wing aircraft and space vehicle display integration:

VIDEO CIRCUITS • CATHODE RAY TUBE DRIVE CIRCUITS • HIGH SPEED ANALOG & DIGITAL PROCESSING • VIDEO SIGNAL SYNTHESIS • RADAR & TV SYNCHRONIZERS • HIGH VOLTAGE POWER SUPPLIES

Also openings for:

SEMICONDUCTOR DEVICE SCIENTISTS & ENGINEERS. R&D of silicon functional electronic blocks. Requires experience with oxide masked multi-diffused structures and knowledge of transistorized circuitry.

SYSTEMS ENGINEERS. Aerospace applications of military ground support equipment; and modern microwave and optical radar systems.

RELIABILITY ENGINEERS. Review system and subsystem tests for design approval. Will recommend design modifications.

EQUIPMENT DESIGN ENGINEERS. Knowledge of stress analysis, heat transfer, high density electronic packaging.

Norden DIVISION OF UNITED AIRCRAFT CORPORATION

**U
A
C**

An Equal Opportunity Employer

Please forward your resume to Mr. James E. Fitzgerald, Employment Dept., Helen Street, Norwalk, Connecticut,

Look what EE's are doing

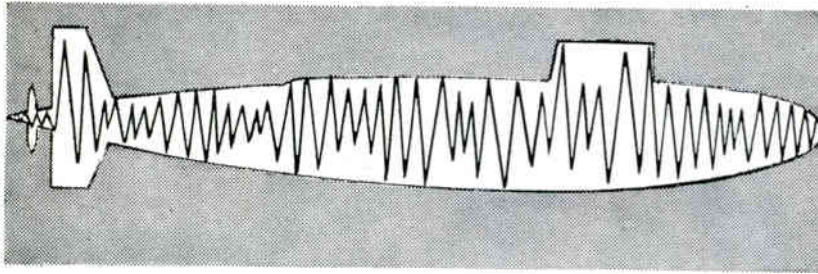

at ELECTRIC BOAT

- Design of Special Instrumentation for Measurement of Acoustic & Vibration Data
- Design & Installation of Interior Communication Systems, Navigation Systems, Ship Control Systems, Depth Control Systems, Steering & Diving Devices
- Application and Systems Engineering of Radio, Radar, Sonar & Countermeasures Systems & Components
- Design and Installation of Electric Power Plants & Distribution Systems
- Quality/Reliability Control & Assurance
- Nuclear Power Plant Systems Schematics Review
- Advanced Circuit Design
- Electronic Systems Engineering
- Missile Fire Control, Guidance and Checkout Systems & Equipment
- Installation and Test of Reactor Plant Auxiliary Power Supplies
- Integration of Control and Instrumentation Systems
- Navigation Systems and Equipment
- Procurement • Signal Systems Analysis
- Vendor Product Application Design
- Electrical Power & Control Systems & Component Design
- Test Development & Instrumentation Design
- Vendor Performance Analysis
- Process Control Engineering & Instrumentation
- Sound, Shock & Vibration Analysis

As a world of technology in miniature—incorporating missile launching systems, a nuclear propulsion plant, and life support systems—the nuclear submarine is an engineering challenge of the highest order. The Electrical and Electronic Engineer working at Electric Boat has a unique opportunity for professional development, not only in his own specialty but through broad knowledge gained in the unity of all technologies.

Your resumes are invited. Please address Mr. Peter Carpenter.

GD

GENERAL DYNAMICS ELECTRIC BOAT

Groton, Connecticut

AN EQUAL OPPORTUNITY EMPLOYER

EXCEPTIONAL ENGINEERING POSITIONS

BENDIX—KANSAS CITY

ELECTRONIC TEST EQUIPMENT DESIGN ENGINEERS

To develop, design and supervise construction of special electronic test instruments, and to direct the technical activities of others in the organization. These positions require familiarity with test equipment problems and inspection techniques. Past association with military electronic equipment or experience in precision measurement of production items would assist you in qualifying for these positions. EE degree required.

ELECTRONIC MANUFACTURING ENGINEERS

For these positions we would prefer experienced engineers with a degree or equivalent experience in light product tooling and machining methods or electronic encapsulation packaging. Responsibilities include determining manufacturing processes, procedures, approving tool designs and capital equipment and facilities planning.

COMPONENTS APPLICATION SPECIALISTS

EE or Physics degree with minimum of 2 years' experience in the application of one or more of the following: Semiconductors, relays, motors, switches, gas filled tubes, or other electronic components. As a specialist you will work as a consultant with engineering design groups, quality engineers, purchasing and manufacturing personnel on component problems.

PLANT LAYOUT ENGINEERS

These positions require EE with power option or equivalent experience in the preparation of general plant layouts of electrical distribution for lighting and equipment installation. This activity would involve project responsibility for engineering and design, including coordination with maintenance following the project to completion.

YOUR FUTURE AT BENDIX!

The Kansas City Division of Bendix, long term prime contractor for the AEC, offers a pleasant, stimulating environment for professional growth. Kansas City is also a delightful place to live; visitors frequently call it America's most beautiful city. Living costs are moderate, recreational, cultural and educational facilities are plentiful. Choice suburban living only minutes away; no traffic problems. For prompt attention, address your confidential inquiry to:

MR. K. L. BEARDSLEY
Technical Personnel
Representative

BENDIX CORPORATION

Box 303-HL
Kansas City 41, Mo.

An Equal Opportunity Employer



KANSAS CITY DIVISION

**DURING IEEE
INVESTIGATE A POSITION WITH
AIR FORCE SYSTEMS COMMAND OR
AIR FORCE LOGISTICS COMMAND
THAT OFFERS**

**Professional Challenge
Recognition
Career Advancement
Financial Assurance**

At 22 installations throughout the nation Engineers and Scientists of Air Force Systems Command and Air Force Logistics Command are discovering, defining and solving important aerospace problems. If you possess a degree and your competence demands more than routine assignments . . . if you seek the opportunity to gain professional stature and recognition . . . and if you have a desire to contribute to important, long-term programs, you are invited to seriously consider the openings listed below. All of these positions offer full Civil Service status and benefits.

PHYSICISTS—Must have extensive knowledge of the physics of plasmas, fluid media (including the upper atmosphere) and electromagnetic scattering theory.

ELECTRONICS ENGINEERS—With a background in development, fabrication, installation, maintenance and experimental operation of large radar sites.

ELECTRONIC ENGINEERS (INSTRUMENTATION)—Must have background in range instrumentation with at least five years in missile testing.

ELECTRONIC ENGINEERS—Should possess a background in training and engineering planning and the ability to recognize deficiencies and incompatibilities in plans.

ELECTRONIC ENGINEERS—With necessary experience to maintain technical surveillance over contractor electrical and electronic engineering activities.

ELECTRONIC ENGINEERS—To conduct system and equipment analysis studies to determine the feasibility and applicability of new and novel techniques to range instrumentation systems.

ELECTRONIC ENGINEERS (ELECTRO-MAGNETICS)—With ability to conduct analysis and design studies of complex search and height finding equipments.

If an interview is inconvenient at this time, you are invited to direct your resume or Civil Service Application (SF 57) in complete confidence to:

**TO ARRANGE A CONVENIENT INTERVIEW
IN NEW YORK CITY
DURING IEEE
Phone PLaza 2-5110**

**AFSC-AFLC
JOINT PROFESSIONAL
PLACEMENT OFFICE**

Room 401
527 Madison Ave. • New York 22, N. Y.

An equal opportunity employer

ENGINEERS SYSTEMS - CONTROLS INSTRUMENTATION

Positions in a firm of established Consulting Engineers where Engineering is our prime function.

Well-trained independent-minded Design ENGINEERS in many fields find satisfying assignments with Sverdrup & Parcel and Associates, Inc.

In addition to a general ability to comprehend broad systems design, specialized experience in one or more areas is necessary. If you are qualified in the following fields, contact us at once.

TEST INSTRUMENTATION:

Provide preliminary and final design on Telemetering Systems, Transducers, Data Acquisition, Transmission and Processing Techniques.

AUTOMATIC CHECKOUT SYSTEMS:

Check out of Components, System Test Calibration, Test Programming.

FACILITY INSTRUMENTATION AND CONTROLS:

Propellents, Cooling Water, Gas and Miscellaneous Systems, Communications, and Warning Systems.

You are invited to submit your qualifications to:

SVERDRUP & PARCEL AND ASSOCIATES, INC.

ENGINEERS • ARCHITECTS

915 Olive Street, St. Louis 1, Mo.

An equal opportunity employer

MEN WANTED

for 12 months duty at isolated bases in Antarctica

Must be physically sound, temperamentally adaptable to the conditions of Antarctic service, and able to be away from home for 12 to 18 months.

Electronic engineers and physicists experienced with the operation and maintenance of radar, guided missiles, or with other complicated electro-mechanical and electronic systems and interested in investigating the electromagnetic environment of the earth are desired. Salary range from \$7,000 to \$12,000 depending upon experience and capability. Reporting date, Boulder, Colorado, July 1, 1963. Send one page resume to: Personnel Officer, National Bureau of Standards, Boulder Laboratories, Boulder, Colorado.

An Equal Opportunity Employer

MICROWAVE AND RADIO COMMUNICATIONS ENGINEERS

U.S. and Foreign Assignments

MICROWAVE ENGINEERS. Responsibilities include systems engineering and/or installation supervision of telecommunications equipment. Ability to conduct and evaluate acceptance tests important. Working acquaintance with site selection and microwave path design helpful.

RADIO ENGINEERS. Position requires transmitter and receiver station design, including rehabilitation of domestic and international communications systems. Knowledge of broadcasting, mobile telephone, marine and public safety networks helpful.

Television Associates engineers and supervises construction of world-wide communications systems. Generous living allowance provided.

Write or call R. J. Rhinehart

TELEVISION ASSOCIATES OF INDIANA, INC.

MICHIGAN CITY, INDIANA

A Subsidiary of Melpar, Inc.

An Equal Opportunity Employer

CHIEF ENGINEER (Electronic Packaging)

Our client is a well established Connecticut manufacturer of on-line data processing systems. They seek a man to direct the packaging design of all equipment in a major expansion of their product lines. He will have several years experience in packaging electronic systems and probably an EE or ME degree.

This position offers an excellent career opportunity for professional growth and recognition with a top starting salary.

Reply in confidence including present earnings to Allen West

VEZAN-WEST & CO.

Management Consultants

1000 FARMINGTON AVE.
WEST HARTFORD 7, CONN.

Inquiries are invited concerning other Supervisory and Sr Engineering positions with this company.

FREE TRIP IEEE (IRE) SHOW NEW YORK CITY MARCH 25-28TH

Electronic Scientists and Engineers you can have an all expense paid trip and confirmed selected interviews with national electronic companies if you qualify. Requirements: BS, MS, or PhD and one year experience. Opportunities available in: Research—Design—Development—Sales—Marketing—Applications.

Air Mail Resume in Complete Confidence—No Obligation

Write or Call Collect Dept. E for Full Details
Boston (617) 444-7113

Alan Glou—Technical/Scientific
Sid Hopner—Sales/Marketing

PERSPECTIVE

A PROFESSIONAL PLACEMENT ORGANIZATION
Ten Kearney Road, Needham Heights 94, Mass.
Highland Ave., Exit #56W Off Rte. 12B—Marr Bldg.

ACROSS INTERDISCIPLINARY BOUNDARIES

Electronic and Electrical Engineers who prefer the climate of non-routine careers are needed for intermediate and senior levels of responsibilities. Immediate openings exist for engineers in the fields of:

- Digital Electronics
- Communications, including U.H.F.—V.H.F.—Microwave
- Information Retrieval
- Command and Control
- Systems Integration
- Data Control
- Operations Research

Experience in practical applications required.

During the I.E.E.E. Show

Call Robert Flint at New York, PLaza 2-2878 (area code 212) from 9:00 a.m. to 7:00 p.m. Or write: Robert Flint, Director of Personnel, 4815 Rugby Ave., Bethesda, Maryland.

BOOZ • ALLEN

APPLIED RESEARCH, INC.

Scientific and Technical Services

AN EQUAL OPPORTUNITY EMPLOYER

ELECTRONICS

National Coverage—All Degrees
SOLID STATE-DIGITAL
COMMUNICATIONS-TELEMTRY
Send resume in confidence.

Dr. L. I. Gilbertson
AEROSPACE PLACEMENT CORP.
P.O. Box 2125, Phila. 3, Pa.

POSITION VACANT

Position for Electrical Engineer with electronics experience now available in Philadelphia's Department of Streets. Work includes determining signal sequence for traffic movement, evaluating and recommending necessary electrical equipment, designing and testing circuits, and developing methods and systems for traffic control or traffic flow analysis. Require degree in electrical engineering plus four years experience including two years electronics experience. Equivalent combination of training and experience will be considered. Salary \$9272-\$10,630. Liberal fringe benefits. Applicants must be U.S. citizens. Apply Director of Recruiting, 792 City Hall, Philadelphia 7, Pa.

SELLING OPPORTUNITY WANTED

Mfrs' Export Reps with exc. world-wide connect., on their toes around the clock, are eager to boost your sales. Aacor International, 198 Broadway, N. Y. 8, BA 7-0482.

"Put Yourself in the Other Fellow's Place"

TO EMPLOYERS TO EMPLOYEES

Letters written offering Employment or applying for same are written with the hope of satisfying a current need. An answer, regardless of whether it is favorable or not, is usually expected.

MR. EMPLOYER, won't you remove the mystery about the status of an employee's application by acknowledging all applicants and not just the promising candidates.

MR. EMPLOYEE you, too, can help by acknowledging applications and job offers. This would encourage more companies to answer position wanted ads in this section. We make this suggestion in a spirit of helpful cooperation between employers and employees.

This section will be the more useful to all as a result of this consideration.

Classified Advertising Division

McGRAW-HILL PUBLISHING CO., INC.
330 West 42nd St., New York 36, N. Y.

To Men Who Can Look Deep Into Tomorrow

SENIOR LEVEL POSITIONS ARE OPEN NOW IN SPACE ELECTRONICS

ADVANCED R&D ENGINEERS

For work beyond the state-of-the-art associated with diversified product lines, involving solid state, controls and communications.

ADVANCED SYSTEMS ENGINEERS

For advanced systems work involving inertial guidance, command and control, radar and data link for application in armed helicopters, lunar landing, earth satellites, weapons and moon excursion vehicles.

LASER DEVELOPMENT ENGINEERS

For project engineering in the investigation of laser applications, and for theoretical analyses involving molecular quantum mechanics.

RADAR DEVELOPMENT ENGINEERS

For R&D work in solid state, circuit design, systems analysis and radar systems integration in both military contracts and company funded programs.

CONTROL SYSTEMS ENGINEERS

For systems and analysis work involving air traffic control, target locator, space electrical, visual simulator and feedback control systems.

OPTICAL SYSTEMS DEVELOPMENT ENGINEERS

For assignment to a variety of programs including visual simulators for space applications, fire control systems, telescopes and digital-to-voice converters.

Top echelon positions are open to men with vision at Bell Aerosystems Co. This growing organization today needs more senior scientists and engineers who can perceive where technology should go to meet tomorrow's aerospace requirements - and lead the way to advances beyond the existing state-of-the-art.

Vision coupled with sound engineering judgment has always been characteristic of this Company, as exemplified by such achievements as:

- HIPERNAS (High PERFORMANCE Navigational System), the most accurate, pure inertial, self-compensating navigation and guidance system known, diversely applied in strategic and tactical missiles, aircraft, space vehicles, ships and submarines.
- The FIRST all-weather, automatic aircraft landing system which can touch down 2 planes a minute even through dense fog.

Engineers and Physicists with thorough background in any of the areas listed are invited to inquire about these high level opportunities. Please address Mr. T. C. Fritschi, Dept. G-16.



BELL AEROSYSTEMS CO.

DIVISION OF BELL AEROSPACE CORPORATION - A **textron** COMPANY

An Equal Opportunity Employer

P.O. Box #1, Buffalo 5, New York

electronics

WEEKLY QUALIFICATIONS FORM FOR POSITIONS AVAILABLE

(Continued from page 216)

SPACE TECHNOLOGY LABORATORIES, INC.	13	17
Sub. of Thompson Ramo Wooldridge Inc. Redondo Beach, California		
SVERDRUP & PARCEL AND ASSOCIATES INC.	222	18
St. Louis, Mo.		
TELEVISION ASSOCIATES OF INDIANA, INC.	222	19
Michigan City, Indiana		
U. S. DEPT. OF COMMERCE	222	20
National Bureau of Standards Boulder Labs. Boulder, Colorado		
VEZAN—WEST & COMPANY	222	21
W. Hartford 7, Conn.		
P 1652	93*	22

* These advertisements appeared in the March 8th issue.

SUPERVISORY POSITIONS

in the Southwest with Albuquerque Division

ACF INDUSTRIES, INC.

A prime contractor for the Atomic Energy Commission

SENIOR ELECTRONICS ENGINEER

To be responsible for maintenance of all electronic equipment in the plant, which includes electronic tape controlled machine tool equipment, gaging equipment, and production processing equipment. BSEE with five years experience required.

ELECTRONICS ENGINEER

To supervise hourly electronic technicians engaged in maintenance of above mentioned equipment. BSEE with two years experience required.

Salary will be commensurate with training and experience. Relocation costs paid. U. S. citizenship required.

Mail resume to:

General Supervisor, Professional Recruiting
Albuquerque Division, ACF Industries, Inc.
P. O. Box 1666, Albuquerque, New Mexico

"ACF IS AN EQUAL OPPORTUNITY EMPLOYER"

SEARCHLIGHT SECTION

(Classified Advertising)

BUSINESS OPPORTUNITIES

EQUIPMENT - USED or RESALE

DISPLAYED RATE

The adv. rate is \$27.75 per ln. for all adv. appearing on other than a contract basis. Contract rates on request. An ADVERTISING INCH is measured 1/8 in. vertically on one col., 3 col.—30 in.—to a page. EQUIPMENT WANTED or FOR SALE ADS acceptable only in Displayed Style.

UNDISPLAYED RATE

\$2.70 a line, min. 3 lines. To figure advance payment count 5 average words as a line.

HEAT FLUSHING BLOWER BARGAIN

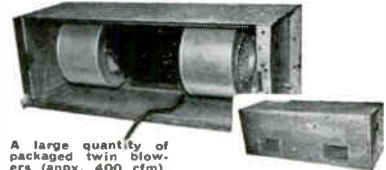

A large quantity of packaged twin blowers (approx. 400 cfm). Unit consists of twin 4" centrifugal blowers powered by 1/2 Hp—single phase—220-AC—continuous duty, ball bearing motor. Unit contained in cabinet as shown. Overall dimensions: Approximately 27 1/2" x 8" x 8" or 22 1/2" x 8" x 8". Will operate on 110V-AC without reconnecting wiring.

Priced for quick sale at... \$22.95 each 6 or more units...\$19.95 each FOB—NYC Warehouse

Large Stocks of Centrifugal and Propeller Fans
ELECTRIC TRADING COMPANY
313 Canal St., N. Y. 13, N. Y. CAnal 6-0575

CIRCLE 631 ON READER SERVICE CARD

RADIO RESEARCH INSTRUMENT CO.

AUTO-TRACK & TELEMETRY ANTENNA PEDESTALS
3 & 10 CM. SCR. 584 AUTOTRACK RADARS
AN/TPS-10 SEARCH, AN/TPS-10 HT. FINDERS
AN/PPS-2500A, AN/APS-10 NAVIG. & WEATHER
AN/APS-15B PRECISION, AN/APG-25B PRECISION
AN/APS-31A SEARCH, DOZENS MORE
5-1-2 MEGAWATT HIGH POWER PULSERS.

RADIO RESEARCH INSTRUMENT CO.
550 Fifth Ave., New York. Judson 6-4691

RADAR SYSTEMS & COMPONENTS/ IMMEDIATE DELIVERY

CIRCLE 632 ON READER SERVICE CARD

Advertisement

INTERESTING TO NOTE . . .

NEW YORK, N. Y. Feb. 1963:—

Universal Relay Corp., 42 White St., New York 13, N. Y. announces that their 1963 catalog is progressing toward publication and will be mailed shortly. With publication of the catalog, they inform their customers that "normal inventory includes over 2,000,000 relays in approximately 30,000 types. In most cases stock is sufficient to give immediate delivery of production quantities.

This catalog is, therefore, not just a listing of items available 'on order' but, by and large, it is an indication of in-stock items (either as complete units or as ready to assembly components).

The average shipment is made within 48 hours. Where coils and frames require assembly, or relays require special testing or adjustment, shipments are made within one week to ten days.

Universal is completely equipped to assemble, adjust and thoroughly test any type of relay. Assembly and test facilities have been imitated by some relay manufacturers.

A personal interest is taken in every order. This interest is maintained as the order is processed. And, it continues even after the customer receives the merchandise until he makes sure that it satisfies his needs.

All merchandise is guaranteed, subject to customers' inspection and approval, and may be returned within 30 days for replacement or credit.

The catalog is full of items to fill everyday relay requirements".

Catalog E-163 may be obtained by writing directly to:

**UNIVERSAL RELAY
CORP.**

42 White Street, New York 13, N. Y.
Walker 5-6900

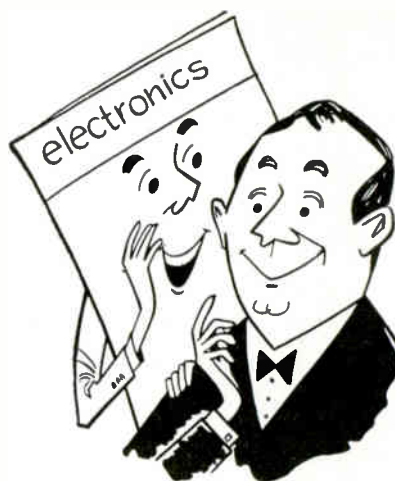

electronics IS EDITED TO KEEP YOU FULLY INFORMED — a "well-rounded" engineer

What's your *present* job in electronics? Do you work on computers? (**electronics** ran 158 articles on computers between July, 1961 and June, 1962!) Are you in semiconductors? (For the same period, **electronics** had 99 articles, not including transistors, solid-state physics, diodes, crystals, etc.) Are you in military electronics? (**electronics** had 179 articles, not including those on aircraft, missiles, radar, etc.)

In all, **electronics'** 28-man editorial staff provided more than 3,000 editorial pages to keep you abreast of all the technical developments in the industry. No matter where you work today or in which job function(s), **electronics** will keep you fully informed. Subscribe today via the Reader Service Card in this issue. Only 7½ cents a copy at the 3 year rate.

electronics

NRC Equipment Corp.....	48
New Jersey Bureau of Commerce.....	203
• Nichicon Capacitor	201
• North Atlantic Industries, Inc.....	100
• Northeastern Engineering, Inc.....	175
• Northern Radio Co., Inc.....	154
• Ohmite Mfg. Co.....	17, 18, 19
Paktron Div. of Illinois Tool Works.....	118
Patwin Electronics	207
Pennsalt Chemicals Corp.....	113
Phileo Sub. of Ford Motor Co.....	99
• Polarad Electronic Instruments A Division of Polarad Electronics Corp.	174
• Potter Instrument Co., Inc.....	23
Precision Instrument Co.....	135
Preformed Line Products Co.....	184
• Premier Metal Products Co., Inc. Sub. of Renwell Ind. Inc.....	200
• Radio Cores, Inc. Permacor Div.	164
• Radio Corporation of America...4th Cover	
• Radio Frequency Laboratories, Inc....	102
• Raytheon Company	101
Reeves-Hoffman	155
• Reeves-Hoffman Div. of Dynamics Corp. of America..	180
Reeves Instrument Corp. Div. of Dynamics Corp. of America	92
Ribet-Desjardins	166
• Rochar Electroique	195
• Rohn Mfg. Co.....	174
Sage Laboratories Inc.	90
• Sanborn Company	105
Sangamo Electric Co.....	41, 42
Schober Organ Corp. The.....	178
Seco Electronics Inc.....	192
Security Devices Laboratory Electronics Div. of Sargent & Greenleaf, Inc.	28
Servomechanisms Inc. Mechatrol Div.	184

Siemens America Inc.....	157
Siliconix Inc.	45
Singer Metrics Div. Singer Mfg. Co.....	103
Space Technology Laboratories, Inc....	13
Sperry Farragut Co. Div. of Sperry Rand Corp.....	206
Sperry Microwave Electronics Co. Div. of Sperry Rand Corp.....	93
Sprague Electric Co.....	9
Stromberg Carlson Div. of General Dynamics.....	194
Struthers-Dunn Inc.	152
Sylvania Electric Products, Inc. Microwave Device Division.....	121
Synthane Corp.	193
• Tech Laboratories, Inc.	50
Tektronix Inc.	60
Texas Instruments Incorporated Industrial Products Group.....	35
Texas Instruments Incorporated Semiconductor-Components Division..	11
Thermal American Fused Quartz Co., Inc.	168
• Toyo Electronics Ind. Corp.....	178
• Transitron Electronic Corp.....	55
Trilo Laboratories, Inc.....	122
• Tru-Ohm Products	198
• Tung-Sol Electric, Inc.	58, 59
United Systems Corp.....	181
United Testing Laboratories.....	201
• United Shoe Machinery Corp. Dynosert Div.	202
U. S. Semicor.....	191
Unitek/Weldmatic Division	173
• Utica Drop Forge & Tool Division, Kelsey-Hayes Co.	126
Victoreen Instrument Co., The.....	128
Virginia Electric & Power Co.....	20
• Westinghouse Electric Corp.....	150, 151
Weston Instruments & Electronics A Division of Daystrom Inc.....	163
West Penn Power.....	176
White S.S.	124

• Yellow Springs Instrument Co., Inc... 172

CLASSIFIED ADVERTISING

F. J. Eberle, Business Mgr.

EMPLOYMENT OPPORTUNITIES217-223

EQUIPMENT (Used or Surplus New) For Sale223, 224

INDEX TO CLASSIFIED ADVERTISERS

Aerospace Placement Corp.....	222
ACF Industries Inc.....	223
AFSC-AFLC Joint Professional Place- ment Office	221
Bell Aerosystems Co.	223
Bendix Corporation, Kansas City Div..	220
Booz, Allen Applied Research Inc....	222
Electric Trading Co.....	223
General Dynamics/Electric Boat.....	220
General Dynamics/Electronics	217
Norden Division of United Aircraft Corp.	219
Pan American World Airways Inc. Guided Missiles Range Div.....	218
Perspective	222
• Radio Research Instrument Co.....	223
Sverdrup & Parcel and Associates Inc.	222
Television Associates of Indiana, Inc..	222
• Universal Relay Corp.....	224
U. S. Dept. of Commerce, National Bureau of Standards Boulder Labs.	222
Vezean-West & Co.....	222

• See advertisement in the July 25, 1962 issue of Electronics Buyers' Guide for complete line of products or services.

This index and our Reader Service Numbers are published as a service. Every precaution is taken to make them accurate, but electronics assumes no responsibilities for errors or omissions.

electronics



Audit Bureau
of Circulation



Associated Business
Publications

Audited Paid Circulation

JAMES T. HAUPTLI

Advertising Sales Manager

BEN ANELLO

Market Services Manager

DAVID CUNNIFF

Promotion Manager

RICHARD J. TOMLINSON

Business Manager

Electronics Buyers' Guide

R. S. QUINT

General Manager

ADVERTISING REPRESENTATIVES

ATLANTA (9):

Michael H. Miller, Robert C. Johnson
1375 Peachtree St. N.E., Trinity 5-0523
(area code 404)

BOSTON (16):

William S. Hodgkinson, Donald R. Furth
McGraw-Hill Building, Copley Square,
Congress 2-1160 (area code 617)

CHICAGO (11):

Harvey W. Wernecke, Robert M. Denmead
645 North Michigan Avenue, Mohawk 4-5800
(area code 312)

CLEVELAND (13):

Paul T. Fegley
55 Public Square, Superior 1-7000
(area code 216)

DALLAS (1):

Frank Le Beau
The Vaughn Bldg., 1712 Commerce St.
Riverside 7-9721 (area code 214)

DENVER (2):

John W. Patten
Tower Bldg., 1700 Broadway,
Alpine 5-2981 (area code 303)

HOUSTON (25):

Joseph C. Page, Jr.
Prudential Bldg., Halcombe Blvd.,
Riverside 8-1280 (area code 713)

LOS ANGELES (17):

Ashley P. Hartman, John G. Zisch,
William C. Gries
1125 W. 6th St., Huntley 2-5450
(area code 213)

NEW YORK (36):

Donald H. Miller, Henry M. Shaw,
George F. Werner
500 Fifth Avenue, LO-4-3000
(area code 212)

PHILADELPHIA (3):

Warren H. Gardner, William J. Boyle
6 Penn Center Plaza, LOcust B-4330
(area code 215)

SAN FRANCISCO (11):

Richard C. Alcorn
255 California Street, Douglas 2-4600
(area code 415)

LONDON W1:

Edwin S. Murphy Jr.
34 Dover St.

FRANKFURT/Main:

Matthée Herfurth
85 Westendstrasse

GENEVA:

Michael R. Zeynel
2 Place du Port

TOKYO:

George Olcott,
1, Kotohiracho, Shiba, Minato-ku

Actual width of record is 6 inches

At Brush it's a matter of record

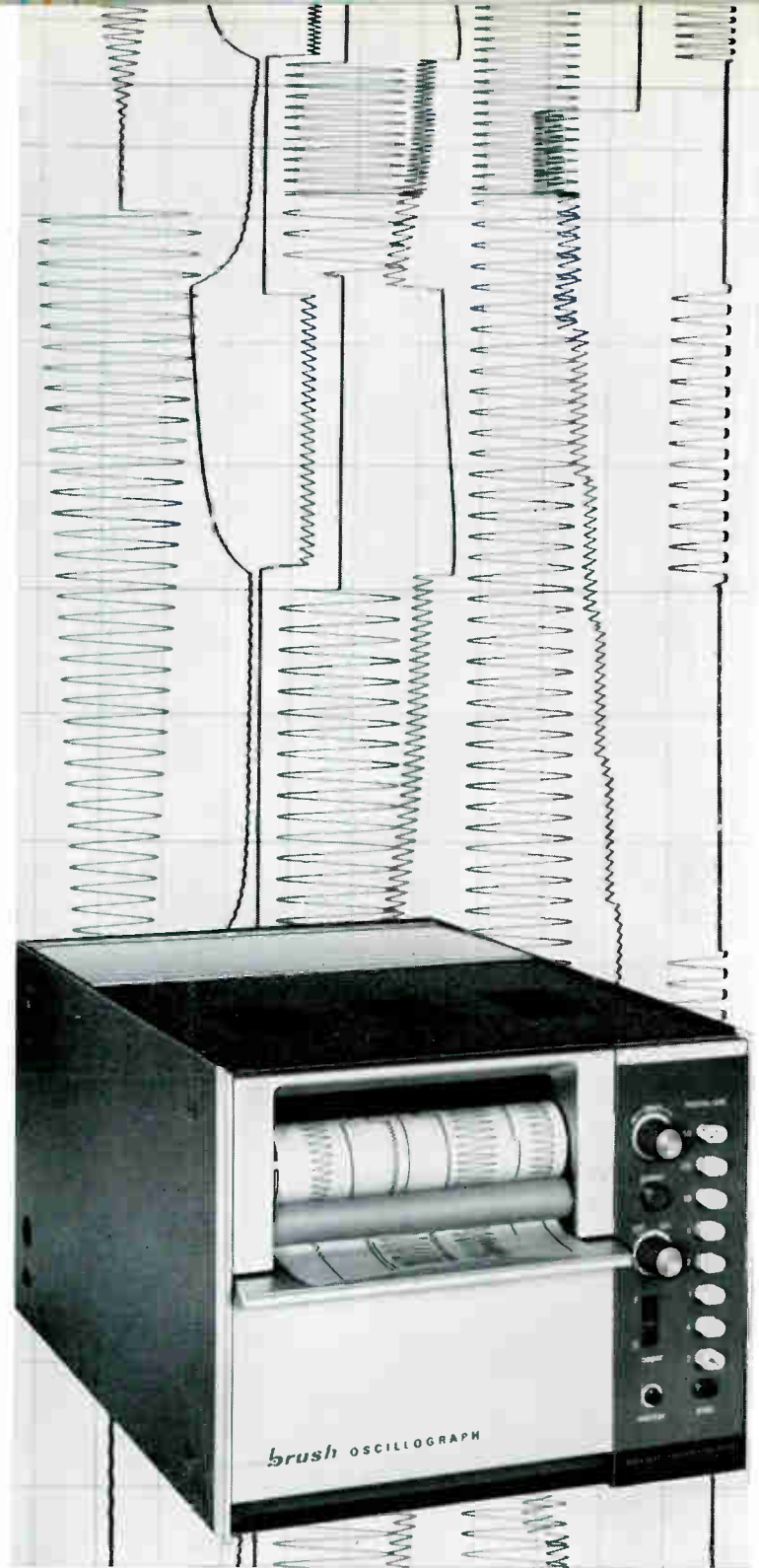

... and *this* record speaks for itself. It was made by the new oscillograph Series 2300 ... a product of Brush's advanced recording system design. Its unique optical system produces these high contrast traces ... at all writing speeds. An extremely stable tungsten light source eliminates cluttered records caused by ultra-violet "jitter" or RF interference. The start-up of this low-cost lamp is virtually instantaneous. Overall system linearity is better than 2%. Eight record speeds are controlled by pushbuttons. Paper take-up is built-in. A complete line of accessories accommodates special requirements. So now, you can record over the whole range of most-used frequencies with Brush systems incorporating all the known refinements in oscillography. Write for full details.

brush INSTRUMENTS

DIVISION OF CLEVITE 37TH AND PERKINS, CLEVELAND 14, OHIO

CIRCLE 901 ON READER SERVICE CARD

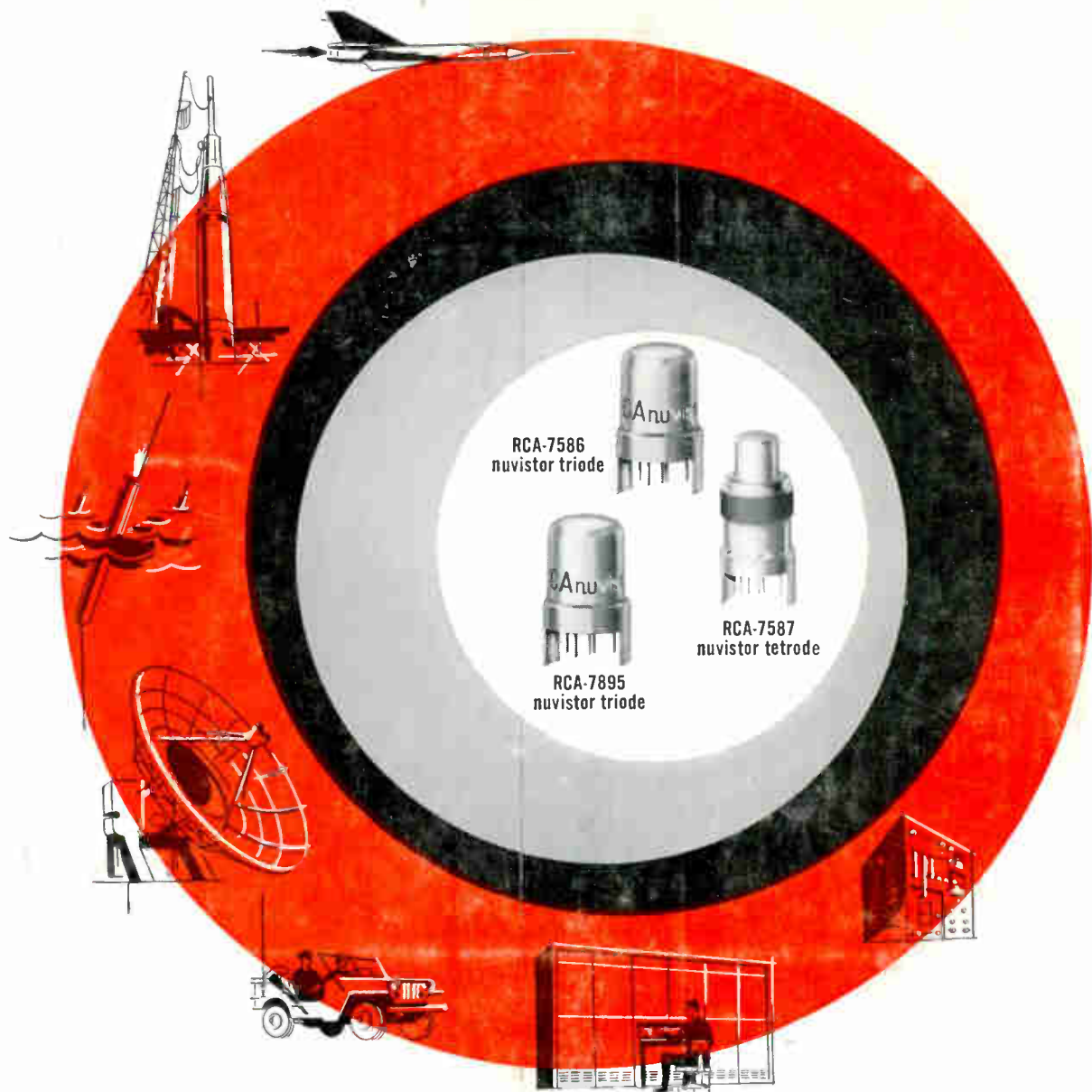

MIL-SPEC NUVISTORS

The RCA-7586, 7895 and 7587 nuvistors are designed and manufactured to meet current military specifications

Now you can incorporate the proven performance advantages of the tiny nuvistors into your military equipment designs.

Three important nuvistors are designed to meet the current military specifications listed below:

NUVISTOR TYPE	MIL-SPEC. NO.	DATE
JAN-7586 medium- μ triode. General-purpose type for military and industrial applications	MIL-E-1/1397A	5 July 1962
USA-7895 high- μ triode ($\mu=64$). General-purpose type for military and industrial applications	MIL-E-1/1433 (Sig C)	1 Feb. 1962
USA-7587 sharp-cutoff tetrode. General-purpose type for military and industrial applications	MIL-E-1/1434 (Sig C)	5 Feb. 1962

Nuvistors have exceptional uniformity of characteristics from tube to tube and throughout life; and high transconductance at low plate current and voltage. These highly reliable tubes feature:

- Low voltage operation ⚡ Low power consumption
- High input impedance ⚡ Low noise

AND...nuvistors are in the class of active electronic circuit components least susceptible to catastrophic failure from nuclear radiation.

MIL-SPECS...compactness...outstanding performance—are the benefits you have immediately available to you by designing these nuvistors into your military equipment. It will be well worth your while to find out more about these unique new tubes by calling your nearest RCA Electron Tube Div. Field Representative.

FIELD OFFICES

EAST: 32-36 Green Street, Newark 2, New Jersey, (201) 485-3900 • MIDWEST: Suite 1154, Merchandise Mart Plaza, Chicago 54, Illinois, (312) 527-2900 • WEST: 6801 E. Washington Blvd., Los Angeles 22, Calif., (213) RAYmond 3-8361 • 1838 El Camino Real, Burlingame, Calif., (415) 697-1620



The Most Trusted Name in Electronics

RCA ELECTRON TUBE DIVISION, HARRISON, N. J.