

# electronics

## Micromodular Systems

*Detailed design information, p 37*

## Magnetron Modulators

*Latest solid-state devices, p 42*

## Undersea Radio

*Charts summarize propagation, p 52*

*Continuous-wave laser emits 50 microwatts of visible coherent light*

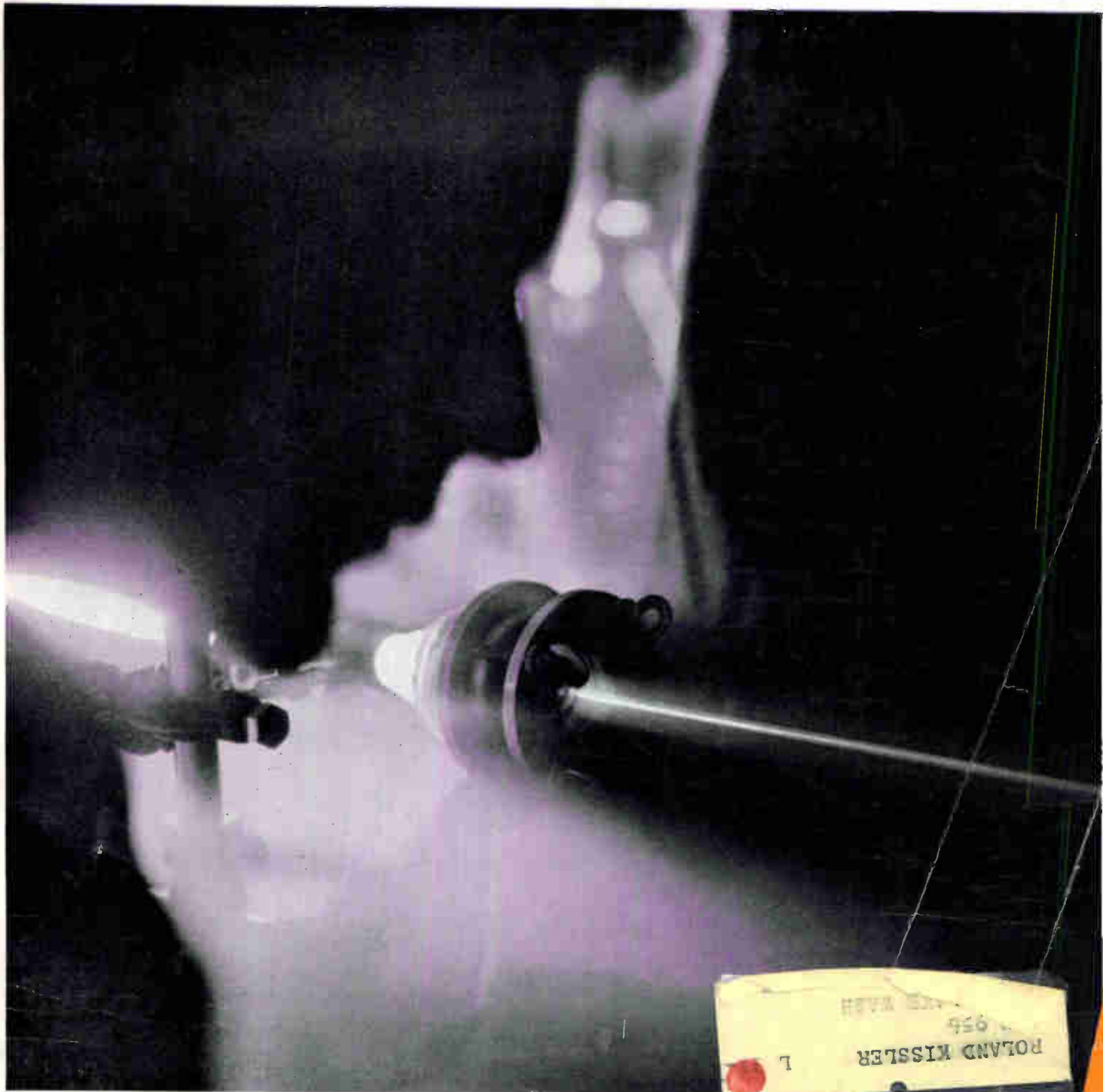



# DO-T & DI-T

## Transistor TRANSFORMERS & INDUCTORS

**PIONEERS IN MINIATURIZATION** **HERMETICALLY SEALED TO MIL-T-27A**

### IMMEDIATE DELIVERY FROM STOCK

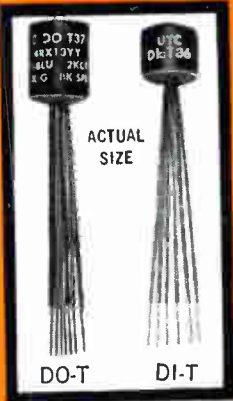

There is no transformer even twice the size of the DO-T and DI-T series which has as much as 1/10th the power handling ability... which can equal the efficiency... or equal the response range. And none to approach the reliability of the DO-T and DI-T units (proved to, but exceeding MIL-T-27A grade 4).

High Power Rating up to 10 times greater  
 Excellent Response twice as good at low end  
 Low Distortion reduced 80%  
 High Efficiency up to 30% better... compare DCR  
 Moisture Proof hermetically sealed to MIL-T-27A  
 Rugged Grade 4, completely metal cased  
 Anchored Leads will withstand 10 pound pull test  
 Printed Circuit Use (solder melting) nylon insulated leads  
 Suited to Clip Mounting use Augat #6009-8A clip

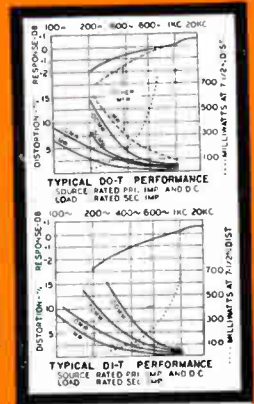

TRANSFORMERS PICTURED DO-T:  $\frac{3}{16}$  Dia. x  $\frac{1}{32}$ " L, 10 Oz.; DI-T:  $\frac{3}{16}$  Dia. x  $\frac{1}{4}$ " L, 15 Oz.

## TRANSFORMERS

DO-T No.	Pri. Imp.	D.C. Ma.† in Pri.	Sec. Imp.	Pri. Res. DO-T	Pri. Res. DI-T	Mw Level	DI-T No.
DO-T44	80 CT 100 CT	12 10	32 split 40 split	9.8	11.5	500	DI-T44*
DO-T29	120 CT 150 CT	10 10	3.2 4	10		500	
DO-T12	150 CT 200 CT	10 10	12 16	11		500	
DO-T13	300 CT 400 CT	7 7	12 16	20		500	
DO-T19	300 CT	7	600	19	20	500	DI-T19
DO-T30	320 CT 400 CT	7 7	3.2 4	20		500	
DO-T43	400 CT 500 CT	8 6	40 split 50 split	46	50	500	DI-T43*
DO-T42	400 CT 500 CT	8 6	120 split 150 split	46		500	
DO-T41	400 CT 500 CT	8 6	400 split 500 split	46	50	500	DI-T41*
DO-T2	500 600	3 3	50 60	60	65	100	DI-T2
DO-T20	500 CT	5.5	600	31	32	500	DI-T20
DO-T4	600	3	3.2	60		100	
DO-T14	600 CT 800 CT	5 5	12 16	43		500	
DO-T31	640 CT 800 CT	5 5	3.2 4	43		500	
DO-T15	800 CT 1070 CT	4 4	12 16	51		500	
DO-T32	800 CT 1000 CT	4 4	3.2 4	51		500	
DO-T21	900 CT	4	600	53	53	500	DI-T21
DO-T3	1000 1200	3 3	50 60	115	110	100	DI-T3
DO-T45	1000 CT 1250 CT	3.5 3.5	16,000 split 20,000 split	120		100	
DO-T16	1000 CT 1330 CT	3.5 3.5	12 16	71		500	
DO-T33	1060 CT 1330 CT	3.5 3.5	3.2 4	71		500	
DO-T5	1200	2	3.2	105	110	100	DI-T5
DO-T17	1500 CT 2000 CT	3 3	12 16	108		500	
DO-T22	1500 CT	3	600	86	87	500	DI-T22
DO-T34	1600 CT 2000 CT	3 3	3.2 4	109		500	
DO-T37	2000 CT 2500 CT	3 3	8000 split 10,000 split	195	180	100	DI-T37*
DO-T18	7500 CT 10,000 CT	1 1	12 16	505		100	
DO-T35	8000 CT 10,000 CT	1 1	3.2 4	505		100	

DO-T No.	Pri. Imp.	D.C. Ma.† in Pri.	Sec. Imp.	Pri. Res. DO-T	Pri. Res. DI-T	Mw Level	DI-T No.
DO-T48	8,000 CT 10,000 CT	1	1200 CT 1500 CT	640		100	
DO-T47	9,000 CT 10,000 CT	1	9000 CT 10,000 CT	850		100	
DO-T6	10,000	1	3.2	790		100	
DO-T9	10,000 12,000	1	500 CT 600 CT	780	870	100	DI-T9
DO-T10	10,000 12,500	1	1200 CT 1500 CT	780	870	100	DI-T10
DO-T25	10,000 CT 12,000 CT	1	1500 CT 1800 CT	780	870	100	DI-T25
DO-T38	10,000 CT 12,000 CT	1	2000 split 2400 split	560	620	100	DI-T38*
DO-T11	10,000 12,500	1	2000 CT 2500 CT	780	870	100	DI-T11
DO-T36	10,000 CT 12,000 CT	1	10,000 CT 12,000 CT	975	970	100	DI-T36
DO-T1	20,000 30,000	.5 .5	800 1200	830	815	50	DI-T1
DO-T23	20,000 CT 30,000 CT	.5 .5	800 CT 1200 CT	830	815	100	DI-T23
DO-T39	20,000 CT 30,000 CT	.5 .5	1000 split 1500 split	800		100	
DO-T40	40,000 CT 50,000 CT	.25 .25	400 split 500 split	1700		50	
DO-T46	100,000 CT	0	500 CT	7900		25	
DO-T7	200,000	0	1000	8500		25	
DO-T24	200,000 CT	0	1000 CT	8500		25	
DO-T500	Power DO-T, Pri 28V 380-1000 cycles, sec 6.3V @ 60 ma						

## INDUCTORS

DO-T50	\$ .075 Hy 10 ma, .06 Hy 30 ma	10.5
(2 wdgs.)	\$ .018 Hy 20 ma, .015 Hy 60 ma	2.6
DO-T28	.3 Hy 4 ma, .15 Hy 20 ma	25
	.1 Hy 4 ma, .08 Hy 10 ma	25
DO-T27	1.2 Hys 2 ma, .5 Hy 11 ma	100
	.9 Hy 2 ma, .5 Hy .6 ma	105
DO-T8	3.5 Hys 2 ma, 1 Hy 5 ma	560
	2.5 Hys 2 ma, .9 Hy 4 ma	630
DO-T26	6 Hys 2 ma, 1.5 Hys 5 ma	2100
	4.5 Hys 2 ma, 1.2 Hys 4 ma	2300
DO-T49	\$20 Hys 1 ma, 8 Hys 3 ma	5100
(2 wdgs.)	\$5 Hys 2 ma, 2 Hys 6 ma	1275
DO-TSH	Drawn Hipermalloy shield and cover 20 30 db	
DI-TSH	for DCMA shown is for single ended usage (under 5% distortion-100MW-1KC) ... for push pull, DCMA can be any balanced value taken by 5W transistors (under 5% distortion-500MW-1KC) DO-T & DI-T units designed for transistor use only. Pats. Pend. *Units newly added to series	

Write for catalog of over 1,000 STOCK ITEMS with UTC High Reliability IMMEDIATELY AVAILABLE from YOUR Local Distributor

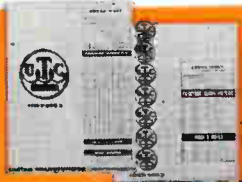

AND CUSTOM BUILT SPECIAL UNITS TO YOUR SPECIFICATIONS

## UNITED TRANSFORMER CORP.

150 VARICK STREET, NEW YORK 13, N.Y.

PACIFIC MFG. DIVISION: 3630 EASTHAM DRIVE, CULVER CITY, CALIF.  
 EXPORT DIVISION: 13 EAST 40th STREET, NEW YORK 16, N. Y. CABLES: "ARLAB"



COPYRIGHT 1971

BRUSH INSTRUMENTS

DIVISION OF CLEVITE CORPORATION

CLEVELAND, OHIO

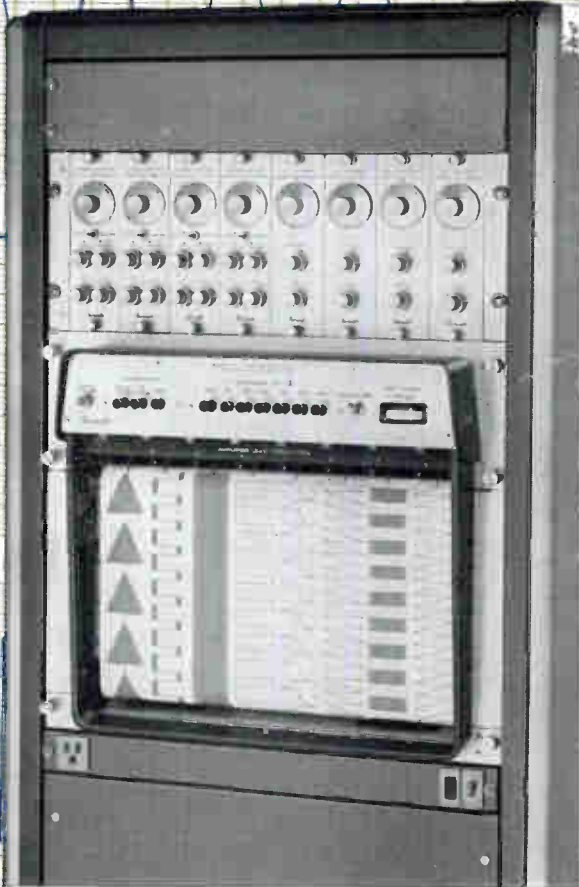

precision and  
clarity never  
before achieved...

The new **Brush Recorder Mark 200** made these incredibly crisp tracings. No other recorder in existence can match them. Note the line width. It never varies . . . regardless of writing velocity, regardless of chart speed. The writing mechanism is electrically signaled by the position-seeking "Metrisite" transducer . . . no parts to wear, infinite resolution, verifiable dynamic  $\pm 2\%$  accuracy. Traces are permanent, high-contrast, reproducible . . . on low cost chart paper. The Mark 200 has but three standard controls . . . attenuator, pen position, chart speed. Such fidelity, simplicity and economy are possible with no other direct writing recorder. Available in both vertical and horizontal models with interchangeable plug-in preamplifiers or signal conditioning push-button controls. Write for details . . . they'll speak for themselves.

CIRCLE 901 ON READER SERVICE CARD

**brush** INSTRUMENTS  
DIVISION OF CLEVITE 37TH AND PERKINS, CLEVELAND 14, OHIO



# SEE HOW RCA RECEIVING TUBES KEEP GETTING BETTER



## 1959-N-132 Cathode Base Material

## 1960-S-311 Plate Material

Virtually ideal black-body characteristics for most effective heat dissipation

## 1961-Dark Heater

Produces required cathode temperature at a heater temperature 200°K to 350°K below that of conventional heaters

## AND NOW 1963...

## THE BONDED CATHODE

Ends cathode peeling, even after long periods of high-temperature, high-voltage tube operation.

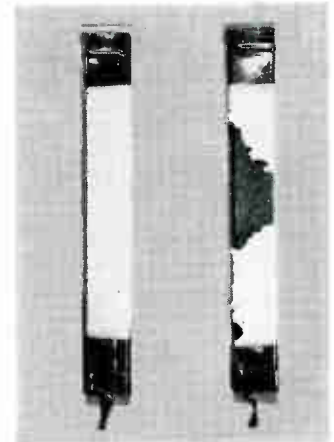

Picture on right is an example of peeling which may occur in nonbonded cathode of a horizontal-deflection-amplifier tube after several hundred hours of operation in a TV receiver.

From RCA research, another major contribution to electron-tube performance and reliability: the bonded cathode. Its emissive-oxide coating will not peel even after extended service under high-voltage, high-temperature conditions encountered in TV horizontal-deflection-amplifier tubes and damper diodes. Permanent adhesion of the emissive-oxide coating of the RCA bonded cathode improves over-all tube performance and reliability...with resultant extension of tube life. Here's why!

### THE NEW RCA BONDED CATHODE:

- virtually eliminates peeling of emissive oxide coating
- reduces cathode interface-type impedance effects during life
- reduces grid-to-cathode shorts during life

- improves stability of cathode-to-grid spacing
- improves anode-voltage-per-mil-spacing safety factor in damper diodes
- transmits heat more efficiently and uniformly—thereby, providing more uniform cathode-current density

The RCA bonded cathode was first applied with outstanding success in beam power tube types 6DQ6-B and 6JB6, and half-wave vacuum rectifier types 6AU4-GTA and 6AY3. This new development is now being incorporated in a growing number of types where service conditions indicate the need. Call your RCA Field Representative for details.

### RCA ELECTRONIC COMPONENTS AND DEVICES, HARRISON, N. J.

RCA FIELD OFFICES—EAST: 32-36 Green Street, Newark 2, N. J., (201) 485-3900 • MIDWEST: Suite 1154, Merchandise Mart Plaza, Chicago 54, Ill., (312) 527-2900 • WEST: 6801 E. Washington Blvd., Los Angeles 22, Calif., (213) RA 3-8361 • 1838 El Camino Real, Burlingame, Calif., (415) 697-1620



The Most Trusted Name in Electronics



# electronics

A McGraw-Hill Publication 75 Cents



W. W. MacDONALD, Editor

J. M. CARROLL, Managing Editor  
 SENIOR EDITORS: Samuel Weber, George W. Sideris. SENIOR ASSOCIATE EDITOR: Michael F. Wolff. ASSOCIATE EDITORS: Michael F. Tomaino, Sylvester P. Carter, William P. O'Brien, John F. Mason, Sy Vogel, Leslie Solomon, George J. Flynn, Lawrence D. Shergalis. ASSISTANT EDITORS: Nilo Lindgren, Stanley Froud, Stephen B. Gray, Roy J. Bruun, George V. Novotny, Leon H. Dulberger. REGIONAL EDITORS: Harold C. Hood (Pacific Coast, Los Angeles), Thomas Maguire (New England, Boston), Cletus M. Wiley (Midwest, Chicago). ART DIRECTOR: Harry Phillips; Howard R. Berry. PRODUCTION EDITOR: John C. Wright, Jr. EDITORIAL ASSISTANTS: Gloria J. Meuer, Lorraine Rossi, Virginia T. Bastian, Lynn Emery, Rosemary Abbruzzese, Ann Mella, Lorraine Werner. FOREIGN NEWS BUREAU: Director, John Wilhelm, Alyne Elias. LONDON—John Shinn, Derek Barlow, Nicholas Landon. BONN—Peter Forbath, Silke McQueen. Paris—Robert Farrell, Arthur Erikson. Milan—Marc A. Messina. Mexico City—Bruce Bendow. Rio de Janeiro—Leslie Warren. Moscow—Stewart Ramsey. Tokyo—Richard Halloran, Charles Cohen, John Yamaguchi.

JAMES GIRDWOOD, Publisher

**CONTINUOUS-WAVE LASER** produces visible light beams in 6,300-Å region. The helium-neon unit uses r-f excitation and delivers 50  $\mu$ w single-mode output. *Raytheon researchers are studying phenomenon of mode patterns and additional red dots that join the dot of light produced by the laser on a screen* COVER

**SCIENTISTS PREPARE TO STUDY QUIET SUN.** Communications industry hopes to benefit from solar activity studies. *This will be the first time since concentrated solar studies began that solar activity will be at a minimum* 20

**INDUSTRY HELP SOUGHT** In Airspace Utilization Design. System up to 1975 is evolutionary, rather than revolutionary. *The big push will be toward data processing and electronic display* 26

**MILITARY MAINTAINABILITY SPECS** Aim at Simplifying Repair Jobs. Military's outlook on maintenance problems is featured at EIA conference. *Latest regulations and specifications are explained* 28

**MICROMODULES IN PRODUCTION.** Now reaching the production stage, micromodules have been put through tough series of reliability tests. *Figures given include those for radiation resistance* 30

**MICROMODULES: How To Design Them, How To Use Them In Systems.** Microelements such as resistors are laid down on ceramic wafers that are then supported in stacks by riser wires. *Step-by-step procedure considers form factors necessary in both circuit and systems design.*  
 By R. DiStefano, Jr., Radio Corp. of America 7

**SEMICONDUCTOR MODULATORS** for Modern Magnetrons. Series-string design with shunting resistors overcomes limitations of *pnpn* transistor switches as magnetron modulators. *An operational 300 Kw modulator has been developed; a 640-Kw unit has been realized in the laboratory.*  
 By F. A. Gateka and M. L. Embree, Bell Telephone Lab 12

**QUASI-DEGENERATE PARAMP: Is This the Simplest Paramp Ever Built?** It requires only one butterfly resonator and one varactor diode with signal and pump coupling loops. *Both signal and idler frequencies are within the resonator passband. Circuit covers vhf and lower microwave frequencies, tunes over a two-to-one band.*  
 By R. J. Meyer, Boeing 46

Published weekly, with Electronics Buyers' Guide and Reference issue as part of the subscription, by McGraw-Hill Publishing Company, Inc. Founder: James H. McGraw (1860-1948).

Title © registered U.S. Patent Office; © copyright 1962 by McGraw-Hill Publishing Co., Inc. All rights reserved, including the right to reproduce the contents of this publication, in whole or in part.

Executive, editorial, circulation and advertising offices McGraw-Hill Building, 330 West 42nd Street, New York 36, N. Y. Telephone Longacre 4-3000. Teletype TWX N.Y. 212-640-4646. Cable McGrawhill, N. Y. PRINTED IN ALBANY, N. Y.; second class postage paid at Albany, N. Y.

OFFICERS OF THE PUBLICATIONS DIVISION: Nelson L. Bond, President; Shelton Fisher, Wallace F. Traendly, Senior Vice Presidents; John R. Callahan, Vice President and Editorial Director; Joseph H. Allen, Vice President and Director of Advertising Sales; A. R. Venezian, Vice President and Circulation Coordinator; Daniel F. Crowley, Vice President and Controller.

OFFICERS OF THE CORPORATION: Donald C. McGraw, President; Hugh J. Kelly, Harry L. Waddell, Executive Vice Presidents; L. Keith Goodrich, Executive Vice President and Treasurer; John J. Cooke, Vice President and Secretary.

Subscriptions are solicited only from those actively engaged in the field of the publication. Position and company connection must be indicated on orders. Subscription rates: United States and Possessions, \$6.00 one year, \$9.00 two years, \$12.00 three years. Canada, \$10.00 one year. All other countries \$20.00 one year. Single Copies, United States and Possessions and Canada 75¢. Single copies all other countries \$1.50.

THE PUBLISHER, UPON WRITTEN REQUEST FROM ANY SUBSCRIBER TO OUR NEW YORK OFFICE, AGREES TO REFUND THAT PART OF THE SUBSCRIPTION PRICE APPLYING TO COPIES NOT YET MAILED.

Subscribers: Please address change of address notices, subscription orders or complaints to Fulfillment Manager, Electronics, at above address. Change of address notices should provide old as well as new address, including postal zone number if any. If possible, attach address label from recent issue. Allow one month for change to become effective.

Postmaster: Please send Form 3579 to Fulfillment Manager, Electronics, 330 West 42nd Street, New York 36, New York.



Audited Paid Circulation

CONTENTS continued

FINDING UNDERSEA CABLE FAULTS With Compact New Instrument. Uses pulse-echo technique to identify either shunt or series faults and displays them on a dual-beam cathode-ray tube. *Pinpoints faults within one-tenth mile in a fifty-mile range.*  
By F. Jones, British General Post Office and J. H. Reyner, Furzehill Labs, Ltd. 48

REFERENCE SHEET: Getting Signals Through to Submerged Submarines. Characteristics of sea water and the air-to-water interface are highly unfavorable for electromagnetic communications. But it is essential to retain contact with missile toting nuclear subs. *This collection of charts neatly sums up the technical difficulties.*  
By E. J. Hilliard, U. S. Navy Underwater Ordnance Station 52

DEPARTMENTS

Crosstalk. <i>Department of Science? Let's Go Slowly</i>	3
Comment. <i>Industry-Education Council. Creativity and Inventions</i>	4
Electronics Newsletter. <i>NASA Negotiates For Lunar Logistics Studies</i>	7
Washington Outlook. <i>Small Business and Depressed Areas Getting More DOD Awards</i>	12
Meetings Ahead. <i>Nonlinear Magnetics International Conference</i>	32
Research and Development. <i>Quasicascading Ups Parametric Amplifier Gain</i>	60
Components and Materials. <i>New Approach to Electroluminescent Display</i>	68
Production Techniques. <i>Reliability of Tantalum Capacitors Increased</i>	78
New Products and Design Application. <i>Microphone Cancels 23-DG Ambient Noise</i>	86
Literature of the Week.	106
People and Plants. <i>Sbordone: Making Time With Teamwork</i>	108
Index to Advertisers.	119



# Department of Science? Let's Go Slowly

EVER SINCE the first Russian sputnik went into orbit on Oct. 4, 1957 the suggestion has been repeatedly advanced that scientists and engineers should have a greater voice in governmental planning and decision making.

One of the first responses to the suggestion was the vesting of more responsibility in the Office of the Science Adviser to President Eisenhower. The trend has continued under the Kennedy administration, and now there is talk of forming a Congressional Commission on Science and Technology, or a cabinet-rank Department of Science and Technology.

ALL THIS ATTENTION is indeed flattering to the scientist and engineer, and it undoubtedly has value in that it focuses public interest on science and engineering as a prime bulwark of our defense. But before we embark upon the planning of a Science Department it would be wise to give more thought to precisely what its function might be.

The present Office of the Science Adviser descends from the Office of Scientific Research and Development (OSRD), the top-drawer government agency that guided much of our research effort during World War II. Appointing such a research body has been part of our wartime syndrome for over a century. Mr. Lincoln's OSRD is still in business—it is the National Academy of Sciences. Mr. Wilson's OSRD is also still around—it is the National Research Council.

THERE ARE TWO VIEWS of what a permanent Department of Science and Technology might do.

It could encompass all the research functions of the federal government: the National Bureau of Standards, Naval Research Laboratory, National Institute of Health, Department of Agriculture Experiment Stations and many, many more. Just how compatible are radio propagation, radar, cancer research and development of prize turkeys? What would be the effect upon the Department of Defense, using its research arms for highly specialized studies aimed at particular missions?

A second view is that the new department could do research on research. This makes more sense but we wonder if it really requires a new cabinet-rank organization to carry it out. Why

couldn't the existing National Science Foundation, or the National Academy of Sciences, be strengthened sufficiently to do the job?

THERE MAY BE AN EASIER WAY to better utilize the abilities of scientists and engineers. The President might more often consider appointing engineers and scientists who have proved their ability in management to agencies such as the Atomic Energy Commission and the Federal Communications Commission.

MICROELECTRONICS—For several years now we have been hearing about various approaches to microelectronics. Several experimental equipment types have been built using them. This year applications of microelectronics are coming thick and fast. And the equipment using them is not all just experimental.

We used to talk about three basic approaches. In the first, circuits are built up on tiny modular wafers; this is generally called the micromodular approach. The second makes use of almost molecularly thin films, usually deposited on a glass substrate; this is the thin-film approach and one of its ramifications includes work in cryogenic or very-low-temperature circuits. The third approach uses circuits diffused into solid blocks of silicon. This approach has been called molecular electronics, monolithic circuits, Functional Electronic Blocks, Semiconductor Solid Circuits, Micrologic and probably many more.

All these approaches aim eventually at producing equipment that is smaller, lighter, hopefully more economical and, above all, more reliable. Each approach has its unique advantages and, in fact, we may even see two or more approaches combined in a single piece of equipment.

The article on p 37 by R. DiStefano of RCA is entitled, *How To Design Micromodules*. But it also tells how to design equipment using micromodules.

Next week we will publish an article on applying functional blocks in system design by the late H. W. Henkels of Westinghouse Electric. These articles will bring you up to date in the technique of applying two of the approaches to microelectronics.

## Coming In Our September 21 Issue

POWER HANDLING—One way to handle high power with transistors is to operate in the switching mode so that dissipation is kept within limits for the device. An application of this switching mode in the design of a 500-watt transistor regulator is discussed next week by P. Balthasar, of Bendix Corporation.

500kc to 100mc  
new

rf **JERROLD**<sup>®</sup>  
**Logarithmic  
Amplifier**  
Model LA-5100

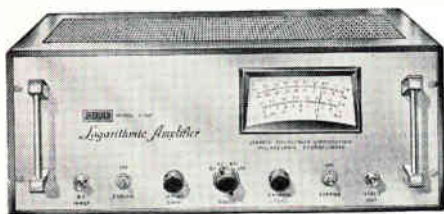

ACCURATE TO WITHIN  
 $\pm 1$  DB OVER 80-DB  
DYNAMIC RANGE

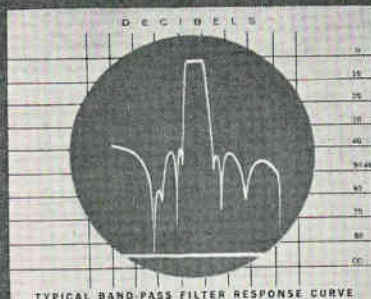

This extremely accurate log amplifier enables exact measurements of attenuation in networks, filters, amplifiers, and other devices exhibiting dynamic operating ranges down to 90 db. Write for complete technical data.

- Frequency range 500kc-100mc, with flatness better than  $\pm 1/2$  db.
- Four calibrated ranges: Logarithmic 0-40, 0-60, 0-80 db (readable to 90 db) and one linear range 0-20 db (variable gain).
- Continuously variable log-expand control permits uncompressed presentation of first 5 db of each range.
- Direct-reading meter for point-by-point measurements.
- Oscilloscope output jack for sweep display measurements.
- Designed for rack mounting: 7" x 14 1/2" x 19". \$795.00

**JERROLD** ELECTRONICS CORPORATION  
Industrial Products Division, Dept. ITE-157  
Philadelphia 32, Pa.

## COMMENT

### Industry-Education Council

I was extremely interested in your August 10 (p 24) article on the Industry-Education Council, entitled *West Starts Recruiting Early*. I want to commend your magazine for its efforts.

If you have inquiries from any of your readers for information on the Industry-Education Council, you may direct them to my attention at the Industry-Education Council office, 700 State Drive, Los Angeles 37, California.

C. F. HORNE  
Chairman of the Board  
Southern California  
Industry-Education Council  
Los Angeles, California

### Creativity and Inventions

F. G. Marble's "R&D and Profit" (*Comment*, p 4, July 13) plea for "help and guidance" by editorial policy, should be echoed by everyone in the electronics industry, especially in conflicts between engineers and management, such as those involved in "who gets the patents."

Industry, via its assign-all-patents employment contracts, now takes those patents from its employees. It also wants them when it is the employee of the government in cost-plus R&D contracts.

But very strange indeed is the fact that the engineers and scientists who create these inventions, whether in industrial or governmental institutions, have no voice whatever in such conflicts! By common law those inventions are the property of the inventor, his employer receiving only a non-exclusive, royalty-free, manufacturing right in return for his salary and the use of the employer's facilities. It is this law which industry has bypassed with its employment contracts.

It may be countered that no one forces creative talent into these industrial or governmental laboratories, which obviously is an undeniable fact. It goes there of its own free will and accord.

But the climate for independent invention has grown so hostile that

it is well-nigh impossible for it to exist. The hostility of the nontechnical courts, the outright piracy of inventions and, if not that, the lone inventor's extremely poor bargaining position, the rough squeeze of the revenue laws on invention returns and on risk capital, all these and more have left only an arid desert in which invention flowers under great difficulty.

If, twenty years ago, a patent was only an invitation to a lawsuit, which an independent inventor might be able to finance against a powerful, piratical industry, its chances now of survival are infinitely worse.

The result: Independent inventors now comprise less than half of the total, whereas a generation or two ago *most* were independents. Realizing the hardships of independent invention in this hostile climate, more than half have gone into industrial or governmental laboratories, willy-nilly signing those assign-all-patents when they did so.

The result of this? The R&D costs of invention have soared, while the quantity and, more importantly, the *quality* of patents has decreased.

When, in speaking of the American free enterprise system, Mr. Marble speaks of rewards "commensurate with the contribution," he unfortunately does not mention the *creative* talent which, now as always, is the source of every product, every industry, all technological progress, as well as our nation's defense against powerful enemies abroad. Most engineers only apply, by copy-cat techniques, what their relatively few creatively endowed brethren have created.

Instead of lessening technical instruction and increasing that devoted to business management, as Mr. Marble finally suggests, I would most strongly emphasize *creativity* in technical school curricula, especially in following the teaching of what has already been created or discovered by the *thinkers* who provided that knowledge. To apply old knowledge is important for today, but to create new knowledge is even more so for insuring progress tomorrow!

B. F. MIESSNER  
Miessner Inventions, Inc.  
Miami Shores, Florida





solid state

**PORCELAIN CAPACITOR**

# Labstock Kits

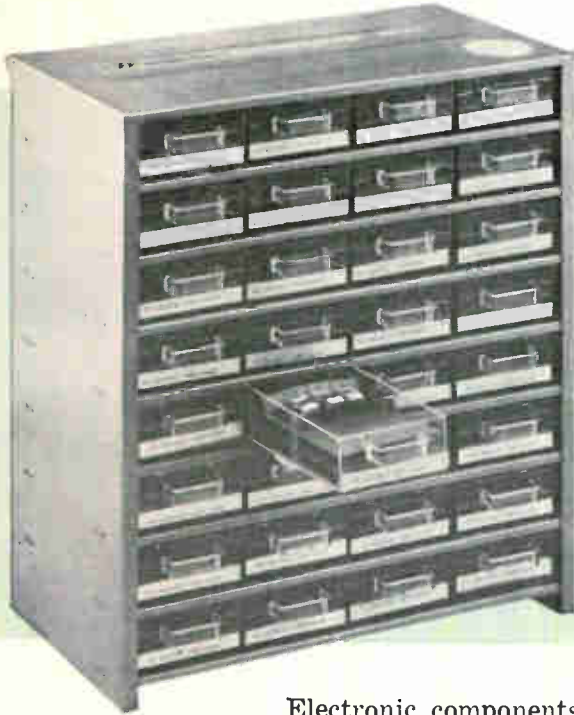

**USE AXIALLY  
OR RADIALLY!**

**SPECIALLY  
PRICED**

**FOR EXPERIMENTAL USE**

Electronic components are used up fast in experimental work, and budgets often take a beating. The two assortments of Axial-Radial "VY" Capacitors not only provide the units you need for prototype and breadboard use, but are offered at 45% off list price.

Parts are packaged and sorted by value in individual, labeled drawers for fast, easy selection. 32-drawer, enameled metal cabinet is compact, sturdy — takes up less than 1/2 sq. ft. of bench space.



**KIT  
#1**

### GENERAL PURPOSE KIT

Contains 576 parts consisting of 18 pieces each of VY 12 and VY 16 case sizes in all values between 100 and 1000 mmf., and the following lower values: 10, 22, 33, 39, 47, 68 and 82 mmf. 5% tolerance.

Complete Kit, Specially Priced At ..... \$380.00



**KIT  
#2**

### RF CAPACITOR KIT

Contains 18 pieces each of the following capacitance values in the VY 12 case size: 1.0, 1.5, 2.7, 3.3, 3.9, 4.7, 5.6, 6.8, 8.2, 10, 12, 15, 18, 22, 33 and 47 mmf. 5% tolerance.

Complete Kit, Specially Priced At ..... \$180.00

Write for FREE CATALOG on the complete line of "Vitraron" Porcelain and Ceramic Capacitors

**VITRAMON**<sup>®</sup>  
INCORPORATED

Box 544 • Bridgeport 1, Connecticut

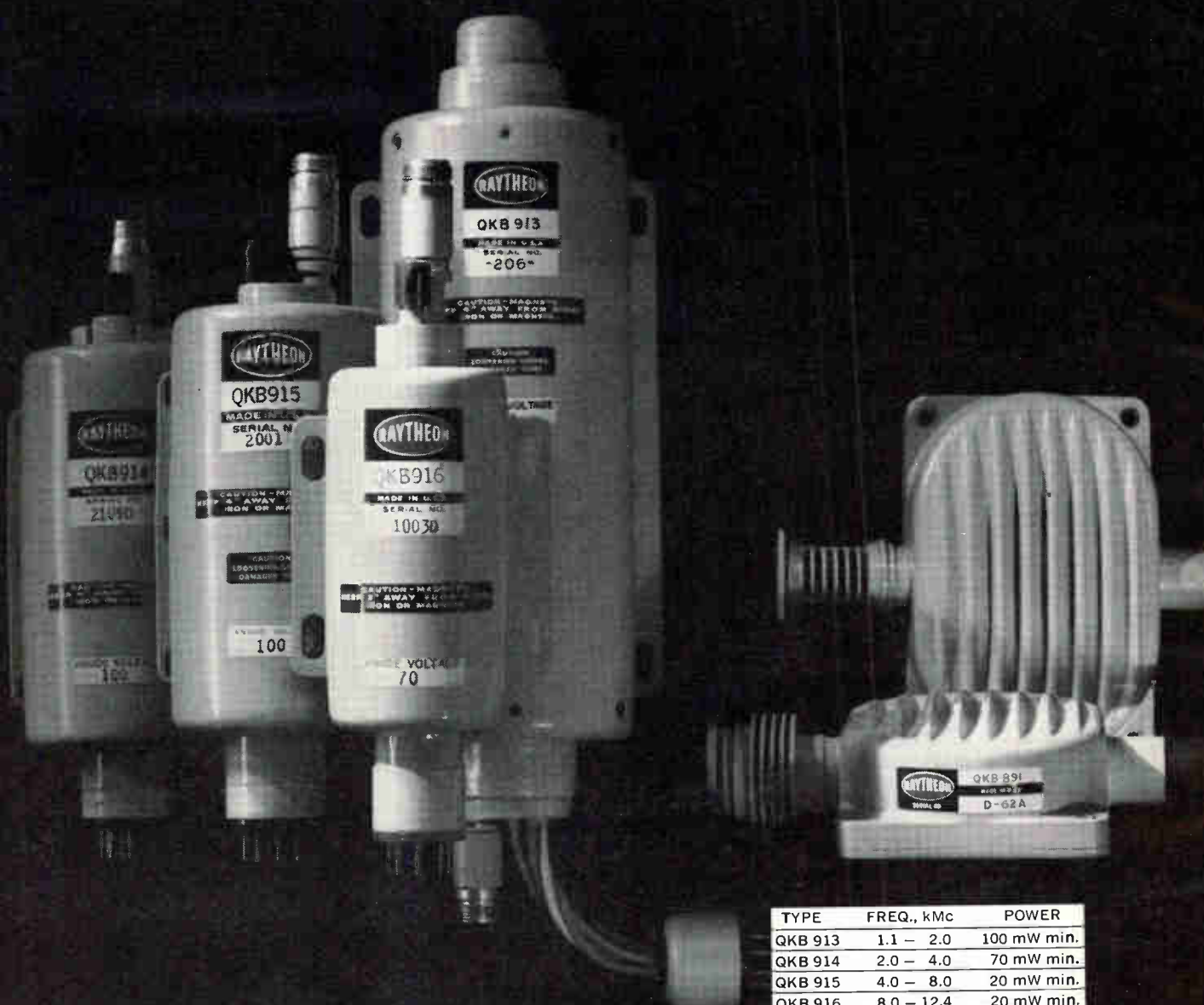

TYPICAL RAYTHEON O-TYPE BWO'S FOR LABORATORY INSTRUMENTS\*

TYPE	FREQ., kMc	POWER
QKB 913	1.1 - 2.0	100 mW min.
QKB 914	2.0 - 4.0	70 mW min.
QKB 915	4.0 - 8.0	20 mW min.
QKB 916	8.0 - 12.4	20 mW min.
QKB 890	12.4 - 18.0	40-180 mW
QKB 891	18.0 - 26.5	40-180 mW

\*Complete O-type BWO line includes 45 different tubes

## Why 3 out of 5 BWO's in new microwave signal generators are Raytheon

Certainly it's more convenient to select from Raytheon's 45 different BWO's. But most needs are met with six tubes covering 1 to 26.5 kMc (above). They're unusually compact and incorporate grids for low-voltage pulse and amplitude modulation or the application of AGC. Write for more reasons in technical data. Raytheon Co. □ Microwave and Power Tube Div., Waltham 54, Mass.



CIRCLE 6 ON READER SERVICE CARD



# ELECTRONICS NEWSLETTER

## NASA Negotiates For Lunar Logistics Studies

NEGOTIATIONS are underway for 3-month studies of a lunar logistic system between NASA and Space Technology Laboratories, Inc., Northrop Space Laboratories and Grumman Aircraft. STL would study various type of spacecraft for carrying supplies to the manned Apollo landing site on the moon. Engineering data will be supplied on how subsystems in a 9,000-lb vehicle carrying some 1,500 lb of gear might form the basis for a follow-on development of a 90,000-lb vehicle carrying 20,000 lb of cargo. Boosters could be Saturn C-1 and C-5. Northrop and Grumman would study cargos the vehicles might carry.

## Profits Down in 1961 for Printed-Circuit Industry

PRINTED CIRCUIT board manufacturers' profits declined in 1961, reported the Institute of Printed Circuits (IPC). The IPC surveyed independent producers that did 40 percent of the \$48 million printed circuit sales in 1961. They said average profits were 1 percent of sales in 1961, compared with 3.2 percent, after taxes, in 1960. The IPC said the reason for the decline of profits was due to the many non-profit operations in the industry in 1961.

## New Computer Memory Planned for Space Use

WOVEN SCREEN computer memory planes are the subject of a \$50,000 research contract awarded to Thompson Ramo Wooldridge Inc. (TRW) by the Applied Physics Laboratory of Johns Hopkins University. Made by weaving strands of bare copper wire into a screen mesh and plating the mesh with magnetic material, the memories will be developed for possible use in the Navy's navigational satellite system.

Random access read-write cycles of less than 1  $\mu$ sec are claimed. The developers say the new design will be more reliable, and will withstand temperature, shock and vibration

effects associated with space vehicle launch and flight much better than present core memories. Cost is expected to be a fraction of conventional memory cost.

## High-Frequency Magnetron To Be Developed for Army

NINETY-THREE-Gc coaxial magnetron and microwave duplexer will be developed by the Westinghouse Electronic Tube Division for the U. S. Army Signal Corps. The magnetron will be of the inverted type with a circular waveguide output. The duplexer will be a broadband, fixed-tuned transmit-receive switch and a dual transmit-receive switch with 3-db couplers. The two development contracts total \$279,204.

## TWT Develops 150 Watts at Millimeter Frequencies

HIGH - POWER millimeter - band traveling-wave tube developed by Hughes Aircraft engineers is reported to have an output of 150 watts c-w at 53.3 Gc. Efficiency of the tube is about 30 percent. Precise electron optics employed in the gun structure permit the high-

power performance. Beam power density achieved is a megawatt per square centimeter at a beam voltage of 11 Kv. Beam transmission is greater than 90 percent using a magnetic focusing field of 2,700 gauss. Hughes engineers hope to use the tube for communication through the ion sheath encountered by spacecraft on reentry.

## Contactless Switch Study Contract Awarded by Navy

CONTACTLESS switching techniques for military aircraft electrical systems will be studied by Ling-Temco-Vought, Inc., under a \$79,000, 18-month contract awarded by the Bureau of Naval Weapons. Static switching characteristics of semiconductors, magnetic, chemical and ferroelectric devices will be investigated.

Besides improving reliability of the electrical systems and reducing physical size, contactless switches are expected to reduce maintenance problems and fire hazards. Such switches are compatible with small conductor flat interconnecting cable, molded harnesses and printed circuits. Future applications are expected to be in missiles, space vehicles and support equipment.

## Licensing Rates to Drop Ten Percent, Japan Says

TOKYO—Japan Electronics Industry Association (JEIA) reported that the Radio Corporation of America (RCA) has agreed to lower licensing rates by ten percent

## Air Force Seeks Builder For Giant Telescope

BOSTON—Air Force is canvassing industry for firms qualified to design and build a giant servo-controlled optical telescope and associated laboratories for studies of the solar atmosphere. A vacuum system and extensive electronic instrumentation will be included with the 300-ft-long, 30-inch aperture telescope planned by the A. F. Cambridge Research Laboratory (AFCRL), Bedford, Mass.

AFCRL's Sacramento Peak Observatory, Sunspot, New Mexico, is the center of USAF solar research, but it has not yet been decided if the new optical system will be built at that site. Formal requests for proposals will be sent to qualified companies by Electronic Systems Div., Bedford, which handles procurement for AFCRL.

on most new production agreements. Old licensing agreements between RCA and Japanese manufacturers are due to expire at the end of this year.

JEIA reported licensing rates for the production of a-m transistor radios will be lowered from 0.5 percent to 0.45 percent. Rates for f-m tube and transistor radios will be lowered from 10.0 percent to 0.9 percent. Black and white television receiver rates are to go from 1.75 percent to 1.575 percent. The association expects that Japanese industry will save more than \$1 million next year after reduction of the licensing fees. JEIA also reported that transistor tape recorders, stereo phonographs, tube stereo and transistor audio amplifiers will be produced in Japan under RCA licensing agreements for the first time next year.

## EIA Recommends Standards For Uhf-Vhf Television

RECOMMENDATIONS for all-channel (uhf and vhf) television set standards were submitted to the Federal Communications Commission by the Electronic Industries Association (EIA). Standards recommended were, "The receiver shall be capable of receiving any uhf channel with a noise figure not to exceed 18 db, and the average of the limits of sensitivity of the uhf channels shall not be more than 8 db below the average of the sensitivity of the vhf channels."

The EIA recommendations were based on the present state-of-the-art capabilities of the industry. They were developed at a conference sponsored by the EIA Engineering Department.

## U. S. and Japanese Firms Sign Business Agreement

JAPANESE FIRMS, Mitsubishi Electric Manufacturing Co. and Fuji Communication Apparatus Manufacturing Co., have signed an agreement with Litton Industries for production, sales and service of an air defense control system of Japan. The Japanese Air Defense Environment (JADE) system, a series of command and control mod-

ules, was developed by Litton. Proposals have been made to the Japanese government on the JADE system, and a contract decision is expected early next year, reported Litton.

## Polaris Submarine Simulator Now in Use

SIMULATOR of Polaris submarine missile control room, built by Curtis-Wright Corp., is now in use at the Navy Submarine School, New London, Conn. Duplicating oceanic operating conditions as well as intermediate range ballistic missile launch tasks, the trainer provides realistic crew experience.

Magnetic drums store 2.5 million bits of submarine and missile data in the form of 80,000 instructions and 2,500 evaluation messages. Instructions are given at a rate of 18 million a minute. Prepunched cards inserted at the control console introduce a variety of malfunctions.

## Integration Contract For Titan III Is Announced

TITAN III systems integration contractor will be Martin-Marietta Corp., the Department of Defense announced. The system is described as a standardized work horse launch vehicle. Appropriations for Titan III for fiscal 1963 totaled \$204 million. Martin had been awarded a previous contract in late 1961 to permit completion of the program definition phase.

## Air Force Develops High Speed Camera

HIGH-SPEED CAMERA system, using an image-converter tube, has been developed through Air Force research, the Department of Commerce announced. The system, which works on an overall light gain, can record 16 pictures, each exposed from  $3 \times 10^{-7}$  sec to  $3 \times 10^{-6}$  sec. The converter tube is capable of amplifying light over 25 times. A mesh grid, with a voltage pulse of +65 v applied to it, controls the flight paths of photoelectrons in their flight to a fluorescent screen. Pulses are synchronized.

## In Brief . . .

SONARS for surface ships will be built for the Navy by Edo Corp. under a \$5.7 million BuShips contract.

MILITARY test equipment will be built for Sperry Gyroscope and Aircraft Armaments by Systron Div. of Systron-Donner Corp. under contracts totaling \$308,000.

SPERRY Gyroscope has received a \$4.9 million addition to its Nike Zeus contract. Sperry Phoenix has received orders for B-52 bomber electronic controls totaling \$4 million.

GAMMA-RAY radiation measurement instruments, pocket size for use by Air Force personnel, will be built by Jordan Electronic Div. of Victoreen Instrument Co. under a \$830,000 contract that also includes 165,000 radiological dosimeter chargers.

ELECTRONIC Industries Association reported that factory sales of receiving tubes and television picture tubes dropped to \$30.7 million in July, lowest monthly total this year.

BUSINESS and Defense Services Administration of the Department of Commerce reported that shipments of electronic components by U.S. producers in the first quarter of 1962 were 4 percent above the previous quarter's level and 18 percent higher than the first-quarter level last year.

NAVY has selected General Precision, Inc.'s doppler navigation system, AN/APN-153 V, for use on ASW, intruder attack, and early warning planes.

DELCO Radio div. of General Motors has been contracted by Army Signal Supply Agency to improve production techniques for the germanium power transistor (2N1358A). Goal is a device capable of a failure rate of no more than 0.03 percent per 1,000 hours of operation at a 90 percent confidence level at 25 deg C.



# Capacitors for Power Supplies (and other applications requiring extremely large values of capacitance)

## WHICH DO YOU NEED -- FINE...or... SUPERFINE?



### **POWERLYTIC® CAPACITORS**

**for 65 C Operation**

With metal cases ranging from 1 3/8" diameter x 2 1/8" long to 3" diameter x 4 5/8" long, Type 36D capacitors pack the highest capacitance values available in these physical sizes. Their maximum capacitance values range from 150,000  $\mu$ F at 3 volts to 1000  $\mu$ F at 450 volts.



### **COMPULYTIC® CAPACITORS**

**for 85 C Operation**

The Type 32D Series offers the ultimate in reliable long-life electrolytic capacitors for computer service. With case sizes similar to those of Type 36D, these higher-temperature units have maximum capacitance values ranging from 130,000  $\mu$ F at 2.5 volts to 630  $\mu$ F at 450 volts.

Both Powerlytics and Compulytics have all of the qualities you expect from Sprague electrolytic capacitors—low equivalent series resistance, low leakage currents, excellent shelf life, and high ripple current capability. They are available with tapped terminal inserts, often preferred for strap or bus bar connections, as well as solder lugs for use with permanently wired connections.



**Popular ratings of Type 36D Powerlytics are now available for fast delivery from your Sprague Industrial Distributor.**

*For complete technical data on Type 36D Powerlytics, write for Engineering Bulletin 3431. For the full story on "blue ribbon" Type 32D Compulytics, write for Bulletin 3441B to the Technical Literature Section, Sprague Electric Company, 35 Marshall St., North Adams, Mass.*

### **SPRAGUE COMPONENTS**

CAPACITORS  
TRANSISTORS  
MAGNETIC COMPONENTS  
RESISTORS  
MICRO CIRCUITS

INTERFERENCE FILTERS  
PULSE TRANSFORMERS  
PIEZOELECTRIC CERAMICS  
PULSE-FORMING NETWORKS  
TOROIDAL INDUCTORS

HIGH TEMPERATURE MAGNET WIRE  
CERAMIC-BASE PRINTED NETWORKS  
PACKAGED COMPONENT ASSEMBLIES  
FUNCTIONAL DIGITAL CIRCUITS  
ELECTRIC WAVE FILTERS



\*Sprague' and '®' are registered trademarks of the Sprague Electric Co.

# MASTER

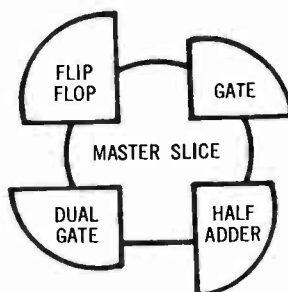
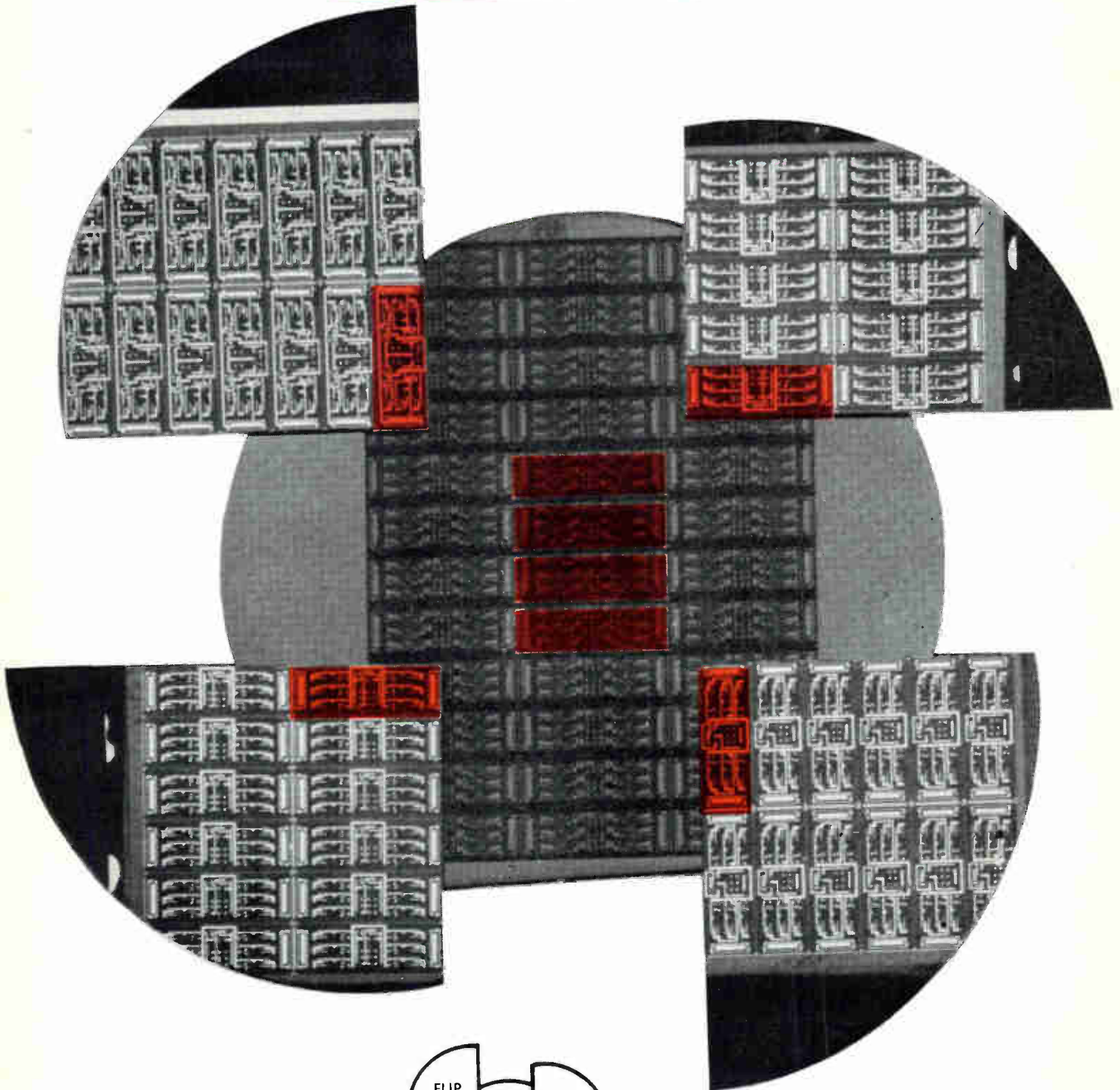

(ACTUAL SIZE)

*SOLID CIRCUIT* semiconductor networks are manufactured from pure silicon "master slice" wafers (center illustration) which contain more than 30 separate circuit bars. Customized interconnection patterns (four corner wafer fragments) are then photo-etched in aluminum on "master slice" wafers, producing completely integrated semiconductor networks ready for packaging.



# SLICE

...the first  
economical  
answer to  
custom  
circuits

Texas Instruments now offers you hundreds of variations in **SOLID CIRCUIT\*** semiconductor networks. Today you can get the exceptional reliability and miniaturization benefits of *SOLID CIRCUIT* semiconductor networks in many customized designs — at only slightly more cost than standard, catalog circuits. The flexible “master slice” design concept developed by Texas Instruments makes this achievement possible.

**HERE'S HOW:** First, standard “master slice” integrated circuit bars — complete except for interconnections — are taken from established, high-volume production lines. Second, a special interconnection pattern mask for your circuit is prepared. Third, your special interconnection pattern is photo-etched in aluminum on the “master slice” circuit bar.

**YOUR BENEFITS:** You get a complete semiconductor network, integrating resistors, capacitors, diodes and transistors into a single, high-purity silicon wafer — to *your* specifications. Evaluation samples can be available within several weeks from final design approval. Because preparation of the special interconnection pattern is the only custom step in the manufacturing process, you get most of the economy and delivery benefits of using standard TI production units.

Of course, “master slice” variations may not satisfy all your circuit requirements. Totally custom semiconductor networks — starting with the pure silicon — can be designed by Texas Instruments to meet an even greater variety of applications.

*\*Trademark of Texas Instruments Incorporated*

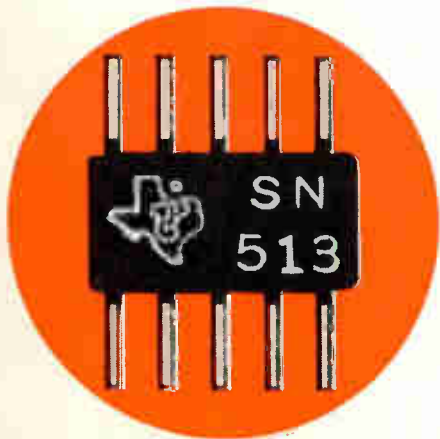

Completed *SOLID CIRCUIT* semiconductor network, enlarged 5½ times.

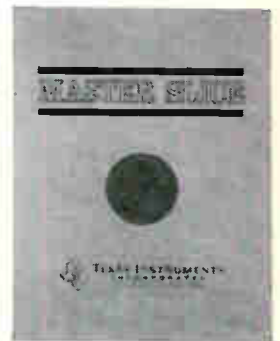

For more detailed information on how “master slice” design offers you the first economical answer to custom circuits, call your local TI Sales Engineer or write to Department 370 today for this brochure.

SEMICONDUCTOR/COMPONENTS  
DIVISION



**TEXAS INSTRUMENTS  
INCORPORATED**  
13500 N. CENTRAL EXPRESSWAY  
P. O. BOX 5012 • DALLAS 22, TEXAS

19370

# WASHINGTON OUTLOOK

## DOD AWARDS TO SMALL BUSINESS AND DEPRESSED AREAS UP

**INCREASING VOLUME** of military contracts to small business and to companies in so-called labor surplus areas is pouring new fuel on the simmering political controversy over the award of military orders. Critics in Congress and industry complain that the military services are placing too much attention on social and political factors in placing contracts while cost, efficiency and technical factors are frequently down-graded. The critics, obviously, speak for areas which do not rate procurement preference.

The facts are these:

Prime contracts to small business in fiscal 1962, amounted to \$4.6 billion, or 17.7 percent of total procurement. This was nearly \$1 billion over the previous year's rate.

Prime contracts to firms in labor surplus areas under a partial set-aside program during July 1961—March 1962 were nearly double the amount for the entire fiscal 1961, and triple the dollar volume in fiscal 1960.

The administration is caught between the need to bolster sagging areas of the economy and its reluctance to use defense procurement as a WPA-type project.

## SENATE TO ACT ON NEW PATENT MEASURE

**LEGISLATION BLOCKING** possible trade conspiracy by requiring filing with the patent office of private agreements in settlement of patent interferences is taking the last Senate hurdle toward probable adoption. The reports would become confidential, except to special parties or agencies. The measure, opposed by some industry interests as forcing disclosure of commercial secrets (i.e. license and royalty details of agreements), passed the House, and this month went before a sympathetic Senate Judiciary Committee. President Kennedy, in March, called for publication of such agreements "in view of the potentially anti-competitive abuses to which use of patents and trademarks are by nature subject," and because, "such agreements may include features designed to weaken future competition at the expense of the consumer."

"Recent experience," reported the House Judiciary Committee in recommending approval of the measure, "has indicated that parties have sometimes used these interference proceedings in derogation of the public interest . . . for the purpose of restricting competition."

## NASA REVEALS SOVIET SPACE FAILURES

**FOR THE FIRST** time, the U. S. has told the Soviets—and the rest of the world—just how effectively our electronic monitoring systems perform. NASA revealed that on Oct. 10 and 14, 1960, the Soviets tried and failed to send a pair of spacecraft to Mars; on Feb. 4, 1961, to Venus; on Feb. 12, 1961 the trajectory to Venus was successful but communications failed; then on Aug. 25 and Sept. 1, 1962, two more Venus shots failed.

Officials won't say how the information was obtained nor why it was released. Although the Central Intelligence Agency may have helped, fact remains that our radar net is better than we thought; reason for releasing the information may have been exasperation at constantly hearing a lopsided version of the Soviet space effort.



RELIABLE products from RAYTHEON



NOW PLUG IN

EXTRA PERFORMANCE  
AT LOWER COST

## Specify Raytheon Reliable Receiving Tube Types

Raytheon's exclusive design features can improve the performance of your radio, television receiver and high fidelity designs. To illustrate:

**Video Pentode 6HB6, 15HB6** — A unique Raytheon grid winding makes possible twice as much sensitivity as conventional tubes and increased voltage output. This tube with transconductance in excess of 20,000  $\mu$ mhos is ideal as a luminescence amplifier in color TV; video amplifier in single-rectifier b&w receivers.

**New Pentode-Diode 6GA7** — A horizontal amplifier and damping rectifier, the 6GA7 utilizes a 12-pin integral all-glass base. It delivers performance equiv-

alent to separate 6DQ6B and 6AX4B tubes along with space, socket, and other savings.

**Horizontal Amplifiers 6GE5, 12GE5, 17GE5** — New 12-pin integral all-glass base types are equivalents of "DQ6B" types with greater reliability and uniformity, plus exceptional performance on low-to-high line voltage variations.

For special engineering assistance on your specific application as well as technical data on these tube types, please contact: Raytheon Company, Receiving Tube Operation, Industrial Components Division, 55 Chapel Street, Newton 58, Massachusetts.

*For small order and prototype requirements  
see your local franchised Raytheon Distributor.*

INDUSTRIAL COMPONENTS DIVISION

NEWTON 58, MASSACHUSETTS

**RAYTHEON**

CIRCLE 13 ON READER SERVICE CARD

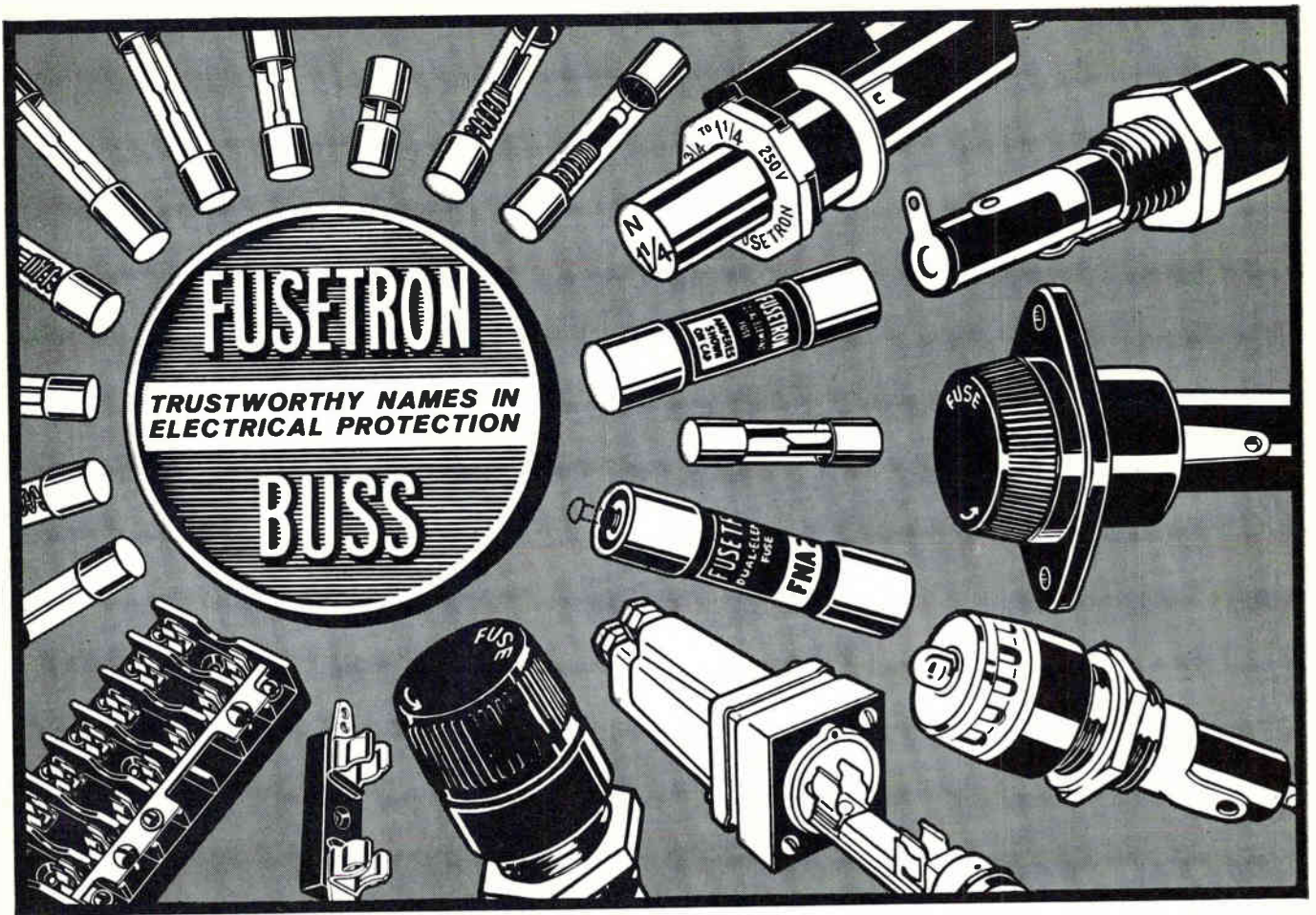

## Save Time and Trouble by standardizing on BUSS Fuses—You'll find the right fuse every time...in the Complete BUSS Line!

By using BUSS as your source for fuses, you can quickly find the type and size fuse you need. The complete BUSS line of fuses includes: dual-element "slow-blowing", single-element "quick-acting", and signal or visual indicating types . . . in sizes from 1/500 amp. up—plus a companion line of fuse clips, blocks and holders.

### BUSS Trademark Is Your Assurance Of Fuses Of Unquestioned High Quality

For almost half a century, millions upon millions of BUSS fuses have operated properly under all service conditions.

To make sure this high standard of dependability is maintained . . . BUSS fuses are tested in a sensitive

electronic device. Any fuse not correctly calibrated, properly constructed and right in all physical dimensions is automatically rejected.

**Should You Have A Special Problem In Electrical Protection . . .** BUSS fuse engineers are at your service—and in many cases can save you engineering time by helping you choose the right fuse for the job. Whenever possible, the fuse selected will be available in local wholesalers' stocks, so that your device can be serviced easily.

For more information on the complete line of BUSS and FUSETRON Small Dimension Fuses and Fuseholders, write for BUSS bulletin SFB.

**BUSS: The complete line of fuses and fuse mountings of unquestioned high quality.**



BUSSMANN MFG. DIVISION  
McGraw-Edison Co.  
St. Louis 7, Mo.



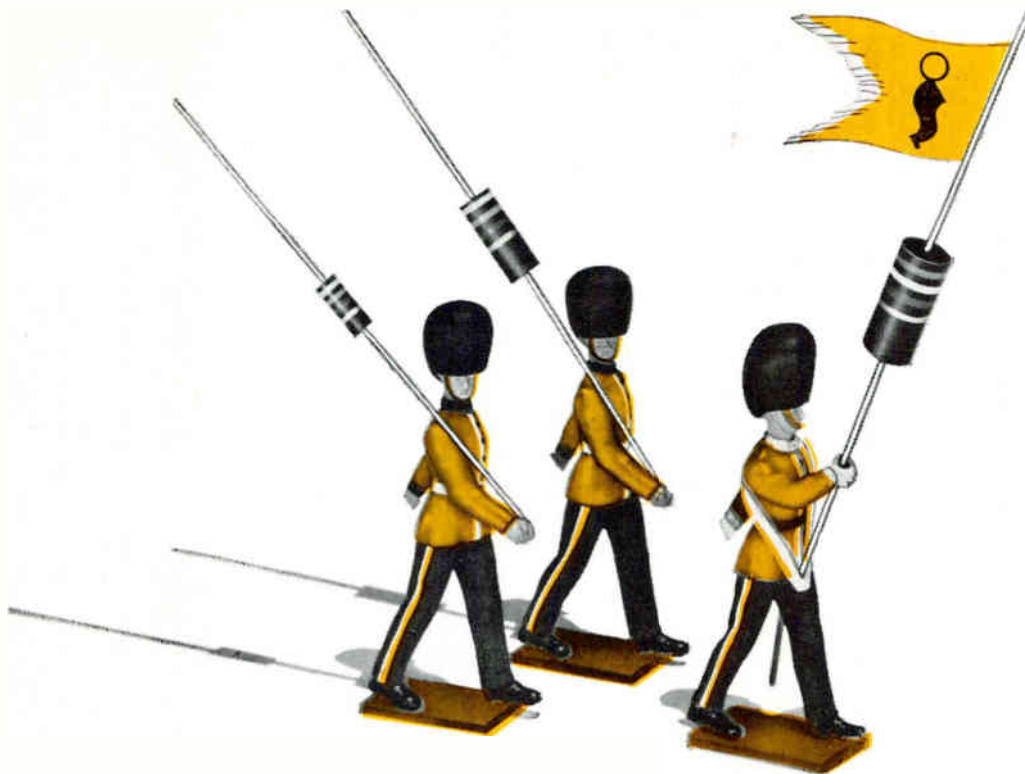

## ***STACKPOLE—proved in service!***

When it comes to stringent service requirements, Stackpole measures up! Designed to meet or exceed every MIL-R-11 requirement, Stackpole Coldite 70+ Fixed Composition Resistors bring in addition extra load life, and moisture and humidity resistance to a host of industrial applications.

**For Extra Dependability**, we mold Coldite 70+ resistance elements and outer insulating shells of similar materials. A completely new process then forms them into a solid, homogeneous structure that defies catastrophic failure or erratic resistance changes in severe environments.

**Easiest of All to Solder by Dip or Iron**, Coldite 70+ Resistors are unequalled for production line efficiency. They're the only resistors, whose leads are solder dipped — not once, but *twice* — besides the usual tin coating. That's why leads stay smooth and tarnish-free even after months in storage.

**Today's Best-Looking Resistors**, Coldite 70+ combine handsome, glossy finish and uniform, easily-read color codes. Their attractive appearance easily survives scrubbing with solvents. They're available in MIL-R-11 Type RC-20 ( $\frac{1}{2}$  watt), Type RC-32 (1-watt), and Type RC-42 (2-watt) in all standard resistance values and at ordinary resistor prices.

**Electronic Components Division**  
**STACKPOLE CARBON COMPANY**  
 St. Marys, Penna.



CERAMAG® FERRITE CORES • VARIABLE COMPOSITION RESISTORS • SLIDE & SNAP SWITCHES • CERAMAGNET®  
 CERAMIC MAGNETS • FIXED COMPOSITION CAPACITORS • BRUSHES FOR ALL ROTATING ELECTRICAL EQUIPMENT  
 ELECTRICAL CONTACTS • GRAPHITE BEARINGS, SEAL RINGS, ANODES • HUNDREDS OF RELATED CARBON & GRAPHITE PRODUCTS.

What's your *present* job in electronics? What will you be working on tomorrow? Do you know the latest electronic developments *outside* your particular specialty that may affect your work?

Below is a sampling of topics within the 3,000 plus editorial pages produced per year by electronics' 28-man editorial staff. No matter where you work today, or in which job function(s), electronics will keep you fully informed as an electronic engineer. Subscribe today via the Reader Service Card in this issue. Only 7½ cents a copy at the 3 year rate.

# electronics

**IS EDITED TO KEEP YOU FULLY INFORMED  
ON ALL PHASES OF ELECTRONICS**

34 Articles	129 Articles	90 Articles	84 Articles	44 Articles	172 Articles
Air Traffic Control	Amplifiers	Antennas	Biophysics	Capacitors	Communications
158 Articles	55 Articles	97 Articles	92 Articles	95 Articles	50 Articles
Computers	Crystals	Data Processing	Detectors	Diodes & Diode Circuits	Filters
84 Articles	49 Articles	104 Articles	77 Articles	88 Articles	73 Articles
Generators	Infrared	Instruments	Lasers & Masers	Magnetics	Memories
179 Articles	96 Articles	64 Articles	53 Articles	75 Articles	48 Articles
Military Electronics	Microwaves	Modulators	Networks	Oscillators	Plasma & Ion Engineering
87 Articles	109 Articles	122 Articles	99 Articles	142 Articles	81 Articles
Pulse Techniques	Radar	Satellites	Semiconductors	Space Electronics	Switches & Switching Circuits
51 Articles	65 Articles	56 Articles	90 Articles		
Thin Films	Transducers	Transistors	Tubes		



New RCA mechanized assembly technique arrays high-speed low-drive cores into high density word strips, utilizes deposited windings for current paths.

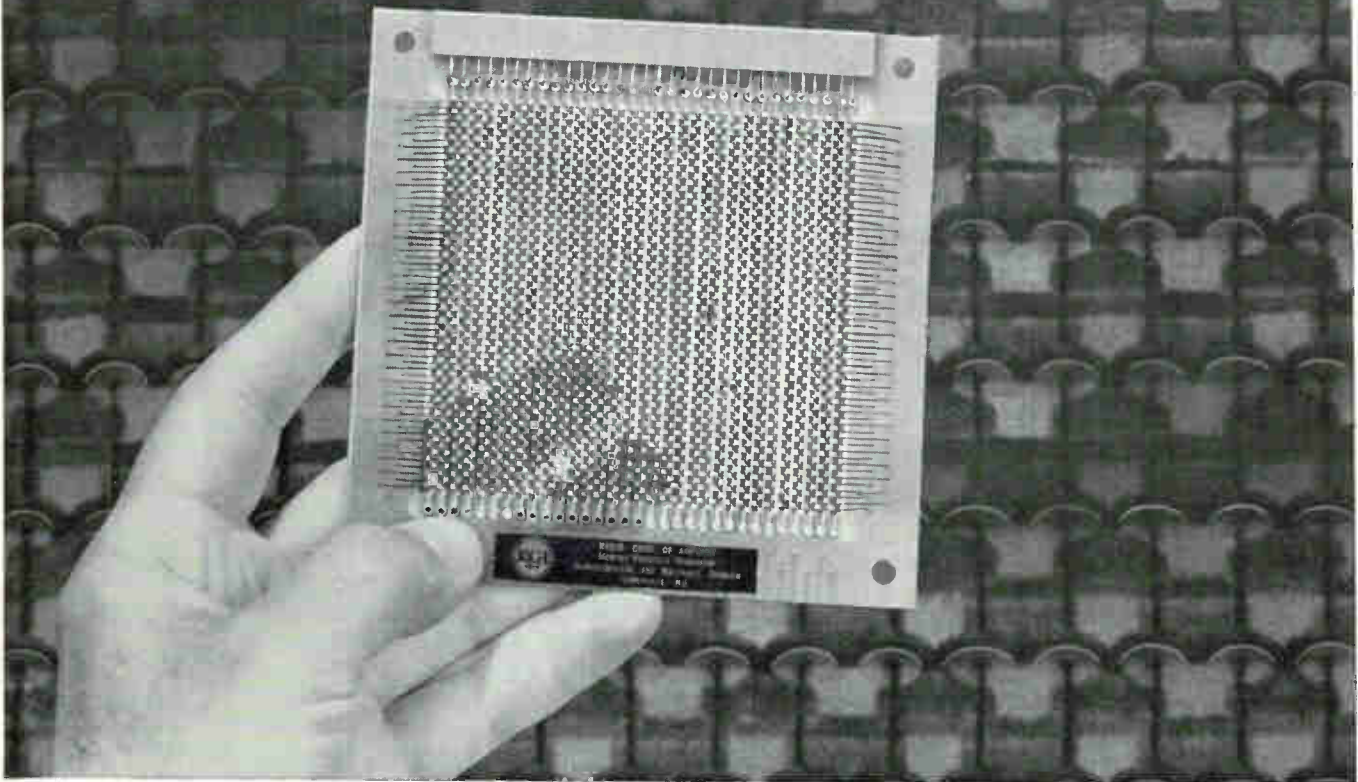

# This Revolutionary New RCA Memory Stack

## Completes A Full Cycle In 300 Nanoseconds With Only 350 ma Drive

Now, a major advance in Ferrite Stack Design and Construction by RCA makes 65-Nanosecond Switching a reality.

Here is the industry's first commercially available Microferrite Memory Stack with complete read/write cycle time of 300 nanoseconds at drive current levels below 350 ma—bit outputs of 50 mv.

This revolutionary two-core-per-bit word-address system bypasses today's experimental memory techniques by using proved, reliable ferrite cores in a high-density array of advanced design. Check these important benefits:

- **High Packing Density**... 1,000 to 2,000 bits per cubic inch.
- **Superior Stability and Ruggedness**... Printed wiring assures positive, rigid contact to each core. Planes designed to meet Military Mechanical and Environmental Specifications.
- **Precision Uniformity**... Mechanized fabrication eliminates many hand-assembly variables.
- **Outstanding Reliability**... Mechanized production techniques permit more precise control of each fabrication step—produce a rugged, high-reliability structure.
- **Broad Capacity Range**... Available in 32 word x 30 bit size, and in any multiple of this size.
- **Plug-In-Convenience**... Each stack incorporates standard plug connections for fast, easy installation.
- **Complete Service**... Whatever your requirements, custom or RCA standard, your local RCA Semiconductor and Materials Division Field Representative is prepared to provide a completely coordinated application service for all RCA Computer-Memory Products. Call him today at your nearby RCA Field Office.

For complete technical information on new RCA Microferrite Memory Stacks, write RCA Semiconductor and Materials Division, Commercial Engineering, Section FN9-2, Somerville, N. J.

TENTATIVE DATA			
TYPICAL DRIVE REQUIREMENTS AT 25°C			
	Amplitude (ma)	Rise Time (nsec)	Duration (msec)
Read Pulse	350	30	100
Partial Write Pulse	250	20	45
Digit Pulse	70	15	85
BIT OUTPUT (Two-Core/Bit Word-Address)			
	Undisturbed '1' (mv)	Undisturbed '0' (mv)	
Bit Out Puts	Amplitude Sensing	60	12
	BiPolar Sensing	+50	-50

RCA SEMICONDUCTOR & MATERIALS DIVISION FIELD OFFICES  
 ... EAST: Newark, N. J., 744 Broad St., HU 5-3900 • (Camden-Philadelphia Area) Erlton, N. J., 605 Marlton Pike, HA 8-4802 • Syracuse, N. Y., 731 James St., Rm. 402, GR 4-5591 • Baltimore, Md., EN 9-1850 • NORTHEAST: Needham Heights 94, Mass., 64 "A" St., HI 4-7200 • SOUTHEAST: Orlando, Fla., 1520 Edgewater Dr., Suite #1, GA 4-4768 • EAST CENTRAL: Detroit 2, Mich., 714 New Center Bldg., TR 5-5600 • CENTRAL: Chicago, Ill., Suite 1154, Merchandise Mart Plaza, WH 4-2900 • Indianapolis 5, Ind., 2132 East 52nd St., CL 1-1405 • Minneapolis 16, Minn., 5805 Excelsior Blvd., WE 9-0678 • Denver 11, Colorado, Continental Terrace Bldg., Suite 301, 2785 N. Speer Blvd., 477-1688 • WEST: Los Angeles 22, Calif., 6801 E. Washington Blvd., RA 3-8361 • (San Francisco Area) Burlingame, Calif., 1838 El Camino Real, OX 7-1620 • Seattle 4, Wash., 2250 First Ave. S., MA 2-8816 • SOUTHWEST: Dallas 7, Texas, 7905 Carpenter Freeway, ME 1-9720 • GOV'T: Dayton, Ohio, 224 N. Wilkinson St., BA 6-2366 • Washington, D. C., 1725 "K" St., N.W., FE 7-8500 • RCA INTERNATIONAL DIVISION, 30 Rockefeller Plaza, New York 20, N. Y. Cable Address: RADIOINTER, N. Y.



THE MOST TRUSTED NAME IN ELECTRONICS

# REQUIRED

Excellence In Receiver Selectivity With Minimum Component Population

## SOLUTION:

1 Midland filters with guaranteed ultimate discrimination of more than 100 db with 60db/3db BWR < 1.8 2 A low cost stock filter with virtually no insertion loss

## FACT

Midland crystal filters are the result of exact design methods and real production knowhow.

Facts are facts and filters are Midland's business. Their filter and crystal engineering skills and facilities assure the user of top reliability and performance. 3 This is Midland's Type FB-5 crystal filter produced by the tens of thousands — the only sure proof of production ability. It is an 8 pole — 6 zero precision network that incorporates no added dissipative elements in inband ripple control. Result: Superior selectivity with essentially no midband insertion loss. A quality production component with immediate delivery. Engineering Bulletin NBS-103 is available detailing complete technical information. Prices on request.

4 Write for Midland's capabilities and facilities brochure, "Midland — in microspect".

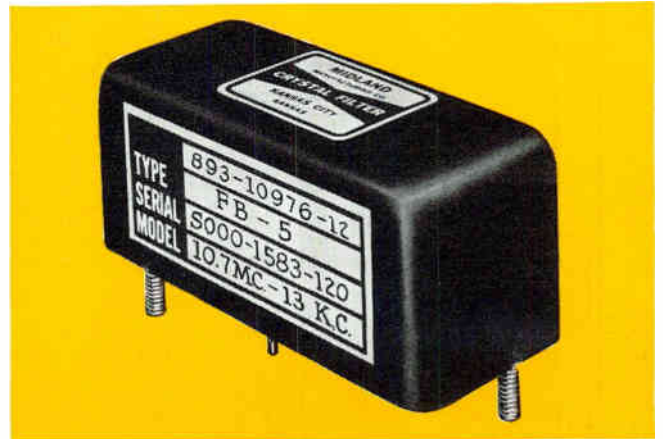

## SPECIFICATIONS

Center Freq: 10.7 MC  $\pm$  375 CPS  
 Bandwidth @ 6 db.: 13.0 KC Min. — 13.8 KC Max.  
 60 db/6 db BWR: 1.8 Max.  
 100 db/6 db BWR: 2.2 Max.  
 Ultimate Attenuation: 105 db. Min., 8 MC to 14 MC  
 Midband Insertion Loss: 0.5 db. Nominal, 1 db. Max.  
 Inband Ripple: 0.5 db. Nominal, 0.8 db. Max.  
 Operating Temp. Range:  $-55^{\circ}$  C to  $+90^{\circ}$  C  
 Zin/Zout Req: 1100 OHMS  $\pm$  5% in parallel with adjustable capacitor 0-5 picofarads.  
 Dimensions: 2 $\frac{3}{8}$ " L x 1" W x 1 $\frac{1}{2}$ " H



MANUFACTURING COMPANY  
 Division Pacific Industries, Inc.

3155 Fiberglas Road

Kansas City 15, Kansas

CIRCLE 200 ON READER SERVICE CARD

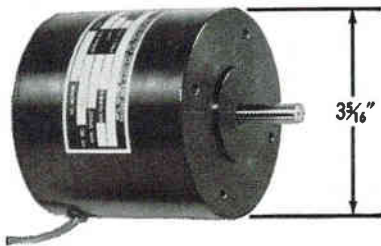

## NEW SMALL A.C. MOTORS

10 to 20 oz. in. torque

Here's big torque from a small, light weight MIL spec unit; hysteresis synchronous motors produce 10 oz. in. maximum sync torque, up to 20 oz. in. from induction types. Globe LC motors weigh only 3 lbs. 5 oz., are 3 $\frac{3}{8}$ " dia. x 3 $\frac{3}{8}$ " long (shorter or longer, depending on performance desired). Where space and weight are critical these motors permit extremely small package designs for blowers, servo systems, actuators, etc. Available with a variety of windings for voltages up to 208 v.a.c., 2, 4, or 6 poles, 1 or 2 phase, 60 or 400 cycles, special or variable frequency. Motors can be furnished with integral brakes and special gear reducers. Write for Bulletin LC from Globe Industries, Inc., 1784 Stanley Ave., Dayton 4, Ohio.

GLOBE

GLOBE  
 INDUSTRIES,  
 INC.



Are you a  
**COMPLETELY  
 INFORMED  
 electronics  
 engineer?**

Today you may be working in microwaves. But on what project will you be working tomorrow? You could have read electronics this past year

and kept abreast of, say, microwave technology. There were 96 individual microwave articles between July, 1961 and June, 1962!

But suppose tomorrow you work in some area of standard electronic components, in semiconductors, in systems? Would you be up-to-date in these technologies? Did you read the more than 3,000 editorial pages that electronics' 28-man editorial staff prepared last year?

electronics is edited to keep you current wherever you work in the industry, whatever your job function(s). If you do not have your own copy of electronics, subscribe today via the Reader Service Card in this issue. Only 7 $\frac{1}{2}$  cents a copy at the 3 year rate.

# electronics

electronics



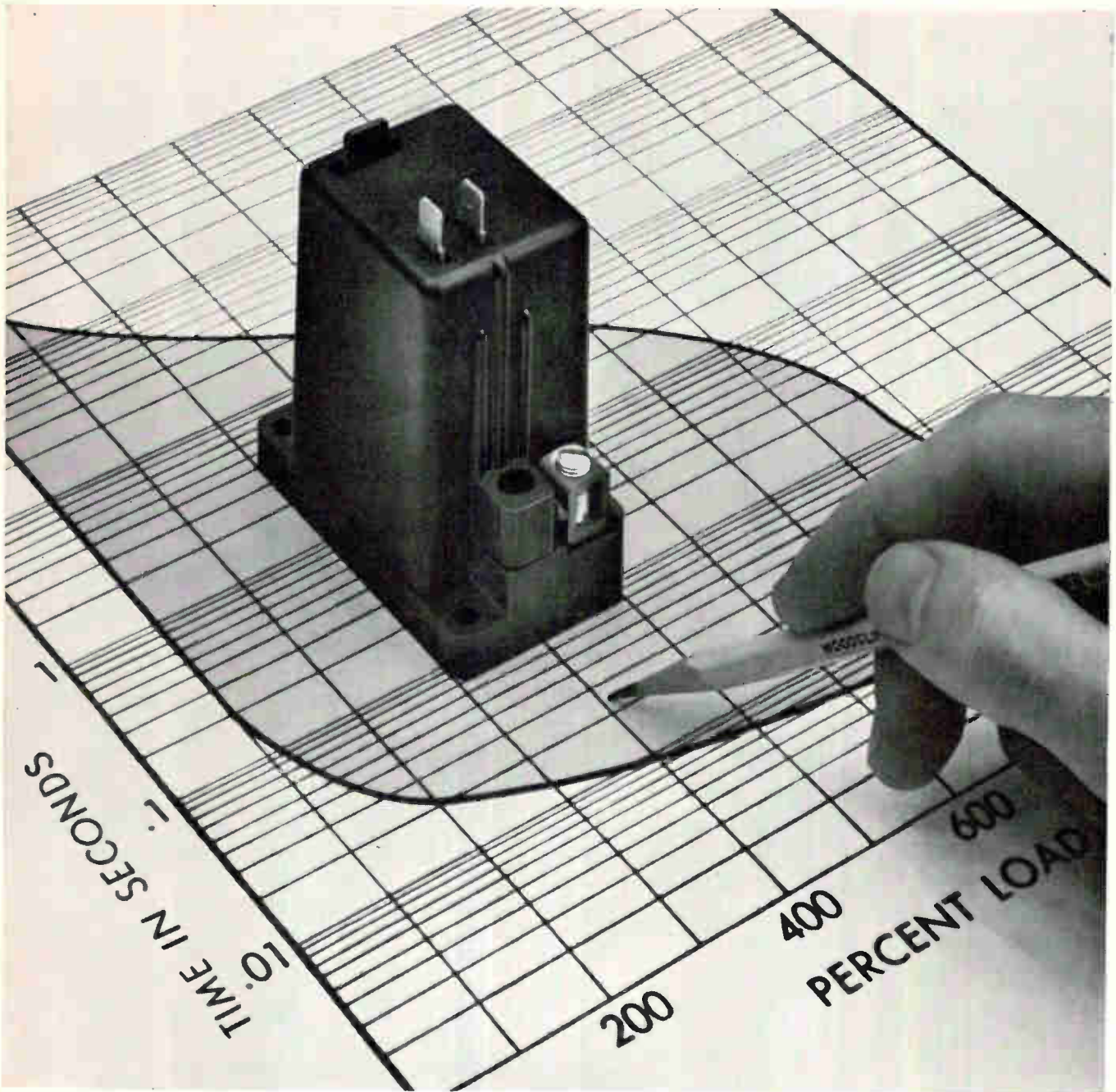

## NEED FAST ACTION ON LOW-VALUE OVERLOADS?

**With the Heinemann Type C Relay  
you can specify the precise  
time-delay-vs-overcurrent response you want**

Where protection requirements are especially critical, you'd do well to consider the Heinemann Type C Overload Relay. Within broad overall limits (defined by the grey area on the above graph), it can give you the exact response characteristics you need.

In fact, there is probably no other protective device that can match its capabilities. The relay can, for example, provide time-delayed tripping at a low 115% load, with high-speed tripping at only 300% load. This, in comparison with thermal-type protectors, verges on the astonishing.

Equally important, the relay can be had in the precise continuous-duty current rating you require. If you need a rating of 0.7 or 11.5 amps, you can get it. No compromise necessary.

And no derating, either. The Type C Relay is *magnetically* actuated (time delay is hydraulically controlled). Its rating and trip points are completely unaffected by ambient temperature.

The Type C is available in three models: automatic reset, auto reset with trip indication, and manual reset. Bulletin 5103 describes them all and gives detailed tech data. Write for a copy.



**HEINEMANN**  
ELECTRIC COMPANY  
2600 Brunswick Pike, Trenton 2, N. J.

SA 2595

## IQSY PARTICIPANTS

Thirty-six countries will participate in IQSY. They are: Argentina, Belgium, Canada, France, Czechoslovakia, Denmark, Finland, German Federal Republic, Hungary, India, Ireland, Italy, Japan, Korea, Malagasy Republic, Netherlands, Poland, Republic of South Africa, Spain, Switzerland, Taiwan, United Kingdom, USA, USSR, Australia, Bolivia, Chile, Iran, Yugoslavia, Mexico, New Zealand, Pakistan, Rhodesia, Nyasaland, Rumania and Vietnam

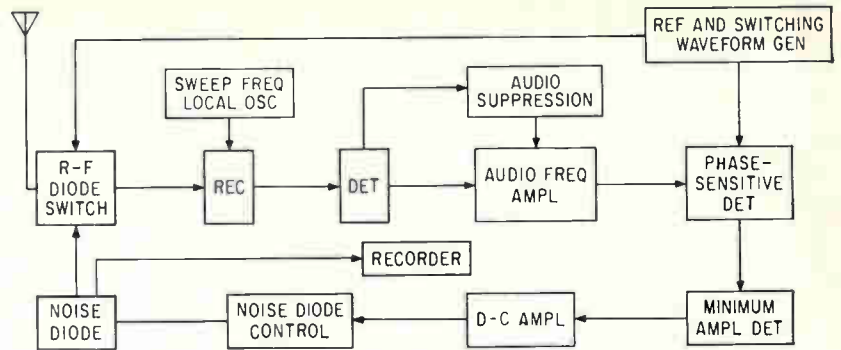

RIOMETER is used to measure degree of ionosphere absorption of radio waves. Most tests will be in the polar regions, where radio waves reflected from the ionosphere are often completely blacked out

# Scientists Prepare to Study Quiet Sun

*Communications industry hopes to benefit from solar activity studies*

SOLAR STORMS and their effect on communications will be more clearly understood—scientists hope—as a result of the International Year of the Quiet Sun (IQSY) program.

Thirty-six nations will participate in the program during 1964-65, a period when solar activity is at a minimum for the first time since concentrated studies of the sun began. Solar activity runs in an eleven year cycle. Studies of a period of high activity were conducted during the International Geophysical Year (IGY).

New experiments are being devised for IQSY to obtain further information about the electromagnetic waves and corpuscular radiation emanating from solar activity. In addition, several experiments begun during the IGY will be continued, after modification to take advantage of the fact that solar outbursts, being at a minimum, will be relatively isolated.

PROJECTS—Solar patrols begun during IGY will be continued, as will studies of geomagnetism, aurora and airglow, the ionosphere and cosmic rays. Newly developed experiments will include a series of optical, radio, radar and magnetic observations.

Sun-earth relationship studies to

be developed for IQSY will include investigation of particle events, flare effects in the ionosphere, the solar daily geomagnetic-field variation in the Pacific, geomagnetically trapped radiation and micropulsations.

Aeronomy studies will include investigations of the density structure of the atmosphere, electron density and structure of the ionosphere, ionospheric motions, airglow relationship and red arcs, and ozone. Cosmic ray studies will include investigations of the primary cosmic ray spectrum, latitude effects and variations in cosmic ray flux.

In addition to the on-ground projects mentioned, NASA will launch several satellites designed to supplement information received from ground experiments (ELECTRONICS,

p 87, November 17, 1961). These satellites will be similar to the Orbiting Astronomical Observatory (p 22, February 23) and Ariel (p 32, April 20), both launched this year. An advanced Orbiting Solar Observatory, now under development, is scheduled for launch in 1965.

RIOMETERS — Relative ionospheric opacity meters (riometers), used to measure the degree of absorption of radio waves by the ionosphere, have improved considerably in design since they were first built for use during IGY.

Extensive use in polar regions during IQSY is expected to further clarify the phenomena of polar cap absorption. Absorption is so strong in the polar regions that radio waves reflected from the ionosphere

COSMIC RAY station in McMurdo Sound, Antarctica, is maintained by the Bartol Research Foundation







**RADIOACTIVE**  
radium element is placed in cosmic ray neutron monitor pile at Bartol Research Foundation's Antarctica base

are often completely blacked out.

Riometers are usually used to measure cosmic radio noise in a frequency range of 20 Mc to 50 Mc, above the critical frequencies of the ionosphere. By comparing the intensity of the cosmic noise at any time with the expected intensity under normal ionospheric conditions, the ionospheric absorption of the signal can be measured.

The input signal from an antenna (see diagram) is continuously compared with a signal from a noise diode source. When the signals differ, the error signal derived from the receiver output is amplified and applied to a phase sensitive detector. The d-c output of the detector is positive or negative, depending on which of the two input signals is stronger. The magnitude of this output is a function of the difference in amplitude of the antenna and noise diode signals.

This phase sensitive detector output is then applied to a control amplifier, which is used to regulate the filament voltage of the noise diode such that its output signal is equal to the antenna signal. By recording the current flowing in the noise diode, a direct proportion to the noise power of the antenna signal is obtained.

The Geophysical Institute at the University of Alaska presently has one of the longest runs of continuous riometer data, riometers there having been in operation since 1957. During IQSY, the Geophysical Institute will operate six riometers throughout Alaska, plus a seventh unit at Thule, Greenland.

**TYPICAL PROGRAM**—Belgium's proposed program for IQSY is typi-

cal of the proposed programs announced by several of the participating countries. Geomagnetic studies will involve recording the geomagnetic field and earth currents. Recordings of the spectra of the night sky will be used to make studies of aurora and airglow.

The Geophysics Center at Dourbes, Belgium, will make measurements aimed at helping to understand the ionosphere. Cosmic radiation observations will also be made at the center.

Solar activity studies include the use of radio astronomy and optical observations. Meteorology studies will be undertaken at the aerology station in Uccle.

### Analyzer Checks Computer Circuits in 45 Seconds

**FAULT-ISOLATION** device, a computer chassis analyzer, has been developed by the Martin Co. The analyzer is able to isolate computer logic malfunctions down to the gate and wire level, checking an entire computer chassis in from 15 seconds to 45 seconds.

Punched tape commands control the logic of the analyzer, which is capable of checking all wiring and components comprising the logic paths of a chassis, as well as considering multiple errors. Tests on logic paths are conducted in a specific order.

Test results showed that 218 gates and 600 wires could be checked in a time-frame ranging from 0.9 sec to 7.0 sec. Martin said it has no immediate plans to market the analyzer.

"Nothing is impossible to diligence and skill"  
Samuel Johnson

## POTTER

**Model LP-1200**  
High Speed  
Printer adds  
new versatility



to modern computer systems. This high-performance, extremely reliable printer provides speeds of 1000 lines per minute with a maximum of 160 columns. An optional Format Control feature permits multi-page forms or books to be printed with completely flexible horizontal or vertical format and up to five carbons.

The Potter LP-1200 reflects the engineering-knowledge gained from extensive experience and research in high-speed printing. Solid-state modular electronics enhance reliability and sturdy, simple mechanical design readily adapts to meet customer requirements.

Three models are available: LP-1200-160 (160 columns), LP-1200-132 (132 columns) and LP-1200-80 (80 columns).

Write for specifications.



Manufacturers of:  
• Digital Magnetic Tape Systems  
• Perforated Tape Readers  
• High Speed Printers  
• Data Storage Systems

**POTTER INSTRUMENT CO., INC.**  
Sunnyside Boulevard • Plainville, New York

It's more than likely you'll find the magnetic performance you need when you order motor or transformer core laminations from our stock of standard shapes. Though they're available right off the shelf, they're designed within exceptionally narrow limits to meet *specific* performance designations. Standard shapes can be supplied in most grades and gages of silicon, soft magnetic iron or nickel alloy material. Special shapes

can be made to your specifications on short notice.

You can be sure of highest quality in Magnetic Metals laminations—quality achieved through custom-selection of material, rigidly controlled methods of manufacture, ultra-precise tooling and stamping, special skills in annealing. Write or call today for a discussion of your lamination requirements. MAGNETIC METALS COMPANY, Hayes Avenue at 21st Street, Camden 1, N.J.

## OFF-THE-SHELF LAMINATIONS

*...with specific performance designations*

UOEI TELFE

transformer laminations • motor laminations • tape-wound cores • powdered molybdenum permalloy cores • electromagnetic shields

MAGNETIC  
METALS



**NOW**  
store transients  
with your standard  
oscilloscope



Missile Test

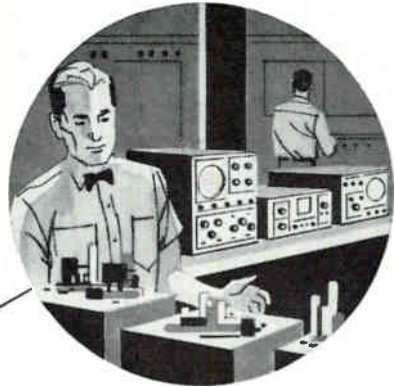

Production Testing



Medical Research



Quality Control

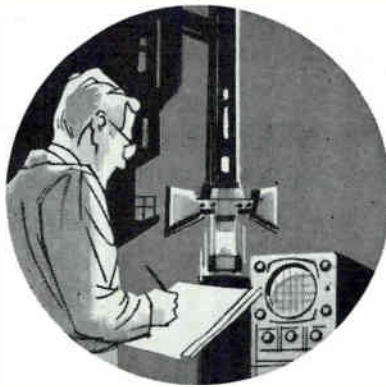

Environmental Test

## Use a HUGHES MEMO-CORDER\* Storage Instrument

Most oscilloscope users find applications where the ability to store traces of fleeting, non-recurring transients would save much time, effort and expense. Until now, oscillographic storage capability required investment in larger, more expensive storage instruments for which only limited use might be found.

The new HUGHES MEMO-CORDER multi-function storage unit changes all this. A precision instrument for laboratory or production use, it is compact and highly portable. You can use it anywhere. The MEMO-CORDER indicator is readily connected and adaptable to most conventional oscilloscopes. Gives you oscillographic storage

when and where you want it. And best of all is its moderate price.

**Added capability!** Matched amplifiers make the Hughes MEMO-CORDER indicator an ideal instrument for X-Y plotting. Excellent as a read-out or display device for systems applications.

Ask Hughes for full information on how you can add storage capability to your present oscilloscopes with the MEMO-CORDER storage unit. Write, wire or telephone today! **HUGHES INSTRUMENTS, VACUUM TUBE PRODUCTS DIVISION**, 2020 Short Street, Oceanside, California.

For export information, write: Hughes International, Culver City, California.

### OPERATING CHARACTERISTICS

Sensitivity: 0.25 v/div.  
Bandpass: DC to 1.25 MC +  
Rise Time: less than 0.27  $\mu$ s  
Writing Speed: 10<sup>6</sup> in/sec.  
Erase Time: less than 150 ms

\*TRADE-MARK, HUGHES AIRCRAFT COMPANY

Creating a new world with Electronics

**HUGHES**

HUGHES AIRCRAFT COMPANY  
VACUUM TUBE PRODUCTS DIVISION

# Before you order . . . check NYLO-FAST® FASTENERS!

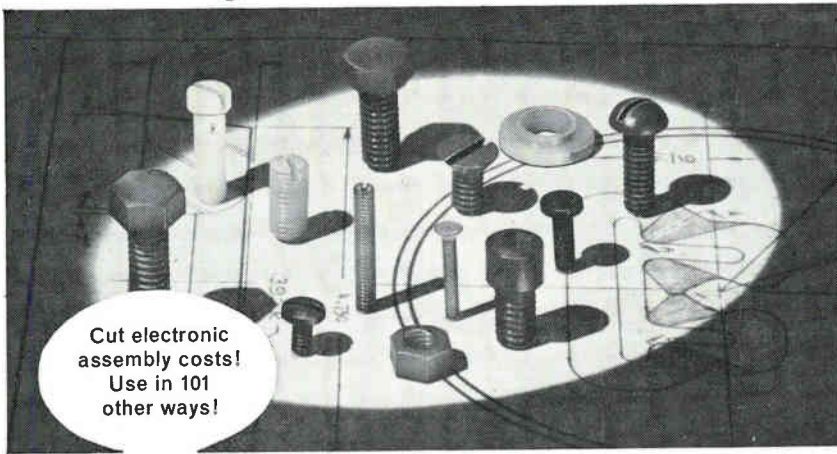

Cut electronic assembly costs!  
Use in 101 other ways!

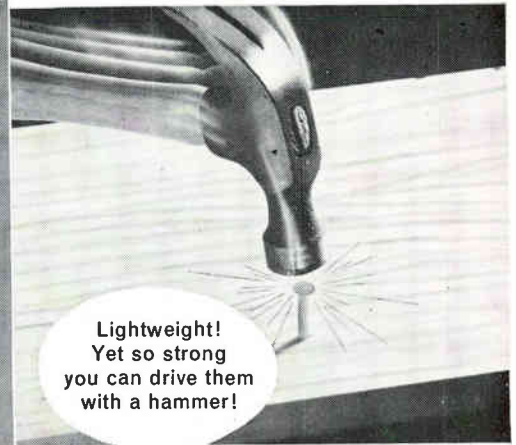

Lightweight!  
Yet so strong  
you can drive them  
with a hammer!

Have you investigated what NYLO-FAST® Fasteners can do for you? They're colorful, strong — yet 1/6 the weight, chemical resistant, heat resistant, elastic, resilient, and non-conducting! You'll be surprised to discover how many ways NYLO-FAST® Fasteners can serve you—BETTER! Write for complete information.

Immediate delivery from our large stocks which include Nylon, Delrin, Teflon, P.V.C., Lexan, etc. 10 different formulations! Write, wire, or telephone today for the facts!

**LEADING MANUFACTURERS OF STAINLESS STEEL AND NYLON FASTENERS!**



# Anti-Corrosive

**METAL PRODUCTS COMPANY, Inc.**

CASTLETON-ON-HUDSON 10, NEW YORK

CIRCLE 220 ON READER SERVICE CARD

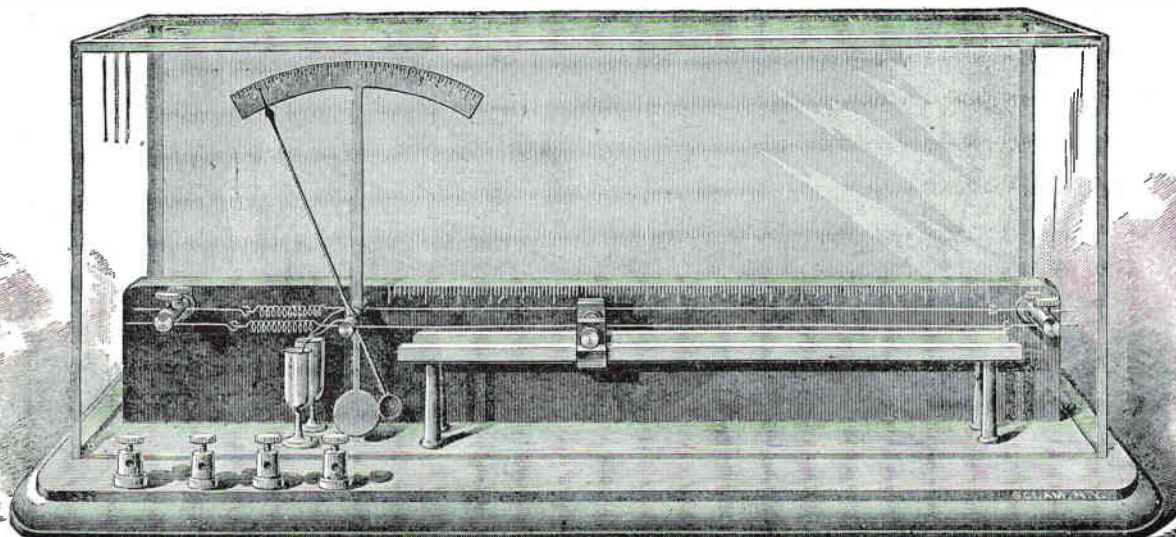

## ***Is it ancient history by the time you see electronics?***

Get the facts while they're new. Don't wait for **electronics** on a route slip. Look in this issue for the Reader Service Card. Fill out and mail the "for subscriptions" section. Only 7½ cents a week.

**electronics** A McGraw-Hill Publication, 330 West 42nd St., N. Y. 36





# SOLID STATE

IN

# Electronics

Men of vision thrive here. And it takes men of vision to cope with today's electronics and space problems. Space in more ways than just up. Space problems of a different nature plague the manufacturer who must expand, but hasn't the land to expand on.

Here in Florida we have the space, the climate, the work force. Florida has more to offer electronics firms than any other area on earth. Men think better where life is pleasant, where off hours can be devoted to just plain *living*—and to just plain *thinking*.

Yes, Florida is a Solid State in Electronics. Already the sun, Mother of Life, shines on over sixty thriving electronics firms in our busy state.

Cape Canaveral is here, too, with its massive, awesome missiles blasting off to make space history. Electronics makes possible every thrust into the universe. Every hope of getting to the moon depends upon electronics—and the first American to the moon will definitely soar to history from Florida.

Engineers and their families dream of living here in Florida. Give them this dream by moving your plant here. Nurture the brains that will give your business a greater and greater stature in this, the Electronics Age.

For complete details of the many advantages Florida offers the Electronics Industry, write us. Let us tell you why some of the greatest names in electronics have impressive plants here in Florida.

### MEET US AT THE SHOW!

Our Industrial Representatives will be at the FLORIDA DEVELOPMENT COMMISSION BOOTH at the NATIONAL ELECTRONICS CONFERENCE to answer your questions about FLORIDA.

### FLORIDA'S ASSURANCE POLICY

"You have my personal assurance of a sunny business climate here in Florida. You have positive assurance of every aid and assistance possible from our Florida Development Commission and from the overwhelming majority of our businessmen, industrialists, and financiers. We have everything to make your large or small enterprise healthy and successful. Write, wire, or phone us TODAY. The only thing better than a FLORIDA vacation is having your plant here."



FARRIS BRYANT  
Governor

Investigate

# Florida

## ...A 10 BILLION DOLLAR MARKET

Ask about free film "Profile of Progress"  
FLORIDA FOR CONVENTIONS—  
Write for free information on Florida's wonderful facilities for your group meeting.



Mr. Wendell Jarrard, Chairman  
FLORIDA DEVELOPMENT COMMISSION  
Box 4247-B • Tallahassee, Florida

Please send me brochure, "Why Your New Plant Should Be Located In Florida," containing the facts about FLORIDA's opportunities for New Industry, the 10 BILLION DOLLAR CONSUMER MARKET, Labor, Climate, Schools, Natural Resources, Favorable Tax Structure.

Name.....

Firm Name.....

Address.....

City.....Zone.....State.....

# Industry Help Sought in Airspace Utilization

*Computers and displays will help attain goal of faster delivery*

ATLANTIC CITY, N.J.—Philosophy and design of the nation's airspace utilization system up to 1975 will not deviate from the present philosophy nor will the design call for revolutionary changes.

A 733-page report, prepared by the Federal Aviation Agency's System Design Team and released on a limited basis late last month, emphasizes that the plan is evolutionary, not revolutionary.

Reasons for this approach are numerous: the present system, although not adequate for the future, is basically a good one. About \$1 billion is already invested in it. The present system could not be junked overnight even if some cure-all concept were available—the FAA doesn't have the money, flight operations could not be interrupted, nor could users afford to outfit their

planes with the new gear.

The System Design Team's plan does predict air-traffic conditions through 1975, the control that must be exercised from now until 1975, the kind of subsystems that can and can't be used, and the performance required of these subsystems.

How the technical problems will be solved and what form some of the subsystems will take is left up to the engineering community, both in FAA and industry.

Here is the objective of the program: to deliver better information, more quickly, to the individual requiring it. The big push, therefore, will be toward improved data acquisition, automation wherever possible, better data processing and electronic displays.

**DATA PROCESSING**—Computers to process information and electronic display consoles to present it both must be bought outright. These two items represent probably the biggest innovation in the new system. Those control centers now

equipped with computers use them as aids to their manual method of operation, and electronic displays are virtually nonexistent. The new system calls for automated control centers.

Whether one computer will handle a center, its several terminal areas, and a number of towers, has not been decided. Probably, each center will represent a different problem and each solution will be an individual one.

**RADAR**—While acquisition of position data by radar will be improved by upgrading present equipment rather than installing new gear, there has been one major decision: the problem of determining aircraft elevation for the controller on his radar scope without voice communication with the planes has been resolved in favor of automatic transmission of altitude information by airborne radar beacon transponders.

FAA would like to have a transponder or secondary radar system

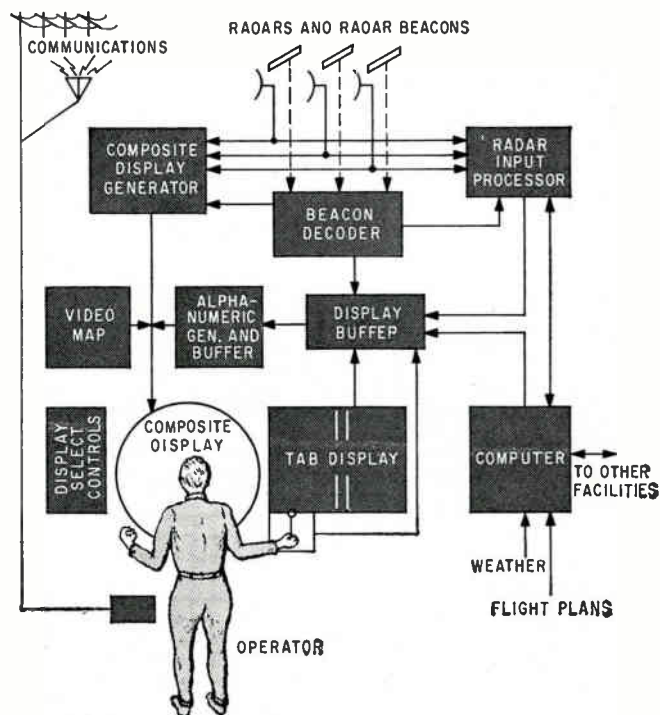

AIR TRAFFIC CONTROL subsystem includes data processing and multiple radar coverage

DATA PROCESSING configuration allows display of both raw and processed radar data

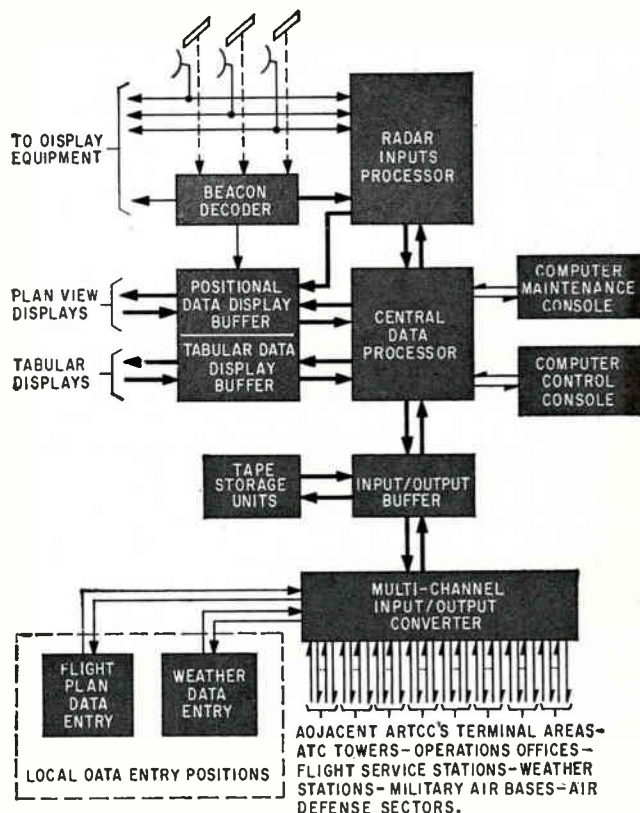



# System Design

By JOHN F. MASON, Associate Editor

that would save money by eliminating primary radars that skin-track aircraft not carrying beacon transponders. There are still, however, unresolved technical, economic and political problems in such a move.

The big height-finding radar at the National Aviation Facilities Experimental Center (NAFEC), Atlantic City, N.J. will, nevertheless, continue to undergo tests. Conceivably, busy terminals will one day be equipped with height-finding radar. Until 1975, however, FAA will rely on beacons as well as primary radar.

One change in viewpoint is the new acceptance by FAA of composite displays from a number of radars and from computer-derived data. Alphanumeric information will be displayed, as well as extrapolated position of aircraft during poor radar reception.

Air-defense radars and FAA radars will be remoted to centers by microwave links and narrow-banding techniques. The latter will be introduced slowly and may become the major remoting method of the future. This technique will enable a single controller to monitor a greater geographical area and will fit in with the plan to cut down on the number of centers in the national system.

**NAVIGATION** — Ground-based navigation will continue to be VORTAC (vhf omnirange and Tacan). Distance Measuring Equipment (DME) will be required for IFR (instrument flight rules) operations in terminal areas. Pictorial displays to be used by the pilot will not be required before 1975, but continued development of this gear is encouraged. NAFEC's Experimental division findings indicate that such gear would be helpful to the air traffic control (ATC) system. The division's findings on the possible value of airborne doppler navigation sets in ATC is not yet complete.

**LANDING AIDS** — At airports meeting specified traffic criteria ILS (instrument landing system) or

GCA (ground-controlled approach) will be used for final approach and landing. Other landing aids under evaluation at NAFEC include: a modified version of Bell Aircraft's GSN-5, designated GSN-5A, to be ready in December for testing; the British Bleu, a system that may use either the ILS localizer or magnetic leader cables for alignment with the runway, and North American Aviation's Autonetics Division APN-114, which provides a vertical measuring unit to be used with the ILS localizer. In the Experimentation division, two breadboard systems are being examined: Gillfillan's Regal, which has achieved range elevation angles with a 0.05-deg accuracy; and Airborne Instruments Laboratory's Flaescan, a system based on angular measurement rather than distance.

Final recommendation from NAFEC may be a composite system using the best techniques being examined. Already of aid to the project is an improved ILS directional localizer that uses a 117-ft wave guide. NAFEC is now experimenting on a new one 300 ft long.

**COMMUNICATIONS**—The system will depend on direct pilot-controller ground-air-ground communications for control. The equipment to be used is two-way vhf/uhf voice ra-

dio with 50-Kc vhf channel selectivity.

Actual advances in communication techniques will not be pushed until the amount of communications that will be needed is determined. Automatic data link from pilot to controller providing periodic flight data plus the use of computers in control centers may obviate the need for increased voice communication. A number of companies are working on automatic data links.

**WEATHER** — NAFEC has produced a system design for a weather system that is now being studied by the Weather Bureau and the Department of Defense. The goal is to deliver useful weather information to the pilot and controller in time for them to use it. New sensing devices, communications, data processing and display equipment are being proposed. FAA is now handling the U.S. portion of the Air Force 433-L global weather information system. USAF is in charge of the areas outside the U.S.

**COLLISION-AVOIDANCE** — Both collision avoidance systems (CAS) and pilot warning instruments (PWI) are still hopes for the future. Techniques proposed to date did not interest the design team sufficiently to include them in their pre-1975 plans.

## Radiation Won't Alter NASA's Plans

NASA DOES NOT now plan to reschedule any of its satellite launchings because of the increased radiation in space from the U.S. July 9 nuclear test. A spokesman told **ELECTRONICS** that NASA had considered delaying some launches but decided to go ahead as planned; one advantage would be acquisition of more data on the exact nature of the radiation belt.

Also, a DOD spokesman said, no military satellites have been delayed by the new radiation.

According to an AEC-DOD announcement, the inner Van Allen

belt has been extended to lower altitudes, and within the natural belt there is a "substantial and greater than anticipated increase" in radiation intensity that may persist for years. Electron densities at the lower altitudes were said to be disappearing as predicted, however.

The new radiation is reported to have damaged solar cells in Navy's Transit IVB and Traac satellites and the U.S.-British Ariel satellite, and halted transmission. The altitudes of these satellites, however, are above those planned for manned flights in the near future.

# Military Maintainability Specs Aim at Simplifying Repair Jobs

## *Military's outlook on maintenance problems featured at conference*

DENVER—Maintainability specifications in military contracts and the military's concern about electronic equipment maintainability were highlighted at the recent Fourth Conference on Maintainability of Electronic Equipment sponsored by EIA and the Department of Defense. It was held at the University of Colorado.

Conducted in a new symposium format, the conference featured 15 workshops for each of five maintainability areas. The workshops were devoted to discussion of data and material, evaluation of techniques and endorsement of methodology for assuring optimum maintainability of the design product.

The five areas were personnel and training, testing techniques, design configuration, trade-offs and design reviews.

The only session that did not use the workshop format was conducted by a DOD spokesman who gave the 250 convention delegates the latest information on proposed specifications of maintainability for military equipment.

MILITARY—The Air Force is now using management maintainability specifications for systems and equipment procurement, reported Major W. P. Crumpacker, Air Force Systems Command headquarters.

"It is our policy to apply this specification (management maintainability), as well as quantitative maintainability requirements, in all system and equipment contracts," he said.

G. Sibthorp, Army Office of the Deputy Chief of Staff for Logistics, reported that separate specifications have been or are being prepared for the two major categories of Army electronic equipment: communications/electronics and missile systems.

The communications/electronics specifications are composed of three parts: generalized maintenance requirements, a compendium of design features whose absence from an equipment would be detrimental to the ease of maintenance, and specific requirements, constraints, and guidance pertinent to the particular equipment under development.

Missile system specifications are based on several concepts. Complexity of maintenance should be minimized through design. Malfunction recognition and faulty component identification should be rapid and positive. Repair and service of equipment should be simple. It is expected that in future missile system contracts an adaptation of maintainability specifications developed by the Air Force will be used by the Army.

AUTOMATION—A tendency toward the adoption of the philosophy that automatic test equipment should extend man's capabilities rather than replace man was cited by J. Cooper, of Thiokol Chemical, at one of the trade-offs section workshops. He proposed a maintainability concept using this philosophy.

Cooper suggested the possibility of a machine that gives a series of logical alternatives to the cause of a malfunction, obtaining these alternatives from the specific symptoms given to the machine. The maintenance technician would then be provided with a limited set of actions to take to track down the malfunction. In this way, automation would extend man's capabilities, leaving the final decision up to him, instead of replacing him.

---

### MAINTAINABILITY SPECIFICATIONS

**AIR FORCE**—has adopted MIL-M-26512B (USAF), 23 March 1962, superseding MIL-M-26512A (USAF), 5 December 1960, a specification detailing maintainability requirements for aerospace systems and equipment.

—has adopted AFR 66-29, 17 January 1962, a regulation stating Air Force policy, responsibility and basic procedures for the USAF maintainability program for systems, subsystems and equipment.

—has adopted AFSCR 80-9, 26 December 1961, a regulation applying to all elements of AF Systems Command responsible for conduct of current and future AF research, development and production programs.

### ARMY

—has drafted a specification, adapted from MIL-M-26512B (USAF), revised 1 June 1962, a proposed specification dealing with maintainability requirements for Army Ordnance Missile Command contracts. It contains as an annex an extract from MIL-M-11991A (ORD), 30 April 1959, a general specification for electrical-electronic equipment, surface and guided missile weapon systems.

—has adopted SCL-4301B, 29 March 1962, superseding SCL-4301A, 19 January 1962, a Signal Corps technical requirement detailing maintainability design requirements for signal equipment.

### NAVY

—has adopted MIL-M-23313 (SHIPS), 12 June 1962, a specification detailing maintainability requirements for shipboard and shore electronic equipment and systems

---



## Contracts Let for Gemini Command and Display Gear

DIGITAL COMMAND system, for the two-man Gemini orbital space program, will be developed by Motorola's Military Electronics Division. Decoders, r-f command receivers and a buffer storage unit will be installed in the spacecraft to receive command signals from the ground and convert them for control of the various spacecraft systems. Motorola components and equipment used in the Mariner program will be re-designed to fit Gemini needs.

A flight director-attitude indicator, to be developed by Lear Siegler, Inc., will be the central control display for Gemini. The single pictorial display, indicating the spacecraft's attitude in roll, pitch and yaw in relation to the horizon, will depict corrections in attitude that must be made during launch and insertion, in orbit and at time of re-entry.

Lear is also developing control-display systems to be used in other manned air and space vehicles, under a \$500,000 USAF contract. Five systems, three of which are intended for flight evaluation in the X-15, will be developed. The systems are a combined temperature, velocity and angle-of-attack display, a computer programmer, a flight director mode selector, a three-axis rate sensor, and a wing temperature and yaw angle display.

## War Games Score Keeper



*TILT, a device that shoots infrared beams instead of bazooka shells, keeps score in war games. It was developed by Raytheon*



# ML-8087 Precision Scan Conversion Tube Fast Erase High Resolution

- 1 High resolution: a minimum of 180 range rings/diameter at 50% amplitude modulation; equivalent to 900 TV lines.
- 2 Fast erase: less than 2 seconds erase cycle to reduce stored information to noise level.
- 3 Wide storage range: to meet FAA 1213b specification and beyond.
- 4 High signal/noise ratio, typically 80:1 (peak signal to rms noise).
- 5 Rapid set-up time: only a few minutes installation time is required to adjust tube for optimum operation. No need for critical dynamic focussing of electron beams.
- 6 No variation of output signal with size of written area.
- 7 Only simple video circuits are needed for readout.

Send For Data

**MACHLETT**

**The Machlett Laboratories, Inc.**  
A division of Raytheon Company  
**Springdale, Connecticut**

# SPRAGUE PIEZO- ELECTRIC CERAMIC ELEMENTS



**ELEMENTS  
FOR ALL  
APPLICATIONS  
AS WELL AS  
COMPLETE  
TRANSDUCER ASSEMBLIES  
FOR MOST APPLICATIONS,  
SUCH AS UNDERWATER  
SOUND AND  
VARIOUS ORDNANCE AND  
MISSILE DEVICES.**



Sprague-developed mass production and quality-control techniques assure lowest possible cost consistent with utmost quality and reliability. Here too, complete fabrication facilities permit prompt production in a full, wide range of sizes and shapes.

Look to Sprague for today's most advanced ceramic elements—where continuing intensive research promises new material with many properties extended beyond present limits.



**YOUR INQUIRIES  
ARE INVITED**

**WRITE FOR  
LITERATURE**

**SPRAGUE ELECTRIC COMPANY**  
35 Marshall Street, North Adams, Mass.

**SPRAGUE®**  
THE MARK OF RELIABILITY



MICROMODULES will be used in a family of combat radios. At left is the conventional AN/PRC-25 case now equipped with micromodule circuits. At right is the AN/PRC-51 micromodule radio transmitting, with micromodule receiver clipped to the soldier's helmet

## Micromodules Show Durability Plus Radiation Resistance

*Micromodules reaching  
production stage have  
high reliability*

RELIABILITY of micromodules going into production (ELECTRONICS, p 7 Sept. 7, and p 37, this week) has been proved in a full range of environmental tests, RCA engineers told ELECTRONICS last week. In addition, they were found to have a radiation resistance equivalent to three years exposure in the Van Allen belt.

TEST RESULTS—Over 6,000 component wafers or elements, built up into 800 micromodule circuits exhibited a mean time to failure of 6½ million hours (for the elements). All elements were under high stress at 60-percent confidence level.

Solder connections in the modules were tested to a total of over 250 million electrical-connection hours with no circuit failure. These tests were run at temperatures close to the junction temperatures of the transistors—75 degrees C with germanium transistors and 125 degrees C with silicon transistors. Although all connections, to date, have been solder type, RCA engineers said they are also working on welded connections.

Radiation tests were made in the Princeton atomic reactor in a neutron field equivalent to  $5 \times 10^{14}$  neutrons/cm<sup>2</sup>.

One micromodule was shot out of a howitzer, subjecting it to 20,000 g's. In a first test, the module suffered an external failure due to an improper mounting of its pins in the module base, but in a repeat

test, it survived without failure.

CIRCUITS — Microwafers, originally intended for single components such as resistors, capacitors, inductors, crystals, transistors and diodes, are in some cases now made with multiple components and are compatible with other microelectronic techniques being developed.

For example, one micromodule has been constructed with three wafers, each wafer mounted with a Texas Instruments Solid Circuit package. Designed for logic circuits, the module wafers hold two gates, two emitter followers and one flip-flop.

RCA is also working on other techniques using solid ceramic circuits. This work, in cooperation with the Signal Corps, is aimed at constructing an advanced computer for the field army.

Micromodules, it is claimed, can be used for almost all low-power, transistor-type circuits now being used in military equipments. Over 500 different kinds of germanium and silicon transistor-type circuits have been designed, of which more than 120 have been fabricated for communications and control functions. More than 85 digital circuits for computer applications have been demonstrated thus far.

Signal Corps' Micropac computer will employ over 10,000 micromodules. It occupies 2.7 cubic feet, weighs 90 pounds, and requires 250 watts d-c power. The unit is to be delivered to the Army for testing in November. Micromodules are also being applied to a family of combat portable radio receivers, transmitters and other equipment.



*New from Bendix*

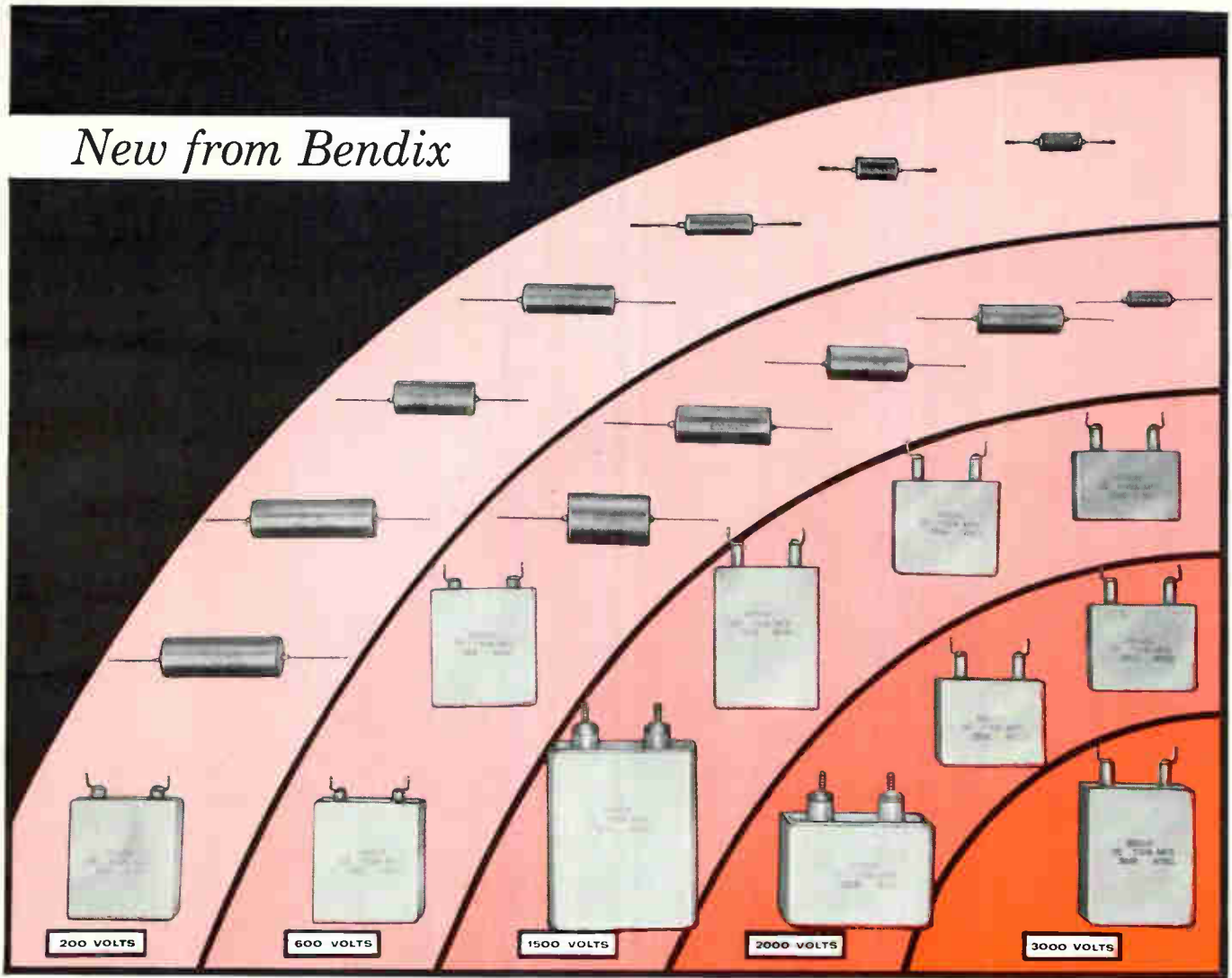

## **E-200 HIGH TEMPERATURE CAPACITORS**

**Operable to +200°C.**

The Bendix® E-200 series of lightweight, small size capacitors is designed for installations requiring a high degree of component reliability at operating temperatures as high as 200°C.

High temperature capability and mica-like electrical characteristics enable the E-200 series to withstand extremely high orders of AC in small envelope size at all ambients under 200°C.

The new series is designed and manufactured

to a Bendix specification which is patterned after the high reliability specification MIL-C-14157B, proposed.

Hermetically sealed in tubular or rectangular housings, these capacitors offer superior resistance to mechanical and climatic environments.

**E-200 CHARACTERISTICS:** • Wound mica papers • Solid impregnants • Exceptional stability • High insulation resistance • Radiation resistance • Outstanding dependability

For full details, write Scintilla Division, Sidney, New York

**Scintilla Division**



Canadian Affiliate: Aviation Electric, Ltd., 200 Laurentien Blvd., Montreal 9, Quebec. Export Sales & Service: Bendix International, 205 E. 42nd St., New York 17, N. Y.

# HOW WE SHRUNK TEFLON\*

## Why Gudebrod's Common Sense Approach to Lacing Problems Pays Dividends for Customers!

Some years ago motor manufacturers had a problem! They required a high temperature lacing tape that would not deteriorate during the baking process of motor manufacture and would be practical in its application.

Teflon offered the most practical solution to the problem since it provides a temperature range from  $-100^{\circ}\text{F}$  to  $500^{\circ}\text{F}$ . We took teflon and flat braided it—we originated the process—but what about shrinkage? When teflon is baked it shrinks . . . it would cut thru fine motor wires!

To meet this problem, we developed an exclusive pre-shrunk process for teflon. This patented process pre-shrinks teflon so that the maximum shrinkage is less than 3% after 16 hours at  $425^{\circ}\text{F}$ . We call this lacing tape Pre-Shrunk TEMP-LACE. Motor manufacturers use it in great quantities.

Pre-shrinking teflon is but one of the many processes we have developed to meet the needs of customers. Whatever your lacing needs—nylon, glass, dacron, fungus proofing, color coding—Gudebrod's common sense approach to the problem will pay dividends for you because

1. Gudebrod lacing tape increases production!
2. Gudebrod lacing tape reduces labor costs!
3. Gudebrod lacing tape means minimal maintenance after installation!
4. Gudebrod is quality—our standards for lacing tape are more exacting than those required for compliance with MIL-T!

Write today for our Technical Products Data Book which explains the many advantages of Gudebrod lacing tape for both civilian and military use. Address your request and your lacing tape problems to Mr. F. W. Krupp, Vice President, Electronics Division.

\*Du Pont registered trademark for its TFE-fluorocarbon fiber.

†Du Pont trade name for its polyester fiber.



**GUDEBROD BROS. SILK CO., INC.**

FOUNDED IN 1870

*Electronics Division*

225 WEST 34th STREET, NEW YORK 1, NEW YORK

## MEETINGS AHEAD

ELECTROCHEMICAL SOCIETY MEETING; Statler-Hilton Hotel, Boston, Mass., Sept. 16-20.

RECTIFIERS IN INDUSTRY MEETING, AIEE; Desher-Hilton Hotel, Columbus, Ohio, Sept. 18-19.

INDUSTRIAL ELECTRONICS ANNUAL SYMPOSIUM, IRE-PGIE, ISA; Sheraton-Chicago Hotel, Chicago, Ill., Sept. 19-20.

TUBE TECHNIQUES NATIONAL CONFERENCE, Advisory Group on Electron Devices in the Office of the Director of Defense Research and Engineering; Western Union Auditorium, N.Y.C., Sept. 19-21.

BROADCAST ANNUAL SYMPOSIUM, IRE-PGB; Willard Hotel, Washington, D. C., Sept. 20-29.

VALUE ENGINEERING & ANALYSIS CONFERENCE, EIA; Statler-Hilton Hotel, St. Louis, Mo., Oct. 1-2.

COMMUNICATIONS NATIONAL SYMPOSIUM, IRE-PGCS; Hotel Utica and Municipal Auditorium, Utica, N. Y., Oct. 1-3.

SPACE ELECTRONICS & TELEMETRY NATIONAL SYMPOSIUM, IRE; Fointainebleau Hotel, Miami Beach, Fla., Oct. 2-4.

ELECTRICAL ENGINEERS FALL GENERAL MEETING, AIEE; Pick-Congress Hotel, Chicago, Oct. 7-12.

NATIONAL ELECTRONICS CONFERENCE, IRE, AIEE, et al; Exposition Hall, Chicago, Ill., Oct. 8-10.

AEROSPACE ELECTRICAL/ELECTRONIC EQUIPMENT & SYSTEMS DISPLAY, Aerospace Electrical Society; Pan Pacific Auditorium, Los Angeles, Oct. 10-12.

RESEARCH AND ENGINEERING NORTHEAST MEETING, IRE; Somerset Hotel and Commonwealth Armory, Boston, Mass., Nov. 5-7.

IEEE INTERNATIONAL CONVENTION, Institute of Electrical and Electronic Engineers; Coliseum and Waldorf-Astoria Hotel, New York, N. Y., March 25-28.

## ADVANCE REPORT

NONLINEAR MAGNETICS INTERNATIONAL CONFERENCE, IRE, AIER; Shoreham Hotel, Washington, D. C., April 17-19, 1963. Nov. 5 is the deadline for submitting 200-word abstract to: J. J. Suozzi, Technical Program Chairman, Bell Telephone Laboratories, Inc., Whippany, N. J. Conference theme will emphasize theory and application of advanced nonlinear magnetic devices in computation and control. Papers will be given on recent developments in: computer logic and memories (thin magnetic films, etc.); power devices (magnetic amplifiers, etc.); nonlinear magnetics and semiconductor combinations (silicon controlled rectifiers, etc.); recording and instrumentation.



# HILLS AND VALLEYS AMPLIFIED 50,000 TIMES

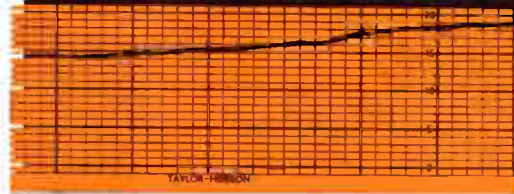

Actual Talysurf tape of AlSiBase ceramic with glaze number 743 at 50,000 amplifications. On the vertical scale, each small division is 2 micro-inches. Note that the hill shown on this graph is ten millionths high.

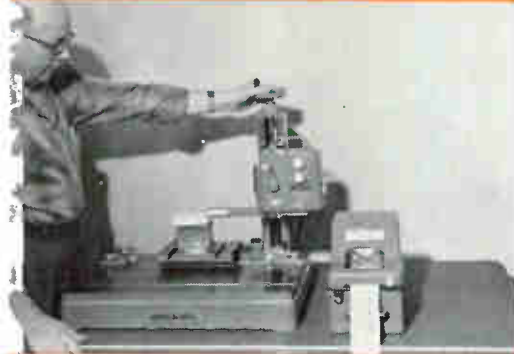

Talysurf electronically records the surface finish, amplified 50,000 times.



Diameters as small as .015 precision ground and electronically verified at the machine.

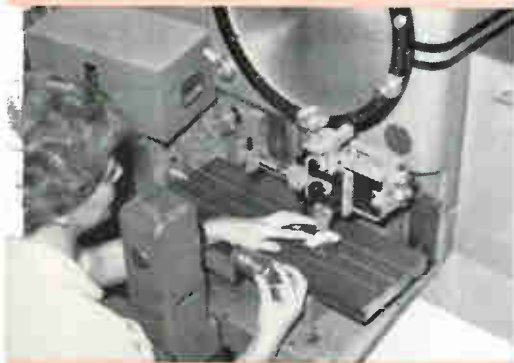

Inspection at magnifications up to 50 times, with tracer for contoured surfaces.

In substrates, the surface is sometimes of primary importance. The surface of AlSiBase and AlSiMag ceramics can be specially processed for smoothness and uniformity. Equipment is available to give you a close reproduction of the surface on a chart amplified up to 50,000 times. On even the smoothest of surfaces, this graph, at that amplification, looks like hills and valleys.

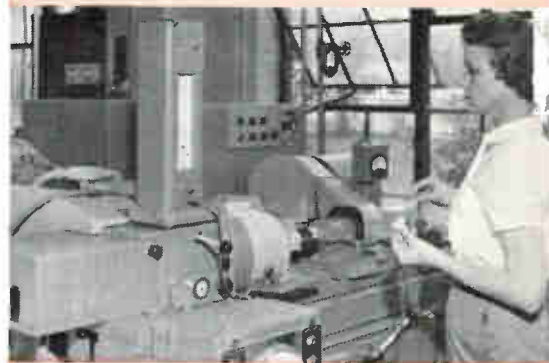

Internal diameters air gauged at the grinder in ten thousandths.

American Lava pioneered in the production of AlSiMag precision ceramics. The development of AlSiBase extended these gains to ultra-thin ceramics. Metallizing techniques have also made a number of recent advances. Techniques and equipment for measuring have kept pace with these advances in production.



Toolmaker's microscope magnifies up to 1,000 times in turret lens, micrometer calibrated in .0001 inch.

If you require technical ceramics to close tolerances, we believe you'll find American Lava has the experience and equipment to make them... and measure them. If you will outline your requirements, our technical staff will be glad to study them and make suggestions.

## ALSiMAG

★ AlSiMag pioneered micro-miniature ceramics... some as thin as 0.005". Relatively high strength, superior performance at high temperatures, high frequencies. Excellent record for withstanding fatigue, heat, shock, vibration.



A subsidiary of  
Minnesota Mining and  
Manufacturing Company



### AMERICAN LAVA CORPORATION

CHATTANOOGA 5, TENN.  
60TH YEAR OF CERAMIC LEADERSHIP

For service, contact American Lava representatives in Offices of Minnesota Mining and Manufacturing Co. in these cities (see your local telephone directory): Boston: Needham Heights, Mass. • Chicago: Bedford Park, Ill. • Cleveland, Ohio. • Farmington, Mich. • Laurens, S. C. • Los Angeles, Cal. • Milwaukee, Wis. • Metropolitan New York: Ridgefield, N. J. • Up-State New York: Newark, N. Y. • Philadelphia, Pennsylvania • Richardson, Texas • St. Paul, Minnesota • South San Francisco, California • Seattle, Washington  
All export except Canada: Minnesota Mining and Manufacturing Co., International Division, 99 Park Ave., New York, N. Y.

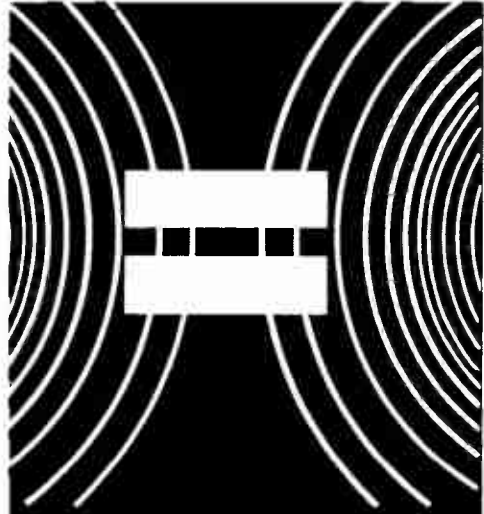

**BULOVA  
FREQUENCY STANDARDS**

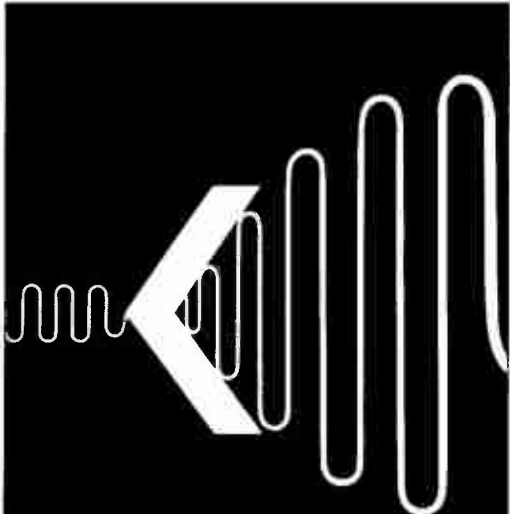

**BULOVA  
SERVO AMPLIFIERS**

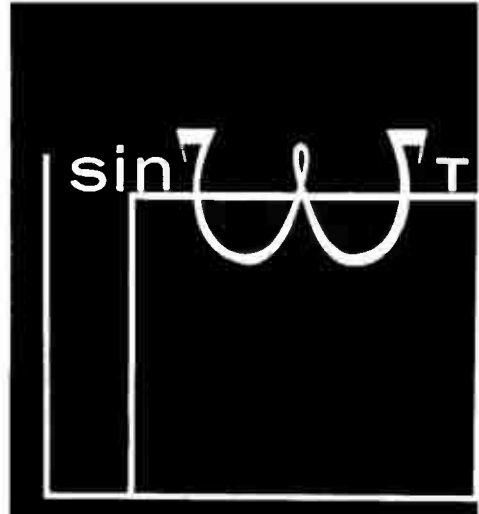

**BULOVA  
OSCILLATORS**

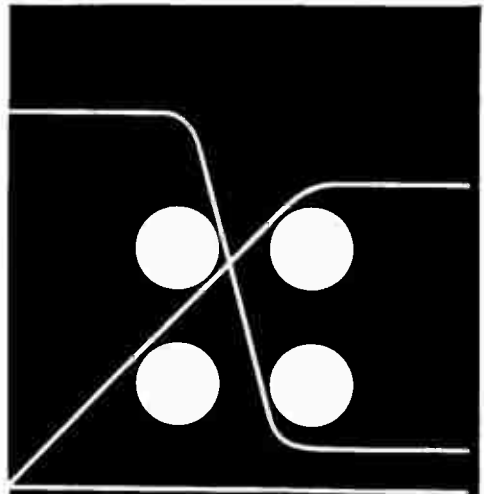

**BULOVA  
OVENS**

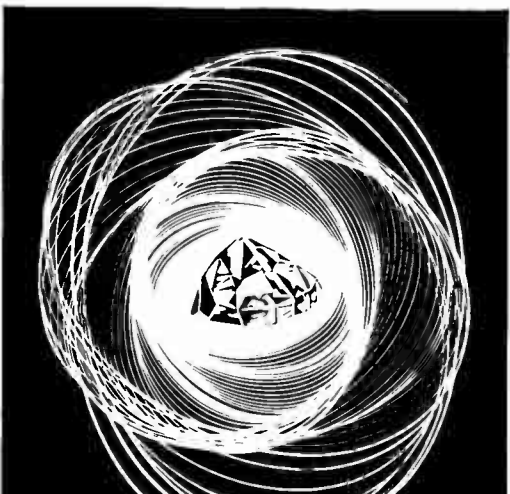

**BULOVA  
CRYSTALS**

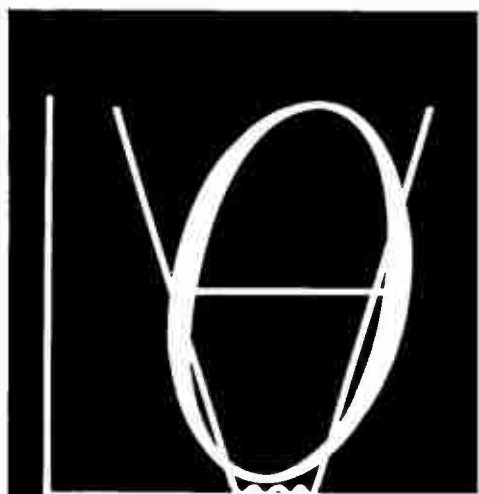

**BULOVA  
CRYSTAL FILTERS**

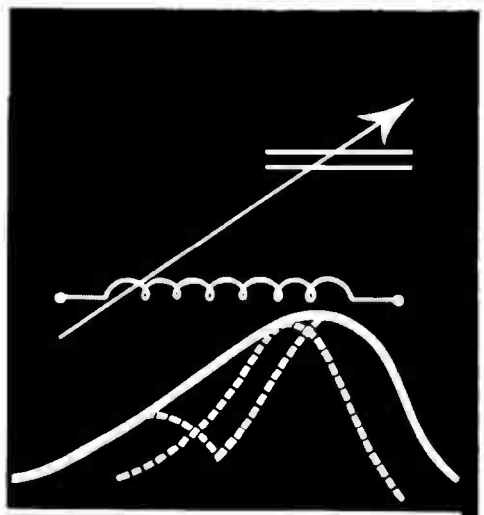

**BULOVA  
COILS**

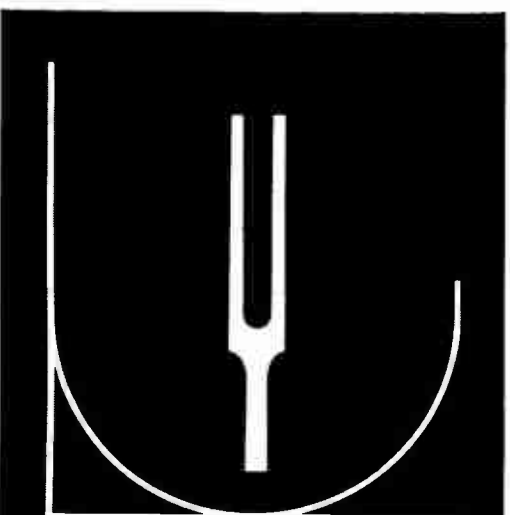

**BULOVA  
TUNING FORKS**

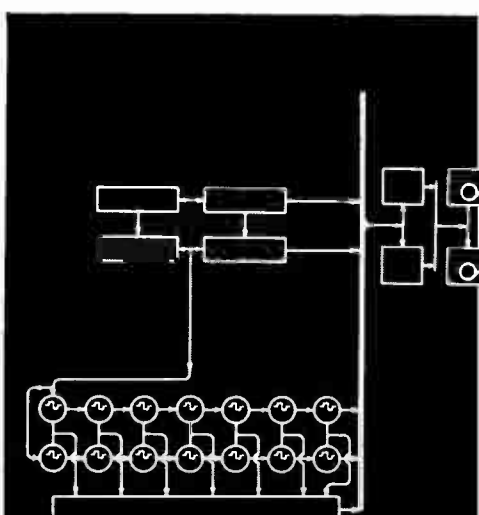

**BULOVA  
SYSTEMS & SUB SYSTEMS**



**BULOVA  
MAKES  
TIME  
IN  
FREQUENCY  
CONTROL**

Bulova has added new muscle and technical scope in frequency control through the integration of the American Time Products and the Electronics Divisions, and through the addition of the development and production facilities of the Keystone Controls Corp. . . . now one versatile design/production complex making millions of frequency control devices for defense and industry. ■ This growth in engineering and production capabilities provides a new range in frequency control, generation, selection and measurement from one proven source . . . Bulova. It includes tuning fork and crystal based oscillators, frequency standards, filters, power supplies, and choppers; as well as coils, ovens and servo-loop products. ■ The alert Bulova engineering staff, together with its smoothly-functioning production lines can deliver reliable performances in custom designing and manufacturing miniaturized components, systems — to meet or exceed the most demanding specifications and schedules. Write Bulova Electronics Division, 61-10 Woodside Avenue, Woodside 77, New York, for full information.

**INDUSTRIAL/DEFENSE GROUP**

**BULOVA**

**ELECTRONICS DIVISION**

**CIRCLE 35 ON READER SERVICE CARD**

# WHY THINK BIG?

# CENTRALAB

"TWO-DIMENSIONAL"



# TRIMMER RESISTORS

## AS SMALL AS

## 1/4" x 1/4"

## WITH VIRTUALLY NO DEPTH!

All the adjustment you need—in a fraction of space, at a fraction the cost—for military or commercial applications.

These versatile ceramic base units are available as single or multiple trimmers. Fixed resistors can be included on multiple units—either associated with, or independent of the trimmer circuitry, through the flexibility of the PEC technique. They can be supplied in all standard resistance values.

# Centralab



### MICRO-MINIATURE (SERIES 3)

ACTUAL SIZE

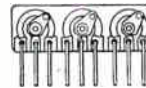
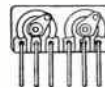

Single trimmer measures only 0.250" square, 0.100" deep, rated at .05 watts at 70° C. Multiple trimmers can include up to 5 fixed resistors, depending upon value and voltage rating.



### SUB-MINIATURE (SERIES 4)

ACTUAL SIZE

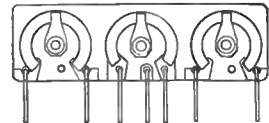
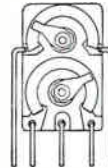

Single trimmer measures only 0.406" x 0.438" x 0.125", rated at 0.1 watts at 70° C. Triple trimmers can include up to 8 fixed resistors, depending on value and voltage rating.

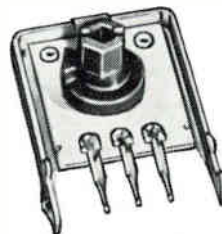

### MINIATURE (SERIES 5)

ACTUAL SIZE

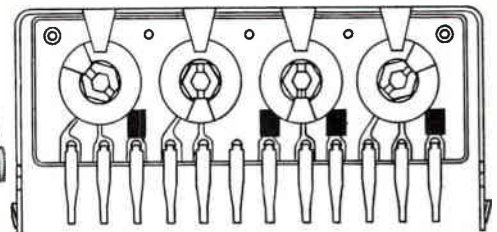

Single trimmer measures  $5\frac{1}{64}$ " x  $4\frac{5}{64}$ " x  $1\frac{19}{32}$ ". Rated at  $\frac{1}{4}$  watt at 70° C. Available with leads, solder or wire-wrap terminals, in a wide range of mounting styles for modern production techniques. One to four variable resistor elements and up to 12 fixed resistors on a single plate. Knob permits adjustment by finger tip, internal or external hex wrench, or screwdriver.

For additional information on these units write for CENTRALAB Engineering Bulletin 42-1216.

Y-6147

THE ELECTRONICS DIVISION OF GLOBE-UNION INC.  
914J EAST KEEFE AVENUE • MILWAUKEE 1, WISCONSIN  
In Canada: Centralab Canada Ltd., P.O. Box 400, Ajax, Ontario

ELECTRONIC SWITCHES • VARIABLE RESISTORS • CERAMIC CAPACITORS • PACKAGED ELECTRONIC CIRCUITS • ENGINEERED CERAMICS



*Step-by-step procedure for designing wafer-mounted microelements and assembling them to riser wires, with design considerations, module assembly methods and system assembly methods*

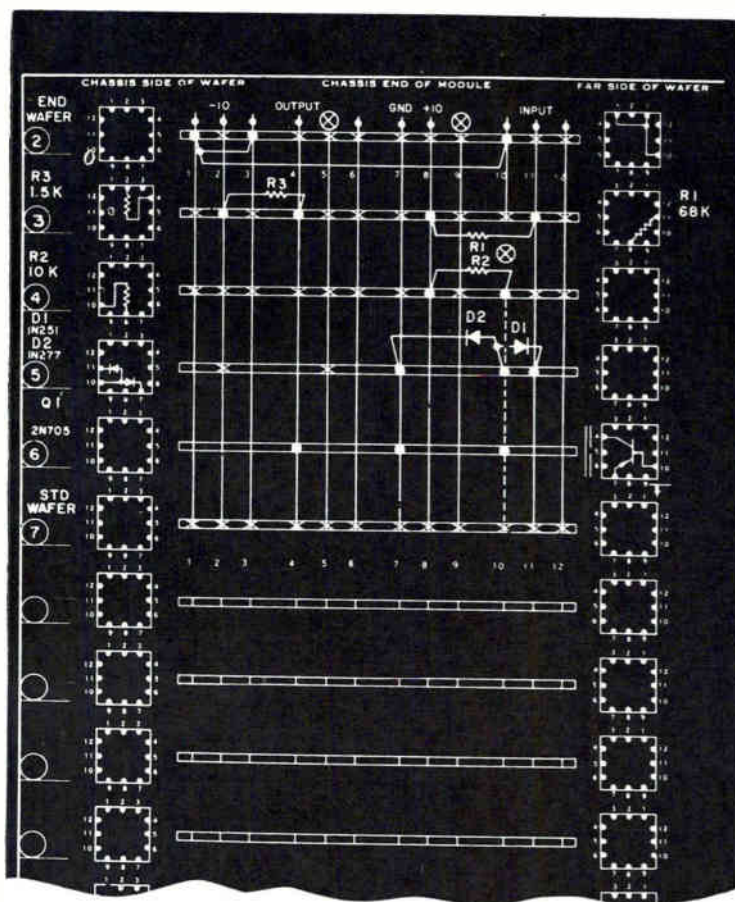

MICROMODULE ASSEMBLY layout sheet shows component locations, jumpers, riser-wire lengths and solder points—Fig. 1

## How To Design Micromodules

By RENATO DiSTEFANO, JR.  
Semiconductor and Materials Div  
Radio Corporation of America  
Somerville, N.J.

DESIGN METHODS for micro-module electronic or electromechanical systems can be applied to existing systems that require a minimum of redesign, as well as to developmental systems that consist of only a performance specification and a list of environmental requirements.

In either case, the design of the system begins with the breadboard construction of the entire system,

or of that portion of the system to be redesigned in micromodule form. The completed breadboard is subjected to all specified operating and storage environmental test conditions, with the exception of such tests as shock, vibration or thermal dissipation, which yield no applicable information when conducted on a breadboard.

DESIGN CONSIDERATIONS — The present range of microelement capability is shown in Table I. When possible, a micromodule is designed to include the microelements required for a complete func-

tional unit or stage, such as an amplifier stage, mixer, local oscillator, multivibrator, inverter or gate. This method of circuit division provides design simplicity and minimizes the number of connections between micromodules. In certain cases, such as cascaded intermediate-frequency stages, the requirement for isolation of signal leads strongly influences the manner in which the circuit is divided into micromodules.

The designer divides the circuits of the entire system or subsystems into sections, each of which represents a separate micromodule, and

## KUDOS FOR MICROMODULES

Just two weeks ago, Major General E. F. Cooke, Chief Signal Officer, said that the Chief of Staff for Logistics has issued a directive to incorporate the micromodule concept in Army equipment where appropriate (ELECTRONICS, p 7, Sept 7). Meanwhile, six items considered highly suitable for micromodule application have been

funded for R&D by the Army in 1963-64. These include an airborne h-f ssb radio, a lightweight hand-held surveillance radar, a "flash ranging set" to detect gun flashes, an electronic teletypewriter, a tactical digital communications system and the production version of Micropac, small field computer to be delivered in November by RCA

TABLE I — PRESENT MICROELEMENT-CAPABILITY

### RESISTORS

	Carbon	Cermet
Number of Resistors per Microelement.....	1 to 4	1 to 4
Value Range per Resistor (ohms).....	10-150,000	10-150,000
Value Range per Microelement (ohms).....	2.5-600,000	2.5-600,000
Maximum Dissipation per Resistor (watts).....	1/8	1/8
Maximum Dissipation per Microelement (watts)...	1/2	1/2
Maximum Micromodule Temperature for Rated Dissipation (degrees C).....	70	70
Temperature Characteristic (ppm per degree C)....	±1,300	±200

### CAPACITORS

	Precision (T. C.)	General- Purpose	Electrolytic (Tantalum)
Number of Capacitors per Microelement.....	1	1	1
Value Range.....	5 pf to 3,000 pf	100 pf to 0.15 mf	1 to 47 mf
Tolerance (percent).....	1 to 10	10 to 20	10 to 20
Temperature Range (degrees C).....	-55 to +85	-55 to +85	-55 to +85
Temperature Characteristic..	±30 ppm/°C (nominal)	+10%, -30%	±15%
Maximum Dissipation.....	0.001	0.015	0.06 at 120 cps
Maximum D-C Voltage.....	50-100	50-100	35 (470 mf- volt) max.

### INDUCTORS

Maximum Inductance (millihenries)	1.5
Maximum Operating Frequency (megacycles)	50

### DIODES

Most miniature diodes that are not larger than 0.2 inch may be mounted on a microelement wafer. From one to four diodes may be mounted on a microelement, depending upon dimensions and terminations. Diodes are now available in packages suitable for microelement mounting

### TRANSISTORS

Any transistor that can be mounted on a microelement wafer so that its case does not short to the micromodule riser wires is suitable for use in micromodules

notes the occurrence of repetitive circuits that can utilize identical micromodules. Identical modules in repetitive circuits are especially desirable in systems to be produced in large volume, because they result in cost savings of materials and testing.

Micromodules can be constructed with external leads at both ends; however, interconnection considerations have made the single-ended micromodule definitely preferable for most systems. The single-ended micromodule normally has twelve external leads spaced on a 0.075-inch grid pattern at one end.

Although micromodules can be made in heights up to one inch, most units are between 0.4 and 0.8 inch high. Micromodule lengths within this range can accommodate many types of stages without exceeding the twelve-lead limit on external connections. Some of the more complicated amplifiers, multivibrators, and other types of stages are subdivided into two or more micromodules; similarly, some simple repetitive stages, such as gates, may be combined with one or more similar stages into a single micromodule. In some cases, the maximum height of one or more micromodules in a system is limited by the volume specifications for the complete system.

A rough estimate of the height of a micromodule may be made by adding the space requirements for each of the microelements, or wafers, of which it is composed. The space requirement for each wafer is determined by adding 0.01 inch to the maximum allowable thickness of each wafer. The 0.01 inch includes the height required by soluble spacers which are inserted between the wafers during the assembly process. Additional allowances of up to 0.02 inches may be required where riser wires are "cut," as explained below.

Since the maximum allowable thickness of standard resistor microelements is 0.02 inch, an allowance of 0.03 inch is made for each resistor in the micromodule. Because each resistor wafer has a maximum dissipation allowance of one-half watt, each wafer can accommodate either four one-eighth-watt elements, or two one-quarter-



watt elements, one on each side of the wafer. When a resistor wafer has two resistors on one side, the ratio of the higher resistance value to the lower should be less than five, and the terminations of the two elements must be so arranged that the elements do not cross each other.

For microdiodes mounted in wafers, space allowance is 0.03 inch more than the maximum diode diameter, for each diode wafer used.

The space requirements for some of the other types of microelements are listed in Table II.

When the space requirements for all of the microelement wafers in the micromodule have been determined, they are added, and an additional 0.12 inch is added for encapsulation, end wafers, module pedestals, and building tolerance. The total is the maximum estimated height of the micromodule; the actual height may be as much as 25 percent less, depending on the actual microelement dimensions, number and location of riser-wire cuts, and similar considerations.

When the height of each micro-module has been estimated, the total height is compared with the system volume specifications to determine if the circuits to be included in each micromodule must be adjusted to fit the space available.

**MODULE ASSEMBLY**—Figure 1, a completed micromodule assembly layout, shows the method of numbering riser wires. Figure 2B shows the system of numbering notches on the microelement wafers. The uncircled numbers are the notch numbers; the circled numbers refer to the corresponding riser-wire numbers. On those wafers that are mounted in the normal, or *A1* position, the notch numbers coincide with the riser wire numbers. The rectangular index notch in the corner of the wafer is used for orientation during assembly. On the assembly drawing, notch numbers are not shown, but all notches not mounted in the normal or *A1* position with respect to the micromodule riser wires are indicated by three short vertical lines adjacent to the drawing of the far side of the wafer. The mounting position of all wafers not mounted in the normal position is indicated by an

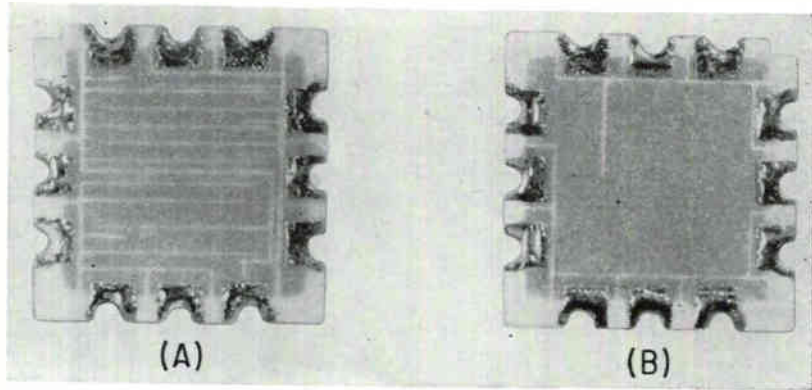

RESISTOR wafer, showing first side (A) and reverse side (B)

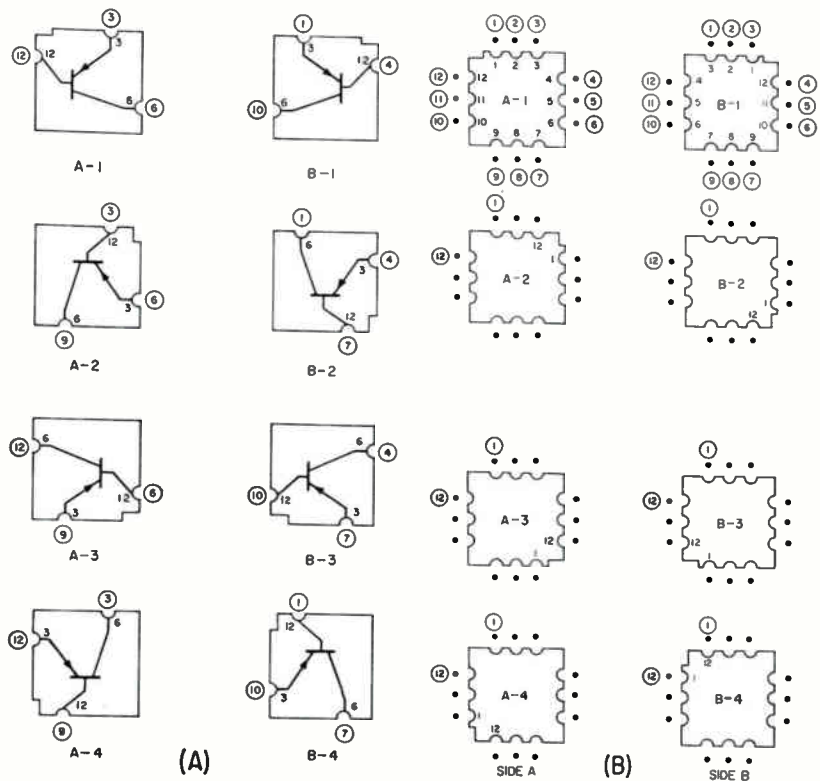

POSSIBLE MOUNTING POSITIONS for a transistor microelement (A); for a microelement wafer (B)—Fig. 2

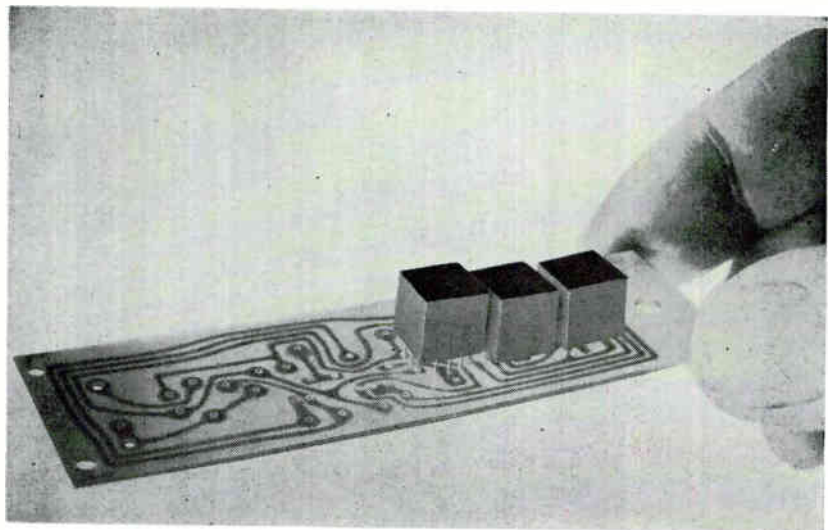

MICROMODULES mounted on a printed-wiring board—Fig. 3

TABLE II — MICROELEMENT DIMENSIONS

Element	Value Range	Dimension Requirements* (Inches)
Capacitor (T.C.)	to 250 pf	0.03
"	250 to 1,000 pf	0.04
"	1,000 to 2,200 pf	0.065
Capacitor, Gen. Purp.	0.003 to 0.022 $\mu$ f	0.04
"	0.022 to 0.1 $\mu$ f	0.09
Capacitor, Electrolytic	1 to 3 $\mu$ f	0.065
"	4.7 to 22 $\mu$ f	0.105
Diode, Microelement	—	0.08
Transistor, TO-46 Package Mounted on Wafer	—	0.115
Transistor, Other Suitable Package Mounted on Wafer	—	Package height plus 0.035 inch

\* Includes 0.01 inch allowance for spacers, etc.

arrow which points to the long side of the wafer index notch, as is the microelement  $Q_1$  (item 6) shown in Fig. 1.

The various microelement wafers are connected by hard-drawn, solder-coated, tinned copper wires, which also form the external leads. These riser wires form the nodes of the module circuits. If thirteen nodes are required in one module, one of the riser wires is extended only far enough through the module to connect all the elements which meet at one of the nodes. An additional node is formed by placing a short section of a riser wire between those wafers, beyond the end of the shortened, or "cut" riser wire, which contain the elements to be connected to the thirteenth node. This procedure may be repeated with as many as seven additional riser wires to form additional nodes as required, but at least one riser wire on each of the four sides of the micromodule must extend along its entire length and form one of the external leads. Where the additional nodes formed by such segmented riser wires consist of connections between adjacent wafers having no more than 0.003 inch of build-up on each side of the substrate, the connection between the wafers is made by solder bridging during the dip-soldering process, and no riser-wire segment is required.

Transistor microelements and

mounting wafers for transistors in TO-46 and similar types of cases are usually made so that the element is terminated to the wafer notches as shown in Fig. 2A, which also indicates the eight possible mounting positions for this wafer in the micromodule. When a micromodule is designed with two transistors connected in a common-emitter configuration, one unit can be mounted in the A1 position and the other in the B1 position, with a connection or jumper located on an end wafer between riser wires 1 and 3.

An end wafer is usually placed at each end of the module to protect the microelement wafers during manufacture, and to provide a mounting for jumpers between riser wires. When necessary, an end wafer may be eliminated if it contains no jumper and if the adjacent wafer does not contain an element on its outer face. Elimination of an end wafer will shorten the module height by about 0.015 inch.

Riser wires may also be shortened for additional isolation of a tuned circuit or other critical element located at the end of the module farthest from the chassis. The operation of such circuits may also be improved by locating input and output leads on opposite sides of the micromodule, and by designing the module so that the two riser wires on each side of a critical signal lead are grounded on the printed-circuit interconnecting board.

If less than twelve leads are required on a single micromodule for external connections, one or two of the riser wires on each side of the module may be cut off within 0.015 inch of the end wafer after the module is assembled to simplify the wiring on the printed-circuit interconnection board, as in the case of riser wires 5 and 9 in Fig. 1. However, in all such cases, at least one of the uncut external leads on each of the four micromodule sides must extend through the length of the micromodule. Printed-circuit interconnection board wiring may be further simplified, on occasion, by providing jumpers on micromodule end wafers between leads which do not connect to nodes within the micromodule, as shown for the end wafer at the chassis end of the micromodule in Fig. 1.

Unless element isolation requirements or cuts in riser wires dictate otherwise, resistors are usually located at the end of the module closest to the chassis, followed by capacitors, inductors, silicon semiconductors and germanium semiconductors, in that order, to ensure the most efficient transfer of heat from the micromodule. When one or more of the micromodule riser wires are shortened, the configuration of the various circuit nodes determines the order in which the wafers must be assembled. In Fig. 1, a cut is indicated on riser wire 10 inside the module, and the riser-wire segment used for the node identified as 10' on the schematic diagram is shown as a dashed line. In this case, the node cannot be formed by solder bridging because one of the wafers involved has more than 0.003 inch of build-up on both sides.

The first step in the design of a micromodule incorporating the circuit shown in Fig. 1 is the assignment of riser-wire numbers. For optimum micromodule system design, this assignment is made during the layout of the printed-circuit board on which the micromodules are to be mounted. Because it is preferable to use the standard transistor microelement wafer (Fig. 2A) when possible, the riser wires that connect to the emitter and collector of  $Q_1$  are assigned first, and the printed-circuit mounting board is then laid out. Riser-wire numbers are then assigned to the remaining



nodes of the micromodule.

The printed-circuit board layout usually determines the assignment of riser-wire numbers to the remaining circuit nodes which must connect to the board. As shown in Fig. 2A, the transistor base should connect to riser-wire 10; however because riser-wire 10 has already been assigned as one terminal of a jumper wire associated with the external circuits, the wire must be cut to form node 10' for the transistor base.

With all the nodes of the circuit assigned, the microelement layouts can be completed. The jumpers required by the external circuits are placed on the end wafer, and  $R_1$  and  $R_2$  are placed on the adjacent wafer. Since  $R_2$  connects to 10' it is placed on the third wafer in order that riser wire 10 may be attached to the required minimum of two wafers before it is cut. The two diodes are mounted on the fourth wafer, followed by the transistor and the second end wafer.

Micromodules may be designed to include circuits tuned by trimmer capacitors with ranges up to sixteen picofarads. In such cases, the trimmer is mounted at the end of the module for access when tuning, and the transformer is mounted on the adjacent wafer, which may also include a larger fixed capacitor connected in parallel with the trimmer. This arrangement also provides some isolation from the remainder of the micromodule.

In the design of a micromodule system, it is often helpful to construct a breadboard of the micromodule by mounting hard-drawn wires about two inches long in each pin of a twelve-pin phenolic plug. The other ends of the wires are secured to a phenolic disk, which is similar to the base in diameter and separated from it by a small two-inch sleeve mounted at the axis of the connector. The twelve wires are numbered according to the numbers of the plug, and the circuit elements to be used in one micromodule may be connected between the riser wires. The resulting totem-pole arrangement is an electrical equivalent of the module in analogous physical form. An entire system may be made in this totem pole configuration, and the test circuits for the system may be mounted on a master board fitted

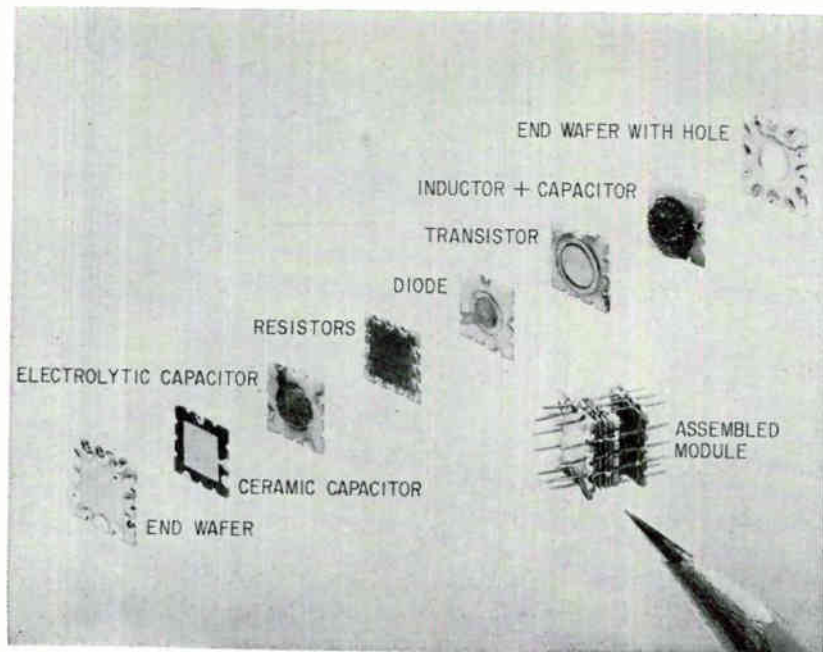

EXPLODED VIEW of a typical micromodule

with receptacles for the totem-pole plugs. This arrangement is often convenient for the tuning, testing, and adjustment of the prototype micromodules or systems of micromodules because, with an adapter socket, one or more micromodules may be substituted for the corresponding totem-pole units.

**SYSTEM ASSEMBLY**—After assembly, micromodules are tested and encapsulated in an epoxy resin. When the completed micromodules have been tested again for specification performance, they are ready for assembly in the system for which they were designed. Micromodules are usually interconnected on a printed-circuit board, as shown in Fig. 3.

The printed-circuit board is designed so that the micromodules are spaced 0.4 inch between centers, but, if room is available, this spacing may be increased to accommodate a complex printed-circuit-board wiring pattern on a single side of the printed-circuit board. If the spacing between the micromodules cannot be increased beyond 0.4 inch, a double-sided printed-circuit board may be used.

A micromodule may be enclosed in a shield covering all surfaces except the chassis end; the major part of the chassis end may be shielded by a portion of the ground plane on the printed-circuit board.

If the system being designed requires components which have not yet been adapted to the micromodule form, the components may be mounted directly on the printed-circuit interconnecting board near the micromodules to which they connect.

The foregoing is a general survey of micromodule system design procedure as it exists in March, 1962. As a result of extensive development work underway at the time of writing, it may be anticipated that the coming months will further improve on the already large range of component values and operating specifications of microelements which are now available, and that the constantly improving favorable situation of micromodules with respect to operating reliability will become an achievement goal for all future generations of microelectronic concepts.

The guidance and comments offered by the author's colleagues, particularly by R. Wilson, R. Pew, H. Keitelman and R. Samuel are gratefully acknowledged.

#### BIBLIOGRAPHY

- D. T. Levy, A Packaged Micromodule Laboratory for Industry, *RCA Engineer*, Dec. 1960-Jan. 1961.
- F. Schwartz and R. Stetson, Ceramics and Micromodule, *RCA Engineer*, Dec. 1959-Jan. 1960.
- Micromodule Design Manual MDM 500 A, RCA Semiconductor and Materials Division, Somerville, New Jersey.

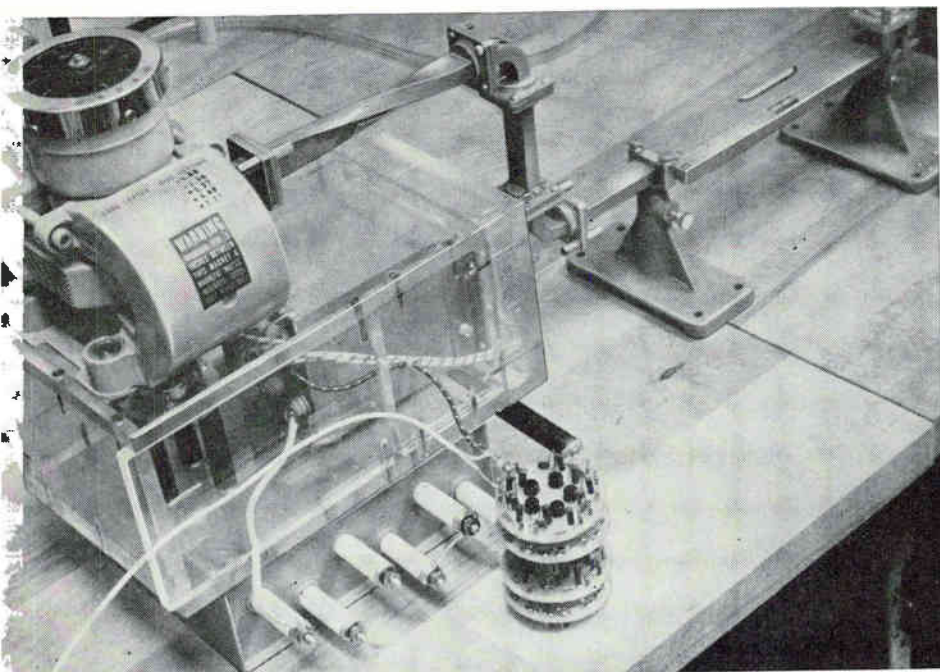

SWITCH ASSEMBLY with 50-ohm pulse-forming network, pulse transformer beneath magnetron and simple charging resistor modulates magnetron that provides about 100 Kw at 16 Gc

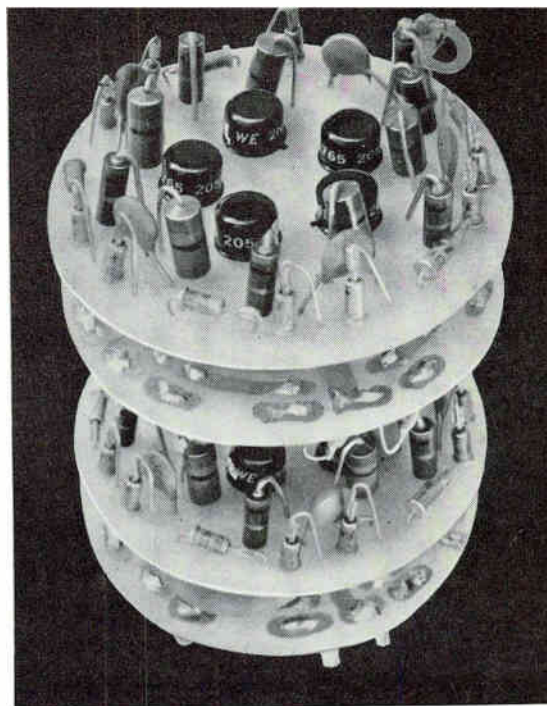

MODULES in 8-Kv experimental switch assembly are mounted back to back to limit inductance

## Semiconductor Modulators for Modern

*Pulse modulator has been developed that delivers 300 Kw and lab setup has provided 640-Kw output. Extending the same design techniques should enable semiconductor modulators to drive the most powerful magnetrons. These modulators can also improve efficiency, reduce size and weight and provide high reliability*

THIS SEMICONDUCTOR high-power modulator has been developed to improve efficiency, reduce size and weight, and provide greater reliability. Extensive use of radar in aircraft, missile and satellite applications spurred development of the unit. However, the high-power modular switch could also be useful in high-current pulse generators, short-circuit protection for high-voltage traveling-wave tubes and klystrons, linear accelerators and lasers.

Several approaches to design of high-power semiconductor pulse modulators have been taken. Reviewing their operation will aid in understanding the design of the

new 300-Kw pulse modulator. All designs discussed use either *pnpn* diodes or *pnpn* transistor switches in line modulator circuits.

Drive requirements of a 100-Kw magnetron, listed in Table I, will be used as design objectives. The combination of 16.5 Kv and 18 amperes

can be transformed using a suitable output transformer to achieve the 300-Kw output with lower voltage and correspondingly higher current.

A magnetron modulator has been described that uses a single *pnpn* transistor<sup>1</sup> to obtain 10- $\mu$ sec, 250-Kw pulses. A similar circuit that operates from a 400-volt supply is shown in Fig. 1. To provide 17-Kv output, a transformer with a 1:80 turns ratio is chosen. The resulting input impedance is 0.13 ohm, so pulse-forming network impedance is also 0.13 ohm. When the trigger switches the *pnpn* transistor, it places a short circuit across the network. The network then produces the de-

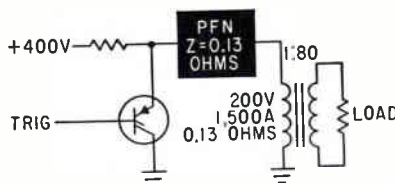

LINE-TYPE modulator uses single *pnpn* transistor—Fig. 1



## IS THIS THE ANSWER?

Radar designers have long been aware of advantages in weight, size and reliability of semiconductor modulators. However, using semiconductors in modern radar presents many problems, not the least of which is the ever growing demand for higher power. A promising solution seemed to be provided by the versatile pnpn devices, and a number of designs based on these devices have been reported. But, as the authors point out, some of these approaches have serious limitations. The authors describe a modulator designed to overcome these disadvantages. It's also based on pnpn devices and looks like it will be adequate for even the most powerful magnetrons

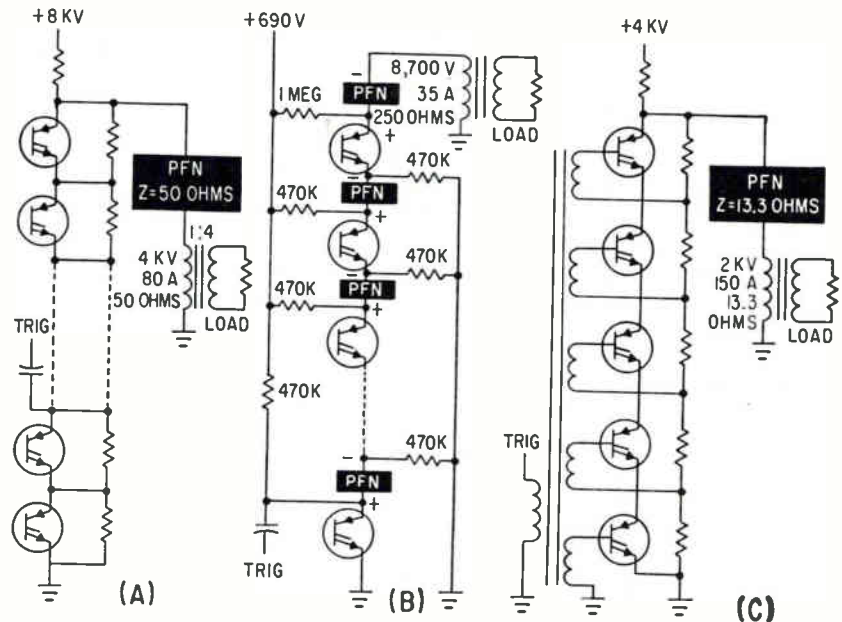

MULTIPLE pnpn modulators can use single pulse-forming network (A) and multiple pulse-forming networks (B) as well as multiwinding transformer trigger (C)—Fig. 2

# Magnetrons

By F. A. GATEKA  
M. L. EMBREE, Bell Telephone Laboratories, Laureldale, Pennsylvania

sired 200-volt, 1,500-ampere pulse across the transformer primary.

This circuit requires only a small number of components and a low-voltage supply. However, it has series inductance in the high-current loop. Only 0.1- $\mu$ h series loop inductance will limit rise time of a 1,500-ampere pulse to about 1  $\mu$ sec. Also, pnpn transistors that can switch 1,500 amperes are necessarily large and have rise times of about 1  $\mu$ sec. The simple charging resistor could be replaced by a conventional resonant-charging arrangement, permitting operation from a lower supply voltage. A similar substitution could be made in all these modulators.

A second approach<sup>2</sup> uses a series arrangement of pnpn diodes, as shown in Fig. 2A. If modulator impedance of 50 ohms is chosen, the 300-Kw load requires about 4,000 volts at 80 amperes and the series pnpn diodes must sustain 8,000 volts in the off state. Since the best available pnpn diodes have breakovers of about 400 volts, 20 are required to sustain the 8-Kv charging

potential of the pulse-forming network (PFM).

A network of shunting resistors is used to avoid unequal voltage division across the pnpn diodes. Switching can be done in two ways. A trigger can be provided to the string that is sufficient to exceed the breakovers. This method requires that distribution of the breakovers of the pnpn diodes be closely controlled, since the trigger signal is divided across the string.

**MODULATOR DESIGNS**—Using the triggering method shown in Fig. 2A, the lower two units are switched, permitting the remaining diodes to be switched by the steeply rising voltage transient. However, this method depends on a presently uncontrolled characteristic of pnpn diodes and could result in problems. Another problem is the variable delay between trigger and output pulse, which results in jitter.

Another approach is a variation of the spark-gap apparatus.<sup>3</sup> This circuit, shown in Fig. 2B, uses 25 pnpn diodes in a series arrange-

ment. An output impedance of 250 ohms was chosen, which requires the modulator to supply 8,700 volts at 35 amperes. The required modulator impedance is achieved by effectively connecting 25 10-ohm pulse-forming networks in series. The 25 pnpn diodes are placed in the series string so that the pulse-forming networks are separated from each other by pnpn diodes.

Charging the pulse-forming networks is achieved by using large resistors from ground and from the 690-volt supply to each side of the networks. The voltages add in series when the pnpn diodes are switched, providing the desired high-voltage output. Triggering is accomplished by providing a pulse to the diode nearest to ground. When this diode switches, a steeply rising voltage pulse propagated through the string switches the remaining diodes.

One serious problem associated with this modulator is that 700-volt pnpn diodes are not presently available. Other problems include the design of a pulse-forming network that will produce an acceptable

pulse when operated in series, using transient switching of *pnpn* diodes, and delay and jitter between trigger and output pulses.

Among modulators that use series arrays of *pnpn* transistors, the circuit in Fig. 2C is a direct extension of a 3-Kw modulator previously described.<sup>4,5</sup> A pulse transformer with an 8.7:1 turns ratio has been selected. The modulator must therefore produce a 2,000-volt pulse at 150 amperes across the 13.3-ohm primary. Impedance of the PFM is thus 13.3 ohms.

Five *pnpn* transistors with break-over voltages of at least 800 volts are required to sustain the 4-Kv charging potential. A resistor shunt network ensures equal voltage division across the transistors. The gate trigger signal is supplied through a multiwinding transformer, which must be insulated for 4 Kv and capable of supplying 0.5 amp at 3 volts to each gate.

A major problem is that an 800-volt 150-amp *pnpn* transistor that will switch up to 150 amperes in less than 100 nsec is not yet available. Also, considerable power is dissipated in the resistor network, and design of a multiwinding triggering transformer is difficult.

The trigger transformer might be simplified by supplying gate trigger current to the lower three transistors and allowing the remaining two to switch as two-terminal devices. However, delay and jitter result from the *pnpn* transistors switching as diodes.

**300-KW MODULATOR**—The modulator in Fig. 3 has been developed to overcome the limitations of the modulators described. Standard modulator impedance of 50 ohms was chosen, resulting in a pulse output requirement of 4 Kv at 80 amp. The 1- $\mu$ sec PFM charges to 8 Kv through a 0.47-megohm resistor from the 8.5-Kv supply. Four 2-Kv switch modules are arranged in series to complete the modulator circuit. A trigger is provided to the lower 2-Kv module, which in turn provides simultaneous triggers to the other modules.

A simplified overall circuit diagram is shown in Fig. 4A. The 16-Kv 20-ampere pulse is supplied to the 7208 magnetron through the bifilar pulse transformer in the filament circuit. The pulse is gen-

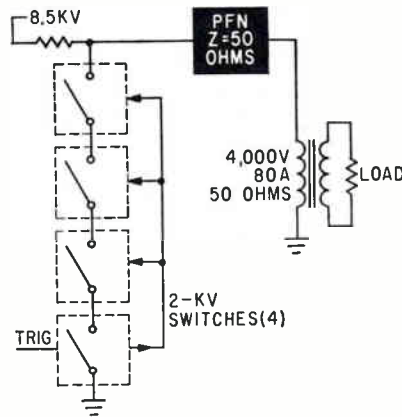

MODULATOR was designed to overcome limitations of earlier semiconductor modulators—Fig. 3

DRIVE REQUIREMENTS—  
TABLE I

FOR 100-KW MAGNETRON		
Pulse Power Input....	300	Kw
Pulse Voltage Input..	16.5	Kv
Pulse Current Input..	18	amp
Pulse Width.....	1	$\mu$ sec
Pulse Rise Time.....	125	nsec

PERFORMANCE CHARACTERISTICS—TABLE II

Input Voltage.....	8.5	Kv
Input Current.....	4.5	ma
Input Power.....	38	w
Output Voltage Pulse.	4	Kv
Output Current Pulse.	80	amp
Output Power Pulse..	320	Kw
Duty Cycle.....	0.005	%
Average Output Power	16	w
Efficiency.....	42	%

erated in a standard 50-ohm PFM, which has an output of 4 Kv at 80 amperes for 1  $\mu$ sec. Each 2-Kv module includes a series arrangement of five 2N1765 *pnpn* transistors. Each transistor can sustain at least 400 volts in the forward direction and can switch 80 amperes in 1  $\mu$ sec. Rise time to 80 amperes is less than 125 nsec.

The 500-pf capacitors were chosen to be large enough to provide adequate triggering current to each *pnpn* transistor for at least 100 nsec but small enough to be effectively discharged in less than 1  $\mu$ sec. Initial gate current for each transistor above the lowest one is about 400 ma and rapidly decreases as the capacitors discharge. The

lower capacitors in the figure must supply increasingly higher currents so successively smaller ones are needed when the modules are stacked as in Fig. 4A.

The 1- $\mu$ h coils were chosen so that inductance would be as low as possible without significantly affecting the trigger pulse. Small inductances effectively terminate the *n* emitter to gate of the *pnpn* transistors, enhancing their forward breakover and recovery characteristics. Since gate to *n* emitter voltage during turn-on is essentially constant at 1 volt, shunt current in the 1- $\mu$ h coil at 100 nsec after trigger is:  $i = 1/L \int v dt = (V/L) \Delta t$ . Therefore, if  $V$  is 1 volt,  $L$  is 1  $\mu$ h and  $\Delta t$  is 100 nsec,  $i = 1/(1 \times 10^{-6}) \times 100 \times 10^{-9} = 100$  ma.

As a result of the combined effects of capacitor discharge and linearly increasing inductor shunt current, the trigger for each *pnpn* transistor is a short high-current pulse that is terminated before completion of the 1- $\mu$ sec high-current output pulse. This type trigger ensures rapid recovery of the transistors permitting reasonably rapid recharging of the PFM.

**SWITCHING MODULES**—Each 2-Kv module of the experimental 8-Kv switch assembly in the photograph contains five 2N1765 transistors. The 400-volt regulator diodes for each stage are composed of two 1N672 and one 1N671 voltage regulators in series. The 2-Kv modules are back to back so that the high-current path is alternately clockwise and counterclockwise to limit inductance.

The complete circuit of a 2-Kv module is shown in Fig. 4B. To describe operation, terminals 1, 2 and 3 are assumed to be at ground potential and terminal 6 at +2,000 volts. The voltage-regulator diodes maintain voltage across each *pnpn* transistor at 400 volts, and the charge on each 500-pf capacitor is also 400 volts. A 0.5-ampere, 3-volt trigger is supplied to the gate of the transistor nearest to ground. When this transistor switches, voltage at point A is reduced by about 400 volts. Because of the voltage-regulator diodes, voltage at point B and every comparable point in the string is reduced by 400 volts.

The 500-pf capacitors have been charged to 400 volts through the



1,000-ohm resistors. When voltage at point A is reduced by 400 volts, voltage on the forward-biased gate terminal of the *pnp* transistor is correspondingly reduced so that there is a 400-volt potential across the 1,000-ohm resistor. Thus the capacitor supplies 400 ma to the gate of the second transistor. Simultaneously, a 400-ma gate signal is provided to the gate of each transistor in the string.

**DIODE CURRENT**—Time is required for the voltage-regulator diodes to accomplish the 400-volt change at point B and comparable points. When the module is in the high-impedance state, the diodes are reverse biased into their avalanche regions. When the first transistor is triggered and the voltage-regulator diodes are voltage-stressed by switching of the first transistor, reverse current of the top diode is increased from the 1-ma off-state current to 400 ma peak. Reverse current of the second diode from the top increases to 800 ma, since it carries the current of the top diode as well as the 400-ma trigger current supplied to the top *pnp* transistor. The third and fourth diodes from the top carry 1,200 and 1,600 ma, respectively, during the early part of the turn-on transient. Since the diodes were in the avalanche region and are driven further into it, less than 1 nsec is required to change current.

Switching waveforms of the 300-Kw modulator operating at full power output are shown in the photograph: 0.25  $\mu$ sec per horizontal division and 4,000 volts per vertical division. The 4-Kv, 300-Kw output pulse is shown at the top. Rise time and pulse length are determined by characteristics of the PFN. Voltage across the 8-Kv switch assembly during switching is shown at the bottom. Rise time of the 600-Kw closure is 125 nsec.

Performance data for the 8-Kv switch assembly made up of four 2-Kv modules is shown in Table II. A 300-Kw pulse at a duty cycle of 0.005 percent is delivered to a 50-ohm load. Pulse repetition rate is limited by thermal design of the switch assembly and could be improved by potting, encapsulating the assembly in oil or air cooling.

Modulator efficiency could be improved by using a resonant-charg-

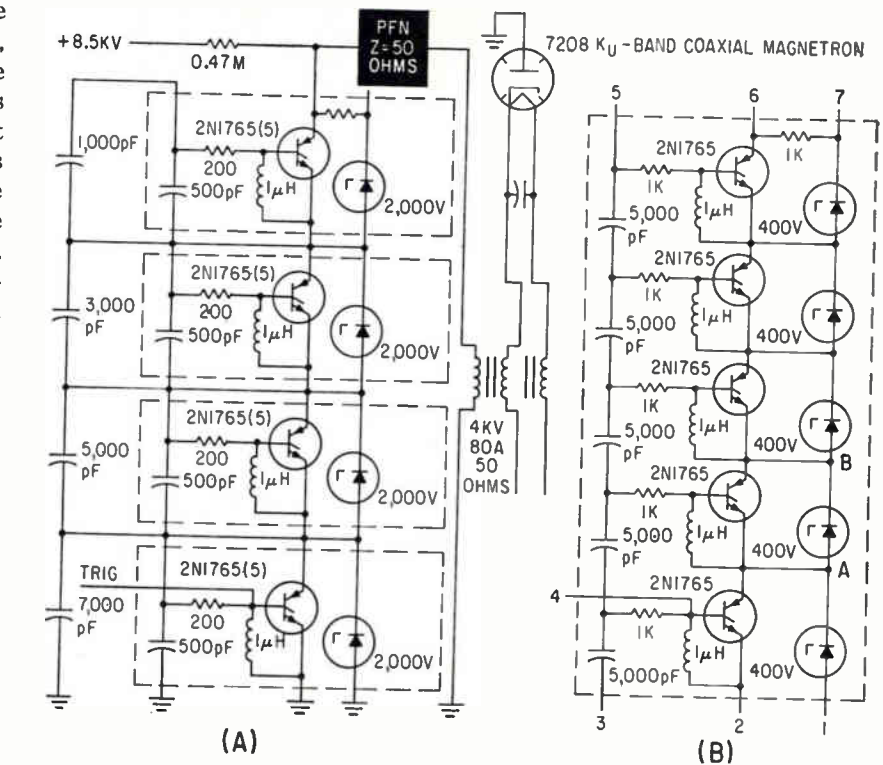

DEVELOPMENTAL 300-Kw modulator (A) uses four 2-Kv switching modules (B) in series—Fig. 4

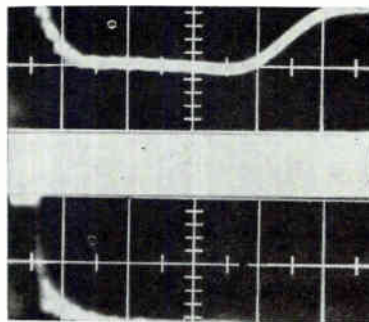

MODULATOR operating at full power has 4-Kv output waveform shown above. Waveform across 8-Kv switch is shown below

ing diode and inductor instead of the charging resistor, which would eliminate about 6 watts of dissipation. Efficiency has been improved significantly by using voltage-regulator diodes to stabilize voltage across the *pnp* transistors. If resistors with the same dynamic resistance as the diodes were used, power losses would be increased.

The 8-Kv, 300-Kw switch assembly in the photograph is being used to modulate a 7208 magnetron, which has output power of about 100 Kw at 16 Gc. The experimental setup includes a 50-ohm PFN and pulse transformer (under magnetron) and a simple charging resistor.

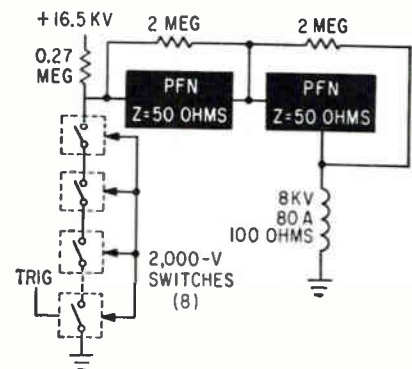

EXPERIMENTAL modulator switches 1.28 megawatts to provide 640-Kv output—Fig. 5

Two 8-Kv switch assemblies were wired in series with two 50-ohm pulse-forming networks with suitable balancing resistors, as in Fig. 5. With this arrangement, a switching operation from 16 Kv to 80 amperes has been obtained.

## REFERENCES

- (1) H. G. Heard, Controlled Rectifier Produces Quarter-Megawatt Pulse Power, *ELECTRONICS*, p 54, June 23, 1961.
- (2) R. L. Biesele, Jr., Solid State Pulse Modulators, *Electronic Industries*, August 1961.
- (3) Diode Net Switches Magawatt in 30 Nsec, *Electronic Daily*, p 12, March 21, 1961.
- (4) F. A. Gateka, A 3 Kw Semiconductor Magnetron Modulator, *Mid-American Electronics Conference*, 1960.
- (5) F. A. Gateka, A Semiconductor Magnetron Modulator, *The Western Electric Engineer*, p 3, October 1960.

# Is This the

By RICHARD J. MAYER

Transport Div., The Boeing Co.,  
Renton, Wash.

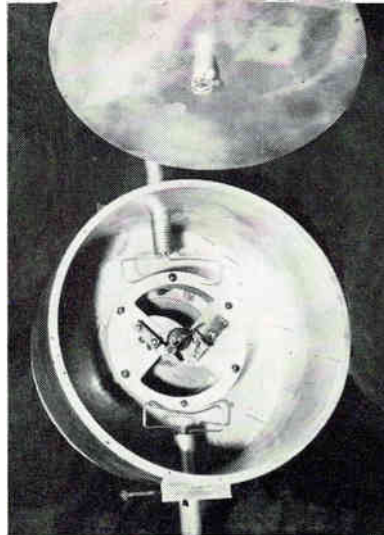
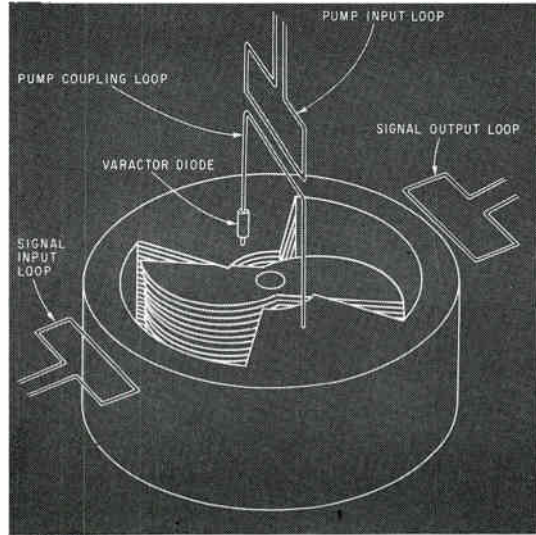

EXTREME SIMPLICITY of parametric amplifier is evident in these pictures—Fig. 1

## DESIGN FOLLOW-THROUGH

Dick Mayer discussed the preliminary design of this vhf parametric amplifier in *ELECTRONICS*, Dec. 15, 1961. Since then he has made several important design changes. Now he says it may be the simplest paramp ever constructed

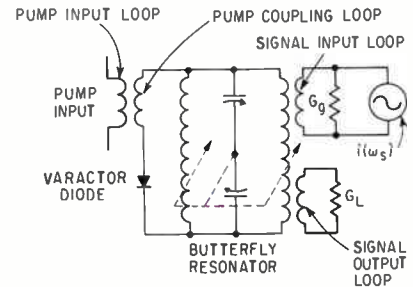

ONLY ONE butterfly resonator, one varactor diode, with coupling loops for signal and pump frequencies, make up the amplifier circuit—Fig. 2

POSSIBLY the simplest parametric amplifier ever constructed consists of only one butterfly resonator and one varactor diode with coupling loops for the signal and pump frequencies. In addition to its simplicity and low cost, the amplifier features a wide operating frequency range: it is tunable over at least a two-to-one frequency band. It operates in a quasidegenerate mode; both signal and idler frequencies are within the passband of the single resonator. This new amplifier differs considerably from a design suggested in an earlier article.<sup>1</sup>

Butterfly resonators have these desirable features at vhf and lower microwave frequencies:<sup>2</sup> freedom from erratic behavior—no sliding contacts; wide tuning range—a tuning ratio (ratio of max to min resonant frequency) of the order of 5:1 is possible; high Q—typical values range from 200 to 1,000; accessibility of points between which maximum impedance is developed; ease of tuning; and small size relative to other resonators covering the same frequency range.

**NEW DESIGN**—Figure 1 shows the new amplifier. The signal is magnetically coupled to the butterfly resonator. The varactor diode is in series with the pump coupling

loop across the high impedance points of the resonator. The pump signal is magnetically coupled through the pump input loop to the varactor. The circuit is shown in Fig. 2 where  $G_s$  and  $G_L$  are the signal generator conductance and the load conductance, respectively. Although this circuit is unlike that of the conventional parametric amplifier, which has been thoroughly analyzed,<sup>3-5</sup> it can be shown to be subject to the same analysis. The circuit (Fig. 2) is reduced to that used by Blackwell and Kotzebue in their analysis of the degenerate amplifier.<sup>6</sup> First, the equivalent circuit at the pump frequency is considered to show that the pump input signal appears across the varactor, but not across the signal input and output terminals. The butterfly resonator, tuned to the signal-idler frequency, is essentially a short circuit to the pump signal. The equivalent circuit at the pump frequency thus reduces to that in Fig. 3A, and virtually all pump power coupled to the pump coupling loop appears across the varactor.

Average capacitance of the varactor is only about 1 to 3 pf. Therefore, its impedance at the signal-idler frequency is much greater than the pump-coupled-impedance. The equivalent circuit at the signal

frequency thus becomes that of Fig. 3B. For convenience, the butterfly resonator has been replaced by a parallel tuned circuit that has a finite passband. For quasidegenerate operation, both the signal and the idler frequencies are within this passband so that only this single tuned circuit is necessary. Finally, the signal input and load conductances can be transformed to appear directly across the signal circuit. In Fig. 3C, where  $G'_s$  and  $G'_L$  are the equivalent, transformed, generator and load conductances, respectively. This circuit is identical to the equivalent circuit used by Blackwell and Kotzebue.

**DESIGN EQUATIONS** — Transducer gain,  $g_t$ , at signal frequency,  $\omega_s$ , is given by:<sup>6</sup>

$$g_t = \frac{4G'_s G'_L}{\left[ G'_s + G'_L - \frac{\omega_s \omega_i (\gamma C_0)^2}{G'_s + G'_L} \right]^2}$$

where  $\omega_i$  is the idler frequency;  $\gamma C_0$  comes from the assumed varactor capacitance variation at the pump frequency,  $\omega_p$ . Its expression is  $C(\omega_p) \cong C_0 + 2C_0 \gamma \cos \omega_p t$ . The single-sideband noise figure is  $F_{s.s.b} = 2[1 + (T/T_0)(G'_s/G_s)]$  where  $G_s$  is the varactor loss conductance,  $T$  is the operating temperature and  $T_0$  is the standard noise temper-



# Simplest Paramp Ever Built?

*This quasi-degenerate parametric amplifier for vhf and lower microwave frequencies features simplicity and low cost.*

*It is tunable over at least a two-to-one frequency band*

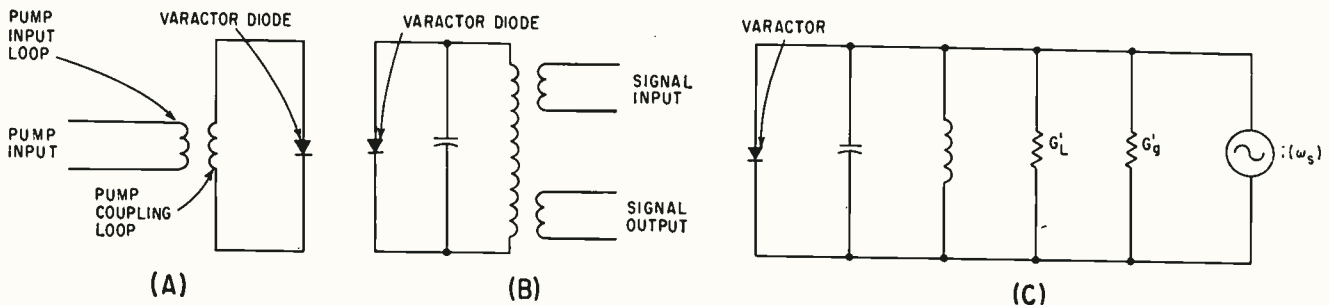

EQUIVALENT CIRCUITS at pump frequency (A), at signal-idler frequency (B) and for mathematical analysis (C) where  $G_g'$  and  $G_L'$  are the equivalent, transformed, generator and load conductances—Fig. 3

ature of 290 degrees K.

In Fig. 1, the pump input loop is in the container cover (top of photo). The amplifier is inside the round, brass container, and the shaft of the resonator rotor protrudes from the container so that the resonator may be tuned from the outside (tuning knob not shown). The signal coupling loops are on either side of the resonator, and the varactor and the pump coupling loop are seen in edge view.

**TEST RESULTS**—Both a spectrum analyzer and a receiver were used during tests. The amplifier was intended as a low-noise amplifier at 150 Mc. On the spectrum analyzer display, the 150 Mc signal and idler differed by approximately 300 Kc, although operation at differences anywhere below about 500 Kc is possible, depending on pump frequency.

Bandwidth is approximately 200 Kc. Maximum stable power gain is about 25 db, although maximum long-term stability is obtained by operating below about 17 db.

Operating frequency can be changed by retuning the resonator and changing the pump frequency. Power gains of 20 to 30 db were obtained at signal frequencies up to 300 Mc. The only tuned circuit

is the resonator that tunes the frequency band 135 to 485 Mc; the amplifier insertion loss (pump off) over this entire band is less than 5 db. Therefore the amplifier should operate over this band if adjustments of the pump frequency are made. However, the upper frequency was restricted to 300 Mc because the power output of the pump source used was too low for operation above 600 Mc. (For quasi-degenerate operation, the pump frequency is approximately twice the signal frequency.) About 200 mw pump power was required. Microwave Associates, MA 450 series varactor diodes were used (MA 450A thru MA 450E diodes produced no change in operating characteristics).

The amplifier was operated without a circulator because none was available for frequencies below 250 Mc. Thus, the amplifier is sensitive to small changes in generator or load impedance, and it is difficult to measure noise figure. A conventional noise source cannot be used because of the change of impedance of the noise source between on and off conditions. Kotzebue<sup>7</sup> reported this difficulty in an earlier investigation; he measured the noise figure of his amplifier by visually observing its

noise output on a spectrum analyzer.

Noise output was too low to be observed on the spectrum analyzer. Crude measurements of the noise figure were made by measuring input and output signal to noise ratios. These measurements yielded a single-sideband noise figure of about 3.5 db, an indication that the noise figure is low.

This amplifier should be operated at signal frequencies of 250 to 3,000 Mc where both circulators and butterfly resonators are available. Besides increasing stability, the circulator will double the voltage-gain-bandwidth product.

The author is indebted to Dwight E. Isbell for his suggestions which led to this development.

## REFERENCES

- (1) R. J. Mayer, Degenerate Parametric Amplifier Uses Butterfly Resonators, *ELECTRONICS*, p 74, Dec. 15, 1961.
- (2) H. J. Reich, P. F. Ordung, H. L. Krauss and J. G. Skalnik, "Microwave Theory and Techniques," p 465, D. Van Nostrand Co., Inc., 1953.
- (3) Heffner and G. Wade, Gain, Bandwidth and Noise Characteristics of the Variable-Parameter Amplifier, Stanford Electronics Labs, Tech. Report No. 28, Feb. 26, 1958.
- (4) S. Bloom and K. K. N. Chang, Theory of Parametric Amplification Using Nonlinear Reactances, p 578, *RCA Rev.*, Dec. 1957.
- (5) L. A. Blackwell and K. L. Kotzebue, "Semiconductor-Diode Parametric Amplifiers," p 53, Prentice-Hall, Inc., Englewood Cliffs, N. J., 1961.
- (6) *Ibid.*, p 73.
- (7) K. L. Kotzebue, A Semiconductor-Diode Parametric Amplifier at Microwave Frequencies, Stanford Electronics Labs, Tech. Report No. 49, p 43, Nov. 4, 1958.

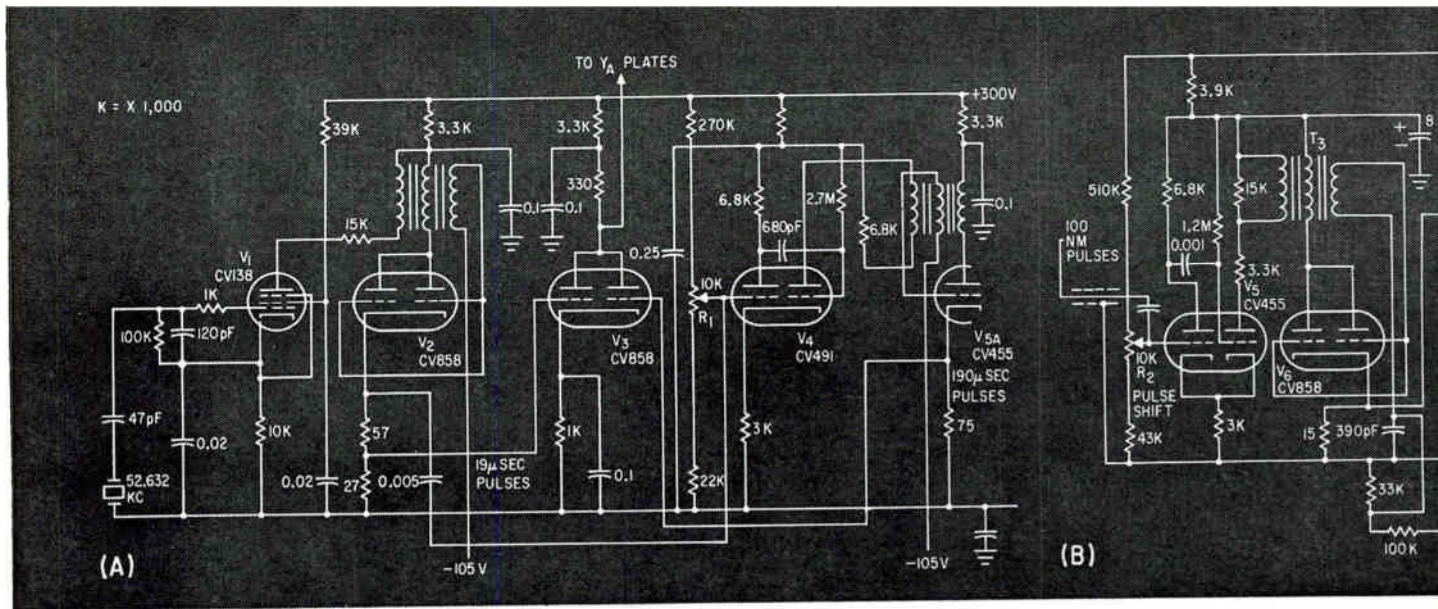

CIRCUITS of marker pulse generator (A), transmit pulse generator (B) and time-base delay (C)—Fig. 1

# Compact New Instrument

By F. JONES  
 General Post Office  
 Research Station  
 Dollis Hill, England

J. H. REYNER  
 Furzehill Laboratories Ltd.,  
 Boreham Wood, England

*Pulse-echo instrument identifies shunt or series faults, pinpoints them within 0.1 mile in a 50-mile range. Dual-beam oscilloscope contributes to fast operation, is easy to read*

THIS NEW pulse-echo instrument for locating faults in submarine telephone cables is both fast and compact; it has to be for use aboard modern cable-repair ships. This instrument abandons the usual highly-complex circuits in favor of a simple scanning system coupled with crystal markers calibrated in nautical miles. But it retains the accuracy of earlier instruments.<sup>1</sup>

It measures only 21 by 18 by 23 inches, but can locate, in a few minutes, the position of a cable fault to within 0.1 mile. The maximum range is 50 nautical miles. It can select any 1 or 10-mile spread within this range, for an accuracy of location of  $\pm 0.5$  percent or  $\pm 40$  fathoms, whichever is greater.

**BASIC DESCRIPTION**—A pulse of 2-v amplitude and approximately sine-squared shape is applied to the input of the cable. Any fault that produces an abnormal variation in impedance causes this pulse to be

reflected and received at the sending end after a time interval that is a measure of the distance to the fault. The pulses are displayed on the upper trace of a double-beam crt. The lower trace displays crystal-controlled marker pulses at intervals corresponding to one nautical mile with every tenth marker of increased height. The transmitted pulse is applied to the cable through a variable delay network that enables it to be aligned with a pulse marker so that the distance of the received pulse can be readily assessed. Figure 2A illustrates the display.

The relative direction of the reflected pulse indicates the type of fault. If it is in the same direction as the transmitted pulse it indicates a series fault, the extreme being an open circuit which gives 100 percent reflection. Conversely a shunt fault gives a reflection in the opposite direction, the extreme being a short circuit which again

gives 100 percent reflection.

Initially, the full sweep width corresponds to 50 nautical miles. A range switch then permits the 10-mile sector in which the fault occurs to be expanded to full screen width. A further expansion can

## WHY ANOTHER FAULT FINDER?

*For people concerned with cables, here is another piece of British ingenuity—a pulse-echo instrument for cable-fault location. Since fault locators using the echo technique have been around for over fifteen years, we were wondering what advantages the new instrument had over previous ones. The answer? Most cable-fault locators are accurate, sophisticated, but bulky. This one is not only accurate but also simple, compact and fast—just what was needed aboard cable repair ships*





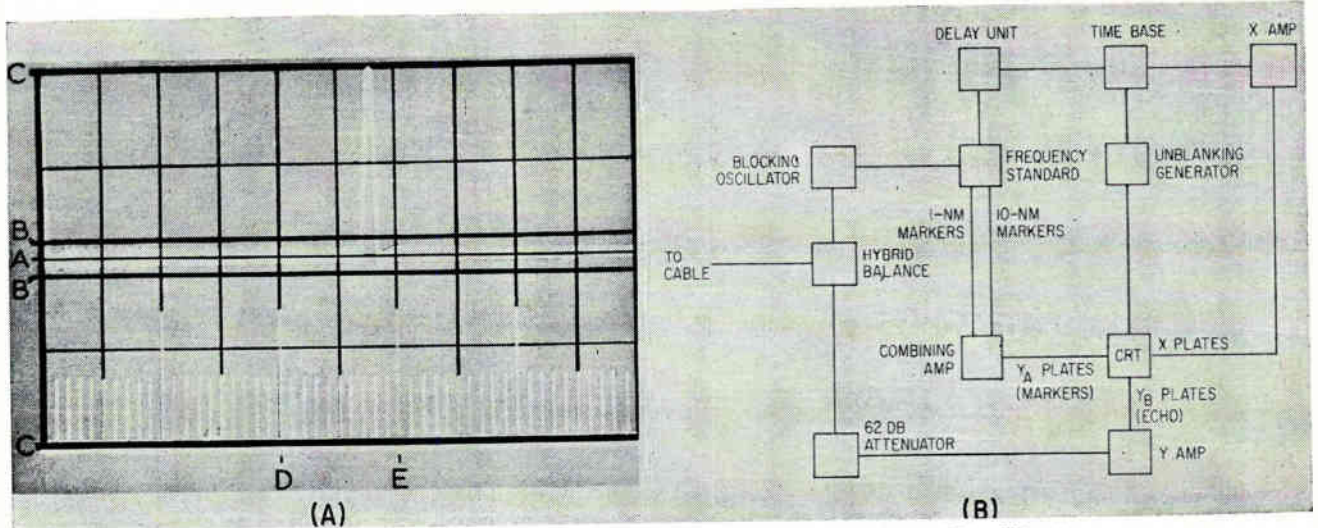

ECHO from fault in cable, with 1 and 10-mile markers (A); complete fault locator (B)—Fig. 2

square-wave output from this circuit is then differentiated in  $T_3$ .

Tube  $V_4$  develops a pulse at the cathode of approximately  $\frac{1}{2}$   $\mu$ sec half-amplitude duration that is fed to transformer  $T_4$ , which has a center-tapped secondary. The pulse developed in one half of the secondary (approximately 2-v amplitude) is applied to the cable. This pulse is also fed to the display amplifier but is offset by an equal and opposite pulse developed across the other half of the secondary so that the amplifier is not blocked, whereas the reflected pulse is applied unattenuated direct to the amplifier input. By adjusting the balancing network, the displayed amplitude of the transmitted pulse may be set to a convenient height comparable with the received pulse.

The display amplifier uses conventional circuits, has a total gain of 77 db, and supplies symmetrical signals to the upper Y plates of the crt. An attenuator of 62 db in 1-db steps allows adjustment of the display amplitude.

With the pulse-check switch open, the hybrid balance is inoperative and the full pulse amplitude is applied to the amplifier. The attenuator is adjusted until the pulse height is the same as that of the received pulse; the additional attenuation required is the pulse attenuation in the cable.

**TIME-BASE GENERATOR**—Conventional circuits are used to generate the horizontal sweep, but a variable delay circuit is incorporated to permit an amplifier dis-

play of selected portions of the trace. See Fig. 1C. The pulses from the frequency standard are fed to time-delay circuit  $V_5$ - $V_6$ . At rest,  $V_5$  is cut-off but upon the arrival of a pulse, capacitor  $C$  begins to discharge, producing a linear fall of plate voltage. The duration of this fall is controlled by the setting of delay network  $R_1$  to  $R_6$ . The minimum delay with  $R_6$  at zero can be set by  $R_1$ , to 190  $\mu$ sec or 10 nm and the maximum with  $R_6$  at maximum is set by  $R_2$ , to 1,140  $\mu$ sec or 60 nm. Potentiometer  $R_3$  thus covers a delay range corresponding to 50 nm. Thus, the beginning of the sweep can be made to coincide with the transmitted pulse, for coarse display, or any point immediately preceding the reflected pulse, for closer estimation of distance.

The saw-tooth pulses in the plate circuit of  $V_5$  are accompanied by square pulses at the screen. These are differentiated and trigger the time-base generator, that uses a bootstrap circuit and feeds a symmetrical amplifier driving both sets of X plates on the crt. Three sweep ranges are provided, giving sweep widths of 50, 10 and 1-nm. The crt trace is normally blacked out but is restored to normal brilliance during the sweep by unblanking pulses derived from the time-base gate.

**OPERATION**—The width of the pulse initially  $\frac{1}{2}$ - $\mu$ sec half-amplitude duration, increases as it progresses along the cable due to the attenuation against frequency characteris-

tic. This might cause errors, but it is found that errors can be obviated by measuring the distance between the 10-percent amplitude points of the sent and received pulses. The crt graticule is provided with a main mark 1-inch from the center line and a subsidiary mark at 0.1-inch. The amplitude of the pulses is adjusted to the main mark by attenuator and pulse control. Distance to the fault is then assessed by the intersection of the pulses with the 10-percent line.

The instrument is first used on the 50-nm range with zero delay, producing a display as shown in Fig. 2A. The time base is then changed to the 10-nm range and the fine control adjusted so that the 10-nm markers coincide with the beginning and end of the scan.

The time-base delay is then increased, noting the number of 10-nm intervals, indicated by the traverse of the 10-nm markers across the screen, until the reflected pulse appears. Total distance can be read off with greater accuracy. The process can be repeated on the 1-nm range, permitting the location of the fault to be determined to an accuracy of  $\pm 0.5$  percent.

The authors thank the engineer-in-chief of the British Post Office for permission to publish these details, and to J. W. Glazbrook of the GPO Research Station, for much detailed work during the development of the equipment.

#### REFERENCES

- (1) F. F. Roberts, Pulse Techniques in Coaxial Cable Testing, *Journ POEE*, 41, April, 1948.



# FOUR NEW WAYS TO HOUSE MICROFUSES

(SUB-MINIATURE)

282001



Front panel mount Microfuse holder (with the hexagon nut rear of panel). Rugged aluminum body and knurled cap; both can be anodized in color. Fungus and shock resistant. Sealing "O" rings in cap and on body. "Eye" type terminals specially designed for easy soldering.

282002



Rear panel mount Microfuse holder (with the round nut mounted from front of panel). Rugged aluminum body and knurled cap; both can be anodized in color. Fungus and shock resistant. Sealing "O" rings in cap and on body. "Eye" type terminals specially designed for easy soldering.

281002



Front panel mount Microfuse holder (with the hexagon nut rear of panel). Molded from high strength, high dielectric material. Knurled cap for easy grip, with skirt for positive "O" ring seal. Rugged "Eye" type plated brass terminals separated by molded barrier to provide complete insulation.

284000 Series



Indicating Microfuse holder —when the fuse blows indicating bulb glows. Knob molded from transparent material with serrations for easy gripping. Skirt of knob for positive "O" ring seal. Body from high strength, high dielectric material. Indicating holders available in wide voltage ranges from 2½ to 125 volts.

PRODUCTS  
SHOWN  
ACTUAL  
SIZE

Microfuses achieve low fuse resistance values with high reliability in ultra-fast blowing characteristics. Microfuses can be hermetically sealed, suitable for potting applications. Glass enclosed visible filament. Microfuses available in 1/500 through 5 amps at 125 V. Short circuit interrupting capacity 125 V—10,000 amps DC.

# LITTELFUSE

Des Plaines, Illinois

CIRCLE 51 ON READER SERVICE CARD

**WORDS UNDER THE SEA**

*Underwater radio propagation is vital to the U. S. Navy. Our Polaris carrying nuclear submarines may remain submerged for months on end. Their only contact with the world above is the Navy Fox broadcast. And only powerful very-low-frequency c-w signals get through the sea water.*

*The Navy knows its vlf well indeed. Stations at Annapolis, Maryland and Balboa, Canal Zone were on the air before World War II. During World War II, the big 16.88-Kc alternator at Haiku, Hawaii came on the air using an antenna strung between two mountain peaks. Right after the war, the rig was replaced with a ½ megawatt vacuum-tube job at Lualualei.*

*Big Jim, a 1-megawatt transmitter with a frequency range from 14.5 to 35 Kc is located in a deep valley at Jim Creek, Washington (ELECTRONICS, p 98, Dec. 1952). Now Big Jim has a brother; another 1-megawatt rig near Camden, Maine*

By **E. J. HILLIARD**

U.S. Naval Underwater Ordnance Station, Newport, Rhode Island

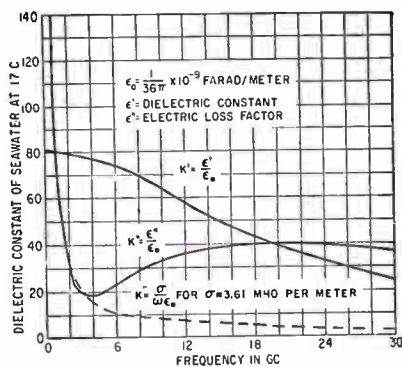

**DIELECTRIC CONSTANT of sea water at 17 C—Fig. 1**

# Getting Signals Through to Submarines

*Characteristics of sea water and the air-to-water interface are highly unfavorable for electromagnetic communication. Signal attenuation at high frequencies is thousands of db per meter*

SEA WATER IS KNOWN to be an extremely poor transmission medium for electromagnetic waves. In tests made so far, no windows have been found up to 100 Gc, and it is unlikely that any will be found. Nevertheless, for radio control of, or communications with, submarines or other submerged devices, sea water and the air-to-sea interface have characteristics that allow some signal transmission.

The signal transmitted to the submerged receiver can generally be maximized by using a vertically polarized transmitting antenna, since this allows the maximum signal through the interface and also minimizes the dependance of signal strength on angle of incidence.

Transmission parameters of interest are attenuation, wavelength and intrinsic impedance, from 10 cps to 100 Gc. Also required for an understanding of radio transmission through the air-water interface are

transmission coefficient against angle of incidence for both horizontal and vertical polarization of the incident wave.

The curves are for sea water at 17 C. No attempt has been made to determine how far the values for other temperatures will depart from those plotted. These curves are intended as a handy guide to electromagnetic radiation into and through sea water, and as a theoretical starting point for further investigation.<sup>1, 2, 3</sup>

**WHAT THE CURVES MEAN**

—Of the many curves that can be plotted there is space here only for the most descriptive and most useful. The dielectric constant of sea water in the rationalized mks system is given in Fig. 1.

Intrinsic impedance  $Z$  of sea water against frequency is shown in Figure 2, where  $Z = E/H$  with  $E$  in v/m and  $H$  in amp/m. While the plot of phase



# SLOTTED LINES for 26 to 110 KMC

FREQUENCY.....full waveguide band  
SLOPE.....1.03 max.  
PROBE..variable depth adjustment and  
built-in slide screw tuner  
TRAVEL MEASUREMENT...dial indicator  
with 0.01 mm divisions

The TRG Model E740 pictured below is a highly accurate slotted line for microwave measurements in the millimeter region. This is another concrete example of TRG's effort to provide you with the most complete line of millimeter components. Today, TRG is the one and only source for more components covering the entire 26 to 220 kmc region than anyone else. Whatever your problem — a component, or complete systems development — TRG has more of everything it takes, including experience, to place the answers right in the palm of your hands. Please write for Catalog 260A today.



TECHNICAL RESEARCH GROUP, 400 Border St., East Boston 28, Mass.

TRG MODEL E740 SLOTTED LINE provides highly accurate microwave measurements in the millimeter region. Precision linear bearings and a smooth friction wheel drive assure accurate control, and long-life of the probe travel. The 0.003 inch diameter probe features a variable depth adjustment, and a built-in slide screw tuner for optimizing the RF coupling to the waveguide. The unit is neatly packaged in a rugged case to protect it against damage and dust.

TRG  
PUTS  
THE FUTURE  
IN THE  
PALM  
OF YOUR  
HAND

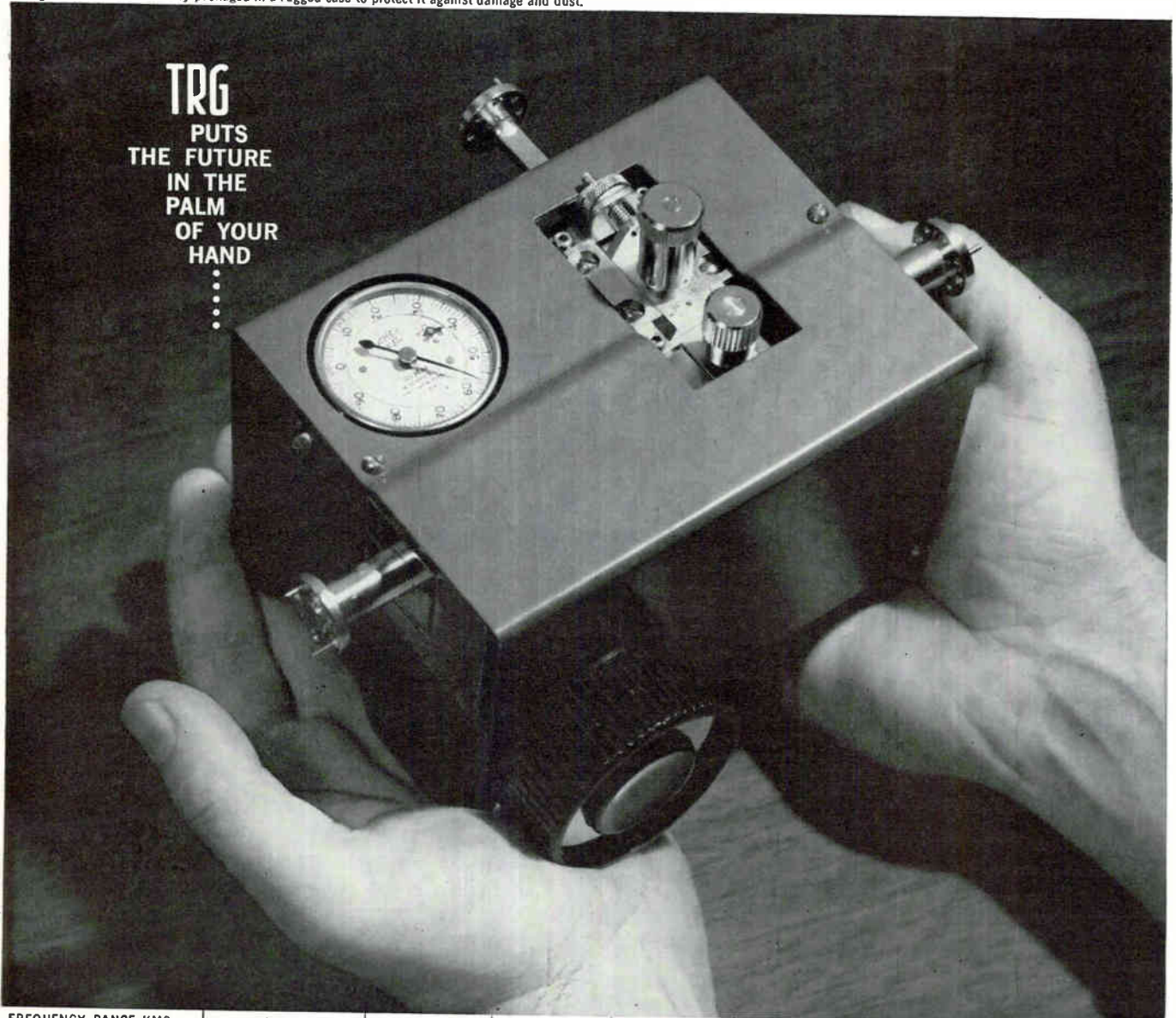

FREQUENCY RANGE-KMC	A-band 26-40	B-band 33-50	V-band 50-75	E-band 60-90	W-band 75-110	F-band 90-140	G-band 140-220
MODEL NUMBER	Under Development	B740	V740	E740	W740	F-740	Under Development

angle is somewhat distorted by the log-log scales, the scale allows the amplitude and phase angle to be plotted on the same graph. The plot shows that the impedance varies directly as the square root of frequency and the phase angle stays at 45 degrees up to 100 Mc. The dip in the phase angle curve corresponds with the minimum in  $K_2$  (relative dielectric constant of sea water at 17 C) at approximately 3.5 Gc.<sup>4</sup>

Wave length of electromagnetic radiation in sea water as shown in Fig. 3 varies inversely

as the square root of frequency up to 100 Mc. Attenuation (also shown in Fig. 3) varies directly as the square root of the frequency up to 100 Mc. Of interest is the notch in the region between 3.5 and 4 Gc. The depth of the notch, measured from the local maximum at about 2 Gc, is at most 5 nepers per meter. In db, this is  $5 \times 8.686 = 43.4$  db. Since the level in this region is about 70 nepers per meter (608 db per meter), the percentage decrease is a minute 0.8 percent. Beyond this valley the curve rises sharply to the

imposing height at 100 Gc of 4,000 nepers per meter or 34,800 db per meter.

Figure 4A shows the variation of transmission coefficient with angle of incidence for vertical polarization of the incident wave. For the lower frequencies, the transmission coefficient is practically independent of angle of incidence ( $\phi$ ) for angles below 89.5 degrees. The angles of refraction were always less than 6.5 degrees for the values of  $\phi$  chosen. For 10 Gc and below, the angles of refraction were always below 1 degree. Figure 4B shows transmission coefficient plotted on an expanded scale of angle of incidence between 80 and 90 degrees.

Figures 4C and 4D are for horizontal polarization of the incident wave. Here the transmission coefficient falls rapidly toward zero as the angle of incidence increases. At zero angle of incidence, at corresponding frequencies, transmission coefficients for both horizontal and vertical polarization are identical (Fig. 4A and 4C). For a wave directed perpendicular to an interface, the sense of polarization is lost.

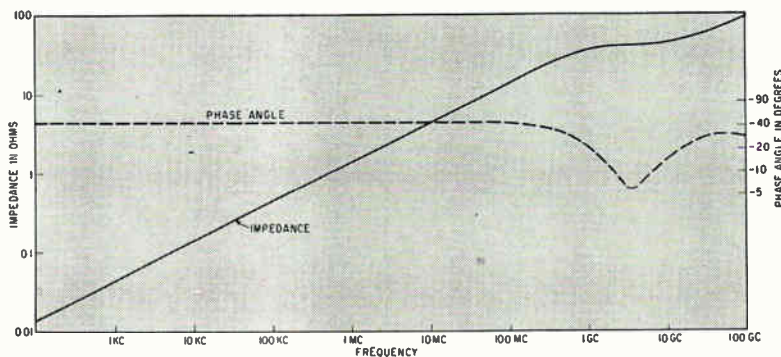

INTRINSIC IMPEDANCE rises exponentially as frequency increases. Phase angle remains at 45 degrees to almost 100 Mc—Fig. 2

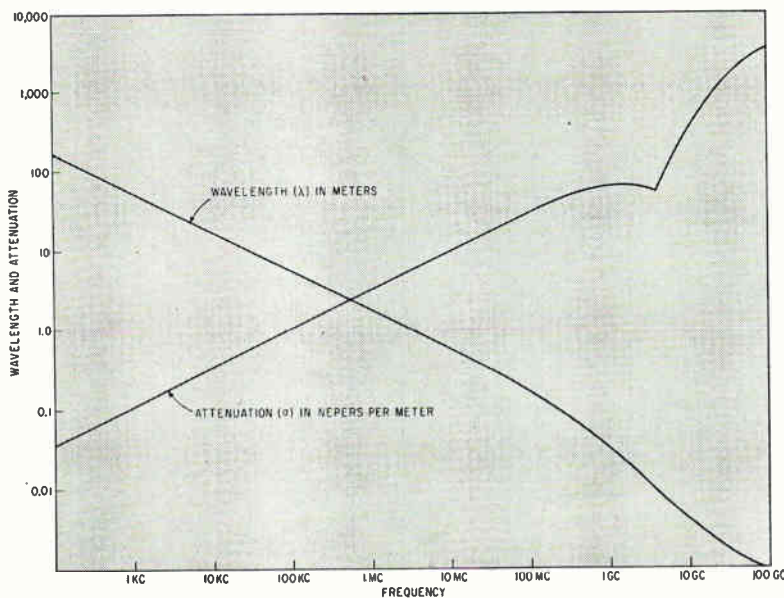

SIGNAL WAVELENGTH and attenuation of electromagnetic radiation in sea water at 17 C—Fig. 3

**FREQUENCY EFFECTS**—As frequency increases the transmission coefficient increases, as does the attenuation. In the region of the frequency spectrum where 10 to 50 percent of the incident field strength is obtained on the under side of the interface, the attenuation is so high that the signals are useless. In the region where attenuation is more reasonable, the losses through the interface are large.

Figure 5 shows the total attenuation to be expected through the interface and through sea water to any depth. Vertical polarization of the incident signal was chosen because the transmission coefficient is virtually in-



# MOST VALUABLE

Why? Because the Varian G-14 bench top recorder enhances the value of your other fine instruments. How? By giving you an accurate, easy-to-read analog record of the data they provide. For complete information about the all new solid-state G-14, or a demonstration in your own laboratory, see your nearest Varian Recorder Representative, or write the INSTRUMENT DIVISION.



Features: Instantly selectable spans of 1 mv, 10 mv, 100 mv and 1 v. Pen speed 0.6 seconds full scale. Accuracy 1.0% on 1 mv span; 0.5% on the other three spans. Zener diode reference voltage. Exceptionally high input impedance allows source resistances up to 100 K ohms. Full scale zero adjustment plus suppression. Choice of two chart speeds from 1"/hr. up to 16"/min. Price: \$685.

## SQUARE FOOT IN YOUR LABORATORY

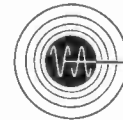

**VARIAN associates**  
PALO ALTO 1, CALIFORNIA

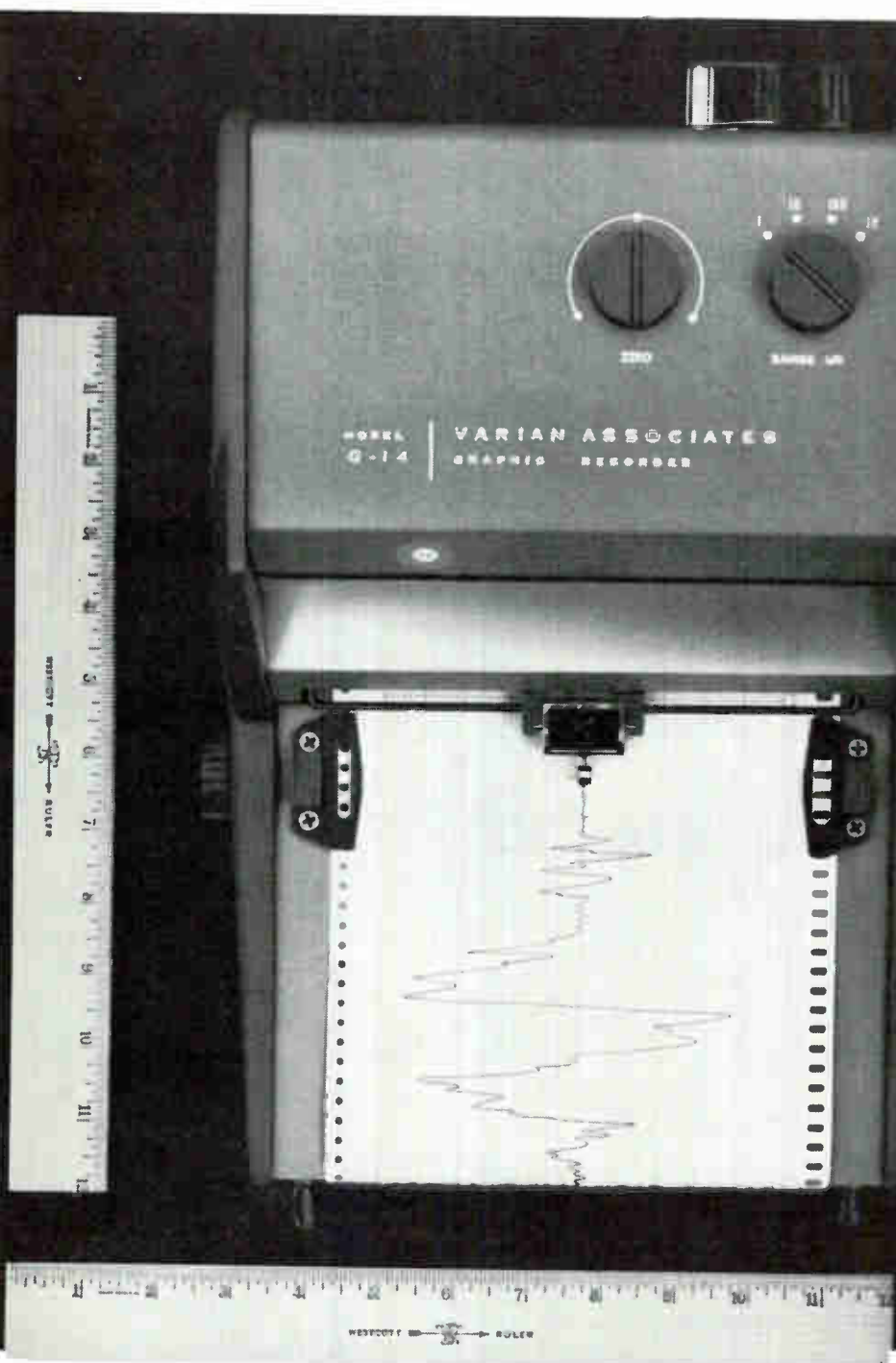

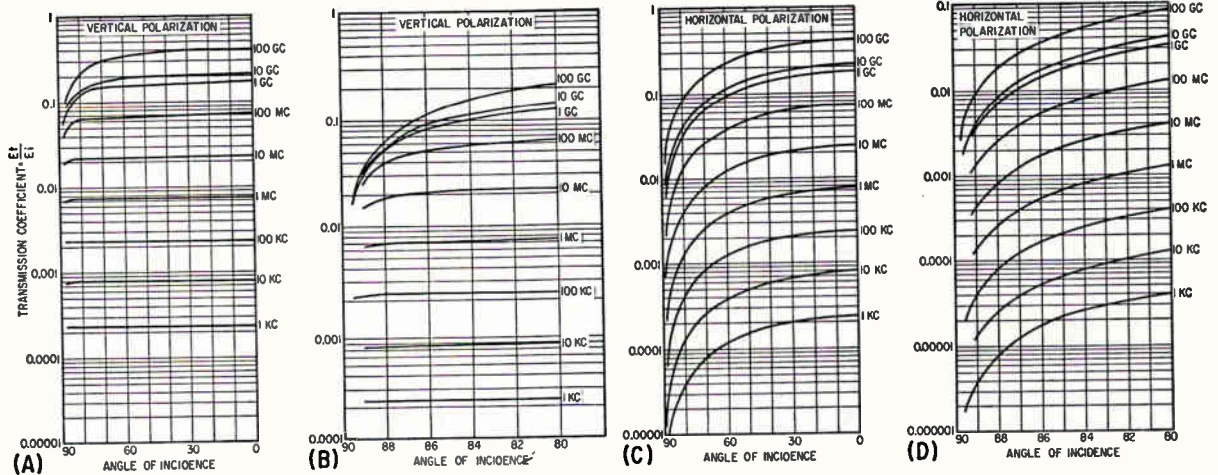

TRANSMISSION COEFFICIENTS for vertically and horizontally polarized waves. At an angle of incidence of zero, transmission is identical for both polarizations for the same frequency—Fig. 4

dependent of angle of incidence. In addition the curves represent the most favorable limit for total attenuation. Horizontally polarized signals will give higher values for all angles of incidence.

The following functions were obtained graphically  
 $\alpha$  (interface) =  $13.25 f^{-.0667}$   
 $\alpha$  (sea water) =  $0.0037 D \sqrt{f}$   
 where  $f$  is the frequency in cps,  
 $D$  is the depth of penetration in

meters and  $\alpha$  is attenuation in nepers. These values of attenuation agree with the results shown in reference 1. The frequency at which the total attenuation is a minimum for any fixed depth  $D$  is

$$f = \left[ \frac{478}{D} \right]^{1.76}$$

MINIMUM ATTENUATION AT BEST FREQUENCY FOR VARIOUS DEPTHS

$D$	$f$ for $\alpha$ Min.	$\alpha$ Total at $f$
100 m	16 cps	13 nepers (113 db)
10 m	900 cps	9.8 nepers (85 db)
1 m	52 Kc	7.2 nepers (62.5 db)

The table shows some representative values for frequency  $f$  and depth of penetration  $D$ . The values for total attenuation are optimistic, not conservative.

Frequencies different from those given will increase the total attenuation  $\alpha$ , as will horizontal polarization. In selecting a carrier frequency for underwater vehicle control systems, the minimum interface-to-sea water attenuation formula should be carefully considered.<sup>5</sup>

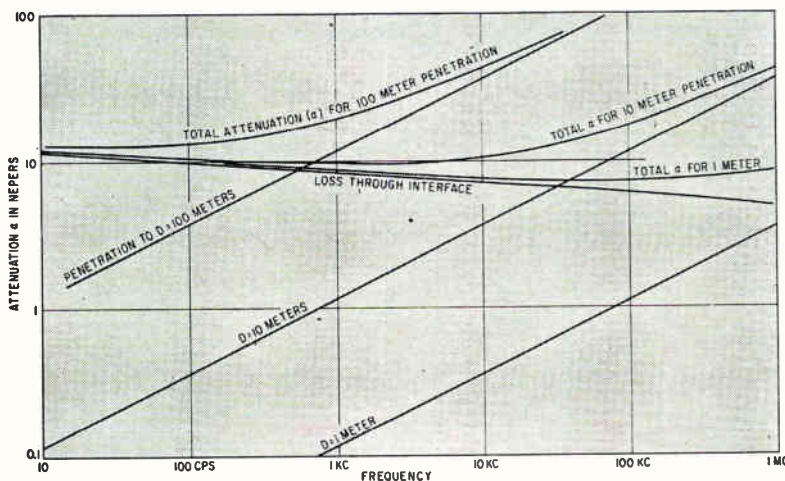

ATTENUATION suffered by a signal passing through the air-to-water interface and penetrating to a given depth increases with frequency. Total attenuation curves are obtained by adding penetration loss to interface loss—Fig. 5

REFERENCES

- (1) Oscar Norgorden, "The Submerged Reception of Radio Frequency Signals", NRL Report No. R-1669, 2 Dec. 1940.
- (2) J. A. Saxton and J. A. Lane, "Electrical Properties of Sea Water, (Reflection and Attenuation Characteristics at V. H. F.)", Wireless Engineer, Oct. 1952.
- (3) A. R. Von Hippel, "Dielectrics and Waves", Table 8.1, p 22, 23, John Wiley and Sons, Inc., 1954.
- (4) "Summary Technical Report of the Committee on Propagation", Fig. 2, p 33, NDRC, Volume 1, pub. 1946.
- (5) E. J. Hilliard Jr., "Electromagnetic Radiation in Sea Water", USNUSOS Consecutive No. 316 (First Revision), Aug. 1960.



ESTERLINE ANGUS

D. C. Milliamperes

0 .2 .4 .6 .8 1.0

NEW

Case design by Raymond Loewy

## rec'ti·lin'e·ar refined

New! An infinitely better rectilinear writing movement, the latest achievement of Esterline Angus *master craftsmen*, is now available in a line of graphic instruments proven in over a half-century of dependable, trouble-free performance.

Simply designed, compactly sized, ruggedly constructed—it's the kind of precision rectilinear movement you'd expect from the manufacturers of instruments with the highest reliability rating in the industry. Called *RECTIGraph*, the movement is a close-coupled, translating mechanism with "V" jeweled pivots. It provides continuous, skip-free records with (you'll appreciate this!) a

minimum of maintenance. Calibration is locked-in. It operates dependably under adverse conditions and will not fail at crucial times.

Our complete line of rectilinear recorders is most reasonably priced, and greater and greater discounts apply as the quantity of recorders you purchase increases.



For detailed information and specifications, send today for free copy of "Rectilinear Recorders." Address: ESTERLINE ANGUS INSTRUMENT COMPANY, INC., Box 596E, Indianapolis 6, Indiana.



AMOS JACKSON,  
veteran E A toolmaker



*Excellence in graphic recording for over 50 years*—ESTERLINE ANGUS

CIRCLE 57 ON READER SERVICE CARD

**SILENT POWER**  
for the hands of time...



# SYNCHRON®

## CLOCK MOVEMENTS

Cut production and assembly costs with Hansen SYNCHRON Clock Movements — simply mount and attach hands. Precision-built, self-starting synchronous movements meet the most rigid requirements of clock manufacture . . . whether you're producing the daintiest bedroom or desk models, wall units for home and office, large display clocks, or programming systems. All moving parts constantly bathed in a sealed, lifetime oil supply. Perfect balance and coordination assure accuracy. (Covers or dust bands available for most models.)

Design assistance by Hansen readily available on your construction or design problems. Special action no problem with Hansen movements for pendulum clocks, oscillating clocks, etc.

*Sustained accuracy for all clocks*  
... up to 26" diameter under glass  
... front, rear, or bottom set  
... 24, 110, or 220 volts  
... 25, 50, or 60 cycles

SEND TODAY for Data Sheet No. 1200, featuring new D-Type Movements as well as C-Type.



**HANSEN REPRESENTATIVES:**  
**ELECTRIC MOTOR ENGINEERING, INC.**  
Los Angeles, Calif., Oakland, Calif.  
**THE FROMM COMPANY**  
Chicago, Illinois  
**H. C. JOHNSON AGENCIES, INC.**  
Binghamton, N.Y.  
Fayetteville, N.Y.  
Rochester, N.Y.  
Schenectady, N.Y.  
Williamsville, N.Y.  
**WINSLOW ELECTRIC COMPANY**  
Essex, Connecticut  
New York, N.Y.  
Philadelphia, Pa.  
**EXPORT DEPARTMENT**  
15 Maoro Street, New York, N.Y.

## 100 MC PRESCALER

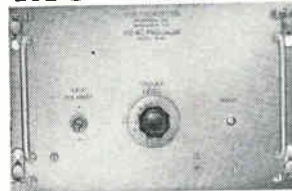

The Model 14-40 MC Prescaler is a plug-in unit designed to work in conjunction with a Northeastern Model 14-20C Counter and counters of other manufacturers. The Model 14-40 provides a basic 10 MC Counter with a 100 MC direct counting capability. Even more important, the 14-40 provides pulse resolution of better than 10 nanoseconds. (Note that in most equipment a 100 MC count capability is not synonymous with 10 nanosecond resolution.) An additional feature is that the 14-40 extends the low frequency capability of the 14-20C from 10 cps to 0 cps. The 14-40 does not alter the accuracy specifications of the basic counter; however, it may store up to nine counts which are not read out.

### Input

Impedance — 50 ohms; Max. Freq. — 110 MC; Min. Freq. DC; Sensitivity — 0.2 V. RMS for sine wave, 0.5 V. peak for pulses; Max. Input Amplitude — 10 V. RMS, 10 V. pulse; Pulse Resolution — 9 Nanoseconds; Min. Pulse Width — 4.5 Nanoseconds; Power Required — 4 Amperes @ 6.3 Volts RMS furnished by counter.

### Controls

Polarity Switch — Selects plus or minus pulse input polarity; Trigger Level — Adjustable from plus to minus 10 Volts.

## NORTHEASTERN

### ENGINEERING INCORPORATED

AFFILIATE OF ATLANTIC RESEARCH CORPORATION

DEPT. 5A MANCHESTER, NEW HAMPSHIRE

Employment Opportunities Open At All Levels

CIRCLE 201 ON READER SERVICE CARD

Around the world it's **KEW**

MODEL F-98

MODEL EW-16

MODEL P-22

MODEL VR-2P

MODEL VO-38

MODEL TK-20A

MODEL FL-202

MODEL PV-200

MODEL TR-A

SWR & RF WATTMETER

## KYORITSU ELECTRICAL INST. WORKS, LTD.

No. 120, Nakone-cho, Meguro-ku, Tokyo, Japan  
Cable Address: "KYORITSUKEIKI TOKYO"  
Tel: (717) 0131-5 • 0151-3

CIRCLE 202 ON READER SERVICE CARD

electronics



# AIRTRONICS

electronic products for the telephone industry...



**Portable Test Hybrid**  
Simplifies cable acceptance tests and return loss measurements.



**Far End Terminating Set**  
Provides precision network termination during cable testing.



**Pulse Meter**  
Furnishes a convenient method of measuring dial speed and percent make.



**Program Equalizer**  
Corrects Attenuation Distortion easily, quickly. In use by many AM and FM Broadcast Stations.

PRECISION NETWORKS  
WE 115 TYPE

BUILD OUT AND  
TERMINATING SET

PROGRAM EQUALIZERS

TRANSMISSION  
MEASURING SET

● FOR DETAILED SPECIFICATIONS AND PRICES, CONTACT YOUR NEAREST DISTRIBUTOR OR WRITE AIRTRONICS INTERNATIONAL CORPORATION — P.O. BOX 8429, FORT LAUDERDALE, FLORIDA.

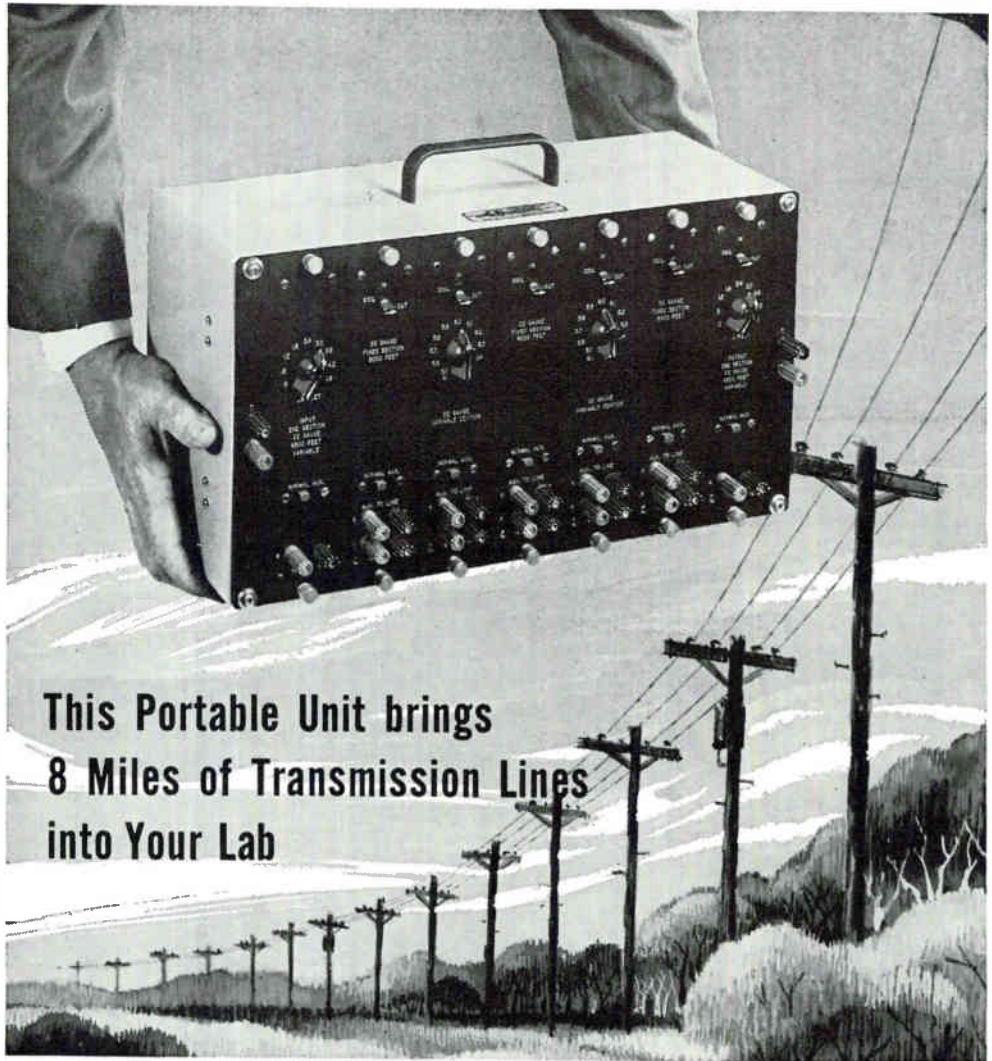

## Eliminates the Need for Leased Lines

Wherever you have a requirement for transmitting information, data, and intelligence this portable equipment will simulate transmission lines right in your lab.

The standard unit simulates 8 miles of transmission line, but it can be modified for any line length required. Plug-in modular construction. Seven plug-in modules each simulate 6,000 ft. of standard telephone cable with loading coil.

The Airtronics Artificial Line meets field engineering requirements. Some time-saving, money-saving laboratory uses are for testing data transmission (offers loaded or unloaded test facility); for testing amplifier operation over telephone lines (permits actual frequency response measurement to be observed over a simulated line); for checking system gain requirements for a pre-determined frequency range; for simulating complex values of AC impedance and DC resistance as incorporated in telemetry circuit transmission; for training purposes (used exclusively by every major telephone company).

The Airtronics Artificial Line is available in 19, 22, 24 and 26 gauge.

FOR FURTHER INFORMATION CONTACT:

AUTOMATIC SALES CORPORATION / A subsidiary of General Telephone & Electronics or Write direct...

another

product first by

**AIRTRONICS INTERNATIONAL CORPORATION**

6900 WEST ROAD 84  
FORT LAUDERDALE, FLA.  
TELEPHONE LU 3-4541

# Cascading Ups Parametric Amplifier Gain

*Ferromagnetic parametric amplifier efficiency is also improved by method*

By WILLIAM B. RIBBENS  
Electrical Engineering Dept.,  
Univ. of Michigan  
Ann Arbor, Michigan

CASCADING technique promises increased gain and improved efficiency from ferromagnetic parametric amplifiers. The quasicascaded parametric amplifier could provide one of the smallest and most economical microwave amplification methods available. The new type amplifier also offers a relatively simple and rugged design that promises good reliability.

Power amplification in the quasicascaded parametric amplifier is increased by properly supplying energy to a second stage of gain. Probably the most convenient device for cascading using this method is the ferromagnetic amplifier. This amplifier requires only a microwave cavity, a sample of ferromagnetic material, a d-c magnetic field and a power source at the cavity resonant frequency. The ferromagnetic material, suitably positioned in the cavity of the ferromagnetic amplifier, can also be used as the extra stage in the quasicascaded parametric amplifier.

**AMPLIFICATION**—An equivalent circuit for a parametric amplifier is a pair of parallel resonant circuits coupled by a time-varying reactance driven by a sinusoidal source or pump. The pump must exceed a threshold and pump frequency must be the sum of the resonant frequencies of the tuned circuits. Power supplied to one of the tuned circuits (signal circuit) at resonance is amplified because a negative conductance is reflected across the signal circuit at resonance. When magnitude of the negative conductance exceeds conductance in the signal circuit, input

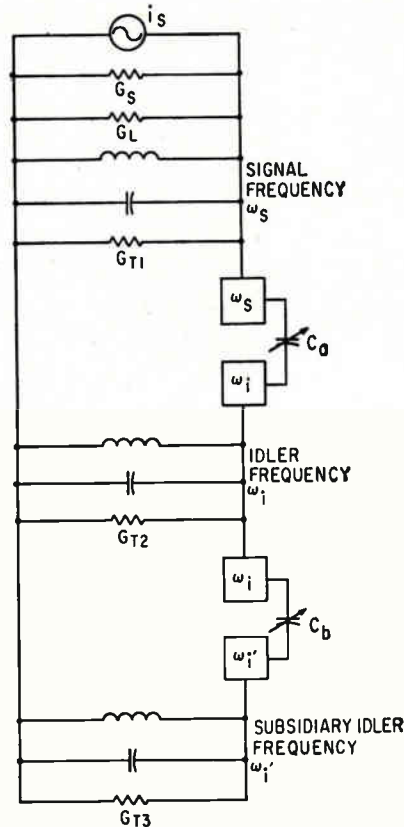

NARROW-BAND ideal bandpass filters for signal, idler and subsidiary idler frequencies are represented by boxes in equivalent circuit—Fig. 1

impedance becomes a negative conductance.

If the time-varying reactance is a capacitor, magnitude of the reflected conductance is  $G = C_c^2 \omega_s \omega_i / G_{T1}$ , where  $C_c$  is magnitude of time-dependent part of the capacitance,  $\omega_s$  is signal frequency,  $\omega_i$  is frequency of second tuned circuit (idler circuit) and  $G_{T1}$  is loss conductance of the idler circuit.

For quasicascading, another circuit (subsidiary idler) is coupled through a second time-varying reactance to the idler, which now becomes the signal circuit for the second parametric amplifier. Power into the idler circuit at its resonant frequency is amplified. In the equivalent circuit in Fig. 1, the subsidiary idler reflects a negative conductance through the coupling ca-

pacitor to the idler circuit, lowering loss conductance of the idler circuit. Because the negative conductance reflected to the signal circuit is inversely proportional to the loss conductance of the idler, a larger negative conductance is reflected to the signal circuit. As this negative conductance increases, power gain increases until the circuit becomes unstable.

Magnitude of the larger conductance is  $G_1 = C_{c1}^2 \omega_s \omega_i / [G_{T2} - (C_{c2}^2 \omega_i \omega_i' / G_{T2})]$ , where, in terms of the equivalent circuit in Fig. 1,  $C_a = C_{c1} + C_{c2} \sin(\omega_{p1} t + \phi_a) = C_{c1} + C_{c2} \sin(\omega_{p2} t + \phi_b)$ , in which  $\omega_{p1}$  is pump frequency for signal-idler pair,  $\omega_{p2}$  is pump frequency for idler-subsidary idler pair,  $G_{T1}$ ,  $G_{T2}$  and  $G_{T3}$  are loss conductances of signal, idler and subsidiary idler, respectively, and  $\phi_a$  and  $\phi_b$  are the phases of the two pump signals. Phase relationships have no effect on gain in this amplifier.

**EFFICIENCY**—For any particular value of power gain, the cascaded amplifier requires less power to operate than the uncascaded amplifier. In fact, if pump frequency for the idler-subsidary idler pair is the second harmonic of pump frequency of the signal-idler pair, operating power can be made about half that of the uncascaded amplifier. This rough estimate depends on efficiency of the coupling capacitors but is a reasonable expectation for proper adjustment. For microwave amplifiers in which a cavity is used, the second harmonic of the pump is most convenient for the second pump.

A practical cascaded amplifier must consist of a device having three mutually coupled resonant circuits, and the ferromagnetic amplifier is such a device. It uses a small yttrium iron garnet sample in a cavity that has many natural modes of oscillation of the sample magnetization. The sample must be placed in a large d-c magnetic field that is directed along the static



FOR THIN FILM RESEARCH APPLICATIONS

# VERSATILE MULTIPLE VAPOR SOURCE

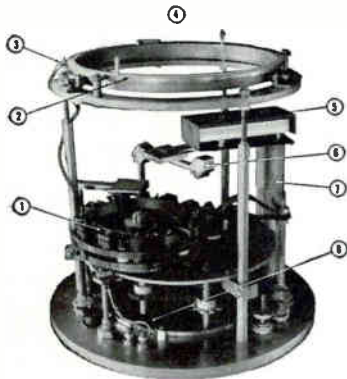
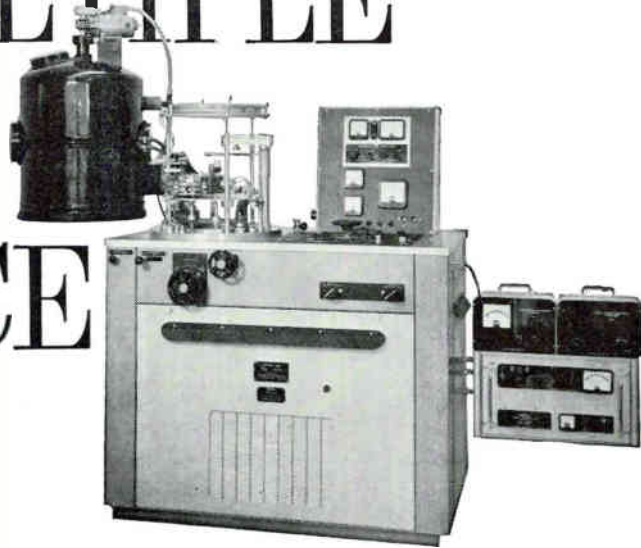

- 1 MULTIPLE VAPOR SOURCES
- 2 ROTATING WORK HOLDER
- 3 SUBSTRATE TEMPERATURE THERMOCOUPLE
- 4 SUBSTRATE HEATER (not shown)
- 5 SPUTTERING CATHODES
- 6 FILM THICKNESS MONITOR
- 7 ION BOMBARDMENT CLEANING
- 8 CIRCULATING LIQUID NITROGEN TRAP

FOR COMPLETE INFORMATION  
ON EACH OF THESE SPECIFIC MODELS  
WRITE FOR BULLETIN E321-8.

## "SPEEDIVAC" VACUUM COATING UNIT

The versatile model 19E6 production unit for evaporated micro-circuits, resistors, and capacitors features fast pump downtime and selection of accessories for almost any evaporation job. The proven Edwards design principles incorporated in this series assures fast, reliable evacuation and many years of dependable operation.

In addition to the many accessories included as standard items such as stainless steel bell jar, viton gaskets, motor driven rotary work holders, multiple vapor sources, substrate heaters; optional accessories such as electron bombarded vapor sources, circulating LN<sup>2</sup> traps and film thickness monitoring are provided. Special jigs for the production of micro-circuitry and coated tubular resistors can also be provided to fit this highly versatile coater.

Four separate models make up the 19E series, each using a pumping system, power supply, cabinet and instrumentation common to all.

**EDWARDS HIGH VACUUM INC.** / 3279 GRAND ISLAND BLVD., GRAND ISLAND, N. Y.  
MANUFACTURERS OF THE MOST COMPLETE LINE OF HIGH VACUUM COMPONENTS AND SYSTEMS

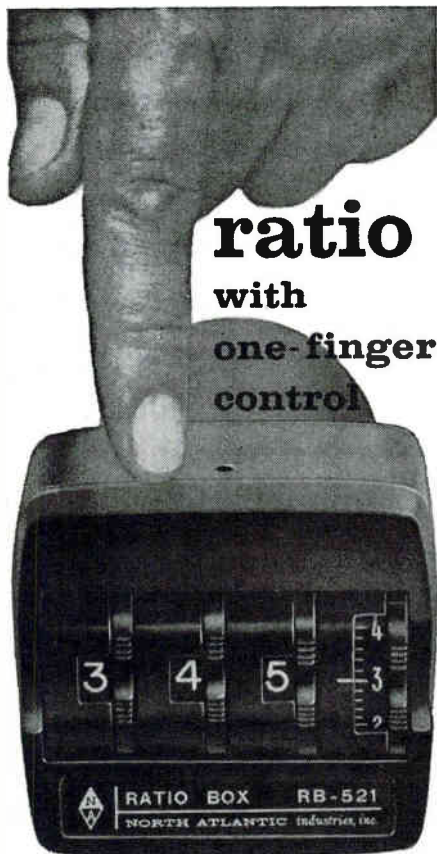

Unique thumb-wheel operation and in-line readout permit ease of setting even under severe field conditions. Sealed switch modules and environment-proof case make these Ratio Boxes ideal for rigorous GSE and commercial applications. In addition to high readability and accuracy in minimum space, they provide previously unavailable design and performance features:

- Four digit in-line readout
- Ratio range to 1.1110
- Accuracy 10 ppm
- Frequency range to 10 kc
- Series impedance as low as 0.8 ohm
- No switching transients
- Splash and drip-proof design
- Meets rugged MIL requirements

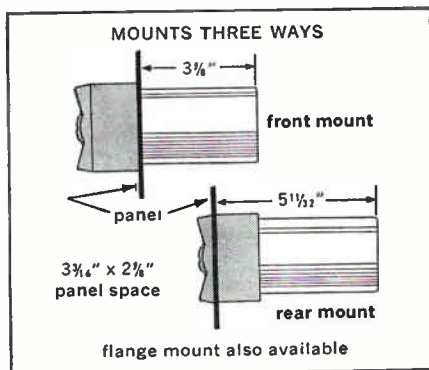

For complete data, write today for Bulletin RB520/521



magnetic moment. The resonant frequency of the modes depends on the strength of the d-c field.

The unloaded Q of the modes is large, and the fields associated with them are such that energy can be conveniently coupled into particular modes. Coupling to certain modes can be accomplished by a loop of wire around the sample. If the loop terminates a coaxial transmission line into which energy is fed at the resonant frequency of a mode, energy is coupled to this mode. The amount of coupling can be controlled by the proximity of the loop to the sample.

**MODE COUPLING**—The relationship of these modes to a parametric amplifier comes from two of their essential features: they are energy storage resonant modes; they can be coupled together by an r-f magnetic field of sufficient intensity and correct frequency. The r-f magnetic field is the pump for parametric amplification. Its frequency must equal the sum of the resonant frequencies of the two modes it is to couple, and it must exceed a threshold. Thus, if the sample is placed in a cavity so that it is properly biased with a d-c magnetic field and so that the r-f magnetic field is maximum, energy can be coupled into one of the modes at its resonant frequency and amplified. The most efficient coupling of the modes occurs with the r-f magnetic field directed along the sample static moment.<sup>1</sup>

Only certain modes can be coupled together with less than infinite pump power. These modes are characterized<sup>2</sup> by a set of three integers ( $n, m, p$ ). For coupling a pair of modes ( $n_1, m_1, p_1$  and  $n_2, m_2, p_2$ ),  $n_1$  and  $n_2$  must be both even or both odd and  $m_1$  must equal  $-m_2$ .

Curves of resonant frequencies of various modes plotted against d-c biasing field<sup>3</sup> enables a pair of modes to be located that can be coupled. This technique can also be used to locate a set of three modes ( $n_1, m_1, p_1; n_2, m_2, p_2; n_3, m_3, p_3$ ) to build a cascaded amplifier. In these modes,  $n_1, n_2$  and  $n_3$  must be all either odd or even and  $m_1$  must equal  $-m_2$  and  $m_3$ . If the modes selected satisfy these conditions, coupling can exist between modes 1 and 2 and modes 2 and 3 but not between modes 1 and 3 since  $m_1$

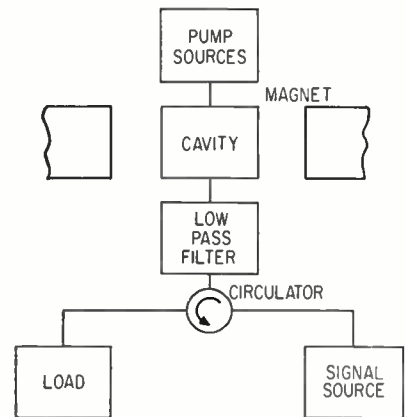

MICROWAVE setup includes low-pass filter to keep pump power from load in ferromagnetic amplifier—Fig. 2

does not equal  $-m_3$ . If the appropriate r-f fields at the respective pump frequencies are present, the equivalent circuit for the arrangement is that in Fig. 1.

When a set of modes has been selected, curves of resonant frequency versus d-c magnetic field are plotted for each mode. One mode must be chosen as the signal mode, another as the idler and the third as the subsidiary idler. By superposing the field frequency curves, a value of d-c magnetic field and a pump frequency are selected so that  $\omega_1 + \omega_2 = \omega_p$  and  $\omega_1 + \omega_3 = 2\omega_p$ .

**CONSTRUCTION** — The cavity must resonate at  $\omega_p$  and  $2\omega_p$  with a large Q at both frequencies. The sample can be mounted in a quartz tube, which is separated from the cavity wall by a Teflon post.<sup>1</sup> The coaxial through which the input is fed can be terminated in a loop surrounding the quartz tube at the sample location. Thickness of the quartz tube can control coupling of the signal mode.

In the general microwave circuit in Fig. 2, the low-pass filter is adjusted to keep pump power out of the load, which is relatively easy if modes with resonant frequencies near  $\omega_p/2$  are selected for signal and idler. Such modes also require the lowest pump power for amplification.

The second pump harmonic can be generated by a ferrite doubler. When amplitudes of the pump fundamental and second harmonic can be controlled individually, amplifier operation can be controlled by ad-



justing relative pump power at  $\omega_p$  and  $2\omega_p$ . Usually operation is most efficient using minimum power at  $\omega_p$ . Amplifier gain can be controlled by varying power at  $2\omega_p$ .

Cascading should enable gain of ferromagnetic amplifiers to be improved materially. Alternatively, the cascading technique should improve operating efficiency at a particular level of gain.

REFERENCES

- (1) R. Denton, *J Appl Phys*, 32, p 300, 1961.
- (2) R. L. Walker, *Phys Rev*, 105, p 390, 1957.
- (3) P. C. Fletcher and R. O. Bell, *J. Appl Phys*, 30, p 687, May 1959.

### Accuracy Is Improved in Vidicon Bandwidth Tests

By J. PIRKLE

Surface Communications Div.  
Radio Corp. of America, Camden, N. J.

BANDWIDTH of vidicon cameras can be measured by a method that is both convenient and accurate. The technique eliminates variations in results by isolating the test signal source from the load.

In normal operation, the mesh of the vidicon is at a-c ground potential and is therefore in parallel with the target load. If an impedance,  $Z$ , is assumed for the load, the transfer circuit can be represented as in Fig. 1A, where  $V_o$  is target signal voltage,  $i(s)$  is target signal current,  $c_t$  is target-to-mesh capacitance and  $Z$  is target load, for which

$$V_o = i(s) Z / (j\omega c_t Z + 1) \quad (1)$$

Bandwidth is measured conventionally by substituting a constant-current signal source for  $i(s)$ . How-

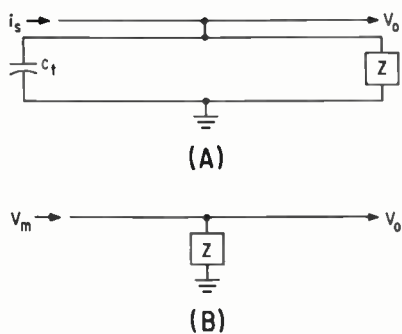

SOURCE of constant current (A) can be replaced by voltage source (B) applied through target-to-mesh capacitance—Fig. 1

### High-Capacitance, Small-Size 'Lytics Now Available for Computer Power Supplies

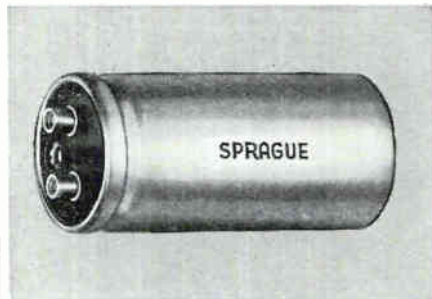

The Sprague Electric Company offers two series of "block-buster" electrolytic capacitors for use in digital power supplies and allied applications requiring extremely large values of capacitance in relatively small physical size.

With metal cases ranging from 1 3/8" dia. x 2 1/8" long to 3" dia. x 4 5/8" long, Type 36D Powerlytic® Capacitors pack the highest capacitance values available in these case sizes. Intended for operation at temperatures to 65 C, their maximum capacitance values range from 150,000  $\mu$ F at 3 volts to 1000  $\mu$ F at 450 volts.

Where 85 C operation is a factor, Sprague offers the Type 32D Compulytic® Series, the ultimate in reliable long-life electrolytic capacitors for digital service. These remarkably trouble-free units have maximum capacitance values ranging from 130,000  $\mu$ F at 2.5 volts to 630  $\mu$ F at 450 volts.

Both 32D and 36D Capacitors have low equivalent series resistance and low leakage currents, as well as excellent shelf life and high ripple current capability.

Tapped terminal inserts, often preferred for strap or bus bar connections, are available as well as solder lug terminals for use with permanently wired connections.

In addition to the standard bare case, either series may also be obtained with a new clear rigid plastic tube which adds very little to the bare case dimensions. They are also available with a Kraftboard tube.

For complete technical data on Type 36D Powerlytics, write for Engineering Bulletin 3431. For the full story on the "blue ribbon" Type 32D Series, write for Engineering Bulletin 3441B to the Technical Literature Section, Sprague Electric Company, 35 Marshall Street, North Adams, Massachusetts.

CIRCLE 203 ON READER SERVICE CARD

### When You Need ELECTRIC WAVE FILTERS

Depend on Sprague for

- ✓ SERVICE
- ✓ DELIVERY
- ✓ RELIABILITY



Sprague Electric Wave Filters for use in telemetry, telephony, and various types of communications systems and laboratory equipment which require selection and/or rejection of specific frequencies are now being designed by *Modern Network Synthesis*, which assures exact matching of wave filter characteristics to application requirements for Low Pass, High Pass, Band Pass, and Band Rejection filters.

Drawing on Sprague's long experience in component manufacture, wave filter engineers are able to employ capacitor, inductor and resistor production facilities for particular sizes, shapes, and materials best suited for specific filter applications. Unlike most filter manufacturers, Sprague is not dependent upon other component suppliers, therefore faster deliveries can be provided.

To further Sprague capabilities, wave filter design and field engineering offices as well as pilot production facilities are maintained in North Adams, Mass.; Vandalia, Ohio; and Los Angeles, Calif. Specialized mass production facilities are located at Visalia, Calif. and North Adams.

For additional information on Sprague Electric Wave Filters, write for Engineering Bulletin 46000 to Technical Literature Section, Sprague Electric Company, 35 Marshall Street, North Adams, Massachusetts.



CIRCLE 63 ON READER SERVICE CARD

# Lapp

## TUBE SUPPORTS

### for air-cooled power tubes

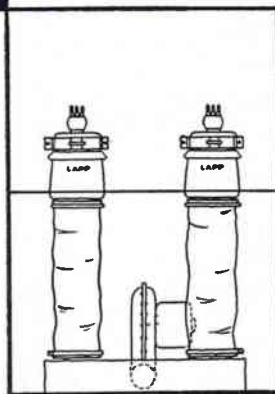
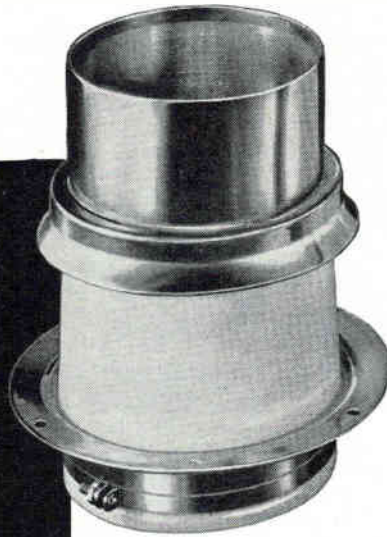

Since forced-air-cooled tubes were first introduced, equipment manufacturers have been designing their own supports, many of which

have been produced by Lapp. To standardize the great variety of tube support designs, Lapp set out to design a complete line which is now available and offers the equipment manufacturer a valuable service by way of more economical production, interchangeability and availability of replacement units. Lapp Tube Supports are compact, efficient and attractive in appearance. Their duty is threefold... they support the tubes, insulate, and furnish an air duct which channels air over tube fins for maximum cooling. Write for Bulletin 301, with complete description and specification data. Lapp Insulator Co., Inc., Radio Specialties Division, 196 Sumner Street, LeRoy, New York.

# Lapp

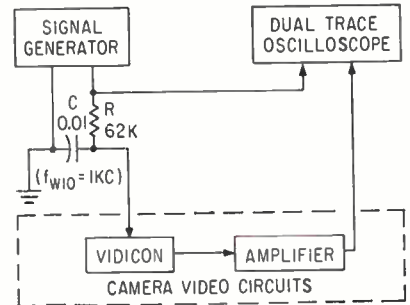

SETUP for measuring vidicon bandwidth is both convenient and accurate—Fig. 2

ever, applying this source to the load invariably disturbs stray capacitance, thereby modifying results. An alternate method is to connect a voltage signal source at  $c_t$ , which isolates the load from the source. If test signal voltage  $V_m$  is applied to the mesh with the socket removed, the transfer functions is as shown in Fig. 1B, for which

$$V_o = V_m j\omega c_t Z / (j\omega c_t Z + 1) \quad (2)$$

Equating Eq. 1 and 2 for the required function of  $(V_m)$  to simulate  $i(s)$  results in

$$i(s) Z / (j\omega c_t Z + 1) = V_m j\omega c_t Z / (j\omega c_t Z + 1), \text{ which solved gives}$$

$$V_m = i(s) / j\omega c_t \quad (3)$$

Eq. 3 indicates that if  $i(s)$  is constant,  $(V_m)$  must vary inversely with frequency. If  $(V_m)$  is derived across the capacitor of a series R-C circuit from voltage source  $(V_g)$ ,

$$V_m = V_g / (j\omega RC + 1) \approx V_g / j\omega RC \quad (4)$$

(for  $\omega > 4/RC$ )

Substituting Eq. 4 into Eq. 3 and rearranging:

$$i(s) = V_g (ct/RC)$$

Thus a true constant-current signal source can be simulated by using the target-to-mesh interelectrode capacitance for signal insertion. The setup for this measurement is shown in Fig. 2. If  $c_t$  is assumed to be  $3 \mu\mu\text{f}$ ,  $i(s)$  ( $\text{m}\mu\text{a}$ ) =  $5 V_g$ .

## Selective Sensors May Spot Enemy Missiles

ENEMY missile detector is one likely application of property sensing cells under development at Armour Research Foundation. Patterned on selective animal vision systems, these single function cells—by filtering out extraneous data at their



source—reduce bandwidth and simplify signal processing.

Cadmium sulfide contrast detector cells deliver an output only when they are nonuniformly illuminated. They deliver no output when illumination remains uniform or overall illumination is changed. Contrast-consciousness could be useful in identifying enemy missiles or industrial complexes during satellite reconnaissance orbits.

Sensor cells as small as 0.5 by 0.5 mm can be formed into a sequentially scanned mosaic retina, according to preliminary work at the microelectronics lab. A single cell in this retinal array of edge detectors, detecting an enemy missile in flight as a nonuniform signal, could provide the earliest possible automatic warning of the potential threat. Industrial buildings, factories, streets and lots yielding nonuniform responses would trigger more detailed scanning, and recording equipment would be energized only when an industrial area was in view.

**BACKGROUNDS** — One critical problem in airborne satellite threat detection has been nonuniform backgrounds of earth and clouds. Sensitivity thresholds could be set so that only the borders of broad areas of homogeneous terrain would elicit a response. The system can also be arranged so illuminated cell outputs are suppressed when a cell cluster indicates large objects.

Greatest current effort in the investigations of property-sensing cells is aimed at developing multiple-output sensors, which yield a signal when several conditions are satisfied, such as from alphanumeric type images. Multiple electrodes have been arranged on a photosensitive material. Each character is then centered on this sensor, and impedance measurements are made between adjacent electrodes. Mathematical analyses of vector distances, inner products and cross correlations determine whether these readings can differentiate each character.

Future investigations are planned in which the size, orientations and fonts of characters will be varied. Ultimate goal is an electrode configuration and a mathematical measuring technique to assure recognition despite misalignments.

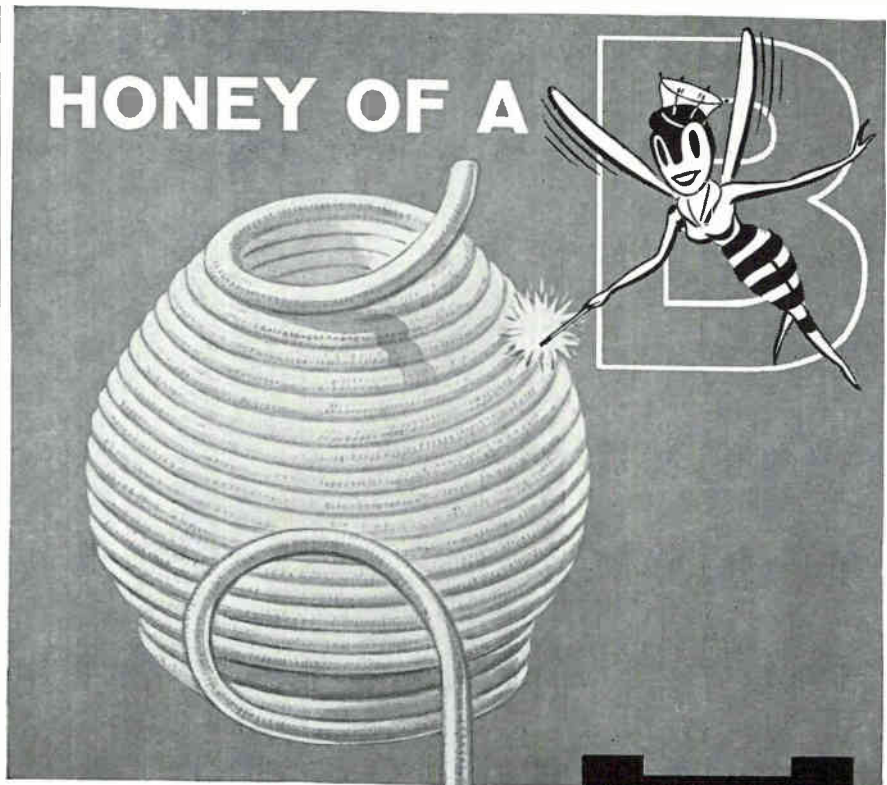

**New Improved**

**HYGRADE**

# POLYTUBE

FLEXIBLE FIBERGLASS  
SLEEVING

Hygrade Polytube, "Queen of the B's" among Class B sleeveings, is now even better. Its braided fiberglass base is coated with newly-formulated resins which impart the flexibility and dielectric dependability usually found only in vinyl coated sleeving, together with improved thermal stability, oil and chemical resistance, and compatibility with other insulations. It is non-thermoplastic, exhibiting good cut-through resistance, and excellent abrasion resistance (tested to MIL-T-5438). Polytube performs to NEMA VS-1 and MIL-I-3190B, and is rated for continuous use from  $-45^{\circ}\text{C}$  (brittle point) to  $130^{\circ}\text{C}$ . It is made in all standard colors, in Grades A, B, C-1, C-2, and C-3.

WITH THE

*flexibility*

OF VINYL AND THE

*compatibility*

OF ACRYLICS



For test samples,  
data and prices,

make a Bee-Line to  
L. Frank Markel & Sons  
Norristown, Pennsylvania



**SOURCE for EXCELLENCE in**

Insulating Tubings and Sleeveings  
High Temperature Wire and Cable

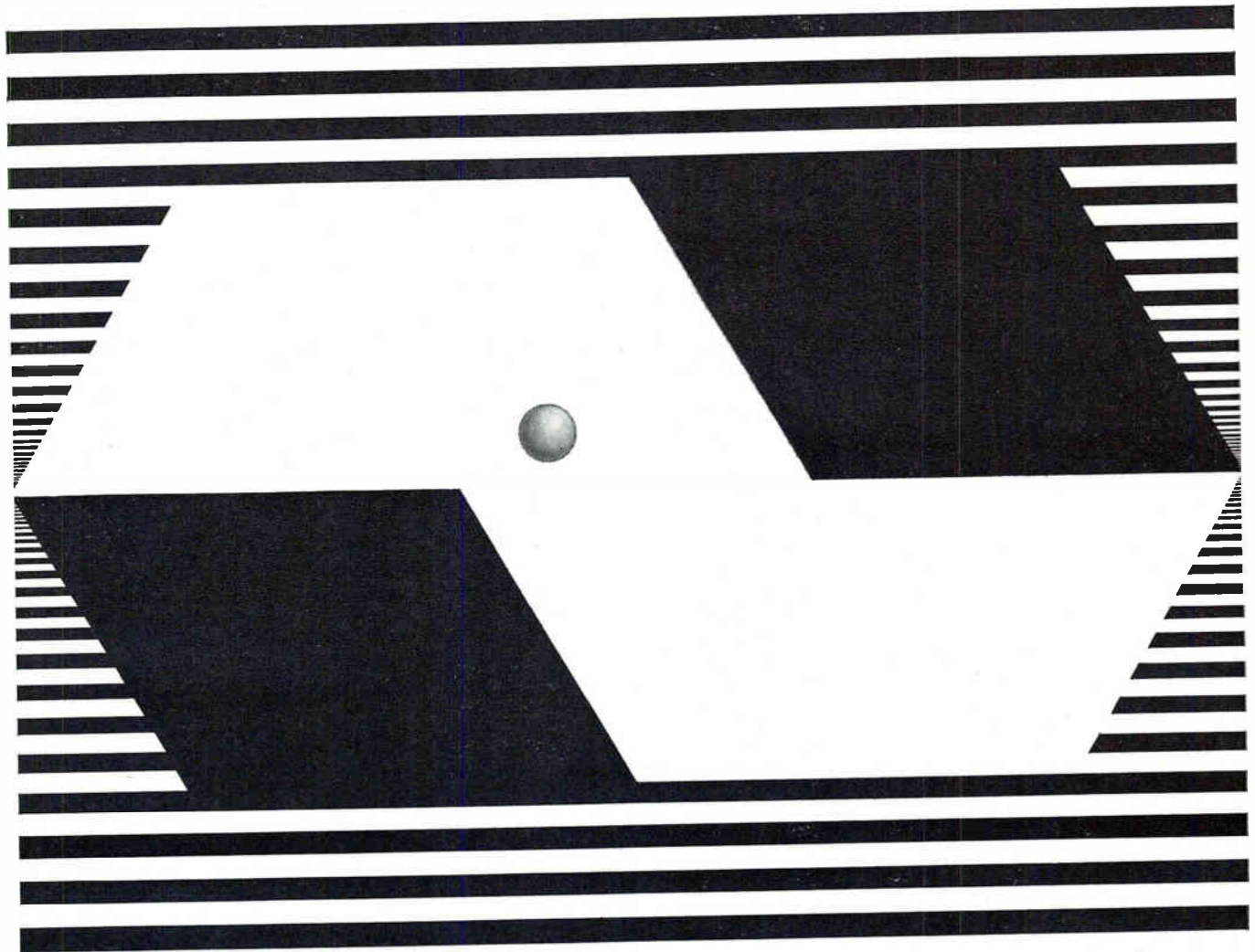

Explorers  
in  
the shape  
of  
things to come

*An idea in the mind of man...* that's where every achievement in the world begins. Peer into the minds of Lockheed Scientists and Engineers. There you see ideas in the making—ideas that some day will take on form and substance. Not all, of course. Some are too "far out." But, no matter how visionary, all ideas win serious attention.

As a result, this freedom of imagination has led to many distinguished accomplishments at Lockheed. And the future holds still more. For, among Lockheed's ever-expanding programs are: Spacecraft; Satellites; Man-in-Space Studies; Hypersonic Manned Aircraft; Advanced Helicopter Design; Sophisticated ASW and Ocean Systems.

*Scientists and Engineers* who thrive in an atmosphere of freedom; whose creative processes flourish through exchange of ideas; who relish exploring the unexplored—to such men we say: Lockheed has a place for you. For example: In Human Factors; Electronics Research; Thermodynamics; Guidance and Control; Stress; Servosystems; Reliability; Dynamics; Manufacturing Engineering; Astrophysics; Astrodynamics; Advanced Systems Planning; RF Equipment Engineering; Bioastronautics and Space Medicine; Weapons Effects; Aerophysics; Digital Communications; Antennas and Propagation Engineering; Tracking, Telemetry and Command Engineering; Communications Analysis. Send résumé to: Mr. E. W. Des Lauriers, Manager Professional Placement Staff, Dept. 1509, 2408 N. Hollywood Way, Burbank, California. An equal opportunity employer.

**LOCKHEED**  
**CALIFORNIA COMPANY**  
A DIVISION OF LOCKHEED AIRCRAFT CORPORATION





# TKK INDUSTRIAL MOTORS

Lowest Drain, Minimum Noise,  
Longest Life — at Low Cost



RM-170 T



FM-250 R



FM-250 N

### APPLICATIONS

- \* Tape-recorders
- \* Record-players
- \* Clocks
- \* Shavers
- \* Music Boxes
- \* Cinecameras
- \* Turntables
- \* Automations
- \* Other Appliances

type	voltage (D.C.)
RM-170 T models	1.5 ~ 3.0 V
RM-170 S models	1.5 ~ 6.0 V
RM-170 SC models	3.0 ~ 12 V
FM-250 N models	1.5 ~ 4.5 V
FM-250 R models	1.5 ~ 6.0 V

Large orders executed reliably and on schedule by the world's largest factory specializing in D.C. magnetic low current motors (Output: up to 2½ million units per month!) Your detailed inquiry is invited — your satisfaction guaranteed.

## MABUCHI SHOJI K.K.

37, Kabuto-cho 2-chome, Nihonbashi, Chuo-ku, Tokyo, Japan  
C.P.O. Box 1084, Tokyo Cables: "NIHONKAKOCO TOKYO"

CIRCLE 204 ON READER SERVICE CARD



### Are you a COMPLETELY INFORMED electronics engineer?

Today you may be working in microwaves. But on what project will you be working tomorrow? You *could* have read **electronics** this past year

and kept abreast of, say, microwave technology. There were 96 individual microwave articles between July, 1961 and June, 1962!

But suppose tomorrow you work in some area of standard electronic components, in semiconductors, in systems? Would you be up-to-date in these technologies? Did you read the more than 3,000 editorial pages that **electronics'** 28-man editorial staff prepared last year?

**electronics** is edited to keep you current *wherever* you work in the industry, *whatever* your job function(s). If you do not have your own copy of **electronics**, subscribe today via the Reader Service Card in this issue. Only 7½ cents a copy at the 3 year rate.

# electronics

September 14, 1962

## How to Design ENCAPSULATED TRANSFORMERS

For certain applications, encapsulated transformers have distinct advantages over conventional designs. Physical design need not be limited to enclosing cases, thus engineering innovations can often be incorporated to improve performance, weight and size. Knowing how to take advantage of these factors, plus many years of experience in creating and producing hundreds of encapsulated transformers, is the service we offer to any new or present customer.

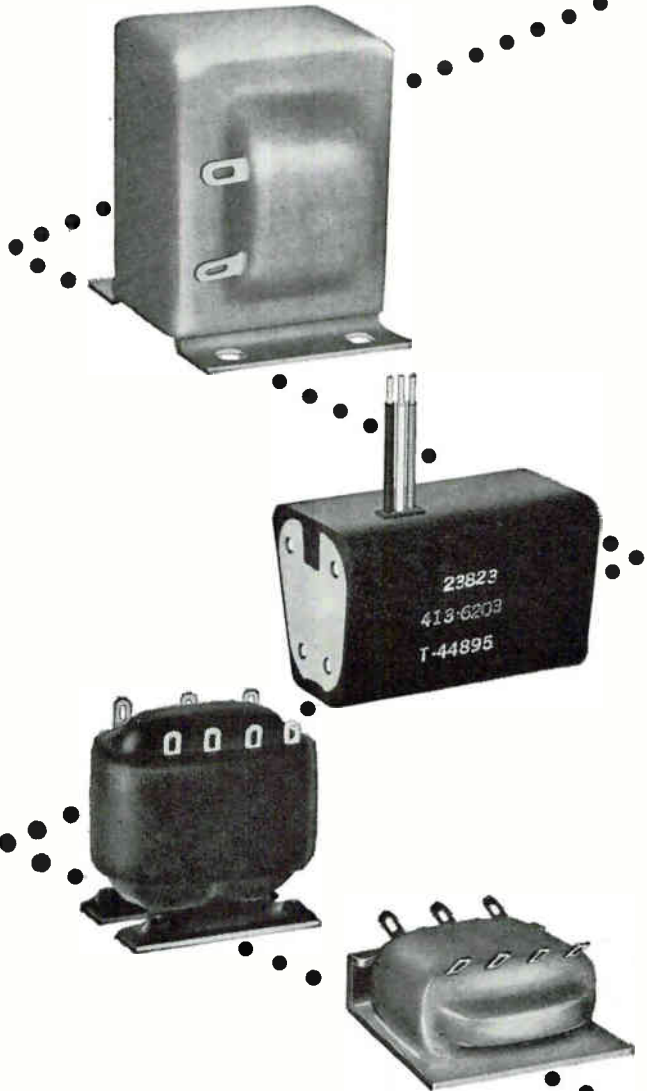

## ACME ELECTRIC CORPORATION

319 WATER STREET • CUBA, NEW YORK  
In Canada: Acme Electric Corp. Ltd., 50 Northline Rd., Toronto, Ont.

SAE/3557-2002 A

# Acme Electric

CIRCLE 67 ON READER SERVICE CARD

# New Approach to Electroluminescent Displays

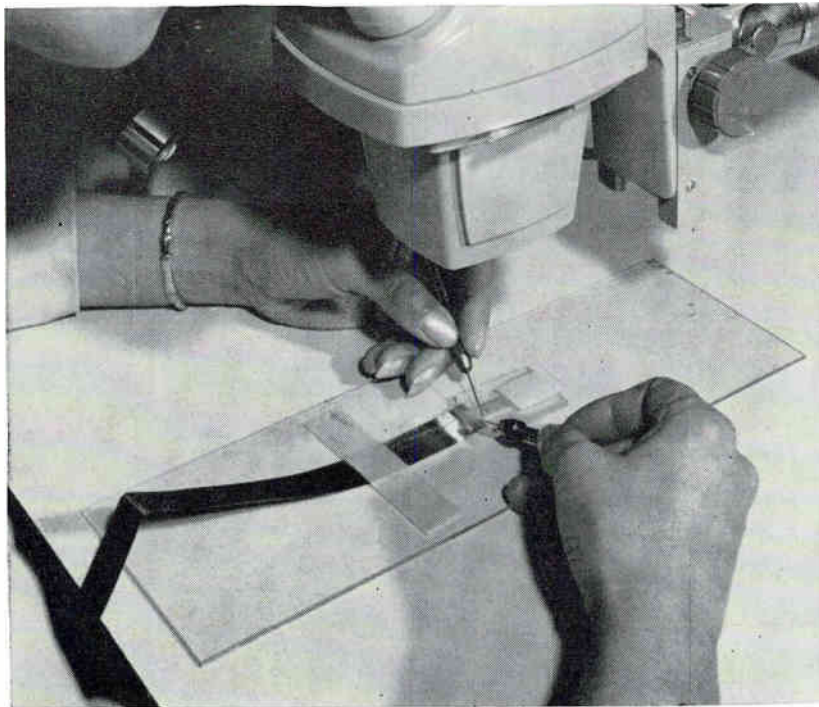

LONG FLAT strip of fine parallel wires, mated to substrate, overcomes major electroluminescent panel obstacle: How to make hundreds of electrical connections to panel and simplify wiring to electronic circuit

## *Solving optical problems common to high-resolution flying-spot scanners*

By P. F. EVANS, C. G. COOK  
D. R. REED

Astronautics Products Dept.  
Kearfott Division, General  
Precision, Inc., Little Falls, N. Y.

COORDINATE PANEL has been made to the exacting needs of an operational electrooptical device.

Electroluminescent light sources can be constructed by evaporating conductive lines on a substrate, depositing a resin-embedded phosphor over the lines, and finally laying down a set of transparent conductive lines at right angles to the first set. Hence a grid pattern is created with a potential light source at each intersection.

If a voltage is applied to each of two intersecting lines, light is generated at the intersection. By ap-

plying the electric field sequentially to appropriate external terminals, the visible spot can be made to progress across the panel, producing a raster scan.

Dynamic information is displayed on electroluminescent panels. When used as a navigational or tactical plotting board, a moving pattern of light shows direction of motion and rate of speed. Actually any information that can be plotted on graph paper can be displayed.

Various low and medium resolution electroluminescent panels were being manufactured at the start of this program; but high-resolution panels with 90,000 elements per sq in. were not available either commercially or on special order.

Although other considerations were involved, the greatest obstacle to high resolution was that of making 300 electrical connections per inch on each of the substrates. The problem of making many connections to fine, tightly spaced lines was sidestepped by a new approach.

Instead of evaporating lines on the substrate, a process was developed whereby a long flat strip of fine, parallel wires could be mated to the substrate. Thus the wires which were external to the coordinate area could be separated and easily connected to the electronic circuit used to provide the raster scan.

A flat strip of parallel wires is made by passing No. 41 wire through a guiding device and winding it on a mandrel. After winding the wire tightly, a bonding coating is applied and allowed to harden. The bonded wires are then slit and removed from the mandrel, forming a sheet of parallel, insulated conductors. Ordinary wire is not suitable for the transparent matrix, and special wire is made by coating glass filaments with a transparent conductive substance and a transparent insulation.

Phosphors were not only evaluated for brightness and discrimination ratio, and had to be tested in the end-use configuration and embedment, as well as energized by pulses appropriate to the end use.

**EVALUATING PARAMETERS—**  
A dual trace oscilloscope technique displaying both voltage and the emitted light waveforms was used to evaluate the effect of changes in various parameters on the light output produced at each coordinate intersection.

The experimental panel is mounted on an optical bench and a lens is used to produce a magnified image of the panel at the aperture of a photometer. Magnifying the image of the panel made it possible to use a larger aperture at the photometer, eliminating the need for an accurately made 0.0033 square inch reticule.

Output of the photometer is coupled to a dual trace oscilloscope so that both the electrical excitation of the panel and the resultant light output can be observed simultaneously. Photographs made with a Polaroid camera provide a perma-



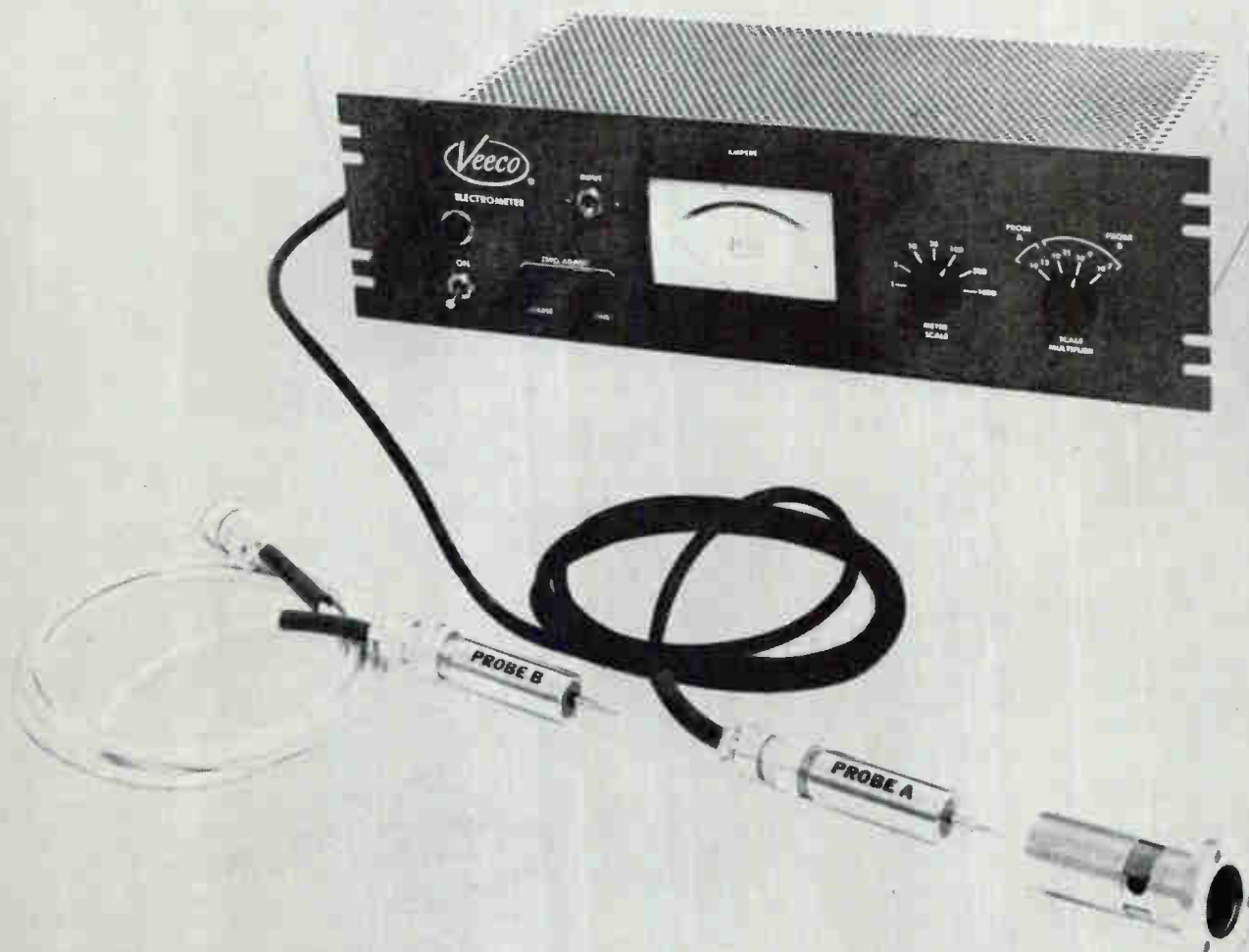

## This new Electrometer is fifteen years old.

The new Veeco EL-1 Electrometer has been reviewed, refined, and updated for over fifteen years. That's how long these sensitive, high impedance micro-microammeters have been in Veeco's renowned Leak Detectors. Now, the EL-1 is available for design into *your* equipment or for *your* use as a separate current measuring device.

The outstanding features of the EL-1 are its two remote interchangeable probes, measuring currents at the signal source. Probe "A" (pictured above) preamplifies and measures cur-

rents in the range  $1 \times 10^{-10}$  ampere to  $2 \times 10^{-15}$  ampere. Probe "B" measures currents from  $1 \times 10^{-4}$  ampere to  $2 \times 10^{-13}$  ampere. Thus, total current measurement of the EL-1 is from  $1 \times 10^{-4}$  ampere to  $2 \times 10^{-15}$  ampere over a twelve decade range. Noise distortion is minimal. Operation is simple.

All the performance-tested quality you have come to expect from Veeco is yours in the new EL-1 Electrometer.

Heard of anyone else who tests a new product for fifteen years?

**VACUUM-ELECTRONICS CORP.**

TERMINAL DRIVE, PLAINVIEW, LONG ISLAND, NEW YORK



CIRCLE 69 ON READER SERVICE CARD

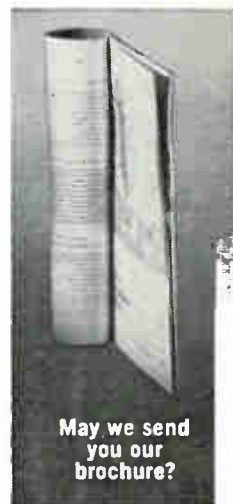

May we send  
you our  
brochure?



# SHIELD

your cables from Radio Frequency Interference with ZIPPERTUBING...

instant jacketing for all applications.

ZIPPERTUBING shields and jackets cables in a single, easy, economical operation. Available in a wide range of materials to meet extreme RFI and environmental conditions, including abrasion, extreme heat and cold.

Send for our free catalog and take advantage of our confidential consultation and design service.

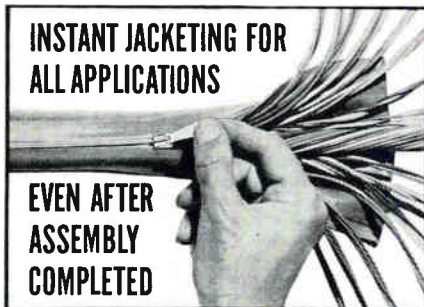

PAT. AND PAT. APP. FOR

THE **Zippertubing**® CO.

Main Office and Plant:  
13000 S. Broadway, Los Angeles 61, Cal. • FA 1-3901  
Eastern Office and Warehouse:  
470 U. S. Hwy. 46, S. Hackensack, N. J. • HU 7-6261

ment record of test results.

Shift register normally used for panel testing produces pulses which are 850 volts peak to peak, and the peak brightness of the light produced is usually between 300 and 400 foot lamberts. This value represents the brightness of a single spot and is contained within an area of slightly less than 20 millionths of a square inch.

Although the peak brightness of a single spot is quite high, the light appears for less than one ten-thousandths of a second and a single flash is invisible to the eye. A spot on the coordinate panel would have to be pulsed 2.5 times for each cycle of a Westinghouse Nightlite lamp for the eye to see a continuous average brightness of two foot lamberts.

The small size of the spot would make even a brightness of two foot lamberts difficult to see. To simplify testing, each spot is pulsed 1,000 times per second to produce a sufficient average brightness for visual alignment.

**EYE LIMITS**—A resolution of 300 lines per inch is too high for the human eye at normal reading distance, although it is ideal for applications where optical systems are used. However, by ganging conductors at the panel's edges, the resolution can be lowered to within the eye's limit. Ganging two conductors gives 150 lines per inch, ganging three gives 100, and so on. Switching can be used to vary the ganging and thus give the panel a variable resolution capability.

Connections for power and signals can be remote. There is little limitation in size, large or small, that a display panel can have. Even curved or flexible panels can be fabricated for special applications. Storage matrices can be built into the panel by using laminations.

With a given configuration, variations of electrical excitation also affects the light output characteristics. In general, higher voltage increases brightness. Higher frequency will also increase brightness, but tends to shift the emitted color to a lower wave length. Similarly, square wave and shaped-pulse excitation have been shown to affect mainly brightness, rise and decay time, and emitted color in complex ways.

Preparation of the phosphor screen contributes another element in control of light output. Phosphor screens are deposited in panels by using a precision Gardner blade. Thin layers, typically one mil thick, are deposited over a copper wire matrix. A second layer is deposited to adhere the conductive glass filaments to the screen.

## Microwatt Counter For Space Computer

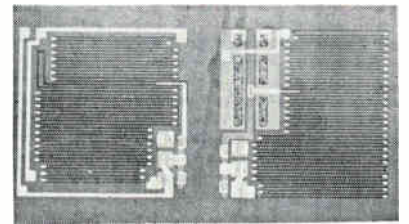

MICROWATT counter stage dimensions are 100 × 200 × 5 mils

THIN-FILM technology for passive components and the usual surface passivated planar technology have been combined both in and on the same wafer with the development of a new microelectronic counter stage that operates at a supply power level of less than three microwatts.

The heavily oxidized silicon surface of the wafer serves as the substrate for vacuum deposited metal resistors. Concept of microwatt microelectronics was formulated by W. W. Gartner, M. Schuller, C. Heizman and C. Levy, all of CBS laboratories. The new counter is now being incorporated into NASA systems.

Counter consumes 10 microwatts d-c at 0.75 volts and operates between -50 and 100 C. Pulse repetition rate is 10 Kc.

## Bent Wire Retains Superconductivity

NIOBIUM-TIN wire can now be processed so that normal mechanical bending does not impair its superconductivity or almost zero resistance to the flow of current at very low temperatures.

Niobium-tin has the highest transition temperature—the point at which the material starts supercon-



# RECORD and MONITOR

on as many as 16 channels



*Simultaneously*

with the new, economical

## DACORD...

Multi-channel

Magnetic Tape Recording System

DACORD systems offer 2-16 channels for simultaneous record/playback of data, comments, etc. Each channel has its own integral monitoring oscilloscope for selectable monitoring and adjustment of signals.

DACORD also features

- Input offset control for maximum sensitivity.
- Wide range of input compatibility.
- System is entirely line operated.
- Fixed or variable bandwidths from DC to 4KC. (Higher frequencies on special order.)
- Modular design for easy expansion.
- Broad line of accessory equipment.

For technical and application information

Write for free bulletin  
"DATA ON DACORD"

 **Electro-Medi-Dyne Inc.**  
60 BAITING PLACE ROAD  
FARMINGDALE, N. Y.

CIRCLE 205 ON READER SERVICE CARD  
September 14, 1962

ducting—of any material so far investigated. It becomes superconducting at 18 deg Kelvin ( $-255$  deg C). However after bending, superconductivity has been lost. Processing methods developed by Materials Research Corporation retained all current carrying capacity of the niobium-tin.

Testing performed at NASA laboratories in Cleveland recently showed that the processed niobium-tin, before bending, carried 200,000 amperes per square centimeter at an applied field of 100,000 gauss. After bending around a  $\frac{3}{8}$ -in. radius, the material had the same current response to the field.

Most immediate application of this material is in winding for magnets. Solution of the superconductivity problem opens the door to many other applications for niobium-tin. Work on this project is being conducted under an 18 month U. S. Air Force contract awarded to Materials Research Corporation of Orangeburg, N. Y. for the establishment of a pilot production facility.

## Tin-Coated Wire Tests

### At Subzero Temperatures

RESULTS OF EXPOSURE of tin-coated wire to temperatures of  $-40$  F to  $-67$  degrees F for periods up to five years were described by Jack Spergel, U. S. Army Signal Research and Development Laboratory at this year's Symposium on Soldering held by the American Society for Testing and Materials in New York City.

Transformation of tin at subzero temperatures from a white solid metal to a gray powder has been known but the concern for this problem has grown recently due to the expanded use of electronics in arctic regions. The complexity of modern electronic equipment has increased the quantity of wiring and components with tin coatings susceptible to transformation. The presence of gray tin powder in electronic equipment may produce a permanent failure or improper performance.

Observations of the tin-coated wire exposure tests disclosed no transformation of white tin to gray tin powder in hot-dip tinned wire,

This new brochure... outlines all the features of Veeco's new EL-1 Electrometer, the unique dual-probe instrument that does the work of two. Learn how and why the EL-1 is capable of measuring currents in the broad range of  $1 \times 10^{-4}$  ampere to  $2 \times 10^{-15}$  ampere.

Charts, detailed specifications, and suggested applications are included in this brochure. Write for your copy today.



**VACUUM-  
ELECTRONICS  
CORP.**



TERMINAL DRIVE  
PLAINVIEW,  
LONG ISLAND, N. Y.

CIRCLE 71 ON READER SERVICE CARD

71

ALL NEW  
from Ingersoll Products

# EMCOR II

## MODULAR ENCLOSURE SYSTEM

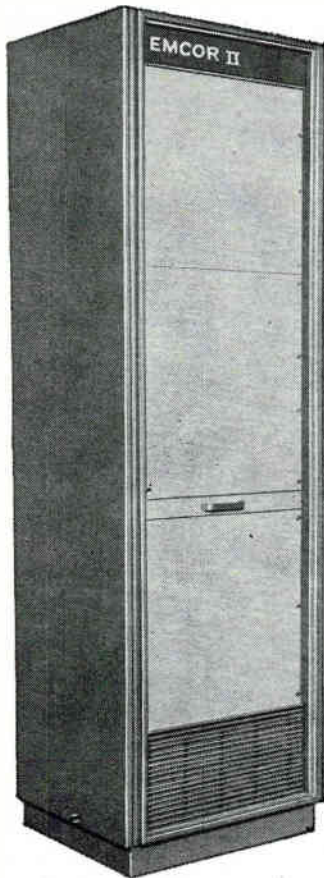

### DESIGNED TO STIMULATE YOUR IMAGINEERING!

EMCOR II Modular Enclosure System provides an exclusive combination of appearance and structural features for distinct, individualized customer identity. Recessed, flush or extended panel mountings; choice of aluminum trim or grillwork extrusions, an assortment of customer nameplate styles, double width frames, pontoon bases and side panels, multi-function enclosures; superior structural strength second to none; externally removable side panels; 1 1/4" pull-out Work Writing Surfaces plus many more features designed to stimulate your imagineering. Your investigation of the EMCOR II Line will be rewarded by virtually unlimited application possibilities.

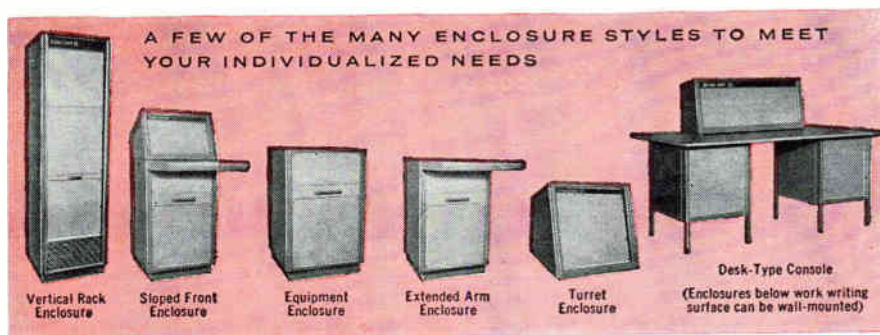

Request New  
EMCOR II  
Literature



**BORG-WARNER®**

EMCOR—The Original Modular Enclosure System By  
**INGERSOLL PRODUCTS**  
Division of Borg-Warner Corporation  
1000 W. 120th ST. • DEPT. 1242 • CHICAGO 43, ILL.

VISIT US AT THE NEC SHOW OCTOBER 8-10—BOOTH 1003

whereas numerous transformations were exhibited in electroplated tinned wire. Transformation in some cases occurred within three months at a temperature of  $-40$  deg. An effective measure in preventing transformation was found to be co-deposition of antimony with the tin.

### Phototube Used For Short Flash Observation

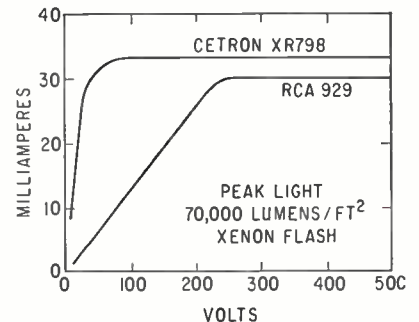

VOLT-AMPERE characteristics of close-anode XR-798 phototube, and 929 phototube, with a peak light of  $7 \times$  daylight or 70,000 lumens per square foot. Area of 929 is 0.0035 square foot. Light on cathode is 235 lumens—Fig. 1

By HAROLD E. EDGERTON  
PAUL W. JAMESON

Department of Electrical Engineering,  
Massachusetts Institute of Technology,  
Cambridge, Mass.

ACCURATE MEASUREMENT of short pulses of light requires certain circuit conditions as discussed by Edgerton and Shaffner.<sup>1</sup> A typical circuit might consist, for example, of a 929 phototube with a 100 ohm load resistor, giving a circuit time constant of 0.015 microseconds. To get a peak output of 3 volts from this circuit requires an applied voltage of 300 volts.

It occurred to one of us that a closer spacing between the anode and cathode might enable the circuit to produce the same output voltage and current with a much lower total applied voltage.

Two sample tubes made by the Cotron Electronic Corporation of Geneva, Illinois show that a plate voltage of 100 v, instead of 300 v, is needed to produce a similar signal to that of the 929.

Figure 1 shows the transient volt-ampere characteristics of the



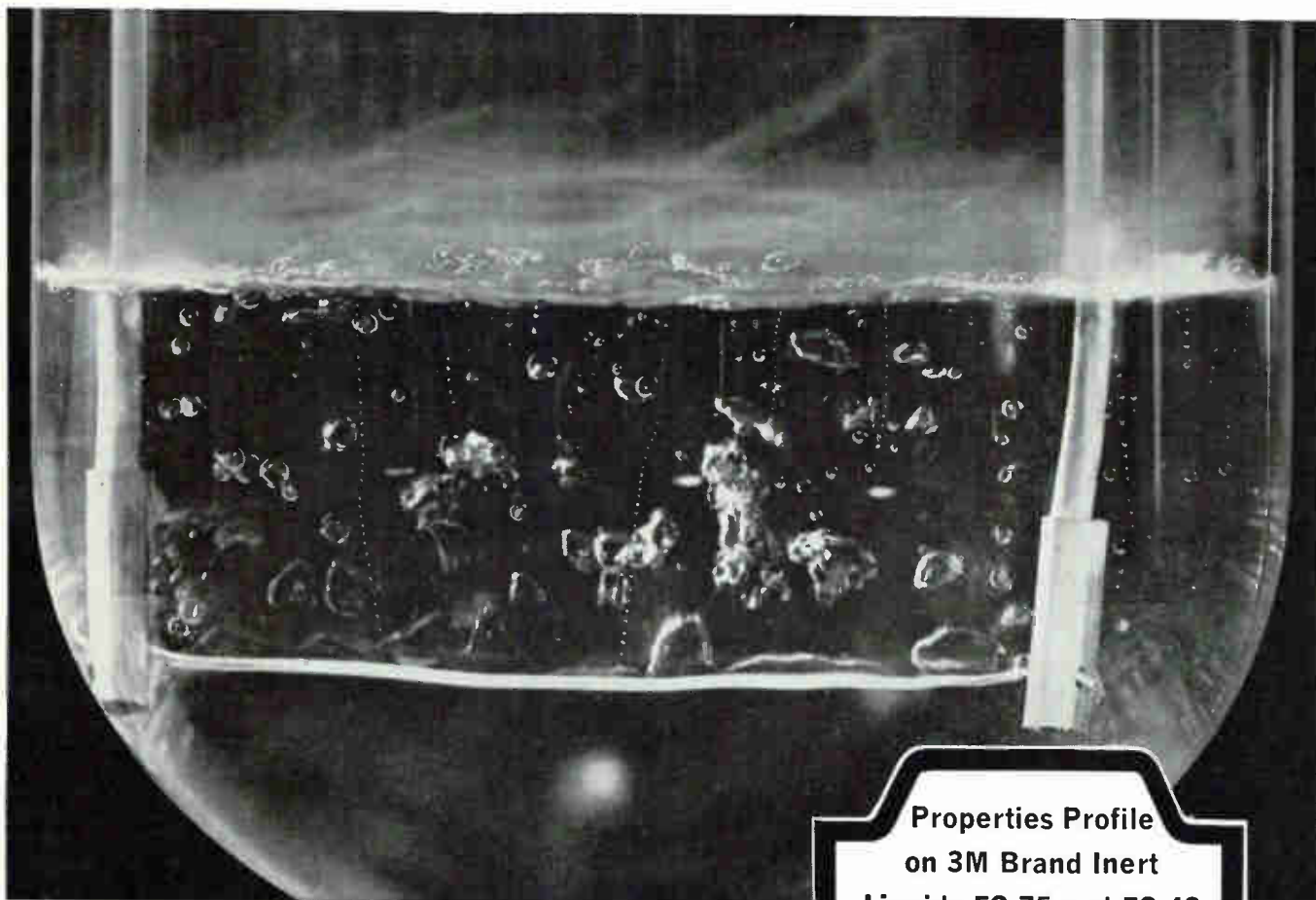

## Heat Fluxes (150-500 watts/in.<sup>2</sup>) no problem when FC-75 cools components!

Using Inert Fluorochemical Liquid FC-75 as a heat transfer medium for cooling electronic gear, designers can practically eliminate hot-spot problems. Heat fluxes—from 150 to 500 watts per square inch, for example—can be handled by this coolant with minimal changes in temperature of components.

FC-75's low boiling point (214°F) permits a high heat transfer rate by evaporation, as illustrated above. Hot spots in a component part attain a temperature above the boiling point of the FC-75, then remain relatively constant. Because of the rapid transfer of heat from the component by the boiling FC-75, burn-out dangers are minimized.

FC-75, as well as its companion product FC-43, are at their best when equipment is specifically designed around their remarkable cooling abilities. FC-75 can remove up to 10 times more heat than such coolants as transformer oil. Thus new designs using FC-75 can drastically reduce the size of electronic units. Design space-savings up to a factor of six have been achieved.

FC-75 is stable up to 750°F and is completely compatible with most materials. It is non-explosive, non-flammable, non-toxic, odorless, and non-corrosive. Unimpaired by arcing, it heals itself in either the liquid or vapor state. Because of its thermal stability, no sludges are formed. Write for further information, and for specific application details.

### Properties Profile on 3M Brand Inert Liquids FC-75 and FC-43

#### ELECTRICAL PROPERTIES

	FC-75	FC-43
Electrical Strength	35KV	35KV
Dielectric Constant (1 to 40 KC @ 75°F)	1.86	1.86
Dissipation Factor (1000 cycles)	<0.0005	<0.0005

#### TYPICAL PHYSICAL PROPERTIES

	FC-75	FC-43
Pour Point	< -100°F	-58°F
Boiling Point	212°F	340°F
Density	1.77	1.88
Surface Tension (77°F) (dynes/cm)	15	16
Viscosity		
Centistokes (77°F)	0.65 Min.	2.74
Thermal Stability	750°F	600°F
Chemical Stability	Inert	Inert
Radiation Resistance	25%	25%
	change @ 1 x 10 <sup>8</sup> rads	change @ 1 x 10 <sup>8</sup> rads

*For more information on FC-75 and FC-43, write today, stating area of interest to: 3M Chemical Division, Dept. KAX-92, St. Paul 1, Minn.*

Gertsch General Purpose RatioTran<sup>®</sup>

# NOW... A LOW-COST AC INDUCTIVE VOLTAGE DIVIDER —ACCURATE TO 0.001%



In addition to the high accuracy, unit features high input impedance, low effective series impedance, and very low phase shift. You get characteristics comparable to those of more expensive instruments, in a Gertsch-quality unit.

**5-decade transformer switching.** Instrument is ideal for checking servos and resolvers...for voltmeter calibration, computer testing, and transformer turns ratio measurements.

**Compact size**—only 3½ inches high. Designed for bench mounting, and easily adapted to half-rack mounting with brackets furnished.

*Send for literature on the RT-60 Series.*

## *Gertsch*

GERTSCH PRODUCTS, Inc.

3211 South La Cienega Boulevard, Los Angeles 16, California/Upton 0-2761 • Vermont 9-2201

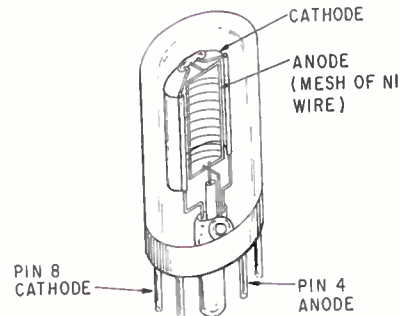

ANODE-CATHODE structure of Cetron XR-798 phototube showing mesh anode shaped to give close spacing to the cathode—Fig. 2

Cetron tube No. XR-798, and the conventional type 929.

The XR-798 Cetron phototube, Fig. 2, is mounted in an octal base so that the tube is interchangeable with the 929. Anode to cathode capacitance of the XR-798 is 7.5 pf while that of the 929 is 4 pf.

The 929 phototube has the type S-4 surface which has a peak sensitivity in the blue, and very small sensitivity in the red. According to the Cetron Company, the XR-798 has a surface resembling the S-10 which like the S-4 lacks red sensitivity.

The close spaced anode-cathode phototube is of great utility in the laboratory for the measurement of the pulses of light from lasers, flash lamps, shock tubes, and similar subjects where light pulses of short duration and high intensity must be measured with good time resolution.

#### REFERENCE

(1) H. E. Edgerton and R. O. Schaffner, Measuring Transient Light with Vacuum Phototubes, *ELECTRONICS*, Aug. 25, 1961, p. 56.

### Aluminum Evaluated For Cryogenics

TESTS of aluminum at temperatures approaching minus 460 deg. F, so-called absolute zero, have produced conclusive findings that at extreme cold this versatile metal retains and even improves upon its desirable strength characteristics.

The findings, reported to the Cryogenics Engineering Conference at UCLA by research scientists of the Battelle Memorial Institute are expected to have important bearings on future contributions of aluminum to space ex-



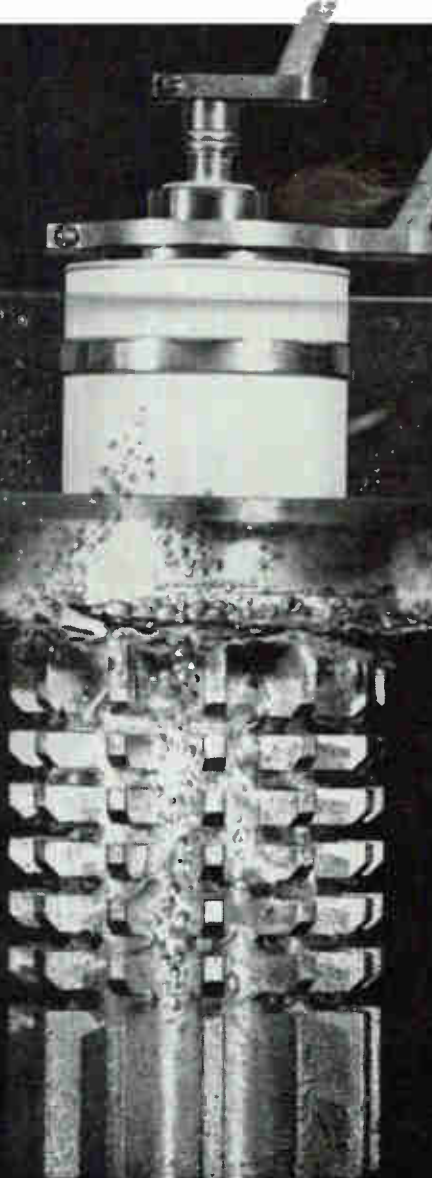

# BOILING FOR "COOL" PERFORMANCE

This tube, the new ITT F-7832 Power Triode is in an open glass tank to demonstrate the new evaporative cooling method. Cooling water is shown boiling at the segmented copper cooling fins. Bubbles are rising off the surfaces and steam is escaping. Normally the tube is enclosed in a boiler (photograph at right) which, in conjunction with an external condenser, becomes a complete system.

Conventional water cooling is capable of dissipating 450 watts/sq. in. Forced air cooling dissipates 150. The ITT Evaporative Cooling



System will dissipate in excess of 800 watts/sq. in. It will operate in an overload condition at 1600 watts/sq. in. with no damage. In addition, ITT Evaporative Cooling offers the advantages of noiseless operation, absence of rotating parts such as blowers and pumps, minimum servicing, self cleaning of tube, and minimum liquid coolant. ITT Evaporative Cooled Tubes feature ceramic construction. The new rugged, mesh cathode, another design innovation, provides improved emission per watt, quick heating and excellent temperature stabilization.

# ITT

*Write for information on the new ITT Evaporative Cooled Power Tubes. Application assistance is available for your specific requirements.*

**ELECTRON TUBE DEPARTMENT ■ COMPONENTS DIVISION**

INTERNATIONAL TELEPHONE AND TELEGRAPH CORPORATION, CLIFTON, NEW JERSEY

ITT COMPONENTS DIVISION PRODUCTS: POWER TRIODES AND DIODES • IATRON STORAGE TUBES • HYDROGEN THYRATRONS • TRAVELING WAVE TUBES • SELENIUM RECTIFIERS • SILICON DIODES AND RECTIFIERS • TANTALUM CAPACITORS

CIRCLE 75 ON READER SERVICE CARD

# NEW FOR PRINTED CIRCUITRY

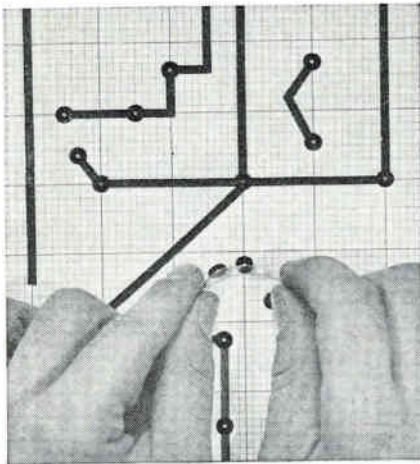

## Place symbols 40% faster with new Trans-Pak

New Trans-Pak makes printed circuit drawings easier to prepare.

You press on a die-cut terminal circle symbol accurately — without distortion — in less than three seconds!

Each Trans-Pak symbol is mounted half-on, half-off the edge of a transparent carrier tape. Just strip the carrier from the roll, position the symbol, press on it, then pull away the carrier. No picking off. No fumbling. No eyestrain.

New Trans-Pak symbols come in ruby red translucent or black crepe paper — 250 to a roll — in 18 sizes ranging in outside diameter from .10" to .50". Like all Chart-Pak pressure-sensitive materials — ovals . . . conductor paths . . . fillets . . . circles — Trans-Pak rids you of routine work on printed circuit drawings, even acts as a resist on printed circuit plates

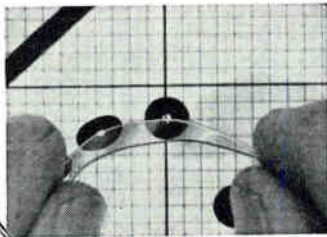

Write for more details on Trans-Pak today. And don't forget to ask for free catalog of Chart-Pak tapes, symbols and sheets that simplify drawings, slides, maps, graphs — almost any visual presentation.

**CHART-PAK, INC.**

ORIGINATOR OF THE TAPE METHOD OF DRAFTING

163 RIVER ROAD, LEEDS, MASSACHUSETTS  
Dealers in principal cities in U.S. and Canada  
(See Yellow Pages)

ploration and other applications involving cryogenic temperatures.

The Battelle investigation, sponsored by The Aluminum Association, was undertaken to evaluate the tensile behavior of aluminum alloy No. 5083 at the temperature of liquid helium—minus 452 deg. F. The alloy, one of the 5000 series of aluminum-magnesium alloys, was tested in plate form.

Earlier laboratory tests had established the suitability of this and other aluminum alloys at temperatures as low as minus 423 deg. F, the temperature of liquid hydrogen.

## Hermetic Seal for Tantalum Capacitor

SEALING tantalum foil capacitors by means of tantalum-to-glass bonding techniques will be achieved on 10 experimental models to be developed within eight months and 50 final models, with test data, to be readied 10 months later. The units, employing a true hermetic seal, will be made at G.E.'s Electronic Specialty Capacitor plant, Irmo, South Carolina, and delivered to the Signal Corps Laboratory, Fort Monmouth, New Jersey.

The capacitors will be rated 100  $\mu$ f, 75 v, d-c, 85 C. They will use etched tantalum foil construction and will be enclosed in a single tubular metallic case with axial leads and glass-to-metal and/or ceramic-to-metal seals.

## Strontium Generator Seeks Higher Output

TWO FORMS of strontium have been combined into a one-piece thermoelectric generator which serves as its own heat source. The new device is a small strontium-titanate rod with strontium-90 concentrated at one end. Radioactive strontium-90 spontaneously produces heat, which is converted to electrical energy through the thermoelectric effect in the strontium titanate.

Efficiency of the experimental device is low and power output is a tiny fraction of a watt, but continued development at Martin may significantly increase both. Barium and cerium titanates, uranium, and plutonium are also being explored, might use same principle.



## ultra-high precision capacitors

Southern Electronics high-precision capacitors are demonstrating their proven reliability today in twelve different missiles, analog computers, and many radar and communications applications.

SEC high-precision capacitors utilize polystyrene, providing .01% tolerances, and mylar and teflon to meet .5% requirements. They show excellent stability characteristics over an extended temperature range, and tolerances are unaffected even at extreme high altitudes.

The unusual accuracy, stability and reliability of SEC capacitors are the result of engineering experience concentrated on the design and manufacture of precision capacitors only, plus rigid quality control standards subjecting each capacitor to seven inspections during manufacture, plus final inspection.

Our engineering experience enables us to meet your size requirements, while holding to exact capacitance and tolerance specifications.

SEC capacitors are manufactured in a wide range of capacitance to meet your needs from 100 mmfd. to any higher value, and meet or exceed the most rigid MIL-SPECS.

Write today for detailed technical data and general catalog.



**SOUTHERN  
ELECTRONICS**  
*Corporation*

150 WEST CYPRESS AVENUE  
BURBANK, CALIFORNIA

CIRCLE 206 ON READER SERVICE CARD

electronics



# WHAT IS THE "HH" SERIES?

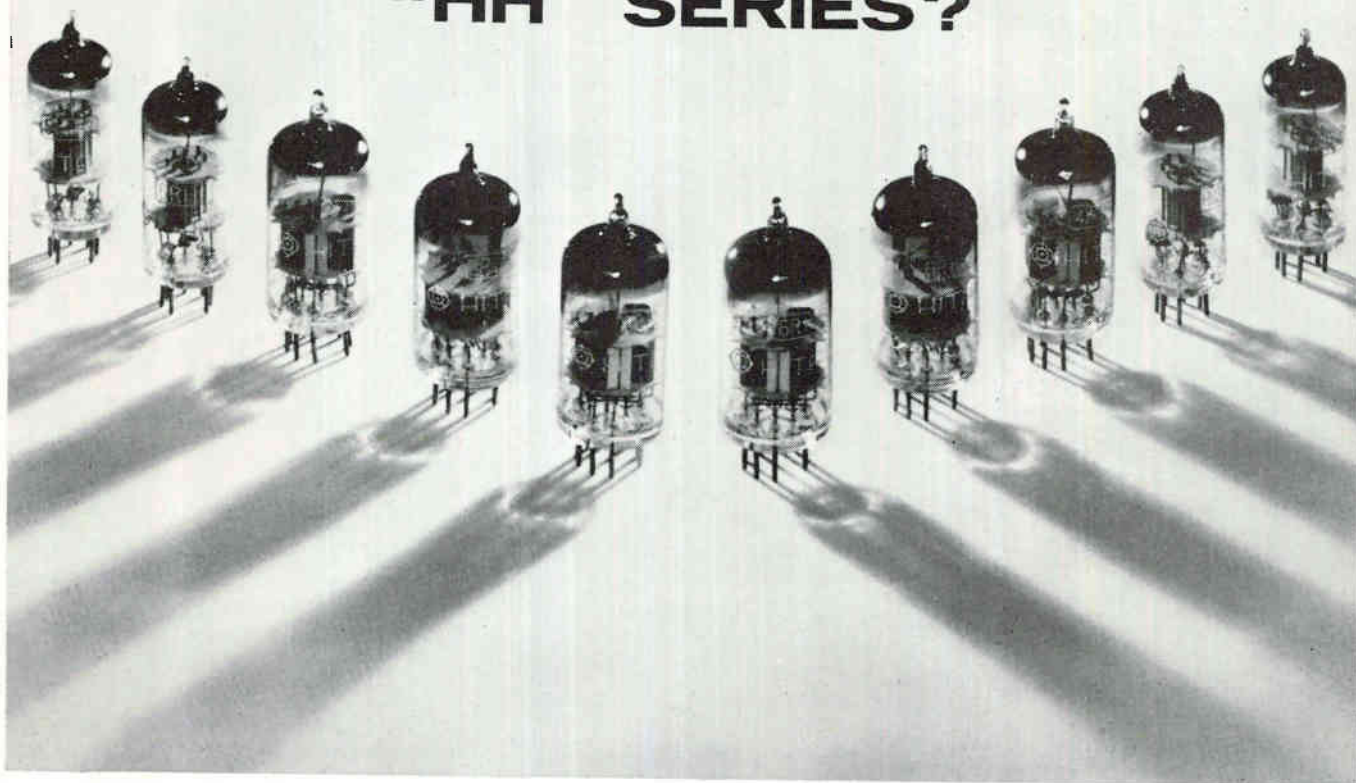

The "HH" series is Hitachi's new superior line of television receiver tubes, the ultimate in far-reaching reception of television waves.

For RF amplifier of VHF television tuners, specify the 4R-HH2 and 6R-HH2 which feature very high transconductance, high sensitivity and low noise. These twin triode tubes replace the 4BQ7A and 6BQ7A without change of circuit.

For frequency convertor and local oscillator of VHF television tuners, specify 5M-HH3 and 6M-HH3 twin triodes which replace the 5J6 and 6J6 without change of circuit.

The "HH" series is another fine quality line from Hitachi, one of the most completely integrated electrical manufacturers in the world.

## INTERNATIONAL IMPORTER INC.

2242 South Western Avenue,  
Chicago 8, Illinois, U.S.A.



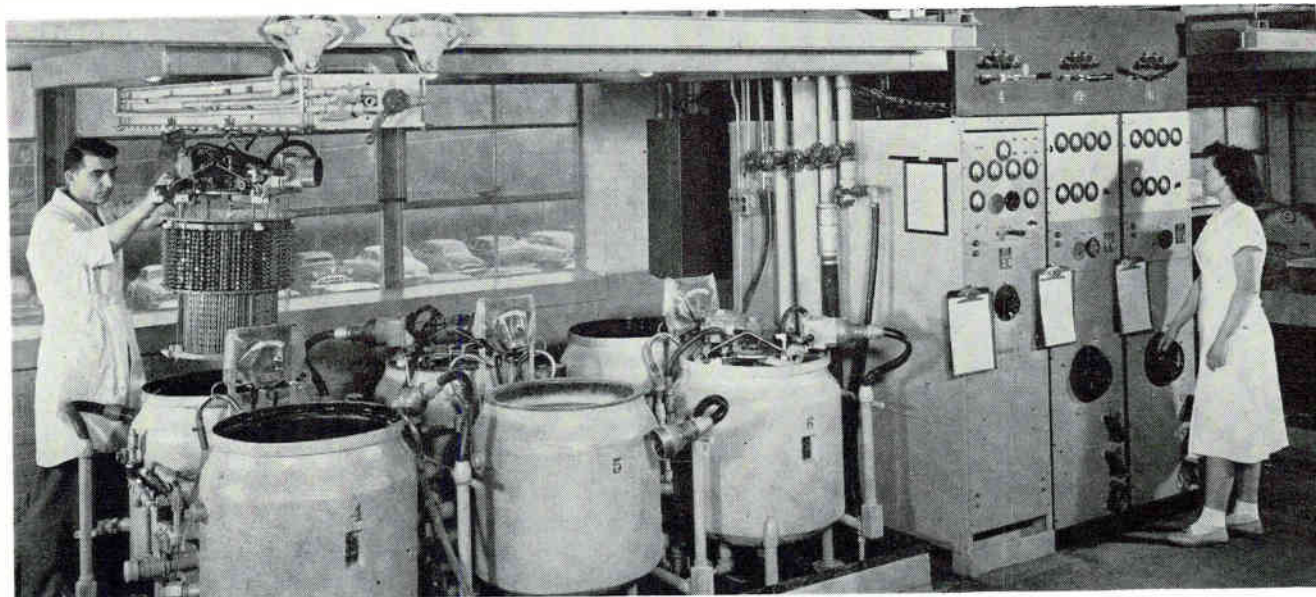

EACH STEP in capacitor manufacturing was investigated to increase reliability by optimizing materials and operations. Electrical forming or anodizing takes place in these tanks

## Reliability of Tantalum Capacitors Increased

*Two-stage case crimping, higher purity materials are the main changes*

By JAMES H. HALL  
Rectifier-Capacitor Div.,  
Fansteel Metallurgical Corp.,  
N. Chicago, Ill.

FAILURE RATES for wet tantalum capacitors have been reduced from 3.43 to 0.173 percent per 1,000 hours (life tested at rated working voltage and maximum rated temperature) by a continuing program of production improvement at this division. The program for improving quality control and processing techniques was initiated several years ago, when reliability specs beyond those possible at the time began to appear.

A testing program on samples from production lots was started to identify the design changes and production techniques that held the most promise for increasing reliability. A board of review was established to review data and examine components that failed as well as those that did not. Research, Development, Quality Con-

trol, Product Engineering, and Manufacturing were represented on this board.

Some improvements involved design changes while others came from better control of existing production techniques. All changes were monitored after they were made.

**TWO-STAGE CRIMP**—Wet tantalum capacitors are sealed with an elastomer gasket material. One of the first problems was to produce a more satisfactory, reproducible seal. The silver capacitor case had originally been crimped to the elastomer gasket in a single operation, but this was found to set up high stresses in the crimp, resulting in relaxation after the crimping die pressure was removed. As a result, electrolyte leakage would occur in a few units.

The relaxation problem was reduced by introducing a two-stage crimping machine. The silver case now is only partially crimped at the first stage, thus minimizing the stresses set up, and a second stage crimp completes the seal and compensates for any relaxation following the first crimp. Failure rate per

thousand hours was reduced by approximately one-half by this operation. Two-stage crimping is performed on a rotary table with individual stations for each stage, so increased reliability is accomplished with no additional cost.

**PURITY LEVELS**—A number of production changes deal with the stability and changes in parameters of the capacitors throughout the environmental testing range.

Tight quality control specifications were set up on tantalum powder, sheet, and wire so as to obtain the best electrical characteristics and lowest impurity levels. These specifications continue to get tighter as the technology of producing the raw materials improves and as continuing analysis of failures shows new direction for improvement. Several changes in processing tantalum powder have resulted in the impurity levels being reduced to a few parts per million in the finished product.

**WELDING**—Another way to improve reliability through production was to improve the weld between the tantalum anode wire and





# 300°C NANOSECOND DIODE

## THE INSIDE STORY OF UNIPLANAR\* VS. MULTI-PART CONSTRUCTION

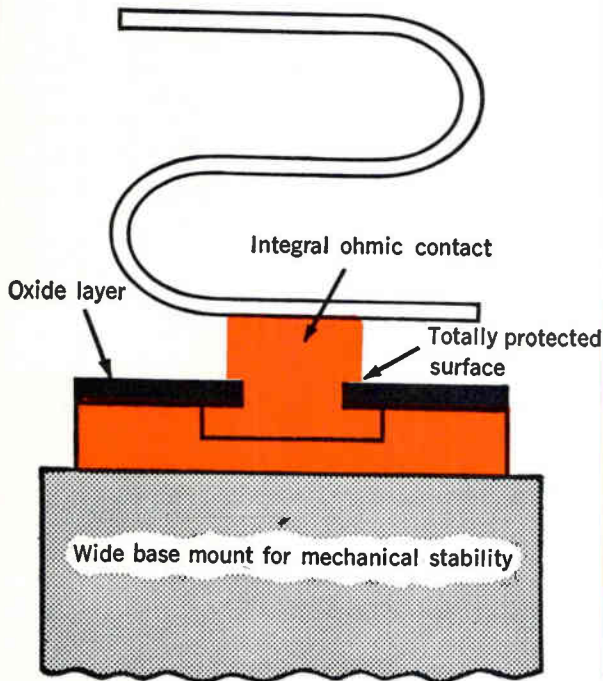

RAYTHEON/RHEEM UNIPLANAR\* DIODE

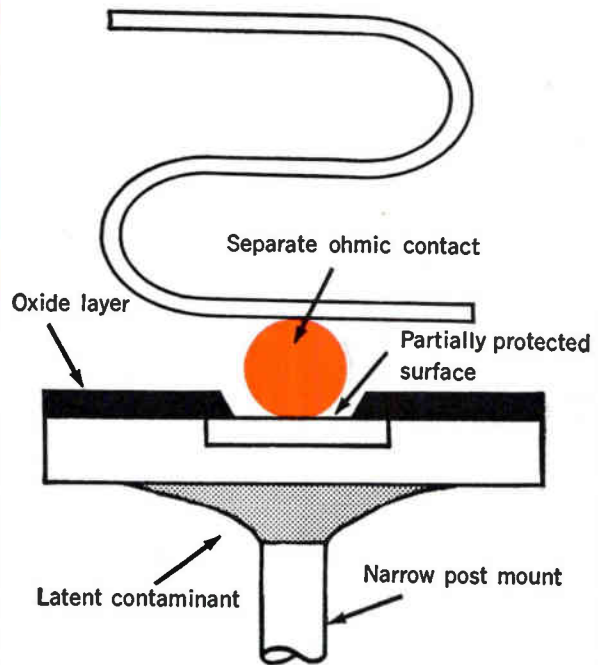

CONVENTIONAL PLANAR MULTI-PART DIODE

## UNIPLANAR\* construction boosts silicon diode reliability

Uniplanar\* one-piece construction, produced at Raytheon/Mountain View (formerly Rheem Semiconductor), brings a major improvement to silicon planar diode reliability. This is demonstrated by a 300°C storage capability, unequalled shock and vibration resistance, and more uniform electrical characteristics.

The result of Raytheon/Rheem Uniplanar\* construction is a one-piece unit that can't shake loose or become misaligned. The entire chip assembly, including ohmic contact, is formed by a single process. This technique permits positive

surface passivation of the entire junction area. A high level of uniformity is achieved, since ohmic contacts are chemically formed thousands at a time.

300°C storage is obtained because, for the first time, it is possible to exclude the latent contaminants introduced by multi-part assembly techniques.

Uniplanar\* construction is available at no extra cost in such types as 1N914, 1N916, 1N3064, and 1N251. For further information, please contact the nearest Raytheon Field Office.

\* Exclusive one-piece planar construction from Raytheon/Mountain View (formerly Rheem Semiconductor).



**For production line testing,  
quality control,  
trouble shooting...**

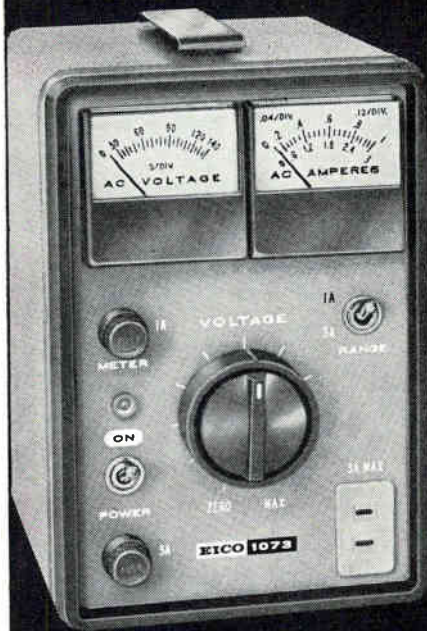

**EICO® NEW METERED  
VARIABLE AUTO-  
TRANSFORMER  
AC BENCH  
SUPPLIES**

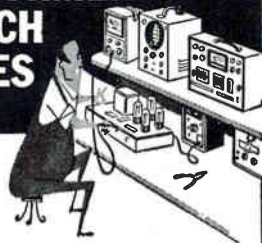

- Deliver any voltage up to 140 VAC
- Linear variation of output throughout entire range
- Smooth rotary brush-tap controlled by dial on panel
- Highly efficient variable auto-transformer of toroidal core design
- No waveform distortion or voltage drop from no-load to full-load
- Separate output ammeter and output voltmeter
- Dual range ammeter: Switching permitted under load
- Rugged, compact, professional appearance

Study the performance of electric or electronic components under varying line conditions . . . expose intermittent components by inducing failure with over-voltage . . . check power consumption . . . compensate for power line voltage variations.

Model 1073 (3 amp. rating)  
Kit \$35.95    Wired \$47.95  
Model 1078 (7½ amp. rating)  
Kit \$42.95    Wired \$54.95  
(Add 5% in the West)

See the 41 additional test instruments . . . helpful for your lab and production work. Write for free Catalog & name of Distributor.

EICO Electronic Instrument Co., Inc.  
Dept. E-9A, 3300 N. Blvd., L. I. C. 1, N. Y.  
Export Dept: Roburn Agencies, Inc.  
431 Greenwich St., New York 13, N. Y.



TANTALUM capacitors have been made more reliable by close control of all production operations

the nickel lead that serves as the positive terminal of the capacitor. Welding equipment was redesigned to provide better control of time and current, and tantalum oxide is removed from that portion of the wire held by the electrodes of the welding machine.

A much more uniform and stronger weld is obtained with the new methods.

**SINTERING**—Pressing and sintering of the anode structures was modified to produce a more constant density throughout. Sintering temperatures and times were changed as the optimum temperature and time for a particular anode structure and powder type were established.

Sintering furnaces were designed for more uniform temperatures throughout the sintering load, and to eliminate gas leakage and back-streaming.

The changes in sintering and in powder impurity levels produce a much purer tantalum anode, making possible the reduction of the d-c leakage limits to a fraction of previous limits.

**LIFE TESTING**—The need for more uniform processing of the

fine silver cast that forms the cathode of wet capacitors was discovered through the data accumulated from life testing. Techniques were introduced to produce a greater and a more uniform surface area.

Leakage of d-c current during life testing at high temperatures was another problem where improvement proved possible. While the tantalum oxide film that forms the dielectric of the capacitor is one of the most stable that is known, investigation indicated that even the usual low value of d-c leakage current could be further reduced by using anodizing techniques.

Anodizing involved investigation and establishment of optimum specifications for electrolytes, current density, anodizing electrolyte, anodizing time, and electrolyte temperatures.

Improvements introduced in all of the variables resulted in a substantial increase in the stability of the capacitors and a dramatic increase in reliability. While it is impossible to assign increased reliability rates to any factor individually, they are responsible collectively for the overall improvement of failure rates of present day capacitors.



## Precious Metals Make Scrap More Valuable

By W. F. PARRY

Handy & Harman, New York, N.Y.

ONE OF THE MOST overlooked sources of profits in industry is the scrap heap. Many companies can save thousands of dollars a year simply by making sure that scrap with precious metal content is not thrown away indiscriminately.

Scrap often contains quantities of precious metals—gold, silver, platinum—that, when recovered through advanced detection and refining methods, are worth large sums. In many cases not only precious metals but also the base metals from which they are extracted are recoverable and valuable. For example, molybdenum is often gold plated and tungsten silver plated. The molybdenum and tungsten have considerable value even after the gold and silver has been recovered.

The precious metal content of scrap is constantly rising because the use of precious metals in industry is rising. In electronics, precious metals are often used to obtain greater miniaturization with better electrical properties. The noble metals are being used to a greater degree in all types of instrumentation because of their resistance to corrosion. Photography, including X-ray photography, is another area where valuable scrap is often thrown away.

**CHECKLIST** — Many electronic companies are using precious metals in one form or another in their manufacturing operations. Not all of the uses are always known.

(1) Does your company buy precious metals in any form? If it does, you have an added stake in a scrap recovery program since a reliable refiner will carry all metal recovered for you on his books in your name and return to you new metal for manufacturing.

(2) Does your company buy parts, components, soldering materials, etc., containing precious met-



## slash production costs with new automated coil winder ... fewer operators ... more coils per operator

Leesona No. 116 will wind 400 to 1,000 bobbin coils per hour... with one operator.

All the operator does, as the rotary table brings the winding heads to her, is load bobbin on arbor, clip start wire.

Automatically the No. 116 closes tailstock, tapes start lead, resets counter, starts winding, stops at  $\pm 2$  turns, waxes or tapes finish lead, indexes arbor, cuts wire, ejects and sorts.

It winds two or more different coils up to 3" diameter by  $2\frac{3}{8}$ " long... simultaneously. Supports and winds from 100 lb. wire container, and stops when spool or container is empty. Six to twelve two-speed heads wind wire AWG 16 to 50 and finer.

No. 116 is designed by Robert Bachi. We build it to the cus-

tomer's specifications. For details call your nearest Leesona representative.



**LEESONA CORPORATION**  
Warwick, Rhode Island

B.2.2

Offices: 5700 West Diversey Ave., Chicago, Ill. 1500 Walnut St., Phila. 2, Pa.  
Sales Representative: A. R. Campman, Los Angeles, Calif.  
Offices and demonstration rooms in Heywood, England; Paris, France; Frankfurt, Germany



## HOW TO INCREASE YOUR READING CAPACITY

ECCO's block, punched-tape reader can digest 80, 96, 120 or 160 bits of information at a step (depending upon the model you select). It's better designed for applications like machine tool control and automatic checkout and tests. For instance, it offers a complete test per block; identification of data function by position in block; elimination of data storage records and address decoding circuits. Straight-forward programming by blocks. Standard units read 80, 96, 120, 160 bit blocks. In modular or standard 19" rack mounting units. Takes 1", 8-level paper or mylar tape punched on 0.1" centers. Reader head designed for either forward or reverse reading. Most models are bi-directional. Write for data sheets.

**CIRCLE 207 ON READER SERVICE CARD**

Automation Division  
**Electronic Engineering Company**  
 of California  
 1601 E. Chestnut Avenue • Santa Ana, California  
 Phone: 547-5501, P.O. Box 58 • Representative In  
 Western Europe and Israel: Electronic Engineering  
 S.A., C.P. 142 Fribourg, Switzerland. EE 2-50

als in any form? Since these items are made or assembled elsewhere, it is common to overlook the fact that scraps, rejects, or turnings from these parts or materials may contain quantities of precious metals.

(3) Does your company work such parts, either in assembly or repair operations?

(4) Do any aspects of your operation involve plating solutions and rinse tanks? One company used to scrap silver plating baths; now it receives about \$8,000 a year for silver recovered.

(5) Do you run your own photo processing laboratory? Sensitized paper and film are major sources of recoverable silver. For example, many companies throw away unexposed leaders in a roll of film although these have significant recoverable silver.

(6) Do you operate technical or research laboratories in which precious metals are being used?

(7) Do your operations include chemical processing that produces precipitates, sludges, and sediments? For example, do you use catalysts?

Setting up a program to recover valuable scrap is essentially an educational job. In many cases the logical person to head up the recovery program is the purchasing agent. He knows whether or not precious metals are purchased directly and in what quantities.

However, a large plant may have a salvage supervisor. Elsewhere it might be the foreman, or heads of departments most directly involved. In other cases the responsibility might logically fall on technicians, if the chief use and recovery potential lies in the technical research areas.

**RECOVERY PROGRAM**—The following procedures have helped a number of plants recover valuable metals that were previously lost.

(1) Estimate all sources of possible metal recovery. A list of possible sources of disguised precious metals is given in the table. If it is uncertain whether a plant-wide recovery program is worthwhile, a plant survey may be in order.

(2) If it seems likely that sufficient precious metals can be recovered, the plant's scrap disposal

## ELECTROPLATED WIRES

Many years of experience and production plus advanced facilities for continuous electroplating—(considered largest in the industry)—enable us to produce coatings that are exceptionally uniform and well-bonded to the base wire... Purity of metals and quantity deposited are always precisely controlled... We plate Gold, Silver, Nickel, Tin, Indium and many other metals onto clad wire or Nickel, Phosphor Bronze, Copper, Silver, etc.... Send us your requirements.

### SIGMUND COHN

Mfg. Co. Inc.  
 121 South Columbus Ave.  
 Mount Vernon, N. Y.



Quality  
 With  
 Economy

SIGMUND COHN CORP. OF CALIFORNIA • 151C NORTH MAPLE STREET, BURBANK, CALIFORNIA



program should be checked.

(3) If the scrap program is not satisfactory, then the movement of all precious metals, from the time the material or part enters the plant until it goes to the scrap heap should be charted. The important thing is to know at all times where the material is, how it is being processed, and what happens to any scrap resulting from processing.

(4) A depot for all scrap, in a separate area, should be established and a security system adopted.

(5) Keep all scrap readily identifiable as precious metal and separate from all other scrap. For example, don't mix silver turnings with steel scrap in a single container, since a small amount of silver, gold, platinum or rhenium may be worth more than a whole carload of unanalyzed scrap.

(6) No matter how worthless scrap may look, if it contains recoverable metals, send a sample to a firm equipped to analyze and refine precious metals. Whether or not the scrap has sufficient precious metal content for recovery can be determined quickly.

#### PARTIAL LIST OF PRECIOUS METAL SCRAP

Turnings, chips, shavings  
Silver on steel bearings  
Silver steel turnings  
Grindings  
Blanking scrap, stampings, strip, wire  
Powder mixtures  
Screen scrap  
Solder scrap  
Brazing alloy scrap  
Contact alloy scrap  
Silver on steel, tungsten, molybdenum  
scrap  
Bimetal scrap  
Silver paint waste, wipe rags, paper,  
cans  
Old batteries  
Plating solutions  
Precipitates, sludges and sediments  
Coated copper wire and racks  
Filter pads  
Anode ends  
Tank scrapings  
Electrolytic silver  
Hypo solutions  
X-Ray film  
Coated plastics, ceramics, glass, mica,  
quartz, etc.  
Chemicals  
Mirror solutions—silver nitrate  
Platinum-bearing material  
Gold on molybdenum or tungsten wire

## New From T/I MODEL 654 transistor and diode tester

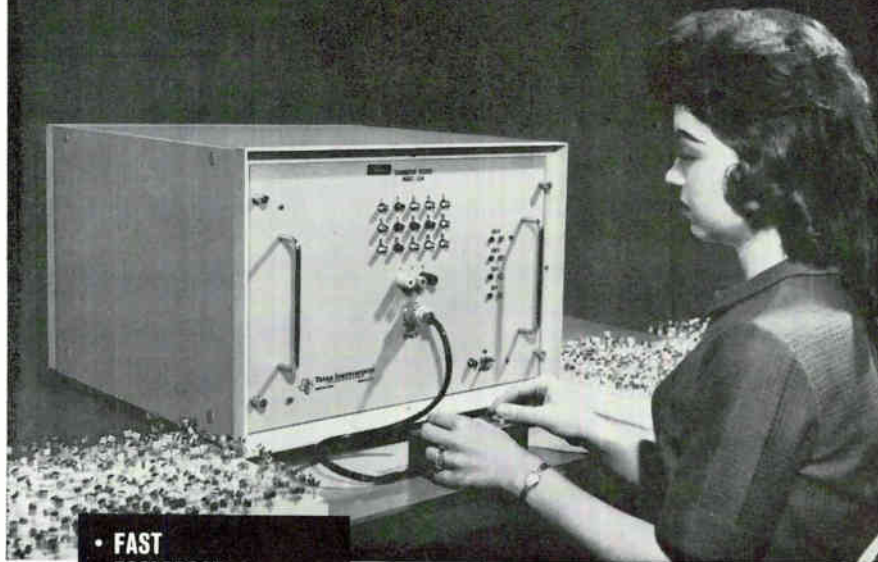

- FAST
- FOOLPROOF
- AUTOMATIC SORTING
- EASILY PROGRAMMED
- FLEXIBLE

## 15 Tests in Less Than a Second!

Texas Instruments Model 654 Transistor and Diode Tester combines speed and accuracy with complete flexibility of application. Fast reprogramming through use of printed circuit boards makes the Model 654 equally useful for high-volume, single-device testing or batch testing of a variety of devices.

**High Speed.** Fifteen parameter testing of 1800 devices per hour. Each test position can be set to provide a testing time of 50 milliseconds to 3 seconds.

**High Accuracy.** Null detector senses variations of less than 2 millivolts and/or 10 nanoamps. Power supply regulation is better than 1 per cent.

**Minimum Operator Training.** Only two controls are accessible to the operator, the ON-OFF switch on the front panel and the START push button on the test fixture. The testing cycle starts when the push button is released. Lights indicating failed tests remain on until the operator starts the next test cycle.

**Fast Reprogramming.** Electrical conditions for each test are preprogrammed on printed circuit boards. By merely changing circuit boards a completely new program may be obtained.

**Flexible System.** Circuit boards built to customer specifications. Modular power supplies permit direct substitution for special requirements. Automatic sorters in six- and eight-bin sizes are available as standard accessories.

Write for complete information.

APPARATUS DIVISION  
PLANTS IN HOUSTON  
AND DALLAS, TEXAS



TEXAS INSTRUMENTS  
INCORPORATED  
3609 BUFFALO SPEEDWAY  
P. O. BOX 66027 HOUSTON 6, TEXAS

495

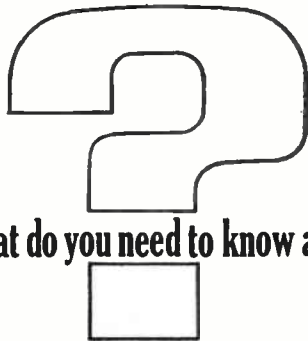

What do you need to know about

**PURE FERRIC OXIDES**  
**MAGNETIC IRON OXIDES**



Since the final quality of your production of ferrites and magnetic recording media depends on the proper use of specialized iron oxides—you'll find it mighty helpful to have the latest, authoritative technical data describing the physical and chemical characteristics of these materials. This information is available to you just for the asking. Meanwhile, here are the highlights.

**PURE FERRIC OXIDES**—For the production of ferrites, both hard and soft, we manufacture a complete range of iron oxides having the required chemical and physical properties. They are produced in both the spheroidal and acicular shapes with average particle diameters from 0.2 to 0.8 microns. Impurities such as soluble salts, silica, alumina and calcium are at a minimum while  $Fe_2O_3$  assay is 99.5+%. A Tech Report tabulating complete chemical analysis, particle shape, particle size distribution, surface area, etc., of several types of ferric oxides, hydrated ferric oxide, and ferroso-ferric oxide is available.

**MAGNETIC IRON OXIDES**—For magnetic recording—audio, video, computer, and instrumentation tapes; memory drums; cinema film striping; magnetic inks; carbon transfers; etc.—we produce special magnetic iron oxides with a range of controlled magnetic properties. Both the black ferroso-ferric and brown gamma ferric oxides are described in a Data Sheet listing magnetic properties of six grades.

*If you have problems involving any of these materials, please let us go to work for you. We maintain fully equipped laboratories for the development of new and better inorganic materials. Write, stating your problem, to C.K. Williams & Co., Dept. 25, 640 N. 13th St., Easton, Pa.*

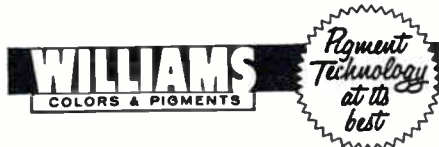

E. ST. LOUIS, ILL. • EASTON, PENNA. • EMERYVILLE, CALIF.

84 CIRCLE 84 ON READER SERVICE CARD

# DYNAMICS

## TEST EQUIPMENT

for

- integrity of test data
- reliable operation
- quality construction

**Model 4072**—dc micro volt-ammeter. Fully isolated, this instrument operates from an automatically rechargeable nickel-cadmium battery—hence eliminates the power line from low-level measurements in sensitive circuits.

Wide voltage and current range: 100  $\mu$ V to 1,000 V, and 0.1  $\mu$  amps to 1.0 amp.

Mirror-back scale eliminates parallax. Scale is 7.2" long, for easy reading.

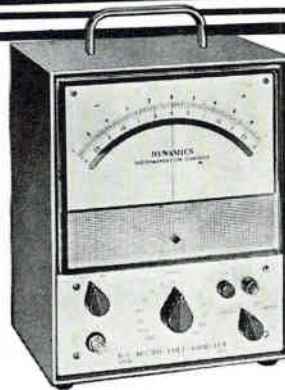

Accuracy:  $\pm 1.0\%$  of full scale on all ranges.

Typical applications: Potentiometric measurements, null indication, measuring thermocouple output and contact potentials... diode matching.

Dynamics manufactures a wide variety of microvoltmeters, micro volt-ammeters, micromultimeters, and general test equipment. Write for complete literature on Model 4072, or the entire line.

**DYNAMICS** INSTRUMENTATION COMPANY

583 Monterey Pass Road, Monterey Park, Calif. • Phone: CUMberland 3-7773

CIRCLE 208 ON READER SERVICE CARD

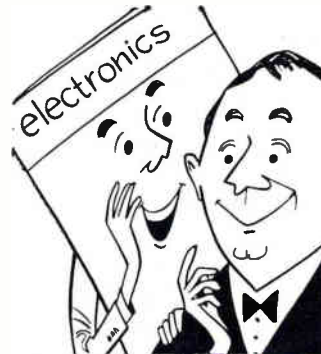

**electronics**  
**IS EDITED**  
**TO KEEP YOU**  
**FULLY INFORMED**  
— a "well-rounded"  
engineer

What's your *present* job in electronics? Do you work on computers? (*electronics* ran 158 articles on computers between July, 1961 and June, 1962!) Are you in semi-conductors? (For the same period, *electronics* had 99 articles, not including transistors, solid-state physics, diodes, crystals, etc.) Are you in military electronics? (*electronics* had 179 articles, not including those on aircraft, missiles, radar, etc.)

In all, *electronics'* 28-man editorial staff provided more than 3,000 editorial pages to keep you abreast of all the technical developments in the industry. No matter where you work today or in which job function(s), *electronics* will keep you fully informed. Subscribe today via the Reader Service Card in this issue. Only 7½ cents a copy at the 3 year rate.

# electronics

electronics



ARE WE  
HUGHES ENGINEERS  
THE LEONARDOS  
OF THE  
SPACE AGE?

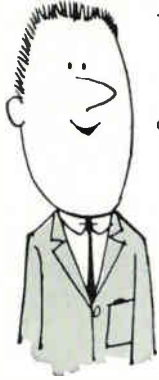

I CAN'T ANSWER  
THAT QUESTION.  
HEAVEN KNOWS,  
I'VE DEBATED  
IT OFTEN  
ENOUGH

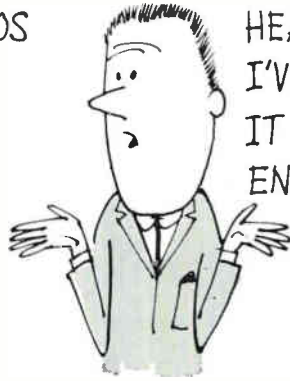

IT'S TRUE THAT  
WE'VE WRUNG A FEW  
SECRETS OUT  
OF THE  
UNIVERSE

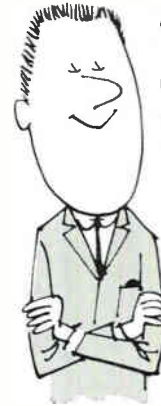

BUT WE'RE NOT ALL FLAIR  
AND INSPIRATION. IT'LL  
TAKE A LITTLE WORK  
TO SOFT-LAND THE  
SURVEYOR ON THE MOON

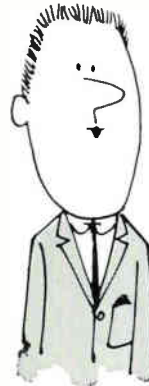

GUESS THAT'S  
WHY WE HIRED  
MORE NEW GUYS  
TODAY

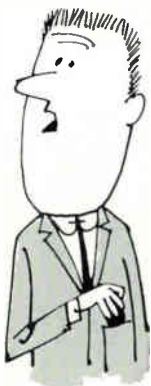

I HOPE THEY  
REALIZE  
THINGS ARE  
GETTING TOUGHER  
AROUND HERE



ALL HUGHES  
ENGINEERS  
ARE RESTRICTED  
TO ONE  
PLANET APIECE

I WORRY ABOUT IT-  
BUT YOU  
CAN'T TELL  
BECAUSE OF  
MY SUN TAN

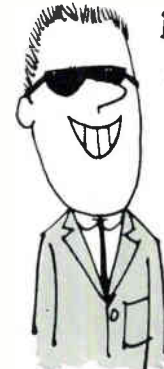

**Hughes is hiring!** Numerous opportunities now exist in a variety of advanced projects and studies. Examples include: The SURVEYOR—which will soft land an instrumented payload on the moon, SYNCOM—synchronous-orbit communications satellite, VATE—automatic test equipment for ballistic missiles, anti-ballistic missile defense systems—boost-intercept, mid-course and terminal, and many others. Positions are open at all levels for specialists with degrees from accredited universities.

**CONTROLS ENGINEERS.** Concerns airborne computers and other controls related areas for: missiles and space vehicles, satellites, radar tracking, control circuitry, control systems, control techniques, transistorized equalization networks and control servomechanisms.

**CIRCUIT DESIGNERS.** Involves analysis and synthesis of systems for: telemetering and command circuits for space vehicles, high efficiency power supplies for airborne and space electronic systems, space command, space television, guidance and control systems, and many others.

**INFRARED SPECIALISTS.** To perform systems analysis and preliminary design in infrared activities for satellite detection and identification, air-to-air missiles AICBM, infrared range measurement, air-to-air detection search sets, optical systems, detection cryogenics and others.

**SYSTEMS ANALYSTS.** To consider such basic problems as: requirements of manned space flight; automatic target recognition requirements for unmanned satellites or high speed strike reconnaissance systems; IR systems requirements for ballistic missile defense.



Please airmail  
your resume to:

**Mr. Robert A. Martin**  
Head of Employment  
Hughes Aerospace Divisions  
11940 W. Jefferson Blvd.  
Culver City 24, California

Creating a new world with Electronics

**HUGHES**

HUGHES AIRCRAFT COMPANY  
AEROSPACE DIVISIONS

An equal opportunity employer.

# DESIGN AND APPLICATION



## Microphone Cancels 23 Db Ambient Noise

*Carbon unit uses two acoustic chambers to balance diaphragm*

MANUFACTURED by Roanwell Corp., 180 Varick St., New York 14, N. Y., the model C-500 Confidencer carbon microphone fits into a conventional 500-style telephone handset. The unit effectively cancels from 14 to 23 db of the ambient noise normally transmitted by a conventional microphone. As shown in the sketch, the voice consists primarily of spherical wave sound pressure level *A* that enters the front port and strikes the diaphragm. The portion of sound pressure which does not enter the front port impinges on the rear of the diaphragm at a much lower level. Noise, at sound

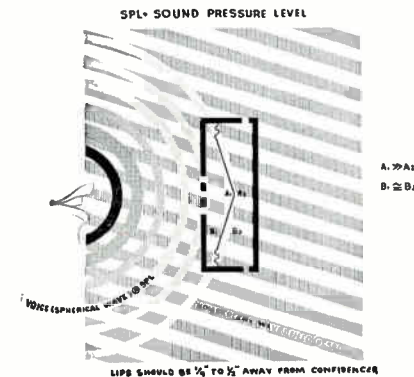

pressure level *B* is primarily a plane wave emanating from a distant source. This plane wave envelops the noise cancelling microphone, entering both front and rear sound ports at the same time and same level. This wave impinges on the front and rear of the diaphragm at the same time and at approximately the same level. Therefore, the diaphragm does not react to sound pressure level *B* inasmuch as its pressure is equal both on the front and rear. Sound pressure level *A* is much greater on the front of the diaphragm than on the rear and the diaphragm reacts to this sound pressure level generating a voltage determined by the voice input.

CIRCLE 301, READER SERVICE CARD

## Accelerometer Features High Sensitivity

DEVELOPED by Massa Div. of Cohu Electronics, Inc., Lincoln St., Rte 3A, Hingham, Mass., the AC-105 accelerometer has an open circuit sensitivity of 600 mv per g, dynamic range between 0.00005 to 200 g, minimum resonant frequency of 10 Kc and a maximum cross axis sensitivity of 2 percent. The unit consists of a mass-loaded assembly (see sketch) of ADP (ammonium

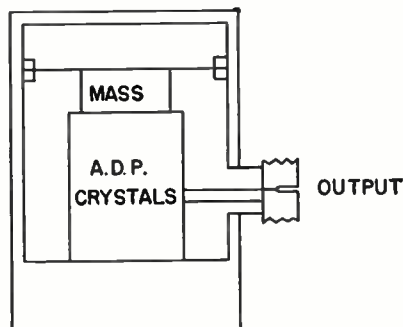

di-hydrogen phosphate) crystal plates mounted within a stainless steel housing. For constant acceleration applied along the longitudinal axis, constant stress occurs along the piezoelectrically sensitive axes of the crystal elements. This results in a generated voltage directly proportional to applied acceleration and independent of frequency to beyond 3 Kc. Effect of mass loading the crystal assembly is to increase stress per unit g which results in extremely high accelerometer sensitivity of 600 mv/g. The ADP crystal has a very high degree of uniformity and long time stability. (302)

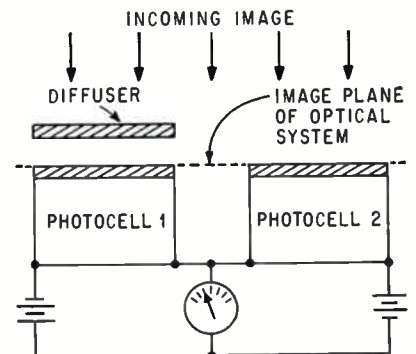

## Static Device Indicates Optical Focus Directly

ANNOUNCED by LogEtronics, Inc., 500 Monroe Ave., Alexandria, Virginia, the Focatron meter can be used to check parallelism of a film holder, lens and copy board; checking that ground glass and film holder are in same plane; calibrating and testing autofocus devices; selecting optimum lenses; checking lenses for field curvature and color correction; calibrating tapes; and focusing on a particular spot with a view camera. Three types are available; one for use in view camera, process camera or enlarger easel and the other is intended for on-easel use in any standard enlarger. The third model is for use in microfilm cameras. The basic



60 CPS REF. & EVENT

# Honeywell test instrumentation records structural soundness of missiles

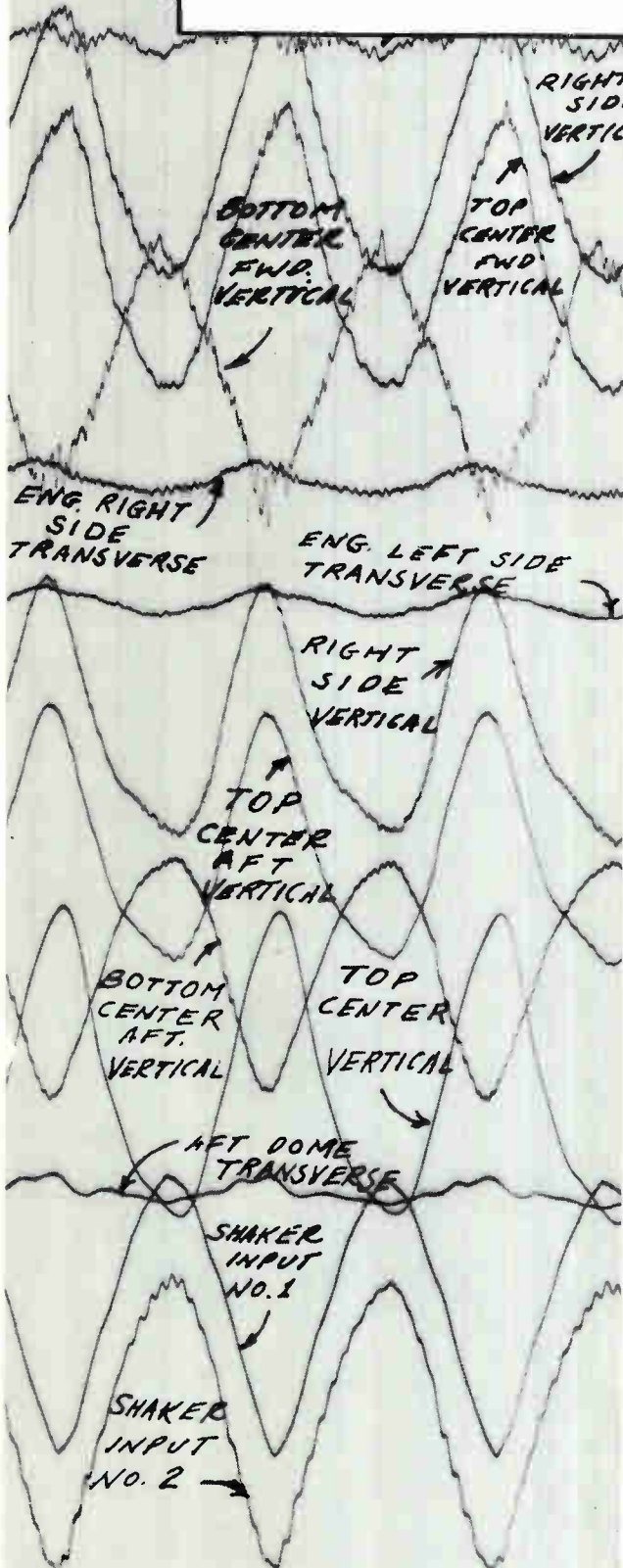

20 CPS 20"/SEC

## System records 112 test parameters simultaneously

Wyle Laboratory, at its Norco, California, facility, tests the structural soundness of Minuteman, Polaris, and Skybolt missile stages under transportation conditions with a battery of four multiplexed Model 1012 Visicorder oscillographs. The total Wyle-Honeywell system at the three Wyle test sites includes eight 1012 Visicorders, 84 Accudata III amplifiers, and a 14 channel FM tape system.

The Wyle test site uses Wyle hydrashaker systems of about 100,000 force pounds, mounted on million pound concrete reaction blocks . . . the only installation of its magnitude in the country. The hydrashaker exciters introduce vibration into the missiles comparable to those encountered during transportation prior to launching.

The specimen record shows data recorded from accelerometers on the third stage of a missile at the locations marked on the record.

The fidelity, contrast, and easy readability of all Honeywell Visicorder records is vividly shown in this record. Where traces are numerous and of this complexity or greater, the trace-identifier interruptions, occurring at regular intervals along the time base of the record, make it easy to identify the individual traces.

For details about Honeywell Signal-Conditioning equipment, the Model 1012, and other Visicorder oscillographs, and the LAR 7400 FM Tape Sub-system write Minneapolis-Honeywell, Heiland Division, 4800 E. Dry Creek Road, P.O. Box 8776, Denver 10, Colorado. Telephone DDD Area Code 303-794-4311.

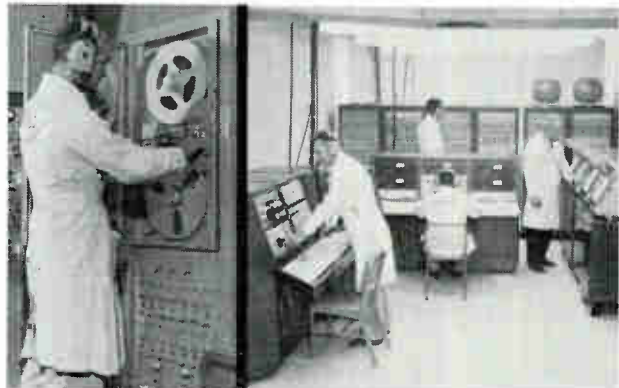

The Honeywell LAR 7400 FM tape system stores 14 channels of data

A battery of multiplexed Model 1012 Visicorders directly records 112 parameters of information

## Honeywell

 First in Control



## Mr. RAFRIN\* got your goat?

He'll take other things, too, including accurate telemetering signals, clear radar displays, correct computer answers — almost anything in the electronics communication field can fall victim to this menace. May we recommend our protection? Electro • International has satisfied Military requirements governing RFI Control for over a decade — all over the world. Write for our RFI Control Capabilities Brochure.

\***RADIO F**requency **I**nterference  
TM

**ELECTRO • INTERNATIONAL**  
Box 391, Annapolis, Md., CO.3-2661  
Subsidiary of Electro Instruments, San Diego, Cal.

system (see sketch p 86) uses two photocells in the image plane of an optical system cable-connected to the external meter system. Light reaching cell 1 has to pass through a diffuser and only a defocused image is projected onto its surface. Light path in front of cell 2 is clear so that either sharp or unsharp image appears on its surface. If the incoming image is a checkerboard pattern and the optical system is run through focus, at best focus the brightness difference between the dark and light patches will reach maximum. When a system is defocused, there will be no brightness difference and meter will read zero. Although theoretically able to focus continuous-tone images, even a live image, its use is presently restricted to those cases where a half-tone dot pattern can be inserted into the object plane of the optical system.

CIRCLE 303, READER SERVICE CARD

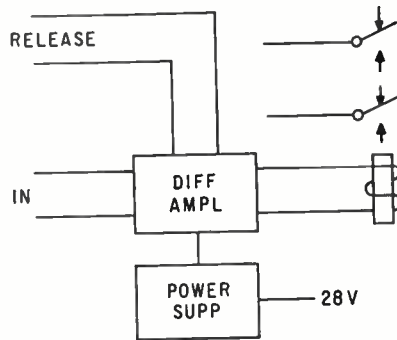

## Voltage Monitor Useful For Many Purposes

RECENTLY announced by Cornell and St. George, Inc., 100 Everett St., Westwood, Mass., the model 709 voltage monitor has an input sensitivity better than 50 mv or 0.1 microwatt power with overload protection up to 100 v. Set point is determined by externally-supplied voltage, input is isolated from ground and input impedance is 25,000 ohms. Drift is less than 30  $\mu$ v/degree C between 0 and 55 C. Range extension is by external voltage divider, current monitoring is by 50 mv shunts, thermistor input may be used, or a photocell input used where light level is low or environment too severe for sensitive relays. The device consists of a differential amplifier, a floating power supply and a relay capable of switch-

ing 3 amperes and 28 v d-c. The power supply provides complete isolation from the power source thus input is insensitive to common-mode voltages. (398)

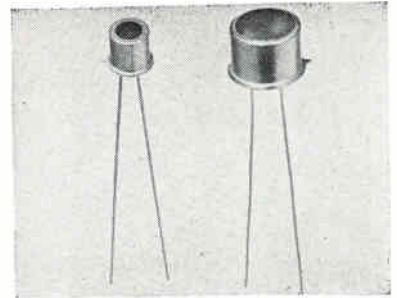

## CdSe Photocells Have Fast Response Times

OPTO-ELECTRONIC DEVICES, INC., 660 National Ave., Mountain View, Calif., offers the OED-3H5 cadmium selenium photocells. Mean rise time specification is 150  $\mu$ sec, with a max of 1.5 millisecc, from SS dark resistance of more than 1,000 megohms to a dynamic light resistance value of 25,000 ohms with neon illumination of 1,000  $\mu$ w/cm<sup>2</sup> at 25 C. Max SS light resistance at this illumination is 6,000 ohms with a mean of 3,000 ohms. Fall time from 3,000 ohms to 100,000 ohms is less than 8.0 millisecc, with a mean value of 5.0 millisecc. (304)



## Null Balance Recorder Features Portability

EMCEE ELECTRONICS, INC., P. O. Box 36, Glenside, Pa. Model 1105 recorder is a portable (battery or line operated) instrument used to record d-c voltages as a function of time. It is available with a minimum span of 10 mv, convenient front panel plug-in modules to con-





**Are you a**

**COMPLETELY INFORMED**

**electronics engineer?**

Today you may be working in microwaves. But on what project will you be working tomorrow? You *could* have read **electronics** this past year and kept abreast of, say, microwave technology. *There were 96 individual microwave articles between July, 1961 and June, 1962!*

But suppose tomorrow you work in some area of standard electronic components, in semiconductors, in systems? Would you be up-to-date in these technologies? Did you read the more than 3,000 editorial pages that **electronics'** 28-man editorial staff prepared last year?

**electronics** is edited to keep you current *wherever* you work in the industry, *whatever* your job function(s). If you do not have your own copy of **electronics**, subscribe today via the Reader Service Card in this issue. Only 7½ cents a copy at the 3 year rate.

**electronics**

# Now, KWIK-TRIM

## THE POTENTIOMETER WITH THE VISUAL INDICATOR

IMPROVED RESOLUTION APPROX. 10% TO 25% OVER MANY COMPARABLE TYPES.

Designed for the ultimate in reliability and performance and to meet applicable military specifications for shock, temperature cycling, vibration, altitude, fungus, humidity, immersion, salt spray, sand and dust.



### MULTIPLE ADJUSTMENT

A KWIK-TRIM one to one nominal adjustment . . . A vernier 45:1 ratio for precise setting . . . Shaft is journaled at each end with precision bearing fit . . . These precision features are your assurance for ease of setability and the stability of setting.



Please Write for ELECTRICAL, MECHANICAL AND ENVIRONMENTAL SPECIFICATION CATALOG.



**General Scientific** CORP.

A SUBSIDIARY OF SAN FERNANDO ELECTRIC MFG. CO.  
1535 FIRST ST. SAN FERNANDO, CALIF.  
EM 1-1193 . . . TWX S.F. CAL 9900

CIRCLE 209 ON READER SERVICE CARD

## NEW Variable Phase Shifter Modules

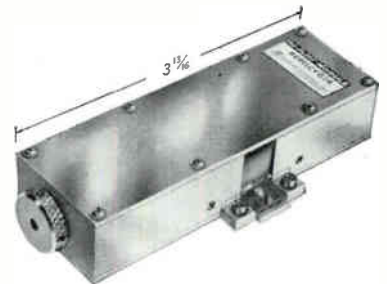

**speed breadboarding of microwave circuits**

Five new Variable Phase Shifters — for use in all microwave applications where phase angle adjustment or empirical selection of a specific phase angle is required — have been added to the Sanders line of more than 600 TRI-PLATE® Strip Transmission Line Modules.

They are also used: (1) as tuners for matching line impedance to load impedance; (2) as stubs with adjustable lengths to form tunable band reject filters; and (3) as delay lines to establish and control a precise delay.

These new Variable Phase Shifters are used anywhere in the DC to 4 Gc frequency range, have a maximum VSWR of 1.5, and are supplied with a 50 ohm (or 10 ohm) impedance. Model numbers, prices and dynamic phase shift ranges are: MVS8, 30°/KMC, \$195; MVS14, 60°/KMC, \$175; MVS34, 120°/KMC, \$195; MVS54, 240°/KMC, \$285; MVS74, 480°/KMC, \$485.

Other TRI-PLATE Modules include variable directional couplers, ferrite circulators and isolators, attenuators, hybrid rings, power dividers, tunable filters and over 150 Mounts for standard and advanced semiconductor devices.

®Registered Trademark, Sanders Associates, Inc.

SEND COUPON FOR COMPLETE DETAILS

Sanders Associates, Inc. E-9  
Microwave Products Dept., Nashua, New Hampshire  
Please send ( ) complete specifications on Variable Phase Shifters  
( ) more information about TRI-PLATE Modules

Name.....

Company.....

Street.....

City.....Zone.....State.....

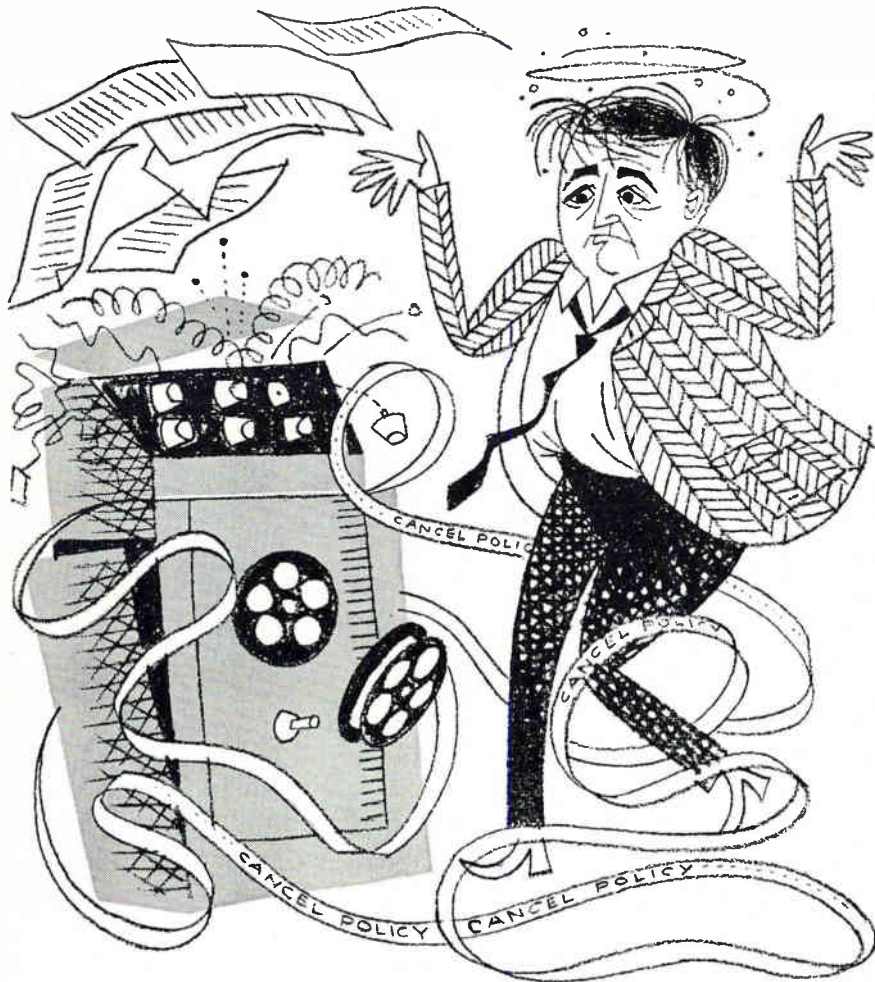

## WHY INSURANCE COMPANIES HATE OUR APPENDAGE PUMPS

Sometimes it does not pay to bet on a sure thing

These little fables about Varian VacIon® pumps usually feature a user-benefit theme. This one\* has a non-user non-benefit gimmick.

Seems an insurance company took a look at the failure rate in electron tubes. The actuaries decided they'd have a good thing going in vacuum tube failure policies and asked their new computer for some projected profit figures. The computer predicted:

|||||||011

Binary translation: Expect 4.092% net yearly on projected volume.

Those insurance fellows didn't reckon with VacIon appendage pumps. They forgot these mighty ion-getter midgets are marvelous for holding optimum vacua in sealed-off devices, or that *all* VacIon pumps are fail-safe, with no danger of compromised vacua in event of power failure. Then somebody remembered. They re-programmed the computer. The result:

0000000000000000!!!!

Binary translation: Who needs vacuum pump insurance policies with VacIon pumps available?

We could have saved them all that trouble (and that burned-out computer). We could have told them that VacIon appendage pumps set an industry standard for reliability and performance. Provide the cleanest vacua available. Pump to pressures as low as  $1 \times 10^{-10}$  mm Hg, at pumping speeds from 0.15 to 1.0 litres/second, and operate on .001 watts of power. Are dandy for use on X-ray tubes, klystrons, magnetrons, TWT's, neutron generators, hyperaltitude simulation chambers, storage tubes, special-purpose CR tubes, and precision gyros. To mention a few.

We could have told them all that—but they didn't ask. So we'll tell you. Of course, we carry our own type of "insurance" on these little beauties. If your VacIon appendage pump fails to perform exactly as we predict, we'll replace the pump or refund your money.

Let's hear from you.

VACUUM  
PRODUCTS  
DIVISION

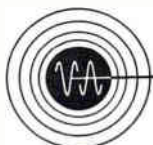

**VARIAN associates**

PALO ALTO 1, CALIFORNIA

vert the basic instrument to one of a variety of spans, and suppression for either voltage, pressure or temperature recording. Unit has a self-contained power pack.

CIRCLE 305, READER SERVICE CARD

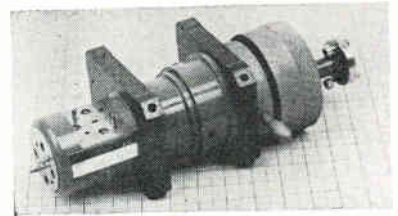

## Reflectometers Cover Five Bands

AMERICAN RADIO CO., INC., 445 Park Ave., New York 22, N. Y. Model REF is a CSF reflectometer that measures vswr's as low as 1.03:1 or as high as 100:1 at millimeter frequencies up to 140 Gc in five bands. Device includes a 10 db directional coupler with directivity better than 40 db and a two-way switch in the coupler. Prices range from \$1,130 to \$2,250. (306)

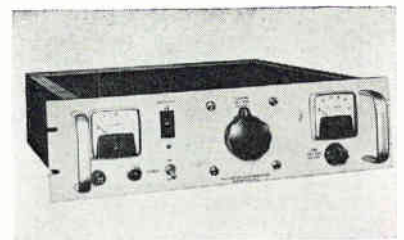

## Power Supply Tests Transistor Life

MID-EASTERN ELECTRONICS, INC., Springfield, N. J., has developed a 0 to 36 v 20 amp power supply in a 5 1/2 in. panel without using scr circuitry, primarily for life testing of transistors. Regulation is better than 10 mv, ripple 2 mv, with no overshoot when turning on or off. Unit features automatic tracking overvoltage circuitry and an electronic overcurrent cutoff circuit. Price \$820. (307)

## Motor-Pot

HELIPOT DIVISION of Beckman Instruments, Inc., 2500 Harbor Blvd., Fullerton, Calif., announces the motor-pot, a compact package including potentiometer, servomotor



# LAMINATED CONTACT MATERIALS



## All Contact Materials are Specials!

When you need top quality and fast service, specify Leach & Garner. All mill shapes and types available, including toplay, thru-lay, inlay, overlay, edge-lay, wire and tubing with alloys of Gold, Silver, Platinum and Palladium. Also available are silver and gold solders, silver and laminated wave-guide tubing, precision rerolling and redrawing of non-ferrous metals.

Engineering assistance available. Quotations rendered promptly.

We build our business on prompt deliveries at competitive prices.



INDUSTRIAL DIVISION  
ATTLEBORO, MASS.

# Leach & Garner

FOUNDED  
1898

SALES OFFICES  
NEW YORK • CHICAGO • LOS ANGELES  
CLEVELAND • DAYTON • DETROIT

For prompt quotations to your print and specifications write:

52 Pearl Street, Attleboro, Mass.  
CIRCLE 211 ON READER SERVICE CARD

September 14, 1962

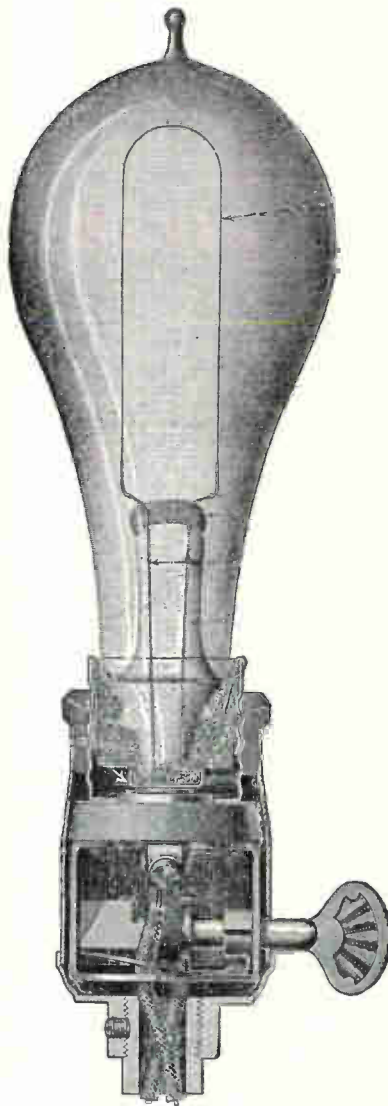

Is it ancient history  
by the time you see  
electronics?

Get the facts while they're new. Don't wait for **electronics** on a route slip. Look in this issue for the Reader Service Card. Fill out and mail the "for subscriptions" section. Only 7½ cents a week.

**electronics**

A McGraw-Hill Publication, 330 West 42nd St., N. Y. 36

NOW READY:

## ANALOG-TO-DIGITAL CONVERTER

NAVCOR MODEL 2201

LOW PRICE: **\$2935**

ACCURACY: **.05%** ABSOLUTE

DELIVERY: **30 DAYS**

Format: Binary, 10 bits plus sign.

Conversion Rate: 10,000 complete conversions per second (9.1 microseconds per bit plus 9.1 microseconds.)

Input Range: ± 10.23 volts; lower or higher ranges available.

Input Impedance: 5,000 ohms; high impedance amplifier optional.

Other models start from \$2,775. Both Binary and Binary-Coded-Decimal formats are available. Options include Sample and Hold, Multiplexing, and Over-Range Indication. For more information, write to NAVIGATION COMPUTER CORPORATION, Valley Forge Industrial Park, Norristown, Pennsylvania.



CIRCLE 91 ON READER SERVICE CARD

91



# MILITARY COMPONENTS VOLUME EXPANDED 1400 Per Cent

In the last four years METHODE ELECTRONICS, INC.'S business in military components has expanded 1400%. The remarkable progress stems from:

- Development of special proprietary equipment to perform the precision manufacturing requirements necessary for military quality wiring devices.
- Design of specialized high environmental components to meet tomorrow's requirements.
- A quality doctrine with controls patterned after the classic MIL-Q-9858 format and further supplemented with engineering management team orientation to product manufacture and inspection.
- Below are examples of Methode's MILITARY CAPABILITIES

**NEW MIDGET 482 CONNECTOR**—full interchangeability with existing MS type miniature connectors with bayonet lock



In addition to its versatility the new Midget 482 connector meets the environmental requirements of MIL-C-26482 and meets or exceeds the requirements of MIL-C-0026482 where applicable. Plus a host of other dependable features including:

- crimp style removable contacts • shells of high strength impact extruded aluminum • cadmium plated with olive drab irridite finish • closed entry sockets meeting or exceeding MIL-C-26636 requirements where applicable • resilient inserts permanently bonded to shell • bayonet coupling with positive lock for easy mating.

**PRINTED WIRING BOARDS to MIL-SPECS**



**Funnel Tubelets** ▶\*

Funnel shaped tubelets permit easy component insertion, repeated removal and re-mounting without damage to board or adhesion—maximum reusability. Application — Air to Surface Missiles.

\*37 to one micro photographic cross-section view

◀ **Fused in Place Eyelets**

Solder flowed under flanges by high current electrode set dies using latest equipment improvements. Application—Ground to Air Missiles.

▲ **Plated Thru Holes**

Copper reduction techniques are used for sensitizing in conjunction with pre-clad laminates—compact, reliable, excellent component soldering and high component density. Application—Intercontinental Ballistic Missiles.

control is accomplished by varying the firing angle of the scr's.  
CIRCLE 310, READER SERVICE CARD

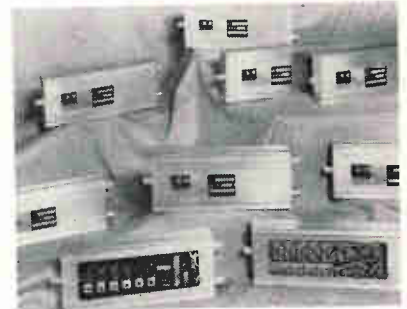

## I-F Amplifiers Are Low in Cost

AIRBORNE INSTRUMENTS LABORATORY, Deer Park, L. I., N. Y. Low power drain i-f amplifiers feature hybrid preamplifiers, completely transistorized post-amplifiers, and combined pre-post-amplifiers. The preamplifiers and combination units use Nuvisitors at the input to obtain low noise figure characteristics. Standard models include both wide- and narrow-band versions at 30 and 60 Mc center frequencies and are available in price ranges from \$375 to \$485. (311)



## Gyro Terminals Sealed with Clear Glass

VERNITRON WEST, INC., 5353 Strohm Ave., N. Hollywood, Calif., offers hermetic seal gyro terminals of Kovar sealed with matched clear glass which enables visual inspection of the quality of the seal. The new parts have minimum glass climb on the terminals, minimum bubble population, complete freedom from cracks in the glass and total absence of burrs. (312)

## Toroidal Core

CONNOLLY & CO., INC., P.O. Box 295, Menlo Park, Calif. Toroidal cores, with o-d of 0.310 in., an i-d of 0.156 in. and a thickness of 0.125



Write for informative literature.

**Methode Electronics, Inc.** 7447 W. Wilson Ave. • Chicago 31, Ill.  
Telephone: UNderhill 7-9600



# LAMINATED CONTACT MATERIALS



**All Contact  
Materials  
are Specials!**

When you need top quality and fast service, specify Leach & Garner. All mill shapes and types available, including toplay, thruway, inlay, overlay, edgelay, wire and tubing with alloys of Gold, Silver, Platinum and Palladium. Also available are silver and gold solders, silver and laminated waveguide tubing, precision rerolling and redrawing of non-ferrous metals.

Engineering assistance available.  
Quotations rendered promptly.

We build our business  
on prompt deliveries at  
competitive prices.

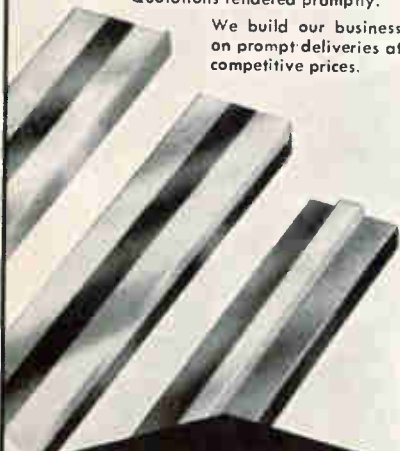

INDUSTRIAL DIVISION  
ATTLEBORO, MASS.

# Leach & Garner

FOUNDED  
1898

SALES OFFICES  
NEW YORK • CHICAGO • LOS ANGELES  
CLEVELAND • DAYTON • DETROIT

For prompt quotations to your print and specifications write:

52 Pearl Street, Attleboro, Mass.  
CIRCLE 211 ON READER SERVICE CARD

September 14, 1962

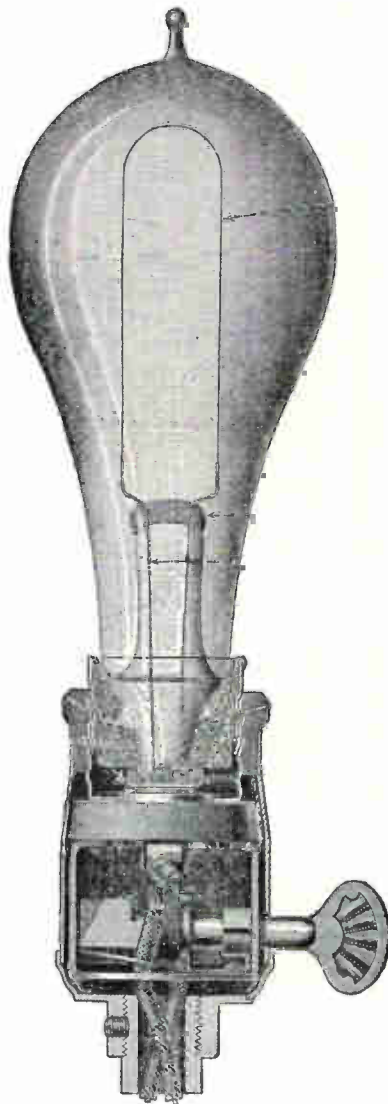

**Is it ancient history  
by the time you see  
electronics?**

Get the facts while they're new. Don't wait for **electronics** on a route slip. Look in this issue for the Reader Service Card. Fill out and mail the "for subscriptions" section. Only 7½ cents a week.

**electronics**

A McGraw-Hill Publication, 330 West 42nd St., N. Y. 36



NOW READY:

## ANALOG-TO-DIGITAL CONVERTER

NAVCOR MODEL 2201

LOW PRICE: **\$2935**

ACCURACY: **.05%** ABSOLUTE

DELIVERY: **30** DAYS

Format: Binary, 10 bits plus sign.

Conversion Rate: 10,000 complete conversions per second (9.1 microseconds per bit plus 9.1 microseconds.)

Input Range: ±10.23 volts; lower or higher ranges available.

Input Impedance: 5,000 ohms; high impedance amplifier optional.

Other models start from \$2,775. Both Binary and Binary-Coded-Decimal formats are available. Options include Sample and Hold, Multiplexing, and Over-Range Indication. For more information, write to NAVIGATION COMPUTER CORPORATION, Valley Forge Industrial Park, Norristown, Pennsylvania.



CIRCLE 91 ON READER SERVICE CARD

91

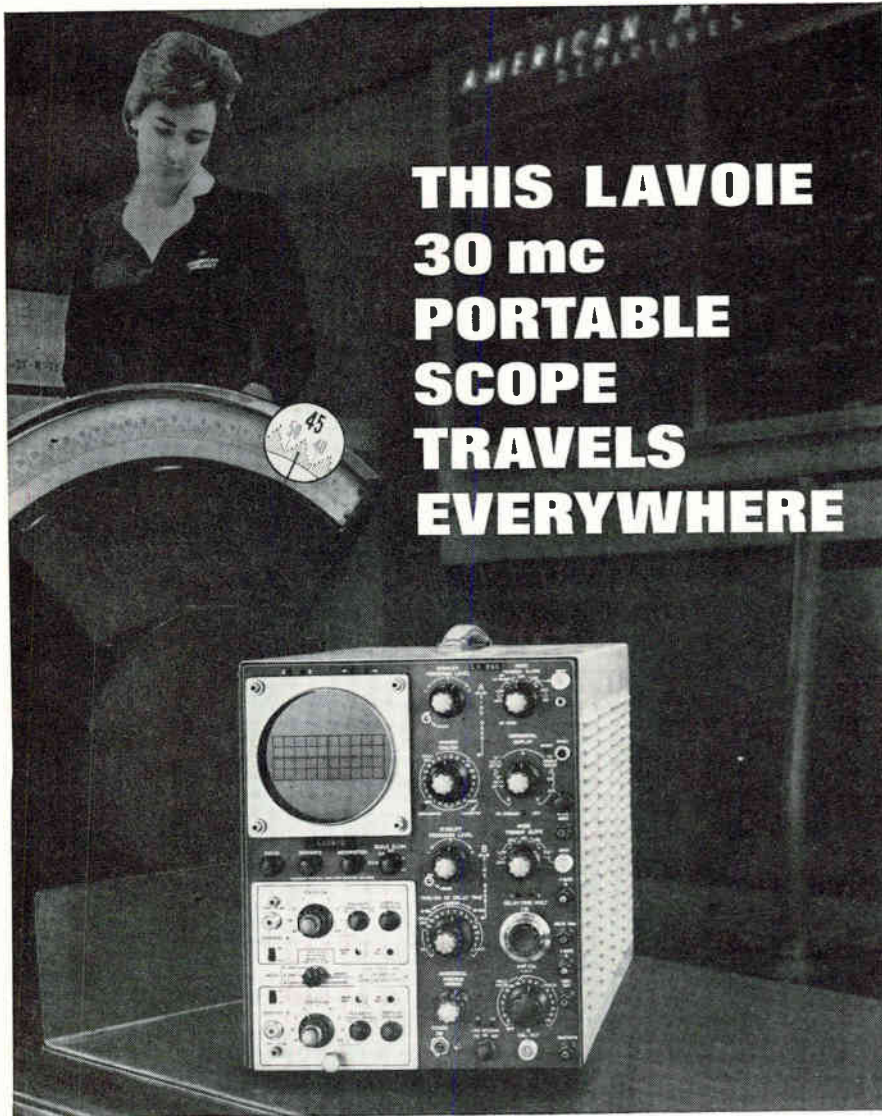

## THIS LAVOIE 30 mc PORTABLE SCOPE TRAVELS EVERYWHERE

**Model LA-285 \$1485.**

Weight 45 lbs. as shown.

Wherever it goes, the new Lavoie LA-285 portable oscilloscope provides a full range of test capabilities. A frequency response of DC to 30 mc and a rise time of only 12 nanoseconds, it has two versatile time bases for a choice of sweeps from 0.02 microseconds per centimeter to 12 seconds per centimeter with a wide range of sweep delay periods. For calibration, portions of the sweep may be magnified and intensified.

This remarkable instrument will operate over a range of line voltages from 95 to 135 volts and is available for 60 to 400 cps use.\*

It will accept plug-in heads from other Lavoie oscilloscopes, as well as heads from scopes of other manufacturers.

Ideally suited for rapid transport in plant, on flight line or shipboard, it can be easily handled by one man. The only portable oscilloscope (12" x 15" x 20") with all of these features plus 10 KV CRT accelerating voltage, it is a truly universal laboratory or field tool.

\*Special

Write today for complete technical details and specifications.

*Lavoie Laboratories, Inc.*

MORGANVILLE, NEW JERSEY • Lowell 6-2600 • TWX MWN-1250

Since 1939, one of America's leading manufacturers and designers of: Oscilloscopes, Spectrum Analyzers, Frequency Standards, Frequency Comparators, Pulse Generators, Digital Counters, Automatic Test Equipment.

and gearhead—with the gearhead and part of the motor hidden inside the pot.

CIRCLE 308, READER SERVICE CARD

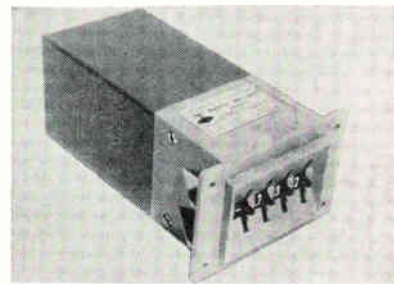

### Ratio Transformer Covers 30 to 1,000 CPS

MAGNETIC AMPLIFIERS DIV., The Siegler Corp., 632 Tinton Ave., New York 55, N. Y. The Decatran is a rugged highly precise 3 decade ratio transformer. A multiposition switch arrangement on the front panel produces easily preset ratios of 0.000 to 1.099 and 0 or 180 deg phase. Applications: for a-c potentiometers, transformer checking, servos, instrument calibration and potentiometer testing. Also suited to computers, digital to analog conversion, and a wide variety of automatic sequence operations using analog techniques. (309)

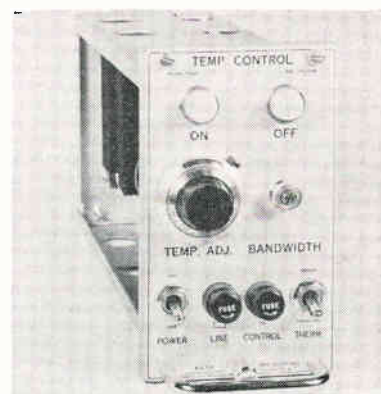

### Temperature Controller Utilizes SCR's

TROTT ELECTRONICS, INC., 412 Smith St., Rochester 6, N. Y. The TR601A is an all solid state 20 amp true proportional control which utilizes silicon controlled rectifiers in a full wave proportioning circuit. The control is supplied as a plug-in module, which may be mounted singly in a portable case or in groups of 4 in a 7 in. by 16 in. panel space. True proportional



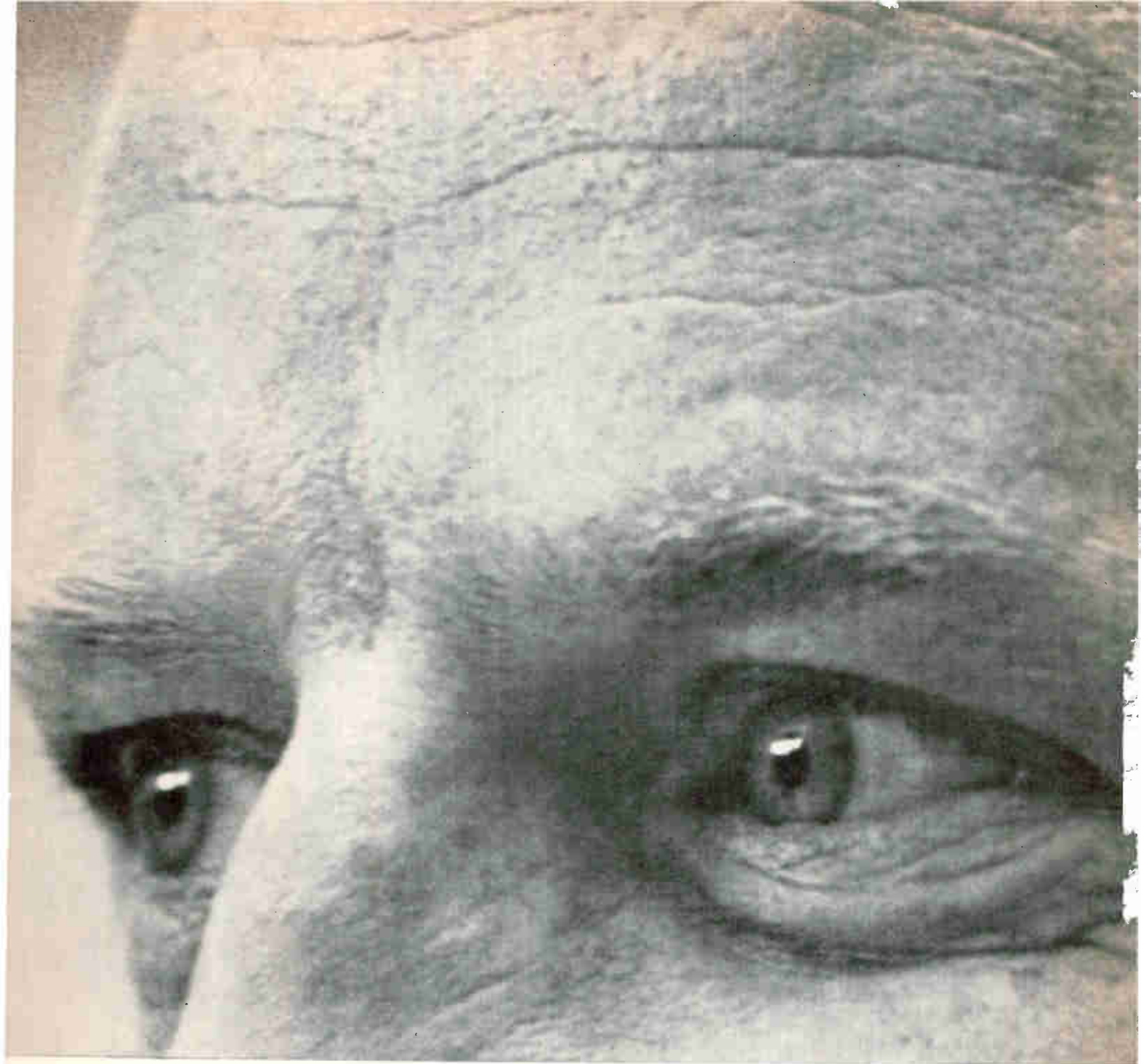

## The moment of insight is a private thing.

It can happen anytime, anywhere. Somewhere in the mind the barrier to a solution crumbles. Everything suddenly slips into place. It can't be forced or commanded. But it comes about most often in a climate of mutual respect and recognition. This is the kind of climate you'll find at Northrop.

You'll also work in a climate of constant professional challenge at Northrop. We have more than 70 active projects in work, and we're always evaluating new lines of inquiry. Projects range from space guidance and navigation to automatic checkout equipment, from computer design and world-wide communications to laminar flow control.

On the following pages you'll find some specific positions available now at Northrop Space Laboratories and the Norair Division. Look them over. One may be just the spot for you.

But even if you don't find your specialty listed—don't go away. We simply don't have room to mention all the opportunities to be found throughout Northrop's several divisions. If you're the kind of man who has fresh insights into problems, there's bound to be a place for you at Northrop. Write to Dr. Alexander Weir at Northrop Corporation, Beverly Hills, Calif., and tell us about yourself. You will receive a prompt reply.

**NORTHROP**  
AN EQUAL OPPORTUNITY EMPLOYER



# MILITARY COMPONENTS VOLUME EXPANDED 1400 Per Cent

In the last four years METHODE ELECTRONICS, INC.'S business in military components has expanded 1400%. The remarkable progress stems from:

- Development of special proprietary equipment to perform the precision manufacturing requirements necessary for military quality wiring devices.
- Design of specialized high environmental components to meet tomorrow's requirements.
- A quality doctrine with controls patterned after the classic MIL-Q-9858 format and further supplemented with engineering management team orientation to product manufacture and inspection.
- Below are examples of Methode's MILITARY CAPABILITIES

**NEW MIDGET 482 CONNECTOR**—full interchangeability with existing MS type miniature connectors with bayonet lock



In addition to its versatility the new Midget 482 connector meets the environmental requirements of MIL-C-26482 and meets or exceeds the requirements of MIL-C-0026482 where applicable. Plus a host of other dependable features including:

- crimp style removable contacts • shells of high strength impact extruded aluminum • cadmium plated with olive drab irridite finish • closed entry sockets meeting or exceeding MIL-C-26636 requirements where applicable • resilient inserts permanently bonded to shell • bayonet coupling with positive lock for easy mating.

**PRINTED WIRING BOARDS to MIL-SPECS**

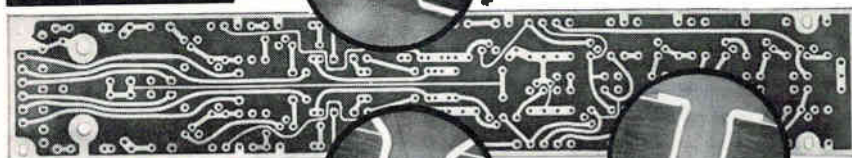

#### ◀ Fused in Place Eyelets

Solder flowed under flanges by high current electrode set dies using latest equipment improvements. Application—Ground to Air Missiles.

#### ▶ Funnel Tubelets

Funnel shaped tubelets permit easy component insertion, repeated removal and re-mounting without damage to board or adhesion—maximum reusability. Application—Air to Surface Missiles.

#### ▲ Plated Thru Holes

Copper reduction techniques are used for sensitizing in conjunction with pre-clad laminates—compact, reliable, excellent component soldering and high component density. Application—Intercontinental Ballistic Missiles.

\*37 to one micro photographic cross-section view



Write for informative literature.

**Methode Electronics, Inc.** 7447 W. Wilson Ave. • Chicago 31, Ill.  
Telephone: UNderhill 7-9600

control is accomplished by varying the firing angle of the scr's.

CIRCLE 310, READER SERVICE CARD

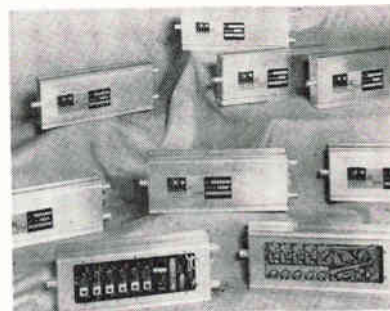

## I-F Amplifiers Are Low in Cost

AIRBORNE INSTRUMENTS LABORATORY, Deer Park, L. I., N. Y. Low power drain i-f amplifiers feature hybrid preamplifiers, completely transistorized post-amplifiers, and combined pre-post-amplifiers. The preamplifiers and combination units use Nuvistors at the input to obtain low noise figure characteristics. Standard models include both wide- and narrow-band versions at 30 and 60 Mc center frequencies and are available in price ranges from \$375 to \$485. (311)

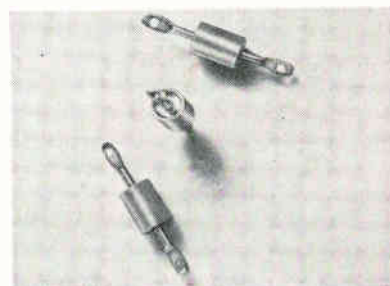

## Gyro Terminals Sealed with Clear Glass

VERNITRON WEST, INC., 5353 Strohm Ave., N. Hollywood, Calif., offers hermetic seal gyro terminals of Kovar sealed with matched clear glass which enables visual inspection of the quality of the seal. The new parts have minimum glass climb on the terminals, minimum bubble population, complete freedom from cracks in the glass and total absence of burrs. (312)

## Toroidal Core

CONNOLLY & CO., INC., P.O. Box 295, Menlo Park, Calif. Toroidal cores, with o-d of 0.310 in., an i-d of 0.156 in. and a thickness of 0.125



in., are designed for quality filters, inductors, pulse transformers and choke coils in the low audio frequencies to 200 Kc. (313)

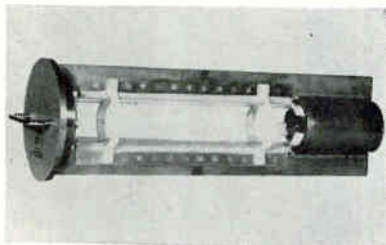

### UHF Folded Cylinder Handles 6 Mw Peak

METCOM, INC., 76 Lafayette St., Salem, Mass., offers a uhf folded cylinder TR switch completely mounted for socket type installation. The MPD-19 is designed for slide installation in WR-2100 waveguide transmission line. It will handle 6 Mw peak and 12,000 w average power in the uhf band with extremely long life. Price is \$700 each. (314)



### SSB Receiver Adapter Features Small Size

KAHN RESEARCH LABORATORIES, INC., 81 South Bergen Place, Freeport, L. I., N. Y. Model RSSB-62-1A is designed to convert conventional a-m receivers to ssb operation. It is completely Nuistorized and operates with a B+ voltage of 60 v which accounts for its small size (5½ in. high by 18½ in. deep by 19 in. wide) and weight (20 lb). Included is an ell-electronic afc with an improved correction speed of 50 cycles per sec/sec. Also included is circuitry which allows the use of a subcarrier as well as the main carrier for afc purposes. Carrier loss protection is featured. (315)

### Temperature Chamber

CAMBRIDGE SYSTEMS, INC., 50 Hunt St., Newton 58, Mass. Model 123A thermoelectrically stabilized temperature chamber is designed to

## Norair needs men with penetrating minds

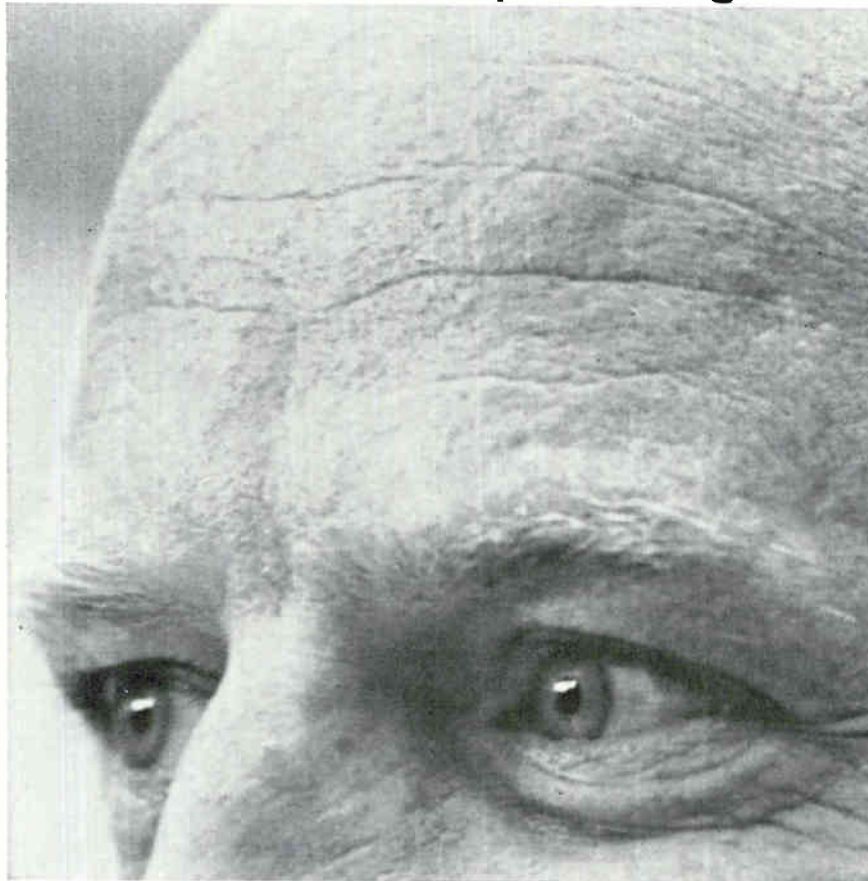

The men we're looking for will tackle many tough problems. Solutions won't come easy. But they'll find them. They have the kind of minds that aren't easily thwarted. If you're of this turn of mind, why not get in touch with us? With new areas of investigation and research constantly challenging us, we need hard-working dreamers to bring them into focus. These positions are available now:

**Engineers** in electronic checkout systems who have worked with advanced design and program development.

**Engineers** whose background is in supersonic aerodynamics, stability and control, inlet design, ducting, and performance analysis.

**Engineers** familiar with airframe structural analysis.

**Scientists** specializing in infrared, optics, and electronic research.

**Engineers** to work in data reduction.

**Scientists** who know structures research and dynamics.

**Scientists** who have done supersonic aerodynamic research.

**Scientists** experienced in working with information and sensing systems, platforms, infrared, sensors, flight controls, airborne computing and data handling systems.

**Engineers** familiar with programming, operations, and instrumentation for ballistic missile flight test.

**Reliability Engineers** to assess the reliability and to optimize the configurations and mission profiles of space systems.

**Chemical Engineers** to work on the development and applications of structural adhesives for aerospace vehicles.

**Metallurgical Engineers** for research and development on materials and joining.

If you'd like more information about these opportunities and others that may be available by the time you read this, write and tell us about yourself. Contact Roy L. Pool, Engineering Center Personnel Office, **NORTHROP** 1001 East Broadway, Hawthorne, California.

AN EQUAL OPPORTUNITY EMPLOYER

# AIRPAX TELEMETRY EQUIPMENTS

Airpax is single source for many telemetry system requirements. In pacing the rapidly changing telemetry art, Airpax provides electronic and electromechanical **COMMUTATORS**, fixed crystal controlled and tunable **TELEMETRY RECEIVERS**, wide band ( $\pm 40\%$ ) sub-carrier **DISCRIMINATORS**, **VCO's** and **CALIBRATOR TEST EQUIPMENT**. These **NEW** products complement a comprehensive line of sub-carrier **FM/FM DISCRIMINATORS** developed during the five years Airpax has been an important factor in the manufacture of telemetry equipment. Typical models of single channel and bandswitching FM/FM sub-carrier discriminators are illustrated below.

**Flash!** The new Model A-135 compact, lightweight, single channel discriminator is priced in the \$350 region.



Model A-136A



Model 43-7959A2

## SPECIFICATIONS

Compact, Single Channel Model A-136A		Bandswitching Model 43-7959A2
Input Impedance	10,000 Ohms	51,000 Ohms
Input Dynamic Range	20MV to 10V	10MV to 10V
Static Linearity	$\pm 0.5\%$	$\pm 0.1\%$ of bandwidth
Output	$\pm 2.5V$ into 330 Ohms (all channels)	$0 \pm 10V, 0 \pm 100MA$
Output Stability	$\pm 0.5\%$	$\pm 0.5\%$
Output Noise	6MV RMS, max.	0.15% of bandwidth
Harmonic Distortion	2% max.	1% max.



SEMINOLE DIVISION  
FT. LAUDERDALE, FLA.  
PHONE: 587-1100 • TWX FU 8021

PACIFIC DIVISION  
NORTHRIDGE, CALIF.  
PHONE: DI 1-4320 • TWX CNPK 5426

maintain low-level p-c cards at any preset temperature between 20 C and 30 C.

CIRCLE 316, READER SERVICE CARD

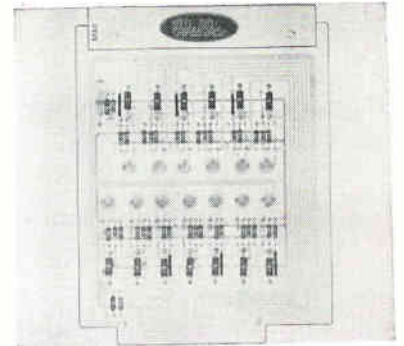

## Output Amplifiers Used for A-D Conversion

NAVIGATION COMPUTER CORP., Valley Forge Industrial Park, Norristown, Pa. Each model 5PA2 has 13 inverting amplifiers on a single p-c card. Each amplifier has an output capability of 5 ma at  $-6.8$  v. These amplifiers are used on the digital outputs of Navcor analog-to-digital converters. Price of the 5PA2 is \$79. (317)

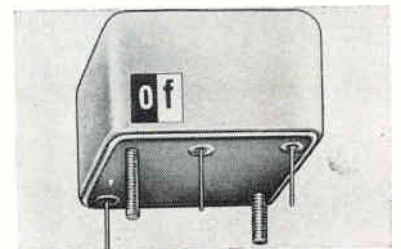

## Crystal Filter Used in VHF Receivers

ORTHO INDUSTRIES INC., 7 Paterson St., Paterson 1, N. J., announces model 2102 filter—108 Mc to 112 Mc, with particular application in vhf receiver front ends and satellite tracking receivers. Center frequency is 112 Mc; 6 db bandwidth, 10 Kc; 60 db bandwidth, 40 Kc; insertion loss, 11 db (nominal); passband ripple, 1 db (nominal); input and output impedance, 120 ohms. (318)

## Dummy Load Packages

ELECTRO IMPULSE LABORATORY, INC., 208 River St., Red Bank, N.J., announces high power dummy load packages, 5,000 w to 100,000 w, co-



axial or waveguide, completely self-contained with cooling units d-c to 12 Gc, c-w or pulse. (319)



### Miniature Binding Posts Help Solve Space Problem

THE SUPERIOR ELECTRIC CO., Bristol, Conn. Five-way binding posts are suited for use on electrical and electronic apparatus where panel space is limited. Extend only  $53/64$  in. from face of panel in closed position,  $1\frac{3}{8}$  in. fully open. Max diameter 0.435 in. for thumbnut, 0.469 in. for panel insulators. Use  $3/8$  in. diameter panel hole but D type shoulders on panel insulators permit mounting in keyed panel hole. Mount in panels from  $1/16$  in. to  $1/4$  in. thick. Rated for 15-amp current capacity and 1,000-v working. (320)



### Magnetic Components Meet MIL Requirements

KENYON TRANSFORMER CO., INC., 1057 Summit Ave., Jersey City 7, N. J., is manufacturing encapsulated transformers and reactors which operate at temperatures up to 170 C and will meet military requirements for airborne and ground support equipment. Construction used assures minimum component weight while maintaining long life characteristics. (321)

### TWT Amplifier Covers 4.4 to 5.0 Gc

HUGGINS LABORATORIES, INC., 999 East Arques Ave., Sunnyvale, Calif. Type HA-35 twt is designed for

## Wanted: Men with fresh insight

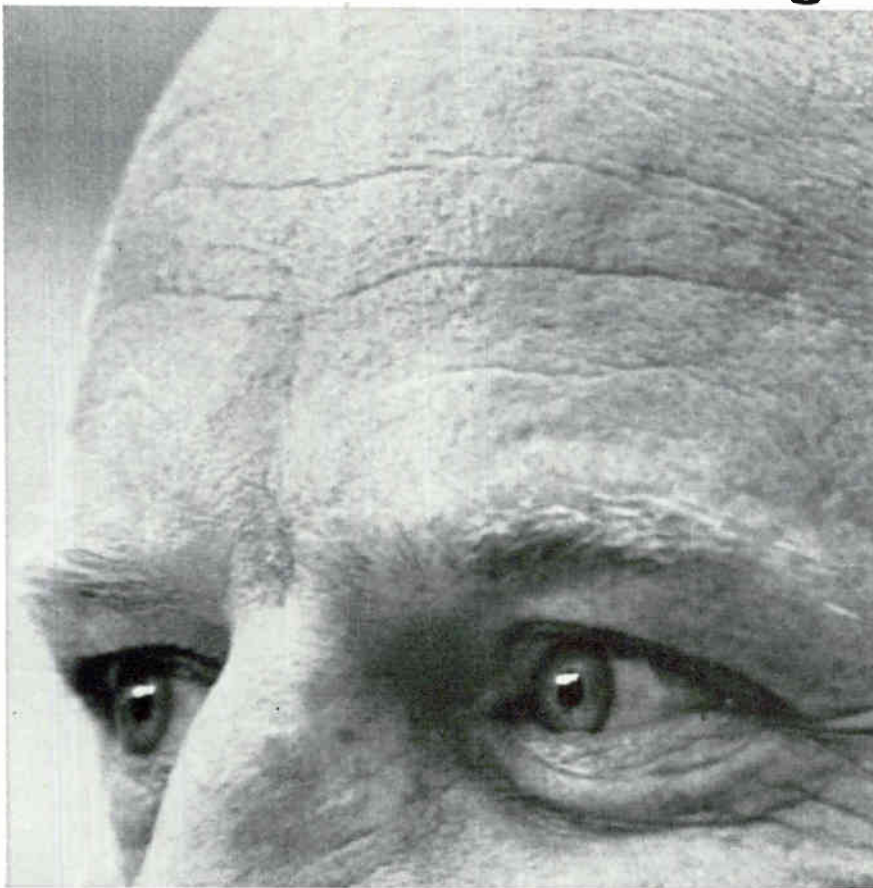

Northrop Space Laboratories needs men whose imaginations are crisp; men who can unriddle problems with a fresh point of view. If this describes you, then you'll feel at home with us. NSL is new, with the freedom of movement only a new organization can have. Its future will be what you can make it. And you'll have the full facilities of the Northrop Corporation behind you. Come in now, and grow along with us. These key openings are immediately available:

**Solid state physicists**, to conduct fundamental research on many-body problems as applied to an ultra high pressure program. The goals of this program are to study the electrical and physical behavior of materials under ultra high pressure, to investigate the origin, history and structure of the moon and planets, and to find ways to utilize their natural resources.

**Scientists**, to perform research in nuclear and radio chemistry, and to conceive and carry out investigations in the fields of activation analysis, dosimetry, gamma ray spectrometry, surface phenomena, and numerous other areas.

**Stress analysts**, to develop fresh analytical techniques and apply them to new space structural concepts; to do stress analysis and design optimization studies on advanced space vehicle structures.

**A plasma physicist**, to join our growing program in the measurement of plasma properties, spectroscopy, diagnostics, accelerators, and power conversion devices.

**A mathematician-physicist**, to concentrate on systems analysis and operations research applied to military and non-military space systems.

**Physicists** experienced in electro-optical imaging devices and laser theory; engineering mathematicians interested in detection theory, reconnaissance and tracking; electronic engineers who know their way around statistical communications theory and noise phenomena; for new and original work in satellite detection systems.

For more information about these and other opportunities, write to W. E. Propst, Space Personnel Office, 1111 East Broadway, Hawthorne, California. You will receive a prompt reply.

**NORTHROP**  
AN EQUAL OPPORTUNITY EMPLOYER

# CHESTER

## MULTI-CONDUCTOR CABLES

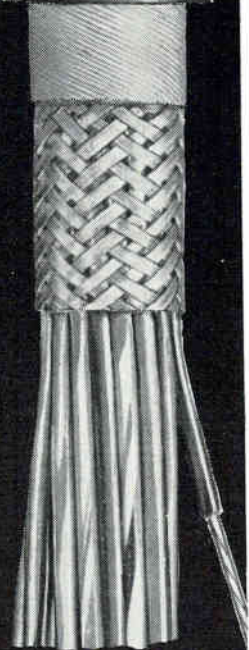

Custom constructions to meet your exact requirements. Any combination of conductors, Plastico<sup>®</sup> insulations, shields, jackets, color coding, etc.

Send for brochure, today!

**CHESTER CABLE CORP.**  
CHESTER, NEW YORK  
a subsidiary of  
TENNESSEE CORPORATION



severe operating conditions. Frequency range is 4.4 to 5.0 Gc with a power output of 1 w. Gain at rated power output is 30 db minimum and the small signal gain is 30- db minimum. Cooling air requirements are 5 cfm.  
CIRCLE 322, READER SERVICE CARD

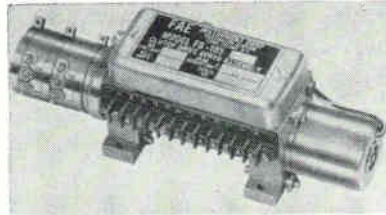

### Servo Assembly Offered in Size 11 Frame

FAE INSTRUMENT CORP., 16 Norden Lane, Huntington Station, N. Y. Miniature size 11 servo assembly is shown in one possible configuration. By varying the amplifier output, motor speed, reduction ratio, and the choice of potentiometer, an infinite number of input-output combinations can be effected. Assembly consists of a potted solid-state amplifier mounted on two aluminum end-caps having 4 mounting holes, a specified pot and motor at either end, a speed reducer and a clutch or clutch-brake, and a miniature terminal strip. (323)



### Time Delay Relays Weigh 2.1 Oz

CRANE ELECTRONICS CO., 4345 Hollister Ave., Santa Barbara, Calif. Time delay relays for military and non-military applications are available for operation at various supply and contact ratings, and with dpdt standard contact arrangement.



## with a DI-ACRO ROL-FORM DIE

Workmarking from forming sheet materials in press brakes and punch presses is greatly reduced and in many metals completely eliminated when formed with the Di-Acro Rol-Form Die. Hardened and precision ground rolls pivot smoothly in the die block to fold material without strain. You save costs by discarding elaborate and time consuming preparation and work methods, reducing polishing time, eliminating scrap parts. You also cut costs in press brakes and punch presses by reducing the number of dies needed and the set-up time.

One Di-Acro Rol-Form Die with a 60° upper die forms any angle to 60° and any thickness of metal to 1/8" just by adjusting the ram or bed of the brake. Where ultra-high finish material is to be formed, nylon inserts can be used in the die block to further reduce the possibility of work marks.

The Rol-Form Die is offered in five styles and in lengths from 6 inches to 12 feet for use in all sizes and models of press brakes and punch presses.

For ordinary press brake forming ask about Di-Acro Standard Press Brake Dies.



Consult the yellow pages of your telephone book under Machinery-Machine Tools for the name of your nearest Di-Acro distributor or write us.

pronounced die-ack-ro



**DI-ACRO CORPORATION**  
Formerly O'Neil Irwin Mfg. Co.  
439 Eighth Avenue  
Lake City, Minnesota

CIRCLE 212 ON READER SERVICE CARD  
electronics



# 4 1/2 MILLION



## TO WORLD MARKETS

Last year Foster Electric Co., Ltd. produced nearly 5½ million speakers in a dozen sizes—from the 1½" (4 cm.) 4B2 to the 12" (30 cm.) PW-120. Of these, fully 4½ million were exported both as components and in electrical products to the world's foremost electronics manufacturers.

A major reason for this demand is unmatched quality at popular prices. A perfect example is the 2" 5A61. This fast-selling 100 ohm speaker is ideal for use in compact portable radios and sound equipment. Its high impedance makes output transformers unnecessary, and therefore reduces space requirements, production costs, and distortion. It has a frequency range of 450 to 4,500 c/s and weighs only 1.55 ounces. Like all Foster speakers its cone is made of select kapok fiber by a patented method that assures exceptional tone quality, low resonance, and great resistance to cone break-up. 5A61 also uses Foster's own special high precision magnetic circuit.

Foster speakers are now available in production quantities for immediate delivery anywhere in the world. For details about quality Foster speakers write directly to the address below.



### FOSTER ELECTRIC CO., LTD.

384 Shimo-Renjaku, Mitaka, Tokyo, Japan •  
CABLE: FOSTERELECTRIC MUSASHINOMITAKA

CIRCLE 213 ON READER SERVICE CARD  
September 14, 1962

Packages measure 1½ in. sq by 1½ in. high, and weigh 2.1 oz. Prices begin at \$55 for standard models in single unit quantities. (324)



### Basic Switch Combines Two in One

CHERRY ELECTRICAL PRODUCTS CORP., P.O. Box 438-5, Highland Park, Ill. The E19-00A combines two switches into one compact case permitting control of four independent circuits. This double pole, enclosed general purpose switch features special coil spring for long life. Designed to simplify circuitry, provide accurate control and offer flexibility in circuitry design. Suitable for 3 phase motor control. Standard 1-in. mounting holes. (325)



### Magnetic Amplifier Will Fire Any SCR

MACE CORP., 900 N.E. 13th St., Ft. Lauderdale, Fla., offers the P series self-regulating scr firing magnetic amplifier that has fail-safe bias. Design is based on the scr as a current triggered device and is thus capable of delivering 200 ma short circuit current but with a low rms current output. Unit delivers 6 v peak with rise time of 100 μsec and pulse duration of 1 millisecc for 60 cycle units. Special feedback assures extremely high stability with temperature variation and voltage variation. (326)

### P-C Board Coating

COLUMBIA TECHNICAL CORP., Woodside 77, N.Y. A single-component,

## COAXIAL CABLES



Accepted by industry as the quality line of Coaxial cables.

Conform to Military Specifications including MIL-C-17C—or your own special requirements.

Send for complete Coaxial Cable catalog.

**CHESTER  
CABLE CORP.,  
CHESTER, NEW YORK**

a subsidiary of  
TENNESSEE CORPORATION



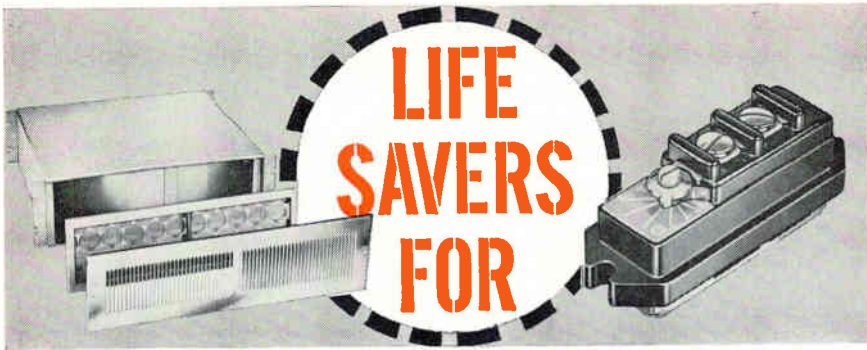

## ELECTRONIC COMPONENTS

### TRANS-AIRE BLOWERS

Ideal for use where excessive heat is generated by equipment in an enclosed rack, cabinet or console. They draw in fresh air or exhaust heated air. These blowers occupy less area, and a smaller panel space than others having similar air displacement capability. They are the lowest priced units of equal capacity and performance. To prevent overheating they have thermal overload protection. Automatic reset. Available in three sizes with air displacement from 100 cfm. to 700 cfm.

### TEM-STAT

When the contents of an enclosure become overheated, the Bud Tem-Stat actuates a warning device, turns on a blower or shuts off current, thus preventing damage to costly electronic components. Available in two temperature ranges.

See these two Bud products at your distributor or write for literature.



**BUD RADIO, INC.**

CLEVELAND 3, OHIO

CIRCLE 214 ON READER SERVICE CARD

SCR-601-RFI HIGH SPEED SIGNALING RELAY

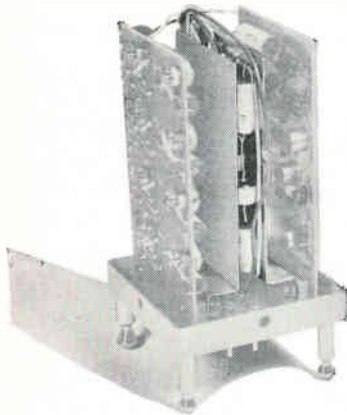

leave  
well enough  
alone?

no!

Rixon's SCR-601 semiconductor relay is an excellent device. It works quietly and efficiently, even at high data rates like 2400 bits per second (more than 4000 words per minute.) So why tamper with it? Well, mainly because we got curious about RFI problems. The result—shown above with its case removed—is the SCR-601-RFI relay.

We added filters to each input/output connection except the ground lead, and, just to be safe, we enclosed them in a brass sheath. The whole filter assembly fits between the two printed circuit cards. Result? Now we have an *ultra quiet* signaling relay for applications where security is standard operating procedure.

For more information about this relay, with or without RFI suppression, contact the Marketing Department at . . .

**RIXON ELECTRONICS, INC.**

2121 INDUSTRIAL PARKWAY—MONTGOMERY INDUSTRIAL PARK—SILVER SPRING, MARYLAND  
TELEPHONE: 622-2121 TWX: S SPG 213

100 CIRCLE 100 ON READER SERVICE CARD

polyurethane coating, HumiSeal type 1A22, is recommended for use where excellent adhesion, flexibility and solderability are important.  
CIRCLE 327, READER SERVICE CARD

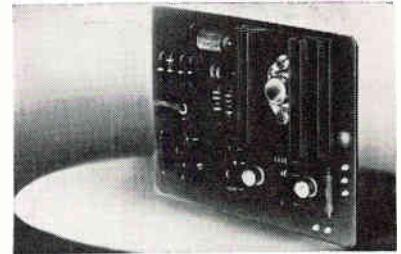

### Circuit Board Coolers Feature Low Profile

WAKEFIELD ENGINEERING, INC., Wakefield, Mass., has designed a line of Delta-T circuit board coolers with low profile and flat bottom (as required for printed circuits and externally mounted power supplies). Models 601 and 602 accept hex. sizes up to  $\frac{1}{2}$  in. and are suitable for TO-8. Models 621, 623 and 641 accept all standard transistor case styles and hex. sizes up to  $1\frac{1}{2}$  in. (328)

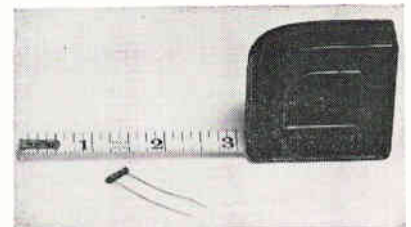

### Radial Lead Resistors Designed for P-C Board

CHARLES T. GAMBLE INDUSTRIES, Reeder & Monroe Sts., Riverside, N. J., offers subminiature radial lead, encapsulated, wire wound resistors for p-c board application. On all resistance values of 500 ohms and above, the resistors are non-inductively wound. Max resistance value is 50,000 ohms. Tolerance is from  $\pm 1$  to  $\pm 0.01$  percent. Temperature coefficient is 10 ppm per deg C. Operating temperature is 125 C at 0.1 w. Size is 0.093 by 0.375 long. (329)

### Extension Wire

DEKORON PRODUCTS DIVISION, Samuel Moore & Co., Mantua, O. Thermo-couple extension wire, type CMX

electronics



Twist-Ex, is designed for use with computers and other equipment demanding a signal free from extraneous noise. (330)



### D-C/D-C Converter Designed for Missiles

SONEX, INC., 20 E. Herman St., Philadelphia 44, Pa. The TEX-3603 is an all solid state high environmental d-c to d-c converter developed for aircraft and missile applications where reliability, size and weight are of prime consideration. This power supply converts 28 v d-c to the range of 200-250 v d-c for a B+ power source for transmitters requiring up to 140 ma. Ripple on the output is less than 1 v peak-to-peak at full load. Unit will operate from -40 F to +165 F. (331)



### Clock Standard Used in Counters

NORTHEASTERN ENGINEERING, INC., 25 S. Bedford St., Manchester, N. H. Model 18-10 clock standard is a basic oscillator which is used in Northeastern electronic counters to obtain the high degree of accuracy and stability specified for them. It produces both 1 Mc and 100 Kc frequencies. It features



If you are manufacturing your own magnetic components profitably, we welcome the competition. However, most companies who manufacture their own components are doing so as a sideline. They believe they're saving money.

But there are always "hidden" costs in making your own parts. In many instances, your sideline operation hurts your over-all profit and loss statement because you are operating outside your specialty. The time, money and effort put into your sideline could actually be more wisely invested in your main business, where you are the expert.

At Aladdin Electronics, we have no sideline business. All of our time and effort is devoted to the research, development, engineering and production of pulse and wide-band transformers, inductors, micromodule and microelement components.

If you use magnetic components in your business, tell us about it. Then let us show you how to save money by buying instead of making.

+  
where the magic of magnetics is a science...™

**Aladdin<sup>®</sup>**  
**electronics**

nashville 10, tennessee phone: 242-3411, code 615  
twx: 615-244-1534

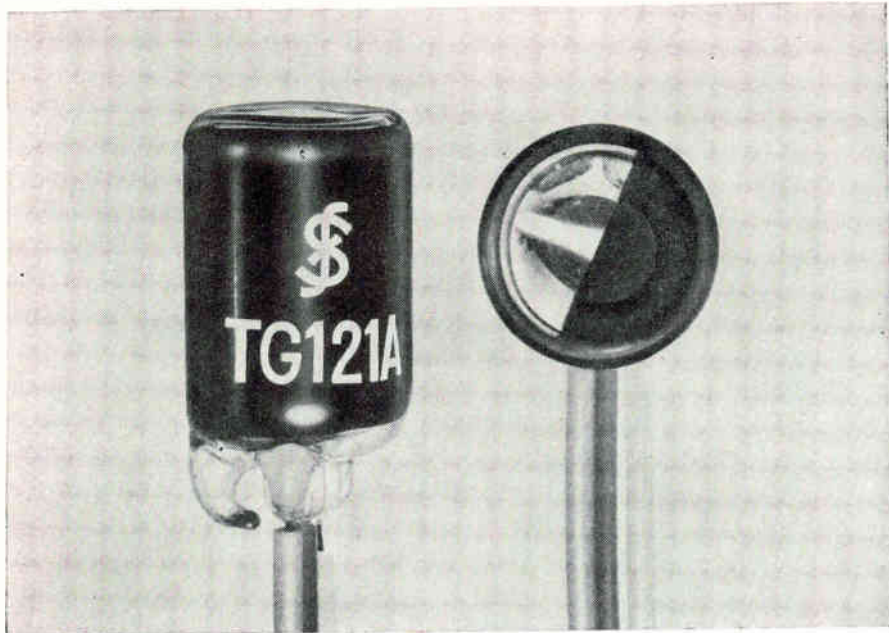

## NEW GAS DISCHARGE INDICATION TUBE FOR SMALL SIGNALS

Designed specifically for display indicator use in transistorized electronic equipment, the TG121A glow discharge tube offers important advantages over neon indicators and miniature incandescent lamps. Of prime importance is the fact that it can be switched on and off by an input signal of a few volts and thus can be operated directly by ordinary transistor output voltage without amplification. Since it is a cold cathode device there is no heating problem such as is encountered with miniature lamps, even when many are used. This advantage coupled with its small size (length 18mm, diameter 8mm) makes it ideal for miniaturized equipment. Characteristics are stable and life is practically limitless. Detailed specifications and application information are available from our representatives listed below.



**FUJI TSUSHINKI SEIZO K.K.,**  
TOKYO, JAPAN

*Represented by:*

■ The Nissho American Corporation □ New York 5, 80 Pine St., WH 3-7840 □ Chicago 3, 140 S. Dearborn St., CE 6-1950 ■ The Nissho Pacific Corporation □ San Francisco 4, 120 Montgomery St., YU 2-7901 □ Los Angeles 14, 649 S. Olive St., MA 7-7691

CIRCLE 102 ON READER SERVICE CARD



**Did you swipe this magazine?**

Only 7½ cents a week is the easy way! (\$6 one year, \$9 for two years, \$12 three years.) Just fill in the handy "For subscriptions" section of the Reader Service Card in this issue . . . and you'll get instant subscription.

**electronics:** 330 West 42nd St., N. Y. 36.

dual oven vacuum-insulated construction, with oscillator and divider circuits in the inner oven, and dual temperature control operated by a high resolution mercury thermostat.

CIRCLE 332, READER SERVICE CARD

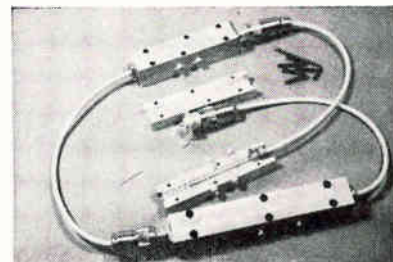

### Band Pass Filters Cover 1.0 Gc to 10.75 Gc

APPLIED MICROWAVE ELECTRONICS, INC., 6707 Whitestone Road, Baltimore 7, Md. Series of coaxial band pass filters cover the frequency range from 1.0 Gc to 10.75 Gc in four bands. Insertion loss is 1.0 db max. Rejection at 0.5 of the lower cutoff frequency and 1.5 of the higher cutoff frequency is 60 db. Filters are designed to withstand environmental conditions of MIL-E-5272. (333)

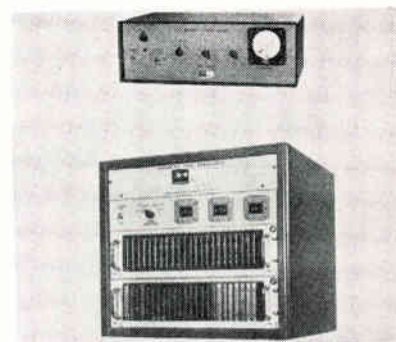

### Coder and Searcher Operate Automatically

AIRBORNE INSTRUMENTS LABORATORY, Deer Park, L. I., N. Y., has available a coder and searcher that automatically retrieves and edits data recorded on analog magnetic tape. Use of the units makes it possible for researchers to examine graphical records for data of interest, locate the data on the magnetic tape record, and replay it for subsequent analysis and processing. This automatic method is less difficult and less time-consuming than methods now used in simul-



taneous recording of data on both graphical recorders and magnetic tape recorders. (334)

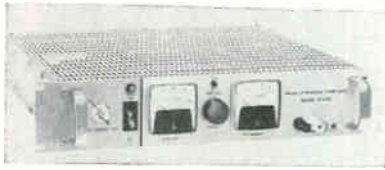

### L-V Power Supplies Have High Regulation

POWER SOURCES, INC., Northwest Industrial Park, Burlington, Mass., has developed a line of low voltage power supplies. Regulation (line) is better than 0.01 percent or 2 mv (whichever is greater) for input variations from 105-125 v a-c. Regulation (load) is better than 0.01 percent or 2 mv (whichever is greater) for load variations from zero to full load. (335)

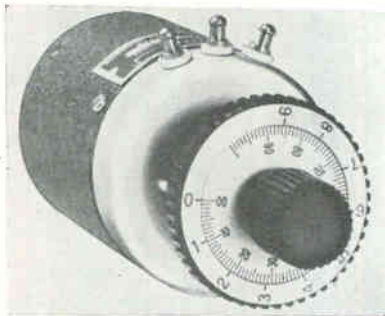

### Decade Vernier Pot Has High Resolution

JOHN FLUKE MFG. CO., INC., P.O. Box 7428, Seattle 33, Wash. Model 40A decade vernier pot is a precision voltage divider consisting of high accuracy fixed resistors and a precision wirewound pot which provides continuous interpolation between decade steps. This combination provides linearity accuracy to better than 1 part in 1,000 and resolution of more than 0.02 percent. (336)

### D-C Amplifier

EPSCO INSTRUMENTS, 275 Massachusetts Ave., Cambridge 39, Mass. Model ADS-1 wideband d-c amplifier is a solid state, chopper stabilized amplifier for use where low noise and drift are of prime importance with high and low source impedance alike. (337)

**.05% RPM ACCURACY!  
24-30 VDC RANGE!  
0.4 OZ-IN TORQUE!  
2000 HR MINIMUM!**

**Impossible?  
Prove it  
yourself!**

We're confident that you can't make our Chronometric motor K5801 go wrong. We tried. We varied line voltage. We varied load. We receive constant rpm's every time. The A. W. Haydon Company's Chronometrically governed DC timing motor, K5801 will deliver 0 to 0.4 oz.-in. torque at 3600 rpm, accurate to  $\pm .05\%$  over a range of 24-30 vdc! It will do this for at least 2000 hours! K5801 weighs only 9 oz.; will take ambient temperatures from  $-55^{\circ}\text{C}$  to  $+100^{\circ}\text{C}$ ; vibration from 5-2000 cps at 10g; shock at 100g for  $11 \pm 1$  milliseconds, and draw 4 watts maximum. Recalibration, if necessary, may be done quickly to  $\pm .02\%$  with a 60 cps strobe light and a screwdriver. All this in a package only  $2\frac{1}{4}$ " long by  $1\frac{1}{4}$ " diameter. This is a mighty motor indeed. Mighty accurate. Mighty reliable. Write The A.W. Haydon Company for ordering information and test procedure booklet SP9-4, or see your nearest A.W. Haydon sales representative.

Available as shown or with integral gear head.



**THE A.W. HAYDON COMPANY**

235 NORTH ELM ST., WATERBURY 20, CONN.



The walls of the short piece of ultra-thin tubing are only .0005 in. thick, or one-third the thickness of cigarette paper.

## New element for electronic designs

### ULTRA-THIN WALL TUBING—only .0005 in. thick

Superior now offers you ultra-thin tubing with walls only one-third the thickness of cigarette paper. Among its applications is the support of miniature vacuum tube cathode sleeves.

As of now we can make tubing with walls as thin as .0005 in. But we may go thinner! We have only begun to explore the capabilities of our unique process—cannot yet foresee the limit.

So far we have made tubing from Nickel 200 ("A" Nickel) and 80% nickel-20% chrome alloy. We believe that the development of electronic applications will require tubing made from some other materials.

Our ultra-thin wall tubing permits new extremes in miniaturization. It offers the obvious advantage of light weight—and of highest strength because of its cylindrical cross section. Its heat conductivity is less than cathode supports with their thicker walls; hence it reduces heater power requirements. It has good electrical conductivity and is easy to weld or solder to cathodes and other metal parts.

Could Superior's ultra-thin tubing improve your design? Write Superior Tube Company, 2500 Germantown Ave., Norristown, Pa., for any help with your problem you may desire.

# Superior Tube

The big name in small tubing  
NORRISTOWN, PA.

West Coast: Pacific Tube Company, Los Angeles, California

Johnson & Hoffman Mfg. Corp., Carle Place, N.Y.

—an affiliated company making precision stampings and deep-drawn parts

## PRODUCT BRIEFS

**TIMING SEQUENCERS** are high speed, all transistorized units. Counting rates programmed to change during cycle. Ken Lee Electronics, 2869 Kennedy St., Livermore, Calif.

CIRCLE 338, READER SERVICE CARD

**REGULATOR MODULE** for use in space environment. The 1 cu. in. unit weighs 30 grams. Transformer Electronics Co., Boulder Industrial Park, Boulder, Colo. (339)

**PLANAR TRIODE AMPLIFIER** for tropospheric scatter communications systems. It features 30 db gain (min), 10 Mc bandwidth (min), 10 w power output (min). Airtron, Hanover Ave., Morris Plains, N.J. (340)

**RACK MOUNTED D-C METER** offers 42 ranges of voltage and current. Price is \$575. Boonton Electronics Corp., 738 Speedwell Ave., Morris Plains, N.J. (341)

**HIGH FREQUENCY STANDARDS RECEIVER** is all transistorized. It is accurate up to 1 part in 10<sup>7</sup>. Gertsch Products, Inc., 3211 S. LaCienega Blvd., Los Angeles 16, Calif. (342)

**DIGITAL VOLTMETER** sells for about \$395. It has four ranges with an accuracy of  $\pm 0.1$  percent. Dynascan Corp., 1801 W. Belle Plaine Ave., Chicago 13, Ill. (343)

**REFRIGERATION COMPRESSOR** for airborne and military installations. It is designed for conservative operating speed (3,900 rpm) and long life. Eastern Industries, 100 Skiff St., Hamden 14, Conn. (344)

**SOLID STATE DECODER** with in-line read-out. Unit utilizes plug-in p-c construction. Burroughs Corp., P.O. Box 1226, Plainfield, N.J. (345)

**CIRCULAR PLUGS** are environmentally resistant. Insulators have a rear-release contact retention system. Cannon Electric Co., 3208 Humboldt St., Los Angeles 31, Calif. (346)

**SILICONE-ASBESTOS LAMINATE** solves difficult design problems. It provides long term service at high temperatures. Johns-Manville, 22 E. 40th St., N.Y. 16, N.Y. (347)

**SILICON POWER TRANSISTORS** are 7.5 amp devices. Collector-to-emitter voltage rating is 250 v. Westinghouse Semiconductor Division, Youngwood, Pa. (348)

**WIRE-WOUND RESISTORS** for commercial and industrial applications. They are available in 3, 5 or 10-w sizes. Clarostat Mfg. Co., Inc., Dover, N.H. (349)

**HIGH-VACUUM MOTOR** aids manufacture of microcircuits and thin-film elements. Available in 1/20th h-p at 3,200 rpm. Photonetics Corp., Walker Valley, N.Y. (350)

**MAGNETIC CIRCUIT** uses Hall effect device. Input-to-output linearity is 1



percent. F. W. Bell, Inc., 1356 Norton Ave., Columbus 12, O. (351)

CONNECTOR contains 3 either male or female coax and 12 pin or socket contacts. It accommodates standard hardware. AMP Inc., Harrisburg, Pa. (352)

RADIATION-RESISTANT SYNCHRO with very high accuracy. Lead wires are made of silicone impregnated Fiberglass. Sperry Gyroscope Co., Great Neck, N.Y. (353)

TUNNEL DIODE AMPLIFIER for 2.2 to 2.3 Gc. It has an operating noise figure of 3.5 db nominal. Micro State Electronics Corp., 152 Floral Ave., Murray Hill, N.J. (354)

UHF PREAMPLIFIER for the 500 to 1,100 Mc range. Minimum gain is 20 db, noise figure 12 db max. Applied Technology Inc., 930 Industrial Ave., Palo Alto, Calif. (355)

TWO-COLUMN WELDING MACHINE seals diode parts. It has automatic unloading and transfer devices. Thomson Electric Welder Co., 161 Pleasant St., Lynn, Mass. (356)

MINIATURE LEAD WIRE used at 1200 F. Flexibility and radiation resistance are offered. Rockbestos Wire and Cable Co., Nicoll and Canner Sts., New Haven, Conn. (357)

RELAY SWITCH with a wide range of uses. It is over-center actuated. Chicago Switch Div., F&F Enterprises, Inc., 1733 Milwaukee Ave., Chicago 47, Ill. (358)

L-F OSCILLATOR features  $\pm 0.002$  percent accuracy with 1 w output. It operates at any frequency from 50 cps to 7 Kc. Accutronics, Inc., 12 South Island, Batavia, Ill. (359)

HIGH POWER LOADS for waveguide systems in the 2.6 to 12.4 Gc range. Max vswr is 1.10. PRD Electronics, Inc., 202 Tillary St., Brooklyn 1, N.Y. (360)

D-C/D-C AMPLIFIER measures 1 cu in. It has two isolated input signal windings and delivers  $\pm 5.0$  v. Acromag, Inc., 15360 Telegraph Rd., Detroit 39, Mich. (361)

SILICONE PASTE for sealing insulation systems. A cure of 10 minutes at 300 F under pressure is adequate for most applications. General Electric Co., Waterford, N.Y. (362)

FILM RESISTORS in ratings of 2, 3, 4, 5 and 7 w. They have welded leads and a hard, heat-resistant finish. P. R. Mallory & Co. Inc., Indianapolis 6, Ind. (363)

SPDT THERMOSTAT measures 0.400 in. o-d. It is hermetically sealed in compression glass. Elmwood Sensors, Inc., 675 Elmwood Ave., Providence 7, R.I. (364)

HALF HEIGHT SLOTTED LINE in waveguide size WR975. Frequency range is 750 Mc to 1,120 Mc. Antenna Systems, Inc., 349 Lincoln St., Hingham, Mass. (365)



... for real Space-Age  
RELIABILITY

## TYPE FC-406 5-AMPERE, 6P-DT

# Dunco

### AIR FRAME RELAY

An inherently dependable design . . . assembled under contaminant-free, super-clean conditions . . . gives the Dunco FC-406 the ultimate reliability demanded by the most critical aerospace applications.

Components of the FC-406 are repeatedly cleaned during manufacture, assembled in white rooms and hermetically sealed in inert atmospheres to assure long, fully dependable operation under minimum current, rated load, and severe overload conditions.

Designed primarily for air frame use to MIL-R-6106C, the FC-406 design is also adaptable to MIL-R-5757D applications. A dual coil magnet operating a balanced armature assures resistance to vibration and shock. Bifurcated contacts are used to improve contact life and to insure minimum-current reliability.

Optional mounting and terminal styles as well as self-contained rectifiers for 115V ac coil operation are available. For full details, ask for Data Bulletin FC-406. Address: Struthers-Dunn, Inc., Pitman, N.J.

# STRUTHERS-DUNN

Member, National Association of Relay Manufacturers

Sales Engineering Offices in: Atlanta • Boston • Buffalo • Charlotte • Chicago • Cincinnati • Cleveland  
Dallas • Dayton • Denver • Detroit • Kansas City • Los Angeles • Memphis • New York • Orlando  
Pittsburgh • St. Louis • San Diego • San Francisco • Seattle. Canadian Licensee: Renfrew Electric  
Co., Toronto, Ontario, Canada. Export Department: 1505 Race St., Philadelphia 2, Pa., U.S.A.

**KLIXON**  
PRECISION CONTROLS

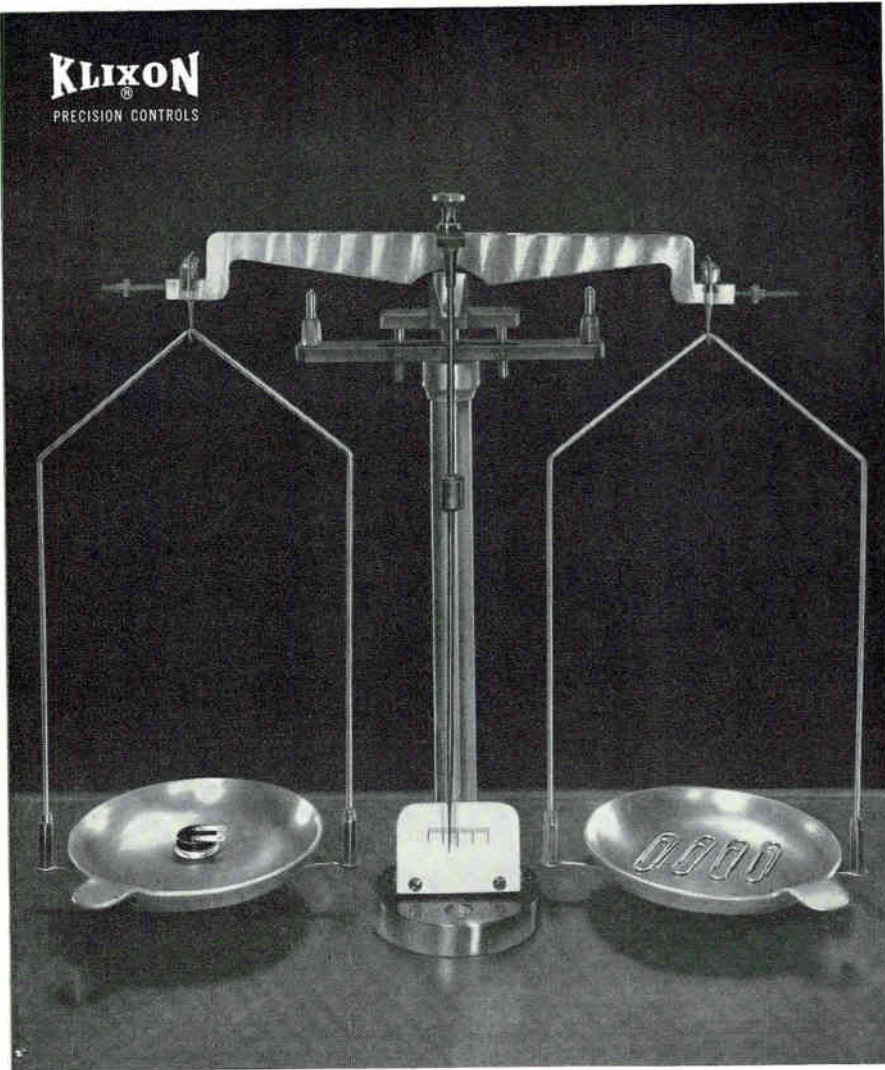

## When temperature control has space and weight limitations...

... specify the thinnest (0.262 in), lightest (0.1 oz)  
snap-acting precision thermostats on the market today!

**KLIXON® 6786 Precision Thermostats** ... for reliable operation in the — 65°F to 450°F ambient temperature range ... offer surprising performance characteristics for their size and weight. They handle electrical loads up to 7 amp, 30 V-ac/dc and 6 amp, 125 V-ac ... deliver 100,000 cycles at 5 amp, 30 V-ac/dc ... resist 30 G impact shock and 40-500 cps vibration at 10 G acceleration.

**These semi-enclosed thermostats** cost less than sealed devices yet provide all the reliability you need where severe environments are not encountered. Designed to open or close on temperature rise, they're widely used as temperature controls or warning devices in crystal ovens, aircraft motor windings, commercial communication equipment, heaters, fans, servo-mechanisms, gyroscopes, aerial cameras, electronic circuits and components.

**Bulletin PRET-5** gives you all the facts about space-saving, weight-saving **KLIXON 6786 Series Thermostats**. Write for your copy today.



**METALS & CONTROLS INC.**  
5009 FOREST ST., ATTLEBORO, MASS.  
A CORPORATE DIVISION OF  
**TEXAS INSTRUMENTS**  
INCORPORATED



**KLIXON 6786 SERIES**  
PRECISION  
THERMOSTAT  
(actual size)

## Literature of the Week

**MODULAR SWITCH ASSEMBLIES** North Atlantic Industries, Inc., Terminal Drive, Plainview, N.Y. Instrumentation data sheet gives electrical and mechanical specifications for modular thumbwheel type switches. **CIRCLE 366, READER SERVICE CARD**

**INTEGRATING MOTOR TACHOMETER GENERATORS** Kearfott Division, General Precision, Inc., Little Falls, N.J. A catalog sheet covers size 8 temperature-compensated integrating motor tachometer generators. (367)

**PULSE EQUIPMENT** General Radio Co., West Concord, Mass. Brochure describes pulse, sweep, and time-delay generators, pulse amplifiers, and variable delay lines. (368)

**INDUSTRIAL TRANSFORMERS** Stancor Electronics, Inc., 3501 W. Addison St., Chicago 18, Ill., has published a 40-page industrial catalog of transformers and related components. (369)

**VARIABLE RESISTOR** CTS of Berne, Inc., Berne, Ind., offers a catalog on a 3-w military grade variable resistor at 2-w industrial price. (370)

**PRECISION ANGLE SENSORS** Del Electronics Corp., 250 Sandford Blvd., Mount Vernon, N.Y. An engineering manual describes the Multisyn, a device capable of measuring and controlling rotary motion with extreme accuracy. (371)

**SYNCHROS** Vernitron Corp., 602 Old Country Road, Garden City, N. Y. Data sheet contains specifications to aid in rapid selection of size 23 MIL synchros. (372)

**STATIC CONVERTERS** Sparton Corp., Jackson, Mich. Product data sheet gives description and specifications of a series of low cost, transistorized d-c/d-c static converters. (373)

**MICROWAVE FILTERS** Watkins-Johnson Co., 3333 Hillview Ave., Palo Alto, Calif. Technical bulletin covers electronically-tuned microwave filters with rapid-switching capabilities. (374)

**ELECTRON BEAM GUNS** Brad Thompson Industries, Inc., 83-810 Tamarisk St., Indio, Calif. Catalog describes electron guns for both internal and external mounting with ratings up to 6 Kw. (375)

**VIBRATION GAGE** Raydata Corp., 1078 E. Granville Rd., Columbus 24, O., has a bulletin on a self-calibrating, non-contacting instrument for the continuous display of vibration amplitude and frequency. (376)

**HIGH VACUUM RELAY** Resitron Laboratories, Inc., 3860 Centinela Ave., Los Angeles 66, Calif. Data sheet illustrates and describes the RVS-1



high voltage, high vacuum transfer relay. (377)

**ACCELEROMETER** Clevite Electronic Components, 232 Forbes Road, Bedford, O., has available literature on model 5D41 self-generating, high capacity accelerometer. (378)

**RELAYS** Ohmite Mfg. Co., 3698 Howard St., Skokie, Ill. A complete line of made-to-order and stock relays is described in a catalog. (379)

**CERAMIC CAPACITORS** Gulton Industries, Inc., 212 Durham Ave., Metuchen, N. J. Bulletin covers epoxy-coated miniature ceramic capacitors with weldable leads for cordwood packaging. (380)

**MEDIUM FREQUENCY RECORDER** Texas Instruments Inc., 3609 Buffalo Speedway, Houston 6, Texas. Bulletin R-509 illustrates and describes the portable Oscillo/Riter medium frequency recorder. (381)

**HIGH POWER AUDIO AMPLIFIER** Bruno-New York Industries Corp., 460 W. 34th St., New York 1, N. Y. Data sheet describes model 944 compact and rugged, transistorized 20 w audio amplifier. (382)

**CAPACITORS** General Electric Co., Schenectady 5, N. Y. Bulletin GEC-1745 contains complete information on a line of fixed paper-dielectric electronic capacitors. (383)

**PARTICLE DETECTORS** Nuclear Diodes, Inc., 1640 Deerfield Road, Highland Park, Ill. Brochure covers a line of silicon surface barrier charged particle detectors. (384)

**POTENTIOMETRIC RECORDER** Barber-Colman Co., Rockford, Ill. Bulletin F-11394 describes a quick change multipoint recorder. (385)

**NEW CIRCUITS MANUAL** Transmagnetics Inc., 40-66 Lawrence St., Flushing 54, N. Y., offers a technical manual entitled "New Circuits for Solving Unique Design Problems." (386)

**MAGNETIC TAPE** Computron Inc., 122 Calvary St., Waltham 54, Mass., has published a 10-page booklet entitled "Facts You Should Know About Magnetic Tape." (387)

**MAGNETIC AMPLIFIER RELAYS** Sigma Instruments, Inc., Braintree 85, Mass. Six-page bulletin covers a series of 400 cps  $\mu$ v-sensitive polarized magnetic amplifier relays. (388)

**FERRITE FOAMS** Emerson & Cuming, Inc., Canton, Mass., has published a technical bulletin on Eccofoam Fe, a series of ferrite materials in foam and honeycomb form. (389)

**SILICON RECTIFIERS** Erie Resistor Corp., 644 W. 12th St., Erie, Pa. Bulletin 523 presents specifications for a line of miniaturized encapsulated silicon rectifiers. (390)

**THIN-FILM MICROCIRCUITS** Hallex, Inc., 310 E. Imperial Ave., El Segundo, Calif. Advantages and construction of thin-film microcircuits are described in a bulletin. (391)

## GATES RADIO COMPANY BUILDS 50 KW TRANSMITTER FOR VOICE OF AMERICA

UCSXHF 450  
40 kv  
60 AMPS

A. UCSF 500  
15 kv  
45 AMPS

MMHC 450  
55 kv  
125 AMPS

B.

A. Output network of Gates HF-50C using Jennings UCSF 500 vacuum variable capacitors. B. Power amplifiers with Jennings UCSXHF 450 capacitors in the plate tuning circuit. Jennings capacitors are also used for grid loading, neutralizing, and plate by-pass.

# RELIABILITY AND REDUCED SIZE GAINED BY USING JENNINGS VACUUM CAPACITORS

These new 50 kw high frequency transmitters built by Gates Radio Company are the first available to meet rigid USA specifications that harmonic and spurious radiation be attenuated at least 80 db. The transmitters only occupy 5x11x6½ feet and are tunable through front panel controls over the entire range of 3.9 to 30 mc.

Jennings vacuum capacitors are the logical choice where compactness is desired because the high strength vacuum dielectric allows them to be made much smaller which results in the added effectiveness of lower inductive losses.

Jennings vacuum capacitors are more reliable because the sealed plates never become contaminated. They possess an extremely wide capacity change ratio that makes possible a wide frequency range. Further, vacuum capacitors have a very low dielectric loss and are self sealing after moderate overloads.

Jennings 350 types of fixed and variable vacuum capacitors permits selection of the right capacitor to meet your circuit requirements.

Write today for more detailed information about our complete line of vacuum fixed and variable capacitors.

RELIABILITY MEANS VACUUM / VACUUM MEANS *Jennings*

JENNINGS RADIO MFG. CORP., 970 McLAUGHLIN AVE., SAN JOSE 8, CALIF., PHONE CYpress 2-4025



DISCUSSING new product possibilities at Tempo Instrument Incorporated are (left to right) Alfred Multari, vice president and technical director; George J. Sbordone, president; Vincent A. Altomare, marketing manager; and Emanuel Poulous, v-p and head of advanced engineering

## Sbordone: Making Time With Teamwork

NEW PRESIDENT of Tempo Instrument Incorporated, Plainview, N. Y., is George J. Sbordone. His election comes after 4½ years as vice president and general manager. He succeeds Franklin Meyer, now chairman of the board.

The new president has seen Tempo grow from a handful of men and dollars to a group of 135 employees (25 percent of them engineers), which constitute what he calls the "Tempo Team."

Tempo has committee management. To those who would point out the old saw about the camel being a horse designed by a committee, Sbordone points up the fact that the company was up 27 percent in sales in the first quarter of 1962, and expects to do \$2.4 million by this year—an increase of more than 20 percent over 1961.

The company was founded in 1957 to bring an idea into reality—an all-electronic, solid-state timer. The first Tempo timer to become a standard component for a missile was for separating the stages of Thor (Douglas). Its timing devices are now used in many American rockets, missiles and satellites.

Although Tempo has been in-

involved primarily in components and subsystems for defense projects, Sbordone emphasized the company's recent progress in devices for industry. For example, it recently developed an all-electronic voltage monitor for electric utilities, and a short magnetostrictive delay line for programmers and computers.

Sbordone brings to his present position a background of 19 years of high level experience in design engineering, project administration cost control and production methods. Before joining Tempo, he spent eight years with Sperry Gyroscope Co., and ten years with Servomechanisms, Inc.

A modest man, Sbordone tells interviewers: "Don't talk about me, talk about Tempo." He says that his only real talent is working with people. He and his wife have four children and live in South Hempstead, Long Island.

## Hawley Products Elects Peck

ARTHUR L. PECK has been elected vice president, manufacturing, engineering and research by the board

of directors of Hawley Products Co., St. Charles, Ill. He was formerly director of manufacturing of the company.

## Sylvania Hires Bruce Barrow

APPOINTMENT of Bruce B. Barrow as a senior engineering specialist at the Applied Research Laboratory of Sylvania Electronic Systems, Waltham, Mass., is announced. He will be concerned with investigation and application of advanced communication systems.

Prior to joining Sylvania, Barrow was a communications scientist and chief of the scientific information group at the Air Defense Technical Center of the Supreme Headquarters Allied Powers Europe, located in the Netherlands.



## Ampex Corporation Names N. L. Head

N. LAWRENCE HEAD has been named senior scientist at Ampex Corporation's magnetic tape laboratory in Redwood City, Calif. He was formerly chief of the chemical and materials laboratory, U.S. Air Force Materiel Command, headquartered at Hill AFB, Ogden, Utah.

## GD/Convair Fills Newly-Created Post

APPOINTMENT of W. J. Martin to the newly-created post of director of reliability for General Dynamics/Convair, San Diego, Calif., was recently announced by J. H. Famme, division president.

Martin, with Convair since 1943, will report directly to the division president.

"This new alignment," said Famme, "will enable the company



**IMPROVE DEPENDABILITY  
SAVE MONEY use INSTRULAB'S**

EXCELLENT VOLTAGE  
OR CURRENT  
REFERENCE  
DEVICE

**evenvolt**  
+ Constant Voltage Unit -

**DRIFT—  
LESS THAN  
0.01% PER  
24 HOURS**



For your  
Isolated,  
Regulated D.C.  
Voltages or Cur-  
rents for Fixed Loads.  
All Solid State.  
Voltages up to 25 VDC,  
Currents up to 50 Ma.  
Available in many case designs.

WRITE or PHONE

**INSTRULAB, INC.**

1207 Lamar Street • Dayton 4, Ohio  
Phone 223-2241 • Area Code 513

**0.01% Overall Regulation!**

CIRCLE 215 ON READER SERVICE CARD

*for maximum  
reliability*

**SPECIFY BIRTCHER  
PCB-TAINERS®**



**NEW—  
LOW COST SPRING  
CLIPS TO RETAIN  
PRINTED  
CIRCUIT BOARDS**

**PROVIDE EXCELLENT  
GROUND AND  
THERMAL PATHS**

Birtcher PCB-Tainers simplify design and production, provide important cost savings. PCB-Tainers are tested to retain printed circuit boards under more than 30Gs, vibration up to 2000 cps. Material is beryllium copper for excellent electrical ground and thermal path. Standard lengths for 3/32-in. and 1/16-in. boards.

*Available from  
authorized distributors*



Send for new technical  
data sheet with  
drawings, test report,  
complete details.

**THE BIRTCHER  
CORPORATION**  
INDUSTRIAL DIVISION

745 S. Monterey Pass Rd. • Monterey Park, Cal.

**TUBE/TRANSISTOR/COMPONENT  
RETENTION AND COOLING DEVICES**

**WRIGHT SPERRY** **GYRO ELEMENTS  
PROVEN RELIABILITY**

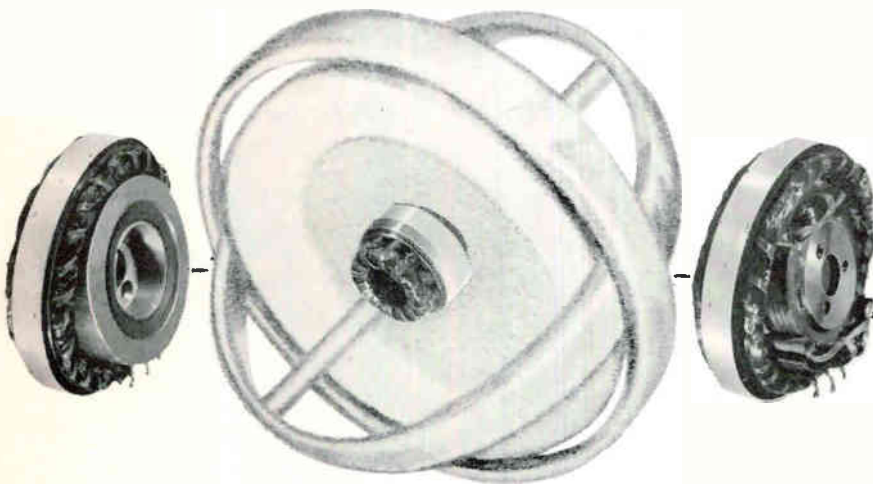

**WRIGHT MACHINERY  
COMPANY**  
DIVISION OF SPERRY RAND CORPORATION  
DURHAM, NORTH CAROLINA  
TELEPHONE 682-8161

- Pancake Synchros, Resolvers
- Torquers, Spin Motors
- Microsyns, Pick-Offs

CIRCLE 210 ON READER SERVICE CARD

**UNITED SYSTEMS CORPORATION**

*Offers...*

**A NEW LOW COST D.C. DIGITAL VOLTMETER**

DIGITEC MODEL 200



**\$287<sup>50</sup>**

**With These FEATURES**

- 0.2% FULL SCALE ACCURACY**
- D.C. RANGES FROM .001 TO 1020 V**
- 2 MEGOHMS INPUT IMPEDANCE**
- SMALL (5½" x 8" x 7") SIZE**
- 7 LBS. TOTAL WEIGHT—PORTABLE**
- MANY PLUS FEATURES**

WRITE OR WIRE FOR DEMONSTRATION

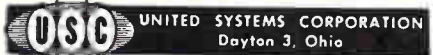

CIRCLE 216 ON READER SERVICE CARD

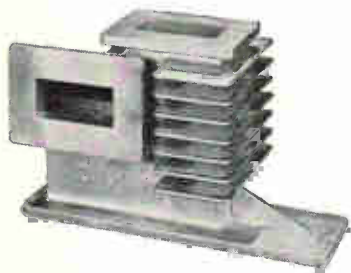

**Casting Problem?**

We pay machining cost on flawed castings. Are you getting this guarantee of quality when you buy castings?

request free Resources & Capabilities booklet:  
Morris Bean & Company  
Yellow Springs 8, Ohio  
aluminum & ductile iron foundries



to give the Department of Defense maximum integration of product reliability, quality control and value control surveillance over development and production of systems and all elements comprising delivered products."



**Hoffman Electronics Appoints Lowance**

FRANKLIN LOWANCE has joined the Military Products division of Hoffman Electronics Corp., Los Angeles, Calif., as chief scientist.

He comes to Hoffman from Electronic Communications, Inc., where he had been president of that company's Advanced Technology division at Santa Barbara, Calif.



**ARRA Promotes Louis Gomez**

ANTENNA & RADOME RESEARCH ASSOCIATES, Westbury, N. Y., announces the appointment of Louis Gomez to the post of vice president for production.

Gomez' prior position at ARRA was that of plant manager.

**Raytheon Company Advances Yates**

DONALD N. YATES, who joined Raytheon Company, Lexington, Mass., in 1961 as director of technical planning, has been elected a vice president of the company and ap-

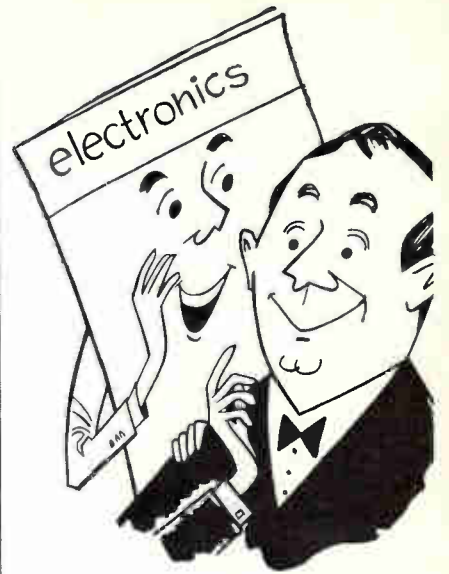

**electronics IS EDITED TO KEEP YOU FULLY INFORMED— a "well-rounded" engineer**

What's your *present* job in electronics? Do you work on computers? (*electronics* ran 158 articles on computers between July, 1961 and June, 1962!) Are you in semi-conductors? (For the same period, *electronics* had 99 articles, not including transistors, solid-state physics, diodes, crystals, etc.) Are you in military electronics? (*electronics* had 179 articles, not including those on aircraft, missiles, radar, etc.)

In all, *electronics'* 28-man editorial staff provided more than 3,000 editorial pages to keep you abreast of all the technical developments in the industry. No matter where you work today or in which job function(s), *electronics* will keep you fully informed. Subscribe today via the Reader Service Card in this issue. Only 7½ cents a copy at the 3 year rate.

**electronics**

electronics



pointed general manager of its Missile and Space Division.

At the time of his retirement from the Air Force as a lieutenant general in 1961, Yates was Deputy Director of Defense Research and Engineering in the office of the Secretary of Defense.



Communicom Names  
Tom Cook

COMMUNICOM, a division of Chaskin-Dimmick Corp., Palo Alto, Calif., has announced the appointment of Tom Cook as communications project engineer. He was previously with ITT-Kellogg Communications Laboratory, and prior to that with Lynch Communications Corp.



Irving Adams  
Joins Airtron

IRVING ADAMS has joined the solid state materials staff of Airtron, a division of Litton Industries, Morris Plains, N. J. He was previously vice president of Optech, Inc., in charge of crystal growth and pure materials research.

Bausch & Lomb Names  
Hasler a Director

MAURICE F. HASLER, chairman of the board of Applied Research Lab-



**CAMBION MOLDED  
CHOKES, Series 2960, are  
available to conform to**

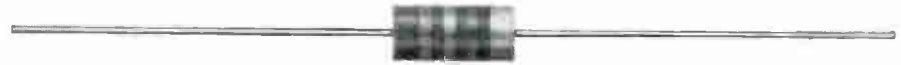

**requirements of MIL-C-15305B,  
MS75008-1 thru -20. Series  
2950 covers MS91189-1 thru-13.**



**For specifications, ranges and  
prices, call, wire or write today  
to Cambridge Thermionic**



**Corporation, 437 Concord  
Ave., Cambridge 38, Mass.  
Phone: TRowbridge 6-2800**



CAMBRIDGE THERMIONIC CORPORATION  
**GAMBION**<sup>®</sup>  
The guaranteed electronic components 

**more usable  
sensitivity  
10 mc to  
44,000 mc  
IN ONE TUNING HEAD**

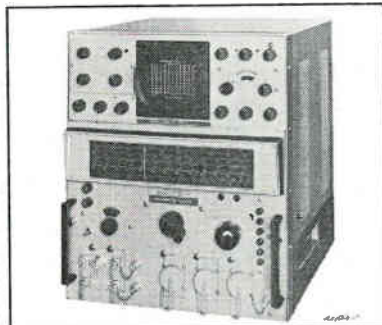

**PANORAMIC'S  
SPA-4a  
SPECTRUM  
ANALYZER**

BAND	SENSITIVITY
1. 10-420 MC	—100* to—110 dbm
2. 350-1000 MC	—95* to—105 dbm
3. 910-2200 MC	—105* to—110 dbm
4. 1980-4500 MC	—100* to—105 dbm
5. 4.5-10.88 KMC	—100* to—110 dbm
6. 10.88-18.0 KMC	—95* to—105 dbm
7. 18.0-26.4 KMC	—85* to—95 dbm
8. 26.4-44.0 KMC	—75* to—90 dbm

\* Guaranteed min. sensitivity throughout bands  
Tuning head includes one triode and two klystron oscillators. Model SPA-4a offers more exclusive advantages for applications demanding extreme sensitivity, stability, versatility, accuracy.

• Exceptionally low distortion • Highly resolved analyses • Three precisely calibrated amplitude scales—30 db log, linear and power (square law)  
• Two independent frequency dispersion ranges—continuously adjustable 0-70 mc and 0-5 mc. Very low internal frequency modulation permits extremely narrow band analysis • Variable I.F. bandwidth from 1 kc to 80 kc • Push-button frequency selector • Synchroscope output with 60 db gain • Accurate measurement of small frequency differences. A self contained marker oscillator, modulated by a calibrated external generator, provides accurate differential marker pips as close as 2 kc.  
Tremendous flexibility and many unique advantages of Panoramic's compact SPA-4a make it unsurpassed for visually analyzing FM, AM and pulsed signal systems; instabilities of oscillators; noise spectra; detection of parasitics; studies of harmonic outputs; radar systems and other signal sources.

Write, wire or phone today for detailed SPA-4a bulletin.



SEE Panoramic "in action" at the EIME exhibits

530 So. Fulton Ave., Mount Vernon, N. Y.  
(Area Code 914) OWens 9-4600  
TWX: MT-V-NY-5229 Cable: Panoramic,  
Mt. Vernon, N. Y. State

oratories, Inc., Glendale, Calif., has been named a director of Bausch & Lomb Inc., Rochester, N. Y. Applied Research Laboratories is a wholly-owned subsidiary of Bausch & Lomb.



**Announce Formation of  
New Company**

FORMATION of a new electronics firm in San Diego known as Micro-netics Inc. has been announced by its president, Robert E. Honer. Company specializes in microwave instrumentation systems.

Honer was formerly manager of product planning for Lockheed's Missiles and Space Co. at Sunnyvale, Calif.



**Siltronics Names  
Schuyler Kase**

SILTRONICS, INC., Pittsburgh electronics and communications manufacturer, has named Schuyler Kase as its director of new product development.

Kase comes to Siltronics from Norwalk, Conn., where he served as assistant director of Engineering in the Perkin Elmer Corp.

**Frequency Engineering  
Hires Jamison**

RUSLIN P. JAMISON has joined Frequency Engineering Labora-

**6° PHASE ACCURACY**

with

**ITT/SCHOMANDL  
FREQUENCY  
SYNTHESIZER**

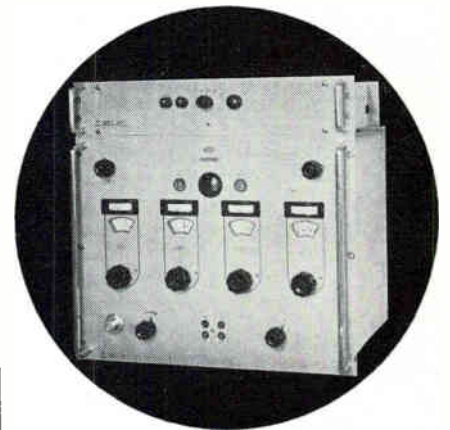

Produces or measures frequencies from 50 cps to 31 mc\* to accuracy of a 100 kc reference source.

EXTREME STABILITY is achieved since every 1 kc step is *phase-locked* reducing "phase jitters" to less than 6°.

DECADE CALIBRATION

FREQUENCY RANGE —  
50 cps to 31 mc

\*With accessories, range can be extended from 0.1 cps to 40 kmc.

ACCURACY — TO 6°

OUTPUT VOLTAGE —  
Greater than 50 mv

**\$3500**

F.O.B. San Fernando, California

For further information write for Data File E-1810-1

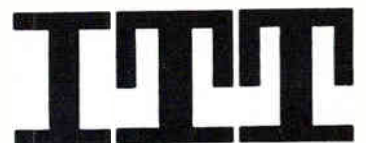

Industrial Products Division  
International Telephone and Telegraph Corporation  
55191 Bledsoe Street • San Fernando, Calif. • EMpire 7-6161



tories, Asbury Park, N. J., as electrical engineer in the firm's Systems Engineering Group. He will be assigned to the AN/WLR-1 countermeasures receiver program recently awarded Frequency Engineering by the U. S. Navy.

Jamison was formerly with Hill Electronics, Inc., Mechanicsburg, Pa.

#### PEOPLE IN BRIEF

Donald S. Jones advances to asst. g-m of Bendix-Scintilla. Kenneth E. Hunter moves up to v-p, g-m of the Hycon Mfg. Co. William D. Gabor, ex-Perkin Elmer Corp., named senior project engineer in the Communications div. of Manson Laboratories, Inc. Harold Goldstein, formerly with Budd Electronics and the Lewyt Corp., joins Paradynamics, Inc., as senior member of the technical staff. M. L. Clevett, Jr., previously with Lockheed Aircraft Corp., appointed to the research engineering staff of the Spindletop Research Center. Taylor Corp. ups Fred P. Baughman to v-p, R&D. Neil L. Brown leaves Woods Hole Oceanographic Institute to become research mgr. of Hytech div. of The Bissett-Berman Corp. Russell K. Jackson, formerly with Minneapolis-Honeywell Regulator Co., now production mgr. of Schaevitz Engineering. Robert F. Schulz, ex-Sylvania Electronic Systems, named mgr. of manufacturing for Applied Technology, Inc. Middletown div. of Aeronca Mfg. Corp. promotes Raymond A. Ruge to director of engineering. John F. Moore of Lockheed Electronics appointed consulting scientist for the company. John K. Shelley, previously with the FAA, has joined Systems Inc. as asst. to the v-p of engineering. Arthur R. J. Johnson advances to mgr., system products for the Systems div. of Beckman Instruments, Inc. Peter M. Kelly transfers from Ford Motor Co. to the Philco Scientific Laboratory as associate director. A. Robert Masters moves up to president of the Hugh H. Eby Co., succeeding Jules Sussman who has been elected chairman of the board.

ask  
**MARKEM**  
to show you  
how to  
identify  
your products  
completely  
— at  
least  
cost



#A-104660  
4000 OHMS  
C. P. CLARE & CO  
CHICAGO, ILL.



Whether your electrical and electronic products range from subminiature and microminiature components to large panels and "packages", you can identify them *all* completely and clearly, at production speeds, with economical Markem methods engineered to your particular requirements. For example: methods to mark odd shapes, sizes and surfaces with your complete, detailed legend, using quick-change type flexibility and ink to meet military specifications and withstand unusual environmental conditions—and above all, with savings in time and money—are offered by Markem, one responsible source for the entire process.

For a complete in-plant analysis of all your product identification processes—or a practical answer to a specific problem—call in your local Markem Technical Representative. Markem Machine Co., Electronics Division, Keene 5, N. H.

12-page catalog on request. Please use inquiry card.



**MARKEM**

HELPS YOUR PRODUCT SPEAK FOR ITSELF

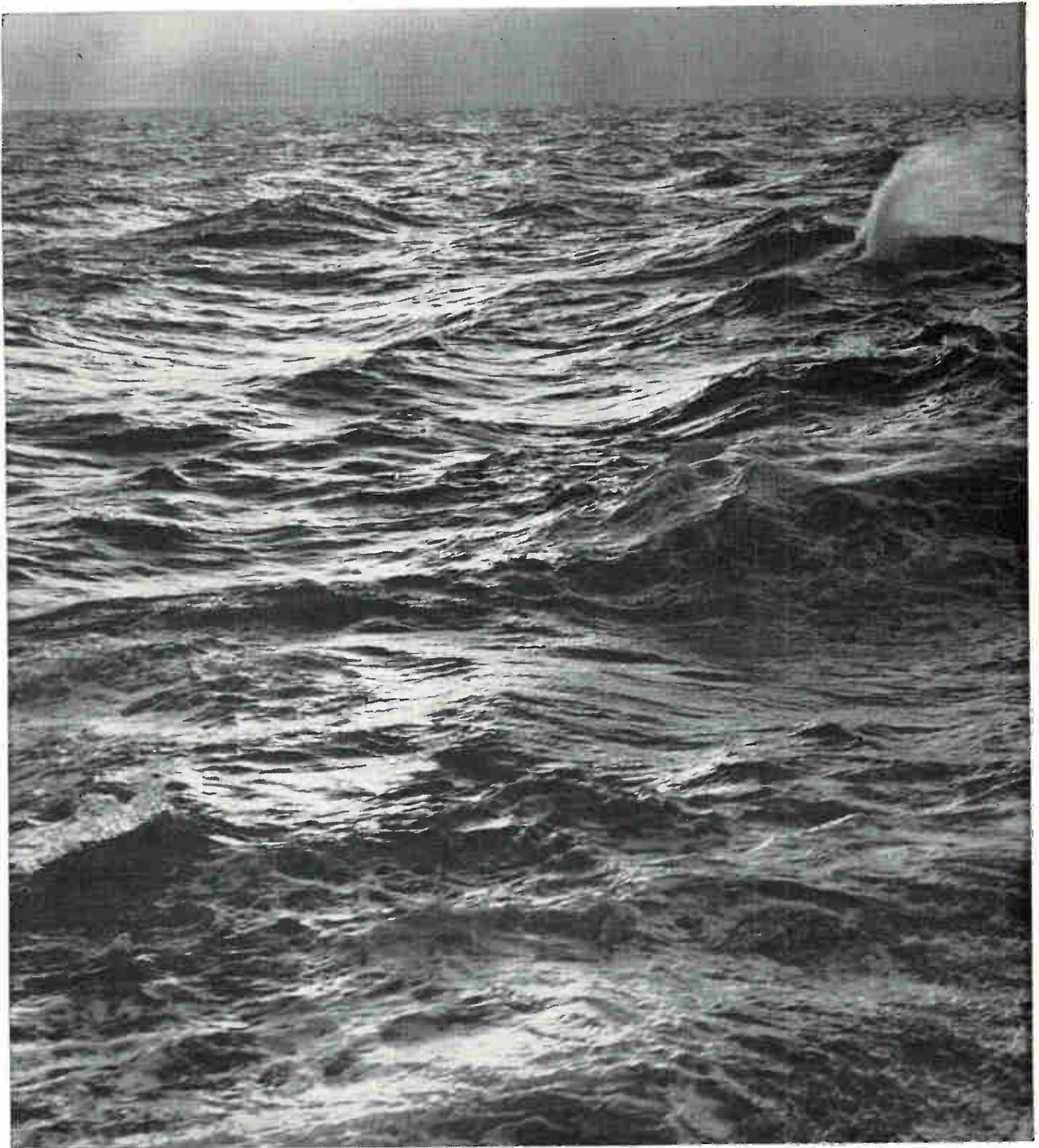

## There's business out there.

You're looking at more than a horizon. It's a future, yours and America's. Out there is Europe and Latin America and Asia and Africa. But in 1960, of all U.S. manufacturers, less than 5% saw these foreign shores for what they are worth: a 19-billion-dollar export market, a vast source of foreign trade.

Move in for your share. Build your business and help keep America growing. Extra production creates more jobs, helps balance the outflow of gold, and wins new friends abroad with U.S.-made products.

Even if you've never sold overseas, you have a rare op-

portunity to start—now. Your U.S. Department of Commerce will help with counsel by experts on what, where and how to sell—with data on credits, payments and financing. A package of invaluable know-how is yours for the asking.

Now's the time to discover the many ways in which your business can grow. In the lucrative export markets. In new U.S. markets. In developing new products. In attracting new industry to your community. Just write or phone the U.S. Department of Commerce Office of Field Services in your city, or Washington 25, D.C. They are ready to help you grow with America!



**NOW'S THE TIME TO GET GROWING IN A GROWING AMERICA!**



# electronics

## WEEKLY QUALIFICATION FORM FOR POSITIONS AVAILABLE

### ATTENTION: ENGINEERS, SCIENTISTS, PHYSICISTS

This Qualification Form is designed to help you advance in the electronics industry. It is unique and compact. Designed with the assistance of professional personnel management, it isolates specific experience in electronics and deals only in essential background information.

The advertisers listed here are seeking professional experience. Fill in the Qualification Form below.

#### STRICTLY CONFIDENTIAL

Your Qualification form will be handled as "Strictly Confidential" by ELECTRONICS. Our processing system is such that your form will be forwarded within 24 hours to the proper executives in the companies you select. You will be contacted at your home by the interested companies.

#### WHAT TO DO

1. Review the positions in the advertisements.
2. Select those for which you qualify.
3. Notice the key numbers.
4. Circle the corresponding key number below the Qualification Form.
5. Fill out the form completely. Please print clearly.
6. Mail to: D. Hawksby, Classified Advertising Div., ELECTRONICS, Box 12, New York 36, N. Y. (No charge, of course).

COMPANY	SEE PAGE	KEY #
ATLANTIC RESEARCH CORPORATION Jansky & Bailey Div. Alexandria, Va.	109*	1
ATOMIC PERSONNEL INC. Philadelphia, Pa.	117	2
BELL AEROSYSTEMS CO. Division of Bell Aerospace Corporation— A Textron Company Buffalo, New York	110*	3
BRISTOL COMPANY Waterbury, Conn.	110*	4
DOUGLAS AIRCRAFT CO., Missile & Space Systems Division Santa Monica, California	37*	5
ESQUIRE PERSONNEL Chicago, Illinois	116	6
GENERAL DYNAMICS/ELECTRONICS A Div. of General Dynamics Corp. Rochester, New York	108*	7
HOUSTON INSTRUMENT CORP. Bellaire, Texas	110*	8
JET PROPULSION LABORATORY Pasadena, California	116	9
LOCKHEED CALIFORNIA COMPANY A Div. of Lockheed Aircraft Corp. Burbank, California	66	10
MICROWAVE SERVICES INTERNATIONAL INC. Denville, New Jersey	110*	11
MOLONEY ELECTRIC CO. St. Louis, Mo.	110*	12
NORTHROP CORP. Norair Div. Hawthorne, California	93, 95	13
NORTHROP CORP. Space Laboratories Hawthorne, California	93, 97	14
PHILCO WESTERN DEVELOPMENT LABS. Sub. of Ford Motor Co., Palo Alto, California	107*	15

(CONTINUED ON FOLLOWING PAGE)

(cut here) **electronics WEEKLY QUALIFICATION FORM FOR POSITIONS AVAILABLE** (cut here)  
(Please type or print clearly. Necessary for reproduction.)

#### Personal Background

NAME .....  
HOME ADDRESS .....  
CITY ..... ZONE ..... STATE .....  
HOME TELEPHONE .....

#### Education

PROFESSIONAL DEGREE(S) .....  
MAJOR(S) .....  
UNIVERSITY .....  
DATE(S) .....

#### FIELDS OF EXPERIENCE (Please Check)

- |  |  |                                       |
|--|--|---------------------------------------|
| <input type="checkbox"/> Aerospace           | <input type="checkbox"/> Fire Control        | <input type="checkbox"/> Radar        |
| <input type="checkbox"/> Antennas            | <input type="checkbox"/> Human Factors       | <input type="checkbox"/> Radio-TV     |
| <input type="checkbox"/> ASW                 | <input type="checkbox"/> Infrared            | <input type="checkbox"/> Simulators   |
| <input type="checkbox"/> Circuits            | <input type="checkbox"/> Instrumentation     | <input type="checkbox"/> Solid State  |
| <input type="checkbox"/> Communications      | <input type="checkbox"/> Medicine            | <input type="checkbox"/> Telemetry    |
| <input type="checkbox"/> Components          | <input type="checkbox"/> Microwave           | <input type="checkbox"/> Transformers |
| <input type="checkbox"/> Computers           | <input type="checkbox"/> Navigation          | <input type="checkbox"/> Other .....  |
| <input type="checkbox"/> ECM                 | <input type="checkbox"/> Operations Research | <input type="checkbox"/> .....        |
| <input type="checkbox"/> Electron Tubes      | <input type="checkbox"/> Optics              | <input type="checkbox"/> .....        |
| <input type="checkbox"/> Engineering Writing | <input type="checkbox"/> Packaging           | <input type="checkbox"/> .....        |

9/14/62

#### CATEGORY OF SPECIALIZATION

Please indicate number of months experience on proper lines.

	Technical Experience (Months)	Supervisory Experience (Months)
RESEARCH (pure, fundamental, basic)	.....	.....
RESEARCH (Applied)	.....	.....
SYSTEMS (New Concepts)	.....	.....
DEVELOPMENT (Model)	.....	.....
DESIGN (Product)	.....	.....
MANUFACTURING (Product)	.....	.....
FIELD (Service)	.....	.....
SALES (Proposals & Products)	.....	.....

CIRCLE KEY NUMBERS OF ABOVE COMPANIES' POSITIONS THAT INTEREST YOU

1 2 3 4 5 6 7 8 9 10 11 12 13 14 15 16 17 18 19 20 21 22 23 24 25

ELECTRONICS ENGINEERS  
& SCIENTISTS

Explore Today's Most  
Advanced Projects in  
Near and Deep

## SPACE COMMUNICATIONS

( Vehicle-to-Ground )  
( Vehicle-to-Vehicle )

A diversity of advanced communications problems offer you stimulating assignments at Republic's Missile Systems Division. These include communications systems for a number of next-generation satellites and hypersonic vehicles. Emphasis is on applications of new digital techniques in wideband information transmission; multiplexing, security coding and noise reduction. Re-entry blackout communications problems are under study; new concepts in IR cameras are under development.

Openings at all levels on  
Systems and Component  
Design & Development,  
Systems Analysis, &  
Test Programs for

**MICROWAVE ENGINEERS**  
**RADAR ENGINEERS**  
**COMMUNICATIONS ENGINEERS**  
**IR & OPTICS SPECIALISTS**  
**DIGITAL COMPUTER  
SPECIALISTS**

Also, unusually varied assignments for **CIRCUIT DESIGN ENGINEERS** with experience in transistorized UHF & microwave systems, including: High Frequency Pulse Circuits, Digital Computer Building Blocks, RF Circuits, Communication Coding Circuits, Feedback Control Circuits.

Write Mr. Paul Hartman,  
Technical Employment Supervisor

**MISSILE  
SYSTEMS  
DIVISION**  
**REPUBLIC**  
AVIATION CORPORATION

223 Jericho Turnpike  
Mineola, Long Island, New York

An Equal Opportunity Employer



**ENGINEERS:**  
Systems, Design,  
Development  
**PHYSICISTS**

opportunity  
and  
advancement  
are

# 'GO'

at VITRO!

### DYNAMIC EXPANSION CREATES NEW CAREER POSITIONS

Vitro Laboratories is expanding on all fronts . . . missile systems engineering . . . design and development . . . analysis . . . research and study. We are stretching the parameters of knowledge in space, in the air, on the ground and overseas. We invite you to enter the "go" climate of Vitro.

Vitro is a good place to work. Here you will find a professional atmosphere conducive to original and imaginative thinking. Skilled clerical and technical support frees you to concentrate on the creative aspects of your assignments, and salaries are at a level worthy of your attention. You will advance as fast as your talents allow.

Career appointments are available immediately in the following areas:

#### MISSILE SYSTEMS ENGINEERING

Polaris, Typhon, Talos, Tartar

#### DESIGN & DEVELOPMENT

Digital equipment  
ASW equipment  
Underwater vehicles  
Simulators • Torpedoes  
Electro-mechanical launching equipment

#### ANALYSIS

Radar and IR systems  
Digital and analog equipment  
Fire control systems

#### RESEARCH & STUDY

Reliability and feasibility studies  
Basic and applied research  
Weapons systems analysis  
Acoustic studies  
ASW studies

WRITE OR PHONE COLLECT for details:  
Manager, Professional Employment

## VITRO LABORATORIES

Division of Vitro Corporation of America  
Dept. .44, 14000 Georgia Ave.  
Silver Spring, Maryland  
(Residential suburb of Washington, D. C.)  
Phone: WHitehall 2-7200  
An equal opportunity employer

# jpl needs

## SENIOR ELECTRONIC DESIGN ENGINEERS

To design flight hardware to be used in lunar and planetary spacecraft. Responsibilities begin with initial design and carry on through spacecraft systems tests. Specific assignments involve:

Auto-calibration and checkout of PCM space telemetry systems.

Optimum data filtering prior to analog to digital conversion.

Special purpose digital computer for optimum detection of pulse code modulation.

BSEE or MSEE is desired.

Send complete resume to  
PERSONNEL DEPT.

## JET PROPULSION LABORATORY

Operated by California Institute of Technology for the National Aeronautics & Space Administration  
4814 OAK GROVE DR. • PASADENA, CALIF.

"An equal opportunity employer"

### CHIEF ENGINEER

To \$22,500 Per Year

BSEE, however a MS or PHD is preferred. Experience at the department or program level, where groups of engineering and support personnel were supervised. Knowledge of Digital Systems and Solid State Devices required. Company client assumes all expenses.

ESQUIRE PERSONNEL SERVICE INC.  
202 S. State St. Chicago 4, Ill.

### EMPLOYMENT SERVICES

Thousands of \$7,000-\$35,000 Executive & Technical jobs available. Get free report. National Employment Reports, 105 W. Adams, A8, Chicago 3.

# electronics

## WEEKLY QUALIFICATIONS FORM FOR POSITIONS AVAILABLE

(Continued from preceding page)

REPUBLIC AVIATION CORPORATION	109*	16
Farmingdale, Long Island, New York		
REPUBLIC AVIATION CORPORATION	116	17
Missile Systems Div. Mineola, Long Island, New York		
SCHUMBERGER WELL SURVEYING CORP.	117	18
Ridgefield, Connecticut		
SPACE TECHNOLOGY LABORATORIES INC.	15*	19
Sub. of Thompson Ramo Wooldridge Inc. Redondo Beach, California		
U. S. NAVAL CIVIL ENGINEERING LABORATORY	108*	20
Port Hueneme, California		
VITRO LABORATORIES	116	21
Div. of Vitro Corp. of America Silver Spring, Maryland		
P-9428	117	22

\* These advertisements appeared in the 9/7/62 issue.



# ELECTRICAL ENGINEERS or PHYSICISTS

Schlumberger Well Surveying Corporation maintains a program of long-range industrial research projects at its Research Laboratory in Ridgefield, Connecticut.

The program includes such scientific fields as electromagnetic theory, wave propagation, nuclear physics, nuclear magnetic resonance, electronic systems, data processing, sonics, physical chemistry and fluid flow in porous media.

Our openings are for graduate electrical or electronic engineers or physicists with a minimum of 3 years experience in industry or in a research laboratory. The candidates should be familiar with electromagnetic theory.

The experimental projects underway in our Electronic Systems Section are concerned with electromagnetic field distributions, high voltage equipment and solid state circuitry.

Our laboratory is located in a small Connecticut town about 50 miles north-east of New York City. The facilities at the Laboratory are extensive and modern. Working conditions and fringe benefits are consistent with the highest industrial standards.

Please send brief resume  
to Mr. J. J. McNamara.

## SCHLUMBERGER WELL SURVEYING CORPORATION

P. O. Box 307  
Ridgefield, Connecticut



**E. E.'s**  
for FEE-PAID Positions  
**WRITE US FIRST!**  
Use our confidential application for professional, individualized service . . . a complete national technical employment agency.  
**ATOMIC PERSONNEL, INC.**  
Suite 1207L, 1518 Walnut St., Phila. 2, Pa.

### RESEARCH SCIENTIST

Leading manufacturer of guidance instruments and control devices in Southern California needs imaginative scientist with background in micro electronics. Must have ability to write engineering proposals and to present new product ideas to customers. Requires Phd in Physical Sciences. Minimum 5 years experience. Salary open.

### ASSOCIATE SCIENTIST

M.S., E.E. Minimum 5 years solid state design. Salary open.

P-9428. Electronics  
255 California St., San Francisco 11, Calif.

An equal opportunity employer.

# SEARCHLIGHT SECTION

(Classified Advertising)

BUSINESS OPPORTUNITIES

EQUIPMENT - USED or RESALE

#### DISPLAYED

The advertising is \$27.25 per inch for all advertising other than on a contract basis. AN ADVERTISING INCH is measured 7/8" vert. on a column, 3 cols.—30 inches—to a page. EQUIPMENT WANTED or FOR SALE ADVERTISEMENTS acceptable only in Displayed Style.

#### ---RATES---

#### UNDISPLAYED

\$2.70 a line, minimum 3 lines. To figure advance payment count 5 average words as a line. BOX NUMBERS count as one line additional. DISCOUNT of 10% if full payment is made in advance for four consecutive insertions.

Send NEW ADVERTISEMENTS or Inquiries to Classified Adv. Div. of Electronics, P. O. Box 12, N. Y. 36, N. Y.

## ANTENNA PEDESTAL SCR 584-MP 61B

Full azimuth and elevation sweeps: 360 degrees in azimuth, 210 degrees in elevation. Accurate to 1 mil. or better over system. Complete for full tracking response. Angle acceleration rate: AZ, 9 degrees per second squared EL, 4 degrees per second squared. Angle slewing rate: AZ 20 degrees per sec. EL, 10 degrees per sec. Can mount up to a 20 ft. dish. Angle tracking rate: 10 degrees per sec. Includes pedestal drives, selsyns, potentiometers, drive motors, control amp/dynes. Excellent condition. Quantity in stock for immediate shipment. Ideal for missile & satellite tracking, antenna pattern ranges, radar system, radio astronomy, any project requiring accurate response in elevation and azimuth. Complete description in McGraw-Hill Radiation Laboratory Series, Volume 1, page 284 and page 209, and Volume 26, page 233.

#### 2 MEGAWATT PULSERS

(A) 31 KV at 60 amps .002 Duty Cycle Ideal for 5J26 at 500 KW \$950.  
(B) 30 KV at 70 amps .001 Duty Cycle. \$1250 w/pulse output trans.

#### MIT MODEL 9 PULSER

#### 1 MEGAWATT-HARD TUBE

Output pulse power 25KV at 40 amp. Max. duty ratio: .002. Uses 6C21 pulse tube. Pulse duration .25 to 2 microsec. Input 115 volts 60 cycles AC. Includes power supply in separate cabinet and driver. Fully guaranteed as new condition. Full Desc. MIT. Rad. Lab. Series "Pulse Generators."

#### 500 KW PULSER

5C22 Hyd. Thyr. Modulator. 22KV at 28 Amps. VV HV & Fil Supplies. 3 pulse length rep rates: 2.25 usec 300 pps. 1.75 usec 550 pps. .4 usec 2500 pps. 115V 60 cy. Will deliver nominal 225 KW X Band using 4J50 magnetron.

#### L BAND RF PKG.

20KW peak 990 to 104MC. Pulse width .7 to 1.2 micro sec. Rep rate 180 to 420 pps. Input 115 vac. Incl. Receiver \$1200.

#### SCR 584 RADAR AUTO-TRACK

3 CM & 10 CM. Our 584s in like new condition, ready to go, and in stock for immediate delivery. Used on Atlantic Missile Range, Pacific Missile Range, NASA Wallops Island, A.B.M.A. Write us. Fully Desc. MIT Rad. Lab. Series, Vol 1, pps. 207-210, 228, 281-286.

#### 300 TO 2400MC RF PKG.

300 to 2400MC CW. Tuneable, Transmitter 10 to 30 Watts. Output. As new \$375.

#### AN/TPS-1D RADAR

500 kw. 1220-1350 mcs. 160 nautical mile search range P.P.I. and A. Scopes, MTI, thyatron mod. 5J26 magnetron. Complete system.

#### AN/TPS 10D HEIGHT FINDER

250 KW X-Band. 60 & 120 mile ranges to 60,000 feet. Complete.

#### AN/APS-15B 3 CM RADAR

Airborne radar. 40kw output using 725A magnetron. Model 3 pulser. 30 in. parabola stabilized antenna. PPI scope. Complete system. \$1200 each. New.

#### 100 KW 3 CM. X BAND RADAR

Complete AN/APS-23 radar system using 4J52 magnetron, PPI antenna 360 degree rotation azimuth 60 degree elevation ΔPX. Complete installation including gyro stabilizer \$2800.

#### M33 TRACKING SYSTEM

Complete two van complex 3 CM automatic tracking system and search system (10 CM) like new.

#### CARCINOTRON

Type CM 709A Freq. 3000 to 4000 mes. CW. Output 200 Watts minimum. New, with full guarantee.

#### VA-800 KLYSTRON

1.7 to 2.4 KMC. (continuously tunable). 10 KW. CW. 50 db Gain output UG-435 A/U Flange \$975 each.

## RADIO RESEARCH INSTRUMENT CO.

550 FIFTH AVE., NEW YORK  
JUDSON 6-4691

CIRCLE 950 ON READER SERVICE CARD

### FOR RESEARCH — DEVELOPMENT & EXPERIMENTAL WORK

Over 10,000 different electronic parts: waveguide, radar components and parts, test sets, pulsers, antennas, pulse xmfrs, magnetrons, IF and output amplifiers, dynamotors, 400 cycle xmfrs, 584 ant. pedestals, etc.

PRICES AT A FRACTION OF ORIGINAL COST!  
**COMMUNICATIONS EQUIP CO.**  
343 CANAL ST., N. Y. 13. WO 6-4045  
CHAS. ROSEN (Formerly at 131 Liberty St.)

CIRCLE 951 ON READER SERVICE CARD

#### TUBE SPECIALS

3CX100A5 (2C39B) Tested and fully guaranteed \$9.95 ea.  
6146A Brand new 3.25 ea.  
Large quant. 6050-socket leads (reliable 5676) Tested and fully guaranteed min. 100 .40 ea.

#### ELECTRO SALES CO.

1608 Milwaukee Ave. Chicago 47, Ill.  
BR 8-8080

CIRCLE 952 ON READER SERVICE CARD

#### TUBE & COMPONENT

**FREE...CATALOG**  
**BARRY ELECTRONICS**

512 BROADWAY Walker 5-7000  
NEW YORK 12, N.Y. TWX- NY 1-3731

CIRCLE 953 ON READER SERVICE CARD

# Wilgreen

can deliver Amphenol  
Bendix  
Cannon  
**CONNECTORS**  
**FITTINGS & CLAMPS**

We stock more than 5,000,000 M5/AN CONNECTORS of 50,000 variations! In PRODUCTION QUANTITIES . . . we sell BELOW "O.E.M." PRICE . . . and offer IMMEDIATE "OFF-THE-SHELF" DELIVERY!

**FREE** . . . Send for latest brochure "LIST-PRICE SHEET"

WILGREEN INDUSTRIES, Inc.  
102 Warren Street, New York 7, N. Y.  
WOrrh 4-2490-1-2 Wire: FXK

CIRCLE 954 ON READER SERVICE CARD

# SPECIAL PURPOSE TUBES

OA2	.80	4-65A	12.00	25Z6WGT	1.50	725A	10.00	5751WA	2.00
OA2WA	2.00	4-125A	20.00	26Z5W	1.50	726A	5.00	5763	1.75
OA3	.85	4-250A	35.00	FG-27A	20.00	726B	5.00	5777	150.00
OB2	.60	4-400A	30.00	28D7W	3.50	726C	7.50	5778	150.00
OB2WA	2.00	4-1000A	80.00	FG-32	10.00	750TL	112.50	5783	2.25
OB3	.70	4AP10	10.00	35T	2.50	802	7.50	5784	2.50
OC3	.50	4B31	12.50	35TG	100.00	803	3.50	5787	2.50
OD3	.30	4C35	15.00	FP-54	10.00	804	15.00	5796	10.00
C1A	8.50	4CX250B	30.00	FG-57	1.50	805	7.50	5800/VX-41	7.50
1AD4	1.50	4CX1000A	125.00	RK-60/1641	3.00	807	1.50	5803/VX-55	5.00
1B24	7.50	4D32	15.00	HY-69	3.00	807W	2.25	5829	1.00
1B24A	12.50	4J32	100.00	BL-75	17.50	808	2.50	5836	50.00
1B35A	3.00	4J34	100.00	75TL	7.50	809	5.00	5837	50.00
1B63A	10.00	4J50	100.00	TG-77	10.00	810	17.50	5840	2.50
1C/3B22	5.00	4J52	35.00	HF-100	12.00	811	2.50	5845	6.00
C1K	7.50	4PR60A	50.00	100TH	12.00	811A	4.00	5852	5.00
1P21	32.50	4X150A	13.50	100TL	12.00	812A	4.75	5876	7.50
1P22	8.00	4X150D	15.00	FG-105	25.00	813	12.50	5879	1.15
1P25	10.00	4X150G	25.00	F-123A	5.00	814	3.50	5881/6L6WGB	2.00
1P28	15.00	4X250B	20.00	FG-172	25.00	815	5.00	5886	4.00
1Z2	1.50	4X250F	30.00	211	2.50	816	2.25	5893	10.00
2-01C	12.50	5BP1A	9.50	212E	50.00	826	3.50	5894	19.85
2AP1A	8.50	5C22	17.50	FG-235	50.00	828	12.50	5915	1.00
2B23	20.00	5CP1A	9.50	242C	10.00	828B	10.00	5931/5U4WG	3.50
2B21	10.00	5CP7A	9.50	244A	3.50	832A	7.50	5933/807W	3.00
2C36	22.50	5D21	7.50	245A	3.50	833A	37.50	5948/1754	100.00
2C39	5.00	5J26	50.00	249B	10.00	836	2.50	5949/1907	50.00
2C39A	9.75	5J31	7.50	249C	6.50	837	1.00	5963	1.00
2C39B	15.00	5LP1	7.50	250R	10.00	842	7.50	5964	.85
2C40	7.50	5R4GY	1.25	250TH	25.00	845	7.50	5965	.85
2C42	3.00	5R4WGA	4.00	251A	50.00	851	75.00	5976	50.00
2C43	7.50	5R4WGB	6.00	254A	3.50	866A	50.00	5993	5.00
2C46	5.00	5R4WGY	2.00	FG-258A	100.00	869B	1.90	6005/6AQ5W	1.50
2C50	4.00	5RP1A	9.50	259A	3.50	872A	5.00	6012	4.00
2C51	1.50	5Y3WGT	1.25	262B	3.50	884	5.00	6021A	2.00
2C52	1.50	5Y3WGTB	2.50	267A	5.00	885	12.50	6032	10.00
2C53	7.50	6AC7W	.50	271A	12.50	889RA	.85	6045	1.15
2D21	.65	6AC7WA	2.00	274A	3.50	891R	150.00	6072	1.50
2D21W	1.25	6AG5WA	1.50	283A	3.50	913	200.00	6073	1.50
2E22	3.00	6AG7Y	1.00	287A	3.50	920	9.50	6074	1.75
2E24	2.25	6AK5W	1.25	QK-288	250.00	927	2.50	6080	3.35
2E26	2.50	6AK5 (WE)	.75	HF-300	25.00	931A	1.50	6080WA	5.00
2J42	75.00	6AL5W	.60	300B	5.00	1000T	3.50	6080WB	10.00
2J51	50.00	6AN5	1.75	304TH	35.00	R1130B	80.00	6082	3.35
2J55	90.00	6AN5WA	3.50	304TL	35.00	1500T	10.00	6087/5Y3WGTB	2.50
2K22	25.00	6AQ5W	1.00	307A	.50	1614	150.00	6101/6J6WA	1.50
2K25	8.50	6AR6	.75	310A	3.50	1620	2.75	6106	1.50
2K26	35.00	6AS6W	1.00	311A	3.50	1624	4.00	6115/QK351	50.00
2K28	25.00	6AS7G	2.50	313C	1.50	1625	1.00	6130/3C45	6.50
2K29	25.00	6AU6WA	1.25	323A	6.00	1629	.50	6136/6AU6WA	1.25
2K30	50.00	6B4G	3.35	328A	3.50	1846	50.00	6146	3.00
2K33A	200.00	6BA6W	.75	329A	4.50	1855	250.00	6159	3.50
2K34	75.00	6BE6W	1.50	336A	2.50	2050	1.25	6161	35.00
2K35	200.00	6BF7W	2.00	337A	3.50	ZB-3200	100.00	6186/6AG5WA	1.50
2K39	150.00	6BH6W	2.75	347A	1.00	5516	7.50	6189/12AU7WA	1.50
2K41	50.00	6BL6	20.00	348A	4.50	5528/C6L	3.50	6197	1.75
2K42	125.00	6BM6	25.00	349A	3.50	5545	20.00	6199	35.00
2K43	200.00	6BM6A	30.00	350A	3.50	5550	30.00	6201/12AT7WA	1.85
2K44	125.00	6CAW	2.50	350B	2.50	5552/FG235	50.00	6202/6X4WA	1.75
2K45	20.00	6CAWA	1.00	352A	8.50	5553/FG258	100.00	6211	2.50
2K47	150.00	6C21	17.50	354A	12.50	5557/FG17	5.00	6213	3.00
2K48	50.00	6D4	1.50	355A	12.50	5558/FG32	10.00	6216	125.00
2K50	175.00	6F4	3.50	371B	2.50	5559/FG57	10.00	6236	250.00
2K54	10.00	6C6J	10.00	388A	2.00	5561/FG104	50.00	6248	250.00
2K55	15.00	6C6J/A	15.00	393A	5.00	5586	125.00	6263	9.00
2K56	50.00	6C6J/K	20.00	394A	3.00	5608A	6.00	6265/6BH6W	2.75
2P21	40.00	6J4	1.75	395A	2.25	5636	2.25	6293	4.50
2X2A	1.25	6J4WA	2.50	396A/2C51	1.50	5642	2.25	6299	37.50
3A5	.75	6J6W	.60	398A/5603	3.00	5647	3.00	6316/BL800A	100.00
3AP1A	3.50	6J6WA	1.00	401A/5590	1.00	5651	1.00	6322/BL25	12.50
3B4	2.50	6K4	2.00	403B/5591	3.00	5663	1.00	6336	8.75
3B24W	3.00	6L6GAY	1.25	404A/5847	7.50	5676	1.00	6344/QK235	500.00
3B24WA	5.00	6L6WGA	1.50	407A	3.75	5677	1.35	6350	1.25
3B25	2.50	6L6WGB	2.00	408A/6028	2.75	5678	1.25	6352	7.50
3B26	2.25	6Q5G	2.50	409A/6AS6	1.00	5686	2.25	6385	10.00
3B28	3.00	6SJ7WGT	1.25	410R	75.00	5687	1.50	6390	125.00
3B29	5.00	6SK7W	.75	GL-414	80.00	5691	5.00	6394	12.75
3BP1A	7.50	6SK7WA	2.00	416B/6280	20.00	5692	3.50	6438	5.00
3C22	15.00	6SL7WGT	1.25	417A/5842	9.50	5693	3.50	6442	25.00
3C23	4.00	6SN7W	.50	418A	9.50	5696	1.00	6463	1.00
3C24/24G	7.50	6SN7WGT	1.00	420A/5755	5.00	5718	1.50	6485	1.50
3C33	7.50	6SN7WGTA	2.50	421A/5998	7.50	5720/FG33	17.50	6533	7.50
3C45	3.50	6SU7GTY	.85	429A	6.50	5721	100.00	6542	5.75
3CX100A5	12.50	6V6GTY	1.00	GL-434A	10.00	5725/6AS6W	1.50	6550	3.50
3D21A	5.00	6X4W	.75	450TH	40.00	5726/6AL5W	.75	6807	20.00
3D22	8.00	6X4WA	1.50	450TL	40.00	5727/2D21W	1.25	6883	3.50
3DP1A	5.00	6X5WGT	1.00	578	5.00	5749/6BA6W	1.00	7044	1.50
3E29	7.50	SRL7W	100.00	KU-610	5.00	5750/6BE6W	1.75	7521	100.00
3GP1	2.50	7AK7	2.50	NL-623	10.00	5751/12AX7W	1.35	7580	35.00
C3J/A	9.50	7MP7	22.50	631-P1	5.00			8002R	25.00
3J21	35.00	10KP7	15.00	673	15.00			8008	7.75
3J31	100.00	12AT7WA	1.50	676	30.00			8013A	5.00
3J31	5.00	12AU7WA	1.50	677	40.00			8014A	30.00
3K21	125.00	12AX7W	1.35	701A	5.00			8020	4.50
3K22	125.00	12AY7	1.00	703A	1.50			8025A	7.50
3K27	150.00	12GP7	25.00	707B	2.50			9003	2.00
3K30	100.00	16J	25.00	715C	15.00			9005	3.50
3KP1	9.75	FG-17	5.00	719A	12.50				
3RP1	7.50	HK-24	5.00	721B	5.00				
3WP1	12.50	25T	10.00	723A/B	3.50				

ALL TUBES ARE NEW, INDIVIDUALLY CARTONED, FULLY GUARANTEED

## western engineers

TELEX or TWX:  
916-681-3061  
Telephone:  
916-685-9582

ELK GROVE, CALIFORNIA

SUPPLIERS OF ELECTRON TUBES SINCE 1932

Prices FOB  
Min order \$10

CIRCLE 955 ON READER SERVICE CARD

## It's UNIVERSAL . . .



This is our idea of a little fun and at the same time . . . let you test your knowledge of the most spectacular achievements of man and nature.

### Do you know . . .

the name and age of the youngest man that ever played major league baseball?

The youngest major league player of all times was the Cincinnati pitcher Joe Nuxhall, who started his career in June, 1944, aged 15 years-10 months and 11 days.

This is quite an achievement—and 1944 was our year, too! Since our beginning in '44—UNIVERSAL RELAY—has become the "House of Relays and Relay Information."

**WE STOCK  
2,000,000 RELAYS**

**SEND FOR  
NEW  
CATALOG EE**



**Universal RELAY CORP.**

42A White St., N. Y. 13, N. Y. Walker 5-6900  
MIDWEST OFFICE: Industrial Rd., Crystal Lake, Ill.  
Phone 459-2313 (Code 815)

CIRCLE 956 ON READER SERVICE CARD

### SMALL AD but BIG STOCK

of choice test equipment  
and surplus electronics

Higher Quality—Lower Costs  
Get our advice on your problem

ENGINEERING ASSOCIATES

434 Patterson Road — Dayton 19, Ohio

CIRCLE 957 ON READER SERVICE CARD

### GLASS TUBING

PYREX - NONEX - URANIUM

BULB & CYLINDERS

WRITE FOR FREE MONTHLY LIST

HOUE GLASS COMPANY

PHONE COLFAX 4-1800

P.O. Box 206 Keyport, N. J.



# INDEX TO ADVERTISERS



## Audited Paid Circulation

• Acme Electric Corp.....	67	• Northeastern Engineering, Inc.....	58
Airpax Electronics, Inc.....	96	Northrop Corp.....	93, 95, 97
Airtronics International Corp.....	59		
Aladdin Electronics.....	101	• Panoramic Electronics Inc.....	112
• American Lava Corporation.....	33	• Potter Instrument Co., Inc.....	21
Anti-Corrosive Metal Prod. Co., Inc.....	24		
		• Radio Corporation of America...4th cover	
Bean & Co., Morris.....	110		
Bendix Corporation		• Raytheon Company.....	6, 13, 79
Sciintilla Division.....	31	• Rixon Electronics, Inc.....	100
Bircher Corporation, The.....	109		
• Bud Radio Inc.....	100	Sanders Associates, Inc.....	89
• Bulova Electronics Div.....	34, 35	• Southern Electronics Corp.....	76
• Busmann Mfg. Co., Div. of McGraw Edison Co.....	14	Sprague Electric Co.....	9, 30, 63
		Stackpole Carbon Co.....	15
Cambridge Thermionic Corp.....	111	Struthers-Dunn Inc.....	105
• Centralab, The Electronics Div. of Globe-Union Inc.....	36	• Superior Tube Co.....	104
Chart-Pak, Inc.....	76		
• Chester Cable Corp.....	98, 99	• TRG, Inc.....	53
Cohn Corp., Sigimund.....	82	Texas Instruments Incorporated	
		Apparatus Division.....	83
Di Aero Corp.....	98	Texas Instruments Incorporated	
Dynamics Instrumentation Co.....	84	Metals & Controls Division.....	106
		Texas Instruments Incorporated	
Edwards High Vacuum Inc.....	61	Semiconductor-Components Div.....	10, 11
Electro-Med-Dyne Inc.....	71		
Electro International Inc.....	88	United Systems Corp.....	110
Electronic Engineering Co. of Calif.....	82	• United Transformer Corp.....2nd cover	
• Electronic Instrument Co., Inc. (EICO).....	80		
Esterline-Angus-Instrument Co., Inc.....	57	Vacuum Electronics Corp.....	69, 71
		Varian Associates.....	55, 90
• Fairchild Semiconductor Corp...3rd cover		• Vitrumon, Inc.....	5
Florida Development Commission.....	25		
• Foster Electric Co., Ltd.....	99	• Williams & Co., C. K.....	84
• Fuji Tsushinki Seizo K.K.....	102	Wright Machinery Co.....	109
		Div. of Sperry Rand Corp.....	
General Scientific Corp.....	89		
Gertsch Products, Inc.....	74	Zippertubing Co., The.....	70
Globe Industries Inc.....	18		
Gudebrod Bros, Silk Co., Inc.....	32		
Hansen Mfg. Co., Inc.....	58		
• Haydon Co., A. W.....	103		
Helland Division, Minneapolis-Honeywell.....	87		
Heinemann Electric Co.....	19		
• Hitachi, Ltd.....	77		
Hughes Aircraft Co.			
Aerospace Divisions.....	85		
Vacuum Tube Prod. Div.....	23		
• Image Instruments Inc.....	119		
• Ingersoll Products,			
Division of Borg-Warner Corp.....	72		
Instrulab, Inc.....	109		
International Telephone and Telegraph Corp., Components Division.....	75		
International Telephone and Telegraph Corp., Industrial Products Div.....	112		
• Jennings Radio Manufacturing Corp.....	107		
Jerrod Electronics Corp.....	4		
• Kyoritsu Electrical Instruments Works, Ltd.....	58		
• Lapp Insulator Co., Inc.....	61		
• Lavole Laboratories Inc.....	92		
• Leach and Garner Co.....	91		
Leeson Corp.....	81		
Littelfuse.....	51		
Lockheed Calif. Co.....	66		
• Mabuchi Shoji K. K.....	67		
Machlett Laboratories, Inc., The.....	29		
Magnetic Metals Company.....	22		
• Markel & Sons, L. Frank.....	65		
Markem Machine Co.....	113		
• Methode Electronics, Inc.....	94		
Midland Mfg. Co.....	18		
Minnesota Mining & Mfg. Co.			
Chemical Div.....	73		
• Navigation Computer Corp. (NAVCOR).....	91		
• North Atlantic Industries, Inc.....	62		

## • SCAN CONVERSION • FLICKERLESS DISPLAY STORE • VIDEO STORAGE

### RECORDING STORAGE TUBE SYSTEMS

Single-gun, dual-gun, multi-tube systems to convert scan for radar, sonar, television, and to perform analog processing, data analysis, contract or expand time scale, auto correlation.

## • SLOWED TELEVISION TRANSMISSION

by telephone line or other narrow-band systems.

## • IMAGE ENGINEERING

OPTICAL CHART READERS, FLYING SPOT SCANNERS, LOW-LIGHT-LEVEL CAMERAS, and IMAGE RECTIFICATION. Automatic inspection and recognition of size, shape, color, and texture.



Write or call for complete information:



INSTRUMENTS, Inc.

2300 Washington Street  
Newton 62, Massachusetts  
617 WOODWARD 9-8440

CIRCLE 119 ON READER SERVICE CARD

### CLASSIFIED ADVERTISING F. J. Eberle, Business Mgr.

EMPLOYMENT OPPORTUNITIES 116, 117

### EQUIPMENT

(Used or Surplus New)

For Sale .....117, 118

### INDEX TO CLASSIFIED ADVERTISERS

Atomic Personnel Inc.....	117
• Barry Electronics Corp.....	117
• Communications Equipment Co.....	117
• Electro Sales Co.....	117
• Engineering Associates.....	118
Esquire Personnel.....	116
• Houde Glass Co.....	118
Jet Propulsion Laboratory.....	116
• Radio Research Instrument Co.....	117
Republic Aviation Corp.....	116
Schlumberger Well Surveying Corp.....	117
• Universal Relay Corp.....	118
Vitro Laboratories Div of Vitro Corp. of America.....	116
• Western Engineers.....	118
• Wilgreen Industries Inc.....	117

• See advertisement in the July 25, 1962 issue of Electronics Buyers' Guide for complete line of products or services.

This index and our Reader Service Numbers are published as a service. Every precaution is taken to make them accurate, but electronics assumes no responsibilities for errors or omissions.

## NIMS

### NATIONWIDE IMPROVED MAIL SERVICE PROGRAM

For Better Service  
Your Post Office  
Suggests

That You Mail Early  
In The Day!



**Are you a  
COMPLETELY INFORMED  
electronics engineer?**

Today you may be working in microwaves. But on what project will you be working tomorrow? You *could* have read **electronics** this past year and kept abreast of, say, microwave technology. *There were 96 individual microwave articles between July, 1961 and June, 1962!*

But suppose tomorrow you work in some area of standard electronic components, in semiconductors, in systems? Would you be up-to-date in these technologies? Did you read the more than 3,000 editorial pages that **electronics'** 28-man editorial staff prepared last year?

**electronics** is edited to keep you current *wherever* you work in the industry, *whatever* your job function(s). If you do not have your own copy of **electronics**, subscribe today via the Reader Service Card in this issue. Only 7½ cents a copy at the 3 year rate.

**electronics**

**electronics**



Audit Bureau  
of Circulations



Associated Business  
Publications

**Audited Paid Circulation**

**JAMES T. HAUPTLI**

Advertising Sales Manager

**R. S. QUINT:**  
Assistant Publisher Buyers'  
Guide and Business Manager  
**FRED STEWART:**  
Promotion Manager  
**B. ANELLO:**  
Market Services Manager

**RICHARD J. TOMLINSON:**  
Production Manager  
**GEORGE E. POMEROY:**  
Classified Manager  
**HUGH J. QUINN:**  
Circulation Manager

**ADVERTISING REPRESENTATIVES**

**ATLANTA (9):**  
Michael H. Miller, Robert C. Johnson  
1375 Peachtree St. N.E., Trinity 5-0523  
(area code 404)

**BOSTON (16):**  
William S. Hodgkinson, Donald R. Furth  
McGraw-Hill Building, Copley Square,  
Congress 2-1160 (area code 617)

**CHICAGO (11):**  
Harvey W. Wernecke, Robert M. Denmead  
645 North Michigan Avenue, Mohawk 4-5800  
(area code 312)

**CLEVELAND (13):**  
Paul T. Fegley  
55 Public Square, Superior 1-7000  
(area code 216)

**DALLAS (1):**  
Frank Le Beau  
The Vaughn Bldg., 1712 Commerce St.  
Riverside 7-9721 (area code 214)

**DENVER (2):**  
J. W. Patten  
Tower Bldg., 1700 Broadway,  
Alpine 5-2981 (area code 303)

**HOUSTON (25):**  
Joseph C. Page, Jr.  
Prudential Bldg., Halcombe Blvd.,  
Riverside 8-1280 (area code 713)

**LOS ANGELES (17):**  
Peter S. Carberry, Ashley P. Hartman  
1125 W. 6th St., Huntley 2-5450  
(area code 213)

**NEW YORK (36):**  
Donald H. Miller, Henry M. Shaw,  
George F. Werner  
500 Fifth Avenue, LO-4-3000  
(area code 212)

**PHILADELPHIA (3):**  
Warren H. Gardner, William J. Boyle  
6 Penn Center Plaza, LOcust 8-4330  
(area code 215)

**SAN FRANCISCO (11):**  
R. C. Alcorn  
235 California Street, Douglas 2-4600  
(area code 415)

**LONDON W1:**  
Edwin S. Murphy Jr.  
34 Dover St.

**FRANKFURT/Main:**  
Matthae Harfurth  
85 Westendstrasse

**GENEVA:**  
Michael R. Zeynel  
2 Place du Port

**"Headquarters for Business Information"**

**McGraw-Hill Technical and Business Publications**

American Machinist/Metal-  
working Manufacturing  
Aviation Week and Space  
Technology  
Business Week  
Chemical Engineering  
Chemical Week  
Coal Age  
Construction Methods and  
Equipment  
Construction Daily  
Control Engineering  
Electrical Construction  
and Maintenance  
Electrical Merchandising Week  
Electrical Newsletter  
Electrical West

Electrical Wholesaling  
Electrical World  
Electronics  
Engineering Digest  
Engineering and Mining Journal  
E & MJ Metal and Mineral  
Markets  
Engineering News-Record  
Factory  
Fleet Owner  
Industrial Distribution  
National Petroleum News  
Nucleonics  
Nucleonics Week  
Platt's Oilgram News  
Platt's Oilgram Price Service  
Power

Product Engineering  
Purchasing Week  
Science Week  
Textile World

Overseas only:  
Automobile International  
(English, Spanish)  
Ingenieria Internacional  
Construccion (Spanish)  
International Management  
(English, Spanish  
Portuguese editions)  
Metalworking Production  
(Great Britain)

Available by subscription only — to qualified persons actively engaged in the field of the publication. For subscription rates and information describing the editorial coverage of any of the above publications, write to: Subscription Manager, Circulation Department, McGraw-Hill Publishing Company, 330 West 42nd Street, New York 36, N. Y.



**High voltage**  
**High gain**  
**Low leakage**  
**Silicon Planar**

# DIFFERENTIAL AMPLIFIERS

**Matched  $h_{FE}$**   
**Matched  $V_{BE}$**   
**Thermally matched**

**Fairchild Planar process alone makes this matching practicable in volume production**

Matching Characteristics	2N2060			2N2223			2N2223A			Test Conditions
	Min.	Max.	Units	Min.	Max.	Units	Min.	Max.	Units	
Beta Ratio	0.9	1.0								$I_C = 1.0 \text{ mA}$ $V_{CE} = 5.0 \text{ V}$
Beta Ratio	0.9	1.0		0.8	1.0		0.9	1.0		$I_C = 0.1 \text{ mA}$ $V_{CE} = 5.0 \text{ V}$
$V_{BE}$ Differential		0.005	Volts							$I_C = 1.0 \text{ mA}$ $V_{CE} = 5.0 \text{ V}$
$V_{BE}$ Differential		0.005	Volts		0.015	Volts		0.005	Volts	$I_C = 0.1 \text{ mA}$ $V_{CE} = 5.0 \text{ V}$
$\Delta V_{BE}$ Tracking		10	$\mu\text{V}/^\circ\text{C}$		25	$\mu\text{V}/^\circ\text{C}$		25	$\mu\text{V}/^\circ\text{C}$	$I_C = 0.1 \text{ mA}$ $V_{CE} = 5.0 \text{ V}$ $T = -55^\circ\text{C}$ to $+125^\circ\text{C}$

**FAIRCHILD**  
**SEMICONDUCTOR**  
 545 WHISMAN ROAD, MOUNTAIN VIEW, CALIF. • YORKSHIRE 8-8161 • TWX: MN VW CAL 853  
 A DIVISION OF FAIRCHILD CAMERA AND INSTRUMENT CORPORATION

CIRCLE 901 READERS SERVICE CARD



ACTUAL SIZE

SS111 Tunnel-Diode Oscillator



SS504 Down Converter

At the RCA Electron Tube Division

## Packaged Tunnel-Diode devices...now in pilot production

### AGAIN—RCA DEMONSTRATES SOLID-STATE CAPABILITY!

Now... in pilot production at RCA: SS111 L-Band Tunnel-Diode Oscillator and SS504 L-Band Down Converter—establishing at the RCA Electron Tube Division a capability that marks another milestone in solid-state achievement.

SS111 is designed to serve as a reliable local oscillator in most applications demanding moderate rf power output. SS504 is a tunnel-diode device well-suited for radar and telemetry applications—or wherever low-noise (5.5 db max.), low-power converters are required.

Opening up new areas of design and application, the SS111 and SS504 incorporate the latest advances in solid-state technology. Both of these compact, efficient, low-cost units are now ready for sampling.

Announcements of other new solid-state products will be made soon. For specifications of SS111 and SS504, see accompanying chart. For additional technical information, consult your RCA Industrial Tube Representative or write: Section I-19-Q-2, Commercial Engineering, RCA Electron Tube Division, Harrison, N. J.

#### Typical Operating Conditions

<b>SS504 ELECTRICAL</b>		<b>NOTE 1</b>
Input Frequency (4)	1250 Mc	This is a double sideband noise figure based on employing a 30-Mc, 300-ohm input impedance intermediate-frequency amplifier with a noise figure of 1.7 db, and a bandwidth of 3 Mc.
Output Frequency	30 Mc	
Input Impedance	50 ohms	
Noise Figure (1)	5.5 db max.	
Bandwidth	3 Mc	
Tuning Range (2)	± 20 Mc	
Local Oscillator Power	5.0 mw	<b>NOTE 2</b>
R.F. Input Power	None required	By varying the frequency of the local oscillator
Dynamic Range (3)	Up to 0.1 mw	<b>NOTE 3</b>
CW	1.0 watt max.	Minimum power input at which the gain is reduced by 3.0 db from its small-signal value
Maximum Input Pulse Energy	80 ergs	<b>NOTE 4</b>
MECHANICAL		Units having similar performance can be supplied in the frequency range of 800 to 1500 Mc.
Weight	7 oz.	<b>NOTE 5</b>
Size	2" diam. x 1½"	Units can be supplied with type N, BNC, or TNC connectors
<b>SS111 ELECTRICAL</b>		
Ebb	0.4 to 0.6 volt	
I <sub>bb</sub>	0.5 to 0.8 amp	
Frequency	1600 Mc	
Power Output	6.0 mw min.	
<b>MECHANICAL</b>		
Size (5)		
(excluding connectors)	2½" diam. x ¾"	
Weight	5 oz.	



The Most Trusted Name in Electronics

**INDUSTRIAL TUBE PRODUCTS FIELD OFFICES: OEM Sales:** Newark 2, N. J., 744 Broad St., 48 5-3900 • Chicago 54, Ill., Suite 1154, Merchandise Mart Plaza, WH 4-2900 • Los Angeles 22, Calif., 6801 E. Washington Blvd., RA 3-8361 • Burlingame, Calif., 1838 El Camino Real, OX 7-1620 • **Government Liaison:** Harrison, N. J., 415 South Fifth St., 48 5-3900 • Dayton 2, Ohio, 224 N. Wilkinson St., BA 6-2366 • Washington 7, D. C., 1725 "K" St., N.W., FE 7-8500 • **International Sales:** RCA International Division, Clark, N. J., FU 1-1000.