

electronics

A McGraw-Hill Publication 75 Cents

TRANSISTORS BY AUTOMATION

*Conducting spheres
replace fine wires, p 56
(Photo below)*

MACHINE READS HANDWRITING

*Recognizes names
of numerals, p 29*

R-F HEATER TESTS MISSILES

*Power oscillator
simulates reentry, p 38*







ROLAND KISSLER
BOX 956
ROSES LAKE WASH

Now you can have a universal oscilloscope with dual trace vertical bandwidth capacity greater than 40 MC—with no sacrifice in sensitivity. Seven separate vertical and horizontal plug-in units give the new  175A the greatest versatility ever offered in a general purpose 50 MC scope. Available are dual-channel, single-channel and high-gain vertical plug-ins, plus these horizontal plug-ins: auxiliary, time mark generator, display scanner and sweep delay generator.

The new  developed 12 Kv CRT presents an easy-to-measure 6 x 10 cm calibrated display without distortion or defocusing. The front panel astigmatism control common to other scopes is no longer necessary. In addition, phosphor and graticule are on the same plane—thus eliminating CRT

parallax error. The front panel is engineered for the simplest possible operation.

 175A features simplified circuitry for more reliable performance and easy maintenance. Simple triode circuits (6DJ8 tubes) are used in the vertical amplifier. Complicated distributed amplifiers are not employed. In addition, an  developed cable delay line eliminates still more adjustments. Only 7 tube types and 5 transistor types are used throughout.

The  175A Universal Oscilloscope is housed in the new  modular cabinet . . . a single instrument for both bench use and rack mount. Cover, bottom and sides are easily removed for simple servicing and routine maintenance. The  175A is as easy to service as it is to use!

These Plug-ins Give Utmost Versatility to the 175A OSCILLOSCOPE:

Vertical plug-ins

1750A 40 MC Dual Channel Amplifier (pictured in 175A opposite)

Permits viewing of two phenomena simultaneously, bandpass dc to 40 MC, rise time 9 nsec, sensitivity 50 mv/cm. Differential input for common mode rejection. \$285.00



1752A High Gain Amplifier

Provides 5 mv/cm sensitivity dc to 18 MC with differential input for high common mode rejection. \$225.00



1753A 40 MC Single Channel Amplifier

Bandpass dc to 40 MC, rise time 9 nsec, sensitivity 50 mv/cm. \$155.00

Horizontal plug-ins

1780A Auxiliary Plug-In (shown in 175A opposite), normal and single sweep, \$25.00



1781A Sweep Delay Generator

For detailed examination of complex signals or pulse trains. Permits viewing expanded waveform segment while still retaining presentation of earlier portions of the waveform. Delay time 1 μ sec to 10 sec.; delaying sweep, 2 μ sec/cm to 1 sec/cm. \$375.00

1782A Display Scanner

Provides output to duplicate on X-Y recorder any repetitive wave appearing on scope. Resolution with permanent records higher than CRT or photograph. (Available soon)



1783A Time Mark Generator

Permits easy time measurements by providing intensity modulated time markers on scope trace. Range, 10 μ sec, 1 μ sec and 0.1 μ sec intervals, $\pm 0.5\%$. \$130.00

SPECIFICATIONS 175A

Sweep Generator

Internal Sweep: 0.1 μ sec/cm to 5 sec/cm, $\pm 3\%$; vernier extends slowest speed to 15 sec/cm

Magnification: x1 and x10

Triggering: Internal, from vertical input signal causing 2 mm or more vertical deflection, or from power line. External, from signal 0.5 v p-p or more

Triggering Point: On positive or negative going signal; on external signal, level adjustable —10 to +10 v

Horizontal Amplifier

Bandpass: DC to 500 KC

Sensitivity: 0.1 and 1 v/cm

Vertical Amplifier

Bandpass: Main amplifier, dc to more than 50 MC

General

Power Requirements: 115/230 v ac $\pm 10\%$, 50-60 cps. Maximum of 425 watts, depending on plug-ins used

Weight: Maximum of 70 lbs., depending on plug-ins used

Price: \$1,325.00

Data subject to change without notice.

Prices f.o.b. factory.

HEWLETT-PACKARD COMPANY



1501 Page Mill Road, Palo Alto, California, Area Code 415, DA 6-7000

Sales and service representatives in all principal areas;

Europe, Hewlett-Packard S.A., 54-54 Bis Route Des Acacias, Geneva

Canada, Hewlett-Packard (Canada) Ltd., 8270 Mayrand St., Montreal

CIRCLE 900 READERS SERVICE CARD

ACTUAL SIZE

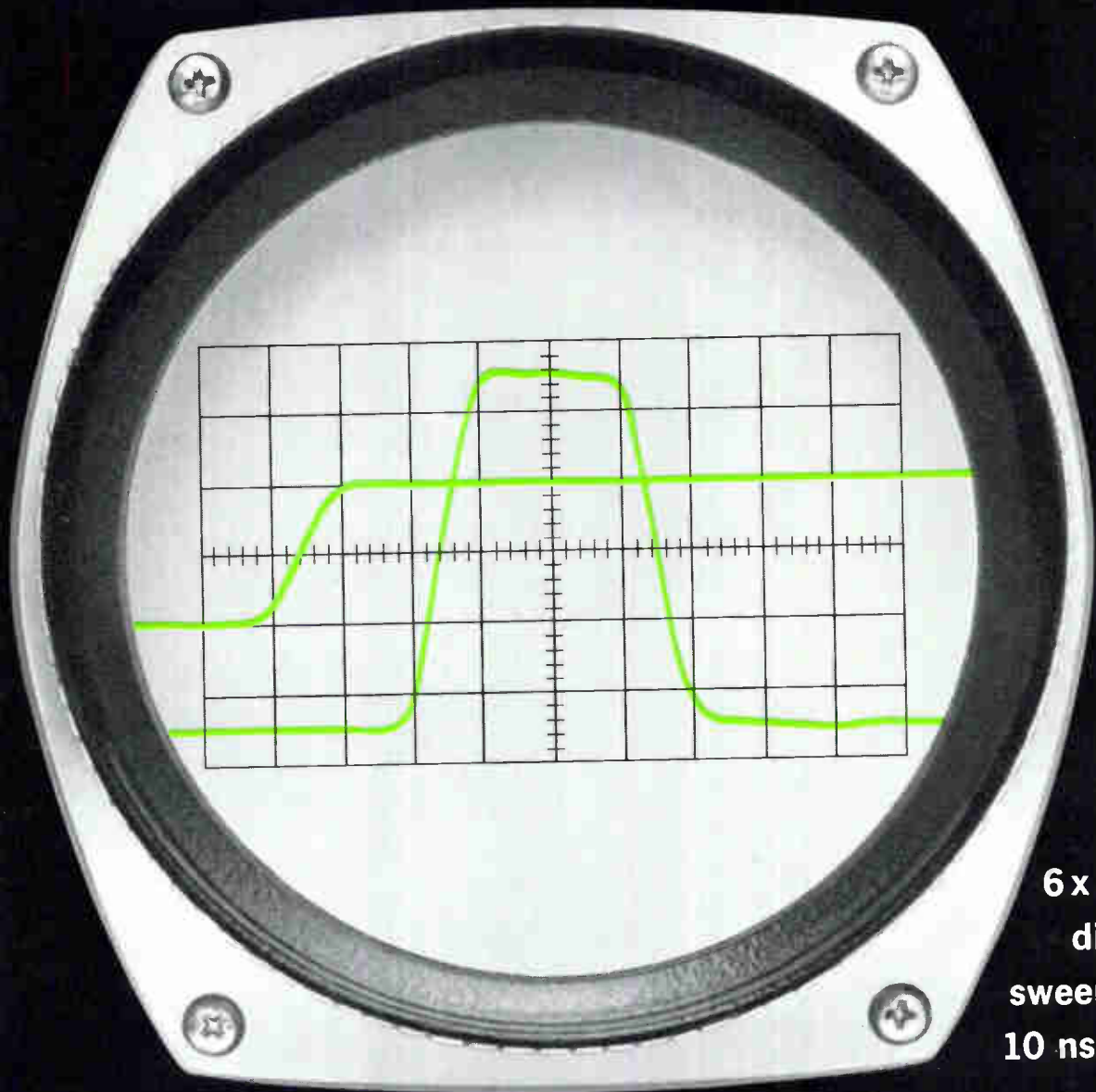

6 x 10 cm
display
sweep time
10 nsec/cm

DUAL TRACE FAST PULSE DISPLAY on the

New  **50 MC**

UNIVERSAL OSCILLOSCOPE

Turn the page for details



**THIS
IS
THE
NEW**



• **175A 50 MC Universal Oscilloscope**
with • **1750A Dual Channel Amplifier**,
• **1780A Auxiliary Plug-in installed.**

175A 50 MC OSCILLOSCOPE

- Bright, 6 x 10 cm display with no parallax, reflections or astigmatism
- Over 50 MC main vertical amplifier
- Dual trace, dc to 40 MC vertical plug-in
- Horizontal and vertical plug-ins for specific applications
- Easier to calibrate and maintain — no distributed amplifiers
- Positive preset syncing over entire bandwidth

electronics

A McGraw-Hill Publication 75 Cents



W. W. MacDONALD, Editor

AUTOMATIC TRANSISTOR ASSEMBLY. Lazy susan carries planar transistor dies through twelve stations, one of which is a gas heater that makes a brazed hermetic closure. *Use of tiny conducting spheres instead of fine wires increases mechanical strength, makes automation possible. See p 56* **COVER**

TWO-WAY RECTIFIERS Use Mobile Dopants. Junctions in germanium resistors are formed according to the forward direction of applied current, making the device adaptive. *Here are fresh details on how flexodes are built and operate* **16**

MICROELECTRONICS Has a New Contender: High-Density Silicon Matrices. More than 5,000 components are formed on silicon wafers. Deposited connections determine the final circuits. *To exploit the concept, a new form of logic circuit is developed* **20**

OPTICAL MODULATOR Puts Single-Sidebands on Laser Beam. Technique is expected to help in design of laser transmitters and superheterodyne receivers. *Polarizing crystals are the active elements* **21**

ADAPTIVE CONTROL Helps X-15 Fly 60 Miles High. Servo system blends aerodynamic and thrust controls in thin air. *Heart of the system is a gain-control computer* **22**

PRIVATE SWITCHBOARD is All-Electronic. Semiconductor devices cut size of telephone exchange in half. *System features time-sharing common control, random-selection switching* **24**

HANDWRITING-READER Recognizes Word Envelopes. Can identify the handwritten names of numerals zero to nine by logical decisions based on length of word and appearance of extenders and descenders. *Operator writes with stylus on striated conductive pattern for real-time input.*
By L. D. Harmon, Bell Telephone Labs **29**

NEW APPROACH TO SERIAL DECODING Eliminates Static Storage. This system uses a bucket capacitor to get the voltage analog of an incoming pulse train. *A small sacrifice of precision pays off in greatly simplified circuits and gets rid of delay lines, drums and shift registers.*
By R. M. Centner and J. R. Wilkinson, Bendix Research Labs **32**

J. M. CARROLL, Managing Editor
SENIOR EDITORS: Samuel Weber, George W. Sideris. SENIOR ASSOCIATE EDITOR: Michael F. Wolff. ASSOCIATE EDITORS: Michael F. Tomaino, Sylvester P. Carter, William P. O'Brien, John F. Mason, Sy Vogel, Leslie Solomon, George J. Flynn, Laurence D. Shergalis. ASSISTANT EDITORS: Nilo Lindgren, Stanley Froud, Stephen B. Gray, Roy J. Bruun, George V. Novatny, Leon H. Dulberger. REGIONAL EDITORS: Harold C. Hood (Pacific Coast, Los Angeles), Thomas Maguire (New England, Boston), Cletus M. Wiley (Midwest, Chicago). ART DIRECTOR: Harry Phillips; Howard R. Berry. PRODUCTION EDITOR: John C. Wright, Jr. EDITORIAL ASSISTANTS: Gloria J. Meurer, Bernice Duffy, Lorraine Rossi, Virginia T. Bastian, Lynn Emery, Bette H. Snyder, Rosemary Abbruzzese, Ann Mella, Lorraine Werner. FOREIGN NEWS BUREAU: Director, John Wilhelm, Alyne Elias. LONDON—John Shinn, Derek Barlow, Nicholas Landon. Bonn—Peter Forbath, Silke McQueen. Paris—Robert Farrell, Arthur Erikson. Milan—Marc A. Messina. Mexico City—Bruce Bendow. Rio de Janeiro—Leslie Warren. Moscow—Stewart Ramsey. Tokyo—Richard Halloran, Charles Cohen, John Yamaguchi.

JAMES GIRDWOOD, Publisher

Published weekly, with Electronics Buyers' Guide and Reference Issue as part of the subscription, by McGraw-Hill Publishing Company, Inc. Founder: James H. McGraw (1860-1948).

Title © registered U.S. Patent Office; © copyright 1962 by McGraw-Hill Publishing Co., Inc. All rights reserved, including the right to reproduce the contents of this publication, in whole or in part.

Executive, editorial, circulation and advertising offices McGraw-Hill Building, 330 West 42nd Street, New York 36, N. Y. Telephone Longacre 4-3000. Teletype TWX N.Y. 1-1636. Cable McGrawhill, N. Y. PRINTED IN ALBANY, N. Y.; second class postage paid at Albany, N. Y.

OFFICERS OF THE PUBLICATIONS DIVISION: Nelson L. Bond, President; Shelton Fisher, Wallace F. Traendly, Senior Vice Presidents; John R. Callahan, Vice President and Editorial Director; Joseph H. Allen, Vice President and Director of Advertising Sales; A. R. Venezian, Vice President and Circulation Coordinator; Daniel F. Crowley, Vice President and Controller.

OFFICERS OF THE CORPORATION: Donald C. McGraw, President; Hugh J. Kelly, Harry L. Waddell, Executive Vice Presidents; L. Keith Goodrich, Executive Vice President and Treasurer; John J. Cooke, Vice President and Secretary.

Subscriptions are solicited only from those actively engaged in the field of the publication. Position and company connection must be indicated on orders. Subscription rates: United States and Possessions, \$6.00 one year, \$9.00 two years, \$12.00 three years. Canada, \$10.00 one year. All other countries \$20.00 one year. Single Copies, United States and Possessions and Canada 75¢. Single copies all other countries \$1.50.

THE PUBLISHER, UPON WRITTEN REQUEST FROM ANY SUBSCRIBER TO OUR NEW YORK OFFICE, AGREES TO REFUND THAT PART OF THE SUBSCRIPTION PRICE APPLYING TO COPIES NOT YET MAILED.

Subscribers: Please address change of address notices, subscription orders or complaints to Fulfillment Manager, Electronics, at above address. Change of address notices should provide old as well as new address, including postal zone number if any. If possible, attach address label from recent issue. Allow one month for change to become effective.

Postmaster: Please send Form 3579 to Fulfillment Manager, Electronics, 330 West 42nd Street, New York 36, New York.



Audited Paid Circulation

CONTENTS continued

SIMPLIFIED CURVE TRACER Displays Transistor Beta. Instrument determines low-frequency a-c beta (h_{fe}) as a function of load-line operating point. *Essential parts are sawtooth sweep and oscilloscope display.*
By J. V. McMillin, Measurement Research Center 36

R-F INDUCTION HEATER Simulates Reentry. Power oscillator tests space-vehicle performance. *Blocked-grid keying determines oscillator power output.*
By B. E. Mathews and F. R. Sias, Jr., University of Florida 38

DIGITAL CIRCUITS: A Novel Design Method. Graphical presentation helps select components for transistor logic circuit. *Method takes care of worst-case conditions without introducing large and arbitrary safety factors.* By R. W. Hockenberger, Avco 42

DEPARTMENTS

Crosstalk. *Field-Effect Transistors* 3

Comment. *Mechanical Getter. Information Storage and Retrieval* 4

Electronics Newsletter. *How the Satellite Communications Corporation Will Operate* 7

Washington Outlook. *Senate Tones Down House's Military Procurement Bill* 12

Meetings Ahead. *Communications Symposium* 26

Research and Development. *Transistor Circuits Control Small D-C Motors* 48

Components and Materials. *Broaden Transformer Frequency Response* 52

Production Techniques. *Transistor's Leads Are Its Hermetic Seal* 56

New Products Design and Applications. *Signal Generator Tests Doppler Receivers* 60

Literature of the Week 65

People and Plants. *Fabri-Tek Doubles Plant Space* 66

Index to Advertisers 77

CROSSTALK

FIELD EFFECTS. Chances are that we will soon see more major changes in the semiconductor components business and in the design of semiconductor circuits. And we are not talking about microelectronic functional devices—these are doing fine, but they are not the individual components that engineers generally use in equipment. We are talking about field effect components.

After 10 years (it was in 1952 that Shockley reported the theory of the field-effect transistor), it appears that reliable field-effect devices that can be reproduced at a reasonable price are at last at hand. Their performance capabilities have been greatly enhanced recently by the use of epitaxial manufacturing techniques. When more types of field-effect transistors become generally available, they should gain wider popularity in circuit design.

FOR A DOZEN YEARS, engineers have coped in one way or another with the problems of the transistor. Transistors have many advantages, but unlike an electron tube, the impedance between input and output is finite. This factor makes circuit design and application conceptually more difficult and, furthermore, changes in this impedance with frequency greatly compound the engineer's problems. Of course, through the years, engineers have learned to live with the transistor and its little quirks. In fact, in some instances such as complementary symmetry, they have turned the peculiarities of the transistor to advantage.

Then along comes the field-effect transistor, which behaves like a pentode tube, and engineers can have their cake and eat it too. They get small size, lack of filaments and almost infinite impedance from input to output. The only thing around with similar promise is the thin-film triode, but research workers are apparently having difficulty establishing a rationale for its operation.

SINCE YOU WILL soon hear a lot more about field-effect devices, you might like to bone up a bit on theory and practice through articles we have published in the past. A good place to start—without digging too far back in the files—is an article we published on p 66, May 15, 1959. That one reviews the field-effect triode transistor and then goes heavily into the theory and use of field-effect tetrodes.

Then there is the unipolar field-effect transistor, described on p 48, Dec. 23, 1960, as the basis

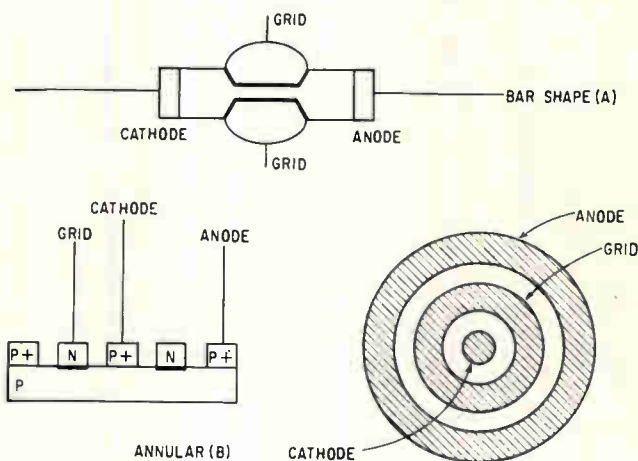

for a binary full adder. Following that, you might look again at p 132, Aug. 12, 1960, an article on how photosensitive field-effect transistors can be used in oscillators and amplifiers. The field-effect transistor as a negative-resistance device, and how to make one, was reported on p 48, Feb. 2, 1962.

For an overall view of the total semiconductor picture, and how field-effect devices fit into the montage, we refer you to our special report, *What's New in Semiconductors*, p 89, Sept. 29, 1961. Like other transistors, field-effect types can be made in many configurations. The illustration reproduced above shows two of them, the bar shape in cross section and the annular in cross section and plan views.

HANDWRITING—Problem of generally recognizing script writing is still far from being solved. The article in this issue by Leon D. Harmon, of Bell Telephone Laboratories, however, gives some insight into a method for analyzing handwriting that could aid development of cursive script-reading machines.

Harmon's article describes a machine that recognizes the 10 digits *zero* through *nine* written in script. The device is simple and is based on a logical analysis of certain properties of carefully written words. Other properties, such as vertical extent, retrograde strokes and closure would probably have to be dealt with in developing more sophisticated machines.

Author Harmon has been working for the past several years in such areas as automata, information processing in nervous systems and artificial electronic neurons. An article by Harmon, on p 39 of our Sept. 2, 1960, issue, described a line-drawing pattern recognizer in which a dilating circular scanner using 32 photocells recognizes opaque two-dimensional geometric figures independent of size, rotation, precision of drawing or positioning.



SQUARE-LOOP TAPE CORES TO MEET YOUR TOUGHEST SPECIFICATIONS

Speed your specs to Dynacor when you want square-loop tape cores to exact requirements—fast! Here you'll find a dependable combination of personnel, experience and facilities—the know-how to deliver parameters to your very tightest tolerance requirements for switching time, flux, and noise.

Dynacor Square-Loop Tape Cores are manufactured with the high permeability alloys—Grain-Oriented 50-50 Nickel Iron, 4-79 Molybdenum Permalloy, and Grain-Oriented 3% Silicon Iron . . . with fully guaranteed uniformity . . . under rigid standards of control and inspection.

Look to Dynacor for reliable production and swift delivery of your tape core requirements. For your convenience a full line of standard units are stocked for immediate off-the-shelf delivery—Send for bulletins DN 2000, DN 2001, DN 2002.



SPRAGUE
THE MARK OF RELIABILITY

SPRAGUE ELECTRIC COMPANY
35, MARSHALL ST. • NORTH ADAMS, MASS.

COMMENT

Mechanical Getter

Clean rooms and clean manufacturing techniques of all types have come into vogue as manufacturers try to make equipment and components more and more reliable. Clean-room manufacture has now reached a degree of sophistication where dust particles can be kept out of assemblies to almost any degree desired.

But the threat to reliability from unwanted particles is still with us, although now the particles are often generated by the device itself, after the manufacturing process is complete. In completed diodes and transistors, for example, loose particles are generated under vibration from minute solder globules and from small chips of various kinds of material breaking off. When these particles come to rest in the wrong places, circuit failure can occur. X-ray photography is about the only way of detecting failure possibilities from this cause.

Potentiometers, by the very nature of the wiping action of the pick-off, generate a large number of dust-like particles, which again appear to be a major cause of failure in these devices. The major parameter in potentiometer degradation is noise, and it is likely that loose particles are a major source of noise.

The problem is reminiscent of the problems of vacuum-tube makers in the early days, before it was recognized that included gases were a major source of trouble. Once this was established, electrical getters were added, and vacuum-tube reliability took a giant step forward.

By obvious analogy then, the question arises, is it time to add some kind of mechanical getter for diodes, transistors and potentiometers, to pick up particles generated after the component is out of the manufacturer's hands?

A number of ways of making such a getter come to mind at once. A small, magnetized core of iron—various shapes and modifications are possible—covered with tiny hooks of nylon or teflon of the type now used in zipper-like closures, might be suitable. If the getter is

clean and inert, it will not interfere with device operation and it will pick up and hold small particles that come within its reach. In quantity production, costs for such a device would be almost negligible. Another obvious way to accomplish the same task might be a simple spiral recess, like a snail shell, which would tend to trap any particle that enters. Such recesses could be molded into many parts in relatively simple ways.

DONALD FLYNN
New York, New York

There is a porous glass dessiccant, made by one manufacturer, which has been installed in enclosed relays to prevent the relay contacts from being dirtied by contaminants given off at high temperatures. According to one user, up to 99 percent of the organic contaminants remaining after production degassing are absorbed by this dessiccant.

Information Storage and Retrieval

Let me congratulate you on your article, Information Storage and Retrieval, in the June 29 issue (p 39). The article is informed and informative, well-balanced, and fair.

You did succumb to a blind spot in virtually all work on retrieval in America when you said:

“Two basic techniques for indexing presently in use are classification and coordinate indexing. These include traditional hierarchical subject classification schemes such as the Dewey Decimal and alphabetical subject index systems. Unfortunately, it is not clear how to establish a hierarchy of classes which will make much search localization possible.”

Your informants thought it unnecessary to refer you to any work on classification in the present century, though much such work exists, including that of Ranganathan in India and the Classification Research Group in England. A book on non-hierarchical classification has recently appeared (Vickery, B. C., “Faceted Classification,” Aslib, London, 1960).

CLIFFORD J. MALONEY
Division of Biologics Standards
National Institutes of Health
Bethesda, Maryland

Higher Performance Standards With Improved Reliability...

Tung-Sol compactrons provide several advantages that can contribute to lower costs and improved performance. For example, the increased number of pins permit greater heat dissipation. As a result, compactrons run cooler with higher reliability than conventional tubes. The exhaust tubulation is situated between the pins so that broken tips rarely occur. This also permits the use of top

caps for very high voltage designs. In addition, the compactron design readily lends itself to combining multiple tube elements within a single envelope.

Compactrons require less space on the chassis or printed circuit boards, less height than conventional tubes, less air cooling volume per function. More space between pins improves element isolation, allows higher voltage ratings, simplifies printed circuit and chassis design.

Tung-Sol compactrons are available in production volume for numerous circuit requirements, including radio, tv, hi-fi and stereo, controls and instrumentation equipment. Write for Tung-Sol compactron data file which includes the following types: 6AX3, 6GE5, 6Q11, 12AX3, 12GE5, 8149, 8150 and 1AJ2. Other types will soon be available and special designs will be considered. Tung-Sol Electric Inc., Newark 4, N.J. TWX: NK193.



TUNG-SOL COMPACTRONS

CAPACITORS OF MYLAR[®]

SAME PRICE RANGE

AS PAPER

BUT WITH EXTRA RELIABILITY

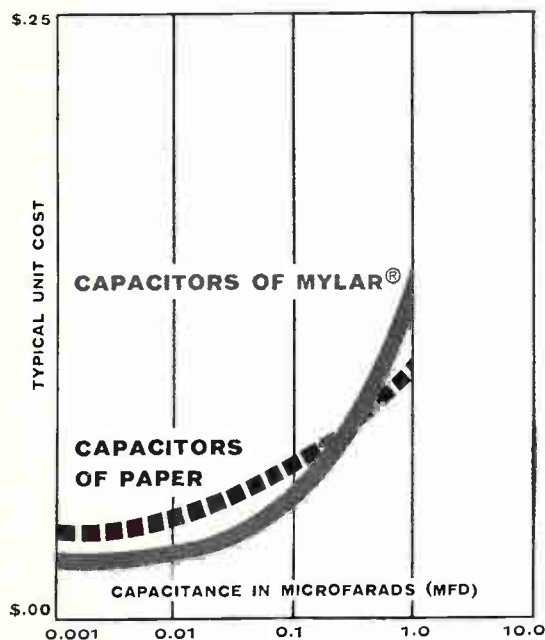

You may not realize it, but you can benefit from the higher dielectric strength, moisture resistance and reduced size of capacitors of "Mylar"^{*} polyester film without paying a premium price. An industry study of manufacturer prices shows THAT OVER A RANGE OF SIMILAR CAPACITANCES AND RATINGS, UNITS OF "MYLAR" COMPARE CLOSELY IN COST WITH THOSE OF PAPER.

According to a recent survey, few engineers are aware of this close price comparison . . . although they recognize the outstanding properties of "Mylar". Look into it yourself. Before specifying capacitors for your design, get this free booklet study with performance facts and price charts. Write: Du Pont Co., Film Dept., Wilmington 98, Delaware.

^{*}Du Pont's registered trademark for its polyester film.



REG. U. S. PAT. OFF.

BETTER THINGS FOR BETTER LIVING . . . THROUGH CHEMISTRY

only DU PONT makes

MYLAR[®]
POLYESTER FILM

ELECTRONICS NEWSLETTER

Satellite Communications, Inc.? Not Just Yet

WASHINGTON—Approval of the satellite communications act is only the first stage of getting the system off the ground. Forming and financing the corporation will take six months to a year, deciding on a type of system will take a year or more and—most experts predict—it will be 1964-65 before continuous, global communications are possible.

Before the type of system is decided, at least two more research satellites will be orbited and tested, in addition to Telstar. NASA is expected to launch Relay, developed by RCA, next month and to launch Syncom, a high-altitude synchronous satellite under development by Hughes, next year. Satellites orbiting 3,000 to 5,000 miles high are expected to make up the first system. Global coverage would require 27 to 50 of those.

A start will probably be made with a few such satellites, with others added gradually. The corporation may petition FCC to let it take over all experimental communications satellite in orbit, as the nucleus of a system.

While technical data on satellites is being accumulated, the corporation can move forward in establishing ground stations and getting frequency allocations and rate approvals. Rates are expected to match existing international rates at first and drop as satellite capacity rises. In the first years, the government will handle international agreements, continue research and make launchings on a cost-reimbursable basis.

Fairchild Licenses Philco On Planar Semiconductors

FAIRCHILD Camera and Instrument Corp. said last week that it has signed a license agreement with Philco Corp. under Fairchild patents for the planar process of semiconductor manufacturing. John Carter, Fairchild's president, said the company plans to license other manufacturers and that it is now negotiating agreements.

Fairchild claims that a process developed by its semiconductor di-

vision is now used by "virtually all of the major silicon transistor and diode manufacturers in the United States," and that it has made possible the building of integrated circuits. Fairchild described the process as "the introduction of impurities through and under a passivated oxide protection layer over basic silicon."

It Takes Two Pilots to Launch a Rocket by Hand

TWO OR MORE pilots could get a spaceship off the ground without automatic controls. One pilot might do it in an emergency, but he would really have his hands full.

That is the gist of a report on 1,100 simulated rocket launchings performed by the Martin Co., which is building the launch vehicle for the two-man Gemini spacecraft. The report was given at an Air Force

symposium last week in Colorado Springs.

A pilot can control the vehicle if that is his primary job, but finds it difficult if he has additional tasks, such as monitoring malfunctions. A pilot could stabilize the booster in an emergency, but he should have an automatic backup system, or other pilots to help.

Vostok III and IV Won't Push Gemini and Apollo

WASHINGTON—NASA was claiming last week that there will not be a speedup in the Gemini or Apollo lunar programs as a result of the latest Soviet space feat.

NASA says it could pump another \$1 billion or \$2 billion into its program and speed it up some, mainly by round-the-clock shifts and development of more parallel equipment. But James E. Webb, the agency's administrator, maintains—as a personal opinion—that the U. S. will beat the Russians to the moon.

The assessment goes like this: the Russians advanced techniques needed for a lunar landing, extended the time of manned space flight and showed they could put more than one satellite into desired orbits. They did not accomplish rendezvous or transfer. They indi-orbits. They indicated they may be going to use the earth orbit ap-

Can the Russians Knock Down Samos and Midas?

WASHINGTON—There is much speculation here that Vostok III and IV demonstrated the USSR's ability to launch a satellite close to another one already in orbit with the next step the ability to destroy another satellite.

One expected effect is that more weight will be given to the Air Force's arguments for a larger role in space, but it is impossible now to predict the outcome.

If it is decided that U. S. satellites can be knocked down, one of the questions will be the fate of the Midas early warning satellite and Samos reconnaissance satellite programs.

Several of these satellites have been launched. Midas reportedly is not working well. Its development has been stretched out and apparently downgraded. Samos is reportedly working well and is being pushed harder than Midas. Specific data, however, are classified.

The Air Force is also keeping mum about how well its space tracking and detection network followed the Vostoks. The reason given: why tell the Russians how good or bad our tracking system is?

proach the U. S. has junked in favor of a lunar-orbiting system. Booster size is pacing the U. S. and USSR programs—and as yet the USSR hasn't shown a booster big enough for a lunar landing attempt. U. S. optimism rides on getting one first.

The U. S. is preparing three boosters, each several times as powerful as the Atlases used for the Mercury flights. NASA is working on Saturns C-1 and C-5 and Air Force this week awarded a development contract to Martin for Titan III, which will loft Dyna Soar and other payloads weighing up to 25,000 pounds. But they won't be ready until the mid-1960's.

Research Aims at Wet Niobium Capacitors, Too

RESEARCH PROGRAM in three types of niobium (columbium) capacitors—foil wet capacitors and both wet and solid electrolyte capacitors of the porous or sintered pellet types—will be undertaken by the Kemet department of the Linde Co. under a \$357,459 Navy contract.

Kemet will work on determining causes of instability in niobium-oxide dielectric films, developing materials and capacitor manufacturing. Kemet says that it has been researching the subject for a year and has evidence that the instability is due to trace impurities in the metal.

In addition to being more available than tantalum (p. 7, Aug. 17), Kemet said niobium oxide has a higher dielectric constant (42) than tantalum oxide (27) and is less dense, promising smaller and lighter capacitors.

Hawaiian and Yankee Hams Talk By Moon Bounce

BOSTON—Amateur radio contact between Massachusetts and Hawaii by moon bounce was accomplished this month by Sam Harris, chief engineer of Tapetone Electronic Labs, Medfield, and Ralph Thomas, of RCA, in Hawaii. They exchanged a message on 1,296 Mc after three months of planning.

Harris had his equipment set up

in his back yard. The transmitter used an Eimac klystron with 300-w output and an 18-foot parabolic antenna loaned by D. S. Kennedy Co. The receiver had a parametric amplifier designed by Harris.

There is an amateur in Switzerland anxious to exchange moon-bounce messages with him, said Harris, so that will be next.

Portable Radio Station to Wage Psychological Warfare

WASHINGTON—Reflecting the Pentagon's new emphasis on counter-insurgency operations (p 14, Aug. 10), the Army Signal Corps has awarded a contract to Gates Radio for a broadcasting system that can be airlifted by helicopter and set up in hours. The station would be used to broadcast to civilians or enemy forces.

The first system will cost \$1.2 million and is to be delivered in 10 months. The station will include two transmitters, a receiver for monitoring hostile broadcasts and for retransmitting U. S. programs, and associated equipment, all in 21 shelters or packages.

One transmitter will be a 50-Kw standard a-m broadcaster, the other will be a 50-Kw short-wave unit with a range of 6,000 miles. A-m coverage will be up to 12,000 square miles.

FAA's Traffic Control Expansion Plan Aired

DESIGN PLAN for an evolutionary air traffic control system has been released by the Federal Aviation Agency for guidance of the agency's R&D arm. The plan is based on the general recommendations of last year's Project Beacon report.

The new plan calls for: increased segregation of visual and instrument traffic in densely traveled airways and terminal areas, more reliance on radar (using besoons) for separation and control, development of altitude transponders to provide height information to ground controllers independent of pilot voice radio, expansion of positive ground control areas, and improved data processing and display.

In Brief . . .

RECENT ACQUISITIONS include the purchase of Consolidated Microwave Corp. by Antenna & Radome Research Associates (ARRA, Inc.). Electro-Mechanical Research has acquired Solartron, Inc. Infrared Industries is taking on the radiation electronics division of Victor Comptometer Corp. Electronic Specialty gets Statham-Swearingen, a Statham Instruments subsidiary.

MERGER has been arranged between Virba Microwave and Kevlin Manufacturing, to enable Kevlin to expand into the microwave components field.

DEVELOPMENT of a 600-Gc radiometer will be undertaken by Electronic Communications under an Army contract. Project includes investigation of harmonic mixing at 600 Gc, antennas and oscillators.

RAYTHEON is developing a pencil-beam radar system with 24-Mw peak power and a 60-foot dish antenna, under a \$4.3-million Air Force contract. It will be used to trace and analyze signatures of reentry test targets.

GENERAL ELECTRIC announced this week it will enter the reed switch business. It estimates total annual market is more than \$4.5 million a year.

LIGHTWEIGHT materials and processes for antennas will be evaluated by Goodyear Aircraft during a 16-month study for Army. Study will include antennas for space use as well as ground structures.

DEVELOPMENT of materials that would permit room-temperature operation of c-w, solid-state, organic lasers will be tried by Electro-Optical Systems under an Air Force contract.

PACKARD-BELL has a \$1.7-million contract from Chrysler Corp. to produce automatic checkout equipment for the Saturn S-1 space vehicle booster.

LEAR-SIEGLER was awarded a \$2.2-million contract by Air Force for meteorological radar systems. Radar frequency is 5 Gc.

(Advertisement)

New Bridge Design For Safe, Accurate, Easy Measurement of Capacitors

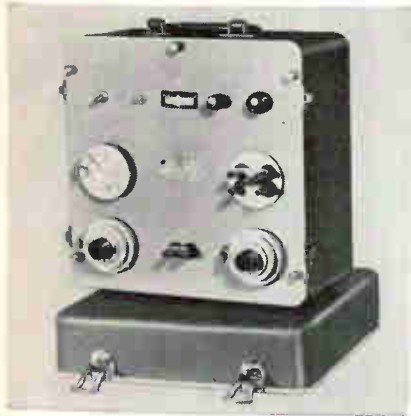

The Sprague Model 1W1 Capacitance Bridge introduces a new concept in bridge design. Built by capacitor engineers for capacitor users, it incorporates the best features of bridges used for many years in Sprague laboratories and production facilities.

Special Features For Greater Accuracy

The internal generator of the 1W1 Bridge is a line-driven frequency converter, and detection is obtained from an internal tuned transistor amplifier-null detector, whose sensitivity increases as the balance point is approached. It has provision for 2-terminal, 3-terminal, and 4-terminal capacitance measurements, which are essential for accurate measurement... $\pm 1\%$ of reading $+ 10\mu\text{F}$... of medium, low, and high capacitance values, respectively.

No Damage to Capacitors

The model 1W1 Capacitance Bridge will not cause degradation or failure in electrolytic or low-voltage ceramic capacitors during test, as is the case in many conventional bridges and test circuits. The 120 cycle A-C voltage, applied to capacitors under test from a built-in source, never exceeds 0.5 volt! It is usually unnecessary to apply d-c polarizing voltage to electrolytic capacitors because of this safe, low voltage.

Complete Specifications Available

For complete technical data on this precision instrument, write for Engineering Bulletin 90,010 to Technical Literature Section, Sprague Electric Company, 35 Marshall Street, North Adams, Massachusetts.

45-433 R3

NEW... for "Bread-Boarding" Your Circuit Designs...



Contains 12 specially-selected Sprague Type 32Z miniature pulse transformers in clear, hinged-lid plastic case, complete with simple instructions.

SPRAGUE 100Z41 EXPERIMENTAL PULSE TRANSFORMER ASSORTMENT

- Helps you choose the right pulse transformer for your specific application.
- Puts at your disposal 58 turns-ratio/primary-inductance combinations, providing the parameters required in most electron tube or transistorized circuits.
- Primary inductances from 160 microhenries to 43 millihenries.
- Turns ratios from 1:5 step-up to 6:1 step-down.
- Potted, pre-molded case construction facilitates bread-board wiring, permits frequent re-use.

Once you determine needed transformer characteristics, it's easy to get production quantities to your exact requirements from Sprague's broad line of hermetically sealed or encapsulated pulse transformers.

For fast delivery or additional information on the 100Z41 Pulse Transformer Assortment, see your Sprague Products Co. Industrial Distributor, or write Sprague Electric Company, 35 Marshall Street, North Adams, Massachusetts.

45-432 R1



'Sprague' and '®' are registered trademarks of the Sprague Electric Co.

MASTER

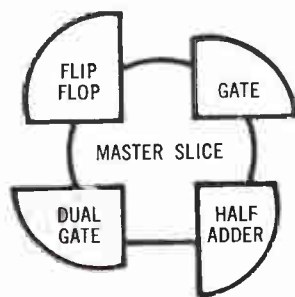
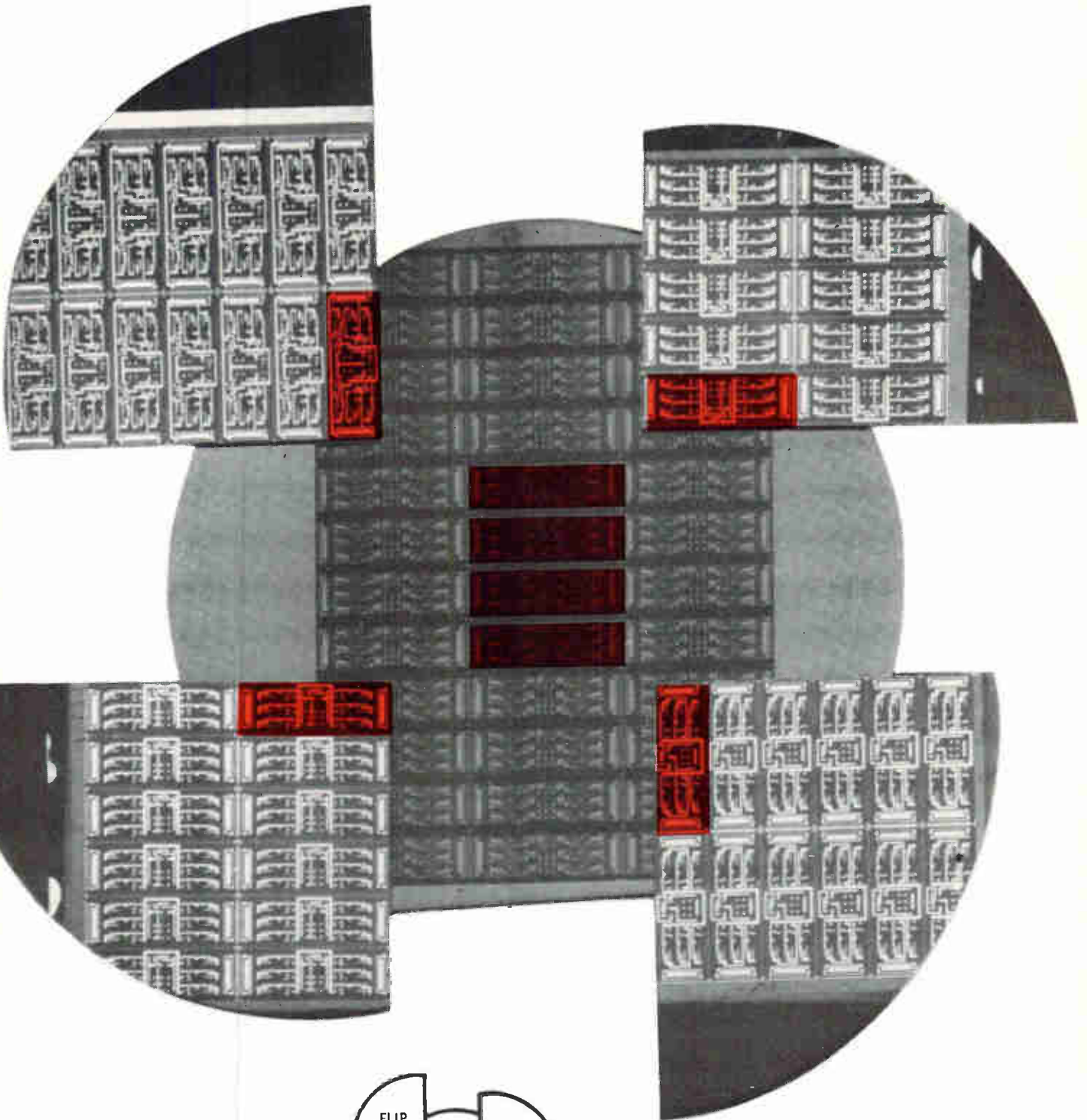

(ACTUAL SIZE)

SOLID CIRCUIT semiconductor networks are manufactured from pure silicon "master slice" wafers (center illustration) which contain more than 30 separate circuit bars. Customized interconnection patterns (four corner wafer fragments) are then photo-etched in aluminum on "master slice" wafers, producing completely integrated semiconductor networks ready for packaging.

SLICE

...the first
economical
answer to
custom
circuits

Texas Instruments now offers you hundreds of variations in **SOLID CIRCUIT*** semiconductor networks. Today you can get the exceptional reliability and miniaturization benefits of **SOLID CIRCUIT** semiconductor networks in many customized designs — at only slightly more cost than standard, catalog circuits. The flexible “master slice” design concept developed by Texas Instruments makes this achievement possible.

HERE'S HOW: First, standard “master slice” integrated circuit bars — complete except for interconnections — are taken from established, high-volume production lines. Second, a special interconnection pattern mask for your circuit is prepared. Third, your special interconnection pattern is photo-etched in aluminum on the “master slice” circuit bar.

YOUR BENEFITS: You get a complete semiconductor network, integrating resistors, capacitors, diodes and transistors into a single, high-purity silicon wafer — to *your* specifications. Evaluation samples can be available within several weeks from final design approval. Because preparation of the special interconnection pattern is the only custom step in the manufacturing process, you get most of the economy and delivery benefits of using standard TI production units.

Of course, “master slice” variations may not satisfy all your circuit requirements. Totally custom semiconductor networks — starting with the pure silicon — can be designed by Texas Instruments to meet an even greater variety of applications.

**Trademark of Texas Instruments Incorporated*

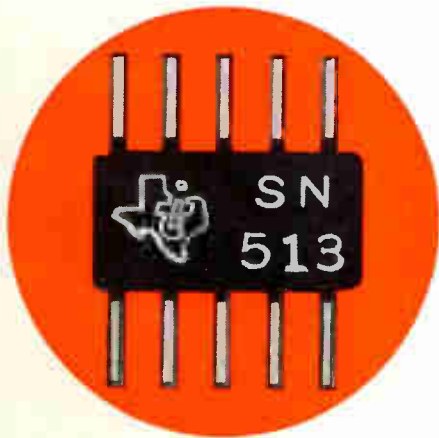

Completed **SOLID CIRCUIT** semiconductor network, enlarged 5½ times.



For more detailed information on how “master slice” design offers you the first economical answer to custom circuits, call your local TI Sales Engineer or write to Department 370 today for this brochure.

SEMICONDUCTOR / COMPONENTS
DIVISION



TEXAS INSTRUMENTS
INCORPORATED
13500 N. CENTRAL EXPRESSWAY
P. O. BOX 5012 • DALLAS 22, TEXAS

19370

WASHINGTON OUTLOOK

SENATE ARMED SERVICES COMMITTEE has approved a bill aimed at increasing competition and the volume of formal advertised bidding in military procurement, reducing the rate of negotiated contracting and sole-source buying, and curbing excessive profit on cost-reimbursement type contracts.

The bill is a milder version of a measure already passed by the House. The Senate version does not contain a House provision authorizing the General Accounting Office to review Pentagon decisions on negotiated sole-source procurement and advance payments and to void such contracts if it disagrees with the Pentagon's actions.

Both the Defense Department and industry spokesmen objected to the provision. EIA claimed the provision would "destroy the finality of negotiated contracts and becloud the financial stability of companies heavily engaged in defense business." House sources hint they are ready to kill or water down the GAO provision to assure passage of the bill.

By adding considerable red tape to contracting procedures, both House and Senate versions make it tougher for procurement officers to award negotiated rather than advertised bid contracts. But this is not expected to have an appreciable effect on contracting methods—some 85 percent of contracts are now negotiated through exceptions to the general rule requiring formal bidding and the major exceptions are essentially retained in the new bill.

IN TESTIMONY before the House Military Operations Subcommittee, Harold Brown, director of defense research and engineering, has provided an interesting insight into his views on selection of R&D contractors.

For major engineering projects, he said, he prefers to select firms with proven reputations based on past defense contracting experience, rather than newborn companies who have been able to recruit hotshot scientists away from older companies. He also said contract performance of multiplant or multidivision corporations should be rated on the basis of individual plants or divisions rather than on an overall corporate basis.

U. S. RADIO ASTRONOMERS in Jicamarca, Peru, have discovered long-lived radio noise from synchrotron radiation injected into the earth's magnetic field by the United States' July 9 high-altitude H-bomb test. They cite harm to radio astronomy and urge scientific and political review of future test plans "since the radio astronomers of the world will shortly become aware of the problem."

But high officials plan no change in test programs yet. The effect, they argue, is a calculated risk of the testing program, is minimal so far (double cosmic background on a quiet day) and blankets only the equatorial region where there is little radio astronomy. The effect—which influences work below 50 Mc—was detected with 6-megawatt pulse radar designed to probe the ionosphere and magnetosphere.

SENATE TONES
DOWN HOUSE'S
MILITARY
BUYING BILL

HERE'S HOW
PENTAGON RATES
R&D FIRMS

ASTRONOMERS
FIND H-BOMB
MAKES NOISE

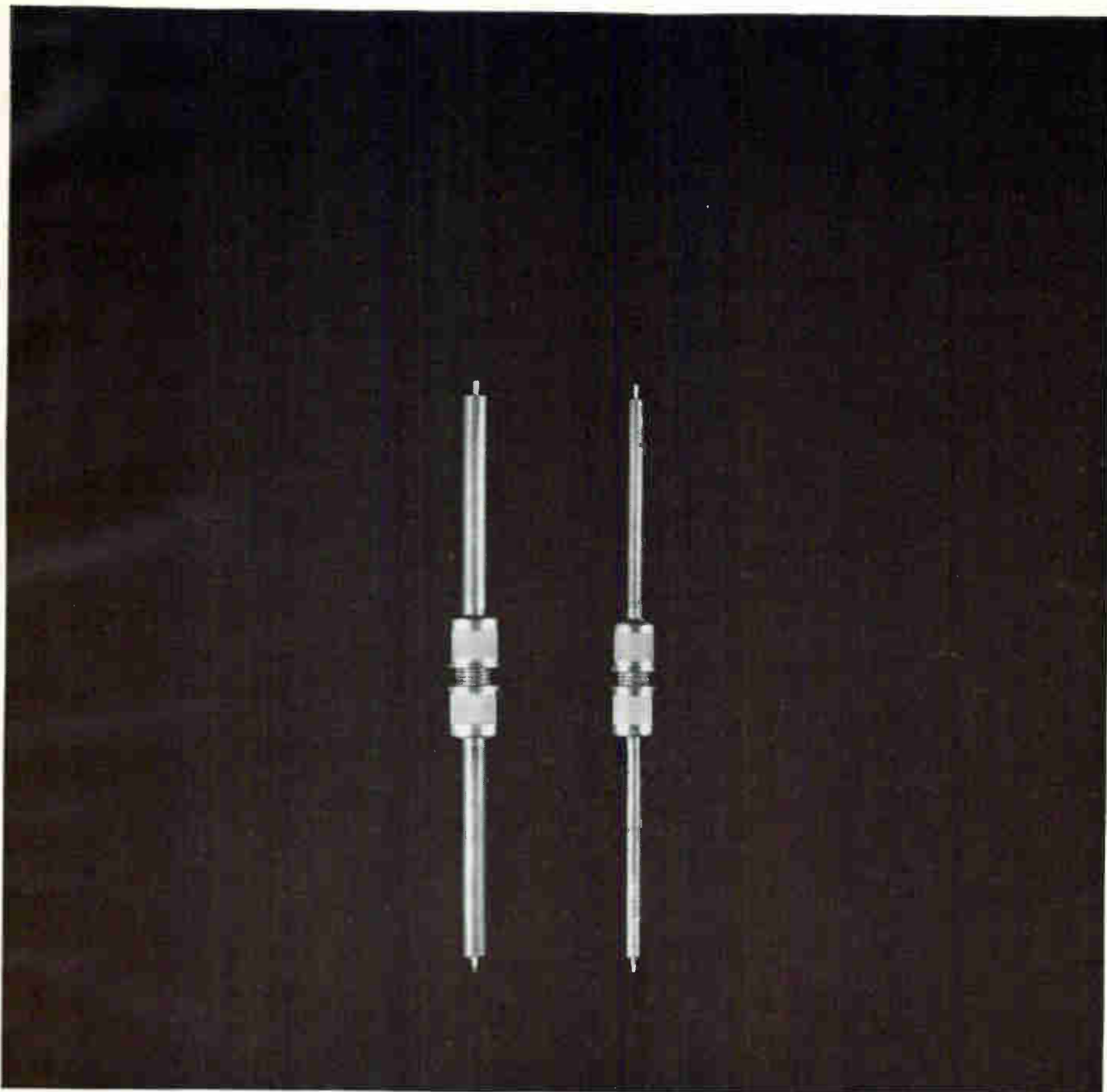

ACTUAL SIZE

We have two new r-f connectors. They are wee ones.

They are designed to replace N series connectors in the 1 to 10 KMC frequency range where size, weight, and low VSWR ratings are critical factors.

The larger small one is the BRM. It terminates .140 semi-rigid cable either by threading or by threading and soldering. The smaller small one is the BRMM. It is for a .085 semi-rigid cable.

Talk about low VSWR ratings. Look at these curves. The black one is for the BRM; the red one is for the BRMM. The maximum VSWR is less than 1.1:1 over the frequency range of 1 to 10 KMC.

Now, about size and weight. The BRM connector is 1/28 the

size of its N series counterpart. And it weighs 1/38 as much. The BRMM unit is 1/48 as large as the N series connector, 1/70 as heavy. You might call them miniatures. They are.

These precision r-f environmental resistant electrical connectors are machined from brass and heavily gold plated over silver underplate. The center dielectrics are electrical grade Teflon. They show high performance and excellent durability.

Developed at the Research Laboratories Division of Bendix, this new series of r-f connectors has been thoroughly production designed by Scintilla Division for maximum user satisfaction. Possibly you have an application in which the use of our new r-f connectors would be advantageous. Tell us about it. Or, write us in Sidney, New York, for technical data.

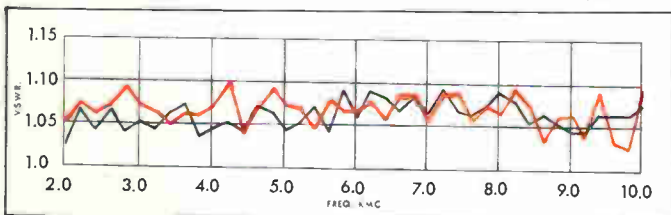

Scintilla Division



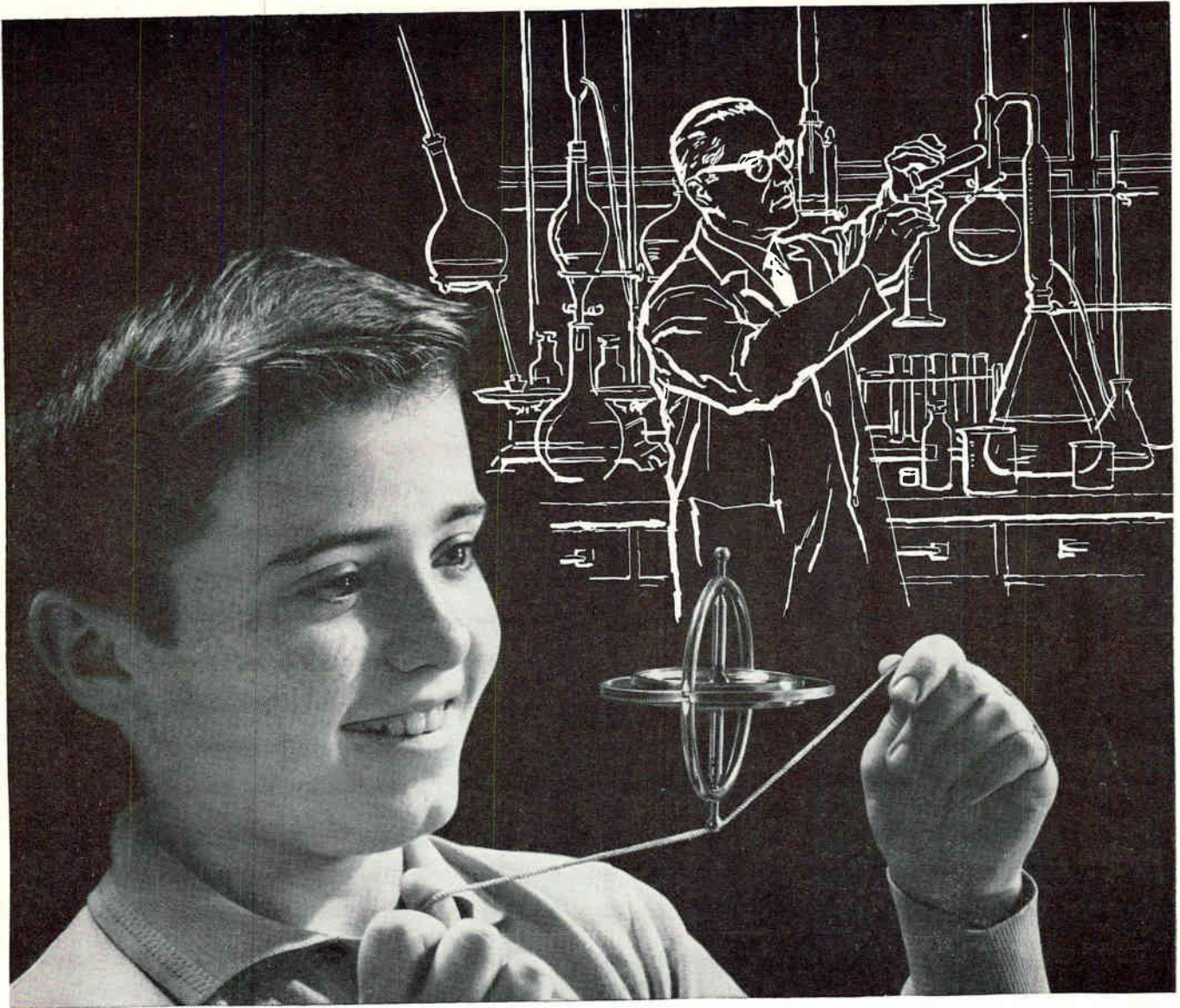

The Future of Your Business

MAY DEPEND UPON HIS EDUCATION

The young mind which today discovers an old principle may someday reveal a new one capable of revolutionizing your business and creating undreamed of growth. But this is possible only if he gets the finest education we can offer.

By the time today's youngsters are ready for college, business and industrial technology will be even more complicated and will require many more trained specialists. To fill this order we must provide our young people with the best possible college educations.

Unfortunately many colleges are already overcrowded. In ten years applications are expected to double. We will need more and better college classrooms and libraries, more efficient college laboratories, and additional top-quality professors. *You can help assure your own future by helping the college of your choice.*

If you want to know what the college crisis means to you, write for a free booklet, "OPEN WIDE THE COLLEGE DOOR," to Higher Education, Box 36, Times Square Station, New York 36, N.Y.



Published as a public service
in cooperation with The Advertising Council and
the Council for Financial Aid to Education



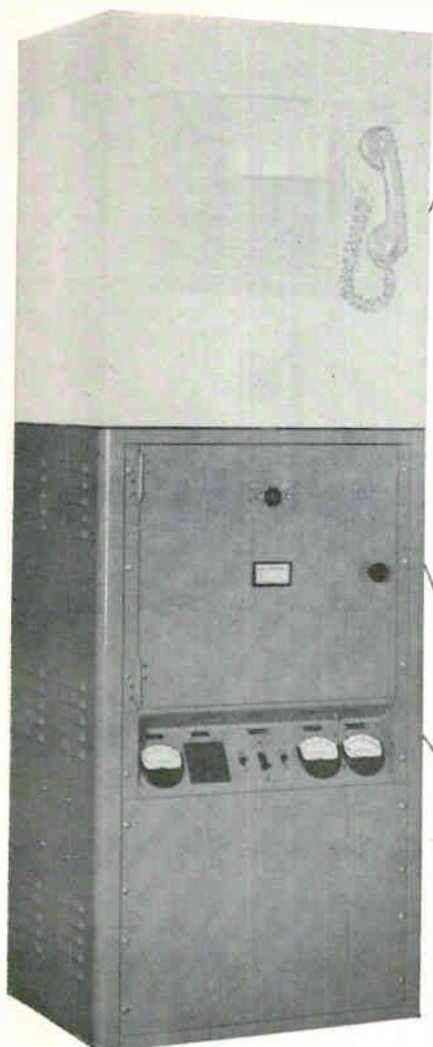

USE AEROCOM'S AMPLIFIER FOR MORE COMMUNICATION POWER!

AEROCOM'S Linear Amplifier used with conventional low power SSB transmitters for excitation, provides power output of 1000 watts PEP, continuous service. The SSB exciter should have at least an output of 65 watts PEP to obtain maximum output of the amplifier.

The Model 10LA amplifier is housed in a cabinet (22" Wx14 $\frac{3}{4}$ " Dx36 $\frac{3}{4}$ " H) which can serve as a base for conventional SSB exciter, or amplifier may be placed a short distance away from the associated exciter, if necessary for convenience.

Frequency range of 10LA is from 2 to 20mc, covered in 6 bands. Up to 4 independent non-simultaneous channels are provided. These four channels are selected externally by exciter channel control. One tuning unit is provided for each frequency specified up to maximum of four.

The 10LA amplifier is designed to work into a 50 ohm coaxial feed line. One output coaxial receptacle,

common to all four channels, or 4 output coaxial receptacles (one for each channel) are available; each channel normally requiring its own antenna. For multi-channel operation with 1 antenna it is recommended that Aerocom Model ATU-410 antenna coupler be used.

A built-in directional coupler provides monitoring of output power and SWR. Grid current, plate current, filament voltage and high voltage are metered.

Harmonic output attenuation: second harmonic is at least 55 db down and higher harmonics are at least 70 db down. Noise level is 40 db below 1000 watts PEP output. Distortion products, in two-tone test, are at least 35 db down, depending on characteristics of exciter.

This linear amplifier, like all Aerocom equipment, is ruggedly constructed to give long trouble-free service. Additional information and technical data on request.



3090 S. W. 37th Avenue — Miami 33, Florida

Mobile Dopants Turn Germanium Resistors



First details on how flexodes are built and how they operate

LAST MONTH, at the solid-state conference at the University of New Hampshire, researchers from RCA Laboratories reported on a new family of reversible semiconductor rectifiers called flexodes (ELECTRONICS, p 7, July 27). Last week, RCA made available to ELECTRONICS further details on how flexodes are built and how they operate.

Flexodes are made from a semiconductor crystal doped with at least one high-mobility impurity. Applying an electric field and passing heating current through the device causes junctions to be formed or destroyed, yielding rectifiers or multicontact devices with variable and reversible characteristics.

FLEXODE OPERATION—For a typical two-contact, small flexode that is unpotted, application of 200 to 700 milliamperes d-c at room temperature will raise the temperature to 100 C. This is enough to convert the flexode from a resistor to a rectifier.

If pulses are applied in the reverse direction so that the device's breakdown voltage is exceeded, the flexode reverts to a resistive state and then becomes a rectifier in the

RCA SCIENTIST observes flexode being processed in temperature-controlled silicone oil bath (photo above)

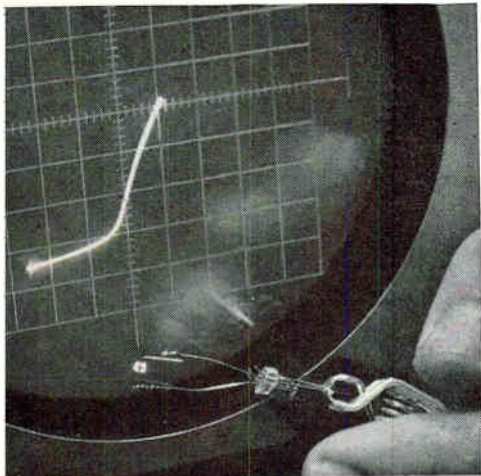

SCOPE TRACE indicates flexode intermediate state. Top of trace will flatten out

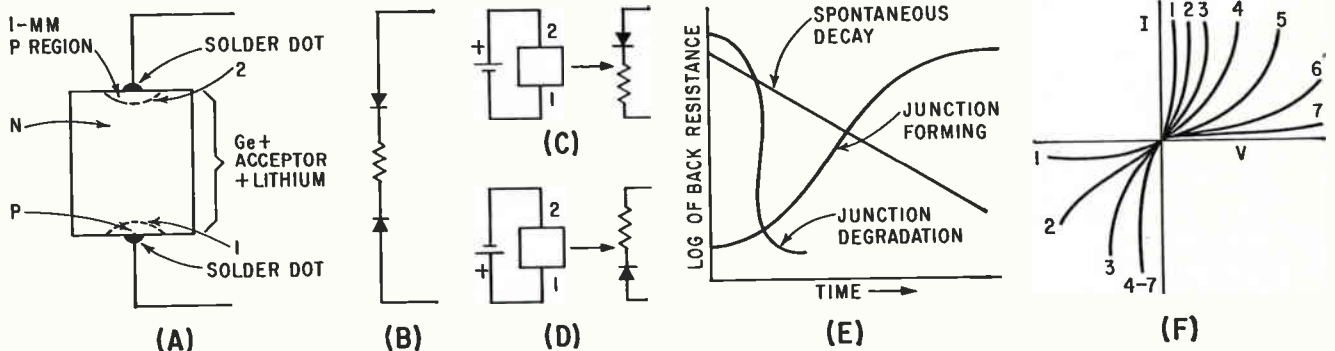

FLEXODE CHARACTERISTICS. Immediately after construction (A), the flexode has an equivalent circuit like (B). A large reverse current will degrade either junction. If both junctions are degraded and current passes through the device, the junction in whose forward direction the current passes will rebuild, as in (C) or (D). This transformation is shown graphically in (E), while (F) shows the progression at equal processing intervals from a rectifier in one direction (1-1) to a resistor and to a rectifier in the opposite direction (7-7)

into Two-Way Rectifiers

reverse direction. A self-limiting current supply is used to avoid destroying the flexode; typical voltage is 100 volts or more.

According to RCA researchers, it has been established that reversing the current destroys the junction near one contact and forms a new junction at the other. Decay of the old junction is relatively quick and begins as soon as a sufficiently large reverse field is applied. The new forward junction forms after an induction time that may vary from one minute to a few hours depending on the material. Forward resistances of 3 ohms to 15 ohms and final back resistances of 500 ohms to 10,000 ohms have been observed.

CONSTRUCTION—Normally, *p*-type germanium doped with lithium is used in flexodes, but in one experiment high-purity intrinsic germanium was doped, thus becoming *n*-type. After annealing, it was found the resulting flexode material required a much longer time for forming the junctions by the field. However, the resulting junction exhibited no spontaneous decrease in back resistance during one month of storage at room temperature whereas most normal flexodes decay almost completely in this time.

This illustrates it may be possible to make stable adaptable devices. Researchers report they have produced flexodes of various characteristics with fairly good reproducibility. Apparatus is being constructed to aid in understanding the fundamental physical and chemical processes involved in flexode action.

Contract Awarded For Stored Logic Computers

STORED-LOGIC COMPUTERS will be built by Thompson Ramo Woolridge's RW division as part of an operational high-accuracy navigation set for Navy's Fleet Ballistic Missile Weapon System. Stored logic permits selection of word

length, order structure and instruction repertoire, without hardware modification. The \$4.5 million contract, awarded by Sperry Gyroscope, calls for delivery of 29 computers by late 1963.

French Announce Program For Electronics Research

PARIS—In an effort to spur research in neglected areas and to increase effectiveness of research in electronic components, the French government has authorized a \$3 million program of cooperative research. The program, set up by government, industry and university electronics experts, will concentrate on new materials and microminiaturization, with emphasis on computer applications. Work will include semiconductors, solid-state physics, masers and lasers, plasma physics and component reliability. The parts program is the first to be financed by a \$60-million research fund set up by the government to aid the French electronics industry.

Texas Tracker



DEEP SPACE tracking station will soon be in operation at Collins Radio Co. facilities near Dallas. This 60-foot antenna contains 140 aluminum panels aligned within 0.024 inch. Total station cost of \$1 million is being borne by Collins

"Nothing is impossible to diligence and skill"
Samuel Johnson

These are the trademarks of some of our customers—each an important contributor to a dramatically growing industry. We at Potter pledge our diligence and skills to this growth through a constantly expanding program of research and development.

Bendix chose POTTER High Density for the G-20

The Potter High Density recording system as used with the Bendix G-20 Computer results in a highly reliable computer system that sets new standards for ease of use, power and efficiency.

The M906 II tape transport is the heart of this advanced technique and provides the G-20 with recording so reliable that in over 40 hours of continuous recording less than a second of re-read time is required to recover drop-outs due to transient errors.

To learn more about the dramatic high density recording technique send for your copy of "The Topic Is High Density."



- Manufacturers of:
- Digital Magnetic Tape Systems
 - Perforated Tape Readers
 - High Speed Printers
 - Data Storage Systems

POTTER INSTRUMENT CO., INC.
Sunnyside Boulevard • Plainview, New York

THE CREATORS OF THIS FAMOUS NERVE CENTER

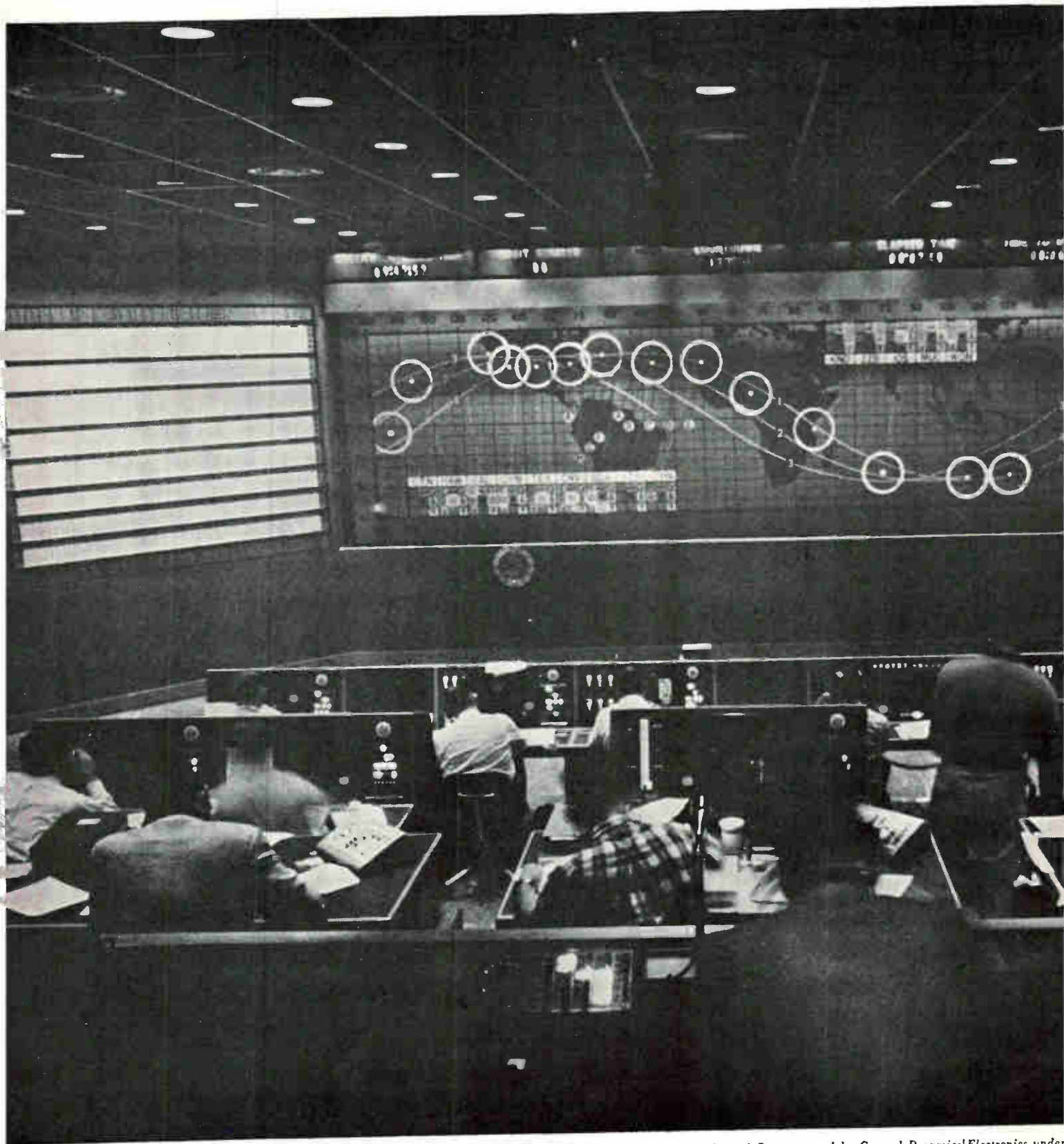

Challenging career opportunities at General Dynamics|Electronics—San Diego. Above is the NASA Project Mercury Control Room created by General Dynamics|Electronics under

electronics

UNDERSTAND COMMAND AND CONTROL PROBLEMS

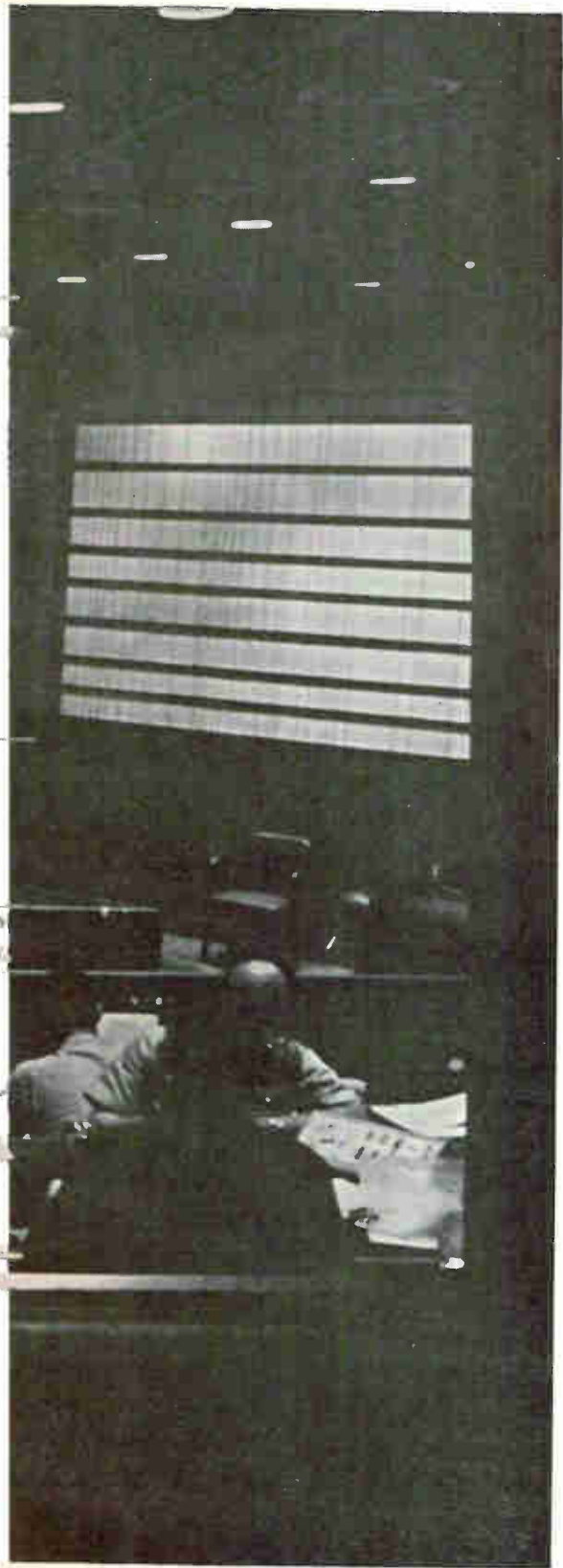

Two new communications tools, perfected by General Dynamics | Electronics research and experience, offer marked advantages to a wide variety of users in the command and control systems field. They are the **3070** Communications Printer and the **1090** Direct View Display.

The **3070** Communications Printer operates at speeds from 400 to 5000 words per minute using standard computer or communications codes over telephone, telegraph and microwave links. The unit prints asynchronously utilizing an electrostatic process to produce highly legible, permanent copy. It is compact, reliable and quiet enough to use in an office.

The **1090** Direct View Display combines high speed, high resolution, compact dimensions, low cost and large 19-inch CHARACTRON® Shaped Beam Tube capable of displaying 1000 flicker-free characters simultaneously anywhere on the tube face. The unit is capable of tabular, situation or graphical presentations and is ideal for computer intervention, monitoring and retrieval jobs, laboratory, simulation, traffic control and surveillance work. If you would like more information about how these units can help you solve your command and control problems, write General Dynamics | Electronics, Dept. C-68 P. O. Box 127, San Diego 12, California.



G | | | | | D
GENERAL DYNAMICS | ELECTRONICS
SAN DIEGO

contract to Bell Telephone Laboratories for Western Electric Company.

New Entry in Microelectronics: High-Density Silicon Matrices

To exploit the concept, a new form of logic circuit is developed

SYRACUSE—General Electric became a late entry in the growing microelectronics field last week, with the simultaneous announcement of their own functional component concept and a new logic circuit scheme designed to take maximum advantage of the concept.

Developed by GE's Semiconductor Products Department, the basis of the new approach is a general-purpose matrix consisting of a pattern of isolated transistors and resistors on a one-inch silicon wafer. The basic matrix contains 1,100 active components and 4,200 resistors.

ELEMENTS—The active elements may be used as *npn* transistors, with characteristics similar to the type 2N914, or as clamp diodes,

zener reference diodes or simply low-resistance transfer points for circuit junctions. The resistors are arrayed in two-pack, four-pack and six-pack groups to permit any series or parallel arrangement to obtain higher or lower resistance values or higher power dissipation as desired.

According to a GE spokesman, the large number of components available on the basic matrix allows the circuit designer maximum flexibility in designing the circuit for his needs. It also has the advantage that test element groups of components may be set up on the same wafer as the circuit under development, thus permitting information to be obtained on parameter stability under life-test conditions for reliability data. Interconnections to form the desired circuits are made by an aluminum deposition process.

The matrix is produced by planar,

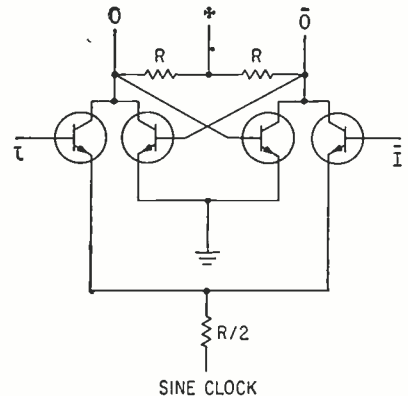

EMITTER-COUPLED *transistor logic is used here in a half-shift register that requires only four transistors*

epitaxial and passivation techniques.

ECTL LOGIC—The new logic circuit scheme is emitter-coupled transistor logic (ECTL). It was developed by GE's Light Military Electronics department at Utica, N. Y.

According to GE engineers, ECTL was developed specifically to overcome the problems encountered in reducing other logic systems to functional component form. As implemented by GE functional components, it uses only resistors and *npn* transistors in negative logic with +0.7 and +0.1 volt being the ZERO and ONE states, respectively.

This logic uses emitter-follower gate inputs, eliminating current-hogging problems. The fan-out is proportioned to the beta of the transistor elements. Under worst case conditions, fan out is $h_{FE}/3$, with h_{FE} falling approximately 2 to 1 from 25 C to -55 C. Other advantages cited include less sensitivity to noise and, generally, a requirement for fewer transistors.

The operators can be used in a d-c mode or clocked by either pulse or sine waves. Since clock loading is constant, clock distribution and

IEEE Nominates Its First Officers



SLATE OF 25 OFFICERS and directors for the new IEEE has been submitted to IRE and AIEE members. Nominees include Ernst Weber (left), president of Polytechnic Institute of Brooklyn, for IEEE president, and B. Richard Teare, Jr., (right), dean of the College of Engineering and Science at Carnegie Institute, and now president of AIEE, for vice president. Balloting will end Oct. 1

termination problems are minimized.

OPERATION—Low saturation resistance (below 10 ohms) permits stable operation over a considerable range of current. While the clock rate depends on the operating current, a 2-Mc clock rate has been achieved at a total dissipation of 6 to 8 mw per half-shift register.

Such a circuit is illustrated on the facing page.

Initially, GE is making seven different functional components now available in sample quantities. These emitter-coupled logic operators are priced at approximately \$110 each to original equipment manufacturers. The circuits are: a half-shift register, a majority logic gate, a four inverter package, a

three double-pair gate circuit, a three input AND gate circuit, a logic flip-flop, and an AND-OR double gate circuit. Test element groups, distributed throughout the wafer, are also available. They are housed in the 10-lead TO-5 type package.

Later on, circuits designed by customers to meet individual requirements using the basic matrix can be produced, says GE.

Polarizers Modulate Laser Beam

Techniques may aid development of optical communications systems

NEW YORK—Development of a single-sideband, suppressed-carrier, optical method for modulating laser beams, permitting tuning of the laser, was announced last week by General Telephone & Electronics Corp.

Herbert Trotter, Jr., president of GT&E Labs, said the modulation technique could be used in design of a laser communications system including transmitters and super-heterodyne receivers with regulated and adjustable frequencies, and for laser radar and spectroscopy.

TECHNIQUE—The procedure followed by C. F. Buhner, V. J. Fowler, and L. R. Bloom, developers, was:

A helium-neon gas laser provided a plane-polarized infrared beam that was converted to left-circular polarization by passage through a quarter-wave birefringent plate. The light then was transmitted through two electro-optic modulator elements, each a single-crystal KDP bar 7 mm long and 10 mm square with transparent electrodes perpendicular to the path of the light.

Modulation voltages of about 2-Kv peak were applied to the electrodes, producing fields in the crystals and causing part of the input left-circularly polarized light to be converted to right-circularly polarized light at the modulation sideband frequencies.

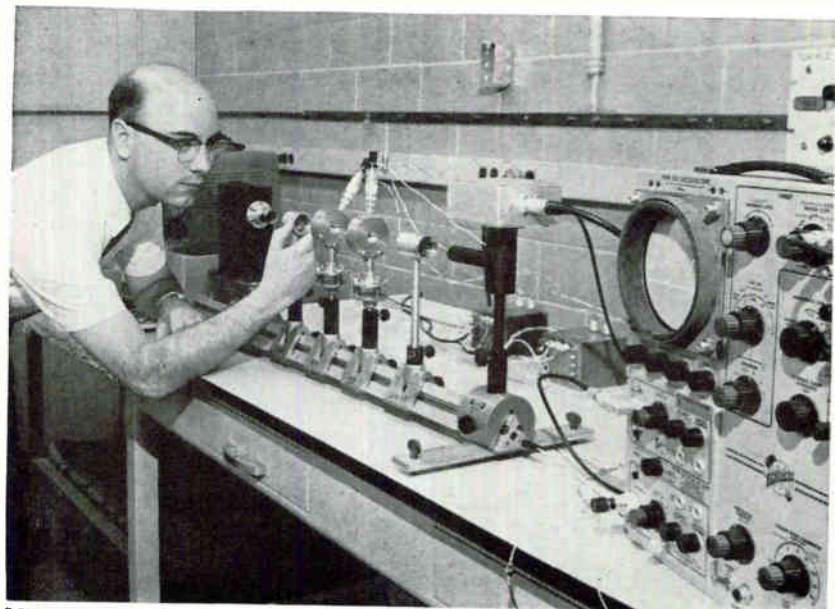

MODULATOR elements, from left, are light source, birefringent plate, two KDP crystals, right circular analyzer and multiplier phototube

Lower sideband light was extinguished by making the phase of the voltage on the second crystal lag the first by 90 degrees and having the second crystal rotated 45 degrees clockwise relative to the first. Light emerging from the second crystal was a mixture of left-polarized light at the laser carrier frequency and right-polarized light at the upper sideband frequency.

This light passed through a second quarter-wave birefringent plate and a plane polarizer that functioned as a right-circular analyzer suppressing the carrier and permitting only the upper-sideband light to pass through. This light was detected with a multiplier phototube, and the envelope wave-

form displayed on an oscilloscope.

VERIFICATION — Evidence of single-sideband, suppressed-carrier generation was obtained by first adjusting the device so that in the absence of modulation voltages on the crystals substantially zero light was transmitted to the phototube. Then, a 1-Kc tone used as the modulation signal produced a constant oscilloscope deflection, indicating that both the carrier and one sideband were suppressed. Tones at 1 Kc and 1.5 Kc applied simultaneously to both crystals produced two upper sidebands and a 0.5-Kc beat frequency. When phasing produced upper and lower sideband signals, beat frequency was 2.5 Kc.

Adaptive Control Helps X-15 Fly

Servo system blends aerodynamic and thrust controls in thin air

MAIN PURPOSE of Major Robert M. White's recent flight in the X-15 to a record-breaking altitude of 314,750 feet was to check out a new adaptive control system developed by Minneapolis-Honeywell.

At that altitude, the air is so thin it offers almost no support to regular aerodynamic controls and reaction or thrust controls are needed. The Honeywell system, under development since 1959, automatically adapts to changes in air density and other control factors and blends the aerodynamic and reaction controls.

Automatic control consumes reaction fuel at only half the rate of manual blending, helping the X-15 fly higher. The system also corrects the plane's attitude.

OPERATION—The model network (see diagram) shapes control and sensor signals so they represent the desired response of the aircraft. These are compared with the plane's actual response obtained from the rate gyro. Errors are applied to the lead network and are corrected by servo action in the inner feedback loop.

The key to this corrective process is the gain computer, acting as a variable attenuator to continually adjust gain of the inner loop. The response speed is several times that of the model, to keep errors small during transient inputs. High forward loop gain provided by the computer and series-lead compensation provided by the lead network make possible high-speed response and bandwidth.

Reaction controls take over when adaptive gain is driven to a maximum, an indication that aerodynamic control surfaces are becoming ineffective.

To keep gain at its maximum stable value, the computer maintains a small, fixed-amplitude control-surface limit-cycle frequency.

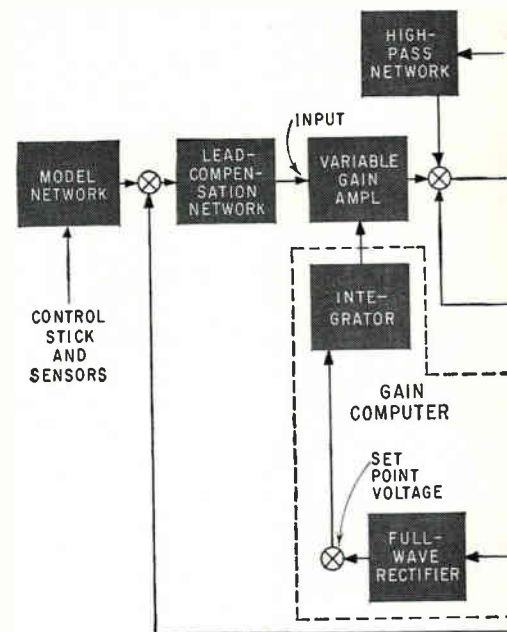

GAIN COMPUTER in the inner detected by the rate gyro and ad-

That is, it responds to small fluctuations in the rate-gyro signals caused by small and rapid movements of the control surfaces.

Any servo feedback signal whose frequency is not near this limit is removed by the bandpass filter, so the rectifier output represents the limit-cycle component of the servo feedback signal.

The d-c signal is compared with the set-point voltage representing the desired limit-cycle amplitude. The resulting error signal goes to an integrator that adjusts the forward loop gain to maintain a constant-amplitude limit cycle.

GUSTS AND BUFFETS—The integrator rapidly reduces loop gain if the limit cycle tends to exceed the set-point reference. The variable-gain amplifier's saturation varies directly with the gain set by the computer. These features reduce nonlinear gain variation during transients caused by gusts of wind. Buffeting can also be tolerated, even when the system noise input becomes periodic near the limit-cycle frequency.

The high-pass filter in the computer reduces the effect of pilot



EDGE OF SPACE is the X-15's flight goal

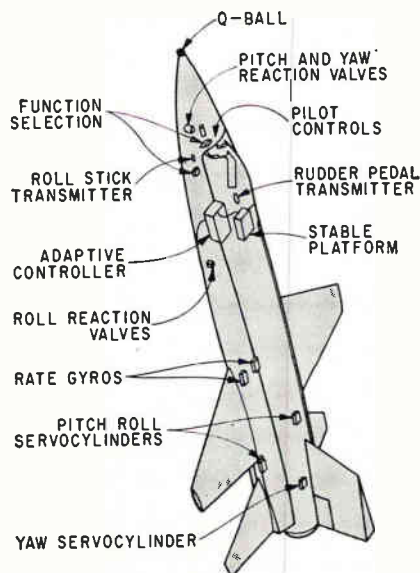

CONTROL SYSTEM components location in the X-15

60 Miles High

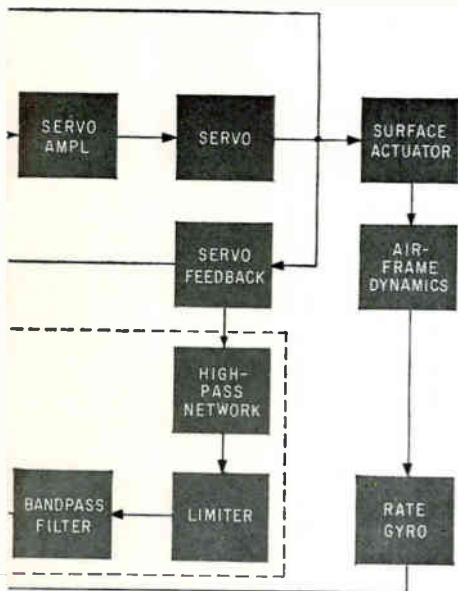

loop evaluates performance errors just as the inner servo loop's gain

commands during landing. Servo displacement signals generated by pilot commands are amplitude limited to prevent a few large, rapid servo movements from driving the gain too low.

Notch filters attenuate signals from rate and acceleration sensors located on the fuselage, to offset the effects of fuselage bending oscillations.

COMPONENTS—More than 90 percent of possible failures in the system are expected to come from interruptions of electrical continuity, so interconnected dual redundant systems are used. Monitors detect failures and switch out offending components.

Small magnetic amplifiers with transistor stages are used extensively to increase gain and output levels. The magnetic amplifiers are made of small ribbon cores and use 3.5-Kc excitation.

Probably the most important use of a magnetic amplifier is in the gain computer as a series-connected saturable reactor. It changes d-c into a pulse-width-modulated 3.5-Kc. square wave that controls system gain attenuation.

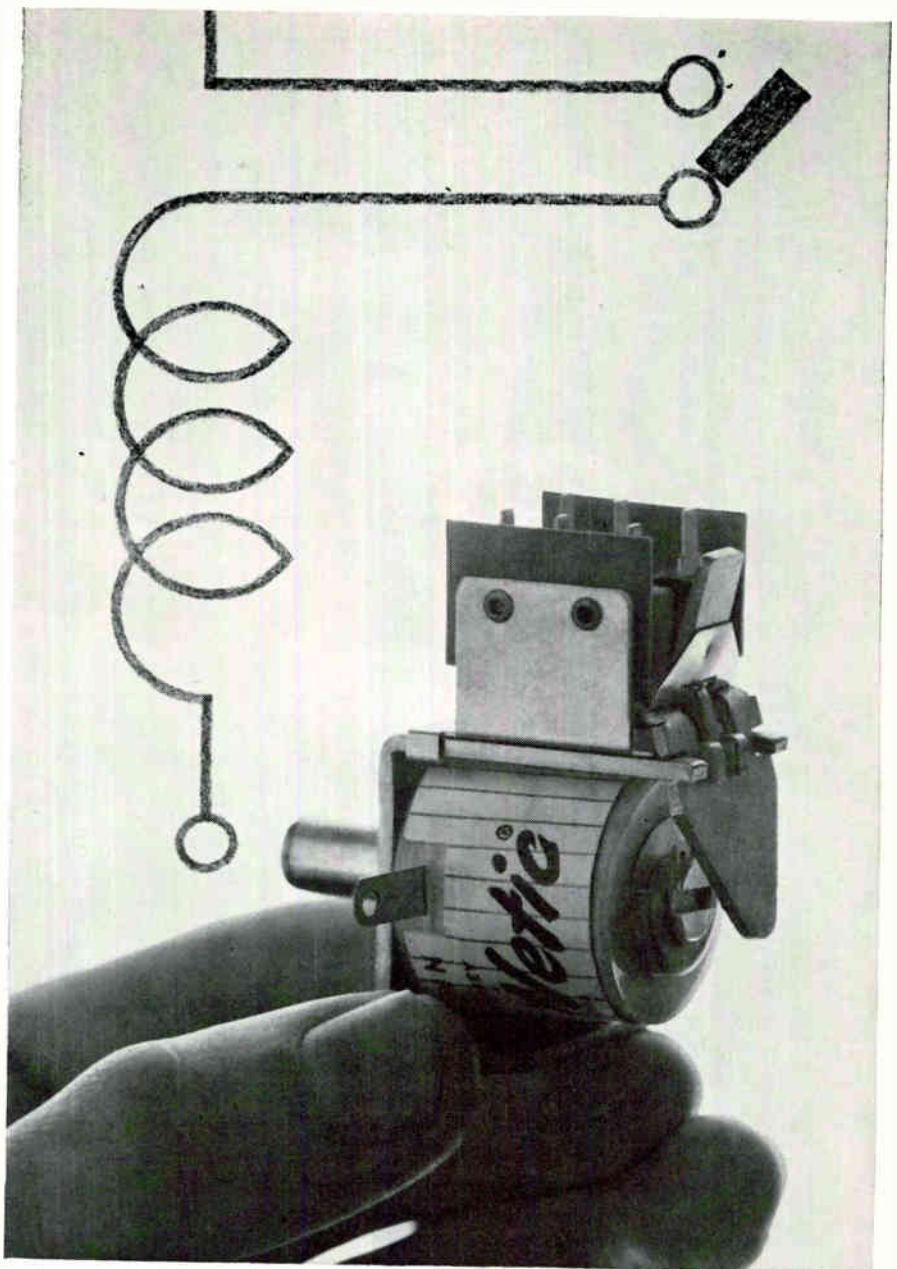

WHY USE TWO IF ONE WILL DO?

The Heinemann Type B Time-Delay Relay can double as its own load relay. It's got a continuous-duty coil. Once actuated, it can remain locked-in indefinitely. This, combined with DPDT snap-action switching at up to 5 amps, can obviate the need for a separate slave relay in many applications.

Yours might be one of them. Here's a quick rundown of the Type B's specs:

Standard Timings: 1/4, 1/2, 1, 2, 3, 4, 5, 8, 10, 15, 20, 30, 45, 60, 90, 120 seconds.

Contact Capacity: 5 amperes at 125V or 250V AC; 5 amperes at 30V DC, resistive; 3 amperes at 30V DC, inductive.

Coil Voltages: 60 cycles AC: 6, 12, 24, 48, 110, 115, 120, 208, 220, 230, 240 volts; DC: 4, 6, 12, 24, 28, 48, 64, 110, 120 volts. (Others available.)

For more detailed specifications on the Type B (and on all the other time-delay relays in the Heinemann line), write for Bulletin 5005.



HEINEMANN
ELECTRIC COMPANY
2600 Brunswick Pike, Trenton 2, N. J.

SA 2578

FILMISTOR®

**METAL FILM RESISTORS
OFFER 5 TEMP. COEFFICIENTS
TO MEET ALL CIRCUIT
REQUIREMENTS**

**RUGGED END-CAP
CONSTRUCTION
FOR LONG TERM
STABILITY**

**EXCEPTIONAL
RESISTANCE TO
MOISTURE AND
MECHANICAL DAMAGE**

**SURPASS MIL-R-10509
PERFORMANCE
REQUIREMENTS**



Providing close accuracy, reliability and stability with low controlled temperature coefficients, these molded case metal-film resistors outperform precision wirewound and carbon film resistors. Prime characteristics include minimum inherent noise level, negligible voltage coefficient of resistance and excellent long-time stability under rated load as well as under severe conditions of humidity.

Close tracking of resistance values of 2 or more resistors over a wide temperature range is another key performance characteristic of molded-case Filmistor Metal Film Resistors. This is especially important where they are used to make highly accurate ratio dividers.

Filmistor Resistors, in 1/8, 1/4, 1/2 and 1 watt ratings, surpass stringent performance requirements of MIL-R-10509D, Characteristics C and E.

Write for Engineering Bulletin No. 7025 to: Technical Literature Section, Sprague Electric Co., 35 Marshall Street, North Adams, Mass.

For application engineering assistance, write: Resistor Div., Sprague Electric Co. Nashua, New Hampshire



'Sprague' and '®' are registered trademarks of the Sprague Electric Co.

Private Switchboard Is All-Electronic

Semiconductor devices cut size in half. Firm also sells big system

NEW YORK—ITT Kellogg's Telecommunications department demonstrated last week a 100-line model of its electronic private automatic telephone exchange, the Kelex 2000. It uses all transistor circuits, weighs about 400 lbs and is about half the size of conventional electromechanical equipment.

The exchange is installed quickly, by connecting the subscriber's lines to terminals in the cabinet and by plugging it into an electric wall socket. Features include provision for paging and conference calls. Automatic call forwarding—transferring incoming calls to another telephone—will be available next year, ITT said.

Cost of the system was described as competitive with conventional exchanges.

The system is designed as a space-division switchboard—providing a separate physical path for each simultaneous phone conversation—with time-sharing common control. For switching, ITT uses what it calls a random-selection principle, an end-marking, self-seeking switching network employing *pnpn* diodes. The network operates in microseconds.

The Information Systems division of ITT recently announced the delivery of their automatic message switching center (p 11, Dec. 15, 1961) to the Aluminum Company of Canada Ltd. The ADX 7300

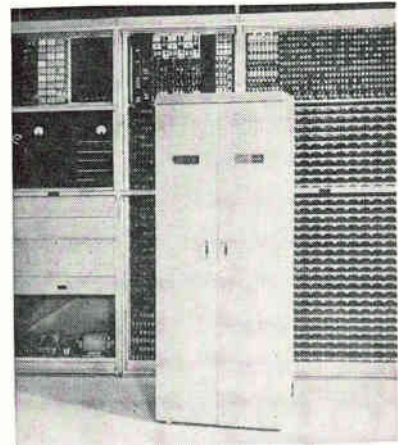

SWITCHBOARD cabinet, filled with printed wiring boards, is smaller than electromechanical switchboard seen in background

automatic data exchange system will handle all administrative messages for Alcan's plants and offices in Canada, the U. S. and London.

ADX 7300 is a commercial version of equipment used in the Air Force 465L global communications network. An ADX 7300 is being installed at the American embassy in Paris, France; five or six systems will go into operation this year, ITT says.

The system can handle 3.6 million bits of information a second. Access time to the core storage memory is 5 μ sec. The system is expandable to service more than 400 duplex lines.

50-Kw Klystrons Ordered For Stanford Accelerator

LIGHT-WEIGHT driver klystrons, using periodic permanent magnets for beam focus, will be built by Eitel-McCullough for the two-mile-long linear accelerator at the Stanford Linear Accelerator Center (Project M). The initial contract for \$170,000 calls for delivery of the first of the klystrons this year.

The klystrons are designed to deliver 50-Kw peak, 50-w average power at S-band. Final amplifiers, to be driven by the klystrons, will deliver peak power of 24 Mw. The accelerator, being built under an AEC contract, is expected to cost \$114 million.

Portable Seismograph

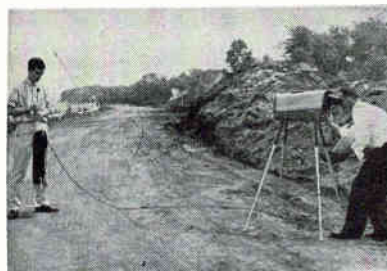

TERRA-SCOUT, made by Soiltest, Inc., Chicago, indicates on crt time for shock wave to travel from hammer (left) to crt indicator

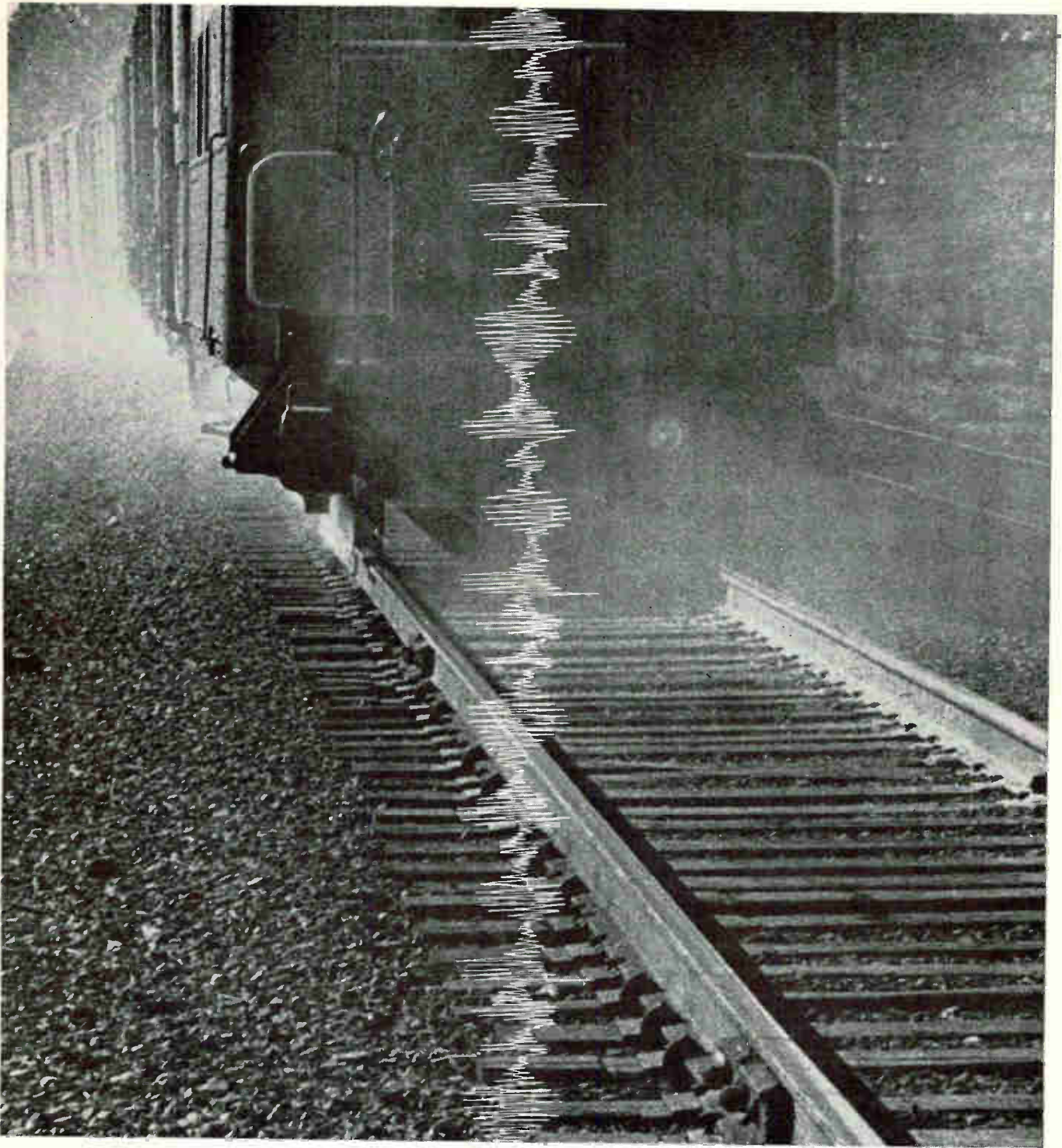

What can ride the rails and still record with laboratory precision? AMPEX CP-100.

What a life the CP-100 recorder leads. It even gets shock-mounted in a train to measure the flatness of the roadbed. And never a change in its true instrumentation quality performance. In fact, you'll find the CP-100 right at home in a down-range test van, nuclear submarine — or a clinical laboratory. (It can be rack-mounted.) It provides Direct, FM-Carrier and PDM recording. Is easily accessible: the entire

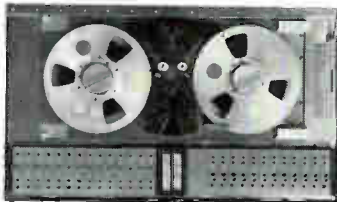

transport assembly lifts up. And it operates on almost any standard source of power, including batteries. The CP-100 is perfect any time, anywhere you need a reliable precise portable. For more data write the only company providing recorders and tape for every application: Ampex Corporation, 934 Charter Street, in Redwood City, California. Sales and service engineers throughout the world.

Pulse magnetrons, used in commercial all-weather radar systems, are part of the extensive line of Litton microwave tubes and display devices. For information write to San Carlos, California. In Europe, Box 110, Zurich 50, Switzerland.

LITTON INDUSTRIES
ELECTRON TUBE DIVISION

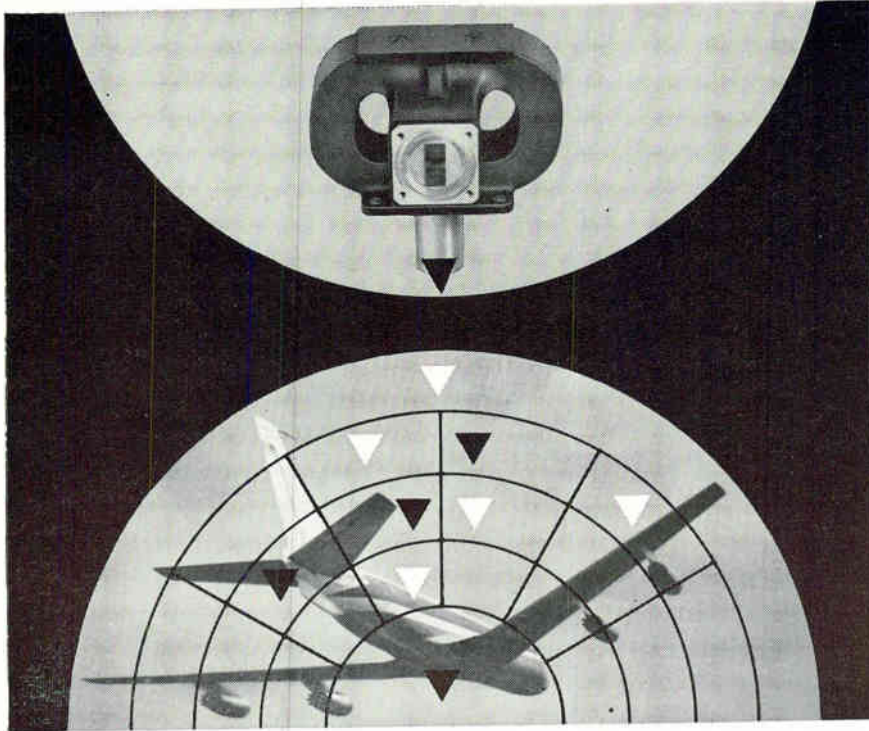

CIRCLE 200 ON READER SERVICE CARD



**THIS MACHINE READS
OUT MORE THAN
ONE ROW AT A TIME**

This machine is an EECO punched-tape reader. It reads 80, 96, 120 or 160 bits (depending upon the model selected). Applications: machine tool control; automatic checkout and testing; and many more. Offers: one complete test per block; identification of data function by position in block; elimination of data storage records and decoding circuits; straightforward programming by blocks. In modular or standard 19" rack mounting units. Takes 1", 8-level paper or mylar tape punched on 0.1" centers. Most models are bi-directional. Write for data sheets.

Automation Division
Electronic Engineering Company
of California
1601 E. Chestnut Avenue • Santa Ana, California
Phone: 547-5501, P.O. Box 58 • Representative in
Western Europe and Israel: Electronic Engineering
S.A., C.P. 142 Fribourg, Switzerland. EE 2-49

MEETINGS AHEAD

- METALLURGY OF SEMICONDUCTORS CONFERENCE;** American Institute of Mining, et al; Ben Franklin Hotel, Philadelphia, Pa., Aug. 27-29.
 - BALLISTIC MISSILE & SPACE TECHNOLOGY SYMPOSIUM,** U.S. Air Force and Aerospace Corp.; Statler-Hilton Hotel, Los Angeles, August 27-29.
 - MAINTAINABILITY OF ELECTRONIC EQUIPMENT,** EIA Engineering Dept. & Dept. of Defense; U. of Colorado, Boulder, Colo., Aug. 28-30.
 - INFORMATION PROCESSING, INTERNATIONAL CONFERENCE, IRE-PGEC, IFIPS, AIFPS;** Munich, Germany, Aug. 29-Sept. 1.
 - INFORMATION ON THEORY INTERNATIONAL SYMPOSIUM, PGIT and Benculux Section of IRE;** Free Univ. of Brussels, Belgium, Sept. 3-7.
 - MICROWAVE TUBES INTERNATIONAL CONFERENCE, URSI;** Technological U. of Delft, Netherlands, Sept. 3-7.
 - ADVANCED TECHNOLOGY MANAGEMENT CONFERENCE, IRE-PGEM, AIEE, et al;** Opera House on World's Fair Grounds, Seattle, Wash., Sept. 3-7.
 - DATA PROCESSING EXHIBIT,** Assoc. for Computing Machinery; Onondaga County War Memorial, Syracuse, N. Y., Sept. 4-7.
 - PETROLEUM INDUSTRY CONFERENCE, AIEE and ISA;** Carter Hotel, Cleveland, Ohio, Sept. 9-14.
 - ENGINEERING MANAGEMENT, IRE-PGEM, AIEE et al;** Hotel Roosevelt, New Orleans, La., Sept. 13-14.
 - ENGINEERING WRITING AND SPEECH SYMPOSIUM, IRE-PGEWS;** Mayflower Hotel, Wash., D. C., Sept. 13-14.
 - ELECTROCHEMICAL SOCIETY MEETING;** Statler-Hilton Hotel, Boston, Mass., Sept. 16-20.
 - RECTIFIERS IN INDUSTRY MEETING, AIEE;** Desher-Hilton Hotel, Columbus, Ohio, Sept. 18-19.
 - ORDNANCE ENVIRONMENTAL SYMPOSIUM (unclassified),** Research & Development Div. of the Army Chief of Ordnance, Southwest Research Institute; El Tropicano Hotel, San Antonio, Texas, Sept. 18-20.
- ADVANCE REPORT**
- COMMUNICATIONS SYMPOSIUM, IRE-PCGS: Municipal Auditorium and Hotel Utica, Utica, N. Y., Oct. 1-3. Sept. 7 is the deadline for forwarding CONFIDENTIAL clearances for classified session attendance to: RADC, Griffiss Air Force Base, Rome, N. Y., Attention RAIS. Classified sessions will be accessible to properly cleared U. S. citizens. Also there are many unclassified sessions. Symposium theme is "Communications-Link to Tomorrow". Government as well as industry personnel will present papers.

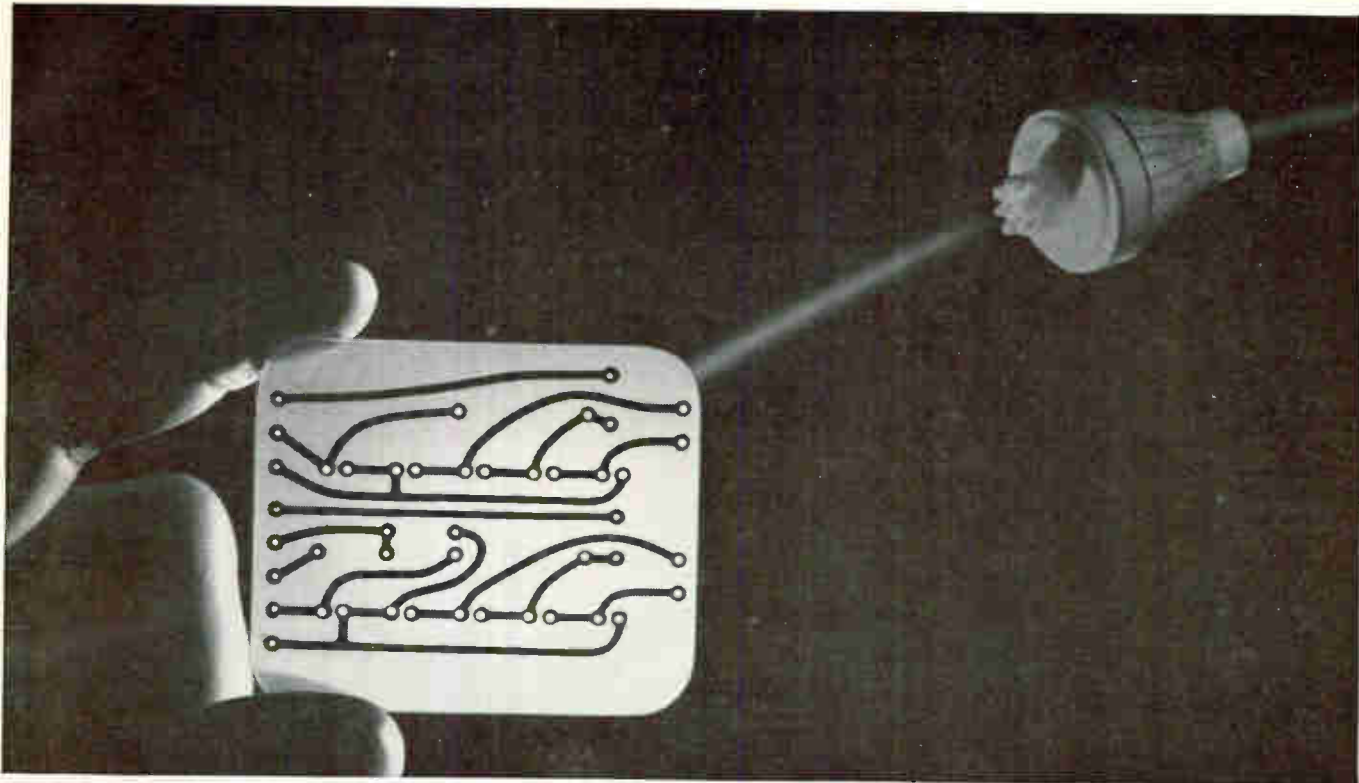

SHIP IT TODAY USE IT TOMORROW ANYWHERE IN THE U.S.A WITH



*35th Anniversary
1927-1962
first and finest Air Shipping service*

For 35 years, the fastest, surest, safest air shipping service has been AIR EXPRESS, a co-ordinated operation of the 37 scheduled U.S. Air Lines and R E A Express. Small components get from you to user, on or off airline routes, when they're needed—shipped by AIR EXPRESS. 13,000 R E A trucks assure door-to-door pick-up and delivery that is as fast and efficient as AIR EXPRESS is in the air. And the cost is low, too—5 lbs. travel 1,500 miles for only \$4.17. To reach the most experienced, most dependable air shipping service, just pick up your telephone. **CALL YOUR LOCAL R E A EXPRESS OFFICE FOR AIR EXPRESS SERVICE**

Seal permanently

with new G-E silicone rubber adhesive

Vapor-tight seal is quickly made with RTV-102 to facilitate and simplify assembly of parts.

Potting of electrical connections assures long-term protection, even for high-temperature applications.

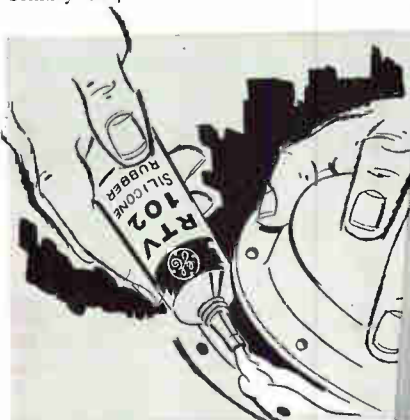

RTV-102 is useful as an adhesive or sealant for metal fabrication. Will not sag on vertical or overhead surfaces.



RTV-102 is an excellent adhesive for most materials. It is the only type of adhesive completely suitable for silicone rubber.

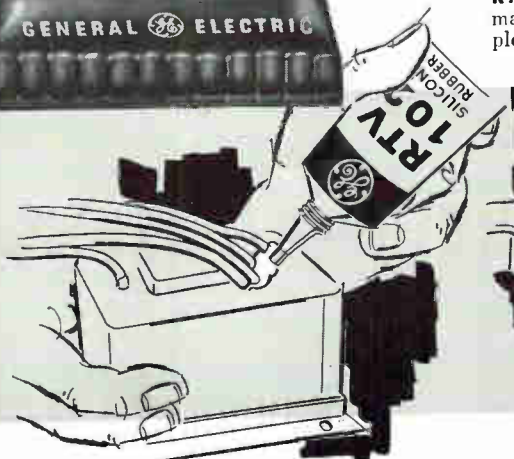

On-the-spot repairs save time. Cured parts remain permanently flexible. RTV-102 can also be smoothed over large areas.



For a thousand jobs, just squeeze it on and it's on to stay! No pre-mixing or priming. RTV-102 silicone rubber adheres to almost anything — glass, metal, plastics, ceramics, wood, silicone rubber. Sets in minutes, air cures in a few hours, forms a resilient rubber that never dries out, cakes or cracks. Resists moisture, grease, weather-

ing, many chemicals, and temperatures from -75°F to 500°F .

For free evaluation sample plus technical data, write on your letterhead describing your application to Section N873, Silicone Products Department, General Electric Company, Waterford, New York.



GENERAL ELECTRIC

electronics

August 24, 1962

This simple cursive-script reading machine detects certain readily distinguishable properties of handwritten names of numbers and separates them logically. Its recognition accuracy is about 97 percent

BY LEON D. HARMON

Bell Telephone Laboratories, Inc., Murray Hill, N. J.

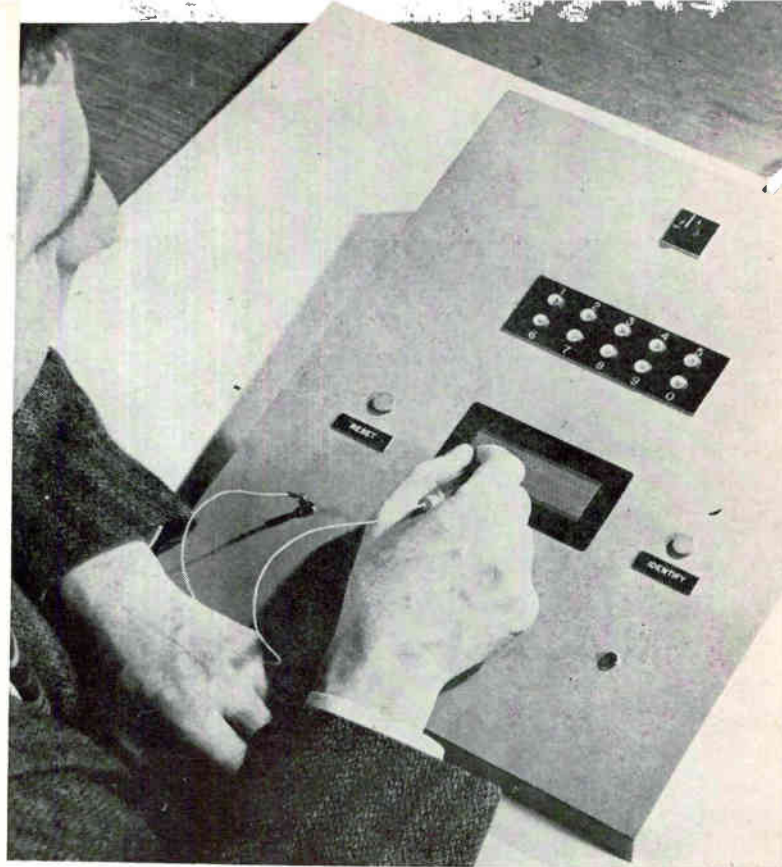

WORKING MODEL of the cursive-script reader contains 12 relays and 8 diodes. Here the author prepares to demonstrate its capabilities

HANDWRITING READER Recognizes Whole Words

AUTOMATIC READING of machine- and hand-printed symbols has received considerable attention, while the problem of reading cursive script has been relatively neglected. Two script-reading systems reported recently (see Ref.) evolved from the automatic reader described here.

This device automatically recognizes the 10 digits, zero through nine, when written in continuous (cursive) script. The system operates in real time, processing the writing as it is produced, thus avoiding the necessity for scanning. No attempt is made to detect letters individually; instead, the over-all shape or envelope of a word is inspected. In addition, tests are made for word length and for the pres-

ence of special marks such as dots, crosses and slashes.

Obviously, such an approach is suitable only for a very small vocabulary. Much greater sophistication is required for extended recognition. However, some of the tests employed here have proven useful for automatic recognition of an unrestricted ensemble.

OPERATING PRINCIPLES —

Real-time signals are derived from a wired stylus which the writer moves over a striated conductive writing surface. This commutator-like surface consists of alternate rows of conductors and insulators. Figure 1 shows the 15 conductors which give crude vertical resolution and none in the horizontal direction.

Two brass bars serve as visual guides for the writing. The writer is asked to consider the bottom one a baseline and to let the *small* letters (e, i, n . . .) occupy the space between the guides, allowing the vertically extended letters (f, h, t . . .) to fall outside these limits.

The 10 numbers as written in Fig. 1 show the differences that can be used in a simple detection system. They are as follows: (1) Numbers 1, 6, 7, 9 are distinct from the others in that they contain only small letters, that is, those lying roughly between the constraining guide lines. (2) Numbers 2, 3, 4, 5, 8 have vertical extensions above the upper guide line while 0, 4, 5, 8 are extended below the baseline. (3) These vertical extensions may occur

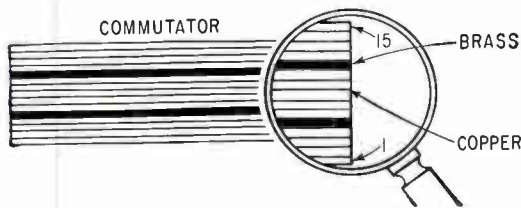

STRAIGHTFORWARD ANALYSIS of these handwritten numbers discloses readily distinguishable properties that can be used in a simple detection system—Fig. 1

		TESTS					
		A	B	C	D	E	F
DIGITS	0	1	-	0	0	-	-
	1	0	0	0	0	0	-
	2	0	0	1	-	-	0
	3	0	0	1	-	-	1
	4	1	-	1	0	-	-
	5	1	-	-	1	-	-
	6	0	0	0	1	0	-
	7	0	0	0	0	1	-
	8	-	1	-	-	-	-
	9	0	0	0	1	1	-

A= LOWER EXTENSION, LEFT
 B= LOWER EXTENSION, RIGHT
 C= ONE UPPER EXTENSION, LEFT
 D= DOT/CROSS
 E= ZERO AXIS CROSSING $\Sigma \geq 9$
 F= TWO UPPER EXTENSIONS, LEFT

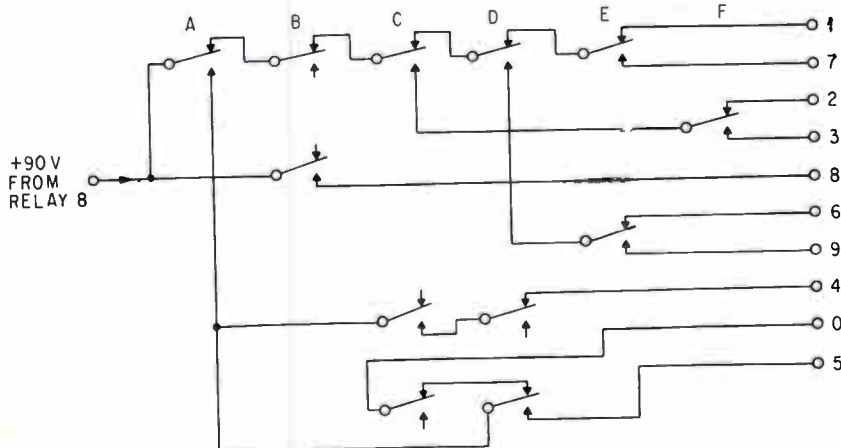

TRUTH TABLE and its relay contact tree used in the number recognizer, although not minimal, allow wide variation in writing style while tending to minimize relay contacts—Fig. 2

in the left (0, 2, 3, 4, 5), middle (8), or right (8) portions of the word. (4) Numbers 5, 6, 8, 9 have dotted letters and 2, 3, 6, 8 have crossed (or slashed) letters. (5) Useful distinctions between words are provided by a measure based on word length or letter count. Consider an arbitrarily placed axis, say halfway between the guide lines. A count of the crossings which the script makes with this axis is typically 7 or 8 for the word *one* and 11 or 12 for *seven*. Other typical counts exist for the other digits.

The information obtained from tests based on the properties listed above is sufficient to separate logically the 10 members of the ensemble. For example, *one* can be distinguished from *two* on the basis of vertical extension. *Two* and *three* are separable since *two* has only one vertically-extended letter while *three* has two. *One* and *six* have essentially the same envelope, but the *x* slash or *i* dot are distinguishing features. *One* and *seven* differ considerably in letter count, hence on axis crossings.

For a system that must select one of 10 alternatives, 3.3 binary decisions are the minimum number possible, and 4 binary devices are the fewest that can be used. Because of great variability in writing styles, any practical system will generally profit from some redundancy; in the present case we have adopted a six-bit logic. The truth table used is shown in Fig. 2.

The "don't cares", indicated by dashes, are not arbitrary. Some, like the case where rule C (top extension, left) is applied to the word *five*, allow for careless writing. Here the writer may make a very short upper extension on the *f*, and it will still be acceptable to the machine. This could not be done in the case of a *four*, since a "1" (yes) is required for effective separation from the word *zero*.

The truth table of Fig. 2 and its relay contact tree are by no means minimal; rather they reflect a set of compromises that appears to allow maximum variation in writing habits while tending to minimize relay contacts.

WORKING MODEL—The resultant circuit, containing 12 relays (10 relays for sequential logic, one counting relay and one counter-

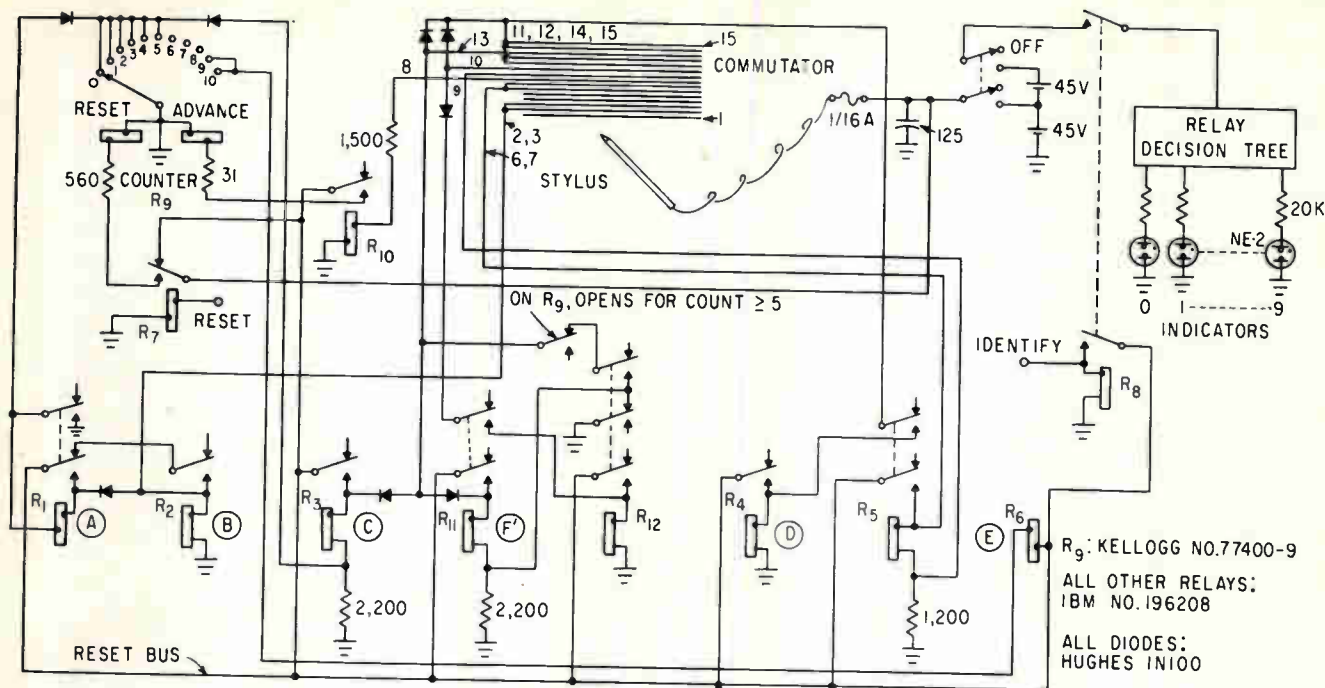

ALTHOUGH RELATIVELY SIMPLE, this script recognition system can read the 10 handwritten numbers with an accuracy of about 97 percent—Fig. 3

driving relay) and 8 diodes is shown in Fig. 3 and in the photograph.

All relays are initially released by touching the stylus to the RESET button, momentarily energizing relay 7. As the subsequent writing proceeds, the counter (relay 9) steps along once for each separate intersection of the stylus with segment 8 (the chosen axis) of the commutator.

The following sequential logic is employed: (1) If segments 2 or 3 are contacted before a count of 6, relay 1 latches up, indicating a bottom vertical extension in the early (five or fewer axis crossings) or left portion of the word. (2) The only conditions under which relay 2 remains latched up at the end of a word are if a bottom extension occurs in the middle or right part of the word (axis crossings ≥ 6) and if there has been no bottom extension on the left. Relay 2 thus latched up indicates a middle or right bottom extension. (3) A top left extension is indicated by relay 3 if segment 13 is contacted and the axis crossing count is ≤ 5 . (4) A dot (or slash or cross) is detected in a rather cheap and dirty way. The logic depends on such a mark being made after the rest of the word has been written. If the stylus hits segment 6 or 7 but fails to contact

segment 9 before any of the upper segments (10 or above) are contacted, relays 4 and 5 contrive to latch up 4. This effectively picks up the discontinuity between the tail end of the script (hopefully in the lower half of the writing space) and the subsequent higher dot, slash or cross. (5) Relay 6 is energized for a counter total ≥ 9 . (6) The presence of two (rather than one) left vertical extensions is detected by the count-of-two circuit formed by relays 11 and 12. Note that relay 11 represents the function F' (the negation of condition F); a simpler circuit results.

This procedure extracts the required 6 bits of information. After a word is written the stylus is touched to the IDENTIFY contact. This latches up relay 8, applying voltage to the selected one of 10 indicator lamps.

The 45-v supply for the relay and counter circuits requires approximately $\frac{1}{2}$ amp, reasonably well regulated. An alternative output display employs a Nixie 7153 indicator tube which requires a 250-v low-current supply.

READING TESTS — In a controlled test of the device, 20 people wrote five complete sequences of the 10 words. They were asked to write with reasonable care and with

their own style and speed. Of these 1,000 trials, there were 96.9 percent correct identifications.

The errors were due to the following causes: *Five*, *six*, and *nine*, identified respectively as *four*, *one*, and *seven*, accounted for 2.5 percent of the errors. This is due to failure of the dot detector. If the upswing of the final letter of the word rises above segment 8 of the commutator, the dot detecting circuit (relays 4 and 5) is frustrated.

Most of the remaining errors (0.6 percent) were due to writing that was too small to properly operate the detection circuits. For example, in some cases an *h* was made no taller than an *e*.

This is a simple script recognition system that demonstrates a few principles. It can be improved, but the inherent limitations of its detection procedures do not warrant much more refinement. However, the device illustrates that given a few modest constraints, a very simple system can read the 10 digits (when cursively hand-written by reasonably careful writers) with an accuracy of about 97 percent.

REFERENCE

L. S. Frishkopf and L. D. Harmon, Machine Reading of Cursive Script, "Proc. 4th London Symp. on Info. Theory", C. Cherry, ed., p 300, Butterworth: London, 1961.

New Approach to Serial Decoding

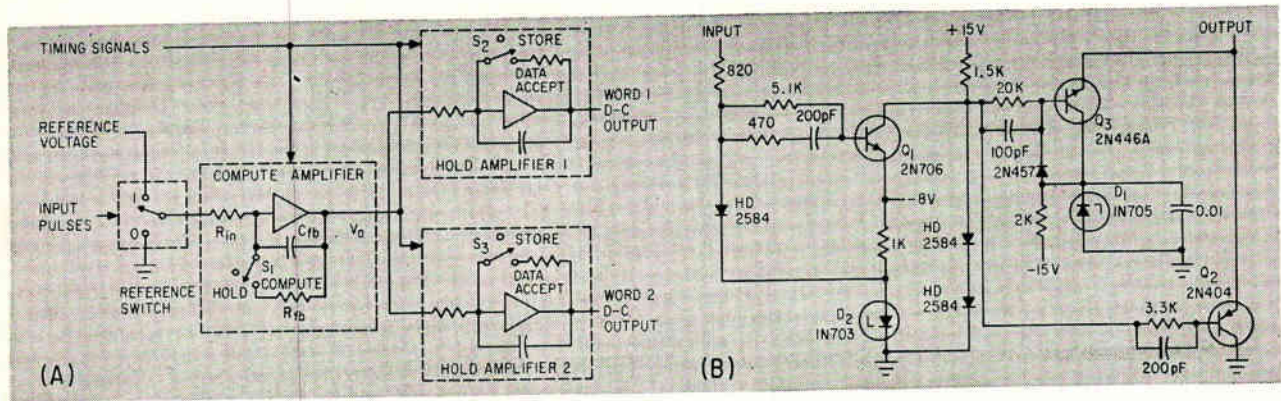

SERIAL DECODER (A) and reference switch (B)—Fig. 1

Linear summation of charges placed on a capacitor by successive pulses of a binary number yields a voltage proportional to that number

DIGITAL COMPUTING and control systems often use serial data handling techniques and serial storage media such as magnetostrictive delay lines, shift registers and magnetic drums. Often, digital data must be converted to analog, such as in a digital servo controlling a proportional servomotor. The conventional way to do this uses a static storage register and weighted resistor summing. But this decoder converts serial binary data directly to analog d-c voltage without static storage. It can be used whenever moderate (1 to 2-percent) accuracy conversion is acceptable. Binary numbers are presented to the decoder least-significant bit first at a clocked rate in non-return-to-zero form. The decoder output is a d-c voltage directly proportional to the input binary number.

SERIAL DECODER—Consider a group of pulses representing a binary-coded number, least-significant bit leading. Successive pulses of the group represent successively higher powers of 2. To decode this pulse train, a method has been shown¹ in which the 2^0 pulse of an n -bit number contributes $k/2^n$ volts to the final decoder output, the 2^1 pulse contributes $k/2^{n-1}$ volts, the 2^2

pulse $k/2^{n-2}$ volts and so forth. Linear summation of the contributions from each pulse yields a voltage directly proportional to the input binary number.

This concept can be implemented by allowing each input pulse to place a standardized charge on a capacitor, and then allowing decay of that charge by 50% during each succeeding pulse period. Assume the capacitor is initially discharged. A pulse in the 2^0 -bit position will place a charge Q on the capacitor. Let the time interval between pulses be the pulse period p . Since the charge decays by one-half each pulse period, the original charge will have decreased to $Q/2^n$ at time T , where $T = np$. A pulse in the 2^1 -bit position will also add a charge Q to the capacitor, and since this pulse arrives p seconds after the 2^0 pulse, its contribution to the total charge will be $Q/2^{n-1}$ at time T . In general, a pulse in the 2^i -bit position will contribute a total charge of $Q/2^{n-i}$ at time T . The total charge Q_T on the capacitor at time T is

$$Q_T = Q/2^n (A_0 2^0 + A_1 2^1 + A_2 2^2 + \dots + A_i 2^i + \dots + A_n 2^n)$$

where $A_0, A_1, A_2 \dots A_n$ are either ONE or ZERO, depending on the presence or absence of a pulse in the

corresponding bit position. Thus Q_T is directly proportional to the magnitude of the input binary number.

PRACTICAL SERIAL DECODER—Figure 1A is a functional diagram of a practical decoder. Input pulses, which represent the input word in binary form, are applied to a reference switch circuit that standardizes the input data by generating pulses of constant amplitude and duration. A ONE input connects the reference switch to a reference voltage, and a ZERO input grounds the switch.

Output pulses from the reference switch are applied to a compute amplifier circuit, which performs the actual decoding of the pulse pattern and then holds the analog voltage for a transfer to another circuit. The amplifier is made up of a d-c operational amplifier, an RC feedback circuit, and a transistor switch. Each pulse from the reference switch applies a fixed current pulse to the amplifier through input resistor R_{in} . Since the pulse width is also constant, a fixed amount of charge is added to C_{fb} for each applied current pulse. Because the operational amplifier maintains its error point at virtual ground, the charge rate is inde-

Eliminates Static Storage

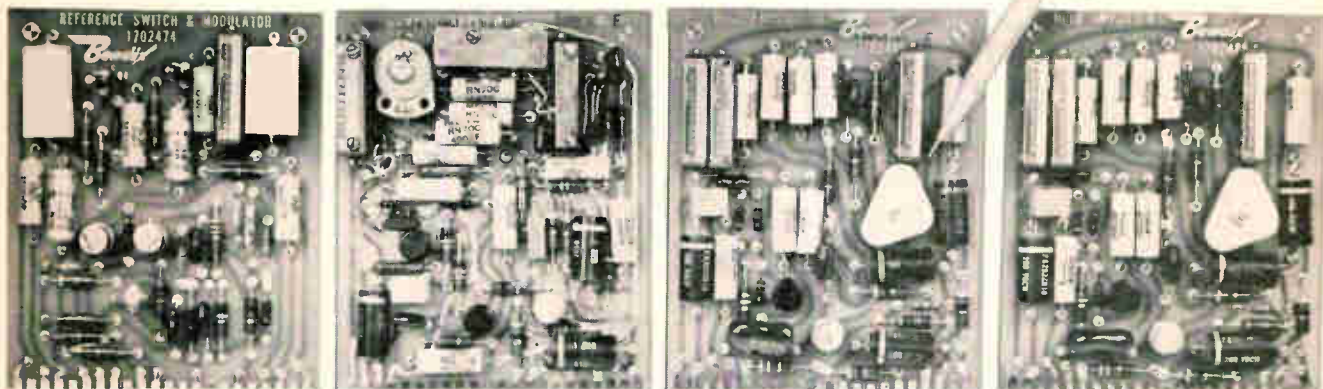

TWO WORD decoder is packaged on four cards. Common heat sink is used for first three stages of hold amplifiers

By R. M. CENTNER and J. R. WILKINSON,
Bendix Corp. Research Laboratories, Southfield, Michigan

pendent of the initial charge on C_{fb} . The time constant $R_{fb} C_{fb}$ is set so that the charge on C_{fb} will decay by 50% each pulse period. The time constant is determined by $e^{-p/\tau} = 1/2$ where p is the pulse period and τ is the time constant $R_{fb} C_{fb}$. For example, if p is 5 μsec , τ must be 7.21 μsec .

Because of the operational amplifier, the contribution of each input current pulse to the output voltage may be calculated independently and the total value may be determined by superposition. If it is assumed that computation begins at t_0 when the least-significant bit enters the system, and concludes at t_x , the end of the most-significant bit, then the final output voltage $V_o(t_x)$ is given by

$$V_o(t_x) = K V_{ref} \left[X_1 + \frac{X_2}{2} + \frac{X_3}{4} + \frac{X_4}{8} + \dots + \frac{X_n}{2^{n-1}} \right]$$

where V_{ref} is the pulse reference voltage, K is the compute amplifier gain, n is the number of bits, X_1 is the state of the most-significant bit, X_2 is the state of the next bit. Value $V_o(t_x)$ is the correct analog representation of the input binary word.

OPERATION—Switch S_1 is in the

compute position from t_0 to t_x . At t_x it is switched to the hold position to remove R_{fb} from the circuit. Therefore, the circuit time constant is increased by a large factor and V_o holds its final value.

While S_1 is in the hold position, the decoded analog voltage is transferred to an analog storage, or hold amplifier. This frees the compute amplifier for decoding a new word and thus permits time-sharing of the circuit. The hold amplifier is similar to the compute amplifier, but has a larger feedback capacitor. Thus, it can store the analog voltage for a longer period of time. Any number of words may be multiplexed with the number of hold amplifiers equaling the number of input words. A two-word system is described. Transfer of the data is accomplished by setting the appropriate hold amplifier switch (S_2 or S_3) to the data-accept position while the compute amplifier is in the hold condition. After sufficient time has elapsed for the hold amplifier capacitor to charge, the switch is returned to the store position and the voltage is held until the next cycle of the storage medium.

The system operation may be clarified further by Fig. 2, which illustrates the switching cycle for a

two-word system. The input data is obtained from a magnetostrictive delay line containing two serial words. Two iterations of the delay line are indicated. The data is presented in non-return-to-zero form, least-significant bit leading, with -8 volts representing binary ONE and 0 volts representing binary ZERO. Delay line length is 200 μsec , word time 100 μsec , and bit time 5 μsec .

Word length is 20 bits and the required decoder accuracy is 2 percent of full scale.

The decoder is required to examine only the eight most significant bits of each word, since the weight of the ninth bit is 2^{-8} , less than 0.4 percent of full scale. Thus, switch S_1 is placed in the compute position only during the last 40 μsec of each word. During this time, S_2 and S_3 are in the store position. At the end of word 1, S_1 is switched to the hold position and S_2 to the data-accept position. During the 60- μsec period that S_1 is in the hold position, the decoded output of word 1 is being transferred into hold amplifier 1. When the transfer is complete, S_2 is returned to the store position and S_1 to the compute position. At the end of word 2, S_1 is returned to the hold position and

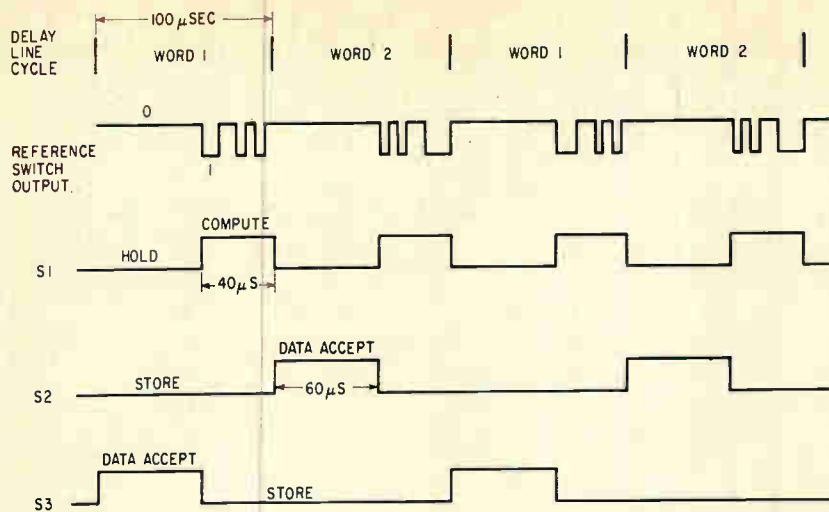

SWITCHING CYCLE for a two word system. Input data was obtained from a magnetostrictive delay line containing two serial words—Fig. 2

S_3 is set to the data-accept position. This allows transfer of the decoded output of word 2 to hold amplifier 2. After transfer, the cycle begins again with the decoding of word 1. Residual voltage from the preceding word causes an initial charge on C_1 , when S_1 is switched to the compute position. However, by the time decoding is complete, the charge due to the residual voltage will have decayed by a factor of 2^8 , and will thus cause less than 0.4 percent error in computation.

The reference switch is shown in Fig. 1B. This provides low-zero-offset 5- μ sec pulses with stabilized amplitude. The input pulses are obtained from a synchronous flip-flop with nominal logic levels of zero and -8 volts. The output pulses switch from zero to -5 volts. The switch uses transistors Q_2 and Q_3 , in series-shunt; the leakage current

of the off transistor is shunted by the on transistor. Collector and emitter connections are reversed to obtain low transistor offset voltages of approximately 2 mv.

The accurate 5-volt reference level is established by the action of zener diode D_1 .

The two switches are driven by Q_3 , which shifts the logic levels and inverts the phase. The end of the pulse input is determined by the rapid turn-on of a control flip-flop transistor rather than the slower and less predictable transistor turn-off time. This is important in minimizing timing error when placing the compute amplifier in the hold position at the end of the most-significant bit. The data input is clamped at -3 volts by zener diode D_2 to remove clock noise which would cause an unwanted d-c compute amplifier output at the 0 level.

Other small offsets from the reference switch are compensated in the bias adjustments of the compute amplifier. Rise and fall times of the output pulse are approximately 0.05 μ sec.

COMPUTE AMPLIFIER — This unit converts the standardized digital output of the reference switch to an equivalent analog voltage and then holds this voltage for transfer to a hold amplifier (see Fig. 3). Transistor switch Q_1 sets the amplifier in the compute or hold position (S_1 in Fig. 1A, R_1 is the input resistor, R_2 the feedback resistor, and C_1 and C_2 make up the feedback capacitor. Trimmer capacitor C_1 is adjusted for optimum decoding linearity. The closed-loop gain of the amplifier is unity, which means the full-scale d-c output is equal to the reference amplitude of 5 volts.

At the end of each word, Q_1 is reverse biased so that only C_1 and C_2 form the amplifier feedback. The amplifier is then on hold and will remain so until computation of the next word begins. During the hold time, the voltage will be transferred to one of the hold amplifiers. The maximum amplifier drift during hold periods must be within approximately $\pm 10^{-7}$ ampere over the temperature range of 5 to 55 C to meet the specified accuracy. This low drift is accomplished by closely matching the temperature coefficients of the transistors in the first three stages. The most significant temperature coefficient is that of V_{bc} of Q_2 . This is compensated by the V_{be} of the same type transistor Q_3 . The beta temperature coefficient

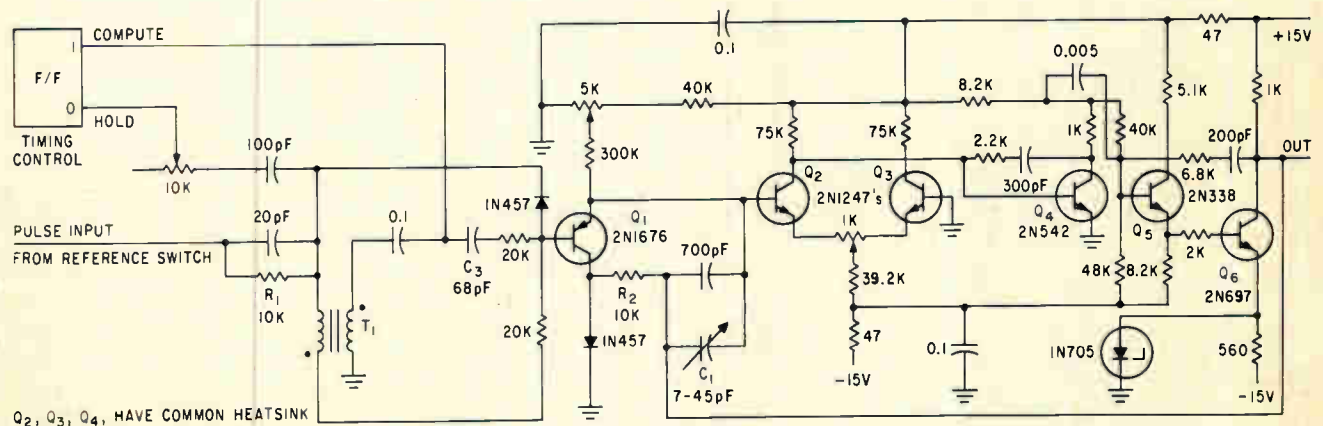

COMPUTE AMPLIFIER converts digital output of reference switch to equivalent analog voltage—Fig. 3

of Q_2 is matched by the beta coefficient of Q_1 . This match establishes the choice of transistor type for Q_1 . A common heat sink for Q_2 , Q_3 , and Q_4 , maintains the transistors at the same temperature. Metal film resistors are used at some points to minimize drift due to resistance changes. The discontinuities in the input waveform require an amplifier bandwidth of approximately 170 Kc. This necessitates a higher Q_2 collector current than would be optimum for temperature stability. However, the required equivalent input drift of approximately $\pm 10^{-7}$ ampere was achieved by temperature compensation technique.

Switch Q_1 is turned off by the rise of a flip-flop output. Timing for the turn-off is critical in that it marks the termination of the most-significant bit. Since the rise time of keying transformer T_1 is insufficient to achieve the required fast turn-off of Q_1 , C_1 is used to supplement the transformer key. The rise time on the base of Q_1 is 0.1 μ sec.

HOLD AMPLIFIER—This is an analog storage device which permits time-sharing of the compute amplifier. At each end-of-word, the output of the compute amplifier is sampled by the hold amplifier to provide a decoder d-c output. Hold amplifier outputs are updated each delay line iteration by recomputed values of the digital words. Sampling begins after the most-significant bit of a word and ends just before computation of the next word begins. The amplifier has a closed-loop gain of two and full-scale output is -10 volts d-c.

The amplifier configuration (Fig. 4), temperature compensation, and control switch are the same as in the compute amplifier; R_1 is the input resistor, R_2 the feedback resistor, and C_1 the feedback capacitor. As the bandwidth requirement is relatively low, a first stage collector current optimum for temperature compensation can be used. Drift current during hold of less than $\pm 5 \times 10^{-8}$ ampere was achieved for an ambient temperature range from 5 to 55 C. The switching time to the data-accept position or the store position is approximately 2 μ sec.

The two-word decoder has been packaged on four printed circuit cards, as shown in the photograph. For applications involving more input words, one hold amplifier card would be added for each word. The common heat sink used for the first three stages of the hold amplifiers is the triangular-shaped piece of metal. The three transistors are enclosed within this block of aluminum. The heat sink on the compute amplifier is the rectangular shaped piece of aluminum at the top of the card. These heat sinks enabled relatively low drift to be attained without stabilizing circuits.

The two-word decoder was given extensive environmental testing. Over the ambient temperature range 5-55 C, the analog output voltage of the two hold amplifiers, plotted as a function of digital input, corresponded with the best straight line to within 2 percent of reading. The maximum zero offset was less than 0.5 percent of full-scale output, resulting in a dynamic

range of 200:1. The zero offset can be decreased by chopper-stabilizing the compute and hold amplifiers. A circuit to accomplish this is now under development. Preliminary results indicate the offset to be less than 0.1-percent of full scale, increasing the dynamic range to 1,000:1. The linearity of the decoder can be improved by decreasing the rise and fall time of the reference switch and compute amplifier input switch.

The serial decoder provides an economical means for converting serial binary digital signals to analog d-c signals with moderate (1-2 percent) accuracy. By eliminating the need for static storage, the serial decoder permits economies to be realized in conversion circuits and thus contributes to more efficient use of hybrid techniques. For example, some control systems having digitized input variables are required to solve complex trigonometric and algebraic equations, which can often be more efficiently handled by analog, rather than digital techniques. Previously, economic trade-off may have favored use of digital computation because of the expense of conversion circuits, the serial decoder now makes the analog approach attractive for certain applications such as automatic checkout equipment, hybrid simulation systems and industrial process control.

REFERENCE

- (1) A. K. Susskind, Analog-Digital Conversion Techniques, MIT Technology Press, 1957.

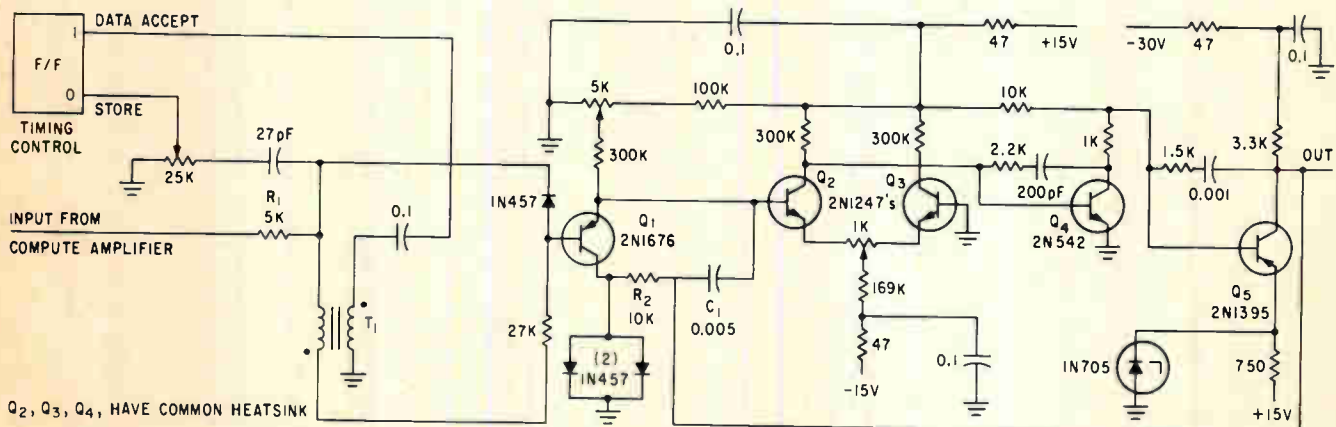

HOLD AMPLIFIER is analog storage device which permits time sharing of the computer amplifier—Fig. 4

OSCILLOSCOPE horizontal axis is fed directly from transistor collector to produce time base, vertical axis input is differentiated collector waveform proportional to desired beta—Fig. 1

By JOHN V. McMILLIN

Project Engineer,
Measurement Research Center Inc.,
Iowa City, Iowa

TRANSISTOR A-C BETA (h_{fe}) varies both with collector voltage and collector current. Beta is a function of the operating point on the load-line; that is, of $f(v_c, i_c)$. It is frequently desirable in design analysis to determine the exact nature of the function $f(v_c, i_c)$ with respect to load-line operating points. A simple curve-tracing method has been developed to plot low-frequency a-c beta versus load-line operating point.

BETA-TRACE—A diagram of the curve-tracing set-up is shown in Fig. 1. A linear sawtooth of duration T and maximum amplitude V_{bb} , is applied to the base of the test transistor through a current-limiting resistor R_b . A dead-time between the repetitive sawtooth waveforms of 5 to 10 percent of T allows recovery of the differentiating circuit in the collector load. This is illustrated in Fig. 1.

The derivative of transistor base current, di_b/dt , is constant for the sweep period T , assuming the peak sweep voltage V_{bb} is much greater than the transistor base-to-emitter voltage drop, V_{be} . (A standing bias applied to the base circuit could make this so.)

The collector output of the test transistor feeds the horizontal input to an ordinary oscilloscope and the vertical input through a high-gain operational amplifier connected in the differentiating mode. Amplifier output, $e_o = k dv_{in}/dt$.

The horizontal scale of the scope represents collector voltage, but may also be calibrated in collector current since these variables are linearly related. Their direction of

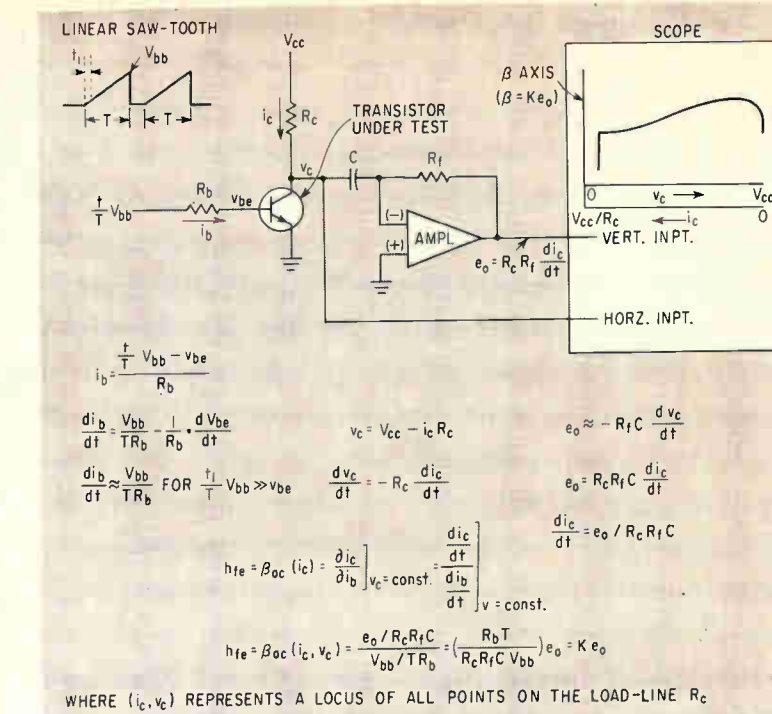

Simple Curve Tracer

Transistor is driven by sawtooth; beta variation is

increase is opposite, however, with the effect that the horizontal scale may be interpreted as a locus of all v_c, i_c load-line operating points.

As shown in Fig. 1, the output voltage of the operational amplifier is proportional to the derivative of the transistor collector current. This derivative, divided by the base-current derivative, which is constant, defines transistor a-c beta h_{fe} . Using these relationships, a-c beta is proportional to the operational amplifier output voltage e_o . The proportionality constant is determined by the value of circuit components and the sweep period T of the sawtooth input.

For each sawtooth sweep cycle a curve is traced on the oscilloscope. The vertical scale is calibrated in beta units and the horizontal scale represents load-line points. Thus an automatic plot of beta versus load-line is obtained. By keeping the ratio of collector resistance to base resistance constant, curves for

various load-lines may be obtained without changing the vertical scale factor.

RESULTS—Comparison measurements were performed on various transistors to check the accuracy of the curve tracing method. Beta was calculated directly from i_c and i_b measurements made with milliammeters. Then i_c and i_b data were taken from a set of common-emitter characteristic curves. Finally, audio frequency gain measurements were made at quiescent points on the load-line. The beta values obtained for various transistors by the curve-tracing technique agreed well with these other methods. Figure 2A shows a typical beta curve. A set of common-emitter characteristic curves for the same transistor is shown in Fig. 2B. When the 2N118 transistor was tested at higher current levels, the beta-trace displayed an unusual shape. As is shown in Fig. 2D,

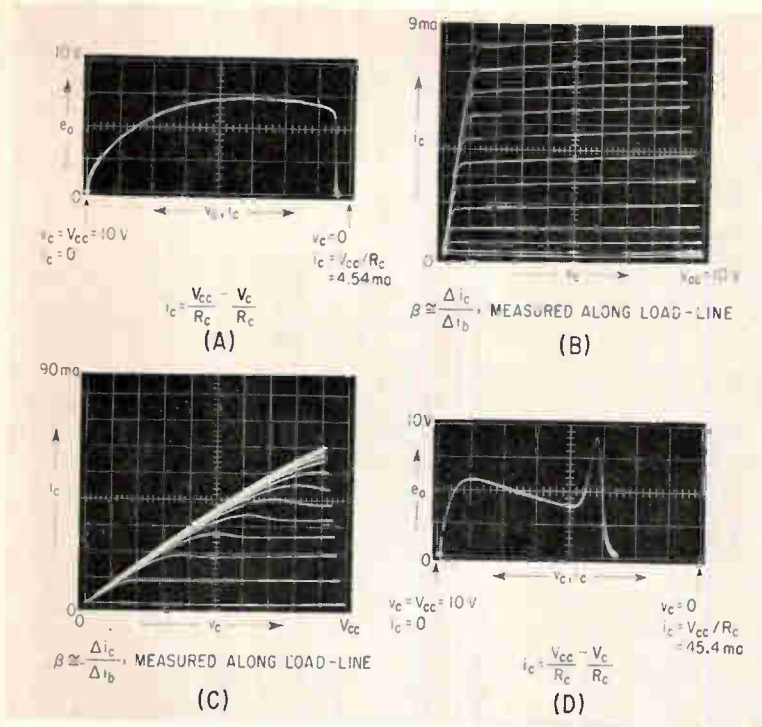

BETA TRACE for 2N118 transistor with $R_c = 2,200$ ohms, $R_b = 680$ ohms and $K = 5.88$ (A); common-emitter characteristic, with base steps of 20 microamp (B). Tests at higher current (C) show common-emitter characteristic for $R_c = 220$ ohms, and 200 microamp base steps; beta display (D) for $K = 8.58$, $R_b = 100,000$ ohms and $R_c = 220$ ohms—Fig. 2

Displays Transistor Beta

shown on oscilloscope for various load values

beta, after falling off with increasing collector current, suddenly peaks to a relatively high value just prior to dropping to zero at the saturation point of maximum current. This apparently anomalous result is correct, however, as is proven by examining the associated set of common-emitter characteristic curves. As is shown in Fig. 2C, the collector curves exhibits a spreading near the collector-voltage saturation line, which would account for a beta increase.

In the test setup, a solid-state operational amplifier was used. In the R,C differentiating network, C was 0.2 microfarad and R_f was 200,000 ohms. Sometimes it is necessary to shunt R_f with a small value of capacitance to prevent ringing in the differentiating-network/operational-amplifier circuit. A value 1 to 2 percent of C should be sufficient.

During tests V_{bb} was about 143 volts and a sweep period T of 108

milliseconds was selected. The collector supply voltage was arbitrarily set at 10 volts d-c.

Values of R_b and R_c ranged from 3.3 megohm to 22,000 ohms, and from 22,000 ohms to 55 ohms respectively, for the transistor tested. Thus the calculated values of the vertical-scale factor K ($h_{fe} = Ke_o$) ranged approximately from 2.8 up to 8.6.

LIMITATIONS—The upper limit on collector load resistance is determined by the parallel loading effects of the differentiating-network amplifier circuit and the scope horizontal input impedance. It should prove feasible, however, to insert a voltage-following isolation amplifier between the collector output and these input points. This modification could probably extend the beta-trace method into the low microampere collector current region for low leakage silicon transistors.

The lower limit on collector re-

sistance is governed by the driving capability of the saw-tooth source. For a constant collector supply voltage V_{cc} , a lower collector load resistance causes higher collector current levels, which in turn dictate higher base currents; R_b is made lower, or V_{bb} must be increased. Caution must be exercised to avoid nonlinearity distortion in the sawtooth due to excessive loading. Thermal heating and/or power handling capability of the transistor being tested also governs the lower limit. Beta is, of course, a sensitive function of junction temperature; consequently, the beta-trace will be distorted if the junction temperature changes during low-speed sweeps. One way to minimize this effect is to make the sawtooth period T as short as possible and have low repetition rates to take advantage of the thermal lag, or time constant, of the transistor.

The maximum value of the collector supply voltage V_{cc} is limited by the collector breakdown voltage V_{cbo} (worst case, assuming R_b is large) and the maximum input/output voltage level of the operational amplifier before clipping. In general, as V_{cc} is increased, the peak value of dv_c/dt will also increase. This increases the amplifier output voltage, since $e_o = R_f dv_c/dt$. Some compensation could be achieved by increasing the sawtooth period T for high collector supply voltages. This would reduce the peak magnitude of dv_c/dt .

The author expresses his appreciation to Rodney A. Mulder of Measurement Research Center for constructing the test set-up, and for recording most of the experimental data.

Testing Space Craft With Induction

Precise control system using power oscillator handles large amounts of heat. Grid blocking controls power

AT THE HIGH VELOCITIES now attained by aircraft and most missile and space vehicles, aerodynamic heating becomes a design consideration. This heating is caused by compression and friction in the air layer directly adjacent to the surface. Although this phenomenon is always present when there is relative velocity between air and the surface, its effects are unimportant until supersonic velocities are attained. Consequently, aerodynamic heating simulation, often combined with aerodynamic loading simulation, is of primary importance in laboratory structure testing.

In a recent test program at the University of Florida, a full-sized

prototype section of a wing leading edge was heated to 3,000 deg F in a simulated re-entry flight lasting two hours. The leading edge was made of molybdenum alloy protected with an oxidation-resistant coating.

The recent achievement of controlled temperatures up to 3,000 deg F on a full-sized specimen was made possible by two new developments. First, a technique for surveying the magnetic field at the test specimen surface permits a desired heat distribution. Second, porcelain copper enamel coated heating coils have permitted operation at high temperatures. The porcelain coating provides an electrical insulation capable of withstanding

high temperatures for long periods.

Work in heating aircraft structural shapes by radio-frequency induction was done under sponsorship of the Structural Division, Directorate of Engineering test, Aeronautical Systems Division, Wright Air Development Division. Radio-frequency currents tend to flow on the surface of metal structures and the consequent heating simulates high speed aerodynamic heating where heat flows from a high-temperature boundary layer of air into the surface of the structure. Emphasis has been placed on achieving prescribed heat distributions and following given time-temperature programs.

CONTROL REQUIREMENTS—

Aerodynamic heating simulation requires a control system that can vary the heat output from zero to full power within a short time. On re-entry into atmosphere the heat input rises suddenly as the density of the atmosphere increases. To simulate such a flight, heating equipment must provide a rapid and continuously variable power output.

Large amounts of radio-frequency power can be generated by two techniques: (1) the master-oscillator, power amplifier system and (2) the power oscillator. The first method is generally used in radio transmitters. A fixed-frequency signal is generated at low level and amplified to the required power output. Power output control, or modulation, may be accomplished at low power levels. A typical example is grid modulation.

Power amplifiers do not accept a change in load reactance. An induction heater must be capable of operating with a changing load reactance since both the resistivity and the dimensions of a specimen will usually change considerably as

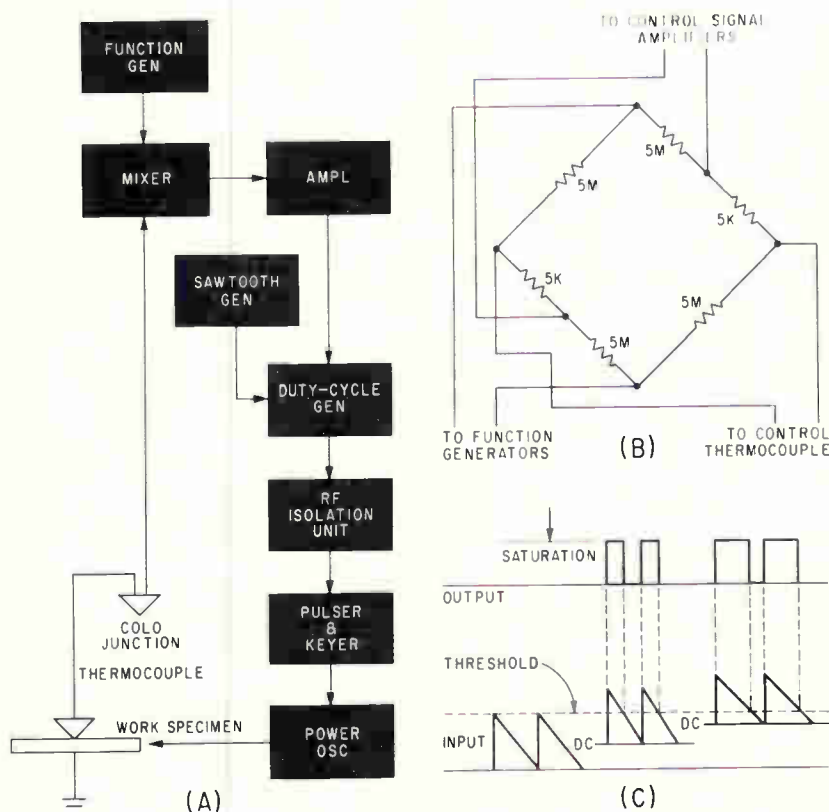

CONTROL SYSTEM block diagram, (A); low-level mixer circuit, (B); method of voltage-to-pulse conversion, (C)—Fig. 1

Heaters

By BRUCE E. MATHEWS
FRED R. SIAS, JR.*

College of Engineering, University of
Florida, Gainesville, Fla.

the temperature increases.

The power oscillator, on the other hand, is self adjusting for load reactance changes. This is one reason why power oscillators are generally used for high-power induction heating.

Power oscillators, however, are not as readily controlled as the power amplifier system. The four conventional methods² of control rely on variation of: (1) grid drive, (2) load matching, (3) filament emission and (4) plate voltage. None of these methods is satisfactory for rapid and complete control.

Mathews³ presents the basic concept of a more satisfactory means of control. This method allows the power oscillator to operate at its optimum point, and permits control of time-average power output by varying the amount of time the circuit oscillates compared to the amount of time the oscillator is off. Since the on- and off-time of the power oscillator may be controlled in the grid circuit, only relatively small amounts of power are handled by the control system. Since the oscillator, when operating, is adjusted to optimum conditions, less instability will develop as power output is varied.

The on-off control is achieved by switching the power oscillator grid-leak resistance and by supplying a high bias through a high resistance to maintain the cutoff condition obtained when the grid-leak resistance is opened during oscillation.

When the grid-leak resistance is open, the high negative bias is maintained and the tube will not oscillate; when the grid-leak resistance is switched in, the bias is shunted and oscillations build up

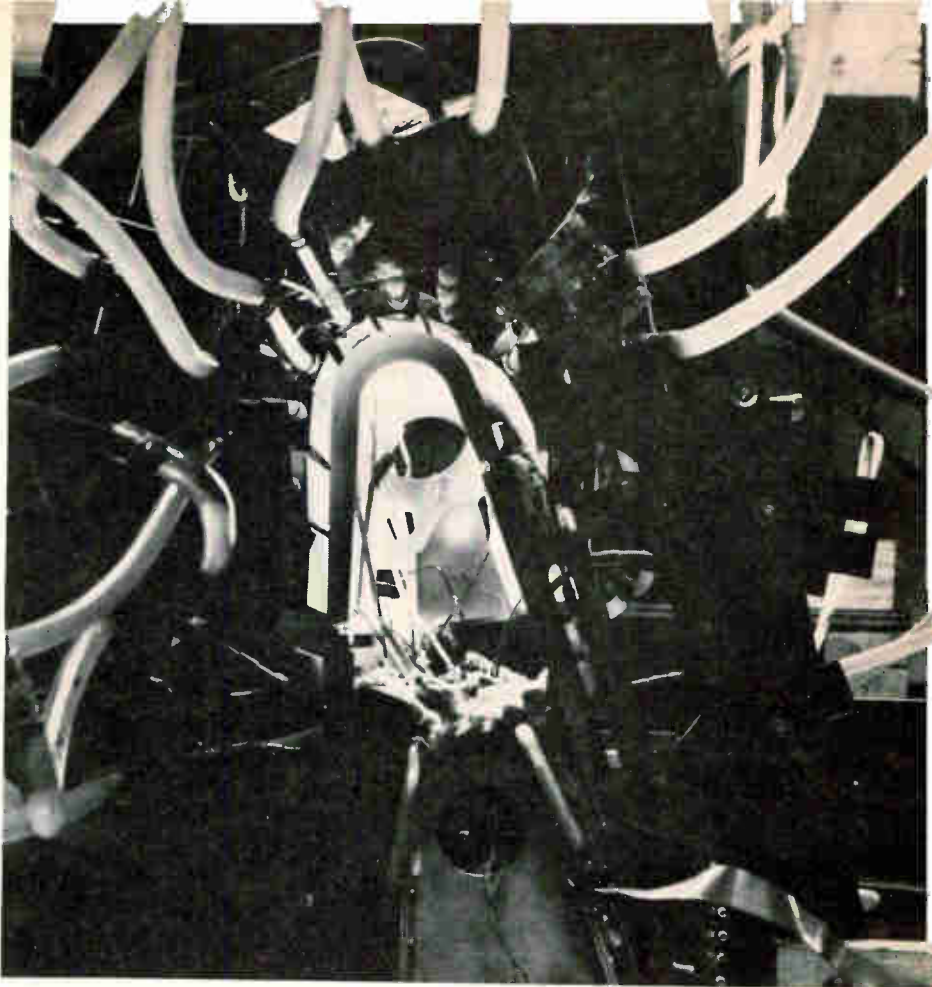

SECTION molybdenum alloy wing leading edge is heated to 3,000 deg F during testing to simulate reentry heat flow

rapidly. Switching of the control circuits is rapid, and full output builds up in a fraction of a millisecond. The time-average power output of the unit depends on the ratio of on-time to off-time.

The ratio of the on-time to the time of one complete on-off cycle is known as the duty cycle. The complete cycle time is so chosen that the pulses of r-f power do not cause individual transient steps in structure temperature. The thermal inertia of structures varies; however, a pulse repetition rate of 360 pulses per second is satisfactory for most conditions.

POWER OUTPUT — Consider a case where the power oscillator has been adjusted to develop a continuous power of 100 kilowatts in the surface of a structure. If the on-time of the oscillator is equal to the off-time, the duty cycle is 50 percent and the average power developed in the specimen is 50 kilowatts.

The average power output of the unit can be represented by the fol-

lowing equation:

$$P_{av} = \theta P_{max}$$

where P_{max} is the power output of the unit while operating continuously and θ , the duty cycle, is represented by $\theta = T_1/(1/360)$ in which T_1 is the on-time and 1/360 is the time of one complete on-off cycle.

A power oscillator whose power output may be varied smoothly from zero to 100 percent is the end component of a complete control system capable of following a prescribed temperature-time history. Figure 1A shows the control system.

Basically, the system is a simple proportional-error servo mechanism where the control signal (or error signal in closed-loop system terminology) is the difference between the output of the control thermocouple attached to the work specimen and a millivolt function-generator output corresponding to the desired temperature program. The control signal corresponding to a small temperature difference is amplified enough to drive a volt-

*Presently with the University of Mississippi Medical Center, Jackson, Miss.

age-to-pulse-width converter. The variable-pulsewidth output is amplified by a pulse driver to drive the keyer unit attached to the power oscillator. The keyer unit pulse-modulates power tubes to provide the average power output necessary to maintain the temperature.

On this basic design, several systems have been developed. An early control system incorporated a d-c preamplifier in the control thermocouple circuit ahead of the mixer. Instability in such d-c circuits gave some trouble since the system voltage gain was as high as

5,000,000. Despite this handicap, tests showed the feasibility of a system of this type.

More recent control systems use what is termed low-level mixing. The function generator output, usually of the order of 10-100 volts, is attenuated to the order of magnitude of the thermocouple output. The control function and the thermocouple signal are then compared in a low-level passive mixer to obtain a control (or error) signal. Figure 1B shows such a mixer. The 5-meg and 5-K resistances provide 1,000:1 attenuation of the function

generator output to provide voltage levels compatible with the millivolt output of normal thermocouples. A stable chopper d-c amplifier provides the necessary amplification for the control signal to operate the duty-cycle generator.

The duty-cycle generator is a voltage-to-pulse-width converter with low-level pulse output to drive the pulse driver unit. In a recent transistorized design, the duty-cycle generator is driven by a sawtooth generator that may be operated at a fixed frequency between 120 and 1,080 pulses per second. The frequency adjustment permits the choice of a high enough frequency to give a smooth temperature response.

The pulse generator produces a variable-width rectangular pulse. Figure 1C illustrates the technique.

The unit is basically a high-gain amplifier that amplifies the signal considerably when a threshold is exceeded. If the amplifier were linear, a high voltage sawtooth would be obtained; however, due to the high gain of the unit and the low saturation point of the final stages, the sawtooth is clipped so that the effective output is a pulse with width proportional to the small amplitude of the sawtooth that is above the threshold level. Figures 2A and 2B show the circuits used.

The pulse driver amplifies the output of the isolation unit to a power level sufficient to control the keyer tubes of the power oscillator (see Fig. 3).

Figure 4 shows the pulse driver unit and the keyer circuits.

SYSTEM PERFORMANCE — Since several of the variables are a function of the test specimen, no categorical statement can be made concerning overall system response, accuracy and stability; only characteristics of the control elements alone can be considered.

Three time constants are significant in the control circuit of this system. These may be classified as follows: (1) keyer and power oscillator build-up time; (2) error-channel response; and (3) function generator rise time.

The power oscillator can be pulsed at up to 800 pulses per second before keyer and oscillator time constants cause erratic be-

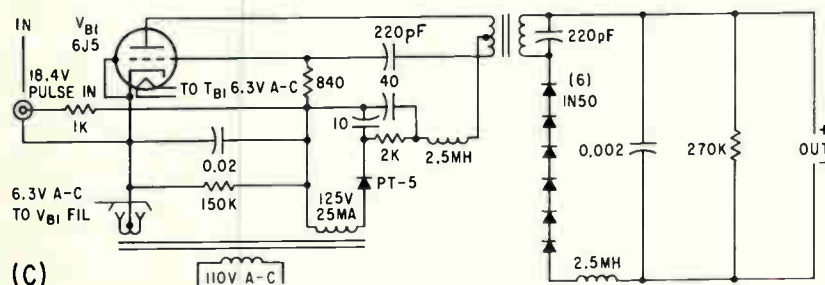
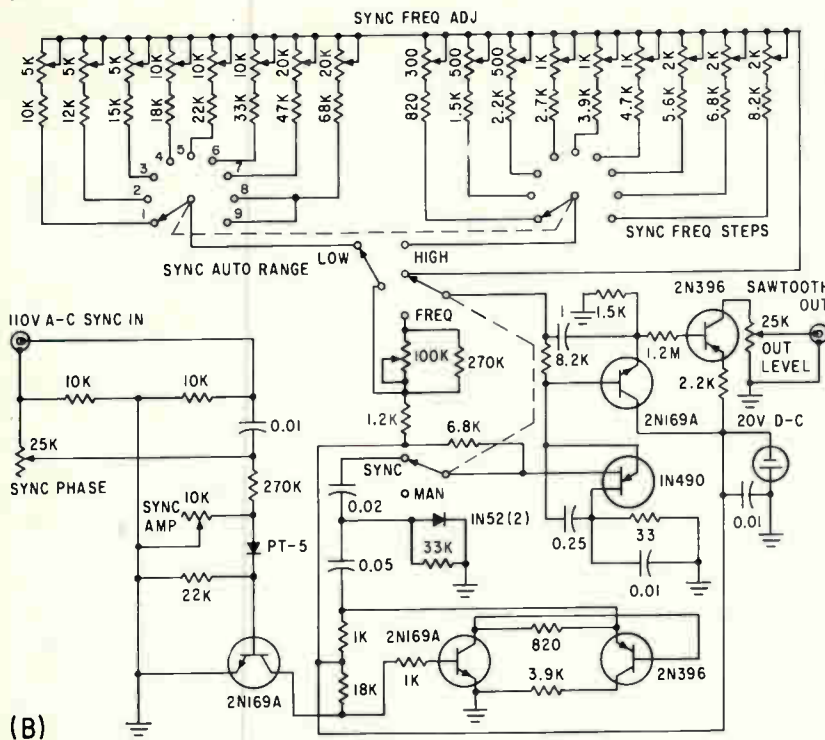
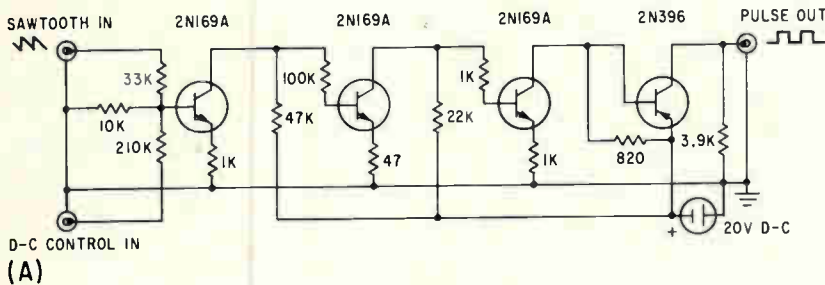

PULSE GENERATOR circuit, (A); sawtooth and sync generator, (B); isolation oscillator, (C)—Fig. 2

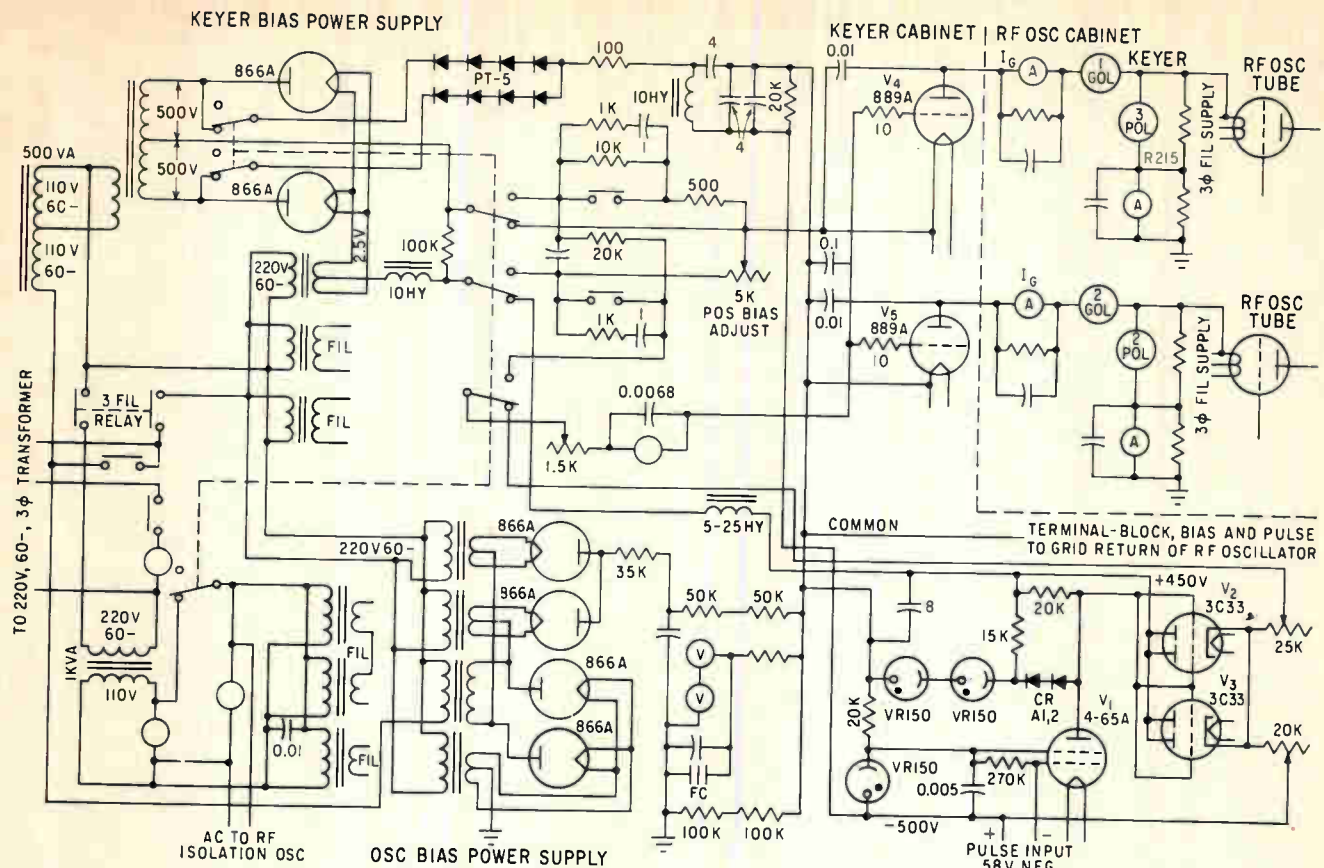

OSCILLATOR, KEYER and pulse driver circuit—Fig. 3

havior. Since both turn-on and turn-off time constants are involved in repetitive pulse operation, the power oscillator and keyer response time to a step function is better than 1 millisecond.

The control signal (or error channel) amplifier is a chopper amplifier utilizing a 440-cps carrier frequency. Published drift stability is $\pm 5\mu\text{V}$ equivalent drift for 1,000 hours. Response to a step function is better than 3 milliseconds.

The maximum controllable temperature rise depends on the function generator. The function generator used with one system permits a 0.5 percent accuracy function if the rise rate doesn't exceed 330 millivolts per second. The full-scale range is 70 millivolts so the most rapid controlled time rise permitted by this function generator is about 20 milliseconds. Using chromel-alumel thermocouples such a function rise rate corresponds to a temperature rise rate of 14,000 deg F per second.

While high temperatures have been achieved in the past, the tests at the University of Florida were the first in which induction heating methods were used to duplicate the distribution of heating intensity

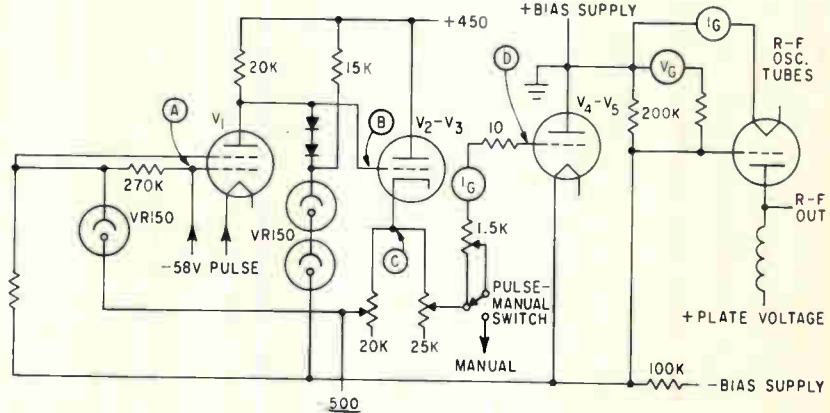

PULSER AND KEYER simplified circuits—Fig. 4

over the surface of a full-sized section of leading edge and to follow a prescribed timewise variation of temperature. The leading edge tested was not intended for any specific aircraft, but was produced for a hypothetical typical manned controllable glider as a result of a research project jointly sponsored by the Metals and Ceramics Laboratory and the Flight Dynamics Laboratory of the Aeronautical Systems Division, AFSC.

This work was performed under a subcontract from the Bell Aero-systems Company.

REFERENCES

- (1) B. E. Mathews, et al, Research and Development on Induction Heating Methods of Simulating Aerodynamic Heating, Final Report for Phase III, to Wright Air Development Center under Contract No. AF 33(616)-5703, University of Florida, Feb 1961.
- (2) L. L. Langton, Radio-Frequency Heating Equipment, London, 1949.
- (3) B. E. Mathews and W. F. Fagen, Disclosure of Invention, University of Florida, June 9, 1954.
- (4) G. F. Perdue, F. R. Sias, Jr. and A. N. Higgins, Research on Pulse-Width Method of Control for Induction Heating, University of Florida, Gainesville, Florida, April 1960.
- (5) WADC Technical Report 55-305, Part II, Oct 1955 (unclassified).
- (6) R. W. Sampson and F. R. Sias, Jr., Scale-Model Testing at Ultra-High Heat Flux Densities by Induction Heating, Florida Conference on High-Speed Aerodynamics and Structures, University of Florida, Gainesville, Florida, Jan 1957.

Novel Design Technique for Transistor Digital Circuits

Permits designers to derive equations for cutoff and saturation conditions of a transistor logic circuit. Equations will provide circuit values for worst-case variations of parameters. By plotting these equations, the designer can then see how to optimize the circuit values

By R. W. HOCKENBERGER, Avco, Electronics and Ordnance Div., Cincinnati, Ohio

ALTHOUGH most transistor-logic-circuit design methods take into account the temperature-stabilization problem, few allow for parameter variations. Rather, they design to nominal values and rely upon moderate-to-large safety factors¹ to compensate for circuit-component tolerances and variations in load requirements. This often results in circuits that are either too critical or have unrecognized capabilities.

This circuit-design method uses fewer safety factors but shows the deviations in performance due to parameter variations graphically. This design method shows there are different combinations of nominal parameter values that will allow the circuits to operate at an optimum. By plotting the circuit cut-off and saturation equations, choices can be based on the graphs, allowing reliable circuits to be designed to meet tighter specifications.

In a single digital system, it is normal to expect the system requirements of each circuit to remain constant. Therefore, the design procedures for each of the logic circuits can be combined, thus minimizing design time as well as the number of different component values for all circuits. It is found often that use of one type of transistor enables one set of design calculations to govern the choice of param-

eters for several circuits, thus saving time, effort and money.

DESIGN STEPS—The first step is to determine the input and output conditions. Normally, the input conditions will have been determined by either previous designs or system logic rules.

The most important factor in determining output conditions is the type of loading. Only d-c loading will be considered. This type of loading may be either a resistor connected to a supply voltage or to a common potential. Each type of loading requires different treatment. A *pn*p common emitter (c.e.) configuration is assumed. Although the derivations involve different-polarity transistor parameters, the equations also hold true for *npn* types.

Where a load is connected to a supply voltage (R_L , Fig. 1A), the internal load of the circuit, that is, the collector resistor (R_C) in the c. e. configuration should be as large as possible to ease collector current requirements. The maximum value of R_C is then determined by the maximum rise or fall times. The minimum load expected, therefore, determines the maximum value of R_C . If $10 RC$ is kept smaller than t_r , the allowable rise or fall time, the degradation of

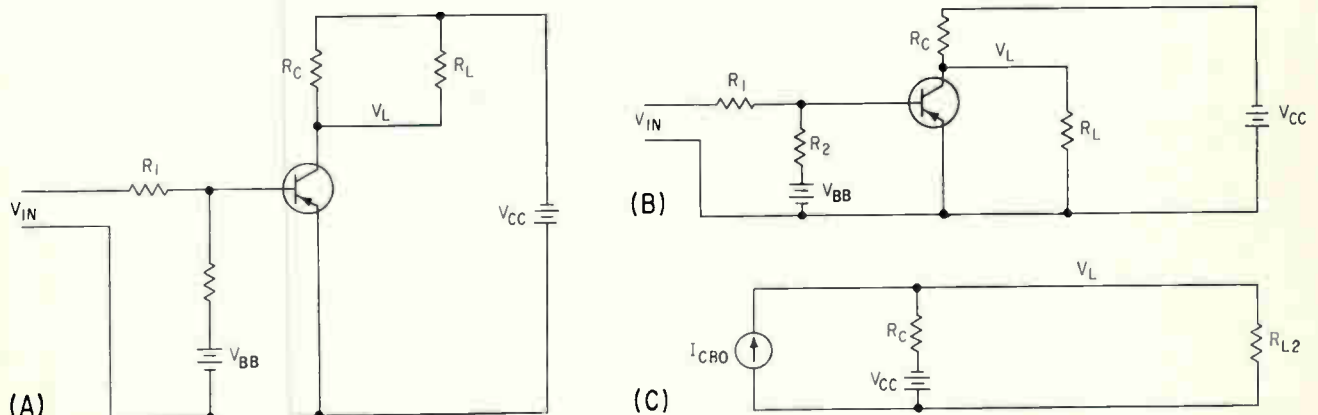

TRANSISTOR CIRCUIT with load tied to supply (A). Transistor circuit with load tied to common (B); equivalent circuit of (B) is shown in (C)—Fig. 1

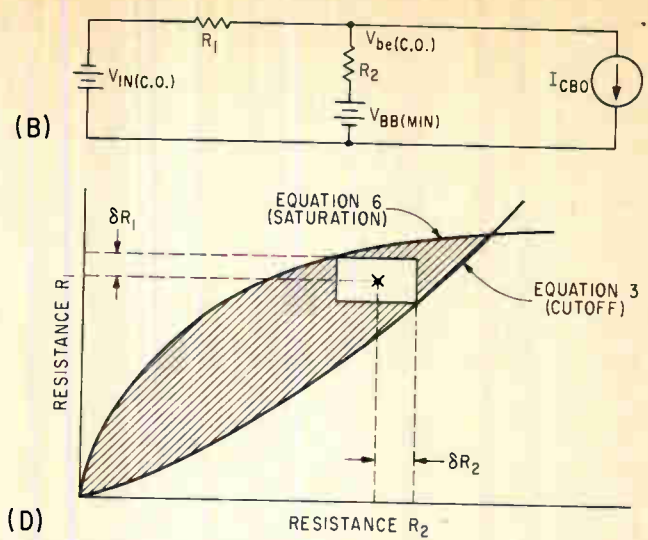
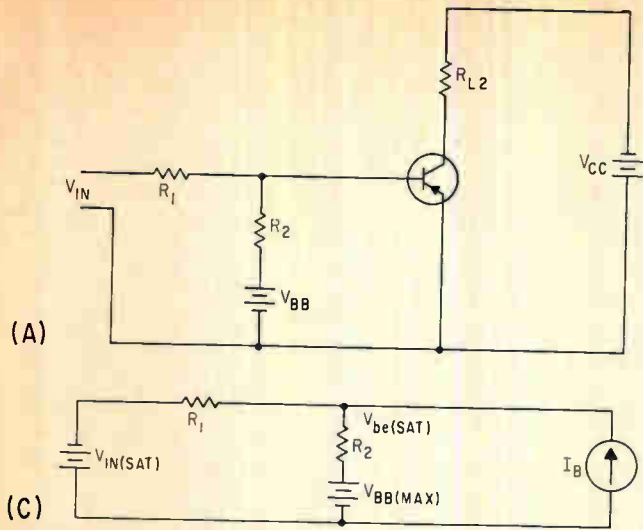

INVERTER AMPLIFIER (A) and its equivalent circuit for cutoff condition (B) and its equivalent circuit for saturated condition (C). Graph (D) plots saturation and cutoff values of R_1 and R_2 —Fig. 2

the waveshape because of these components will be negligible

$$R = \frac{R_C R_{L1}}{(R_C + R_{L1})}$$

where R_C is the collector resistor, R_{L1} represents the maximum value of external load resistor R_L and C is the sum of the wiring and stray capacitance and any bypass capacitors; thus

$$RC \leq t_r/10 \quad (1)$$

Where the load is connected to a common potential, as in Fig. 1B, R_C must be selected so that the voltage appearing at the load meets system specifications. From the equivalent circuit shown in Fig. 1C

$$R_C \leq R_{L2} \frac{|V_{CC(min)}| - |V_L|}{|V_L| + I_{CBO} R_{L2}} \quad (2)$$

where $|V_{CC(min)}|$ is the minimum value of collector supply voltage, $|V_L|$ is the minimum allowable voltage at the load, R_{L2} represents the minimum value of the load resistance, I_{CBO} is the maximum leakage current of the output transistor, and absolute values of voltages are used to prevent confusion in writing about maximum and minimum values of negative voltages.

If R_C , as determined above, can be large (that is, if the collector current is small compared to the transistor ratings), then the value for R_C may be selected from the collector current versus current amplification factor curves for the transistor. Resistor R_C should be selected so that the variations in I_C due to supply fluctuations and resistor variations have a minimum effect on beta.

To insure operation at high temperatures, the maximum power dissipated at the junction must fall within the manufacturer's specifications. Also in the computations, I_{CBO} at the maximum operating temperature is used. To insure operation at low temperatures, a minimum beta is used in all equations.

INVERTER OR BUFFER AMPLIFIER—Having determined the maximum load on the amplifier, the supply voltages and fluctuations and the type of transistor to be used, the circuit in Fig. 2A will now be

designed. In Fig. 2A, R_{L2} represents the maximum total load on the transistor when saturated and thus would include the parallel resistance of a R_C and R_L combination such as that shown in Fig. 1A. If needed, speed-up or delay capacitors may be added in parallel with R_1 or R_2 .

The equivalent circuit for cut-off is shown in Fig. 2B. Here

$$R_1 = R_2 \frac{V_{be(c.o.)} + V_{in(c.o.)}}{V_{BB(min)} - V_{be(c.o.)} - I_{CBO} R_2} \quad (3)$$

where $V_{be(c.o.)}$ is taken to be positive.

After a design has been made, a calculation of $V_{be(c.o.)}$ will provide a check on design accuracy. Rearranging Eq. 3

$$V_{be(c.o.)} = V_{BB(min)} \frac{R_1}{R_1 + R_2} - V_{in(c.o.)} \frac{R_2}{R_1 + R_2} - I_{CBO} \frac{R_1 R_2}{R_1 + R_2} \quad (4)$$

To insure the stage being cut-off, $V_{be(c.o.)}$ must be greater than zero volts when I_{CBO} is maximum, R_2 is maximum, V_{BB} is on the low side, R_1 is minimum, and $V_{in(c.o.)}$ is in the most critical condition for the cut-off state, that is, when $V_{in(c.o.)}$ is on the high side of its tolerance. The use of $I_{CBO(max)}$ insures the stage being cut off. As I_{CBO} decreases, $V_{be(c.o.)}$ will become more positive.

The equivalent circuit for the saturated state is shown in Fig. 2C.

To insure saturation, I_B is selected slightly greater than necessary. Hence

$$I_B > V_{CC(max)}/\beta_{min} R_{L2} \quad (5)$$

From Fig. 2C

$$R_1 = R_2 \frac{V_{in(sat)} - V_{be(sat)}}{V_{BB(max)} + V_{be(sat)} + I_B R_2} \quad (6)$$

where $V_{be(sat)}$ is taken to be negative and $|V_{in(sat)}|$ is the minimum value for the ON condition.

Knowing the load current, the maximum value of $V_{be(sat)}$ may be found from the manufacturer's specification sheet.

The curves of Eq. 3 and 6 are plotted on Fig. 2D. Any combination of nominal values of R_1 and R_2 are

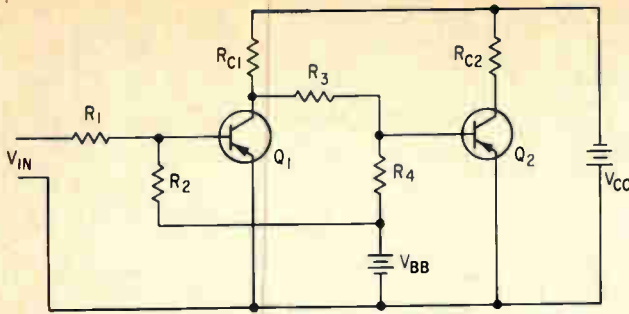

NONINVERTING transistor amplifier—Fig. 3

permissible which allow the maximum variations of these parameters to remain within the cross-hatched area.

It is best, because of power supply and triggering requirements, to choose a value of R_2 as large as possible.

The maximum value of R_2 that enables the allowable resistor variations to remain in the cross-hatched area may be determined analytically. If the allowable deviations (δ) of R_1 and R_2 are the same, for the cutoff condition

$$R_{1(\min)} = R_2 \frac{(1+\delta)}{(1-\delta)} \frac{V_{be(c-o)} + V_{in(c-o)}}{V_{BB(\min)} - V_{be(c-o)} - I_{CBO}R_2(1+\delta)} \quad (7)$$

and for the saturated state condition

$$R_{1(\max)} = R_2 \frac{(1-\delta)}{(1+\delta)} \frac{V_{in(sat)} - V_{be(sat)}}{V_{BB(\max)} + V_{be(sat)} + I_{BR_2}(1-\delta)} \quad (8)$$

Here δ represents the maximum fractional variation in R_1 and R_2 . Since Eq. 8 must be greater than Eq. 7, combining the two equations

$$\left(\frac{1-\delta}{1+\delta} \right)^2 \frac{V_{in(sat)} - V_{be(sat)}}{V_{BB(\max)} + V_{be(sat)} + I_{BR_2}(1-\delta)} \geq \frac{V_{be(c-o)} - V_{in(c-o)}}{V_{BB(\min)} - V_{be(c-o)} - I_{CBO}R_2(1+\delta)} \quad (9)$$

Since $V_{be(c-o)}$ must be only slightly greater than zero, setting this equal to zero has no effect on the stability of the design, providing the parametric variations remain in the cross-hatched area.

After algebraic manipulations

$$R_{2\max} = \frac{\left(\frac{1-\delta}{1+\delta} \right)^2 (V_{in(s)} - V_{be(s)}) V_{BB\min} - (V_{BB\max} + V_{be(s)}) V_{in(c-o)}}{[1-\delta] \left[V_{in(c-o)} I_{BB} + \frac{1-\delta}{1+\delta} (V_{in(s)} - V_{be(s)}) I_{CBO} \right]} \quad (10)$$

Also from power considerations

$$R_{2(\min)} = (V_{BB(\max)} + V_{be(sat)}) / I_{BB} \quad (11)$$

where I_{BB} is the total allowable current drain per stage from the bias supply. Thus

$$R_{2(\min)} \leq R_2 \leq R_{2(\max)} \quad (12)$$

If R_2 is chosen from Eq. 12, then R_1 may be calculated from

$$R_{1(\min)} \leq R_1 \leq R_{1(\max)} \quad (13)$$

where $R_{1(\min)}$ is given by Eq. 7 and $R_{1(\max)}$ is given by Eq. 8.

Thus, the need to plot Eq. 3 and 6 occurs only in critical design specifications. Then, the graphical solution enables the designer to see the effects of

parameter variations and, if necessary, to make the best compromises.

NONINVERTING AMPLIFIER—A noninverting amplifier (Fig. 3) can be designed using the same methods and often the same value components as the buffer amplifier. If the same transistors and power supplies are used throughout, the difference in this design and that of the buffer amplifier lies in the selection of R_{C1} , R_3 and R_4 . As in the inverter, speed up or delay capacitors may be added according to the designer's needs. Resistor R_{C2} is dependent upon the type of load (the load resistance of Q_2 is not shown) and may be calculated from either equations 1 or 2. The saturation base current may be calculated from Eq. 5; if the load resistance is connected to the supply, as in Fig. 1A, R_{L2} is the parallel resistance of R_{C2} and the load resistance. Normally, the output requirements of this circuit will be identical to that of the inverter. Hence, R_{C2} will be the same as the R_C of the inverter and the base currents will be identical.

To find R_3 and R_4 , proceed as in the design method to find R_1 and R_2 of the buffer amplifier. The input to stage Q_2 is the V_{ce} of Q_1 . Providing system rules be followed for internal connections, $V_{ce(c-o)}$ will represent the same level as $V_{in(sat)}$ of the buffer amplifier. Thus, the saturation equation for the second stage is identical with Eq. 6 of the inverter amplifier, with $V_{in(sat)}$ replaced by $V_{ce(c-o)}$ of Q_1 , R_1 with R_3 and R_2 with R_4 . The magnitude of the $V_{ce(c-o)}$ of Q_1 determines the value of R_{C1} .

The cut-off conditions for these parameters are defined by Eq. 3 with $V_{ce(sat)}$ of Q_1 replacing $V_{in(c-o)}$, R_3 replacing R_1 and R_4 replacing R_2 .

BISTABLE MULTIVIBRATOR—The design of this circuit (Fig. 4A) is similar to the inverter amplifier. Resistor R_C is determined by the use of either Eq. 1 or Eq. 2 as in the inverter amplifier. Figure 4B shows the equivalent circuit of the cut-off stage.

Usually $V_{ce(sat)}$ is known from the manufacturer's specifications. Choosing a value for $V_{ce(sat)}$ that is slightly more negative than the specifications will insure the cut-off condition. If $V_{ce(sat)}$ is known or assumed, then Fig. 4B becomes identical to Fig. 2B, with $V_{ce(sat)}$ replacing $V_{in(c-o)}$. Thus,

$$R_1 = R_2 \frac{V_{ce(sat)} + V_{be(c-o)}}{V_{BB(\min)} - V_{be(c-o)} - I_{CBO}R_2} \quad (14)$$

The equivalent circuit for the saturated case shown in Fig. 4C. To insure saturation, the base current

SYSTEM SPECIFICATIONS

Operating Temperature: -20 to $+60$ C

Transistor: 2N404 (*prp*)

V_{CC} -12 ± 0.50 volts

V_{BB} $+12 \pm 0.50$ volts

Negative logic used; rise and fall times to be $2.0 \mu\text{sec}$

Max False input: 2.0 volts

Minimum True input: 8.0 volts

Resistors: to have 5% tolerance

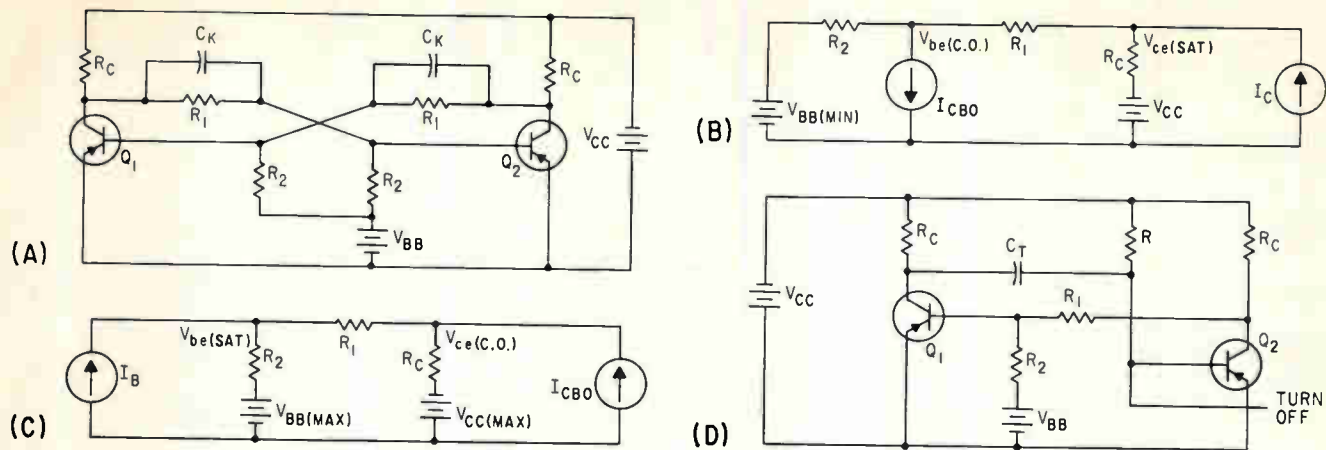

BISTABLE MULTIVIBRATOR (A) and its equivalent circuits for (B) the cutoff and (C) the saturated conditions. A monostable multivibrator is shown in (D)—Fig. 4

is selected by Eq. 5. Then

$$R_1 = R_2 \frac{V_{ce(c.o.)} - V_{be(sat)}}{V_{BB(max)} + V_{be(sat)} + I_B R_2} \quad (15)$$

where

$$V_{ce(c.o.)} = \left(\frac{V_{be(sat)}}{R_1} + \frac{V_{CC(max)}}{R_C} - I_{CBO} \right) \frac{R_1 R_C}{R_1 + R_C} \quad (16)$$

and where $V_{be(sat)}$ and $V_{ce(c.o.)}$ are negative.

Notice that the equations for the multivibrator can be interchanged with those of the inverting amplifier, with V_{ce} replacing V_{in} . Therefore, once V_{ce} is calculated, the design procedures are identical.

The C_K capacitors speed switching and are usually determined by the allowable fall or rise time of the multivibrator output waveshape. The larger the capacitor, the easier it becomes to switch the circuit. However

$$R_C C_K < T_R / 10 \quad (17)$$

to prevent distortion of the waveshape.

MONOSTABLE MULTIVIBRATOR—The method of determining R_C , R_1 , and R_2 in Fig. 4D is identical to that of the bistable multivibrator. The value of R is determined by the collector current of Q_2 which in turn is determined by R_C and the load resistance, which is not shown in the drawing. Thus

$$R \leq \beta_{(min)} \frac{(V_{CC(min)} - V_{be(sat)})}{I_{C(max)}} \quad (18)$$

Then C_T is determined by the desired timing of the multivibrator and the selected value of R . Thus

$$C_T \approx T_d / 0.693R \quad (19)$$

where T_d is the pulse width of the multivibrator.

DESIGN EXAMPLE—Design a noninverting amplifier that can drive six OR gates and produce a complementary output capable of the same power. The Table lists system specifications. Figure 5A shows the OR gate configuration that is driven by the amplifier (Fig. 5B). In Fig. 5B, R_L represents the OR-gate load of a transistor.

The maximum collector dissipation at an ambient temperature of 55 C is 35 mw. Assuming a 2.5 mw per degree derating curve

$$P_{C(50C)} = 35 - 5 \times 2.5 = 22.5 \text{ mw}$$

The maximum current required by any OR gate is

$$I_o = 26.4 / 5.04 \times 10^{-3} = 5.25 \text{ ma}$$

Therefore, the maximum total load which Q_2 must supply is

$$5.25 \times 6 + 12.5 / R_C = I_{C2}$$

Assuming the wiring capacitance to be about 100 μmf , then from Eq. 1,

$$R_{C2} \leq 2.0 \times 10^{-6} / 10 \times 100 \times 10^{-12} = 2,000 \text{ ohms}$$

Allowing for a 10-percent deviation from a 5-percent tolerance resistor, choose $R_{C2} = 1,800$ ohms. Then

$$I_{C2} = 31.5 + 12.5 / 1.62 = 39.2 \text{ ma}$$

From the manufacturer's specifications, at a collector current of 50 ma, $V_{ce(sat)}$ is at most 0.35 volt. Therefore, the maximum dissipation across the junction is $0.35 \times 40 = 14$ mw, which falls within the allowable limits.

To insure saturation

$$I_B \geq V_{CC(max)} / \beta_{min} R_L(min) = I_{C(max)} / \beta_{min}$$

Choosing a minimum β of 20 (5 units below the manufacturer's guaranteed saturation beta of 25) then

$$I_B \geq 40 / 20 = 2 \text{ ma}$$

From the transistor specifications $V_{be(sat)}$ is at most -0.5 volts with $I_c = 48$ ma and $I_B = 2.9$ ma. Then for saturation, Eq. 6 becomes

$$R_3 = R_4 (V_{in(sat)} - 0.5) / 13 + 2R_4$$

For cutoff, I_{CBO} must be calculated. The manufacturer specifies a maximum $I_{CBO} = 90$ microamps at a 80-C junction temperature. At 25 C, I_{CBO} is 5 microamp maximum. Assuming a straight line increase in leakage current, 20-milliwatt collector dissipation and 0.35 C/mw junction temperature rise, $I_{CBO(max)}$ at 60 C ambient is 70 microamp.

From Eq. 3, with the resistances in kilohms and $V_{be(c.o.)} \approx 0$

$$R_3 = R_4 [V_{in(c.o.)} / (11.5 - 0.07R_4)]$$

Figure 5 C shows a family of curves for R_3 and R_4 . Different values of input voltage conditions are used to obtain the curves. However, any or all of the parameters could be varied to obtain several graphs, thereby gaining insight about circuit operation.

If $V_{in(sat)} = 8.0$ volts and $V_{in(c.o.)} = 2.0$ volts, as the

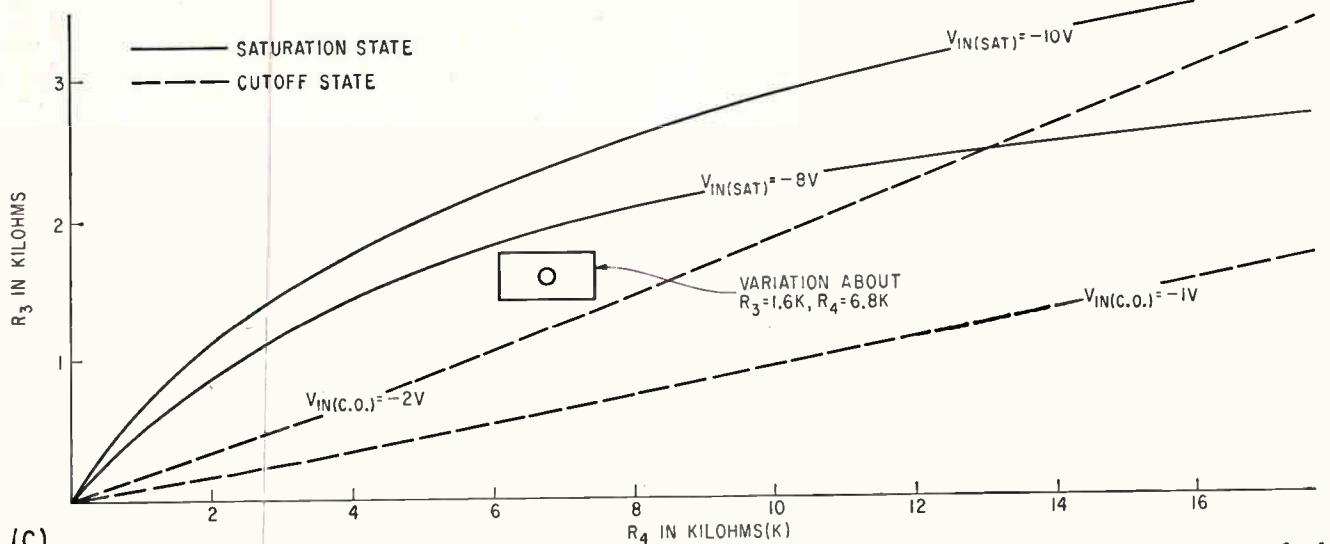
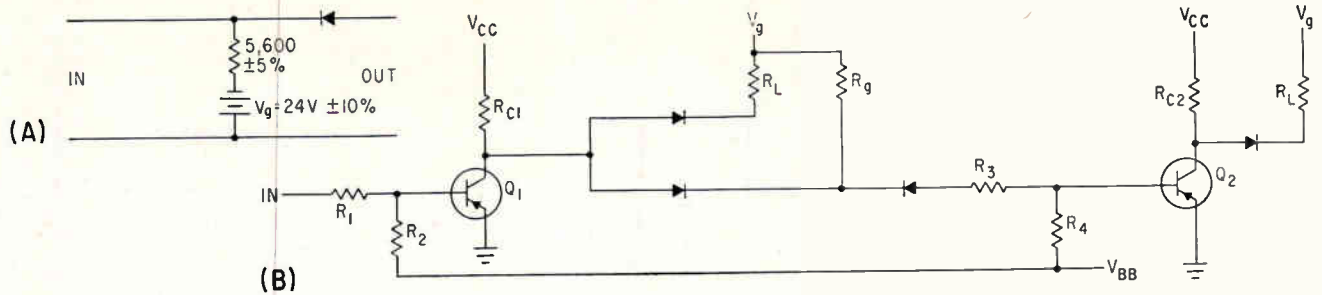

(C) EXAMPLE uses basic OR gate shown in (A) in the noninverting amplifier (B). Graph (C) provides insight on final choice of resistance values—Fig. 5

system specifications require, and $\delta = 0.10$, then from Eq. 10

$$R_{4(max)} = \frac{(0.67)(7.5)(11.5) - (13)(2)}{[0.9][(2)(2) + (0.82)(7.5)(0.07)]} = 7.95 \text{ kilohms}$$

Choosing nominal values, let R_1 be 6.8 kilohms. Then R_3 is calculated from Eq. 7 and 8 according to Eq. 13. Thus

$$R_3 \geq \frac{(2.0)(1.22)(6.8)}{11.5 - (0.07)(1.1)(6.8)} \geq 1.52 \text{ kilohms}$$

$$R_3 \leq \frac{(0.82)(6.8)8.0 - 0.5}{12.5 + 0.5 + (2.0)(6.8)(0.9)} \leq 1.66 \text{ kilohms}$$

Therefore, let $R_3 = 1.6$ kilohms.

This choice, as shown in Fig. 5C, allows a 10-percent variation of parameters to have no noticeable effect on circuit operation. Note that as the input and output conditions become more critical, the area of permissible design values becomes smaller.

The first stage has loads connected to the common as well as to a supply. Thus, the stage must supply the base current of the second stage through R_3 to essentially a ground potential.

Therefore, from Eq. 2

$$R_{c1} \leq 1.44 \frac{11.5 - 8.0}{8.0 + .07 \times 1.44} \leq 0.622 \text{ kilohms}$$

where 1.44 (kilohms) is the minimum resistance of R_3 (Fig. 5B), where R_3 corresponds to R_{L2} of Fig. 1C. Then let $R_{c1} = 560$ ohms.

Also, Q_1 must supply a total load current

$$I_C = 31.5 + 12.5/R_{c1} = 56.3 \text{ ma}$$

where the 31.5 ma go through the OR gate load designated by the R_L - R_3 combination in Fig. 5B (R_3 denotes one OR gate and R_L denotes 5 OR gates). To supply this current with a minimum β of 20, $I_B \geq 2.82$ ma. Therefore, let $I_B = 3.0$ ma.

At $I_C = 60$ ma and $I_B = 3.0$ ma, $V_{ce(sat)} = 0.35$ volts maximum. Thus, junction power dissipation will be

$$P_C = 56.3 \times 0.35 = 19.7 \text{ milliwatts}$$

This could be near the power capacity of the transistor. If a greater safety margin is wanted, a redesign of the second stage using a lower value for $V_{in(sat)}$ would ease the current requirements of Q_1 . (This raises the allowable maximum value of R_c in the first stage.) The design of R_1 and R_2 can be carried out by utilizing Eq. 10 and 13. The results are such that $R_2 \leq 5.5$ kilohms. By choosing $R_2 = 5.1$ kilohms, 1.15 kilohms $\leq R_1 \leq 3.14$ kilohms. The choice of R_1 would probably be made dependent on availability and/or quantity of other resistor design values in the same range.

Any circuit using d-c parameters for cut-off and saturation biasing may be designed in this manner. By allowing for realistic variations, circuits designed by this method will operate in all specified environments. Sometimes it is impossible to incorporate every safety factor. Here, engineering judgment must be used to determine which condition must be improved or held to tighter specifications.

REFERENCE

- (1) J. E. Hull, Flip-Flop Circuit Using Saturated Transistors, *Elect Ind*, 18, p 88-91, Sept. 1959.

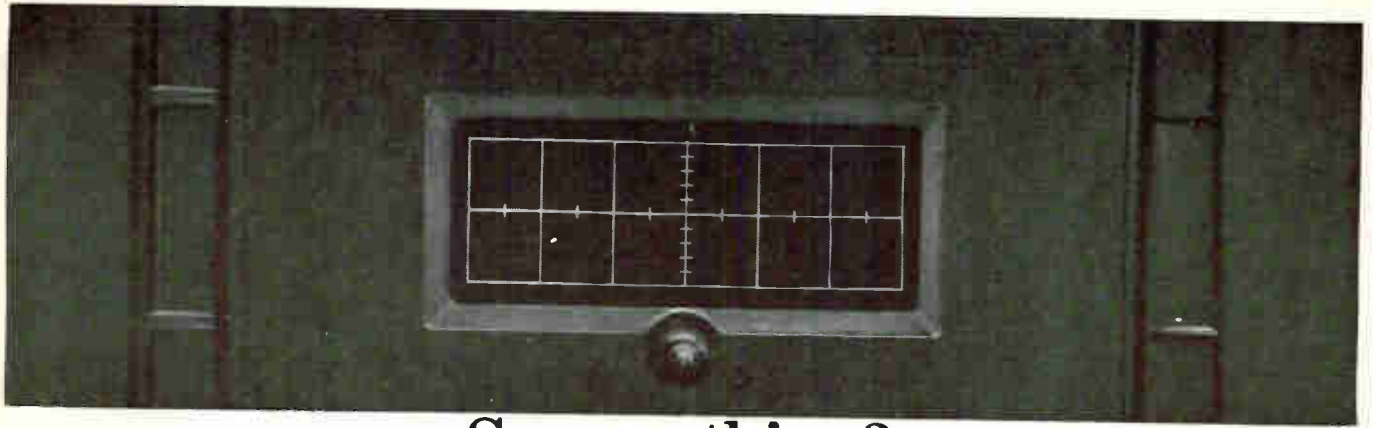

See anything?

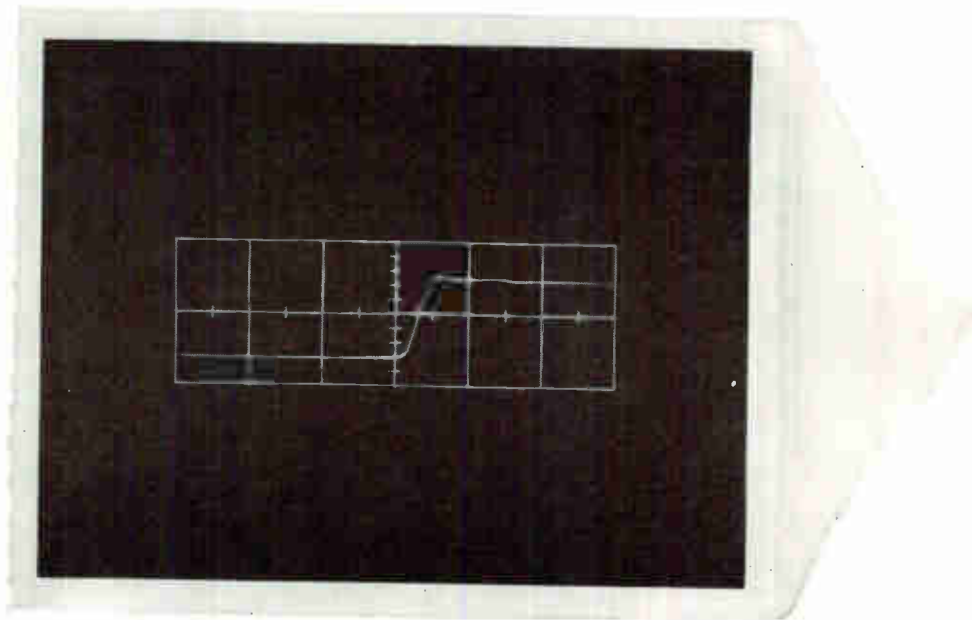

This new film did.

This new film saw something the eye couldn't: the rise time of a single pulse on a Textronix 519 scope at a sweep rate of 2 nanoseconds/cm. The new film, Polaroid PolaScope Land Film, actually extends the usefulness of existing oscilloscopes by supplying "brightness" that the scope hasn't got!

The reason is that this PolaScope film has an ASA equivalent rating of 10,000, which means it can see things your eye cannot. It has about twice the writing rate of the Polaroid 3000-speed film, currently the standard for

high speed oscilloscope photography. (No other commercially available films come anywhere near the speed of PolaScope film.) And because it's made by Polaroid you get a finished usable print—see above—ten seconds after exposure.

PolaScope film will also give you better shots of slower pulses and stationary waveforms. So little light is required, camera aperture and scope intensity can be reduced considerably, and that's how to get really sharp oscilloscope pictures.

And wherever else light is at a premium—such as photomicrography and Kerr Cell photography—PolaScope film will make new applications possible, old applications more useful.

PolaScope Type 410 Film is packed 12 rolls to the carton. The price is about the same as the Polaroid 3000-speed film. For the name of the industrial photographic dealer nearest you, write to Technical Sales Department, Polaroid Corporation, Cambridge 39, Massachusetts.

POLAROID®

New Polaroid Land 10,000-speed film for oscillography

Transistor Circuits Control Small D-C Motors

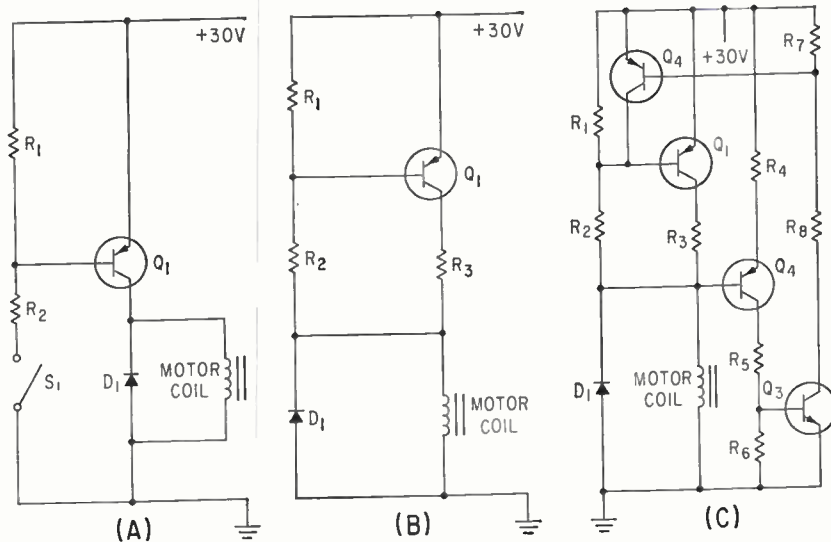

TRANSISTOR circuits for on-off control (A), load compensation (B) and protection from motor overload (C)—Fig. 1

On-off, load compensation, overload protection and speed control are provided

By FRED W. KEAR

Lytle Corp., Albuquerque, N. M.

TRANSISTOR circuits offer an accurate and dependable means for controlling small d-c motors. Their use enables a relatively small signal to apply, remove or otherwise regulate electrical power to the motor.

D-c motors have become widely accepted in military systems and industrial control applications. In many applications, such as timing, control, programming and data recording, the control of power to the motor determines the accuracy and efficiency of the system.

A typical requirement of a d-c motor control circuit is simply the application and removal of power to start and stop the motor. The circuit in Fig. 1A is one of many control circuits that could be used for this function. Transistor Q_1 is in series with the motor coil and controls power to it. Damage to the transistor is prevented by D_1 , which removes inverse voltage

spikes. When S_1 is closed, the base-bias network consisting of R_1 and R_2 applies forward bias to Q_1 , applying power to the motor. When S_1 is opened, R_1 applies reverse bias to Q_1 , and power is removed from the motor. This type circuit has remote control applications where motor power may not be switched directly by a switch.

LOAD COMPENSATION—When motor current must be varied to compensate motor loading, the cir-

cuit in Fig. 1B may be used. Reverse bias applied to Q_1 in series with the motor coil removes motor power. The low resistance of R_2 develops emitter bias at high values of motor coil current. Diode D_1 protects the transistor by removing inverse voltage spikes from the circuit. Relatively high values of resistance are chosen for R_1 and R_2 to maintain forward bias on the transistor. When mechanical loading of the motor causes more current to flow through it, the added current through R_1 and R_2 increases forward bias on the base of Q_1 . Thus the transistor provides more current through the motor to compensate the overload.

In applications where equipment must be protected from damage caused by overloading of d-c motors, a circuit like that in Fig. 1C can be used. Transistor Q_1 is in series with the motor coil so that reverse biasing of the transistor removes power from the motor coil. Diode D_1 again removes inverse voltage spikes resulting from motor inductance.

The bias necessary to provide motor current under normal load conditions is provided by resistors R_1 and R_2 shown in diagram.

A low value of resistance is chosen for bias resistor R_2 , so that

Mirror Intensifies Laser Output

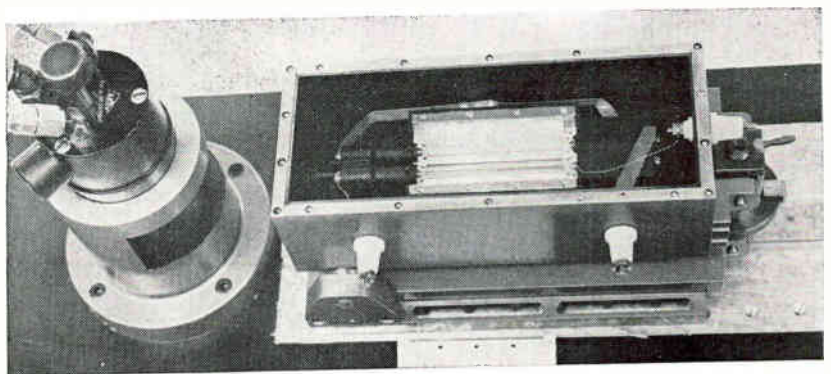

RUBY LASER is pumped by rotating mirror at Stanford Research Institute, enabling it to generate very short pulses of increased intensity. Mirror can rotate up to 10,000 rps, has rotated at 7,000 rps so far

THIS



OR THIS

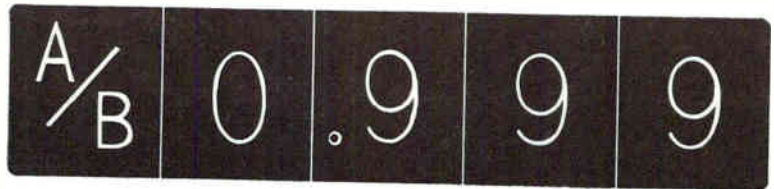

OR THIS

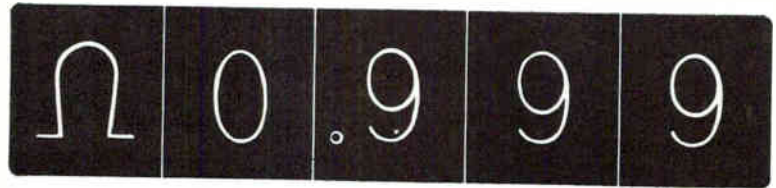

ALL THREE IN ONE INSTRUMENT... THE NEW

CUBIC VROMETER



Only multimeter with the reliability and simplicity of reed relays. Cubic announces the first reed relay instrument to give you the functions of a digital voltmeter, ratiometer and ohmmeter all in one package. The ultra-reliable reed relays in the new Cubic VROMeter have been life-tested for more than 1 billion operations without maintenance, equivalent to 10 years normal use. Price of the VROMeter is the lowest of any multimeter on the market today. For complete information on this remarkable new Cubic product, write to Department A-157, Cubic Corporation, San Diego 11, California; or Cubic Europa, S.p.A., Via Archimede 181, Rome, Italy.



INDUSTRIAL DIVISION
SAN DIEGO 11, CALIFORNIA • ROME, ITALY

OTHER OFFICES AND REPRESENTATIVES IN PRINCIPAL U.S. AND CANADIAN CITIES

August 24, 1962

CIRCLE 49 ON READER SERVICE CARD 49

HOW do you want to record your TRACES?

Continuous Flow?

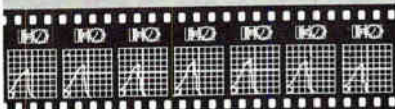

Single Frame?

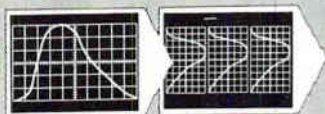

Polaroid® Prints?

The new Beattie-Coleman KD-5 Oscillotron is a most versatile 'scope camera. Available with continuous-flow 35mm electric magazine, 35mm electric pulse magazine or Polaroid back for 10 sec. prints. Dichroic mirror for simultaneous, parallax-free viewing. Rotates 90° for vert. or horiz. format. Hinged mounting for easy focusing.

RECORD DATA, TOO
Written data, counter and 24 hr. clock can all be recorded on same frame as trace. Write for information on the full Oscillotron line.

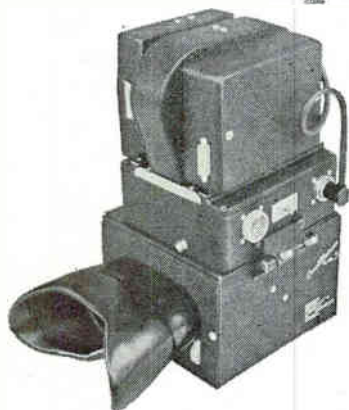

BEATTIE-COLEMAN INC.

1004 N. OLIVE ST., ANAHEIM, CALIFORNIA

appreciable increases in motor coil current produce a useful voltage drop. The base circuit of Q_2 which is connected to the junction of R_3 and the motor coil, is provided with emitter bias from Q_1 . This bias is adjusted so that motor current exceeding a nominal value will cause Q_2 to conduct. As a result, current through R_3 and R_4 will increase and forward bias will be applied to Q_3 .

Conduction in Q_3 causes drop in voltage at the junction of R_1 and R_2 , applying forward bias to Q_1 . When transistor Q_1 is switched on, it clamps the base of Q_1 to the positive bus and this reverse bias removes power from the motor. After an overload, the motor must be started again by shorting the positive motor lead to the positive bus, grounding the base of Q_3 or connecting the base of Q_1 to the positive bus. This switching can be accomplished by a time-delay mechanism or directly or remotely by switches.

REGULATING SPEED—Speed of a d-c motor can be controlled through the contacts of an inertial governor using the circuit in Fig. 2.

Closure of the normally open governor contacts provides a surge of reverse current through the motor that rapidly overcomes its

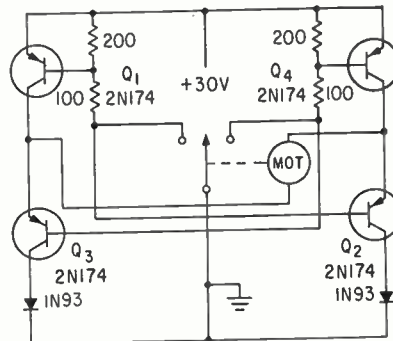

INERTIAL governor with transistor circuit regulates tendency toward motor overshoot—Fig. 2

tendency to overshoot. When the arm of the governor closes the circuit to the base of Q_2 , transistors Q_1 and Q_2 conduct. Thus a current path is provided from ground through Q_1 , the motor coil and Q_2 to the 30-volt bus. When the governor arm closes the circuit to the base of Q_3 , transistors Q_3 and Q_1 conduct and provide current to the motor.

The current path is from ground through Q_3 , the motor coil and Q_1 to the positive bus. Thus the motor can be made to rotate normally in either direction using this circuit by alter the normally closed governor contacts.

These circuits are representative of many techniques for using transistors to control d-c motors.

Solar Generator for Satellites

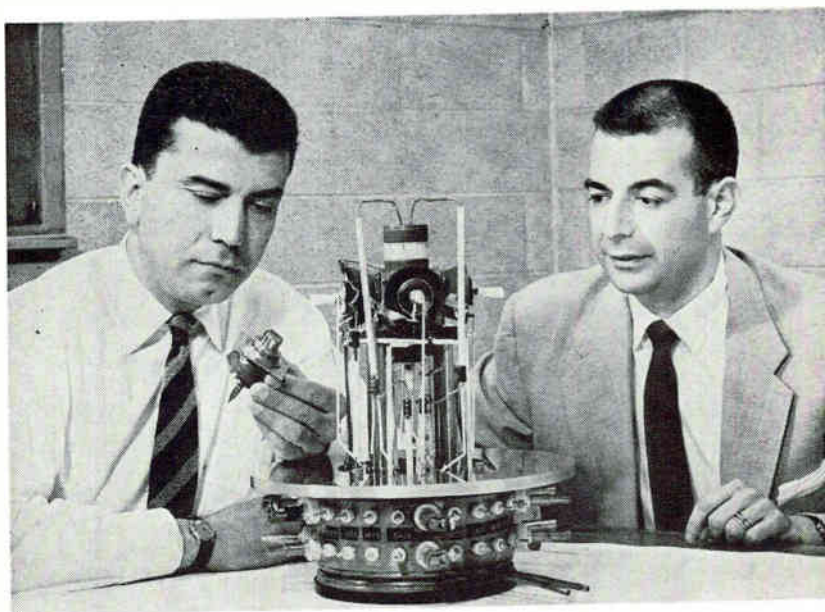

CESIUM diodes in series deliver 100 watts in Thermo Electron Engineering solar thermionic generator. Satellite power source was developed under USAF Aeronautical Systems Division sponsorship for Thomson Ramo Wooldridge

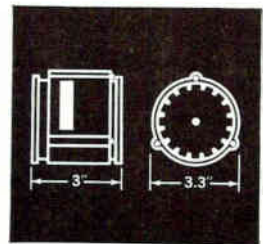
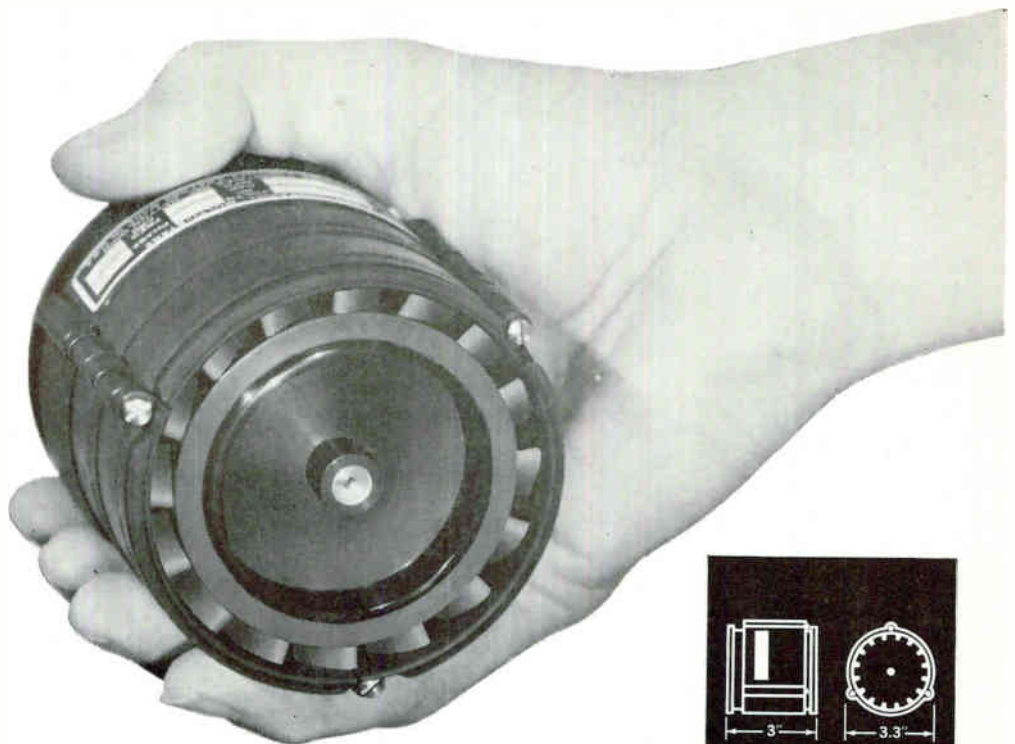
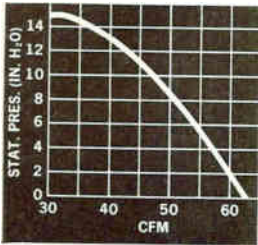

MULTI-STAGE BLOWER THIS SMALL?

New Globe multi-stage blowers drive cooling air against the extreme pressure resistance you encounter in heat exchangers, tightly packed black boxes, and crammed transistor circuitry. They deliver 39 cfm against 14" H₂O back pressure! (65 cfm free air.) With STAX-3-FC blowers you can design right past costly devices and heavy centrifugal air "pumps" (that use 1/4 hp or more for comparable volume/pressure). And you can keep the whole package small. A limited number of units are stocked for prototype quantity delivery to you in 24 hours.

With a low specific speed ($N_s = 15,000$) STAX blowers perform far past the stall regions of other axial blowers. Unique dynamically balanced rotor design permits the use of one, two, or three stages in the same size package. Motor operates on 200 v.a.c., 400 cycle, three phase power. Units are designed to meet applicable MIL specs; nominal continuous life is 1000 hours. Weight: 29 oz. (3-stage). Production tooling keeps the price within reason. If you need more performance, different power, etc., Globe will design the exact multi-stage blower you require.

The powerful STAX is one of hundreds of miniature blowers made by Globe and engineered for your application. Request Bulletin STX, or call direct: Globe Industries, Inc., 1784 Stanley Avenue, Dayton 4, Ohio. Baldwin 2-3741.

GLOBE INDUSTRIES, INC.

PRECISION MINIATURE A.C. & D.C. MOTORS. ACTUATORS.
TIMERS. CLUTCHES. BLOWERS. FANS. MOTORIZED. DEVICES

GLOBE

Broaden Transformer Frequency Response

Encompass ultrasonic range, perform wider variety of signal functions

By T. A. O. GROSS, President

Spectran Electronics Corp.,
Maynard, Massachusetts

NEW MATERIALS combined with more sophisticated core windings are responsible for the development of ultrasonic frequency transformers that have desirable characteristics useful in digital and analog applications. These units are now receiving attention by circuit designers for applications in balanced modulators, phase inverters and in power output stages.

Originally designed to accommodate magnetostrictive rod resonators (see ELECTRONICS, July 13, 1962, p 62), wideband ultrasonic-frequency signal transformers operate from a few kilocycles to a few megacycles per second.

Prior to 1961, ultrasonic transformers were limited to power-coupling types for industrial cleaning and mixing equipment, and handled up to two kilowatts with frequency response typically 10 Kc to 100 Kc. Transformers now developed are signal types having low power, but with frequency response extended both in terms of octaves and absolute cycles per second. Flat response falls off at 3 db at 3 Kc and 22 Mc without compensation, when the new units are properly wound and terminated.

Improved phase characteristics go along with improved response, and amplifiers and other circuits equal to their lower frequency audio counterparts can be constructed. These transformers are now being used in circuits other than those involving magnetostrictive rods because their range of operation is adapted to perform a wide variety of circuit functions.

CIRCUIT APPLICATIONS—Examples of u-f signal transformers

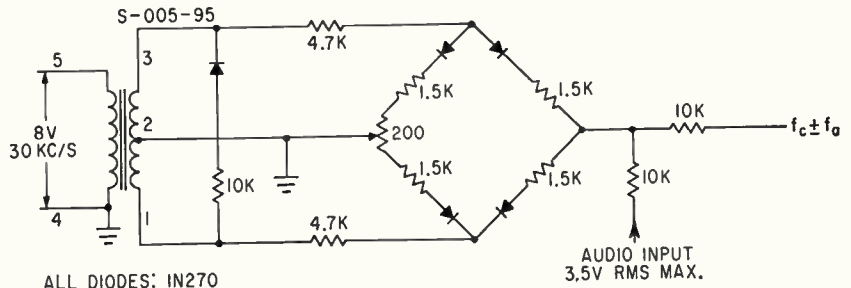

ALL DIODES: IN270

BOYNTON-SCHOLT modulator gives a 60 db suppression of 30 Kc carrier without adjustment over a wide range of ambient temperature and frequency—Fig. 1

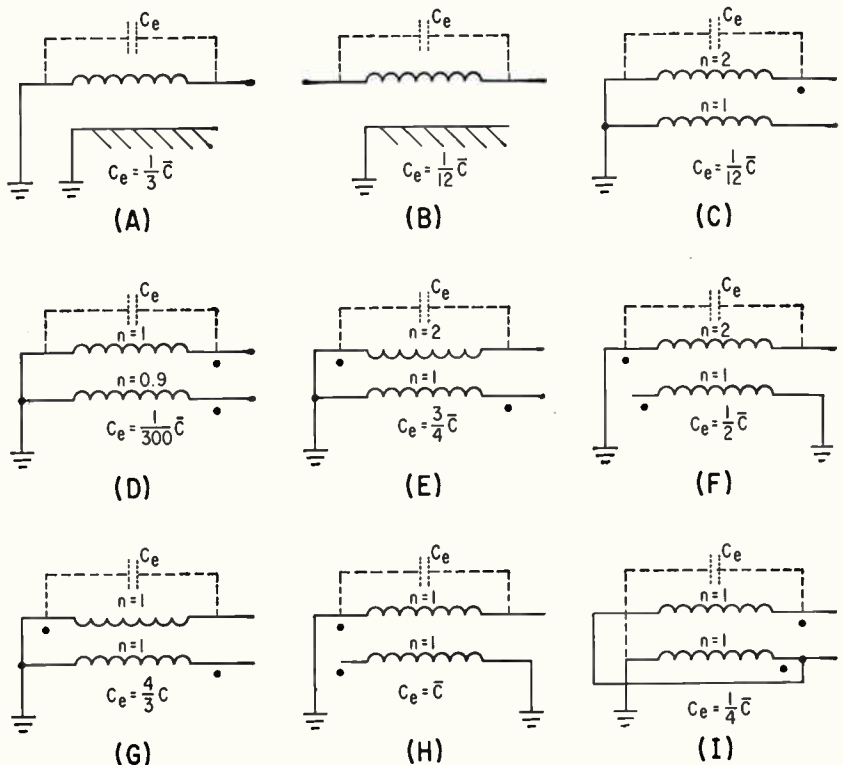

MONOLAYER WINDING configurations and the magnitude of equivalent capacitance in terms of physical capacitance—Fig. 2

which have been developed for use with magnetostrictive rod devices includes a transformer used in 480-element spectrum analyzer to couple push-pull 6CA7/EL-34 pentodes to a 30-ohm filter bank. If the secondary is terminated into 15 ohms, this transformer delivers more than 100 watts from four 6CA7 or 6550 pentodes. Frequency response is ± 2 db between 4 Kc and 1.5 Mc.

A small transformer, was developed for balanced modulator applications which require the highest possible symmetry and balance in a centertapped winding. One of many balanced modulator circuits which can be used with this transformer is shown in Fig. 1.

An incidental result of the pursuit for balance in this transformer is an unusually wide frequency response which is remarkable both

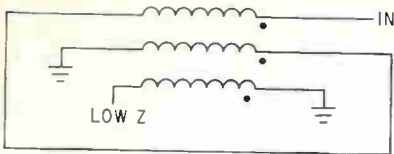

WINDING CONFIGURATION
capable of large bandwidth with a phase reversal and high impedance transformation—Fig. 3

joined leads of the coil and the adjacent surface). In Fig. 2, C_e is the equivalent capacitance which determines the upper frequency response, and C is the physical capacitance. These are not necessarily the same.

We learn from Figure 2D that the effective capacitance can be made very small when small impedance ratios without phase inversion is all that is required of transformer. Figures 2E through 2H show that capacitance is minimized when all layers are wound in the same direction. This is a happy circumstance for the insulation stresses are minimized at the same time. Figures 2E and 2G represent a "wrong" method for phase inversion.

WIDE RESPONSE — Monolayer autotransformers can give very wide frequency response even with substantial impedance ratios. The configuration of 2I has low capacitance together with only one-fourth the leakage inductance of the equivalent isotransformer.¹ A two-stage phase reversing transformer, shown in Fig. 3, performs the inversion at a low impedance to reduce capacitance and uses two auto-former connected layers to change impedance.⁶

Multifilar windings are frequently used in u-f transformers to achieve unity coupling between sections. For examples, the modern version of the TF2A35YY is a double bifilar not to be confused with quadrifilars which have four identical sections.⁹

REFERENCES

- (1) Richard Boynton, M. B. Co., unpublished communication May 14, 1962
- (2) Spectran Electronics Corp., Data Sheet S-005-35
- (3) R. S. Berg and B. Howland, *Rev of Sci Instr.* 32, No. 7: July, 1961
- (4) T. A. O. Gross, U. S. Patent 2, 448,028
- (5) T. A. O. Gross, U. S. Patent 2, 475,611
- (6) Spectran Electronics Corp. Data Sheet S-005-30
- (7) Spectran Electronics Corp. Data Sheet S-005-95 (see Fig. 1)

August 24, 1962

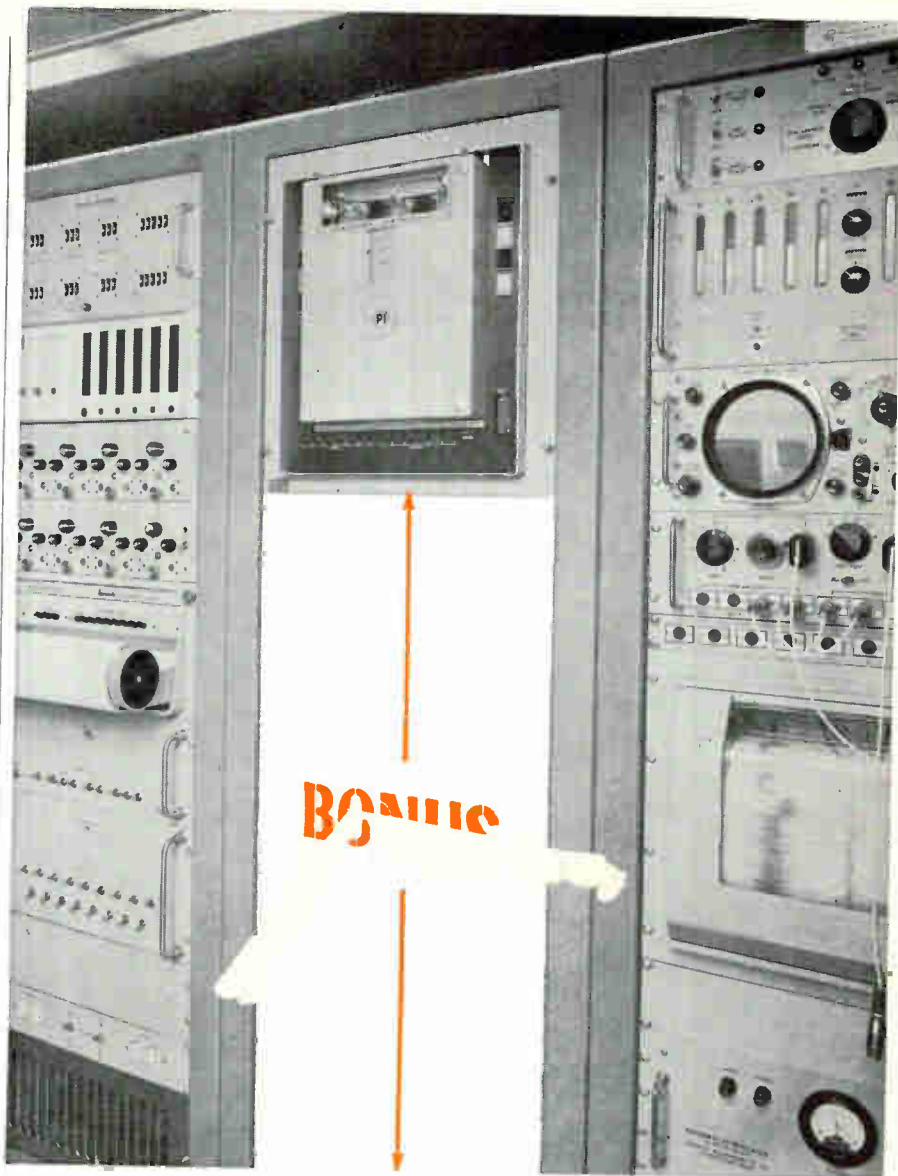

WITH A P.I. TAPE RECORDER: UP TO 4' OF EXTRA RACK SPACE

When you want full-size performance but can't afford the space, you'll find PI recorders measure up in many ways better than ordinary instrumentation magnetic tape equipment.

Flick open the magazine of a PI recorder, and you'll find a unique space-saving stacked-reel design. Turn the recorder around and you'll see how neatly the precision tape drive mechanism shares space with the plug-in, all-solid-state electronics. Finally, press the start button — you'll find performance on a par with recorders several times the size.

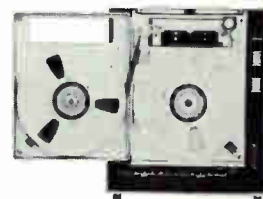

You'll find PI recorders wherever space is at a premium — in aircraft, ships, submarines, blockhouses, and instrumentation trailers such as that above. And for these and many other applications, whether your yardstick is calibrated in inches, decibels, or dollars, you'll find their value all out of proportion to their size. Write today for our new 12-page brochure.



**PRECISION
INSTRUMENT**

SAN CARLOS, CALIFORNIA / LY 1-4441

P.I. Invites inquiries from senior engineers seeking a challenging future.

32

CIRCLE 55 ON READER SERVICE CARD

55

Transistor's Leads Are Its Hermetic Seals

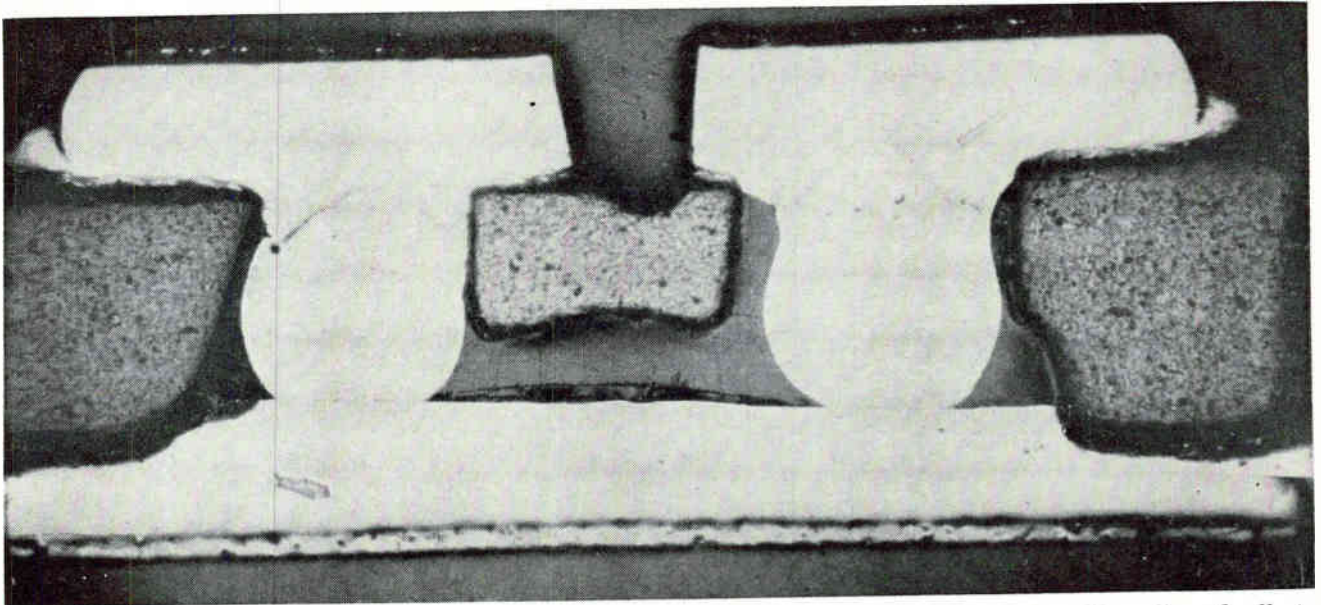

CROSS SECTION of transistor shows base and emitter plates at top, connecting alloy spheres, silicon die and collector plate. Active element is hermetically sealed, can be used as is or can be assembled into various conventional cases

Conducting alloy spheres replace fine wires; brazing replaces soldering, welding

By HERBERT S. EVANDER
Hughes Aircraft Co.
Semiconductor Div.,
Newport Beach, Calif.

IN MANUFACTURING diffused planar transistors, as much as 80 percent of the total cost can be in assembling the device into a package. This is mainly because each device must be assembled individually into its own package. In contrast, device processing in the slice area, which establishes electrical parameters, involves processes such as gaseous diffusion and evaporations, where as many as 1,000 devices are formed on a slice of silicon, with up to 100 slices processed at one time. High assembly cost is due to the high labor content in handling and the loss of some units at various assembly operations.

The most costly assembly operation is attaching fine gold wires to the emitter and base regions on the

silicon die and to the leads of the package header. Low mechanical strength of the fine wires plus the placement accuracy make this a difficult operation to mechanize. In addition, fast changing device characteristics and packages militate against mechanized assembly.

In the automatically assembled Microseal transistor, however, the design is such that the parts virtually fall together. Instead of fine wires, small alloy spheres are used in a ceramic housing to make connections both to base and emitter areas and to the leads. The sketch indicates the design concept.

Although the machine used for assembly (see cover) is a prototype, it can produce production line volume. Composed essentially of an indexing turntable and a brazing heater, it requires two operators to hand load the component parts into the alignment jigs; clamping is automatic and the brazing gas heater is timed into the machine and comes on automatically long enough to make the brazed hermetic closure.

There are 12 stations on the lazy susan turntable, all exactly the same

and consisting of a nest that receives the component parts and two spring loaded, cam-operated clamps to hold the assembly.

The nest is made of ceramic and is shaped to control the flow of heating gas around the unit. It has slots and pins to align the parts and a stainless steel platform to steady the two long leads of the emitter and base top plates. A stirrup clamp is used to hold the two long leads and a finger clamp to hold the complete assembly.

Each set of clamps can be moved out of the way independently, giving easy access to the alignment nest. The clamps can be seen in various positions in the photograph on the cover.

MACHINE OPERATION — Machine loading is simple and straightforward. At the first loading station, the alignment fixture stops with both clamps up and off to the side. The operator removes the previously completed assembly, then places the emitter and base plates into the nest, then the ceramic body; the holes in the ceramic body fit over cylindrical pins on

FOUR NEW WAYS TO HOUSE MICROFUSES

(SUB-MINIATURE)

282001



Front panel mount Microfuse holder (with the hexagon nut rear of panel). Rugged aluminum body and knurled cap; both can be anodized in color. Fungus and shock resistant. Sealing "O" rings in cap and on body. "Eye" type terminals specially designed for easy soldering.

282002



Rear panel mount Microfuse holder (with the round nut mounted from front of panel). Rugged aluminum body and knurled cap; both can be anodized in color. Fungus and shock resistant. Sealing "O" rings in cap and on body. "Eye" type terminals specially designed for easy soldering.

281002



Front panel mount Microfuse holder (with the hexagon nut rear of panel). Molded from high strength, high dielectric material. Knurled cap for easy grip, with skirt for positive "O" ring seal. Rugged "Eye" type plated brass terminals separated by molded barrier to provide complete insulation.

284000 Series



Indicating Microfuse holder—when the fuse blows indicating bulb glows. Knob molded from transparent material with serrations for easy gripping. Skirt of knob for positive "O" ring seal. Body from high strength, high dielectric material. Indicating holders available in wide voltage ranges from 2½ to 125 volts.

PRODUCTS
SHOWN
ACTUAL
SIZE

Microfuses achieve low fuse resistance values with high reliability in ultra-fast blowing characteristics. Microfuses can be hermetically sealed, suitable for potting applications. Glass enclosed visible filament. Microfuses available in 1/500 through 5 amps at 125 V. Short circuit interrupting capacity 125 V—10,000 amps DC.

LITTELFUSE

Des Plaines, Illinois

closed-cycle MASER COOLER

- ¾-watt refrigeration at 4.4°K
- simplified cryostat design
- reliable, unattended operation

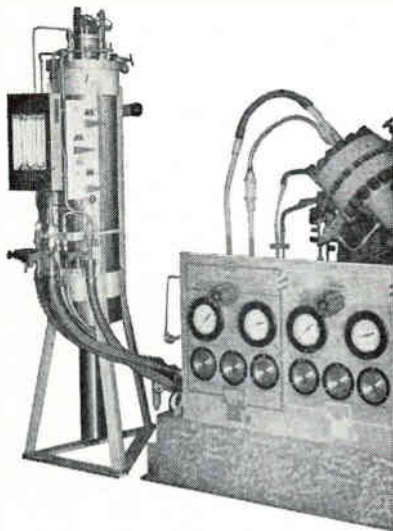

Advanced capabilities in cryogenic design, development, and fabrication, enable Air Products to meet specific customer requirements for closed-cycle electronic coolers.

Cryostat unit pictured here, for example, is part of a cryogenic refrigeration system developed for the Lincoln Laboratory of the Massachusetts Institute of Technology.

System operates on Joule-Thomson principle to provide maser-cooling temperatures as low as -452°F (4.4°K) without cold moving parts . . . is also adaptable for cooling superconducting magnets and cryogenic computer devices . . . eliminates handling of cryogenic liquids which boil away in open-cycle systems.

Cryostat, physically separate from compressor unit to make possible remote operation, contains coiled-finned heat exchangers of Air Products design.

Air Products closed-cycle systems maintain temperatures as low as 2.5°K . . . are ideal for field as well as laboratory applications.

ADVANCED PRODUCTS DEPARTMENT
DEFENSE AND SPACE DIVISION



Air Products and Chemicals
INC.

Allentown, Pennsylvania

▶ AIR PRODUCTS MANUFACTURES A COMPLETE LINE OF CRYOGENIC ELECTRONIC COOLERS.



BASE AND EMITTER plates are visible in comparator scope. Inventory control of transistors is improved because of flexibility in adding cases of various types after basic transistor unit is completed

the leads. As the turntable indexes to the next loading position, the stirrup clamp swings over and

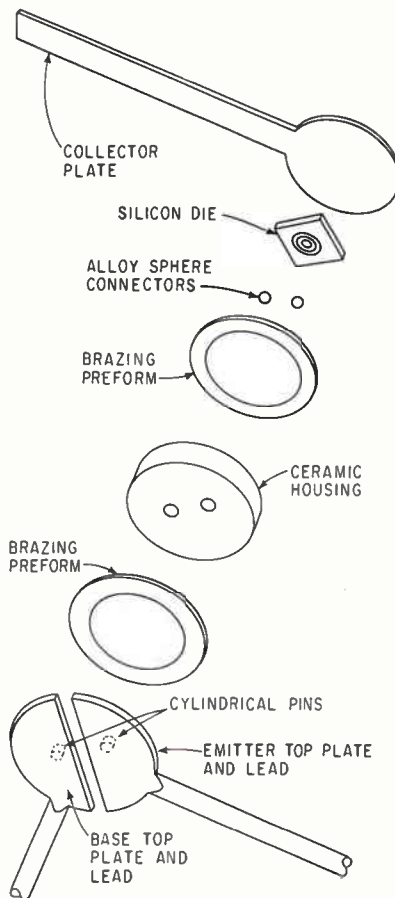

TRANSISTOR is assembled by letting parts essentially fall together and then brazing to obtain hermetic sealing

straight down, holding the two long leads firmly in place.

At the second loading position the two alloy spheres and the collector plate with silicon die are added. As the turntable again indexes, the finger clamp swings over and moves down to clamp the sandwiched parts.

Finally, the assembled transistor stops at the brazing station where gas, heated electrically by an element at the nozzle, and surrounded by a shroud of nitrogen gas to prevent oxidation, complete the seal. The completed transistor is 0.08 inch in diameter and 0.03 inch thick, and has three integral leads.

The cross section photomicrograph shows how the connecting spheres have fused with the silicon die and with the base and emitter leads. The hermetic seal at base and emitter results from the fusion of the cylinders to the ceramic body, producing, in effect, a ceramic-to-metal header assembly. The spheres play no part in producing hermeticity.

Once the basic hermetically sealed transistor has been fabricated, it can be used as is or it can be assembled into various types of cases to suit customer requirements. As a result of the flexibility in using various case styles, much greater control over excess inventory is possible.

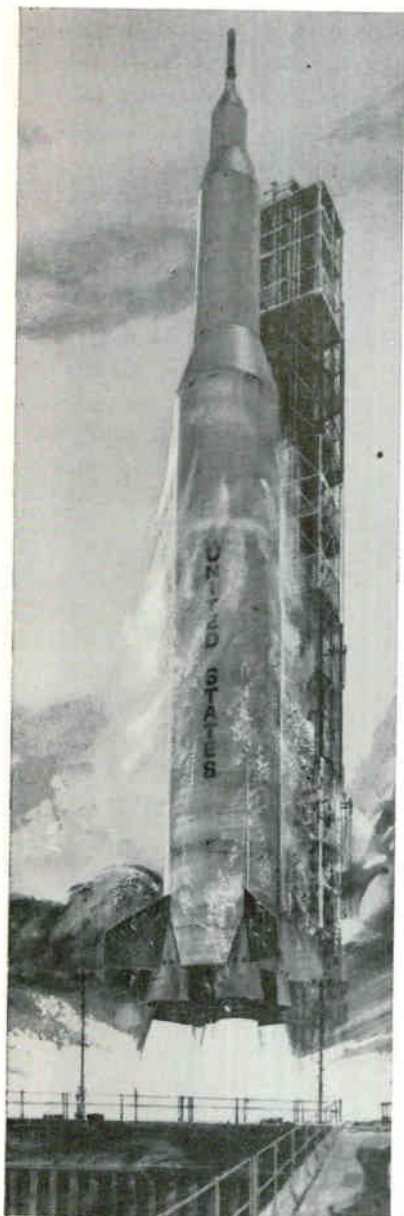

Saturn Launch Vehicle



Dyna-Soar Space Glider

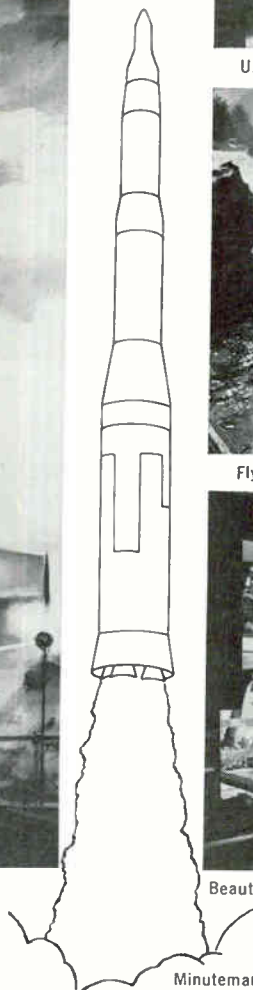

Minuteman ICBM



U.S. Science Pavilion at Seattle World's Fair



Fly-casting on Skykomish River near Seattle



Beautiful homes line Seattle's 200 miles of shore

Advanced Boeing openings for Engineers and Scientists

You will find career excitement in many of the challenging programs at Boeing's Aero-Space Division. Some of these programs—the advanced Saturn S-IC first-stage booster, for example—are under the management of newly-formed divisional organizations that can offer you unique ground-floor opportunities.

Other openings with rapid-advancement potential are immediately available on the Dyna-Soar space glider program and the solid-fuel Minuteman ICBM. Assignments are available in many fields of activity, including Research and Development, Design, Manufacturing and Test.

In addition to professionally stimulating

careers, these Boeing openings can offer you—and your family—a wide variety of living advantages, including geographic locations such as the uncongested Pacific Northwest, Florida resort areas and historic New Orleans.

Salaries are commensurate with education and experience. Minimum requirements are a B.S. degree in any applicable scientific discipline. Boeing pays moving and travel allowances to newly-hired engineers.

Send your resume today to Mr. Lawrence W. Blakeley, The Boeing Company, P. O. Box 3822-ECL, Seattle 24, Washington. Boeing is an equal opportunity employer.

Assignments are available for:

- Structures Engineers
- Electronic/Electrical Engineers
- Mechanical Engineers
- Industrial Engineers
- Manufacturing Engineers
- Propulsion Engineers
- Aeronautical Engineers
- Cryogenicists
- Base Installation Engineers
- Physicists
- Mathematicians

BOEING

Divisions: Military Aircraft Systems • Transport • Vertol • AERO-SPACE • Industrial Products—Boeing Scientific Research Laboratories

August 24, 1962

DESIGN AND APPLICATION

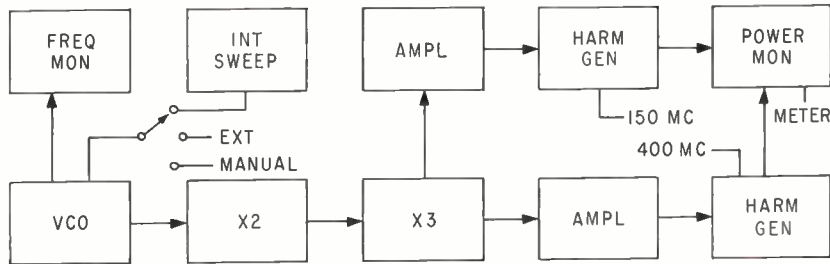

Signal Generator Tests Doppler Receivers

Sweep adjustable between 50 cps and 1Kc modulates the r-f carrier

NEW from General Dynamics/Electronics, 1400 N. Goodman St., Rochester 1, N. Y., the model SC-741 transistorized doppler signal generator comes with outputs at 150 and 400 Mc but other frequency pairs are available between 30 Mc and 1 Gc with maximum tuning range of 0.1 percent of center frequency. Frequency calibration accuracy is 0.002 percent, drift is less than 0.00002 percent per hour after warmup and short-term jitter is less than 0.1 radian rms. Output range is -60 to -160 dbm within 2 db, internal f-m modulation is a linear one shot sweep over the entire frequency range at a rate adjustable from 50 cps to 1 Kc. Manual frequency control is also available. An external sweep may be applied between d-c and 1 Kc with a sensitivity of 24 Kc per volt. External p-m is adjustable between

0 and ± 90 degrees with sensitivity of 45 degrees per volt. Modulating frequency is read directly on a front panel meter. A precision voltage-controlled crystal oscillator is

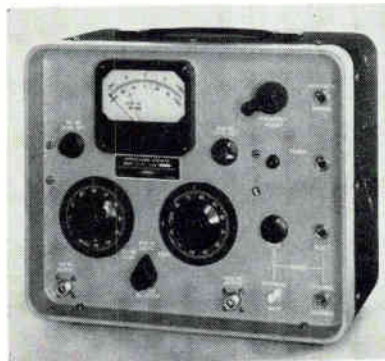

the r-f source and is multiplied to provide output frequencies. In manual operation, a vernier 10-turn control sets output to 400 Mc \pm 60 Kc or 150 Mc \pm 22 Kc. Operation is either 106-125 v, 50 to 400 cps or an internal battery supply. CIRCLE 301 READER SERVICE CARD

Tunnel Diode Amplifier Has 17 Db Gain at 1.7 Gc

IN production at Micro State Electronics Corp., 152 Floral Ave., Murray Hill, N. J., the model NC-1601 low noise tunnel diode amplifier was designed for radio theodolite use. This model has an operating bandwidth from 1.6 to 1.7 Gc with 17 db gain. With gallium-antimonide

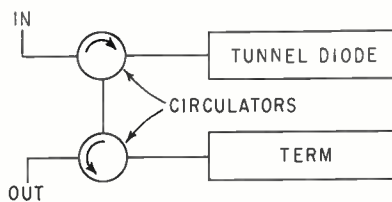

tunnel diodes, noise figure is 3.5 db and with germanium diodes noise figure is 4.5 db. Power supply is

from an internal battery source. When biased, the tunnel diode will amplify all signals up to its cutoff frequency. The microwave mount determines frequency of interest. Circulators are used to separate incoming and amplified signals. The circulator provides nearly constant match to amplifier while isolating changes in antenna swr from affecting the amplifier. Any portion of the amplified signal reflected from the receiver is terminated. The unit is insensitive to reactive termination at all frequencies in and out of band. The amplifier is then fail-safe and should either amplifier or power supply fail, the signal will still pass through. The mtbf is calculated at 35,000 hours. As no r-f pumps are required for operation, no spurious signals can be generated. (302)

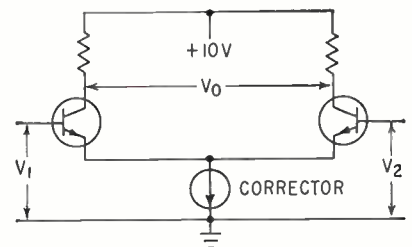

Current Regulator Operates Over Wide Voltage Range

INTRODUCED by CircuitDyne Corp., 480 Mermaid St., Laguna Beach, California, the Currector series of solid-state, two-terminal devices regulate current to a constant value analogous to the voltage limiting action of a zener diode. These devices come in a variety of current values in polar and non-polar versions. The sketch shows typical operation in an improved differential amplifier. In this circuit, the Currector acts as a common emitter impedance. Since the common-mode rejection ratio is directly proportional to this impedance value, it is desirable to select the largest

both
10mc

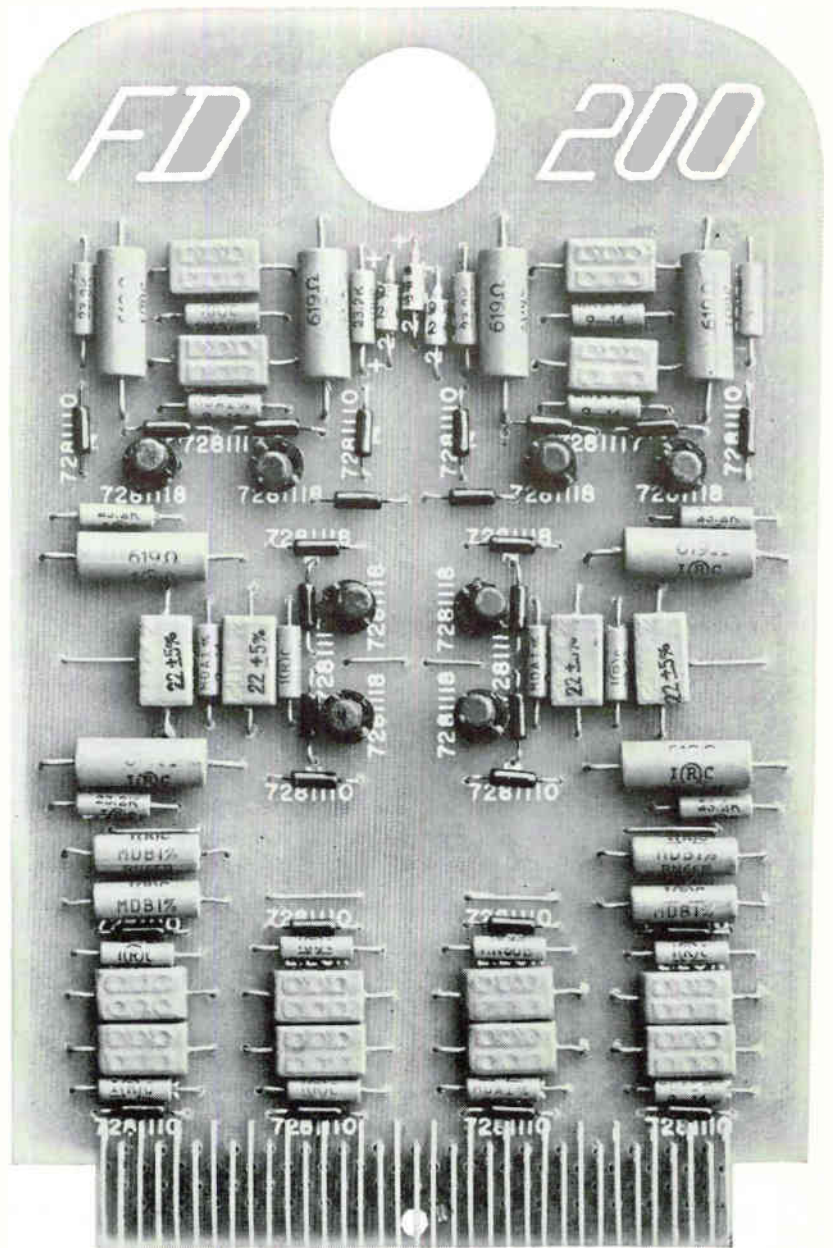
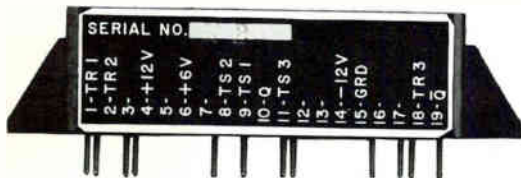

ONE FOR THE BIRD

Tested, proved, ready for work . . . Delco's new 10 mc Silicon Digital Modules are available in either building block or plug-in card. Both circuits are exactly the same electrically. Either way, these modules meet or exceed all MIL-E-5272D (ASG) environmental requirements. In the blockhouse, the plug-in card package offers extreme accuracy and reliability with a gate-switch speed of 40 nanoseconds. The building block package and the card offer the same high speed at temperatures of -55°C to $+100^{\circ}\text{C}$. Ideally suited to airborne guidance and control, the building block package is environmentally

ONE FOR THE BLOCKHOUSE

proved to: *Shock*, 1,000G's in all planes; *Vibration*, 15G's at 10 to 2,000 cps.; *Humidity*, 95% at max. temp.; *Storage and Sterilization Temp.*, -65°C to $+125^{\circ}\text{C}$; *Acceleration*, 20G's. Both building block and plug-in card modules are designed for systems using from one module to 100,000, and the module's rated performance considers the problems of interconnection. Delco

DELCO
DEPENDABILITY
RADIO
RELIABILITY

Radio can offer both 10 mc module packages off-the-shelf or can supply circuits to meet your specific needs. Write Delco Radio Military Sales Department, Kokomo, Indiana.

Division of General Motors • Kokomo, Indiana

COMPUTER RESEARCH ENGINEERS & LOGICAL DESIGNERS

Rapid expansion of the Computer Laboratory at Hughes-Fullerton has created several attractive professional opportunities for qualified Computer Research Engineers and Logical Designers. These positions require active participation in broad computer R & D activities in connection with Army/Navy computer systems and new large-scale, general-purpose computers. These multiple processor computers utilize advanced solid-state circuitry, gating and resolution times in the millimicrosecond regions; combine synchronous and asynchronous techniques for maximum speed and reliability.

These professional assignments involve broad areas of logical design, programming and system conception. Fields of interest include:

- Distributed computers ■ Advanced arithmetic processing techniques ■ Mechanized design
- Asynchronous design techniques ■ Utilization of parametrons in computers ■ Studies in the utilization of multiple processor computers.

These professional assignments involve such R & D areas as:

- Solid state digital circuitry involving millimicrosecond logic
- Microwave carrier digital circuits
- Sub-microsecond core memory
- Thin film storage techniques
- Functional circuit concepts
- Micro-miniaturization concepts
- Tunnel diodes ■ Microwave parametrons ■ Circuit organization for maximal-speed computing.

Located in Southern California's Orange County (the nation's fastest growing electronics center), Hughes-Fullerton offers you: a stimulating working environment; private or semi-private offices; long-term stability.

CALL COLLECT TODAY!

For complete information on these challenging assignments, call us collect today! Ask for:

Mr. J. E. TENNEY at:
TRojan 1-4080, ext. 3741.

Or, airmail resume to: HUGHES-FULLERTON R & D, P. O. Box 2097, Fullerton 1, California.

An equal opportunity employer.

HUGHES

HUGHES AIRCRAFT COMPANY

value that the magnitude of the available bias supply will permit. Assume that the emitter impedance must supply 2 ma to the transistor pair and a 500,000-ohm impedance is required by stability and common-mode rejection specifications. A 500,000-ohm resistor and 1 Kv bias will prove awkward. Same performance can be achieved using a 2 ma Currector and bias of 10 v. CIRCLE 303, READER SERVICE CARD

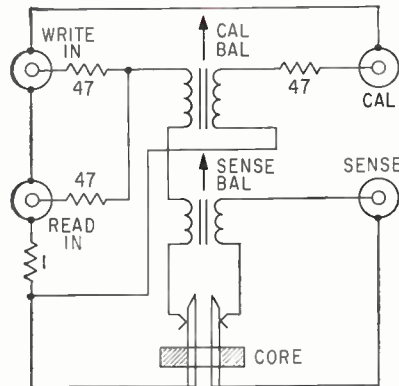

Simple Method of Testing Miniature Ferrite Cores

MANUFACTURED by Computer Instrumentation Corp., Rt 38 and Lonwood Ave., Cherry Hill, N. J., the model 4021-B core test jig is a manually operated instrument for easy and rapid analysis of miniature ferrite cores or metal tape wound cores. Cores between 0.015 inside diameter and 1.0 inch outside diameter can be inserted into the jig which has a two conductor probe, one for driving and the other for sensing. Core voltage response is observed on a cro connected to the output. Current amplitude is monitored through non-inductive 1-ohm, 1-percent calibration resistor. Two adjustable coupling bucking transformers are used to eliminate common-mode noise voltages caused by airflux pickup and capacitance between input and output pins. (304)

Parametric Amplifier With Ultra High Input Impedance

ANNOUNCED by Denro Labs, 2801 15th St., N.W., Washington 9, D. C., the model 514A amplifier has 20,000 megohm input resistance, 3 cps to 300 Kc bandwidth and a rise time of 2.5 μ sec. Broadband noise level with input open is under 100

μ v rms, power gain is up to 50 db, dynamic range is 100 μ v to 0.1 v,

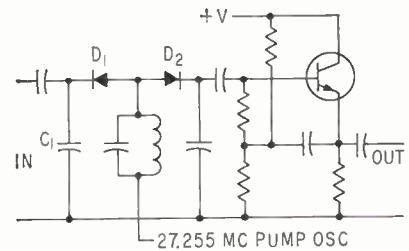

voltage gain is unity, output impedance is under 500,000 ohms, detectable signal power is 10^{-10} watts and the phase is adjustable either 0 or 180 degrees. A 27 Mc crystal-controlled oscillator is used as pump source and is fed to a parallel-tuned circuit aligned 100 Kc above pump source frequency. As shown in the sketch, the tank coil is connected to two diodes. Diode D_1 is a high Q silicon with very low reverse leakage and capacitance. Diode D_2 has low Q but high rectification efficiency and low noise. Both diodes will be space charged. Input signal sees reverse biased junction resistance and capacitance of D_1 , and swamping capacitor C_1 . Signal varies junction capacitance of D_1 , which affects tuned circuit impedance proportionately. Diode D_2 linearly reproduces the r-f level change into a bootstrapped emitter follower amplifier which also acts as an isolation stage to prevent reflection and output impedance loading. Phase reversal is by inverting the diodes. (305)



Multipin Connector Withstands Vibration

MICRODOT INC., 220 Pasadena Ave., S. Pasadena, Calif. Microminiature multipin connector features a threaded coupling ring mated to a threaded receptacle that furnishes positive holding for installations subjected to vibration. It can provide 61 power contacts or 19 coaxial contacts within a shell of 1 $\frac{1}{8}$ in. in diameter. Smallest connector contains up to 19 power contacts in a $\frac{3}{4}$ -in. shell. (306)

PRODUCT BRIEFS

ONE-SHOT MULTIVIBRATOR, a 10 Mc module. It operates from -55 C to +125 C. Solid State Electronics Corp., 15321 Rayen St., Sepulveda, Calif. (307)

MICROMINIATURE RELAYS have welded header-to-can. The BR-11 series is capable of switching dry circuit to 2 amp loads at 28 v d-c. Babcock Relays, 1645 Babcock Ave., Costa Mesa, Calif. (308)

NON-POSITION SENSITIVE RELAYS for single-phase motors. Dependable life is over 1,000,000 cycles. Metals & Controls Inc., a corporate division of Texas Instruments Inc., 34 Forest St., Attleboro, Mass. (309)

MINIATURE CONNECTORS are hermetically sealed. They are available in flangeless, square flange, bulkhead and socket types. Hermetic Industries, 4232 Temple City Blvd., Rosemead, Calif. (310)

SINGLE-ARM PLOTTING BOARD for analog, digital application. It utilizes an electroluminescent panel to backlight the plotting area. Computer Systems, Inc., Monmouth Junction, N. J. (311)

MAGNETRON TEST SET for all-purpose use. All tests are in accordance with MIL-E-1D. Electronics for Education, Inc., Horsham, Pa. (312)

BROADBAND ISOLATOR covers 18.0 to 26.5 Gc. Isolation is 25 db minimum, insertion loss 1.0 db maximum. E&M Laboratories, 15145 Califa St., Van Nuys, Calif. (313)

SOLID STATE COUNTER with five digit in-line readout. Input range is 0 to 20,000 cps. Cox Instruments Corp., 15300 Fullerton, Detroit 27, Mich. (314)

SAMPLING SCOPE PLUG-IN has 3,500 Mc bandpass. Risetime is 0.1×10^{-9} sec (0.1 nsec). Tektronix, Inc., P. O. Box 500, Beaverton, Ore. (315)

PRECISION RESISTANCE CARDS for microwaves. Standard sizes are 6 in. by 12 in. Metavac Inc., 45-63 162nd St., Flushing 58, N. Y. (316)

D-C SUPPLY has 10 v output at 0-250 ma. Ripple is 1 mv peak to peak max. Atlas Controls Inc., 9 Erie Drive, Natick, Mass. (317)

DIGITALLY PROGRAMMABLE SCALER offers manual or electrical control. Accuracy is ± 0.05 percent. Trio Laboratories, Inc., Dupont St., Plainview, L. I., N. Y. (318)

TRANSFORMERS & REACTORS meet MIL-T-27. They are in custom production. Nothelfer Winding Laboratories, Inc., P. O. Box 455, Trenton 3, N. J. (319)

INSTRUMENT CART transports oscilloscopes. The aluminum cart measures 41 in. high, 18 in. wide and 26

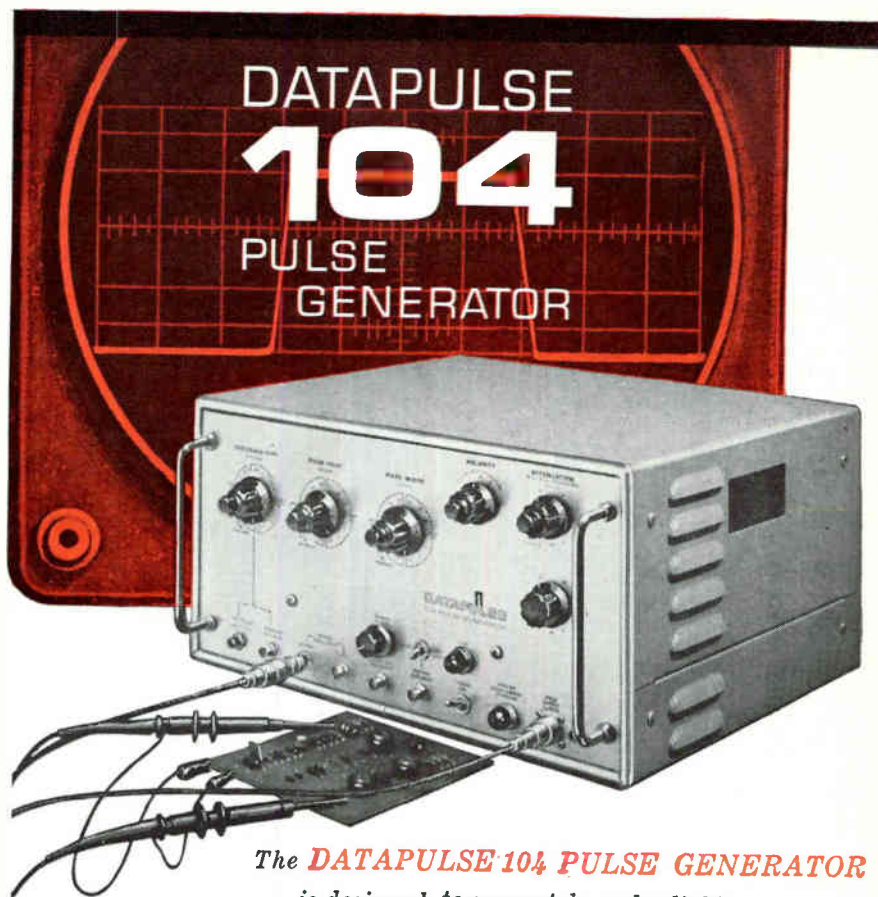

The **DATAPULSE 104 PULSE GENERATOR**

is designed to accurately and reliably

generate the pulses necessary to test this high speed flip flop module.

The 104 meets this requirement and many others such as:

- HIGH SPEED CLOCK GENERATION
- THIN FILM STUDIES
- MAGNETIC CORE DRIVING
- SEMICONDUCTOR EVALUATION
- DIGITAL CIRCUIT DEVELOPMENT
- PULSE TELEMETRY SYSTEM DESIGN
- IMPULSE GENERATION
- KLYSTRON AND TWT PULSE MODULATION
- PULSED DOPPLER RADAR DESIGN
- COUNTERMEASURES DEVELOPMENT

The 104 provides very short duration, high power pulses at repetition rates to 10 mc, with variable delay and broad pulse width range permitting full general purpose use at lower rates.

VISIT OUR EXHIBIT AT NEC BOOTH 914 OCT. 8 - OCT. 10

ABBREVIATED SPECIFICATIONS

REPETITION RATE - Variable, 5cps to 10mc, single shot or externally triggered.

AMPLITUDE - Variable to ± 40 v peak into 50 ohms.

RISE TIME - Variable 10 to 200 nanosec.

PULSE DELAY - Variable 50 nanosec to 10 millisecond.

PULSE DURATION - Variable 20 nanosec. to 500 μ sec.

DUTY CYCLE - Provide up to 300 ma average output current, with fully automatic overload protection.

SIZE AND WEIGHT - 8 $\frac{3}{4}$ "h x 17"w x 15 $\frac{1}{4}$ "d, 45 lbs.

Additional Datapulse products



100 PULSE GENERATOR

\$345.00

Repetition rates 5cps to 500kc (to 1mc externally triggered)
Outputs to 150v or ± 10 v into 50 ohms
Rise times to 30 nanosec.

DATAPULSE
INCORPORATED

509 HINDRY AVE. INGLEWOOD 1, CALIFORNIA

Data Systems • Pulse Instrumentation

ORchard 1-7713

ORegon 8-3983

Hickory Brand Double Shielded Flexible Coaxial Cable for Direct Burial Applications



For all-system use in
the HF, VHF, UHF Ranges

Tough solid dielectric core provides high crush resistance. First shield is standard copper braid. Inner jacket is rugged, moisture-resistant polyethylene. Second shield is 5 mil corrosion-resistant corrugated copper, longitudinally applied over inner jacket. This tubular solid shield provides freedom from radiation, adds exceptional mechanical strength and rodent protection; its corrugations permit the cable to be bent freely without special tools or equipment. Applied over the second shield is an outer jacket of weather and moisture-resistant black polyethylene. The cable has the electrical characteristics of premium types of coaxial cable.

- PROVIDES LOWER LOSSES
- AVAILABLE IN CONTINUOUS LENGTHS UP TO 5000 FEET, 100% SWEEP TESTED OVER THE FULL LENGTH
- CAN BE PLOUGHED DIRECTLY INTO THE EARTH, FROM NON-RETURNABLE REELS
- EMPLOYS STANDARD COAXIAL FITTINGS

Cat. No.	Conductor	O. D. Over Dielectric	O. D. Over 1st Jacket	Nom. Overall O. D.	Impedance
		4820	7/0249" Bare Copper	.460"	
4830	.1045" solid copper	.680"	.870"	1.06"	75

Comparison of Hickory Brand 4800 Series Coaxial Cable with Solid Sheathed Foam Coaxial Cable

Channel	Frequency	ATTENUATION (db/100 Ft.)			
		HB4820 75 Ohm	3/8" 70 Ohm SS Foam	HB4830 75 Ohm	1/2" 70 Ohm SS Foam
2	54-60 MC	0.90	0.88	0.65	0.67
6	82-88 MC	1.18	1.10	0.79	0.83
	100 MC	1.30	1.21	0.85	0.94
7	174-180 MC	1.92	1.69	1.19	1.29
13	210-216 MC	2.16	1.87	1.32	1.45

Also available as type I.M. (Integrated Messenger) construction for aerial use.



For further information, technical assistance
and prices, write to
HICKORY BRAND
Electronic Wires and Cables

SUPERIOR CABLE CORPORATION

P. O. Box 480-A • Hickory, N. C.

in. deep. Lavoie Laboratories, Inc., Morganville, N. J. (320)

INTEGRAL LEVER ACTUATORS with low force-high overtravel. Two models are available. Cherry Electrical Products Corp., P. O. Box 438-7, Highland Park, Ill. (321)

THERMOELECTRIC MODULES are miniaturized. Units cool temperature sensitive components. Semitronics, Inc., 63 Swanton St., Winchester, Mass. (322)

TEMPERATURE RECORDER features low-cost. Unit has high resolution. Rustrak Instrument Co., Inc., 130 Silver St., Manchester, N. H. (323)

DUCT PANEL ADAPTERS for cooling electronic equipment. They are quiet and reliable. McLean Engineering Laboratories, P. O. Box 288, Princeton, N. J. (324)

SOLID STATE A-C CONTACTOR replaces bulky electromechanical type. Load circuit can be from 10 cps to 25 kc. LJ Products, 7450 Girard Ave., La Jolla, Calif. (325)

MOTOR TIE CORD made of waxed Nylon. It ties smoothly and flat. Gudebrod Bros. Silk Co., Inc., 225 W. 34th St., New York 1, N. Y. (326)

L-V POWER SUPPLY has 1 percent regulation NL to FL. Price is \$87.50. Trelcom Engineering Co., P. O. Box 6209, Baltimore 6, Md. (327)

BERYLLIUM COPPER POWDER is moldable, sinterable. It is made in a standard-100 mesh particle size range. The Brush Beryllium Co., 5209 Euclid Ave., Cleveland 3, O. (328)

HEAVY DUTY TOWER for microwave installation. It is constructed in an equilateral triangular pattern. Rohn Mfg. Co., Peoria, Ill. (329)

VOLTAGE VARIABLE CAPACITORS range from 7 to 120 pf at -4 v. Prices range from \$1.85 to \$7.75 in 100 quantities. Eastron Corp., 25 Locust St., Haverhill, Mass. (330)

C-C TV SYSTEM with high picture clarity. It is fully automatic. GPL Div., General Precision, Inc., 63 Bedford Rd., Pleasantville, N. Y. (331)

DELAY LINES are molded in epoxy. Temperature stability is 50 parts per million per deg C. Allen Avionics, Inc., Mineola, N. Y. (332)

SOLID STATE DECODER with in-line read-out. It uses plug-in p-c construction. Burroughs Corp., P. O. Box 1226, Plainfield, N. J. (333)

TIME TOTALIZER for the data processing industry. It automatically records computer usage time. Advance Data Systems Corp., 2037 Granville Ave., Los Angeles 25, Calif. (334)

INDUSTRIAL VOLTAGE SCANNING SYSTEM measures 50 channels. Information is presented in digital display and as permanent printed record. Dymec, a division of Hewlett-Packard Co., 395 Page Mill Road, Palo Alto, Calif. (335)

Literature of the Week

- VIBRATION METER** Consolidated Electrodynamics Corp., 360 Sierra Madre Villa, Pasadena, Calif. Capabilities of the type 1-117 vibration meter are described in a four-page bulletin. (336)
- ULTRAMICROWAVE EQUIPMENT** DeMornay-Bonardi Corp., 780 S. Arroyo Parkway, Pasadena, Calif. Catalog contains photos, specifications and dimensional drawings on millimeter wave equipment for the W size, 90 to 140 Gc. (337)
- H-V TEST EQUIPMENT** Peschel Instruments Inc., Route 216, Towners, Patterson, N. Y. Short-form catalog No. 62 covers h-v test sets and h-v power supplies. (338)
- MIL SYNCHROS** Vernitron Corp., 602 Old Country Road, Garden City, L. I., N. Y. Detailed specifications to aid in rapid selection of size 23.60 cycle Thru-Bore synchros for servo applications are given in a data sheet. (339)
- UNIVERSAL CONTACT FEEDER** Fansteel Metallurgical Corp., North Chicago, Ill., has issued a bulletin on a universal contact feeder that increases production rates up to 35 percent. (340)
- IN-BAND SIGNALING SYSTEM** Lenkurt Electric Co., Inc., 1105 County Road, San Carlos, Calif., offers a pamphlet on the type 927A in-band signaling system that converts d-c signaling pulses to 2,600-cycle tone pulses for transmission. (341)
- NARROW-HEIGHT COMPONENTS** Microwave Development Laboratories, Inc., 15 Strathmore Road, Natick Industrial Centre, Natick, Mass. Bulletin O-1 lists narrow-height microwave components. (342)
- SHAFT POSITION ENCODER** Datex Corp., 1307 S. Myrtle Ave., Monrovia, Calif. Bulletin contains information on a self-selecting brush U-Scan shaft position encoder. (343)
- TRANSPARENT WELDED CIRCUIT** RG Circuits Co., 15216 Mansel Ave., Lawndale, Calif., offers a catalog sheet on the nonresonant, rigid, heat-cold-humidity-resistant welded circuit. (344)
- ROTARY SWITCH** Oak Mfg. Co., Crystal Lake, Ill. Four-page brochure highlights a subminiature, 12-position, 1/2-in. rotary switch. (345)
- COOLING EQUIPMENT** McLean Engineering Laboratories, P.O. Box 228, Princeton, N.J., has published a catalog presenting its packaged Mil-Spec blower line. (346)
- ACOUSTIC CALIBRATOR** Engineering Dynamics Associates, Inc., 6651 S. Wellington Ct., Littleton, Colo. Four-page technical brochure describes a portable high-intensity acoustic calibrator. (347)

TWINS

Honeywell AC Iron Vane meters, available in a wide selection of case styles, are counterparts to the popular Honeywell DC line. Whether you prefer conventional round or square meter cases or the distinctive Honeywell Medalist series, you can enhance the appearance of your equipment and instrument panels by using matching case styles for both AC and DC meter requirements.

■ *Honeywell's AC Iron Vane meters deliver top performance at moderate cost. Scale linearity equals or exceeds that of any comparable meters and for applications where space is at a premium, the shallow depth of Honeywell AC Iron Vane meter cases is a distinct advantage. For a catalog write to: Honeywell Precision Meter Division, Manchester, New Hampshire.*

MM3 (3 1/4") Case style illustrated. Note high readability of extended scale.

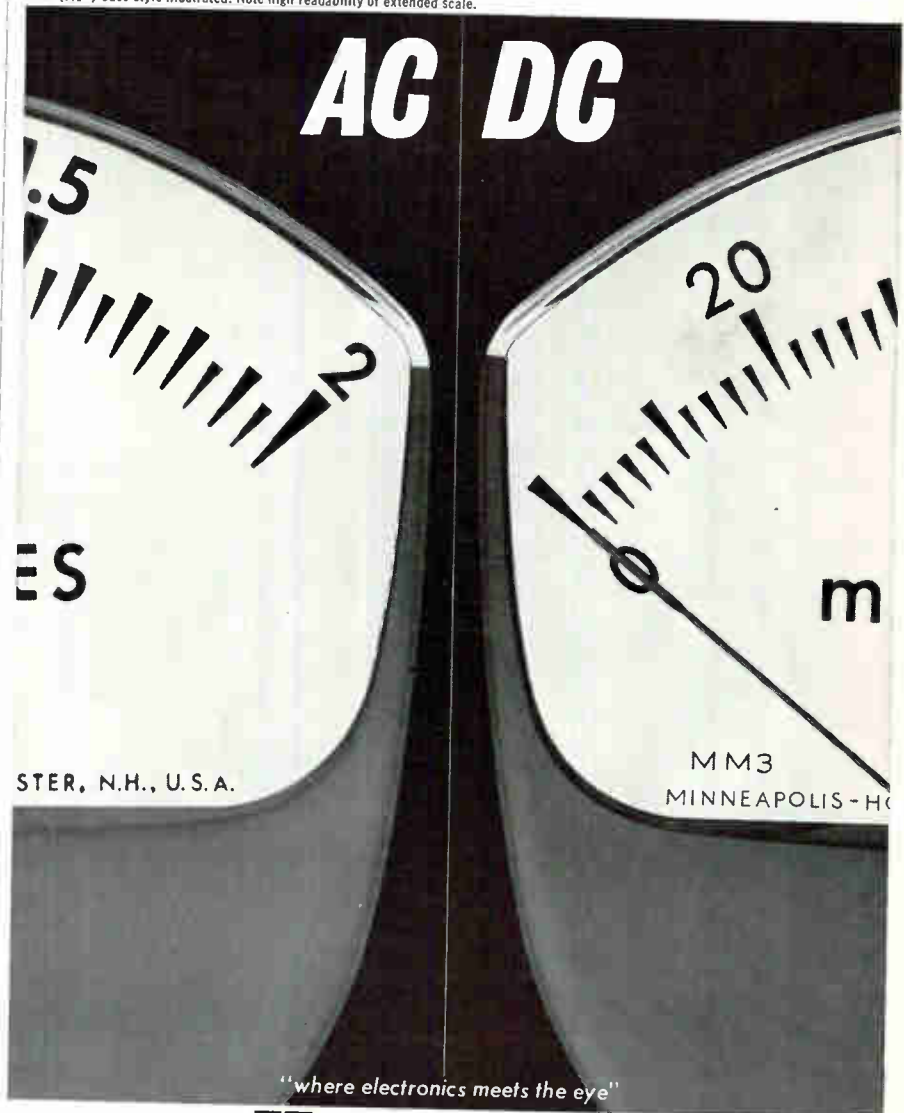

Honeywell



Precision Meters

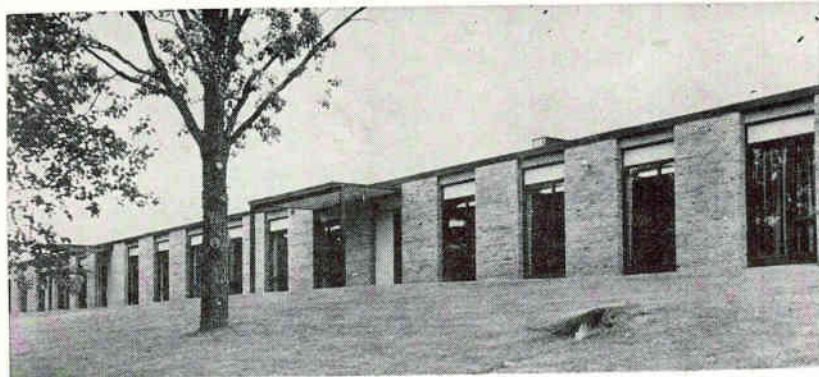

Fabri-Tek Doubles Plant Space

FABRI-TEK, INC., magnetic memory manufacturer, has more than doubled its production space with an addition to its plant at Amery, Wisc.

The firm, with headquarters in the Minneapolis suburb of Hopkins, Minn., has been manufacturing core memory planes and stacks at Amery since 1959. It moved into a new 12,000-square foot building there in 1960. This year's addition brings Amery plant space to 25,000 square feet.

Most of the company's 400 employees now work in this installation. Two plants in Hopkins house

the headquarters staff and R&D.

The firm was founded in 1957 by M. F. (Mike) Michelson to manufacture high quality magnetic core memory planes and stacks for the growing electronic computer industry. Core memory components are still the mainstay of the business, but Fabri-Tek has expanded its line to include a broader variety of types and sizes, plus a line of complete memory systems.

The expanding Fabri-Tek R&D department is doing advanced research on thin film memory components and on new systems using core and film elements.



Leonard Kent Takes ARRA Executive Post

ANTENNA & RADOME RESEARCH ASSOCIATES, Westbury, L. I., N. Y., announces the appointment of Leonard I. Kent to the position of vice president for engineering. In this capacity he will be responsible for the company's design, research and development efforts which will include those in the fields of solid

state and ferrite devices.

Kent was president of Consolidated Microwave Corp. whose assets were acquired by Antenna & Radome Research Associates.



Measurement Systems Hires Rhyins

RICHARD W. RHYINS has joined the staff of Measurement Systems, Inc.,

Norwalk, Conn. as manager of advanced development engineering.

He was formerly with the Barnes Engineering Co. in Stamford, Conn.

TI Realigns Components Activity

MARK SHEPHERD, JR., executive vice president of Texas Instruments Inc., Dallas, Texas, has announced that TI's Transistor Products and Components divisions have been combined into one division to be known as the Semiconductor Components division.

The new division will be under the direction of TI vice president Cecil Dotson. He formerly headed the Transistor Products division and International division.

TI vice president Jay Rodney Reese, who has headed the Components division, becomes manager of the International division.



Elect F. A. Lindsay Itek President

FRANKLIN A. LINDSAY has been elected president of Itek Corp., Lexington, Mass., replacing Richard S. Leghorn who recently resigned. Leghorn will retain a part-time relationship with the company.

Lindsay has been executive vice president of the firm which specializes in information handling equipment for military and civilian uses.

Lionel Corporation Elects Raney

MELVIN A. RANEY has been elected president and chief executive officer of The Lionel Corp., Hillside, N. J.

Raney joined Lionel in 1961 as general manager of Induction Heating Corp., Brooklyn, N. Y., a wholly

WHAT IS THE "HH" SERIES?

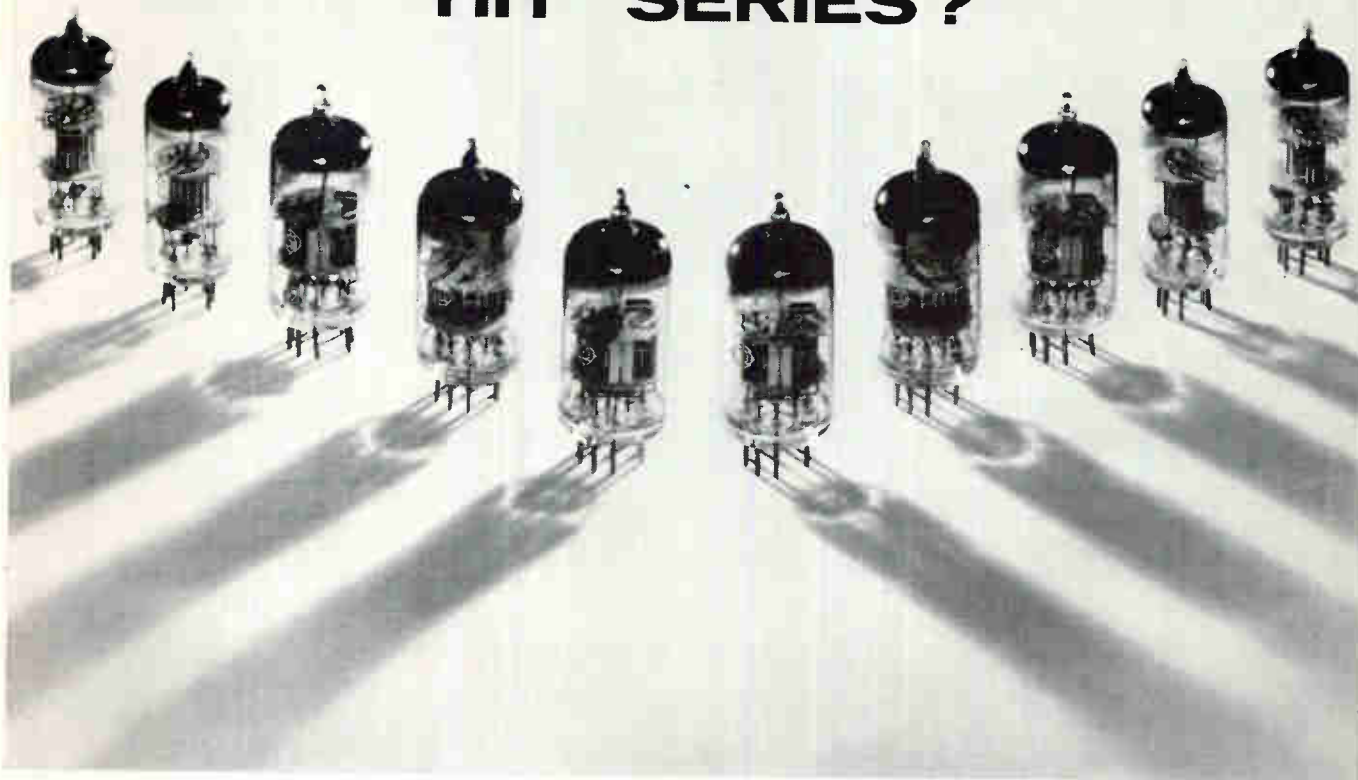

The "HH" series is Hitachi's new superior line of television receiver tubes, the ultimate in far-reaching reception of television waves.

For RF amplifier of VHF television tuners, specify the 4R-HH2 and 6R-HH2 which feature very high transconductance, high sensitivity and low noise. These twin triode tubes replace the 4BQ7A and 6BQ7A without change of circuit.

For frequency convertor and local oscillator of VHF television tuners, specify 5M-HH3 and 6M-HH3 twin triodes which replace the 5J6 and 6J6 without change of circuit.

The "HH" series is another fine quality line from Hitachi, one of the most completely integrated electrical manufacturers in the world.

INTERNATIONAL IMPORTER INC.

2242 South Western Avenue,
Chicago 8, Illinois, U.S.A.

 **Hitachi Ltd.**
Tokyo Japan

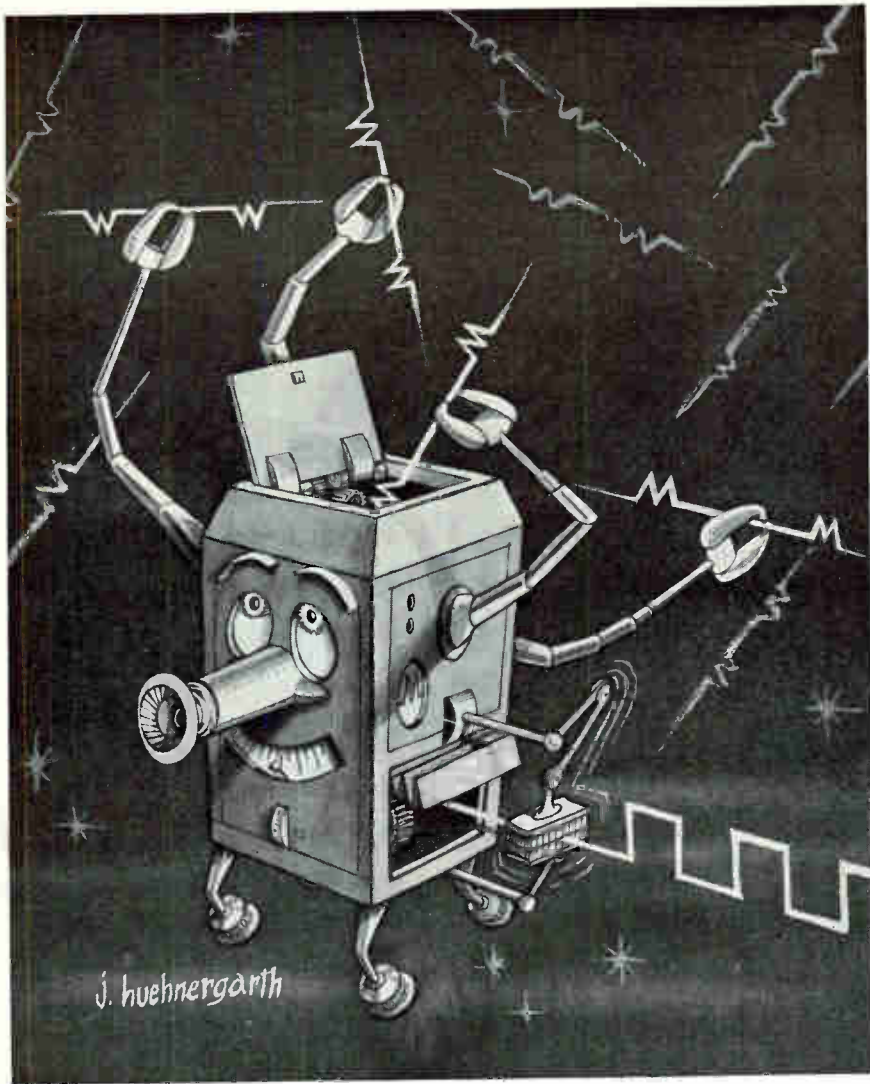

Rejuvenate tired, dirty signals with NEMS-CLARKE® Universal Combiner!

Recent competitive tests rank this new universal signal-controlled combiner, the DCA 4000, the best of the AGC post-detection combiners. It accepts signals from up to four separate receivers and produces a single output with a signal-to-noise ratio better than the best input signal. It can be used for combining communications signals or any type of signal presently defined under IRIG standards. This equipment was designed and constructed in accordance with the requirements of MIL-E-4158 (USAF) and has a stability of continuous operation for a minimum of eight hours without readjustment.

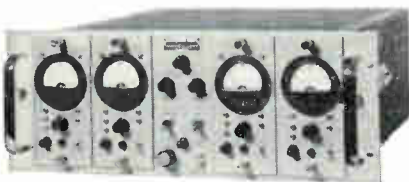

Write for Data Sheet 4000.
Vitro Electronics, 919 Jesup-Blair Dr.
Silver Spring, Maryland
A Division of Vitro Corp. of America

Vitro ELECTRONICS

SPECIFICATIONS

Type Reception FM/FM or FM/Pulse,
IPDM, PCM, PAM
Diversity Channels 2, 3 or 4
S/N Ratio Improvement for
Equal S/N Ratio Input Signals
4 channels 5 to 6 db
3 channels 4 db to 4.7 db
2 channels 2.0 db to 3.0 db
Output Impedance 75 ohms
Stability Eight hours continuous
without readjustment

owned Lionel subsidiary. He was then elected president of the subsidiary.



Sylvania's EDL Promotes Smith

APPOINTMENTS of C. A. (Kip) Smith as manager of technical liaison for the Electronic Defense Laboratories of Sylvania Electric Products Inc., Mountain View, Calif., is announced.

With Sylvania since 1932, Smith joined liaison at EDL in 1957.



SDS Appoints J. M. Mitchell

SCIENTIFIC DATA SYSTEMS, INC., Santa Monica, Calif., has appointed Jack M. Mitchell associate manager of digital computers.

Mitchell was computer engineering manager at Packard-Bell Computer prior to joining SDS.

LFE Electronics Names Anderstrom

EDWARD A. ANDERSTROM has been promoted to director of manufacturing for LFE Electronics, the major operating group of Laboratory For Electronics, Inc., Boston, Mass. Included in his new assignment is responsibility for produc-



**Are you a
COMPLETELY INFORMED
electronics engineer?**

Today you may be working in microwaves. But on what project will you be working tomorrow? You *could* have read **electronics** this past year and kept abreast of, say, microwave technology. *There were 96 individual microwave articles between July, 1961 and June, 1962!*

But suppose tomorrow you work in some area of standard electronic components, in semiconductors, in systems? Would you be up-to-date in these technologies? Did you read the more than 3,000 editorial pages that **electronics'** 28-man editorial staff prepared last year?

electronics is edited to keep you current *wherever* you work in the industry, *whatever* your job function(s). If you do not have your own copy of **electronics**, subscribe today via the Reader Service Card in this issue. Only 7½ cents a copy at the 3 year rate.

electronics

August 24, 1962



**Good
parts
work
best!**

Intermediate
Frequency
Transformer
IFT



The high standards of MITSUMI electronic components are insured by a fully-automated assembly system, and double-checked by rigid quality controls. Mitsumi Electric Company is Japan's largest manufacturer of components for radio, television and communications equipment.

POLYVARICON
Variable
Capacitor



MITSUMI PARTS

MITSUMI ELECTRIC CO., LTD.

Komae, Kitatama, Tokyo



CIRCLE 201 ON READER SERVICE CARD

**TRY THIS FOR
size**

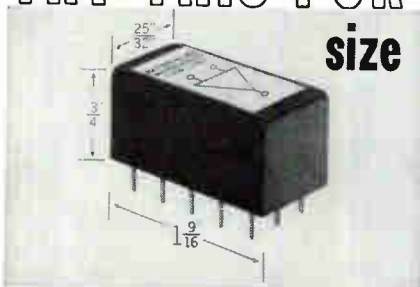

Our new silicon transistor operational amplifiers for analog instrumentation, offer:

- Wide range of specifications, catalog units for most applications.
- Encapsulated for ruggedness, environmental protection and stability.
- Grid-spaced pins for plug-in or card mounting.
- Prices from \$85. (as low as \$68. in quantity).

For complete data
write or call:

NEXUS

RESEARCH LABORATORY, INC.

19 NEEDHAM ST., DEDHAM, MASS. TEL. 326-8414

CIRCLE 202 ON READER SERVICE CARD

Telrex

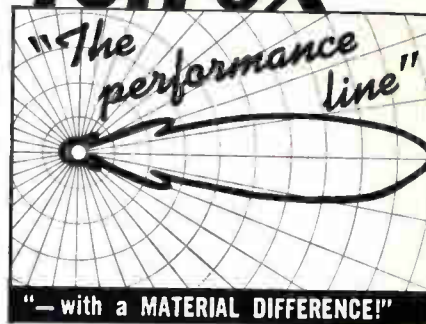

The Choice of the Discriminating
Communication Engineer . . . the
Man who Never Settles for Anything
Less than THE-VERY-BEST!

**telrex "BEAMED-POWER"
ANTENNAS and ANTENNA SYSTEMS**

Provide optimum performance and reliability per element, per dollar. Antennas from 500 Mc to 1500 Mc. Free P1.88 condensed data and pricing catalog, describes military and commercial antennas, systems, accessories, Towers, Masts, Rotators, "Baluns" and transmission line data.

ANTENNAS
SINCE 1921 **telrex**
LABORATORIES

Communication
and TV Antennas

Asbury Park 41, New Jersey, U.S.A.

CIRCLE 69 ON READER SERVICE CARD

69

services for aerospace contractors:

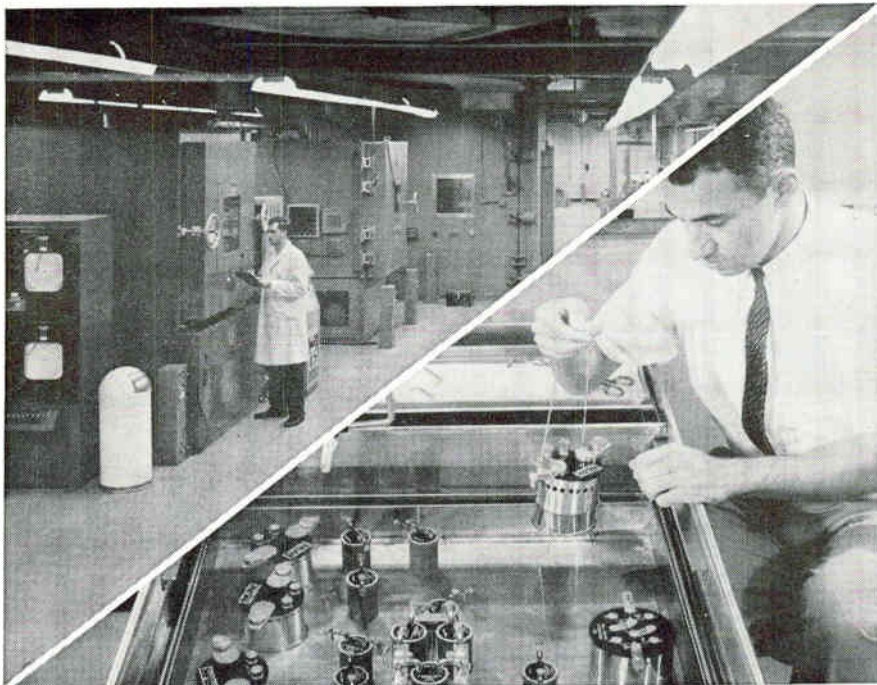

ENVIRONMENTAL EVALUATION

Arma environmental laboratories are among the finest in the nation, originally designed for stringent testing of the all-inertial guidance equipment now in operational service on Air Force ATLAS missiles. These facilities, including the world's most precise large centrifuge test unit, can now provide complete engineering evaluation services for contractors. Outstanding simulation equipment plus a competent staff of experienced engineers is available to help design and develop better, more reliable equipment and components through environmental testing.

STANDARDS AND MEASUREMENTS

Comparable in many respects to National Bureau of Standards facilities, the Arma standards & measurement laboratory is available to outside contractors for assistance on specialized measurement problems and quality control activities. Certification of reference and working standards and maintenance of records can be provided. Facilities for electrical measurements in the audio spectrum are the finest available.

These Arma laboratories were used in the development and production of the Atlas all-inertial guidance system and the B-52 fire control system. These sophisticated projects fully demonstrate Arma's qualifications to offer expert assistance to those seeking the finest in facilities, personnel, and experience.

Complete technical information on the services available is contained in a 24 page brochure ESAT-1. Write Corporate Government Marketing, Arma Division, American Bosch Arma Corporation, Garden City, N. Y.



tion of Doppler navigation systems, ground controlled approach radars and ground support equipment being made by LFE Electronics for the military.

Anderstrom succeeds Richard C. Sorensen, now president of Tracerlab, LFE's nucleonics division, and the Keleket X-Ray Corp., a wholly-owned LFE subsidiary.

PEOPLE IN BRIEF

Col. Albert R. Shiely, Jr. of the Air Force's Electronic Systems div. appointed program director of BMEWS. B. Richard Climie, ex-Collins Radio, named technical staff assistant at Aeronautical Radio, Inc. Lawrence C. Murdock from Bissett-Berman, to its Hytech, San Diego, div. as chief engineer. Melvin A. Goldberg, formerly with Westinghouse Broadcasting Co., now v-p and director of research of NAB. James Sanders moves up at Electronic Associates, Inc., to group mgr. of the process control engineering group. Franklin E. Jutton, previously with GE, named production mgr. of the Systems div. of Electro-Mechanical Research, Inc. Robert T. McTigue, v-p and director of Oak Mfg. Co., elected president of its subsidiary, Hart Mfg. Co. Robert W. Lambdin leaves Kollsman Instrument Corp. to join Airtron, a div. of Litton Industries, as a senior staff scientist for solid state materials. Bruce A. Highstrete promoted to asst. mgr. of the research dept. of Hughes Aircraft Co.'s microwave tube div. Corning Electronic Components advances Glenn A. Blackmon to supervisor of capacitor market development, and A. J. Hotte to supervisor of capacitor product engineering. George W. Spencer, previously with Erie-Pacific, appointed mgr. of the military data systems dept. of the System Sciences div. of Control Data Corp. Z. K. Geanes, ex-Quantatron, Inc., now marketing director, western region, for GPI's Librascope div. O. Dexter Covell Jr., ex-AMF Corp., named exec v-p of Detec-tron, Inc. Joseph Baumel has left Liquidometer Corp. to form an engineering consultation firm in Jericho, N. Y.

ARMA DIVISION

AMERICAN BOSCH ARMA CORPORATION

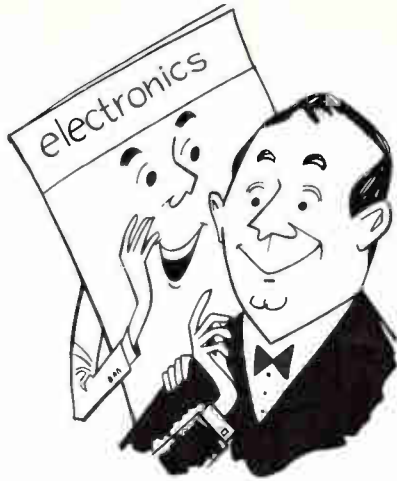

**electronics IS EDITED
TO KEEP YOU FULLY INFORMED**
— a “well-rounded” engineer

What's your *present* job in electronics? Do you work on computers? (**electronics** ran 158 articles on computers between July, 1961 and June, 1962!) Are you in semiconductors? (For the same period, **electronics** had 99 articles, not including transistors, solid-state physics, diodes, crystals, etc.) Are you in military electronics? (**electronics** had 179 articles, not including those on aircraft, missiles, radar, etc.)

In all, **electronics'** 28-man editorial staff provided more than 3,000 editorial pages to keep you abreast of all the technical developments in the industry. No matter where you work today or in which job function(s), **electronics** will keep you fully informed. Subscribe today via the Reader Service Card in this issue. Only 7½ cents a copy at the 3 year rate.

electronics

aerospace
component
engineers
&
chemists

Development contracts for SURVEYOR, SYNCOM, VATE, advanced POLARIS guidance, anti-missile defense systems and several advanced space probe vehicles have created growth opportunities at Hughes in Southern California for Chemical, Mechanical and Electronics specialists in the following fields:

COMPONENT PARTS ENGINEERS Familiar with semiconductor, electromechanical, mechanical and passive components. Experience required in application, design and/or development of component parts.

TESTING/TEST EQUIPMENT ENGINEERS Experience required in electrical test methods, environmental equipment, test equipment design and testing of component parts.

LUBRICATION ENGINEER Knowledge of bearing and lubricant materials technology is required, with experience involving oils, greases and other lubricants (fluid through solid) as applied to rotating components and sliding bearings. Vacuum testing experience is desirable.

CERAMICS ENGINEER Experience is desired in aerospace ceramics applications plus ability in oral and written communications and in the development of consultant relationships.

Basic requirements include an appropriate degree from an accredited university, U. S. Citizenship and several years of directly related work in aerospace applications. For complete information, please airmail your resume to:

MR. ROBERT A. MARTIN
Head of Employment

creating a new world with electronics

HUGHES

HUGHES AIRCRAFT COMPANY
AEROSPACE DIVISIONS
11940 W. JEFFERSON BLVD.
CULVER CITY 47, CALIFORNIA
An equal opportunity employer.

electronics

WEEKLY QUALIFICATION FORM FOR POSITIONS AVAILABLE

ATTENTION: ENGINEERS, SCIENTISTS, PHYSICISTS

This Qualification Form is designed to help you advance in the electronics industry. It is unique and compact. Designed with the assistance of professional personnel management, it isolates specific experience in electronics and deals only in essential background information.

The advertisers listed here are seeking professional experience. Fill in the Qualification Form below.

STRICTLY CONFIDENTIAL

Your Qualification form will be handled as "Strictly Confidential" by ELECTRONICS. Our processing system is such that your form will be forwarded within 24 hours to the proper executives in the companies you select. You will be contacted at your home by the interested companies.

WHAT TO DO

1. Review the positions in the advertisements.
2. Select those for which you qualify.
3. Notice the key numbers.
4. Circle the corresponding key number below the Qualification Form.
5. Fill out the form completely. Please print clearly.
6. Mail to: D. Howksby, Classified Advertising Div., ELECTRONICS, Box 12, New York 36, N. Y. (No charge, of course).

COMPANY	SEE PAGE	KEY #
ATLANTIC RESEARCH CORPORATION Jansky & Bailey Div. Alexandria, Va.	75	1
ATOMIC PERSONNEL INC. Philadelphia, Pennsylvania	73	2
AVCO RESEARCH AND ADVANCED DEVELOPMENT Division of Avco Corporation Wilmington, Massachusetts	74	3
DELCO RADIO Div. of General Motors Corp. Kokomo, Indiana	62*	4
ESQUIRE PERSONNEL SERVICE INC. Chicago, Illinois	74	5
F & M SCIENTIFIC CORP. Avondale, Penna.	74	6
HOUSTON INSTRUMENT CORPORATION Bellaire, Texas	108*	7
JET PROPULSION LABORATORY Pasadena, California	73	8
LOCKHEED AIRCRAFT CO. Burbank, California	24*	9
MCDONNELL St. Louis, Mo.	73	10
MICROWAVE SERVICES INTERNATIONAL INC. Denville, New Jersey	74	11
REPUBLIC AVIATION CORPORATION Farmingdale, Long Island, New York	75	12

Continued on page 74

(cut here)

electronics WEEKLY QUALIFICATION FORM FOR POSITIONS AVAILABLE

(cut here)

(Please type or print clearly. Necessary for reproduction.)

Personal Background

NAME

HOME ADDRESS

CITYZONE.....STATE.....

HOME TELEPHONE

Education

PROFESSIONAL DEGREE(S)

MAJOR(S)

UNIVERSITY

DATE(S)

FIELDS OF EXPERIENCE (Please Check)

82462

- | | | |
|--|--|---------------------------------------|
| <input type="checkbox"/> Aerospace | <input type="checkbox"/> Fire Control | <input type="checkbox"/> Radar |
| <input type="checkbox"/> Antennas | <input type="checkbox"/> Human Factors | <input type="checkbox"/> Radio-TV |
| <input type="checkbox"/> ASW | <input type="checkbox"/> Infrared | <input type="checkbox"/> Simulators |
| <input type="checkbox"/> Circuits | <input type="checkbox"/> Instrumentation | <input type="checkbox"/> Solid State |
| <input type="checkbox"/> Communications | <input type="checkbox"/> Medicine | <input type="checkbox"/> Telemetry |
| <input type="checkbox"/> Components | <input type="checkbox"/> Microwave | <input type="checkbox"/> Transformers |
| <input type="checkbox"/> Computers | <input type="checkbox"/> Navigation | <input type="checkbox"/> Other |
| <input type="checkbox"/> ECM | <input type="checkbox"/> Operations Research | <input type="checkbox"/> |
| <input type="checkbox"/> Electron Tubes | <input type="checkbox"/> Optics | <input type="checkbox"/> |
| <input type="checkbox"/> Engineering Writing | <input type="checkbox"/> Packaging | <input type="checkbox"/> |

CATEGORY OF SPECIALIZATION

Please indicate number of months experience on proper lines.

	Technical Experience (Months)	Supervisory Experience (Months)
RESEARCH (pure, fundamental, basic)
RESEARCH (Applied)
SYSTEMS (New Concepts)
DEVELOPMENT (Model)
DESIGN (Product)
MANUFACTURING (Product)
FIELD (Service)
SALES (Proposals & Products)

CIRCLE KEY NUMBERS OF ABOVE COMPANIES' POSITIONS THAT INTEREST YOU

1 2 3 4 5 6 7 8 9 10 11 12 13 14 15 16 17 18 19 20 21 22 23 24 25

EMPLOYMENT OPPORTUNITIES



The advertisements in this section include all employment opportunities — executive, management, technical, selling, office, skilled, manual, etc.

Look in the forward section of the magazine for additional Employment Opportunities advertising.

— RATES —

DISPLAYED: The advertising rate is \$40.17 per inch for all advertising appearing on other than a contract basis. Contract rates quoted on request.

An advertising inch is measured 3/4" vertically on a column—3 columns—30 inches to a page.

Subject to Agency Commission.

UNDISPLAYED: \$2.70 per line, minimum 3 lines. To figure advance payment count 5 average words as a line.

Box numbers—count as 1 line.

Discount of 10% if full payment is made in advance for 4 consecutive insertions.

Not subject to Agency Commission.

jpl needs

SYSTEMS ENGINEERS

SPACECRAFT SYSTEMS DESIGN STUDIES

To initiate and develop, for unmanned lunar and interplanetary programs, initial design criteria, mission requirements, advanced capability studies and direction of the systems preliminary design efforts. Direction and management of preliminary design contracts with industry. BS or MS in EE, ME or AE with broad experience and abilities in systems.

Send complete resume to
PERSONNEL DEPT.

JET PROPULSION LABORATORY

CALIFORNIA INSTITUTE OF TECHNOLOGY
4814 OAK GROVE DR. • PASADENA, CALIF.

"An equal opportunity employer"



E.E.'s

For professional, individualized fee-paid service write for confidential application.

A national employment agency for the Nuclear & Scientific Fields.

ATOMIC PERSONNEL, INC.
Suite 1207L, 1518 Walnut St., Phila. 2, Pa.

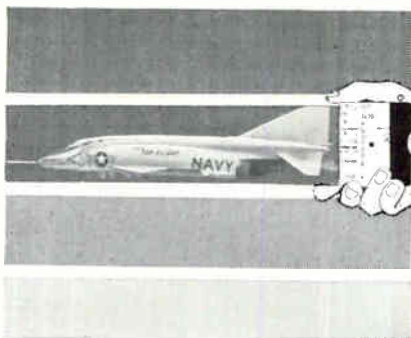

ENGINEERS

Why you should know more about

MCDONNELL

In the 22 years since its founding, the McDonnell name has become associated with an increasing number of outstanding engineering achievements in aeronautics and astronautics.

Among these are America's Manned Spacecraft built for NASA . . . the record-setting F4H Phantom II, all weather fighter and attack airplane; the world's fastest jet.

Programs initiated include:

FOR NASA: GEMINI . . . an extended mission, two-man spacecraft capable of orbital rendezvous.

FOR THE AIR FORCE: F-110A and RF-110 Tactical Fighter and Photo-Reconnaissance Aircraft.

FOR THE NAVY & MARINE CORPS: Continuing F4H Phantom II and Fighter Attack Aircraft.

Other projects now under way include Typhon and Tolos Airframes, Asset and Aeroballistic Space Research Vehicles.

The extensive McDonnell facilities—encompassing modern aerospace engineering research laboratories and production facilities are located in suburban St. Louis, Missouri. Diversified industry and commerce, well-established cultural and entertainment centers and a progressive minded population exceeding two million make this important metropolitan city an excellent one in which to work and reside.

Present and planned phases of our activities have created these career opportunities:

ELECTRONIC ENGINEERS

Responsible for concept, design, analysis and development of electronic equipment in the areas of: R.F. SYSTEMS, OPTICAL SYSTEMS, SPECIAL DEVICES, MICROWAVE AND ANTENNAS, THIN FILM TECHNIQUES, ADVANCED WELDED PACKAGING TECHNIQUES AND NUCLEAR STUDY PROGRAMS.

Please submit resume in confidence to:

Mr. D. F. Waters,
Supervisor of Engineering Employment,
Dept. 62W

MCDONNELL

P. O. Box 516, St. Louis 66, Missouri

An Equal Opportunity Employer

ELECTRONICS ENGINEERS & SCIENTISTS

Explore Today's Most Advanced Projects in Near and Deep

SPACE COMMUNICATIONS

(Vehicle-to-Ground)
(Vehicle-to-Vehicle)

A diversity of advanced communications problems offer you stimulating assignments at Republic's Missile Systems Division. These include communications systems for a number of next-generation satellites and hypersonic vehicles. Emphasis is on applications of new digital techniques in wideband information transmission; multiplexing, security coding and noise reduction. Re-entry blackout communications problems are under study; new concepts in IR cameras are under development.

Openings at all levels on Systems and Component Design & Development, Systems Analysis, & Test Programs for

MICROWAVE ENGINEERS RADAR ENGINEERS COMMUNICATIONS ENGINEERS IR & OPTICS SPECIALISTS DIGITAL COMPUTER SPECIALISTS

Also, unusually varied assignments for CIRCUIT DESIGN ENGINEERS with experience in transistorized UHF & microwave systems, including: High Frequency Pulse Circuits, Digital Computer Building Blocks, RF Circuits, Communication Coding Circuits, Feedback Control Circuits.

Write Mr. Paul Hartman,
Technical Employment Supervisor

MISSILE SYSTEMS DIVISION

REPUBLIC AVIATION CORPORATION

223 Jericho Turnpike
Mineola, Long Island, New York

An Equal Opportunity Employer



New ★
Avenues in
Space Technology
at AVCO/RAD

★
Electronics

Putting "man among the stars" through the design and development of a new generation of space vehicles plus a multitude of advanced space-oriented programs at Avco/RAD have created broad vistas of professional advancement for qualified engineers and scientists.

Openings exist for
*Electronic Engineers and
Engineering Physicists in:*

**Optics & Infrared
Communications**

**Antenna & Microwave
Equipment Systems**

**Deep Space & Re-entry
Communications**

Component & Circuit Design

**Sensor Development &
Telemetry Systems**

Radar Cross-Section Analysis

Airborne Tracking Systems

The Division is located in a superbly equipped \$23,000,000 laboratory facility in the Boston suburbs. At Avco/RAD you will find a liberal benefits program including educational assistance.

Send resume to
Mr. J. Bergin, Dept. EE

Avco/RAD is presently associated with Apollo; Titan, Atlas, Minuteman, Nike-Zeus and other classified space projects.

Avco

Research & Advanced Development

A Division of Avco Corporation

201 Lowell St., Wilmington, Mass.

An equal opportunity employer

Electronic
ENGINEERS

Established in 1959, F & M activities in chemical and biomedical instrumentation include gas chromatographs and new designed instruments in the electronics, micro-equipment and temperature control fields.

Our domestic and international sales volume has increased rapidly creating the following outstanding professional opportunities for qualified personnel:

■ **Research**

For newly formed section of research department to design and develop electronic equipment for the scientific instrument field. Experience in vacuum tubes and solid state, DC amplifiers or power supplies desired.

■ **Sales Manager**

To establish sales function of new division. Previous experience in marketing of electronic products is necessary.

Our new modern facility is ideally situated on a 30 acre site in the heart of historic Brandywine countryside, less than an hour from the many educational, cultural and recreational attractions of Philadelphia, Wilmington and Baltimore.

Send Resume In Confidence To
MR. C. A. BUTLER



SCIENTIFIC CORPORATION

*Starr Road and Route 41
AVONDALE, PENNA*

AN EQUAL OPPORTUNITY EMPLOYER

COMMUNICATIONS APPLICATION ENGINEER
Analysis of advanced electronic communication systems including radio, carrier, telephone, microwave:

Must have design and marketing experience with commercial and military users.

EE degree, 5 yrs. exp. min.
Send Resume to:

Microwave Services International Inc.
Consulting Engineers
Route 46 Denville, N. J.

GENERAL MANAGER

\$15,000 Per Year

Graduate IE or Metallurgist with 5 years experience in the manufacture of refractory metals or high temp. alloys. Exp. in Powder Metallurgy, Product Scheduling and Manufacture. Company client assumes all expenses.

ESQUIRE PERSONNEL SERVICE INC.
202 S. State St. Chicago 4, Ill.

electronics

**WEEKLY QUALIFICATIONS FORM
FOR POSITIONS AVAILABLE**

(Continued from page 72)

REPUBLIC AVIATION CORPORATION Missile Systems Division Mineola, Long Island, NY	73	13
SYLVANIA ELECTRONIC SYSTEMS • WEST Mountain View, California	107*	14
UNION CARBIDE NUCLEAR CO. Oak Ridge, Tennessee	108*	15
P 9428	75	16

* These advertisements appeared in the 8/17/62 issue.

**Method for
measuring
an engineer...**

**What's his
technical ?
publication ?**



When an engineer pays for a technical publication, it's a safe bet that that is the one he respects most.

He makes it his business to read **electronics**. It keeps him well informed of up - to - the - minute events and developments in the electronics industry and the technology to which he contributes his experience.

Where your recruitment program calls for engineers and other technical people of this calibre, you can reach them in the **EMPLOYMENT OPPORTUNITIES** section of:

electronics

A MCGRAW-HILL PUBLICATION
CLASSIFIED ADVERTISING DIVISION
POST OFFICE BOX 12 NEW YORK 36, NEW YORK

RESEARCH SCIENTIST

Leading manufacturer of guidance instruments and control devices in Southern California needs imaginative scientist with background in micro electronics. Must have ability to write engineering proposals and to present new product ideas to customers. Requires Phd in Physical Sciences. Minimum 5 years experience. Salary open.

ASSOCIATE SCIENTIST

M.S., E.E. Minimum 5 years solid state design. Salary open.

P-9428. Electronics

255 California St., San Francisco 11, Calif.

An equal opportunity employer.

ADDRESS BOX NO. REPLIES TO: Box No.
Classified Adv. Div. of this publication.

Send to office nearest you.

NEW YORK 36: P. O. Box 12

CHICAGO 11: 615 N. Michigan Ave.

SAN FRANCISCO 11: 255 California St.

POSITION VACANT

Sales Engineer Administrator Electronic Components—Excellent growth opportunity offered by established, progressive company. Must have proven administrative sales record, in resistors and capacitors. Resume. P-9524. Electronics.

PROFESSIONAL SERVICES

GIBBS & HILL, Inc.

Consulting Engineers

Systems Engineering

Operations Research • Development
Field Studies • Design • Procurement
Power • Transportation • Communications
Water Supply • Waste Treatment

393 Seventh Avenue New York 1, N. Y.

SEARCHLIGHT SECTION

(Classified Advertising)

BUSINESS OPPORTUNITIES

EQUIPMENT - USED or RESALE

DISPLAYED RATE

The advertising rate is \$27.75 per inch for all advertising appearing on other than a contract basis. Contract rates quoted on request. An ADVERTISING INCH is measured 1/8 inch vertically on one column, 3 columns—30 inches—to a page. EQUIPMENT WANTED or FOR SALE ADVERTISEMENTS acceptable only in Displayed Style.

UNDISPLAYED RATE

\$2.70 a line, minimum 3 lines. To figure advance payment count 5 average words as a line. BOX NUMBERS count as one line additional in undisplayed ads.

FOR RESEARCH — DEVELOPMENT & EXPERIMENTAL WORK

Over 10,000 different electronic parts: waveguide, radar components and parts, test sets, pulsed, antennas, pulse xmts, magnetrons, IF and pulse amplifiers, dynamotors, 400 cycle xmtrs, 584 ant. pedestals, etc.

PRICES AT A FRACTION OF ORIGINAL COST!
COMMUNICATIONS EQUIP CO.

343 CANAL ST., N. Y. 13, WO 6-3045

CHAS. ROSEN (Formerly at 181 Liberty St.)

CIRCLE 950 ON READER SERVICE CARD

OVER 2,000,000

RELAYS IN STOCK!

Send for Catalog 55

Universal RELAY CORP.

42 WHITE ST., N.Y. 13, N.Y. • Walker 5-6900

CIRCLE 951 ON READER SERVICE CARD

EXPLORE

COMMUNICATIONS AND
ELECTRONIC FRONTIERS AT



JANSKY & BAILEY

rapidly expanding division of
ATLANTIC RESEARCH
CORPORATION

Jansky & Bailey, for 30 years a trusted name in electronic communications, is expanding rapidly and offers outstanding career positions to qualified engineers. Our modern facilities are located in Alexandria, Virginia, a residential suburb of Washington, D. C.

SYSTEMS ENGINEER

Responsibilities include systems engineering and advanced techniques evaluation with particular emphasis on navigation, traffic control, communications, and electromagnetic warfare. BS or MS in EE or physics plus experience.

ANTENNA ENGINEER

To work under Project Director as lead engineer supervising a group concerned with shipboard antenna problems. Duties require knowledge and experience in antenna impedance, field strength measurements, and design of matching Networks in HF and UHF frequency range.

PRINCIPAL COMMUNICATIONS ENGINEER

Will direct programs involving communication circuits or systems. Position requires substantial experience in operation, design or evaluation of communication systems, as well as background in the inter-relations of antenna, transmitter, receiver, propagation, and terminal equipment.

ELECTRONICS ENGINEER

Will work with Test Manager on design, selection, modification and supervision of activity concerning instrumentation components and systems used in testing propulsion units. BS or MS in EE or physics and experience, preferably in the rocket instrumentation field.

INSTRUMENT ENGINEER

To work with Rocket Test Manager coordinating activities of instrumentation staff with other segments in the test group and throughout ARC. Responsibilities include design, selection, modification and operation of instrument components and systems used in static testing of propulsion units. BS or MS in EE or physics and several years' experience.

Send resume to:

Director, Professional Personnel

ATLANTIC RESEARCH
CORPORATION

Alexandria, Virginia

A residential suburb of Washington, D. C.

An equal opportunity employer.

ELECTRONIC ENGINEERS

assignments in engineering ingenuity

If you prefer problems to policy, challenges to conformity, there's growth ahead for you at Republic. Assignments are varied — many on advanced manned aircraft, some on next-generation vehicles. All are an open door to participation in Republic's growing role in aerospace. And to further accelerate personal growth, graduate study with generous company support is available right next door. Brooklyn Polytechnic's Graduate School adjoins Republic's facilities.

IMMEDIATE OPENINGS IN THESE AREAS:

FIRE CONTROL — 3 yrs. exp. Development, design and/or testing of radar and fire control systems.

ELECTRONIC SYSTEMS — 3 yrs. exp. Development, design and/or testing of air data computer, gyro reference table, integrated instrument systems.

DOPPLER SYSTEMS — 3 yrs. exp. Development, design and/or testing of Doppler navigation systems. Analog or digital exp.

COMMUNICATION SYSTEMS — 3 yrs. exp. Development, design of modern airborne communications systems. Troubleshooting exp. desired.

NAVIGATION SYSTEMS — 3 yrs. exp. Development and design of Doppler, inertial guidance and radio systems for airborne applications.

AEROSPACE GROUND SUPPORT — 3 yrs. exp. Design and development of electronic test equipment for airborne vehicles.

ELECTRONIC WEAPONS SYSTEMS — 10 yrs. combined exp. in radar, navigation, automatic flight controls, aircraft power systems, aircraft instruments.

SYSTEMS INTEGRATION — 3 yrs. exp. Aircraft or missile electrical or electronic systems analysis, performance and/or subsystem integration.

ELECTRONIC FIELD ENGINEERS — 3 yrs. exp. installation, test and automatic checkout of electrical or electronic systems. Assignments to East or West Coast and overseas.

ANTENNAE AND RADOME — 3 yrs. exp. Development, design and/or testing of radar antennae and radomes.

ELECTRONIC INSTRUMENTATION — 3 yrs. exp. in design and test using oscilloscope, strain gauge, temperature, pressure, potentiometer and synchro techniques.

ELECTRONIC TEST — 3 yrs. exp. Analysis and test of advanced electronic systems: radar, communications, navigation and identification.

CIRCUIT DESIGN — 3 yrs. exp. Aircraft systems interconnections, power generation, distribution, communication, navigation, fire control, autopilot. Must know HIAD requirements and MIL specs.

INSTRUMENTATION — Exp. airborne oscillographic, photorecording, tape-recording, telemetering systems, ground reception, data handling and conversion systems.

Write, including salary requirements, to
Mr. James Hunter
Professional Employment, Dept. 11H-4

REPUBLIC AVIATION CORPORATION

FARMINGDALE, LONG ISLAND, NEW YORK
An Equal Opportunity Employer

INDEX TO ADVERTISERS

Aerocom	15
Air Express	27
Air Products & Chemicals, Inc.	58
American Bosch Arma Corp. Arma Div.	70
Ampex Corporation	25
Beattie-Coleman Inc.	50
Bendix Corporation Scintilla Division	13
Boeing Co., The	59
Cubic Corp.	49
• Datapulse Inc.	63
Delco Radio	61
duPont de Nemours & Co., Inc. E. I.	6
Electronic Engineering Co. of Calif.	26
General Dynamics/Electronics	18, 19
General Electric Co. Silicone Products Dept.	28
Globe Industries Inc.	51
Heinemann Electric Co.	23
• Hewlett-Packard Company	Inside front cover
• Hitachi, Ltd.	67
Honeywell Precision Meter Div.	65
Hughes Aircraft Co.	62
Aerospace Divisions	71
International Telephone and Telegraph Corp. Kellogg Division	54
Kintel, A Division of Cohu Electronics Inc.	3rd cover
Littlefuse	57
• Litton Industries Electron Tube Div.	26
Mitsumi Electric Co., Ltd.	69
Motorola Semiconductor Products Inc.	53
Nexus Research Laboratory Inc.	69
Polaroid Corp.	47
Potter Instrument Co., Inc.	17
Precision Instrument Co.	55
• Radio Corporation of America ...	4th cover
Sprague Electric Co.	4, 9, 24
Superior Cable Corp.	64
Telrex Laboratories	69
Texas Instruments Incorporated Semiconductor/Components Division	10, 11
Tung-Sol Electric, Inc.	5
• Vitro Electronics	68
PROFESSIONAL SERVICES	75
CLASSIFIED ADVERTISING	
F. J. Eberle, Business Mgr.	
EMPLOYMENT OPPORTUNITIES ..	73-75
EQUIPMENT (Used or Surplus New) For Sale	75
INDEX TO CLASSIFIED ADVERTISERS	
Atlantic Research Corp.	75
Atomic Personnel Inc.	73
Avco Research & Advanced Develop- ment Division of Avco Corporation	74
• Communications Equipment Co.	75
Esquire Personnel Service Inc.	74
F & M Scientific Corp.	74
Jet Propulsion Laboratory	73
McDonnell	73
Microwave Services International Inc. Republic Aviation Corporation Missile Systems Division, Mineola, NY	74
Republic Aviation Corp. Farmingdale, NY	73
• Universal Relay Corp.	75
• See advertisement in the July 25, 1962 issue of Electronics Buyers' Guide for complete line of products or services.	

This Index and our Reader Service Numbers are published as a service. Every precaution is taken to make them accurate, but electronics assumes no responsibilities for errors or omissions.

electronics



Audit Bureau
of Circulations

Associated Business
Publications

Audited Paid Circulation

JAMES T. HAUPTLI

Advertising Sales Manager

R. S. QUINT:
Assistant Publisher Buyers'
Guide and Business Manager
FRED STEWART:
Promotion Manager
B. ANELLO:
Market Services Manager

RICHARD J. TOMLINSON:
Production Manager
GEORGE E. POMEROY:
Classified Manager
HUGH J. QUINN:
Circulation Manager

ADVERTISING REPRESENTATIVES

ATLANTA (9):
Michael H. Miller, Robert C. Johnson
1375 Peachtree St. N.E., Trinity 5-0523
(area code 404)

BOSTON (16):
William S. Hodgkinson, Donald R. Furth
McGraw-Hill Building, Copley Square,
Congress 2-1160 (area code 617)

CHICAGO (11):
Harvey W. Wernecke, Robert M. Denmead
645 North Michigan Avenue, Mohawk 4-5800
(area code 312)

CLEVELAND (13):
Paul T. Fegley
55 Public Square, Superior 1-7000
(area code 216)

DALLAS (1):
Frank Le Beau
The Vaughn Bldg., 1712 Commerce St.
Riverside 7-9721 (area code 214)

DENVER (2):
J. W. Patten
Tower Bldg., 1700 Broadway,
Alpine 5-2981 (area code 303)

HOUSTON (25):
Joseph C. Page, Jr.
Prudential Bldg., Halcombe Blvd.,
Riverside 8-1280 (area code 713)

LOS ANGELES (17):
Peter S. Carberry, Ashley P. Hartman
1125 W. 6th St., Huntley 2-5450
(area code 213)

NEW YORK (36):
Donald H. Miller, Henry M. Shaw,
George F. Werner
500 Fifth Avenue, LO-4-3000
(area code 212)

PHILADELPHIA (3):
Warren H. Gardner, William J. Boyle
6 Penn Center Plaza, LOcust 8-4330
(area code 215)

SAN FRANCISCO (11):
R. C. Alcorn
255 California Street, Douglas 2-4600
(area code 415)

LONDON W1:
Edwin S. Murphy Jr.
34 Dover St.

FRANKFURT/Main:
Matthée Harfurth
85 Westendstrasse

GENEVA:
Michael R. Zeynel
2 Place du Port

"Headquarters for Business Information"

McGraw-Hill Technical and Business Publications

American Machinist/Metal-
working Manufacturing
Aviation Week and Space
Technology
Business Week
Chemical Engineering
Chemical Week
Coal Age
Construction Methods and
Equipment
Construction Daily
Control Engineering
Electrical Construction
and Maintenance
Electrical Merchandising Week
Electrical Newsletter
Electrical West

Electrical Wholesaling
Electrical World
Electronics
Engineering Digest
Engineering and Mining Journal
E & MJ Metal and Mineral
Markets
Engineering News-Record
Factory
Fleet Owner
Industrial Distribution
National Petroleum News
Nucleonics
Nucleonics Week
Platt's Oilgram News
Platt's Oilgram Price Service
Power

Product Engineering
Purchasing Week
Science Week
Textile World

Overseas only:
Automobile International
(English, Spanish)
Ingenieria Internacional
Construccion (Spanish)
International Management
(English, Spanish)
Portuguese editions)
Metalworking Production
(Great Britain)

Available by subscription only — to qualified persons actively engaged in the field of the publication. For subscription rates and information describing the editorial coverage of any of the above publications, write to: Subscription Manager, Circulation Department, McGraw-Hill Publishing Company, 330 West 42nd Street, New York 36, N. Y.

Closed circuit TV systems go modern!
KIN TEL puts TV on a production-line basis...now carries 207 separate TV components and accessories in stock!
This means you can order a proven, completely checked-out system to handle any job, and - for standard applications - get delivery within 14 days!



KIN TEL's 1995 TV System



KIN TEL's 20/20 TV System

2 BASIC KIN TEL TV SYSTEMS

The 1995 system is designed for continuous-duty operation under the most adverse conditions. Consists of an electronic solid state camera assembly in a protective cylindrical housing; a separate, rack mount camera control of modular construction that may be located up to 2000 feet from the camera; and any number of monitors. Extremes of temperature, moisture, noise, vibration, shock, acceleration, altitude, or dynamic pressure will not affect camera operation. Provides full 700-line horizontal resolution with GRM-series monitors.

The 20/20 system consists of a self-contained camera that provides clear, 650-line resolution pictures and works with any TV monitor—with accessory, you can even use the TV receiver you have in your home. So sensitive, you get usable pictures with less light than is falling on this page. Low, 25 watt power consumption; easy-to-service, swing-out circuit boards; and transistor circuits make for trouble free operation.

TYPICAL ACCESSORIES:

A wide variety of accessories for both systems lets you "custom build" a TV system to fit your particular needs, no matter how involved. For example: a light compensation circuit adjusts the camera for light variations as great as 4000:1. Motors provide remote control of the lens turret focus, and a lens-speed filter. Sync generators provide 2:1 interlace either in the standard E.I.A. sweep/scan pattern or in the *Fineline* pattern that gives you greatly increased vertical resolution. A Westinghouse PERMACHION tube lets you retain the image at any time for up to 5 minutes. Pan/tilt units permit remote control of camera to cover subject action on horizontal or vertical planes.

At no obligation, KIN TEL engineers will determine if a TV system can be put to profitable use in your application. Write direct for our detailed catalog and name of closest KIN TEL representative. There's one in every major city.

5725 Kearny Villa Road, San Diego 12, California • Phone 277-6700 (Area Code 714)



CIRCLE 901 READERS SERVICE CARD

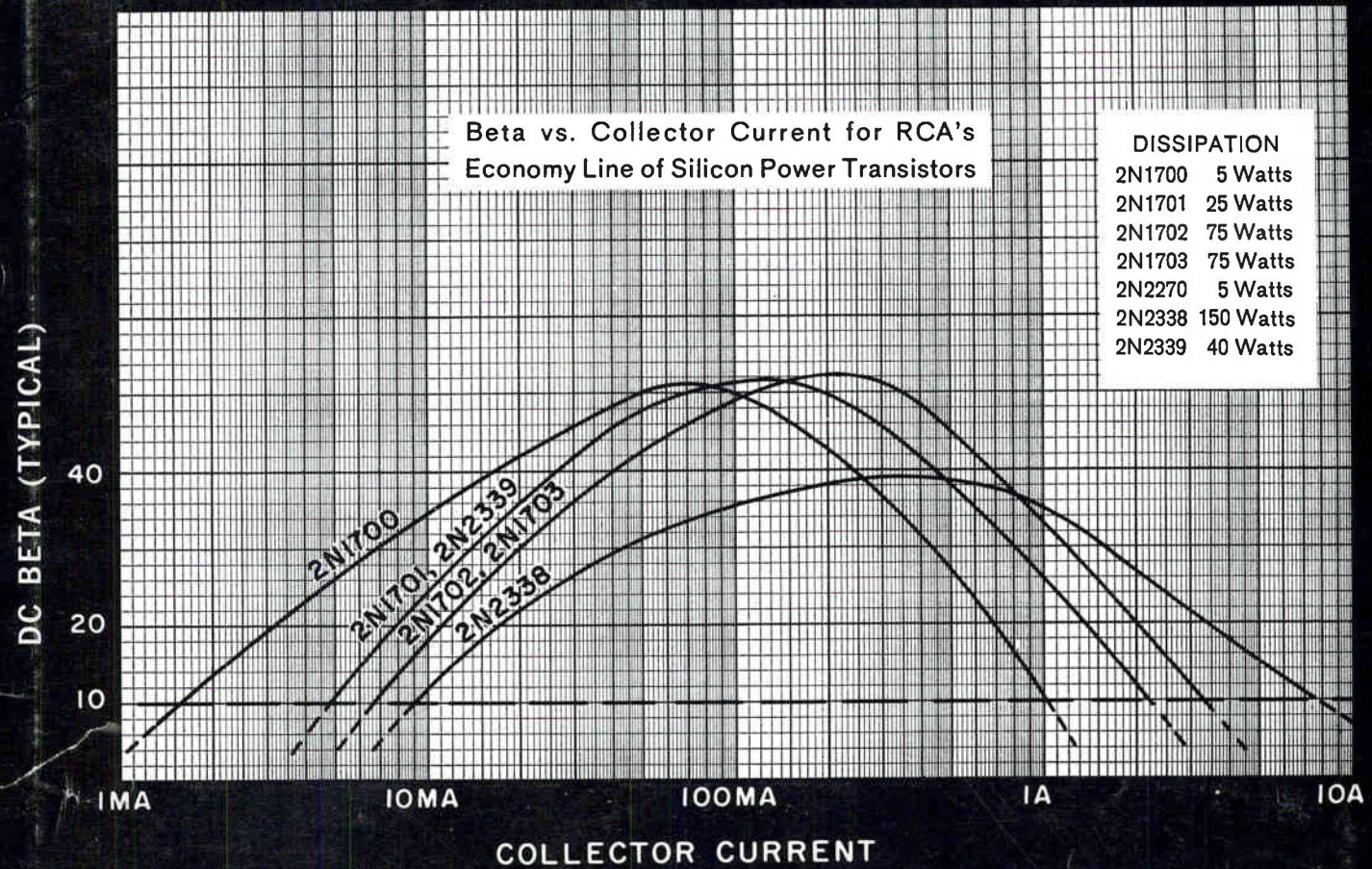

RCA EXPANDS ECONOMY SILICON-LINE FOR LOW COST DESIGN FLEXIBILITY UP TO 150 WATTS

Now, RCA adds 3 new types, 2N2338, 2N2339, 2N2270 to its line-up of low-cost silicon transistors at prices starting as low as comparable Germanium Power Types.

Here's RCA's answer to today's value and performance requirements for industrial and military applications... a broad new economy line of silicon transistors. This low-cost, high performance line now includes three new types, 2N2338 and 2N2339, high and medium power types, respectively, and the 2N2270, RCA's new economy version of the "Universal" triple-diffused planar silicon transistor type 2N2102. With these additions, RCA's economy silicon line now offers:

- High dissipation... up to 150 watts
- Top performance at high temperatures... up to 200°C
- Wide-range beta control... up to 10 amps

These low-cost silicon types are immediately available to bring you new economy and greater design freedom for industrial and military circuits demanding the reliability and performance of silicon transistors.

AVAILABLE THROUGH YOUR RCA DISTRIBUTOR



New RCA 2N2270
Triple-Diffused Planar

New 150-watt
RCA 2N2338

New 40-watt
RCA 2N2339

For new low prices call your RCA representative today. For FREE Technical Bulletin on RCA's Economy Silicon Line, write RCA Semiconductor and Materials Division, Commercial Engineering, Section AN8-3, Somerville, N. J.



FIELD OFFICES...

EAST: Newark, N. J., 744 Broad St., HU 5-3900 • (Camden-Philadelphia Area) Erlton, N. J., 605 Marlton Pike, HA 8-4802 • Syracuse, N. Y., 731 James St., Rm. 402, GR 4-5591 • Baltimore, Md., EN 9-1850 • NORTHEAST: Needham Heights 94, Mass., 64 "A" St., HI 4-7200 • SOUTHEAST: Orlando, Fla., 1520 Edgewater Dr., Suite #1, GA 4-4768 • EAST CENTRAL: Detroit 2, Mich., 714 New Center Bldg., TR 5-5600 • CENTRAL: Chicago, Ill., Suite 1154, Merchandise Mart Plaza, WH 4-2900 • Indianapolis 5, Ind., 2132 East 52nd St., CL 1-1405 • Minneapolis 16, Minn., 5805 Excelsior Blvd., WE 9-0676 • Denver 11, Colorado, Continental Terrace Bldg., Suite 301, 2785 N. Speer Blvd., 477-1688 • WEST: Los Angeles 22, Calif., 6801 E. Washington Blvd., RA 3-8361 • (San Francisco Area) Burlingame, Calif., 1838 El Camino Real, OX 7-1620 • Seattle 4, Wash., 2250 First Ave. S., MA 2-8816 • SOUTHWEST: Dallas 7, Texas, 7905 Carpenter Freeway, ME 1-9720 • GOVT: Dayton, Ohio, 224 N. Wilkinson St., BA 6-2366 • Washington, D. C., 1725 "K" St., N.W., FE 7-8500 • RCA INTERNATIONAL DIV., 30 Rockefeller Plaza, N. Y. 20, N. Y. Cable Address: RADIOINTER, N. Y.



THE MOST TRUSTED NAME IN ELECTRONICS

CIRCLE 902 READERS SERVICE CARD