

electronics

OPTICAL SUPERHETS

*Phototube demodulates
laser signals, p 37*

TWO-WAY DOPPLER

*Doubles satellite
tracking accuracy, p 42*

TELEVISION TRANSMITTERS

*Designing a built-in
sideband filter, p 53*



BORESIGHTING antenna for radar cross-section measurements. But how good will they be?

ROLAND KISSLER
BOX 956
NOSES LAKE WASH
L 11-



**PIONEERS IN
MINIATURIZATION**

NEW PIP SERIES

ULTRAMINIATURE TRANSISTOR PULSE TRANSFORMERS

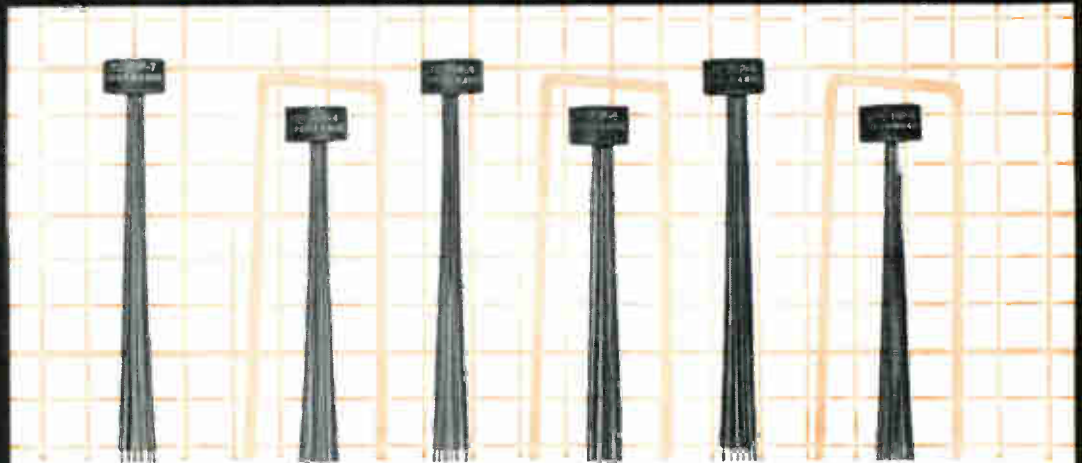

UNITS SHOWN ACTUAL SIZE—IMMEDIATE DELIVERY FROM STOCK

TRANSISTOR TEST CIRCUIT

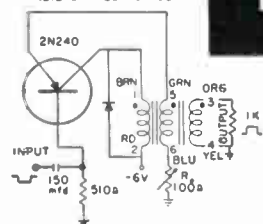

All units individually checked and adjusted, in transistor circuit illustrated, to parameters in table.

DEFINITIONS

Amplitude: Intersection of leading pulse edge with smooth curve approximating top of pulse.
Pulse width: Microseconds between 50% amplitude points on leading and trailing pulse edges.
Rise Time: Microseconds required to increase from 10% to 90% amplitude.
Overshoot: Percentage by which first excursion of pulse exceeds 100% amplitude.
Droop: Percentage reduction from 100% amplitude a specified time after 100% amplitude point.
Backswing: Negative swing after trailing edge as percentage of 100% amplitude.

- MIL type TP6RX4410CZ — METAL CASED
- Manufactured & Guaranteed to MIL-T-21038
- 5/16" Dia. x 3/16" Ht.; Wt. 1/20 oz.
- Ratio 4:4:1
- Anchored leads, withstands 10 lb. pull test
- Printed circuit use, plastic insulated leads
- Can be suspended by leads or clip mounted

Type No.	APPROX. DCR, OHMS			BLOCKING OSCILLATOR PULSE					COUPLING CIRCUIT CHARACTERISTICS						
	1-Brn 2-Rd	3-Org 4-Yel	5-Grn 6-Blu	Width μ Sec.	Rise Time	% Over Shoot	Droop %	% Back Swing	P Width μ Sec.	Volt Out	Rise Time	% Over Shoot	Droop %	Back Swing	Imp. in, out,
PIP-1	.18	.20	.07	.05	.02	0	0	37	.05	9	.018	0	0	12	50
PIP-2	.47	.56	.17	.1	.025	0	0	25	.1	8	.02	0	0	5	50
PIP-3	1.01	1.25	.37	.2	.030	2	0	15	.2	7	.035	0	0	5	100
PIP-4	1.5	1.85	.54	.5	.05	0	0	15	.5	7	.06	0	0	0	100
PIP-5	2.45	3.1	.9	1	.08	0	0	14	1	6.8	.15	0	0	5	100
PIP-6	3.0	3.7	1.1	2	.10	0	0	15	2	6.6	.18	0	2	10	100
PIP-7	4.9	6.05	1.8	3	.20	0	0	14	3	6.8	.20	0	2	10	100
PIP-8	8.0	9.7	2.9	5	.30	0	0	3	5	7.9	.22	0	13	25	200
PIP-9	13.1	15.9	4.7	10	.35	0	5	12	10	6.5	.4	0	15	20	200

PIP-100 Transistor pulse transformer kit, consisting of PIP-1 thru PIP-9 in plastic case.

**AND CUSTOM BUILT
UNITS TO YOUR SPECS.**

Write for catalog for full details on these and 1000 other stock items



UNITED TRANSFORMER CORP.

150 VARICK STREET, NEW YORK 13, N. Y.

PACIFIC MFG. DIVISION: 3630 EASTHAM DRIVE, CULVER CITY, CALIF.

EXPORT DIVISION: 13 EAST 40th STREET, NEW YORK 16, N. Y. CABLES: "ARLAB"

electronics

A McGraw-Hill Publication 75 Cents



W. W. MacDONALD, Editor

J. M. CARROLL, Managing Editor
 SENIOR EDITORS: Samuel Weber, George W. Sideris. SENIOR ASSOCIATE EDITOR: Michael F. Wolff. ASSOCIATE EDITORS: Michael F. Tomaino, Sylvester P. Carter, William P. O'Brien, John F. Mason, Thomas Emma, Sy Vogel, Leslie Solomon, George J. Flynn, Laurence D. Shergalis. ASSISTANT EDITORS: Nilo Lindgren, Stanley Froud, Stephen B. Gray, Roy J. Bruun, George V. Navatny, Leon H. Dulberger. REGIONAL EDITORS: Harold C. Hood (Pacific Coast, Los Angeles), Thomas Maguire (New England, Boston), Cletus M. Wiley (Midwest, Chicago). ART DIRECTOR: Harry Phillips; Howard R. Berry. PRODUCTION EDITOR: John C. Wright, Jr. EDITORIAL ASSISTANTS: Gloria J. Meurer, Bernice Duffy, Lorraine Rossi, Virginia T. Bastian, Lynn Emery, Bette H. Snyder, Rosemary Abbruzzese, Judy Haskins, Ann Mella, Lorraine Werner. FOREIGN NEWS BUREAU: Director, John Wilhelm, Alyne Elias. LONDON — John Shinn, Derek Barlow, Nicholas Landon. Bonn—Peter Forbath, Silke McQueen. Paris—Robert Farrell, Arthur Erikson. Milan—Marc A. Messina. Mexico City—Bruce Bendow. Rio de Janeiro—Leslie Warren. Moscow — Stewart Ramsey. Tokyo — Richard Halloran, Charles Cohen, John Yamaguchi.

JAMES GIRDWOOD, Publisher

BORESIGHTING an antenna on Cornell Aeronautical Laboratories radar range. *Targets for radar cross-section measurements are suspended within a huge hangar whose interior walls are coated with microwave absorbent material. See p 48*

COVER

HOW H-BLAST AFFECTED Communications Links. Scientists were surprised at the short-duration effects the recent blast had on radio communications. *Trans-Pacific services were never completely out*

20

DOPPLER LASER Measures Speed Down to 0.00004 MPH. Closing speed between two satellites can now be measured from 3 miles per second down to 1/1,000 of an in. per sec. *Sperry says the gas laser with a 1-meter diameter mirror will illuminate an 1,850-ft area on the Moon*

26

CANADA ELECTRONICS Wary of Import Squeeze. Some radio and tv manufacturers advocate raising protective tariffs. Others say defense equipment must be produced in Canada to the greatest extent possible. *One thing certain: R&D efforts will be stepped up*

27

ADAPTIVE AUTOMATIC CONTROL Stressed at JACC Meeting. Survey shows extent, and area of, effort of U.S. research on automatic control. *Scientist predicts that "in ten years, at least 75 percent of computer engineers will be working on learning machines"*

28

TELSTAR SUCCESS Clinches NASA Budget for Communications Satellites. Excellent performances Telstar put on between France, England and the U.S. scrubbed any lingering doubt about feasibility of world-wide tv. *NASA will spend \$85 million on communications satellites in 1963*

30

THE MICROWAVE PHOTOTUBE: New Detector for Optical Receivers. Experimental X-band phototubes detect microwave modulation and mix modulated with unmodulated laser light beams. *They make superheterodyne optical receivers possible.*

By R. G. E. Hutter, Sylvania

37

DOUBLE TRACKING ACCURACY With a Two-Way Doppler System. Radar System beams a C-W signal to a satellite that multiplies the signal frequency and retransmits it. *System doubles the accuracy of one-way doppler systems in finding launch trajectory and orbit.* By J. A. Huie, General Dynamics

42

ELIMINATING ONE-COUNT UNCERTAINTY in Cycle-Counting Interval Timers. When you chop up continuous time into discrete intervals there is always doubt whether an event occurs in one or another of two adjacent intervals. *Here a tunnel diode, delay line and crystal oscillator resolve this uncertainty.*

By W. O. LeCroy, Jr., Columbia University

46

Contents continued

Published weekly, with Electronics Buyers' Guide and Reference issue, as part of the subscription, by McGraw-Hill Publishing Company, Inc. Founder: James H. McGraw (1860-1948).

Indexed Annually in Buyers' Guide and Reference Issue.

Title ® registered U.S. Patent Office; © copyright 1962 by McGraw-Hill Publishing Co., Inc. All rights reserved, including the right to reproduce the contents of this publication, in whole or in part.

Executive, editorial, circulation and advertising offices McGraw-Hill Building, 330 West 42nd Street, New York 36, N. Y. Telephone Longacre 4-3000. Teletype TWX N.Y. 1-1636. Cable McGrawhill, N. Y. PRINTED IN ALBANY, N. Y.; second class postage paid at Albany, N. Y.

OFFICERS OF THE PUBLICATIONS DIVISION: Nelson L. Bond, President; Shelton Fisher, Wallace F. Traendly, Senior Vice Presidents; John R. Callahan, Vice President and Editorial Director; Joseph H. Allen, Vice President and Director of Advertising Sales; A. R. Venezian, Vice President and Circulation Coordinator; Daniel F. Crowley, Vice President and Controller.

OFFICERS OF THE CORPORATION: Donald C. McGraw, President; Hugh J. Kelly, Harry L. Waddell, Executive Vice Presidents; L. Keith Goodrich, Executive Vice President and Treasurer; John J. Cooke, Vice President and Secretary.

Subscriptions are solicited only from those actively engaged in the field of the publication. Position and company connection must be indicated on orders. Subscription rates: United States and Possessions, \$6.00 one year; \$9.00 two years; \$12.00 three years. Canada, \$10.00 one year. All other countries \$20.00 one year. Single Copies, United States and Possessions and Canada 75¢. Single copies all other countries \$1.50.

THE PUBLISHER, UPON WRITTEN REQUEST FROM ANY SUBSCRIBER TO OUR NEW YORK OFFICE, AGREES TO REFUND THAT PART OF THE SUBSCRIPTION PRICE APPLYING TO COPIES NOT YET MAILED.

Subscribers: Please address all correspondence, change of address notices, subscription orders or complaints to Fulfillment Manager, Electronics, at above address. Change of address notices should provide old as well as new address, including postal zone number if any. If possible, attach address label from recent issue. Allow one month for change to become effective.

Postmaster: Please send Form 3579 to Fulfillment Manager, Electronics, 330 West 42nd Street, New York 36, New York.



Audited Paid Circulation

CONTENTS continued

RADAR CROSS-SECTION MEASUREMENTS: How Good Are They? They are essential for good radar systems design but house flies, June bugs, grass and weeds on the radar range can ruin man's best laid plans, as can the threads that support targets. *This article tells how to compensate for common interfering objects.* By L. Solomon 48

MODERN TELEVISION TRANSMITTERS and Their Design Problems. Conventional transmitters require addition of vestigial sideband filter that is often bulky, physically separated from the transmitter and hard to tune. *But the sideband filter can be incorporated within a band-pass filter that forms part of the plate load.* By W. Roos, Brown Boveri 53

DEPARTMENTS

Crosstalk. <i>What the Russians Are Up To</i>	3
Comment. <i>Frequency Effects</i>	4
Electronics Newsletter. <i>New Tax Deductions Rule Benefits Industry</i>	7
Washington Outlook. <i>Missile X Plans Still Hazy</i>	12
Meetings Ahead. <i>AIEE On-Line Data Processing Application Sessions</i>	32
Research and Development. <i>Ion Orbs Warn of Excessive R-F Field Strength</i>	58
Components and Materials. <i>Will Irradiation Really Improve Transistors?</i>	66
Production Techniques. <i>Packaging Methods for Thin Films</i>	72
New Products Design and Application. <i>Infrared Camera Uses High Resolution Scanning</i>	78
Literature of the Week	89
People and Plants. <i>NCR To Expand Dayton R&D Center</i>	90
Index to Advertisers	95

What the Russians Are Up To

WHY HAVE THE SOVIETS turned from spectacular 'prestige' space shots to more scientifically oriented satellites? And what motivates their recent interest in international cooperation?

Possible answers to these questions have recently been presented to the Senate Committee on Aeronautical and Space Sciences in a 360-page report prepared by the Legislative Reference Service of the Library of Congress. The report, entitled "Soviet Space Program: Organization, Plans, Goals, and International Implications," is based on open sources.

SOME OF THE ANSWERS suggest that the two Soviet actions serve the same end.

Possible reasons offered in the report for the "shift from grandiose 'prestige' shots" to the recent series of six Cosmos scientific satellites include: (1) the high cost of prestige shots motivated the shift to cheaper satellites; (2) a smaller military booster tested in the Pacific has made possible acquisition of scientific data at lower costs; (3) tv cameras are being tested for weather or reconnaissance to catch up with us in these areas; (4) scientific data are being gathered to prepare for more manned flights.

Any one, or all of these, may be the answer. The Russians have indicated that the series is to further manned flight. This may well be true. During the four-year absence of satellites their information input came from their own sounding rocket program and from published data on our scientific satellite program. Both sources may have proved limited.

ANOTHER POSSIBILITY offered by the report is that the Russians may have upgraded the prestige value of practical application satellites. The interest underdeveloped nations have expressed in communications and weather satellites "has not escaped Soviet attention." Getting into the act on a cooperative basis with us would serve several ends: they could reap some of the rewards of our long and expensive spade work in this area and share the bows when a system becomes operational—this is reminiscent of their timely declaration of war on Japan near the end of World War II.

Besides the low cost and quick acquisition of scientific data that would come from joining us in space work, they could also enhance their

party line of "peaceful pursuits in space." According to the report, "cooperation in space" is another form of "peaceful coexistence" to promote the image of the "peace-loving state."

Nowhere is the political theme neglected. Working on the assumptions that scientific progress is the road to utopia and that no vehicle holds the road like communism, the Soviets herald each space success as proof of both assumptions.

A good indication of Soviet activity in development of military space weapons is revealed by the usual Soviet pattern of projecting on to us what they themselves are up to. Their "dedication to the peaceful uses of space" is becoming more vocal and their self-righteous accusations of our "military plans in space" more vehement. The report quotes Soviet Colonel Larionov, who manages to put across the Soviets' intentions in space by citing the need to counter "the Americans' feverish . . . arms race in outer space." When the Soviets eventually admit to their own space weapons, they will, as usual, describe them as protective measures against the "paranoic" designs of the capitalist countries, or America's "obsessive magalomania." Whether this constant preparation against "threats" is sincere paranoia or conscious propaganda is difficult to say.

A HOPEFUL NOTE is offered in one psychological interpretation of their interest in space cooperation. The Soviets' inferiority complex has been alleviated in the field of space, where they have obviously done well. Therefore in this area—as in the arts—they feel less suspicion and are less reluctant to cooperate with outsiders.

Actively helping the Soviets to gain proficiency in more areas, with the hope that less inferiority complex would result in less suspicion and more normalcy, is a provocative idea. Such altruistic therapy would be very appealing if it were not for the possibility of the patient's suddenly producing a zip gun just when we thought he was well.

The safest attitude to take in entering into any cooperative efforts with the Soviets is to make sure we are fully aware of what we are doing, what the Soviets are doing and why, and continue to be prepared for zip guns.

NEW! FACILOGIC BY H-K FOR DIGITAL SYSTEMS BREADBOARDING

FaciLOG modules provide a new simplified system for breadboarding, building specialized test equipment and training personnel...easily, sensibly and economically. FaciLOG offers: BUILT-IN INDICATOR LIGHTS show "logical state of circuit" ■ FRONT AND BACK PLUG CONNECTIONS Use front for breadboard and checkout...rear for semi-permanent wiring ■ "NO-MAZE" WIRING with modular construction ■ MIL SPEC SYMBOLS and simplified loading rules on front of each module. And 14 more exclusive features. Breadboard and checkout with FACILOG. Specify your system with H-K Encapsulated Logic Modules on FLEXI-CARD Assemblies.

Data Systems Division

harman kardon

Incorporated ■ Plainville, Long Island

Write for FREE guide to Boolean Algebra and complete FACILOGIC and exclusive "Lease-Loan" information. Dept. E-720

COMMENT

Frequency Effects

The recent controversy in *Comment* [p 4: Mar. 23, Apr. 6, May 4, May 25] concerning the retinal reaction to light, with one group holding that it was a chemical reaction initiated by light and the other group holding just as firmly that everything could be explained by electromagnetic reaction, started me thinking about material that I have been randomly gathering over many years and the many puzzling aspects presented by this material:

(1) The reaction of metallic halides to specific frequencies of light. All metallic halides (that is, the halides of all metals) prepared in the dark exhibit light sensitivity, and this sensitivity will vary with the frequency of the light. There does not, as far as I can see, seem to be any predictable relation between the light frequency and the specific reaction, unless the greater reaction speed toward the shorter wavelength direction could be considered a constant. But even this is doubtful, as the halide can be so treated that the reaction speed direction will be shifted toward another frequency band, as with the pincryptol dyes to produce so-called panchromatic film.

(2) The work that is being done in many places on the so-called "pearl chain" reaction at various frequencies, and the quite remarkable motion pictures that have been made by Hibbard in Massachusetts on the reaction of cytoplasmic granules in living organisms under varying frequencies. Particularly the portion of film that exhibits two motions in the same organism with two simultaneous different frequencies.

(3) The reaction of the crystalline lens of the eye under very weak high-frequency exposure.

(4) The recent publication of a note that the direct combination of hydrogen and carbon was effected by a relatively weak but high-frequency field.

(5) The change in metabolic activities of various microorganisms depending on the frequency of the light or field to which they are exposed.

In other words, a great many

people in a great many fields and many different places are nibbling on the edge of the problem of "What is the Specific Effect of Frequency in the Field to Which a Given Reaction is Exposed?" The problem is seldom expressed in this fashion, but if it is considered in the whole, I believe that this is the correct statement. I am not concerned by the overwhelming use of power in the field leading to heat reactions, but rather by specific frequency effects.

I think that the total problem has not been broached due to the very large outlay in equipment that would be necessary to cover the spectrum at any sort of reasonable narrow band from, say, 10 Mc to perhaps 10 Gc. Also, for any given reaction or cell structure, the amount of work represented is relatively enormous for any one person. So the job must be done by team work and even then it will take a great deal of time.

I cannot see any private group undertaking such a monumental task, but if some government office would get behind such an exploration, I believe that a whole new field of production is waiting to be tapped. If photosynthesis could be set up in a factory reaction vessel, think of the economy. Or if the combination of hydrogen and carbon can be controlled, think of the power source and with no dangerous waste products.

While everything I have mentioned has been concerned in the effect of a frequency field on a reaction, we also know that a great many reactions produce a frequency field as the reverse (apparently) side of the picture. However, there is some reason to think that perhaps this does not always represent a production, but rather a transformation from one level to another, usually lower. This aspect could be investigated at the same time as the forward-going one and with essentially the same equipment.

I hope that you do not get the idea that I am suggesting that there is any such thing as free power. All that I hope to see is a better utilization of what we have by perhaps by-passing some of the waste in our present set-up.

W. A. MOOR

Collinsville, Illinois

10,000 hours without parametric drift...



it's reliable!



solid state PORCELAIN CAPACITORS

- * low loss
 - * low noise
 - * greater stability
- * wide temperature range
 - * impervious to humidity

-55°C to +125°C operation
0.5 mmf to 6800 mmf
50 to 500 vdc
Conforms to MIL-C-11272B

© Vitramon, Inc. 1962

Punishing life tests under both accelerated and long term conditions have verified the reliability of "VY" Capacitors for use over extended periods of time. After an accelerated test of 10,000 hours at 125°C with 150% of rated voltage applied (equivalent to a 5-year test at maximum rated conditions) Dissipation Factor was .00203 and Insulation Resistance 10^{10} . After a long term test of 30,000 hours at 25°C and rated voltage, Dissipation Factor was .00072 and Insulation Resistance 100 ohm farads. In actual application, "VY" Capacitors designed into VANGUARD II are still performing after more than two years in orbit.

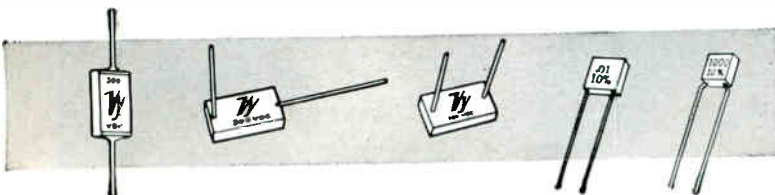

Vitramon[®]
INCORPORATED

Box 544 • Bridgeport 1, Connecticut

Now! The AMPin-cert* DUO-TYNE* Leaf Connector . . . so adaptable it offers virtually unlimited application possibilities. Individually housed contacts snap-mount into aluminum plates which can be designed to most any size or configuration imaginable. Makes no difference whether you need 10, 20, 40, 100 . . . 1,000 or more positions in modular construction connectors. Any way you adapt it, the AMPin-cert DUO-TYNE Leaf Connector will be right at home. To make doubly sure that it's right for you, the AMPin-cert DUO-TYNE Leaf Connector uses special A-MP* crimp-type, snap-in contacts. These contacts, originally designed to meet the stringent application requirements in atomic submarines, provide unmatched electrical qualities. The unique shape of the female contact creates pressure-spring mating with the flat male tab (.031 x .082) . . . provides enlarged redundant areas of contact . . . and insures greatly increased wiping action for maximum conductivity. And these are but a few of the advantages. Check these additional AMPin-cert DUO-TYNE Leaf Connector features:

- Precision-engineered contacts applied by A-MP* automatic crimping machines on A-MP* hand tools guarantee the most reliable connections possible with the lowest applied costs in the industry.
- Rugged, shock resistant nylon housings provide high dielectric strength.
- Insulation support crimp eliminates small wire handling problems.
- Contacts are duplex-plated. Gold over nickel on a phosphor bronze base.
- Contacts hand-inserted, easily removed and reinserted. See how the AMPin-cert

DUO-TYNE Leaf Connector can be at home in your design plans. Send for more information.

AMP

INCORPORATED
Harrisburg, Pennsylvania

AMP products and engineering assistance are available through subsidiary companies in Australia • Canada • England
France • Holland • Italy • Japan • Mexico • West Germany

up for adaption

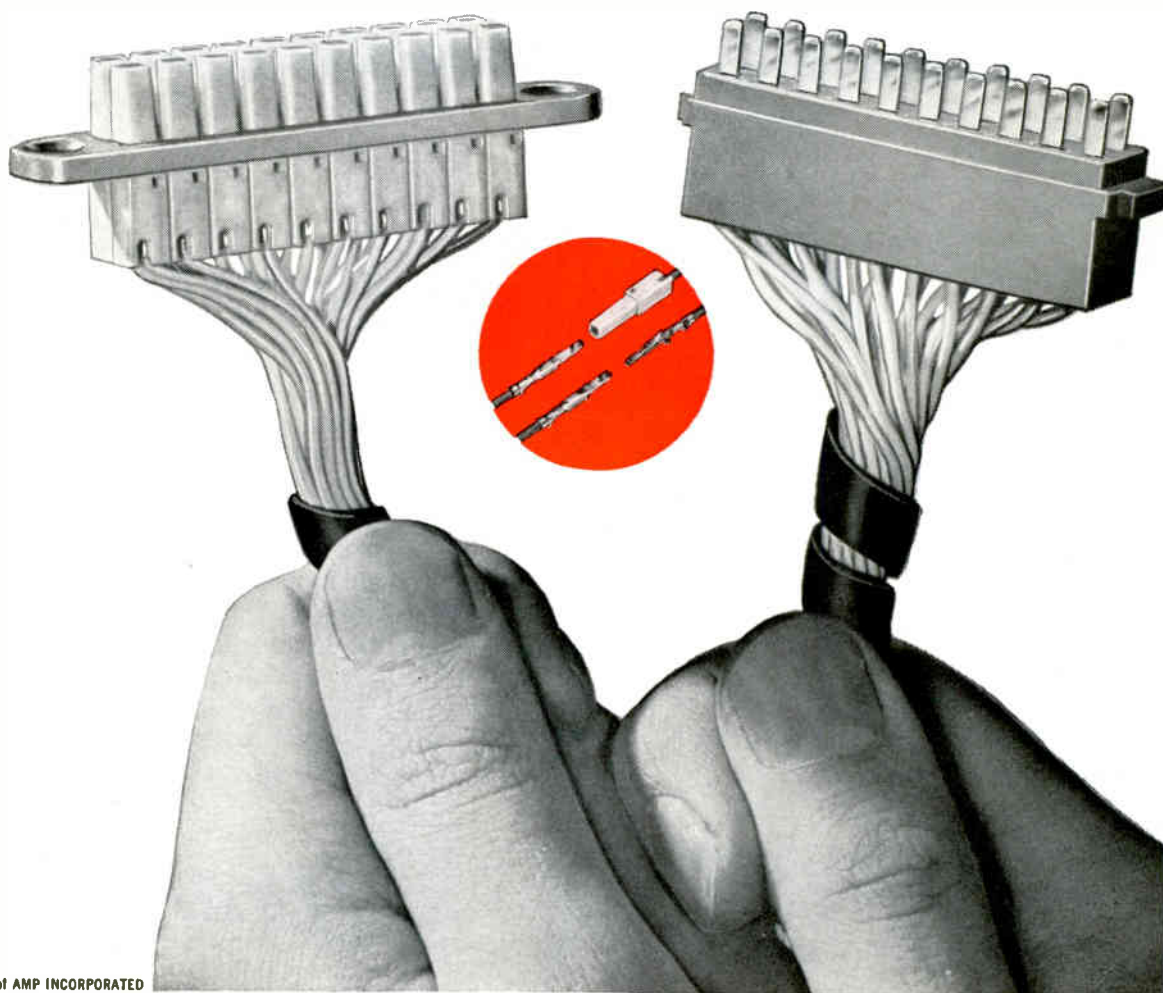

*Trademark of AMP INCORPORATED

ELECTRONICS NEWSLETTER

New Tax Deductions Rule Benefits Industry

WASHINGTON—Electronics companies are among the prime beneficiaries of the major tax reform made effective July 12 with the issuance of its new rules governing tax deductions business can take for depreciation of production equipment.

Now, an electronics producer may write off the cost of his production equipment over an 8-year period—giving the electronics industry for the first time an official guideline in this respect.

A company may set almost any depreciation rate it chooses—either faster or slower than the new rule book provides—providing, of course, that its replacement schedules conform to the allowances it is taking for tax purposes.

Microwave Component Sales Figures Solicited by EIA

WASHINGTON — Electronic Industries Association is asking microwave component makers to participate in a statistical program aimed at compiling sales data on 16 categories of microwave hardware. Included are isolators, circulators, attenuators, switches, harmonic generators, mixers and other components by material types such as ferrite and semiconductor. Research and development figures will also be collected. EIA members and non-members are being asked to participate by reporting quarterly dollar sales. They will receive consolidated industry figures in return.

Collection of the information is being handled by EIA's Marketing Services Department in Washington, D. C.

Japan Quotas on Radios To Hold Same Level

TOKYO—Japanese exports of radios with three or more transistors will be held to the same levels as last year. Agreement to this effect has been reached this week between Japan's Ministry of International Trade and the nation's electronics manufacturers. The pact is appli-

cable to all world areas with which Japan now trades including the United States.

"We have no thought of increasing the volume of transistor radio exports despite the strong trend in the U. S. towards slashing the price of American-made six-transistor radios," commented Misao Matsuda of the Japan Machinery Exporters Association. The JMEA director said that present export volumes were good and from all indications will remain so.

Optical Scanner Reads Handwritten Numbers

BEDFORD, MASS.—An experimental model of a numeric handwriting reader is undergoing evaluation

IRE Votes For IEEE Merger Seven To One

NEW YORK—IRE-AIEE merger was approved by IRE voters by a seven-to-one margin (ELECTRONICS, p 20, July 13). In favor were 87 percent (36,221), opposed were 13 percent (5,489). Sixty-seven percent of the 66,152 eligible members voted. The new Institute of Electrical and Electronic Engineers will have over 150,000 members.

The vote paved the way for the Implementation Committee to begin work on the actual merger. The last three of 14 members to be named to this committee are J. T. Henderson, Past IRE President; W. E. Peterson, Past Chairman of the Los Angeles IRE section; and J. D. Ryder, Past IRE President and Editor

testing at the Institute For Psychological Research at Tufts University. The model, developed by IBM, is the first step in a computer input system that will process information directly from blueprints, fingerprints, and biological specimens.

An optical scanner will read handwritten numerals on a card, then record them on another card in the form of punched holes. In recent tests, it was reported that 98.5 percent of the numerals were correctly read from widely differing handwriting styles. IBM said it will not market the experimental model.

Japan Space Plans Get Most Help From Industry

TOKYO—Japanese space survey by Japan Machinery Exporters Association indicates 59 percent of the nation's spending for space research has come from private companies. Of this portion, 30 percent has come from the electronics/electrical industry.

Industrial monetary contributions for space research were \$24 million in 1952, \$46 million in 1956, \$60 million in 1957, \$69 million in 1959 and \$94 million in 1960.

Additional contributions have been made to technical departments of universities for space research. The JMEA survey indicates that between Sept. 1959 and Sept. 1961, \$6,400,000 was contributed to universities by 198 companies.

Industry funds in Japan are being used in many projects including one to launch a communications satellite that will cover Asia and most of the U.S. Work related to this project includes developments in solar batteries, transmitting equipment and relay devices.

New Thermoelectric Generators Announced

THERMOELECTRIC GENERATORS, using bottled propane gas as the heat source, are now commercially available from Minnesota Mining and Manufacturing Co. A newly patented material, essentially a solid solution alloy of lead telluride and tin telluride, gives the generators

an efficiency below 10 percent. The 2, 4, 8 and 15-watt generators are priced at \$30 per watt, with larger sizes soon to be available. A similar generator using small nuclear Snap devices for heat has been tested in Navy Transit satellites. Further development of this generator is expected to be continued.

A reversible thermoelectric home cooler and heater, not yet developed for marketing, was introduced at the Housewares Show in Chicago by Arvin Industries. The 144-thermocouple built-in unit, about the size of a wall-type kitchen oven, has jets which blow hot or cold depending on selection. Cooling power is comparable to two-horsepower portable units, heating power comparable to 1,650-watt portable units, according to the developers.

Glass Scintillators In Cathode Ray Tubes

WASHINGTON—The feasibility of preparing glass scintillators for use as phosphors on the inside of cathode ray tube faces was described by British scientists at the Sixth International Congress on Glass. The technique, similar to that used in preparation of glass alpha detecting screens, calls for a thin (0.001-in.) layer of glass scintillator to be fused to a glass base plate of similar expansion characteristics. The scintillator is then overlaid with a thin coat of aluminum deposited by vacuum evaporation.

The scientists, from the British Scientific Instrument Research Association, said this technique would provide cathode ray screens capable of high definition images. The glass scintillator fibers offer an improvement in detection efficiency, they said.

X-20 Flight Simulator Contract is Awarded

LONG BRANCH, N. J.—A large-scale analog computer system for flight simulation of the X-20 (Dyna-Soar) program will be built by Electronic Associates, Inc. under a USAF contract.

The 558-operational amplifier,

\$679,000 system, will be used for pilot training and preflight mission studies at the Air Force Flight Test Center, Edwards AFB, Calif. The system will use three PACE 231R computers, each capable of being programmed independently. Three electronic resolvers will also be installed.

Automatic Electronic Laboratory Centrifuge

HARROGATE, ENGLAND—A fully automatic electronic centrifuge, designed to meet requirements calling for centrifugal forces of up to 176,000 G, was demonstrated at the Laboratory Apparatus and Materials Exhibition. Speeds of up to 40,000 rpm accurate to 1 percent, with a voltage tolerance of 10 percent, may be selected by a simple presetting procedure, with no further adjustment necessary. The centrifuge, Super-Speed 40, was developed by Measuring and Scientific Equipment Ltd.

Canadian Government Splits Research Cost

HAMILTON, ONTARIO—Negotiations on a 50-50 cost sharing program for R & D will be conducted between the Canadian government and Canadian Westinghouse. Over a dozen firms will participate in discussions to be conducted by the Department of Industrial Research, a three-month-old organization within the Defence Research Board of the Canadian government. The first project to be discussed, development of low voltage electroluminescent material, has been to date solely supported by Westinghouse. Government allotments for the first year's operation of this program total \$1½ million.

The Canadian government is hopeful that other firms will join in negotiations, thus encouraging further R & D, which the government feels has been lacking in Canadian industry. It is also hoped that useful defense knowledge will be gained at lower cost, and that saleable products will be produced more rapidly than without government support.

In Brief . . .

JAPAN will send a seven-member electrical communications mission to Iran for a three-month survey of communication, radio and wire service needs.

CALIFORNIA COMPUTER PRODUCTS, INC., has received a \$1,169,027 contract for the production of test units to check out computer equipment in the Army's automated field artillery control system.

HOW TO USE RADAR in battlefield situations is the subject of a \$100,000 study contract awarded by the Army Signal Corps to General Dynamics/Electronics.

MITSUBISHI ELECTRIC, Tokyo, has sold an automatic weather observation rocket tracking radar to the Yugoslav Astronautical Society.

MILLSTONE HILL RADAR in Westford, Mass., a high power satellite tracker, will soon be operational after a three-month shutdown for overhauling and updating. New frequency will be 1295 Mc, nearly three times the original frequency of 440 Mc.

OPTICAL SYSTEM that will track a missile automatically and read out its angular position in space will be designed and fabricated by Measurement Systems, Inc., for NASA.

REMOTE READING SHELTER METER, a radiation detector for fallout shelters, will be developed by Nuclear-Chicago Corp. under a \$50,000 Office of Civil Defense contract.

ELECTRO-NEUTRONICS, INC., Oakland, Calif., has been awarded a \$1.2 million contract for production of precision portable radiation survey equipment, to be used for civil defense, military use, and weather observation computing equipment.

SILTRONICS, INC., has been awarded a \$2,356,393 contract by the Army Signal Supply Agency for the construction of 485 communication control systems.



SPRAGUE HYREL® ST CAPACITORS ACHIEVE MINUTEMAN GOAL OF ULTRA-HIGH RELIABILITY

Failure rate of .001%/1000 hours* has now been reached!

- Following comprehensive life tests, Sprague HYREL ST Capacitors have now attained Minuteman's component development objective.
- Minuteman quality means reliability *100 times greater* than that of former "highly reliable" capacitors. This standard allows *only one failure in 202,000 units per 1000 hours of test* under Minuteman use conditions.
- Behind this achievement is an unequalled test history of more than 130 million unit-hours. Backing this performance is Sprague's record of pioneering in highly reliable capacitors, which earned us the opportunity to participate in the

Air Force's Minuteman Component Development Program at Autonetics, a division of North American Aviation, Inc.

- All of the special processes and quality control procedures that make HYREL ST Capacitors the most reliable in the world can now help you in your Military electronic circuitry. A tantalum capacitor engineer will be glad to discuss the application of these capacitors to your missile and space projects. Write to Mr. C. G. Killen, Vice-President, Industrial and Military Sales, Sprague Electric Company, 35 Marshall Street, North Adams, Massachusetts.

*At 60% confidence level by accelerated qualification tests.

SPRAGUE COMPONENTS

CAPACITORS
TRANSISTORS
MAGNETIC COMPONENTS
RESISTORS
MICRO CIRCUITS

INTERFERENCE FILTERS
PULSE TRANSFORMERS
PIEZOELECTRIC CERAMICS
PULSE-FORMING NETWORKS
TOROIDAL INDUCTORS

HIGH TEMPERATURE MAGNET WIRE
CERAMIC-BASE PRINTED NETWORKS
PACKAGED COMPONENT ASSEMBLIES
FUNCTIONAL DIGITAL CIRCUITS
ELECTRIC WAVE FILTERS



"Sprague" and "®" are registered trademarks of the Sprague Electric Co.

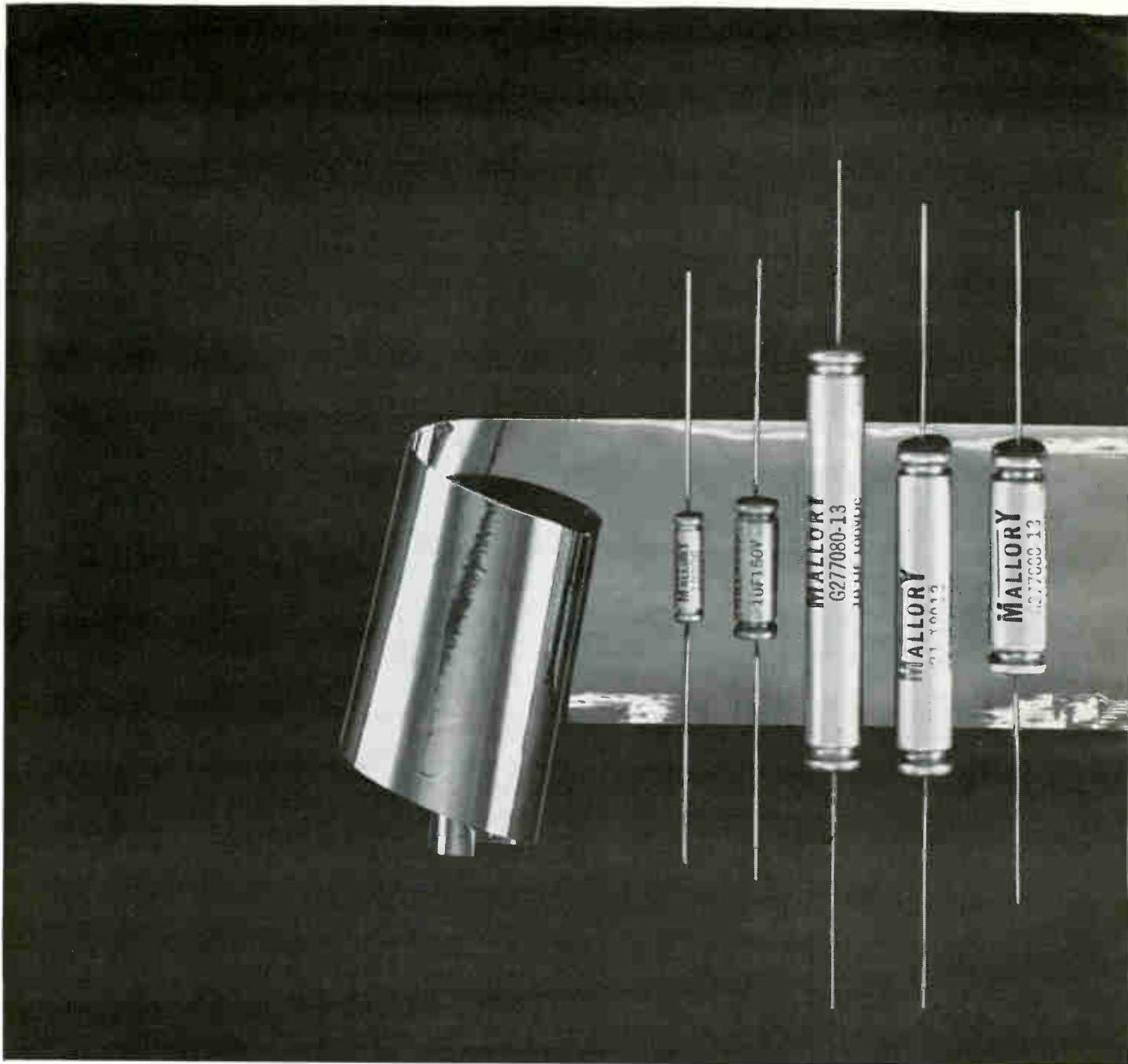

Mallory tantalum foil capacitors

Now available in new higher voltage ratings, Mallory tantalum foil capacitors consistently test out with values of capacitance stability, leakage and power factor that exceed requirements of MIL-C-3965B. The line includes TAF and TAG plain foil types, and TBF and TBG etched foil types. Types TAF and TBF are rated at 85°C; Types TAG and TBG are rated for 125°C maximum. All are available polarized or non-polarized, in hundreds of ratings, with or without a Mylar* insulating sleeve. All are supplied in all military case styles and ratings.

Newly added ratings for the Type TAF include 200,

250 and 300 volt models, either polar or non-polar, in five MIL case sizes. For the Type TAG, four MIL case sizes are added for polar and non-polar types, at 200 volts.

Widest selection available anywhere. Unmatched for variety and completeness, the Mallory line of tantalum capacitors includes 15 different types of wet slug, etched and plain foil, and solid electrolyte capacitors . . . ranging from microminiature to high capacity and 200°C models. Write today for our latest literature, and for a consultation on your requirements. Mallory Capacitor Company, Indianapolis 6, Indiana.

*Du Pont trademark

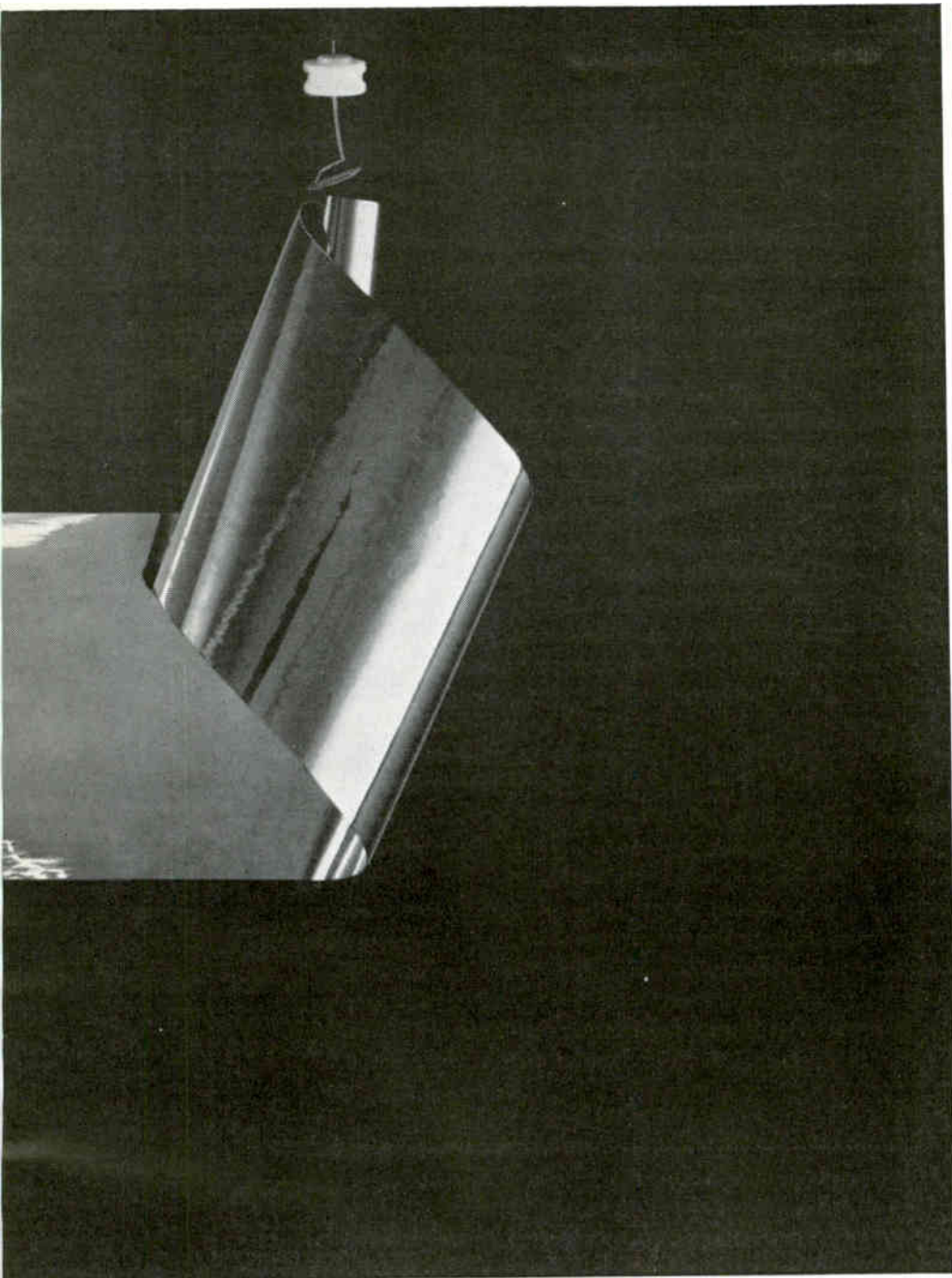

meet or beat MIL specs

	MIL-C-3965B Limits	Typical Test Values: Mallory Type TAF (160 mfd 15 VDC)
After 2000 hour life test at 85°C:		
Leakage Current	48 μ a	0.4 μ a
Change in Capacity	$\pm 25\%$	-5%
Power Factor	19.5%	3.8%
25°C:		
Leakage Current	48 μ a	0.2 μ a
Power Factor	15%	4.5%
-55°C:		
Change in Capacity	-35%	-12%
Impedance	14.0 ohms	7.0 ohms
85°C:		
Leakage Current	240 μ a	6.5 μ a
Change in Capacity	-0 +15%	+4.8%
Power Factor	15%	4.5%

Delivered from stock at factory prices by these distributors:

Baltimore, Md.
Radio Electric Service

Binghamton, N.Y.
Federal Electronics

Boston, Mass.
Cramer Electronics
DeMambro Radio Supply Co.
Lafayette Radio

Bridgeport, Conn.
Westconn Electronics

Buffalo, N.Y.
Wehle Electronics

Chicago, Ill.
Allied Electronics Corp.
Newark Electronics Corp.

Cincinnati, Ohio
United Radio

Cleveland, Ohio
Pioneer Electronics

Dallas, Texas
Engineering Supply Co.
Hall-Mark Electronic Corp.

Dayton, Ohio
Stotts-Friedman Co.

Denver, Colo.
Denver Electronics

Houston, Texas
Harrison Equipment Co., Inc.
Lenert Company

Indianapolis, Ind.
Graham Electronics

Los Angeles, Calif.
Allied Radio of California
California Electronics
Kierulff Electronics, Inc.
Lynch Electronics
Radio Product Sales

Minneapolis, Minn.
Northwest Electronics Corp.

Montreal, Que.
Canadian Electrical Supply Co.

Mountainside, N.J.
Federated Purchaser, Inc.

Nashville, Tenn.
Electra Dist. Co.

Newark, N.J.
Lafayette Radio

New York, N.Y.
Harrison Radio Corp.
Harvey Radio Co., Inc.
Lafayette Radio
Milo Electronics
Terminal Hudson Electronics

Oakland, Calif.
Elmar Electronics, Inc.

Orlando, Fla.
East Coast Electronics

Ottawa, Ont.
Wackid Radio-TV Lab.

Palo Alto, Calif.
Zack Electronics

Perth Amboy, N.J.
Atlas Electronics

Philadelphia, Pa.
Herbach & Rademan
Philadelphia Electronics

Pittsburgh, Pa.
Radio Parts Co.

Salt Lake City, Utah
Kimball Electronics

St. Louis, Mo.
Olive Electronics

Seattle, Wash.
F. B. Connelly Co.

Tampa, Florida
Thurow Electronics, Inc.

Toronto, Ont.
Alpha Aracon Radio Co.
Electro Sonic Supply
Wholesale Radio & Electronics

Tulsa, Okla.
Engineering Supply Co.

Washington, D.C.
Capitol Radio Wholesalers
Electronic Industrial Sales

White Plains, N.Y.
Westchester Electronic Supply Co., Inc.

Winston-Salem, N.C.
Electronic Wholesalers Inc.



Complete line of aluminum and tantalum electrolytics, motor start and run capacitors



WASHINGTON OUTLOOK

MISSILE X PLANS STILL HAZY

THE MOBILE MEDIUM-RANGE ballistic missile (MMRBM) project—also known as “Missile X”—faces tough sledding, even while an Air Force source selection board is readying recommendations to the Pentagon on a team of associate contractors to conduct short-term design studies.

The MMRBM has two potential missions—as a tactical weapon to replace fighter-bomber planes and air-breathing missiles in Europe or as a strategic missile for an independent NATO nuclear deterrent force.

The tactical weapon plan, requested by U. S. Commander in Europe, Gen. Norstad, has already been rejected by Defense Secretary McNamara. Status of the MMRBM as a strategic weapon for NATO—the U. S. has told NATO countries that while the U. S. sees no need for a separate nuclear striking force, the U. S. will supply the MMRBM for it if the Europeans want to pay for production.

While NATO is deciding on financing and operational control plans satisfactory to the U. S., the Air Force has been authorized to begin development of the new weapon on a very limited scale.

Dozens of companies have been invited to submit separate proposals for the propulsion, assembly, reentry subsystem, command and control, and transporter-launcher phases of the project.

But what, if anything, will come after the short-term design studies has yet to be decided.

LUNAR ORBIT AWARDS SOON

LUNAR ORBIT RENDEZVOUS, once the dark-horse candidate among three proposed procedures for landing a man on the Moon, won the competition after more than a year of evaluation by NASA and industry.

Industry will now submit proposals to NASA for development of the lunar excursion vehicle, a spacecraft to be launched on the same Saturn C-5 booster with the Apollo mother craft. It must be capable of landing two men on the Moon and returning them to the mother craft, standing by in lunar orbit.

NASA will also begin an immediate in-depth study of an unmanned lunar vehicle to determine how such a vehicle could be used to support the lunar exploration program.

Feasibility studies of the earth orbit rendezvous procedure will also be continued. The advanced Saturn (configuration C-5) carrying a 2-man command module will be used. Possibilities of using this spacecraft for a direct flight to the moon will also be considered.

AIRCRAFT COLLISION AVOIDANCE DISCUSSED

AIRCRAFT ANTI-COLLISION techniques were presented at a joint government-industry symposium on midair collisions last week. The symposium, sponsored by the FAA, was conducted to acquaint government and industry with the progress being made.

A range altitude system, developed by Bendix Radio, has been successfully flight tested. It is based on direct and ground-bounced radio signals between aircraft. Airborne computation of collision hazard is then made.

The FAA plans to award a contract for development of an i-r sensor, which would react to heat given off by another aircraft's engines.

Sperry Rand is working on a system using microwave transmission techniques of missilery. They have thus far demonstrated the capability of the necessary airborne flush-mounted antenna.

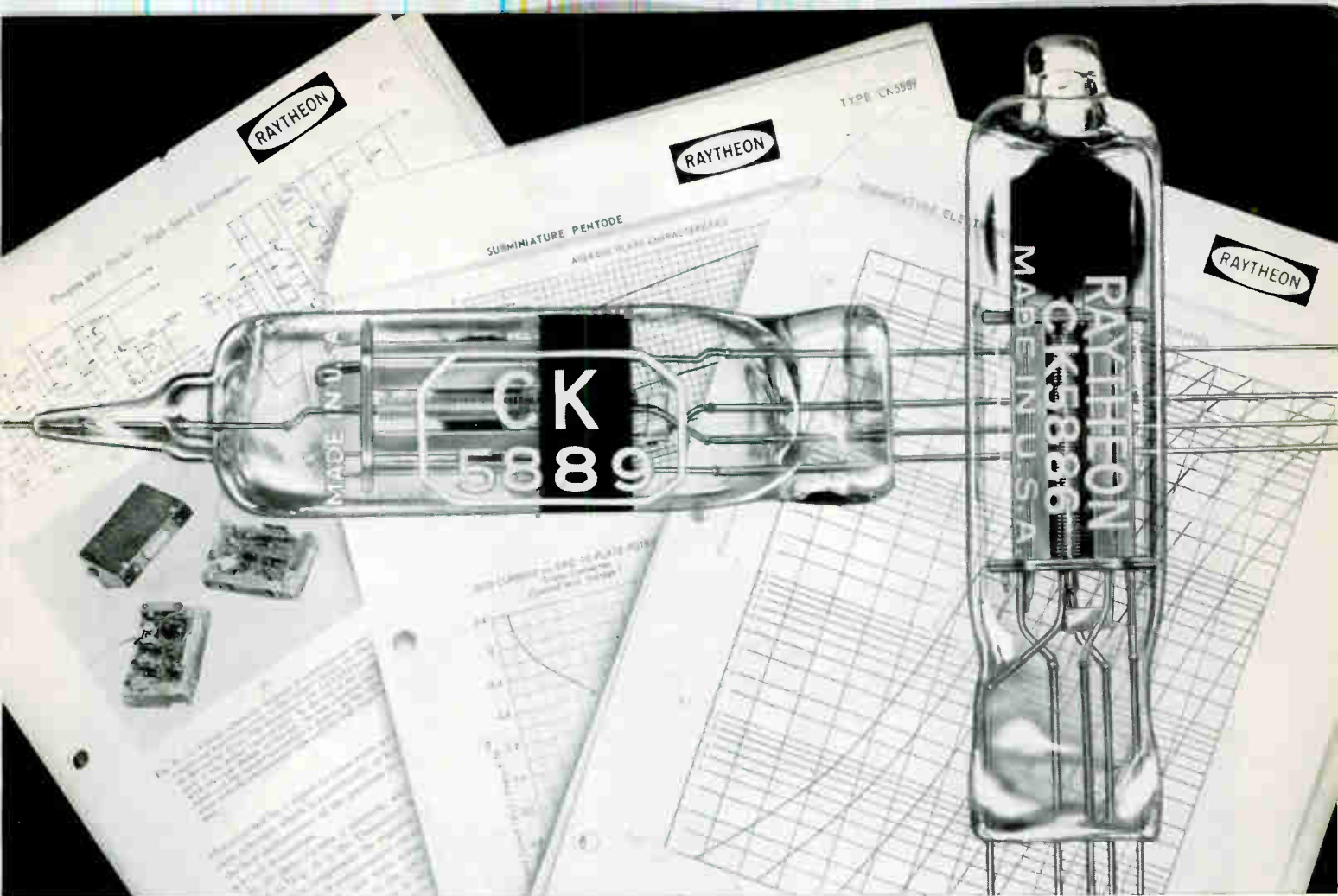

how to amplify 3×10^{-12} ampere with input impedance of 10^{14} ohms

Raytheon subminiature electrometer tubes CK5886 and CK5889 answer the problem of amplifying very low currents with low noise and high input impedance. Grid currents as low as 3×10^{-15} ampere, input resistance greater than 10^{14} ohms, plus compact size, low power consumption and minimum circuitry make these tubes outstanding for this application.



TYPICAL OPERATING CONDITIONS	CK5886 (Triode)	CK5889 (Pentode)
Filament Voltage	1.25 volts	1.25 volts
Filament Current	10 ma	7.5 ma
Plate Voltage	10.5 volts	12 volts
Screen Grid Voltage		4.5 volts
Control Grid Voltage	-3 volts	-2 volts
Nominal Control Grid Current	2.5×10^{-12} amp.	3×10^{-15} amp.

Interested in low cost amplification of minute outputs from ion chambers, photomultiplier tubes, proportional counters or biological transducer probes and sensors? Raytheon has a complete package of technical and application data. Please write: Raytheon, Industrial Components Division, 55 Chapel Street, Newton 58, Massachusetts. For small order and prototype requirements see your local franchised Raytheon Distributor.

CIRCLE 13 ON READER SERVICE CARD



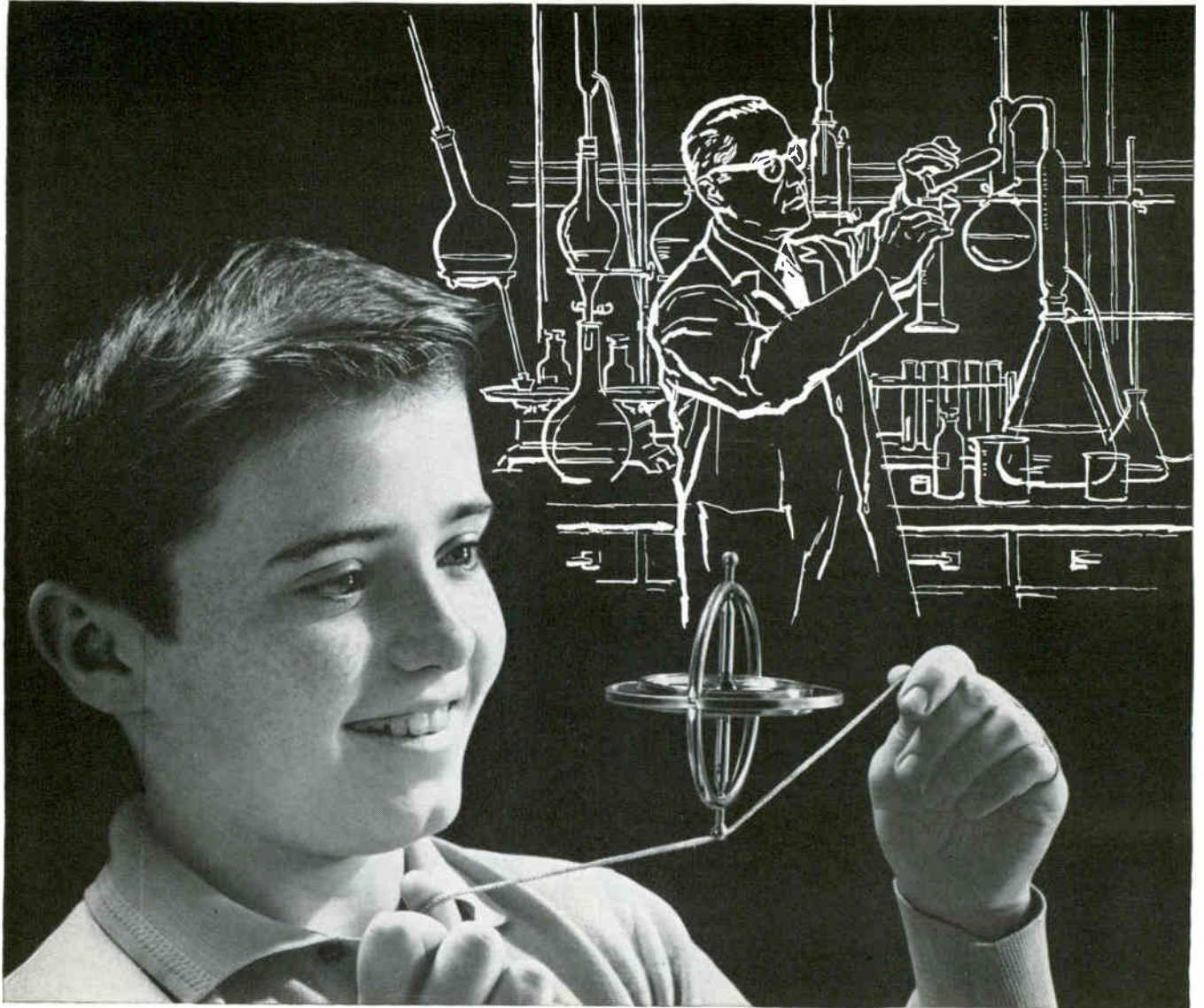

The Future of Your Business

MAY DEPEND UPON HIS EDUCATION

The young mind which today discovers an old principle may someday reveal a new one capable of revolutionizing your business and creating undreamed of growth. But this is possible only if he gets the finest education we can offer.

By the time today's youngsters are ready for college, business and industrial technology will be even more complicated and will require many more trained specialists. To fill this order we must provide our young people with the best possible college educations.

Unfortunately many colleges are already overcrowded. In ten years applications are expected to double. We will need more and better college classrooms and libraries, more efficient college laboratories, and additional top-quality professors. *You can help assure your own future by helping the college of your choice.*

If you want to know what the college crisis means to you, write for a free booklet, "OPEN WIDE THE COLLEGE DOOR," to Higher Education, Box 36, Times Square Station, New York 36, N.Y.



Published as a public service
in cooperation with The Advertising Council and
the Council for Financial Aid to Education





PNP POWER

IN A TO-5

SILICON TRANSISTOR

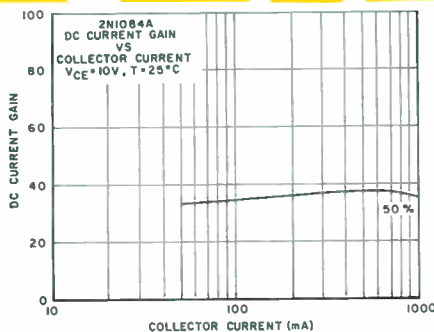

A new high in power... a new low in RCS

Broad new areas of circuit design have been opened with the perfection of Transitron's TO-5 2N1084 PNP silicon transistor. Developed in association with the U. S. Army Signal Corps, the new device brings greater simplicity and improved reliability and performance to both industrial and military circuitry. It features: operation at current ratings up to 1 amp, a low saturation resistance of under 3 ohms and cut-off frequencies as high as 30 Mc. A silicon transistor produced by gaseous diffusion techniques, the 2N1084 is available in prototype quantities with compatible heat sink mountings. For complete details write to Transitron, Wakefield, Mass., for Bulletin TE-1354-1084A.

Type	Collector to Base Breakdown Voltage (Volts)	Typical Saturation Voltage (Volts @ 500mA)	Typical Gain Bandwidth Product (Mc)	DC Current Gain @ I _c =500mA	
				Min.	Max.
2N1084	60	1.6	30	10	40
2N1084A	60	1.35	30	20	60

OTHER MEMBERS OF TRANSITRON'S BROADENING FAMILY OF PNP SILICON TRANSISTORS include the popular 2N1131 with a 20-45 beta range and 2N1132 with a 30-90 beta range. Both are designed for 1 to 200 mils operation and come in a TO-5 package. They are also available in TO-18 packaging as the 2N721 and 2N722, and in micro and nano packaging as the TMT1131-32 and TNT1131-32. All are produced by gaseous diffusion techniques. All are available in quantity through your Transitron Distributor.

CIRCLE 15 ON READER SERVICE CARD

Transitron

electronic corporation

wakefield, melrose, boston, mass.

SALES OFFICES IN PRINCIPAL CITIES THROUGHOUT THE U.S.A. AND EUROPE • CABLE ADDRESS: TRELCO

What does Chase Manhattan do for me ?

...and what does it do for the nation's Electronics Industry

First and foremost we make loans ■ Being the nation's number one commercial bank lender to American industry we put up a good deal of money to help electronics companies prosper, and build better products for industrial, consumer and national defense use ■ These loans help put men and women to work all over the country ■ And in the case of the independent television repairman here in New York, we also offer loans to help him build his business and better serve neighborhood needs ■ Taken together our loans to electronics come to many millions each year ■ But even more, they demonstrate our belief in greater usefulness to New York, the nation and the world.



THE CHASE MANHATTAN BANK

1 Chase Manhattan Plaza, N.Y. 15 • Member Federal Deposit Insurance Corp.

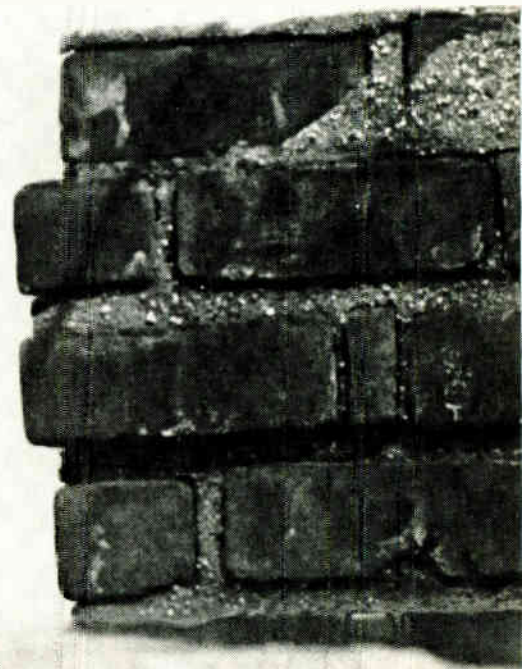





MORE TIMING PROBLEMS

more effectively solved...

...because HANSEN
takes more time
to be sure!



HANSEN SYNCHRON® Timing Motors and Movements are results of thorough and continuous research and development. None is released until it has been solidly tested and proved for its applications. Each is a product of more than 50 years of specializing in this one area.

This adds up to an unequalled backlog of engineering experience that you command at Hansen. Whatever your timing problem, you can count on Hansen engineers to come up with the most effective solution — with the timing motor or movement that has been *pre-proved right* for the job.

Distance no obstacle to _____ 
Hansen service

Hansen service knows no limits — as present customers know from profitable experience. A company airplane stands ready to fly Hansen engineers to study “on-the-job” difficulties — and to determine the surest solution to every timing problem.

SEND TODAY for complete data on all Hansen SYNCHRON Motors and Clock Movements.



HANSEN REPRESENTATIVES:
ELECTRIC MOTOR ENGINEERING, INC.
Los Angeles, Calif., Oakland, Calif.
THE FROMM COMPANY
Chicago, Illinois
H. C. JOHNSON AGENCIES, INC.
Binghamton, N.Y.
Fayetteville, N.Y.
Rochester, N.Y.
Schenectady, N.Y.
Williamsville, N.Y.
WINSLOW ELECTRIC COMPANY
Essex, Connecticut
New York, N.Y.
Philadelphia, Pa.
EXPORT DEPARTMENT
15 Moore Street, New York, N.Y.

Copper-clad laminate should be WORTH the circuit printed on it

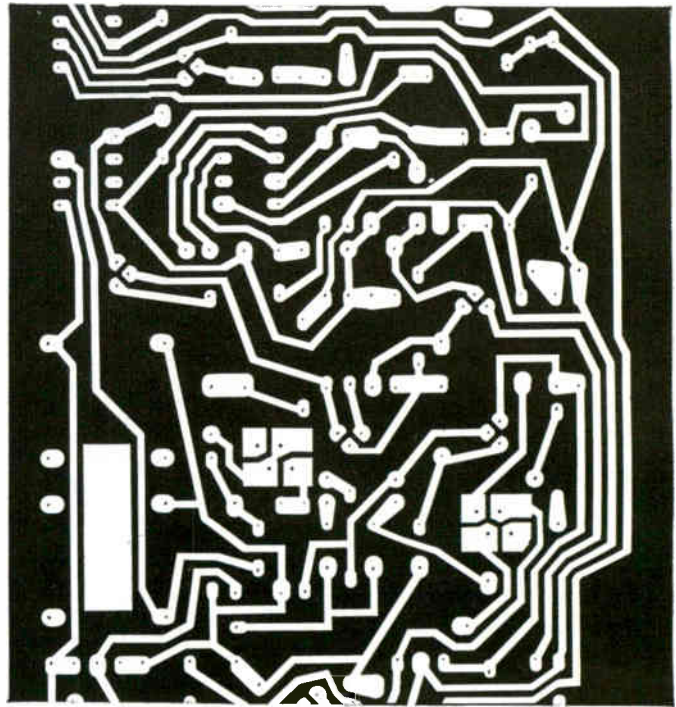

Most printed circuits require a high-quality, reliable copper-clad laminate. Synthane goes to extremes to check foil quality, adhesives and the laminate. We test peel strength at room temperature *and* at 500°F, using a newly-developed peel tester. Synthane checks blister resistance and heat resistance, and measures the thickness of the entire sheet (not merely the edges) with a new Synthane-designed instrument. Synthane prints and checks test patterns. Be sure the laminate is worth the circuit *you* print on it. Write for Copper-clad Bulletin.

SYNTHANE

CORPORATION  OAKS, PENNA.
GLendale 2-2211 TWX Valley Forge 735U

Synthane-Pacific, 518 W. Garfield Ave., Glendale 4, Calif. TWX GLDL 4417U

Synthane Corporation, 36 River Rd., Oaks, Pa.
Gentlemen:
Please send me new bulletin, "Synthane Metal-clad Laminated Plastics"

Name _____

Address _____

City _____ Zone _____ State _____

CIRCLE 97 ON READER SERVICE CARD

electronics



There's business out there.

You're looking at more than a horizon. It's a future, yours and America's. Out there is Europe and Latin America and Asia and Africa. But in 1960, of all U. S. manufacturers, less than 5% saw these foreign shores for what they are worth: a 19-billion-dollar export market, a vast source of foreign trade.

Move in for your share. Build your business and help keep America growing. Extra production creates more jobs, helps balance the outflow of gold, and wins new friends abroad with U. S.-made products.

Even if you've never sold overseas, you have a rare op-

portunity to start—now. Your U. S. Department of Commerce will help with counsel by experts on what, where and how to sell—with data on credits, payments and financing. A package of invaluable know-how is yours for the asking.

Now's the time to discover the many ways in which your business can grow. In the lucrative export markets. In new U. S. markets. In developing new products. In attracting new industry to your community. Just write or phone the U. S. Department of Commerce Office of Field Services in your city, or Washington 25, D. C. They are ready to help you grow with America!



NOW'S THE TIME TO GET GROWING IN A GROWING AMERICA!



How H-Blast Affected Communication Links

Blackouts less severe than were expected

RELATIVELY MILD effect of last week's thermonuclear blast on h-f communications came as a surprise to the scientists involved as well as to many in the electronics industry. Crippling blackouts of many hours duration had been expected for communication links as well as aircraft communications and navigation equipment. The Johnston Island test, so spectacular it made the earth's magnetic field visible for 15 minutes, apparently did not cause such severe disruption.

A spokesman for RCA Communications told *ELECTRONICS* there was far less interruption of overseas telegraph services than had been anticipated. There was no effect on Atlantic circuits. Pacific circuits, in general, recovered to approximately 80 percent of their pre-blast signal strength in ap-

proximately five minutes; complete recovery came in about 40 minutes. (Natural magnetic storms often black out circuits for 3 or 4 hours.)

CIRCUIT DROPOUTS—For circuits operating out of San Francisco, immediate dropouts occurred over the 11-Mc Sidney channel, the 16-Mc Guam channel and an 18-Mc Tokyo channel. Other Tokyo channels on 12-13 Mc were only slightly affected. Sidney came back in 20 minutes and Guam in 45 minutes.

At no time was trans-Pacific communication completely out, and there were even reports of ham voice contact with the area shortly after the blast.

The FAA had planned to ground planes for up to 32 hours after the blast but reported no serious effects on airline channels and thus no major delays on commercial flights.

The test reportedly involved a hydrogen bomb of around 1-2 megatons (Mt) at an altitude of ap-

proximately 200 miles. Radius over which communications are blacked out by a nuclear blast increases with blast altitude and bomb size, while duration of blackout decreases as altitude increases. It has been estimated that 50-Mt bombs 50 miles up might knock out communications for about 24 hours over thousands of miles (*ELECTRONICS*, p 27, May 11, 1962).

H-F EFFECTS—It had been expected that the maximum disruptive effect of last week's test would occur in the 3-30 Mc range, as it did. At these frequencies long-distance communication is provided by the reflection of signals from E and F region electrons. Information on the effects of nuclear explosions on radar and communications systems released recently by the Department of Defense and Atomic Energy Commission pointed out there are two main ways in which the additional ionization produced by a nuclear blast can affect an h-f system. First is that bomb-produced ionization of the lower D region causes attenuation of 3-30 Mc signals passing through it. Transmission at the low frequency end is affected when electron density reaches 10^8 per cu cm; a density of 10^4 electrons per cu cm affects the high frequency end.

Megaton blasts occurring more than 10 miles above the earth cause instant disruption of 3-30 Mc signals passing close enough to be affected. A 1-Mt blast at 50 miles altitude will be felt out to 600 miles, and last from roughly 17 minutes to 3 hours, depending on frequency.

Additionally, delayed nuclear radiation will produce effects that last much longer. A 1-Mt burst at 40-70 miles altitude will affect a signal 500 miles away in 15 minutes, and last for more than 10 hours.

Second way in which h-f communications may be affected is by hydrodynamic disturbances of the ionosphere. If the ionosphere is disturbed at one of the points where a signal is reflected, then communications will be disturbed over that particular circuit. If an h-f system has one of its reflection points within 1,000 miles of a megaton burst in the altitude range from 40 to 70 miles, it will probably be disrupted for an hour or more.

Many instances of h-f distur-

bance were observed during high-altitude nuclear tests in 1958 (the Teak and Orange shots).

VLF EFFECTS—Last week's test was also reported to have affected the Navy's vlf circuits. Signals in this range (3-30 Kc) are transmitted below the ionosphere through reflections along the duct thus formed with the surface of the earth.

With no signal penetration into the ionosphere, increased ionization there due to a bomb burst does not black out vlf communications. According to the DOD-AEC report, however, a phase shift of the signal occurs due to changes in reflection height of the duct. The effect may be felt over great distances from the burst point. An 18.6-Kc signal underwent a 40-degree phase shift during the Teak and Orange tests, though no part of its path was closer to the blast than 3,000 miles.

OTHER FREQUENCIES—For the low frequency, 30-300 Kc and medium frequency, 300 Kc-3 Mc ranges, nuclear blasts at high altitude will have little effect on the ground wave signals normally employed at these wavelengths.

Very-high-frequency, 30-300 Mc, used for line of sight and also long distance forward scatter communications, may suffer effects that are not completely predictable at this time. Increased electron density in the ionosphere will increase signal scattering, thus improving reception. It will also absorb some energy thereby weakening reception as well. Though no test results are available, it is expected that the net results will effect a balance.

Changes in the scattering distance due to a lowering of the D-region altitude at which scattering normally occurs, may take place, reducing possible range.

Ultra-high-frequency, 300 Mc-3 Gc signals, used for line-of-sight and atmospheric scattering (tropospheric scatter) communications are for the most part unaffected by ionospheric bomb bursts. Earth-to-satellite uhf communications would be affected since the signals must penetrate the D region.

RADAR—In addition to studying the effects of high-altitude blasts

on radio communications, the Johnston Island test was aimed at radar and antimissile system studies.

Radar performance is not, in general, affected by nuclear explosions unless the radar signals must pass through the ionosphere. If they do, attenuation results and can cause a returning signal to be lost in the noise level, important in the case of search radars which operate over great distances.

Another effect is the refraction of a radar beam caused by electron density variations. For frequencies above 10 Mc and for angles of refraction under 5 degrees, the amount of bending is proportional to electron density change and inversely proportional to the square of the signal frequency.

With large angles of incidence, reflection can turn back a radar signal and prevent it from passing through the attenuating layer.

Other burst-produced phenomena can disrupt radar operation. Patches of ionization aligned in the direction of the earth's magnetic field can produce clutter and similar effects. Little is known with precision about them, however.

VAN ALLEN BELTS — Last week's explosion was apparently a few hundred miles beneath the Van Allen belts and therefore not expected to have much effect on them. If there were any effects, however, they may have been detected by the Injun I satellite which was reported to have been over Hawaii when the bomb was fired.

Injun I was launched piggyback on the Navy's Transit IV-A satellite in June 1961. It carries cadmium sulphide detectors, a photometer, a magnetic electron spectrometer and a Geiger counter provided by the State University of Iowa, and a package of four p-n junction, silicon, proton detectors developed by the Johns Hopkins Applied Physics Laboratory.

If there are any long-term changes due to the blast, these may be measured by NASA's S-3A energetic particles satellite which is presently scheduled for launch in the third quarter of this year. This will carry several particle detection systems to measure protons and electrons and their relation to magnetic fields.

"Nothing is impossible to diligence and skill"
Samuel Johnson

These are the trademarks of some of our customers—each an important contributor to a dramatically growing industry. We at Potter pledge our diligence and skills to this growth through a constantly expanding program of research and development.

Technical Paper Available from

POTTER

Performance Characteristics of HIGH DENSITY Recording

By
Dr. Andrew Gabor
Systems Engineering Manager
George E. Comstock, III
Chief Engineer

With the revolutionary new Potter High Density Recording System, one tape transport has the capacity of 5 or more conventional transports. This dramatic breakthrough provides for simultaneous recording on ten channels with data transfer rates of 242,000 to 450,000 binary coded decimal digits per second . . . and a guaranteed recovery of at least 99,999,999 out of 100,000,000 bits recorded at the higher transfer rate.

High Density Recording is detailed in two technical papers. They are available on request.



EUROPE BOUND?
VISIT US AT Booth 28
IFIP Interdata Exhibition
in Munich, Germany
August 28 to September 2

POTTER INSTRUMENT CO., INC.
Sunnyside Boulevard • Plainview, New York

How to get your money's worth when you buy a digital voltmeter

by

IAN HOOD

Chief Engineer

Cubic Corporation, Industrial Division
San Diego, California

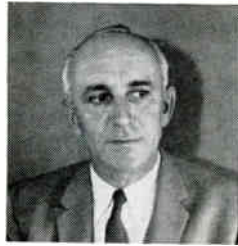

YOU CAN PAY over \$6000 for a digital voltmeter, or you can get an instrument that will be entirely adequate for most requirements for less than \$1000. Which one is right for you? To answer that question, let's take a look at some of the key factors affecting digital voltmeter economics. The first rule to help you get your money's worth is this: (1.) *Don't buy more sophistication than you really need!* There are many variables controlling DVM price. Here are a few of them:

RESOLUTION A four-digit voltmeter is adequate for many requirements. If you really need one more decade or magnitude of resolution, you'll have to go to a five-digit voltmeter which will be more expensive.

SENSITIVITY Instruments are available with sufficient sensitivity to

measure to 100 microvolts. For even greater sensitivity, accessory pre-amplifiers are required. All this naturally costs money. If your application requires only one-millivolt sensitivity, that is all you should buy.

SPEED A good digital voltmeter will do in two seconds what it would take a skilled lab technician 2 or 3 minutes to do with a pointer meter. This is satisfactory speed for most applications. If you require greater speed, however, a DVM that will make 2 or 3 readings a second can be supplied.

AUTOMATIC RANGING If most of your voltage readings are going to be in the same range and have the same polarity, manual ranging and polarity should be adequate. However, if you require high-speed shifting from one range and one polarity to another,

automatic ranging and polarity will pay for itself.

ENVIRONMENT Environmental requirements have an important effect on price. An instrument that will be used under laboratory conditions is less expensive to produce than one built to rugged military specifications covering humidity resistance, shock capability and operating temperature.

ACCESSORIES There is a wide variety of accessories available for use with DVM's. All of them are extremely useful for specific applications, but they do add to the cost of the system. A basic accessory is the a-c converter for adapting a DVM to a-c measurements. Digital ohmmeters are available for resistance measurements. Pre-amplifiers may be added to extend the sensitivity of a DVM. A limit detector may be supplied to give an audible or visual signal when measurements don't fall within established limits.

PRINTERS Printers may be furnished to make a permanent record of the measurements. Typical system readouts include Flexowriters, hard copy printers, BCD outputs, IBM card or tape punches or outputs to operate almost any data recording device. Scanning systems are offered for the most complex scanning problems. For example, in one system, up to 1000 input channels may be read in rapid sequence by one DVM. Special paint colors are also available at extra cost.

FREE HELP AVAILABLE So you see, the problem of selecting a digital voltmeter with just the right amount of sophistication for your application can be a complex one. This leads naturally to rule number two for getting your money's worth when you buy a DVM or system: (2.) *Call upon the field engineering personnel of the supplier to help you decide what you need!* Cubic Corporation and all other reputable suppliers have engineering representatives available to work with you without charge planning your requirements.

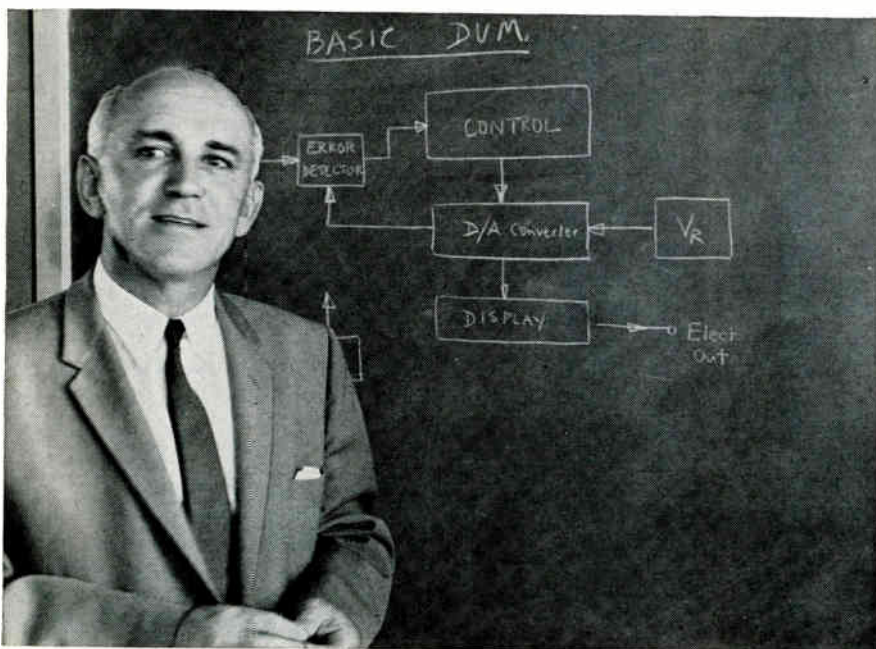

Here are the digital instruments that give you your money's worth



V-41 AND V-51 VOLTMETERS

Meeting industry requirements for ruggedness, sensitivity, and accuracy, Model V-41 (4-digit) and Model V-51 (5-digit) D-C Digital Voltmeters have 100 microvolt sensitivity, accuracy to $\pm 0.012\% \pm 1$ digit on all scales. Decimal, polarity, AC and A/B symbols are displayed. Either unit may be powered by a C-1 Control Unit. Price: Model V-41, \$1200; Model V-51, \$1700. (Order with Control Unit Model C-1, \$1400.)



AC-1 AND AC-2 CONVERTERS

For a-c voltage measurements. Feature wide frequency range with extreme stability and linearity. Model AC-1 (manual ranging) and AC-2 (automatic ranging) are companion units which provide AC voltage measuring capability to compatible D-C digital voltmeters. Cover .000 to 999.9 in four ranges. Price: Model AC-1, \$1000; Model AC-2, \$1200.



O-41 AND O-51 OHMMETERS

A self-balancing wheatstone bridge with automatic range selection, the

Ohmmeter, Model O-41, provides automatic, rapid and accurate resistance measurement in six ranges (five ranges on the 5-digit Model O-51) with a typical accuracy of $\pm 0.01\%$ and 1 digit. Price: Model O-41, \$1200; Model O-51, \$1700. (Order with Control Unit C-2, \$1100.)



V-45 AND V-46A VOLTMETERS

Laboratory accuracy at low cost are attractive features of the Models V-45 (manual ranging and polarity) and the V-46A (automatic ranging and polarity) D-C Digital Voltmeters. Maintains absolute accuracy to $0.01\% \pm 1$ digit. Fully transistorized, with long-life stepping switches. Measures from 100 microvolts to 1099.9 volts. Units are especially suited for bench and production line use. Floating or grounded input from front panel connections. Price: Model V-45, \$940. Model V-46 with automatic ranging and polarity \$1340.



V-70 REED RELAY DVM

A fully transistorized reed relay digital voltmeter offering speed, accuracy and simplicity of operation at low cost. Long-life reed relays permit simplified circuit logic with marked improvement in reliability and longer maintenance-free service. Models available with manual or automatic ranging and polarity, and with connections provided to drive ten-line decimal-coded printer. Price: V-70, \$1580. Also available: V-71 (auto-ranging and polarity) \$2200; V-71P (printing option) \$2800.



PACKAGED DIGITAL DATA SYSTEMS

The Cubic line of quality digital instruments is designed for easy integration into flexible, multi-purpose systems. Compatible combinations provide for AC-DC voltage measurement, ohms and voltage ratio measurement, strain gauge instrumentation systems, automatic multi-point scanning for inspection and production testing, and others. All units can be supplied for 19" rack mounting, or in custom cabinets to suit system requirements.

FOR MORE INFORMATION

Write Cubic Corporation, Industrial Division, Dept. A-149, 5575 Kearny Villa Rd., San Diego 11, California for additional technical data. Phone Area Code 714, BRowning 7-6780, TWX: SD 6254.

Other Offices: Los Angeles, California - Rome, Italy (Cubic Europa S.p.A.) Cubic representatives in principal U. S. and Canadian Cities.



INDUSTRIAL DIVISION
SAN DIEGO 11, CALIFORNIA & ROME, ITALY

AIRTRONICS

electronic products for the telephone industry...



Portable Test Hybrid
Simplifies cable acceptance tests and return loss measurements.



Far End Terminating Set
Provides precision network termination during cable testing.



Pulse Meter
Furnishes a convenient method of measuring dial speed and percent make.



Program Equalizer
Corrects Attenuation Distortion easily, quickly. In use by many AM and FM Broadcast Stations.

PRECISION NETWORKS
WE 115 TYPE

BUILD OUT AND
TERMINATING SET

PROGRAM EQUALIZERS

TRANSMISSION
MEASURING SET

• FOR DETAILED SPECIFICATIONS AND PRICES, CONTACT YOUR NEAREST DISTRIBUTOR OR WRITE AIRTRONICS INTERNATIONAL CORPORATION — P.O. BOX 8429, FORT LAUDERDALE, FLORIDA.



This Portable Unit brings
8 Miles of Transmission Lines
into Your Lab

Eliminates the Need for Leased Lines

Wherever you have a requirement for transmitting information, data, and intelligence this portable equipment will simulate transmission lines right in your lab.

The standard unit simulates 8 miles of transmission line, but it can be modified for any line length required. Plug-in modular construction. Seven plug-in modules each simulate 6,000 ft. of standard telephone cable with loading coil.

The Airtronics Artificial Line meets field engineering requirements. Some time-saving, money-saving laboratory uses are for testing data transmission (offers loaded or unloaded test facility); for testing amplifier operation over telephone lines (permits actual frequency response measurement to be observed over a simulated line); for checking system gain requirements for a pre-determined frequency range; for simulating complex values of AC impedance and DC resistance as incorporated in telemetry circuit transmission; for training purposes (used exclusively by every major telephone company).

The Airtronics Artificial Line is available in 19, 22, 24 and 26 gauge.

FOR FURTHER INFORMATION CONTACT:

AUTOMATIC SALES CORPORATION / A subsidiary of General Telephone & Electronics
or Write direct...



6900 WEST ROAD 84
FORT LAUDERDALE, FLA.
TELEPHONE LU 3-4541



SOLID STATE IN Electronics

Men of vision thrive here. And it takes men of vision to cope with today's electronics and space problems. Space in more ways than just up. Space problems of a different nature plague the manufacturer who must expand, but hasn't the land to expand on.

Here in Florida we have the space, the climate, the work force. Florida has more to offer electronics firms than any other area on earth. Men think better where life is pleasant, where off hours can be devoted to just plain *living*—and to just plain *thinking*.

Yes, Florida is a Solid State in Electronics. Already the sun, Mother of Life, shines on over sixty thriving electronics firms in our busy state.

Cape Canaveral is here, too, with its massive, awesome missiles blasting off to make space history. Electronics makes possible every thrust into the universe. Every hope of getting to the moon depends upon electronics—and the first American to the moon will definitely soar to history from Florida.

Engineers and their families dream of living here in Florida. Give them this dream by moving your plant here. Nurture the brains that will give your business a greater and greater stature in this, the Electronics Age.

For complete details of the many advantages Florida offers the Electronics Industry, write us. Let us tell you why some of the greatest names in electronics have impressive plants here in Florida.

FLORIDA'S ASSURANCE POLICY

"You have my personal assurance of a sunny business climate here in Florida. You have positive assurance of every aid and assistance possible from our Florida Development Commission and from the overwhelming majority of our businessmen, industrialists, and financiers. We have everything to make your large or small enterprise healthy and successful. Write, wire, or phone us TODAY. The only thing better than a FLORIDA vacation is having your plant here."



FARRIS BRYANT
Governor

Investigate

Florida

...A 10 BILLION DOLLAR MARKET

Ask about free film "Profile of Progress"
FLORIDA FOR CONVENTIONS—
Write for free information on Florida's wonderful facilities for your group meeting.



Mr. Wendell Jarrard, Chairman
FLORIDA DEVELOPMENT COMMISSION
Box 4247A • Tallahassee, Florida

Please send me brochure, "Why Your New Plant Should Be Located In Florida," containing the facts about FLORIDA's opportunities for New Industry, the 10 BILLION DOLLAR CONSUMER MARKET, Labor, Climate, Schools, Natural Resources, Favorable Tax Structure.

Name.....

Firm Name.....

Address.....

City..... Zone..... State.....

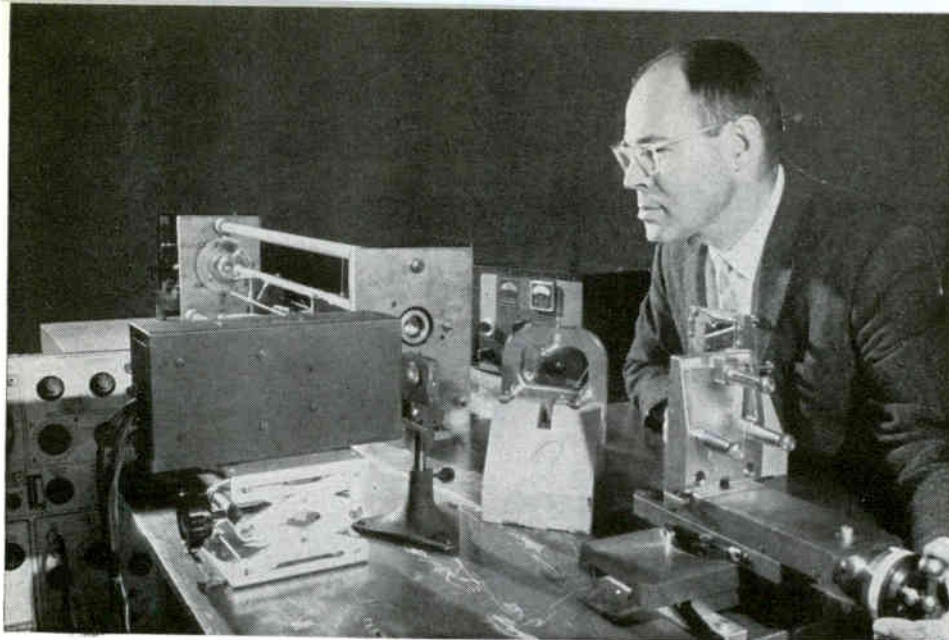

EXPERIMENTAL
doppler laser
uses continuous-wave
gas laser
recently developed
by Sperry

DOPPLER LASER

Measures Speeds Down to 0.00004 MPH

By LESLIE SOLOMON
Associate Editor

CLOSING SPEED between two satellites can now be measured from 3 miles per second down to 1/1,000 of an inch per second with an experimental laser doppler radar demonstrated for *ELECTRONICS* by Sperry Rand's Electronic Tube Division, Great Neck, N. Y. The beam from a single gas laser is used as both the local oscillator and the transmitted signal. According to Sperry engineers, this will make possible signal resolution 10,000 times better than that obtained from typical microwave radar systems. The experimental system uses the newly released SLG-201 helium-neon continuous-

wave laser operating at 11,530 Angstroms with a power output of 1 mw.

OPTICAL HETERODYNE—The angular difference between the two received beams at the multiplier phototube cathode converges within 10 seconds of arc.

The criteria for optical heterodyning, based on a coherence acceptance area, must be $\theta_{\max} = \lambda_o/D_s$, where λ_o is the wavelength of the laser and D_s is the diameter of the two imaged beams on the phototube. If this equation is not satisfied, the output signal will drop rapidly and the signal-to-noise ratio will decrease.

Receiver signal-to-noise ratio is

expressed as

$$(\eta_d / h\nu\Delta f) [(A_o \times A_s)^2 / (A_o^2 + A_s^2)]$$

where η_d is quantum efficiency of the photodetector, h is Plank's constant, μ is the laser center frequency, Δf is the receiver system bandwidth, A_o is the amplitude of intensity of the local oscillator beam in watts (energy of light photons as they strike the surface) and A_s is the signal amplitude in watts. The term $h\mu\Delta f$ is the multiplier phototube shot noise that determines overall noise level of system.

With a cooperative system and 1 mw output, doppler range will be about 30 miles and with 1 watt output, range will go to approximately 1,000 miles.

In comparison with conventional L-band microwave radar that requires between 2 and 10 Mw r-f power and has a weight of several hundreds of pounds, a complete laser system with 10 watts output would probably weigh about fifteen pounds.

Sperry engineers also claimed that this gas laser in conjunction with a 1 meter diameter mirror will illuminate an area about 1,850 ft in diameter on the surface of the moon. Typical range would be 250,000 miles.

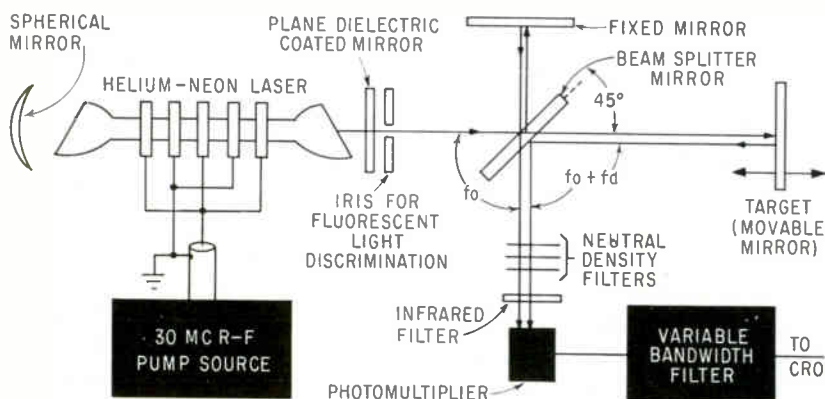

MULTIPLIER PHOTOTUBE noise determines system signal-to-noise level

Canada Electronics Face Import Squeeze

Manufacturers demand protection from Commonwealth radio-tv imports

CANADIAN ELECTRONICS manufacturers are taking some long, hard looks at where they will be standing in future tariff situations and some don't like all they see.

Some of the sore points were brought to light at the 33rd annual meeting of the Electronic Industries Association of Canada held late last month.

One topic aired in a question-and-answer session threw new light on some manufacturers' worries that Canadian-made radio and tv receiver sales will be badly hit unless protective tariffs on such equipment coming into the country are raised. The tariff situation is further complicated by the possibility of the United Kingdom entering the European Common Market.

DUTY PROPOSED—EIAC's proposal in May that radio and tv receivers entering Canada from within the British Commonwealth be subjected to a 15-percent duty raised considerable protest from other industries.

One major trade group, Canadian Importers and Traders Association, hinted the EIAC proposal showed that Canadian electronics is highly dominated by the U.S. since the tariff plan would maintain import levies on radios and tv sets from the U.S. at present levels. The same would apply to sets from Japan.

One EIAC spokesman countered by saying the majority of electrical products entering Canada from the U.K. bore a 15-percent tariff and that Canadian radio and tv manufacturers should have the same protection as others. Record players and tape recorders now have a 15-percent duty.

The speaker added that Canadian radio and tv sales are now getting only 34 percent of the nation's purchases and even this small amount must be guarded against "further invasions."

A special angle on foreign competition affecting Canadian sales

came in for comment as one EIAC man said, "The Japanese are already using Shannon, Ireland, as a manufacturing base to get radio receivers with Japanese parts contents into Canada free of duty. This lets them bypass the voluntary quotas set up with Japan. What's to stop the West Germans, the Italians and the French from setting up plants in some parts of the U.K., importing components and further exploiting our market by the present no-duty British preferential tariff? It is hardly conceivable that if the U.K. joins the Common Market, that the other partners will long sit back and let the U.K. send things to Canada duty free without claiming similar privileges."

To one question asking what the effect of Britain joining ECM will be on Canadian electronics, the answer was that it would be difficult to state until more is known of the U.S. position and of the conditions of Britain's entry.

J. D. Houlding, retiring president of EIAC, said in summing up a four-point set of goals for Canada's electronics industry, that in the area of defense electronics, the in-

dustry must be alert to urge that production of equipment for Canadian forces is carried out to the greatest possible extent in Canada. He also called for a step-up in research and development, an independent effort in space technology systems, particularly for weather and communications, and for more attention to color television.

COLOR TELEVISION—The Association made a presentation on color in the Spring of this year to Canadian government officials. EIAC spokesmen feel the interest level is high both within the government and among potential viewers. The Board of Broadcast Governors, which serves a function similar to the U.S. Federal Communications Commission, is now obtaining additional information on color.

In the near future, the Association plans to approach Canadian appliance dealers to obtain their support for color at the retail level. In addition, the group plans to seek greater support from Canadian broadcasters. EIAC says both groups will cooperate.

What's Ahead In Reliability

PRINCETON, N. J.—Last week engineers at the IRE-ASQC reliability training course heard:

- In addition to numerical reliability specifications, now in nearly all government development contracts, new CPFF contracts will have incentive and penalties. For example, on a 7 percent fee you can get up to 15 percent for exceeding specs, lose 10 percent for failing to meet them.
- New USAF specs will carry quantitative requirements for maintainability and human engineering.
- Reliability performance will be a major factor in USAF source selection including: How well do you get along with vendors and subcontractors?
- NASA wants reliability on manned space missions equal to

that of the X-15.

- In Project Gemini, a punched card is attached to every part and the history of the part punched into the card to track part degradation to its source.
- One major manufacturer now stocks all parts in a central stockroom, releases them to divisions to control reliability.
- One lecturer declared, "There is no such thing as a random failure; we just don't understand causes." Another inquired, "Are we life-testing ourselves into national bankruptcy?"
- Forty-three engineers and managers attended the course; 60 more had to be turned away. Lecturers represented a cross section of education, industry and government personnel.

Adaptive Automatic Control Stressed at JACC Meeting

*Survey shows
areas stressed
in the U. S.*

By NILO LINDGREN
Assistant Editor

NEW YORK—American concern was aroused during the 1960 Moscow Automatic Control Congress (IFAC) over the lack of definitive information on automatic control research in the U.S. Soon after the Moscow meeting, the American Automatic Council initiated a survey to determine what we are doing in this area. Results of this survey were heard a few weeks ago (June 27-29) by control engineers from five technical societies (ASME, ISA, AIEE, AIChE and IRE) assembled here for their third annual

Joint Automatic Control Conference.

The conferees also heard a broad range of technical papers, largely theoretically oriented, on automatic control theory in several classical areas of specialization, including nonlinear systems, adaption and optimization, process dynamics, statistical methods in control and sampled data systems. A special tutorial workshop was held on state space technique. Remarkable to the newcomer to these meetings was the apparent influence of Russian theoretical work, especially in work dealing with space systems.

CONTROL SURVEY—Since proprietary considerations precluded assessment of industry's efforts, only universities were approached in the AACC survey. The extent and direction of automatic control research now going on in the U.S.

engineering schools was reported by John Ward of MIT.

Ward's table, shown here, lists the effort by specific areas of control work underway in 52 schools; this is estimated to represent about 80 percent of the total university effort. One unexpected development was the number of schools that reported work on biological control systems.

ADAPTIVE PROCESSES — The need for better understanding of the dynamics of adaptive processes, by bringing together theoretical concepts from psychology, biology, computer logic and feedback theory, was emphasized in two JACC sessions. The interrelationship between feedback theory in engineering and adaption theory in the life sciences was stressed in papers on the use of pattern recognition techniques in adaptive control, analytical study of neural nets, concept formulations and learning models.

J. Sklansky of RCA drew an analogy between three characteristics of adaption in living systems—stability, learning and reliability—and three utility measures commonly used in feedback theory—noise suppression, step response and sensitivity.

Bernard Widrow of Stanford University summarized his recent work on adaptive linear neuron systems called Adalines (ELECTRONICS, p 20, June 8) and combinations of these adaptive elements with outputs connected to logical structures (Madalines). Such adaptive pattern-recognizing systems may be used in control systems. A broom-balancing machine, using Madalines and a photocell array eyeball, is being built at Stanford. It will learn to follow a man's reactions as he stabilizes an upright broom; once trained in the complex sequences of reactions needed, this machine will take over the broom-balancing act.

In view of the surprisingly few adaptive elements required to learn complex tasks, and the demon-

TABLE—SUMMARY OF EFFORT IN VARIOUS AREAS OF CONTROL RESEARCH REPORTED BY 52 U. S. ENGINEERING SCHOOLS

Areas of Control Work	No. of Groups		Annual Budget (000)	Man-power		Reports or Theses per year
	T*	A*		No. of people	Equiv. full-time	
Feedback theory.....	27	11	\$378	74	31	70
Multi-dimensional systems.....	19	9	466	58	33	37
Model techniques.....	14	7	106	27	12	20
Non-linear analysis.....	35	15	394	104	51	72
Linear analysis.....	17	9	171	47	23	42
Adaptive control.....	33	8	433	112	52	67
Learning and Self-organizing.....	13	8	315	67	35	39
Optimal systems.....	23	6	236	74	34	55
On-off systems.....	13	5	112	27	11	19
Sampled-data systems.....	14	3	133	35	17	28
Time-varying active systems.....	10	4	159	30	15	21
Computer-control.....	16	7	273	62	31	33
Hybrid A/D systems.....	3	4	292	21	14	11
Analog-digital conversion.....	2	12	159	12	7	10
Data processing for control.....	6	8	588	57	36	42
Network synthesis.....	18	6	177	59	21	49
Active network synthesis.....	9	6	115	28	11	29
Process dynamics.....	17	9	173	56	28	38
Economic/management dynamics.....	7	5	217	57	30	38
Control components.....	5	5	444	49	31	26
Biological control systems.....	5	4	360	60	35	29
Miscellaneous.....	5	3	767	78	44	37
Totals.....	311	154	\$6,161	1,194	608	812

* Theoretical (T) or Application (A)

strated capabilities of learning machines, Widrow predicts that "in ten years, at least 75 percent of computer engineers will be working on learning machines."

BIONICS SYSTEMS—The impact and far-reaching effects of microelectronics and bionics were stressed by John R. Moore, president of Autonetics div. of North American Aviation Corp. Moore said that microelectronics will provide the tools needed to reproduce electronically many of the capabilities of thinking, learning and reacting which characterize living beings. Systems with such capabilities (bionics type systems), Moore said, would play an important part in all aspects of space programs, particularly aboard vehicles used to explore the surface of the moon and planets.

ASHBY'S LECTURE—In a talk that was enthusiastically received, control engineers were criticized for having got hung up on the question: "What is intelligence?" W. Ross Ashby, now of the University of Illinois, and long a recognized leader in biological control systems work, told the engineers they should stop worrying about the old word "intelligence" and get to work on well-defined jobs in which successes and failures are clearly distinguishable. When you succeed, he said, you will, as a by-product, have built a machine that is in a real sense intelligent. Stressing the relation of intelligence to goals, Ashby said that in 1962 the question should be answered: "If a goal is given, and a complex control mechanism is set to achieving that goal, then that mechanism is judged 'intelligent' essentially according to its success in achieving the goal."

In any case, Ashby concluded, the building of a mechanical chess player to beat the present world champion would be, for most people, the decisive event—it would put to rest once and for all the question of whether or not a machine is truly intelligent. "The attempt" (to build such a machine), he said, "far from being a game, would be perhaps the most serious and meaningful piece of research that can be undertaken on the subject at the present time."



ML-8087 Precision Scan Conversion Tube Fast Erase High Resolution

- 1 High resolution: a minimum of 180 range rings/diameter at 50% amplitude modulation; equivalent to 900 TV lines.
- 2 Fast erase: less than 2 seconds erase cycle to reduce stored information to noise level.
- 3 Wide storage range: to meet FAA 1213b specification and beyond.
- 4 High signal/noise ratio, typically 80:1 (peak signal to rms noise).
- 5 Rapid set-up time: only a few minutes installation time is required to adjust tube for optimum operation. No need for critical dynamic focussing of electron beams.
- 6 No variation of output signal with size of written area.
- 7 Only simple video circuits are needed for readout.

Send For Data



The Machlett Laboratories, Inc.
A division of Raytheon Company
Springdale, Connecticut



SQUARE-LOOP TAPE CORES TO MEET YOUR TOUGHEST SPECIFICATIONS

Speed your specs to Dynacor when you want square-loop tape cores to exact requirements—fast! Here you'll find a dependable combination of personnel, experience and facilities—the know-how to deliver parameters to your very tightest tolerance requirements for switching time, flux, and noise.

Dynacor Square-Loop Tape Cores are manufactured with the high permeability alloys—Grain-Oriented 50-50 Nickel Iron, 4-79 Molybdenum Permalloy, and Grain-Oriented 3% Silicon Iron . . . with fully guaranteed uniformity . . . under rigid standards of control and inspection.

Look to Dynacor for reliable production and swift delivery of your tape core requirements. For your convenience a full line of standard units are stocked for immediate off-the-shelf delivery—Send for bulletins DN 2000, DN 2001, DN 2002.



SPRAGUE
THE MARK OF RELIABILITY

SPRAGUE ELECTRIC COMPANY
35, MARSHALL ST. • NORTH ADAMS, MASS.

Telstar Aids NASA Budget

WASHINGTON—The highly successful trans-Atlantic tv performances AT&T's Telstar communications satellite provided in its first two days of operation have excited the imagination of both continents, prompted the White House to initiate a study on international communications, and made the Senate wholehearted in its authorization (July 11) of NASA's budget for communication satellites.

The bill provides \$2,688,000 for advanced research, \$2,473,000 for

advanced technical development, and \$80,216,000 for the flight program outlined below. Total amounts to \$85,377,000.

Similar to Telstar will be NASA's Relay, a low orbit, active communications satellite; it will use many of Telstar's ground stations.

An extension of Relay will be an intermediate altitude satellite.

Three Syncoms, high altitude satellite, will be funded with the new money, plus the beginning of an advanced Syncom.

NASA'S COMMUNICATIONS SATELLITE FLIGHT PROGRAM HARDWARE BUDGETS FOR 1961-63

	1961	1962	1963
Echo (rigidized sphere):			
Data reduction and analysis-contract		\$330,000	\$135,000
Thor launch vehicles	3,200,000		
Thor-Agena launch vehicle	2,200,000	4,680,000	
Total Echo (rigidized sphere)	8,678,000	5,010,000	135,000
Rebound:			
Spacecraft design study	325,000	555,000	
Spacecraft		4,750,000	1,612,000
Satellite flight units		1,115,000	1,075,000
Systems analysis, coordination and planning		836,000	807,000
Receivers, antenna feeds and terminal equipment			807,000
Communications experiments			618,000
Atlas-Agena launch vehicles		6,244,000	11,828,000
Total, Rebound	325,000	13,500,000	16,747,000
Relay:			
Systems engineering study	500,000		
Spacecraft fabrication and checkout	5,500,000	4,720,000	6,237,000
Systems coordination and planning	3,650,000		3,011,000
Command and control equipment	1,000,000	2,007,000	
Special ground equipment	2,000,000	446,000	1,075,000
Operations		1,450,000	2,258,000
Thor-Delta launch vehicles	8,000,000		6,560,000
Total, relay	20,650,000	8,623,000	19,141,000
Radiation measurements satellite:			
Engineering services	1,100,000	527,000	
Structures	260,000		
Solar paddles	175,000	446,000	
Flight data systems	75,000		
Mechanical systems	120,000	100,000	
Systems integration	160,000	235,000	
Total, radiation measurements satellite	1,890,000	1,308,000	
Synchronous communications satellite (Syncom):			
Spacecraft		4,450,000	2,043,000
Backup traveling wavetube		446,000	
Special telemetry equipment		223,000	
Command transmitter		335,000	
Reliability services		112,000	
Injection motor		558,000	
Traeking and data acquisition and services:			
Communication equipment		200,000	
Minitrack operational support test		223,000	323,000
Computer services			108,000
Data reduction			430,000
Side tone ranging equipment			
Transportation, installation, and operation of ground station:		1,004,000	
Station operation			1,022,000
Transportation		670,000	107,000
Logistic support		23,000	54,000
Thor-Delta launch vehicles		8,350,000	
Total syncom		16,594,000	4,087,000
Intermediate altitude satellite:			
Spacecraft			6,452,000
Systems coordination and planning			2,150,000
Radiation experiment			1,613,000
Special ground equipment			1,075,000
Atlas-Agena launch vehicles			10,215,000
Total, intermediate altitude satellite			21,505,000
Advanced synchronous communications satellite:			
Spacecraft			6,450,000
Ground control and communications equipment			5,915,000
Atlas-Agena launch vehicles			6,236,000
Total, advanced syncom			18,601,000
Total, flight program	31,793,000	45,035,000	80,216,000

Simplex Electronic Cables...

Reduce Low-Level Signal Noise

Protect Hard Site Communications

Facilitate Ocean Implantment

Typical of designs within the Simplex family of electronic cables is an antimicrophonic construction which reduces externally caused noise to a level of 2 millivolts as compared with a level of 60 millivolts in a typical RG 8/U cable subjected to identical testing.

Simplex can incorporate this long-lasting antimicrophonic design feature into any special cable construction, and high demand items such as 2 conductor #18 and single conductor #16 are stocked for immediate delivery.



Many critical installations require cables that are both pliable and strong. Cables, armored by Simplex with extra heavy corrugated metallic sheaths, provide protection for vital communications at hardened missile sites.



This cable provides power and instrumentation circuits plus tensile strength for lowering and retrieving complicated electronic equipment in ocean depths of several miles. These Simplex cables are of "balanced-torque" construction minimizing residual torque of the armor wires.

The Simplex family of electronic cables offers designs to meet the demands of most applications — plus unusual capabilities in the development and construction of special cables to solve specific problems. For further details write to Department 365, Simplex Wire & Cable Co., Cambridge, Mass.



Simplex

WIRE & CABLE CO.

EXECUTIVE OFFICES: Cambridge, Mass.

Plants at Cambridge, Mass., Portsmouth, N.H.,

Westbury, L.I., Monrovia, Calif.

CIRCLE 31 ON READER SERVICE CARD

HOW CHEAP IS "CHEAP"?

"Why should we buy from you when we can get the 'same thing' from other suppliers at a lower price?"

In selecting a supplier of lacing tape (or any component), price and compliance with specifications are not the only criteria. But too often, manufacturers ignore the other factors involved and consequently lose money.

For example, in a \$15,000 piece of equipment there may be only 15 cents worth of Gudebrod lacing tape. It costs \$75 to work this tape. It may be possible to buy the same amount of tape from other suppliers for 2 or 3 cents less . . . it "will meet the specs" according to these suppliers. But one of our customers recently pointed out why he still specifies only Gudebrod lacing tape in such cases.

"We tried buying some cheaper tape that 'met the specs.' Within a few months our production was off by 50% . . . boy, did the production people really scream about that tape. And our labor costs doubled . . . our costing people really flipped!

"Another thing, why should we risk the possible loss of thousands of dollars when the original material cost difference is only a few cents. Once you put cheaper tape on and something goes wrong after the equipment is finished . . . you've had it. No, thank you! We learned our lesson! We buy Gudebrod lacing tape!"

Whether your firm uses one spool of lacing tape or thousands, there are four advantages in specifying Gudebrod for all your lacing requirements:

1. *Gudebrod lacing tape guarantees increased production!*
2. *Gudebrod lacing tape guarantees reduced labor costs!*
3. *Gudebrod lacing tape guarantees minimal maintenance after installation!*
4. *Gudebrod guarantees quality!* On every spool is a lot number and seal which guarantees that all Gudebrod lacing tape is produced under strict quality control. Our standards are more exacting than those required for compliance with Mil-T.

Our Technical Products Data Book explains in detail the complete line of Gudebrod lacing tapes for both civilian and military use. For your copy write to Mr. F. W. Krupp, Vice President, Electronics Division

GUDEBROD BROS. SILK CO., INC.

Electronics Division
225 West 34th Street
New York 1, New York

Executive Offices
12 South 12th Street
Philadelphia 7, Pa.

MEETINGS AHEAD

INDUSTRIAL RESEARCH CONFERENCE, Columbia University; Arden House, Harriman, N. Y., Aug. 5.

ENERGY CONVERSION PACIFIC CONFERENCE, AIEE; Fairmount Hotel, San Francisco, Calif., Aug. 13-16.

PRECISION ELECTRONIC MEASUREMENTS INTERNATIONAL CONFERENCE, IRE-PGI, NBS, AIEE; NBS Boulder Labs, Boulder, Colo., Aug. 14-16.

CRYOGENIC ENGINEERING CONFERENCE, University of California; at UCLA, Los Angeles, Calif., Aug. 14-16.

ELECTRONIC CIRCUIT PACKAGING SYMPOSIUM, University of Colorado, et al; at the University, Boulder, Colo.; Aug. 15-17.

AIRCRAFT & MISSILES JOINT WESTERN REGIONAL CONFERENCE, ASQC; Benjamin Franklin Hotel, Seattle, Wash., Aug. 16-18.

APPLICATIONS & RELIABILITY SYMPOSIUM, Precision Potentiometer Manufacturer's Assoc.; Statler-Hilton Hotel, Los Angeles, August 20.

WESTERN ELECTRONICS SHOW AND CONFERENCE, WEMA, IRE; Los Angeles, Calif., Aug. 21-24.

METALLURGY OF SEMICONDUCTORS CONFERENCE; American Institute of Mining, et al; Ben Franklin Hotel, Philadelphia, Pa., Aug. 27-29.

BALLISTIC MISSILE & SPACE TECHNOLOGY SYMPOSIUM, US Air Force and Aerospace Corp.; Statler Hilton Hotel, Los Angeles, August 27-29.

MAINTAINABILITY OF ELECTRONIC EQUIPMENT, EIA Engineering Dept. & Dept. of Defense; U. of Colorado, Boulder, Colo., Aug. 28-30.

INFORMATION PROCESSING INTERNATIONAL CONFERENCE, IRE-PGEC, IFIPS, AIFPS; Munich, Germany, Aug. 29-Sept. 1.

INFORMATION THEORY INTERNATIONAL SYMPOSIUM, PGIT and Benlux Section of IRE; Free Univ. of Brussels, Brussels, Belgium, Sept. 3-7.

DATA PROCESSING INTERNATIONAL EXHIBIT, Assoc. for Computing Machinery; Onondaga County War Memorial, Syracuse, N. Y., Sept. 4-7.

ADVANCE REPORT

ON-LINE DATA PROCESSING APPLICATIONS SESSIONS OF AIEE WINTER GENERAL MEETING, *AIEE Computing Devices Committee; New York City, Jan. 28-Feb. 1, 1963. Sept. 1 is the deadline for submitting a 500-word informal summary to D. R. Helman, ITT Federal Laboratories, 500 Washington Avenue, Nutley 10, N. J. Papers should be oriented towards the entire system, but may deal specifically with aspects such as: analysis of requirements for a specific on-line application; system organization and operating procedures highlighting processor interrupt features, backup equipment and procedures for reliability; actual operating experience of on-line application systems.*



Single-Place Gyrocopter by Bensen Aircraft Corp.

Get a close-up of transportation savings in VIRGINIA'S CAPITAL AREA

Ship by train or truck, or this modern combination of the two. Ship air cargo or deepsea cargo. You have your choice in the Richmond-Petersburg-Hopewell-Colonial Heights-Ashland area.

Here your plant gets the advantage of Southern climate, Southern manpower, Southern production savings. Yet six major railroads, 56 scheduled truck lines put your products within overnight range of the top Northeastern, Midwestern markets. A deep-water channel

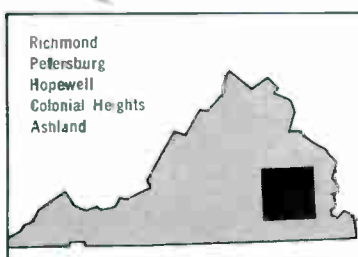

links you direct with world markets and sources of supply. Ask VEPCO for available site data and an economic study of Virginia's Capital Area. Write, wire or phone in confidence, without cost or obligation.



VIRGINIA ELECTRIC and POWER COMPANY
Clark P. Spellman, Manager Area Development
Electric Bldg., Richmond 9, Virginia • Milton 9-1411
Serving the Top-of-the-South with 2,049,000 kilowatts
—due to reach 3,019,000 kilowatts by 1964.

- Inexpensive way to switch rf power manually
- New line of aluminum heavy-wall waveguide for systems
- Frequency standard MTBF > 10,000 hours

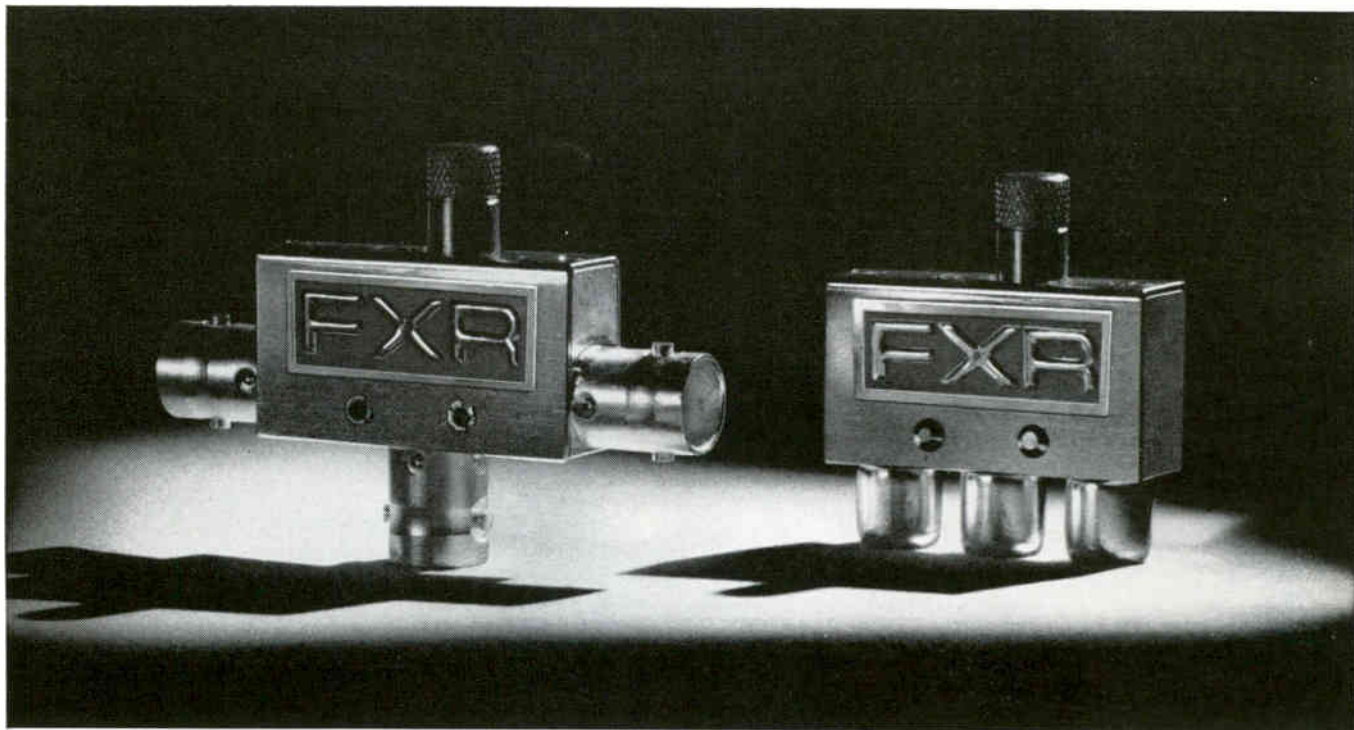

Inexpensive way to switch rf power manually

Weighing only 1.5 ounces and measuring 1-5/16 inches in its longest dimension, this SPDT coaxial switch handles up to 50 watts of power in a non-shorting 50 ohm circuit. VSWR at 250 mc and 400 mc is 1.08 and 1.16; crosstalk is -46 db and -42 db.

Standard configuration (above right), fitted with Phono connectors, is available from stock in prototype quantities for your evaluation at \$8.20 each. The "T" version, using BNC connectors, is available on the same basis at \$10.50. Production quantities (100-249 units) of either type cost half as much with delivery in 12 weeks.

For details on these coaxial switches or any of the hundreds of other DK® Coax Switches manufactured by FXR circle Reader Service Card 253. ■

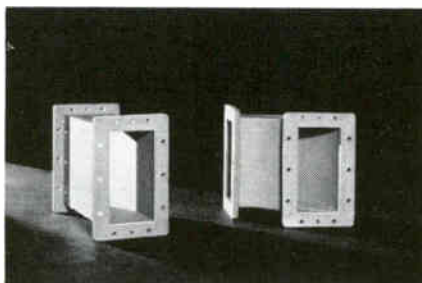

New line of aluminum heavy-wall waveguide for systems

FXR is now offering the first items in a new line of standard waveguide components for systems applications.

Available in straight lengths up to 19-feet, with or without flanges, and in 90-degree E-or H-Plane bends, these components are designed for L-band systems. Their 0.320-inch thick aluminum walls give them unusual structural strength and allow pressurization up to 45 psig.

TABLE OF CHARACTERISTICS

Frequency	L-band (1.12-1.70 GC)
Internal Dims.	3.250" x 6.500"
Bend radii	4.652" H-Plane 5.075" E-Plane
Finish	Chemical film per MIL-C-5541 Painted gray

Standardization and volume production make possible lower costs to designers of L-band systems. At present, delivery is on an 8 to 10-week basis depending on the items ordered.

Prices of straights, minus flanges, is \$20.00 a ft.; with 2 flanges \$160.00 for first foot, \$25.00 for each additional foot. Bends \$248.00 each (E- or H-Plane). Prices are F.O.B. FXR Woodside, N. Y. For more information, circle Reader Service Card 254. ■

Frequency standard MTBF > 10,000 hours



You get better than 10,000 hours mean time between failures from the new transistorized Borg Frequency Standard, Model 1555. This is a brand-new addition to the FXR line of precision test equipment.

Stability of the Borg 1555 is assured by the 5 mc overtone crystal, and is maintained by dual ovens which hold crystal temperature to $\pm 0.0033^\circ\text{C}$. Short-term stability is better than 5 parts in 10^{11} ; long-term better than 5 parts in 10^{10} per day.

You get more than six hours stand-by operation from batteries which are an integral part of the unit. You can plug in two extra frequency modules, dividers or multipliers. An external status indicator gives you quick read-out. And there are frequency outputs front and rear.

The Borg 1555 can also be supplied to meet military specifications, including MIL-E-16400D. Special project engineering assistance is also available from FXR.

SPECIFICATIONS

Transistorized Frequency Standard, BORG MODEL 1555

FREQUENCY STABILITY

Long Term: 5 parts in 10^{10} per day; 1 part in 10^8 per 60 days; after 21 days of continuous operation.

Short Term: rms deviation of 1000 successive 0.2 second measurements; better than 5 parts in 10^{11} .

OUTPUT FREQUENCY

5 mc: output of 1 volt minimum rms into 50 ohm load.

HARMONIC DISTORTION

Less than 1%.

FREQUENCY ADJUSTMENT

Coarse: adjustable with range of 500 parts in 10^9 .
Fine: adjustable with range of 1000 parts in 10^{10} readable to 1 part in 10^{10} .

LINEARITY OF FINE FREQUENCY ADJUSTMENT

Over any range of 500 parts in 10^{10} shall be within ± 20 parts in 10^{10} .

METERING

Front panel with 12-position switch to meter all critical circuits and provision for remote metering of output.

TEMPERATURE RANGE

0°C . to 50°C .

DELIVERY

60 Days: if military specifications required—90 to 120 days.

Borg frequency and time standards are now marketed by FXR. For complete information on Borg precision time and frequency standards, write, TWX, or telephone R. W. Delcamp, FXR, 25-29 50th St., Woodside, N. Y. RAvenswood 1-9000, or circle Reader Service Card 255. ■

Two new connector series



Aluminum Series HN Coaxial Connectors . . . weigh approximately 35% less, yet

have electrical characteristics equivalent to their standard counterparts. Series HN with captivated contacts, have a hard-coat finish to neutralize galvanic action with other metals. This series, designed for aerospace application, can be used whenever you are faced with weight problems, environmental extremes of shock, vibration, or exposure. Circle Reader Service Card 256. ■

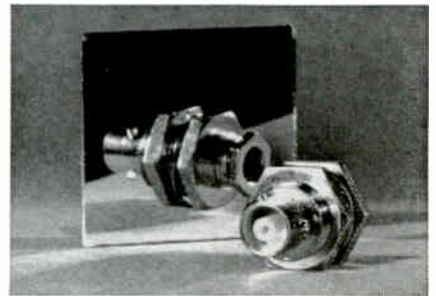

TPS Series Coaxial Connectors . . . small light-weight UG types with triple-stud bayonet lock. The U.S. Signal Corps developed the design to give quick-disconnect and high vibration stability in missile, airborne, sea-borne, land-mobile and submarine applications. TPS connectors have greater locking stability, are both smaller and lighter by approximately $\frac{1}{3}$ than comparable BNC types. Circle Reader Service Card 257. ■

The RF Products and Microwave Division Amphenol-Borg Electronics Corporation 33 East Franklin Street, Danbury, Connecticut.

FXR™

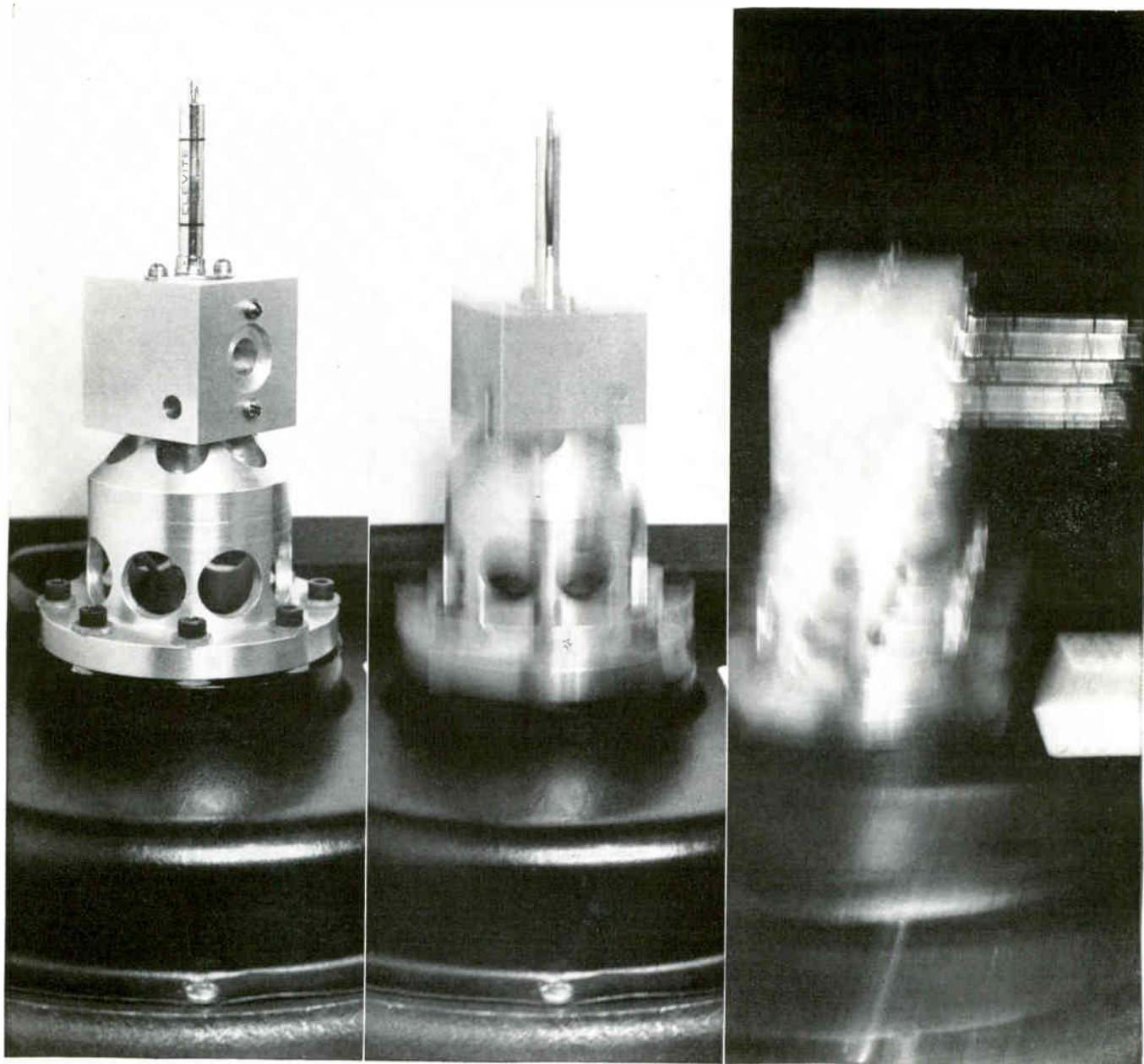

Specify proven stability



with CLEVITE Ceramic Filters

Does your i-f filter maintain center frequency under vibration and shock? It does if it's a Clevite ceramic ladder filter. Center frequency shift is negligible after MIL 202B shock and vibration tests*. ■ Stability like this is worth considering whether your next receiver is ground or airborne. Clevite now stocks 455 kc and 500 kc ladder filters in 12 bandwidths from 2 kc to 50 kc. Standard models pack 80 db stopband rejection into a 0.1 cu. in. package. ■ Write or phone the nearest Clevite office for immediate information, prices and delivery on Clevite ceramic ladder filters.

*actual test plots on request.

Field Sales offices: New York, New York/Chicago, Illinois/Denver, Colorado/Inglewood, California.

**CLEVITE
ELECTRONIC
COMPONENTS**
DIVISION OF CLEVITE CORPORATION
232 FORBES ROAD, BEDFORD, OHIO

Microwave phototube has many advantages over other light detectors and mixers. Here's how it performs as a detector of microwave modulation and as a mixer of modulated with unmodulated laser light beams

By **RUDOLF G. E. HUTTER**,
Chief Engineer and Lab Manager,
Sylvania Electric Products, Inc.,
Microwave Device Div.,
Mountain View, Cal.

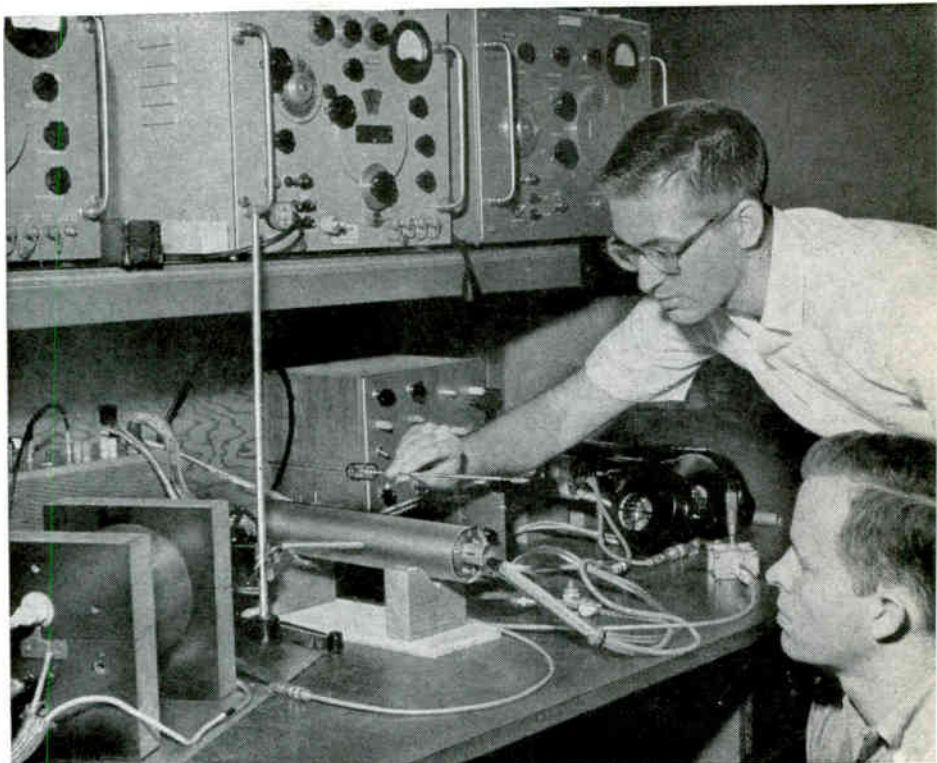

LAB SETUP for studying behavior of microwave phototube

THE MICROWAVE PHOTOTUBE

New Detector for Optical Receivers

MICROWAVE PHOTOTUBES have been extremely useful in studying performance characteristics of lasers. Further improvement in lasers, microwave phototubes and associated devices will bring about widespread use of microwave phototubes as light mixers and detectors in optical-communications receivers.

A microwave phototube (Fig. 1A and 1B) consists of a photosensitive cathode (which may simultaneously serve as a thermionic cathode), followed by a microwave-electron-tube structure to amplify, detect and remove the modulation placed on the electron beam by the incident light-beam signal. Although there are many possible variations on this idea,

only one version of a microwave phototube will be discussed in detail. The article will also compare the use of microwave phototubes with other devices as light detectors and mixers, and analyze the functioning of a microwave phototube as a detector and as the mixer of a superheterodyne light receiver.

For a light wave to carry an enormous volume of information, full advantage must be taken of the enormous bandwidths possible at optical frequencies. Broadband modulation must be employed, and the light-detecting system must be capable of broadband and therefore, high-frequency detection and demodulation. This means microwave or low-mm-wave modulation

and demodulation frequencies.

Practical light-detection methods that are capable of handling microwave-modulated light include fast multiplier phototubes, fast semiconductor photodetectors, and microwave phototubes. The table summarizes and compares the properties of these devices. Conclusions may be drawn from the comparisons in the Table. The multiplier phototube has a number of major disadvantages that make it unsuitable as a light detector for high-frequency modulated light beams. The photodiode may be of interest, particularly as a detector in the infrared region beyond the range of photocathodes, and as a simple detector in strong-signal situations.

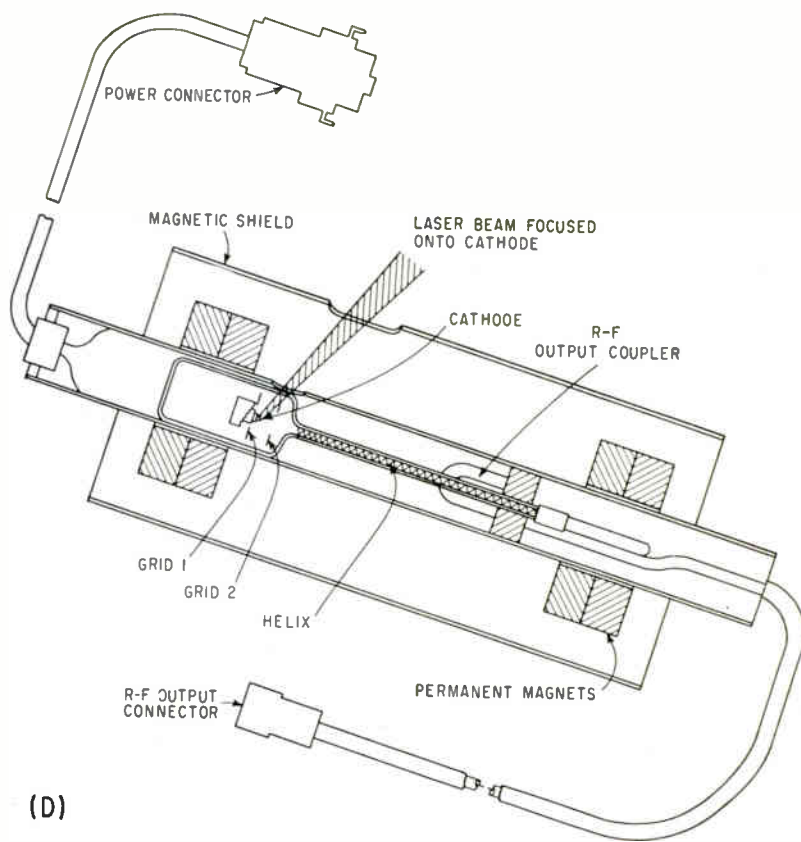
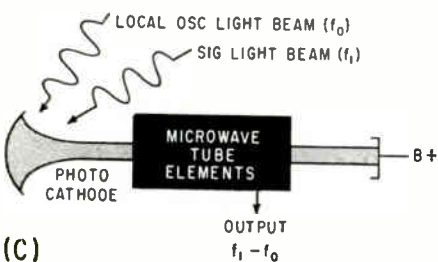
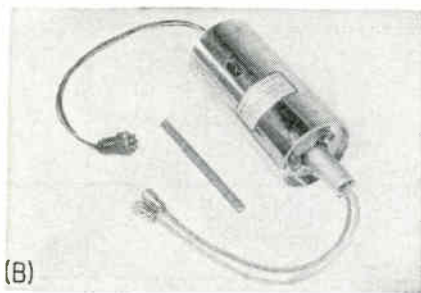
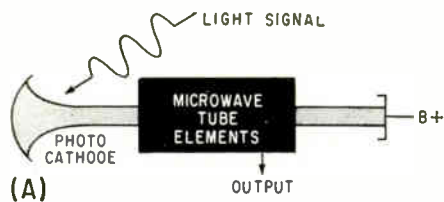

USING MICROWAVE PHOTOTUBE as a detector of a-m light (A). First experimental X-band phototube (B). Using a microwave phototube as a mixer (C). Tube shown in (D) is similar to (B) tube—Fig. 1

The microwave phototubes appear to be by far the optimum method for demodulating broadband coherent modulated light signals. Some of the advantages such as the responsiveness to frequency modulated light are not present in the device that has been developed into a commercial product. Work is going on to develop an f-m detector tube. Further work on improving the infrared response of the photocathode is also being carried out.

DIRECT DETECTION—Consider the design of microwave phototubes for the direct detection of ordinary amplitude-modulated light signals. Figure 1A shows the type of structure. The signal is an amplitude-modulated light beam. When it falls on the photocathode surface, it produces a correspondingly amplitude-modulated electron beam. The electron beam has an initial current modulation, or is already bunched, when it leaves the cathode. Assume that this modulation is at a microwave frequency. The beam is then accelerated and passed through microwave tube elements, which both amplify the modulation and also remove it as an electrical

signal, which emerges from the output of the microwave phototube. The microwave tube elements might consist of, for example, a microwave cavity, helix, or some other slow-wave circuit.

In this device, problems of transit time do not arise as they do in a multiplier phototube. There is simply an initial current modulation at the input-cathode plane, which excites slow and fast space-charge waves on the beam. The energy in these waves is then amplified and removed by the microwave tube elements. Such devices can operate at any frequency at which any other microwave tube can operate.

This device is called a video microwave phototube because it is the optical analog of an ordinary r-f video receiver. The modulated light is like the incoming r-f signal; the photocathode is like the video detector crystal; and the microwave tube elements are like the video amplifier section. The video frequency in the optical case is, of course, a microwave or higher frequency. The response bandwidth of such video microwave-phototubes is limited only by the inter-

action bandwidth of the beam with the microwave tube elements. This bandwidth can be at least as large as the bandwidth of helix traveling-wave tubes. The amplification method used in commercially available tubes is identical with that of the helix-type traveling wave amplifier. Other amplification mechanisms may also be used such as velocity-jump amplification and parametric amplification.

Figure 1C depicts the use of a microwave phototube as a mixer.

The SY-4302 tube (Fig. 1D), which is similar to Fig. 1B, has a 3:1 modulation frequency range, extending from 1.5 Gc to 4.5 Gc with no adjustment or tuning. The tube, which is permanent-magnet focused, employs a conventional rugged oxide photosurface with more than ample sensitivity for light mixing experiments with crystal-laser signals.

PHOTOTUBE MIXING—Figure 2A shows an experimental setup of an optical superheterodyne in which a twt (V_1) was used as a microwave phototube to mix output frequencies of a ruby laser.

A ruby laser oscillates simultane-

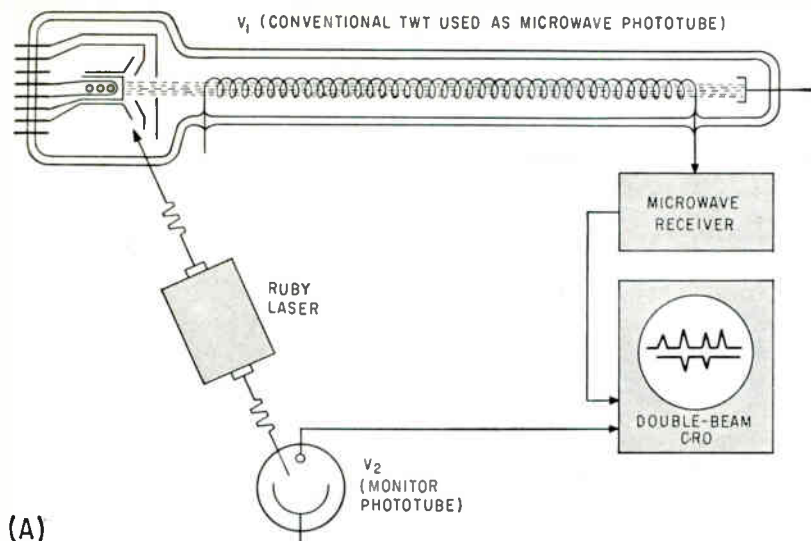

(A)

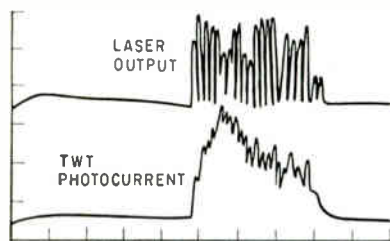

(B)

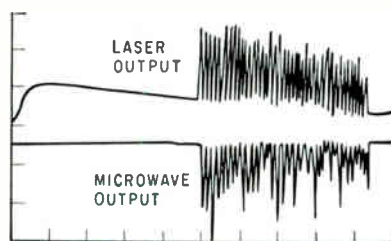

(C)

SUPERHETERODYNE DETECTION demonstrated in experimental setup (A). *Waveshapes in (B) show microwave phototube current resulting from laser pulse; (C) shows microwave output—Fig. 2*

ously in a number of different and discrete axial resonant modes. Each mode is at a slightly different frequency.

When the ruby laser was beamed onto the microwave phototube, large photocurrents (up to 0.5-ma peak) were measured during the laser pulse, using a load resistance inserted in the cathode lead. Figure 2B shows the laser light output on the top trace, as monitored by the monitor phototube (V_2), and shows the photocurrent from the microwave phototube on the bottom trace.

MICROWAVE OUTPUT—Figure 2C shows that when the laser was fired, strong coherent microwave signals were obtained from the output of V_1 , at the difference frequency between the ruby laser's modes. The upper trace shows the laser light output, which consists of a series of short spikes, and the lower trace shows the microwave output from the microwave phototube, which is detected by the microwave receiver. These microwave outputs, which are produced by optical superheterodyne action

in the microwave twt, are strong and readily detected with no noise difficulties. The outputs are at discrete microwave frequencies corresponding to the optical-mode intervals. For example, with the 5-inch ruby rod, outputs were seen from the nominal 2-Gc to 4-Gc traveling wave tube at 1.8, 2.4, 3.0, 3.6 and 4.2 Gc. With a 2-inch laser rod, outputs were seen simultaneously at 1.5, 3.0 and 4.5 Gc, a 3:1 i-f bandwidth range in the optical superheterodyne receiver.

Figure 3 shows the configuration of an optical superheterodyne re-

ceiver that uses a microwave phototube to mix a signal light beam and the light beam from a local oscillator laser. These beams must be parallel and the wavefronts must arrive at the phototube cathode parallel and in phase over the cathode surface if superheterodyne action is to occur. If not, the signal and local-oscillator beams will have different relative phases at different points on the cathode surface. A partially silvered mirror is used as a beam splitter to focus the output of the laser local oscillator onto the microwave phototube while permitting signal light to enter. Now, there is a narrow and sharply defined cone angle within which the signal light must enter if it is to be parallel with the local-oscillator light at the cathode, as indicated in the drawing. If the photocathode surface is thought of as a receiving antenna, the light cone is similar to the receiving pattern of a highly directional receiving antenna—which is what is likely to be wanted in an optical communications system. The cone angle of the receiving beam of this antenna has a width given roughly by $\Delta\theta = \lambda/a$, where a is the diameter of the photocathode surface in the microwave phototube. If it is desired to spoil (enlarge) this receiving angle, optics to do so can readily be placed in the beam just beyond the partially silvered mirror.

WHY SUPERHETS—There are a number of reasons for placing so much emphasis on optical superheterodyne reception with microwave phototubes.

First, optical superheterodyne reception is important because of its high sensitivity and low noise.

Secondly, optical superhetero-

OTHER PHOTOTUBE EXPERIMENTS

The photomixer tube will be used in more involved experiments than those indicated in Fig. 2A to study other characteristics and features of laser output such as:

- Frequency stability and spectral purity
- Frequency pulling
- Zeeman, Stark and pressure-tuning effects
- Mode jumping
- Transverse modes of oscillation
- Ground-state splitting effects
- Optical cross relaxation

DEVICES FOR HIGH-FREQUENCY DETECTION AND DEMODULATION OF LIGHT

(A) FAST MULTIPLIER PHOTOTUBES

ADVANTAGES:

- (1) High sensitivity: fair quantum efficiency; low dark current (cooling required)
- (2) Internal amplification (by electron multiplication)

DISADVANTAGES:

- (1) Limited frequency response and bandwidth: f_{max} 1,000 Mc at present, due to transit time and other effects; great improvements not likely
- (2) Not suitable for optical superheterodyne reception: direct current due to local oscillator would be amplified, causing burnout
- (3) Not responsive to frequency-modulated light
- (4) Not a rugged component: response sensitive to temperature, aging; easily damaged by overload; mechanically complex; multiple electron multiplication stages make fabrication complicated
- (5) Infrared response limited (with present-day photosurfaces)

(B) FAST SEMICONDUCTOR PHOTODETECTORS (*pin* JUNCTION PHOTODIODES)

ADVANTAGES:

- (1) High sensitivity: near-unity quantum efficiency; low dark current
- (2) Simple rugged device (although it requires auxiliary equipment)
- (3) Infrared response good (due to small band gap)
- (4) Suitable for optical superheterodyne reception

DISADVANTAGES:

- (1) Limited bandwidth: response occurs in small lumped element with high capacitance; must be resonated
- (2) No internal amplification (auxiliary amplification required)
- (3) Small detection area (light must be focused onto small junction region)
- (4) Not responsive to frequency-modulated light

(C) MICROWAVE PHOTOTUBES

ADVANTAGES:

- (1) Extremely broad frequency response: up to highest microwave-tube frequencies; bandwidths comparable to traveling wave tubes—at least 3:1
- (2) Internal amplification (by traveling-wave interaction or by other methods)
- (3) Suitable for optical superheterodyne reception (local oscillator's direct current will assist amplification)
- (4) Responsive to frequency-modulated light (by use of transverse-wave interactions)^a
- (5) Good sensitivity (sensitivity depends on photosurface)
- (6) Ruggedness, ease of manufacture comparable to or better than other microwave tubes)

DISADVANTAGES:

- (1) Infrared response limited (with present-day photosurfaces)
 - (a) Phototube described has to be slightly modified, using transverse cyclotron wave interaction with a microwave circuit such as a helix, to be used for f-m light detection; multiplier phototubes and semiconductor photodetectors cannot be modified

dyne reception is important because it permits frequency filtering at the intermediate frequency rather than the optical frequency. It is usually desired to pick out weak optical signals against a fairly strong background of sunlight or other background light. Filtering at the optical frequency is extremely difficult, because good narrow-band optical filters ($\leq 1 \text{ \AA}$) are not available. The superheterodyne, on the other hand, responds only to light lying within the i-f passband away from the local oscillator wavelength. For example, a 1-Gc i-f bandwidth corresponds to an optical bandwidth of only about 0.016 \AA (Angstrom) at 7,000 \AA . Background light outside

this band is not detected.

Third, superheterodyne reception with microwave phototubes seems to be by far the most practical method. This is because the photocathode is such a good square-law device to use as a mixer, and because the wide bandwidth of the microwave phototube reduces the stiff tolerances on local oscillator and signal frequency stabilities and also gives the maximum useful bandwidth for such a device.

Thus, optical superheterodyne applications of microwave phototubes are likely to be their most important applications.

POWER OUTPUT AND NOISE— In conventional phototubes, such

as multiplier phototubes, maximum sensitivity and performance are generally associated with minimum dark current, that is, that there should be no direct current (I_0) in the tube in the absence of light. This thinking may require some alteration in dealing with microwave phototubes, however, since the presence of some direct current can be useful in increasing gain and power output, at the cost of some loss in noise performance due to shot noise.

Consider, for example, the situation in which a 100-percent amplitude-modulated light signal produces a 100-percent a-m photocurrent of amplitude I_1 , as shown in Fig. 4A. If these photoelectrons

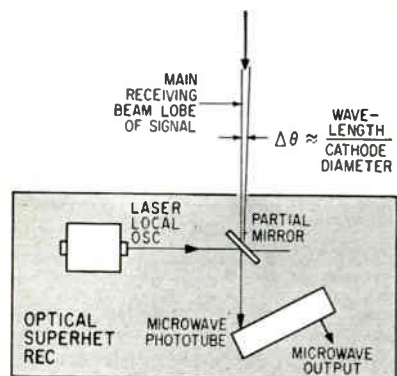

OPTICAL SUPERHETERODYNE RECEIVER consists of laser local oscillator and microwave phototube. Partial mirror passes signal beam and reflects the local oscillator beam—Fig. 3

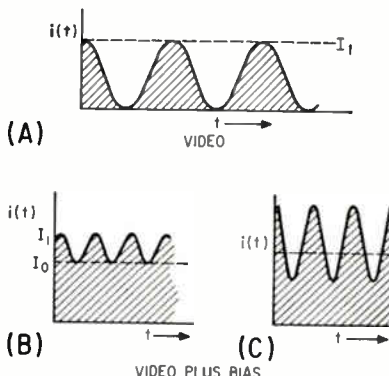

A-M WAVESHAPES (A) shows photocurrent due to 100-percent a-m light input. Waveshape (B) shows photocurrent due to this light superimposed on d-c bias; (C) shows tube output current—Fig. 4

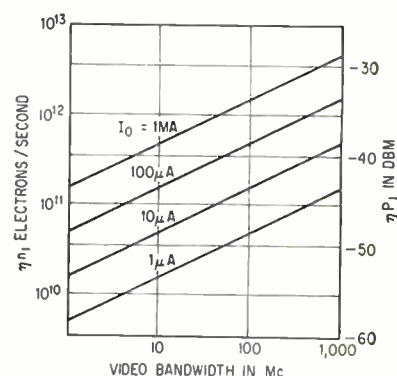

MINIMUM DETECTABLE NUMBER of electrons/sec and minimum detectable power at 7,000 Å, both multiplied by η , are shown for an amplitude-modulated microwave phototube—Fig. 5

are then accelerated by a d-c voltage (V_o), the maximum microwave power output that can be obtained from the phototube, regardless of the amplification methods employed, is

$$P_{out} \leq \frac{1}{2} I_1 V_o$$

since the most the microwave circuit fields can do is completely stop the photoelectrons. For small photocurrents, P_{out} may be small.

Suppose, on the other hand, that the beam current also contains a biasing direct current component, I_o , due to thermionic emission or to additional light falling on the cathode, as shown in Fig. 4B. The microwave modulation can be amplified by interaction with the direct current, so that the modulation depth of the beam current modulation is increased as shown in Fig. 4C. The maximum microwave power output now is the d-c beam power, or

$$P_{out} \leq I_o V_o$$

The presence of I_o can greatly increase the available gain and power output for small photocurrents.

SHOT NOISE—However, the presence of I_o also increases the amount of shot noise in the tube. It is difficult to give a useful analysis of noise in such optical detectors without specifying in more detail the situation being considered. For example, there is likely to be a large amount of background light in addition to the signal, so that the signal-to-noise ratio is set by the background light rather than by the noise in the photodetector. Then the presence of some shot noise in the microwave phototube will not do any particular harm.

Suppose, however, the optical sensitivity is determined solely by shot noise in a microwave phototube, and examine some order of magnitude possibilities. Suppose that the incident signal light has average power P_1 , and is 100-percent amplitude modulated. The average number of arriving signal photons per unit time is

$$n_1 = P_1/hf$$

where f is the frequency of the signal light and h is Planck's constant. Let the photo-cathode have a quantum efficiency η defined as

$$\eta = \frac{\text{Number of electrons emitted}}{\text{Number of photons arriving}}$$

Good photosurfaces in different spectral ranges have η values ranging from 0.1 percent to 20 percent. The initial microwave current modulation at the photocathode will be

$$I_1 = \eta n_1 e / 2^{1/2}$$

where e is the charge on an electron. If the cathode also emits a direct current, I_o , the shot-noise initial current modulation in bandwidth B will be

$$I_o^2 = 2eI_o B$$

Therefore, the signal-to-noise ratio of the phototube (still ignoring background noise) will be

$$\frac{S}{N} = \frac{\eta^2 n_1^2 e^2}{4eI_o B}$$

The minimum detectable number of signal photons per unit time (for $S/N = 1$) is, therefore

$$n_{1 \min} = (2/\eta) \times (I_o B/e)^{1/2}$$

This can be understood as the rms fluctuation of a Poisson quantity. The minimum detectable light power is

$$P_{1 \min} = n_{1 \min} hf = (2hf/\eta) \times (I_o B/e)^{1/2}$$

Assuming a light wavelength of 7,000 Å for the ruby laser, the results are

$$\eta n_{1 \min} = 5 \times 10^9 (I_o B)^{1/2}$$

$$\eta P_{1 \min 7,000 \text{ Å}} = 1.4 \times 10^{-9} (I_o B)^{1/2}$$

where I_o is in μA and B is in Mc. Figure 5 is a plot of these relations as a function of the video bandwidth, with direct current as a parameter. The video sensitivity can be moderately good, but not extremely good, with direct current present. In general, superheterodyne detection is much more sensitive.

NOISE ANALYSIS—Let the electric field of the local oscillator light falling on the cathode (Fig. 3) be $E_o \cos \omega_o t$ and the same quantity for the signal light be $E_1 \cos \omega_1 t$, where the difference frequency ($\omega_1 - \omega_o$) is presumably a microwave frequency. The total electric field on the cathode can then be written

$$e(t) = E_o \cos \omega_o t + E_1 \cos \omega_1 t$$

$$= [E_o + E_1 \cos(\omega_1 - \omega_o)t] \cos \omega_o t - [E_1 \sin(\omega_1 - \omega_o)t] \sin \omega_o t$$

The terms are separated into the optical frequency variation $\cos \omega_o t$ or $\sin \omega_o t$, multiplied by the envelope amplitude terms inside the brackets. The photocurrent from the cathode is proportional to the square of the electric field envelope

amplitude, or

$$i(t) \sim e^2(t) = [E_o + E_1 \cos(\omega_1 - \omega_o)t]^2$$

$$+ [E_1 \sin(\omega_1 - \omega_o)t]^2$$

$$= E_o^2 + E_1^2 + 2E_o E_1 \cos(\omega_1 - \omega_o)t$$

In terms of the number of incident light photons per unit time, the number of local oscillator photons per unit time is $n_o \sim E_o^2$ and the number of signal photons per unit time is $n_1 \sim E_1^2$. From these proportionalities and equations, the total number of photons per unit time arriving can be written as

$$n(t) = n_o + n_1 + 2(n_o n_1)^{1/2} \cos(\omega_1 - \omega_o)t$$

In quantum efficiency η of a photosurface, the beam current is

$$i(t) = \eta n_o e + \eta n_1 e + 2\eta(n_o n_1)^{1/2} e \cos(\omega_1 - \omega_o)t \quad (2)$$

Ignore the second term on the assumption that the local oscillator will be much stronger than the signal, so that $n_1 \ll n_o$. The direct beam current in the tube is then

$$I_o = \eta n_o e$$

This causes a shot-noise background in a bandwidth B given by

$$i_o^2 = 2eI_o B = 2\eta n_o e^2 B$$

On the other hand, the rms signal current is the a-c term in Eq. 2 divided by 2^{1/2}, or

$$i_1 = \eta(2n_o n_1)^{1/2} e$$

The signal-to-noise ratio is given by

$$\frac{S}{N} = \frac{i_1^2}{i_o^2} = \frac{2\eta^2 n_o n_1 e^2}{2\eta n_o e^2 B} = \frac{\eta n_1}{B}$$

Suppose the amplifier resolution time is $\tau = 1/B$. Then, the minimum detectable number of signal photons (that is, for $S/N = 1$) can be written

$$n_{1 \min} = (1/\eta)B = (1/\eta)(1/\tau)$$

= 1/ η photons ampl resolution time.

Research on microwave phototubes for optical mixers and receivers was first initiated by A. E. Siegman at Stanford University; the initial microwave phototube experiments, using modified Sylvania twt's, were performed at Stanford by B. J. McMurtry. The microwave modulation-demodulation experiments using a Sylvania microwave phototube were carried out at Stanford by S. E. Harris. John Gaenzle has contributed greatly to the development of the SY-4300 line of tubes.

BIBLIOGRAPHY

Sy Vogel and Leon H. Dulberger, Lasers: Devices and Systems, ELECTRONICS, Part I—Oct. 27, 1961, Part II—Nov. 3, 1961, Part III—Nov. 10, 1961, Part IV—Nov 24, 1961.

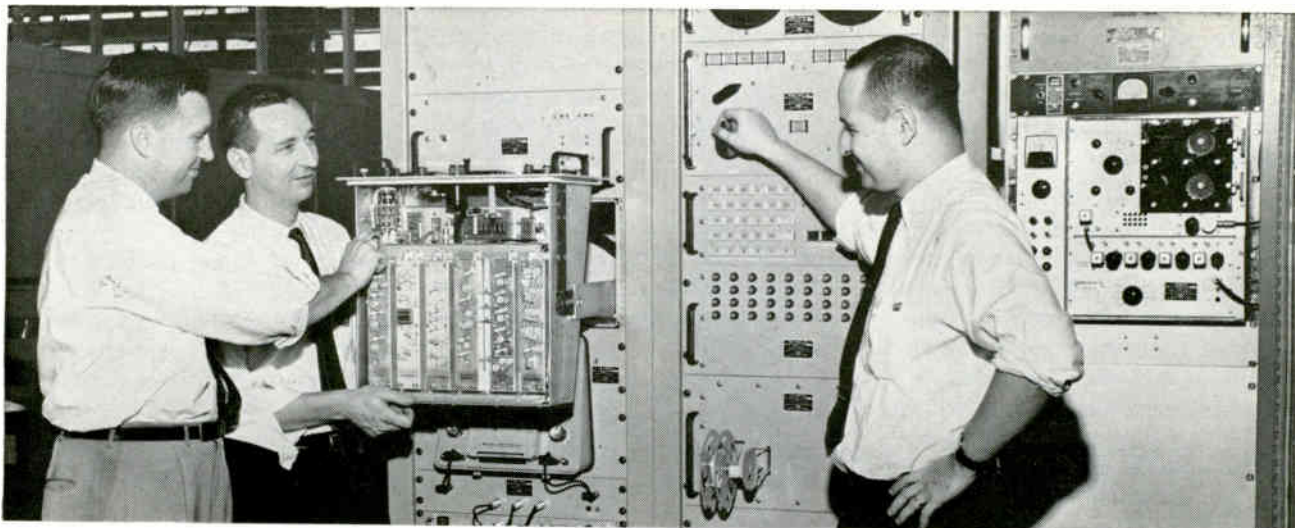

FINAL CHECKOUT of two-way doppler tracking equipment before its shipment to Navy's Pacific Missile Range

DOUBLING TRACKING ACCURACY

Unlike conventional one-way doppler systems, this radar system beams a c-w signal to a satellite transponder that multiplies the signal frequency and retransmits it to the interrogating station. Receiver of interrogating station extracts doppler-shift data

By JOSEPH A. HUIE
R. H. MOEHLMAN
H. R. DOBSON
R. H. KAY

General Dynamics/Electronics,
Rochester, N. Y.

THIS DOPPLER TRACKING equipment measures and periodically records the relative velocity between a satellite and a fixed receiving station. The receiving station may be land based or on a ship whose location has been precisely determined.

Figure 1 pictures the operational situation in which the equipment is mounted on a down-range instrumentation ship. A 375-Mc c-w signal is transmitted from the ship to the satellite. The satellite carries a coherent transponder that multiplies the received signal frequency by exactly 16/15 and retransmits a c-w signal. The ship then receives the return, which is 400 Mc plus or minus the doppler shift in frequency caused by the relative motion of ship and satellite. This doppler frequency shift is recovered and digitized. The coded frequency information with range time is re-

corded on paper tape. A central computer receives this data with other tracking information through an h-f teletypewriter link. These data are used for launch trajectory and orbit calculation.

If the relative velocity between transmitter and receiver is much less than the velocity of light then the doppler shift is

$$f_{d1} \approx \dot{a}f/c \quad (1)$$

where f_{d1} = shift in the received frequency from f , the transmitted frequency, \dot{a} = relative velocity between receiver and transmitter (range rate), and c = velocity of light.

For the two-way system, the shift is just twice that given in Eq. 1

$$f_{d2} \approx 2\dot{a}f/c \quad (2)$$

An indication of doppler shift magnitude may be gleaned from Eq. 2. This gives predicted range-rate/doppler curves for a satellite in a 400-mile circular orbit about the earth (the earth assumed to be spherical and nonrotating). The curves give the effect for the receiver being at different distances off the satellite subtrack. The time

values are referred to the point of closest satellite approach. At this instant the relative velocity and hence the doppler shift is zero.

SYSTEM ACCURACY—The overall system provides for measurement of range rate to an accuracy of better than ± 1 foot per second excluding propagation errors over more than 1,700 nautical miles. Figure 3A shows a signal-margin analysis for the system at the 1,700-mile range. The margin for the ship to satellite link is about 24 db and for the return link 13 db.

Figure 3B is a simplified diagram of the shipboard equipment. The oscillator of the transmitter operates at 5.2 Mc and the transmitter multiplies this 72 times to provide the 375-Mc output frequency. The short-term-stability of the oscillator is important, since any drift during the time of signal propagation to the satellite and return introduces an error in the doppler measurement. For a range of 1,700 miles, the drift rate must be less than 1 part in 10^8 per second, so that the range rate error

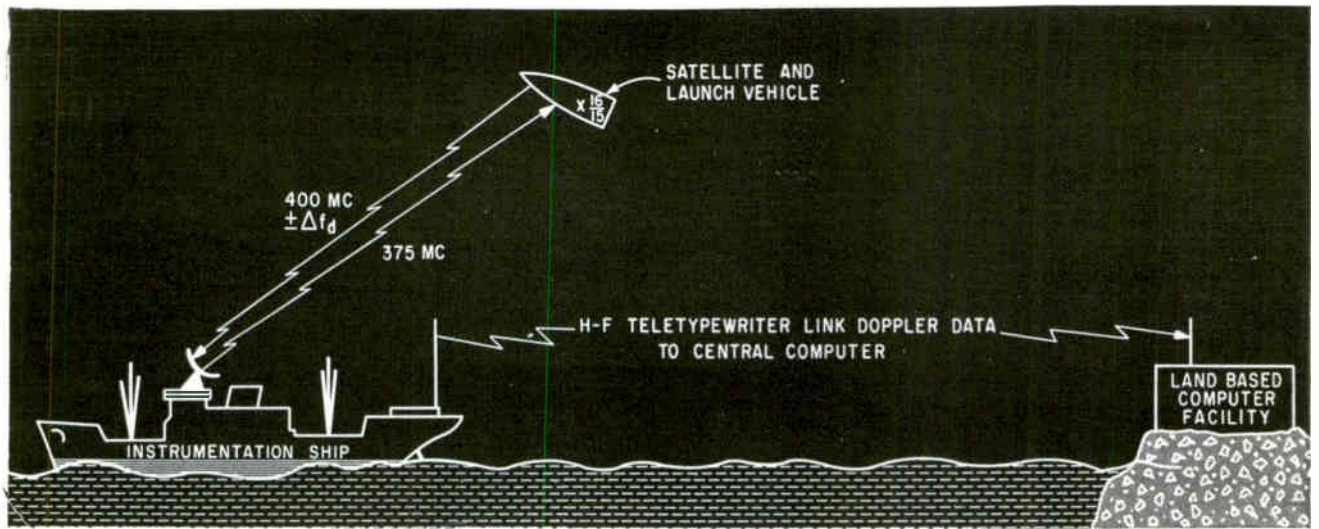

TWO-WAY DOPPLER system. The 375-Mc beam transmitted to satellite is multiplied to 400 Mc and retransmitted by satellite transponder—Fig. 1

With a Two-Way Doppler System

is less than 0.1 foot per second. This stability is far exceeded through the use of regulated power supplies and a controlled oven for maintaining constant crystal and circuit temperature.

The 375-Mc transmitter signal frequency and a $f_c/360$ ($= 1.04$ Mc) frequency go to the receiver. These frequencies are used in the recovery of the doppler shift from the received signal. The receiver output is at 50 Kc plus or minus the doppler shift (f_d). This 50 Kc $\pm f_d$ frequency is digitized and, at 4-second intervals, punched on to 5-bit tape together with an externally generated time code. This is the primary data output from the system. Auxiliary outputs in the form of frequency and signal strength also go to a dual-channel recorder.

The 5.2-Mc input to the transmitter is at a level of about 2 mw. This is multiplied 72 times to 375 Mc, the output frequency, and brought to an r-f power level of 100 watts. The output tube is a 4CX250B tetrode using a quarter-wave-line tank. Phase jitter in the output is held to less than 0.1 radian rms to insure stable operation with the satellite transponder. Since the equipment will be installed on an instrumentation ship with many different receivers and antenna systems in close proximity,

the spurious emissions from the transmitter are held to a low level. Thus, the transmitter is isolated in a shielded cabinet with filtering on all interconnecting cables. A band-pass and a low-pass filter in the transmitter output insure all spurious signals to the antenna are at least 100 db below the main signal.

The antenna, which is a twelve-foot parabolic dish with a helical feed, is mounted on a mast near the center of the ship. The helical feed provides circular polarization which is necessary since the satellite radiation is linearly polarized, but of unknown direction. Antenna gain is greater than 17 db compared with a linear isotropic source over the band of 375 to 400 Mc. Automatic positioning is accom-

plished by slaving the antenna to either a radar or telemetry tracker.

RECEIVER—The heart of the doppler tracking system is the receiver. It is necessary to recover the doppler shift from the satellite transmission with high precision and with weak signal inputs, 10^{-18} w or -150 dbm. To attain this order of sensitivity it is necessary to have a low noise figure front end and to utilize a narrow noise bandwidth. The former requirement is met by use of the GL-6299 planar triode as a grounded grid 400-Mc preamplifier (Fig. 3C). The noise figure is better than 5.5 db. Phase lock correlation detection achieves r-f noise bandwidths adjustable from 10 to 200 cps. The receiver local oscillator is phase

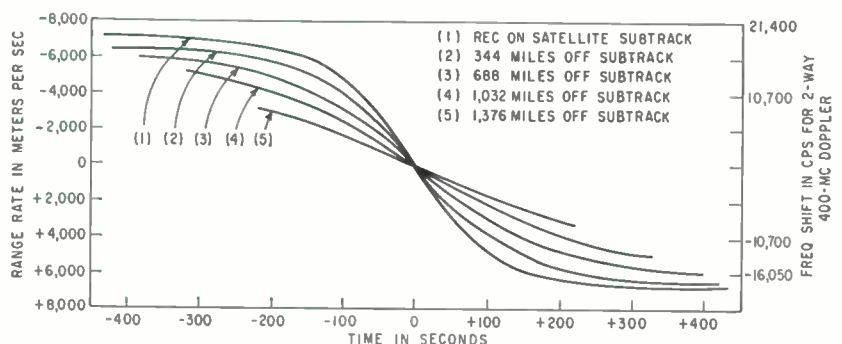

DOPPLER-SHIFT and range-rate curves for satellite in circular orbit of 400 nautical miles—Fig. 2

locked to the incoming signal and the effective receiver r-f bandwidth is twice the phase control servo bandwidth.

The transmitter frequency is used as the first local oscillator in the mixer, producing a first i-f frequency of $f_i/15$ or 25 Mc. The second local oscillator is a voltage-controlled or tunable oscillator (vco) and is automatically adjusted (once the signal has been acquired) so that the difference between $f_i/15$, the signal into the first i-f amplifier, and the vco is exactly 5 Mc. The 5-Mc difference is amplified in the narrow-band second i-f amplifier

and compared in phase with the 5-Mc frequency standard. The phase detector output is a d-c voltage which is proportional to the phase difference between the two signals. This voltage, amplified and filtered, controls the vco frequency. The vco tracks over the relatively wide doppler shifts of the received signal (up to ± 30 Kc) while still maintaining a narrow noise bandwidth which is determined in part by the active filter. This circuit is often referred to as a tracking filter.

OPERATIONAL TECHNIQUES

—The performance of the phase

loop can be predicted by operational techniques assuming that the loop is locked in and that it is thus represented as a linear system. The mathematical model of the phase loop is shown in Fig. 4A with Laplace notation. Here: $\theta_i(s)$ = Laplace transform of signal phase, $\theta_o(s)$ = Laplace transform of vco phase, K_1 = sensitivity of phase detector (assumed constant), K_2 = sensitivity of vco, and $Y(s)$ = transfer function of the active filter. Since the vco frequency is proportional to voltage and the phase is equal to the integral of the voltage, its transfer function has a

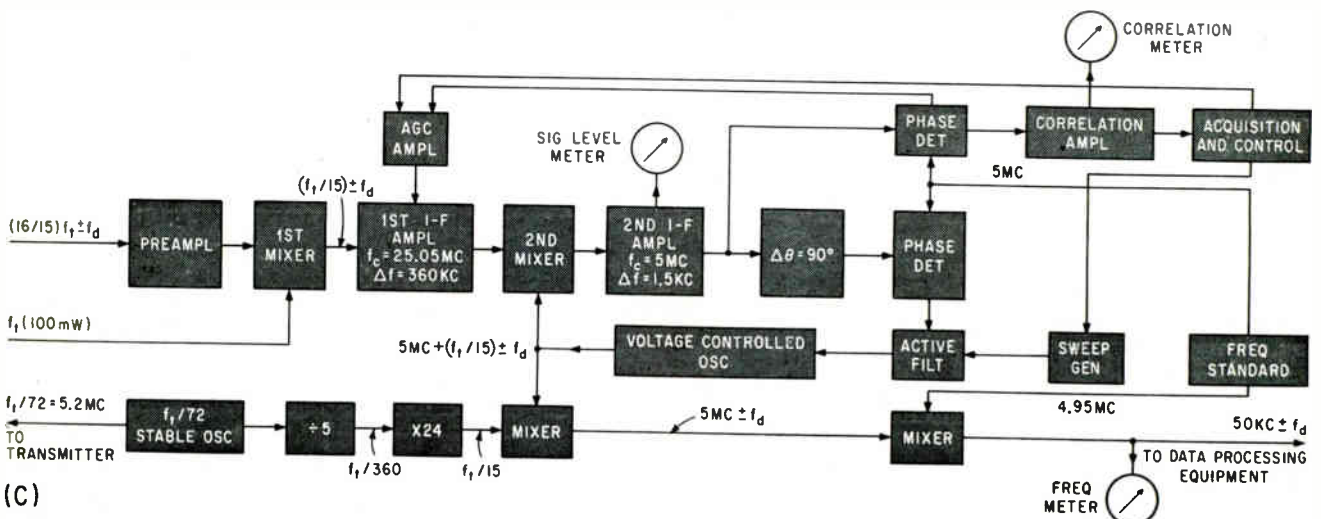
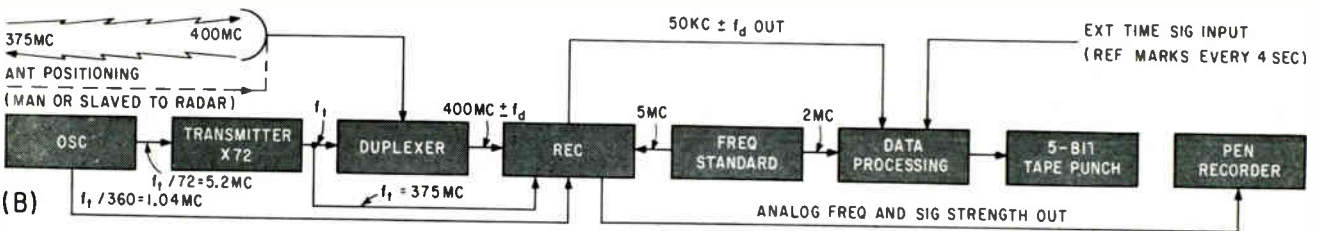
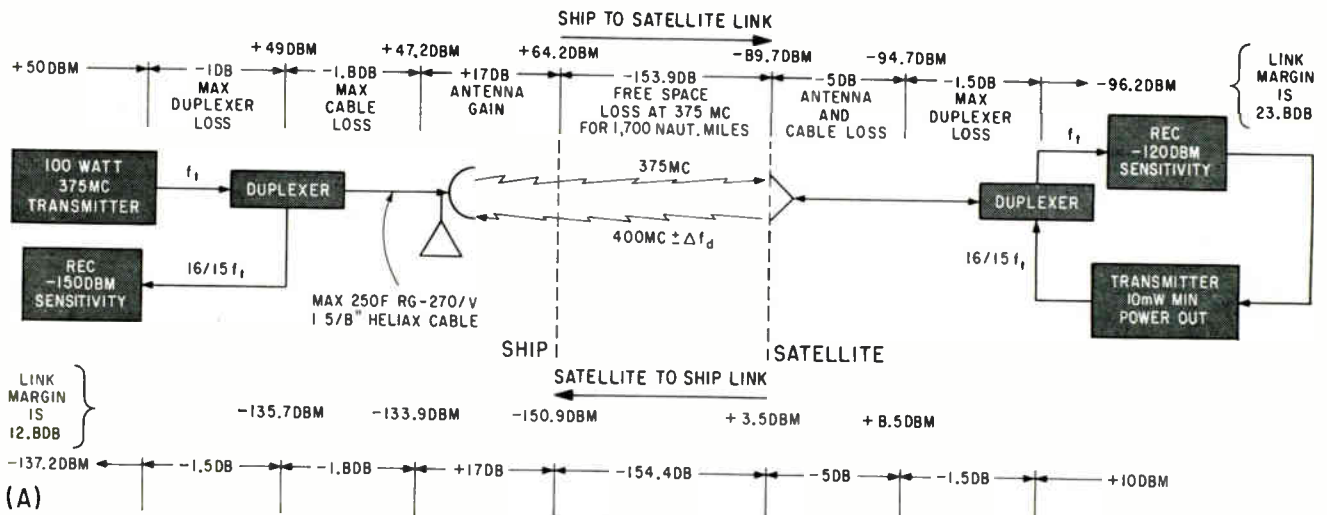

GAIN AND SIGNAL-MARGIN analysis (A) of two-way system. Earth-based transmitter and receiver (B) of two-way system. Receiver is shown in more detail in (C)—Fig. 3

1/s term. The closed loop transfer function for phase lock system is

$$\frac{\theta_o(s)}{\theta_i(s)} = C(s) = \frac{K_1 K_2 Y(s)}{s + K_1 K_2 Y(s)} \quad (3)$$

The phase error caused by imperfect tracking of the signal is:

$$\begin{aligned} \epsilon(s) &= K_1 [\theta_i(s) - \theta_o(s)] \\ &= K_1 \frac{s \theta_i(s)}{s + K_1 K_2 Y(s)} \end{aligned} \quad (4)$$

Effective servo noise bandwidth is

$$f_n = (1/2\pi) \int_0^\infty |C(j\omega)|^2 d\omega \quad (5)$$

Also, the rms phase jitter due to additive white noise is

$$\theta_n^2 = K T F f_n / S \quad (6)$$

where θ_n^2 = rms phase jitter, F = effective system noise figure, K = Boltzmann's constant, T = 290 Kelvin, and S = signal strength.

The design problem is to select $C(s)$ so as to minimize the sum of the signal tracking error (Eq. 4) and the noise error (Eq. 6). This minimization problem has been solved for $\theta_i(t) = at^2$, a step acceleration (and other step inputs).¹ The transfer function gives good, but not optimum, performance²

$$C(s) = \frac{9}{4} \frac{\omega_n [s + (\omega_n/3)]^2}{(s + \omega_n)^2 (s + \omega_n/4)} \quad (7)$$

where ω_n is related to the noise bandwidth

$$f_n = 0.743 \omega_n \quad (8)$$

This closed loop function gives critically-damped transient response and has zero steady state acceleration error. The open loop function required is:

$$\begin{aligned} G(s) &= \frac{\theta_o}{\epsilon(s)} = \frac{9}{4} \frac{\omega_n [s + \omega_n/3]^2}{s^3} \\ &= \frac{K_1 K_2 Y(s)}{s} \end{aligned} \quad (9)$$

The active filter must then be

$$Y(s) = \frac{9}{4} \frac{\omega_n (s + \omega_n/3)^2}{K_1 K_2 s^2}$$

This requires two integrators and as such can only be approximated electronically. This is accomplished by a passive network and an operational amplifier. A simplified schematic is shown in Fig. 4B. The approximation holds when

$$R_2/(R_1 + R_2) \ll 1 \text{ and } R_4/R_3 G \ll 1$$

Test results have indicated that for 10-cps servo-noise bandwidth, the receiver will acquire and track a -150 dbm signal.

Automatic acquisition is provided in the receiver by slowly sweeping the vco across the expected range of the signal. When

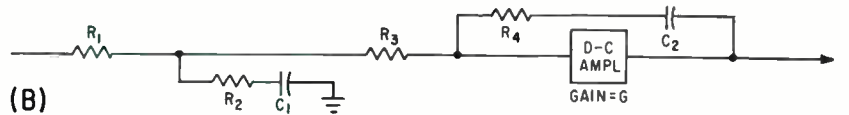

MATHEMATICAL MODEL (A) of phase loop. Circuit of active filter is shown in (B)—Fig. 4

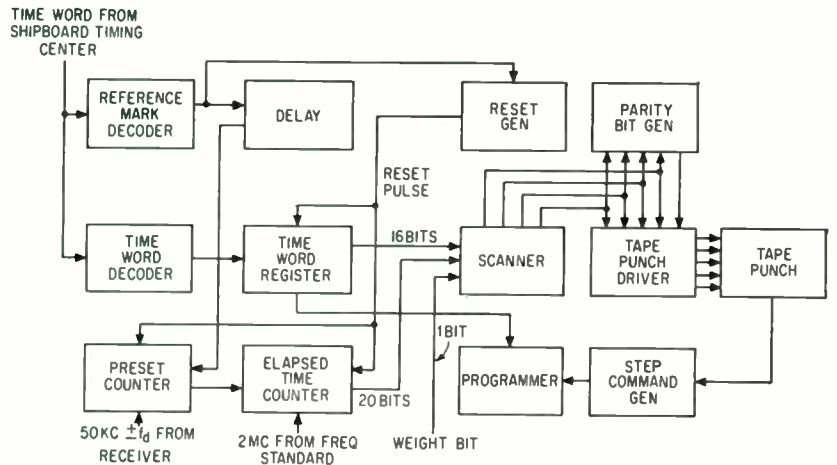

DATA PROCESSING equipment converts the analog doppler data from the receiver into digital form—Fig. 5

a signal of sufficient amplitude appears in the pass band of the second i-f amplifier, the phase loop locks in. An auxiliary phase detector (Fig. 3C) fed 90 deg out of phase with the main phase detector provides a d-c voltage when the system is locked in. This correlation voltage is used to deenergize the sweep and to provide agc.

The vco frequency being phase locked to the received signal contains all the Doppler information. Through appropriate mixing steps it is translated to an output of 50 Kc $\pm f_d$, without the effects of transmitter frequency variations.

DATA PROCESSING—Operation of the data equipment (Fig. 5) is initiated by a 50-msec reference pulse received from the ship's central timing system. Immediately following the reference pulse is a 16-bit binary-coded time word. The reference pulse and the time word are repeated every 4 seconds. The reference mark resets all the digital circuits and gates on a preset binary counter which accumulates a preset number of cycles of the receiver output frequency, 50 Kc $\pm f_d$. A binary elapsed time counter ac-

cumulates 2-Mc pulses from the frequency standard measuring the time for the preset counter to load; thus the elapsed time count, b , is a measure of the receiver output frequency and the doppler shift; thus

$$50 \text{ Kc} + f_d = a/\Delta t = 2 \times 10^6 a/b \quad (10)$$

The use of the 2-Mc elapsed time counter rather than directly counting the receiver output for a fixed time decreases the effect on accuracy of the usual ± 1 ambiguity.

Concurrently with the preset and elapsed time counter operation, the range time word is loaded into a shift register. Completion of the register loading (which always takes longer than the elapsed time measurement) triggers recording.

The scanner samples the time-word register and elapsed time counter in sequence 4 bits at a time. The four information bits and an odd-parity bit is punched on the tape. This process is repeated until all the information is read out.

REFERENCES

- (1) R. Jaffe and E. Rehtin, Phase-Lock Circuits Capable of Near Optimum Performance, *IRE Trans on Information Theory*, p 66, Mar. 1955.
- (2) A. J. Mallinckrodt, Passive Ranging Doppler System, Phase A Completion Report No. 961-R1, prepared for Ballistic Research Laboratory, Nov. 2, 1953.

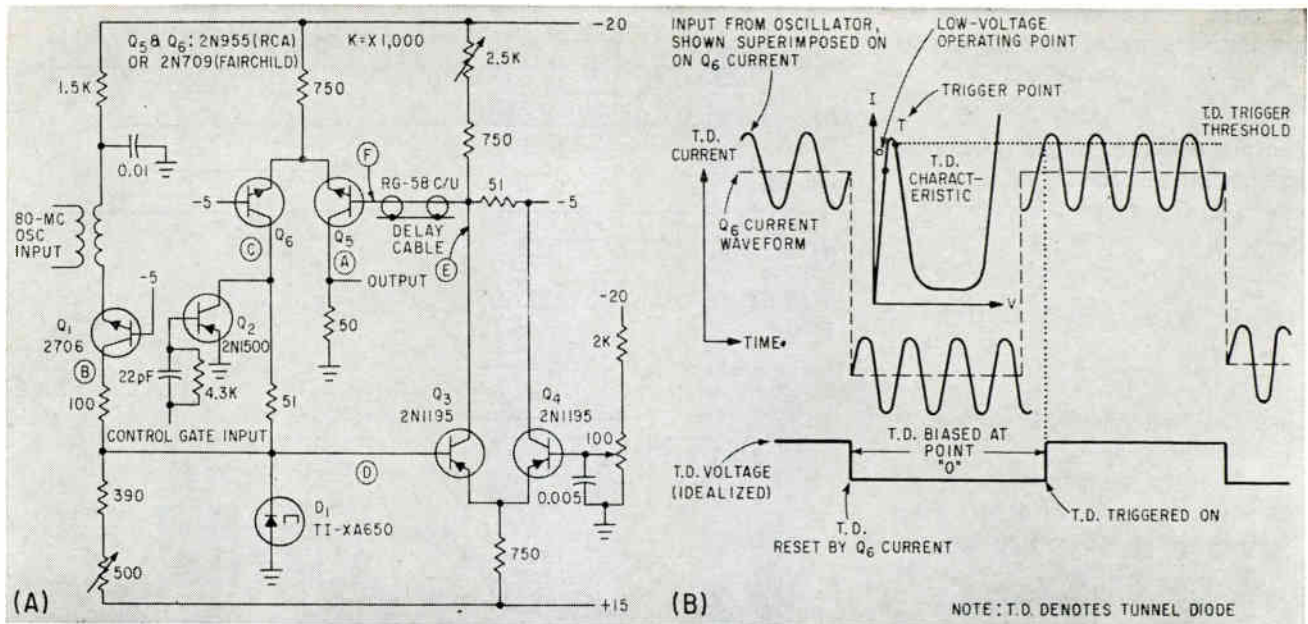

CALLOUT LETTERS A to F of frequency divider (A) refer to waveshapes in Fig. 3. In (B), the broken-line square wave shows current through Q_6 . With tunnel diode biased at O, an increase in current due to oscillator input raises it to triggering point T—Fig. 1

Eliminating One-Count Uncertainty In Cycle-Counting Interval Timers

By WALTER O. LECROY, JR.
Columbia University,
New York, N. Y.

IN slow-neutron spectroscopy, a pulsed oscillator is used as a time base for measuring neutron flight times. The oscillator is started at the instant that a group of neutrons are generated. Successive cycles of the oscillator time base demarcate successive time intervals to which neutrons are assigned as they arrive at the end of a flight path of fixed length. The oscillator must start coherently with the generation of the neutrons; otherwise a one-cycle uncertainty would exist in the timing of each neutron.

Previously, a pulsed Hartley L-C oscillator was employed.¹ Recent improvements in system resolution, in particular an increase in neutron flight distance from 35 to 200 meters, made it necessary to replace the L-C oscillator with a time base of greater stability. The tech-

nique to be described provides a time base that is functionally indistinguishable from an ideal pulsed crystal oscillator, but which does not suffer from the defects usually associated with pulsed crystals.

This technique uses a free-running crystal master oscillator (Fig. 1A) whose frequency is much higher than the frequency of the desired time base, and a gated frequency-dividing circuit that provides the desired time-base output. Effectively, the circuit is a quasi-pulsed crystal oscillator, which possesses crystal frequency stability and starts coherently with a gating signal to within one period of the master oscillator frequency (Fig. 2). If the frequency of the master oscillator is sufficiently high compared to the frequency of the pulsed output, this starting jitter may be small (Fig. 2C). In the present system the desired pulsed

oscillator or time-base frequency is 10 Mc; a master-oscillator frequency of 80 Mc gives a starting jitter of 12.5 nsec, which is negligible in the present application.

CIRCUIT FUNCTIONING — In Fig. 1A, the 80-Mc master oscillator signal is applied to D_1 , a 10-ma gallium-arsenide tunnel diode, by amplifier Q_1 . The gating transistor, Q_2 , is normally saturated, and shunts away current that otherwise would add to the forward bias current of the tunnel diode; thus, the tunnel diode remains in its low-voltage state (denoted by point O, Fig. 1B). Circuit output (A, Fig. 1A) is at ground. A gating signal turns off Q_2 , and the additional forward bias current thus provided permits D_1 to trigger (point T, Fig. 1B) to its high-voltage state on the next negative crest of the 80-Mc signal. Tunnel diode bias currents and the 80-Mc amplitude are so ad-

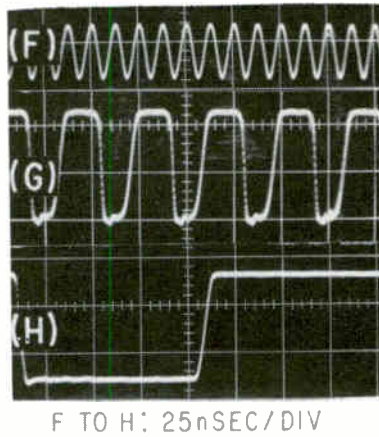
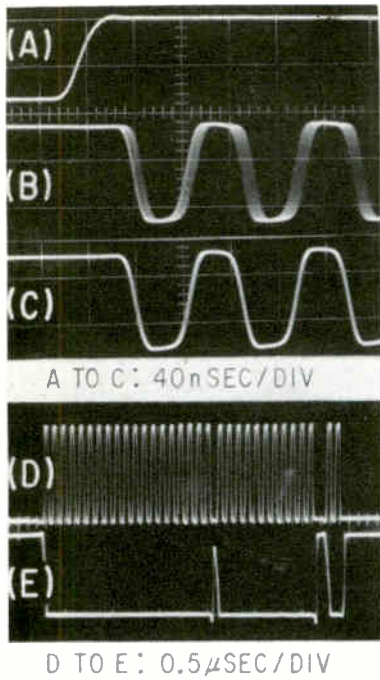

RELATION OF CONTROL GATE (A) to 10-Mc divider outputs (B) and (C); output (B) is for input frequency of 80 Mc and shows jitter; (C) is for 250 Mc. Control gate (D) and output (E) demonstrate transient-free gating. Input (F) is at 80 Mc and (G) and (H) are 3:1 and 16:1 output division ratios—Fig. 2

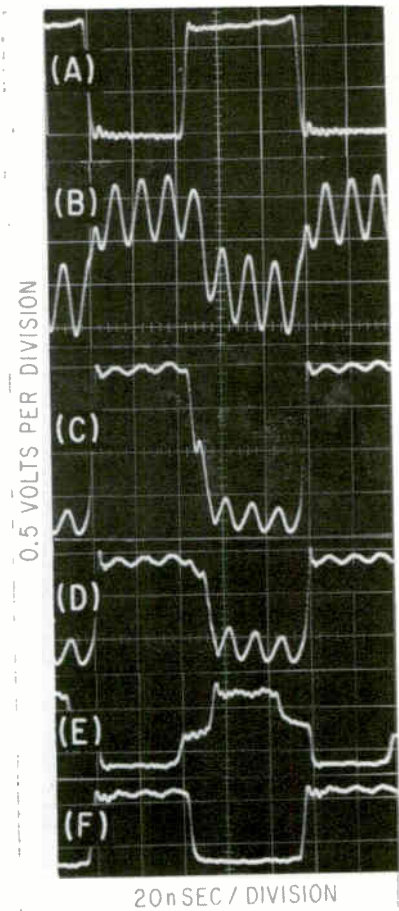

WAVEFORMS ARE FOR 80-Mc to 10-Mc division. Letters (A) to (F) refer to measurement points denoted by callouts on Fig. 1A—Fig. 3

Tunnel-diode trigger and hold circuit is combined with a delay line to divide the frequency of a crystal oscillator and thereby provide stable timing pulses that denote time intervals

justed that the tunnel diode, once triggered to its high-voltage state by the 80-Mc master oscillator signal, remains there independently of the 80-Mc signal. With D_1 in its high-voltage state, current quiescently flowing through Q_1 is diverted through Q_2 . The positive voltage step thus generated at the collector of Q_2 moves down the delay cable and appears at the base of Q_3 with double its original amplitude because of the absence of a termination. This positive voltage turns on Q_3 , and diverts to the output in the collector of Q_3 the current that formerly flowed through Q_1 and provided forward bias for the tunnel diode. Removal of forward bias from D_1 returns it to its low-voltage state. Transistor Q_3 now ceases conducting, the voltage step at its collector terminates, and, after a time equal to the delay of the cable, so does the positive voltage at the base of Q_3 .

This restores forward bias to D_1 through Q_1 , priming it to trigger again on the next negative peak of the 80-Mc input and thus initiate another cycle identical to the first. This sequence continues until Q_3 is again saturated by a negative excursion of the gating signal.

Figure 3 shows waveshapes for the circuit when its delay cable is such that the circuit provides an 8-to-1 division of the 80-Mc reference frequency. Polarities of all waveshapes in Fig. 3 are inverted. The 10-Mc output is almost a perfect square wave. Because of direct coupling, there are no visible start-up transients and the output waveshape remains unchanged regardless of duty cycle (Fig. 2D and 2E).

CIRCUIT FEATURES—The division ratio depends on the total signal propagation time around the circuit, and the stability of the

division ratio depends on the stability of this propagation time. This propagation time consists of two parts, one due to the delay time of the cable, which is stable, and the other due to transistor delays. For maximum stability, it is desirable to minimize the transistor delays; hence the use of high-speed transistors in a nonsaturating current-steering mode. Circuit delay, exclusive of cable delay, for the circuit shown is about 4 nsec, indicating that the circuit can function reliably with input signals of a few hundred megacycles.

The tunnel diode is used in a way that capitalizes on its stable triggering threshold, fast switching, and memory.

This work was supported by the U. S. Atomic Energy Commission and the Office of Naval Research.

REFERENCE

(1) J. Hahn and W. W. Havens, Jr., *Rev Sci Instr*, 31, p 490, 1960.

Radar Cross Section Measurements: HOW ACCURATE ARE THEY?

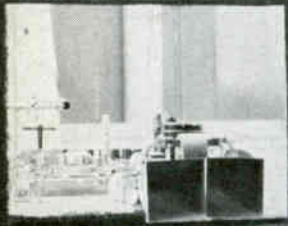

RADAR CROSS SECTION *measurement ranges usually use plastic line model supports*

By **LESLIE SOLOMON**
Associate Editor

RADAR CROSS SECTION describes the effectiveness of a target in scattering electromagnetic waves and is defined as 4π times the ratio of the power per unit solid angle scattered back to the power per unit area striking the target. In general, a large radar cross section does not necessarily represent a large physical size as decoys can be built in which a relatively small physical package can be built to produce large radar returns.

In general, many of the important radar targets are being designed with smaller cross sections and thus have smaller radar returns. This can lead to large increases in radar transmitter power and more sensitive receivers. One example of state-of-the-art transmitter power appears to be the Cornell Aeronautical Laboratories radar transmitter capable of generating 50 Mw peak power.

Quantitative descriptions of radar target cross sections are essential to the radar systems designer. These descriptions must be derived from experimental meas-

urements. A theoretical approach to radar scattering is important primarily in target design and can sometimes yield the detailed numerical values required for prediction of radar system performance.

CROSS SECTION—This depends on target aspect and wavelength and polarization of the illuminating radar, and a complete description is usually given in terms of patterns of cross section versus aspect angle for a variety of antenna polarizations at each of a number of discrete wavelengths. A test model is set up in front of the test radar and the return signal is measured as the model is rotated.

The relationship between radar return and cross section is calibrated by a sphere of known cross section. Usually, small target models are used with a test radar that bears the same scale relation to the operational wavelength as the model does to the real target.

Radar cross section σ divided by λ^2 yields a quantity independent of specific wavelength at which tests are made provided that ratio of target dimension to wavelength (D/λ) is fixed.

Several types of radars are used, mainly pulse or c-w. Each of these radar types has its place in cross section measurements. The c-w radar has excellent sensitivity if the maximum target dimension is only a few wavelengths, but it is generally unsuited against larger targets. Pulse radar is superior to c-w when the target is many wavelengths in size. A pulse radar cannot be used at short ranges since practical receivers will limit acceptable minimums. Continuous-wave radar suffers from inherent low sensitivity (the ratio of minimum resolvable received power to the transmitted power). Minimum distance between radar and target model is determined by the requirement that the wavefront at the target should approximate the planar conditions under operating conditions and the $1/R$ field intensity difference between model extremes be negligible. This distance is proportional to the square of the target dimension measured in wavelengths. When the target size is only a few wavelengths, as with airborne targets illuminated with uhf radar, the acceptable minimum range may be a few feet

... Cross-section measurement ranges often use scaled models and frequencies. Due to the small physical size of models sometimes used, the support lines can contribute to radar return. June bugs, houseflies and nearby vegetation can also affect results

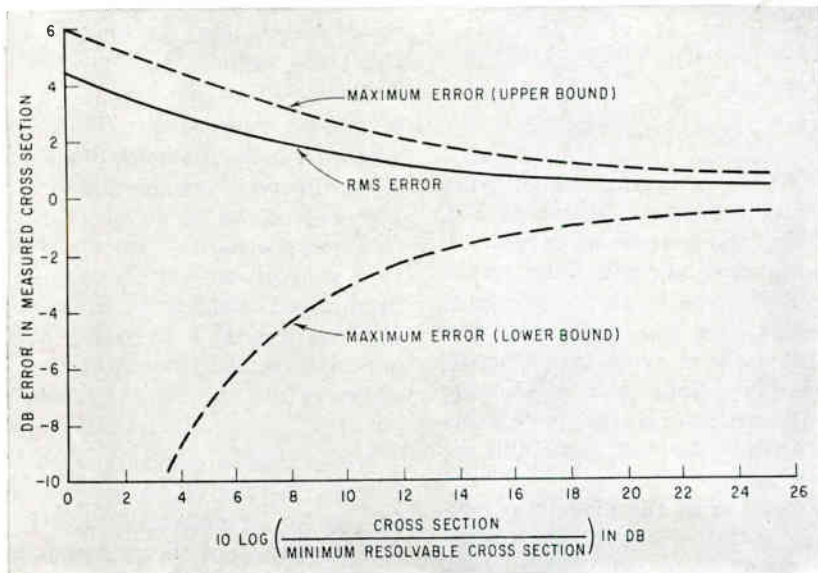

MEASUREMENT ERROR as function of ratio of measured cross section to minimum resolvable cross section—Fig. 1

at X band. Disadvantage of the low inherent sensitivity of a c-w radar is outweighed by the large return signal implicit in the short test distance. When a large target is being tested and pulse radar is used, the superior inherent sensitivity of pulse radar allows better determination of smaller cross sections values.

OBJECTIVE—Determination of typical values of cross section that would occur in free space. In any ground-based system, measurement will be disturbed by returns from the surroundings and echoes from the model supports. The former are more serious with c-w systems but it is probable that model support problems will dictate the limitations of the pulse system. Other testing methods can be

used. For example, an f-m/c-w radar can transmit much the same mean power as a pulse radar and receives background radiation from a similar range bracket. Limitations of a c-w doppler system where the model is moved towards the radar arise from model support problems no less severe than with pulse radar and from an inherent sensitivity that is unlikely to be superior to that of a pulse radar.

PERFORMANCE—Measurement range is usually described in the minimum cross section that can be resolved that is, that which results in a return signal equal in magnitude to the unwanted background signal in the receiver of the system being used for the tests.

In general, the phase of the receiver noise or background compo-

nent will differ in a random manner from that of the signal. A maximum error will occur when the signal and unwanted amplitudes reinforce or oppose each other. Where random noise predominates, cross section measurement error can then be described by an rms error predicated on the assumption that phase difference between wanted and unwanted signals is completely random. Figure 1 shows the maximum and rms errors possible plotted against the ratio of cross section under measurement to the minimum resolvable cross section. Even when the cross section of the target exceeds the minimum resolvable cross section by a factor of 10, the rms error is 1.6 db and an error, in the presence of a stationary background, as high as +2.4 db or -3.2 db could occur. Cross section of the model must exceed the minimum resolvable value by 19 db for an rms error of 0.5 db and a maximum error of less than 1 db.

A typical indoor c-w test range (such as used at C.A.L.) is shown in Fig. 2A where the model is suspended within a room lined with radar absorbent material. The

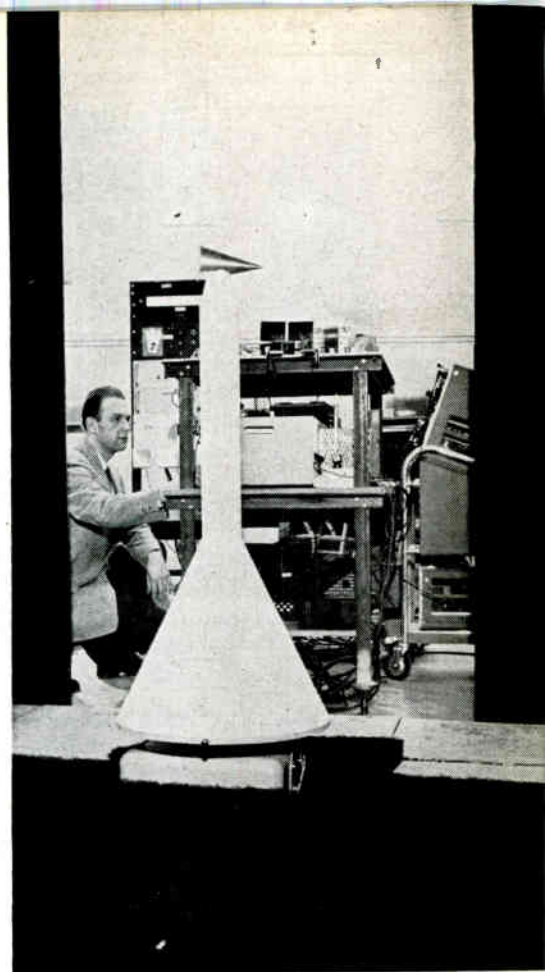

SOME cross-section ranges use solid plastic model supports

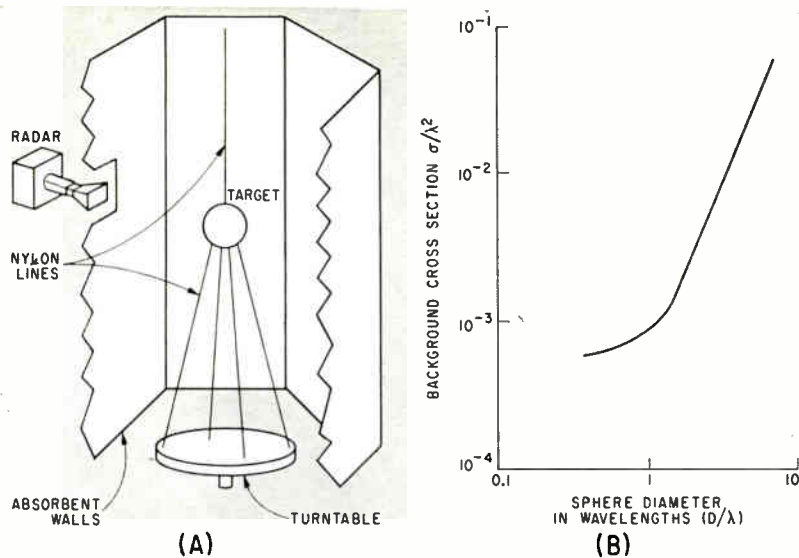

TYPICAL C-W TEST range (A) is a radar darkroom. Range sensitivity versus sphere is shown in (B)—Fig. 2

model is rotated by a turntable. Some c-w ranges use Styrofoam columns for model support. Figure 2B is an example of the measured sensitivity of a practical c-w test range. Returns from a set of spheres were plotted as a function of small changes in distance from the antenna while magnitudes of the unwanted background were derived from analysis of the periodic nature of the return. Antenna-to-target distance was approximately 7 ft, the test room was roughly 24 ft in diameter and walls were covered with Plessey/Gulton AF20 absorbent.

For targets up to 1 wavelength diameter, sensitivity was roughly constant at 35 db below one wavelength squared. This result indicated that zero imbalance is the major source of error. As size of the target is increased beyond one wavelength, sensitivity decreases rapidly as a result of wall illumination changes. For a target 5 wavelengths in diameter, sensitivity of only 10 db below one wavelength squared is obtained. In a strict sense, sensitivity indicated in Fig. 2B is applicable only when the target has a forward scattering characteristic similar to that of a sphere. Because a sphere focuses energy efficiently in a forward direction, results may lead to overly pessimistic estimates of errors in measurement of nonspherical targets with more complex forward scattering patterns.

LAYOUT—A typical radar pulse measuring range is shown in Fig. 3 where the sources of extraneous returns are indicated. The return signal must be larger, to a degree inferred from Fig. 1, than the sum of the returns from target model supporting lines and supporting towers, ground returns, insects flying within the test area and receiver noise.

A portion of the model supporting lines lies within the main beam of the radar and contributes to the radar return signal. The magnitude of some typical lines have been experimentally determined and are shown in the table. The return from these lines varies markedly and sets a serious limitation on measurement sensitivity. Consequently, the model should be light enough to allow use of the lightest possible line as measurement error introduced by the line return increases as the diameter of the plastic line is increased. For example, at K_u band supporting lines of 4-lb test impose a sensitivity limitation of about 20 db below one wavelength squared and the sensitivity may be worsened if a number of lines are used for model support.

PLASTIC SUPPORT — Nylon monofilament line represents a radar cross section small enough to be negligible at X-band. To provide an estimate of the utility of such lines in a K_u band range, scale model tests were made at X band.

Such tests are valid provided that the lines are simulated by a substantially loss-free material of the same permittivity. Lines were simulated by nylon rods with diameters of $\frac{1}{8}$ to $\frac{3}{8}$ inch, corresponding to equivalent lines from 16 to 50 mils at 35 Gc. A 50-lb test line is 28 mils diameter. Figure 4A shows the X-band cross sections plotted as functions of their diameters. The results were obtained with the antenna oriented so that the E vector of the incident radiation is parallel to the line. The cross section is at a maximum under these circumstances. If the measurement of the largest line tested is ignored (diametric resonance effects may be significant), the cross section σ_0 applicable to X-band is

$$\sigma_0 \text{ (in square centimeters)} = 716 D_0^{3.4} \quad (1)$$

where D_0 is the diameter of the line in centimeters. Application of scaling laws allows reduction of Eq. 1 to a more general form applicable to a generalized wavelength and a generalized diameter D . Since scaling requires D/λ to equal D_0/λ_0 , and since scaled cross section σ is given by $\sigma = \sigma_0 (D/D_0)^2$, then

$$\sigma/\lambda^2 = 3.75 \times 10^3 (D/\lambda)^{3.4} \quad (2)$$

Nylon line is generally specified by its test strength in pounds. Checks of commercially available line indicate that the expected proportionality between the area of the line and the test strength is correct. Hence, if W is the test strength in pounds then D varies as square root of W .

A 50-lb test line has a diameter of 0.028 inch (0.71 cm), therefore Eq. 2 may be reduced to

$$\sigma/\lambda^2 = 6 \times 10^{-4} (\sqrt{W}/\lambda)^{3.4} \quad (3)$$

where test strength W of the line is in pounds and λ is in cm.

Length of the target model is chosen proportional to the test wavelength. Therefore, the weight of the solid model will be proportional to the cube of the test wavelength. However, if the model construction techniques are approximately constant, it is inconceivable that the weight varies at a lesser rate than with the square of the test wavelength.

Assume that the thickness of the line used depends solely on the model weight. The strength of the line W is $W \propto \lambda^{2+n}$ where $1 > n > 0$.

$$\text{From Eq. 3, } (\sigma/\lambda^2) \propto (\lambda^{1+n/2}/\lambda)^{3.4} \propto \lambda^{1.7}$$

ground is illuminated by antenna side lobes and since the return can enter only through the side lobes, the effective echoing area σ' , becomes $(\rho 2\pi R \Delta)/n^2$ where n is the power density in the main beam divided by the mean transmitted power density in the side lobes illuminating the ground at target range.

This emphasizes the importance of minimizing returns originating at or near the model support tower.

Reduction of unwanted side lobes through the use of tunnel antennas is one expedient. Another is to cover the model support tower with some type of radar absorbent material. Good ground housekeeping also plays an important role in clutter reduction.

BACKGROUND REFLECTIVITY

—Experimental observations at one measurement range indicate that the maximum tolerable wind velocity is about 5 knots with the limit varying with the condition of the local vegetation. Good housekeeping is essential for an outdoor range and grass or weeds must be cut or removed from incident radiation. During early spring with vegeta-

tion fairly short, wind velocity can approach 7 to 10 knots without seriously deteriorating system performance. As vegetation grew with warmer weather, wind limit was reduced to about 2 knots. Cutting weeds at height of summer, maximum tolerable wind velocity was about 5 knots. During late fall, with vegetation still short, but dying, wind velocity could be 7 to 10 knots. With advent of snow, wind effects appeared negligible but large temperature variations ruled out operations.

Variations in background reflectivity are usually slow functions of time, the most rapid being reflectivity change associated with a change in background moisture content. Since evaporation and condensation rates are slow in comparison to a measurement period, background variability can also be ignored. Precipitation, a catastrophic rate of change, rules out measurements entirely. For a given viewing angle, cross section of a backscattering target is constant with time. Variations in received signal reflected from the target are caused by changes in receiver gain and transmitter power. Since there

is a definite time lapse between equipment calibration and measurement of an unknown target, errors do exist because of this effect. It is impossible to generalize and errors of this sort can only be evaluated for the particular measuring equipment in use.

A house fly or June bug can present a radar cross section of about 10^{-6} square meters, more than a tenth of a wavelength squared. Use of a high frequency in a K_u band range requires keeping all insects out of the range. Presumably, an insect approximates a Rayleigh scatterer so that its cross section decreases rapidly with increasing wavelength.

The level of receiver noise will be small compared with the radar return, when only nominal values of peak transmitter power are used.

This article is based on information gathered at Cornell Aeronautical Laboratories, Buffalo, N. Y.

BIBLIOGRAPHY

W. P. Melling, An Analysis of Radar Cross Section Measurement Techniques, Report UB-1088-P-104, C.A.L., Buffalo, N. Y.

R. J. Wohlers, Error Analysis of Ruby Radar Cross Section Measurement System, Report UB-1088-P-103, C.A.L., Buffalo, N. Y.

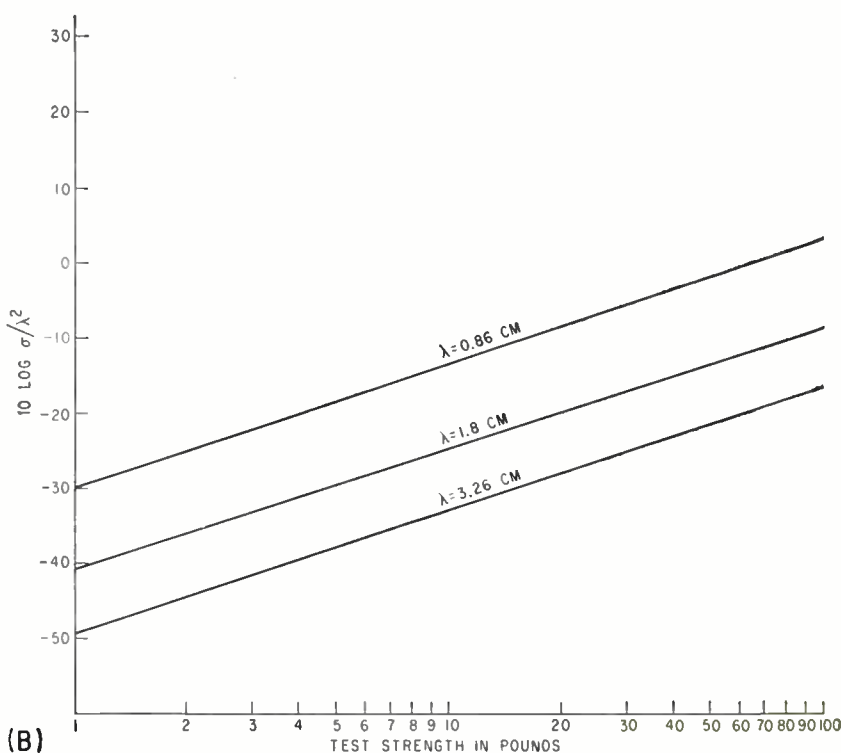
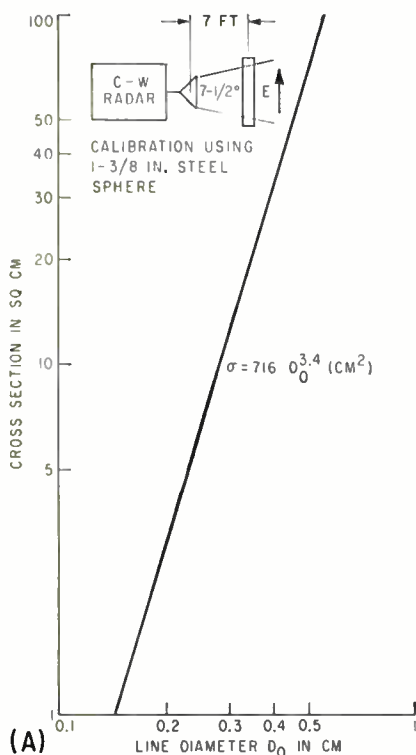

DETERMINATION OF NYLON line cross section at X-band (9.2 Gc) (A) and estimated cross section of nylon line as a function of test strength and radar frequency—Fig. 4

DESIGN PROBLEMS OF Modern Television Transmitters

Residual sideband filter is incorporated within a bandpass filter that forms the plate load for the output stage of a conventional television transmitter

By WILLI ROOS

Television Development Engineer, Brown Boveri and Co., Ltd.,
Baden, Switzerland

RESIDUAL SIDEBAND transmission as applied in tv, requires a high rate of attenuation versus frequency at the edges of the passband. This requires, in addition to broadband characteristics of the transmitter final stage, an additional residual sideband filter at the transmitter output. This filter may be bulky, especially at the lower frequencies, and is usually physically separated from the transmitter. The filter input impedance must correspond as closely as possible over the whole transmission range to the impedance of the transmission line between the filter and transmitter.

Transmitter output is usually split into two symmetrical channels in which corresponding resonators are provided for suppression of the lower sideband. Reflected sideband power is absorbed in a dummy load. Apart from the transmitter, the filter must be tuned and care taken that the resonators of the sym-

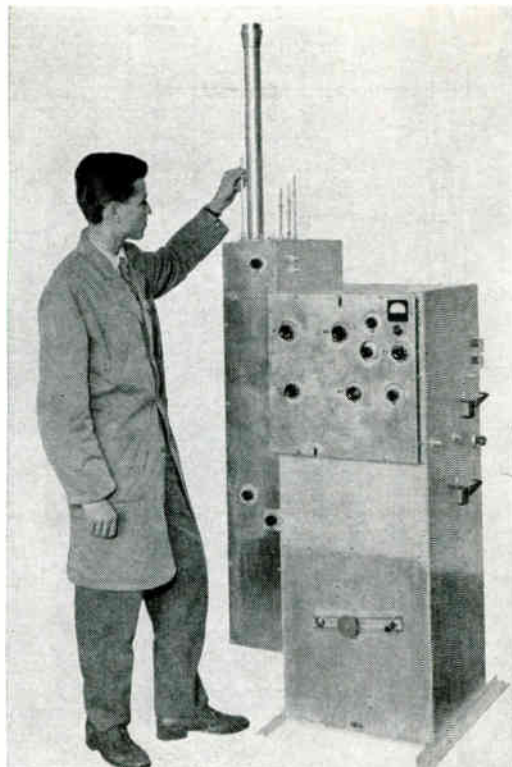

FINAL STAGE of low-power tv transmitter showing bandpass filters

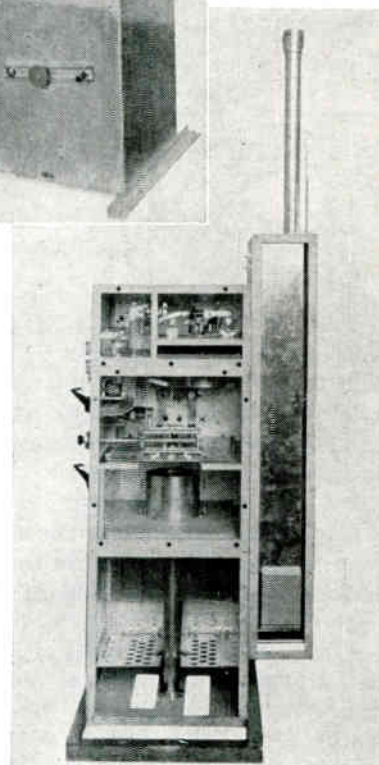

metrical branches form equal impedances to guarantee proper matching.

ELIMINATING THE PROBLEM—One method is to modulate on an intermediate frequency as the filter then works on a single pre-fixed low-level transmitter stage. Output frequency is obtained by frequency conversion. The method to be discussed reduces space requirements without introducing further complications of frequency conversion.

Extensive tests have been carried out on transmitters where the modulated r-f final stage used a coaxial r-f bandpass filter. Such a circuit is shown in Fig. 1A. Plate load 1 is coupled through capacitor C_1 which is a short circuit for r-f and together with circuits 2, 3 and 4, forms the bandpass filter. Resonators 1 and 4 are tuned to the center frequency and resonators 2 and 3 are tuned to the band limits.

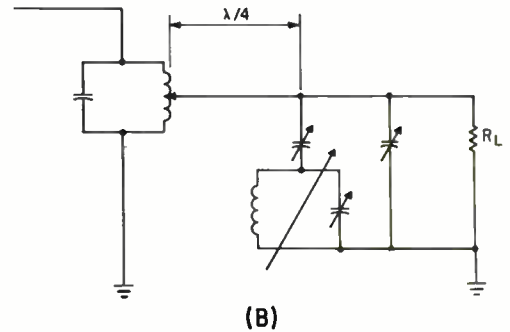
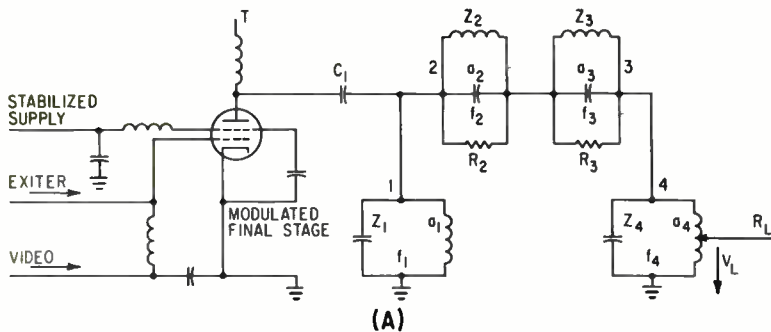

COAXIAL BANDPASS FILTER is incorporated within r-f final stage of video transmitter (A). At lower band limit, further absorption is incorporated in feeder line $\lambda/4$ from the feeder output—Fig. 1

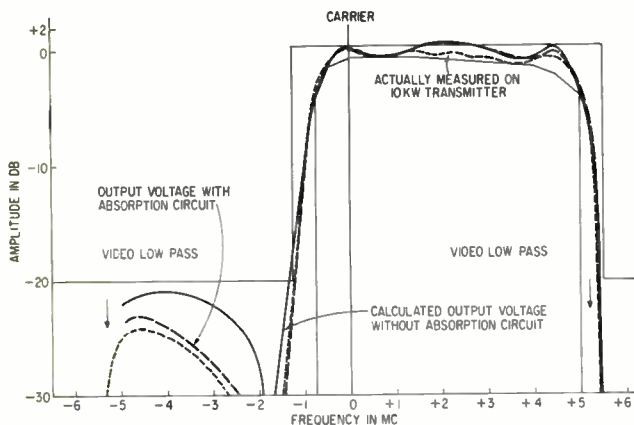

CURVES SHOW calculated output voltage without absorption circuit, with the absorption circuit and actual measurements of a transmitter—Fig. 2

Impedance of the output line (R_L) is transformed to the optimum load by circuit 4. To determine frequency response of output voltage V_L , losses of the parallel circuits can be neglected since attenuation of the load resistance is predominant. Losses in the series circuits can be assumed to be identical ($R_2 = R_3$) and are significant only in the region of the pole frequencies. Assuming the tube to be an ideal current source, the equation in the box describes the ratio (k) of the output voltage at the center frequency (f_m) to the voltage at any frequency (f), where $a_n = 4f_n Z_n/\pi$, $a_2 = a_3$, $x =$ double frequency deviation from center frequency f_m ($|x| < 0.95$), $S =$ frequency spacing of the pole frequencies, $Z_n =$ impedance of the pole circuits, $R_n =$ the losses and $f_n =$ the resonant frequencies.

Attenuation d in the pole can be calculated from

$$d = (SR_2/a_1) \sqrt{[S^2 R_2^2/a_1^2] + 1}$$

TOLERANCE SPECIFICATIONS—To adapt the frequency response to CCIR tolerance specifications, values for a_n are determined in such a way that at the same time variation within the passband is small and attenuation in the stop band is as high as possible. This results in a rate of attenuation versus frequency characteristic that does not fulfill stipulated tolerances. In this case, S is dimensioned so that tolerance at passband limits are maintained (attenua-

tion at band limits is a little too small). This is of no significance at the upper band limit where a low-pass filter on the video side already produces sufficient attenuation. At the lower band limit, a further absorption circuit provides additional attenuation. This circuit is incorporated in the feeder line at $\lambda/4$ from the feeder output.

Figure 1B shows that this circuit uses the same working principle as a conventional vestigial side-band filter. To exclude excessive losses and heating, it must be laid out so that only the lower end of the filter slope is affected. The maximum losses encountered amount to 0.05 db referred to the total output power. Figure 2 shows calculated output voltage without the absorption circuit, the output with the absorption circuit and the actual measured voltage of a 10-Kw video transmitter. These curves demonstrate a good correlated between calculated and measured characteristics. The amplitude maximum at the center frequency is counteracted by the unavoidable small drops of the all-pass filters which must be inserted in the video channel for correcting the group delay characteristic. At higher frequencies, the frequency response of the modulator, video low pass and stabilization amplifier become significant.

This article is based on a paper read at the First International Television Symposium held in Montreux. The author acknowledges Dr. Dick and Mr. Milliquet of Brown Boveri and Co., Baden.

$$k = 1 / \left[\left[1 - \frac{2a_2 x^2}{a_1 (S^2 - x^2)} \right] + j \left[\frac{[2a_2^2 x (1 + R_1 R_2 S^2 (a_1 + a_4)) / (2a_2^2 a_4)] - [(R_1 R_2 x^2) / (a_2 a_4)] - [(R_1 R_2 (a_1 + a_4) x^2) / 2a_2^2 a_4]}{a_1 R_2 (S^2 - x^2)} \right] \right]$$

New RCA mechanized assembly technique arrays high-speed low-drive cores into high density word strips, utilizes deposited windings for current paths.

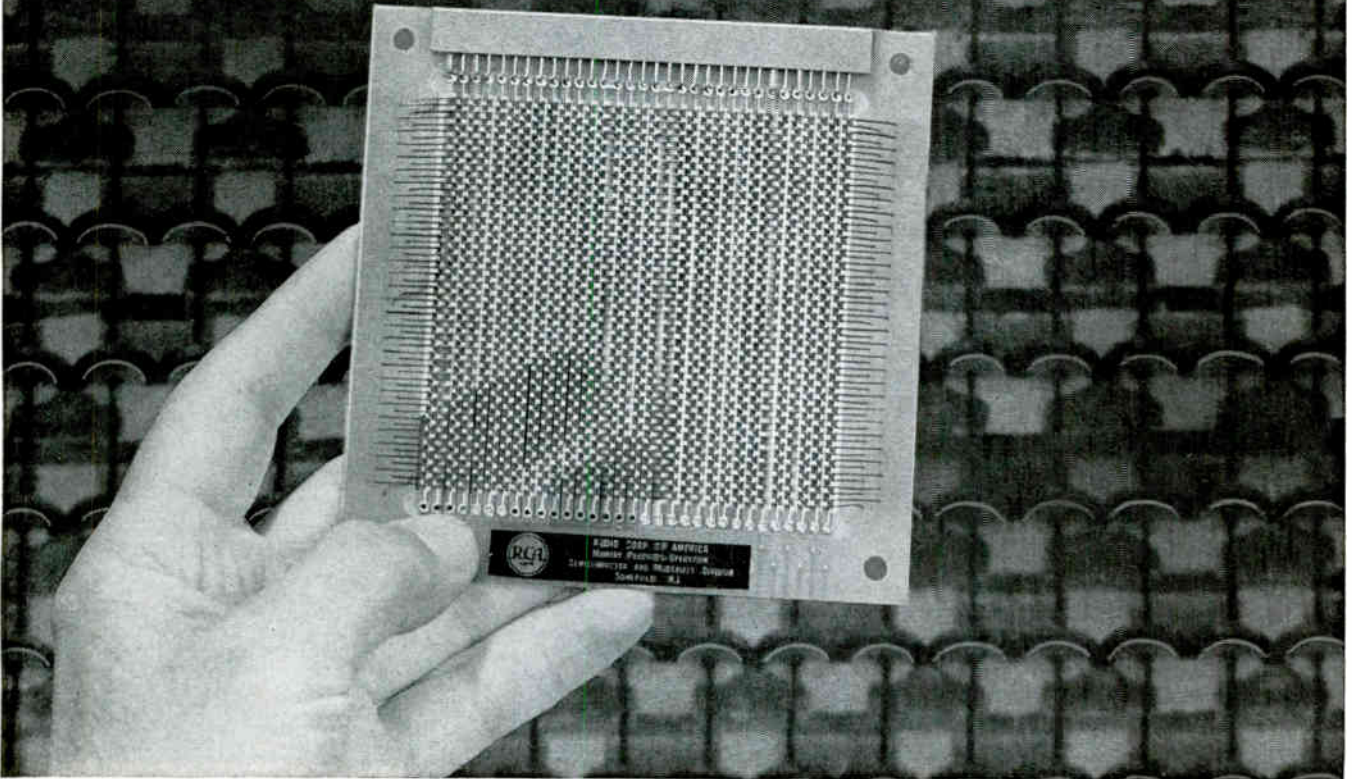

This Revolutionary New RCA Memory Stack

Completes A Full Cycle In 300 Nanoseconds With Only 350 ma Drive

Now, a major advance in Ferrite Stack Design and Construction by RCA makes 65-Nanosecond Switching a reality.

Here is the industry's first commercially available Microferrite Memory Stack with complete read/write cycle time of 300 nanoseconds at drive current levels below 350 ma—bit outputs of 50 mv.

This revolutionary two-core-per-bit word-address system bypasses today's experimental memory techniques by using proved, reliable ferrite cores in a high-density array of advanced design. Check these important benefits:

- **High Packing Density**... 1,000 to 2,000 bits per cubic inch.
- **Superior Stability and Ruggedness**... Printed wiring assures positive, rigid contact to each core. Planes designed to meet Military Mechanical and Environmental Specifications.
- **Precision Uniformity**... Mechanized fabrication eliminates many hand-assembly variables.

- **Outstanding Reliability**... Mechanized production techniques permit more precise control of each fabrication step—produce a rugged, high-reliability structure.

- **Broad Capacity Range**... Available in 32 word x 30 bit size, and in any multiple of this size.

- **Plug-In-Convenience**... Each stack incorporates standard plug connections for fast, easy installation.

- **Complete Service**... Whatever your requirements, custom or RCA standard, your local RCA Semiconductor and Materials Division Field Representative is prepared to provide a completely coordinated application service for all RCA Computer-Memory Products. Call him today at your nearby RCA Field Office.

For complete technical information on new RCA Microferrite Memory Stacks, write RCA Semiconductor and Materials Division, Commercial Engineering, Section FN7-3, Somerville, N. J.

TENTATIVE DATA			
TYPICAL DRIVE REQUIREMENTS AT 25°C			
	Amplitude (ma)	Rise Time (ns-c)	Duration (nsec)
Read Pulse	350	30	100
Partial Write Pulse	250	20	45
Digit Pulse	70	15	85
BIT OUTPUT (Two-Core/Bit Word-Address)			
	Undisturbed '1' (mv)	Undisturbed '0' (mv)	
Bit Outputs	Amplitude Sensing	60	12
	BiPolar Sensing	+50	-50



THE MOST TRUSTED NAME IN ELECTRONICS

Visit the RCA Exhibit at WESCON—Booths 1043-1050.

RCA SEMICONDUCTOR & MATERIALS DIVISION FIELD OFFICES
 ... EAST: Newark, N. J., 744 Broad St., HU 5-3900 • (Camden-Philadelphia Area) Ertan, N. J., 605 Marlton Pike, HA 8-4802 • Syracuse, N. Y., 731 James St., RM. 402, GR 4-5581 • Baltimore, Md., EN 9-1850 • NORTHEAST: Needham Heights 94, Mass., 64 "A" St., H 4-7200 • SOUTHEAST: Orlando, Fla., 1520 Edgewater Dr., Suite #1, GA 4-4768 • EAST CENTRAL: Detroit 2, Mich., 714 New Center Bldg., TR 5-5500 • CENTRAL: Chicago, Ill., Suite 115c, Merchandise Mart Plaza, WI 4-2900 • Indianapolis 5, Ind., 2132 East 52nd St., CL 1-1405 • Minneapolis 16, Minn., 5805 Excelsior Blvd., WE 9-0876 • Denver 11, Colorado, Continental Terrace Bldg., Suite 301, 2705 N. Speer Blvd., 477-1688 • WEST: Los Angeles 22, Calif., 6301 E. Washington Blvd., RA 3-8361 • (San Francisco Area) Burlingame, Calif., 1838 El Camino Real, OX 7-1120 • Seattle 4, Wash., 2250 First Ave. S., MA 2-8816 • SOUTHWEST: Dallas 7, Texas, 7905 Carpenter Freeway, ME 1-9720 • GOVT: Dayton, Ohio, 224 N. Wilkinson St., BA 6-2366 • Washington, D. C., 1725 "K" St., N.W., FE 7-8500 • RCA INTERNATIONAL DIVISION, 30 Rockefeller Plaza, New York 20, N. Y. Cable Address: RADIINTER, N. Y.

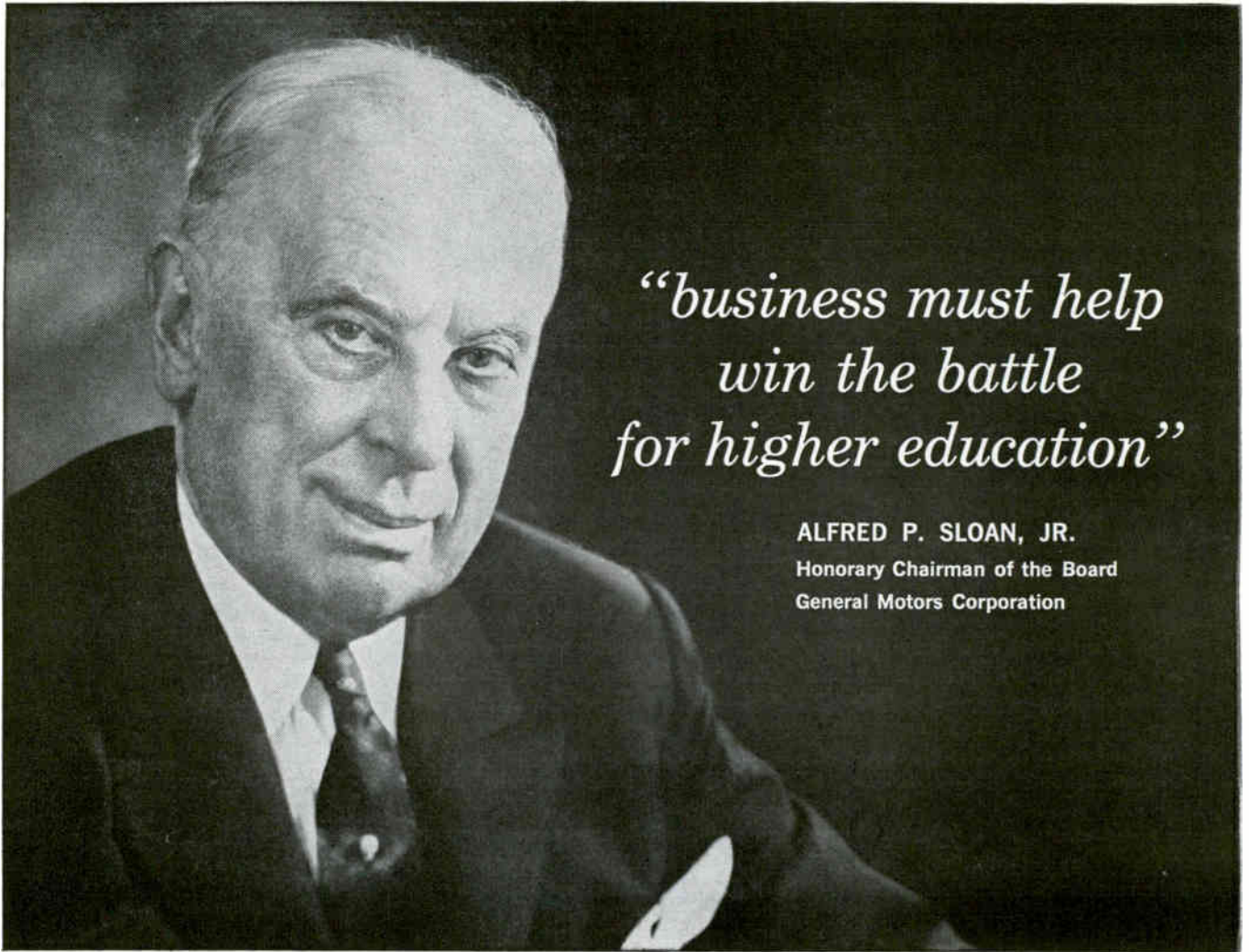

*“business must help
win the battle
for higher education”*

ALFRED P. SLOAN, JR.
Honorary Chairman of the Board
General Motors Corporation

“Regardless of the strengths and attributes our nation possesses, if we fall behind in the field of education, we will fall behind as a world power.

“Our scientific, cultural and economic growth—and our political strength—will depend largely upon the educational facilities we make available to our youth. We owe it to ourselves as a nation; we owe it to our young people who will inherit this nation to provide the financial aid that will make our institutions of higher learning second to none in the world. This is of vital importance to our business community.

“Business must put its support on the line to help win the battle for higher education.”

Today many of our colleges are overcrowded. In ten years, applications will have doubled and we will be faced with an even more serious crisis in our institutions of higher learning. We will need more and better college classrooms, many more well-equipped college laboratories and thousands more of the most dedicated and well-trained professors.

Only increased financial aid will provide our young people with the best college facilities. Only increased financial aid will keep our finest minds from leaving the teaching profession.

For additional information on the crisis faced by higher education write to: Higher Education, Box 36, Times Square Station, New York 36, N. Y.



Published as a public service
in cooperation with The Advertising Council and
the Council for Financial Aid to Education



Problem for you:

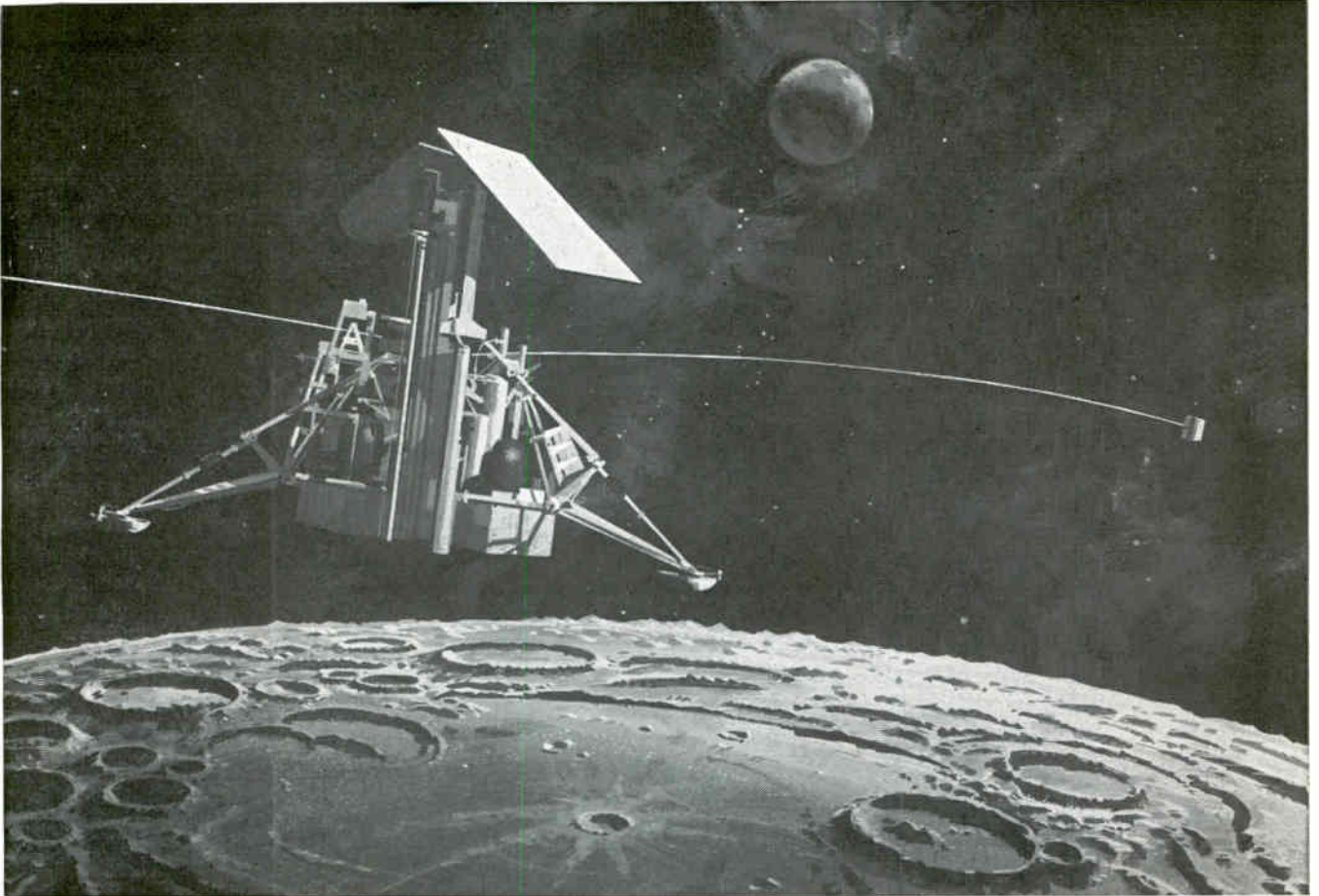

Soft land this vehicle on the moon

CONTROLS ENGINEERS. Concerns airborne computers and other controls related areas for: missiles and space vehicles, satellites, radar tracking, control circuitry, control systems, control techniques, transistorized equalization networks and control servomechanisms.

CIRCUIT DESIGNERS. Involves analysis and synthesis of systems for: telemetering and command circuits for space vehicles, high efficiency power supplies for airborne and space electronic systems, space command, space television, guidance and control systems, and many others.

This spacecraft is SURVEYOR, one of the many important projects now under way at Hughes. It will "soft" land on the moon sometime in 1963. Its mission: to pierce and analyze the moon's surface; to transmit back to earth high quality television pictures; and to measure the moon's magnetic and radiation characteristics. To accomplish these demanding objectives, Project Surveyor requires the talents of many imaginative junior and senior engineers and physicists to augment its outstanding staff. A degree from an accredited university and U.S. citizenship are required. Experience in Aerospace Vehicles is preferred but not necessary. A few of the openings include:

INFRARED SPECIALISTS. To perform systems analysis and preliminary design in infrared activities for satellite detection and identification, air-to-air missiles, AICBM, infrared range measurement, air-to-air detection search sets, optical systems, detection cryogenics and others.

SYSTEMS ANALYSTS. To consider such basic problems as: requirements of manned space flight; automatic target recognition requirements for unmanned satellites or high speed strike

reconnaissance systems; IR systems requirements for ballistic missile defense. Inquire today. Please airmail your resume to:

Mr. Robert A. Martin,
Supervisor of Scientific Employment,
Hughes Aerospace Divisions,
11940 W. Jefferson Blvd.,
Culver City 78, California.

We promise a reply
within one week.

creating a new world with electronics

HUGHES

HUGHES AIRCRAFT COMPANY
AEROSPACE DIVISIONS
An equal opportunity employer.



Ion Orbs Warn of Excessive R-F Field Strength

Omnidirectional devices are also independent of radiation polarization

By HARRY R. MEAHL

General Engineering Laboratory,
General Electric Company,
Schenectady, New York

OMNIDIRECTIONAL r-f field-strength indicator has been developed that responds to frequencies from 50 to 500 Mc and probably to 3,000 Mc. No power supply is needed, and operation is not affected by changes in ambient temperature or relative humidity. The indicator responds to both c-w and pulsed signals independently of polarization.

Potential hazards to personnel are increasing because of greater radiated power from radar and other transmitters and the use of more than one transmitter at radar sites. In these environments, electromagnetic energy also causes malfunctioning or damage to commercially available field strength meters. A field strength indicator was sought having a variety of characteristics for use under these conditions.

Since neon lamps have long been used to indicate the presence of r-f voltage in tuned circuits, a variety of neon lamps were investigated. The General Electric NE2 at frequencies below 1 Gc usually starts glowing at less than 0.01 watt per square cm and may be used as part of a tuned circuit. It withstands excessive overloads and meets many other requirements of a field strength indicator. However, the NE2 is directional, operates at only one frequency and its sensitivity may change three to one for small deformations of the tuned loop.

ION ORB STUDIED—To get omnidirectional operation, spheres filled with gas at low pressure and having no electrodes were investigated. A gas or combination of gases that would glow at low enough field strength to be useful

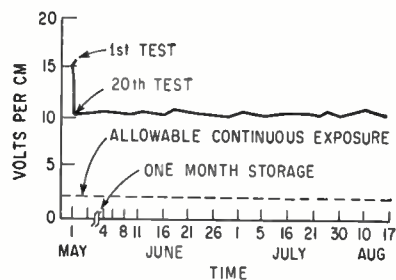

SENSITIVITY of helium-neon ion orb is shown as a function of time—Fig. 1

was sought. Helium has been shown to be much less sensitive to pressure changes between 0 and 40 mm of mercury than nitrogen, hydrogen or argon.¹ Also, a minimum of about 82 volts per cm at pressure of 8 mm of mercury is required to start a glow. The same study showed the relationship between sphere diameter and volts per cm to start glow in spheres from $\frac{1}{4}$ to $\frac{7}{8}$ inch diameter. Data included on the effect of r-f from 10 to 80 Mc showed that frequency effects are reduced as frequency is increased.

Four 1-inch spheres filled with helium were tested at 50 Mc. Sensitivity over two months varied between 33 and 38 volts per cm. Sensitivity of two spheres 2 $\frac{3}{4}$ inches in diameter varied between 20 and 22 volts over the same period. It was inferred from these results that little would be gained using spheres larger than 4 inches in diameter.

Sensitivity of two 4-inch spheres filled with helium varied between 13 and 15 volts per cm over a two-month period. Later, two 4-inch spheres were filled with helium at a pressure of 2.7 mm of mercury and a trace of neon added. Over two weeks, sensitivity varied between 9 and 11 volts per cm. In two more, pressure was 3.5 mm of mercury and 30 microns of mercury. Variation was 10 to 12 volts per cm.

FIELD TESTS—In tests at a radar site, pulsed L-band peak voltage per cm was correlated with the field strength data obtained at 50 Mc rms and agreement was within 20

percent. Thus an ion orb is a field strength indicator rather than a field density indicator. When duty cycle is known, one can be calculated from the other. One ion orb started glowing at 15.6 volts per cm peak and 50 Mc c-w or at 0.32 watt per square cm average power density, and it started glowing at 19.5 volts per cm peak and 500 Mc pulsed or 0.06 watt per square cm average power density.

This agreement is reasonable considering that the data for 50 Mc was taken in a laboratory with the ion orb between two electrodes 6 inches in diameter. The data at 500 Mc was taken at a radar site with the orb on a block of radiation absorbing material supported on a ladder between a scanner and reflector. In the laboratory, voltage between electrodes was measured with a vacuum-tube voltmeter. In the field, average field strength was measured using a 6 square cm tuned resistive loop antenna and a thermistor-bridge power meter.

Tests were made on 14 ion orbs over 15 months. Some were tested there times a day for a week and then stored a week before further tests. Others were mounted on a tower at a radar site and exposed to weather for 10 weeks before being retested. Except for initial effects, no aging effects were found. The first exposure may require a relatively strong field to start glow. Successively less field strength is required for the first 10 or 20 times, after which glow starts at the same field strength within 10 percent or less.

PERFORMANCE—Amplitude at which 4-inch orbs glow is fixed for each at 10 to 12 volts per cm and higher field strengths in smaller orbs. Response at frequencies from 50 to 500 Mc was found to be comparable and is believed to be flat to 3,000 Mc. Accuracy is within 50 percent. The indication is a red glow that pulses at the prf of pulse signals. Exposure to 100 watts per square cm for 5 minutes did not

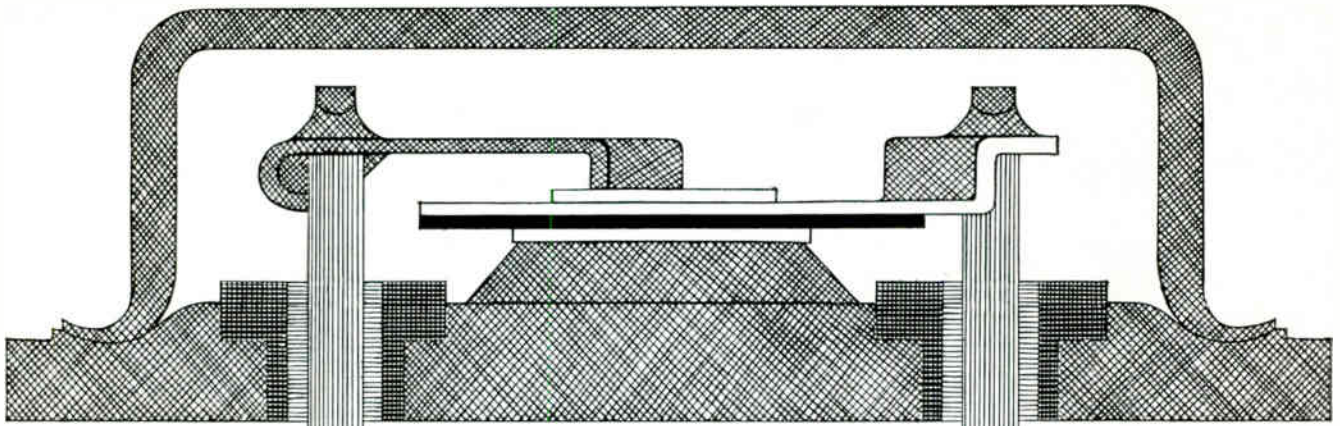

DELCO RADIO INTRODUCES "NU-BASE"*

For high voltage—high speed

A non-uniform distribution of impurities in the germanium base region between the collector and emitter junctions gives Delco Radio's NU-BASE Germanium Power Transistors a low input resistance and a high cut-off frequency while maintaining a high breakdown voltage. Capable of handling 120 volts maximum . . . with faster switching speeds, higher frequency response and gain that is less dependent on current . . . these new units offer such exclusive Delco advantages as: a TO-3 cold-weld package; planar junctions that are the best in the industry for increased reliability; thermal resistance of .8° C/W; and saturation voltage of .6V, lowest available. This efficient, high current switching at high frequencies gives Delco's NU-BASE Germanium Power Transistors wide applications in solid state ignition systems, hi-fi systems, ultrasonics and computer print-out. For more information, contact one of our sales offices listed below or your nearest Delco Radio Semi-conductor distributor.

*non-uniform base germanium power transistors



TYPE	V _{cb0}	V _{cer} *	V _{ce} **	h _{fe} I _c @ 5A	I _{cb0} @ 85°C	T _j
2N1073	40V	40V	0.6	20-60	10MA @ 25V	110°C
2N1073A	80V	80V	0.6	20-60	10MA @ 60V	110°C
2N1073B	120V	120V	0.6	20-60	10MA @ 100V	110°C

*Reb = 100 Ω **I_c = 5A, I_b = 0.5A

Sales Offices

Union, New Jersey
324 Chestnut Street
MUrdoch 7-3770
AREA CODE 201

Detroit, Michigan
57 Harper Avenue
TRinity 3-6560
AREA CODE 313

Santa Monica, California
726 Santa Monica Blvd.
UPlon 0-8807
AREA CODE 213

Syracuse, New York
1054 James Street
GRanite 2-2668
AREA CODE 315

Chicago, Illinois
5151 N. Harlem Ave.
775-5411
AREA CODE 312

General Sales Office: 700 E. Firmin, Kokomo, Ind., Gladstone 2-8211—Ext. 500 • AREA CODE 317 • Division of General Motors

Kokomo, Indiana

DELCO
RELIABILITY
RADIO
RELIABILITY



NOW READY:

ANALOG-TO-DIGITAL CONVERTER

NAVCOR MODEL 2201

LOW PRICE: **\$2935**

ACCURACY: **.05%** ABSOLUTE

DELIVERY: **30 DAYS**

Format: Binary, 10 bits plus sign.

Conversion Rate: 10,000 complete conversions per second (9.1 microseconds per bit plus 9.1 microseconds.)

Input Range: ± 10.23 volts; lower or higher ranges available.

Input Impedance: 5,000 ohms; high impedance amplifier optional.

Other models start from \$2,775. Both Binary and Binary-Coded-Decimal formats are available. Options include Sample and Hold, Multiplexing, and Over-Range Indication. For more information, write to NAVIGATION COMPUTER CORPORATION, Valley Forge Industrial Park, Norristown, Pennsylvania.

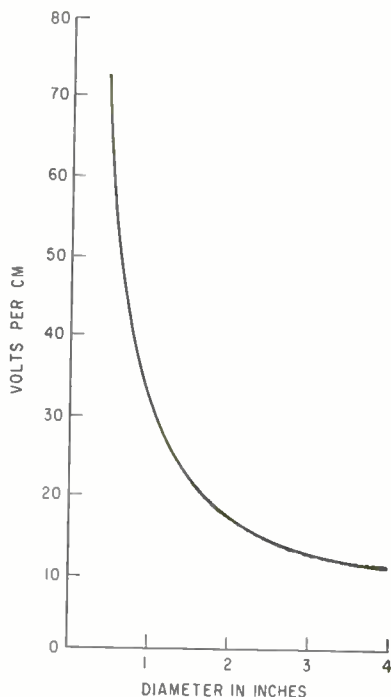

SENSITIVITY of helium-neon ion orb is shown as a function of orb diameter—Fig. 2

change operating level. During this test, the glass envelope was heated to about 50 degrees C.

Operation is independent of temperature. The glow started at the same field strength when the orb was packed in dry ice and the envelope covered with frost. The ion orbs are also independent of relative humidity. The 4-inch orbs weigh 5 ounces.

If a visual indication of excessive r-f field strength is required at the location rather than both visual and audible indications at a control center, an ion orb may be mounted in a mesh net of nylon cord. After glow starts, brightness increases with field strength. Although this characteristic could be calibrated, it is affected by frequency. Light output versus field strength is also a function of duty cycle for pulsed signals. Since r-f field strength would be above the allowable continuous exposure limit at the location, some means of remote observation would be needed.

Volts per cm is shown as a function of frequency in Fig. 1 for an ion orb filled with helium at 3.5 mm of mercury pressure and neon at 30 microns. The bright red center is surrounded with orange. Between tests 19 and 20, the orb glowed continuously for two hours and was then stored for 33 days

before resuming tests. The consistency shown in Fig. 1 and the agreement between tests at 50 and 500 Mc is important for ensuring personnel safety. That this characteristic is inherent in each orb and cannot be changed is also important.

CHARACTERISTICS—The relation between orb diameter and volts per cm when glow starts for a particular gas mixture is shown in Fig. 2. Other gases have different characteristics. Nitrogen, oxygen and argon have steep characteristics of field strength versus pressure over the range of 2 to 10 mm of mercury. Minimum field strength for helium is at a pressure of about 7 mm of mercury, rising only 13 percent at 5 and 20 mm of mercury.

Seeing an empty glass sphere suddenly glow red and orange proved to be a good psychological stimulus to investigate its cause cautiously.

The compact and simple ion orbs are expected to be useful for other applications. For example, they might be used as a three-dimensional indicator of r-f field strength patterns in cavities or waveguides. Light patterns within the sphere may provide quantitative information about the vector fields.

REFERENCE

(1) James F. Steinhaus, Glo-ball Development, *Rev Scien Inst*, 27, p 575, 1956.

Field Increases Laser Instantaneous Output

MODULATING TECHNIQUE concentrates energy from a laser so that instantaneous power output is multiplied as many as 1,000 times. The same method permits a laser beam to be switched on and off at 100 Kc.

In the new modulating technique, which was developed by General Dynamics/Electronics, Rochester, N. Y., a nonuniform magnetic field surrounds the laser. When the strong magnetic field is removed, the energy that the laser had been forced to store is suddenly released. The concentrated pulse is many times more powerful than the uncontrolled discharge.

Using existing control methods either greatly reduces energy output of the laser or the intense light

POLARIS—U. S. Navy operational long-range missile uses seven types of Texas Instruments transistors in its Mark 84 fire control system and navigational computer system. As many as 39 transistor parameters meet a 0.65 AQL to fulfill the stringent reliability demands of Polaris.



FLYING FISH FROM INNER SPACE

Rely On TI Advanced Transistor Technology

As Many As 39 Parameters Meet 0.65 AQL . . .

Now you can design this same Polaris transistor performance into your circuits, products or systems. TI's Circuit Development-Applications department would welcome the opportunity to consult with you on your military or industrial design requirements. ■ The following TI device types are the counterparts of the Polaris units delivered to a 0.65 AQL. They are produced by the same technology, equipment and personnel that produce "Polaris quality" transistors . . . and made possible by TI's capabilities in precise process control. 2N1047 series, 2N1893/2N696 series, 2N1132 series, 2N743 series, 2N490 series, 2N1302 series, 2N428 series. When you add TI reliability to your products, you add it at low cost

because many years of high-volume production have allowed TI to develop extensive mechanization techniques. ■ More than 800 separate automatic production and testing facilities provide the manufacturing flexibility to meet your special product requirements . . . again at low cost. ■ You will find the transistors you need among the over 400 standard TI device types already in stock for your convenience. ■ Put TI transistors and TI's creative engineering assistance to work for you to provide better reliability for your products at lower cost. Call your TI sales representative, or write directly to TI's Circuit Development-Applications department about your specific requirements. You'll find out why so many already specify TI.

TRANSISTOR
PRODUCTS
DIVISION

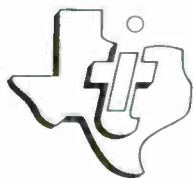

TEXAS INSTRUMENTS

INCORPORATED

13500 N. CENTRAL EXPRESSWAY
P. O. BOX 5012 • DALLAS 22, TEXAS

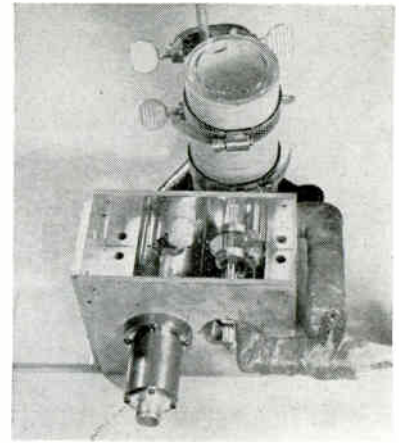
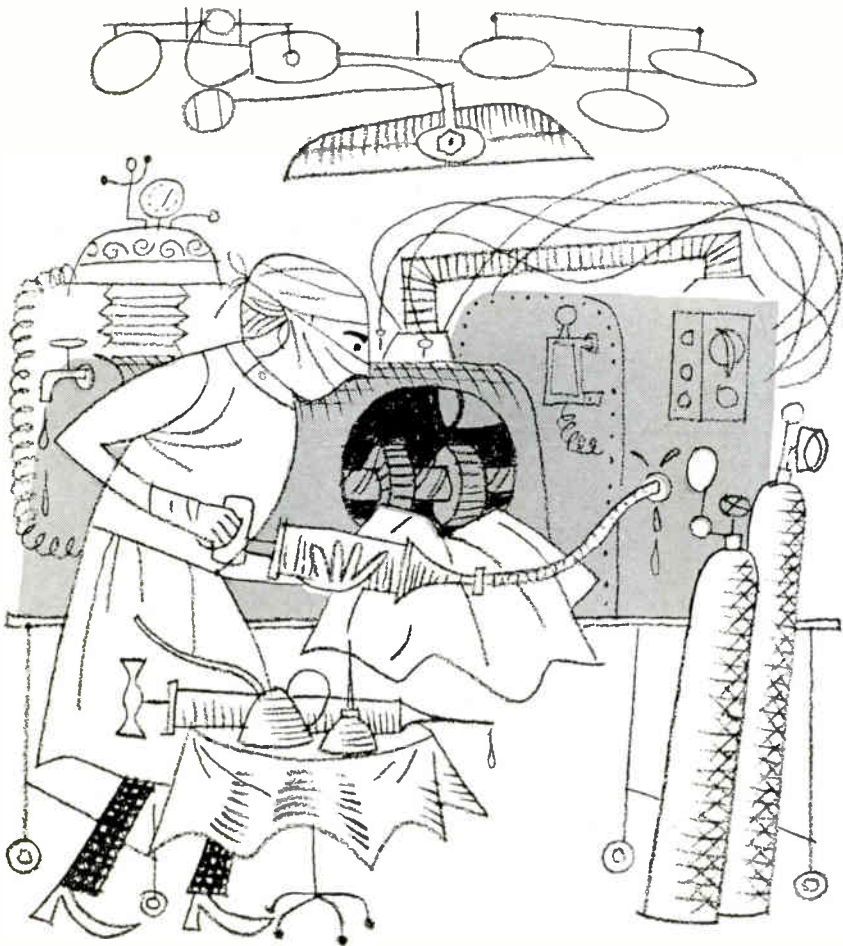

RUBY ROD at right in pumping cavity with cover removed is provided with strong magnetic field when coil is energized through heavily insulated conductors

THE CARE AND FEEDING OF VERY CLEAN VACUUMS

(An object lesson in what to do with stray organic molecules)

Oil is fine on the bearings of a car. Or after baby's bath. Oil is not fine on the walls of your vacuum system. If you're not using a Varian VacIon® all-electronic pump, you've probably got oil in your system.

In thin-film evaporation or semiconductor work, this can be troublesome. Oily systems produce grubby vacuums. Grubby vacuums produce thin films that don't come up to par, or semiconductors that behave in mysterious ways. If at all.

Now, ion-getter pumps are dandy for avoiding oil contamination. They remove gases by reconstituting them into stable solids. There aren't any stray organic molecules wandering around in your vacuum system. Hard to say that for oil-diffusion pumps.

Varian VacIon pumps can pump down to the 5×10^{-10} mm Hg range. They're extra-reliable; fail-safe design

means no messy clean-up jobs in the event of vacuum or power failure.

We can provide all sorts of excellent vacuum hardware. High thru-put pumps. Miniature pumps with speeds of 0.2 litres/second. Monster pumps with speeds of 10,000 litres/second. Catalog-item systems, for a bewildering variety of applications.

We've been told we sound smugly confident when we talk about VacIon pumps. That, we'll admit. We're so confident that we guarantee to replace your VacIon pump if it doesn't perform *exactly* the way we say it will. Or your money back. We ask only that you design your vacuum system after heeding the thoughtful advice of our wise old vacuum scientists.

We could tell you more, but we've done it better (and with formulae) in a brochure. Write for your copy.

beam damages the mechanical or optical devices used or both. Both of these problems are said to be eliminated by use of the magnetic field. A synthetic ruby rod one-quarter inch in diameter and 1½ inches long is cooled to liquid nitrogen temperature. The rod is enclosed in a double-walled nitrogen-filled flask to maintain the low temperature.

The magnetic field is provided by a single turn of heavy copper wire wound around the middle of the rod. Discharge of 138,000 amperes from a capacitor bank through the coil produces a magnetic field of about 60 kilogauss at the center of the rod and about 8 kilogauss at the ends. The variation in distribution of the magnetic field is an important factor in control.

Discharge of the capacitors is timed to coincide with maximum intensity of the pumping light. Without the controlling magnetic field, the laser would start to emit light at about the same time in a burst that gradually increased to a peak and then even more gradually subsided to zero light output.

However, because of the magnetic field, the ions in the ruby crystal cannot radiate cooperatively to produce a characteristic laser light pulse. When the field is removed, most of the light energy stored in the crystal is suddenly released.

Experiments were also conducted at room temperature. In these tests, the magnetic field must be ten times greater to achieve similar control.

VACUUM
PRODUCTS
DIVISION

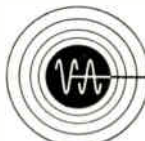

VARIAN associates

PALO ALTO 1, CALIFORNIA

Lacing Problems Solved
with these
Specially Processed
Tapes

**HEMINWAY
& BARTLETT**

NYLON or DACRON Cords and Flat Braided Lacing Tapes

- Great stability under high heats
- Tie faster . . . easier . . . tighter
- Knots won't slip
- Fungus-proof
- Wax-coated, wax-free or G.E. Finish
- Meets Govt. Spec. MIL-T-713B

For ultra-high temperature work...

TEFLON-COATED FIBERGLAS TAPES

withstand temperatures up to 600°—in ¼" and ½" widths

Write for full information and free samples!

THE HEMINWAY & BARTLETT MFG. CO.

Electronics Division: 500 Fifth Avenue, New York 36, N.Y.

CIRCLE 98 ON READER SERVICE CARD



How to grow a beard...

Sit back and wait for your copy on that routing list. Okay if you like beards. Otherwise, look in this issue for the Reader Service Card. Fill in the "for subscriptions" section. Mail. Only 7½ cents a week.

electronics

A McGraw-Hill Publication,
330 West 42nd St., N. Y. 36



Time after time engineers specify Johnson sockets!

Whatever the choice . . . a miniature 7-pin steatite wafer—or a low-loss Kel-F socket for high power transmitting tubes . . . time and time again design and development engineers specify Johnson tube sockets! All sockets have been categorized under a socket standardization program, reducing the number of variations in each socket type. Standardized specifications and immediately available stock shortens delivery cycles—permits the selection of a Johnson socket for almost any application!

Kel-F Series—Molded of low dielectric loss-factor Kel-F plastic—designed for use with high power transmitting tubes such as the 4X150A, 4X250B, 7032, etc. Available in many designs—with or without low inductance screen grid by-pass capacitors, mounting saddle, or steatite chimney.

Bayonet Types—include Medium and Heavy Duty Medium, Jumbo and Super Jumbo 4-pin types.

Steatite Wafer Types—available in 4, 5, 6, 7, and 8 pin standard sockets, as well as Super Jumbo 4 pin, Giant 5 and 7 pin models and VHF Septar Sockets for tubes with E.I.A. Base No. E7-20 and E7-2.

Miniature Types—all steatite, available in Standard Wafer Type or Shield Base Type for 7 pin miniatures with E.I.A. Base No. E7-1.

Special Purpose Types—include sockets for tubes such as the 204A and 849, the 833 and 833A, 152TL, 304TL, 750TL, 1500T, 2-2000A, 5D21, 705A and other special purpose tubes.



E. F. JOHNSON COMPANY

2020 TENTH AVENUE S.W. • WASECA, MINN.

STANDARD INDUSTRIAL, MILITARY TUBE SOCKETS

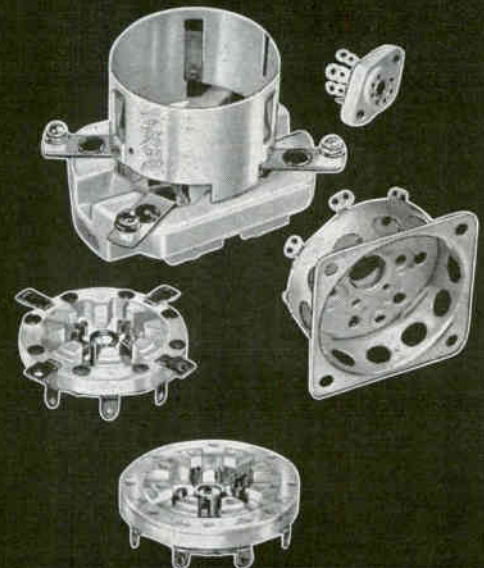

DETAILED COMPONENTS CATALOG AVAILABLE

—Write today on company letterhead!

- CAPACITORS • TUBE SOCKETS • CONNECTORS • PILOT LIGHTS
- INSULATORS • KNOBS AND DIALS • INDUCTORS • HARDWARE

NEW

4-TRACE

PREAMPLIFIER

for Tektronix
Oscilloscopes that
accept
letter-series
plug-in units

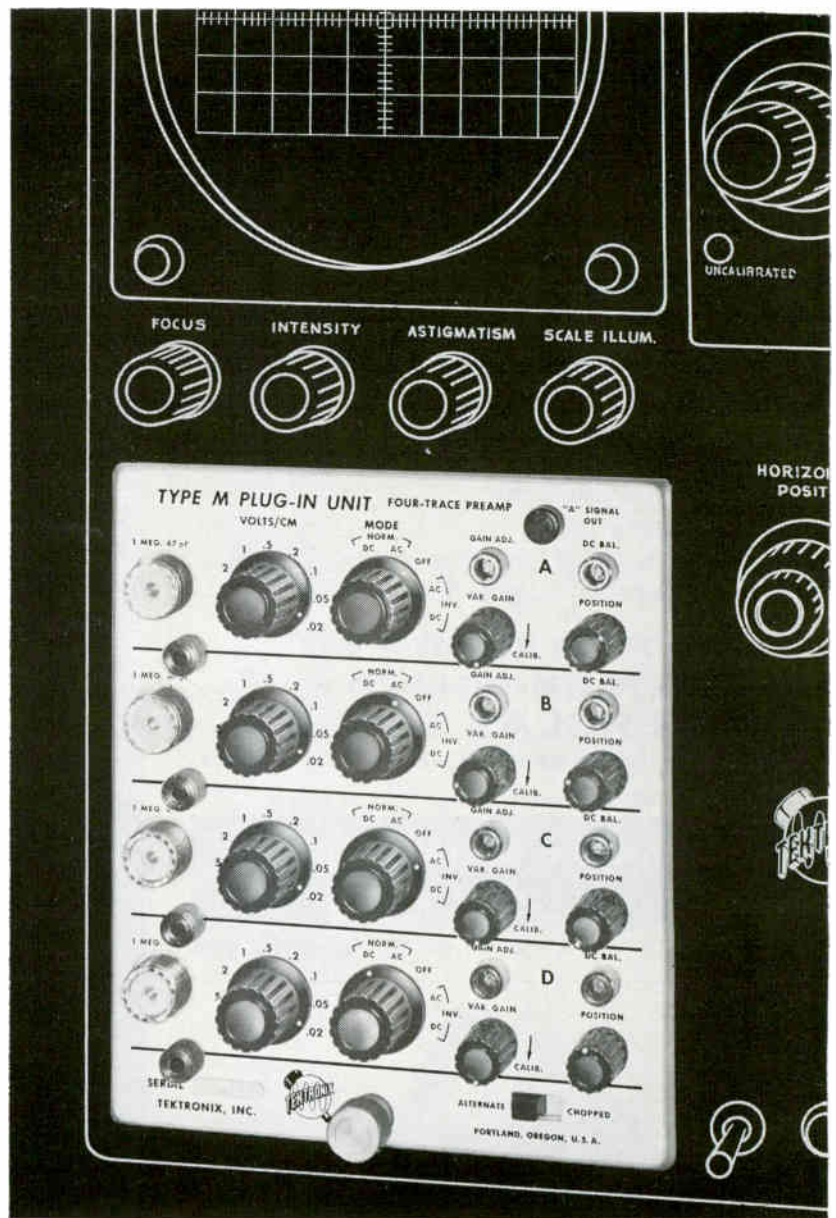
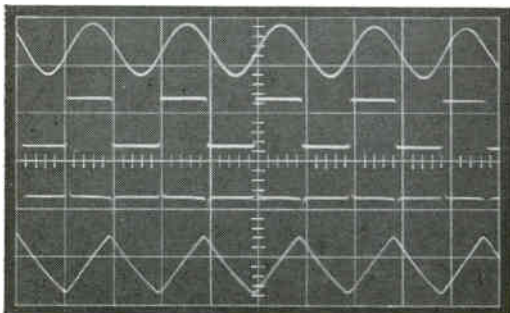

TYPE M UNIT Seventeenth in the letter-series of plug-in units, the new Type M Unit adds multiple-trace displays to the wide range of applications possible with your Tektronix oscilloscope.

With a Type M Unit, you can observe up to four signals—either separately, or in any combination.

Independent controls for each amplifier channel permit you to position, attenuate, invert input signals as desired.

Other convenient preamplifier features—such as triggered or free-running electronic switching . . . ac-coupling or dc-coupling . . . and, after initial hookup, little or no cable switching—ideally suit the new Type M Unit for multiple-trace presentations in the laboratory or in the field.

*For a demonstration of this new 4-Trace Preamplifier,
please call your Tektronix Field Engineer.*

CHARACTERISTICS

Operating Modes—Any combination of one to four channels electronically switched—at the end of each sweep or at a free-running rate of about 1 mc (1 μ sec width samples). Or each channel separately. **Channel Sensitivity**—20 mv/cm to 10 v/cm in 9 calibrated steps. Continuously variable uncalibrated between steps, and to 25 v/cm. **Channel A Signal**—available on front panel for optimum triggering in some applications. **Frequency Response and Rise Time**—With Type 540-Series and Type 550-Series Oscilloscopes dc to 20 mc, 17 nsec. With Type 531A, 533A, 535A Oscilloscopes dc to 14 mc, 25 nsec. **Constant Input Impedance**—at all attenuator settings.

Type M Plug-in Unit \$525.00

U.S. Sales Price, f.o.b. Beaverton, Oregon

Tektronix, Inc. P. O. BOX 500 • BEAVERTON, OREGON / Mitchell 4-0161 • TWX—BEAV 311 • Cable: TEKTRONIX

TEKTRONIX FIELD OFFICES: Albuquerque, N. Mex. • Atlanta, Ga. • Baltimore (Towson) Md. • Boston (Levittown) Mass. • Buffalo, N.Y. • Chicago (Park Ridge) Ill. • Cleveland, Ohio • Dallas, Texas • Dayton, Ohio • Denver, Colo. • Detroit (Lathrup Village) Mich. • Endicott (Endicott) N.Y. • Greensboro, N.C. • Houston, Texas • Indianapolis, Ind. • Kansas City (Mission) Kan. • Los Angeles, Calif. Area (Encino) • Long Beach, Calif. • Los Angeles • Pasadena • West Los Angeles • Minneapolis, Minn. • New York City Area (Albertson, L.I., N.Y. • Stamford, Conn. • Union, N.J.) • Orlando, Fla. • Philadelphia (Bala Cynwyd) Pa. • Phoenix (Scottsdale) Ariz. • Pittsburgh (Monroeville) Pa. • Portland, Ore. • Poughkeepsie, N.Y. • San Diego, Calif. • San Francisco, Calif. Area (Lafayette) • Palo Alto • Seattle, Wash. • Syracuse, N.Y. • Washington, D.C. (Annandale, Va.)

TEKTRONIX CANADA LTD: Montreal, Quebec • Toronto (Willowdale) Ontario.

ENGINEERING REPRESENTATIVES: Kronton Hawaii Ltd., Honolulu, Hawaii. Tektronix is represented in twenty-five overseas countries by qualified engineering organizations. European and African countries, the countries of Lebanon and Turkey, please contact TEKTRONIX INTERNATIONAL A.G., Terrassenweg 1A, Zug, Switzerland, for the name of your local engineering representative. Other Overseas areas, please write or cable directly to Tektronix, Inc., International Marketing Department, P. O. Box 500, Beaverton, Oregon, U.S.A. Cable: TEKTRONIX.



KYNAR[®] insulated wire ... new standard in performance and production

Wire and cable insulated with Kynar—the new fluorocarbon resin from Pennsalt Chemicals—delivers premium performance in your product and on your production line. Kynar-insulated hook-up wire has high dielectric strength and resistivity . . . strips cleanly, won't tear or cut-through in automatic assembly equipment. Kynar has a useful temperature range of -80° to $+300^{\circ}$ F. and Kynar-insulated wire forms strong, tight seals with epoxy-base potting compounds. As a jacketing material, Kynar offers superior resistance to abrasion, corrosion, weathering, and radiation . . . extrudes readily over single or multi-strand constructions as well as vinyls, PTFE and metallic shields. It can be pigmented and striped to identify circuits. Typical

properties of 10-mil Kynar insulation extruded over AWG 24 solid soft copper conductor:

Dielectric strength, volts.....	10,000
Insulation Resistance, meg-ohm/M.....	> 1,000
Cold bend, 1/2" dia., 1 lb. weight at -70° F, volts.....	8,000
Abrasion Resistance, Janco Tester grade 400 alumina, inches of tape.....	50
Cut through, anvil at 90° , 350 gm. hours at 270° F....	> 500
Soldering test, flare back.....	None
Flammability	self extinguishing

Kynar-insulated wire is available from Surprenant Mfg. Co., Clinton, Mass.; Revere Corp. of America, Wallingford, Conn.; L. Frank Markel, Norristown, Pa.; Hitemp Wires Co., Westbury, L.I.; and Brand-Rex, Concord, Mass. Write to us for details. Plastics Department, PENNSALT CHEMICALS CORPORATION, 3 Penn Center, Phila. 2, Pa.



Will Irradiation Really Improve Transistors?

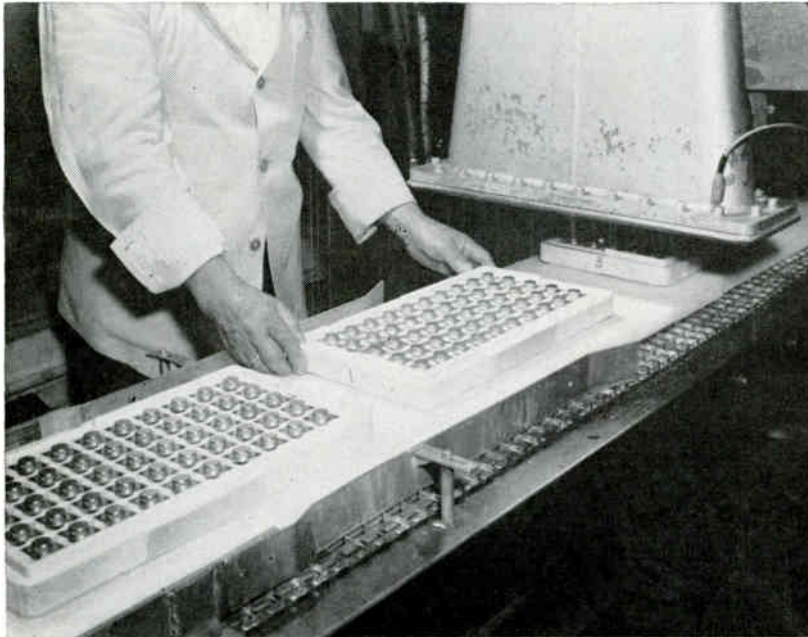

SEMICONDUCTORS on conveyor line in irradiation vault at High Voltage Engineering Corp., Burlington, Mass.

Half a dozen makers now use accelerators, others deprecate the idea

ELECTRON IRRADIATION of production-batch transistors to match customers' varying beta specifications marks a significant step in the use of radiation as a tool for modification of semiconductor properties. Production-line irradiation of diodes to increase switching speed was reported in *ELECTRONICS*, p. 28, Feb. 17, 1961.

Electrons have two very different reactions with solids. One is the process of ionization, a transient and reversible effect on valence-band electrons. It is the second reaction, atomic displacement and the resultant creation of interstitial-vacancy pairs, which modify a semiconductor's electrical characteristics.

More than a half-dozen U. S. manufacturers have adopted the irradiation technique for diodes and transistors, most of them time-renting accelerator facilities.

Among companies which have in-house Van de Graaff accelerators are Transitron and Rheem. Transitron, one of the first to adopt the technique, has been irradiating semiconductors on a production basis for about five years.

TWO OPINIONS—One company reports it has investigated the irradiation tool and rejected it, for the present. "This process doesn't really buy us anything," says a spokesman for Clevite Transistor.

On the other hand, George C. Messenger, manager of the transistor division at Transitron, describes irradiation as an effective and economically advantageous production tool. At a cost of a few pennies per unit, says Messenger, irradiation gives better control over transistor current gain than other processes.

Transitron now irradiates about 10 percent of its transistor production line. The process is considered a worthwhile tool in the production of transistors for flip-flop circuits in data processing, e.g. where they

can be mass-produced with beta ranges of 20-40 or 30-60, and then batches irradiated to decrease the gain to specs; also for communications transistors with tight gain tolerances.

In switching transistors, irradiation affects both switching time and beta; with amplifier-type transistors, the process is used to bring beta down to the precise range of application.

According to Messenger, post-irradiation treatment is one key to successful use of the process. The transistors are stored at an elevated temperature for a pre-set time, to stabilize the effects produced in the crystal lattice. Temperature and storage time for annealing can vary even with different kinds of silicon or germanium, and can be determined experimentally.

Post-irradiation "curing" prevents further annealing, and electrical characteristics remain stable under operating conditions. To prevent spot annealing during irradiation, provision is made for thermal dissipation—in some plants water-cooling is used; in others, trays of semiconductors are placed on dry ice during the process.

Several companies on the East Coast make transistors with a standard beta of about 150 on a high-volume production line. Batches placed under the accelerator beam for various dosages end up with four or five yields with betas ranging from 50 to 100. Dosages range from 1/10th to as high as 24 megarads.

For companies which rent time on an accelerator, cost of irradiation ranges from a fraction of a cent to 5 cents per unit, depending on dosage and on the energy required to penetrate the semiconductor package. In one instance, a device which sells for \$35 to \$40 per unit received a dosage of 20 megarads at a unit cost of 5 cents.

At Electronized Chemicals Corp., Burlington, Mass., more than a half-million production-type semi-

Additional precision in both **ALSiMAG[®]** ceramics and in **ALSiBASE** thin substrate ceramics

Technical requirements for precision ALSiMag ceramics have led to significant advances in the several areas:

UP-TO-THE-MINUTE FORMING PROCESSES

Injection molding produces many complex designs to close tolerances. Isostatic pressing gives close control over large tubular forms. Special dry pressing equipment compacts from several directions and at higher pressures. ALSiBase produces thin and ultra-thin ceramics to close tolerances and with exceptional surface smoothness and flatness.

These processes along with conventional dry pressing, extrusion, etc., can be augmented by advanced machining and grinding techniques.

NEW COMPOSITIONS

American Lava has long offered a variety of compositions to meet different

requirements. A recent addition to the ALSiMag family is, for example: ALSiMag 719, a 94% alumina ceramic developed especially for its compatibility with frequently used metallization processes and with increased bond strength.

NEW GRINDING AND FINISHING METHODS

New techniques and ingenious approaches to work holding devices for precision subminiatures, plus advanced equipment operating in temperature and humidity controlled areas enable us to meet many new and closer dimensional requirements, in production quantities, on a daily basis.

NEW FACILITIES FOR MEASUREMENTS

In addition to the conventional precision measuring and inspection devices, you

will find at American Lava, advanced instruments such as:

Talysurf surface analyzing equipment which provides a graphic record of surface finish to a new order of exactness. Amplifications on vertical scales up to 50,000.

Equipment for measuring internal diameters to an accuracy of .000025.

Equipment for enlarging to 2000 diameters and making photomicrographs.

However varied or complex your requirements in custom technical ceramics, we believe that you are most apt to find the prompt, economical answer at American Lava Corporation. Our technical men will be glad to make suggestions if you outline your requirements.

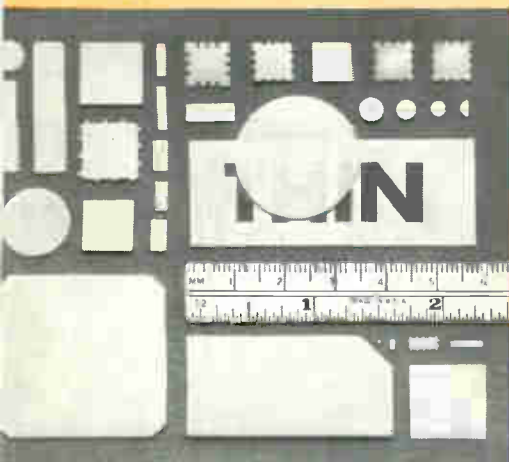

Here are five groups of thin ALSiMag ceramics. Each group is produced by a different process. The process is chosen because of the physical or surface characteristics desired for the application. Some designs are produced to unusually close dimensional tolerances without grinding. Metallizing and plating is available over a wide range of processes and materials. In addition to low temperature, refractory metal and active metal processes are used.

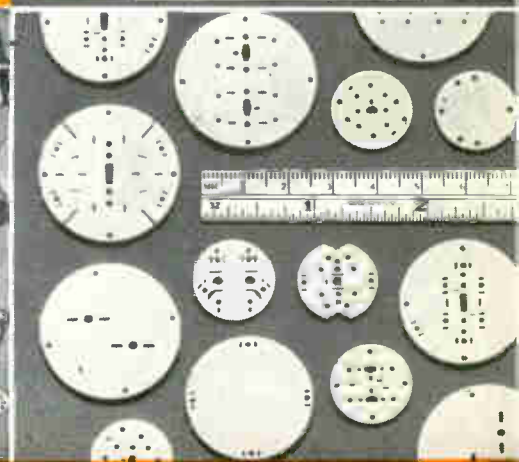
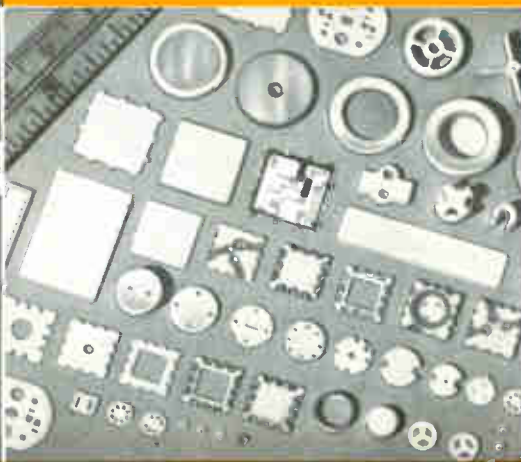
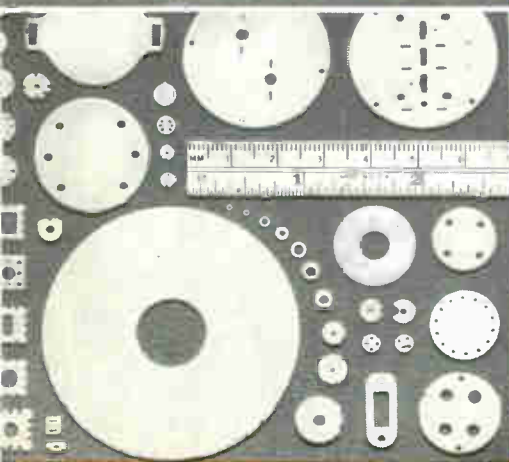
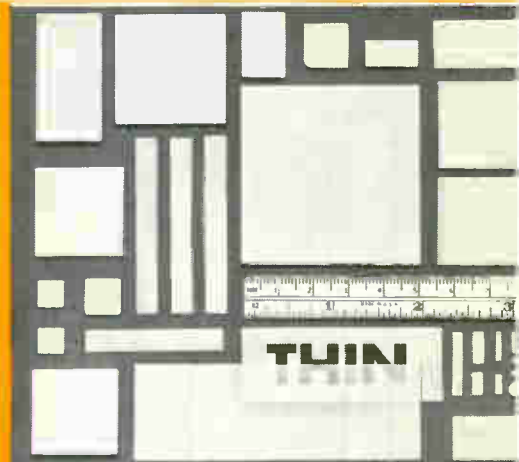

A Subsidiary of
Minnesota Mining and
Manufacturing Company

**AMERICAN LAVA
CORPORATION**

CHATTANOOGA 5, TENN.
61ST YEAR OF CERAMIC LEADERSHIP

For service, contact American Lava representatives in Offices of Minnesota Mining & Manufacturing Co. in these cities (see your local telephone directory): Boston: Needham Heights, Mass. • Chicago: Bedford Park, Ill. • Cleveland, Ohio • Farmington, Mich. Laurens, S. C. • Los Angeles, Cal. • Milwaukee, Wis. • Metropolitan New York: Ridgefield, N. J. • Up-State New York: Newark, N. Y. Philadelphia, Pa. • Richardson, Texas • St. Louis, Mo. • St. Paul, Minn. • South San Francisco, Cal. • Seattle, Washngton. All export except Canada: Minnesota Mining & Manufacturing Co., International Division, 99 Park Ave., New York, N. Y.

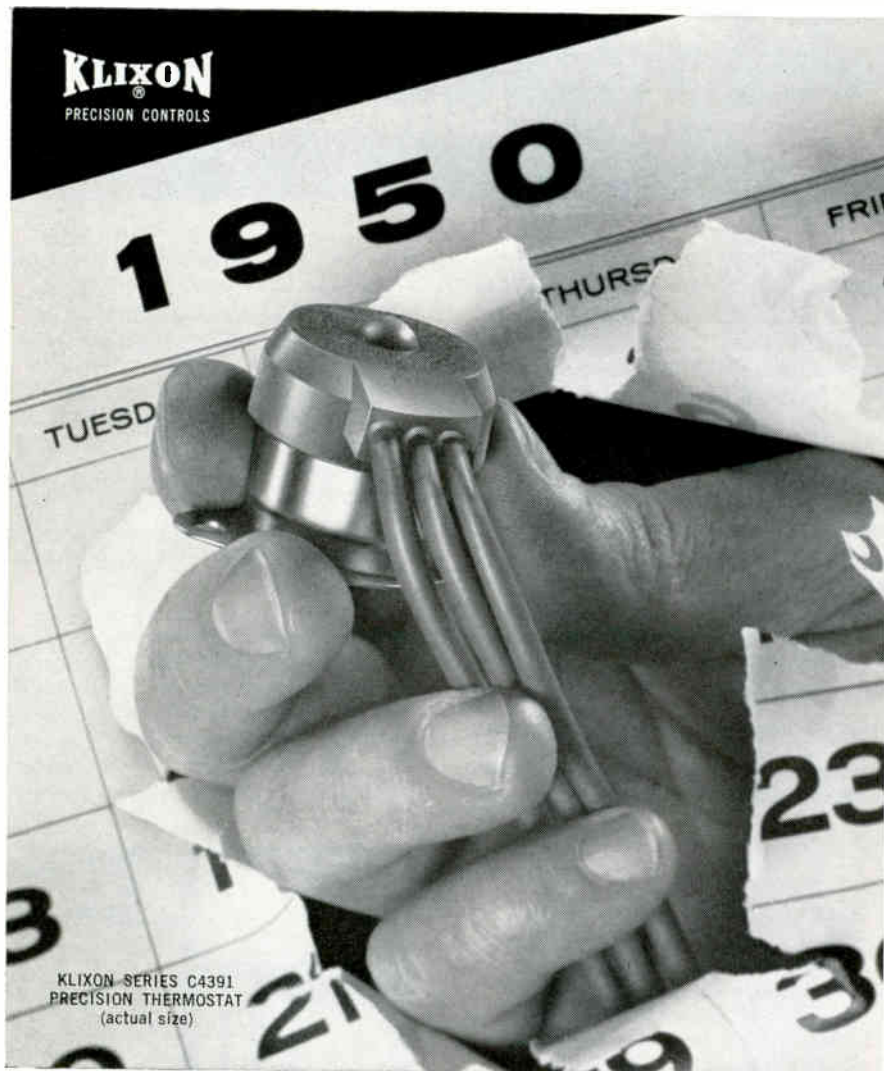

This time-tested thermostat meets space-age demands!

Backed by a dozen years of proven performance, KLIXON® C4391 Series SPDT, manual-reset, hermetically-sealed thermostats are finding increased usage in precision applications. Designed for air conditioning, heating and refrigeration equipment, these fixed-temperature controls are now widely used in missile and aircraft systems... protecting large power source tubes... keeping "black box" temperatures on the safe side.

Why so popular? One good reason — KLIXON C4391 Thermostats are available with SPDT switch action and/or manual reset. Other reasons are: capacity up to 14 amp 30 V-ac/dc; elimination of the need for relays in some applications; option of opening or closing on temperature rise; 100,000 cycles at 10 amp; inherent dependability of KLIXON snap-acting disc under shock and vibration extremes; wide choice of mountings and other design options.

Get All the Facts! Write today for Bulletin THSN-9 which presents complete performance data and physical characteristics.



METALS & CONTROLS INC.

5007 FOREST ST., ATTLEBORO, MASS.
A CORPORATE DIVISION OF

TEXAS INSTRUMENTS
INCORPORATED

conductors are irradiated per year, by manufacturers who time-rent the facility. ECC, a subsidiary of High Voltage Engineering Corp., uses a 1.5 Mev Van de Graaff accelerator, also a 3 Mev Van de Graaff at Burlington, and a linear accelerator at Rockford, Ill., which has an electron beam energy variable from 4 to 12 Mev for irradiation of power diodes and other heavy-capped semiconductors. Under construction at Burlington is a new ECC building which will also include a three-phase insulating-core transformer operating as an accelerator system. With existing equipment, ECC can irradiate 15,000 semiconductors in an hour.

SWITCHING SPEEDS—Diodes were the first semiconductors to be irradiated on a production-line basis. By attacking minority carrier lifetime, switching speeds can be improved by factors of 10 to 100, even 1,000 in one instance reported. A company which buys scrap diodes for one cent a pound irradiates them to increase switching speed and sells them for 60 cents to one dollar each.

Another manufacturer produces diodes with a standard switching time and sells some of these right off the production line. For applications which call for faster switching, 20,000 per month are irradiated at a cost of a fraction of a cent per unit. In a recent batch, the cost was 1/10th cent per unit.

More extensive, of course, is the use of radiation in semiconductor research programs, as a tool for a better understanding of semiconductor physics and to help produce radiation-resistant devices.

At the Raytheon Research Division, Harold Roth bombards germanium tunnel diodes with 3 Mev electrons. Goal is to understand better the characteristics of band structure, junctions and the material itself. Previous work by C. T. Sah has shown that doping with gold creates deep states through which tunneling to forbidden levels can take place. Roth creates similar deep states by irradiation. It is hoped that the research will someday permit tailor-made tunnel diodes.

ELECTRICAL EFFECTS—Roth's studies have resulted in discovery

that there are two types of damage produced by irradiation: one is voltage-annealable and the other thermal-annealable.

When tunnel diodes irradiated at liquid nitrogen temperatures were taken up to room temperature, only 5 to 10 per cent of the damage remained, the rest having been thermally annealed. But when kept at liquid nitrogen temperature, roughly half of the damage was annealed by a forward bias voltage of several hundred millivolts. A negative bias did not anneal, so it cannot be explained as a heating effect. Further research is being done on the relationships between voltage-annealable and thermal-annealable damage, both of which can be annealed when tunnel diodes irradiated at liquid nitrogen temperature are returned to room temperature.

Roth also reports that radiation damage apparently does not affect capacitance. Irradiation has raised $I_{r.}$ by 3 or 4, essentially wiped out the negative resistance region, yet the capacitance was not affected.

Laboratories are also investigating the radiation of semiconductors with neutrons, protons and very high gamma rays, which produce second-order effects different from those generated by electron irradiation. Neutron irradiation is a faster process, and some researchers predict that a more general availability of sources will someday make it economically attractive.

T.M.

Shielding Beads for H-f. Choke Functions

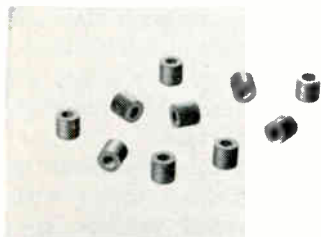

A SIMPLE, effective means of decoupling signals between circuit components, suggested by Ferroxcube Corp., Saugerties, N. Y., is to use ferrite shielding beads strung on wires at circuit points where capacitive decoupling is desired. These beads can be used in applica-

ask
MARKEM
 to show you
 how to
 identify
 your products
 completely
 — at
 least
 cost



#A-104660
 4000 OHMS
 C. P. CLARE & CO
 CHICAGO, ILL



Whether your electrical and electronic products range from subminiature and microminiature components to large panels and "packages", you can identify them *all* completely and clearly, at production speeds, with economical Markem methods engineered to your particular requirements. For example: methods to mark odd shapes, sizes and surfaces with your complete, detailed legend, using quick-change type flexibility and ink to meet military specifications and withstand unusual environmental conditions—and above all, with savings in time and money—are offered by Markem, one responsible source for the entire process.

For a complete in-plant analysis of all your product identification processes—or a practical answer to a specific problem—call in your local Markem Technical Representative. Markem Machine Co., Electronics Division, Keene 5, N. H.

12-page catalog on request. Please use inquiry card.



MARKEM

HELPS YOUR PRODUCT SPEAK FOR ITSELF

NEW

(actual size)

1/10 WATT RESISTORS

to meet MIL-R-10509D

WARD LEONARD METOHM[®]

metal film precision resistors

For space age electronic use, these newly engineered 1/10 watt metal film precision resistors fulfill the most exacting circuit requirements. More compact than the 1/8, 1/4 and 1/2 watt METOHMS, the 1/10 watt units meet present and future needs for miniaturized precision resistors.

Only .260" long by .120" diameter, with 1-1/2" axial leads, the 1/10 watt METOHMS (Type WL 55) offer the same high reliability, high stability, close accuracy and low TC's as the larger METOHMS. Designed to meet MIL-R-10509D for Characteristics B, C and E, the new WL 55 METOHMS are available in resistance values to 100,000 ohms, TC's as low as ± 25 PPM and tolerances of $\pm 1\%$, $\pm .5\%$, $\pm .25\%$, and $\pm .1\%$.

Applications assistance, evaluation samples and catalog data are now available. Write today to Ward Leonard Electric Co., Metal Film Division, 30 South Street, Mount Vernon, N. Y.

2-10



RESULT-ENGINEERED CONTROLS
WARD LEONARD
ELECTRIC CO. MOUNT VERNON
NEW YORK
RESISTORS • RHEOSTATS • RELAYS • CONTROLS • DIMMERS

tions where supply leads form a path for the output to feed back to the input, resulting in regeneration.

The usual form of capacitive decoupling of the lead is prone to parasitic resonances. Ferrite beads offer an ohmic damping in inductance, acting as a high-frequency choke.

New Alloys Upgrade Metal Oxide Properties



TD NICKEL bar reaches red heat, does not fail at 2,100 deg F under load of 6,000 psi. The best superalloys now used failed under similar tests

UNIFORM DISPERSION of tiny particles of stable oxides within the grain structure of aluminum, nickel, molybdenum, iron, tungsten, cobalt, and other basic metals yields materials with dramatically improved stability, tensile strength, and resistance to creep, oxidation, and corrosion at high temperatures.

The first of a broad range of dispersion-modified metals is a 98 per cent nickel, two percent thorium oxide alloy known as TD Nickel. It is commercially available at the Du Pont Metals Center in Baltimore in the form of bar stock.

Application of this technology to copper would yield a metal with usable strength and valuable mechanical properties up to 1,700 deg F, maintaining 98 per cent of the thermal and electrical conductivity of the pure metal. In certain nickel-base alloys there would be a remarkable improvement in oxidation resistance. Other potential uses include electronic component applications such as cathodes.

THIS IS A... **TRUE RMS VOLTMETER**

**THIS VOLTMETER
DOES NOT**

- ... respond to the average voltage and multiply by 1.1
- ... respond to the peak voltage and divide by 1.414
- ... use a diode matrix to approximate a square law response

IT DOES... RESPOND to TRUE RMS and IT READS TRUE RMS!



MODEL 910A



ACCURACY 1%
BAND WIDTH:
(10 cps - 7 mc)

Accurate measurement of complex waves is now possible over a wide range of frequency with the NEW jf MODEL 910A.

For the first time one instrument provides 1% midband accuracy, 10 cps to 7mc bandwidth, plus 100 u v sensitivity. For added versatility an amplifier output is provided for simultaneous oscilloscope or recorder monitoring.

Model 910A employs a thermocouple located in the feedback loop of a sensitive DC amplifier to measure the actual heating effect of the input waveform. This circuit arrangement is the key to the rapid response and high calibration accuracy of the Model 910A and also prevents any error in reading due to ambient temperature variation. Isolation of the thermocouple from the input terminals by a high gain, ultra stable AC amplifier provides high input impedance and completely protects the thermocouple from burnout under any condition of overload.

Model 910A is ideal for measuring AC currents in non linear devices, total harmonic content of distorted waveforms, noise, average power of pulse trains, and other measurements that involve waveforms which are not necessarily pure sinusoids.

Partial Specifications—jf MODEL 910A

Voltage Range:	1 MV to 300V (full scale readings)
Decibel Range:	-72 to +52 dbm
Frequency Response:	10 cps to 7Mc
Accuracy:	± 1% of full scale 50 cps to 800 KC ± 2% of full scale 20 cps to 2Mc ± 3% of full scale 20 cps to 3.5 Mc ± 5% of full scale 10 cps to 7 Mc
Input Impedance:	10 megohms shunted by 30 pf for 0.3 volt range and below. 10 megohms shunted by 15 pf for 1.0 volt range and above.
Crest Factor:	3 at full scale, proportionately higher for readings less than full scale.
Price:	Cabinet Model—\$545.00 Rack Model—\$565.00 Prices f.o.b. factory.

Prices and data subject to change without notice.

A more complete description will be sent to you upon request.



JOHN FLUKE MFG. CO., INC.
P. O. Box 7428 Seattle 33, Washington

Packaging Methods for Thin Films

Six packaging system concepts are analyzed using decision theory techniques

By DONALD L. BRISENDINE
The Martin Co., Orlando, Fla.

PACKAGING MINIATURIZED electronic equipment, such as thin films, is more complicated than packaging conventional printed circuit boards. More trade-offs are involved. As size goes down, maintainability goes down, heat dissipation becomes more critical, costs generally go up; as reliability goes up, maintainability goes down, costs go up.

Operations Analysis techniques, used in market analysis, business planning, organization studies, etc., are suitable for evaluating thin film packaging designs. A useful tool is a Decision Theory Analysis

Chart, which is essentially a method of evaluating system concepts using weighted importance factors.

Decision theory techniques have been applied to select an optimum packaging interconnection concept for a thin film arithmetic unit. The six interconnection techniques considered are shown in Fig. 1.

Several configurations are possible using the principle of attaching thin film substrates to flexible printed circuit boards. In one typical technique, shown in Fig. 1A, substrates are connected to conductor paths on the flexible mylar and the assembly is then folded. The package has reasonable surface areas for thin film interconnection, design simplicity, and low cost. Flexibility of substrate circuit design is somewhat limited, however, since interconnections must exit from the periphery of the substrate. In addition, reliability is question-

able from a thermal standpoint and it would be necessary to encapsulate the assembly with a material with high heat transfer characteristics to carry off generated heat. Encapsulation or filling the container with oil would make maintenance by substrates replacement difficult.

The interleaved principle shown in Fig. 1B is similar to the folded circuit in that the interconnection medium is flexible. The thin film substrates are electrically connected to the mylar printed circuit and folded into position. Features and problems are essentially the same as the folded accordion technique. Component density is higher but since all external substrate connections are from one side, circuit design simplicity and flexibility are compromised.

In the sandwich interconnection technique, Fig. 1C, the two board interconnection technique incorpo-

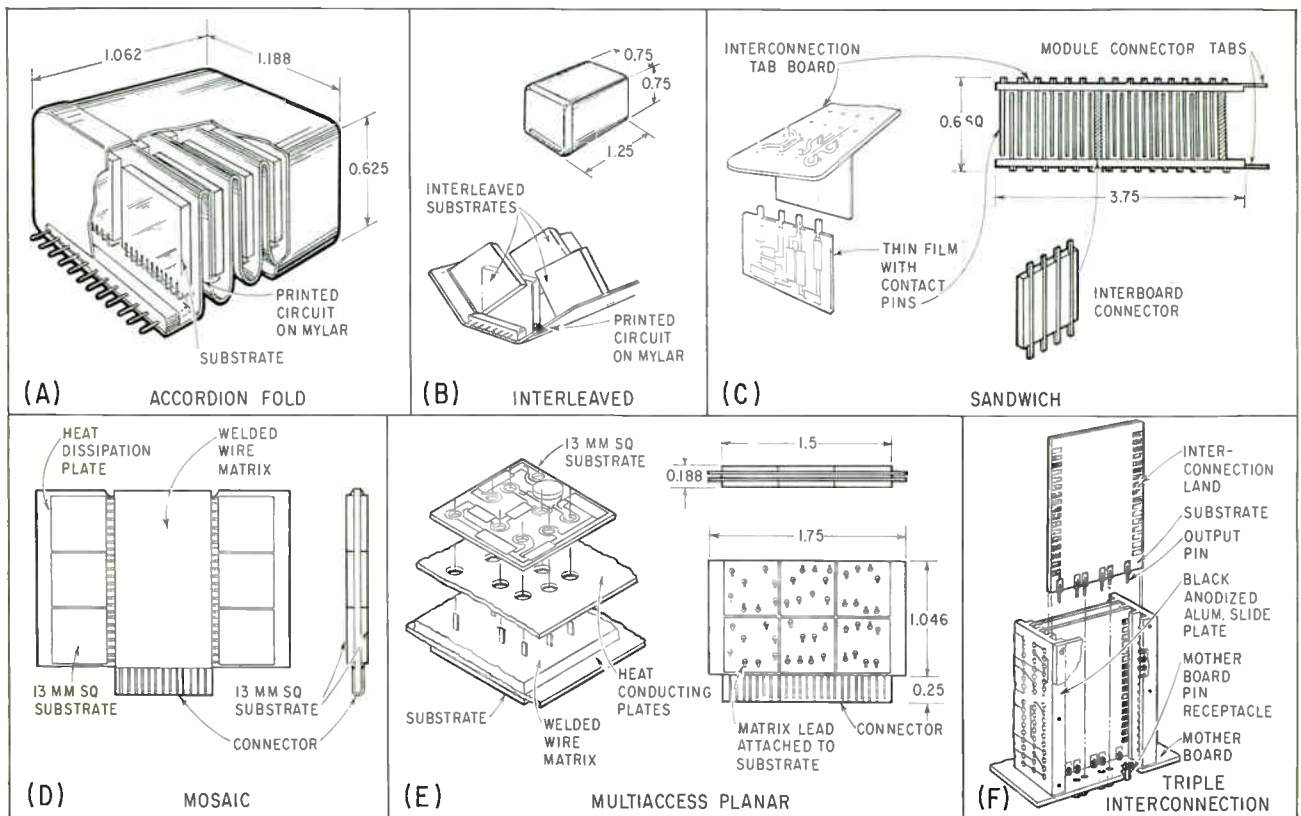

SIX OF THE many possible ways of packaging thin film circuits are indicated here. An analysis of the methods with respect to the particular application led to the selection of the triple interconnection technique—Fig. 1



ELECTRONICS
PROGRESS IN SEMICONDUCTORS



Passivation inactivates the junction surface, greatly increasing reliability and stability. Getter and retaining ring are dispensed with.

**NO
GETTER... NO
RETAINING RING**

PASSIVATED 2N332A-338A's

General Electric's new passivated 2N332A thru 2N338A transistors exceed in reliability even the heretofore unsurpassed G-E 2N332 series, an industry standard. General Electric developed its new process for the MINUTEMAN RELIABILITY Program. The surface passivation technique inactivates the junction surface and dispenses with the need for getter and retaining ring.

4700 units now on MINUTEMAN life test at G.E. have operated for 1000 hours without a single failure. These units have already operated for 6,650,000 transistor hours @ 280 mw., and are still on test. This new passivated series may well comprise the most reliable silicon grown-junction triodes available today . . . and they are

in stock now at all General Electric Semiconductor distributors. Every "A" and MIL version of the 2N332A-338A series you purchase from now on will be this new, high-reliability passivated transistor type. And at the same price as before.

Your General Electric Semiconductor Products District Sales Manager can give you complete details. Or write Semiconductor Products Department, Section 16G131, General Electric Company, Electronics Park, Syracuse, New York. In Canada: Canadian General Electric Co., 189 Dufferin Street, Toronto, Ont. Export: International General Electric, 159 Madison Avenue, New York 16, N.Y.

AVAILABLE THROUGH YOUR GENERAL ELECTRIC SEMICONDUCTOR DISTRIBUTOR

GENERAL  ELECTRIC

HAS ANYONE TOLD YOU ABOUT

ACME Electric

POWER SUPPLIES?

The hundreds of Power Supply types and designs that we have engineered and produced gives us a wealth of experience and "know-how" that can be put to your advantage. Whether your need is for custom-designed units to meet a specific application or standard stock models, there will be a definite advantage in checking your requirements with Acme Electric. The following illustrated units indicate our wide range of production.

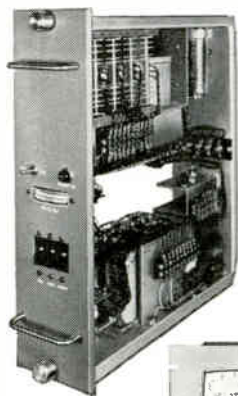

This custom designed unit, which is produced in production quantities, features modular construction and advanced circuitry.

This sturdily built design, for the manual regulation of saturable core reactors, features silicon rectifiers for full-wave d-c output. Available in 300, 500, 1000, 2000 watts; 0-100 volts d.c.



High efficiency, regulated power supply. Less than 1% ripple. Negligible thermal drift. Tubeless circuitry achieves maximum reliability. Output voltage maintained under varied conditions of input and load. Six other big features described in Bulletin 174.



This Signal Developer Power Supply provides the necessary d-c for the signal control circuit of a magnetic amplifier. One-eighth watt, 0-25 volts.

SAA 3574-2022A

ACME ELECTRIC CORPORATION
317 WATER STREET CUBA, N. Y.
In Canada: Acme Electric Corp. Ltd., 50 Northline Rd., Toronto, Ont.

ACME Electric

	DENSITY (0.5)	COST (0.9)	RELIABILITY (1)	DESIGN FLEXIBILITY (0.6)	MAINTAINABILITY (0.8)	TOTAL
ACCORDION FOLD	0.8	1	0.6	0.9	0.4	2.76
INTERLEAVED	0.8	0.9	0.6	0.8	0.3	2.53
SANDWICH	0.8	0.9	0.6	0.7	0.2	2.39
MOSAIC	0.7	0.8	0.8	0.7	0.6	2.77
MULTIACCESS PLANAR	0.9	0.8	0.8	1	0.8	3.21
TRIPLE INTERCONN TECHNIQUE	1	0.8	1	0.6	1	3.38

DECISION THEORY ANALYSIS CHART shows how various factors are weighted and how each technique is rated for each factor. Multiplying weight by rating and then adding across leads to the selection of triple interconnection scheme as best for the application—Fig. 2

rates an innovation of Amphenol-Borg "Intercon" wiring boards. The assembly has essentially the same overall volume as the accordion fold and the interleaved techniques, and advantages and disadvantages are similar. Design flexibility is somewhat less since interboard connections are required to connect the two halves of the assembly.

The three preceding techniques have potential reliability problems from overheating and they lack accessibility for substrate replacement. The mosaic technique, Fig. 1D, is an attempt to alleviate these potential problems without losing the advantages. Heat generated by the substrates is dissipated by natural convection and by conduction through the heat dissipation plate to the heat-sink or mounting surface. The wrap-around welded wire matrix provides adequate substrate interconnections and serves as a connector. Reliability is significantly improved by the heat flow paths and maintainability is improved by the greater accessibility. The method still limits substrate design flexibility since interconnections must be made on one side of the substrate only.

The multiaccess planar scheme shown in Fig. 1E uses a welded wire matrix sandwich between two heat conducting plates. Substrates are held to the plates by lead projections from the interconnection matrix, which also provides electrical connections. Matrix lead attachments to the substrate can be made by thermo-compression bond-

ing, soldering, spot welding, ultrasonic welding or conductive adhesives. The technique provides accessibility, heat flow paths, substrate circuit design flexibility, low cost in automatic production, and high density.

In the triple interconnection technique, Fig. 1F, the substrate is large enough for 12 circuits. With more circuits on a substrate, the number of interconnections is reduced. Each substrate has deposited lands, which are used for electrical connection to the housing. Three edges of the substrates are available for connections to the side plate assembly.

Lands along the long edges are reserved for substrate to substrate connections; those on the short side are for input and output. The technique achieves a substrate density of 1.2 million parts per cubic foot, and a system density of 610,000 parts per cubic foot. Reliability is improved since many connections are made by deposition on the substrate and interconnections are reduced. Access for maintainability is not jeopardized.

DECISION THEORY—The optimum thin film interconnection technique is determined with a decision theory analysis chart, Fig. 2. Reliability is the most important objective of thin film circuits so it is given an importance factor of 1. Density is given a relatively low importance value (0.5) since high density is inherent in thin films. Cost is important since microcomponent as-

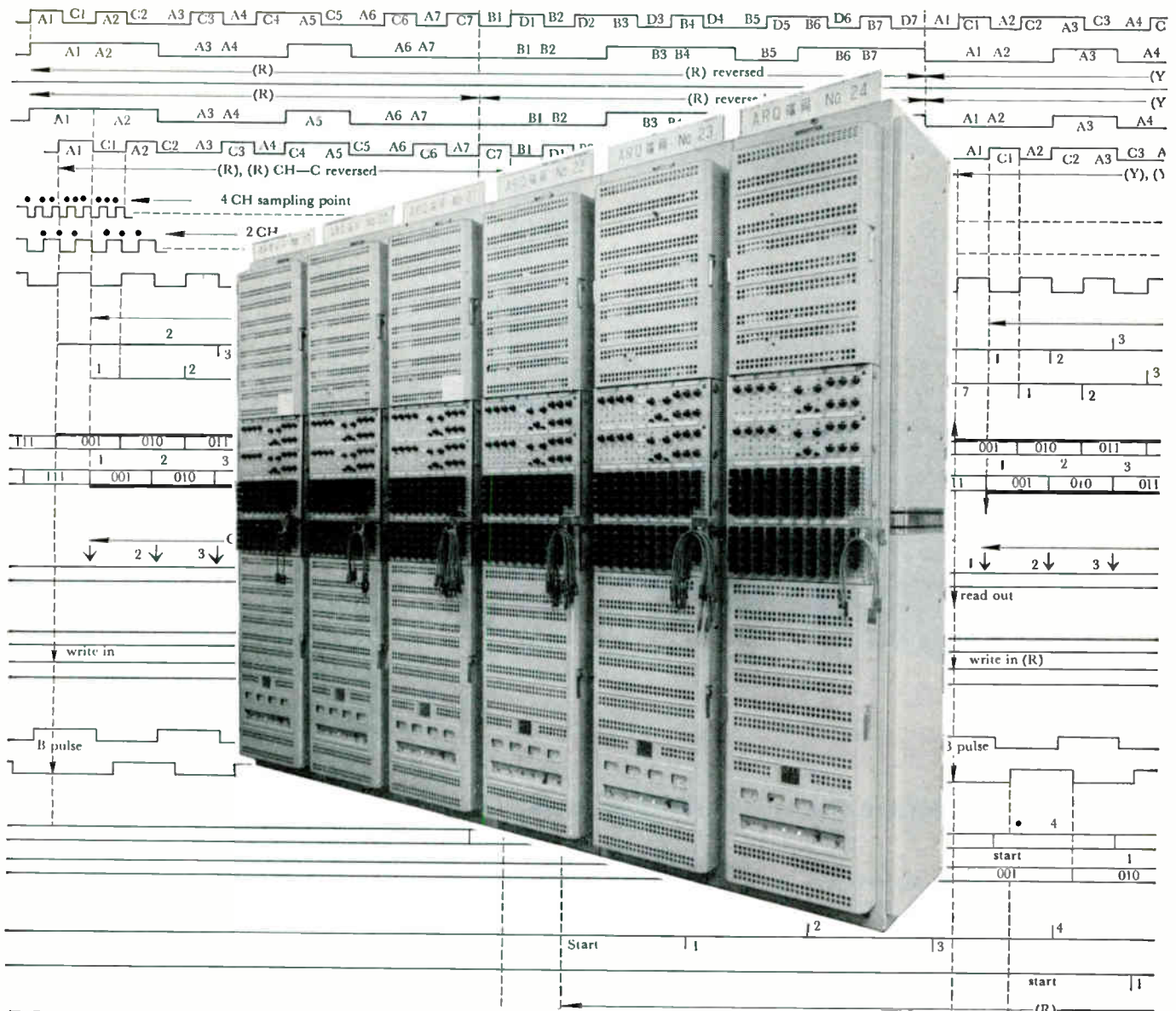

New Parametric ARQ equipment requires much less power, no maintenance

Mitsubishi Electric's TZ-3 ARQ equipment for multiplex telegraphy with automatic error correction employs a new electronic element called the parametron. This device enables the equipment to operate effectively on only one-fourth the power ordinarily required. Unlike regular equipment which depends on mechanical parts, vacuum tubes and semi-conductors, parametric ARQ equipment requires no routine maintenance and takes up only half as much space making possible considerable savings in installation and operating costs. For complete details on the technical specifications of parametric equipment and its extensive capabilities, write:



MITSUBISHI ELECTRIC MANUFACTURING COMPANY
 Head Office: Tokyo Building, Marunouchi, Tokyo
 Cable Address: MELCO TOKYO

**SHRINKS SKIN-TIGHT...
THEN STOPS!**



**NOW IN HANDY
PACKAGED ASSORTMENTS**

For Lab / Short Runs / Prototype Use

IN STOCK FOR IMMEDIATE DELIVERY

A complete selection of Alphlex FIT-275 irradiated polyolefin heat shrinkable tubing is now available packaged in small quantity assortments.

Designed to introduce the user to the unique properties of Alphlex Shrinkable Tubing, the assortments are ideal for laboratory, prototype, design, or electronic service applications. All assortments are packaged and labeled for easy handling and storage.

6" lengths

FIT-275M—Individual Size Per Box
Contains 6" lengths of Shrinkable Tubing, packaged one size per box. Available in 17 size assortments from No. 24 to 5/8" tubing. Net price per box—\$3.75.

6" lengths

FIT-275MS—Assorted Sizes Per Box
Each box contains an assortment of 6" lengths of Shrinkable Tubing in various sizes. Available in three ranges of tubing sizes, in black only. Net price from \$3.75 to \$7.50, depending on assortment.

4' lengths

FIT-275C—Individual Size Per Box—Assorted Colors
Contains 25 four foot lengths of a single size tubing in assorted colors, 11 sizes from No. 24 to No. 4 tubing. Net price per box, \$16.00-\$37.30, depending on size.

4' lengths

FIT-275S—Assorted Sizes Per Box
Contains an assortment of 4 ft. lengths of Shrinkable Tubing in various sizes. Available in three ranges of tubing sizes. Net price per box \$12.00-\$24.00, depending on assortment.

ALWAYS IN STOCK



New — ALPHLEX®

SHRINKABLE TUBING
With Controlled Shrinkage

An irradiated Polyolefin material that, when heated to 135°C, shrinks within seven seconds to form a permanent, flexible, tight-fitting bond.

Simply apply heat (135°C) for seven seconds—watch it shrink smoothly and firmly to the exact configurations of the object to be covered. Further heating does not affect it.

Alphlex Shrinkable Tubing is supplied in expanded form so that it may easily be slipped over the component to be covered.

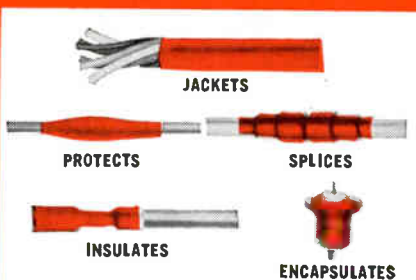

See your local Alpha Wire distributor or write for catalog #168B

ALPHA WIRE CORPORATION

Subsidiary of LORAL Electronics Corporation
200 Varick Street, New York 14, N.Y.

Pacific Division:
11844 Mississippi Ave., Los Angeles 25, Calif.,

semblies can achieve nearly the same density as thin films. Maintainability is important in ground support systems. Design flexibility means ease of repeatedly developing new designs.

Each interconnection technique is assigned an efficiency function for each of the five objectives. Each efficiency function is multiplied by its appropriate importance value (thus, evaluating the accordion fold for density; $0.5 \times 0.8 = 0.4$) and the products are added for each method. The resulting sum serves as a rating for each technique for the assumed objectives.

**Special Kits Speed
Circuit Assembly**



CIRCUIT BOARD assembly at General Dynamics/Pomona has been expedited and improved by delivering parts to work stations in a special kit. Material collection is simplified for the production worker since all materials for a specific number of circuit boards are delivered in one package on the scheduled manufacturing day.

One complete planning operation is eliminated for each assembly, material control is better and the chances of a material shortage are lessened. To assemble a kit, identification tags placed in tray compartments and the trays are filled and assembled in carrying racks. Tube sleeving and pigtailling operations are performed and the re-assembled kits are checked.

In the short time the system has been in effect, assembly time for a circuit board has been reduced by about 10 percent.

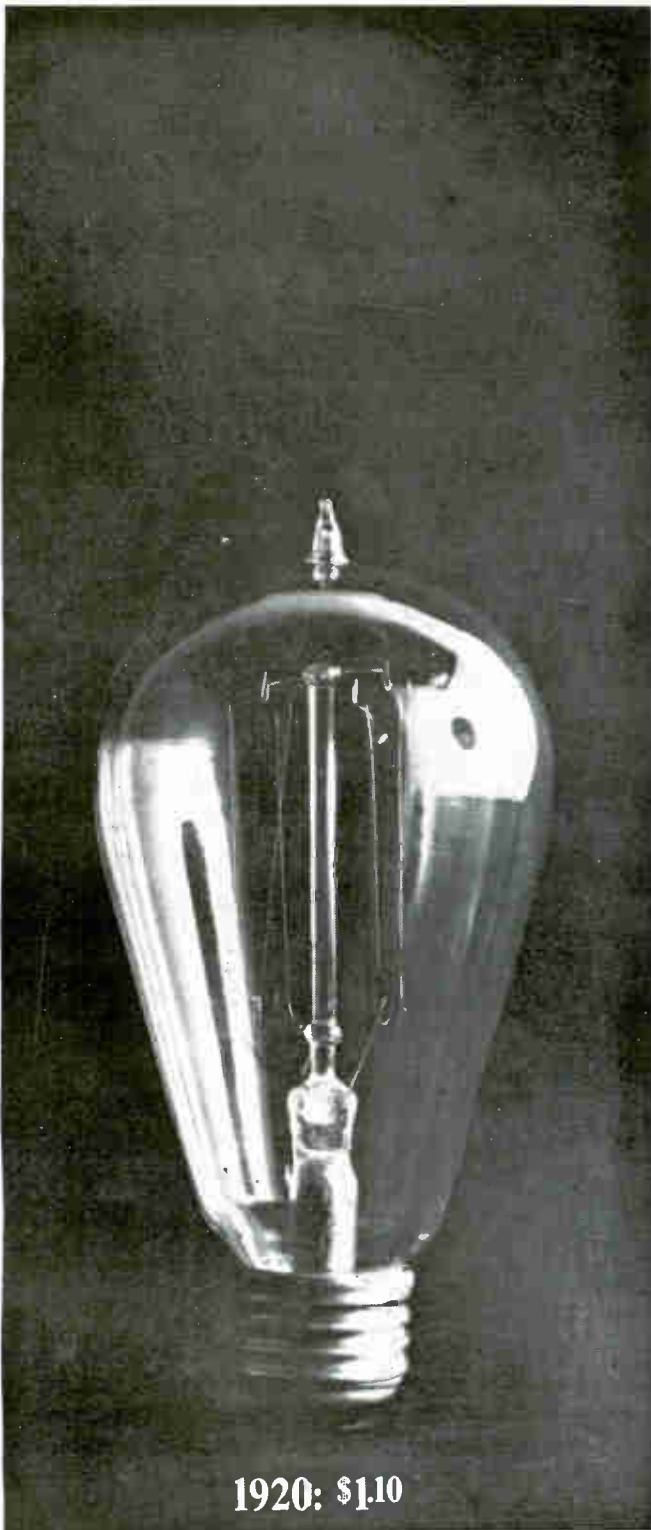

1920: \$1.10



1962: 25¢

Advertising helped it happen

. . . for the benefit of everyone in business, including manufacturers and distributors of electric light bulbs. Advertising helps businessmen sell new and better products to other businessmen. By broadening markets for both consumer and industrial products, it helps business bring costs and selling prices down . . . to the mutual benefit of businessmen, their companies, their families.

Prepared by the Advertising Federation of America and the Advertising Association of the West / Published through the courtesy of this publication.

July 20, 1962

DESIGN AND APPLICATION

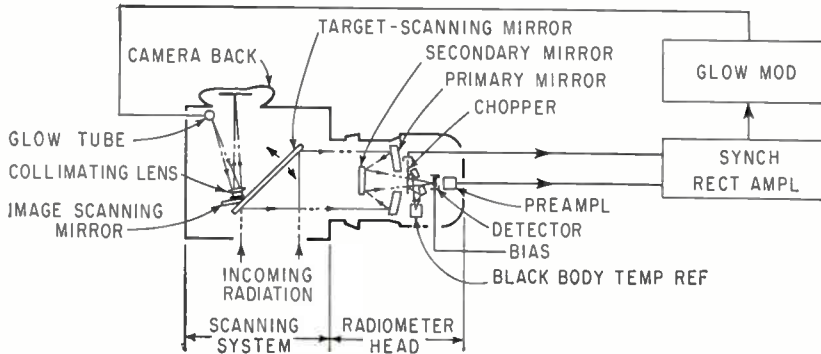

Infrared Camera Uses High Resolution Scanning

Not dependent on external sources of illumination or irradiation

MANUFACTURED by Barnes Engineering Co., 30 Commerce Rd., Stamford, Conn., the model 12-600

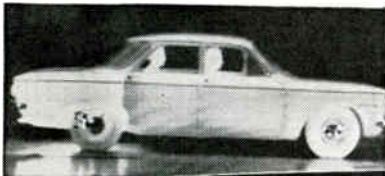

infrared camera uses high resolution scanning and advanced radiometric techniques to make thermographs (thermal photographs) depicting temperature distribution over extended areas. The instrument is not dependent on external source of illumination or irradiation, but responds only to the infrared energy naturally radiated by all objects. The thermal image is formed on a Polaroid-Land camera for fast processing. The thermograph is a raster of horizontal lines similar to a tv screen and is produced by 60,000 individual temperature measurements. Target details are shown in true spatial arrangement and density of each detail corresponds to the radiation tem-

perature of that detail in the target. A gray scale is used along one edge for quantitative analysis. Instrument normally scans 20 degrees but can be furnished to 10. Height is selectable between 5 and 10 degrees, and typical scan time is 13 minutes. Picture resolution for 20-degree width is 350 elements per line, and target temperature range is -170 to $+300$ C. Smallest detectable temperature difference is 0.5 C. CIRCLE 301, READER SERVICE CARD

California, the model MR020-L Magristor is a two-pole switch closed by a common magnetic field and using liquid as the enabling means to remove contact bounce. Capable of sampling several groups of low-level signals, the device can be used with signals between 1 mv and 5 v with less than $5 \mu\text{v}$ peak-to-peak noise, less than $10 \mu\text{v}$ per pole d-c offset and less than $5 \mu\text{v}$ when differentially combined, and operation of over 18,000 hours. Make time is less than 200 μsec while break time is less than 250 μsec . At present, usable duty cycle is 60-percent or greater for 1 Kc operation. Average is approximately 85 percent with 1 ms applied drive pulse. Make resistance is less than 1 ohm per pole while open circuit is greater than 500 megohms per pole. Sketch shows use in sampling circuit where Magristors are operated time sequential. (302)

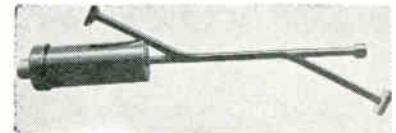

Two-Pole Switch Uses Liquid as Enabler

ANNOUNCED by Stellarmetrics Inc., 210 E. Ortega St., Santa Barbara,

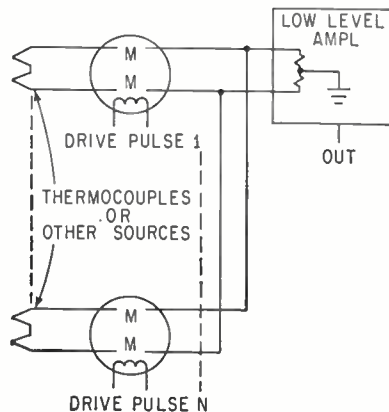

Pulsed Attenuator Developed for X-band

TUCOR, INC., 59 Danbury Road, Wilton, Conn. The T43H1B X-band attenuator has an insertion loss, when cold, of less than 0.07 db, and when hot of more than 120 db. It covers a range of $7,750 \text{ Mc} \pm 10$ percent. Vswr, cold, is less than 1.15. The attenuators are designed to protect masers, tunnel diodes and paramps in super-sensitive receiving systems from power leakage from high power transmitters. (303)

D-C Thyatron Operates at 1,700 PIV

ELECTRONS, INC., 127 Sussex Ave., Newark 3, N. J. The ELC16H is a



VIBRATION NEWS

MB ELECTRONICS • A DIVISION OF TEXTRON ELECTRONICS, INC.
Representatives in principal cities throughout the world

MB Hydraulic Shakers cut vibration-testing costs for large payloads

Vibration or shock testing of very large payloads—such as missile sections, or complete missiles—usually requires extremely high forces at moderate velocities and frequencies. It is not unusual for force levels to be in the order of 100,000 lbs.

In this force range, MB's electro-hydraulic shakers may cost as low as 1/5th the price of comparable electro-dynamic units. What's more the electro-hydraulic shaker is much smaller and more compact. For example, a hydraulic actuator with a 100,000 lb. force rating is only 18" square by 13" high!

MB's hydraulic shakers complement our line of electro-dynamic exciters and extend the limits of vibration, shock and fatigue testing. The electro-dynamic exciter fills the need for testing at high frequencies and relatively low forces and amplitudes, whereas hydraulic shakers are most advantageous for tests requiring ex-

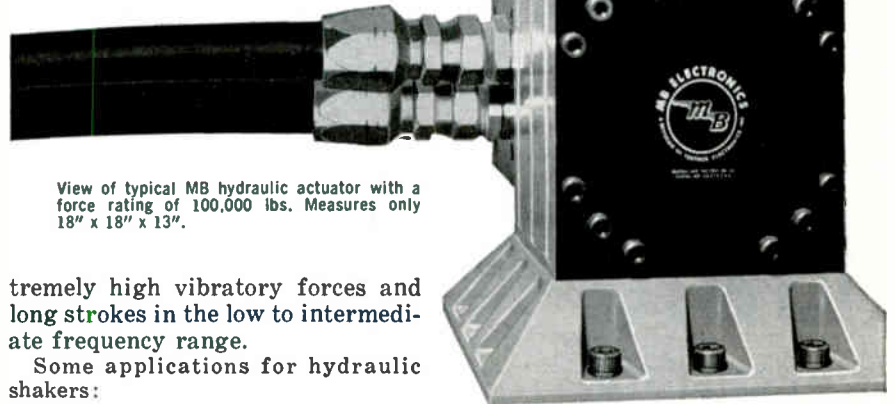

View of typical MB hydraulic actuator with a force rating of 100,000 lbs. Measures only 18" x 18" x 13".

tremely high vibratory forces and long strokes in the low to intermediate frequency range.

Some applications for hydraulic shakers:

- fatigue testing of heavy structures and members
- brute force testing of large, high pressure pipe, massive weldments

- vibrating heavy mass loads directly-supported on the shaker
- simulating transportation specifications
- applying static and dynamic loads simultaneously
- pulse testing and combined tests in environmental chambers
- simulating vibratory loading transmitted through more than one support

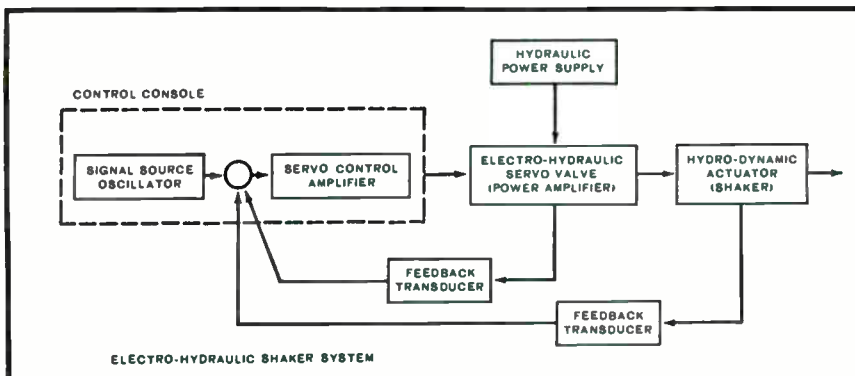

Principle of operation—input signals are fed to electronic servo amplifier, where they are combined with feedback signals from hydraulic shaker. After amplification, this signal is supplied to the electro-hydraulic servo valve which converts electrical variations into fluid flow variations which in turn are reproduced by the hydraulic power stage of the valve. Actuator velocity is proportional to oil flow and varies according to electric input signal.

An MB hydraulic shaker system can add extensively to your testing capabilities; available in 27 standard models with forces of 1,000 to 100,000 lbs. and strokes to 18". These shaker systems can also be custom designed to meet your specific requirements.

For detailed information write to MB Electronics; 781 Whalley Ave., New Haven 8, Conn.



NOW...
versatility
you can carry!

**A portable,
 3-channel
 direct-writing
 recorder...
 with interchangeable
 amplifiers!**

American Optical
 COMPANY

INSTRUMENT DIVISION, BUFFALO 15, NEW YORK

high voltage, high commutation factor, long averaging time, 16 amp d-c thyatron. Power switching capability is said to be 70 percent greater than other tubes of this class. Tube, with its commutation

factor of 100 at 1,700 v requires no cushioning when used to control inductive loads. It is designed to operate at 1,700 pfv and 1,700 piv.

CIRCLE 304, READER SERVICE CARD

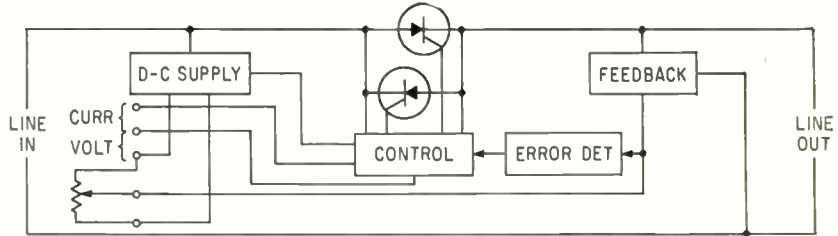

Controlling Inductive or Lagging Power Factors

RECENTLY announced by Superior Electric Co., Bristol, Conn., the solid state variable voltage control use silicon-controlled rectifiers in a closed-loop, error-detection system to provide instantaneous response insensitive to line or load changes. They are available for 120 or 240 v operation with ratings to 24 Kva. Any load between zero and full rating can be controlled with efficiency of 98 percent or higher. Loads from

any power factor from 100 percent to zero lagging can be controlled. The error detector (see sketch) compares voltage from control with load voltage and supplies unbalance to an amplifier. The amplifier controls the scr. The device can be controlled with a remote potentiometer, an external current sensing or voltage-sensing circuit and is useful for a number of applications including closed-loop temperature control, photochemical processing, power regulation, input control of plating rectifiers and the like. (305)

Spacecraft Modules Operate up to 2 Mc

COMPUTER CONTROLS CO., INC., 2251 Barry Ave., Los Angeles 64, Calif. High density, low power miniaturized digital modules for spacecraft data processing systems are available. They operate at frequencies of up to 2 Mc from 3 to 25 mw of power. A typical data acquisition system built from the low power Space PAC's samples 50 scientific experiments, stores 100 million bits, and processes 700,000 bits an hour at a total power consumption of only 12 w. (306)

a controlled inductance resistor for use in signal generators, oscilloscopes, wide band amplifiers and computers. Units are available to a top frequency of 20 Mc, in axial lead styles in 4 distinct physical sizes (ranging from $\frac{1}{8}$ by $\frac{3}{8}$ to $\frac{3}{4}$ by $\frac{1}{2}$ in.). Resistance range on types LE5 and LE10 is 1 ohm to 5,000 ohms; on LE20, 0.5 ohm to 10,000 ohms and on LE30, 1 ohm to 20,000 ohms. Price in quantities of 1,000 is approximately \$1.50 to \$5 depending on particular application. (307)

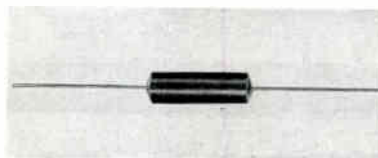

H-F Resistor Has Varied Uses

RCL ELECTRONICS INC., 1 New Jersey Ave., Riverside, N. J., has developed

Coax Attenuators Rated At 1 W Average

MECA ELECTRONICS, INC., P.O. Box 645 Dover, N. J. Line of coaxial microwave attenuators feature low cost, rugged construction and stable electrical characteristics. Specifications include an average power rating of 1 w, frequency range from 0 to 1,500 Mc, max vswr of 1.15, and a flat attenuation vs frequency response. Units are available in 8

standard connector types, including types N, C, BNC, TNC male and female. (308)

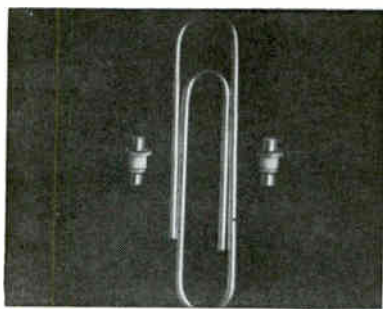

Epitaxial Varactors Added To Silicon Line

MICRO STATE ELECTRONICS CORP., 152 Floral Ave., Murray Hill, N. J., offers a line of silicon planar epitaxial varactors for use in harmonic generators, solid state limiters, switches, modulators and duplexers. The MS4500 series features breakdown voltages to 120 v, power dissipation to 1½ w and cutoff frequencies to 140 Gc. Units are hermetically sealed in a high thermal conductance package with a parasitic capacitance of 0.18 pf and a series inductance of 0.4 nh. (309)



Stepper Motor Weighs 1.6 Ounce

DAYSTROM, INC., Transicoil division, Worcester, Pa. Successfully bridging the gap between digital command signals and analog actuation, this size 8 stepper motor is expected to find wide application in both military and commercial positioning systems. Sequential programming of the two center-tapped excitation windings causes the p-m

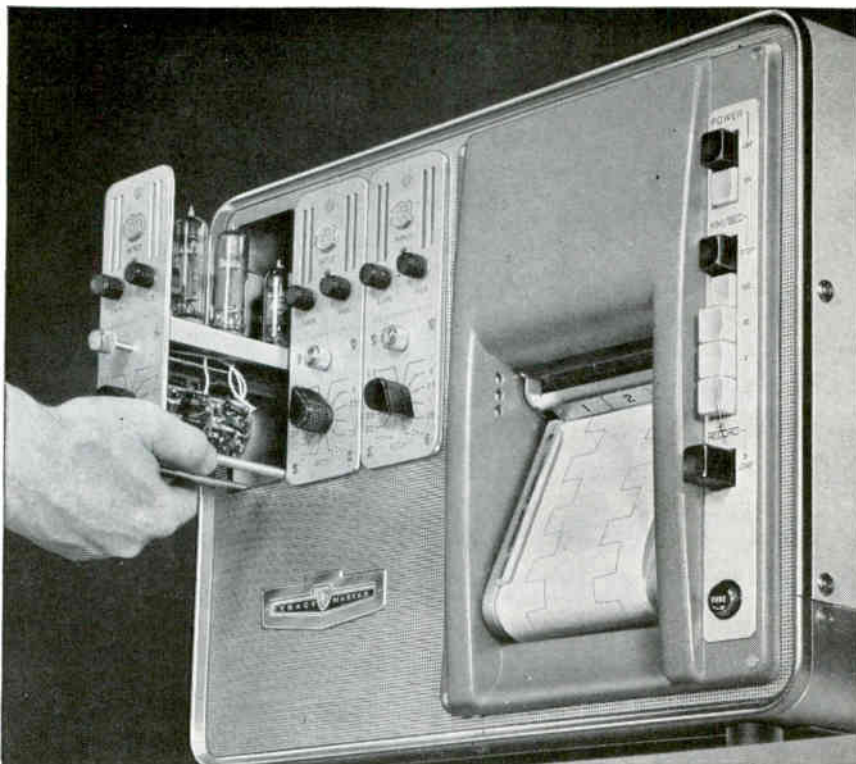

Versatility, portability and economy...with the AO TRACEMASTER Series 290

This new 3-channel portable Tracemaster breaks through the performance limitations common to all other portable direct writing recorders. Modular pre-amplifiers for each input signal have plug-in interchangeability to provide the widest range of signal conditioning capability of any truly portable recorder. Perfect for those countless applications in research, development, plant or field work where *both* portability and the ability to record a wide diversity of signals is a must.

Exclusive Tracemaster direct-carbon-transfer writing method provides uniformly black trace . . . 2 to 3 times thinner than that made by any other recorder . . . can't fade . . . readily reproducible. Low-cost chart paper means truly economical data acquisition.

Provides convenient push-button selection of 4 chart speeds, 1-100 mm/sec;

frequency response to 125 cps, with 30 mm amplitude; 50 mv/cm sensitivity and high input impedance.

The outstanding specifications below are only part of the story. Write for full information or, better still, let us demonstrate the AO Tracemaster at your facility . . . at your convenience.

SPECIFICATIONS:

Frequency Response: DC to 90 cps $\pm 5\%$ at 30 mm peak to peak. Down 3 db at 125 cps

Band Amplitude Product: 3750 (i.e. 30 mm x 125 cps)

Sensitivity Range: 50 mv/cm to 50 v/cm

Chart Speeds: 1 to 100 mm/sec

Chart Capacity: 200 ft. roll

Weight: 40 lbs.

American Optical

COMPANY

INSTRUMENT DIVISION, BUFFALO 15, NEW YORK

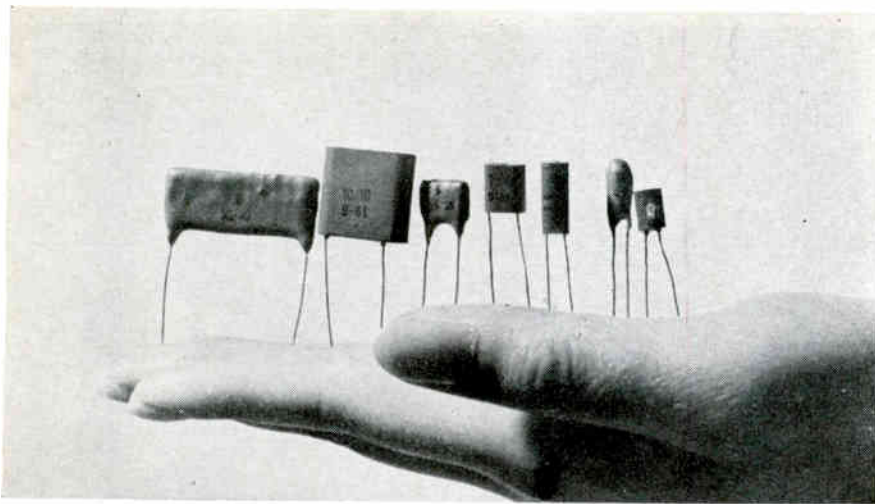

The F/T 'Aloxcon', A New Electrolytic Capacitor: The high quality of tantalum at the low cost of aluminum

Designed for use in printed and transistorized circuits, F/T's newly developed aluminum-oxide electrolytic capacitor 'Aloxcon' functions effectively at temperatures ranging from -60°C to $+80^{\circ}\text{C}$ and frequencies up to 100 kc or more. A semiconductor layer replaces the usual type of electrolytic and so the capacitance of an 'Aloxcon' is less affected by temperature and frequency than other types. 'Aloxcon' capacitors are highly resistant to moisture, and have low leakage current and extremely high life expectancy. They are ideal for transistor circuits requiring low impedance and miniaturization. Detailed specifications and application data available from our representatives.

	Working Voltage (V)	Surge Voltage (V)	Capacitance (mf)
AR & GR Type (Standard Style)	6	8	1 2 5 10 20
	10	12	0.5 1 2 5 10
	25	30	0.1 0.2 0.5 1 2
AZ & GZ Type (Compact, moisture resistant style)	6	8	0.1 0.2 0.5
	10	12	0.05 0.1 0.2
	25	30	0.01 0.02 0.05 0.1

"Where the Future
is Today"



FUJI TSUSHINKI SEIZO K.K.

Fuji Communication Apparatus Mfg. Co., Ltd.

Tokyo, Japan.

Represented by: □The Nissho American Corporation: New York 5, 80 Pine St., WH 3-7840. Chicago 3, 140 S. Dearborn St., CE 6-1950
□The Nissho Pacific Corporation: San Francisco 4, 120 Montgomery St., YU 2-7901. Los Angeles 14, 649 S. Olive St., MA 7-7691

CIRCLE 99 ON READER SERVICE CARD

Is your advertising selling the same four key buyers your salesmen call on? Competition demands it! Only advertising in electronics reaches and sells the electronics man *wherever* he is: in *Research,*

TODAY YOU MUST SELL ALL FOUR!

Design, Production, and Management. Put your advertising where it works *hardest...*

in **electronics**

rotor to index in 90 deg increments, exerting an output torque up to 0.7 oz in. A max stepping rate of 125 pps is possible using the recommended excitation of 28 v d-c at 0.058 amp.

CIRCLE 310, READER SERVICE CARD

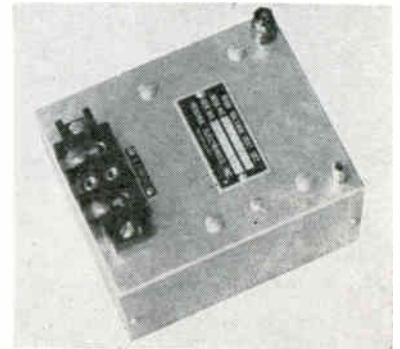

D-C Power Pack Priced In Low Range

PESCHEL ELECTRONICS, INC., Route 216, Towners, Patterson, N. Y. Featuring small size, low price, and rugged reliability, model PP2-5 provides 2,000 v d-c at 5 ma. Unit uses a selenium rectifier and is air insulated to facilitate field repairs. It is designed for capacitor charging, cable testing, electrostatic processes, powering tubes, infrared devices and general lab work. Price is \$120. (311)

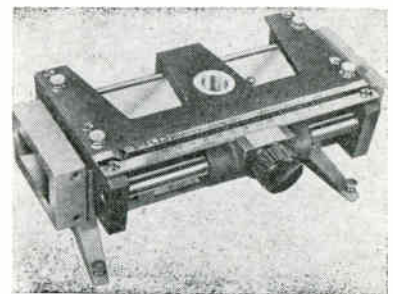

Slotted Sections Measure Standing Waves

PRD ELECTRONICS, INC., 202 Tillary St., Brooklyn 1, N. Y. The PRD 232 universal probe carriage is a precision-built instrument designed to operate with the PRD 233 waveguide or coaxial slotted lines in the frequency range 2.50 to 12.4 Gc. These l-f waveguide slotted lines have a max residual vswr of 1.005. The vswr of the PRDN233 coax type ($\frac{3}{8}$ in.) depends on the standard connector being used (a type N male adapter is supplied). Probe

position of the PRD232 carriage is indicated on an engraved metric scale whose vernier resolution can be read to 0.01 mm. (312)

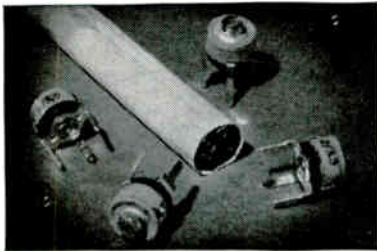

Ceramic Trimmer Rated at 160 V

AIR-O-TRONICS ENGINEERING CO., Morrisville, N. Y., exclusive U. S. agent for Stettner & Co., West Germany, announces a ceramic disk trimmer capacitor slightly over $\frac{1}{4}$ in. in diameter and depth. Available in four capacitance sweeps. Rated voltage 160 v, test voltage 740 v. Operating temperature range -25 to $+85$ C. (313)

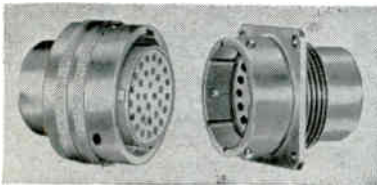

Miniature Connectors Meet MIL Standards

THE BENDIX CORP., Scintilla division, Sidney, N. Y. Electrical connectors providing intermateability with existing specification MIL-C-26482 connectors, plus military standard crimp contact geometry, are now available in the PT-SE Pygmy series. Design features eliminate wiring diagram changes when using the SE connector, retain solder option, and provide contacts compatible with military standard tooling. (314)

Teflon Terminals Resist Shock, Vibration

MICRODOT INC., 220 Pasadena Ave., S. Pasadena, Calif. Line of Teflon insulated terminals, which mount directly to either plastic or metal chassis, are of one-piece Teflon bushing construction and are pressed into place by simple instal-



OUTSTANDING AMPLIFICATION

CEC's Type 1-155 wide-band DC amplifier will help you derive full bandwidth capabilities from recording oscillograph galvanometers. Designed for both military and general purpose applications, the 1-155 has a frequency response of $\pm 1\%$ to 5 kc, $\pm 2\%$ to 10 kc and $\pm 5\%$ to 20 kc. Its accuracy and stability is $\pm 0.1\%$ at seven fixed gain steps: 0, 20, 50, 100, 200, 500, and 1,000. For full facts, call your CEC office or write for Bulletin CEC 1155-X11.



CEC

Data Recorders Division

CONSOLIDATED ELECTRODYNAMICS

PASADENA, CALIFORNIA • A SUBSIDIARY OF BELL & HOWELL

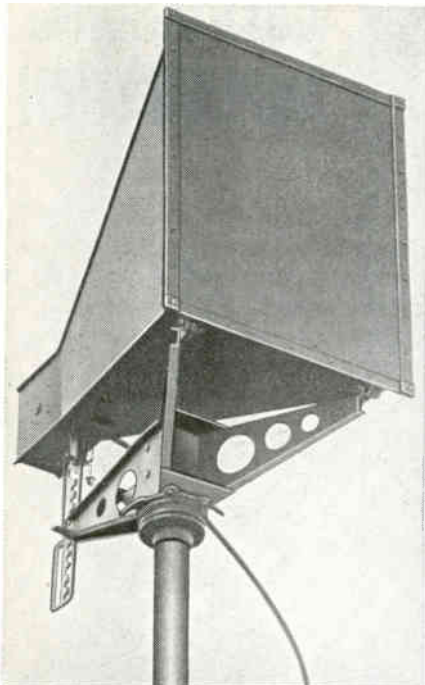

ANTENNA CAPABILITIES

The advanced design and precision construction of Ainslie antenna systems and associated equipment bear testimony to nearly two decades of microwave communication, detection and identification experience. By virtue of complete design-to-delivery capabilities and facilities, Ainslie Corporation offers its customers not only comprehensive standard lines of mesh, spun and horn antennas, but also the flexibility required to develop custom designed prototypes for on-schedule delivery.

We invite your inquiry.



Ainslie

CORPORATION

531 Pond Street
Braintree 85, Massachusetts

lation tools mounted on any hand-arbor or drill press. They are highly resistant to shock, vibration, moisture, and fungus.

CIRCLE 315, READER SERVICE CARD

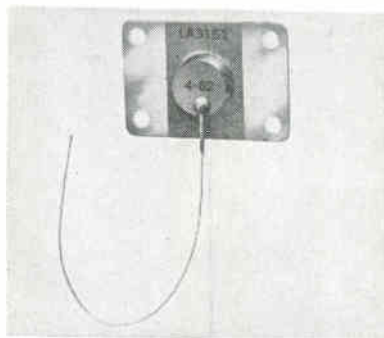

Thermistor Disk Mounted to Plate

FENWAL ELECTRONICS, INC., 63 Fountain St., Framingham, Mass., has available a thermistor disk that has been soldered on brass to a plate. This configuration gives rapid heat dissipation. Plate acts as a heat sink because heat is distributed through a larger area. It is suited to transistor compensation since it can be mounted on the same surface in close proximity to the transistor. Assemblies are available with a variety of thermistor resistances and are cycle welded and lacquer coated for environmental protection. (316)



Display System Features Flexibility

COMPUTER PRODUCTS, INC., 21 Broad St., Manasquan, N. J., announces a display system for use with all repetitive analog computers. Extreme flexibility of the system permits use in the same manner as conventional real time devices such as X-Y plotters and recorders. Voltages representing problem variables are accurately displayed

Wright/Sperry

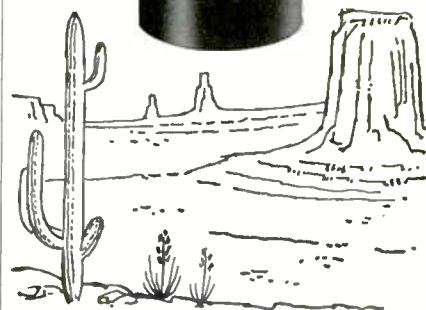

Temperature Compensated Servo Motor Tachometers

Now available are servo motor tachometers which operate reliably over a wide ambient temperature range. For example, from 0°C. to 85°C., this Size 11 will maintain a speed sensitive voltage to within 0.3%, a phase shift to within 1°, and a tachometer linearity of 0.07% from 0 to 3600 rpm.

Write For Data Sheet 20C673

WRIGHT MACHINERY COMPANY

Division of Sperry Rand
Durham, North Carolina
Telephone 682-8161

CIRCLE 100 ON READER SERVICE CARD

electronics

on an electronically generated coordinate system. Readout accuracy is ± 0.25 percent. Up to 10 inputs may be viewed as functions of time. (317)

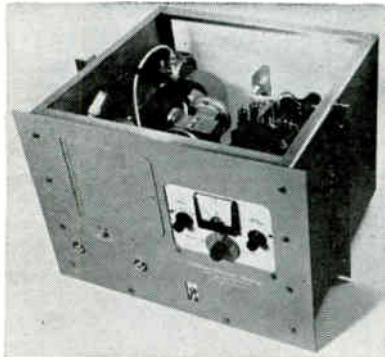

Parametric Amplifier For Tropo Systems

AIRBORNE INSTRUMENTS LABORATORY, a division of Cutler-Hammer, Inc., Deer Park, L. I., N. Y., offers a narrow-band tunable uhf parametric amplifier for use with uhf troposcatter communications systems. Specifications: frequency, 685 to 965 Mc; bandwidth, 20 Mc; noise figure, less than 2 db; gain, 20 db; size, standard 19-in. rack panel or case; weight, 40 lb including pump power supply. (318)

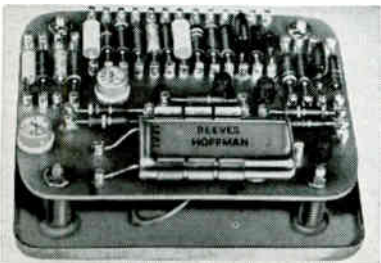

Pulse Oscillator Offers High Accuracy

REEVES-HOFFMAN division of Dynamics Corp. of America, Cherry and North Sts., Carlisle, Pa. Model S1565 is a 24-Kc pulse oscillator with an accuracy of 0.01 percent over an operating ambient-temperature range of 10 C to 55 C. Storage temperature range is -55 C to 85 C. It is capable of withstanding continuous vibration of up to 2 g, over 30 to 500 cycles, or shock up to 30 g in any direction. Output, 6 v across a 2,000-ohm load, is a precision positive pulse 2 to 6 μ sec duration with a rise and fall time

EQUALIZATION! WHO NEEDS IT?

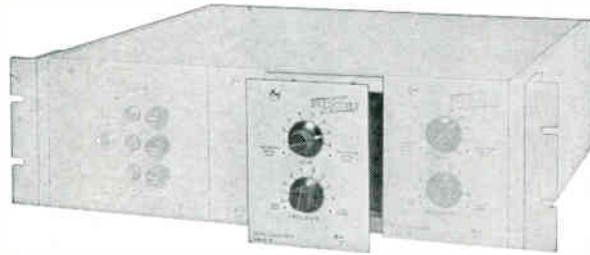

Nearly everyone who uses voice quality channels for data transmission . . .

Why? Because varying amounts of time delay, as a function of frequency, exist in communication networks the world over. To compensate for this delay, Rixon engineers designed the EN-766 delay equalizer.

Recently, one of our customers asked us if this equalizer was available in modular form, like the DD Line of digital data communication equipment.

Our Answer? Yes . . . This is our DDAE series of delay equalizers, available in five models covering the useful audio band up to 3000 cps. These units combine reliability and complete flexibility at low cost—a result of more than five years experience with data transmission systems . . .

Delivery? Off the shelf...

RIXON ELECTRONICS, INC.

2121 Industrial Parkway—Montgomery Industrial Park—Silver Spring, Maryland
Telephone: 622-2121

TWX: S Spg 213
CIRCLE 101 ON READER SERVICE CARD

SERVO NEWS

NOW! VERNITRON EXTENDS ITS SCOPE TO INCLUDE GYRO COMPONENTS



- TORQUERS
- A.C. SYNCHRO AND RESOLVER PANCAKE PICKOFFS
- SPIN MOTORS
Induction and Hysteresis types

Vernitron offers a unique and complete capability for the R&D and production of gyro stable platform electromagnetic components. Design, engineering and quality control are all geared to the ultra-precise requirements of space, flight and underwater stability and navigation (At Vernitron Mil Spec is a minimum quality standard). Vernitron facilities are ready and capable to assist in your gyro component development and production requirements.

Complete specifications of Vernitron gyro components on request, or let us know your requirements and our engineering staff will make recommendations.



Executive Offices and Research and Development:
606 Old Country Rd., Garden City, Long Island, N. Y. Telephone—Pioneer 1-4130
Engineering and Manufacturing:
1742 South Crenshaw Boulevard, Torrance, California. FAirfax 8-2504

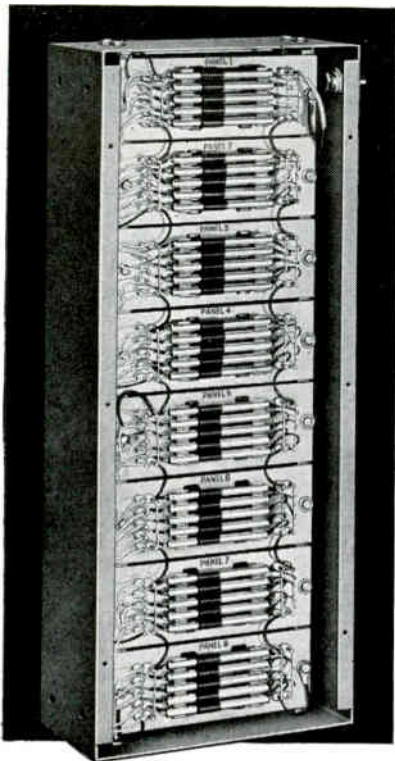

DOPPLER FILTERS

ELEMENTAL BANDWIDTHS FROM 1 TO 400 CPS.

SPECTRAN
ELECTRONICS CORP.

Tel. (617) 897-8881
MAYNARD, MASS.

CIRCLE 102 ON READER SERVICE CARD

of 0.1 μ sec. Approximate size, 3 by 3 by $1\frac{1}{4}$ in.

CIRCLE 319, READER SERVICE CARD

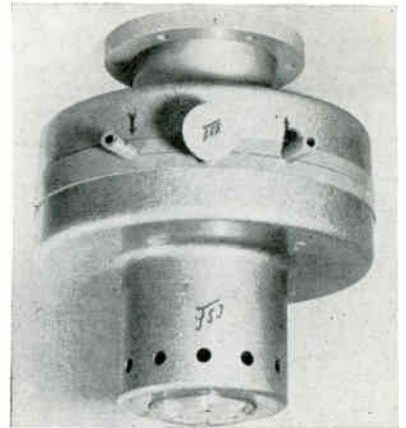

B-W Oscillator Operates In 8 MM Range

AMERICAN RADIO CO., INC., 445 Park Ave., New York 22, N. Y., has available a new M type backward wave oscillator delivering a minimum of 15 w c-w power output over a 31 to 37 Gc band. Operating in the 8 mm range, model CM-08X Carcinotron is packaged in an integral permanent magnet which creates the focusing field. Other features include liquid cooling and low voltage power supply requirements. (320)

NEW FROM T/I

HIGH SPEED A-D CONVERTER

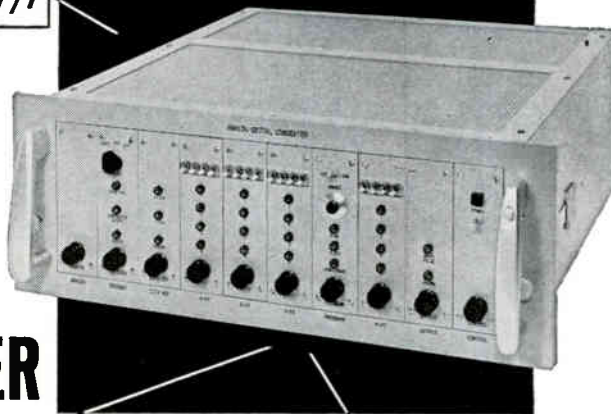

1.5 μ sec per bit

Automatic Zero Stabilization

Texas Instruments Model 834 Analog-Digital Converter is a versatile, all solid state instrument combining high speed with high accuracy. Basic speed is 25 microseconds per conversion (40,000 12 bit conversions per second); accuracy is $\pm 0.05\%$ of full scale, $\pm 1/2$ the least significant bit. The instrument provides full scale ranges of ± 2.5 , ± 5.0 , and ± 10.0 volts with an input impedance of 200,000 ohms. Modular construction allows modification of output logic levels and digital code to suit various system requirements.

Write for complete information.

APPARATUS DIVISION
PLANTS IN HOUSTON
AND DALLAS, TEXAS



TEXAS INSTRUMENTS
INCORPORATED
3609 BUFFALO SPEEDWAY
P. O. BOX 66027 HOUSTON 6, TEXAS

479

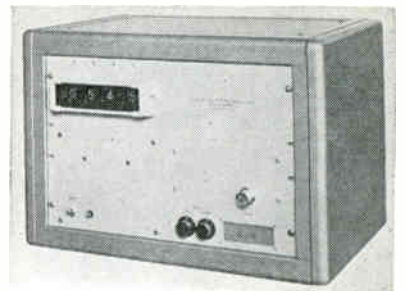

Capacitance Tester Has In-Line Readout

MICRO INSTRUMENT CO., 3851 Sepulveda Blvd., Culver City, Calif. Model 1201 fills a requirement for the direct reading, small signal measurement of low capacitance per MIL specs. The very low signal level of 40 mv rms at a test frequency of 1 Mc makes it suitable for semiconductor capacitance measurements in the range of 0 to 40 pf. Low values of shunt resistance have negligible effect on the 1 percent accuracy of the 4 digit, in-line readout, tester. Price is \$3,740. (321)

PRODUCT BRIEFS

PULSE MODULATOR TETRODE ruggedized model. Reinforced grid/cathode structure has been added. Calvert Electronics, Inc., 220 E. 23rd St., New York 10, N. Y. (322)

SOLID STATE CARRIER SYSTEM is compact and light weight. Temperature range is from -65 to +200 F. The Scionics Corp., 7400 Deering Ave., Canoga Park, Calif. (323)

NICKEL-CADMIUM BATTERIES are encapsulated. They feature high current yield, long cycle life. Gulton Industries, Inc., 212 Durham Ave., Metuchen, N. J. (324)

THIN-BLADE SWITCH requires less than 2 oz operating force. Price is about \$1.40 each in lots of 100 or more. Fansteel Metallurgical Corp., North Chicago, Ill. (325)

MICROMINIATURE RELAY has diagonally mounted coil. Life: 100,000 operations at 2 amp, 26.5 v d-c. Phillips Control Co., 59 W. Washington St., Joliet, Ill. (326)

TUNED AMPLIFIER for microwave measurements. Unit has an input impedance of 200 ohms. Telesound Electronic Associates, 5938 Metcalf, Shawnee Mission, Kansas. (327)

PRECISION MINIATURE DRIVE calibrated to 0.05 deg. It uses two scales. Acton Laboratories, Inc., 533 Main St., Acton, Mass. (328)

MULTIPLEX EQUIPMENT, solid-state. It is error-correcting. Marconi's Wireless Telegraph Co. Ltd., Chelmsford, Essex, England. (329)

ACCELEROMETER operates uncooled to +750 F. Unit is useful in high speed flight testing. Endeveo Corp., 161 E. California Boulevard, Pasadena, Calif. (330)

INTRUMENT CHOPPERS for industrial recorders. One 6 prong, two octal base units available. James Electronics, Inc., 4050 N. Rockwell St., Chicago, Ill. (331)

TRANSISTORIZED TAPE RECORDER features six channels on single $\frac{1}{2}$ in. tape. Fairchild Camera and Instrument Corp., 5550 Harbor St., Los Angeles, Calif. (332)

VHF RADIO-TELEPHONE covers 108 to 136 Mc. It has a self-contained 3-way power supply. FranAir Products, Inc., 403 Roosevelt Ave., Central Falls, R. I. (333)

TANTALUM WIRE AND STRIP for capacitor industry. Prices range from \$60-\$110 per pound. Metallurgical International, Inc., 174 Main Ave., Wallington, N. J. (334)

REINFORCED POLYPROPYLENE with high rigidity. It is recommended for processing into molded parts. Union Carbide Corp., 270 Park Ave., New York 17, N. Y. (335)

SILICON CONTROLLED RECTIFIER, medium current. Device is available in six voltage grades. General

what
is
your
business



If you are manufacturing your own pulse transformers profitably, we welcome the competition. However, most companies manufacture their own components as a sideline—and believe they save money.

But there are always "hidden" costs in making your own parts. In many instances, your sideline operation hurts your over-all profit and loss statement because you are operating outside your specialty. The time, money and effort put into your sideline could actually be more wisely invested in your main business, where you are the expert.

At Aladdin Electronics, we have no sideline business. All of our time and effort is devoted to the research, development, engineering and production of pulse and wide-band transformers, inductors, micromodule and microelement components.

If you use magnetic components in your business, tell us about it. Then let us show you how to save money by buying instead of making.

where the magic of magnetism is a science...
Aladdin[®]
electronics
nashville 10, tennessee phone: 242-3411, code 615
twx: nv 252

CHESTER



MULTI- CONDUCTOR CABLES

Custom constructions to meet your exact requirements. Any combination of conductors, Plastico® insulations, shields, jackets, color coding, etc.
Send for brochure, today!

**CHESTER
CABLE CORP.,
CHESTER, NEW YORK**
a subsidiary of
TENNESSEE CORPORATION

Electric Co., West Genesee St., Auburn, N. Y. (336)

TAPE-TIME REFERENCE CLOCKS for satellite use. Units measure approximately 2 by 2 by 4 in. Adcole Corp., 186 Massachusetts Ave., Cambridge 39, Mass. (337)

TRANSIENT VOLTAGE DETECTOR designed for rack mounting. Accuracy is ± 2 percent of reading. Regent Controls, Inc., Harvard Ave., Stamford, Conn. (338)

TRANSIENT VOLTAGE ARRESTORS, fast responding circuitry. Arrestor is completely self-restoring. Electro-Neutronics, Inc., 1401 Middle Harbor Road, Oakland 20, Calif. (339)

CRYSTAL-ROUNDING MACHINE cuts production time over 95 percent. It is based on lathe principles. Itek Electro-Products, a div. of Itek Corp., Lexington 73, Mass. (340)

VHF TELEMETRY RECEIVER for military and industry. Covers 225-245 Mc, fixed or tunable. Regency Electronics Inc., 7900 Pendleton Pike, Indianapolis, Ind. (341)

ACCELEROMETER, 200 mv/g sensitivity. Designed for missile and lab applications. Columbia Research Laboratories, MacDade Blvd. & Bullens Lane, Woodlyn, Pa. (342)

BALL BEARING RACK SLIDES feature quick disconnect. They carry 100 lb load when fully extended. Premier Metal Products Co., Inc., 337 Manida St., New York 59, N. Y. (343)

SILICON CARBIDE-COATED PRODUCTS, impermeable to all gases including helium. Material also has high thermal shock resistance. Texas Instruments Inc., 13500 North Central Expressway, Dallas, Texas. (344)

MU-METAL MAGNETIC SHIELDS, custom designed. They effect a high rate of field strength reduction. Tech Panel Co., Inc., 37 Milford St., Binghamton, N. Y. (345)

P-C CONNECTORS with die-cast aluminum alloy shells. Units feature ease of mounting. Lionel Electronic Laboratories, Inc., 1226 Flushing Ave., Brooklyn, N. Y. (346)

BAROMETRIC PRESSURE SWITCH, offers accurate repeatability and stability. Haydon Switch Inc., Waterbury 20, Conn. (347)

FREQUENCY DIVIDER and distribution system. It uses plug-in p-c modules to perform variety of functions. RMS Engineering, Inc., 486-14th St., NW, Atlanta 13, Ga. (348)

COAXIAL COMPONENTS offer long term stability, low price. Attenuators and terminations are available. Weinschel Engineering, 10503 Metropolitan Ave., Kensington, Md. (349)

HALL CRYSTAL used in multiplier and magnetic field measurement applications. Max control current is 35 ma. Kearfott Division, General Precision Inc., 1150 McBride Ave., Little Falls, N. J. (350)

Acoustical Components of Superior Quality

JAPAN PIEZO supplies 80% of Japan's crystal product requirements.

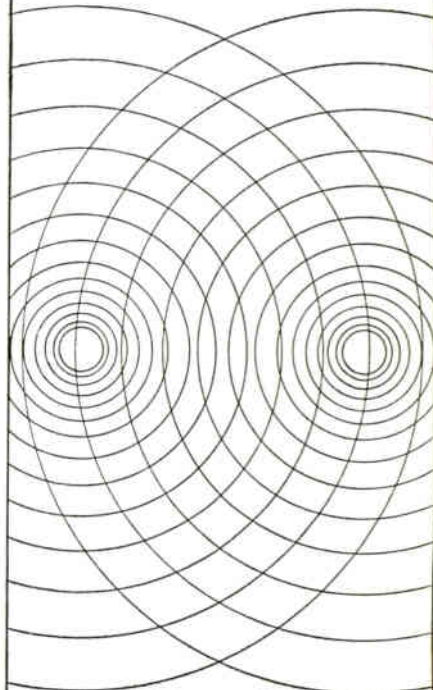

STEREO CARTRIDGE Crystal — "PIEZO" Y-130 X'TAL STEREO CARTRIDGE

At 20°C, response: 50 to 10,000 c/s with a separation of 16.5 db. 0.6 V output at 50 mm/sec. Tracking force: 6 ± 1 gm. Compliance: 1.5×10^{-6} cm/dyne. Termination: $1M\Omega + 150$ pF.

Write for detailed catalog on our complete line of acoustical products including pickups, microphones, record players, phonograph motors and many associated products.



JAPAN PIEZO ELECTRIC CO., LTD.

Kami-renjaku, Mitaka, Tokyo, Japan

4 1/2 MILLION



TO WORLD MARKETS

Last year Foster Electric Co., Ltd. produced nearly 5½ million speakers in a dozen sizes—from the 1½" (4 cm.) 4B2 to the 12" (30 cm.) PW-120. Of these, fully 4½ million were exported both as components and in electrical products to the world's foremost electronics manufacturers.

A major reason for this demand is unmatched quality at popular prices. A perfect example is the 2" 5A61. This fast-selling 100 ohm speaker is ideal for use in compact portable radios and sound equipment. Its high impedance makes output transformers unnecessary, and therefore reduces space requirements, production costs, and distortion. It has a frequency range of 450 to 4,500 c/s and weighs only 1.55 ounces. Like all Foster speakers its cone is made of select kapok fiber by a patented method that assures exceptional tone quality, low resonance, and great resistance to cone break-up. 5A61 also uses Foster's own special high precision magnetic circuit.

Foster speakers are now available in production quantities for immediate delivery anywhere in the world. For details about quality Foster speakers write directly to the address below.



FOSTER ELECTRIC CO., LTD.

384 Shimo-Renjaku, Mitaka, Tokyo, Japan
 CABLE: FOSTERELECTRIC MUSASHINOMITAKA
 CIRCLE 104 ON READER SERVICE CARD

July 20, 1962

Literature of the Week

GLASS-TO-METAL SEALS Seal-A-Metic Co., Haledon, N. J., has available a technical data sheet that includes a glossary of glass-to-metal seal terms. (351)

ELECTROLYTIC CAPACITORS Sangamo Electric Co., Springfield, Ill. Bulletin 2231A covers computer-grade electrolytic capacitors. (352)

CIRCUIT MODULE TESTER Datex Corp., P.O. Box 667, Monrovia, Calif. Product specification sheet DPS/A71 describes the TU-704 portable circuit module tester. (353)

TRANSISTOR INVERTER Rese Engineering Inc., A & Courtland Sts., Philadelphia 20, Pa. Bulletin describes a 1 Mc transistor inverter plug-in logic circuit package. (354)

PHOSPHOR DATA CHART International Telephone and Telegraph Corp., Fort Wayne, Ind., offers an 18 by 22 in. wall chart on the "Typical Absolute Spectral Response Characteristics of Aluminized Phosphor Screens." (355)

SWITCHING TRANSISTORS Clevite Transistor, Waltham 54, Mass., has published 5 new bulletins on planar epitaxial transistors. (356)

L-F OSCILLATORS Accutronics, Inc., 12 South Island, Batavia, Ill. Short form catalog illustrates a line of tuning fork oscillators. (357)

ALLOYS AND FORMS Techalloy Co., Inc., Bahns, Pa. A 48-page handbook provides data on electrical resistance alloys and forms. (358)

WINDING MACHINES Geo. Stevens Mfg. Co., Inc., Pulaski Road at Peterson, Chicago 46, Ill. Catalog 62HD covers 17 transformer and field coil winding machines and 4 heavy duty tensions. (359)

AUDIO TRANSFORMERS Polyphase Instrument Co., E. Fourth St., Bridgeport, Pa. Bulletin lists full specifications for 46 ultraminiature J-TRAN audio transformers. (360)

MINIATURE PREAMPLIFIER Ad-Yu Electronics Lab., Inc., 249 Terhune Ave., Passaic, N. J. Bulletin contains description and specifications for type A102 series miniature preamplifier. (361)

T-W TUBES Sylvania Electric Products Inc., 1100 Main St., Buffalo 9, N. Y. A 14-page brochure explains the steps in the manufacture of twt's, functions of the tubes and possible future applications. (362)

SEMICONDUCTORS Amperex Electronic Corp., 230 Duffy Ave., Hicksville, L. I., N. Y. Condensed semiconductor catalog contains listings and specifications of a complete line. Copies are obtainable by writing on company letterhead.

COAXIAL CABLES

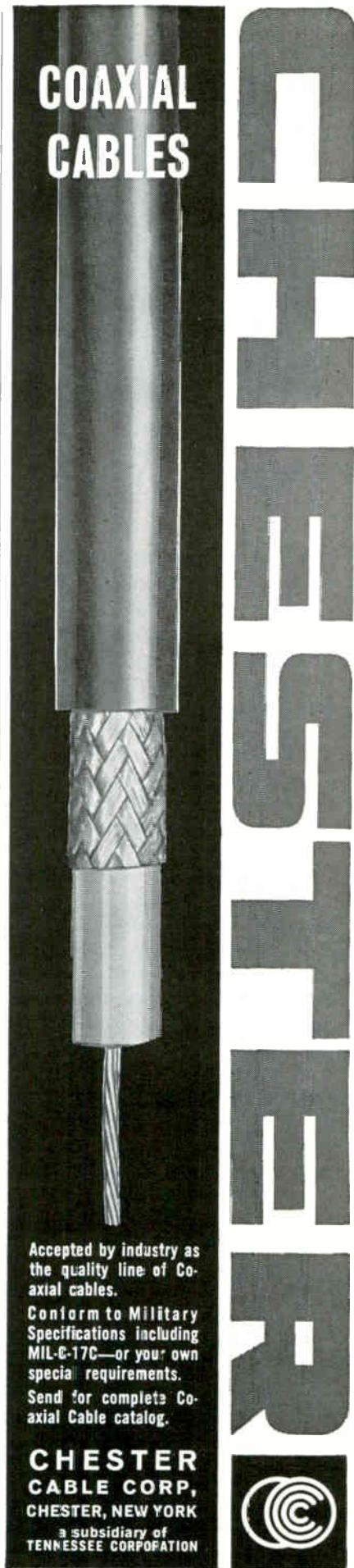

Accepted by industry as the quality line of Coaxial cables.

Conform to Military Specifications including MIL-C-17C—or your own special requirements.

Send for complete Coaxial Cable catalog.

**CHESTER
CABLE CORP.,
CHESTER, NEW YORK**

a subsidiary of
TENNESSEE CORPORATION





NCR To Expand Dayton R&D Center

THE NATIONAL CASH REGISTER CO., Dayton, O., has announced plans to construct a \$3-million six-story addition to its Dayton Research and Development Center.

The new structure will add 112,000 square feet of floor space, increasing by 45 percent the area of the present R&D center which was completed in 1957. Construction will begin this fall, with the addition scheduled to be completed a year later.

NCR's chairman and president, Robert S. Oelman, said the new addition would expand facilities for all of the company's R&D departments including research, product engineering, advanced development, product planning, and technical services.

"During the past five years," Oelman said, "NCR has carried out the most extensive research and development program in its 78-year history, representing a total investment of over \$75 million. The rate of annual R&D expenditures has increased by 25 percent since

1957. A substantial portion of this amount has been used to develop electronic computer systems and related peripheral equipment."

Added space in the new structure will provide room for new equipment and larger work areas. According to NCR, the additional facility will also enable the company to increase its research in several areas of technology which have important long-range implications. These include electronic memories which utilize magnetic thin films for faster operating speeds, new systems for information storage, retrieval, and display, and integrated electronic circuit assemblies.

When the addition is completed, the R&D Center will provide 357,000 square feet of space. NCR also has R&D facilities at its Hawthorne, Calif., electronics division; at its adding machine division in Ithaca, N. Y.; in London, England; Dundee, Scotland; Zurich, Switzerland; Augsburg, West Germany, and West Berlin.

Geoscience Instruments Names Eric Mendel

ERIC MENDEL was recently elected vice president and director of Geoscience Instruments Corp., New York, N. Y. He was previously with Materials Research Corp.

Geoscience specializes in materials, machines, and techniques involved in surface-preparation

work: machining, slicing, lapping, polishing and dicing of semiconductor and exotic materials.

Karl Spangenberg Joins Lockheed

KARL R. SPANGENBERG has joined Lockheed Missiles & Space Co. as a senior consulting scientist of the

Research and Engineering Laboratories in Palo Alto, Calif.

He is a former Stanford University professor and associate director of the Stanford Electronics Laboratories.

Martin Company Appoints Metcalf

THE MARTIN CO., Baltimore, Md., announces the appointment of George F. Metcalf as vice president for engineering.

Metcalf comes to Martin from the General Electric Co., where since 1958 he had been regional vice president for defense activities in Washington, D. C.

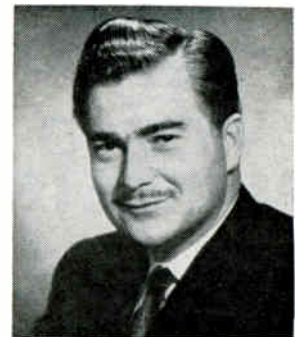

Wilkins Assumes Endeveco Post

ENDEVCO CORP., Pasadena, Calif., has appointed J. Richard Wilkins to the post of assistant contracts administrator for the company's line of piezoelectric accelerometers and for the d-c instruments manufactured by the company's Video Instruments division.

Wilkins was formerly a field engineer with Hoffman Electronics Corp., Los Angeles.

Trak Electronics Elects Degen

TRAK ELECTRONICS CO., INC., Wilton, Conn., has elected Joseph F. Degen as president and director. Degen is a former vice president of Daystrom, Inc., where he was the general manager of the Weston Instrument division. He previously was associated with IBM.

Trak designs and manufactures electronic reconnaissance, counter-

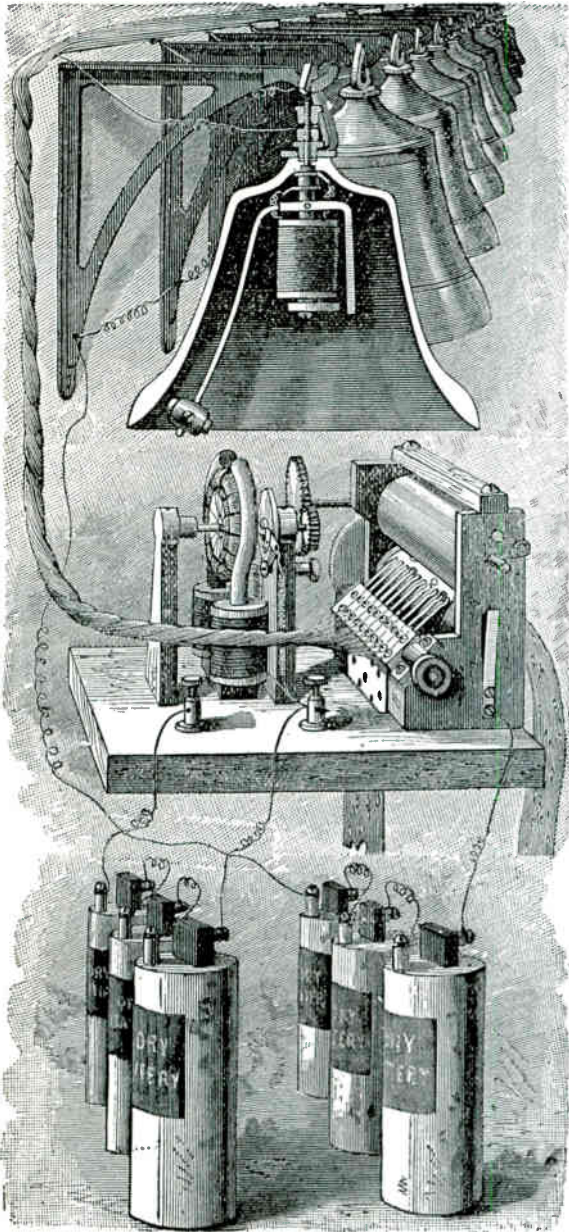

**Is it ancient history
by the time you see
electronics?**

Get the facts while they're new. Don't wait for **electronics** on a route slip. Look in this issue for the Reader Service Card. Fill out and mail the "for subscriptions" section. Only 7½ cents a week.

electronics

A McGraw-Hill Publication, 330 West 42nd St., N. Y. 36



Newest of the rapidly increasing **CAMBION®** miniature plugs and jacks is Part No. 3103, a solid front plug-jack combination, .045", that is insulated, and permits multiple contacts by "piggy-backing." Its supplied insulation can be quickly and permanently shrunk into place.

Other newcomers are the .025" No. 3231 plug and No. 3230 jack, ideal for dip soldering or encapsulation. The jack after 68,000 cycles showed no change in contact resistance, thanks to its unique beryllium copper caged spring. Like all **CAMBION** components, **CAMBION** plugs and jacks are quality guaranteed. For prints, and Plug and Jack Catalog No. 70, write to Cambridge Thermionic Corporation, 437 Concord Avenue, Cambridge 38, Massachusetts.

CAMBRIDGE THERMIONIC CORPORATION
GAMBION®
The guaranteed electronic components
CIRCLE 105 ON READER SERVICE CARD

Now, **KWIK-TRIM**
THE POTENTIOMETER WITH THE
VISUAL INDICATOR

IMPROVED RESOLUTION APPROX. 10% TO 25% OVER MANY COMPARABLE TYPES.

Designed for the ultimate in reliability and performance and to meet applicable military specifications for shock, temperature cycling, vibration, altitude, fungus, humidity, immersion, salt spray, sand and dust.



MULTIPLE ADJUSTMENT

A KWIK-TRIM one to one nominal adjustment . . . A vernier 45:1 ratio for precise setting . . . Shaft is journaled at each end with precision bearing fit . . . These precision features are your assurance for ease of setability and the stability of setting.

Please Write for **ELECTRICAL, MECHANICAL AND ENVIRONMENTAL SPECIFICATION CATALOG.**



General Scientific CORP.

A SUBSIDIARY OF SAN FERNANDO ELECTRIC MFG. CO.
1535 FIRST ST. SAN FERNANDO, CALIF.
EM 1-1193 . . . TWX S.F. CAL 9900

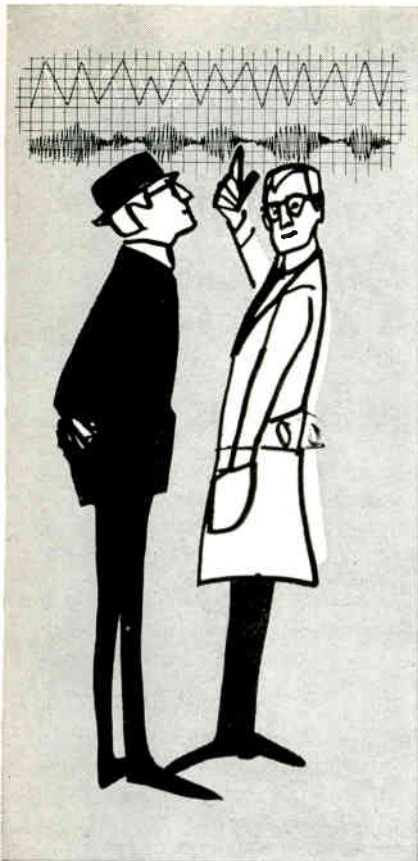

Electronics manufacturers find triple-A work force in WESTern PENNSylvania

Electronics firms locate and expand here because of the triple-A work force: Available . . . Adaptable . . . and with a good Attitude. One firm traveled 20,000 miles, then selected WESTern PENNSylvania; another interviewed 500 job applicants from one help-wanted ad. Pre-production training of a work force at no cost to you . . . plus a favorable tax climate . . . plus 100% industrial plant financing gives WESTern PENNSylvania a top combination of plant location values. Learn more—wire or phone collect or mail the coupon today.

WEST PENN POWER an operating unit of ALLEGHENY POWER SYSTEM



Now Available:
Shell buildings at \$2.95 to \$3.25 a sq. ft.—can be completed to your specs in 60-90 days. Or select from 200 other industrial properties.

WEST PENN PDWER, Area Development Department
Greensburg, Pa., Phone: TEmple 7-3000 (Area Code 412)
EL 2-16-7

Please send me data on Labor Availability Pre-production Training Taxes 100% Industrial Plant Financing Industrial Properties

Name _____
Title _____
Company _____
Address _____
City _____ Zone _____
State _____ Phone _____

measures and communications equipment.

Raytheon Promotes Harold Asquith

HAROLD M. ASQUITH advances at Raytheon Co., Lexington, Mass., to director of technical support, a new position created to promote proper exchange of the company's technical know-how between Raytheon and its subsidiaries and licensees.

PEOPLE IN BRIEF

United Aircraft's Norden div. announces two promotions in the engineering dept.: **James J. Alimena** to supervisor, video and display; **Sidney Saslovsky** to supervisor, r-f design. **Howard T. Mooers** leaves Honeywell Research Center to become mgr. of the Military Electronics dept. of Rosemount Engineering Co. **Edward S. Hensperger**, ex-Narda Microwave Corp., appointed engineering mgr. of Airtron's sub-systems section. **Robert J. Horak** advances to mgr. of the Datagraph engineering dept. of the Data Recorders div., Consolidated Electrodynamics Corp. **Charles K. Raynsford**, formerly with Vitro Laboratories, named engineering and research mgr. for the Paramus plant of ACF Electronics. **Ralph Montali**, industrial consultant, elected chairman of the board of Isolation Products Inc. **William Chepulis** and **Robert L. Kent**, previously with Hermes Electronics Co. and Itek Electro-Products Co., respectively, are added to the technical staff of Damon Engineering, Inc. **Harold Sigurdson** moves up at Mallory Semiconductor Co. to mgr. of the Silicon Controlled Rectifier dept. **Rex D. Lindsay**, from Cutter Laboratories, to Memorex Corp. as plant mgr. **Felix Zandman**, formerly with The Budd Co., elected president of Vishay Instruments, Inc. **Datex Corp.** ups **William H. Reinholtz** to systems engineering mgr. **Robert W. Bemer**, previously with IBM, becomes director of systems programming for Univac. Lockheed Electronics elevates **Arnold A. Isford** to product mgr. of the Telemetry and Space Communications dept.



Guaranteed Castings!

Of the 5,396 foundries in the U.S.A., we know of only one that guarantees casting quality with the Machining Bond on Castings. We're that one. Write us about your problem casting.

request free Resources & Capabilities booklet:
Morris Bean & Company
Yellow Springs 8, Ohio



aluminum & ductile iron foundries
CIRCLE 107 ON READER SERVICE CARD

VARIABLE CONDENSER



3 types: AM, AM-FM, FM.
2 gang, 3 gang, 4 gang.

PLASTIC INSULATED VARIABLE CONDENSER

Square Sizes:
15mm., 17mm.,
20mm., 21mm.,
24mm.,
Single band,
2 band, 3 band
and for FM only.



SANKAISHA CO., LTD.

Cable address: SANESVARICON TOKYO
1425, 4-chome, Higashinakanobu,
Shinagawa-Ku, Tokyo, Japan.

CIRCLE 108 ON READER SERVICE CARD

electronics

WEEKLY QUALIFICATION FORM FOR POSITIONS AVAILABLE

ATTENTION: ENGINEERS, SCIENTISTS, PHYSICISTS

This Qualification Form is designed to help you advance in the electronics industry. It is unique and compact. Designed with the assistance of professional personnel management, it isolates specific experience in electronics and deals only in essential background information.

The advertisers listed here are seeking professional experience. Fill in the Qualification Form below.

STRICTLY CONFIDENTIAL

Your Qualification form will be handled as "Strictly Confidential" by ELECTRONICS. Our processing system is such that your form will be forwarded within 24 hours to the proper executives in the companies you select. You will be contacted at your home by the interested companies.

WHAT TO DO

1. Review the positions in the advertisements.
2. Select those for which you qualify.
3. Notice the key numbers.
4. Circle the corresponding key number below the Qualification Form.
5. Fill out the form completely. Please print clearly.
6. Mail to: D. Hawksby, Classified Advertising Div., ELECTRONICS, Box 12, New York 36, N. Y. (No charge, of course).

COMPANY	SEE PAGE	KEY #
ATOMIC PERSONNEL INC. Philadelphia, Pennsylvania	103*	1
ESQUIRE PERSONNEL SERVICE INC. Chicago, Illinois	103*	2
INTERNATIONAL BUSINESS MACHINES CORP. Space Guidance Center Owego, New York	103*	3
LOCKHEED CALIFORNIA CO. Div. of Lockheed Aircraft Corp. Burbank, California	69*	4
MICROWAVE SERVICES INTERNATIONAL, INC. Denville, New Jersey	103*	5
NORTHROP CORP. Norair Div. Hawthorne, California	85*	6
NORTHROP CORP. Space Laboratories Hawthorne, California	83*	7
REPUBLIC AVIATION CORPORATION Farmingdale, L. I., New York	104*	8
UNION CARBIDE NUCLEAR CO. Oak Ridge, Tennessee	94	9
WEATHERHEAD COMPANY Cleveland, Ohio	94	10

* These advertisements appeared in the 7/13/62 issue.

(cut here)

electronics WEEKLY QUALIFICATION FORM FOR POSITIONS AVAILABLE

(cut here)

(Please type or print clearly. Necessary for reproduction.)

Personal Background

NAME

HOME ADDRESS

CITY ZONE STATE

HOME TELEPHONE

Education

PROFESSIONAL DEGREE(S)

MAJOR(S)

UNIVERSITY

DATE(S)

FIELDS OF EXPERIENCE (Please Check)

7/20/62

- | | | |
|--|--|---------------------------------------|
| <input type="checkbox"/> Aerospace | <input type="checkbox"/> Fire Control | <input type="checkbox"/> Radar |
| <input type="checkbox"/> Antennas | <input type="checkbox"/> Human Factors | <input type="checkbox"/> Radio-TV |
| <input type="checkbox"/> ASW | <input type="checkbox"/> Infrared | <input type="checkbox"/> Simulators |
| <input type="checkbox"/> Circuits | <input type="checkbox"/> Instrumentation | <input type="checkbox"/> Solid State |
| <input type="checkbox"/> Communications | <input type="checkbox"/> Medicine | <input type="checkbox"/> Telemetry |
| <input type="checkbox"/> Components | <input type="checkbox"/> Microwave | <input type="checkbox"/> Transformers |
| <input type="checkbox"/> Computers | <input type="checkbox"/> Navigation | <input type="checkbox"/> Other |
| <input type="checkbox"/> ECM | <input type="checkbox"/> Operations Research | <input type="checkbox"/> |
| <input type="checkbox"/> Electron Tubes | <input type="checkbox"/> Optics | <input type="checkbox"/> |
| <input type="checkbox"/> Engineering Writing | <input type="checkbox"/> Packaging | <input type="checkbox"/> |

CATEGORY OF SPECIALIZATION

Please indicate number of months experience on proper lines.

	Technical Experience (Months)	Supervisory Experience (Months)
RESEARCH (pure, fundamental, basic)
RESEARCH (Applied)
SYSTEMS (New Concepts)
DEVELOPMENT (Model)
DESIGN (Product)
MANUFACTURING (Product)
FIELD (Service)
SALES (Proposals & Products)

CIRCLE KEY NUMBERS OF ABOVE COMPANIES' POSITIONS THAT INTEREST YOU

1 2 3 4 5 6 7 8 9 10 11 12 13 14 15 16 17 18 19 20 21 22 23 24 25



EMPLOYMENT OPPORTUNITIES

The Advertisements in this section include all employment opportunities—executive, management, technical, selling, office, skilled, manual, etc. Look in the forward section of the magazine for additional Employment Opportunities advertising.

Positions Vacant	Civil Service Opportunities	Employment Agencies
Positions Wanted	Selling Opportunities Wanted	Employment Services
Part Time Work	Selling Opportunities Offered	Labor Bureaus

DISPLAYED

The advertising rate is \$40.17 per inch for all advertising appearing in other than a contract basis. Contract rates quoted on request.

An advertising inch is measured $\frac{3}{4}$ " vertically on a column—3 columns—30 inches to a page.

Subject to Agency Commission.

RATES

\$2.70 per line, minimum 3 lines. To figure advance payment count 5 average words as a line.

Box Numbers—counts as 1 line.

Discount of 10% if full payment is made in advance for 4 consecutive insertions.

Not subject to Agency Commission.

UNDISPLAYED

Send **NEW ADS** to CLASSIFIED ADV. DIV. of ELECTRONICS, P.O. Box 12, N. Y. 36, N. Y.

Electronic Instrument Technicians The Oak Ridge National Laboratory Operated by UNION CARBIDE NUCLEAR COMPANY at Oak Ridge, Tennessee Has openings for

Highly skilled electronic instrument technicians to work with electronic engineers in the development, installation and maintenance of electronic systems. Digital data handling, transistorized pulse height analyzers, analog and digital computer systems are only a few examples.

Minimum high school education, with additional training in electronics and at least three years' experience in installation and maintenance of complex electronic systems. Entrance rate \$3.10 per hour; \$3.16 per hour after six months. Reasonable interview and relocation expenses paid by Company.

Excellent Working Conditions
and

Employee Benefit Plans
An Equal Opportunity Employer

Send detailed resume to:

Central Employment Office
UNION CARBIDE NUCLEAR COMPANY
Post Office Box M Oak Ridge, Tennessee

ELECTRONIC ENGINEER

To design & develop electro-mechanical devices and electronic circuits. Electrical engineering degree required with 3 to 8 years experience in controls and/or instrumentation.

Contact: R. F. Sommer

THE WEATHERHEAD COMPANY

300 E. 131st St. Cleveland 8, Ohio

Equal Opportunity Employment

POSITION VACANT

The Denver Research Institute of the University of Denver seeks Graduate Electrical Engineers for interesting positions in the Study of Ionospheric and Upper Atmospheric Phenomena. Supervisory positions in the operation of Field Stations located throughout the world. Single Engineers, free to travel will be afforded preference. Recent E.E. graduates will be given consideration. Base salary plus overseas differential and per diem. American citizen. Direct inquiries to J. L. McGrath, Electronics Division, Denver Research Institute, University of Denver, Denver 10, Colorado. An equal opportunity employer.

NEW ADVERTISEMENTS

received by July 27th will appear in the August 17th issue subject to space available.

Method for measuring an engineer...

What's his technical publication ?



When an engineer pays for a technical publication, it's a safe bet that that is the one he respects most.

He makes it his business to read **electronics**. It keeps him well informed of up-to-the-minute events and developments in the electronics industry and the technology to which he contributes his experience.

Where your recruitment program calls for engineers and other technical people of this calibre, you can reach them in the **EMPLOYMENT OPPORTUNITIES** section of:

electronics

A MCGRAW-HILL PUBLICATION
CLASSIFIED ADVERTISING DIVISION
POST OFFICE BOX 12 NEW YORK 36, NEW YORK

EMPLOYMENT PROBLEM?

When you are in need of specialized men for specialized jobs, contact them through an employment ad in this publication.

SEARCHLIGHT SECTION

(Classified Advertising)

BUSINESS OPPORTUNITIES

EQUIPMENT - USED or RESALE

DISPLAYED

The advertising is \$27.25 per inch for all advertising other than on a contract basis. AN ADVERTISING INCH is measured $\frac{7}{8}$ " vert. on a column, 3 cols.—30 inches—to a page. EQUIPMENT WANTED or FOR SALE ADVERTISEMENTS acceptable only in Displayed Style.

Send **NEW ADVERTISEMENTS** or Inquiries to Classified Adv. Div. of Electronics, P. O. Box 12, N. Y. 36, N. Y.

RATES

\$2.70 a line, minimum 3 lines. To figure advance payment count 5 average words as a line.

BOX NUMBERS count as one line additional.

DISCOUNT of 10% if full payment is made in advance for four consecutive insertions.

UNDISPLAYED

FOR RESEARCH — DEVELOPMENT & EXPERIMENTAL WORK

Over 10,000 different electronic parts: waveguide, radar components and parts, test sets, pulsers, antennas, pulse xmfrs, magnetrons, IF and pulse amplifiers, dynamotors, 400 cycle xmfrs, 504 ant. pedestals, etc.

PRICES AT A FRACTION OF ORIGINAL COST!
COMMUNICATIONS EQUIP CO.
343 CANAL ST., N. Y. 13, WD 6-4045
CHAS. ROSEN (Formerly at 131 Liberty St.)

CIRCLE 951 ON READER SERVICE CARD

WEAK IN MATH?

Don't let inadequacy in mathematics hold you back. Now you can learn the basic math you must know to succeed as a technical man. Learn through Grantham Schools' unusual home study math course for technicians, engineers, and mechanics. Write for details today.

Write to: Dept. 2E,
GRANTHAM SCHOOLS, INC.
1505 N. Western Ave.,
Los Angeles 27, Calif.

CIRCLE 952 ON READER SERVICE CARD

LOOKING FOR

USED/SURPLUS ELECTRONIC EQUIPMENT/COMPONENTS?

For an up-to-date listing of such equipment see Searchlight Section of July 13th issue.

INDEX TO ADVERTISERS



Audited Paid Circulation

AMP Incorporated	6	Sankalsha Co., Ltd.	92
Acme Electric Corp.	74	Simplex Wire & Cable Co.	31
Ainslie Corporation	84	Simpson Electric Company	96
Airtronics International Corp.	24	Spectran Electronics Corp.	86
Aladdin Electronics	87	Sprague Electric Co.	9, 30
Alpha Wire Corp.	76	Synthane Corp.	18
American Lava Corporation	67		
American Optical Co.	80, 81		
		Tech Laboratories, Inc.	95
Cambridge Thermionic Corp.	91	Tektronix, Inc.	64
Chase Manhattan Bank, The	16, 17	Texas Instruments Incorporated	
Chester Cable Corp.	88, 89	Apparatus Division	86
Clevite Electronic Components		Texas Instruments Incorporated	
A Div. of Clevite Corp.	36	Transistor Products Division	61
Consolidated Electrodynamics Corp.	83	Texas Instruments Incorporated	
Cubic Corp.	22, 23	Metals & Controls Division	68
		Transitron Electronic Corp.	15
Delco Radio	59	United Transformer Corp.	2nd cover
FXR, A Div. of Amphenol-Borg		Varian Associates	62
Electronics Corp.	34, 35	Vernitron Corporation	85
Fairchild Semiconductor Corp.	3rd cover	Virginia Electric & Power Co.	33
Florida Development Commission	25	Vitramon, Inc.	5
Fluke Mfg. Co., Inc., John	71		
Foster Electric Co., Ltd.	89	Ward Leonard Electric Co.	70
Fuji Tsushinki Seizo K. K.	82	West Penn Power	92
		Wright Machinery Co.,	
General Electric Co.		Div. of Sperry Rand	84
Semiconductor Products Dept.	73		
General Scientific Corp.	91		
Gudebrod Bros. Silk Co., Inc.	32		
Hansen Mfg. Co., Inc.	18		
Harman Kardon Inc.	4		
Heminway & Bartlett Mfg. Co., The	63		
Hughes Aircraft Co.			
Aerospace Divisions	57		
Japan Piezo Electric Co., Ltd.	88		
Johnson Company, E. F.	63		
M B Electronics, A Division of			
Textron Electronics, Inc.	79		
Machlett Laboratories, Inc., The	29		
Mallory and Co., Inc., P. R.	10, 11		
Markem Machine Co.	69		
Mitsubishi Electric Mfg. Co.	75		
Morris Bean & Company	92		
Navigation Computer Corp. (NAVCOR).	60		
Pennsalt Chemicals Corp.	65		
Potter Instrument Co., Inc.	21		
Radio Corporation of America	55, 4th cover		
Raytheon Company	13		
Rixon Electronics, Inc.	85		

CLASSIFIED ADVERTISING

F. J. Eberle, Business Mgr.

EMPLOYMENT OPPORTUNITIES	94
EDUCATIONAL	94
EQUIPMENT	
(Used or Surplus New)	
For Sale	94

INDEX TO CLASSIFIED ADVERTISERS

Communications Equipment Co.	94
Grantham Schools Inc.	94
Union Carbide Nuclear Company	94
Weatherhead Co.	94

This Index and our Reader Service Numbers are published as a service. Every precaution is taken to make them accurate, but ELECTRONICS assumes no responsibilities for errors or omissions.

MIDGET TAP SWITCH

has
giant
range

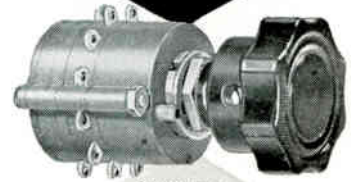

\$3.00 List

TYPE 3A

MOLDED FROM DIALYL PHTHALATE

Only 1" in diameter ... weighs 30 grams ... as many as 8 decks and up to 12 positions per deck. These are among the features of Tech Labs' new all-molded miniature Type 3A tap switch.

Designed for a wide range of military and commercial applications, this single-hole mounted switch has adjustable stops if fewer than 12 positions, single pole, or 6 positions, double pole, are required. "Shorting" and "non-shorting" types are available and the switch can be furnished solenoid-operated and hermetically sealed.

SPECIFICATIONS

Size: 1" diameter, 1 1/4" with terminals. First deck, 1-1/16" long. Each additional deck, 1/2" long.

Weight: First deck, 30 grams. 10 grams for each additional deck.

Rating: 1200 volts rms, 2000 VDC, 5 amps (carrying) 115V.

Insulating resistance: 100 megohms minimum at 500 volts DC.

Life: 1.5 - 2 million revolutions.

Contact resistance:

(standard) 6-10 milliohms.

(silver) 3-5 milliohms.

Temperature range: -65°C to 100°C.

Mounting: Single-hole.

Meets MIL-S-3786A



Write for details
and prices.

PALISADES PARK, NEW JERSEY

OWN A SIMPSON 260® VOM?

CONVERT IT TO A
**TRANSISTOR
TESTER**
WITH THIS
\$26.95 ADAPTER



Eight other types available
Write for Bulletin 2064

Simpson

SIMPSON ELECTRIC COMPANY

5203 West Kinzie Street • Chicago 44, Illinois
Phone: (312) EStebrook 9-1121

CIRCLE 109 ON READER SERVICE CARD



Are you selling the whole buying team

Tough competition *demands* that the electronics man be reached and *sold* wherever you find him: *Research, Design, Production, and Management*. Only advertising in electronics reaches all four... the same men your salesmen call on. Put your advertising where it works *hardest*....

in **electronics**

electronics



Audit Bureau
of Circulations



Associated Business
Publications

Audited Paid Circulation

JAMES T. HAUPTLI

Advertising Sales Manager

R. S. QUINT:
Assistant Publisher Buyers'
Guide and Business Manager
FRED STEWART:
Promotion Manager
B. ANELLO:
Market Services Manager

RICHARD J. TOMLINSON:
Production Manager
GEORGE E. POMEROY:
Classified Manager
HUGH J. QUINN:
Circulation Manager

ADVERTISING REPRESENTATIVES

NEW YORK (36):
Donald H. Miller, Henry M. Shaw,
George F. Werner
500 Fifth Avenue, LO-4-3000
(area code 212)

BOSTON (16):
William S. Hodgkinson, Donald R. Furth
McGraw-Hill Building, Copley Square,
Congress 2-1160 (area code 617)

PHILADELPHIA (3):
Warren H. Gardner, William J. Boyle
6 Penn Center Plaza, LOcust 8-4330
(area code 215)

CHICAGO (11):
Harvey W. Wernecke, Robert M. Denmead
645 North Michigan Avenue, Mohawk 4-5800
(area code 312)

CLEVELAND (13):
Paul T. Fegley
55 Public Square, Superior 1-7000
(area code 216)

SAN FRANCISCO (11):
R. C. Alcorn
255 California Street, Douglas 2-4600
(area code 415)

LOS ANGELES (17):
Peter S. Carberry, Ashley P. Hartman
1125 W. 6th St., Huntley 2-5450
(area code 213)

DENVER (2):
J. W. Patten
Tower Bldg., 1700 Broadway,
Alpine 5-2981 (area code 303)

ATLANTA (9):
Michael H. Miller, Robert C. Johnson
1375 Peachtree St. N.E., Trinity 5-0523
(area code 404)

HOUSTON (25):
Joseph C. Page, Jr.
Prudential Bldg., Holcomb Blvd.,
Riverside 8-1280 (area code 713)

DALLAS (1):
Frank Le Beau
The Vaughn Bldg., 1712 Commerce St.
Riverside 7-9721 (area code 214)

LONDON W1:
Edwin S. Murphy Jr.
34 Dover St.

FRANKFURT/Main:
Matthée Herfurth
85 Westendstrasse

GENEVA:
Michael R. Zeynel
2 Place du Port

"Headquarters for Business Information"

McGraw-Hill Technical and Business Publications

American Machinist/Metal-
working Manufacturing
Aviation Week and Space
Technology
Business Week
Chemical Engineering
Chemical Week
Coal Age
Construction Methods and
Equipment
Construction Daily
Control Engineering
Electrical Construction
and Maintenance
Electrical Merchandising Week
Electrical Newsletter
Electrical West

Electrical Wholesaling
Electrical World
Electronics
Engineering Digest
Engineering and Mining Journal
E & MJ Metal and Mineral
Markets
Engineering News-Record
Factory
Fleet Owner
Industrial Distribution
National Petroleum News
Nucleonics
Nucleonics Week
Platt's Oilgram News
Platt's Oilgram Price Service
Power

Product Engineering
Purchasing Week
Science Week
Textile World

Overseas only:
Automobile International
(English, Spanish)
Ingenieria Internacional
Construccion (Spanish)
International Management
(English, Spanish
Portuguese editions)
Metalworking Production
(Great Britain)

Available by subscription only — to qualified persons actively engaged in the field of the publication. For subscription rates and information describing the editorial coverage of any of the above publications, write to: *Subscription Manager, Circulation Department, McGraw-Hill Publishing Company, 330 West 42nd Street, New York 36, N. Y.*



NOW AVAILABLE THROUGH DISTRIBUTORS:



1 MC/COMPATABLE DIGITAL FUNCTIONAL BLOCKS

Fairchild Micrologic elements were introduced to the computer industry a year ago. Today, Fairchild announces their availability, in volume, through distributors.

This family of functional elements — in which transistors and resistors are diffused via the Planar process into a single, monolithic chip of silicon — can be used to efficiently fabricate a computer logic section. No other components are required.

They are designed to operate in a full military environment, over a temperature range of -55 degrees C. to +125 degrees C. When integrated into a computer, they will operate at 1 mc clock rates over this temperature range.

Micrologic elements are designed for low cost, highly reliable data processing logic. They make possible a simplified approach to the job and hence greatly reduce the lead time from design to the prototype computer.

The choice of the elements and the nature of the package are the major factors in the total cost reduction associated with the reliability, maintainability, reparability, logistics, and training.

Size reduction (one order of magnitude) gained with Micrologic is an important by-product of the manufacturing process.

AVAILABLE NOW FOR VOLUME DELIVERY.

90% COST REDUCTIONS IN LOGIC DESIGN & ASSEMBLY Micrologic elements can cut logic system design and assembly costs up to 90%; space requirements up to 95%; power up to 75%. These savings are made possible through simpler layouts, standard handling with TO-5 type packages, fewer board connections, one power supply, and single clock rates.

PLANAR RELIABILITY: Fairchild Micrologic elements have been life tested for 1,000,000 element operating hours without a single electrical failure. The Fairchild Micrologic provides total protection with its integral oxide coating.

GENERAL SPECIFICATIONS FOR MICROLOGIC ELEMENTS	
Speed	• 50 nsec. delay per stage for all loads over temp. range of -55° C. to +125° C.
Power	• 15 mW per node
Fan Out	• 5* over temp. range of -55° C. to +125° C.
Voltage	• 3 V ± 30%
Package	• 8 lead TO-5 type (.170 height)

*The buffer element has a fan out of 25



ACTUAL SIZE

μL and μLogic are trademarks of Fairchild Semiconductor



545 WHISMAN ROAD, MOUNTAIN VIEW, CALIF. · YORKSHIRE 8-8161 · TWX: MN VW CAL 853
A DIVISION OF FAIRCHILD CAMERA AND INSTRUMENT CORPORATION

CIRCLE 901 READERS SERVICE CARD

DC CURRENT GAIN (TYPICAL)

Beta vs. Collector Current for RCA's Economy Line of Silicon Power Transistors

DISSIPATION	
2N1700	5 Watts
2N1701	25 Watts
2N1702	75 Watts
2N1703	75 Watts
2N2270	5 Watts
2N2338	150 Watts
2N2339	40 Watts

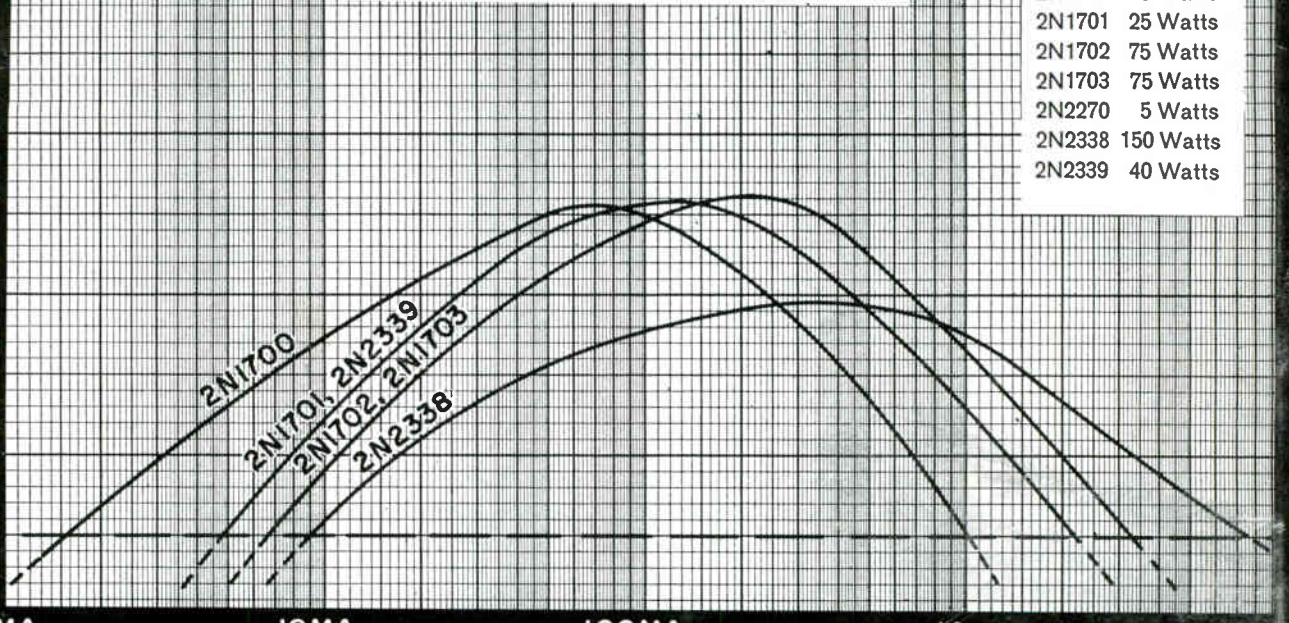

COLLECTOR CURRENT

RCA EXPANDS ECONOMY SILICON LINE FOR LOW COST DESIGN FLEXIBILITY UP TO 150 WATTS

Now, RCA adds 3 new types, 2N2338, 2N2339, 2N2270 to its line-up of low cost silicon transistors at prices starting as low as comparable germanium Power Types.

Here's RCA's industrial and military to today's value and performance requirements for transistors. This broad new economy line of silicon types, 2N2338 and high performance line now includes three new and the 2N2270, B39, high and medium power types, respectively, diffused planar silicon economy version of the "Universal" triple-RCA's economy silicon transistor type 2N2102. With these additions,

- High dissipation offers:
- Top performance up to 150 watts
- Wide-range high temperatures... up to 200°C

These low-cost silicon types... up to 10 amps economy and greater design flexibility immediately available to bring you new demanding the reliability and performance of silicon transistors.

THROUGH YOUR RCA DISTRIBUTOR



THE MOST TR
Visit The RCA Exhibit **IN ELECTRONICS**

Booths 1043-1050

CIRCLE 902 READERS SERVICE CARD



New RCA 2N2270 Triple-Diffused Planar



New 150-watt RCA 2N2338



New 40-watt RCA 2N2339

For new low prices call your RCA representative today. For FREE Technical Bulletin on RCA's Economy Silicon Line, write RCA Semiconductor and Materials Division, Commercial Engineering, Section IN7-3, Somerville, N. J.

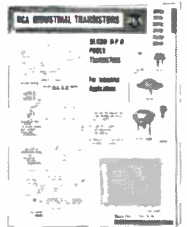

FIELD OFFICES...
 EAST: Newark, N. J., 744 Broad St., HU 5-3900 • (Camden-Philadelphia Area) Erlton, N. J., 605 Marlton Pike, HA 8-4802 • Syracuse, N. Y., 731 James St., Rm. 402, GR 4-5591 • Baltimore, Md., EN 9-1850 • NORTHEAST: Needham Heights 94, Mass., 64 "A" St., HI 4-7200 • SOUTHEAST: Orlando, Fla., 1520 Edgewater Dr., Suite #1, GA 4-4768 • EAST CENTRAL: Detroit 2, Mich., 714 New Center Bldg., TR 5-5600 • CENTRAL: Chicago, Ill., Suite 1154, Merchandise Mart Plaza, WH 4-2900 • Indianapolis 5, Ind., 2132 East 52nd St., CL 1-1405 • Minneapolis 16, Minn., 5805 Excelsior Blvd., WE 9-0676 • Denver 11, Colorado, Continental Terrace Bldg., Suite 301, 2785 N. Speer Blvd., RA 3-8361 • (San Francisco Area) Burlingame, Calif., 1838 El Camino Real, OX 7-1620 • Seattle 4, Wash., 2250 First Ave. S., MA 2-8816 • SOUTHWEST: Dallas 7, Texas, 7905 Carpenter Freeway, ME 1-9720 • GOVT: Dayton, Ohio, 224 N. Wilkinson St., BA 6-2366 • Washington, D. C., 1725 "K" St., N.W., FE 7-8500 • RCA INTERNATIONAL DIV., 30 Rockefeller Plaza, N. Y. 20, N. Y. Cable Address: RAD10INTER, N. Y.