

# electronics

**SPECIAL** *Survey of latest automatic checkout systems, how to design them and how to use them with military, industrial and aerospace equipment*

*NASA technicians check out first stainless-steel satellite*



R D SKINNER  
1020 COWINGTON RD  
LOS ALTOS CALIF  
C-3-3



**SMOOTH OUT**

**LINE-VOLTAGE VARIATIONS...**

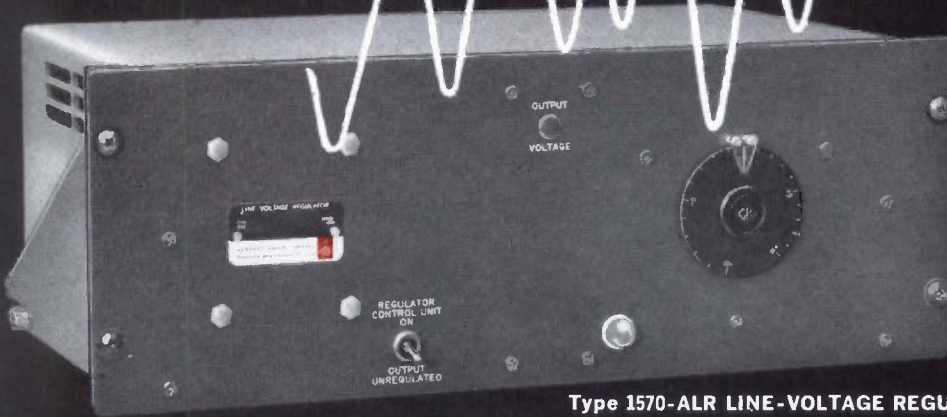
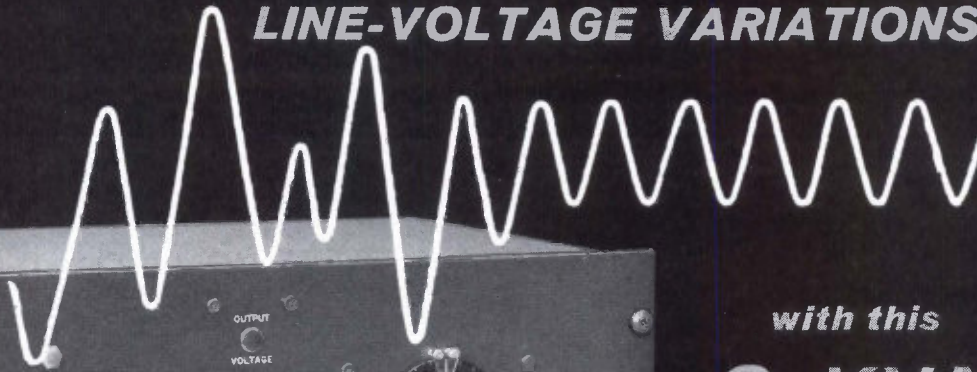

*with this*  
**6-KVA  
regulator**

**Type 1570-ALR LINE-VOLTAGE REGULATOR, 115v, 60 cps . . . \$530**

. . . a simple, reliable, proportional-control servomechanism. It has only three major elements . . . a motor-driven Variac® autotransformer, a "buck-or-boost" step-down transformer, and a control circuit to position the Variac autotransformer automatically. Its design simplicity assures long trouble-free service.

- ★ Capable of handling short-time overloads up to 500 amperes.
- ★ Holds line voltage constant to  $\pm 0.25\%$ .
- ★ Introduces *NO* waveform distortion.
- ★ Output voltage is independent of load.
- ★ Not restricted by the power factor of the load, nor does it affect the power factor of the system.
- ★ No relays to cause transient pulses or chattering.
- ★ Voltage control is smooth . . . no "on-off" action.
- ★ Fast response . . . 10 volts per second.
- ★ Can be connected to handle 10% or 20% line-voltage variations.
- ★ No "dead zones" . . . corrects over entire range.
- ★ Output voltage can be adjusted over a  $\pm 10\%$  range from nominal voltage.
- ★ Low cost per kva rating.
- ★ Units can be combined to regulate legs of poly-phase circuits independently.
- ★ Compact . . . 0.9 cubic-foot package.
- ★ High system efficiency of 98%.
- ★ Available in table, relay-rack, and wall models.
- ★ Negligible overshoot and hunting.
- ★ 6-kva rating at 40°C ambient temperature.
- ★ Motor-driven Variac autotransformer has ball-bearings throughout to reduce torque and friction.
- ★ Militarized models available as well as 230-volt and 50-cycles models.

*Write for Complete Information*

**GENERAL RADIO COMPANY**

WEST CONCORD, MASSACHUSETTS

NEW YORK, WOrth 4-2722  
District Office in Ridgfield, N. J.  
Whitney 3-3140

CHICAGO  
Oak Park  
Village 8-9400

PHILADELPHIA  
Abington  
HAncock 4-7419

WASHINGTON, D. C.  
Silver Spring  
JUUniper 5-1088

SYRACUSE  
Syracuse  
GLeview 4-9323

SAN FRANCISCO  
Los Altos  
WHitecliff 8-8233

LOS ANGELES  
Los Angeles  
HOLlywood 9-6201

ORLANDO, FLA.  
Orlando  
GArden 5-4671

IN CANADA  
Toronto  
CHerry 6-2171

CIRCLE 900 READERS SERVICE CARD

# electronics

A McGraw-Hill Publication 75 Cents



W. W. MacDONALD, Editor

J. M. CARROLL, Managing Editor  
 SENIOR EDITORS: Samuel Weber, George W. Sideris. SENIOR ASSOCIATE EDITOR: Michael F. Wolff. ASSOCIATE EDITORS: Michael F. Tomaino, Sylvester P. Carter, William P. O'Brien, John F. Mason, Thomas Emma, Sy Vogel, Leslie Solomon, George J. Flynn, Laurence D. Shergalis. ASSISTANT EDITORS: Nilo Lindgren, Stanley Froud, Stephen B. Gray, Roy J. Bruun, George V. Novotny, Leon H. Dulberger. REGIONAL EDITORS: Harold C. Hood (Pacific Coast, Los Angeles), Thomas Maguire (New England, Boston), Cletus M. Wiley (Midwest, Chicago). ART DIRECTOR: Harry Phillips; Howard R. Berry. PRODUCTION EDITOR: John C. Wright, Jr. EDITORIAL ASSISTANTS: Gloria J. Meurer, Bernice Duffy, Lorraine Rossi, Virginia T. Bastian, Lynn Emery, Bette H. Snyder, Rosemary Abbruzzese, Judy Haskins, Ann Mella, Lorraine Werner. FOREIGN NEWS BUREAU: Director, John Wilhelm, Alyne Elias. LONDON — John Shinn, Derek Barlow, Nicholas Landon. Bonn—Peter Forbath, Silke McQueen. Paris—Robert Farrell, Arthur Erikson. Milan—Marc A. Messina. Mexico City—Bruce Bendorf. Rio de Janeiro—Leslie Warren. Moscow — Stewart Ramsey. Tokyo — Richard Halloran, Charles Cohen, John Yamaguchi.

JAMES GIRWOOD, Publisher

**STEEL SATELLITE**—Technicians at NASA's Goddard Space Flight Center, Greenbelt, Md. check out unnamed project S-6 satellite. Its instrumentation will measure characteristics of the upper atmosphere such as ion density and chemical composition. *Budd Corp. of Philadelphia built the all stainless-steel vehicle*

COVER

**IRE + AIEE = IEEE**—Will the Merger Prosper? Success depends on quick solution to a number of problems. *Although there have been strongly differing opinions expressed as to ways and means, relatively few engineers question the overall logic of the merger*

20

**TELSTAR SATELLITE GETS LAST MINUTE MODIFICATION**. Bell Telephone Labs' engineers replaced three antennas with one compact, stationary antenna. *Ground stations in U.S. and England are ready for long series of planned tests*

28

**NEW APPLICATIONS FOR MILITARY COMPUTERS** received emphasis at the Sixth National MIL-E-Con in Washington. Operational model using thin-film memory executes the pre-flight and inflight programs on guidance techniques. *Panel discussion on nonprofit corporations agreed on need for their existence but specified limitations*

30

**PHOTO RECONNAISSANCE SYSTEM** for high speed aircraft. Automatic recording of position and heading is made directly on film's edge for each exposed frame. *Picture-taking exposure control compensates for three possible lighting conditions.*

32

**AUTOMATIC CHECKOUT EQUIPMENT** for Today's Complex Systems. Here is information you can put to work for you:

- How to test complex electronic equipment
- Designing checkout systems
- Making checkout equipment adaptable
- New trends in automatic checkout

*This equipment resolves the dilemma of what to do when testing time exceeds planned meantime between failures.*

By George V. Novotny 37

**FIRST DESIGN DETAILS:** The Paramp that Tracked a Space Probe 70,000 Miles. Negative-resistance parametric amplifier uses three separately tuned cavities closely coupled at the varactor diode. *Design affords rapid tuning over a broad range with low noise.*

By A. P. Heyman, General Electric 45

**NEW WAY TO MULTIPLY Q** With Transistors. Emitter follower and grounded-base amplifier with feedback make a negative impedance converter. *It achieves high Q in audio tuned circuits.*

By T. Ormond, Sylvania 48

Published weekly, with Electronics Buyers' Guide and Reference Issue, as part of the subscription, by McGraw-Hill Publishing Company, Inc. Founder: James H. McGraw (1860-1948).

Indexed Annually in Buyers' Guide and Reference issue.

Title ® registered U.S. Patent Office; © copyright 1962 by McGraw-Hill Publishing Co., Inc. All rights reserved, including the right to reproduce the contents of this publication, in whole or in part.

Executive, editorial, circulation and advertising offices McGraw-Hill Building, 330 West 42nd Street, New York 36, N. Y. Telephone Longacre 4-3000. Teletype TWX N.Y. 1-1636. Cable McGrawhill, N. Y. PRINTED IN ALBANY, N. Y.; second class postage paid at Albany, N. Y.

OFFICERS OF THE PUBLICATIONS DIVISION: Nelson L. Bond, President; Shelton Fisher, Wallace F. Traendly, Senior Vice Presidents; John R. Callahan, Vice President and Editorial Director; Joseph H. Allen, Vice President and Director of Advertising Sales; A. R. Venezian, Vice President and Circulation Coordinator; Daniel F. Crowley, Vice President and Controller.

OFFICERS OF THE CORPORATION: Donald C. McGraw, President; Hugh J. Kelly, Harry L. Waddell, Executive Vice Presidents; L. Keith Goodrich, Executive Vice President and Treasurer; John J. Cooke, Vice President and Secretary.

Subscriptions are solicited only from those actively engaged in the field of the publication. Position and company connection must be indicated on orders. Subscription rates: United States and Possessions, \$6.00 one year; \$9.00 two years; \$12.00 three years. Canada, \$10.00 one year. All other countries \$20.00 one year. Single Copies, United States and Possessions and Canada 75¢. Single copies all other countries \$1.50.

THE PUBLISHER, UPON WRITTEN REQUEST FROM ANY SUBSCRIBER TO OUR NEW YORK OFFICE, AGREES TO REFUND THAT PART OF THE SUBSCRIPTION PRICE APPLYING TO COPIES NOT YET MAILED.

Subscribers: Please address all correspondence, change of address notices, subscription orders or complaints to Fulfillment Manager, Electronics, at above address. Change of address notices should provide old as well as new address, including postal zone number if any. If possible, attach address label from recent issue. Allow one month for change to become effective.

Postmaster: Please send Form 3579 to Fulfillment Manager, Electronics, 330 West 42nd Street, New York 36, New York.



Audited Paid Circulation

CONTENTS continued

STEERING RADAR ANTENNA BEAMS With Lossless R-F Matrix. New radar systems achieve rapid scanning by a phased antenna array that uses electronic beam forming and scanning. This system uses an r-f beam-forming matrix and does away with need for coherent mixers and amplifiers between antenna and beam former. By W. P. Delaney, Lincoln Laboratory 50
INEXPENSIVE CONVERTER Gives 5,000 Volts D-C. Circuit consists of sinusoidal oscillator and a voltage-doubler rectifier circuit. It is 2 1/2 inches high by 1 1/2 inches square and delivers 50 microamperes. By R. D. Morrow, Morrow Products 54

DEPARTMENTS

Crosstalk. IEEE: Now Let's Get to Work 3
Comment. R&D and Profit 4
Electronics Newsletter. NATO to Get Air Defense Net 8
Washington Outlook. Trade Bill Gets Bi-Partisan Support 14
Meetings Ahead. Electromagnetic Compatibility Conference 34
Research and Development. Do Field-Effect Transistors Resist Nuclear Radiation? 56
Components and Materials. New Magnetic Rods Simplify Circuits 62
Production Techniques. Making New Production Ideas Work 70
New Products Design and Application. Oscillation Ages Less than 2 Parts in 10^9 76
Literature of the Week 90
New Books. The Encyclopedia of Electronics 92
People and Plants. Wilson: Take the Initiative 96
Index to Advertisers 107

## IEEE: Now Let's Get to Work

THE VOTES are in and counted. And by a substantial majority the members of the Institute of Radio Engineers and the American Institute of Electrical Engineers have agreed to merge. So, whether you call the new body the IEEE, the I-triple-E or just IE<sup>3</sup>, the Institute of Electrical and Electronic Engineers, more than 160,000 strong, will come into being January 1, 1963.

Some of us had misgivings about the merger. These misgivings were not over the desirability of achieving unity within our profession. They were, rather, over many unanswered questions about the detailed operations of the combined society.

We who voted for the merger in many cases did so in spite of doubts. In effect, we gave the officers of IRE and AIEE and the committee members who put the merger together a blank check on faith because we felt the advantages of the combined society would outweigh its disadvantages. In many cases, members voted affirmatively in spite of uncertainty concerning the constitution and the articles of consolidation and equivocal statements of society officers, not because of them.

Now that the merger is a fact it is up to the officers and members of the IEEE to make the new institute really work. It should combine the best features of both the IRE and AIEE.

Let's look at some of the objections and questions raised during merger talks:

- Some AIEE members said the new society would be less democratic than the AIEE. The AIEE has a nominating committee that represents both incumbent national officers and professional and regional interests. In the new society, the nominating committee is the incumbent Board of Directors itself. It could become self-perpetuating. However, if the board is unresponsive to legitimate interests of groups or individuals, or acts in an arbitrary or inequitable fashion, the constitution can be amended to curb the board's powers and change its manner of nomination. Amendment can be proposed by petition of 500 members, and achieved by two-thirds vote among the membership; twenty percent or more of all members must cast ballots.

- The first IEEE Board of Directors will have to make many important decisions. Membership requirements must be spelled out in detail.

And here a firm line must be drawn between professional qualifications and society size. Will IEEE membership be meaningful, or will we take everybody with a few dollars in his jeans and a hankering to wear our membership insignia?

- The existing IRE Professional Groups and AIEE Technical Groups must be realigned into IEEE Professional Technical Groups. The ground rules say that groups with conflicting interests must consolidate or redefine their fields of interest. It will take infinite wisdom to accomplish this without alienating many sincere and dedicated individuals.

- Merger papers say that IRE and AIEE sections may delay consolidation where two sections exist in one overlapping area. But how long may they delay? Might we not have, in fact, a single institute that is really a federal union of two institutes if consolidation drags on indefinitely? There has to be some time limit, however generous.

- There has been no decision on what to do about the institute's publications. It is generally believed that the *Proceedings of the IEEE* will be a vehicle for publication of original work of broad significance. The *Transactions* of the various PTGs will provide for publication of important work of narrower interest. What happens to *Electrical Engineering*? Is it needed at all?

- Last, but far from least, there is the matter of engineering standards for definitions, measurements, terminology and symbology. To some engineers this is a key activity of the institute. The merger documents are uniformly silent on this important issue.

The IEEE ballots are in and the word is out. The largest professional engineering society in the world is on its way. But the work for officers and members alike has just begun.

### Coming In Our July 20 Issue

MICROWAVE PHOTOTUBE. R. G. E. Hutter of Sylvania describes how these tubes detect microwave modulation and mix modulated with unmodulated laser beams to make possible superhet optical receivers.

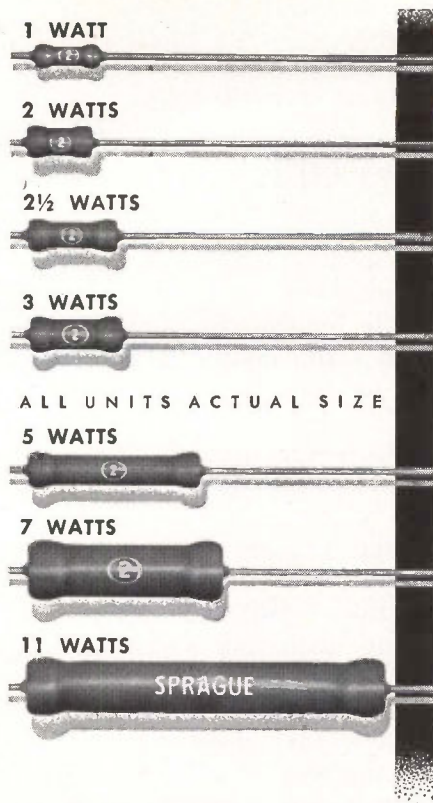

## NEXT TIME ... USE TINY Blue Jacket® WIREWOUND RESISTORS

*Sprague builds reliability... efficiency... economy right into minified Blue Jackets with these important features:*

- \* All-welded end-cap construction with special vitreous-enamel coating for total protection against humidity, mechanical damage, heat, corrosion gives long-term dependability under severe environmental conditions
- \* Available in resistance tolerances as close as  $\pm 1\%$
- \* Low in cost... quick and easy to install

Tiny axial-lead Blue Jackets are specially designed for use with conventional wiring or on printed boards in miniature electronic assemblies. Write for complete technical data in Sprague Engineering Bulletin 7410B.

**SPRAGUE ELECTRIC COMPANY**  
35 Marshall Street, North Adams, Mass.



## COMMENT

### Complex-Dielectric Capacitors

On page 66 of the May 11 issue of ELECTRONICS, which contained the story round-up on Modern Electronic Components, there appears a statement by Mr. J. F. Ferrante, Vice President and Research Director of Cornell-Dubilier Electronics that "A forthcoming capacitor development will employ Mylar and polystyrene film that will feature a T-C curve that is virtually horizontal.

We would appreciate it if you would call to the attention of your readers that capacitors employing a complex dielectric consisting of polyethylene terephthalate (Mylar) and polystyrene are not a new development. These capacitors were invented by Dr. Preston Robinson, Director and Consultant to the Sprague Electric Company, and Mr. David B. Peck, now Vice President and Manager, Special Products Division.

Our patent application was filed on October 22, 1952, and U. S. Letters Patent 2,749,490 were granted on June 5, 1956.

Capacitors employing this complex dielectric and having a virtually horizontal T-C curve have been commercially marketed by Sprague under the trademarks Isifarad and Filmite 'F' as plastic-encased and metal-clad capacitors, respectively.

SIDNEY L. CHERTOK

Sprague Electric Company  
North Adams, Massachusetts

### R & D and Profit

I have been a reader of ELECTRONICS for a considerable number of years. I saw my first copy in the early 1930's and have subscribed over a substantial number of years. I've seen the magazine change from a thin pioneer to a commanding position as a monthly record of the practical and useful, and to its current weekly format. It is in this context that I find myself greatly encouraged by your editorial [on R & D and profit]. The Dangerous Years, in your issue of June 1 (p 122).

There are two sources of en-

couragement; by your editorial you have taken a step toward establishing ELECTRONICS as a stronger, clearer voice in a growing industry that very desperately needs help and guidance. Your magazine and the industry will profit from a continuing editorial policy that permits further study and discussion of industry problems. Also the actual content of this one editorial has been seeking a voice for some time. Congratulations.

There are several basic problems which you suggest. The progress that is needed to obtain understanding of business by the Government is excellently stated in your editorial. We seem (possibly as a short-sighted expedient policy) to be developing a government philosophy which is forgetting the basics of the American system that has proved so fabulously successful in the past. These basics are simple. By making a contribution, by providing something new and useful, we earn a profit *commensurate* with the contribution, a profit which can then be freely used to take further risks to provide additional new and useful products and services. What we pay in future years for today's expediency may well dwarf the apparent cost of current profits.

I'd like to suggest another industry problem for your consideration. For a number of years, we've been concerned by the qualitative and quantitative inadequacy of our technical talent. Great effort has been made to increase the number of engineering graduates. The fact that business came so easily and failure was relatively hard to achieve, has made us overlook the weakness that fast growth and easy times have developed in our management ranks.

This is such a critical problem that it may be more serious than our shortage of technical talent. For this reason it may well be better for the technical schools to drop some of their technical instruction in favor of instruction in business fundamentals. At least the students might then be self-sufficient to the point of needing less supervision.

F. G. MARBLE

Systron-Donner Corporation  
Concord, California

# FOR YOUR MICROWAVE APPLICATIONS SPECIFY ARNOLD C-TYPE MAGNETS

Arnold C-type Alnico Magnets are available in a wide selection of gap densities ranging from 1,000 to over 7,500 gauss. There are six different basic configurations with a wide range of stock sizes in each group.

The over-all size and gap density requirements of many prototype designs can be met with stock sizes of Arnold C Magnets on an immediate-shipment basis, or readily supplied in production quantities to meet your requirements.

When used in transverse field isolators, Arnold C Magnets supply the magnetizing field to bias the ferrite into

the region of resonance, thus preventing interaction between microwave networks and isolating the receiver from the transmitter. These magnets are also used in differential phase shifters and duplexers, and Arnold is ready to design and supply tubular magnets to provide axial fields in circular wave guides.

A feature of all Arnold C Magnets is the excellent field uniformity along the length of the magnet. Versatility in design may be realized by using multiple lengths of the same size magnet stacked to accomplish the needs of your magnetic structure.

Let us work with you on any requirement for permanent magnets, including high coercive force Alnico VIII for TWT focusing applications. ● For information on Arnold C Magnets, write for Bulletin PM-115. For data on Alnico VIII, ask for Bulletin PM-119. Address *The Arnold Engineering Company, Marengo, Illinois.*

ADDRESS DEPT. E-7



**ARNOLD**  
SPECIALISTS in MAGNETIC MATERIALS

BRANCH OFFICES and DISTRIBUTORS in PRINCIPAL CITIES  
Find them FAST in the YELLOW PAGES

11-4320

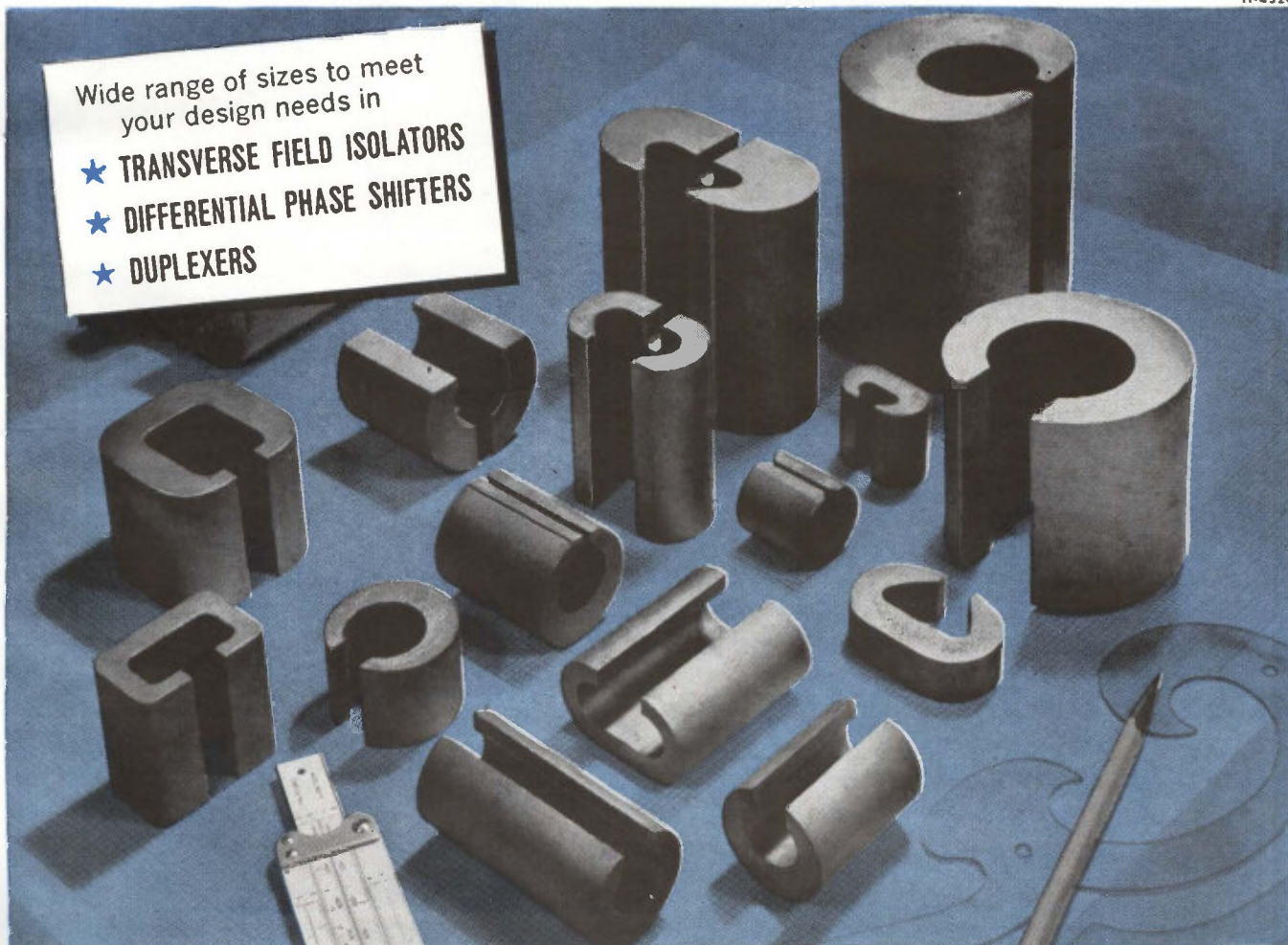

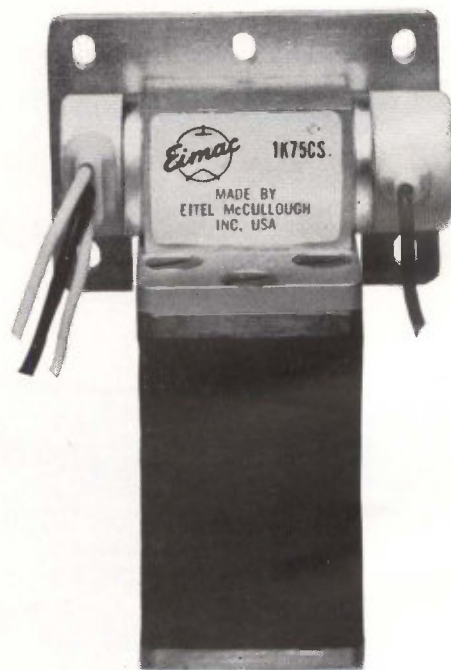
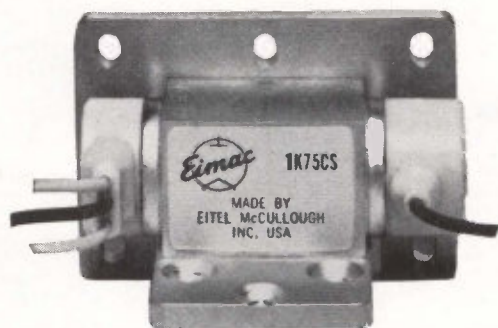

**Isolator + Klystron = Iso-Klystron**

Announcing an innovation from Eimac: the Iso-Klystron. A superior reflex klystron matched with ferrite isolator — in a unified package of optimum design. Time saved, performance improved. Three Eimac Iso-Klystrons are now available: X-band 1K20 series, C-band X-1079, fixed frequency C-band 1K75CS. And four more are on the way. Another example of how Eimac meets tomorrow's tube needs today. Another reason to keep your eye on Eimac — for advanced microwave tubes, high power klystrons, power grid tubes, accessories. Eitel-McCullough, Inc., San Carlos, California. Subsidiaries: Eitel-McCullough, S.A., Geneva, Switzerland; Nat'l Electronics, Geneva, Ill. **KEEP YOUR EYE ON**





# ELECTRONICS NEWSLETTER

## NATO Air Defense Market To Be Competitive

ADMINISTRATIVE ORGANIZATION for creating an air defense system for the NATO countries of Europe will be set up in Paris early next month and functioning by mid-September. Initiated by the Defense Department's Office of Research and Engineering, with consulting support by the non-profit Mitre Corp., the NATO group will be called the Systems Engineering Management Organization (SEMO).

Parallel with SEMO will be a team of national experts to assist SEMO in preparing specifications for the equipment to be bought. For this group, Mitre will provide the leadership and about five technical staff members. Industry will lend about ten technical men to Mitre for the duration, probably one year.

How elaborate the air defense system will be, how much gear will be bought from the U.S. and how much from Europe, remains to be seen. At best, competition will be tight.

## Where Bulk of NASA's 1963 Money Will Go

WASHINGTON—Largest layout in NASA's 1963 spending will go for Advanced Manned Space Flight—\$863,628,000. For the manned 1-day missions—\$12.2 million; Gemini—\$203.2 million; and Apollo—\$617.2 million. All this is over and above the \$13.3 million slated for Mercury in 1963.

Lunar and planetary exploration will get \$263,560,000—almost \$100 million more than was budgeted for this program in 1962. For the lunar flight program alone, Ranger will get \$44 million; Surveyor, \$97.3 million and Prospector, \$400,000. For the planetary and interplanetary flight program: Mariner R, \$9.2 million; Mariner B, \$73.7 million; and Voyager, \$6.8 million.

Scientific satellites will cost \$175.1 million, with orbiting observatories getting the larger portion—geophysical, astronomical and solar. The sounding rocket program will expand to a \$19 million effort. NASA will buy approximately 160 sounding rocket vehicles.

Slated for tracking and data ac-

quisition—\$158.4 million; nuclear systems technology—\$122.9 million; advanced Saturn—\$335.1 million; Saturn C—\$249.2 million; and Nova—\$163.5 million.

## Infrared Generating Diode Developed at MIT

BEDFORD, MASS.—A gallium arsenide diode has been developed at Lincoln Laboratory that generates modulated ir light with an intensity of 2,500 watts per sq cm.

The diode does not produce coherent radiation, but is said to provide a combination of high power, narrow spectral bandwidth and high speed reaction to input. It may be a candidate for some communications applications proposed for the optical maser.

When operated at liquid nitrogen temperatures, electrical input is converted into ir light in a band only 100 angstroms wide, centered at 8,600 angstroms. In tests a peak ir power of 3 watts has been achieved. Larger diodes are expected to yield peak outputs of 15 Kw.

The diode is fabricated from N-type single-crystal Ga-As diffused

with P-type zinc. For optimum efficiency, the diodes are operated at liquid nitrogen temperature. At room temperature, a light spectrum of about 300 angstroms wide, centered at 9,300 Mc is produced.

## World's Fastest Computer Is Ordered by AEC

WASHINGTON — An electronic computer of unprecedented speed is to be developed for one of the Atomic Energy Commission's key weapons labs by Control Data Corp., Minneapolis. The \$5,574,000 contract calls for a computer system faster than any existing machine to be installed at Lawrence Radiation Laboratory, Livermore, Calif., for testing by Feb. 29, 1964.

The system, known as the 6600, consists of a single central processor with a high-speed arithmetic and logical unit, a central memory of 61,440 words, peripheral memory processors, associated consoles and input-output equipment.

## Senate Committee Gives NASA More Than House

WASHINGTON—The Senate Committee on Aeronautical and Space Sciences restored all but \$10 million of the \$33.3 million the House cut off the National Aeronautics and Space Administration's budget request for research, development and operation for fiscal year 1963. The \$10 million reduction had been money slated for the Prospector program, the advanced mobile unmanned vehicle to land on the

## Can The Electronic Lock Be Picked?

WASHINGTON—President Kennedy's request to Congress for \$23.3 million for the Atomic Energy Commission for production of an electronic lock to reinforce safeguards against accidental or unauthorized firing of nuclear weapons raises a number of questions.

If the device is "an electro-mechanical system controlled by a radio signal to be sent from a command headquarters remote from the actual missile site" (as it was described by the Associated Press), how can efficient radio communications be assured to unlock the weapons should they be needed? What is to prevent jamming, or deliberate, unauthorized unlocking? Will SAC's nuclear bombs be locked? No one was answering these questions when Electronics went to press.

Moon. The Senate authorized \$400,000 for continuation of in House studies on the project. Total Senate committee authorization for R&D and operations (which means "salaries and expenses") is \$2,958,278,000.

The Senate committee also restored some of the money the House had knocked off NASA's request for construction of facilities. The House had cut off \$82.7 million. The Senate committee reduced NASA's request by approximately \$60 million. Total now authorized is \$791,237,250. NASA also gets new 1962 money: \$55 million for land acquisition at Canaveral and \$16 million at the Mississippi Test Facility.

### Soviets Say Cosmos VI Continues Space Research

MOSCOW—The Soviet Union's sixth Cosmos scientific satellite, launched June 30, is rounding the earth every 90.6 minutes, inclined 49 deg to the equator, according to Soviet news agency Tass.

Apogee is reported at 360 km, perigee at 274 km. Besides its payload for "space research" the satellite is said to carry a multichannel transmitter for telemetry, radio devices for trajectory measurements, and a transmitter operating at 90.0233 Mc.

### FAA Symposium Hears Air-Collision Avoidance Plan

WASHINGTON—Air-collision avoidance technique outlined yesterday by National Co. at the FAA-sponsored symposium provides a new way to utilize altitude, minimum range and estimated time to collision—criteria that heretofore have not been considered practical due to the large airborne computer required.

National's approach reduces the demands on the computer, and therefore the computer's size. The technique measures the altitude in each aircraft with an aneroid barometer, periodically transmitting this information to all other planes. The range and range rate are measured by one-way radio transmissions from each plane, transmitted at a time precisely known to all

other aircraft. Time of arrival of the signals at each aircraft is then converted to range. Precise timing is achieved by use of precise synchronized clocks.

FAA has given National a nine-month feasibility contract.

### FCC Homing In On All Channel Tv Specs

WASHINGTON—Federal Communications Commission chief, Newton Minow, has asked the Electronic Industries Association to propose a deadline for prohibiting interstate shipment for sale or resale to the public of tv sets "not capable adequately of receiving uhf signals." Minow also asked EIA to outline performance capabilities to insure the set is capable of handling uhf.

In compliance with Minow's request, EIA has invited tv set and tube manufacturers to attend a meeting in New York on Aug. 7. Chief engineers are being asked to comment particularly on noise figures and sensitivity, and to base their discussions on the present level of technology rather than on anticipated future performance.

### New Gear for Missile Ranges on Land and Ship

SECOND GENERATION missile tracking radar is now operational at the Atlantic Missile Range station at Antigua Island. Designated AN/TPQ-18, the radar is the transportable version of the C-band, monopulse AN/FPQ-6 (ELECTRONICS, p 26, dec. 15, 1961). The system's 29-ft dish is capable of tracking at lunar distances; can give unambiguous range readings of a beacon-carrying spacecraft at 32,000 mi. Two additional FPQ-6 installations will be checked out at AMR this fall. RCA built the new radar as well as the FPS-16, out of which it evolved.

For a new Pacific Missile Range ship, the electronics system will be designed, supplied, installed and checked out for performance by RCA under a slightly-less-than \$2 million subcontract with Boland Machine and Manufacturing Co. who is converting the World War II Victory ship. A modified FPS-16 radar will be used.

## In Brief...

MYSTERIOUS RESUMPTION of continuous transmission from NASA's Orbiting Solar Observatory after it developed a malfunction due to excessive spin rate on May 22 and transmitted only intermittently thereafter may be due to two things, NASA says: the spin rate was slowed back down due to either bearing friction within the turning wheel or the position of the satellite in respect to the earth's magnetic field.

MOTOROLA will develop and fabricate the ground-to-air uhf voice communications equipment (AN/TRC-87) for the 412L Air Weapons Control System.

NASA will soon open a Northeastern Operations Office in the Boston area to conduct technical and administrative liaison with contractors in the area. In the last ten months, NASA has awarded \$15 million worth of contracts in New England.

RCA will build a Mobile Random Access Fielddata Computer System for the Army Electronic Proving Ground, Ft. Huachuca, Ariz. under a \$2 million contract.

BURROUGHS CORP. will produce Back Up Interceptor Control—BUIC—systems for USAF under \$8 million contract. Main components of the radar course directing gear are electronic computers and display equipment. BUIC is a backup for Sage.

JAPANESE GOVERNMENT has approved a joint venture between Komatsu Works, a leading heavy machinery manufacturer, and Hoffman Electronics of Los Angeles, with capitalization of \$½ million to manufacture silicon diodes, solar batteries, and semiconductors that are not being currently produced in Japan.

NIPPON MUSEN of Japan has sold weather radar to Pakistan to be delivered next June. More Southeast Asian countries are expected to follow suit in ordering weather radar from Japan.

# PRODUCED...PACKAGED...AND READY TO USE



**USA 1N2970B  
THRU  
USA 1N3004B  
10 WATT ZENER  
REGULATORS**



We've got 'em and we're shipping 'em—6.8 thru 91 volts—also available with reverse polarity at no extra charge.

These mil-type devices are part of a complete line of 10 Watt Zener Regulators, including standard 5%, 10% and 20% tolerances, with voltage ratings from 6.8 thru 200V. All are packaged in our exclusive environment-proof "bubble pack," another Hoffman quality assurance.

**Hoffman** / **ELECTRONICS CORPORATION**  
Semiconductor Division

4501 N. Arden Dr., El Monte, Calif. • Cumberbund 3-7191 • TWX: El Monte 9735

CIRCLE 9 ON READER SERVICE CARD

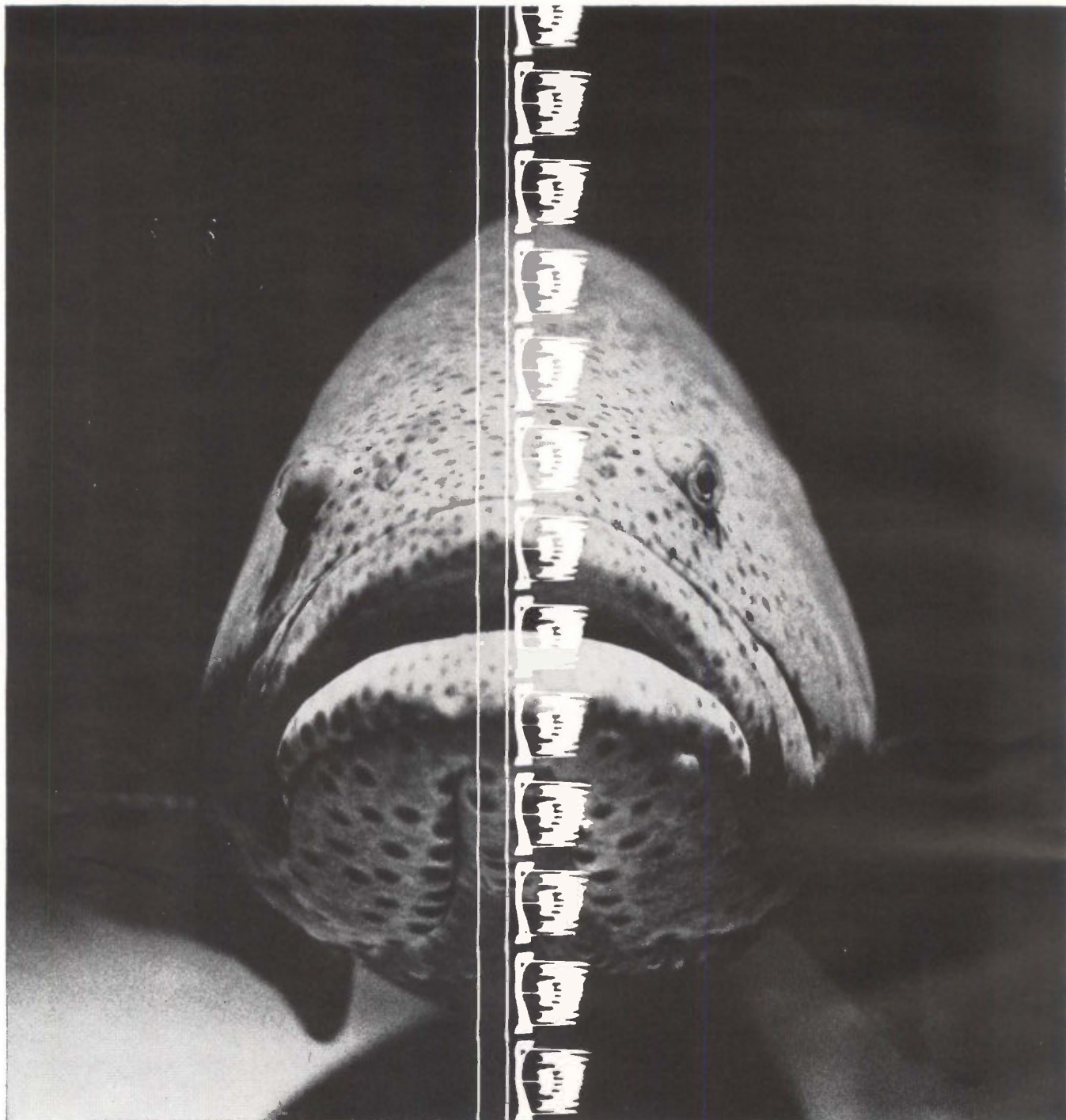

What data recorder can take pictures under the sea?

**AMPEX AR-300.**

So small it can fit into the hatch of a submarine. So advanced it can capture visual images, digital data, analog data, sound waves—all at the same time. That's the Ampex AR-300. It records from 10 cycles to 4 megacycles—a wideband performance matched by no other recorder. It goes down to the sea or up into the sky. (Needs only 3½ cubic feet of space.) Together with the FR-700 laboratory recorder/reproducer, the AR-300 pro-



vides a remarkable recording system for many uses: laboratory experimentation, predetection, radar tracking, oceanography, any wideband application of today—and tomorrow. For more information on the FR-700/AR-300 write the only company providing recorders and tape for every application: Ampex Corporation, 934 Charter Street, Redwood City, California. Sales and service engineers in major cities throughout the world.

New from Bendix

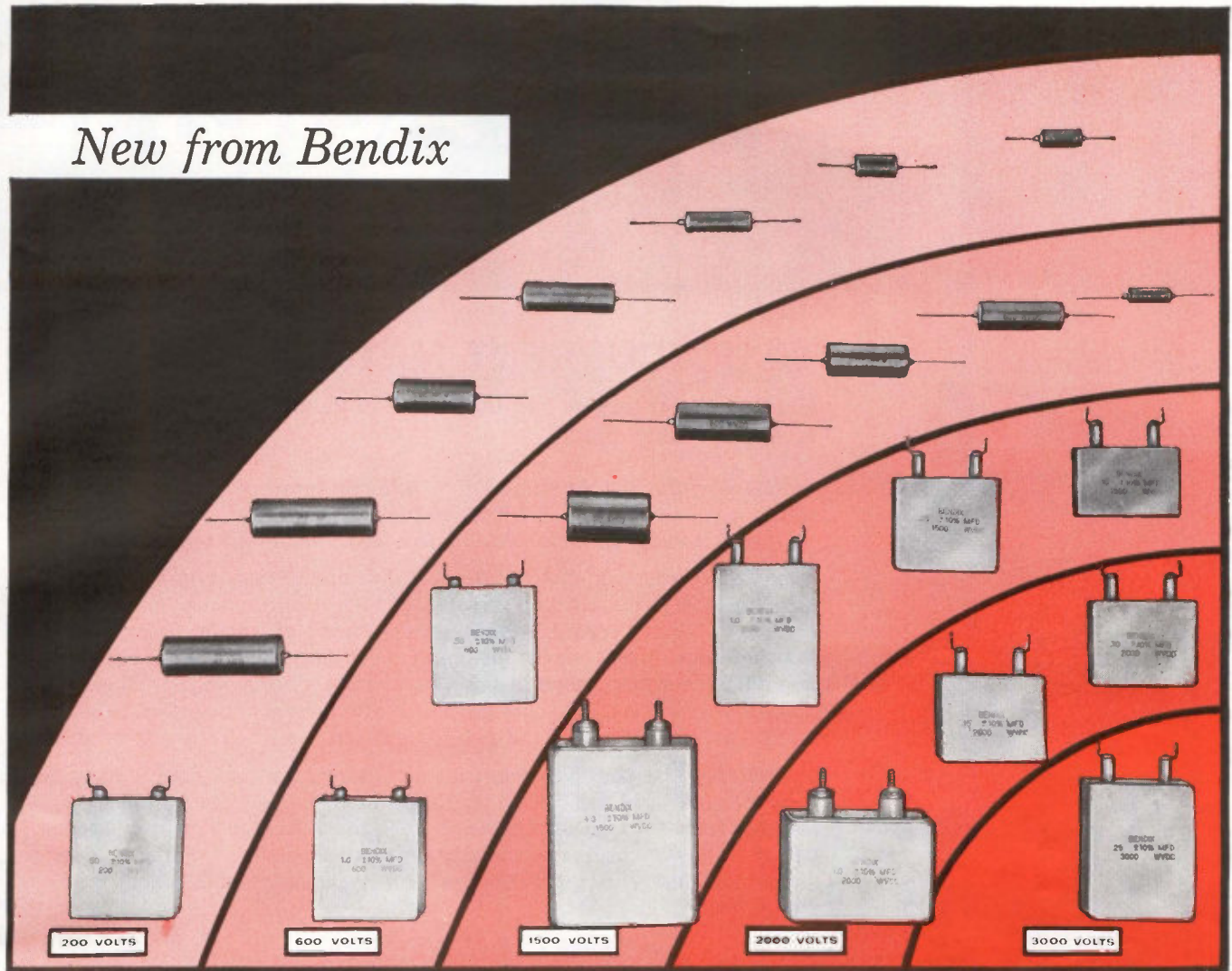

## E-200 HIGH TEMPERATURE CAPACITORS

### Operable to +200°C.

The Bendix® E-200 series of lightweight, small size capacitors is designed for installations requiring a high degree of component reliability at operating temperatures as high as 200°C.

High temperature capability and mica-like electrical characteristics enable the E-200 series to withstand extremely high orders of AC in small envelope size at all ambients under 200°C.

The new series is designed and manufactured

to a Bendix specification which is patterned after the high reliability specification MIL-C-14157B, proposed.

Hermetically sealed in tubular or rectangular housings, these capacitors offer superior resistance to mechanical and climatic environments.

**E-200 CHARACTERISTICS:** • Wound mica papers • Solid impregnants • Exceptional stability • High insulation resistance • Radiation resistance • Outstanding dependability

For full details, write Scintilla Division, Sidney, New York

Scintilla Division



Canadian Affiliate: Aviation Electric, Ltd., 200 Laurentien Blvd., Montreal 9, Quebec. Export Sales & Service: Bendix International, 205 E. 42nd St., New York 17, N. Y.

# DC

# MEASURE

## Without Breaking Leads

### hp DC CURRENT METERS

Measure and record dc current, 0.1 ma to 10 amps without breaking leads or loading circuit

hp 428A/B current meters make fast, accurate measurements in circuits where conventional current-measuring devices would alter conditions to such an extent that the desired measurement would no longer be accurate!

In any application, hp 428A/B current meters are without equal for ease and speed of operation. Just clip the jaws of the probe around a bare or insulated wire and read dc—even in the presence of equally strong ac on the same wire. These current meters are also valuable for measuring sums and differences of currents in separate wires. When the probe is clipped around two wires carrying current in the same direction, their sum is indicated on the meter; when one of the wires is reversed, their difference is measured.

Models 428A and 428B are almost identical except for their current measurement range. hp 428B has three more ranges than hp 428A to give it full scale readings from 1 ma to 10 amperes. hp 428B also has a recorder/oscilloscope output, dc to 400 cps, to make it easy to record dc levels as well as analyze ground bus, hum and ripple currents on an oscilloscope—all without circuit loading.

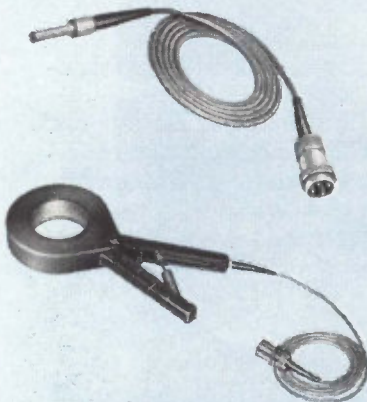

### SPECIFICATIONS

|                               |   |
|-------------------------------|---|
| <b>Current range:</b>         | hp 428A, 3 ma to 1 amp full scale in 6 ranges<br>hp 428B, 1 ma to 10 amp full scale in 9 ranges   |
| <b>Accuracy:</b>              | $\pm 3\%$ , $\pm 0.1$ ma  |
| <b>Probe inductance:</b>      | Less than 0.5 $\mu$ h introduced into measured circuit  |
| <b>Probe induced voltage:</b> | Less than 15 mv into measured circuit   |
| <b>AC rejection:</b>          | AC with peak value less than full scale affects meter accuracy less than 2% at frequencies above 5 cps and different from the carrier (40 KC) and its harmonics. (On 428B 10 amperes range, ac is limited to 4 amperes peak.) |
| <b>Output:</b>                | hp 428B approximately 1.5 volts and 1 ma max. for full scale  |
| <b>Probe insulation:</b>      | 300 v maximum   |
| <b>Probe tip:</b>             | 1/2" x 9/32". Aperture diam. 3/16"  |
| <b>Size:</b>                  | Cabinet, 7 1/2" x 11 1/2" x 14 1/4"; rack mount, 19" x 7" x 13" behind panel  |
| <b>Weight:</b>                | Cabinet, 19 lbs.; rack mount, 24 lbs.   |
| <b>Price:</b>                 | hp 428A, \$500.00 (cabinet); hp 428AR, \$505.00 (rack mount)<br>hp 428B, \$600.00 (cabinet); hp 428BR, \$605.00 (rack mount)  |

### Accessory Probes for the hp 428A/B DC Current Meters

New hp 3529A Magnetometer Probe—Useful anywhere magnetism is found and an accurate measurement of the magnetic field strength is desired: i.e. orientation of components for minimum magnetic interaction. Features direct conversion of milligauss to milliamps, so that hp 428 meters read magnetic field directly. Accuracy 3%  $\pm 0.1$  milligauss. Accuracy also depends on calibrating the probe with the specific 428 meter being used. \$75.00.

New hp 3528A Clip-On DC Current Probe—2 5/8" aperture for large conductors: wires, pipes, multi-conductor cables (including lead-sheathed), ground straps, waveguide testing, waveguide circulating dc current testing. Accuracy obtainable equal to that of hp 428 meters. \$350.00.

7755R

# CURRENT

## Without Loading Circuit

# AC

### **hp** 456A AC CURRENT PROBE

Converts ac current to ac voltage directly! 1 amp = 1 volt for reading on your scope or voltmeter

Measure ac current with an ac voltmeter with the **hp** 456A AC Current Probe. Useful in observing current waveforms with an oscilloscope or measuring signal current in vacuum tubes or transistors. May also be used with electronic counters to measure frequency.

Just clamp the **hp** 456A probe around the wire under test and view or read ac current directly on your scope or voltmeter. Model 456A's 1 ma to 1 mv unity conversion permits direct readings up to 1 ampere rms. No direct circuit connection is required; there is no loading, no appreciable impedance change in the circuit under test, and the impedance of the test circuit is immaterial.

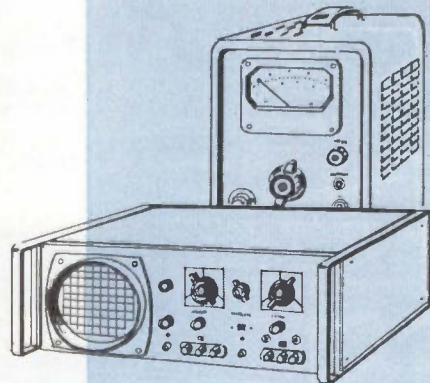
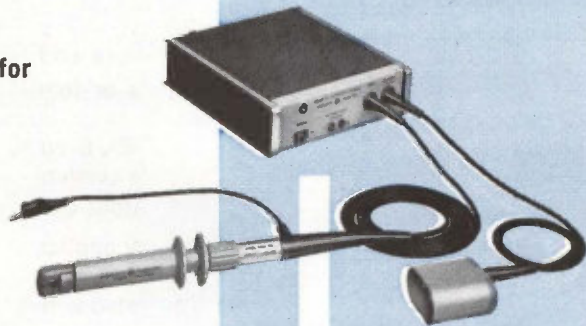

### SPECIFICATIONS

|                            |  |
|----------------------------|--|
| <b>Sensitivity:</b>        | 1 mv/ma $\pm 1\%$ at 1 KC  |
| <b>Frequency response:</b> | $\pm 2\%$ , 100 cps to 3 MC<br>$\pm 5\%$ , 60 cps to 4 MC<br>-3 db at 25 cps and greater than 20 MC                            |
| <b>Maximum input:</b>      | 1 amp rms; 1.5 amp peak. 100 ma above 5 MC   |
| <b>Maximum dc current:</b> | DC up to 0.5 amp has no appreciable effect   |
| <b>Input impedance:</b>    | Probe adds to test circuit only approx. 0.05 ohms in series with 0.05 $\mu$ h  |
| <b>Power:</b>              | Two Mallory Battery Co. TR 233R and one TR 234 batteries. Life approximately 400 hours. AC power supply optional at extra cost |
| <b>Size:</b>               | 5" wide, 6" deep, 1 1/2" high  |
| <b>Price:</b>              | <b>hp</b> 456A with batteries, \$190.00; with ac supply installed, \$210.00; ac supply for field installation, \$40.00         |

### **hp** AC-21F CURRENT PROBE

**hp** AC-21F probe with 100-ohm terminations permits measurement and observation of ac currents on your scope or voltmeter without breaking circuit or inserting a resistor. The probe clamps around the wire and forms a transformer with a single-turn primary. Output is 1 mv per ma. Maximum current is 10 amps above 20 KC. Below 20 KC current capacity is reduced proportional to frequency and is 1 amp at 2 KC. DC current up to 0.5 amp has no appreciable effect on probe's operation. \$100.00.

Two 100-ohm terminations are available for use with **hp** AC-21F Current Probe: **hp** AC-67B Feed-Through Termination, 2,500 cps to 30 MC bandpass, \$17.50; **hp** AC-67C Compensated Termination, 1,400 cps to 30 MC bandpass, \$30.00.

Data subject to change. Prices f.o.b. factory.



## HEWLETT-PACKARD COMPANY

1501 Page Mill Road, Palo Alto, California, Area Code 415, DA 6-7000  
Sales and service representatives in all principal areas;  
Europe, Hewlett-Packard S.A., 54-54bis Route des Acacias, Geneva;  
Canada, Hewlett-Packard (Canada) Ltd., 8270 Mayrand Street, Montreal 7755

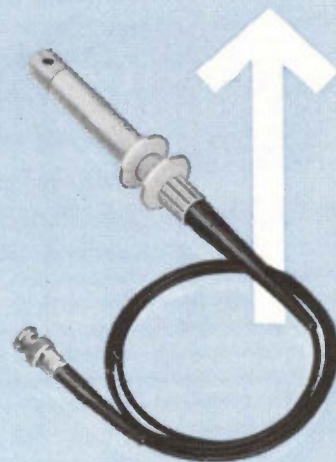

# WASHINGTON OUTLOOK

## FCC SAYS PROMOTE ALL-CHANNEL TV NOW

MANUFACTURERS OF TV SETS and the technical staff at the Federal Communications Commission have begun working out procedures for the swing to all-channel receivers. FCC officials hope major manufacturers will go still further and initiate broad-scale promotion of 82-channel sets before they are legally required to do so.

FCC Commissioner Robert E. Lee, one of the Commission's staunchest promoters of full use of the 70 uhf and 12 vhf channels, told **ELECTRONICS** that it will probably be two years before manufacturers are required to market all-channel sets.

Based on a turnover rate in sets of 15 percent or 20 percent per year, it will take five to six years for substantial saturation of all-channel sets. Saturation will come sooner, Lee pointed out, if manufacturers move to promote all channel sets without waiting for the FCC's rules. Major manufacturers, he said, will be safe in moving ahead now, for they are already making sets that are certain to meet the specifications FCC sets for "adequately" receiving uhf signals.

## TFX AWARD DELAYED UNTIL FALL

AWARD TO DEVELOP and produce a joint Air Force-Navy tactical fighter plane, TFX (USAF calls it the F-111A) has been delayed until Fall.

The two competitors for the contract, Boeing Co. and General Dynamics Corp. (teamed up with Grumman Aircraft Engineering Corp.) have been given 60 days to refine their proposals in a way that irons out differences in Air Force and Navy design requirements and that will establish definitive cost estimates.

Unit costs estimated by Boeing, General Dynamics and the DOD vary anywhere from \$5 million to \$10 million. To draw up a fixed price contract, DOD needs firmer figures than these.

## TRADE BILL GAINING BI-PARTISAN SUPPORT

SENATE FINANCE COMMITTEE HEARINGS on the President's trade bill, already passed by a sweeping majority in the House, will not begin until sometime next week. Until then, industry spokesmen will have time to voice their opinions.

The bill does two major things: It gives the President power to cut tariffs—over a minimum of five years—a small amount or 100 percent (20 percent each of the five years). He can also raise tariffs up to 700 percent in some cases and work out import quota arrangements.

Second, it attempts to balance these new negotiating powers with a list of checks, restrictions, and new Presidential and other governmental responsibilities. A new trade negotiator post has been created that could turn out to be one of the country's top cabinet-level jobs.

Congress will get to send four representatives to each tariff negotiation plus a simple majority veto right over a negative decision by the President on any tariff commission ruling that recommends higher tariffs or other trade adjustment assistance.

The bill, soon to go before the Senate, is different from the one proposed by the administration. The bill now has more of a balance between an industry's right to appeal for higher tariffs and its right to be given adjustment assistance in the form of loans, technical help or tax rebates. The tariff commission will have more of a role as arbitrator than was originally envisioned by the administration.

These modifications seem to be stimulating bi-partisan support for the bill in the Senate.





plenty  
plus  
one

**equals the ever growing family of CAPITRON® Capacitors**

And plenty doesn't say enough! Now Capatron adds this silicone rubber encapsulated Wafer Capacitor to its more than 2,500 special capacitor designs, available as standard in our line. When your requirements go beyond this . . . we will create a capacitor to fit your requirements. If you're working in advanced areas of design—atomic energy, radar, communications and control—there's no need to let ordinary "off-the-shelf" capacitors freeze your design creativity . . . you may find exactly what you want in the big Capatron line. From single wafers to encapsulated multiple capacitors . . . whatever your choice or requirement . . . you can depend on Capatron products for:

- high resistance to thermal extremes (−65°C to +125°C)
- maximum stability, reliability and longevity with AMPLI-film® dielectric
- choice of waxdipped, encapsulated or armored types

Complete information on Capatron Capacitors available upon request.

®Reg. U.S. Pat. Off.

**CAPITRON DIVISION**  
**AMP INCORPORATED**  
**Elizabethtown, Pennsylvania**

Capatron products and engineering assistance are available in Canada through Aircraft-Marine Products of Canada, Ltd., Toronto, Canada

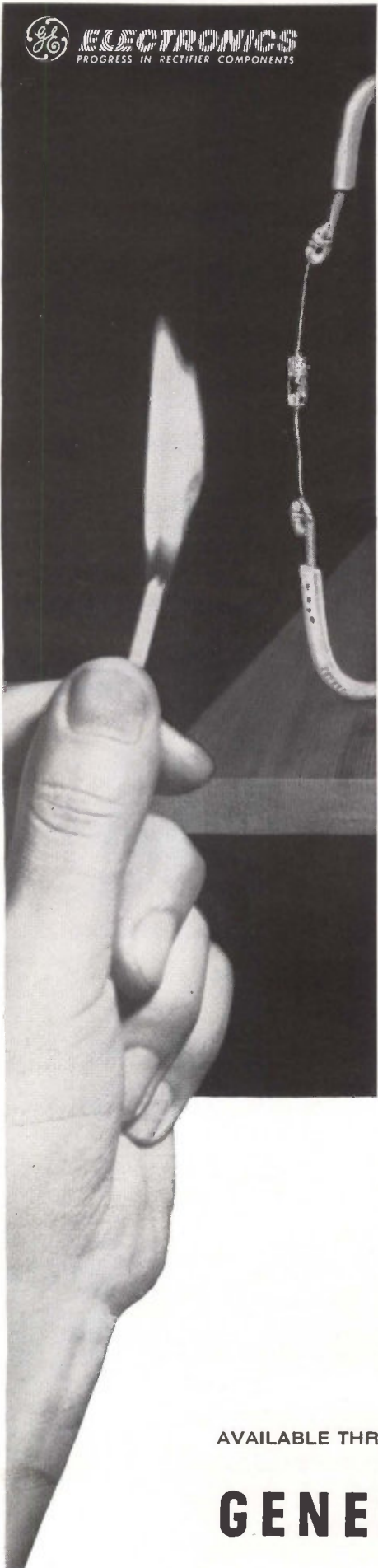

# NEW LIGHT ACTIVATED PNPN SWITCH

## ALL VOLTAGES IN STOCK

New applications are being found every day for the new ZJ235 subminiature silicon switch that can handle up to 160 watts of power continuously with complete electrical isolation between input and output. The circuits shown are just a few samples. The ZJ235 is 1/3 inch long, 1/8 inch diameter, rated at 400 ma d.c. In latching applications, with surge current rating of 5 amps. A short impulse of light of as little as 80 foot candles will trigger the ZJ235 into conduction, making it ideal for applications such as card and tape reading, character recognition, logic circuits, relay replacement, explosion proof static switches, tower light monitoring, and many others.

Available from stock in all voltage ratings from 50 PRV to 400 PRV, ZJ235 prices range from as low as \$5 to \$25 in single lot sample quantities. Ask your G-E Semiconductor Products District Sales Manager about the help available from our Application Engineering Center. Or write Section 16G66, Rectifier Components Department, General Electric Company, Auburn, New York. In Canada: Canadian General Electric, 189 Dufferin St., Toronto, Ont. Export: International General Electric, 159 Madison Avenue, New York 16, N.Y.

AVAILABLE THROUGH YOUR G-E SEMICONDUCTOR DISTRIBUTOR

**GENERAL**  **ELECTRIC**

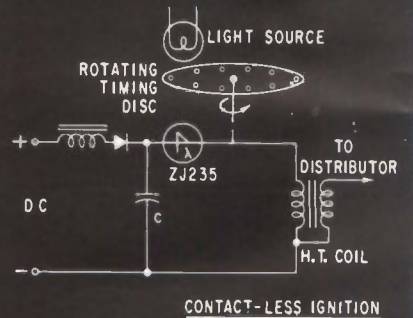
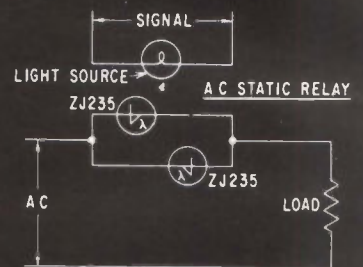
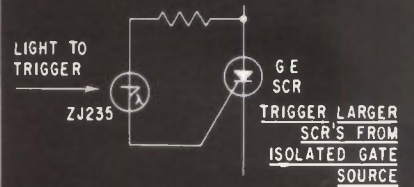
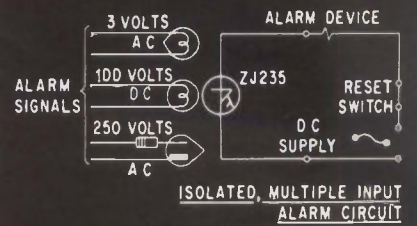

# MICRO-MACHINED PARTS MADE BETTER

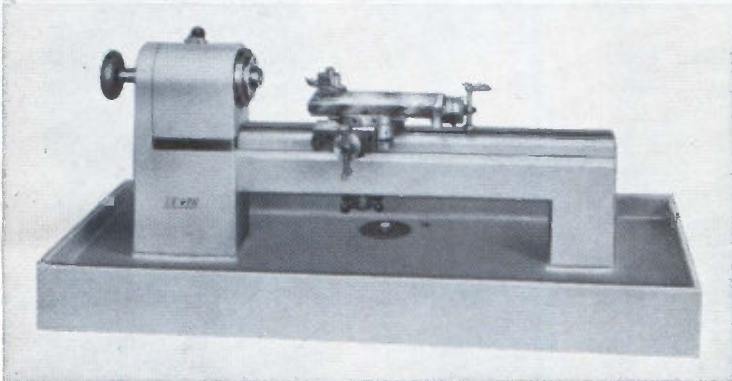
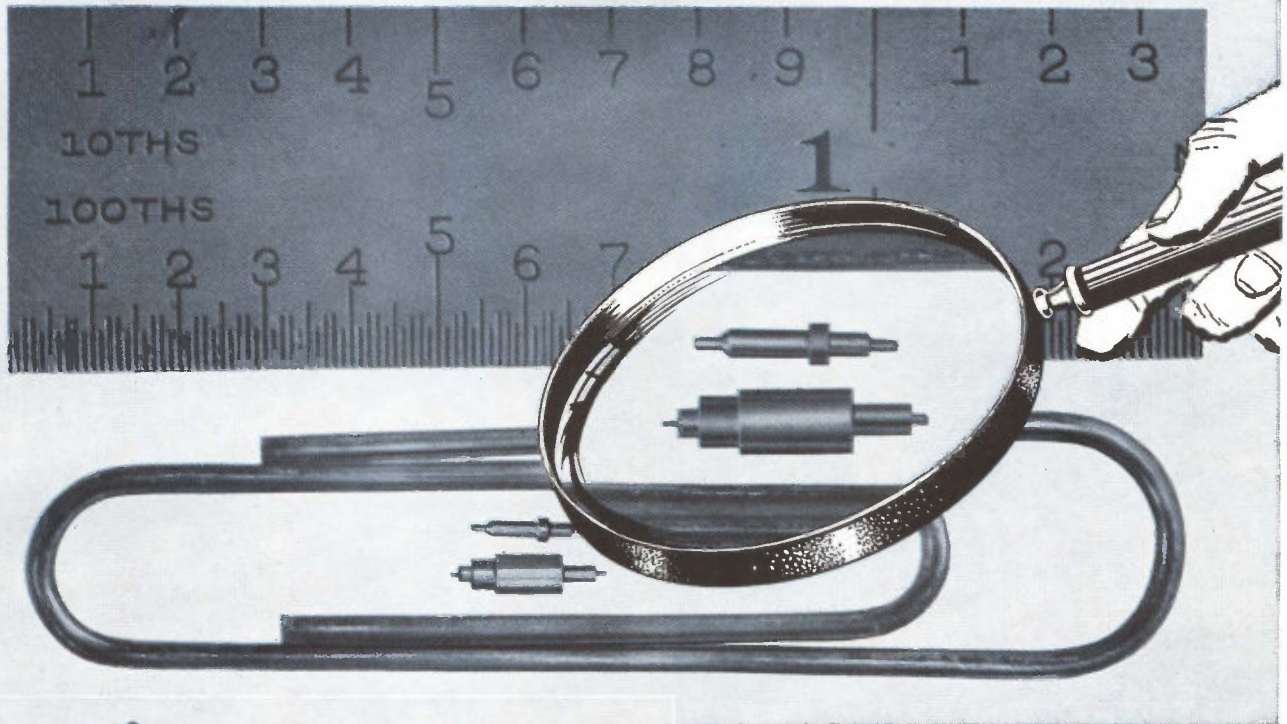

**LEVIN** instrument lathes are specifically designed for the production of small parts. Due to their high degree of precision, these lathes easily operate in the microrange of measurements on size, concentricity, and finish.

Larger and more costly lathes can often be relieved of the burden of microrange production with the installation of the proper *LEVIN* lathe. In addition, the speed and ease of operation of *LEVIN* instrument lathes generally surpasses that attainable on larger machines. With 41 standard models to select from, there is a proper *LEVIN* lathe for your application. Available in 3/16", 5/16", and 1/2" collect capacities.

SEND FOR COMPLETE CATALOG



## **LEVIN** INSTRUMENT LATHES

LOUIS LEVIN & SON, INC.  
3573 Hayden Ave., Culver City, California

New York Representative and Showroom  
RUSSELL-HOLBROOK & HENDERSON, INC.  
292 Madison Ave., New York 17, N.Y.

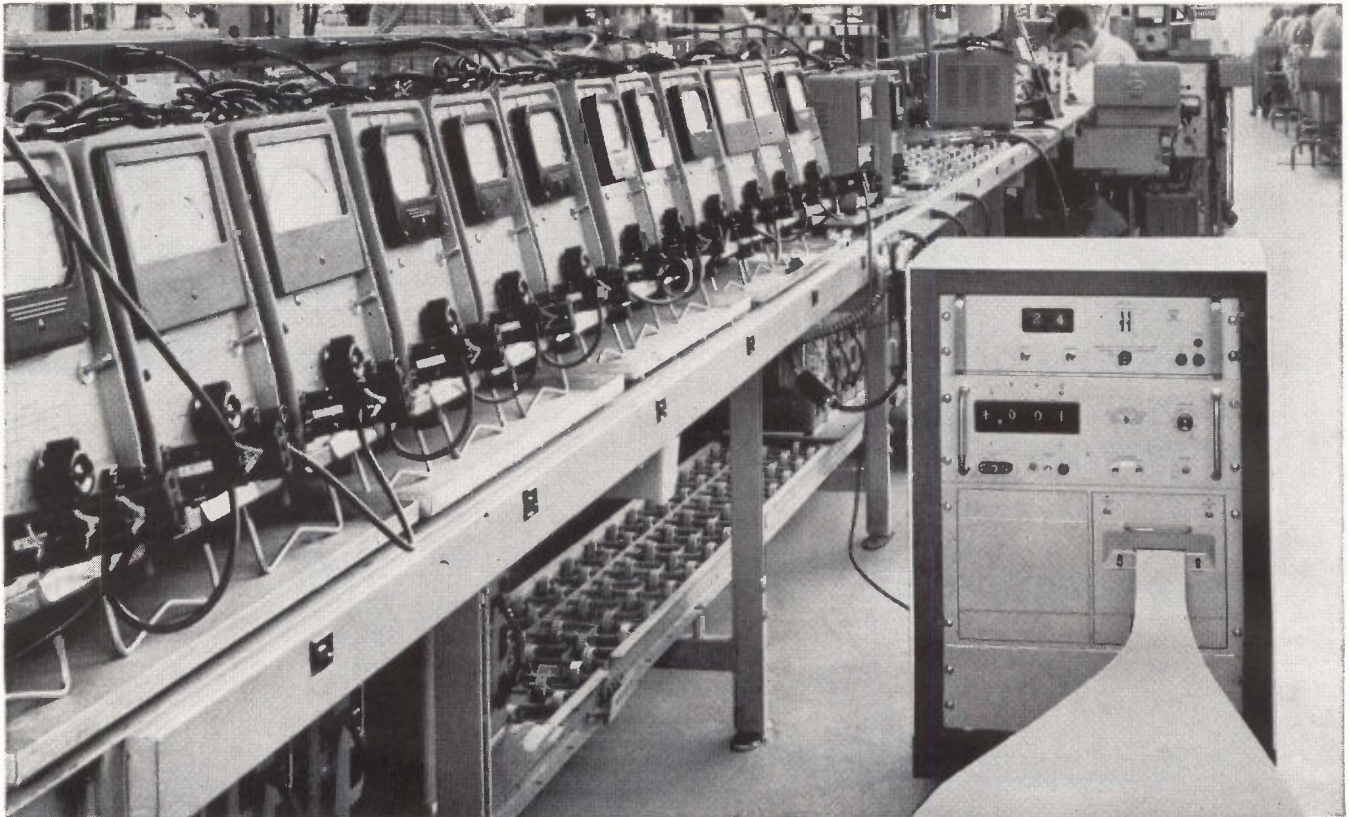

**DYMEC'S** Model 6100 Industrial Voltage Scanning System permits automatic, unattended data monitoring, complete with printed record, of 50 single-wire or 25 two-wire channels. The inexpensive system is useful in quality control, production checkout, routine lab measurements, system checkout, environmental and reliability tests . . . in any application where dc voltage is the parameter of measurement. With a converter, the DY-6100 also permits multi-point ac measurements.

The basic system consists of the Dymec Model 2900A Input Scanner, an hp 405CR Digital Voltmeter and hp 561B Recorder. It measures dc voltages 0.001 to 750 volts with automatic ranging and polarity, and it provides visual and printed readout of measurement, channel identification and polarity.

A scan limit selector switch permits simple omission of unused channel points, and the scanner provides four operating modes: System scans continuously, system scans all data points once and then stops, system is manually stepped by front-panel or remote control, system repeatedly measures a single point.

Input impedance is 11 megohms for minimum circuit loading. Accuracy is better than  $\pm 0.2\%$  of reading  $\pm 1$  digit. Effective rejection of 60 cps permits accurate measurements even in the presence of noise.

Optional equipment available for the system includes a digital clock which mounts adjacent to the recorder and permits time data logging and automatic programming, plus an ac converter (hp 457A) which permits measurement of ac voltages in ranges of 1, 10, 100 and 1000 volts, 300 volts rms maximum, 50 cps to 100 KC.

You may purchase the entire basic system for just \$3100 (cabinet optional at extra cost) or, merely add the DY-2900A Scanner to your present hp 405CR and 561B for \$950 (plus cabling). Write or call today for complete information or a demonstration on your bench.

*Data subject to change without notice. Prices f.o.b. factory.*

A U T O M A T I C  
 A U T O M A T I C  
 A U T O M A T I C  
 . . . . . 50  
 . . . . . CHANNEL  
 . . . . . DATA  
 . . . . . MONITORING  
 . . . . . FOR JUST  
 . . . . . \$3100  
 A U T O M A T I C

**D Y M E C**  
 A DIVISION OF HEWLETT-PACKARD COMPANY



Dept. E-5, 395 Page Mill Road, Palo Alto, Calif. Phone DA 6-1755 (Area Code 415) TWX-117-U

# NEW Simpson PANEL METERS

## New 1½" Wide-Vue

Another new member in this popular family. Needs only 3.1 sq inches of panel area. Supplied in DC, AC (rectifier), and VU types. Colors are standard black or your choice. Self-shielded core magnet type movements. *Forty-seven stock ranges in six types . . . Model 1212C, DC; Model 1214C, AC and VU. This very popular style of meter is also stocked in 2½", 3½", and 4½" sizes. See your electronic distributor for the many stock ranges.*



All Meters Shown 60% Actual Size

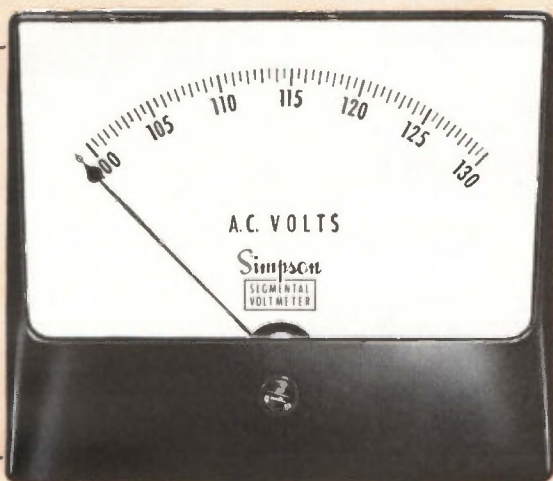

Wide-Vue Case Style

## Segmental (Expanded Scale) AC Voltmeters—3½" and 4½"

Stock meter reads 100 to 130 AC volts. Other ranges supplied on special order. Frequency range is 20-2,000 cps. Accuracy is  $\pm 0.5\%$  of center scale value at 25°C and 60 cps sine wave. Self-shielded core type movement; rectangular cases. Stock units are 3½" Model 1347C (Wide-Vue Style), 4½" Model 1349C (Wide-Vue Style), and 4½" Model 49C. *See your electronic distributor.*

## 1% and 2% DC Meters From Stock

Rectangular 6" cases. Mirror scales on 1% meters. Self-shielded core movement or external magnet type depending on range. Order Model 1150-E and specify either 1% or 2% accuracy. Milliammeters and microammeters stocked in both accuracies; voltmeters, millivoltmeters, and ammeters stocked in 2% only. *See your electronic distributor.* For other than stock ranges, send us your specifications.

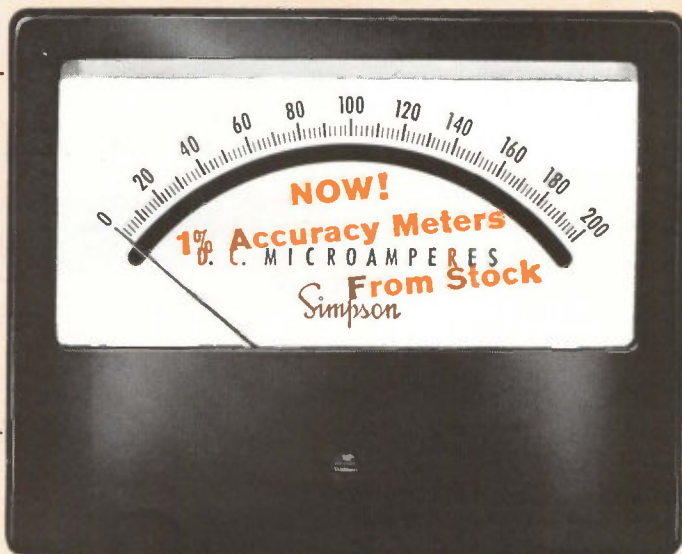

Write on Company Letterhead for Completely NEW 88-Page Catalog and Engineering Manual No. 18. Gives Comprehensive Listings on All Simpson Panel Meters.

# Simpson

INSTRUMENTS THAT STAY ACCURATE

SIMPSON ELECTRIC COMPANY  
5203 West Kinzie Street, Chicago 44, Ill.  
Phone: ESTbrook 9-1121 (Area Code 312)  
In Canada: Bach-Simpson Ltd., London, Ontario

*Lasting bond depends on how quickly many problems are solved*

# IRE + AIEE = IEEE — Will

NEW YORK—Approval of the merger of the Institute of Radio Engineers and the American Institute of Electrical Engineers into a giant 150,000-member Institute of Electrical and Electronic Engineers was a foregone conclusion even before the formal IRE balloting this week. The actual merger is scheduled to take place on January 1, 1963.

Last month, AIEE members voted 29,464 to 4,381 in favor of the merger, with the remainder of the 55,156 eligible members abstaining. IRE proxy votes had been running nine to one in favor.

**IMPLEMENTATION**—Next on the agenda will be meetings of the implementation committee, composed of seven leaders of each society. The committee's job will be to:

- Select a general manager for IEEE, with the approval of the IRE and AIEE boards of directors.
- Nominate new directors and officers of IEEE.
- Make recommendations to IRE and AIEE boards on geographical boundaries of regions, sections and other IEEE units.
- Take all necessary steps to implement the merger on January 1, 1963, then turn over the reins of the new society to its officers and the general manager.

The general manager is to reconcile the differences between practices and policies of IRE and AIEE with respect to the full-time administrative staff.

**PROBLEMS** — It seems unlikely that the merger could miscarry, but there is a possibility that the bond may not be a firm one unless many problems facing the combined society are ironed out in a reasonable time (see p 3, this issue).

An appreciable minority feels that the merger has been rushed too fast and that a necessary catalyst in the form of adequate membership consultation has been lacking. Relatively few question the overall logic of the merger, but some express reservations about what they con-

sider overcentralization.

One implication is that electrical and electronics engineers may find themselves divided by issues and practices when membership action is attempted at the level of the professional technical groups and chapters.

Another impression is that IRE traits will dominate in the IEEE, not only because of IRE's larger membership, but because of a point in the agreement of merger.

Paragraph 5 says the agreement will be terminated unless AIEE amends its constitution to conform to the IEEE constitution. There is no mention of amending the IRE constitution. This, we are told, was done to avoid the hiatus in corporate existence that would occur if both societies ceased to exist before the actual merger. The IRE will be discontinued first and merged into the AIEE, so there will be no IRE constitution to amend.

**CONSTITUTION** — Even so, the IEEE constitution is expected to reflect more of the IRE constitution than the AIEE's.

A point that bothers some AIEE members is the replacement of their technical committees with professional technical groups "wherever possible." The new society may contain 35, 40, or more such groups, raising fears that former AIEE members will have less control over technical guidance and publications.

Also, in AIEE, the board and the technical committees have equal representation. IEEE will probably adopt an IRE type of governing board, which has much greater power.

Signatures required for independent nomination will be raised from 25 to "at least one-third of one percent of the total number of voting members" of IEEE—close to 500 signatures. This may tend to

## MERGER HIGHLIGHTS

- IEEE's Constitution will resemble IRE's more closely than AIEE's.*
- IEEE may contain 40 or more professional technical groups.*
- AIEE Technical Committee will be replaced by Professional Technical Groups wherever possible.*
- IEEE will retain the IRE type of governing board.*
- IEEE operating expenses will exceed income for the first two years.*

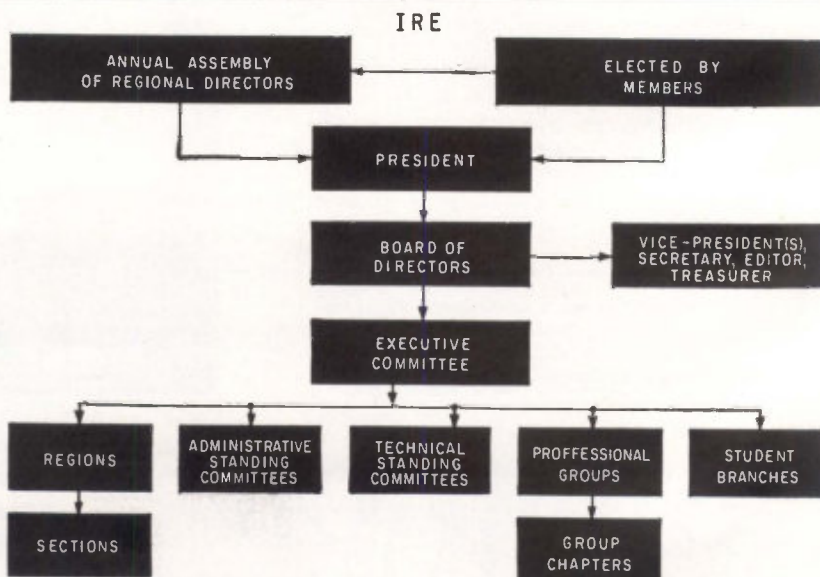

**"FEDERAL" MAKEUP OF IRE.** This organizational structure is likely to be adopted in large part by the IEEE

# the Merger Prosper?

delegate independent nominations of officers essentially to the larger metropolitan area sections.

Basic items, such as membership qualifications, terms of office of the directors and details of nominations are to be included in bylaws that can be changed by the board.

**ADVANTAGES**—The majority in favor of the merger say it will:

- Bring closer together the various specialties in engineering.
- Form a single institution more efficient than the two separate ones (some 5,000 to 6,000 engineers are members of both IRE and AIEE).
- Remove the duplication in meetings, technical conferences and engineering committees.
- Advance the cause of unity in the engineering profession.

IRE and AIEE leaders say the merger must be done quickly to work out the practical details of the new organization.

## IMPLEMENTATION COMMITTEE

### IRE members:

*L. V. Berkner, Past IRE President*  
*P. E. Haggerty, IRE President*  
*R. L. McFarlane, Past President*  
*Haraden Pratt, IRE Secretary*  
*3 Additional Members*

### AIEE members:

*C. H. Binder, former AIEE President*  
*Hendley Blackmon, Westinghouse's Engineering Manager of Association Activities*  
*W. H. Chase, AIEE President*  
*W. R. Clark, AIEE Treasurer*  
*Elgin B. Robertson, former AIEE President*  
*L. M. Robertson, Manager of Engineering at Public Service Co. of Colorado*  
*B. R. Teare, Dean of Science and Engineering at Carnegie Tech and president-elect of AIEE*

"Nothing is impossible to diligence and skill"  
 Samuel Johnson



These are the trademarks of some of our customers—each an important contributor to a dramatically growing industry. We at Potter pledge our diligence and skills to this growth through a constantly expanding program of research and development.

## POTTER

**Tape Tester guarantees PERFECT tapes**

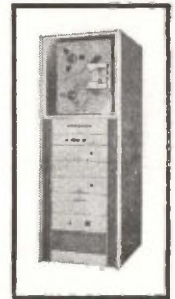

The new, improved Model 3320A Tape Tester was designed to accommodate the ever-increasing demands for high-quality digital instrumentation tapes. By testing new tapes and periodically checking used tapes, the reliability of digital computers and digital systems is increased, errors decreased, maintenance costs substantially reduced, and tape costs brought under close control.

The Potter Tape Testers now in use are capable of testing over a million miles of tape annually.

Complete specifications on the fully automatic Model 3320A are available on request. Simply write . . .



EUROPE BOUND?  
 VISIT US AT Booth 29  
 IFIP Interdata Exhibition  
 in Munich, Germany  
 August 26 to September 2

**POTTER INSTRUMENT CO., INC.**  
 Sunnyside Boulevard • Plainview, New York

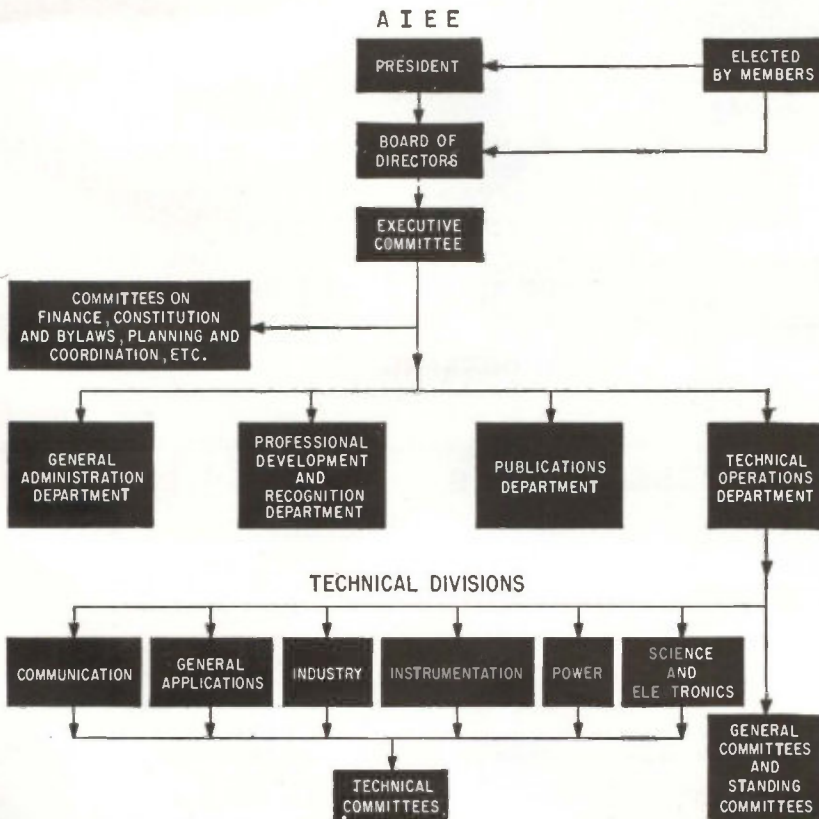

OPERATIONAL character of AIEE is emphasized by this simplified organizational chart



# ELECTRONIC INSTRUMENTATION FOR INDUSTRIAL, MILITARY AND PETROLEUM APPLICATIONS

## SOLID STATE POWER SUPPLIES From milliwatts to kilowatts



Marine - Airborne - Mobile - Aircraft - Missiles - Communications - Automation - Laboratory - Test Control.

Regulated DC-DC converters for reliable performance in marine, airborne, mobile, and portable electronic equipment. Provides regulated or unregulated DC power for B+ or bias circuits from 6 to 48V input.

DC-AC inverters are superior to motor-generator sets, assure

reliability and afford excellent frequency stability. Available in regulated or unregulated models with free running oscillator, fork, or crystal-controlled frequency control. Supplies sine or square-wave output from DC input of 6 to 48V.

AC-DC for research and test laboratories, automatic control, and ground-support telemetry installations. Extremely low output impedance, low ripple and negligible servicing make a BER an ideal replacement for storage batteries.

## TRANSFORMERS AND CHOKES

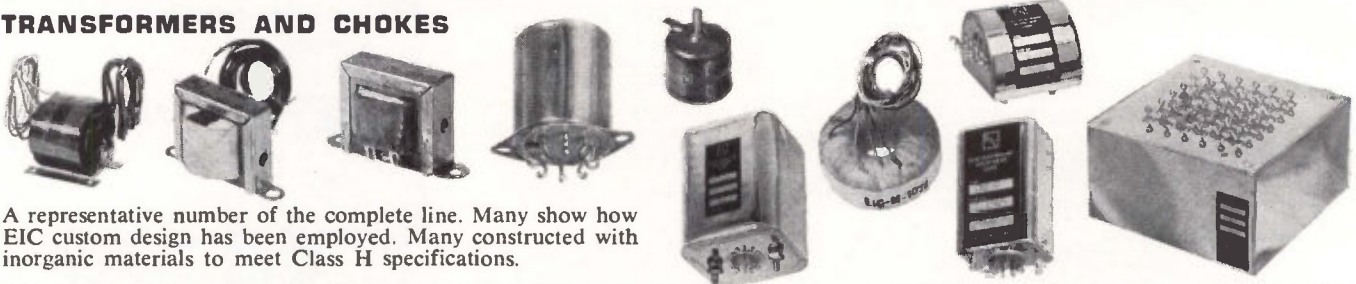

A representative number of the complete line. Many show how EIC custom design has been employed. Many constructed with inorganic materials to meet Class H specifications.

## MAGNETIC RECORDING HEADS

Wide range of electrical and mechanical characteristics adapts these heads to many laboratory and industrial applications in recording, control, and data analysis.

Vacuum impregnated, potted in epoxy resin, available singly or in multihead blocks.

Used for drum, reel, or disk recording; sound or seismic recording; process instrumentation and control computers.

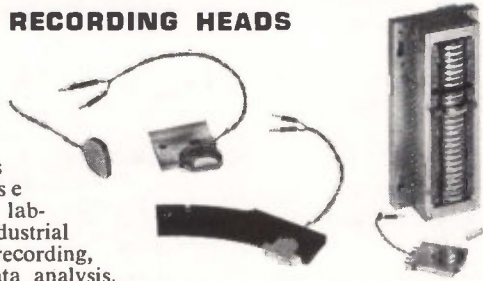

## ANALOG INTERVAL TIMER AND PLOTTER

Used in any application requiring seismological evaluation of subterranean structures for geophysics, civil engineering foundation tests, for buildings, roadways, dams and excavations, college laboratories and research.

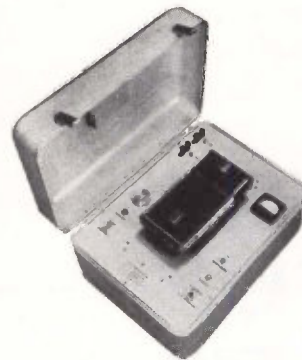

## SEISMIC INSTRUMENTATION

Transcoders • Interval Timers • Data Logging Systems • Complete Field Equipment • Multichannel recording oscillographs • Modulators and demodulators • AM-FM • Direct-recording magnetic tape systems • Recording and data-reduction systems

## OTHER AREAS OF EIC APPLICATION

Subassembly Electromechanical • Electronic • Research and Development

## OCEANOGRAPHIC

Broadband underwater acoustic transducers  
Magnetic detectors • Research and Development

## EIC REPRESENTATIVES

### CLYDE M. SALISBURY CO.

San Francisco 22  
1453 Seventh Ave.—MO 4-0586

### REPCO SALES

Miami  
401 N.W. 71st Street—PL 7-2911

### EDWARD F. AYMOND CO.

Dallas—3915 Lemmon Ave.—LA 6-5233—TWX DL-206-U  
Houston—5010 Carew Street—MO 6-1804  
New Orleans—6305 Leslie—834-0196

### ELECTRONIC SALES, INC.

Denver 22  
2641 S. Ivy Street—SK 6-4148

### WALLACE AND WALLACE

Los Angeles 15  
1206 Maple Ave.—RI 7-0401



# ELECTRODYNAMIC INSTRUMENT CORPORATION

Subsidiary of Reed Roller Bit Company

TWX HO-1147-U / RI 8-2760 • 1841 Old Spanish Trail • Houston 25, Texas



**IMMEDIATE DELIVERY**

of **ALITE**<sup>®</sup>  
**STANDARD  
HIGH ALUMINA  
BUSHINGS**

**In Over 100 Types and Sizes**

More than 100 sizes of standard Alite high voltage terminals, feed-throughs, cable end seals and high amperage bushings are stocked for immediate, "off-the-shelf" delivery to simplify design problems, save time and help reduce costs.

One of these standard Alite high alumina ceramic-to-metal hermetic seals may be just the answer to your problems of reliability and maintenance where service conditions are extremely severe or critical.

- Alite hermetic seals — tested for vacuum-tightness with a high sensitivity helium mass spectrometer — are adaptable to virtually any assembly procedure, such as welding, brazing or soldering.
- Alite's mechanical strength and thermal-shock properties far exceed those of glass or porcelain.
- Alite retains its dielectric properties at elevated operating temperatures.
- Alite's smooth, white glaze resists build-up of contaminants on surfaces — easy to see, easy to clean.

From ceramic formulation to finished part, every manufacturing step is handled within our own plant. Strict quality control assures absolute adherence to specifications, utmost uniformity and reliability.

\* \* \* \*

When special bushings are called for, it is often possible to save time and money by modifying one of the standard units. However, when necessary a team of Alite engineers stands ready to help you by designing new bushings.

ALITE DIVISION



**U. S. STONEWARE**

BOX 119

ORRVILLE, OHIO

Write for these free helpful brochures. Bulletin A-40R illustrates, describes and gives complete specifications of standard Alite bushings, both high voltage and high amperage. Bulletin A-8 provides detailed descriptions of Alite formulations. 235-H



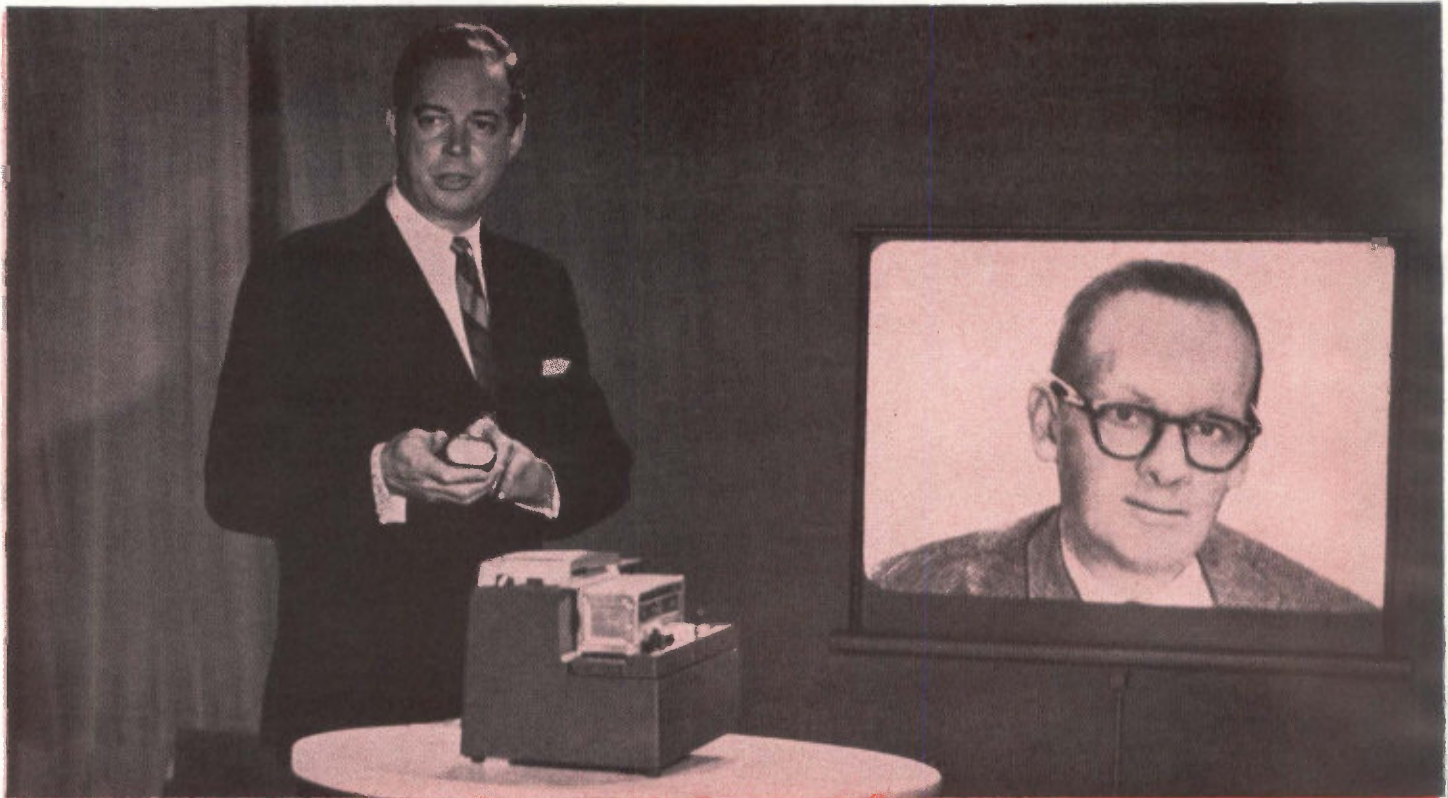

**SLIDE SHOW BY REMOTE CONTROL** Slides are changed and focus is sharpened by tiny wireless remote control unit with new Airequipt Superba Sonic projector. Mallory Mercury Batteries were chosen for control unit because of their higher energy content, lower internal resistance, long service life . . . plus greater convenience to the user because of less frequent battery changes.

## Put extra sales power into new products

Scale down the size of your new product. Make it more easily portable. Add to its service life and dependability. Turn battery power into selling power . . . by designing with Mallory Mercury Batteries.

These are the high-performance batteries chosen for reliability in ultra-critical military and space applications, and for superior service in many kinds of industrial and consumer products. Here's why.

Mallory Mercury Batteries deliver 3 to 4 times more energy per unit volume, last 3 to 5 times longer than conventional batteries. Voltage remains steady during their discharge life, relatively unaffected by temperature from  $-65^{\circ}$  to  $+80^{\circ}\text{C}$ . They withstand temporary overloads of up to 1 amp. Mallory Mercury Batteries can be stored for six years or more without serious loss of capacity. And they're leakproof.

Choose from a broad line of single or multiple voltage cells. Custom power packs developed on request. Write for engineering data or to arrange a consultation.



**TRANSISTORIZED METRONOME**, the "Baton" designed and made by Connecticut Technical Corporation, flashes in synchronization with audible beat, is powered by Mallory Mercury Battery that provides 5 years or more average service. Mallory was selected for constant voltage discharge, long-term service.



## with Mallory Mercury Batteries

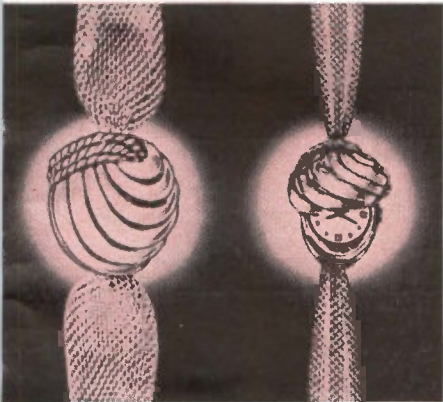

**LUCIEN PICCARD WATCH WITH BUILT-IN LIGHT** New "Lumin-  
esque\*" is tiny watch with flower-  
seed-size bulb that lights when  
cover is raised. Mallory Mercury  
Battery was choice for small size,  
long-lived dependability. Battery  
is scarcely larger than a sequin.

\*Trade Mark Registered by Lucien Piccard



**PORTABLE POTENTIOMETER** New re-  
corder made by Instrument Corporation  
of America uses Mallory Mercury Battery  
as constant voltage reference against which  
input signal is nulled by potentiometer  
circuit. Mallory was specified for enduring  
voltage precision of  $\pm 1/2\%$ , freedom from  
leakage, long life in service and storage.

*Mallory Battery Company  
North Tarrytown, N.Y.  
a division of P. R. Mallory & Co. Inc.*



*Mallory Batteries Ltd., Crawley, Sussex, England  
Mallory Battery Company of Canada Limited,  
Clarkson, Ont.*

**MR. JAMES SAYS:**

"LET US SUPPLY YOUR INSTRUMENT COMPONENT REQUIREMENTS...  
CHOPPERS, TRANSFORMERS  
TRANSDUCERS, HIGH  
SPEED RELAYS."



**INSTRUMENT CHOPPERS**

A component for every industrial and military application . . . mechanical, photo and solid state.



**MICRO-SCAN RELAYS**

Micro second switching of microvolt signals for data handling, transducer sampling and analogue computation.



**INSTRUMENT TRANSFORMERS**

A complete line of unique input and low power transformers designed for instrumentation circuits where accuracy, balance, precision with both electromagnetic and electrostatic shielding are required.



**MINIATURE TRANSFORMER**

Miniature and microminiature designs for all applications, industrial and military. Use the unique James transformer kits for design . . . the economical and convenient way to production models by James.

**MECHANICAL CHOPPERS**

- Low Residual Noise
- DPDT and SPDT Models
- 1-500 CPS Wide Driving Frequency
- 7 Pin, 9 Pin, Octal and Printed Circuit Board Models.

| Model  | Nominal Freq. | Ckts. | Closures | Pkg. |
|--------|---------------|-------|----------|------|
| C-1201 | 60            | DPDT  | BBM      | A    |
| C-1202 | 60            | DPDT  | MBB      | A    |
| C-1210 | 400           | DPDT  | BBM      | A    |
| C-1204 | 60            | DPDT  | BBM      | B    |
| C-1205 | 60            | DPDT  | MBB      | B    |
| C-1275 | 400           | DPDT  | BBM      | B    |
| C-1276 | 400           | DPDT  | MBB      | B    |
| C-1281 | 60            | SPDT  | BBM      | B    |
| C-1282 | 60            | SPDT  | MBB      | B    |
| C-1968 | 60            | DPDT  | BBM      | I    |
| C-1969 | 60            | DPDT  | MBB      | I    |
| C-1970 | 400           | DPDT  | BBM      | I    |
| C-2701 | 60            | SPDT  | BBM      | V    |
| C-2702 | 60            | SPDT  | MBB      | V    |
| C-2703 | 400           | SPDT  | BBM      | V    |
| C-2715 | 400           | SPDT  | BBM      | X    |

Closures BBM = 45% MBB = 55%

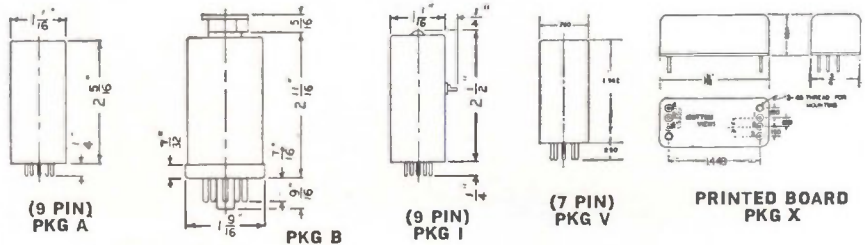

**MICROSCAN RELAYS**

- LIFE—1 billion operations
- SPEED—600  $\mu$  sec. maximum pull in and drop out
- LOW NOISE—2  $\mu$ v in 100K ohms
- LOW THERMALS—Less than 1  $\mu$ v
- POSITIONING—Non-critical
- VIBRATION AND SHOCK RESISTANT
- MODELS FOR ALL SWITCHING SPEEDS AND CIRCUITS

| Model  | CKT  | Coil Voltage | Pkg. |
|--------|------|--------------|------|
| C-2207 | DPDT | 6            | I    |
| C-2216 | SPDT | 6            | V    |
| C-2350 | DPDT | 18           | I    |
| C-2769 | SPDT | 6            | X    |

**INSTRUMENT TRANSFORMERS**

- Balanced 4 windings to .05%
- Electrostatic shields on all windings to 105 db
- Magnetic Shielding to 135 db
- Low thermal shielded lead out

| Model | Pri. Imp. | Sec. Imp. | Mag. Shielding |
|-------|-----------|-----------|----------------|
| 7100  | 630 K     | 630 K     | 135 db         |
| 7101  | 630 K     | 200 K     | 135 db         |
| 7102  | 630 K     | 95 K      | 135 db         |
| 7115  | 630 K     | 25 K      | 75 db          |
| 7116  | 630 K     | 4 K       | 75 db          |
| 7117  | 630 K     | 400       | 75 db          |

Impedance with open ckt. at 60 cps.

**MINIATURE TRANSFORMER**

- JAMES "decade box" type miniature transformer kits save time and money in the application of transformers.
- Model C-2450, a kit of 12 transformers, 250 milliwatt, 4 winding 8 terminals. Each 1 $\frac{1}{4}$ " dia. x 1 $\frac{3}{8}$ ", covering the full transformer range.
  - Model C-2650, a kit of 10 micro-miniature, 25 milliwatt transformers, 4 winding "plug in" or "solder in",  $\frac{1}{2}$ " dia. x  $\frac{1}{2}$ " covering the full transformer range.



**JAMES**

**ELECTRONICS INC.**  
4050 N. Rockwell, Chicago 18, Illinois  
CO 7-6333



Series 82, low-cost trimmer  
rated at 0.25 watts.

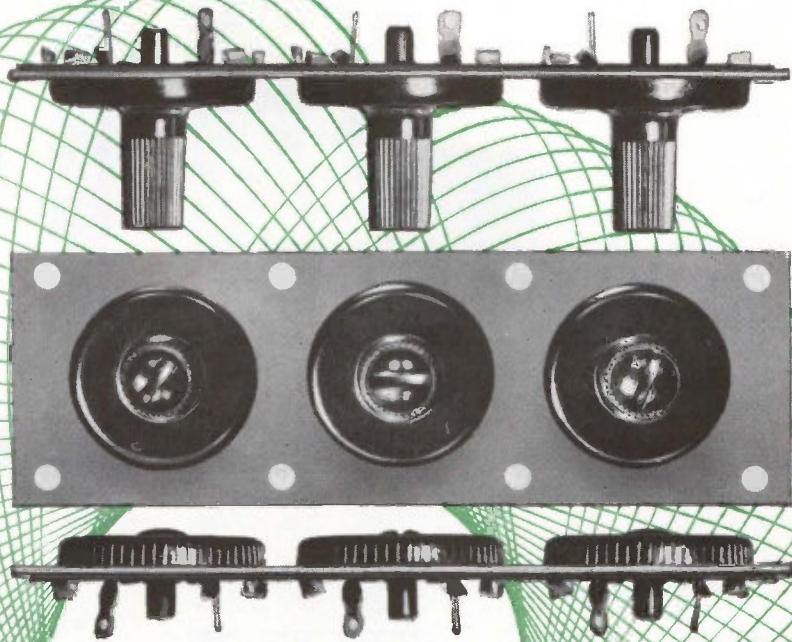

a new  
dimension...

## IN POTENTIOMETERS

### SPECIFICATIONS

Composition element rated at 0.5 watts @ 40°C, linear; 0.25 watts, tapered.

Resistance range from 1,000 ohms to 5 megohms.

Resistance tolerance is plus/minus 20% of stated value.

Tested at 2,000 volts AC Break-down. Recommended maximum operating voltage, 750 volts AC.

Mechanical rotation is 300°. Electrical or effective rotation, 280°.

Standard torque, 1 to 5 oz. in.

Diameter: 1-3/16". "Pancake" configuration, 3/32" from mounting surface. Knobs optional.

Strip or singularly mounted.

Look again — here's a new dimension in potentiometers that excites the engineer's imagination. The Clarostat Series 81 lends itself to entirely new mounting techniques, new control panel designs, saves space and performs like a much more expensive pot. Ideally suited to entertainment equipment, industrial instrumentation, and any other application looking for a fresh approach.

Write for complete details. Ask your Clarostat representative to show you the amazing new Clarostat Series 81.



**SERIES 81** by

# CLAROSTAT

CLAROSTAT MFG. CO., INC. DOVER, NEW HAMPSHIRE

# TELSTAR

*Last minute  
antenna changes  
improve satellite*

By THOMAS MAGUIRE  
New England Editor

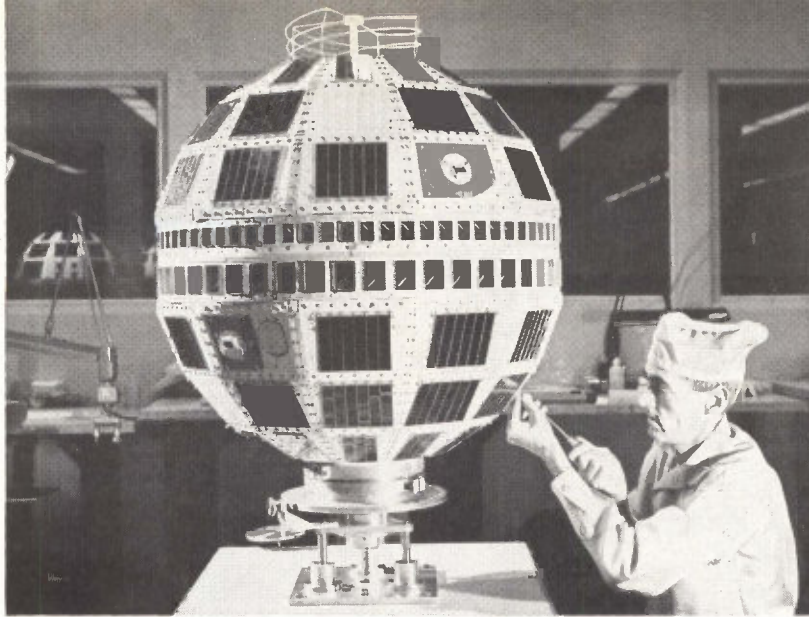

TELSTAR prototype model communication satellite, being assembled in surgically clean environment at Bell Telephone Laboratories in Hillside, N. J.

TO ELIMINATE "one more thing that could go wrong" in the first Telstar satellite, which at press time was scheduled for launch early Tuesday, the telemetry-command-beacon antenna system has been modified.

Originally, telemetry during launch was to be sent back to the ground by two small whip antennas at the base of Telstar. After the protective launching nose fairing had been cast off, an antenna atop the satellite was to be extended by a telescoping mechanism.

In recent months, Bell Telephone Laboratories' engineers incorporated a small compact antenna system as part of the top surface of the vehicle. No release mechanism is required, and the whip antennas at the base have been removed.

A Delta vehicle will place the 34-inch sphere into an elliptical orbit of 500 to 3,000 nautical miles. Inclination will be about 45 degrees, and the period of orbit 2 hr, 40 min. Launch of a second Telstar is planned for the Fall.

Nerve center of the historic experiment is in Andover, Maine, at the world's first permanent ground station for satellite communications.

**PERFORMANCE**—First two or three passes of the orbiting sphere will be used strictly for testing the tracking, command and beacon circuits. Then, also on the day of launch, first domestic communications experiments will be tried between Andover and BTL in Holmdel, N. J. A series of telephone calls, which will probably include the voice of President Kennedy, will be transmitted to and from various parts of the country, using the satellite as just one link in transmission over land telephone lines,

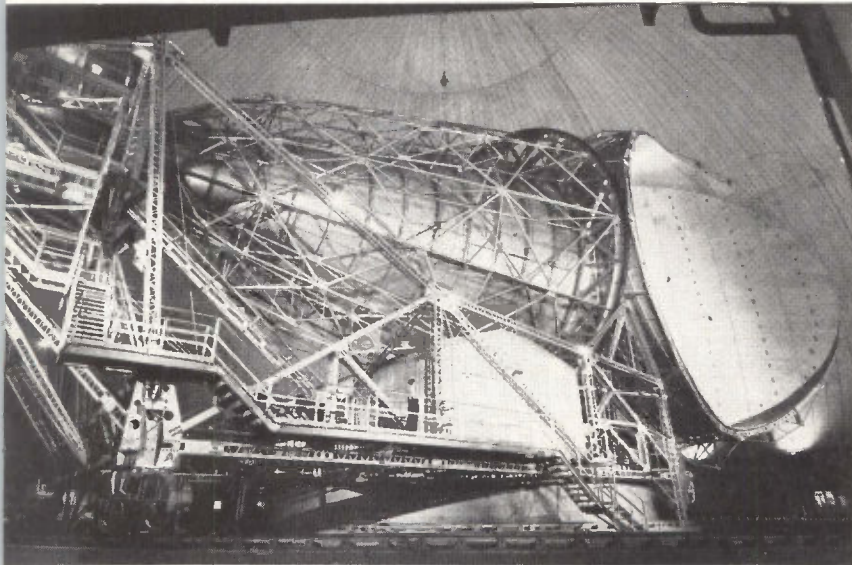

HORN REFLECTOR satellite communications antenna at Andover, Maine, to be used for experiments in broadband communications by the Telstar satellite. Antenna is built as rigidly and accurately as a fine watch

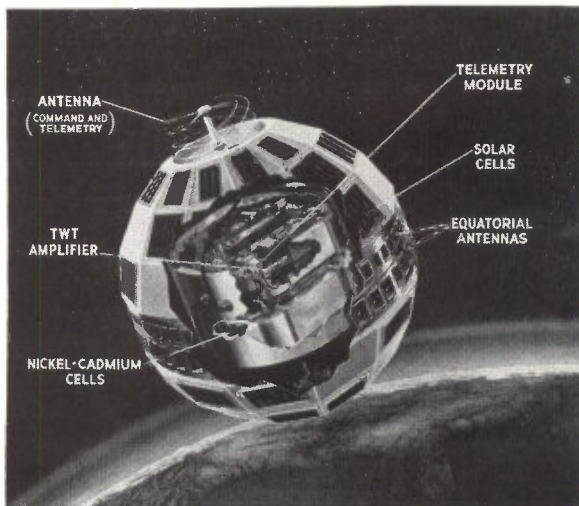

**CUT - AWAY VIEW** of Telstar. Cannister containing Telstar's electronics is laced to inside of satellite frame for shock resistance

# TO OFFER TRANSOCEANIC TV

microwave relay towers and perhaps a short section of underwater cable in the waters of Portland, Me. Transmission of video tape will also be attempted the first day.

Second phase is expected to come about two weeks after the launch, when the system's potentiality for overseas communications will be demonstrated. Transmission will be attempted between Andover and the British General Post Office station at Goonhilly Downs, England, the first of the overseas ground facilities to be ready. Also in this phase, the first live trans-Atlantic telecasts will be attempted, with Eurovision beaming a show from European capitals, and the American networks transmitting to viewers in Europe. Discussions are being held with Soviet officials for possible participation.

**ANDOVER SYSTEM** — Overall noise temperature of the ground station system is 50 deg K at antenna elevation of  $7\frac{1}{2}$  degrees above the horizon. This includes background noise, antenna, maser and receiver. When the antenna is pointed at the zenith, system noise temperature is 26 deg K.

The ruby traveling-wave maser designed by BTL's H. E. D. Scovil contributes only 4 deg K to the system. Engineers say parametric amplifier front-end may also be tried in future Telstar ground stations. The maser at Andover is immersed in liquid helium dewar surrounded by a liquid nitrogen jacket. Later, a closed-cycle continuous refrigeration system, under construction by A. D. Little Inc., will be installed at the Andover site.

A complete receiver system, including maser and fm feedback circuitry, is installed in the cab at the apex of the horn antenna. Telstar satellite will transmit a 3-watt signal, but this will be only about  $10^{-12}$  watt when it is scooped in by the 340-ton cornucopia-shaped antenna.

Also in the cab is the transmitting equipment, providing an unusual combination of high power,

extreme bandwidth and continuous operation. Amplification for the broadband Bell System transmitter is provided by a 4 ft, 3 in. long water-cooled traveling-wave tube, one of the largest ever built. Power output on the 25 Mc bandwidth transmitter is about 2 Kw.

Just outside the control building are two tracking antennas. A quad-helix command tracker like the one at Cape Canaveral will pick up the satellite's 136 Mc beacon and telemetry and transmit commands to the satellite on about 120 Mc (ELECTRONICS, p 23, Dec. 22, 1961). Once the satellite has begun to transmit its broadband communications signal and associated 4,080 Mc precision beacon, the other antenna, an 8-ft dish with a parametric amplifier, will track on this signal.

**TRACKING**—Also as part of the cooperative program to achieve transoceanic broadband communi-

cations, a transmitter for NASA's Relay satellite is being installed at the Andover station to help test the first Relay, which will be launched late this Summer. The program also includes cooperation with communications organizations in England, France, Italy, West Germany and Brazil. The Andover station, an identical one close to completion at Pleumeur-Bodou, France, and an 85-ft parabolic antenna at Goonhilly Downs, England, will be used for tv, voice and data communications experiments with both Telstar and Relay. Voice and data transmissions via Relay will be conducted from the ITT 40-ft dish at Nutley, N. J., and a 30-ft dish near Rio de Janeiro. The Italian station, a 30-ft dish, near Milan, will have voice receiving capability this year, and a transmitter is being installed for full participation in 1963. An 85-ft dish, being built near Munich, Germany, will be ready next year.

## Modulated Ionosphere Offers Secure Communications

**MICROWAVE** cross-modulation of the ionosphere using the Luxemburg effect may open up intercept-free communication channels, according to Prof. Ladislaus Goldstein, head of the University of Illinois' gaseous electronics lab.

Goldstein's group has modulated several types of plasmas with 5-to-10Gc lab-scale transmitters over the past three years, to demonstrate the possibility that microwaves might control ionospheric propagation.

Energy transferred from microwaves to the plasmas, at cyclotron resonance, increased the temperature of free electrons and changed those plasma properties which control propagation, Goldstein said.

An Aerobee rocket fired 40 to 60 miles above Eglin Air Force Base, Fla., in early May provided the first field check on efficiency of microwaves in altering ionospheric propagation. A transmitter abroad fed a pulsed 10-20  $\mu$ sec signal to 12-foot

antenna elements at 1.4 Mc—close to the electron gyro frequency.

Meanwhile, a ground transmitter beamed a 2.1-Mc signal to a tuned receiver in the rocket. The rocket's transmitter relayed this signal back to earth, where tapes recorded the effects of absence, presence and wake of the excitation pulses at 4 w, 40 w and 400 w.

Although a complete analysis won't be finished for a year, early results have confirmed the lab experiments. Radio waves from ground or a rocket can probably make transmissions easier at certain frequencies and more difficult at others, Goldstein said, by modulating or controlling density of electrons in the ionosphere.

Selective control of these conduction properties, in chosen regions, could open paths for messages which would be denied to any but the addressee alerted and equipped to pick them up, he suggested.

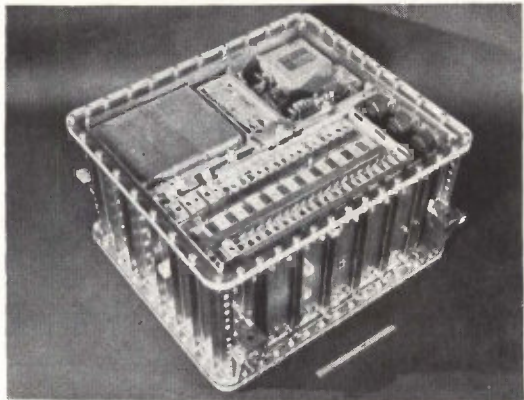

THIN-FILM memory in this Univac ADD computer has a capacity of 166,000 bits. Modular design allows flexibility in adapting it to various types of guidance systems

# Latest Military Computer Applications

## Digital techniques explored at PGMIL Conference

By LAURENCE D. SHERGALIS,  
Associate Editor

COMPUTERS and their application to military systems were prominent among the wide range of subjects discussed at the Sixth National MIL-E-CON in Washington, D. C., last month. Among the new devices announced was an operational computer using a thin-film memory. Designed by the Univac div. of Sperry Rand Corp., the machine utilizes modules made by the microminiature cordwood technique. The computer weighs 88 lb, occupies 1.2 cu ft and is expected to achieve over 10,000 hours of operational time without a failure.

Called the ADD-1000 (for Aerospace Digital Development), the computer has a random-access memory consisting of 6,656 24-bit words of permanent, and 256 24-bit words of variable storage. Basic operating clock frequency is 1 Mc,

and the basic instruction phase cycle is tied to the memory cycle time of 3 microseconds. In describing the capabilities of the computer, B. J. Jansen of Univac's Advanced Engineering Development Dept. indicated that the machine is capable of executing the preflight and in-flight programs associated with a number of guidance techniques.

**COMPUTER BATTLES** — Computer-controlled battles are being simulated at the Army Electronic Proving Ground, Ft. Huachuca, Arizona, to determine effectiveness of communication systems in a combat environment. Some of the parameters fed into the computer include the range of a radio set, reliability, electromagnetic environment, and attrition of personnel and materiel.

Digital control of aerial cameras was described by C. Walter Diem of the Librascope div. of General Precision, Inc. His system uses an adaptive calibration technique with a digital computer to control film velocity. Camera functions that are controlled include image motion

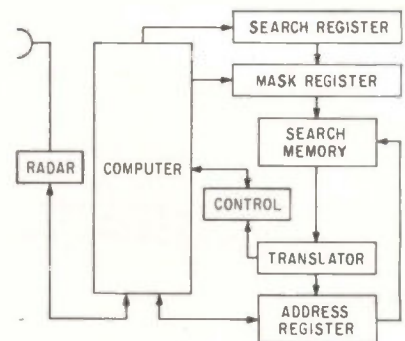

SEARCH MEMORY in a system consists of these six basic parts in addition to the computer and radar equipment

compensation, shutter speed, diaphragm opening and exposure rate. To reduce blur caused by image motion, and adaptive calibration technique used in a digital servo moves the film across the camera focal plane at the velocity of the image.

**SEARCH MEMORY**—Digital computers have been supplemented by a search memory to reduce the computational time in determining a radar target track. In a paper by E. C. Joseph and A. Kaplan, Remington Rand Univac, a system was disclosed that reduces the time devoted to correlation of target tracks by a factor of 400. The search memory complements the conventional memory. Where input to a conventional memory is an address and the output is the data contained in that address, the input to the search memory is the data and the output is the address of data that matches the input data. When a match occurs, the address is used to retrieve

### WHAT ROLE FOR NONPROFIT LABS?

Panel discussion on the role of government and nonprofit laboratories in the national defense effort revealed that technical standards in government laboratories must be raised and morale improved to avoid mediocrity. The panel, consisting of representatives from government, industry, a nonprofit corporation and a university, also indicated that the role of the nonprofit laboratory is to develop concepts and evaluate advanced techniques; it must not undertake applied research and development nor produce hardware. Also, panel members said, it must have stringent policies against conflict of interest.



associated information.

Therefore, the function of the target track correlator is to associate a set of radar returns with existing returns. The association begins when a radar return is compared with the predicted positions in track storage. This is done by determining whether the radar return lies within a volume of space around a predicted target position.

Gerald B. Speen, ITT Federal Laboratories, described an all-pneumatic gyro that rotates on gas films. The device is reported to have a better drift rate than that of conventional gyros.

**DIGITAL MODULES** — Martin Marietta Corp., Electronic Systems and Products div., announced the availability of a set of digital module patchboards, unique in that jumpers are used from one patchboard to another to breadboard an entire system. Consisting of 32 modules and four patchboards, the system permits a designer to set up any logic scheme. Terminal connections are standardized to provide flexibility in placing the modules in receptacles.

## Computers Developed for Spacecraft, Aircraft

**MINNEAPOLIS**—Two new computer developments for support and checkout systems were recently announced by Minneapolis-Honeywell.

For long-term space missions, a check-out computer will permit continuous in-flight monitoring of entire spacecraft systems. Operational performance of subsystems is calculated by scanning a small number of major test points rapidly enough to approximate simultaneous sampling. Impending failure is predicted long enough in advance for the electronic subsystem to be repaired before failure occurs.

In another development, maintenance requirements for a number of aircraft weapon systems can be checked in one central ground location. Data from on-board automatic systems analyzers are transmitted to a ground-based digital computer. Modularized microminiature NOR circuits and digital mechanization are used in the monitor systems.

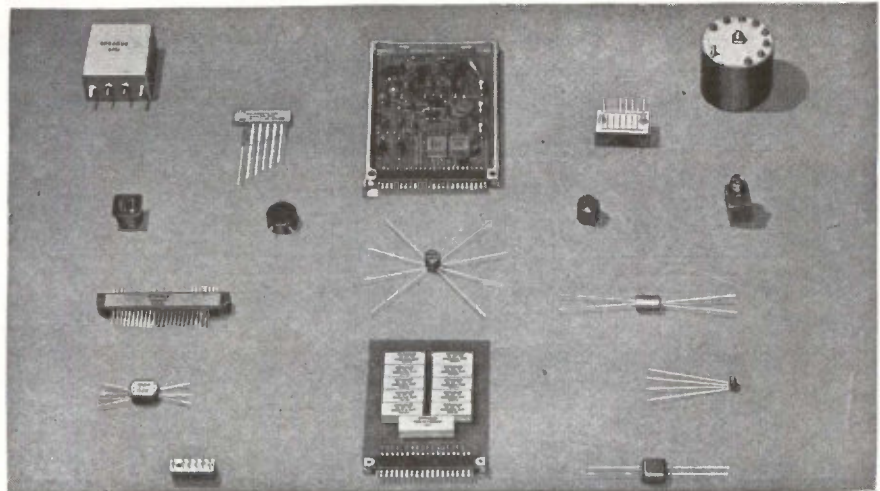

## CUSTOM PACKAGING IS NO NOVELTY AT SPRAGUE'S SPECIAL PRODUCTS DIVISION

★ Sprague Electric Company's *SPECIAL PRODUCTS DIVISION* was founded originally to meet the electronic industry's needs for reliable packaged assemblies and subassemblies.

★ Sprague has developed and produced packages with countless variations in electrical characteristics and mechanical configurations, in all shapes and sizes, with and without semiconductors, as wiring boards, in encapsulated cases, in cast blocks, in hermetically-sealed packages.

★ In Sprague packaged assemblies, internal components are connected by soldering, welding, wire-wrapping, or printed wiring techniques.

★ Sprague versatility offers several basic types of construction, including molded cellular, high-density "cordwood", and molded multiple-circuit construction, permitting densities in excess of 200,000 standard components per cu. ft.

★ For application engineering assistance without obligation, write or call the Special Products Division, Sprague Electric Company, 35 Union Street, North Adams, Massachusetts.

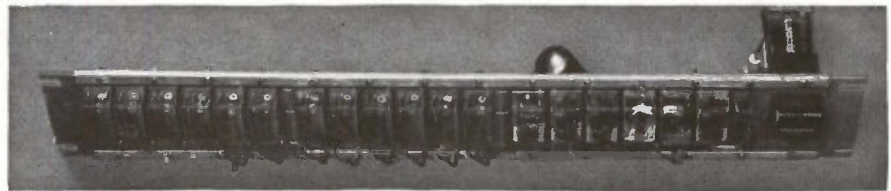

### SPRAGUE COMPONENTS

|                               |                        |
|-------------------------------|------------------------|
| PACKAGED COMPONENT ASSEMBLIES | CAPACITORS             |
| FUNCTIONAL DIGITAL CIRCUITS   | RESISTORS              |
| MAGNETIC COMPONENTS           | TRANSISTORS            |
| PULSE TRANSFORMERS            | INTERFERENCE FILTERS   |
| CERAMIC-BASE PRINTED NETWORKS | PIEZOELECTRIC CERAMICS |
| HIGH TEMPERATURE MAGNET WIRE  | PULSE-FORMING NETWORKS |

45-367 03

**SPRAGUE**<sup>®</sup>  
THE MARK OF RELIABILITY

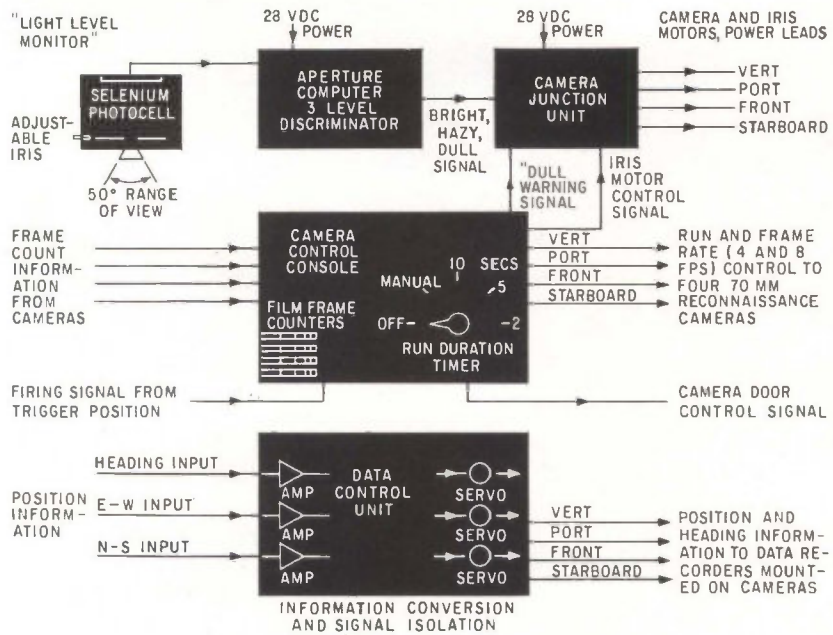

PHOTO RECONNAISSANCE system records navigation data direct on film edge. Four-camera design is shown

## AIRCRAFT CAMERA Records Position Automatically

THE ROYAL CANADIAN Air Force has taken delivery of a photo-reconnaissance system that automatically records position and heading information.

The system processes navigation information and applies it to a data recorder mounted on each of the cameras. Position is printed on each exposed frame. The RCAF installation, in a pod slung below the aircraft, operates four cameras.

The system was designed for low-level, high-speed aircraft reconnaissance by Computing Devices of Canada Ltd. in Ottawa, Ontario, and employs cameras of British manufacture.

The 70-mm cameras receive automatic exposure control signals to compensate for three possible lighting conditions. A light level monitor views down and slightly ahead of the aircraft. Signals are fed to an aperture computer that automatically adjusts the camera irises.

A camera junction unit distributes power and control signals, and a control console incorporates a run-duration timer and film-rate control. The data-control unit accepts position and heading information from the aircraft's navigation system and converts it for operation

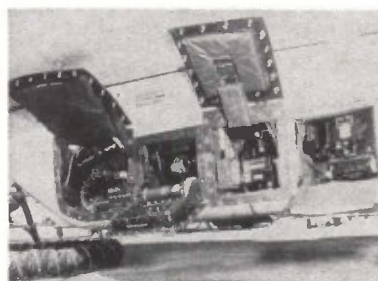

CAMERAS in equipment pod below CF-104 are aligned in various attitudes

tion of the data recorders. Servo control loops and synchros are used and supply a synchro receiver and counter in the data recorder mounted on each camera. An optical system on the camera relays the numerical image to the film edge. Navigational data recorded on the film is printed directly with the photo during processing. Transistor circuits and modular packaging are used in the aperture computer for light control, and the data-control unit that converts information to proper form for the data recorders.

An in-flight processing system is being developed by the Canadian firm to handle 100 feet of standard 70-mm film in a magazine using a saturated web monobath process.



C H E M I N A X

### ADVANTAGES

- 40% less weight
- Lower attenuation
- Lower capacitance
- Stronger center conductor

Weight reduction is proportional to a positive gain in payload and fuel. This gain has greatest significance where it can be effected without loss of reliability or performance.

CheminaX has this property of conserving weight while also presenting an equally important benefit, a larger center conductor. This larger center conductor means a stronger, more reliable cable with no over-all dimensional increase.

Greater strength, reduced weight, and increased reliability are engineered into CheminaX.



RAYCHEM  
CORPORATION

OAKSIDE AT NORTHSIDE  
REDWOOD CITY, CALIF.

in the

0-50

# CHEMINAX

MINIATURE COAXIAL CABLE

replaces **RG 180**

|                 | CONDUCTOR                        | DIELECTRIC | O. D. | CAPACITANCE                  | IMPEDANCE | ATTENUATION            | WEIGHT         |
|-----------------|----------------------------------|------------|-------|------------------------------|-----------|------------------------|----------------|
| <b>CHEMINAX</b> | AWG 28<br>(Copper Covered Steel) | RAYFOAM L  | .135" | 13.5 $\mu\text{f}/\text{ft}$ | 93 ohms   | 10 db/100'<br>@ 400 mc | 9.5 lbs./1000' |
| <b>RG-180</b>   | AWG 30<br>(Copper Covered Steel) | *TEFLON    | .135" | 14.5 $\mu\text{f}/\text{ft}$ | 93 ohms   | 14 db/100'<br>@ 400 mc | 17 lbs./1000'  |

\*DUPONT T. M.



RAYCHEM  
CORPORATION

LEADER IN RADIATION CHEMISTRY  
FOR ELECTRONIC WIRE AND CABLE

# draw your own conclusions...

## ABOUT TRYGON'S MERCURY SYSTEM SERIES

Just follow the reasons from point to point and it's easy to see why Trygon's man in the white coat has developed a series of DC regulated power supplies which are uniquely qualified to power your electronic systems. He has combined the economy and small panel height of fixed voltage supplies with the flexibility of a wide range unit.

Here is truly unique design, with a voltage vernier on the front panel to allow narrow range adjustment and four toggle switches on the rear panel, which provide a wide voltage range by switching input transformer taps. The Mercury System design achieves significant savings in space and costs, yet retains the highest standards of quality in components, construction and overall performance.

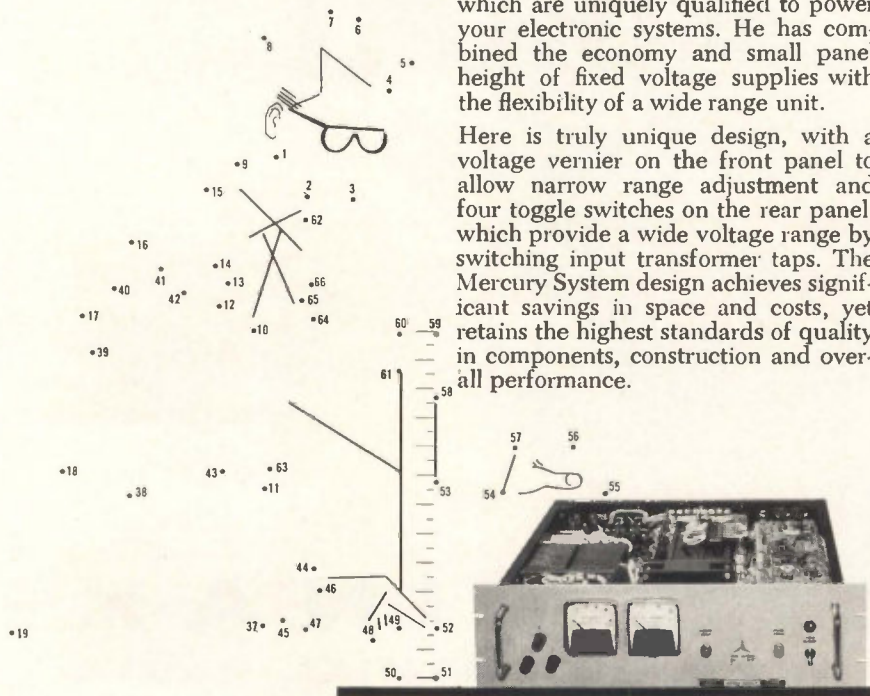

This new series more than measures up in models too, with 16 individual units to choose from, ranging up to 160 volts and 30 amperes... 2 different panel heights: 3½" and 5¼". Prove-out computations have shown MTBF figures of 15,000 to 20,000 hours, depending on the specific unit involved. Prove it to yourself... an inquiry will bring complete data—plus a box of crayons for the kids (you've drawn the conclusion, let them color the picture).

**OUTPUT:**  
 0-15 VDC, 10 and 20 Amp  
 0-36 VDC, 2.5, 5, 10, 15, 20 Amp  
 0-60 VDC, 5, 10 Amp  
 0-160 VDC, 1, 2, 3 Amp  
 6, 12, 18 VDC @ 30 Amp

**REGULATION:** 0.01% or 3 mv

**RIPPLE:** Less than 1 mv RMS

**TRANSIENT RESPONSE:** Better than 50 μsec

**PANEL HEIGHT** 3½" and 5¼"

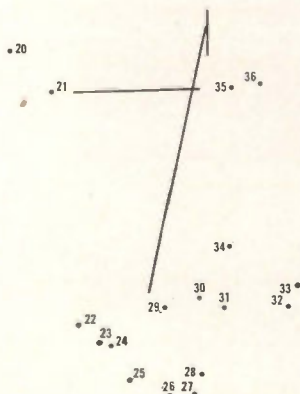

# TRYGON

**ELECTRONICS, INC.**  
 111 Pleasant Ave., Roosevelt, L.I., N.Y.  
 FReeport 8-2800

## MEETINGS AHEAD

**RADIO PROPAGATION COURSE**, National Bureau of Standards and University of Colorado; NBS Boulder Laboratories, Boulder, Colo., July 16-Aug. 3.

**LUNAR MISSIONS MEETING**, American Rocket Society; Pick-Carter and Statler-Hilton Hotels, Cleveland, Ohio, July 17-19.

**MEDICINE & BIOLOGY DATA ACQUISITION AND PROCESSING**, IRE-PGME, AIEE, ISA.; Strong Memorial Hosp., Rochester, N. Y., July 18-19.

**INTERNATIONAL SOUND FAIR**, Institute of High Fidelity Manufacturers, Magnetic Recording Industry Assoc., et al; Cobo Hall, Detroit, July 25-29.

**ENERGY CONVERSION PACIFIC CONFERENCE**, AIEE; Fairmount Hotel, San Francisco, Calif., Aug. 13-16.

**CRYOGENIC ENGINEERING CONFERENCE**, University of California; Los Angeles, Calif., Aug. 14-16.

**PRECISION ELECTRONIC MEASUREMENTS INTERNATIONAL CONFERENCE**, IRE-PGI, NBS, AIEE; NBS Boulder Labs, Boulder, Colo., Aug. 14-16.

**ELECTRONIC CIRCUIT PACKAGING SYMPOSIUM**, U. of Colorado, et al; Boulder, Colo.; Aug. 15-17.

**APPLICATIONS & RELIABILITY SYMPOSIUM**, Precision Potentiometer Manufacturer's Assoc., Statler-Hilton Hotel, Los Angeles, August 20.

**WESTERN ELECTRONICS SHOW AND CONFERENCE**, WEMA, IRE; Los Angeles, Calif., Aug. 21-24.

**METALLURGY OF SEMICONDUCTOR CONFERENCE**; the American Institute of Mining, et al; Ben Franklin Hotel, Philadelphia, Pa., Aug. 27-29.

**MAINTAINABILITY OF ELECTRONIC EQUIPMENT**, EIA Engineering Dept. & Dept. of Defense; U. of Colorado, Boulder, Colo., Aug. 28-30.

**INFORMATION PROCESSING INTERNATIONAL CONFERENCE**, IRE-PGEC, IFIPS, AIFPS; Munich, Germany, Aug. 29-Sept. 1.

**INFORMATION THEORY INTERNATIONAL SYMPOSIUM**, PGIT and Benelux Section of IRE; Brussels, Belgium, Sept. 3-7.

**DATA PROCESSING INTERNATIONAL EXHIBIT**, Assoc., for Computing Machinery; Syracuse, N. Y. Sept. 4-7.

### ADVANCE REPORT

**ELECTROMAGNETIC COMPATIBILITY CONFERENCE**, Army, Navy, Air Force, IRE; Armour Research Foundation, Chicago, Ill., Oct. 30-Nov. 1. Aug. 1 is the deadline for submitting a 150-word abstract or a copy of the paper to: J. E. McManus, Conference Chairman, Armour Research Foundation, 10 West 35th Street, Chicago 16, Illinois. Areas of interest include: interference prediction; equipment design techniques; instruments; measurement techniques; interference reduction measures.

## You may not need capacitors as good as these

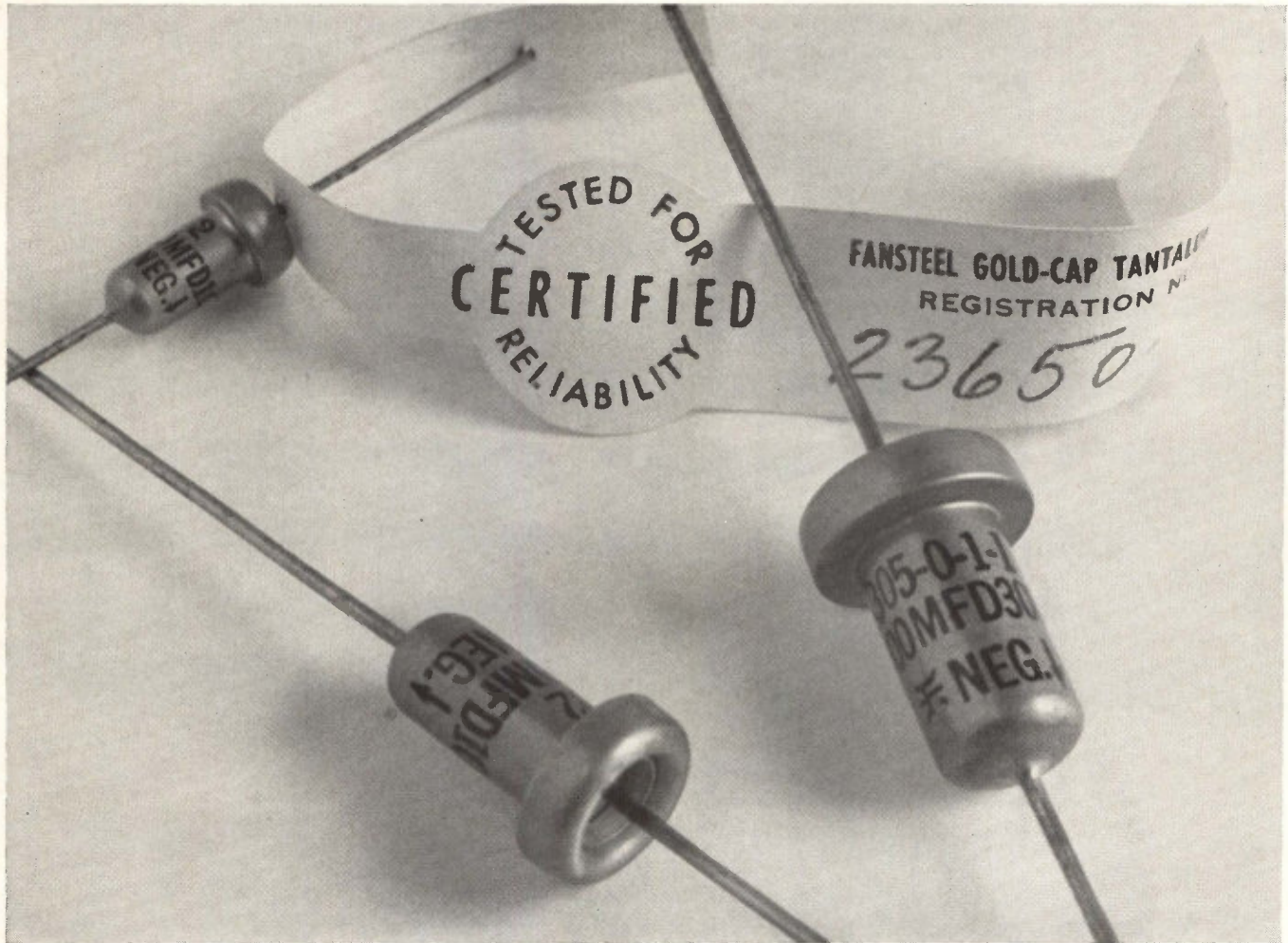

Fansteel GOLD-CAP® tantalum capacitors satisfy a very particular need for extremely high reliability. Your design may not justify their extra cost. If so, Fansteel makes and stocks twelve other types of tantalum capacitors that will surely fill the bill. Gold-Caps are produced under Fansteel Spec. No. 6CA-101 which exceeds the requirements of any Mil. Spec. The stability of each and every unit is tested at temperature extremes for Capacitance, D-C Leakage, E S R, and Impedance. Altogether, 7,891 readings, calculations, examinations, and comparisons are made for every 100 units by Fansteel's tough Reliability Center with the aid of modern computers. When a capacitor is given a GOLD-CAP tag, individually serialized, and provided with certified test results, it has *earned* it. No, we can't be positive that these are the best tantalum capacitors in the world, but

we have no reason to think that they aren't. Send for GOLD-CAP Spec. No. 6CA-101 and see what we mean. Rectifier-Capacitor Division, Fansteel Metallurgical Corporation, North Chicago, Ill.

This is what you get—certified test data, such as illustrated, is furnished with each and every GOLD-CAP capacitor. Further inspecting or testing is unnecessary.

| ● | CAPACITOR NO. | TEST NO. | TEMP. °C | C    | DF % | DC LKG. | % INITIAL C |
|---|---------------|----------|----------|------|------|---------|-------------|
| ● | 23650-0012    | 1        | +25      | 54.0 | 4.8  | .80     |             |
| ● | 23650-0012    | 2        | +55      | 47.0 | 18.6 | .20     | 87.0        |
| ● | 23650-0012    | 3        | +25      | 54.0 | 4.8  | .80     | 100.0       |
| ● | 23650-0012    | 4        | +125     | 56.0 | 4.6  | 2.40    | 108.7       |
| ● | 23650-0012    | 5        | +25      | 53.3 | 4.8  | .80     | 98.7        |

# UNIFORMITY

of semiconductor devices

Western Electric-Laureldale semiconductors are designed to meet specific requirements and do not depend upon selection from a broad distribution of products.

Typical reproducibility of Laureldale's semiconductor devices is illustrated in these monthly parameter distribution charts for the JAN 2N1195 diffused base germanium mesa transistor:

### 3 HIGH-FREQUENCY PARAMETERS (median values)

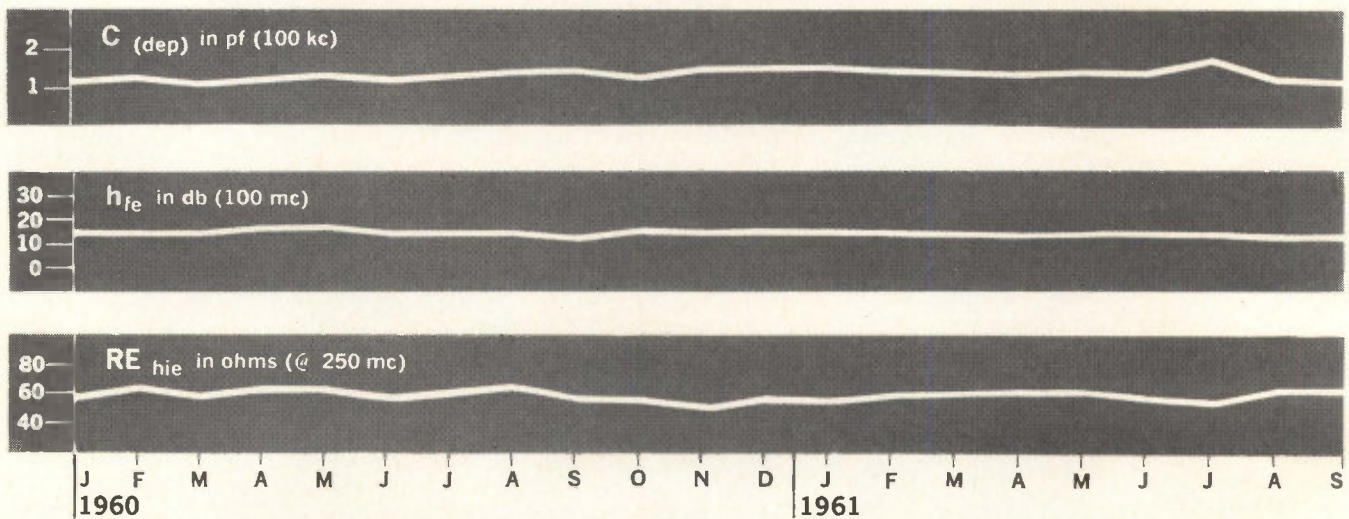

Western Electric-Laureldale, working together with Bell Laboratories' design and development team, produces a broad range of transistors and diodes, both germanium and silicon. These devices are available only to U.S. Government agencies, their contractors and subcontractors and may be purchased in quantity directly from Western Electric's Laureldale Plant. For technical information, price and delivery, address your request to Sales Department, Room 102, Western Electric Company, Laureldale Plant, Laureldale, Pa. Telephone—Area Code 215—929-5811.

## LAURELDALE PLANT

MAKER OF ELECTRON PRODUCTS





AUTOMATIC ELECTRONIC ANALYZER D-PAT (Drum-programmed Automatic Tester) by Hughes Aircraft uses digital computer control to test ICBMs and predict operation. System flashes large-screen picture of missile electronics with arrow indicating malfunctioning component

## Automatic Checkout Equipment

FOR TODAY'S COMPLEX SYSTEMS

*With automatic checkout equipment coming into general use, new trends are emerging in its development. This report summarizes recent approaches to equipment and system design, where and how to use automatic checkout equipment*

By GEORGE V. NOVOTNY, Assistant Editor

AS ELECTRONIC SYSTEMS become more and more complex, and the number of components in a system approaches the order of one million, the mean time between failures (MTBF) of the equipment as a whole tends to grow shorter. Thus, a system containing one million components, each with a reliability of 99.9999 percent, might have an overall reliability of nearly zero, with a correspondingly low confidence that it can ever perform its mission.

The electronic system in a modern supersonic bomber has an MTBF of the order of ten hours. At the same time, its complexity makes it impossible to check the entire system in that time, using conventional manual methods: the system may fail long before a normal checkout procedure can be carried out.

To perform a confidence check on such a system and still have enough of the operating lifetime to perform a mission, the check must be done by a high-speed automatic tester. Hence, automatic testing today is not a luxury but a necessity; this justifies its sometimes high cost.

Automatic testing, coupled with the corresponding repair ability, is one technique for improving equipment reliability. Testing and repair imply the availability of spare parts for replacement of faulty ones. In fully automated test-and-repair systems, such as will be used aboard advanced space vehicles, spare parts and provision for their installation will be carried aboard, and the system will thus have become a self-adapting redundant one.

Automatic system checkout minimizes the need for trained operators, saving training time. By eliminating the chance of human error, a high degree of test uniformity is attained. The on time of the equipment under test is reduced, thus eliminating some failures and allowing longer useful service life.

Automatic testing techniques have been applied to testing components as well as to system testing. Since component testers as a rule are much less complex than system checkout units, this report is not concerned with them.

**BASIC KINDS OF TESTS**—There are three basic kinds of tests to be done on an electronic system. All of these can be performed manually or with varying degrees of automation.

- *Confidence check* merely assesses the readiness of a system to function or to perform a mission. The confidence check usually takes place in the field or on the flight line, with time severely limited, and little or no chance for repair. It may be a GO-NO GO test, or it may determine the possibility of a limited-performance mission by measuring how far outside normal limits the system is functioning. Example: pre-flight checkout.

- *Certification test.* This is usually a periodic test, done on a system kept in readiness; its purpose is to certify the system's reliability and to predict the success of a possible mission. Time may be limited, but there is more chance for fault isolation and for replacement of major components. Example: periodic testing of a Polaris missile's gyroscope aboard the parent submarine, with spare gyroscope units available for replacement.

- *Maintenance test.* Involves primarily the isolation of malfunctioning parts and their replacement, hence it's a diagnostic test. Depending on limitations of time and equipment, an attempt is made to isolate malfunctions

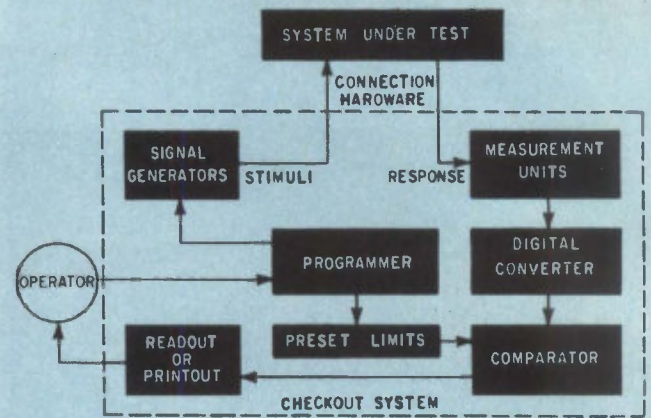

BLOCK DIAGRAM of automatic checkout system illustrates the main functions found in most contemporary systems—Fig. 1

to the smallest replaceable component. The faulty parts are then replaced and a certification test usually follows before the equipment is considered in readiness.

While this classification is based on military and space systems, it applies as well to industrial and civilian equipment, with simplifications. However, the time squeeze produced by the high complexity of an electronic system rarely occurs, at the present time, in industrial systems. When automatic testing equipment is applied to such systems, it is usually a simplified version of a military or space checkout system, or a single-function production testing machine of a lower order of complexity.

**HOW TO TEST EQUIPMENT**—There are a number of ways of testing a piece of equipment: inspection and testing of individual components, signal tracing, transfer-function analysis and white-noise techniques and transient response analysis. However, most present-day automatic checkout systems use the approach derived from signal-tracing servicing of radio receivers. See Fig. 1.

- *Stimulation.* A stimulus, such as a voltage, current or r-f signal, is fed into the equipment under test. Often this stimulus is intended to be a close approximation of the working conditions, however, some systems use stimuli such as step voltages, transients or white noise, when these can better reveal malfunctions of the unit. Included under stimulation are dummy loads, used to approximate operating conditions. Power is supplied to the equipment under test within limits of normal power-supply operation.

- *Measurement.* The response of the equipment to the applied excitation is then measured at convenient output points. Again the measurement may be a voltage, frequency or any other physical quantity, that is then converted by a transducer into an electrical signal. Enough measurements must be made at enough points to insure satisfactory diagnosis. In a fault isolation test, more measurements will generally be made than in a confidence check. Present-day checkout systems generally have the following measurement capability: a-c and d-c voltage, a-c and d-c current, frequency, time interval, events per unit time, voltage ratio, phase, continuity and



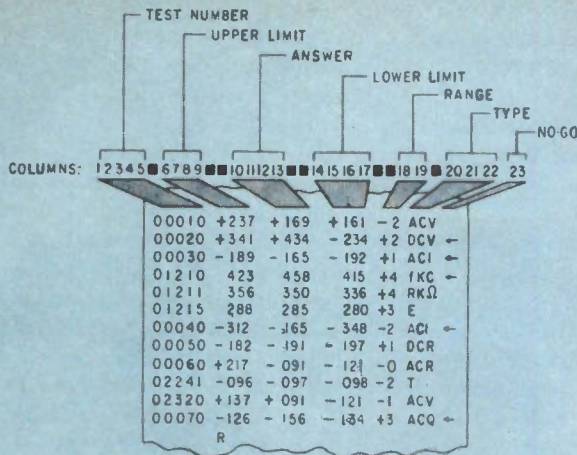

EXAMPLE OF A PRINTOUT TAPE, identifying the test number, test limits, measurement value, type of measurement and GO-NO-GO result—Fig. 2

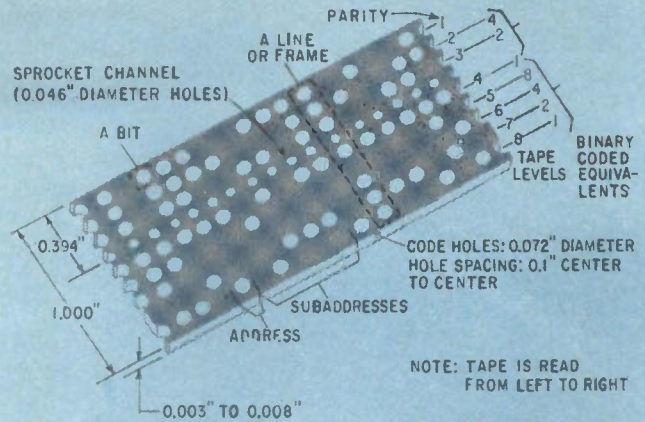

PUNCHED MYLAR TAPE is typical of 8-channel programming tapes used by automatic checkout systems—Fig. 3

leakage, resistance and impedance.

• *Conversion to digital information.* Since as a rule the comparison and logic circuits are digital, measured quantities must be converted into digital data. This is often done by a separate analog-to-digital converter. Or a digital measuring device, such as a voltmeter, may be used. The closer the conversion to the point of measurement, the less degradation of the signal occurs. The output of the converter is generally a binary train.

• *Comparison.* This operation compares the digital information from the measurements against preset quantities or acceptable limits, which are stored in a memory or supplied by the programmer for each measurement. The comparator has logic and arithmetic units, their complexity depending on the kind of readout and the nature of the check. The comparator may be required to give a simple GO-NO GO readout, or it may be designed to compute the amount and direction off limits.

In a fault isolation test, a considerable number of logic circuits may be needed to determine which component is faulty, using the available measurements. A trade-off situation exists: the fewer measurements are made, the more sophisticated the logic circuits must be; on the other hand, if enough tests have been made (which consumes more time) the analysis is simpler and the faulty module is more easily isolated. The final compromise depends on required speed, space and weight limitations, cost and other factors. Some advanced automatic test systems have the data-processing capacity and speed of a medium-size computer.

• *Printout and display.* This may be a simple GO-NO GO indicator, depending on the equipment and the test, HIGH-GO-LOW, or even more detailed. For example the early DATS (Dynamic Accuracy Test System, by RCA) checkout system for aircraft fire control equipment was designed to indicate, in addition to GO and NO GO, the miss distance in azimuth and elevation, in yards, and also to indicate whether the armament fired early or late. This quantitative readout enables the operator to make a decision in a tactical situation where a somewhat defective system may still be acceptable, providing the deviation from normal is known. Quantitative readout, of

course, requires an arithmetic unit such as the DATS miss computer.

In a fault isolation test, the printout unit gives the serial number of the NO GO check, and often gives the faulty reading. See Fig. 2. Some systems will print out instructions for the operator to make an adjustment or to replace a specific module.

• *Controlling unit or programmer.* This unit sequences the tests according to a predetermined program. The program may be inserted as punched paper or plastic tape, magnetic tape or punched cards. Punched 8-channel Mylar tape, see Fig 3, is popular in medium-speed checkout systems. Some systems, such as Race, read off the program from a tape and then store it on a magnetic drum. The selection of the programming medium depends on the duration, number, speed and repeatability of the tests. The programming medium may also tell the allowable limits on each measurement.

The automatic programmer will generally sound an alarm and stop the testing sequence when a NO GO reading is entered, forcing the operator to acknowledge the situation by manually restarting the sequence. Alternately, the programmer may switch into a fault-isolation subroutine. In testing missile engines a NO GO reading will be programmed to automatically disable the unit under test to prevent damage.

Other functions of the control unit include introducing time delays into the sequence as required by the unit under test, and selection and insertion of tolerances into measurement-limit storage. Periodically the programmer may switch in a self-check sequence to test the automatic tester itself.

• *Self checking provisions.* The automatic checkout system is highly complex and likely to fail occasionally. To increase confidence in the testing, most modern systems contain provisions for self-check, which is carried out automatically at intervals as a subroutine, sometimes while a test is in progress. Motorola's Pate system, for example, carries out a self check periodically, and if a NO GO reading is encountered, switches itself into a further self-test sequence, which then isolates and identifies the faulty module of the test system. The self-check exercises all Pate's digital circuits; their

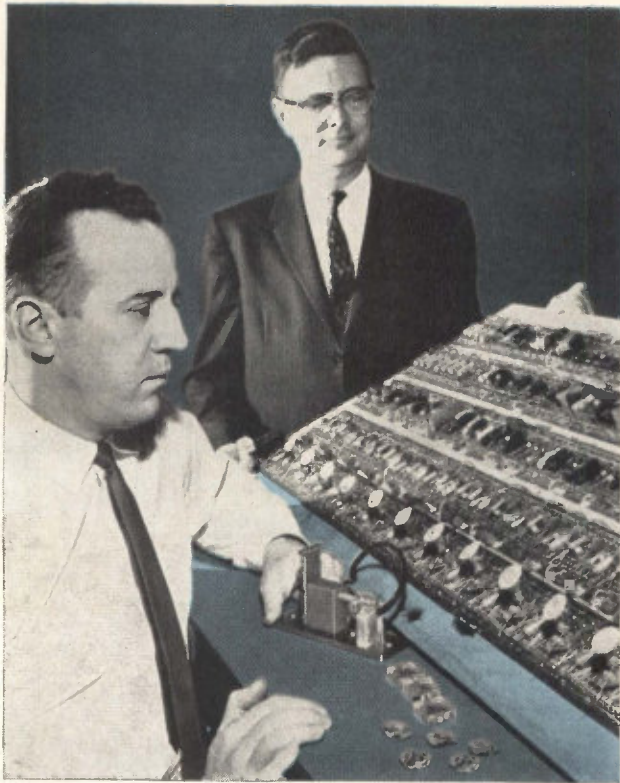

**INDUSTRIAL automatic tester is Bulova Watch analyzer for Accutron electronic watch movements. Analyzer checks 15 functions sequentially in one second. Such systems are not designed to be adaptable to other uses—Fig. 4**

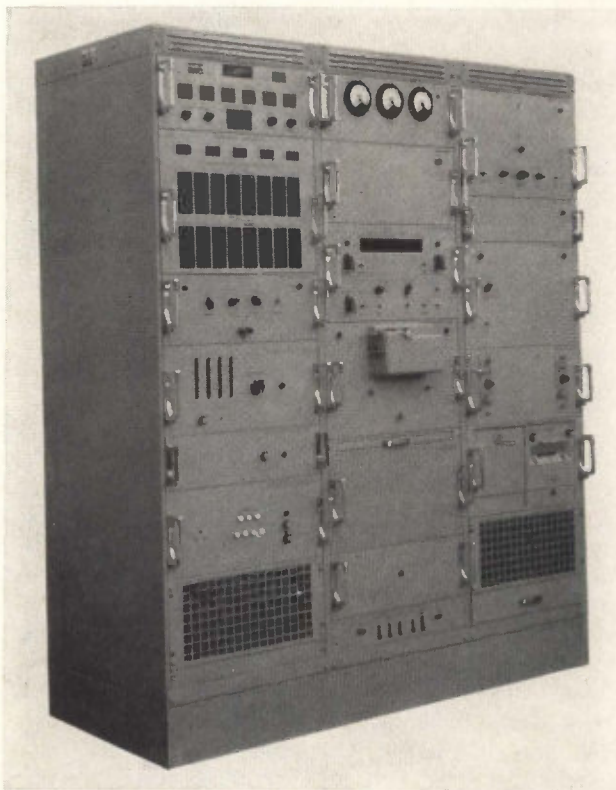

**DATICO EQUIPMENT for Polaris missile checkout, installed aboard the USS George Washington and Patrick Henry. Later version is installed aboard all Polaris submarines—Fig. 5**

logical response is compared against the response that should occur. The measuring units are also tested, by connecting them to secondary standards and evaluating the measurements against known values.

• *Means of access to equipment under test.* Connections must be made from the tester to the unit under test. This includes connecting the stimuli to the input points, connecting dummy loads to output points, and making measurement connections. Since automatic checkout must be done rapidly, connecting and disconnecting must be quick and easy. Most testing systems have adapter cables for each kind of unit tested; this accommodates the requirement for a variety of connectors, simplifies test system design and reduces required operator skill.

In checking out a large, complex system, 12,000 wires to and from the equipment may be required. This poses a problem with mobile systems, where cable hoists, booms and similar equipment may be needed; another problem is how to store the cables.

Many techniques have been applied to reducing the number of connections. These are mostly switching techniques, including multiplexing with remote switching amplifiers. An increased logic capacity in the test control computer can make many connections unnecessary, since it can draw more conclusions from fewer figures. Usually it is also desirable to use all input and output connections on the equipment, and to take advantage of all interconnections and information channels in the system under test.

**DESIGN OF CHECKOUT SYSTEMS**—The speed of a checkout procedure is vital. It is speed that forced the introduction of automatic checkout equipment in the first place, and there is a continuing effort to reduce the overall time of each test cycle. It is desirable also to keep to a minimum the on time of the equipment under test to prevent unnecessary failures.

Switching, both at the input and output, limits speed. Most checkout systems use relay-tree switching, cross-bar, stepping-switch and latch relay configurations, although electronic solid-state switching has been introduced in some advanced systems. In contemporary checkout systems millisecond switching times are normal.

Memory access and readout times in most of today's systems are of the order of 5 milliseconds. With punched tape programming, mechanical readers are being replaced with photoelectric readers; this increases readout speed from about 20 frames a second to up to 200. Block readout techniques, supplementary memories and similar approaches have cut readout time to the order of 1 millisecond. Shorter times are encountered in some computer-controlled units.

Another speed limitation is the measurement and conversion speed. These are intrinsic limitations of the measurement units.

However, the overall checkout speed in modern systems is limited not so much by the checkout system itself as by the equipment under test: warmup time, built-in delays, response time, the time taken by the operator to dispose of NO GO indications, to make adjustments, the connecting and disconnecting time.

Early automatic checkout systems were custom built. However, with the rapid obsolescence of space and military equipment types, and their increasing complexity, this proved uneconomical; large amounts of support equip-

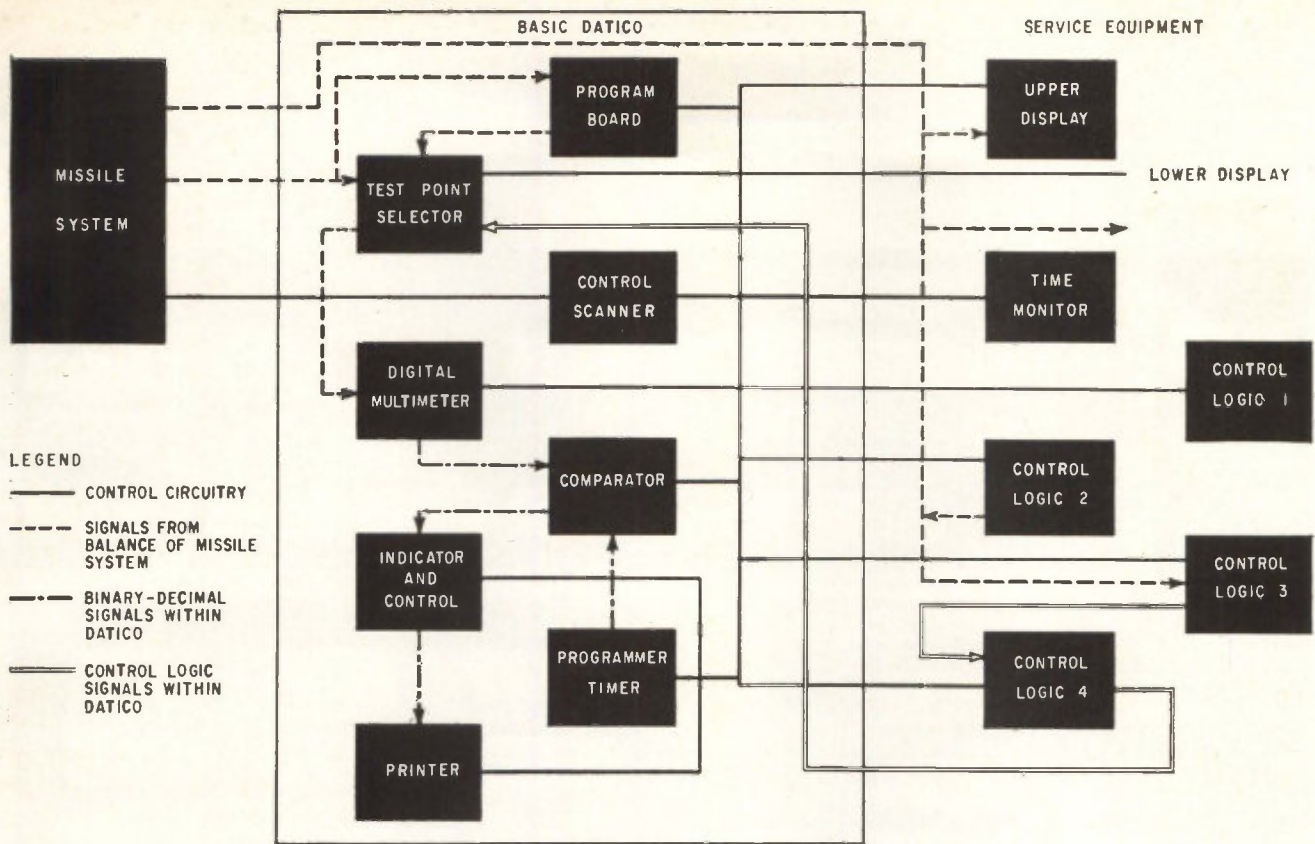

BLOCK DIAGRAM of Nortronics' Datico shows the basic-unit-plus-adaptor approach to adaptability—Fig. 6

ment carried with each electronic system frequently had to be replaced, and were unsuited for anything else. At the same time, the automatic checkout system became more complex and its control and logic circuits came to resemble a general computer.

It soon became apparent that a test system that could be adapted to handle several weapon systems would be more practical and economical, and several ways of building adaptability into test equipment were developed. Most of the large automatic testing systems today are flexible, and some are called universal.

However, custom-designed testing systems, designed for one job only, are common in industrial applications and wherever complexity is low. Testers for repetitive production-line work, such as the one shown in Fig. 4 for testing movements of electronic watches, are not likely to be adaptable to other work.

Similarly, automatic selftesting systems for use aboard space vehicles and intended to perform only one kind

MARTIN-DENVER'S MARTAC checkout system has central unit (center and left) that can control remote units (right) at equipment locations. System uses photoelectric tape reader, is set up for missile launch control and checkout—Fig. 7



of test sequence do not have to be adaptable; in these applications the equipment is expendable and space and weight must be saved.

**MAKING TEST GEAR ADAPTABLE**—The ideal automatic tester, of course, would have no limitations. Since voltages, currents, time phenomena and other physical quantities occur in all electronic equipment, with proper programming the ideal tester could test almost anything. For each piece of new equipment a new program tape would be inserted, connections made, and a test run immediately.

In practice this is not so simple, because universality carries with it certain penalties. Several basic approaches have been developed toward making automatic checkout equipment adaptable.

• *Basic-unit-plus-adaptor system.* This approach to automatic testing equipment uses one basic unit, comprising the elements that are common to all intended applications, and an adaptor that completes the test system. The adaptor is custom-built for each kind of equipment to be tested.

An example of this approach is Nortronics' Datico (Digital Automatic Tape Intelligence Checkout) test system, which has been applied to monitoring the readiness of submarine-based Polaris missiles (see Fig. 5), as well as other systems ranging from system checkout to component fault isolation on the Nike-Hercules missile and on automatic pilots.

The basic Datico is unchanged in different applications, except for physical characteristics to conform to the different armed services' specifications. The equipment includes the program board, test-point selector, control

scanner, comparator, indicator and control, programmer-timer and printer circuits. Figure 6 is a block diagram of Datico.

To this package is added the adapter, which includes the signal (stimuli) generators, measuring devices and dis-

plays, as well as connection hardware. Thus units that are common to all testing schemes need not be duplicated, while the specialized features whose requirements vary from system to system can be designed for each, without compromise in measurement accuracies.

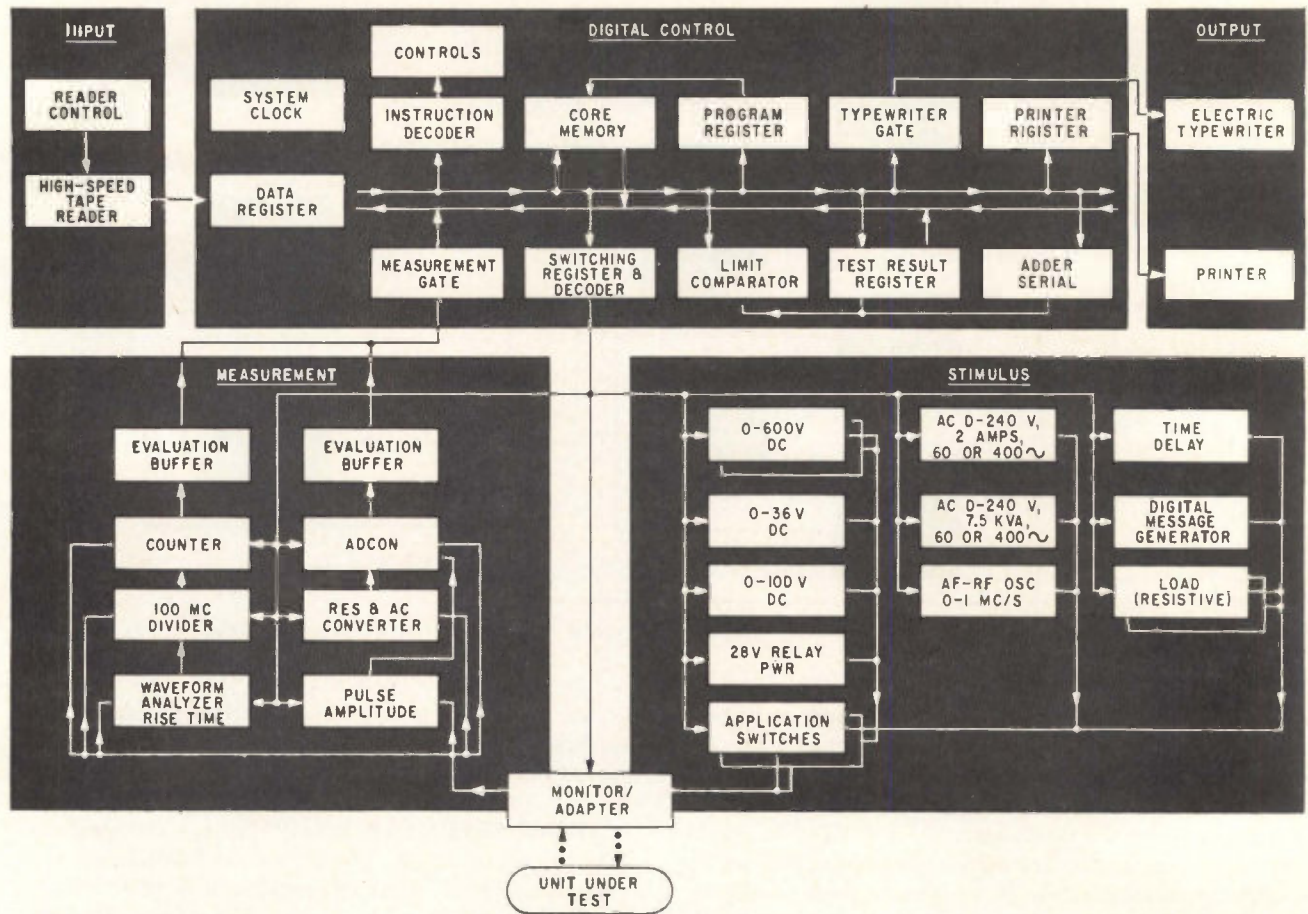

DEE, by RCA, is a flexible universal test system. Equipment is shown in its high-speed automatic configuration, block

DEE SYSTEM before delivery to Signal Corps. This is a magnetic-tape system with electric-typewriter printout. Other configurations are available for other applications of the same system—Fig. 9

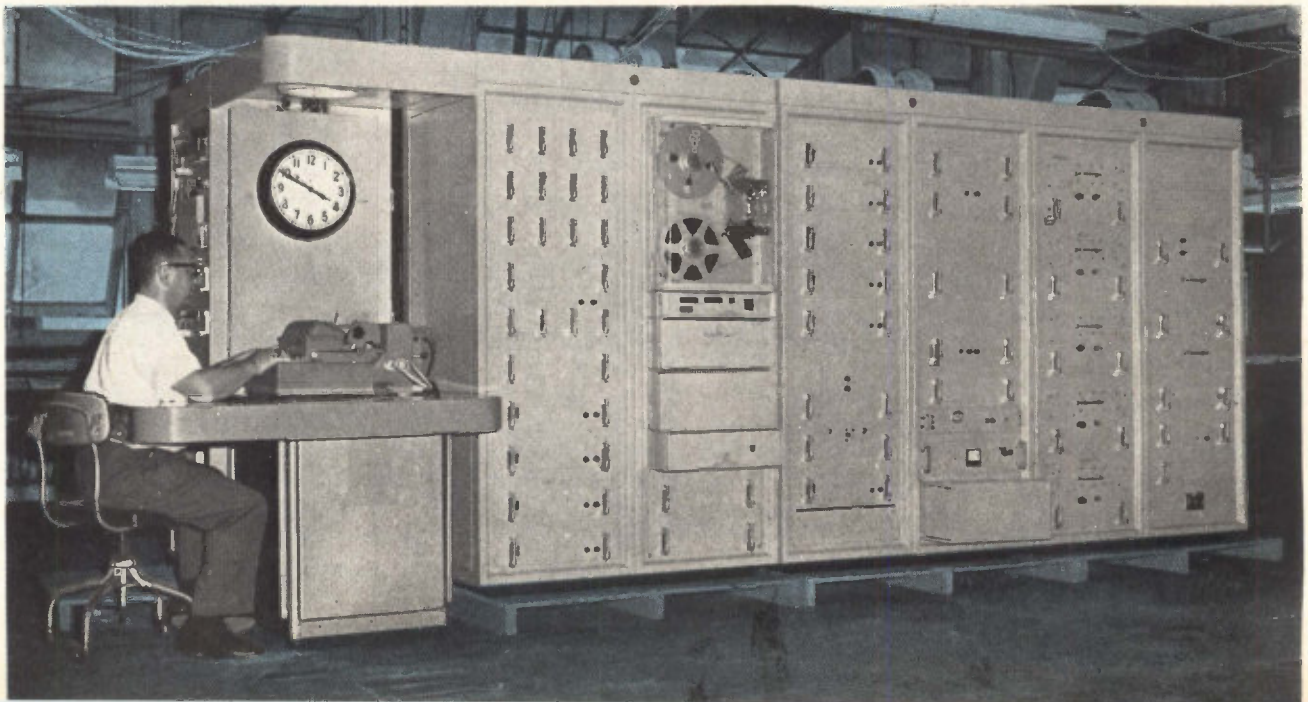

The Polaris Datico operates on three levels: watch mode, for continuous monitoring of the readiness of the missile circuits; test mode, a periodic maintenance check to ensure readiness; and operate mode, for the final countdown sequence before launching. The system

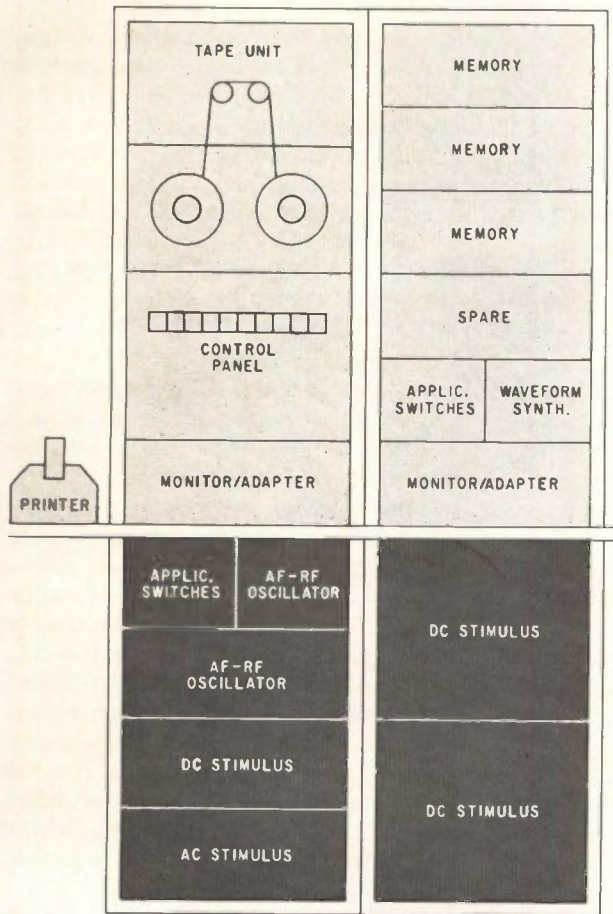
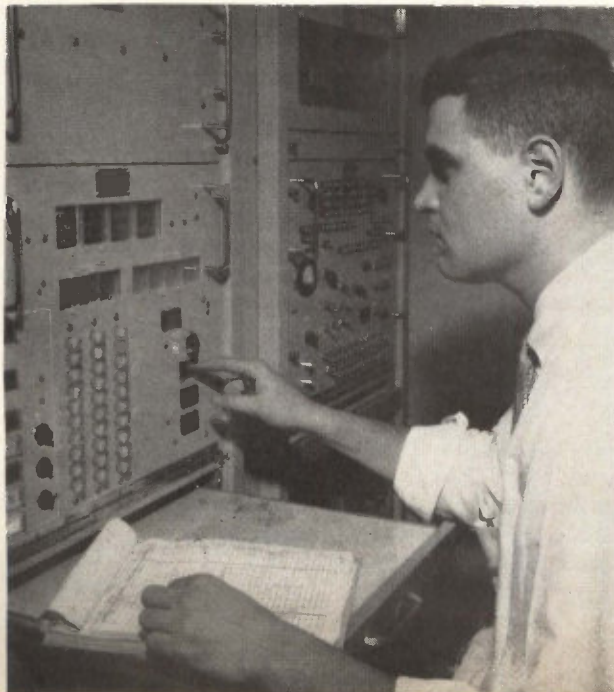

Diagram is at left, front panel at right—Fig. 8

SPERRY's RACE checkout system accomplishes entire sequence by use of two pushbuttons: START and DISPLAY FAULT NUMBERS—Fig. 10



is controlled by punched Mylar tape.

The basic-unit-plus-adapter system is also used in the Martin Denver Company's Martac 420 system, a solid-state, high-speed automatic checkout system. Martac has the additional feature of one central unit controlling a number of remote units located at the equipment sites. A system is illustrated in Fig. 7.

• *Erector-set approach.* Called also the functional building-block principle, this approach uses an assortment of physical modules each of which has only one function, such as tape reader, voltmeter, counter or printer. The modules have standardized physical dimensions; electrical characteristics can be also standardized.

For any automatic testing program, only the relevant functional modules are selected and assembled. A programming unit is selected according to the speed and complexity of the test, and connection made to the equipment. This approach is illustrated by RCA's DEE (Digital Evaluation Equipment) system. The basic DEE has 108 different modules, built in five standard module sizes. Fieldata code is the program language.

This system assumes that the basic physical measurements will recur in different systems to be tested, and that measuring units will not be made obsolete by new equipment or increased accuracy requirements. Its advantage is that in any testing program only the necessary units are carried, thus saving space and weight, and that modules can be interchanged to accommodate changing requirements. Obsolescence of individual modules does not necessitate redesign of the system, and expansion capability is maximum.

Thus the DEE open-end system makes possible a variety of testing programs, ranging from semi automated punched-card-programmed units, suitable for production testing and component grading, to computer-controlled research and development evaluation systems, see Fig. 8 and 9. An interface converter available with DEE makes it possible to control the DEE equipment with an external digital computer, so that the testing program can time-share the computer with other activities.

Here automatic checkout equipment becomes an extension of a computer, a tool that enables the controlling computer to perform checking and analytic functions on other electronic equipment without human intermediaries.

Another modern automatic checkout system that illustrates some of the points mentioned above is Sperry's Race (Rapid Automatic Checkout Equipment), a computer-controlled dynamic test system that uses a 1-mega-cycle digital computer with a half-million-bit memory, a computing capacity equivalent to a conventional digital business-type computer. The system is adaptable to radar system testing, data processing stations, bombing-navigation systems and countermeasures systems, and is self-adapting to system design variations.

Race, shown in Fig 10, performs about 1,500 test cycles in 30 minutes, completing the equivalent of six man-weeks of testing. Without relay switching-time and human-response delays, the system could complete the 1,500 tests in one minute.

The Race checkout systems use a human operator as part of the checkout loop, to cover all modes of operation in the shortest possible time. The operator has a small box by which he can communicate with the control unit: the control unit requests the operator by a flashing-



**REMOTE COMMUNICATOR UNIT** enables checkout system to "converse" with operator of system. By code numbers, checkout system instructs operator to change switch positions, and compare displays. Operator replies by pressing YES and NO buttons—Fig. 11

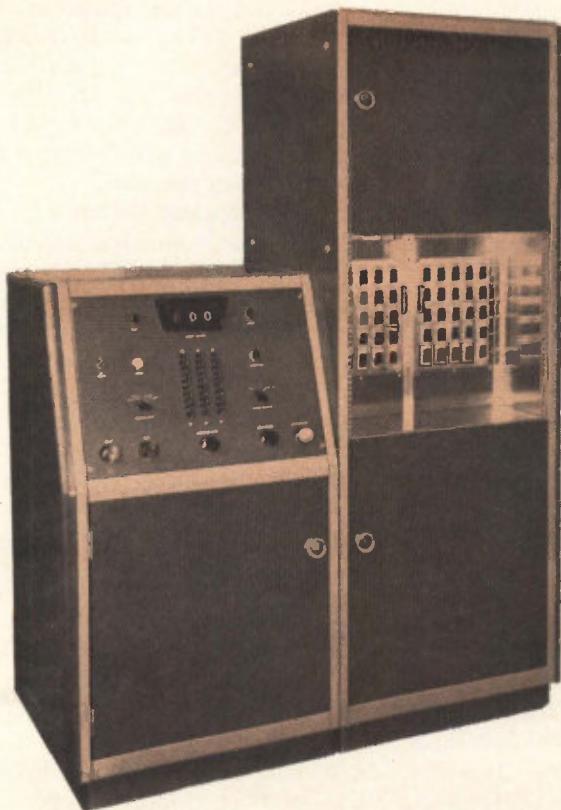

**INDUSTRIAL TESTER** by Datronics applies the principles of automatic checkout to continuity and leakage tests—Fig. 12

light code to select switch positions, verify scope patterns and make adjustments. Operator acknowledges orders and replies by pressing buttons, Fig. 11.

Programming of the Race system is by magnetic-drum memory. The logic circuits operate at a one-megacycle clock rate; the drum runs asynchronously slightly slower, and the system under test has its own clock frequency; thus the entire testing system operates on three simultaneous time scales.

An example of an industrial automatic tester is Datronics' Automatic Continuity and Leakage Tester shown in Fig. 12. This unit can be used in production tests, computer checkout and troubleshooting. It tests a circuit's continuity, with GO limits 0.4 and 5.0 ohms at 10-milliampere d-c test current, and leakage resistance from 20 to 200 megohms at 500 volts d-c test voltage. The tester has a capacity of 1,000 circuits, each being assigned a three-digit decimal code, and will test these in predetermined sequence at 100 circuits a minute.

The readout indicates the number of the tested circuit, continuity and leakage NO GO lights, test-cycle-complete light, and a fault alarm is sounded in NO GO cases. Programming is by patchboard. Sequence stops when a NO GO reading is obtained. The fault reading can then be repeated or bypassed at the operator's option. Switching is done by stepping switches and relays.

An example of an industrial on-line automatic tester is the DIT-MCO company's model 720 logic-module tester. Programmed by punched Mylar tape in endless loop, the model 720 performs static and dynamic tests on active or passive logic modules, such as memory boards, computer logic cards and component cards. The testing is GO-NO GO, measurements are made of resistance, voltage and current. Marginal tests can be programmed to evaluate a logic module under conditions of lowered or raised supply levels, combined with lowered or raised signal levels. Passive logic circuits can be checked against logical outputs conforming to the logic equation.

**TRENDS IN DESIGN**—Several trends are emerging in the development of automatic testing systems. They are for the most part in the direction of increased automation, increased speed and smaller physical size.

Computer-controlled checkout systems, capable of analyzing the performance of a unit under test from only a limited number of measurements, will be able to isolate and identify the smallest replaceable component and instruct the operator to that effect. From logical analysis of operation, future systems will probably be able to predict the remaining useful life of any piece of equipment, and also to determine tolerance limits of operation for selected portions of a system where they are contingent on actual performance values measured in other portions of the system. Through computer-controlled checkout equipment, interconnecting cables will be kept to a minimum.

Other features recently appearing in checkout systems are all-solid-state circuits, fully digital circuits, expandable modular design, flat-wire cabling, wire-wrapped connections, use of standard logic modules, photoelectric rather than electromechanical punched-tape readers, and less reliance on operating technicians.

A major part of the automatic checkout equipment made today is designed in conformance with USAF specification MIL-D-9412, covering data for aerospace ground equipment (AGE).

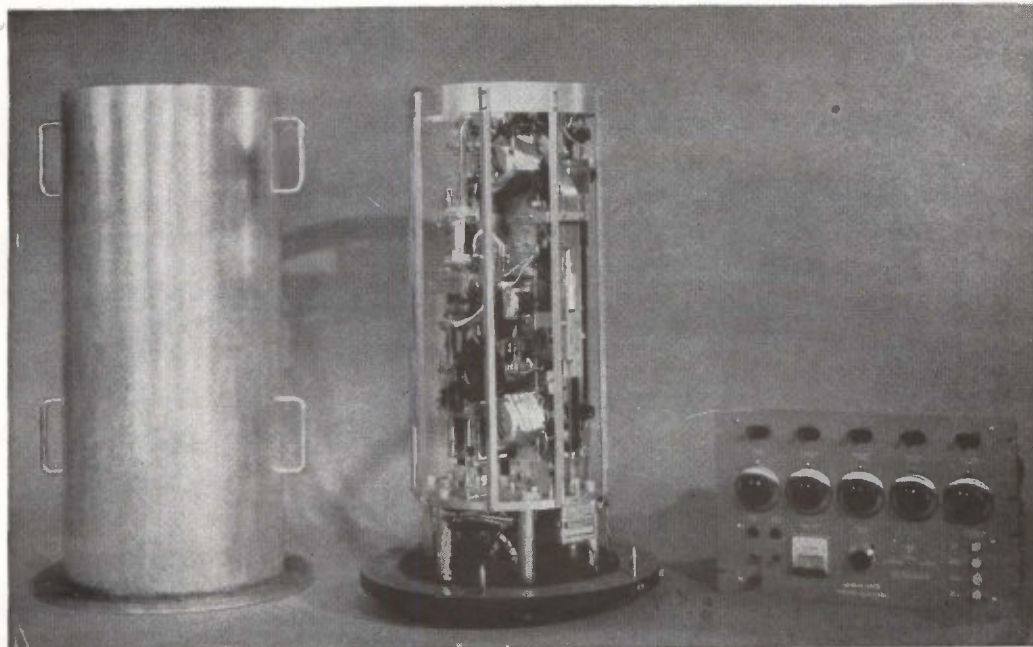

*Weatherproof container for the paramp (left) permits its mounting at the feed point of the antenna. Control panel (right) is in a ground-level control room*

## FIRST CIRCUIT DETAILS

# Paramp that Tracked Pioneer IV Deep-Space Probe

*Rapid tuning over a broad frequency range at low noise is made possible by a unique three-cavity design and varactor-diode mount*

By **A. P. HEYMANN**  
Specialty Devices Operation,  
General Electric Company,  
Syracuse, New York

**THREE CAVITIES**, tightly coupled at the varactor diode, but tuned separately, overcome tuning-range limitations of the usual parametric amplifier. This negative-resistance amplifier tunes from 375 to 1,200 Mc with a noise figure of less than 2.5 db. Frequency-selective filters in all the tuning circuits allow independent tuning. The filters and cavities are arranged around the diode so that there is no spurious resonance or interaction between tuning controls.

A rectangular waveguide H-plane cross is used for the pump and idler circuits with the diode at the

center of the cross. Pump frequency, fixed at 10 Gc, is supplied by a 100-milliwatt reflex klystron.

Mounted directly on the cross assembly, the coaxial cavity is tuned to the signal frequency. The signal cavity is a modified  $\frac{1}{4}$  or  $\frac{3}{4}$  wavelength shorted line capacitively loaded by the diode. A coaxial low-pass filter keeps out X-band frequencies.

The cross design is mechanically simple and lends itself ideally to the electrical requirements.

The physical size of the common frequency area containing the diode is small and of a shape that blends perfectly with the three cavity structures. This simplifies theoretical design.

This configuration permits the

use of up to six filter and cavity tuning elements, which are coupled closely to the diode. This relatively large number of independent tuning and matching adjustments results in the unusually wide tuning range.

Two idler-frequency filters and two idler tuning adjustments are arranged in a line with the diode in the center, Fig. 1. The complete circuit may be viewed as a multi-wavelength waveguide cavity loaded in the center by the diode.

Two idler adjustments prevent a voltage standing wave minimum from falling at the diode position and decoupling the idler circuit at spot frequencies.

Because both filters are tuned in the same frequency, the two tuning

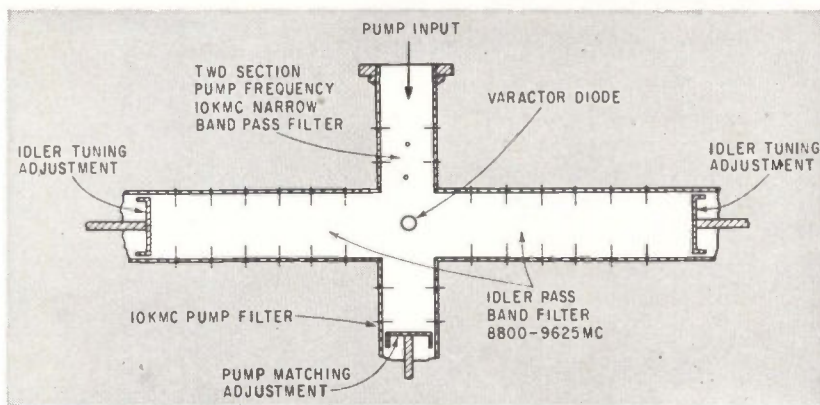

WAVEGUIDE CROSS ASSEMBLY for mounting the varactor diode is shaped to match the three-cavity structure—Fig. 1

adjustments interact with each other, providing a tuning adjustment and a diode coupling adjustment for the circuit. The two filters prevent interaction with the pump circuit adjustments.

Band-pass idler filters cover the idler tuning range of 8,800 to 9,625 Mc and have over 30 db attenuation at the pump (10 Gc) and upper-sideband frequencies. The filters are a Tchebyscheff design with maximum passband attenuation of  $\frac{1}{2}$  db and sharp cutoff slope.

The pump circuit is similar to the idler circuit except that, because of fixed-frequency operation, the filters are narrow band-pass units. With the source at one end of the pump circuit, a sliding short is a matching device at the other end. The sliding short matches the diode to the pump to conserve pump power.

**SIGNAL CAVITY**—Because of the wide-band tuning requirement plus the requirements of the antenna and post-receiver coupling, the signal cavity (Fig. 2) is the most critical portion of the amplifier. The cavity operates as a coaxial quarter-wave resonant line, which is foreshortened by the diode capacitance, for frequencies up to 550 Mc. The three-quarter mode is used above 550 Mc because its length is more convenient.

The filter section of the signal cavity, a two-section constant-K filter of coaxial design with a cutoff frequency of 4 Gc, is designed for high attenuation in the pump and sideband region (8 to 12 Gc) and the pump second harmonic re-

gion (20 Gc). High attenuation at these frequencies assures their absence from the signal cavity resonant circuits, simplifying the design of the signal cavity and providing independence for quick and easy adjustment.

A unique split-conductor construction is used in which both inner and outer conductors are divided for the full length of the cavity to permit the insertion of an adjustable shorting bar. This bar controls both the signal frequency tuning of the amplifier and the coupling between the signal cavity and the signal input and output circuits.

To adjust the signal frequency, the bar is moved to vary the length of the resonant portion of the cavity, which lies between the bar and the varactor diode. The remainder of the cavity acts as a coaxial line to connect the resonant portion to the signal input and output circuits.

The shorting bar is a leaky short that permits energy to couple into and out of the resonant cavity. Coupling is controlled by varying the cross-section of the shorting bar. By making the bar with a lengthwise taper, its effective cross-section is adjusted by moving it into or out of the split signal cavity.

The bar makes contact at all times to both halves of the center and outer portions of the signal cavity. Six rhodium-plated beryllium-copper contact strips make high-pressure contact with the rhodium-plated shorting bar. The split-center conductor is supported

by a low-loss foamed-in-place plastic that is almost completely transparent to the signal-frequency energy. This construction makes the signal cavity a rugged structure, practically immune to shock, vibration or moisture and dirt contamination.

A phasing adjustment, Fig. 3, allows optimum matching between the antenna and the signal cavity. This is a trombone-type constant-impedance coaxial line stretcher.

**COUPLER**—A wide-band directional coupler couples signal input and output lines to the amplifier. A circulator would be better but no circulator covers more than a small fraction of the tuning range of the amplifier. It may be possible to cover the 825 Mc tuning range using two circulators with coaxial switching. These devices have not yet been developed but their use would double the bandwidth of the amplifier and increase its stability.

Any conventional circulator can be used with the amplifier over a tuning range determined by the passband of the circulator. Such a circulator could either directly replace the directional coupler or be installed external to the amplifier and the directional coupler left in place.

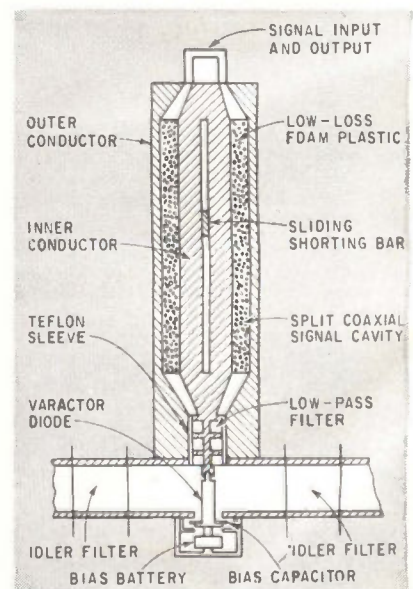

FILTER SECTION of this signal cavity reduces possibility of unwanted resonant circuits—Fig. 2



A loop coupler introduces a test signal into the amplifier for adjusting and verifying operation.

In the pump circuit a 20-db cross-guide coupler diverts 1 percent of the pump power to a crystal detector. The rectified current goes to a 0-1 millimeter that monitors pump power. An attenuator diode across the pump waveguide acts as an electrically-operated control of the pump power reaching the varactor diode. This controls amplifier gain which is a function of pump power. A low-noise high-stability power supply furnishes bias voltage to the attenuator diode.

The varactor diode is operated with a fixed bias of 1.35 volts from a Mallory PX13 mercury battery.

As shown in Fig. 3 five servo motors in the amplifier operate the adjustments. These are conventional a-c servos with carbon-film stepless reference and feedback potentiometers.

**MOUNTING**—The amplifier is mounted on, but thermally isolated from, a round aluminum base plate. The cylindrical aluminum cover is double walled with a foamed-in-place plastic thermal insulation. To reduce radiant heat pickup from sunlight, the outer surface is polished and bright anodized. The cover bolts to the base plate with an O-ring seal to provide a weather-tight joint.

To avoid artificial cooling, the amplifier is operated at an internal temperature of 125 F. The temperature control system consists of four thermostiches and a number of heater units distributed over the amplifier structure.

For wide-range operation on a parabolic antenna, a broadband feed must be used. A log periodic structure would meet this requirement.

Since this is a regenerative amplifier, its gain is limited only by self oscillation. In laboratory tests it operated with gains as high as 50 db. However, stability, bandwidth and system noise usually limit the param gain to 20 db or less. At 20-db gain the bandwidth is between 100 Kc and 300 Kc at 400 Mc and between 250 Kc and 700 Kc at 1,000 Mc. Bandwidth is determined by the antenna phasing

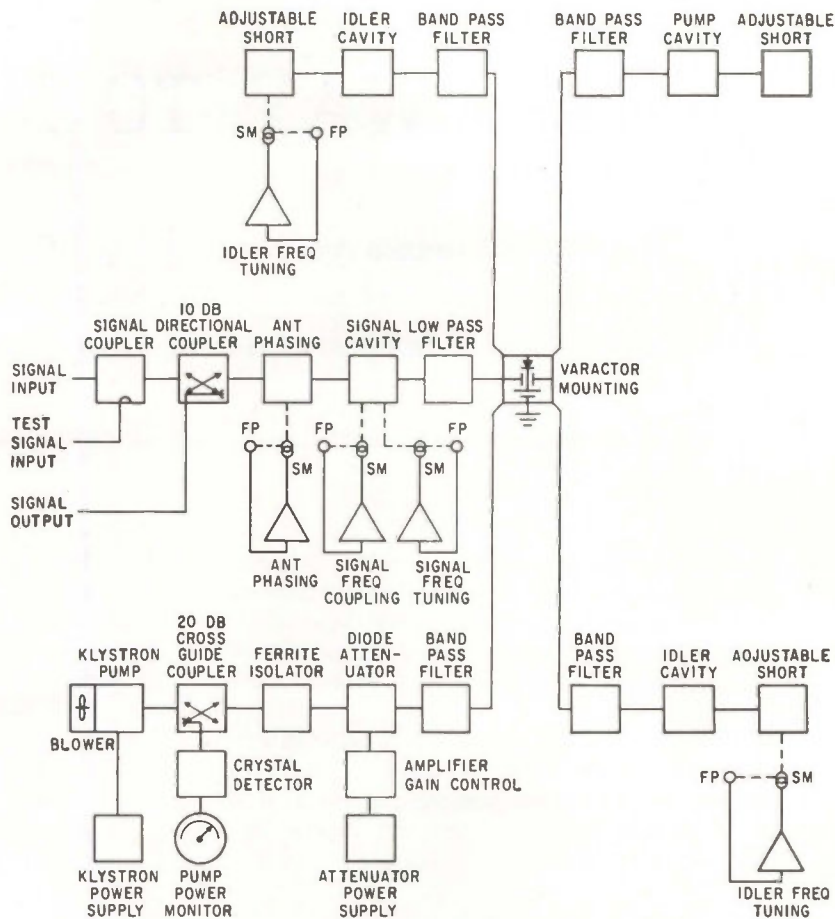

VARACTOR MOUNTING in this block diagram shows the bypass capacitor and the bias battery; FP is a feedback potentiometer and SM is a servo motor—Fig. 3

control. Use of a circulator will result in the doubling of the bandwidth. With 20-db gain the noise figure is approximately 1.3 db at 375 Mc and 2 db at 1,200 Mc using a Microwave Associates MA-460H varactor diode.

In spite of the apparent complexity of its controls, the amplifier can be tuned to any frequency within its range in less than 30 seconds by an unskilled operator using calibration curves and checking equipment.

Although the paramp was designed to enhance the capabilities of space tracking and space communication facilities it is a general-purpose, signal-frequency, low-noise, 50-ohm amplifier, which can be used with any radar, radio-astronomy or noise-measuring equipment. A developmental prototype of this amplifier was used in March 1959 to track the Pioneer IV deep-space probe to a range of 407,000

miles. An 18-foot parabolic antenna was used with a phase-lock receiver. Signal frequency was 960 Mc.

Although this unit was specifically designed for a tuning range of 375 to 1,200 Mc it can be made to operate at any frequency up to about 2,500 Mc by changes in the passband of the idler filters. With a redesign of the waveguide cross to accommodate a higher frequency pump, the amplifier can be made to operate at signal frequencies up to 5,000 Mc.

## REFERENCES

1. Gittinger, N. C., "Tunable Parametric Amplifier for the 350-1200 mc Frequency Range," Proceedings of the National Electronics Conference, Vol. 16, pp. 462-467, October 10-12, 1960.
2. Reed, E. D., "The Variable-Capacitance Parametric Amplifier," IRE Trans. on Electron Devices, Vol. ED-6, pp. 216-225, April 1959.
3. Heffner, H., Wade, G., "Gain, Bandwidth, and Noise Characteristics of a Variable-Parameter Amplifier," J. of Appl. Phys., Vol. 29, pp. 1321-1331, Sept., 1958.

# NEW WAY TO MULTIPLY Q

*Negative-impedance converter increases Q by a factor of 4 or more, by reducing circuit losses. Transistor matching is not necessary, and component tolerances are not critical*

By T. ORMOND, Sylvania Electric Products, Inc., Woburn, Mass.

TUNED CIRCUITS in the audio range seldom achieve a high circuit Q. The difficulty is a combination of low operating frequency and high series losses with inductors. This article presents a method for reducing circuit losses, thereby increasing over-all circuit Q.

Consider a tank circuit composed of a lossless capacitor in parallel with a lossy inductor, Fig. 1A. Figure 1B also represents the circuit, and the analysis lends itself more readily to this representation. For Fig. 1B, Q is given by

$$Q = \left( \frac{R_p}{\omega L} \right) \quad (1)$$

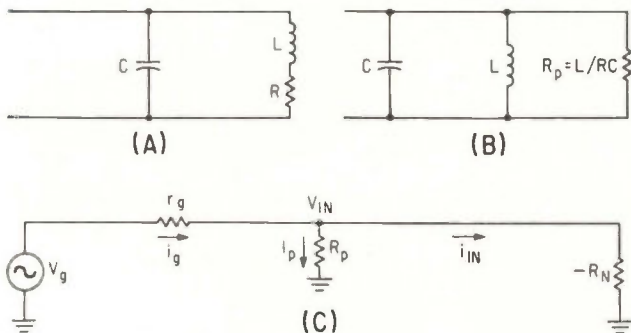

TANK CIRCUIT (A) is also represented as (B); tank circuit with negative resistance added (C) — Fig. 1

NEGATIVE-IMPEDANCE converter (A); equivalent circuit for analysis (B)—Fig. 2

Multiplication of Q can be obtained by raising the value of  $R_p$ . This is most easily accomplished by adding some negative resistance to the circuit as shown in Fig. 1C (the tank circuit losses are represented by resistance  $R_p$ ). The new circuit Q will be

$$Q = \frac{Rx}{\omega L}, \text{ where } Rx = -\frac{R_p R_N}{R_p - R_N} \quad (2)$$

Since  $Rx$  must be positive to prevent oscillation, the magnitude of  $R_N$  must be greater than  $R_p$ . Referring to Fig. 1C,

$$V_{in} = V_g - i_o r_o$$

$$i_p = V_{in}/R_p$$

$$\text{and } i_o = \frac{V_o}{r_o + R_x}$$

The equation for  $V_{in}$  can be rewritten as

$$V_{in} = Rx(i_p + i_{in}) \quad (3)$$

Solving Eq. 3 for  $i_{in}$

$$i_{in} = \frac{V_{in} - i_p R_x}{R_x} \quad (4)$$

Defining a multiplication factor  $M$ , such that  $R_x =$

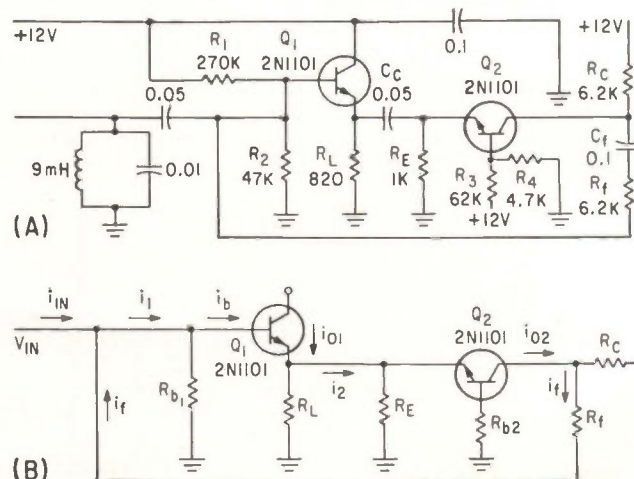

# WITH TRANSISTORS

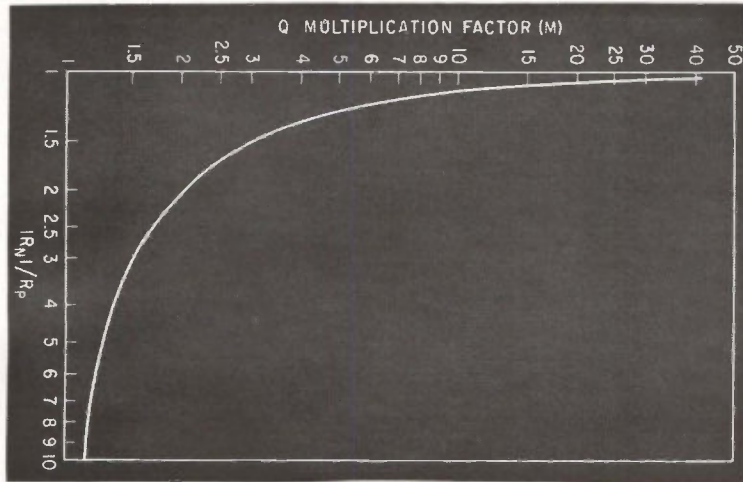

CAPABILITIES of the negative-impedance converter for Q-multiplication—Fig. 3

$MR_p$ , then

$$i_{in} = \frac{V_{in} - M i_p R_p}{MR_p} = \frac{V_{in}(1 - M)}{MR_p} \quad (5)$$

$$\frac{V_{in}}{i_{in}} = R_N = \frac{MR_p}{1 - M} \quad (6)$$

The designer will have all the information necessary to solve Eq. 5 and 6.

Figure 2A is a schematic of a negative impedance converter. It consists of an emitter follower and grounded base amplifier, with positive feedback from the collector of  $Q_2$  to the base of  $Q_1$ . The circuit of Fig. 2A may be reduced to that shown in Fig. 2B. Resistance  $Rb_1$  represents the parallel combination of  $R_1$  and  $R_2$ ,  $Rb_2$  represents the parallel combination of  $R_3$  and  $R_4$ , and all capacitances have been omitted since their reactances can be made negligible at the operating frequency. Referring to Fig. 2B, and using only magnitudes for  $\alpha$  and  $\beta$

$$i_b = K i_1 \quad \text{where } K = \frac{Rb_1}{Rb_1 + (\beta_1 + 1) R_L}$$

$$i_{01} = (\beta_1 + 1) i_b = K (\beta_1 + 1) i_1$$

$$i_2 = \frac{R_L}{R_L + R'} i_{01}$$

where  $R'$  equals  $R_E$  in parallel with the input resistance of  $Q_2$ ,

$$i_2 = \frac{KR_L (\beta_1 + 1) i_1}{R_L + R'}$$

Since  $R'$  will be much smaller than  $R_L$  and can be neglected, and  $(\beta_1 + 1)$  is essentially  $\beta_1$ ,

$$i_2 = K \beta_1 i_1$$

Neglecting the small current that will flow in  $R_E$ ,

$$i_{02} = \alpha_2 i_2 = \alpha_2 K \beta_1 i_1$$

$$i_f = \frac{R_c}{R_c + R_f} i_{02} = \frac{\alpha_2 K \beta_1 i_1 R_c}{R_c + R_f}$$

At the input

$$i_{in} = i_1 - i_f \\ = i_1 - i_1 \frac{\alpha_2 K \beta_1 R_c}{R_c + R_f}$$

$$i_{in} = i_1 \frac{(R_c + R_f) - \alpha_2 K \beta_1 R_c}{(R_c + R_f)}$$

Solving for  $R_f$  yields

$$R_f = i_1 \frac{(1 - \alpha_2 K \beta_1) R_c - i_{in} R_c}{i_{in} - i_1}$$

Assume  $\alpha_2 = 1$  and

$$R_f = \frac{i_1 (1 - K \beta_1) R_c - i_{in} R_c}{i_{in} - i_1} \quad (7)$$

Conventional biasing techniques will determine the values of the biasing resistors shown in Fig. 3 ( $R_1$ ,  $R_2$ ,  $R_L$ ,  $R_E$ ,  $R_3$ ,  $R_4$ ,  $R_c$ ). The original circuit conditions give values of  $V_{in}$  and  $R_p$ . With these two values and the desired multiplication factor  $M$ , Eq. 5 can be solved for  $i_{in}$ . Current  $i_1$  can be found from

$$i_1 = \frac{V_{in}}{Rb_1 (1 - K)}$$

Equation 7 can be solved for  $R_f$ . Making  $R_f$  variable will allow for any corrections that may be necessary due to assumptions made in the analysis.

Figure 3 shows the multiplication capabilities of the circuit. Transistor matching is not necessary and component tolerances are not critical. Lead lengths could become critical when large multiplication factors are desired, so good wiring practice should be observed. Figure 2A gives component values of a circuit built in the lab to demonstrate Q multiplication. The tank circuit Q was multiplied by 4, giving an overall circuit Q of 20. As shown in Fig. 3, much higher multiplication may be obtained, the limit being the condition where  $|R_N| = R_p$  and oscillations result.

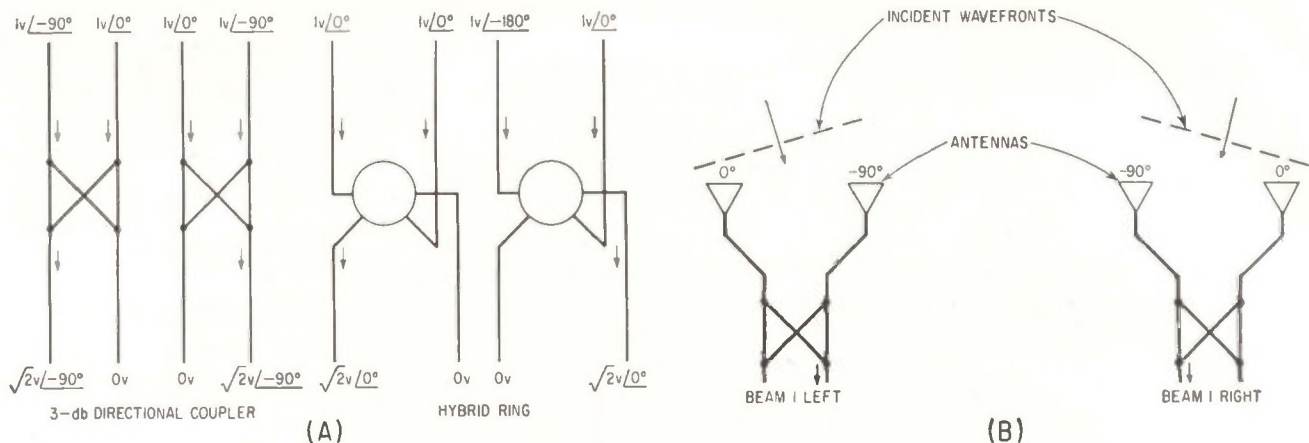

PHASE-SHIFT CONVENTIONS (A) for directional couplers and hybrid rings. Simplest beam forming matrix (B) uses two antenna elements and one coupler—Fig. 1

## Steering Radar Antenna Beams

*Made from passive microwave elements, beam-forming matrix can be placed next to antenna array, is theoretically lossless and forms as many simultaneous beams as there are antenna elements in the array*

By WILLIAM P. DELANEY  
MIT Lincoln Laboratory,  
Lexington, Mass.

MANY PRESENT and future radar systems require a rapid and flexible means of steering the antenna beam. Some of the limitations inherent in mechanical steering methods can be overcome by the phased array radar, which uses electronic beam-forming and beam-scanning.

All phased array receivers combine the outputs of discrete antenna elements to form one or more antenna beams. This combining process can take place in the r-f or i-f portions of the receiver. One major disadvantage of forming the beam in the lower frequency portions of the receiver is the need for amplitude- and phase-stable mixing and amplifying circuits between the antennas and the low-frequency beam former.

A theoretically lossless multiple-beam forming technique can be used to form  $n$  simultaneous beams from an  $n$  element linear array. The beam-forming matrix operates

directly at the r-f carrier frequency and thus can be located directly behind the antenna elements. All the beams formed by this technique have the full gain of the array aperture. Since the technique uses a matrix of passive microwave devices, it can be rugged and reliable, and is not susceptible to the phase and amplitude instabilities common in active r-f devices.

### COUPLERS & PHASE SHIFTERS

—Basic components of the matrix are 3-db directional couplers or hybrid rings and fixed phase shifters. Conventions concerning the phase shift through hybrids and directional couplers are shown in Fig. 1A. When the input voltages have the amplitudes and relative phase angles shown in Fig. 1A, all the input signal power will appear at the indicated terminal.

The simplest multibeam array is formed with two antenna elements plus one hybrid ring or one 3-db directional coupler. Figure 1B shows a two-beam, two-element array using a 3-db directional coupler.

A certain incident wavefront will excite antenna element currents that are 90 degrees out of phase, and therefore all the received signal energy will appear at one terminal of the directional coupler. Thus, a beam right and a beam left are formed. If a hybrid ring is used, the two-element array has a broadside beam and an endfire beam, assuming an antenna element spacing close to one-half wavelength.

A four-beam matrix can be built by interlacing two two-beam matrices and then providing a second level of directional couplers or hybrid rings to combine the outputs. Fixed phase shifters are required between the upper and lower levels of couplers. Figure 2A shows a four-element, four-beam array using directional couplers. The amplitudes and phases of an incident beam-1-left signal are shown at various points in the matrix. Figure 2B shows the amplitudes and phases of an incident beam-2-left signal. The directional couplers shown shaded are used to form

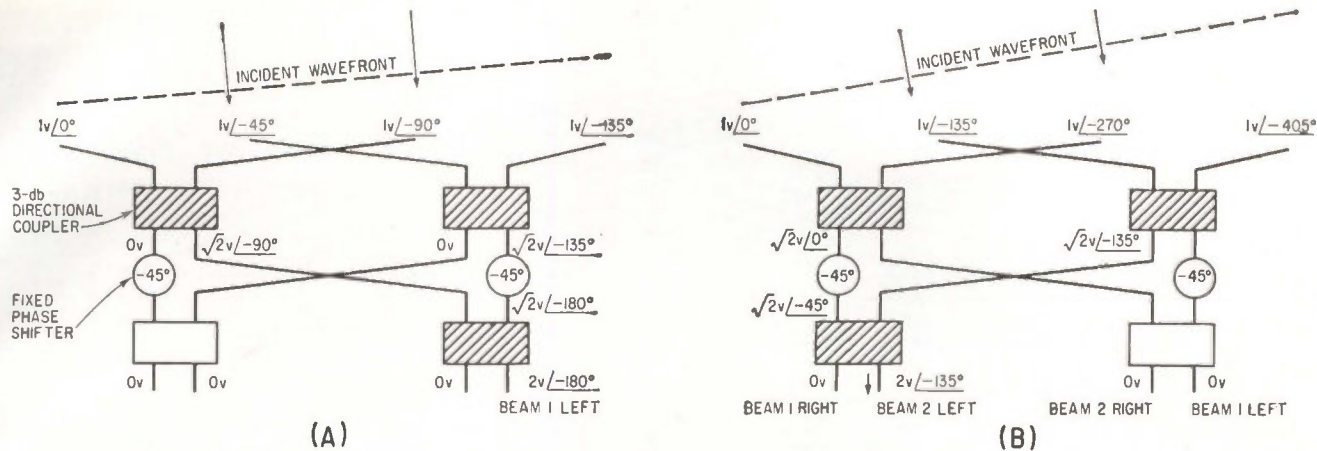

AMPLITUDES AND PHASES of voltages in a 4-element matrix for a beam-1-left signal (A) and a beam-2-left signal (B). Couplers shown shaded form the beams—Fig. 2

# With a Lossless R-F Matrix

the particular beam. Thus, the beam-forming matrix behaves like a multiple port feed structure that routes a signal originating at a particular point in space to a particular output port of the matrix. Since the matrix is symmetrical about a vertical line through the center, the 1-right and 2-right beams can be found by using the same approach.

**SIXTEEN-ELEMENT MATRIX**  
—This can be thought of as four interlaced four-element matrices. Two extra levels of phase shifters

and combining elements (directional couplers or hybrid rings) are required. Figure 3 is a diagram of the 16-element matrix used to obtain the experimental measurements presented here.

The beam-forming technique can be used in planar arrays by first combining the columns of antenna elements in matrices and then combining the outputs of the column matrices in a group of row matrices. Some of the fundamental characteristics of the r-f beam-forming matrix are given in Table I.

The basic antenna beams formed

using the r-f matrix will have the same beam shape as a uniformly illuminated antenna array. Thus first sidelobe levels of -13 db are to be expected for arrays of eight elements or more. The beams formed by this technique occupy fixed positions in space for fixed values of antenna element spacing and frequency. When the frequency is changed the beam positions will shift. Typically, a 10 percent frequency change will shift the positions of the beams near broadside by 10 percent and the beams furthest removed from broadside by as much as 28 percent.

The adjacent beams formed by this technique overlap each other with the cross-overs at the  $2/\pi$  (at -4 db) points. The top portion of Fig. 4 shows three typical beams: 1R = first beam to the right of broadside, 2R = second beam to right.

Figure 4 also shows how two adjacent beams (1R and 2R for example) can be added to form a new beam (1R + 2R), which is somewhat broader than the component beams but has lower sidelobe levels. This addition of two adjacent beams changes the array illumination from a uniform distribution to a cosine distribution and thus first sidelobe levels of -23 db are to be expected in a large array. These reduced sidelobe levels are

## CHARACTERISTICS OF R-F BEAM FORMING MATRICES—TABLE I

**Number of beams:** Number of beams formed is equal to the number of antenna elements. Number of antenna elements must be equal to a power of 2

**Number of Directional Couplers or Hybrids:** Number of combining devices is equal to  $(N/2) \log_2 N$ , where  $N$  = number of elements in the array

**Number of Fixed Phase Shifters:** Number of phase shifters is  $(N/2) (\log_2 N - 1)$

**Operating Frequency:** Operating frequency is limited only by the practicality of building and interconnecting fixed phase shifters and directional couplers or hybrids. Hybrid transformers can be used in low-frequency matrices

**Bandwidth:** Phase shifters and directional couplers can be built with bandwidths greater than 30 percent but there are problems, such as beam movement with frequency, in operating phased arrays over bandwidths this wide

**Insertion Loss:** Beam-forming technique is theoretically lossless and in practice matrices can be built with low insertion loss. The 16 element matrix tested has an insertion loss of 0.75 db at 900 Mc

**Antenna Array Illumination:** Matrix provides a uniform illumination of array elements. However, simple beam-combining techniques can yield (cosine)<sup>n</sup> illuminations of the antenna aperture

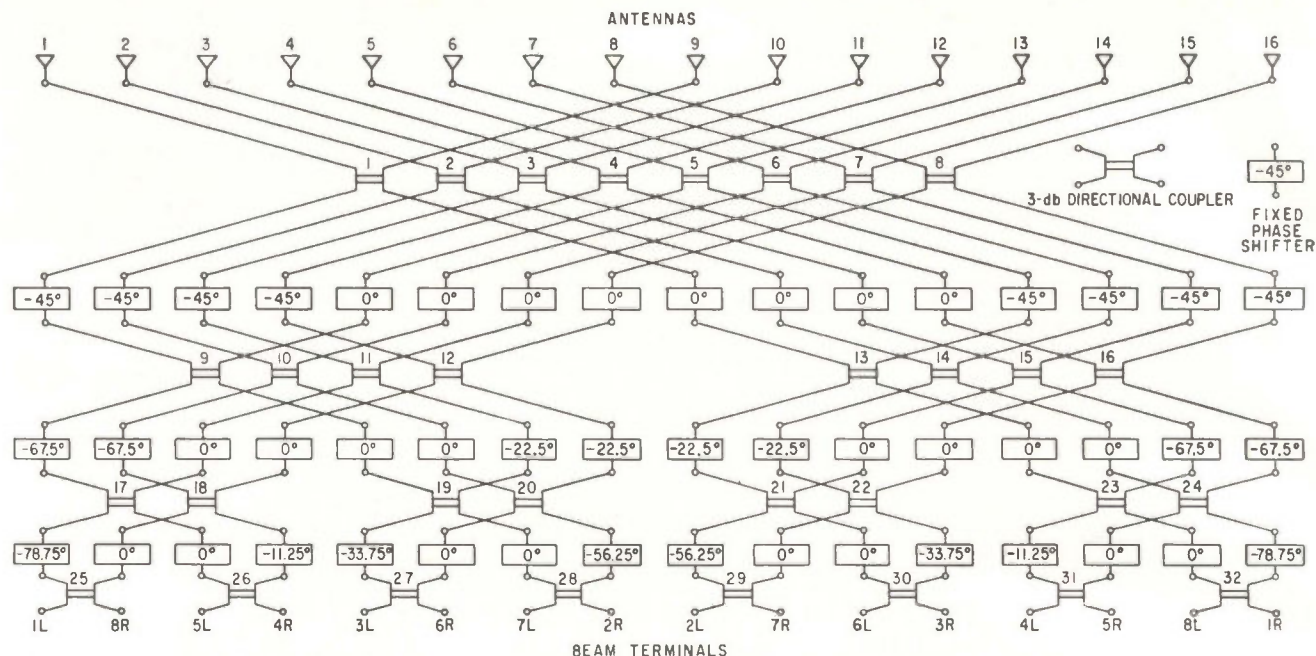

SIXTEEN-ELEMENT beam-forming matrix, showing how directional couplers and fixed phase shifters are combined. Such a matrix was used to obtain the data in this article—Fig. 3

achieved at the expense of a 0.9-db decrease in antenna gain and a 35 percent increase in half-power beamwidth. Adjacent cosine illumination beams shown at the bottom of Fig. 5 cannot be realized both simultaneously and without loss.

Three uniform-illumination beams can be added to form a cosine-squared illumination of the aperture; in general,  $n + 1$  beams can be added to give a  $(\cosine)^n$  illumination. Directional couplers in the matrix are of the coupled-strip type<sup>2</sup>. This type of coupler, shown schematically in Fig. 5A, has broadband characteristics.

Input power to port 1 is split equally between ports 2 and 4, with no power coupled to port 3. Power transfer from port 1 to 2 is accomplished by electromagnetic coupling between the two center conductor strips. Figure 5B shows a cross section of this coupler in strip transmission line.

**EXPERIMENTAL RESULTS**—The couplers used in the matrix coupled 3 db  $\pm 1/4$  db over the 880 to 1,160 Mc range, with good isolation (26 db minimum) and low vswr (1.10 to 1 maximum). The phase shifters in the matrix also utilize a coupled-line technique<sup>3</sup> to obtain a broadband phase characteristic.

Figure 5C shows a network with

close to constant differential phase shift between the output ports for a wide range of frequencies. The phase shift,  $\phi$ , from input to output port 1 is a linear function of frequency since this path contains a straight piece of transmission line. Phase shifts  $\phi_s$  from input to output port 3, has a different characteristic because of the coupled line in this path. Differential phase shift  $\Delta\phi$  is reasonably constant from  $0.67 f_0$  to  $1.33 f_0$ .

The technique was fully explored using broadband couplers and phase shifters (see Table II). The beam-forming matrix was tested in a 16-element linear array of parallel dipoles 0.58 wavelength apart. Figure 6A shows the major lobes of all 16 beams. Beam peaks occur close to theoretical positions, with a worst case error of 1.2 degrees in beam-7-right. The envelope of the beam peaks follows the antenna element pattern closely, as would be expected from the principle of pattern multiplications. The near-in beam, (1-right, Fig. 6B) has first sidelobes of -13 db. The antenna element spacing of  $0.58 \lambda$  in this test allows grating lobes to form for beams further than 45 degrees off broadside. The start of this grating lobe structure is evident in beam-7-right.

A cosine illumination of the aperture can be achieved by adding two

adjacent beams. Figure 6D shows a cosine illumination beam obtained by adding beams 4-right and 5-right in a hybrid ring. The first sidelobe in this beam is about 22 db down, which is close to the theoretical value of -23 db for a cosine illumination on a 16-element array. The hybrid ring also provides the difference of the two adjacent beams corresponding to a sine illumination. The difference pattern has a sharp null at the same position as the peak of the sum pattern and may be useful for amplitude-comparison monopulse applications.

Acknowledgement is due J. Blass,<sup>4</sup> J. Butler and R. Lowe,<sup>5</sup> and J. Shelton and K. Kelleher<sup>6</sup>; the matrix was designed and built by Sanders Associates.

#### REFERENCES

- (1) W. P. Delaney, An RF Multiple Beam Forming Technique, MIT Lincoln Laboratory Group Report 41G-0012 (Astia 262 017) Aug. 9, 1961.
- (2) J. K. Shimizu, A Strip Line 3-db Directional Coupler, SRI Project 1592, Scientific Report No. 1 (AF 19 604-1571), June, 1957.
- (3) B. M. Schiffman, A New Class of Broadband Microwave 90 Degree Phase Shifters, *IRE Trans on Microwave Theory and Techniques*, p 232, April 1958.
- (4) J. Blass Multidirectional Antenna—A New Approach to Stacked Beams, *IRE Convention Record Part 1*, p 48, 1960.
- (5) J. Butler and R. Lowe, Beam Forming Matrix Simplifies Design of Electronically Scanned Antennas, *Electronic Design*, p 170, April 12, 1961.
- (6) J. P. Shelton and K. S. Kelleher, Multiple Beams from Linear Arrays, *IRE TRANS on Antennas and Propagation*, Vol. AP-9, No. 2, p 154, March, 1961.

MEASUREMENTS OF 16-ELEMENT AT 900 MC—TABLE II

|  |                                   |
|--|-----------------------------------|
| Maximum Input or Output Vswr                     | 1.27 to 1                         |
| Minimum Isolation Between Beam Terminals         | 15 db (average isolation = 28 db) |
| Minimum Isolation Between Antenna terminals      | 20 db ( " " = 30 db)              |
| Insertion Loss                                   | 0.75 db                           |
| Average of Rms Amplitude Errors in Matrix output | 0.3 db                            |
| Average of Rms Phase Errors in Output            | 4.8 deg                           |

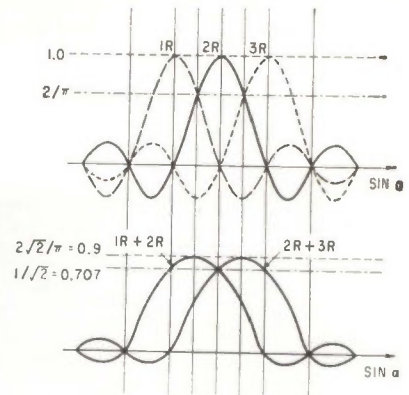

THREE MATRIX BEAMS and the formation of cosine illumination beams—Fig. 4

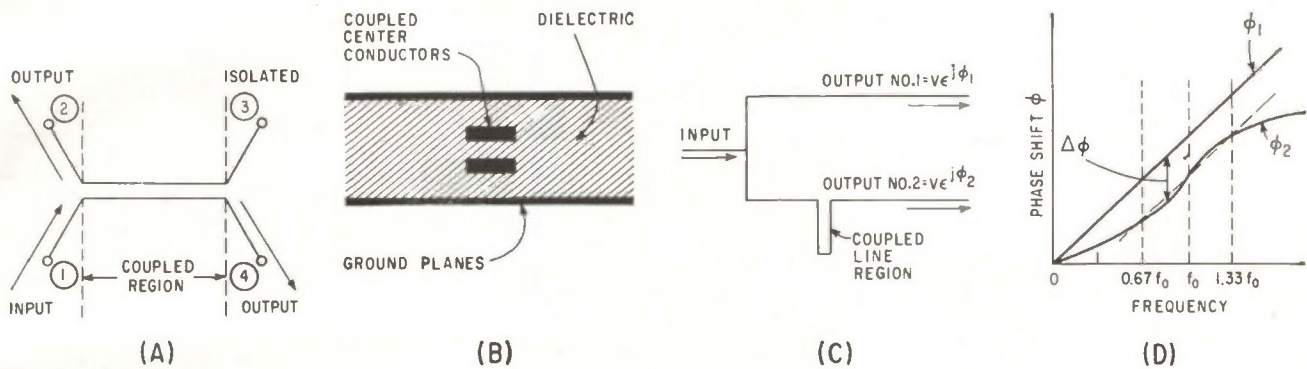

COUPLED-STRIP directional coupler (A); cross section of a 3-db coupler (B). Broadband differential phase-shift network (C) and its phase characteristics (D)—Fig. 5

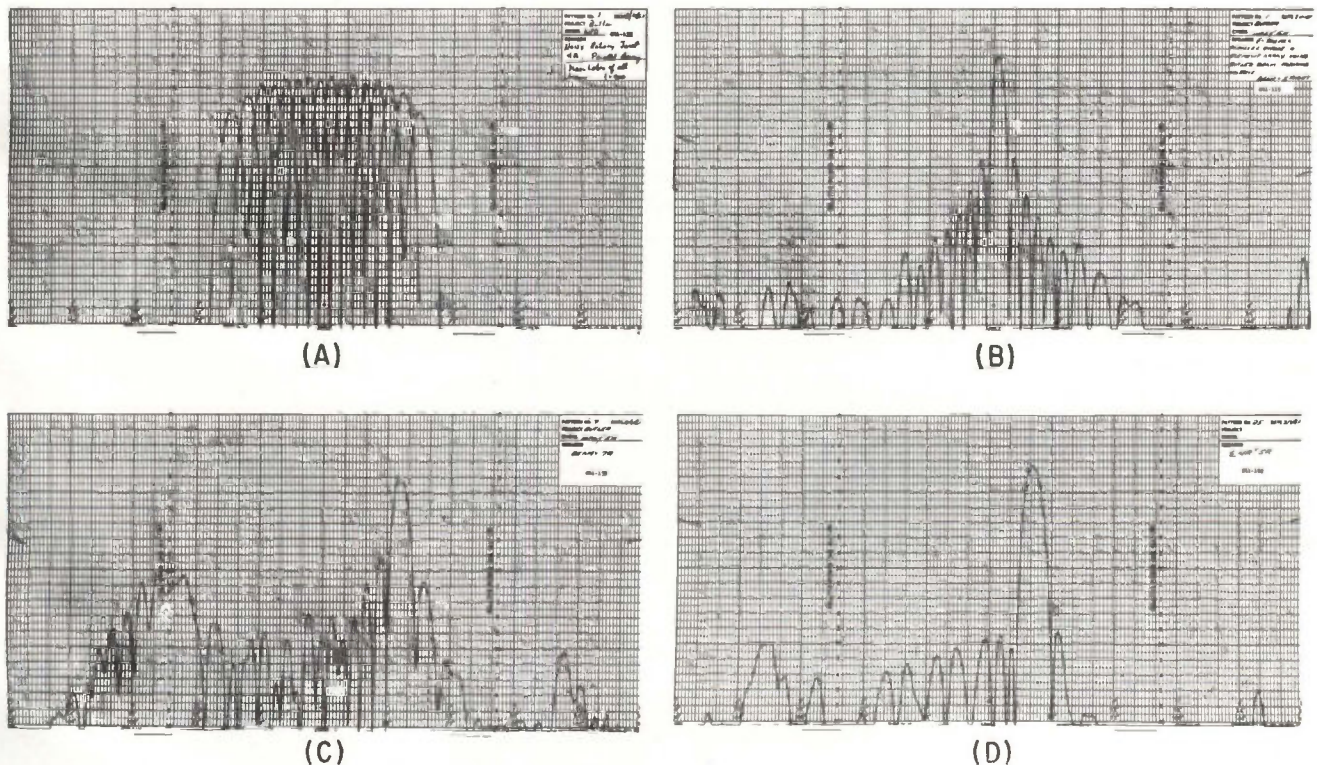

MAJOR LOBES of all 16 beams (A), beam-1-right (B), beam-7-right (C), and cosine illumination beam (beam-4-right plus beam-5-right) (D)—Fig. 6

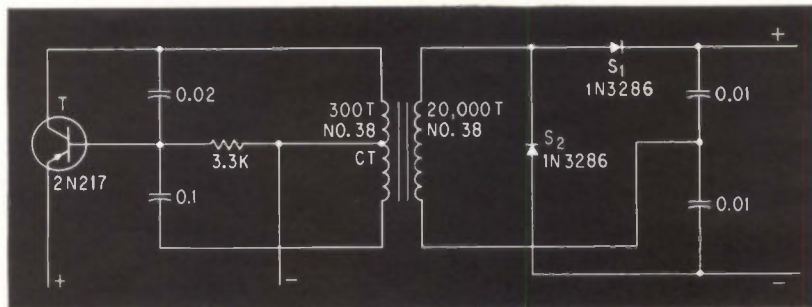

OSCILLATOR operates at about 22 percent overall efficiency in commercial unit, slightly higher in military version

## INEXPENSIVE Converter Gives 5,000 Volts D-C

*Converter uses sinusoidal oscillator rather than relaxation type;*

*voltage-doubling capacitors provide smoothing with less than 0.01-percent ripple*

By R. D. MORROW Morrow Products Inc., Baltimore, Md.

THE NEED FOR a high-performance high-voltage power supply has led to the design of a unit 2½ in. high by 1½ in. square with an output of 5,000 v d-c at 50µa. Input is 26 volt d-c with a current drain of 44 ma for the military model and 26 v d-c at 60 ma for the commercial model.

The circuit uses a voltage-doubler rectifier output, although more expensive transistors used in experimental models have permitted the use of a single silicon rectifier at full voltage to achieve the same output characteristics.

**OPERATION** — The transformer acts as a voltage step-up and oscillator section and the transformer core is the transistor heat sink. The 0.01µf capacitors in the voltage-doubler section provide sufficient

filtering for most applications. However, in the military unit additional filter capacitance has been added to attenuate a-c ripple to less than 0.01 percent over the range.

The transformer secondary loading characteristics require silicon rectifiers having piv (peak inverse voltage) ratings of not less than 3,000 volt d-c, permitting 1µa to flow at 3,000 volts for the 1N3286 rectifier. Leakage in inexpensive diodes causes high loading and distortion of the sine wave.

The design characteristics of the coil are rigid, yet it can be wound on multiple winding machines in production. The ferrite core is a Q<sub>1</sub> type used in tv flyback transformers and is hollow in the center, thus permitting the core to be used as the transistor heat sink. The

transformer primary was wound with No. 38 Mylar wire to determine empirically the best oscillatory characteristic of an inexpensive 2N217 transistor. After checking of 2N217s in various circuits, it was determined that 175 turns either side of the center tap was optimal disregarding the inductance of the secondary. The No. 38 wire was selected to give 40 ohms total d-c winding resistance of the transformer primary to match the collector-to-base voltage ratio ( $BV_{cbo}$ ) of the 2N217 transistor in series with its base resistor. This design resulted in 8 volts rms from the primary winding on the ferrite core. Using 20,000 secondary turns gave 2,500 volts output, which when doubled gave the necessary 5,000 volts d-c.



# MORE OPERATING FEATURES THAN ANY OTHER MEDIUM FREQUENCY RECORDER

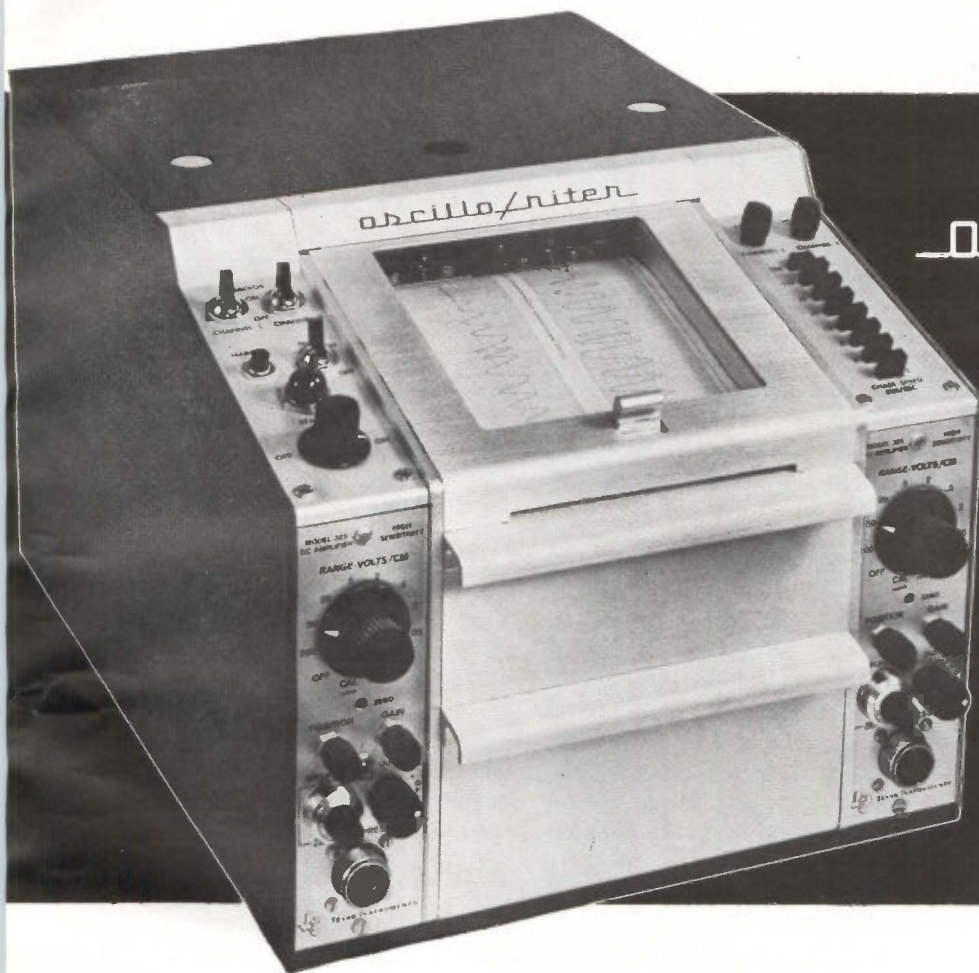

oscillo/riter\*

MEDIUM FREQUENCY RECORDER

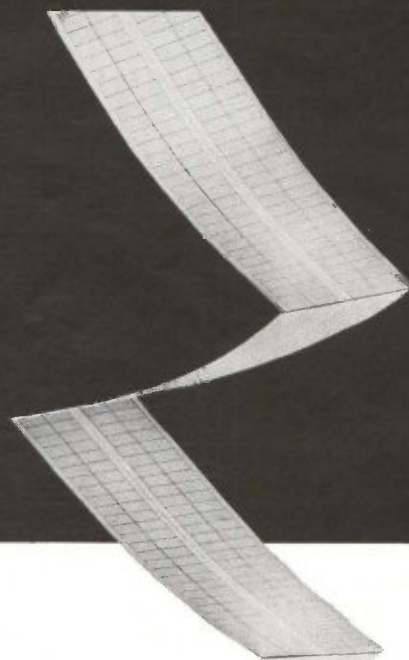

Here is the instrument that combines *all* the features found in other medium frequency recorders plus some TI exclusives. The *oscillo/riter* offers highest sensitivity, widest selection of ranges and chart speeds, rectilinear recording in either heat or ink, transistorized electronics, interchangeable plug-in amplifiers, and the convenience of Z-fold chart paper.

**Broad Frequency Response.** Flat to 200 cps within 1 db, 10 mm peak to peak with ink writing system.

**High Sensitivity.** Sensitivity range with high-gain amplifier is 0.5 mv/mm to 200 V/cm in 10 steps.

**Push-Button Chart Speeds.** Eight push buttons select 1, 2, 5, 10, 25, 50, 125, and 250 mm/sec.

**Plug-In Amplifiers.** Interchangeable amplifiers offer complete flexibility to economically handle more recording jobs. All electronics are fully transistorized for long-term reliability and convenience of no warm-up time.

**Z-Fold Chart Paper.** Provides random access to minutes, hours or days of recorded data by simply flipping pages of the chart as you would pages of a book. Roll chart paper optional.

Compare feature for feature, and you'll choose the *oscillo/riter* from industry's most complete line of strip chart recorders . . . made by Texas Instruments.

WRITE FOR COMPLETE INFORMATION

\*A trademark of Texas Instruments Incorporated



## TEXAS INSTRUMENTS

INCORPORATED  
3609 BUFFALO SPEEDWAY  
P. O. BOX 66027 HOUSTON 6, TEXAS



CIRCLE 55 ON READER SERVICE CARD

# Do Field-Effect Transistors Resist Nuclear Radiation?

*Semiconductor majority carrier characteristics may determine resistance*

By ALVIN B. KAUFMAN  
Litton Systems, Inc.,  
Woodland Hills, Calif.

IRRADIATION of field-effect transistors indicates that majority-carrier characteristics may be the limiting factor in obtaining nuclear-resistant semiconductors. This implication results from tests in which degradation of gain to a predetermined value required about the same level of exposure as with high alpha cutoff frequency transistors.

The tests also indicate that majority-carrier properties may be improved by lowering semiconductor resistivity and possibly by better surface passivation. Use of germanium rather than silicon may also improve nuclear resistance.

The field-effect transistor at the top of Fig. 1 consists of an *n*-type silicon bar with an ohmic cathode contact at one end and an anode contact at the other. Positive voltage is applied to the anode or drain electrode. Two *pn* junctions built into the middle of the bar and con-

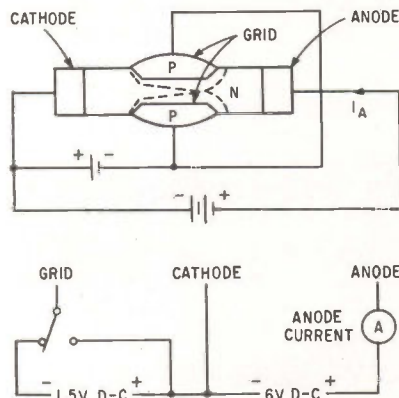

FIELD-EFFECT transistor construction is shown above test arrangement used to determine mutual conductance—Fig. 1

nected in parallel serve as the grid or gate. Negative bias applied to the grid projects the depletion layers shown by broken lines into the silicon, increasing effective anode-to-cathode resistance.

OPERATION—As anode voltage increases, the voltage drop resulting from anode current reverse biases the grid junctions so that the depletion layers are extended and finally meet in the bulk material. Increasing anode voltage further does not increase anode current appreciably. Pinch-off voltage is the anode potential at which anode current reaches saturation, and pinch-off current is anode current after pinch-off voltage has been reached. With zero grid bias, pinch-off current is maximum specified anode current. The field-effect transistor is said to be in the triode region before pinch-off and in the pentode region after pinch-off has been reached. Interchanging anode and cathode terminals results in little or no change in operating parameters.

Since there are no junctions in the output current path, the major source of noise is the thermal noise of the anode-to-cathode resistance, which is typically 1,000 to 10,000 ohms. In transistors, emitter and collector junctions change contact potential and leakage resistance under irradiation, shifting operating characteristics. These junctions are lacking in the field-effect transistor, which also depends on majority-carrier characteristics instead of the majority-minority properties used in transistor operation.

During irradiation in the General Dynamics reactor at Fort Worth, mutual gain was measured dynamically. The observed change in anode current was divided by the variation in gate voltage us-

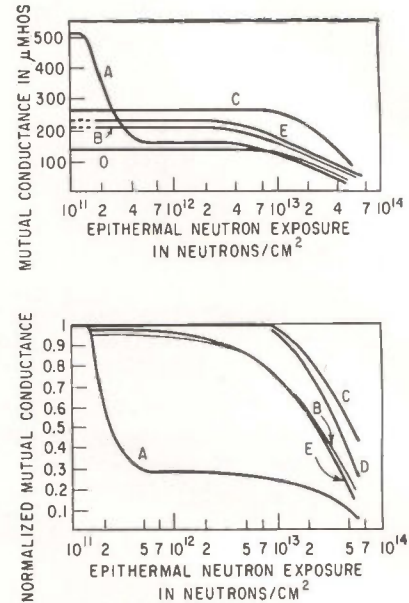

EPITHERMAL neutron exposure is compared to mutual conductance in upper graph and to normalized mutual conductance—Fig. 2

ing the circuit at the bottom of Fig. 1 to compute mutual conductance.

Radiation exposure was determined by the Litton microfoil technique.<sup>1</sup> It is estimated from previous experiments that the gamma-ray exposure, measured in ergs/gm (C), was  $2.7 \times 10^{-3}$  as intense as the epithermal neutron exposure, measured in neutrons/cm<sup>2</sup>, with  $E_n$  greater than 0.48 ev. Irradiation was carried out at 17.5 degrees C.

TEST RESULTS—Mutual conductance of the Crystalonics C652 silicon *npn* field-effect devices before and during irradiation is shown at the top of Fig. 2. Resistivity of units A and B is about 10 ohms/cm and of the remaining units is 3 to 5 ohms/cm. The same data, normalized by dividing observed values by baseline values is shown at the bottom of the figure.

Although the number of samples was small, apparently low-resistance devices might withstand exposure twice as great as high-resistance devices. This interpretation requires that devices A and E be neglected, performance of A being questionable at any rate.

Exposure needed to degrade gain to 0.7 of baseline value was about  $2 \times 10^{13}$  epithermal neutrons per cm<sup>2</sup> (*nv.t*), about the same as required to damage high alpha cutoff

# KEPCO PIONEERS THRU RESEARCH and DEVELOPMENT!

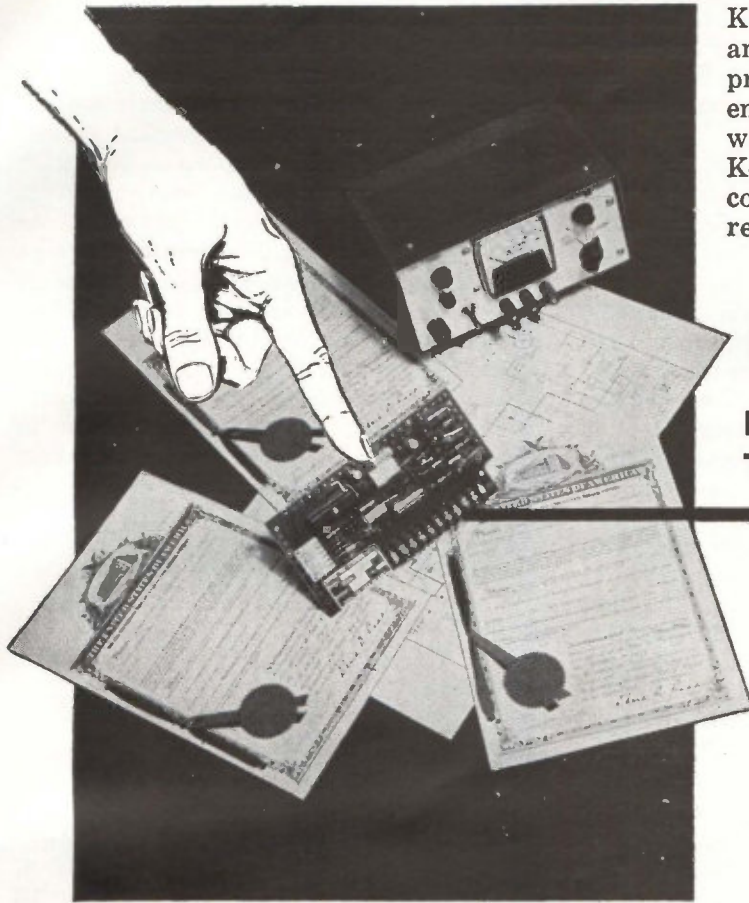

Kepeco knows that progress begins with critical analysis, research and development. Guided by a practical approach, the creative minds of Kepeco's engineers are able to supply the leaders of industry with consistently better equipment. Many of Kepeco's original techniques and concepts have become prevailing practice in the manufacture of regulated power supplies.

## CHECK KEPCO ENGINEERING CONTRIBUTIONS TO THE POWER SUPPLY FIELD!

- The Voltage Comparison Bridge Regulator
- Full Voltage Range Regulation
- Short Circuit Protection by Current Limiting
- Remote Programming
- Remote Error Sensing
- Wide Range Magnetic Regulators
- Hybrid Regulators
- Voltage Correcting Systems
- Proportional Control of Multiple Supplies
- High Efficiency Lateral Cooling

### KEPCO HIGH-CURRENT, DUAL PRECISION REGULATION REGULATED DC SUPPLY

*an example of Kepeco's creative engineering and research...*

**ADJUSTABLE CURRENT LIMITING** over the full range of current with automatic crossover from constant voltage to constant current.

**PROGRAMMING OF OUTPUT VOLTAGE** by resistance or voltage.

**PROGRAMMING OF OUTPUT CURRENT** by resistance or voltage.

**ERROR SENSING** at remote load assures regulation at the load.

**HIGH-RESOLUTION ADJUSTMENT** with 10-turn voltage control and 10-turn current limit control.

**NO VOLTAGE OVERSHOOT** from turn-on, turn-off or power failure.

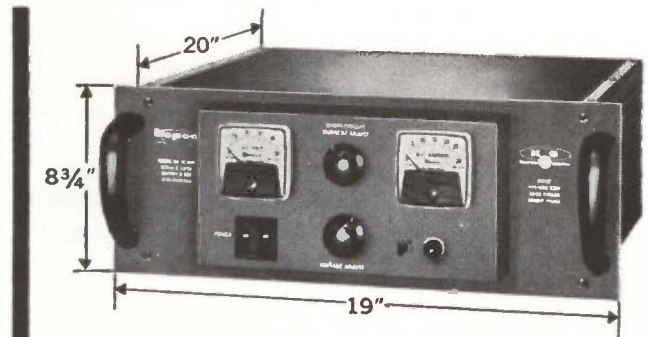

- **REGULATION: 0.01% LINE/LOAD**
- **STABILITY: 0.01%**
- **COMPLETELY PROGRAMMABLE**

| MODEL     | DC OUTPUT RANGE |      | REGULATION |       | STABILITY % | OUTPUT IMPEDANCE OHMS MAX. |        |          | RIPPLE RMS | INPUT WATTS MAX. | INPUT AMPS, MAX.* | PRICE      |
|-----------|-----------------|------|------------|-------|-------------|----------------------------|--------|----------|------------|------------------|-------------------|------------|
|           | VOLTS           | AMPS | %LINE      | %LOAD |             | 0-1K                       | 1K-10K | 10K-100K |            |                  |                   |            |
| KS 8-100M | 0-8             | 100  | 0.01       | 0.01  | 0.01        | 0.0002                     | 0.02   | 0.1      | 1 mv       | 1400             | 24                | \$1,395.00 |
| KS 18-50M | 0-18            | 50   | 0.01       | 0.01  | 0.01        | 0.0004                     | 0.02   | 0.1      | 1 mv       | 1400             | 24                | 1,295.00   |
| KS 36-30M | 0-36            | 30   | 0.01       | 0.01  | 0.01        | 0.0006                     | 0.03   | 0.1      | 1 mv       | 1400             | 24                | 1,195.00   |
| KS 60-20M | 0-60            | 20   | 0.01       | 0.01  | 0.01        | 0.001                      | 0.05   | 0.1      | 1mv        | 1500             | 26                | 1,295.00   |

\*At 125 volts input



Over 200 Standard Models to choose from . . . WRITE FOR NEW CATALOG B-621  
311-48 SANFORD AVENUE • FLUSHING 52, N. Y. • Area Code 212 IN 1-7000 • TWX # NY 4-5196

# More Relay 25 Amps!

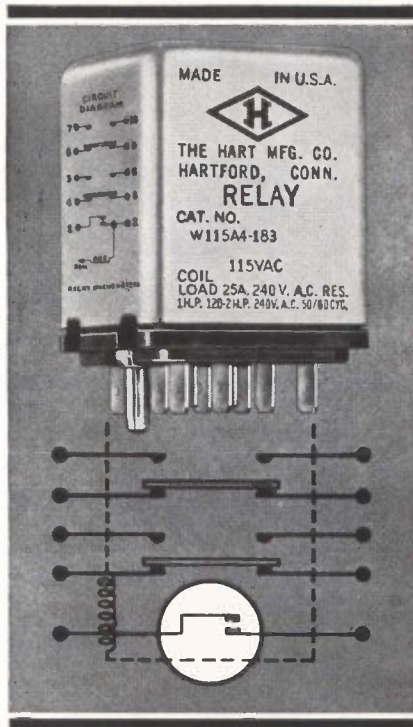

## NEW! HOLDING CONTACT With Series "W" Plug-in Relay

You get *more* relay with the new Model WA. It features a new holding coil and contact for momentary contact switching which lets you build "inching" or "jogging" capability into machinery.

Like other Series W relays, this new version is:

**COMPACT:** Measures only 1½" x 1½" x 1⅞". Weighs only 10 oz. More compact than most 10 amp relays. You can fit up to fourteen 25-amp circuits into a group of Series W relays occupying a space of only 11½" x 1½" x 1⅞".

**VERSATILE:** a-c or d-c units available with choice of eight different contact circuits.

**RELIABLE:** Mechanical life in excess of 10,000,000 cycles.

**RATED HIGH IN AMPERAGE:** Up to 25 amps, 240V, a-c, or 28V, d-c.

**EASY TO INSTALL:** Spade terminals for socket or quick disconnect installations. Solder or pigtail terminals available.

Write today for Bulletin WU-09 giving specifications and applications of Series W Relays. Additional data on the new WA model with holding contact is available on request.

The **HART**

Manufacturing Company

202 Bartholomew Avenue  
Hartford 2, Connecticut  
Phone: JACKSON 5-3491



frequency transistors.<sup>2,3</sup> Thus majority-carrier characteristics may be the significant factor in nuclear resistance and might be improved by lowering semiconductor resistivity and by better surface passivation.

Degradation for specified exposure does not appear to be the same at different nuclear facilities. Basically these differences result from differences in reactor neutron energy spectra and energy above which neutron flux is specified and from differences among specimens.

For exposures that could be compared, the energy point above which all neutrons are reported should include all neutrons producing damage and exclude all neutrons not producing damage. This point is not easily selected, particularly in a device containing materials of different atomic weights and with widely varying operational requirements.

Lattice displacements occur with a transfer of 25 ev kinetic energy to the typical atom, and their magnitude and effect on components or hardware may differ. Seitz has shown that maximum energy imparted to a target atom in perfect collision is  $E_{max} = E_n [1 - (m - 1)^2 / (m + 1)^2]$ , where  $E_n$  is initial neutron energy and  $m$  is target atom mass. Thus for germanium semiconductors, minimum energy of the neutron is 450 ev if 25 ev is transferred to its target atom and if the secondary neutron recoils straight back. Otherwise initial energy must be higher.

For silicon, the value is 175 ev. This difference in threshold energy for damage might account for the difference in radiation sensitivity between silicon and germanium.

**NEUTRON ENERGY**—If all factors are equal, degradation of a given semiconductor for the same exposure should be invariant in different neutron environments if the neutrons measured are those above the threshold damage point. Presently the epicadium point ( $nv,t$ ) is the closest to the desired energy threshold. With improved resonant-foil techniques, measurement of  $nv,t$  at  $E_n$  greater than 450 or 175 ev may show closer correlation of component performance in different reactors. Semiconductor data reported at  $nv,t$  exposures with vari-

ous energies should be converted (by multiplication of ratio values of differential flux for reactor used) to  $nv,t$  for correlation.

Gate current, which reflects input impedance, was not measured and may be an important parameter. Severe increase in gate leakage current has been reported<sup>4</sup>, probably induced by the high level of ionization. Considering the high input resistance, the leakage might have been induced in the instrumentation rather than in the test specimen.

Degradation of normalized gain to about 0.9 at  $10^{13} nv,t$  shown in Fig. 2 has been reported for other field-effect transistors.<sup>5</sup>

## REFERENCES

- (1) L. B. Gardner, A. B. Kaufman and R. Gaz, Nuclear Dosimetry Techniques, Internal Technical Note available from Litton.
- (2) L. B. Gardner and A. B. Kaufman, NGL Platform Nuclear Radiation Program, 1, ASD Technical Report 61-511.
- (3) L. B. Gardner and A. B. Kaufman, The Feasibility of Nuclear Resistance Inertial Platform and Control Systems, NAECON 1962.
- (4) R. V. Babcock, Radiation Damage to Unipolar Transistors, Amer Nuc Soc Trans. 4, p 60, June 1961.

## Laser-Pumped Maser Shows Way to Fill Spectrum Gap

RUBY CRYSTAL pumped by coherent optical radiation from a ruby laser has generated and amplified microwaves at 22.4 Gc. The optically pumped maser extends the frequency range over which maser devices can be pumped by three orders of magnitude.

The laser-pumped maser was developed at the research laboratories of Hughes Aircraft Co. under a one-year contract with the U. S. Army Signal Corps, Fort Monmouth, N. J.

The maser cavity consisted of a section of 0.05 by 0.13 inch waveguide that was beyond cutoff at 22.4 Gc. The waveguide was loaded with a 0.078-inch length of 0.05-percent ruby. The structure functioned as a ruby-loaded reflection cavity that was resonant in a perturbed  $TE_{011}$  mode at 22.4 Gc. Optical pumping was effected through the waveguide.

The ruby cavity structure was oriented so that the crystalline C axis was at 67 degrees to a magnetic field of 6,700 oersteds. This arrangement split the ground and

# PREMIUM PERFORMANCE AT PRODUCTION PRICES... ITT KELLOGG INDUSTRIAL SYSTEM COMPONENTS...

ITT Kellogg designs and manufactures a broad range of electronic and electro-mechanical components for hundreds of industrial and commercial applications . . . including:

- Data storage devices
- Switching matrices and other assemblies
- Relays of many kinds
- Transistorized circuit modules
- Communications equipment, components, hardware
- Monitoring, sensing, alarm devices

You'll find ITT Kellogg components are reliable, durable,

efficient . . . yet moderately priced. They are built to exacting high-performance standards developed by more than 60 years of design and manufacturing experience for the telephone industry.

## got a problem?

ITT Kellogg will engineer relays for the special, exacting needs of the modern systems and control designer. Write or call for a specialist to discuss your needs. Whatever your problem, ITT Kellogg has the experts to help you. No obligation.

THESE ARE ONLY A FEW EXAMPLES OF ITT KELLOGG COMPONENTS

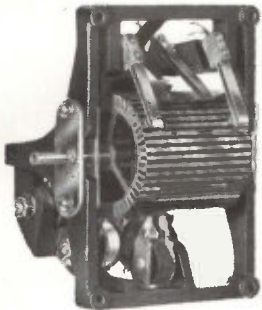

### MAGNETIC DATA-STORAGE DRUM

Non-destructive store, 250 bit 5 track, selective pulse record and erasure contact closure for read-out. High reliability.

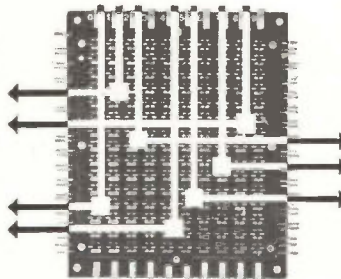

### MINIATURIZED TRANSLATION MATRIX

For automation systems, plug-in selenium disc rectifiers, not soldered or wired . . . rearrange circuits by simply repositioning discs.



### COMMUNICATIONS EQUIPMENT AND COMPONENTS

Telephones, handsets, hook switches, dials, cam keys and accessories, lamps, caps, jacks, plugs, mountings, plates . . . all types of telephone-type hardware for industrial application.

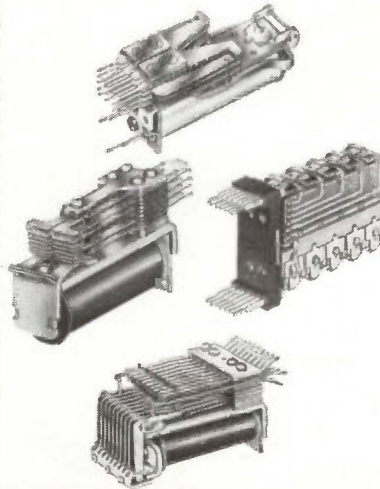

### LOW-COST INDUSTRIAL RELAYS AND MAGNETIC IMPULSE COUNTER

For a multitude of uses . . . types for "memory" devices, binary data storage, multiple-circuit operation, special requirements.

FOR MORE INFORMATION, OR A DISCUSSION OF YOUR NEEDS, WRITE OR CALL YOUR NEAREST REPRESENTATIVE—OR, SEND THE COUPON AT RIGHT.



## KELLOGG

A Division of International Telephone & Telegraph Corporation  
6650 S. Cicero Ave., Chicago 38, Ill.

#### Representatives:

Penwarden/Dailey Associates  
14547 Titus Street  
Van Nuys, California  
Berndt & Klein Associates  
6322 N. Milwaukee Avenue  
Chicago 46, Illinois  
T. H. Ellis Sales Co., Inc.  
7711 State Line Road  
Kansas City 14, Missouri  
Albert A. Jacobs  
3913 North 35th Street  
Milwaukee 16, Wisconsin

H. Markowitz  
511 Montana Street  
P. O. Box 191  
El Paso, Texas  
Land-C-Air Sales Co.  
76 Main Street  
Tuckahoe, New York  
Robert W. Gray  
572 Washington Street  
Wellesley 81, Massachusetts  
47 DeForest Street  
Watertown, Connecticut

ITT Kellogg, Industrial Sales Department  
6650 South Cicero Avenue, Chicago 38, Illinois

Please send

- Industrial Products Catalog  
 Have representative call

Name \_\_\_\_\_

Company \_\_\_\_\_

Address \_\_\_\_\_

City, Zone, State \_\_\_\_\_

**W**hy torture or overdesign a circuit to accept a low-impedance panel meter? On the other hand, why accept non-linearity or inaccuracy? A trio/lab "build-in" provides a simple, elegant, and ultimately less-expensive solution.

trio/lab produces over 1400 standard variations of these stable, accurate, and very versatile VTVM's. In a size scarcely larger than the meter movement, at a cost 1/20th of a meter built especially for the circuit, you can choose among multi-functions and multi-scales, single and multi-ranges, normal and phase-sensitive modes, AC and DC capabilities and ruggedized versions for MIL-spec applications. And scaleplates read out in the parameter you specify: degrees of yaw, foot-pounds, PSI, millivolts — just name it.

Why compromise? Get VTVM sensitivity, impedance level and overload-immunity with a trio/lab build-in. You'll unburden your circuits and yourself.

**Measure ...  
Indicate ...  
Verify ...**  
**every circuit parameter  
without compromise**

- VTVM performance
- meter-movement compactness
- remarkable economy!

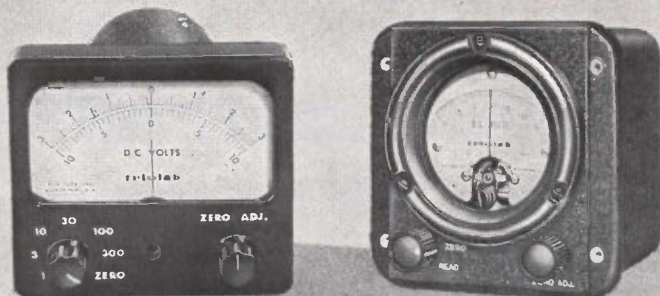

TRIO LABORATORIES, INC., PLAINVIEW, L. I., NEW YORK  
OVERBROOK 1-0400, AREA CODE 516, TWX HKVL 1166

excited states of the ruby so that a particular level could be pumped by coherent emission from the ruby laser, which resulted in the inversion of a pair of ground-state levels. At the transition between these levels, amplification and emission were observed at 22.4 Gc.

Optical pumping is expected to be useful in low-noise maser amplifiers and in the generation of coherent radiation in the region of the spectrum from submillimeter waves to the near infrared. Optical pumping can lower noise temperature in maser amplifiers and increase gain-bandwidth product while allowing operating temperature to be raised.

Efforts to increase operating frequency of masers have been hampered by the lack of sources for pumping at frequencies above 150 Gc. Thus, even with harmonic pumping and cross relaxation at idler frequencies, the most optimistic operating frequency limit of masers was about 400 Gc. The optical pumping technique should lead to filling the gap between submillimeter and infrared.

**Wind-Tunnel Models Are  
Magnetically Supported**

BOSTON—Magnetic suspension and balance system eliminates the interference caused by supports of models in a wind tunnel. The system is being used at the Naval supersonic facility at Massachusetts Institute of Technology.

The technique developed at MIT is a modification of the method first successfully used by French aeronautics researchers in 1957. At the MIT wind tunnel, a half-inch diameter, 20-ounce brass model containing a ferromagnetic cylinder is magnetically suspended and controlled by lift, drag and lateral coils.

The control system for the magnetic suspension equipment includes position-sensing light beams. Thyratons are connected in a six-phase, half-wave star configuration to form the basic power supply.

Researchers are now working on development of a roll-position control and precise angle-measuring systems. They are also studying the application of the system for dynamic problems.

**This Cerameterm<sup>®</sup> terminal withstands extreme soldering temperatures. Even blazing heat up to 1700°F can't crack it.**



**This Cerameterm terminal resists shock and tensile forces up to 250 pounds. The ceramic insulation won't crack through impact.**

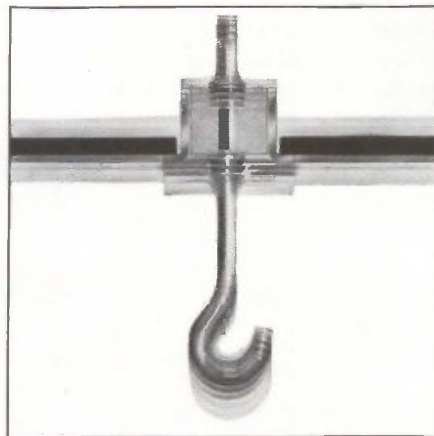

**This Cerameterm terminal stands up under the severest vibration. The ceramic insulation won't fail, won't leak.**

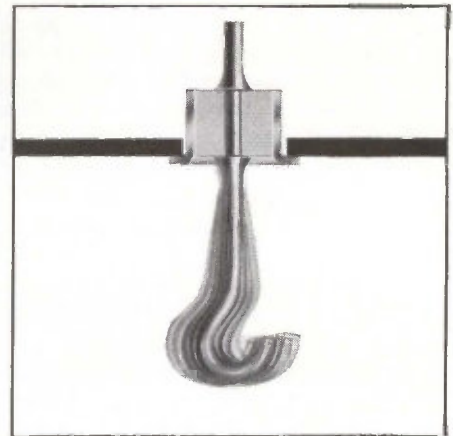

## **WOULDN'T IT BE HELPFUL IF SOMEONE COULD COMBINE THESE PROPERTIES INTO ONE TERMINAL?**

**That's what we thought. So we did it.**

Bendix<sup>®</sup> Cerameterm ceramic-metal terminal assemblies provide unheard-of reliability for transistor platforms, feed-thrus, terminals, and multiple headers of all sizes, types and shapes.

They are practically indestructible and are alumina-insulated. They have vacuum-tight seals. They are ideal for encapsulated devices.

Want a free sample? Write us in Eatontown, New Jersey.

**Red Bank Division**



# New Magnetic Rods Simplify Circuits

*Major advances also offer increased stability with temperature change*

By T. A. O. GROSS, President  
Spectran Electronics Corp.,  
Maynard, Massachusetts

EFFICIENCY and dynamic range of magnetostrictive filters have improved at least several db in recent months, but the big step forward has been improved stability with variations in ambient temperature. New high-efficiency rods now offer opportunity for simplified and more reliable circuit design.

Improvements in transfer efficiency is illustrated by a simple circuit adopted for Spectran's own use, Fig. 1. This circuit takes advantage of these new high-efficiency rods, and permits oscillation with a single transistor stage.

A temperature coefficient of 2 ppm per deg C is now representative. Much of the advance is due to the introduction of modified Elinvar constant modulus materials, but small refinements in the many steps of manufacture have been major contributions to the performance and reliability of magnetostrictive rods.

The rods are now cut to lengths accurate to  $2 \times 10^{-4}$  inches. This precision minimizes the amount of final tailoring necessary which contributes to the stability of the resonator.

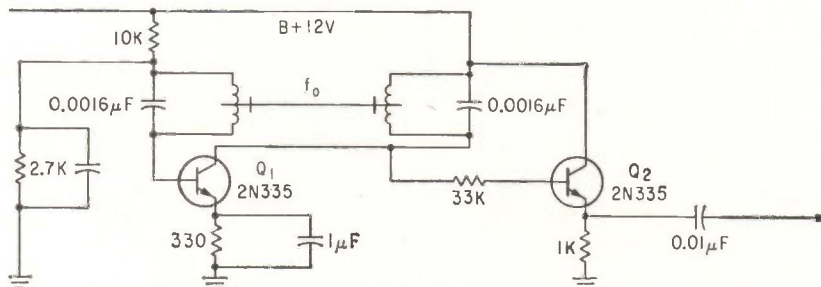

TRANSFER EFFICIENCY improvements of magnetostrictive rods permits design of 100 Kc magnetostrictive-rod controlled stable oscillator with a single transistor stage,  $Q_1$ . Transistor  $Q_2$  is an emitter follower whose sole function is to reduce pulling by variations in load—Fig. 1

Magnetostrictive rods are now the principal type of filter used in multiple-filter spectrum analyzers, and resonant rods are rapidly assuming a dominant position in telemetry and command systems.

New applications of resonant rods in space programs account for some of the increased activity in magnetostrictive filters, just as the closely related magnetostrictive delay lines have benefitted by the recent upsurge in digital equipment. More important, however, has been the increased acceptance of magnetostrictive devices in established applications—in transducers, magnetostriction oscillators, filters and storage delay lines—representing a method of converting an electrical pulse into a mechanical pulse or conversely. This upsurge in activity has been due to improvement of the rod elements themselves.

IMPROVED MATERIALS—Present studies includes work with ferromagnetics having greater magnetostrictive effects. The most promising materials are variations on the nickel-zinc ferrites which have been modified to improve their frequency versus temperature characteristics. The coupling coefficient of these materials is much higher than for the Elinvar and their higher resistivity permits operation with much lower losses.

The assembly shown in Fig. 2 shows a bank of filters used to separate subcarrier modulation tones in satellite and rocket command-con-

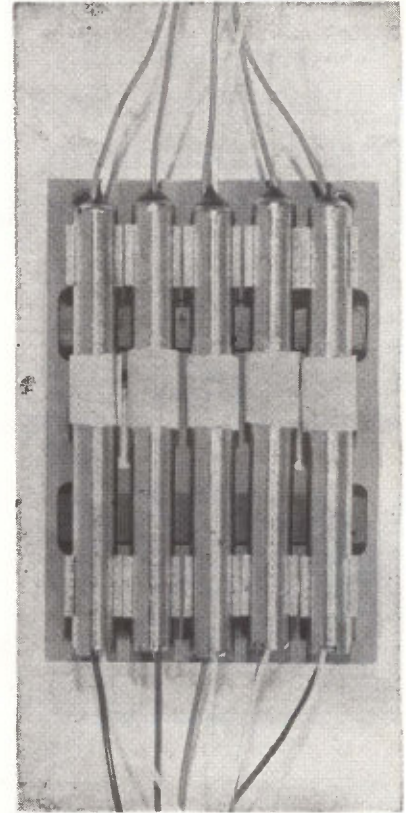

FILTER BANK assembly, shown actual size, separates subcarrier modulation tones in satellite and rocket command-control and command-destruct receivers. Important design consideration was to minimize weight. Excess material was drilled out of base plate to keep weight of entire assembly down to two ounces—Fig. 2

rol and command-destruct receivers. Great pains were taken to minimize weight. Excess material has been drilled out of the base plate so that the weight of the entire assembly is two ounces.

Present day magnetostrictive filters have a Q range of 2,000 to 20,000 and a resonant frequency range of 10 Kc to 500 Kc. Not all Q's can be obtained over the entire frequency range so that the practicable range in half-power bandwidth is about one cps to 200 cps.

This article discusses only four-terminal resonant devices used as filters and as frequency standards. The nonresonant devices are used in different fields of application. Intriguing possibilities of the two-



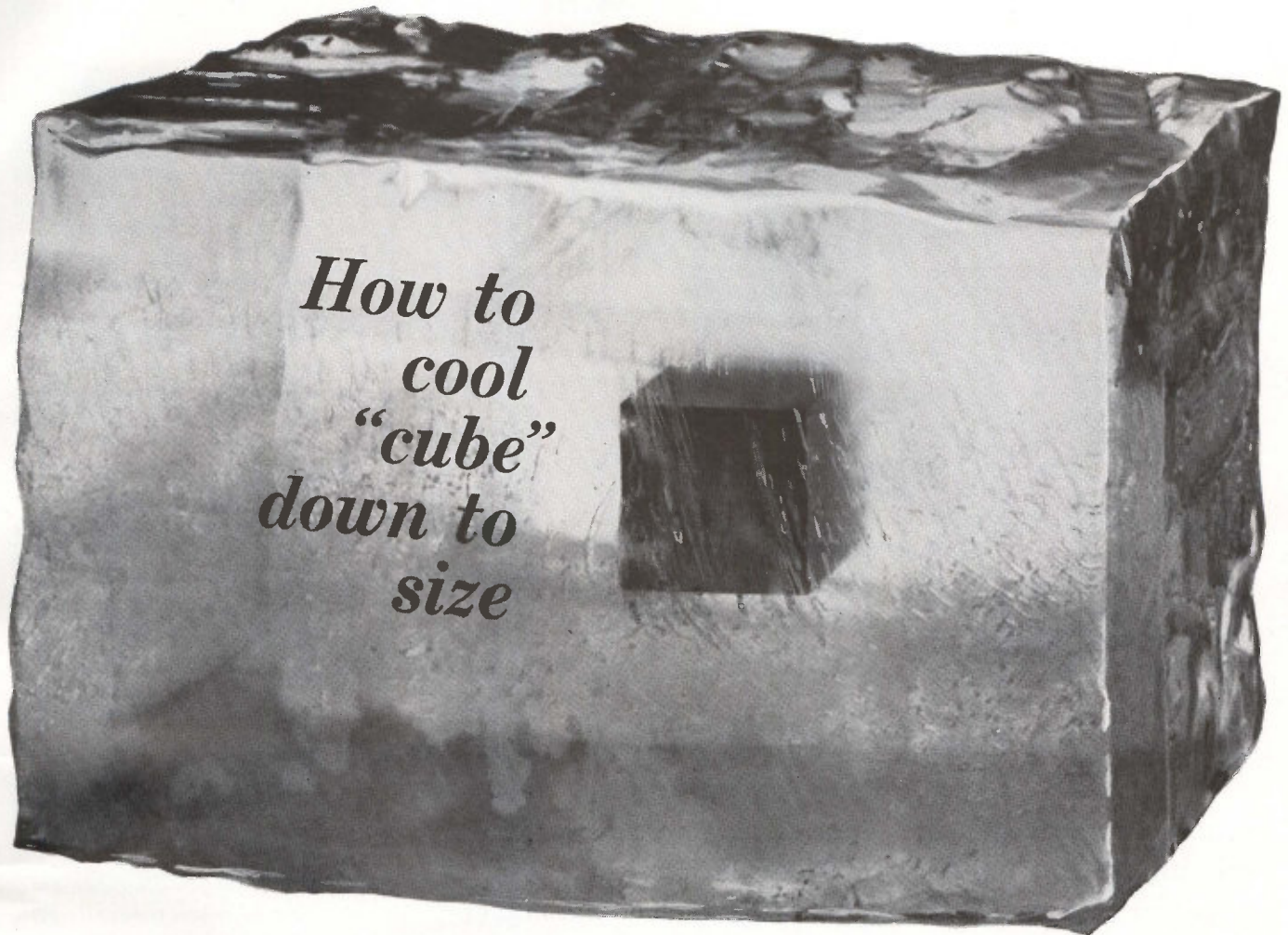

*How to  
 cool  
 "cube"  
 down to  
 size*

**4-to-1 volume reduction  
 (and more) for electronics gear  
 with FC-75 and FC-43 coolants!**

Heat problems soar as miniaturization demands put the squeeze on electronics housing space. That's why more and more designers are turning to 3M Brand Inert Liquids FC-75 and FC-43. These fluorochemicals have exceptional heat dissipation properties that help melt excess size off electronics equipment. For example . . .

Transformers redesigned with FC-75 cooling have been reduced in volume by 4 to 1, in weight by as much as 2 to 1. An airborne VHF amplifier was re-engineered, using FC-75, from a unit that weighed over a half ton to one of only 200 pounds. A blend of FC-75 and FC-43 helped another amplifier redesign achieve a compression in volume by a factor of 6.

Low boiling points of 3M Inert Liquids (see "profile") permit exceptional rates of heat transfer by evaporation. Boiling FC-75, for instance, removes up to 10 times more heat than standard transformer oil does by convection. And inert fluids remove 30 to 40 times more heat than many less volatile organic coolants.

FC-75 and FC-43 are compatible with most materials, remain chemically inert, dielectrically strong. Both are non-explosive, non-flammable, non-toxic, odorless and provide great thermal stability. Write for further details.

**PROPERTIES PROFILE  
 ON 3M BRAND INERT LIQUIDS  
 FC-43 AND FC-75**

**ELECTRICAL PROPERTIES**

|  | FC-43   | FC-75   |
|--|---------|---------|
| Electrical strength                        | 35KV    | 35KV    |
| Dielectric constant<br>(1 to 40 KC @ 75°F) | 1.86    | 1.86    |
| Dissipation factor<br>(75°F) (1000 cycles) | <0.0005 | <0.0005 |

**TYPICAL PHYSICAL PROPERTIES**

|                                      | FC-43   | FC-75   |
|--------------------------------------|---|---|
| Pour point                           | <-40°F  | <-80°F  |
| Boiling point                        | 340°F   | 212°F   |
| Density                              | 1.88  | 1.77  |
| Surface tension<br>(77°F) (dynes/cm) | 16  | 15  |
| Viscosity centi-<br>stokes (77°F)    | 2.74  | 0.65  |
| Thermal stability                    | 600°F   | 700°F   |
| Chemical stability                   | Inert   | Inert   |
| Radiation resistance                 | 25%<br>change@<br>1 x 10 <sup>6</sup><br>rads | 25%<br>change@<br>1 x 10 <sup>6</sup><br>rads |

For more information on FC-43 and FC-75, write today, stating area of interest, to 3M Chemical Division, Dept. KAX-72, St. Paul 19, Minn.

# TELEMETRY BY TELE-DYNAMICS

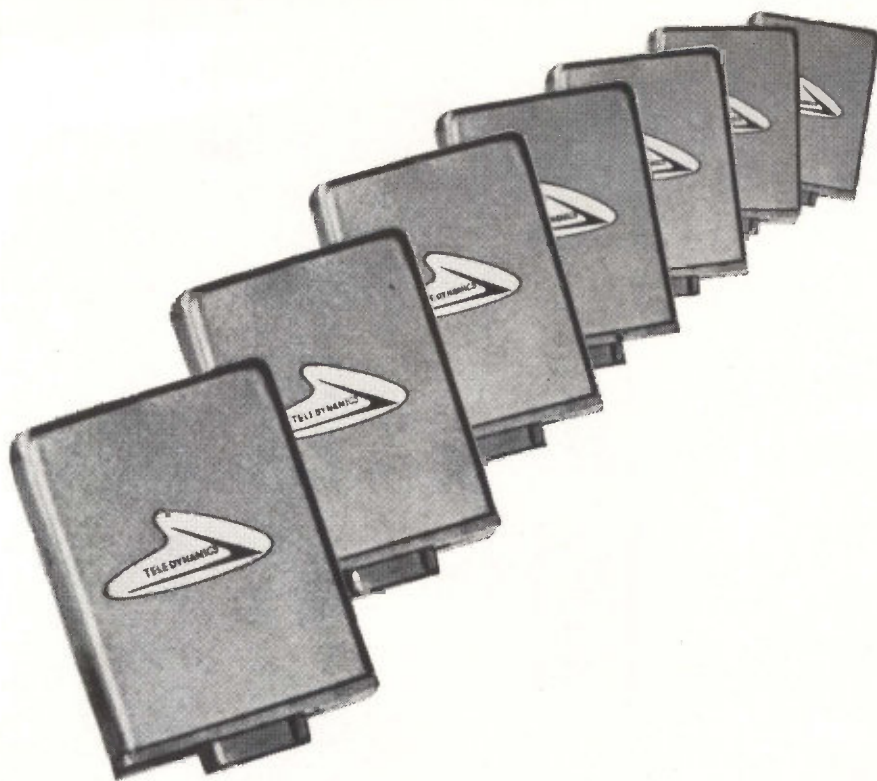

## You can tell an oscillator by its cover!

With a Tele-Dynamics seal on the cover, you know you've got the ultimate in performance and dependability. Tele-Dynamics' SCO line is characterized by exceptional electrical and environmental qualities and proved by high customer acceptance.

**1270**—service proven 0-5 volt, outstanding performance in all characteristics, on the bench and in the air—

**1262**—includes all 1270 features plus high input impedance (1 megohm) and compact form factor—

**1275**—differential high level input plus switchable input signal range  $\pm 2.5$  or 0-5 volts at turn of switch—

**1284**—the LOW LEVEL subcarrier!

*Write for complete specifications*

8790

## TELE-DYNAMICS

DIVISION

**AMERICAN BOSCH ARMA CORPORATION**

5000 Parkside Avenue, Philadelphia 31, Pa.

terminal devices must await more development to make them practical.

The resonant element, Fig. 3A, in a typical 100 Kc/s magnetostrictive resonator is a nickel-iron alloy rod or tube supported by two or more node washers—so named because they are located at the motional nodes. At no other point may the rod touch coils or other objects lest the motion become damped. The vibratory motion of the rod is longitudinal; it becomes alternately longer and shorter by about 200 microinches at resonance with a strong signal. This motion is small to the engineer who would use it to actuate some sort of readout, but it is large to the metallurgist concerned with the elastic limit of the material. The enormous stresses cause no permanent damage but the Q falls off during excitation with excessively large signals.

The rod is driven by a coil accurately positioned so as not to interfere with its motion. This coil produces an axial field which alternates with the signal to add or subtract from the flux produced by the bias magnet.

Magnetostriction causes the rod to change its length-diameter ratio with changes in the magnetic flux. The rod can be driven without the bias magnet, but the device then becomes nonlinear with small signals and there are two mechanical cycles for each electrical cycle. There are applications where this frequency multiplication is desirable. The difference in frequency between input and output can be exploited to improve off-resonance isolation and the higher mechanical frequency reduces the length of the filter.

**DRIVE AND PICKUP**—The output or pickup configuration is similar and often identical to the drive end. The bias magnet, however, now has an essential role because the pickoff signal is generated by its flux. The alternating stress produced by the mechanical vibration produces a corresponding variation in the rod permeability. As the reluctance of the flux path through the coil varies, so does the distribution of the bias magnet flux vary between external leakage and the

path linking with the coil.

The resonant frequency of the rod is equal to

$$\frac{N}{2L} V$$

where  $N$  is an integer,  $L$  is the length, and  $V$  is the velocity of sound in the rod—about  $2 \times 10^6$  in./sec.

Simple low frequency filters operate in the second order ( $N = 2$ ) which is the lowest that can be used with two or more node washers. The second order motion diagram is given in Fig. 3B. Higher orders are often used to obtain larger spacing between drive and pickoff coils which improves off-resonance isolation.

The resonant frequency is adjusted within 0.05 percent of the

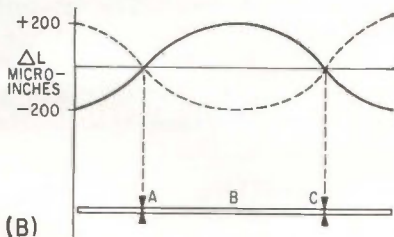
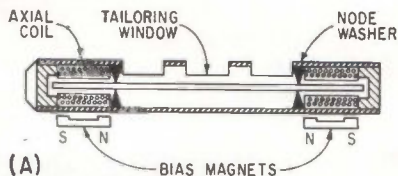

**CONSTRUCTION DETAILS** of typical magnetostrictive rod resonator (A). Curve (B) shows relative longitudinal motion of rod operating in second order—Fig. 3

desired value by manipulation of the length alone. Final tailoring is accomplished by removing minute amounts of material from region B in Fig. 3B, if it is desired to raise the frequency, or from region of A or C if it is desired to lower frequency.

If desired, it is practicable to adjust a filter or frequency standard to within 0.1 cycles per second at 200 Kc per second. Interestingly enough, the only difficulty is the time required to read a frequency to the requisite accuracy.

It is the usual practice to multiply the rod frequency by a factor of ten before feeding into the

# THE ONE TIMER WITH ALL THE FEATURES...



Only in a STANDARD instrument do you get all the features "most wanted" in an interval timer:

**UNEXCELLED PRECISION**—Consistent, continuous accuracy over years of use. Accuracy to  $\pm .001$  second available in standard models.

**INSTANTANEOUS ELECTRIC RESET**—A "must" in many instrument complexes—a plus benefit for all other applications.

**PROVEN MECHANISM**—Synchronous motor driven—electric clutch operated. Proved reliably accurate and dependable by years of service.

**CHOICE OF CONTROL**—Start, stop and reset can be manual, by electric circuit or output of electronic tubes.

**RANGE OF MODELS**—Portable or panel mounting—in a wide selection of accuracies and ranges.

Request Catalog No. 198-B

**THE STANDARD ELECTRIC TIME COMPANY**

89 LOGAN ST., SPRINGFIELD, MASS.



# METALS for ELECTRONIC APPLICATION

## rolled ULTRA THIN

by OUR SPECIAL ROLLING  
TECHNIQUE

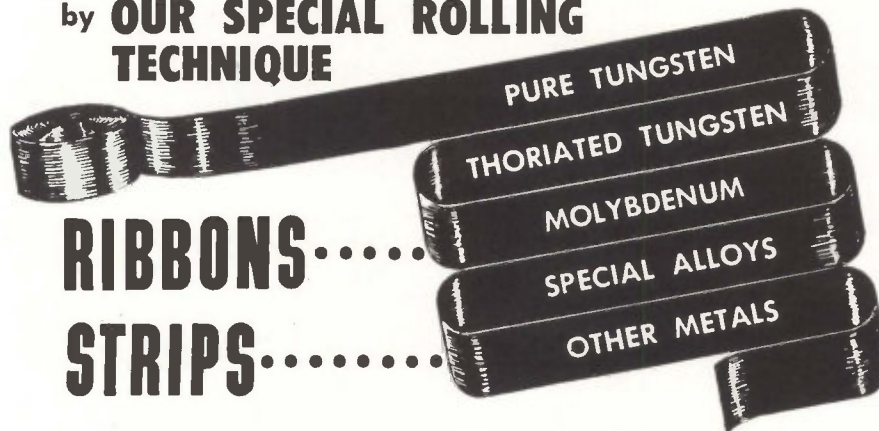

RIBBONS.....  
STRIPS.....

TOLERANCES CLOSER THAN COMMERCIAL STANDARDS

Note: for highly engineered applications—strips of TUNGSTEN and some other metals can be supplied

*rolled down to .0003 thickness*

- Finish: Roll Finish or cleaned
- Ribbons may be supplied in Mg. weights

Developed and Manufactured by

# H. CROSS CO.

363 PARK AVE.  
WEEHAWKEN, NEW JERSEY  
Tele. UN-3-1134

CIRCLE 200 ON READER SERVICE CARD



## Good parts work best!

Intermediate Frequency Transformer IFT



POLYVARICON Variable Capacitor

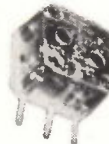

The high standards of MITSUMI electronic components are insured by a fully-automated assembly system, and double-checked by rigid quality controls. Mitsumi Electric Company is Japan's largest manufacturer of components for radio, television and communications equipment.

## MITSUMI PARTS

MITSUMI ELECTRIC CO., LTD.  
Komae, Kitatama, Tokyo



counter, so that the tailoring process can be accomplished rapidly.

### BIBLIOGRAPHY

Hawkes, F. C., Investigation of precipitation Hardening Elinvar, *J of Appl Phys*, 30, No. 4, 1959.

Nevelle E. J. Jr., Multiple Filter Spectrum Analyzers, *Electrical Manufacturing*, May, 1960.

Nevelle, E. J. Jr., Designing Magnetostrictive Filters, *ELECTRONICS*, p 88, Dec., 16, 1960.

Pierce, G. W., U. S. Patents:  
1,750,124 1,882,395 2,014,411 2,266,070  
1,962,154 1,882,396 2,014,412 2,063,946  
1,962,155 1,882,398 2,014,413 2,063,948  
1,997,599 1,882,399 2,133,643 2,063,949  
1,882,394 2,014,410 2,133,647

### New Phosphor Screen Improves Crt Resolution

HIGH-RESOLUTION cathode ray tube, now available from Westinghouse, has a screen deposited on the faceplate by electrolysis before it is mounted on the tube. The new deposition technique results in a compact and exceptionally smooth screen. Coating uniformity of deposit results in low screen noise levels and the P16 phosphor provides rapid image decay.

The new tube's precision electrostatically focused electron gun produces a line of light energy that is 0.001 inch in diam at its one-half amplitude level. The five-inch diam tube, WX-4647P16 is designed for use as a high-information-content flying-spot scanner, and as a photographic recorder.

### New Microwave Tube Produced in Japan

NEW MICROWAVE tube, the Laddertron, is now being commercially produced at Oki's new Tokyo factory, built exclusively for the production of millimeter and submillimeter tubes.

The new tube was invented at Kobe University by Kazuo Fujisawa. Oki financed research and holds exclusive patent license. Fujisawa recently transferred to Osaka University.

Three to 15 millimeter range versions of the Laddertron are now in production. Other tubes to be produced initially include magnetrons and klystrons in the same frequency range as the Laddertron. Future plans include production of twt and bwo tubes, also extension of frequency range of tubes produced to submillimeter and production of higher power tubes.

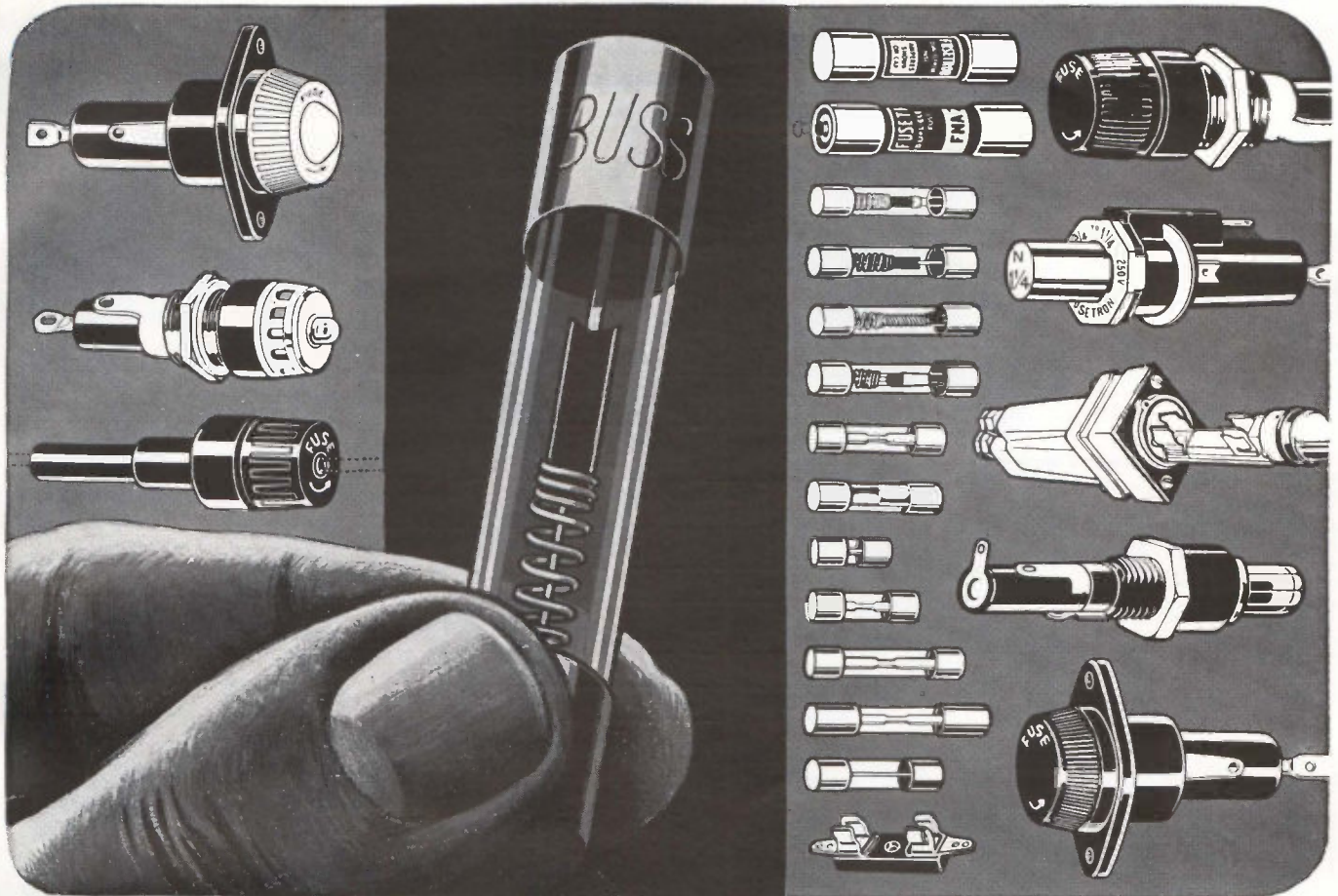

## For Every Electrical Protection Need

there's a safe and  
dependable **BUSS** or  
**FUSETRON** Fuse!

BUSS fuse engineers have consistently pioneered the development of new fuses to keep pace with the demands of the Electronic industry. Today, the complete line includes:

Single-element fuses for circuits where quick-blowing is needed;—or single-element fuses for normal circuit protection;—or dual-element, "slow-blowing" fuses for circuits where harmless current surges occur;—or indicating fuses for circuits where signals must be given when fuses open. Fuses range in sizes from 1/500 amperes up—and there's a companion line of fuse clips, blocks and holders.

### If you have a special protection problem

The world's largest fuse research laboratory, plus the experience gained by solving many, many electrical protection problems is on call to you at all times. Our engineers work with yours and can help you save engineering time and trouble.

For more information, write for BUSS bulletin SFB.

**BUSS: The complete line of fuses and fuse mountings of unquestioned high quality.**



**BUSSMANN MFG. DIVISION**  
McGraw-Edison Co.  
St. Louis 7, Mo.

NEW—

## MATHEMATICS MANUAL

Helps you solve all kinds of mathematical problems faster and easier. Brings you a tremendous fund of information on everything from elementary arithmetic to higher mathematics, including tensor calculus, probabilities, and statistics.

• Gives important definitions, principles, theorems, corollaries, relationships, and the methods most commonly used in mathematics. The one handy volume to have for instant access to essentials for solving business, engineering, or scientific problems. By F. S. Merritt, Senior Editor, *Engineering News-Record*. 378 pp., 178 illus., \$9.50.



## NUMERICAL METHODS FOR SCIENTISTS and ENGINEERS

Just Published. Gives a unified approach to modern computing methods using large-scale digital computers as tools for research and development. Emphasis is on insight into the meaning of computations, and the development of formulas, rather than on mathematical derivations. By R. W. Hamming, Bell Telephone Laboratories, 411 pp., 39 ill., \$11.00

## FUNDAMENTALS of the LAPLACE TRANSFORMATION

Just Published. Fundamental and basic approach to the Laplace-transform method of solving differential equations arising in connection with electrical, mechanical, and electromechanical systems. By C. J. Savant, Jr., Hughes Tool Co., Aircraft Div. Tables, Ezra C. Levy, Space Technological Labs. 229 pp., 159 ill., \$7.75

## INTRODUCTION to MICROWAVE THEORY

Just Published. Develops the physical phenomena governing behavior of microwave systems and components, from point of view of the electromagnetic field in interaction with wave guiding structures and component materials. Wave propagation in waveguides, equivalent circuit methods for microwave systems, and the interactions of microwaves with solids are discussed. By Harry A. Atwater, Pennsylvania State Univ. 264 pp., 6 x 9, 120 illus., \$8.75

## ELECTRICAL and MECHANICAL NETWORKS

Just Published. Introductory treatment of basic principles of linear network analysis. Includes introduction to systematic methods of formulating and solving analysis equations, and application to electrical, mechanical, and electromechanical networks, including feedback networks. By Willis W. Harman, Stanford Univ., and Dean W. Lytle, Univ. of Washington. 640 pp., 6 x 9, 499 illus., \$11.50

## 10 DAYS' FREE EXAMINATION

McGraw-Hill Book Co., Inc., Dept. L-7-13  
327 W. 41st., N. Y. C. 36  
Send me book(s) checked below for 10 days' examination on approval. In 10 days I will remit for book(s) I keep, plus few cents for delivery costs, and return unwanted book(s) postpaid. (We pay delivery costs if you remit with this coupon—same return privilege.)

- Merritt—Mathematics Manual, \$9.50
- Hamming—Numerical Meth. for Sci. & Eng., \$11.00
- Savant—Fund. of the Laplace Trans., \$7.75
- Atwater—Intro. to Microwave Theory, \$8.75
- Harman & Lytle—Elec. & Mech. Networks, \$11.50

(PRINT)

Name .....  
Address .....  
City ..... Zone ..... State .....  
Company .....  
Position .....  
For price and terms outside U.S., write McGraw-Hill Int'l., N.Y.C. L-7-13

## SKL VARIABLE ELECTRONIC FILTERS

These versatile instruments feature a continuous adjustment of cut-off frequency and a flexible arrangement of operational modes. Widely used in research and industry, their application is constantly solving new problems of signal selection, measurement and control.



MODEL 302



MODEL 300



MODEL 308A

| FUNCTION            |             | High or Low Pass Band Pass or Reject | High or Low Pass                  | High or Low Pass Band Pass or Reject |
|---------------------|-------------|--------------------------------------|-----------------------------------|--------------------------------------|
| Cut-off Freq. Range |             | 20 cps to 200 kc                     | 20 cps to 200 kc                  | 0.2 cps to 20 kc                     |
| Attenuation Rate    | Per Section | 18 db/octave                         | 18 db/octave                      | 24 db/octave                         |
|                     | Max.        | 36 db/octave                         | 18 db/octave                      | 48 db/octave                         |
| PASS BAND           |             | 2 cps to 4 mc                        | 2 cps to 4 mc                     | DC to 1 mc                           |
| DIAL ACCURACY       |             | ± 3% to 20 kc<br>± 5% above 20 kc    | ± 3% to 20 kc<br>± 5% above 20 kc | ± 3.5%                               |
| INSERTION LOSS      |             | 0 ± 1 db                             | 0 ± 1 db                          | 4.5 db ± 1 db                        |
| NOISE LEVEL         |             | 60 microvolts                        | 60 microvolts                     | 80 microvolts                        |

Write for further information to:

SKL

SPENCER-KENNEDY LABORATORIES, INC.

1320 SOLDIERS FIELD ROAD, BOSTON 35, MASS.

CIRCLE 201 ON READER SERVICE CARD

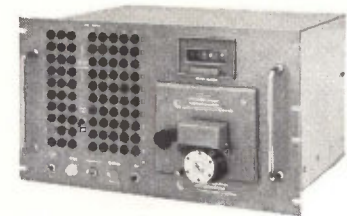

## HOW TO INCREASE YOUR READING CAPACITY

EECO's block, punched-tape reader can digest 80, 96, 120 or 160 bits of information at a step (depending upon the model you select). It's better designed for applications like machine tool control and automatic checkout and tests. For instance, it offers a complete test per block; identification of data function by position in block; elimination of data storage records and address decoding circuits. Straight-forward programming by blocks. Standard units read 80, 96, 120, 160 bit blocks. In modular or standard 19" rack mounting units. Takes 1", 8-level paper or mylar tape punched on 0.1" centers. Reader head designed for either forward or reverse reading. Most models are bi-directional. Write for data sheets.

CIRCLE 202 ON READER SERVICE CARD

electronics



Automation Division

Electronic Engineering Company  
of California

1601 E. Chestnut Avenue • Santa Ana, California  
Phone: 547-5501, P.O. Box 58 • Representative in Western Europe and Israel: Electronic Engineering S.A., C.P. 142 Fribourg, Switzerland. EE 2-80

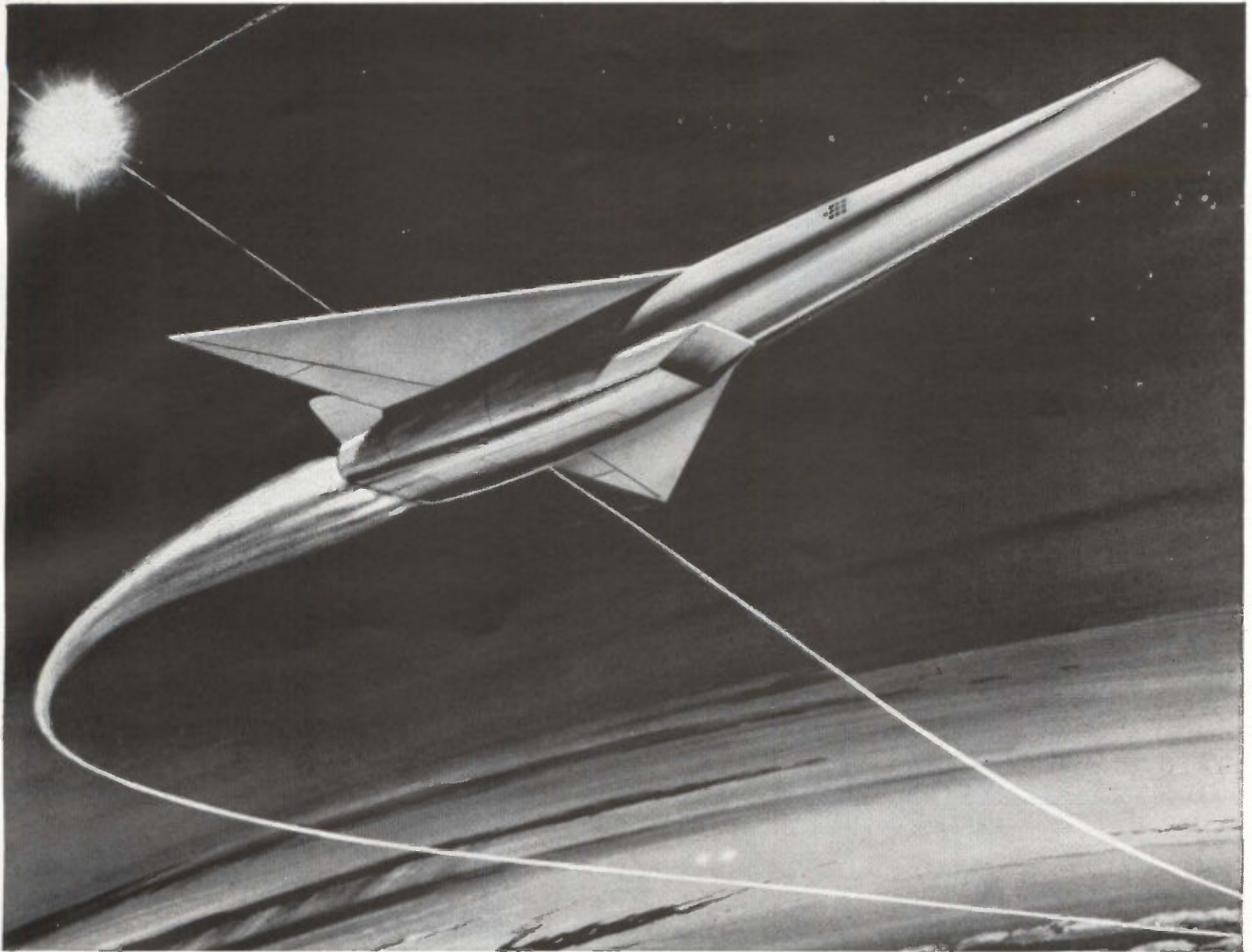

**From sea to stars—the range of LOCKHEED ADVANCED DEVELOPMENT**

Air. Space. Sea. Vast frontiers that challenge Lockheed's scientific creativity, engineering knowledge, manufacturing skills! None offers greater scope than Advanced Aircraft.

The Hypersonic Fighter pictured above is only one example of many advanced concepts. Others—illustrated below—are:

- 1) The Supersonic Transport design concept typifies the Company's creative thinking and planning.
- 2) So does the Rigid Rotor Helicopter. Lockheed's helicopter test bed, flying for several years, already has demonstrated outstanding stability and maneuverability.
- 3) Hydrofoil: its stability, control and noise, now are under intensive study.

Other major projects—in Spacecraft and ASW Systems—engross the attention of Lockheed Scientists and Engineers.

Result: Genuine opportunities for genuine career-progress—in an environment in which inventive minds flourish.

**Scientists and Engineers** of top-level talent and training are invited to explore these immediate openings: Human Factors; Design Engineering (aircraft and non-aircraft) structures, electronics, mechanical; Thermodynamics; Servosystems; Reliability; Guidance and Control; Dynamics; Electronic Systems; Aerospace Ground Equipment; Bioastronautics; Systems Integration and Trade-off; Space Mechanics; Sub-Systems Synthesis and Analysis; Nuclear, Electric and Liquid Rocket Propulsion; Electronics Research; Hydrodynamics. Send résumé to: Mr. E. W. Des Lauriers, Manager Professional Placement Staff, Dept. 1507, 2408 N. Hollywood Way, Burbank, California. An equal opportunity employer.



**LOCKHEED CALIFORNIA COMPANY**  
A DIVISION OF LOCKHEED AIRCRAFT CORPORATION



NEW, SMALLER work benches save space, provide greater comfort to workers, and are a factor in a general improvement in production efficiency

## Making New Production Ideas Work

*Systematic effort to find and put best ideas to work pays off*

By C. J. GEATING

Westinghouse Air Arm Div.,  
Baltimore, Md.

TO OBTAIN maximum production efficiency, this division has set up a special methods engineering department. Much of the production in the plant is highly complex electronic equipment, but produced in relatively small lots. As a result, highly automated production techniques are not generally economical and thus manual methods are extensively used.

Since the labor costs in manual assembly are relatively high, the Methods Engineering Group was established to determine best practices and to get them accepted throughout the plant. Since, in many cases, past practice has become habitual and is assumed to be best practice, new methods are often criticized and resisted as being too refined or too theoretical; thus special attention is needed in getting acceptance.

One of the first steps in the program was to set up monthly meetings of the members of the line and staff groups immediately concerned with production, including production line supervisors, manufacturing engineers, methods engineers, industrial engineers and quality control. Because of the size of the staff, four meetings, each one and one-half hours long, are held each month; but a given supervisor, for example, will attend only one of the meetings.

At each meeting, six presentations of various ideas for improving production are made, using samples, charts, drawings, slides, etc., as required by the idea. In addition, each person attending the meeting is required to present, in writing, an idea that he or one of the people in his group has come up with. An incentive is provided to each member of the group, not only to generate new ideas, but to put those that others thought of to work in their own department if they are suitable. Thus, a total of 24 production ideas are presented each month. After the formal presentations, the meeting considers problems raised by those attending.

Movies are made of each presentation and are shown the following month at each of the four sessions, thereby, making possible a complete interchange of ideas. In addition, ten to fifteen minutes are allotted at each session to representatives of outside companies who present ideas using samples or film. Representatives from the engineering department also will occasionally discuss equipment or a process still in development stage.

PRODUCTION LAB—Besides providing a forum for airing produc-



MACHINE TO TIN component leads automatically was developed under supervision of methods engineering group



# HOW FREON® SOLVENTS

## SAVE YOU MONEY

AT \$7.50\*

PER GALLON

Freon\*\* solvents are relatively high priced, yet their unique combination of advantages permits numerous economies that can save you money! Here's how you can save.

1

**Clean entire assemblies at one time.** "Freon" seeks out and removes oil, grease and soils but does not harm metals, plastics or electrical components. **Example:** An Eastern manufacturer cleans complete office machines by immersion in "Freon" solvents.

2

**Cut rejects from contamination.** "Freon" cleans effectively, dries quickly, and leaves no residue. **Example:** One Midwest maker of electronic relays cut his reject rate to less than 1% by using "Freon".

3

**Reduce need for safety facilities** because "Freon" is non-flammable, virtually nontoxic. Your cleaning facility requires no expensive modifications to protect workers. **Example:** A Midwest missile component manufacturer saved \$250,000 in air handling and refrigeration facilities by designing his White Room Complex to use "Freon".

4

**Eliminate employee time loss** and complaints due to headaches and related problems. There is not a single recorded case of an employee complaint caused by using "Freon". In fact, chronic complaints have stopped when "Freon" replaced ordinary solvents.

5

**Cut solvent losses** because "Freon" is stable. It does not contain or require additives. "Freon" doesn't turn acid. Both vapors and liquid can be recovered easily and used over and over again. **Example:** Hundreds of enthusiastic users.

Now back to that \$7.50 per gallon! You know that, compared to labor and equipment, the solvent is normally only a small part of the cost of your cleaning operation. And compared to the expensive parts being cleaned, solvent cost is negligible. In fact, you can't afford **not** to use "Freon" for parts damageable by harsh solvents!

For any cleaning problem, it can pay you to investi-

gate "Freon" cleaning agents. Write Du Pont for detailed technical information; or if you wish, we'll arrange a visit by a technical man to analyze your particular problem. Address: Du Pont Co., N-2420-E7, Wilmington 98, Delaware.

**FREON®**  
solvents



Better Things for Better Living...through Chemistry

\*Price is for "Freon" TF solvent delivered in 55-gallon drums. Price subject to change without notice.

\*\*Du Pont's registered trademark for its fluorocarbon solvents.

NEW! FROM



## Wide Bandwidth Multiplier-Divider

for highest speed and  
dynamic accuracy in  
analog computation,  
data correlation or  
reduction and  
automatic control

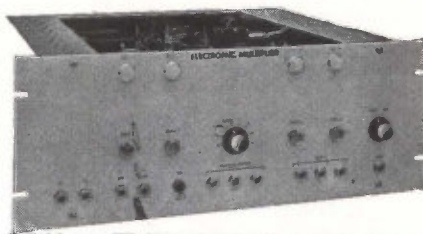

### FEATURING

D-C to 400,000 cps operation;  
less than 2  $\mu$ secs. response.

Less than 1° phase shift  
at 12,000 cps.

Four-quadrant operation.

High gain minimizes need for  
external amplifiers.

Instantaneous recovery  
from overloads.

Positive-negative switch  
— no inverter needed

Write for Technical Bulletin MU500F

**GPS INSTRUMENT CO., Inc.**

180 NEEDHAM ST., NEWTON 64, MASS.

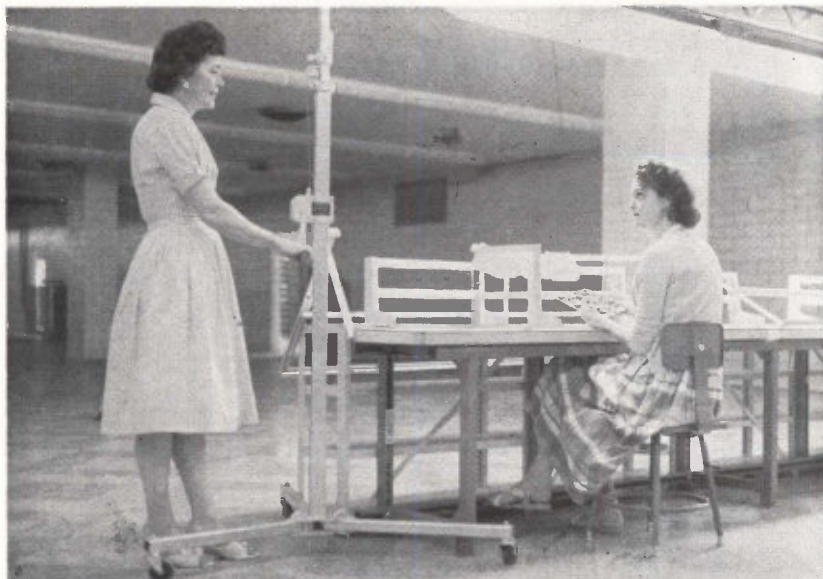

**BENCH, WITH LIGHTING fixture variable both in height and candle-power, before installation in production laboratory. From studies conducted under conditions similar to actual production area, lighting to 200 candle-power was found desirable for some jobs**

tion problems, the methods engineering department also operates a special production laboratory, where systematic attention to production problems of larger scope can be applied, and where special machines can be built.

One of the first ideas for improving production was an investigation into the effect of operator comfort on output. The conventional workbench and highchair, for example, allows the operator to put her feet either on the rung of the chair or on the rail under the bench. But the rail under the bench is sometimes used for storage, in which case only the rung of the chair is available.

Two types of adjustable workbenches and adjustable stools were purchased so that the effects of varying workbench height could be studied. For small work, such as printed circuit boards and small chassis, the benches were set at normal desk height and the operator has his or her feet on the floor, with consequent freedom of movement. For heavier work, a bench height of 35 inches was found more suitable.

During the study of bench height it was realized that much space was wasted with conventional tables, since workspace 18 inches deep and three feet long was found to be adequate for many operations.

From the studies on workbenches made to date, new low benches and

chairs have been installed in part of the production area and more will be installed. The workbenches are 30 inches high, 18 inches deep and six feet long, and provide space for two operators. On the back of the benches are six shelves, 12 inches deep; when the benches are arranged in rows, these shelves are storage space for the operator at the bench in front. Table tops are gray Micarta but pastel greens and blues should also be suitable. For some work, however, a less polished surface is desirable.

Instead of large lazy susan type component storage racks on the tops of the table, which were on the older type tables, racks of component holding trays are provided each operator in the new arrangement; these racks swivel to allow access to the back tier of components. Tops of the new tables are detachable, so that a work space can be moved easily without disturbing the setup of the job in progress.

Lighting studies have also been carried out on a systematic basis and one of the photographs shows an adjustable lighting fixture. As a result of the experiments, lighting is being increased for some types of work up to 180 candle power and up to 200 candle power for printed circuit work. Comments from operators indicate a reduction in headache, eyestrain and fatigue. Production increases as a result

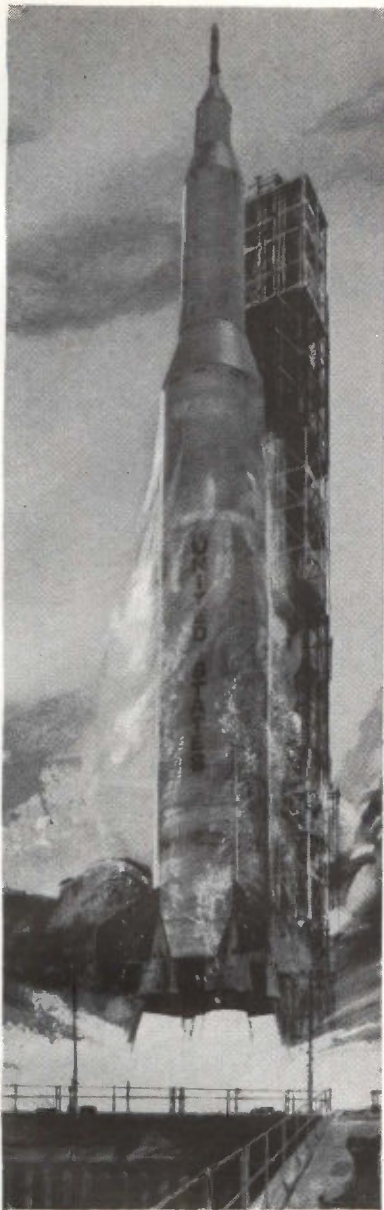

Saturn Launch Vehicle



Dyna-Soar Space Glider

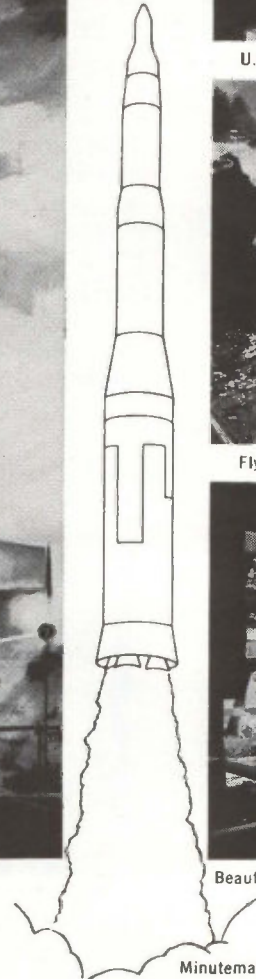

Minuteman ICBM



U.S. Science Pavilion at Seattle World's Fair



Fly-casting on Skykomish River near Seattle



Beautiful homes line Seattle's 200 miles of shore

## Advanced Boeing openings for Engineers and Scientists

You will find career excitement in many of the challenging programs at Boeing's Aero-Space Division. Some of these programs—the advanced Saturn S-IC first-stage booster, for example—are under the management of newly-formed divisional organizations that can offer you unique ground-floor opportunities.

Other openings with rapid-advancement potential are immediately available on the Dyna-Soar space glider program and the solid-fuel Minuteman ICBM. Assignments are available in many fields of activity, including Research and Development, Design, Manufacturing and Test.

In addition to professionally stimulating

careers, these Boeing openings can offer you—and your family—a wide variety of living advantages, including geographic locations such as the uncongested Pacific Northwest, Florida resort areas and historic New Orleans.

Salaries are commensurate with education and experience. Minimum requirements are a B.S. degree in any applicable scientific discipline. Boeing pays liberal moving allowances for newly-hired engineers.

Send your resume today to Mr. Lawrence W. Blakeley, The Boeing Company, P. O. Box 3822-ECJ, Seattle 24, Washington. Boeing is an equal opportunity employer.

### Assignments are available for:

- Structures Engineers
- Electronic/Electrical Engineers
- Mechanical Engineers
- Industrial Engineers
- Manufacturing Engineers
- Propulsion Engineers
- Aeronautical Engineers
- Cryogenicists
- Base Installation Engineers
- Physicists
- Mathematicians

# BOEING

Divisions: Military Aircraft Systems • Transport • Vertol • AERO-SPACE • Industrial Products—Boeing Scientific Research Laboratories

# NEW Stromberg- Carlson® lightweight telephone handsets



... for a wide range of applications such as dictating systems, mobile radio, carrier and microwave.

These new lightweight Stromberg-Carlson handsets, No. 33 and No. 35, incorporate push-to-talk switches, broadening the range of their applications. Both feature high-gain, high-efficiency transmitter and receiver.

The No. 33 model is furnished with a bar-type switch, located on the underside of the handle.

The No. 35 handset is furnished with a button switch on the side of the handle near the receiver end. Also available with both button and bar switches.

For technical details and ordering information, contact any of these sales offices: Atlanta—750 Ponce de Leon Place, N.E.; Chicago—564 W. Adams Street; Kansas City (Mo.)—2017 Grand Avenue; Rochester—1040 University Ave.; San Francisco—1805 Rollins Rd.

**GENERAL DYNAMICS  
TELECOMMUNICATION**

of board can be placed on one tape. of changes in bench and chair height are estimated at about four percent, without taking reduction of rework or increased space utilization into account. It is estimated the improved lighting will increase production an additional four to six percent.

## Automatic Tester for Computer Logic Boards

AUTOMATIC EQUIPMENT to test computer logic boards in one-twentieth the time formerly needed has been developed by Autonetics, a division of North American Aviation, Inc.

The machine is being used for functional tests of logic circuit and diode matrix boards for the Air Force Minuteman's airborne digital computer.

Major advantages of the tester are speed, accuracy and versatility; the functional test of a logic board

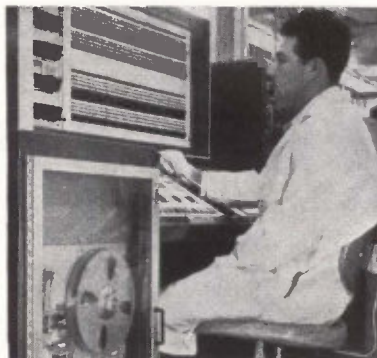

takes 12 minutes instead of the approximately four hours required previously.

Errors have been located that previously were almost impossible to find. Trouble-shooting of finished boards assembled in the computer has been drastically reduced.

If a logic board error is discovered during test, the error is displayed visually and printed out on paper tape. The test continues until the complete board is fully checked. By referring to the tape the operator can immediately locate the error and determine its cause.

Programming is comparatively simple. Schematics are translated onto punched cards and the cards are then fed into a tape converter. Programs for more than one type of board can be placed on one tape.

*for maximum  
reliability*

## SPECIFY BIRTCHER 3-B SERIES HEAT RADIATORS



# PREVENT THERMAL RUNAWAY— GET MAXIMUM SEMICONDUCTOR PERFORMANCE

Semiconductor devices derate rapidly when operated at temperatures above those recommended by the manufacturer. Destructive heat rise can be controlled, even when solid state devices are operated at maximum rated load, by using Birtcher 3-B Series Heat Radiators. The exclusive, compact, patented stacked fin design provides up to 12 square inches of radiating surface... permits maximum density packaging. Sizes IN STOCK for every popular semiconductor device.

*Available from authorized  
distributors coast-to-coast*



Write for catalog and test reports on world's largest line of semiconductor cooling and retention devices

**THE BIRTCHER  
CORPORATION**  
INDUSTRIAL DIVISION

745 S. Monterey Pass Road, Monterey Park, Calif.

**TUBE/TRANSISTOR/COMPONENT  
RETENTION AND COOLING DEVICES**

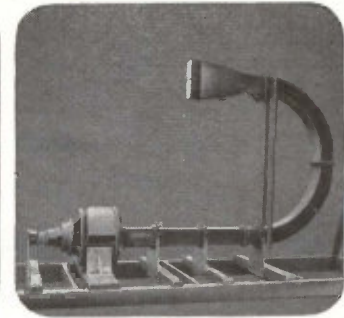
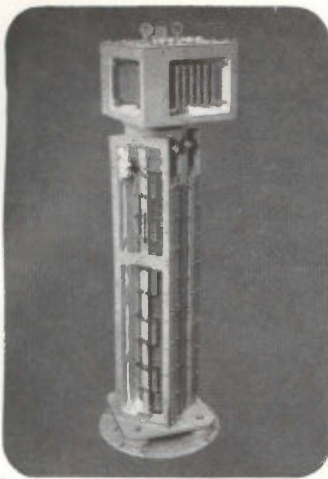

**PRECISION CAST HORN**

Precision Microwave Castings — We pour aluminum, magnesium and copper base alloys. Precision sand, plaster and investment castings complete with metallurgical tests are processed at our foundry.

**WAVEGUIDE ASSEMBLY**

Microwave Devices — Typical microwave devices ranging between L and KU Band include duplexers, switches, phase shifters, power dividers, horns, directional couplers and mixers. We test to your specifications.

**CIRCULAR LINEAR POLARIZER**

Antenna Assemblies — Complex assemblies in the L through KU Band frequency ranges for ground, shipboard, airborne and missile applications are available.

**360 RING SLIP RING ASSEMBLY**

Slip Ring Assemblies—Our new concept of button type spacing eliminates moisture and dust traps, gives maximum ring capacity within minimum space requirements. Dynamic characteristics are improved because of lower torque, heat dissipation is better and capacitance is reduced. Cost is lower.

**PRODUCTS OF PROVEN RELIABILITY**

Gorham Electronics has established a reputation of supplying complex precision castings, microwave devices and slip ring assemblies of proven reliability to the country's major contractors. Completely integrated facilities covering design, precision casting, close tolerance machining and assembly, plus final electrical test — all at one location—are your assurance of a quality product, at lowest cost.

Hidden costs associated with vendor liaison, incoming inspection, divided technical responsibilities, and multiple profits are eliminated by placing a single order for timely delivery of a final tested product with an "Integrated Facility of Proven Reliability"—Gorham Electronics. Write today for our brochure.



**G O R H A M E L E C T R O N I C S**

DIVISION OF GORHAM CORPORATION  
333 ADELAIDE AVENUE, PROVIDENCE 7, RHODE ISLAND  
Tel. Area Code 401 Williams 1-1000

ENGINEERING DESIGN • FOUNDRY • MODEL SHOP • MACHINE SHOP • PLATING & PAINTING • ASSEMBLY • TEST

CIRCLE 204 ON READER SERVICE CARD



**TKK INDUSTRIAL MOTORS**

**Lowest Drain, Minimum Noise,  
Longest Life — at Low Cost**



RM-170 T



FM-250 R

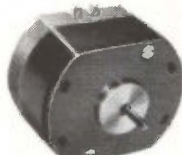

FM-250 N

**APPLICATIONS**

- \* Tape-recorders
- \* Record-players
- \* Clocks
- \* Shavers
- \* Music Boxes
- \* Cinecameras
- \* Turntables
- \* Automations
- \* Other Appliances

| type             | voltage (D.C.) |
|------------------|----------------|
| RM-170 T models  | 1.5 ~ 3.0 V    |
| RM-170 S models  | 1.5 ~ 6.0 V    |
| RM-170 SC models | 3.0 ~ 12 V     |
| FM-250 N models  | 1.5 ~ 4.5 V    |
| FM-250 R models  | 1.5 ~ 6.0 V    |

Large orders executed reliably and on schedule by the world's largest factory specializing in D.C. magnetic low current motors (Output: up to 2½ million units per month!) Your detailed inquiry is invited — your satisfaction guaranteed.

**MABUCHI SHOJI K.K.**

37, Kabuto-cho 2-chome, Nihonbashi, Chuo-ku, Tokyo, Japan  
C.P.O. Box 1084, Tokyo Cables: "NIHONKAKOCO TOKYO"

**TRANSISTOR AND DIODE  
TEST FIXTURES**

BY DELTA DESIGN



**CONVENIENT!**

**RELIABLE!**

Just open drawer and quickly insert dozens of diodes or transistors for temperature evaluation from —100 F. to +400 F. Fast decade switching!

*Cut Testing Costs!*

These Delta fixtures radically reduce testing costs; accuracy assured. Fit all Delta Portable Temperature Chambers without modification.

**DELTA DESIGN**

INC.

Call your Delta representative  
or write direct.

8000 FLETCHER PKWY. LA MESA, CALIFORNIA  
PHONE: 465-4141 (SAN DIEGO) • TWX: LMSA 6538-U

CIRCLE 205 ON READER SERVICE CARD

July 13, 1962

CIRCLE 75 ON READER SERVICE CARD 75

# DESIGN AND APPLICATION

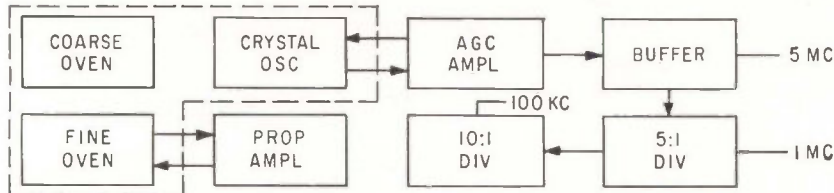

## Oscillator Ages Less Than 2 Parts in $10^{10}$

*Solid-state device has accurate outputs at 100 Kc, 1 Mc and 5 Mc*

MANUFACTURED by Manson Laboratories, 375 Fairfield Ave., Stamford, Conn., the model RD-180A transistorized frequency standard has outputs at 100 Kc and 1 Mc of 0.75 v rms into a 50-ohm load and 5 Mc at 0.25 v rms into a 1,000-ohm load. Frequency stability is 1 to 2 parts in  $10^{10}$  per day after six months continuous operation. Frequency adjustments can be made to 500 parts in  $10^9$  total. The standard consists of a high-stability Pierce oscillator using a ruggedized plano-convex 5th overtone precision AT-cut crystal with a three-point mount. The oscillator is enclosed in a glass flask within a temperature-regulated oven. Fine temperature control is by a temperature-sensitive bridge and proportional ampli-

fier. Coarse temperature regulation is by a mercury switch oven. The crystal is nominally operated at the point where oscillations are sustained with minimum current flow and any tendency for the crystal current to increase is cancelled by feedback from the agc amplifier.

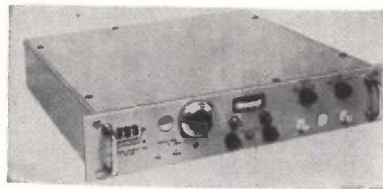

Two locked dividers convert the 5 Mc to 1 Mc and 100 Kc and buffers isolate the oscillator from load variations. The oscillator can be finely tuned by a front panel control. A self-contained 50-hour battery supply is switched on in the event of line failure.

CIRCLE 301, READER SERVICE CARD

silicon controlled rectifier phase control rather than full power being applied intermittently. Heating rates between 0.5, 1, 2, 3, 4, 5, 7.5, 10, 15, 20, 25 and 30 degrees C per minute between 0 and 500 C with power up to 1,500 watts are provided. Phase control of the scr is through a unijunction firing circuit and by controlling the scr firing phase, power applied to the load is controlled. Temperature detection is by a thermocouple reference bridge and microsignal amplifier. Proportional bandwidth is adjustable between 2 and 20 C and temperature control is  $\pm 0.1$  C or better. The thermocouple bridge is stabilized by a two-stage zener diode regulator. Applications include DTA units, hotstage microscope studies, heated cells for IR, ovens for crystal growing or wherever precise temperature control is needed. (302)

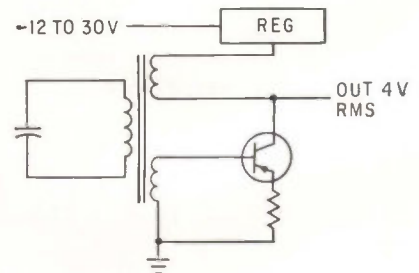

## Low-Frequency Oscillator

RECENTLY announced by Grafix Inc., POB 3296, Albuquerque, New Mexico, the new line of solid-state low-frequency oscillators supply fixed tones or timing frequencies comparable to tuning-fork oscillators and are very rugged, have superior reliability and cost less. Frequencies can be supplied between 400 cps and 100 Kc  $\pm 0.01$  percent. Output is 4 v rms into a 2,000-ohm load. Harmonic distortion is less than 5 percent and can be ordered to essentially zero per-

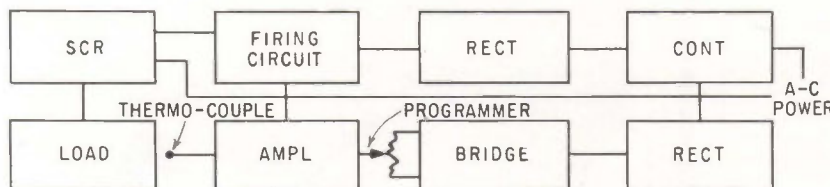

## Temperature Programmer Uses Power Proportioning

ANNOUNCED by F & M Scientific Corp., Starr Rd. and Rt 41, Avon-

dale, Pa., the model 240 power proportioning temperature programmer is a lightweight unit in which the amount of power supplied to a heater is increased continuously by

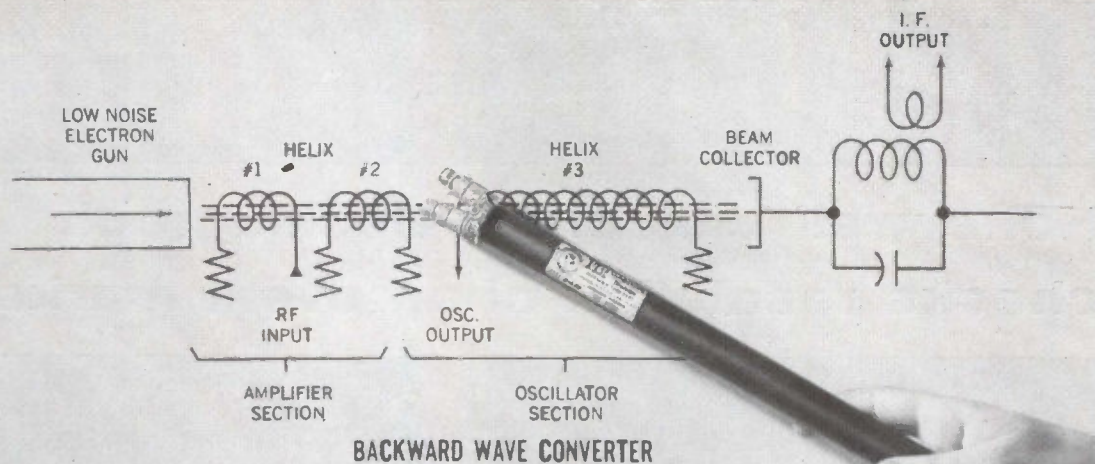

Replaces  
a 3-unit  
microwave  
front end

## RF TO IF IN ONE ENVELOPE

In a single envelope, ITT's new backward wave converter provides a complete microwave receiver front end, amplifier/pre-selector, a local oscillator and mixer. The BWC operates as a swept superheterodyne receiver with octave coverage without the use of an external local oscillator or external mixer. ■ This design eliminates crystal detectors and their burn-out problems and virtually eliminates blocking by strong signals at the pass band. Seven frequency ranges from 500 to 12,000 MC in seven bands are now available. BWA tubes for use as pre-selectors with the converters are also in production. ■ The ITT microwave tube line includes BWC, BWA and BWO types as well as TWT's for L, S, C and X band.

| BACKWARD WAVE CONVERTER SPECIFICATIONS |                                       |                                    |                   |                              |                    |
|--|---------------------------------------|------------------------------------|-------------------|------------------------------|--------------------|
| Tube Type                              | Nominal Input Frequency Coverage (mc) | Output Intermediate Frequency (mc) | Noise Figure (db) | Minimum Image Rejection (db) | Tube Size* L" x D" |
| X-388                                  | 500-900                               | 50                                 | 20                | 35                           | 55½ x 3¼           |
| X-390                                  | 850-1500                              | 50                                 | 20                | 35                           | 49½ x 2½           |
| X-392                                  | 1450-2650                             | 130                                | 20                | 35                           | 41 x 2             |
| X-394                                  | 2500-4000                             | 180                                | 20                | 35                           | 33 x 1¾            |
| X-396                                  | 3850-6000                             | 280                                | 20                | 35                           | 27½ x 1½           |
| X-398                                  | 5700-8400                             | 320                                | 20                | 35                           | 21 x 7/8           |
| X-400                                  | 8000-12,000                           | 480                                | 20                | 35                           | 19 x 7/8           |



Write for information on the complete line of ITT traveling wave tubes. Application assistance is available for your specific requirements.

**ELECTRON TUBE DEPARTMENT** ■ COMPONENTS DIVISION  
INTERNATIONAL TELEPHONE AND TELEGRAPH CORPORATION, CLIFTON, NEW JERSEY

ITT COMPONENTS DIVISION PRODUCTS: POWER TUBES • IATRON STORAGE TUBES • HYDROGEN THYRATRONS  
TRAVELING WAVE TUBES • SELENIUM RECTIFIERS • SILICON DIODES AND RECTIFIERS • TANTALUM CAPACITORS

## Honeywell Visicorder Oscillograph checks resolution of an event marker

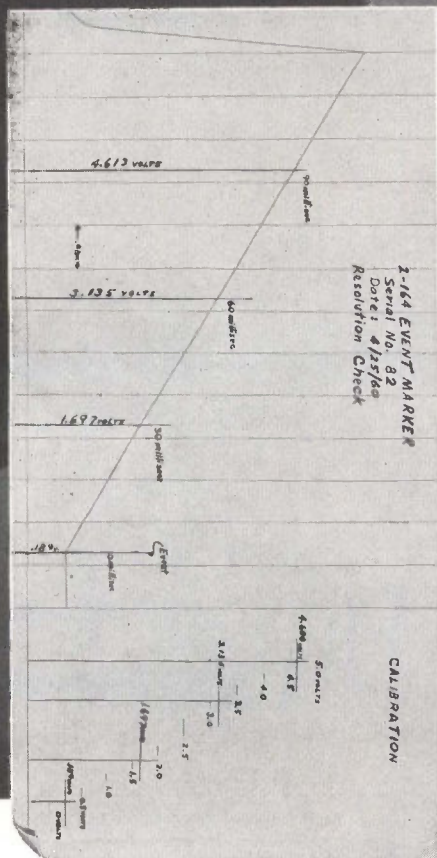
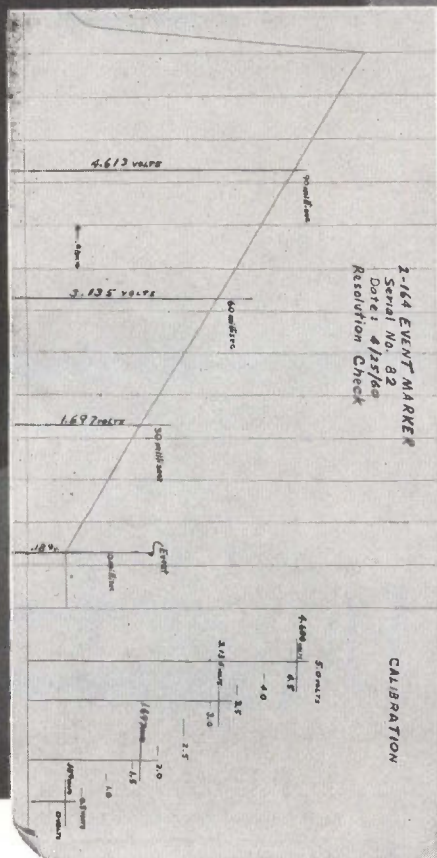

Electro Development Corporation, Seattle, Wash., uses a Model 1108 Honeywell Visicorder Oscillograph to prove the linearity and resolution of signal conditioner-event markers which they supply to the Boeing Company.

A missile telemetering system samples each channel only once every 30 milliseconds, but missile engineers want to know when some events occur to an accuracy of better than one millisecond.

The event marker (the small cube atop the Visicorder) produces a highly-linear ramp output that starts exactly when the marker is triggered by the event in question. This ramp continues for about 100 milliseconds . . . enough time so that the telemeter system can sample the ramp at least three times. A straight line drawn through these

points will accurately determine the occurrence of the event.

To check event marker linearity, the ramp is recorded at the very high record speed of 80"/sec. It's this high speed, the .01-second timing lines, the ease of operation, and the wide deflection capabilities of Honeywell galvanometers (approx. 7" in this application) that caused the Electro Development Corporation to select the Model 1108 Honeywell Visicorder.

# Honeywell



*First in Control*





*Dick Daniel, EDC Design Engineer, tests linearity of Model 2-164 event marker (small cube atop the Visicorder). Included in the rack at Daniel's right are a voltage calibrator, cathode follower, switching unit, trigger source and power 28V supply designed and built by EDC, and a Honeywell Model T6GA Galvanometer amplifier.*

For more details about the Model 1108 (24 channels), the 1012 (36 channels) and other Honeywell Visicorders, write to Minneapolis-Honeywell, Heiland Division, 4800 E. Dry Creek Road, Denver 10, Colorado. Our DDD phone number is 303-794-4311.

CIRCLE 79 ON READER SERVICE CARD

cent. The oscillator (sketch p 76) uses two transistors, one for power regulation and the other for the oscillator. A transformer feedback loop, loosely coupled to the tank circuit, minimizes effects of collector capacitance change with temperature. Collector and base windings have much lower impedance than the tank circuit thus allowing output loads as low as 2,000 ohms without significant change in output or frequency. The tank circuit core provides a change of inductance with temperature to compensate changes in tuning capacitor used. By matching these two components, it is practical to achieve stabilities of better than 0.001 percent. The regulator makes output and frequency virtually independent of supply voltage.

CIRCLE 303, READER SERVICE CARD

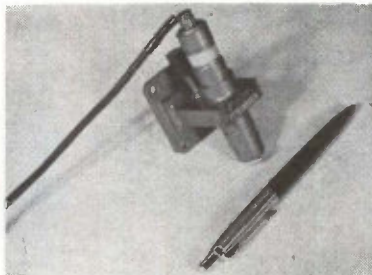

### B-W Oscillator Tunes Electronically

MICROWAVE ASSOCIATES, INC., Burlington, Mass. The MA-2200 is a bwo with electrostatic focusing and design for airborne and missile applications at X-band. It generates a minimum of 20 mw over the 8.5-9.6 Gc range. It is equal in size, weight and configuration to reflex klystron oscillators and may be substituted for them in many instances. Unit has all-electronic tuning. (304)



### Fast Pulse Amplifier Has Wide Response

COMMUNITY ENGINEERING CORP., 234 E. College Ave., State College, Pa. Response of the solid state model

3029 is 20 cps to 50 Mc  $\pm$  0.3 db with an output level of 10 v peak to peak, into 75 ohm load. Rise time is 6 nsec with less than 2 percent ringing. Tilt is 10 percent with a 5 millisecc pulse. Input and output impedance is 75 ohms with a vswr better than 1.5 to 1. (305)



### Coax Connectors Feature Low VSWR

GREMAR MFG. CO., INC., 7 North Ave., Wakefield, Mass., offers a series of modified series N precision coax connectors for use with microwave components such as twt's, amplifiers and bwo's. The TWT series connectors feature a low vswr. They are available for X-band and S-band uses and for either RG-55/U flexible cable or 0.140 in.-diameter 50-ohm rigid cable. (306)

### Connectors

GARDE MFG. CO., 53 John St., Cumberland, R. I. The 630 series of right angle pin and socket connectors for dip soldering to p-c boards meets all requirements of MIL-C-8384 specifications. (307)

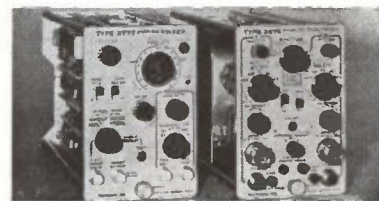

### Sampling Plug-Ins Extend Scope Range

TEKTRONIX, INC., P. O. Box 500, Beaverton, Ore. Two new sampling plug-ins will extend the range of 4 Mc scopes to 875 Mc. Type 3S76 dual-trace sampling unit and type 3T77 sampling sweep unit, when combined with a 561 crt indicator, permit observation of recurrent

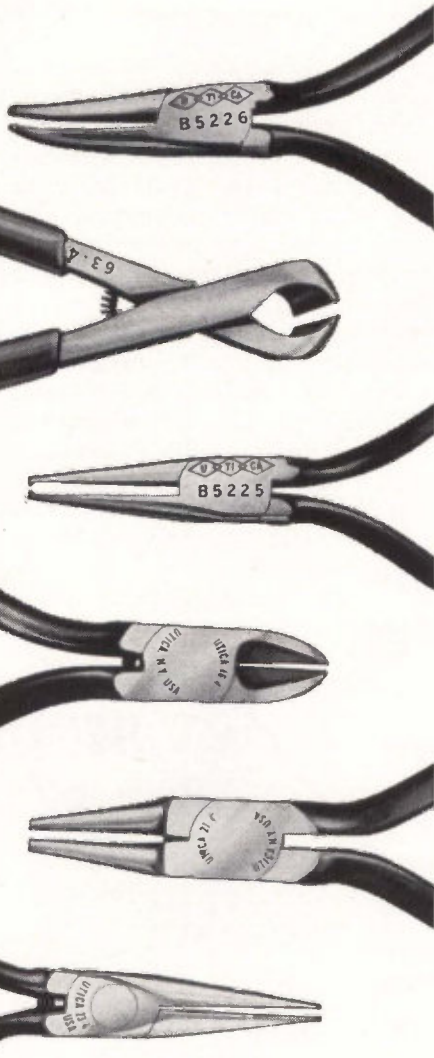

ACTUAL SIZE

### MIDGET TOOLS FOR MINIATURIZED WORK!

Midget tools for work on miniature assemblies are another Utica specialty. We have designed and stock the industry's broadest line of midget pliers and other special hand tools for working with ease in the most confined places. All are precision, finely finished tools. All are backed by famous full guarantee. See for yourself! Contact your Utica distributor or write for our latest hand tool catalog.

**Utica Tool Division  
Kelsey-Hayes Company  
Utica 4, New York**

**tools the experts use!**

pulses with risetimes as brief as  $0.4 \times 10^{-9}$  sec. Internal delay lines provide a convenient, 50 ohm impedance input to signal sources. CIRCLE 308, READER SERVICE CARD

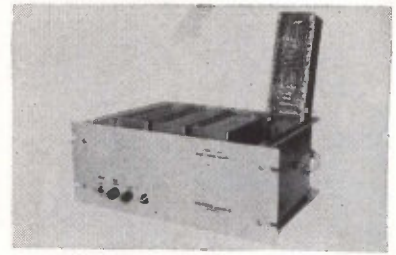

### Converters Accept Various Inputs

HOWARD INSTRUMENT CO., Red Bank, N. J. The C series binary-decimal converters are available in capacities up to 7 decimal digits. Model 1007-C, illustrated, accepts 21 bit serial binary inputs, and converts the data in  $210 \mu\text{sec}$ , to 7 digit binary-coded-decimal. Other models accept parallel inputs in true binary, or serial, or parallel reflected binary. (309)

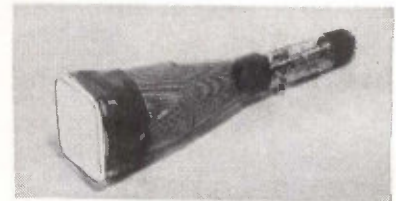

### C-R Tubes Use Spiral Acceleration

SYLVANIA ELECTRIC PRODUCTS INC., 1100 Main St., Buffalo 9, N. Y., announces the SC-3377 and SC-3511 high sensitivity crt's, employing spiral acceleration and designed for use with transistor deflection circuits. Overall tube length is only  $13\frac{1}{4}$  in., making the units suitable for compact, efficient scope designs. Pressed faceplates provide good quality and strength. (310)

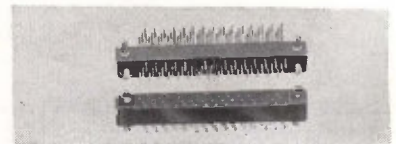

### Plug & Socket Connector Designed for P-C Boards

CONTINENTAL CONNECTOR CORP., 34-63 56th St., Woodside 77, N. Y.,

offers a subminiature right angle plug and socket connector for p-c board applications. Series 600-1-45 has three rows of right angle pins with staggered contact placement having 0.050 in. center-to-center contact spacing. A total of 45 contacts are used in a molding only  $2\frac{1}{8}$  in. long. Pins solder directly to a p-c board. Pins and guides are polarized to prevent improper mating with the socket. (311)

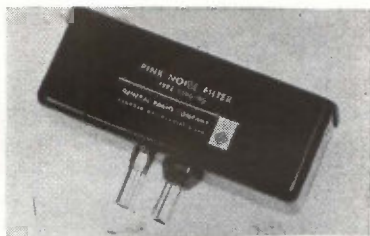

### Noise Filter Translates White Output to Pink

GENERAL RADIO CO., West Concord, Mass. Type 1390-P2 translates the white-noise output of an a-f random-noise generator into pink noise, that is noise with constant energy per octave. Although designed to plug directly into the GR type 1390-B random-noise generator, the pink-noise filter can be used in any circuit where such a characteristic is desired, providing the source impedance is less than 1,000 ohms and the load impedance is at least 20 kilohms. (312)

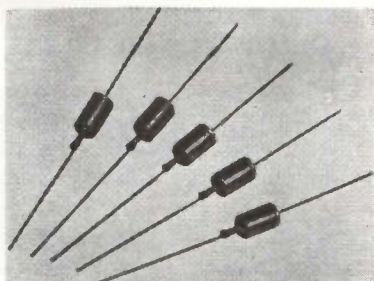

### Flangeless Diode Operates From -65 to +200 C

INTERNATIONAL TELEPHONE AND TELEGRAPH CORP., Clifton, N. J., announces a flangeless 1-w Zener voltage-regulator diode. The regulators will operate over a temperature range of -65 to +200 C. They feature low dynamic impedance with a sharp Zener knee, 100 percent tested, and have controlled forward characteristics. The diodes

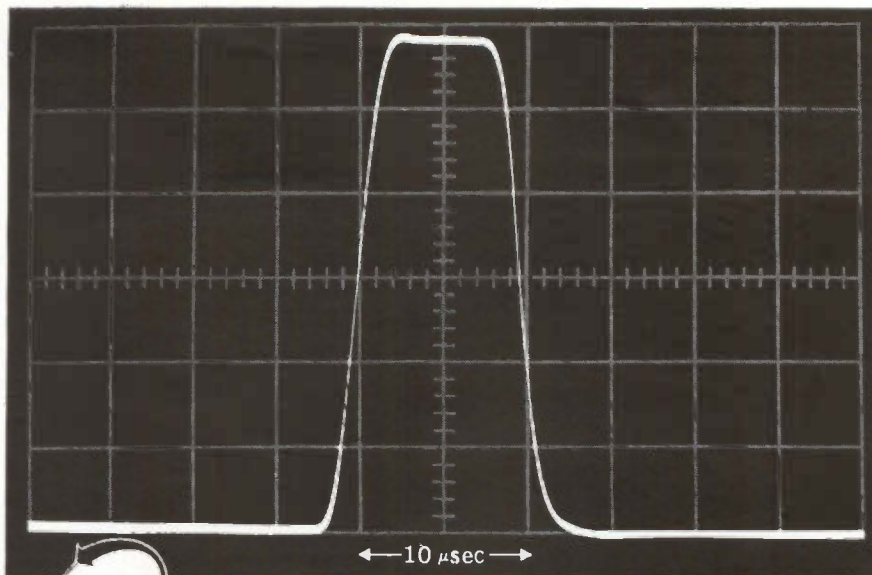

Unretouched Polaroid photograph of a 10- $\mu$ second pulse after processing through DCS' GOV-3 and GFD-4. Subcarrier frequency: 750 kc  $\pm$ 40% deviation. Output filter: 150 kc Gaussian.

## Now! Capture transient events like never before!

### • Virtually no overshoot • Fastest rise time attainable

Want to capture transients that have eluded you up to now? Or, if you are getting them, want them more faithfully? The photo above proves it can be done—providing you use DCS high-frequency FM subcarrier oscillators and discriminators. These new DCS components are based on a high-frequency current switching device, operating with unsaturated transistors in a manner that permits very long recovery periods. Result: faster rise time than ever before possible, with virtually no overshoot!

Components now available for immediate, off-the-shelf delivery:

### DCS High-Frequency VCO (UNIDAP Configuration)

High-frequency VCO plug-in modules for all standard DCS UNIDAP systems. Standard frequencies available: 250, 400, 550, 700 and 850 kc, all  $\pm$ 40 kc. Also 800 kc,  $\pm$ 300 kc. Others available on request. Permits analog intelligence frequencies to 300 kc to be converted to FM subcarriers for both direct tape recording and multiplexing.



### DCS High-Frequency Discriminator



High-frequency, phase-lock playback discriminator for use with standard DCS UNIDAP and telemetry data systems. Recovers data from all DCS airborne and ground high-frequency VCO's. Also used with standard DCS predetection telemetry recording and standard DCS frequency translation systems. Output intelligence frequencies up to 300 kc.

For more information, complete specifications, etc., write to Dept. E-2-3.

## DATA-CONTROL SYSTEMS, INC.

*Instrumentation for Research*

Los Angeles • Santa Clara • Wash., D. C. • Cape Canaveral  
Home Office: E. Liberty St., Danbury, Conn. • Pioneer 3-9241



# MAKING ROOM AT THE TOP



*EICO creates a new, professional lab quality test instrument series at moderate prices.*

**EICO®**

**AC VTVM & AMPLIFIER #250**

Kit \$49.95, Wired \$79.95

**VTVM:** 12 ranges from 1mv to 300v rms; response absolutely flat from 10 cps to 600 kc; input impedance 10M $\Omega$  shunted by 15 $\mu$ f; accuracy  $\pm$ 3% of full scale.

**Note:** Average responding meter calibrated in rms. Linear 0-1, 0-3 scales. Decibel scales based on 0db=1mw in 600 $\Omega$  with 10db interval between ranges.

**AMPLIFIER:** 60db gain on 1mv range; response +0, -3db from 8cps to 800kc; output to 5V rms undistorted, variable down to zero by attenuator control at output; input impedance 10M $\Omega$ , output impedance 5K $\Omega$ ; hum & noise -40db for signal inputs above 2mv.

**DESIGN QUALITY:** All frame-grid tubes; 60db frequency-compensated input attenuator ahead of cathode follower with 10db/step attenuator following; two-stage R-C coupled amplifier and full-bridge meter circuit in one overall feedback loop; no response adjustment required in amplifier circuit; single sensitivity adjustment; voltage-regulated power supply. 50/60 cycle operation.

**EICO MODEL 255 AC VTVM**  
Identical to Model 250 described above, but less amplifier facility. 50/60 cycle operation.  
Kit \$44.95      Wired \$72.95

Add 5% in the West.

See the 41 additional EICO instruments helpful for your lab and line work. Write for free catalog and name of neighborhood distributor.

**EICO®** Dept. E-7B  
3300 N. Blvd., L.I.C. 1, N. Y.  
Export Dept.: Roburn Agencies, Inc.  
431 Greenwich St., N. Y. 13, N. Y.

CIRCLE 206 ON READER SERVICE CARD



TWO AFFILIATED COMPANIES PROVIDE A SINGLE SOURCE FOR SEMICONDUCTOR CLAD METALS & PARTS



Clad Metal Combinations

- Tin Clad Nickel
- Lead-Tin-Antimony Clad Nickel Iron
- Tin-Lead Clad Nickel
- Gold-Antimony Clad Molybdenum
- Gold-Antimony Clad Nickel Iron

Single or Double clad in continuous coils  
NEW COMBINATIONS BEING DEVELOPED DAILY

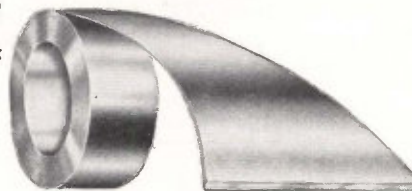

Precision Parts Fabrication



Long experience with the electronics and allied industries plus exceptional tooling facilities qualify to meet semiconductor parts requirements at low cost with complete conformity.

SPECIFY BOTH L & G AND G F

For Alloys and Clad Metals

For Precision Parts

**LEACH & GARNER COMPANY / GENERAL FINDINGS INC.**

For complete information on materials and parts write 52 Pearl Street, Attleboro, Massachusetts  
SALES OFFICES: NEW YORK • CHICAGO • LOS ANGELES

are available in 33 voltage ranges between 6.8 and 200 v. Prices range from \$2.95 to \$7.75 in small quantities.

CIRCLE 313, READER SERVICE CARD



R-F Converter Utilizes Nuvistors

TAPETONE ELECTRONICS LAB., INC., 99 Elm St., West Newton 65, Mass. Model 100-A is designed for telemetry and satellite tracking applications. Available at frequencies from 200 to 500 Mc, with i-f outputs of 5 to 100 Mc. Utilizing Nuvistors as the r-f amplifiers and mixer, this converter has a noise figure of 5 db at 400 Mc, with an overall gain of 25 db. Design incorporates high gain with very high overload resistance. (314)



Precision Clock Has Square Wave Output

TECH SERV, INC., 4911 College Ave., College Park, Md. Precision clock with frequencies of 1000, 100, 10, and 1 pps utilizes tuning fork device as basic generator deriving tolerances of  $\pm$ 0.10 percent. Output pulse trains are symmetrical square waves having a voltage excursion from 0 to -10 v and rise time of less than 1  $\mu$ sec. (315)

Solid State Converter Offered in Four Models

SOLID STATE ELECTRONICS CO., 15321 Rayen St., Sepulveda, Calif. The Freqmeter is a completely solid state unit which will linearly convert frequency or repetition rate of signals to a proportional d-c volt-

age. This is accomplished with 4 standard models over an input frequency range extending from 0 to 100 Kc (model 410, 0-100 cps; model 420, 0-1 Kc; model 430, 0 to 10 Kc; model 440, 0-100 Kc). Freqmeter output is virtually insensitive to supply voltage, temperature, input amplitude or waveforms. (316)

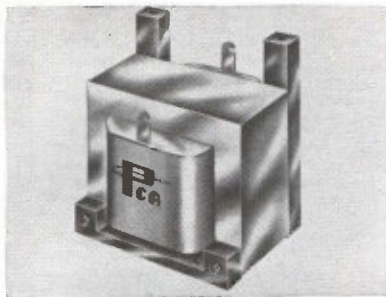

### Power Reactor Used in Filters

PCA ELECTRONICS, INC., 16799 Schoenborn St., Sepulveda, Calif., offers a 60 cycle power reactor with an inductance swing of 1.5 mh at 13 amp to 15 mh at 1.3 amp. Unit is designed for use in wide variety of power supply filters. Also available in 400 cycles, reactor acts as swinging choke in the filter with varying d-c loads. It is built to meet MIL-T-27A specifications Type TF5SX04ZZ. (317)

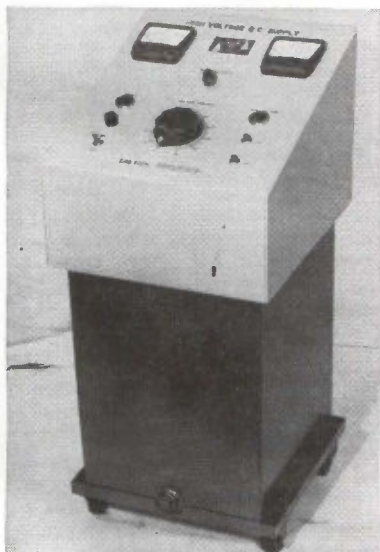

### H-V Power Supplies Have Reversible Polarity

DEL ELECTRONICS CORP., 521 Homestead Ave., Mount Vernon, N. Y. The TC series are multipurpose

## Northrop Space Laboratories needs uncompromising men

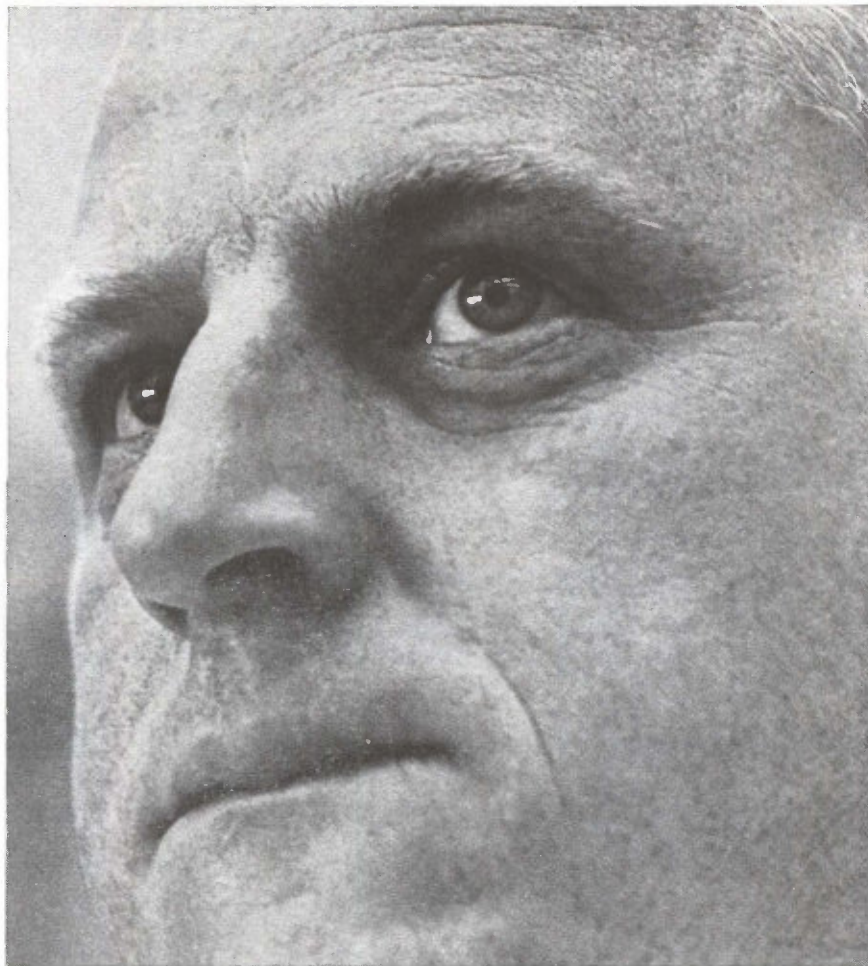

It takes dedicated men to breathe life into a new undertaking. Determined men, to guide and guard its goals through the formative years.

Though newly organized, Northrop Space Laboratories is backed by the full facilities of the Northrop Corporation. It will grow. Yet it needs purposeful men to take up the challenge and grow with it. Will you be one of them? Key spots are now waiting for: **Solid state physicists**, to conduct fundamental research on many-body problems as applied to an ultra high pressure program. The goals of this program are to study the electrical and physical behavior of materials under ultra high pressure, to investigate the origin, history and structure of the moon and planets, and to find ways to utilize their natural resources.

**Scientists**, to perform research in nuclear and radio chemistry, and to conceive and carry out investigations in the fields of activation analysis, dosimetry, gamma ray spectrometry, surface phenomena, and numerous other areas.

**Stress analysts**, to develop fresh analytical techniques and apply them to new space structural concepts; to do stress analysis and design optimization studies on advanced space vehicle structures.

**A plasma physicist**, to join our growing program in the measurement of plasma properties, spectroscopy, diagnostics, accelerators, and power conversion devices.

**A mathematician-physicist**, to concentrate on systems analysis and operations research applied to military and non-military space systems.

**Physicists** experienced in electro-optical imaging devices and laser theory; **engineering mathematicians** interested in detection theory, reconnaissance and tracking; **electronic engineers** who know their way around statistical communications theory and noise phenomena; for new and original work in satellite detection systems.

For more information about these and other opportunities, write to W. E. Propst, Space Personnel Office, 1111 East Broadway, Hawthorne, California. You will receive a prompt reply.

**NORTHROP**  
AN EQUAL OPPORTUNITY EMPLOYER

*How to develop*  
**0.01% accuracy**  
*in a*  
**size 23 resolver**



First develop a size 23 resolver for naval fire control computers. Next develop one for the B-58's navigational system. Then combine the best features of both, add a couple of new ideas, and produce the Size 23, 0.01% Resolver. That's what Ford Instrument did. With the result that this new resolver has a maximum variation of transformation ratio (with input voltage from 0.3 to 6 volts) that is only 0.02% of 6 volts. Far as we know, this is the most accurate resolver made today. Most durable and trouble-free. Priced right, too. Conforms to Mil-E 5272A. Specify this resolver for application in analog computers, automatic control systems, and data transmission systems for coordinate conversion, precision phase shifting, and similar operations. Bulletin 23TR-61-1 gives full specifications. It's yours for the asking. Write:

**FORD INSTRUMENT CO.**  
 DIVISION OF SPERRY RAND CORPORATION  
 31-10 Thomson Ave., Long Island City 1, N.Y.

units available from 30 Kv up to 80 Kv (insteps of 10 Kv) and current up to 5 ma. They are designed for single phase, 115 v, 60 cycle input and output is continuously variable from zero to max voltage. Polarity is reversible. Typical applications include laboratory use; maintenance, such as dielectric testing; industrial, such as power supply for electrostatic painting, flocking, etc.

CIRCLE 318, READER SERVICE CARD



**UHF Coax Isolator**  
**Features Broad Band**

E & M LABORATORIES, 15145 Califa St., Van Nuys, Calif. Model U112LC1 exhibits these characteristics over the entire 600 to 1,000 Mc range: 10 db minimum isolation, 1.0 db max insertion loss, and 1.20 max vswr. Uses include standards and microwave laboratories as well as radar, communications, and telemetry systems and ground support equipment. (319)



**Spectrum Analyzers**  
**Have Variety of Uses**

SPECTRAN ELECTRONICS CORP., 146 Main St., Maynard, Mass. The 480 series spectrum analyzers are now available in a rack mounted assembly providing readout on an ITT model 1735D oscilloscope. The 480-WS assembly provides substantially instantaneous 480 line reso-

**NEW**  
**LOW**  
**PRICED**

**BEATTIE-COLEMAN**  
**OSCILLOTRON**

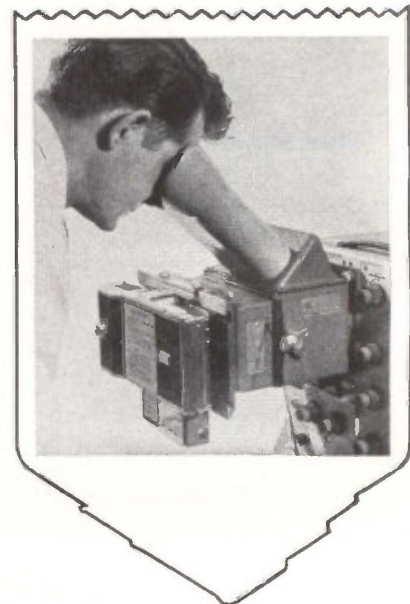

**POLAROID®**  
**PRINTS IN**  
**10 SECONDS**

It's new! It's efficient! It's versatile! It's the Beattie-Coleman K5 Oscilloscope Camera.

- Direct view while recording.
- Single traces at 1:0.9 ratio or 13 traces at 1:0.7 on one frame of Polaroid Land film.
- Choice of Polaroid roll film back or 4x5 back for Polaroid or regular cut film holders.
- Uses Polaroid Land 10,000 speed film.
- f/1.9 Oscillo-Raptar lens.

**\$395 complete**

**ACCESSORIES:**

- Electric shutter actuator.
- Data recording chamber.

Circle number on card for info. on full Oscillotron line.

"Polaroid"® by Polaroid Corp.



1004 N. Olive St., Anaheim, Calif. • PR 4-4503  
**CIRCLE 207 ON READER SERVICE CARD**  
 electronics

lution analysis of both steady state and transient phenomena. Uses include signature studies of sonar signals and doppler radar echoes, mis-distance indication, speech studies, shock and vibration analysis. (320)

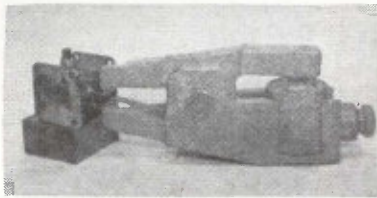

### Pinch-Off Presses Reach Inaccessible Areas

CHARRON PRECISION GAGE & TOOL CORP., 821 Washington St., Lynn, Mass., offers pinch-off presses primarily used for pinching off tubing after the exhaust period in the electronic and transistor industry. They are powerful, yet small and compact, which enables them to reach inaccessible areas. Presses, made for either automatic or semi-automatic installations, are manufactured in 2, 4, 10 and 20 ton capacities. (321)

### Electronic Weatherstrip

METEX ELECTRONICS CORP., Clark, N. J., announces Metalex, a knitted wire mesh, electronic weatherstrip that is mechanically joined to a solid aluminum extrusion. (322)

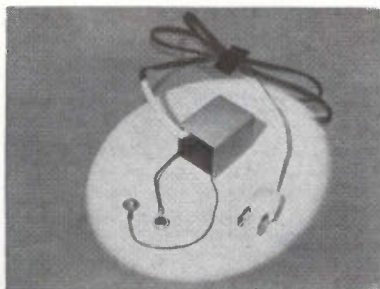

### Battery Chargers Sell in \$2 to \$5 Range

MILLI-SWITCH CORP., 1400 Mill Creek Rd., Gladwyne, Pa., offers nickel-cadmium battery chargers for portable battery operated equipment. They sell in the range of \$2 to \$5 depending on rating, terminals and quantity desired. Il-

## We're looking for men who can't let well enough alone



Northrop-Norair needs men who ask questions; men who aren't afraid to rock the boat. In the advanced areas we're exploring at Norair, you don't dare take anything for granted. If this kind of challenge appeals to you, put down the magazine now, while it's on your mind, and write us a letter. Positions are immediately available for:

**Engineers** in electronic checkout systems who have worked with advanced design and program development.

**Engineers** whose background is in supersonic aerodynamics, stability and control, inlet design, ducting, and performance analysis.

**Engineers** familiar with airframe structural analysis.

**Scientists** specializing in infrared, optics, and electronic research.

**Engineers** to work in data reduction.

**Scientists** who know structures research and dynamics.

**Scientists** who have done supersonic aerodynamic research.

**Scientists** experienced in working with information and sensing systems, platforms, infrared, sensors, flight controls, airborne computing and data handling systems.

**Engineers** familiar with programming, operations, and instrumentation for ballistic missile flight test.

**Reliability Engineers** to assess the reliability and to optimize the configurations and mission profiles of space systems.

**Chemical Engineers** to work on the development and applications of structural adhesives for aerospace vehicles.

**Metallurgical Engineers** for research and development on materials and joining.

If you'd like more information about these opportunities and others that may be available by the time you read this, write and tell us about yourself. Contact Roy L. Pool, Engineering Center Personnel Office, **NORTHROP** 1001 East Broadway, Hawthorne, California.

**NORTHROP**  
AN EQUAL OPPORTUNITY EMPLOYER

# GIANT PLOTTER

## New, ultra compact 30" x 30" X-Y Plotter

with the quality, convenience and functions  
you expect in a Moseley recorder

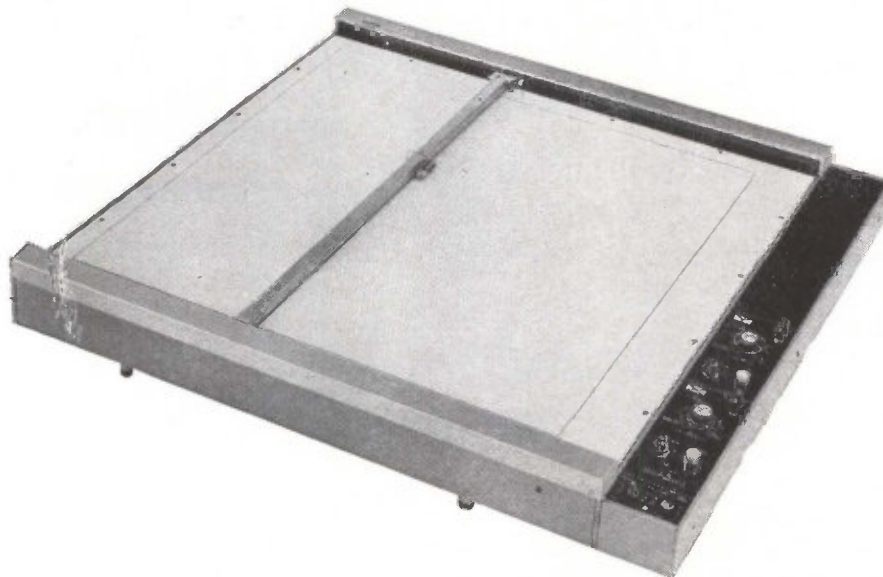

The Moseley Model 7 Autograf Recorder combines in one 6" deep instrument all the facilities needed for rapid, accurate 30" x 30" plotting of two variables in ranges from 30 mv to 300 v full scale. Accuracy is better than  $\pm 0.1\%$  of full scale, and maximum pen speed is 20"/second for each axis. The instrument may be rack mounted or used in table position.

Its large recording area makes the Model 7 ideal for point plotting of digital data with Moseley digital-to-analog conversion accessories. Modular construction makes it easy to adapt for time base operation, ac input, logarithmic conversion, or curve follower operation with either magnetic or optical followers.

Selector switches provide 13 voltage ranges, 1 millivolt/inch to 10 volts/inch. Dual drive cables assure accurate X and Y alignment, with X and Y servo systems completely independent and isolated from ground.

Model 7 uses either individual sheets of graph paper or 50-yard roll charts. Price, \$6500.

*Call your Moseley representative today  
or write direct for detailed information.*

**AUTOGRAF** recorders

**F. L. MOSELEY CO.**

409 N. Fair Oaks Avenue, Pasadena, California

illustrated is a charger for a 1.25 v cell. It is housed in a  $1\frac{1}{8}$  by  $1\frac{1}{8}$  by  $1\frac{1}{4}$  in. plastic box and encapsulated in a thermosetting plastic.

CIRCLE 323, READER SERVICE CARD

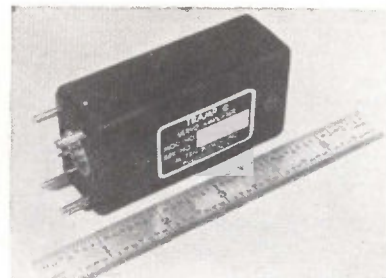

## Servo Amplifier Priced at \$272

M. TEN BOSCH, INC., Pleasantville, N. Y., offers a 400-cycle servo amplifier capable of yielding 6 w over a temperature range of  $-55$  to  $+125$  C. Hermetically sealed unit is transistorized and weighs 7 oz. Power gain at 2 w output with a 20,000 ohms input impedance is 2,400. Phase shift is adjusted internally to 0 deg. Model 1800-4700 is unit priced at \$272 (for orders of 10 to 99). (324)

## Shielding Material

METEX ELECTRONICS CORP., Clark, N. J., offers a spring-type, formed rfi gasketing material that can be installed or replaced quickly and easily by snapping it into a channel that is either attached to or is an integral part of the unit to be shielded. (325)

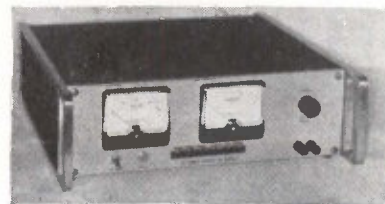

## Power Supply Packaged for Bench Mount

PERKIN ELECTRONICS CORP., 345 Kansas St., El Segundo, Calif. Model 28-10WXA is a magnetic amplifier regulated 28 v at 10 amp d-c power supply for inclusion in ground support systems. It provides 24 to 32 v at 10 amp with automatic voltage regulation of  $\pm 0.5$



percent and ripple of 1 percent rms. Unit is contained within a 5½ in. high by 16½ in. wide by 14½ in. deep package for bench mount. Price is \$375. (326)

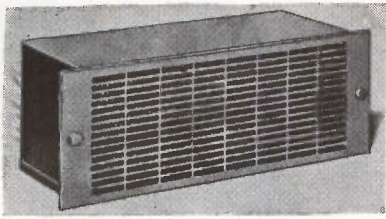

**Blowers  
Offered in Four Models**

PREMIER METAL PRODUCTS CO., INC., 337 Manida St., New York 59, N. Y. The PMB series of Prem-O-Kool panel mounted blowers, designed for low noise level with minimum of vibration and space, have permanent type washable filters and are available in four models having 150, 285, 410 and 750 cfm. Motors are permanently lubricated with lubricant temperature range from -29 to +148 C. (327)

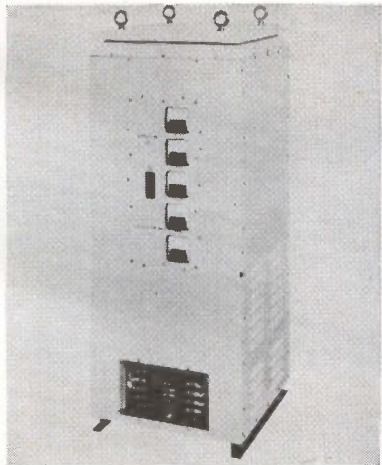

**H-V Static Inverter  
Uses No Moving Parts**

MICRODOT INC., 220 Pasadena Ave., S. Pasadena, Calif. A 5 Kva static inverter, operating from a wide range d-c battery source, supplies up to 5,000 w of a-c power. Conversion system allows an adjustable output frequency over the range of 380 to 2,000 cps. No moving parts are employed in the unit which measures 17 in. by 17 in. by 42 in. and weighs 200 lb. Power conversion system inherently provides excellent voltage regulation

**MAGNETIC  
RELIABILITY**  
*guaranteed*  
with 10 years' minimum life!

**ULTAMAG®** instrument type magnetic amplifiers are practically invulnerable to shock, vibration, moisture, and radiation. All solid state construction! Easily withstand 1000% overload or can be operated into dead short without damage. Applications — where vacuum tubes or transistors are used!

**PERFORMANCE:**

- ~ Stability - - - - under 1%
- ~ Sensitivity - - - microamperes
- ~ Output - - - - 7.5 to 10 volts



**100 Line**  
*in 50 or 60 cps*  
**\$69.50** each  
1 to 5 units

**20 Line Miniature**  
*in full military configuration*  
**\$139.50** each  
1 to 5 units



MILITARY AND COMPUTER ELECTRONICS, INC.  
900 N.E. 13th St. • Ft. Lauderdale, Fla. • JA 3-1438

**WESCON BOOTH 3016**

# THINNER THAN EVER!

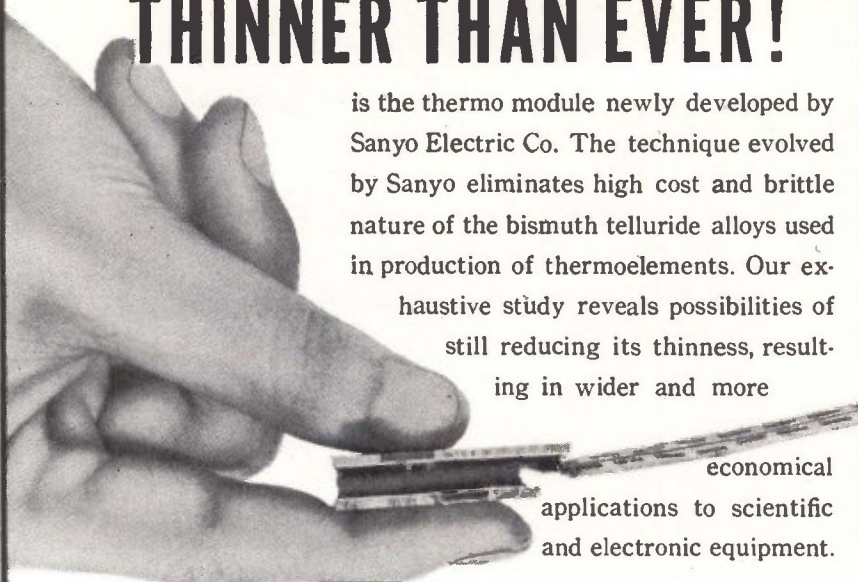

is the thermo module newly developed by Sanyo Electric Co. The technique evolved by Sanyo eliminates high cost and brittle nature of the bismuth telluride alloys used in production of thermoelements. Our exhaustive study reveals possibilities of still reducing its thinness, resulting in wider and more

economical applications to scientific and electronic equipment.

## SPECIFICATIONS

| Type     | Thermo couple | Optimum Current (amps) | Optimum Voltage (Volts) | (1) Insulation ΔT (°C) | (2) Voltage (Volts) | Dimensions mm (Inch)             |
|----------|---------------|------------------------|-------------------------|------------------------|---------------------|----------------------------------|
| STM-1023 | 10            | 25                     | 0.9                     | 53                     | 30                  | 57×43×10.3<br>(2.24×1.69×0.413)  |
| STM-1021 | 10            | 21                     | 0.9                     | 53                     | 30                  | 57×43×10.3<br>(2.24×1.69×0.413)  |
| STM-1016 | 10            | 16                     | 0.9                     | 53                     | 30                  | 57×43×10.0<br>(2.24×1.69×0.393)  |
| STM-1012 | 10            | 12                     | 0.9                     | 53                     | 30                  | 41×32.3×9.3<br>(1.62×1.28×0.374) |
| STM-1006 | 10            | 6                      | 0.9                     | 53                     | 30                  | 41×29×9.3<br>(1.62×1.28×0.374)   |

Subject to change without notice.  
Note: (1) No heat load;  $T_h$  is 27°C.  
(2) Voltage applied between circuit and hot or cold plate.

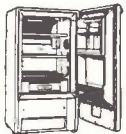

Thermo-electric Refrigerator



Thermo Electric Jar

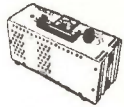

Power Unit



Power Units



Thermo Pac



Thermo Processing Tray

Apply for further details to:

# SANYO

**SANYO ELECTRIC INC., ELLENVILLE, N.Y.**  
SUBSIDIARY OF SANYO ELECTRIC CO., LTD. OSAKA, JAPAN  
MAKERS OF RADIO, TV, STEREPHONOGRAPH, ROOM AIR CONDITIONER,  
REFRIGERATOR, WASHING MACHINE, SEMICONDUCTOR, THERMOELEMENT.

CIRCLE 88 ON READER SERVICE CARD



**Did you swipe this magazine?**

Only 7½ cents a week is the easy way! (\$6 one year, \$9 for two years, \$12 three years.) Just fill in the handy "For subscriptions" section of the Reader Service Card in this issue . . . and you'll get instant subscription.

**electronics:** 330 West 42nd St., N. Y. 36.

of  $\pm 1$  percent wax over an input voltage range of 190-360 v d-c. Output power is held to 2 percent harmonic distortion and is virtually transient-free.

CIRCLE 328, READER SERVICE CARD

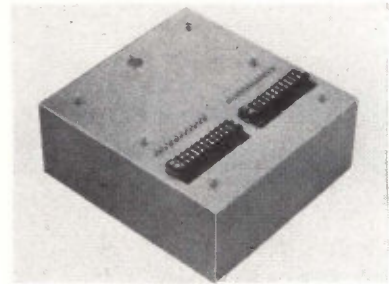

## H-V Delay Line Operates From -55 to +125 C

COLUMBIA TECHNICAL CORP., Woodside 77, N. Y. Type CTC-1411 has an operating input signal level in excess of 200 v. Operating temperature range, from -55 C to +125 C; total delay, 50  $\mu$ sec (multiple taps); rise time, 0.5  $\mu$ sec max; delay to rise time ratio, over 100:1; impedance, 500 ohms; accuracy of delay, 0.1 percent or 0.05  $\mu$ sec whichever is larger; attenuation, less than 2 db; total volume, approximately 200 cu in. (329)

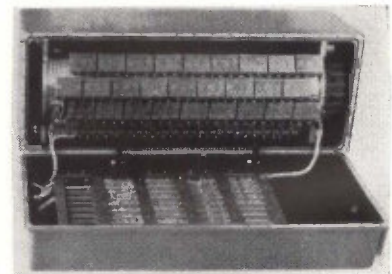

## Memory Drum Has Over 10 Year Life

DIGITAL DEVELOPMENT CORP., 7541 Eads Ave., LaJolla, Calif., announces a 5.5 million bit magnetic memory drum for industrial process-control computers. The 1100 track drum has a design life in excess of 10 years, and may be operated in an oxygen purged nitrogen atmosphere at 1½ psi  $N_2$ , to extend bearing life further. Integral selection diode matrices are designed as an additional feature. All read-write amplifiers and selection drivers are mounted in the housing cover. (330)

## PRODUCT BRIEFS

**D-C CAPACITORS** for laser applications. General Electric Co., Hudson Falls, N. Y. (331)

**PACKAGED CENTRIFUGAL BLOWERS**, eight models. McLean Engineering Laboratories, Princeton, N. J. (332)

**MASS SPECTROMETER LEAK DETECTOR** has high sensitivity. Vacuum Instrument Corp., Stepar Place, Huntington Station, N. Y. (333)

**SPOT WELDERS** are small, ultraprecise. Wells Electronics, Inc., 1701 S. Main St., South Bend 23, Ind. (334)

**MULTIPLE CONNECTOR** takes 6 wires. Conolex Corp., Box 468, Silver Spring, Md. (335)

**RATE GYRO** eliminates gimbal. Humphrey, Inc., 2805 Canon St., San Diego 6, Calif. (336)

**CUSTOMIZED RECORDER**, low-cost. Texas Instruments Inc., 3609 Buffalo Speedway, Houston, Texas. (337)

**SATURABLE REACTOR PACKAGES** offer high-gain. Instrument Systems Corp., 129-07 18th Ave., College Point 56, L. I., N. Y. (338)

**X-BAND T-W AMPLIFIER**, ultra-broad bandwidth. Sperry Electronic Tube Division, Gainesville, Fla. (339)

**DIGITAL ASPECT SYSTEM** for rockets and satellites. Adcole Corp., 186 Massachusetts Ave., Cambridge 39, Mass. (340)

**DUAL ADAPTER** simplifies line voltage connectors. The Superior Electric Co., Bristol, Conn. (341)

**COAXIAL BAND PASS FILTERS** for operation from 1,000 Mc to 10 Gc. RLC Electronics, Inc., 25 Martin Place, Port Chester, N. Y. (342)

**ULTRA-HIGH VACUUM EVAPORATOR** for laboratory use. General Vacuum Corp., 81 Hicks Ave., Medford 55, Mass. (343)

**CROSS FLOW BLOWERS** provide high pressure, low noise. The Torrington Mfg. Co., Torrington, Conn. (344)

**SUPER-THIN FOIL** for capacitors. Republic Foil Inc., 55 Triangle St., Danbury, Conn. (345)

**POWER SUPPLY**, constant current and voltage. NJE Corp., 20 Boright Ave., Kenilworth, N. J. (346)

**TOGGLE SWITCHES** are panel mounted devices. Milli-Switch Corp., Gladwyne, Pa. (347)

**DIGITAL INDICATOR**, end-fire-illuminated display. General Radio Co., West Concord, Mass. (348)

**PNPN SWITCH**, light actuated. International Rectifier Corp., 233 Kansas St., El Segundo, Calif. (349)

**AUDIO CONNECTORS**, three circuit contacts. Switchcraft, Inc., 5555 N. Elston Ave., Chicago, Ill. (350)

# AIRPAX Electronic Tachometer

**Converts signal information frequency into a directly proportional DC output**

## TYPICAL SIGNAL SOURCES

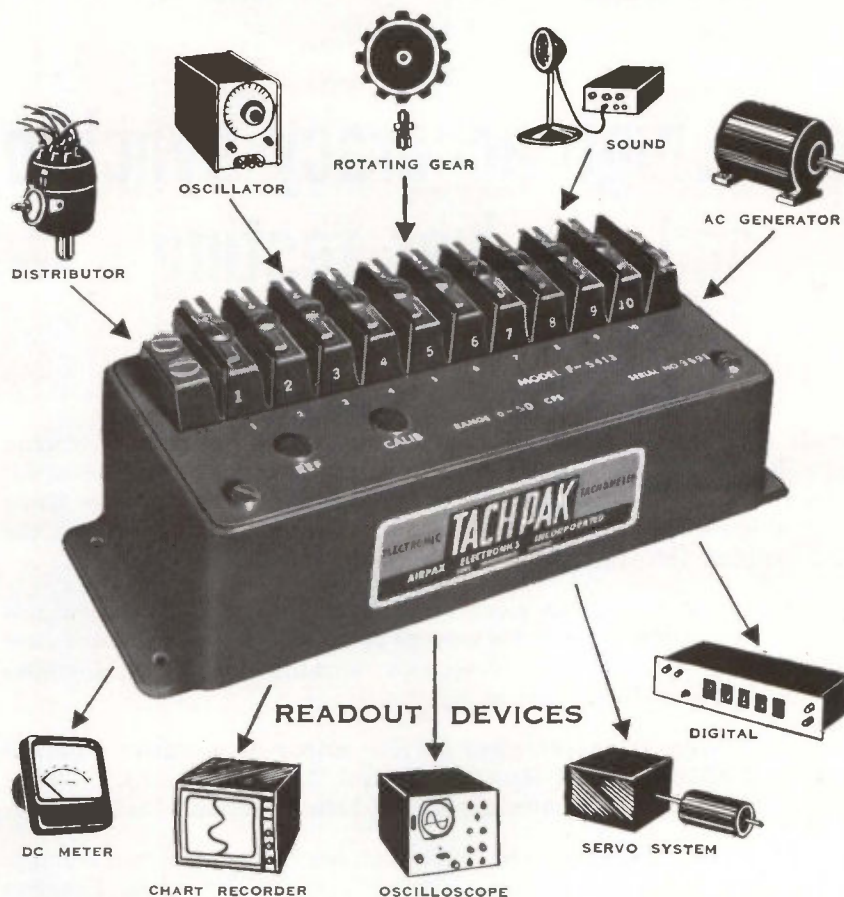

The Airpax Tach-Pak solid state electronic tachometer employs a combination of transistor and magnetic circuits to produce a device of exceptional accuracy and versatility. Other than its common use as a speed indicator, present applications include: ★ Propeller shaft rotation indicator on atomic submarines ★ Starter cut-off on jet aircraft engines ★ Turbine overspeed warning system ★ Speed recorder on railway rolling stock ★ Impact tool frequency recorder. The Tach-Pak is available in a hermetically sealed case, explosion proof housing or cast aluminum or NEMA enclosure with barrier strip or plug connectors.

Write, wire or phone for descriptive literature

TWX: FU8021



Phone 587-1100

SEMINOLE DIVISION

FT. LAUDERDALE, FLA.

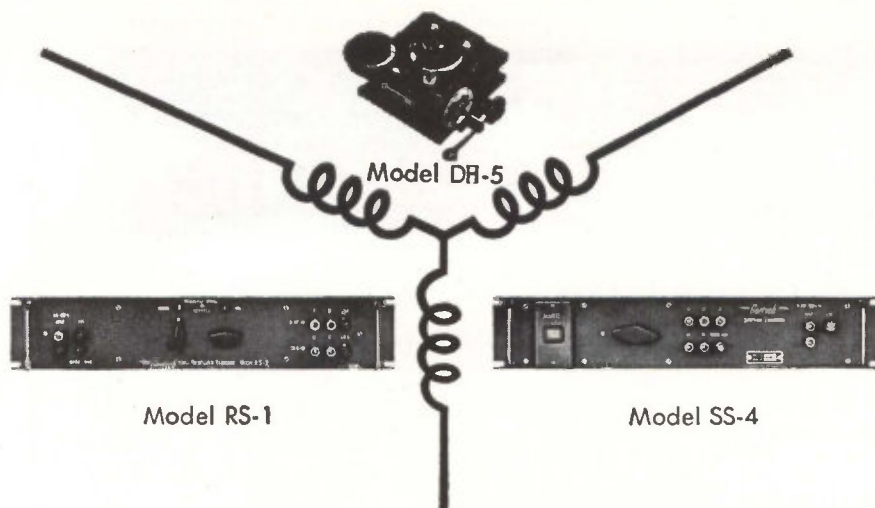

# now ...high accuracy synchro and resolver testing

## — GERTSCH STANDARDS REPLACE COSTLY ELECTRO-MECHANICAL METHODS

Gertsch Synchro Standards simulate the output of a master Synchro Transmitter (CX), with better than 2 seconds of arc accuracy. Ideal for checking Synchro Control Transformers (CTs), or complete systems. Units feature a low effective unbalance impedance which permits loading the output without introducing stator output errors.

When driven by a suitable signal source, unit provides stator outputs  $S_1$ ,  $S_2$  and  $S_3$ , corresponding to the outputs of a master Synchro Transmitter as the shaft is rotated in  $5^\circ$  increments. Quadrant switching simulates operation over a full  $360^\circ$ . Series SS.

Gertsch Resolver Standards simulate the output of a master Resolver Transmitter (RX). Checks Resolver Control Transformer (RCT). Unit features low effective unbalance impedance, hence negligible loading error.

Driven by a suitable signal source, unit produces 2 isolated output voltages corresponding to the sine and cosine output voltages of a master Resolver Transmitter as the shaft is rotated in  $5^\circ$  increments. Full  $360^\circ$  operation. Series RS.

Synchro and Resolver Standards rotate throughout a full  $360^\circ$ , in  $5^\circ$  increments. Accuracy is better than 2 seconds of arc. Both single-switch and 2-switch models are available to cover all standard voltages and frequencies. Bulletins SS and RS on request.

Gertsch Divider Heads—for checking angular measurements on all types of rotary components. Accuracy is  $\pm 15$  seconds. Repeatability:  $\pm 5$  seconds. Large dial indicator provides direct readings with 3-second resolution. Unit rotates in  $5^\circ$  steps through a full  $360^\circ$  in either direction . . . is quickly set up, easy to operate, and fully portable. Bulletin DH-5.

# —Gertsch—

**GERTSCH PRODUCTS, Inc.,**

3211 South La Cienega Boulevard, Los Angeles 16, California / UPlon 0-2761 — VERmont 9-2201

## Literature of the Week

**TORQUE PICKUPS** Baldwin-Lima-Hamilton Corp., 42 Fourth Ave., Waltham 54, Mass. Two types of electronic torque pickups are covered in bulletin 4370-A. (351)

**TEMPERATURE PROBE** Gulton Industries, Inc., 212 Durham Ave., Metuchen, N. J., has issued a bulletin on the Glennite cryogenic temperature probe. (352)

**DIODE RELIABILITY PROGRAM** Sperry Semiconductor, division of Sperry Rand Corp., Norwalk, Conn. Booklet describes company facilities for testing and sorting high reliability silicon diodes. (353)

**MICROWAVE TEST EQUIPMENT** PRD Electronics, Inc., 202 Tillary St., Brooklyn 1, N. Y. Bulletin 801 illustrates and describes precision microwave test equipment. (354)

**P-C DRAFTING AIDS** By-Buk Co., 4314 W. Pico Blvd., Los Angeles 19, Calif. New shapes and sizes of pre-cut pressure sensitive drafting aids appear in bulletin P-40. (355)

**X-Y PLOTTER** The Gerber Scientific Instrument Co., P.O. Box 305, Hartford Conn. An 8-page booklet illustrates and describes the GP-30-D digital X-Y plotter. (356)

**FERRITES** Ferroxcube Corp. of America, Saugerties, N. Y. Bulletin details the company's ferrite materials and applications. (357)

**SUBCARRIER OSCILLATOR** Telemet Co., 185 Dixon Ave., Amityville, N. Y. Single sheet covers subcarrier oscillator that features 11 standard IRIG channels. (358)

**SPECTROMETER SYSTEM** Varian Associates, 611 Hansen Way, Palo Alto, Calif. Brochure describes the high resolution 100 Mc NMR spectrometer system. (359)

**RELATIVE HUMIDITY INDICATOR** Cybernetics, Inc., 136 Washington St., Paterson 1, N. J. Bulletin illustrates and describes the Rhindicator portable relative humidity indicator. (360)

**SOLID STATE CHOPPERS** Airpax Electronics Inc., Cambridge, Md., has available a 2-page article on solid state chopper design. (361)

**SEMICONDUCTOR PRODUCT GUIDE** Radio Corp. of America, Somerville, N. J., offers a 12-page semiconductor product guide which includes a by-application classification. (362)

**ROTARY EQUIPMENT** Beau Electronics, Inc., P.O. Box 624, Waterbury, Conn., announces a catalog illustrating and describing a line of precision rotary equipment. (363)

**POWER SOURCE** Amulex Electronics Inc., 467 Connecticut Ave., S. Norwalk, Conn., announces availability of a power source catalog. (364)

# L & R ULTRASONIC CLEANING SOLUTIONS



**L & R #112**  
Waterless Ultrasonic  
Instrument Cleaning  
Solution (Ammoniated)



**L & R #222**  
Waterless Ultrasonic  
Instrument Cleaning  
Solution (Ammonia-free)

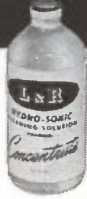

**L & R**  
Hydro-Sonic  
Cleaning Solution  
Concentrate

*are specific!*

We'll prove it! Send us small parts you find difficult to clean for test cleaning in our laboratory. We will do the job and return the cleaned parts to you, together with a recommendation for the right L & R cleaning solution which you can use in your ultrasonic cleaning equipment. For over 30 years L & R has been a world leader in precision cleaning for the watch and instrument fields. This experience is at your disposal. Or write for a copy of our latest catalog describing L & R's ultrasonic cleaning and rinsing solutions and ultrasonic cleaning equipment.

WATCHWORD OF THE WATCHMAKER  
**L & R** MANUFACTURING COMPANY  
577 Elm Street, Kearny, N. J. • Chicago 2, Ill. • Los Angeles 13, Calif.

CIRCLE 208 ON READER SERVICE CARD



Around the world it's **KEW**



MODEL F-98



MODEL EW-16



MODEL P-22



MODEL VR-2P



MODEL VO-38



MODEL TK-20A



MODEL FL-202



MODEL PV-200



MODEL TR-A



SWR & RF WATTMETER

**KYORITSU ELECTRICAL INST. WORKS, LTD.**

No. 120, Nakane-cho, Meguro-ku, Tokyo, Japan  
Cable Address: "KYORITSUKEIKI TOKYO"  
Tel: (717) 0131 ~ 5 • 0151 ~ 3

CIRCLE 209 ON READER SERVICE CARD

## electronics

### Editorial Opportunity

IT DOESN'T HAPPEN OFTEN, but electronics, "bible of the industry" and a McGraw-Hill publication, has an opening for an Assistant Editor.

Ideally, the man we are looking for and to whom a post on our New York staff could be a long-term challenge, would have an electrical engineering degree or technical equivalent, practical experience in our field and a demonstrated aptitude for editing, writing, reporting. He probably lives somewhere in the metropolitan area and therefore would have no relocation problem.

Write The Editor, electronics, 330 W. 42nd St., New York 36, stating experience, aspirations and past earnings. Mark the envelope "Confidential" and it will be kept that way.

## NEW MODULAR CONCEPT IN PRESELECTORS

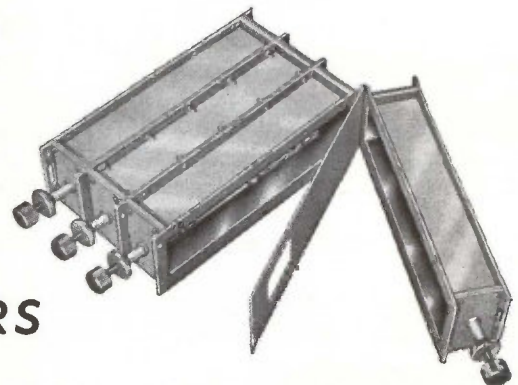

REL can provide you with the preselector you require for use in the 400 mc, 1 kmc and 2 kmc frequency bands. Basic units with an exceptionally low insertion loss and VSWR are available for use in filter configurations of one to six sections. Tell us your requirements for:

- |                                     |                               |
|-------------------------------------|-------------------------------|
| A. Operating center frequency       | E. VSWR                       |
| B. Pass band characteristics        | F. Tunability                 |
| C. Attenuation band characteristics | G. Other special requirements |
| D. Insertion loss                   |                               |

We will provide you with the solution to your preselector problem. WRITE or CALL for our Preselector Technical Data Bulletin.



**Radio Engineering Laboratories • Inc.**

A subsidiary of Dynamics Corporation of America

Dept. ES • 29-01 Borden Ave • Long Island City 1, NY  
STillwell 6-2100 • Teletype: NY 4-2816

CIRCLE 91 ON READER SERVICE CARD 91

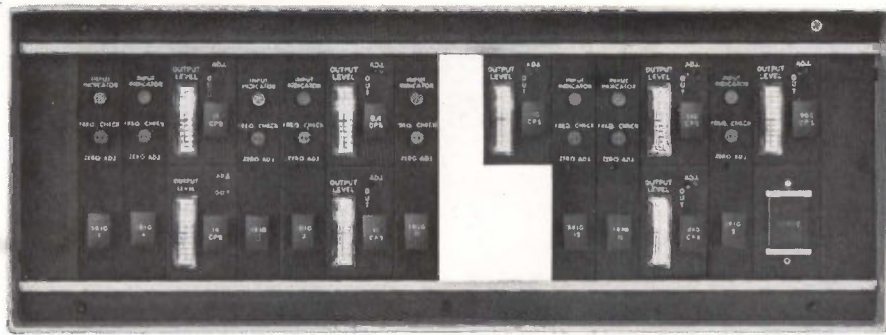

## FULL-SIZE PERFORMANCE IN A MINIATURE TELEMETRY DISCRIMINATOR

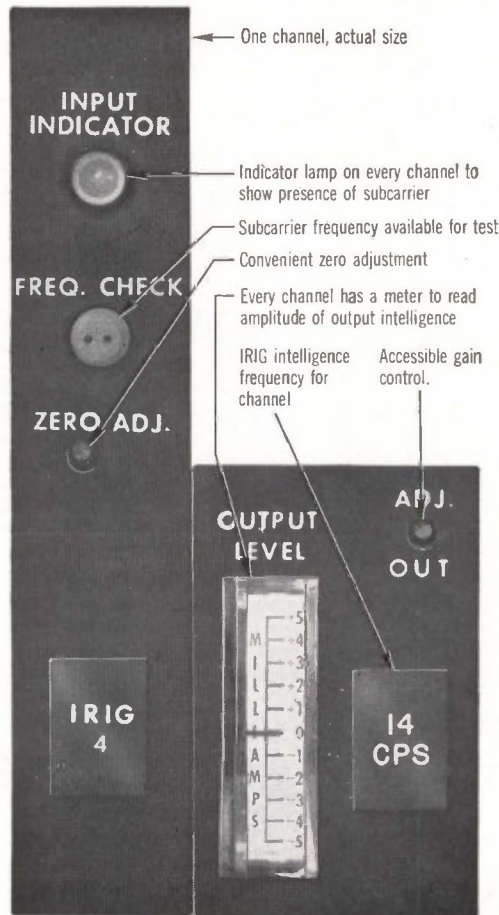

Now you can install 9 IRIG discriminator channels in only 7" of rack space. Advanced solid-state design has packed essential accuracy and reliability into a small package without crowding out the operating refinements that become so important in actual use. The indicators, controls and test points you need are all there — right up front. The output signal is tailored to give you good, clean graphic recordings, with a squelch circuit to eliminate noise traces when no signal is present, and output limiting to protect sensitive recorders. And with zero drift less than 0.2% in 12 hours, you won't be bothered with incessant adjustment.

Accuracy? We can sum it up by saying that data error contributed by the discriminator is so small that you can't detect it on the graphic record. For detailed performance specs — and a look at the superior construction features — send for our new 6-page brochure on TD-109.



**PRECISION INSTRUMENT**  
SAN CARLOS, CALIFORNIA / LY 1-4441

*P.I. Invites inquiries from senior engineers seeking a challenging future.*

## NEW BOOKS

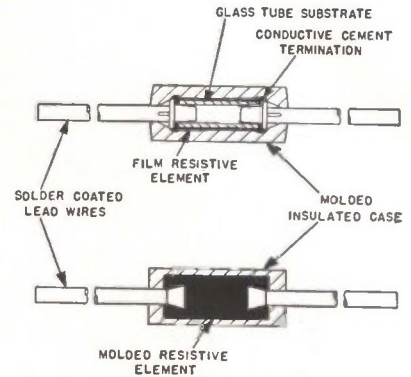

CROSS SECTION of a slug-type composition resistor, from article on resistors

## The Encyclopedia of Electronics

Edited by CHARLES SUSSKIND  
*Reinhold Publishing Corporation, New York, 1962, 974 p, \$22.50*

About 500 selected topics in electronics are covered by short articles in alphabetical order. The articles are for the most part state-of-the-art summaries, limited by space requirements to general terms; this makes it difficult to look up a particular specialized term. The book will serve as a fine introduction to topics outside one's own specialty; however, because of the state-of-the-art approach, there will be danger of obsolescence.—G.V.N.

## Superconductive Devices

By JOHN W. BREMER

*McGraw-Hill Book Co., Inc., New York, 1962, 184 p, \$8.*

A fairly complete introduction to the basic phenomena, theory and applications of superconductivity up to date. Several chapters are devoted to the cryotron and croytron circuits applied to digital computers. Superconductive magnets, a fast-moving subject of research, are mentioned only briefly. The closing section is devoted to low-temperature techniques.

No book can hope to remain up-to-date for long in this fast moving area, or to cover all existing developments; however, "Superconductive Devices" gives the reader a good grounding in the fundamen-

tals that are not likely to change radically.—G.V.N.

## Switching Circuits For Engineers

By MITCHELL P. MARCUS

Prentice-Hall, Inc., Englewood Cliffs, N. J., 1962, 296 p, \$12.

This excellent book is highly useful to the logic design engineer, both for study and reference. Its clear, step-by-step explanations also make it valuable as a school text.

Applications as well as theory are stressed, and the author goes into detail seldom seen elsewhere. An original method is given for obtaining flip-flop excitation expressions.—S.B.G.

## Redundancy Techniques for Computing Systems

Edited by RICHARD H. WILCOX  
and WILLIAM C. MANN

Spartan Books, Washington, D.C.,  
1962, 403 p, \$6.50.

A collection of 23 papers presented at the Symposium on Redundancy Techniques in February. The papers range in subject matter from very basic to speculative, and indicate well the present state of the art. A bibliography on redundancy techniques is included and should prove very useful.

## Elements of Electronic Circuits

By J. M. PETERS

Iliffe Books Ltd., London, 1962, 98  
p, \$3.00.

These building bricks for circuit design are taken from a feature in British *Wireless World* magazine. The articles are noted for their clear and highly instructive diagrams, most of which are input and output waveforms, and for the easily understood text.

The chapter headings are general principles, two-state circuits, time-bases, electronic markers, the logarithmic amplifier, gates and coincidence circuits, and waveforms operated on mathematically.—S.B.G.

*continued*

## TODAY'S MOST STABLE PLUG-IN FREQUENCY AND TIME BASE

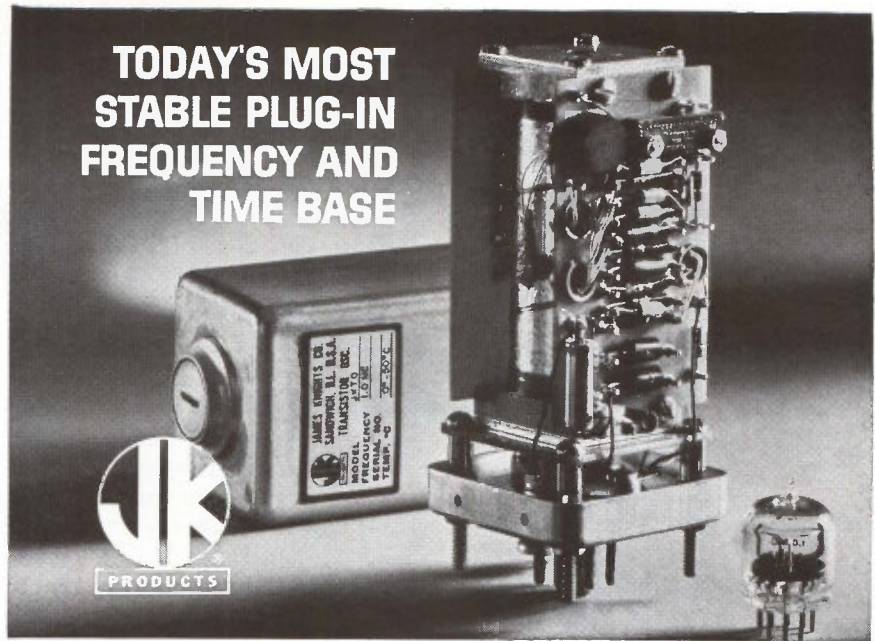

### SPECIFICATIONS

**Stability:**  $5 \times 10^{-9}$ /Day. **Frequency:** 1 mc to 5 mc normal range; 31.25 kc to 50 mc extended range. **Oven:** DC type proportional control. **Power:** 28 volt input. **Output:** 1.25 volts into 5 K ohm load. **Dimensions:** 2" x 2" x 4.5" seated height. Write for data sheet. James Knights Company, Sandwich, Ill.

## JKTO-43 Transistorized FREQUENCY STANDARD

Designed for both  
laboratory and field service

CIRCLE 210 ON READER SERVICE CARD

# DYNAMICS TEST EQUIPMENT

for

- integrity of test data
- reliable operation
- quality construction

**Model 4072—dc micro volt-ammeter.** Fully isolated, this instrument operates from an automatically rechargeable nickel-cadmium battery—hence eliminates the power line from low-level measurements in sensitive circuits.

Wide voltage and current range: 100  $\mu$ V to 1,000 V, and 0.1  $\mu$  amps to 1.0 amp.

Mirror-back scale eliminates parallax. Scale is 7.2" long, for easy reading.



**Accuracy:**  $\pm 1.0\%$  of full scale on all ranges.

**Typical applications:** Potentiometric measurements, null indication, measuring thermocouple output and contact potentials... diode matching.

Dynamics manufactures a wide variety of microvoltmeters, micro volt-ammeters, micromultimeters, and general test equipment. Write for complete literature on Model 4072, or the entire line.

## DYNAMICS INSTRUMENTATION COMPANY

583 Monterey Pass Road, Monterey Park, Calif. • Phone: Cumberland 3-7773

# GREEN PANTOGRAPH ENGRAVERS

● ELIMINATE DELAYS!

● KEEP YOUR OPERATING COSTS WHERE THEY SHOULD BE!



**PORTABLE 40-POUND BENCH MODEL 106**

*You Make Your Own Engraved Nameplates!*

Here is a speedy, economical 2 or 3-dimensional engraver used by thousands of dollar-conscious companies. It features 5 positive, accurate pantographic ratios; ball bearing spindle with 3 speeds up to 14,000 rpm. Is supplied with one copy carrier that accepts all standard master type sizes. Will actually work up to 10" by any width. Height of pantograph and position of cutter are continuously adjustable.

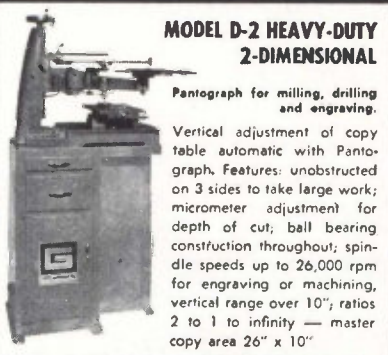

**MODEL D-2 HEAVY-DUTY 2-DIMENSIONAL**

*Pantograph for milling, drilling and engraving.*

Vertical adjustment of copy table automatic with Pantograph. Features: unobstructed on 3 sides to take large work; micrometer adjustment for depth of cut; ball bearing construction throughout; spindle speeds up to 26,000 rpm for engraving or machining, vertical range over 10"; ratios 2 to 1 to infinity — master copy area 26" x 10"

**NEW**

**MODEL D2-201 PNEUMATIC ATTACHMENT**

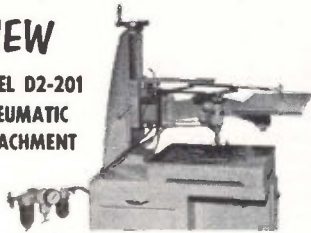

for use with Model D2 Pantograph Engraver to rapidly drill holes in printed circuits by tracing templates. Drills as many as 100 holes per minute. Equipped with foot switch, spindle air cylinder; regulating valve and pressure gauge; filter and oiler. It's ready to use as soon as it's attached to an air compressor

*Write or call for full details and prices.*

**GREEN INSTRUMENT COMPANY, INC.**

Dept. 63, 295 Vassar St., Cambridge 39, Mass. Tel. Eliot 4-2989

## Analysis and Design of Non-linear Feedback Control Systems

By GEORGE J. THALER and MARVIN P. PASTEL

McGraw-Hill Book Co., Inc., New York, 1962, 464 p, \$14.50

A graduate-level text that presupposes an elementary knowledge of the subject, the book has two parts. The first is devoted to analysis, the second to design. Among the topics included are analysis with random inputs, dual-mode servos, self-adaptive control systems and analog simulation. A brief introduction to the Second Method of Lyapunov closes the book.

## A Survey of Switching Circuit Theory

Edited by E. J. McCLUSKEY, Jr. and T. C. BARTEE

McGraw-Hill Book Co., Inc., New York, 1962, 205 p, \$7.75.

This book contains a group of tutorial papers presented at the 1959 Fall and 1960 Winter General Meetings of the AIEE, at sessions sponsored by the Subcommittee on Logic and Switching Theory.

As a short introduction to switching theory, the book covers the field very well. Divided equally between combinational and sequential switching circuits, the chapters deal with such subjects as switching algebra, binary numbers, map methods, minimization theory, and state tables.—S.B.G.

## Radiation and Waves in Plasmas

Edited by MORTON MITCHNER

Stanford University Press, Stanford, Calif., 156 p. \$4.50.

Seven papers presented at the Fifth Lockheed Symposium of magneto-hydrodynamics cover experimental and theoretical work in this field.

The first five papers deal with theoretical problems, valuable primarily to those actively engaged in research in this field.

The last two papers on experiments are general enough to be of interest to those not expert in the field.

# COMPUTER RESEARCH ENGINEERS & LOGICAL DESIGNERS

Rapid expansion of the Computer Laboratory at Hughes-Fullerton has created several attractive professional opportunities for qualified Computer Research Engineers and Logical Designers. These positions require active participation in broad computer R & D activities in connection with Army/Navy computer systems and new large-scale, general-purpose computers. These multiple processor computers utilize advanced solid-state circuitry, gating and resolution times in the millimicrosecond regions; combine synchronous and asynchronous techniques for maximum speed and reliability.

These professional assignments involve broad areas of logical design, programming and system conception. Fields of interest include:

- Distributed computers
- Advanced arithmetic processing techniques
- Mechanized design
- Asynchronous design techniques
- Utilization of parametrons in computers
- Studies in the utilization of multiple processor computers.

These professional assignments involve such R & D areas as:

- Solid state digital circuitry involving millimicrosecond logic
- Microwave carrier digital circuits
- Sub-microsecond core memory
- Thin film storage techniques
- Functional circuit concepts
- Micro-miniaturization concepts
- Tunnel diodes
- Microwave parametrons
- Circuit organization for maximal-speed computing.

Located in Southern California's Orange County (the nation's fastest growing electronics center), Hughes-Fullerton offers you: a stimulating working environment; private or semi-private offices; long-term stability.

**CALL COLLECT TODAY!**

For complete information on these challenging assignments, call us collect today! Ask for:

**Mr. J. E. TENNEY at: TRojan 1-4080, ext. 3741.**

Or, airmail resume to: HUGHES-FULLERTON R & D, P. O. Box 2097, Fullerton 1, California.

An equal opportunity employer.

**HUGHES**

HUGHES AIRCRAFT COMPANY





NEW BETTER-THAN-EVER  
**RELIABILITY**  
 for long-distance point-to-point communications

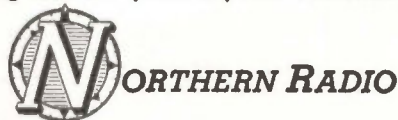

NEW 16-CHANNEL TRANSISTORIZED  
 VOICE FREQUENCY DIVERSITY CARRIER  
 TELEGRAPH TERMINAL TYPE 235 MODEL 3  
**MIL DESIGNATION AN/FGC-61A**

- ... All units militarized: components and design approved by U.S. Military.
- ... Converters have equalized gain and adjustable time delay in each channel for better diversity performance and interchangeability.
- ... Switching Panels provide "local" or "remote" selection of 2-channel or 4-channel diversity modes.
- ... Combiners have adjustable gains in each channel, for complete switching flexibility, and the combining follows an ideally modified square law function for both 2-channel space or frequency and 4-channel space plus frequency diversity.
- ... Keyers have adjustable "threshold" sensitivity control and simplified input circuit selection.
- ... Dotter and Delay Indicator provides test keying signal source for keyers and delay equalizers in all channels.

Write for complete literature.  
*Pace-Setters in Quality Communication Equipment.*  
**NORTHERN RADIO COMPANY, inc.**  
 147 WEST 22nd ST., NEW YORK 11, NEW YORK

In Canada: Northern Radio Mfg. Co., Ltd., 1950 Bank St., Billings Bridge, Ottawa, Ontario.

CIRCLE 211 ON READER SERVICE CARD

**W  
A  
R  
P  
E  
T  
E  
R  
I  
N  
T**

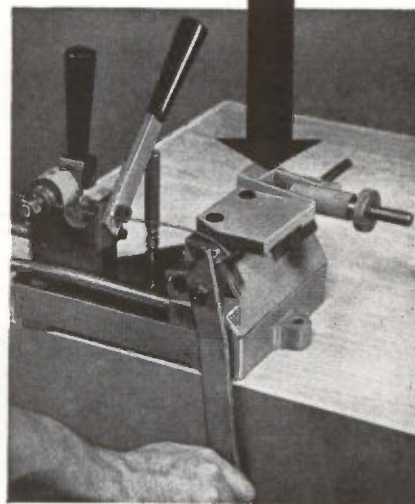

Save Costly Special Orders  
 With the NEW  
**DI-ACRO\***  
**Spring Winder**

This unique machine eliminates costly special spring orders, saves valuable waiting time. Winds compression and extension springs to 1 1/2" O.D. Handles round, flat and rectangular wire to 1/8" dimension. Note exclusive features in the hand operated Di-Acro Spring Winder which assure accurate tension and fast operation without special experience or skill.

- new** TENSION CONTROL—Simply adjust to desired tension—the control keeps it uniform, for winding one spring or hundreds, and releases when each spring is wound.
- new** WIRE CUT-OFF—After spring is wound, release tension and use cut-off lever to quickly cut end of spring to desired length.
- new** CAM LOCK—Simply feed wire under cam, turn handle and wire is securely locked to arbor while spring is wound. No threading required.

**FREE ENGINEERING SERVICE**



Send us your spring forming problems—samples or dimension sketches—together with sufficient test material, and let us wind some sample springs for you free of charge. No obligation.

Quick Facts Folder gives details on all Di-Acro Precision Machines. Consult the yellow pages of your phone book under Machinery, Machine Tools, for the name of your Di-Acro distributor or write.

\*pronounced Die-ack-ro



DI-ACRO CORPORATION  
 formerly O'Neill-Irwin  
 Mfg. Co.  
 437 8th Ave., Lake City, Minn.

CIRCLE 95 ON READER SERVICE CARD 95

**RECORDING  
 STORAGE TUBE SYSTEMS**

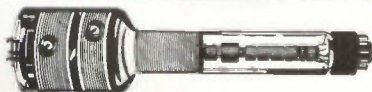

Originated and Built By  
**IMAGE INSTRUMENTS, INC.**

- ELECTROSTATIC PICTURE STORAGE AND RECALL SYSTEMS
- LOW-LIGHT-LEVEL CAMERA AND DUAL STORAGE TUBE SYSTEMS
- DOUBLE-ENDED STORAGE TUBE SYSTEMS
- DATA SUMMATION UNITS
- COMPUTER OUTPUT STORAGE FOR TELEVISION DISPLAY.

Standard storage tube systems are readily available. A custom-engineered system can be built to meet your special needs.

For further information,  
 write: Dept. A.

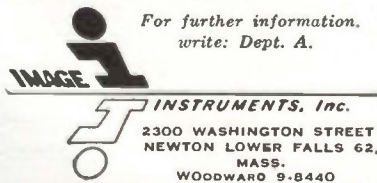

CIRCLE 212 ON READER SERVICE CARD

**How To Get Things Done  
 Better And Faster**

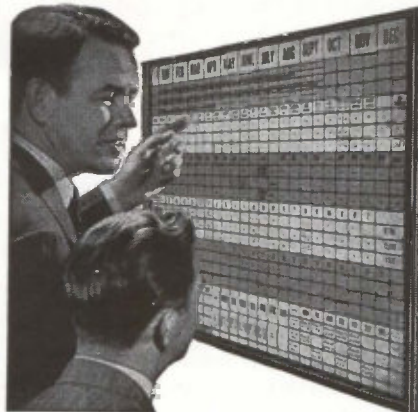

**BOARDMASTER VISUAL CONTROL**

- ☆ Gives Graphic Picture—Saves Time, Saves Money, Prevents Errors
- ☆ Simple to operate—Type or Write on Cards, Snap in Grooves
- ☆ Ideal for Production, Traffic, Inventory Scheduling, Sales, Etc.
- ☆ Made of Metal. Compact and Attractive. Over 750,000 in Use.

Full price \$4950 with cards

**FREE** 24-PAGE BOOKLET NO. C-20  
 Without Obligation

Write for Your Copy Today  
**GRAPHIC SYSTEMS**  
 YANCEYVILLE, NORTH CAROLINA

CIRCLE 213 ON READER SERVICE CARD

## Wilson: Take the initiative

USING HIS QUALITIES of quiet determination to see the job through is a key characteristic of Webster H. Wilson, chairman and president of Hazeltine Corporation. The effectiveness of the Wilson approach was recently made evident in the form of a contract award to a five-company team headed by his firm, for a second phase study of the coordination of electronics into a guided-missile destroyer escort class of ships.

Since World War II when he was in charge of Bureau of Ships installations and maintenance of electronic identification equipment, "Web" has been interested in the concept of merging electronics and architectural functions of ship design. The studies in which Hazeltine is now engaged, in association with Newport News Shipbuilding and Dry Dock, Sperry Rand, DECO Electronics and Nortronics, represent the fruition of Wilson's initial planning.

"Sure, ideas like this have been around for years", says Wilson with his almost shy smile. "But someone has to have the incentive to push and push hard to implement them. So many these days are afraid to try new approaches." Navy's Bureau of Ships has taken the initiative in this case.

Since graduation from Phillips Andover, Wilson, who was born in Wollaston, Mass., has always had a double barreled approach to his work. Majoring in aeronautical engineering and business administration at Massachusetts Institute of Technology from which he was graduated in 1936, he approaches his corporate decisions with the combined outlook of a businessman and an engineer.

He has been with Hazeltine since leaving the Navy in 1946. Starting then as a project administrator, he soon became a chief project administrator and a vice president in charge of the Government and Commercial Sales department. In 1958 he became executive vice president of the Electronics division and



a director of the corporation. He was elected president of Hazeltine in 1960 and last year succeeded the late William A. MacDonald as chairman of the board. In 1961, he was also elected a director of the Western Union Telegraph Company.

His associates appreciate Wilson's friendly, warm good humor and his wide interests. He is a ham radio addict and an avid baseball and football fan. He tempers this with interest in the writings of C. P. Snow, and has developed a green thumb in the garden of his Locust Valley, Long Island home.

This flexibility of character is reflected in some of his actions since taking over the helm at Hazeltine. He feels strongly that the successful company in today's ever-shifting electronics industry must remain flexible both technically and in business methods. One of his recent moves was the formation of the company's International division under which reciprocal technical and sales agreements will be concluded with overseas companies.

A member of many organizations, including IRE, AFCEA, National Security Industrial Associa-

tion, American Society of Naval Engineers, Air Forces Association, and American Ordnance Association, he served as a member of the U. S. delegation to the First International Meeting on Radio Aids to Marine Navigation held in London in 1946.



**Elect J. L. Sprague  
Senior V-P**

JOHN L. SPRAGUE was recently elected a senior vice president of the Sprague Electric Co., North Adams, Mass., and named co-director of the firm's engineering laboratories.

A director of the company since

Available! Ultra-Modern Bldg.  
**AIR CONDITIONED AND  
 HUMIDITY CONTROLLED**

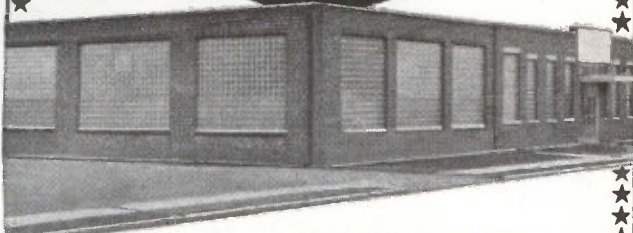

**ONE STORY  
 64,500 SQ. FT.  
 NEWARK, DELAWARE**

Ground for expansion. Excellent  
 loading and shipping.

**BINSWANGER**

**CORPORATION** • INDUSTRIAL LOCATION SPECIALISTS  
 1420 Walnut Street, Philadelphia 2, Pa. • PE 5-0202  
 New York City • Charlotte, N. C. • Yemassee, S. C. • Birmingham, Ala.

CIRCLE 214 ON READER SERVICE CARD

**RELIANCE DEVELOPS ADVANCED COMMERCIAL  
 FREQUENCY-CONVERTED D-C POWER SUPPLY**

*Facts book now ready covering data  
 processing and communications equipment*

Converting from 60 to 3000 cycles before rectifying to d-c. this new Reliance D-C Power Supply brings you these major advantages:

1. High frequency A-c. distribution — multiple rectifiers at point of use.
2. Low cost, compact, high frequency components.
3. Maximum protection against line voltage and frequency disturbance.
4. Simplicity in maintaining high quality D-c. voltages.

**Talk to our people about this new Reliance development . . .** and be sure to get the booklet with all technical facts. Write today. Reliance Electric and Engineering Co., Dept. 837-A, Cleveland 17, Ohio. Canadian Division: Toronto, Ontario.

**RELIANCE** ELECTRIC AND ENGINEERING CO.

CIRCLE 215 ON READER SERVICE CARD

July 13, 1962

**MODULAR!**

**DATA ACQUISITION INSTRUMENTS**

*Sample and Hold*



*Multiplex*



*Digitize*



**HIGH SPEED  
 HIGH ACCURACY  
 HIGH RELIABILITY**

The above instruments are typical of ADC's wide selection of modular data units. Each instrument is completely integrated, with its own power supply and operating controls.

Sample-and-Hold, for accurate, micro-second-aperture sampling of high-frequency analog data.

Multiplexors, for programmed and sequential operation.

High-Speed Analog-to-Digital Converters, for continuous or peak digitizing.

All ADC instruments use plug-in solid-state circuits to simplify future expansion.

The ADC Systems Division can supply complete data-acquisition, data-processing and computing systems.

*Write for complete information.*

*Other ADC Products — card files • equipment drawers  
 cabinet sections • logic modules*



**Applied Development Corporation**  
 1131 Monterey Pass Road  
 Monterey Park, California  
 AN 4-1381

CIRCLE 97 ON READER SERVICE CARD 97



### HOW MANY TUNES FROM ONE HORN?

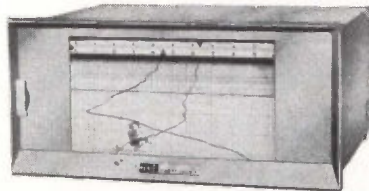

### HOW MANY JOBS FROM ONE RECORDER?

No musician uses a different horn for each tune he plays... why should scientists, researchers and engineers use a different instrument each time they record a different variable? Or, spend precious hours, sometimes even days in modifying existing conventional recorders or the added expense of another recorder? Westronics now offers totally new, quickly interchangeable, **EXTERNAL INPUT MODULES** that will convert a standard Westronics Universal recorder from any given application to another in a matter of minutes.

Get the full story on Westronics Recorders... free catalog on request. Westronics, Inc. has 30 sales-service representatives throughout the United States, Canada and Europe.

**WESTRONICS UNIVERSAL RECORDER WITH QUICK CHANGE EXTERNAL INPUT MODULES ALLOWS ONE STANDARD RECORDER TO DO A MULTITUDE OF JOBS**

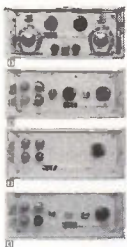

- 1 PLUG-IN ASZ FOR ADJUSTABLE SPAN AND ZERO
- 2 PLUG-IN SG-1 FOR STRAIN GAGE
- 3 PLUG-IN RB-1 FOR RESISTANCE BULB
- 3 PLUG-IN RB-2 FOR WHEATSTONE BRIDGE
- 4 PLUG-IN PF-1 FOR PRESSURE OR POTENTIOMETER FOLLOWER



**WESTRONICS  
INCORPORATED**

TWX FT8248U • 3605 McCART  
STREET • FORT WORTH, TEXAS  
62-B1

March of this year, Sprague has most recently been head of the Transistor Research department of Sprague Electric's research laboratories.

### Applied Dynamics Promotes Three

PROMOTION of three engineering staff members has been announced by Applied Dynamics, Inc., Ann Arbor, Mich., manufacturer of electronic analog computers and components.

The three are: Peter W. Barhydt, named quality control department manager; Jay B. King, advanced to chief designer and staff advisor; and Charles W. Kleekamp, appointed engineering department manager.



### General Electric Hires Schulz

JOHN E. SCHULZ has joined the traveling-wave tube product section of GE's Power Tube Dept. as a senior engineer for advanced high-power electronic devices.

His appointment was announced by S. E. Webber, manager-engineering of the Product Section in Palo Alto, Calif.

Schulz was formerly manager of the superpower klystron group for Eitel McCullough, San Bruno Calif.

### Elco Erecting New Plants

ELCO CORP., Philadelphia, Pa., manufacturer of connectors and components, announces that expanding operation has necessitated construction of two new plants.

One is a 111,000 sq ft facility in

# DUTY- BOUND

## FLEXLEAD®

### HIGH TEMPERATURE WIRE

When you specify Teflon® FLEXLEAD for lead wire and cable applications, you're buying from the *Line of Excellence*... assurance of reliable performance. FLEXLEAD's tough coating of precision-extruded Teflon resists abrasion, moisture, corrosion; and withstands temperatures to 250°C without affecting its flexibility or superior electricals.

Market processing includes careful and complete testing of every foot at several times rated voltage. FLEXLEAD, to MIL-W-16878C, is stocked for immediate delivery in all the standard colors and sizes. Ask for samples, data, and prices.

\*Du Pont Trademark

L. FRANK **MARKEL** & SONS  
SINCE 1922



**SOURCE for EXCELLENCE in**  
Insulating Tubings, Sleevings, and Lead Wire

NORRISTOWN, PENNSYLVANIA

CIRCLE 216 ON READER SERVICE CARD  
electronics

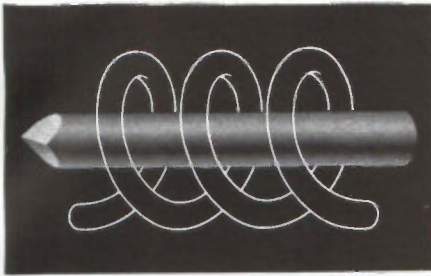

**NOW!**  
**Optically Corrected**  
**Single Crystal**  
**Laser Rods**

Meller offers optically corrected laser rods in ruby or sapphire-clad ruby, doped calcium fluoride, calcium tungstate, glass and other single crystals. Only Meller offers these outstanding guarantees: all faces flat to 1/20th wave or better . . . ends optically parallel within 2 secs. of arc. Chisel right angle correct within 5 secs. of arc . . . apex of angle parallel to flat end within 4 secs. of arc so that maximum TIR (total internal reflection) will be attained. Guarantees apply to ruby rods from 1/2" to 9" . . . and up to 2" lengths on other single crystals.

Meller offers round, square, triangular, and other configurations. Also white sapphire tubes for any size ruby rod—piston fit. Trumpet shape ruby/sapphire completely lapped and silvered available for less than \$1,000.00!

Write or call ADOLF MELLER CO.,  
 Box 601, Providence, Rhode Island  
 Phone (401) 331-3717



Synthetic Sapphires • Ruby Lasers & Masers  
 Alumina Powder

CIRCLE 218 ON READER SERVICE CARD



**Operational guidance for buyers**

That's what your 1961 electronics Buyers' Guide and Reference Issue gives you . . . this year more than ever before.

Your EBG is bigger and better this year than ever . . . and more helpful than ever . . . with more new exclusive features than ever. Keep it close at hand, you'll find it's useful day in and day out.

**electronics**  
**BUYERS' GUIDE**  
 and Reference Issue  
 The Basic Buying Guide  
 in Electronics since 1941

Willow Grove, Pa., which will take the place of the company's present Philadelphia plant. The second is a 52,000 sq ft building in Huntingdon, Pa. Both are expected to be ready for occupancy in September of this year.



**Varian Associates**  
**Appoints Miller**

SOLOMON L. MILLER has joined the central research staff at Varian Associates, Palo Alto, Calif., as a senior research scientist. He formerly headed research at Rheem Semiconductor Corp. in Mountain View, Calif.



**John Royan Joins**  
**National Transistor**

JOHN ROYAN recently joined the R&D department of National Transistor Mfg., Inc., Lawrence, Mass.

Before joining the firm, Royan was employed by Farranti, Ltd., in Manchester, England, where he specialized in semiconductor devices.

**Hi-G, Inc., Continues**  
**Facilities Expansion**

HI-G, INC., Windsor Locks, Conn., recently announced the completion of a 22,000 sq ft addition to its

**0 TO 1500 V**  
**compliance**



with  
**ELECTRONIC**  
**MEASUREMENTS**  
**constant-current**  
**POWER**  
**SUPPLIES**

You'll find a whole new spectrum of application in Electronic Measurements Constant-Current Power Supplies. Take the husky Model C638A shown here. It'll deliver up to 1500 V DC at any output current from a few microamperes up to 100 MA. There are other features too . . . a modulation input, programmability, less than 0.01% +1  $\mu$ a ripple . . . and the all-important voltage control that lets you set the maximum voltage compliance.

For complete information ask for Specification Sheet 3072C.

**BRIEF SPECIFICATIONS**

| MODEL  | CURRENT RANGE |         | VOLTAGE COMPLIANCE |        |
|--------|---------------|---------|--------------------|--------|
|        | MIN.          | MAX.    | MAX.               | MIN.   |
| C612A  | 1 $\mu$ a     | 100 ma. | 260 V              | 100 V  |
| C631A  | 1 $\mu$ a     | 100 ma. | 420 V              | 300 V  |
| *C638A | 0.5 $\mu$ a   | 100 ma. | 2100 V             | 1500 V |
| C624A  | 2.2 $\mu$ a   | 220 ma. | 260 V              | 100 V  |
| C632A  | 2.2 $\mu$ a   | 220 ma. | 420 V              | 300 V  |
| *C636A | 2.2 $\mu$ a   | 220 ma. | 735 V              | 600 V  |
| C629A  | 2.2 $\mu$ a   | 300 ma. | 205 V              | 150 V  |
| C633A  | 2.2 $\mu$ a   | 300 ma. | 420 V              | 300 V  |
| C620A  | 5 $\mu$ a     | 500 ma. | 110 V              | 50 V   |
| C621A  | 5 $\mu$ a     | 500 ma. | 160 V              | 100 V  |
| C613A  | 10 $\mu$ a    | 1 AMP   | 115 V              | 50 V   |
| C614A  | 10 $\mu$ a    | 1 AMP   | 170 V              | 100 V  |
| *C628A | 10 $\mu$ a    | 1 AMP   | 215 V              | 150 V  |
| *C630A | 10 $\mu$ a    | 1 AMP   | 280 V              | 200 V  |
| *C625A | 22 $\mu$ a    | 2 AMP   | 150 V              | 75 V   |
| *C626A | 22 $\mu$ a    | 2 AMP   | 190 V              | 100 V  |
| *C615A | 22 $\mu$ a    | 3 AMP   | 125 V              | 50 V   |
| *C618A | 22 $\mu$ a    | 3 AMP   | 170 V              | 100 V  |

\* Voltage limiting control standard. Optional on all other models.

† For current vs. voltage compliance curves, request Specification Sheet 3072C.



**ELECTRONIC**  
**MEASUREMENTS**  
 COMPANY, INCORPORATED  
 EATONTOWN, NEW JERSEY



## Capacitors for **NO COMPROMISE** Circuit Design

Unusual requirements in capacitance, tolerance, case size or configuration no longer need compromise your circuit designs. **SOUTHERN ELECTRONICS'** engineers are experienced in solving these problems to the extent that non-standard capacitors have become routine at **SEC**.

**SEC** has developed multiple block capacitors that are now saving space and weight in a production missile. Two 12mfd capacitors were designed to take less space than one, with improved electrical characteristics. In another application, **SEC** eliminated 6 tubular capacitors, utilizing a single can, 6 terminals and a common ground. Result: Room for additional components, easier wiring, and a less expensive component.

**SEC**, in addition to designing special capacitors to save weight and space, has developed dual-dielectrics to solve unusual temperature coefficient problems, and has introduced special dielectrics and oils for extreme high temperature and high voltage applications.

This engineering know-how has resulted in the use of **SEC capacitors** in twelve U.S. missiles, analog computers, and many radar and communications services.

**SEC capacitors** are manufactured in a wide range of capacitance to meet your needs from 100mmf to any higher value, with tolerances as low as 0.1%. They are made under unusually critical quality control standards, and meet or exceed the most rigid MIL-SPECS.

Write for Catalog and  
 Technical Data



**SOUTHERN ELECTRONICS Corporation**

150 WEST CYPRESS AVENUE  
 BURBANK, CALIFORNIA

main production facilities, and the start of a second addition of 9,000 sq ft as an advanced research and engineering center.

Company manufactures components for many switching functions and control circuits in the current space vehicle and computer programs.



### Electro-Optical Appoints Munk

**ROBERT MUNK** has joined the technical staff of Electro-Optical Systems, Inc., Pasadena, Calif., as chief scientist of the company's Advanced Electronics and Information Systems division. He will be responsible for systems research and analysis activities for space vehicles and weapon systems.

Prior to joining EOS, Munk was with Ryan Aeronautical Corp. in San Diego.



### Granger Associates Elects Pappenfus

THE BOARD of directors of Granger Associates, Palo Alto, Calif., has elected E. W. Pappenfus vice president, engineering. He will assume wide responsibilities for development of the company's programs in radio communications systems and devices.

Pappenfus spent 19 years with

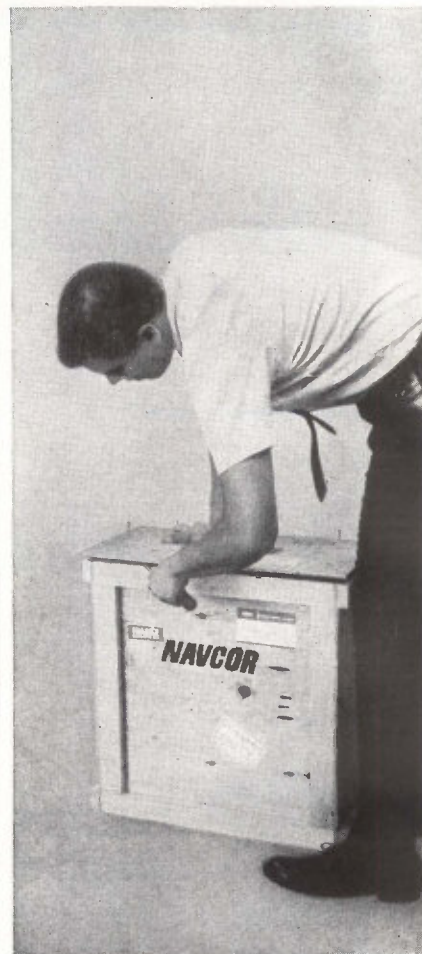

NOW READY:

## ANALOG-TO-DIGITAL CONVERTER

NAVCOR MODEL 2201

LOW PRICE: **\$2935**

ACCURACY: **.05%** ABSOLUTE

DELIVERY: **30 DAYS**

Format: Binary, 10 bits plus sign.  
 Conversion Rate: 10,000 complete conversions per second (9.1 microseconds per bit plus 9.1 microseconds.)  
 Input Range: ±10.23 volts; lower or higher ranges available.  
 Input Impedance: 5,000 ohms; high impedance amplifier optional.

Other models start from \$2,775. Both Binary and Binary-Coded-Decimal formats are available. Options include Sample and Hold, Multiplexing, and Over-Range Indication. For more information, write to NAVIGATION COMPUTER CORPORATION, Valley Forge Industrial Park, Norristown, Pennsylvania.



CIRCLE 217 ON READER SERVICE CARD  
 electronics

Collins Radio Co., where he was at the last director of development of the firm's largest design division.

### Ford Instrument Names Montani

ANGELO MONTANI has been appointed assistant to the president of Ford Instrument Co., a division of Sperry Rand Corp., Long Island City, N. Y.

He was formerly research manager for Philco Corp.

### PEOPLE IN BRIEF

Louis Mager leaves Tyco Inc. to join U. S. Dielectric Inc. as exec v-p. Minneapolis-Honeywell promotes John S. Blakemore to mgr. of applied research at its Semiconductor R&D center. Bernard G. Beck, ex-Magnavox Co., now with new projects staff of Vitro Laboratories. Lenkurt Electric Co., Inc., ups Glenn H. Vought to mgr. of its Rome, N. Y., office. Bill Strunk, manufacturing mgr. of Astro-Systems, Inc., elected a v-p. Malcolm L. Stitch advances at Hughes Aircraft to mgr. of the Aerospace Laser dept. Murray G. Wachsman, formerly with J. A. Maurer, Inc., appointed v-p/g-m of Knight Electronics Corp. William E. Seaman, previously head of his own consulting firm, named engineering mgr. for Radiation Counter Laboratories, Inc. Warren G. Austin, retired USAF electronic warfare officer, now g-m of Southern Electronics Engineering Co. C. E. T. White moves up at Cominco Products, Inc., to mgr. of Electronic Materials div. Robert J. Orwin is elevated to technical director of the commercial products div. at The Hallicrafters Co. Edward M. Hoey promoted to v-p of Hektor Scientific Co. Ralph F. Lowe of GE appointed mgr. of multiplex carrier engineering in the company's telecommunications organization. Paul Gheorghiu from Transiron, Inc., to Advanced Research Corp. (a new div. of Hi-G, Inc.) as director of research. George C. Brown, ex-Telectro Industries Corp., named senior project engineer for Potter Instrument Co., Inc.

## INVESTIGATE GREATER ATLANTA'S

## DYNAMIC DEKALB COUNTY

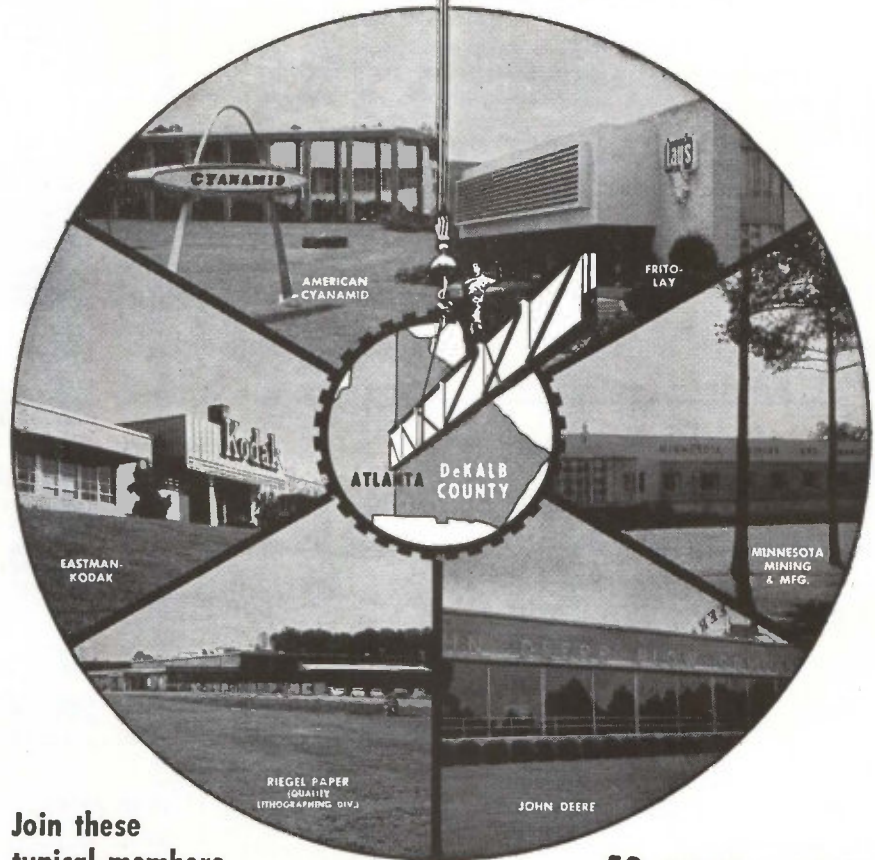

Join these  
typical members  
of DeKalb-Atlanta's  
diversified industrial family:

General Electric  
Armour Agricultural  
Chemical Co.  
General Foods  
Singer Sewing Machine  
General Motors  
(Buick, Oldsmobile, Pontiac Assembly)  
Kraft Foods  
DuPont Paints  
Ralston Purina  
Southeastern Ford Tractor

**10 OUTSTANDING  
INDUSTRIAL DISTRICTS  
NOW READY!**

- PRIVATE FINANCING AVAILABLE
- CHOICE BUILDINGS FOR LEASE

**45¢ — 65¢ Square foot per year**  
(20,000 square feet or more)

**Big-City transportation and commu-  
nications, with room for your busi-  
ness to grow and prosper**

**INQUIRIES CONFIDENTIAL**

SEND FOR FREE  
FULL COLOR BROCHURE

Write, wire or phone

**F. WM. BROOME, Manager,**  
DeKalb Industrial Committee of 100  
P. O. Drawer 759, Atlanta 22, Ga.  
Telephone 378-3691

Name \_\_\_\_\_  
Title \_\_\_\_\_  
Company \_\_\_\_\_  
Address \_\_\_\_\_  
City & State \_\_\_\_\_

# electronics

## WEEKLY QUALIFICATION FORM FOR POSITIONS AVAILABLE

### ATTENTION: ENGINEERS, SCIENTISTS, PHYSICISTS

This Qualification Form is designed to help you advance in the electronics industry. It is unique and compact. Designed with the assistance of professional personnel management, it isolates specific experience in electronics and deals only in essential background information.

The advertisers listed here are seeking professional experience. Fill in the Qualification Form below.

#### STRICTLY CONFIDENTIAL

Your Qualification form will be handled as "Strictly Confidential" by ELECTRONICS. Our processing system is such that your form will be forwarded within 24 hours to the proper executives in the companies you select. You will be contacted at your home by the interested companies.

#### WHAT TO DO

1. Review the positions in the advertisements.
2. Select those for which you qualify.
3. Notice the key numbers.
4. Circle the corresponding key number below the Qualification Form.
5. Fill out the form completely. Please print clearly.
6. Mail to: D. Hawksby, Classified Advertising Div., ELECTRONICS, Box 12, New York 36, N. Y. (No charge, of course).

| COMPANY   | SEE PAGE | KEY # |
|---|----------|-------|
| ATOMIC PERSONNEL INC.<br>Philadelphia, Pennsylvania                                       | 103      | 1     |
| BRISTOL COMPANY<br>Waterbury, Connecticut   | 104*     | 2     |
| COLLINS RADIO COMPANY<br>Dallas, Texas  | 18*      | 3     |
| DOUGLAS AIRCRAFT CO.<br>Missile and Space Systems Division<br>Santa Monica, California    | 97*      | 4     |
| ESQUIRE PERSONNEL SERVICE INC.<br>Chicago, Illinois                                       | 103      | 5     |
| GENERAL DYNAMICS/ELECTRONICS<br>Div. of General Dynamics Corp.<br>Rochester, New York     | 102*     | 6     |
| INTERNATIONAL BUSINESS MACHINES CORP.<br>Space Guidance Center<br>Owego, New York         | 103      | 7     |
| LOCKHEED CALIFORNIA CO.<br>Div. of Lockheed Aircraft Corp.<br>Burbank, California         | 69       | 8     |
| LOCKHEED MISSILES & SPACE CO.<br>Div. of Lockheed Aircraft Corp.<br>Sunnyvale, California | 70, 71*  | 9     |
| MELPAR, INC.<br>Sub. of Westinghouse Air Brake Co.<br>Falls Church, Virginia              | 101*     | 10    |
| MICROWAVE SERVICES INTERNATIONAL INC.<br>Denville, New Jersey                             | 103      | 11    |
| NORTHROP CORP.<br>Norair Division<br>Hawthorne, California                                | 85       | 12    |

CONTINUED ON OPPOSITE PAGE

(cut here)

### electronics WEEKLY QUALIFICATION FORM FOR POSITIONS AVAILABLE

(cut here)

(Please type or print clearly. Necessary for reproduction.)

#### Personal Background

NAME .....

HOME ADDRESS .....

CITY ..... ZONE ..... STATE .....

HOME TELEPHONE .....

#### Education

PROFESSIONAL DEGREE(S) .....

MAJOR(S) .....

UNIVERSITY .....

DATE(S) .....

#### FIELDS OF EXPERIENCE (Please Check)

- |  |  |                                       |
|--|--|---------------------------------------|
| <input type="checkbox"/> Aerospace           | <input type="checkbox"/> Fire Control        | <input type="checkbox"/> Radar        |
| <input type="checkbox"/> Antennas            | <input type="checkbox"/> Human Factors       | <input type="checkbox"/> Radio-TV     |
| <input type="checkbox"/> ASW                 | <input type="checkbox"/> Infrared            | <input type="checkbox"/> Simulators   |
| <input type="checkbox"/> Circuits            | <input type="checkbox"/> Instrumentation     | <input type="checkbox"/> Solid State  |
| <input type="checkbox"/> Communications      | <input type="checkbox"/> Medicine            | <input type="checkbox"/> Telemetry    |
| <input type="checkbox"/> Components          | <input type="checkbox"/> Microwave           | <input type="checkbox"/> Transformers |
| <input type="checkbox"/> Computers           | <input type="checkbox"/> Navigation          | <input type="checkbox"/> Other .....  |
| <input type="checkbox"/> ECM                 | <input type="checkbox"/> Operations Research | <input type="checkbox"/> .....        |
| <input type="checkbox"/> Electron Tubes      | <input type="checkbox"/> Optics              | <input type="checkbox"/> .....        |
| <input type="checkbox"/> Engineering Writing | <input type="checkbox"/> Packaging           | <input type="checkbox"/> .....        |

71362

#### CATEGORY OF SPECIALIZATION

Please indicate number of months  
experience on proper lines.

|                                     | Technical<br>Experience<br>(Months) | Supervisory<br>Experience<br>(Months) |
|-------------------------------------|-------------------------------------|---------------------------------------|
| RESEARCH (pure, fundamental, basic) | .....                               | .....                                 |
| RESEARCH (Applied)                  | .....                               | .....                                 |
| SYSTEMS (New Concepts)              | .....                               | .....                                 |
| DEVELOPMENT (Model)                 | .....                               | .....                                 |
| DESIGN (Product)                    | .....                               | .....                                 |
| MANUFACTURING (Product)             | .....                               | .....                                 |
| FIELD (Service)                     | .....                               | .....                                 |
| SALES (Proposals & Products)        | .....                               | .....                                 |

CIRCLE KEY NUMBERS OF ABOVE COMPANIES' POSITIONS THAT INTEREST YOU

1 2 3 4 5 6 7 8 9 10 11 12 13 14 15 16 17 18 19 20 21 22 23 24 25



# EMPLOYMENT OPPORTUNITIES



The Advertisements in this section include all employment opportunities—executive, management, technical, selling, office, skilled, manual, etc. Look in the forward section of the magazine for Additional Employment Opportunities advertising.

Positions Vacant  
Positions Wanted  
Part Time Work

Civil Service Opportunities  
Selling Opportunities Wanted  
Selling Opportunities Offered

Employment Agencies  
Employment Services  
Labor Bureaus

## DISPLAYED

The advertising rate is \$40.17 per inch for all advertising appearing on other than a contract basis. Contract rates quoted on request.

An advertising inch is measured  $\frac{1}{8}$ " vertically on a column—3 columns—30 inches to a page.

Subject to Agency Commission.

Send NEW ADS to CLASSIFIED ADV. DIV. of ELECTRONICS, P.O. Box 12, N. Y. 36, N. Y.

## ---RATES---

## UNDISPLAYED

\$2.70 per line, minimum 3 lines. To figure advance payment count 5 average words as a line.

Box Numbers—counts as 1 line.

Discount of 10% if full payment is made in advance for 4 consecutive insertions.

Not subject to Agency Commission.

### CHIEF ENGINEER

To \$22,000—No Fee

Individual to assume Technical and Administrative responsibility of a Communications Lab engaged in Surface and Airborne application of Radio and Digital Communications Equipments, MSEE or equiv. Will assist Marketing Div. in attracting New Business.

ESQUIRE PERSONNEL, INC.

202 So. State St. Chicago 4, Illinois



### E.E.'s

For professional, individualized fee-paid service write for confidential application.

A national employment agency for the Nuclear & Scientific Fields.

ATOMIC PERSONNEL, INC.  
Suite 1207L, 1518 Walnut St., Phila. 2, Pa.

### POSITION VACANT

**Immediate Opening for professional-level applicant as Research Associate or Assistant Professor to supervise designing, fabricating, and maintaining specialized electronic equipment for research in science and engineering. A properly qualified person will, if he desires, have the opportunity to participate in electronic research or teach. A staff member on full-time appointment may enroll for one course each semester. Salary in range of \$7,500 to \$8,500. Annual appointment with one month vacation. Application or further inquiry should be made to Dean Virgil W. Adkisson, Research Coordinator, University of Arkansas, Fayetteville, Arkansas.**

### Electronic Instrument Technicians The Oak Ridge National Laboratory Operated by UNION CARBIDE NUCLEAR COMPANY

at  
Oak Ridge, Tennessee  
Has openings for

Highly skilled electronic instrument technicians to work with electronic engineers in the development, installation and maintenance of electronic systems. Digital data handling, transistorized pulse height analyzers, analog and digital computer systems are only a few examples.

Minimum high school education, with additional training in electronics and at least three years' experience in installation and maintenance of complex electronic systems. Entrance rate \$3.10 per hour; \$3.16 per hour after six months. Reasonable interview and relocation expenses paid by Company.

Excellent Working Conditions  
and

Employee Benefit Plans  
An Equal Opportunity Employer

Send detailed resume to:

Central Employment Office  
UNION CARBIDE NUCLEAR COMPANY  
Post Office Box M Oak Ridge, Tennessee

### COMMUNICATIONS APPLICATION ENGINEER Analysis of advanced electronic communication systems including radio, carrier, telephone, microwave:



Must have design and marketing experience with commercial and military users.

EE degree, 5 yrs. exp. min.  
Send Resume to:

Microwave Services International Inc.  
Consulting Engineers  
Route 46 Denville, N. J.

"Put Yourself in the Other  
Fellow's Place"

### TO EMPLOYERS

### TO EMPLOYEES

Letters written offering Employment or applying for same are written with the hope of satisfying a current need. An answer, regardless of whether it is favorable or not, is usually expected.

MR. EMPLOYER won't you remove the mystery about the status of an employee's application by acknowledging all applicants and not just the promising candidates.

MR. EMPLOYEE you, too, can help by acknowledging applications and job offers. This would encourage more companies to answer position wanted ads in this section. We make this suggestion in a spirit of helpful cooperation between employers and employees.

This section will be more useful to all as a result of this consideration.

Classified Advertising Division

McGraw-Hill Publishing Co., Inc.  
330 West 42nd St., New York 36, N. Y.

# Space Guidance Systems

- Solid State Physicists (Radiation Effects Studies)
- Reliability Statisticians
- Logic Designers
- Circuit Designers
- Contract Negotiators
- Quality Engineers
- Control Systems Engineers
- Mechanical Engineers (Heat Transfer/Stress Analyst)

# IBM SPACE GUIDANCE CENTER

At its Space Guidance Center in Owego, New York, IBM is responsible for vehicle guidance and control systems for manned aircraft, satellites, space craft, submarines, and other vehicles. Accomplishments include: successful test flights of the rugged IBM computer used in the all-inertial AChiever guidance system that directs the TITAN intercontinental ballistic missile to its target; an advanced memory system for the NASA Orbiting Astronomical Observatory; guidance computers for flight testing with the SATURN space vehicles.

The IBM Space Guidance Center is situated in pleasant surroundings with ample housing, good schools, and fine recreational facilities. The company-paid benefit program features broad educational opportunities. Relocation expenses are paid. IBM is an Equal Opportunity Employer.

For full details on career opportunities, please write, outlining your interests and background, to:

Fred Guth, Dept. 554T2  
Space Guidance Center  
IBM Corporation  
Owego, New York

# IBM

INTERNATIONAL BUSINESS  
MACHINES CORPORATION

# electronics

## WEEKLY QUALIFICATIONS FORM FOR POSITIONS AVAILABLE

(Continued from opposite page)

|   |      |    |
|---|------|----|
| NORTHROP CORP.<br>Space Laboratories<br>Hawthorne, California | 83   | 13 |
| PHILCO WESTERN DEVELOPMENT<br>LABS<br>Palo Alto, California   | 103* | 14 |
| REPUBLIC AVIATION CORPORATION<br>Farmingdale, L.I., New York  | 104  | 15 |
| UNION CARBIDE NUCLEAR CO.<br>Oak Ridge, Tennessee             | 103  | 16 |

\*These advertisements appeared in the 7/6/62 issue.

ELECTRONICS ENGINEERS  
& PHYSICISTS

JOIN US IN  
GIVING A  
NEW  
DIRECTION  
TO  
AEROSPACE  
TECHNOLOGY thru  
RESEARCH & DEVELOPMENT in

# aerospace electronics

Republic's Paul Moore Research & Development Center is the most sophisticated and integrated research complex in the East. Advances made here in many critical aerospace problem areas have brought Republic a diversity of new and follow-on R & D contracts leading to next-generation space and re-entry vehicles, satellites, space power and communication systems.

Electronics Engineers and Physicists are invited to consider the challenging opportunities to make important contributions on these programs in the areas of:

**SPACE CRAFT COMMUNICATION — B.S., M.S.**  
Design and develop space vehicle communications systems including telemetry, command and on-board data handling.

**DATA HANDLING (ASGSE) — B.S., M.S.**  
Design and develop ground station and on-board data handling systems for re-entry and space vehicle applications.

**COMMUNICATION TECHNIQUES — B.S., M.S.**  
Develop advanced communications techniques for aerospace and space craft, includes communications theory and network synthesis.

**ADVANCED SPACE RADARS — B.S., M.S.**  
Develop concepts and components for advanced space radar including rendezvous, mapping, acquisition and tracking applications.

**RADAR INTEGRATION — B.S.**  
Develop specifications, install and integrate advanced radar in hypersonic and space vehicles, including antennas, transmitters, receivers, displays, power supplies, controls.

**ANTENNA DESIGN — M.S.**  
Design and development of antennas for re-entry vehicles. Knowledge of wind effects and general re-entry radiation blackout problems.

**RADAR TEST (GSE) — B.S.**  
Test, checkout and maintain ground radar systems. Make required circuit modifications including range gating circuits, modulators. No travel.

**RE-ENTRY INSTRUMENTATION — B.S., M.S.**  
Design instrumentation for specific re-entry and space vehicles including telemetry systems.

**MATHEMATICAL ANALYSIS CONTROLS — Ph.D.**  
Theoretical analysis of noise effects and nonlinear mechanisms on automatic controls. Includes optimal control theory and generalized stability criteria.

**ELECTRONIC INSTRUMENTATION — B.S., M.S.**  
Develop instrumentation for space vehicles. Knowledge of system integration and telemetry desirable.

**SPACE GUIDANCE SYSTEMS — M.S., Ph.D.**  
Develop and analyze navigation and guidance systems using inertial and Doppler techniques and advanced nuclear gyros.

**ECM REQUIREMENTS — B.S., M.S.**  
Mathematical analysis of ECM requirements for advanced aerospace and space craft, and specification of equipment.

**FLIGHT CONTROL DESIGN — M.S.**  
Automatic flight controls, servo systems, nonlinear dynamic systems for space craft.

**PYROTECHNIC CIRCUIT DESIGN — B.S., M.S.**  
Develop pyrotechnic missile circuits including safe arm, squib ignition and RFI elimination devices.

**EXPERIMENTAL PHYSICIST — Ph.D.**  
Conduct experimental studies of the application of nuclear or electron resonance to gyroscopics.

**ENVIRONMENTAL TESTING — B.S., M.S.**  
Undertake test programs to estimate component and system reliability using AGREE type methods; monitor offsite testing.

**DESIGN REVIEW — B.S., M.S.**  
Perform mechanical or electronic design reviews, failure analyses, quantitative analyses and reports. Includes circuit analysis, component selection.

**STATISTICAL ANALYSIS — B.S., M.S.**  
Apply statistical theory and method to prediction and analysis of aerospace component performance.

**IDEP PRISM PROCEDURES — B.S., M.S.**  
Participate in "Interservice Data Exchange Programming" and "Program Reliability Information Systems for Management."

Interested applicants are invited to write in confidence to: Mr. George R. Hickman, Technical Employment Manager, Dept. 11G-2

## REPUBLIC AVIATION CORPORATION

FARMINGDALE, LONG ISLAND, NEW YORK

An Equal Opportunity Employer

## SEARCHLIGHT SECTION

(Classified Advertising)

BUSINESS OPPORTUNITIES

EQUIPMENT - USED or RESALE

### DISPLAYED RATE

The advertising rate is \$27.25 per inch for all advertising appearing on other than a contract basis. Contract rates quoted on request. AN ADVERTISING INCH is measured 3/4 inch vertically on one column, 3 columns—30 inches—to a page. EQUIPMENT WANTED or FOR SALE ADVERTISEMENTS acceptable only in Displayed Style.

### UNDISPLAYED RATE

\$2.70 a line, minimum 3 lines. To figure advance payment count 5 average words as a line.

PROPOSALS, \$2.70 a line an insertion. BOX NUMBERS count as one line additional in undisplayed ads.

DISCOUNT OF 10% if full payment is made in advance for four consecutive insertions of undisplayed ads (not including proposals).

### FOR RESEARCH — DEVELOPMENT & EXPERIMENTAL WORK

Over 10,000 different electronic parts: waveguide, radar components and parts, test sets, pulsed, antennas, pulse xmfrs, magnetrons, IF and pulse amplifiers, dynamotors, 400 cycle xmfrs, 584 ant. pedestals, etc.

PRICES AT A FRACTION OF ORIGINAL COST!  
**COMMUNICATIONS EQUIP CO.**  
343 CANAL ST., N. Y. 13, WO 6-4045  
CHAS. ROSEN (Formerly at 131 Liberty St.)

CIRCLE 950 ON READER SERVICE CARD

### TUBE SPECIALS

3CX100A5 (2C39B) . . . Tested and fully guaranteed . . . \$9.95 ea.  
2C39WA . . . Brand new sealed cartons \$14.50 ea.

### ELECTRO SALES CO.

1608 Milwaukee Ave. Chicago 47, Ill.  
BR 8-8080

CIRCLE 951 ON READER SERVICE CARD

## FOR MORE INFORMATION

about Classified Advertising  
contact the McGraw-Hill  
office nearest you.

ATLANTA, 9 D. Hicks  
1375 Peachtree St., N.E. TRinity 5-0523

BOSTON, 16 O. Davis  
Copley Square COngress 2-1160

CHICAGO, 11 W. J. Higgins, D. Beran  
645 No. Michigan Avenue MOhawk 4-5800

CLEVELAND, 13 I. C. Hill  
1164 Illuminating Bldg. SUperior 1-7000

DALLAS, 7 F. LeBeau  
1712 Commerce St., Vaughn Bldg. RIVERSide 7-9721

DENVER, 2 J. Patten  
1700 Broadway—Tower Bldg. ALPine 5-2981

DETROIT, 26 Wm. H. Ginder, Jr.  
856 Penobscot Bldg. WOODward 2-1793

HOUSTON, 25 J. Page  
Prudential Bldg., Holcombe Blvd. RIVERSide 8-1280

LOS ANGELES, 17 Wm. C. Gries  
1125 W. 6th Street HUNtley 2-5450

NEW YORK, 36 H. T. Buchanan-T. W. Bender  
500 Fifth Avenue LONGacre 4-3000

PHILADELPHIA, 3 Wm. B. Sullivan  
Six Penn Center Plaza LOCust 8-4330

PITTSBURGH, 22 J. Williams  
4 Gateway Center EXpress 1-1314

ST. LOUIS, B  
7751 Carondelet Avenue PARKview 5-7285

SAN FRANCISCO, 11 J. A. Hartley  
255 California Street DOUGlas 2-4600

Advertisement

# INTERESTING TO NOTE . . .

NEW YORK, N. Y. Feb. 1962:—

Universal Relay Corp., 42 White St., New York 13, N. Y. announces the publication of their 52 page Spring 1962 catalog. With publication of the catalog, they inform their customers that "normal inventory includes over 1,500,000 relays in approximately 30,000 types. In most cases stock is sufficient to give immediate delivery of production quantities.

This catalog is, therefore, not just a listing of items available 'on order' but, by and large, it is an indication of in-stock items (either as complete units or as ready to assembly components).

The average shipment is made within 48 hours. Where coils and frames require assembly, or relays require special testing or adjustment, shipments are made within one week to ten days.

Universal is completely equipped to assemble, adjust and thoroughly test any type of relay. Assembly and test facilities have been imitated by some relay manufacturers.

A personal interest is taken in every order. This interest is maintained as the order is processed. And, it continues even after the customer receives the merchandise until he makes sure that it satisfies his needs.

All merchandise is guaranteed, subject to customers' inspection and approval, and may be returned within 30 days for replacement or credit.

The catalog is full of items to fill everyday relay requirements".

Catalog E-162 may be obtained by writing directly to:

## UNIVERSAL RELAY CORP.

42 White Street, New York 13, N. Y.  
WAlker 5-6900

# SPECIAL PURPOSE TUBES

|          |        |           |        |            |        |             |        |              |        |
|----------|--------|-----------|--------|------------|--------|-------------|--------|--------------|--------|
| OA2      | .80    | 4-65A     | 10.00  | 25Z6WGT    | 1.50   | 725A        | 10.00  | 5751WA       | 2.00   |
| OA2WA    | 2.00   | 4-125A    | 20.00  | 26Z5W      | 1.50   | 726A        | 5.00   | 5763         | 1.75   |
| OA3      | .85    | 4-250A    | 35.00  | FG-27A     | 20.00  | 726B        | 5.00   | 5777         | 150.00 |
| OB2      | .60    | 4-400A    | 30.00  | 28D7W      | 3.50   | 726C        | 7.50   | 5778         | 150.00 |
| OB2WA    | 2.00   | 4-1000A   | 80.00  | FG-32      | 10.00  | 750TL       | 112.50 | 5783         | 2.25   |
| OB3      | .70    | 4AP10     | 10.00  | 35T        | 10.00  | NL-760      | 20.00  | 5784         | 2.50   |
| OC3      | .50    | 4B31      | 12.50  | 35TG       | 2.50   | 802         | 7.50   | 5787         | 2.50   |
| OD3      | .30    | 4C35      | 15.00  | FP-54      | 100.00 | 803         | 3.50   | 5796         | 10.00  |
| C1A      | 8.50   | 4CX250B   | 30.00  | FG-57      | 10.00  | 804         | 15.00  | 5800/VX-41   | 7.50   |
| 1AD4     | 1.50   | 4CX1000A  | 125.00 | RK-60/1641 | 1.50   | 805         | 7.50   | 5803/VX-55   | 5.00   |
| 1B24     | 7.50   | 4D32      | 15.00  | HY-69      | 3.00   | 807         | 1.50   | 5814A        | 1.35   |
| 1B24A    | 12.50  | 4E27A     | 27.50  | BL-75      | 3.00   | 807W        | 2.25   | 5829         | 1.00   |
| 1B35A    | 3.00   | 4J32      | 100.00 | 75TL       | 17.50  | 808         | 2.50   | 5836         | 50.00  |
| 1B63A    | 10.00  | 4J34      | 100.00 | TG-77      | 7.50   | 809         | 5.00   | 5837         | 50.00  |
| 1C/3B22  | 5.00   | 4J50      | 100.00 | HF-100     | 10.00  | 810         | 15.00  | 5840         | 2.50   |
| C1K      | 7.50   | 4J52      | 35.00  | 100TH      | 12.00  | 811         | 2.50   | 5845         | 6.00   |
| 1P21     | 32.50  | 4PR60A    | 50.00  | 100TL      | 12.00  | 811A        | 4.00   | 5852         | 5.00   |
| 1P22     | 8.00   | 4X150A    | 13.50  | FG-105     | 25.00  | 812A        | 4.75   | 5876         | 7.50   |
| 1P25     | 10.00  | 4X150D    | 15.00  | F-123A     | 5.00   | 813         | 12.50  | 5879         | 1.15   |
| 1P28     | 15.00  | 4X150G    | 25.00  | FG-172     | 25.00  | 814         | 3.50   | 5881/6L6WGB  | 2.00   |
| 1Z2      | 1.50   | 4X250B    | 20.00  | 211        | 2.50   | 815         | 5.00   | 5886         | 4.00   |
| 2-01C    | 12.50  | 4X250F    | 30.00  | 212E       | 50.00  | 816         | 2.25   | 5893         | 10.00  |
| 2AP1A    | 8.50   | 5B11A     | 9.50   | FG-235     | 50.00  | 826         | 3.50   | 5894         | 18.85  |
| 2B23     | 20.00  | 5C22      | 17.50  | 242C       | 10.00  | 828         | 12.50  | 5915         | 1.00   |
| 2BP1     | 10.00  | 5CP1A     | 9.50   | 244A       | 3.50   | 829B        | 10.00  | 5931/SU4WG   | 2.00   |
| 2C36     | 22.50  | 5CP7A     | 9.50   | 245A       | 3.50   | 832         | 2.50   | 5933/807W    | 3.00   |
| 2C39A    | 9.75   | 5D21      | 7.50   | 249B       | 10.00  | 832A        | 7.50   | 5948/1754    | 100.00 |
| 2C39B    | 15.00  | 5J26      | 50.00  | 249C       | 5.00   | 833A        | 37.50  | 5949/1907    | 50.00  |
| 2C40     | 7.50   | 5JP1      | 7.50   | 250R       | 10.00  | 836         | 2.50   | 5963         | 1.00   |
| 2C42     | 3.00   | 5LP1      | 7.50   | 250TH      | 25.00  | 837         | 1.00   | 5964         | .85    |
| 2C43     | 7.50   | 5R4GY     | 1.25   | 251A       | 50.00  | 842         | 7.50   | 5965         | .85    |
| 2C46     | 5.00   | 5R4WGA    | 4.00   | 254A       | 3.50   | 845         | 7.50   | 5976         | 50.00  |
| 2C50     | 4.00   | 5R4WGB    | 6.00   | FG-258A    | 100.00 | 849         | 75.00  | 5993         | 5.00   |
| 2C51     | 1.50   | 5R4WGY    | 2.00   | 259A       | 3.50   | 851         | 50.00  | 6005/6AQ5W   | 1.50   |
| 2C52     | 1.50   | 5R11A     | 9.50   | 262B       | 3.50   | 866A        | 1.90   | 6012         | 4.00   |
| 2C53     | 7.50   | 5Y1WGT    | 1.25   | 267B       | 3.50   | 869B        | 50.00  | 6021A        | 2.00   |
| 2D21     | .50    | 5Y3WGTB   | 2.50   | 271A       | 12.50  | 872A        | 5.00   | 6032         | 10.00  |
| 2D21W    | 1.00   | 6AC7W     | .50    | 274A       | 3.50   | 884         | 1.25   | 6045         | 1.15   |
| 2E24     | 2.25   | 6AC7WA    | 2.00   | 283A       | 3.50   | 885         | .85    | 6072         | 1.50   |
| 2E26     | 2.50   | 6AG5WA    | 1.50   | 287A       | 3.50   | 889A        | 150.00 | 6073         | 1.50   |
| 2E30     | 3.50   | 6AG7Y     | 1.00   | QK-288     | 250.00 | 891R        | 200.00 | 6074         | 1.75   |
| 2J42     | 75.00  | 6AK5W     | 1.25   | HF-300     | 35.00  | 913         | 9.50   | 6080         | 3.35   |
| 2J51     | 50.00  | 6AK5 (WE) | .75    | 300B       | 5.00   | 920         | 2.50   | 6080WA       | 5.00   |
| 2J55     | 90.00  | 6AL5W     | .60    | 304TH      | 35.00  | 927         | 1.50   | 6080WB       | 10.00  |
| 2K22     | 25.00  | 6AN5      | 1.75   | 304TL      | 35.00  | 931A        | 3.50   | 6082         | 3.35   |
| 2K25     | 8.50   | 6AN5WA    | 3.50   | 307A       | .50    | 1000T       | 80.00  | 6087/5Y3WGTB | 2.50   |
| 2K26     | 35.00  | 6AQ5W     | 1.00   | 310A       | 3.50   | R1130B      | 10.00  | 6101/6J6WA   | 1.50   |
| 2K28     | 25.00  | 6AR6      | 7.50   | 311A       | 3.50   | 1500T       | 150.00 | 6106         | 1.50   |
| 2K29     | 25.00  | 6AS6W     | 1.00   | 313C       | 1.50   | 1614        | 2.75   | 6115/QK351   | 50.00  |
| 2K30     | 50.00  | 6AS7G     | 2.50   | 323A       | 6.00   | 1620        | 4.00   | 6130/3C45    | 6.50   |
| 2K33A    | 200.00 | 6AU6WA    | 1.25   | 328A       | 3.50   | 1624        | 1.00   | 6136/6AU6WA  | 1.25   |
| 2K34     | 75.00  | 6B4G      | 3.35   | 329A       | 4.50   | 1625        | .50    | 6146         | 3.00   |
| 2K35     | 200.00 | 6BA6W     | .75    | 336A       | 2.50   | 1635        | 2.00   | 6159         | 3.50   |
| 2K39     | 150.00 | 6BE6W     | 1.50   | 337A       | 3.50   | 1846        | 50.00  | 6161         | 35.00  |
| 2K41     | 50.00  | 6BF7W     | 2.00   | 347A       | 1.00   | 1855        | 250.00 | 6186/6AG5WA  | 1.50   |
| 2K42     | 125.00 | 6BH6W     | 2.75   | 348A       | 4.50   | 2050        | 1.25   | 6189/12AU7WA | 1.50   |
| 2K43     | 200.00 | 6BL6      | 20.00  | 349A       | 3.50   | ZB-3200     | 100.00 | 6197         | 1.75   |
| 2K44     | 125.00 | 6BM6      | 25.00  | 350A       | 3.50   | 5516        | 7.50   | 6201/12AT7WA | 1.85   |
| 2K45     | 20.00  | 6BM6A     | 30.00  | 350B       | 2.50   | 5528/C6L    | 3.50   | 6202/6X4WA   | 1.50   |
| 2K47     | 150.00 | 6C4W      | 2.50   | 352A       | 8.50   | 5545        | 20.00  | 6211         | .75    |
| 2K48     | 50.00  | 6C4WA     | 1.00   | 354A       | 12.50  | 5550        | 30.00  | 6213         | 2.50   |
| 2K50     | 175.00 | 6C21      | 17.50  | 355A       | 12.50  | 5552/FG235  | 50.00  | 6216         | 3.00   |
| 2K54     | 10.00  | 6D4       | 1.50   | 371B       | 2.50   | 5553/FG258  | 100.00 | 6236         | 125.00 |
| 2K55     | 15.00  | 6F4       | 3.50   | 388A       | 2.00   | 5557/FG17   | 5.00   | 6248         | 250.00 |
| 2K56     | 50.00  | C6J       | 10.00  | 393A       | 5.00   | 5558/FG32   | 10.00  | 6263         | 9.00   |
| 2P21     | 40.00  | C6J/A     | 15.00  | 394A       | 3.00   | 5559/FG57   | 10.00  | 6265/6BH6W   | 2.75   |
| 2X2A     | 1.25   | C6J/K     | 20.00  | 395A       | 2.25   | 5560/FG95   | 25.00  | 6293         | 4.50   |
| 3A5      | .75    | 6J4       | 1.75   | 396A/2C51  | 1.50   | 5561/FG104  | 50.00  | 6299         | 37.50  |
| 3AP1     | 3.50   | 6J4WA     | 2.50   | 398A/5603  | 3.00   | 5586        | 125.00 | 6316/BL800A  | 100.00 |
| 3B4      | 2.50   | 6J6W      | .60    | 401A/5590  | 1.00   | 5608A       | 6.00   | 6322/BL25    | 12.50  |
| 3B24W    | 3.00   | 6J6WA     | 1.00   | 403B/5591  | 3.00   | 5636        | 2.25   | 6336         | 8.75   |
| 3B24WA   | 5.00   | 6K4       | 2.00   | 404A/5847  | 7.50   | 5642        | 2.25   | 6336A        | 12.75  |
| 3B25     | 2.50   | 6L6GAY    | .75    | 407A       | 3.75   | 5643        | 3.00   | 6344/QK235   | 500.00 |
| 3B26     | 2.25   | 6L6WGA    | 1.50   | 408A/6028  | 2.75   | 5647        | 3.50   | 6350         | 1.25   |
| 3B28     | 3.00   | 6L6WGB    | 2.00   | 409A/6AS6  | 1.00   | 5651        | 1.00   | 6352         | 7.50   |
| 3B29     | 5.00   | 6Q5G      | 2.50   | 410R       | 75.00  | 5654/6AK5W  | 1.50   | 6385         | 10.00  |
| 3BP1A    | 7.50   | 6SJ7WGT   | 1.25   | GL-414     | 80.00  | 5656        | 5.00   | 6390         | 125.00 |
| 3C22     | 15.00  | 6SK7W     | .75    | 416B/6280  | 20.00  | 5663        | 1.00   | 6394         | 12.75  |
| 3C23     | 4.00   | 6SK7WA    | 2.00   | 417A/5842  | 9.50   | 5665/CT6J   | 35.00  | 6438         | 5.00   |
| 3C24/24G | 7.50   | 6SL7WGT   | 1.00   | 418A       | 9.50   | 5667        | 125.00 | 6442         | 25.00  |
| 3C33     | 7.50   | 6SN7W     | .50    | 420A/5755  | 5.00   | 5670        | 1.00   | 6463         | 1.00   |
| 3C45     | 3.50   | 6SN7WGT   | 1.00   | 421A/5998  | 7.50   | 5672        | 1.35   | 6485         | 1.50   |
| 3CX100A5 | 12.50  | 6SN7WGTA  | 2.50   | 429A       | 6.50   | 5675        | 10.00  | 6517/QK358   | 500.00 |
| 3D21A    | 5.00   | 6SU7GTY   | .85    | GL-434A    | 10.00  | 5678        | 1.25   | 6533         | 7.50   |
| 3D22     | 8.00   | 6V6GTY    | 1.00   | 450TH      | 40.00  | 5686        | 2.25   | 6542         | 5.75   |
| 3DP1A    | 5.00   | 6X4W      | .75    | 450TL      | 40.00  | 5687        | 1.50   | 6550         | 3.00   |
| 3E29     | 7.50   | 6X4WA     | 1.50   | 578        | 5.00   | 5691        | 5.00   | 6807         | 20.00  |
| 3GP1     | 2.50   | 6X5WGT    | 1.00   | KU-610     | 5.00   | 5692        | 3.50   | 6883         | 3.50   |
| C3J      | 7.50   | 5RL7H     | 100.00 | NL-623     | 10.00  | 5693        | 3.50   | 7034/4X150A  | 15.00  |
| C3J/A    | 9.50   | 7AK7      | 2.50   | 631-P1     | 5.00   | 5696        | 1.00   | 7044         | 1.50   |
| 3J21     | 35.00  | 7MP7      | 22.50  | 673        | 15.00  | 5718        | 1.50   | 7580         | 35.00  |
| 3J31     | 100.00 | 10KP7     | 15.00  | 676        | 30.00  | 5720/FG33   | 17.50  | 8002R        | 25.00  |
| 3JP1     | 5.00   | 12AT7WA   | 1.50   | 677        | 40.00  | 5721        | 100.00 | 8005         | 10.00  |
| 3K21     | 125.00 | 12AU7WA   | 1.50   | 701A       | 5.00   | 5725/6AS6W  | 1.50   | 8008         | 7.75   |
| 3K22     | 125.00 | 12AX7W    | 1.35   | 703A       | 1.50   | 5726/6AL5W  | .75    | 8013A        | 5.00   |
| 3K27     | 150.00 | 12AY7     | 1.00   | 707B       | 2.50   | 5727/2D21W  | 1.25   | 8014A        | 30.00  |
| 3K30     | 100.00 | C16J      | 25.00  | 715C       | 15.00  | 5728/FG67   | 10.00  | 8020         | 4.50   |
| 3KP1     | 9.75   | FG-17     | 5.00   | 719A       | 12.50  | 5749/6BA6W  | 1.00   | 8025A        | 7.50   |
| 3RP1     | 7.50   | HK-24     | 5.00   | 721B       | 5.00   | 5750/6BE6W  | 1.50   | 9003         | 2.00   |
| 3WP1     | 12.50  | 25T       | 10.00  | 723A/B     | 3.50   | 5751/12AX7W | 1.35   | 9005         | 3.50   |

ALL TUBES ARE NEW, INDIVIDUALLY CARTONED, FULLY GUARANTEED

## western engineers

ELK GROVE, CALIFORNIA

SUPPLIERS OF ELECTRON TUBES SINCE 1932

Prices FOB  
Min order \$10

TELEX or TWX:  
Elk Gr Cal 123  
Telephone:  
916-685-9582

# HIGH FREQUENCY SETS • ELECTRIC MACHINERY UNICORE

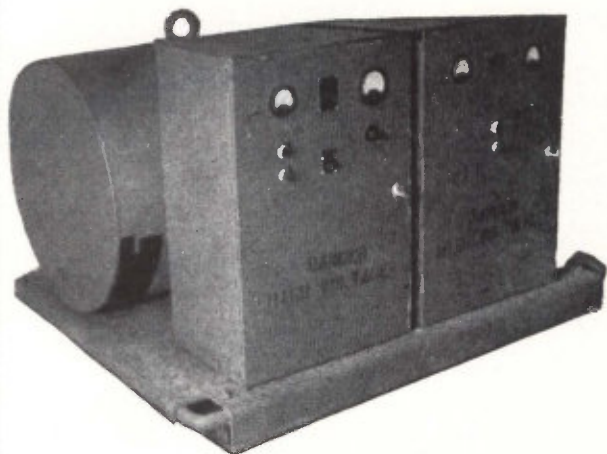

ACTUAL PHOTO

20 Sets, Type BRKT  
 Ball Bearing, Drip Proof  
 62.5 KVA - 3 PH. - 400 CYC.  
 120/208 VOLTS-0.8 P.F.

DRIVEN BY . . .

Synchronous 3 ph.  
 60 Cyc.—440 volts  
 1200 RPM—1.0 P.F.

With all controls mounted on 1 base  
 Government surplus Near new condition

Ask for complete 400 cycle stock list  
 Other sizes in stock! Inquire!

AC-DC Motor Generator Sets

Special low price \$2975. ea.

**EMPIRE ELECTRIC CO., INC.** 5200 FIRST AVE., BROOKLYN 32, N.Y.  
 HYacinth 2-5555

CIRCLE 954 ON READER SERVICE CARD

*Wilgreen*  
 can deliver **Amphenol**  
**Bendix**  
**Cannon**  
**CONNECTORS**  
**FITTINGS & CLAMPS**

We stock more than 5,000,000 MS/AN CONNECTORS of 50,000 variations! In PRODUCTION QUANTITIES . . . we sell BELOW "O.E.M." PRICE . . . and offer IMMEDIATE "OFF-THE-SHELF" DELIVERY!

**FREE** . . . Send for latest brochure "LIST-PRICE SHEET"

WILGREEN INDUSTRIES, Inc.  
 102 Warren Street, New York 7, N. Y.  
 WOrth 4-2490-1-2 Wire: FXX

CIRCLE 956 ON READER SERVICE CARD

**SMALL AD but BIG STOCK**  
 of choice test equipment  
 and surplus electronics  
 Higher Quality—Lower Costs  
 Get our advice on your problem  
**ENGINEERING ASSOCIATES**  
 434 Patterson Road — Dayton 19, Ohio

CIRCLE 957 ON READER SERVICE CARD

**FREE...CATALOG**  
**TUBE & COMPONENT**  
**BARRY ELECTRONICS**

512 BROADWAY NEW YORK 12, N.Y. WAlker 5-7000 TWX- NY 1-3731

CIRCLE 958 ON READER SERVICE CARD

## SEARCHLIGHT Equipment Locating Service

NO COST OR OBLIGATION

This service is aimed at helping you, the reader of "SEARCHLIGHT", to locate Surplus new and used electronic equipment and components *not* currently advertised. (This service is for USER-BUYERS only).

How to Use: Check the dealer ads to see if what you want is not currently advertised. If not, send us the specifications of the equipment wanted on the coupon below, or on your own company letterhead to:

**Searchlight Equipment Locating Service**  
 c/o ELECTRONICS, P. O. Box 12, N. Y. 36, N. Y.

Your requirements will be brought promptly to the attention of the equipment dealers advertising in this section. You will receive replies directly from them.

---

*Searchlight Equipment Locating Service*  
 c/o ELECTRONICS, P. O. Box 12, N. Y. 36, N. Y.

Please help us locate the following equipment components.

.....

NAME ..... TITLE.....

COMPANY ..... STREET ..... CITY ..... 7/13/62

# INDEX TO ADVERTISERS



Audited Paid Circulation

|  |           |   |           |
|--|-----------|---|-----------|
| AMP Incorporated, Capatron Div. ....   | 15        | Mallory and Co., Inc., P. R. ....                     | 24, 25    |
| Airpax Electronics, Inc. ....  | 89        | Markel & Sons, L. Frank ....                          | 98        |
| American Bosch Arma Corp.,<br>Teledynamics Div. ....   | 64        | McGraw-Hill Book Co. ....                             | 68        |
| Ampex Corporation ....   | 10        | Meller Co., Adolf ....                                | 99        |
| Applied Development Corp. ....   | 97        | Minnesota Mining & Mfg. Co.<br>Chemical Div. ....     | 63        |
| Arnold Engineering Co., The. ....  | 5         | Mitsumi Electric Co., Ltd. ....                       | 66        |
| Beattie-Coleman Inc. ....  | 84        | Moseley Co., F. L. ....                               | 86        |
| Bendix Corporation<br>Red Bank Division ....   | 61        | Navigation Computer Corp. ....                        | 100       |
| Scintilla Division ....  | 11        | Northern Radio Co., Inc. ....                         | 95        |
| Blnswanger Corp. ....  | 97        | Northrop Corp. ....                                   | 83, 85    |
| Birtcher Corporation, The ....   | 74        | Potter Instrument Co., Inc. ....                      | 21        |
| Boeing Co., The ....   | 73        | Precision Instrument Co. ....                         | 92        |
| Bussmann Mfg. Co., Div. of<br>McGraw Edison Co. ....   | 67        | Radio Corporation of America ... 4th Cover            |           |
| Chart-Pak, Inc. ....   | 108       | Radio Engineering Laboratories, Inc. ....             | 91        |
| Clarostat Mfg. Co., Inc. ....  | 27        | Raychem Corp. ....                                    | 32, 33    |
| Cross Co., H. ....   | 66        | Reliance Electric and Engineering Co. ....            | 97        |
| Data-Control Systems, Inc. ....  | 81        | Sanyo Electric Inc. ....                              | 88        |
| De Kalb Industrial Committee. ....   | 101       | Servo Corporation of America ....                     | 107       |
| Delta Design, Inc. ....  | 75        | Simpson Electric Company ....                         | 19        |
| Di Acro Corp. ....   | 95        | Southern Electronics Corp. ....                       | 100       |
| duPont de Nemours & Co., Inc. E. I. ....   | 71        | Spencer-Kennedy Laboratories, Inc. ....               | 68        |
| Dymec, A Division of<br>Hewlett Packard Co. ....   | 18        | Sperry Electronic Tube Div.<br>Sperry Rand Corp. .... | 3rd Cover |
| Dynamics Instrumentation Co. ....  | 93        | Sprague Electric Co. ....                             | 4, 31     |
| Eitel-McCullough, Inc. ....  | 6         | Standard Electric Time Co., The. ....                 | 65        |
| Electrodynamical Instrument Corporation. ....  | 22        | Texas Instruments Incorporated. ....                  | 55        |
| Electronic Engineering Co. of Calif. ....  | 68        | Trio Laboratories, Inc. ....                          | 60        |
| Electronic Instrument Co., (EICO) ....   | 82        | Trygon Electronics Inc. ....                          | 34        |
| Electronic Measurements Co. Inc. ....  | 99        | U. S. Stoneware ....                                  | 23        |
| Fansteel Metallurgical Corp. ....  | 35        | Utica Drop Tool Division,<br>Kelsey-Hayes Co. ....    | 80        |
| Ford Instrument Co. Div. of<br>Sperry Rand Corp. ....  | 84        | Western Electric Co. Laureldale Plant. ....           | 36        |
| GPS Instrument Co., Inc. ....  | 72        | Westronics Inc. ....                                  | 98        |
| General Dynamics Telecommunication. ....   | 74        |   |           |
| General Electric Co.<br>Rectifier Components Dept. ....                                      | 16        |   |           |
| General Findings Inc. ....   | 82        |   |           |
| General Radio Co. ....   | 2nd Cover |   |           |
| Gertsch Products, Inc. ....  | 90        |   |           |
| Gorham Electronics ....  | 75        |   |           |
| Graphic Systems, Inc. ....   | 95        |   |           |
| Green Instrument Co., Inc. ....  | 94        |   |           |
| Hart Manufacturing Co. ....  | 58        |   |           |
| Heiland Division,<br>Minneapolis-Honeywell Co. ....  | 78, 79    |   |           |
| Hewlett-Packard Company ....   | 12, 13    |   |           |
| Hoffman Electronics Corp. ....   | 9         |   |           |
| Hughes Aircraft Co. ....   | 94        |   |           |
| Image Instruments Inc. ....  | 95        |   |           |
| International Telephone and Telegraph<br>Corp., Components Division<br>Kellogg Division .... | 77, 59    |   |           |
| James Electronics Inc. ....  | 26        |   |           |
| Kepeco, Inc. ....  | 57        |   |           |
| Knights Company, James<br>Kyoritsu Electrical Instruments Works,<br>Ltd. ....                | 93, 91    |   |           |
| L & R Mfg. Co. ....  | 91        |   |           |
| Leach and Gatner Co. ....  | 82        |   |           |
| Levin and Son, Inc., Louis. ....   | 17        |   |           |
| Lockheed Calif. Co. ....   | 69        |   |           |
| Mabuchi Shoji K.K. ....  | 75        |   |           |
| Mace Electronics, Inc. ....  | 87        |   |           |

## CLASSIFIED ADVERTISING

F. J. Eberle, Business Mgr.

## EMPLOYMENT OPPORTUNITIES 103, 104

## EQUIPMENT

(Used or Surplus New)

For Sale .....104-106

## INDEX TO CLASSIFIED ADVERTISERS

|  |     |
|--|-----|
| Atomic Personnel Inc. ....                                     | 103 |
| Barry Electronics Corp. ....                                   | 106 |
| Communications Equipment Co. ....                              | 104 |
| Electro Sales Co. ....   | 104 |
| Empire Electric Co., Inc. ....                                 | 106 |
| Engineering Associates ....                                    | 106 |
| Esquire Personnel Inc. ....                                    | 103 |
| International Business Machines, Space<br>Guidance Center .... | 103 |
| Microwave Services International, Inc. ....                    | 103 |
| Radio Research Instrument Co. ....                             | 106 |
| Republic Aviation Corp. ....                                   | 104 |
| Universal Relay Corp. ....                                     | 105 |
| Western Engineers ....   | 105 |
| Wilgreen Industries Inc. ....                                  | 106 |
| Union Carbide Nuclear Company. ....                            | 103 |

This Index and our Reader Service Numbers are published as a service. Every precaution is taken to make them accurate, but ELECTRONICS assumes no responsibilities for errors or omissions.

## PULSE POINTERS

Double Pulse Generator  
Recommended For  
Semi-Automatic  
Checkout Systems

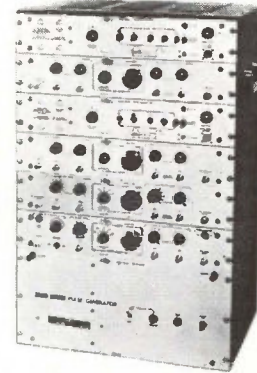

Model 2140A Precision Double Pulse Generator

**Fast rise time, calibrated controls, separate or mixed signals**—Pulse simulation and control problems are easily resolved over a broad range by the multiple capabilities of SERVO-PULSE™ Model 2140A Precision Double Pulse Generator. Reliable output parameters allow immediate use of the equipment without calibration and monitoring instruments. Model 2140A offers wide-range adaptability to special purpose applications through the use of standard pulse and digital circuit modules.

**Compact, Medium-Power Pulse Generator Features Modular Adaptability**

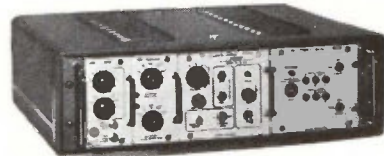

Model 3350A Pulse Generator

**Fast rise time pulses are fully controllable in a variety of parameters**—Model 3350A Pulse Generator offers broad performance range in a unit designed for console mounting. Uses include pulse circuit design and testing of RADAR, navigational systems, digital computers, and control systems. It may be operated from the internal oscillator, slaved to an external trigger, or used single shot by pushbutton for transient testing. SERVO-PULSE™ Model 3350A has 2 mc-2 cps rep rate and 10 nanosecond rise time.

For complete details, write:

**SERVO-PULSE™ PRODUCTS**  
**SERVO CORPORATION OF AMERICA**



111 New South Road  
Hicksville, L. I., N. Y.  
WE11s 8-9700

# TRANS-PAK!

## A New Concept for making Printed Circuit Masters

- Easy to Use
- Distortion-free Placement
- 40% Faster
- 100% Accuracy

With new Trans-Pak, you POSITION, PRESS, PEEL for fast, accurate, distortion-free die-cut symbol placement. It's a strictly HANDS OFF APPLICATION. No fumbling, no picking off, no eye strain, no tools needed.

Trans-Pak symbols are packaged 250 to a roll, in pressure sensitive ruby red translucent or black crepe paper. 18 outside diameter sizes range from .100" to .500". We furnish both standard and special shapes and sizes. NO ADDED DIE CHARGES.

Write today for full details and samples of the new Trans-Pak printed circuit method.

### CHART-PAK, INC.

ORIGINATOR OF THE TAPE METHOD OF DRAFTING

164 River Road, Leeds, Massachusetts  
Dealers in principal cities in U. S. and Canada  
(See Yellow Pages)

electronics



Audit Bureau  
of Circulations



Associated Business  
Publications

Audited Paid Circulation

JAMES T. HAUPTLI

Advertising Sales Manager

R. S. QUINT:  
Assistant Publisher Buyers'  
Guide and Business Manager  
FRED STEWART:  
Promotion Manager  
B. ANELLO:  
Market Services Manager

RICHARD J. TOMLINSON:  
Production Manager  
GEORGE E. POMEROY:  
Classified Manager  
HUGH J. QUINN:  
Circulation Manager

#### ADVERTISING REPRESENTATIVES

NEW YORK (36):  
Donald H. Miller, Henry M. Shaw,  
George F. Werner  
500 Fifth Avenue, LO-4-3000  
(area code 212)

BOSTON (16):  
William S. Hodgkinson, Donald R. Furth  
McGraw-Hill Building, Copley Square,  
Congress 2-1160 (area code 617)

PHILADELPHIA (3):  
Warren H. Gardner, William J. Boyle  
6 Penn Center Plaza, LOcust 8-4330  
(area code 215)

CHICAGO (11):  
Harvey W. Wernecke, Robert M. Denmead  
645 North Michigan Avenue, Mohawk 4-5800  
(area code 312)

CLEVELAND (13):  
Paul T. Fegley  
55 Public Square, Superior 1-7000  
(area code 216)

SAN FRANCISCO (11):  
R. C. Alcorn  
255 California Street, Douglas 2-4600  
(area code 415)

LOS ANGELES (17):  
Peter S. Carberry, Ashley P. Hartman  
1125 W. 6th St., Huntley 2-5450  
(area code 213)

DENVER (2):  
J. W. Patten  
Tower Bldg., 1700 Broadway,  
Alpine 5-2981 (area code 303)

ATLANTA (9):  
Michael H. Miller, Robert C. Johnson  
1375 Peachtree St. N.E., Trinity 5-0523  
(area code 404)

HOUSTON (25):  
Joseph C. Page, Jr.  
Prudential Bldg., Holcomb Blvd.,  
Riverside 8-1280 (area code 713)

DALLAS (1):  
Frank Le Beau  
The Vaughn Bldg., 1712 Commerce St.  
Riverside 7-9721 (area code 214)

LONDON W1:  
Edwin S. Murphy Jr.  
34 Dover St.

FRANKFURT/Main:  
Matthée Herfurth  
85 Westendstrasse

GENEVA:  
Michael R. Zeynel  
2 Place du Port

#### "Headquarters for Business Information"

#### McGraw-Hill Technical and Business Publications

American Machinist/Metal-  
working Manufacturing  
Aviation Week and Space  
Technology  
Business Week  
Chemical Engineering  
Chemical Week  
Coal Age  
Construction Methods and  
Equipment  
Construction Daily  
Control Engineering  
Electrical Construction  
and Maintenance  
Electrical Merchandising Week  
Electrical Newsletter  
Electrical West

Electrical Wholesaling  
Electrical World  
Electronics  
Engineering Digest  
Engineering and Mining Journal  
E & MJ Metal and Mineral  
Markets  
Engineering News-Record  
Factory  
Fleet Owner  
Industrial Distribution  
National Petroleum News  
Nucleonics  
Nucleonics Week  
Platt's Oilgram News  
Platt's Oilgram Price Service  
Power

Product Engineering  
Purchasing Week  
Science Week  
Textile World

Overseas only:  
Automobile International  
(English, Spanish)  
Ingenieria Internacional  
Construccion (Spanish)  
International Management  
(English, Spanish  
Portuguese editions)  
Metalworking Production  
(Great Britain)

Available by subscription only — to qualified persons actively engaged in the field of the publication. For subscription rates and information describing the editorial coverage of any of the above publications, write to: Subscription Manager, Circulation Department, McGraw-Hill Publishing Company, 330 West 42nd Street, New York 36, N. Y.



## Sperry offers 60-day delivery on a low-cost K band reflex klystron

The SRK-291, a new low-cost K band reflex klystron oscillator offering dramatic cost savings in microwave systems, is now available from Sperry Electronic Tube Division within 60 days from receipt of your order! Sperry's new tube operates at frequencies ranging from 21 to 24.5 Gc. Within these frequency limits, it offers a 1½ Gc mechanical tuning range and a low temperature coefficient. The SRK-291 is priced at only \$1495.

### PARAMETRIC PUMPING APPLICATIONS

The SRK-291 is specially suited to the requirements of parametric amplifier pumping, since its power output — 80 mW minimum — is more than adequate for parametric amplifier pumping demands. Its low price, wide bandwidth, and inherent stability remove the technical and economic limitations that for-

merly hindered the use of parametric amplifiers in many systems.

### OTHER APPLICATIONS

Sperry's versatile new tube also shows great desirability for application in short range communications systems, beacons, and microwave links. Extreme mechanical ruggedness, light weight (only 3½ oz.), and small size, make the tube ideal for airborne as well as ground-based installations.

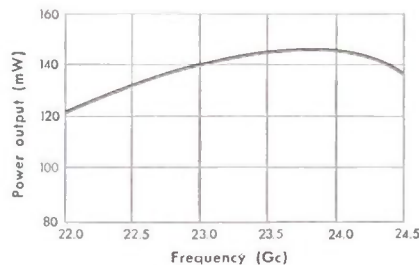

SRK-291, typical P out vs. Freq.

### NEW, FREE BROCHURE

*A new, free brochure describes the capabilities of the SRK-291 in greater detail. For your copy, write to Sperry Electronic Tube Division, Sec. 141, Gainesville, Florida.*

Since the SRK-291 is available within 60 days, it represents an *immediate* solution to your present problems, whether you are designing a new system or concentrating on improved performance for an operational one. Cain & Co., which represents Sperry nationally, has a sales engineer near you. He'll be happy to help you work out specification details. Call him today.



GAINESVILLE, FLA. / GREAT NECK, N. Y.  
SPERRY RAND CORPORATION

CIRCLE 901 READERS SERVICE CARD



INTEGRAL-  
CIRCUIT  
TRIODE

## RCA A15038 COAXITRON

### Integral Cavity Design Means Greater Reliability Over Broader Bandwidth

Broad bandwidth and outstanding power-output uniformity mark the new RCA A15038—a developmental Coaxitron—as a quality, high- $\mu$  super-power triode. A linear amplifier incorporating integral circuitry, the A15038 is designed for use in long-range search radar, broad-band multi-channel communications, and wherever electronic pulse-to-pulse frequency agility is important.

This RCA Triode Coaxitron operates with exceptional power-output uniformity in the range of 400 to 450 Mc and covers the range of 385 to 465 Mc to the  $-3$ db power-output level.

In short pulse service (pulse duration: 30  $\mu$ sec), its efficiency is 43 per cent—at a gain of 13 db. Power output capability is 5 megawatts, minimum.

Operation of RCA A15038 over this bandwidth is made possible by integrating the radio-frequency input

and output circuitry, high-voltage blocking circuit and the gridded tube structure within a common vacuum envelope. The tube is suited to a variety of modulation techniques—amplifying at any frequency within the pass-band at which it is driven.

Developed by RCA for the Rome Air Development Center, A15038 Coaxitron also features a low temperature matrix-oxide filamentary cathode to provide high emission, long life, and economical operation. These and other features combine to provide greater power output, broader bandwidth, higher power gain, better stability and greater reliability.

For further information contact your RCA Industrial Tube Representative or write: Marketing Manager, Industrial Tube Products, RCA Electron Tube Division, Lancaster, Pennsylvania.



THE MOST TRUSTED NAME IN ELECTRONICS

**INDUSTRIAL TUBE PRODUCTS FIELD OFFICES—OEM Sales:** Newark 2, N. J., 744 Broad St., HU 5-3900 • Chicago 54, Ill., Suite 1154, Merchandise Mart Plaza, WH 4-2900 • Los Angeles 22, Calif., 6801 E. Washington Boulevard, RA 3-8361 • Burlingame, Calif., 1838 El Camino Real, OX 7-1620. **Government Liaison:** Harrison, N. J., 415 South Fifth St., HU 5-3900 • Dayton 2, Ohio, 224 N. Wilkinson St., BA 6-2366 • Washington 7, D.C., 1725 "K" St., N.W., FE 7-8500. **International Sales:** RCA International Division, Clark, N. J., FU 1-1000