

TRINIDAD RADAR

*probes missile trails,
tracks satellites, p 20*

(photo below)

THE SOUND OF MUSIC

*synthesized in ring-
bridge modulator, p 33*

LOGARITHMIC LINE CHARTS

*straightening out the
Smith chart, See p 48*

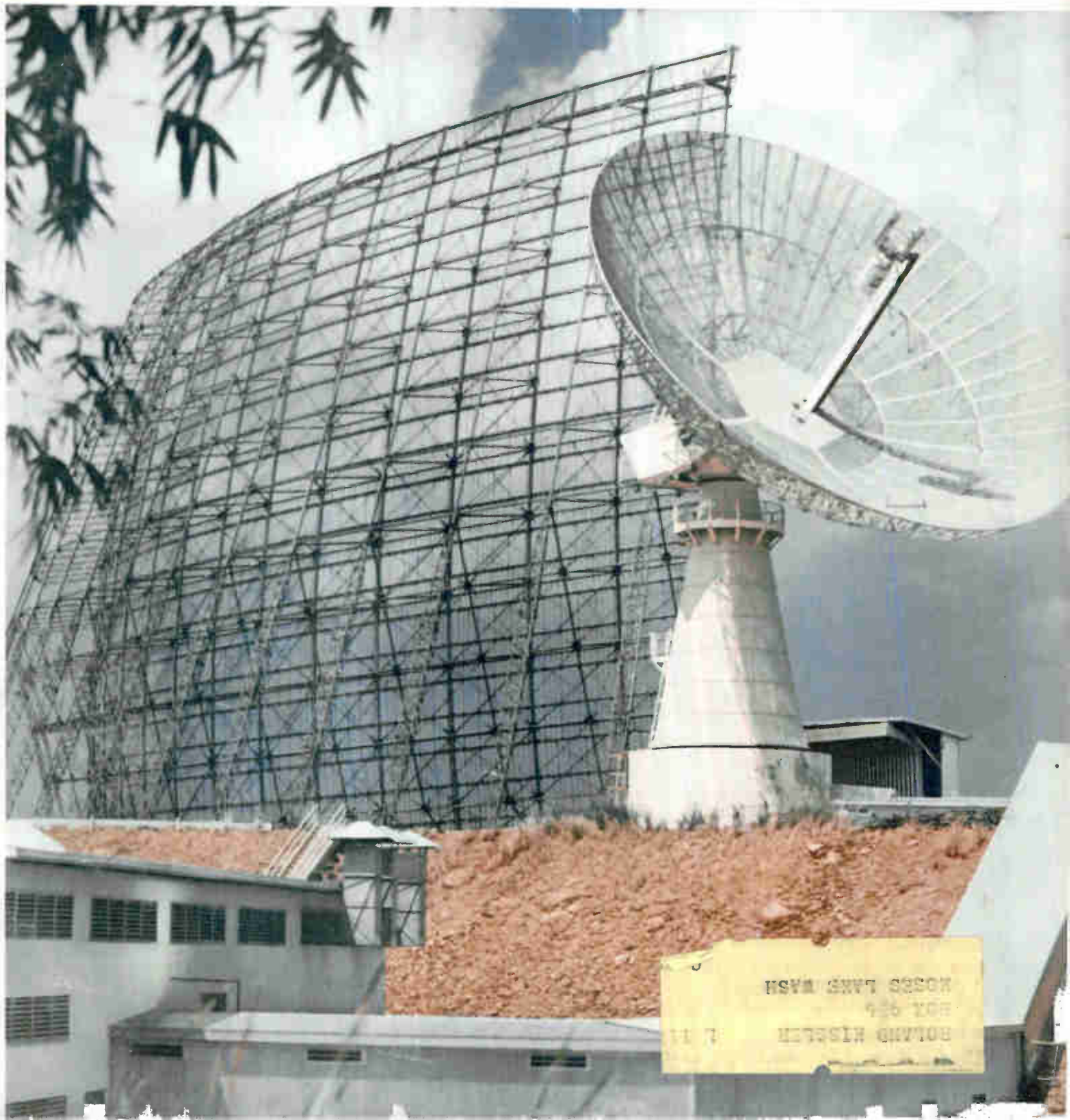

ROSS TAKE WASH
HOT 664
HOWARD HISENBERG

Versatile Enough to "Specialize"

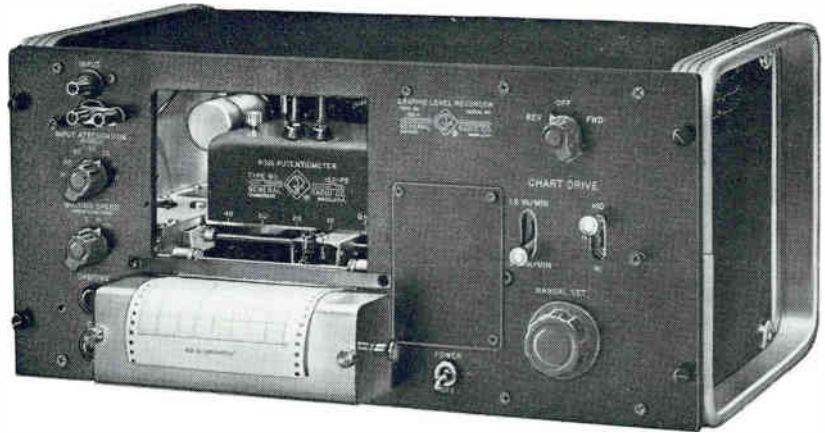

At CBS Laboratories,
Stamford, Conn.

General Radio Type 1521-A
Graphic Level Recorders
serve in three specialized applications:

1521-A Graphic Level Recorder . . . \$995

- ★ **Frequency Range:** 20 cps to 200 kc for level recording; dc recording (with accessory d-c pot), dc to 10 cps.
- ★ **Recording Range:** 0 to 40 db (20-db and 80-db pots available as accessories); 0 to 0.8 v with d-c pot.
- ★ **Input Sensitivity:** 1 mv (corresponds to 0 db). Can be varied from 1 mv to 1 v in steps of 10 db with 60-db input attenuator.
- ★ **Accuracy:** ±1% of full scale.
- ★ **Input Impedance:** 10,000 ohms as ac level recorder, 1000 ohms as dc recorder.
- ★ **Pen Writing Speed:** 20 in/sec (200 db/sec) max. with 40-db pot with less than 1 db overshoot. Slower speeds (1, 3, or 10 in/sec) selectable by switch to provide mechan-

ical filtering of rapidly fluctuating levels.

★ **Paper Speed:** 2.5 to 75 in/min; slow-speed model available with speeds from 2.5 to 75 in/hr.

★ **Price:** \$995 with 40-db pot. (accessory 20-db and d-c pots \$55 each; 80-db pot \$155)

Accessories Needed for Frequency Response Recording

Type 1304-B Beat-Frequency Generator, \$680 . . . Couples to recorder for completely automatic response recording

Type 1521-P10 Drive Unit, \$72 . . .

Power take off from Recorder to drive generator

Type 1521-P11 Link Unit, \$18 . . .

Couples Drive Unit to Generator

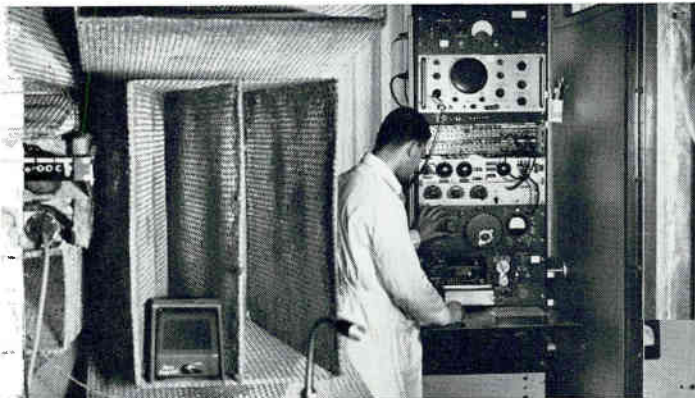

▲ **ANECHOIC-CHAMBER INVESTIGATIONS** CBS Laboratories finds the 1521-A Recorder and 1304-B Generator combination indispensable for anechoic chamber investigations of microphones, amplifiers, and other acoustical equipment. With this system, frequency response curves over the full audio range can be made in less than a minute.



▲ **EQUALIZER NETWORK MEASUREMENTS** 1521-A Recorder chain-coupled to a G-R 1304-A Beat-Frequency Generator records the frequency response of equalizer networks. The chain coupling drives the generator's dial in complete synchronism with the recorder to produce a continuous logarithmic response curve. The system is automatic and has far greater accuracy than methods requiring meter watching and point-by-point plotting.

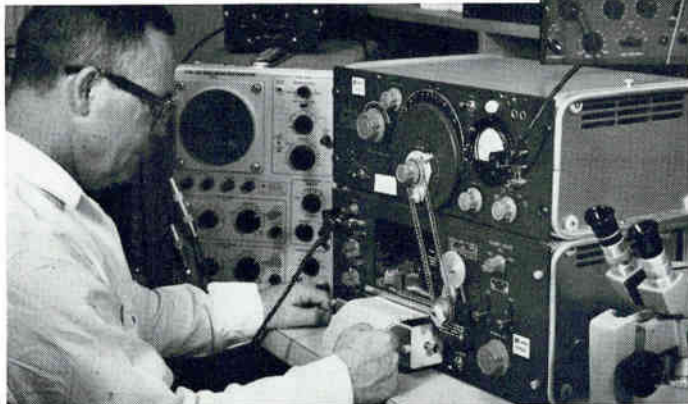

◀ **RECORDING-HEAD RESPONSE CHECKS** Detailed frequency-response characteristics of magnetic recording heads are obtained quickly with the G-R Graphic Level Recorder. The measurement involves the use of a series of wavelength dependent nulls which are a function of the effective gap of the recording head.

Photos Courtesy of CBS Laboratories, A Division of Columbia Broadcasting Systems, Inc.

Write for Complete Information

GENERAL RADIO COMPANY

WEST CONCORD, MASSACHUSETTS

NEW YORK, Worth 4-2722
District Office in Ridgefield, N. J.
WHitney 3-3140

CHICAGO
Oak Park
Village 8-9400

PHILADELPHIA
Abington
HAncock 4-7419

WASHINGTON, D. C.
Silver Spring
JUniper 5-1088

SYRACUSE
Syracuse
GLenview 4-9323

SAN FRANCISCO
Los Altos
WHitecliff 8-8233

LOS ANGELES
Los Angeles
HOLLYWOOD 9-6201

ORLANDO, FLA.
Orlando
GArden 5-4671

IN CANADA
Toronto
CHerry 6-2171

December 1, 1961

electronics

A McGraw-Hill Publication 75 Cents



W. W. MacDONALD, Editor

J. M. CARROLL, Managing Editor
 SENIOR EDITORS: Samuel Weber, George W. Sideris. SENIOR ASSOCIATE EDITORS: William E. Bushor, Michael F. Wolff. ASSOCIATE EDITORS: Michael F. Tomaino, Sylvester P. Carter, William P. O'Brien, John F. Mason, Thomas Emma, Sy Vogel, Leslie Solomon, M. M. Perugini, George J. Flynn, Laurence D. Shergalis. ASSISTANT EDITORS: Nilo Lindgren, Stanley Froud, Stephen B. Gray, Roy J. Bruun, George V. Novotny, Leon H. Dulberger. REGIONAL EDITORS: Harold C. Hood (Pacific Coast, Los Angeles), Thomas Maguire (New England, Boston), Cletus M. Wiley (Midwest, Chicago). ART DIRECTOR: Harry Phillips; HOWARD R. BERRY. PRODUCTION EDITOR: John C. Wright, Jr. EDITORIAL ASSISTANTS: Gloria J. Meurer, Bernice Duffy, Lorraine Rossi, Virginia T. Bastian, Lynn Emery, Laura W. Smith, Bette H. Snyder, Rosemary Abbruzzese, Judy Haskins.

JAMES GIRDWOOD, Publisher

Trinidad radar installation with prototype of Bmews scanner and 84-foot tracking antenna is used for missile defense studies and does part time satellite tracking. See p 20 **COVER**

MISSILE DETECTION RADARS Get New Space Jobs. Air Force reveals activities and equipment at long-classified sites in Trinidad and Laredo, Texas. They now hunt for satellites 20

Corkscrew Field Cuts Thermonuclear Fusion Power Needs 21

PHONETIC TYPEWRITER Nears Practical Use. Acoustics engineers report transducer developments, predict communications needs 22

Cryogenics Spurs Magnet R&D. Progress in superconductor materials jumps field strength, scientific and space uses for magnets 24

Engineers Debate Reliability. Shirtsleeve solutions are suggested 26

SOUND SYNTHESIZER Creates New Musical Effects. Unconventional sounds from conventional sources. H. Bode 33

SCANNER ANALYZES COLOR Content of Movie Film. Gives data for producing positives. R. J. Farber and K. M. St. John 38

Subaudio Sawtooth Generator Gives One Percent Linearity. Uses neon tube as switching element. A. Angelone 42

Cobalt in Electronics. Magnetic materials, thin films, ferrites, hermetic seals, printed circuits, semiconductors and masers use cobalt. F. R. Morral 44

REFERENCE SHEET: Logarithmic Transmission-Line Charts. Linear versions of Smith and Carter charts. H. F. Mathis 48

| | | | |
|--------------------------|----|--------------------------|----|
| Crosstalk | 2 | Components and Materials | 60 |
| Comment | 6 | Production Techniques | 64 |
| Electronics Newsletter | 9 | New on the Market | 68 |
| Washington Outlook | 14 | Literature of the Week | 80 |
| Meetings Ahead | 30 | People and Plants | 82 |
| Research and Development | 56 | Index to Advertisers | 89 |

Published weekly, with Electronics Buyers' Guide and Reference issue, as part of the subscription, by McGraw-Hill Publishing Company, Inc. Founder: James H. McGraw (1860-1948).

Title © registered U.S. Patent Office; Copyrighted © 1961, McGraw-Hill Publishing Company, Inc. All rights reserved, including the right to reproduce the contents of this publication, in whole or in part.

Executive, editorial, circulation and advertising offices McGraw-Hill Building, 330 West 42nd Street, New York 36, N. Y. Telephone Longacre 4-3000. Teletype TWX N.Y. 1-1636. Cable McGrawhill, N. Y. PRINTED IN ALBANY, N. Y.; second class postage paid.

OFFICERS OF THE PUBLICATIONS DIVISION: Nelson L. Bond, President; Shelton Fisher, Wallace F. Traendly, Senior Vice Presidents; John R. Callahan, Vice President and Editorial Director; Joseph H. Allen, Vice President and Director of Advertising Sales; A. R. Venezian, Vice President and Circulation Coordinator; Daniel F. Crowley, Vice President and Controller.

OFFICERS OF THE CORPORATION: Donald C. McGraw, President; Hugh J. Kelly, Harry L. Waddell, Executive Vice Presidents; L. Keith Goodrich, Executive Vice President and Treasurer; John J. Cooke, Vice President and Secretary.

Subscriptions are solicited only from those actively engaged in the field of the publication. Position and company connection must be indicated on orders. Subscription rates: United States and Possessions, \$6.00 one year; \$9.00 two years; \$12.00 three years. Canada, \$10.00 one year. All other countries \$20.00 one year. Single Copies, United States and Possessions and Canada 75¢; Buyers' Guide \$3.00; Single copies all other countries \$1.50; Buyers' Guide \$10.00.

THE PUBLISHER, UPON WRITTEN REQUEST FROM ANY SUBSCRIBER TO OUR NEW YORK OFFICE, AGREES TO REFUND THAT PART OF THE SUBSCRIPTION PRICE APPLYING TO COPIES NOT YET MAILED.

Subscribers: Please address all correspondence, change of address notices, subscription orders or complaints to Fulfillment Manager, Electronics, at above address. Change of address notices should provide old as well as new address, including postal zone number if any. If possible, attach address label from recent issue. Allow one month for change to become effective.

Postmaster: Please send Form 3579 to Fulfillment Manager, Electronics, 330 West 42nd Street, New York 36, New York.



Audited Paid Circulation

Classified Competition

OVER THE PAST few years there has been a tendency to hold classified sessions in conjunction with IRE professional group meetings. For example, NAECON in Dayton, PCGS in Utica and ECCANE in Baltimore. While just about every engineer working on a government contract does hold a security clearance—and these are the majority in attendance—there is a small minority that does not.

Now, the IRE is incorporated under the laws of the State of New York as a membership organization. The law states specifically that any such organization must make its meetings and services available to any member in good standing. Legally, no one can be barred from attending any meeting. This includes Russian IRE members.

How do the professional groups get around this problem? They do it by having classified sessions sponsored by an outside organization, namely a military agency. At Dayton, WADC sponsored the classified sessions. Classified sessions at Utica are sponsored by RADC. In Baltimore this fall, no mention was made of the sponsoring agency on the program, but it was probably the Air Force Systems Command at Andrews AFB.

It is commendable that the professional groups have provided interchange of classified technical information without the red tape of "need to know." But we think running them concurrently with other sessions is bad practice. For example, in Baltimore total attendance at an unclassified Microminiaturization and Microwaves session was only about 20 persons. At the concurrent classified session upwards of 200 engineers were in attendance.

Are unclassified papers that much less interesting or that much less important? Don't unclassified papers take just as much effort and time to prepare? Some classified papers are adaptations of reports required under the terms of a contract. Many would not be available for presentation if they were not already in the files. Some are not particularly important.

Several years ago, classified sessions were held on a different day, rather than concurrently with other sessions. Apparently convention chairman have recently felt that they boost attendance during the entire meeting, and at exhibits, by having the sessions concurrent. We think it is a poor way of boosting attendance.

Classified sessions held at the start or at the end of the meeting, would serve to hold the audience. Sessions should not compete with each other.

Specify "ARNOLD"

for your PERMANENT MAGNET requirements

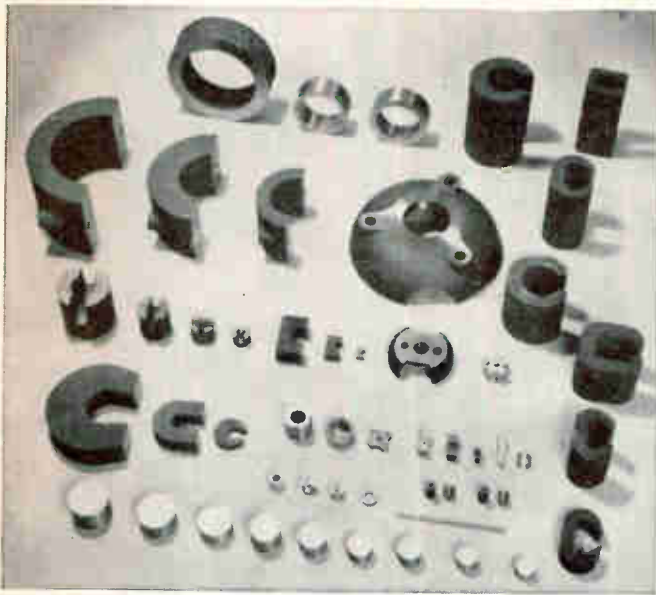

Typical group of Arnold permanent magnets, both cast and sintered types.



Typical group of permanent magnet assemblies.

ALNICO MAGNETS

Arnold permanent magnets are available in all types of Alnico material, in sizes ranging from large castings weighing over 80 pounds to very small sintered parts weighing less than one gram.

Alnico V can usually be depended upon to deliver the greatest energy product to the magnetic circuit per unit weight of magnet material. It is therefore generally the first choice for a magnetic material except where special physical considerations are paramount.

Special assemblies such as rotors, traveling wave tube magnets, magnetron magnets, etc. may be supplied in an aluminum jacket to facilitate mounting and supply an added protection to the magnet.

Large magnet assemblies may also be supplied for mass spectrometer and other measuring applications where a

high degree of stability and uniformity of field is required.

Many sizes and types of Alnico magnets are carried in stock for immediate delivery. For more information, write for Bulletin GC-106C.

ALNICO VIII

Available from Arnold in production quantities, Alnico VIII possesses the highest coercive force of all Alnico grades, as well as a high energy product and a relatively low temperature coefficient. It is especially suited for traveling wave tube focusing applications. Gap flux densities as high as 1000 gauss are attainable in tubular-type straight field focusing magnets. Alnico VIII is also recommended for applications which involve strong demagnetizing fields, or where space considerations dictate the use of a short magnet. Write for Bulletin PM-119.

SPECIAL PERMANENT MAGNET MATERIALS

ARNOX III

Arnox III is a molded-type magnet having high coercive force and moderately low residual induction and energy product. Principal uses are for magnetic requirements which are not stringent, and for a relatively short magnet of reasonable cross section. Accurate dimensions and close tolerances can be economically obtained. These magnets can be premagnetized before assembly, and have very high resistance to demagnetization. Slightly better magnetic properties are obtained in the pressing direction than in other directions.

ARNOX V

Arnox V is a ceramic permanent magnet material composed of highly oriented barium ferrite. It has many times the energy product of Arnox III and is comparable in many applications to Alnico V. Because of its high coercive force, its use is recommended in applications where a short magnetic length is desirable, or where extremely high demagnetizing forces may be encountered.

VICALLOY

Vicalloy is a carbon-free permanent magnet alloy containing about 10% vanadium, 50% cobalt and the balance iron.

Vicalloy may be fabricated in the form of castings, hot rolled bars and forgings, or cold rolled strip, wire and tubing. After suitable heat treatment, the material is quite readily machinable. Vicalloy is available on special order in bar, strip and thin tape for recording purposes.

For more complete information, write for your copy of "The Magneteer," Vol. 2, No. 1.

7806-B



ARNOLD

SPECIALISTS in MAGNETIC MATERIALS

THE ARNOLD ENGINEERING COMPANY, Main Office: MARENGO, ILL.
BRANCH OFFICES and REPRESENTATIVES in PRINCIPAL CITIES

"Touch-and-read" dc

 dependable automatic



voltage measurements

digital voltmeters for lab,
production line, systems!

Simple touch-and-read dc voltage measurements—
Automatic range and polarity selection—
Easily used by inexperienced personnel—
Bright, clear in-line Nixie readout—
Command, recorder outputs*

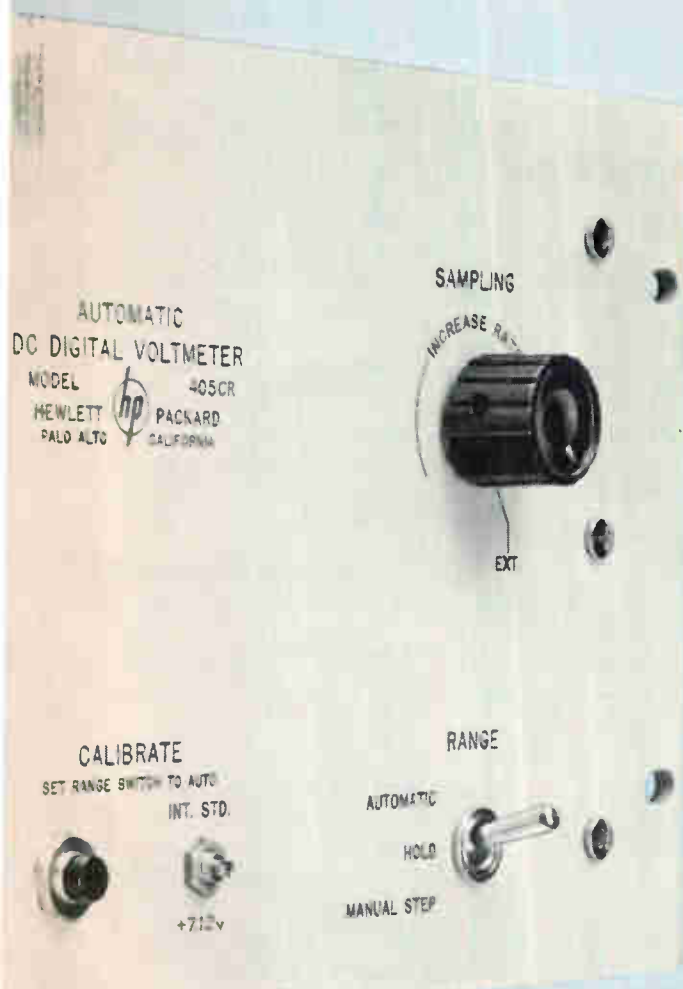

⊕ 405BR/CR Automatic DC Digital Voltmeters automatically zero-set themselves, choose the proper voltage range and polarity and present an accurate reading in bright clear numerals. ⊕ 405BR and CR are identical except that ⊕ 405CR offers unique systems versatility—provisions for external sampling command and recording outputs, plus reading hold-off capability, print command when overranging, and remote readout.

Both instruments feature well known ⊕ reliability, with superior components, circuit design and broad-range environmental dependability, all at moderate price.

Brief Specifications, ⊕ 405BR/CR

| | |
|------------------|---|
| Range: | 0.001 to 999 v dc; 4 ranges |
| Presentation: | 3 significant figures, polarity indicator |
| Accuracy: | ± 0.2% full scale ± 1 count |
| Ranging time: | 0.2 sec to 2 sec |
| Input impedance: | 11 megohms to dc, all ranges |
| Response time: | Less than 1 sec |
| AC rejection: | 3 db at 1.5 cps; min. 44 db at 60 cps |
| Recorder output: | Digital recorder output, ⊕ 405CR only |
| Price: | ⊕ 405BR, \$850.00; ⊕ 405CR, \$925.00 (both rack mount) |

*Model 405CR only.

HEWLETT-PACKARD COMPANY

1068A Page Mill Road Palo Alto, California, U.S.A.
Cable "HEWPACK" DAvenport 6-7000

Sales representatives in all principal areas

HEWLETT-PACKARD S.A.

Rue du Vieux Billard No. 1 Geneva, Switzerland
Cable "HEWPACKSA" Tel. No. (022) 26. 43. 36



SPRAGUE PIEZO- ELECTRIC CERAMIC ELEMENTS



ELEMENTS
FOR ALL
APPLICATIONS
AS WELL AS
COMPLETE

TRANSDUCER ASSEMBLIES
FOR MOST APPLICATIONS,
SUCH AS UNDERWATER
SOUND AND
VARIOUS ORDNANCE AND
MISSILE DEVICES.



Sprague-developed mass production and quality-control techniques assure lowest possible cost consistent with utmost quality and reliability. Here too, complete fabrication facilities permit prompt production in a full, wide range of sizes and shapes.

Look to Sprague for today's most advanced ceramic elements—where continuing intensive research promises new material with many properties extended beyond present limits.



YOUR INQUIRIES
ARE INVITED

WRITE FOR
LITERATURE

SPRAGUE ELECTRIC COMPANY
35 Marshall Street, North Adams, Mass.

SPRAGUE[®]
THE MARK OF RELIABILITY

COMMENT

I was very interested in the article Feedback Linearizes Voltage-To-Frequency Converter, by James D. Long (p 48, Sept. 1). There are, however, two questions I have concerning Mr. Long's presentation of data obtained from his laboratory breadboard.

Mr. Long presents his data as a comparison of the measured frequency to a "theoretical frequency" and he has computed a percent error as a measure of the deviation between actual frequency and theoretical frequency. I would expect some measure of linearity, however, as the title of the article suggests that feedback has been used to improve the linearity of the voltage-to-frequency relationship. Also, Mr. Long has stated the input voltage to be from 0 to 3 volts, yet has presented data for voltages no lower than 0.25 volts.

In order to examine the linearity of the circuit, I have used the data in the article to compile the table below, with percent error as a measure of the deviation from linearity (with the input requirements as stated and a maximum output frequency of 400 cps).

AUTHOR LONG'S TABLE

| E_{in} (Volts) | Theoretical | | Percent Error |
|---------------------|---------------|----------------|------------------|
| | Freq (CPS) | Actual Freq | |
| 0.25 | 43.9 | 43.6 | -0.7 |
| 0.5 | 76.4 | 76.4 | 0 |
| 1 | 141.3 | 141.3 | 0 |
| 1.5 | 206.2 | 206 | -0.1 |
| 2 | 271.1 | 270.9 | -0.07 |
| 2.5 | 336 | 336 | 0 |
| 3 | 400.9 | 401 | +0.05 |
| 3.5 | 465.8 | 465.7 | -0.02 |

READER CRENSHAW'S TABLE

| E_{in} (Volts) | Linear Freq | Measured Freq | Percent Error |
|---------------------|----------------|------------------|------------------|
| 0.25 | 33.3 | 43.6 | 31 |
| 0.5 | 66.7 | 76.4 | 14.5 |
| 1 | 133 | 141.3 | 6.2 |
| 1.5 | 200 | 206 | 3.0 |
| 2 | 267 | 270.9 | 1.5 |
| 2.5 | 333 | 336 | 0.9 |
| 3 | 400 | 401 | 0.25 |
| 3.5 | 466.7 | 465.7 | 0.2 |

You will note that there is a marked difference in the percent

error when the breadboard results are interpreted this way.

If this linearity is sufficient for Mr. Long's requirements, my only question would be his choice of title with respect to his presentation of data, for I am certain you will agree that a 31-percent deviation is not within the generally accepted realm of linearity.

R. P. CRENSHAW
Minneapolis-Honeywell
Regulator Co.
Duarte, California

Author Long takes exception to Reader Crenshaw's linear frequency values as "obviously in opposition to my stated values of theoretically desired frequencies," and continues:

The general equation of a straight line is $Y = mX + b$ where, in this case, Y is equal to the input voltage and X is equal to the output frequency. Mr. Crenshaw's difficulty has arisen, evidently, from his assumption that b in this equation is zero, whereas in fact it is equal to -0.089 . The complete equation is: $Y = (0.5/64.9)X - 0.089$.

This curve, even though it is the theoretically desired one for the specific application, does not pass through zero of the coordinate system. In particular, the theoretical output frequency for an input voltage of zero volts is about 11.5 cps. In the application of the device, the voltage range of 0.5 to 3 volts was of particular interest, and the region near zero input voltage was of no interest.

In the article, an input voltage range of 0 to 3 volts and a maximum output frequency of 400 cps was mentioned to introduce to the reader the general range of operation of the device. The specific values of input voltage and output frequency, for the described circuit application, were listed in the table, and the percent error from the desired theoretical frequency was also exactly as indicated.

The title of the article was not of my design, so the defense of it will be left to others, although it does seem appropriate to me.

To close, the circuit technique is general, but the described application is quite specific.

JAMES D. LONG
Space-General Corporation
Glendale, California

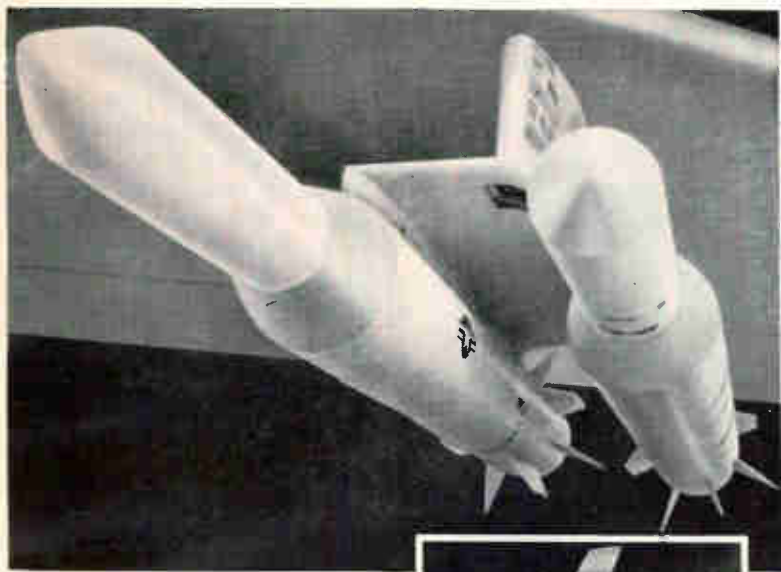

FC-75 takes the heat off "Skybolt's" guidance system

The "Skybolt" ballistic missile under development by Douglas Aircraft will be launched from B52-type bombers. It will blast to a trajectory above the atmosphere, and race at hypersonic speed to a pre-determined target. 3M Brand Fluorochemical Liquid FC-75 will keep the inertial guidance system cool on the trip.

Douglas engineers set these critical specifications for the coolant: it must maintain constant temperature in the guidance system's solid state components . . . have exceptional thermal stability to 750°F.

with pour point of $< -100^{\circ}\text{F}$. . . and remain stable in the temperature range of the missile's flight pattern. The high co-efficiency of heat transfer to minimal space and power requirements earned specification for FC-75.

If you're looking for coolant answers to hot design problems in electronics, missiles, jet aircraft, then investigate the dielectric strength, limited solubility, thermal stability, and low pour points of FC-75 (and FC-43)! Scan the "Properties Profile" to the right, then write for further information . . .

PROPERTIES PROFILE

on

3M INERT LIQUIDS

BRAND

FC-75 and FC-43

These unique dielectric coolants possess unusual properties that can prove advantageous to the designer of electrical devices and instruments, as well as to the manufacturer. Increased range of operating temperatures, improved heat dissipation which permits miniaturization, and greatly increased protection from thermal or electrical overload are possible with their use.

FC-75 and FC-43 are non-explosive, non-flammable, non-toxic, odorless and non-corrosive. They are stable in excess of 750°F., and are completely compatible with most materials . . . even above the maximum temperatures permissible with all other dielectric coolants. Both are self-healing after repeated arcing in either the liquid or vapor state.

ELECTRICAL PROPERTIES

| | FC-75 | FC-43 |
|--|--------|--------|
| Electrical Strength | 35KV | 40KV |
| Dielectric Constant (1 to 40 KC @ 75°F.) | 1.86 | 1.86 |
| Dissipation Factor (1000 cycles) | 0.0005 | 0.0005 |

TYPICAL PHYSICAL PROPERTIES

| | FC-75 | FC-43 |
|---------------------------------------|--|--|
| Pour Point | $< -100^{\circ}\text{F}$. | -58°F . |
| Boiling Point | 212°F. | 340°F. |
| Density | 1.77 | 1.88 |
| Surface Tension (77°F.) (dynes/cm) | 15 | 16 |
| Viscosity Centistokes | 0.65 Min. | 2.74 |
| Thermal Stability | 750°F. | 600°F. |
| Chemical Stability | Inert | Inert |
| Radiation Resistance | 25% change @ 1×10^8 rads | 25% change @ 1×10^8 rads |

FC-75 and FC-43 have nearly equivalent heat capacities in the liquid and gaseous states.

For more information on FC-75 and FC-43, write today, stating area of interest to: 3M Chemical Division, Dept. KAX-121, St. Paul 6, Minn.

ranges were obtainable with electronic modulation methods, but these were not satisfactory for prolonged operation, the British said.

\$300 Two-Color Tv Set Is Introduced in Japan

TWO-COLOR TV set has been introduced in Tokyo by a new company, Orico Color Television. Based on the Land two-color vision theory, the design employs two single-gun tubes. One tube has a green phosphor screen, the other a red screen with a filter to tone down red colors. The two tubes are aligned at a 90-degree angle. Images are blended in a mirror set at 45 degrees. Initial price tag was 100,000 yen.

EIA in Walsh-Healey Wage Controversy

EIA'S WALSH-HEALEY committee reports that labor unions are asking for a \$1.72 electronics wage minimum from the Labor Department. EIA says a survey shows that a minimum above \$1.40 would be too much for small companies, would retard growth in some areas (prevailing minimum in New England was reported as \$1.34) and would raise defense costs.

FAA Takes Head Start On ATC Project Beacon

WASHINGTON — Federal Aviation Agency system design team is implementing recommendations of a presidential task force for a new air traffic control system (ELECTRONICS, p 15, Nov. 17).

FAA is reshaping its R&D program, which had been concentrating on a computer-oriented ATC system relying on position reporting by pilots and gradual introduction of 3-D radar. Most of this work is being shifted back to research and away from hardware.

Project Beacon proposals for altitude-reporting transponders will remove the need for 3-D radar. Work on an automatic ground-air data link will be downgraded be-

cause expanded use of standard radar will sharply reduce need for position reporting.

Automobile Electronics On the Market in Japan

TOKYO—Several manufacturers at the Eighth Annual Tokyo Automobile Show exhibited three-phase alternators with silicon diode rectifiers, transistor ignition systems, alternator and generator regulators, headlight dimmers and a magnetic fuel pump. Many of the devices were still experimental. However, two production model cars have Nippon Denso's germanium diode regulator as standard original equipment. Headlight dimmers using CdS photocells and transistor amplifiers are being sold by Koito Electric and Matsushita Electric.

Third VLF Transmitter To Be Built in England

ANOTHER BIG vlf transmitter for fleet communications is to be built in England, near Carlisle, for NATO. Like the U. S. Navy transmitter at Cutler, Me., and another Navy transmitter under construction in Australia, it will be able to contact submerged submarines.

Continental Electronics Systems was again selected as the contractor, this time by the British Post Office. Continental bid in association with Redifon, Ltd., which will develop a precision frequency generator and other special equipment, and provide some of the technical personnel.

Cubic-Foot Computer Uses Thin-Film Memory

UNIVAC reports development of a general-purpose space computer occupying one cubic foot with a maximum rate of 80,000 operations a second. It uses thin-film memory and welded encapsulated circuit modules. The company says progress in microminiature circuits should result in a half-cubic-foot computer with equal capacity becoming feasible within two years.

In Brief . . .

NASA ANNOUNCES: its nuclear-electric propulsion program is being consolidated at Lewis Research Center, Cleveland; a new satellite tracking station will be built in Pisgah National Forest, N. C.; Chrysler will build 20 Saturn C-1 launch vehicles.

COMPUTERS without air-conditioning can result, RCA says, from its new memory cores which operate at -55 C to 85 C.

ADMIRAL president Ross D. Siragusa predicts eight percent tv-appliance sales rise next year, with tv set volume up around 500,000 to 6.5 million.

INTERNATIONAL agreements include: Raytheon and Japan Radio form New Japan Radio Co. to produce microwave tubes; Raytheon and Warwick will supply parts to a new Argentinian tv assembly firm, Visorama; Solartron, of England, licenses Packard Bell to produce instruments, including low-cost, dual-gun oscilloscope; Siemens & Halske, of Germany, buys 25 percent of U. S. Instrument Corp., communications manufacturer.

NAVIGATION of long-range commercial aircraft by inertial systems, satellites, vlf radio and heading references is being studied for FAA by University of Michigan.

NERVOUS SYSTEM study and simulation research, aimed at advanced computer design, is being done at Librascope under Air Force contract.

MOBILE, computer-based counter-countermeasures system developed by Sylvania for Army field radar is being tested at Fort Bliss, after six-year, \$3 million R&D program.

MILITARY contracts include \$10 million to Magnavox for a new airborne communications system; \$2.3 million to General Precision for doppler radar navigation equipment for B-58; \$2.2 million to Elco for connectors; \$1 million to Collins for airborne equipment and service; \$440,000 to Giannini Controls for gyros for DynaSoar, Polaris and F8U fighters.

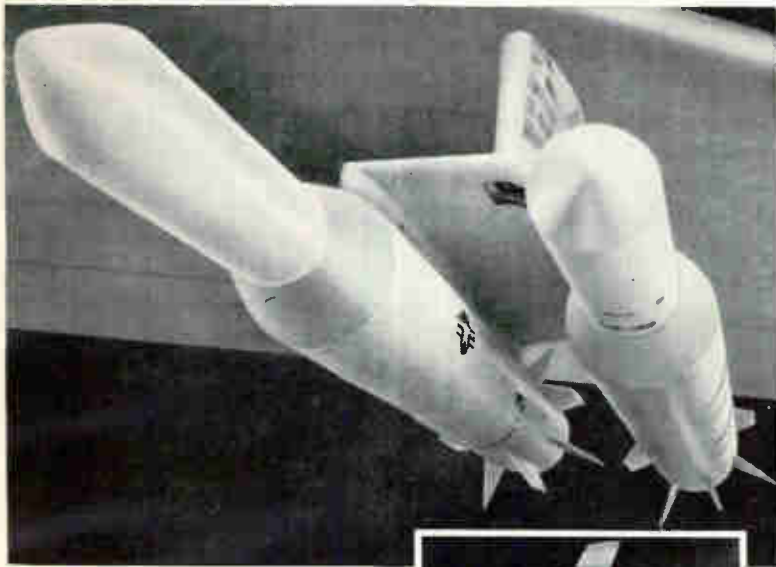

FC-75 takes the heat off "Skybolt's" guidance system

The "Skybolt" ballistic missile under development by Douglas Aircraft will be launched from B52-type bombers. It will blast to a trajectory above the atmosphere, and race at hypersonic speed to a pre-determined target. 3M Brand Fluorochemical Liquid FC-75 will keep the inertial guidance system cool on the trip.

Douglas engineers set these critical specifications for the coolant: it must maintain constant temperature in the guidance system's solid state components . . . have exceptional thermal stability to 750°F.

with pour point of $< -100^{\circ}\text{F}$. . . and remain stable in the temperature range of the missile's flight pattern. The high co-efficiency of heat transfer to minimal space and power requirements earned specification for FC-75.

If you're looking for coolant answers to hot design problems in electronics, missiles, jet aircraft, then investigate the dielectric strength, limited solubility, thermal stability, and low pour points of FC-75 (and FC-43)! Scan the "Properties Profile" to the right, then write for further information . . .

PROPERTIES PROFILE

on

3M INERT LIQUIDS BRAND FC-75 and FC-43

These unique dielectric coolants possess unusual properties that can prove advantageous to the designer of electrical devices and instruments, as well as to the manufacturer. Increased range of operating temperatures, improved heat dissipation which permits miniaturization, and greatly increased protection from thermal or electrical overload are possible with their use.

FC-75 and FC-43 are non-explosive, non-flammable, non-toxic, odorless and non-corrosive. They are stable in excess of 750°F., and are completely compatible with most materials . . . even above the maximum temperatures permissible with all other dielectric coolants. Both are self-healing after repeated arcing in either the liquid or vapor state.

ELECTRICAL PROPERTIES

| | FC-75 | FC-43 |
|--|--------|--------|
| Electrical Strength | 35KV | 40KV |
| Dielectric Constant (1 to 40 KC @ 75°F.) | 1.86 | 1.86 |
| Dissipation Factor (1000 cycles) | 0.0005 | 0.0005 |

TYPICAL PHYSICAL PROPERTIES

| | FC-75 | FC-43 |
|------------------------------------|-----------------------------------|-----------------------------------|
| Pour Point | $< -100^{\circ}\text{F}$. | -58°F . |
| Boiling Point | 212°F. | 340°F. |
| Density | 1.77 | 1.88 |
| Surface Tension (77°F.) (dynes/cm) | 15 | 16 |
| Viscosity Centistokes | 0.65 Min. | 2.74 |
| Thermal Stability | 750°F. | 600°F. |
| Chemical Stability | Inert | Inert |
| Radiation Resistance | 25% change @ 1×10^8 rads | 25% change @ 1×10^8 rads |

FC-75 and FC-43 have nearly equivalent heat capacities in the liquid and gaseous states.

For more information on FC-75 and FC-43, write today, stating area of interest to: 3M Chemical Division, Dept. KAX-121, St. Paul 6, Minn.

Elcor's Current Indicator & Integrator is praised highly in government, university and industrial labs around the world.

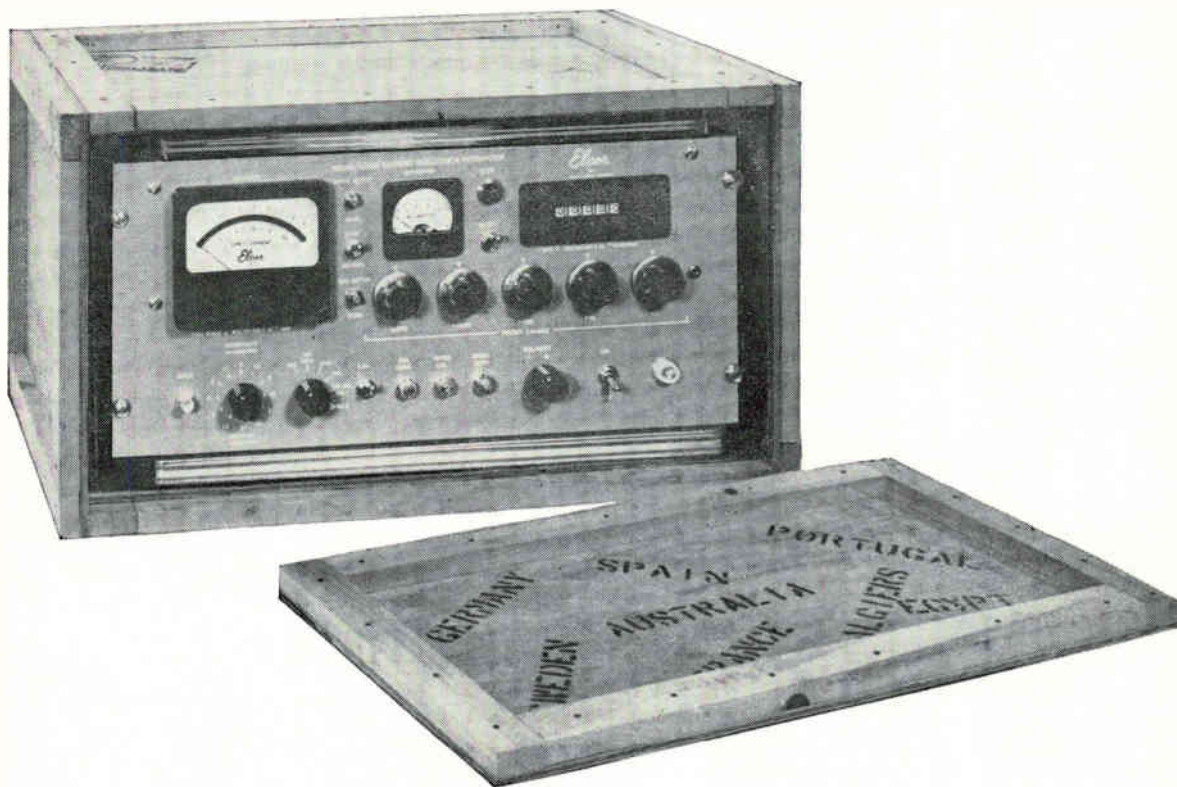

The use of Elcor pioneered Isoplys (Isolated Power Supplies) helps make this instrument unique . . . and highly reliable. Circuitry is advanced. Sensitivity and accuracy are high. Drift is low. Features are many: Internal calibrating current source—Digital read-out—Pre-set control—Versatile external circuit controls.

Although originally designed for use with high-voltage particle accelerators such as the Van de Graaf generator, Elcor's Model A309A Current Indicator and Integrator is ideally suited for other applications: Monitoring and integrating electron or positive-ion beam current—Measuring radiation intensity and total radiation exposure—Integrating any quantity such as nuclear radiation, temperature, displacement, absorption, etc., that can be converted into a proportional current or voltage. Write for full information.



ELCOR Incorporated

*Subsidiary of Welex Electronics Corporation
Sales / R & D Laboratory / Manufacturing
1225 W. Broad Street / Falls Church, Virginia
JEfferson 2-8850*

ELECTRONICS NEWSLETTER

West Ford Dipole Package Found?

RADAR contact may have been made with Project West Ford's package of tuned dipoles. Weak radar returns have been recorded several times during the past few weeks from a small, high-flying object. Although definite identification was not possible early this week, extrapolation of orbital and telemetry data from the Agena launch vehicle indicate the returns are from the package.

Returns were received by MIT Lincoln Lab's Millstone Hill radar, which has a two-degree beamwidth. The orbital communications experiment project's radars at Westford, Mass., and Camp Parks, Calif., have a beamwidth of only 0.15 degree and need altitude and direction information.

Repeated observations at Millstone Hill should narrow down the search area for the West Ford radars. Calculated orbit has been released to optical astronomers and the Smithsonian Astrophysical Observatory, whose Baker-Nunn cameras have participated in the search. Lincoln Lab is rerunning experiments and calculations to find out what went wrong. Space conditions may have inhibited melting of the naphthalene binder.

Microwave Field Generates Hypersonic Waves of Sound

SOLID-STATE research applications and the possibility of using microwave sound in new devices has prompted Air Force Cambridge Research Lab to build apparatus that generates coherent phonons—monochromatic hypersonic waves.

Device possibilities include maser pumps and microwave delay lines. Novel amplifiers may result if coherent lattice vibrations permit alternating between superconducting and normal resistance states of materials. Transport of tunneling currents through tunnel diode barriers may be enhanced.

In research, short wavelength phonons provide a unique "microscope" for viewing the behavior of atoms in semiconductor and magnetic materials.

AFCRL's generator consists of two microwave cavities coupled

acoustically by a quartz rod. Hypersonic waves are excited at the end surfaces of the piezoelectric crystal, which extend into the electric field. Waves travel along the rod. By replacing part of the rod with another material, phonons propagate through the sample and phonon interactions can be studied.

Scanner Would Correct Space Photo Distortion

ANALOG SYSTEM for rectifying weather satellite photos and displaying them on a common map scale is under study for Air Force Geophysics Research Directorate, by Image Instruments, Inc.

Photos would be rescanned along longitude and latitude lines instead of x-y coordinates. Output would be

Barnyard Sonar

ULTRASONIC instruments that tell what is suet and what isn't are winning favor with animal husbandmen.

Champion-steer judges at the International Livestock Exposition in Chicago last week were helped by a Branson Instruments probe developed at Cornell University.

Varying reflection distances of 20-Kc signals indicated fat layers and ratio of lean meat and fat in loins of live steers.

The British Pig Industry Development Authority reported recently that an ultrasonic instrument at the National Pig Progeny Testing Station can tell within two to four percent how much lard a hog carries.

rectified picture on map scale with photographic perspective corrected and geometric distortion removed. Display on small crt tube could be projected to large scale for weather observers.

First model would process individual photos. Goal is automatic handling of weather satellite photo output.

Congress to Investigate Government Consultants

WASHINGTON—A House armed services investigation subcommittee is planning hearings on conflict of interest questions involving the Department of Defense's scientific consultants in nonprofit research corporations, industrial research firms and universities.

Among the questions: Do consultants use privileged inside information to guide personal stock transactions? How do consultants develop interlocking government-commercial directorates and can they use advance knowledge of government R&D decisions for personal profit?

Hearings may result in legislation placing consultants under the same restraints as government scientists. Subcommittee chairman is Rep. F. Edward Hebert (D-La.), who conducted hearings two years ago on hiring by defense contractors of retired military officers.

English Develop X-Ray Stroboscope for Testing

LONDON—Stroboscopic x-ray system developed by the Ministry of Aviation permits visual study of sealed or deeply encapsulated components during vibration testing. Pulsed beam is directed at the test specimen. The image is intensified and viewed on a standard fluoroscopic screen.

X-ray beam is pulsed by contra-rotating, slotted shutters and adjustable screens. Pulse frequency is controlled by a split-field, d-c drive to the shutters. The mechanical modulator pulses the 150-Kv beam at 150 cps. Wider frequency

ranges were obtainable with electronic modulation methods, but these were not satisfactory for prolonged operation, the British said.

\$300 Two-Color Tv Set Is Introduced in Japan

TWO-COLOR TV set has been introduced in Tokyo by a new company, Orico Color Television. Based on the Land two-color vision theory, the design employs two single-gun tubes. One tube has a green phosphor screen, the other a red screen with a filter to tone down red colors. The two tubes are aligned at a 90-degree angle. Images are blended in a mirror set at 45 degrees. Initial price tag was 100,000 yen.

EIA in Walsh-Healey Wage Controversy

EIA'S WALSH-HEALEY committee reports that labor unions are asking for a \$1.72 electronics wage minimum from the Labor Department. EIA says a survey shows that a minimum above \$1.40 would be too much for small companies, would retard growth in some areas (prevailing minimum in New England was reported as \$1.34) and would raise defense costs.

FAA Takes Head Start On ATC Project Beacon

WASHINGTON — Federal Aviation Agency system design team is implementing recommendations of a presidential task force for a new air traffic control system (ELECTRONICS, p 15, Nov. 17).

FAA is reshaping its R&D program, which had been concentrating on a computer-oriented ATC system relying on position reporting by pilots and gradual introduction of 3-D radar. Most of this work is being shifted back to research and away from hardware.

Project Beacon proposals for altitude-reporting transponders will remove the need for 3-D radar. Work on an automatic ground-air data link will be downgraded be-

cause expanded use of standard radar will sharply reduce need for position reporting.

Automobile Electronics On the Market in Japan

TOKYO—Several manufacturers at the Eighth Annual Tokyo Automobile Show exhibited three-phase alternators with silicon diode rectifiers, transistor ignition systems, alternator and generator regulators, headlight dimmers and a magnetic fuel pump. Many of the devices were still experimental. However, two production model cars have Nippon Denso's germanium diode regulator as standard original equipment. Headlight dimmers using CdS photocells and transistor amplifiers are being sold by Koito Electric and Matsushita Electric.

Third VLF Transmitter To Be Built in England

ANOTHER BIG vlf transmitter for fleet communications is to be built in England, near Carlisle, for NATO. Like the U. S. Navy transmitter at Cutler, Me., and another Navy transmitter under construction in Australia, it will be able to contact submerged submarines.

Continental Electronics Systems was again selected as the contractor, this time by the British Post Office. Continental bid in association with Redifon, Ltd., which will develop a precision frequency generator and other special equipment, and provide some of the technical personnel.

Cubic-Foot Computer Uses Thin-Film Memory

UNIVAC reports development of a general-purpose space computer occupying one cubic foot with a maximum rate of 80,000 operations a second. It uses thin-film memory and welded encapsulated circuit modules. The company says progress in microminiature circuits should result in a half-cubic-foot computer with equal capacity becoming feasible within two years.

In Brief . . .

NASA ANNOUNCES: its nuclear-electric propulsion program is being consolidated at Lewis Research Center, Cleveland; a new satellite tracking station will be built in Pisgah National Forest, N. C.; Chrysler will build 20 Saturn C-1 launch vehicles.

COMPUTERS without air-conditioning can result, RCA says, from its new memory cores which operate at -55 C to 85 C.

ADMIRAL president Ross D. Siragusa predicts eight percent tv-appliance sales rise next year, with tv set volume up around 500,000 to 6.5 million.

INTERNATIONAL agreements include: Raytheon and Japan Radio form New Japan Radio Co. to produce microwave tubes; Raytheon and Warwick will supply parts to a new Argentinian tv assembly firm, Visorama; Solartron, of England, licenses Packard Bell to produce instruments, including low-cost, dual-gun oscilloscope; Siemens & Halske, of Germany, buys 25 percent of U. S. Instrument Corp., communications manufacturer.

NAVIGATION of long-range commercial aircraft by inertial systems, satellites, vlf radio and heading references is being studied for FAA by University of Michigan.

NERVOUS SYSTEM study and simulation research, aimed at advanced computer design, is being done at Librascope under Air Force contract.

MOBILE, computer-based counter-countermeasures system developed by Sylvania for Army field radar is being tested at Fort Bliss, after six-year, \$3 million R&D program.

MILITARY contracts include \$10 million to Magnavox for a new airborne communications system; \$2.3 million to General Precision for doppler radar navigation equipment for B-58; \$2.2 million to Elco for connectors; \$1 million to Collins for airborne equipment and service; \$440,000 to Giannini Controls for gyros for DynaSoar, Polaris and F8U fighters.

NEW! MICRO LOGIC TWINS!

Offering specifications never before available in micro components

Ultra fast triple diffused planar

LOGIC SWITCHING MICRO TRANSISTOR 2N2214

- $h_{FE} > 20$ @ $100\mu A$ and 3.0 Volts
- $T_s < 20ns$ @ $10mA$ ● $I_{CBO} < 5nA$ @ 15 Volts ● $V_{CE}(Sat) < .15$ Volts @ $100\mu A$

MICRO-TRANSISTOR SPECIFICATIONS

ABSOLUTE MAX. RATINGS:

| | |
|----------------------------------|------------|
| V_{CEO} | 15 Volts |
| V_{CER} ($R = 10\Omega$) | 20 Volts |
| V_{CBO} | 25 Volts |
| V_{EBO} | 5 Volts |
| Power Dissipation @ $25^\circ C$ | .250 Watts |

ELECTRICAL SPECIFICATIONS:

| | | MIN. | MAX. |
|---------------|--------------------------------------|-------|-----------|
| h_{FE} | $I_C = 10mA; V_{CE} = 1.0V.$ | 25 | |
| | $I_C = .1mA; V_{CE} = 3.0V.$ | 20 | |
| C_{ob} | $V_{CB} = 5V.$ | | 7 pf |
| | $I_C = 10mA; I_b = 1.0mA$ | | 0.2 V |
| $V_{CE}(SAT)$ | $I_C = .1mA; I_b = .01mA$ | | 0.15 V |
| | $I_C = 10mA; I_b = 1.0mA$ | .75V. | .85V. |
| $V_{BE}(SAT)$ | $I_C = .1mA; I_b = .01mA$ | .60V. | .70V. |
| | $I_C = 10mA; I_{b1} = I_{b2} = 10mA$ | | 20 ns |
| T_s | $V_{CB} = 15V. @ 25^\circ C$ | | 5 nA |
| | $V_{CB} = 15V. @ 150^\circ C$ | | 5 μA |
| I_{CBO} | $V_{EB} = 5V.$ | | 5 nA |

HIGH CONDUCTANCE LOGIC MICRO-DIODE 1N3567

- $t_{rr} < 2ns$ — ($10mA$ to -6 Volts)
- $C_o < 2pf$ @ $0V.$ ● $I_f > 100mA$ @ $1V.$
- Rectification Efficiency $> 60\%$ @ $100mc$

MICRO-DIODE SPECIFICATIONS

ABSOLUTE MAX. RATINGS:

| | | |
|----------------------------------|----------------|-------|
| PIV | 50 volts | |
| I_o | 60 mA | |
| Power Dissipation @ $25^\circ C$ | .150 watts | |
| Surge Current | 1 second | .500A |
| | 1 μ second | 2.0 A |

ELECTRICAL SPECIFICATIONS:

| | | MIN. | MAX. |
|--------------------------|---|--------|-------------|
| I_f | 1 V. | 100 mA | |
| I_b | 50 V. @ $25^\circ C$ | | .05 μA |
| | @ $150^\circ C$ | | 25 μA |
| BV | 100 μA | 75 V. | |
| C | 0 V. | | 2.0 pf |
| t_{rr} | 10 mA to $-6V.$ | | 2.0 ns |
| | Recovery to 1 mA Lumatron Circuit | | |
| Rectification Efficiency | | 60% | |
| | 100 mc; $2.0V_{rms}$ $R_L = 5K\Omega; C_L = 20 pf$ | | |

These brand new micro devices are ideal companions for use in advanced designs of high performance microminiaturized logic circuits. In the various configurations available they lend themselves admirably to all assembly techniques... "swiss cheese", "cordwood", "wafer" and the ultimate in microminia-

turization—the PSI "pico" approach. Another reason it will pay you to "look first to PSI" for micro-components, transistors and all your requirements for silicon diodes, rectifiers, zeners and welded assemblies. For full details ask for your copy of the new 16-page PSI Micro-Electronics Brochure.

COMING SOON! PSI Micro-Zeners... 27 types electrical equivalents of 1N702 thru 1N728... 2 to 39 volts!



Pacific Semiconductors, Inc.



A SUBSIDIARY THOMPSON RAMO WOOLDRIDGE INC.

12955 CHADRON AVE., HAWTHORNE, CALIFORNIA

SMALL PART PROBLEMS ?

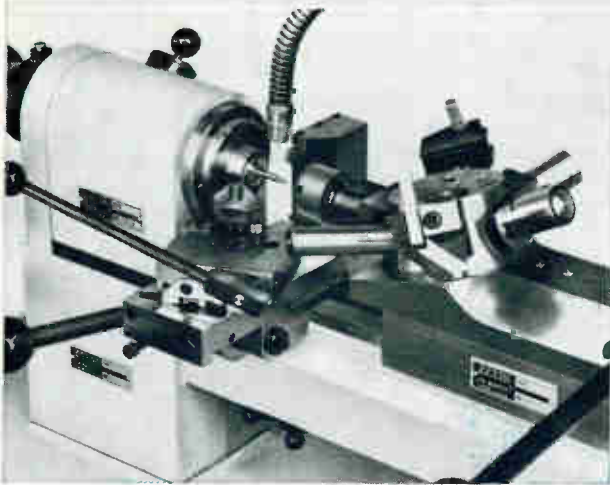

Shown above, an ACAF turret lathe set up to produce the small needle valve, illustrated, with a 0.0118" bleed hole. The self indexing turret is extremely sensitive for fine work. Speed regulation is continuously variable from 0 to 4000 r.p.m. with IR drop compensation.

SEND FOR COMPLETE CATALOG

LEVIN Heavy duty instrument lathes offer the best solution to small part lathe operations. 29 standard models for first and second operation work in 3/16", 5/16", and 1/2" collet capacities.

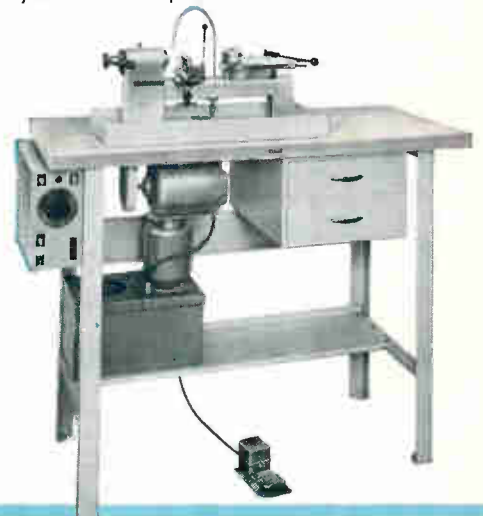

LEVIN INSTRUMENT LATHES

LOUIS LEVIN & SON, INC.
3573 Hayden Ave., Dept. E • Culver City, California

New York Representative and Showroom
RUSSELL-HOLBROOK & HENDERSON, INC.
292 Madison Ave., New York 17, N.Y.

Specify MOTOROLA SILICON SEMICONDUCTORS



for the most performance per dollar!

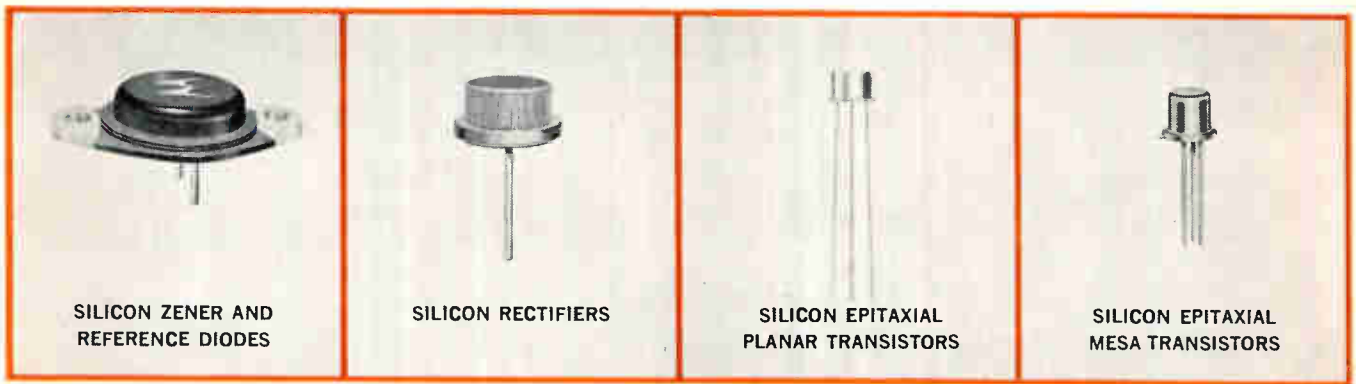

SILICON ZENER AND
REFERENCE DIODES

SILICON RECTIFIERS

SILICON EPITAXIAL
PLANAR TRANSISTORS

SILICON EPITAXIAL
MESA TRANSISTORS

In mass production processes, in optimized device design, and in mastery of new epitaxial techniques, Motorola's advanced silicon semiconductor technology has made possible high performance, low-cost silicon devices for the designer.

Whether you need silicon rectifiers by the millions for high-volume, low-cost applications or high-gain, high-speed silicon mesa transistors for special circuit requirements, you get top performance value per dollar from Motorola.

And, this superior capability in silicon processing has brought you these firsts in silicon semiconductors from Motorola:

FOR COMPLETE INFORMATION on silicon semiconductors, contact your local Motorola Semiconductor Distributor or District Office.

DISTRIBUTORS: PACIFIC — LOS ANGELES, Hamilton Electro Sales, K-Tronics OAKLAND, Elmar Electronics / PALO ALTO, Hamilton Electro Sales - North / SAN DIEGO, San Delcor, Inc. / SEATTLE, Almac Electronics Corp. / MOUNTAIN STATES — DENVER, Inter-State Radio & Supply Co. / MIDWESTERN — CEDAR RAPIDS, Deeco, Inc. / CHICAGO, Allied Electronics Corp., Newark Electronics Corp., Semiconductor Distributor Specialists, Inc. / CLEVELAND, Pioneer Electronic Supply Co. DETROIT, Radio Specialties Co., Inc. / MINNEAPOLIS, Allied Electronic Corp. SOUTHERN — BIRMINGHAM, Ack Semiconductors, Inc. / MELBOURNE, Electronic Wholesalers, Inc. / MIAMI, Gulf Semiconductors, Inc. / SOUTHWESTERN — DALLAS, Tekko, Inc. / HOUSTON, Lenert Co. / PHOENIX, Electronic Specialties Co. / NEW ENGLAND — BOSTON, Cramer Electronics, Inc. / EASTERN — BUFFALO, Summit Distributors, Inc. / CAMDEN, General Radio Supply Co., Inc. / HAMDEN, Cramer Electronic Corp. / MINEOLA, L. I., Schweber Electronics / NEW YORK, Milgray Electronics, Inc. / WASHINGTON, Electronic Wholesalers, Inc. / OUTSIDE U. S. A. — CHICAGO, Motorola Overseas Corp.

1st
1st
1st
1st

FIRST with 50 watt zeners . . . Motorola now offers over 2000 zener and reference diode types — the industry's most comprehensive line of silicon zener diodes.

FIRST to develop and mass produce by the millions the rugged, 18-amp, silicon rectifier for automotive alternators . . . Motorola now offers over 80 different types of silicon rectifiers for all segments of industry.

FIRST with the new "star" geometry in surface-passivated, silicon, epitaxial, planar transistors . . . Motorola now offers 9 devices in this new series.

FIRST volume producer of silicon-epitaxial mesa transistors . . . Motorola now offers over 10 different types for amplifier and switching applications.

In your new designs, specify Motorola silicon semiconductors. Motorola is the one source you can depend upon for reliable devices to meet almost any silicon semiconductor requirement.



MOTOROLA
Semiconductor Products Inc.

A SUBSIDIARY OF MOTOROLA, INC.

5005 EAST McDOWELL ROAD • PHOENIX 8, ARIZONA

LOOK TO MOTOROLA FOR ALL YOUR SEMICONDUCTOR REQUIREMENTS
POWER TRANSISTORS • MESA SWITCHING & AMPLIFIER TRANSISTORS • MILLIWATT TRANSISTORS • SILICON RECTIFIERS • ZENER DIODES

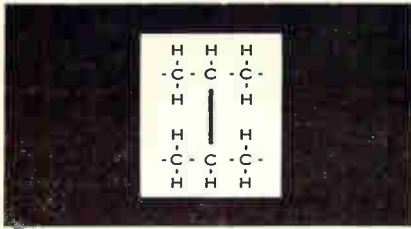

The products manufactured by Raychem Corporation are produced by exposing especially compounded mixtures of chemicals and plastics to high-energy electron radiation. Electrons traveling at nine-tenths the speed of light cause an irreversible chemical change to take place in these plastics. This is illustrated by the heavy black line connecting the carbon atoms (see facing page). The black line represents a "cross-link" or chemical bond between two otherwise separate and independent molecules.

In an irradiated plastic insulation each molecule is joined to another molecule, producing a three dimensional network structure which will not melt and flow as will non-cross-linked thermoplastics. These cross-linked materials resist hot soldering irons and will not cold flow.

All Raychem insulated wire, cable and coaxial cable are cross-linked by radiation.

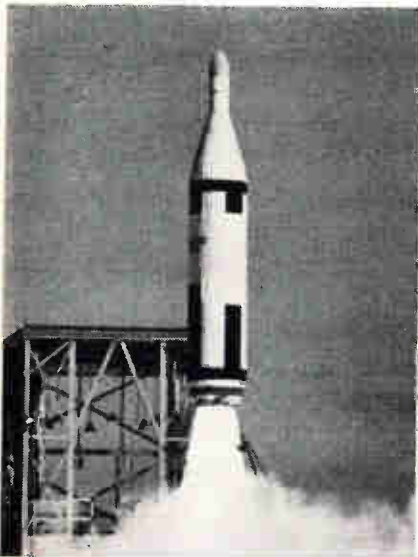

OAKSIDE AT NORTHSIDE
REDWOOD CITY, CALIFORNIA

WASHINGTON OUTLOOK

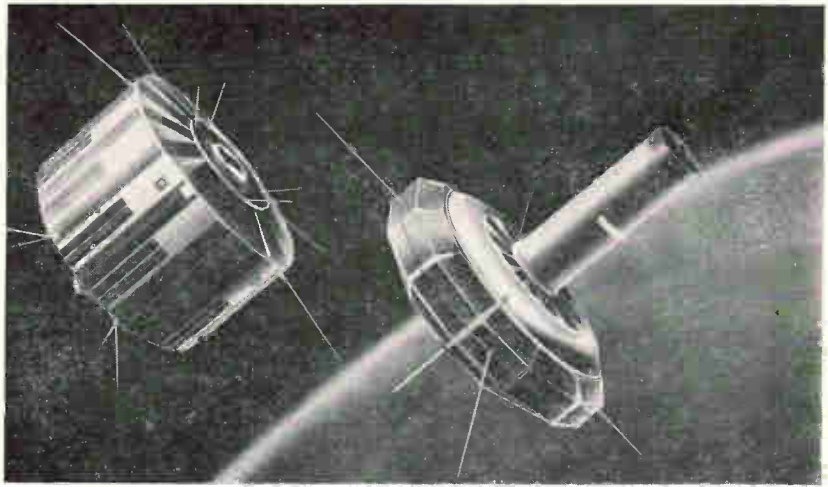

NUCLEAR POWER in future meteorological satellites is planned by the National Aeronautics and Space Administration. Although plans are not firm, NASA says some 200 watts of power can be obtained from beefed up nuclear devices similar to the Snap-3 in Navy's Transit navigational satellites (with companion Traac in sketch).

Atomic power would be used in advanced Nimbus, polar-orbiting weather satellites and possibly in Aeros satellites that will hover over the same position on earth. Added power will enable countries around the world to obtain data from the satellites.

AIR FORCE plans to orbit soon a small satellite to provide the more than 200,000 licensed ham radio operators in the country a chance to participate in the development and operation of space communications systems. Known as Project Oscar (Orbiting Satellite Carrying Amateur Radio), the satellite is designed to investigate radio propagation phenomena in the two meter (144-146 Mc) portion of the radio frequency spectrum. It will transmit a series of HI's (four dots—two dots).

U.S. ELECTRONIC EXPORTS this year are running 33 percent over last year's rate. Shipments during January-September totaled \$437.4 million which compares with \$329.8 million in the same period last year. The export boost stems mainly from increased sales of computers and test equipment to Japan and Western Europe, crystal diodes and transistors to France and Canada, television picture tubes to Argentina and West Germany, and receiving tubes to Canada, Argentina, and Mexico.

DESPITE increasing congressional criticism over the use of non-profit research organizations, the Defense Department is sponsoring a new Logistics Management Institute with headquarters here, which will serve as a "think factory" on military procurement and other supply problems. The institute will have a staff of about 12 top-flight supply experts, will provide braintrusting services to the Pentagon on such issues as evaluating contractor performance, expanding competition for military orders, simplifying design specifications and standards, and streamlining the Pentagon's system of toting up requirements.

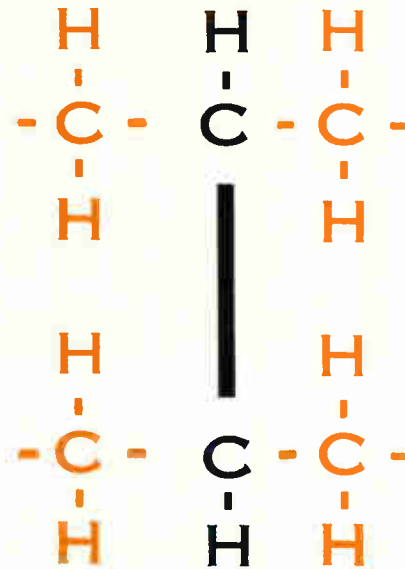

**LEADER IN RADIATION CHEMISTRY
FOR ELECTRONIC WIRE AND CABLE**



**RAYCHEM
CORPORATION**

Designed for



Application

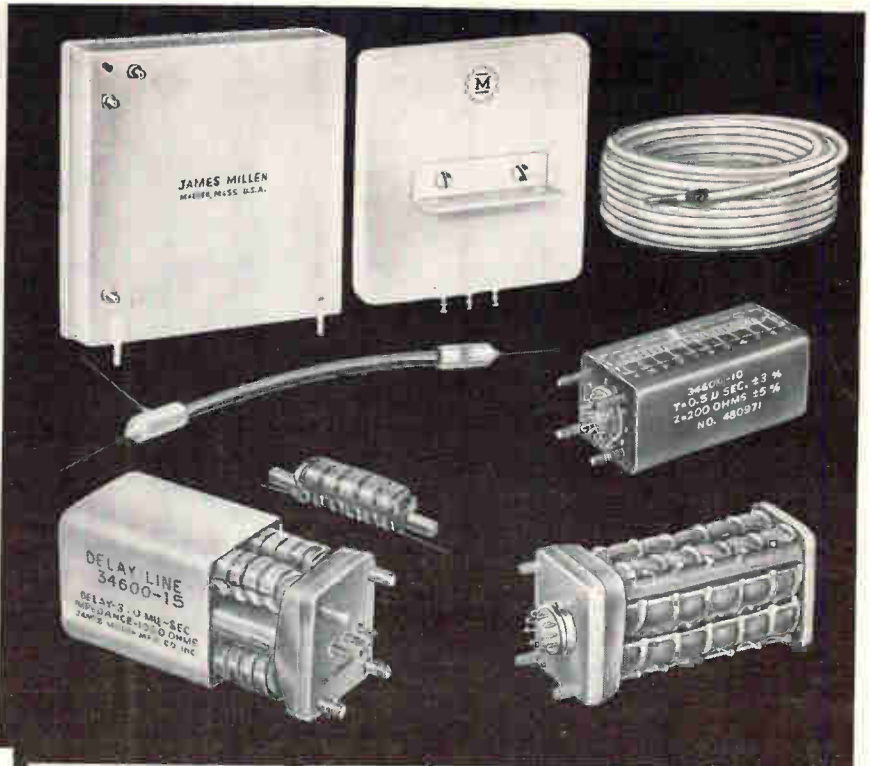

DELAY LINES

Distributed parameter delay lines available in bulk or packaged for prompt shipment. Supplied as flexible cable with molded ends, encapsulated assemblies, or hermetically sealed in metal cases.

Lumped parameter delay lines to meet special requirements for miniature size, fast rise time, or low pulse attenuation.

JAMES MILLEN MFG. CO., INC.

**MALDEN
MASSACHUSETTS**

CIRCLE 200 ON READER SERVICE CARD

MINIATURE INDUCTORS STILL TOO BIG?

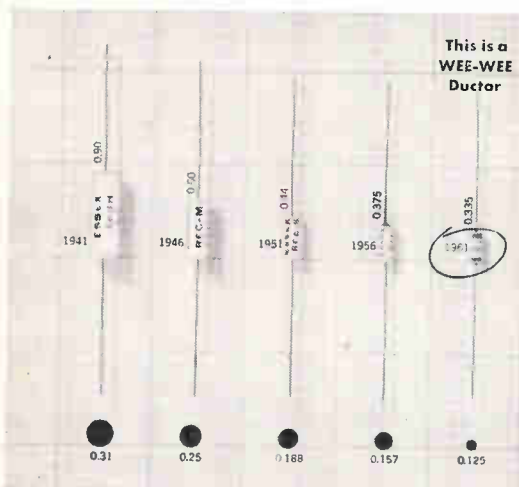

try the new **WEE-WEE DUCTOR** for size

— the smallest inductor immediately available to the engineer with a complete set of values from 0.10 μ h to 1000 μ h. Meets Mil Spec. MIL-C-15305 B.

For complete engineering data, write to Dept. WW-A, or phone 464-9300.

NYTRONICS, INC.

550 SPRINGFIELD AVENUE, BERKELEY HEIGHTS, N. J.

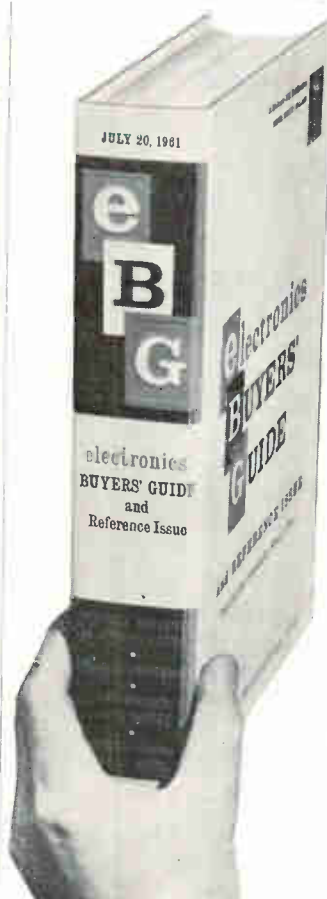

“BEST BUY”

for buying or selling in
the electronics industry

Your 1961 electronics Buyers' Guide and Reference Issue is the one book that “tells all” so far as buying or selling in the electronics industry is concerned.

Use your EBG today, and every day, and see what we mean.

electronics BUYERS' GUIDE
and Reference Issue

The Basic Buying Guide in Electronics since 1941

ELECTRONIC ENGINEERS



At General Dynamics|Astronautics, the electronic engineer enjoys the freedom and prestige afforded men who are creating and testing the space and missile systems of the future.

General Dynamics|Astronautics needs circuit designers for systems design and integration of:

LAUNCH CONTROL CIRCUITS. These are relay and transistorized open loop, and sequential switching circuits for the automatic control of the count-down process for the Atlas missile.

TEST EQUIPMENT DESIGN. Switching and analogue circuitry for automatic test and checkout equipment. Assignment will be of a project nature from conception to production.

TRACKING SYSTEMS DESIGN. Communications, pulse and phase shift techniques for the design of ultra-precise missile and satellite tracking systems.

TELEMETERING DESIGN. Communications, modulation, and data sampling techniques for telemetering and data acquisition systems.

Inquiries are also invited from scientists possessing doctorate degrees and the desire to do research beyond the state of the art in communication techniques and solid state devices.

You will be associated with General Dynamics|Astronautics, the company that designed, builds and tests this country's first operational ICBM.

These positions provide stability, growth opportunity and the satisfaction of working on a program which is both highly advanced and of vital significance to the future of the free world.

You will find more information on the back of this page and a convenient, confidential Professional Placement Inquiry. A prompt reply to your inquiry will be forthcoming from Mr. R. M. Smith, Industrial Relations Administrator-Engineering, Dept. 130-90, General Dynamics|Astronautics, 5715 Kearny Villa Road, San Diego, California. (If you live in the New York area, it may be more convenient to contact General Dynamics|Astronautics, 1 Rockefeller Plaza, New York City, Circle 5-5034).

GENERAL DYNAMICS



GD
ASTRONAUTICS
FORMERLY CONVAIR/ASTRONAUTICS

ENGINEERS AND SCIENTISTS

General Dynamics|Astronautics is located in San Diego, California, the third fastest growing community in the United States. Situated 10 miles north of the Mexican border and a little over 100 miles south of Los Angeles, San Diego and its environs enjoy a year round mild, sunny climate with smog-free air. The 30 miles of coastline are dotted with private and public beaches, inlets, and bays where fishing and water sports prevail year long. Engineers and scientists find the temperate climate and variety of after hour activities add up to superb living and working conditions all within 15-20 minutes from home.

General Dynamics|Astronautics' plant is one of the largest and newest facilities in the free world for research, development and production of long-range missiles and space vehicles.

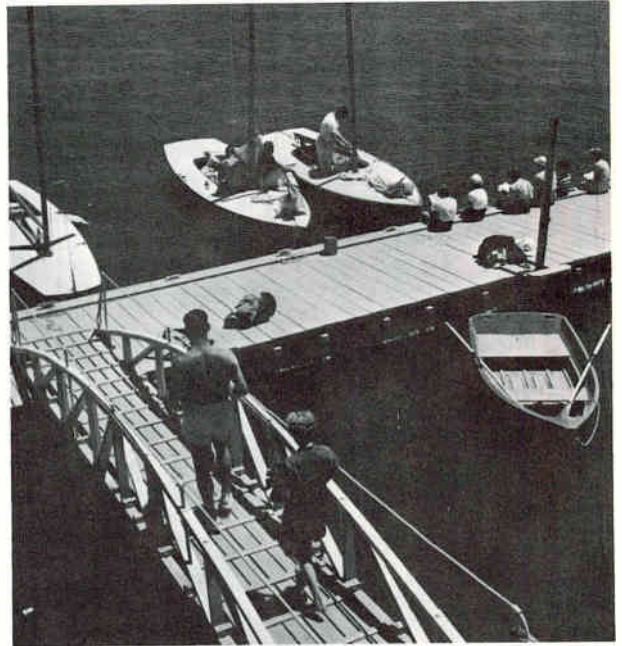

In addition to the positions described on the other side, openings also exist in these and other specialties:

Technical Writing • Field Engineering • R. F. Systems
• Technical Instruction • Human Factors • Landlines •
Launch Control Systems • Closed Loop TV Systems
• Telemetry • Ground Support Equipment • Auto-
pilot • Guidance • Systems Checkout.

Technical openings also exist in other specialties. Write Mr. R. M. Smith, Industrial Relations Administrator-Engineering, Dept. 130-90, General Dynamics | Astronautics, 5715 Kearny Villa Road, San Diego, California. (If you live in the New York area, it may be more convenient to contact General Dynamics | Astronautics, 1 Rockefeller Plaza, New York City, Circle 5-5034).

AN EQUAL OPPORTUNITY EMPLOYER

GENERAL DYNAMICS



GENERAL DYNAMICS
ASTRONAUTICS
FORMERLY CONVAIR/ASTRONAUTICS

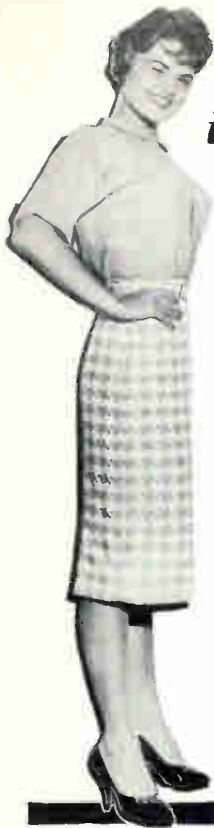

Things are shaped for **ELECTRONICS** in Columbia, S. C.

• STATEMENT •
ANNUAL OPERATING COST
OF ELECTRONICS PLANT
AT
NORTHEASTERN LOCATION
\$937,752

• STATEMENT •
ANNUAL OPERATING COST
OF SAME PLANT
AT
WEST COAST LOCATION
\$1,009,698

• STATEMENT •
ANNUAL OPERATING COST
OF SAME PLANT
AT
COLUMBIA, SOUTH CAROLINA
\$680,254

Operating Cost includes wages, lease, electricity and property taxes for a plant employing 200 production workers and is the average for such plants in three phases of the electronics industry.

For our special "profit" study on electronics, write in confidence to C. Lamar Clifton, Industrial Manager, Box 1405, Columbia, S. C.



committee of one hundred
COLUMBIA, SOUTH CAROLINA

GREATER COLUMBIA CHAMBER OF COMMERCE — INDUSTRIAL DEPARTMENT

CIRCLE 201 ON READER SERVICE CARD

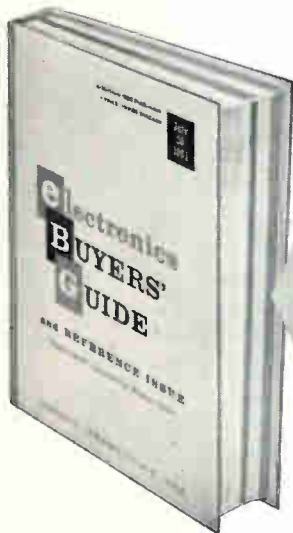

Seen
the new
**IDEA
INDEX
IN EBG?**

The INDEX to the editorial articles in electronics magazine, previously published annually in a December issue, now appears ONLY in the EBG. Another original EBG idea that saves time and trouble for users! Keep your EBG copy on your desk!

EXTRA!

Also in the EBG are condensed ABSTRACTS of all the editorial feature articles which have appeared to date in 1961. Another reason why EBG is used more by all four — men in research, design, production and management.



McGraw-Hill Publication,
330 West 42nd St., New York 36, N. Y.



**electro-pac
STANDBY
POWER
SYSTEMS**

"Fail Safe"
OPERATION OF
MICROWAVE
TRANSMITTERS

SWITCHLESS Load Transition from primary to emergency power source

A-C POWER . . . automatically applied to the load by the ELECTRO-PAC when the a-c line drops below a predetermined level. Ratings to 5 kva and higher. Solid state circuitry, employing silicon controlled rectifiers eliminates moving parts.

NEW BULLETIN

"How A-C Line Voltage Is Regulated and Harmonics Suppressed by the ELECTRO-PAC in 'Standby and Emergency State' . . . and Emergency A-C Power Provided When Line Fails"

Write for your copy of this
new engineering bulletin.

E-102.

**ELECTRO-SEAL
CORPORATION**

946-C North Ave. . . Des Plaines, Ill.

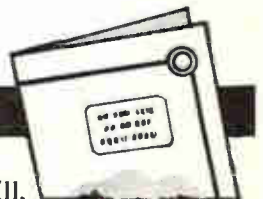

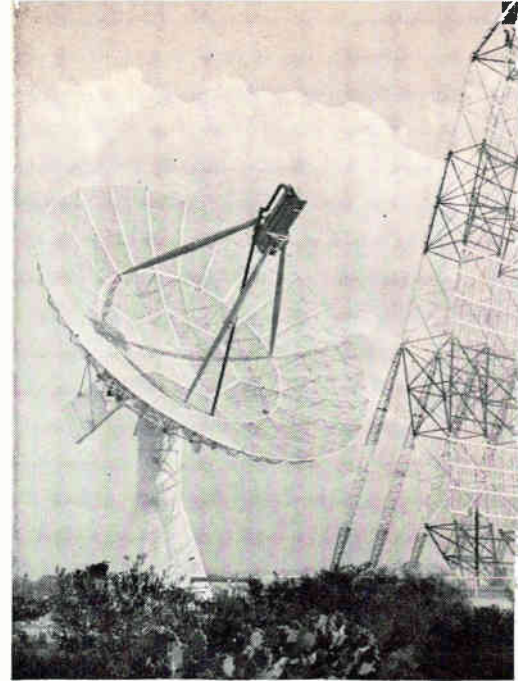

Trinidad missile detectors (left) now track satellites part time. Laredo site (right) is tracking full time

Trinidad and Texas Radars Hunt Satellites

Missile detection radar installations operated by Air Force in Trinidad and Laredo, Texas, are now doing operational and experimental satellite tracking

By JOHN F. MASON,
Associate Editor

PHOTOGRAPHS AND SOME DETAILS of the current activities of two long-classified radar installations have recently been released. The sites—one at Trinidad, B.W.I. (see cover) and the other at Laredo, Texas—are both operated by the General Electric Heavy Military Electronics Dept. for the Air Force.

The Trinidad installation consists of an 84-ft paraboloid tracker modeled after the Millstone Hill radar and a torus-shaped scanner, 330 ft wide and 165 ft high, using an organ pipe feed system. The scanner is the prototype for the Ballistic Missile Early Warning System scanner later built by GE in Greenland and Alaska.

Now part of the Air Force Missile Test Center, the Trinidad installation has two functions:

(1) Part-time tracking of satellites when requested by the Space

Surveillance Facility operated by the Navy as part of the North American Air Defense Command.

(2) Studying from a defense standpoint the behavior of missiles fired from Cape Canaveral.

Purpose of these studies is not to aid the Cape in tracking missiles but to acquire data on the flight characteristics of missiles in the often-inaccessible mid-course phase. This information collected by Rome Air Development Center is used to devise better means of detecting and identifying enemy missiles and discriminating between warheads and decoys. Findings should result in new hardware.

Although the Advanced Research Projects Agency's Defender has no official part in this program, RADC forwards data on to Defender for purposes of cross fertilization. Defender, responsible for inspiring breakthroughs in advanced methods of defense against enemy missiles, is more concerned with the other

two phases of a missile's trajectory: boost and terminal, as exemplified in Bambi and Arpat, respectively.

Trinidad's satellite-tracking work for Norad is of both operational and experimental value. The tracker can skin track a $\frac{1}{16}$ -sq-meter target at 1,200 n. mi or a 1-sq-m target at 2,000 n. mi. Located just 10 degrees north of the equator (600 n. mi) the tracker picks up satellites as they cross the equator. Minimum satellite altitude above the equator at which it can be observed from Trinidad is well below 100 mi. (The horizon is exactly 100 mi above the equator for an observer located at 13° 40' north or south latitude.)

The tracker is currently being modified by GE to improve range resolution by more advanced signal processing techniques.

Basic planning and conceptual design of the installation originated at Lincoln Laboratory in



1958. USAF took over the project and gave GE overall responsibility for implementing the design, with the exception of the tracker which was retained by Lincoln Laboratory. Lincoln Lab contracted the tracker dish to D. S. Kennedy and the mount to Watertown Arsenal. GE provided Lincoln Lab with a Continental Electronics transmitter, designated AN/FPT-5.

GE, responsible for the scanner, bought the antenna from D. S. Kennedy and the transmitter, designated AN/FPT-2, from RCA.

Another service the Trinidad station has performed was transmission of radar and communications signals to the National Aeronautics and Space Administration's Echo balloon, passive reflector satellite, in 1960. R-F feeder assembly was added to the 84-ft tracker for communications capability. Receiving installation was constructed at Floyd, N. Y. about five miles from RADC. Types of signals sent via the satellite over the 2,000-Mc link included teletypewriter and voice.

The Laredo Sensor Site has also been converted to the satellite tracking business. The 60-ft parabolic tracker to the left of the large fixed AN/FPS-17 (see photo) was developed, installed and is operated for the Air Force by GE's Heavy Military Electronics Dept. It is now being modified for automatic tracking and to provide automatic

output of tracking information.

The tracker as well as the FPS-17 were originally used by the Advanced Research and Development Command (now Air Force Systems Command) to test electronic communications equipment, and to watch Nike Hercules and Zeus being fired from White Sands, N. M. The tracker, now a part of Norad's Space Detection and Tracking System (Spadats), has made over 3,500 radar intercepts of objects in space over the U. S. since 1957. Spadats in Colorado Springs maintains a catalogue of all known orbital vehicles with exact data on their positions and orbits.

The FPS-17 at Laredo is currently not being used. Other FPS-17s, although not part of Norad, do contribute satellite data to Norad on a cooperative basis. These installations are located at Ft. Churchill, Canada; Shemya, Aleutian Islands; Puerto Rico; and Turkey.

Norad-operated sensors, besides Laredo, are the Ballistic Missile Early Warning System (Bmews) and the Navy operated Space Surveillance c-w radar interferometer

fence across the southern U. S.

RCA's AN/FPS-49, prototype for the Bmews tracker and located in Moorestown, N. J. (ELECTRONICS, p 47, Mar. 18, 1960) may be contracted by USAF next year to track satellites on a part-time basis. The 84-ft dish tracker has already been checked out under contract for this work with successful results. Obstacle to putting the Moorestown radar on a full-time basis for satellite tracking is its prior commitment to continue certain experimental work for the Bmews sites. As this need decreases, the radar will probably be utilized more hours per week for satellite tracking.

Norad's desire for a new radar designed specifically for satellite detection and tracking has been hovering on the verge of fulfillment for a long time. When industry will finally be invited to submit proposals is a matter of when Air Force money will be released.

Although USAF has not released firm specifications, the radar will probably use phased array. It will be located as close to the equator as political security permits in order to pick up satellites on first orbit.

Corkscrew Field Cuts Fusion Current

RECENT CALCULATIONS indicate thermonuclear fusion mirror machine utilizing MIT's corkscrew trapping system (ELECTRONICS, p 9, Sept. 15) may allow containment of molecular ions for around 10 msec with injected beam currents of 10 ma.

This is substantially less than the ampere-range current required for DCX-2 and Ogra (ELECTRONICS, p 29, Sept. 1) which such a device would resemble. Work was described in paper presented at American Physical Society meeting in Colorado Springs last month by D. J. Rose, of MIT.

According to calculations, plasma of 10^{12} particles/cu cm can be obtained from 10-ma molecular ion current at about 100 Kev with background pressure of 3×10^{-8} mm.

They propose building a 50-ft-long device of this type, using superconducting niobium-zirconium coils to create magnetic fields of 40

kilogauss at ends and 20 Kg in middle. A four-ft-long magnet of this type with 8-inch diameter bore is presently being constructed by L. Donadieu. This 25-Kg magnet would contain plasma at center of three concentric cylinders which are at temperatures of 4 K, 77 K and 300 K, respectively.

A scaled down system for electron work is presently being built to study corkscrew trapping further. One problem is to keep beam divergence below one degree so beam velocity and angle will be well defined along the whole length of the helical field. Ion gun extraction systems that would provide immediate focusing will be investigated.

A six-ma ion beam with three-degree half angle can be obtained. This may be improved by using a combination of electrostatic and electromagnetic focusing in the extraction system.

Acoustic Society members report new developments in voice-to-print conversion, semiconductor transducers. Future nonacoustic communications systems predicted include intercity waveguide systems

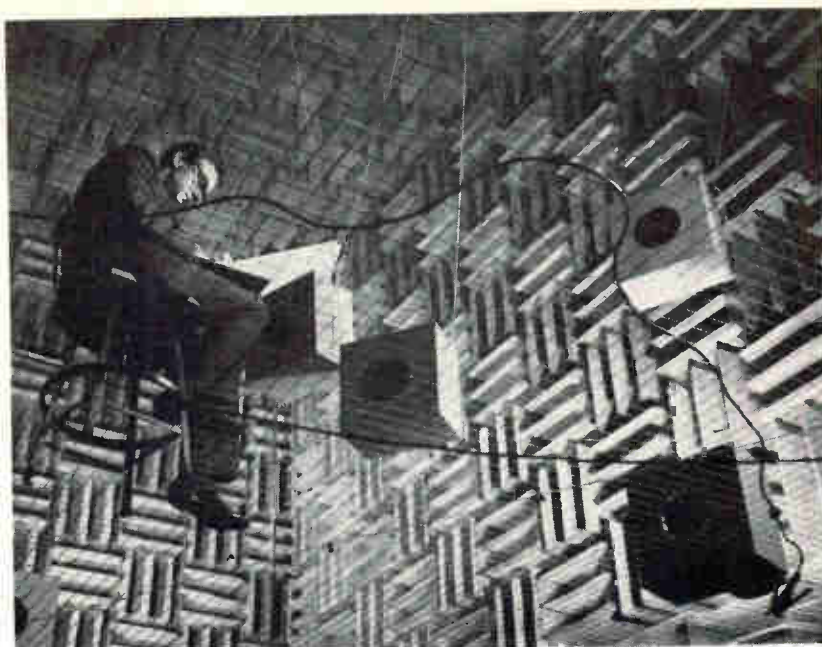

To appraise acoustics of an auditorium before it is built, Bell Labs processes music through a digital computer programmed to simulate auditorium effects. Processed signals are evaluated in anechoic chamber

Phonetic Typewriter Nears Practical Use

By WILLIAM E. BUSHOR,
Senior Associate Editor

CINCINNATI—Development of a phonetic typewriter—one which will print out spoken words—has progressed at Kyoto University, Japan (*ELECTRONICS*, p 87, May 27, 1960), to prototype.

One of the inventors, T. Sakai, reported at the Acoustical Society meeting here last month that the Sonotype will now handle any language. Early version could handle only 100 Japanese monosyllables.

Computer-type circuits are divided into three subsystems: a phoneme classifier, control and analysis systems. Control pulses are derived from the input speech sound wave. Distinctive features of speech sound are detected by spectrum analysis and phoneme recognition. Discrimination is made by digital techniques using order pulses, AND gates, OR gates and other binary circuits.

Bell Telephone Labs personnel discussed three new developments in semiconductor transducers.

One unit is similar to existing semiconductor strain gages, but

gage sensitivity was increased to the point where output factors of 1,000 have been obtained. This was achieved by studying effects of doping levels, piezoresistive effect linearity and elastic properties as a function of size and orientation. Gages based on this information are free from temperature effects, elastic effects and finding stresses.

Semiconductor Transducers

Piezoelectric semiconductors with $p-n$ junctions can generate ultrasonic waves. Absence of electrical carriers in the depletion region between the p and n layers will cause signal voltage applied across the gap to generate a wave whose magnitude is determined by the electromechanical coupling factor of the semiconductor. Thickness of the depletion layer can be controlled by varying the d-c bias used. Transducers respond to driving frequencies to 30 Gc.

The third transducer depends on the fact that the height and slope of the current-voltage curve in the positive resistance region of a tunnel diode is a function of the pressure applied to the device. Re-

sponse is instantaneous and relatively good over a range of 0 to 20,000 psi. Extremely good sensitivity is obtained over restricted ranges.

Units can be made sensitive to differential pressures with proper biasing and can measure d-c pressures—a feat acoustic microphones cannot duplicate. Power output can equal piezoelectric crystals. If necessary, units only 1/1000-in. in diameter can be made. These easy to calibrate devices may provide probes for testing sound fields.

More sensitive devices may utilize the negative resistance region of the tunnel diode curve. A positive resistance whose absolute value is about equal to the negative resistance could be shunted across the diode. A larger change in voltage with pressure is obtained because pressure controls the diode's amplifying characteristics.

Another Bell Labs' scientist, J. R. Pierce, was invited to talk on non-acoustical communications techniques. He prophesied about the future, both in his paper and in an exclusive interview with *ELECTRONICS*. Pierce emphasized the

need for higher information handling rates and the desirability in some instances of obtaining permanent records of conversations.

While digital systems exist for transmitting data over ordinary switched telephone circuits, a convenient office device for putting typewritten information into both man and machine-readable form will be needed within the next decade, he said. With such a system letters could be filed chronologically and file searches made by electronically scanning stored information. Pierce feels equipment of this type may come in three years.

Character recognition devices, although useful in certain applications such as sorting mail, are not the answer to the input problem of information storage and retrieval systems in general, according to Pierce. In the future practically all documents will be originally recorded in machine-readable form.

Pierce feels economical data transmission of computer, voice and video signals will come to pass through use of digital circuits. At present it is possible to send 1½ million pulses a second over a cable pair using pulse code modulation techniques, but wider band circuits are needed.

A possible solution is intercity waveguides which would transmit up to one billion pulses a second. This form of communication would be essentially noninterfering, so the same frequency allocations could be made in adjacent areas. More special-purpose digital equipment will be needed.

Speech Compression Systems

Speech compression systems reports took a complete afternoon. Among techniques described were low-bit rate digital speech communication using a two-way analysis/synthesis formant tracking technique and bandwidth compression of speech by spectrum sampling.

Design versus performance factors for speech compression systems were also analyzed. A semivocoder developed for the Air Force transmits telephone speech using a system of multiple analog vocoders fed from any phone line. Another paper outlined a narrow-band analog multiplexing arrangement which can accommodate three telephone semivocoders.



Airpax electro-magnetic circuit breakers add less than 0.5% to an equipment's base price while adding years of maintenance free, fail-safe performance. These circuit breakers have a versatility of application not available with other circuit protectors. They incorporate the protective features of fuses, thermal units and overload relays without their inherent disadvantages.



Series 500, Military Type
hermetically sealed, withstands 75 G shock

Series C-500, Industrial Type
positive protection at lowest cost



Series 500-R, Remote Indicating Type
auxiliary contacts for remote indication

Ratings from 50 MA to 15 amps

DC, 60 and 400 CPS types

No temperature derating

Instantaneous or delay types

Gang assemblies available

Series, shunt and relay circuit use

-55 C to +100 C temperature range

Trip free

CC33



CAMBRIDGE DIVISION • CAMBRIDGE, MARYLAND

SPRAGUE®

MODEL 500

INTERFERENCE LOCATOR



This versatile instrument is a highly sensitive interference locator—with the widest frequency range of any standard available unit! Model 500 tunes across the entire standard and FM broadcast, shortwave, and VHF-TV spectrums from 550 kc. to 220 mc. in 6 bands.

It's a compact, portable, rugged, versatile instrument—engineered and designed for most efficient operation in practical field use. It features a transistorized power supply, meter indications proportional to carrier strength as well as sensitivity of 5 microvolts minimum for 5% meter deflection over entire tuning range.

For full details, send for brochure IL-106.

SPRAGUE ELECTRIC COMPANY
35 Marshall Street, North Adams, Mass.

SPRAGUE®
THE MARK OF RELIABILITY

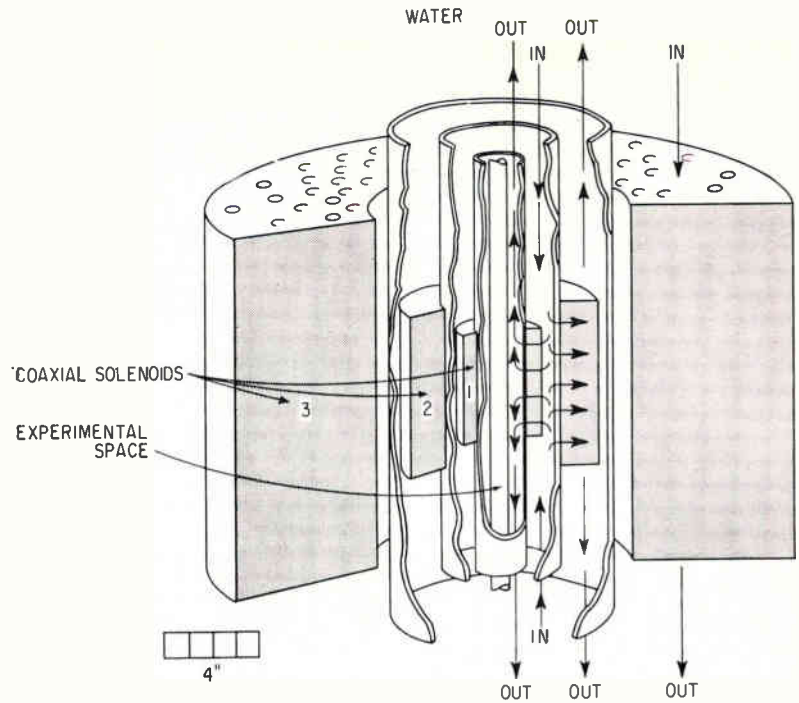

National Magnet Laboratory's 250-Kg solenoid design

Cryogenics Spurs Magnet R&D

By THOMAS MAGUIRE,
New England Editor

BOSTON—Engineering spotlight at the First International Conference on High Magnetic Fields, at MIT, was on the relatively new field of superconducting magnets.

Evidence that superconducting magnets are going to prove extremely useful engineering and research tools appeared conclusive. Four or five laboratories have already gone beyond 50 kilogauss with existing materials; materials research is extensive.

Highest field yet attained with superconducting material was reported by Bell Telephone Laboratories. On the closing day of the conference, it reported a field of 67 Kg with niobium zirconium. Also on the closing day, Westinghouse reported 58 Kg with the same material and Atomics International, 59 Kg. Lincoln Laboratory got 50 Kg with niobium zirconium and 28.5 Kg with niobium tin.

Researchers are confident that, within a year, superconducting magnets will give 150 Kg.

Among principal materials now being used, niobium tin has better electrical properties than niobium

zirconium, but its mechanical strength is not as good. Bell Labs reported at the conference on another material for superconducting magnets—vanadium gallium. They disclosed evidence for a critical magnetic field in excess of 500 Kg. Extrapolation from experimental data indicates this.

NASA work on magnets is concentrating on cryogenically-cooled types, made of either normal or superconducting materials, to get light weight and low power consumption needed for space flight. Possible applications include magnetic shielding of space vehicles, magnetohydrodynamic power generation, magnetic nozzles, fusion power plants and fusion propulsion systems.

NASA researchers are studying various configurations of superconducting coils for possible shielding of manned space vehicles from Van Allen belt radiations, solar flares and cosmic rays. Magnetic fields could deflect incoming charged particles, replacing a massive material shield with a lighter magnetic shield generated by superconducting coils needing little power.

Benjamin T. Lax, director of the National Magnet Laboratory, points

out that fields of 100 kg and beyond give a new dimension to solid-state studies, already aided by low temperatures, perfect single crystals and improved instrumentation.

Prof. Nicolaas Bloembergen, of Harvard, says higher fields will help in getting good tuning range on optical masers and increased intensity of nuclear resonance signals.

At the temporary quarters of the National Magnet Laboratory at MIT, solid-state research programs include Faraday rotation in semiconductors, magneto-plasma effects, Zeeman effects in solids, properties of antiferromagnetics, Mössbauer effect and superconductivity.

NML facilities are also being used by other organizations for projects which include research on tunneling in high magnetic fields, magneto-optical measurements in solids, behavior of conducting fluids in magnetic fields, magnetic susceptibility measurements and biological effects of magnetic fields.

D. Bruce Montgomery, of NML, said the preliminary design of a 250-Kg magnet has been completed. Current density in the successive windings will be set to keep fiber stress below 20,000 psi. It will have a one-inch tube for experimental space, use 3,000 gallons a minute of cooling water.

For some applications at NML, superconductive and water-cooled magnets will be used in combination. Now under design is a 100-Kg magnet for nuclear magnetic resonance work. Shielding the water-cooled magnet with a superconducting field will provide a constant, uniform central field.

Fields over 300 Kg are believed feasible with designs underway. In fact, Prof. Francis Bitter, of MIT, predicted 500-Kg fields.



B. T. Lax and D. B. Montgomery, of NML, with wooden mockup of 250-Kg solenoid

Special Engineering Section Maintained for Design and Development of Pulse-forming Networks

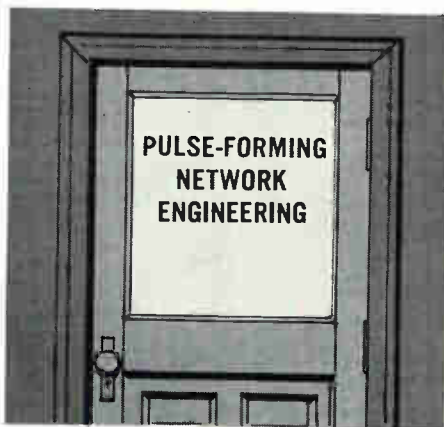

BEHIND this door, the Sprague Electric Company, North Adams, Massachusetts, maintains a highly-technical special engineering section devoted exclusively to the design, development, and manufacture of pulse capacitors and pulse-forming networks. The many complexities of these highly-specialized units demand that they be handled by a highly-specialized organization. For this reason, Sprague has been, from the very beginning, a major supplier of pulse capacitors and networks for radar equipment (ground, marine, aircraft, missile), tube testing, and similar pulse circuit applications.

This special engineering section performs four important functions: One group *designs* custom units in accordance with required parameters. Another group *builds* pulse capacitors and networks to these precise specifications. In another area, a group of specially-trained field engineers *provides application assistance* wherever needed. And yet another independent group *works toward the future* developing new materials, new design concepts, and new techniques for manufacture, enabling Sprague to introduce product improvements such as heliarc sealing of cases, rugged alumina bushing assemblies, Fabmika[®] dielectric, and improved hermetic sealing of closures.

Save time and money by working with Sprague from the start. Application engineering services are available to you without obligation.

Write for Engineering Bulletin No. 10,001 to Technical Literature Section, Sprague Electric Co., 35 Marshall Street, North Adams, Massachusetts.

CIRCLE 202 ON READER SERVICE CARD

SPRAGUE'S ALL-NEW TYPE 2N2100 ECDC* TRANSISTOR...



Head-and-Shoulders Above Any Other Core Driver on the Market Today!

Sprague Type 2N2100 Germanium Electro-Chemical Diffused-Collector Transistors, especially developed for high current core driver applications, offer a combination of ratings (with 15 guaranteed minimums and maximums) which is far superior to anything you've ever seen before.

ECDC construction combines the optimum features of the electro-chemical precision-etch techniques and diffused-collector techniques in one highly-mechanized process. That's why the 2N2100 meets all of the conditions for an "ideal" transistor.

Compare these characteristics and ratings with those of any other core driver!

| | | | |
|--------------------------------|------------------------------|---|------------|
| V _{CB} | -40V | h _{FE} (min. at I _C = 400ma | |
| V _{CEs} | 35V | V _{CE} = 1.5V) | 20 |
| V _{EB} | -2V | V _{CE} (SAT) | |
| I _C | -500ma | (max. at I _C = 200ma | |
| P _d (25° C case) | 750mw | I _B = 10ma) | 0.5V |
| P _d (25° C ambient) | 250mw | V _{BE} (max. at I _C = 200ma | |
| I _{CBO} (max.) | 12µa at 15V | I _B = 10ma) | 0.8V |
| BV _{CEO} (min.) | 40 at I _C = 100µa | C _{ob} (max.) | 20pf |
| BV _{CEs} (min.) | 40 | t _f | 300mc typ. |
| BV _{CEO} (min.) | 20 | t _r (nsec. max.) | 20 |
| BV _{EB0} (min.) | 4 | t _s (nsec. max.) | 50 |
| | | t _f (nsec. max.) | 40 |

For complete technical information on Type 2N2100 Transistors, write for Engineering Bulletin 30,401 to Technical Literature Section, Sprague Electric Company, 35 Marshall Street, North Adams, Massachusetts.

*Trademark of Sprague Electric Co.

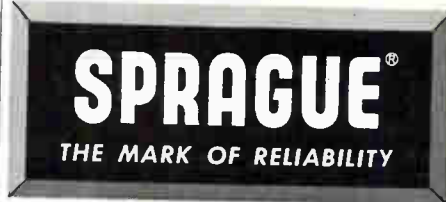

CIRCLE 25 ON READER SERVICE CARD

HIGH PURITY METALS

AND ELECTRONIC MATERIALS

METALS AND ALLOYS

| | |
|----------|----------|
| ALUMINUM | ANTIMONY |
| ARSENIC | BISMUTH |
| CADMIUM | GOLD |
| INDIUM | LEAD |
| SILVER | TIN |
| | ZINC |

High purity alloys are made from these metals to customer specifications.

STANDARD FORMS

| | |
|--------|--------|
| INGOTS | SHEET |
| BAR | SHOT |
| RODS | POWDER |
| RIBBON | WIRE |

PREFORMS

Preforms are available in a range of sizes and shapes such as discs, dots, washers, squares and spheres. Enquiries are invited on our alloy preforms.

COMPOUND SEMICONDUCTORS

INDIUM ANTIMONIDE

Available as crystals, wafers, circles, rings and other shapes made to precise tolerances.

CHEMICALS

SALTS SOLUTIONS

COMINCO PRODUCTS INC.

Electronic Materials Department
933 West Third Avenue
Spokane, Washington
Ph. RI 7-7103 TWX: SP 311

Engineers Debate Reliability

KANSAS CITY—Some of the more direct ways by which engineers and production people can cope with reliability problems were scrutinized last month at the Kansas City IRE's Electronic Systems Reliability Symposium. The conference, an off-year alternate to MAECON, drew 120 engineers, including some from Japan and France.

The keynote speaker, Maj. Gen John Medaris (formerly one of the Army's top missilemen and now president of Lionel), said crudity can be a virtue when it provides the systems engineer with the approach least subject to complex problems. Premature overextension of the state of the art is one of today's biggest reliability problems, he said.

Noting that "you can't inspect reliability into a product," he added that closer attention to psychological climate on the production line pays off in improved reliability.

Ill-advised application of certain value engineering concepts "cost-reduced a microwave communications system to death," by eroding tolerances, warned Anthony Finocchi, of ITT Federal.

He advised meticulous attention to production details, to ensure that reliability designed into experimental models is maintained. A "cradle to grave" engineering group should follow equipment into production, "keeping out that first little change that opens the door to the confusion of hundreds—or even thousands—more."

Experimental design of a product is the best place to start estimating its required reliability, suggested H. T. Gruber, Battelle. Monitoring should follow through to the finished product, to make certain production changes and cost modifications don't damage designed-in reliability.

Since vendor supplies of data to its Electronic Component Reliability Center have failed to provide all hoped-for data, the Institute is currently collecting its own facts for more comprehensive reliability analysis, Gruber said.

Reliability control "by exception" was recommended as practical and economical, by A. L. Floyd, of Hoff-

man Electronics. Reliability control of parts on a Tacan contract was brought down to a "passable" level by requiring vendors to provide parts in kits, he said.

Vendors were monitored in terms of average reliability of parts in their kits. Parts had to meet circuit reliability requirements whether the rest of the circuit worked or not. If they were below requirement, the entire kit was rejected.

Accelerated life tests, though expensive, are useful to compare alternate devices and materials, according to W. E. Boyes, Sandia. Connectors still offer plenty of room for ingenuity in improvements he added, noting that bent pins are their worst problem.

Tv Backs Up Radar

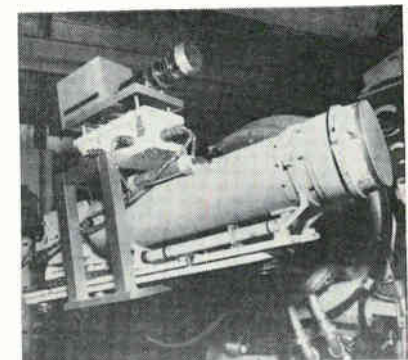
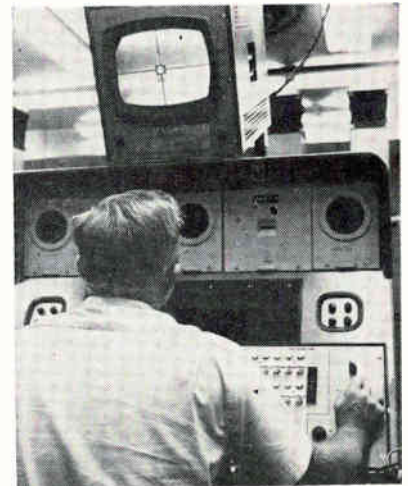

Radar operator at Cape Canaveral sees missile launch on both radar and tv. GE, which operates R&D guidance facility, mounted tv camera on tracking camera

**MOVING
AIR
IS
CHILD'S
PLAY**

**CONTROLLING
IT
TAKES
AN
EXPERT**



Dexterity is achieved through patience and practice. Our ability to solve the most complex air moving and cooling problems depends partly on these qualities, but mostly on imaginative design, which comes only with experience . . . and maturity. Brochure 102 gives our background. Write for it.

TORRINGTON
MANUFACTURING COMPANY
TORRINGTON CONNECTICUT



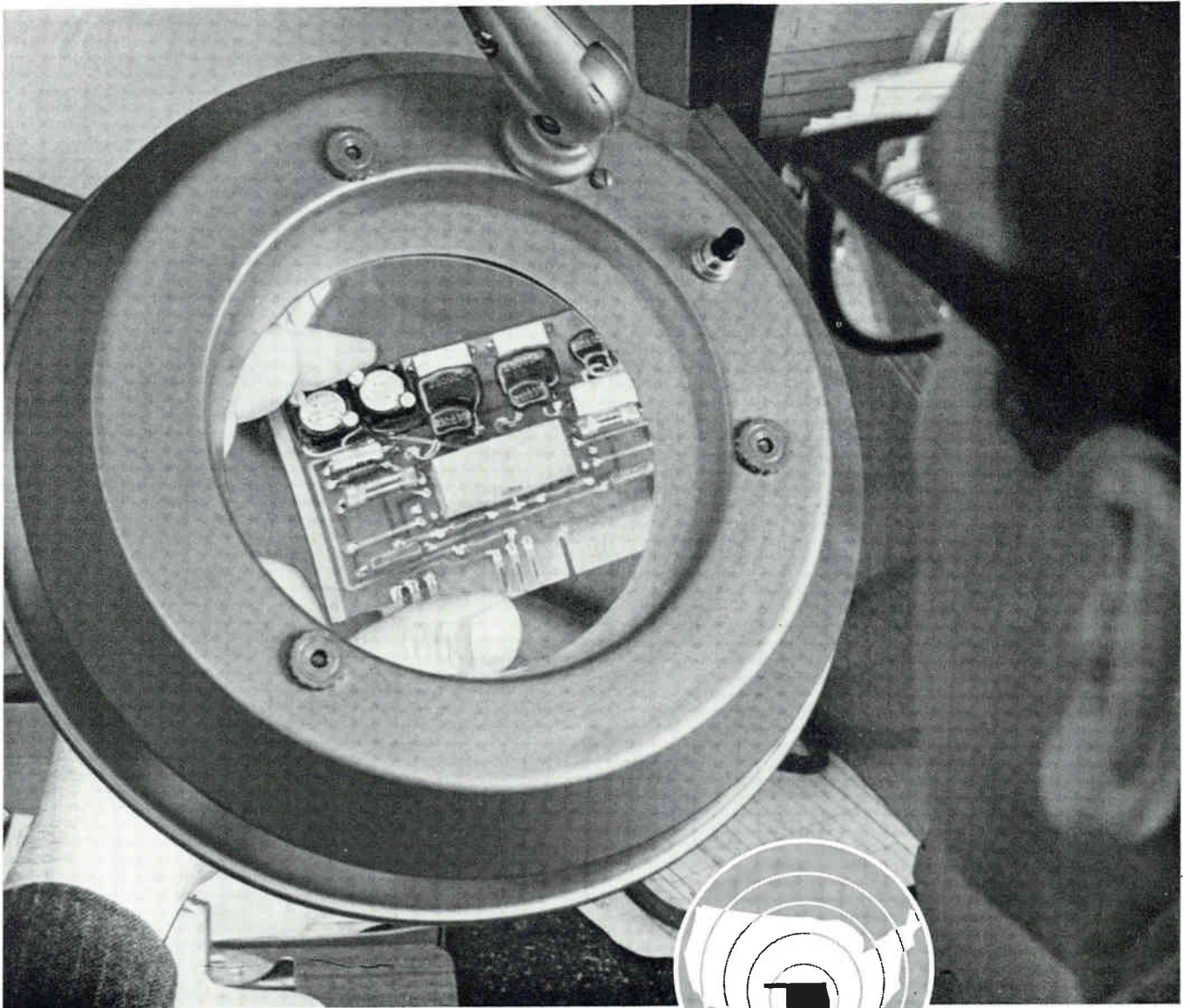

Under the magnifying glass — Transistorized sub-carrier oscillator used in Project Mercury and manufactured by Dorsett Electronics, Inc., Norman, Oklahoma.

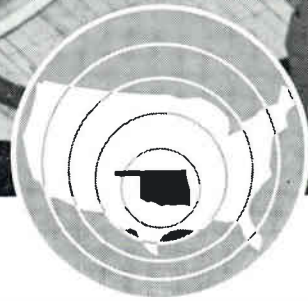

Success is the best Example

Electronics firms are finding success in Oklahoma, because of two very special reasons.

First, Oklahoma — with its advantageous central location — is the hub of an expanding variety of markets for electronic equipment and components ranging from special equipment for government and private business to bread-and-butter items for manufacturers of consumer goods.

Second, Oklahoma is ideally suited to electronics by existing resources and facilities. You'll find the right kind of workers — bright and adaptable; many small, highly skilled shops for subcontract work; great educational institutions; strong lines of distribution in all directions and jet air services (passenger and freight) to either coast.

Most of all, you'll find Oklahoma a state that's eager to work with you — eager to help you build real success here. Let us tell you about it. Contact Max Genet, Jr., Director, Oklahoma Department of Commerce and Industry, Box 3327-EC, Capitol Station, Oklahoma City, Oklahoma.

OKLAHOMA!

...where the future is just beginning

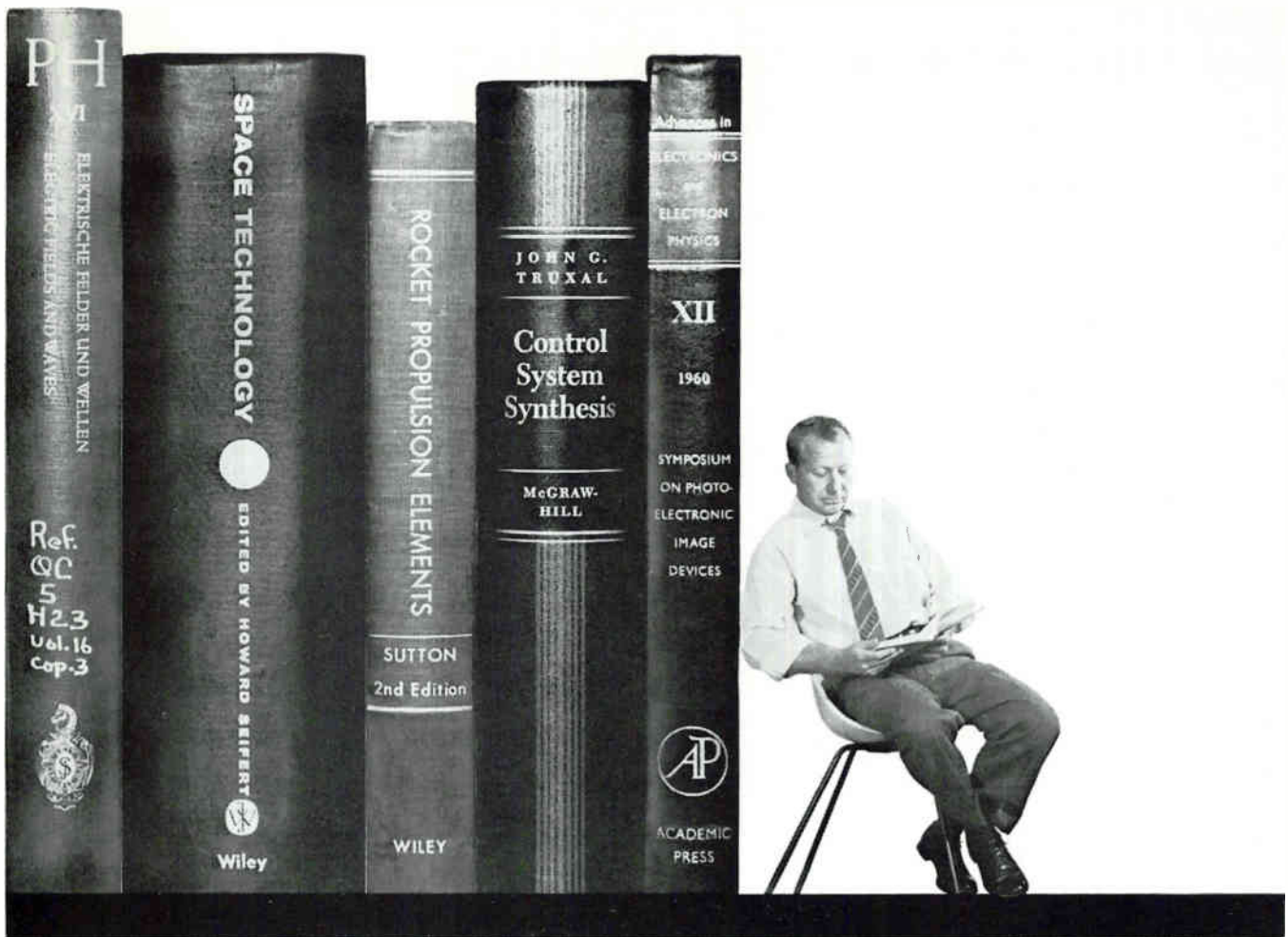

electronic and cybernetics engineers in a unique role

The engineers and scientists of Aerospace Corporation are in the forefront of a rapidly advancing state-of-the-art in sensing and information systems. Their unique role: a critical civilian link uniting government and the scientific-industrial team responsible for development of space systems and advanced ballistic missiles. In this mission Aerospace Corporation provides advanced systems analysis and planning, theoretical and experimental research, initial systems engineering, initial technical direction and general technical supervision. Specific areas of interest include inertial and radio guidance, automatic control, communications, instrumentation, space- and ground-based computing, telemetering, tracking, auxiliary power, infrared, television, optics, and photography. Immediate assignments exist for those highly skilled in these specialties and who are knowledgeable in inter-disciplinary problem solving. Men with advanced degrees are urged to contact Mr. Herndon, Aerospace Corporation, Room 110, P.O. Box 95081, Los Angeles 45, Calif.

Organized in the public interest and dedicated to providing objective leadership in the advancement and application of space science and technology for the United States Government.

AEROSPACE CORPORATION

All qualified applicants will receive consideration for employment without regard to race, creed, color or national origin.

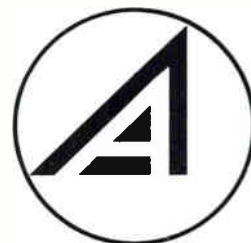



Why you need both

ZOOM and 3-D

for thorough inspection

Zoom microscopy gives you the exact magnification for each specific inspection need, from big area scanning at lower powers . . . to critical area examination at higher powers . . . to whatever power best shows what you're looking for.

3-dimensional microscopy shows your work piece in depth and in natural position, upright and unreversed from left to right, just as it would be positioned to the unaided eye.

And only Bausch & Lomb StereoZoom® Microscopes give you Zoom and 3-D. See for yourself how this revolutionary new design can save on your inspection jobs by keeping work constantly in focus throughout the continuous magnification range . . . available from 3.5X to 120X. Just mail the coupon now.



Made in America, to the world's highest standards.

BAUSCH & LOMB INCORPORATED
 61424 Bausch Street, Rochester 2, N. Y.

Please demonstrate StereoZoom Microscopes at my convenience.

Please send Catalog D-15.

NAME

COMPANY

ADDRESS

MEETINGS AHEAD

VEHICULAR COMMUNICATIONS, PGVC of IRE; Madison Hotel, Minneapolis, Minn., Nov. 30-Dec. 1.

COMPUTER CONFERENCE, EASTERN JOINT, PGEC of IRE, AIEE, ACM; Sheraton Park Hotel, Wash., D.C., Dec. 12-14.

RELIABILITY AND QUALITY CONTROL, 8th National Symposium, PGRQC of IRE, AIEE, ASQC, EIA; Statler Hilton Hotel, Washington, D.C., Jan. 9-11, 1962.

MILITARY ELECTRONICS, 3rd Winter Convention PGMIL of IRE (L.A. Section); Ambassador Hotel, Los Angeles, Calif., Feb. 7-9, 1962.

SOLID STATE CIRCUITS, International Conference, PGCT of IRE, AIEE; Sheraton Hotel and U. of Penn., Philadelphia, Pa., Feb. 14-16, 1962.

APPLICATION OF SWITCHING THEORY TO SPACE TECHNOLOGY Symposium, USAF, Lockheed Missiles and Space; at Lockheed, Sunnyvale, California, Feb. 27-Mar. 1962.

SCINTILLATION AND SEMICONDUCTOR Counter Symp, PGNS of IRE, AIEE, AEC, NBS; Shoreham Hotel, Washington, D.C. Mar. 1-3, 1962.

IRE INTERNATIONAL CONVENTION, Coliseum & Waldorf Astoria Hotel, New York City, Mar. 26-29, 1962.

SOUTHWEST IRE CONFERENCE AND SHOW; Rice Hotel, Houston, Texas, April 11-13, 1962.

JOINT COMPUTER CONFERENCE, PGEC of IRE, AIEE, ACM; Fairmont Hotel, San Francisco, Calif., May 1-3, 1962.

HUMAN FACTORS in Electronics, 3rd National Symposium, PGHFE of IRE; Los Angeles, California, May 3-4, 1962.

ELECTRONIC COMPONENTS Conference, PGCP of IRE, AIEE, EIA; Marriott Twin Bridges, Hotel Washington, D.C., May 8-10, 1962.

NATIONAL AEROSPACE Electronics Conference, PGANE of IRE; Biltmore Hotel, Dayton, Ohio, May 14-16, 1962.

ADVANCE REPORT

PRECISION ELECTROMAGNETIC MEASUREMENTS, *International Conference, Radio Standards Laboratory of the National Bureau of Standards, PGI of IRE, Instrumentation Division of American Institute of Electrical Engineers; Boulder Laboratories of the National Bureau of Standards, Boulder, Colo., August 11, 15, and 16.*

Original papers in the following areas will be considered for presentation: (1) atomic frequency and time, (2) determination of conductivity and complex (tensor) electric and magnetic susceptibilities, (3) direct current and low frequency measurements, (4) radio frequency and microwave measurements, (5) quantum electronics in precision measurements, (6) electromagnetic measurements for space exploration, and (7) data reduction in precision measurements.

Papers should be submitted to: Dr. George Birbaum, Hughes Research Laboratory, Malibu, California. These should be in the form of 500 to 1,000 word summaries. The deadline for submission of summaries is March 15, 1962.

1
Microsecond

MEMORY*
MODULES!

*STANDARDIZED

Now available from Daystrom as standard units, these 1 μ sec modularized core memories permit manufacturers of digital machines to eliminate expensive component development. The modules offer design flexibility never before available to computer engineers. Full read-write cycle time for the modules is 1 μ sec or less, and access time is typically 0.5 μ sec. The standard memory has a capacity of 1024 words, 50 bits to the word, and can be expanded in multiples of this capacity up to 4096 words and 200 bits per word. Components are stacked to give high package density. Only two different voltages...+20V and -20V... are required, and the full driving current is only 360ma. All solid-state and highly reliable, the standardized modules reflect Daystrom Military Electronics Division's extensive experience with MIL memories and circuitry such as the NORC and 465L systems. Send for technical data.

 **DAYSTROM**, INCORPORATED
MILITARY ELECTRONICS DIVISION
ARCHBALD, PENNSYLVANIA • JERMYN 876-1500

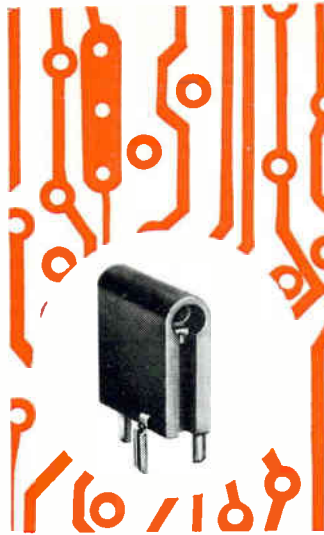

The taller three-leg mount permits testing above components, anywhere on the board.

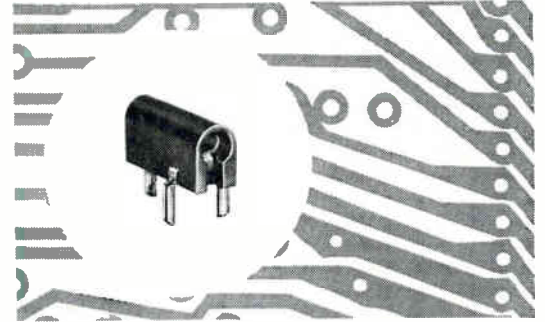

The standard-height three-leg mount achieves maximum stability for board-end testing.

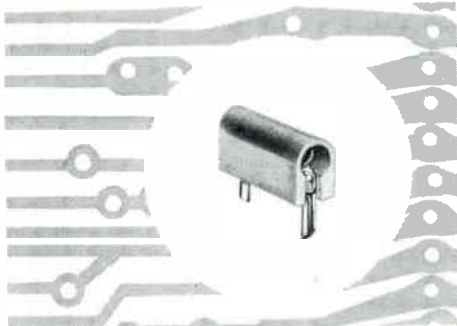

The two-leg mount receptacle yields maximum density for test probes at the board ends.

BEST FOR ANY TEST

These three test probe receptacles will permit you to test probe any printed circuitry anywhere on the board . . . on the ends or in the middle . . . without interrupting operating currents.

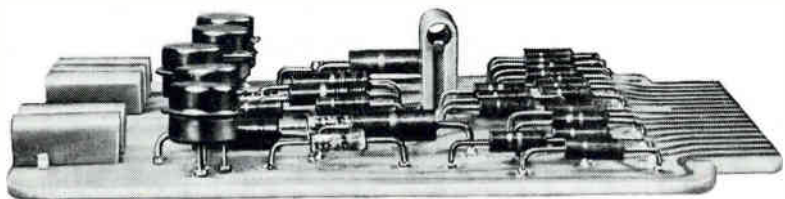

Each of the receptacles is available in 10 nylon housing colors and natural. The receptacle inserts, in either gold or silver plate, are recessed in the housings to prevent flashover, and are double-ended for either-end probes. Leg mounts are "V" shaped, to promote controlled solder wicking. Each of the receptacles accepts the standard .080 test probe.

Ask AMP Incorporated today for performance data, samples and quotations.

AMP INCORPORATED

GENERAL OFFICES: HARRISBURG, PENNSYLVANIA

AMP products and engineering assistance are available through subsidiary companies in: Australia • Canada • England • France • Holland • Italy • Japan • Mexico • West Germany

Author sets up tonal effects on synthesizer. Conventional tape deck at top, tape-loop reverb below, and plug-in modules at bottom



Sound Synthesizer Creates New Musical Effects

Well-known electronic circuits are used in system combinations so that unconventional sounds and patterns can be produced from ordinary audio. For example, a singer can generate his own string bass accompaniment simultaneously with his voice

By HARALD BODE The Wurlitzer Company, North Tonawanda, New York

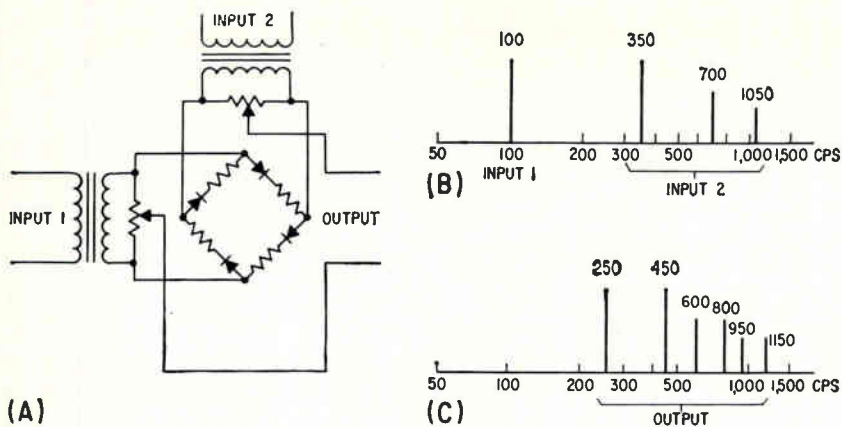

FIG. 1—Ring-bridge modulator (A) with input signals (B) and output (C)

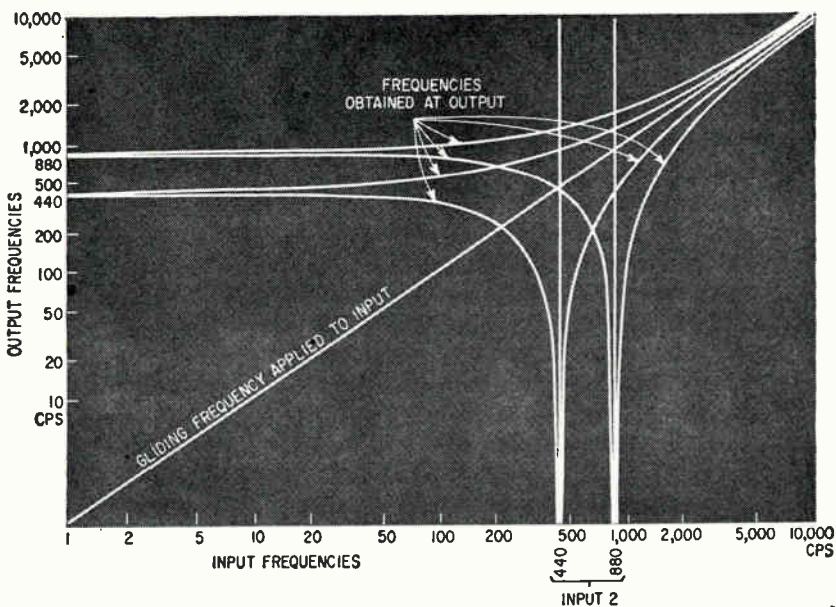

FIG. 2—Output of ring-bridge modulator with gliding frequency applied to one input and two harmonically related frequencies to the other

NEW SOUNDS and musical effects can be created either by synthesizing acoustical phenomena, by processing natural or artificial (usually electronically generated) sounds, or by applying both methods. Processing acoustical phenomena often results in substantial deviations from the original.

Production of new sounds or musical effects can be made either by intermediate or immediate processing methods. Some methods of intermediate processing may include punched tapes for control of the parameters of a sound synthesizer, and may also include such tape recording procedures as reversal, pitch-through-speed changes, editing and dubbing.

Because of the time differential between production and performance when using the intermediate process, the composer-performer cannot immediately hear or judge his performance, therefore corrections can be made only after some lapse of time. Immediate processing presents no such problems.

Methods of immediate processing include spectrum and envelope shaping, change of pitch, change of overtone structure including modification from harmonic to non-harmonic overtone relations, application of periodic modulation effects, reverberation, echo and other repetition phenomena.

The output of the ring-bridge

NEW FRONTIERS IN ELECTRONIC MUSIC

Music is the art of making pleasing, expressive or intelligible combinations of sounds and making such combinations into compositions of definite structure and significance according to the laws of melody harmony and rhythm. It is also the art of inventing, writing or rendering such compositions, whether vocal or instrumental.

Ancient Greek music was limited in expression by the primitive instruments used, mostly of the lyre and flute types. However, it did establish the diatonic scales based on the tetrachord as a unit and gave us the rudiments of key rela-

tionships.

Early church music gave us the neumes to indicate pitch, the development of staff notation, and the superseding of the tetrachord unit by the hexachord. The practice of descendant, or simultaneous melody, gave rise to mensurable music which in turn gave birth to counterpoint.

Establishment of modern major and minor scales with the octave as a unit and of equal temperament made possible modulation into any key and led to the development of harmony.

Great improvements in instru-

ment making marked the growth of purely instrumental music. The modern symphony originated in the time of Haydn and others about 1770.

Recently, increasingly dissonant linear counterpoint, Schoenberg as an example, is becoming popular. The French gave us polytonality and the Russian composers have given us barbaric, dynamic rhythms while American jazz has contributed to the music of the dynamic era in which we live.

Modern proponents of musical thought and expression have often complained of being musically restricted by instrument range and

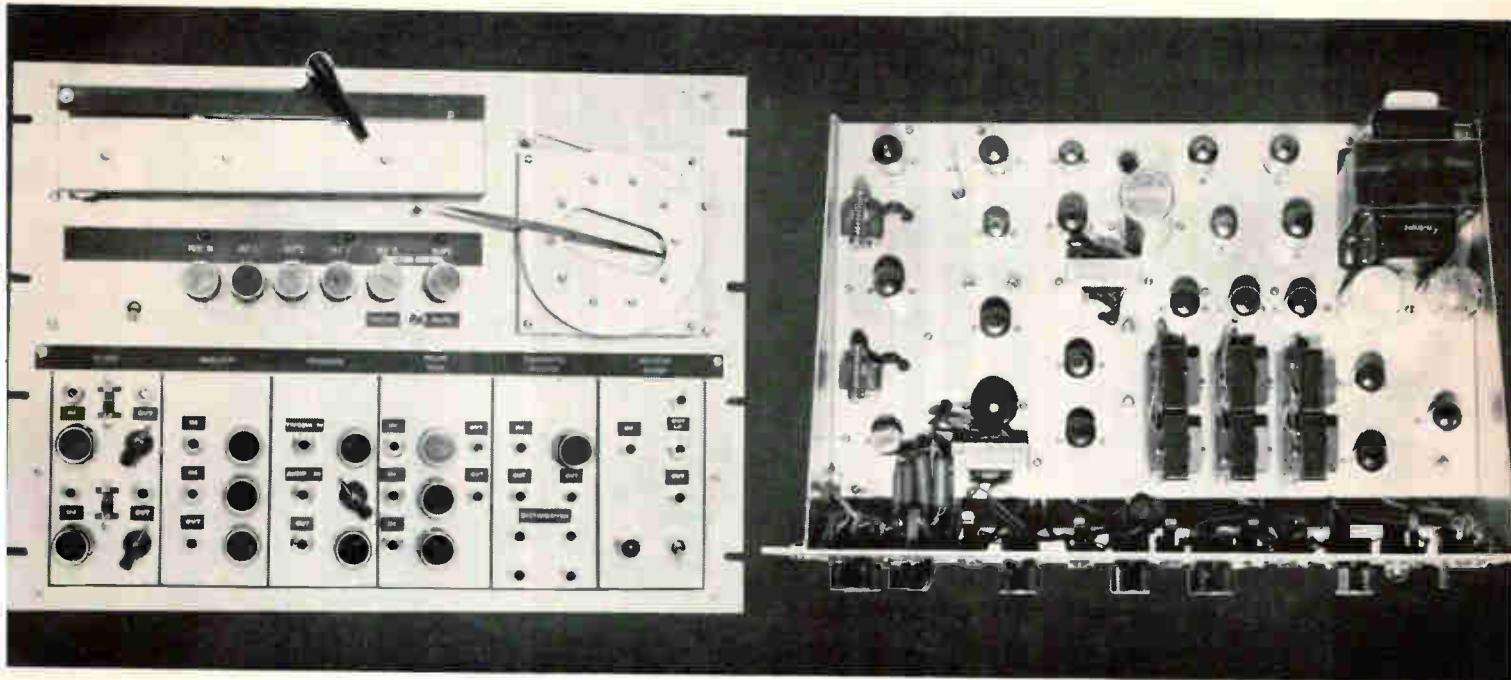

Front panel of tape-loop reverberation and modular units (left) with top view of module chassis (right)

modulator shown in Fig. 1A yields the sum and differences of the frequencies applied to its two inputs but contains neither input frequency. This feature has been used to create new sounds and effects. Figure 1B shows a tone applied to input 1 and a group of harmonically related frequencies applied to input 2. The output spectrum is shown in Fig. 1C.

Due to operation of the ring-bridge modulator, the output fre-

quencies are no longer harmonically related to each other. If a group of properly related frequencies were applied to both inputs and a percussive-type envelope were applied to the output signal, a bell-like tone would be produced.

In a more general presentation, the curves of Fig. 2 show the variety of tone spectra that may be derived with a gliding frequency between 1 cps and 10 Kc applied to one and two fixed 440 and 880 cps frequencies (in octave relationship) applied to the other input of the ring-bridge modulator. The output frequencies are identified on the graph.

Frequencies applied to the ring-bridge modulator inputs are not limited to the audio range. Application of a subsonic frequency to one input will periodically modulate a frequency applied to the other. Application of white noise to one input and a single audio frequency to the other input will yield tuned noise at the output. Application of a percussive envelope to one input simultaneously with a steady tone at the other input will result in a percussive-type output that will have the characteristics of the steady tone modulated by the percussive envelope.

The unit shown in Fig. 3 provides

congruent envelope shaping as well as the coincident percussive envelope shaping of the program material. One input accepts the control signal while the other input accepts the material to be subjected to envelope shaping. The processed audio appears at the output of the gating circuit.

To derive control voltages for the gating functions, the audio at the control input is amplified, rectified and applied to a low-pass filter. Thus, a relatively ripple-free variable d-c bias will actuate the variable-gain, push-pull amplifier gate. When switch S_1 is in the gating position, the envelope of the control signal shapes that of the program material.

To prevent the delay caused by C_1 and C_2 on fast-changing control voltages, and to eliminate asymmetry caused by the different output impedances at the plate and cathode of V_3 , relatively high-value resistors R_3 and R_4 are inserted between phase inverter V_2 and the push-pull output of the gate circuit. These resistors are of the same order of magnitude as biasing resistors R_1 and R_2 to secure a balance between the control d-c signal and the audio portion of the program material.

The input circuits of V_3 and V_4

color; thus most of their compositions cannot express the emotions they feel and wish to communicate. New forms of music await new type instruments or the development of sound synthesizers that can produce all possible audio tones, in any combination, at any amplitude, and with any form of envelope shaping that will enable any imaginable combination of tones to be played.

Synthetically produced sound offers a broad canvas upon which all tones, regardless of their nature, can be painted, thus opening new avenues for the composers of tomorrow

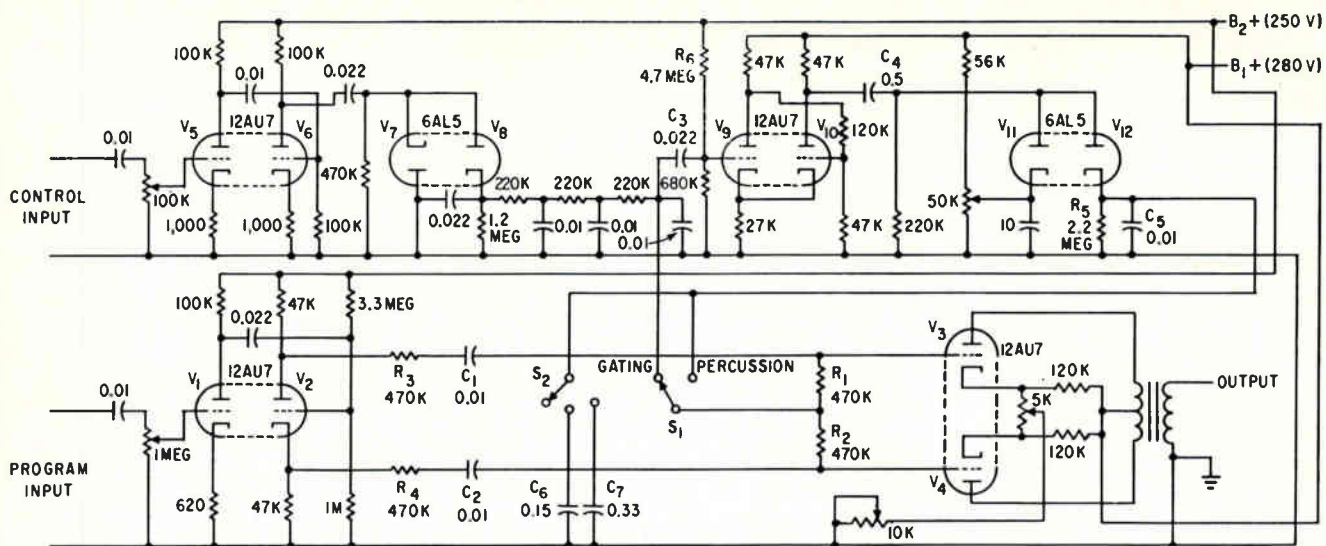

FIG. 3—Audio-controlled gate and percussion unit

act as a high-pass filter. The cut-off frequency of these filters exceeds that of the ripple filter by such an amount that no disturbing audio frequency from the control input will feed through to the gate. This is important for clean operation of the percussive envelope circuit. The pulses that initiate the percussive envelopes are generated by Schmitt trigger V_5 and V_{10} . Positive-going output pulses charge C_5 (or C_5 plus C_6 or C_7 , chosen by S_2) with the discharge through R_5 . The time constant depends on the position of S_2 .

To make the trigger circuit respond to the beginning of a signal as well as to signal growth, differentiator C_3 and R_6 plus R_7 is used at the input of V_9 . The response to signal growth is especially useful in causing the system to yield to a crescendo in a music passage or to instants of accentuation in the flow of speech frequencies.

The practical application of the audio-controlled percussion device within a system for the production of new musical effects is shown in Fig. 4. The sound of a bongo drum

triggers the percussion circuit, which in turn converts the sustained chords played by the organ into percussive tones. The output signal is applied to a tape-loop repetition unit that has four equally spaced heads, one for record and three for playback. By connecting the record head and playback head 2 in parallel, output A is produced. By connecting playback head 1 and playback head 3 in parallel, output B is produced, and a distinctive ABAB pattern may be achieved. Outputs A and B can be connected

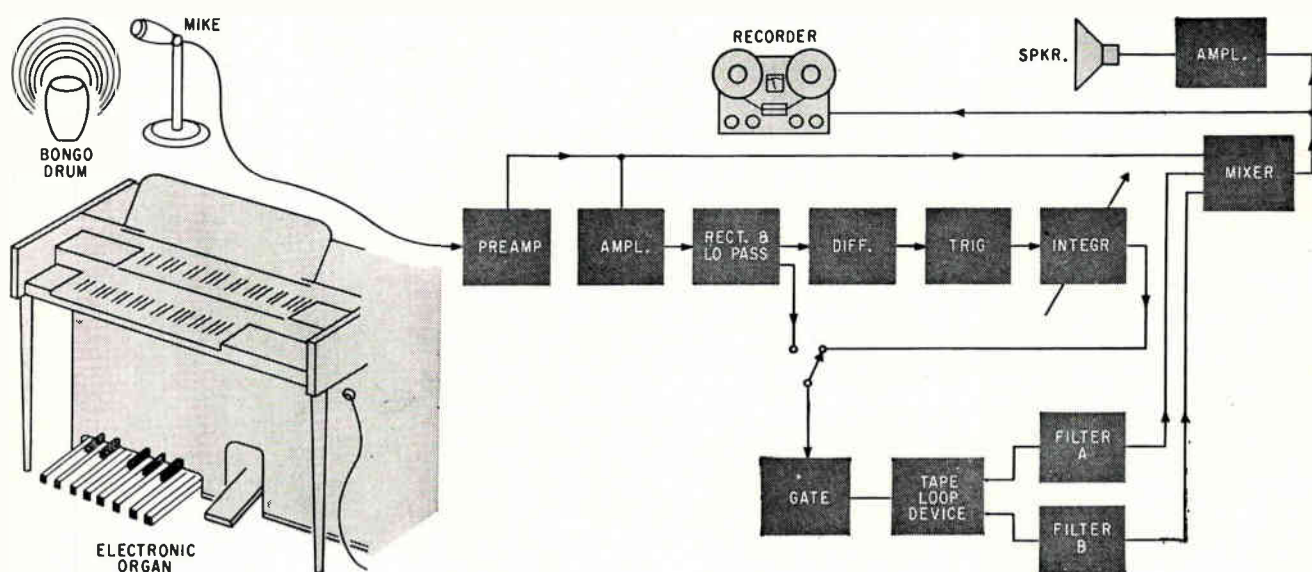

FIG. 4—Organ chords are given drum envelope to produce musical drum effect. Other instruments, including voice, may be substituted for the organ

to formant filters having different resonance frequencies.

The number of repetitions may be extended if a feedback loop is inserted between playback head 2 and the record amplifier. The output voltages of the two filters and the microphone preamplifier are applied to a mixer in which the ratio of drum sound to modified percussive organ sound may be controlled.

A presentation dealing more specifically with the tape-loop device and the sound-processing modules used in the synthesizer is shown in Fig. 5.

The program material originating from the melody instrument is applied to one of the inputs of the audio-controlled gate and percussion unit. There it is gated by the audio from a percussion instrument. The percussive melody sounds at the output of the gate are applied to the tape-loop repetition system. Output signal A—the direct signal and the information from playback head 2—is applied through amplifier A and filter 1 to the mixer. Output signal B—the signals from playback heads 1 and 3—is applied through amplifier B to one input of the ring-bridge modulator. The other ring-bridge modulator input is connected to the output of an audio signal generator.

The mixed and frequency converted signal at the output of the

ring-bridge modulator is applied through filter 2 to the mixer. At the mixer output a percussive ABAB signal (stemming from a single melody note, triggered by a single drum signal) is obtained. In its A portion it has the original melody instrument pitch while its B portion is the converted nonharmonic overtone structure, both affected by the different voicings of the two filters. When the direct drum signal is applied to a third mixer input, the output will sound like a voiced drum with an intricate aftersound. The repetition of the ABAB pattern may be extended by a feedback loop between playback head 2 and the record amplifier.

When applying the human singing voice to the input of the fundamental frequency selector, the extracted fundamental pitch may be distorted in the squaring circuit and applied to the frequency divider (or dividers). This will derive a melody line whose pitch will be one octave lower than that of the singer. The output of the frequency divider may then be applied through a voicing filter to the program input of the audio-controlled gate and percussion unit. The control input of this circuit may be actuated by the original singing voice, after having passed through a low-pass filter of such a cutoff frequency that only vowels—typical for syl-

lables—would trigger the circuit. At the output of the audio-controlled gate, percussive sounds with the voicing of a string bass will be obtained mixed with the original voice of the singer. The human voice output signal will now be accompanied by a coincident string bass sound which may be further processed in the tape-loop repetition unit.

The arbitrarily selected electronic modules of this synthesizer are of a limited variety and could be supplemented by other modules.

A system synthesizer may find many applications such as exploration of new types of electronic music or as a tool for composers who are searching for novel sounds and musical effects. Such a device will present a challenge to the imagination of composer-programmer.

The modern approach of synthesizing intricate electronic systems from modules with a limited number of basic functions has proven successful in the computer field. This approach has now been made in the area of sound synthesis.

With means for compiling any desired modular configuration, an audio system synthesizer could become a flexible and versatile tool for sound processing and would be suited to meet the evergrowing demand for exploration and production of new sounds.

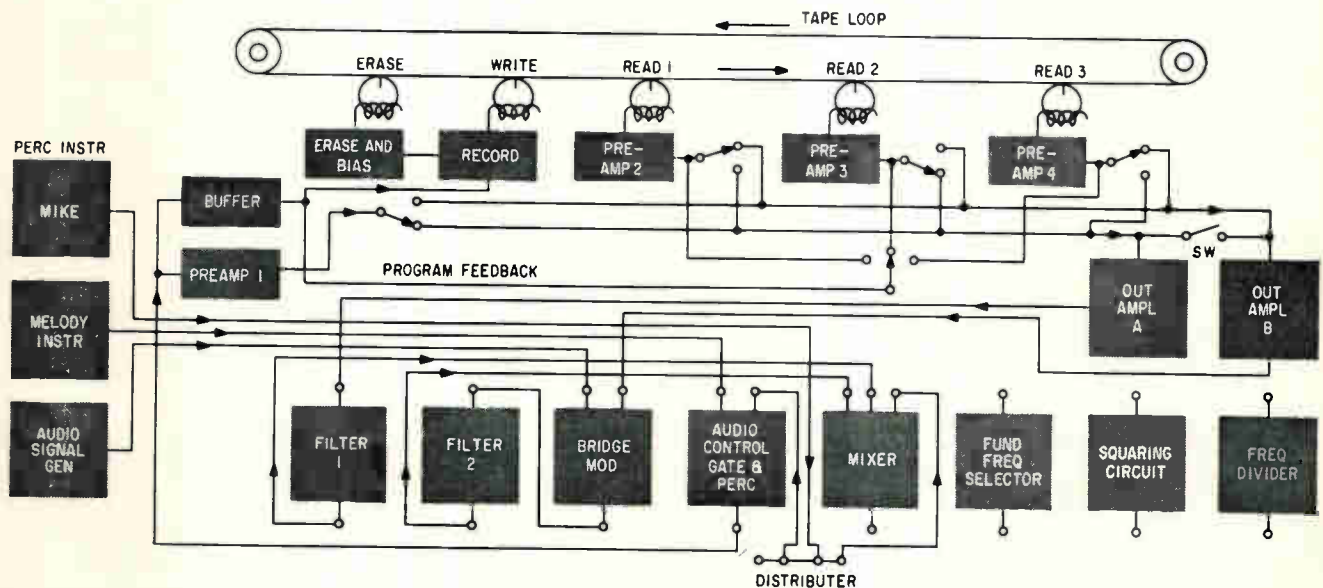

FIG. 5—Overall synthesizer system with tape-loop device and sound and envelope shaping units. Various combinations of shaping circuits can be patched together to generate desired tonal effects

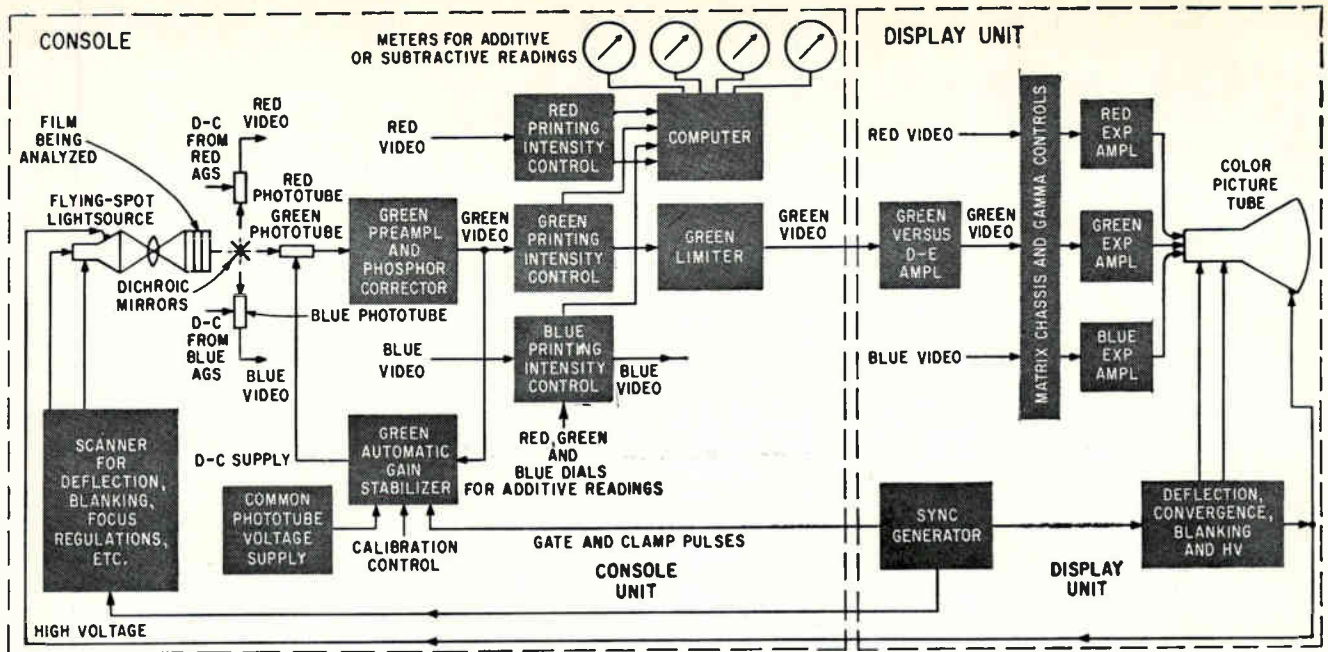

FIG. 1—Three color channels produce red, green and blue analog signals by scanning the film negative; signals are mixed in final circuits for presentation on picture tube. Color blend is controlled by operator to yield data for printing

Scanner Analyzes Color

Analyzer scans film negative and presents color picture on crt. Picture is adjusted for color balance, and printing conditions for color positive are read from calibrated controls

By R. M. FARBER
K. M. ST. JOHN,
Hazeltine Research Corp.,
Little Neck, N. Y.

COMMERCIAL 35-mm color motion pictures are produced by a negative-positive film process, as contrasted with the reversal film used for 35-mm still photography. The output of a 35-mm color motion picture camera is a color negative, from which any number of positive prints can be made. In this negative-positive process both color balance and density of the positive are controlled by choice of light color and intensity to print negatives onto positive stock. Therefore, the printing light color and intensity must be selected and this selection reviewed for each scene in the film.

Some timing methods involve trial and error processes in which test prints are made; then, based on the results of several trials, a

final selection of conditions is made for each scene. This cut and try method is both time consuming and costly. The color film analyzer provides an alternative method that reduces both time and film stock lost by trial and error, and enables the operator to see instantaneously the results for any given printing light, and thus enables him to select the printing conditions.

The color film analyzer consists of a flying-spot scanner that scans the color negative and enables subsequent circuits to see the negative substantially as it is seen by the positive film stock. The taking sensitivities, chemical processing and cross-coupling in the image dyes are all simulated. Finally, an image is presented on a three-color picture tube equivalent to the image that would be given by projecting the developed positive with a normal light source. Therefore, when the controls representing intensity and

color of the printing light are varied, the image on the picture tube varies accordingly. The operator adjusts the printing light until he obtains the desired image, and then records data for making prints.

The operation of the analyzer has been described in detail^{1,2}. This article describes some of the unconventional circuit arrangements that have been used to accomplish the simulation of motion-picture film.

A block diagram of the equipment is shown in Fig. 1. In this diagram, the green channel is shown in full detail. The red and blue channels are similar to the green, and some details of these are omitted.

The flying-spot tube produces a scanning light which, after passing through the film, is split into red, green and blue components by dichroic mirrors. The combination of the characteristics of the mirrors and trimming filters simulates

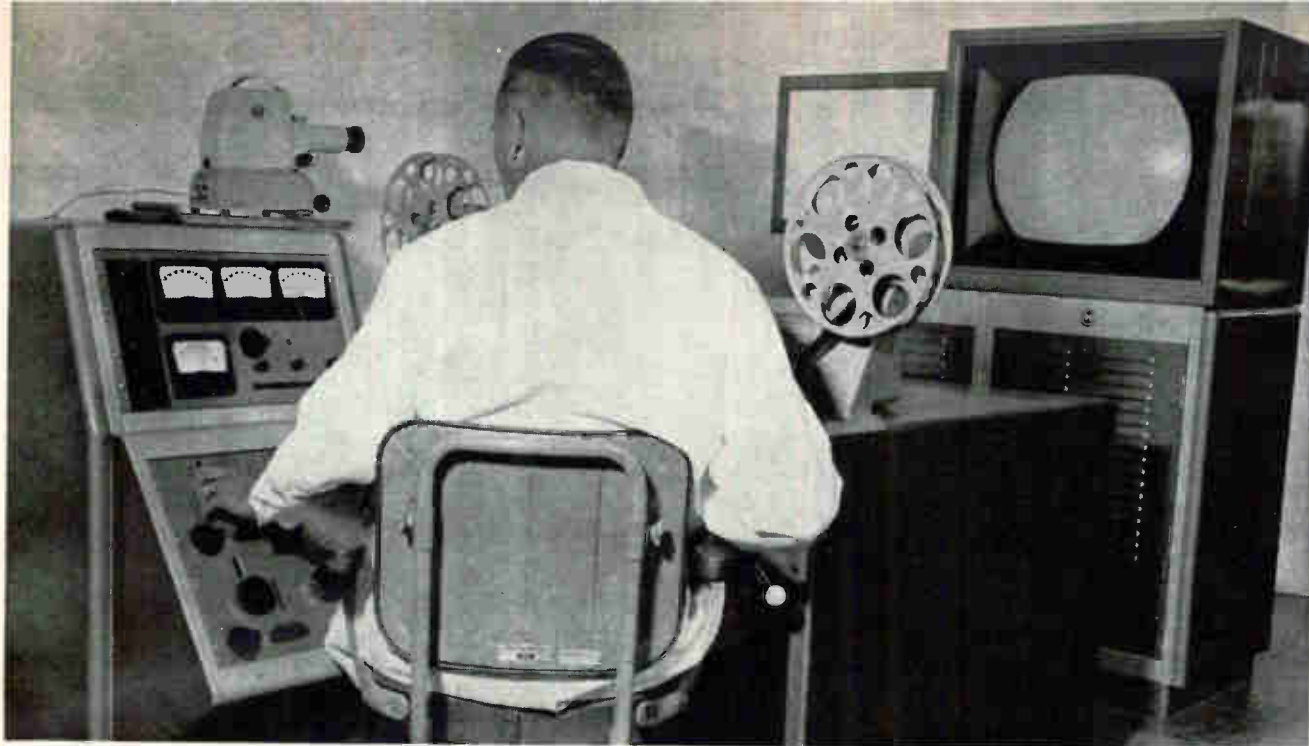

Operator prepares to project analog of the color positive onto crt screen. Controls enable him to adjust color balance and determine conditions for printing positives

Content of Movie Film

the spectral taking sensitivities of the three layers of positive print film. Signals in each channel are then fed through a preamplifier and phosphor corrector that reduces the excessive low-frequency response produced by the scanner-tube phosphor decay or after-glow.

Next in the chain is a stepped attenuator that simulates variations in intensity of the exposing light in each channel. This attenuator is controlled from the computer panel, and is used by the operator to produce the final picture. The three stepped attenuators are calibrated in terms that can be used directly in additive motion-picture printing machines. Total exposing light is composed of selected amounts of three narrow-band red, green and blue primary lights. An alternative type, known as a subtractive printer, employs a white light, and combinations of color correcting and neutral density filters.

In producing data for a subtractive printer, a computer derives its input from auxiliary stepped resistances associated with the printing intensity controls. This computer presents its output on meters cali-

brated in terms of filter density.

The next block is a limiter that prevents signal excursions in the blacker-than-black direction from overloading the following D -versus- E amplifier. This stage is a non-linear amplifier that simulates the nearly logarithmic relationship between exposure E of a film layer, and the density D developed in the layer.

The electrical values in each channel then represents dye densities that are logarithmic terms. Simple cross-coupling or masking can be performed by linear circuits, and gamma can be changed by linear changes in gain. The density signals are so processed to simulate the characteristics of the print film, including the unwanted absorptions of the three dye layers. Finally, these signals are delivered through three exponential amplifiers, which with the square-law characteristics of beam current versus grid voltage of the picture tube guns, produce the correct colors on the face of the tube.

Since the Color Film Analyzer is used in processing laboratories, it must provide accurate information

and exhibit a high degree of stability. Several features have been incorporated in the basic design to insure this stability: they include feedback techniques, stabilized keyed clamps, careful choice of critical components, and precise calibration procedures.

Highly stable feedback amplifiers provide initial amplification in the density-versus-exposure units and also in the exponential amplifier units that deliver analogues of the projected picture to the crt screen. Feedback circuits are also used in the preamplifier units.

The largest feedback loop is that used to provide automatic gain stabilization (ags) of the multiplier phototubes. A sketch containing the details of this circuit is shown in Figure 2a. Identical arrangements are employed in each of the three color channels.

The image of the flying spot scanner raster that is focused on the motion picture frame is so positioned that part of its light falls on the sprocket hole area and is transmitted through with no attenuation. This transmitted light provides a reference level that is converted to

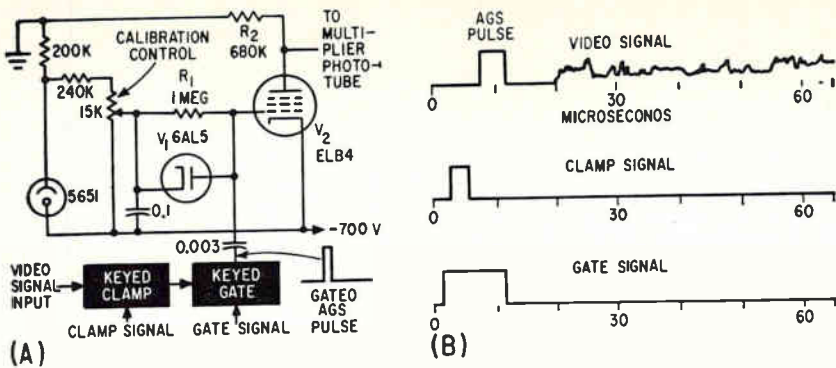

FIG. 2—Ags circuit provides gain stabilization for the multiplier phototubes (A) while (B) shows the timing relationships between the video and clamp circuit pulses

electrical pulses by the three photomultipliers. The electrical timings of this reference pulse and other pertinent signals are shown in Fig. 2b.

The video signal from the multiplier phototube is amplified and fed to a keyed clamp circuit that maintains the d-c component of the signal without disturbing the useful portions of the video signal. As Fig. 2b shows, the clamp signal is timed to lie in a dead spot between the end of video information on a scanning line and the beginning of the ags pulse on the next scanning line. Thus, the video signal is referenced to a fixed voltage during the period just preceding the ags pulse.

The clamped signal is fed to a keyed gate circuit. This circuit is controlled by a gate pulse whose timing and duration are arranged to coincide with the clamp signal plus the ags pulse. This gate then couples that portion of the video signal containing the clamped reference level and the ags pulse to the grid circuit of a voltage control tube V_2 .

The d-c voltage at V_2 grid is the sum of the voltage derived from the calibration potentiometer and the voltage appearing across R_1 , produced by rectification by V_1 of the ags control pulse. This latter voltage is so polarized that an increase in ags pulse amplitude makes the grid voltage more negative and causes V_2 to conduct less heavily.

The voltage control tube has its cathode returned to -700 V d-c and its plate connected to ground through the load resistor R_2 . The output voltage to the photomultiplier then consists of $+300$ V plus the voltage drop across R_2 . This latter voltage drop is dependent on the

amplitude of the ags pulse.

Thus if the gain of the system should change or the light amplitude fluctuate, this change appears as a change in level of the ags pulse, a change in the voltage developed across R_1 , and a compensating change in the voltage applied to the photomultiplier.

Keyed clamps at the nonlinear amplifiers inputs ensure that the d-c reference levels are rigidly maintained. The keying signals, like all synchronizing signals in the system, are derived from the synchronizing signal generator. This generator provides outputs at 60 cps (field scanning rate) and 15,750 cps (line scanning rate) and incorporates a reliable frequency

divider circuit and phase detector to lock the film analyzer timing system to the power-line frequency. Use of density signals makes it easy to represent variations in the toe and gamma characteristics of the processed film. Conversion of electrical signals representing exposure of the positive emulsion (as derived by the multiplier phototubes) to those representing dye density is accomplished in the D -versus- E amplifiers.

Conversion from density signals to light output requires an exponential function. The picture tube provides an approximately square-law output-input characteristic; additional nonlinearity is obtained in the exponential amplifier.

The transfer characteristics of each channel from the output of the multiplier phototubes (measured in $\log E$) to the light output of the picture tube (measured in equivalent density) must match closely the D -versus- $\log E$ characteristic of the positive film stock.

Gains of both the D -versus- E and the exponential amplifier decrease as the input signal level increases.

A linear plot of output versus input for the D -versus- E amplifier is given in Fig. 3. If the abscissa were changed to \log exposure volts, the curve would match the D - $\log E$

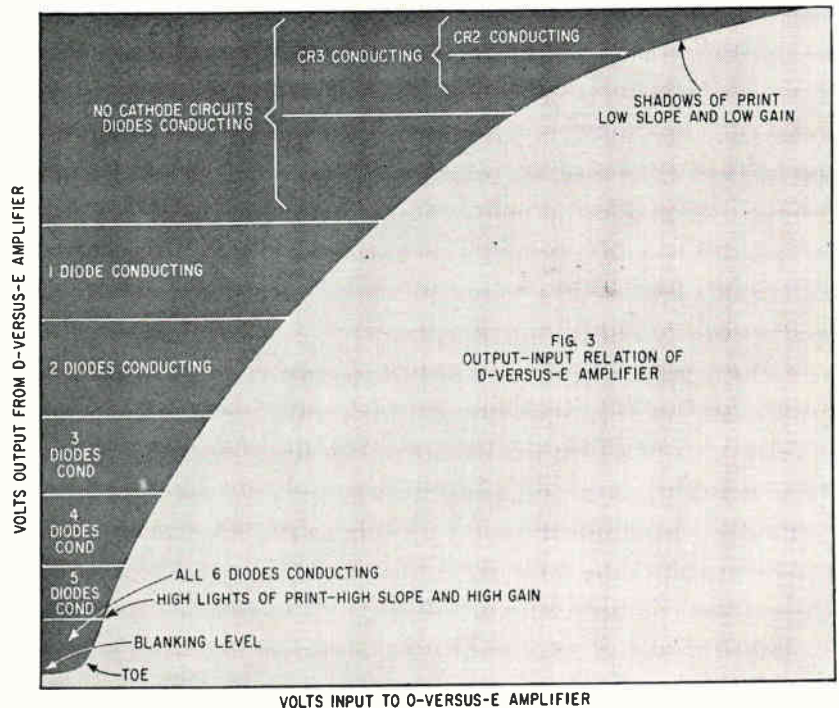

FIG. 3—Highest gain is achieved with all diodes conducting; gain approaches exponential curve as successive diodes drop out of action with increased input signal

curve for a typical positive print film. In the film analyzer, the voltage applied to this amplifier is applied in steps corresponding to $0.025 \log E$. Exposure voltage is divided into these steps by a precision attenuator that the operator controls.

Figure 3 shows that the gain of the D -versus- E amplifier is at its highest level at the lowest amplitude of signals. This corresponds to the highlight regions of the print. To simulate the toe region of the film characteristic, the output signal is held to a low value until the input has reached a predetermined level.

The circuit of the D -versus- $\log E$ amplifier is shown in Fig. 4, where V_1 and V_2 form the nonlinear amplifier. Tube V_3 is a cathode follower that provides isolation from the following circuits. The signal applied to the grid of V_1 comes from a stabilized three-tube video amplifier. The signal is negative going and is rigidly referenced to d-c by a keyed clamp circuit.

Two methods are used to vary the gain as a function of input signal level. The first increases the degenerative resistance in the cathode of V_1 , by successively removing the shunting resistor R_a, R_b, R_c, \dots . When no signal is applied to the grid of V_1 , all diodes in the cathode

circuits are conducting and the equivalent cathode resistance is at its lowest value and the stage gain at its highest value.

The REF ADJ potentiometer is adjusted so that the diode V_1 barely conducts with no signal input. All the other diodes in the chain are biased more in the forward direction than is V_1 . As the signal increases, a point is soon reached at which V_1 ceases to conduct. The equivalent cathode resistance increases and the stage gain decreases. As the input signal increases still farther, V_2 turns off, then V_3 , until all the diodes in the cathode are turned off and the stage gain is minimum.

In the second method of reducing the gain as a function of signal level, the plate load resistors are shunted at certain levels of input. This method is used after the gain variation due to the changing cathode resistance is completed. The basic plate load for this nonlinear circuit consists of R_1 and R_2 in series. Shunting this plate load is the resistor R_3 in series with diode D_2 . The diode is returned to a reference d-c potential established by the zener diode D_1 . Similarly, R_2 alone is further shunted by R_4 and D_3 in series and returned to the same reference potential.

With no signal input to V_1 , maximum plate current flows and the plate potential of V_1 is at its least positive level. Under this condition, D_2 and D_3 are open-circuited and the plate load is R_1 plus R_2 .

As the input signal increases, the stage gain decreases due to the changing cathode degeneration. At a certain level of input signal, the voltage at the junction of R_1 and R_2 becomes sufficiently positive to cause D_2 to conduct and shunt R_2 , thus lowering the effective load resistance. As the input signal is increased still more D_2 conducts and shunts R_1 across the plate-load combination. Thus two more steps of stage gain are added by this plate-circuit network making a total of nine steps in this circuit.

The break points and the circuit gain at each step are selected so that the transfer characteristic of this nonlinear stage closely matches the curve shown in Fig. 3. Although the gain function is made up of a number of discrete steps the curve does turn out to be smooth.

The diode D_1 couples the signal from the plate of V_1 to the grid of the cathode follower. The cathode of this diode is returned to a source of variable voltage controlled by the TOE ADJ potentiometer. The voltage is normally adjusted so that D_1 is turned off for a small range of a-c voltage above zero at the plate of V_1 . Thus the voltage near the highlight region of the print film is limited to simulate the toe region of the film.

The exponential amplifier uses only the cathode degeneration method of obtaining the nonlinear transfer characteristic. The toe diode is not used, nor are the plate-load shunting resistors. The transfer characteristic of the exponential amplifier cascaded with the approximately square-law characteristic of the picture tube produces an overall response such that equal changes in input voltage (representing density) produces changes in picture tube light output that correspond to equal positive-film density changes.

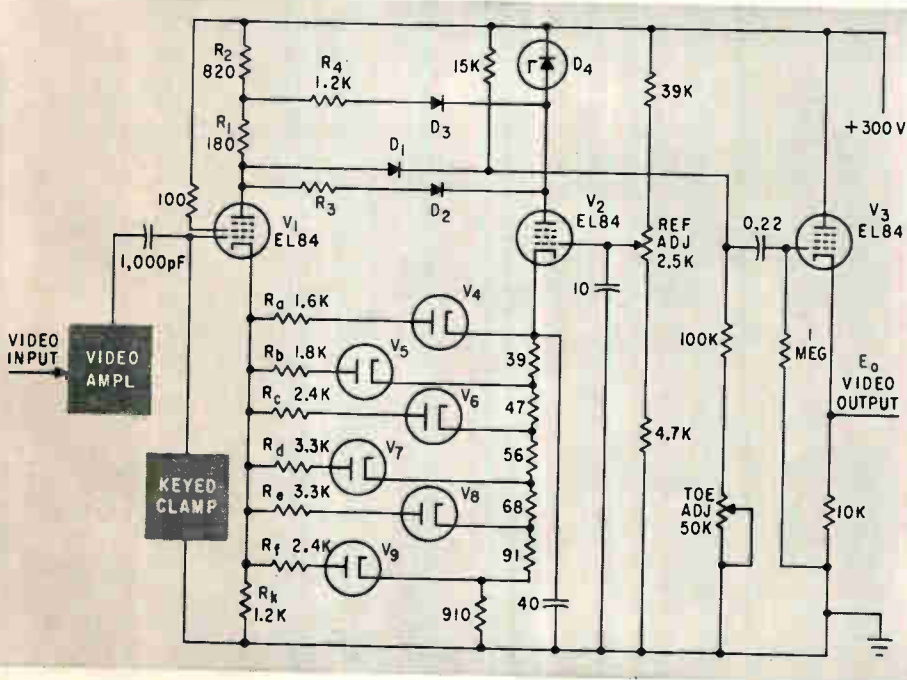

FIG. 4—Amplifier produces curve of Fig. 3 and is used with additional nonlinear circuit elements to get characteristics approximating that of positive color-film stock

REFERENCES

- (1) B. D. Loughlin et al, An Instantaneous Electronic Color Film Analyzer *Journal of the SMPTE*, 67, No. 1, p 17, Jan. 1958.
- (2) U. S. Patent 2,976,348, March 21, 1961.

Subaudio Sawtooth Generator

FIG. 1—Integrator uses mechanical switch to reset circuit to zero (A). In more elaborate versions a neon tube does the resetting (B), while a resistance network enables the output to vary around the level set by R_1 .

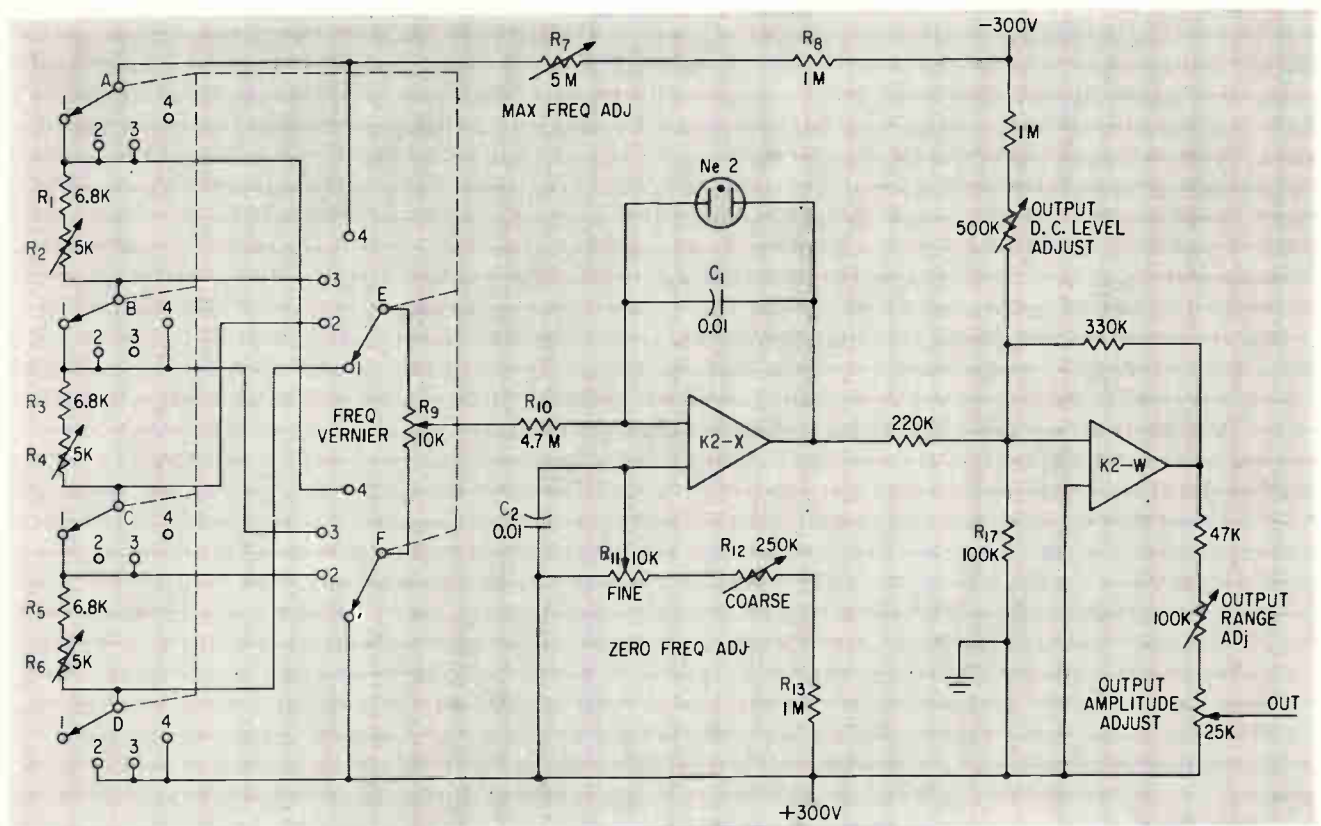
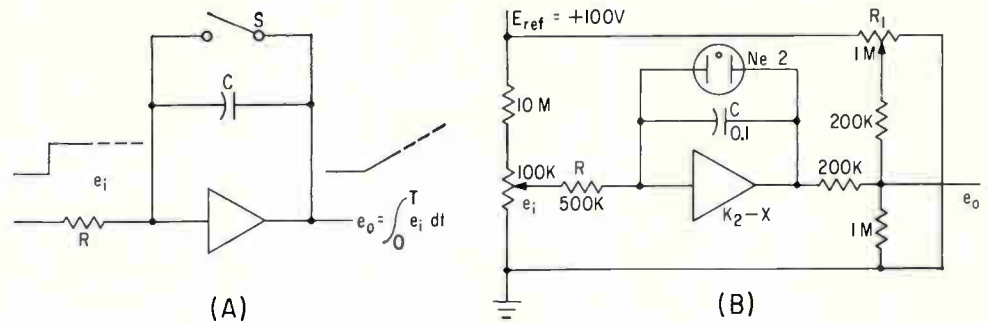
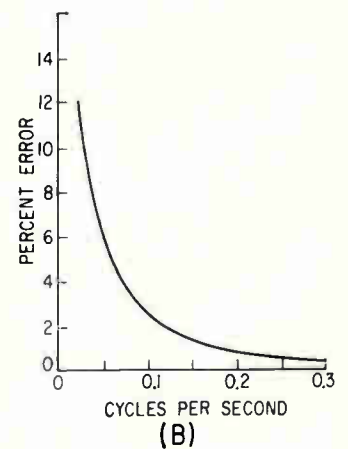
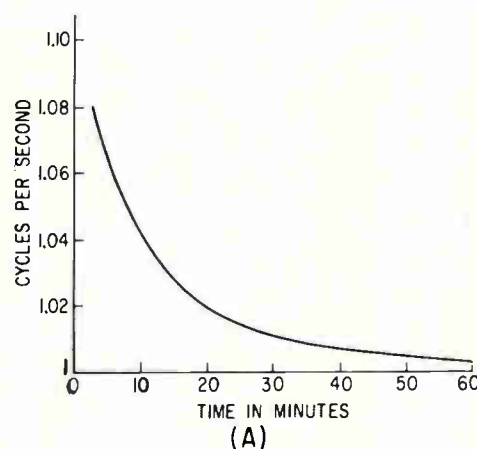

FIG. 2—Ganged switch covers the operating range from about 0.2 cps to 18 cps; output sweep is about 5 volts amplitude

FIG. 3—Frequency drift is equivalent to ± 20 ms an hour after one hour's warmup (A), while frequency variation at low frequency levels is probably due to jitter in the neon firing



Gives One-Percent Linearity

Instrument was designed to provide low-frequency sweeps of high linearity to complement conventional generators having maximum accuracy at faster sweeps. Maximum frequency is about 18 cps and the output sweep has about 5 volts amplitude

By A. ANGELONE

Research Associate
Physiology Department,
Ohio State University,
Columbus, Ohio

THE INTERNALLY GENERATED sawtooth waveform of an ordinary oscilloscope generally deteriorates at low frequencies. Sometimes it is desirable to generate an external sawtooth of known linearity; this article describes such a sawtooth generator having a deviation from linearity of less than 1 percent at frequencies as low as 0.2 cps. It has been used for driving an accurate display of heart pulses, for driving a photoformer function generator, and as a sweep voltage source for feeding an arbitrary-function generator during adjustment of its function.

A high-gain operational amplifier can be arranged to yield a mathematical integral, Fig. 1A. If a constant voltage, e_i , is applied to this integrating circuit, then at $t = 0$, $e_o = 0$; and at $t = T$

$$e_o = \frac{1}{RC} \int_0^T e_i dt.$$

As t varies from $t = 0$ to $t = T$, e_o describes a ramp function whose slope is a constant determined by the choice of C , R and e_i . If C and R are fixed, then the slope is controlled by e_i .

Now if the switch, S , is closed some time after $t = 0$ and before the amplifier saturates, C is discharged, e_o is returned to zero, and the result is a single finite ramp function possessing a high degree of linearity. Further, if S is selected to be an automatic, repetitive

action switch operated by e_o , then the desired free-running sawtooth oscillator is obtained.

The circuit of Fig. 1B uses an operational amplifier in the integrating circuit and a neon bulb as the automatic switch. When e_o reaches approximately 70 volts, the neon conducts and discharges C until e_o drops to about 60 volts, at which time the neon again becomes a high impedance. Since the firing of the neon depends on e_o , and since the slope of e_o is a function of e_i , then the frequency is controlled by e_i (for fixed R and C). The amplitude of the sawtooth is relatively constant, being the difference between the conducting voltage and the extinction voltage of the neon.

Since a low-frequency sawtooth oscillator operating between the voltage levels of approximately 60 volts and 70 volts is inconvenient, the output is biased by the one-megohm variable resistor R_1 so that either end of the sawtooth may be chosen to start from zero. If a function of opposite slope is required, E_{ref} should be reversed in polarity.

Figure 2 circuit is more flexible than Fig. 1B and, with the given circuit values, its maximum frequency and maximum output voltage are about 18 cps and 5 volts respectively.

The alignment of this circuit is accomplished in three steps:

(1) Set the ranges to continuity of frequency selection by adjusting $R_1 + R_2 = R_3 + R_4 = R_5 + R_6 = R_7$.

(2) With the switch in position 1 and R_8 set to zero resistance,

set zero cps by adjusting R_{11} and R_{12} until the output voltage is approximately halfway between the extreme voltages of the sawtooth ramp and does not drift.

(3) With the switch in position 4 and R_9 set at maximum resistance, adjust R_7 for maximum frequency desired. If this frequency is 4 cps, then the frequency vernier will cover exactly one cycle per second in each of the switch positions. For example, in position 2 the vernier will yield frequencies ranging from one cps to 2 cps; in position 3, frequencies from 2 to 3 cps.

Figure 3A shows the initial frequency drift as a function of warmup time. After one hour the drift is equivalent to ± 20 ms per hr, and after 24 hours the drift is equivalent to ± 5 ms per hr.

For frequencies above one cps the linearity error is negligible. As zero frequency is approached, however, the error increases as shown by Fig. 3B. Note that the error is still only one percent at 0.2 cps. This linearity error appears primarily at the tail end of the ramp function and seems to be caused by leakage currents delaying the achievement of the neon firing voltage. Linearity can be increased considerably by using high quality C_1 and R_{11} , and also by cleaning the base of the neon lamp and by shielding it from light.

This work was supported in part by projects H3446 of the National Institute of Health and AF33(616)-5780 of Wright Patterson Air Force Base.

Seven Ways to Use COBALT

MAGNETIC MATERIALS
THIN FILMS
FERRITES
HERMETIC SEALS
PRINTED CIRCUITS
SEMICONDUCTORS
MASERS

By F. R. MORRAL

Cobalt Information Center,
Battelle Memorial Institute,
Columbus, Ohio

THE electronics industry, because of its wide range of parts and products, requires a great variety of materials. Cobalt-base and cobalt-containing alloys, as well as cobalt chemical compounds, are in use and have possibilities for new applications.

The properties of some cobalt-containing materials that make them particularly interesting for the electronics industry are shown in Table I.

The most important use of cobalt in the electronics industry is for magnetic materials. Listings of these materials by trade name, giving composition, mechanical and magnetic properties, and heat treatment, are available.^{1,2} There is a vast amount of technical literature on common and unusual cobalt-containing magnets.¹⁻¹¹ A summary of magnet materials is shown in Table II.

New materials announced in the U.S. are listed in Table III and discussed below:

Alnico VII-A is less affected by temperature (-65 to 500 C) (-85 to 1,020 F) than other Alnico magnets. The high cobalt content minimizes the reversible effect of temperature on remanence and improves resistance to demagnetization.¹²

Alnico V-7 (Hyflux) with BH_{max} values of 7×10^6 gauss-oersteds is an advance over the current 5.5×10^6 for commercial Alnico V, permitting reduction in size and weight without loss of energy.

Alnico V has been used for focusing atomic beams.¹³

By taking advantage of improved properties noted on oriented crystals of Alnico V, Ticonal X was developed¹⁴ with a BH_{max} of 11.0×10^6 gauss-oersteds, the permanent magnet with the highest energy product so far achieved.

Alnico VIII, a high-coercive permanent magnet, was designed for traveling-wave tubes.

Supermendur, an alloy containing cobalt, iron, and vanadium, has been named as a leading candidate for the space age because of the

significant reductions that are possible in weight and size of transformers, magnetic modulators, filter chokes, and the inductive complements.¹⁵ This soft magnetic material is produced from very pure raw materials, melted and annealed in controlled atmospheres. Of all magnetic materials, Supermendur has the highest permeability associated with a high flux density, the highest remanence, and a rectangular hysteresis loop. The forerunner of Supermendur, 2V-Permendur, is used in electrical equipment of special design in

TABLE I — PROPERTIES OF COBALT ALLOYS

| | | |
|-------------------------------|---|---------------------------|
| Magnetic Properties: | PERMANENT MAGNETS (includes ferrites) (See Table II) | |
| | SOFT AND HIGH-PERMEABILITY MAGNETS (See Table II) | |
| | THIN FILMS | |
| Expansion Properties: | LOW-EXPANSION ALLOYS | |
| | Super Invar | Stainless Invar |
| | Super Nilvar | Japanese Invar Nicosel |
| | CONTROLLED-EXPANSION ALLOYS: | |
| | <i>Metal-Glass Seals</i> | |
| | Fernico | Therlo |
| | Fernichrome | Sealvac A |
| | Kovar | Nilo K |
| | Kovar A | EMK |
| | Rodar | Wonico |
| | Dilver P | Vacon |
| | <i>Metal-Ceramic Seals</i> | |
| | Fernico 5 | |
| | Cobalt | |
| | MAGNETOSTRICTION ALLOYS | |
| Constant Modulus: | Co-Elinvar, Volinvar | |
| Spring: | Elgiloy, Cobenium, HIS-25, 8-J-Alloy, Dynavar, Havar, Nilcor, Durapowder | |
| Electrical Resistance: | FILAMENT ALLOYS, HEATING ELEMENTS | |
| | Konel | Cobanic RCA N91 |
| | Nilamic | Cochrome RCA N94 |
| | Filmic | Hilo Kanthal |

which a high magnetic permeability at very high induction is essential. This usually results in a large reduction in weight and space. The 2V-Permendur is used in receiver diaphragms. Because of its high values of positive magnetostriction, it is also used in sonar equipment.

Recently, single-domain cobalt and Co-Fe powders were produced. The latter have become available commercially^{20, b} in a lead matrix and are known as Lodex.

Thin-film memories seem to provide the answer to reduction in size of computers and to speeding up their operation. The thin film reduces access time to the memory from the usual microseconds to nanoseconds.¹⁶

Electrodeposited Co-Ni alloys are used extensively as a permanent-magnetic coating on memory drums in digital computers for fine control.¹⁷ The memory drum is manufactured from an aluminum alloy, copper-coated, and then plated with an 80Co-20Ni plate. An 80Co-20Ni alloy plated on a brass wire has been used as a metallic recording media³ ($H_c = 250$ oersteds, $B_r = 10,000$ gauss). It was not cold-worked or heat-treated. The Co-Ni electroplate has also been suggested for manufacture of

printed circuits.¹⁸

Recent developments on thin-film materials include: a 90Co-10Fe alloy is used for magnetrons; Vapalloy, a Co-Fe alloy, produced by vacuum-induction melting is used in the Univac 1107 thin-film computer.¹⁹ This alloy is evaporated onto glass in a vacuum of 10^{-5} mm Hg in the presence of a magnetic field²⁰; Havar, cold rolled to 0.00025-inch thickness, is used as a protective film over Univac tape heads; general electrical and magnetic properties of thin cobalt films²¹; and materials such as Co₂Y have been investigated.²²

Two books have been written^{23, 24} in the ferrite field.

Among the latest announcements is a magnetic composition with a density of 3.7, a coercive force $H_c = 1,600$ oersteds; and $B_r = 6,000$ gauss; $BH_{max} = 4 \times 10^6$ gauss-oersteds. This is an iron-cobalt oxide (57Fe, 28Co, 15O₂). Oxides Nb₂Co₂O₆ and Ta₂Co₂O₆ have also been studied.²⁵ A ferrite material with magnetic properties for magnetic recorders which can be modified over wide limits (made by powder metallurgy) is composed of 40-50 Fe₂O₃, 10-40 MgO, 10-40 Co, 10-15 ZnO mole %.²⁶

Research work is also in progress

on magnetic films, on thin films for capacitors and resistors, and on thin films for low-temperature operation.²⁷ Researchers are attempting to surpass the properties of these excellent cobalt-containing materials:

- (1) Alnico V: most important industrial alloy
- (2) Ticonal X: highest BH_{max} (11×10^6 gauss-oersteds)
- (3) Pt-Co: highest coercive force
- (4) Supermendur: soft magnetic material with highest permeability at high flux densities.
- (5) Elongated fine particle: highest BH_{max} /density ratio.

Cobalt serves the electronics industry not only as an important alloying element in magnetic materials, but in other alloys as well. Some of the alloys may be applied by electroplating, electroless deposition, vapor, and other methods of deposition.²⁸

Expansion alloys may be grouped as low-expansion, glass-metal seals,²⁹ ceramic-metal seals, and magnetostriction materials. The first three are listed in Table II.

Fernico 5 is a new alloy for ceramic-metal seals. A sealing alloy not commonly used in the United States is EMK (70 Fe, 20 Cr, 10 Mo), which is available in rod (made by powder metallurgy). This material is insensitive to mercury and is frequently used as conductors for anodes and cathodes in mercury rectifiers.³⁰ Wonico (74-84 W, 12-22 Ni, 5 Co) is used in sodium-vapor lamps.

Cobalt and cobalt-alloy magnetostriction is the subject of an informative abstract bibliography.³¹ An alloy recently developed in England of nickel and 4-percent cobalt gives superior magnetostriction performance and is employed in underwater sound devices for depth finding, detection, and related purposes.³²

Electrical-resistance alloys are listed in Table I, together with radio tube filaments. Cobalt additions (to 5 percent) have been recommended for a nickel-alloy electron-tube cathode containing tungsten and zirconium.³³ The co-

TABLE II — MAGNET MATERIALS IN THE ELECTRONICS INDUSTRY

Permanent Magnet Materials

| STEELS | FERRITES | STRUCTURES | PARTICLE | MAGNETRON |
|-------------------------------|----------------------------|-----------------|---|----------------------|
| 9, 17, 36, 38, 40% Co | Vectolite | Pt-Co (23%) | ESD (Fe-Co) Lodex | ALLOY Fe-Co (90%) |
| PRECIPITATION-HARDENED ALLOYS | | | | |
| <i>Fe-Co-Mo, Fe-Co-W</i> | <i>Fe-Co-V</i> | <i>Co-Ni-Cu</i> | <i>Alnico Alloys</i> | |
| Remalloy | Vicalloy I | Cunico | I-A, B, C | |
| Indalloy | Vicalloy II ^(a) | Permet | II-A, B, H ^(b) also sintered | |
| Comol | P-6 ^(a) | | III-A, B, C | |
| | | | IV-A, B also sintered | |
| | | | V-A ^(b) , AB ^(b) , VAB ^(b) , B ^(b) , BDC ^(b) , C ^(b) , E ^(b) , Hyflux 7 also sintered | |
| | | | VI-A ^(b) , B ^(b) | |
| | | | VII ^(b) , A ^(b) , S, C | |
| | | | VIII, XII | |
| | | | Columax tm | |
| | | | Alnicus | |

Soft Magnet Materials (High-Permeability)

| | | |
|--------------|----------------|--------------|
| Permendur | Perminvar | Hiperco |
| 2V-Permendur | 7-70 Perminvar | Ferrites |
| Supermendur | Mo-Perminvar | Ferroxplanas |

(a) Work hardened

(b) Directional magnetic properties

balt increases the yield strength of the alloy below 1,500 F.

Power for servicing electronic parts in aerospace becomes a problem. Solar energy has been collected by using alloy reflectors. Cobalt-base alloys of the Stellite class have been successfully used as reflectors in other industries and may have possibilities here. Their interesting property is high reflectivity in the infrared.

A brazing alloy (16 Co, 16 Ni, 1 B, Bal. Mn) particularly suitable for the electronics industry has been announced recently. Another alloy consists of 60 Co - 40 Pb for brazing in the range 2,290-2,350 F. Alloys of Ga-Co have been suggested for low-temperature bonding in electronic devices.³¹

Fasaloy (Ag, Cu, Co) has been used for electrical contacts. The electric contact alloys are Mallory 8CC (Cu-Co-Cd-Si) and Elkonite 1062 (Ag-WC-Co).

Some studies of the magnetic properties of Au-Co alloys were made, although these were not made on thin films.³² Magnetic and structural properties of the precipitating alloy system Au + 5 atomic percent cobalt have been reported.³³ Magneto-resistance measurements were made on Au-Co alloys (0.44 percent Co) in the temperature range 4.2 to 20 K in fields up to 23 K gauss.³⁷ Cobalt causes only a small deviation from the normal resistance-temperature curves. The thermoelectromotive force of gold with 2.1 atomic percent cobalt against copper over the range 0-300 K has been determined.³⁸ In addition, a low-temperature thermocouple is being marketed by Cryogenics, Inc. Low-temperature magnetic measurements on Au-Co were made.³⁹ Electrical resistance of Au-Co alloys at liquid-helium temperatures was studied.⁴⁰ Electrical resistivity and the coefficient of electrical resistivity (between 25 and 100 C) is at a minimum at about 15 percent cobalt.

Earlier, Au-Co (0.75-5-percent) alloys had been investigated for their electrical resistance⁴¹ and for use as circuit breakers.⁴² Earlier work on electrical and magnetic properties of Au-Co alloys has been reviewed and evaluated.^{43, 44}

The general metallography of the Au-Co system has been described⁴⁵

The solid solubility of cobalt in gold falls from 8 percent at 995 C to 5 percent at 900 C.⁴⁶

Certain cobalt compounds seem to have possibilities in sensing systems, although results on these have not been reported. In silicon semiconductors, if the silicon is heated in the presence of cobalt, higher minority-carrier lifetime is obtained.⁴⁷ The compound Co₂Gd has been found to have antiferromagnetic coupling, and thus other rare-earth cobalt compounds have been studied and reported.⁴⁸ The semiconducting properties in the Si-Co system have been studied.⁴⁸

Cobalt oxide has been used in thermistors (oxide semiconductors), and its introduction into the formulation can have pronounced effect on both the resistivity and the temperature coefficient. Li_mT (1-m), where T = Co, etc., and X = O₂, S₂, etc., has been found to be a good thermoelement.⁴⁹ Compound CoSb₃ has semiconducting properties, and the effect of a third element, Ni, has been studied by the Russians. Compound Co₂V, has simultaneously an uncommon compensation point and an asymmetric hysteresis loop.⁵⁰ Thermistors of the Mn₂O₃-CoO system have a thermistor constant *B* between 3,800 and 5,500 K, a temperature coefficient of electrical resistivity -4.1 to -6 × 10⁻² at 30 C, and a thermal dissipation constant 8-12 mw/C at 25. By heating these thermistors at 500 C for longer than 20 hours, the characteristics are stabilized and the change of electrical resistivity by further heating is less than 0.3 percent.⁵¹

Maser operation⁵² requires crystals containing paramagnetic ions such as Cr or Ni in minute quantities, which generally substitute for Co, Al, or Mg. Crystals of K₃(Co_{0.1005}Cr_{0.0995})(CN)₆ are grown at 4-5 K and have been made to sizes such as 12 × 4 × 3 cm.⁵³ Some of the characteristics of this type maser at 1,420 Mc have been reported.⁵⁴

The compound K₃Co(CN)₆ has a very useful place in maser research.⁵⁵ Another compound considered for maser research is BaCo(CN)₆. A vast amount of experimental work must still be done before a catalogue of maser materials becomes a reality.⁵⁶

TABLE III — NEW COBALT MATERIALS

| Trade Name | Composition, weight per cent | | | | | | Manufacturer |
|-----------------------|------------------------------|------|---------|----|-----|------|--------------|
| | Co | Ni | Al | Ti | Cu | Fe | |
| Alnico V | 24 | 14 | 8 | — | 3 | Bal. | GM,S, |
| Alnico V-7 | 24 | 14 | 8 | — | 3 | Bal. | I, C |
| Columax tm | | | | | | | T |
| Alnicus (USM 75) | | | | | | | U |
| Alnicus (USM 65) | | | | | | | U |
| Alnico VIII | 35 | 15 | 7 | 5 | 4 | Bal. | I, GE, A |
| Alnico VII-A | | | | | | | |
| (o) ^(b) | 34 | 14.4 | 7.5 | 5 | 4.5 | Bal. | I |
| (n-o) | | | | | | | I |
| Alnico VII-S (o) | | | | | | | I |
| (n-o) | | | | | | | I |
| Alnico 7-C | | | | | | | T |
| 7-C _A | | | | | | | T |
| 7-C ₁ | | | | | | | T |
| Super- | | | | | | | |
| mendur | 49 | | (2V) | | | 49 | A, C, V |
| Lodex 31 | X | — | — | — | — | X | GE |
| 32 | X | — | — | — | — | X | GE |
| 41 | X | — | — | — | — | X | GE |
| 42 | X | — | — | — | — | X | GE |
| Co-Pt | 23 | — | (77 Pt) | — | — | — | II |

(a) Code: GM— General Magnetic Corporation, Detroit, Michigan
 S — Simonds Saw and Steel Company, Lockport, New York
 I — Indiana Products Division, Valparaiso, Indiana
 C — Crucible Steel Corporation of America, Pittsburgh, Pennsylvania

REFERENCES

- (1) E. M. Underhill, Editor, "Permanent Magnet Handbook", Crucible Steel Company, May, 1957.
- (2) F. Anselin, Permanent Magnet Materials, *Cobalt*, June and Sept. 1959; also Sept. 1961. (Available from Cobalt Information Center.)
- (3) H. W. Katz, Editor, "Solid State Magnetic Dielectric Devices", J. Wiley & Sons, 1959.
- (4) Max Knoll, "Materials and Processes of Electron Devices", Springer Verlag, Berlin, 1959.
- (5) Magnetic Properties of Metals and Alloys, ASM Seminar, 1959, *Trans.*, 51A, 1959.
- (6) Proceedings of Symposia on Magnetism and Magnetic Materials:
 - (a) *J. Appl. Phys.*, Suppl., 32, March, 1961, 1s-400s, 6th Conference, New York City, Nov. 14-17, 1960.
 - (b) *J. Appl. Phys.*, Suppl., 31, 1960, 5th Conference, Detroit, Nov. 16-19, 1959.
 - (c) *J. Appl. Phys.*, Suppl., 30, 1959, 4th Conference, Philadelphia, Nov. 17-20, 1958.
 - (d) *J. Appl. Phys.*, Suppl., 29, 1958, 3rd Conference, Washington, Nov. 18-21, 1957.
- (7) Cobalt: Chemistry, Metallurgy and Uses, ACS Monograph No. 149, 1960, edited by R. S. Young, Chapter on Magnetic, Electrical, and Electronic Applications, by E. A. Nesbitt, p 184, Reinhold Publishing Corporation.
- (8) Cobalt Monograph, p 296, 1960, Centre d'Information du Cobalt, Brussels, Belgium; available from M. Weissenbruch, S.A., 49 rue du Poinçon, Brussels.
- (9) E. P. Wolfarth, Hard Magnetic Materials, *Adv. in Phys.*, 8, p 87, April, 1959.
- (10) E. W. Lee and A. C. Lynch, Soft Magnetic Materials, *Adv. in Phys.*, 8, p 292, July, 1959.

|)max. auss- teds | Residual Induction, B _r gauss | Coercive Force, H _c oersteds | Peak Magnetic Force Required, oersteds | Permeance Coefficient, (B _d H _d) _{max} | Curie Temp, C | Weight, lb/cu in. | Electrical Resistivity, microhm-cm at 25 C | Tensile Strength, ksi | Transverse Modulus of Rupture, ksi | Coefficient of Thermal Expansion, per °C x 10 ⁻⁶ | Hardness |
|------------------------|---|--|--|--|---------------------|----------------------|---|-----------------------------|---|--|-----------------------------|
| | | | | | | | | | | | |
| | 10,000 | 500 | 3,000 | 7 | 880 | 0.265 | | 5.45 | 10.5 | | C-50 |
| 0 | 12,750 | 765 | 3,000 | 16.5 | | 0.265 | | | | | |
| 5 | 13,500 | 760 | 3,000 | | | 0.264 | 47 | 5.5 | 9 | 11.25 | |
| 5 | 13,900 | 750 | | | | 0.265 | | | | | |
| 5 | 13,500 | 650 | | | | 0.265 | | | | | |
| 4.5 | 8,700 | 1,450 | 3,000 | 6.5 | 845 | 0.265 | 50 | | | | C-56-58 |
| 8 | 8,000 | 1,035 | 3,000 | 7.50 | | | | | | | |
| 6 | 5,500 | 950 | 3,000 | 5.63 | | | | | | | |
| 7 | 8,570 | 1,040 | 3,000 | 8.0 | | | | | | | |
| 5 | 7,540 | 890 | 3,000 | 8.5 | | | | | | | |
| 5.0 | 8,800 | 1,400 | 4,000 | 4-6 | | 0.265 | 50 | | | 11.0 | |
| 75 | 8,400 | 1,200 | 4,000 | | | 0.265 | 50 | | | 11.0 | |
| 5 | 7,500 | 950 | 3,500 | | | 0.265 | 50 | | | 11.0 | |
| | 21,000 | 0.18 | | | 940 | 8.2g/cc | 25 | | | 7.35 | |
| | | | | | | 0.320 | | | | | |
| | | | | | | 0.310 | | | | | |
| | | | | | | 0.358 | | | | | |
| | | | | | | 0.346 | | | | | |
| 5 | 6,450 | 4,300 | 15,000-20,000 | ≈500 | | 15.7 g/cc | 42.4(a) ^(c) | | | 9.3 | 200 VPH (a) 305 VPH (ht) |
| | | | | | | | 30.2 (ht) | | | | |

T — Thomas and Skinner, Inc.,
Indianapolis, Indiana
U — U.S. Magnet and Alloy Corpora-
tion, Bloomfield, New Jersey
GE — General Electric Company,
Edmore, Michigan
A — Arnold Engineering Company,
Marengo, Illinois

W — Westinghouse Electric Corporation,
Blairsville, Pennsylvania
H — Hamilton Watch Company,
Lancaster, Pennsylvania.

(b) o = oriented; n-o = nonoriented.
(c) a = annealed; ht = heat treated.

(11) Magnetische Werkstoffe, Zugleich 2, Ergänzungsband zu Eisen, Teil D, System No. 59, Gmelin Handbuch, 8th Edition, 1959.
(12) Electronic Technology, p 12, Oct., 1960.
(13) R. L. Christensen and D. R. Hamilton, *Rev. Scientific Inst.*, 30, p 356, May, 1959.
(14) Philips Res. Rep. (North American Philips, Inc.) 11, p 489, 1956, and 2nd Conf. on Magnetism & Magnetic Materials (T-91) AIEE, New York, p 177, Feb. 1957.
(15) *Research/Development*, p 84, Aug. 1960.
(16) *Chemical & Engineering News*, p 43, Jan. 16, 1961.
(17) V. Zentner, Magnetic Properties of Electrodeposited Co-Ni Alloys, 47th Proc. Am. Electroplaters Soc., 166, p 249, 1960.
(18) T. F. Dytrt, Industrial and Engineering Chemistry, 51, (3), p 286, 1959.
(19) *Electronic News*, p 25, Jan. 23, 1961.
(20) *Chemical and Engineering News*, p 50, Jan. 23, 1961.
(21) A. Dupre, Electrical and Magnetic Properties of Thin Cobalt Films, *Cobalt*, 6, 1960. (Available from Cobalt Information Center.)
(22) *Electronic News*, p 29, June 15, 1959.
(23) J. Smit and H. P. J. Wijn, *Ferrites*, J. Wiley & Sons, 1959.
(24) "Ferrites . . . Physical and Physical-Chemical Properties" Izd. vO AS BSSR, pp 137-41, 95-9, 233-35, 258-62, Minsk, 1960.
(25) R. Aeonard and R. Panthenet, Magnetic Properties of Cobalt Niobate, *Compt. Rend.*, 251, pp 1730, 1733, Oct. 1960.
(26) French Patent 1,129,532, 1957.
(27) *Chemical and Engineering News*, p 43, Jan. 16, 1961.

(28) Bibliography on Electroplating of Cobalt and Cobalt Alloys, also Informative Bibliography on Thin Films. (Available from Cobalt Information Center.)
(29) K. H. Maier, *J. Metals*, 4, p 460, 1952; and W. Espe, *Kovar*, C. F. Winter'sche Verlagshandlung Fussen/Bayern, 1956; Kohl, W. H., "Materials and Techniques for Electron Tubes", Reinhold, p 448, 1960.
(30) Max Knoll, "Materials and Processes of Electron Devices", Springer-Verlag, Berlin, p 195, 1959.
(31) E. E. Fletcher, Selected Abstracts on Magnetostriction in Cobalt and Cobalt Alloys, 1959. (Available from Cobalt Information Center.)
(32) *Industrial Heating*, p 270, Feb. 1960.
(33) U. S. Patent 2,833,647, May 6, 1958.
(34) Gallium Alloys for Low-Temperature Bonding in Electronic Devices, *Electro-Technology*, p 12, May 1961.
(35) P. Gaunt, A Magnetic Study of Precipitation on a Au-Co (1.5% at.) Alloy, *Phil. Mag.*, 5, p 1127, Nov., 1960.
(36) Magnetic and Structural Properties of the Precipitating Alloy System: Au + 5 Atomic Per Cent Co, Univ. Microfilms, Ann Arbor, Mich., L. C. Card No. Mic 59-6930; Dissertation Abstr. 20, p 3348, 1960.
(37) A. N. Gerritsen, *Physica*, 25, p 489, 1959.
(38) R. L. Powell, M. D. Bunch and R. J. Corruccini, Low-Temperature Thermocouples. Part I. Gold-Cobalt or Constantan Versus Copper or Normal Silver, *Cryogenics*, 1, p 139, March, 1961; also R. L. Powell, M. D. Bunch and E. F. Gibson, Low-Temperature Transport Properties of Commercial Metals and Alloys. III. Gold-Cobalt, *J. Appl. Phys.*, 31, (3), p 504, Mar. 1960.
(39) *Z. Physik Chem. Neue Folge*, 16, Simon-Gedenkheft, pp 368-71, 1958.

(40) Electrical Resistance of Some Noble-Metal Alloys at Liquid Helium Temperatures, *Phys. and Chem. Solids*, 7, (1), p 94, 1958.
(41) J. L. Thomas, National Bureau of Standards RP789, in *J. of Res. NBS*, 14, p 589, May 1935.
(42) A. Kell and W. Merl, *Zt. f. Metallkunde*, 48, p 16, 1957.
(43) Gmelin's Handbuch, System 62, on gold, p 878, 1954.
(44) E. Raub, "Die Edelmetalle u. Ihre Legierungen, Springer-Verlag, p 204, 1940.
(45) *Zt. f. Metallkunde*, 41, p. 234, 1950.
(46) A. T. Grigor'ev, E. M. Sokolovskaya and M. V. Maksimova, Investigation of Alloys in the System Gold-Cobalt, *Zhur. Neorg. Khim.*, 1, p 1047, 1956.
(47) U. S. Patent 2,827,436.
(48) E. N. Nikitin, An Investigation of the Semiconducting Properties in the Silicon-Cobalt System, *Fiz. Tverdogo Tela*, 2, p 633, 1960.
(49) R. R. Heikes, et al., U. S. Patent 2,953,617, Sept. 20, 1960.
(50) N. Menzük, et al., *Phys. Rev. Letters*, 4, p 119, 1960.
(51) K. Nonaka, Thermistors I. Mn₂O₇-NiO and Mn₂O₃-CoO Systems, *Nagoya Kogyo Gijutsu Shikensho Hokoku*, 5, p 613, 1956.
(52) J. R. Singer, *Masers*, J. Wiley & Sons, 1959.
(53) C. W. Wolfe, *Am. Mineralogist*, 45, p 1211, 1960.
(54) B. Bolger, B. J. Robinson and J. Ubbink, Some Characteristics of a Maser at 1420 Mc./sec., *Physica*, 26, p 1, 1960.
(55) J. W. Meyer, Variety of Maser Materials Sought, *Electronic News*, p 29, June 15, 1959.
(56) J. W. Meyer, *ELECTRONICS*, p 58, Nov. 4, 1960.

LOGARITHMIC

Transmission-Line Charts

By H. F. MATHIS, Professor, Dept. of E. E., The Ohio State University, Columbus, Ohio

IMPEDANCE OR ADMITTANCE along a lossy transmission line when plotted on a circular transmission-line chart (Smith' or Carter² chart) is a logarithmic spiral. The same plot on a logarithmic transmission-line chart is a straight line, and the slope of the line is directly proportional to the loss per unit length. Such a linear plot may be more convenient for some problems.

The well-known Smith (R-X) and Carter (Z-θ) charts are based on the transformation $\Gamma = (Z - Z_0)/(Z + Z_0)$. Logarithmic charts are based on the transformation $w = \log \Gamma = \log (Z - Z_0)/(Z + Z_0)$. For logarithmic charts, it is desirable to interchange the x and y axes.

Logarithmic charts for impedances with only positive-resistance components are shown in Fig. 1 and 2. Charts for impedances with both positive and negative-resistance components are shown in Fig. 3 and 4. The chart in Fig. 1 corresponds to the Smith chart, the one in Fig. 2 corresponds to the Carter chart. The charts in Fig. 3 and 4 are similar to extended transmission-line charts.³

Logarithmic charts may be drawn by plotting $|\Gamma|$ as a function of the angle ϕ of Γ on semilog paper. First, circular transmission-line charts are considered to obtain these functions.

An R -circle (or G -circle) on the Smith chart has its center at $(x = R/(R + 1), y = 0)$ and radius $r = 1/|R + 1|$. On this chart, an X -circle (or B -circle) has its center at $(x = 1, y = 1/X)$ and radius $r = 1/|X|$.

On the Carter chart, a Z -circle (or Y -circle) has its center at $(x = (Z^2 + 1)/(Z^2 - 1), y = 0)$ and radius $r = 2|Z/(Z^2 - 1)|$. A θ -circle has its center at $(x = 0, y = -\cot \theta)$ and radius $r = |\csc \theta|$. The ambiguity due to $Z/\theta = -Z/\theta + \pi$ may be removed by requiring that $Z \geq 0$.

The substitution $x = |\Gamma| \cos \phi$ and $y = |\Gamma| \sin \phi$ may be used to obtain the functions

$$\Gamma_R = \frac{1}{R+1} \left[R \cos \phi \pm \sqrt{1 - R^2 \sin^2 \phi} \right]$$

$$\Gamma_X = \frac{1}{X} \left[X \cos \phi + \sin \phi \pm \sqrt{(X \cos \phi + \sin \phi)^2 - X^2} \right]$$

$$\Gamma_Z = \frac{1}{Z^2 - 1} \left[(Z^2 + 1) \cos \phi \pm \sqrt{(Z^2 + 1)^2 \cos^2 \phi - (Z^2 - 1)^2} \right]$$

$$\Gamma_\theta = -\cot \theta \sin \phi \pm \sqrt{\cot^2 \theta \sin^2 \phi + 1}$$

For the curves Γ_R and Γ_X and the curves Γ_Z and Γ_θ to be orthogonal, the distances on the charts cor-

responding to the ratio ϵ on the log scale and one radian on the linear scale must be equal.

With these charts, procedures are similar to those used with Smith and Carter charts, except that circles about the center on circular charts correspond to horizontal lines on logarithmic charts.

Many problems can be solved equally well on either circular or logarithmic transmission-line charts. Typical of these are finding the impedance along a lossless transmission line, converting an impedance to an admittance, and designing a single-stub tuner. The examples below are handled more conveniently on logarithmic charts:

(1) A plot of the normalized impedance along a lossy transmission line is shown in Fig. 5. For this example, $Z_0/Z_0 = 1 - j1$, the attenuation along the line is 5 db per wavelength when it is terminated in a matched load. The impedance at the point 0.3 wavelength toward the generator is $Z_0/Z_0 = 0.903 + j0.627$.

(2) Logarithmic charts are convenient for determining the normalized impedance along a lossless transmission line for two frequencies, as shown in Fig. 6. The point N is located on the line through Z_{10} and Z_{12} so that $d_2/d_1 = f_2/f_1$. The impedances Z_1' and Z_2' along the line for the two frequencies are given by the intersections of the lines as shown. For the example, the normalized terminating impedances for the two frequencies are $Z_{10} = 1 - j1$ and $Z_{12} = 0.8 - j0.4$; and $f_2/f_1 = 1.5$. At the point 0.133 wavelength for f_1 and 0.170 wavelength for f_2 toward the generator, $Z_1' = 0.414 - j0.277$ and $Z_2' = 0.676 + j0.252$.

Circular transmission-line charts have found many applications not associated with transmission lines because all impedances with positive resistive components are located within a finite area. Logarithmic charts do not have this characteristic. It is not possible to include the point $Z = Z_0$. Also, circular charts can map circles or straight lines in the impedance, admittance, or reflection coefficient plane into circles or straight lines.

REFERENCES

- (1) P. H. Smith, Transmission-Line Calculator, *ELECTRONICS*, 12, p 29, Jan. 1939. Also, An Improved Transmission-Line Calculator, *ELECTRONICS*, 17, pp 130, 318, Jan. 1944.
 - (2) P. S. Carter, Charts for Transmission-Line Measurements and Computations, *RCA Rev.* 3, p 255, Jan. 1939.
 - (3) H. F. Mathis, Extended Transmission-Line Charts, *ELECTRONICS*, 33, pp 76, 78, Sept. 23, 1960.
- (continued on p 50)

**NEW HIGH IN
RELIABILITY**

**Transitron's
EXCLUSIVE**

HEATLESS SEAL RECTIFIERS

This new line of heatless seal silicon rectifiers by Transitron, the originator of the silicon rectifier, brings to the electronic industry a notable new advance in the state of the art.

The reliability of internal rectifier junctions is now further enhanced because no heat is used to seal the packages. Cap and base are joined by the "cold flow" of copper into steel as the parts are forced together under high pressure. Rectifier junctions are no longer exposed to contamination by the sputtering or splashing of molten metals or by flux fumes and gases, weld flashes, or hot sparks. Therefore the new process creates the most reliable hermetic seal yet attained in silicon rectifiers. Consequently heatless seal rectifiers meet or exceed all required military and industrial tests for moisture resistance and hermeticity. Four series now in quantity production are available for immediate delivery.

For further information, write for bulletins indicated in the chart at right.



TWICE SIZE

| SERIES TYPE | PEAK INVERSE VOLTAGE (VOLTS) | | | | | | | | | | BULLETIN NUMBER |
|----------------|------------------------------|---------------|-------|---------------|-------|---------------|-------|---------------|---------------|---------------|-----------------|
| | 50 | 100 | 150 | 200 | 250 | 300 | 350 | 400 | 500 | 600 | |
| 3 AMP TYPES | 1N1581 (TM7) | 1N1582 (TM17) | | 1N1583 (TM27) | | 1N1584 (TM37) | | 1N1585 (TM47) | 1N1586 (TM57) | 1N1587 (TM67) | TE-1351F |
| 20 AMP TYPES | 1N248A | 1N249A | TR152 | 1N250A | TR252 | TR302 | TR352 | TR402 | TR502 | TR602 | TE-1351K |
| 35 AMP TYPES | TR53 | TR103 | TR153 | TR203 | TR253 | TR303 | TR353 | TR403 | TR503 | TR603 | TE-1351K-1 |
| MILITARY TYPES | | 1N253 | | 1N254 | | | | 1N255 | | 1N256 | TE-1336 |

Bases and caps supplied by Standard Pressed Steel Co., Jenkintown, Pa. **CIRCLE 259 ON READER SERVICE CARD**

Transitron

electronic corporation
wakefield, melrose, boston, mass.



SALES OFFICES IN PRINCIPAL CITIES THROUGHOUT THE U.S.A. AND EUROPE • CABLE ADDRESS: TRELCO
For quantities 1-999 call your nearest Transitron Industrial Distributor.

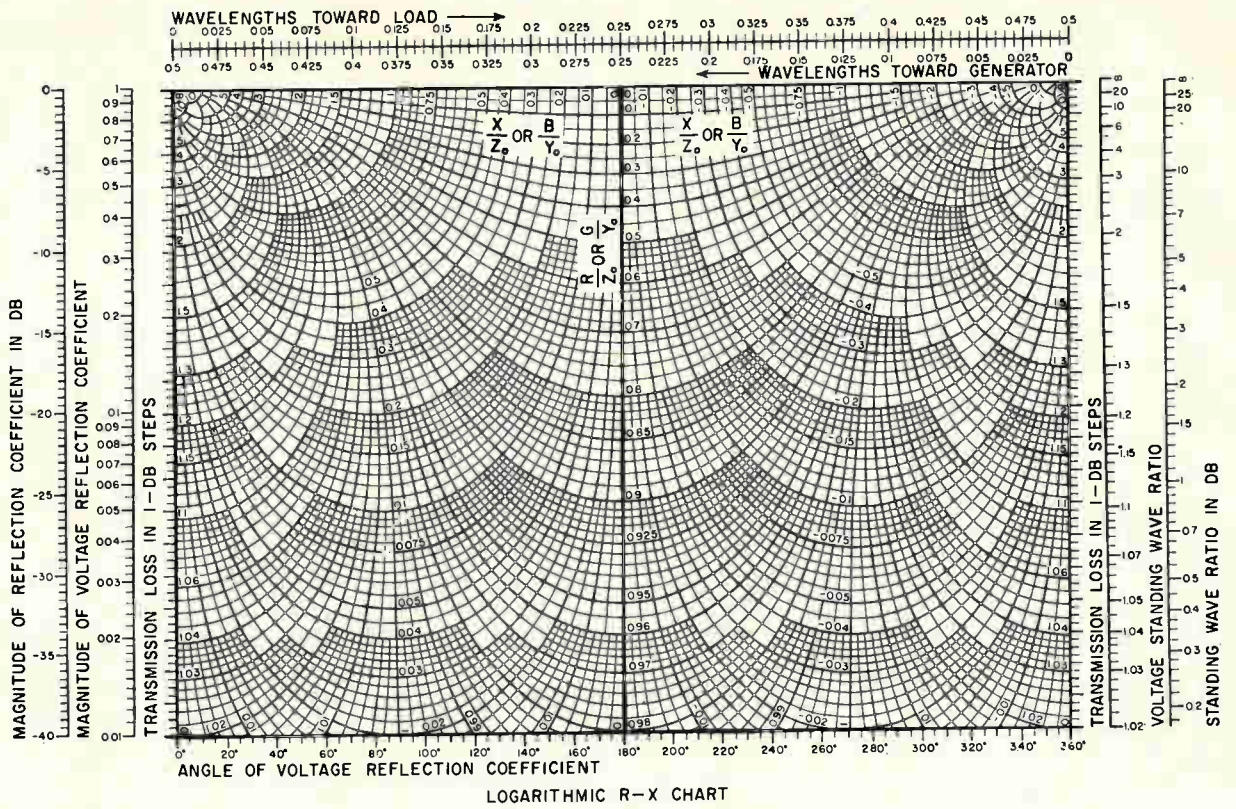

FIG. 1—Logarithmic R-X chart, with only positive values of R

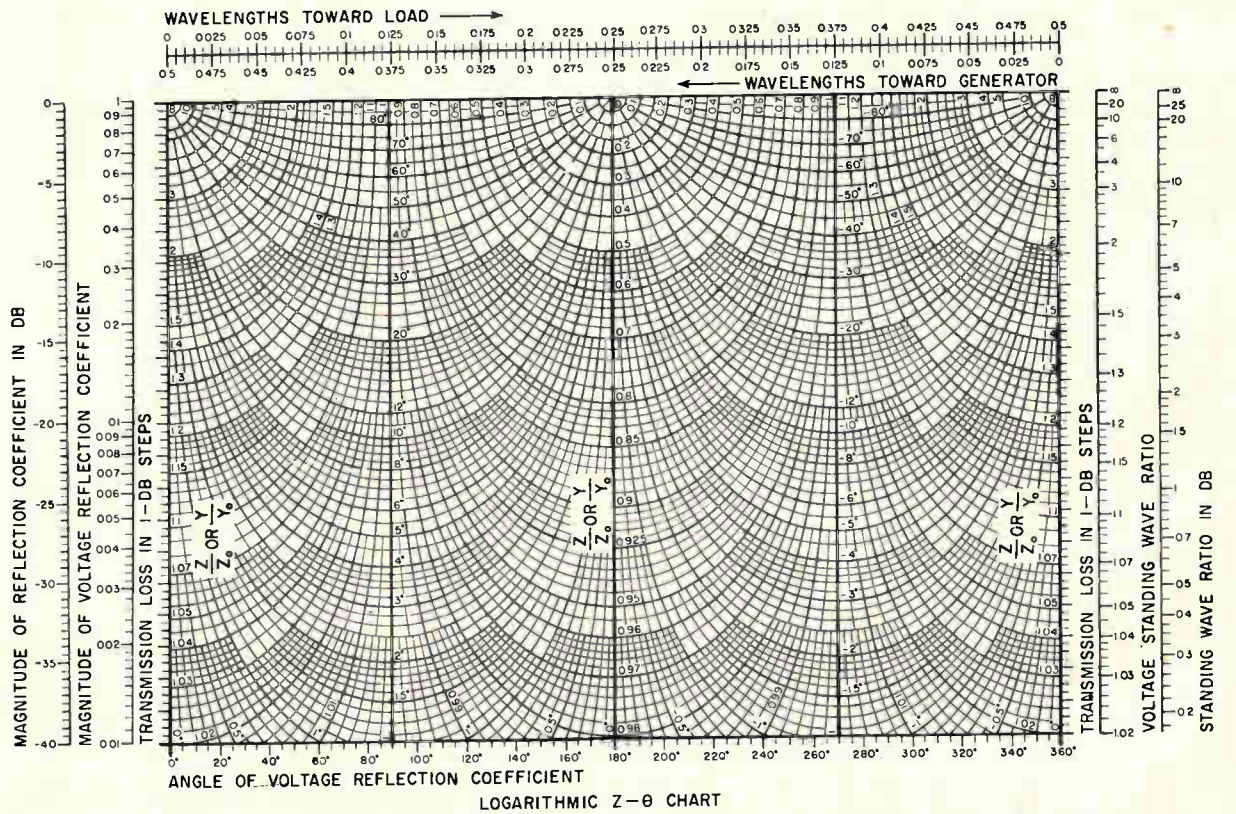

FIG. 2—Logarithmic Z-θ chart for impedances with only positive-resistance components



INLAND

Standard DC Torquers available in the widest range of sizes and capacities

Silent, gearless, Inland DC pancake torque motors have high torque-to-inertia ratios and excellent linearity throughout the torque range. They provide an exceptional degree of accuracy for direct-drive servo positioning, while eliminating problems of backlash, windup, and compliance.

Inland's complete line of DC torquers serves in such varied applications as: missile and aircraft stable platforms, radar tracking antenna, space vehicle reaction wheel drive, rate table drives, rotary solenoids for missile arming systems, and special machine tool applications—just to name a few.

For systems duty with Inland torque motors, a line of rotary and solid state amplifiers is also avail-

able. All Inland products are backed by extensive experience . . . thorough quality control, reliability, and field testing . . . successful performance in practically every major missile and space vehicle program. For details, complete specifications, and illustrated brochure, write Department 1212

| Standard Model Specification Range from smallest to largest torque motors* | | |
|---|------------|-------------|
| FRAME SIZE | 1.3 INCHES | 36.0 INCHES |
| Peak torque, lb.-ft. | 0.1 | 3000 |
| Volts at peak torque, stalled at 25°C | 48 | 246 |
| Amps at peak torque | 1.21 | 30 |
| Sensitivity, lb.-ft./amp | .09 | 100 |
| Temperature rise per watt, ultimate, °C | 13.4 | 0.04 |
| Total friction, lb.-ft. | 0.003 | 18 |
| Ripple torque, pound-feet | | |
| At low torque levels | 0 | 0 |
| At peak torque | 0.1 | trace |
| Weight, lbs. | 0.313 | 1200 |

*Numerous sizes available in between. Non-Standard sizes designed to meet specific requirements in these ranges and larger.

INLAND MOTOR

CORPORATION OF VIRGINIA
A SUBSIDIARY OF
KOLLMORGEN CORP.
NORTHAMPTON, MASS.



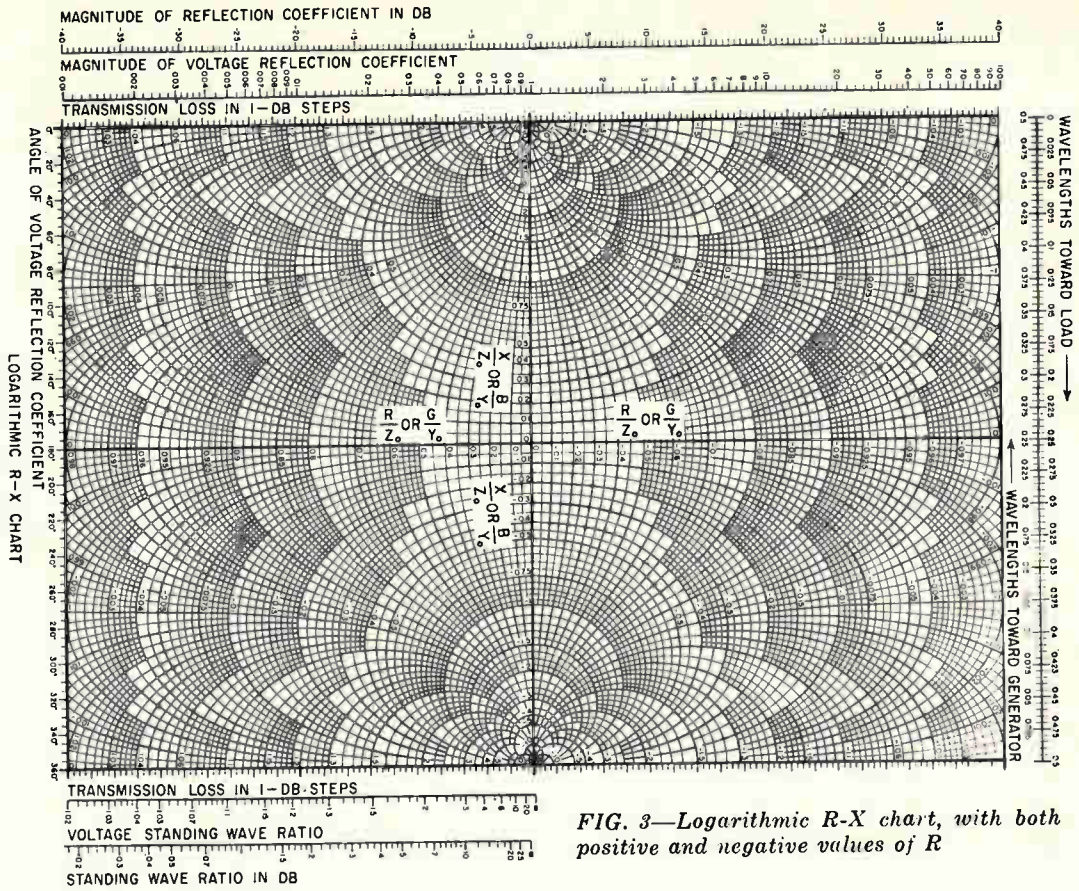

FIG. 3—Logarithmic R-X chart, with both positive and negative values of R

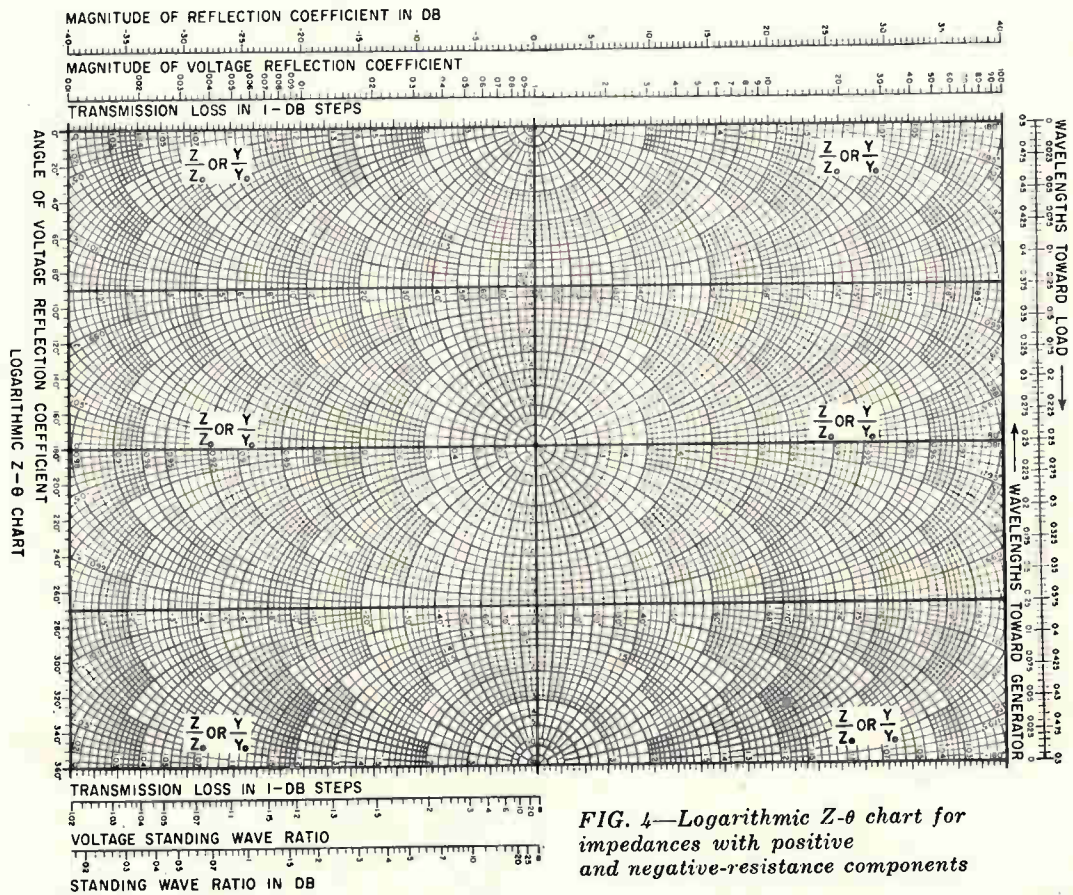

FIG. 4—Logarithmic Z-θ chart for impedances with positive and negative-resistance components

BENDIX DIGITAL MODULE TESTER

REDUCE
TEST
TIME
TO
SECONDS

This portable, suitcase-type unit tests transistorized digital modules on a go, no-go basis in approximately 20 seconds. Larger, more complex printed circuit boards can be checked in approximately 45 seconds. It also reduces set-up time from hours to minutes over other methods. Net results: lower production costs; minimum downtime of the main computer; accelerated production rates; and positive test results.

The Bendix® Tester is highly reliable with a mean-time-between-failure in excess of 1000 hours.

It is now being used to test 150 different types of digital modules but has the capability for checking an unlimited number. Analog-type modules, power supplies, signal relays, and sensors can be assessed with appropriate accessory equipment.

Other uses for the Bendix Tester include: production testing of modules; troubleshooting printed circuit boards; laboratory breadboarding; aiding in digital system troubleshooting.

For further information, write us today. Bendix Eclipse-Pioneer Division, Teterboro, New Jersey.

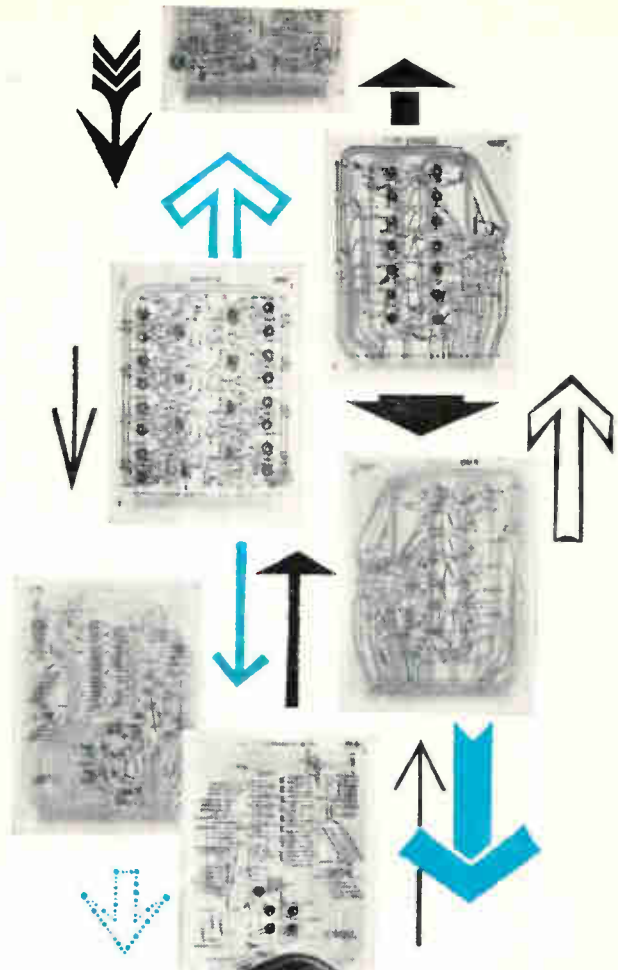

Eclipse-Pioneer Division

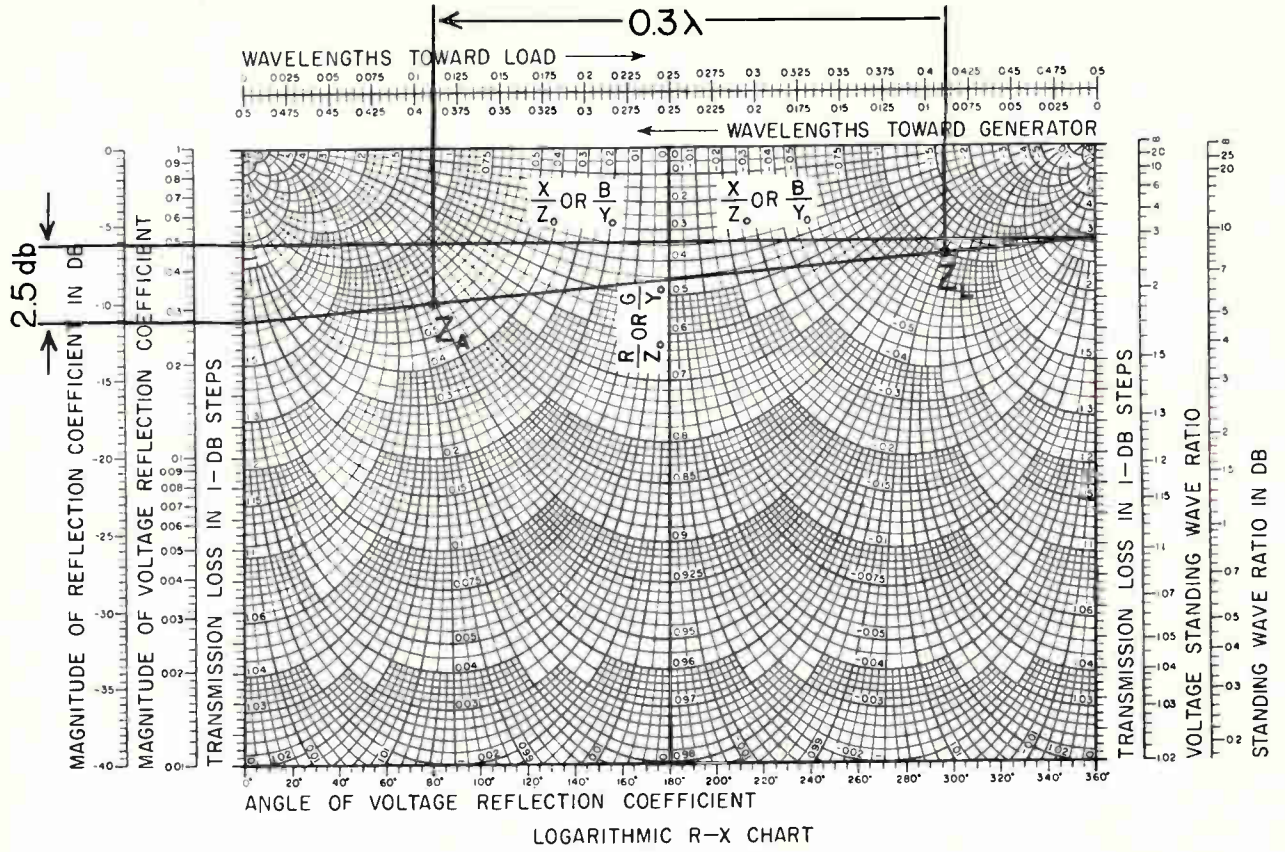

FIG. 5—Impedance along lossy transmission line

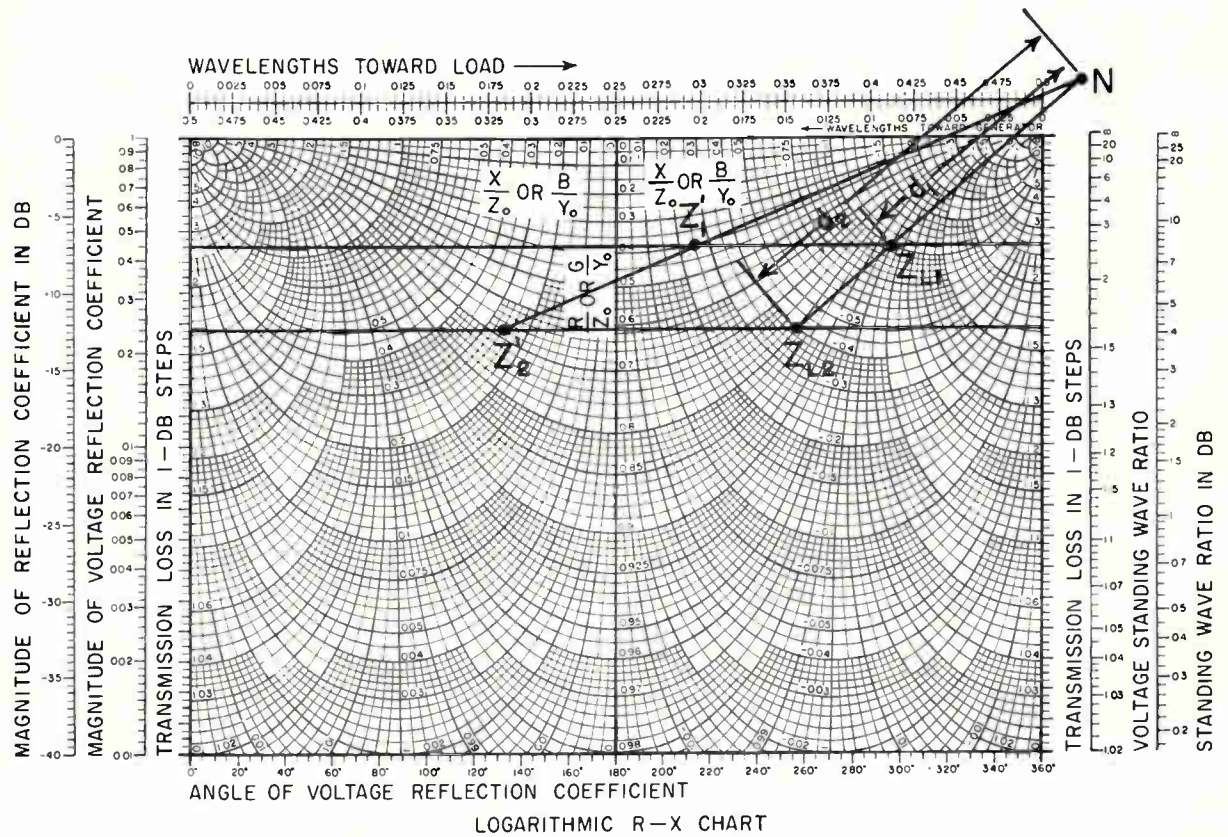
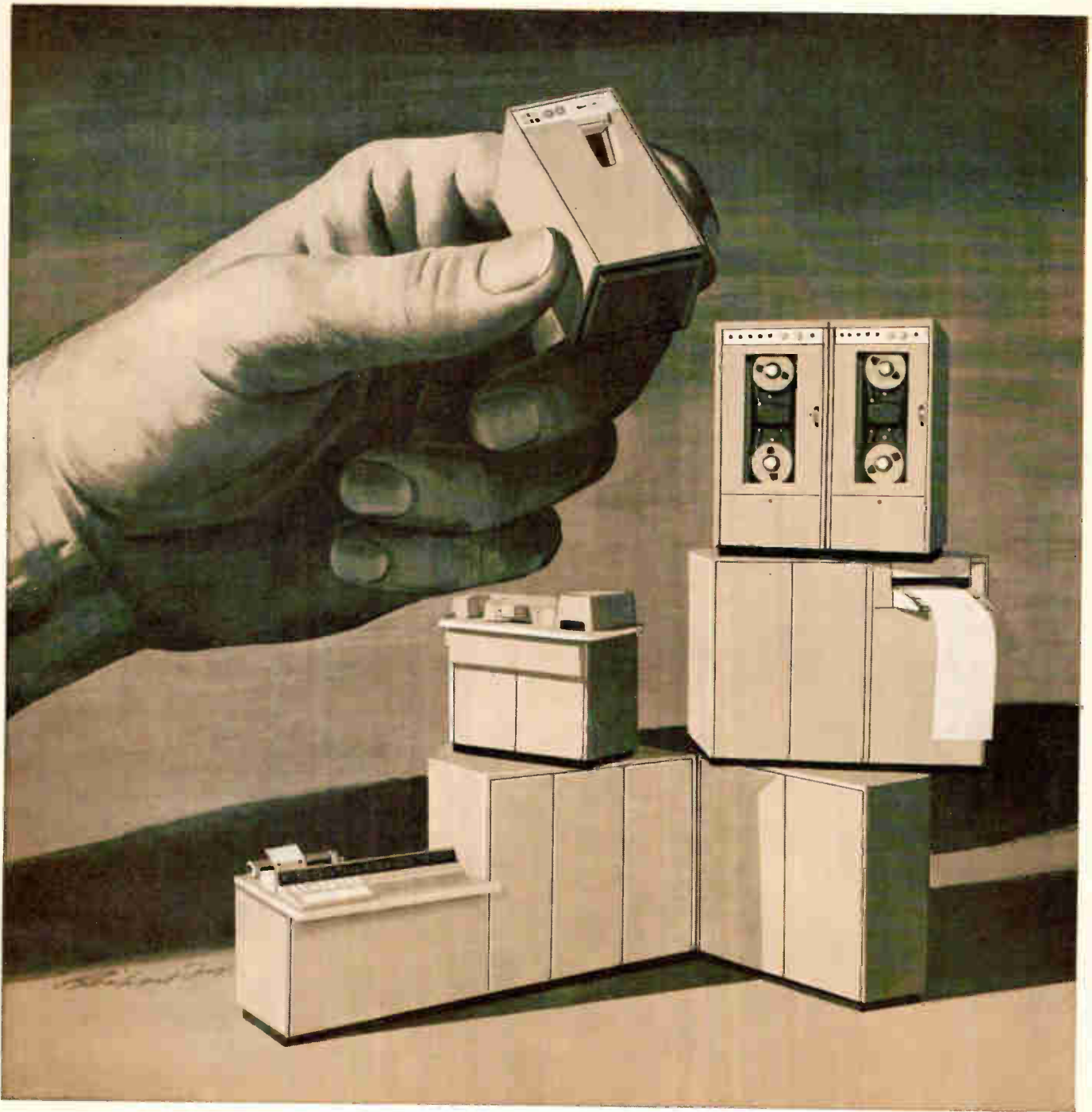

FIG. 6—Impedances for two frequencies along transmission line



BUILD A BETTER FUTURE AT NATIONAL'S ELECTRONICS DIVISION IN LOS ANGELES

Demand for the National 315 Electronic Data Processing System has brought about rapid expansion at National's Electronics Division. In less than two years the Division's facilities in Southern California have tripled in size.

Because its major activity is development of systems for established commercial markets in 120 countries, the Electronics Division is advancing on exceptionally solid ground. These vast markets, served by National's Marketing Division, point to excellent career stability for the men who create the systems.

If you qualify for one of the new openings, you will experience constant technological challenge and continuous opportunity for personal growth. You will also enjoy discovering that Southern California provides year-round opportunities for recreational and cultural activities.

*Trade Mark Reg. U.S. Pat. Off.

CAREERS NOW OPEN IN THESE COMPUTER AREAS
 TRANSISTOR CIRCUITRY □ SYSTEMS ENGINEERING □ SYSTEMS TEST ENGINEERING □ SCIENTIFIC, DIAGNOSTIC AND ACCEPTANCE PROGRAMMING □ PRODUCT ENGINEERING □ PRODUCT DESIGN ENGINEERING □ RESEARCH ENGINEERING □ MILITARY SYSTEMS DESIGN

Interviews at the Eastern Joint Computer Conference, Washington, D.C. For an appointment, call Norval Powell, during the conference, at the Sheraton-Park Hotel. COlumbia 5-2021.

Interviews will also be held during the Solid State Circuits Conference, in Philadelphia. Please send your résumé immediately to Norval Powell at the address below.

National

The National Cash Register Company
ELECTRONICS DIVISION

1401 E. El Segundo Blvd., Hawthorne, Calif. • PL 7-1811

Antenna Feed Has Ten-to-One Bandwidth

By B. W. BALES, RF Section Head
ELLIOTT VOLKENBURG,
Senior Project Engineer
Daytronics, Inc., Orlando, Fla.

DEVELOPMENTAL conical feed will provide telemetry tracking antennas on the Atlantic Missile Range with complete coverage from 100 to 1,000 Mc. The feed, which was developed for the Air Force Missile Test Center, is scheduled for installation in early 1962.

The new feed will increase capabilities of the 60-foot TLM-18 antennas at Cape Canaveral and down-range stations. It not only provides for frequency diversity but can reduce or even cancel modulation of telemetry signals caused by multipath conditions and by missile spin and roll. This capability combined with increased pointing accuracy provides some of the characteristics of simultaneous lobing (monopulse) without its receiving-system complexities.

The antennas receive simultaneously telemetered data and a separately transmitted tracking signal. The long ranges and low transmitted power require high pointing accuracy. The broadband tracking feed must also illuminate the reflector with equal and constant E- and H-plane patterns. Circular polarization with low axial ratio over the entire antenna beam is desirable, and constant driving-point impedance is necessary.

Log Periodic Elements

Because these requirements must be fulfilled simultaneously over the entire operating frequency band, radiator characteristics must be essentially frequency-independent for a range of at least 10:1. The desired characteristics were obtained with log periodic elements. In adapting them to the geometry required for high-speed automatic sensing in a steerable reflector, a new technique was evolved.

The dual-channel feed has two oppositely wound conical spiral radiators diametrically opposed about

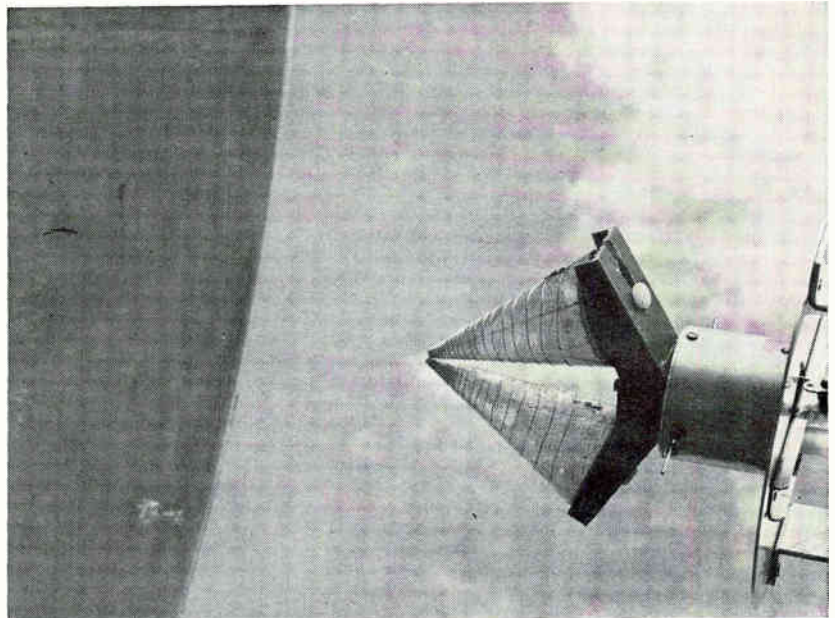

Scale model dual conical feed mounted with parabolic reflector was used for measurements

the focal axis. It was initially proposed to overcome the limitation in polarization of a single conical spiral feed. However study revealed that performance is somewhat like a monopulse antenna while retaining the simplicity of a conical scan.

When the feed is rotated to obtain far-field pattern nutation, the radiators are 180 degrees different in phase in the nutation cycle. Thus oppositely phased error signals are obtained for a target offset from the boresight axis, which permits canceling undesired coherent modulation common to both radiators. Such modulation can cause loss of track, particularly during re-entry and termination.

The influences of mutual interaction on impedance and primary pattern performance are quite complex with a multitude of parameters, making a simple theoretical analysis difficult. The technique was therefore evaluated with an accurate 1/4-scale model of two spiral radiators, as shown in the photograph. The model was tested over a band of 600 to 6,000 Mc to obtain data for the 100- to 1,000-Mc band. Results indicate that average cross-

over will be constant within ± 0.5 over a 10:1 frequency band. (See Fig. 1.) Side lobes will be -16 db and might be reduced to -18 db. Maximum axial ratios are 2 to 3 db.

In designing a rotary joint to handle the two channels, some parts had an undesirable effect on frequency sensitivity. Achieving a broadband transition for the second channel also proved difficult. These problems were overcome with a dual joint composed of four concentric cylinders. The two inner cylinders form the center and outer conductors of a coaxial line for one chan-

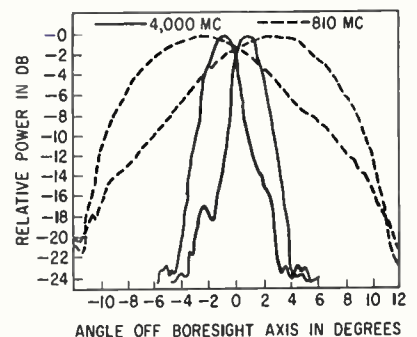
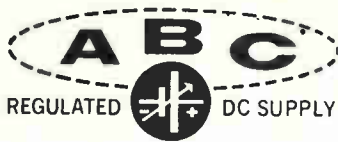
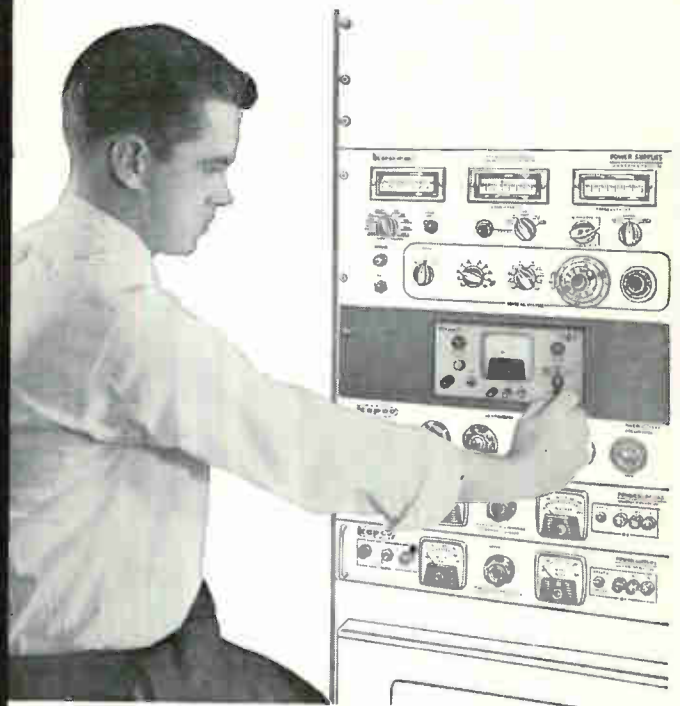
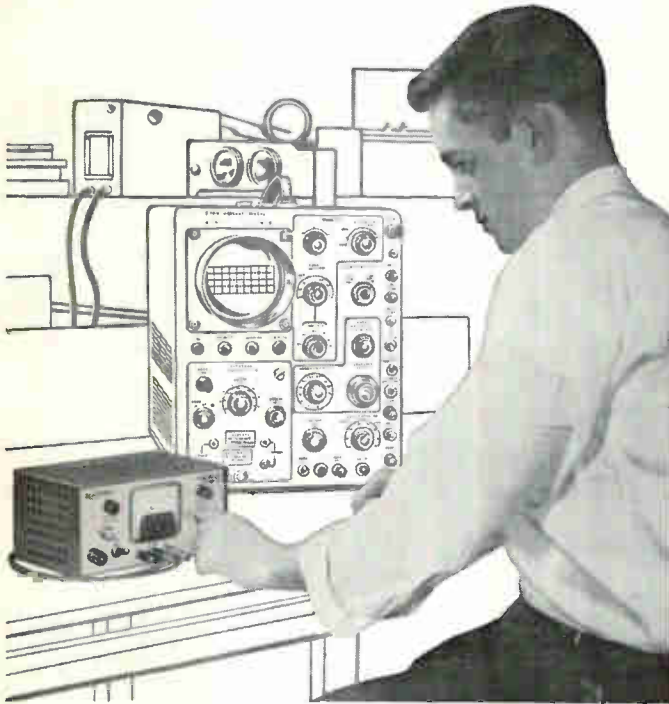

FIG. 1—Typical pattern measurements show crossover characteristics of scale model



test-bench instrument

or systems component



KEPCO "ABC" POWER SUPPLY

KEPCO "ABC" POWER SUPPLY



MODEL ABC 30-0.3M

| MODEL | DC OUTPUT RANGE | | DIMENSIONS | | | PRICE |
|------------|-----------------|----------|------------|-----|-----|----------|
| | VOLTS | CURRENT | H | W | D | |
| ABC 30-0.3 | 0-30 | 0-300ma. | 4¼" | 8½" | 5⅝" | \$ 99.00 |
| ABC 40-0.5 | 0-40 | 0-500ma. | 4¼" | 8½" | 9⅝" | \$139.00 |
| ABC 7.5-2 | 0-7.5 | 0-2 amp | 4¼" | 8½" | 9⅝" | \$139.00 |
| ABC 15-1 | 0-15 | 0-1 amp | 4¼" | 8½" | 9⅝" | \$139.00 |

For meter: Add suffix "M" to Model No. and \$20.00 to price.
Rack Adapter: Model RA-4 (for 2 units), RA-5 (for 1 unit)
available at \$15.00 each.

WRITE FOR COMPLETE SPECIFICATIONS.

Its small, lightweight design makes the Kepco "ABC" Power Supply equally at home on the test bench for R & D, rack-mounted as a system element, and chassis-mounted as a modular component.

Its precise, versatile capability makes it compatible with stringent and varied applications:

- Line/Load Regulation: 0.05% ■ Stability: 0.05% or 6mv, whichever is greater
- Ripple: 0.5mv RMS
- Input: 105-125v ac, 50-440 cps
- Constant Current operation
- Remote Programming at 1000 ohms per volt
- Remote error sensing: to maintain regulation at the load
- Automatic overload protection
- Adjustable current limiting.

Its Low Price is achieved by efficient design without sacrifice in quality and reliability.



131-48 SANFORD AVENUE • FLUSHING 52, N. Y.
Area Code 212 IN 1-7000 • TWX # NY 4-5196

**COST-SAVER
FOR
TV SYSTEMS**



**HICKORY BRAND
I.M.
Coaxial
Distribution
Cable**

Here's an aerial coaxial cable with the support wire constructed as an integral part of the cable jacket!

Eliminates the need for separate messenger—speeds installation! The overall jacket is high molecular weight polyethylene. SUPERIOR I.M. (Integrated Messenger) Coaxial Distribution Cable provides maximum efficiency and economy for use with Community TV, Educational TV, Closed Circuit Industrial TV, Closed Circuit Entertainment Systems, and other high frequency applications.



Write for complete information
on the full line of
**HICKORY BRAND
Electronic Wires and Cables**

Manufactured by
SUPERIOR CABLE CORPORATION, Hickory, North Carolina

5578

nel. The exterior surface of the outer conductor serves as part of a folded coaxial line formed with the two outer cylinders for the second channel.

Two coaxial connectors are used on each end of the joint for the second channel. Each set of terminals is connected by a stripline divider designed for precise impedance match and minimum size (4 by 4 by 1 7/8 inches).

Ideally the channel preamplifiers in Fig. 2 should each have 900 Mc bandwidth. Because of high ambient r-f noise, however, seven narrowband (5-Mc) preamplifiers will be used, each tunable over its respective segment of the 900-Mc band. Seven r-f heads operating

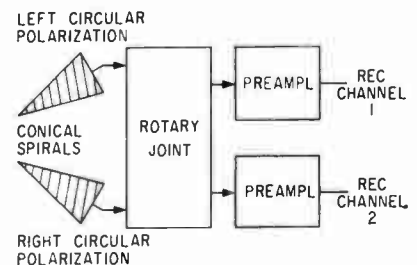

FIG. 2—Each of the seven narrowband channel preamplifiers is tunable over its part of the 900-Mc band

over the same frequencies convert the incoming signal to 30-Mc i-f, which is compatible with the pre-detection-receiving equipment now also under development at Dynatronics.

For coherent noise cancellation, input signals from the two spiral radiators must be combined. A special combiner designed for the feed includes the noise cancellation function as one of its three operating modes.

The two input signals to the combiner are maintained at equal amplitudes. The carrier i-f outputs of the two channels are detected, filtered and compared in a bridge. If a difference voltage exists, it is used to control gain of the first amplifier in one channel. A reference level is thus established in one channel, and output of the gain-controlled channel is made equal to that level.

In another mode, the combiner in the existing feed is used. This mode will be used to minimize incoherent noise when interference modulation

is present, as in tracking deep-space probes.

The third or frequency-selection mode is used to receive frequencies in two different bands. If track-breaking interference modulation appears on one of the operating frequencies, the system detects the interference and automatically switches to the alternate frequency. This mode is particularly useful during missile lift-off and re-entry where multipath conditions are prevalent.

Construction of each conical radiator involves winding two round copper wires alternately into a dual spiral of constant pitch angle. The spiral is bonded between the double walls of a right circular cone 40 inches in diameter at the base and 74 inches long. Each cone is a tapered sandwich with $\frac{1}{8}$ -inch thick surfaces and filled with a foam core. Each cone is bonded to an elliptical adaptor that is in turn bonded to a flat mounting plate. The plate is a sandwich with 2-inch thick plastic honeycomb center and $\frac{1}{4}$ -inch thick outer surfaces. The plate is contoured to provide equal-strength sections in both horizontal and vertical planes, and holes are made in it the size of the adaptors to reduce weight.

Component Data Is Recorded Automatically

DATA recording system for component research automatically measures specimen properties, types the data and codes it on paper tape. The data can be transferred directly to punched cards and fed to a computer to calculate characteristics. The system was developed by Battelle Memorial Institute.

Current, resistivity and magnetic field are typical of properties that can be measured. The information is translated into a d-c voltage from 1 microvolt to 100 v. Up to 17 signals can be measured from one specimen, 4 from 4 specimens simultaneously or combinations.

Up to 100 measurements can be made in any sequence, and the set can be repeated with up to 100 variations in time or environmental conditions. Thus in one program, up to 10,000 measurements can be recorded.



P. I. tape recorder secret is an open book

A unique stacked-reel tape magazine is one of many space-saving secrets which enable Precision instrumentation recorders to out-perform conventional magnetic tape instruments many times their size. Other design secrets are push-button selection of function and speed, light beam end-of-tape sensing, front panel calibration and testing, interchangeable tape loop magazines, and all-solid-state plug-in electronics.

All the secrets of these recorders are unveiled in detailed new brochure 55B. Write for your copy today.

P. S. - Here's an installation secret - two complete 14-channel analog (or 16-channel digital) recorders mount in only 51" of vertical rack space.

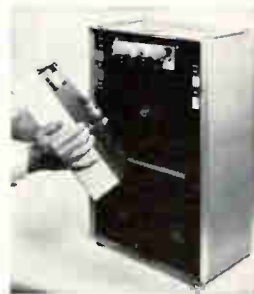

14-CHANNEL
PRECISION RECORDER
Loaded magazines can be
interchanged in 5 seconds.

P. I. Invites Inquiries from senior engineers seeking a challenging future.



PRECISION INSTRUMENT COMPANY

1011 Commercial Street • San Carlos • California
Phone LYtell 1-4441 • TWX: SCAR BEL 30

REPRESENTATIVES IN PRINCIPAL CITIES THROUGHOUT THE WORLD

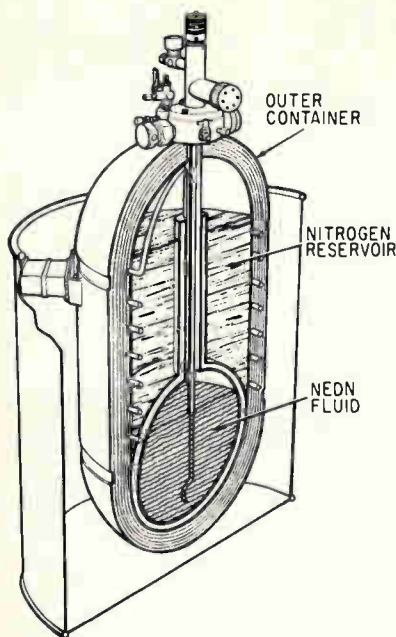

Evaporation loss of liquid neon is minimized by liquid nitrogen shield

HOW THE CRYOGENIC REFRIGERANTS COMPARE

| Physical Properties | Neon | Hydrogen | Helium |
|---|--------|----------|--------------|
| Molecular weight | 20.183 | 2.016 | 4.003 |
| Triple point, deg K | 24.4 | 13.8 | ^c |
| Boiling pt.: deg K at 1 atm | 27.2 | 20.3 | 4.2 |
| Critical point, deg K | 41.7 | 33 | 5.2 |
| Density of gas, gm/liter at STP ^a | 0.90 | 0.090 | 0.18 |
| Density of gas, gm/liter at b.p. | 9.72 | 1.35 | 17 |
| Density of liquid, gm/cm ³ at b.p. | 1.21 | 0.071 | 0.125 |
| Critical pressure, atm | 27.2 | 12.8 | 2.26 |
| Critical density, gm/cm ³ | 0.48 | 0.031 | 0.069 |
| Heat of vaporization at b.p.; Calories/liter | 24,853 | 7,600 | 611 |
| Heat of fusion at m.p.; Calories/liter | 4,700 | 10,600 | ^b |
| Vapor pressure, solid at m.p.; mm. Hg | 323 | 51 | ^c |
| Cp of liquid at 1 atm.; boiling pt. cal/gm. deg K | 0.48 | 2.4 | 1 |

^a STP=0 deg C. at 1 atmosphere. Gas Density at STP×0.9283=gas density at NTP (70 deg F.; 1 atm.).

^b Approx. 2.09 joules/gm @ 17.2 deg K and 0 @ approx. 1 deg K.

^c Will not solidify at 1 atmosphere. The approximate pressure required for solidification at 4.2 deg K has been determined experimentally at 140 atmospheres.

Liquid Neon—New Tool in Cryoelectronics

By F. J. GRAHAM,
Cryogenics Products Development Lab.,
Linde Co., Speedway, Indiana

BY UTILIZING the properties exhibited by crystalline materials at extremely low temperatures, supercooled electronic devices operate with efficiencies and sensitivities far beyond those attained at ordinary temperatures. These supercooled electronic systems have been applied to computers (see *ELECTRONICS*, Nov. 24, p 45), lasers (*ELECTRONICS*, Oct 27, p 47), quantum detectors for millimeter wave generation, infrared detection devices, delay lines, magnetostrictive current sensors, pulsed magnets, spectrometers, and signal amplifiers. Several important government projects in these areas are now listed as classified.

Liquid hydrogen has become available for cooling within the last three years as a result of demand from the aerospace industry. Within the past year there has been a demand for liquid helium and liquid neon refrigerants, in a flurry of activity among electron-device workers.

Liquid neon interests cryoelec-

tronics workers because of its relatively high refrigeration density, making the fluid especially valuable for supercooling components. But utilization of neon has been limited by the inherent problem of evaporation loss—perhaps the most critical single factor in handling of cryogenic fluids.

Solving Heat Leak Loss

Recently, Linde solved the evaporation problem by designing a liquid container that reduces product loss to a very low acceptable level. The key to the thermal efficiency of this LDN-15 liquid neon container is a combination of vacuum insulation with liquid nitrogen shielding. This double-walled container holds 15 liters of liquid neon with a loss of less than 0.3 per cent per day. Almost all of the heat leaking through the container is absorbed by 13 liters of nitrogen shielding, which is consumed sacrificially at the rate of less than one liter per day under normal conditions.

This ability to handle and store liquid neon with almost negligible evaporation loss makes it feasible, for the first time, for electronics

men to develop devices to utilize this extremely useful 27 K fluid.

Because liquid neon is dense and has a high heat of evaporation, it provides 3½ times more cryogenic refrigeration than an equivalent volume of liquid hydrogen, and about 40 times more than an equivalent volume of liquid helium. And because liquid neon is completely inert, it requires no special provision for the safe disposal of the vaporized gas.

Liquid neon has the ability to add about 20 per cent to its refrigeration capacity by freezing it into a solid. Since the melting point of the fluid is less than 3 K below its boiling point, the liquid can be easily frozen by liquid hydrogen (now widely available at low cost) to take advantage of its heat of fusion as well as its heat of evaporation.

The high efficiency with which liquid neon can be transferred is also important to cryoelectronic workers. By virtue of its high refrigeration density, less of the liquid is lost as a result of heat leak into transfer lines, and less gas is evolved than would be in the case

Announcing . . .

1/10 of 1%

GAUSSMETER

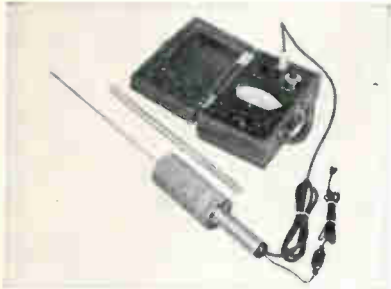

MEASURE DC MAGNETIC FIELDS TO NEW HIGH ACCURACY

Voltage developed in rotating pickup coil is balanced against internal reference generator. Indicator used for null balance. No longer depends on power line frequency. All features of previous type 720 included for preliminary measurements.

Type 820—Range: 0—10,000 gauss
Accuracy: 1/10 of 1% above 2000 gauss

Type 824—Range: 0—10,000 gauss
Accuracy: 1/10 of 1% above 500 gauss

Send for new bulletin



Rawson

ELECTRICAL INSTRUMENT CO.

fine instruments since 1918

111 Potter Street • Cambridge, Mass.

CIRCLE 203 ON READER SERVICE CARD



Operational guidance for buyers'

That's what your 1961 electronics Buyers' Guide and Reference Issue gives you . . . this year more than ever before.

Your EBG is bigger and better this year than ever . . . and more helpful than ever . . . with more new exclusive features than ever. Keep it close at hand, you'll find it's useful day in and day out.

electronics
BUYERS' GUIDE
and Reference Issue
The Basic Buying Guide
in Electronics since 1941

MINIATURIZATION PLUS LOWER COST

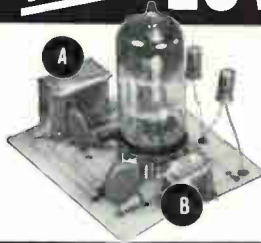

Thin Versatile Co-Netic and Netic Magnetic Shielding Foils

Permit positioning foil-wrapped components A & B closely, minimizing interaction due to magnetic fields . . . making possible compact and less costly systems.

How thin Co-Netic and Netic foils lower your magnetic shielding costs:

- 1) Weight reduction. Less shielding material is used because foils (a) are only .004" thick and (b) cut and contour easily.
- 2) Odd shaped and hard-to-get-at components are readily shielded, saving valuable time, minimizing tooling costs.

These foils are non-shock sensitive, non-retentive, require no periodic annealing. When grounded, they effectively shield electrostatic and magnetic fields over a wide range of intensities. Both foils available from stock in any desired length in various widths.

Co-Netic and Netic foils are successfully solving many types of electronic circuitry magnetic shielding problems for commercial, military and laboratory applications. These foils can be your short cut in solving magnetic problems.

PROTECT VITAL MAGNETIC TAPES

When accidentally exposed to unpredictable magnetic fields, presto!—your valuable data is combined with confusing signals or even erased.



For complete, distortion-free protection of valuable magnetic tapes during transportation or storage. Single or multiple reel Rigid Netic Enclosures available in many convenient sizes and shapes.



Rigid Netic (.014" and up in thickness) Shielded Rooms and Enclosures for safe, distortion-free storage of large quantities of recorded magnetic tapes.

Composite photo demonstrating that magnetic shielding qualities of Rigid Netic Alloy Material are not significantly affected by vibration, shock (including dropping or bumping) etc. Netic is non-retentive, requires no periodic annealing.



Thin pliable foil wraps easily around magnetic tape, maintaining original recorded fidelity.



Cuts readily to any shape with ordinary scissors.



Wraps easily.



Inserts readily to convert existing non-shielding enclosures.



Shielding cables reduces magnetic radiation or pickup.



Wrapping tubes prevents outside magnetic interference.

Write for further details today.

MAGNETIC SHIELD DIVISION PERFECTION MICA CO.
1322 No. Elston Avenue, Chicago 22, Illinois
ORIGINATORS OF PERMANENTLY EFFECTIVE NETIC CO-NETIC MAGNETIC SHIELDING

ANNOUNCING THE ALL NEW VARIAN G-14 GRAPHIC RECORDER

1 MV SPAN...PLUS 10 MV, 100 MV, 1 VOLT SPANS INSTANTLY SELECTABLE • ALL TRANSISTOR CIRCUITRY • PEN SPEED 0.6 SECONDS FULL SCALE • ZENER DIODE REFERENCE • 0.5% ACCURACY AT 10 MV • FULL SCALE ZERO PLUS SUPPRESSION

The all new G-14 is carefully designed to provide the optimum combination of performance, operator convenience, versatility, size and price. Solid state circuitry, high negative amplifier feedback, rugged construction, quality components and null-balance potentiometer operation provide stable, accurate and reliable recording. Complete specifications available from the Instrument Division.



VARIAN associates
PALO ALTO CALIFORNIA

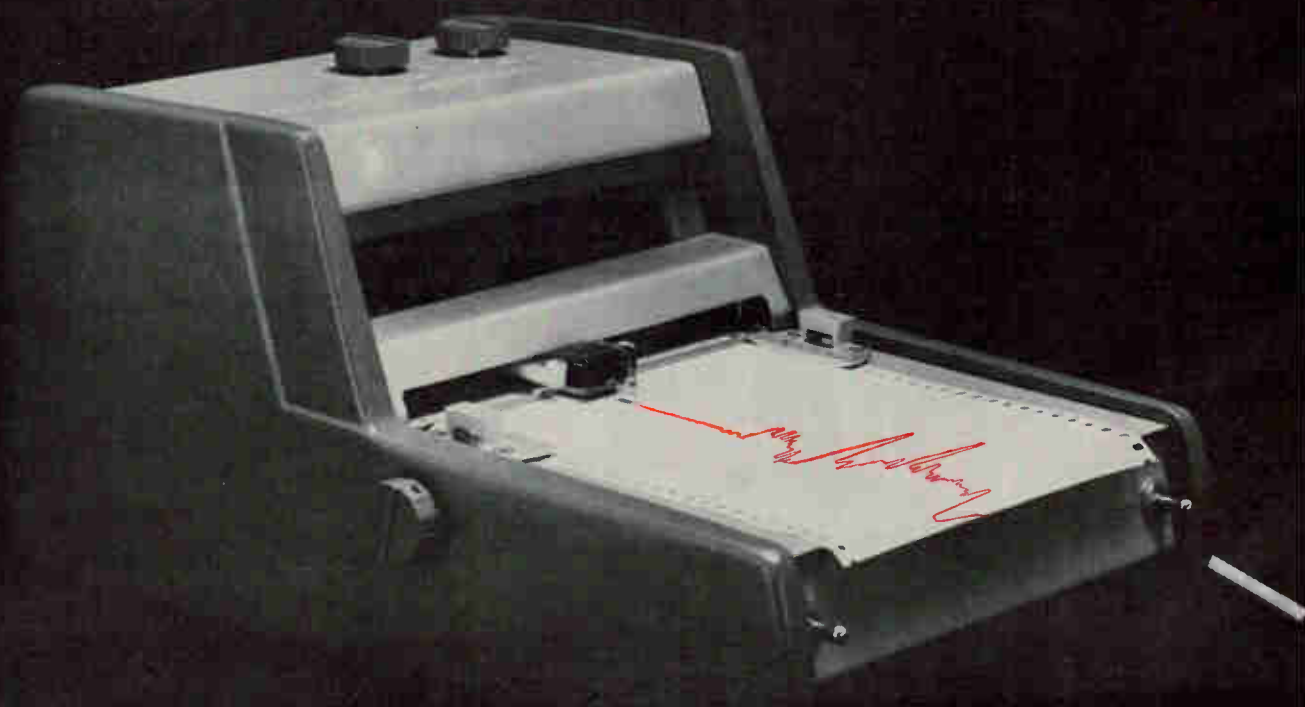

with either liquid hydrogen or liquid helium. Consequently, pressure drop is reduced, further reducing liquid losses by cutting down transfer time and size of transfer tube.

Compactness and inertness make liquid helium an ideal cryogenic refrigerant for aerospace applications. If an outer-space system were accidentally punctured, only a small fraction of the liquid-neon refrigerant would evaporate. The remainder would freeze and remain in the system as a solid, with very little loss of refrigeration capacity.

The relationship between liquid neon's vapor pressure and temperature permits precise temperature control with only moderate control of pressure. In the temperature range from 32K to 40K, the equilibrium pressure changes from 52.5 psia to 213 psia. Thus, 32 K temperature can be accurately maintained within 0.1K by controlling the pressure within 1.7 per cent. This property is utilized in a special Dewar container designed by Linde to provide precise tempera-

ture control of integrally-mounted infrared cells used in an airborne radiometer developed for the Air Force.

Finally, for applications where large volumes of evolved gas are required, liquid neon provides a much higher gas-to-liquid ratio than other cryogenic fluids. One liter of liquid neon yields 1,445 liters of gas, compared with ratios of 850-1 for hydrogen, 860-1 for helium, and 700-1 for nitrogen. See table on p. 60.

The 150-liters per month capacity of Linde's new facility for producing liquid neon is small compared to the tonnage quantities produced daily of oxygen, nitrogen, hydrogen and argon. But the supply of neon is adequate for present cryoelectronic needs.

Cryogenic manufacturing techniques may be required for many of the newer electronic devices. In the case of thin films, manufacturers may employ low-temperature substrates to control grain size or surface migration.

Ladder Filter Module for Receivers

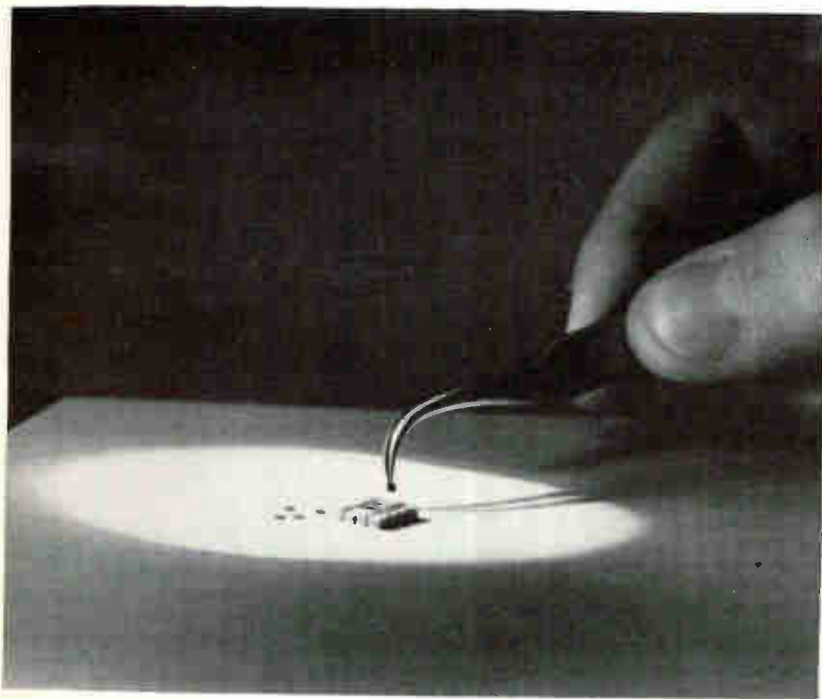

Ceramic composition studies at Clevite Research Center, conducted for Signal Corps, resulted in micromodule ladder filter module for precision receivers that does work of 45 conventional components. Each filter disc is equivalent to two capacitors and one inductor. Typical assembly weighs 0.1 ounce, was developed for one to eight megacycle range. D. R. Curran, of Clevite, headed group that developed complete package. Significance: superior performance in tiny package for space and missile receivers and other frequency selective devices

←CIRCLE 62 ON READER SERVICE CARD

CIRCLE 63 ON READER SERVICE CARD→

VARIAN G-14

ALL NEW GENERAL-PURPOSE
LAB RECORDER • IDEAL
FOR GAS CHROMATOGRAPHY



VARIAN associates
PALO ALTO, CALIFORNIA

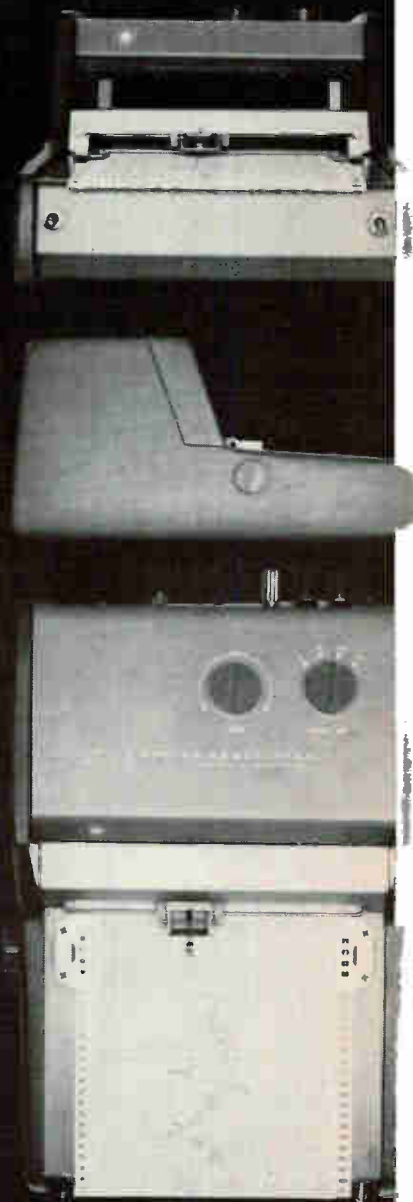

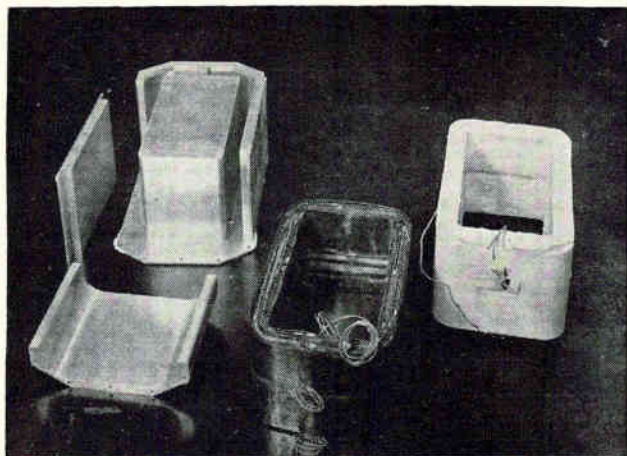

Coil foreground, is placed in 3-piece aluminum mold, left, for encapsulation; finished coil at right

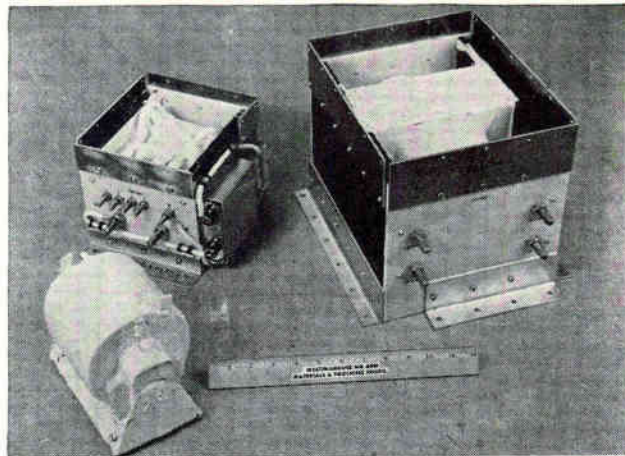

Ready for assembly in power supply are reactor, left, power transformer, right, and buck-boost transformer

Vacuum-Encapsulated Coils Operate at 190 C

By F. T. PARR,
R. E. LEE
Westinghouse Air Arm Div.,
Baltimore, Md.

AN AIRBORNE EDUCATIONAL tv transmitter designed at the Westinghouse Air Arm Div. required a power supply to provide 30 Kw at 15 Kv to the final amplifier. To reduce size and weight, silicon rubber and silicon varnish insulating materials were used to treat the transformers and reactor; this permitted operation of transformers and reactors at hot spot temperatures up to 190 C.

The power supply consists of a conventional three-phase double-voltage rectifier with surge protection in both a-c and d-c sides, and with d-c voltage adjustable approximately ± 30 percent.

To dissipate losses, 300 cfm of air at 40 C is forced through the supply. The silicone rectifier diodes are mounted in an air duct made of silicone glass laminate, which supports the rectifiers and provides high voltage insulation. Filter chokes are mounted in a similar duct, thus allowing a smaller choke since much of the insulation between coil and core can be eliminated.

Silicone rubber for impregnating coils has long been used for Class H low voltage applications. In the

process the high viscosity is reduced by a solvent, then the solvent must be volatilized before cure. But in this application the high voltage coils are impregnated without using a solvent so that the impregnant would be 100 percent polymerized, thus eliminating the possibility of voids.

The selection of DC-2031 as the impregnation rubber was on the basis of low viscosity and long pot life. Low viscosity permits penetration of the coil and long pot life permits a long impregnating cycle, essential for complete impregnation.

Coil Processing

The high voltage coils are wound, without coil form, on a three-piece aluminum mandrel. Materials are #19 round silicone varnish treated double glass served copper wire, silicone bonded mica layer insulation, 0.005 inch glass tape (woven, continuous filament type), and a minimum of adhesive DC-40-C. Coil interconnections and leads are attached with high temperature rosin-core solder. A static shield of 0.0015 inch sheet copper used over the last layer of each coil is pretreated with a dip in silicone varnish DC-997 and cured at 200 C for 12 hours. This prevents the copper from inhibiting the cure of the silicone

rubber where the two come in contact.

Before removal from the mandrel, the coil is baked at 200 C for 15 hours to cure the adhesive and drive off the volatiles in the mica bond and in the varnish on the wire.

The coils (two part-coils for each phase) are interconnected and the series connection insulated with silicone rubber tape. Spacers of silicone rubber tape are also placed between the two part-coils and at each end of the assembly. A single wrap of silicone tape is used around both part-coils at several spots to hold them together and establish dimensions.

The coil is then assembled in an aluminum mold that has been cleaned with trichloroethylene, heated to 120 C, and sprayed with a detergent solution for mold release.

The mold with coil is held in a vacuum chamber at 3 to 5 mm of mercury for 30 minutes. Without releasing the vacuum, preevacuated silicone rubber DC-2031 is used to cover the coil to 1 inch and the vacuum is continued for 30 minutes. The process then goes: no vacuum for 10 min.; 30 min. vacuum; 10 min., no vacuum; 30 min. vacuum; 80 psi pressure for 1 hr.; 30 min. vacuum; 11 hr. at room pressure and temperature; curing in an air

NEED AC-OPERATED MILITARY RELAYS?



Relay shown actual size

Rectifier circuits . . . full-wave bridge and half-wave . . . use highest quality miniature silicon diodes. Note potted construction.

For reliable switching . . . try "Diamond H" Series RA and SA relays with a-c coils

These relays for 400 cps and 60 cps operation are identical in size and weight to Hart's widely specified Series R and S d-c relays and meet the same specifications*. They provide the same shock resistance (to 50G), the same vibration resistance (to 20G-2000 cps), and the same performance under temperatures ranging from -65°C to $+125^{\circ}\text{C}$. Contact ratings from dry circuit to 10 amps, 115 volts a-c resistive and 30 volts d-c resistive.

The "Diamond H" line includes hundreds of standard models and special variations are possible. Ask for literature and specification list.

*Like the R and S series, they meet the requirements of MIL-R-5757C. Models are also available to fill the requirements of MIL-I-6181.



THE **HART**
MANUFACTURING COMPANY
202 Bartholomew Avenue
Hartford 2, Conn.
Phone Jackson 5-3491

CIRCLE 65 ON READER SERVICE CARD 65

From the largest facilities in the field



ELECTROPLATED WIRES

Production equipment, designed and built in our own plant, assures precise, continuous plating of wire. . . . Our electroplates are consistently uniform and well bonded to the base wire. . . . Several metals may be plated one over the other, or two metals may be deposited simultaneously as an alloy. . . . A desirable application is the Gold plating of Copper wire. This combines the conductivity of Copper with the solderability and corrosion-resistance of Gold. Many other combinations are possible.

Send us details of your specific requirements

SIGMUND COHN
Manufacturing Co., Inc.



121 South Columbus Ave.
Mount Vernon, New York

CIRCLE 204 ON READER SERVICE CARD

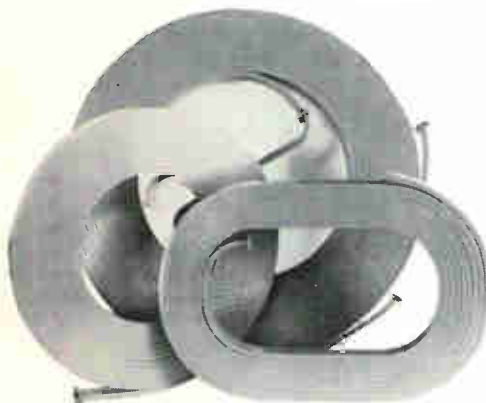

X Band



X_L Band



K Band

MICROWAVE DELAY LINES

where accuracy counts

In delay lines, where exacting design and construction standards apply, look to Turbo.

Turbo designs are available, with complete testing, for both fixed and variable systems, for waveguide and coaxial lines, from 1 to 26 kmc. from 0.01 to 2.5 microsecond. Write for complete specification and price data for standard units. Or ask about special designs involving problems of space, configuration, and performance.

TURBO MACHINE CO., Lansdale, Pa.
Telephone: Ulysses 5-5131

TURBO

CIRCLE 205 ON READER SERVICE CARD

FOR TIME FOUR

ALL FOUR IRIG FORMATS ON ONE COMPACT CHASSIS WITH EECO 811 TIME CODE GENERATOR

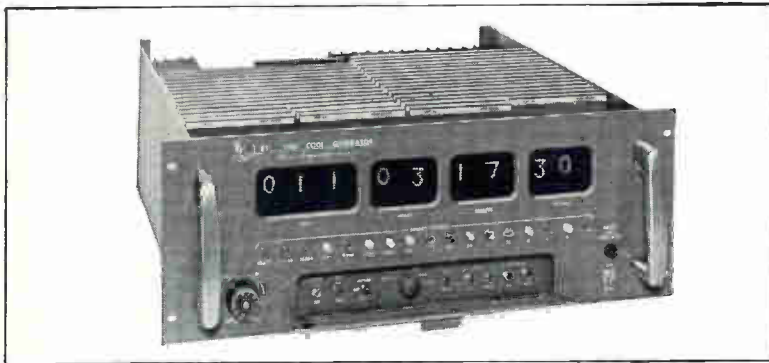

EECO 811 IRIG FORMATS

| | A | B | C | D |
|------------------------|---|--|--|---|
| Time Code Format | 34 Bit BCD Code identifying days, hours, minutes, seconds and 1/10 seconds and a 17-bit binary code identifying time of day in seconds. | 30 Bit BCD Code identifying days, hours, minutes, seconds and a 17-bit binary code identifying time of day in seconds. | 23 Bit BCD Code identifying days, hours and minutes. | 16 Bit BCD Code identifying days and hours. |
| Code Frame Length | 0.1 second | 1 second | 1 minute | 1 hour |
| Code Scan Rates | 1000 pps | 100 pps | 2 pps | 1 ppm |
| Code Carrier Frequency | 10 kc | 1 kc | 1 kc or 100 cps (switch selection) | 1 kc or 100 cps (switch selection) |

An all solid state, card construction, precision "metronome" for the most demanding range of laboratory instrumentation. Supplies all four serial IRIG time-code formats with an accuracy of better than 1 second a month. Frequency stability is 1×10^{-5} per day at laboratory temperatures; 3×10^{-5} per day throughout entire operating range of -20°C to $+55^{\circ}\text{C}$. Parallel code output. 10 pps and 1 pps synchronizing pulses. Synchronizing pulse for controlling external control element scanner. Both digital and resolver time shift for fast, accurate synchronization with WWV or other time standard. Operates on 115v ac $\pm 10\%$, 50-400 cps, 1 amp, with power supply on same chassis.

Specify small (7" x 19" x 17"), light (32 pounds) EECO 811 Time Code Generator as the heart of your instrumentation and be assured of accurate time correlation. Price \$9750, less with fewer formats. Write for EECO 811 data sheet plus information on auxiliary equipment.



Electronic Engineering Company of California

1601 E. Chestnut Avenue, Santa Ana, California • Klumberly 7-5501, TWX S ANA 5263
Representative in Western Europe and Israel: Electronic Engineering S.A., C.P. 142, Fribourg, Switzerland

circulating oven for 4 hr. at 120 C, 2 hr. at 160 C, 4 hr. at 200 C.

Several coils have been cut open and showed complete impregnation. However, if all volatiles are not driven off by the prebake, tiny bubbles may form along the surface of the wire or there may be inhibition of the cure. Final cure of the embedded rubber coil consists of 20 hours at 200 C in an air circulating oven.

After final cure, the leads are attached and the molded secondary is taped in-and-out with 0.040 and 0.080 inch triangular shape silicone rubber tape known as "guide-line" tape. Teflon filling plugs are used on one end of the coil. These are removed to allow the resin to enter any irregularities in the molded coil and to fill all the voids between tape and molded coil.

Transformer Processing

The taped secondary is placed over the primary and the cores and heat sink brackets assembled. All space between the coils and core, and the core and bracket is filled to insure good heat transfer; silicone bonded mica is used between the coil and core and aluminum strips are used as shims between the core and bracket.

The entire transformer is next baked at 200 C for 6 hours to cure the "guide line" tape and drive off moisture and volatiles from the primary coil. Next, all space between the primary and secondary coils and the margins of the primary coil is packed with a paste of a binder and asbestos powder wetted with acetone. This is air dried for 24 hours to evaporate the acetone. Teflon filling plugs are held in place with this material and later removed to leave channels for the impregnation material.

Metal parts requiring adhesion of the outer coat are primed with DC A-4094 and air-dried 30 minutes prior to encapsulating. Then the coil and core section is encapsulated by flow coating with DC 2031.

After coating, the units are drained 15 minutes at room temperature and then step-cured 15 minutes at 60 C followed by 4 hours at 160 C.

The buck-boost transformers and filter reactors are processed in a similar manner except that the pre-

bake before packing is at 135 C for 4 hours because there is no guide line tape on these units to cure.

Good heat transfer requires complete filling and elimination of all dead air spaces. Solventless silicone resin DC 7521 catalyzed with 2 percent dicumyl peroxide is used for final impregnation.

Final Cycle

The final impregnation cycle for all three magnetic components consists of preheating the unit and resin to 60 C and immersing preheated DC 7521 in a heated vacuum chamber. A vacuum of 3 to 5 mm of mercury is maintained for 30 minutes. The vacuum is then released for 10 minutes and reestablished for a second 30 minute period. At the end of the second vacuum period the vacuum is released and the unit soaked for 1 hour at 65 C and cured for 8 hours at 160 C.

Excess resin or rubber is removed by trimming and the coating is dusted with mica powder to remove any tackiness. Final assembly of terminal boards and final test completes the units.

Aisle Lights Aid Stock Pickups



Pickup and delivery of subassemblies and parts is expedited by aisle signal lights at Kollsman Instrument Corporation's plant in Syosset, New York. The lights reduce working inventory, since lay-down time is minimized, and increase the efficiency of transportation clerks since the yellow signal light is apparent from every part of the large assembly floor. Lamps are switched on when parts are ready for transfer, are switched off when a transportation clerk picks up the parts

(ADVERTISEMENT)

GETTING INFORMATION FROM ONE PLACE TO ANOTHER—for communication or control between people and (or) machines—has been a job pulses have been doing very well for quite a few years. Lately, more sources have had more and more to say in the same or less time, so it's only natural that pulse trains have been getting increasingly crowded and travelling at higher and higher speeds. If your problem is in this area—trying to perform a control or communications function with several hundred pulses per second—we can probably help you. We have been making a well-proven, pulse-repeating relay which operates dependably at speeds up to 500 pulses per second, that can do more to reshape weak and distorted signals into useful waveforms than any other relay we know of. (Modest, huh?) We're even beginning to suspect that this veteran may have been a little ahead of its time when it was introduced in 1953.

If your pulses start out as beautiful square waves



but suffer the consequences of distributed constants, line losses, random noise and wholesale dissipation, they probably arrive for work at the receiving end looking something like this



It takes an extremely sensitive relay to look at these little bumps as if they were nice square pulses. The Sigma Series 72 is this sensitive, operating positively on as little as a fraction of a milliwatt. While your drive circuit probably provides several times this amount of coil signal to the relay, such high sensitivity nevertheless gives reliable operation and plenty of overdrive even if input power becomes marginal:



With the shrunken pulse amplitude problem now taken care of, the next question is one of distortion at high operating speeds. With a "72", total operate time (break plus transfer) is typically 0.9 ms; contact bounce is virtually non-existent because of special compliant, shock-absorbing contact mounts; and the relay is symmetrical in operation—in both directions there are equalities in trip points, speed of operation and travel.

But since you're buying results and not slick design features, here is what a "72" will do: (1) rarely, if ever, misinterpret even the most distorted pulse; (2) give high contact efficiency (max. dwell time) through rapid transfer and max. bounce of 50 microseconds



(3) won't introduce unsymmetrical response and output (although you can turn a screw and deliberately introduce bias, to compensate for an unsymmetrical input).

Saying that you can have all this *and* long life in a compact, polarized relay may seem like stretching it a little, but a "72" will dependably switch a 60 ma, 120 VDC inductive load 500 million times, with correct drive circuit design and arc suppression. When wearing parts do need maintenance, you can replace the contacts and armature yourself—a good instruction manual is available. You can also buy a comprehensive test set if you use many relays of this type and follow a regular adjustment and maintenance program. For such work, the Sigma Test Set can be a very useful addition to your lab.

A new bulletin on the "72" is now available on request; the relays have been tooled up and built in quantity since 1953. Send us your weak and weary pulses today, attention Pulse Reclamation and Wildlife Bureau. SIGMA INSTRUMENTS, INC., 62 Pearl St., So. Braintree 85, Mass.

New On The Market

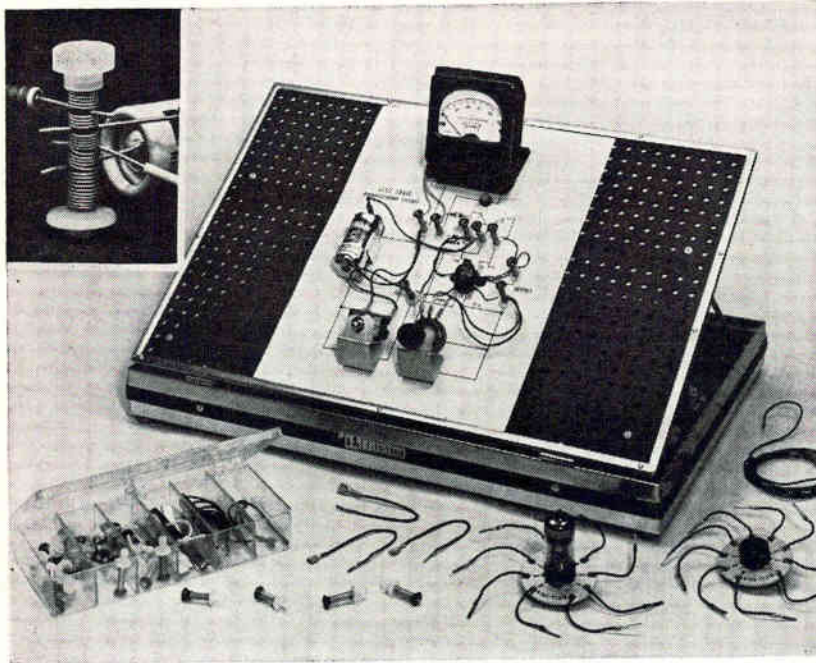

Training and Development Aid WITH HELICAL SPRING CONNECTOR

ELEC-TRAIID, P. O. Box 53, Cambridge 41, Mass. A time saving, breadboarding system featuring the Koil-Klip, a connector using helical spring design, provides the circuit designer with a highly versatile aid. Basic components of the system are the KoilKlips and perforated circuit board. The Koil-

Klip may be inserted anywhere on the $\frac{1}{2}$ in. grid board. Once inserted the Klip may be pulled upward and component leads and wires threaded through the coils. Subminiature components which are easily damaged due to soldering are well suited to this connector.

CIRCLE 301 ON READER SERVICE CARD

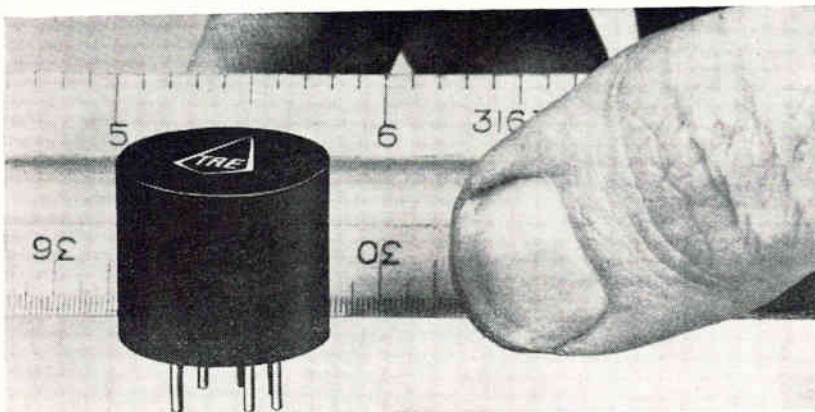

Solion Tetrodes

USED AS INTEGRATORS & L-F AMPLIFIERS

TEXAS RESEARCH AND ELECTRONIC CORP., 738 Meadows Building, Dallas, Texas, announces two solion tetrodes, electrochemical devices that function as integrators and l-f

amplifiers. Typical of the applications for integrators are process control, gas chromatography and analog computers. The SE100 and SE110 require very low input

power, in the microwatt range, with maximum input currents of 25 and 10 μ a respectively, and give outputs of up to 1 ma which are proportional to the time integral of the inputs.

CIRCLE 302 ON READER SERVICE CARD



Diode Detector

HIGH POWERED

HYCON MFG CO., 700 Royal Oaks Drive, Monrovia, Calif. Model HDM-1005 high powered microwave diode detector employs a GE7266 thermionic diode tube. Frequency is 2.6 to 3.2 Gc. Small terminals are provided on the back of the unit for the 6.3 v filament and 1.5 v biasing voltage. A built-in 1,000 ohm resistor load is inserted at the output side but this load can be easily increased to raise the detected voltage. R-F matching and absorbers are provided within the unit.

CIRCLE 303 ON READER SERVICE CARD

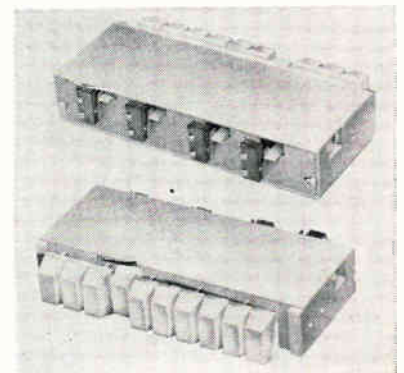

Binary Coded Switch

FULLY-MECHANICAL

ULTRONIC SYSTEMS CORP., 7300 N. Crescent Blvd., Pennsauken, N. J. Series 2000 is a push-button switch made for the manual conversion of decimal to various binary code systems. Standard models are designed to convert to the 1-2-4-8 standard binary code; they are easily adapted to other codes. Two standard 10-

*ENVIRONMENTALIZED

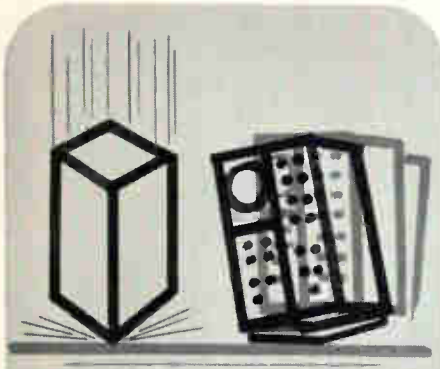

SHOCK

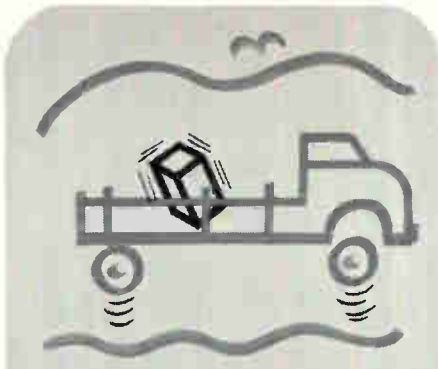

VIBRATION

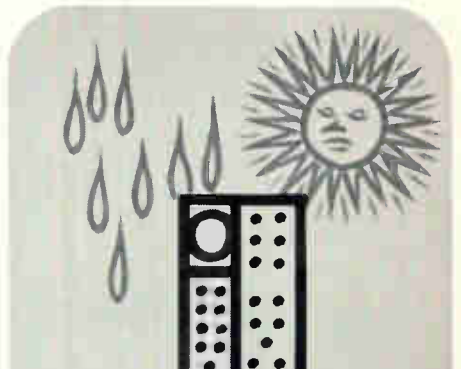

HUMIDITY

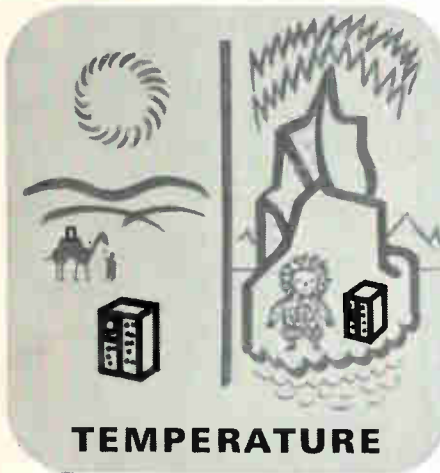

TEMPERATURE

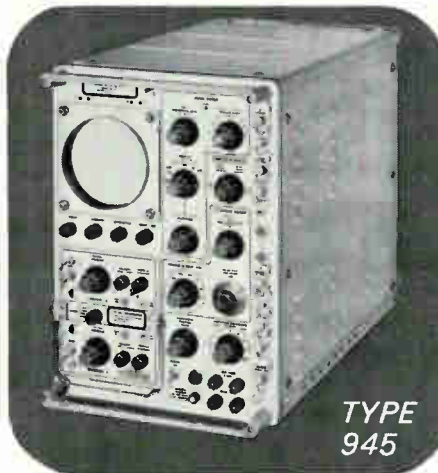

**TYPE
945**

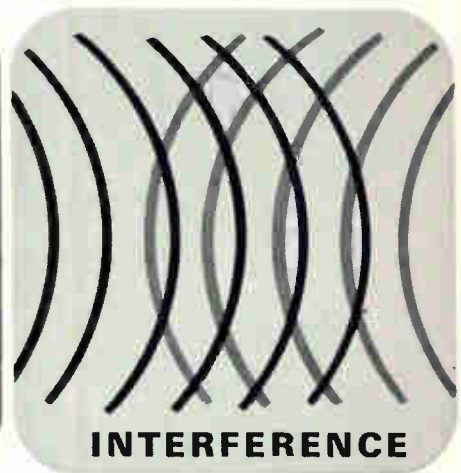

INTERFERENCE



OSCILLOSCOPE THAT'S BUILT TO TAKE IT

DC-TO-24 MC WITH DUAL-TRACE UNIT • DC-TO-30 MC WITH FAST-RISE UNIT

ELECTRICAL CHARACTERISTICS SIMILAR TO THE TEKTRONIX TYPE 545 OSCILLOSCOPE

*** DEPENDABLE OPERATION
WHILE SUBJECT TO THESE ENVIRONMENTS:**

TEMPERATURE from -40°C to $+55^{\circ}\text{C}$ (71°F) • VIBRATION to 5 G's, 55 cps, 0.03" peak-to-peak • SHOCK of 400-pound hammer drop • ALTITUDE to 20,000 feet • RADIO INTERFERENCE from 15 kc to 400 mc.

*** RELIABLE PERFORMANCE
AFTER STORAGE IN THESE ENVIRONMENTS:**

TEMPERATURE from -65°C to $+85^{\circ}\text{C}$ • ALTITUDE to 50,000 feet • FUNGUS for 28 days • HUMIDITY for 10 days at 95% relative humidity from $+18^{\circ}\text{C}$ to $+65^{\circ}\text{C}$ • RAIN CONDITIONS of 5 minutes steady dripping.

For those applications not demanding such environmental capabilities, the Type 945 will perform with even greater reliability and flexibility.

The Type 945 will accept any of 17 Tektronix letter-series plug-ins for use in commercial applications.

Type 945 Oscilloscope (without plug-ins) \$2850
Type MC Dual-Trace Plug-In Unit \$ 475
Type ML Fast-Rise Plug-In Unit \$ 425

U.S. Sales Prices, f.o.b. Beaverton, Oregon

For complete specifications of the new environmentalized oscilloscope—or a demonstration in your own environment—please call your Tektronix Field Engineer.

Tektronix, Inc. P. O. BOX 500 • BEAVERTON, OREGON / Mitchell 4-0161 • TWX—BEAV 311 • Cable: TEKTRONIX

TEKTRONIX FIELD OFFICES: Albuquerque, N.M. • Atlanta, Ga. • Baltimore, Md. • Boston, Mass. • Buffalo, N.Y. • Chicago, Ill. • Cincinnati, Ohio • Dallas, Texas • Denver, Colo. • Detroit, Mich. • El Paso, Texas • Fort Worth, Texas • Houston, Texas • Indianapolis, Ind. • Los Angeles, Calif. • Miami, Fla. • Minneapolis, Minn. • New York, N.Y. • Philadelphia, Pa. • Portland, Ore. • Raleigh, N.C. • San Diego, Calif. • San Francisco, Calif. • Seattle, Wash. • St. Louis, Mo. • Toronto, Ont., Canada • Washington, D.C. (Arlington, Va.)

ENGINEERING REPRESENTATIVES: Tektronix International A.G., Terrassenweg 1A, Zug, Switzerland, for the name of your local engineering representative. European and African countries, the countries of Lebanon and Turkey, please contact TEKTRONIX INTERNATIONAL A.G., Terrassenweg 1A, Zug, Switzerland, for the name of your local engineering representative. Other Overseas areas, please write or cable directly to Tektronix, Inc., International Marketing Department, P. O. Box 500, Beaverton, Oregon, U.S.A. Cable: TEKTRONIX.

key models are available vertical mounting in a single row, and horizontal mounting in two rows of 5 buttons each. Switches are simple,

compact, sturdy and economically priced.

CIRCLE 304 ON READER SERVICE CARD

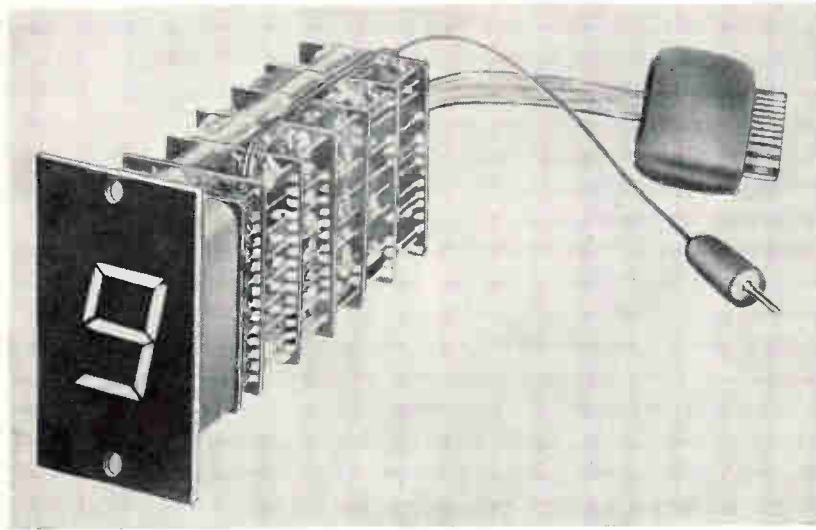

Decade Counter

FULLY TRANSISTORIZED

ROBOTOMICS, INC., 2422 E. Indian School, Phoenix 16, Ariz. The F1601K decade counter can readily divide by any number from 0 to 9 by jumpering two wires on rear module board. Can drive up to five F1621K remote displays. Will function as preset counter by addition

of simple external switching circuit. Ideal for low frequencies or high frequencies in excess of 100 Kc. Operates on +12 v at 100 ma. Has separate line for display intensity control.

CIRCLE 305 ON READER SERVICE CARD



Zener References

ACCURATE DEVICES

AMERICAN SEMICONDUCTOR CORP., 3940 N. Kilpatrick Ave., Chicago 41, Ill., has introduced a complete line of silicon reference devices with a maximum voltage change of 0.01, 0.005, 0.001, and 0.0005 percent. Working voltages range from

5.9 v through 300 v in temperatures from -55 C to +100 C.

CIRCLE 306 ON READER SERVICE CARD



IR Detector

COOLED SYSTEM

BLOCK ASSOCIATES INC., 385 Putnam Ave., Cambridge, Mass., announces a thermoelectrically cooled indium antimonide photoconductive detector with self-contained cooling. Price is \$500, complete with cooler. Sensitivity of 10^6 at wavelengths to 6 microns is available without the complexities of gaseous or liq-

uid nitrogen cooling. The KH-51C operates at a temperature of -40 C. It requires 30 amp, low ripple, d-c current at approximately 0.2 v.

CIRCLE 307 ON READER SERVICE CARD

Silicon Diode

ULTRAHIGH CONDUCTANCE

RHEEM SEMICONDUCTOR CORP., 350 Ellis St., Mountain View, Calif. Conductance of the RD750 silicon diode is typically 1,000 ma at 1 v, permitting new levels of high-current switching for applications such as thin-film computer memories. At low current levels the voltage drop is very low, being only 0.65 v at 10 ma. Power dissipation is 750 mw, but package size remains the DO-7 configuration. Reverse recovery time is typically as little as 10 nsec. Price is \$2.65 in quantities 100 to 999.

CIRCLE 308 ON READER SERVICE CARD



Dual Output Relay

FOR SERVOS

NORBATROL ELECTRONICS CORP., 356 Collins Ave., Pittsburgh 6, Pa., announces a static balanced beam relay for use in position servo systems to drive small split-field series d-c actuating motors or other motors through interposing relays. Consisting of combined magnetic amplifier-ser circuitry, the dual output device delivers outputs of 24 v at 1 amp. Four isolated logic windings are supplied. Bandwidth between pick-up points of the two outputs is nominally 3 milli-AT. Pickup drop out differential for each output is 0.3 milli-AT.

CIRCLE 309 ON READER SERVICE CARD

Teflon Insulation

INSO ELECTRONIC PRODUCTS, INC., 103 Park Ave., Nutley 10, N.J. Process for sub-surface marking of thin-wall (0.006 in.) Teflon in-



**SPECTRAL D* OF 10⁹ AT
6 MICRONS WITH SELF-
CONTAINED THERMO-
ELECTRIC COOLING
\$500.**

Block Associates introduces the KH-51C — a photoconductive IR detector with self-contained thermoelectric cooling at 1/3 the cost of comparable detectors. In addition to the extremely high sensitivity of the cooled cell, the KH-51C provides the advantages of speed, long wavelength response, stability and repeatability found in conventional uncooled cells. Invaluable for use in radiometers, spectrometers and spectrophotometers, the KH-51C can be used in the most rugged environments with unsurpassed reliability. KH-51C detectors are available in any rectangular shape up to 6 mm².

TYPICAL SPECIFICATIONS WITH SENSITIVE AREA OF 1 mm x 1 mm

| | |
|---------------------------------------|--|
| • Spectral range | visible to 7.0 μ |
| • Cell Temperature (30°C heat sink) | -40°C |
| • *Responsivity | 2 volts/watt |
| • D* (—, 1000, 1) Peak (at 6 microns) | 10 ⁹ CM CPS ^{1/2} watts ^{1/2} minimum |
| • NEP (500°K, 1000, 1) | 3 x 10 ⁻¹⁰ watts RMS |
| • Resistance | 20 ohms |
| • Time Constant | < 1.0 μ sec |
| • Bias Current | 20 ma |
| • Cooler requirements | 30 amps at approximately 0.2 volts |

*Cooling permits precise control of detector responsivity.

For complete specifications write: Mr. S. Bobo

Block Associates, Inc.
385 Putnam Avenue • Cambridge, Mass.

CIRCLE 206 ON READER SERVICE CARD

**MIDGET
TAP
SWITCH**

**has
giant
range**

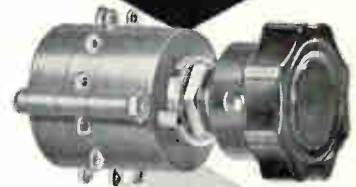

TYPE 3A

Only 1" in diameter . . . weighs 30 grams . . . as many as 8 decks and up to 12 positions per deck. These are among the features of Tech Labs' new all-molded miniature Type 3A tap switch.

Designed for a wide range of military and commercial applications, this single-hole mounted switch has adjustable stops if fewer than 12 positions, single pole, or 6 positions, double pole, are required.

"Shorting" and "non-shorting" types are available and the switch can be furnished solenoid-operated and hermetically sealed.

SPECIFICATIONS

Size: 1" diameter, 1 1/4" with terminals. First deck, 1-1/16" long. Each additional deck, 1/2" long.

Weight: First deck, 30 grams. 10 grams for each additional deck.

Rating: 1200 volts rms, 2000 VDC, 5 amps (carrying) 115V.

Insulating resistance: 100 megohms minimum at 500 volts DC.

Life: 1.5 — 2 million revolutions.

Contact resistance:

(standard) 6-10 milliohms.

(silver) 3-5 milliohms.

Temperature range: -65°C to 100°C.

Mounting: Single-hole.

Meets MIL-S-3786 and MIL-E-5272C



Write for details
and prices.

PALISADES PARK, NEW JERSEY

CIRCLE 71 ON READER SERVICE CARD

71

**PRECISION - Square, Flat
and Rectangular Wire
with Controlled Edges**

For WELDED electronic circuitry
For WIRE-WRAP and PLUG or PIN
type CONNECTORS for computers,
control systems, missiles, etc., Also
for springs, terminals, forms, fit-
tings, prongs, contacts and clips.

Silvercote® Beryllium Copper — Brass — Bronze — ni-clad-ti
Titanium — Aluminum — Hot Solder Dipped — Tinned — etc.

Square and rectangular shaped wires are frequently used in modern "wrapped" terminal and pin or plug type connectors. For this application the edges must be finished quite sharp (usually .003 radius corners or less) but without a burr or flashing. Also required are closely controlled dimensional tolerances and smooth finish. Uniformity of temper is essential. Therefore close control of all facets of wire manufacturing is of paramount importance.

LITTLE FALLS ALLOYS, INC. 194 CALDWELL AVENUE,
PATERSON 1, NEW JERSEY

CIRCLE 207 ON READER SERVICE CARD

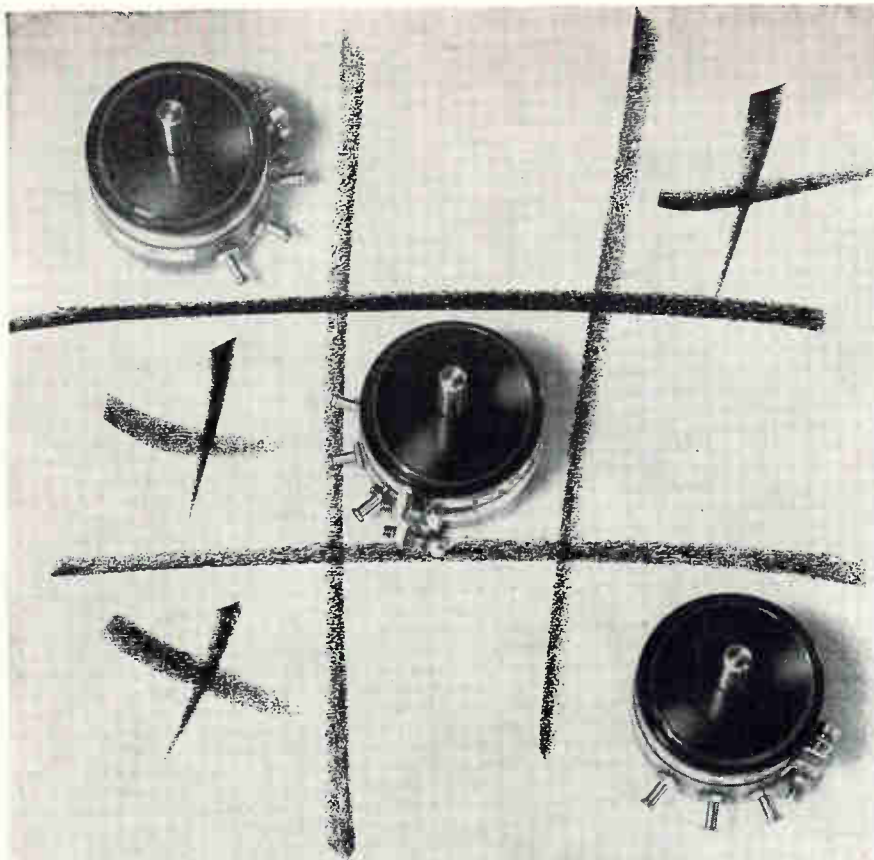

WINNER!

It's not the game, it's winning that counts—and Duncan potentiometers score right down the line. Precision, quality and reliability (three in a row) offer a combination that thwarts competition. Simple? Only because Duncan has improved design and manufacturing techniques—become expert in potentiometer oneupmanship.

Our pots can fill that blank spot on your board. The next move is yours. Put your x on this advertisement (name and address will further clarify) and return it to us. We'll be pleased to send you a complete list of the Duncan winners.

Exceptional vibration and shock performance (30g to 2,000 cps vibration and 50g shock) make Duncan's miniature $\frac{3}{8}$ " single turn Model 1201 above, particularly suitable for military servo packages. Diallyl pthalate housing withstands shock and protects against fungus, acid and alkali attack. Operating temperatures to 150°C are available.

DUNCAN ELECTRONICS, INC.
2865 FAIRVIEW ROAD • COSTA MESA, CALIFORNIA

sulation precludes possibility of damage to insulation (thin spots) or erasure.

CIRCLE 310 ON READER SERVICE CARD



D-C/D-C Converter SOLID STATE

MAGNETIC RESEARCH CORP., 3160 W. El Segundo Blvd., Hawthorne, Calif., introduces a d-c to d-c converter designed for airborne, ground or shipboard computer applications. The multiple-output 40 w converter, which measures 4 by 6 $\frac{1}{2}$ by 1 $\frac{1}{2}$ in., furnishes ± 3 percent regulated +15 and -15 v d-c, and ± 5 percent regulated +6 and -6 v d-c output voltages. Input is 22 to 32 v d-c; efficiency is 65 percent at 28 v d-c input and full load.

CIRCLE 311 ON READER SERVICE CARD

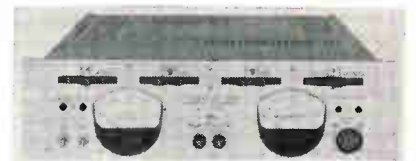

D-C Sources HIGH VOLTAGE

SMITH FLORENCE, INC., Seattle, Wash. Offering accuracies of 0.25 percent of any output voltage dialed, the model 120 provides 20 ma over the range of 500 to 2,210 v d-c; model 122, 20 ma from 0 to 3,000 v d-c; model 123, 20 ma from 0 to 6,000 v d-c. Stability is 0.005 percent per hr; regulation vs line change, 0.01 percent for ± 10 percent line; regulation vs load, 0.01 percent for 20 ma change; ripple, less than 5 mv rms at any output voltage and current in either polarity.

CIRCLE 312 ON READER SERVICE CARD

Time Delays

ADC ELECTRONICS, 1205 S. Santa Fe Ave., Compton, Calif. Miniaturized

solid state delays are unaffected by polarity reversals, voltage variations or transient spikes.

CIRCLE 313 ON READER SERVICE CARD

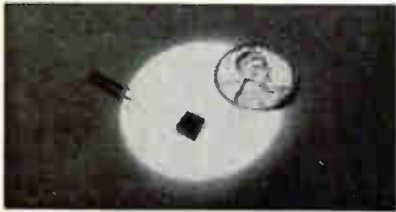

Toroidal Inductors SUBMINIATURE

VANGUARD ELECTRONICS CO., 3384 Motor Ave., Los Angeles 34, Calif., announces two series of toroidal inductors that have a volume of 0.004 cu in., are vacuum encapsulated in epoxy, and meet specification MIL-C-15305B, Grade 1, Class B (-55 to +125 C). Series 91 is for vhf; and 92, for h-f applications. Units are of single-ended (plug-in) construction for p-c and module applications.

CIRCLE 314 ON READER SERVICE CARD



Telemetering Switch MICROMINIATURE

GENERAL TELEMTRY, INC., 475 Watchung Ave., Watchung, N.J. The Micro-Com provides up to 90 channels per pole on each of five poles in a 5½ cu in. volume and 7 oz weight for airborne and ground telemetering applications, such as signal sampling and programming functions. Sampling rate: up to 30 revolutions per second. Contact resistance is less than 1 ohm with a 100 ohm switching load. Insulation resistance is a minimum of 100 megohms.

CIRCLE 315 ON READER SERVICE CARD

V-T Voltmeter

TRIO LABORATORIES, INC., Dupont St., Plainview, L. I., N. Y. Dual-

*"A new perforated
tape reader?"*

"By Digitronics?"

"All photo-electric?"

*"At the cost of
mechanical readers?"*

*"Reads at 300
characters/second?"*



*I want to see
this for myself
at the EJCC"*

BOOTH 95

In case you won't make the Eastern Joint Computer Conference, we'll be happy to send you all the details—just write to: Digitronics Corporation, Albertson, New York

METALS for ELECTRONIC APPLICATION

rolled ULTRA THIN

by OUR SPECIAL ROLLING
TECHNIQUE



RIBBONS.....
STRIPS.....

TOLERANCES CLOSER THAN COMMERCIAL STANDARDS

Note: for highly engineered applications—strips of TUNGSTEN and some other metals can be supplied

rolled down to .0003 thickness

- Finish: Roll Finish—Black
- Ribbons may be supplied in Mg. weights

Developed and Manufactured by

H.CROSS CO.

3229 BERGENLINE AVE., UNION CITY, NEW JERSEY
Tele: Union City, N. J.: UN. 3-1134
N. Y. C., N. Y.: BR 9-4425

CIRCLE 208 ON READER SERVICE CARD

mode vtvm implements complete phase and amplitude analysis of the performance of a-c circuits and components.

CIRCLE 316 ON READER SERVICE CARD



Wall Cabinets FOR AUDIO EQUIPMENT

STEELCRAFT, INC., 1296 E. Keating, Muskegon, Mich. Electronic equipment cabinets, made in a variety of sizes for different types of wall installations, feature rugged construction. A vertical piano hinge supports several hundred pounds of equipment, yet allows it to swing out easily for service and maintenance. They are available in standard widths and depths with heights ranging from 19½ to 82½ in.

CIRCLE 317 ON READER SERVICE CARD

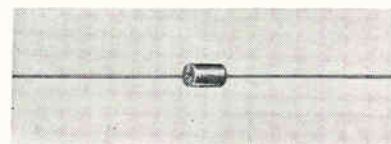

Ferrite Bead Choke FOR H-F AND VHF USE

NATIONAL RADIO CO., INC., Melrose, Mass., has developed a ferrite bead choke for use in h-f and vhf ranges. At power supply and audio frequencies, it presents no more impedance to these circuits than an ordinary hookup lead. At frequencies in the range above 10 Mc, it exhibits a substantially constant a-c resistance and impedance, making it useful for isolating h-f signals from the power supply and a-f circuits. It is completely free of undesired resonant effects.

CIRCLE 318 ON READER SERVICE CARD

Gallium Arsenide

HENLEY & CO., INC., 202 E. 44th St., New York 17, N. Y., as agents of

**PUTS THE BEST IN
CREATIVE ELECTRONICS
INTO YOUR HANDS**

Send for
FREE
Catalog

28 pages of professional electronic equipment in kit and wired form—for Lab . . . Line . . . Home

EICO, 3300 N. Blvd., L.I.C. 1, N. Y. E-12A
 Send free 32-page catalog & dealer's name.
 Send new 36-page Guidebook to NI-FI for which I enclose 25¢ for postage & handling.

Name _____
 Address _____
 City _____ Zone _____ State _____

EICO 3300 N. Blvd., L.I.C. 1, N. Y.
 Export Dept., Roburn Agencies
 431 Greenwich St., N. Y. 13, N. Y.

'On PW Boards'

**DYNASERT
COMPONENT
INSERTING
MACHINE
CAN PAY
FOR ITSELF**

**IN A YEAR
or less!**

BY DYNASERT
BY HAND

With only a few hundred PW boards a week, when Dynasert automatically feeds, prepares and inserts components, direct labor is cut to a fraction. Insertion rates go up to ten times faster, model changeovers made in seconds, boards are neater, more dependable, easier to solder tightly. Result: Savings that can return the cost of Dynasert in six months' to a year's time, plus more accurate and uniform insertions.

Send for the facts and figures. Dynasert Dept., United Shoe Machinery Corp., Boston, Mass.

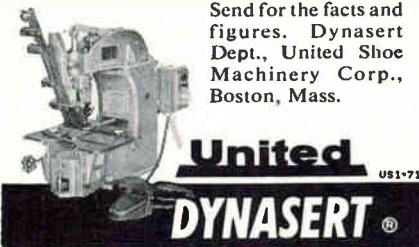

CIRCLE 209 ON READER SERVICE CARD

Wacker-Chemie, Munich, Germany, offers float-zone refined single crystalline gallium arsenide.

CIRCLE 319 ON READER SERVICE CARD

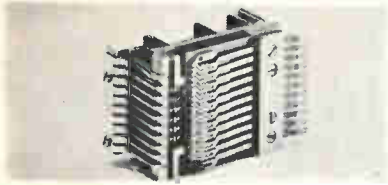

Pulse Counter ELECTROMAGNETIC

INTERNATIONAL TELEPHONE AND TELEGRAPH CORP., Clifton, N.J. Type ZM-53 electromagnetic pulse counter is a relay-like device with 10 armatures operating sequentially on application of a pulse series. Precious-metal contacts are closed by the armatures. The nominal minimum pulse duration for operation of the device is 20 millisecc and the minimum interval between pulses, the same.

CIRCLE 320 ON READER SERVICE CARD



Semiconductor Networks SIX DIGITAL CIRCUITS

TEXAS INSTRUMENTS INC., 13500 North Central Expressway, Dallas, Texas. A line of Solid Circuit semiconductor networks, series 51, includes six different digital circuit modules. Each silicon network is contained in an hermetically sealed package measuring 1/4 by 1/4 by 1/8 in. They perform flip-flop, counter, NOR gate, NAND gate, and exclusive OR gate functions. Designed for space-age equipments, they drain but 1/10 as much power as many advanced types of conventional circuits. They operate over a temperature range of -55 C to +125 C.

CIRCLE 321 ON READER SERVICE CARD

TWT Amplifier

WATKINS-JOHNSON CO., 3333 Hillview Ave., Stanford Industrial

BEHLMAN-INVAR IS TO ELECTRONIC POWER AS PROCTER IS TO GAMBLE

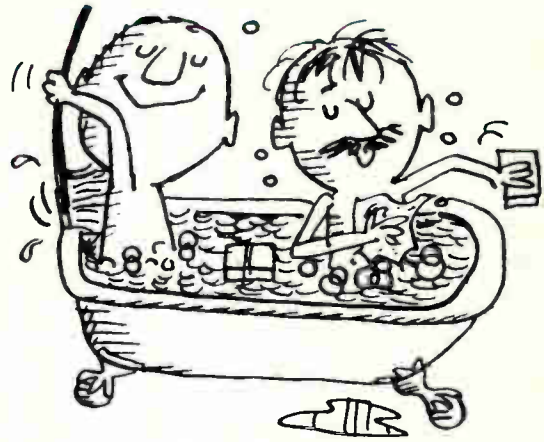

And to determine what Behlman-Invar means to you, B/I has a complete catalog of AC and DC power supplies which is yours for the asking. Ask!



BEHLMAN-INVAR ELECTRONICS CORP.

1723 Cloverfield Blvd., Santa Monica, California

CIRCLE 210 ON READER SERVICE CARD



FOR PRINTING
of
ELECTRONIC COMPONENTS
of almost any shape:

REJAFIX MARKING MACHINES

Hand-operated, semi-automatic and fully automatic models.

Why not send us samples of your products. They will be test-printed and returned to you for your examination!

Est. 1922

POPPER & SONS, INC.

300 Park Ave. South New York 10, N. Y.

CIRCLE 77 ON READER SERVICE CARD

Is your advertising selling the same four key buyers your salesmen call on? Competition demands it! Only advertising in electronics reaches and sells the electronics man wherever he is: in Research,

TODAY YOU MUST SELL ALL FOUR!

Design, Production, and Management. Put your advertising where it works hardest...

in **electronics**



That "special" IF strip or



amplifier is probably an

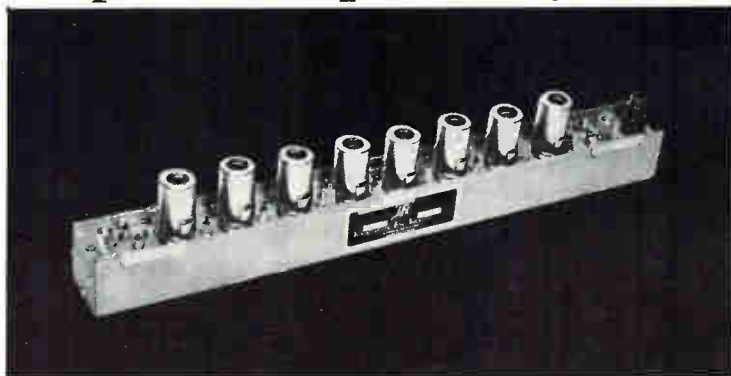

INSTRUMENTS FOR INDUSTRY standard

Check with IFI first for that IF strip or "special purpose" amplifier! Our work in designing and producing electronics systems has resulted in an array of IFI units that meet stringent specifications at lower cost than you'll find elsewhere... and most of them are available for immediate, off-the-shelf delivery. Just tell us your requirement. More than likely, we'll come up with the goods!



INSTRUMENTS FOR INDUSTRY, INC.

101 NEW SOUTH ROAD • HICKSVILLE, L. I., N. Y. • OV 1-7100

Park, Palo Alto, Calif., announces a high-gain periodically-focused 15 Kw pulsed twt amplifier for C-band radar systems.

CIRCLE 322 ON READER SERVICE CARD

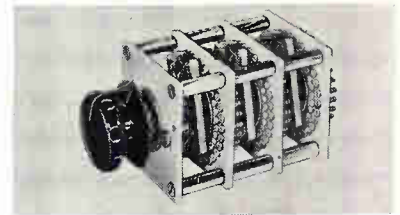

Stop Switches ADJUSTABLE

THE DAVEN CO., Livingston, N. J. Line of 87 adjustable stop switches are built in square configuration, in 1 1/4 in. and 2 1/4 in. sizes. They are constructed of corrosion-resistant metals and inorganic fibre-filled plastics capable of withstanding high temperatures. Switch contacts and rotor arms are solid silver alloy, and all rotors have knee action and tamper-proof design. They meet and exceed all applicable paragraphs of MIL-S-3786 and MIL-E-5272.

CIRCLE 323 ON READER SERVICE CARD

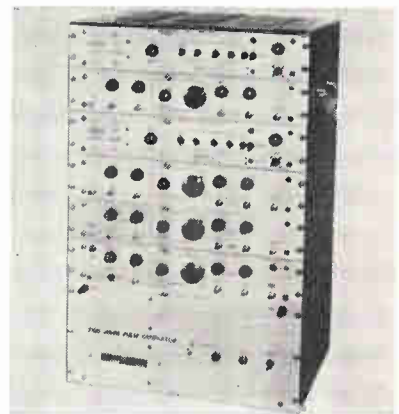

Double Pulse Generator FAST RISE TIME

SERVO CORP. OF AMERICA, 111 New South Road, Hicksville, L.I., N.Y. A precision double pulse generator that provides a multiplicity of separate or mixed output signals features flexible modular construction. High power, accuracy to 0.5 percent, 0.02 μ sec rise time, and repetition rate to 100 Kc make the general-purpose instrument applicable to a broad range of pulse simulation and control problems.

CIRCLE 324 ON READER SERVICE CARD

PRODUCT BRIEFS

FOLDED TEE standard II plane. Microwave Development Laboratories, Inc., 15 Strathmore Rd., Natick, Mass. (325)

RECYCLING TIMER electronically controlled. Hufco Industries, 2815 W. Olive Ave., Burbank, Calif. (326)

GROUND STUD multiterminal. Jan Engineering, 2018 Pico Blvd., Santa Monica, Calif. (327)

PROGRAMMER for MIL-STD 202B. Delta Design, Inc., 3163 Adams Ave., San Diego 16, Calif. (328)

MINIATURE CONNECTORS & shielded cables. Gulton Industries, 212 Durham Ave., Metuchen, N. J. (329)

ULTRASONIC GENERATOR 400-watt. Branson Instruments, Inc., 40 Brown House Road, Stamford, Conn. (330)

VERTICAL SENSING ELEMENT highly reliable. Kearfott Division, General Precision, Inc., 1150 McBride Ave., Little Falls, N. J. (331)

CROSSPOINT RELAYS use miniature reed switches. Struthers-Dunn, Inc., Pitman, N. J. (332)

SSB MODULATORS from C to Ku bands. Varian Associates, 611 Hansen Way, Palo Alto, Calif. (333)

RESISTANCE DECADE low cost unit. Skiatron Electronics & Television Corp., 180 Varick St., New York 14, N. Y. (334)

TRANSDUCER EXCITER-DEMODULATOR fully transistorized. Daytronic Corp., 225 S. Jefferson St., Dayton 2, O. (335)

ALL-ANGLE BLOWER multipurpose device. Western Devices, Inc., 600 W. Florence Ave., Inglewood 1, Calif. (336)

HEAT SHRINKABLE SLEEVE for resistor and capacitor encapsulation. Rayclad Tubes, Inc., Redwood City, Calif. (337)

LOAD CELL designed for compression service. Allegany Instrument Co., 1091 Wills Mountain, Cumberland, Md. (338)

CONTACT ASSEMBLIES spring-loaded. Orstby & Barton Co., P.O. Box 6267, Providence 4, R. I. (339)

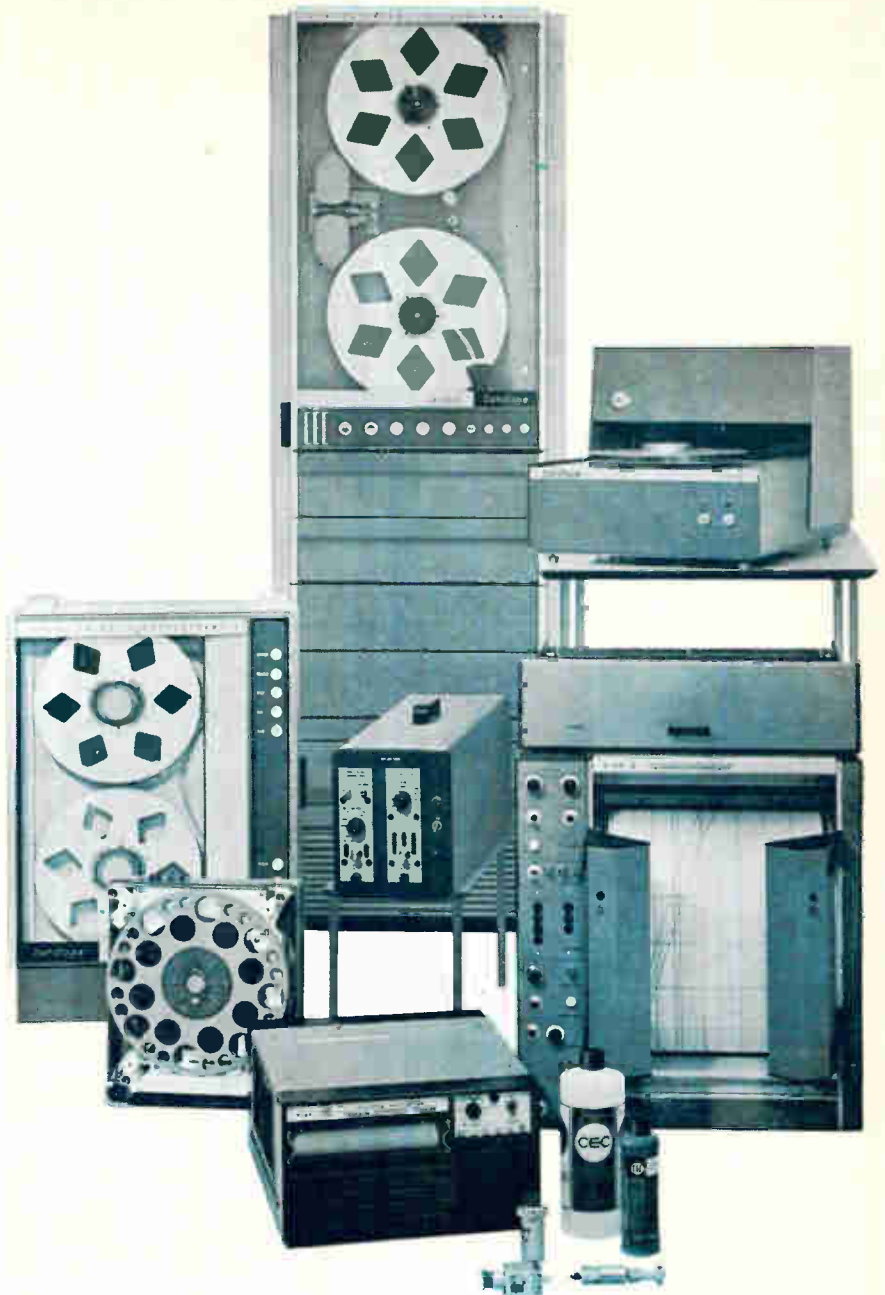

recognize the family?

You might. They keep the best of company. And they're just part of the *total* data recording capability only CEC can give you. □ There are Magnetic Tape Recorders for ground station systems and portable use . . . Tape Degaussers . . . D-C Amplifiers . . . Multichannel Recording Oscillographs with a complete line of recording papers and processing chemicals . . . Transducers, too. A whole lot. From data input to output, the CEC family is the most extensive and compatible anywhere! □ Special project? CEC can handle it. As they did with the Mercury Space Capsule Recorder shown in the left middleground. For *any* data recording job, call your nearest CEC office. Or write today for CEC Bulletins 1309-X1 and 1310-X1.

CEC

Data Recorders Division

CONSOLIDATED ELECTRODYNAMICS
PASADENA, CALIFORNIA • A SUBSIDIARY OF BELL & HOWELL

NEW

from **DICKSON**

... the industry's broadest line of

High Voltage Temperature Compensated ZENER REFERENCE DIODES

(Units shown in actual size)

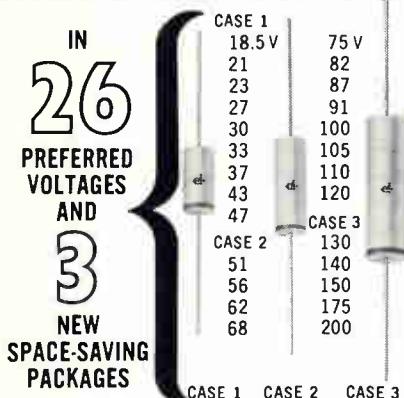

TEMPERATURE COEFFICIENT : 0.005%/°C Max.
TEMPERATURE RANGES : 0° to +75°C;
-55°C to +25°C to +100°C
V_Z TOLERANCE : ±5% Max.

Designed to Meet Requirements of MIL-S-19500B

New techniques developed by Dickson Electronics engineers for producing high voltage zener reference diodes result in a sophisticated combination of performance, small size, stability, ruggedness, reliability and value rarely, if ever, approached by any other semiconductor product. And Dickson's standardization of these hitherto special order devices results in ready availability.

Other series with voltages of 9.3 volts (1N2620-1N2624B) and 11.7 volts (Series 3/4T100A11.7-3/4T5C11.7) also available as standard items.

For prototype orders, complete technical information and prices, call your Dickson distributor or representative... or write

DICKSON
ELECTRONICS CORPORATION



248 WELLS FARGO AVE. SCOTTSDALE, ARIZONA

Literature of the Week

ALUMINUM CIRCUIT BOARD Electrolab Printed Electronics Corp., Needham Heights 94, Mass. Brochure covers Dielox circuitry for continuous operation at temperature up to 900 F. (340)

MICROMODULAR FLIP-FLOP Eleo Corp., M St. below Erie Ave., Philadelphia 24, Pa. Bulletin illustrates and describes the Modu-Con pluggable micromodular flip-flop. (341)

P-C CAPACITORS John E. Fast & Co., 3580 N. Elston Ave., Chicago 18, Ill. Catalog sheet describes Mylar dielectric p-c capacitors. (342)

FREQUENCY SPECTRUM Raytheon Co., Lexington 73, Mass., offers a folder on the frequency spectrum of the industry, with a sampling of the company's products pictured within the spectrum. (343)

CROSSBAR SCANNER James Cunningham, Son & Co., 33 Litchfield St., Rochester, N. Y. Technical bulletin describes the ST series of crossbar scanning systems. (344)

COAXIAL CONNECTOR Microdot Inc., 220 Pasadena Ave., South Pasadena, Calif. Two-page data sheet describes the features of a micro-miniature crimp-type coaxial connector. (345)

NOISE GENERATOR Elgenco, Inc., 1231 Colorado Ave., Santa Monica, Calif. Bulletin EI-301A describes a low frequency noise generator featuring a solid state chopper and regulated rms level. (346)

TRANSISTORIZED ANNUNCIATORS Rochester Instrument Systems, Inc., 271 North Union St., Rochester, N. Y., has available a 12-page brochure on a line of transistorized annunciators. (347)

DEFENSE ELECTRONICS Republic Electronics, 575 Broad Hollow Road, Huntington, L. I., N. Y., offers a brochure discussing its experience in the development of precision electronic equipment for rigorous operational, ground support and checkout requirements. (348)

BLOOD VOLUME COMPUTER Delta Instrument Corp., 250 Delawanna Ave., Clifton, N. J. A folder describes the VolumeComputer, which

NEW opportunities in MISSILE ENGINEERING for:

PHYSICISTS MECHANICAL & ELECTRICAL DESIGN ENGINEERS SYSTEMS ENGINEERS

The Hughes Tucson Engineering Laboratory is again expanding its scope of operations. Challenging new opportunities have been created with state-of-the-art advances in missile & space engineering.

The scope of engineering effort at Hughes Tucson includes operational as well as advanced missiles and subsystem designs for space programs.

Specific areas of immediate needs include:

- Circuit Design
- Transistor Techniques
- Electromechanical Design
- Infrared Theory
- Microwave Antenna Design
- Miniaturization
- Hydraulics
- Controls

Engineers and Physicists who like to work on important problems will find this dynamic organization an ideal environment in which to exercise creative talents.

If your goals include — work on vital projects with recognized leaders in the field — to live in the heart of the year-around, healthful Southwestern vacation land — to continue advanced studies (at the University of Arizona) — and to contribute to our Nation's Defense while securing your own future — send your resume to MR. W. A. BARNES.

creating a new world with electronics

HUGHES

HUGHES AIRCRAFT COMPANY
TUCSON ENGINEERING
LABORATORY
Tucson, Arizona

An equal opportunity employer

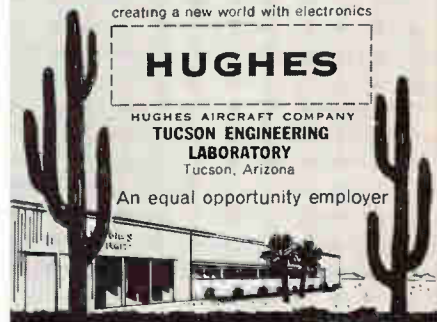

provides precise blood volume monitoring—digitally displayed. (349)

COMPACT MOTORS Martronics, Inc., 82 Sanford St., Hamden, Conn. Bulletin 125-A covers a line of hysteresis, synchronous and induction motors. (350)

WHITE NOISE DIODE Solitron Devices, Inc., 500 Livingston St., Norwood, N. J. A 16-page manual is devoted to the Sounvister white noise diode. (351)

PULSED TWT's Sperry Electronic Tube Division, Gainesville, Fla. Brochure gives technical information on a line of high-power pulsed traveling wave tubes. (352)

SYNCHRO FUNCTIONS Servo Systems Co., Belleville, N. J. A precision instrument for live demonstration of all torque and control synchro functions is described in a 4-page catalog. (353)

NOR CIRCUIT MODULES Engineered Electronics Co., 1441 E. Chestnut Ave., Santa Ana, Calif. Eight-page bulletin covers the U-series universal NOR circuit modules. (354)

CAPABILITIES BROCHURE Walter Kidde & Co., Inc., Belleville 9, N. J. Booklet describes Kidde Electronics Laboratories capabilities in ground support, test and automated equipment. Request copy on company letterhead only.

LARGE ANTENNAS Andrew Corp., P.O. Box 807, Chicago 42, Ill. Catalog on large parabolic antennas discusses the new patented Hubloc construction. (355)

POWER CONTROL UNITS Magnetics Inc., Butler, Pa. An 8-page bulletin covers characteristics, operational details, and applications of power control units. (356)

AIRBORNE PARTICLE MONITOR Royco Instruments, Inc., 440 Olive St., Palo Alto, Calif., has issued a leaflet describing model PC 200-A airborne particle monitor. (357)

PROPORTIONAL CONTROLLER Thermo Electric Co., Inc., Saddle Brook, N. J. Instrument Section 53 deals with model 80410 Thermo Electronic proportional controller. (358)

DELAY LINES Computer Devices Corp., 6 W. 18th St., Huntington Station, N. Y., has available a folder providing a presentation of the field of delay lines. (359)

ANY RATIO

from 1:1

to 1:0.5

with the all new Beattie MARK II OSCILLOTRON

Everything you need in oscilloscope recording is provided by the versatile new Beattie Mark II Oscillotron. Easily change ratios from 1:1 to 1:0.9, 1:0.7 or 1:0.5 without extra lenses. Prints in just 10 secs. with new 3000 speed Polaroid® film plus these many important features:

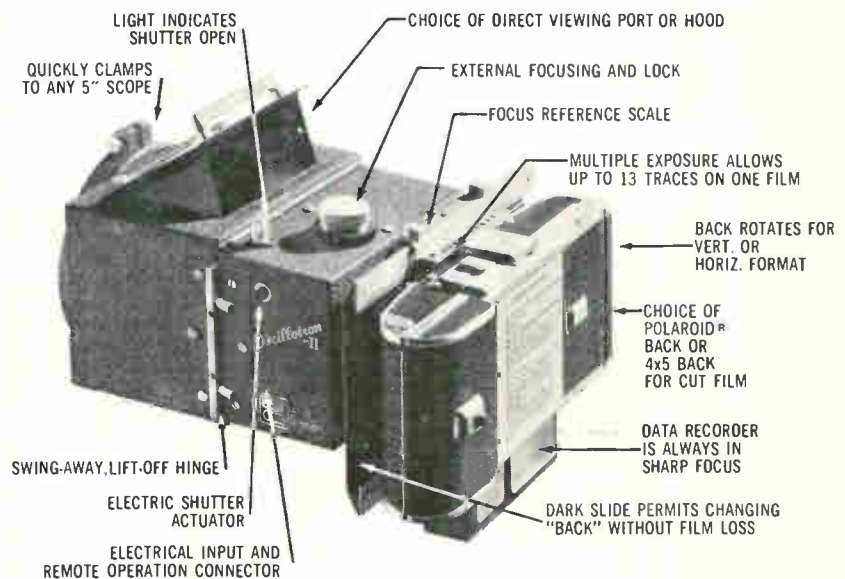

BEATTIE-COLEMAN, INC.
1004 North Olive Street, Anaheim, California

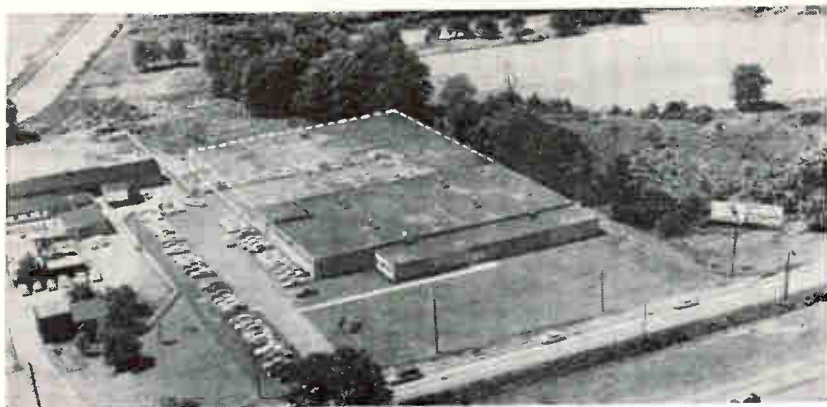

Associated To Expand Headquarters

ASSOCIATED TESTING LABORATORIES, INC., is adding 32,000 sq ft (dotted line in photo) to its present 30,000 sq ft plant in Wayne, N.J.

William Tonkowich, president, said the 62,000 sq ft plant will provide increased space for both environmental testing services and manufacturing of test chambers.

The testing division is adding larger, more complex test equipment to its expanded facility. Recent equipment acquisitions include a 7,500 force-pound sine and random wave vibration system that allows vibration up to 100 g at 3,000 cps. New altitude systems will raise the company's capabilities over the

present 500,000 ft. Associated, which recently announced a program of growth within the hydraulics and pneumatics areas, will devote even more space to this program in the new addition. ATL tests missile, rocket and aircraft components.

The manufacturing division produces Econ-O-Line chambers. These standard units, currently in full production, include Mark II low-high temperature chambers, larger temperature chambers and temperature-humidity chambers.

The company has regional laboratories in Winter Park, Fla., and Burlington, Mass.



TRW's Dage Division Names Zehnpfennig

WILLIAM C. ZEHNPFENNIG has been appointed manager of industrial control systems field engineering by Dage Division, Thompson Ramo Wooldridge Inc., Michigan City, Ind. He will be in charge of all field

engineering and customer service for TRW's point-to-point and contouring numerical control systems, directing the firm's field engineers throughout the U.S.

Before joining TRW this year, Zehnpfennig was a private consulting engineer, had been senior project engineer for Bailey Meter Co., and a project engineer for Bendix Products division in South Bend.

Tracerlab Completes Belgium Plant

DEDICATION ceremonies in Malines (Mechlen), Belgium, recently marked completion of a modern 25,000 sq ft manufacturing, sales, and administrative headquarters by

Tracerlab, S.A., subsidiary of Tracerlab, Inc., Waltham, Mass.

In making his dedicatory statement, S. S. Auchincloss, Tracerlab president, expressed hope that with these additional facilities, Tracerlab would now be better able to serve the growing needs of the European Common Market for advanced nuclear instrumentation and equipment.



Weiner Accepts New Position

APPOINTMENT of James R. Weiner as associate manager of the guidance and controls division of the aerospace group of Hughes Aircraft Co., Culver City, Calif., is announced.

Weiner was formerly vice president-engineering for Philco Corporation's government and industrial group in Philadelphia, where he was responsible for the coordination of the engineering and development work of the five divisions within the group.



Joseph Waldman & Sons Sets Up New Company

A NEW COMPANY, Intermetallic Products, Inc., has been established by Joseph Waldman & Sons for the manufacture of bismuth telluride and gallium arsenide compounds and cooling modules. Assets, facili-

Reliable products depend on reliable parts

The worldwide success of Japan's transistor radios is a tribute to their highly efficient yet minute components, of which the ultra-small Mitsumi IFT Poly-vari-con is typical. With other superb Mitsumi parts, it is being extensively used by leading radio manufacturers.

For Transistor Radio Parts



IFT

Intermediate
Frequency
Transformer



POLY-VARI-CON

Variable
Capacitor



Mitsumi Parts

MITSUMI ELECTRIC CO., LTD.

1056-1, Koadachi, Komae-cha, Kitatama-gun, Tokyo, Japan

CIRCLE 211 ON READER SERVICE CARD

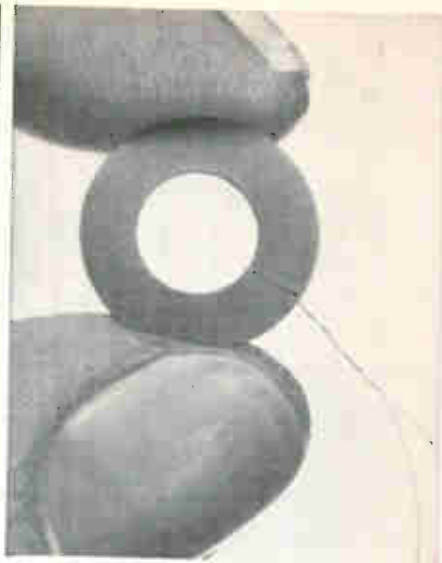

In the Remington Rand Univac physics laboratory, 5 mil. diameter holes are ultrasonically drilled in ferrite cores, then threaded with fine wire in the examination of domain structure. Such experiments prove that a series of alternate-polarity pulses of diminishing amplitude result in concentric rings of alternately directed magnetization. Much smaller cores (80 mil. o.d.) were then studied by means of residual magnetization curves for flux distribution under various modes of partial switching.

Opportunity for personal progress has never been greater than it is today at Remington Rand Univac.

In addition to an attractive salary, you will work with engineers and scientists who have made significant advances in solid state development and computer reliability. Immediate openings include:

RESEARCH ENGINEERS

Attractive positions are now available for Research Engineers. These permanent assignments include circuit development work and the logical design of high speed computer elements.

- TRANSISTOR CIRCUIT DESIGNERS
- ELECTRONIC PACKAGING ENGINEERS
- SERVO-ENGINEERS
- ELECTROMECHANICAL ENGINEERS
- QUALITY CONTROL ENGINEERS
- PRODUCTION ENGINEERS
- RELIABILITY ENGINEERS
- STANDARDS & SPECIFICATIONS ENGINEERS

Send resume of education and experience to:

R. K. PATTERSON, DEPT. T-12

Remington Rand

Univac

DIVISION OF SPERRY RAND CORPORATION
2750 West Seventh St., St. Paul 16, Minn.

There are also immediate openings in all areas of digital computer development at our other laboratories. Inquiries should be addressed to:

F. E. NAGLE, Dept. T-12
REMINGTON RAND UNIVAC
P. O. Box 500
Blue Bell, Pa.

D. CLAVELOUX, Dept. T-12
REMINGTON RAND UNIVAC
Wilson Avenue
South Norwalk, Conn.

(All qualified applicants will be considered regardless of race, creed, color or national origin.)



HELP YOUR POSTMASTER
TO EXPEDITE YOUR CHRISTMAS
GREETINGS AND PACKAGES
MAIL EARLY!

to Distant Points, before December 10th
for Local Delivery, before December 16th

Address Legibly—Include Postal Zone
Number and Your Return Address—Wrap
Packages Securely—AND . . .

MAIL EARLY!

ELECTRONIC ENGINEERS

Here's your ticket
to visit Hughes
in Southern California

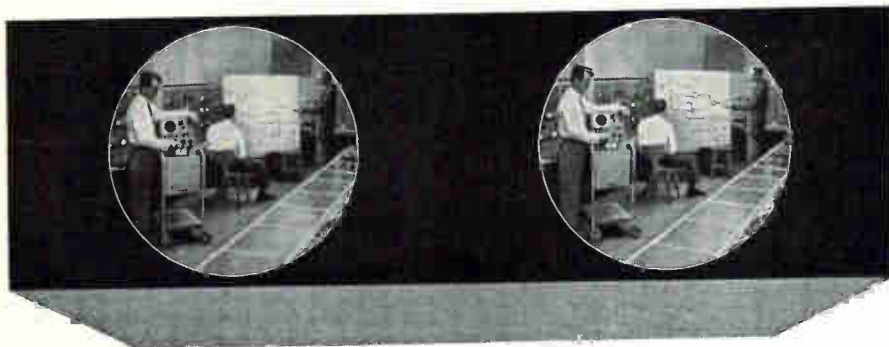

via the Hughes stereo viewer

tour . . . our modern facility. **see** for yourself why HUGHES is the West's leader in advanced electronics. **look** . . . at all the advantages living in a Southern California suburb has to offer. ■ What the HUGHES Stereo Viewer won't show you is that our Advanced Electronics Division has new, long-range aerospace contracts creating immediate need for degreed ELECTRONIC ENGINEERS with two to four years' experience in one of the following areas: ■ TEST EQUIPMENT DESIGN ■ RADAR ■ MICROWAVE ■ QUALITY CONTROL ■ SYSTEMS ANALYSIS ■ CIRCUIT DESIGN ■ SEMICONDUCTORS ■ COMPUTERS.

CREATING A NEW WORLD WITH ELECTRONICS

HUGHES

HUGHES AIRCRAFT COMPANY

An equal opportunity employer.

To receive your free HUGHES Stereo Viewer, just complete and mail the coupon below:

**HUGHES Aerospace Group,
El Segundo Division
ATTN: Wallace Peterson,
Head of Employment
P. O. Box 90426, Los Angeles 9, California**

I am a degreed ELECTRONICS ENGINEER and would like to receive a FREE HUGHES Stereo Viewer and further information about growth opportunities at HUGHES.

Name _____

Address _____

City _____ Zone _____ State _____



ties and personnel of Crystal Labs, Inc., Riverton, N.J., were acquired in forming the new company and moved to a 5,000 sq ft laboratory and pilot plant in Irvington, N.J.

Charles Wood (picture), director of research of the new corporation, has been in semiconductor R&D for the past 11 years. He was associated with GE and the Plessey Co. in England. Since coming to this country in 1956, he has continued in the R&D of new thermoelectric materials at Philco and Crystal Labs, Inc.

Hewlett-Packard Forms Two New Divisions

HEWLETT-PACKARD CO., Palo Alto, Calif., has announced the formation of two new divisions. One, the Advanced Research and Development division, will investigate new product areas and provide development services for other operating divisions. The other, the Frequency and Time division, will engineer and manufacture precision frequency counters and highly accurate time measuring devices.

Paul E. Stoff, with H-P since 1958, has been named manager of the Advanced R&D division.

Alan S. Bagley, with the company since 1949, becomes general manager for the engineering and production division for precision frequency and time measuring instruments.



Downs Advances At Radiation Inc.

RADIATION INCORPORATED, Orlando, Fla., has announced the appointment of John W. Downs as general manager of its newly created corporate division, Radiation at Orlando. This division combines the existing Orlando Systems Develop-

JULY 20, 1961

e

B

G

electronics
BUYERS' GUIDE
and
Reference Issue

PRODUCTS, MATERIALS
and SERVICES LISTINGS

Registered TRADENAMES

MANUFACTURERS'
SALES OFFICES

ANNUAL electronics
INDEX of ARTICLES

VOL. 34 28A

ment and Manufacturing divisions and will be put on a self-sustaining basis as soon as possible.

Downs, who reports directly to the vice president, operations, joined Radiation Inc. in 1955. Since that time, he has assumed increased responsibility rapidly.

EOS Elects Ponedel
Vice President

IVAN M. PONEDEL has been elected vice president of Electro-Optical Systems, Inc., Pasadena, Calif. With the company since 1959, he will continue to function as manager of government and industry relations.

PEOPLE IN BRIEF

Rolf R. Haberecht of P. R. Mallory & Co. Inc. has transferred to the staff of its new Laboratory for Physical Science. C. Hunter McShan, formerly of Columbia Technical Corp., named chief engineer of the Wire Sonic div. of Andersen Laboratories, Inc. Henry M. O'Bryan, ex-General Telephone and Electronics Corp., appointed scientific asst. to the v-p of engineering and research of The Bendix Corp. John G. Frayne leaves Consolidated Electrodynamics Corp. to become manager of the data systems dept. of Marquardt-Pomona. Ralph W. Wight promoted to v-p of the Westrex Recording Equipment div. of Litton Systems, Inc. Stanley M. Handelman of Theta Instrument Corp. elected chairman of the board. Harold Shnitkin advances at Avien, Inc. to head of advanced R&D in the Antenna Div. Joseph Oppenheim elevated to director of programs management for Raytheon Co.'s electronic components and devices group. R. W. Peirce, previously with ITT Kellogg, joins Oak Mfg. Co. as manager, new products. Henry Epstein moves up at Metals & Controls Inc. to manager of the precision controls dept. Donald O. Schwennesen, ex-Magnetic Metals Co., appointed v-p in charge of the Pacific Div. of The Arnold Engineering Co. Allen S. Clarke, former president of Nems-Clarke Co., elected to the board of directors of Weinschel Engineering Co.

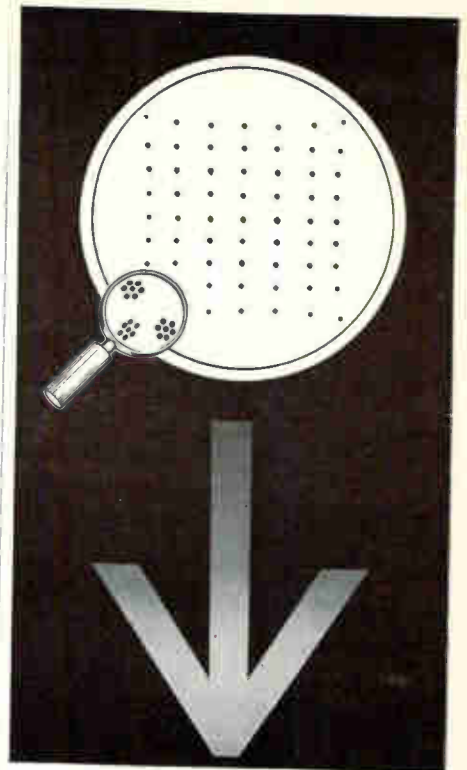

WHY

MAJOR C. R. TUBE MFGRS.
RECOMMEND
SYNTRONIC YOKES

Exceptional manufacturing uniformity. Achieved by unique pepperpot tube testing—the most comprehensive method known for precise measurement for spot uniformity . . . to attain extremely accurate focusing. For technical details, request ELECTRONIC INDUSTRIES reprint #6-57 from Syntronic Instruments, Inc.

Call your nearest SYNTRONIC REP today

Boston-New Eng.: NORwood 7-3164
New York Area: OXford 5-0255
Phila. Area: MOhawk 4-4200
Wash.-Balt. Area: APpleton 7-1023
Indianapolis: VICTor 6-0359
Los Angeles: CUMberland 3-1201

syntronic

INSTRUMENTS, INC!

100 Industrial Road, Addison, Illinois
Phone: Kingswood 3-6444

The industry's broadest yoke line . . . already tooled for quantity production. Or, yokes can be custom designed to your precise requirement.

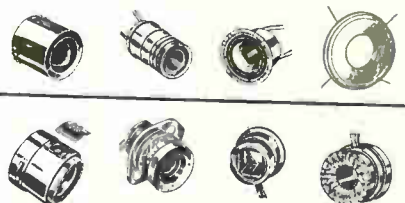

electronics

WEEKLY QUALIFICATION FORM FOR POSITIONS AVAILABLE

ATTENTION: ENGINEERS, SCIENTISTS, PHYSICISTS

This Qualification Form is designed to help you advance in the electronics industry. It is unique and compact. Designed with the assistance of professional personnel management, it isolates specific experience in electronics and deals only in essential background information.

The advertisers listed here are seeking professional experience. Fill in the Qualification Form below.

STRICTLY CONFIDENTIAL

Your Qualification form will be handled as "Strictly Confidential" by ELECTRONICS. Our processing system is such that your form will be forwarded within 24 hours to the proper executives in the companies you select. You will be contacted at your home by the interested companies.

WHAT TO DO

1. Review the positions in the advertisements.
2. Select those for which you qualify.
3. Notice the key numbers.
4. Circle the corresponding key number below the Qualification Form.
5. Fill out the form completely. Please print clearly.
6. Mail to: D. Hawksby, Classified Advertising Div., ELECTRONICS, Box 12, New York 36, N. Y. (No charge, of course).

| COMPANY | SEE PAGE | KEY # |
|---|----------|-------|
| AMERICAN MACHINE & FOUNDRY COMPANY Stamford, Connecticut | 97* | 1 |
| AMPEX CORPORATION Redwood City, California | 87 | 2 |
| RICHARD D. BREW & CO., INC. Concord, New Hampshire | 88 | 3 |
| ERIE ELECTRONICS DIV. Erie Resistor Corp. Erie, Pennsylvania | 88 | 4 |
| ESQUIRE PERSONNEL Chicago, Illinois | 97* | 5 |
| GENERAL DYNAMICS/ASTRONAUTICS San Diego, California | 17, 18 | 6 |
| GENERAL ELECTRIC COMPANY Electronics Park Syracuse, New York | 97* | 7 |
| HUGHES AIRCRAFT COMPANY El Segundo, California | 84 | 8 |
| HUGHES AIRCRAFT COMPANY Tuscon Engineering Lab. Tuscon, Arizona | 80 | 9 |
| LAWRENCE RADIATION LABORATORY Livermore, California | 88 | 10 |
| MICROWAVE SERVICES INTERNATIONAL, INC. Denville, New Jersey | 88 | 11 |

CONTINUED ON PAGE 88

(cut here)

(cut here)

electronics WEEKLY QUALIFICATION FORM FOR POSITIONS AVAILABLE

Personal Background Education

NAME

HOME ADDRESS.....

CITY..... ZONE..... STATE.....

HOME TELEPHONE.....

PROFESSIONAL DEGREE(S).....

MAJOR(S)

UNIVERSITY

DATE(S)

FIELDS OF EXPERIENCE (Please Check)

1211

| | | |
|--|--|---------------------------------------|
| <input type="checkbox"/> Aerospace | <input type="checkbox"/> Fire Control | <input type="checkbox"/> Radar |
| <input type="checkbox"/> Antennas | <input type="checkbox"/> Human Factors | <input type="checkbox"/> Radio-TV |
| <input type="checkbox"/> ASW | <input type="checkbox"/> Infrared | <input type="checkbox"/> Simulators |
| <input type="checkbox"/> Circuits | <input type="checkbox"/> Instrumentation | <input type="checkbox"/> Solid State |
| <input type="checkbox"/> Communications | <input type="checkbox"/> Medicine | <input type="checkbox"/> Telemetry |
| <input type="checkbox"/> Components | <input type="checkbox"/> Microwave | <input type="checkbox"/> Transformers |
| <input type="checkbox"/> Computers | <input type="checkbox"/> Navigation | <input type="checkbox"/> Other |
| <input type="checkbox"/> ECM | <input type="checkbox"/> Operations Research | <input type="checkbox"/> |
| <input type="checkbox"/> Electron Tubes | <input type="checkbox"/> Optics | <input type="checkbox"/> |
| <input type="checkbox"/> Engineering Writing | <input type="checkbox"/> Packaging | <input type="checkbox"/> |

CATEGORY OF SPECIALIZATION

Please indicate number of months experience on proper lines.

| | Technical Experience (Months) | Supervisory Experience (Months) |
|-------------------------------------|-------------------------------|---------------------------------|
| RESEARCH (pure, fundamental, basic) | | |
| RESEARCH (Applied) | | |
| SYSTEMS (New Concepts) | | |
| DEVELOPMENT (Model) | | |
| DESIGN (Product) | | |
| MANUFACTURING (Product) | | |
| FIELD (Service) | | |
| SALES (Proposals & Products) | | |

CIRCLE KEY NUMBERS OF ABOVE COMPANIES' POSITIONS THAT INTEREST YOU

1 2 3 4 5 6 7 8 9 10 11 12 13 14 15 16 17 18 19 20 21 22 23 24 25

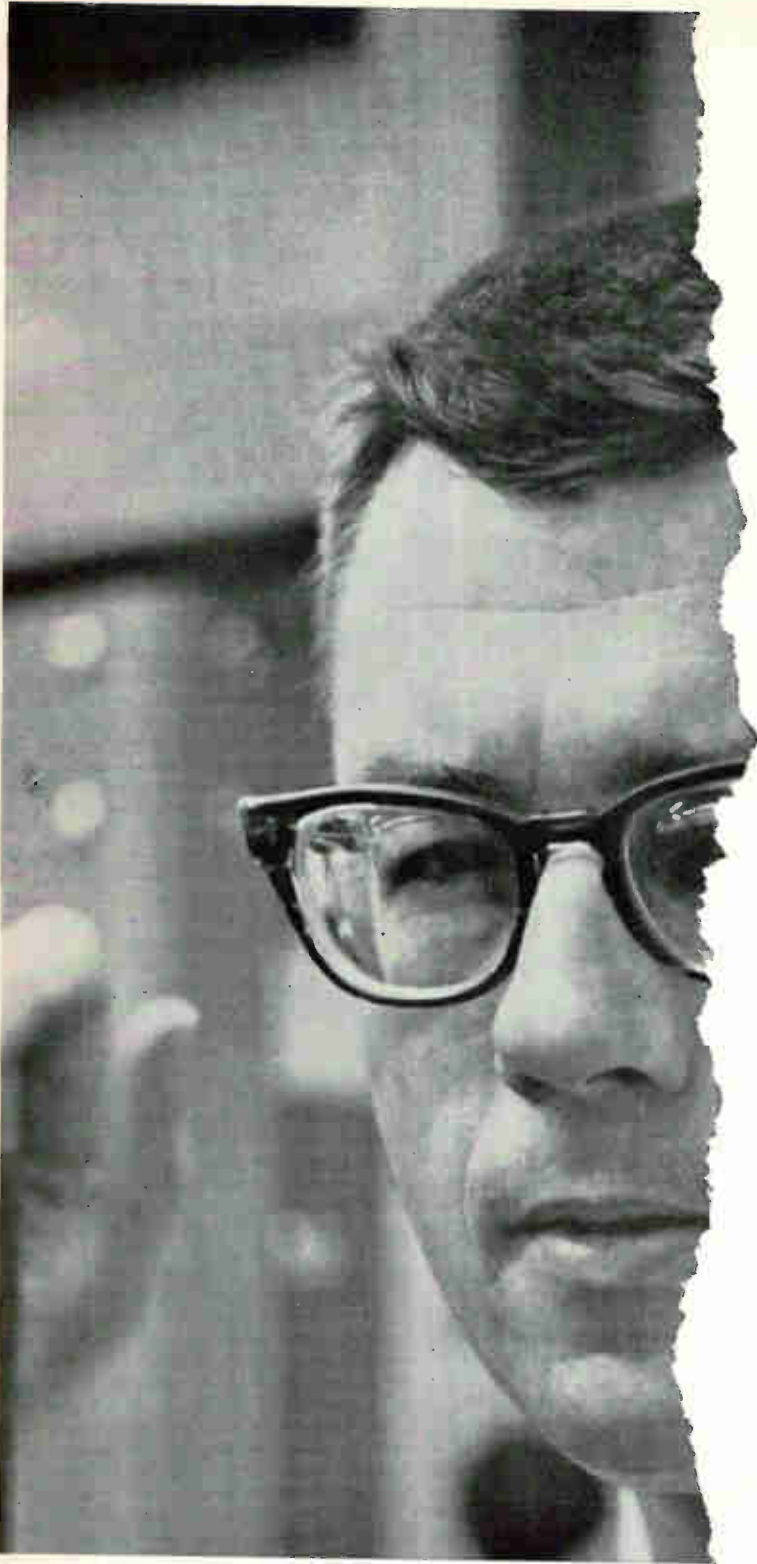

To the electro/mechanical development engineer who's realizing only part of his potential

Ampex can make your job picture complete.

For Ampex offers you an opportunity to conceive, design, develop the most advanced magnetic tape recorders in the world. You won't be confined to a fraction of a job. You'll be given free reign to work on ideas of your own. Supervise their original engineering, breadboarding and refinement. And then see them wind up in a working model. For what has always come first at Ampex? Product development.

AMPEX

You'll work in one of the finest areas anywhere: either Redwood City, near San Francisco, or Culver City in Southern California. If you have a BSEE or advanced degrees, 2 to 6 years experience and aptitudes in data acquisition, transducers, modulation, telemetry, data storage handling and digital recording systems, write for details. Or send your resume to: Mr. John A. Doolittle, Office of Scientific Placement, Ampex Corp., 2401 Bay Road, Redwood City, Calif.

NCR

*National**

PHYSICAL RESEARCH AND ENGINEERING

Continued growth and lasting stability underline the excellent professional opportunities at NCR's Engineering and Research Center in Dayton, Ohio. Projects in progress require personnel for the following positions:

SEMI-CONDUCTOR PHYSICIST

Ph.D. with 2-4 years of experience in semi-conductor development and applied research.

MAGNETICS RESEARCH PHYSICIST

Ph.D. with 2-4 years of research and development experience in field of magnetics.

SOLID STATE ELECTRONICS

Ph.D. or M.S. in Physics with 2-4 years experience in Solid State Physics and Electronics.

LOW TEMPERATURE ELECTRONICS

Ph.D. or M.S. in Physics with experience in low temperature field to work in cryotron research program.

PHYSICAL CHEMIST

Ph.D. with background and experience in materials preparation, in particular — magnetic materials, thin films, inorganics, or semi-conductors.

To be considered for one of the above openings or others that may match your particular professional training, write now to:

Mr. Thomas Wade, Technical Placement, The National Cash Register Company, Main and K Streets, Dayton 9, Ohio

AN EQUAL OPPORTUNITY EMPLOYER

LAWRENCE RADIATION LABORATORY

ELECTRONIC ENGINEERS: B.S. or higher degree in E.E. Openings in:

- Systems Engineering
- Environmental Instrumentation Engineering
- Digital Computer Circuitry
- Transistor Circuitry
- Pulse Circuitry
- General Design
- Reliability
- Quality Control
- Liaison Engineering

The Lawrence Radiation Laboratory in the San Francisco Bay Area is operated by the University of California for the United States Atomic Energy Commission.

Current projects are in the area of nuclear explosives for industry and defense, nuclear propulsion, controlled thermonuclear reaction, space physics, and other advanced problems in nuclear physics and engineering.

For additional information, address inquiries to the

PERSONNEL DEPARTMENT

LAWRENCE RADIATION LABORATORY

P.O. BOX 808 MG
LIVERMORE, CALIFORNIA

U. S. Citizenship Required

An Equal Opportunity Employer

BSEE

2 or more years experience in Electronics-Radar-Radio-Avionics. Field Engineering experience desirable.

Assignments—U. S. and overseas.

Send resume to I. F. Markham

National Scientific Laboratories, Inc.

2010 Massachusetts Ave. N. W.
Washington 6, D. C.

electronics

WEEKLY QUALIFICATIONS FORM FOR POSITIONS AVAILABLE

(Continued from page 86)

| COMPANY | SEE PAGE | KEY # |
|--|----------|-------|
| NATIONAL CASH REGISTER CO Electronics Division Hawthorne, California | 55 | 12 |
| NATIONAL CASH REGISTER CO Dayton, Ohio | 88 | 13 |
| NATIONAL SCIENTIFIC LABORATORY INC. Washington, D. C. | 88 | 14 |
| REMINGTON RAND UNIVAC Div. of Sperry Rand Corp St. Paul, Minnesota | 83 | 15 |

* These advertisements appeared in the 11/24/61 issue.

TRANSFORMER ENGINEER

With experience in the design and development of Hi-Frequency and Pulse transformers for commercial and military applications.

Ideal opportunity for ambitious man to develop full potential of present small department. Salary—open. Location—Erie, Pa. Call or send resume to Chief Engineer

Erie Electronics Division

Erie Resistor Corporation

645 West 12th Street Erie, Pa.
GL 6-8592

DELAY LINE ENGINEERS

Electronic Engineers with experience in the design of electromagnetic or ultrasonic delay lines. Project Engineer positions available for the engineer who will accept technical challenge and responsibility. Call or send resume to

T. Podolak

Richard D. Brew & Company, Inc.
90 Airport Road
Concord, New Hampshire

An equal opportunity employer.

COMMUNICATIONS APPLICATION ENGINEER

Analysis of advanced electronic communication systems including radio, carrier, telephone, microwave. Must have design and marketing experience with commercial and military users.



EE degree, 5 yrs. exp. min.
Send Resume to:

Microwave Services International Inc.
Consulting Engineers
Route 46 Denville, N. J.

POSITION VACANT

Experienced Production man on solid Tantalum capacitors for Calif. firm. Practical man preferred. Give complete resume—absolutely confidential. P-7851, Electronics, Classified Adv. Div., 255 California St., San Francisco 11, Calif.

SEARCHLIGHT SECTION

(Classified Advertising)

BUSINESS OPPORTUNITIES

EQUIPMENT - USED or RESALE

DISPLAYED RATE

The advertising rate is \$24.75 per inch for all advertising appearing on other than a contract basis. Contract rates quoted on request. AN ADVERTISING INCH is measured 1/8 inch vertically on one column, 3 columns—30 inches—to a page. EQUIPMENT WANTED or FOR SALE ADVERTISEMENTS acceptable only in Displayed Style.

UNDISPLAYED RATE

\$2.40 a line, minimum 3 lines. To figure advance payment count 5 average words as a line. PROPOSALS, 2.40 a line an insertion. BOX NUMBERS count as one line additional in undisplayed ads. DISCOUNT OF 10% if full payment is made in advance for four consecutive insertions of undisplayed ads (not including proposals).

AUTO-TRACK & TELEMETRY ANTENNA PEDESTALS
3 & 10 CM. SCR. 584 AUTOTRACK RADARS
AN/TPS-1D SEARCH AN/TPS-10 HT. FINDERS
AN/FPN-32GCA AN/APS-30 NAVIG. & WEATHER
AN/APS-31A PRECISION AN/APQ-35B PRECISION
AN/APS-31A SEARCH. DOZENS MORE.
.5-1.2 MEGAWATT HIGH POWER PULSERS.
MICROWAVE PLUMBING-TEST EQUIP.
LARGEST RADAR STOCK IN U.S.A.
RADIO RESEARCH INSTRUMENT CO.
550 Fifth Ave. New York Judson 6-4691

RADAR SYSTEMS & COMPONENTS / IMMEDIATE DELIVERY

CIRCLE 460 ON READER SERVICE CARD

electronics

INDEX TO ADVERTISERS



Audited Paid Circulation

| | | | |
|--|-----------|---|-----------|
| • AMP Incorporated | 32 | • Kepco, Inc. | 57 |
| Aerospace Corporation | 29 | Levin and Son, Inc., Louis | 12 |
| • Airpax Electronics, Inc. | 23 | Little Falls Alloys Inc. | 71 |
| • Arnold Engineering Co., The | 3 | | |
| Bausch & Lomb, Inc. | 30 | • Magnetic Shield Division | |
| Beattie-Coleman Inc. | 81 | Perfection Mica Co. | 61 |
| Behlman-Invar Electronics Corp. | 77 | McGraw-Hill Book Co. | 89 |
| • Bendix Corporation | | Millen Mfg. Co., Inc., James | 16 |
| Eclipse Pioneer Division | 53 | Minnesota Mining & Mfg. Co. | |
| Block Associates, Inc. | 71 | Chemical Div. | 7 |
| | | • Mitsumi Electric Co., Ltd. | 83 |
| | | Motorola Semiconductor Products Inc. | 13 |
| • Cohn Corp., Sigmund | 65 | | |
| Cominco Products Inc. | 26 | National Cash Register Co. | 55 |
| Committee of One Hundred | | Nytronics Inc. | 16 |
| Columbia, S. C. | 19 | | |
| Consolidated Electrodynamics Corp. | 79 | Oklahoma Dept. of Commerce | 28 |
| • Cross Co., H. | 76 | | |
| | | Pacific Semiconductors Inc. | 11 |
| • Daystrom Incorporated | 31 | • Perfection Mica Co. | |
| Dickson Electronics Corp. | 80 | Magnetic Shield Div. | 61 |
| Digitronics Corp. | 75 | Popper & Sons Inc. | 77 |
| Duncan Electronics Inc. | 72 | Precision Instrument Co. | 59 |
| Elcor, Inc. | 8 | | |
| Electro-Seal Corp. | 19 | • Radio Corporation of America | 4th Cover |
| Electronic Engineering Co. | 66 | • Rawson Electrical Instrument Co. | 61 |
| • Electronic Instrument Co., Inc. (EICO) | 76 | Raychem Corp. | 14, 15 |
| | | Remington Rand Univac | |
| General Dynamics Astronautics | 17-18 | Div. of Sperry Rand Corp. | 83 |
| General Radio Co. | 2nd Cover | | |
| Graphic Systems, Inc. | 90 | • Sigma Instruments, Inc. | 67 |
| | | Sprague Electric Co. | 6, 24, 25 |
| • Hart Manufacturing Co. | 65 | Superior Cable Corp. | 58 |
| • Hewlett-Packard Company | 4-5 | • Syntronic Instruments, Inc. | 85 |
| • Heyman Manufacturing Co. | 90 | | |
| Hughes Aircraft Co. | 80, 84 | | |
| | | • See Advertisement in the July 20, 1961 issue | |
| • Inland Motor Corp. of Virginia | 51 | of Electronics Buyers' Guide for complete line of | |
| • Instruments for Industry, Inc. | 78 | products or services. | |

December 1, 1961

NEW

From
McGraw-Hill

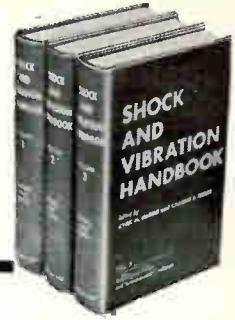

How to solve major engineering problems in shock/vibration

Here is a 3-volume library of tremendous scope for engineers who must control or minimize shock and vibration. Only in this one authoritative source will you find all the information you need to apply all major aspects of shock and vibration to engineering problems. It more than covers vibration theory fully . . . it also details the most practical, specialized phases. Fundamentals, descriptions of apparatus, explanations of methods, practical examples, and useful data are presented in a wealth of detail.

SHOCK AND VIBRATION Handbook Library

Prepared by a Staff of Specialists
Edited by Cyril M. Harris and Charles E. Crede
3 volumes, 2029 pages, 1209 illustrations
\$47.50, payable \$7.50 in 10 days and \$8.00
monthly

- Basic Theory and Measurements
- Data Analysis, Testing, and Methods of Control
- Engineering Design and Environmental Conditions

72 specialists bring you a comprehensive array of dependable facts . . . in 50 sections. These 3 volumes, the equivalent in compressed information to a large number of technical books, meet the needs of engineers in a wide range of fields . . . mechanical, electronic, air conditioning, aeronautical, civil, chemical, naval, manufacturing, and automotive, to mention a few. Wherever projects for the design of machinery, vehicles, missiles, structures, electrical systems, transportation packages or other devices involve shock or vibration, you can find solutions more readily and effectively here. Contains liberal cross-referencing. Bristled with facts, details, and data.

10 DAYS' FREE EXAMINATION

McGraw-Hill Book Co., Dept. L-11-24
327 W. 41 St., New York 36, N.Y.

Send me Shock and Vibration Handbook Library for 10 days' examination on approval. In 10 days I will (check one) remit \$47.50 plus few cents delivery costs; or \$7.50 in 10 days and \$8.00 a month until \$47.50 is paid. Otherwise I will return books postpaid. (We pay delivery costs if you remit with order; same examination and return privilege.)

Name

Address

City

Zone

State

Company

Position

For price and terms outside U.S., write McGraw-Hill Int'l., N.Y.C. 36 L-11-24

CIRCLE 89 ON READER SERVICE CARD

Heyco Nylon BUSHINGS



STRAIN RELIEFS
The insulating bushing that anchors a cord set to an electrically operated machine or appliance.



JUNCTION-TERMINAL BUSHINGS

Eliminate "pig-tails" — Miniature size. Snap-in assembly, color or number coded. Can be used as plug-in receptacle. Simple quick disconnect.

ACCORDIAN TYPE

Fit curved surfaces
Nylon bushing — brass tab

HEYCO NYLON Snap Bushings

10 Sizes for holes from $\frac{1}{8}$ " to $1\frac{1}{2}$ " dia. — various inside diameters. Snap locks into panels up to $\frac{1}{8}$ " thick.



FREE SAMPLES! BUSHINGS OF YOUR CHOICE

HEYMAN MANUFACTURING COMPANY
KENILWORTH 3, NEW JERSEY

CIRCLE 212 ON READER SERVICE CARD

You Get Things Done With Boardmaster Visual Control

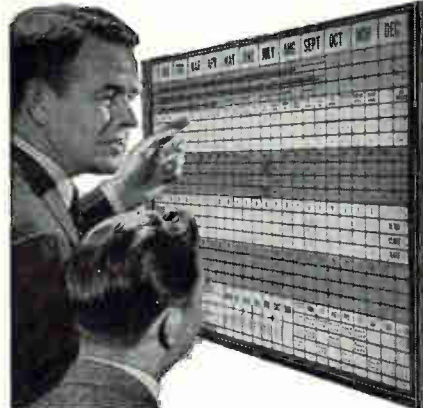

- ☆ Gives Graphic Picture of Your Operations—Spotlighted by Color
- ☆ Facts at a glance—Saves Time, Saves Money, Prevents Errors
- ☆ Simple to operate—Type or write on Cards, Snap in Grooves
- ☆ Ideal for Production, Traffic, Inventory, Scheduling, Sales, Etc.
- ☆ Made of Metal. Compact and Attractive. Over 500,000 in Use

Full price **\$49.50** with cards

FREE 24-PAGE BOOKLET NO. C-50 Without Obligation

Write for Your Copy Today
GRAPHIC SYSTEMS
YANCEYVILLE, NORTH CAROLINA

90 CIRCLE 90 ON READER SERVICE CARD

- Tech Laboratories, Inc. 71
- Tektronix, Inc. 69
- Texas Instruments Incorporated
Transistor Products Division...3rd Cover
- Torrington Mfg. Co. 27
- **Transitron Electronic Corp.** 49
- Turbo Machine Co. 65
- United Shoe Machinery Corp. 76
- Varian Associates 62, 63

INDEX TO CLASSIFIED ADVERTISERS

- Ampex Corporation 87
- Brew & Co., Inc., Richard D. 88
- Erie Electronics Division,
Erie Resistor Corporation. 88
- Lawrence Radiation Laboratory. 88
- Microwave Services International, Inc. 88
- National Cash Register Company. 88
- National Scientific Laboratory Inc. 88
- **Radio Research Instrument Co.** 88

• See Advertisement in the July 20, 1961 issue of Electronics Buyers' Guide for complete line of products or services.

CLASSIFIED ADVERTISING

F. J. Eberle, Business Mgr.

- EMPLOYMENT OPPORTUNITIES. 87, 88
- EQUIPMENT
(Used or Surplus New)
For Sale 88

This index and our Reader Service Numbers are published as a service. Every precaution is taken to make them accurate, but ELECTRONICS assumes no responsibilities for errors or omissions.

electronics



Audit Bureau of Circulations



Associated Business Publications

Audited Paid Circulation

JAMES T. HAUPTLI
Advertising Sales Manager

R. S. QUINT:
Assistant Publisher Buyers' Guide and Business Manager
FRED STEWART:
Promotion Manager
B. ANELLO:
Marketing Service Manager

RICHARD J. TOMLINSON:
Production Manager
GEORGE E. POMEROY:
Classified Manager
HUGH J. QUINN:
Circulation Manager

ADVERTISING REPRESENTATIVES

NEW YORK (36):
Donald H. Miller, Henry M. Shaw, George F. Werner, Robert M. Denmead
500 Fifth Avenue, OXFord 5-5959
BOSTON (16):
William S. Hodgkinson, Donald R. Furth
McGraw-Hill Building, Copley Square, Congress 2-1160
PITTSBURGH (22):
David M. Watson
Four Gateway Center, Express 1-1314
PHILADELPHIA (3):
Warren H. Gardner, William J. Boyle
6 Penn Center Plaza, LOcust 8-4330
CHICAGO (11):
Harvey W. Wernecke
645 North Michigan Avenue, Mohawk 4-5800
CLEVELAND (13):
Paul T. Fegley
55 Public Square, Superior 1-7000
SAN FRANCISCO (11):
T. H. Carmody, R. C. Alcorn
255 California Street, Douglas 2-4600
LOS ANGELES (17):
Peter S. Carberry, Ashley P. Hartman
1125 W. 6th St., Huntley 2-5450

DENVER (2):
J. W. Patten
Tower Bldg., 1700 Broadway, Alpine 5-2981
ATLANTA (9):
Michael H. Miller
1375 Peachtree St. N.E., Trinity 5-0523
HOUSTON (25):
Joseph C. Page, Jr.
Prudential Bldg., Holcomb Blvd., Jackson 6-1281
DALLAS (1):
Frank Le Beau
The Vaughn Bldg., 1712 Commerce St. Riverside 7-9721
LONDON W1:
Dennis McDonald
34 Dover St.
FRANKFURT/Main:
Stanley R. Kimes
B5 Westendstrasse
GENEVA:
Michael R. Zeynel
2 Place du Port

PERFORMANCE DATA

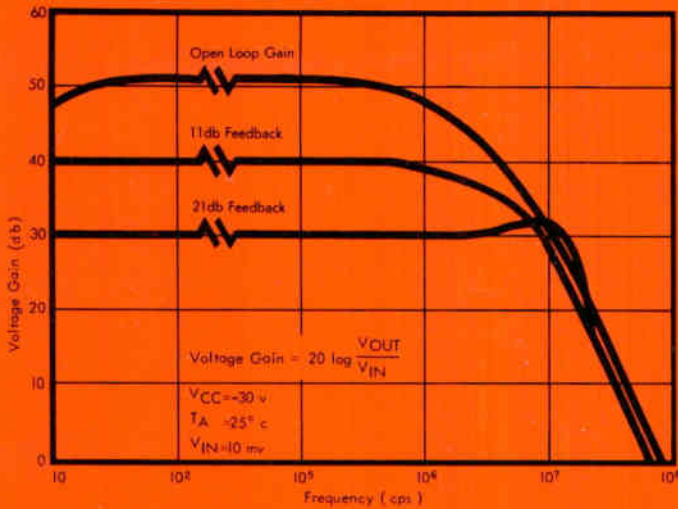

DALMESA WIDE BAND AMPLIFIER

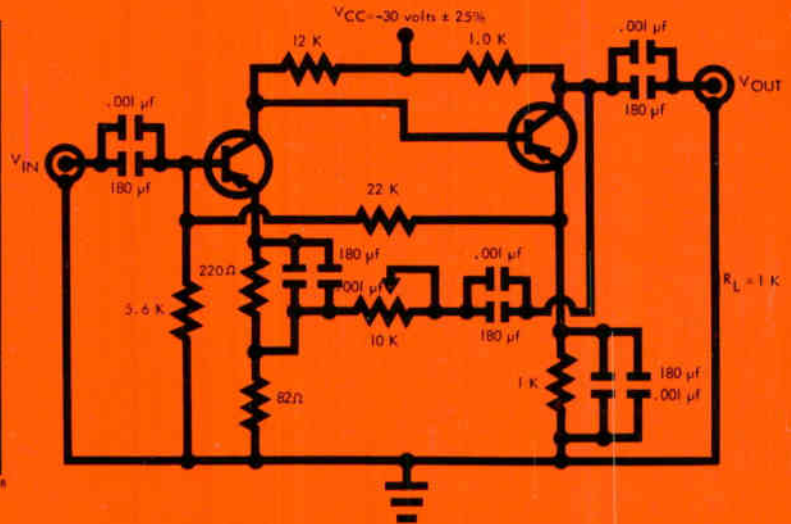

Apply Low-Noise, Low-Cost DALMESA Transistors to Your Wide-Band Amplifier Designs

■ Solve your industrial communications design problems today with TI's new DALMESA 2N2188 series. This new germanium alloy diffused mesa transistor family is specifically designed to meet your requirements for high-performance, low-noise, economically-priced transistors for application over the entire communications band from dc to 150 mc. ■ The extremely low, low-frequency noise corner and high alpha cutoff frequency offered by new DALMESA transistors result in low-noise performance over a very wide bandwidth—the 2N2188 series gives you a typical mid-frequency noise

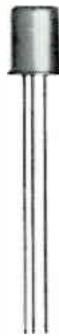

figure of 1.5 db. ■ These new devices also give you guaranteed gain/bandwidth products of 60 and 102 mc to assure excellent performance in your IF, RF and video amplifiers. Increased high-frequency stability results from the guaranteed maximum output capacitance of 2.5 pf at 9 volts. ■ Apply new DALMESA transistors to your communications designs today and take advantage of the increased performance capabilities of this new Texas Instruments series. These new 125-mw transistors are immediately available through your nearest TI Sales Office or Authorized TI Distributor.

| PARAMETER | TEST CONDITIONS | 2N2188 | 2N2189 | 2N2190 | 2N2191 |
|--------------------------------|--------------------------------|---------------|---------------|---------------|---------------|
| $BV_{CE0}†$ AND BV_{CES} | $I_C = -50 \mu a$ | 40 v min | 40 v min | 60 v min | 60 v min |
| BV_{E0} | $I_C = 0, I_E = -100 \mu a$ | 2 v min | 2 v min | 2 v min | 2 v min |
| h_{FE} | $V_{CE} = -6 v, I_C = -2 ma$ | 40 min | 60 min | 40 min | 60 min |
| h_{FE} (at 1 kc) | $V_{CE} = -6 v, I_E = -2 ma$ | 40 min | 60 min | 40 min | 60 min |
| f_T | $V_{CE} = -9 v, I_E = -1.5 ma$ | 60 mc min | 102 mc min | 60 mc min | 102 mc min |
| I_{CBO} | $V_{CB} = -12 v, I_E = 0$ | 3 μa max | 3 μa max | 3 μa max | 3 μa max |
| C_{OB} (at 1 mc) | $V_{CB} = -9 v, I_E = 1.5 ma$ | 2.5 pf max | 2.5 pf max | 2.5 pf max | 2.5 pf max |
| Noise Figures § (at 1 mc) | $V_{CE} = -5 v, I_E = 0.5 ma$ | 1.5 db typ | 1.5 db typ | 1.5 db typ | 1.5 db typ |
| Maximum Power Dissipation | 25°C Ambient | 125 mw | 125 mw | 125 mw | 125 mw |
| † $I_E = 0$ § $R_G = 1K\Omega$ | | | | | |

TRANSISTOR
PRODUCTS
DIVISION



TEXAS INSTRUMENTS
INCORPORATED
13500 N. CENTRAL EXPRESSWAY
P. O. BOX 5012 • DALLAS 22, TEXAS

An advertisement for the RCA 7551 miniature beam power tube. The tube is shown in a vertical orientation, with its base pins visible. The background is dark with a stylized illustration of a car and a bridge. An orange triangle is in the top left corner.

FOR MOBILE COMMUNICATIONS EQUIPMENT

An advertisement for the RCA 7558 miniature beam power tube. The tube is shown in a vertical orientation, with its base pins visible. The background is dark with a stylized illustration of a radio tower and a building.

FOR FIXED-STATION COMMUNICATIONS EQUIPMENT

Best Miniature Beam Power Tubes in their Price Class

More performance per dollar is packed into the RCA-7551 and 7558 miniature beam power tubes than in any comparable tubes on the market. With the 7551 and 7558, you can design top-quality communications equipment while keeping costs down.

Either tube gives top performance as a Class C r-f amplifier, oscillator, or frequency-multiplier at frequencies up to 175 Mc. Either may also be used in modulator or a-f power amplifier applications. A pair of either type, in Class AB₁ push-pull a-f amplifier service, can deliver up to 20.5 watts signal power output.

Identical in all respects except for heater ratings, the 7558 has a 6.3-volt heater (for use in fixed-station communications equipment) while the 7551 operates over a fluctuating heater-voltage (12 to 15 volts) such as that encountered in mobile systems operating from 6-cell storage-battery systems. In addition, the 7551 is subjected to rigid controls and tests for heater cycling, H-K leakage, interelectrode leakage, low-frequency vibration, and 500-hour intermittent life—to assure dependable performance in mobile systems.

Features contributing to efficient high-frequency performance of these tubes include:

- *Low lead inductance*
- *Two base-pin connections for both the cathode and the No. 2 grid—to minimize degeneration and facilitate r-f bypassing*
- *Low interelectrode capacitances*
- *Low r-f loss and high input resistance—permit use of high grid-No. 1 circuit resistance to minimize loading of the driver stage.*

These remarkable tubes help you to design compact communications equipment with assurance of dependable performance and long life. See your RCA Field Representative, or write, Commercial Engineering, Section L-19-DE-1, RCA Electron Tube Division, Harrison, New Jersey.

RCA Electron Tube Division Field Offices

EAST: 744 Broad Street, Newark 2, New Jersey, HUmboldt 5-3900 • MIDWEST: Suite 1154, Merchandise Mart Plaza, Chicago 54, Illinois, WHitehall 4-2900 • WEST: 6801 E. Washington Blvd., Los Angeles 22, California, RAymond 3-8361



The Most Trusted Name in Electronics