

electronics

A McGraw-Hill Publication 75 Cents

NEREM MEETING

Technical preview, p 73

COAXIAL MAGNETRON

High-power output, p 78

SPEEDUP CIRCUIT

Inverter switching, p 92

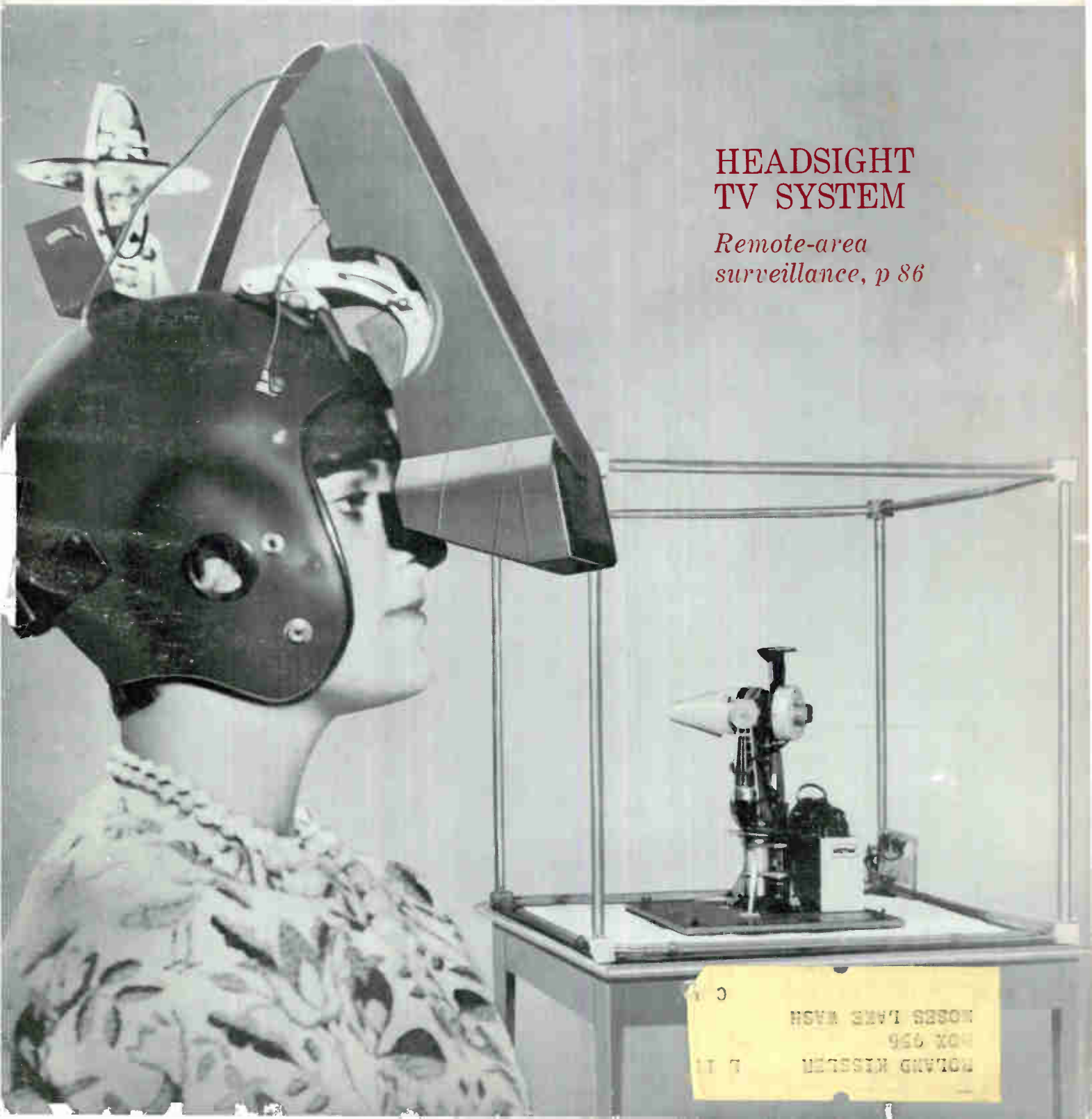

HEADSIGHT TV SYSTEM

Remote-area surveillance, p 86

3
ROSLAND KISSLER
BOX 956
WASH DC 20541



SPECIAL FILTERS

TO YOUR REQUIREMENTS

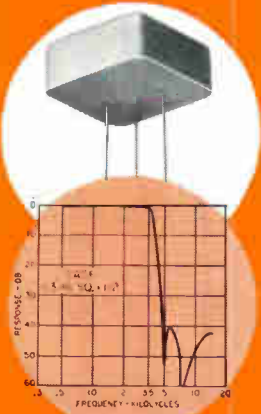

Miniaturized 3.5 KC low pass filter. 10K ohms to 10K ohms. Within 1 db up to 3500 cycles. Greater than 40 db beyond 4800 cycles.

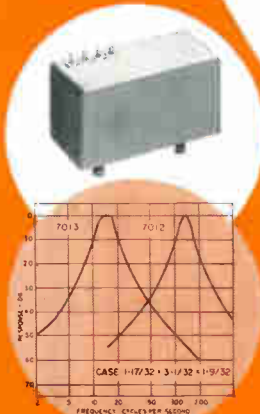

Fifteen cycle and 135 cycle filters for Tacan. 600 ohms to high impedance. Extreme stability —55°C. to +100°C.

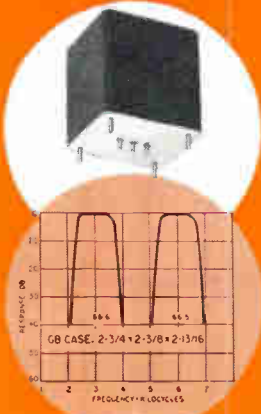

Three KC and 6 KC flat top band pass filters. 400 ohms to 20K ohms. MIL-T-27A; each filter 1.7 lbs.

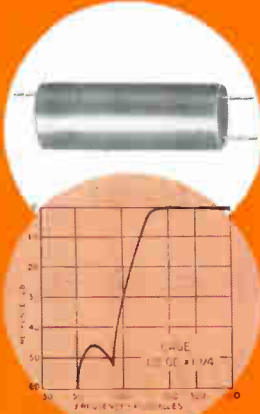

High frequency Mini-filters, .33 oz. MIL-T-27A Grade 5. 150 KC High Pass 3 db to 150 KC, down 45 db below 85 KC. 7500 ohms.

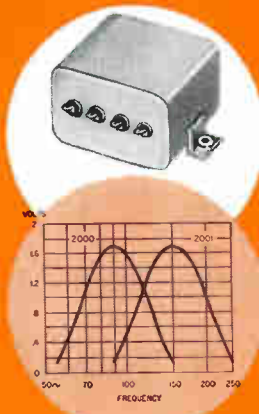

Curves of our miniaturized 90 and 150 cycle filters for glide path systems. 1 1/4" x 1 1/4" x 1 1/8".

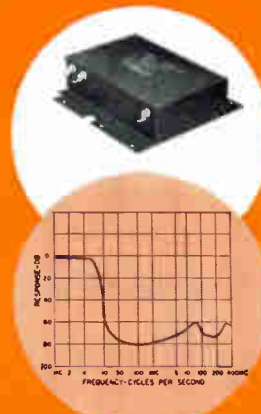

Power line filter from sources of 50 to 400 cycles . . . attenuation from 14 KC to 400 MC . . . 29 cubic inches.

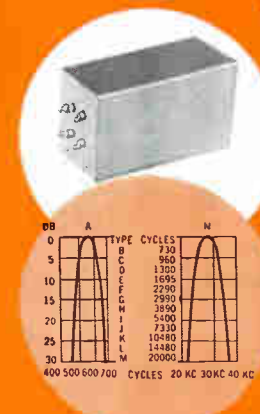

Multi-channel telemetering band pass filters for 400 cycle to 40 KC. Miniaturized units for many applications.

Plus
over 1,000
STOCK ITEMS
with UTC
High Reliability
from your local
distributor



→ write for catalog

UNITED TRANSFORMER CORP.

150 VARICK STREET, NEW YORK 13, N. Y.

PACIFIC MFG. DIVISION: 4008 W. JEFFERSON BLVD., LOS ANGELES 16, CALIF.
EXPORT DIVISION: 13 EAST 40th STREET, NEW YORK 16, N. Y. CABLES: "ARLAB"

electronics

A McGraw-Hill Publication 75 Cents



W. W. MacDONALD, Editor

J. M. CARROLL, Managing Editor
 SENIOR EDITORS: Samuel Weber, George W. Sideris. SENIOR ASSOCIATE EDITORS: William E. Bushor, Michael F. Wolff. ASSOCIATE EDITORS: Michael F. Tomaino, Sylvester P. Corter, William P. O'Brien, John F. Mason, Thomas Emma, Sy Vogel, Leslie Solomon, M. M. Perugini, George J. Flynn, Laurence D. Shergalis. ASSISTANT EDITORS: Nilo Lindgren, Stanley Froud, Stephen B. Gray, Roy J. Bruun, George V. Novotny, Leon H. Dulberger. REGIONAL EDITORS: Harold C. Hood (Pacific Coast, Los Angeles), Thomas Mogueire (New England, Boston), Cletus M. Wiley (Midwest, Chicago). ART DIRECTOR: Harry Phillips; Howard R. Berry. PRODUCTION EDITOR: John C. Wright, Jr. EDITORIAL ASSISTANTS: Gloria J. Meurer, Bernice Duffy, Lorraine Rossi, Virginia T. Bastian, Lynn Emery, Laura W. Smith, Bette H. Snyder, Rosemary Abbruzzese, Judy Haskins.

JAMES GIRDWOOD, Publisher

Closed circuit tv system developed by Philco gives operator sense of presence at the remote area under surveillance. See p 86 COVER

Medical Electronics. Market growing, survey finds 24

DEVICE DESIGNERS EXTEND COMPONENT RANGES. Advances in semiconductors and tubes reported at Electron Devices Meeting 30

NEREM Mirrors Growth of Electronics in New England. Concentration of R&D facilities around Boston is wellspring of area's industrial development 32

Executive Pay Reaches New High. Compensation in electronics industry is higher than average pay in all industries 34

Electro-Optic Developments Highlight NEREM. Summary of selected technical papers. T. Maguire 73

COAXIAL MAGNETRON: A New Microwave Power Source. Attains high output, frequency stability and wide tuning range. H. M. Olson and L. H. Von Ohlsen 78

LASERS: Devices and Systems. Military and computer applications and laser-circuit techniques. S. Vogel and L. Dulberger 81

HEADSIGHT TV SYSTEM Provides Remote Surveillance. Operator feels he is at scene viewed. C. F. Comeau and J. S. Bryan 86

Simple Circuit Times Camera Exposures. Wide range of timer settings control time between exposures as well as exposure time. J. G. Fullerton 91

SPEED-UP CIRCUITS Improve Switching of Transistor Inverters. Better waveforms result when capacitors and transformer windings are added. A. G. Lloyd 92

Crosstalk	4	Components and Materials	100
Comment	6	Production Techniques	104
Electronics Newsletter	9	New on the Market	112
Washington Outlook	14	Literature of the Week	130
Meetings Ahead	42	People and Plants	132
Research and Development	96	Index to Advertisers	140

From General Ceramics Division of
INDIANA GENERAL CORPORATION

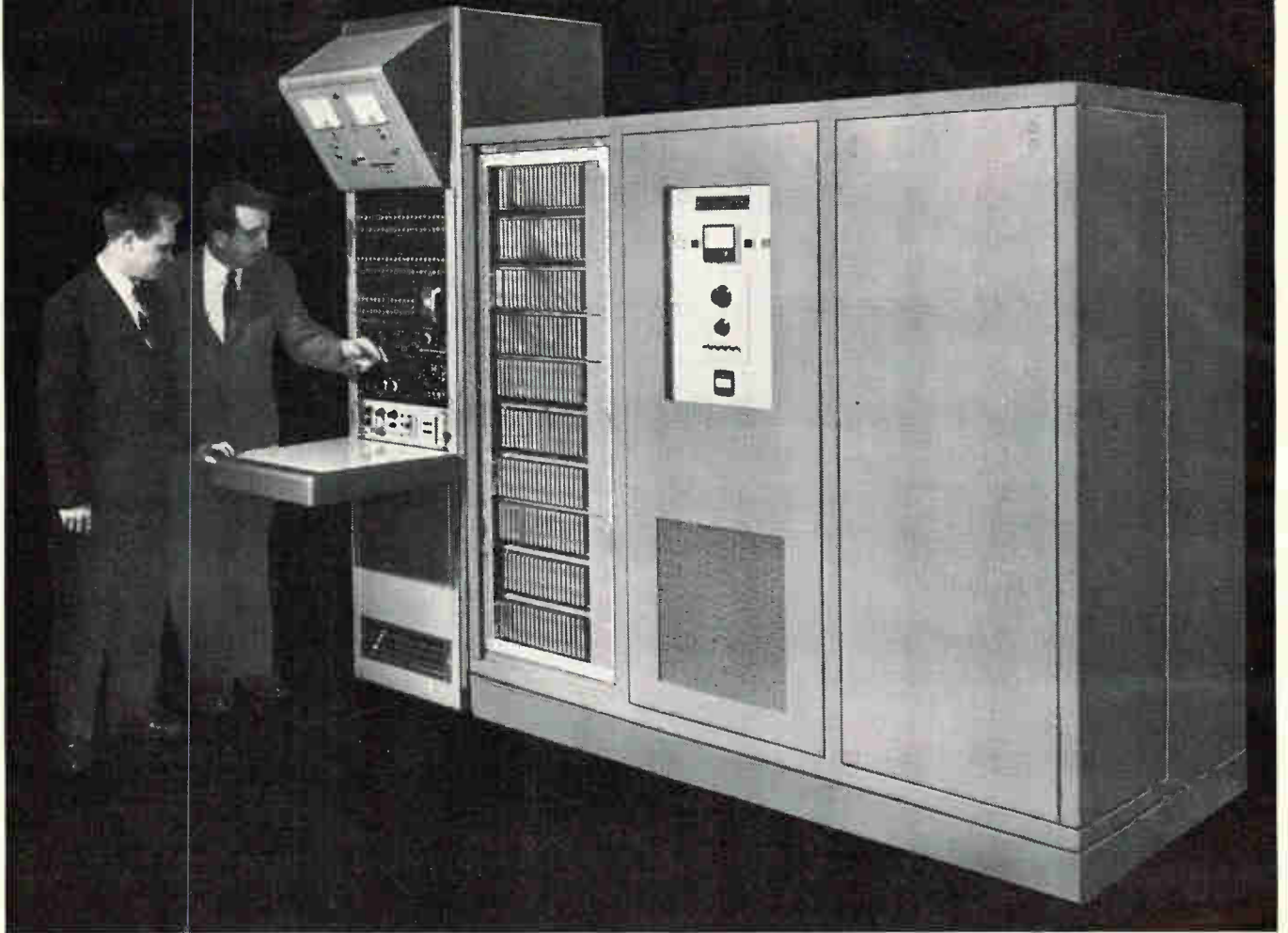

ADVANCED MEMORY CONCEPT improves computer design, speeds assembly

Complete, packaged memory systems, designed by our General Ceramics Division, save time, space and cost in building large-scale computers, and offer a new high in reliability.

The specially built General Ceramics unit shown above contains 8,000 characters, 56 bits per character — some 450,000 bits of central memory for a large-scale computer. It operates with 6 microsecond cycle time, 2.5 microsecond data access time. At far left is a memory exerciser which automatically checks the unit with six different automatic programs.

We offer these systems in random access memories, and either sequential, interlaced or non-interlaced buffer memories. Standard in-stock units are available with word capacities of 32 to 32,000 (any bit length)

with sequential cycle times down to 3.3 microseconds, data access to 2 microseconds.

Reliability is assured through 100-percent quality control at all levels — beginning with mechanical and electrical testing of each individual core and continuing with both visual and electrical inspections at all stages of assembly. Advanced techniques, such as ultrasonic cleaning, automatic 12-per-second core testing and other electronic functional checks made by specially designed equipment, provide that extra edge of reliability which Indiana General's customers have come to expect.

For further details about the advantages of utilizing our complete memory systems in your computers, write to General Ceramics, Memory Core Products Department, Keasbey, N. J. Ask for Bulletin 26-A11.



MEMORY CORE PRODUCTS DEPARTMENT

GENERAL CERAMICS

Phone VALley 6-5100 • Direct Distance Dialing Code 201

KEASBEY, NEW JERSEY

TECHNICAL CERAMICS, FERRITES AND MEMORY PRODUCTS

Typical response curves indicating the various shape factors available in standardized Burnell Crystal Filters

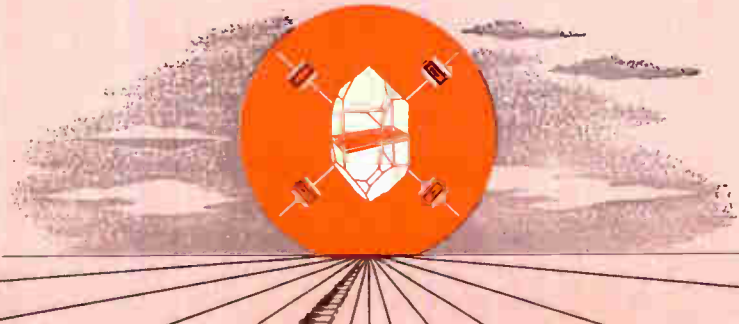
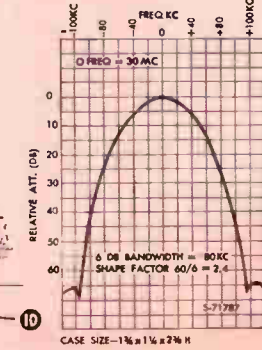
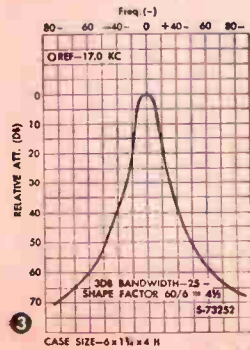
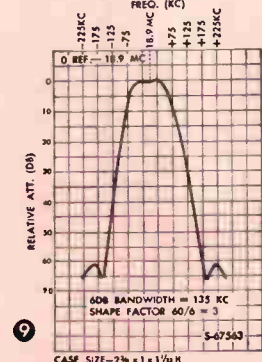
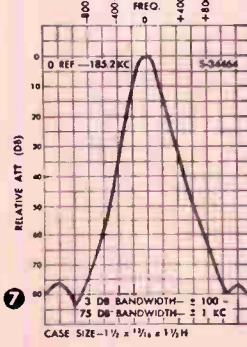
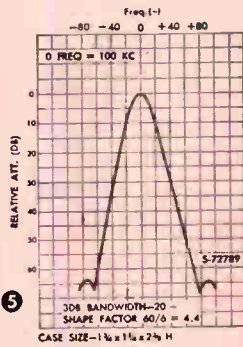
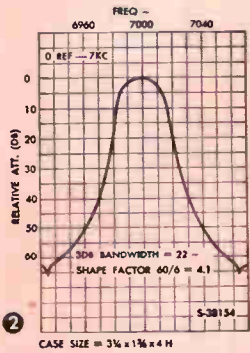
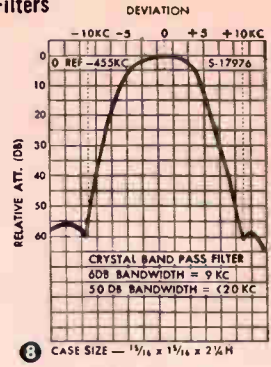
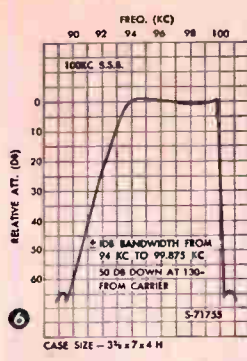
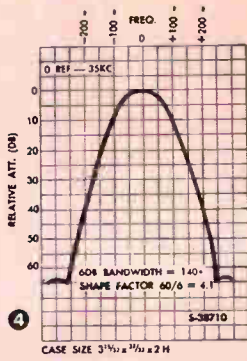
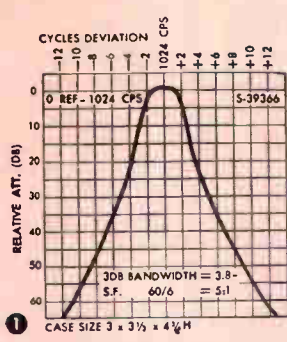

Running the gamut in crystal filters

BURNELL CRYSTAL FILTERS NOW COVER FULLEST RANGE YET POSSIBLE
1 kc to 30 mcs

To its notable achievements in advancing the electronic arts, Burnell & Co. now adds another—the development of moderately priced high attenuation crystal filters covering the extraordinary range of 1 kc. to 30 mc. This represents a range many times broader than previously thought practicable. In addition, the Burnell Crystal Filter line now includes several types heretofore considered impossible.

More than 15 years research, development and experience are represented in the designs illustrated in the response curves shown. Burnell & Co. has taken crystal filters out of the luxury class in applying its experience to their design and manufacturing without incurring developmental and engineering costs.

Whether your crystal filter needs are for standard units or those engineered to center frequency, band width, selectivity and impedance level, call on our Crystal Filter Division for quick delivery. Send now for Crystal Filter Catalog, XT455.



Burnell & Co., Inc.

PIONEERS IN microminiaturization OF TOROIDS, FILTERS AND RELATED NETWORKS

DIVISIONS: Gray & Kuhn, Inc., Westbury, L. I., New York • Guillemin Research Laboratory, Cambridge, Mass.

EXECUTIVE OFFICE AND PLANT
DEPT. 38
PELHAM, NEW YORK
PELHAM 8-5000
TELETYPE PELHAM 3633



PACIFIC DIVISION
SOUTH PASADENA, CALIF.
MFD. IN CANADA
BY EDO (CANADA) LTD.
CORNWALL, ONT.
WELLINGTON 2-6774

Published weekly, with Electronics Buyers' Guide and Reference issue, as part of the subscription, by McGraw-Hill Publishing Company, Inc. Founder: James H. McGraw (1860-1948).

Title ® registered U.S. Patent Office; Copyrighted © 1961, McGraw-Hill Publishing Company, Inc. All rights reserved, including the right to reproduce the contents of this publication, in whole or in part.

Executive, editorial, circulation and advertising offices McGraw-Hill Building, 330 West 42nd Street, New York 36, N. Y. Telephone Longacre 4-3000. Teletype TWX N.Y. 1-1636. Cable McGrawhill, N. Y. PRINTED IN ALBANY, N. Y.; second class postage paid.

OFFICERS OF THE PUBLICATIONS DIVISION: Nelson L. Bond, President; Shelton Fisher, Wallace F. Traendly, Senior Vice Presidents; John R. Callahan, Vice President and Editorial Director; Joseph H. Allen, Vice President and Director of Advertising Sales; A. R. Venezian, Vice President and Circulation Coordinator; Daniel F. Crowley, Vice President and Controller.

OFFICERS OF THE CORPORATION: Donald C. McGraw, President; Hugh J. Kelly, Harry L. Waddell, Executive Vice Presidents; L. Keith Goodrich, Executive Vice President and Treasurer; John J. Cooke, Vice President and Secretary.

Subscriptions are solicited only from those actively engaged in the field of the publication. Position and company connection must be indicated on orders. Subscription rates: United States and Possessions, \$6.00 one year; \$9.00 two years; \$12.00 three years. Canada, \$10.00 one year. All other countries \$20.00 one year. Single Copies, United States and Possessions and Canada 75¢; Buyers' Guide \$3.00; Single copies all other countries \$1.50; Buyers' Guide \$10.00.

THE PUBLISHER, UPON WRITTEN REQUEST FROM ANY SUBSCRIBER TO OUR NEW YORK OFFICE, AGREES TO REFUND THAT PART OF THE SUBSCRIPTION PRICE APPLYING TO COPIES NOT YET MAILED.

Subscribers: Please address all correspondence, change of address notices, subscription orders or complaints to Fulfillment Manager, Electronics, at above address. Change of address notices should provide old as well as new address, including postal zone number if any. If possible, attach address label from recent issue. Allow one month for change to become effective.

Postmaster: Please send Form 3579 to Fulfillment Manager, Electronics, 330 West 42nd Street, New York 36, New York.



Audited Paid Circulation

CROSSTALK



ASK A BOSTONIAN what his favorite industry is and he will probably answer, "electronics". While New England Editor Maguire was collecting information for his NEREM previews in this issue (pages 32 and 73) he spoke with Ephron Catlin, Jr., president of the Greater Boston Chamber of Commerce.

Catlin calls the laboratories which have sprung up in and around Hanscom Field, MIT, Harvard and other institutions "the real guts of our economy, now that our textile and shoe industries have been falling on their faces". MIT, he said, "is the greatest single economic asset of any city in the free world".

Boston has good reason to be a willing host to NEREM. Since World War II, more than 400 science-oriented enterprises have been started in the Boston area. Most are in electronics. Many will be displaying their best new products in the exhibit hall (photo) next week.

VIDICON CAMERA that gives an observer a sense of presence at a scene several hundred miles away is described on p 86 by C. P. Comeau and J. S. Bryan, of Philco's research division. Mounted, for example, in a spacecraft, the camera follows the head motions of an operator sitting safely on the ground.

Coming In Our November 17 Issue

SPECIAL REPORT. Missile and space technology is one of the most dynamic and fascinating areas of our industry. Vast strides have been made since our April 24, 1959, special report on the first days of the space age. Even though the first steps are being taken toward exploring the planets, we are still only at the beginning.

Next week **ELECTRONICS** brings you a 32-page special report on the vital subject of electronics for missiles and spacecraft. To bring you this compre-

hensive survey, Associate Editor Mason and Senior Associate Editor Wolff have spent months talking with experts in government agencies, private companies and scientific and academic institutions.

You'll read about future plans, and trends in electronic equipment for guidance and control, data acquisition and transmission, propulsion and power generation, missile ranges and launch sites, ground tracking networks, detection, and radio and radar astronomy.



TINY...

Latest space-maker for size-conscious designers of transistorized commercial and entertainment equipment is the new Sprague Type 157P Molded-case Filmite® "E" Capacitor, which combines unusual compactness with exceptional performance characteristics.

TAN...

Distinctive *tan coloring* identifies the Type 157P Capacitor and serves as your warranty of outstanding shock-and-humidity resistance. The tough molded armor also protects against possible damage during soldering operations, or changes in capacitance from mechanical pressure where wrapped capacitors are clamped or cast in assemblies.

TERRIFIC!

Standard operating temperature range is -40 C to $+85\text{ C}$. And with voltage derating, this outstanding capacitor may be operated to $+105\text{ C}$! Its high insulation resistance (due to the polyester film dielectric and molded housing) is another characteristic which qualifies the 157P Capacitor for critical coupling applications.



For complete technical data on Type 157P Filmite "E" Capacitors, write for Engineering Bulletin 2065 to Technical Literature Section, Sprague Electric Company, 35 Marshall Street, North Adams, Mass.

SPRAGUE COMPONENTS

CAPACITORS
RESISTORS
MAGNETIC COMPONENTS
TRANSISTORS

INTERFERENCE FILTERS
PULSE TRANSFORMERS
PIEZOELECTRIC CERAMICS
PULSE-FORMING NETWORKS

HIGH TEMPERATURE MAGNET WIRE
CERAMIC-BASE PRINTED NETWORKS
PACKAGED COMPONENT ASSEMBLIES
FUNCTIONAL DIGITAL CIRCUITS

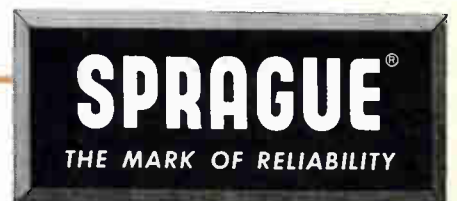

Sprague' and '®' are registered trademarks of the Sprague Electric Co.

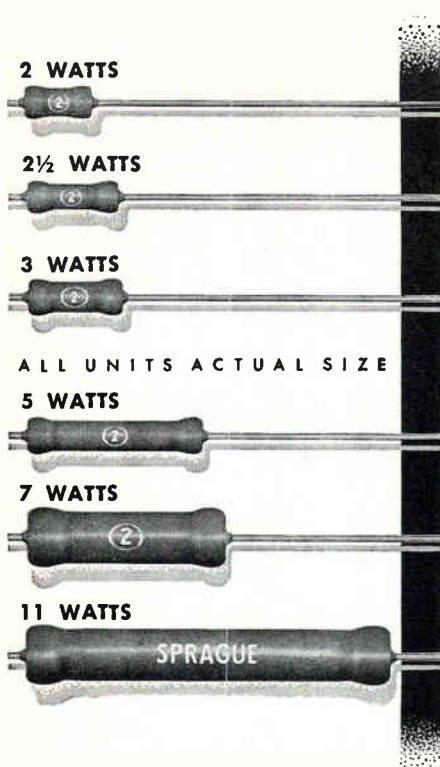

NEXT TIME ... USE TINY
Blue Jacket®
WIREWOUND RESISTORS

Sprague builds reliability... efficiency... economy right into miniaturized Blue Jackets with these important features:

- * All-welded end-cap construction with special vitreous-enamel coating for total protection against humidity, mechanical damage, heat, corrosion gives long-term dependability under severe environmental conditions
- * Available in resistance tolerances as close as $\pm 1\%$
- * Low in cost... quick and easy to install

Tiny axial-lead Blue Jackets are specially designed for use with conventional wiring or on printed boards in miniature electronic assemblies. Write for complete technical data in Sprague Engineering Bulletin 7410B.

SPRAGUE ELECTRIC COMPANY
 35 Marshall Street, North Adams, Mass.



COMMENT

Inventions Wanted

Some time ago a list was published of new inventions needed by the armed services. Knowing the reputation of your publication, we felt that contacting you was our best chance to obtain this list. What is desired is something similar, only more extensive, to the article entitled *Defense Needs Electronics Inventions*, which appeared in the July 28 issue (p 26). Mainly we would like a list of inventions needed by the armed services, but one tabulating those needed in the commercial field would also be valuable. If you have access to this information, we would appreciate your passing it along to us.

The timeliness and foresight of your publication makes it of great value to our systems group.

DAVID E. DOWNIE

Melabs
 Palo Alto, California

The article was based on a 14-page booklet, *Inventions Wanted By The Armed Forces And Other Government Agencies*, published by the National Inventors Council, U. S. Department of Commerce, Washington 25, D. C. The booklet is a supplement to prior issues of *Inventions Wanted*, which are available in a cumulative reprint from the Council or the nearest field office of the Department of Commerce, as is the booklet itself.

The booklet lists 89 inventions wanted, in categories such as *Aeronautics, Applied Mechanics, Chemistry, Electronics, and Instrumentation*. Some of the inventions wanted are listed with a simple statement of requirements; others also give background information or status of the problem.

The Council is interested in all ideas that may be of value to the military agencies or other branches of the government, but not in inventions of primary interest to a civilian market.

Many of the inventions listed do have commercial applications, such as a fast linear recorder, a linear sawtooth generator, high-energy solar radiation sources, and devices for prevention of mid-air collisions.

We do not know of any tabula-

tion of needed commercial inventions, nor does it seem likely that such a listing would exist. But if any of our readers have information on the subject, we'd like to hear about it.

Word From Down Under

I would like to take advantage of your offer in the November 11, 1960, issue of *ELECTRONICS* (p 132), rather belatedly, for the booklet *How To Cut Your Reading Time*. If there are spare copies, two engineers in my office would be very grateful to receive a booklet.

We are engineers in the Radio Section of the Australian Post Office, engaged in radio, telephone and broadcasting. Your journal is regularly circulated through our engineering library, and, as you can see, is very well read by all engineers in the Post Office.

I personally find the present format very good, particularly the *Electronics Newsletter*, which I prefer to think of as a "stop press."

The nomographs are always of interest, along with *New on the Market*.

In short, I would say that your journal is a must for the radio engineer today if he wishes to keep abreast of scientific advances.

JACK E. BURGESSON
 Cheltenham, Victoria
 Australia

Newsletter is in fact sent to the presses later than the rest of the magazine, so that we can print last-minute news.

Rectification Efficiency

I have a comment on the letter concerning rectification efficiency (*Comment*, October 13, p 7).

Reader Pinnell is perfectly correct that for an ideal rectifier the ratio of the total load power to input power yields an efficiency of 100 percent. That, however, is not the definition of conversion efficiency, which is defined as 100 percent times the ratio of the d-c load power to the input power. A Fourier series of the load voltage shows it to be composed of a d-c term plus numerous a-c ripple components. The d-c load power is defined as $(E_{dc})^2/R_L$ or $E_{dc}I_{dc}$ and is thus less than the input power by the factor 0.812 in the ideal case in question.

DON G. DAUGHERTY
 Madison, Wisconsin

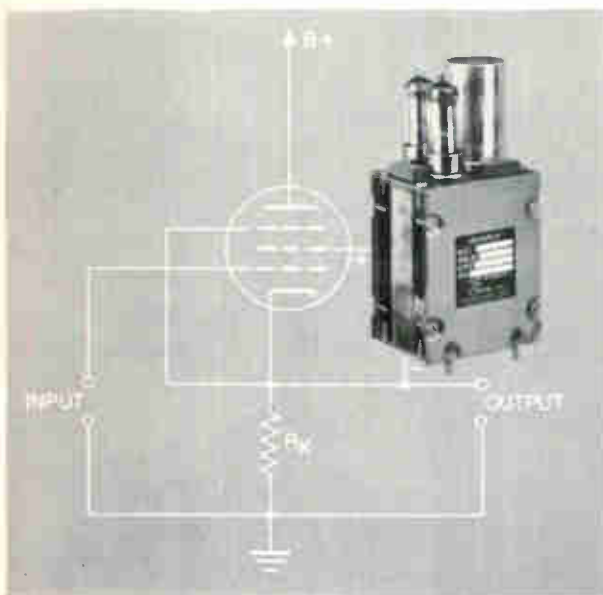
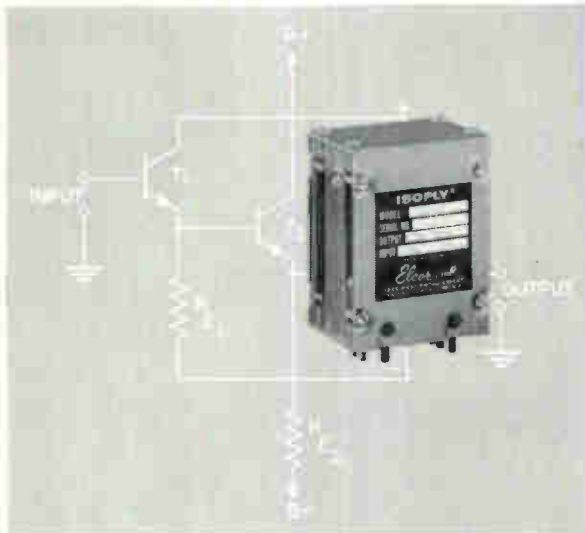
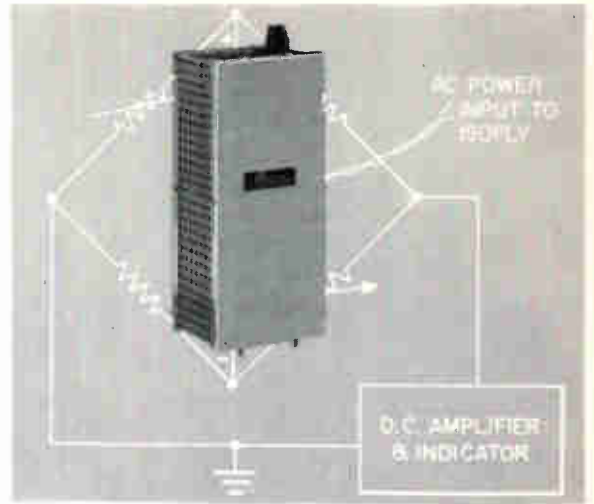
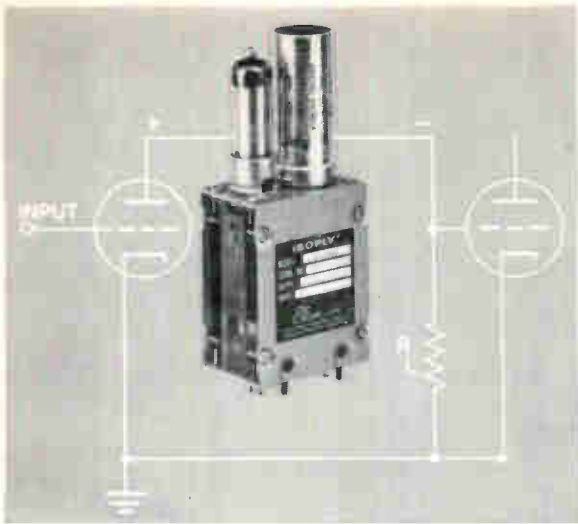

Circuit designs made simpler and more economical with new Elcor ISOPLYS®

Isoplys (isolated power supplies) can be used ungrounded. Unlike conventional power supplies, Isoplys have low shunt capacitance to ground and low noise in ungrounded applications. They are relatively insensitive to power line fluctuations and give excellent frequency response.

Many components once thought essential in conventional circuits can be eliminated. Design and assembly time can be speeded. Troublesome interaction between circuits is substantially reduced. This also helps simplify maintenance as well as solve difficult circuit problems.

Let Isoplys help simplify a circuit design you are working on now. Be prepared for design problems in the future.



write for full information: **ELCOR Incorporated**

Subsidiary of Welex Electronics Corporation
Sales | R & D Laboratory | Manufacturing
1225 W. Broad Street | Falls Church, Virginia
JEfferson 2-8850

Transient Voltages... Cause and Cure

A transient voltage can be generated whenever a magnetic component is energized, or de-energized. The peak amplitude of the spike can be many times the normal steady state peak inverse voltage, and is dependent on the amount of magnetic energy stored in the circuit and the rate of change of the collapse of the resultant flux field.

The amount of magnetic energy stored in various circuit reactances can be approximated by $L \frac{i^2}{2}$, and this energy, when current is interrupted can produce a voltage equal to $L \frac{di}{dt}$. It is apparent, therefore, that under severe load or overload conditions, a high level transient voltage with substantial energy can be generated.

In actual applications, transients are generated mainly through interruption of current by switching, although circuit characteristics and phenomena can contribute to the problem. Full advantages to be gained from silicon rectifiers are available only if they are properly applied and protected. Silicon rectifiers have low inverse voltage capabilities and thermal capacity, so any overvoltage condition, even for a few microseconds, can destroy the junction. The circuits illustrated are typical of those where problems have been found.

In addition to the three most common causes, less obvious circuits and phenomena can generate transients. Among these are minority carrier recovery, switching magnetic amplifiers, lightning or random line conditions and motor regeneration.

The problem of computing C or RC filters is complicated because of the possibility of changing circuit operating parameters or causing oscillation.

Tarzian's recently developed line of "klipvolt" selenium transient voltage suppressors, therefore, offers a relatively low cost, simply applied method of positive protection. In many applications, a "klipvolt" suppressor will reduce overall circuit cost and increase reliability. The accompanying table covers the important design factors

of voltage and current that govern typical application of suppressors; however, special designs and ratings are available on request. There are two basic types of suppressors, the non-polarized for use primarily across AC components, and the polarized for use in DC load circuits. In some instances, however, it may be preferable to use non-polarized suppressors in output circuits for more positive clamping or non-interference with circuit timing or operation.

Switching in Primary—Transients are caused by interruption of "magnetic" current, or by energizing the primary and causing oscillation between inductance and distributed capacity.

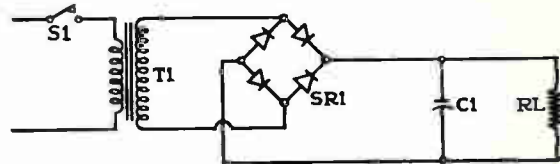

FIGURE 1

Switching Load—When the load is switched, the magnetic energy stored in the input circuit generates a voltage across the rectifiers and switch.

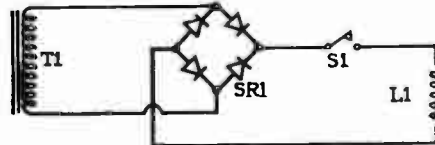

FIGURE 2

Magnetic Components on Common Line—Other magnetic components like motors, solenoids, relays or breakers can generate a transient peak when input is interrupted. The generated voltage will appear across the rectifier.

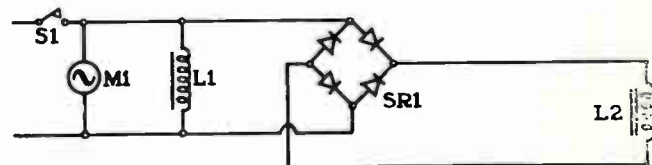
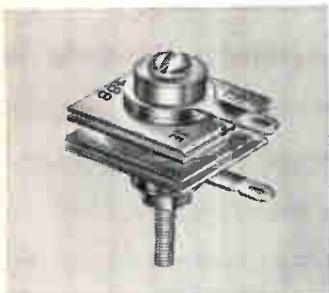

FIGURE 3

TYPICAL *klipvolt* SUPPRESSORS—SINGLE PHASE



DC LOAD CURRENT		0-35	36-55	56-100	101-110	110-200	201-350
PIV	RMS VOLTS	AMPS	AMPS	AMPS	AMPS	AMPS	AMPS
50	35	S-487	S-487A	S-487B	S-487A	S-487B	S-487C
100	70	S-488	S-488A	S-488B	S-488A	S-488B	S-488C
200	140	S-490	S-490A	S-490B	S-490A	S-490B	S-490C
300	210	S-492	S-492A	S-492B	S-492A	S-492B	S-492C
400	280	S-493	S-493A	S-493B	S-493A	S-493B	S-493C
500	350	S-494	S-494A	S-494B	S-494A	S-494B	S-494C
600	420	S-495	S-495A	S-495B	S-495A	S-495B	S-495C

TYPICAL THREE PHASE SUPPRESSORS

DC LOAD CURRENT		0-60a		61-115a		116-200a		201-450a	
PIV	RMS VOLTS	H.W.	BR	H.W.	BR	H.W.	BR	H.W.	BR
50	35	S-539	S-539	S-539	S-539A	S-539A	S-539B	S-539B	S-539C
100	70	S-540	S-540	S-540	S-540A	S-540A	S-540B	S-540B	S-540C
200	140	S-542	S-542	S-542	S-542A	S-542A	S-542B	S-542B	S-542C
300	210	S-544	S-544	S-544	S-544A	S-544A	S-544B	S-544B	S-544C

Note: All types without suffix letter use plates 1" square; with "A"—1¼", with "B"—1.6", and with "C"—2" square. Length depends on voltage rating and varies from 1⅞" to 4¾".

Write for complete
"klipvolt" application information.



SARKES TARZIAN, INC.

World's Leading Manufacturers of TV and FM Tuners • Closed Circuit TV Systems • Broadcast Equipment • Air Trimmers • FM Radios • Magnetic Recording Tape • Semiconductor Devices

SEMICONDUCTOR DIVISION • BLOOMINGTON, INDIANA

In Canada: 700 Weston Rd., Toronto 9 • Export: Ad Auriema, Inc., New York

ELECTRONICS NEWSLETTER

Big Bomb's Aim to Destroy Communications?

PROPOSERS of atmospheric A-bomb tests by the U.S. were pointing out last week that such tests were essential to development of weapons able to jam enemy communications.

There is evidence in recent Communist propaganda broadcasts that development of jamming bombs was, in fact, the real reason why the USSR exploded its 50-megaton-plus bomb despite worldwide pleas and condemnation.

Said an East German broadcast: "It is now dawning on them (the Western allies) that the USSR with one single nuclear weapon of 100 megatons can, for all practical purposes, put the entire electronic system of the United State out of action".

USSR bombs have been dirty ones. Apparently, for electronic countermeasures, the dirtier the better.

NASA has reported that high concentrations of electron particles in radiation belts can jam radio and radar signals. The charged particles absorb r-f energy, causing radio blackouts or obscuring radar targets.

Coupled with the East German comment, this implies that a few well-placed big bombs, fired in advance of a saturation missile attack, could affect our communications and detection systems enough to snarl a retaliatory attack.

Feasibility of jamming with bombs was indicated by Project Argus in 1958 when two nuclear warheads were exploded high above Johnston Island in the Pacific.

Report prepared for Congress by the Rand Corp. said the blasts disrupted radio communications, especially at 5 Mc to 25 Mc. Most links within a few hundred miles of the island experienced outages up to several hours at various periods for about a day. The effect on h-f communications was like that of a giant solar flare.

These factors also indicate why Communist propaganda broadcasts have been vehemently opposing our Project West Ford and reiterating protests made by astronomers.

One purpose of West Ford's orbiting belt of tuned dipoles is to free over-the-horizon scatter system from dependence on stability of transmission properties of the up-

per atmosphere. The belt would provide an artificial reflecting medium in space.

West Ford's importance is underscored by the fact that the decision to go ahead, despite astronomers' protests, was made at the top—by President Kennedy.

Ionospheric and tropospheric scatter systems provide a major portion of the West's long-distance military communications. The USSR is understood to be concentrating on wireline and point-to-point relay systems.

Cryogenics Give Magnet Researchers High Hopes

CRYOGENIC techniques were in the spotlight at the Air Force-sponsored First International Conference on High Magnetic Fields at MIT. The conference was attended by 500 scientists and engineers

No Loud Ties, We Hope

DALLAS—For the girlfriend of the man who has everything, Neiman-Marcus had an answer recently.

The department store programmed a computer to cross-check its inventory against data on potential gift receivers and price, to give a customer 10 probably acceptable gifts.

Sample query: gift costing over \$1,000 for a 12-year-old boy. Answer: monopoly game to be played with real money.

IBM loaned a computer for the two-week promotion stunt. It handled about 2,000 queries a day.

from 12 nations.

Applications being explored include combining high magnetic fields and superconducting electromagnetic lenses to extend resolution of electron microscopes by a factor of 100. Macromolecular structures in biological systems could be visualized.

Dr. H. Fernandez-Moran, of Massachusetts General Hospital, added that such microscopes could view lattice strains in metals and single dislocations in crystals. Advances may also permit use of microbeams as information storage tools and for fabrication of printed circuits the size of blood corpuscles.

Other reports discussed included lightweight radiation shielding for space vehicles and miniaturizing MHD power and propulsion plants. Prof. Francis Ritter predicted 500,000-gauss constant fields would be attained by combining superconductivity, long pulse and water-cooling techniques.

Metal-Porcelain Sandwich Changes Heat to Power

WESTINGHOUSE ELECTRIC reports that when certain metals are separated by porcelain enamel and heated, electric power is produced. One of these cells the size of a slice of bread placed in an electric toaster produced enough power to drive a small electric motor. Westinghouse has a \$75,000 Air Force contract to research applications. The cells—called Austin cells for B. O. Austin, the developer—could probably utilize waste heat in rocket exhausts.

Solid-State Components Feature of Tokyo Show

TOKYO—Japanese component manufacturers at the 1962 Japan Electronic Parts Show went all-out to display their best products to foreign buyers. Consumer products took a back seat to basic components, materials and integrated modules.

Several companies showed micro-miniature modules in the wafer size used by the U.S. Signal Corps. Resistor manufacturers said they would produce to MIL specs. New

types of transistors and diodes were featured.

Some products were so new neither catalogs nor literature were available. Catalogs in English were available from many manufacturers and one firm labeled its display only in English. Attendance exceeded 40,000.

RCA Sells 150 Computers To British and French

RCA HAS ANNOUNCED terms of its recent multimillion dollar agreements with British and French firms:

International Computers and Tabulators Ltd. will buy 50 data processing systems by 1964 and has options for 50 more. The two firms exchange nonexclusive patent licenses and knowhow.

Compagnie des Machines Bull buys 100 computers and has options for another 100.

Doppler Alarm Catches Burglars over 50 Lb

MOTION-SENSITIVE doppler radar developed by Sylvania sounds an alarm when an intruder attempts to enter a protected area. The miniature system is reported to reliably detect moving objects weighing 50 pounds or more which have specific gravity similar to that of humans.

Foot-high transmitter and receiver units are located at separate stations to produce an electromagnetic field in the area to be protected. Signals generated by entry of objects into the field are analyzed. If it is a person, an alarm is triggered. Component failure, tampering or jamming attempts also set off alarms.

Program to Stimulate Science in Midwest

PROGRAM TO EXPAND science, education and industry in six states has been jointly announced by James E. Webb, NASA administrator, and Charles N. Kimball, president of Midwest Research Institute, Kansas City.

MRI, working with universities and industry in Arkansas, Iowa, Kansas, Missouri, Nebraska and Oklahoma, will spend \$250,000 annually to bring more space research and education into the area and to stimulate local industries to make use of space technology.

NASA will be kept informed of unexploited technical capabilities and local industry will be advised of untapped commercial opportunities in techniques developed for space.

Zener Diode Barrier Capacitance Only 5 pf

TOKYO—High-frequency zener diodes with typical barrier capacitances of 5 pf have been jointly developed by Nippon T&T Public Corp. and Nippon Electric Co. Voltage change is about 0.02 v for current changes of 5 to 500 μ a. These compare with several hundred pf and 0.2 v for conventional zener diodes made by NEC.

The diodes have been tried in a variety of pulse circuits, including limiters, clippers, shapers, subtractors and discriminators, with reportedly superior results. Output of a clipped clamper, for example, is said to have square corners while the waveshape from conventional diodes were round and elongated.

Radio Conferees Stress Consumer Gear Reliability

RELIABILITY and the development of product warranties for stereo and other consumer electronics products were given a close look at the Radio Fall Meeting in Syracuse last week.

Speakers pointed out ways in which improved reliability would benefit manufacturers. A. B. Mundel, of Sonotone, said the goals are the same as in military reliability: economic performance, reduction of repairs and replacements.

Reliability programs are not too expensive, according to G. R. Herd, of Booz, Allen Applied Research. A commercial manufacturer, he said, has a greater stake in reliability because customers are responsive to economic affects of reliability lapses.

In Brief . . .

BURROUGHS reports it has accepted over \$20 million in contracts during the past 30 days for its new B200 series computers, at prices ranging from \$165,000 to \$585,000.

AUTOMATIC ELECTRIC has installed a 94-station, two-way Teletypewriter network in Chicago police stations.

U. S. PATENT OFFICE is observing its 125th anniversary. The three-millionth patent was awarded this year.

LATEST NIKE-ZEUS contract from Army to Western Electric totals \$20.5 million for ground equipment. Ampex has a \$500,000 contract from Bell Labs for video tape recorders for Zeus.

MINUTEMAN contracts include \$321,258 to United Electro-Dynamics for digital telemetering and ground support equipment: \$300,000 to Texas Instruments for electro-optical guidance system aligners.

SYLVANIA won \$372,000 contract for Polaris fire control system modules, and \$314,000 in expendable radar deceivers.

OTHER missile and space contracts include \$2 million to Benrus for a variety of equipment; Dage division of TRW, \$800,000 for closed circuit tv; \$130,000 to Electro-Mechanical Research for satellite telemetry; \$500,000 to ACF for missile radar beacons.

COLLINS contracts include \$890,000 for fighter plane and helicopter navigation instruments.

RAYTHEON is supplying FAA with 11 more bright displays for airport radar, at \$1.6 million.

NAVY contracts include \$675,000 to TRW for missile range computers; \$600,000 to U. S. Sonics for hydrophones; \$360,000 to Cardion Electronics for weather radar and \$500,000 to Consolidated Electrodynamics for depth transducers.

T-MARKED...

to tell you it's
worry-proofed
at the factory



Other spring fasteners may look like Tinnerman SPEED NUTS. But only the *T-marked* ones really are SPEED NUTS . . . really are "Tinnermans" . . . made to highest quality and precision standards to assure worry-proof performance on your assembly.

Here's what the exclusive Tinnerman T-mark means to fastener users:

Over thirty-five years of Tinnerman experience as the originator and largest producer of spring-steel fasteners...the leader in solving your fastening problems,

Outstanding fastener design and production experi-

ence that assures you the best possible design of SPEED NUT, whether it is a special SPEED NUT or one of the 10,000 SPEED NUT brand fasteners presently available,

Stringent control of SPEED NUT quality from coil strip to you, including die design, production, heat treatment and finishing.

Be sure you specify "Tinnerman T-marked SPEED NUTS" that give you better fastening, that cut parts and assembly costs, that never let you or your customer down. *Tinnerman Products, Inc., Dept. 12, Box 6688, Cleveland 1, Ohio.*

CANADA: Dominion Fasteners Ltd., Hamilton, Ontario.
GREAT BRITAIN: Simmonds Aeroaccessories Ltd., Treforest, Wales.
FRANCE: Simmonds S.A., 3 rue Salomon de Rothschild, Suresnes (Seine).
GERMANY: Mecano Simmonds GMBH, Heidelberg.



TINNERMAN

Speed Nuts®

Look for the Tinnerman "T"

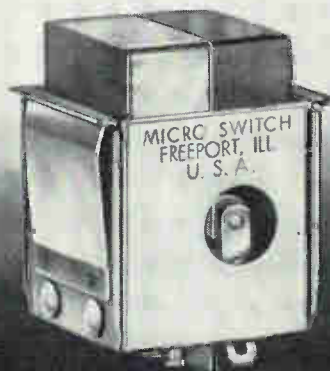

NEW! ALTERNATE ACTION LIGHTED PUSHBUTTON

Reliable snap-action switches

Here is a new concept in ultra-small lighted pushbutton switches for control with integral simultaneous visual indication. Switches in the "300" series are designed for military and industrial electronic control panels where space is an important factor.

In less than one cubic inch: double-pole double-throw switching; two integral lamps; choice of 15 combinations of two-color display screens. Alternate-action operation (push on—push off). Designed to conform to MIL-S-6743, MIL-S-6744, and MIL-E-5272.

Within the assembly are two SPDT switches, rated 7 amps, 115-230 vac or 28 vdc. A 5-volt sub-miniature lamp is under each half of display screen and there are 15 combinations of color display available. The complete unit snaps into panels 0.047 in. thick or greater. No installation tools needed. Minimum mechanical life is 100,000 operations. Lamp life is 60,000 hours at rated load.

Available in the same size are a momentary-action switch, and an indicator unit without switching function.

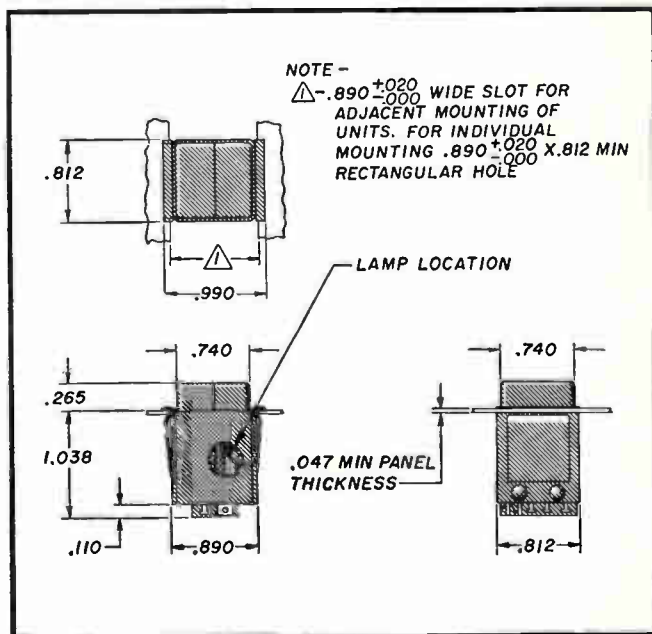

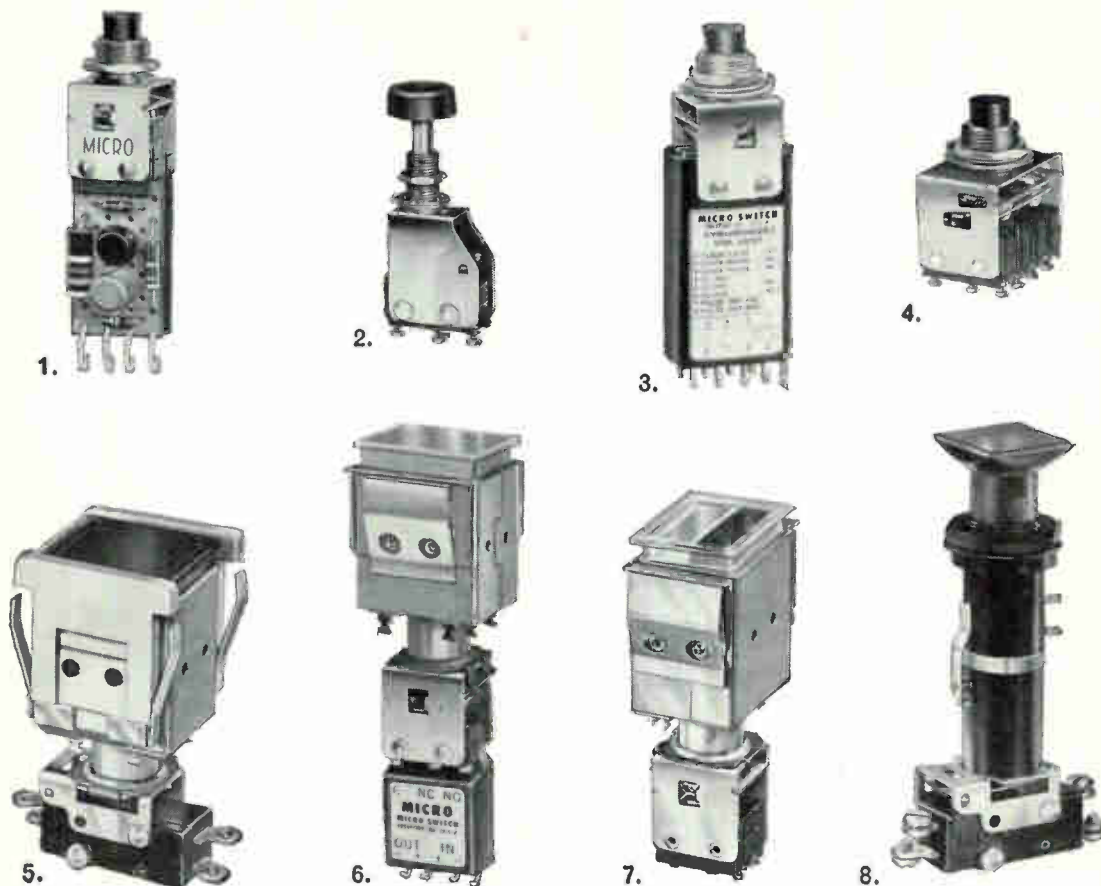

for electronic control panels

CUSTOM-BUILT CONTROL PANELS REQUIRE CAREFUL SELECTION OF SWITCHES

Immediately available are hundreds of small size switch units with variations in dimension, electrical capacity, shape, appearance and circuitry. All have undergone thorough tests in the most complete test laboratory of its kind.

Shown above and briefly described here are only a few of the hundreds of types of switch assemblies available.

1. Electronic switch-circuit for bounce-free voltage output.
2. Light force, rapid repeat pushbutton.

3. Synchronized "one-shot" pulse circuit.
4. Compact, 4-pole snap-action pushbutton.
5. Lighted pushbutton, modular design, barrier mount.
6. Lighted pushbutton, electronic "one-shot" switch-circuit.
7. Two-color lighted pushbutton, snap-in flange mounting.
8. Bushing mount lighted pushbutton, high capacity, 2-ckt switch.

For more information and for experienced help in selection, contact one of our many branch offices listed in the Yellow Pages, or write for Catalog 67 and Bulletin 22.

MICRO SWITCH, FREEPORT, ILLINOIS

A division of Honeywell

In Canada: Honeywell Controls, Limited, Toronto 17, Ontario

November 10, 1961



Honeywell
MICRO SWITCH Precision Switches

JERROLD®

SWEEP GENERATORS

NEW!

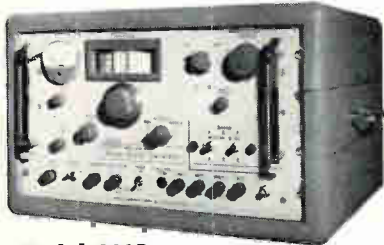

Model 900B

Very narrow to very wide sweep widths in one sweep SIGNAL generator

\$1980.00

Unusual stability in sweep widths from 10 kc to 400 mc. Frequency range 500 kc to 1200 mc. Built-in crystal-controlled harmonic markers, direct coupled scope pre-amplifier, and attenuators. The ultimate instrument for your IF-VHF-UHF requirements.



Model 900A

Wide-band sweep generator

\$1260.00

Center frequency: VHF, 0.5 to 400 mc; UHF, 275 to 1000 mc. Sweep widths from 100 kc up to 400 mc. Flatness: ± 0.5 db over widest sweep.



Model 707

Ultra-flat sweep generator

\$795.00

Featuring $\pm 5/100$ db flatness; plug-in oscillator heads*; variable sweep rates from 1/min. to 60/sec.; all electronic sweep fundamental frequencies; sweep width min. of 1% to 120% of C.F. *Heads available within the spectrum 2 to 265 mc. Narrow-band heads on request.

For applications bulletin and complete catalog (including wide-band comparators, precision attenuators and accessories), write:

JERROLD® ELECTRONICS CORPORATION
Industrial Products Division, Dept. IYE-122

The Jerrold Building, Philadelphia 32, Pa.

Jerrold Electronics (Canada) Ltd., Toronto
Export Representative: Rocke International, N. Y. 16, N. Y.

WASHINGTON OUTLOOK

DEFENSE SECRETARY McNamara is considering a major organizational overhaul of the Army's technical services. The result is likely to be consolidation of Army contracting for electronic research, development, and production into a new "Logistics Command." Signals Corps and Ordnance Corps, which now buy the Army's electronics, would probably be limited in function to the training of troops. (A recent Signal Corps development was the lightweight field transceiver shown at right.)



This would be still another step in the Kennedy administration's drive to centralize control over military procurement. A Defense Supply Agency has already been set up to handle all military buying of common-use, commercial-type goods—to eventually include electronic parts.

NEW RESTRICTIONS on patent rights of electronics contractors working on space communications development projects are coming from the Pentagon. Purpose is to assure the availability of Defense Department-financed inventions to all companies engaged in commercial space communications operations.

Under the Defense Department's basic policy on patents, a contractor can take title to an invention. The military gets a royalty-free license and can sublicense other firms to use the patent on military work. Now the Pentagon will be able to sublicense the use of patents in the space communications field for commercial work, too.

SEN. HUBERT H. HUMPHREY (D., Minn.), chairman of a Senate subcommittee studying federal supported medical research, calls for a "vast expansion" in government spending on medical electronic R&D.

He says there are now 273 "extra-mural" medical electronic research projects amounting to only \$8.4 million (plus 93 in-house projects), urges a "systematic, coordinated effort so that medical science can capitalize for civilian purposes on defense-supported discoveries and technology".

Copies of a new Humphrey subcommittee report on activities in medical electronics can be obtained from Rm. 162, Old Senate Office Bldg., Washington 25, D. C.

DEFENSE DEPARTMENT has again decided not to spend the \$780 million extra funds appropriated to Air Force for more B-52 bombers and for speedups in development of B-70 and Dynasoar (ELECTRONICS, p 14, Sept. 29). Extra spending for B-70 would have resulted in large electronics contracts, but now only a few stripped down prototypes for air testing will be built.



SERIES
57M
1/2" PRECISION
POTENTIOMETER

precise electronic control

Precision in miniaturization. The Clarostat Series 57M 1/2" diameter potentiometer is designed for use as a pad or trimmer under extreme temperature, moisture, shock and vibration conditions. Series 57EM utilizes glass sealed terminals for operation up to 150°C.

Brief specifications: 57M—1.75 watts @ 70°C; 57EM—2.0 watts @ 70°C; Dielectric strength—1000 volts AC; Maximum resistance standard, up to 25,000 ohms, special up to 100,000 ohms; Resistance tolerance $\pm 10\%$, on special order to $\pm 3\%$; Functional output linear; Independent linearity $\pm 2\%$.

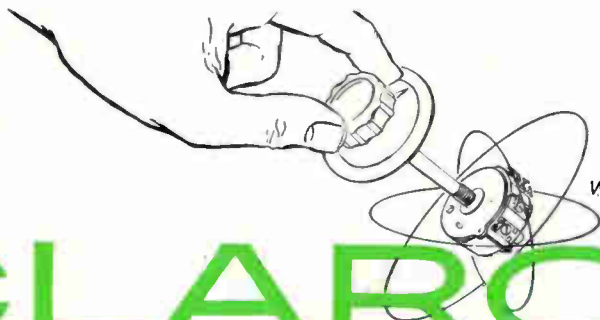

write for complete precision catalog...

 **CLAROSTAT**

CLAROSTAT MFG. CO., INC. DOVER, NEW HAMPSHIRE



Single-Place Gyrocopter by Bensen Aircraft Corp.

Looking for production savings?

Look into Northern Virginia

Planning a research center or light technical plant? You'll find important savings of productive time in being close to the matchless research facilities of the Nation's Capital. And the area's air facilities, including new Dulles International Airport, put you close to research and scientific operations throughout the world. Write, wire or phone VEPCO for available site and economic data on this area's hospitable communities, where trained personnel find congenial living and a rich cultural life.



VIRGINIA ELECTRIC and POWER COMPANY

Clark P. Spellman, Manager—Area Development, Electric Building, Richmond 9, Virginia • MIlton 9-1411
Serving the Top-of-the-South with 2,086,000 kilowatts—due to reach 2,720,000 kilowatts by 1963.



New... for systems use... the

Rack Mounted

MODEL 1508 HONEYWELL VISICORDER OSCILLOGRAPH

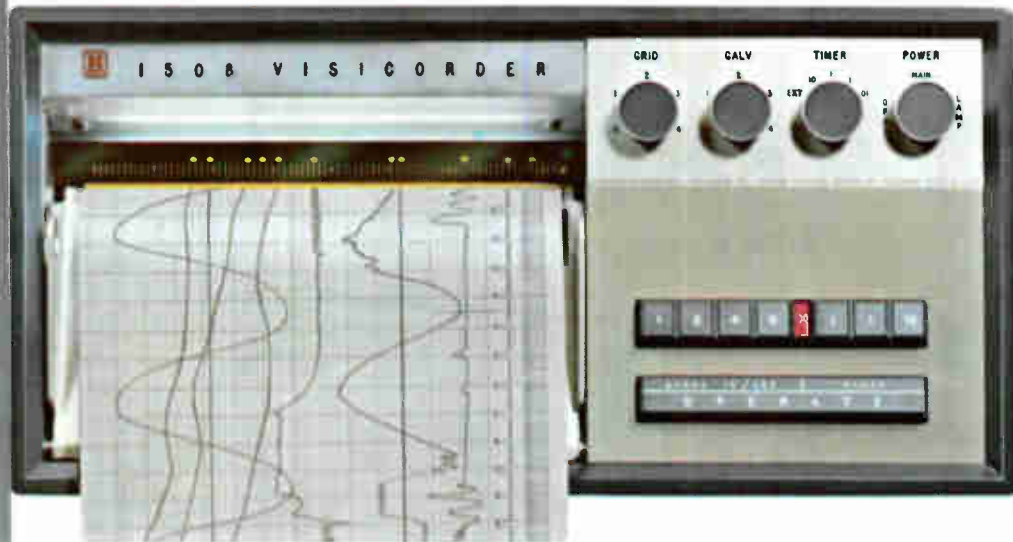

Specifically designed to fit in only 7 inches of rack height, the Model 1508 Visicorder Oscillograph gives you a wider record, a greater record speed range, and more recording channels in less rack space than any other recording oscillograph.

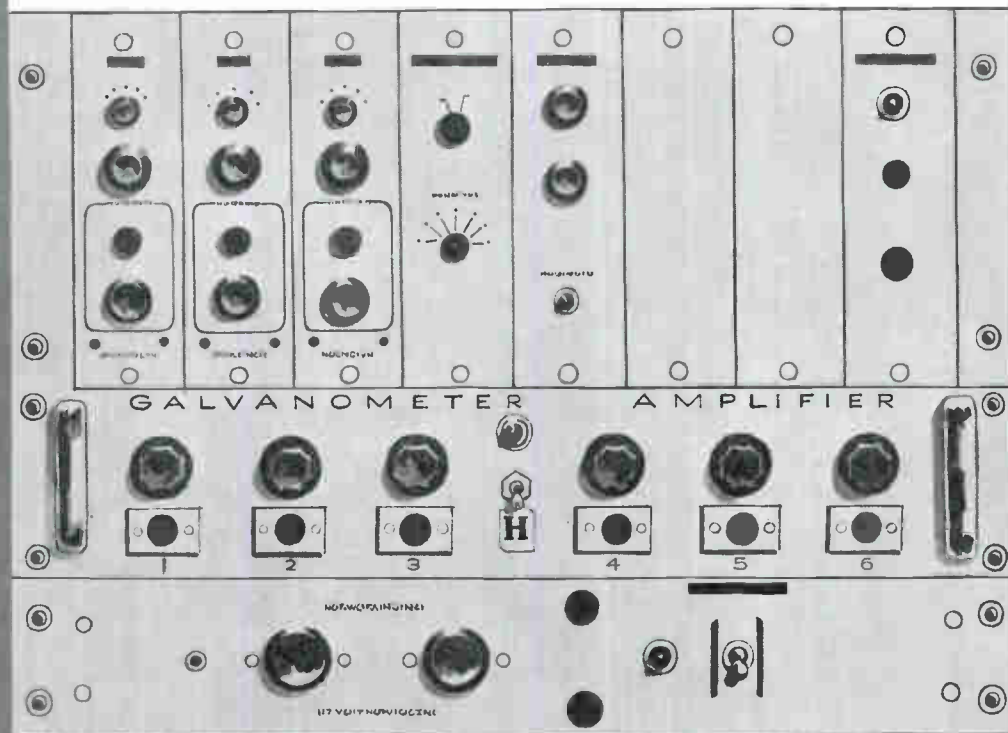



Features of the Model 1508 Visicorder Oscillograph

Using the famous Visicorder direct-recording principle that was pioneered, developed, and introduced by Honeywell, the New Model 1508 oscillograph records up to 24 channels of information simultaneously, producing immediately readable analog records without ink, styli, heat, powders, or chemical processing. Yet it is extremely compact—occupying only 7 inches of height in its rack-mount version—with many automatic features and the convenience of pushbutton controls. It is also available in a bench-mount model.

Maximum Operating Convenience

The 1508 has been designed for easy operation and service. 12 record speeds—from 0.1" through 80"/second—are push-button selected. All controls are handy on the front panel. You can load paper in seconds. In the rack model, the cover of the 1508 stays in the rack when the instrument is pulled

forward, thus providing complete accessibility for service, lamp and galvanometer adjustment. As in all Honeywell Visicorders, the actual recording spots are visible at the point of recording for precise galvanometer calibration and monitoring of information.

Solid, One-Piece Magnesium Casting

To prevent outside stresses on the instrument from introducing recording errors, the 1508 optical system, magnet assemblies, and drive system are mounted on a solid, one-piece magnesium casting.

These design refinements and extra quality features are typical of the superior instruments that have established Honeywell's leadership in the field of oscillography.

Ask your nearest Honeywell Field Engineer for a demonstration of the new 1508 Visicorder and other products described in these pages.



The 1508 is available in two styles: one for rack-mounting (shown on opposite page) and one for bench-mounting (shown above).

**Condensed Specifications
Model 1508
Visicorder Oscillograph**

CHANNELS: 12 or 24

GALVANOMETERS: type M, sub-miniature.

RECORD WIDTH: 8" (actual recording width 7 $\frac{3}{8}$ "") with provision for narrower widths.

RECORD LENGTH: 100' standard, 150' extra-thin, 200' super-thin. Unused paper indicator.

RECORD SPEEDS: 12, push-button selected, as follows: 0.1, 0.2, 0.4, 0.8, 1.0, 2.0, 4.0, 8.0, 10, 20, 40, 80"/second, changeable during operation.

FREQUENCIES: DC to 5,000 cps.

WRITING SPEEDS: greatly in excess of 50,000"/second.

TIME LINES: 4-interval system with .01, 0.1, 1.0, and 10-sec. intervals. On-off switch; provision for external synchronization.

GRID LINES: 0.1" with 5th line heavy, or 2mm with 1 cm heavy. On-off and density control. Special scales available.

OPTICAL ARM: 11.8" (30 cm) standard in all Honeywell Visicorders.

TRACE IDENTIFIER: 45° slope every 8", spaced .032" max., .02" min.

POWER: 117v 60 cycle; 230v 50 cycle; 5-6 amps at 117v.

DIMENSIONS: 19" wide x 7" high x 17 $\frac{1}{2}$ " deep excluding connectors and handles. Weight approximately 50 lb.

The loading of recording paper into the 1508 is a simple process. The roll of paper drops easily into the receptacle with no need for threading.



All operating controls on the 1508 are located conveniently on the front panel.



Other Models of Honeywell Visicorder Oscillographs



MODEL 1406...An efficient, dependable direct-recording oscillograph which makes the Visicorder principle available, on an extremely low-cost per channel basis, to users with recording requirements in the middle frequency range. Records up to 6 channels with special Type L Honeywell galvanometers.



MODEL 906C... with 8- or 14-channel capacity, built-in grid line and timing system, and self-starting lamp for remote operation. The built-in flash-tube timing system may be used normally or triggered externally.



MODEL 1108... an intermediate 24-channel instrument which fits logically between the 14-channel 906C models and the 36-channel model 1012. The 1108 has such extra features as automatic record length control, record reverse, record numbering, push-button record speeds and time-line intervals, and integral record take-up.



MODEL 1012... the ideal instrument for large-scale uses, the 1012 is the most convenient and versatile oscillograph ever built for directly recording as many as 36 channels of dynamic data. It includes all the automatic features of the Model 1108 and more besides.

USES OF THE VISICORDER

Visicorder Oscillographs are useful as direct readout units in systems for either **RECORDING** or **MONITORING** of almost any type... in **CONTROL** applications to monitor reference and error signals... in **MISSILE** and **ENGINE ANALYSIS** for test stand recording... for analog recording of **TELEMETERED SIGNALS**... in **NUCLEAR TESTING** to record temperatures, pressures, impacts... in **LABORATORY** work for all-purpose analyses... in **PRODUCTION** for final dynamic inspection... in **COMPUTING** for immediately-readable analog records... in **PILOT TEST** for rapid examination of prototypes... in **ALL TESTS** which are non-repetitive in sequence where oscilloscopes are impractical.

Write for further details on the new Model 1508 Visicorder Oscillograph, or call us at SKYline 6-3681, Direct Distance Dialing Code 303 Minneapolis-Honeywell, Heiland Division, 5200 E. Evans Avenue, Denver 22, Colorado

HONEYWELL INTERNATIONAL

Sales and Service offices in all principal cities of the world. Manufacturing in United States, United Kingdom, Canada, Netherlands, Germany, France, Japan.

Honeywell



First in Control

**Creative minds
thrive best
where the climate
is best**

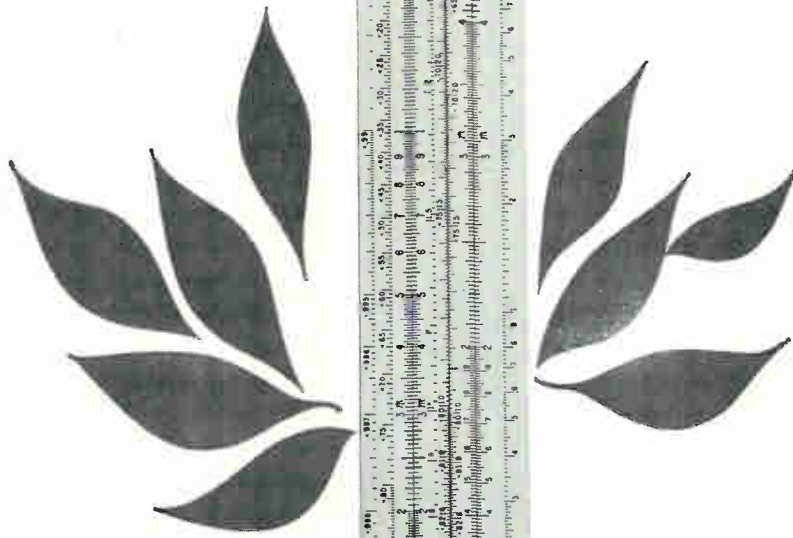

Lockheed-California Company proves this every day. For nowhere do Scientists and Engineers find a more creative, more stimulating, more academic climate.

In this environment Scientists and Engineers are encouraged to try the untried; to express new ideas; to experiment and explore. And in so doing, win recognition and reward.

Small wonder Lockheed's future in *Spacecraft and Aircraft* is brighter than ever before!

Scientists and Engineers of initiative and talent will find it worthwhile to examine immediate openings in: Aerodynamics;

thermodynamics; dynamics; electronic research, servosystems; electronic systems; physics (theoretical, infrared, plasma, high energy, solid state, optics); electrical and electronic designers; structural design (wing, empennage, fuselage).

Write today to Mr. E. W. Des Lauriers, Manager Professional Placement Staff, Dept. 1511, 2408 N. Hollywood Way, Burbank, California. All qualified applicants will receive consideration for employment without regard to race, creed, color, or national origin. U.S. citizenship or existing Department of Defense industrial security clearance required.

LOCKHEED-CALIFORNIA CO.

A DIVISION OF LOCKHEED AIRCRAFT CORPORATION

←CIRCLE 20 ON READER SERVICE CARD

CIRCLE 22 ON READER SERVICE CARD→

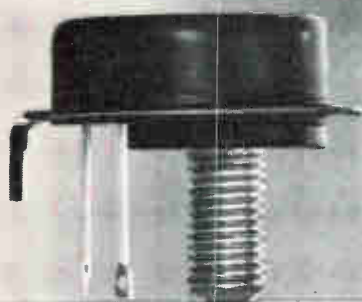

WX118

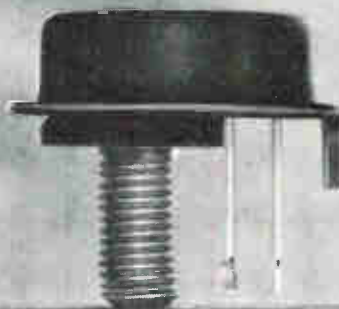

2N1015 - 2N1016

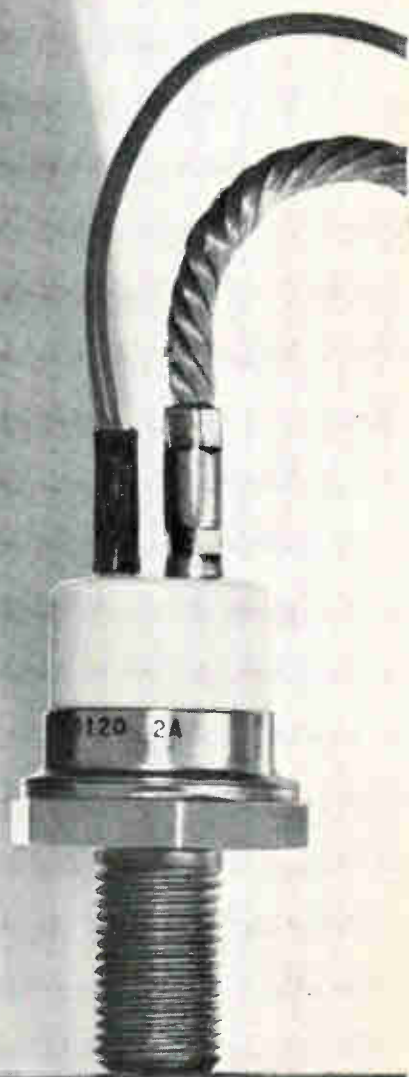

2N1809

Look to Westinghouse for Silicon Power Transistors with lowest saturation resistance

LSR^{*} = .037 Lowest saturation resistance ratings in the industry enable design engineers to obtain three-fold increases in power-handling capability. Now—with these higher performance specifications you can replace germanium units and gain the silicon power transistor advantages of reduced heat sink size . . . higher allowable ambient . . . improved control range . . . and upgraded reliability in almost all circuits.

	I _c	V _{ce}	Typical R _{ce} (SAT)
2N1809-2N2109 series	30 A	50-200V	.037
2N1015-2N1016 series	7.5 A	30-200V	.25
WX118 series	10 A	50-150V	.22

*Lowest Saturation Resistance

2N1809-2N2109 series. New 30-amp "Rock-Top" transistors . . . world's most powerful! With 30-amp, 200-volt, 250-watt ratings these newest Westinghouse series 2N1809 and 2N2109 transistors are designed to meet the most exacting high power applications. Germanium-level saturation resistance (.037 ohms), and freedom from secondary breakdown mean highest efficiency and operating reliability.

WX118 series. World's highest gain power transistors provide current gain of 400 at 10 amps! New Westinghouse Type WX118 high-gain silicon transistors simplify circuitry, increase reliability, reduce cost of assembly. They're ideal for application in high power, high efficiency regulators, inverters and switching circuits. Saturation resistance is only 0.22 ohms.

2N1015-2N1016 series. Highest reliability from production-proved 150 watt designs. Get maximum circuit reliability at no extra cost by specifying the Westinghouse 2N1015-2N1016 series. These popular transistors have

been field-proven in thousands of operating equipments. They can replace lower rated transistors (2N1489-2N1490, 2N1069-2N1070, 2N389 and others), and give you up to twice-the-power derating margin. In addition to the exclusive rating characteristics of these transistors, you get greater assurance of performance reliability from:

- **True voltage ratings.** Westinghouse transistors can be operated continuously at their full published ratings into highly inductive loads. True Voltage Ratings are verified by 100% Power Testing.
- **100% Power Testing.** Each Westinghouse transistor is 100% Power Tested before leaving the plant. Tests are conducted over the full operating range—under all conditions of base bias and collector current at maximum rated dissipation.

For more information or technical assistance, see your nearest Westinghouse representative or write: Westinghouse Electric Corporation, Semiconductor Department, Youngwood, Penna. *You can be sure . . . if it's Westinghouse.* SC-1054



2N2109

For immediate "off-the-shelf" delivery, order from these Westinghouse Distributors:

EASTERN

- ACK SEMICONDUCTOR, INC. Birmingham 5, Ala /FA 2-0588
- CAMERADIO Pittsburgh, Pa /EX 1-4000
- CRAMER ELECTRONICS, INC. Boston, Mass /CO 7-4700
- ELECTRONIC WHOLESALERS, INC. Melbourne, Florida/PA 3-1441
- GENERAL RADIO SUPPLY CO., INC. Camden, N.J. /WO 4-8560
- KANN-ELLERT ELECTRONICS, INC. Buffalo, N.Y. /TR 3-9561
- GENESEE RADIO PTS. CO. Baltimore, Md. /TU 9-4242
- MILGRAY ELECTRONICS New York, N.Y. /RE 2-4400
- RADIO & ELECTRONIC PTS. CORP. Long Island, N.Y. /PI 6-6520
- SCHWEBER ELECTRONICS Cleveland, O. /UT 1-6060
- Long Island, N.Y. /PI 6-6520
- Silver Spring, Md. /JU 5-7023

MIDWESTERN

- E.C.I. SEMICONDUCTORS, INC. Kansas City, Mo. /WE 1-0829

- ELECTRONIC COMPONENTS FOR INDUSTRY CO. St. Louis, Mo. /WO 2-9916
- HALLMARK INSTRUMENTS CORP. Dallas, Texas /RI 7-8933
- INTER-STATE RADIO & SUPPLY CO. Denver 4, Colo. /TA 5-8257
- LENERT CO. Houston, Texas /CA 4-2663
- MIDLAND SPECIALTY CO. El Paso, Texas /KE 3-9555
- Phoenix, Ariz. /AL 5-8254
- Albuquerque, N.M. /CH 7-0236
- RADIO DISTRIB. CO. Indianapolis, Ind. /ME 7-5571
- SEMICONDUCTOR SPECIALISTS, INC. Chicago, Ill. /NA 2-8860
- S. STERLING CO. Detroit, Mich. /BR 3-2900
- UNITED RADIO, INC. Cincinnati, O. /MA 1-6530

WESTERN

- ALMAC ELECTRONICS CORP. Seattle, Wash. /PA 3-7310
- ELMAR ELECTRONICS Oakland, Cal. /TE 4-3311
- HAMILTON ELECTRO SLS. Los Angeles, Cal. /BR 2-9154
- Palo Alto, Cal. /DA 1-7541
- NEWARK ELECTRONICS CO. Inglewood, Cal. /OR 4-8440

Westinghouse



— the ultra
new **YOKE!**

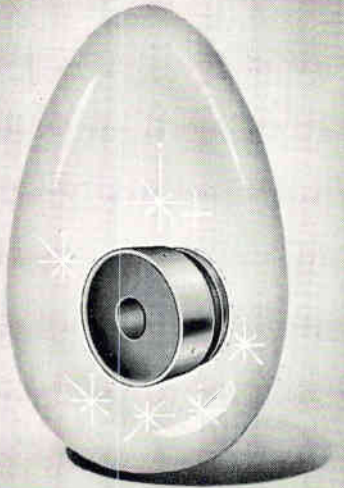

Deflectron*
By **Celco**

**MAJOR ADVANCE IN
THE SCIENCE OF
ELECTRON BEAM DEFLECTION!**

SPOT RECOVERY

Fastest! to 1 μ S

SPOT SIZE

Smallest — by 25%

SPOT SWEEP

Straightest.....

*** DEFLECTRONS for DISPLAYS**

Where ordinary precision
yokes **FAIL** to meet your
requirements.

Write for NEW "DEFLECTRON"
Data and Standard Yoke
Catalog.

Celco
Constantine Engineering
Laboratories Co.

Main Plant: MAHWAH, N. J. DAvIs 7-1123
PACIFIC DIV.—UPLAND, CALIF. YUkon 2-0215
CENTRAL DIV.—LANESBORO, PA. ULYsses 3-3500

Medical Market Growing

MEDICAL electronics market this year appears to be headed for the greatest advances yet in its short but active history. Conservative estimates of its size range between \$150 million and \$200 million.

Main factor in the soaring growth since January has been the introduction of commercially feasible equipment in several fields. Among these are electronic systems for hospital monitoring, pace-makers for the heart, endocardio-sondes (radio pill transmitters) and associated equipment, pupillo-graphs, phonocardiographs and electronic analgesics.

Among prototype developments are ballistocardiographs which measure cardiovascular dynamics electronically, equipment for measuring blood parameters externally, equipment using ultrasonics for tissue visualization. Also in prototype form is color tv equipment allowing retinal studies to be made at light intensities harmless to the human eye, surgical diathermy, fiber optic systems for internal body examination, ultrasonic neurosurgery and artificial muscles.

Medical electronics consumers today consist mainly of the 6,786 hospitals recognized by the American Hospital Association, 2,000 other hospitals, 3,000 related organizations (nursing homes, clinics and

sanitariums), 230,000 physicians, 100,000 dentists, and a large number of research institutions and universities.

Until recently, medical instrument companies provided the technology and instruments for this market. Now, however, large companies with diversified interests are offering entire systems.

A recent marketing survey of the medical electronics industry sponsored by Sproul & Associates, Inc., New York, highlights some interesting market developments. Sales figures were received from 37 companies.

Sales Leaders

Leading in dollar volume sales among 151 types of medical electronic equipment were radioactive tracer equipment (\$980,000), x-ray supplies and accessories (\$540,750), dosimeters (\$494,000), research and development (\$275,000), stimulators (\$221,250), electrocardiographs (\$221,000), x-ray equipment (diagnostic \$210,000, therapeutic \$196,000), thermistor thermometers and controllers (\$165,000), fluorometers and accessories (\$150,000) and blood pressure recorders (\$100,000). The large sales of radioactive-tracers is tied in with the fact that now 2,100 medical institutions and physicians have been licensed by the Atomic Energy Commission to use radioisotopes as compared with 1,500 five years ago.

Total sales for hospital monitoring systems were \$30,000—according to the survey. By next June this figure may well be among the leaders. Ultrasonic diagnostic equipment, selling at \$50,000, also shows future promise of greatly exceeding this figure.

Asked what they expected sales to do during the rest of 1961, 28 firms said increases could be expected and 8 feel things will stay about the same. The same question referred to 1962 got 28 increases and seven about-the-same votes; for 1965 there were 26 increase and six about-the-same votes.

Judging from the survey, medical electronic equipment is most used in research activities. Diag-

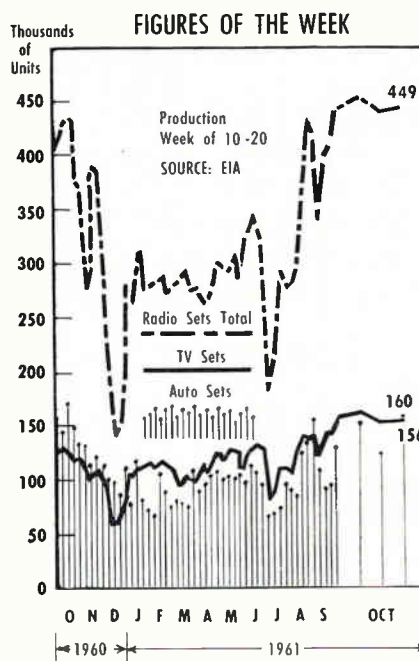

nostic and therapeutic applications follow in that order.

In sales procedures, 24 firms use their own staffs, while sales representatives were used by 11, laboratory supply houses by six, hospital supply houses by four and x-ray equipment manufacturers by three firms.

Importer Sees Shift In Japanese Exports

TOKYO—After surveying the market in Japan, Samuel Frankel, vice-president of American Radio Importers Association, predicts the U. S. market for Japanese electronics will be permanent and steady.

He said Japanese manufacturers—if they stress engineering and design even more—can compete with Americans in “complex” entertainment electronics. They should now look to opportunities in high-quality a-m/f-m radios, stereo and tv, he advised.

Japan, he said, squeezed itself out of the six-transistor radio market by self-imposed quotas. This opened the door to radios made in Hong Kong and Okinawa. There’s no future for such radio exports, anyway, he said, because of their abundance in the U. S.

MILITARY CONTRACTING

MISSILE & ELECTRONICS FIRST QUARTER FISCAL 1962

NAVY

Gen Elec	\$ 92,318,000	Polaris
Gen Dynamics	59,100,000	Terrier/Tartar
Raytheon	42,400,000	Sparrow II

ARMY

Western Elec	171,821,000	Nike-Zeus
Martin Co.	120,000,000	Pershing
Kiewit & Sons	56,220,000	Minuteman (Inch)
Martin Co.	51,685,000	Pershing
P. Hardeman Inc.	37,700,000	Titan II (Inch)
Eby Martin Const.	37,598,000	Launch facilities
Sperry Rand	29,511,000	Sergeant (gse)

AIR FORCE

Hercules Pow	50,000,000	Minuteman
Sanders Assoc	40,000,000	ASW & Anti-ms
Boeing	30,000,000	Dynasoar Gldr
Avco	28,500,000	Hgt Fndr Radar
Systems Dev	28,164,000	Sage Training
RCA	27,700,000	Dynasoar Comm.

NASA

MIT	4,100,000	Apollo (guide)
Hughes Air	4,000,000	Syncom Satellite

FAA

Raytheon	11,578,000	ATC Radar
Servo Corp	1,734,000	DF Systems
Western Elec	1,574,000	Auto Teletype
United Air	1,000,000	Weather Comptr
Datex Corp	635,000	Weather Units

The above figures represent prime military systems awards. They are recorded for ELECTRONICS by Frost & Sullivan, Inc., of New York City, defense marketing specialists.

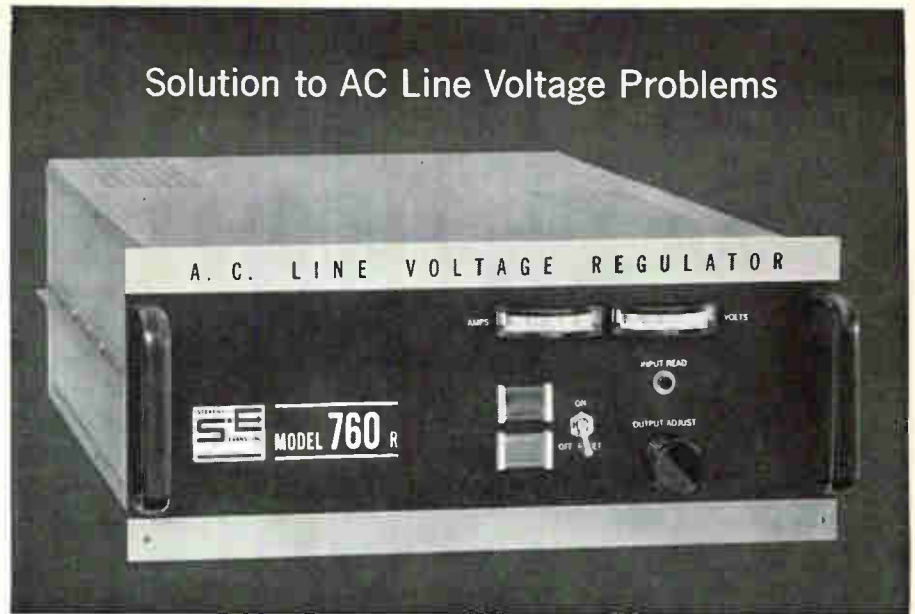

NEW SOLID-STATE AC REGULATOR FAST ENOUGH TO ELIMINATE TRANSIENTS!

The Stevens-Evens 700 is much more than an AC line voltage regulator—it’s a line conditioner and stabilizer with 100 microsecond response, fast enough to eliminate transients. Here in one compact, solid-state instrument is the solution to virtually all AC line voltage problems—whether caused by transient interruption, changing line voltages or harmonic distortion, three conditions associated with most primary power lines.

Available in six bench and rack models, S-E Series 700 instruments provide complete isolation and independence from primary AC power grounds. Each model features 100 db line isolation, 0.1% regulation, and completely transistorized circuitry. For complete information or a demonstration, contact Stevens-Evens.

BRIEF SPECIFICATIONS

- Input Ranges:** 3 ranges (95-115 VAC, 105-125 VAC, 115-135 VAC)
- Regulation (Line and Load):** 0.1%
- Output Harmonics:** Less than 0.25%
- Harmonic Attenuation:** 40 db (100 to 1)
- Transient Rejection:** 40 db (100 to 1)
- Input/Output Isolation:** 100 db (effective capacitive coupling between input line and output line is less than 1 micro-microfarad)
- Response Time:** 100 microseconds
- Output Power:** 0 to 1 KVA
- Size:** Rack models—7" high x 19" wide x 15" deep. Bench models—7" high x 17" wide x 15" deep
- Models:** Available in 50, 60 and 400 cps; other frequencies on special order. 230-volt models also available
- Delivery:** from stock, 30 days max.

S-E STEVENS-EVANS, INC.
3801 HICOCK STREET, SAN DIEGO, CALIFORNIA • CYPRESS 7-4077

Stevens-Evens manufactures a full line of AC line voltage regulators and monitor oscilloscopes for industrial, commercial and military applications.

SELECTED BY
RCA
FOR
A HIGH
RELIABILITY
*** PROJECT**

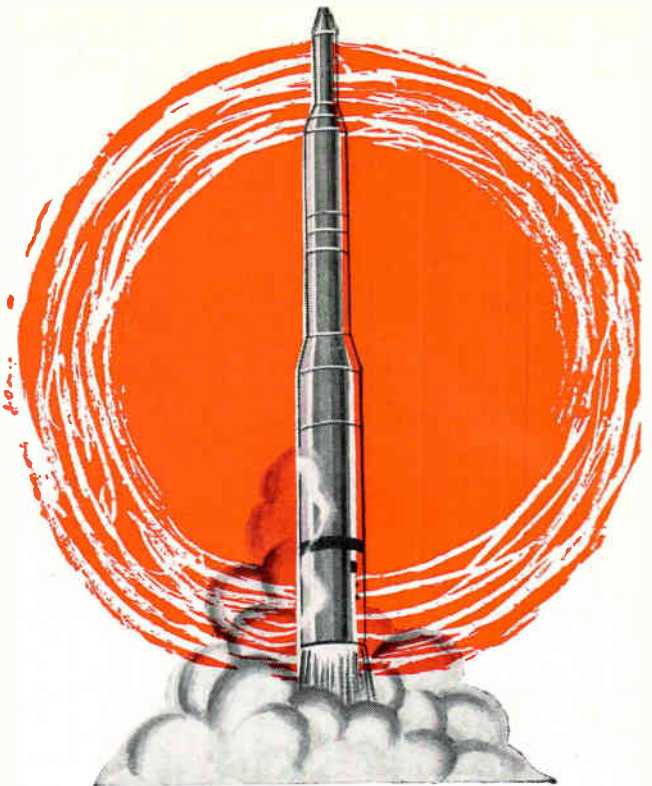

Here is MEASURED RELIABILITY!

Ten thousand El-Menco high reliability dipped mica capacitors were put on life test at 85°C with 225% of the rated DC voltage applied in accordance with an RCA high reliability specification.

*After 22,000,000 actual test unit-hours no** failures of any type occurred*

The accumulated 22×10^6 test unit-hours without any failures can be used to calculate many different failure rates depending upon the confidence level desired. However, we shall explore the meaning of the results at a 90% confidence level.

Assuming no acceleration factor for either temperature or voltage, we have verified a failure rate of approximately .01% per 1000 hours. (Actually, there is a temperature effect and it has been found that, with the DC voltage stress remaining constant, the life decreases approximately 50% for every 10°C rise in temperature. There is also a voltage effect such that, with the temperature stress remaining constant, the life is inversely proportional to the 8th power of the applied DC voltage.)

Assuming no temperature acceleration factor and assuming the voltage acceleration exponent is such as to yield an acceleration factor as low as 100, we have nevertheless verified a failure rate of approximately .0001% per 1000 hours.

Assuming no temperature acceleration factor and assuming the voltage acceleration factor is on the order of 250 (test results are available to confirm this) we have accumulated sufficient unit-hours to verify a failure rate of less than 00005% per 1000 hours!

Note that all the above failure rates are calculated at a 90% confidence level!

* The El-Menco high reliability dipped mica capacitors are being supplied to the Radio Corporation of America for a high reliability military ground electronics project.

** A failure was defined as follows:

1. A short or open circuited capacitor occurring during life test.
2. A part whose capacitance changed more than $\pm 2\%$ and whose capacitance did not fall within the original tolerance of $\pm 5\%$.
3. A part whose final dissipation factor exceeded .002.
4. A part whose final insulation resistance measured less than 100,000 megohms.

Write for a copy of our "Reliability Study of Silvered Mica Capacitors".



THE ELECTRO MOTIVE MFG. CO., INC.

Manufacturers of El-Menco Capacitors

WILLIMANTIC CONNECTICUT

- molded mica • mica trimmer • dipped mica • silvered mica films
- tubular paper • mylar-paper dipped • ceramic feed throes • ceramic discs

Arco Electronics, Inc., Community Drive, Great Neck, L.I., New York
 Exclusive Supplier To Jobbers and Distributors in the U.S. and Canada

WEST COAST MANUFACTURERS CONTACT:
 COLLINS ELECTRONIC SALES, INC., 535 MIDDLEFIELD ROAD, PALO ALTO, CALIFORNIA

New Copper-Clad Reliability

In March, 1961, CDF Grade 614, glass-epoxy laminate, was announced . . . and met with almost overnight acceptance. Particular electronics and electrical manufacturers wasted no time in specifying this premium performance material with zero burnout and minimum "haloing."

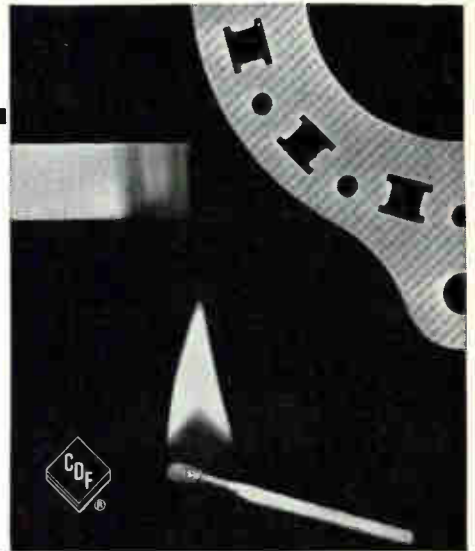

By June, 1961, CDF Grade 614 had become the new standard of comparison for applications in critical ground and air-borne circuitry. Designers like its specifications, production men like the way it handles, management likes its reasonable price.

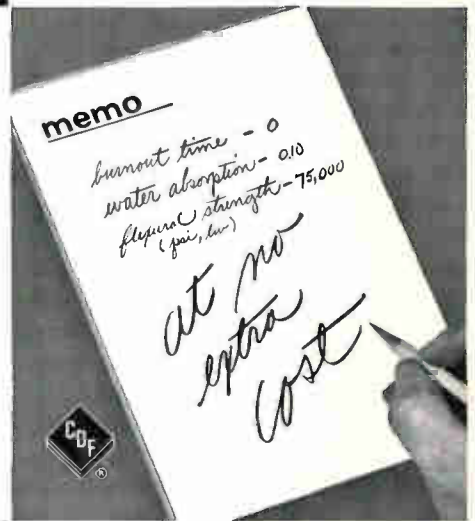

Now, CDF Grade 614 Copper-Clad is setting a new pace among particular producers of printed circuits . . . offering a new high in reliability for high packaging densities . . . and offering researchers a new tool in the investigation of molecular and submicro-circuitry.

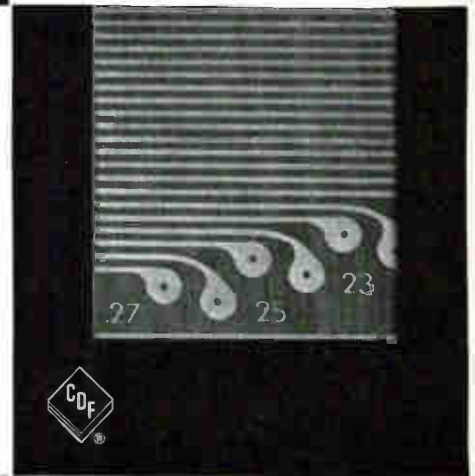

You can take advantage of 614 Copper-Clad's unique features right now . . . in research, development or production operations. Continental-Diamond Fibre Corporation, Newark, Delaware. A Subsidiary of the *Budd* Company.

NOW... IN ONE INSTRUMENT ANALOG DISPLAYS PLUS DIGITAL READOUT

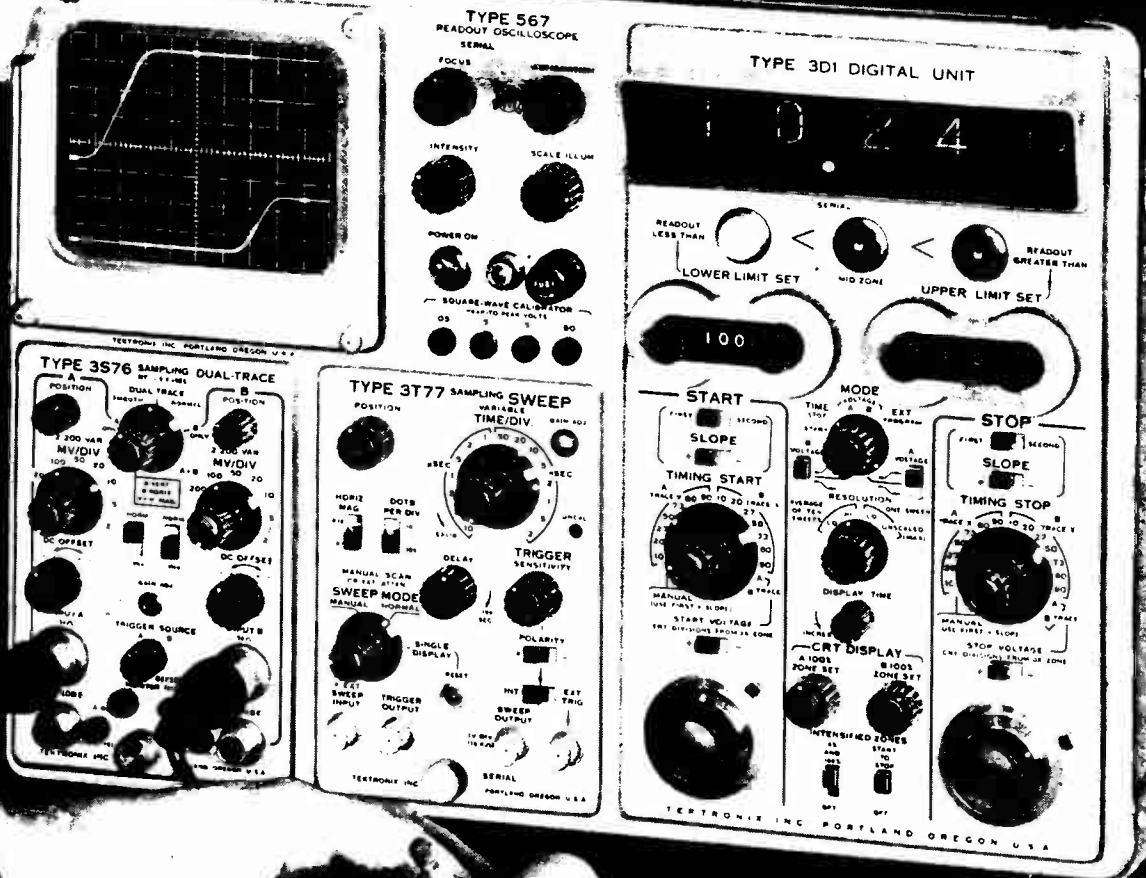

TEKTRONIX DIGITAL READOUT OSCILLOSCOPE TYPE 567

DIGITAL READOUT
of time differences to
50 picoseconds.

DIGITAL READOUT
of pulse risetimes to
one-half nanosecond.

DIGITAL READOUT
of pulse amplitudes to
2 millivolts peak-to-peak.

The Tektronix Type 567 Oscilloscope adds digital readout convenience to your dual-trace applications. It presents simultaneously an analog display on the 5-inch crt with a digital presentation on the automatic computing programmer. It enables you to select and intensify the actual points—for the automatic normalization—on the crt waveforms which you wish to measure. Then you merely read directly the corresponding up-to-4-digit decimal units of actual measurement. Indicators light to designate the readout status—whether *in* the preset-limit range, *below* it, or *above* it. You set the program *once* for all successive similar measurements.

To achieve this faster and simpler approach to precision measurement, the Type 567 incorporates many features *new* to an oscilloscope. In the automatic computing programmer, for example, some of these new features include: positionable measurement-reference zones, automatic normalization, zone-intensity markers, automatic and manual start-timing and stop-timing systems, preset-limit selector and

indicators, and provision for external programming. These features—and others in the two sampling plug-in units and the oscilloscope itself—enable the new Type 567 to greatly increase your measurement proficiency.

You can measure pulse amplitudes and time increments between percentages of selected amplitude levels *on an absolute or relative basis* faster and with more accuracy—especially in sustained testing programs. In addition, you can also measure pulse amplitudes and time increments on differential signals between A and B inputs.

In a typical application such as transistor-switching-time measurements, you can read directly such characteristics as the delay, rise, storage, and fall times; the total turn-on and turn-off times; the width of pulse A and pulse B; and time and amplitude between two selected points on either or both waveforms. You know immediately by the digital presentation and indicator lights whether or not the item tested has met specifications.

←
Type 567 Readout Oscilloscope (without plug-ins) \$700
5-inch rectangular crt. 3.3-kv accelerating potential. 8-cm by 10-cm display area. Amplitude Calibrator. Edge-lighted graticule. Separate regulated heater supply. Electronically-regulated dc-supply—powers plug-in units, operates between 105-125 volts or 210-250 volts, 50 to 60 cycles.

Type 3S76 Sampling Dual-Trace Unit \$1100
Identical Channels with Independent Controls—for positioning, dc-offsetting, attenuating, inverting input signals as desired. **Risetime**—less than one-half nanosecond. **Calibrated Sensitivity**—from 2 mv/div to 200 mv/div in 7 steps, also continuously variable between steps uncalibrated. **Noise**—less than 2 mv peak-to-peak (referred to input). **Operating Modes**—either channel separately, dual-trace, algebraic additions, differential output (with common mode rejection ratio approximately 50:1), lissajous (A vertical, B horizontal). **DC-Offset Voltage**—for measuring millivolt signals in the presence of a substantial dc component (offset voltage monitorable at front panel). **Internal Triggering**—built-in trigger takeoffs and delay lines internally connected to Sampling Sweep Unit. Sweep Unit receives a nominal one-fifth amplitude signal from trigger takeoff.

Type 3T77 Sampling Sweep Unit \$650
Calibrated Sweep Range—for equivalent sweep times from 0.2 nsec/div to 10 μ sec/div in 15 steps, also continuously variable between steps uncalibrated, and to approximately .007 nsec/div. **10X Horizontal Magnifier**. **Single-Sweep Provision**. **10 or 100 Samples-Per-Division**. **Sweep Delay Through 100 Nanoseconds**. **Manual Control of Scanning Function**—for XY or YT Recorders.

Internal or External Triggering—either positive or negative, 5 mv sensitivity. (Internal 25 mv signal in *Type 3S76* results in 5 mv at *3T77*.)

Type 3D1 Digital Plug-In Unit \$2500
Internal Input—from horizontal and vertical plug-in units. **In-Line Nixie*Readouts**—with up-to-4-digit decimal units of actual measurement. **Measurement-Reference Zone**—from fixed zero to 100% zone positionable over the sweep range . . . for each trace. **Automatic Normalization**—for establishing pulse amplitude or time measurements independent of dc position or pulse amplitude. **Zone-Intensity Markers**—for indicating the position of the reference zone in relation to the waveform and also the actual start-to-stop interval . . . for each trace. **Automatic Start-Timing and Stop-Timing Systems**—for controlling start and stop . . . on any of 7 calibrated % steps on either trace . . . or any combination of percentage, amplitude, polarity, first or second pulse slope or input channels A or B. **Manual Timing**—for setting the start-timing and stop-timing at selected points on the displayed waveforms. **Display-Time Control**—for varying amount of display time needed to take readings or operate associated equipment. **Preset-Limit Selector**—for setting the upper and lower limits of the readout digits. **Limit-Selector Indicators**—for designating measurements occurring *below, in, or above* the preset-limit range. **Provision for External Programming**—for sequencing automatically between various measurement programs, or for other applications.

*Registered by Burroughs

U.S. Sales Prices f.o.b. Beaverton, Oregon

To arrange a demonstration of this compact and complete Digital Readout Oscilloscope, please call your Tektronix Field Engineer.

Tektronix, Inc. P. O. BOX 500 • BEAVERTON, OREGON / Mitchell 4-0161 • TWX—BEAV 311 • Cable: TEKTRONIX

TEKTRONIX FIELD OFFICES: Albuquerque, N. Mex. • Atlanta, Ga. • Baltimore (Towson), Md. • Boston (Lexington), Mass. • Buffalo, N.Y. • Chicago (Park Ridge) Ill. • Cleveland, Ohio • Dallas, Texas • Dayton, Ohio • Denver, Colo. • Detroit (Livestock Village) Mich. • Endicott (Endwell) N.Y. • Greensboro, N.C. • Houston, Texas • Indianapolis, Ind. • Kansas City (Mission) Kan. • Los Angeles, Calif. Area (East Los Angeles • Inglewood • West Los Angeles) • Minneapolis, Minn. • Montreal, Quebec, Canada • New York City Area (Albany, L.I., N.Y. • Stamford, Conn. • Union, N.J.) • Orlando, Fla. • Philadelphia, Pa. • Phoenix (Scottsdale) Ariz. • Portland, Oreg. • Poughkeepsie, N.Y. • San Diego, Calif. • San Francisco, Calif. Area (Berkeley, Palo Alto) • Seattle, Wash. • Syracuse, N.Y. • Toronto (Willowdale) Ont., Canada • Washington, D.C. (Annandale, Va.).

ENGINEERING REPRESENTATIVES: Kentron Hawaii Ltd., Honolulu, Hawaii. Tektronix is represented in twenty-five overseas countries by qualified engineering organizations. European and African countries, the countries of Lebanon and Turkey, please contact TEKTRONIX INTERNATIONAL A.G., Terrassenweg 1A, Zug, Switzerland, for the name of your local engineering representative. Other Overseas areas, please write or cable directly to Tektronix, Inc., International Marketing Department, P. O. Box 500, Beaverton, Oregon, U.S.A. Cable: TEKTRONIX.

SEE THE TYPE 567 AND OTHER NEW TEKTRONIX INSTRUMENTS AT NEREM, BOOTHS 7 & 8

Device Designers Extend Component Ranges With Advances in Semiconductors and Tubes

*Monolithic solid-state amplifiers, semiconductor delay line
and wideband, high-power amplifiers are reported at meeting*

By SAMUEL WEBER,
Senior Editor

WASHINGTON — Although major breakthroughs in new device development were not reported at the Electron Devices Meeting here Oct. 26-28, significant engineering improvements in solid-state technology, display devices and microwave tubes were reported.

A monolithic functional block amplifier (ELECTRONICS, p 118, Sept. 29) was described by Karl Yu and Larry Pollock, of Westinghouse. Fabricated on a single crystal silicon block, it provides transformation from high to low impedance levels with power gain over a limited frequency range.

The device—called a Unibi—consists of two active regions. The input region operates as a field effect transistor, while the output region is a conventional bipolar transistor. Both regions are processed simultaneously using photo masking techniques. Input impedance is of the order of five megohms. With the present design, the block is ca-

pable of 40-50 db power grant at current levels of 2-5 ma. Signal to noise ratio is 65 db.

Westinghouse sees the major applications for the device in audio preamplifiers, infra-red detectors, high-efficiency class-A amplifiers and as an interstage element in common base circuit configurations. A cross-section diagram of the Unibi and an experimental circuit in which it was used are illustrated.

J. S. Winslow of Electro-Optical Systems Inc. reported work with a semiconductor delay line which exhibited a nearly Gaussian frequency response. Since the Gaussian response is difficult to obtain with lumped circuit elements, yet is desirable for many applications, the semiconductor delay line may fill a need in low pass filtering applications where space is at a premium.

The delay line is a germanium bar about one cm long and 0.1 cm square in cross section. An electric field is maintained by means of ohmic contacts made to the ends of the bar. An emitter junction injects minority carriers near one end

of the bar and these carriers drift under the influence of the electric field toward three equally spaced collectors whose outputs feed a resistive summing network. When a periodic signal whose period is equal to the delay increment between taps is fed into the device, the output from the summary network is a maximum.

The second sketch shows the experimental setup. The delay increment can be changed by changing the electric field, hence the device is voltage tunable. In the devices made, tuning could be accomplished between 10 and 40 Kc.

In a session on storage and display tubes, General Electric's Kurt Schlesinger reported an ultra-high resolution cathode ray tube. The new microspot tube produces a spot size of eight microns permitting an information density of 3,000 lines an inch. It can scan an 8-cm square in 10,000 lines, using 42-deg deflection. This is equivalent to the display of 100 million dots on its five-inch face.

Among several new approaches to

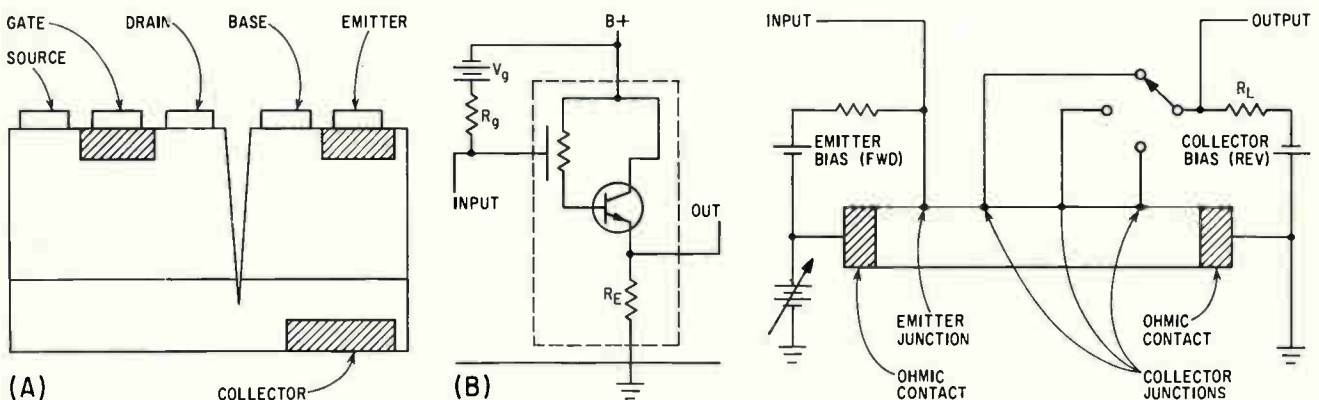

Cross-section of Unibi, a new solid-state amplifier (A) and an experimental circuit using the component (B). Frequency response that is nearly Gaussian is exhibited by semiconductor delay line (right). Here is experimental setup

electron optical design in the tube is the use of a spiral anode to double the effective length of the neck. A special microgun generates an electron focus whose brightness exceeds that at the cathode by a factor of 10.

The phosphor screen employs a thin, grainless film deposited by a vapor reaction process invented by D. Cusano, also of GE. The screen can withstand continuous loading of 30 Kw a sq cm, a common condition in the operation of this tube.

A two-color display storage tube, able to display stored information in either of two primary colors, or in intermediate hues has been developed at Hughes Aircraft Company. The tube, which has been built in the 10-in. size, can be operated with simple circuitry. It exhibits only a moderate sacrifice in resolution over its monochromatic half-tone counterpart, according to the developers, C. D. Beintema, N. J. Koda and L. S. Yaggy.

Staffers G. E. Pokorny, A. E. Kushnick and J. F. Hull, of Litton, described experiments with a new type of crossed-field microwave amplifier which they called a Dematron. To date, various developmental models of the Dematron have yielded at X-band a pulsed

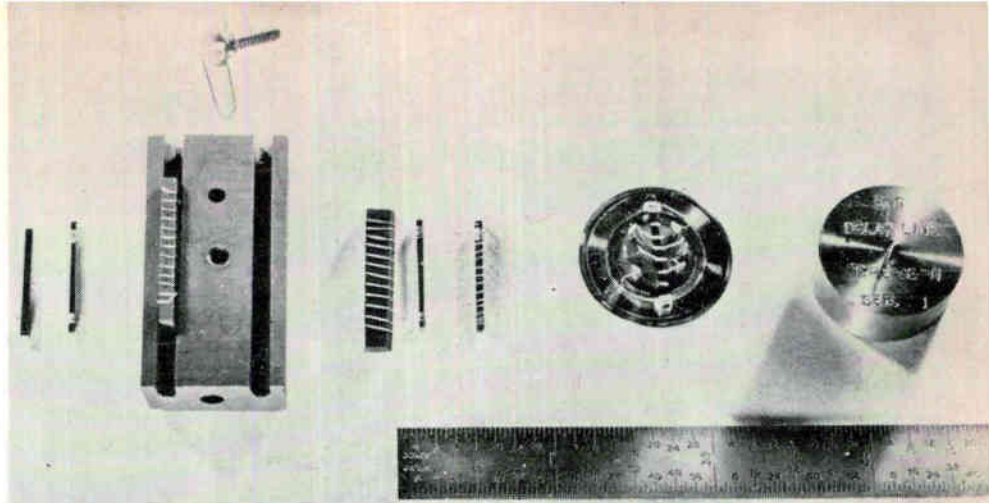

Semiconductor delay line fabrication steps: etched bar, gold wire wrapped around ends, alloying jig, graphite mandrel wrapped with aluminum wire, and delay line after alloying, mounted on header and sealed in case

reentrant electron beam, making significant bandwidth increases possible.

New radar power amplifier tube with a wide frequency range was described by Carl Burklund, Sperry Electron Tube division of Sperry Rand. Still under development, it is expected to improve the ability of ground defense radars to avoid enemy airborne countermeasures and jamming by permitting high-power frequency shifts.

The tube is called the Meanderline traveling wave tube because of its unusual construction (see photo). Its signal is transmitted along the surface of one or more conductors which meander the length of a two-foot row of parallel rings within the four-foot tube envelope. The electron beam travels through the rings.

Meander conductors are made of small diameter copper-plated stainless steel tubes through which liquid coolant is pumped. At present the tube has a 30 percent bandwidth, ranging from 2,550 Mc to 3,450 Mc. Further work is expected



Meanderline traveling wave tube gets its name from shape of tubes used to conduct signal

to produce frequency spreads as large as 5 Gc to 10 Gc.

A. V. Brown, of IBM, reported that if electron beams are used to switch silicon diodes, output currents are higher and switching times shorter than with transistors. Experimental diodes had junctions six microns below the surface. The technique, illustrated below, may provide a high-speed, many position selector-driver for computer core memories.

PHYSICISTS TAKING LEAD?

Is electronic engineering a dying profession? This was somewhat wryly implied to the more than 1,000 designers attending the IRE's 1961 Electron Devices Meeting.

R. Kompfner, of Bell Telephone Laboratories, stated that all major advances in the profession are now being made by physicists rather than engineers.

Unless engineers are willing to abdicate creativity to physicists, they must keep abreast by continuous education, Kompfner said. He gave an invited paper on masers and optical masers

power output of 500 Kw, 13 db gain, 15 percent bandwidth and 35 percent efficiency. One-megawatt tubes are now being built. The Dematron design for the first time, permits gains of greater than six db in a distributed emission crossed-field amplifier without the use of the regenerative feedback of

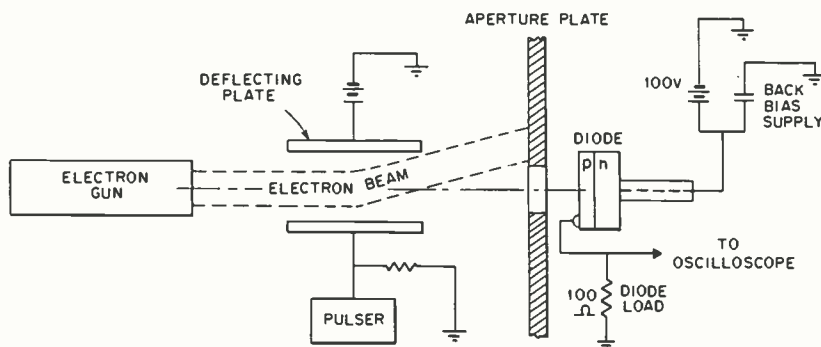

Experimental setup for switching diodes with electron beam

New England Research Cluster Grows

NEREM will draw 15,000 engineers to Boston next week, making it the industry's third largest show and reflecting area's growth

By THOMAS MAGUIRE,
New England Editor

BOSTON—The 15th Northeast Electronics Research and Engineering Meeting will be held here next week amidst evidence that New England is further strengthening its position as a principal center of electronic research—and that this role is reshaping the entire New England economy.

More than 15,000 are expected to attend the three-day NEREM, which will open Tuesday at Commonwealth Armory and the Hotel Somerset under sponsorship of the Boston, Connecticut and Western Massachusetts sections of the IRE. Since 1947, NEREM has grown from a hotel exhibit into the third largest national electronics convention.

The technical program of more than 80 papers has been organized with a view to reflecting the role of New England in the vanguard

of electronics R&D.

Indicative of the area's enhanced role in research is the increasing number of decisions by non-New England companies to establish research laboratories in the area. Most recent examples are P. R. Mallory Co., Burnell & Co., Sperry-Rand and Kennecott Copper.

Laboratories Are Spur

Attracting these and other companies to the New England area are its two focal points of advanced electronics: Massachusetts Institute of Technology and the Air Force's Hanscom complex.

The Hanscom complex, core of which is the Electronic Systems Division at Hanscom Field in Bedford, Mass., has been given primary responsibility as a division of the AF Systems Command to design, develop and produce the electronic command and control systems of the future. The Hanscom complex is fast moving to the point where it

will directly control the allocation of \$1 billion per year in ground electronics for aerospace command and control, notably the "L" systems. Included in the Hanscom complex, in addition to ESD, are AF Cambridge Research Laboratories, MIT Lincoln Laboratory, the Rome, N. Y., Air Development Center, and Mitre Corp., the private non-profit firm which is engineering systems adviser to ESD.

Since World War II, more than 400 science-oriented enterprises have been started in the Boston area. Most are in the electronics field, and many have sprung directly from MIT labs.

Another attraction for science-based companies is the fact that there are about 30,000 degree-holding scientists and engineers in the Greater Boston area, one of the greatest concentrations in the free world.

Interdisciplinary Research

Among the most significant new developments in New England electronics—and sweeping across academic, military and commercial segments of the industry—is the emergence of interdisciplinary research as the major emphasis.

Already organized at MIT are the new centers cutting across traditional departments: the Centers of Materials Science and Engineering, Communication Sciences, Life Sciences, Earth Sciences, and Aeronautics and Astronautics.

Analogously, the staffs of the Electronics Research Directorate and the Geophysics Research Directorate at Hanscom Field have been merged into the AF Cambridge Research Laboratories. "The classical demarcation between these two research areas over the past decade has become increasingly blurred," says Brig. Gen. B. G. Holtzman, commander of AFCRL.

Decision of the world's largest copper producer, Kennecott Copper

Tv Helps Train Air Officers

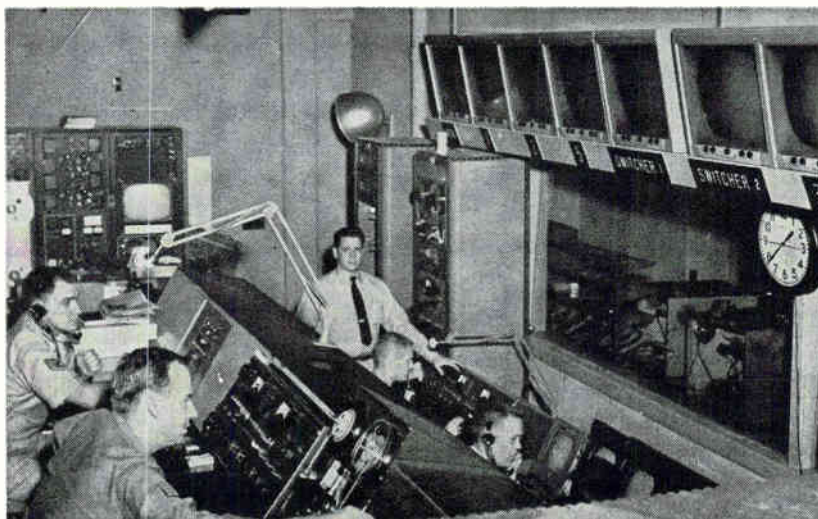

Control room of closed circuit tv system installed by RCA at Air University, Maxwell AFB, Ala., feeds live, film, tape or off-air programs to 165 viewing locations. Auxiliary communications allows students in classrooms to ask questions of lecturer

Corp., to set up a research lab on Massachusetts Route 128 emphasizes the interdisciplinary trend in industry also. The new laboratory will conduct basic research emphasizing solid-state physics of metals. Director will be Ewan W. Fletcher, formerly associate professor of electrical engineering at MIT.

Fletcher recently expressed the goal of "searching for basic relations between electronic, atomic and molecular structure . . . in the form of physical, mechanical, electrical, magnetic and thermal properties of materials.

"We shall cooperate with academic, governmental and industrial groups on an international scale to contribute to the generation of an interdisciplinary materials science which will undoubtedly evolve in the present decade."

Nearly 400 Exhibits

NEREM exhibits at Commonwealth Armory next week will number nearly 400 and will highlight technical advances principally.

Keynote address, "New Directions in Electronics Research", will be given on the opening day by John L. Burns, president of RCA. Also at this formal opening ceremony, Dr. Burns will be honored by Eta Kappa Nu, electrical engineering honor society.

At the NEREM banquet Wednesday night, Charles H. Townes, newly named provost of MIT, will speak on: "Optical Masers: Past, Present, Future and Imaginary".

The NEREM Record will be available on opening day and will include illustrated digests of all technical papers.

New Registration Card

A new registration and product inquiry card will be tried out at NEREM '61. Called Reg-Ident, the plastic "credit card" has been obtained in advance by many NEREM visitors. It is designed to increase speed and efficiency of registration and also simplify the distribution of product literature.

Each NEREM exhibitor will have one or more imprinters to register product inquiries. Using Reg-Ident, either the exhibitor or the visitor can register the inquiry. System will eliminate need for spectators to carry quantities of literature from the show.

November 10, 1961



NEW CERAMIC VACUUM CAPACITORS

HOUSING: CERAMIC
DIELECTRIC: VACUUM
RESULT: Better vibration performance • Greater shock resistance • Higher current ratings • Smaller size

Jennings Vacuum Capacitors already have the unmatched advantage of 19 years of production experience behind them. Now to the proven advantages of a high vacuum dielectric we've added a high strength ceramic envelope for applications that require higher shock, vibration, and current ratings. The lower loss ceramic permits operation at much higher frequencies and temperature levels. High strength ceramic also minimizes problems of physical damage. New design makes mounting easier since the new units are standardized with respect to their mounting rings.

As an example of their capabilities, note the ratings achieved by our ceramic vacuum type CFDB 320 mmfd fixed capacitor.

Size: 2 $\frac{3}{8}$ " x 2 $\frac{3}{8}$ "

Peak Test Voltage (60 cycle): 15 kv

Continuous current —65°C rise: 65 amps @ 12 kv
(4 mc) —100°C rise: 75 amps @ 14 kv

Vibration: 30G to 2,000 cps

Shock: 75G 11 msec.

Capacitance change —65°C to +125°C: 15 ppm.



We will be pleased to send further details about these new capacitors at your request

RELIABILITY MEANS VACUUM / VACUUM MEANS *Jennings*

JENNINGS RADIO MFG. CORP., 970 McLAUGHLIN AVE., SAN JOSE 8, CALIF., PHONE CVpress 2-4025

CIRCLE 33 ON READER SERVICE CARD 33

**POWER,
CONTROL,
SIGNAL
CIRCUITS...**

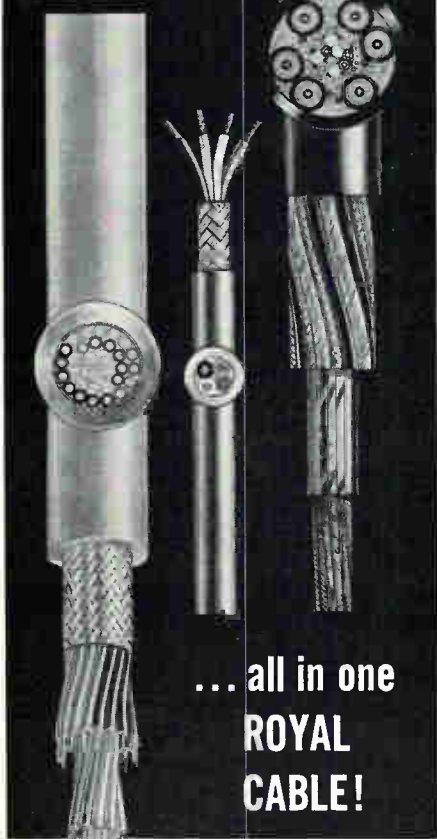

**... all in one
ROYAL
CABLE!**

ROYAL MULTI-CONDUCTOR CABLES are designed, manufactured and quality-controlled to your exact specifications . . . for a myriad of uses . . . for simple or complex applications. Cable elements and materials may be combined to include signal, control and power circuits into one construction and within one jacket. Royal is equipped and experienced to provide a finished cable that will assure predictable, dependable on-the-job performance. And remember, Royal is ready . . . to quote . . . to supply . . . to satisfy.



Write for new Catalog No. 4C-61 . . . (includes charts on Royal RG and special application cables, physical characteristics, test procedures, engineering tables, etc.)

ROYAL ELECTRIC CORPORATION
301 Saratoga Ave., Pawtucket, R. I.
In Canada: Royal Electric Company
(Quebec) Ltd., Pointe Claire, Quebec



Executive Pay Reaches

By A. B. NICHOLS, III,
McKinsey & Co., Inc.,
Management Consultants,
New York, N. Y.

INCOME for chief executives in the electronics industry rose three percent last year as industry sales reached new highs. Although this increase is modest, it was granted in a year when top management pay in industry as a whole was unchanged from 1959.

This information was developed from a survey of top executive pay in 585 American companies listed on the New York Stock Exchange. For purposes of the study, these companies were grouped into 25 major industries to provide a broad picture of top executive compensation.

This survey has consistently shown that the pay of chief executives is closely tied to the level of sales and profits achieved by their companies. This industry-wide compensation relationship also holds true for the electronics industry, as shown by the closely parallel lines

on the accompanying chart.

Chief executives of electronics firms are paid slightly more than their counterparts in industry generally. This differential may be a measure of the risks involved in managing a small company in the rapidly changing electronics industry. For example, an electronics company with sales of \$10 million paid its chief executive about \$5,000 more per year than the average paid by industry generally. However, as the electronics company grows and achieves greater stability in the markets, this pay advantage gradually disappears.

Profits Affect Pay

Profits tell a somewhat different story. The electronics chief executive earns more than his counterparts in industry generally who produce the same profit figure.

Top electronics executives increasingly out-earn other executives as profits grow. This is not surprising in view of the dynamic nature of the industry. It emphasizes that unusually competent ex-

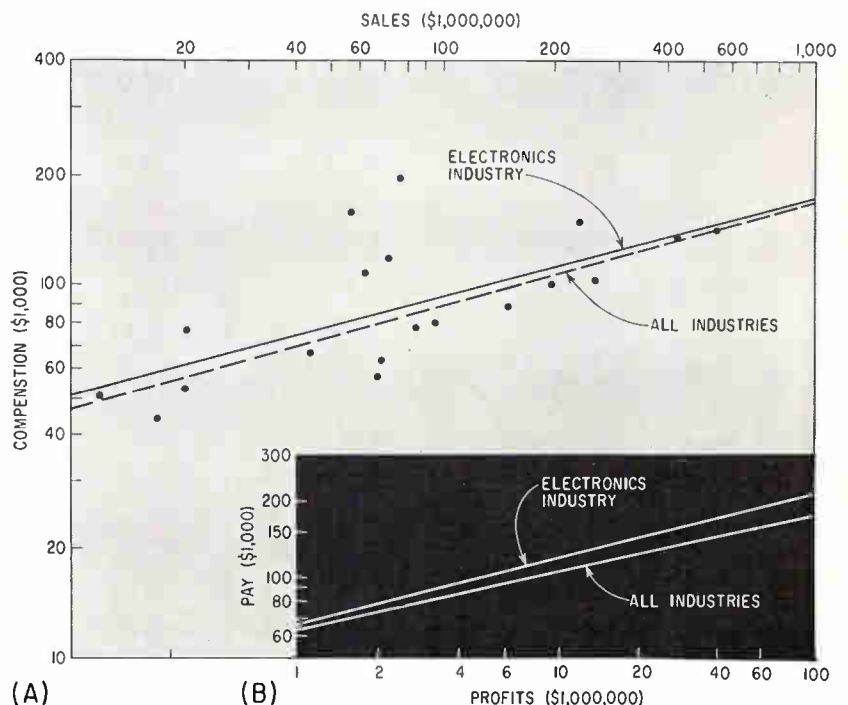

Pay of executives in electronics companies is better than compensation in industry in general, both as percentage of sales (A) and as percentage of profits (B) dots represent actual compensation

New High

EXECUTIVE PAY AS PERCENT OF CHIEF EXECUTIVE'S COMPENSATION

	2nd	3rd	4th
Air transport	65%	59%	57%
Aircraft and missiles	79	62	53
Automotive	71	66	62
Building materials	66	56	49
Business machines	70	53	50
Chemicals	71	63	59
Consumer durables	79	61	61
Department stores	76	70	63
Electrical equipment	67	56	50
Electronics	79	63	59
Foods	71	72	61
Food and drug chains	76	61	51
Industrial metal products	68	55	47
Large diversified companies	76	68	63
Machinery (nonelectric)	69	58	56
Nonferrous metals	69	57	50
Paper	82	66	59
Petroleum	73	62	50
Public utilities	71	55	45
Railroads	60	50	49
Rubber	75	56	46
Soaps, cosmetics, pharm	71	59	51
Steel	95	56	49
Textiles	77	63	59
Tobacco	78	61	55
All Industries	73	61	51

executives are needed to produce profits in electronic companies.

The sensitivity of chief executive pay to company profits shows clearly in company practice within the electronics industry. Over half of the companies studied paid their chief executives the same or less than in 1959. Most of these companies suffered a decline in profits or earned the same as in the year before.

In the more stable industries, top level pay is relatively insensitive to profit shifts. For example, electrical equipment chief executives received a two percent increase in compensation in 1960, while profits actually declined 14 percent.

Pension Pay Low

Data on pension plans suggests that electronics chief executives may have somewhat smaller post-retirement earnings than chief executives in industry as a whole. While 78 percent of electronics companies surveyed have pension plans for top executives, industry generally reports 87 percent. Furthermore, electronics companies estimated annual pension was 17 percent of 1960 chief executive compensation—the lowest level among all industries surveyed. Public utilities chief executives topped the list with pensions averaging 33 percent of recent compensation.

To round out the picture of ex-



THIS SEAL GUARANTEES YOU REAL LACING ECONOMY... increased production with fewer rejects!

Always specify Gudebrod whether you use one spool of lacing tape or thousands because Gudebrod lacing tape is produced under strict quality control. Gudebrod checks and rechecks every lot of tape to insure that it meets the highest standards . . . higher standards than those required to meet MIL-T specifications.

Gudebrod helps increase your production because we carefully test, measure and maintain close tolerances on such characteristics as slip resistance, fray resistance, breaking strength, wax content, fungistatic effectiveness. These and other tests assure you that when Gudebrod lacing tape is used production increases. *Knots don't slip . . . harnesses stay tied . . . assemblies remain firm . . . there are fewer rejects!*

Whatever your lacing needs—Teflon*, dacron†, glass, nylon, high temperatures, special finishes—Gudebrod makes it or will produce a tape to meet your special requirements. If you want a tape to meet 1500°F . . . Gudebrod Experimental Research Project 173 is the answer. If you want a tape that meets MIL-T-713A . . . Gudelace® (Style 18 Natural) is the answer.

MAKE THE H-R TEST! Write for samples of Gudelace or other Gudebrod lacing tapes and have them tested in your harness room. Compare a harness tied with a "Quality Controlled" Gudebrod tape and any other tape. This test will convince you that when you specify Gudebrod you specify *real* economy—increased production with fewer rejects.

Write for our free Technical Products Data Book. It explains Gudelace and other Gudebrod lacing tapes in detail.

*Dupont's TFE fluorocarbon fiber.

†Dupont's polyester fiber.

GUDEBROD BROS. SILK CO., INC.

Electronics Division
225 West 34th Street
New York 1, New York

Executive Offices
12 South 12th Street
Philadelphia 7, Pa.



You mix 'em!

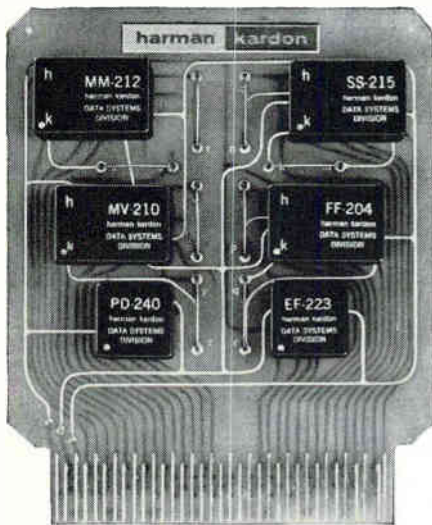

We mount 'em!

To your systems specifications

on **Flexi-Card**

Harman-Kardon's new economical Digital Card Assembly

Now, Harman-Kardon's new flexi-card circuit assemblies bring logical versatility to logical circuits. Each Flexi-card is factory-assembled to your specific requirement quickly, and at competitive prices, for any of the thousands of combinations of digital logic you require.

...And two new series of Encapsulated Logic Modules

Completely compatible modules now available at 125°C. • 5 MC. • 250 KC.

Send for complete details and...
FREE guide to Boolean Algebra!

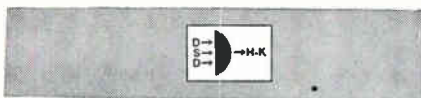

Data Systems Division



INCORPORATED • PLAINVIEW, L. I., N. Y.

ecutive compensation in the electronics industry, the study was extended to include the second, third, and fourth highest paid men in each company. Expressing their pay as a percentage of chief executive compensation discloses that these executives are above the number two, number three, and number four men for all industry. For example, the second highest paid executives among electronics companies averaged 79 percent of the top man's compensation, as against 73 percent average for the number two men in industry as a whole.

Those electronics executives just below the chief executive are closing the pay gap on the boss. Again taking the number two executives as an example, they received pay increases approximating 12 percent over 1959, while chief executives received only three percent. Apparently the pay of next-in-line electronics executives continued to rise in line with increases in sales volume.

Yet top electronics executives fared well compared with chief executives throughout industry. Only three of the 25 industries studied increased the compensation of their top men by more than three percent, and in 14 out of the 25 industries, chief executive pay was actually lower than in 1959. Chief executives in the tobacco industry took a seven percent pay set back. The big gainers were chief executives in air transport, who averaged nine percent above 1959 compensation.

Another Orthicon Made



Toshiba reports it will be making about 100 a year of 4.5-inch image orthicons for tv tape recording. This size tube is also being made by RCA and the English Electric Valve Co.

Computer Controls Rocket Testing

ON-LINE automatic data acquisition system and computer complex (Adacc) is used at the Naval Propellant Plant, Indian Head, Md. to



Test is watched in blockhouse

step up pilot production of more efficient fuels for motors used in Polaris and other missiles.

To date, over 300 firings have been completed with the system. Capt. Otis A. Wesche, commanding officer, says the system has increased production 20 to 25 percent. In addition to on-line analysis of motor characteristics, the system helps prevent costly motor blowups.

Adacc was designed primarily for static firings. It includes a \$400,000 data system, built by Interstate Electronics Corp., and a rented RCA 501 computer. System costs can be recaptured in a year by savings.

The acquisition system consists of an analog section feeding the computer through a digital assembly and adapter unit. The computer can work on other programs up to test time. After the motor fires and is analyzed—about three minutes—the program is resumed.

Any of 128 previously calibrated transducers can be selected for a test. Calibrations stored on tape are selected at time of interruption according to preset identification words on the console. ID words are transmitted with data to the computer. Errors arising during transmittal can be corrected by an off-line program. The computer checks firing conditions every 6 msec.

The Navy plans to expand Adacc programs until practically all large scale firings are handled.

ELECTRON TUBE NEWS from SYLVANIA



Recording data on film with fiber optic CRT.

- 30 times increased light output
- improved image resolution

NEW! FIBER OPTIC CRT's!



At Sylvania, the amazing phenomenon of optical fibers is revolutionizing resolution capabilities of cathode ray tubes. These tiny light pipes, transparent dielectric cylinders only 10 microns in diameter, conduct light from the phosphor screen to the outside surface of the CRT face. This dramatic new technique completely eliminates parallax. Used in photo-recording applications, it eliminates lens requirements, enables direct photoprinting.

Now available for sampling are: 5" diameter CRT's with faceplates composed entirely of optical fibers or with a .250" x 4.125" array of optical fibers for linear scanning; a rectangular 3" x 1½" CRT featuring a .250" x 2.750" array of fiber optics. These remarkable tubes can be supplied with either electrostatic or magnetic deflection and

focus and with aluminized or nonaluminized P11 or P16 screens.

Currently under development are fiber optic CRT's capable of magnifying images and of coding signals by "scrambling" light transmission.

If your project calls for exceptionally high resolution in photo recording, flying spot scanning, mapping or reconnaissance systems, these extraordinary developments deserve your careful examination. Ask your Sylvania Sales Engineer for complete information.

NEW from SYLVANIA!

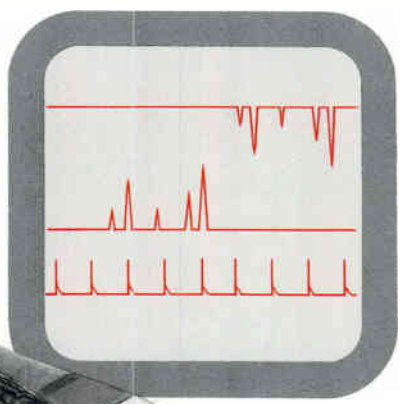

3-Gun Spiral Accelerator

for multiple tracking radar

Sylvania SC-3090 is a high-precision instrument with a 5½" square face. Its tri-gun structure is so accurately designed and aligned it provides a tracking error of less than .055" at any point on the tube face. Electrostatically deflected and focused, it offers high deflection sensitivity, high resolution and writing speed, minimal pattern distortion. SC-3090 is available with aluminized screen and P19 phosphor.

Single-gun Spiral Accelerators, 5BGP/T51, 5BHP/T54, are available with a new brighter phosphor and "Bonded Shield" safety cap for increased image readability. Assembled on Sylvania-developed mounting jigs to exceptionally close tolerances, they provide superlative precision performance.

Absolute Max. Ratings	SC-3090	5BGP—	5BHP—	Units
Anode #3 Voltage	10,500	13,200	13,200	Vdc
Isolation Shield Voltage	3,500	2,300	2,300	Vdc
Deflection Plate Shield Voltage			2,300	Vdc
Anode #2 Voltage	3,500	2,200	2,200	Vdc
Anode #1 Voltage	1,750	880	880	Vdc

Low drain heater-cathode design
for battery-powered applications . . .

Now in 3 CRT families!

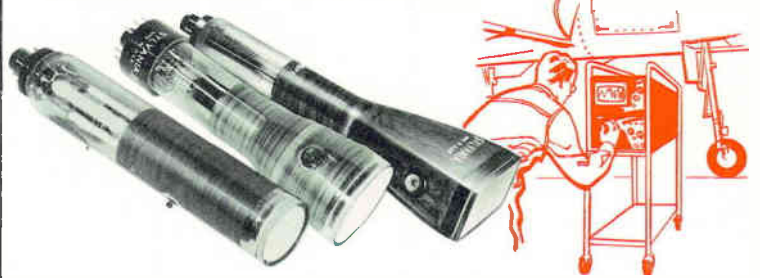

Typical of continuing Sylvania advancements in the "state of the art" is the remarkably efficient heater-cathode assembly employed in Sylvania-3BGP—, 3BMP—, SC-3016. With a rating of 1.5V @ 140mA, it consumes only 0.2 watts and enables battery life of 400 hours from a #6 dry cell operating up to 2 hours daily. Further, it possesses extremely low mass (0.05" dia., 0.011" thick), thereby enhancing resistance to shock and vibration, so vital for reliable, portable operation. Significantly, this unusual development is adaptable to virtually any existing CRT design.

Key Characteristics	3BGP—	3BMP—	SC-3016	Units
Anode #3 Voltage		6600*		Vdc
Anode #2 Voltage	2750*	2200*	2750*	Vdc
Anode #1 Voltage	1100*	1500*	1100*	Vdc
Face Dimension	1½x3	3	1⅛	Inches
Over-All Length	9¼	10	6	Inches

*Absolute maximum ratings

Low grid drive! Low current heater!

Sylvania-10ANP for radar display



Sylvania-10ANP is ideally suited to compact radar equipment. Here's why: small yoke for increased sensitivity, low grid voltage requirements and 300mA heater enable excellent performance from transistorized power supplies; further, it features small, 0.840" diameter neck, short over-all length of only 16" and 9-pin miniature base.

Sylvania-10ANP offers magnetic deflection and focus, aluminized screen and a wide range of phosphors. Currently under development at Sylvania are 5", 7" and 12" versions of the 10ANP.

If your design demands specialized cathode ray tubes, call on the high quality-quantity capabilities of Sylvania. For technical data on specific types, write Electronic Tubes Division, Sylvania Electric Products Inc., 1100 Main Street, Buffalo 9, New York.



**NEEDED
NOW:**

Radiation-Resistant Components!



Few reliability studies hold such great import for national security as those investigating radiation effects on electronic components. Will, for example, electronic components withstand continuous radiation from the reactor of a nuclear-powered craft?

Intense radiation is known to have disastrous effects on solid-state performance. How, then, do you design for reliable, compact circuitry without imposing prohibitive weight penalties of massive shielding?

One good way: design around radiation-resistant Sylvania Gold Brand Subminiature Vacuum Tubes. All Gold Brand Subminiature types are rated for steady state radiation resistance. Extensive testing prove them capable of withstanding 10^{12} neutrons/sq. cm./sec. dose rate

for a total dosage of 10^{16} neutrons/sq. cm. Further, Gold Brand Subminiature Tubes tolerate pulses of pure gamma radiation of approximately 10^6 R./sec. Compare this with the gamma dose rate of 0.1 R./sec. absorbed $\frac{3}{4}$ mile from a 20KT bomb—it's well within the operating capability of Gold Brand Subminiature Tubes.

Vacuum tubes are compatible not only with nuclear environments but extreme shock and excessive temperatures. Extended periods of storage, too, have little or no effect on vacuum tubes. Ask your Sylvania Sales Engineer for complete information on the many remarkable capabilities of electronic tubes. He can supply you with detailed documentation of Sylvania Gold Brand Subminiature Tube reliability.

bright performance lights up sales
when you design around . . .

SYLVANIA CdS Photoconductors

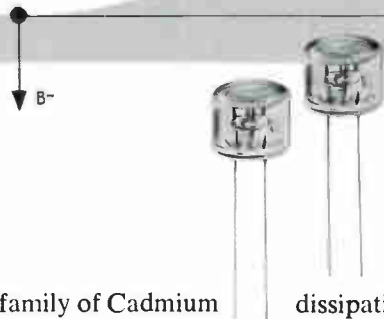
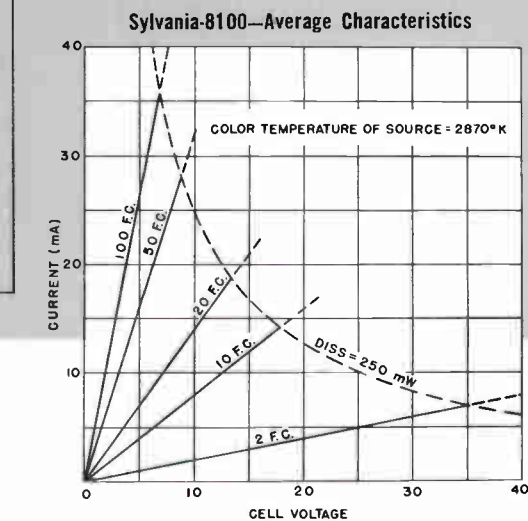
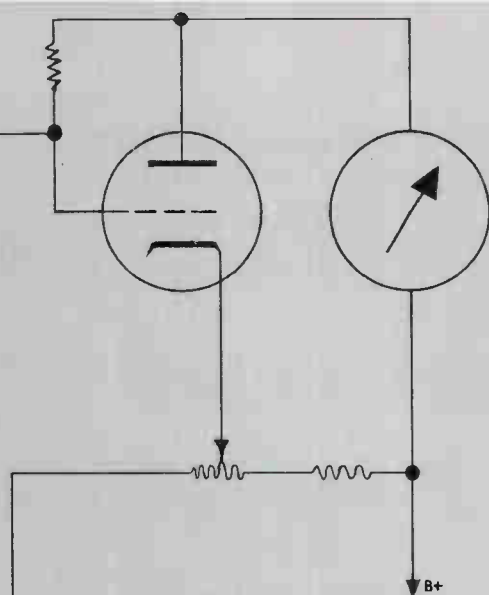

Sylvania-8100 is the first of a new family of Cadmium Sulfide photoconductive devices for industrial-commercial light-actuated control applications. Proven in self-adjusting TV brightness and contrast controls, Sylvania-8100 features two foot-candle resistance of 5000 Ohms and a minimum dark resistance of 200,000 Ohms.

Sealed-in-glass techniques provide a moisture-resistant device, protect wafer, assure long, reliable life.

Blue Dot Protection on light-sensitive wafer indicates device is vacuum-tight. If the unusual occurs and a leak develops, blue dot turns to pink . . . a special confidence feature on all Sylvania photoconductors.

Hydrogen-Filled after thorough evacuation; improves

dissipation characteristics, enhances stability and uniformity.

Automated Techniques provide excellent control of physical characteristics such as the configuration of electrodes on the CdS wafer, assure superior characteristics of uniformity.

If your design area includes lighting, sorting, door controls, headlight dimmers, data processing, fire or smoke detection or similar work, contact your Sylvania Sales Engineer. He will give you complete information on this and other photoconductors under development at Sylvania. For technical data on Sylvania-8100, write Electronic Tubes Division, Sylvania Electric Products Inc., 1100 Main St., Buffalo 9, N. Y.

SYLVANIA

SUBSIDIARY OF

GENERAL TELEPHONE & ELECTRONICS



TWA's superior experience is your assurance of superior cargo service



Fast, efficient service across the country or across the Atlantic. Detailed, meticulous service. When your business can profit by that kind of service, call TWA Air Freight. To serve you as no other airline can, TWA has:

Exclusive nation-wide, world-wide routes. Only TWA can give you one-carrier service to key cities within U. S. and major markets in Europe, Africa and Asia.

Experienced personnel. TWA's cargo experts are professionals like yourself. Abreast of the latest developments, they're ready to serve you with knowledge and skill.

A fast growing fleet of modern planes. Fast SuperJets and all-cargo Jetstream express flights move cargo of all descriptions over the world day and night.

Unsurpassed maintenance for on-time performance. Care that exceeds government standards keeps TWA planes in peak condition. Experience keeps them on time.

TWA has grown with the air freight industry. What's more, we've planned for its future. That's why in the busy years to come, TWA will continue to deliver your goods where the business is . . . *quickly, efficiently, dependably!*

Call your freight forwarder, cargo agent or nearest TWA Air Freight office for details of how TWA Air Freight can save you time and money.

*TWA THE SUPERJET AIRLINE is a service mark owned exclusively by Trans World Airlines, Inc.

TWA THE
SUPERJET
AIRLINE®
U.S.A. · EUROPE · AFRICA · ASIA

Lapp

TUBE SUPPORTS for air-cooled power tubes

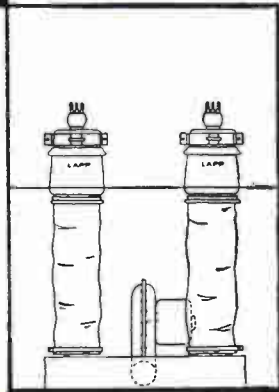

Since forced-air-cooled tubes were first introduced, equipment manufacturers have been designing their own supports, many of which

have been produced by Lapp. To standardize the great variety of tube support designs, Lapp set out to design a complete line which is now available and offers the equipment manufacturer a valuable service by way of more economical production, interchangeability and availability of replacement units. Lapp Tube Supports are compact, efficient and attractive in appearance. Their duty is threefold... they support the tubes, insulate, and furnish an air duct which channels air over tube fins for maximum cooling. Write for Bulletin 301, with complete description and specification data. Lapp Insulator Co., Inc., Radio Specialties Division, 185 Sumner Street, LeRoy, New York.

Lapp

MEETINGS AHEAD

COMPUTERS, Transistorized, Effective Use of Marginal checking, PGRQC of IRE, PGEC of IRE; Burroughs Corp, 215 Park Ave S., N.Y.C., Nov. 13.

EXPLODED WIRE Phenomena, Electrical, Air Force Cambridge Research Laboratories, Hotel Kenmore, Boston, Mass., Nov. 13-14.

MAGNESIUM & MAGNETIC MATERIALS, IRE, AIEE, AIP, ONR, AIME; Westward Ho Hotel, Phoenix, Ariz., Nov. 13-18.

MATERIALS AND DESIGN Exhibition Conf., Earls Ct., London, Nov. 13-18.

RELIABILITY Symposium, Electronic System, IRE, Linda Hall, Library Auditorium, 5109 Cherry, Kansas City Mo., Nov. 14.

NEREM, Northeast Research & Engineering Meeting, Commonwealth Armory and Somerset Hotel, Boston, Mass., Nov. 15-17.

AEROSPACE ELECTRICAL SOCIETY, Pan Pacific Auditorium, Los Angeles, California, Nov. 15-17.

ELECTRICAL MANUFACTURERS, National Assoc., Annual, Plaza Hotel, New York City, Nov. 16.

VEHICULAR COMMUNICATIONS, PGVC of IRE; Madison Hotel, Minneapolis, Minn., Nov. 30-Dec. 1.

JOINT COMPUTER CONFERENCE, Eastern, PGEC of IRE, AIEE, ACM; Sheraton-Park Hotel, Washington, D.C., Dec. 12-14.

RELIABILITY AND QUALITY CONTROL, 8th National Symposium, PRGQC of IRE, AIEE, ASQC, EIA; Statler Hilton Hotel, Washington, D.C., Jan. 9-11.

MILITARY ELECTRONICS, 3rd Winter Convention PGMIL of IRE (L. A. Section); Ambassador Hotel, Los Angeles, Calif., Feb. 7-9.

SOLID STATE CIRCUITS, International Conference, PGCT of IRE, AIEE; Sheraton Hotel and University of Pennsylvania, Philadelphia, Pa., Feb. 14-16.

SWITCHING THEORY, Application to Space Technology Symp., USAF, Lockheed Missiles & Space; Lockheed, Sunnyvale, Calif., Feb. 27-Mar. 1.

SCINTILLATION AND SEMICONDUCTOR Counter Symp. PGNS of IRE, AIEE, AEC, NBS; Shoreham Hotel, Washington, D. C., Mar. 1-3.

IRE INTERNATIONAL CONVENTION, Coliseum & Waldorf Astoria Hotel, New York City, Mar. 26-29.

SOUTHWEST CONFERENCE AND SHOW; Rice Hotel, Houston, Tex., April 11-13.

JOINT COMPUTER CONFERENCE, PGEC of IRE, AIEE, ACM; Fairmont Hotel, San Francisco, Calif., May 1-3.

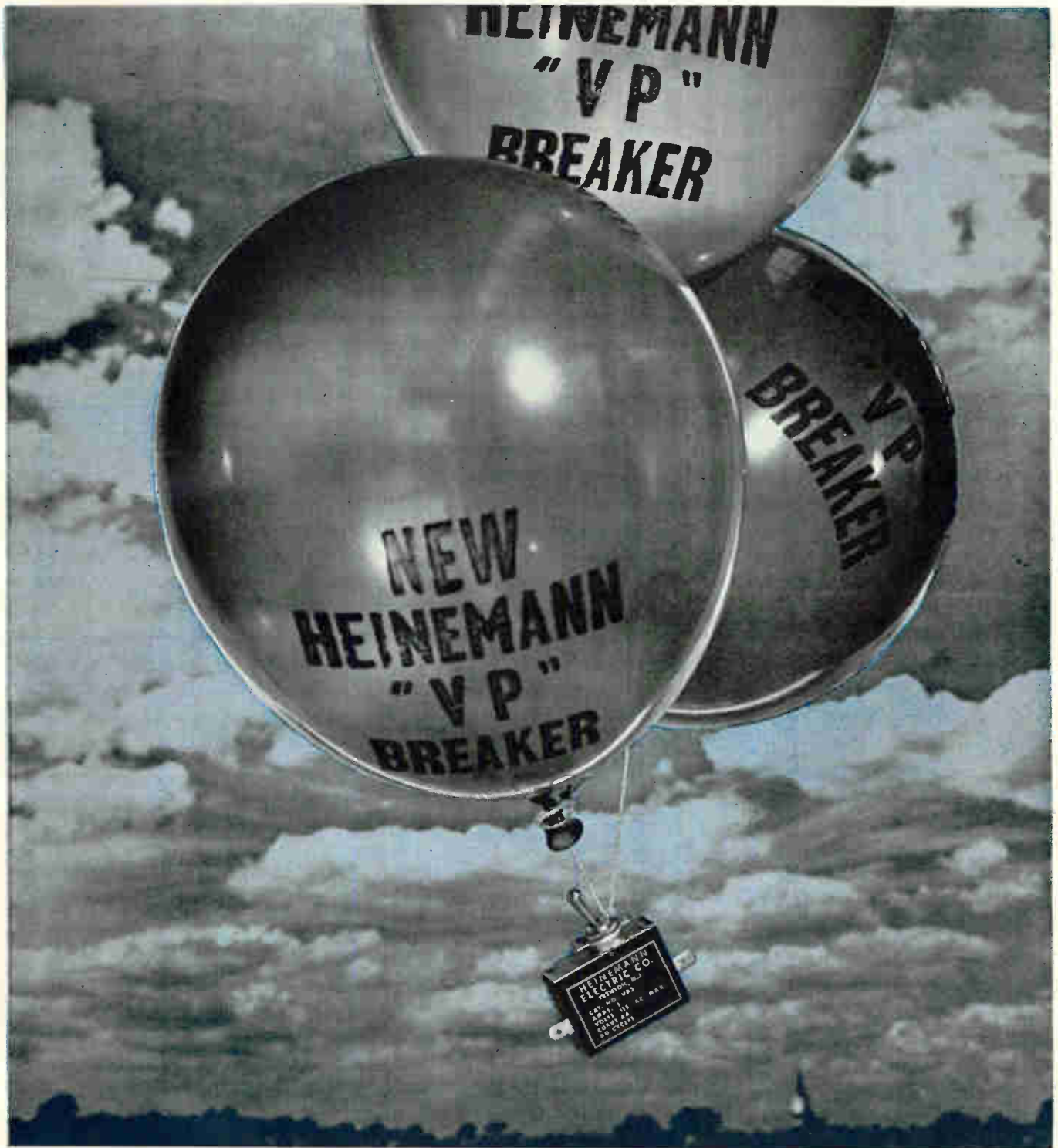

Only 1-1/2 ounces (including the switch plate)

Heinemann's new Series VP may well be the lightest circuit breaker made. For sure, it's one of the smallest and most compact you'll find around. Yet, remarkably, it's capable of handling all the functions of much larger Heinemann breakers.

It is temperature-stable. Current rating and calibrated trip-points are completely unaffected by ambient

temperature. No derating . . . ever.

It is available with a choice of time relays. You can have either a "fast" or "slow" delay. Or instantaneous response.

It can be furnished with any of Heinemann's special-function internal circuits. With a little ingenuity and a special circuit, you can make the breaker do such out-of-the-

ordinary chores as remote switching, circuit "slaving," alarm signaling.

The matchbox-size Series VP is available in any integral or fractional rating you might need, from 0.050 to 15 amps (at 110V, 60 or 400 cycles AC, or 50V DC).

Bulletin VP will give you detailed specifications and dimensions. A copy is yours for the asking.

HEINEMANN ELECTRIC COMPANY  **176 BRUNSWICK PIKE, TRENTON 2, N. J.**

SA 2460

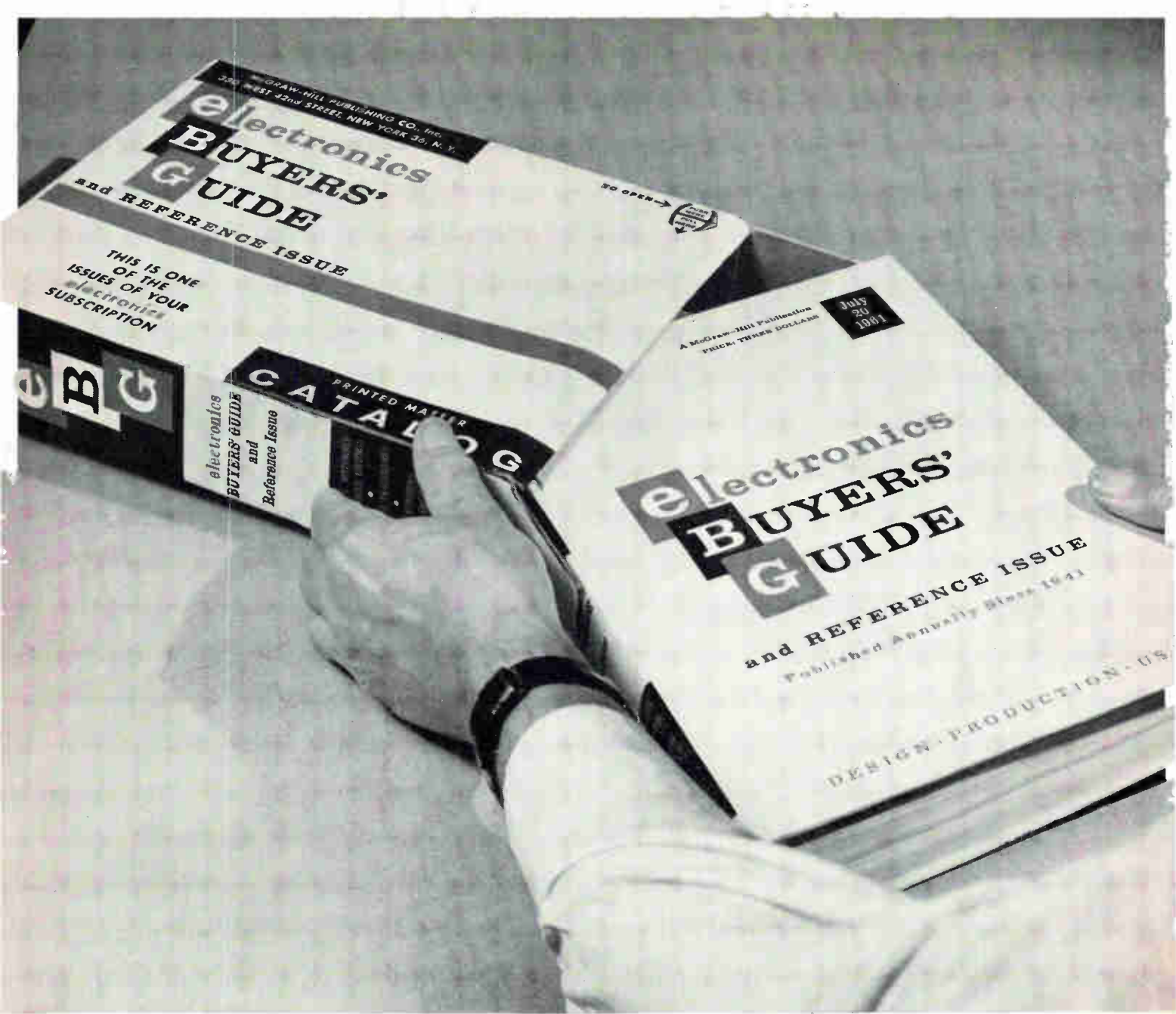

Look for new, time-saving IDEA INDEX in your new 1961 EBG!

NEW! Complete INDEX OF EDITORIAL ARTICLES, broken down by subject matter, that have appeared for a full year in *electronics*, published in EBG for the first time ... available nowhere else.

NEW! ABSTRACTS of all 1961 Feature Articles published to date in *electronics*, appears in EBG only. This makes the Index of articles fully meaningful for users and provides a quick summary of the editorial highlights of an entire year's effort.

4 MORE IDEAS THAT MAKE EBG THE MOST USED CATALOG-DIRECTORY IN THE INDUSTRY!

- *Specific Product Listing!* No matter how many products a company makes, each is listed under its specific heading, more than 3,000 are cross indexed. Listings are ACCU-

RATE, COMPLETE, AUTHENTIC. *Specially Edited Reference Section!* 64 pages of Data — an invaluable source of buying information about military electronic procurement, subcontracting, materials information centers, listing of industry organizations, government services, design data, extensive symbols dictionary. *Registered Trade Name Index!* If a product is known by trade name only, EBG quickly tells who makes it and where to buy it! *Local Sales Office Listing!* The nearest manufacturer's sales office, address, phone number is easily available.

These ideas make EBG the *most used* directory in the industry, make it the *most valuable catalog-directory medium* for electronic advertisers. Makes your advertising in *electronics* pay off 12 months a year, whenever your customers and prospects are ready to buy.

electronics BUYERS' GUIDE and Reference Issue



A McGraw-Hill Publication, 330 West 42nd Street, New York 36, N. Y.



The Basic Buying Book in Electronics

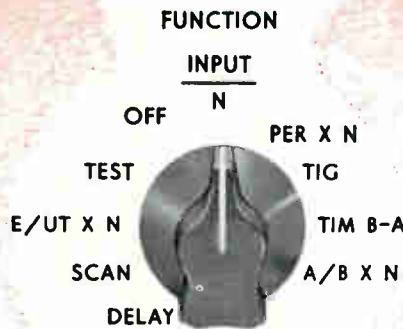
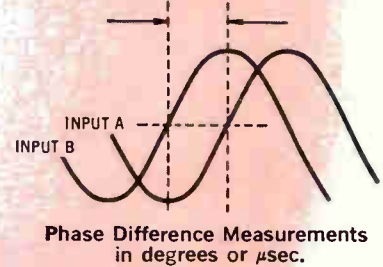
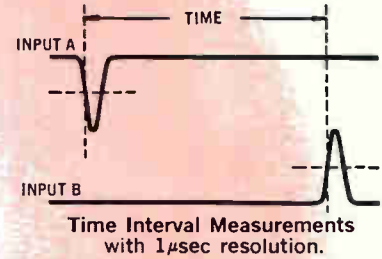
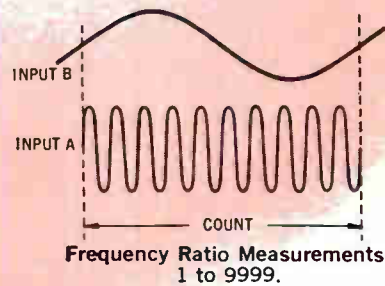
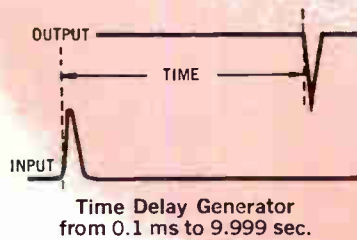
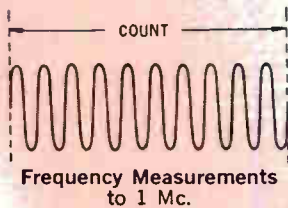
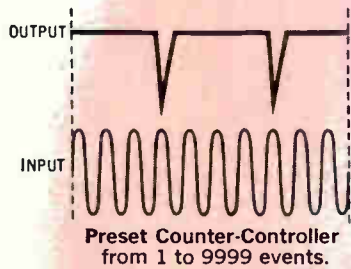
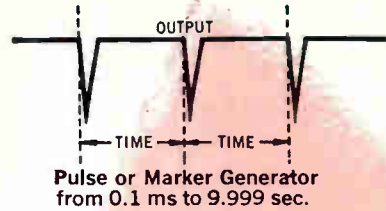
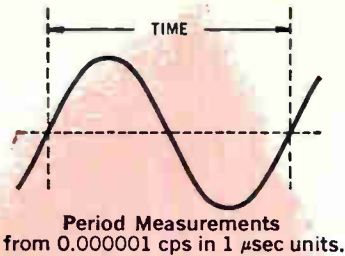

Look what you can do with this DIGITAL TEST INSTRUMENT



As useful as your oscilloscope... the Preset Universal EPUT® and Timer is fast becoming THE basic digital test instrument whenever the accuracy and resolution of digital techniques are called for. With *eight distinct operating functions* this instrument gives you an almost unlimited range of applications... satisfying both present and future needs. The

illustrations above suggest a number of immediate uses for this versatile instrument. You'll discover many more applications through actual use. For complete information on why the Beckman® Preset Universal EPUT and Timer can become your most relied-on digital test instrument, write for Technical Product Bulletin 8361.

BRIEF SPECS: Freq. Range—0 cps to 1 Mc; Timing Units—1,10,100, and 1000 μ sec; Preset Range—1 to 9999; Oscillator Stability—3 parts in 10^7 per week; Input Sensitivity—100 mv (all functions); Price—\$1750.



INSTRUMENTS INC.
BERKELEY DIVISION
RICHMOND, CALIFORNIA

Highly Reliable

HITACHI "SEMI-CONDUCTORS"

For Industrial Use
Switching Transistors and Diodes



2SA18
2SA41
2SA42
2SA86
2SA208
2SA209
2SA210
2SB66
2SB67
2SB68
2SB81
2SB82
2SC89
2SC90
2SC91

Hitachi semi-conductors provide the basis for the excellent capacity of the Hitachi Electronic Computer HITAC 103.



1N34A
1N35
1N38A
1N56A
1N60
1S77
1S78
1S79
1S84

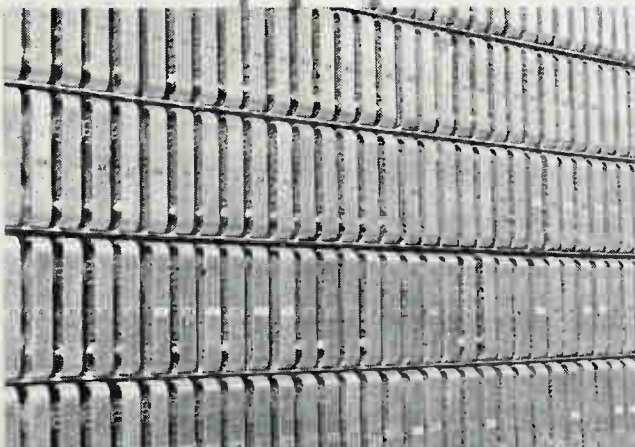

Back of HITAC 103.



Hitachi, Ltd.

Tokyo Japan

Cable Address: "HITACHY" TOKYO

**NOW CURES FAST AT ROOM TEMPERATURE TOO!
(OR 2 HOURS WITH HEAT)**

A clear, solventless liquid, General Electric clear LTV-602* cures at 75-80°C to form a resilient compound with excellent electrical properties. Even thick sections are perfectly transparent. Useful from -65 to 175°C, this self-supporting material provides protection against thermal shock, vibration, moisture, ozone, dust and other hazards.

*Low Temperature Vulcanizing

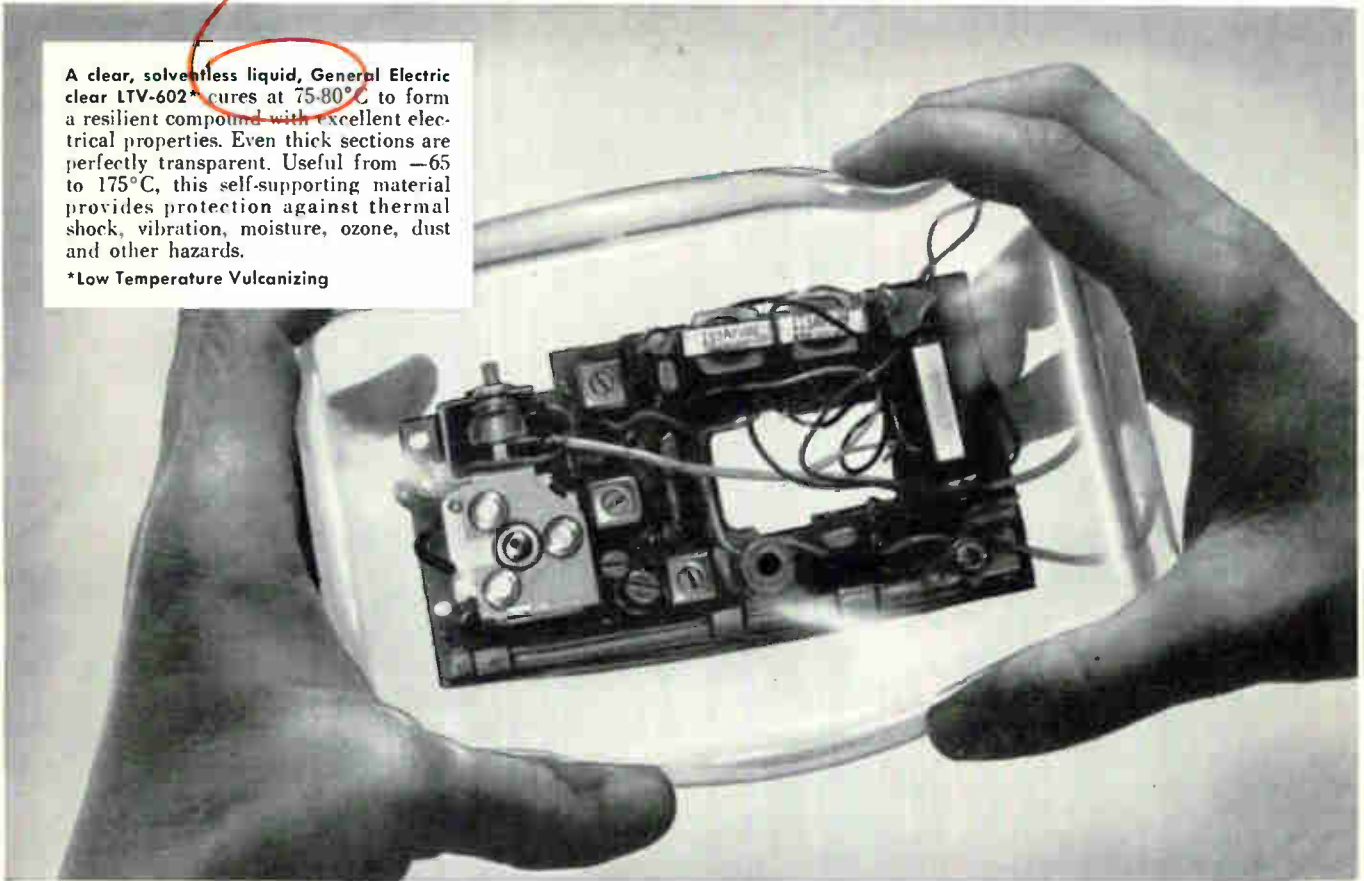

General Electric clear LTV silicone compound for potting and embedding

Transparent, resilient, self-supporting and easy to repair



LTV-602 is easily applied, flows freely in-and-around complicated parts. Having a low viscosity in the uncured state, 800-1500 centipoise, LTV is ideal for potting and embedding of electronic assemblies. Unlike "gel-like" potting materials, LTV-602 cures to a flexible solid. Oven cure is overnight, or from 6 to 8 hours at 75 to 80°C.



LTV-602 is easy to work with and easy to repair. To repair parts embedded in LTV, merely cut out and remove section of material, repair or replace defective part, pour fresh LTV into opening and cure. Pot life, with catalyst added, is approximately 8 hours and may be extended with refrigeration. When desirable LTV may also be cured at room temperature.



Resiliency offers excellent shock resistance. LTV-602 easily meets thermal shock tests described in MIL-STD-202A test condition B which specifies five temperature cycles from -65 to 125°C. Tests indicate that LTV retains protective properties even after 1800 hours aging at 175°C. Other tests confirm LTV's resistance to moisture and water immersion.

**NOW CURES IN
2 HOURS - CAN
EVEN USE HEAT
LAMP!**

LTV-602 is the newest addition to the broad line of G-E silicone potting and encapsulating materials which also include the RTV silicone rubbers. For more information write to General Electric Company, Silicone Products Department, Section N1163, Watford, New York.

**3 TIMES FASTER
THAN BEFORE**

**SEND FOR DATA
ON NEW FAST CURE**

GENERAL ELECTRIC



Select from *four*, big, basic families . . .

VT2	VT4	TV8	VT20
1.5-1.8 amp	3.5-4.75 amp	7.5-10 amp	20 amp

- Get *immediate delivery* from your distributor or the factory on 39 stock sizes and types: single transformers, tandems, with and without over-voltage, low voltage, single-phase, three-phase, cased, fixed mounting, portable, 120V and 240V.
- Choose from *many special features*: tandems, multi-taps, motor drives, concentric controls, special windings, shafts of all types, and job-matched enclosures among others.
- Specify from innumerable possibilities in "custom-engineered" combinations with unusual reciprocating motor drives, complex double-track arrangements, rheostats, toggle switches, and precision switches.
- Pick 36V transformers in 5-, 12-, or 22-amp ratings for your transistorized circuits.

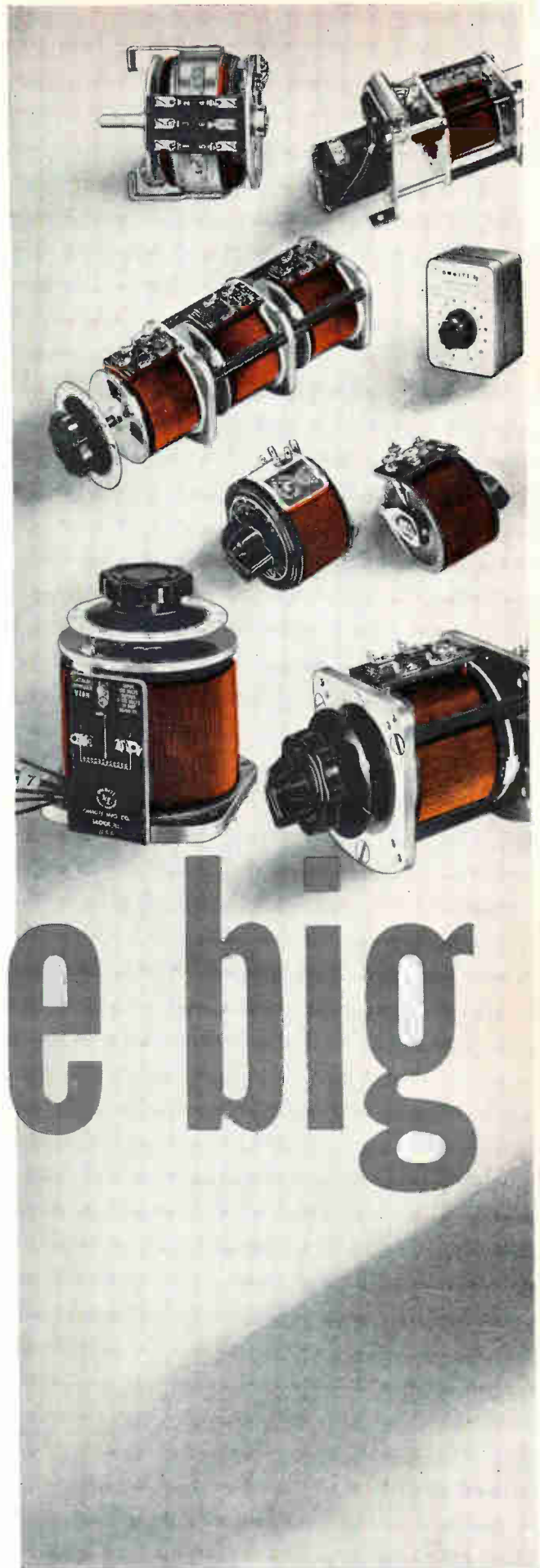

the big

From every aspect, you'll find that Ohmite is a good place to purchase variable transformers. If you need a "special" . . . okay, just tell Ohmite. Need some engineering assistance? All right! What about quantity? Ohmite can handle big orders, medium, and small. The Ohmite VT line of variable transformers is broad and deep. So is the service. Find out by specifying "Ohmite" on your next requirement for variable transformers.

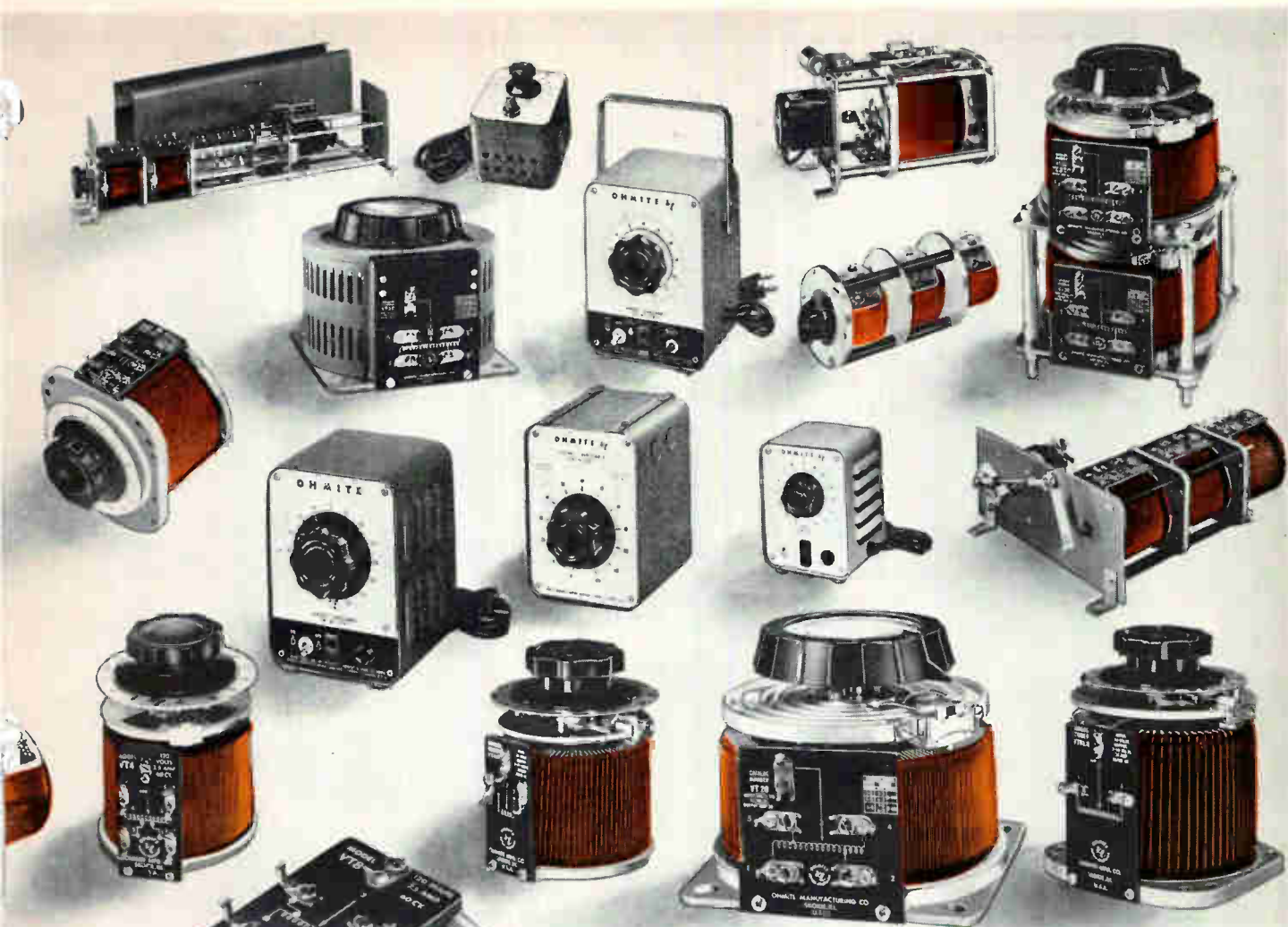

choice in fine variable transformers



OHMITE
MANUFACTURING COMPANY
3610 Howard Street, Skokie, Illinois

Rheostats Power Resistors Precision Resistors Relays
R. F. Chokes Germanium Diodes Micromodules
Variable Transformers Tantalum Capacitors Tap Switches

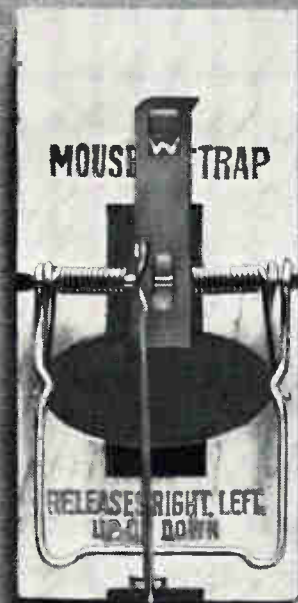

9 billion dollars to build a better one.

We're living in a needing, buying, growing America—a time for new and improved products and services—the creation of new jobs. More than ever, a businessman with an idea, with the urge for something better will move ahead with our expanding economy.

But after the idea, what follows can be a costly period of research and development. Not necessarily—if you use the immense 9-billion-dollar fund of research and patent information that's available at your U.S. Department of Commerce. Think of the saving—in time and money.

For example: there are reports on extensive research by your Government in new products and processes. A trans-

lation of data on inventions and discoveries abroad—information on over 3 million patents—a fortune in patents owned by your Government. All this is yours—for your use and your benefit.

Take advantage of the many ways in which your business can grow. In developing new products and services. In the lucrative foreign markets. In new U.S. markets. In attracting new industry to your local community. Just phone or write the U.S. Department of Commerce Office of Field Services in your city, or Washington 25, D.C. Your U.S. Department of Commerce is always ready to help you grow with America!



NOW'S THE TIME TO GET GROWING IN A GROWING AMERICA!

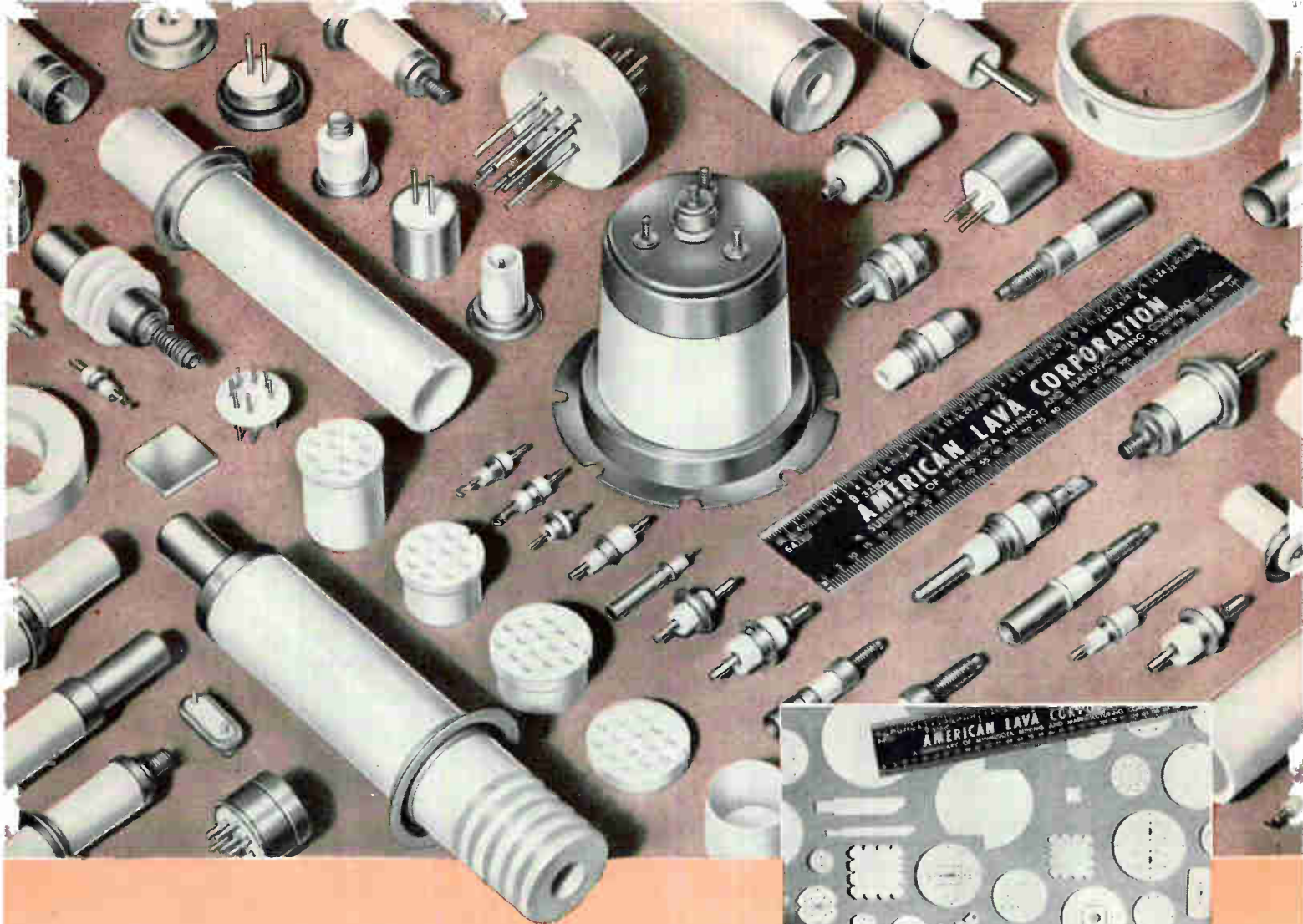

RELIABILITY

IS AN OUTSTANDING CHARACTERISTIC OF

ALSiMAG® CERAMICS

ALSiMag Ceramics offer exceptional resistance to heat and erosion. They have marked electrical and physical stability at elevated temperatures and in varying environments. Chemically inert. Good strength. Can be accurately fabricated in micro-miniatures.

ALSiMag Ceramics include many special purpose ceramics, some especially adapted to hermetic sealing. Widest choice of materials, more than half a century of specialized experience. Send blue print and operating conditions.

ALSiMag pioneered micro-miniature ceramics . . . some as thin as 0.005". Relatively high strength, superior performance at high temperatures, high frequencies. Excellent record for withstanding fatigue, heat, shock, vibration.



The ALSiMag Ceramics in these multiple pin headers may be safely used up to 2800°F. The metal components are the limiting factors.

These tantalum pins with nickel braze alloy operate around 1000° F. All materials are rugged. Strong hermetic seal. Low vapor pressure. High temperature bake-out is practical.

A Subsidiary of
Minnesota Mining and
Manufacturing Company



AMERICAN LAVA CORPORATION

CHATTANOOGA 5, TENN.
60TH YEAR OF CERAMIC LEADERSHIP

For service, contact American Lava representatives in Offices of Minnesota Mining & Manufacturing Co. in these cities (see your local telephone directory): Boston: Newton Center, Mass. • Chicago: Bedford Park, Ill. • Cleveland, O. • Dallas, Texas • Los Angeles, Cal. New York: Ridgefield, N. J. • Philadelphia, Pa. • St. Louis, Mo. • St. Paul, Minn. • So. San Francisco, Cal. • Seattle, Wash. All other exports: Minnesota Mining & Manufacturing Co., International Division, 99 Park Ave., New York, N. Y.

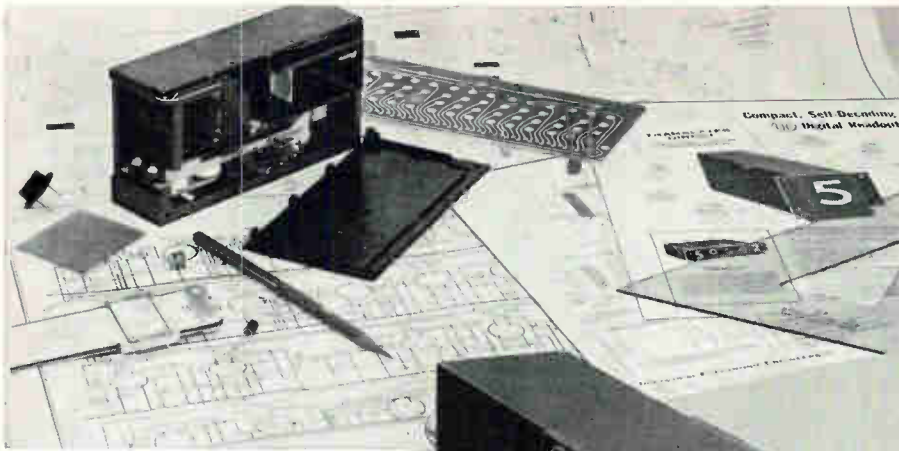

NEW BINARY DECODING DIGITAL READOUT

BINA-VIEW



Now, with the new Bina-View, digital readouts take on an added dimension. Here is a readout that operates direct from binary input, has its own retentive memory, and offers one-plane in-line presentation. Realistically priced and designed with the user in mind, it is not to be confused with other readout devices on the market. The Bina-View Digital Readout fills the long-standing need for a fast, accurate, binary operated display in the fields of digital computers, missile checkout systems, ground support equipment, etc. Its ability to operate within a wide range of binary codes makes it the most versatile readout available today.

Translates Direct—Coded Binary-to-Decimal and Alpha-numeric

Self-Decoding. The new Bina-View Digital Readout accepts any BCD or teletype code up to six bits, does its own translating, and displays the proper character. There are no auxiliary translators, relays, or diodes required.

Low Power. The Bina-View Digital Readout may be operated with as little as ten milliwatts per bit of signal power. It may be connected directly into computers and other electronic equipment.

Character Storage. The Bina-View Digital Readout will continue to display the last character entered after the signal-input power has been removed.

Memory and Verification (Optional). When required, contact closures may be provided for verification that the input signals have been properly accepted.

Practical. The Bina-View Digital Readout offers clear distinct characters, high even brightness, and wide viewing angle. Extremely durable and vibration-free, it is designed for thousands of hours of trouble-free operation.

Prices start at \$50.00 each

Representatives in principal cities.



INDUSTRIAL ELECTRONIC ENGINEERS, Inc.
Engineers & Manufacturers of Fully Automatic Systems & Digital Readouts
5528 Vineland Avenue, North Hollywood, California

Available in individual units or assemblies.
Write today for complete detailed specifications.

CIRCLE 200 ON READER SERVICE CARD

When you need **POWER...**
choose **NICAD**[®]

NEW Nickel Cadmium Rechargeable Batteries

SEALED CELLS

Hermetically sealed and rechargeable, Nicad batteries are small in size, require no maintenance, operate in any position. They make practical the battery operation of many types of equipment not previously suited to dry, mercury, or lead acid types.

VENTED CELLS

High surge power cells, in sintered or pocket plate types, are capable of sustained voltage at high discharge rates over a wide temperature range. They have extremely long life... little or no maintenance. For more of the POWER story, write



NICAD BATTERY DIVISION
GOULD-NATIONAL
BATTERIES, INC. E-1411 First National
Bank Bldg., St. Paul 1, Minn.

52 CIRCLE 52 ON READER SERVICE CARD

MODEL P-25

MODEL EW-16

MODEL FL-202

MODEL VO-38

MODEL TK-20A

MODEL TR-A

MODEL VR-2P

MODEL TR-B

MODEL TR-C

MODEL TK-70B

MODEL VTVM-500

KEW

Around the world it's **KEW**

KYORITSU ELECTRICAL INST. WORKS, LTD.
No. 120, Nakane-cho, Meguro-ku, Tokyo, Japan
Cable Address: "KYORITSUKEIKI TOKYO"
Tel: (717) 0131-5

CIRCLE 201 ON READER SERVICE CARD
electronics

ANNOUNCING THE FAIRCHILD FD600

PLANAR for surface protection and reliability EPITAXIAL for high speed, high conductance DIODES

FAIRCHILD PLANAR EPITAXIAL DIODE STRUCTURE

PLANAR CONSTRUCTION features an integral passivated surface of silicon oxide over the junction, protecting it against contamination.

EPITAXIAL CONSTRUCTION consists of a very pure, high-resistivity silicon layer grown on a low resistance wafer.

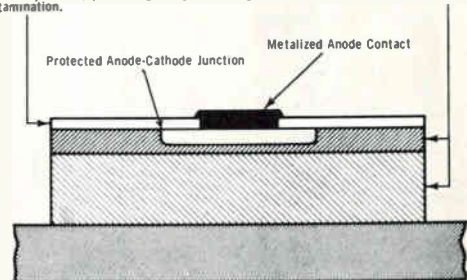

EPITAXIAL CONSTRUCTION

A thin pure silicon epitaxial layer provides high breakdown voltage, low capacitance and fast reverse recovery. Added mechanical strength, low resistance path to the collector connection are made possible by thicker, low resistivity supporting wafer.

SILICON PLANAR RELIABILITY

An integral silicon oxide surface permanently protects the junction against contamination from the start of manufacture.

ADVANTAGES

Increases current handling capabilities of diode matrices without reducing speed. Decreases number of gate amplifiers between diode gates in series diode logic circuitry.

APPLICATIONS

High-speed, high conductance applications such as avalanche circuitry; core drivers; logarithmic amplifiers for pulse applications; critical circuitry requiring high conductance and low internal power dissipation, without sacrificing speed.

FD600 GUARANTEED CHARACTERISTICS

Forward Current	: 200 mA (min.) @ 1 Volt
Breakdown Voltage	: 75 Volts (min.) @ 5 μ A
Capacitance	: 2 μ f (max.) @ 0 Volts
Reverse Current	: 50 m μ A (max.) @ 50 Volts
Power Dissipation	: 500 mW @ 25°C

REVERSE RECOVERY TIME SPECIFIED FOR YOUR USE

◆ For magnetic memory applications

Fast recovery with no turn-off current required

$$t_{rr} = 20 \text{ m}\mu\text{sec (} I_F = 200 \text{ mA, } I_R = 0 \text{ mA)}$$

● For current mode switching in driver applications

Fast recovery with high forward conductance

$$t_{rr} = 2 \text{ m}\mu\text{sec (} I_F = I_R = 10 \text{ to } 400 \text{ mA)}$$

● For diode logic applications

Fast recovery with low reverse current

$$t_{rr} = 4 \text{ m}\mu\text{sec (} I_F = 10 \text{ mA, } I_R = 1 \text{ mA, recovery to } 0.1 \text{ mA)}$$

FAIRCHILD

SEMICONDUCTOR

545 WHISMAN ROAD, MOUNTAIN VIEW, CALIF. · YORKSHIRE 8-8161 · TWX: MN VW CAL 853
A DIVISION OF FAIRCHILD CAMERA AND INSTRUMENT CORPORATION

Standard Order Form for Publications
(Please Print Name, Address, City, State, Zip Code)

FARM & PATTERSON
PUBLISHERS OF ELECTRONICS BUYERS' GUIDE

Advertising

TO: Mr. Paul T. Kelly
55 Public Square
Cleveland 11, Ohio

FROM: Stevens Manufacturing Company, Inc.
Stevens Thermostats
Cleveland 11, Ohio

4203

DATE: June 29, 1962

ISSUE: July 20, 1962
(Annual Buyer's Guide Reference Issue)

1 page color

1 page 2-color

1010.00

1030.00

1010.00

FARM & PATTERSON, INC. *Paul T. Kelly*

Stevens Manufacturing Co.
inc., manufacturer
of Stemco® thermostats

Standard Order Form for Publications
(Please Print Name, Address, City, State, Zip Code)

FARM & PATTERSON
PUBLISHERS OF ELECTRONICS BUYERS' GUIDE

TO: Mr. H. Wenzel
Electronics Support Units and Reference Dept.
310 West 42nd Street
New York 36, New York

FROM: Ray-O-Vac Company, A Division of Electric Storage Battery Company, Madison, Wisconsin

9992

DATE: June 20, 1961

ISSUE: 1962, July 20

1 page 2-color

1

177.75

155

40.15

25

1010.00 (1-page rate of 1,010, plus 155, ad, color)

COMPLETE SECTION

COMPLETE PLATES WILL BE FURNISHED

Ray-O-Vac Company, A Division of Electric Storage Battery Company, Madison, Wisconsin

W.H. Koenig

Ray-O-Vac Company,
manufacturer of a
complete line of batteries
for all radio and electronic
applications — A Division of The
Electric Storage Battery Company

OVER THE TRANSOM — *More than a year prior to issue date*

One month before the 1961-62 electronics BUYERS' GUIDE and Reference Issue was off press, unsolicited, signed contracts for space in the 1962-63 EBG started coming in...an outstanding display of advertiser confidence!

This belief in EBG as the *basic buying book* in the field of electronics has been enjoyed by the BUYERS' GUIDE for more than twenty years. The accuracy of its Product Listings, its unique Reference Section (and new exclusive features in the current issue, including the annual Index of Articles that has appeared in **electronics**, plus Abstracts of engineering articles)...these and many other features inspire confidence so that EBG'S Advertiser Index reads like the "electronics social register." More advertisers (648) used the 1961 EBG than any other catalog-directory serving the electronics industry. Reserve *your* space in the 1962-63 EBG now!



electronics **BUYERS' GUIDE and Reference Issue**

A McGraw-Hill Publication

• 330 West 42nd Street, New York 36, New York

IMAGINATION IN AN INSTRUMENT

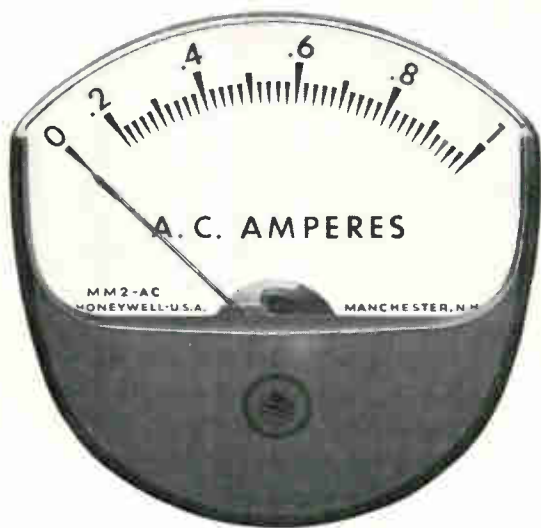

IMAGINATION . . . AN
IMPORTANT
COMPONENT
IN EVERY
HONEYWELL
METER

If hard work and technical skill were the only requirements, almost anyone could build superior meters. But in many meter applications, success depends on the disciplined imagination of gifted designers and engineers. This is where Honeywell is outstanding. We can design and assemble panel instruments to solve any specific problems you may have. In fact, there's an excellent chance that we've already done so. ■ To find out more about quality instruments from Honeywell, get in touch with our representative in your area. He's listed in the classified pages of your telephone directory. Or contact us directly:

Precision Meter Division, Minneapolis-Honeywell Regulator Company,
Manchester, New Hampshire, U.S.A. In Canada, Honeywell Controls
Limited, Toronto 17, Ontario. HONEYWELL INTERNATIONAL
Sales and service offices in all principal cities of the world.

Honeywell



Precision Meters

introducing

an Advanced Materials Service backed by a research organization with extensive experience in

SUPER-PURE MATERIALS

Item: Single crystal nickel, tungsten, tantalum, niobium and molybdenum with interstitial impurity levels of less than 25 ppm in stock.

DOPED MATERIALS

Item: Homogeneous alloys of aluminum-3% boron, indium-3% aluminum, eutectic gold alloys and many others available.

PRECISION SHAPES

Item: Large diameter spheres (greater than .040); super-pure refractory metal foil and wire; strip, discs, buttons, special castings.

The research know-how that produced these breakthroughs can be put to work for your special materials needs. All items available in production and experimental quantities. Write us for full details.



**ADVANCED MATERIALS DIVISION
MATERIALS RESEARCH CORPORATION**
47 Buena Vista Avenue, Yonkers, N. Y.

CIRCLE 202 ON READER SERVICE CARD



115/60-BER-12/600, in case

50 amp power supplies 0.1% regulation

Model	Output Voltage*	Ripple	Delivery	Price
115/60-BER-12/600	12	1 mv, rms	From stock	\$ 945
230/60-BER-28/1400	28	2 mv, rms	Less than 30 days	\$1750

*Output voltage adjustable over $\pm 17\%$ range.

These supplies have magnetic circuit breakers for overload protection, metered outputs, and remote sensing capability. Optional features include modifications for parallel operation and remote programming. Available for 19-inch racks or in case mountings.

Write for complete specifications on these and many other EIC power supplies.

ELECTRODYNAMIC INSTRUMENT CORPORATION

Subsidiary of Reed Roller Bit Company

JA 6-3761 • 1841 Old Spanish Trail • Houston 25, Texas

CIRCLE 203 ON READER SERVICE CARD

Do you know?

29

Yes, 29 Hi-Q engineers and electronic specialists are ready at all times to work "on your staff"...qualified by experience to analyze your resistor/capacitor applications. New units can be designed to meet your specific requirements, if necessary...even if you are looking for the smallest ceramic capacitor in the world! Want further info? Simply write today to...



AEROVOX CORPORATION 1007 SENECA ST.,
CLEAN, NEW YORK

NOW... 2 YEAR WARRANTY
ON ALL
HI-Q CAPACITORS & RESISTORS

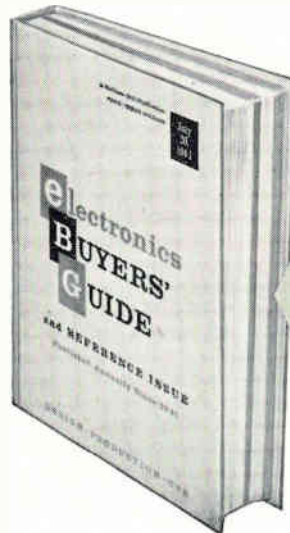

Seen the new IDEA INDEX IN EBG?

The INDEX to the editorial articles in **electronics** magazine, previously published annually in a December issue, now appears ONLY in the EBG. Another original EBG idea that saves time and trouble for users! Keep your EBG copy on your desk!

EXTRA!

Also in the EBG are condensed ABSTRACTS of *all* the editorial feature articles which have appeared to date in 1961. Another reason why EBG is used more by all four - men in research, design, production and management.



McGraw-Hill Publication,
330 West 42nd St., New York 36, N. Y.



GUARANTEED

to meet
"WORST CASE"
 Conditions

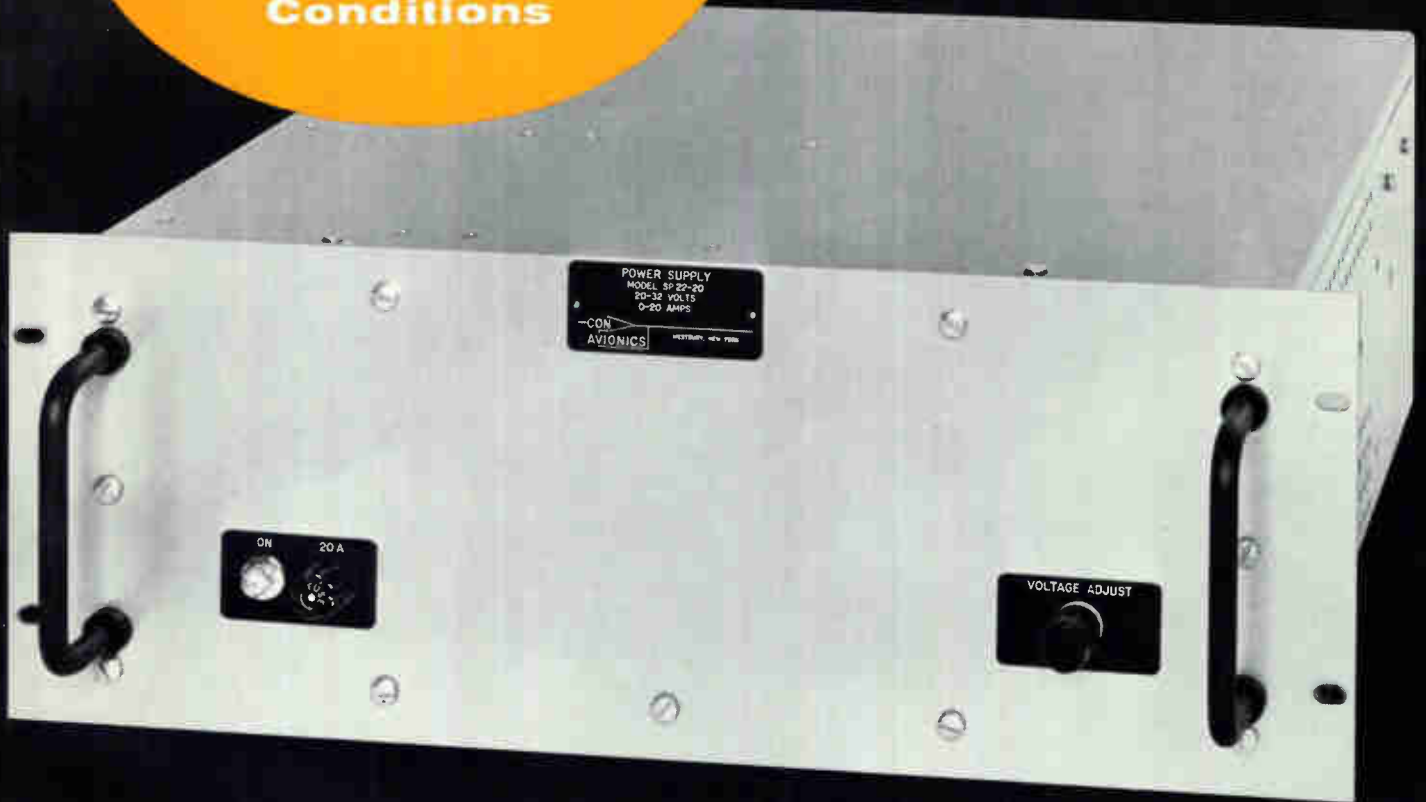

New "Switching" Power Supply Gives More Current at Less Cost

Just out. Con Avionics announces a new line of transistorized "switching" power supplies that provide more current, more reliable current, at a lower cost to you.

The secret? This unit continuously turns itself on and off. The result is exceptionally high current for its size and price. High efficiency is built in through low pass dissipation, high reliability, minimum components and small size. Most of the semi-conductors operate in the switch mode, adding to the long life of the supply.

Priced to compete with magnetic amplifier and constant voltage power supplies, the performance characteristics are decidedly superior. Like all Avionics power supplies these new "switching" power supplies are designed and tested by "Worst Case Analysis" for virtually failure-proof performance.

Voltage Range	50 Amp	30 Amp	20 Amp	10 Amp
24 — 32 V DC	SP28-50 \$820.00	SP28-30 \$590.00	SP28-20 \$525.00	SP28-10 \$450.00
18 — 26 V DC	SP22-50 \$820.00	SP22-30 \$590.00	SP22-20 \$525.00	SP22-10 \$450.00
10 — 20 V DC	SP15-50 \$820.00	SP15-30 \$590.00	SP15-20 \$525.00	SP15-10 \$450.00

Prices subject to change without notice.

CONSOLIDATED AVIONICS CORPORATION
 800 Shames Drive, Westbury, New York

- Send literature on new "switching" power supplies
- Have representative call with demonstrator

Name.....
 Company.....
 Street.....
 City..... Zone..... State.....

CON AVIONICS

A Member
 of The Condec Group

Other Transistorized Power Supplies



GUARANTEED

to meet
"WORST CASE"
Conditions

AC-DC "MODULAR" POWER SUPPLIES 2 to 305 VDC; 100 ma — 1 amp

Unique heat sink construction of these supplies permits operation in ambient temperatures up to 65°C, when mounted on a typical rack chassis. Power to 30 watts. Adjustable output. 0.1% regulation. Reliable short circuit protection. Small size makes it ideal for electronic assemblies or systems. Guaranteed for two years to meet all specifications.

Input 105 to 125V AC
Line Regulation 0.1% or 10mv
Load Regulation 0.1% or 20mv
Stability ±0.25% for 8 hours
Ripple 0.02% or 5 mv rms
Response time less than 100 microseconds
Operating Temperature . . . 0C to 65C on a typical rack chassis
Temp. Coeff. 0.01% per C.

WIDE RANGE POWER SUPPLIES 0-50 VDC/2, 5, 10 and 15 Amp.



For unusually wide voltage range and high current capacity. Three rack-mounted series available with 0.5%, 0.10% and 0.01% regulation. Completely transistorized. Regulated without "gimmick" pre-regulators. Positive short circuit protection. Guaranteed for two years to meet all specifications. Includes remote sensing and programming, fan cooling with thermostat protection. Over-voltage, current-limiting option.

LOW COST GENERAL PURPOSE POWER SUPPLIES 0-60VDC/0-1.5 Amp.



A durable, general purpose power supply available with regulated and unregulated outputs. Simple and straightforward circuitry with components used conservatively for long trouble-free life and high reliability. Designed for ease of operation and convenience in bench-mounting. Cases heavily dimpled so two or more units may be stacked on top of each other.



WARRANTY

Con Avionics guarantees that its power supplies will meet their published specifications for two years after date of shipment. Guarantee does not cover transistors, diodes, fuses.



GMW TRON FUSE
Diameter: .270 inch
Length of Body: 1/4 inch



HWA FUSEHOLDER
Diameter: .500 inch
Length with Knob and Terminals: 15/16 inch

ACTUAL SIZES SHOWN

Another BUSS sub-miniature fuse and holder combination

EXTREME RELIABILITY UNDER HIGH SHOCK AND SEVERE ENVIRONMENTAL CONDITIONS.

Rigid construction of fuse and holder assures extraordinary reliability under high shock and vibration conditions. Fully insulated ceramic body isolates fusible element from effect of dust, corrosion, moisture and vapors.

DESIGNED FOR SPACE-TIGHT APPLICATIONS

Panel Mounted. Holder can be mounted on panel by hand. No special tool required to run down holding nut.

Prong type contacts on fuse make it easy to install or replace.

A knob for the holder may be used to make holder water proof from front of panel.

HOLDER CAN BE MOUNTED IN PRINTED CIRCUITS

Terminals of holder can be inserted into holes and soldered on printed circuit board without additional forming.

If desired, GMW fuse may be used without holder and mounted directly into printed circuit boards.

AVAILABLE RATINGS FOR GMW FUSES.

Fuses are made in sizes from 1/10 to 5 amperes for use on circuits of 125 volts or less where fault current does not exceed 50 amperes.

Transparent window in end of fuse body permits visual inspection of fusible element.

Before crystallizing your design using sub-miniature fuses be sure to get full data on the Buss GMW fuse and HWA holder combination.

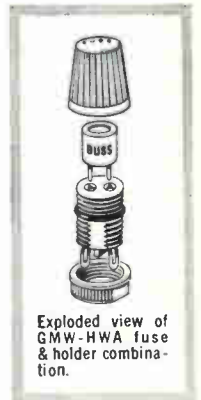

Exploded view of GMW-HWA fuse & holder combination.

IN THE BUSS LINE, you'll find the type and size fuse to fit your every need... plus a companion line of clips, blocks and holders.



BUSSMANN MFG. DIVISION, McGraw-Edison Co., UNIVERSITY AT JEFFERSON, ST. LOUIS 7, MO.



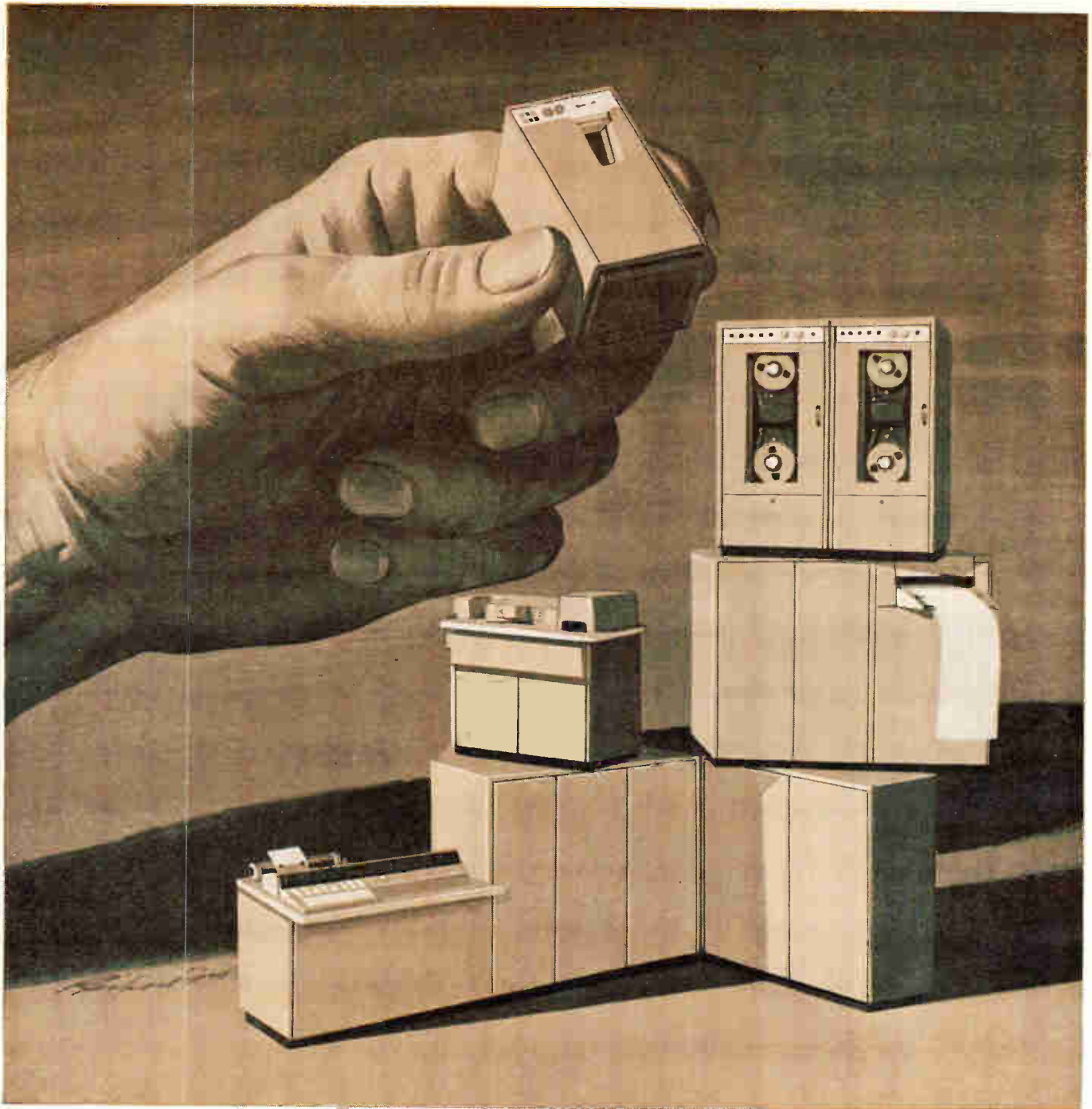

BUILD A BETTER FUTURE AT NATIONAL'S ELECTRONICS DIVISION IN LOS ANGELES

Demand for the National 315 Electronic Data Processing System has brought about rapid expansion at National's Electronics Division. In less than two years the Division's facilities in Southern California have tripled in size.

Because its major activity is development of systems for established commercial markets in 120 countries, the Electronics Division is advancing on exceptionally solid ground. These vast markets, served by National's Marketing Division, point to excellent career stability for the men who create the systems.

If you qualify for one of the new openings, you will experience constant technological challenge and continuous opportunity for personal growth. You will also enjoy discovering that Southern California provides year-round opportunities for recreational and cultural activities.

CAREERS NOW OPEN IN THESE COMPUTER AREAS
 TRANSISTOR CIRCUITRY □ SYSTEMS ENGINEERING □ SYSTEMS TEST ENGINEERING □ SCIENTIFIC, DIAGNOSTIC AND ACCEPTANCE PROGRAMMING □ PRODUCT ENGINEERING □ PRODUCT DESIGN ENGINEERING □ RESEARCH ENGINEERING □ MILITARY SYSTEMS DESIGN

PLEASE SUBMIT RESUME IMMEDIATELY TO ARRANGE FOR INTERVIEW DURING EASTERN JOINT COMPUTER CONFERENCE IN WASHINGTON. Write to Norval E. Powell, Personnel Manager, at the address below.

National[®]

The National Cash Register Company
ELECTRONICS DIVISION
 1401 E. El Segundo Blvd., Hawthorne, Calif. • PL 7-1811
*Trade Mark Reg. U. S. Pat. Off.

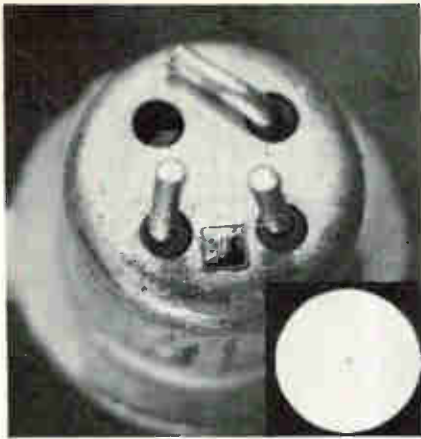

TRANSISTORS—Shown here in magnification is a Mesa transistor with fine gold wire. Handy & Harman manufactures this whisker wire to exact tolerances and highest purity standards. The cap is gold plated from Handy & Harman fine gold anodes. Photo courtesy of Western Electric.

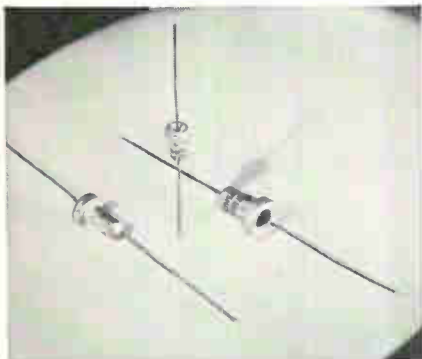

CAPACITOR CANS—These tantalum electrolytic capacitors are completely leaktight and highly resistant to corrosion. The containers that are also used to seal the liquid and internals are drawn from Handy & Harman fine silver sheet. Photo courtesy of Faustel Metallurgical Corporation, North Chicago, Ill.

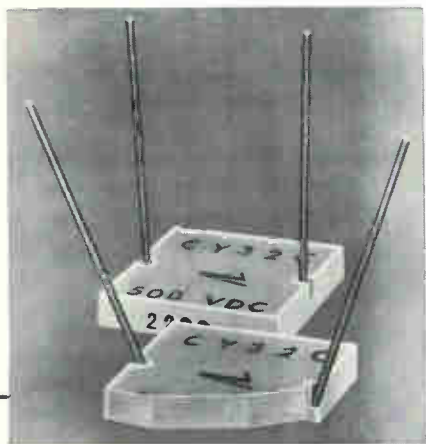

CAPACITORS—Electrodes in these solid-state porcelain capacitors are formed from silver paste derived from Handy & Harman silver flake. Other types of capacitors for high-temperature applications have lead wires of Handy & Harman Consil 998, a nickel-bearing alloy. Photo courtesy of Vitramon, Incorporated, Bridgeport, Conn.

TRANSISTORS, CAPACITORS AND COME WHAT MAY

*... just a few of the jobs involving
HANDY & HARMAN precious metals*

Handy & Harman's effectiveness in supplying the semiconductor and related fields is based on long experience with precious metals, coupled with our interest and ability in working closely with designers, engineers and manufacturers in the electrical and electronics industries.

These few examples are indicative of our continuing and expanding activities in furnishing precious metals: gold and silver and their alloys in wire, strip and foil; silver powders, flake and paint; silver bimetals; silver sintered metals; anodes, etc. The "etc." is our invitation to you to send us any questions you may have regarding the applicability of precious metals in your products or processes.

Would you like further information on these and others of our precious-metals products? Our Technical Bulletins contain a wealth of information and are yours for the asking:

- | | |
|---------------------------------------|---|
| A-1 Fine Silver | A-4 . . . Silver Conductive Coatings |
| A-2 Silver-Copper Alloys | A-5 Silver Powder and Flake |
| A-3 Silver-Magnesium-Nickel | 25 . . Vacuum Tube Grade Brazing Alloys |

Your No. 1 Source of Supply and Authority on Precious Metals

HH HANDY & HARMAN

850 Third Ave. New York 22, N. Y.

Offices and Plants: Bridgeport, Conn. • Chicago, Ill. • Cleveland, Ohio
Dallas, Texas • Detroit, Mich. • Los Angeles, Calif. • Providence, R. I.
Toronto, Ontario • Montreal, Quebec





A full line of capacities from 10 to 52 points. Capable of millions of steps without adjustment.

Fast "Off-The-Shelf" delivery

Overnight delivery on many items at factory prices

When standard CLARE relays or switches meet your needs, distributor service saves you time, costs you no more.

Top quality

—the same fine design and long life you get in CLARE custom-built relays and switches.

Easy purchasing

—you can order CLARE relays at the same time you purchase other components... have them delivered together.

Engineering assistance

—always available from CLARE field engineers who work in close cooperation with CLARE distributors.

CIRCLE 62 ON READER SERVICE CARD

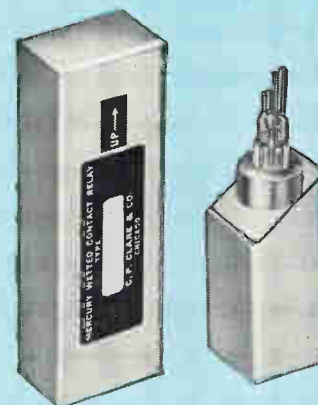

NOW AVAILABLE

...mercury-wetted contact relay modules
for mounting on your own printed circuit board

Type HGM relay module (left) with cut-away (right) showing mercury-wetted switch capsule and coil potted in steel enclosure.

Your nearby CLARE distributor can now supply you with the new CLARE mercury-wetted relays, steel enclosed and ready for mounting. They combine the famous CLARE billion-operation reliability with unusual ease of handling and application. You can choose either the standard CLARE HG relay module or the HGS, super-fast and super-sensitive. Each module contains the CLARE mercury-wetted contact switch capsule with contacts continually wetted by capillary action. They never bounce, never get dirty, never weld and never wear out.



TYPE J RELAY

A compact telephone type relay of unequalled long life and superior performance.

SEALED CONTACT REED RELAY

A highly reliable switching device for single or multiple circuit control... wide mounting versatility.

MERCURY-WETTED CONTACT RELAY

Single or multiple switch capsules potted in steel container. Gives billions of operations with no maintenance.

TYPE F RELAY

A crystal can relay with unusual flexibility and a variety of mounting styles.

of top-quality Clare relays

From these distributors

PACIFIC COAST

1. **Puget Electro Products**
5319 Fourth Ave., South
Seattle 8, Washington
Tel: Parkway 5-9700
2. **Bell Electronic Corporation**
1070 O'Brien Drive
Menlo Park, California
Tel: Davenport 3-9431
2. **Bell Electronic Corporation**
306 E. Alondra
Gardena, California
Tel: Faculty 1-5802
2. **Bell Electronic Corporation**
8072 Engineers Road
San Diego 12, California
Tel: Browning 8-4350

SOUTHWEST

3. **Radio Specialties Co., Inc.**
6323 Acoma Road, S.E.
Albuquerque, New Mexico
Tel: Amherst 8-3901
3. **Radio Specialties Co., Inc.**
209 Penn Avenue
Alamogordo, New Mexico
Tel: Hemlock 7-0370
4. **Engineering Supply Co.**
6000 Denton Drive
Dallas 35, Texas
Tel: Fleetwood 7-6121
5. **Harrison Equipment Co., Inc.**
1422 San Jacinto St.
P. O. Box 1505
Houston 1, Texas
Tel: Capitol 4-9131
6. **Engineering Supply Co.**
1124 East Fourth Street
Tulsa 20, Oklahoma
Tel: Luther 3-8121



EAST

7. **R & D Supply, Inc.**
1492 Highland Ave.
Needham 92, Mass.
Tel: Hillcrest 4-4500
8. **Avnet Electronics Corp.**
70 State Street
Westbury, L.I., New York
Tel: Edgewood 3-5800
9. **Electronic Wholesalers, Inc.**
1301 Hibiscus Boulevard
P. O. Drawer 1655
Melbourne, Florida
Tel: PA 3-1441
9. **Electronic Wholesalers, Inc.**
9390 N.W. 27th Ave.
Miami 47, Florida
Tel: Oxford 6-1620

CENTRAL

10. **Relay Sales, Inc.**
P. O. Box 186
West Chicago, Illinois
Tel: 231-1100
11. **Srepco, Inc.**
314 Leo Street
Dayton 4, Ohio
Tel: Baldwin 6-2546
12. **Pioneer Electronics Supply Co.**
5403 Prospect Avenue
Cleveland 3, Ohio
Tel: 432-0010
13. **M G Electronics & Equip. Co.**
201-3 South 18th Street
Birmingham 3, Alabama
Tel: FA 2-0449

C. P. Clare & Co., 3101 Pratt Blvd.,
Chicago 45, Illinois.
Cable Address: CLARELAY
In Canada: C. P. Clare Canada Limited
840 Caledonia Road, Toronto 19, Ontario.
In Europe: Europelec,
les Clayes-sous-Bois (S.et O.), France.



C. P. CLARE & CO.

Relays and related control components

CHESTER

SPECIALISTS IN QUALITY CABLE CONSTRUCTION FOR THE ELECTRONIC INDUSTRY

Single conductors or any number of pairs . . . for coaxial and control applications. As a "specialist in specials" Chester concentrates on meeting the increasing demands of both military and commercial electronics for plastic insulated wire and cable — particularly coaxial cables and multi-conductor constructions. Typical types are shown here. All Chester products may be varied in conducting, insulating, jacketing, shielding or armoring materials to meet your particular needs.

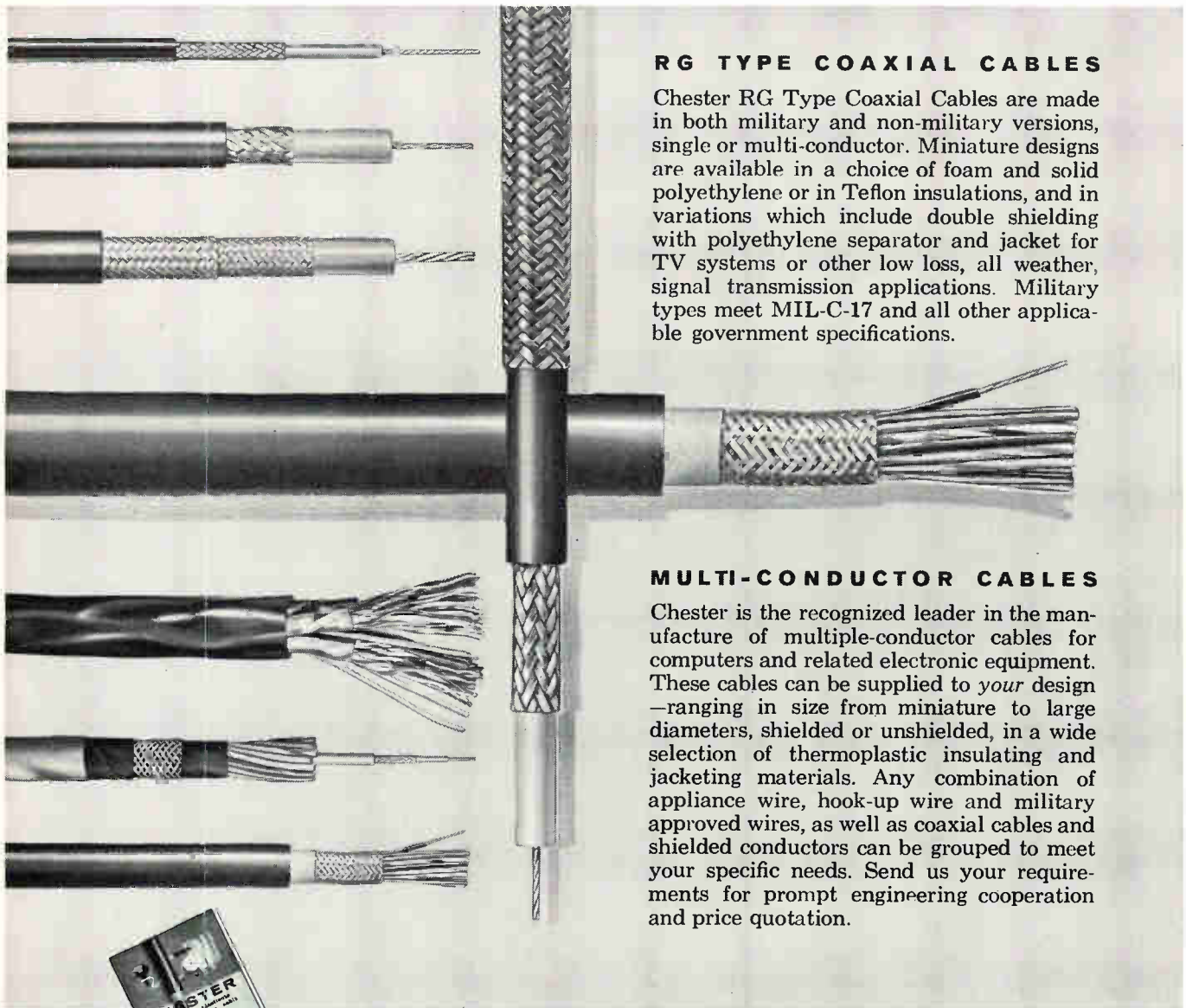

RG TYPE COAXIAL CABLES

Chester RG Type Coaxial Cables are made in both military and non-military versions, single or multi-conductor. Miniature designs are available in a choice of foam and solid polyethylene or in Teflon insulations, and in variations which include double shielding with polyethylene separator and jacket for TV systems or other low loss, all weather, signal transmission applications. Military types meet MIL-C-17 and all other applicable government specifications.

MULTI-CONDUCTOR CABLES

Chester is the recognized leader in the manufacture of multiple-conductor cables for computers and related electronic equipment. These cables can be supplied to *your* design — ranging in size from miniature to large diameters, shielded or unshielded, in a wide selection of thermoplastic insulating and jacketing materials. Any combination of appliance wire, hook-up wire and military approved wires, as well as coaxial cables and shielded conductors can be grouped to meet your specific needs. Send us your requirements for prompt engineering cooperation and price quotation.

NEW, Chester's fact-packed coaxial cable selection guide. Write for your free copy.

CHESTER CABLE CORP., CHESTER, NEW YORK

A SUBSIDIARY OF TENNESSEE CORPORATION

SPECIFY CHESTER WIRE AND CABLE FOR ALL YOUR ELECTRONIC EQUIPMENT NEEDS

Coaxial Cables • Hook-Up Wire • Multi-Conductor Cable • Appliance Wire • Audio Wire • Miniature Wire and Cable • High Voltage Wires
• High Frequency Wires • Antenna Loop Wire • Annunciator Wire • Telephone Wires and Cables • Television Transmission Lines



genus: homo • species: sapiens discipline: factors engineering

At the six major RCA Defense Electronic Products facilities, teams of psychologists and design engineers are deeply involved in the highly specialized, incredibly complex study of human factors engineering—man/machine interfaces, auto-instructional methods, decision processes, read-in/read-out optimization techniques, sensory perception, the entire spectrum of psychological-physiological-

physical disciplines. Whether your requirements involve human factors study of command and control functions for defense networks, or projected life support systems for space exploration, a total RCA capability stands ready to assist you . . . from feasibility study to project completion. Write Defense Electronic Products, Radio Corporation of America, Camden, N. J.



The Most Trusted Name
in Electronics

RADIO CORPORATION OF AMERICA

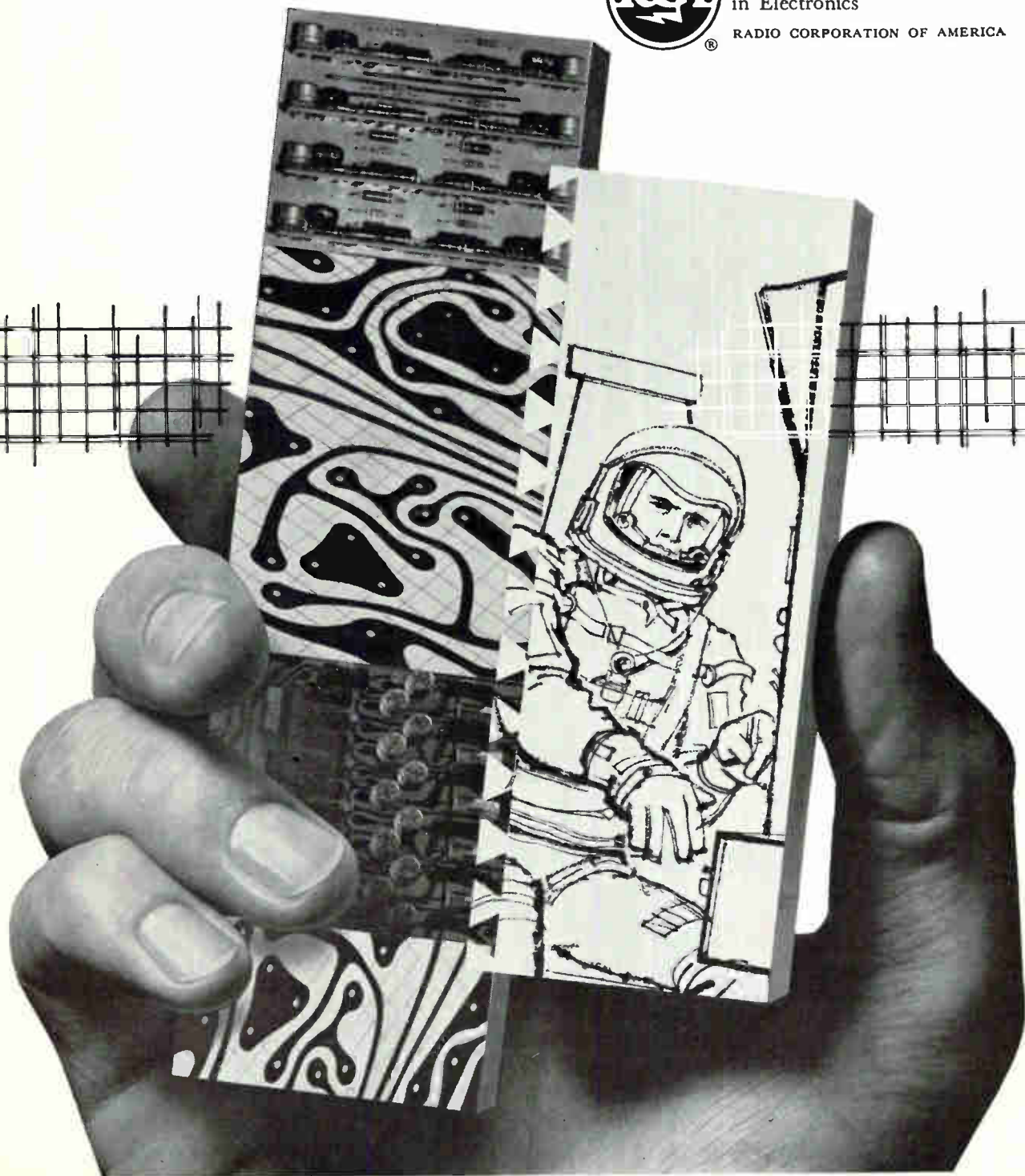

VIBRATION-PROOF CARD PACKAGING

Pre-test data used to prevent vibration-induced failure of parts leads on printed circuit cards

Probably the most unrelenting adversary of packaging engineers is vibration, the all too persistent specter that hovers malevolently over complex electronic systems. Hours, days, weeks, and even longer, especially during pre-delivery system tests, are repeatedly lost as technicians and engineers patiently stalk malfunctions arising from parts rendered ineffectual by vibration.

Packaging engineers at Litton Systems have devised still another technique of combatting this eternal bugaboo. They have developed a relatively simple pre-test means whereby each of the innumerable parts attached to printed circuit cards in a digital system can be so located and positioned on a card that the probability of its resistance to "the shakes" is virtually 100 percent assured.

The essence of the method, which was perfected for application on an

advanced digital tactical data system intended for installation in a carrier-based airborne early-warning and control aircraft, is exemplified in the accompanying diagram. The over 2,000 printed circuit cards in the system were classified into two basic types, the only difference between the two being that type II is equipped along the forward edge with a transistor holder bracket.

Notwithstanding the small size (3" x 3") of the card, vibration characteristics were compiled for several zones of each card type. On

of type I, and in zone B along either the X or Y-axis of type II. For another, a .50-inch square by .47-inch high coil could be oriented along the Z-axis in all zones of both card types with the exception of zone A of type I.

The parts placement and orientation data for capacitors, resistors, transistors, diodes, coils, and equivalent parts fit readily on a single oversized sheet. The proof of the technique is in thousands of printed circuit card modules that have consistently met not only the requisite airborne electronic equipment

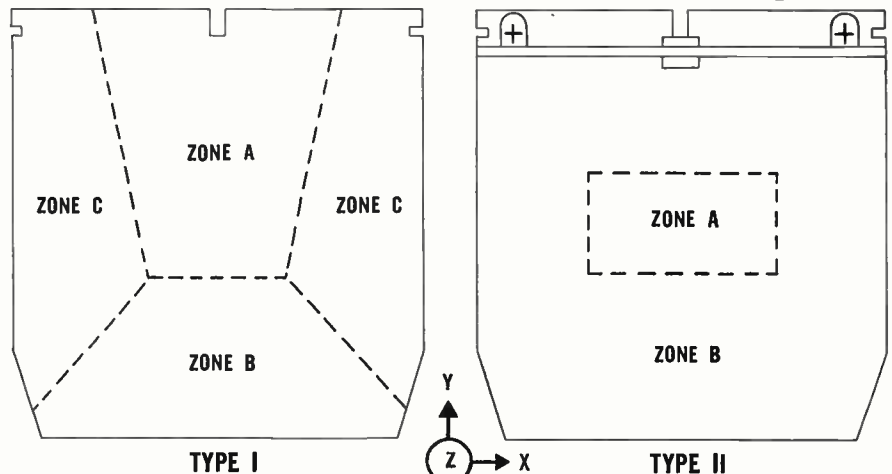

the basis of this data, zones of permissibility and non-permissibility were established for each part to be attached to the card according to the size, weight, and shape of the part.

An A-size capacitor, or equivalent part, for example, could be placed in any zone of either card type with the part axis oriented in any direction. An R-size capacitor or its equivalent, however, could not be placed in zone A of either card type, but could be placed in zone B and oriented along the X-axis on type I, in zone C along the Y-axis

specifications for vibration, but the even more stringent specifications for missile-borne equipment.

Ingenuity of this kind is characteristic of engineering performed at Litton Systems. Those who feel inclined to work in an environment that encourages and inspires thoughtful and fruitful engineering will find satisfaction at Litton Systems. Write to: S. L. Hirsch, Litton Systems, Inc., Data Systems Division, 6700 Eton Avenue, Canoga Park, California; or telephone DIamond 6-4040.

An equal opportunity employer

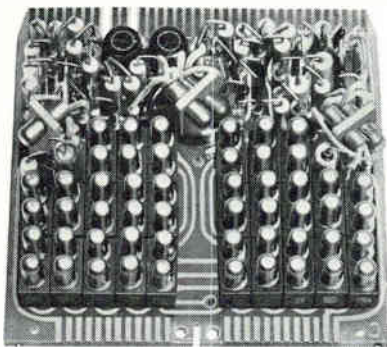

shift-register assembly
circuit card with components
arranged according
to zoning methods.

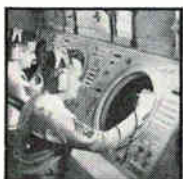

**LITTON
SYSTEMS, INC.**

A DIVISION OF LITTON INDUSTRIES

DATA HANDLING & DISPLAY SYSTEMS • GUIDANCE & CONTROL SYSTEMS • COMPUTER SYSTEMS • SPACE SCIENCE • BIOELECTRONICS • ADVANCED COMMUNICATIONS TECHNOLOGY









Now
Reduce
Your

This semiconductor network data processor was developed by Texas Instruments Incorporated under the direction of Manufacturing and Electronic Technologies Laboratories, Aeronautical Systems Division, Dayton, Ohio.

Microelectronic Design Time

with Series 51 **SOLID CIRCUIT*** semiconductor networks

HERE'S HOW:

-  designed to fulfill logic functions of complete equipment assemblies—compatible with most of today's logic circuitry.
-  low power drain minimizes thermal problems and reduces power supply requirements.
-  advanced manufacturing techniques including diffused planar structures, deposited leads, oxide protection, and hermetically sealed package—offer you the potential for improved circuit reliability.
-  today's ultimate in microelectronics—with the highest function/size ratio for your digital circuits or equipments.
-  provide reduced microelectronic cost through TI's standard silicon wafer design.
-  meet military requirements:

Power Drain _____ 2-4 mw @ 3 volts
 Fan-Out (TI SN 510, 512, 514, 515) _____ 4
 Fan-Out (TI SN 511, 513) _____ 20
 Propagation Delay _____ 75 to 450 nsec
 Power Supply _____ 3 to 6 volts
 Temperature Range _____ -55° to +125°C

UNIT	TI SN 510	TI SN 511	TI SN 512	TI SN 513	TI SN 514	TI SN 515
FUNCTION	Flip Flop, Counter	Flip Flop with emitter follower output	NOR/NAND Gate (6 input)	NOR/NAND Gate (6 input) with emitter follower output	Two NOR/NAND Gates (3 inputs each)	Exclusive OR
	Clock pulse is internally capacitive-coupled					

CONTACT YOUR NEARBY TI SALES ENGINEER TODAY FOR COMPLETE  SPECIFICATIONS AND CUSTOM DESIGN ASSISTANCE.

**Trademark of Texas Instruments Incorporated*

COMPONENTS DIVISION
 CAPACITORS, DIODES,
 RECTIFIERS, RESISTORS,
 SEMICONDUCTOR NETWORKS,
 SILICON CONTROLLED RECTIFIERS



TEXAS INSTRUMENTS
 INCORPORATED
 13500 N. CENTRAL EXPRESSWAY
 P. O. BOX 5012 • DALLAS 22, TEXAS

18686

CIRCLE 67 ON READER SERVICE CARD

For ease of processing

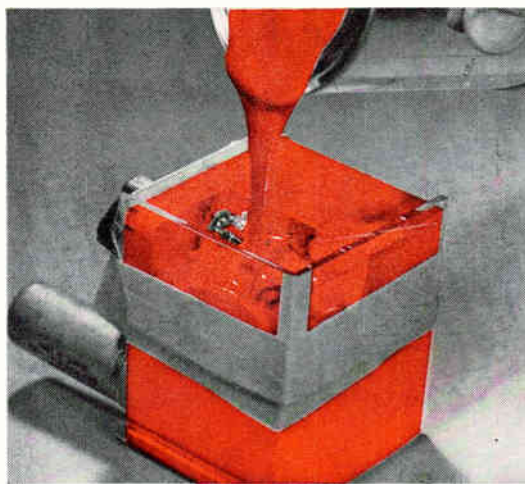
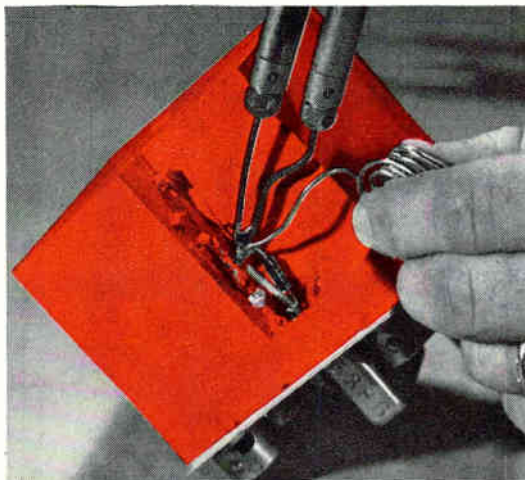
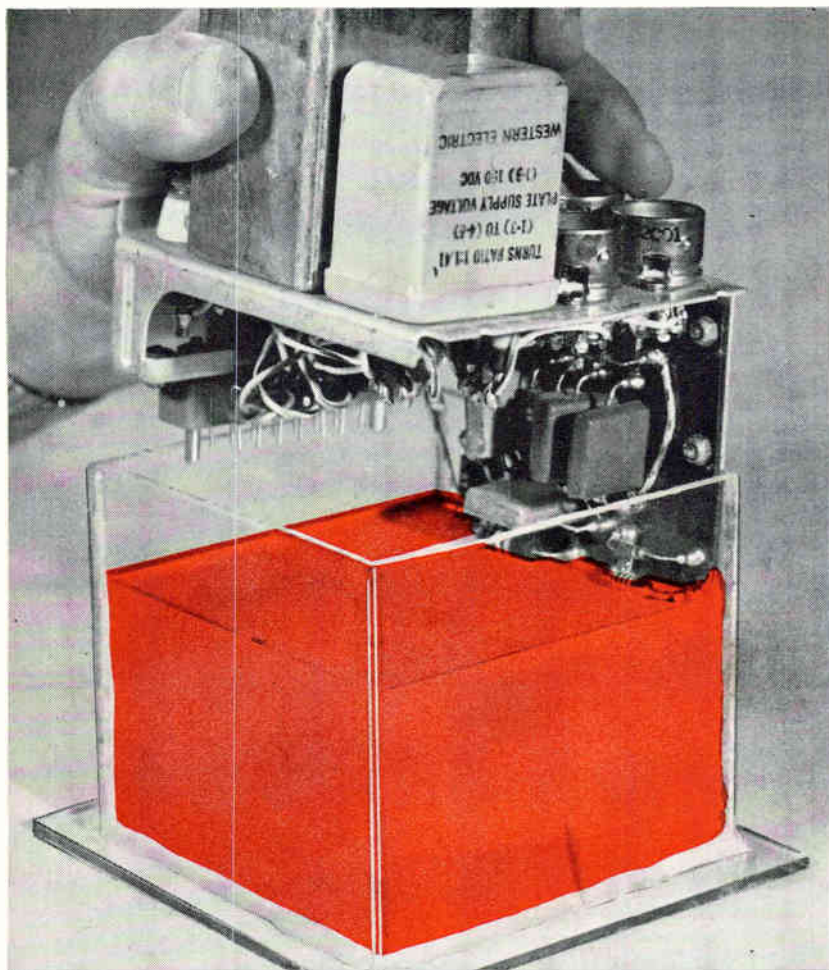

Silastic® RTV now gives greater protection with thicker section

For thick section embedding, specify Silastic RTV 601, a new fluid silicone rubber that vulcanizes at room temperature, cures thoroughly and completely . . . even in deep sections.

Like all potting and embedding materials in the Silastic RTV family, this one has excellent electrical and physical properties — resists moisture, voltage stress, corona, thermal cycling, temperature extremes, aging, weathering, ozone, many corrosive chemicals and their fumes.

Initial processing is easy. Mix RTV 601 with catalyst, vacuum de-air, and pour the low viscosity mixture into the desired area.

No exothermic heat or damaging internal stresses develop. Cure is uniform throughout sections even a foot or more thick. After curing, this Silastic RTV is usable over the wide temperature range of -60 to 260 C.

Embedded circuits can be repaired and components replaced by cutting Silastic RTV away from the defective section with a sharp knife. New Silastic RTV poured into the repaired area restores the original integrity of the encapsulant.

CIRCLE 289 ON READER SERVICE CARD

Dow Corning is your best source of a broad line of silicone fluids, gels, elastomers and rigid forms for potting, filling, embedding and encapsulating.



Dow Corning

— specify these silicones

Solder melts — laminate unaffected

Specified for their excellent resistance to space age environments, silicone-glass laminates are easy to work with, too. Soldering heat doesn't loosen terminals even where complex wiring requires repeated soldering in a small, confined area. Made with Dow Corning silicone resins, glass laminates retain their excellent dielectric properties despite heat, moisture, storage, environmental aging, rapidly changing ambients and vibratory shock. Light in weight, strong at elevated temperatures, they resist ozone, arcing, corona and fungus attack. In addition, they are easy to fabricate and assemble, have good physical properties . . . resist creep under pressure.

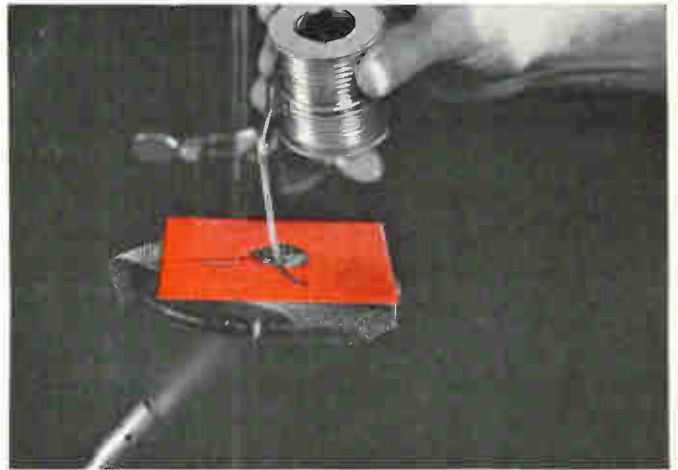

CIRCLE 290 ON READER SERVICE CARD

Silicone compound for heat sink seal

Heat sinks built by Fairfield Controls, Inc., Stamford, Conn., combine pure copper fins with Dow Corning 3 Compound to assure full load operation of silicon control rectifiers within the maximum allowable junction temperature of 125 C. Dow Corning compound with its petroleum jelly-like consistency, provides excellent heat transfer between the 25.5 amps diode shown here and the metallic parts of the heat sink assembly. The operating portion of the rectifier is inside the heat sink, with silicone compound to facilitate heat transfer from the entire diode body to the heat sink proper. At the same time, moisture and contaminants are sealed from the diode lead connections.

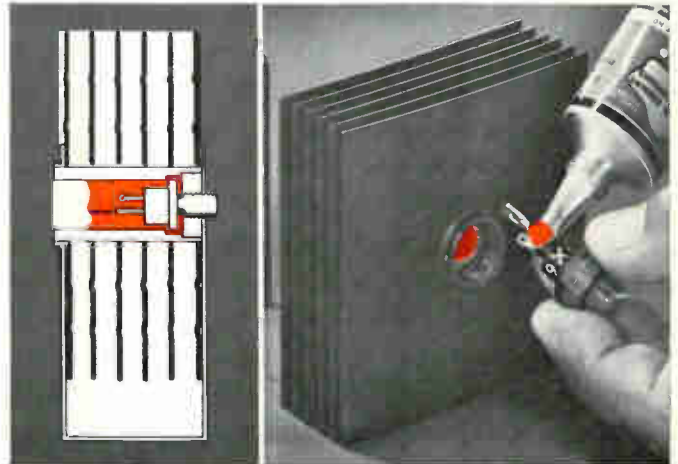

CIRCLE 291 ON READER SERVICE CARD

Key to stability — silicone fluid

Dow Corning silicone fluid is used in a new line of hermetically sealed precision film resistors developed by Key Resistor Corporation of Gardena, California, to "provide the ultimate in long term life and stability." According to Key engineers, "the unique silicone fluid filled construction results in excellent heat dissipation characteristics — minimizes effects of severe overloads." Dow Corning silicone fluids are used as filling and cooling media in numerous electronic and electro-mechanical applications because they maintain initial viscosity over a wide temperature range, are stable at high temperature, are excellent dielectrics . . . offer numerous other advantages.



CIRCLE 292 ON READER SERVICE CARD

Free 12-page manual, "Silicones for the Electronic Engineer".
Write Dept. 4223, Dow Corning Corporation, Midland, Michigan.

ENGINEERED COMPONENTS

for the Electronics
Industry

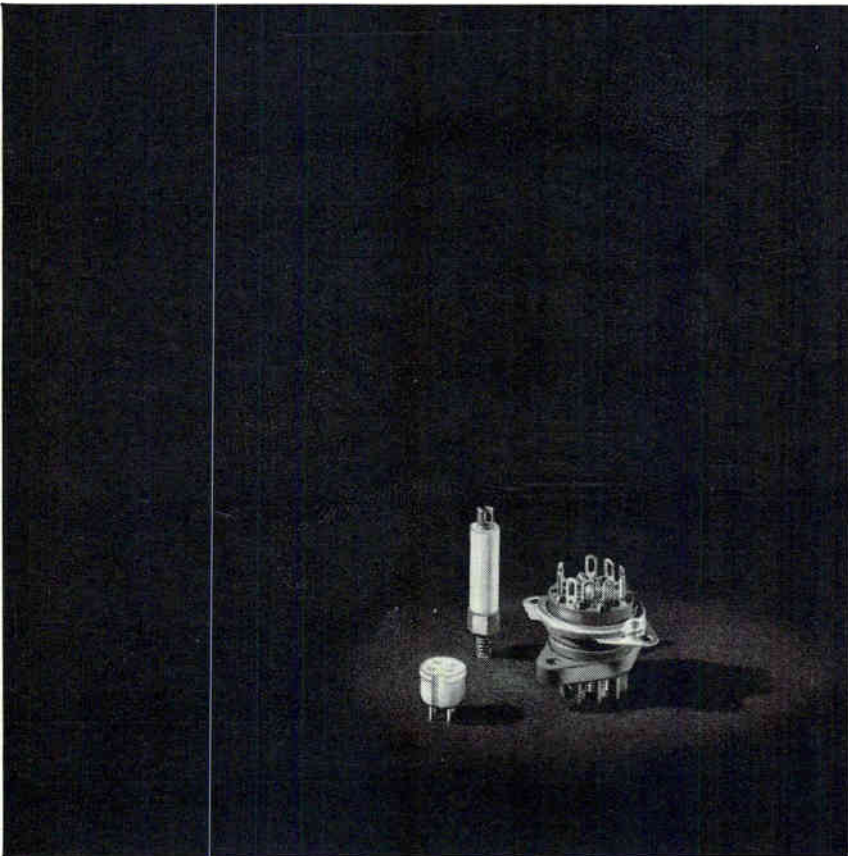

As close at hand as your nearest authorized Garlock distributor—
CHEMELEC* Insulators, Subminiature Tube and Transistor Sockets, Connectors.

Availability as well as reliability are two reasons why it is smart to specify Garlock when buying components.

Through a new organization of authorized distributors, Garlock now offers immediate delivery of CHEMELEC Stand-off and Feed-Thru Insulators, Subminiature Tube and Transistor Sockets, Connectors, and other standard components.

As near as the telephone, your authorized Garlock Electronic Products Distributor offers prompt, courteous service. Call him at the nearest of these locations:

CALIF. NEWARK ELECTRONICS CO. 4747 W. Century Blvd. Inglewood, Calif. SCHAD ELECTRONICS 499 S. Market St. San Jose, Calif. WESCO ELECTRONICS 1715 E. Colorado Blvd. Pasadena, Calif.	MASS. DE MAMBRO RADIO SUPPLY CO. INC. 1095 Commonwealth Ave. Boston 15, Mass.
COLORADO INTER-STATE RADIO & SUPPLY CORP. 1200 Stout Street Denver, Colorado	NEW YORK ELECTRONIC CENTER INC. 160 5th Avenue New York 10, New York HARRISON RADIO CORP. 225 Greenwich St. New York 7, New York
ILLINOIS NEWARK ELECTRONICS CO. 223 West Madison St. Chicago 6, Illinois	ONTARIO LAKE ENGINEERING CO. LTD. 767 Warden Ave. Scarborough, Ontario, Canada
MARYLAND ELECTRONIC ENTERPRISES, INC. 4902 Snader Avenue Baltimore 15, Md.	N. CAROLINA DALTON-HEGE, INC. 938 Burke St. Winston-Salem, N. C.

Take advantage of on-the-spot availability—specify these skillfully engineered Garlock electronic components. Reliable under the most severe conditions, they are ideal for high temperature, high voltage, high frequency service on missile guidance, fire control, tracking, and radar systems. Garlock has the technical personnel and modern facilities to produce components of all materials—Teflon† TFE and FEP, Nylon, Delrin†, C.T.F.E.†—and a range of sizes, designs, and tolerances to fit your exact needs. At your disposal, too, for development of new electronic products, Garlock maintains complete electrical, chemical and physical laboratories staffed by top-flight engineers.

Remember, too, the newest of the Garlock electronic products—Flexible Printed Circuitry of Teflon FEP. For complete details on what Garlock has to offer, write for Catalogs AD-169, 171, and 188. Garlock Electronic Products, Garlock Inc., Camden 1, New Jersey.

GARLOCK

ELECTRONIC PRODUCTS

Canadian Div.: Garlock of Canada Ltd.
Plastics Div.: United States Gasket
Company

Order from the Garlock 2,000 . . . two thousand different styles of Packings, Gaskets, Seals, Molded and Extruded Rubber, Plastic Products.

*Registered Trademark
†DuPont Trademark

‡polychlorotrifluoroethylene

MORE FROM PRD!



BROADBAND DIRECT-READING ATTENUATORS now available through K bands . . . up to 40 kmc. Compact, precision instruments feature 60 DB Attenuation Range, VSWR 1.15 Maximum, Accuracy to ± 0.1 DB, Insertion Loss as low as 0.5 DB, Spectrum Coverage from 3.95 to 40.0 kmc/s (nine models). Direct Reading. Send for data.

PRD ELECTRONICS, INC.
202 Tillary St., Brooklyn 1, N. Y., ULster 2-6800;
1608 Centinela Ave., Inglewood, Calif., ORegon
8-9048 • A Subsidiary of Harris-Intertype Corp.



CIRCLE 204 ON READER SERVICE CARD

It's the Combination that Counts

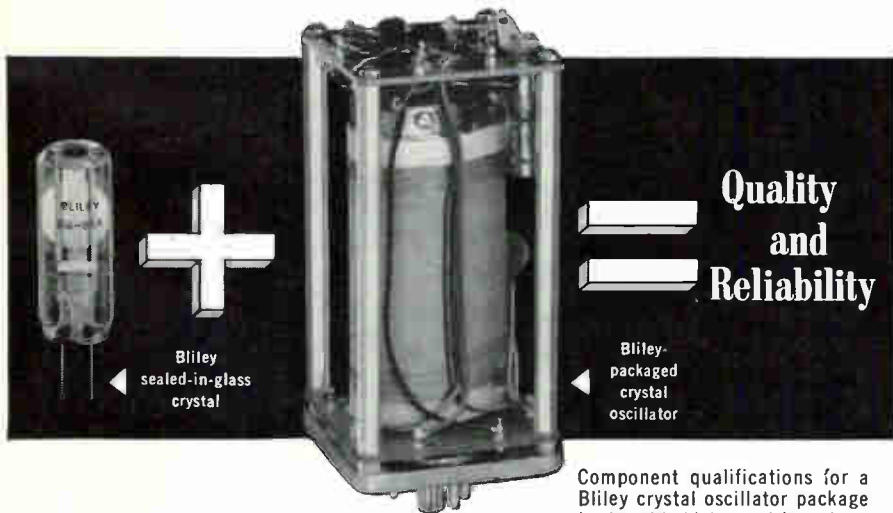

Packaged oscillator stability can only be as reliable as the crystal source!

Component qualifications for a Bliley crystal oscillator package begin with high precision glass-mounted crystals that will deliver long-term performance with minimum aging. In combination with custom built circuitry and temperature control, each unit is individually tested to meet rigid quality standards. This is the essence of product reliability.

Typical Bliley oscillator packages are described in Bulletins 520A, 522 and 526.

Bliley ...if you buy quality

BLILEY ELECTRIC COMPANY • Union Station Building • Erie, Pennsylvania

CIRCLE 205 ON READER SERVICE CARD

JUST OUT HANDBOOK OF ASTRONAUTICAL ENGINEERING

Editor-in-Chief:
H.H. KOELLE

Editorial Board Chairman:
WERNHER VON BRAUN

Summarized in this book are data on developments in space flight—new ideas in the field—engineering design data—and scientific information. Prepared by 150 specialists from government agencies, industry, and universities, this comprehensive, major handbook provides the essential information necessary for designing the space vehicles of today and tomorrow—and for calculating their cost and performance. 1850 pp., 1052 illus., \$27.50

10 Days
FREE
Examination

PEACETIME USES OF OUTER SPACE

Just Out. Contains discussions of investigating the universe, private enterprise in space, and much more. Ed. by S. Ramo. 320 pp., 58 illus., \$6.95

SYNTHESIS OF OPTIMUM CONTROL SYSTEMS

Just Out. Explains advanced design techniques for high performance systems requiring the ultimate in response. By S. S. L. Chang, N.Y. 381 pp., \$11.75

SYSTEMS ENGINEERING FOR THE PROCESS INDUSTRIES

Just Out. Describes how to apply systems engineering profitably in chemical engineer's terms. By J. T. Williams, Monsanto Chem. Co. 102 pp., \$4.95

WRITING FOR ENGINEERING AND SCIENCE

Just Out. Provides comprehensive coverage of modern technical writing for engineer, scientist, and writer. Includes techniques, examples. By T. Hicks. 432 pp., illus., \$7.50

PRINCIPLES OF LINEAR NETWORKS

Just Out. Introduces linear electric circuits. Gives balanced presentation of circuit theory concepts. By B. Friedland, G. Wing, & R. Ash. 288 pp., \$8.95

STATISTICAL DECISION THEORY

Just Out. Describes how this theory solves industrial engineering, operations research, applied mathematics problems, and much more. By L. Weiss, Cornell Univ. 195 pp., \$7.50

Free Examination Coupon

McGraw-Hill Book Co., Dept. L-11-10
327 W. 41st St., New York 36, N. Y.

Send me book(s) checked below for 10 days' examination on approval. In 10 days I will remit for book(s) I keep, plus few cents for delivery costs, and return unwanted book(s) postpaid. (We pay delivery costs if you remit with this coupon—same return privilege.)

- Koelle & von Braun—Handb. of Astr. Eng.—\$27.50
- Chang—Peacetime Uses of Outer Space—\$6.95
- Chang—Synth. of Opt. Control Sys.—\$11.75
- Williams—Sys. Eng. for the Proc. Inds.—\$4.95
- Hicks—Writing for Eng. & Science—\$7.50
- Friedland et al.—Prin. of Lin. Networks—\$8.95
- Weiss—Stat. Decision Theory—\$7.50

(PRINT)

Name

Address

City..... Zone..... State.....

Company

Position

For price and terms outside U.S. write McGraw-Hill Int'l., N.Y.C.

L-11-10

NEW PHILCO SILICON CHOPPERS



T2357
Matched pair of
Philco type T2363
SPAT® Choppers, in
TO-18 Packages.



With SPAT® Matched-Pair Uniformity
Bring High Fidelity To Low Level Switching!

T2363 CHARACTERISTICS

Emitter Voltage, BV_{EEO}	-30 volts
Collector Cutoff Current $I_{CBO}(V_{CB} = -10V)$	0.001 μ a max.
Emitter Collector Current $I_{EEO}(V_{EB} = -10V)$	0.001 μ a max.
Offset Voltage $V_{EC}(I_B = -200 \mu$ a, $I_E = 0)$	1.5 mv max.
Offset Voltage V_{EC} (T2357 Matched Pair, $I_B = -1$ ma at all temperatures from 25° to 85° C)	50 μ v max.

TYPICAL CHOPPER CIRCUIT

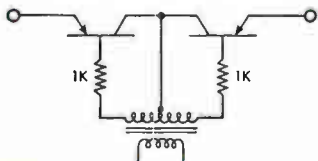

T2363: I-V CHARACTERISTIC (in above circuit)

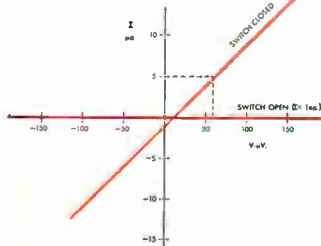

For low level switching applications, Philco now makes available *Silicon Precision Alloy Transistor Choppers—produced on industry's only fully-automatic chopper production line—to assure the uniformity so important to matched pairs.

Only Philco Choppers offer you all these advantages—made possible by the SPAT® process:

- Low offset current—1 nanoampere maximum;
- Low offset voltage—50 μ v maximum (for the matched pair);
- Guaranteed match over a temperature range—25° to 85° C;
- Guaranteed maximum offset voltage for a wide range of base current values;
- High gain-bandwidth product;
- Meet all requirements of MIL-S-1950B.

To assure ultra-high fidelity in multiplex systems for telemetry, multi-channel communications, analog computers, and other low level data handling applications, be sure to specify Philco SPAT® Choppers. For complete data, write Dept. E111061.

Philco SPAT®
Choppers are
immediately available
in quantities 1-999
from your Philco
Industrial Semiconductor
Distributor.

PHILCO®



Famous for Quality the World Over

LANSDALE DIVISION, LANSDALE, PA.



*Boston show features
advances in coherent light,
solid-state electronics,
microwaves,
radio astronomy,
microminiaturization
and superconductivity*

By **THOMAS MAGUIRE**
New England Editor

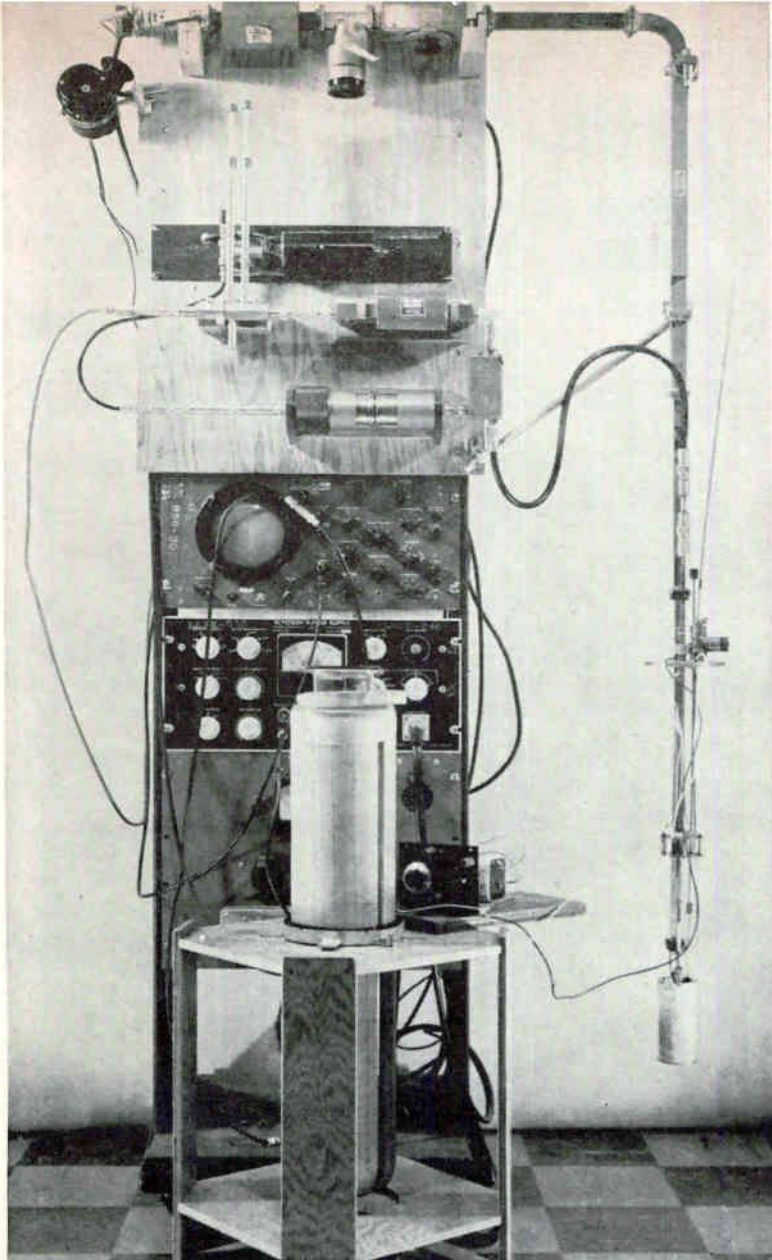

Tunable solid-state ruby maser amplifies 1,350-1,450 Mc. Variable magnetic fields up to 7 Kgauss are provided by niobium solenoid at lower right

Electro-Optical Developments Highlight NEREM

ENGINEERING ADVANCES will be mirrored in depth next week in Boston during the 15th Northeast Electronics Research and Engineering Meeting. With a heavy R&D flavor characteristic of the industry in New England, more than 90 papers at 22 sessions will detail recent advances.

In addition to descriptions of current work on optical masers, both gaseous and solid-state, modulation concepts will be explored.

An experimental device for modulation of optical maser output has been operated on a pulsed basis at 9,250 Mc.' The modulator uses electro-optical effects in crystals of

the dihydrogen phosphate type, in this case KDP. About 2 Kw is required to produce a peak phase retardation of about 1.9 radians. A traveling microwave modulating field in synchronism with the optical wave permits use of a long sample with reduced power. Forward wave component of a TM_{013}

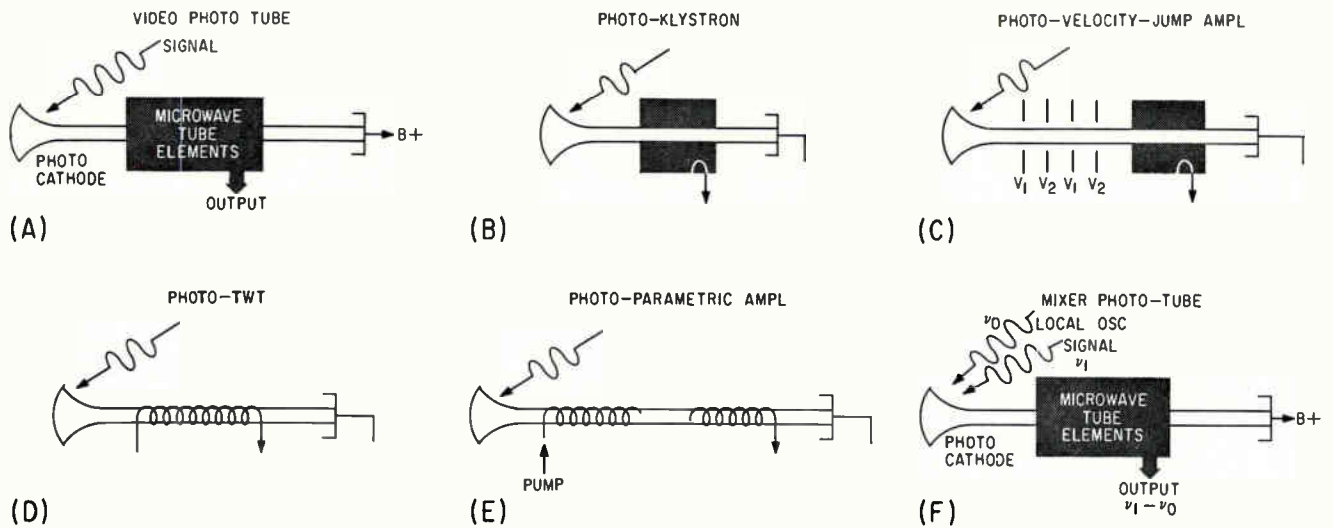

FIG. 1—Prebunched beam from photocathode carries video modulation in simplest phototube for detecting amplitude-modulated light (A). Some phototube types for demodulation of light (B to E). Optical superheterodyne (F) responds only to optical frequencies within band corresponding to i-f bandwidth away from the local oscillator

cavity standing wave is used. The backward wave has no net effect on the light when the microwave velocity equals the optical velocity.

Ideal material for microwave electro-optic modulators would exhibit a large electro-optic effect, have optical phase velocity close to microwave phase velocity, possess isotropic optical symmetry, and belong to a crystal class which permits the modulating field to be applied normal to direction of light propagation. Many of the requirements are contradictory from a physical viewpoint.

Ability to confine the maser beam to a small cross-section with small divergence makes low-power modulation with KDP feasible. It is quite lossy at X-band, so most of the power in the cavity is dissipated in the crystal volume. By confining the beam to a small cross-section and reducing cross-section of the KDP rod, power dissipated may be reduced.

Experiments at Stanford University have produced what is believed to be the broadest-band phototube yet built, and the first mixing of two coherent light signals to yield a coherent microwave output.²

Figure 1A shows the simplest form of microwave phototube for detecting amplitude-modulated light. The photocathode serves the same purpose as the video crystal detector at radio frequencies.

Figures 1B to E show some of the forms such tubes might take.

The photo-klystron will serve for narrowband microwave signals. Modulation on the beam can be preamplified by velocity-jump methods. The device would be like a low-noise microwave tube gun operated so as to amplify rather than de-amplify the initial cathode current modulation on the beam. The twt type will yield greater bandwidth; and the parametric pumping principle can be used also to preamplify beam modulation.

These same microwave phototubes can be employed as optical superheterodynes (Fig. 1F). An optical local oscillator at frequency f_0 and an optical signal at f_1 will produce a photo current at the difference frequency $f = (f_1 - f_0)$, which can be amplified and detected by the microwave-tube elements.

The photocathode is the mixer, and the electron beam and microwave-tube elements are the i-f amplifier. Such an optical superheterodyne offers unprecedented selectivity: it responds only to optical frequencies within a band corresponding to the i-f bandwidth away from the local oscillator. The two light beams must be in phase everywhere on the cathode or cancellation effects occur.

In the Stanford experiments, a ruby laser's output consisting of a large number of discrete spectral components spaced by 600 Mc was fired at an improvised phototube. These outputs beat or mix in the cathode. Strong outputs are obtained at 1,800, 2,400, 3,000, 3,600 and 4,200 Mc. The microwave signals are coherent and nearly monochromatic; zero-beat patterns can

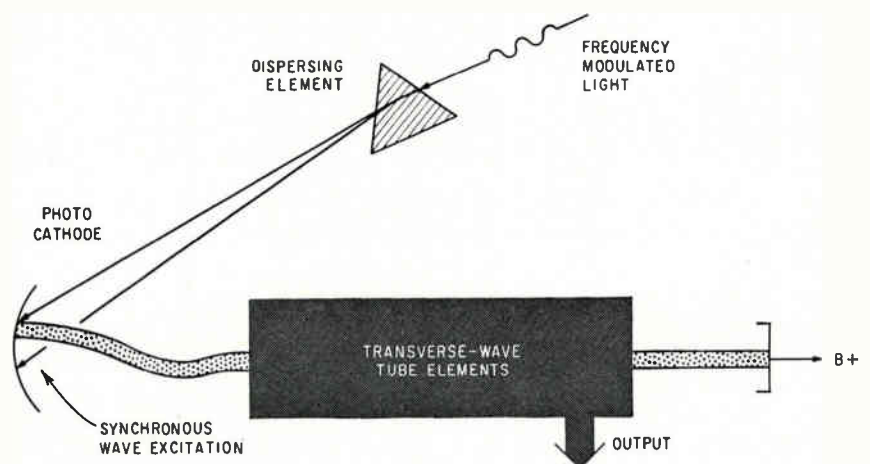

FIG. 2—Prism of novel microwave discriminator phototube converts f-m to ray-angle modulation

be obtained by mixing them with a microwave signal generator tuned to the same frequency.

Figure 2 shows a microwave discriminator phototube for demodulating frequency-modulated coherent light. The prism or other dispersing element converts the f-m to ray-angle modulation and hence position modulation on the photocathode. The resulting sideways modulation of the electron beam is, in microwave-tube terms, initial excitation of the synchronous cyclotron transverse waves, which can be amplified and detected by appropriate transverse-wave-tube elements.

The extraordinary intensity of light beams from pulsed optical masers can be exploited for the production of optical harmonics.³ These monochromatic beams, when focused, exhibit electric fields of the order of 10^6 volts per cm.

A commercially available ruby optical maser which produces approximately 3 joules of 6943-A light in a one-millisecond pulse is utilized. The light is passed through a red filter to eliminate the xenon flash background and is then brought to a focus inside a crystalline quartz sample. The emergent beam is sampled by a quartz prism spectrometer equipped with red insensitive spectrographic plates. Dense images were obtained at the second harmonic (~ 3472 Å).

The hydrogen maser promises to serve as a source of radiation of unprecedented spectral purity and frequency stability.⁴ It uses a hyperfine transition in the ground state of atomic hydrogen and in its present form obtains the required non-equilibrium distribution of atoms in the resonance states by an atomic beam.

The hydrogen maser, unlike previous devices, uses the storage box technique. The atoms are stored in a container which has non-interacting walls—the hyperfine state of the atom is not perturbed by wall collisions. The atoms can interact with the radiation field for times vastly longer than that necessary for a single traversal across the storage box, and the resonance width of the device is consequently extremely narrow. Calculations indicate that with an observation time of 1 sec the fractional width of the radiation spectrum is 10^{-15} .

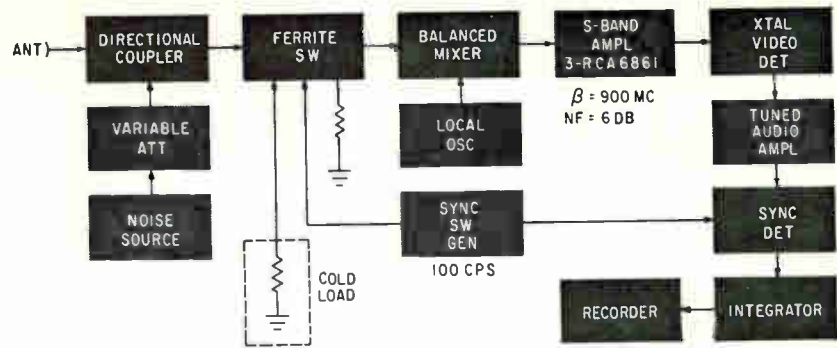

FIG. 3.—Hybrid receiver using traveling wave tube intermediate-frequency amplifier

In the maser, hydrogen molecules are dissociated in a d-c or r-f discharge and effuse into a vacuum. A beam of the atoms passes through a state selector, a small hexapolar magnet, which deflects them toward the axis atoms in the upper hyperfine state, and these atoms are focused on the aperture of a quartz bulb. The bulb is lined with a non-interacting wall coating and is surrounded by a resonant cavity tuned to the hyperfine transition frequency. If the lifetime of the atoms is sufficiently long, and the beam flux great enough, the atoms radiate by self-induced stimulated emission and a signal at the resonance frequency is detected by means of a coupling loop.

It is anticipated that factors on which frequency stability depend can be controlled to allow operation to a stability of one part in 10^{13} for long periods.

Availability in the near future of intense fields produced at a reasonable price and in a compact package by superconducting magnets will have a significant impact on electronics and other fields.⁵

New alloys and compounds have given rise to small magnets which generate fields in the 30- to 40-kilogauss range. Of the common elements, niobium has the highest transition temperature, T_c (about 9 K). It also has the highest critical field strength, and solenoids of up to 10 kilogauss have been made with niobium wire.

For generation of intense and large-volume fields, most promising among the new materials are Nb₃Sn ($T_c = 18$ K) and Nb Zr ($T_c = 11$ K–12 K).

Small magnets using these materials have been built. One solenoid uses 2,800 ft. of wire with a core of niobium and tin, and pro-

duces 28.5 kilogauss at 4.2 K. Another solenoid, slightly smaller, contains 4,000 ft. of .010" diameter niobium-zirconium alloy wire insulated with nylon and generates 33 kilogauss at 4.2 K. The same techniques and more wire should result in small 50-100 kilogauss solenoids.

An 8.6 mm radiometer designed to capitalize on the wide bandwidth capabilities of presently available twt's has been developed at MIT Lincoln Laboratory and used in lunar measurements.⁶ Under development is an 8.7-mm system using a maser, the alternate approach in radiometer instrumentation.

Under construction is a 28-foot spuncast parabolic antenna which hopefully will give the required precision for 8-mm operation. With the 28-foot paraboloid and a traveling-wave maser, sensitivity to radiation from Venus will be increased by two orders of magnitude.

Lincoln Laboratory also plans to use the 28-foot dish, a maser pre-amplifier and tens of watts of cw power for an 8.6 mm radar bounce off the moon. Angular resolution provided by this system would be smaller than the moon's subtended angle. In the two approaches to radiometry twt's have the advantage in bandwidth and masers in noise temperature.

Lincoln Lab's system using twt's is shown in Fig. 3. Three twt's are operated in series as an i-f amplifier at S-band with a gain of 75 db. The signals are converted from Ka band to S-band by a special wide band, balanced mixer. This radiometer shows good capability for measurement of weak thermal signals such as in temperature measurement of planets.

Most sensitive parameter affecting ultimate sensitivity of a radiometer is the internal noise of

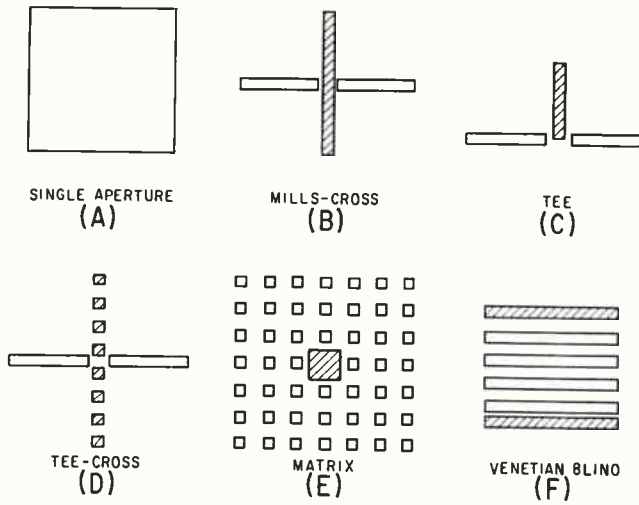

FIG. 4—Equivalent pencil-beam antennas. Shaded part is phase-switched with nonshaded part in (D)-(F).

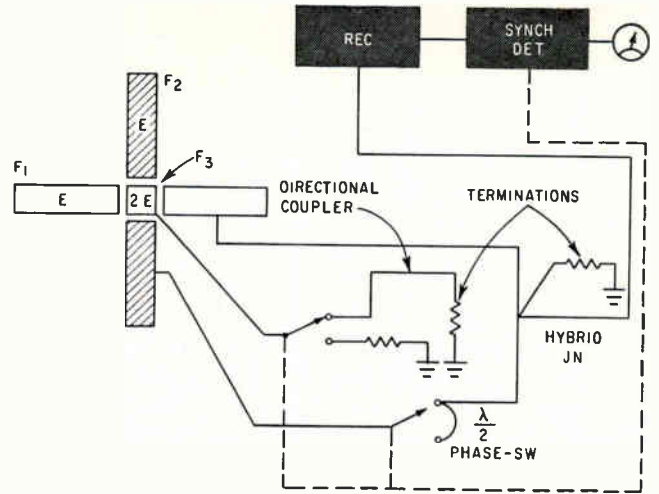

FIG. 5—Modification to make Mills cross sensitive to extended sources

the preamplifier. Masers, especially traveling wave types, appear attractive here. Noise contributed by other components far outweighs maser noise.

In superpower microwave tubes, the debate is intensifying over the crossed-field approach vs. linear beam tubes.^{7, 8}

Merit of linear beam tubes is seen as inherent in the physical separation of the three basic functional regions of such devices: electron beam generation; r-f interaction; and collection of spent beam.⁷

Linear beam tubes now in development feature large cathode area protected from back bombardment and resultant deleterious effect on life, low dissipation density circuit, whose only function is r-f interaction and arbitrarily low collector power density.

Operational and constructional advantages are seen resulting from the simplified energy conversion system of a crossed-field device.⁸ It converts the potential energy of the power supply directly into r-f energy, while other classes of microwave tubes first convert to kinetic energy of electron motion, from which r-f energy is extracted.

Progress in crossed-field devices has been principally through the continuous-cathode class. High average power ratings can be attained in these compact devices only if suitable means can be found to handle the inherent power losses. These power losses appear as heat which must be carried away.

The main power loss consists of

heat generated by the relatively low kinetic energy of spent electrons as they strike the combined anode and r-f network of the tube.

Present progress results from the need for handling the greatly increased power levels at both the input and output of super power devices, by quasi-optical means; and also from the development of the concept of axial gain in a crossed-field device which permits an increase of anode area by several orders of magnitude. Close analogy of the latest device in appearance and function to a microwave lens—but with integral gain—has led to the name Electromagnetic Amplifying lens (EAL). Theory indicates capability of average power in the megawatt range.

As an alternative to larger pa-

raboloidal or spherical reflectors, many ingenious phase-switched antennas such as the Mills cross have been developed in recent years. They offer very high resolution and sensitivity at a relatively low cost, but with some limitations.⁹

In a Mills cross antenna two long broadside arrays are placed in the form of a cross. The pencil beam is formed by multiplying the fan-beam voltage responses of the two linear arrays. Multiplication is usually done by connecting the two arrays of the cross alternately in phase and out of phase to a receiver, and by recording the modulated component of the receiver output.

Some arrangements of phase-switched antennas are shown in Fig. 4. The resolution of a tee-

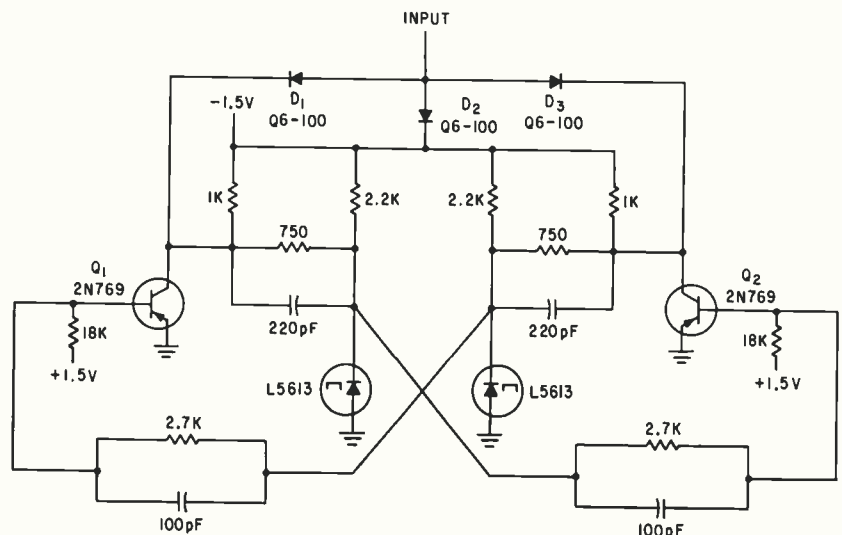

Fig. 6—Micro-energy flip flop

antenna (Fig. 4C) is the same as of the original cross (Fig. 4B). The tee-cross has been evolved for design of the large Benelux cross antenna, 3-5 Km long, to achieve a 1 minute of arc pencil beam width at 400 Mc.

The phase-switched matrix array of Fig. 4E makes it possible to increase the resolution of a single aperture of modest size. Any spurious lobes arising because of antenna adjustment errors are distributed in all directions.

For high resolution along with high sensitivity, R. N. Bracewell has suggested the arrangement in 4F. The antenna consists of a row of cylindrical parabolic reflectors. Grating responses caused by periodicity in the aperture illumination are suppressed by phase-switching the central part with the outer two elements.

The scheme outlined in Fig. 5 makes the Mills cross sensitive to extended sources. Field distribution impressed over the central portion of the cross is made twice in amplitude to that elsewhere. The central portion is periodically chopped in synchronism with the phase-switch. This makes the Mills cross uniformly sensitive to all spatial frequencies from zero to a certain cut-off, the latter dependent on the over-all length of each arm.

A logic circuit, termed "tunnel diode-coupled micro-energy transistor logic", combines the desirable operating characteristics of the tunnel diode and the transistor.¹⁰

In the circuit, fan-in and fan-out

capabilities per unit dissipation are improved by five to 10 times over existing types of logic schemes. Switching speed of this tunnel diode-transistor hybrid circuit depends primarily upon the transient response characteristics of the transistor. The flip flop in Fig. 6 may be triggered by conventional techniques. Use of tunnel diodes allows low supply voltages resulting in low circuit dissipation, with a minimization of the collector circuit RC time constant; and provides voltage drive which results in fast switching speeds.

Metal deposition techniques called scribe-plating and trace-plating are suitable for a wide range of sizes of semi-conductor devices and, in particular, for micro-miniature devices.¹¹

Minute nucleation centers for chemical or electrolytical plating of the semiconductor are created by suitable preparation of the surface, either by removal of semiconductor material along microscopically fine lines scribed with a hard stylus, or by deposition of a microscopically fine trace along the surface by abrasion from a soft metallic stylus.

Scribing is performed with a pointed stylus made of a hard material such as diamond or steel, using radius and applied pressure as parameters to control the width and depth of the scribed line. Subsequent plating, usually electrolytic, nucleates preferentially along the scribed regions.

In trace-plating the stylus is

made of a soft and suitably pointed metal. Moving the stylus along the semiconductor surface causes a very small amount of the stylus metal to be deposited by abrasion. Though usually very thin, this deposit provides a nucleation center for subsequent plating.

All-chemical technique has been developed for fabrication of thin film circuits from titanium and its compounds.¹² Electronic characteristics of the oxides of titanium are shown in Fig. 7.

Fabrication with a molten salt process gives a complete coating of an inorganic substrate with a thick film of very pure titanium metal. After cleaning, a pattern of copper or other conductive material is electroplated onto the metallized substrate to produce termination areas or interconnection tabs. The circuit pattern is then fabricated from the metallized substrate by photoetching. External ribbon leads are fastened to the metallized pads by furnace brazing.

Conversion of selected areas of the continuous circuit pattern into a resistive or dielectric material is by an anodic process. Resistances are individually trimmed to precise values by further anodizing or mechanical operations. Capacitors are formed by the addition of a counterelectrode to the dielectric pattern and mechanically adjusted. Active devices are assembled to the circuit by spot welding, thermal compression bonding or soldering.

REFERENCES

- (All papers prepared for the 1961 Northeast Electronics Research and Engineering Meeting, Boston.)
- (1) I. P. Kaminow, Bell Telephone Laboratories, Microwave Modulation of Light By The Electro-optic Effect.
 - (2) A. E. Siegman, Stanford University, Microwave Phototubes and Light Demodulators.
 - (3) P. A. Franken, A. E. Hill, C. W. Peters, G. Weinreich, University of Michigan, The Generation of Optical Harmonics.
 - (4) D. Kleppner, Harvard University, The Hydrogen Maser.
 - (5) S. H. Autler, M.I.T. Lincoln Laboratory, Superconducting Magnets.
 - (6) J. W. Meyer, James J. Kirwan, David M. Towle, M.I.T. Lincoln Laboratory, Radiometric Instrumentation at Eight Millimeters.
 - (7) T. D. Sege, Sperry Gyroscope Co., Superpower Microwave Tubes—The Case for Linear Beam Tubes.
 - (8) W. C. Brown, Raytheon Co., The Cross-Field Approach to Microwave Super Power.
 - (9) G. Swarup, Stanford University, Mills Cross and Related Pencil-Beam Antennas.
 - (10) J. A. El Kiss and P. Spiegel, Philco Corp., A Low-Power, High-Speed Transistor, Tunnel Diode Hybrid Logic Circuit.
 - (11) W. Rindner and J. M. Lavine, Raytheon Co., Scribe- and Trace-Plating: New Techniques for Microelectric Semiconductor Devices.
 - (12) W. D. Fuller, Lockheed Missiles and Space Co., Titanium Thin Film Circuits.

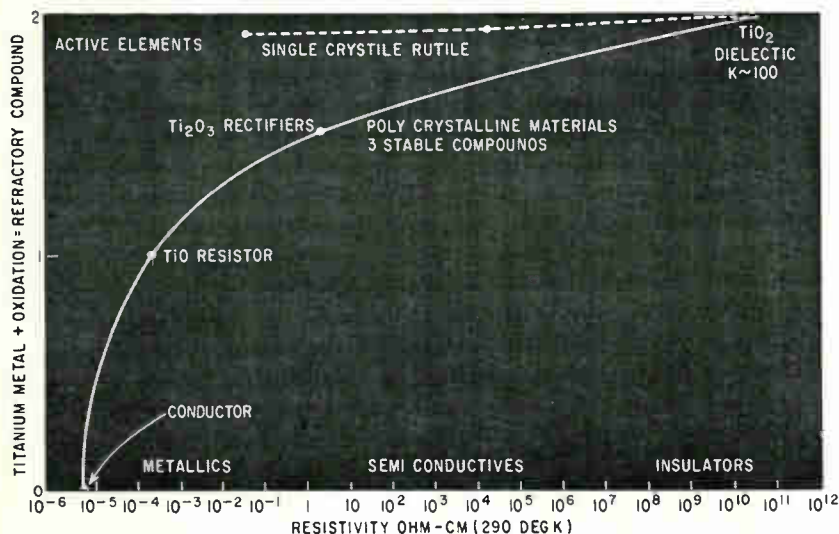

FIG. 7—Resistivity of the oxides of titanium covers 16 orders of magnitude

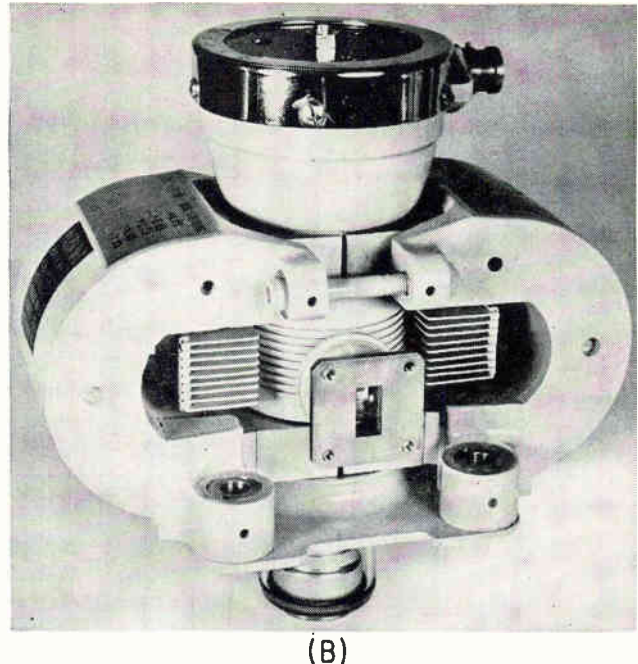
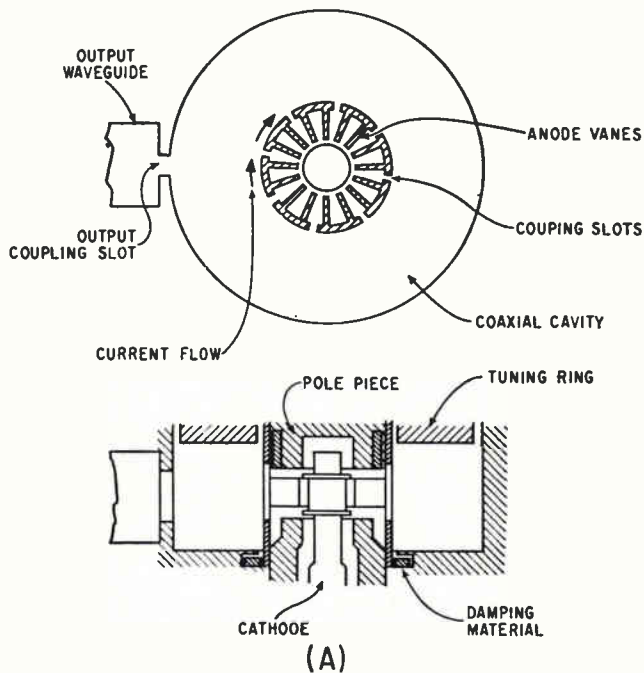

FIG. 1—Cross-sectional view of anode resonator geometry (A) with actual coaxial magnetron (B)

COAXIAL MAGNETRON

A New Microwave Power Source

High power output from tunable coaxial magnetrons makes long range K_u-band radar feasible. Wideband microwave generator also provides high frequency stability and simplified tuning

By H. M. OLSON
L. H. VON OHLSEN,
Bell Telephone Laboratories, Inc.,
Laureldale, Pennsylvania

NEW technique to control the oscillating mode of a magnetron has resulted in significantly improved frequency stability, power-generating efficiency and tuning range. Over a 2:1 range of input power, the operating frequency of the coaxial magnetron varies less than 0.001 percent. Output power of 125 Kw is generated at more than 40 percent efficiency over a range of 2,000 Mc.

The importance of the magnetron

as a microwave electron device has been due to its ability to generate large amounts of pulse power. In developing this power capability to its utmost, the trend has been toward increasing the number of anode resonators arrayed around the cathode. As the complexity of this multicavity structure has grown, it has become increasingly difficult to restrict the electron interaction process to one of the many natural modes of the structure.

In the early years of magnetron development, two approaches to this mode control problem evolved. One involved strapping alternate

resonators together while the other made use of rising-sun structures in which alternate resonators were of different sizes and different resonant frequencies. These schemes, which have become accepted as the conventional means of mode control, favor interaction with the mode characterized by a reversal of phase at each successive resonator around the array and is designated as the π mode.

More recently another method for mode control¹ has been conceived and perfected at the Bell Telephone Laboratories. This technique has served as the basis for the develop-

ment of the coaxial magnetron.

The new method of mode control is best described by contrasting it with strapping. In strapping, points of high r-f voltage that have identical phases in the desired mode are tied together by conducting straps. In the new method, r-f currents are tightly coupled together rather than voltages at points of identical phase in the desired mode.

The sketch in Fig. 1 shows anode resonator geometry. The high-current points are at the closed ends of the cavities formed between the vanes. The counterpart of the strap is the current flowing circumferentially around the center post and the outer circumference of the central cavities of a coaxial cavity excited in the circular electric (TE_{011}) mode. The amplitude and phase of this current is the same at all points around the center post of the cavity. Thus, by coupling the currents of every other vane cavity to the current of the circular electric mode of a coaxial cavity, the oscillation of the magnetron in the π mode produces excitation of the circular electric mode in the coaxial cavity. The currents of the vane structure are coupled to currents of the coaxial cavity by arranging the vane array inside the center post of the coaxial cavity and cutting slots through the closed ends of alternate vane cavities. This causes the currents established in the vane array to flow out onto the center post of the coaxial cavity. Other modes of the vanes, as well as the π mode, couple to modes of the coaxial cavity, just as in the strapped magnetron the strapping does not prevent the existence of the other vane modes. Instead, both schemes of mode control widen the separation between the frequencies of the various modes. This simplifies the problem of obtaining interaction with a particular mode by making it possible to selectively synchronize the electron stream with the fields of the desired mode only.

Since energy storage occurs in different parts of the coaxial cavity for various modes, it is possible to damp selectively undesired modes of oscillation with strategically placed microwave absorbing material. This affords a further advantage in mode control since it favors starting oscillation in the

relatively undamped π mode.

Two by-products of incorporating the coaxial cavity into the magnetron for mode control are simplified tuning and greater frequency stability. Instead of tuning each vane cavity individually, only the coaxial cavity need be tuned. Tuning is done by making one of the end walls movable as in a cavity wavemeter. The threefold increase in oscillating frequency stability against changes in load or input power is due to the additional energy stored in the coaxial cavity.

This construction also yields a more efficient electronic interaction process by eliminating the straps or other discontinuities that distort the fields in the interaction region. The improved interaction more than compensates losses in the coaxial cavity so that overall the coaxial design is more efficient than conventional designs.

Three tunable coaxial magnetrons using these principles have been developed. Together they cover the frequency range of 13.6 to 19.5 Gc. These magnetrons are coded the 7976, 7208B, and 8079 and are suitable for both ground-based and airborne applications.

The 7208B magnetron, which is typical of the three, is shown in

Fig. 1. This tube is mechanically tunable over the frequency range from 15.5 to 17.5 Gc. This range is larger by a factor of 2 than that obtained from available conventional magnetrons. The coaxial cavity design permits an internal Q of about 4,000, which is about five times better than that obtainable from magnetrons of conventional design in this frequency range. In addition, the coaxial cavity design results in only a small variation of internal Q as the tube is tuned throughout its frequency range. Thus the 7208B magnetron operates at an overall efficiency of better than 40 percent with less than a 20-percent variation in power output across the 2,000-Mc operating band. Power output at a 0.001 duty cycle as function of frequency is shown in Fig. 2A for operation at pulse lengths of both 0.1 and 3.0 microseconds. For comparison, lines of constant efficiency are shown in the same figure. Power output is flat and varies smoothly across the operating band without discontinuities. The 7208B is rated at more than 125 Kw of power output at a 0.001 duty cycle and for pulse lengths varying from 0.05 to 3 microseconds.

Operating at pulse lengths of one microsecond, power output greater than 300 Kw has been obtained over the frequency band, as shown in Fig. 2B. In conventional magnetrons operating over this frequency range, efficiencies of only 25 to 30 percent are obtained and power outputs are about one-half that of the 7208B.

The high frequency stability inherent in the coaxial cavity design is significantly improved over that of conventional designs. The pulling figure of the 7208B as a function of frequency is shown in Fig. 2C. This performance is better than that of conventional magnetrons by more than a factor of 3. The excellent frequency stability also results in excellent r-f spectrums.

The more than 125 Kw peak power available from these coaxial magnetrons makes relatively long-range Ku-band radars feasible. Increasing radar operating frequency can improve target resolution. In the absence of atmospheric attenuation and for constant power output, antenna size and receiver performance, radar range would be

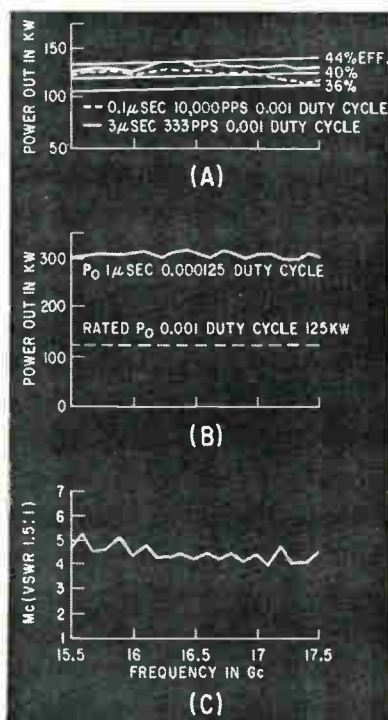

FIG. 2—Typical power characteristics (A) and (B) with pulling figure (C)

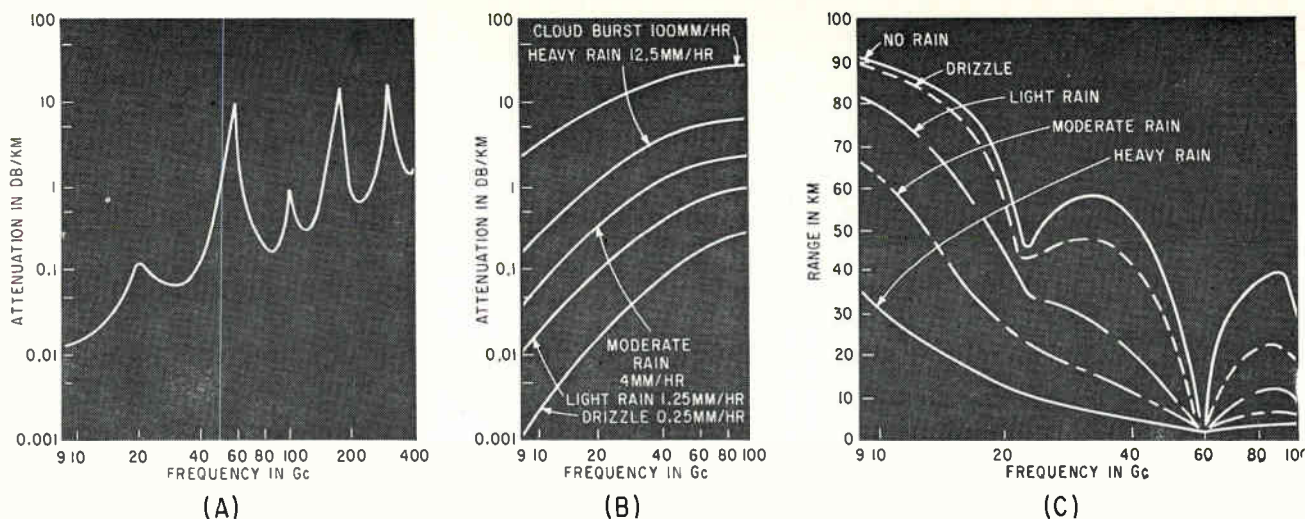

FIG. 3—Oxygen and water vapor attenuation (A), rain attenuation (B) and radar range (C)

independent of frequency. Unfortunately, atmospheric absorption cannot be ignored, particularly as the millimeter region is approached. Here attenuation resulting from absorption by water and oxygen molecules in the atmosphere and scattering caused by rainfall become serious. A study, by Van Vleck^{2,3}, Tolbert, Straiton⁴, and others, of microwave absorption by oxygen and water vapor has resulted in an estimate of attenuation as a function of frequency. A curve depicting this attenuation is shown in Fig. 3A. The estimated attenuation caused by precipitation is based on the work of Haddock⁵ and is reproduced in Fig. 3B for five rates of rainfall. The effects of these atmospheric attenuations on radar range as a function of frequency is shown in Fig. 3C with several precipitation rates as parameters. The curves were developed by assuming a modest group of design parameters that would result in a range of 100 kilometers (62 miles) in the absence of atmospheric attenuation. Although windows appear in the atmospheric absorption spectrum at Ka and W bands in the absence of rainfall, these windows almost completely disappear at modest rainfalls. The atmospheric attenuation effects become more serious as attempts are made to improve radar performance. For instance, if the 100-kilometer range in the example chosen were doubled by a 16 fold increase in the power radiated, a 71-percent range improvement would result at X band, 52-percent at Ku band, 32-

percent at Ka band and only 20-percent at W band in light rainfall.

The Ku band offers a good compromise between target resolution and range deterioration from atmospheric losses. To obtain modest radar range performance for radars located near the earth's surface under inclement weather, Ku band represents the upper limit of practical operating frequency.

By scaling a particular geometry either up or down in size, it is possible to design coaxial magnetrons for other frequency ranges. The change in size is accompanied by a change in power handling ability and some change in efficiency. However, the power handling capability can be varied at a particular frequency by varying the number of vane resonators in proportion to the power required.

Several factors complicate the design. For example, the power output that can be derived from a magnetron depends on the operating conditions. The 7208 coaxial magnetron can be operated satisfactorily at more than three times its rated power under favorable pulse conditions. Moreover, despite the advantage gained in mode control from the coaxial design, the problem of obtaining stable operation in the π mode will become more difficult as the number of vane resonators is increased. Operating efficiency tends to decrease as the size of the tube is reduced. However, these are the kind of problems normally encountered in any microwave tube development and there are strong potentialities for higher

power and frequencies in the coaxial principle of magnetron design.

The 7208B coaxial magnetron tunes over about a 12-percent band. The band is limited by the mechanical design of the tuner drive and by interfering resonances in the magnetron resonant structure just outside the band. However, the tuning range capability of the coaxial design is much greater. Using improved designs, the tuning range has been extended to 20 percent and designs in development are expected to have more than a 30-percent tuning range. The ultimate limit to the tuning range arises from the disparity in the natural resonance frequencies between the vane resonators and the coaxial cavity. As the coaxial cavity is tuned farther from the resonance frequency of the vane resonators, interaction between resonator fields and the electron stream will become weaker. Whatever the practical limit, exploiting the full capabilities of tuning range in the coaxial magnetron, a device will result that is adaptable to many applications.

This article is based on a paper presented at 1961 Wescon.

REFERENCES

- (1) J. Feinstein and R. J. Collier, A Magnetron Controlled by a Symmetrically-Coupled TE_{011} Mode Cavity, *Le Vide*, 70, p. 247, July-August 1957.
- (2) J. H. Van Vleck, The Absorption of Microwaves by Oxygen, *Phys Rev*, 71, p. 413, April 1947.
- (3) J. H. Van Vleck, The Absorption of Microwaves by Uncondensed Water Vapor, *Phys Rev*, 71, p. 425, April 1947.
- (4) A. W. Straiton and C. W. Tolbert, An Analysis of Recent Measurements of the Atmospheric Absorption of Millimeter Radio Waves, *Proc IRE*, 49, Nov. 3, p. 649.
- (5) F. T. Haddock, Scattering and Attenuation of Microwave Radiation Through Rain, Report of NRL Progress, June 1956.

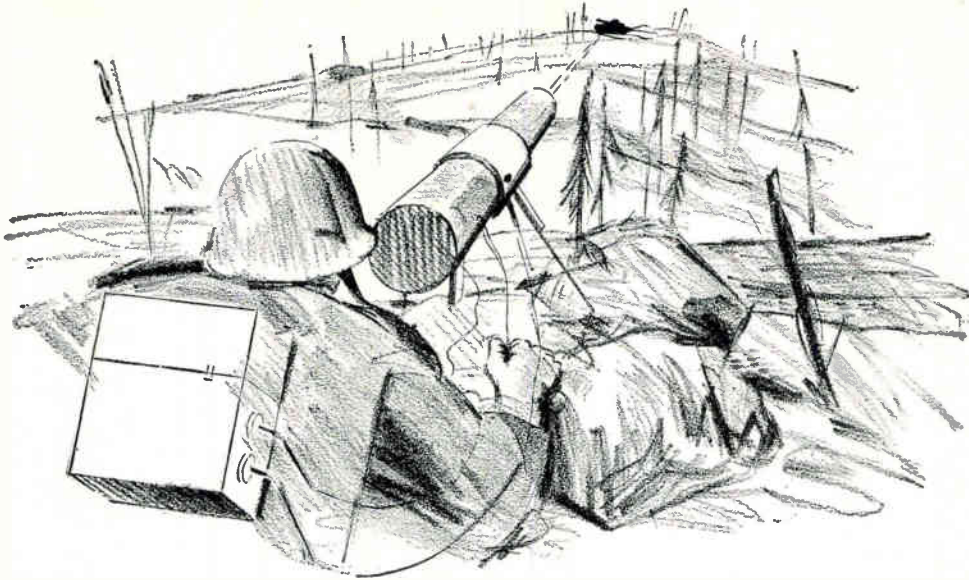

Tactical operation of surveillance unit, which comprises a gas laser and receiving apparatus (Martin-Orlando)

LASERS:

DEVICES AND SYSTEMS-PART III

Applications of lasers to military and computing fields and ideas on frequency variation, modulation, demodulation and mixing

By SY VOGEL,
Associate Editor, and
LEON DULBERGER,
Assistant Editor

MILITARY APPLICATIONS of the laser go beyond ranging, communications and undersea warfare.¹ An application of the laser that admits to extensive speculation is a heat beam for military weapon use. Colloquially known as a death ray, such military devices fall into two groups: antipersonnel and antimachine, the last for destroying missiles, planes and tanks.

When the ruby laser was announced in 1960, uses such as these were speculated upon. Many scientific and engineering experts famil-

iar with laser properties continue to speak about the possibility of developing such weapons. Further, some have suggested that Eastern block nations may be active in this work.

The highly collimated beam of infrared light generated by a laser can be focused to produce intense heat. In an experiment at Bell Laboratories, a laser beam was directed at a carbon block and focused with a simple lens. A spot on the target was heated to 8,000 C in only 0.5 millisecond.

A high-power laser built by the Trident Corp., has vaporized carbon, leaving craters on a carbon plate in tens of microseconds. The laser firing rate is 4 per second. Focal length of the projection sys-

tem is short.

There has been mention in the literature of burning holes in thin steel by focused laser beams.

To achieve distant operation, techniques must be worked out to focus the beam selectively at any point up to the maximum range of the weapon. In using the device as an antimissile intercept unit, a means of tracking accurately a precise spot on the target must also be provided. There is also the problem of attenuation of the beam by the atmosphere in operating from an earth installation.

To overcome this it may be practical to locate an antimissile kill system in an orbiting space station, controlled from the earth. The sur-

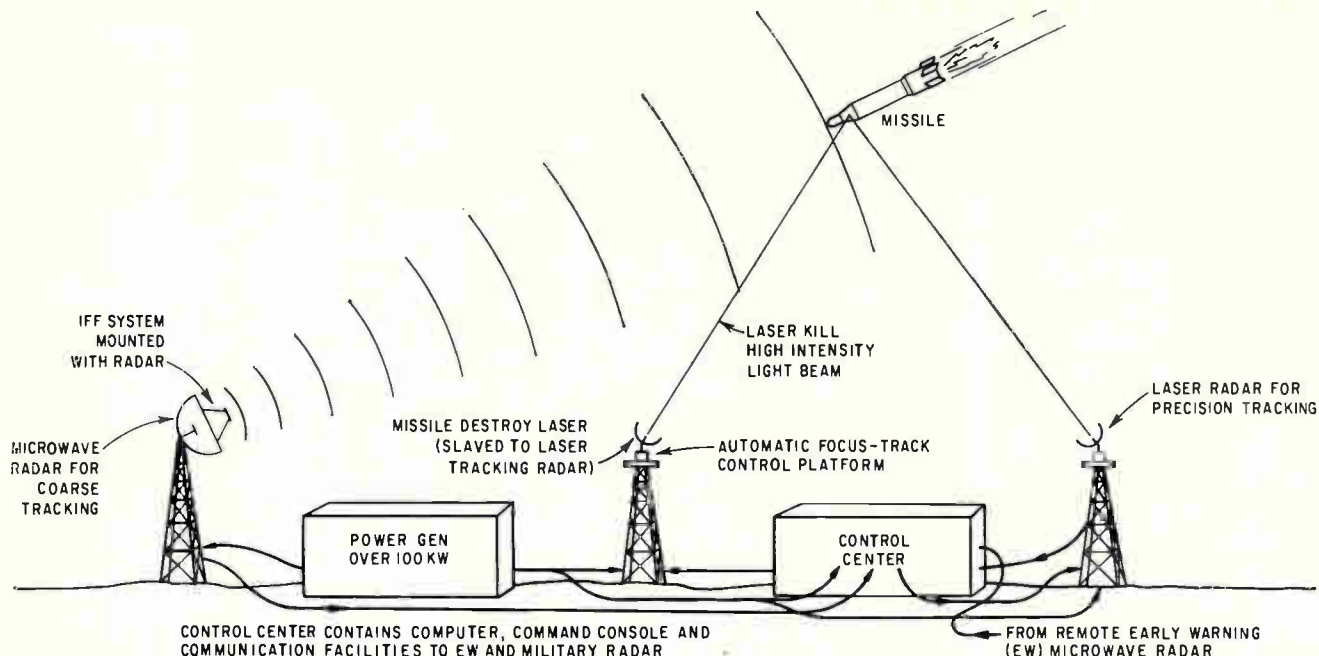

FIG. 1—Antimissile system shows how lasers might be used to track and destroy missiles

veillance area open to a laser beam originating from a point in space is much greater than achieved with a ground station. Another approach would include a laser in an anti-missile missile, fired into space when required.

The means of destroying the missile might depend on burning a hole, however thin, through an important support member of the missile's frame. There are locations on an airframe where severe vibration will develop if a guiding vane is fractured. One can depend on disintegration of the major sensitive portions of the missile in this manner.

A complete earth-based laser kill system would include an acquisition center with inputs from early-warning radar and a microwave tracking radar to provide rough position information on the approaching missile. The tracking radar would align an optical radar (using a laser for ranging) on the target (Fig. 1). This method is analagous to the astronomer's method of using a wide field telescope to locate a star for study with a high-power narrow-field telescope.

The optical radar would provide precision tracking and range data to another laser unit that does the actual target burning. It will focus and train the kill laser on a vulnerable point, and hold it there long enough for burning. A high-speed

servo system, and a complex focusing system must be developed to take advantage of the laser's potential in antimissile weaponry.

It would not be necessary to identify decoys, since a laser could account for many enemy missiles and decoys in a short time. However, an identification friend-or-foe system would be included to avoid attacking friendly vehicles.

It has been suggested that a liquid laser operating in the near infrared range is possible in theory, using the action of two chemicals and nothing else—to produce coherent light output. This has raised speculation about a "squirt-gun" like device to be used as a side arm by personnel. It might include a chamber containing one of the chemicals, with a lens ahead of the output area of this chamber. A second chemical would be pumped into the first chamber by trigger operation of a miniature pump. When the two liquids combine, an output focused to a fine point on the target by the lens would develop the heat required for use as a weapon.

An alternate might be a solid-state laser with battery power supply to operate the excitation light source. Since peak power is of major interest, the short duty cycle would allow design of compact side arms.

Other tactical uses of the laser are ranging and surveillance radar units operating at infrared and op-

tical wavelengths. It has been suggested that the detail possible with optical radars will allow outline delineation of the target. Use of such equipment may be limited to clear weather. Use of infrared frequencies could maintain secrecy of operation against the observing eye of a battlefield soldier; unless he is equipped with ir detectors.

Optical computers that would use laser memory sections may be developed.² Such computers might operate at higher speeds than computers using wires or microwave plumbing to transmit information within the computer. Light guides such as optical fibers would transmit information that would be free from noise and cross talk between transmission lines. A laser memory section could provide fast switching times, since transition times between energy levels can be in the order of 10^{-9} sec or less.

Figure 2 shows a possible memory configuration that uses two lasers as a memory unit.² The pumping sources bring the lasers near, but not into, stimulated-emission. A write pulse puts a ONE into cell No. 1 by raising enough atoms to the level at which stimulated emission begins. The nondestructive readout line senses only the stimulated emission produced by cell No. 1, since the narrowband filter passes optical energy of only the stimulated-emission frequency and spon-

taneous radiation at this frequency is too weak to be sensed. Stimulated-emission light also goes to cell No. 2. After the write pulse, the stimulated emission produced by cell No. 1 decays towards zero.

A short time after the write pulse goes to cell No. 1, a rewrite pulse goes to cell No. 2 and, aided by the transferred input from cell No. 1, produces stimulated emission in cell No. 2. A transfer line circulates enough of cell No. 2's emission back to cell No. 1 to return cell No. 1 to its condition of strong stimulated emission. Thus, the recirculation circuit preserves the ONE bit of information. The ONE can be erased by omitting a rewrite pulse. A ZERO is represented by the absence of a write pulse. The memory unit can store a ZERO since cell No. 1 does not go into stimulated-emission if it does not receive a write pulse, and cell No. 2 does not produce stimulated emission unless it receives a ONE light pulse from cell No. 1.

Among other proposed laser-memory ideas² are: prohibiting transitions between energy levels by applying external electrical or/and magnetic fields to laser cells; using an optical delay line of low attenuation, rather than a second laser cell and transfer lines, to circulate enough energy back to the laser cell to restore a ONE; and using a three or four energy-level laser to alternately store a bit of information between the pairs of energy levels.

Frequency tuning of a laser, that is, changing a laser's output wavelength, may be desirable in producing a beat frequency by mixing two laser beams; here it might be desirable to vary the frequency of one of the lasers, which could be used as a local oscillator.³

Lasers that produce several wavelengths simultaneously—the He-Ne and 0.5-percent-Cr⁺⁺⁺ ruby lasers are examples of such lasers—could be designed as stepped-frequency generators by providing a filter system that selects the desired wavelength. Another way to select the output wavelength of the 0.5-percent Cr⁺⁺⁺ ruby laser is to change its excitation power, since each of its output wavelengths appears at different lasing thresholds;^{4, 5} hence, application of enough excita-

tion power to equal only the lowest lasing threshold would select a desired wavelength.

Temperature variations can be used to vary the output wavelength of a laser. Figure 3 shows how the R₁ spectral output of a 0.05-percent Cr⁺⁺⁺ ruby laser varies with temperature.⁶ This graph indicates that if temperature could be stabilized at any desired operating point, the selected output could be any wavelength between 6.943 Å to 6.947 Å; this tuning range is 24 Gc.

The Zeeman or Stark effects, by which the application of a magnetic or electric field to a lasing material increases the number of output spectral lines, might be used to shift the operating frequency of a laser. In a recent experiment,⁷ an electric field of 1.7×10^5 v per cm was applied in a direction parallel to the optic axis of a ruby; the field shifted the R₁-line output about 15 Gc.

Operating frequency of a laser might be changed by inverting the populations of a different pair of energy levels.⁸ Changing the excitation could be a way to do this. Retuning the cavity might be necessary when the operating frequency is changed.

Changing the gas density of a gas laser is a possible way to shift frequencies.⁹ A change of gas density varies light velocity, thus changing the resonating condition (mode) of the laser. Different pressures would produce different frequencies.

Frequency changing in a gas-laser system could be accomplished by exhausting one lasing gas, or gas combination, from the cavity and replacing it with another lasing gas, or gases.¹⁰ The laser cavity would probably have to be returned.

Frequency multiplication of a ruby laser's 6,943-Å output was demonstrated in a recent experiment.¹¹ A 1-msec laser output pulse of 3 joules was passed through a filter to eliminate lamp-excitation radiation and then applied to a quartz crystal. Output of the quartz, which has a nonlinear dielectric coefficient and is transparent to 6,943 Å and to 3,472 Å, was 3,472 Å. This second harmonic was considerably weaker than the fundamental; theoretical calculations indicates that 2nd-harmonic output intensi-

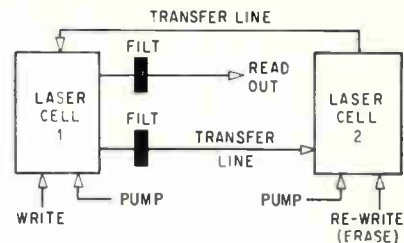

FIG. 2—Laser cells make up computer memory unit that can store one bit

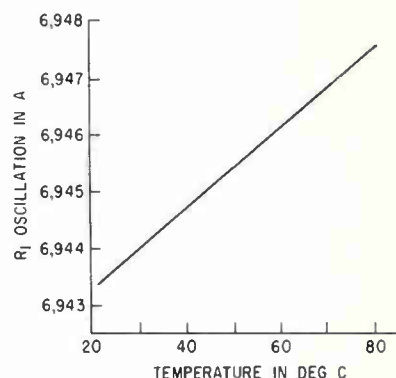

FIG. 3—Effect of ruby heating on ruby-laser output wavelength

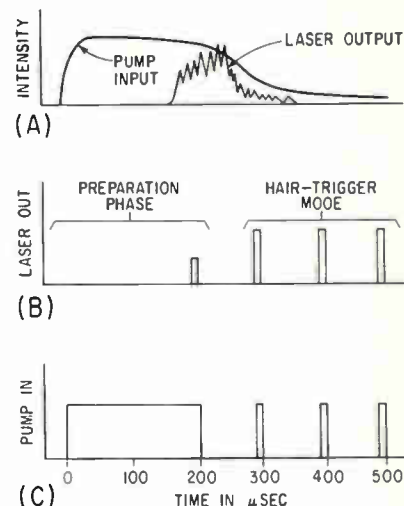

FIG. 4—Ruby laser output pulse (A) produced in conventional operation. Laser output pulses (B) are different, due to hair-trigger pumping (C)

ties can be, at best, 1 percent of the fundamental. Although coherency of the 2nd-harmonic output was not checked, it may be partly coherent.

Laser modulation techniques include internal and external modulation. Internal modulation modifies the laser carrier beam within the laser itself; external modulation modifies the laser carrier beam after it emerges from the laser.

One way to internally modulate

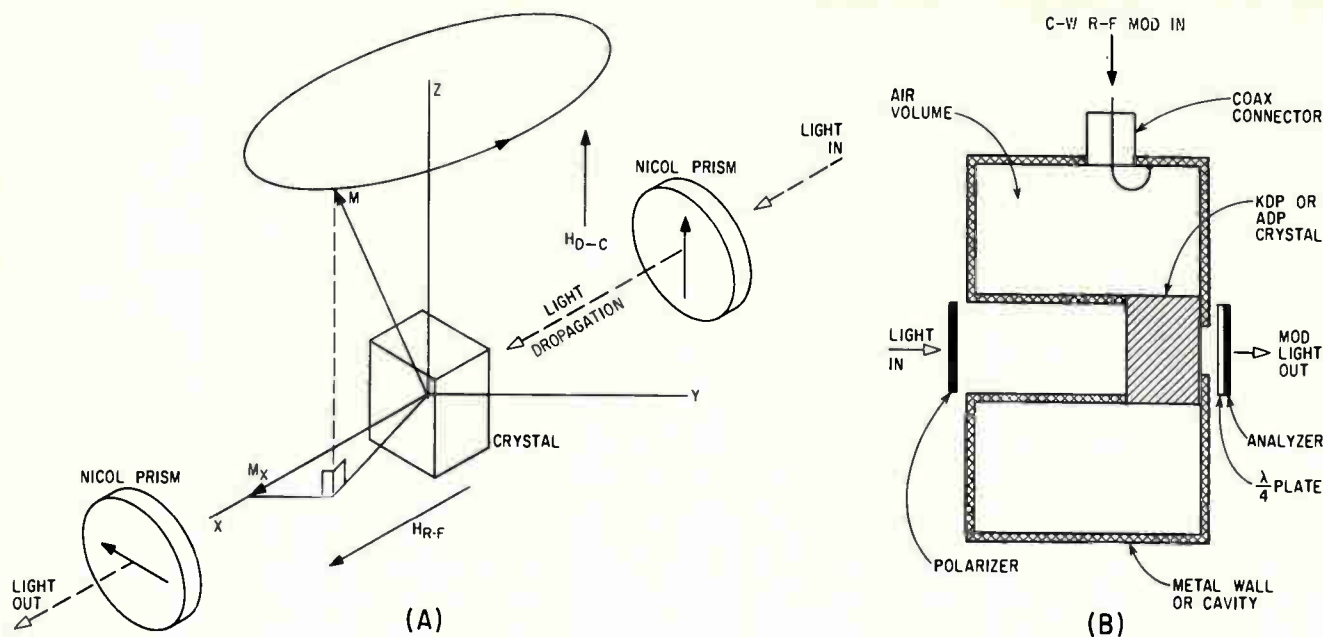

FIG. 5—Light modulation with magnetic field variation (A). Modulator (B) uses electric field (Sperry Gyroscope)

the laser is to modulate its excitation power. This method may be suitable for pulse modulation.

Up to now, pulsed-laser equipments that have used this method of modulation have switched the excitation source on and off. Their prf's have been low, in the order of several pulses per minute. A typical on-off equipment is a ranging system that provides a rectangular excitation pulse to a ruby-laser transmitter; the target reflects the light pulse back to the ranging receiver, which indicates the distance to target.^{1, 12}

A recently proposed triggering method would increase prf rates of ruby lasers, as well as decrease pulse jitter.¹³ Instead of switching the laser-excitation source fully ON to make the ruby lase, which is the conventional method indicated in Fig. 4A, just enough excitation is applied to barely start laser action (Fig. 4B and 4C). The low-amplitude pulse in Fig. 4B indicates the onset of laser action. Immediately after laser action begins, the excitation source goes off and laser action stops. At this time there are a large number of ions in a high-energy state; since the relaxation time between the upper state (the \bar{E} -level) and the ground state is in the order of several msec, a relatively weak excitation pulse can restart laser action. About 100- μ sec later, another excitation source ap-

plies a short-duration light pulse of low-energy to the ruby, causing it to lase. Pulses that follow at 100- μ sec intervals provide a prf of 10⁴ pps, with little jitter. The experimental laser that demonstrated this hair-trigger mode of operation encircles the ruby with two spiral and coaxial flashtubes. The smaller inner tube provides the trigger-excitation pulses and the larger tube, which surrounds the inner flash as well as the ruby, provides the 200- μ sec preparation pulse.

High rates of information transmission may be achieved with a proposed internal-modulation technique that would use either ppm (pulse-position modulation) or pam (pulse-amplitude modulation).¹¹ Enough pumping power would be applied to a laser to make it lase, though not so much that laser action would be at a maximum. Thus, the number of excited molecules (that is, ions, atoms or molecules) would not be equal to the maximum possible number, that is, the saturation number. Application of partially coherent, or coherent, modulation light pulses to the laser would then increase the laser output. A ppm input would modulate a laser at approximately the maximum information-transmission rate possible for pulse-modulated lasers. Pulse-amplitude modulation can be combined with ppm by using low enough pump and input-excitation

levels to prevent laser saturation.

The Stark and Zeeman effects may be used to modulate lasers internally. In using the Stark effect to modulate a ruby laser, a strong electric field would be applied to the ruby.¹⁵ Ruby energy levels would be shifted, the shifts being dependent on the strength of the modulating electric field. Thus, microwave modulation of the field produces a frequency modulated light output. However, delivering sufficient excitation radiation to the ruby, which must be placed in a microwave cavity or waveguide, may be difficult.

Ultrasonic variation of crystal stress might be used to internally modulate solid-state lasing materials.¹⁶ Laser heating would have to be minimized since heat affects crystal stress.

External modulation of a laser takes place in a modulation material that is placed in the path of the beam emerging from the laser. Solids show more promise as modulating materials than liquids or gases.¹⁷ Acoustic, magnetic and electric effects on various materials can be used to modulate light.¹⁷ The maximum modulation frequency when an acoustic wave modulates a crystal is in the order of 10 Gc.

There are several magnetic effects that can be used to modulate light.¹⁷ The Faraday effect is the strongest of these magneto-optic effects. Figure 5A illustrates the

application of the Faraday effect to modulate a crystal. If magnetic field H_{a-c} and H_{r-f} are not present, the Nicol prism at the left of Fig. 5A will not pass light. Application of a magnetic field rotates the light's plane of polarization and produces a light output. The d-c field (H_{a-c}) causes the paramagnetic ions to have a resonant frequency. The sinusoidal r-f field (H_{r-f}) causes magnetization vector M to swing out and precess, thus sinusoidally rotating the plane of polarization of the polarized light going into the crystal. Typical crystals using the Faraday effect have a resonant frequency of 15 Gc and a rotation in the order of minutes. Bandwidth is in the order of megacycles.

Figure 5B shows a modulator that uses the Kerr (electro-optic) effect.¹⁸ The microwave cavity contains the crystal that is modulated. Although its normal operating range is 30 Mc to 1,000 Mc, it can modulate light at frequencies up to 15 Gc, though at a lower level of modulation than for the normal range of operation. The r-f can vary intensity of the light transmitted through the crystal from 0 to 100 percent. Normally, the r-f input level is set so that 50-percent of the light input is transmitted by the crystal. The c-w r-f may be either a-m or f-m. Modulation power is only a few watts.

Researchers are investigating another type of light modulator.¹⁹ A strong electric field slightly modifies the energy-bands of semiconductor crystals such as amorphous selenium, cadmium selenide and selenium-tellurium mixtures. Modifying the energy bands shifts the optical-absorption edge to longer wavelengths. Thus, it may be possible to use an electrical field to modulate the optical absorption of semiconductors at above-microwave frequencies.

Demodulation and mixing are being developed for laser circuits. When a microwave-modulated laser light beam strikes the photocathode of a phototube detector, the phototube produces a microwave-modulated electron beam. Using r-f terminology, the light input is the modulated carrier, the microwave modulation corresponds to the video signal and the phototube corresponds to the crystal detector of an r-f receiver.¹⁰ Applying a local-oscillator-laser light signal to the phototube detector makes the phototube correspond to the mixer of a superheterodyne receiver.

A recently developed phototube demodulates frequency-modulated light.¹⁰ A prism converts the f-m light beam into rays having angles corresponding to the frequency dispersion. These rays fall on different spots on the photocathode face. The electron beam of the phototube

converts the ray-position modulation into an electrical f-m signal.

A recent experiment²⁰ reproduced the microwave beat frequency between two light wavelengths, thus demonstrating the feasibility of mixing light beams to produce an r-f frequency.¹ Source of the light wavelengths was a ruby laser. The laser light was focused on the cathode of a 2,500-to-4,000 Mc traveling-wave tube (twt) that was modified for the experiment. Laser light produced a small photocurrent in the twt, which was superimposed on the twt's 300- μ a beam current. The amplified output of the twt comprised signals of about 1,800, 2,402, 3,004, and 3,606 Mc. These signals are produced by the mixing of various ruby-laser wavelengths in the twt cathode.

Amplification of laser outputs has been reported by ruby and gas lasers.^{3, 21} Figure 6 shows the experimental amplifier setup that demonstrated ruby-laser light gains up to a factor of two. The common trigger energizes both pumps. Output of the ruby laser at the left of the drawing is amplified by the ruby laser at the right. The rubies have 0.05 percent Cr⁺⁺⁺ dopings and have the same construction, except for their ends. One silvered end of the ruby oscillator is opaque and the other silvered end allows 5-percent transmission; the ends of the ruby amplifier are untreated.

REFERENCES

- (1) L. Dulberger and S. Vogel, Lasers: Devices and Systems, Part 2, *ELECTRONICS*, Nov. 3, 1961.
- (2) L. C. Clapp, High Speed Optical Computers and Quantum Transition Memory Devices, West Joint Computer Conf. L. A., Cal., May 9, 1961.
- (3) S. Vogel and L. Dulberger, Lasers: Devices and Systems, Part 1, *ELECTRONICS*, Oct. 27, 1961.
- (4) A. L. Schawlow and G. E. Devlin, Simultaneous Optical Maser Action in Two Ruby Satellite Lines, *Phys Rev Lett*, 6, No. 3, p 96, Feb. 1, 1961.
- (5) A. L. Schawlow, Optical Masers, *Sci Amer*, 204, No. 6, p 52, June, 1961.
- (6) I. D. Abella and H. Z. Cummins,

- Thermal Tuning of Ruby Optical Maser, *J Appl Phys*, 32, No. 6, p 1, 177, June, 1961.
- (7) W. Kaiser, S. Sugano and D. L. Wood, Splitting of the Emission Lines of Ruby by an External Electric Field, *Phys Rev Lett*, 6, No. 11, June 1, 1961.
- (8) S. B. Collins, Sperry Gyroscope Div. Sperry Rand, Great Neck, N. Y., private commun.
- (9) C. E. Ellis and I. A. Greenwood, 17th Annual Meeting of Inst of Navigation, Williamsburg, Va., June 30, 1961.
- (10) M. Sidran, Grumman Aircraft Engineering Corp., Bethpage, N. Y., private commun.
- (11) P. A. Franken, A. E. Hill, C. W. Peters, and G. Weinreich, Generation of

- Optical Harmonics, *Phys Rev Lett*, 7, No. 4, p 118, Aug. 15, 1961.
- (12) E. J. Woodbury, R. S. Congleton, J. H. Morse and M. L. Stitch, Design and Operation of an Experimental Colidar, WESCON, San Francisco, Aug. 22, 1961.
- (13) M. L. Stitch, E. J. Woodbury and J. H. Morse, Repetitive Hair-Trigger Mode of Optical Maser Operation, WESCON, San Francisco, Aug. 22, 1961.
- (14) J. R. Singer and S. Wang, The Emission, Pulse-Level Inversion, and Modulation of Optical Masers, Second Int'l Conf on Quantum Electronics, Berkeley, Cal., Mar. 21, 1961.
- (15) A. D. Kamal and S. D. Sims, Proposed Technique for Modulation of Coherent Light, *Proc IRE*, p 1331, Aug., 1961.
- (16) L. M. Vallese, IT & T, Nutley, N. J., private commun.
- (17) P. S. Pershan and N. Bloembergen, Microwave Modulation of Light, Second Int'l Conf on Quantum Electronics, Berkeley, Cal., Mar. 21, 1961.
- (18) R. Schneider and E. Stark, Sperry Gyroscope Div. Sperry Rand, Great Neck, N. Y., private commun.
- (19) B. J. McMurtry, S. A. Harris and A. E. Siegman, Microwave Light Modulators and Demodulators, Review of Stanford Electronics Research, Aug. 15, 1961.
- (20) B. J. McMurtry and A. E. Siegman, Direct Observation of Microwave Frequency Beats due to Photomixing of Ruby Optical Maser Modes, Tech Report 177-1, Aug. 25, 1961, Electron Devices Lab, Stanford Electronics Laboratories, Stanford U, Stanford, Cal.
- (21) P. P. Kisliuk and W. S. Boyle, The Pulsed Ruby Maser as a Light Amplifier, WESCON, San Francisco, Cal., Aug. 22, 1961.

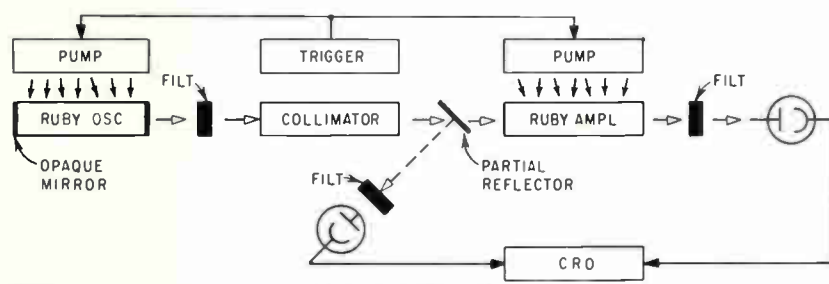

FIG. 6—Experimental setup for amplifying laser light

Headsight Television System Provides Remote Surveillance

Surveillance of a remote area is possible with this unusual closed-circuit tv system. Miniature crt viewer is mounted on helmet worn by operator and camera at remote location follows operator's head motions

By CHARLES P. COMEAU
JAMES S. BRYAN,
Research Division, Philco Corp.,
Blue Bell, Pa.

HEADSIGHT is a closed-circuit television surveillance system in which the monitor is mounted on the forehead of an operator. This is done by light weight viewing optics similar to those used in this company's 2010L commercial portable television set. The 2010L uses a half silvered mirror combined with a section of a spherical mirror as shown in Fig. 1A to produce a virtual image of the face of a miniature, high-resolution crt. The effective image is 10 in. high, at a distance of 1½ feet from the observer, and is satisfactory from the standpoint of viewing comfort.

In the headsight system, similar light-weight optics and a similar miniature crt are mounted on a helmet so that the large virtual image is directly before the wearer's eyes. The viewing device moves with the operator's head motions, thus keeping the image of the crt directly in front of the operator's eyes. In addition, the helmet position controls smoothly and continuously the directional positioning of a remote vidicon television camera. The angle of view of the camera is adjusted to match exactly the angle subtended by the image seen by the helmeted observer. When the two angles are properly matched, all viewed objects appear to remain stationary as the camera pans past them. The net subjective effect is a sense of presence in the environment of the remote camera.

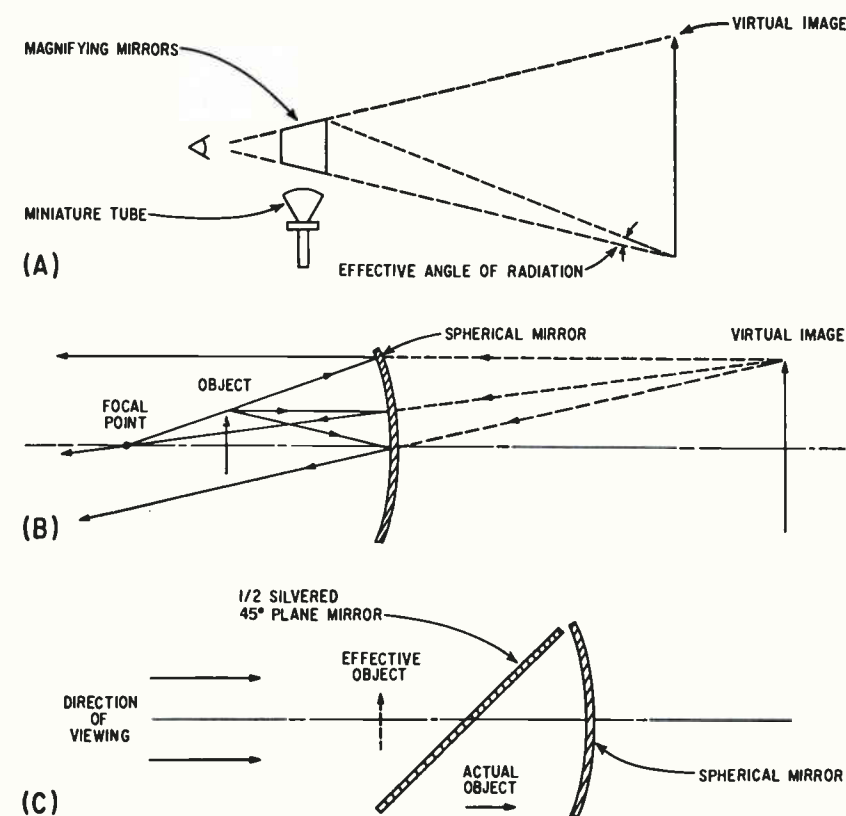

FIG. 1—Basic viewing optics for headsight system: miniature tube approach (A); typical reflective magnifier producing virtual image (B); and method of removing object from viewing path (C)

Wherever the operator points his head, right, left, up or down, the camera follows, viewing each portion of the scene in its correct relative position to the observer. If the observer tilts his head to one side the camera also tilts maintaining the viewed horizon at a constant level position. An operator, without any previous training, is able to follow rapid action from a distance and accurately relate the observations to the central point of

camera reference. In addition, the operator's hands remain free to operate other controls.

To achieve the smooth and faithful following action of the camera required to create the illusion of presence, three servo motors position the camera in its three degrees of freedom, rotation (azimuth), nod (elevation and depression) and tilt (rotation about camera axis).

To supply the error signals to control the positioning servo



FIG. 2—Author Comeau demonstrates experimental model of the headsight viewer

motors, the camera and the observer are each placed in a set of identical magnetic fields which rotate at three different frequencies in three geometric planes (two vertical and one horizontal). These rotating magnetic fields then induce similar potentials in identical sets of position sensing coils placed atop the helmet and camera. The a-c potentials induced in these two sets of coils are phase compared to yield signals proportional to positioning errors in the three planes of magnetic rotation. Head motion is sensed without restricting the operator's freedom of motion and without adding significantly to the weight of the helmet. The camera positioning servo motors then keep always identically timed fields in the two sets of position-sensing coils, and all head motions are followed faithfully. The servo mechanism response times were so chosen that, after gross head motions, the camera always achieves equilibrium before eye fixation is complete.

Figure 1B illustrates the principle of the viewer mechanism. Objects closer to a spherical mirror than the focal point produce magnified virtual images. With a suffi-

ciently large mirror surface, the virtual image may be viewed simultaneously with both eyes to produce the illusion of a large picture suspended in space a few feet from the observer. No image brightness need be lost in viewing, since the magnification is accomplished at the expense of directing the object light into a more limited viewing angle. The optical system permits a low-power television display by directing most of the light generated by the crt into a narrow beam suitable for a single viewer. So that the object itself might not interfere with the field of view, the optical system is folded as shown in Fig. 1C by means of a half silvered mirror. The mirror introduces light loss into the system but at the same time it protects the crt face from ambient illumination. With cathode currents of only $40 \mu\text{a}$ at 10 Kv, satisfactory viewing is possible, even in bright sunlight.

The cathode ray tube is unusual in that exceptional resolution is required in a small, light-weight package. A triode gun with permanent magnetic focus is used to achieve the small electron spot required. Figure 2 shows how the 2

pound crt assembly is worn by the operator. With this arrangement full 525 line television resolution was possible in the $1 \text{ in.} \times 1 \frac{1}{2} \text{ in.}$ raster. Slightly modified designs would permit resolutions of 1,000 lines or better, and electrostatic focus could provide even further weight reduction.

In the camera, a vidicon tube is used because of its small size and light weight. Since the camera must move fast enough to follow the operator's head motion, it is important that the moment-of-inertia be kept low. The short compact camera package shown in Fig. 3 was designed to have a low moment-of-inertia about its three axes of rotation. Although the long persistence of image in a vidicon tube would seem to make it less desirable as a camera tube where fast moving objects are to be viewed, this persistence did not present a problem.

The camera preamplifier is mounted in front of the camera on a ring which surrounds the lens. This transistor amplifier increases the level of the video signal before it is transmitted through cables to the video display monitors. This placement of the preamp between the vidicon and the transmission lines results in satisfactory noise performance.

The duplication of head motion is accomplished by mounting the camera in motor driven gimbals. These gimbals simulate the neck and body motions of the operator.

Figure 4A shows a skeleton view of the servo motors and gear train. The camera is suspended on a yoke that can be rotated 360 degrees to generate the azimuth motion. This motion about the vertical axis is controlled by motor 3. This action duplicates the turning motion of the head, either at the neck, or the entire body rotation.

Motors #1 and #2 operate as a pair to generate the tilt and nod motions. If both motor shafts are rotated in the same direction, the camera will rotate about its prin-

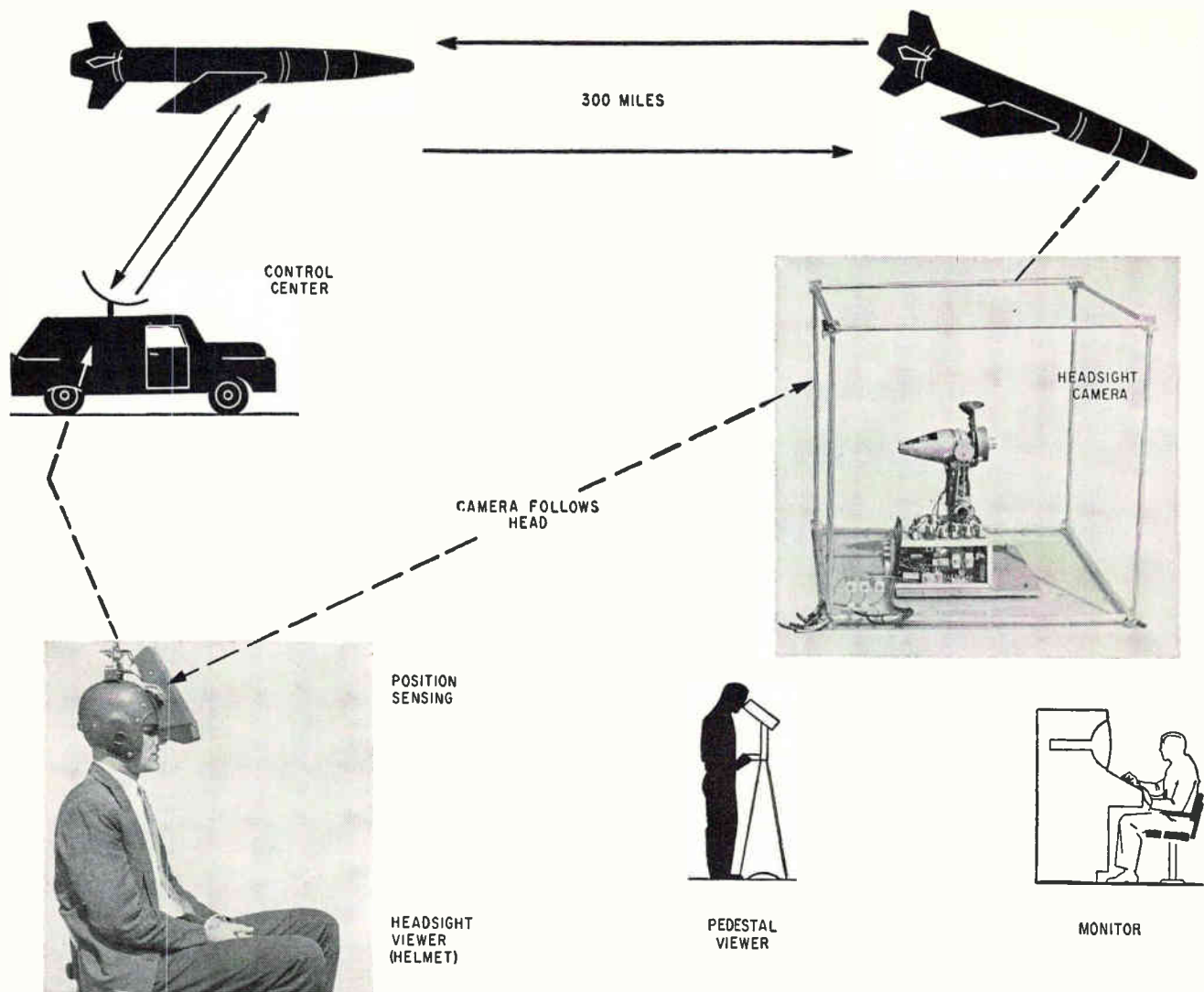

FIG. 3—Possible application of the headsight system is to mount camera in drone or rocket. The viewer, at home base, has the sense of being in the drone and can survey remote areas in complete safety

cial axis, causing the picture to tilt (solid arrows in Fig. 4B). If both motor shafts are turning in opposite directions, the camera will tilt up or down, generating the motion called nod. This motion is shown by dotted arrows in Fig. 4B. Both tilt and nod function simultaneously. This maintains a level, stationary horizon regardless of the position of the head.

The differential gear train that controls the tilt and nod motion results in a balanced, low-inertia package. The low moment-of-inertia, which is aided by the placement of all of the heavy components close to the vertical axis, minimizes the power requirement of motor No. 3. Since the force required to accelerate the camera in either the nod or tilt mode is shared by both motors 1 and 2, the power required for each motor is half of that which would be needed to perform the two

tasks with separate independent motors. The ability to control tilt and nod independently is not compromised with this arrangement. Whenever the velocities of these two motors are not identical, they are performing the actions of tilt and nod simultaneously.

The head position sensing mechanism employs a pair of coils which is mounted rigidly on the operator's helmet, as in Fig. 3. An identical set of coils is mounted on top of the camera (Fig. 3). These coils are redrawn in Fig. 5. The coil wound in the vertical plane senses both the azimuth and nod position of the head. The horizontal coil senses the tilt of the head with respect to the viewed horizon.

The position detecting coils detect orientation by sensing the phase of three fields which are rotating in the direction of azimuth, nod and tilt. These fields are gener-

ated by large sets of Helmholtz coils placed in a cube around the observer. A second smaller but electrically identical set of coils surrounds the camera.

For sensing the position of any one of the three degrees of freedom, the fields generated by 2 pairs of coils are used. One pair of coils is connected directly to the signal generator. The phase of the signal in the second pair is shifted by 90 degrees to form a quadrature signal. The combination of the signals in the two pairs of coils forms a constant-amplitude field that rotates in space at ω_0 , similar to the rotating fields in a two-phase induction motor. If the field generating coils are large, and of the proper geometric configuration, the phase and amplitude of the generated field will be essentially uniform everywhere within the space enclosed by the coils. Large coils

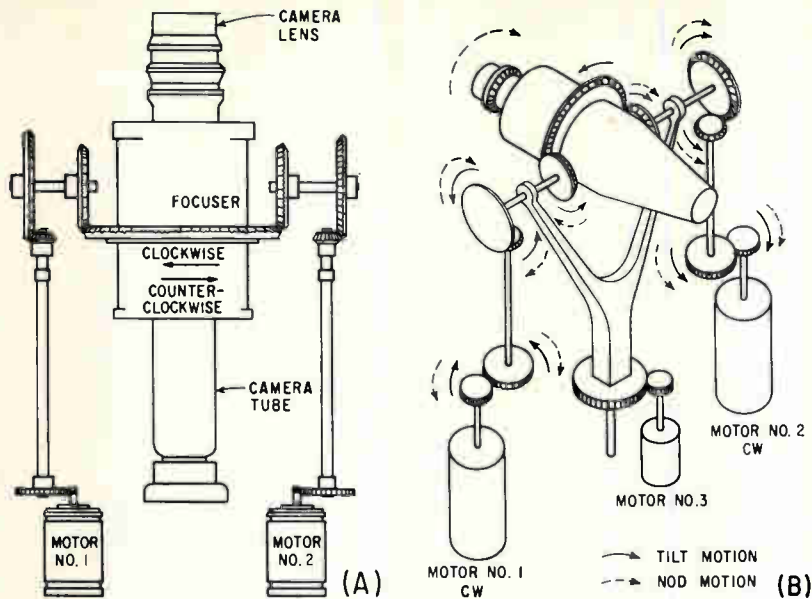

FIG. 4—Servo motors and gear train (A), and illustration of how tilt and nod motions are generated (B)

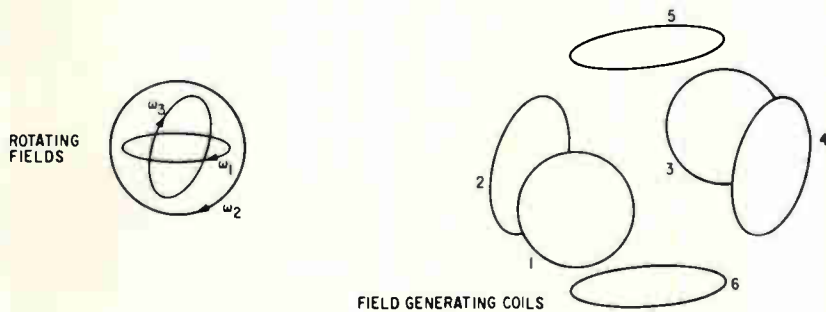

FIG. 5—Relationships of field generating coils (right), and rotating fields (left)

also have the advantage that they do not restrict the free movements of the operator within the room. The three independent rotating fields, ω_1 , ω_2 , and ω_3 , are generated by three independent signal generators.

Figure 5 represents the three sets of coils needed to generate the rotating fields. Coils 1, 2, 3 and 4 are connected to a generator that generates a constant amplitude field rotating about a vertical axis at a rate ω_1 .

In a similar manner, coils 1, 5, 3, 6 are connected to a second generator so as to produce a constant amplitude signal, ω_2 , which is rotating about an axis normal to the paper. A third rotating field is generated by connecting coils 2, 5, 4 and 6 to form a field rotating about a horizontal axis parallel to the paper. The three rotating fields are at three different frequencies and

act independently of each other.

A large set of the coils described above was built in the shape of a small square room in which the operator sits. The operator could move freely around the room without a sense of restriction. A similar, but much smaller, set of coils was placed around the camera. This set of coils can be observed in the cubic frame that surrounds the camera in Fig. 3.

On top of the camera is a small pair of coils used for detecting the three rotating fields. The phase of the signals induced in the sensing coils is directly related to the orientation of the sensing coil. Coil 1C (Fig. 6) is used for sensing the azimuth position of the camera. Since signal ω_1 is rotating about a vertical axis, the phase of ω_1 induced in coil 1C would depend on the orientation of coil 1C.

An identical pair of coils is

placed on the helmet of the operator. These coils follow all the head motions of the operator. Coil 1H (Fig. 6) on the operator's helmet senses the phase of the signal (ω_1) generated by the azimuth coils surrounding the operator. If the operator is facing in exactly the same direction as the camera, the phase of ω_1 induced in the operator's coil 1H will be identical to the phase of the signal induced in the camera coil 1C. If the two coils are not facing in exactly the same direction, the phase of the current induced in the two coils will differ by an amount exactly equal to the angle between the head coil and the camera coil. When a phase error is detected, the high-gain servo amplifier energizes the servo motor, that rotates the camera reducing the phase error to zero.

The tilt and nod control work in a similar manner, by using the signals induced in coil 2C and 2H. When the camera is facing coil 2 or 4, the signal generated by coils 2, 5, 4 and 6 (see Fig. 5) control the motion of nod. However, when the camera azimuth is rotated by 90 degrees, the nod position will be controlled by the signal generated in coils 1, 5, 3, 6. The transition between the two signals that alternately control the nod position is made by the block called nod relay (Fig. 6). The nod relay is an electronic switch that slowly shifts the control signal as the head is rotated through the transition points. The tilt relay (Fig. 6) performs a similar function for the tilt signals. The tilt and nod relay enable the camera to rotate through 360 degrees (azimuth) while the tilt and nod control is alternately shifted every 90 degrees.

Since the same two motors that control the nod position also control the tilt position, a passive matrix network (Fig. 6) adds or subtracts the error signals needed to drive the two motors. Both tilt and nod corrections can be made simultaneously without having the two operations interfere with each other.

The unit in Fig. 2 was built and tested to evaluate its operating characteristics. Further development of the viewer could easily achieve still further weight reduction, yet the weight of 2 lb including the helmet was not ob-

jectionable.

The operator was able to view and follow fast moving objects, such as might be seen at a tennis match. Even an untrained operator could follow the tennis ball precisely, after only a few moments of operation. The operator achieves this camera control through his head motions only. The same operations were attempted, using manual control of the camera position. Manual control of the camera proved to be more difficult and much less precise than the head-sight control system.

The headsight system also allows an observer to view dangerous operations as if he were at the scene, and yet he can be far away. Typical situations might include explorations of ocean depths, space

or radioactive areas; it might also be used in military combat surveillance.

A further variation can be added to the above headsight system that would improve the effective resolution without adding more weight, or using a larger cathode-ray tube. Since the viewed scene is always directly in front of the observer, the resolution pattern of the viewer can to some extent be made to match the resolution pattern of the human eye. Such a system would obtain improved resolution at the center of the crt at the expense of poorer resolution at the edge of the crt. This then would be similar to the high resolution obtainable in the fovea (central position) of the eye as compared to the decreased resolution toward the

edges of the field of view of the eye.

The use of fovea-matched system resolutions would not lessen the system performance below that of a system that had high resolution over the entire raster. A normal stationary monitor would ordinarily need the high resolution performance over its entire raster to allow the observer to concentrate his attention on any portion of the included scene. The foveal headsight automatically moves the center of visual attention to the central high-resolution portion of the monitor. The use of the foveal headsight system would produce an image equivalent to that of a high resolution system with at least eighteen times the video bandwidth of the headsight approach.

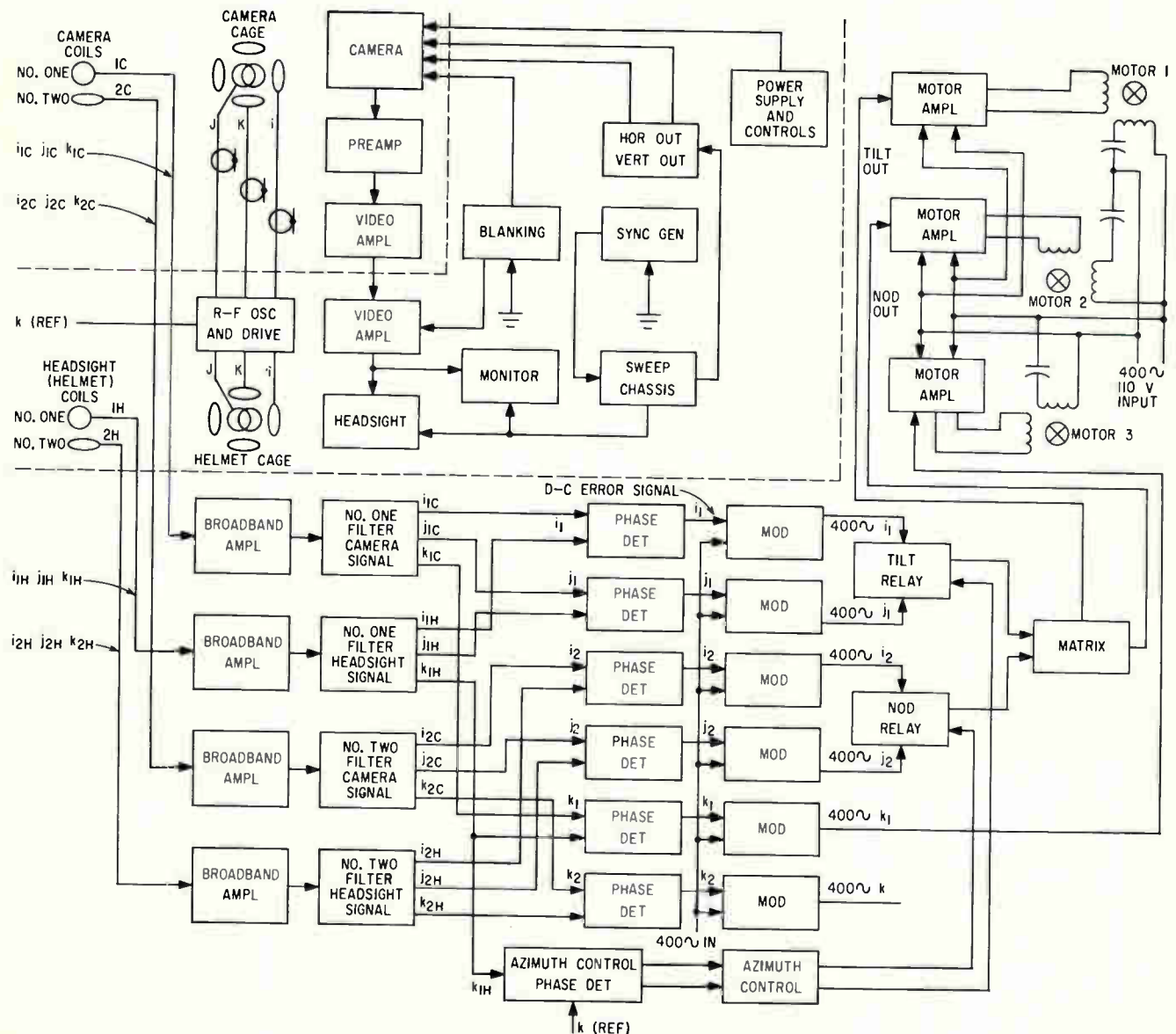

FIG. 6—Headsight television viewing and control systems. Coil IC senses azimuthal position of camera

BISTABLE CIRCUIT

Times Camera Exposures

Timer controls both exposure time and interval between exposures; has range from 0.1 second to 2 hours

By JOHN G. FULLERTON,
High Altitude Observatory,
University of Colorado,
Boulder, Colorado

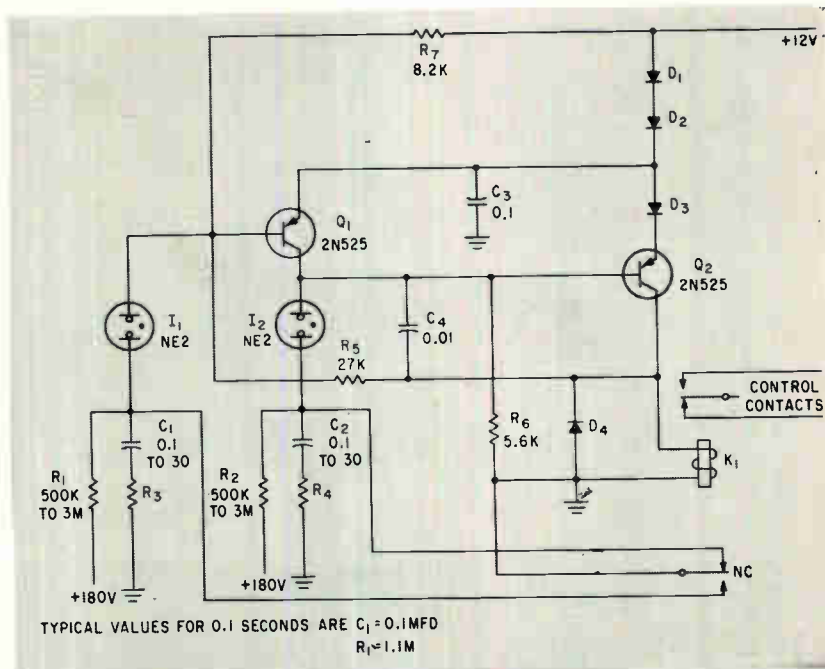

Bistable circuit is so arranged that each half-cycle can be adjusted independently by changing time constants with capacitors C_1 and C_2

A SMALL, FLEXIBLE, preferably non-mechanical timer was required for controlling the exposure time and the interval between exposures of a data recording camera. Similar timers were to control calibration intervals of the associated experiment. Time intervals of exposure and between exposures had to be varied over wide ranges between 0.1 second and 2 hours, and had to be independent of each other. Such flexibility is not readily available in mechanical devices.

The time intervals are determined by RC time constants and latching of the circuit ON or OFF by a two-stage transistor circuit with feedback. The basic circuit is shown in the figure.

Consider the timer as being ON, that is Q_2 in conduction, K_1 energized, and Q_1 off. The timer is kept ON by current flowing through R_6 to the base of Q_2 . Since Q_2 is saturated, the voltage at Q_2 's collector is approximately 10 v. Since R_7 is tied positive with respect to Q_1 's emitter, and the ratio of R_7 and R_5

keeps Q_1 's base positive, Q_1 is turned off. When C_2 charges to about 80 v, I_2 will fire and turn Q_2 off. When Q_2 's collector goes negative, enough current is supplied through R_5 to saturate Q_1 ; its collector pulls Q_2 's base to cutoff. The cycle begins again when C_1 charges to about 80 v, lamp I_1 fires, and supplies current to turn off Q_1 and energize K_1 . The forward conduction voltage drop of diodes D_1 , D_2 and D_3 supplies proper bias for the circuit.

Capacitors C_1 and C_2 are charged from a 180-v supply to maintain the charge rate at a near linear value up to the point where I_1 and I_2 fire. The 180-v supply could be eliminated by substituting unijunction transistors or similar devices, such as 4-layer diodes, for neon lamps I_1 and I_2 . Capacitors C_1 and C_2 could then be charged from the main power source. Mylar film capacitors are chosen for C_1 and C_2 , to have low leakage. Leakage through semiconductor devices does limit the dynamic range of the timer and

may limit the repeatability of time intervals due to temperature variations; for this reason gas discharge tubes were chosen because of their low leakage and consequent extension of the dynamic range.

While one capacitor is charging, the other capacitor is prevented from charging by relay contacts which ground its charging source. Current through the relay contacts and through the neon lamps and the base junctions of the transistors is limited by resistors in the ground return leads of the capacitors. Capacitors C_3 and C_4 suppress transients from other sources which might falsely trigger the timer.

The values of C_1 and C_2 , as well as R_1 and R_2 , may be varied to give the timer great dynamic range. Speed of operation is primarily limited by the speed of the two-contact relay.

Credit is due to R. H. Lee for the basic concept of the timer and to the Office of Naval Research and The National Science Foundation for support of the experiment.

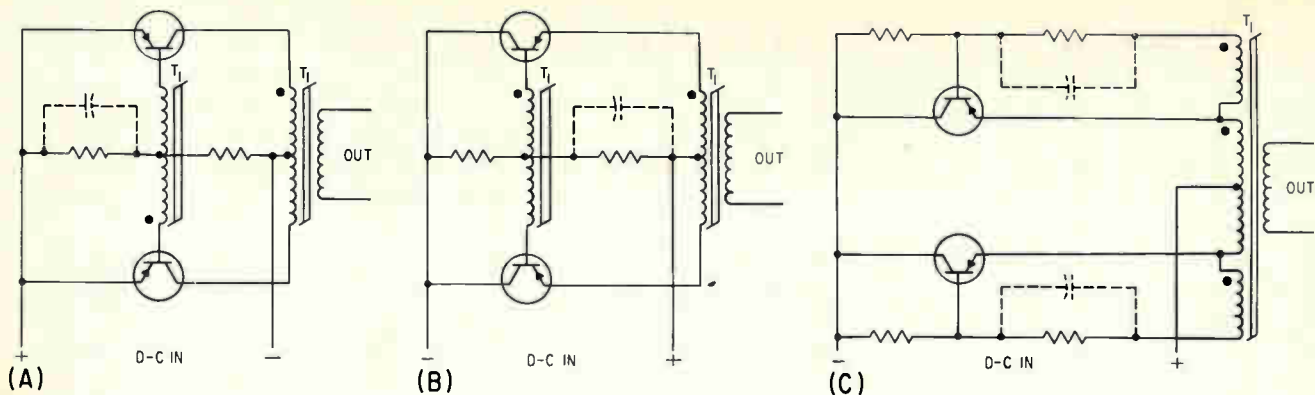

FIG. 1—Basic configurations of transistor inverter circuits are indicated by solid lines in (A), (B) and (C). Dotted lines show capacitors that are added to speed switching

SPEED-UP CIRCUITS IMPROVE

Switching of Transistor Inverters

Quickening switching speeds decreases transistor dissipation and lowers the ripple in the d-c produced by rectifying the inverter's output. Additional capacitors and transformer windings provide the increase in switching speed

By ALLAN G. LLOYD,
Bread-Boards, Inc., Newark, N. J.

INVERTER CIRCUITS such as those shown in Fig. 1 sometimes produce poor switching waveforms. Among the causes of poor switching is the use of very square hysteresis-loop core material having few primary turns (ten to twenty) per half. The resulting notches, steps or pauses produced during voltage reversals at switching cause excess transistor power dissipation and increased ripple of d-c produced by rectification of the inverter's output. High-power (100 watts and up), high-frequency (1,500 cps) germanium inverters with resistive loads are particularly prone to sluggish switching because there are usually only three or four turns on the feedback windings; the high-frequency loop gain, which is related to switching speed, is low. Magnetic saturation of the transformer core at the end of a half-cycle quickly forces the ON

transistor to OFF, but turning on the OFF transistor requires sufficient energy return from the transformer to overcome the bias and turn-on time requirements of the OFF transistor. Also, time is required to sweep all the minority carriers from the ON transistor junction, and until this is done, the ON transistor constitutes an additional burden to turning on the OFF transistor. Figure 1 shows capacitors (dotted) that can be added to the basic inverter circuits to help switching. These capacitors are usually large-value electrolytics and frequently give only partial improvement of the switching waveforms.

Figure 2 shows circuits that produce better switching waveforms. In Fig. 2A base resistors R_1 and R_2 allow the addition of cross-coupled positive-feedback capacitors C_1 and C_2 . These capacitors greatly increase the high-frequency gain of the feedback loop, and provide energy storage to drive the OFF

transistor fully on when the core saturates. Each capacitor differentiates the square-wave output voltage and applies the positive and negative current spikes as additional positive feedback to the transistor bases during switching. There is an optimum value for these capacitors. Too small a value will have no effect. Too large a value may cause high frequency oscillations at no load, generate excessive base-emitter and base-collector voltage spikes, and load the inverter capacitively. Small resistors can be placed in series with each capacitor to modify the current spikes. Figure 2B shows a speed-up arrangement applied to the common collector circuit of Fig. 1B.

Figure 2C shows the Fig. 1C circuit modified with speed-up winding N_1 and capacitor C_1 . The number of turns on N_1 is not critical but must exceed $(N_p + 2N_s)$. As N_1 is increased above this value, the required value of C_1 is reduced. Prac-

LOOK WHAT ONE MOTOROLA 2N1142 GERMANIUM EPITAXIAL MESA DOES IN THIS CIRCUIT!!

PROVIDES 250 mW @ 160 mc WITH
10 db POWER GAIN AND 45% EFFICIENCY

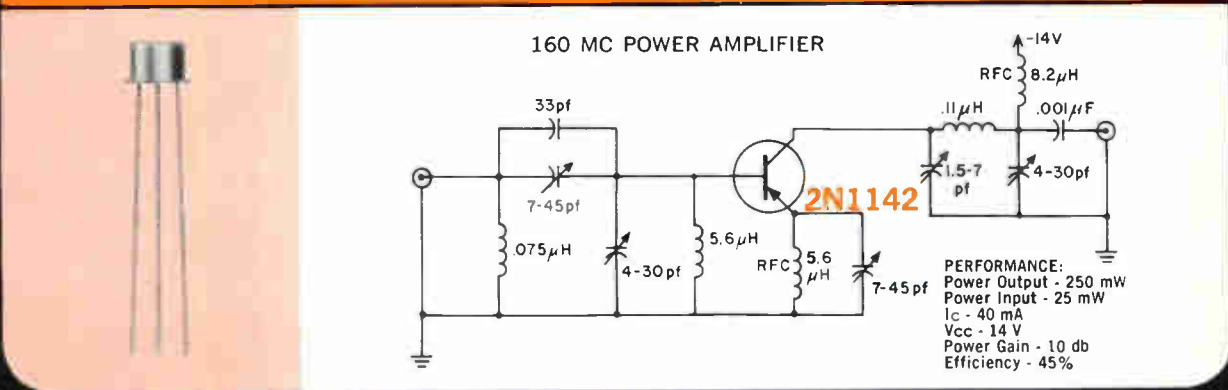

The latest devices to join Motorola's epitaxial mesa family are four new PNP germanium transistors, the 2N1141-2-3 and the 2N1195. These new Motorola communication amplifiers provide very high power gain and low R-F noise in the VHF-UHF frequency ranges. They not only make ideal drivers for 160 mc power mesas (Motorola 2N1692) in transmitter output stages, but they also solve critical design problems in frequency multipliers, R-F and I-F amplifiers, mixers, and oscillators.

In addition to higher power gain and lower R-F noise, the new epitaxial units also offer typically:

$$V_{CE(sat)} = .185 \text{ V @ } I_c = 50 \text{ mA};$$

$$100 \text{ mc } h_{FE} = 18 \text{ db.}$$



MOTOROLA
Semiconductor Products Inc.

A SUBSIDIARY OF MOTOROLA, INC.

5005 EAST McDOWELL ROAD • PHOENIX 8, ARIZONA

MOTOROLA DISTRICT OFFICES:

Belmont, Mass. / Burlingame, Calif. / Chicago / Clifton, N. J. / Dallas
Dayton / Detroit / Glenside, Pa. / Hollywood / Minneapolis / Orlando,
Fla. / Phoenix / Silver Spring, Md. / Syracuse / Toronto, Canada.

November 10, 1961

LOW NOISE 200 MC AMPLIFIER

5 db noise figure at 15 db power gain

And, this new Motorola 2N1141 series offers performance breakthroughs in the communication field for low-noise R-F circuits and broad-band high-frequency amplifiers. In front-end applications the low noise of this series provides new extended receiver range. A typical low noise, broad-band amplifier circuit is shown below.

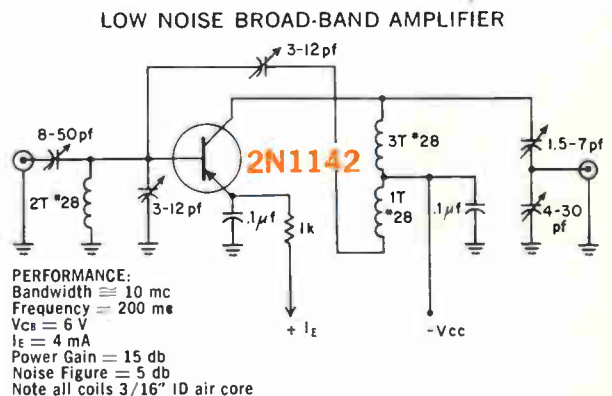

For more complete specifications, contact your Motorola district office, or write: Motorola Semiconductor Products, Inc., Technical Information Department, 5005 East McDowell Road, Phoenix 8, Arizona

CIRCLE 93 ON READER SERVICE CARD

93

tice shows that $N_1 = 2N_p$ works well. The v-a rating of N_1 is small because the speed-up current flows only during switching and has a very low rms value. Capacitor C_1 is nonpolar. Production tolerance can be taken care of by making C_1 twice as large as necessary for adequate switching and clipping the resulting base-collector voltage spikes with despiking network D_1, D_2, C_2, R_3 .

Figure 2D shows speed-up windings individually applied to each base circuit. Figure 2E shows a speed-up arrangement for a silicon transistor. Such transistors have

a low value of allowable reverse base-emitter voltage. Diode D_1 limits negative-drive excursions, and D_2 uncouples base resistor R_1 from the positive-current spikes coming from C_1 during turn-on. Resistor R_2 supplies a path for I_{c0} during the OFF period.

Figure 2F shows the base-drive two-generator equivalent circuit. Here, the speed-up voltage (E_1) is 24 v and the drive voltage (E_2) is 3 v. In Fig. 2G, generator E_2 and R_1 are replaced by their Thevenin-circuit equivalents, using E_1 as the source. This results in $R_2 = 24$ ohms and $R_1' = 3.43$ ohms. How-

ever, an extra 24 watts of power loss is incurred in R_2 as a result of this configuration, so that the price of using a single high-voltage winding for both speed-up and base drive is gross inefficiency. Otherwise, the circuits of Fig. 2F and 2G have the same performance.

These speed-up circuits allow inverters to switch at the highest possible speed without sacrificing large amounts of power in base-drive resistors. Switching times of 4 microseconds have been observed for 2N174's and 2 microseconds for some types of germanium power transistors.

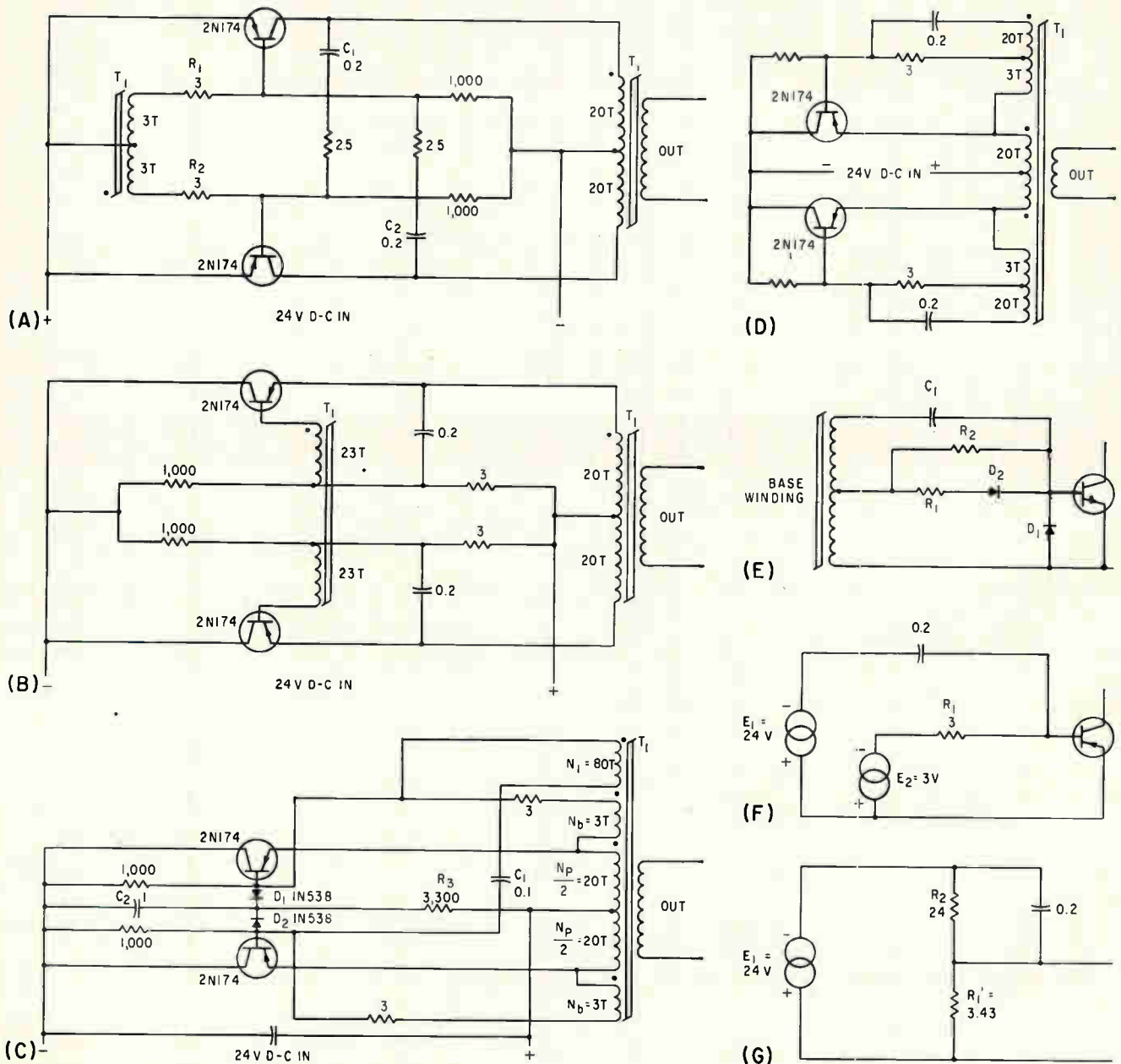

FIG. 2—Circuits (A) through (D) show complete configurations having fast switching. Circuit (E) indicates modification of (D) for a silicon transistor. Equivalent circuit (F) has two base-drive sources, as do (D) and (E). Equivalent circuit (G) produces two base drives from a single source



IN ELECTRICAL CONNECTORS, TOO



Craftsmanship produces enduring quality

For over three centuries, the Stradivarius has provided unmatched violin quality, reflecting the integrity of its maker. Similarly, companies today achieve their goals—or fall short—through varying degrees of quality and integrity.

Bendix® Electrical Connectors, made by the Scintilla Division, are recognized by their users as products of the highest quality—with no premium in cost. If connector quality interests you, write us at Sidney, N. Y.

Scintilla Division



Canadian Affiliate: Aviation Electric, Ltd., 200 Laurentien Blvd., Montreal 9, Quebec. Export Sales & Service: Bendix International, 205 E. 42nd St., New York 17, N. Y.

Cryogenic Inductors May Become Power Source

By A. HEMEL

Illinois Institute of Technology,
Chicago, Ill.

LARGE AMOUNTS of energy that can be stored in cryogenically cooled inductors could become a valuable new source of energy. If practical methods are developed to recover this energy, such inductors might perform some of the functions of rechargeable batteries. For example, supercooled coils might be used as a power source for fleets of automobiles or trucks.

The potential usefulness of cryogenic inductive energy storage was suggested by a report on the behavior of niobium-tin alloy (ELECTRONICS, p 9, Feb. 10). In the superconducting state, average current densities of 100 amp per sq cm were observed in Nb₃Sn, and superconductivity persisted in magnetic fields of 88 kilogauss. Other materials have been produced in which considerably higher currents have persisted in stronger magnetic fields.

Using Stored Energy

The possibilities inherent in this type of energy storage can be demonstrated using a fleet of electrically powered vehicles as an example, although many engineering problems would have to be solved for practical realization.

With d-c flowing in a superconducting coil with its ends shorted together, the amount of energy in the coil is $W = 1/2Li^2$, where W is energy in joules or watt-seconds, L is inductance in henries and i is current in amperes. Normally this energy would be rapidly dissipated in i^2r losses but resistance is negligible in a superconductor.

If current in a superconducting wire were 100,000 amperes and the wire were formed into a 1 henry coil, theoretically the inductor could store 1390 kilowatt-hours or 1860 horsepower-hours of energy. If this stored energy could be used in a 200-horsepower electrically powered vehicle, the vehicle could

operate at top speed for about 7 hours, assuming 75 percent efficiency in converting electrical energy into mechanical energy.

This energy might conceivably be extracted from the coil using an arrangement like that shown in the figure. One segment of the thermally insulated supercooled coil is extended through a rotating magnetic field forming a d-c motor. Only the supercooled coil segment would be maintained at superconducting temperature.

Current for the rotor segments is assumed to be provided by an auxiliary power source although other arrangements might be possible that would eliminate need for the power supply. The rotating magnetic field would be provided by a commutator.

Force applied to the rotor is $F = Bli$, where B is rotor magnetic field density, l is length of superconducting segment in the rotor magnetic field and i is current through the supercooled stator segment. Because rotor magnetic field density is determined by an electrical power source, power provided

to the vehicle by the motor can be controlled electrically.

Counter emf reduces current in the supercooled coil as energy is extracted in accordance with the relationship $E = -Blv$, where E is counter emf and v is velocity of the rotor field passing the stator field provided by the supercooled coil segment. Current is reduced at the rate of $di/dt = -Fv/Li$.

Recharging Cryogenic Inductor

The supercooled coil segment might also be used to recharge the coil. If the rotor were driven in the opposite direction, voltage induced in the supercooled coil would be $E = L di/dt$ and the change in current would be $di/dt = -Blv/L$. Because v is negative when the coil is driven in the opposite direction, the value of di/dt is positive. A prime mover at a base of operations for the vehicle could be used to recharge the supercooled inductors by driving them in the reverse direction. Recharged inductors might be kept on hand to keep the vehicles operating while the original inductors are recharged.

Application of cryogenic inductive energy storage requires an adequate supply of liquid helium. Even with the best thermal insulation, heat would leak into the coil, vaporizing the helium. A supply of liquid helium at an operating base seems more practical than providing vehicles with small liquefiers because of their cost.

The estimated cost of providing liquid helium for the vehicles is subject to wide variations and must therefore be made with reservations. One manufacturer offers an 8 liter-per-hour cryostat for slightly more than \$30,000. This unit operating continuously could service a maximum of 786 coils having an evaporation rate of $\frac{1}{4}$ liter an hour. This limited evaporation rate might be sustained by insulating the coils and liquid helium with modified dewar flasks.

Time that a vehicle could stay

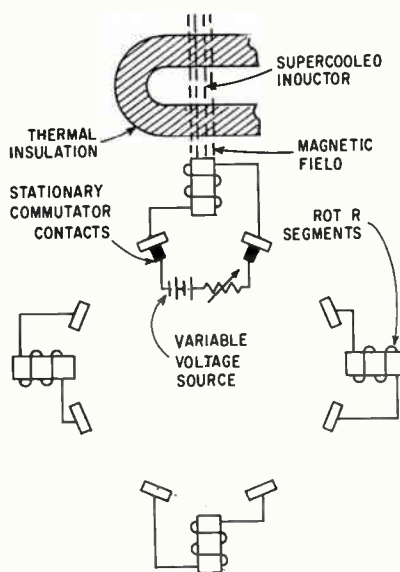

Rotor segments are the only moving parts of machine that might extract stored energy from supercooled inductor

WHY THINK BIG?

CENTRALAB

"TWO-DIMENSIONAL"

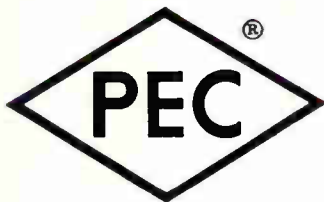

TRIMMER RESISTORS

AS SMALL AS

$\frac{1}{4}'' \times \frac{1}{4}''$

WITH VIRTUALLY NO DEPTH!

All the adjustment you need—in a fraction of space, at a fraction the cost—for military or commercial applications.

These versatile ceramic base units are available as single or multiple trimmers. Fixed resistors can be included on multiple units—either associated with, or independent of the trimmer circuitry, through the flexibility of the  technique. They can be supplied in all standard resistance values.



ACTUAL SIZE

MICRO-MINIATURE (SERIES 3)

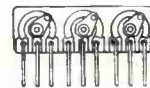
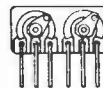

Single trimmer measures only 0.250" square, 0.100" deep, rated at .05 watts at 70° C. Multiple trimmers can include up to 5 fixed resistors, depending upon value and voltage rating.



ACTUAL SIZE

SUB-MINIATURE (SERIES 4)

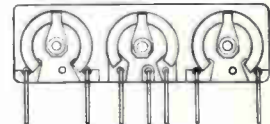
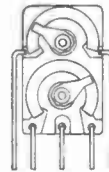

Single trimmer measures only 0.406" x 0.438" x 0.125", rated at 0.1 watts at 70° C. Triple trimmers can include up to 8 fixed resistors, depending on value and voltage rating.

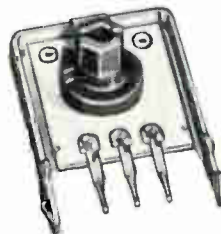

ACTUAL SIZE

MINIATURE (SERIES 5)

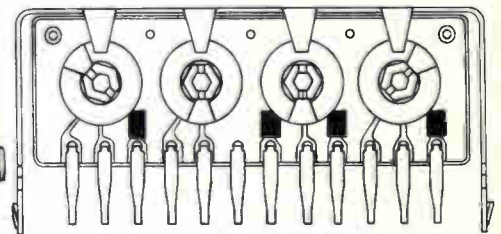

Single trimmer measures $\frac{5}{64}'' \times \frac{45}{64}'' \times \frac{19}{32}''$. Rated at $\frac{1}{4}$ watt at 70° C. Available with leads, solder or wire-wrap terminals, in a wide range of mounting styles for modern production techniques. One to four variable resistor elements and up to 12 fixed resistors on a single plate. Knob permits adjustment by finger tip, internal or external hex wrench, or screwdriver.

For additional information on these units write for CENTRALAB Engineering Bulletin 42-1216.

Y-6147

THE ELECTRONICS DIVISION OF GLOBE-UNION INC.
914L EAST KEEFE AVENUE • MILWAUKEE 1, WISCONSIN
In Canada: Centralab Canada Ltd., P.O. Box 400, Ajax, Ontario

ELECTRONIC SWITCHES • VARIABLE RESISTORS • CERAMIC CAPACITORS • PACKAGED ELECTRONIC CIRCUITS • ENGINEERED CERAMICS



GROWTH! Vector announces a new **COMMERCIAL** and **INDUSTRIAL DIVISION**—formed to develop and manufacture a full line of communication equipment and digital instruments.

Vector's experience gained in development and manufacture of aero-space and medical electronics products now will be applied in meeting the requirements of commerce and industry.

Write for information on Vector's commercial and industrial capabilities and products.

 **VECTOR MANUFACTURING CO., INC.**
Commercial and Industrial Division
Southampton, Pennsylvania

away from the operating base would vary greatly with design of the supercooled inductor, but presently available liquid helium containers require liquification after 3 to 5 days. Total evaporation of the helium must be prevented to prevent coil temperature from rising above the superconducting level, which would cause rapid dissipation of the stored energy in resistive losses. In addition to the inconvenience of losing vehicle power, complete vaporization of the helium

could be dangerous. Warning devices would be required to indicate liquid helium level and ensure that heat would be dissipated over a safe period of time.

Extensive research and experimentation will be required to determine whether practical methods can be developed for recovering energy stored in supercooled inductors. If this effort is successful, cryogenic inductive energy storage could provide power for many other applications.

Fabricating Diodes With Electron Beams

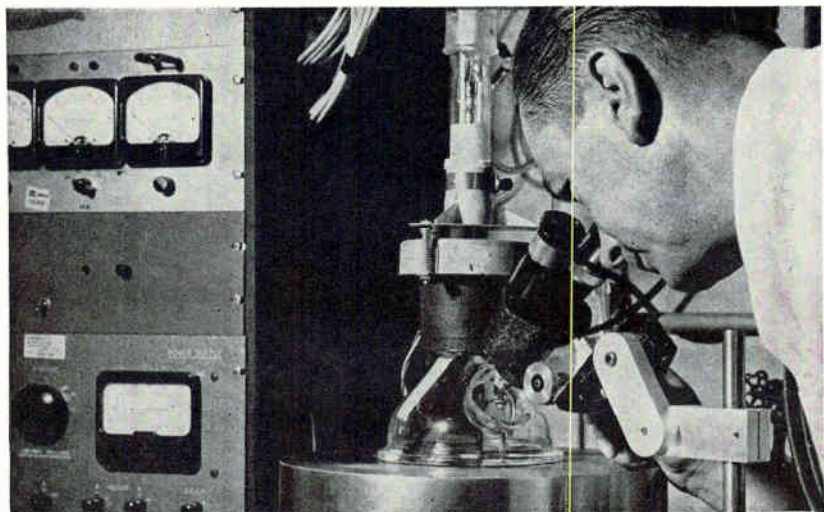

Electron beam vacuum processing unit is used in investigating metallurgical and electronic properties of semiconductor junctions

ELECTRON beam processing may be useful in fabricating semiconductor devices. The beams have been used to form aluminum-silicon junctions with good electrical characteristics, and the process seems suitable for automatic production of small and intricate structures.

The fabricating technique has been developed at CBS Laboratories, a division of Columbia Broadcasting System, Inc. A year-long project was recently completed under sponsorship of the U. S. Army Signal Research and Development Laboratories and has been renewed for another year.

A microjunction diode was fabricated, demonstrating that aluminum-silicon junctions can be formed with good electrical characteristics. The technique indicates the possibility of automatic operation. The electron beam could

be directed by a master video control unit as it machines and alloys the semiconductor wafer.

During the past year, two basic patents were obtained on formation of junctions in semiconductors. The electron beam processing unit shown in the photograph was developed. It was used to investigate the metallurgical and electronic properties of junctions and contacts formed by electron bombardment.

It as found that many materials, such as tin, aluminum, silver and gold, could be alloyed onto silicon surfaces by an electron beam. Thin metal films are deposited under vacuum in thicknesses from 2,000 Angstroms to 2 microns.

Under the new contract the physical and electrical effects of electron and ion bombardment are being studied. A structure such as a planar transistor will soon be built.

Communications, Sensing Systems and Cybernetics in a unique role at **AEROSPACE CORPORATION**

Aerospace Corporation is chartered exclusively to serve the United States Government in applying the full resources of modern science and technology to advanced space and ballistic missile systems.

As the civilian link uniting the Air Force-scientific-industrial team organized for this mission Aerospace Corporation provides: advanced systems analysis and planning; theoretical and experimental research; initial systems engineering, initial technical direction and general technical supervision.

COMMUNICATIONS

Scientists and engineers working in this area are concerned with: the analysis of digital, analog and voice communication techniques; statistical studies of communications systems; information theory; tracking and telemetry links; antenna design; orbit determination; command and control systems; and secure communications and anti-jam techniques.

SENSING SYSTEMS

Visual-Optical Sensors Work in this area concerns advanced cameras, lenses, exposure timing devices, film and emulsions, photo analyses and copy devices, and image transducers. Scientists and engineers here are concerned with: scoring and miss-distance indication, information theory analysis of photo-visual problems; photographic tracking; spectrophotometry; densitometry and sensitometry; and optical reproduction systems analysis.

Infrared and Ultraviolet Sensors Assignments in this area include investigations of position sensing, guidance, and other systems. This work provides requirements for advanced component and technique considerations including optical design, detector devices, and like areas of interest.

High Frequency, Laser & Optical Radar Activities here concern advanced components and techniques related to: tracking and aiming; ECM and CCM techniques, frequency agility systems; noise correlation systems; propagation and attenuation factors; target reflectivity and scattering; and beam power density effects.

AUXILIARY POWER SYSTEMS

Utilizing chemical and nuclear sources, fuel cells, solar cells, and solar thermal engines, these Aerospace Corporation scientists and engineers are concerned with: weight and efficiency as related to missile power systems for instrumentation and control; and with orbital or space vehicle systems for communication, instrumentation, and control.

CYBERNETICS

In this area scientists and engineers are concerned with: powered flight, free flight and re-entry attitude controls; energy management systems; vehicle launch and general control systems; inertial platforms; accuracy analysis; guidance equations for rocket vehicles; homing and radio guidance; stellar or radio-aided inertial guidance; and the geodetic and geophysical aspects of inertial guidance.

Today more men with advanced degrees are needed to meet growing responsibilities. Immediate assignments exist for highly skilled scientists and engineers knowledgeable in interdisciplinary problem solving.

All qualified applicants will receive consideration for employment without regard to race, creed, color or national origin and are urged to contact: Mr. George Herndon (OSborne 9-4661, Extension 1171), Aerospace Corporation, Room 110, P.O. Box 95081, Los Angeles 45, California.



AEROSPACE CORPORATION

*Organized in the public interest and dedicated to providing objective leadership
in the advancement and application of space science and technology
for the United States Government.*

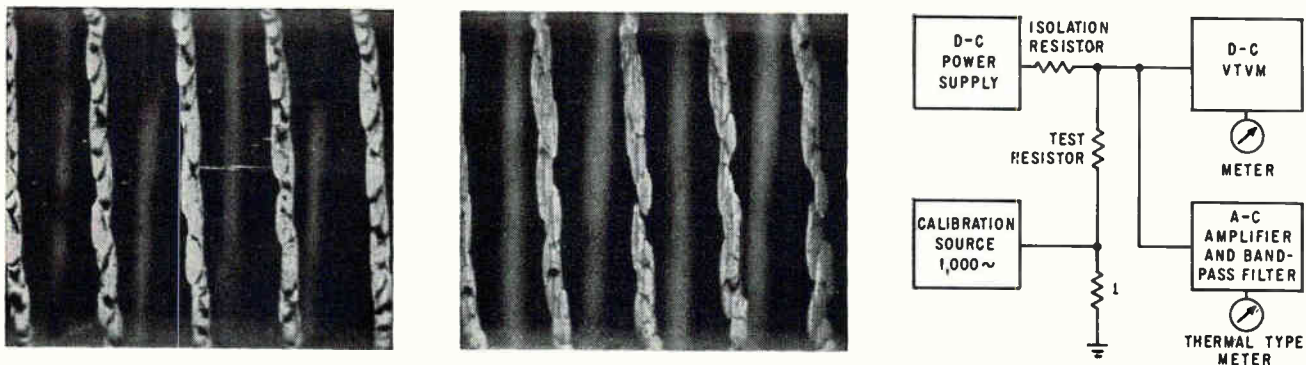

FIG. 1—Noise index of 1.5 db for tin oxide film resistor with scratches (left) was corrected to -18 db by silvering. Noise index of -6.5 db for resistor with bridge defect (center) was corrected to -26.2 db by removing bridge. Final noise performance correlations were made using standard resistor-noise test set (right)

Noise-Performance in Tin Oxide Resistors

By J. G. CURTIS,

Corning Electronic Components,
Corning Glass Works, Bradford, Pa.

DIFFERENT CURRENT noise levels in apparently identical resistors indicate that noise may be related to electrical performance. This hypothesis arises because it is logical to assume that differences in noise level result from differences in construction. However, even though construction differences can be detected visually or electrically, past searches for noise-performance correlations have resulted in limited and sometimes negative findings.

During an investigation of resistor noise at Corning Glass Works, positive noise-performance relationships were observed in tin oxide film resistors. Experiments show that, although not all noisy resistors are substandard, all substandard resistors are noisy. And none of the quiet resistors are substandard.

The data obtained does not necessarily prove that all resistors, or even all tin oxide resistors, exhibit noise-performance relationships. But test results do point up definite relationships that are being extended to confirm the test's usefulness.

As a result of the tests conducted so far, current noise screening is now included on many Corning resistor reliability programs.

Correlating excess noise with

construction defects constituted the first phase of the study. A commercial test set was not readily available and a simple wide-band test set was built, which identified unusually noisy samples. This set consisted of a quiet current source (battery), a high-gain audio amplifier, a vtm for measuring audio output level, and a speaker.

The task of physically examining Corning tin oxide film resistors was no problem, since the glass substrate and the resistive film are relatively transparent. Also, since the film is inherently quiet, small noise sources were easily detected.

Using the test set, in combination with a binocular microscope and a grounding probe, the noise-producing defect was located with precision. The sample (uncoated) resistor was mounted in the test clips and rated voltage applied, with the amplified noise voltage from the resistor fed to the speaker.

The grounding probe connection against the resistive film is itself a relatively noisy contact. This effectively limits the sensitivity of the test method to defects indicated by a noise index in excess of (more positive than) -15 db. A portion of the defects producing noise less than -15 db can be identified as less severe forms of easily recognized defects. The remainder requires a more sensitive

system of analysis.

The test isolated some ten modes of noise defects. The samples were not intended to depict conditions existing in finished components. All finished resistors are subjected to power overloads and resistance measurement on the production finishing lines on a 100 per cent basis. The overload level removed units such as those discussed below.

Noise defects were placed in two broad groups. One group consisted of series type defects such as film scratches, film porosity, checks in the substrate glass, wide chips, excessive cap-to-film contact resistance, and ragged path edges. In the other group were parallel defects, including bridges of undisturbed film across the cut path and foreign materials bridging the cut.

Defect locations were confirmed by silvering over series defects and by removing the bridging defects. In some cases, the relatively high 'after' level indicates presence of other defects in the sample. The resistance values of most of these samples were within tolerance.

Once noise-defect correlations were established, load life performance seemed a likely place to look for noise-performance relationships, since drift of resistance is primarily a function of active film area and power loading—other things being equal.

Measurements for noise-perform-

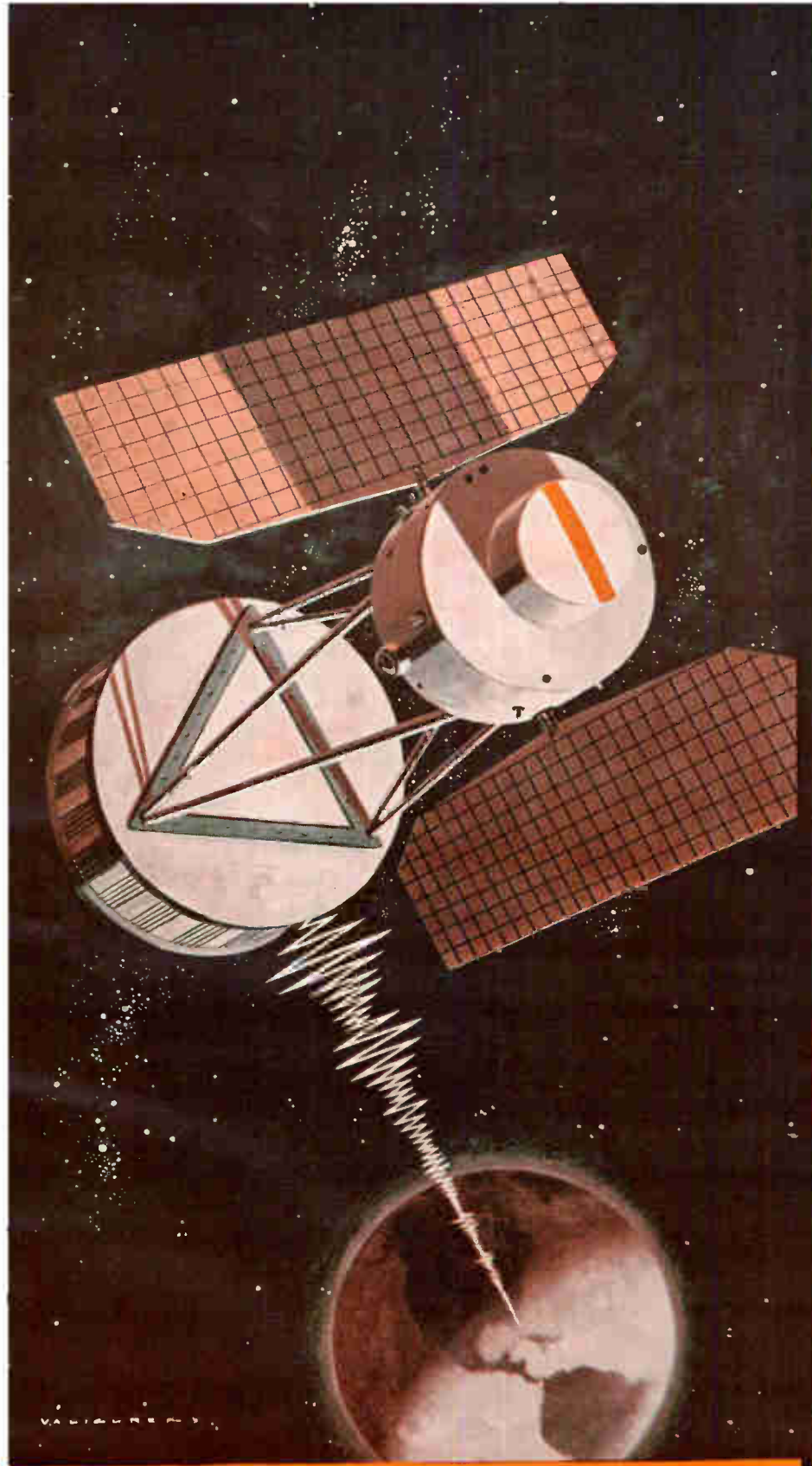

Avco and ... satellite signal selection

Space vehicles are constantly exposed to many signals as they orbit the earth. Electronic interference, false messages . . . these are but two of the problems they contend with.

To receive correct commands, a new coder-decoder has been developed by Avco's Electronics and Ordnance Division working with NASA. Built around a single-conversion concept, the Avco unit ignores stray signals, shuns radio noise and interference. Today it is operating in Explorer XI, now orbiting the earth.

Miniaturized to save weight and space, this uniquely selective radio device will pull in only proper information, feed it to the decoder, and actuate the correct on-off controls and other satellite equipment as ordered.

Communications capabilities are among the many contributions of the Electronics and Ordnance Division's experienced engineering talent and skill. For more information on this new satellite receiver-decoder, or answers to your own communications problems, write: Director of Marketing, Communications Operation, Electronics and Ordnance Division, Avco Corporation, Cincinnati 15, Ohio.

Avco // **ELECTRONICS
AND ORDNANCE**
DIVISION

CIRCLE 101 ON READER SERVICE CARD

New Avco receiver-decoder withstands extreme vibration, shock. 6.3" in diameter, only 3.5 lbs.

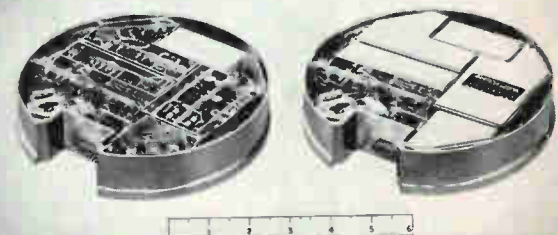

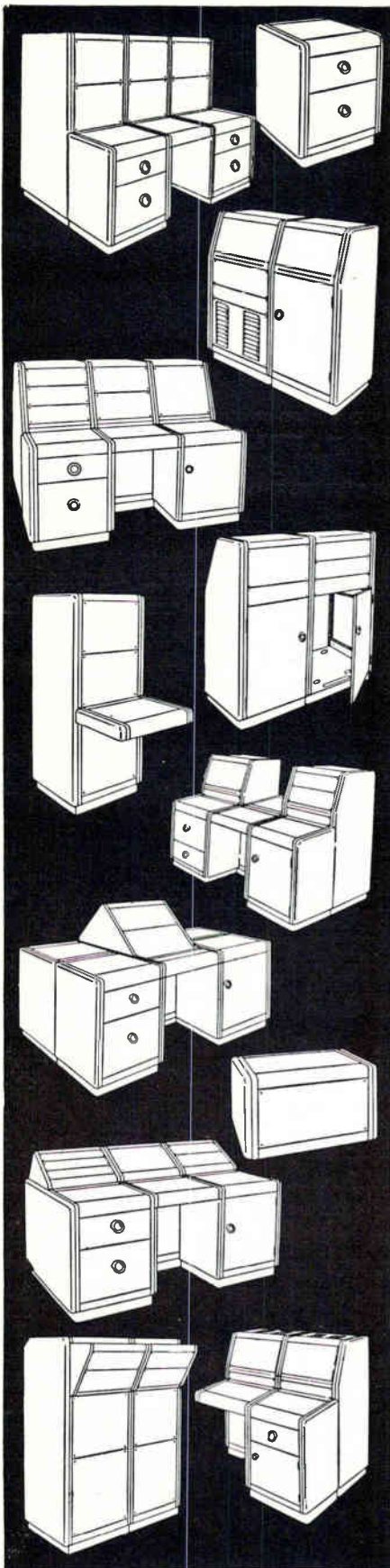

HUNDREDS OF Widths, Depths & Heights

TO MEET YOUR ENCLOSURE REQUIREMENTS WITH EMCOR[®] STANDARD CABINETS

- Cut costly enclosure design time. Select your packaging needs from a complete line of standard and heavy duty EMCOR Cabinets.
- EMCOR MODULAR ENCLOSURE SYSTEM Cabinetry provides for thousands of control center combinations.
- Engineered simplicity of basic frames and components affords quickest and easiest erection of control center assembly.
- EMCOR Cabinetry Engineers backed by the research and development "know-how" of the Roy C. Ingersoll Research Center set the pace for the packaging needs of electronics, instrumentation and electro-mechanical engineers from coast to coast.
- Rugged frame construction surpasses all standard requirements for increased load carrying capacities.
- Compatible cabinet design assures simplified and economical expansion at any time.
- EMCOR Cabinet manufacturing meets rigid quality-controlled craftsmanship standards.
- Nationwide organization of EMCOR Sales-Engineering Representatives assist in planning stages and assure customer satisfaction beyond the sale.

Condensed Version of Catalog 106 Available Upon Request.
Originators of the Modular Enclosure System

INGERSOLL PRODUCTS
Division of Borg-Warner Corporation
1000 W. 120th ST. • DEPT. 1242 • CHICAGO 43, ILLINOIS



ance correlations were made on the Quan-Tech Model 315 Resistor-Noise Test Set. This instrument consists basically of a quiet, variable d-c power supply, an accurate vtvm indicating the applied voltage in db, a low-noise, sensitive amplifier with an accurately controlled pass band centered at 1,000 cps, an rms noise voltage meter calibrated in db, and a 1,000 cps calibration source.

Measure of Current Noise

The current noise index was obtained from the relation: Index = $T - f(T - S) - D$, where T is the measured value of total noise; S is the measured value of system noise before application of test voltage; D is 20 log applied voltage and values of f (T - S) are given in a table in the set's instruction manual as a function of T - S.

The Index is defined as,

$20 \log \frac{\text{rms noise voltage } (\mu\text{v})}{\text{applied voltage } (\text{v})}$ db in a frequency decade.

To establish load life performance and current noise relationships, an experiment was designed utilizing 4,000 Corning C-20 ($\frac{1}{2}$ W), 150 K, general purpose tin oxide resistors, chosen from a group where a high defect ratio was suspected. The samples were measured individually and sorted into 12 bins representing 5-db noise modules ranging from 25 to -35 db. A sampling of 100 units were then remeasured for exact noise levels and tagged, after which temperature coefficient (tc) tests were run. Noise levels were remeasured and the samples placed on a 1,000-hour cycled load life test. At the conclusion of the life tests, the units were measured for resistance drift, and for noise.

Analysis of results in both the life test and the tc test showed a striking relationship between noise and performance.

An arbitrary noise index (-21.3 db) could be assumed below which there were no instances of abnormal tc and no instances of abnormal drift.

The dividing line between normality and abnormality was established as follows. Temperature co-

efficient was measured at -15 deg C, -55 C, 65 C and 150 C, referred to 25 C. Values for the type of film used on this unit generally exhibit a nominal tc lying close to 0 ppm/deg C, with maximum excursions in the area of 100 to 150 ppm/deg C. Values exceeding 150 ppm for this particular resistor were consequently termed abnormal. In the group quieter than the arbitrary noise level, the largest tc found was -93 ppm/deg C, at 150 C. In the noisy group, certain tc 's were observed ranging from 335 to $-3,284$ ppm/deg C with values scattering wildly, even though the majority of pieces behaved normally.

Quiet and Noisy Samples

In the load life performance, this particular resistor was considered abnormal if it drifted appreciably with a negative slope at any time during the $1,000$ hour period, or if it drifted with a positive slope at a rate not commensurate with the other members of its group. In the quiet samples, there were no appreciably negative drifts. Maximum and minimum drifts were 0.59 per cent and 0.21 per cent respectively. In the noisy group, there were many instances of negative drift. Maximum values of drift ranged from 2.07 per cent to -2.11 per cent. It is interesting to note that even the maverick drifters in the group did not exceed the 3 per cent allowable for this style resistor.

An analysis of this data indicates that for this particular sample, all resistors destined for erratic tc and life performance could have been eliminated by removing units exceeding a noise index of -21.3 db. Since tested pieces constituted a sample of a much larger group, a similar sorting at the same noise level would eliminate potential failures with high efficiency.

The majority of rejected pieces would not necessarily exhibit substandard performance in standard tests, even assuming they are, to some degree, abnormal in construction.

Corning is continuing the experimentation for tin oxide films, and will publish findings when they are available.

BALLANTINE VOLTMETER

model
305A

Price \$415.

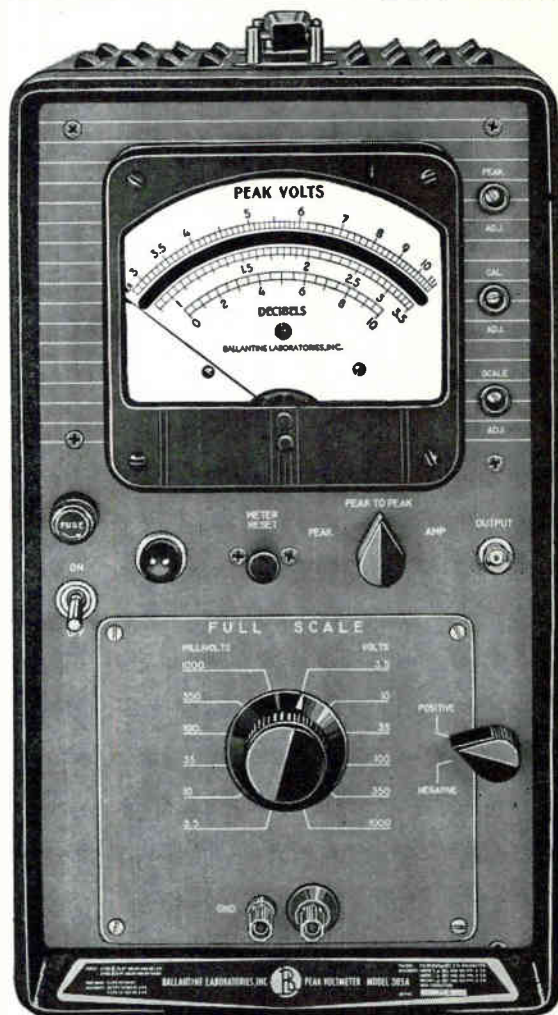

**MEASURES
PEAK
OR PEAK-TO-PEAK PULSES
AS SHORT AS $0.5 \mu s$**

**... at pulse rates as low as 5 pps ... voltages
of 1 mV to 1000 V**

Also measures **COMPLEX WAVEFORMS** having fundamental of 5 cps to 500 kc with harmonics to 2 Mc.

ACCURACY is 2% to 5% OF INDICATED VOLTAGE, depending upon waveform and frequency.

SCALE is the usual Ballantine log-voltage and linear db, individually hand-calibrated for optimum precision.

INPUT IMPEDANCE is 2 meg, shunted by 10 pF to 25 pF.

Write for brochure giving many more details

— Since 1932 —

B **BALLANTINE LABORATORIES INC.**
Boonton, New Jersey

CHECK WITH BALLANTINE FIRST FOR LABORATORY AC VACUUM TUBE VOLTMETERS, REGARDLESS OF YOUR REQUIREMENTS FOR AMPLITUDE, FREQUENCY, OR WAVEFORM. WE HAVE A LARGE LINE, WITH ADDITIONS EACH YEAR. ALSO AC/DC AND DC/AC INVERTERS, CALIBRATORS, CALIBRATED WIDE BAND AF AMPLIFIER, DIRECT-READING CAPACITANCE METER, OTHER ACCESSORIES. ASK ABOUT OUR LABORATORY VOLTAGE STANDARDS TO 1,000 MC.

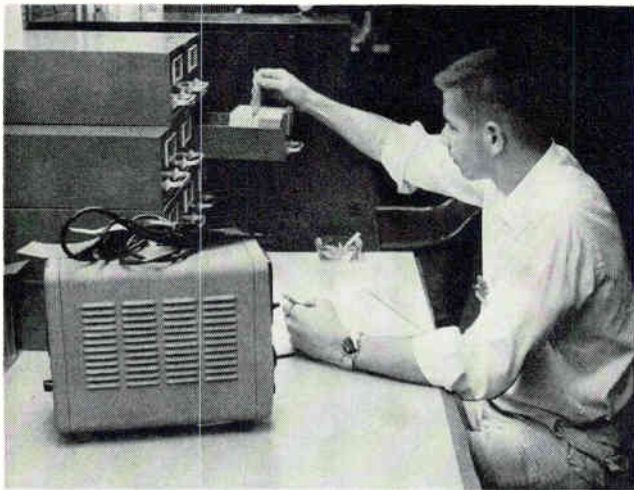

Each instrument has an identification number, is scheduled for a current job and as many as two future jobs

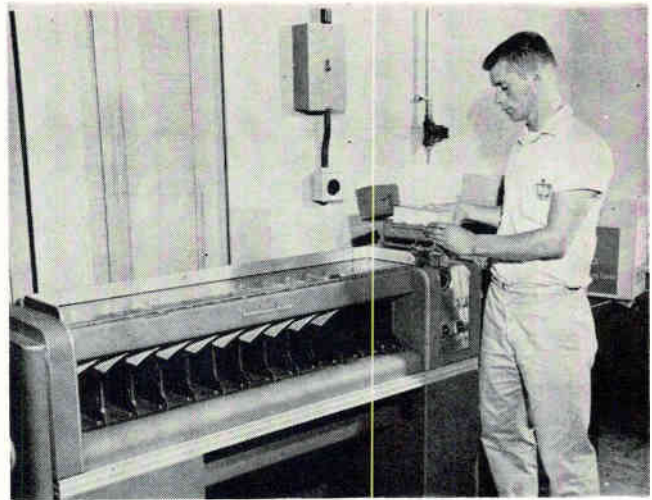

Special information about instruments, such as the number required by a given contract, is quickly available

Controlling Production Test Instruments

By C. M. WEEMS, JR.,
Electronics Div.,
Westinghouse Electric Corp.,
Baltimore, Md.

DURING THE PAST DECADE several problems have developed in the efficient use of test equipment in production. There has been a general and rapid increase in measurement precision and a significant increase in the variety and complexity of equipment. Calibration has become

more rigorous and difficult, and obsolescence of general equipment is rapid. There is also increased need for special expensive equipment that is required only for relatively brief intervals during a particular contract.

These problems are compounded by the industry-wide trend away from a few high-production-rate contracts to many low-quantity, high-complexity contracts. At Wes-

tinghouse in Baltimore, Md., greater efficiency in instrument use has been obtained with standard punched-card, data-processing equipment normally available in accounting departments.

The system is designed to perform three separate functions from one control center: planning and controlling the utilization of equipment; providing records and controls for regular calibration of all equipment; and collecting repair records for cost control. Two tab cards for each instrument provide space for all the necessary data and some extra room for possible future needs. One card, the calibration card, contains identification data and all data required for calibration and repair. The second card contains equipment utilization information and enough basic identification for the cards to be used and processed essentially as one. Basic identification consists of the name of the equipment, identification number, manufacturer, model number, serial number and, if borrowed, the owner's identification number. This information is entered only for a new instrument and, in general, never changes. The local identification number is stamped in a metal tag affixed to the instrument when it is procured; it remains a permanent part of the instrument.

Outputs from the tabulating ma-

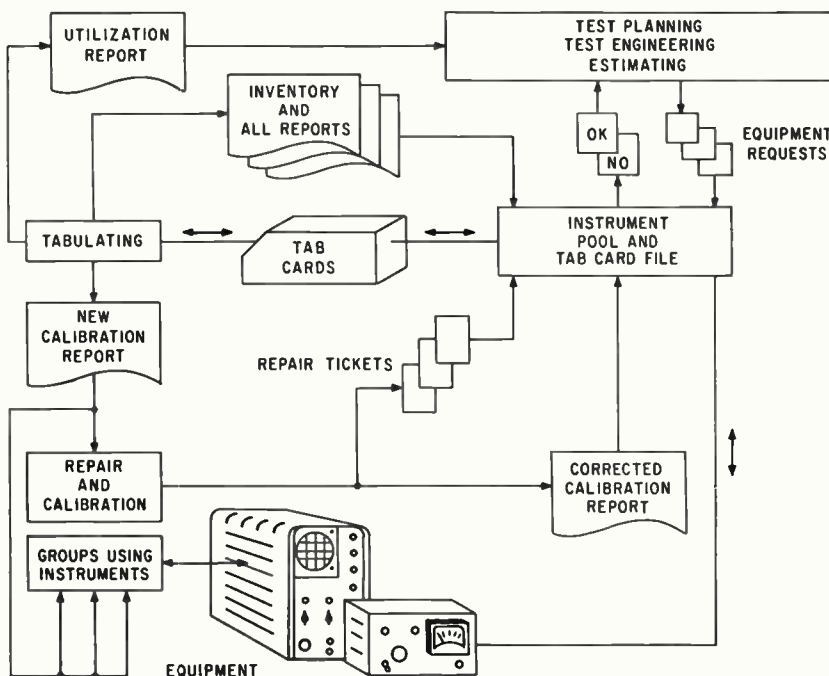

Three reports—utilization, calibration, inventory—are the major tools controlling test instrument flow

NEW FROM ELECTRONIC MEASUREMENTS

A portable
POWER SUPPLY
with all the advantages
of big semiconductor
units. Notice the
continuously
variable

CURRENT-LIMITER,
programmability,
two full-time
meters ...
Size? Just about
a half inch wider
than shown here.

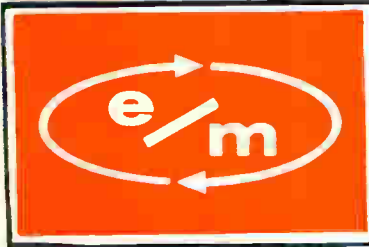
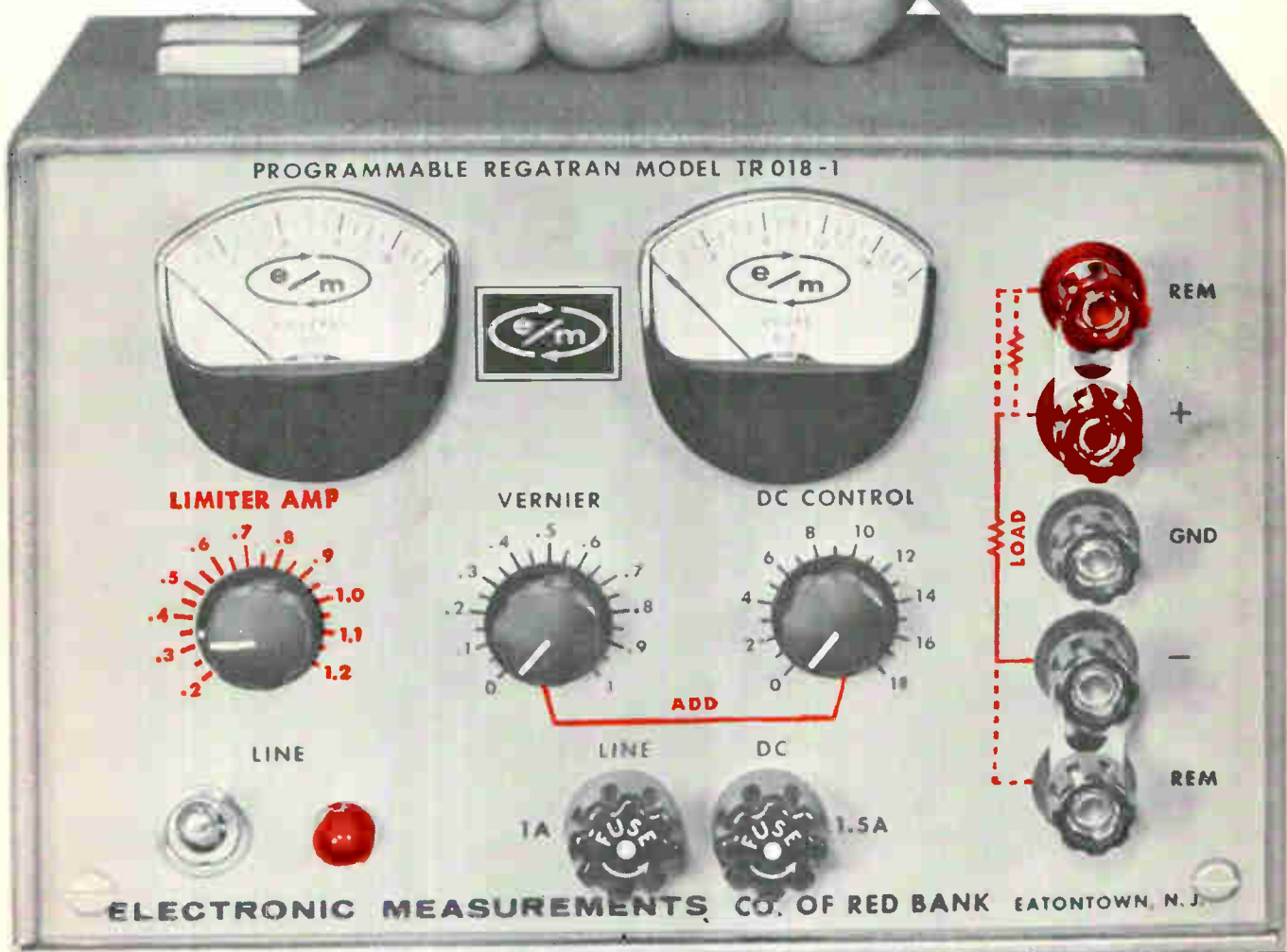
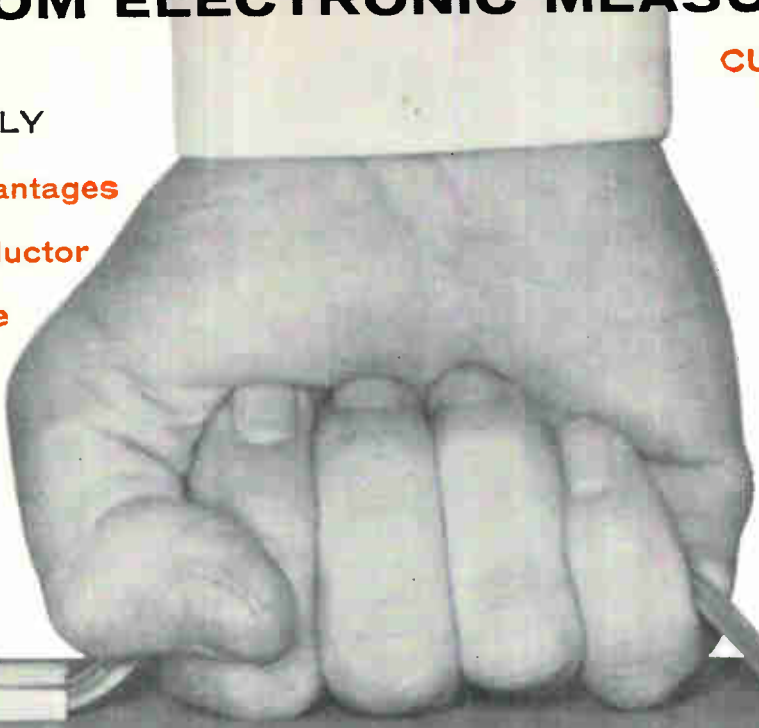

ELECTRONIC MEASUREMENTS

COMPANY OF RED BANK
EATONTOWN · NEW JERSEY



In 184 words or less, write to Sigma saying why you intend, without hesitation, to use a new Sigma Series 46 instead of almost any other AC or DC DPDT octal plug-in relay. This contest isn't limited just to your exciting new designs—the products you've been making every day are also eligible. (See helpful hints below.) All entries will be judged on the basis of ingenuity, originality and Sales Dept. records of purchases made by the entrant. (Entries by Sigma competitors will be given special consideration.)

First prize will be one (1) magnificently dented left front fender from the Sigma Sales Manager's Lily-White Sportscar, removed after recent spirited trip by owner. Second prize will be a genuine memento of the Advertising Manager's European Tour; 3rd through 10th prize will be a Series 46 relay in winner's choice of type, adjustment and contact material.

All entries must be received by Nov. 30th, 1961 and indicate that entrant knows what a Sigma Series 46 Relay is (for). Judges will include various qualified Sigma personnel, such as the engineer who designed the Series 46, Head Shipper and Chief Dietician. Suitable final arrangements will be made for all entries.



some hints on preparing winning entries

- rated to switch 5 amps at 28 VDC, 1 amp at 120 VDC; on AC, 1200 volt-amperes per pole with 240-volt and 10-amp maximums
- outlasts other things: works 10 million times on 1-amp loads, half a million times on 10-amp loads
- trips on as little as 200 milliwatts (DC types) or 0.2 v-a (AC types)
- fits octal sockets wired for conventional DPDT relays
- big contacts and "motor" visible to all who enjoy watching relays operate
- Mack truck construction with Rolls-Royce touches
- very competitive (price- and appeal-wise)
- available off the shelf at your friendly neighborhood Sigma Distributor (if you don't have a nearby Sigma Distributor, you're not living in a friendly neighborhood)

This is serious. Equipment designers, industry and The Public shouldn't go another day without the benefits of Sigma Series 46 relays. Enter this glorious, rewarding quest now!



Data on instrument use is up to date, allowing rush jobs to be handled efficiently

chines are three reports interpreting the punched data found along the top of the cards. The three reports—utilization, calibration, inventory—are normally prepared once a month. The utilization report contains the basic identification of the instrument and the dates for its present job and for two future scheduled jobs. Test planning uses this report to schedule future contracts and to determine what new equipment is required. This report is listed by the equipment's name, manufacturer and model number.

The inventory report is the master report used by the instrument pool to locate equipment and cross index other information. This report is listed by identification number and contains all the basic identification, utilization, and repair data.

The calibration report is listed by the group using the equipment, and within that by the calibration due date, and then by identification number. Both the calibration group and the equipment user get a copy of this report. The basic flow is illustrated in the figure.

Instrument Pool Has Control

The instrument pool is the central control for movement of equipment and record keeping. In the case of test equipment utilization, this represents more clerical control than actual control, with actual control resting in test planning. The test planner uses the utilization report to select the instruments needed for a particular contract. The instrument pool puts this information on the tab cards, and



SIGMA

SIGMA INSTRUMENTS, INC.
62 PEARL ST., SO. BRAINTREE 85, MASS.

*a comprehensive guide to current
information on every branch of
Science and Technology*

*... a practical new way to bridge the gap between your
specialty and other fields into which your work leads you*

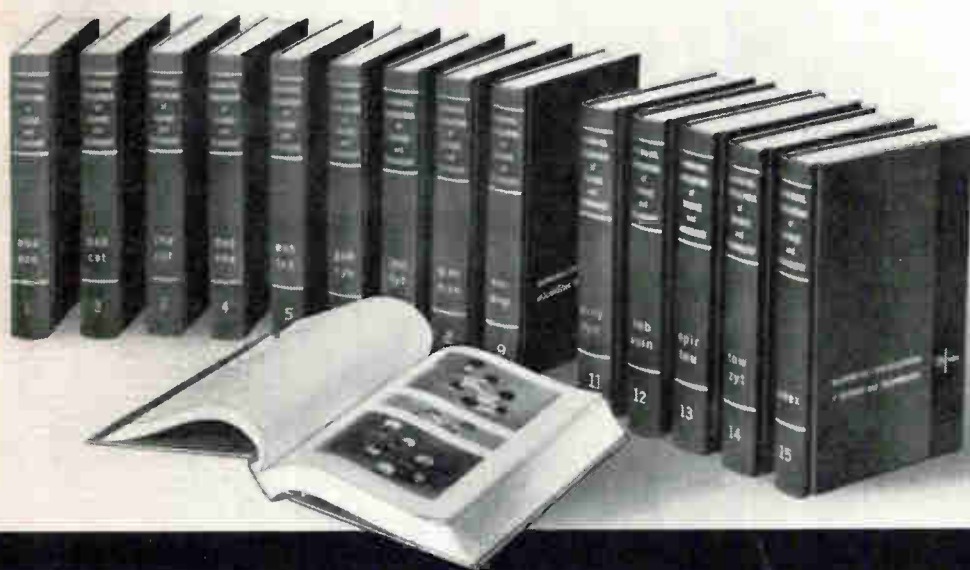

New from
McGRAW
HILL



**If you find yourself among the
growing number of science and
engineering specialists unable
to keep up with the explosive
pace of developments today, you
will see a valuable solution at
the top of this page.**

Itek

Crystal Filters do Wonderful Things



Needle-sharp filtering in a single jump is a wonderful thing! Itek Crystal Filter 754A is only 10 cycles wide at the 3db points — a bandwidth requiring a “Q” that only crystal can provide. Circuit simplification, ruggedness, temperature and long time stability, and utmost reliability are built-in extras.

Perhaps you don't need a 10 cycle wide crystal filter. But could you use the ingenuity that built one? Could Itek technical leadership help you?

Of course, the world's largest and most complete selection of stock crystal filters is available, too. Choose from more than 3,000 Itek-Hermes designs.

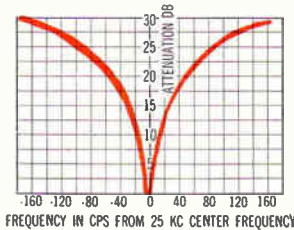

Write for free Brochure “WEESKACFAACP” or, What Every Engineer Should Know About Crystal Filters At A Cocktail Party. You'll enjoy it.

Itek Electro-Products Company

75 CAMBRIDGE PARKWAY, CAMBRIDGE 42, MASS. A DIVISION OF

thus the instruments are reserved. A check form used by the test planner prevents two planners from reserving the same instrument during the month before the next utilization report is available.

The calibration report is issued to the group using the equipment so they have a current inventory of what instruments they are charged with and when an instrument is scheduled for calibration. The calibrator feeds corrections back into the system by marking his copy of the calibration report; the instrument pool corrects the tab cards. Since all calibrations are scheduled during the first 15 days of the month, ample time is allowed for card correction.

Repair data consists of the number of times an instrument is repaired, total repair man-hours and replacement parts cost. This data, entered by the repairman and then added to the tab card by the instrument pool, is used to aid in determining the total cost of repair, when to retire an instrument, to rate manufacturers and to spot unreliable instruments.

Automatic Pliers For Volume Operation



Automatic cut-off pliers, a boon to any operation that uses pliers for volume operation, have been developed by the tool design department at the IBM Poughkeepsie plant. Air-operated and controlled either by a foot switch or hand pistol grip, the pliers cut wire, crimp it, or form it in any specified length, depending on the type of plier head used. The device (not a commercial product) eliminates the hand fatigue in operations that require long or excessive use of manual pliers.

now - tin oxide trimmers



"Infinitrim"® by Intellux

Resolution is stepless, TC is better than 50ppm/°C and they are great for high ambient temperatures. Yet, Infinitrim's are interchangeable with ordinary trimming potentiometers.

Available in the popular 1/2" square shape as well as round, in values from 100 ohms to 10K.

Up date your circuits now . . . improve performance and reliability.

intellux

INCORPORATED

P.O. Box 929, Santa Barbara, Calif.

CIRCLE 206 ON READER SERVICE CARD

Write for complete
"Infinitrim Data"

Acoustical Components of Superior Quality

JAPAN PIEZO supplies 80% of Japan's crystal product requirements. Here are a few examples of our capabilities.



STEREO CARTRIDGE
Crystal—"PIEZO" Y-130
X'TAL STEREO CARTRIDGE
At 20°C, response: 50 to 10,000
c/s with a separation of 16.5db.
0.6V output at 50 mm/sec. Tracking
force: 6±1gm. Compliance:
1.5 X 10⁻⁶ cm/dyne. Termination:
1MΩ + 150pF.

MICROPHONE
Crystal—X-29
At 20°C, 1KC/s, Sensitivity is
-58 ± 5db. Impedence: 100KΩ.
Capacitance: 1,500 pF.



PHONOGRAPH MOTOR—DC
PM-31-1
9V, 2,500 RPM: No-load current,
35 mA; load current, 80 mA.
Starting torque, 13 g-cm; load
torque, 5g-m. Size: 2.4cm X 4.6cm.
Weight: 100 gm.



Write for detailed catalog to :

JAPAN PIEZO ELECTRIC CO., LTD.

Kami-renjaku, Mitaka, Tokyo, Japan

CIRCLE 207 ON READER SERVICE CARD

NEW opportunities in
MISSILE ENGINEERING
for:

**PHYSICISTS
MECHANICAL &
ELECTRICAL
DESIGN ENGINEERS
SYSTEMS
ENGINEERS**

The Hughes Tucson Engineering Laboratory is again expanding its scope of operations. Challenging new opportunities have been created with state-of-the-art advances in missile & space engineering.

The scope of engineering effort at Hughes Tucson includes operational as well as advanced missiles and sub-system designs for space programs.

Specific areas of immediate needs include:

- Circuit Design
- Transistor Techniques
- Electromechanical Design
- Infrared Theory
- Microwave Antenna Design
- Miniaturization
- Hydraulics
- Controls

Engineers and Physicists who like to work on important problems will find this dynamic organization an ideal environment in which to exercise creative talents.

If your goals include — work on vital projects with recognized leaders in the field — to live in the heart of the year-around, healthful Southwestern vacation land — to continue advanced studies (at the University of Arizona) — and to contribute to our Nation's Defense while securing your own future — send your resume to MR. W. A. BARNES.

creating a new world with electronics

HUGHES

HUGHES AIRCRAFT COMPANY
**TUCSON ENGINEERING
LABORATORY**
Tucson, Arizona

An equal opportunity employer



New On The Market



High Purity Magnesia Crystals

WITH DIMENSIONS UP TO $\frac{3}{4}$ IN.

NORTON CO., Worcester 6, Mass., is producing single crystals of Magnorite fused magnesia in developmental quantities with dimensions up to $\frac{3}{4}$ in. Company techniques have made it possible to produce crystals of predetermined quality. The process also permits making crystals with definite percentages of known

impurities. The doped crystals exhibit different electronic characteristics when the impurities consist of certain metallic transition elements. Major fields of application of these crystals is in laser and maser studies.

CIRCLE 301 ON READER SERVICE CARD

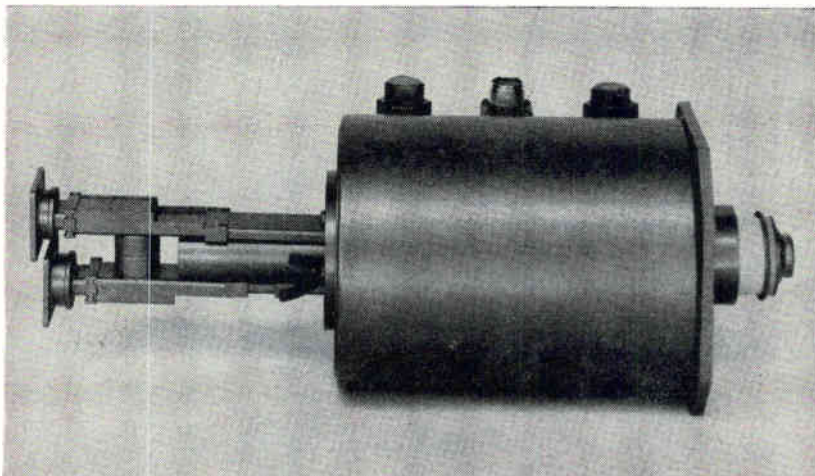

High Power C-W T-W Tube

METAL-CERAMIC CONSTRUCTION

HUGHES AIRCRAFT CO., 11105 S. La-Cienega Blvd., Los Angeles 9, Calif. The 355H is a broadband c-w twt producing 1 Kw minimum power output at X-band. It can be operated from 8.0 to 11.0 Gc without electrical or mechanical adjustment. It weighs 30 lb complete with solenoid, and is suited for frequency diversity c-w radar, high power countermeasures jammers and extremely

wideband communications system applications.

CIRCLE 302 ON READER SERVICE CARD

Compression Amplifier

WITH AGC

GULTON INDUSTRIES, INC., 212 Durham Ave., Metuchen, N. J. Model OR-LA/1 linear amplifier with

automatic stepped gain control has a wideband response of from 30 to 20,000 cps and low distortion. Input signals of up to 100 db dynamic range can be compressed to 20 db. Variable gain is provided in discrete 10 db increments. Output gain is continuously adjustable from 0 to 50 db, for a maximum output voltage range of 1 to 10 v.

CIRCLE 303 ON READER SERVICE CARD

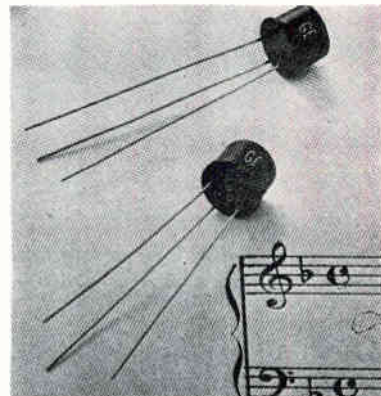

Low Current SCR

ALL DIFFUSED

GENERAL ELECTRIC CO., West Genesee St., Auburn, N. Y. The C5 silicon controlled rectifier will be used as both a sensitive signal amplifier and power switching element in the low power switching control circuits. It may also be operated as a h-v *pn*p transistor. Eight models differ by forward breakover voltages which range from 25 v to 400 v. The devices will accommodate transient peak reverse voltages up to 500 v. Average forward current rating is 1 ampere d-c at 82 C case temperature.

CIRCLE 304 ON READER SERVICE CARD

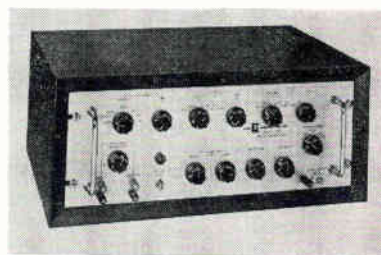

Pulse Generator

VARIABLE RISE TIME

RESE ENGINEERING INC., A & Courtland Streets, Philadelphia 20, Pa. Model 203 has an output pulse whose rise and fall time can be varied continuously from 20 nsec to



● STILL OPERATIVE!

TI GROWN-JUNCTION TRANSISTORS in satellite survive torture treatment: The satellite fell from atop a missile carrier and bounced across a launching pad into a LOX- and kerosene-filled ditch. The fuel in the ditch ignited and the satellite burned for several hours. Result — TI transistors are still operative... dramatic proof of the high reliability of TI units under extreme conditions.

Here's Long-term Proof of TI Grown-Junction Transistor Reliability

● *Only Texas Instruments offers life-test data from lots that have been continuously on operating life test for over five years — showing an extremely low average failure rate of less than 5×10^{-6} . More than six-million life-test hours give you the industry's greatest source of reliability data for predicting TI transistor performance.*

● *Successful applications in thousands of circuits over the years testify to the consistent reliability of these TI units.*

● *Independent Quality and Reliability Assurance department augments TI's own production and testing know-how... independently measuring device reliability at every manufacturing stage. Approximately one-million life-test hours monthly offer continuous verification of TI grown-junction reliability.*

● *Low cost of TI grown-junction transistors is made possible through industry's wide acceptance and usage of these units in many applications, enabling TI to provide fast, cost-saving production in large quantities. Added savings in time and money too, through one-source purchasing from TI's complete line of military and industrial grown-junction types.*

Take advantage of the predictable reliability of these devices in your low frequency and switching designs. Call your local TI sales office or TI distributor now for immediate delivery in sample or production quantities.

Write on your company letterhead for TI grown-junction reliability data, application notes, data sheets or engineering assistance.



TRANSISTOR
PRODUCTS
DIVISION



TEXAS INSTRUMENTS
INCORPORATED
13500 N. CENTRAL EXPRESSWAY
P. O. BOX 5012 • DALLAS 22, TEXAS

2 μ sec. Unit has a prf of 30 cps to 3 Mc and will trigger on any kind of a positive or negative input waveform of 6 v minimum amplitude at frequencies as low as 30 cps. Both delay time and output

pulse width can be varied continuously in 4 decade ranges from 50 nsec to 1 millise. Jitter is less than 0.1 percent over-all.

CIRCLE 305 ON READER SERVICE CARD

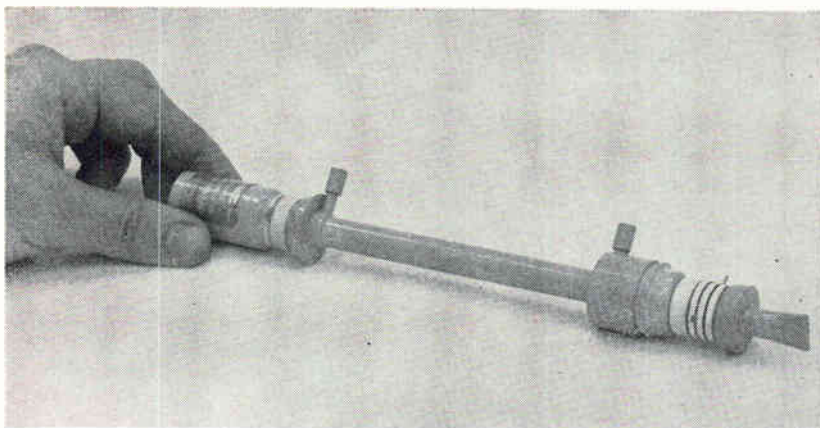

Miniature Traveling Wave Tube FOR SPACE COMMUNICATION

SPERRY ELECTRONIC TUBE DIV., Sperry Rand Corp., Gainesville, Fla. The STX-186 miniature twt hikes power and bandwidth for space communication systems. It can produce more than 10 w over frequency ranges from 5,000 to

11,000 Mc. The twt weighs only 1 lb and is 9 in. long. This miniaturization was achieved while realizing a 4.0 db gain within the tube. Current units are priced at approximately \$3,500.

CIRCLE 306 ON READER SERVICE CARD

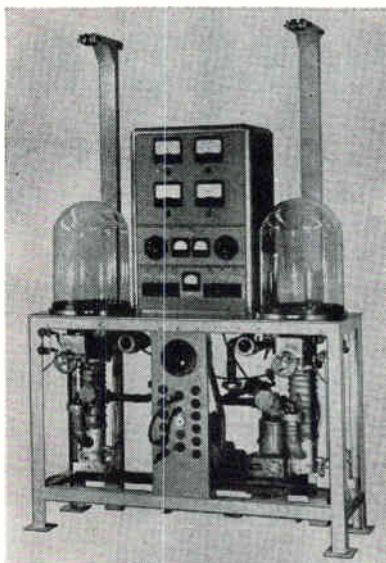

High Vacuum System DUAL UNITS

VACUUM EQUIPMENT AND COMPONENTS, Division of Suburban Plastics Co. Inc., 4041 Ridge Ave., Philadelphia 29, Pa., has developed the Dual 12 vacuum system, designed to produce a vacuum of 1 by

10^{-4} mm Hg in less than 10 minutes and 5 by 10^{-5} mm Hg in less than 20 minutes. It was developed for depositing thin films on electronic components. System consists of two independently operating units mounted on a common frame.

CIRCLE 307 ON READER SERVICE CARD

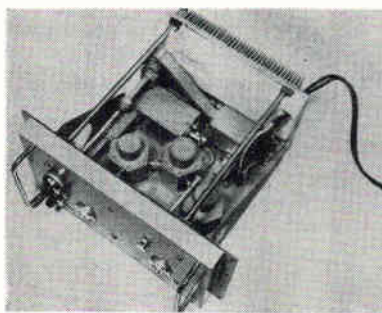

Parametric Amplifier 2 DB NOISE FIGURE

MICROMEGA CORP., 4134 Del Rey Ave., Venice, Calif. A uhf parametric amplifier designed to reduce the noise figure of existing re-

ceivers is tunable in minutes from 750 Mc to 1,000 Mc. It can be supplied with mixer and local oscillator to provide output at an intermediate frequency. The one-port, reflection-type amplifier utilizes mechanically tunable ferrite circulators. Gain is 17 db; bandwidth, 10 Mc; input and output impedance, 50 ohms.

CIRCLE 308 ON READER SERVICE CARD



Sphygmomanometer AUTOMATIC UNIT

SYSTEMS RESEARCH LABORATORIES, INC., 500 Woods Drive, Dayton 32, O. Portable automatic blood pressure measuring instrument performs in about 18 sec the same duties as the physician's stethoscope, manometer and ears. It utilizes transistor logic for performing the automatic program functions. To perform switching operations, it employs solid state devices. Three techniques are employed to minimize noise interference: a contact type microphone, a coincidence circuit and the logic design of the programmer.

CIRCLE 309 ON READER SERVICE CARD



Fluid Quality Meter FOR CRYOGENIC WORK

ALLIED RESEARCH ASSOCIATES, INC., 43 Leon St., Boston 15, Mass., has developed an automatic instrument that continuously measures the fluid quality in a two-phase cryogenic flow system. Its operation is based upon the determination of dielectric constants of the liquid and of the vapor in two-phase fluids such as liquid hydrogen, liquid oxygen and liquid nitrogen. Instrument pro-

Now Mincom offers the industry extended bandwidth and improved predetection recording...the **MINCOM Series CM-100** Instrumentation Recorder/Reproducer

At 120 ips the Mincom Series CM-100 now delivers 1.5 mc*—and also makes possible predetection recording/reproducing with dropouts virtually reduced to zero. This superb improvement in predetection performance is accomplished by redundant data recording. The two carrier tracks are fed through a new and exclusive Tracklok® to eliminate skew, and thence as a single track into a demodulator to recover the original information. It's well worth seeing, especially if you need reliable operational predetection at your facility—and need it in FM/FM modulation, PCM and PCM/FM.

*Optional

1.5 megacycles*
...at 120 ips

MINCOM
SERIES
CM-100



Frequency response of 1.5 mc is obtained in the single-rack CM-100. A second auxiliary rack houses a demodulator, an oscilloscope monitor unit, and Mincom's new and exclusive Tracklok.



Mincom Division **3M** MINNESOTA MINING & MANUFACTURING CO.

2049 SO. BARRINGTON AVE., LOS ANGELES 25, CALIFORNIA • 529 PENN BLDG., 425 13th ST. N.W., WASHINGTON 4, D.C.

VIBRA.

In jet engines?

CEC Vibration Transducer (4-124) will tell.

It's all new. It detects the slightest jet engine vibration in ground tests or in-flight monitoring. It has a temperature range from -65°F to 800°F . Four-and-a-quarter ounces light, $2\frac{1}{8}$ inches high, hermetically-sealed, tough as nails and will last a long long time. How many do you want? Call your nearest CEC office or write for Bulletin CEC 1628-X4 today.



CEC

Transducer Division

CONSOLIDATED ELECTRODYNAMICS
PASADENA, CALIFORNIA • A SUBSIDIARY OF BELL & HOWELL

vides a continuous indication of percent vapor, by volume, over the range 0 to 100 percent vapor with an accuracy of 1 percent full scale, and to within 1 db to 400 cps.

CIRCLE 310 ON READER SERVICE CARD



F-M Deviation Meter LOW DISTORTION

DERO RESEARCH & DEVELOPMENT CORP., Broadway & Park Ave., Huntington, N.Y. The DM-4A is designed to measure and analyze f-m signals in the missile range command band of 400-550 Mc. It is a low sensitivity f-m receiver employing a stable counter type discriminator where the demodulated signal is displayed on a direct reading deviation meter. Calibration accuracy is 1 percent. Price is \$1,595.

CIRCLE 311 ON READER SERVICE CARD



Microwave Switch SOLID-STATE

SOMERSET RADIATION LABORATORY, INC., 192 Central Ave., Stirling, N. J. Ultra-high speed double-throw microwave switch features relatively-high power handling capability over the frequency range 8,200-12,400 Mc. Temperature range is -55 to $+90$ C.

CIRCLE 312 ON READER SERVICE CARD

Miniature D-C Pot HIGH ACCURACY

SENSITIVE RESEARCH INSTRUMENT CORP., 310 Main St., New Rochelle, N. Y. Model PC PocketPot is suited for use as an infinite impedance calibrator or measuring instrument.

Ranges: 0-5,100 v. When used with PC-S current-volt-box, 0-500 v and 0-1 amp. Resolution: continuous, 1 mv divisions on slide wire. Accuracy: ± 0.05 percent of reading or ± 0.5 mv, whichever is greater.

CIRCLE 313 ON READER SERVICE CARD



Clutched Synchro SIZE 10 PACKAGE

ASTRODYNE INC., 121 Clinton Rd., Caldwell, N. J. Size 10 package contains electromagnetic clutch, spring return mechanism and synchro for computer applications. The return mechanism is set to ± 1 minute of electrical zero of the synchro and repeats synchro position to within ± 1 minute. Synchro can be rotated through 360 deg.

CIRCLE 314 ON READER SERVICE CARD

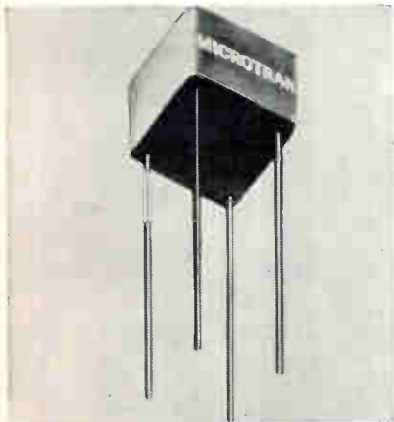

Transformers WELDABLE LEADS

MICROTRAN CO., INC., 145 E. Mineola Ave., Valley Stream, N.Y., announces miniature transformers with weldable leads to permit high reliability welded connections in high-density electronic assemblies. Special gold plated nickel iron alloy lead wire is used to provide superior weld joints.

CIRCLE 315 ON READER SERVICE CARD

Broadband Switch

RMS ENGINEERING, INC., P.O. Box 6354, Station H, Atlanta 8, Ga. Model RFS-LU broadband r-f switch covering the frequency range

TRANSITION?

In trucks, trailers, flatcars? CEC Accelerometer (4-202) will tell.

This little strain gage accelerometer (1 cubic inch, 3 ounces) tells how missiles and electronic equipment stand up in transit. Little as it is, it happens to be better than all comparable accelerometers. I.e., lowest cross axis response; smallest damping change with temperature; highest resonant frequency; operable temperature range from -70°F to 300°F . And it's just as durable as that one over there on the left. Need some? Call your nearest CEC office or write for Bulletin CEC 4202-X15.



CEC

Transducer Division

CONSOLIDATED ELECTRODYNAMICS
PASADENA, CALIFORNIA • A SUBSIDIARY OF BELL & HOWELL

ask
MARKEM
 to show you
 how to
 identify
 your products
 completely
 — at
 least
 cost

#A-104660
 4000 OHMS
 C. P. CLARE & CO
 CHICAGO, ILL.

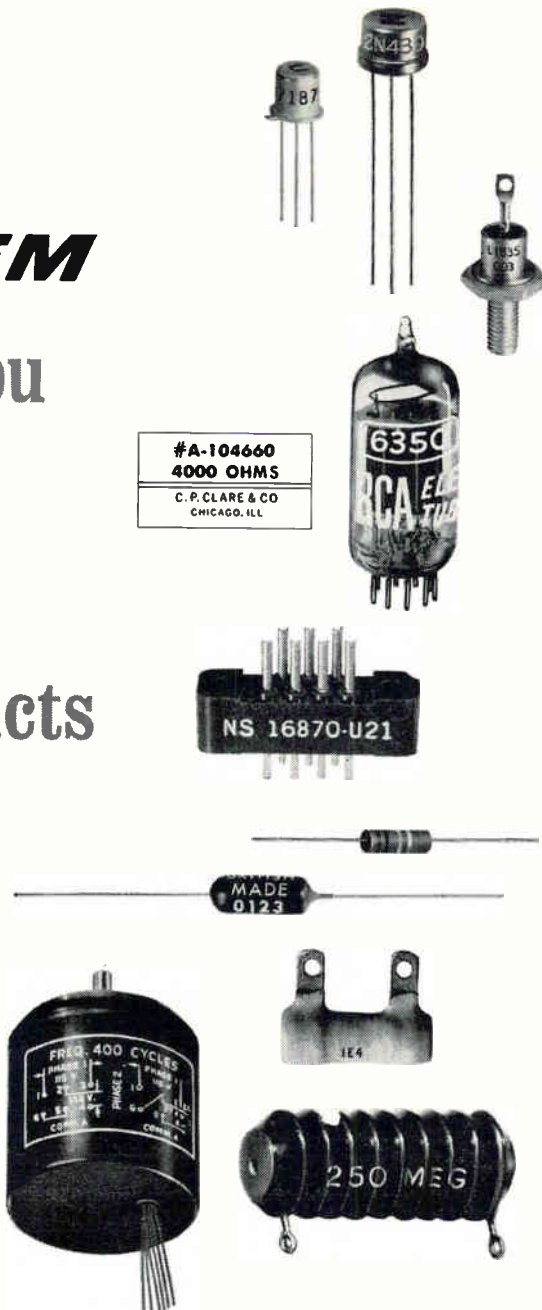

Whether your electrical and electronic products range from subminiature and microminiature components to large panels and "packages", you can identify them *all* completely and clearly, at production speeds, with economical Markem methods engineered to your particular requirements. For example: methods to mark odd shapes, sizes and surfaces with your complete, detailed legend, using quick-change type flexibility and ink to meet military specifications and withstand unusual environmental conditions—and above all, with savings in time and money—are offered by Markem, one responsible source for the entire process.

For a *complete in-plant analysis of all your product identification processes*—or a practical answer to a specific problem—call in your local Markem Technical Representative. Markem Machine Co., Electronics Division, Keene 5, N. H.

12-page catalog on request. Please use inquiry card.



MARKEM

HELPS YOUR PRODUCT SPEAK FOR ITSELF

200 to 400 Mc provides a means for rapidly gating the input of a receiver.

CIRCLE 316 ON READER SERVICE CARD

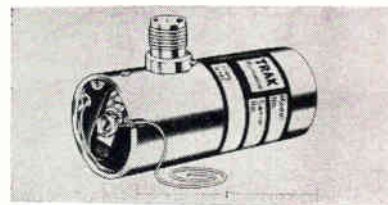

**Microwave Oscillator
 MICROMINIATURE**

TRAK MICROWAVE CORP., Tampa, Fla. Type 2970 (CW) is $\frac{3}{8}$ in. in diameter and 2 in. long and weighs 3 oz. It will tune the entire C-band from 5.2 Gc to 6.0 Gc by adjusting a screw on one end of the C-band cavity. Power output is greater than 10 mw from 5.4 to 5.9 Gc and greater than 5 mw over the entire band.

CIRCLE 317 ON READER SERVICE CARD

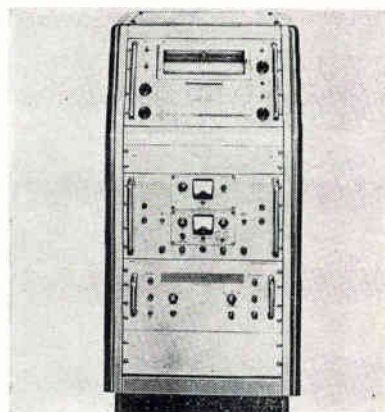

**Contour Plotter
 THREE-DIMENSIONAL**

SCIENTIFIC-ATLANTA, INC., 2162 Piedmont Road, N.E., Atlanta 9, Ga. Model ACP 1 antenna contour plotter maps ϕ , θ , and amplitude coordinates quickly and easily in the new IRIG format. Used with model PCPI automatic positioner programmer and two-axis positioner, a complete contour plot can be made by raster scanning over the sphere of radiation of an antenna, missile or scale model of an airframe.

CIRCLE 318 ON READER SERVICE CARD

Ceramic Capacitors

CENTRALAB, division of Globe-Union Inc., 900 E. Keefe Ave., Milwaukee 1, Wisc. These 20-v Ultra-Kap

ceramic capacitors for use in semiconductor circuits are available in values of up to 0.2 μ f.

CIRCLE 319 ON READER SERVICE CARD

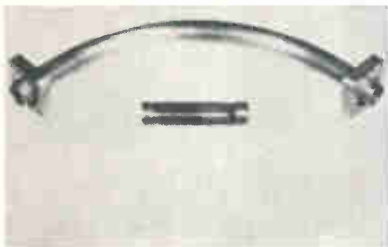

Waveguide Bends FOR MILLIMETER BAND

TRG, INC., 9 Union Square, Somerville, Mass., is fabricating simple and complex bends in millimeter-band circular waveguides for operation in the low loss TE_{01} mode. The bends are made by first corrugating the inside of lengths of straight copper waveguide and then bending them to the desired shape. A typical 90 deg bend at 70 Gc has a 3 in. radius, and 0.3 db loss.

CIRCLE 320 ON READER SERVICE CARD



Power Supply WITH DIAL OPERATION

DAVENPORT MFG. DIV., Duncan Electric Co., Inc., 2530 N. Elston Ave., Chicago 47, Ill. Line of d-c power supplies is available with both constant voltage and constant current output as selected by the operator without need for calibrating or balancing null meters. Six models cover ranges of 100 v and 1,000 v d-c at currents of 100 ma and 1 amp. Units have a repeatable accuracy of 0.01 percent, and an absolute accuracy of 0.05 percent, as referenced to the international volt, as corrected.

CIRCLE 321 ON READER SERVICE CARD

Oscilloscope

TEKTRONIX, INC., P. O. Box 500, Beaverton, Ore. Type 661 dual-trace oscilloscope is a complete



Model GFD-3
Subcarrier Discriminator

Model GFD-4
High-Frequency Discriminator

Modular Accessories:

Model
GFD-3/TASL

Model
GFD-3/TSL

Model
GFD-3/TU/LSM

Model
GFD-3/TUA



Optimum phase lock tracking!

— Just one reason
you can't beat DCS Discriminators!

COMPARE THESE DCS FEATURES:

- Super reliability — MTBF in excess of 5000 hours!
- Optimum phase-locked tracking — operator controlled.
- Widest frequency range — subcarriers to 1 mc.
- Maximum adaptability — widest variety of modular accessories.
- All solid-state — individual power supplies.
- YET — priced below many models with inferior performance!

Don't just take our word — ask our customers, who are actually using thousands of DCS Discriminators!

For example, consider reliability. Actual field data gathered by users has shown MTBF in excess of 5000 hours! What's more, we guarantee our MTBF data!

Also, DCS offers operator-controlled variable-loop tracking filters. Unlike inferior discriminators which are limited to a pre-set loop bandwidth and damping (claimed "optimum"), DCS Discriminators permit complete operator control in adapting characteristics of the phase-locked loop for *truly* optimum data reduction. A bench demonstration will quickly prove the superior performance possible with operator control. Numerous comparative customer evaluation reports attest to the superiority of the DCS operator-controlled phase-locked loop when signals are extremely weak.

The DCS family of discriminators offers the widest frequency ranges available. Discriminators to accommodate subcarriers in excess of 1 mc, intelligence frequencies in excess of 100 kc, constant-bandwidth, frequency translation, and predetection signals are standard, off-the-shelf products.

For complete information on the entire family of DCS Discriminators and accessories, call your nearest DCS Field Engineer or write: Dept. E-8.

Instrumentation for Research:

Ground and Air

Analog and Digital Data Components and Systems



DATA-CONTROL SYSTEMS, INC.

Los Angeles • Palo Alto • Wash., D. C. • Cape Canaveral
Home Office: E. Liberty St., Danbury, Conn. • Pioneer 3-9241

BIRD

"Termaline" 50 ohm Coaxial Line LOAD RESISTORS



82-A
(500 Watts)



80A
(20 Watts Max.)



81
(50 Watts)



81-B
(80 Watts)

SERIES 80-82

- Frequency Range: DC to 4000 mc
- Power Range: 20 to 2500 Watts
- Non-Radiating
- VSWR: 1.1 max. to 1000 mc.

APPLICATIONS

Accurate termination for 50-ohm coaxial systems, as dummy antennas, during adjustment, alignment and testing.

SPECIFICATIONS

MODEL	MAXIMUM POWER (In Still Air)	FREQUENCY RANGE	MAX. VSWR	INPUT CONNECTOR	WEIGHT	MAXIMUM DIMENSIONS		
						HEIGHT	LENGTH	WIDTH
80-A	20 W	0-1000 mc	1.1	"N" Female	2 lbs.	4 1/4"	4 5/16"	1 1/2"
81	50 W	0-4 kmc	1.2	"N" Female	4 lbs.	4 1/2"	9 3/4"	2 21/32"
81-B	80 W	0-4 kmc	1.2	"N" Female	4 lbs.	6 11/32"	9 3/8"	3 15/16"
82-A	500 W	0-3.3 kmc	1.2	Coplanar Adapter to UG-21 B/U Supplied. RG-17, RG-19 cable assemblies available.	17 lbs.	8 7/16"	18 1/2"	5 1/16"
82-AU	500 W	0-3.3 kmc	1.2	LC Jack mates with UG-154/U plug on RG-17 U cable.	17 lbs.	8 7/16"	19 1/8"	5 1/16"
82-C	2500 W Water cooled	0-3.3 kmc	1.2	Coplanar Adapter to UG-21 B/U Supplied. RG-17, RG-19 cable assemblies available.	26 lbs.	8 7/16"	20 13/16"	5 1/16"

OTHER BIRD PRODUCTS



"Thruline"
Directional
RF Wattmeters



Coaxial
RF Filters



Coaxial
RF Switches.



"Termaline"
RF Absorption
Wattmeters



BIRD

ELECTRONIC CORPORATION
30303 Aurora Rd., Cleveland 39 (Solon), Ohio
CHurchill 8-1200 TWX CGN FS 679
Western Representative:
VAN GROOS COMPANY, Woodland Hills, Calif.

pulse-sampling system with rise-time of 0.35 nsec.

CIRCLE 322 ON READER SERVICE CARD

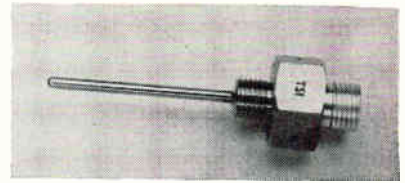

Temperature Sensor PLATINUM IMMERSION

TEMPERATURE SYSTEMS, INC., 1871 South Orange Drive, Los Angeles 19, Calif. Platinum immersion temperature sensor has been designed and tested to meet nuclear environments of 1(11) ergs/gram(c) gamma and 1(15)n/cm², En > 2.9 Mev neutron flux. It is rated at 100 ohms at 32 F and covers a temperature measuring span of -364 to +1,000 F.

CIRCLE 323 ON READER SERVICE CARD

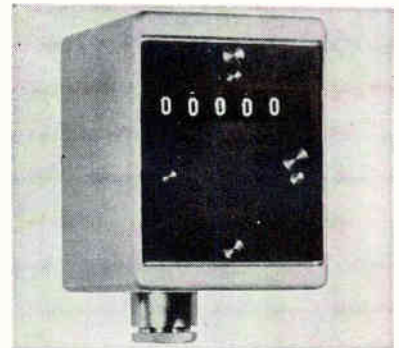

Impulse Counter SURFACE MOUNTED

LANDIS & GYR, INC., 45 W. 45th St., New York 36, N. Y. Type TCeBZ5A surface mounting, 5-digit Sodeco electric impulse counter has a rectifier incorporated to provide reliable d-c operation direct from a 110 v a-c source. It may be used with any pulse generator capable of creating a pulse of the required specifications. The coil may be continuously energized. Rated counting speed is 667 counts/min.

CIRCLE 324 ON READER SERVICE CARD

Oscillograph RECORDING/PROJECTING

MICROSOUND, INC., 4627 Leahy St., Culver City, Calif. The Datascope/RPO is a two-channel recording/projecting oscillograph that pro-

vides immediate viewing and a permanent record of variable or transient phenomena from d-c to beyond 600 cps.

CIRCLE 325 ON READER SERVICE CARD

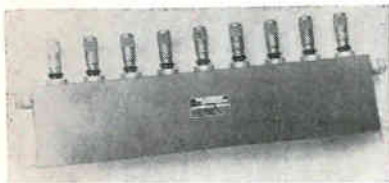

Bandpass Filter MULTIPLE-TUNED

FREQUENCY ENGINEERING LABORATORIES, P.O. Box 504, Asbury Park, N.J. A nine-section bandpass filter features steep skirt selectivity. Tunable over a frequency range of 2,200-2,300 Mc, it has a rejection bandwidth of 40 and 86 Mc at 3 db and 50 db respectively. Insertion loss of the unit is 1.0 db max and input vswr with matched load is 1.3:1.

CIRCLE 326 ON READER SERVICE CARD



Trimmer Capacitor WITH P-C TERMINAL

ERIE RESISTOR CORP., Erie, Pa. Style 538 miniature ceramic trimmer capacitor measuring $\frac{3}{8}$ in. in diameter is available with a printed circuit terminal that is readily inserted in standard p-c mounting holes. When mounted the trimmer is horizontally adjustable, thus eliminating the need for vertical clearance for adjusting or removing the entire assembly in order to adjust.

CIRCLE 327 ON READER SERVICE CARD

Circuit Synthesizer

INSTANT CIRCUITS CORP., Terminal Drive, Plainview, L. I., N. Y. Com-

at **AUTONETICS**

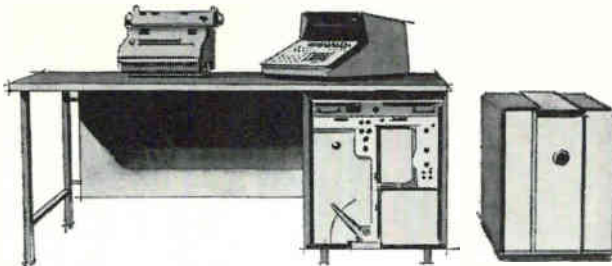

they chose **POTTER**
tape transports...

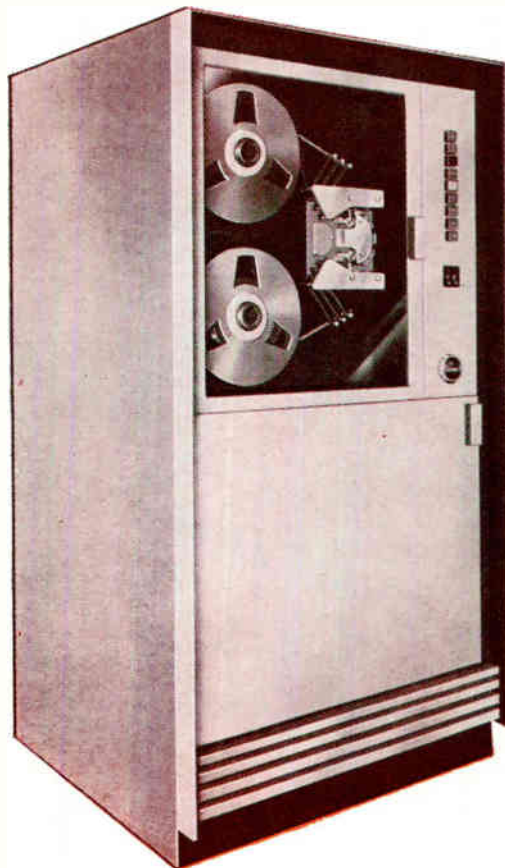

for the Recomp II computer system

This system offers the user a magnetic tape memory unit with a capacity of over 600,000 words—and four of these units can be coupled to permit a total memory capacity of over 2,500,000 words.

Key to this highly reliable memory system is the Potter Model 910 Digital Magnetic Tape Transport. This solid-state unit provides data transfer rates to 22,500 per second on $\frac{1}{2}$ -inch tape or 40,000 characters per second on 1-inch tape at tape speeds up to 75 inches per second. In Recomp II, the Model 910 is teamed with the transistorized Model 921A Read-Write Amplifier system, which provides flexibility to match virtually any digital tape application.

To learn more about Potter Digital Magnetic Tape Transports write today.

POTTER



INSTRUMENT CO., INC.

PLAINVIEW, NEW YORK

More than 107 types standard
solder terminals



WEBSTER KNOWS

In fact, his definition certainly applies to CAMBION® Standard Solder Terminals. As parts which terminate plenty of trouble in electronic circuitry construction, they've gained universal approval from manufacturers, professional technicians and hams.

Starting with top quality brass, each CAMBION solder terminal is precision machined, quality inspected, electroplated with silver, electro-tin or gold — or to your own plating specifications. Close quality control is maintained, and inspections made at each successive manufacturing step to assure that each terminal meets or exceeds applicable MIL specifications, such as MIL-Q-5923C.

That's why, as with all components in the broad CAMBION line, top quality is guaranteed for the more than 30,000,000 CAMBION Solder Terminals in stock . . . in more than 107 different types: single, double and triple turret; feed-through, double-ended, hollow and split.

The broad CAMBION line includes plugs and jacks, solder terminals, insulated terminals, terminal boards, capacitors, shielded coils, coil forms, panel hardware, digital computer components. For a catalog, for design assistance or for both, write to Cambridge Thermionic Corporation, 437 Concord Ave., Cambridge 38, Mass.

CAMBRIDGE THERMIONIC CORPORATION
CAMBION®
The guaranteed electronic components



compact circuit synthesizer eliminates the need for soldering and combines ease of operation with modular convenience.

CIRCLE 328 ON READER SERVICE CARD

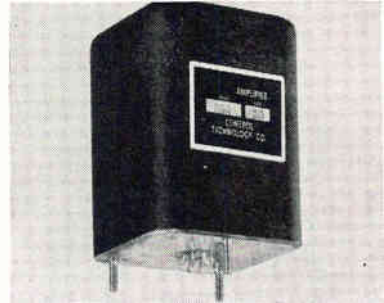

Isolation Amplifier TRANSISTORIZED

CONTROL TECHNOLOGY CO., INC., 41-16 29th St., Long Island City 1, N. Y. Model 260 features 20,000 ohm input impedance, a gain of 40, and a gain accuracy of 0.1 percent over the temperature range of - 55 to 125 C. Used to drive resolvers, synchros, potentiometers or other transducers in airborne or ground support applications.

CIRCLE 329 ON READER SERVICE CARD



Infrared Hygrometer HIGH SENSITIVITY

GENERAL MILLS, INC., 1620 Central Ave., Minneapolis 13, Minn. Infrared hygrometer can measure water vapor in factory, laboratory or the atmosphere. It is proposed for use in meteorology, studies of evaporation, monitoring and control of humidity in environmental chambers and plant processes, and as a laboratory standard for other types of humidity devices.

CIRCLE 330 ON READER SERVICE CARD

Sampling Scope

HEWLETT-PACKARD CO., 1501 Page Mill Road, Palo Alto, Calif. Sampling oscilloscope gives calibrated,

high resolution measurement of nanosecond pulse phenomena.

CIRCLE 331 ON READER SERVICE CARD



NOR-Gate CONVERTIBLE

DIGITAL DESIGN CORP., Box 21, Clay, N.Y. Model N-131-DC Nand-Gate (NOR-Gate) features two triple input and two dual input gates. Additional inputs are available by terminal interconnection by the user. Switching rates up to 1 Mc are accommodated. Addition of external capacitors converts the device to an integrator, a differentiator or multivibrator. Connector is a 35-pin plug.

CIRCLE 332 ON READER SERVICE CARD

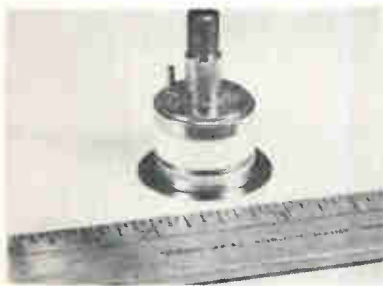

Semiconductor Housing HIGH-ALUMINA

CERAMASEAL, INC., New Lebanon Center, N.Y. High-alumina semiconductor housing features a ceramic-metal bond that remains high-vacuum-tight during continuous operation at 350 C in air. Bonding technique is a variation of the active alloy process. Advantages of high-alumina ceramic over glass include higher resistance to thermal and mechanical stresses, and longer creepage paths in a compact design.

CIRCLE 333 ON READER SERVICE CARD

Epoxy Compounds 7 TRANSPARENT COLORS

TECHFORM LABORATORIES, INC., 332 Sunset Ave., Venice, Calif. Series EPC100 potting and encapsulating compounds combine the advantages



NEW THERMOSTAT COMBINES FOUR DESIGN ADVANTAGES

Only the KLIXON M2 THERMOSTAT brings you all four of these desirable features:

1. the dependability of a snap-acting bimetallic disc;
2. a differential range as narrow as 2° to 5°F;
3. a welded hermetic seal;
4. a switch-action option of opening or closing on temperature rise or drop.

Features (3) and (4) are exclusive . . . and what a rewarding difference they make.

The KLIXON M2 Welded Hermetic Seal prevents contamination of the thermostat due to trapped solder or flux. Moreover, you're sure that the seal is free of voids or undetected weak spots that might lead to corrosion. So, you get extra assurance of long-lived performance.

THE KLIXON M2 Optional Switch Action allows you to use the same basic thermostat not only to control temperature in heating boots and blankets and anti-fogging systems but also to turn on warning lights when temperatures get too high.

Write Today for complete specifications, prices, delivery schedules or packaging design assistance.

PERFORMANCE CHARACTERISTICS of M-2 THERMOSTAT

Calibration	0-250°F Standard $\pm 4^\circ\text{F}$ on closing temp Special $\pm 3^\circ\text{F}$ on closing temp	
Differential	0-250°F 5 to 9°F or 2 to 5°F 251-350°F 5 to 9°F	
Temp settings	-65 to 350°F 350 to 450°F under development	
Switch action	SPST, closes on temp rise or temp drop	
Electrical rating	Amperage (non-inductive)	Cycles
Voltage	2 amp	250,000 cycles
Dielectric strength	1250V rms, 60 cycles for 30 sec	
Vibration resistance	5-500 cps at 10 G's accel. or .36 D.A.	
Leakage	Surpasses immersion test MIL-E-5272C	
Approximate weight	5.6 grams	



METALS & CONTROLS INC.

5011 FOREST ST. • ATTLEBORO, MASS.

A CORPORATE DIVISION OF
TEXAS INSTRUMENTS
INCORPORATED

NEW!

ERIE *Instru/mation*®

Model 725A

220KC UNIVERSAL COUNTER/TIMER



Only ERIE produces an instrument with all of these quality features as standard at no extra cost:

- IN-LINE NIXIE READOUT
- TRIGGER LEVEL CONTROLS $-100V$ to $+100V$
- 220KC OPERATION
- 50 MILLIVOLT SENSITIVITY
- 5¼" RACK PANEL HEIGHT
- TRUE MODULAR CONSTRUCTION

In addition to these features, many of which are usually offered as options at additional cost, the Model 725A is an outstanding quality instrument. It accurately counts cyclic or random electrical events and precisely measures frequency, period and time intervals. NIXIE readout is available in five or six decades.

Model 725A is part of the newly designed 700 series of counter/timers. The panels have been planned for simplicity of operation and to reduce the opportunity for operator error. They are available for either rack mounting or in a heavy gauge aluminum case with carrying handles, where portability is desired.

Considering quality, flexibility, performance and price, the Model 725 is your best instrument for production or laboratory use. Why not send for complete technical information today.



ERIE PACIFIC, DIVISION OF ERIE RESISTOR CORPORATION

12932 S. Weber Way, Hawthorne, California

ERIE-PACIFIC manufactures a complete line of digital counting, timing and control instruments and systems for military or commercial use.

of easily identifiable colors and complete transparency, thus allowing both color coding and viewing of embedded components, regardless of casting size.

CIRCLE 334 ON READER SERVICE CARD

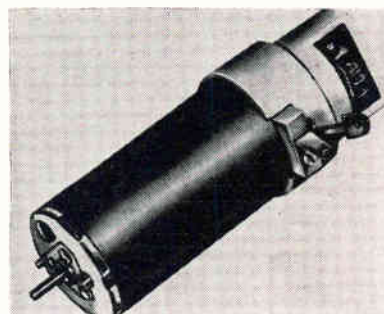

Small D-C Motor BATTERY-POWERED

JONARD INT. CORP., 624 Madison Ave., New York 22, N.Y. A 9-v battery-powered motor offers excellent control with less than 2 percent variation in speed and a low power consumption rating. A critical component of the motor is its governor-regulator with a torque measured at a constant 2050 rpm. However, variations of 500 to 600 rpm centered on 2050 rpm can be made with a simple screw adjustment.

CIRCLE 335 ON READER SERVICE CARD



Current Regulator TWO-TERMINAL

GRAFIX CO., 2841 San Mateo Blvd., N.E., Albuquerque, N.M. The KI 2-terminal constant current regulator is useful in applications where a low dissipation, voltage-dropping component with a constant current or negative resistance characteristic is needed. With a 2,000 cps sinusoidal ripple modulation over the range from 10 to 28 v d-c, current is regulated to within 1 percent.

CIRCLE 336 ON READER SERVICE CARD

Foamed Plastic Pack

PAC-TRON, INC., 225 Crescent St., Waltham, Mass. Custom-designed

packaging of expanded foamed plastic is used to protect delicate components and assemblies during shipment.

CIRCLE 337 ON READER SERVICE CARD



Thermistor Mounts BROADBAND

GENERAL MICROWAVE CORP., 47 Gazza Blvd., Farmingdale, N.Y. Model 402 series of temperature-compensated thermistor mounts cover the frequency range from 0.01 to 18.0 Gc. They are designed for measurement of a wide range of c-w or modulated powers in conjunction with model 450 precision microwave power meter which features a direct-reading accuracy of 0.5 percent of full scale.

CIRCLE 338 ON READER SERVICE CARD

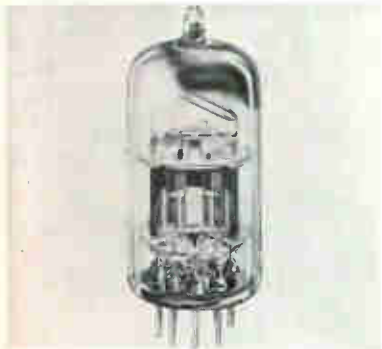

Miniature Pentode TWO FRAME GRIDS

AMPREX ELECTRONIC CORP., 230 Duffy Ave., Hicksville, L. I., N. Y. Type 7788, a miniature 9-pin pentode incorporates two frame grids (control and screen) to attain a transconductance of 50,000 μ mhos at 35 ma. It is designed for use in broadband amplifying circuits such as radio and tv relay systems, coaxial telephone lines, radar equipment and oscilloscopes. It has a figure of merit of 410 Mc.

CIRCLE 339 ON READER SERVICE CARD

Preamplifier

AD-YU ELECTRONICS LAB., INC., 249 Terhune Ave., Passaic, N. J. Mini-

*Up to 19.6% less
cost per megohm!*

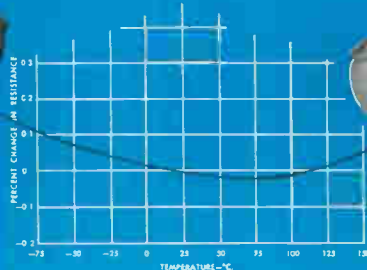

*Up to 14.1% more
ohms per pound!*

HOSKINS ALLOY

815-R

Precision Resistor Wire



The trouble with using only one type of alloy wire in all of your precision resistors is that very often you and your customers end up paying for something that really isn't required so far as the end use is concerned. Now take Hoskins Alloy 815-R, for example. It's a relatively new custom-quality iron-chromium-aluminum composition. But a number of alert and cost-conscious manufacturers have already found that it possesses all of the physical and electrical properties necessary for many precision resistor applications. High strength, good ductility. Excellent resistance to corrosion. Controlled low temperature coefficient. What's more—and more to the point these days—they've also found that Alloy 815-R's lower density and higher electrical resistivity combine to give them very worthwhile savings. Up to 14.1% more ohms per pound—up to 19.6% less cost per megohm!

Yours for the Asking—If you're a man who fancies such figures, we'd like to send you an eyeful—namely: A handy little "Cost-per-Megohm" Comparator, plus a 12 page catalog that's loaded with technical data. If you also happen to make precision resistors, sample spools of 815-R wire are available for testing and evaluation.



Sizes from .0031" down to .0004"—Bare and enameled—Temperature Coefficients: 0 ± 10 ppm and 0 ± 20 ppm /°C.

HOSKINS MANUFACTURING COMPANY

4445 Lawton Avenue • Detroit 8, Michigan • TYler 5-2860

In Canada: Hoskins Alloys of Canada, Ltd., 45 Racine Rd., Rexdale P.O., Toronto, Ontario

Producers of Custom Quality Resistance, Resistor and Thermo-Electric Alloys since 1908



NEW KEITHLEY AC AMPLIFIER

*can increase
scope sensitivity
1000 times!*

The Keithley Model 103 gives you the best attainable signal-to-noise ratio for source impedances from 3000 ohms to over 10 megohms. (The equivalent input noise resistance on the low noise position is only 3 k ohms.) Bandwidth of .1 cps to 100 kc covers a wide range of uses; even high and low frequency cuts permit restricted bandwidths for minimum noise.

Applications include Hall Effect studies, bridge null detection, and semi-conductor investigations, as well as such biophysical applications as recording nerve action potentials.

The usefulness of the Model 103 is enhanced by its versatility:

NOISE can be improved by changing input impedance with a "Normal" and "Low Noise" switch. Chart below indicates noise levels with input shorted, gain 1000x, 10 cps to indicated cutoff:

BANDWIDTH can be selected by using 11 high and low frequency cutoffs between .1 cps and 100 kc.

INPUT IMPEDANCE in the "Normal" mode is 10 megohms; in the "Low Noise" mode, 100 k ohms.

AMPLIFIER GAIN may be set at either 100 or 1000 and adjusted to precise values.

INPUT CONNECTIONS can be made single-ended or differential.

DIFFERENTIAL REJECTION is at least 80 db permitting increased signal-to-noise ratios in many applications.

POWER—from batteries or the Keithley Model 1031, a separate, solid state power supply with noise characteristics equivalent to batteries.

PRICES: Model 103, \$245; rack, \$255
1031 Power Supply, \$245; rack, \$255

Frequency of high cutoff point	Maximum noise, microvolts RMS referred to input	
	Normal (10 meg impedance)	Low Noise (100 k impedance)
100 kc	3.0	1.9
30 kc	1.9	1.1
10 kc	1.4	0.8
3 kc	0.9	0.6
1 kc	0.7	0.4
300 cps	0.5	0.3
100 cps	0.4	0.25

This oscillograph shows a 2 kc square wave of 5 microvolts peak-to-peak amplitude at input with the amplifier in "Low Noise" position. Horizontal calibration equals 200 μ v per division; vertical equals 2 μ v per division. Low cut is 10 cps, high cut 1 kc. The unusually low noise levels in the 103 are achieved through the use of ceramic tubes in cascode circuitry.



send for complete specifications in latest engineering note . . .



KEITHLEY INSTRUMENTS
12415 EUCLID AVENUE CLEVELAND 6, OHIO

electrometers • micro-microammeters • microvoltmeters • milliohmmeters

ature preamplifier with bandwidth over 1 Mc is suitable for increasing the sensitivity of laboratory instruments, electronic devices, mechanical pickup or transducers.

CIRCLE 340 ON READER SERVICE CARD

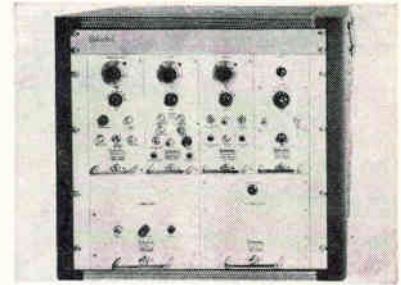

Modular Systems PULSE & TIME DELAY

RUTHERFORD ELECTRONICS CO., 8944 Lindblade St., Culver City, Calif. Designed on the modular building block concept, a complete line of repetition rate, delay, width, pulse forming, and power supply packages will make possible a new line of standard pulse and time delay generators, as well as giving the company the ability to easily build up special purpose generators to meet any pulse requirement.

CIRCLE 341 ON READER SERVICE CARD

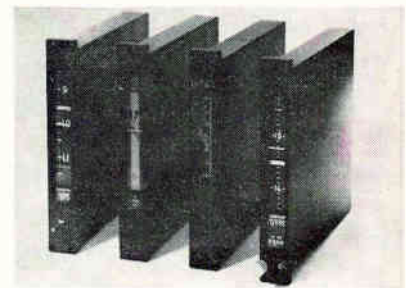

Instrument Indicators BOOKSHELF TYPE

KOLLSMAN INSTRUMENT CORP., Elmhurst, N. Y. Instrument indicators built as separate vertical parameters promise high readability and compactness for aircraft cockpit instrument panels. Shown are four units—a Mach-indicated air speed indicator, an indicator of angle of attack and acceleration, a vertical speed (rate-of-climb) indicator and an altitude indicator—each measuring 1 1/8 in. wide and designed to be mounted side-by-side as a single unit.

CIRCLE 342 ON READER SERVICE CARD

PRODUCT BRIEFS

IMPACT NOISE ANALYZER push-button resetting. General Radio Co., West Concord, Mass. (343)

SILICON RECTIFIERS double-diffused. Solitron Devices, Inc., 500 Livingston St., Norwood, N. J. (344)

SMALL MOTORS unidirectional, non-geared. Barber-Colman Co., Rockford, Ill. (345)

PRESSURE SWITCH military-industrial. International Resistance Co., 401 N. Broad St., Philadelphia 8, Pa. (346)

TINY LAMP twin filament. Chicago Miniature Lamp Works, 1500 No. Ogden Ave., Chicago, Ill. (347)

COIL BOBBIN one-piece laminated glass cloth. Silicone Insulation, Inc., 1383 Seabury Ave., Bronx 61, N. Y. (348)

CERAMIC CAPACITORS 50 and 200 vdcw. Aerovox Corp., Olean, New York. (349)

POWER SUPPLY for variable purpose use. Chalco Engineering Corp., 15126 South Broadway, Gardena, Calif. (350)

BERYLLIUM ANALYZER for lab use. Kleber Laboratories, Inc., 2530 N. Ontario St., Burbank, Calif. (351)

ACCELEROMETER SWITCH ruggedized. Humphrey, Inc., 2805 Canon St., San Diego 6, Calif. (352)

INSULATING COATING high temperature. Columbia Technical Corp., Woodside 77, N. Y. (353)

SET/RESET INDICATOR plug-in module. Electronic Control Products, U.S. Highway 22, P.O. Box 286, Dunellen, N. J. (354)

C-C TV CAMERA uses 7-tube circuit. Marsan Industries, Inc., 49 Edison Place, Newark, N. J. (355)

PORTABLE OHMMETER accurate to 0.5 percent. Associated Research, Inc., 3777 W. Belmont Ave., Chicago 18, Ill. (356)

TIME DELAY SWITCH small, rugged. Inertia Switch, Inc., 311 W. 43rd St., New York 36, N. Y. (357)

PHASE CHECKER sound-powered. Radio Corp. of America, Harrison, N. J. (358)

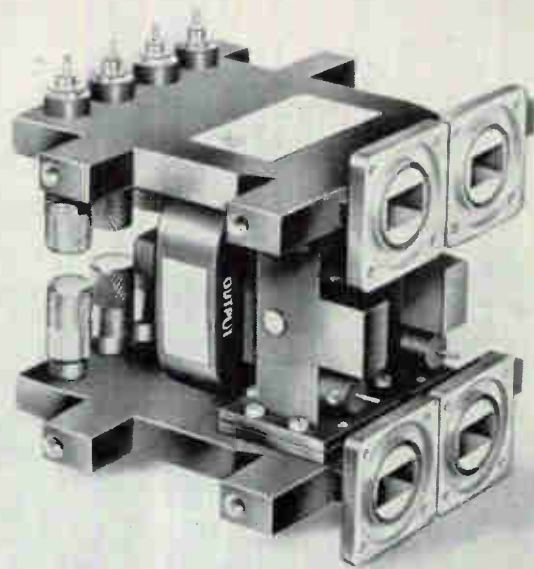

PACKAGED PRECISION FOR YOUR EXACT REQUIREMENTS

MICROWAVE SUB-SYSTEMS

Kearfott has the experience and ability to design precision sub-systems to the customer's actual configuration and performance needs. The availability of a wide variety of standard components, coupled with advanced techniques, makes it possible to provide packaged r-f assemblies with a high component density—tailored to precise volumetric specifications. For minimum size and weight in airborne or missile applications — for military system environment — Kearfott will successfully design your sub-system — to your most exacting requirement.



Mono-Pulse Radar



S-Band Strip-transmission Head



Mixer Duplexer

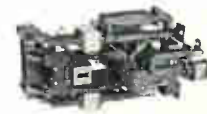

High Power Mixer Duplexer

Write for complete data



**KEARFOTT DIVISION
GENERAL PRECISION, INC.**

Little Falls, New Jersey

now... analyze both SSB & AM transmitters & receivers faster, with uniform sensitivity over entire 100 cps-40 mc range AT MINIMUM COST

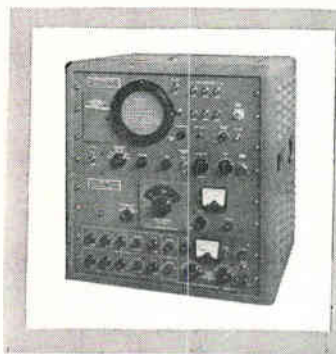

new — improved
PANORAMIC SSB-3a
SPECTRUM ANALYZER

Panoramic adds important NEW design features to the time-proven model SSB-3! Now, in one convenient, compact package, you get the comprehensive unit you need to set up, adjust, monitor and trouble shoot SSB and AM transmitters and receivers.

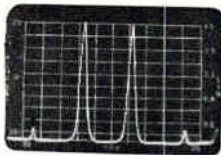

TWO TONE TEST*
Fixed sweep width 2000 cps. Full scale log sideband tones 1.5 kc and 2.1 kc from carrier (not shown). Odd order I. M. distortion products down 37 db.

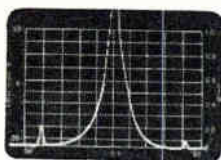

HUM TEST*
Indication of one sideband in above photo increased 20 db. Sweep width set to 150 cps reveals hum sidebands down 53 db and 60 db.

*See Panoramic Analyzer No. 3 describing testing techniques, etc., for single sidebands. A copy is yours for the asking.

GREATER FREQUENCY RANGE New Optional REC-1 Range converter extends SSB-3a 2 mc-40 mc range down to 100 cps . . . speeds distortion analysis of receiver AF and IF outputs, transmitter bass band.

NEW 2-TONE AF GENERATOR MODEL TTG-2 2 generator frequencies, each selectable from 100 cps-10 kc • Resettable to 3 significant digits • Accuracy: $\pm 1\%$ • Output Levels: each adjustable from 2 to 4 volts into matched 600 ohm load • Output DB Meter • Spurious, hum, etc., less than -60 db. • 100 db precision attenuation in 1 db steps.

FASTER-NEW TUNING HEAD FEATURES RAPID "SIGNAL SEARCH" PLUS PRECISE FINE TUNING.

ALL THESE NEW FEATURES . . . PLUS A SENSITIVE SPECTRUM ANALYZER

Panoramic's Model SB-12aS Panalyzer. Pre-set sweep widths of 150, 500, 2000, 10,000 and 30,000 cps with automatic optimum resolution for fast, easy operation. Continuously variable sweep width up to 100 kc for additional flexibility. 60 db dynamic range. 60 cps hum sidebands measurable to -60 db. High order sweep stability thru AFC network. Precisely calibrated lin & log amplitude scales. Standard 5" CRT with camera mount bezel. Two auxiliary outputs for chart recorder or large screen CRT.

INTERNAL CALIBRATING CIRCUITRY Two RF signal sources simulate two-tone test and check internal distortion and hum of analyzer. Center frequency marker with external AM provisions for sweep width calibrations.

Write, wire, phone RIGHT NOW for technical bulletin and prices on the new SSB-3a. Send for our new CATALOG DIGEST and ask to be put on our regular mailing list for The PANORAMIC ANALYZER featuring application data.



2900 Sec.

PANORAMIC ELECTRONICS, INC.

530 So. Fulton Ave., Mount Vernon, N. Y. Phone: OWens 9-4600 • TWX: MT-V-NY S229 Cables: Panoramic, Mount Vernon, N. Y. State

Literature of the Week

ELECTRONIC TIMERS Electronic Products Corp., 4642 Belair Road, Baltimore 6, Md. Literature contains specifications, photos and prices on an assortment of transistorized timing devices. (359)

FEED-THROUGH CAPACITORS Fansteel Metallurgical Corp., North Chicago, Ill. Data sheet describes 1.0-amp feed-through, solid tantalum capacitors. (360)

EPITAXIAL TRANSISTOR Radio Corp. of America, Somerville, N. J. Four-page bulletin announces the 2N828 germanium epitaxial mesa transistor. (361)

MICROWAVE DIODES Sylvania Electric Products Inc., 100 Sylvan Road, Woburn, Mass., has available a 26-page microwave diode product guide. (362)

STRAIN GAGES Baldwin - Lima-Hamilton Corp., Waltham 54, Mass. A data sheet describes a line of weldable strain gages. (363)

SEALANT American Sealants Co., 705 N. Mountain Road, Hartford 11, Conn., has published a memorandum on the approval of Loctite sealants for use in military electronic equipment. (364)

MAGNETIC HEADS International Electro-Magnetics, Inc., Box 7, North Chicago, Ill. Folder contains typical configurations and specification considerations for magnetic heads. (365)

RFI SUPPRESSORS Relcoil Products Corp., Spring St. & Route 75, Windsor Locks, Conn. Four-page folder covers a line of r-f noise suppressors. (366)

TEST TERMINATIONS Holland Electronics Inc., 772 E. 53rd St., Brooklyn 3, N. Y., offers two bulletins describing a line of precision test terminations for pulse, video and r-f applications. (367)

CARD RECEPTACLES Methode Electronics, Inc., 7447 W. Wilson Ave., Chicago 31, Ill. Bulletin R9-261 describes the FD-900 and SMI-600 Reli-Acon printed circuit card receptacles. (368)

TELEMETRY PREAMPLIFIER Defense Electronics, Inc., 5451-B



formerly Panoramic Radio Products, Inc. See us at N.E.R.E.M. Booth #809

**DESIGNED TO MEET THE
CHALLENGE OF ENVIRONMENT**

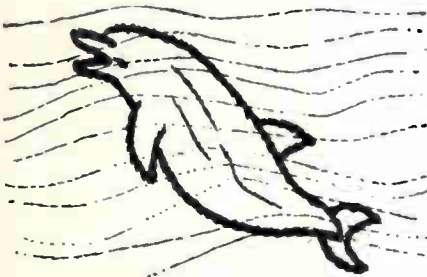

Connectors

A well-developed sonar system is standard equipment for the Porpoise... That, plus speed, maneuverability, and intelligence, rates him highly adaptable for underwater existence.

An equally well-adapted man-made combination is the Polaris Missile and its subsurface, nuclear-powered launching pad. The Polaris program adds extra-reliability with Anton Series WM-20 Connectors by Lionel... These rugged, dependable devices afford the utmost in reliability and construction, the maximum in quality, design, materials and workmanship... as proven by Polaris.

- Die-Cast housings
- Diallyl Phthalate moldings
- Five sizes, 34 to 104 contact range
- Also available to accept #16 wire
- Extended insertion/withdrawal life
- Meet applicable MIL Specs

(Special materials and modifications to meet specific requirements)



Delivery time slashed for Anton "special" connectors! New Lionel tooling practices provide rapid delivery of "specials" for unusual applications... within 6-8 weeks* of order date!

*"Standard" catalog units are in-stock items.

Write Dept. 211A-W for Series WM-20 Technical Literature.



LIONEL
Electronic Laboratories
FORMERLY ANTON ELECTRONIC LABORATORIES
1226 Flushing Ave., Brooklyn 37, N.Y.

CIRCLE 208 ON READER SERVICE CARD
November 10, 1961

Randolph Rd., Rockville, Md. Data sheet illustrates and describes model TPA-1 telemetry preamplifier. (369)

PLUG-IN CHOPPER Solid State Electronics Co., 15321 Rayen St., Sepulveda, Calif., has available literature describing model 66 plug-in line-driven chopper (or modulator). (370)

STANDBY A-C POWER SYSTEMS Electro-Seal Corp., Des Plaines, Ill. Bulletin 6131 describes the Electro-Pac "A" standby a-c power systems. (371)

ZONE SCANNERS Lindberg Engineering Co., 2450 W. Hubbard St., Chicago 12, Ill., has issued bulletins showing the features and capabilities of two zone scanners. (372)

FILTERS Stancor Electronics, Inc., 3501 W. Addison St., Chicago 18, Ill. Bulletin discusses typical MIL-F-18327A filters. (373)

SOLID STATE AMPLIFIER Neff Instrument Co., 1088 E. Hamilton Rd., Duarte, Calif. Four-page bulletin describes a reliable open-loop d-c amplifier. (374)

DIGITAL CIRCUITRY Interstate Electronics Corp., 707 E. Vermont Ave., Anaheim, Calif., has available a 68-page handbook covering applications of digital circuitry. (375)

FIELD EFFECT TRANSISTORS Texas Instruments Inc., P.O. Box 5012, Dallas 22, Texas. Unipolar field effect transistor characteristics and applications are discussed in a technical information bulletin. (376)

NOISE CONTROL H. H. Scott, Inc., 111 Powdermill Rd., Maynard, Mass. Booklet entitled "The Why and How of Noise Control" discusses fundamentals of industrial noise control. (377)

CUSTOM SYSTEMS CAPABILITIES Consolidated Systems Corp., 1500 S. Shamrock Ave., Monrovia, Calif. Brochure contains a summary of the company's operating methods, an explanation of its organizational divisions and examples of its projects. (378)

WAVEGUIDE PRESSURE WINDOWS Microwave Development Laboratories, Inc., 15 Strathmore Road, Natick, Mass. Catalog WD-61 contains electrical and mechanical data for a line of waveguide pressure windows. (379)



Your
ingenuity

PLUS

simple
tools

can
transform

BUD IMLOK

extrusions
and
connectors



into housings
like these



When you need cabinets, racks or cases for experimental or prototype work, make them, quickly and inexpensively with BUD IMLOK extrusions and connectors. No tooling costs or expensive labor are involved. The new BUD IMLOK manual gives complete details on this system. Write us for a copy or obtain one at your local BUD distributor.



BUD RADIO, INC.
CLEVELAND 3, OHIO

CIRCLE 131 ON READER SERVICE CARD 131



Univac Dedicates \$20-Million Center

DISCOVERY of better ways to build electronic computers is the purpose of the new Univac Engineering Center recently dedicated in Whitpain Township, Pa. The center represents an investment of \$20 million by the Sperry Rand Corp., of which Remington Rand Univac is a division.

At the new center, on a 112-acre tract, more than 700 engineers, scientists and technicians are engaged in basic and advanced research, product design, quality assurance and human engineering. There are some 25 separate laboratories for such fields as the chemistry of magnetic materials and solid-state physics.

Among new techniques being developed are, for example, the use of fluids as amplifiers and digital logical devices.

Work in the plating laboratory

Jackson Moves Up At Ryan Aeronautical

ELECTION of Robert C. Jackson as president of Ryan Aeronautical Co., San Diego, Calif., to be effective Nov. 1, has been announced by T. Claude Ryan, chairman of the board.

Ryan, who has held the positions of president and chairman, continues as chairman of the board and chief executive officer. Jack-

is opening the way to extreme high pulse densities on magnetic drums and tapes. From these new techniques, Univac scientists foresee smaller memory devices with larger capacities.

Research in mass storage devices at the center gives promise in the near future of four to 10 times the capacities and speeds of present components, company says. Other research, in the software field of English and mathematical languages, involves over 80 projects in four main areas: product design, systems programming, R&D, and government projects.

Univac engineering centers are also located in St. Paul, Minn., and Norwalk, Conn. Basic research on a corporate-wide basis is conducted at the new Sperry Rand Sudbury Engineering and Research Center in Sudbury, Mass.

son has been the company's executive vice president for the past two years.

Colorado Instruments Hires R. E. Howard

RICHARD E. HOWARD has joined the staff of Colorado Instruments, Inc., Broomfield, Colo., as senior engineer. His background includes five years with Colorado Research

Corp., where he was assistant manager of engineering, and three and one-half years with Denver Research Institute of the U. of Denver.

Colorado Instruments designs and manufactures digital electronic instruments, controls, and image transmission systems. Firm also conducts general electronic systems research and development work.



Quantatron Elects Maiman a V-P

ELECTION of Theodore H. Maiman as a vice president of Quantatron, Inc., is announced.

For six months before this appointment he held the post of director of the applied physics laboratory in this Santa Monica applied science company. Current activity of the laboratory embraces the entire spectrum of lasers from basic materials research to systems application.



Burnell Names Lab In Guillemin's Honor

THE GUILLEMIN RESEARCH LABORATORY of Burnell & Co., Inc., of Pelham, N.Y., which was recently formally dedicated in Cambridge, Mass., honors the name of Ernst A. Guillemin, Webster professor of electrical engineering at MIT, and a vice president and director of re-

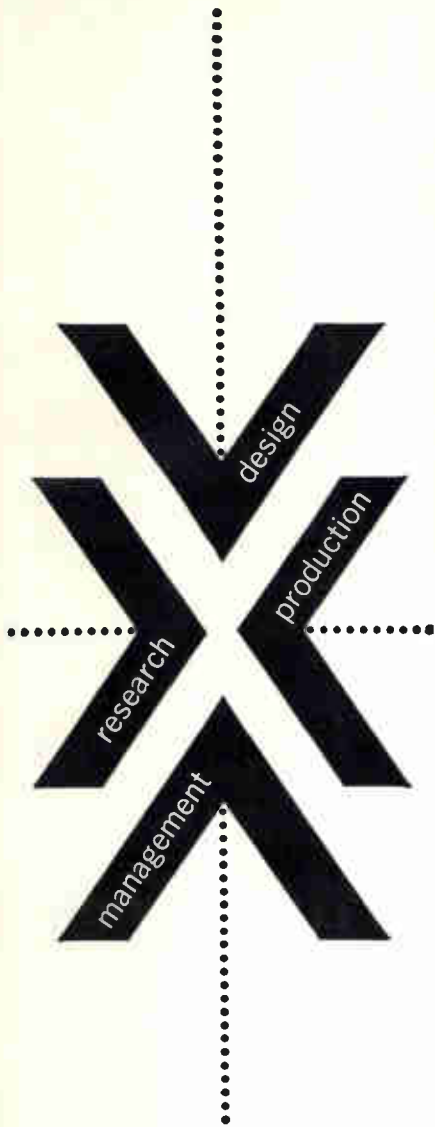

it's read
more
by all 4!

electronics magazine covers engineering and technically interpreted market trends every week. Government, military and economic developments, new applications, and technical data you'll want to file and keep. Subscribe now and read it first (don't be low man on a routing slip). Mail the reader service card (postpaid) to **electronics**, the magazine that helps you to know and to grow! Rates: three years for \$12; one year for \$6; Canadian, one year for \$10; foreign, one year for \$20. Annual **electronics BUYERS' GUIDE** (single issue price \$3.00) included with every subscription.

subscribe today to
electronics

November 10, 1961



10⁻¹⁰ VACUUMS... IN THE FIELD!

If you've been baffled by the problem of maintaining high vacuums under field conditions, Varian can supply the answer—the Battery-Operated VacIon® Pump Power Supply.

This DC-DC converter unit employs a combination of transistor and magnetic circuitry. VacIon all-electronic high vacuum pumps can be operated wherever a 12V power source is available. Designed for use with VacIon pumps from 0.2 to 8 litres/second pumping speed.

Here's a low-cost means of low-pressure appendage pumping (under ideal conditions, up to 10⁻¹⁰mm Hg) in situations where normal sources are unavailable: during shipping, in-plant movement, standby operation, or at remote field locations. Compact, rugged, shockproof. Operable at temperatures from 0°F to 150°F, at humidities up to 100%.

For full technical data, write Vacuum Products Division.

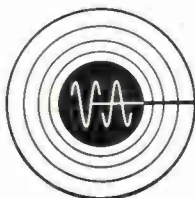

VARIAN associates

PALO ALTO 1, CALIFORNIA

BOMAC LABORATORIES, INC.
VARIAN ASSOCIATES OF CANADA, LTD.
S-F-D LABORATORIES, INC.
SEMICON ASSOCIATES, INC.
SEMICON OF CALIFORNIA, INC.
VARIAN A. G. (SWITZERLAND)

CIRCLE 133 ON READER SERVICE CARD

133

GREEN PANTOGRAPH ENGRAVERS

- ELIMINATE DELAYS!
- KEEP YOUR OPERATING COSTS WHERE THEY SHOULD BE!



PORTABLE 40-POUND BENCH MODEL 106

*You Make
Your Own
Engraved
Nameplates!*

Here is a speedy, economical 2 or 3-dimensional engraver used by thousands of dollar-conscious companies. It features 5 positive, accurate pantographic ratios; ball bearing spindle with 3 speeds up to 14,000 rpm. Is supplied with one copy carrier that accepts all standard master type sizes. Will actually work up to 10" by any width. Height of pantograph and position of cutter are continuously adjustable.

MODEL D-2 HEAVY-DUTY 2-DIMENSIONAL

Pantograph for milling, drilling and engraving.

Vertical adjustment of copy table automatic with Pantograph. Features: unobstructed on 3 sides to take large work; micrometer adjustment for depth of cut; ball bearing construction throughout; spindle speeds up to 26,000 rpm for engraving or machining, vertical range over 10"; ratios 2 to 1 to infinity — master copy area 26" x 10"

NEW

MODEL D2-201 PNEUMATIC ATTACHMENT

for use with Model D2 Pantograph Engraver to rapidly drill holes in printed circuits by tracing templates. Drills as many as 100 holes per minute. Equipped with foot switch, spindle air cylinder, regulating valve and pressure gauge, filter and oiler. It's ready to use as soon as it's attached to an air compressor

Write or call for full details and prices.

GREEN INSTRUMENT COMPANY, INC.

Dept. 63, 295 Vassar St.,
Cambridge 39, Mass. Tel. Eliot 4-2989

search of Burnell & Co. Burnell manufactures electronic filter networks, delay lines and related components.

An authority and consultant on communications and electronic network analysis, Guillemin has been a member of the MIT faculty since 1928. He was advanced from professor of electrical communications to the Webster chair in March, 1960, the seventh man to be selected for the honor.

Last March, Guillemin received the 1961 Medal of Honor of the IRE. He also holds a Presidential Certificate of Merit for his work during World War II.



Gross Heads Up New Company

FORMATION of Spectran Electronics Corp., Maynard, Mass., for the development and manufacture of magnetostriction components and instruments has been announced by its six founders.

Heading the Spectran group is T.A.O. Gross, president. Frank R. Stevens is vice president and treasurer; Edward J. Neville, Jr., vice president of manufacturing; James C. Davis, Jr., chief engineer; Frederick C. Hawkes, head of physical metallurgy. All the above were formerly with Raytheon.

Completing the founding group is Garland L. Tomlin, Jr., director of design activities. He was formerly with Microwave Associates.

Rothstein Assumes New Position

JEROME ROTHSTEIN has been named vice president and chief scientist for Maser Optics, Inc., Cambridge, Mass. The position is a new one in the recently formed company, which performs research and development

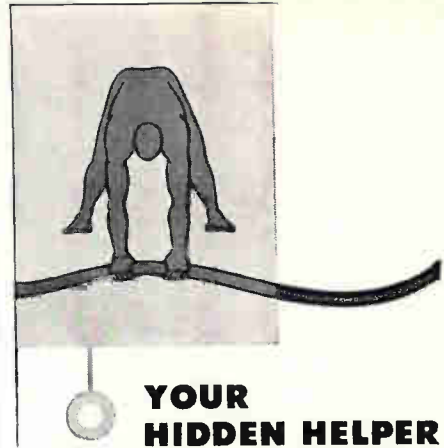

YOUR HIDDEN HELPER

—eliminates the old bugaboo of cable entanglement which damages tubes and components in lower chassis each time the one above is withdrawn for service and returned to position.

Our new Cable Retractor's double action maintains constant tension and correct suspension of cable at all times—permits ample cable length for full extension and tilting of chassis without hazard of snagging.

For use with all types of chassis or drawer slides, adjustable to fit varying chassis lengths, simple to install, inexpensive, proven thoroughly reliable in operation.

Mounts on rear support rails on standard 1 3/4" hole increments. Cadmium plated CRS.

Write for Bulletin CR-100E

ORegon 8-7827

WESTERN DEVICES, INC.

600 W. FLORENCE AVE., INGLEWOOD 1, CALIF.
CIRCLE 210 ON READER SERVICE CARD

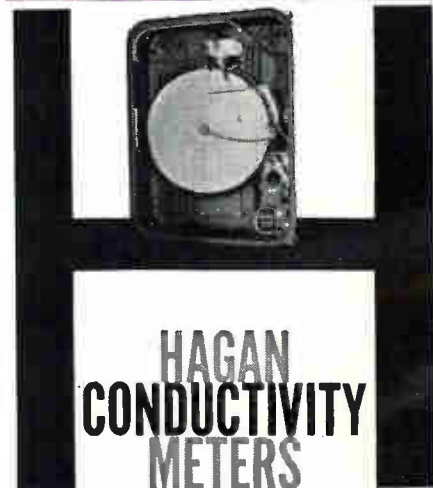

HAGAN CONDUCTIVITY METERS

The Hagan Model H-O may be used as a single instrument, or up to four different conductivity measurements may be recorded in a single meter case. Provides continuous reliable measurement for a moderate investment.

Temperature compensation is continuous and automatic, and limit switches may be installed for applications where drastic changes in dissolved solids may damage equipment.

Write for Bulletin OE-10004



HAGAN

CHEMICALS & CONTROLS, INC.
HAGAN CENTER, PITTSBURGH 30, PA.

EICO®

PUTS THE BEST IN CREATIVE ELECTRONICS INTO YOUR HANDS



Send for
FREE
Catalog

28 pages of professional electronic equipment in kit and wired form—for Lab . . . Line . . . Home

EICO, 3300 N. Blvd., L.I.C. 1, N. Y. E-11A
 Send free 32-page catalog & dealer's name.
 Send new 36-page Guidebook to MI-FI for which I enclose 25¢ for postage & handling.

Name _____
Address _____
City _____ Zone _____ State _____

EICO 3300 N. Blvd., L.I.C. 1, N. Y.
Export Dept., Roburn Agencies
431 Greenwich St., N. Y. 13, N. Y.

CIRCLE 212 ON READER SERVICE CARD



Are you selling the whole buying team

Tough competition *demands* that the electronics man be reached and sold wherever you find him: *Research, Design, Production, and Management*. Only advertising in electronics reaches all four . . . the same men your salesmen call on. Put your advertising where it works *hardest* . . .

in **electronics**

in the field of lasers and coherent optics.

Rothstein was formerly senior scientific executive for Edgerton, Germeshausen and Grier, Inc., Boston, Mass.

DeWitte Joins EOS As Research Scientist

SERGE DEWITTE has joined Electro-Optical Systems, Inc., Pasadena, Calif., as a research scientist in the materials research department of the Quantum Physics division. He will investigate laser and maser materials.

Prior to joining EOS, DeWitte was with Pacific Semiconductors, Inc.

PEOPLE IN BRIEF

Philco Corp.'s Computer div. has promoted Robert A. Leithman to manager of quality assurance. Stephen A. Keller, formerly with Electric Autolite Co., named executive v-p of Telex, Inc. Robert S. Donnelly, ex-Federal Electric Corp., appointed assistant to the president of Northeastern Engineering, Inc. Marcos E. Ruiz leaves RCA to join the engineering staff of Instrument Corp. of Florida. Leon Lerman advances at Sylvania to product manager—commercial twt's for the Microwave Device div. The Daven Co. elevates Richard J. Newman to director of planning and development. Walter D. Heisler, formerly of Airpax Electronics, has joined Cambridge Scientific Industries as sales manager. David C. Goldberg and Roger A. McIntyre move up to director and associate director, respectively, at Westinghouse's new space materials dept. Jerald R. Haegele, of Eitel-McCullough, Inc., named manager of the company's newly created Accessory Products div. Leland A. Sidwell promoted to v-p and manager of the Connector Division of Microdot Inc. RCA ups Lawrence M. Falk to the post of manager, support engineering, in the data communications and custom projects dept. of its Electronic Data Processing div.



YOU'RE WASTING \$25,000!

That's what our non-profit development corporation paid for a survey to determine what kind of industry we are best equipped to serve.

The survey by the nation's outstanding consulting firm **discovered five competitive advantages vital to an electronics manufacturer.**

So, you're wasting \$25,000 worth of research, vital to **you**, until you write for your confidential copy of this report to . . .

Box 102
c/o electronics
330 West 42nd Street
New York 36, N. Y.



Yes, I'd like \$25,000 worth of information.
Name.....
Firm.....
Address.....

electronics

WEEKLY QUALIFICATION FORM FOR POSITIONS AVAILABLE

ATTENTION: ENGINEERS, SCIENTISTS, PHYSICISTS

This Qualification Form is designed to help you advance in the electronics industry. It is unique and compact. Designed with the assistance of professional personnel management, it isolates specific experience in electronics and deals only in essential background information.

The advertisers listed here are seeking professional experience. Fill in the Qualification Form below.

STRICTLY CONFIDENTIAL

Your Qualification form will be handled as "Strictly Confidential" by ELECTRONICS. Our processing system is such that your form will be forwarded within 24 hours to the proper executives in the companies you select. You will be contacted at your home by the interested companies.

WHAT TO DO

1. Review the positions in the advertisements.
2. Select those for which you qualify.
3. Notice the key numbers.
4. Circle the corresponding key number below the Qualification Form.
5. Fill out the form completely. Please print clearly.
6. Mail to: D. Howksby, Classified Advertising Div., ELECTRONICS, Box 12, New York 36, N. Y. (No charge, of course).

COMPANY	SEE PAGE	KEY #
ERIE ELECTRONICS DIV. Erie Resistor Corp. Erie, Pennsylvania	84*	1
ESQUIRE PERSONNEL Chicago, Illinois	137	2
HUGHES AIRCRAFT COMPANY Tuscon Engineering Lab. Tuscon, Arizona	111	3
INTERNATIONAL NICKEL CO., INC. New York, New York	137	4
LOCKHEED CALIFORNIA CO. A Div. of Lockheed Aircraft Corp. Burbank, California	21	5
LOCKHEED MISSILES & SPACE CO. A Group Div. of Lockheed Aircraft Corp. Sunnyvale, California	22, 23	6
MCDONNELL St. Louis, Missouri	85*	7
NATIONAL CASH REGISTER CO. Electronics Division Hawthorne, California	60	8
NATIONAL CASH REGISTER CO. Dayton, Ohio	86*	9
SANDERS ASSOCIATES INC. Nashua, New Hampshire	84*	10
UNION CARBIDE NUCLEAR CO. Oak Ridge, Tennessee	84*	11

*These advertisements appeared in the 11/3/61 issue.

(cut here)

(cut here)

electronics WEEKLY QUALIFICATION FORM FOR POSITIONS AVAILABLE

Personal Background

NAME
HOME ADDRESS.....
CITY..... ZONE..... STATE.....
HOME TELEPHONE.....

Education

PROFESSIONAL DEGREE(S).....
MAJOR(S)
UNIVERSITY
DATE(S)

FIELDS OF EXPERIENCE (Please Check)

11101

- | | | |
|--|--|---------------------------------------|
| <input type="checkbox"/> Aerospace | <input type="checkbox"/> Fire Control | <input type="checkbox"/> Radar |
| <input type="checkbox"/> Antennas | <input type="checkbox"/> Human Factors | <input type="checkbox"/> Radio—TV |
| <input type="checkbox"/> ASW | <input type="checkbox"/> Infrared | <input type="checkbox"/> Simulators |
| <input type="checkbox"/> Circuits | <input type="checkbox"/> Instrumentation | <input type="checkbox"/> Solid State |
| <input type="checkbox"/> Communications | <input type="checkbox"/> Medicine | <input type="checkbox"/> Telemetry |
| <input type="checkbox"/> Components | <input type="checkbox"/> Microwave | <input type="checkbox"/> Transformers |
| <input type="checkbox"/> Computers | <input type="checkbox"/> Navigation | <input type="checkbox"/> Other |
| <input type="checkbox"/> ECM | <input type="checkbox"/> Operations Research | <input type="checkbox"/> |
| <input type="checkbox"/> Electron Tubes | <input type="checkbox"/> Optics | <input type="checkbox"/> |
| <input type="checkbox"/> Engineering Writing | <input type="checkbox"/> Packaging | <input type="checkbox"/> |

CATEGORY OF SPECIALIZATION

Please indicate number of months
experience on proper lines.

	Technical Experience (Months)	Supervisory Experience (Months)
RESEARCH (pure, fundamental, basic)
RESEARCH (Applied)
SYSTEMS (New Concepts)
DEVELOPMENT (Model)
DESIGN (Product)
MANUFACTURING (Product)
FIELD (Service)
SALES (Proposals & Products)

CIRCLE KEY NUMBERS OF ABOVE COMPANIES' POSITIONS THAT INTEREST YOU

1 2 3 4 5 6 7 8 9 10 11 12 13 14 15 16 17 18 19 20 21 22 23 24 25

Metallurgist

Application Engineering

... to promote the use of nickel and nickel containing materials in the electrical and electronic industries, and to assist in the planning, coordination, execution and evaluation of development and research activities directed toward achieving this result.

The position requires a BS or MS in Metallurgy with 3 to 10 years experience in the use of a wide variety of materials and processes in these industries, particularly with advanced devices. Knowledge of physical instruments and/or modern electrical and electronic devices is desirable. Familiarity with special electrical magnetic expansivity and related properties and materials is desirable. This is a headquarters staff assignment in New York City requiring some travel. Please forward resume and salary requirements, in confidence, to: Personnel Department #28.

THE INTERNATIONAL NICKEL CO., INC.

67 Wall Street
New York 5, New York

An equal opportunity employer



Helpful books from McGraw-Hill

1 ULTRASONICS

Covers the design, repair, and construction of ultrasonic equipment. Includes special experimental results of many details of equipment, plus advances in cleaning, degreasing, soldering, plating, and other operations. By B. Carlin, formerly Product Research Supv. Sperry Products. 2nd Ed., 320 pp., 263 illus., \$11.50

2 FIXED AND VARIABLE CAPACITORS

Gives a wealth of working information on fixed and variable capacitors—details of design and construction, application in modern electronic equipment, experimental types of capacitors, and more. By G. W. A. Dummer, Royal Radar Establishment; and Harold M. Nordenberg, Bureau of Ships. 281 pp., 164 illus., \$10.00

3 DIGITAL COMPUTER AND CONTROL ENGINEERING

Covers all phases of digital computer engineering from basic electronic design of digital circuits to advanced automatic programming techniques. By R. Ledley assisted by L. Rotolo and J. Wilson, all of The George Washington Univ. 835 pp., 398 illus., 62 tables, \$14.50

4 INTRODUCTORY ELECTRIC CIRCUITS

Discusses a-c circuits as a problem in differential equations; treats steady state circuits by the simplified techniques of phasors and complex algebra; presents Fourier series; and develops the Laplace transform as a technique for solving problems in transients. By J. Walsh, Columbia Univ.; and K. Miller, N.Y.U. 360 pp., 32 illus., \$8.50

5 WAVE PROPAGATION IN A RANDOM MEDIUM

Examines the problem of wave propagation using the ray approximation—deals with diffraction theory of wave propagation—and shows how fluctuations in the incident wave affect the diffraction image formed by a focusing system. Trans. from Russian by R. A. Silverman, N.Y.U. 168 pp., 13 illus., \$7.50

6 INFORMATION AND DECISION PROCESSES

Contains 12 articles on important advances in modern information and design theory. Covers such subjects as computation in decision making, sequential decisioning, and statistical decision theory in engineering. Edited by Robert E. Machol, Purdue Univ. 200 pp., illus., \$5.95

7 SELF-SATURATING MAGNETIC AMPLIFIERS

A practical guide covering basic theory, operating principles, design techniques and applications of magnetic amplifiers employing self-saturation. By G. Lynn, T. Paha, J. Ringelman, and F. Timmel, Air Arm Div. Westinghouse Elec. Corp. 232 pp., 152 illus., \$8.00

8 INFRARED RADIATION

Explains exactly what infrared radiation is and what it does. Analyzes a typical infrared system and discusses the components of such a system, the laws of physics by which it operates, and the materials involved. By H. Huckforth, Northrop, Div. of Northrop Aircraft, 280 pp., 172 illus., \$10.00

9 ANALYSIS AND DESIGN OF FEEDBACK CONTROL SYSTEMS

Shows how to apply principles and techniques of analysis to solve design problems, and presents a schedule of design procedures with cases illustrating how typical design problems are solved. By G. Thaler, U. S. Naval Postgraduate School; and R. Brown, Electronics Div., General Motors Corp. 2nd Ed., 640 pp., 472 diagrams, charts, tables, \$14.50

10 TWO-WAY RADIO

A complete guide to two-way radio—from a description of a typical radio system and its many uses in business and industry, to technical information on transmitters and receivers, circuit details, selective calling methods, installation, trouble-shooting, and repair. By A. Lytel, Avco Mfg. Co., Crosley Div., 281 pp., 283 illus., \$9.50

11 PROFESSIONAL ENGINEER'S EXAMINATION QUESTIONS AND ANSWERS

Gives 600 questions and complete answers to help engineers pass state license examinations. Covers mechanical, electrical, civil, and chemical engineering, and includes engineering economics and land surveying. By William S. LaLonde, Jr., Newark Coll. of Eng. 2nd Ed., 615 pp., 273 illus., \$7.50

12 FUNDAMENTALS OF SIGNAL THEORY

Explains important mathematical techniques useful in understanding excitation and response of linear systems. Coverage ranges from complex algebra—through pole-zero and operational methods—to Fourier integrals, spectrum concepts, and optimum systems for separating signals from interference. By J. Stewart, Univ. of Arizona. 368 pp., 129 illus., \$9.00

MAIL COUPON FOR 10-DAY FREE EXAMINATION

McGraw-Hill Book Co., Dept. FL-11-10, 327 W. 41st St., N.Y.C. 36

Send me book(s) circled below for 10 days' examination on approval. In 10 days I will remit for book(s) I keep plus few cents for delivery costs, and return unwanted book(s) postpaid. (We pay delivery costs if you remit with this coupon—same return privilege.)

(PRINT) Name

Address

City..... Zone.... State.....

Company

Position

- | | | | | | |
|---|---|---|----|----|----|
| 1 | 2 | 3 | 4 | 5 | 6 |
| 7 | 8 | 9 | 10 | 11 | 12 |

For price and terms outside U. S., write McGraw-Hill Int'l. N.Y.C. FL-11-10

MANAGER
ELECTRONICS RESEARCH & DEVELOPMENT
TO \$18,000 Per Year
M.S. or Ph.D. in E.E. and broad background in feedback systems and circuits, and digital techniques. Min. of 8 years experience in audio, computer, communication, telemetry or instrumentation. Will direct a group of competent engineers.
ESQUIRE PERSONNEL
202 South State St. Chicago 4, Illinois

MANUFACTURERS' REPRESENTATIVES
IN THE ELECTRONIC INDUSTRY

SAMUEL K. MACDONALD, INC.
manufacturers representatives over 25 years
1531 SPRUCE STREET, PHILA. 2, PA.
Territory: Pennsylvania • New Jersey
Delaware • Maryland
Virginia • West Virginia
District of Columbia
Other Offices: Pittsburgh
Baltimore
Washington, D.C.

ANTENNA PEDESTAL SCR 584—MP 61B

Full azimuth and elevation sweeps 360 degrees in azimuth, 210 degrees in elevation. Accurate to 1 mil. or better over system. Complete for full tracking response. Angle acceleration rate: AZ, 9 degrees per second squared EL, 4 degrees per second squared. Angle slewing rate: AZ 20 degrees per sec. EL 10 degrees per sec. Can mount up to a 20 ft. dish. Angle tracking rate: 10 degrees per sec. Includes pedestal drives, selsyns, potentiometers, drive motors, control amplifiers. Excellent condition. Quantity in stock for immediate shipment. Ideal for missile & satellite tracking, antenna pattern ranges, radar systems, radio astronomy, any project requiring accurate response in elevation and azimuth. Complete description in McGraw-Hill Radiation Laboratory Series, Volume 1, page 284 and page 209, and Volume 26, page 233.

MIT MODEL 9 PULSER 1 MEGAWATT-HARD TUBE

Output pulse power 25 KV at 40 amp. Max duty ratio: .002. Uses 6C21 pulse tube. Pulse duration .25 to 2 microsec. Input 115 volts 60 cycle AC. Includes power supply in separate cabinet and driver. Fully guaranteed as new condition. Full Desc. MIT. Rad. Lab. series "Pulse Generators."

MIT MODEL 3 PULSER

Output: 144kw (12kv at 12 amp). Duty ratio: .001 max. Pulse duration: .5 1 and 2 micro sec. Input: 115v 400 to 2400 ops and 24vdc. \$325 ea. Full desc. Vol. 5 MIT Rad. Lab. series pg. 140.

AN/TPS-10D HEIGHT FINDER

250 KW X-Band. 60 & 120 mile ranges to 60,000 feet. Complete.

500 KW PULSER

5C22 Hydrogen Thyatron Modulator. 22KV at 28 Amps. W/HV & Fil supplies. 3 pulse length rep rates: 2.25 μ sec 300 pps. 1.75 μ sec 550 pps. .4 μ sec 2500 pps. 115V 60cy AC input.

60 MC I.F. STRIP

—95 DBM sensitivity. 130 DB gain. 1 MC & 5 MC band widths. Mfg. Texas Instruments. \$125 each w/tubes.

AN/TPS-1D RADAR

500kw. 1220-1350mc. 160 nautical mile search range. P.P.T. and A Scopes. MFI. Thyatron mod. 5126 magnetron. Like new. Complete system incl. spare parts and gas generator field supply.

225 KW X-BAND RF

4750 Magnetron RF Generator with dummy load & Dir. Cplr. Variable rep rates. Variable power output. 115V 60-cycle AC input. New. \$2400 complete.

WESTINGHOUSE 3CM RADAR

Complete X band system oper. from 115v 60cy ac with 40 kw power output 2J35 magnetron. Ranges 0-1.5, 4, 16, 40 miles. Includes installation waveguide. An ideal system for lab school, demonstration or shipboard. \$1800. New with spares.

10 CM. WEATHER RADAR SYSTEM

US Navy Raytheon. 275 KW peak output S band. Rotating yoke Plan position Indicator. Magnetron supplied for any S band frequency specified, incl. Weather Band. 4, 20 and 80 mile range. 360 degree azimuth scan. Sensitive rcvr using 2K28/707E and 1X21E. Supplied brand new complete with instruction books and installation drawings. Can be supplied to operate from 32VDC or 115 volts. Price \$975. Ideal for weather work. Has picked up clouds at 50 miles. Weight 488 lbs.

10KW 3 CM. X BAND RADAR

Complete RF head including transmitter, receiver, modulator. Uses 2J42 magnetron. Fully described in MIT Rad. Lab. Series Vol. I, pps. 616-625 and Vol. II, pps. 171-185. \$375. Complete X band radar system also avail. incl. 360-deg antenna, PPI, syn pwr supply. Similar to \$17,000 weather radar now in use by airlines. \$750 complete.

AN/APS-15B 3 CM RADAR

Airborne radar. 40kw output using 725A magnetron. Model 3 pulser. 30 in. parabola stabilized antenna. PPI scope. Complete system. \$1200 each, new.

SCR 584 RADARS AUTOMATIC TRACKING RADAR

Our 584s in like new condition, ready to go, and in stock for immediate delivery. Ideal for research and development, airway control, GCA, missile tracking, balloon tracking, weather forecasting, anti-aircraft defense tactical air support. Write us. Fully Desc. MIT Rad. Lab. Series, Vol. I, pps. 207-210, 228, 284-286.

RADIO RESEARCH INSTRUMENT CO.

550
FIFTH AVE.
NEW YORK
JUDSON
6-4691

CIRCLE 460 ON READER SERVICE CARD

BC-221 Frequency Meters

For checking CB transmitter frequencies to FCC specs. of 0.005%. Like new condition with crystal and original calibration books for a low price. Supply limited. . . . \$69.50

TM 11 300 BC-221 Tech Manuals. . . . \$1.50

TS-173 90-450 MC. AC Power Supply. . . \$169.50

AN/APR-4 MC Receiver with 5 tuning units. Direct reading dials. Wide and narrow bandwidth 30 MC I.F. Amp. Output meter for measuring signal strength. Pulse analyzer and pan adapter output connections. 110V. 1 Ph. 60-2000 Cy power. Excellent condition. 4 tuning units, 38-2200 MC. . . . \$259.50
5 tuning units, 38-4000 MC. . . . \$389.50

RT-100A/APS-19 "X" Band Transceiver. Complete with 2J55 & magnet, 3B36, 2-K25. 5956/E36, 6AG7, 14-6AK5, 6AL5, 2D21, 6SN7, WL 1023 & 6C4—25 tubes in all—plus 4-1N23B & 3 fans 27.5VDC. Excellent condition. Ship. wt. 70 lbs. . . . \$99.50

Write for Bargain Flyer

R W Electronics

2430 S. Michigan Chicago, Ill.
CA 5-1281

CIRCLE 463 ON READER SERVICE CARD

TUBE & COMPONENT FREE...CATALOG BARRY ELECTRONICS

512 BROADWAY WALKER 5-7000
NEW YORK 12, N.Y. TWX-NY 1-3731

CIRCLE 464 ON READER SERVICE CARD

GET IT from GOODHEART!

0.1% SORENSEN Line Voltage Regulator

#5000S, Brand new at low surplus price! Input 95-130 V. 1 ph., with taps for 50 or 60 cy. Use for any power up to 5000 watts. Output adjustable 110-120 V and holds to $\pm 0.1\%$ at line frequency, or to $\pm 0.25\%$ if line frequency drifts 5%. Regulates against line changes of 95-130V and against load changes from 0 to 5 KVA. Maximum harmonics less than 3%! Recovery time 0.15 seconds. Input to the control section can be moved to the point where you will use the power, thus compensating for line drop. In rack cabinet 28" h., 22" wd., 15" dp. Net wt 190 lbs. Shpg wt 285 lbs FOB Utica, N. Y. In original factory pack suitable for export, including SPARE PARTS group. Sorensen catalog net price is \$695.00. $\pm 1000-25$, 190-260 V 1 ph to 230 V, for Los Ang., \$179.50



#10,000S, same as above but 10 kva, factory-reconditioned Norway Corp., \$895.00. $\pm 1000-25$, 190-260 V 1 ph to 230 V, for Los Ang., \$179.50

Write us, stating your specific needs in Line Voltage Regulators, Receivers, Signal Generators, Transmitters, Tuning-Fork Frequency Standards, Graphic Recorders, etc., all at low surplus prices, all certified and guaranteed unconditionally.

R. E. GOODHEART CO.

P. O. Box 1220-E Beverly Hills, Calif.

CIRCLE 465 ON READER SERVICE CARD

LIFSCHULTZ FASTEST TO BOTH COASTS

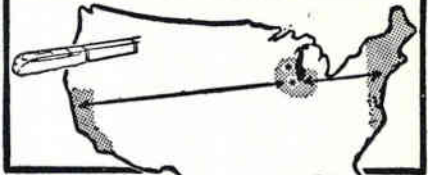

Over 62 years of dependable ON-TIME Freight Forwarding Service.

We welcome your inquiry.

PROMPT DAILY PICKUP and DELIVERY

LIFSCHULTZ FAST FREIGHT

CIRCLE 466 ON READER SERVICE CARD

CAPACITORS

MFD	VOLTS	PRICE	MFD	VOLTS	PRICE
.001	75KV	80.00	1	600V	7.75
*.025	50KV	29.50	† 1	7500V	8.00
*†.2	50KV	64.50	† 2	6000V	24.50
†.25	15KV	15.95	3	20KV	125.00
†.25	20KV	22.50	4	10KV	67.50
†.25	32.5KV	44.50	5	10KV	70.50
†.5	25KV	29.50	9	10KV	115.00
†.65	12.5KV	24.00	† 10	5000V	45.00
			† 15	5000V	48.00

— SPECIAL —

32 mfd—800 V. \$3.50
Comprising four 8 mfd sections, 5 solder lug terminals.
Dims. 4.4x3.3x3.4. Large qua. available.

* Case Common.
† Large qua. available.

Write for complete listing

MONMOUTH RADIO LABS.

BOX 247—OAKHURST, N. J.
CAPITOL 2-0121 ART HANKINS, Prop.

CIRCLE 467 ON READER SERVICE CARD

G.R. Strobolux Model 648A New, Manual. . . \$75.00
Oumont 256B A/R Scope New, Manual. . . 125.00
Hammarlund SP600JX28 .54-54MC Like New 525.00
R101A/ARNE Used, Excellent. 32.50
PP719/APQ41 Power Supply Used 32.50 New 50.00
TS13/AP Test Set Used 35.00 New, Manual. 55.00
Hewlett Packard OB Meter Ruggedized New. . . 6.00
Stromberg Carlson Blower 28Vdc .63A New. . . 6.00
Oehl Motor 27VDC 1/6 HP New. 6.00
Ohio Electric Motor 1/20 HP New. 3.00
Transmitter Filter, Passband 50-80MC New. 6.00
TS62/AP Test Set Used Excellent. 30.00

Carver Electronics

2759 Rainbow Rd. Jacksonville 17, Fla.

CIRCLE 468 ON READER SERVICE CARD

can deliver Amphenol
Bendix
Cannon
CONNECTORS
FITTINGS & CLAMPS

We stock more than 5,000,000 MS/AN CONNECTORS . . . of 50,000 variations! In PRODUCTION QUANTITIES . . . we sell BELOW "O.E.M." PRICE . . . and offer IMMEDIATE "OFF-THE-SHELF" DELIVERY!

FREE . . . Send for latest brochure and list price chart

WILGREEN INDUSTRIES, Inc.
102 Warren Street, New York 7, N. Y.
WOrth 4-2490-1-2 Wire: FXX

CIRCLE 461 ON READER SERVICE CARD

SMALL AD but BIG STOCK
of choice test equipment
and surplus electronics
Higher Quality—Lower Costs
Get our advice on your problem

ENGINEERING ASSOCIATES
434 Patterson Road — Dayton 19, Ohio

CIRCLE 462 ON READER SERVICE CARD

MIDGET TAP SWITCH

has
giant
range

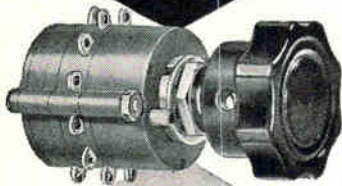

TYPE 3A

Only 1" in diameter . . . weighs 30 grams . . . as many as 8 decks and up to 12 positions per deck. These are among the features of Tech Labs' new all-molded miniature Type 3A tap switch.

Designed for a wide range of military and commercial applications, this single-hole mounted switch has adjustable stops if fewer than 12 positions, single pole, or 6 positions, double pole, are required. "Shorting" and "non-shorting" types are available and the switch can be furnished solenoid-operated and hermetically sealed.

SPECIFICATIONS

Size: 1" diameter, 1 1/4" with terminals. First deck, 1-1/16" long. Each additional deck, 1/2" long.

Weight: First deck, 30 grams. 10 grams for each additional deck.

Rating: 1200 volts rms, 2000 VDC, 5 amps (carrying) 115V.

Insulating resistance: 100 megohms minimum at 500 volts DC.

Life: 1.5 - 2 million revolutions.

Contact resistance:

(standard) 6-10 milliohms.

(silver) 3-5 milliohms.

Temperature range: -65°C to 100°C.

Mounting: Single-hole.

Meets MIL-S-3786 and MIL-E-5272C



Write for details
and prices.

PALISADES PARK, NEW JERSEY

INDEX TO ADVERTISERS



Audited Paid Circulation

Aerospace Corporation	99	Garlock Electronic Products	70
Aerovox Corp.	56	• General Electric Co. Silicone Products Dept.	47
American Elite Inc.	141	• Gould National Batteries Inc.	52
• American Lava Corporation	51	• Green Instrument Co., Inc.	134
Avco Corp.	101	Gries Reproducer Corp.	142
		• Gudebrod Bros. Silk Co., Inc.	35
• Ballantine Laboratories, Inc.	103		
• Beckman Instruments, Inc. Berkeley Division	45	Hagan Chemicals & Controls, Inc.	134
• Bendix Corporation Scintilla Division	95	• Handy & Harman	61
• Bird Electronic Corporation	120	Harman Kardon Inc.	36
• Black & Webster, Inc.	141	Helland Division, Minneapolis-Honeywell Regulator Co.	17, 18, 19, 20
• Billey Electric Co.	71	Heinemann Electric Co.	43
• Bud Radio Inc.	131	• Hitachi, Ltd.	46
• Burnell & Co. Inc.	3	• Hoskins Mfg. Co.	127
Bussmann Mfg. Co.	59	Hughes Aircraft Co.	111
Cambridge Thermionic Corp.	122	• Indiana General Corp.	2
• Celco-Constantine Engineering Labora- tories	24	• Industrial Electronic Engineers, Inc.	52
• Centralab, The Electronics Div. of Globe-Union Inc.	97	• Ingersoll Products, Division of Borg-Warner Corp.	102
• Chester Cable Corp.	64	• Itek Electro-Products Co.	110
Clare & Co., C. P.	62, 63	Intellux Inc.	111
• Clarostat Mfg. Co., Inc.	15		
Consolidated Avionics	57, 58	• Japan Piezo Electric Co. Ltd.	111
Consolidated Electrodynamics Corp.	116, 117	• Jennings Radio Manufacturing Corp.	33
• Constantine Engineering Laboratories	24	Jerrold Electronics Corp.	14
Continental-Diamond Fibre Subsidiary of the Budd Company	27		
Data-Control Systems, Inc.	119	• Kearfott Div. General Precision Inc.	129
• Daven Company, The.	3rd Cover	Keithley Instruments, Inc.	128
Dow Corning Corp.	68, 69	• Kyoritsu Electrical Instruments Works, Ltd.	52
Elcor, Inc.	7	• Lapp Insulator Co., Inc.	42
Electrodynamic Instrument Corpora- tion	56	Lionel Electronic Laboratories	131
• Electro Motive Mfg. Co., Inc.	26	Litton Systems Inc.	66
• Electronic Instrument Co., Inc. (EICO)	135	Lockheed-California Co.	21
Electronic Measurements Co., Inc.	105		
• Erie Pacific, Division of Erie Resistor Corp.	124		
• Fairchild Semiconductor Corp.	53		

• See Advertisement in the July 20, 1961 issue of Electronics Buyers' Guide for complete line of products or services.

TELEFUNKEN SEMICONDUCTORS

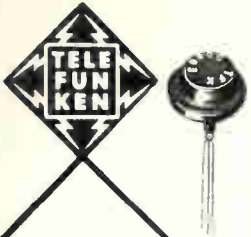

**GERMANIUM-SILICON DIODES
TRANSISTORS
RECEIVING TUBES
CATHODE RAY TUBES**



SEND FOR FREE SEMICONDUCTOR MANUAL =4

AMERICAN ELITE INC.
48-50 34th STREET,
LONG ISLAND CITY, N. Y.
Telephone: ST 6-8913

CIRCLE 213 ON READER SERVICE CARD

ON PW BOARDS...

STOP COSTLY COMPONENT PREPARATION



WITH **DYNASERT**

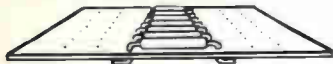

Cards or reels of components are loaded into self-feeding raceways and prepared for insertion *automatically*... The Dynasert Component Inserting Machine does all the work! Components are inserted accurately, uniformly at high rates of speeds. Operators are easily trained, changes made from one board or component type to another in seconds. Let us show you how Dynasert can actually pay for itself on only a few hundred insertions per week. Send for Facts. Dynasert Dept., United Shoe Machinery Corp., Boston, Mass.

United

US1-72

DYNASERT®

CIRCLE 214 ON READER SERVICE CARD

November 10, 1961

- Markem Machine Co. 118
- Materials Research Corp. 56
- McGraw Hill Book Co. 71, 107, 108, 109
- Microswitch, Div. of Honeywell. 12, 13
- Minneapolis-Honeywell Precision Meter Division. 55
- Minnesota Mining & Mfg. Co. Mincom Division. 115
- Motorola Semiconductor Products Inc. 93

- National Cash Register Co. Electronics Division. 60

- Ohmite Mfg. Co. 48, 49

- PRD Electronics, Inc. 71
- Panoramic Electronics, Inc. 130
- Phileo Corporation. 72
- Potter Instrument Co., Inc. 121

- Radio Corporation of America. 65, 4th Cover
- Royal Electric Corp. 34

- Sarkes Tarzian Inc. 8
- Seccon Metals Corp. 142
- Sigma Instruments, Inc. 106
- Sprague Electric Co. 5, 6
- Stevens-Evans, Inc. 25
- Sylvania Electric Products, Inc. Electron Tube Div. 37, 38, 39, 40

- Tech Laboratories, Inc. 140
- Tektronix, Inc. 28, 29
- Texas Instruments Incorporated Components Division. 67
- Texas Instruments Incorporated Metals & Controls Division. 123
- Texas Instruments Incorporated Transistor Products Division. 113
- Tinnerman Products, Inc. 11
- Trans World Airlines Inc. 41

- United Shoe Machinery Corp. 141
- United Transformer Corp. 2nd Cover

- Varian Associates. 133
- Vector Mfg. Co., Inc. 98
- Virginia Electric & Power Co. 16

- Western Devices, Inc. 134
- Westinghouse Electric Corp. 22, 23

• See Advertisement in the July 20, 1961 issue of Electronics Buyers' Guide for complete line of products or services.



LOOKING FOR THE IDEAL TERMINAL SETTER?

STOP. You've found it. A Black & Webster Electropunch or full automatic Electroset can solve your terminal setting problems **\$148⁰⁰** — for as little as



SHORT RUNS: Electropunch — sets hand fed terminals twice as fast as conventional methods. All electric. Foot switch operated.

LONG RUNS: Electroset — automatically feeds and sets terminals up to 3600 per hour. All electric. Customized to your needs.



WHAT'S YOUR PROBLEM?

Black & Webster can help. Send sample terminal and requirements.

Write today for free 14-page catalog describing our complete line of production tools.

BLACK & WEBSTER, INC.

Dept. E, 570 Pleasant Street
Watertown 72, Mass.

CIRCLE 141 ON READER SERVICE CARD

141

SECON/engineered component wire



drawn to your specifications down to .00025"

in base and precious metals and alloys

These wires can be supplied bare, enameled, ceramic insulated for use at 1000° F., or electroplated—to close tolerances.

Let our research and development staff solve your wire problems. For more information please write today to Secon Metals Corporation, 7 Intervale Street, White Plains, N. Y. (White Plains 9-4757).



SECON METALS CORPORATION

CIRCLE 215 ON READER SERVICE CARD

GRC tiny parts

die cast
ZINC ALLOY

molded
PLASTICS



Coil Bobbins
Gears & Pinions



"SMALL ZINC
DIE CASTINGS"

Get GRC's fact filled brochures. GRC's methods give you quality and accuracy in small parts of die cast zinc alloy, Nylon, Delrin, other engineering thermo-plastics. Exclusive single cavity, automatic techniques allow new designs, new production and assembly shortcuts. Write, wire, phone for samples and bulletins. Send prints for quotations.

NO MINIMUM SIZE! Maximum sizes:
Zinc Alloy—
2" long, 1/2
oz. Plastic—
1 3/4" long,
.05 oz.



GRIES REPRODUCER CORP.

World's Foremost Producer of Small Die Castings
151 Beechwood Avenue, New Rochelle, New York
Phone (914) NEW Rochelle 3-8600

MANUFACTURERS' REPRESENTATIVES

MacDonald Inc., Samuel K. 137

- Esquire Personnel 137
- Goodheart Co., R. E. 138
- International Nickel Co., Inc. 137
- Lifschultz Fast Freight 138
- Monmouth Radio Labs. 138
- Radio Research Instrument Co. 138
- R W Electronics 138
- Universal Relay Corp. 139
- Western Engineers 139
- Wilgreen Industries Inc. 138

CLASSIFIED ADVERTISING

F. J. Eberle, Business Mgr.

EMPLOYMENT OPPORTUNITIES ... 137

EQUIPMENT
(Used or Surplus New)
For Sale 138, 139

INDEX TO CLASSIFIED ADVERTISERS

- Barry Electronics 138
- Carver Electronics 138
- Engineering Associates 138

• See Advertisement in the July 20, 1961 issue of Electronics Buyers' Guide for complete line of products or services.

This index and our Reader Service Numbers are published as a service. Every precaution is taken to make them accurate, but ELECTRONICS assumes no responsibilities for errors or omissions.

electronics



Audit Bureau
of Circulations



Associated Business
Publications

Audited Paid Circulation

JAMES T. HAUPTLI
Advertising Sales Manager

R. S. QUINT:
Assistant Publisher Buyers' Guide and
Business Manager
FRED STEWART:
Promotion Manager
B. ANELLO:
Marketing Service Manager

RICHARD J. TOMLINSON:
Production Manager
GEORGE E. POMEROY:
Classified Manager
HUGH J. QUINN:
Circulation Manager

ADVERTISING REPRESENTATIVES

NEW YORK (36):
Donald H. Miller, Henry M. Shaw, George
F. Werner, Robert M. Denmead
500 Fifth Avenue, OXford 5-5959
BOSTON (16):
William S. Hodgkinson, Donald R. Furth
McGraw-Hill Building, Copley Square,
Congress 2-1160
PITTSBURGH (22):
David M. Watson
Four Gateway Center, Express 1-1314
PHILADELPHIA (3):
Warren H. Gardner, William J. Boyle
6 Penn Center Plaza, LOcust B-4330
CHICAGO (11):
Harvey W. Wernecke, Martin J. Gallay
645 North Michigan Avenue, Mohawk 4-5800
CLEVELAND (13):
Paul T. Fegley
55 Public Square, Superior 1-7000
SAN FRANCISCO (11):
T. H. Carmody, R. C. Alcorn
255 California Street, Douglas 2-4600
LOS ANGELES (17):
Marshall Freeman, Peter S. Carberry
1125 W. 6th St., Huntley 2-5450

DENVER (2):
J. W. Patten
Tower Bldg., 1700 Broadway, Alpine 5-2981
ATLANTA (9):
Michael H. Miller
1375 Peachtree St. N.E., Trinity 5-0523
HOUSTON (25):
Joseph C. Page, Jr.
Prudential Bldg., Holcomb Blvd.,
Jackson 6-1281
DALLAS (1):
Frank Le Beau
The Vaughn Bldg., 1712 Commerce St.
Riverside 7-9721
LONDON W1:
Dennis McDonald
34 Dover St.
FRANKFURT/Main:
Stanley R. Kimes
85 Westendstrasse
GENEVA:
Michael R. Zeynel
2 Place du Port

DAVEN/GENERAL MILLS
...Blazing new trails in component reliability!



**Solve Printed Circuit Assembly and Wiring Problems
with Daven's Lollypop Wire Wound Resistor**

HERE'S the perfect precision wire wound resistor for printed circuits, miniature plug-in packages or any tight spot where small size and high reliability is needed. Daven's Type 1284 is just one of many Daven plug-in types which exceed all requirements of MIL-R-93-B and MIL-R-9444, plus exceptional overall stability.

The reason: Daven's unique spool design permits low-stress winding of fine resistance wire, thus

achieving 2 to 3 times the resistance value previously possible on a miniature bobbin.

Daven specializes in high stability, low temperature coefficient resistors in very small packages. If you have a problem in this area, let us help you solve it.

For a complete catalog on the industry's widest range of resistor types, write today!



THE DAVEN COMPANY, Livingston, New Jersey

RESISTORS

TDDAY, MDRE THAN EVER, THE DAVEN © STANDS FOR DEPENDABILITY

RCA Announces The "TO-1" Rectifier

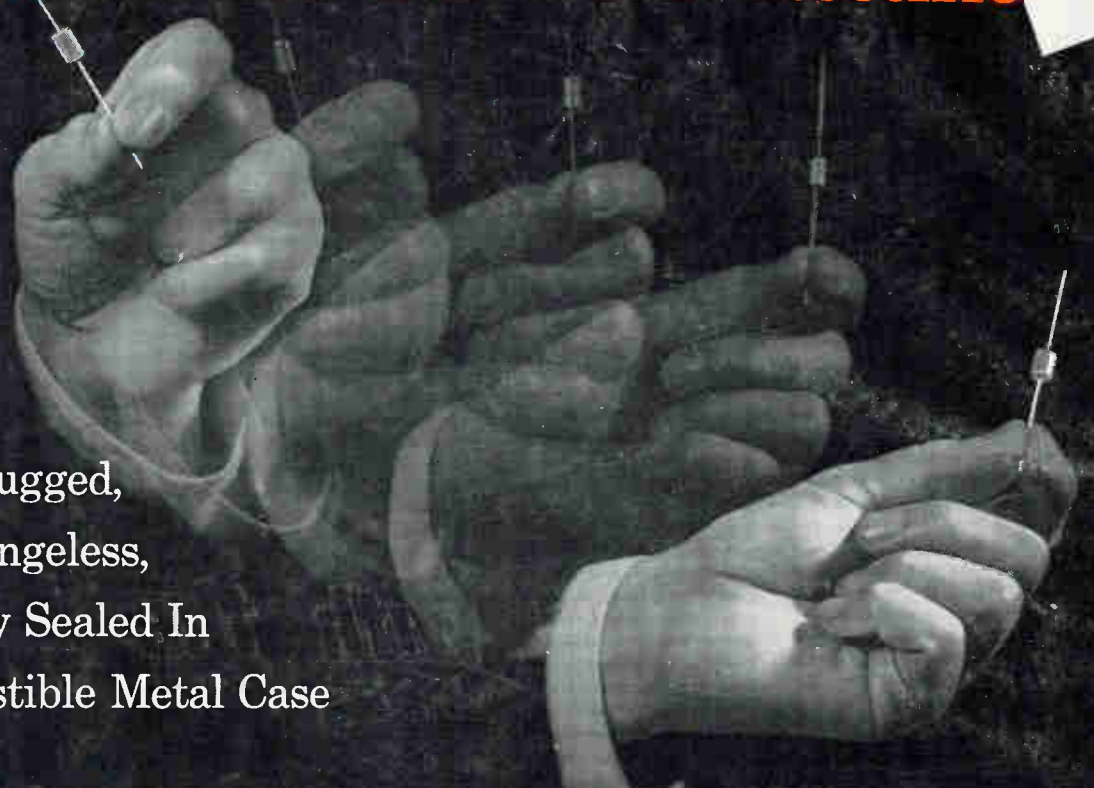

New Tiny, Rugged,
Tubular, Flangeless,
Hermetically Sealed In
Non-Combustible Metal Case

4 New RCA Silicon Rectifiers

for Industrial Applications

$\frac{3}{4}$ Amp. from 200 to 600v— $\frac{1}{2}$ Amp. at 800v.

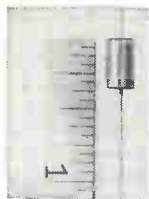

Here's RCA's brand-new idea in rectifier case design—four new silicon rectifiers in hermetically sealed flangeless metal packages. These four new types now make silicon rectifiers as easy to handle and mount as other standard tubular components. They are designed to outperform plastic-packaged rectifiers and meet the stringent heat and humidity requirements of

today's industrial and commercial applications.

Using a unique combination of a silicon diffused-junction and a new case, these units can be operated at temperatures up to 75°C without derating. They are designed and priced to bring you economy and performance plus easy handling and assembly.

Sample these new RCA SILICON RECTIFIERS yourself and put them to work in your product. Call your RCA representative today at the Field Office near you. For additional technical information, write RCA Semiconductor and Materials Division, Commercial Engineering, Section K-19-NN-2, Somerville, N. J.

Available Through Your RCA Distributor



The Most Trusted Name in Electronics
RADIO CORPORATION OF AMERICA

RCA "TO-1" SILICON RECTIFIERS					
Type	Max Ratings PIV	Max. Ratings Forward Current * @ 75 °C	Max Ratings Recurrent Peak Current @ 75 °C	Max Instantaneous Forward Voltage Drop @ 0.5 DC amp. @ 25 °C	Max Reverse Current @ 25 °C and rated PIV
1N3193	200 v	750 ma	6 amp	12 v	10 μ a
1N3194	400 v	750 ma	6 amp.	12 v	10 μ a
1N3195	600 v	750 ma	6 amp.	12 v	10 μ a
1N3196	800 v	500 ma	5 amp.	12 v	10 μ a

*Resistive or inductive load

RCA SEMICONDUCTOR & MATERIALS DIVISION FIELD OFFICES . . .
EAST: Newark, N. J., 744 Broad St., Humboldt 5-3900 • (Camden, N. J. area) Erlton, N. J., 605 Marlton Pike, HAZel 8-4802 • Syracuse, N. Y., 731 James St., Room 402, GRAnite 4-5591 • Baltimore, Md., ENTERprise 9-1850 • NORTHEAST: Needham Heights 94, Mass., 64 "A" St., HILLcrest 4-7200 • SOUTHEAST: Orlando, Fla., 1520 Edgewater Drive, Suite #1, GArden 4-4768 • EAST CENTRAL: Detroit 2, Mich., 714 New Center Bldg., TRinity 5-5600 • CENTRAL: Chicago, Ill., Suite 1154, Merchandise Mart Plaza, WHitehall 4-2900 • Indianapolis, Ind., 2132 East 52nd St., CLifford 1-1405 • Minneapolis 16, Minn., 5805 Excelsior Blvd., WEST 9-0676 • WEST: Los Angeles 22, Calif., 6801 E. Washington Blvd., RAYmond 3-8361 • (San Francisco area) Burlingame, Calif., 1838 El Camino Real, OXFord 7-1620 • SOUTHWEST: Dallas 7, Texas, 7905 Carpenter Freeway, MEIrose 1-9720 • GOV'T: Somerville, N. J., Route 202, RAndolph 2-3200

New...

RCA'S TO-1 Rectifiers Are
Now Available in Clear
Plastic High-Dielectric-
Strength Insulating Sleeves



RCA-1N3253
200V PIV, 750 ma insulated
version of RCA-1N3193



RCA-1N3254
400V PIV, 750 ma insulated
version of RCA-1N3194



RCA-1N3255
600V PIV, 750 ma insulated
version of RCA-1N3195



RCA-1N3256
800V PIV, 500 ma insulated
version of RCA-1N3196