

September 29, 1961

A McGraw-Hill Publication

75 Cents

electronics

SPECIAL REPORT: What's New in Semiconductors
*Microphotograph shows surface of planar transistor with
metalized emitter dot and base ring*

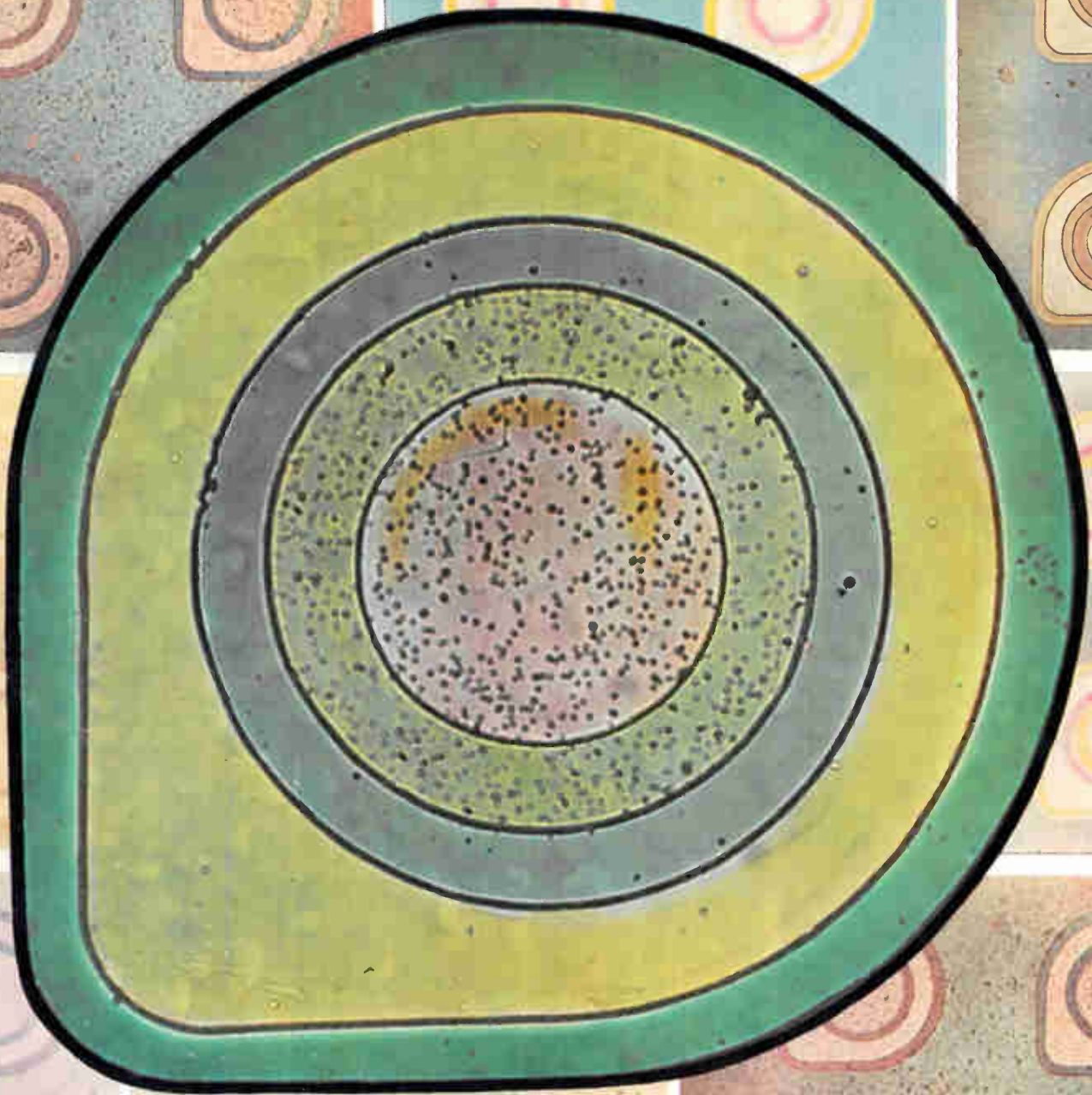



ALL CERAMIC AND METAL X-BAND MAGNETRON provides 250 kW power at 8,500-9,600 Mc. Available in mechanically and hydraulically tuned models, QKH 1000 and QKH 1001.



LIGHTWEIGHT X-BAND BWO is electrostatically focused, ideal for voltage tunable applications. QKB 830 covers 8.5 to 9.6 Mc range.



EXTREMELY RUGGED K-BAND KLYSTRONS have very low microphonics, excellent thermal stability. QKK 923 for 23.5-24.5 and QKB 834 for 34.0-35.6 kMc.



NEWEST ELECTRONICALLY TUNED BWO's have 40 mW minimum power output; are half the size and weight of their predecessors. QKB 890 for 12.4-18 and QKB 891 for 18-26.5 kMc.

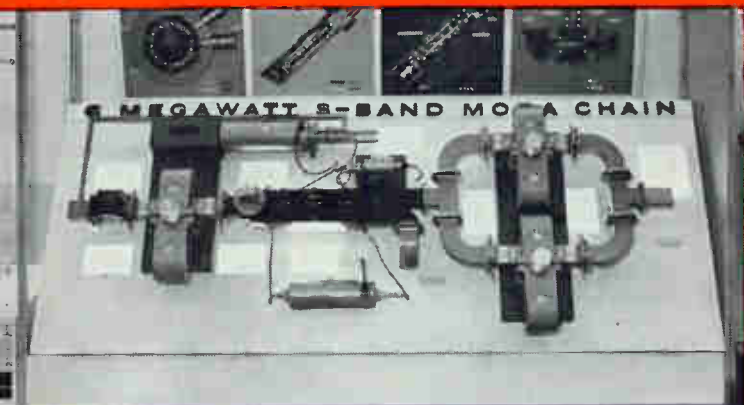

PHASE STABILITY AND HIGH EFFICIENCY are features of Raytheon designed high-power amplifier chains for sophisticated search and track radar applications. Chain shown is one example of Raytheon's ability to supply microwave tubes, ferrite devices and magnetic components in a completely integrated package.

AEROSPACE MICROWAVE TUBES

WRITE TODAY, SPECIFYING TUBES that interest you, or tell us about your particular microwave problem. Address Microwave and Power Tube Division, Raytheon Company, Waltham 54, Massachusetts.



RAYTHEON COMPANY

MICROWAVE AND POWER TUBE DIVISION

CIRCLE 251 ON READER SERVICE CARD

electronics

A McGraw-Hill Publication 75 Cents



W. W. MacDONALD, Editor

J. M. CARROLL, Managing Editor
 SENIOR ASSOCIATE EDITORS: Samuel Weber, George W. Sideris. ASSOCIATE EDITORS: Michael F. Tomaino, Sylvester P. Carter, William P. O'Brien, John F. Mason, William E. Bushor, Thomas Emma, Sy Vogel, Leslie Solomon, M. M. Perugini, George J. Flynn, Michael F. Wolff.
 ASSISTANT EDITORS: Nilo Lindgren, Stanley Froud, Stephen B. Gray, Roy J. Bruun, George V. Novotny, Leon H. Dulberger.
 REGIONAL EDITORS: Harold C. Hood (Pacific Coast, Los Angeles), Thomas Maguire (New England, Boston), Cletus M. Wiley (Midwest, Chicago).
 ART DIRECTOR: Harry Phillips; Howard R. Berry. PRODUCTION EDITOR: John C. Wright, Jr. EDITORIAL ASSISTANTS: Gloria J. Meurer, Bernice Duffy, Lorraine Rossi, Virginia T. Bastian, Lynn Emery, Florence Hajaistran, Laura W. Smith, Bette H. Snyder, Rosemary Abbruzzese, Judy Haskins.

JAMES GIRDWOOD, Publisher

Microphotographs of silicon planar transistors by Fairchild Semiconductor. Interference colors are caused by thin silicon-dioxide films that protect junctions. See p 89 **COVER**

BRITISH AIRCRAFT EQUIPMENT. Review of new systems at Farnborough 30

New Way to Gage Varying Pressure 32

Automatic Stereo Circuit. Puts f-m tuner in stereo-receive mode 34

Three-Terminal Tunnel Diodes. Voltage and current control methods 36

SPECIAL REPORT: What's New in Semiconductors. Recent developments in materials, diodes, rectifiers, transistors, microcircuits and majority-carrier amplifiers; epitaxy, triple-diffusion, device structures and junction geometries. J. M. Carroll 89

TUNNEL DIODES Control Quartz Crystal Chronometer. Battery-powered, it requires only 1.5 ma at 1.3 volts. R. L. Watters 129

Pulse-Duration Telemetry for Atmosphere Research. All solid-state, high-accuracy system. M. D. Wilt 132

INFRARED CIRCUITS in Tiros Weather Satellites. Second part deals with horizon sensors. F. Schwarz and W. Chou 136

Measuring Microseconds of Envelope Delay. Distortion is determined quickly by finding tonal phase differences. T. M. Stump 138

PRECISION ANALOG MEMORY Has Extended Frequency Response. Uses high-gain operational amplifiers. T. A. Brubaker 141

Solid-State Devices for Electromechanical Applications. New families of transducers are operational and in development. M. Bialer 144

AUTOMATIC REPETITION Corrects Transmission Errors. Computers determine and compare check symbols. Th. Reumerman and W. H. Th. Helmig 146

Crosstalk	4	Components and Materials	154
Comment	6	Production Techniques	160
Electronics Newsletter	9	New on the Market	164
Washington Outlook	14	Literature of the Week	182
Marketing	22	New Books	187
Meetings Ahead	41	People and Plants	190
Research and Development	150	Index to Advertisers	200



REPORT FROM SPACE

A-OK

via Project Mercury Ground Instrumentation Stations

Congratulations to the National Aeronautics and Space Administration on the first orbital space flight of the Mercury spacecraft. We at Bendix-Pacific are justly proud of the successful functioning of our telemetry systems designed and built for the 18 world-wide stations as a member of the Western Electric team. These stations — the vital link during flight — receive, record and display the physiological, environmental and other physical data transmitted from the capsule.

Bendix-Pacific Division
NORTH HOLLYWOOD, CALIFORNIA



1962

1963

1964

1965

1966

All
LAMBDA
Power Supplies
guaranteed
for
5
years

Every Lambda power supply carries a written guarantee that it will perform to specifications for five full years. You can install power supplies now with complete assurance that they will still perform to design standards in 1966. *Lambda's guarantee, which covers workmanship and materials (except for tubes and fuses), has been in effect on all power supplies sold since 1953.* It is your strongest assurance of power supply performance in installations where dependability is an absolute necessity for round-the-clock, heavy-duty service.

SEND FOR NEW LAMBDA CATALOG 61

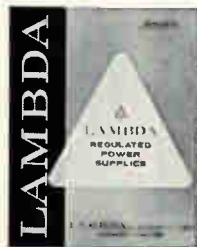

**ALL-TRANSISTORIZED
LA SERIES**

Nine Models Available
Voltages up to 330 VDC—Currents up to 20 Amp
Convection Cooled—Short Circuit Proof



LAMBDA ELECTRONICS CORP.

515 BROAD HOLLOW ROAD • HUNTINGTON, L. I., NEW YORK • 516 MYRTLE 4-4200

Western Regional Office: 230 North Lake Avenue, Pasadena, California • Phone: Code 213, MUrray 1-2544
New England Regional Office: 275 Boston Post Road, Marlboro, Massachusetts • Phone: Code 617, HUrtle 5-7122
Middle Atlantic District Office: 515 Broad Hollow Road, Huntington, L. I., New York • Phone: Code 516, MYrtle 4-4200
CIRCLE 3 ON READER SERVICE CARD

Published weekly, with Electronics Buyers' Guide and Reference issue, as part of the subscription, by McGraw-Hill Publishing Company, Inc. Founder: James H. McGraw (1860-1948).

Title ® registered U.S. Patent Office; Copyrighted © 1961, McGraw-Hill Publishing Company, Inc. All rights reserved, including the right to reproduce the contents of this publication, in whole or in part.

Executive, editorial, circulation and advertising offices McGraw-Hill Building, 330 West 42nd Street, New York 36, N. Y. Telephone Longacre 4-3000. Teletype TWX N.Y. 1-1636. Cable McGrawhill, N. Y. PRINTED IN ALBANY, N. Y.; second class postage paid.

OFFICERS OF THE PUBLICATIONS DIVISION: Nelson L. Bond, President; Shelton Fisher, Wallace F. Traendly, Senior Vice Presidents; John R. Callahan, Vice President and Editorial Director; Joseph H. Allen, Vice President and Director of Advertising Sales; A. R. Venezian, Vice President and Circulation Coordinator; Daniel F. Crowley, Vice President and Controller.

OFFICERS OF THE CORPORATION: Donald C. McGraw, President; Hugh J. Kelly, Harry L. Waddell, Executive Vice Presidents; L. Keith Goodrich, Executive Vice President and Treasurer; John J. Cooke, Vice President and Secretary.

Subscriptions are solicited only from those actively engaged in the field of the publication. Position and company connection must be indicated on orders. Subscription rates: United States and Possessions, \$6.00 one year; \$9.00 two years; \$12.00 three years. Canada, \$10.00 one year. All other countries \$20.00 one year. Single Copies, United States and Possessions and Canada 75¢; Buyers' Guide \$3.00; Single copies all other countries \$1.50; Buyers' Guide \$10.00.

THE PUBLISHER, UPON WRITTEN REQUEST FROM ANY SUBSCRIBER TO OUR NEW YORK OFFICE, AGREES TO REFUND THAT PART OF THE SUBSCRIPTION PRICE APPLYING TO COPIES NOT YET MAILED.

Subscribers: Please address all correspondence, change of address notices, subscription orders or complaints to Fulfillment Manager, Electronics, at above address. Change of address notices should provide old as well as new address, including postal zone number if any. If possible, attach address label from recent issue. Allow one month for change to become effective.

Postmaster: Please send Form 3579 to Fulfillment Manager, Electronics, 330 West 42nd Street, New York 36, New York.



Audited Paid Circulation

CROSSTALK



APPEARING in this issue is **ELECTRONICS'** seventh big special report for 1961. Its title: What's New in Semiconductors.

Reporting what's new in semiconductors has been a long suit for this magazine since that day in the summer of 1948 when two editors sat down with Bill Shockley, soon to win the Nobel Prize, and his associates over at Murray Hill and took notes for our article, Transistor—A Crystal Triode.

Practical applications of the new component were a while in coming, but in the spring of 1952 another editor was trudging through the Pentagon hand-carrying Captain Gerry Epstein's article, Transistorizing Communications Equipment, through Army security clearance to meet a short deadline.

A year later we were correcting the proofs of a 13-part series, Transistors: Theory and Practice, by Abe Coblentz and Harry Owens. It later became one of the first textbooks in the field.

That book was the first of many transistor books that had their origin on the pages of **ELECTRONICS**. The latest: "Transistor Circuit Design Manual" has just been published by the McGraw-Hill Book Co.

When transistors became an important commercial product this magazine was there; specifically, sitting in a Chinese restaurant in Boston with Seymour Schwartz hammering out an outline for his 12-page article, Transistor Characteristics for Circuit Designers.

Collectively, our editors treasure many fond memories of the semiconductor business: burning out dozens of CK722's, stretching a football weekend to get the first peek at double-doping at Western Electric's Allentown plant, breaking news of gaseous diffusion and epitaxial growth, touring New York City with Leo Esaki. It has been an exciting 13 years.

Covering the semiconductor industry for a special report is no easy job. It represents months of work not only for the author but also for editors whose names never figure in the report: Tom Maguire, New England Editor; Hal Hood, Pacific Coast Editor; Clete Wiley, Midwestern Editor; and Don Winston, McGraw-Hill World News, Bureau Chief, Chicago, all helped with on-the-spot coverage of plants and laboratories in their areas. And members of the New York staff, above, whose collective knowledge and experience helped round out the whole picture of What's New in Semiconductors. It begins on p 89.

FILMISTOR® 'C'

METAL FILM RESISTORS OFFER 5 DISTINCT TEMPERATURE COEFFICIENTS TO MEET ALL CIRCUIT REQUIREMENTS

**RUGGED END-CAP
CONSTRUCTION
FOR LONG TERM
STABILITY**

• • •

**EXCEPTIONAL
RESISTANCE TO
MOISTURE AND
MECHANICAL DAMAGE**

• • •

**SURPASS MIL-R-10509
PERFORMANCE
REQUIREMENTS**

Providing close accuracy, reliability and stability with low controlled temperature coefficients, these molded case metal-film resistors outperform precision wirewound and carbon film resistors. Prime characteristics include minimum inherent noise level, negligible voltage coefficient of resistance and excellent long-time stability under rated load as well as under severe conditions of humidity.

Close tracking of resistance values of 2 or more resistors over a wide temperature range is another key performance characteristic of molded-case Filmistor "C" Resistors. This is especially important where they are used to make highly accurate ratio dividers.

Filmistor "C" Resistors are automatically spiralled to desired resistance values by exclusive Sprague equipment. The metallic resistive film, deposited by high vacuum evaporation, bonds firmly to special ceramic cores. Noble metal terminals insure low contact resistance.

The resistance elements, complete with end caps and leads attached are molded in dense, high temperature thermosetting material to form a tough molded shell for maximum protection against mechanical damage, moisture penetration and repeated temperature cycling.

Filmistor "C" Resistors, in $\frac{1}{8}$, $\frac{1}{4}$, $\frac{1}{2}$ and 1 watt ratings, surpass stringent performance requirements of MIL-R-10509C, Characteristic C. Write for Engineering Bulletin No. 7025 to: Technical Literature Section, Sprague Electric Co., 35 Marshall Street, North Adams, Mass.

*For application engineering assistance write:
Resistor Division, Sprague Electric Co.
Nashua, New Hampshire*



SPRAGUE COMPONENTS

RESISTORS
CAPACITORS
MAGNETIC COMPONENTS
TRANSISTORS

INTERFERENCE FILTERS
PULSE TRANSFORMERS
PIEZOELECTRIC CERAMICS
PULSE-FORMING NETWORKS

HIGH TEMPERATURE MAGNET WIRE
CERAMIC-BASE PRINTED NETWORKS
PACKAGED COMPONENT ASSEMBLIES
FUNCTIONAL DIGITAL CIRCUITS



'Sprague' and '®' are registered trademarks of the Sprague Electric Co.

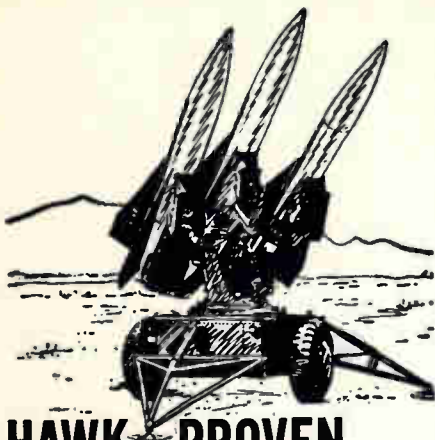

HAWK PROVEN CONNECTORS

LIONEL

Series S-20

Extra Reliability With—

- Shell-Enclosed, Die-Cast Housings
- Diallyl Phthalate Moldings
- Positive Alignment & Polarization
- Minimum Depth in Mated Position
- Beryllium Copper Contacts for Extended Insertion/Withdrawal Life

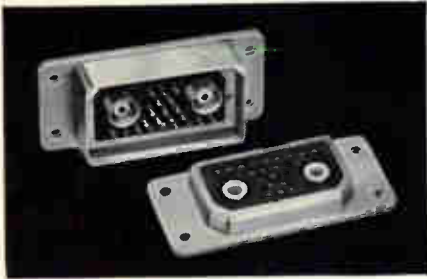

4 sizes: 13 to 41 high voltage contacts, 2 and 4 coaxial contacts; Meet applicable MIL specs; Materials & specifications modified to meet your special needs.

- Write Dept. 29A-W for Series S-20 Dimensional Data Sheets



Lionel Electronic Laboratories

(Formerly Anton Electronic Laboratories)

1226 Flushing Ave.
Brooklyn 37, N. Y.

COMMENT

Responsibility

The current crises in which the United States finds itself around the world are recognized by most citizens as threats to the national well-being, but not everyone realizes that these threats, serious as they are, are mere hints of the deadlier threat that the international Communist empire poses to constitutional democracies such as ours. One vigorous voice has been raised to document the greater threat: Alexander P. de Seversky, whose book "America: Too Young To Die!" was recently published by McGraw-Hill.

One of the important points which Major de Seversky makes in his book should be of great interest to the whole electronics industry. After pointing out the areas in which, through national indolence and bureaucratic fumbling, the Soviet Union has been allowed to steal a march on the United States (areas such as missile propulsion, aircraft engine design, and so forth), Major de Seversky indicates that in the rock-solid foundation of our industrial capability we still have, and will continue to have, a significant advantage over the Soviets. He also points out that this industrial excellence is especially noteworthy in the newer technological areas such as electronics. It is in this field that Major de Seversky sees the greatest promise for an active and effective defense against the towering threat of Soviet military might.

It has been said that Americans have become a nation of apologists, always seeming to be ashamed of what they are and seeking excuses for not being different. However, the electronics industry at least has every reason to be proud.

As part of that pride, of course, comes increased responsibility, and for this too we should be grateful. To those who risk much, rewards are commensurately great; and we who manage parts of the electronics industry in the U. S. should be prepared to risk our own substance to ensure that we keep our lead and increase it as time passes. Major de Seversky's book suggests many areas in which electronics can serve the national well-being. Not all of

these are financed by defense dollars, for various reasons: insufficient money, insufficient faith, insufficient time and many others. But if electronics management realizes that the welfare of this nation, and its future existence, may depend on the excellence of the electronics technology, then perhaps inventiveness and ingenuity will not require 100-percent Federal financing, but may be encouraged and developed within the industry on risk capital.

Major de Seversky points out that we need to recapture our independence and to stop leaning so heavily on the Federal government. It is an important point. It applies both to the business world and to the private citizen. As businessmen, we should do more work on our own, and in this present time of crisis, we should aim that work towards the solution to national problems. As private citizens, we should take greater direct interest in national and international affairs, and not allow professional bureaucrats to assume the management of our affairs by simple default.

JEROME TAISHOFF

MYCALEX CORPORATION OF AMERICA
NEW YORK

Weather Information Printer

May we inform you of the incorrectness of ascribing the ADIS system to Burroughs (p 33, Feb. 24).

The ADIS (Service "A" Data Interchange System) was developed and manufactured for the Federal Aviation Agency by Teletype Corporation. It was cut over to service in January of this year. It collects and distributes weather reports from each of 600 originating stations to 2,400 receiving stations three times each hour. Its backbone is an 857 words per minute nationwide broadcast circuit that interconnects over one hundred 100-wpm party-line circuits. Teletype printers are used exclusively: over 2,000 of them.

B. G. GRIFFITH

TELETYPE CORPORATION
SKOKIE, ILLINOIS

The ADIS system is indeed a Teletype Corp. service. The Burroughs printer was connected to the ADIS circuit at an AMS convention.

A *Super* pair for the circuit board industry

NEW DRILL POINT FOR EPOXY AND PHENOLIC LAMINATES

Meeting the demands of industry can sometimes be a problem. But in this case, industry demanded a solid carbide drill point for drilling accurate, smooth, and burr-free holes in epoxy and phenolic laminates — and the Super Tool Company, pioneers in circuit board drilling, met these demands with a new drill point that offers the ultimate in drilling life. List "201-CB" fractional size solid carbide circuit board drill and List "202-CB" wire gauge size solid carbide drill can be resharpened many times and, both are capable of **hundreds of thousands** of holes before they have to be discarded!

FOR FURTHER DETAILS PLEASE REQUEST PRICE BULLETIN #106

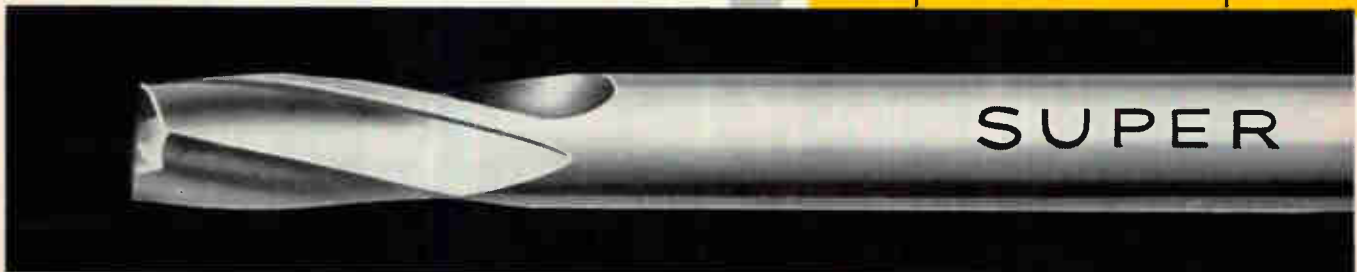
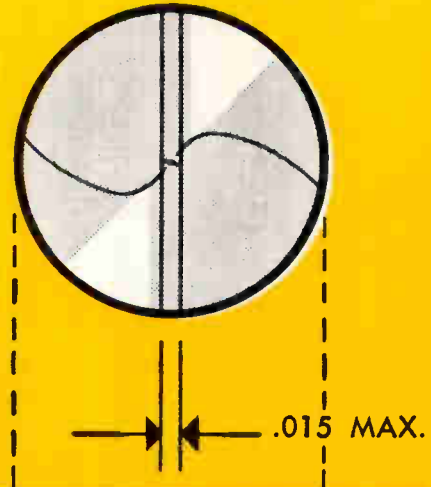

NEW ROUTER FOR CIRCUIT BOARDS AND LAMINATED PLASTICS

A new **SOLID CARBIDE** router bit, designed to meet the exacting specifications of the plastics and plastic laminates industry, eliminates scrap loss due to burned, chipped, or broken edges on the work piece. Super List "2-CBR" router bits can be used in stationary and portable routers . . . no special equipment necessary. These two flute, end and side cutting router bits are designed for routing internal and external shapes in all types of plastics as well as epoxy-glass laminates and phenolic laminates.

FOR FURTHER DETAILS PLEASE REQUEST PRICE BULLETIN #107

A complete line of Super tools are available from:

SURPLESS, DUNN & APPELYARD
57 Leonard St.
New York 13, N. Y.
BArclay 7-4770

SUPER TOOL COMPANY
10161 Pacific Ave.
Franklin Park, Illinois
GLadstone 1-2347

SUPER TOOL COMPANY
5210 San Fernando Rd.
Glendale 3, Calif.
CHapman 5-2668

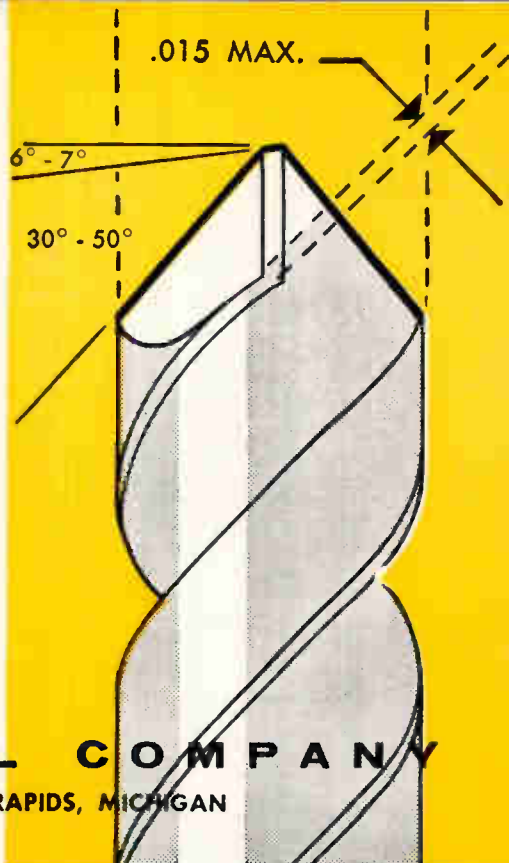

 A DIVISION OF VAN NORMAN INDUSTRIES



SUPER TOOL COMPANY
DEPT. E • ELK RAPIDS, MICHIGAN



If a klystron lasts 20,000 hours before lying down on the job, it's exceptional.



If a klystron is still standing up after 50,000 hours, it's Eimac's.

Eimac's 3K50,000LF klystron is still going strong after six years of almost continuous operation. That's longer than most companies have been building klystrons. But it's typical of the way Eimac designs them: for peak performance, maximum life. For details on Eimac's complete line, write: Power Klystron Marketing, Eitel-McCullough, Inc., San Carlos, Calif.



ELECTRONICS NEWSLETTER

New Family of Solid-States Devices Seen

ULTRASONIC WAVE AMPLIFICATION in a piezoelectric semiconductor crystal may open the way to a new class of solid-state amplifiers, oscillators, isolators, delay lines and other devices based on a combination of piezoelectricity and semiconduction in crystals.

Experiments by D. L. White, A. R. Hutson and J. H. McFee, of Bell Telephone Laboratories, have demonstrated that sound waves are amplified by interaction with electrons drifting in the crystal. The process is similar to electromagnetic wave amplification in a traveling-wave tube.

A cadmium-sulfide crystal is used. A d-c field is applied in the direction of sound-wave propagation. Gains of 18 db in a 15-Mc wave and 38 db in a 45-Mc wave traveling through a 7-mm length of CdS have been observed. Crystal conductivity can be adjusted to the correct value for amplification by shining light on it.

Amplification is explained as

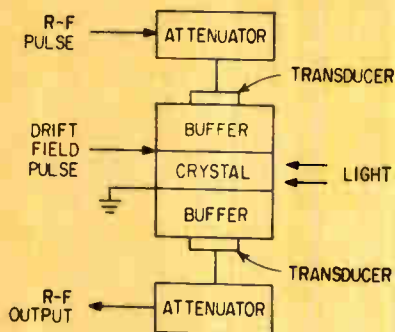

Lab model of ultrasonic amplifier

follows: A sound wave traveling in a piezoelectric crystal produces a longitudinal electric field which travels along with the wave. If the material is also conductive, the field causes currents to flow in the material. Because the piezoelectric field is periodic, the electrons bunch in parts of the ultrasonic wave. The bunched electrons tend to interact with the piezoelectric field and react back on the material, changing the sound wave's velocity and amplitude. Light plus a sufficient field makes the carriers drift faster than the sound wave and amplify it.

Quartz transducers are placed on each end of the cadmium-sulfide crystal. An r-f pulse to one trans-

ducer produces the ultrasonic wave. The other transducer converts the wave to an r-f signal, which is measured under varying field and photoconductivity conditions.

Show Plasma-Pinch Engine For Spaceship Power

Unit shown by Republic Aviation is powered by 28-v battery, rechargeable from solar cells. Solid-state converter supplies 3,000 v a-c to ionize nitrogen. Plasma is electromagnetically accelerated through nozzle, gives exhaust velocity of 100,000 mph and thrust of 0.01 lb at 10^{-5} mm of Hg. A flyable prototype is planned for June 1962.

NASA Picks Manager, Site for Moon Flight

TWO IMPORTANT CHOICES were announced last week by National Aeronautics and Space Administration. D. Brainerd Holmes, general manager of RCA Defense Electronics Products, was selected to head the manned moon flight program. The program's command center and manned space flight laboratory will be located in Houston, Texas.

Holmes is also expected to take charge of Mercury and other projects related to Apollo, the moon project. An electrical engineer, Holmes has been BMEWS, Talos and Atlas contracts manager for RCA since he joined the company in 1953. He was formerly with Western Electric and Bell Telephone Laboratories.

When the Houston laboratory is completed in two or three years, it will have four main divisions: a flight projects facility, equipment evaluation and environmental testing laboratories, and flight opera-

tions facility. It will also be the command center for follow-on projects to Apollo, will be used to train Apollo crews and to design, develop, evaluate and test Apollo spacecraft and subsystems.

There are hundreds of electronics firms involved in the multi-billion-dollar Apollo project. Many of these are expected to open offices—or even production facilities—near the laboratory. The lab itself will cost some \$60 million and will have extensive open-air facilities on a 1,000-acre site made available by Rice University.

Radar Photo System Map Shows Where Rain Falls

WEATHER RADAR data on precipitation fronts can be transmitted in digital form with a scope scanning technique developed by R. T. H. Collis, head of Stanford Research Institute's radar aerophysics program. Information on rainfall can be sent over telephone or teletypewriter lines from remote radar installations and can be displayed on wall maps. Several radars could feed to one map.

A mask with a grid of small holes is placed over the radar screen. As the radar trace passes under each

Do We Remember Mama?

IS ELECTRONICS—the lusty offspring of electric power generation—neglecting its parent industry and a tremendous potential market?

Yes, says Robert W. Lewis, of Boston Edison Co. He said at the Industrial Electronics Symposium in Boston last week that too many electronic manufacturers "just don't understand utilities' problems".

Most applications of electronics to utility operations have been developed by the utilities, not electronic manufacturers, he said. Utilities want more money-saving techniques in such areas as low-speed data transmission, telemetering and centralized load distribution.

hole, echo light which indicates rainfall is seen by a light sensor over the hole. The yes or no information is transmitted. The map has a grid of lights corresponding to the holes in the mask. A yes signal from the sensor lights the appropriate spot on the map.

Raytheon Purchases Cossor of England

THIS WEEK Raytheon is settling details of purchase of A. C. Cossor of England. The company makes radar and mobile radio, had \$17 million sales in 1960. It runs 10 subsidiaries throughout world.

Submarines to Navigate By Transit Satellites

APPLIED PHYSICS Laboratory of The Johns Hopkins University has awarded \$4.5 million in contracts for design and fabrication of submarine navigation equipment using the doppler shift of Transit satellite signals.

Westinghouse Electric will design and make the shipboard receivers and Ramo Wooldridge will provide the data-processing equipment. The system will be designed for automatic and manual operation.

APL developed the Transit system under a prime contract from Navy. Three satellites have been launched successfully. At last report earlier this month, two of the satellites were still transmitting.

Four Labs Report Gains In Power-Source Search

REPORTS OF PROGRESS in the search for new sources of electric power continue to arrive from research laboratories around the country. Among the latest are:

Battelle Memorial Institute says it has converted atomic fission directly into electricity. A triode converter changes kinetic energy of nuclear fission fragments to a high-voltage charge on an electrode. The triode's grid repels negatively charged secondary electrons and admits positively charged particles.

Armour Research Foundation reports a fuel cell converts heat to

electricity with efficiency exceeding 50 percent. The chemicals are heated, give off power as they cool, then are regenerated by heating again. A nuclear reactor would provide a long-term heat source.

Allis Chalmers, also working on fuel cells, says gaseous ammonia makes an ideal fuel cell power source. The cell has potassium hydroxide in a diaphragm between two electrodes. Current flows when ammonia is fed to the anode side and oxygen is fed to the cathode. Voltages of 1.1 to 1.2 volts is considered feasible.

Westinghouse Electric has made an experimental backpack thermoelectric generator for Navy. It burns gas, weighs 36 pounds. It develops 340 watts, of which 80 watts are used to power the fan that blows air over the cool side of the thermocouples.

Letter Router Reads Varying Type Styles

ALPHANUMERIC READER able to identify variable font characters at the rate of 60,000 a minute has been developed by Philco's new Data Recognition department. Work is going on under an \$84,185 Post Office contract. The reader will be designed to recognize names and abbreviations of the 50 states, 250 cities and 50 postal zones, and to process 36,000 letters an hour.

High-speed reading is achieved by a flying-spot scanner with an extremely small light beam. As it vertically scans letters, light of varying intensity is reflected from the paper and printing to a multiplier-phototube. The video signal is converted to a binary signal. One voltage level represents printing, the other represents the envelope background. As each character is scanned, its pulse pattern is compared with patterns stored in a shift-register cross-correlator.

Type-size variations are compensated for by proportional increases in the scanning raster. Degraded print is identified by processing the multiplier-phototube output in a Laplacian correction circuit before the signal is quantized. Inventory handling, pictorial analysis and learning machines are among possible applications of the reader.

In Brief . . .

UHF TV tests in New York City (ELECTRONICS, p 24, Sept. 1, 1961) can mean \$100 million in converter sales within 35 miles of New York, estimates Isaac Blonder, Blonder-Tongue Labs. There are some four million sets in range of the public affairs and educational programming planned by WNYC.

JAPAN has displaced Britain as the second biggest exporter to the U.S., according to a British trade survey. Canada is first.

AIR FORCE gave RCA \$18 million more in contracts for BMEWS system development, installation and test.

RAYTHEON receives \$42 million in Navy contracts for Sparrow III air-to-air missiles, over and above scheduled procurement, as result of Berlin crisis.

SINCE JULY 1, Magnavox has won \$57 million in defense contracts for sonobuoys, airborne radar, communications, other hardware and R&D.

SPARTAN ELECTRONICS also won a sonobuoy contract, \$14.5 million.

LFE ELECTRONICS has received in eight weeks \$29 million in Air Force doppler contracts. Latest is \$1.8 million for airborne navigation systems checkout equipment.

NAVY has ordered 100 radar video processors—signal strength enhancers—from General Instrument, for \$403,035.

BOEING is buying \$175,000 in transistors from Delco Radio for Minuteman missiles.

COLLINS RADIO sells \$215,000 worth of high-speed data-transmission equipment to Cape Canaveral's Atlantic Missile Range.

GE ANNOUNCES it will compete in photoconductive-cell market with a line of cadmium-sulfide cells.

TOSHIBA, Japan, announces a 14-inch color tv set—selling around \$550. It has only one color adjustment.

CASSEGRAIN ANTENNAS: another prime capability of Goodyear Aircraft

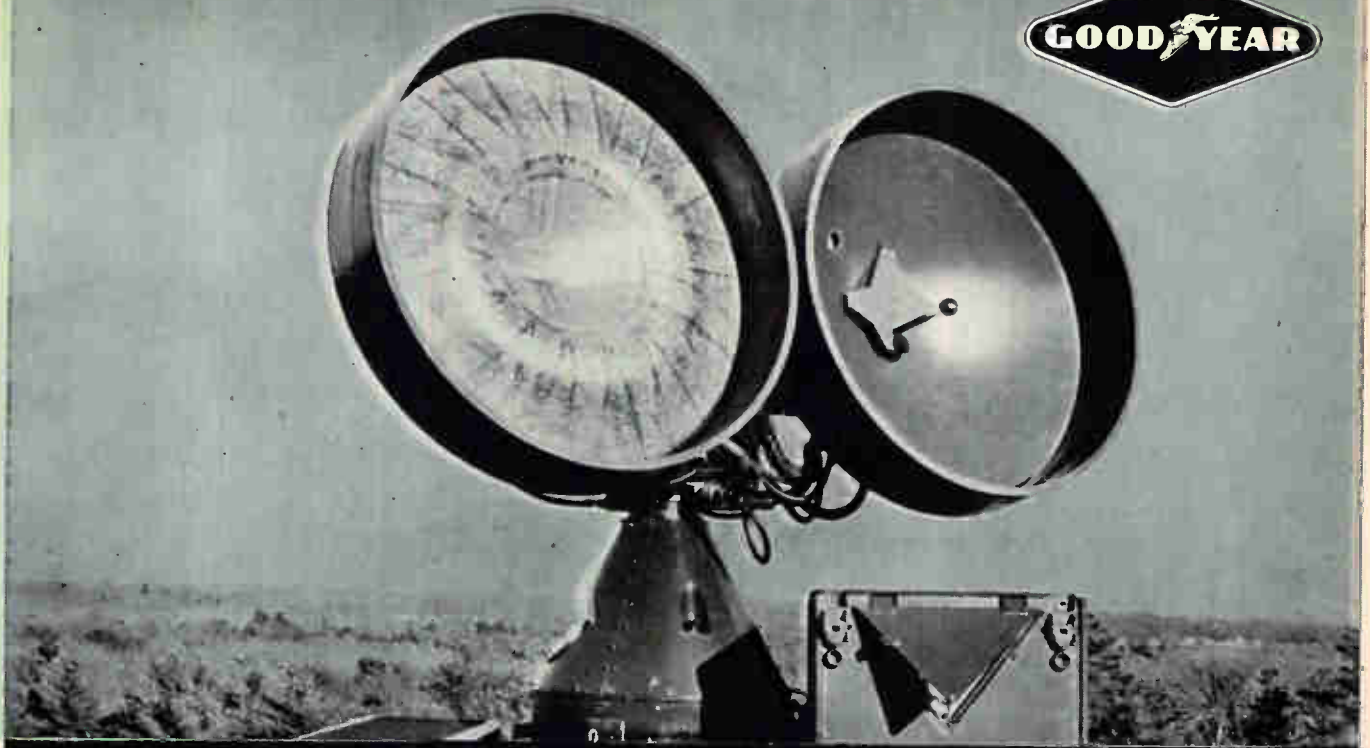

1 Transmitting & receiving antennas for U. S. Army Hawk missile

**ON REFLECTION,
THEY AGREED
ON GAC!**

Plastic radar reflectors—as pioneered by Goodyear—offer better return on investment because (1) light weight means higher performance, (2) tooling-up is less costly; so are design changes, (3) high impact strength takes dents, hard knocks, (4) plastic fights corrosion, chemicals. Also, plastic offers important insulating, vibration-damping qualities, is readily formed into difficult shapes and is easily repaired. Add Goodyear's long experience in designing, fabricating, erecting and testing in reinforced plastics, metal sandwich-type materials, and structural metals, and you too will use Goodyear Aircraft Corporation—the source of supply that handles the *entire* job to your specification. For more information, write Goodyear Aircraft Corporation, Dept. 914KB, Akron 15, Ohio.

Lots of good things come from

GOOD YEAR AIRCRAFT

Plants in Akron, Ohio, and Litchfield Park, Arizona | Providing all 3 weapon system skills

DESIGN

MANUFACTURE

MANAGEMENT



2 Navy missile cruisers employ this large reflector



3 Cassegrain antenna built for U. S. Army Nike-Hercules radar

not a price war...

a price REVOLUTION!

a revolution that started in Slatersville

(An announcement of vital interest to transistor buyers)

A price war occurs when manufacturers compete for sales by reducing prices on the same old product. A price *revolution* occurs when a new manufacturing process results in a better, more uniform product at a substantially lower cost.

In the case of transistors, it began in Slatersville, Rhode Island. Here Amperex built a new plant devoted exclusively to using the Post Alloy Diffusion Technique for producing transistors. This process is inherently reproducible and lends itself to self-jigging and other mass production techniques. PADT transistors have very thin base regions, high gain, high frequency performance and low noise...in short, are high quality transistors produced at very low cost!

The ultra-modern plant in Slatersville has been in operation for a full year. Yields have been extremely high. Therefore on September 1st Amperex announced *an across-the-board price reduction of 50% on all PADT transistors!*

Revolution in Application

Lower prices inevitably broaden the market—open up new design possibilities for the alert engineer and buyer. For example, it is now economically feasible to use transistors instead of tubes for widespread applications in the HF and VHF bands. They are not only less costly than comparable brands but assure better performance because they are relatively independent of collector supply voltage. These types include the 2N2089, 2N2090, 2N2091, 2N2092 and 2N2093 for entertainment applications.

Even before the price revolution was felt, PADT germanium alloy mesa types were being widely used in broadcast, auto AM/FM sets, Citizens Band radio and mobile equipment.

At last, the "Universal Communications Transistor"

The new low price on the new PADT 2N2084 germanium alloy mesa transistor will enable it to obsolete and replace many other types for HF and VHF mobile, aircraft and radar applications. It combines the best features of many specialized front end and IF types—high voltage, high beta and high frequency—thus making it the closest approach to a "universal" communications transistor that has ever been offered. Its universality reduces inventory costs, designing costs and procurement costs...a *real* price revolution! The PADT 2N2084 is available in the TO-33 case. The same transistor, with different ratings, is also available in the subminiature TO-18 case.

High speed PADT Switching Transistors are also included in the Amperex price revolution. Detailed descriptions of the PADT process, data sheets on the full line of PADT transistors and special circuits developed by Amperex Applications Engineering Laboratories are available to interested design engineers. Write on company stationery, please: For more information on the new Amperex universal communications transistor and geographical listing of franchised distributors, please turn to pages 40 and 41

Amperex Electronic Corporation, 230 Duffy Avenue, Hicksville, Long Island, New York

In Canada: Philips Electronics Industries Ltd., Tube, Semiconductor & Component Depts., 116 Vonderhooft Avenue, Toronto 17, Ontario

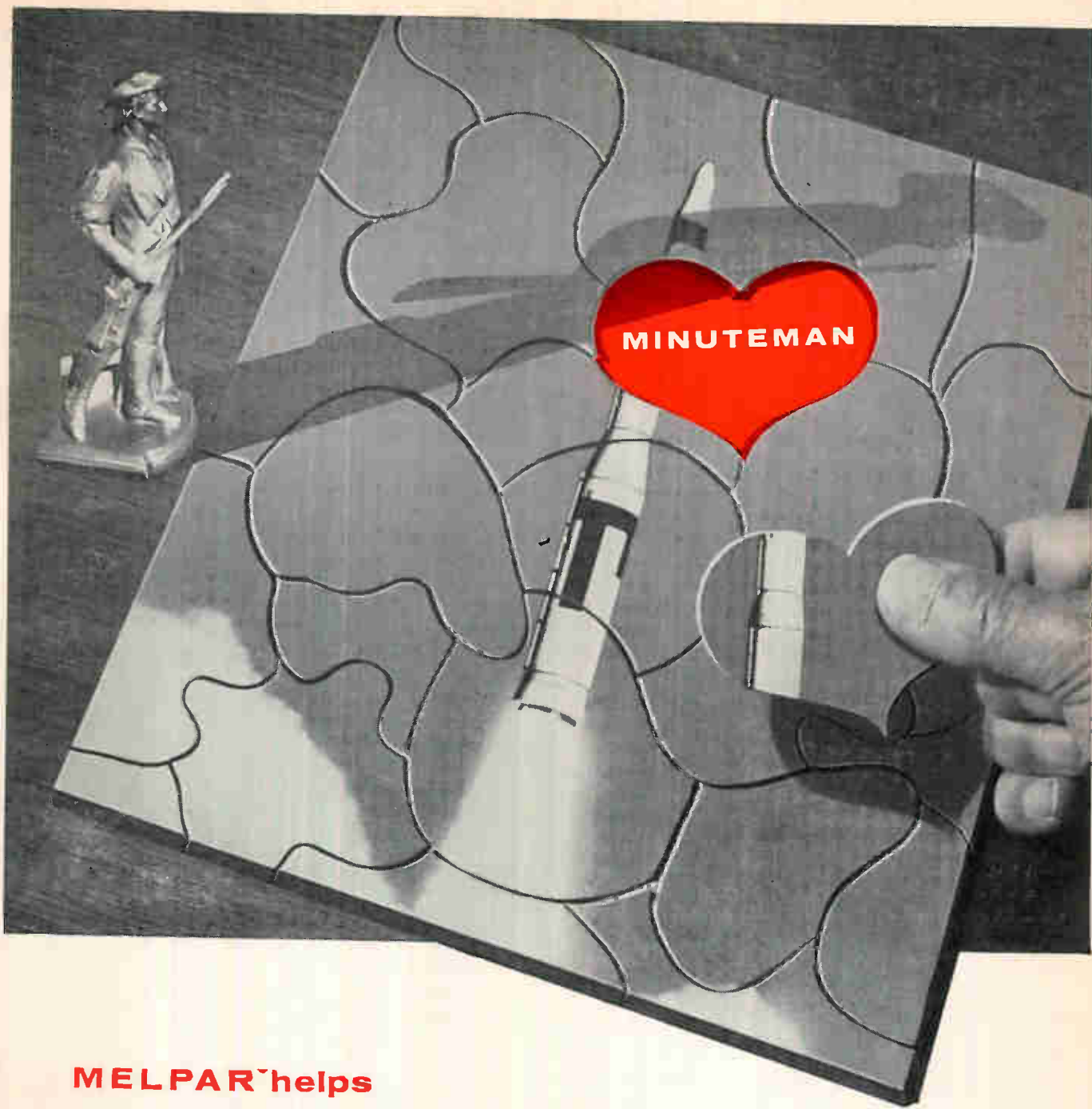

**MELPAR helps
complete the picture . . .**

At the heart of MINUTEMAN'S ultimate defense effectiveness is its all important guidance and flight control system built by AUTONETICS. Now with infinite pride and uncompromising dedication to excellence and reliability, MELPAR begins work on this key project. MELPAR will produce high reliability circuit board assemblies and modules for use in the inertial guidance, flight control and ground checkout systems.

MELPAR is greatly honored to have been selected by AUTONETICS, a division of NORTH AMERICAN AVIATION, INC. to participate in the production of the Air Force Minuteman, America's newest ICBM. MELPAR's renowned technological leadership manifests itself in over 120 projects with military, industrial and space application. At MELPAR, excellence in vital projects in the nation's defense and space exploration has become a tradition.

MELPAR  **INC**

A Subsidiary of Westinghouse Air Brake Company
3000 ARLINGTON BOULEVARD, FALLS CHURCH, VA.

ADDITIONAL OPERATING FACILITIES IN WATERTOWN, MASS.; TUCSON, ARIZONA; LOS ANGELES, CALIF., AND FLORENCE, ITALY.

CALIBRATED Thermistor Mounts

For Greater Accuracy
in Power Measuring Systems



Model 675-A

Coaxial Thermistor Mount

The Model 675-A is a 200 ohm thermistor mount for use in the 100 to 4000 mc range. Its extremely long thermal time constant virtually eliminates effects of ambient temperature changes. Calibration factor is supplied to an accuracy of 2% at 400, 1000 and 1500 mc.

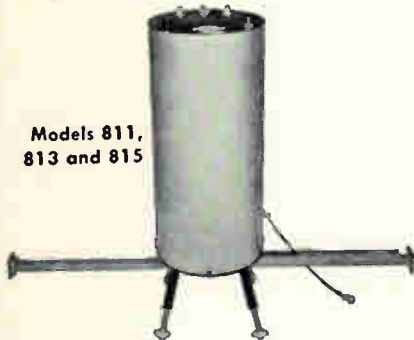

Models 811,
813 and 815

X-Band Power Standard

This 200 ohm thermistor mount-coupler-temperature chamber combination operates over any specified 200 mc band between 8.2 and 11.2 kmc. The thermostatically controlled constant temperature chamber eliminates effects of ambient temperature changes. An NBS test report is supplied giving the calibration factor to an accuracy of 1%.

Precision Power Bridges

Weinschel Engineering also manufactures precision power bridges for use with these thermistor mounts. These bridges give accuracies to 0.1% of substituted power.

For complete specifications:
Write for Weinschel Bulletin #386

WEINSCHEL

ENGINEERING

KENSINGTON, MARYLAND
949-0141 (Code 301)
TWX: KENS 446

Santa Monica,
631 Wilshire Boulevard,
TWX: SMON 7185

WASHINGTON OUTLOOK

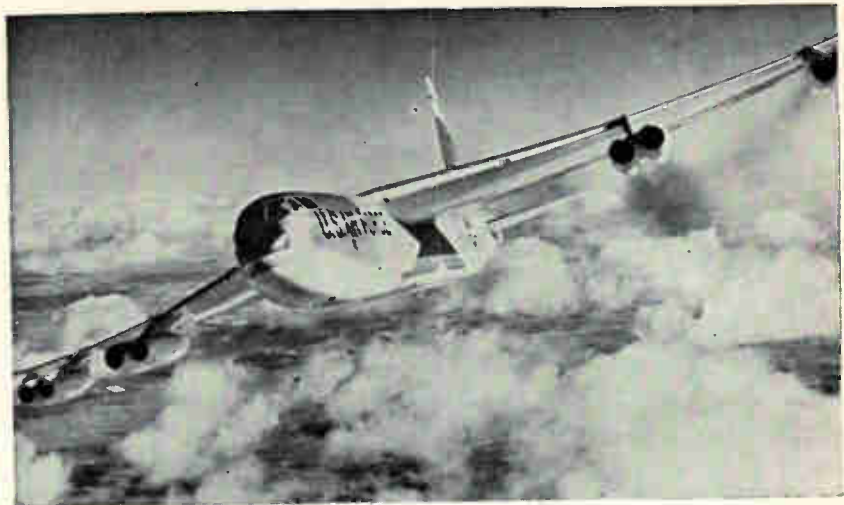

LOOK FOR a big Pentagon policy shift on the B-52 bomber program. The outlook is for a decision to continue production of the Boeing aircraft beyond next year's scheduled termination and to buy at least 45 more of the bombers (photo) for a fifteenth Strategic Air Command B-52 bomber wing.

Up to now, Defense Secretary McNamara has opposed Air Force proposals to continue B-52 output. He has been saying that he does not want to spend the \$525 million Congress added to the current Air Force appropriation for continued bomber procurement. Now he is saying that the B-52 decision is "under study" once more and that in view of the "overwhelming" congressional vote in favor of continued manned bomber production, it "is incumbent upon us to review the facts again."

Actually, the additional bomber funds could also be spent to build more Convair B-58 medium-range bombers, as Congress wrote the appropriation bill. But Air Force generals prefer the longer-range B-52.

ALSO UNDER REVIEW are decisions to use extra congressional appropriations to speed development work on North American Aviation's B-70 bomber and Boeing's Dyna-Soar boost-glide spacecraft. Congress tacked on \$180 million for B-70 (the basic request was for \$220 million this year and \$86 million for Dyna-Soar, Kennedy had already boosted the project's budget from \$70 million to \$100 million). The extra B-70 money would be used to speed delivery of prototype planes now under production and to reinstate some of the development work on electronic subsystems cancelled earlier this year.

DEFENSE SECRETARY is also under intensifying pressures to accelerate work on the Army's Nike Zeus. Rumors here are that research on an anti-ICBM system figures prominently in the resumption of Russian nuclear testing. There's fear here that the Soviet Union may have made a technological breakthrough on development of an anti-missile missile.

McNamara says, however, that up to now, "nothing has given us the basis for changing our plans on the Nike Zeus". The plan is to withhold approval on production until next year's first operational-type tests in the Pacific. McNamara met recently with Bell Telephone Laboratory officials for a personal briefing on progress.

By July 1962, the Nike Zeus project will have cost \$1.2 billion. The current year's budget earmarks expenditures of about \$200 million. This was the first time in about three years that Congress did not add funds to the defense appropriation to start production of long leadtime components. In the past, DOD never allowed Army to use the extra money.

Now, with one instrument, you can instantly measure **1 mv**

at
1,000 mc!



Specifications

Voltage Range:	10 mv rms full scale to 10 v rms full scale in seven ranges. Full scale readings of 0.01, 0.03, 0.1, 0.3, 1, 3 and 10 v rms.
Frequency Range:	500 KC to 1 GC with accessory probe tips. Usable indications to 4 GC.
Accuracy:	1 MC to 50 MC, $\pm 3\%$ of full scale; 50 MC to 150 MC, $\pm 6\%$ of full scale; 500 KC to 1 GC, 1 db.
Meter Scales:	Two linear voltage scales, 0 to 1 and 0 to 3, calibrated in the rms value of a sine wave. Db scale, calibrated from +3 to -12 db; 0 db = 1 mw in 50 ohms.
Probe Tip Furnished:	411A-21E BNC open circuit tip, 500 KC to 500 MC. Shunt capacity less than 4 pf. Max. input 200 v dc. Input resistance at 10 MC typically 80 K ohms.
Galvanometer Recorder Output:	Proportional to meter deflection, 1 ma into 1000 ohms at full scale deflection.
Power:	115/230 v $\pm 10\%$, 50 to 60 cps, 35 watts.
Dimensions:	Cabinet Mount: 11 $\frac{3}{4}$ " high, 7 $\frac{1}{2}$ " wide, 12" deep. Rack Mount: 6 $\frac{3}{32}$ " high, 19" wide, 10 $\frac{3}{8}$ " deep behind panel.
Price:	Ⓢ 411A, (cabinet) \$450.00. Ⓢ 411AR (rack mount) \$455.00.

*Data subject to change without notice.
Price f.o.b. factory.*



or any rf voltage 1 mv to 10 v, from 500 KC to 1,000 MC. Measuring is as simple as "touch and read;" resolution is high, thermal drift errors are virtually eliminated!

Now, easily and dependably and with utmost accuracy, you can measure millivolts at rf frequencies — and on one simple-to-use instrument, the 411A Voltmeter. This remarkable instrument has true linear operation (no correcting networks) and readings are presented on a large, mirror-backed linear meter. Temperature stability is such that there is virtually no change from 10° to 40° C.

Specifications alongside indicate basic features of this important new, time-saving instrument. Other special features include (a) matched diodes protected against burnout (b) probe temperature compensated for low drift (c) amplifier photochopper eliminating contact noise, guaranteeing high sensitivity and zero-drift freedom (d) extra probe tips available including a 500 KC to 250 MC tip; 100:1 Capacity Divider tip, and Type N Tee tip for coax use to 1,000 MC.

Why tolerate a complex, cumbersome voltmeter. Get a new 411A into action on your bench now!

HEWLETT-PACKARD COMPANY

1061A Page Mill Road, Palo Alto, California, U.S.A.
Cable "HEWPACK" Davenport 6-7000
Sales representatives in all principal areas

HEWLETT-PACKARD S. A.

Rue du Vieux Billard No. 1, Geneva, Switzerland
Cable "HEWPACKSA" Tel. No. (022) 26.43.36

6955

From Japan...

Capacitors - Resistors - Relays

Fuji "systems-proved" components from one of Japan's leading producers of radio and carrier transmission systems, computers, and telephone exchanges.

FUJI STYCON polystyrene capacitor • Monthly output of 5 million units makes Fuji one of the world's leading polystyrene capacitor producers.



- Capacities from 2 MMF to 0.05 MFD
- Tolerances to 0.5%.
- Operating temperature: 10°C. to +70°C.
- Available in standard, non-inductive, twin, micro, and TV & radio broadcast receiver types.

FUJI ESCON mylar* capacitor

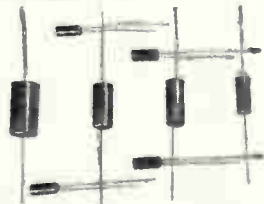

- Small, lightweight design and low failure rate assure a high order of performance in compact electronic equipment.
- Capacities from 500 MMF to 0.5 MFD.
- Tolerances to 5%.
- Operating temperature: -40°C to +100°C.
- Available in standard and non-inductive types.

* DuPont trademark

FUJI ELCON electrolytic capacitor



- Capacities from 0.5 MFD to 1,000 MFD.
- Tolerances (at 120 cs): -10% to +50%.
- Operating temperatures: Standard, -20°C. to +70°C.
Special, -40°C. to +85°C.
- Available in single & multiple section tubulars and twist-prong types.

FUJI FUJISTOR carbon film resistor



- Strict quality control assures accuracy and reliability throughout frequency range.
- Capacities from 5Ω to 20 meg.
- Tolerances from 1% to 20%.
- 40°C. ambient temperature at full load.
- When operated at full load for 500 hours (90 min. "on", 30 min. "off"), resistance changes are from 0.01% to 0.85%.

FUJI MIDGET RELAY type 151
FUJI MIDGET RELAY type 153



- Contact rating for DPDT, DPST, 4PST, 4PDT, & 6PST: dc 0.3 amp., 100 volts.
- Contact rating for DPDP: dc 0.2 amp., 100 volts.
- Normal operating power: DPDP, DPST, 4PST, DPDP, 500 milliwatts.
4PDT, 6PST, 800 milliwatts.
- Relay Assembly (type 152) available with up to 14 type 151 midget relays wired to your specifications.

* Similar to type 151, except can be wired on opposite side of pannel or chassis, and can be mounted by (a) special 10 or 16-pin plug-in or (b) stud without socket

U.S. distribution for Fuji's complete line of quality components is smoothly handled through representatives in New York, Chicago, San Francisco. and Los Angeles. Complete specifications are available on request.

FUJI TSUSHINKI SEIZO K.K. Tokyo, Japan

Represented by: ■ The Nissho American Corporation □ New York 5, 80 Pine St., WH 3-7840
□ Chicago 3, 140 S. Dearborn St., CE-6-1950
■ The Nissho Pacific Corporation □ San Francisco 4, 120 Montgomery St., YU 2-7901
□ Los Angeles 14, 649 S. Olive St., MA 7-7691



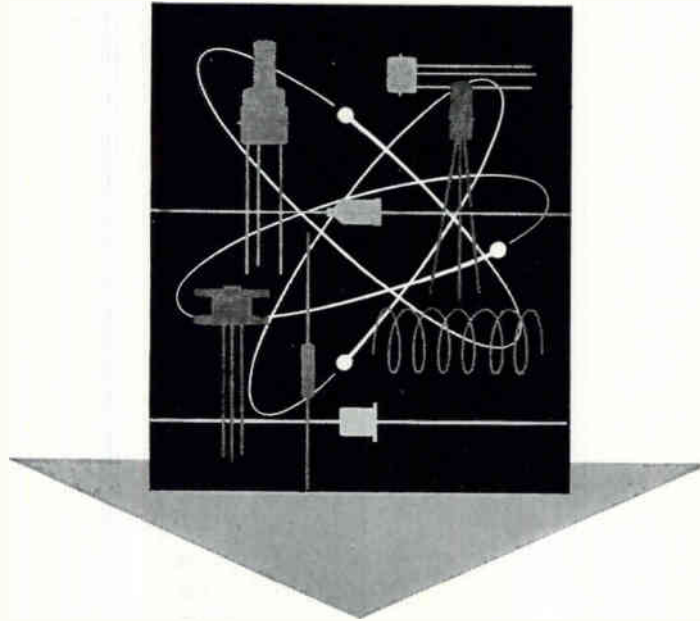

ENGELHARD

ESTABLISHES SEMICONDUCTOR MATERIALS DIVISION

.....

Engelhard Industries, world's largest refiner and fabricator of precious metals, has devoted a substantial effort in the past few years to exploring the metallurgical requirements of the semiconductor industry. Research work in platinum and gold alloys has been carried on in the company's fully equipped research laboratories at headquarters in Newark, New Jersey. Prototype, development work, and product application have also been carried out there.

It is recognized that in order to produce materials for this industry, having the highest levels of purity, consistent analysis and cladding ratio as well as complete lack of contamination, it is necessary that all such related operations be concentrated in an isolated area. It is also well known that the equipment to be used for such metallurgical products shall not be used for any other metallurgical products. It is also imperative that the various types of semiconductor materials be segregated from each other during fabrication.

Engelhard has therefore established an ultra-modern "clean room". This air-conditioned, dust-free clean room is completely integrated to furnish the semi-

conductor industry with materials made under the most rigid purity controls. This facility is located in the main Attleboro plant of the D. E. Makepeace Division in Attleboro, Massachusetts.

This step has now been completed and previously initiated prototype and small production orders are being produced in this facility. The development and research personnel who have been associated with this project in development have been transferred to the Attleboro facility, and additional supervisory personnel familiar with the requirements of the industry have been added.

The full metallurgical weight and the vast precious metal experience of Engelhard Industries is behind this new department and is prepared to supply, all of the manufacturing and technical requirements of the precious metal semiconductor field. The products immediately available include: The Gold, Platinum, and Silver group, furnished as solid alloys, doped alloys, or clad to various base metals. These materials can be furnished in the form of sheet, ribbon, fine wire and preforms. * * * * *

We welcome the opportunity to supply further information on your specific needs.



The cost of miniaturization just dropped 20%

Trends can be overpowering. Once established, they're tough to reverse.

Take the cost of miniaturization, for example. As electronic packages get smaller, price tags get bigger. No one seems surprised. It's a trend.

There's a reason, of course. Tiny things are hard to build, especially with space-age reliability requirements.

Amphenol designers decided that if ever a trend needed reversing—it was this one.

"How" was another question. They knew that conventional miniaturized pin and socket connectors were about as small as they were ever going to be. The spring member in the female contact (necessary for a snug, low-resistance connection) took up valuable space and set a lower limit for practical center-to-center contact spacing. The spring was obviously holding up progress in miniaturization. It had to go.

So, it went.

►Amphenol designers developed the Wire-Form Poke-Home® contact, a male contact that supplies its own tension and can be crimped or welded before assembly. Overnight, contact spacing plunged from .175 inch to .100 inch. And, best of all, the new contact was less costly to manufacture. (It's built on automatic equipment.)

The trend reversal was well on its way. Amphenol designers had a new contact—the next step: putting it to work in connectors.

To answer the need for an economical micro-miniature rack and panel connector, the Micro-Rac was unveiled. Space-saving Wire-Form contacts and an integral-body-dielectric construction made it possible to pack 20% more connections in the same space—and at nearly half the previous cost. As for reliability, after 1,000 repeated insertion and withdrawal cycles, the Micro-Rac retained its original low resistance characteristics.

►Next came the Strip Connector, six-inch lengths of Lexan* plastic with contact holes on .100 inch centers. A do-it-yourselfer's delight, strips can be cut and stacked to suit hundreds of applications where a connector is a must—but for which no other economical connector exists. Example: strips can be stacked to form micro-miniature programming boards or instrumentation terminations. They also

can be used as economical tape cable connectors, modular connectors, logic card connectors, to mention a few.

Wire-Form contacts can be used separately, too. Example: contacts can be crimped or welded to modules and plugged into special eyelet-type receptacles on printed circuit boards. Non-modular components, such as transistors, become pluggable by crimping Wire-Form contacts to their leads.

And that was that. The trend was reversed.

►If you would like more information about Wire-Form Poke-Home contacts, Micro-Rac 52- and 104-contact rack and panel connectors, Strip Connectors (or any Amphenol Connector for that matter) call your Amphenol Sales Engineer. Or, write to Dick Hall, Vice President, Marketing, Amphenol Connector Division, 1830 S. 54th Avenue, Chicago 50, Illinois.

* Registered TM General Electric Co.

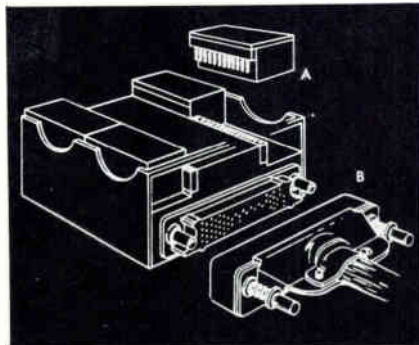

The Amphenol Wire-Form contact at work. Multi-purpose Strip Connectors (A) connect modules to chassis; Micro-Rac Connectors (B) connect chassis to cable assembly.

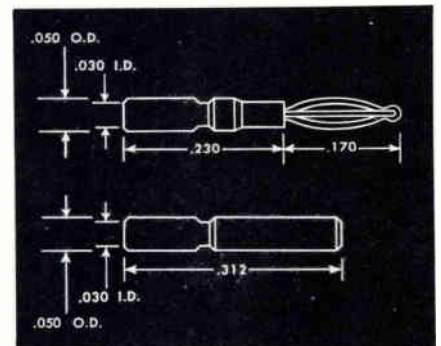

Acting like four spring fingers, Wire-Form beryllium-copper beam sections assure a low resistance connection (.0025 to .0030 ohm) even after 1,000 insertion-withdrawal cycles.



Connector Division / Amphenol-Borg Electronics Corporation



Another outstanding development by the Makers of BUSS fuses

TRON FUSES

Fuses actual size

Sub-miniatures — hermetically sealed Body size only .140 x .300 inches

For Use Where Space is at a Premium

Tron fuses are so small they can easily be used as an integral part of circuit — to protect miniaturized devices — or gigantic multi-circuit electronic devices — without sacrifice of space.

Fuse elements hermetically sealed. Tron fuses may be potted or encapsulated without danger of sealing material affecting operation. They are not affected by atmospheric conditions. They are designed for installation in high shock and vibration ambients.

They are self-protecting and operate without exterior flash or venting, so they can be installed anywhere in the circuit. Likewise, they may be teamed in one capsule or replaceable unit with such components as resistors or condensers.

Available in ratings from $1/20$ to 5 amps. for use on circuits of 125 volts or less where available fault current is not over 50 amps. Color coding indicates ampere rating and assists in final inspection of fused circuits.

Made with Axial pigtailed that are adapted to feed through automatic wire forming machines — or with right angle pigtailed conveniently spaced for assembly on printed circuit chassis.

Get the full story: —
Write for BUSS Bulletin TRON

In the BUSS line,
you'll find the type and size fuse to fit your every need
... plus a companion line of clips, blocks and holders.



BUSSMANN MFG. DIVISION, McGraw-Edison Co.,
UNIVERSITY AT JEFFERSON, ST. LOUIS 7, MO.

**Question: Can circuits
be simplified with
increased reliability?**

Answer: Yes!

**With the Tung-Sol
dynaquad.**

—a four-layer device.

Dynaquad is a PNP bistable transistor which makes it possible to accomplish flip-flops, binary counters, solid state relays, shift registers and various forms of logic with a saving of one-third to one-half in components and space. In many circuits it directly replaces a number of transistors and their associated components. In others it permits use of transistor techniques where they previously had not been practical.

Finding its chief application in the fields of computation and control, the Dynaquad is a new circuit tool for small signal switching, driving and pulse-forming applications.

Tung-Sol's applications engineers have developed 100 kilocycle shift registers and a 1 megacycle reversible ring counter,

using amazingly few components. Circuit diagrams and complete design information are available on request. With great simplicity, bistable, monostable and astable multi-vibrators can be fabricated, using the Dynaquad. One such example is shown below. You are also invited to discuss any special questions you may have with Tung-Sol's applications engineers. Tung-Sol Electric Inc., Newark 4, N. J. TWX:NK193

TECHNICAL ASSISTANCE AVAILABLE THROUGH:
Atlanta, Ga.; Columbus, Ohio; Culver City, Calif.;
Dallas, Tex.; Denver, Colo.; Detroit, Mich.; Irvington,
N.J.; Melrose Park, Ill.; Newark, N.J.; Seattle, Wash.
In Canada: Abbey Electronics, Toronto, Ont.

 **TUNG-SOL**

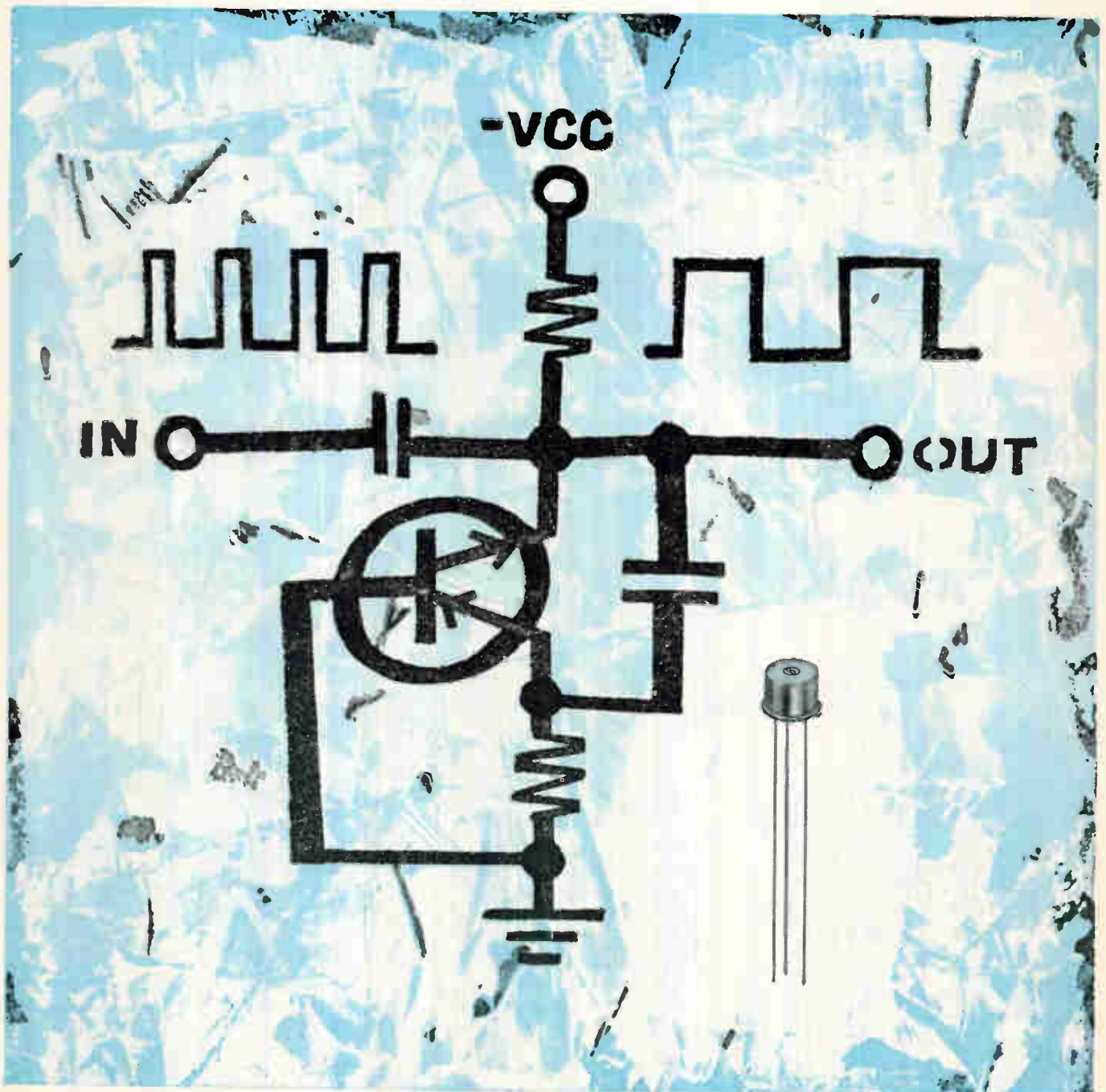

Two resistors, two capacitors and one Dynaquad make a bistable.

Army Avionics Spending to Rise

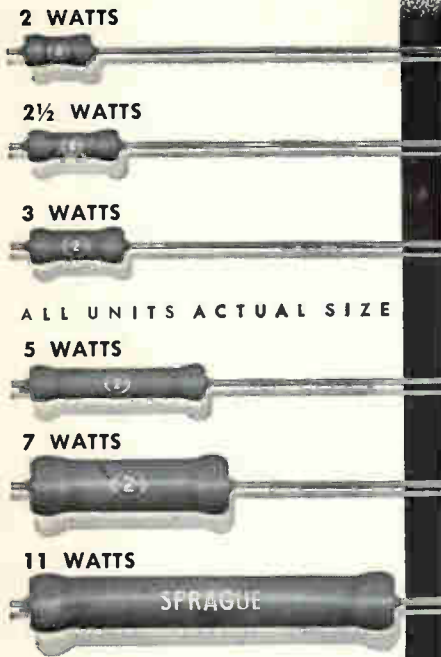

NEXT TIME ... USE TINY *Blue Jacket*[®] WIREWOUND RESISTORS

Sprague builds reliability... efficiency... economy right into minified Blue Jackets with these important features:

- * All-welded end-cap construction with special vitreous-enamel coating for total protection against humidity, mechanical damage, heat, corrosion gives long-term dependability under severe environmental conditions
- * Available in resistance tolerances as close as $\pm 1\%$
- * Low in cost... quick and easy to install

Tiny axial-lead Blue Jackets are specially designed for use with conventional wiring or on printed boards in miniature electronic assemblies. Write for complete technical data in Sprague Engineering Bulletin 7410B.

SPRAGUE ELECTRIC COMPANY
35 Marshall Street, North Adams, Mass.



ELECTRONICS DEFENSE market changes under the impact of the international situation was one of the major topics of discussion at the Electronics Industries Association's Fall Conference last week. Army avionics spending came under close scrutiny at one of the longest and most heavily attended of the 50 sessions.

General consensus of a panel discussion on electronics' role in Army modernization was that spending will continue to rise. Equipment will emphasize simplicity of operation and maintenance. Panelists included Albert Clark, General Electric; Julius Braun, North American Aviation; L. G. Regan, Douglas Aircraft; C. P. Page, Motorola, and T. G. Pearson, Marquardt, moderator.

"Do your research and development right now if you plan to go after this market in the later '60's," Regan advised manufacturers seeking a share of the growing Army aircraft market.

Spending on aircraft now about \$130-140 million, will climb to \$250 million by 1965 and jump to \$620 million in 1970, Regan predicted. The Army will have 19,280 aircraft in 1970, he said. Percentage spent for electronic equipment was five percent, is now 10 percent and will rise to 30 percent for some types in the 1960's.

Most planes will be light observation craft, closely followed in number by heavy transports. Another important type will be planes able to deeply penetrate enemy territory on surveillance flights. High speeds will make adequate electronics equipment vital, Regan said.

"Without electronic controls," Regan said, "the chances for successful air operations at the speeds now possible will go way down."

Clark, of GE's Missile and Space Vehicle department, predicted that Army budgeting for small tactical missiles will remain on a plateau or even decline slightly over the next 10 years. Other services will take over some of the Army's role in this field. At present, Army spends \$350-400 million for mis-

siles, with about 30 percent going for deep penetration programs.

Clark predicted a large demand for missiles not now in existence. Among these will be a Jay-type missile with a range of 1,000 to 10,000 yards for closeup combat missions. He estimates cost at \$5,000 each, including \$1,500 for electronic controls.

Army spending for Ar-Bee (Radar Buster) missiles will also increase, Clark thinks. This missile will have a tactical mission similar to the Navy's cancelled Corvus. It will home on enemy radar.

Page, Motorola's manager of defense requirements, predicted spending in several areas of Army avionics. Total procurement of \$9 million in 1960 will increase to more than \$45.5 million in 1965, peak at more than \$49 million in 1967 and decline to about \$39 million in 1970. Page said the rise and fall would result from a tapering-off in heavy aircraft and a step-up in helicopters which require less navigation, radar and infrared gear.

Army spent about \$3 million on avionics communications in 1960, Page said. This will rise to \$14.5 million in 1965 and peak at nearly \$27 million in 1968. Peaking would be caused by an expected leveling-off in light observation helicopters.

Spending for electronic navigation equipment stood at \$6 million last year and will climb to \$24 million in 1965. A drop in production of large aircraft requiring complex gear will cause a decline to \$11 million in 1970, Page said.

Army IFF spending was \$260,000 in 1960. This will go to \$1.6 million in 1965 and \$2.6 million in 1970. The peak will be around 2.9 million as light observation helicopter production levels.

Infrared detection devices will get more than \$1 million of Army avionics spending by 1963, rise to \$2.5 million by 1965 and decline to \$1.5 million in 1968. The decline, Page says, will result from operational status of the AO-1C Mohawk aircraft, which will handle close surveillance, observation and target

location missions.

Page predicts radar spending, now \$2.5 million, will peak at \$7.5 million next year and be on a plateau of about \$3.5 million by 1965, due to requirements for an earlier model of the Mohawk (AO-1B).

Air Force Establishes Reward-Penalty Policy

AIR FORCE will allow higher profits to defense contractors who save taxpayers' money and will exact corresponding penalties of those whose costs exceed estimates, EIA members were informed at the Fall Conference. Under the new policy, Air Force may also allow higher profits for faster delivery and better quality and may penalize contractors for poor performance.

Instead of limiting fees to nine percent on cost-plus or fixed price incentive contracts, fees up to 15 percent for R&D and 10 percent for production might be allowed. However, penalties for poor performance might be the full amount of a fee, or more. Details of the policy were outlined in a letter from Maj. Gen. W. T. Thurman, director of procurement management, to Air Force commanders. EIA and other associations had urged such a move at an Air Force-Industry symposium on ways to improve procurement and contractor incentives.

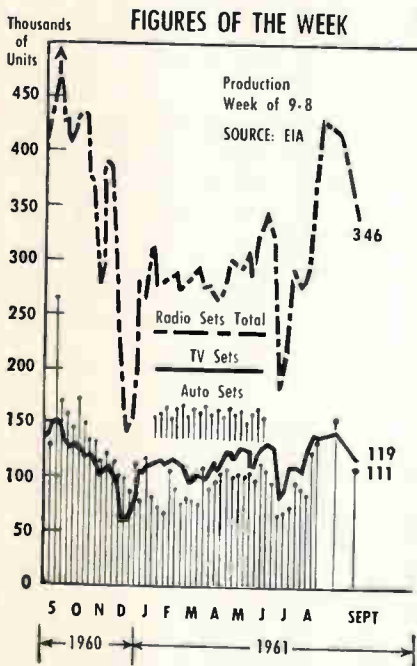

September 29, 1961

ONE RECTIFIER REPLACES 12 COMPONENTS!

The simple diagrams above clearly illustrate how the single unit 1600 Volt IN2359 axial lead top hat silicon rectifier can replace a series string of four 400 Volt IN540's along with their R-C shunting elements.

Now, manufacturers of commercial equipment can join military users in taking advantage of the higher reliability and lower assembly costs gained by using the high voltage single unit in place of space consuming series strings.

This economy is made possible by major advances in mass production techniques enabling Columbus to drastically reduce price of the 1000 to 1800 Volt axial lead top hat types — IN3486, IN3487, IN2357, IN2358, IN2359, IN2360. As a result, prices of these hermetically sealed high voltage units are now directly in line with series strings of the commercial 400 to 600 Volt types.

SEND FOR SPECIFICATION SHEETS AND PRICES, NOW!



COLUMBUS ELECTRONICS CORP.

1000 Saw Mill River Rd.
Tel: YO 8-1221

Yonkers, N. Y.
TWX: Yonkers, NY-1369

CIRCLE 23 ON READER SERVICE CARD

23

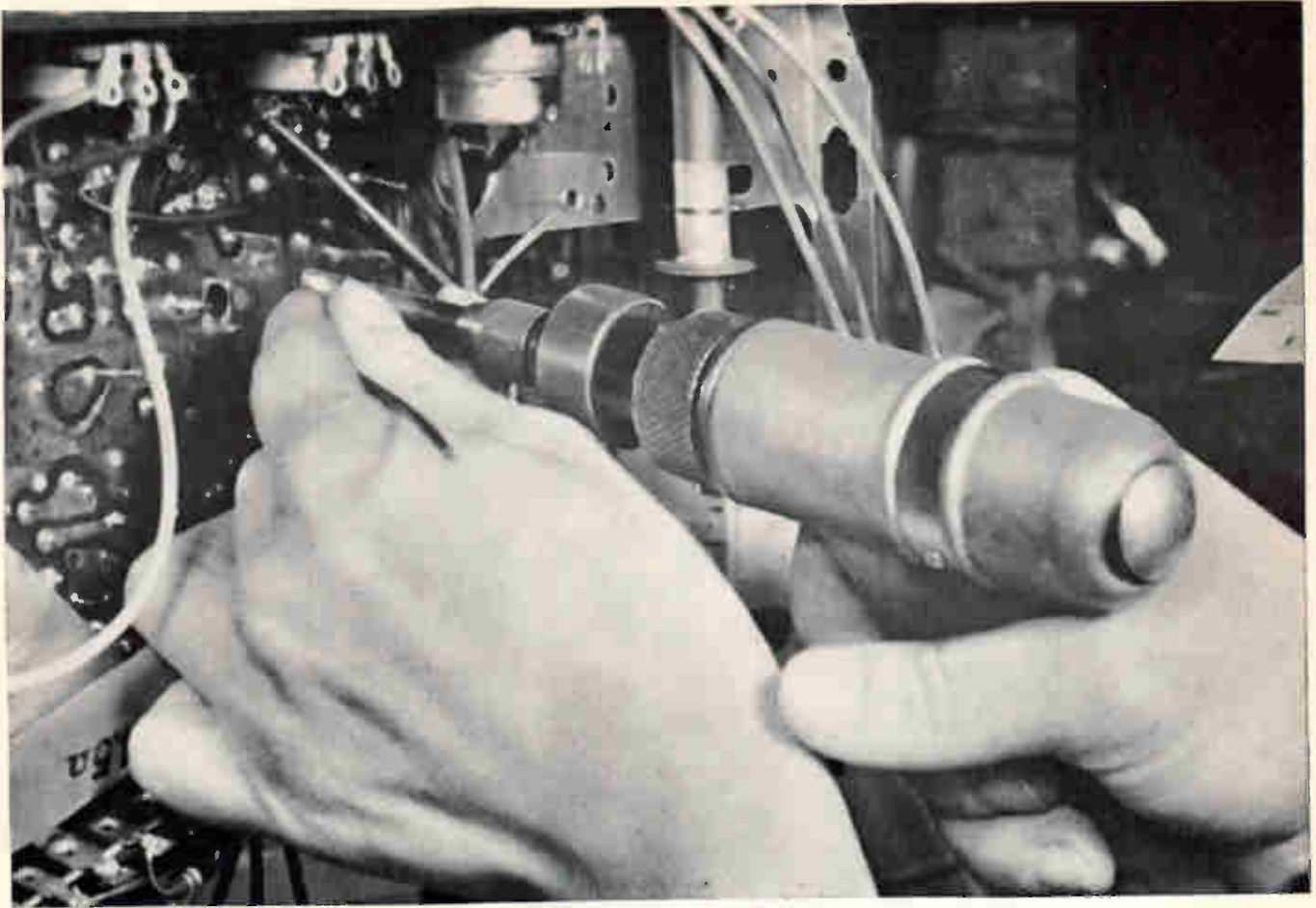

With Wire-Wrap[®] tools these hands wrap up wiring jobs fast

Keep expensive hands working at top efficiency and get permanent, solderless electrical connections in a hurry with Gardner-Denver "Wire-Wrap" tools.

Proved superior by leaders in communications and electronics, solderless wrapped connections are last-

ingly secure, conquer vibration failure and corrosion. And only Gardner-Denver offers a complete line of equipment for making such connections—including custom-designed, automatic machines to expedite multiple operations.

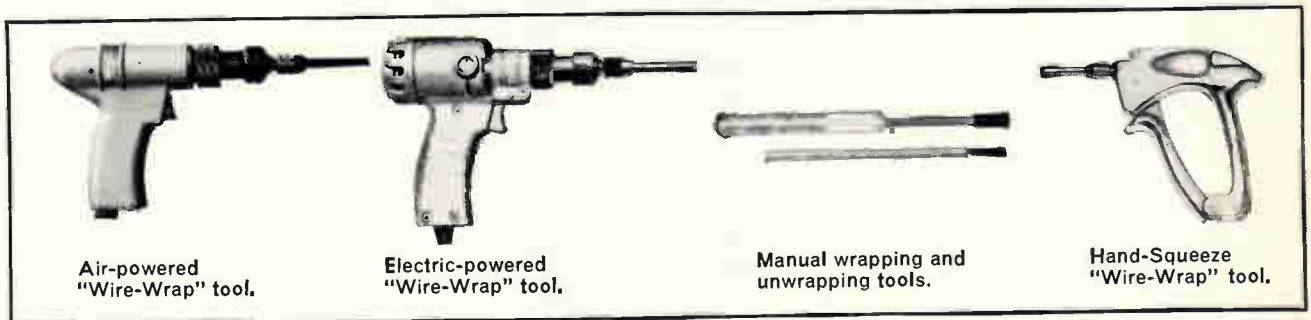

Air-powered
"Wire-Wrap" tool.

Electric-powered
"Wire-Wrap" tool.

Manual wrapping and
unwrapping tools.

Hand-Squeeze
"Wire-Wrap" tool.

EQUIPMENT TODAY FOR THE CHALLENGE OF TOMORROW

GARDNER - DENVER



Gardner-Denver Company, Quincy, Illinois—Offices in principal U.S., Canadian and Mexican cities
In Canada: Gardner-Denver Company (Canada), Ltd., 14 Curity Ave., Toronto 16, Ontario

International: Gardner-Denver International Division, 233 Broadway, New York 7, N. Y.
International Offices: Buenos Aires, Argentina; Artarmon, N.S.W. Australia; Brussels, Belgium; Rio de Janeiro, Brazil;
Santiago, Chile; Barranquilla, Colombia; Lima, Peru; Ndola, N. Rhodesia; Salisbury, S. Rhodesia; Johannesburg, Transvaal

Military—Commercial—Entertainment Rectifier Purchasers

NOW FILL
138
DIFFERENT
RECTIFIER
NEEDS...

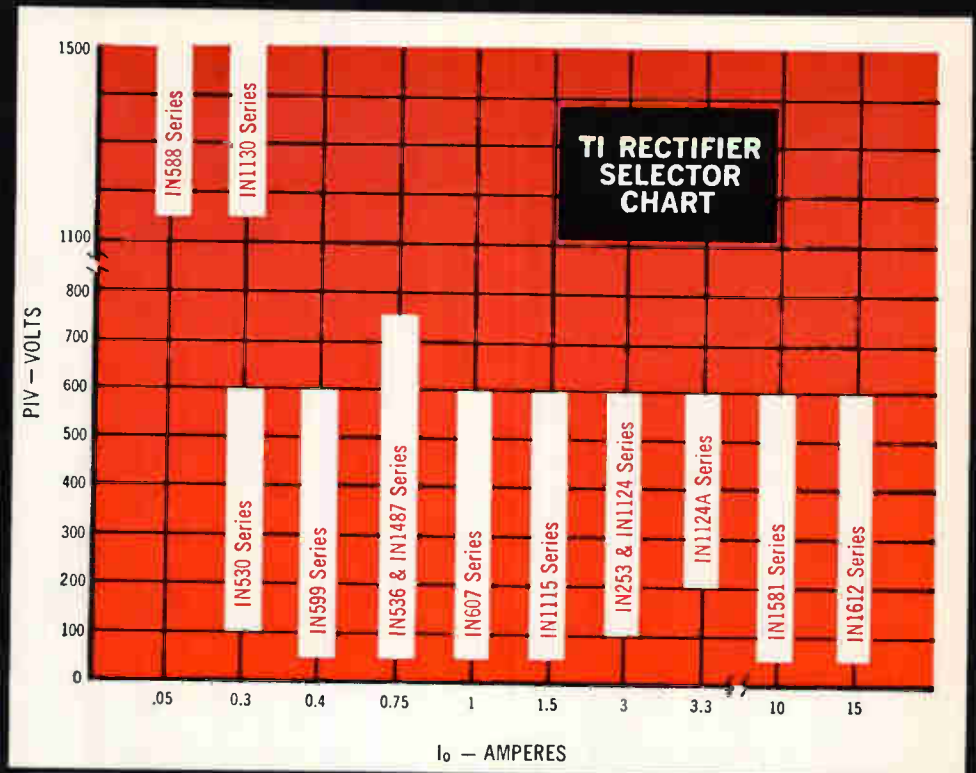

With TI Broad Line Diffused Silicon Rectifiers

HERE'S WHY:

BROAD LINE

You get real savings in time and money with single-source procurement from TI's broad rectifier line. Choose from more than 138 rectifier types: Stud and axial top hats, high-voltage types, potted stacks, epoxy economy rectifiers . . . all with *one order, one invoice.*

QUALITY ASSURANCE

With TI rectifiers you buy confidence. Over fifteen million hours of controlled life test data back-up your guaranteed TI rectifier reliability.

IMMEDIATE LOCAL DELIVERY

One call to your TI distributor brings you immediate delivery from *local* shelf stocks. Meet your tightest production schedules with TI custom service . . . and still pay only low factory prices.

Start simplifying *your* rectifier purchasing now. Call your local TI sales office or nearby TI distributor for complete details. For more technical TI rectifier information fill out and mail the coupon on this page.

Send me complete product information and prices on TI's

- Complete line of rectifiers Top Hat General Purpose Rectifiers
 High-voltage Diode Stacks Epoxy Economy Rectifiers

NAME _____

TITLE _____

COMPANY _____

STREET ADDRESS _____

CITY _____ STATE _____

COMPONENTS DIVISION
 CAPACITORS, DIODES,
 RECTIFIERS, RESISTORS,
 SEMICONDUCTOR NETWORKS,
 SILICON CONTROLLED RECTIFIERS



TEXAS INSTRUMENTS
INCORPORATED
 13500 N. CENTRAL EXPRESSWAY
 P. O. BOX 5012 • DALLAS 22, TEXAS



SERIES
59M
10-TURN TIGHT TOLERANCE
POTENTIOMETER

precise electronic control

For tight tolerance quantitative functions. The Clarostat Series 59M ten-turn potentiometer incorporates a significant design breakthrough which results in greater winding length and resolution for its diameter. Resolution is of the order of .009%/total turns in a 100,000 Ω unit. Outside diameter is only .875".

Brief specifications: 4.5 watts @ 40°C; Dielectric strength—1000 volts AC; Maximum resistance—100,000 Ω ; Resistance tolerance— \pm 5%; Linear functional output; Absolute linearity— \pm .25%; Speed of rotation — 60 rpm maximum; Life — 2,000,000 shaft revolutions; Ambient temperature range — -55°C to + 125°C.... quality characteristics and construction at low cost!

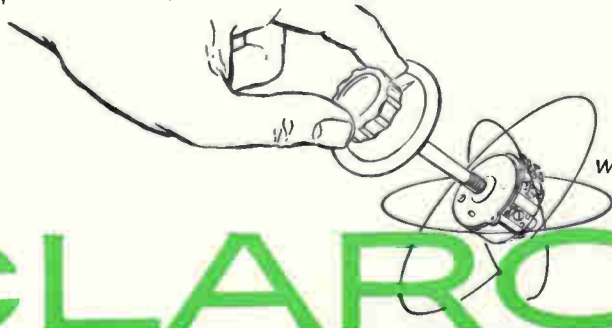

write for complete precision catalog...

CLAROSTAT

CLAROSTAT MFG. CO., INC. DOVER, NEW HAMPSHIRE

Through the sophisticated use of hydraulics and air, IBM engineers and scientists have developed the IBM 1301 disk storage. In this new disk memory, a hydraulic actuator simultaneously positions 40 magnetic data heads to read and write on magnetic disk surfaces. The special design of the hydraulic actuator combines speed, accuracy and reliability. The magnetic heads glide on a self-acting air bearing which requires no external air supply. Heads float at precise distances above disk surfaces, supported only by air flow generated by the rotating disks.

With this random-access storage file, five units can be grouped together in one memory system to provide a 280-million-character capacity. With this capacity, "setup" time between computer processing jobs can be virtually eliminated. The memory can hold a library of all the various programs needed for an installation. It also provides

information storage for handling vast files of data such as insurance companies require for processing policies.

It takes engineers and scientists with both skill and imagination to develop new systems like this to meet increasingly complex data processing needs. Perhaps you have been searching for a challenging opportunity in one of the many fields where IBM is making important advances such as: solid state physics, paper and ink chemistry, closed-loop control, cryogenics, optics. All qualified applicants will receive consideration for employment without regard to race, creed, color or national origin. Write to:

Manager of Technical Employment
IBM Corporation, Dept. 554J5
590 Madison Avenue
New York 22, New York

IBM[®]

ADVANCED DISK STORAGE

random access through

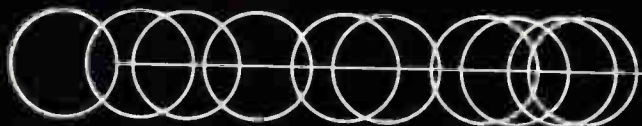

use of hydraulics and air



Automatic Impedance Plotters

RF UNITS

0.1 to 2.5 mc

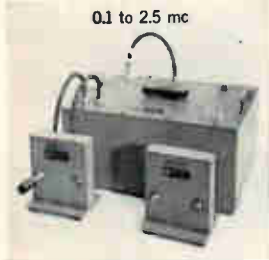

2.5 to 250 mc



30 to 400 mc



180 to 1100 mc



1100 to 1700 mc



Type 14
0.1 to 1700
mc.

Presentation Unit

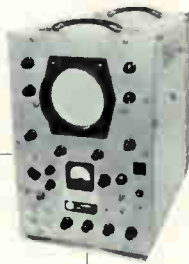

X-Y Recorder

Complex rf impedances or transfer characteristics can be rapidly measured and plotted as a continuous function of frequency.

Impedance versus frequency curve is automatically plotted as it would be seen at any point desired.

OTHER FEATURES:

- Entirely self-contained, except for the use of an external oscillator.
- Instantaneous choice of three different Smith-Charts: infinity to 1, 2 to 1, and 1.2 to 1.
- Quick investigation of impedance and transfer characteristics even when several independent variables exist.
- Can be used to measure impedances, admittances, and reflection coefficients in systems under power.

Write for complete details and catalog.

AMCI ANTENNA SYSTEMS—COMPONENTS—AIR NAVIGATION AIDS—INSTRUMENTS

ALFORD Manufacturing Company
299 ATLANTIC AVE., BOSTON, MASS.

POWER from

NICAD NICKEL CADMIUM

Rechargeable Batteries

DESIGNED FOR

- Low Maintenance Cost
- Instant Efficient Operation
- Durability

NICAD Sealed and Vented Cells make practical the battery operation of many types of equipment not previously suited to dry, mercury, or lead acid types.

Capable of sustained or stable voltage over a wide temperature range these NICAD Cells have extremely long life, require little or no maintenance, and are always ready to operate in any position under even the most adverse operating conditions . . . with POWER to spare.

For the full POWER story, write . . .



NICAD BATTERY DIVISION

GOULD-NATIONAL

BATTERIES, INC. E-1403 First National Bank Bldg., St. Paul 1, Minn.

NICAD is a trademark of Gould-National Batteries, Inc.

CIRCLE 30 ON READER SERVICE CARD

SEALED CELLS



VENTED CELLS



Jet-fast deliveries



on all TI
semiconductors
tantalum capacitors
precision resistors
and sensistors

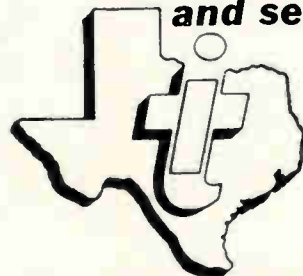

LAFAYETTE
INDUSTRIAL
ELECTRONICS DIVISIONS
RADIO

NEW YORK 13 100 SIXTH AVENUE WO 6-5300
JAMAICA 33 165-08 LIBERTY AVE. AX 1-7000
BOSTON 10 110 FEDERAL ST. HU 2-7850
NEWARK 2 24 CENTRAL AVE. MA 2-1661

CIRCLE 32 ON READER SERVICE CARD
CIRCLE 29 ON READER SERVICE CARD→



The Eltronic Series

SIX NEW DIGITAL INSTRUMENTS for measuring voltage, ratios, and resistance with **all-electronic speed and reliability**

...including the world's first full-**5-digit solid state** digital voltmeter / ratiometer

They're all-electronic! No moving parts. No contacts to clatter or wear. All the inherent advantages of solid state circuitry: speed, ruggedness, reliability and coolness.

They're fast! 20 readings per second, average. High speed eliminates reading delays due to cycling caused by decreasing voltages.

They're reliable! Carefully selected components, rigorous testing programs and accelerated aging—equivalent to 100 hours of actual operation—combine to give EITRONIC instruments an unequalled mean-time-to-failure figure.

They're accurate! Production EITRONIC instruments provide a

true, absolute DC accuracy of 0.01%; AC 0.1%.

They're automatic! Virtually eliminates operator error. Even decimal point placement and polarity indication are automatic.

They're human engineered! Unique readout tilts to 3 positions, is easy to read whether instrument is used on a bench, at eye level or high in a rack. Modular construction permits exhaustive testing during assembly, facilitates trouble shooting and field servicing.

They're available now! Your EI field engineer has a new 8-page folder which gives complete specifications on the EITRONIC Series. Ask him for a copy today.

Another significant breakthrough in digital instrumentation from

 **Electro Instruments, Inc.**
8611 BALBOA AVENUE, SAN DIEGO 11, CALIFORNIA

Engineers: Challenging opportunities now available. Contact Mr. Harvey Fleming





Grouped on the tarmac at Farnborough in Hampshire are military and commercial aircraft. Note radical design of single-seater jet at right

Farnborough

By DEREK BARLOW,
McGraw-Hill World News

LONDON — Increased computer usage, an upsurge of lightweight communications equipment for executive aircraft, new navigation displays and automated cockpit warning systems were the talking points among avionics men at the British Airshow at Farnborough this month.

The current situation in Britain's aviation industry is mirrored in an increase in applications rather than basic new tools. New aircraft are a rarity. Missile development has slowed while improvements are made in Bloodhound and Firestreak. The abortive Blue Streak long-range missile is being revamped into its new role as the first stage of an all-European satellite launching system.

Said one manufacturer: "This is the time to get what tools we have got incorporated into acceptable systems rather than dream up new equipments."

One of the main roles being given computers is simplification of data presentation to air traffic controllers and aircrews. The first Ferranti Apollo computer is now operational at Prestwick, Scotland, working in parallel with manual ATC procedure. Aim of the experimental installation is to determine possible reduction in air spacings on the North Atlantic route.

A second experimental unit, at London in 1964, will use an Elliott 502 computer to determine optimum display and presentation methods.

Subsystems and components of ATC systems are also on the increase. A new one is an automatic vhf direction finder developed by Standard Telephones and Cables. It uses an antenna system rotating at 180 rpm to generate a true dop-



Optical projection of cathode ray display by new system (below) lets pilot see his attitude without looking down at instrument panel

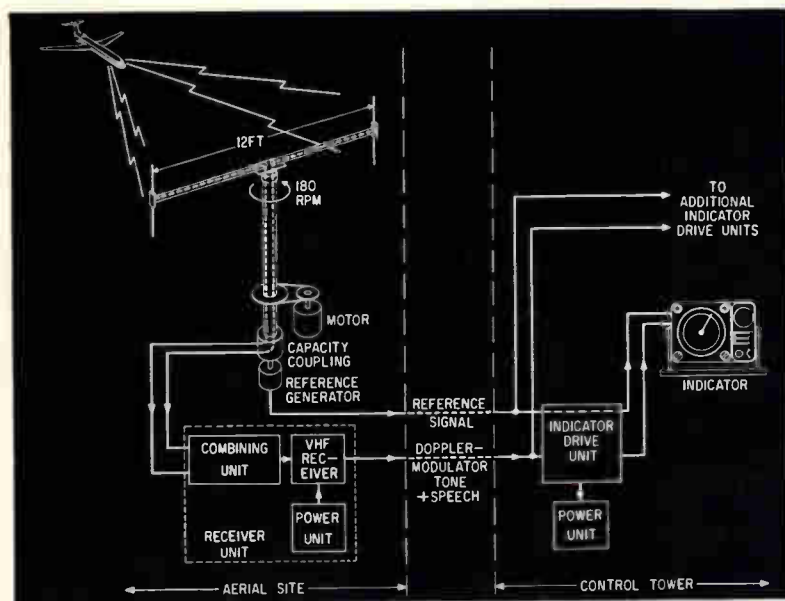

Antenna rotating at 180 rpm generates true doppler effect in direction-finding system. Bearing detection is automatic

Shows British Perfecting Aircraft Gear

Emphasis is on further applications of computer and display techniques

rather than introduction of new concepts for aircraft and missile systems

pler effect instead of the simulated doppler effect used in other long base-line systems. Bearing detection is automatic and is displayed on an electromechanical indicator accurate to 0.5 degree. Site error suppression is reported to be up a factor of seven on conventional short base systems.

A radar display unit developed by Marconi's Wireless Telegraph Co. displays both raw radar and synthetically produced information. Characters, range rings and azimuth markers are shown on one 12-inch ppi tube. Character details are derived from a digital symbol computer, converted into analog waveforms and applied to x and y axes of the ppi during each inter-scan period. Intersection points of a four-by-four grid are used for writing. Writing time is 20 microseconds, achieved by a separate driving coil and amplifier.

Another Marconi display operates on the same principle for computer readout. It produces 50,000 characters a second, writing 400 characters on a seven-by-five-inch screen.

Character generation is becoming airborne, too. One approach to eliminating warning lights on flight panels uses character gener-

ation and a crt screen divided into red, amber and green sectors. A central character generator developed by Rank Cintel is triggered by the 28-volt signal formerly used for fault lamps. Logic and waveform generating circuits write failure details on the crt screen, in a color zone indicating warning priority. Non-vital, amber zone failures can be cancelled and redisplayed later by storage facilities. First installation will be in a new helicopter.

An aural approach by Ferranti also saves panel space by eliminating warning lamps. A selector switch continuously samples inputs to connect the appropriate track of a magnetic tape playback amplifier. Warning messages—recorded on a nine-inch tape loop with a capacity of 15 messages—are fed through the pilot's headset. Message access time is 0.25 second. Priority failures take precedence over normal warnings and are repeated until manually cancelled by the pilot.

New display techniques featured two other pilot aids shown at Farnborough. Another Ferranti unit, a moving map display, will be installed in one of Britain's new generation commercial aircraft. The display is fed northings and

eastings of the ground speed and aircraft track angle from a navigational computer. Microfilms of standard air navigation charts are optically projected onto a six-inch-diameter screen. As the plane flies over the earth's surface, the projected map moves at the current speed, keeping the plane's position in the center of the screen.

The second display system, by Rank Cintel, is aimed at reducing pilot fatigue by making it unnecessary for him to continually refocus between the instrument panel and outside objects. An electronically generated attitude and steering display is superimposed upon the pilot's external visual field. This display uses optical projection of waveforms generated on a crt. In the display are a central reference circle (see photo) representing the flight vector, an artificial horizon bar operating as a visual horizon and a line pathway structure.

Matching the introduction of the first British small executive type of aircraft is a new range of lightweight, miniature communication equipment. Typical of these is the Elliott Brothers' 720-channel vhf transmitter-receiver with a 12-watt output. Divided into two modules, it weighs less than 10 lb.



Rotating antenna of automatic direction finder is seen in partially assembled glass fiber radome



Radar display combines radar picture with identifying symbols, range rings, video map and azimuth marks

New Way to Gage Varying Pressure

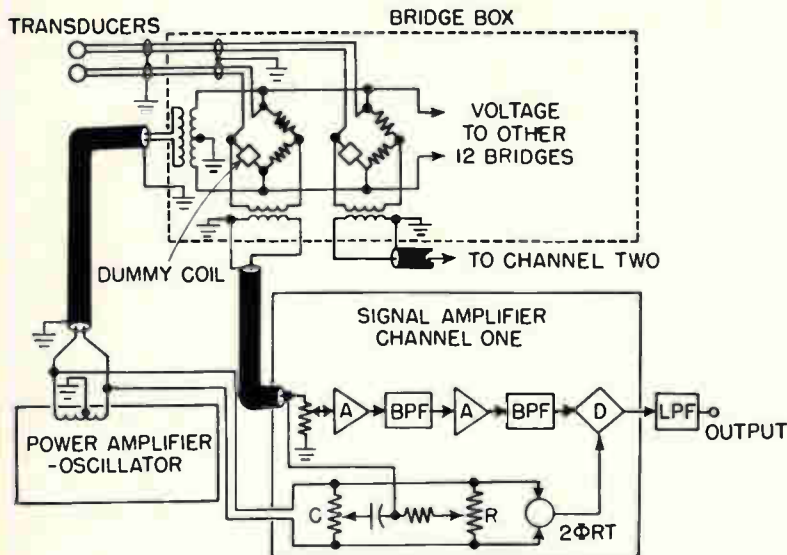

System which measures rapidly varying pressures on aerodynamic model has frequency response of 20 Kc

MEASUREMENT of rapidly varying pressures has been made possible with a system designed at NASA's Langley Research Center. Described at the Instrument Society of America meeting in Los Angeles this month, the system provides accurate data during an unusual combination of test conditions.

Richard W. Morton and John L. Patterson, both of NASA, designed the system to measure effects of pressures on a model which is subjected to a high supersonic flow and a simultaneous blast-induced gust from another direction. These two phenomena, plus the necessity of remote operation, dictated the use of some unusual circuits.

The system is shown in the block diagram. A variable inductance transducer provides the input to the system. Because steady-state pressures must be recorded, the variable-inductance type transducer was selected instead of the piezoelectric type. The latter do not respond to steady-state pressures. Also, it was necessary to locate the equipment about 1,000 feet from the model. A low-impedance device was required to minimize stray pickup.

The power amplifier-oscillator supplies 10 watts of stable 120-Kc carrier power to the bridge circuits. The transducer is connected as one arm of the bridge. Output

of the bridge is fed to the signal amplifier whose output is filtered for recording.

Input to the signal amplifier is mixed with a balancing voltage, then fed to a gain control. Following the gain control is a feedback amplifier, a bandpass filter, a second similar feedback amplifier, a second bandpass filter, a synchronous demodulator and a low-pass filter.

Bandpass filters are needed to

minimize foldover, remove harmonics and eliminate microphonics. Operation of the demodulator requires a synchronizing voltage of constant magnitude and variable phase. This is obtained from the armature of a two-phase rotatable transformer which is fed from the 120-Kc oscillator.

Overall frequency response of the system is 20 Kc. A system rise time of 20 microseconds is required to respond to the pressure variations encountered in the tests. Operation of the system shows that this result has been achieved. The complete test facility uses 16 channels of carrier and 75 transducers.

Other subjects covered at the meeting included papers on semiconductor strain gages, reliability of automatic processing equipment, and a discussion of management's attitude toward automation. Altogether, more than 250 papers were presented on late developments in all types of instrumentation, data handling, computation and automatic control equipment and systems. Generally, presentations were confined to specialized development work.

Warren P. Mason, of Bell Telephone Laboratories, reported on work in progress aimed at producing weldable semiconductor strain

Coded Radar Beam Lands Planes



Bell Aerosystems Company reports successful flight tests of an automatic landing system developed for the Air Force. Coded commands in the radar beam serve as the data link and an S-band beacon is used for automatic tracking. Ground equipment includes tracking radar (above)

gages of high sensitivity. Deposition of thin p and n type materials into high resistance materials may make gages of this type possible.

Tunnel diodes can be made as sensitive pressure gages with gage factors of up to 30,000. Such devices find application as hydrophones, seismographs and ultrasonic wave detectors.

James Dorsey and Ludwig Reifers, of Baldwin-Lima-Hamilton, reported results of an evaluation of Bakelite-backed, p -doped silicon strain gages. Resistance to mechanical abuse and ease of installation were found to be notably improved by this construction. But further material development is still needed, the authors stated. A semiconductor material able to withstand a certain amount of plastic strain would be most helpful, as would one whose output is linear over a wider range.

Reliability, as seen by both the large processor and the small user, was discussed in a keynote speech by W. A. Beck, vice president of Robertshaw-Fulton Controls Co. Customers with large installations, he said, are demanding reliability against expensive shutdowns and against variations in performance which affect product quality. They no longer accept conventional fail-safe approaches, but will require instrumented verification to warn against pending malfunction. Smaller users cannot afford more instrument maintenance. Therefore, simplification and ruggedization would help their problem. Instrument makers, Beck concluded, must be prepared to meet these requirements.

Air Force Seeks Gear For A-Bomb Detection

PROPOSALS for a nuclear detection reporting system, system 477-L, are to be received today by the Electronic Systems Division, Air Force Systems Command. Proposals, invited from 36 firms, will lead to a prototype development contract. The system is to automatically detect any nuclear explosion in North America and report such information as blast magnitude and fallout pattern to North American Air Defense Command and other agencies.

VERSATILE

is the WORD!

The big
difference in
Sheet Metal Cabinetry
for Electronics
and Instrumentation
is offered only

by *EQUIPTO*

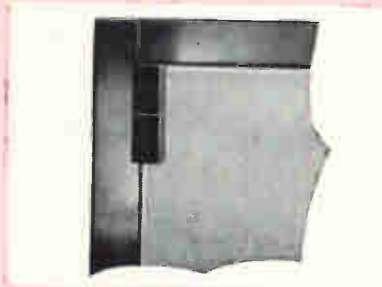

SAG-PROOF DOORS

All doors are mounted flush and recessed within the frame members. Doors are removable and are mounted with heavy-duty separable hinges with a 1/4" stainless steel pin and nylon anti-friction bearing. They can be mounted just as easily on sides as on front or back.



MOVABLE SIDE STRUTS

Horizontal side frame members can be moved and re-installed or completely removed to suit specific requirements of the user. Side members need no longer interfere with cabling between cabinets, impede air flow, or create other unnecessary difficulties.

Get the Facts! Write today for descriptive Brochure No. 100.

See us at The National
Electronics Conference—Booth 744

EQUIPTO ELECTRONICS CORPORATION

319 NORTH WEBSTER STREET • NAPERVILLE 2, ILLINOIS



Straits Tin Report

100% Timplating of silicon diodes meets rigid military specifications for resistance to corrosive salt spray and provides optimum solderability of these hermetically sealed units, accord-

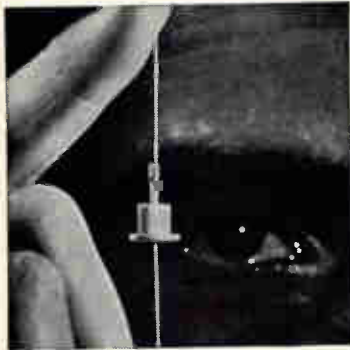

Photo courtesy International Rectifier

ing to one manufacturer. In addition, timplating protects against adverse environmental conditions, including corrosion resulting from excessive humidity.

Another capacitor maker recommends consideration of hot-dip tinning, plus centrifugal spinning. This method provides a fine solderability base and increased corrosion resistance. It also affords longer shelf life in storage.

Solder clad miniature base tab stampings can speed transistor production. Each replaces two components used to make ohmic junctions to germanium or silicon transistor triodes. They consist of a layer of high purity solder alloys metallurgically bonded to a base tab conductor such as Kovar, nickel or nickel-iron. Solder and base ratio is 6:1.

Free Bulletin

Write today for a free subscription to TIN NEWS—a monthly bulletin on tin supply, prices and new uses.



The Malayan Tin Bureau
Dept. T-64J, 2000 K Street, N.W., Washington 6, D.C.

Audio Show Features Automatic Stereo,

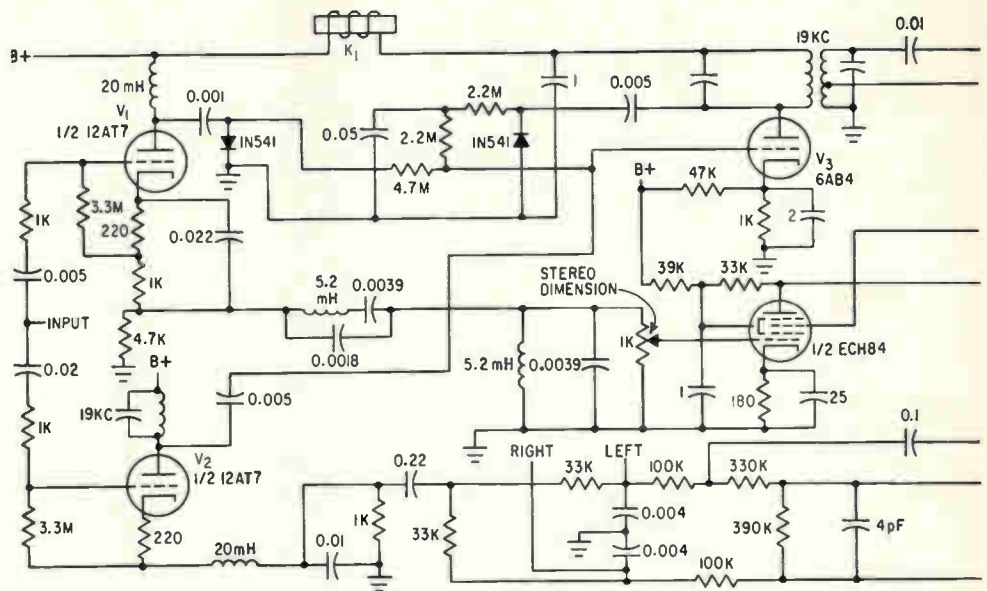

When station turns on its stereo subcarrier relay *K*, lights indicator lamp and

By **LESLIE SOLOMON**,
Associate Editor

Stereophonic f-m broadcasting's impact on the audio industry was the big story at the New York High Fidelity Show this month. Almost without exception, manufacturers of f-m receivers and tuners are coming out with adapters for present f-m receivers or new designs with integral adapters.

Every part of the audio industry was represented in the 125 exhibits. Equipment ranged from f-m antennas through conventional component systems to completely integrated home music centers. There was renewed interest in earphones; some claimed frequency response of 20 cps to approximately 20 Kc. One earpiece included a woofer and a tweeter.

Several improvements were noted in f-m tuners. Fisher Radio, for example, has modified its line of tuners so that when a station carrying a subcarrier is tuned in a panel indicator lamp lights and the system is automatically switched to stereo operation. A portion of the circuit is shown above.

The composite input signal is fed to both V_1 and V_2 . The amplified 19-Kc signal from V_2 causes V_3 to draw current, actuating relay K_1 .

The relay contacts complete the indicator lamp circuit causing it to come on. At the same time, the contacts remove the ground from the subcarrier signal path, permitting it to operate. To prevent interstation noise (which also might include a 19-Kc component) from turning on the system, a 100-Kc amplifier and detector (the plate circuit components of V_1) also supplies a signal to V_3 . When only the 19-Kc signal without 100-Kc noise components is present at V_2 , the relay operates to place the system in the stereo mode.

A number of manufacturers are leaning towards all-transistor systems that include tuner, preamplifier and power amplifier. Among several new circuits is one developed by Omega Electronics.

An output-transformerless circuit, it uses four diffused-base, high-frequency power transistors in a bridge. This permits symmetrical operation and uniform distribution of power dissipation. A difference amplifier, sampling the signal at each side of the load, allows feedback to the input single-ended driver. This circuit is claimed to have a frequency response from d-c to 20 Kc within 0.3 db with less than one percent

Hi-Fi Earphones

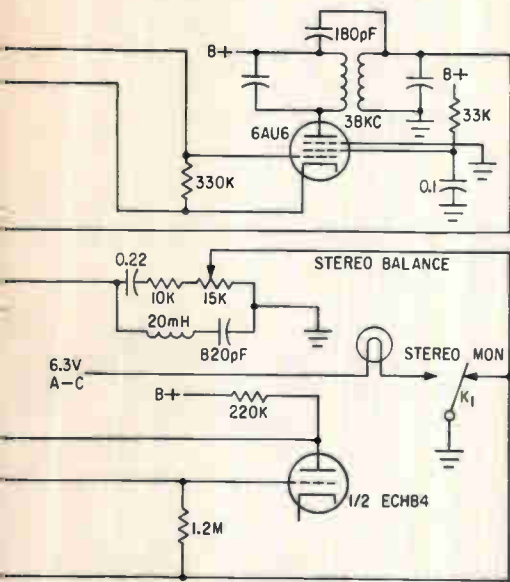

switches tuner into stereo mode

harmonic distortion at 30 watts.

Electro-Voice unveiled a relatively new method of recording sounds for a new organ. The organ's tone generators use permanent memory circuits to duplicate the sound of actual pipe organs. To make the memories, microphones were placed in selected pipes of well-known pipe organs. Frequencies of pipes and pipe ranks were displayed on a cathode ray screen and photographed. The waveforms were engraved on printed circuit boards.

The organ produces its tone from 12 generators. Each has two stationary stators with the engraved complex waveforms for each note and each voice. A synchronous motor rotates a scanner having radial lines corresponding to the number of octaves on the stator. Each scanner operates at a fixed speed that determines the note of the scale and all related octaves. Relative motion between the stator and scanner reproduces the signal by a variable capacitance change.

By playing a key or selecting a tab, the organist completes the electrical bridge between the key and the generating element. The signal is then amplified by the system's audio circuits.



**THIS SEAL GUARANTEES YOU
REAL LACING ECONOMY...
increased production
with fewer rejects!**

Always specify Gudebrod whether you use one spool of lacing tape or thousands because Gudebrod lacing tape is produced under strict quality control. Gudebrod checks and rechecks every lot of tape to insure that it meets the highest standards . . . higher standards than those required to meet MIL-T specifications.

Gudebrod helps increase your production because we carefully test, measure and maintain close tolerances on such characteristics as slip resistance, fray resistance, breaking strength, wax content, fungistatic effectiveness. These and other tests assure you that when Gudebrod lacing tape is used production increases. *Knots don't slip . . . harnesses stay tied . . . assemblies remain firm . . . there are fewer rejects!*

Whatever your lacing needs—Teflon*, dacron†, glass, nylon, high temperatures, special finishes—Gudebrod makes it or will produce a tape to meet your special requirements. If you want a tape to meet 1500°F . . . Gudebrod Experimental Research Project 173 is the answer. If you want a tape that meets MIL-T-713A . . . Gudelace® (Style 18 Natural) is the answer.

MAKE THE H-R TEST! Write for samples of Gudelace or other Gudebrod lacing tapes and have them tested in your harness room. Compare a harness tied with a "Quality Controlled" Gudebrod tape and any other tape. This test will convince you that when you specify Gudebrod you specify *real* economy—increased production with fewer rejects.

Write for our free Technical Products Data Book. It explains Gudelace and other Gudebrod lacing tapes in detail.

*Dupont's TFE fluorocarbon fiber.

†Dupont's polyester fiber.

GUDEBROD BROS. SILK CO., INC.

Electronics Division
225 West 34th Street
New York 1, New York

Executive Offices
12 South 12th Street
Philadelphia 7, Pa.

K&S NEWS



FOIL-DICE BONDER — Equipped with new automatic foil feed and indexing heat columns, machine positions and bonds both foil and dice on semiconductor headers. K&S Model 604 (not shown) available without foil feed.

K&S MODEL 604FF for precision bonding of foil and dice

Inherent design of this precision equipment cuts time and cost, gives high output in positioning and bonding of foil and microcomponents to semiconductor headers.

- Carries foil of specified width and thickness; automatically feeds and cuts foil to exact pre-determined length
- In sequence, (1) picks up foil, (2) positions it on header, (3) picks up component, (4) positions it on foil, (5) bonds
- Positioning on header, heat and force of bonding hammer pre-set with positive controls
- Geneva movement rotary table, equipped with 2 heat columns and 2 component trays, operates on planned cycle of 10 to 20 seconds
- Entire operation under constant visual control (B&L Stereo-Zoom microscope optional) and protected by cover of forming gas

For additional information about K&S equipment — including probes, scribes, dice mounters, wire bonders, micropositioners and microcircuit machines — write or call . . .

**KULICKE
and SOFFA**
MANUFACTURING CO. INC.



Pioneer Designers and Builders
of Equipment
for the Semiconductor
and Microcircuit Industries

401 NORTH BROAD ST.
PHILADELPHIA 8, PA.
WAInut 5-4270
Direct Distance Dial Code: 215

Using Three-Terminal Tunnel Diodes

TOKYO—The Electrical Communications Laboratory has revealed voltage and current control methods using three-terminal tunnel diodes. Reports indicate that bistable switching with the circuits illustrated reached an on-off current ratio of 1,500.

The work was reported by To-shiya Hayashi and Yoshio Sunohara, in the Institute of Electrical Communication Engineers of Japan *Journal*.

A three-terminal tunnel diode (A) is shown in a voltage-control circuit. The diode structure is like a double-base diode. It is made with a semiconductor bar having one *p-n* junction and two ohmic contacts. The *p-n* junction exhibits the tunnel effect.

In the circuit containing the controller, the base and load act as a secondary circuit which shows a voltage-controlled, negative-resistance characteristic. If primary current I_c begins to flow, the voltage drop between emitter and base will rise. As a result, the $V-I$ characteristics in the secondary circuit shift along the voltage axis. This effect is similar to the trigger action in a bistable tunnel diode circuit.

The current control circuit is shown in (B). The primary circuit is from controller to emitter and the secondary circuit is from emitter to base. A valley current introduced by the dynatron char-

acteristic of the secondary circuit may be decreased by increasing current I_c and finally approaches zero. When an appropriate condition is reached, the current ratio of the tunnel diode becomes a high value.

Semiconductor Diamonds Grown in Laboratory

SEMICONDUCTING diamonds, which constitute less than one percent of natural diamonds, have been grown at General Electric's Research Laboratory in Schenectady, N. Y. By taking the mixture of graphite and catalyst from which lab-grown diamonds are made and adding impurities such as boron, beryllium or aluminum, then subjecting the mixture to pressures of about 1 million pounds per square inch and to temperatures above 2,000 F, diamonds are formed with concentrations of one percent or less of the desired impurity.

All the semiconducting diamonds made so far have been *p*-type. Since *n*-types are also needed in transistors and other semiconducting devices, work is continuing on *n*-type diamonds, GE said.

Robert H. Wentorf and Peter Cannon have also produced *p*-type diamonds by diffusing boron into already-formed diamonds, both man-made and natural, at high pressures and temperatures.

A cubic form of boron nitride, called borazon, has a structure very similar to that of diamond and is equally hard; *n*-type and *p*-type crystals of borazon have been grown. One can be grown onto a seed of the other to form *pn* junctions able to act as rectifiers; *p*-type borazon has beryllium as an impurity. *N*-type borazon results when a number of substances including sulfur, silicon, many organic compounds, and potassium cyanide are added to the mix.

Chief problem in producing the semiconductor diamond was the elimination of metal impurities, such as nickel, from the basic diamond mix. Diamond semiconductors may be stable at temperatures of 450 to 500 C.

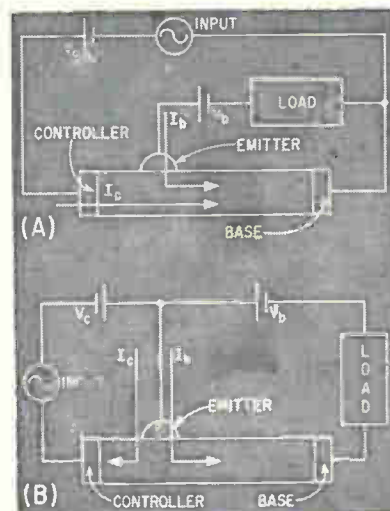

Voltage (A) and current (B) control circuits

ELECTRON TUBE NEWS from SYLVANIA

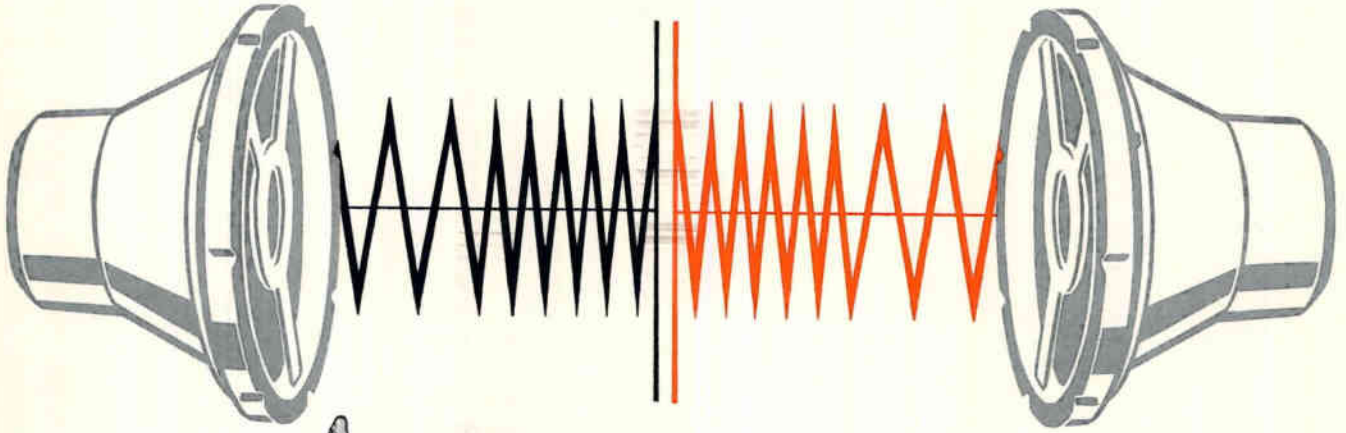

New! Sylvania-6JK8 especially designed for FM Tuners for Stereo Multiplex

Features strap frame grid! Provides high signal-to-noise!

Sylvania-6JK8, double triode, opens new design possibilities for high gain, low noise performance in a low-cost, compact FM tuner. 6JK8 combines a strap frame grid RF amplifier and an oscillator-mixer in a T-6½ envelope with miniature 9-pin circle. It enables the design of a simplified circuit capable of better than 40db quieting with less than 10 μ Volts signal input for superb multiplex performance. Equally significant, 6JK8 and its associated family — 8JK8, 17JK8—cost less than two single triodes of comparable performance.

TYPICAL CHARACTERISTICS — 6JK8			
	Ef — 6.3V		If — 400mA
	Triode #1	Triode #2*	Units
Eb	150	135	V
Ec ₁	—1	—1.2	V
Ib	5.3	11.5	mA
Gm	6800	14,500	μ mhos
Mu	50	70	

*Utilizes Strap Frame Grid

SYLVANIA 10-PIN TYPES FOR 1-TUBE FM TUNER FRONT ENDS



Sylvania-6/17C9 combines two high performance sharp-cutoff tetrodes in a T-6½ envelope. Tenth pin enables separate connections for cathodes and the use of effective shielding to reduce undesirable oscillator signal radiation. They are designed for VHF service as an RF amplifier and autodyne mixer.

Sylvania SR-2946A, triple triode in a T-6½ bulb. Ten-pin base provides excellent isolation, heater from cathodes, facilitating circuit design for series string operation. SR-2946A provides the combined functions of RF amplifier, oscillator-mixer, AFC control.

IMPROVED SYLVANIA TYPES FOR SUB-CARRIER GENERATORS

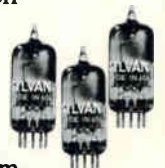

Sylvania-12AT7, 12AU7A, 12AX7A are improved versions of these popular types featuring low hum, noise and microphonics and offering amplification factors of 62, 20, 100 respectively.

For further information, contact your Sylvania Sales Engineering Office. For technical data on specific types, write Electronic Tubes Division, Sylvania Electric Products Inc., 1100 Main St., Buffalo 9, N. Y.

How high is the confidence level of the components in your design?

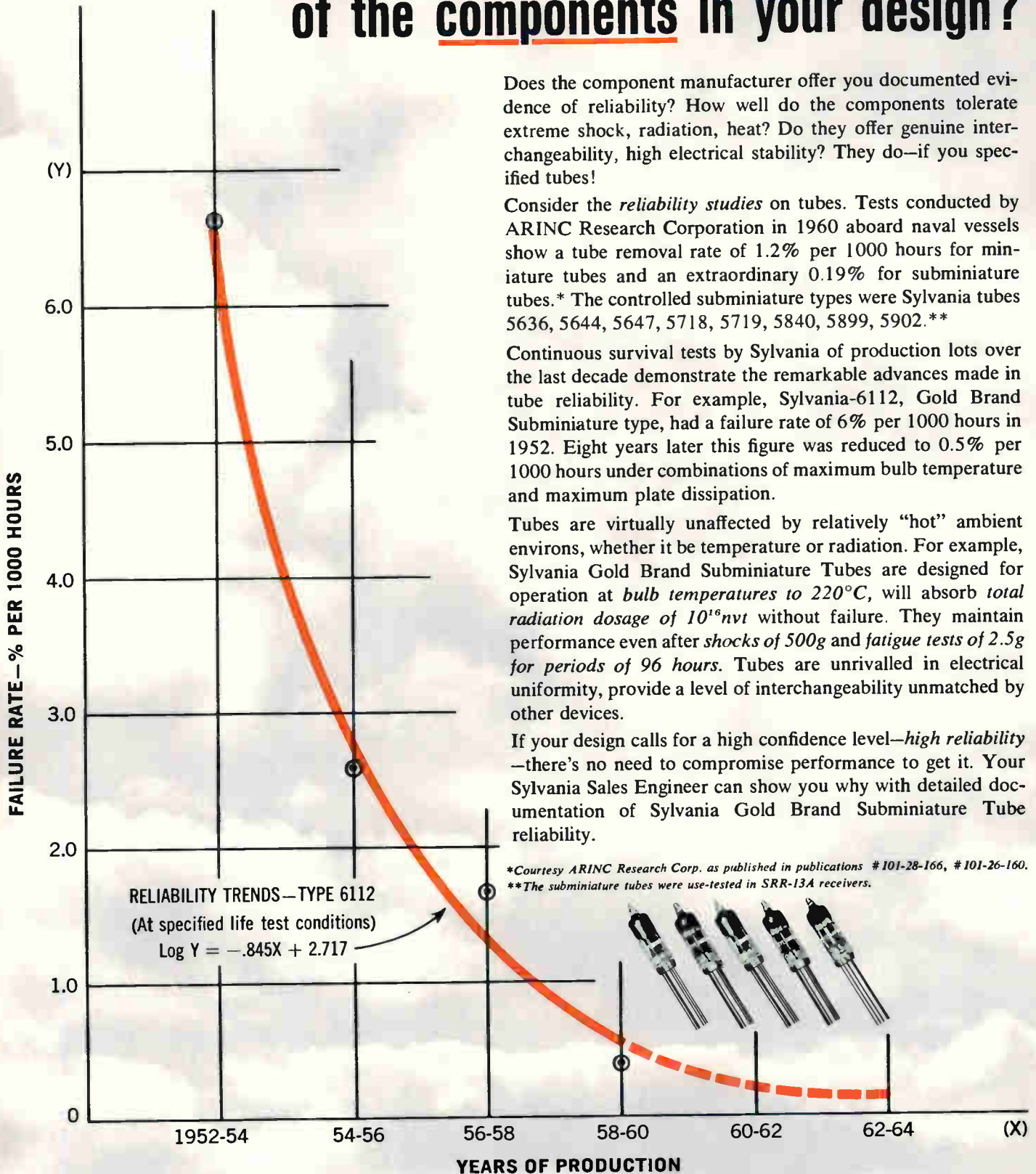

Does the component manufacturer offer you documented evidence of reliability? How well do the components tolerate extreme shock, radiation, heat? Do they offer genuine interchangeability, high electrical stability? They do—if you specified tubes!

Consider the *reliability studies* on tubes. Tests conducted by ARINC Research Corporation in 1960 aboard naval vessels show a tube removal rate of 1.2% per 1000 hours for miniature tubes and an extraordinary 0.19% for subminiature tubes.* The controlled subminiature types were Sylvania tubes 5636, 5644, 5647, 5718, 5719, 5840, 5899, 5902.**

Continuous survival tests by Sylvania of production lots over the last decade demonstrate the remarkable advances made in tube reliability. For example, Sylvania-6112, Gold Brand Subminiature type, had a failure rate of 6% per 1000 hours in 1952. Eight years later this figure was reduced to 0.5% per 1000 hours under combinations of maximum bulb temperature and maximum plate dissipation.

Tubes are virtually unaffected by relatively "hot" ambient environs, whether it be temperature or radiation. For example, Sylvania Gold Brand Subminiature Tubes are designed for operation at *bulb temperatures to 220°C*, will absorb *total radiation dosage of 10¹⁶nvt* without failure. They maintain performance even after *shocks of 500g* and *fatigue tests of 2.5g for periods of 96 hours*. Tubes are unrivalled in electrical uniformity, provide a level of interchangeability unmatched by other devices.

If your design calls for a high confidence level—*high reliability*—there's no need to compromise performance to get it. Your Sylvania Sales Engineer can show you why with detailed documentation of Sylvania Gold Brand Subminiature Tube reliability.

*Courtesy ARINC Research Corp. as published in publications #101-28-166, #101-26-160.
**The subminiature tubes were use-tested in SRR-13A receivers.

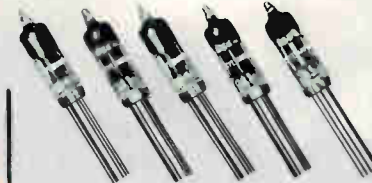

EQUIPMENT SALES OFFICES

CHICAGO: 2001 N. Cornell Ave., Melrose Park, Ill., Esterbrook 9-2525; CINCINNATI: 411 Oak St., Plaza 1-8454; DALLAS: 100 Fordyce St., Riverside 1-4836; DAYTON: 333 W. First St., Baldwin 3-6227; FORT WAYNE, IND.: 4740 Coldwater Rd., T3-1145; LOS ANGELES: 6505 E. Gayhart St., Raymond 3-5371; NEW YORK CITY: 1000 Huyler St., Teterboro, N. J., Atlas 8-9884; N.Y.—UPSTATE: Seneca Falls, Logan 8-5881; ORLANDO: Suite C, 1520 Edgewater Dr., P.O. Box 7248, Orlando, Fla., Garden 4-8245; SAN FRANCISCO: 1811 Adrian Rd., Burlingame, Calif., Oxford 7-3500; WASHINGTON, D.C.: 1120 Connecticut, N.W., Federal 7-6600; WILMINGTON, MASS.: 281 Main St., Oliver 8-3357.

SYLVANIA

SUBSIDIARY OF

GENERAL TELEPHONE & ELECTRONICS



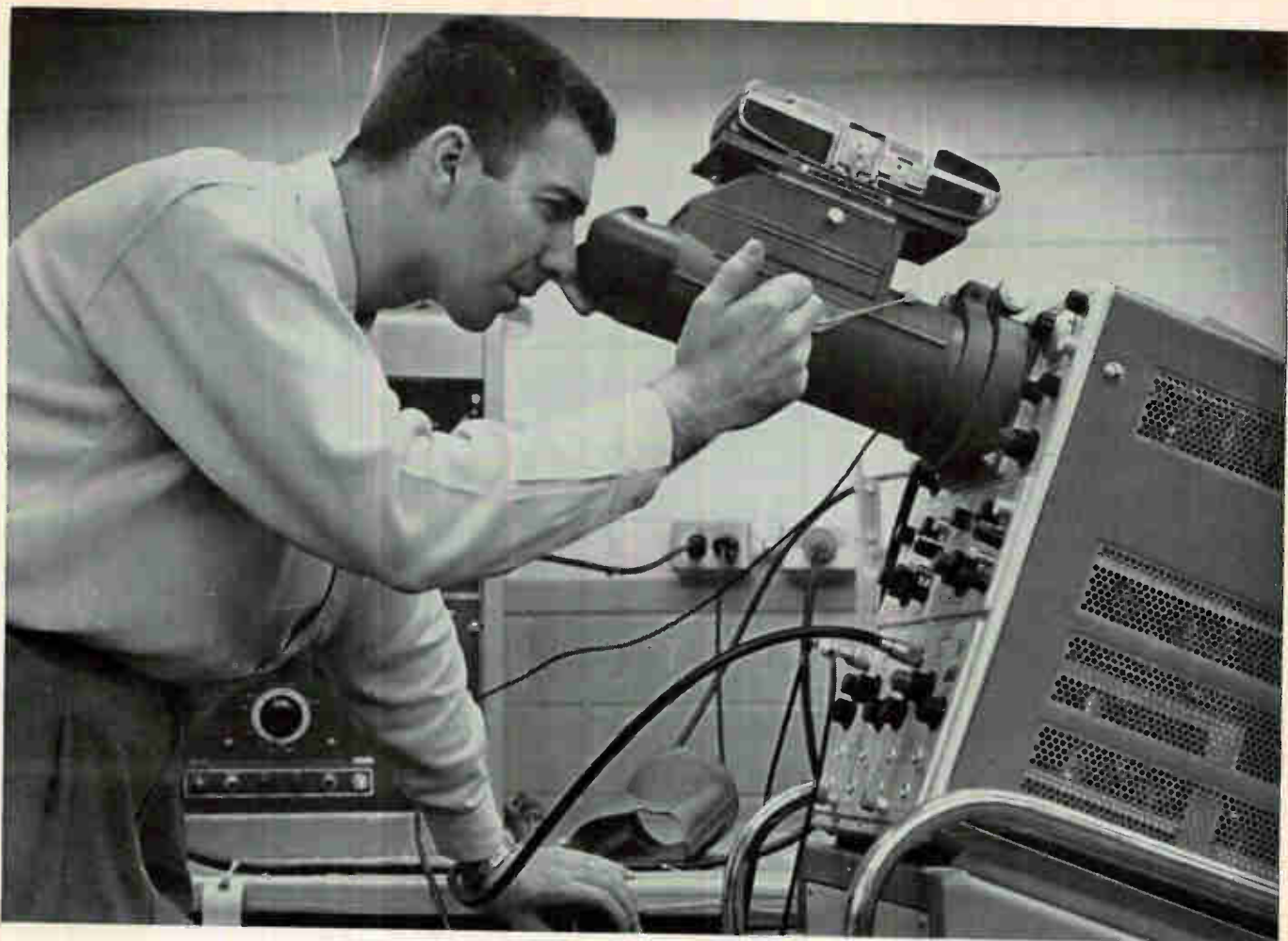

Fundamental instrumentation used in plasma diagnostics: Republic Aviation

What is "Pinpoint Recruiting"?

It is the act of going directly to the most concentrated source of supply to find 'the right man' for the job.

No matter in what field of specialization the electronics engineer belongs, he claims **electronics** as his professional literature. Through its consistently high calibre editorial content, he keeps abreast of technological developments in the industry in which he is a vital force.

Your most direct link to 'the right man' is in the pages of the publication he makes it his business to read.

*Write for the new 52-page booklet "Recruiting Engineers"
Address: David Hawksby, Classified Advertising Division,
electronics, Post Office Box 12, New York 36, N. Y.*

The engineers you need are the engineers who read

electronics



A MCGRAW-HILL PUBLICATION



CLASSIFIED ADVERTISING DIVISION

POST OFFICE BOX 12 NEW YORK 36, NEW YORK

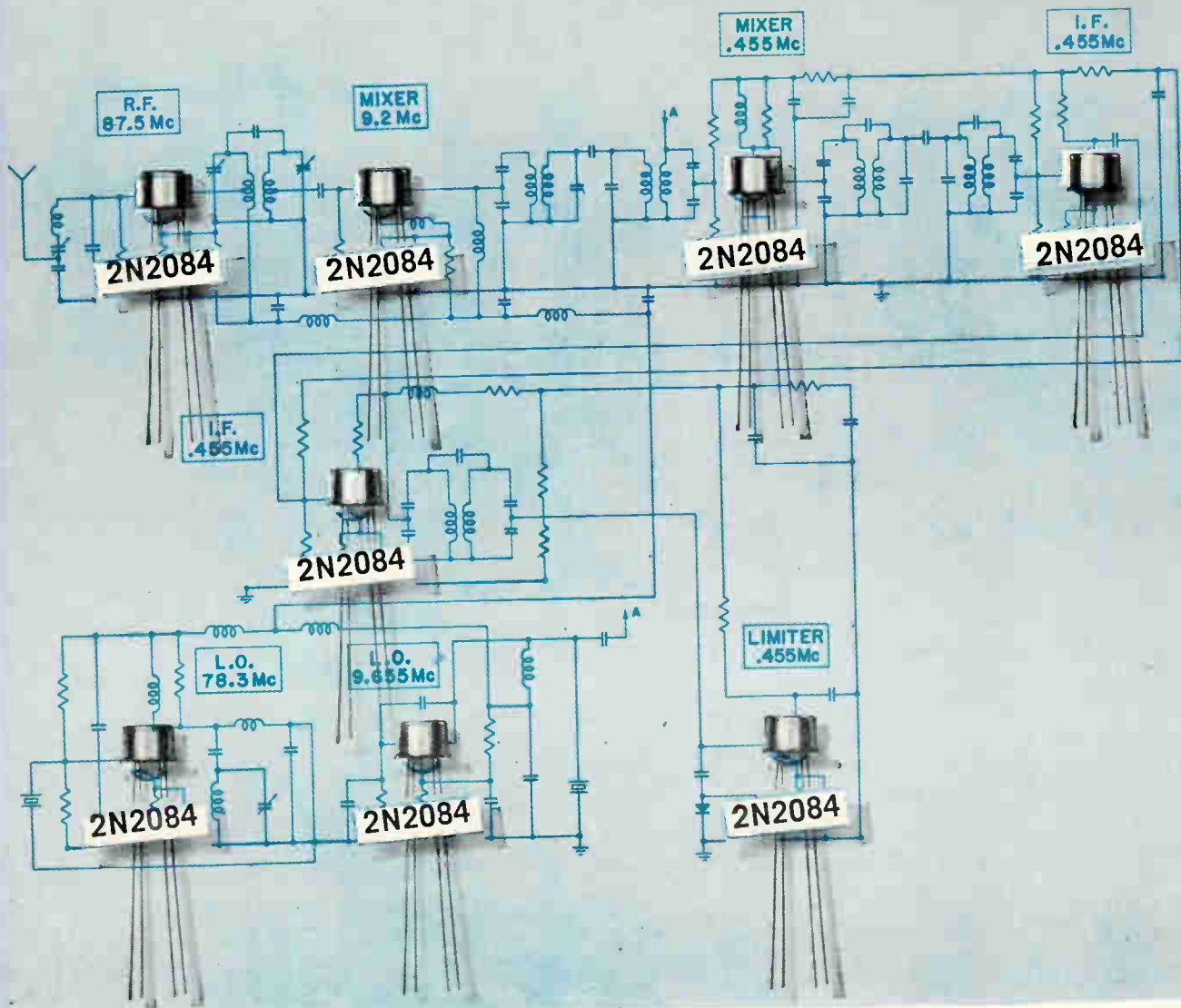

Now you can standardize and really cut costs with the

NEW Amperex® 2N2084

the industry's closest approach to the 'universal communications transistor'

Combining the best features—high voltage, high beta and high frequency—of many specialized front end and IF types, this new PADT germanium-alloy-mesa transistor will obsolete and replace such types* as 2N1224, 2N1225, 2N1226, 2N1395, 2N1396 and 2N1397 for HF and and VHF mobile, aircraft and radar applications.

Cuts costs 3 ways

Amperex advanced design—plus the high yields characteristic of the PADT process—now provides to the industrial equipment manufacturer a single communications transistor with an unrivaled combination of application flexibility, high quality and low price. The long-sought degree of universality offered by the new Amperex 2N2084 results in—

1. Lower procurement costs: only one type to order—with a better price break through volume purchasing.
2. Lower designing costs: only one type to specify—because of the wide range of desirable characteristics.
3. Lower inventory costs: only one type to stock—simplifies inventory control and disbursement.

CIRCLE 40 ON READER SERVICE CARD

It's as simple as that!

TYPE 2N2084

SPECIFICATIONS AND FEATURES

Gain Bandwidth Product $f_T = 100$ mc
Typical Beta $\beta_{FE} = 140$
Breakdown Voltage $BV_{CEO} = 40$ V
Typical Power Gain14 db (at 100 mc) 27 db (at 30 mc)
Output Capacitance $C_{ob} = 2 \mu\text{f}$
CaseJEDEC TO-33



for complete data and applications information on the 2N2084 and other transistors in standard TO-33 envelopes

*Currently available for immediate delivery

AMPEREX ELECTRONIC CORPORATION
230 Duffy Avenue, Hicksville, Long Island, N. Y.

In Canada:
Philips Electronics Industries, Ltd., Tube, Semiconductor & Component Depts., 116 Vanderhoof Ave., Toronto 17, Ont.

HOW RED IS A BLUSH?

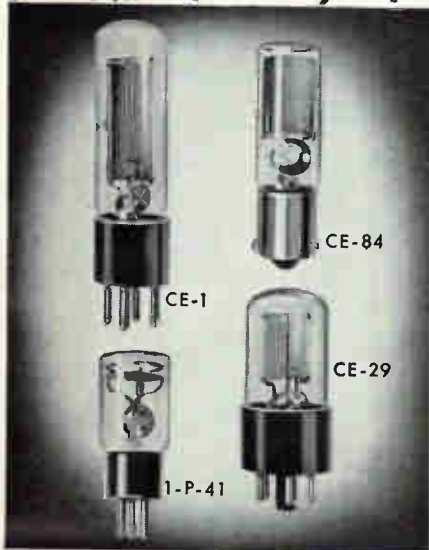
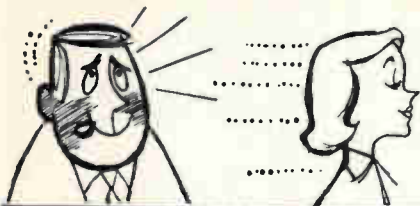

CETRON

PHOTO CELLS DO HUNDREDS OF JOBS

How red is red! How bright is a light! These answers, and hundreds of others are all possible—instantly with the use of Cetron Photo Cells.

For counting, color sorting, color registration, light intensity, Cetron Photo Cells do the job fast and accurately. Wherever circuitry for automation requires energy from changing light or color . . . you can be certain with Cetron.

Cetron Photo Cells are used in:

- Sound Reproduction
- Facsimile
- Counting and Sorting
- Burglar Alarms
- High Speed Color Registration
- Spectroscope Reproduction

Cetron Photo Tubes are available to meet requirements of JAN Specifications.

Cetron Engineers are always available to help in your tube requirements—just write, wire or phone.

YOUR DEPENDABLE SOURCE FOR RECTIFIER, THYRATRON AND PHOTO TUBES



CETRON
ELECTRONIC CORPORATION
715 HAMILTON ST. • GENEVA, ILL.

CBS INTERNATIONAL | ATLAS RADIO CORP., LTD.
New York 22, New York | Toronto 19, Ontario
European Representatives | Canadian Representatives

CIRCLE 31 ON READER SERVICE CARD
September 29, 1961

MEETINGS AHEAD

ELECTROCHEMICAL SOCIETY; Statler Hotel, Detroit, Mich., Oct. 1-5.

RADIO INTERFERENCE, Suppression of, International Comm., CISPR, ASA, PGRFI of IRE; Univ. of Pa., Philadelphia, Oct. 1-6.

ENGINEERING EDUCATION, Engineers Council for Prof. Devel.; Sheraton Hotel, Louisville, Kentucky, Oct. 2-3.

COMMUNICATIONS SYMPOSIUM, PGCS of IRE; Utica, N. Y., Oct. 2-4.

IRE CANADIAN CONVENTION, Region 8; Automotive Bldg., Exhibition Park, Toronto, Canada, Oct. 2-4.

MOTION PICTURE AND TELEVISION Engineers, Society of, SMPTE; Lake Placid Club, Essex County, N. Y., Oct. 2-6.

ASTRONAUTICAL CONGRESS, International, IAE, ARS; Washington, D. C., Oct. 2-7.

COMPUTER EXHIBITION & Symposium, British, Electronic Engineering Assoc., Office Appliance Trades; National Hall, Olympia, London, Oct. 3-12.

BROADCAST SYMPOSIUM, PGB of IRE; Willard Hotel, Wash., D. C., Oct. 6-7.

NATIONAL ELECTRONICS CONF., IRE, AIEE, EIA, SMPTE; Int. Amphitheatre, Chicago, Oct. 9-11.

AUDIO ENGINEERING SOCIETY, Convention and Exhibit; Hotel New Yorker, New York City, Oct. 9-13.

PRINTED CIRCUITS, Institute of, Annual; Sheraton-Chicago Hotel, Chicago, Oct. 10-11.

STANDARDS, National Conf. on, ASA; Rice Hotel, Houston, Texas, Oct. 10-12.

DIGITAL COMPUTERS, Application to Automated Instructions, ONR, Systems Devel. Corp.; Dept. of Interior Auditorium, C. Street, Wash., D. C., Oct. 11-13.

WRITING & SPEECH, Engineering, PGEWS of IRE; Kellogg Center, Michigan State Univ., East Lansing, Mich., Oct. 16-17.

RADIO FALL MEETING, EIA, IRE; Hotel Syracuse, Syracuse, N. Y., Oct. 30-Nov. 1.

AEROSPACE Electrical Society, Pan Pacific Auditorium, Los Angeles, Nov. 15-17.

NEREM, Northeast Research & Engineering Meeting, Commonwealth Armory and Somerset Hotel, Boston, Mass., Nov. 14-16.

IRE INTERNATIONAL CONVENTION, Coliseum & Waldorf Astoria Hotel, New York City, Mar. 26-29, 1962.

Now you can standardize and really cut costs with **Amperex[®]** **P·A·D·T** Industrial and Entertainment Transistors

Now in full production in our Slatersville, Rhode Island semiconductor plant, the 2N2084 is available in quantity from these and other leading industrial electronic distributors.

CALIFORNIA

R. V. WEATHERFORD COMPANY
Glendale 1, Calif.
BRILL SEMICONDUCTOR CORP.
Oakland 6, Calif.
ELMAR ELECTRONICS INC.
Oakland 7, Calif.

COLORADO

INTERSTATE RADIO & SUPPLY
Denver 4, Colorado

CONNECTICUT

RADIO SHACK CORP.
Stamford, Conn.
W. Hartford, Conn.
New Haven 10, Conn.

DISTRICT OF COLUMBIA

ELECTRONIC WHOLESALERS, INC.
Washington 1, D. C.

FLORIDA

THUROW ELECTRONICS, INC:
Cocoa, Fla. • Jacksonville, Fla.
Miami, Fla. • Orlando, Fla.
Pensacola, Fla. • Tampa, Fla.

ILLINOIS

NEWARK ELECTRONICS CORP.
Chicago, Ill.

INDIANA

RADIO DISTRIBUTING COMPANY
Indianapolis 6, Indiana

MASSACHUSETTS

RADIO SHACK CORP.
Boston, Mass.

MICHIGAN

RADIO SPECIALTIES COMPANY
Detroit, Michigan

MISSOURI

INTERSTATE INDUSTRIAL ELECTRONICS
St. Louis 32, Missouri

NEW YORK

MILO ELECTRONICS
New York, N. Y.
ROME ELECTRONICS
Rome, N. Y.

OREGON

UNITED RADIO SUPPLY, INC.
Portland 9, Oregon

PENNSYLVANIA

RADIO ELECTRIC SERVICE CO.
Philadelphia, Pa.

TEXAS

ADELETA COMPANY
Dallas 1, Texas
Fort Worth, Texas



PARAMETRIC AMPLIFIERS

with exceptional stability

Shown is Model X-316, a typical Melabs high-stability L-band parametric amplifier. The many exclusive features of this Melabs amplifier are the result of several years of experience in the design of parametric amplifiers and up-converters for operation at frequencies as high as 35 Gc. Melabs is also a major supplier of circulators, an important component in this type of equipment.

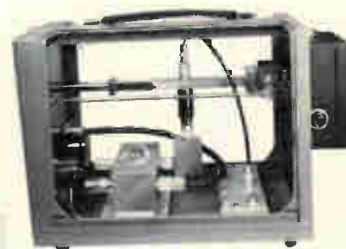

FEATURES

Radar Noise Figure (single channel) 2 db Operating Bandwidth ... 1150-1350 Mc
 Bandwidth 10 Mc Gain 20 db

EXCEPTIONAL STABILITY BY—

Highly regulated, well filtered klystron power supply • Temperature controlled klystron environment • Custom designed Melabs' 4-port circulator and iso-attenuator

SIMPLE TUNING—

Single knob frequency control
 Single knob gain control
 Bias adjust for optimum noise figure

COMPLETE DATA AND SPECIFICATIONS FURNISHED ON REQUEST ...



LOW NOISE TWT AMPLIFIERS

The RP Series of TWT amplifiers covering a frequency range of 500 Mc to 18 Gc in six units, is widely used for preamplifiers associated with high sensitivity receiving systems. Units can be packaged for laboratory or military specifications. Typical Specifications (Model RPL-1): Frequency

range, 1-2 Gc; Gain, 20 db; Noise Figure, 6.0 db. Options include Melabs' RF filters for input and output to minimize possibility of out-of-band interference and a special IAGC circuit which eliminates intermodulation distortion. Complete details on request.

UNIVERSAL BEACON TRANSMITTER

The TR0-1 is a medium power transmitter capable of producing 500 to 2000 watt pulses within the 1-6 Gc range. Individual plug-in triode oscillator units are available for most bands. Pulse width is adjustable between 0.7 and 1.0 microseconds. Transmitter is keyed by external synch pulse.



Employment opportunities at Melabs are exceptional for ambitious engineers and physicists; write in confidence.



3300 HILLVIEW AVENUE / STANFORD INDUSTRIAL PARK / PALO ALTO, CALIFORNIA

TELEPHONE: DA 6-9500, AREA CODE: 415; TWX: PAL AL 138

Dept. B-4

electronics

FILTORS, INC./RELAYS

PORT WASHINGTON, NEW YORK
POrt Washington 7-8220, area code 516

In Canada: Filtors Division: Marsland Engineering Co., 154 Victoria St., Kitchener, Ont.

FILTORS' NEW ANTI-ARC SWITCHING CIRCUIT prevents catastrophic relay failures in microminiature relays due to contact-to-case transient discharges. Although the crystal-case-size relay you are now using may have contacts rated for 2 amperes at 115 volts ac, this relay will suffer a catastrophic relay failure within 2000 operations if it is used to switch this load with a grounded relay case. There is only one relay configuration available today that can switch more than half an ampere at 115 volts, 60 cycles...it is the Pillbox Relay configuration...exclusive with Filtors, Inc.

Filtors' Pillbox relays are designed to switch 16 times more power at 115 volts, 60 cycles, than any other microminiature relay.

Documentation, describing the nature of the phenomenon of discharge transients in grounded-case relays, is available from your Filtors' sales representative, or it may be obtained by circling the number given below on the inquiry card.



DANGER DISCHARGE TRANSIENTS

CIRCLE 43 ON READER
SERVICE CARD

Before you order . . . check NYLO-FAST® FASTENERS!

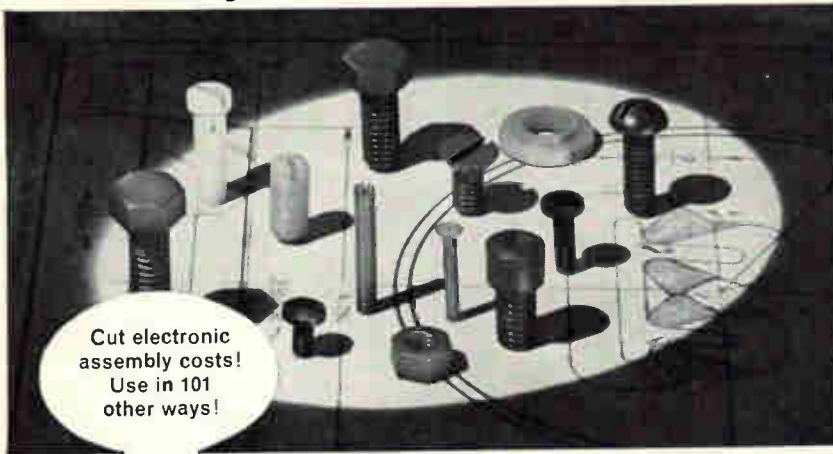

Cut electronic assembly costs!
Use in 101 other ways!

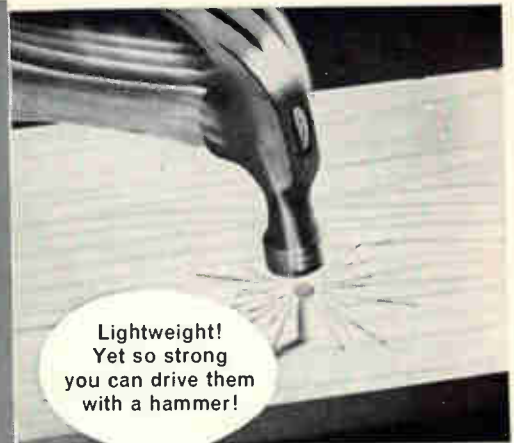

Lightweight!
Yet so strong
you can drive them
with a hammer!

Have you investigated what NYLO-FAST® Fasteners can do for you? They're colorful, strong — yet 1/6 the weight, chemical resistant, heat resistant, elastic, resilient, and non-conducting! You'll be surprised to discover how many ways NYLO-FAST® Fasteners can serve you—BETTER! Write for complete information.

Immediate delivery from our large stocks which include Nylon, Delrin, Teflon, P.V.C., Lexan, etc. 10 different formulations! Write, wire, or telephone today for the facts!

LEADING MANUFACTURERS OF STAINLESS STEEL AND NYLON FASTENERS!



Anti-Corrosive

METAL PRODUCTS COMPANY, Inc.

CASTLETON-ON-HUDSON 10, NEW YORK

CIRCLE 202 ON READER SERVICE CARD



BLOCK VACUUM VALVES

BELLOWS SEALED

Maximum Flow . . .
Minimum Space . . . Low Cost

NRC Equipment Corp.'s block valves assure you:

- Porosity-free body . . . machined from sulphur-free solid brass.
- Freedom from stem leakage . . . positive bellows seal.
- Full opening . . . sizes from 1/4" to 1 1/2".
- Easy mounting . . . available in angle or in-line types — for soldered or screwed connections.
- Low-cost maintenance . . . bellows removable without removing valve from line.
- Neoprene disc gasket . . . teflon, viton or other materials available on request.

Write for data sheet on NRC Block Valves.

160 Charlemont Street, Dept. 26F
Newton 61, Massachusetts
DEcatur 2-5800

A Subsidiary of National Research Corporation



SPECIALIZED CHEMICALS

NOW AVAILABLE FOR THE SEMICONDUCTOR INDUSTRY

To meet the exacting needs of the electronics field, Fidelity now offers the products and services of a new Electronic Chemicals Division.

Special purpose chemicals for descaling and bright dipping transistor headers . . . for cleaning and bright dipping Dumet wire with no undercutting . . . for salvaging encapsulated epoxy components . . . these and other electronic chemicals are ready to speed up your production.

For information on special formulations in descalers, bright dips and cleaners, write Fidelity direct. Our technical staff is ready for consultation on individual problems, with no obligation on your part.

FIDELITY CHEMICAL PRODUCTS CORP.

Electronic Chemicals Division

470-472 Frelinghuysen Ave., Newark 14, N. J.

A SIGNIFICANT BREAK-THROUGH IN TRANSISTOR TECHNOLOGY...

ECDC*

ELECTRO-

CHEMICAL

DIFFUSED

COLLECTOR

The Best High-Power, High-Speed Switching Transistors Ever Developed Provide the Optimum Combination of Voltage, Power, and Speed

The Sprague ECDC Transistor is the first to combine the optimum features of the electro-chemical precision-etch techniques and diffused collector techniques in one highly-mechanized process.

The ECDC Transistor meets these 7 conditions for an "ideal" transistor:

1. Very low collector-to-case thermal resistance through the utilization of high thermal conductivity material as the collector body, resulting in high power dissipation.
2. Thin base width for high radiation resistance and lower storage time.
3. Precision-etched emitter pit permits placement of emitter junction at proper resistivity for optimum breakdown voltage and frequency response.
4. High conductivity surface surrounds emitter pit and close emitter-to-base spacing results in extremely low base resistance.
5. Precision-etched collector provides optimum control of collector series resistance with attendant low saturation voltage, low storage time, and high breakdown voltage.
6. Low collector series resistance as a result of the use of high conductivity material for the mass of the collector area.
7. The structure and manufacturing processes are suited for automated production equipment with immediate in-process feedback.



TYPES 2N2099 & 2N2100

These P-N-P Germanium Electro-Chemical, Diffused-Collector Transistors are especially designed for high current core driver applications. They feature excellent beta linearity from less than 1 ma to over 400 ma, high frequency response, and low saturation resistance. The low-height TO-9 case is ideally suited to meet equipment designers' needs.



TYPES 2N2096 & 2N2097

Types 2N2096 and 2N2097 are electrically identical to Types 2N2099 and 2N2100, respectively, except for their TO-31 Case, with its threaded stud mounting.

For complete information on ECDC Transistors, write Product Marketing Section, Transistor Division, Sprague Electric Company, Concord, New Hampshire.

SPRAGUE COMPONENTS

TRANSISTORS
CAPACITORS
MAGNETIC COMPONENTS
RESISTORS

INTERFERENCE FILTERS
PULSE TRANSFORMERS
PIEZOELECTRIC CERAMICS
PULSE-FORMING NETWORKS

HIGH TEMPERATURE MAGNET WIRE
CERAMIC-BASE PRINTED NETWORKS
PACKAGED COMPONENT ASSEMBLIES
FUNCTIONAL DIGITAL CIRCUITS

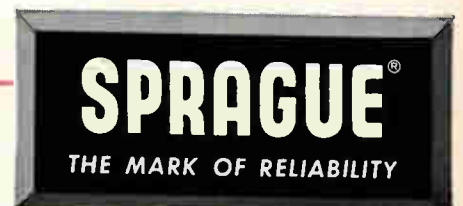

'Sprague' and '®' are registered trademarks of the Sprague Electric Co.

For protection of value

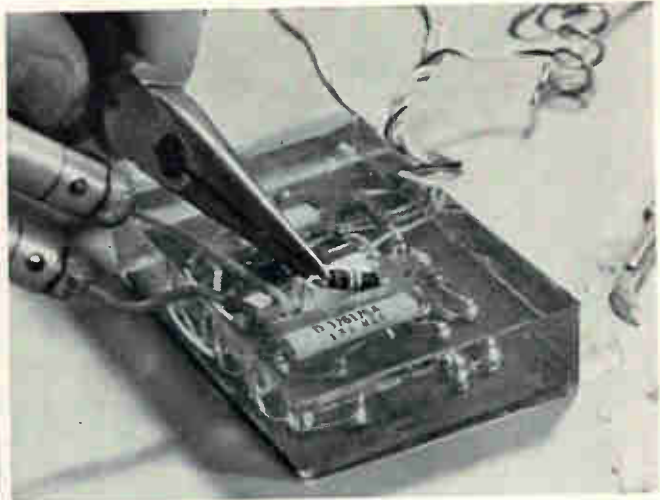

New casting resin - Sylgard® 182 - is tough, flexible and repairable

Visual inspection . . . environmental protection . . . ease of processing . . . simplicity of repairs — these and other features make Sylgard 182 an important new tool when engineering for value.

Tough yet flexible, this solventless silicone casting resin cushions against shock and vibration from -70 to 225 C . . . assures constant dielectric strength in any environment . . . resists the effects of ozone, voltage stress, heat aging and thermal cycling.

Processing is simplified since Sylgard 182 and its curing agent are not toxic to the skin . . . nor do they give off toxic fumes or heat during blending or curing. Curing time can be controlled by the external heat applied — from as little as 15 minutes at 225 C to 72 hours at 25 C.

Deep sections cure thoroughly. There are no solvent fumes to be trapped . . . and visibility is excellent. Applied as a fluid, Sylgard 182 resin flows readily around intricate shapes . . . cures even in deep sections without damage from internal stresses or exothermic heating.

Repairability is assured when circuits are embedded in Sylgard 182. Defective components can be removed and replaced after cutting away the cured resin with a sharp knife. New resin, poured over the repaired area, adheres to the existing encapsulant restoring the entire unit to its original condition.

CIRCLE 289 ON READER SERVICE CARD

Dow Corning is your best source for a broad line of silicone fluids, gels, elastomers and rigid forms for potting, filling, embedding and encapsulating.



Dow Corning

-- specify these silicones

Visually inspect... instrument check and replace faulty parts with ease

Dielectric Gel permits both visual and instrument inspection of potted circuits and components. Poured as a liquid, Dielectric Gel fills all voids, then sets up as a transparent, heat-stable, resilient mass. No significant stresses or exothermic heating develops during cure. Even the most delicate electronic components are safe. Instrument probes can be inserted and withdrawn repeatedly without damaging the outstanding dielectric properties of this Dow Corning silicone potting material.

Circuit Repair is easy to accomplish. Simply cut away the gel surrounding a defective component with knife or scissors. After the circuit is repaired, simply pour new gel into the repaired area to restore original high quality protection.

CIRCLE 290 ON READER SERVICE CARD



Deep section... rugged protection with repairable Silastic® RTV

Silastic RTV, Dow Corning's fluid silicone rubber that vulcanizes at room temperature, is available in several variations. Select the best one suited for your application or processing requirements. All have excellent dielectric properties, low water absorption, stability under extreme temperatures, resistance to thermal cycling and aging. The newest Silastic RTV cures in thick sections in 24 hours at 77 F. Variations in thickness have no significant effect on curing rate or material uniformity.

Vulcanized Patch. Defective parts embedded or encapsulated in Silastic RTV... even where thick sections are used... can be replaced. The cured Silastic RTV is cut away with a knife, the component replaced, and new Silastic RTV applied to the repair area. The fresh material bonds to the original, restoring the encapsulant's integrity.

CIRCLE 291 ON READER SERVICE CARD

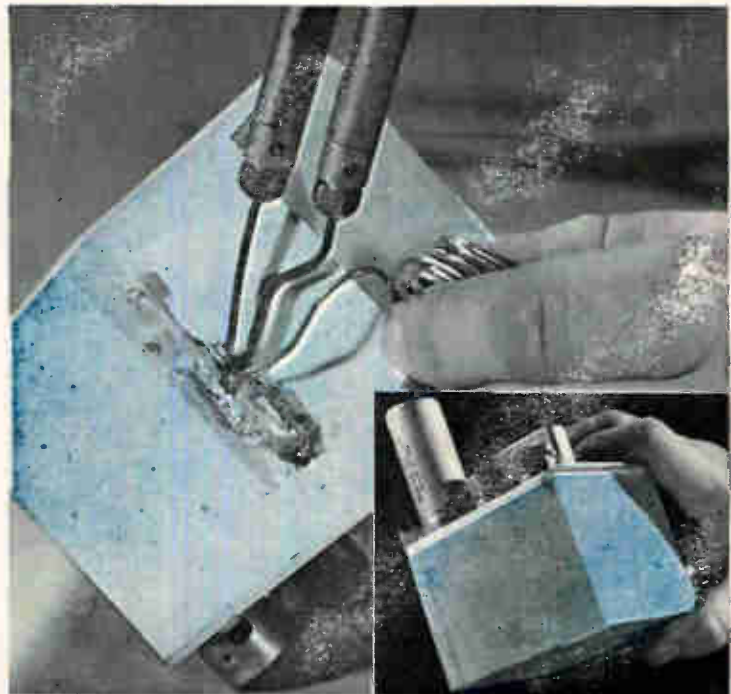

Free 12-page manual, "Silicones for the Electronic Engineer".
Write Dept. 4221, Dow Corning Corporation, Midland, Michigan.



Available in 7 JEDEC types.
Shown above, 2N681 Transistor is enlarged 6 times.

Westinghouse announces new 16-amp "Rock-Top" Trinistor[®] controlled rectifier

Proven "Rock-Top" quality is now available in JEDEC 2N681 Trinistor Controlled Rectifier series! These latest additions to the Westinghouse power semiconductor family incorporate the field-proven design features of the broadest line of medium and high-power switching devices. Such features as hard-soldered junctions and hermetically welded cases provide an extra assurance of reliability at no extra cost. Additionally, each device is 100% tested to maximum ratings. These new devices from Westinghouse, world leader in silicon technology, are backed by production experience with high-power semiconductors for military and industrial applications.

Westinghouse 2N681 series Trinistors are ideal for such applications as: motor speed control ■ temperature control ■ inverters ■ static switching. For more information, or technical assistance, call or write: Westinghouse Electric Corporation, Semiconductor Dept., Youngwood, Penna. *You can be sure... if it's Westinghouse.*

SC-1049

For prompt delivery, order from these Westinghouse distributors:

EASTERN		HALLMARK INSTRUMENTS CORP. Dallas, Texas/RI 7-8933	
ACK SEMICONDUCTOR INC.	Birmingham 5, Ala./FA 2-0588	INTER-STATE RADIO & SUPPLY CO.	Denver 4, Colo./TA 5-8257
CAMERADIO	Pittsburgh, Pa./EX 1-4000	LENERT CO.	Houston, Texas/CA 4-2663
CRAMER ELECTRONICS, INC.	Boston, Mass./CO 7-4700	MIDLAND SPECIALTY CO.	El Paso, Texas/KE 3-9555
ELECTRONIC WHOLESALERS, INC.	Melbourne, Florida/PA 3-1441		Phoenix, Ariz./AL 8-8254
GENERAL RADIO SUPPLY CO., INC.	Camden, N. J./WO 4-8560	RADIO DISTRIB. CO.	Albuquerque, N. M./CH 7-0236
GENESEE RADIO PARTS CO., INC.	Buffalo, N. Y./TR 3-9561	SEMICONDUCTOR SPEC. INC.	Indianapolis, Ind./ME 7-5571
KANN-ELLERT ELECTRONICS, INC.	Baltimore, Md./TU 9-4242	S. STERLING CO.	Chicago, Ill./NA 2-8860
MILGRAY ELECTRONICS	New York, N. Y./RE 2-4400	UNITED RADIO, INC.	Detroit, Mich./BR 3-2900
RADIO & ELECTRONIC PARTS CORP.	Cleveland, Ohio/UT 1-6060		Cincinnati, Ohio/MA 1-6530
SCHWEBER ELECTRONICS	Long Island, N. Y./PI 6-6520		
	Silver Spring, Md./JU 5-7023		
MIDWESTERN		WESTERN	
E.C.I. SEMICONDUCTORS, INC.	Kansas City, Mo./WE 1-0829	ALMAC ELECTRONICS CORP.	Seattle, Wash./PA 3-7310
ELECTRONIC COMPONENTS FOR INDUSTRY CO.	St. Louis, Mo./WO 2-9916	ELMAR ELECTRONICS	Oakland, Cal./TE 4-3311
		HAMILTON ELECTRO SLS.	Los Angeles, Cal./BR 2-9154
		NEWARK ELECTRONICS CO.	Palo Alto, Cal./DA 1-7541
			Inglewood, Cal./OR 4-8440

Westinghouse

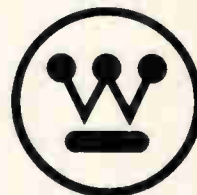

AUTOMATION...in RFI MEASUREMENT

(Radio Frequency Interference)

Autoscan with the

STODDART NM-62A

(AN/URM-138)

The Stoddart NM-62A with AUTOSCAN cuts your measurement time. The operator can analyze and correlate data while the NM-62A automatically scans frequency range of 1 to 10 gc. Additional information, such as the amplitude, visual and aural characteristics of the signal can also be **simultaneously recorded**.

The NM-62A is the **ONLY** RFI Measuring Equipment operating within the 1 to 10 gc range, designed under contract to the Bureau of Ships, to meet the **approval and requirements of ALL government services and industry**.

For completely Automatic Spectrum Signatures, the NM-62A incorporates:

- **X-Y OUTPUT** — for accurate recording of amplitude vs frequency of incoming signals
- **AUTOSCAN** (Automatic Frequency Scanning) over the entire range 1 to 10 gc with variable speed forward/reverse motor drive system
- **AUTOMATIC BANDSWITCHING** — 1 knob changes output, input and voltage connections with **NO TUNING HEADS** to change

OPERATING SPECIFICATIONS INCLUDE:

Sensitivity:	2 to 4 microvolts with 500 kc bandwidth; 6 to 12 microvolts with 5 mc bandwidth
Bandwidths:	500 kc; 5 mc
VSWR:	1.5 to 1 with 50 ohms input impedance
Oscillator Radiation:	18 micromicrowatts
Case Shielding:	90 db
Outputs:	Remote Meter, Headphones, Video, 60 mc IF, Recorder, FM and, of course, X-Y Output

FOR SALE NOW

Send for complete information

STODDART

AIRCRAFT RADIO CO., INC.
LEADER IN RFI CONTROL
6644 Santa Monica Blvd. • Hollywood 38, California
HOLLYWOOD 4-9292

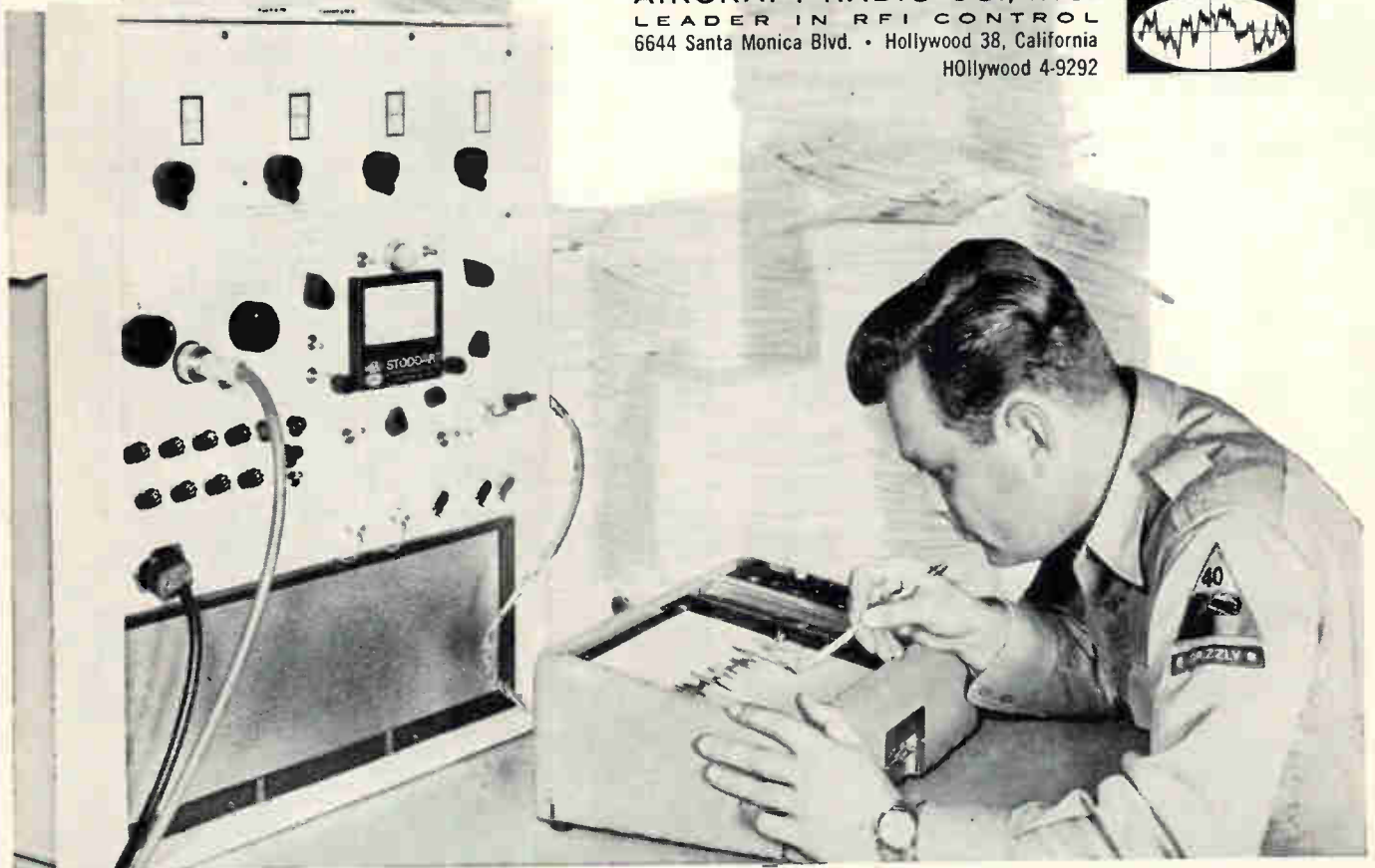
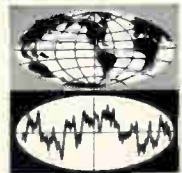

2

NEW PRODUCT ADVANCES FROM Transitron

ACTUAL SIZE



TMD-914 and TMD-916 DIFFUSED SILICON MICRODIODES MICRO-EQUIVALENTS of the 1N914 and 1N916

Duplicating the specifications of the popular 1N914 and 1N916, these microminiature very fast switching silicon diodes offer low capacitance and are designed for use in extremely high speed transistorized computer circuitry. Their durable construction in an all-glass package features TRUE hermetic sealing and a unit capable of providing long-term reliability under extreme environmental conditions.

Recovery time: 0.004 micro-second.

SPECIFICATIONS AT 25°C

	TMD-914	TMD-916
Maximum Forward Voltage at 10mA	1 Volt	1 Volt
Maximum Inverse Current at 20V	.025 μ A	.025 μ A
Minimum Inverse Voltage at 100 μ A	100 Volts	100 Volts
Maximum Capacitance at 0 Volts	4 μ F	2 μ F

For further information, write for Bulletin PB-71C. **CIRCLE 258 ON READER SERVICE CARD**

6.3 VOLT CERTIFIED SILICON VOLTAGE REFERENCES

Now, for the first time in the industry, silicon voltage references that have exhibited voltage stabilities as low as $\pm 0.002\%$ for 1000 hours are being CERTIFIED and offered by Transitron. These significant features are associated with each unit:

- Actual readings recorded periodically over 1000 hours included with each certification document.
- Serialization of units for convenient reference to their production and life test histories at Transitron.

Manufacturers of missiles and precision instruments who require a stable voltage reference of small size and weight may look to Transitron for these references which are certified at point of purchase.

Type	Certified* Voltage Stability (%)	Voltage Range at $I_z = 7.5\text{mA}$ at 25°C (Volts)		Temperature Stability Maximum Voltage Change (+25°C to +100°C) at $I_z = 7.5\text{mA}$ (Volts)	Maximum Dynamic Resistance at $I_z = 7.5\text{mA}$ at 25°C (Ohms)
		Min.	Max.		
1N3501	± 0.01	6.2	6.5	± 0.006	12
1N3502	± 0.01	6.2	6.5	± 0.003	12
1N3503	± 0.005	6.2	6.5	± 0.006	12
1N3504	± 0.002	6.2	6.5	± 0.006	12

*Voltage References certified for voltage stability observed during 1000 hours operation.

For further information, write for Bulletin TE-1352F-1.

CIRCLE 259 ON READER SERVICE CARD

ACTUAL SIZE



Transitron



electronic corporation
wakefield, melrose, boston, mass.

SALES OFFICES IN PRINCIPAL CITIES THROUGHOUT THE U.S.A. AND EUROPE • CABLE ADDRESS: TRELCO

For quantities 1-999 call your nearest Transitron Industrial Distributor.

NEW GENERAL ELECTRIC
"PENLINE-120"
SOLDERING IRON

Now you can get all the *electronic industry proved* features of General Electric's 6-volt Midget iron, plus the convenience of 120-volt design. "Penline-120" irons are available in 30- and 50-watt ratings.

Check these features:

LOW COST. G-E "Penline-120" irons are competitively priced.

LOW OPERATING COST—due to longer tip and heater life and low-cost replacement.

HIGHEST OPERATING EFFICIENCY. Calrod® heater built right in the tip assures fastest heatup and tip temperature recovery, rapid void-free solder connections.

OPERATOR COMFORT ASSURED. G-E Lexan® plastic handle is shaped to fit the hand. It stays cool during full shift operation.

PEN-LIKE SHAPE EASY TO MANEUVER—important for miniaturization designs. Solder in congested areas with little danger of damage to adjacent joints and wiring.

GET ALL THE FACTS on General Electric's complete line of proved industrial soldering irons from your local G-E sales office or authorized distributor. Or write Section 758-05, General Electric Co., Schenectady 5, N. Y.

ACTUAL SIZE

Progress Is Our Most Important Product

GENERAL  ELECTRIC



where stability
and miniaturization
are primary



SEMICONDUCTORS
COPPER OXIDE
AND SELENIUM

INSTRUMENT RECTIFIERS
RING MODULATORS
HIGH-VOLTAGE RECTIFIERS
VOLTAGE REGULATORS
SWITCHED RECTIFIERS
CHOPPERS

SPECIAL PURPOSE UNITS
LIST PRICES FROM .42c

5 COPPER OXIDE CELL STYLES FROM .080" to .500" DIA. ACTIVE AREAS .0012 to .125 SQ. IN.

SELENIUM CELL SIZES FROM .080" round TO 2" SQUARE. .020" TO .045" THICK.

Write for
Free Bulletins
Dept. 20

CONANT LABORATORIES
LINCOLN, NEBRASKA

CIRCLE 204 ON READER SERVICE CARD

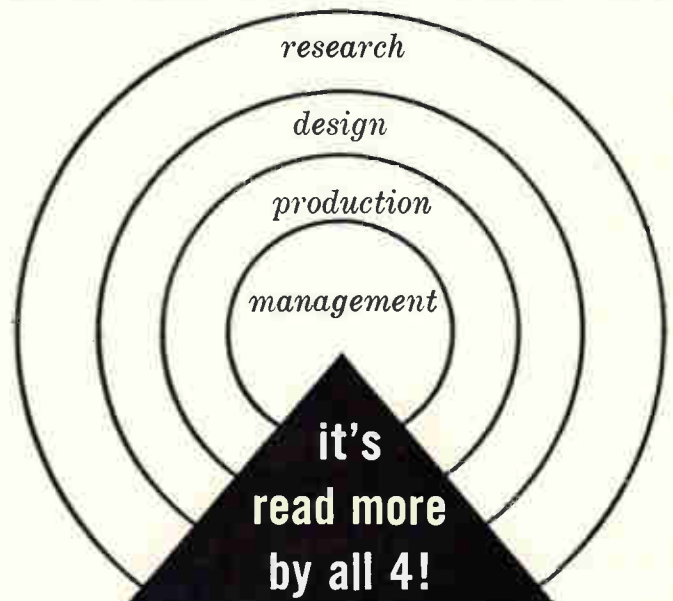

Get the technical facts in *electronics*, the magazine that features the latest engineering developments and technically interprets markets, business statistics, trends. Special issues on Electronic Markets and other reports you'll want to file and keep. Mail the reader service card (postpaid) and start your own subscription to *electronics*, the magazine that helps you to know and therefore to grow! Rates: three years for \$12, one year for \$6; Canadian, one year for \$10; foreign, one year for \$20. Annual *electronics* BUYERS' GUIDE (single issue price \$3) included with every subscription.

subscribe today to **electronics**



MODEL 0-28



MODEL 0-18

Shown Actual Size



MODEL 0-20

DORSETT'S 3 NEW SILICON SOLID STATE SUBCARRIER OSCILLATORS FOR FM TELEMETRY

To meet increased demand for a wide range of subcarrier oscillator configurations Dorsett Electronics now offers its extremely reliable solid state subcarrier oscillator in three new package forms.

Dorsett's three new configurations provide the systems engineers with unmatched mechanical flexibility in telemetry system design, without sacrificing component reliability and stability.

These new subcarrier oscillators are only a few of the many state of the art telemetry components currently in production at Dorsett Electronics. Put Dorsett's experience to work for you on your next telemetry requirement. Your inquiries and specifications will receive a prompt reply.

SPECIFICATIONS

Input:	0 to 5 volts, or ± 2.5 volts to ± 2.5 volts.
Output:	Adjustable from 0 to .5 volts RMS into 8K load impedance. Fixed output at least 3 volts RMS into 100K or higher load impedance.
Power Requirements:	28 volts DC at 10 milliamperes.
Linearity:	Deviation from the best straight line less than .25%.
Distortion:	Less than .75% harmonic distortion.
Amplitude Modulation:	Less than 1db across the band.
Input Impedance:	500K for Channels 1 through 18. 250K for Channels A through E.
Electrical Stability:	No more than $\pm .5\%$ FBW change in center frequency or deviation sensitivity for a supply voltage change of $\pm 10\%$.
Temperature Stability:	Less than 2% FBW change in center frequency or band-width for a 50°C change within the range of -55°C to $+100^\circ\text{C}$.
Acceleration:	100G Linear
Vibration:	20G, 55 to 100 cps
Shock:	100G for 11 milliseconds
Altitude:	Unlimited
Size:	0-18 1.75 in. x 1.36 in. x .76 in. 0-20 2.25 in. x 1.88 in. x .88 in. 0-28 1.27 in. x 1.25 in. x 1.25 in.
Connector:	Cannon DE-9P.
Controls:	Output, Centering, Deviation Sensitivity



DORSETT ELECTRONICS, INC.

P. O. BOX 862 • NORMAN, OKLAHOMA • JEFFERSON 4-3750

NEW TYPE VARACTOR DIODES

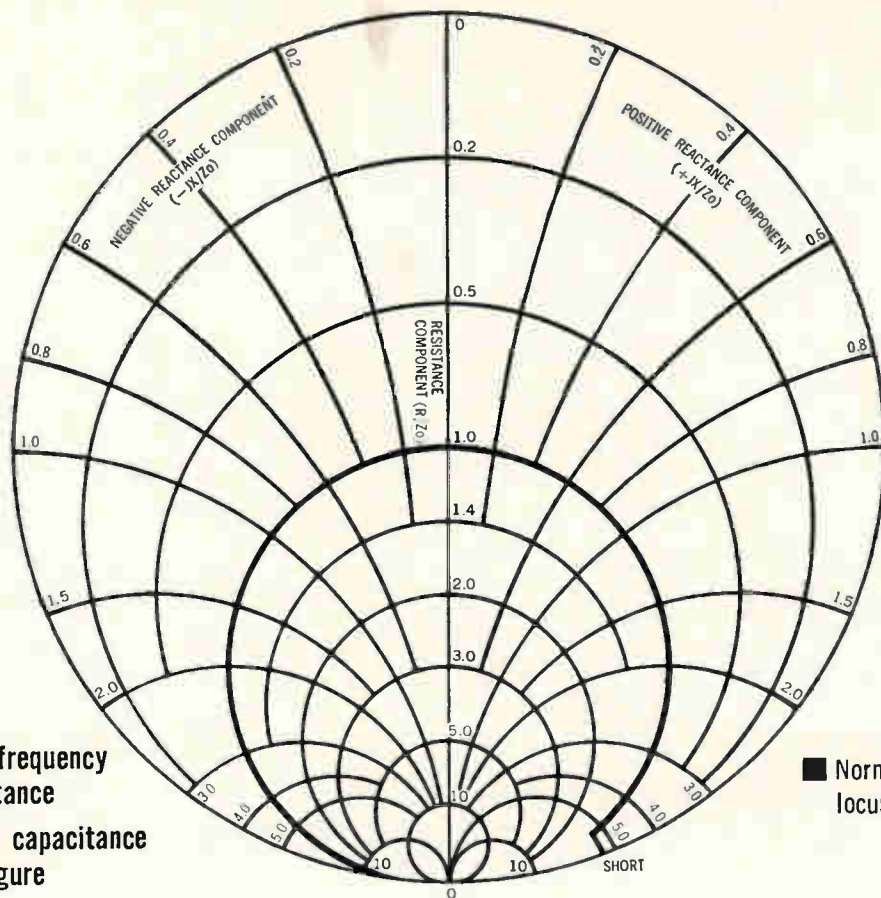

with high cutoff frequency
high conductance
low junction capacitance
low noise figure

Normalized impedance locus of GSB1 at 6 kMc

A series of silver bonded diodes, developed by Mr. Shoichi Kita at the NTT Laboratory, is now in commercial production at NEC. The Kita Diode is a bonded contact type using a silver whisker with a small gallium content.

Advantages over other varactor diodes include low junction capacitance with high cutoff frequency, resulting in low pumping power. Junction capacitance of GSB1A, for example, is rated at .30 $\mu\mu\text{f}$ max.

These new diodes are designed for use in parametric amplifiers, frequency multipliers, high-power upconverters (GSB2), amplitude limiters, microwave harmonic generators, ultra-fast switching, and microwave switches.

Other features common to all types: Stability of reverse current in 2,000-hour tests measures $\pm 5\%$ ($T_{stg} = 90^\circ\text{C}$). Hermetic glass-to-metal seal. MIL dimensions. Reversible polarity with detachable base adapter.

Immediate shipment in commercial quantities is now possible—and at prices well below those of comparable diodes. Please write for details.

Electrical Characteristics

Type	GSB1A	GSB1B	GSB2
Forward current at 1V (min) (mA)	100	100	70
Inverse current at -1V (max) (μA)	1.5	1.0	1.0
Breakdown Voltage at -50 μA (min) (V)	6.0	6.0	11.0
Junction capacitance at zero bias ($\mu\mu\text{F}$)	.30 (max)	.25 (max)	.30 (typical)
Cutoff frequency * (kMc)	60 (min)	100 (min)	40 (typical)

* f_c is calculated from Q measurement at $V_b = -5\text{V}$ at 6 kMc, $f_c = f \cdot Q$

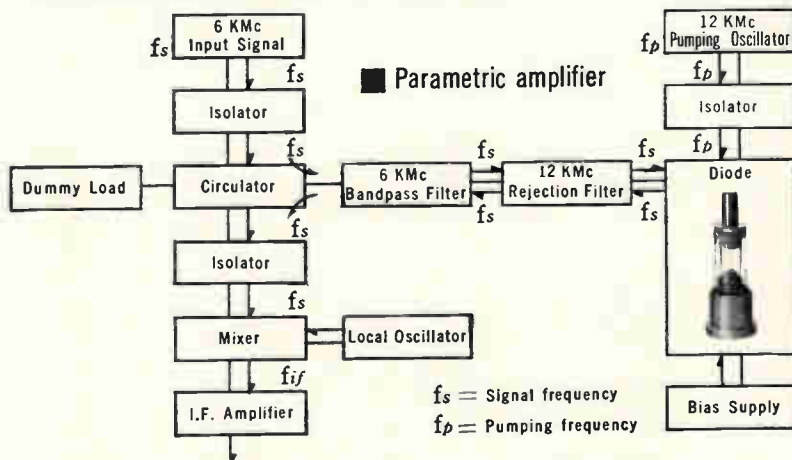

Typical GSB1 application data for parametric amplifier, 25°C.
Signal frequency... 6 kMc Amplifier gain... 18 db Pumping power... 5 mw
Pumping frequency... 12 kMc Noise figure... 2.5 db (double sideband)



Centralab[®]

introduces

four styles of

HOT MOLDED CARBON POTENTIOMETERS

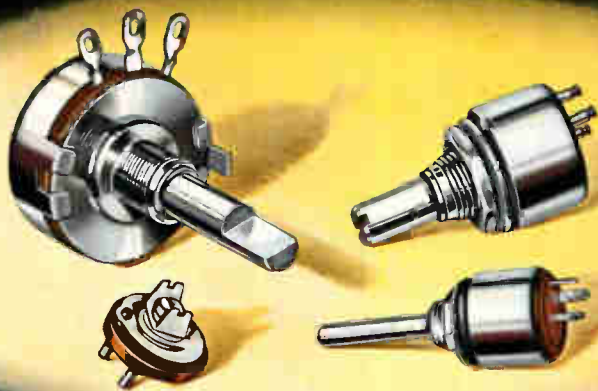

For smooth, noise-free operation and high stability . . . The widest selection anywhere . . . Designed to meet **MIL-R-9** environmental and test requirements

In addition to the smooth, noise-free operation and high reliability for which hot molded potentiometers are well known . . . each model in this series incorporates many features that result in even greater reliability than was previously available. . .

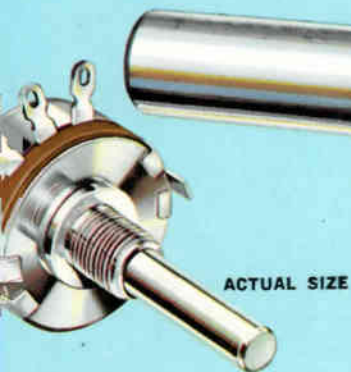

CENTRALAB MODEL A

Three ways better than other hot molded units

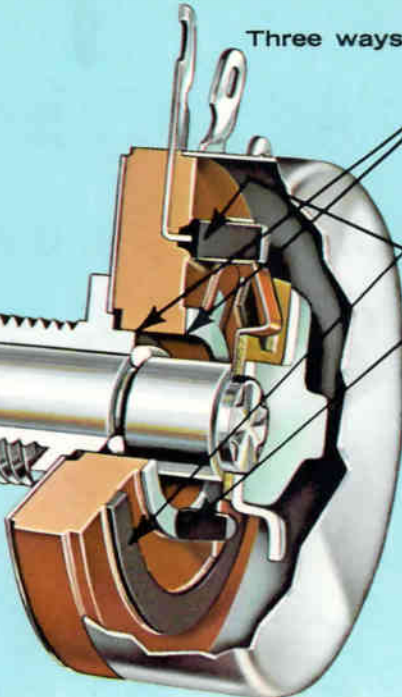

1. Greatly increased high voltage capability, due to the wide clearance between the bushing and the collector track.
2. Greater freedom from contamination of dirt, carbon particles and sealing compounds, due to the elevated resistance track construction.
3. Exceptionally long noise free operation that actually improves with use, provided by the carbon composition material of which both the collector and pick-off brushes are constructed.

SPECIFICATIONS:

RATING: 2 watts at 70° C.
SIZE: 1-3/32" diameter, 37/64" deep from mounting surface.
CONSTRUCTION: Completely enclosed. metallic parts are non-magnetic and corrosion resistant. Available in tangent triple or dual concentric construction.
ROTATION: 312° ±3°.
TORQUE: 1.0 to 6.0 ounce inches
RESISTANCES: Linear taper, 50 ohms to 5 MEG. Log taper, 100 ohms to 2.5 MEG.

MODEL N



This intermediate size potentiometer has never before been offered. Rated at 3/4 watt, the Model "N" can replace 2 watt units in many military and commercial applications where size is important.

A flush resistance track is protected against contamination by the raised rim of the insulating base. Although small in size, the model "N" also has carbon composition pick up and collector brushes for long, noise-free operation.

The one-piece metal case and bushing is spun over the molded insulating base to provide a near-perfect seal. Triple shaft seals and water-tight panel seals can be supplied.

SPECIFICATIONS:

RATING: 3/4 watt at 70° C.
SIZE: 23/32" diameter, 1/2" deep from mounting surface.
CONSTRUCTION: Completely enclosed. metallic parts are non-magnetic and corrosion resistant.
ROTATION: 300° ±3°
TORQUE: 5.0 ounce inches average.
RESISTANCES: Linear taper, 50 ohms to 5 MEG. Log taper, 100 ohms to 2.5 MEG.

MODEL P (RV6 Style)



Although much smaller than the Model "N", the Model "P" is rated at 1/2 watt and is similar in external construction.

The resistance track is hot molded, flush type. An outstanding feature of the Model "P" is the single carbon brush that serves both collector and pick-off purposes. The one-piece aluminum case is spun over the insulating base to provide a near-perfect seal.

This unit meets all applicable military requirements.

SPECIFICATIONS:

RATING: 1/2 watt at 70° C.
SIZE: 1/2" diameter, 15/32" deep from mounting surface.
CONSTRUCTION: Completely enclosed.
ROTATION: 290° ±3°.
TORQUE: 1.5 ounce inches.
RESISTANCES: Linear taper, 100 ohms to 5 MEG. Log taper, 500 ohms to 2.5 MEG.

MODEL T



This unique trimmer resistor, or locking-type trimmer potentiometer, is the only hot molded, single turn unit available on today's market. Rated at 1/3 watt, it has been designed primarily for printed-circuit board applications.

The Model "T" has a positive screw actuated lock and is extremely resistant to shock, vibration and acceleration.

These units can be encapsulated in a rigid resin without damage.

SPECIFICATIONS:

RATING: 1/3 watt at 70° C.
SIZE: 19/32" diameter, 11/32" deep from mounting surface.
CONSTRUCTION: Open (however, rugged construction permits potting of all types).
ROTATION: 300° ±3°.
TORQUE: Locking type.
RESISTANCES: Linear taper, 500 ohms to 5 MEG.

MEDIATE DELIVERY FROM STOCK

A full range of values of all four types of Centralab hot molded carbon potentiometers are available in quantity, from stock, through Centralab industrial distributors.

Centralab[®]

THE ELECTRONICS DIVISION OF GLOBE-UNION INC.
 900 E. KEEFE AVENUE • MILWAUKEE 1, WISCONSIN
 In Canada: Centralab Canada Ltd. P.O. Box 400, Ajax, Ontario

TEKTRONIX TRANSISTOR-CURVE TRACER

INVALUABLE TOOL FOR EVALUATING SEMICONDUCTOR DEVICES

The Type 575 provides 20-ampere collector displays (10-ampere average supply current), two ranges of collector supply (0 to 20 volts, 0 to 200 volts), and 2.4-ampere base supply (positive or negative base stepping).

With a Type 575, you can plot and measure 7 different transistor characteristics. You can display 4 to 12 curves per family—with input current from 1 microampere/step to 200 milliamperes/step or input voltage from 10 millivolts/step to 200 millivolts/step—in repetitive or single-family presentations. You can select either common-emitter or common-base configurations.

Add a Type 175 Adapter and you extend the range of collector displays 10 times and the range of base supply 5 times.

You can also test diodes under a wide variety of conditions and observe waveform characteristics on the 5-inch crt with a high degree of accuracy.

Type 575 Calibrated Displays

Vertical Axis—Collector Current, 16 steps from 0.01 ma/div to 1000 ma/div. Pushbuttons are provided for multiplying each current step by 2 and dividing by 10, increasing the current range to 0.001 ma/div to 2000 ma/div.

Horizontal Axis—Collector Voltage, 11 steps from 0.01 v/div to 20 v/div.

Both Axes—Base Voltage, 6 steps from 0.01 v/div to 0.5 v/div.
Base Current, 17 steps from 0.001 ma/div to 200 ma/div.
Base Source Voltage, 5 steps from 0.01 v/div to 0.2 v/div.

Type 575 Transistor-Curve Tracer \$975

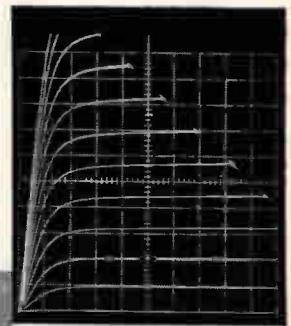

Family of characteristic curves
(for NPN transistor).

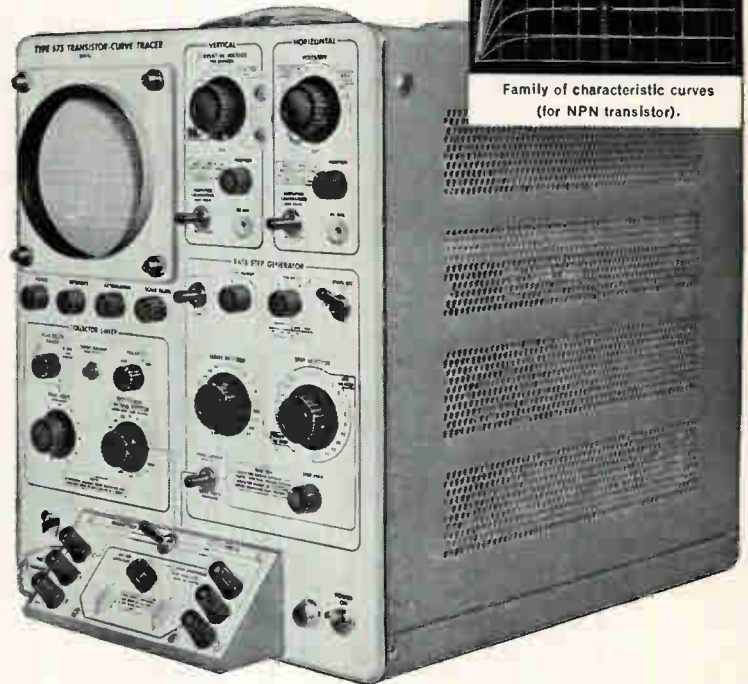

HIGH-CURRENT ADAPTER

For measuring high-powered semiconductor devices which exceed the current capabilities of a Type 575, ask your Tektronix Field Engineer about the Type 175 High-Current Adapter. Not intended for separate use, the Type 175 depends upon the circuitry and crt of a Type 575 to provide 200-ampere collector displays, three ranges of collector supply, and 12-ampere base supply—for calibrated displays with Collector Current on the Vertical Axis and either Collector Voltage or Base Voltage on the Horizontal Axis.

Type 175 Transistor-Curve Tracer
High-Current Adapter \$1425



HIGH-VOLTAGE TYPE 575

Supplied on order from your Tektronix Field Engineer is a special model of the Type 575 Transistor-Curve Tracer. Although similar to the Type 575, the special model provides much higher diode breakdown test voltage (variable from zero to 1500 volts at a maximum current of 1 milliamperes) and also much higher Collector Supply (up to 400 volts, at 0.5 ampere).

For complete specifications of this special model—call your Tektronix Field Engineer.

Type 575 Mod 122C \$1175

(prices f.o.b. factory)

. . . for more information about evaluating semiconductor devices with a Type 575 or other Tektronix test equipment, call your Tektronix Field Engineer. He will be glad to assist you.

Tektronix, Inc. P. O. BOX 500 · BEAVERTON, OREGON / Mitchell 4-0161 · TWX—BEAV 311 · Cable: TEKTRONIX

TEKTRONIX FIELD OFFICES: Albuquerque, N. Mex. • Atlanta, Ga. • Baltimore (Towson) Md. • Boston (Lexington) Mass. • Buffalo, N.Y. • Chicago (Park Ridge) Ill. • Cleveland, Ohio • Dallas, Texas • Dayton, Ohio • Denver, Colo. • Detroit (Lathrup Village) Mich. • Endicott (Endwell) N.Y. • Greensboro, N.C. • Houston, Texas • Indianapolis, Ind. • Kansas City (Mission) Kan. • Los Angeles, Calif. Area (East Los Angeles Encino • West Los Angeles) • Minneapolis, Minn. • Montreal, Quebec, Canada • New York City Area (Albertson, L.I., N.Y. • Stamford, Conn. • Union, N.J.) • Orlando, Fla. • Philadelphia, Pa. • Phoenix (Scottsdale) Ariz. • Portland, Oreg. • Poughkeepsie, N.Y. • San Diego, Calif. • San Francisco, Calif. Area (Lafayette, Palo Alto) • Seattle, Wash. • Syracuse, N.Y. • Toronto (Willowdale) Ont., Canada • Washington, O.C. (Annandale, Va.).

ENGINEERING REPRESENTATIVES: Kentron Hawaii Ltd., Honolulu, Hawaii. Tektronix is represented in twenty-five overseas countries by qualified engineering organizations. European and African countries, the countries of Lebanon and Turkey, please contact TEKTRONIX INTERNATIONAL A.G., Terrassenweg 1A, Zug, Switzerland, for the name of your local engineering representative. Other Overseas areas, please write or cable directly to Tektronix, Inc., International Marketing Department, P. O. Box 500, Beaverton, Oregon, U.S.A. Cable: TEKTRONIX.

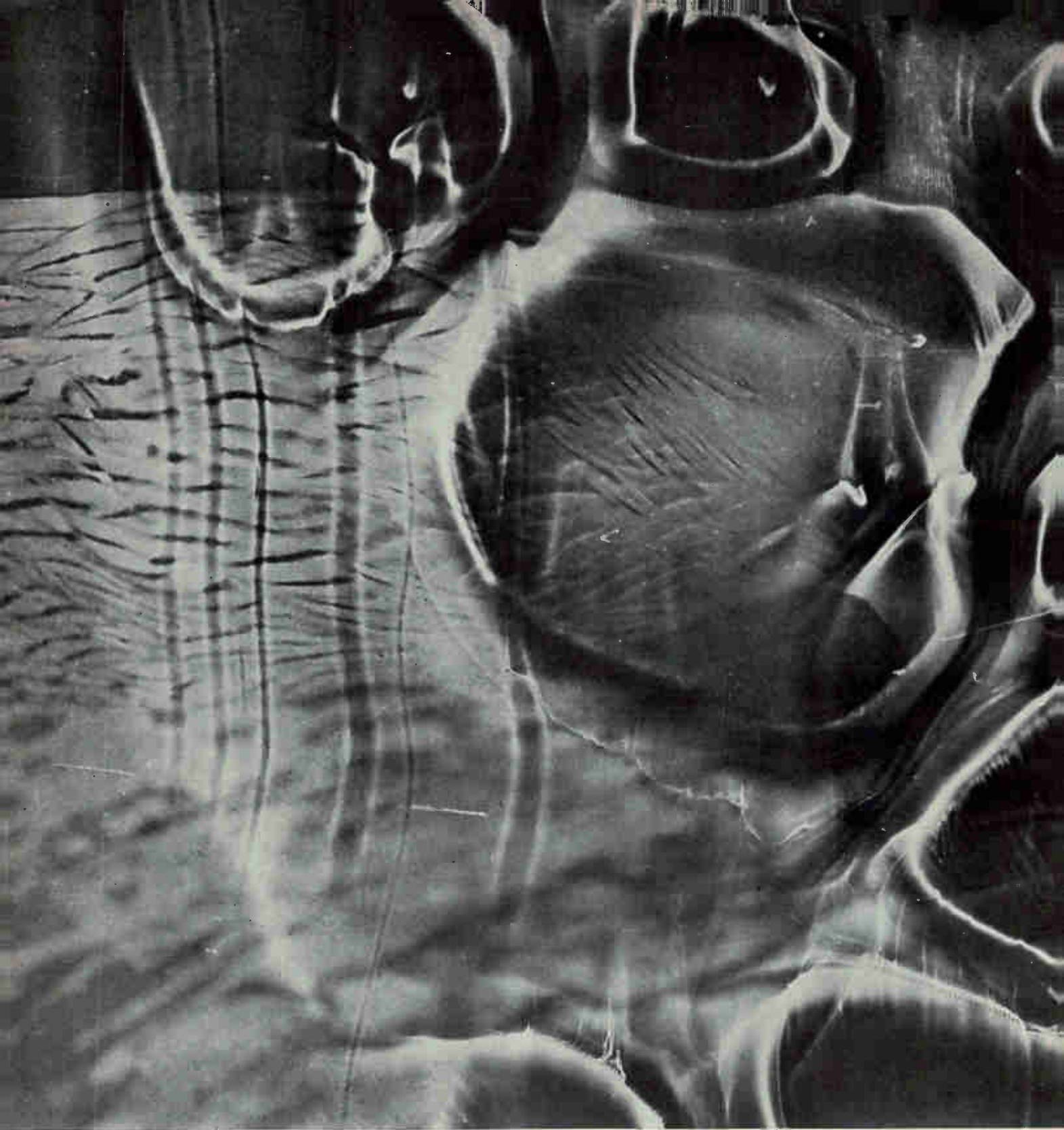

To prove what you think must be so...



That's the toughest job. Somebody's got to pore over every ounce of research that's gone before. And look into every possible place for a clue...or even a place to get started. That's where CEC comes in. That's all CEC men do for a living—discovering the way, or ways, to measure, record, and analyze what you have to know. And building the

CEC

instruments to get the job done. Are you looking for a place to start? Or ready to check out an elusive clue now? Call in a man from the CEC sales and service office nearest you. He might know a way.

CONSOLIDATED ELECTRODYNAMICS
PASADENA, CALIFORNIA • A SUBSIDIARY OF BELL & HOWELL
DATA RECORDERS DIVISION • ANALYTICAL & CONTROL DIVISION • TRANSDUCER
DIVISION • CONSOLIDATED SYSTEMS CORP. • CONSOLIDATED VACUUM CORP.

CIRCLE 59 ON READER SERVICE CARD

How do you talk to a man to sell him something when he can be working in any or all of the areas of research, design, production and management in the dynamic electronics industry? Obviously you can't follow him unless *he keeps in touch with you*. That's exactly what **electronics'** 52,721 subscribers do. They **PAY** to read **electronics** because they want and need it in their work. As they progress they voluntarily contact us week in and week out...more than 61,721 changes in titles, addresses, etc. during 1960...and that's where **electronics'** membership in the Audit Bureau of Circulation — where subscribers actually pay — reaps dividends for the advertiser.

Illustrated below are major steps in the career of Mr. Dorman D. Israel, a charter subscriber to **electronics**. Mr. Israel has paid approximately \$160.00 to receive **electronics** since it was established in April, 1930. Mr. Israel estimates that he spends between 60 and 100 hours a year studying the pages of the publication. (The average subscriber

he paid to read **electronics**





Mr. Dorman D. Israel
as radio design
engineer



As chief engineer

currently spends 5 hours 25 minutes every month.) Mr. Israel has obviously invested a considerable amount of time as well as his money in electronics over the past 31 years.

Only paid circulation has the drawing power to keep track of key people in America's most dynamic growth industry. Only **electronics** reaches so deep into the industry. And only **electronics** reaches all four major buying influences in the industry—engineers in research, design, production and management, working in any or all four areas. Place your advertising alongside editorial material for which the buyer has demonstrated a need... in ABC publications such as **electronics**.

  A McGraw-Hill Publication, 330 West 42nd Street, New York 36, N. Y..

all the way to the top

As development engineer



As vice president in charge of engineering and production



As Executive Vice President
Emerson Radio & Phonograph
Corporation



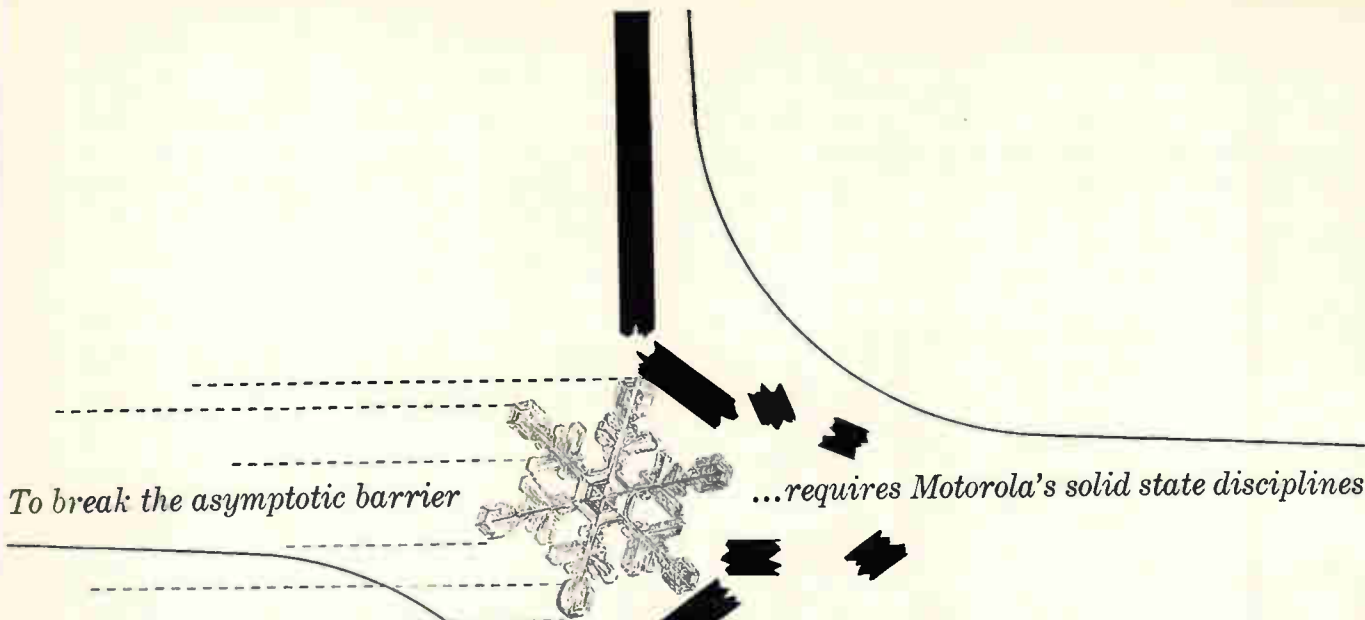

To break the asymptotic barrier

...requires Motorola's solid state disciplines

INTRINSIC CHANGES to molecular engineering techniques are required to break the asymptotic barrier of systems complexity versus systems reliability. The basis for Motorola's solid state electronics capability has been as carefully laid down as the vapor phase formation of an epitaxially grown, single-layer crystal. ☆ At Motorola, scientists and engineers have been brought together in *one* superbly equipped organization under single leadership. These molecular specialists have at their command the disciplines associated with semiconductors, epitaxial growth crystals, deposition, thin-films, surface passivation and encapsulation, electronic ceramics, and equipment and systems design. They are pioneers in the design of solid state equipment and systems of superior reliability and performance. ☆ Motorola-integrated circuit research and development, using thin-film and semiconductor hybrids and pure morphological circuit structures, have opened new areas of microscopic technology to practical application. ☆ If your application problems lie within the parameters of solid state electronics, look to Motorola for practical solutions.

Military Electronics Division



MOTOROLA

All qualified applicants will receive consideration for employment without regard for race, creed, color, or national origin

CHICAGO 51, Illinois, 1450 North Cicero Avenue
SCOTTSDALE, Arizona, 8201 East McDowell Road
RIVERSIDE, California, 8330 Indiana Avenue.

TRI METAL VACUUM OVENS

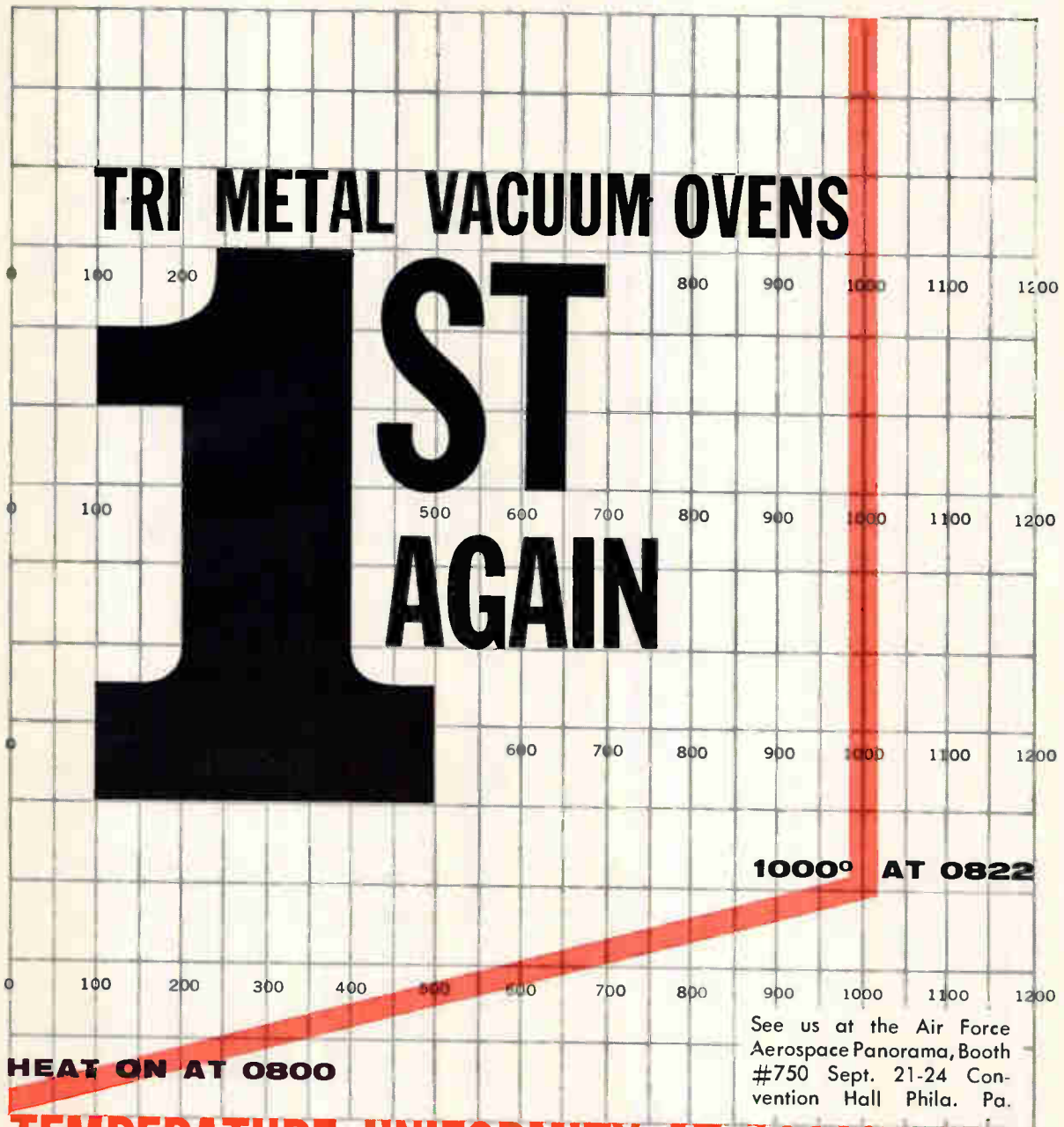

TEMPERATURE UNIFORMITY AT 1000°F ± 3° WITH OUR NEW QUARTZ HEATING ELEMENTS

Tri Metal Works, vacuum specialists since 1946, has taken another giant step ahead in high vacuum ovens with new low-mass quartz heating elements that insure temperature uniformity at 1000°F ± 3°. (Temperatures up to 2500°F available.) Other advantages include no temperature override, better uniformity, closer temperature control, cleaner system, linear heat-up and faster cool-down. For the finest in standard high vacuum oven equipment, dry boxes, pump-

ing systems or custom fabrication contact Tri Metal Works, Inc. For a free detailed brochure write to: TRI METAL WORKS INC. Industrial Division 1600 Bannard Street, East Riverton, New Jersey, or Phone 829-2000.

A PARTIAL LIST OF CLIENTS: RCA Western Electric Co., Tullahoma Air Force Base General Electric Co., Clevite Corp., Union Carbide-Nuclear Div.—Dak Ridge Burroughs Corp., Princeton University University of Virginia/F.J. Stokes Corp. H.W. Butterworth—Div. of Van Norman Industries/Drever Co., Taber Instruments, Inc., Monsanto Chem. Co., Bendix Corp.



TRI METAL WORKS INC.
EAST RIVERTON, NEW JERSEY

 **QUARTZ HEATING ELEMENTS BY WESTINGHOUSE**

Designed for



Application



MAGNETIC SHIELDS

Illustrated are a few of the stock mumetal or nicaloy magnetic shields for multiplier photo tubes and cathode ray tubes. Stock shields are available for all popular tubes. Custom designed shields are made for special applications.

JAMES MILLEN MFG. CO., INC.

**MALDEN
MASSACHUSETTS**

CIRCLE 205 ON READER SERVICE CARD

*Performance
Unparalleled!
Applications
Unlimited!*

new
BELL

HALL-PAK
Hall effect devices

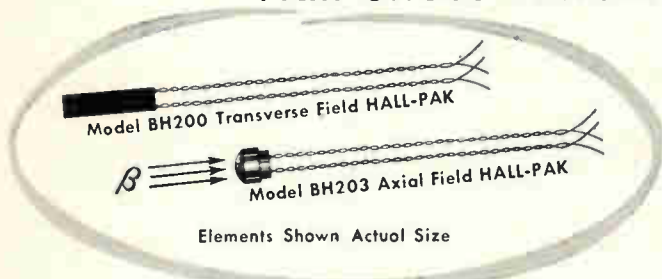

Elements Shown Actual Size

- Non-inductive construction, making possible new and improved AC applications
- Low noise output — improved low level performance
- High Hall output combined with low zero field output voltage; eliminates need for external null voltage compensation in many applications
- Operating Temperature Range: -40°C to $+85^{\circ}\text{C}$

New magnetic sensing devices with high performance standards never before attainable commercially. Many applications in measurement and control of magnetic fields. (gaussmeters; magnetometers; production testing; AC or DC fields; magnetic tape, ink and film) wherever a magnetic transducer or Hall multiplier is needed.

Write for details.

fw

ELECTRONIC DESIGN
DEVELOPMENT • MANUFACTURING



BELL INC.
1356 NORTON AVE.
COLUMBUS 12, OHIO
PHONE AX 4-4906

64 CIRCLE 64 ON READER SERVICE CARD

Lepel

High Frequency Induction

HEATING EQUIPMENT

For **Hardening • Annealing • Soldering
Brazing • Zone Refining • Crystal Growing**

ELECTRONIC TUBE GENERATORS:

1 kw; 2½ kw; 5 kw; 10 kw;
20 kw; 30 kw; 50 kw;
75 kw; 100 kw.

SPARK GAP CONVERTERS:

2 kw; 4 kw; 7½ kw;
15 kw; 30 kw.



WRITE FOR THE NEW LEPEL
CATALOG 36 illustrated pages
of valuable information.

**Lepel HIGH FREQUENCY
LABORATORIES, INC.**

55th ST. & 37th AVE., WOODSIDE 77, N. Y.

CHICAGO OFFICE: 6246 WEST NORTH AVE.

CIRCLE 206 ON READER SERVICE CARD
electronics

**NOW CURES FAST AT ROOM TEMPERATURE TOO!
(OR 2 HOURS WITH HEAT)**

A clear, solventless liquid, General Electric clear LTV-602 cures at 75-80°C to form a resilient compound with excellent electrical properties. Even thick sections are perfectly transparent. Useful from -65 to 175°C, this self-supporting material provides protection against thermal shock, vibration, moisture, ozone, dust and other hazards.

*Low Temperature Vulcanizing

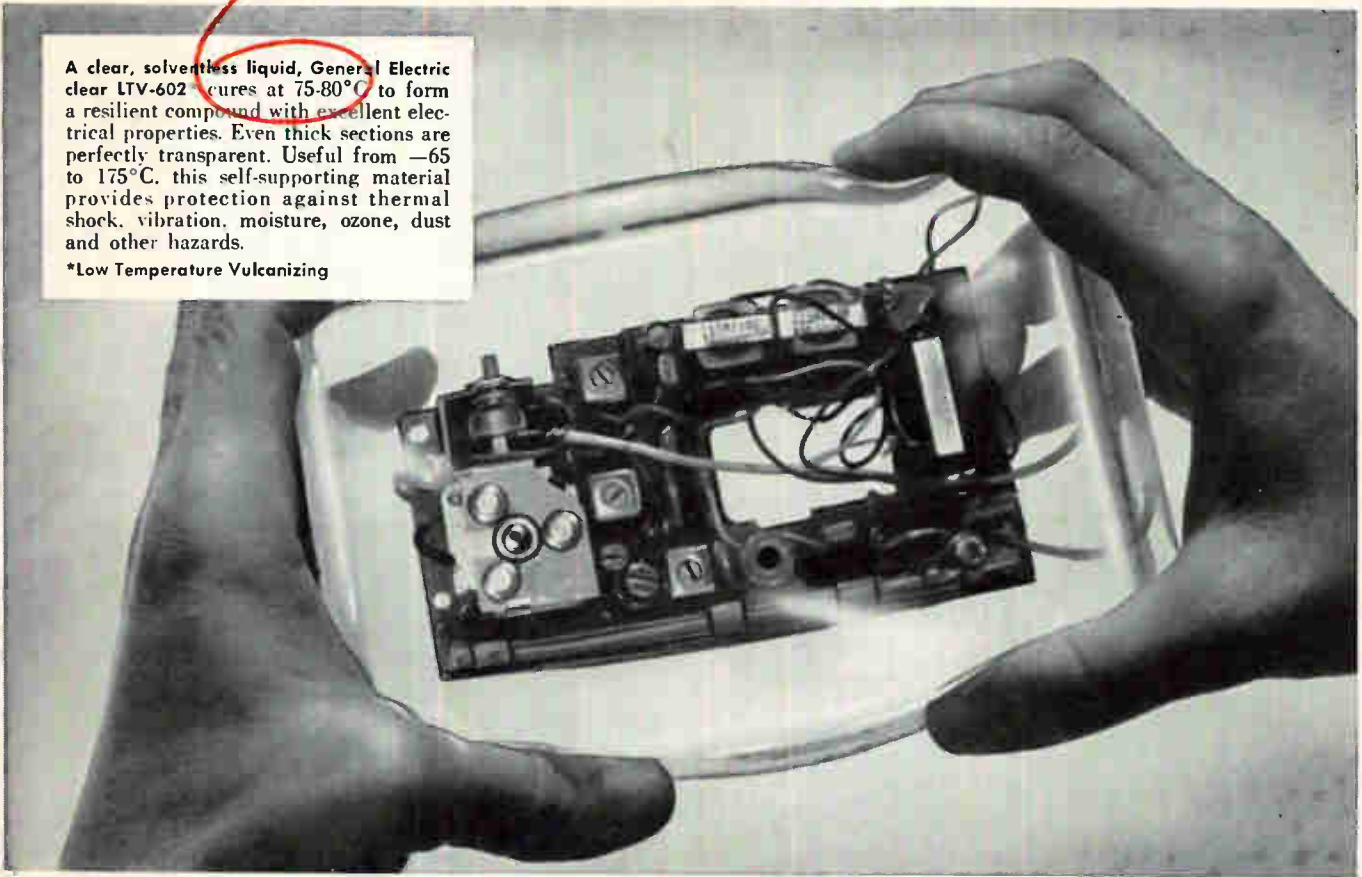

General Electric clear LTV silicone compound for potting and embedding

Transparent, resilient, self-supporting and easy to repair

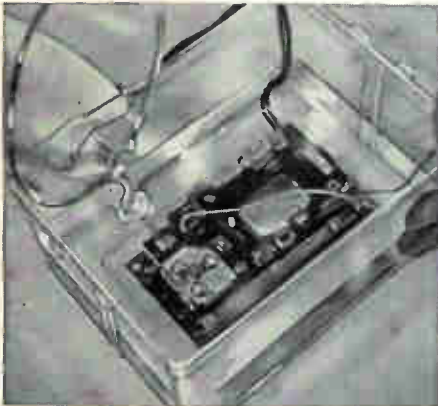

LTV-602 is easily applied, flows freely in-and-around complicated parts. Having a low viscosity in the uncured state, 800-1500 centipoise, LTV is ideal for potting and embedding of electronic assemblies. Unlike "gel-like" potting materials, LTV-602 cures to a flexible solid. Oven cure is overnight, or from 6 to 8 hours at 75 to 80°C.

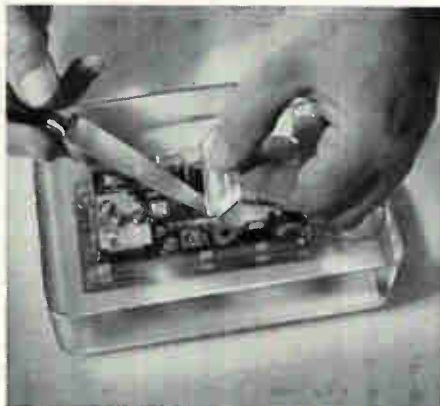

LTV-602 is easy to work with and easy to repair. To repair parts embedded in LTV, merely cut out and remove section of material, repair or replace defective part, pour fresh LTV into opening and cure. Pot life, with catalyst added, is approximately 8 hours and may be extended with refrigeration. When desirable, LTV may also be cured at room temperature.

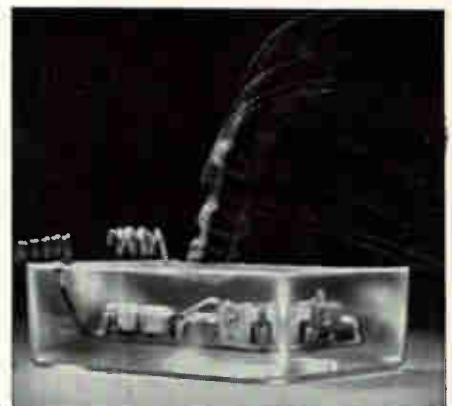

Resiliency offers excellent shock resistance. LTV-602 easily meets thermal shock tests described in MIL-STD-202A test condition B which specifies five temperature cycles from -65 to 125°C. Tests indicate that LTV retains protective properties even after 1800 hours aging at 175°C. Other tests confirm LTV's resistance to moisture and water immersion.

**NOW CURES IN
2 HOURS - CAN
EVEN USE HEAT
LAMP!**

LTV-602 is the newest addition to the broad line of G-E silicone potting and encapsulating materials which also include the RTV silicone rubbers. For more information write to General Electric Company, Silicone Products Department, Section N963, Waterford, New York.

**3 TIMES FASTER
THAN BEFORE
SEND FOR DATA
ON NEW FAST CURE**

GENERAL  ELECTRIC



ONLY POLARAD CAN A 4,000 mc BANDWIDTH VISUAL MICROWAVE

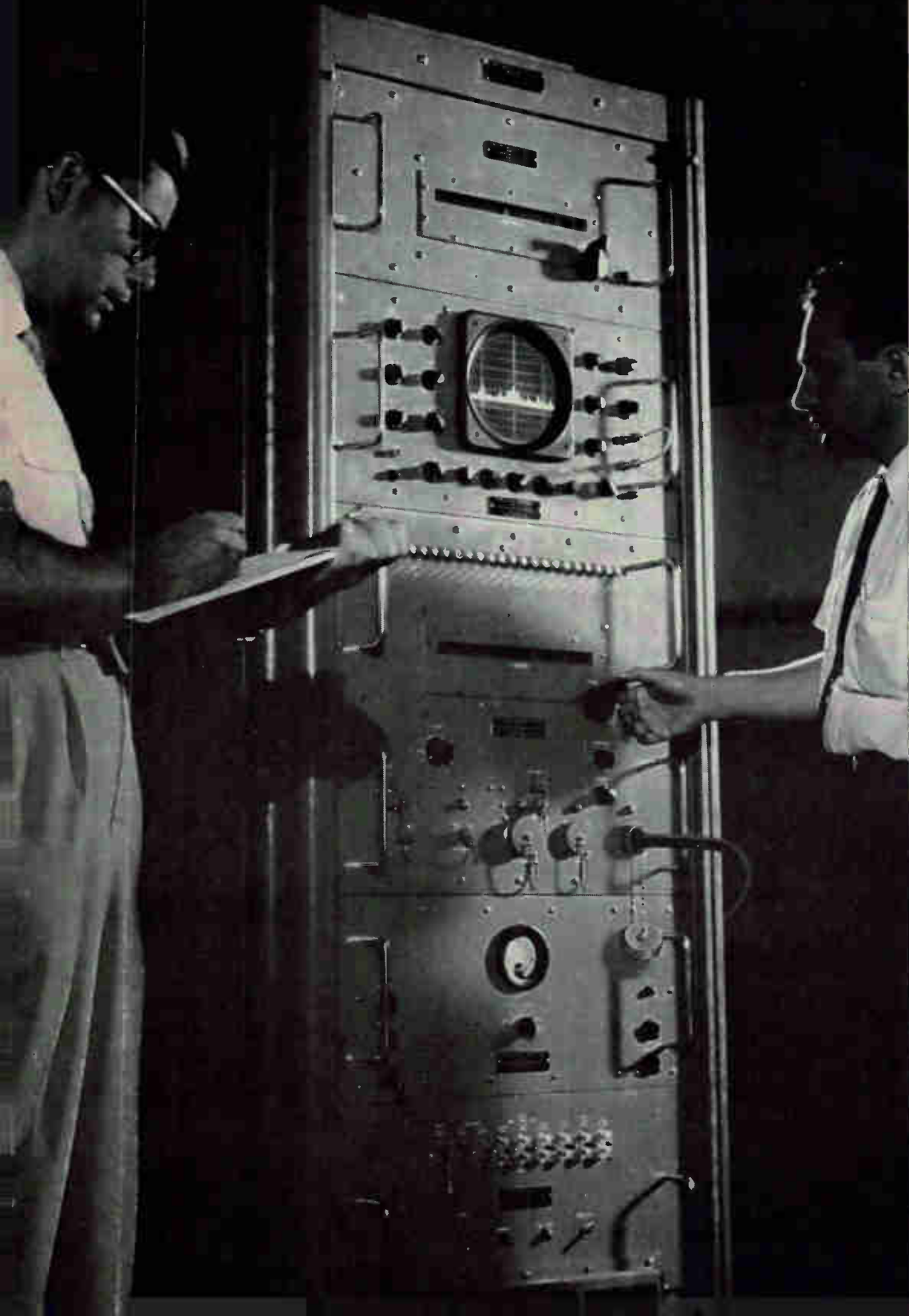

Polarad takes another giant stride in advancing the state of the art for microwave research and development—you can now observe a complete 4,000 mc bandwidth on *one scope, at one time*, with the new Model WSA Wide Band Spectrum Analyzer.

Here's the value to microwave engineers. To see the *entire* tuning range of transmitters, generators and all other broadband devices, just push one appropriate band selection button—*no tracking*, no further tuning.

Here's the value in RFI work. Because you can view a wide band of frequencies at one time, you can see interfering signals instantly. And by switching over to narrow band analysis, the exact nature of the signal can be determined—an aid in compiling a "spectrum signature."

Model WSA joins the most comprehensive line of visual microwave analysis equipment available today.

SPECIFICATIONS MODEL WSA

Frequency Range
10 mc to 40,000 mc in 20 Bands

Band Selection
Automatic; with illuminated pushbuttons

Dispersion
Narrow Band: 1 mc to 25 mc.
Wide Band: 50 mc to 4,000 mc.

Resolution.....Narrow Band: 20 kc
Wide Band: 1.5 mc

I-F Frequencies
8,200 mc, 3,600 mc, 1,000 mc, 160 mc, depending on band selection.

High Intermediate Frequency
Assures image rejection and prevents video detection.

DISPLAY FOR ANALYSIS

Which of these
Polarad Microwave
Spectrum Analyzers
solves your problem?

From 10 to 100,000 mc, Polarad offers spectrum analyzers for every aspect of microwave research and development. Thousands of the instruments shown here are in use today throughout the electronics industry—in laboratories, on the production line, in systems, out in the field and at research centers.

Ask your Polarad representative to work with you in selecting the equipment that will most efficiently accomplish your objectives.

ALL POLARAD SPECTRUM ANALYZERS FEATURE:

- 1 to 30 cps adjustable sweep rate
- Direct-reading UNIDIAL® tuning control, with no klystron modes to set
- High accuracy, resolution and sensitivity
- Non-contacting klystron cavity chokes for noiseless tuning
- Provision for use with Multi-pulse Spectrum Decoder (Model SD-1)

UNIVERSAL
OPERATION?

TRANSISTORIZED
MOBILITY?

STANDARD
OPERATION?

TIME AND
FREQUENCY
DISPLAY?

WIDE
DISPERSION?

ULTRA-BROAD
BAND?

EXTENDED
FREQUENCY?

SPECTRUM
SELECTOR?

Self-Contained Units Cover

10 to 40,880 mc

MODEL SA-84

- Dispersion: 10 to 55 mc: 500 kc to 5 mc, adjustable
- 55 to 40,880 mc: 500 kc to 25 mc, adjustable
- Resolution: 20 kc
- Internal Marker: variable

MODEL SA-84W

- Wide Dispersion: 10 mc to 240 mc: 10 mc
- 240 mc to 40,880 mc: 80 mc
- Resolution: 2 kc to 80 kc variable
- Crystal controlled markers from 10 to 40,880 mc
- Log-linear display
- Accurately calibrated IF attenuator

MODEL SA-84T

Single Unit Covers

10 to 40,880 mc

- Dispersion: 500 kc to 25 mc, adjustable
- Resolution: 20 kc at all frequencies
- Internal Marker: ± 13 mc
- Power Consumption: when battery operated, 110 watts, 12 vdc
- Sensitivity: —50 to —105 dbm, depending on frequency.
- Weight: 70 lbs. One half the weight of conventional vacuum-tube equivalent
- Meets MIL-1-26600 for r-f interference

MODEL TSA

10 to 44,000 mc in 5 Plug-In Tuning Units

- Dispersion: 400 kc to 25 mc
- Resolution: 2 to 80 kc variable
- Attenuation: Continuously variable
- Sensitivity: —50 to —95 dbm, depending on frequency
- Internal Marker: ± 14 mc

MODEL TSA-S

SYNCHROSCOPE ANALYZER

10 to 44,000 mc in 5 Plug-In Tuning Units

- Bandwidth: 5 kc, 50 kc, 500 kc, 5 mc
- Synchroscope sweep rate: 2, 10, 100, 1,000, 10,000, and 100,000 μ sec per screen diameter.
- Dispersion, Sensitivity and Internal Marker same as TSA.

MODEL TSA-W

Narrow And Wide Pulse Analysis

10 to 44,000 mc in 5 Plug-In Tuning Units

- Dispersion: 200 kc to 80 mc (2 ranges)
- 80 mc dispersion displays pulses narrow as 0.1 μ sec. For wide pulses, dispersion may be adjusted down to 200 kc.
- Resolution: 2 to 80 kc variable
- Internal Marker: ± 40 mc
- Screen Display: Linear or log

MODEL WSA

Self-Contained Unit Covers

10 to 40,000 mc in 20 Bands

- Dispersion: 1 mc to 25 mc in narrow band, 50 mc to 4000 mc in wide band
- Resolution: 20 kc in narrow band; 1.5 mc in wide band
- Rapid band selection by means of illuminated push-button switches.
- Frequency difference marker up to 4000 mc.
- Sensitivity: —50 to —80 dbm, depending on frequency

MODEL DA-70

50,000 mc to 100,000 mc

in Three Bands

- Dispersion: Continuously adjustable from 50 mc to 1000 mc. Permits narrow pulse inspection.
- Resolution: 1 mc
- High intermediate frequency assures image rejection and prevents video detection.
- Dial Frequency Accuracy: $\pm 1.0\%$
- Nominal Sensitivity: —50 dbm for entire frequency range.

MODEL SD-1

MULTI-PULSE SPECTRUM SELECTOR

Permits spectrum analysis of individual microwave pulses in a pulse group when used with any Polarad Spectrum Analyzer. Any pulse in a complex coded signal may be isolated for examination.

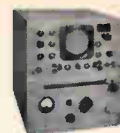

POLARAD

FREE LIFETIME
SERVICE

ELECTRONICS CORPORATION

43-20 34th Street • Long Island City 1, New York

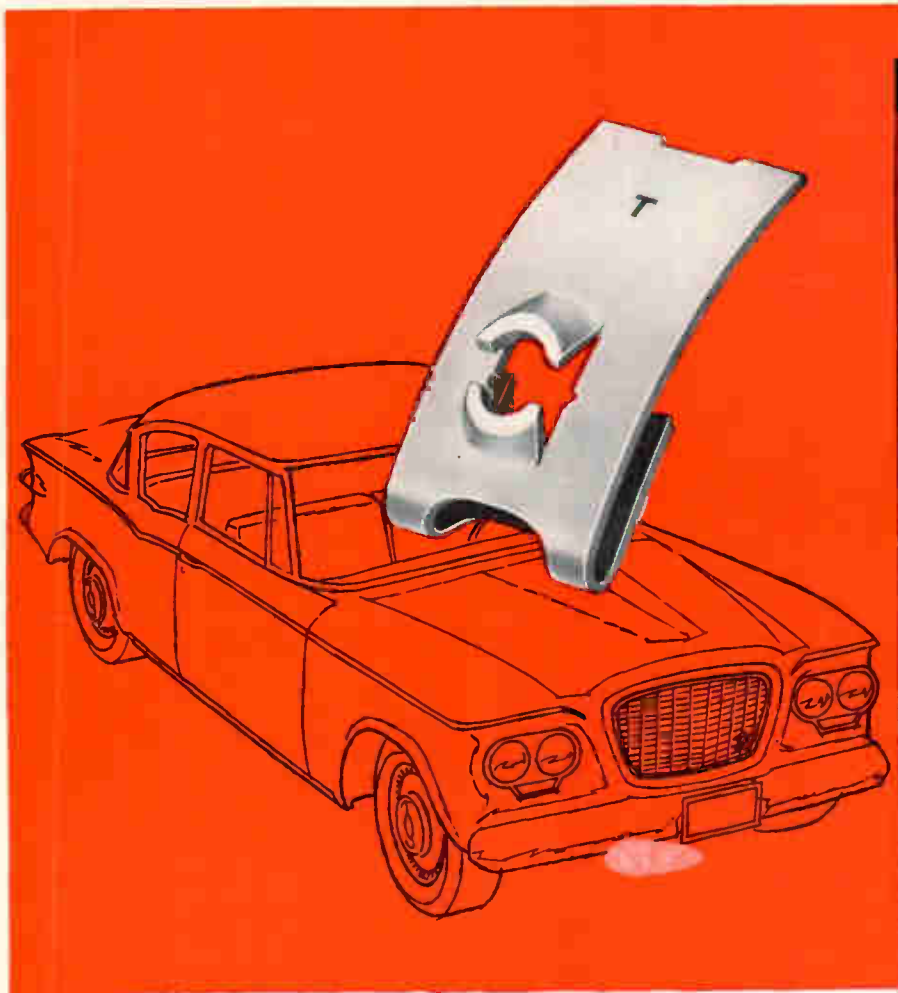

A Tinnerman T-Marked Original...

Studebaker Lark assembled faster, at lower cost with **SPEED NUTS**[®]

The rear fenders of the new Studebaker Lark are secured in a vibration-proof, watertight seal with this special heavy gauge Tinnerman J-type SPEED NUT brand fastener. It eliminates rubber stripping and costly spot-welded bearing plates, and allows the fenders to be easily removed for repair.

Preassembled to the Lark's rear quarter panel, the J-nuts hold themselves in place while the panel is first attached to the chassis. The fender is then positioned on the quarter panel and the acme bolts driven home.

In applications like this—where *total* fastener reliability is vital—Tinnerman SPEED NUT brand fasteners are your only choice. Only Tinnerman maintains *total* quality control from coil strip selection to finish coat. The Tinnerman T-mark on every fastener is your assurance of that quality.

For samples, literature, prices, call your Tinnerman sales office ... listed in the "Yellow Pages" under "Fasteners." Or write to: *Tinnerman Products, Inc., Dept. 12, Box 6688, Cleveland 1, Ohio.*



TINNERMAN

Speed Nuts[®]

Look for the Tinnerman "T"

T-MARK ENGINEERED SPECIALS

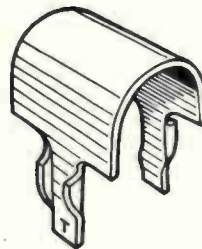

TUBE CLIP is designed for fastening refrigerant tubes to liners. A split rubber cushion insert is placed over the tube, and the entire unit is snapped into a rectangular mounting hole. Spring tension locks the legs in a strong, vibration-proof assembly. Has many application possibilities where tube, cable or wire must be secured.



PRINTED CIRCUIT NUT provides positive contact between printed circuit panels and connecting wires. This highly-conductive, phosphor bronze fastener snaps firmly over terminal area, allows wiring connections to be made at any station on the assembly line. A screw through the eyelet wire completes the assembly. Easy to assemble ... easy to service.

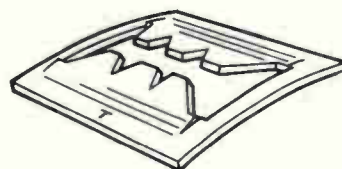

RUBBER STRIP FASTENER locks bumper strips on a famous-name vacuum cleaner, can solve rubber-strip fastening problems in many fields. This SPEED NUT brand fastener is simply pushed over one end of the bumper strip. Triple-tooth prong secures strip firmly while bumper is wrapped around cleaner base and anchored with identical fastener. No special tools required.

CANADA: Dominion Fasteners Ltd., Hamilton, Ontario.
GREAT BRITAIN: Simmonds Aerocessories Ltd., Treforest, Wales. FRANCE: Simmonds S.A., 3 rue Salomon de Rothschild, Suresnes (Seine). GERMANY: Mecano Simmonds GMBH, Heidelberg.

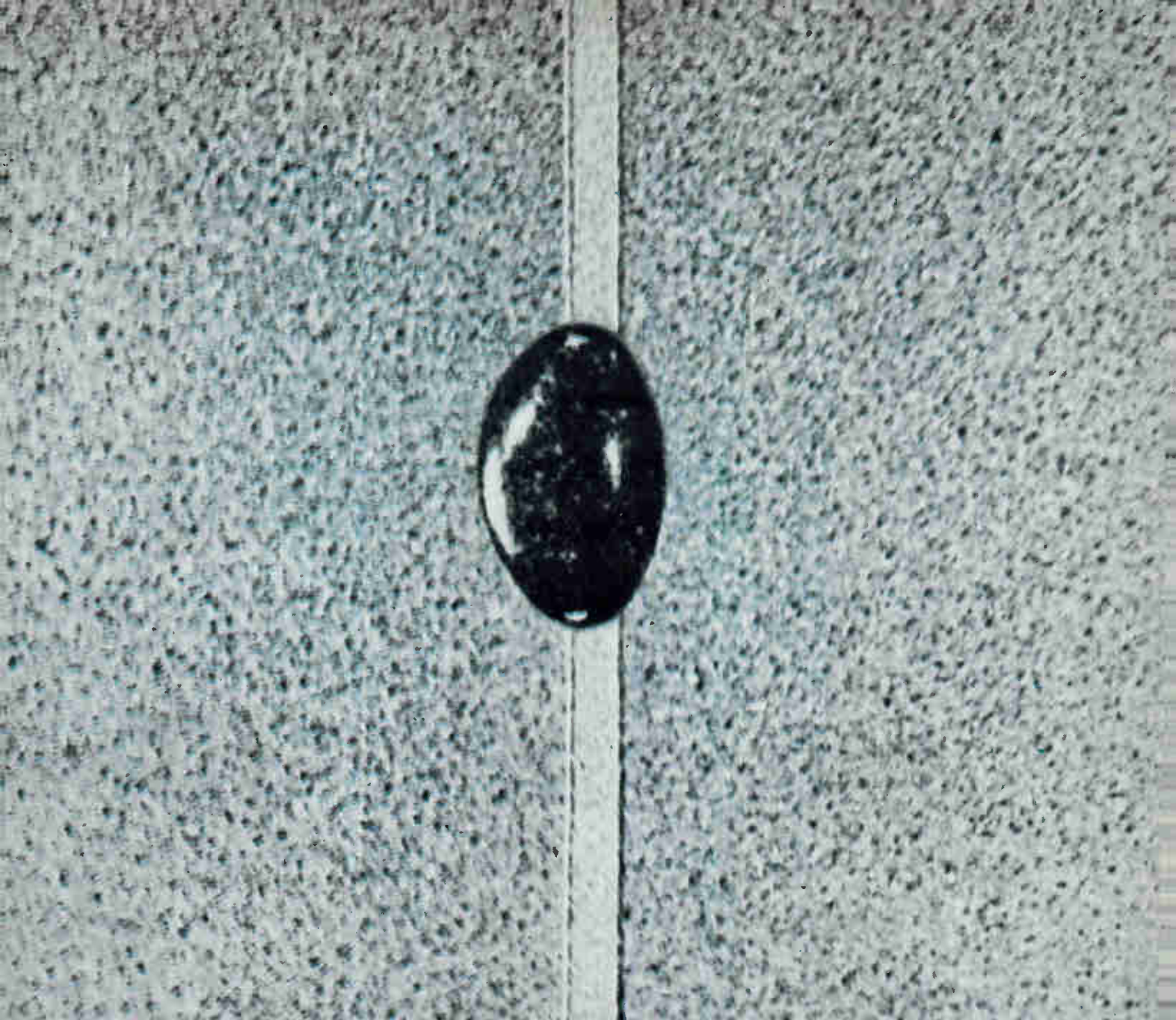

General Instrument Silicon Planar Microdiodes

Source for Silicon Planar Microdiodes. Now get "big" planar diode parameters and reliability in a package that's only 0.080" x 0.045". General Instrument silicon planar microdiodes are truly reliable because they're truly passivated. Fully protected against ambients and contaminants by General Instrument's unique Molecular Shield™ passivation process, these microdiodes actually need no encapsulation. The ceramic bead surrounding the semiconductor wafer serves only to provide mechanical rigidity. ■ Production quantities of

Typical Nanocircuit Assemblies Available In T0-5 Packages...

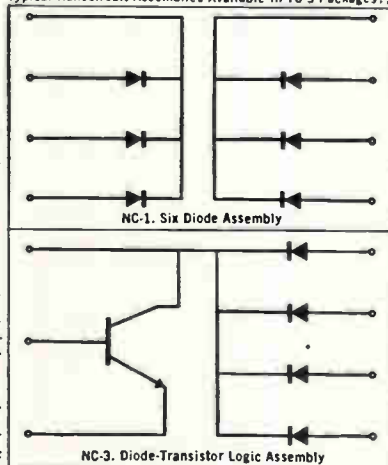

microdiodes are immediately available for computer and general-purpose use in two convenient forms: either as individual devices or preassembled as complete Nanocircuits in standard T0-5 cans (up to six diodes per can). For full information on microdiode types MD 4, 6, 8 and 10, or any semiconductor device in our complete line (including truly passivated silicon planar microtransistors), call the sales office or franchised distributor nearest you or write today. General Instrument Semiconductor Division, 65 Gouverneur Street, Newark 4, New Jersey.

GENERAL INSTRUMENT SEMICONDUCTOR DIVISION
 GENERAL INSTRUMENT CORPORATION

ACTUAL SIZE



ELECTRONICS

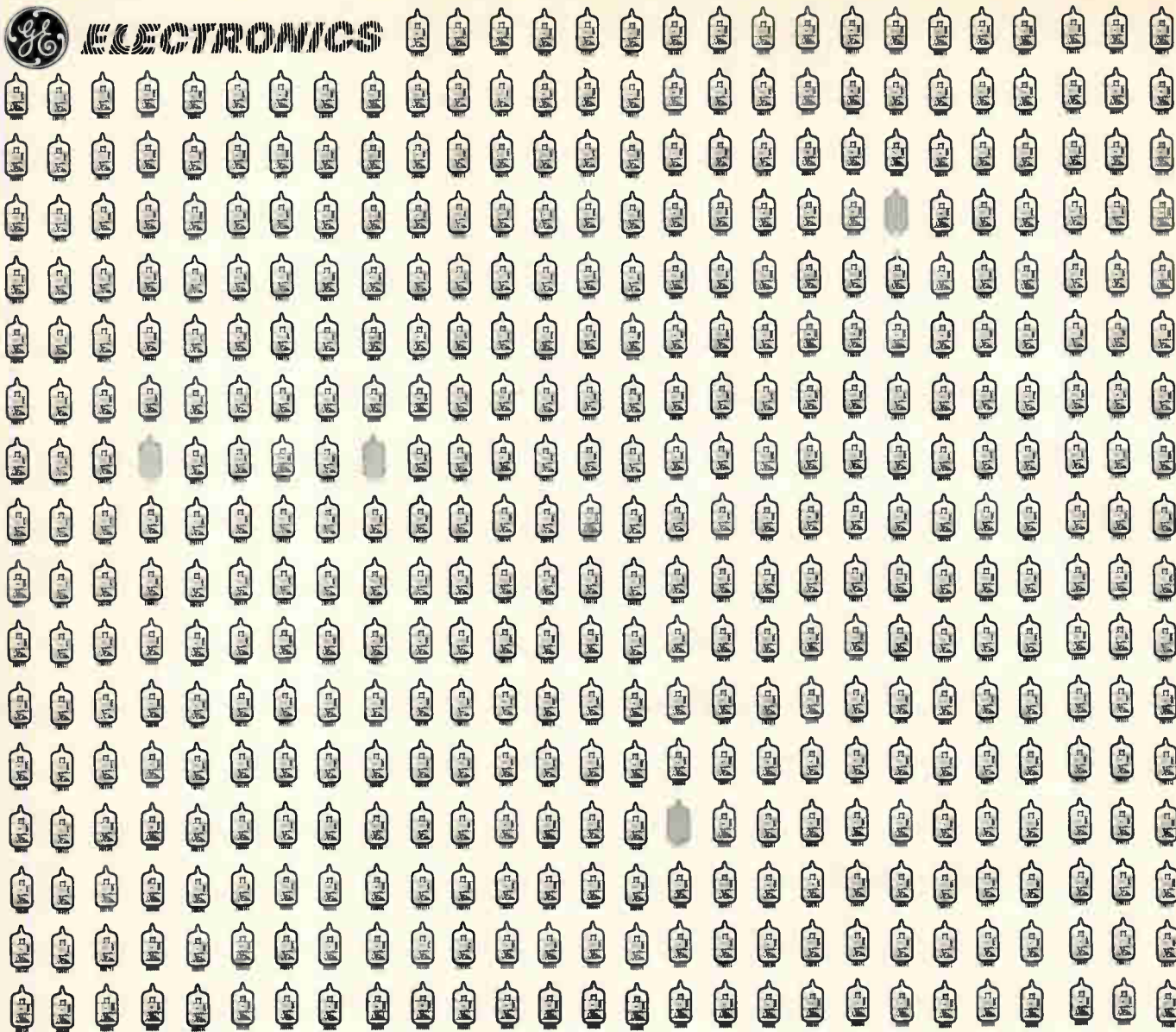

G-E Five-Star tubes prove 99.11% reliable in 10,000 hour life test

Four hundred and fifty type 6829 Five-Star tubes were subjected to a DC life test to study the effects of heater voltage, heater-cathode potential and plate dissipation on vacuum tube life and reliability. After 10,000 hours of operation, failure rates were such that no statistical significance could be attached to them. Of the 450 tubes tested, only four failures occurred: two at 3000 hours, one at 3200 hours, one at 9000 hours—despite the fact that the test parameters were purposely made severe enough to produce early failures. For example, in test lot number six, 30 type 6829 Five-Star tubes were tested

under severe conditions (elevated heater voltage: 6.5 volts, over 100 volts negative heater-cathode potential, 2.88 watts per plate dissipation). There were no failures at 10,000 hours. Test data supplied upon request.

In life tests such as this, and in everyday performance, G-E Five-Star tubes prove their reliability in critical applications: airborne navigation and communications, industrial controls, two-way communications, broadcast. *Five-Stars are not tubes selected from standard receiving types.* They are specially designed, specially manufactured to cope with particular electrical requirements

and withstand severe environmental conditions such as shock and vibration. Where you can't afford to compromise performance and reliability, order Five-Star tubes from your General Electric tube distributor. Distributor Sales, General Electric Company, Room 7143A. Owensboro, Kentucky.

INDUSTRIAL TUBES • SEMICONDUCTORS
PANEL METERS • RESISTORS

Progress Is Our Most Important Product

GENERAL  ELECTRIC

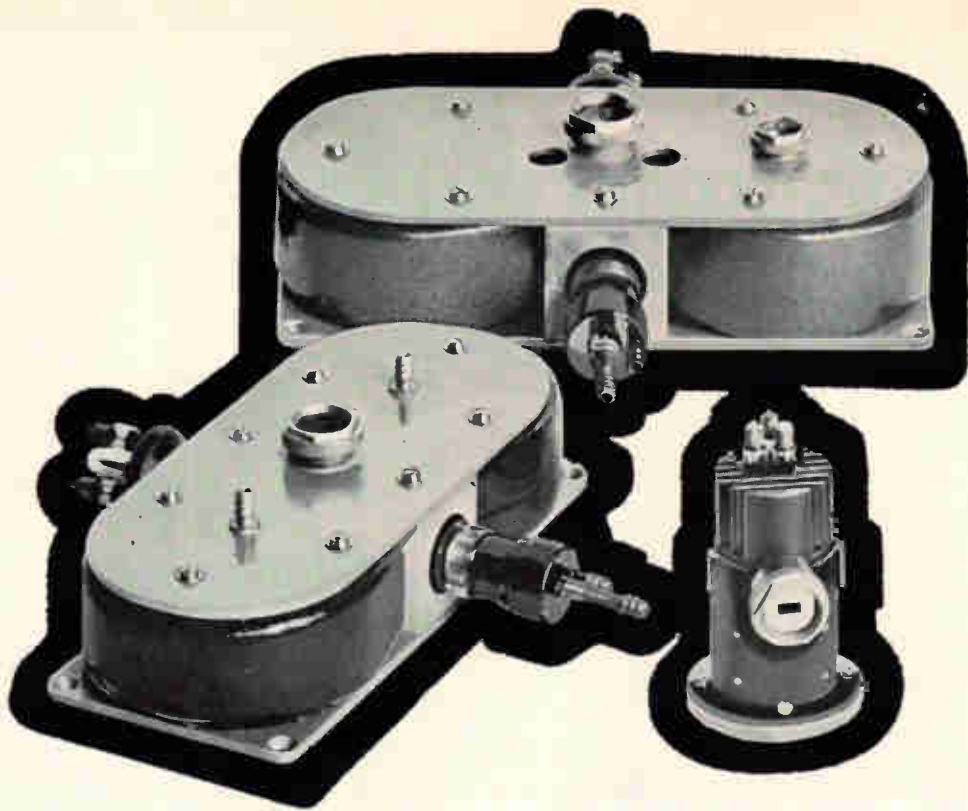

Ku-BAND TO 80 KMC

LONG-LIFE MILLIMETER WAVE KLYSTRON TUBES FROM LITTON

For applications in the 18-80 kMc range, the Litton Electron Tube Division now offers the Elliott-Litton line of quality-engineered millimeter wave tubes.

The floating drift tube design used for most Elliott-Litton klystron oscillators produces the effect of a single-cavity tube with the working efficiency of a two-cavity klystron. **Additional advantages of this design are freedom from hysteresis, stability of operation, and exceptionally low thermal drift.** Reflex klystrons are available in the 12 and 8 millimeter regions.

Applications include radar and communication systems, signal sources for microwave spectroscopy, gaseous plasma experiments, high-stability pumps for masers or parametric amplifiers, and local oscillators.

Contact us at San Carlos, California, for more information on Elliott-Litton tube types or on any of an extensive array of Litton microwave and display tubes and accessories.

ELLIOTT-LITTON LTD. FLOATING DRIFT TUBE AND REFLEX KLYSTRONS

Type No.	Frequency Band kMc/s	Minimum Tuning Range Mc/s	Minimum Power Output Watts	Cooling
L-3638	68 - 80	Fixed	0.100	Liquid
L-3639	68 - 80	Fixed	0.500	Liquid
L-3689	68 - 80	1500	0.500 average	Liquid
L-3690	68 - 80	1500	0.100	Liquid
L-3691	68 - 80	1500	0.100 average	Liquid
L-3640	48 - 52	Fixed	1.0	Liquid
L-3693	48 - 52	1500	1.0	Liquid
L-3629	33 - 37	Fixed	15.0	Liquid
L-3628	33 - 37	1600	10.0	Liquid
L-3632*	33 - 37	1000	0.030	Air
L-3633*	33 - 37	1000	0.200	Air
L-3659	32 - 37	700	5.0	Liquid
L-3697	30 - 37	1600	1.5	Liquid
L-3698	30 - 37	1600	1.0	Air
L-3630	21 - 25	Fixed	10.0	Liquid
L-3631	21 - 25	1000	8.0	Liquid
L-3642*	18 - 25	400	0.100	Air
L-3692*	18 - 25	400	0.350	Air
L-3699	21 - 25	1000	1.5	Liquid
L-3700	21 - 25	1000	1.0	Air

* REFLEX KLYSTRON

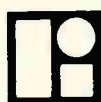

LITTON INDUSTRIES
Electron Tube Division

MICROWAVE TUBES AND DISPLAY DEVICES

now see this...

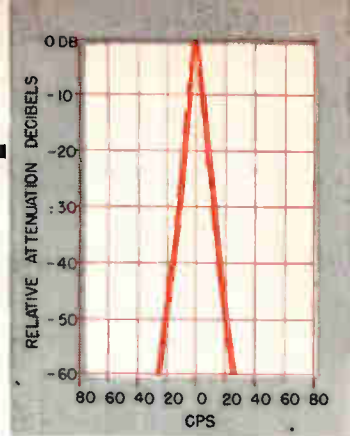

Bandpass response for 2 cps I-F bandwidth

2 cps resolution from 5 cps through 20 kc



with Panoramic's **LP-1a**
SONIC SPECTRUM ANALYZER
 IN COMBINATION WITH THE **NEW**
C-2 AUXILIARY FUNCTION UNIT.

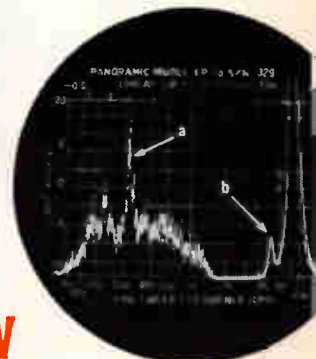

Narrow IF bandwidths with steep skirts enable:

- a) analysis of CW signal deep in noise
- b) amplitude measurement of weak signal closely adjacent to very strong signal.

Panoramic's new low cost system, consisting of the famed Model LP-1a Sonic Analyzer, new C-2 Auxiliary Function Unit and RC-3b Recorder, is designed to solve an extremely wide range of noise, vibration and other waveform analysis problems.

The system incorporates several variable operating parameters which are inter-related. For quick spectrum appraisal . . . 1 sec. log scan from 40 cps to 20 kc. For precise detailed analysis . . . 30 preset linear scan widths of 20 to 5000 cps, centerable between 0 and 20 kc; 1 sec. to 16 hrs. scan intervals; 2 cps to 200 cps steep skirted selectivity range.

Direct frequency and amplitude readouts of discrete and random waveform contents are fast and accurate . . . simplifying use at production test stations or in the laboratory.

Indeed, whether your need is to analyze random or line spectra either with components deep in noise or widely apart in level but close in frequency, this new Panoramic system is your assurance of faster, easier solutions.

Among the system's outstanding capabilities:

Overall Frequency Range: 5 cps to 22,500 cps

Scan Provisions: Precalibrated "quick look" log scan 40 cps to 20 kc in only one second. For precise detailed analysis 30 selectable pre-set linear scans 20 to 5000 cps wide, centerable anywhere between 0 and 20 kc. Scan times: 1 and 10 sec. with C-2 and 30 sec. to 16 hrs. with RC-3b Recorder. Latter permits unattended analysis, provides longer sampling times required for best selectivity and quantitative random signal analysis.

Selectivity Characteristics: Automatic optimum (second scan) plus adjustable I-F bandwidths from 2 cps to 200 cps with extremely steep skirts—see graph above—closely approaches ideal rectangular filter desired in random signal analysis.

Read out: 5" CRT and 12" x 4 1/2" inked chart (with RC-3b)

Amplitude scales: Calibrated linear and 40 db log

Residual distortion: Dynamic range better than 60 db

Analyzer stability: less than 5 cps/HOUR drift (after warm-up) assures meaningful analysis with 2 cps resolution

Sensitivity compensation, random and discrete: Sensitivity remains constant for all IF bandwidth settings for either random or discrete input signals

Adjustable smoothing time constant: Smooths random fluctuations, clearly displays average noise level at each frequency for faster analysis

Manual scan control: CRT beam and analyzer tuning positioned anywhere within sweep width range for extended time vs. amplitude studies. Amplitude vs. time analysis also provided with RC-3b Recorder

For detailed information on the LP-1a, C-2, and RC-3b, separately or rack mounted as a system, CALL, WRITE OR WIRE:



formerly Panoramic Radio Products, Inc.

PANORAMIC ELECTRONICS, INC. 530 South Fulton Avenue, Mount Vernon, N. Y. • Phone: OWens 9-4600 TWX: MT-V-N.Y.-5229 • Cables: Panoramic, Mount Vernon, N. Y. State

See us at E.I.M.E. /Cedar Grove, N. J. • The Towers • Oct. 2/Phila., Pa. • Bellevue-Stratford Hotel • Oct. 3, 4/ Wachtung, N. J. • Wally's • October 9/Washington, O. C. • Marriott Hotel • Oct. 11



CONGRATULATIONS NAVY..! WORLD'S MOST PO

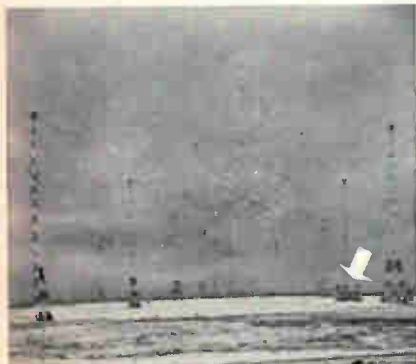

2800 acres . . . an area greater than two dozen Pentagon Buildings . . . two identical antenna arrays . . . center towers nearly as high as the Empire State Building support the gigantic spider web of steel towering a thousand feet up and embracing two square miles . . . nearly an entire peninsula at Cutler, Maine. (Arrow indicates comparative size of Helix House to tower.)



(Arrow points to truck. Compare Helix House size in first photo.) 8-story Helix House contains antenna coupling and automatic de-icing equipment to rid the immense antenna system of ice. Buried beneath the ground: another 11 million feet of copper wire in the radiating system terminating in the sea water itself.

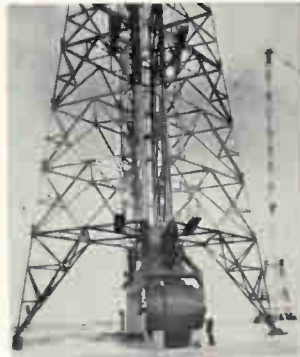

42 counter-weight towers—36 of them like this—carrying tremendous counter balances of 202 tons each to maintain and correct antenna tension and strain from winds up to 150 knots or ice forming on the 64 miles of bronze antenna.



Enormous variometer coil for inductance to tune the antenna system through a range of 14 to 30 KC . . . very low frequency. These VLF radio waves penetrate the depths of the sea to submerged submarines.

THIS AMAZING ENGINEERING ACHIEVEMENT RESULTED FROM SUPERB TEAMWORK BETWEEN THE PRIME CONTRACTOR — CONTINENTAL ELECTRONICS . . . THE UNITED STATES CONGRESS . . . AND THE U.S. NAVY . . . WORKING TOGETHER IN HARMONY TO STRENGTHEN AND SOLIDIFY NATIONAL DEFENSE. THAT THE U.S. NAVAL RADIO STATION AT CUTLER WAS COMPLETED IN RECORD TIME, ONE FULL YEAR AHEAD OF SCHEDULE IS ADEQUATE TESTIMONY TO THE SMOOTH EFFICIENCY OF THIS COMBINED EFFORT.

Continental

MANUFACTURING

4212 South Buckner Boulevard ■ Dallas 27, Texas

DESIGNERS AND BUILDERS OF THE WORLD'S

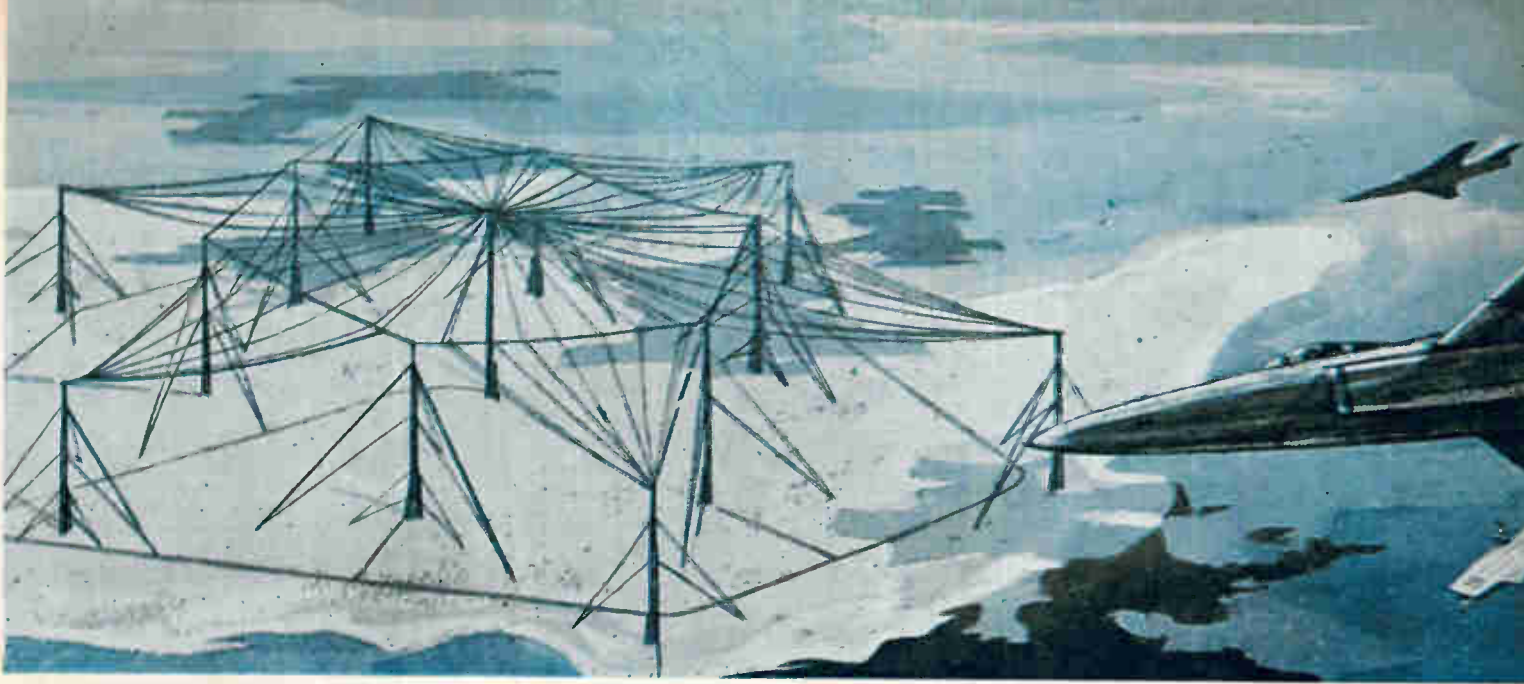

WERFUL TRANSMITTER..2,000,000 WATTS VLF

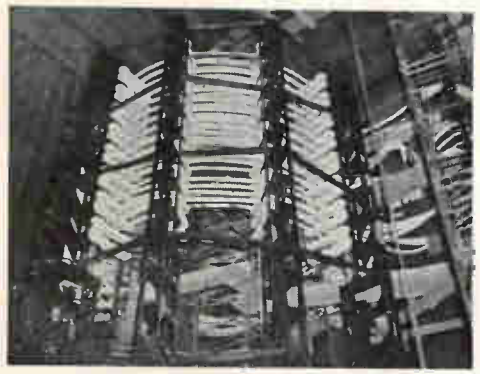

Huge Helix coil 20 feet in diameter and 40 feet tall is wound with 3½ inch Litz Wire . . . just one of the scores of huge components that combine to give this new communication station maximum power . . . range . . . reliability . . . and the special penetration possibilities VLF possesses that no normal high frequency radio provides.



Control console and portion of the unique CEMC Type-125 2,000,000 watt VLF Transmitter that propagates along the curvature of the earth instead of bouncing off the IONOSPHERE: thus eliminating dead communication areas or skip distances to give this Naval voice of command greater range and improved reliability.



In one instant 2,000,000 watts will blast the U. S. Navy's voice of command around the world. At the control console, during operation, push-button simplicity provides a new and highly reliable major element of command to the U. S. Navy . . . another element of that might by which the nation promotes the keeping of the peace.

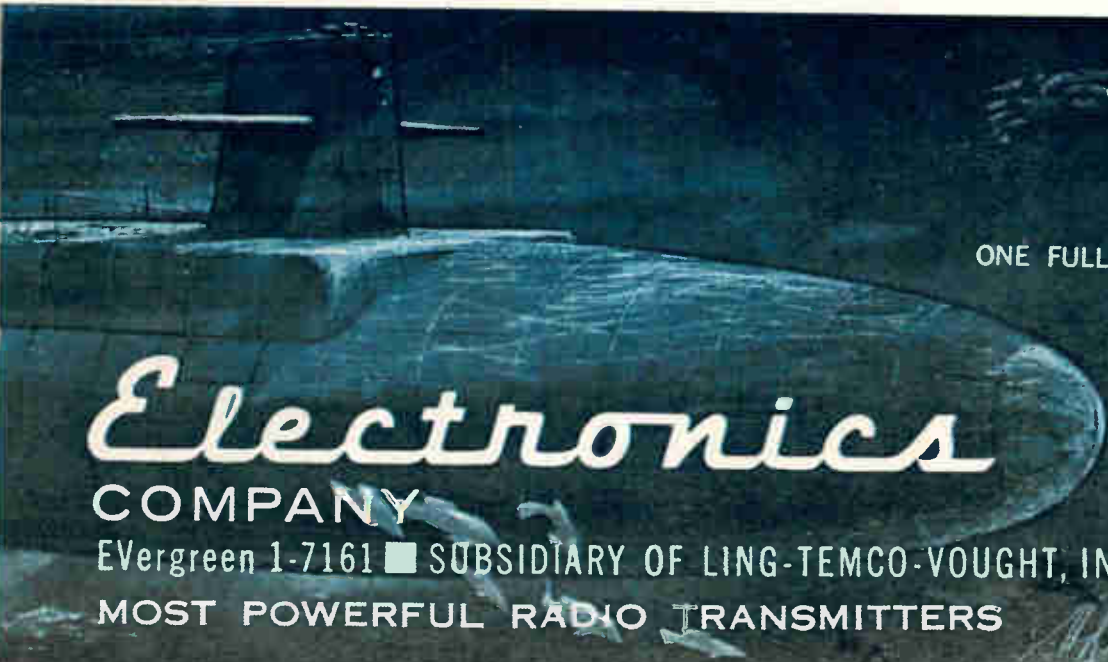

WORLD'S MIGHTIEST VOICE
OF COMMAND TO HELP KEEP
THE PEACE. OFFERING NEW
RELIABILITY
DEPENDABILITY
MAINTAINABILITY
ONE FULL YEAR AHEAD OF SCHEDULE!

Electronics
COMPANY
EVergreen 1-7161 ■ SUBSIDIARY OF LING-TEMCO-VOUGHT, INC.
MOST POWERFUL RADIO TRANSMITTERS



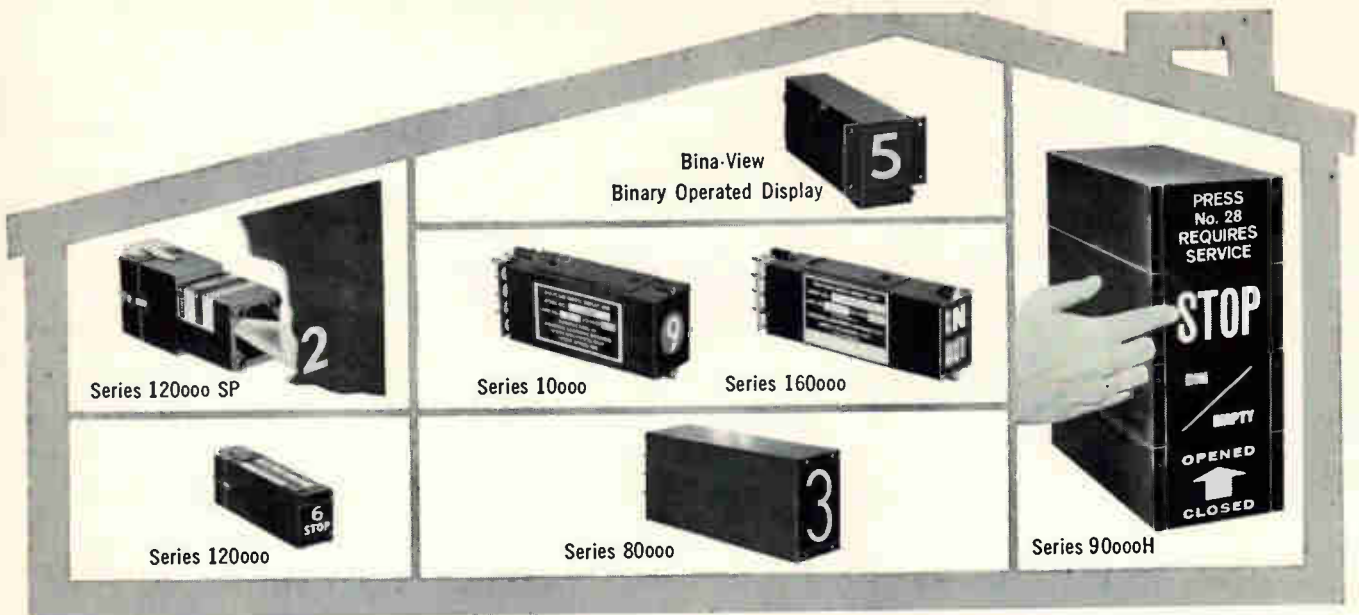

READOUTS THAT DO MORE THAN DISPLAY NUMBERS

I.E.E.'s complete line of rear-projection readouts display words, numbers, symbols, and color. The alpha-numeric Bina-View readout is self-decoding and operates direct from binary output. And all can satisfy human factors requirements!

The engineering staff and facilities of Industrial Electronic Engineers, Inc. have approached the problem of readouts as one of visual communications, the case in point being that

complete!
under
the
IE
roof

numbers are only one form in a host of methods in visual communications. The engineering talent at I.E.E. work under the formula that the more forms of visual communications that are available the less chance there is for communicative breakdown. *In a word; complete.*

Your inquiry to complete readout visual communications is invited.

IE INDUSTRIAL ELECTRONIC ENGINEERS, Inc.
5528 Vineland Avenue, North Hollywood, California

CIRCLE 207 ON READER SERVICE CARD

Precision **AUTOMATIC TRANSISTOR/DIODE TESTER**

SELF-TESTING AND FAIL-SAFE

FOR: Reliability Testing • Incoming Inspection • Production Testing Engineering Studies

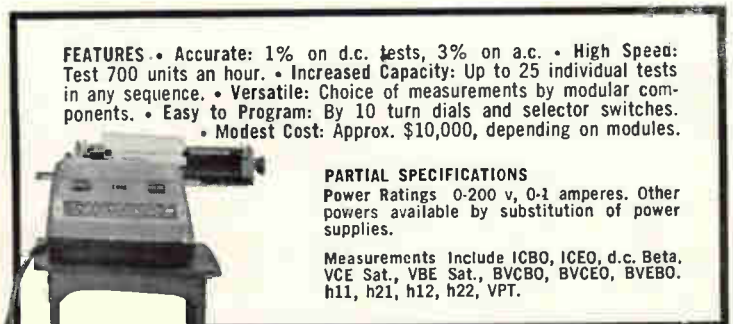
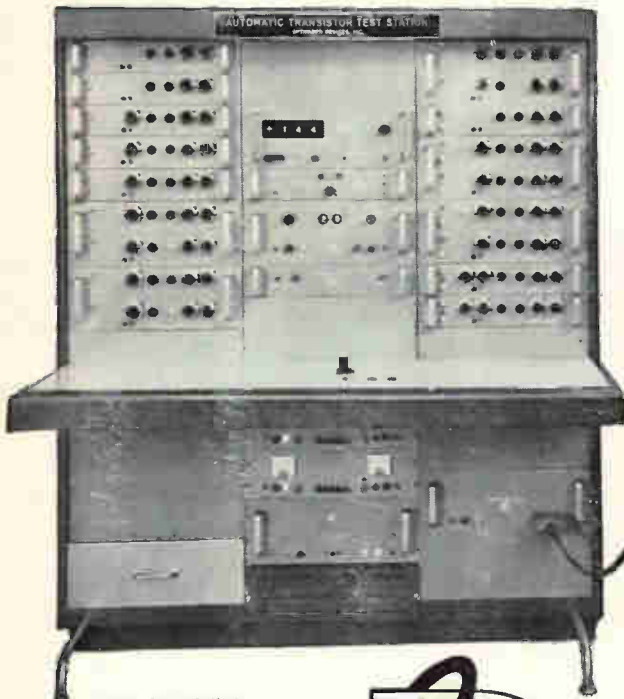

FEATURES • Accurate: 1% on d.c. tests, 3% on a.c. • High Speed: Test 700 units an hour. • Increased Capacity: Up to 25 individual tests in any sequence. • Versatile: Choice of measurements by modular components. • Easy to Program: By 10 turn dials and selector switches. • Modest Cost: Approx. \$10,000, depending on modules.

PARTIAL SPECIFICATIONS

Power Ratings 0-200 v, 0-1 amperes. Other powers available by substitution of power supplies.

Measurements include ICBO, ICEO, d.c. Beta, VCE Sat., VBE Sat., BVCEO, BVCEO, BVEBO, h11, h21, h12, h22, VPT.

Each system assembled from standard modules to meet particular requirements. Output choice is Go, No-Go; digital indication; printout; card or tape punch; or bin selection.

Write for Detailed Literature and Specifications to Dept. E



OPTIMIZED DEVICES INC. THORNWOOD, NEW YORK
ROGERS 9-6110

←CIRCLE 73 ON READER SERVICE CARD

CIRCLE 74 ON READER SERVICE CARD

CIRCLE 75 ON READER SERVICE CARD →

PRODUCTS OF ADVANCED SEMICONDUCTOR TECHNOLOGY...

FAST FIRING—FAST RECOVERY

INTERNATIONAL RECTIFIER SILICON CONTROLLED RECTIFIERS

**3, 5, 10 AND 16 AMPERE TYPES
RATED TO 400 VOLTS PRV**

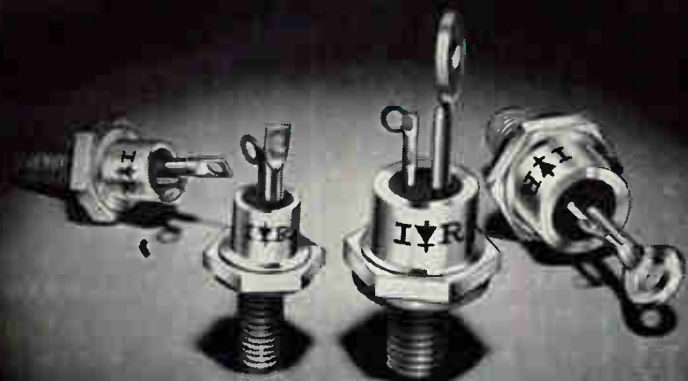

IR SILICON CONTROLLED RECTIFIERS

are the remarkable solid-state devices that provide complete control of current turn-on at microsecond switching speeds with no moving parts...no contacts. In the field of high-frequency power conversion they offer a totally new concept for versatile, contemporary circuitry highly efficient in operation...dramatically smaller in size.

THE TABLE BELOW lists the devices now in full production at International Rectifier that feature:

- Low Gate Currents that Control High Load Currents
- Fast Switching Speeds
- Low Forward Voltage Drop
- Low Forward and Reverse Leakage

Int'l Type No.	Max. Rep. PRV, Volts	Max. Average Forward Current @ 25°C, Amps	Gate Power, Watts		Max. Forward Voltage Drop @ Rated Current, Volts
			Peak	Average	
3 AMPERE RATED SERIES — 8 TYPES — TEMP. RANGE: -30°C to +105°C					
3RC2 thru 3RC40	25 thru 400	3	5	0.5	1.25
5 AMPERE RATED SERIES — 8 TYPES — TEMP. RANGE: -30°C to +105°C					
5RC2 thru 5RC40	25 thru 400	4.7	5	0.5	1.0
10 AMPERE RATED SERIES — 8 TYPES — TEMP. RANGE: -30°C to +100°C					
10RC2 thru 10RC40	25 thru 400	10	5	0.5	1.25
16 AMPERE RATED SERIES — 8 TYPES — TEMP. RANGE: -30°C to +125°C					
16RC2 thru 16RC40	25 thru 400	16	5	0.5	0.85

For detailed data on all types, request Bulletins SR-350 thru 354.

Circle Reader Card Number _____

Beyond the advanced design opportunities they present, International Rectifier Silicon Controlled Rectifiers possess significant technical advantages: ELECTRICAL CHARACTERISTICS representative of the highest state of the art. MECHANICAL CHARACTERISTICS that provide rugged packages in configurations that have become industry standards...directly interchangeable with other makes. RELIABILITY that stems from two and a half years of continuous refinement of production techniques, test procedures

and rigid military quality control programs including the U.S. Army Signal Corps RIQAP plan, a distinguishing mark of quality assurance awarded to International Rectifier for six consecutive years. As a source of supply, International Rectifier extends these benefits: APPLICATION ASSISTANCE without delay from three strategically located engineering groups. DELIVERY from stock on most types...from the factory or from 65 industrial distributors. PRICE AND DELIVERY attractively competitive on both counts...TRY US!

WRITE FOR DETAILS ON HOW YOU MAY OBTAIN SAMPLE SCR's AT NO COST ON THE NEW IR COOPERATIVE SAMPLING PROGRAM!

INTERNATIONAL RECTIFIER CORPORATION:
EL SEGUNDO, CALIF. • PHONE OREGON 8-6281 • CABLE RECTUSA

REGIONAL OFFICES IN NEW YORK CITY, CHICKERING 4-0748 • FORT LEE, NEW JERSEY, WINDSOR 7-3311 • SYRACUSE, NEW YORK, HEMPSTEAD 7-8495 • CAMBRIDGE, MASSACHUSETTS, UNIVERSITY 4-6520 • ARDMORE, PENNSYLVANIA, MIDWAY 9-1428 • SILVER SPRING, MARYLAND, JUNIPER 9-3305 • CHICAGO, ILLINOIS, JUNIPER 3-3085 • BERKLEY, MICHIGAN, LINCOLN 8-1144 • LOS ANGELES, CALIFORNIA, OREGON 8-6281 • IN CANADA: TORONTO, ONTARIO, PLAZA 9-2291

IMMEDIATE OFF-THE-SHELF DELIVERY FROM
65 INDUSTRIAL DISTRIBUTORS THROUGHOUT THE U.S.

INTERNATIONAL RECTIFIER



SYMBOL OF QUALITY IN SEMICONDUCTORS

FOR YOUR REVIEW...

Four of the Twenty Product lines that comprise

THE INDUSTRY'S WIDEST SEMICONDUCTOR LINE!

SILICON ZENER DIODES—1863 TYPES
Ratings: 250mw to 10w 2.6 to 30 Volts



HIGH VOLTAGE RECTIFIERS—157 TYPES
Ratings: to 440ma, to 16,000 PRV



SILICON POWER RECTIFIERS—187 TYPES
Ratings: to 250 amps to 600 PRV



SUBMINIATURE GLASS DIODES—49 TYPES
Ratings: to 200ma/to 380 PRV



**Veeder-Root announces Veederline:
108 versatile counters
for military, commercial and
industrial applications.**

**Veederline sets a new standard
in direct-drive high-speed counters.**

**Typical fields of use range from
navigation, tracking,
radar, ground approach,
fire control and guidance systems
to data processing, gaging,
measuring, machine tool indication
and process totalizing devices.**

**Veederline — a new range of
single, tandem and
dual counters.**

**Series 1742:
68 single counters
for basic digital communication.**

**Series 1758:
28 tandem counters
for additive counting
from a fixed reference
in either direction.**

**Series 1759:
12 dual counters
for alternate space considerations.
Low torque, low inertia, all rotations.**

**For new catalog write:
Veederline,
Veeder-Root Incorporated,
Hartford 2, Connecticut
count on...VEEDER-ROOT**

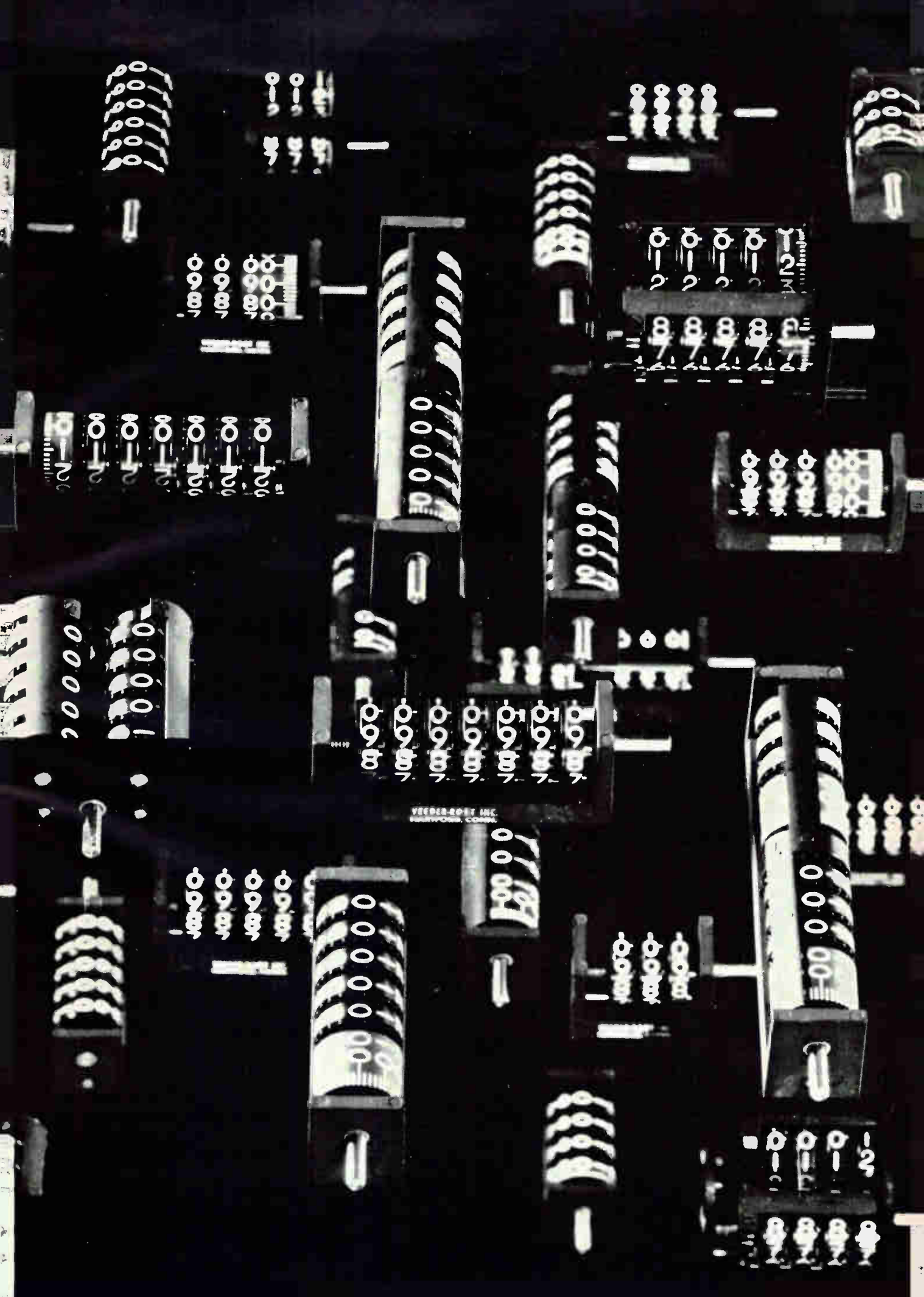

0000000000
0000000000
0000000000
0000000000
0000000000

0000000000
0000000000
0000000000

0000000000
0000000000
0000000000

0000000000
0000000000
0000000000
0000000000

0000000000
0000000000
0000000000
0000000000

0000000000
0000000000
0000000000
0000000000

0000000000
0000000000
0000000000
0000000000
0000000000

0000000000
0000000000
0000000000
0000000000

0000000000
0000000000
0000000000
0000000000

0000000000
0000000000
0000000000
0000000000

0000000000
0000000000
0000000000
0000000000

0000000000
0000000000
0000000000
0000000000

0000000000
0000000000
0000000000
0000000000
0000000000
0000000000

VEEDER-ROOT INC
MILWAUKEE, WIS.

0000000000
0000000000
0000000000

0000000000
0000000000
0000000000
0000000000

0000000000
0000000000
0000000000
0000000000
0000000000

0000000000
0000000000
0000000000

0000000000
0000000000
0000000000
0000000000
0000000000

0000000000
0000000000
0000000000
0000000000

0000000000
0000000000
0000000000
0000000000

0000000000
0000000000
0000000000
0000000000



All

gone

Here in Zurich's new cargo terminal, transshipping time is measured in minutes—not hours. There are 27 reasons why. One is the terminal itself—120,000 square feet of the world's most complete jet-age cargo facilities. The other 26 reasons are the 26 major international airlines that link Zurich with all Europe, Africa, the Middle East and the Orient. At the head of the list—Swissair, whose jet fleet serves 56 cities on 5 continents. Next time you ship cargo, take advantage of Zurich's unique facilities—including high-speed conveyor systems, refrigerator rooms, animal hostels, 9,000-square foot free trade zone, radiation storage, guarded vaults, plus all forwarders, agents and airline offices all under one roof. Phone your cargo agent, forwarder, or Swissair. 10 West 49th Street, New York 20, New York, FAculty 2-8600

SWISSAIR
SWISSCARE • WORLDWIDE

SELECTED BY
RCA
FOR
A HIGH
RELIABILITY
*** PROJECT**

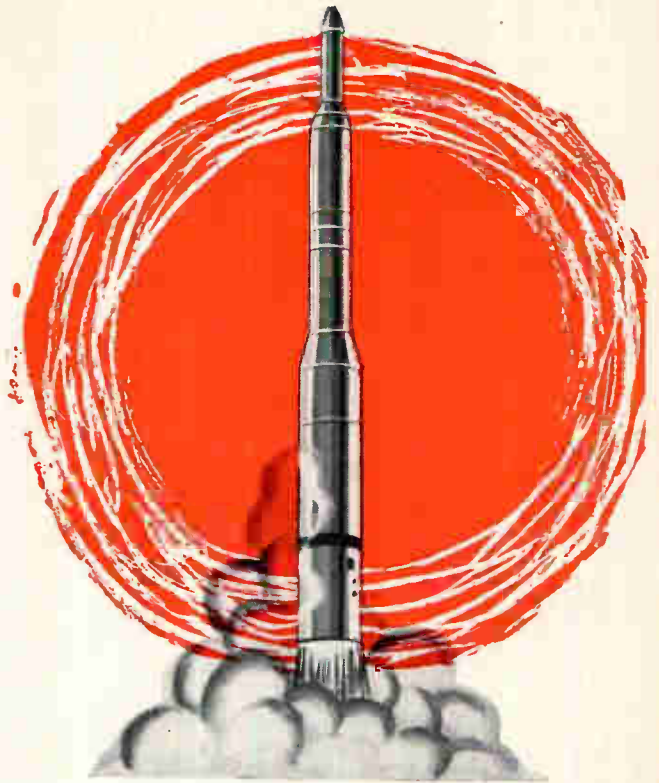
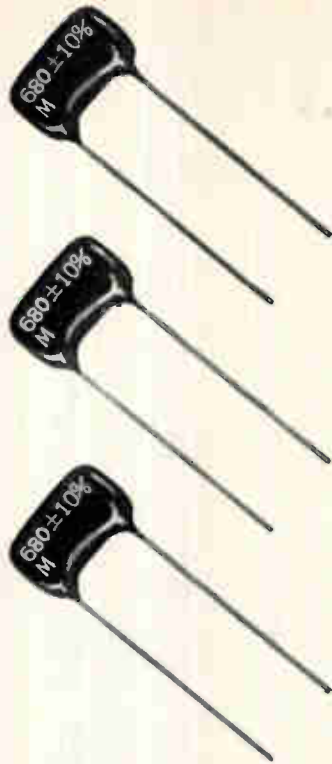

Here is MEASURED RELIABILITY!

Ten thousand El-Menco high reliability dipped mica capacitors were put on life test at 85°C with 225% of the rated DC voltage applied in accordance with an RCA high reliability specification.

*After 22,000,000 actual test unit-hours no** failures of any type occurred*

The accumulated 22 x 10⁶ test unit-hours without any failures can be used to calculate many different failure rates depending upon the confidence level desired. However, we shall explore the meaning of the results at a **90% confidence level**.

Assuming no acceleration factor for either temperature or voltage, we have verified a failure rate of approximately .01% per 1000 hours. (Actually, there is a temperature effect and it has been found that, with the DC voltage stress remaining constant, the life decreases approximately 50% for every 10°C rise in temperature. There is also a voltage effect such that, with the temperature stress remaining constant, the life is inversely proportional to the 8th power of the applied DC voltage.)

Assuming no temperature acceleration factor and assuming the voltage acceleration exponent is such as to yield an acceleration factor as low as 100, we have nevertheless verified a failure rate of approximately .0001% per 1000 hours.

Assuming no temperature acceleration factor and assuming the voltage acceleration factor is on the order of 250 (test results are available to confirm this) we have accumulated sufficient unit-hours to verify a failure rate of less than 00005% per 1000 hours!

Note that all the above failure rates are calculated at a 90% confidence level!

* The El-Menco high reliability dipped mica capacitors are being supplied to the Radio Corporation of America for a high reliability military ground electronics project.

** A failure was defined as follows:

1. A short or open circuited capacitor occurring during life test.
2. A part whose capacitance changed more than $\pm 2\%$ and whose capacitance did not fall within the original tolerance of $\pm 5\%$.
3. A part whose final dissipation factor exceeded .002.
4. A part whose final insulation resistance measured less than 100,000 megohms.

Write for a copy of our "Reliability Study of Silvered Mica Capacitors".

El-Menco
Capacitors

THE ELECTRO MOTIVE MFG. CO., INC.

Manufacturers of El-Menco Capacitors

WILLIMANTIC CONNECTICUT

- molded mica • mica trimmer • dipped mica • silvered mica films
 - tubular paper • mylar-paper dipped • ceramic feed thrus • ceramic discs
- Arco Electronics, Inc., Community Drive, Great Neck, L.I., New York
 Exclusive Supplier To Jobbers and Distributors in the U.S. and Conado
 WEST COAST MANUFACTURERS CONTACT:
 COLLINS ELECTRONIC SALES, INC., 535 MIDDLEFIELD ROAD, PALO ALTO, CALIFORNIA

THE EXCITING STORY OF THERMA BOND

FEATURED IN THE NEW 

ULTRA FAST SWITCHING Computer Designed Low Capacitance Diode

Now, Semcor develops the first basically improved ultra fast computer diode . . . precision built utilizing a new process called Therma BOND. The diode is a unique "middle mesa" device with permanently high performance guaranteed by Therma BOND.

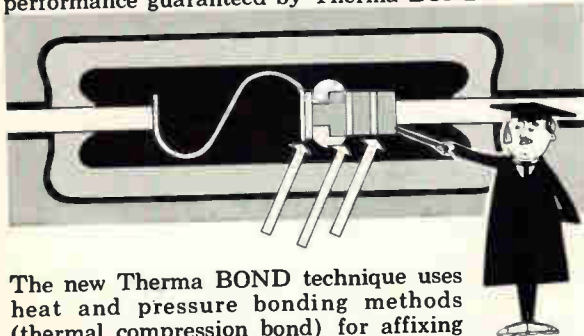

The new Therma BOND technique uses heat and pressure bonding methods (thermal compression bond) for affixing the silicon die in computer diodes, thus assuring stability against vibrations and shock conditions in high reliability applications.

Under extensive laboratory torture tests, the performance characteristics of the Therma BOND computer diode remained unaffected. Random, production line devices were supplied to several major users of computer diodes, and their engineering staffs found that Therma BOND was everything we claimed it was . . . and more. Therma BOND is new, yet proven in extensive life tests.

PERFORMANCE CHARACTERISTICS

REVERSE RECOVERY	$T_{RR} < 2.0\mu\text{sec.} \dagger$
FORWARD TRANSIENT	$T_{FT} < 1.0\mu\text{sec.} \ddagger$
CAPACITANCE	$C_0 < 2\mu\text{mf} @ 0V.$
SATURATION VOLTAGE	$E_s > 100V @ 100\mu a$
*FORWARD CURRENT	$I_f > 20 \text{ ma} @ 1V$
REVERSE CURRENT	$I_k < .025\mu a @ -20V (25^\circ C)$
RECTIFICATION EFFICIENCY	$R.E. > 45\% @ 100 \text{ mc}$

\dagger Recovery to 1.0 mA switching from 10 mA to -6 v in a 100 Ω loop.
 \ddagger Recovery to 110% of d.c. forward drop switching from 0-30 ma.
 *Higher forward currents available - send in your inquiries.

THERMA BOND is a pioneering development of 

SOLID STATE DIVISION OF NUCLEAR CORPORATION OF AMERICA

DIVISIONS: ELECTRON TUBE DIVISION • NUCLEONICS SERVICE CORP.
 • INSTRUMENT AND CONTROLS DIVISION • RESEARCH CHEMICALS,
 ADVANCED MATERIALS DEVELOPMENT DIVISION • U. S. SEMCOR,
 SOLID STATE DIVISION

For more information contact your representative or send in this handy coupon

U. S. SEMCOR

3540 West Osborn Road
Phoenix, Arizona

NAME _____

ADDRESS _____

CITY _____ STATE _____

Check here if you would like a free Therma BOND puzzle for your child

free

send for the

ALLIED 1962 ELECTRONICS SUPPLY CATALOG

592 PAGES
MOST COMPLETE

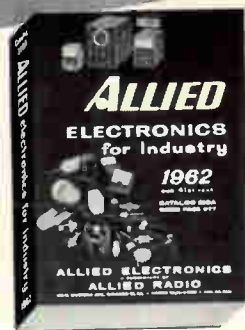

BUY AT FACTORY PRICES

- WORLD'S LARGEST STOCKS . . . SPECIALIZING IN:
- Semiconductors
 - Special-Purpose Tubes
 - Connectors
 - Test Equipment, Meters
 - Relays, Switches
 - Resistors, Controls
 - Transformers
 - Capacitors
 - Knight-Kit® Instruments in Low-Cost Kit Form
 - Electronic Parts for Every Industrial Need

ANYTHING IN ELECTRONICS IN A HURRY

One order to Allied fills the whole bill—from the world's largest stocks of electronic equipment. You get same-day shipment. You buy at factory prices. Write today for the FREE 1962 ALLIED catalog.

ONE ORDER
TO ALLIED
FILLS THE
WHOLE BILL

ALLIED ELECTRONICS
a subsidiary of
ALLIED RADIO

100 N. Western Ave., Dept. 922-J1, Chicago 80, Ill.

send for
**FREE
CATALOG**

CIRCLE 208 ON READER SERVICE CARD

NEED 65-80 db ISOLATION BETWEEN TRANSFORMER WINDINGS?

You do if your project involves very low signal levels. This was the case recently when a major transistor manufacturer specified EIC custom transformers with 65 db isolation between windings, from 60 cycles to 10 kc. (We can give you 80 db if required.) Insulation resistance specified (winding to winding and winding to case) was 300,000 megohms. Send us your complete specifications for prompt price and performance quotations.

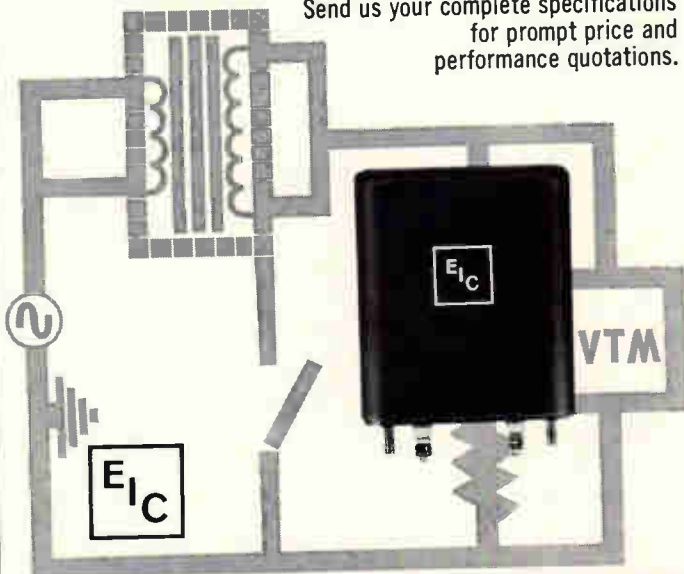

ELECTRODYNAMIC INSTRUMENT CORPORATION

Subsidiary of Reed Roller Bit Company
JA 6-3761 • 1841 Old Spanish Trail • Houston 25, Texas

CIRCLE 209 ON READER SERVICE CARD
electronics



THE RAW MATERIALS OF PROGRESS

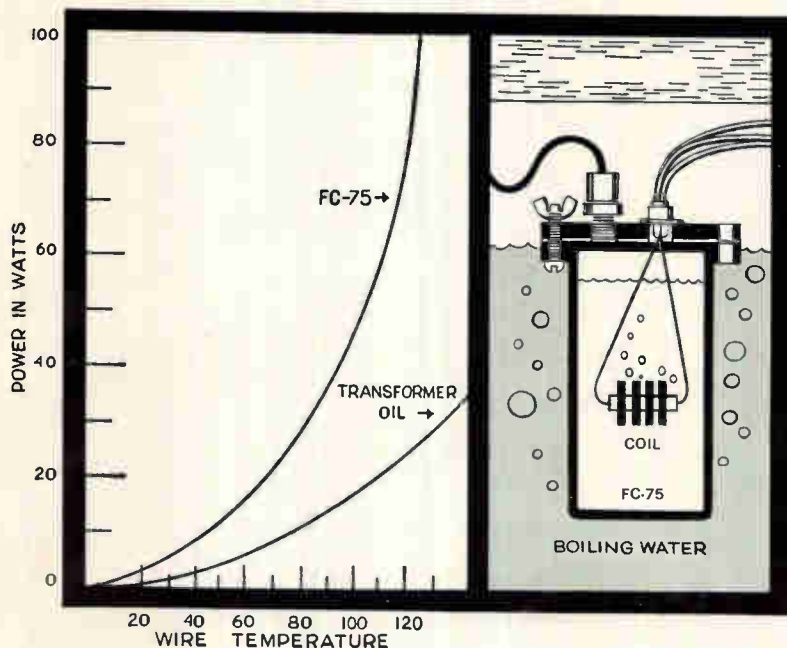

FC-75 Moves 10 Times More Heat... Dwarfs Design "Cube" by 4!

When the heat's on the electronics designer to crowd more and more into less and less space, he can count on 3M Brand Fluorochemical Liquids FC-75 and FC-43 for real help with cooling problems.

Graphed above are results of heat transfer tests where a wire coil was immersed first in standard transformer oil, then in FC-75. In each medium varying power inputs were applied to the coil and temperature rises charted. Quick summary: FC-75 transferred 10 times as much heat as did the oil, for the same temperature rise!

Many designers have used FC-75 successfully to reduce the size of electronic units. For

example, a transformer designer using FC-75 achieved volume reduction of 4 to 1, weight reduction of 2 to 1, without compromise of performance or power output. A leading aerospace designer used FC-75 to help miniaturize a power unit by a factor of six.

FC-75 is equally effective as a convective or evaporative coolant; and in both liquid and vapor forms is non-flammable and non-corrosive. The vapors at one atmosphere have a dielectric strength comparable to that of the liquid. For more information about FC-75 and FC-43, see the "Profile" column, right. Then write for specific application details.

PROPERTIES PROFILE

on 3M Brand Inert Liquids FC-75 AND FC-43

These unique dielectric coolants possess unusual properties that can prove advantageous to the designer of electrical devices and instruments, as well as to the manufacturer. Increased range of operating temperatures, improved heat dissipation which permits miniaturization, and greatly increased protection from thermal or electrical overload are possible with their use.

FC-75 and FC-43 are non-explosive, non-flammable, non-toxic, odorless and non-corrosive. They are stable up to 750° F., and are completely compatible with most materials... even above the maximum temperatures permissible with all other dielectric coolants. Both are self-healing after repeated arcing in either the liquid or vapor state.

ELECTRICAL PROPERTIES

	FC-75	FC-43
Electrical Strength	35KV	40KV
Dielectric Constant (1 to 40KC @ 75°F.)	1.86	1.86
Dissipation Factor (1000 cycles)	< 0.0005	< 0.0005

TYPICAL PHYSICAL PROPERTIES

	FC-75	FC-43
Pour Point	< -100°F.	-58°F.
Boiling Point	212°F.	340°F.
Density	1.77	1.88
Surface Tension (77°F.) (dynes/cm)	15	16
Viscosity Centistokes	0.65 min.	2.74
Thermal Stability	750°F.	> 600°F.
Chemical Stability	Inert	Inert
Radiation Resistance	25%	25%
	change @ 1 x 10 ⁸ rads	change @ 1 x 10 ⁸ rads

FC-75 and FC-43 have nearly equivalent heat capacities in the liquid and gaseous states.

For more information on FC-75 and FC-43, write today, stating area of interest to: 3M Chemical Division, Dept. KAX-91, St. Paul 6, Minn.

MINNESOTA MINING AND MANUFACTURING COMPANY

...WHERE RESEARCH IS THE KEY TO TOMORROW





pacesetter in electron beam technology

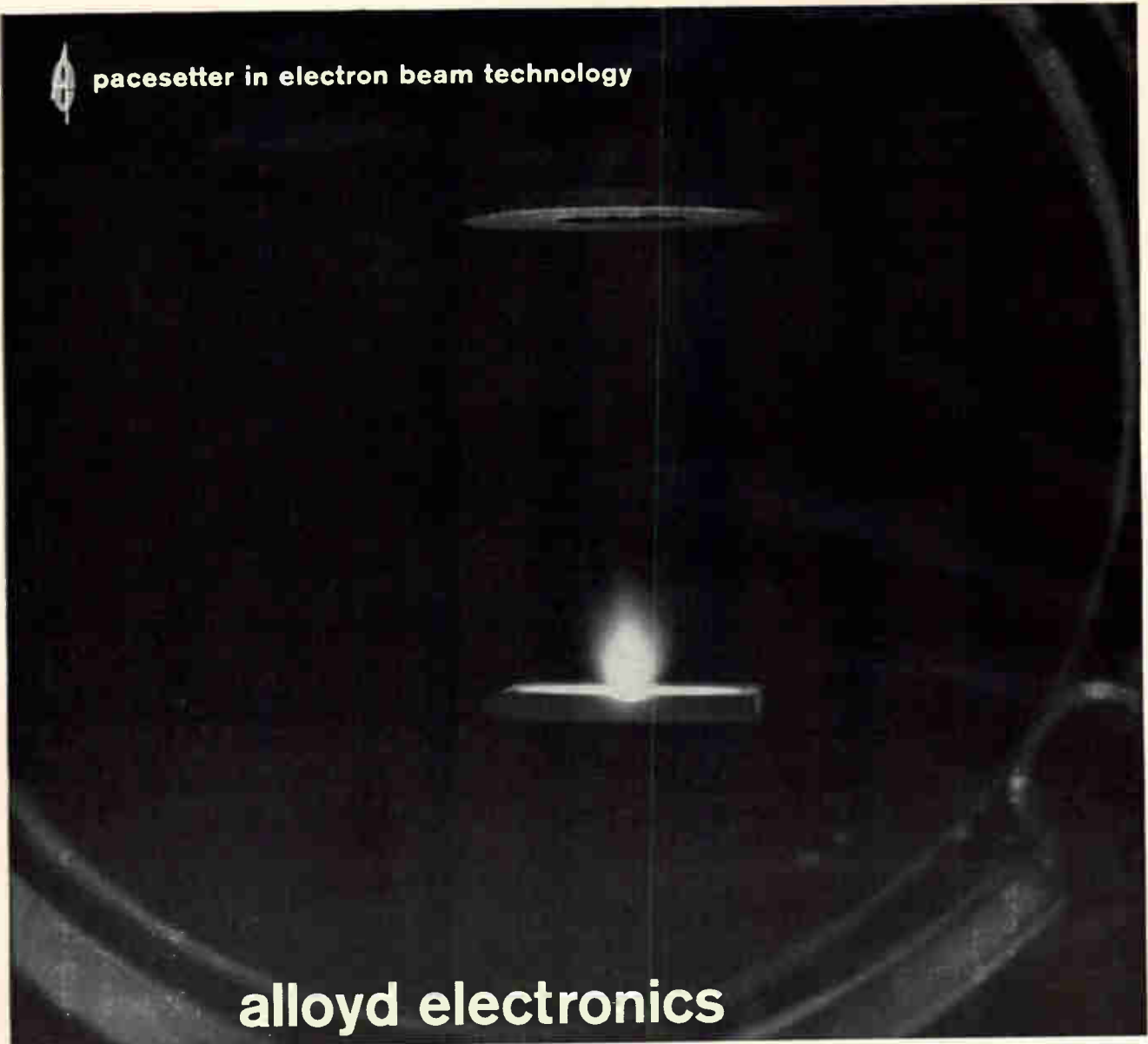

alloyd electronics

introduces the E-Beam Mark VI electron beam welder

The Mark VI electron beam welder makes possible what has previously been impossible in welding and brazing of refractory and reactive metals.

It utilizes electron bombardment heating, carried out in a high vacuum to make possible ductile welds in reactive metals and in super-alloys containing reactive elements. It makes possible narrow welds with controlled depth-to-width ratios. It makes it possible to weld thin-to-thick sections with highly accurate positioning of the beam. It produces welds in the new ultra-high strength materials that match or exceed the properties of the base material. It holds dimensional

change to a minimum. And the process is *fast*. It could hardly be otherwise at these temperatures.

The results: clean, crack free welds in even the most refractory and reactive metals . . . no contamination . . . optimum control and precision.

For complete information on the Mark VI welder, the Mark V evaporator, and Alloyd's engineering and custom services in electron beam applications, just write:

alloyd electronics corporation

An affiliate of Alloyd Corporation — 37 CAMBRIDGE PARKWAY, CAMBRIDGE, MASS.



The electron beam at your service — This Laboratory Welder is part of an advanced, complete facility for electron beam welding, brazing, evaporating, melting, and zone refining, maintained by Alloyd to meet custom requirements. We also offer engineering, consulting and research and development services in system design and development. Ask us for complete information.



Mark V Electron Beam Evaporator — a reasonably priced, highly flexible unit for producing thin metallic and non-metallic films by vapor deposition through electron bombardment heating. Completely self-contained. An invaluable research and development tool for thin-film applications, including micro-miniaturized electronic circuitry, optical filters, resistors, capacitors, memory devices and countless other components.





Actual Size

6 NEW MOTOROLA GERMANIUM EPITAXIAL MESA SWITCHES REPLACE MICRO-ALLOY, DRIFT AND OTHER MESA TYPES

with improved performance over a broader range...at lower cost!

Six new germanium epitaxial switching transistors from Motorola — the 2N960-62, 2N964-66 series — will replace several hundred similar old type devices in 90% of all applications.

With their faster switching time ($\tau_{RE} = 0.6$ nsec), this new epitaxial mesa switching series will supplant virtually all other germanium micro-alloy, drift, mesa, and other types for high-speed switching applications . . . in many cases at considerably lower prices.

Designed with improved geometry, the new switch series is intended for applications at both high and low current. Current gain and saturation characteristics are specified at three points (10 mA, 50 mA, & 100 mA), thus clearly characterizing device performance over a broad current range.

For applications where the advantages offered by this new epitaxial series are not essential, Motorola also offers eight new non-epitaxial germanium mesa transistors — the 2N968-75 series — at even lower prices.



FOR MORE INFORMATION on either of these important new mesa series, contact your Motorola District Office, or call or write: Motorola Semiconductor Products Inc., Technical Information Department, 5005 East McDowell Road, Phoenix 8, Arizona.

MOTOROLA DISTRICT OFFICES:
Belmont, Mass. / Burlingame, Calif. / Chicago / Clifton, N. J. / Dallas / Dayton
Detroit / Glenside, Pa. / Hollywood / Minneapolis / Orlando, Fla. / Phoenix
Silver Spring, Md. / Syracuse / Toronto, Canada.

REPLACEMENT CHART *						
Process Group	MOTOROLA EPITAXIAL MESA TYPES					
	2N960	2N961	2N962	2N964	2N965	2N966
Micro-alloy Diffused	2N501 2N846 2N588 2N1510	2N769 2N768	2N1499A 2N1500	2N779	—	—
Mesa	2N781 2N705 2N710	2N711	2N782	2N1301 2N795 2N1183 2N934	—	2N1300 2N794
Micro-alloy	2N1122A	2N1122	2N393 2N1427 2N1411	—	—	2N393
Surface Barrier	—	2N128	2N210 2N344 2N345 2N346	—	—	—
Alloy	2N583	—	—	2N582 2N584	—	—
Drift	—	2N643 2N644 2N645	2N1450 2N602	—	2N609	2N603

*Interchangeability of types shown is on the basis of performance in switching circuit applications. (All Motorola types have 150 mW dissipation in free air, 300 mW at 25°C case temperature.)



MOTOROLA
Semiconductor Products Inc.

A SUBSIDIARY OF MOTOROLA, INC.

5005 EAST McDOWELL ROAD • PHOENIX 8, ARIZONA

Highly Reliable

HITACHI "SEMI-CONDUCTORS"

For Industrial Use
Switching Transistors, and Diodes

2SA18
2SA41
2SA42
2SA86
2SA208
2SA209
2SA210
2SB66
2SB67
2SB68
2SB81
2SB82
2SC89
2SC90
2SC91

Hitachi semi-conductors provide the basis for the excellent capacity of the Hitachi Electronic Computer HITAC 103.

1N34A
1N35
1N38A
1N56A
1N60
1S77
1S78
1S79
1S84

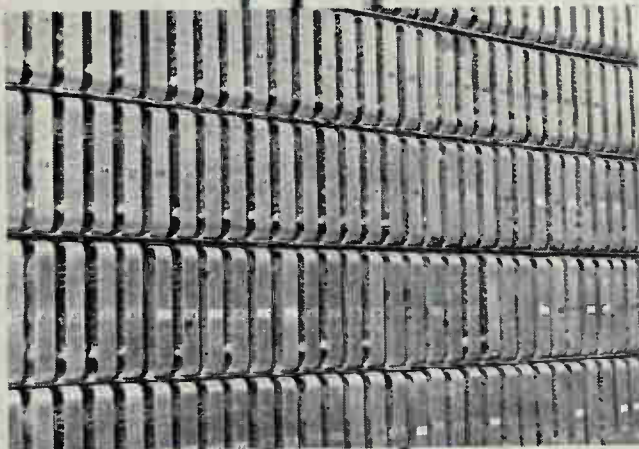

Back of HITAC 103.



Hitachi, Ltd.

Tokyo Japan

Cable Address: "HITACHY" TOKYO

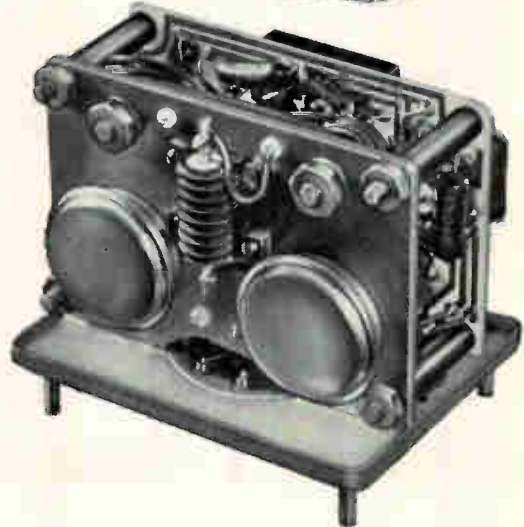

INLAND

first with solid state 100-watt d-c amplifier

Inland's new Model 579.35 d-c amplifier has a high power output of 100 watts when used with low impedance loads requiring direct current. And this completely transistorized amplifier is packaged in a hermetically sealed can only 2½" x 3¾" x 2½".

Designed for use with d-c torquers, in one typical application Model 579.35 provides 65 db power gain between the output of a d-c driver stage and the input terminals of a permanent magnet torque motor. This amplifier has these outstanding performance characteristics:

- The d-c output has magnitude and polarity proportional to the input signal.
- All amplifier circuits use a combination of silicon and germanium transistors (all-silicon models also available).
- Amplifier null and gain are stable and independent of temperature.

Inland also makes a complete line of rotary amplifiers for matched use with Inland's distinctive pancake shape d-c torquers.

A brochure on this new high-power amplifier is available. For your copy and complete data on Inland torquers and amplifiers, write Dept. 12-9.

TYPICAL SPECIFICATIONS

Maximum Power Output, watts (6 ohm load)	100
Power Gain	4,000,000
Current Gain	200,000
Voltage Gain	15
Frequency Response	DC to 1000 cps
Input Impedance, ohms	50,000
Dimensions, inches	2½ wide 3¾ long 2½ high
Operating Temperature Range in °C	minus 50° to plus 50°

INLAND MOTOR



INLAND MOTOR CORPORATION OF VIRGINIA • A SUBSIDIARY OF KOLLMORGEN CORP., NORTHAMPTON, MASS.

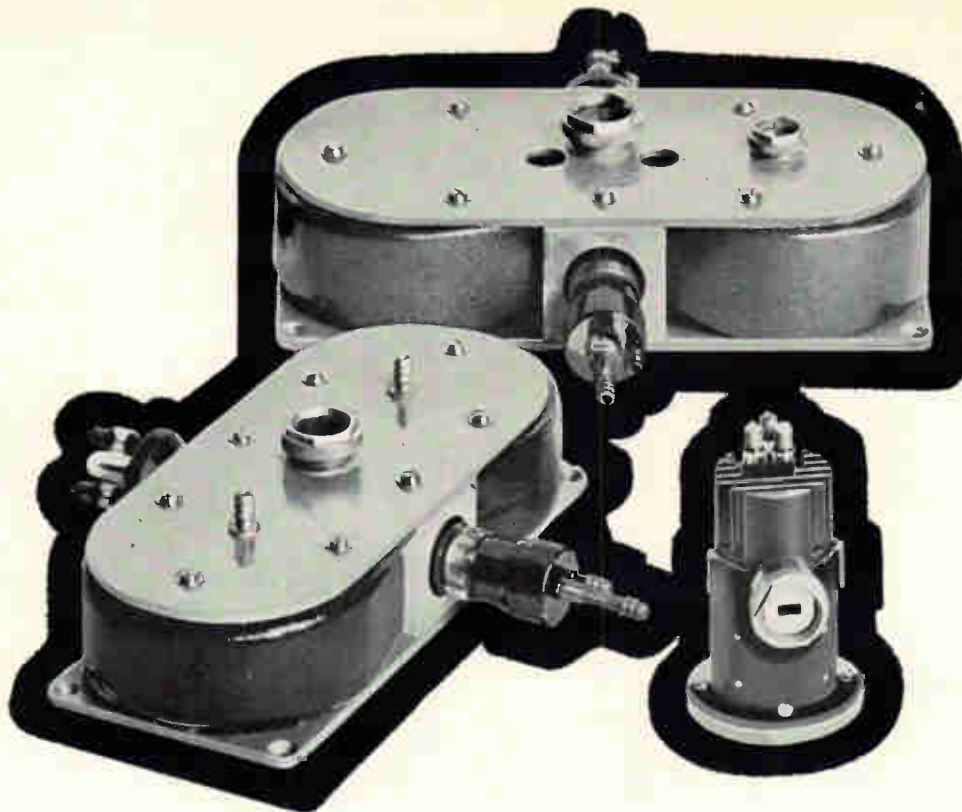

Ku-BAND TO 80 KMC

LONG-LIFE MILLIMETER WAVE KLYSTRON TUBES FROM LITTON

For applications in the 18-80 kMc range, the Litton Electron Tube Division now offers the Elliott-Litton line of quality-engineered millimeter wave tubes.

The floating drift tube design used for most Elliott-Litton klystron oscillators produces the effect of a single-cavity tube with the working efficiency of a two-cavity klystron. **Additional advantages of this design are freedom from hysteresis, stability of operation, and exceptionally low thermal drift.** Reflex klystrons are available in the 12 and 8 millimeter regions.

Applications include radar and communication systems, signal sources for microwave spectroscopy, gaseous plasma experiments, high-stability pumps for masers or parametric amplifiers, and local oscillators.

Contact us at San Carlos, California, for more information on Elliott-Litton tube types or on any of an extensive array of Litton microwave and display tubes and accessories.

ELLIOTT-LITTON LTD. FLOATING DRIFT TUBE AND REFLEX KLYSTRONS

Type No.	Frequency Band kMc/s	Minimum Tuning Range Mc/s	Minimum Power Output Watts	Cooling
L-3638	68 - 80	Fixed	0.100	Liquid
L-3639	68 - 80	Fixed	0.500	Liquid
L-3689	68 - 80	1500	0.500 average	Liquid
L-3690	68 - 80	1500	0.100	Liquid
L-3691	68 - 80	1500	0.100 average	Liquid
L-3640	48 - 52	Fixed	1.0	Liquid
L-3693	48 - 52	1500	1.0	Liquid
L-3629	33 - 37	Fixed	15.0	Liquid
L-3628	33 - 37	1600	10.0	Liquid
L-3632*	33 - 37	1000	0.030	Air
L-3633*	33 - 37	1000	0.200	Air
L-3659	32 - 37	700	5.0	Liquid
L-3697	30 - 37	1600	1.5	Liquid
L-3698	30 - 37	1600	1.0	Air
L-3630	21 - 25	Fixed	10.0	Liquid
L-3631	21 - 25	1000	8.0	Liquid
L-3642*	18 - 25	400	0.100	Air
L-3692*	18 - 25	400	0.350	Air
L-3699	21 - 25	1000	1.5	Liquid
L-3700	21 - 25	1000	1.0	Air

* REFLEX KLYSTRON

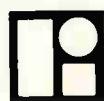

LITTON INDUSTRIES
Electron Tube Division

MICROWAVE TUBES AND DISPLAY DEVICES

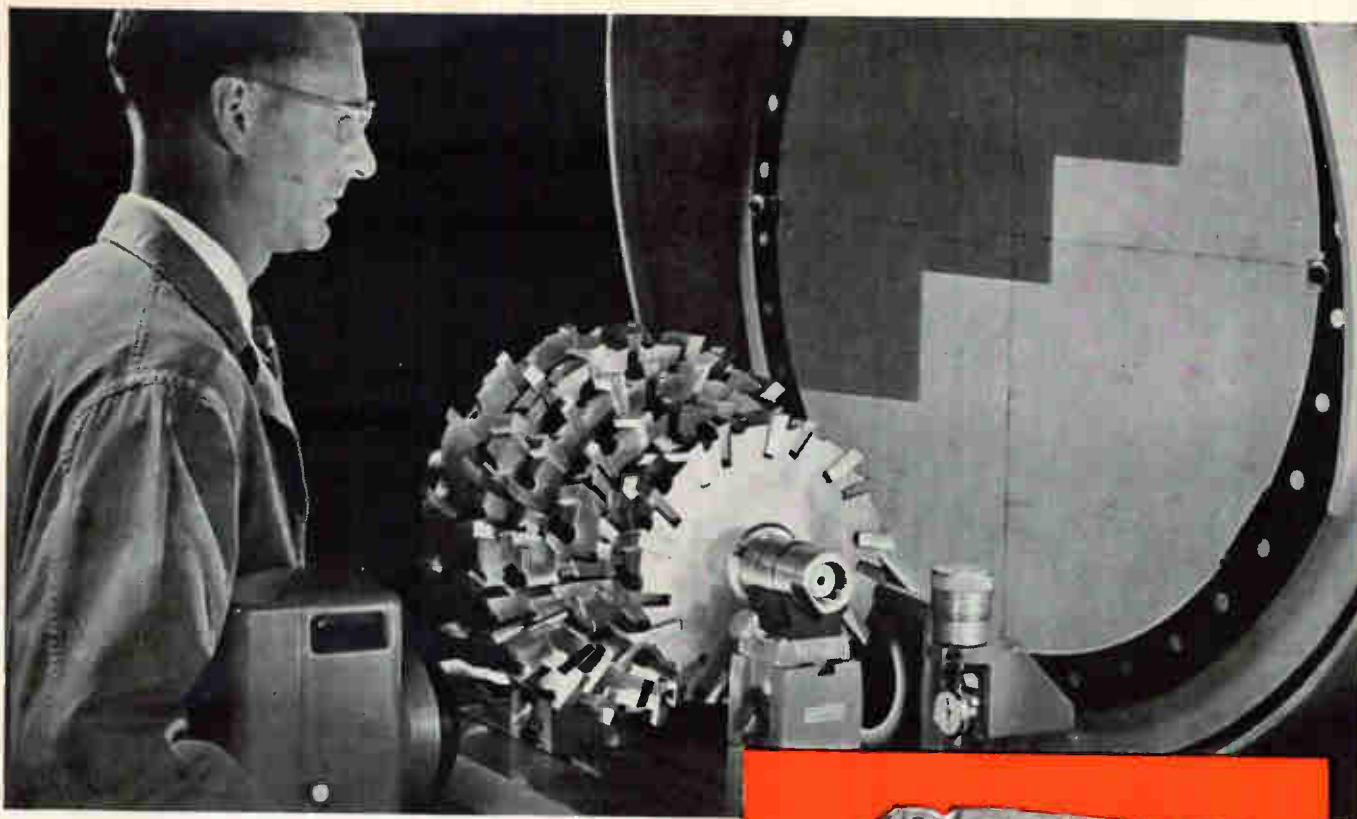

Built by **EX-CELL-O** To Insure Accuracy

Rugged, precision construction of Ex-Cell-O Contour Projectors results in stable support for the optical systems providing accuracy in the order of .0001". This rigidity is a major consideration in achieving for Ex-Cell-O Projectors an outstanding record of trouble free operation and almost total elimination of down time.

Typical of the sturdy, precision workmanship to be found throughout Ex-Cell-O Contour Projectors is the worktable of the Model 14-5 and Model 30. Engineers will recognize the superior design features shown in the inset at right. To cite just a few, the large 5" O.D. columns, supported in widely spaced bearings; the heavy channel skirt to stabilize the table assembly and the flexible elevating screw which can't impart deflections to the column.

Because of these construction features Ex-Cell-O Contour Projectors support heavy loads firmly, yet move easily and smoothly.

Whether your problem involves receiving, production or final inspection there's an Ex-Cell-O Contour Projector to do the job accurately, quickly and at low cost. The "why" and "how" is condensed in our new booklet—"43 Reasons Why Ex-Cell-O Contour Projectors are the First Choice of Industry." Yours for the asking!

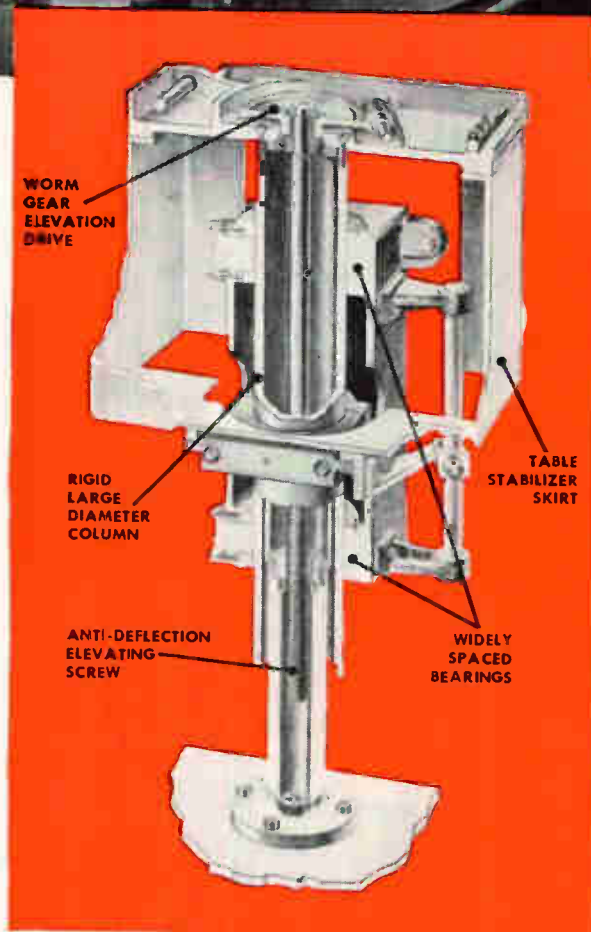

Manufactured by EX-CELL-O Corporation at Detroit, Mich.

SOLD AND SERVICED BY

OPTICAL GAGING PRODUCTS, INC.

26 FORBES STREET

ROCHESTER 11, N. Y.

Subsidiary of **EX-CELL-O** Corporation

CP61-2

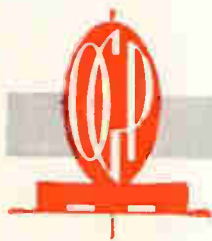



MICROCIRCUITRY AVAILABLE IN QUANTITY

THREE NEW FAIRCHILD MICROLOGIC COMPUTER ELEMENTS Available for immediate volume delivery are the Flip-flop, the Gate, and the Half-shift Register. These high-speed, low-power devices operate at bit rates in excess of 1 mc. For the first time complete arithmetic and control sections can be produced with SILICON PLANAR, SINGLE CHIP logic building blocks.

DESIGN AND ASSEMBLY COST REDUCTIONS—UP TO 90% Fairchild Micrologic elements can reduce

system design and assembly costs up to 90%, space requirements up to 95%, and power needs up to 75%, thus making many new computer applications practical and economically feasible. They can be used over the full military temperature range (-55°C . to $+125^{\circ}\text{C}$.).

RELIABILITY—500,000 HOURS AT 125°C
The equivalent of 3,000,000 component operating hours without a single failure. A new order of stability and reliability is made possible by the Fairchild Planar process with total protection of the passivated oxide surface.

SILICON PLANAR SINGLE CHIP CIRCUITS

UNRETouched PHOTOGRAPHS MAGNIFIED 5 TIMES

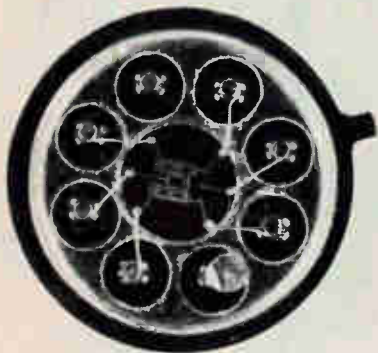

"F" FLIP-FLOP
TO-5 size header

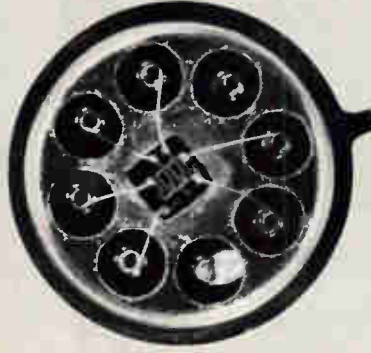
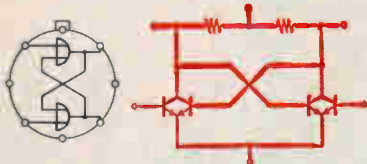

"G" GATE
TO-5 size header

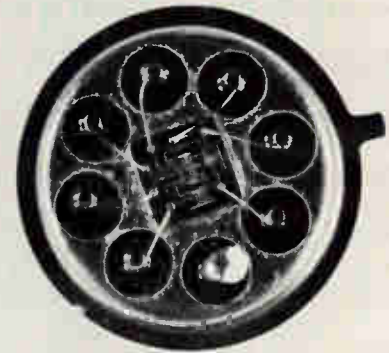
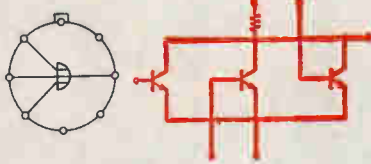

"S" HALF-SHIFT REGISTER
TO-5 size header

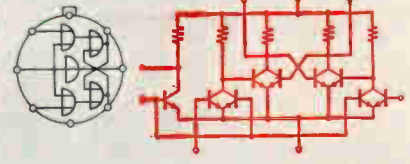

NOR DIAGRAMS AND CIRCUITS FOR EQUIVALENT FUNCTIONS

For complete data, specifications and pricing information contact your Fairchild Field Sales Office. Or write direct. Three additional elements (the Half-adder, Buffer and Counter Adapter) will be available soon to complete the Fairchild Micrologic family.

μL and μLogic are trademarks of Fairchild Semiconductor, a Division of Fairchild Camera and Instrument Corporation

FAIRCHILD

SEMICONDUCTOR

545 WHISMAN ROAD, MOUNTAIN VIEW, CALIF. · YORKSHIRE 8-8161 · TWX: MN VW CAL 853
A DIVISION OF FAIRCHILD CAMERA AND INSTRUMENT CORPORATION

WHAT'S NEW IN SEMICONDUCTORS

By JOHN M. CARROLL, Managing Editor

MATERIALS

MAJORITY-CARRIER DEVICES

MICROCIRCUITS

TRANSISTORS

RECTIFIERS

DIODES

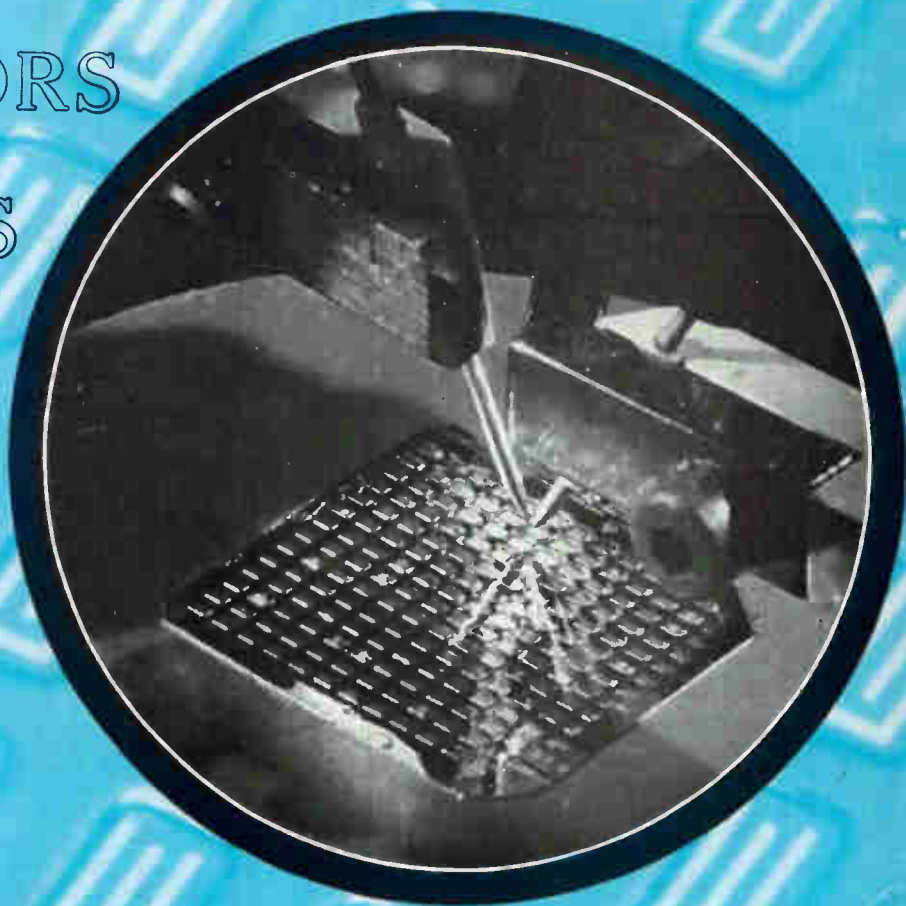

REPRINTS
AVAILABLE
300
READER SERVICE CARD

© 1961 ELECTRONICS, a McGraw-Hill Publication

Inspecting planar transistors before dicing and assembly. Operator uses electrodes in micromanipulators and works under microscope. Units are marked with micromanipulator not only good or bad but even by type. Background shows a field of planar transistors (General Instrument)

WHAT'S NEW IN SEMICONDUCTORS

INTR

- * *There is an oversupply of transistors and diodes. Reasons: more manufacturers and better yields*
- * *Device designers are pushing towards faster speed, higher power*
- * *Recent developments: epitaxial and diffused substrates, planar structure, improved junction geometries*
- * *Research frontiers: new semiconducting materials, microcircuits, thin-film amplifiers*

STATE OF BUSINESS—In the early 1950's the semiconductor business was the Cinderella of the electronics industry. Almost any group of engineers with know-how, a home-made crystal puller and sufficient capital to meet a payroll of 40 girls could get into business. Once in the business almost everyone seemed to make money.

But after a decade of making diodes and transistors, the Cinderella industry has become an attractive young matron. She is still exciting and filled with promise but is maturing through facing the hard facts of business life.

Technological development is still basic to success in the semiconductor field but more prosaic talents are needed also. Many major problems today have to do with marketing, distribution, production and quality control.

For the first time semiconductor manufacturers are realizing that they too are in the components business just like manufacturers of capacitors, resistors and electron tubes. Today the business is characterized by sharp competition, oversupply, price-cutting and narrowing profit margins. For the first time there are more transistors and diodes than there are sockets to fill.

There are two basic reasons. First, there are more manufacturers in the business—more than 80 as compared with 40 only a few years ago. Secondly, manufacturing technology has improved the yield of acceptable transistors. A yield of 50 percent was good a few years ago; yields of 70 to 80 percent are not uncommon today.

The price of being in the semiconductor business has steadily gone up. Even being a "me-too" manufacturer today costs big money for research staff and facilities. The magic combination of technological excellence, sound financing and easy access to markets means the difference between profitable operation and bankruptcy.

The shake-out among transistor manufacturers that some financial experts have been predicting for some years seems now to be at hand. The next three years will see many manufacturing entities disappear through

RODUCTION

merger, acquisition, sale of assets or failure. It would not be surprising to see only 15 transistor manufacturers of consequence by 1965. That more marginal manufacturers have not been forced to the wall sooner is due mainly to intravenous financial feeding by hopeful investment groups.

KEY TECHNICAL DEVELOPMENTS—Developments in the semiconductor business can be summed up in four words: more power, more speed.

Most recent advances in device design and metallurgy have been aimed at increasing speed of operation, increasing power handling ability, or both. Other developments aimed at increasing the yield of acceptable units or increasing device reliability have been microevolutionary. These include improved mechanical design of devices and cases, refinements in shop practice and procedure and management techniques, especially quality control.

Outside of the entertainment field, where the transistor business has long been on a barrel-of-nails basis anyhow, the largest single use of transistors has been in computers. Here designers are looking for the true fast-operating switch. The ideal switch should turn on instantaneously. Circuitwise this requires a large gain-bandwidth product to handle fast rise time. The ideal switch should also turn off rapidly. The switch should present infinite impedance when closed and almost zero impedance when open. Since the output of a computer switch must frequently drive many other switches, the so-called fanout requirement, it is essential a switch also handle power in the order of watts.

Many significant semiconductor developments have as their impetus the quest for a better computer switch. These include mesa and planar structures, special junction geometries, epitaxial, triple diffused and electrochemical processes. Factors important in characterizing switching transistors are $r_b C_j$ (base lead resistance times junction capacitance, should be low), f_t (gain-bandwidth

product, should be high) and minority-carrier storage time (should be low).

The main stream of semiconductor device development aimed at increasing speed and power has evolved many unique devices. These include zener and avalanche diodes, varactor diodes, tunnel diodes, unijunction transistors and four-layer trigger devices. One of these, the tunnel diode, was once thought to be the answer to every designer's prayer. This device has evolved, however, as a microwave oscillator/amplifier and a high-speed switch with some restrictions on its application. The tunnel diode, however, has pointed the way to what may be a more interesting application. This is the thin-film majority carrier amplifier, which may in time find applications to rival those of the transistor.

Another broad gage development is that of micro-miniature circuits. These circuits are talked about under a wide range of proprietary names. Basically, development was aimed at producing useful circuits having several active and passive components but fabricated in a single block of semiconductor material. The development of microminiature circuits has been pushed by the armed services to develop lightweight, highly reliable circuits for complex equipment. Now it is technologically feasible to fabricate almost any communications or computer circuit in monolithic solid-state form. The question is whether this can be done cheaply enough to compete with conventional components which are already extremely small, and whether a sufficient diversity of styles and sources of supply becomes available to make the technique attractive to equipment designers.

A great deal of development has been devoted to materials. Much of this has centered around germanium and silicon with special emphasis on the latter. However, the quest for faster devices and devices capable of handling higher power has led to exploration of other semiconductor materials, notably intermetallic compounds of metals in groups 3 and 5 of the periodic chart of the elements.

MATERIALS

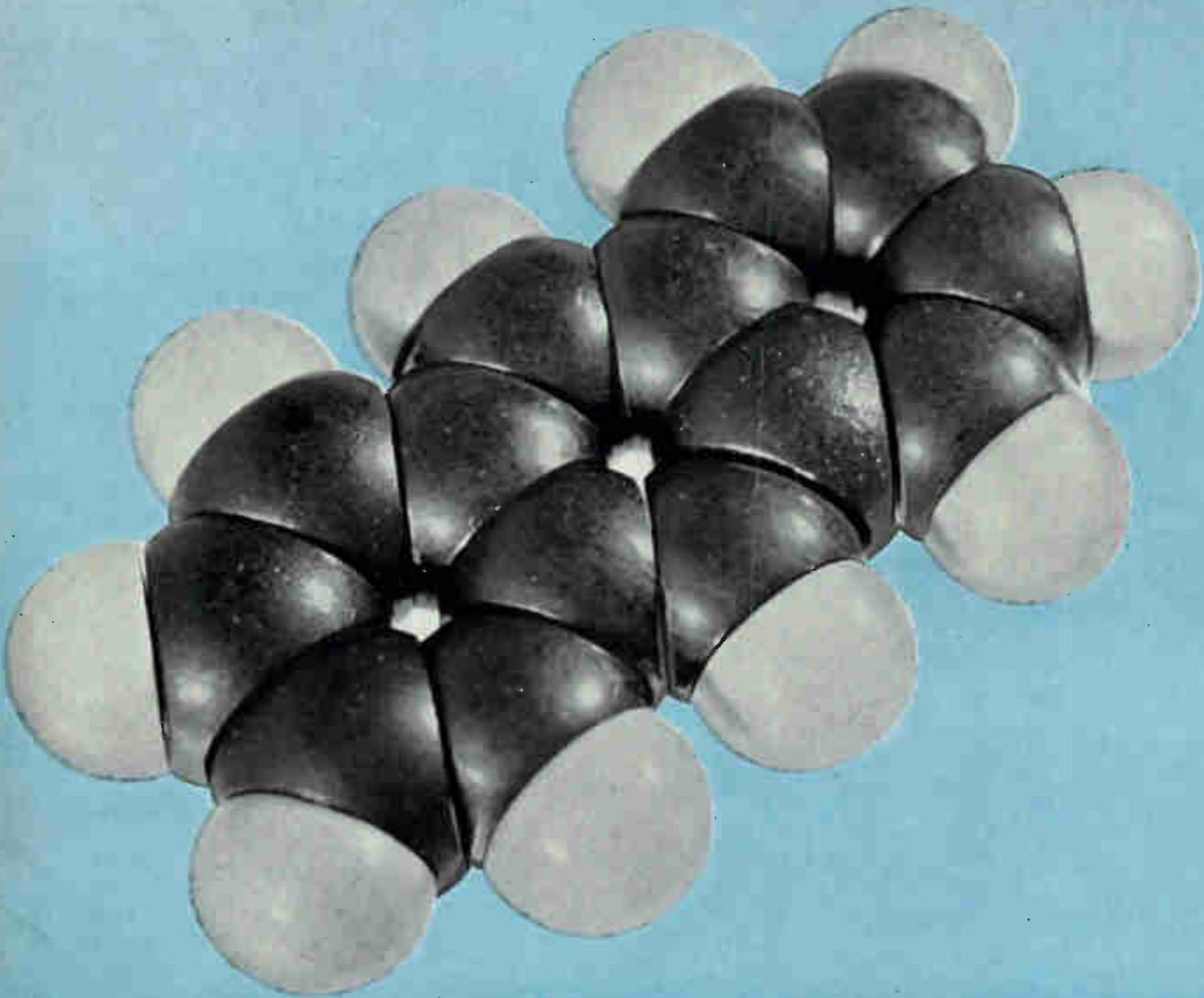

Anthracene molecule, an organic semiconductor (Armour Research Institute)

REFINING AND CRYSTAL GROWING—A semiconductor is a substance whose electrical conductivity is midway between that of a conductor and an insulator. The first semiconducting substances investigated came from group 4 of the periodic table. These include silicon, germanium, gray tin and blue diamond. Silicon and germanium are commercially important.

More recently intermetallic compounds of group 3 and group 5 elements have been investigated. These include compounds such as gallium arsenide and indium antimonide. Some of these compounds have commercial interest at the present time. More advanced work is going on

in the study of group 2 and group 6 intermetallics such as selenides and tellurides. Alloys of bismuth and antimony are also under investigation. These are called semimetals rather than semiconductors. Organic materials such as anthracene are being studied.

The first step in production of semiconductor metals is to produce polycrystalline rods of as high a purity as possible. The next step is to grow from this material monocrystalline ingots which may or may not be doped with impurity material. The monocrystalline ingots are then sliced for diffusion or epitaxy or they are sliced and diced for alloying.

There are four common techniques for crystal growing: the Czochralski, Bridgman, floating-zone and gradient-freeze methods.

The Czochralski method is widely used with germanium and also used with silicon. The magnetic Czochralski technique has been used with intermetallic compounds such as gallium arsenide.

In the Czochralski technique a seed is withdrawn from the melt and is rotated to maintain thermal symmetry and cylindrical geometry. (See Fig. 1A.) In germanium the polycrystalline metal is melted in a graphite crucible. Silicon is melted in a quartz crucible. This crucible is partly consumed during crystal growing. In intermetallics both translation and rotation of the seed holder must be carried out within a heated and sealed quartz tube. The intermetallic is melted in a graphite crucible by an inductor coil. The seed holder moves on a graphite bearing within the sealed quartz tube. Concentric with the sealed tube is another quartz tube through which an inert gas is circulated and around the tubing are resistance heating wires. Attached to the seed holder are four Permadur slugs. Four permanent magnetics are mounted in a support concentric with the heater wires. The support rotates and translates, pulling the seed out of the melt.

The floating-zone technique is used with silicon to prevent contamination from the quartz crucible. A rod of pure polycrystalline silicon is held vertically by two quartz clamps. The thermal gradient produced by r-f heating coils is moved upward along the rod to produce a single crystal. To insure against contamination the quartz clamps may be water cooled. (See Fig. 1B.)

The Bridgman and gradient-freeze techniques are used mainly with intermetallic compounds and in a laboratory environment. In the Bridgman technique, a polycrystalline rod is laid in a carbon boat and the boat is slowly drawn through a stationary temperature gradient produced in an electric furnace.

In the gradient-freeze technique, the carbon boat remains stationary and the furnace temperature is lowered so that the temperature gradient sweeps across the boat. The Bridgman and gradient-freeze techniques are shown in Fig. 1C and Fig. 1D.

GERMANIUM—Germanium is found in nature in complex ores of zinc, arsenic, copper and iron. One method of recovering germanium is by distillation in hydrochloric acid to obtain germanium tetrachloride from which germanium is subsequently recovered by hydrolysis as germanium dioxide. Most manufacturers start with the pure germanium dioxide. Germanium metal is obtained by hydrogen reduction of the oxide.

The metallic germanium is purified by zone refining. A carbon boat containing the germanium is drawn through a temperature gradient.

Single crystal germanium is obtained by the Czochralski technique. Germanium has a room-temperature band gap of 0.7 electron volt. It has an electron mobility of 3,900 centimeters square per volt second and a hole mobility of 1,900 centimeters square per volt second. In resistivity, pure germanium runs about 200 ohm centimeters.

SILICON—Intensive work is being done on silicon.

Silicon has a higher melting point, higher band gap (1.1 e-v) and lower electron and hole mobilities (1,500 and 500) than germanium. It is less sensitive to thermal effects and has a stable dioxide that makes it attractive for making planar transistors and microcircuits.

Much high purity silicon today is produced by an integrated process of trichlorosilane reduction. Trichlorosilane is reduced by hydrogen and heat to form silicon and hydrochloric acid.

Pure polycrystalline silicon is available in rod form at 1,000-ohm centimeter resistivity. Vacuum floating-zone monocrystalline silicon is available with resistivities greater than 1,000-ohm centimeters. Silicon of *p* type with over 20,000-ohm centimeter resistivity has been supplied. Material of much lower resistivity is generally used in the industry. Manufacturers report that the nominal 1,000-ohm centimeter resistivity material seldom attains that in practice and that after growing single crystals by the Czochralski technique, the material has about 20-ohm centimeters resistivity. After the usual boron or phosphorus doping, resistivity is about 2 ohm centimeters.

Radiation has been used to cause *n* doping in silicon. The semiconductor substrate is bombarded with fast neutrons. The neutrons convert a few of the silicon atoms to short-half-life radioactive isotopes that decay to form phosphorus.

GALLIUM ARSENIDE—Gallium arsenide has been used experimentally for tunnel diodes, varactor diodes and transistors. It is an attractive material in that it has a higher energy gap than silicon (1.4) and has a higher electron mobility than germanium (5,000 centimeters square per volt second or better). However, the hole mobility is lower (around 400). The measure of merit for a material for high-frequency devices is $\sqrt{\mu_n \mu_p / \kappa}$. Where μ_n is electron mobility, μ_p is hole mobility and κ is the dielectric constant. This measure

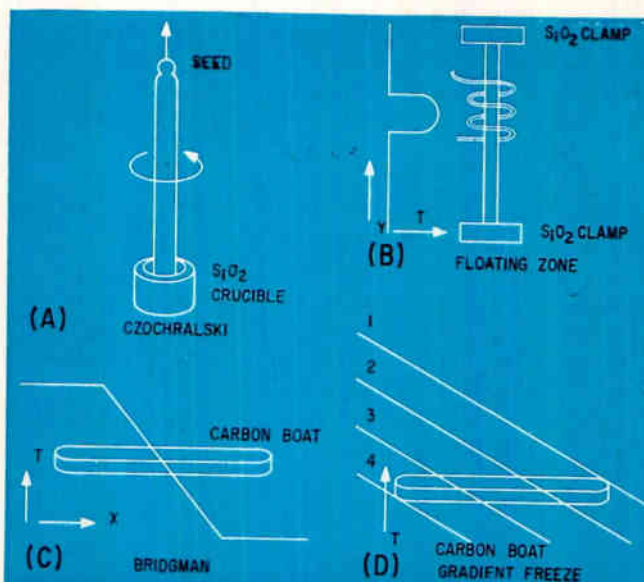

FIG. 1—Methods for growing single-crystal semiconductor ingots: Czochralski (A), floating-zone (B), Bridgman (C) and gradient-freeze (D)

of merit is related to f_i , the gain-bandwidth product. Frequency f_i is defined as the frequency at which gain (beta) has dropped to unity. The factor is higher for gallium arsenide than for either silicon or germanium.

Gallium-arsenide tunnel diodes exhibit effects of local heating when biased in the forward conduction state. These effects are in the direction of degradation, tending to lower the peak current, and often to increase the excess current. The roles of the electric field, the presence of impurities near the junction, and the metallurgy of the alloyed region in this degradation are not completely clear. It would therefore be premature to make any prediction concerning the suitability of gallium arsenide for tunnel diodes at this time.

It is true that in limited aging experiments, devices not employing majority-carrier tunneling have shown no degradation in observed parameters. However, this work is also incomplete.

GALLIUM ANTIMONIDE—Gallium antimonide has been used to make extremely low-noise tunnel diodes. It has an energy gap of 0.68 electron volt, an electron mobility of 4,000 and a hole mobility of 700. The quantity, $I^2R = a \text{ constant}$, is a figure of merit for noise figure in tunnel diodes. A low value makes for a good noise figure. This quantity is measured by the negative reciprocal of the slope of the log I versus V curve in the negative resistance region of the tunnel diode. For germanium, the figure is 65 to 70 millivolts; for gallium arsenide 120; for gallium antimonide 35 to 40.

INDIUM ANTIMONIDE—Indium antimonide has been used to make fast tunnel diodes. The material has an energy gap of 0.17 electron volt and the tunnel diodes must be operated below room temperature. Indium antimonide and indium arsenide have found use in Hall-effect devices.

GALLIUM PHOSPHIDE — Gallium phosphide p - n junction devices have been studied experimentally. They exhibit electroluminescence, emitting red light when forward biased and a dimmer white light when reverse biased.

Gallium phosphide is created by synthesis of gallium in carbon boats under 25 atmospheres of phosphorus at a temperature close to 1,500 C (a little below the melting point).

Single crystals are grown by the floating-zone process under 25 atmospheres of phosphorus. Dopants used to make n material are selenium, tellurium and sulphur. Zinc is used to make p material. The energy gap of gallium phosphide is 2.25 electron volts as compared with 2.8 for silicon carbide. The charge-carrier mobility is 100 centimeters square per volt second, 65 for holes. Charge-carrier lifetime is lower for gallium phosphide than for gallium arsenide.

SEMIMETALS—A binary alloy of bismuth and antimony has been shown to be semiconductive with concentration of antimony greater than 5 percent and lower than 40. It exhibits a 0.02 to 0.05 electron-volt energy gap. With this alloy, group 4 elements such as lead and tin are acceptor (p) impurities and group 6 elements

such as selenium and tellurium are donor (n) impurities.

ORGANICS—Both organic crystals such as anthracene and polymers have been studied as possible semiconductors. No p - n junctions have been produced in any organic material and only now is the nature of electrical conduction in organics beginning to become understood.

Techniques familiar in inorganic semiconductor research have been used to study conduction in anthracene even though the bonding between molecules in anthracene differs from that in silicon and germanium. However, it appears that the mechanisms of electrical conductivity in polymers are entirely different than those in organic crystals. Present studies indicate that purity comparable to that of inorganic semiconductors must be achieved before polymers can possibly be studied and evaluated. Although organic transistors cannot be categorically ruled out, they are improbable. Electrical cooling and solar generation of heat, however, seem likely because of low thermal conductivity.

LOW TEMPERATURE EFFECTS—The cryosar is a negative-resistance two-terminal device utilizing impact ionization of impurities in germanium at liquid-helium temperatures. Researchers at MIT's Lincoln Lab, are now designing a small cryosar memory. They speculate that low temperature may be the best road to higher speed, smaller computers. Epitaxial growth appears to be the best way to get the compound cryosars needed.

MAGNETIC EFFECTS—The effect of very high magnetic fields on diodes and tunnel diodes is being studied at Lincoln Lab. The hope is to get a four-terminal device in which input and output are isolated. The effects of magnetic fields on current voltage characteristics of indium antimonide diodes are being studied. The effects are orientation and temperature dependent.

OSCILLISTORS—Progress is underway at Lincoln to investigate oscillistor action in germanium, silicon and indium antimonide. This action is a magneto-oscillatory effect manifested as an oscillatory variation in the conductivity of a semiconductor sample that contains excess minority carriers and is subjected to nearly parallel d-c electric and magnetic fields. The frequency of the oscillistor is about 500 Kc or more and requires an extremely fast detector. Zinc-doped germanium cooled to liquid-helium temperature is used.

SILICON CARBIDE—In a quest for semiconductor devices to operate at extremely high temperatures even silicon carbide has been tried. Indeed, silicon-carbide rectifiers have been marketed. However, these devices have a high forward voltage drop.

Actually silicon carbide was one of the first semiconductor materials to be used. In the 1920's Western Electric took silicon carbide right out of the furnaces at Niagara, ground it up and mixed it in a ceramic slurry that could be cast into desired shapes. The result was a bipolar voltage breakdown device that telephone companies used to protect their pole lines against lightning strokes. Silicon-carbide varistors are used in electronic circuits.

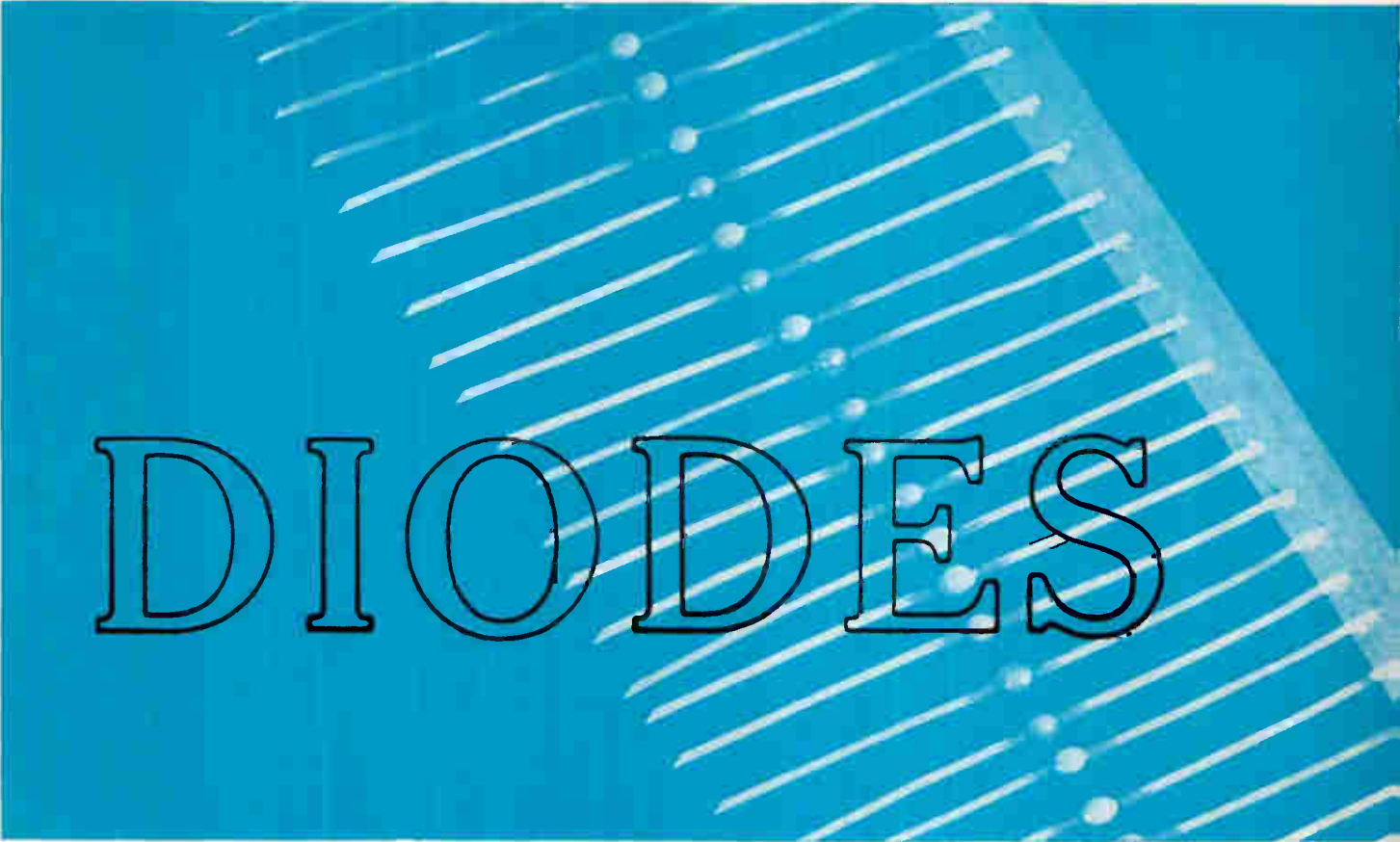

DIODES

Computer diodes sealed in hard glass bonded to silicon (Microwave Associates)

POINT-CONTACT DIODES—Among the first semiconductor devices were detector and mixer diodes of polycrystalline silicon using a point contact.

These devices are now obsolete but single crystal point-contact diodes of both silicon and germanium are still used as microwave mixers. The substrate is *n* type. The point may be tungsten, phosphorus-bronze or platinum-iridium. Pressure on the point forms a *p* region. A point-contact diode is shown in Fig. 2A.

In one manufacturing process, an *n*-type silicon wafer is heated to form an oxide. Then the oxide is removed. The wafer is placed in a ceramic case. The whisker is shoved into a case on a lathe as the operator watches the reverse diode characteristics on a scope. To get the proper characteristic the operator varies the feed. Such a diode cannot withstand high power.

GOLD-BONDED DIODES—The gold-bonded diode has taken the place of the point-contact unit in most computer logic circuits. In the gold-bonded diode a pre-formed whisker of gold is brought into contact with an *n* germanium substrate as the junction is formed by

electrical pulses. (See Fig. 2B) The pulsing may be either a-c or d-c. Pulses are of millisecond duration. Uniform pressure is applied to the whisker.

In making gold-bonded diodes the whisker is doped with one percent gallium. The whisker alloys to the germanium forming a hemispheric contact.

Gold-bonded diodes can switch in about 20 nanoseconds. Units as fast as 0.6 nanosecond have been made. However, these devices have poor reverse characteristics and are useful in the 6 to 10 volt range only.

High speed in gold-bonded diodes may be obtained by killing carrier lifetime. This is done by adding nickel to germanium. Killing carrier lifetime increases the rate of minority charge-carrier recombination while at the same time it degrades the reverse characteristics. The forward resistance also increases. Therefore, in computer switching, transistor amplifiers must be added to make up losses even though the diodes themselves are cheap. Incidentally, gold is added to silicon to kill carrier lifetimes.

ALLOYED AND DIFFUSED DIODES—Practically any

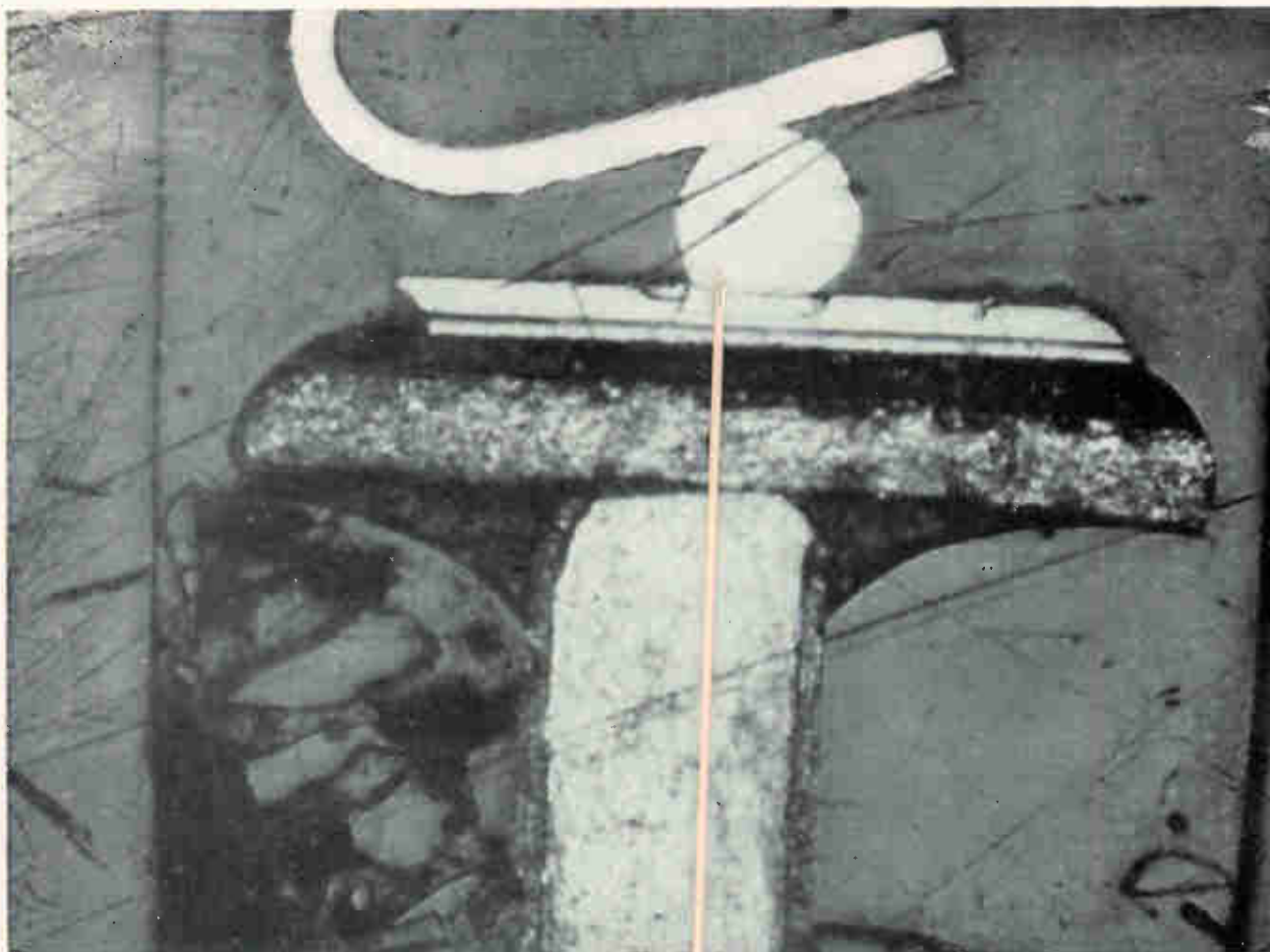

Cross section of a planar diode (photo by Semi-Alloys, Inc.)

manufacturing technique used with transistors has also been used with diodes. Hence, there are alloy-junction diodes in which, for example, an indium dot may be alloyed to an n germanium die or an aluminum dot alloyed to an n silicon die.

A solid-state diffusion process is illustrated in Fig. 2C. Either an n or p substrate may be used. The illustration shows n silicon substrates. Boric acid in an organic solvent is painted on one side of the substrate and phosphorus pentoxide is painted on the other side. The wafers are then stacked and many slices heated at once. Mesas may be etched upon the diffused diodes to make a cheap general-purpose device.

In gaseous diffusion, boric and phosphoric oxides are used. Gallium vapor may be also used for p diffusion. Gaseous diffused diodes can be either p on n or n on p devices.

For high current, n on p is used. For high-speed switching, p on n is used. Gaseous diffused diodes can be made in the mesa configuration shown in Fig. 2D or the planar configuration shown in Fig. 2E. The Semicor undercut mesa illustrated in Fig. 2F is said to provide a low capacitance computer diode with high mechanical stability. The mesa is etched after the lead is attached to the die. This allows a large surface for lead con-

tact. The leads are attached by thermal bonding rather than pressure contact.

MULTIPLE DIODES—Because so many diodes are used in computer logic circuits much work has been done towards developing a more compact way of packaging these devices. One approach is an RCA triple diode illustrated in Fig. 3A. The triple diode is a type 3DG001. A double diode type 2DG001 is available. These are germanium diodes post-alloy diffused using a lead-antimony dot on a p germanium substrate. The germanium substrate is then soldered to a Kovar header using an indium preform. The triple diode has four leads, the double diode, three. The leads from the alloy dots are bonded together and brought to a single lead in the heater. Each wafer substrate has its own lead.

A Burroughs Bipco or built-in-place module contains 40 silicon diodes, can convert binary to decimal numbers. A single silicon wafer is diffused to form a large planar diode. Diode elements are fabricated in a specific pattern. Interconnections are made by a silk-screened circuit plate.

The multielement diode shown in Fig. 3B is made by Sylvania. It is a "pancake" packaged four-element diode on a common silicon substrate. Each diode has the

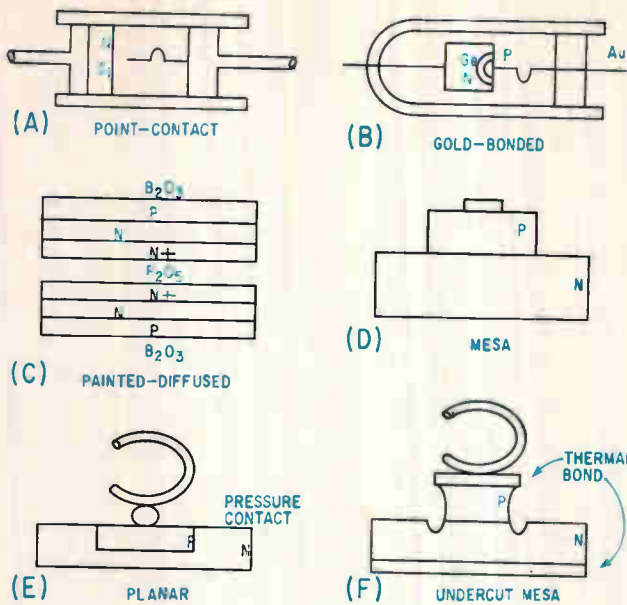

FIG. 2—Semiconductor diode types: point-contact (A), gold-bonded (B), painted-diffused stack ready for furnace (C), mesa (D), planar (E) and undercut mesa (F)

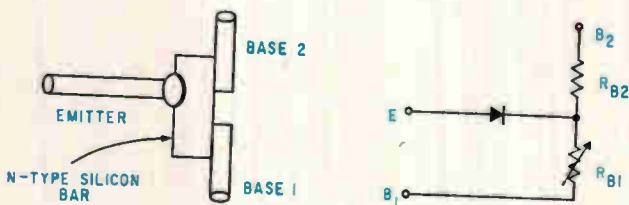

FIG. 4—Unijunction transistor or double-base diode: cross section, left, and schematic, right

characteristics of the type 1N903. Sylvania says power dissipation of the single package is greater than that of four separate diodes and that uniformity is excellent. In the present package the substrate is *n* silicon. A multielement diode using a *p* substrate is under development. The manufacturer is planning an eight-diode element and another containing two transistors and a diode.

The diode cluster shown in Fig. 3C is made by Delta Semiconductors. It consists of several junctions on one sliver of silicon. Encapsulated in a glass package, they come in triples, quads and quints.

BREAKDOWN DIODES—Breakdown diodes are designed to conduct in the reverse direction at some specific value of reverse bias. They may operate in either the avalanche or zener modes.

Avalanche conduction is similar to the breakdown of a gas tube. Charged-particle collisions create additional hole-electron pairs. Zener breakdown occurs when electrons are pulled out of their covalent bonds by a high electric field.

Avalanche transistors and diodes may be made by either diffusion or alloying. The avalanche effect can be achieved by heavily doping the *n* or *p* substrate in

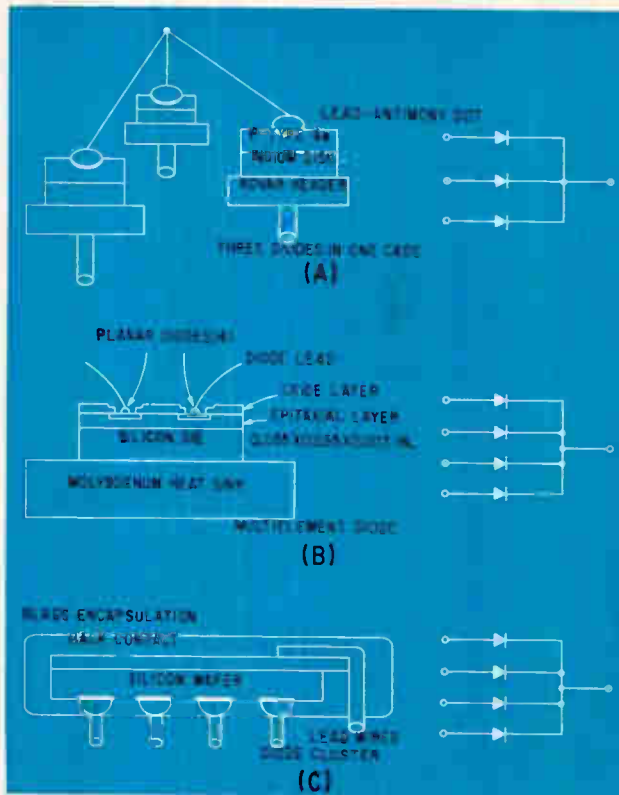

FIG. 3—Multiple diode types: three diodes in one case (A), multielement diode (B) and diode cluster (C)

alloy-junction devices. This lowers the reverse breakdown voltage. In diffused avalanche devices it is necessary both to control the substrate doping and to diffuse deeper than when making conventional devices. At low reverse-bias potentials (1 to 3 volts) a pure zener effect may be observed. Generally, breakdown devices operate in the avalanche mode. Avalanche devices are characterized by low resistivity and an abrupt junction.

One special type of avalanche diode announced by Raytheon displays a negative-resistance characteristic. It is apparently an *n⁺n* junction device in which negative resistance arises from a combination of avalanche breakdown and conductivity modulation due to current through the junction. The bonded negative-resistance diode is made by pulsing a doped gold wire attached to a high resistivity *n* substrate.

The *pin* diode consists of a *p* layer, an intrinsic (*i*) layer and an *n* layer. These diodes are used in microwave circuits to substitute for gas breakdown devices such as transmit-receive (t-r) and anti-transmit-receive (atr) boxes.

UNIUNCTION TRANSISTORS—The unijunction transistor illustrated in Fig. 4 is actually a double-base diode. The device made by General Electric is an *n* silicon bar

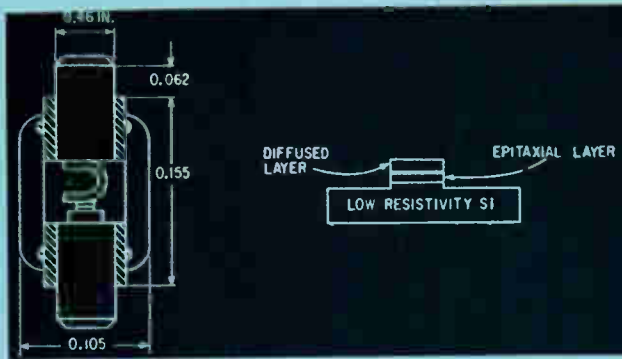

FIG. 5—Varactor diode in case, left, and cross section showing layers, right

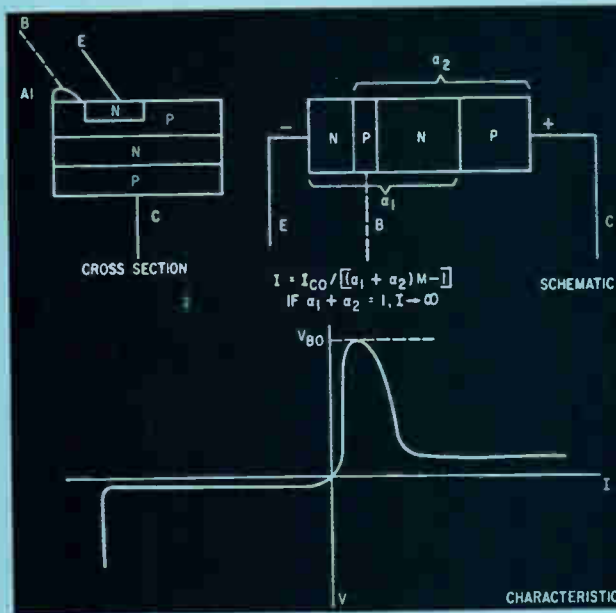

FIG. 6—Cross section, schematic and I-V characteristic of four-layer switching diode

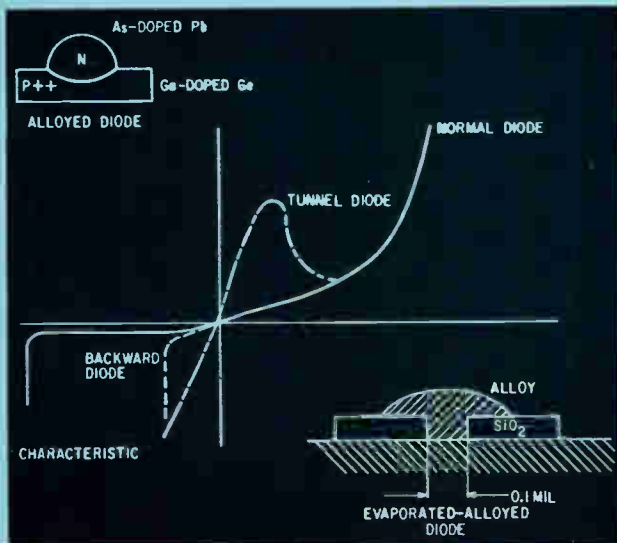

FIG. 7—Cross sections of tunnel diodes made by alloying and by alloying through an evaporated mask. Current-voltage curve shows characteristic of normal diode, tunnel diode and backward diode

with two ohmic contacts called base 1 and base 2 respectively. A single rectifying contact called the emitter is made to the opposite side of the bar close to base 2. Interbase resistance is 5,000 to 10,000 ohms. Base 1 is usually grounded and a positive bias applied to base 2. With no emitter current, the bar acts as a voltage divider and a fraction of the base 2 voltage appears at the emitter. If the emitter voltage is less than this fraction, the emitter will be reverse biased and only leakage current will flow. If emitter voltage is greater than the fraction, the emitter will be forward biased and current will flow. This current consists of holes injected into the bar. These move down the bar and result in an equal increase in the number of electrons in the emitter-to-base 1 region. The net result is a decrease in resistance between emitter and base 1. Thus, as emitter current increases, emitter voltage decreases and a negative resistance is obtained. Unijunction transistors are used in sweep generators, pulse generators and multi-vibrators.

VARACTOR DIODES—Varactor diodes are microwave devices designed to capitalize on the fact that diode junction capacitance decreases with increasing reverse bias potential. This effect is especially useful in parametric amplifiers. Varactor diodes have been made from germanium, silicon and gallium arsenide. They have been made by alloying, diffusion and point contact. A silicon epitaxial diffused varactor diode made by Sylvania is shown in Fig. 5. This device is said to be especially useful as a harmonic generator.

Typical microwave diodes are the Western Electric 1N3152 and 1N3153. These are silicon diffused units in a vacuum-tight metal-ceramic case threaded for screw mounting. The devices are boron diffused silicon mesas of both *p-n* and *n-p* types. They drop to 1/2 capacitance at 4 volts and their cutoff frequency is 27 to 45 Gc. The case is designed for strip-line use. Their forward voltage drop is less than 1.1 volts. Capacitance at 500 Mc and zero volts is between 3.55 and 4.45 picofarads. Series resistance is less than 2 ohms at 9 Gc; Q at 9 Gc and zero volts is approximately 3.

Generally, diffused silicon varactor diodes give a capacitance range from 1 to 0.5 pf measured at 100 Kc and 1 Gc. Experimental gallium-arsenide diodes have given a capacitance range from 1 to 0.4 pf measured at 100 Kc and 1 Gc. Experimental gallium-arsenide point-contact mixer diodes have given better results at high frequencies than experimental silicon point-contact diodes.

Microwave Associates offer varactor diodes rated from 6 to 120 volts peak inverse for harmonic generation in the 1 to 40,000 Mc region. Junction capacitance measured at breakdown voltage ranges from 0.1 to 50 pf. Junction series resistance ranges from 1.1 to 21 ohms.

RCA reports a diffused-junction gallium-arsenide diode with a cutoff in excess of 200 Gc.

FOUR-LAYER TRIGGER DIODES—The four-layer or Shockley-diode is shown in Fig. 6. It is simply a controlled rectifier without a base connection. In making a four-layer diode as illustrated, the starting point is an *n* silicon substrate. Around this is diffused a *p*

layer using either gallium or boron. The emitter may be diffused or it may be alloyed using a gold-antimony dot. If it is desired to make a controlled rectifier or four-layer transistor, the base lead could be attached to the top *p*-layer using an aluminum pellet or wire.

The four-layer switch may be looked upon as consisting of two transistors, an *npn* unit with a narrow base and a *pnp* unit with a wide base. Assuming a collector multiplication factor of unity, emitter current for the device tends to become infinite as the sum of the forward current gains of the two transistors becomes equal to unity.

The characteristic shows that there is a value of voltage called the forward voltage breakover point at which the voltage dropped across the device becomes small and emitter current increases rapidly. Addition of a base lead to form a controlled rectifier or four-layer transistor permits the forward breakover voltage to be varied by the base bias.

TUNNEL DIODES—The tunnel diode is a majority carrier device that depends for its operation on the quantum mechanical tunneling of electrons through a *p-n* junction. The tunnel diode exhibits the *N*-shaped voltage-current characteristic shown in Fig. 7. Because of this characteristic, the tunnel diode can provide a negative resistance. Tunnel diodes are extremely fast switches, however, they are bidirectional, which presents a problem to circuit designers. Tunnel diodes have been made of many materials, including germanium, silicon, gallium arsenide and gallium antimonide. Gallium-arsenide tunnel diodes have a low and unpredictable service life. Gallium-antimonide tunnel diodes provide an extremely low noise figure.

Tunnel diodes must be heavily doped and have an abrupt junction. The junction area must be carefully controlled to give the desired value of peak current. The peak to valley current ratio determines the gain of the device. Many tunnel diodes are *n* on *p* types. However, some are *p* on *n* types. Generally, the *n* on *p* diodes have high peak-to-valley ratios and low capacitance for a high peak current. Switching times are less than ½ nanosecond.

A germanium tunnel diode begins with an *n* germanium substrate that is degeneratively doped with gallium. A degeneratively doped semiconductor is one that begins to take on the characteristics of conductor. The alloy junction is formed using a dot of arsenic-doped lead. To get an abrupt junction, the heating and cooling cycles are critical during alloy formation. Alloying temperature is between 475 and 525 C.

Tunnel-diode peak current depends both on the doping and the junction area. General Instrument uses an automatic machine to etch a junction for a desired peak current. The peak current through the device is itself the etching current. The machine shuts off automatically when the desired value is obtained.

In gallium-arsenide tunnel diodes the *p* dopant is zinc, while the *n* dopant may be selenium, tellurium or sulphur. Tunnel diodes are useful as high-speed switches or in uhf amplifiers, detectors and oscillators. There is considerable research underway in use of tunnel diodes as memory components.

In tunnel diodes, it has been observed that switching time is lowest when high peak current is carried. For example, a ½-nanosecond switch may have a 20-milliamper peak current while a 2-nanosecond switch may have a 1-milliamper peak current. One explanation is that the higher peak currents increase the ability to charge the capacitance of the tunnel diode.

One figure of merit for tunnel diodes is the ratio of peak current to junction capacitance. Germanium tunnel diodes may give a 10-milliamper peak-to-valley current swing with a voltage swing from 0.05 to 0.3 volt. Gallium arsenide tunnel diodes may give a 30-milliamper swing with a voltage swing from 0.05 to 0.7 volt.

At Bell Labs an evaporated mask technique has been tried experimentally in making tunnel diodes. A silicon-oxide coating is evaporated on a semiconductor substrate with 0.1-mil diameter holes at each junction. An alloy dot is placed on each hole. This technique restricts the tunnel diode diffusion area without controlled etching (Fig. 7).

BACKWARD DIODES—The backward diode is also known as a tunnel rectifier. These devices have been made from silicon, germanium and gallium arsenide. It is another type of heavily doped two-terminal device and may be said to be a poor tunnel diode. Near the origin, its conduction is approximately linear in the reverse direction while it displays some rectification in the forward direction. The backward-diode characteristic is illustrated in Fig. 7. Backward diodes are used with tunnel diodes to give to a circuit the unidirectional impedance characteristic that tunnel diodes themselves lack.

PHOTODIODES—There are two main types of light detecting devices: photoconductive and photovoltaic. In the former, the conductivity of the device increases with incident light. Various doped semiconductors such as germanium may be used. Junction-barrier devices may be used as photovoltaic cells in which voltage is generated across a circuit element upon illumination.

Light is allowed to strike a reverse-biased *p-n* junction and in so doing produces hole-electron pairs that cause current flow across the junction and develop a voltage across the diode load resistor.

The phototransistor is usually operated as a diode, with the base lead unconnected. The emitter-base junction is exposed and transistor action contributes to an inherent power gain. When modulated light is being received, a slight forward bias may be used on the emitter-base junction.

The Photran by Solid-State Products is a *pnpn* switch that is triggered by light energy instead of or in addition to electrical energy. Before light strikes, the device is in a high-impedance (10 megohm) off state. When the light impulse is applied, it is switched to a low-impedance (10 ohm) on state. It will remain on until electrically turned off. The light energy used to trigger the device need be momentary only since light energy is not required to sustain the device in its on state. Turn-on time for the device is typically 10 microseconds. Turn-off time is typically 30 microseconds. Spectral response ranges from 0.4 to 1.1 microns.

RECTIFIERS

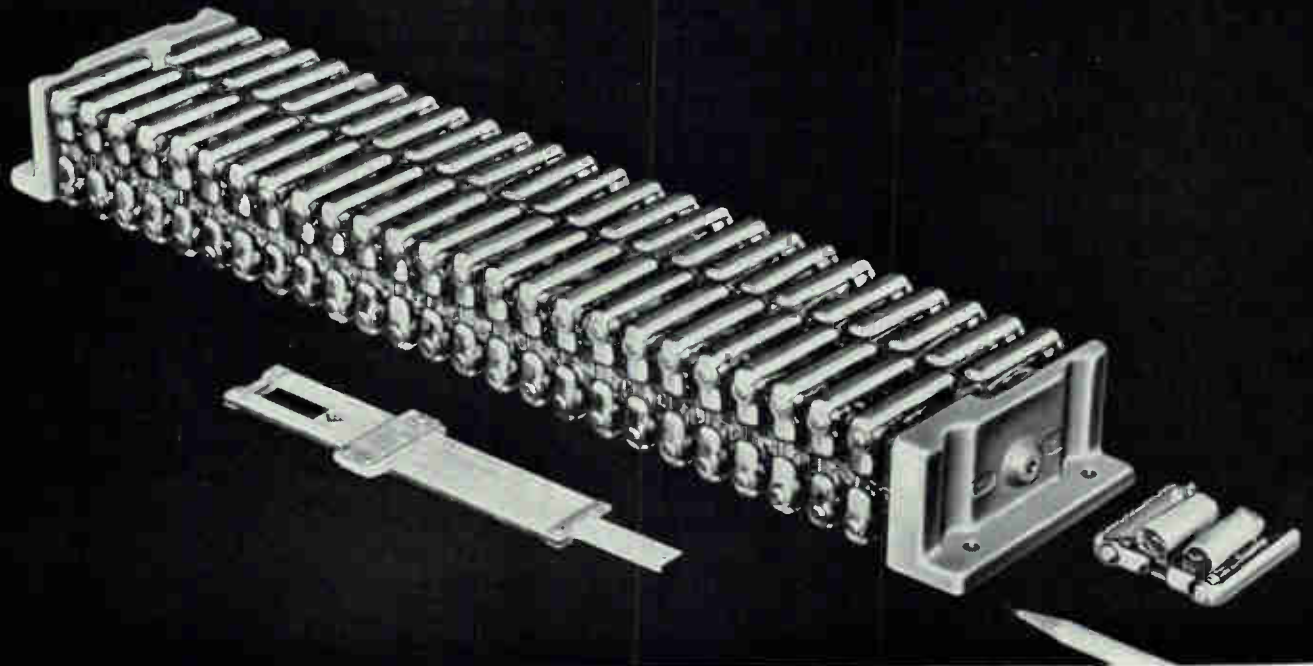

Superpower rectifier stacks with filter module at right (International Rectifier)

HIGH-CURRENT RECTIFIERS—Rectifiers are two-terminal semiconductor devices used primarily to change alternating to direct current.

The controlled rectifier is a three-terminal device and is actually a *pnpn* or *npnp* transistor but its applications put it in the rectifier class.

Extremely high-power rectifiers are frequently alloy-junction types. They may be rated at from $\frac{1}{2}$ to 240 amp at up to 1,000 volts with peak inverse voltage also 1,000. Alloy-junction rectifiers are made by alloying a gold-boron or aluminum disk to an *n* silicon substrate. A 240-amp rectifier by Westinghouse uses a $\frac{5}{8}$ -in. circular disk junction.

One trick in manufacturing high-power silicon devices is to use silver solder in mounting the silicon on the base plate to prevent thermal fatigue or solder recrystallization that occurs with soft solder when soft solder devices are temperature cycled to their rated power limit. In high-power devices ceramic cases are used. Because the coefficient of expansion is a problem, a disk of tungsten or molybdenum alloy is placed between

the silicon substrate and the copper base plate of a high-power device.

HIGH-VOLTAGE RECTIFIERS—Much work is being done toward increasing the peak-inverse-voltage (piv) rating of rectifiers. Rectifier stacks rated from 1,200 to 10,000 piv are available. In such stacks the variable leakage characteristics of the device may put full voltage across one diode. To prevent this, an *R-C* circuit as shown in Fig. 8A is built around each diode. International Rectifier makes a line of superpower rectifier stacks for voltages ranging from 10,000 to more than 100,000 volts. Current capacity ranges from 1 to 50 amperes. In using rectifiers, limiting factors are short circuit current and overvoltage transient. To reduce these, external surge suppressors are used and the device is operated within its recommended safety margin.

It would be desirable to produce high-peak-inverse voltage rectifiers without having to stack several devices. Present manufacturing techniques can produce rectifiers capable of withstanding 2,000 to 3,000 piv. However,

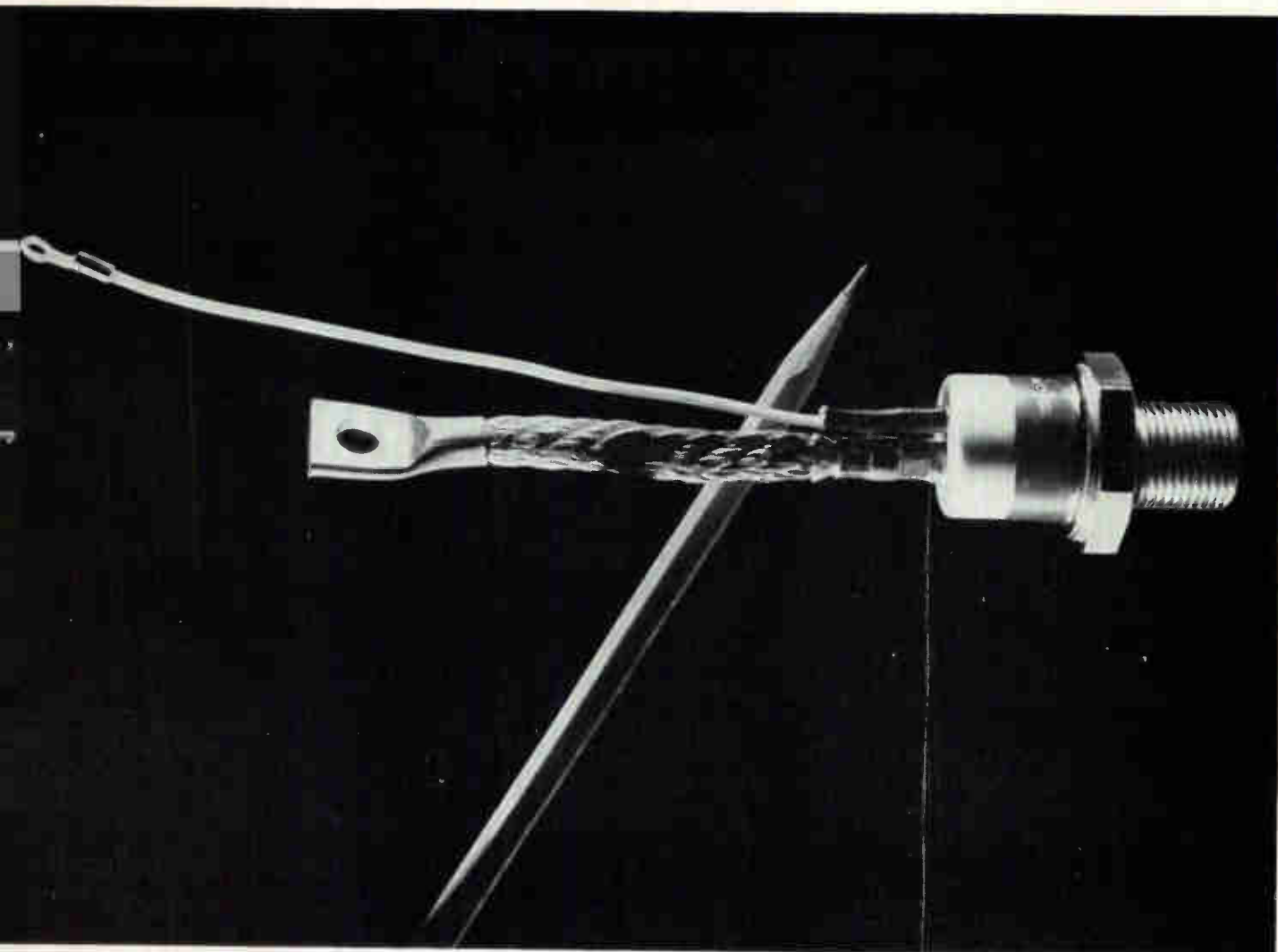

Four-layer switch handles 100 amperes (Westinghouse)

the surface of presently available semiconductors is not always capable of withstanding this voltage. It is generally felt that 1,000 piv represents the state-of-the-art today although Columbus Electronics claims to be in production with 2,000 piv units. They report that the key to success is utmost cleanliness.

Either diffusion or alloying processes may be used in rectifier manufacturing. However, there seems to be less danger from failure due to hot spots with diffused

junctions because they are flat. Diffused junctions yield high piv ratings and low reverse currents. High surge current capabilities are readily obtainable with diffused junctions.

LOW-CURRENT RECTIFIERS—Double-diffused rectifiers used at low currents are actually four-layer sandwiches. Such a device is shown in Fig. 8B. The substrate is n silicon. Boron is diffused to form a p layer and phosphorus is diffused to form an n^+ layer. A gold-boron contact creates a p^+ region on the p layer while a gold-antimony contact creates an n^{++} region on the n^+ layer. This construction reduces the forward drop of the rectifier.

ALLOYED-DIFFUSED CONTROLLED RECTIFIERS

—Four-layer trigger devices are sold under a variety of proprietary names. Westinghouse calls their's a Tristor. A Tristor as shown in Fig. 9A is made by a process combining diffusion and alloying. The substrate is n silicon. Aluminum or gallium diffusion creates the col-

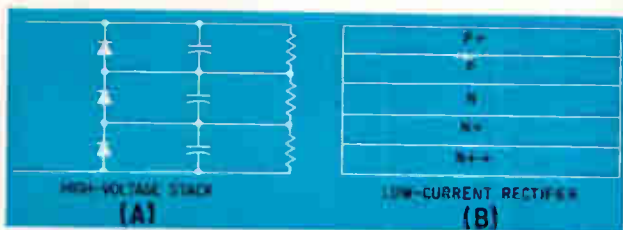

FIG. 8—High-voltage rectifier stack, left, and cross section of low-current rectifier

lector junction. The collector sits on a molybdenum disk that is silver soldered to the copper base plate. The p base is also created by diffusion. The emitter is an annular ring of gold-antimony alloyed to the base. A molybdenum ring sits on top of the emitter ring and is hard soldered to the copper-sleeve contact. The gate connection is made with a silver wire to the base in the center of the emitter ring. Units are in production that will carry 16, 50 and 100 amperes, at 400 volts. The 50-ampere units have 10 to 20-microsecond switching.

Most but not all controlled rectifiers are made from silicon. TungSol has a unit called the Dynaquad that switches in the megacycle-range providing a swing of 35 volts. It is made from germanium. The unit is a $pnpn$ device and affords turn off control at the base. The four layers are made by multiple diffusion and a controlled etch.

DIFFUSED CONTROLLED RECTIFIERS—Figure 9B shows an example of all-diffused switches. This is the Western Electric 2N1765. It is made from silicon by diffusion of boron and phosphorus. The gate and n -emitter electrodes are on a mesa. The n -emitter electrode is a gold square while the gate is a single stripe. The gate is attached to a p region; the underlying n region is thin.

The device is used in high-speed, high-current switches, magnetron modulators, power rectifiers or memory drivers. Its rise time to 30 amp is less than 100 nanoseconds. It is operational at emitter currents to 50 amp with gate drives from 5 milliamp to 2 amp. Forward breakover voltage is 400 volts; reverse breakdown voltage is 100 volts.

FIVE-LAYER CONTROLLED RECTIFIERS — Bell Labs has developed a silicon diffused $nnpn$ three-terminal switch for driving magnetrons. The device operates

at 800 volts, 50 to 60 amp and switches in 0.1 nanosec. Actually this switch is a five-layer rather than a 4-layer device.

In a conventional four-layer switch, p diffusions may be carried out on each side of the wafer followed by a localized n diffusion on one side of the wafer. A variation on this method is used in the magnetron pulser. Though this method sacrifices reverse breakdown voltage, forward breakover voltage and switching time are enhanced. The starting point is a very high resistivity n -type material referred to as ν . A thin n layer is diffused into one side and the process continues as in a conventional unit.

It is possible to make a four-layer device with gain on turn off. This is to say, the device can be turned off with less reverse current on the base than the device is carrying. For example, turning off 50 milliamp of emitter current with 2 milliamp on the base. This can be done if the sum of the alphas of the $nnpn$ and the pnp transistors is just over unity.

FOUR-TERMINAL CONTROLLED RECTIFIERS —

The device shown in Fig. 9D is made by Transiron and is called a binistor. It has four-layers but is described as a silicon $nnpn$ tetrode—a bistable negative-resistance device. Primary applications are in switching and storage circuits such as flip flops. Operating temperature range is from -65 to 150 C. Limiting factor is speed—presently from 200 to 300 Kc maximum. A faster device is under development; Transiron is hoping for 10 Mc or better. In the binistor, a p layer is added to an $nnpn$ transistor. A fourth lead, called the injector is connected to this p layer. Device operation is similar to a controlled rectifier during turn on. Turn off is accomplished by biasing off at the injector.

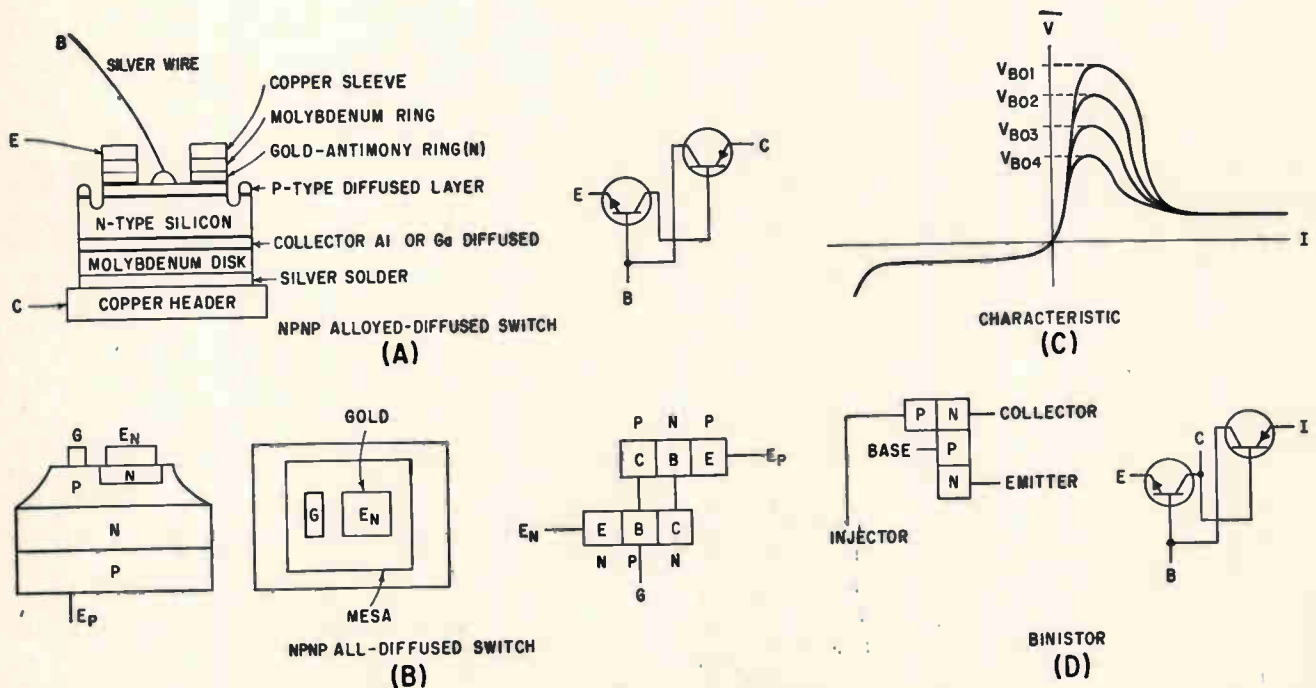
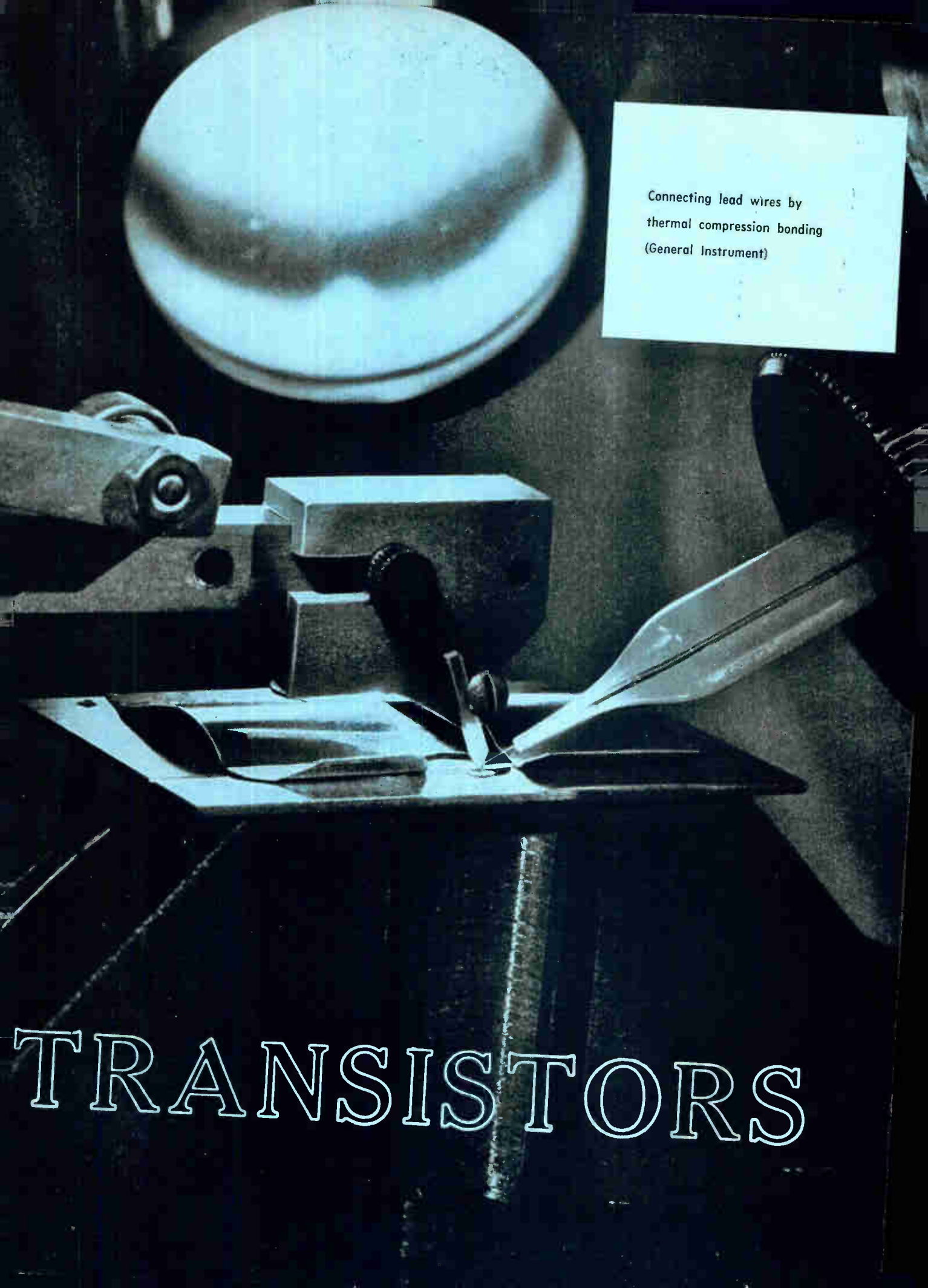

FIG. 9—Cross section and schematic of $nnpn$ alloyed-diffused switch (A), cross section, plan view and schematic of $nnpn$ all-

diffused switch (B), typical current-voltage characteristic of four-layer transistor (C) and binistor four-terminal switch (D)



Connecting lead wires by
thermal compression bonding
(General Instrument)

TRANSISTORS

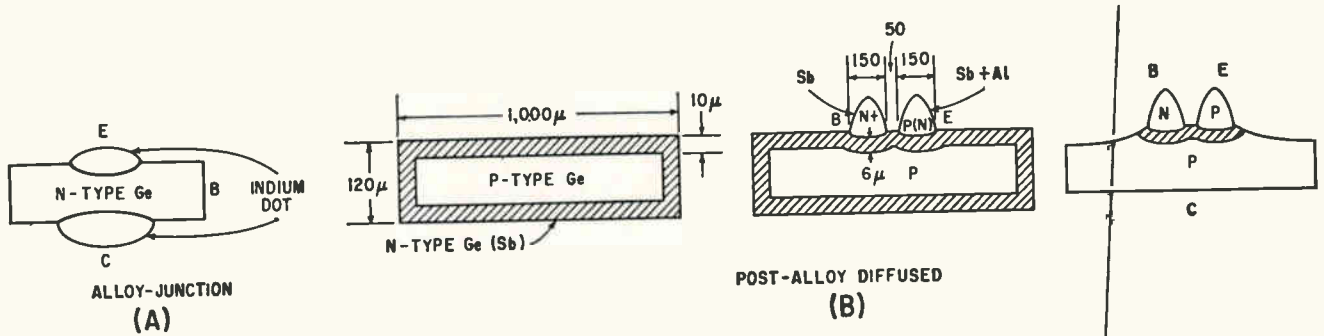

FIG. 10—Cross section of alloy-junction transistor (A) and of a post-alloy diffused transistor (B) showing diffused substrate, left, transistor after alloying, center, and etching, right

TRANSISTORS—Most transistors used today are made either from silicon or germanium. Gallium-arsenide transistors have been made but only experimentally. The majority of transistors manufactured are germanium units. These are designed largely for the home-entertainment field.

Silicon is the preferred material for most industrial and military applications. Most notable of these is computer switching. Germanium transistors still find some use in industrial and military applications especially where high-frequency operation is required or where design has been frozen.

Most units made today are fabricated either by alloying, diffusion or a combination of these techniques.

ALLOY-JUNCTION TRANSISTORS — In the unit shown in Fig. 10A, the die forms the base region. Spheres of impurity metal are placed on top and bottom. Then the assembly is heated. The metallic impurity alloys with the die and on cooling recrystallizes to form two *p-n* junctions. The collector sphere is usually about twice as large as the emitter sphere. In the common *pnp* germanium alloy transistor the die is *n* germanium and the dots indium. A *pnp* silicon unit would probably use aluminum pellets.

In assembly, the die is seated in a metal base tab and assembled to the header. The emitter and collector wires are affixed to the impurity pellets. Alloy diffusion results in a step junction. The transition between the *n* and *p* regions is abrupt. This does not give as good high-frequency performance as the graded junction in which an impurity gradient in the base region provides an accelerating electric field for minority carriers.

DIFFUSION—Graded junctions can be obtained when

impurity atoms are allowed to diffuse into the substrate. Diffusion is accomplished at elevated temperatures. It is a slow process taking hours and sometimes days depending on diffusion depth and impurity concentration. Diffusion can be carefully controlled by the device designer.

In diffusion, the impurities may be introduced at the surface of the substrate from either the vapor phase or from a solid containing the diffusant.

In germanium, popular *n* or donor diffusants are antimony and arsenic. Acceptor or *p* diffusants are gallium and indium. In silicon, a popular donor diffusant is phosphorus. Acceptor diffusants are boron and aluminum. Phosphorus and boron are usually diffused from their oxides. This is useful in making planar transistors since the diffusion process also causes a protective oxide coating to regrow on the substrate. Other metals are diffused from their vapor phase.

In germanium, donors diffuse more rapidly than acceptors. In silicon, acceptors diffuse more rapidly than donors. In diffusion the substrate generally becomes the collector. It is necessary to form a base and then an emitter region. This can be done by single diffusion in which the base only is diffused and the emitter formed by alloying.

It can also be done by double diffusion. The base is diffused first, then the device masked to reveal only the desired emitter region and diffused a second time. Silicon Transistors reports that they make silicon *npn* power transistors with very low saturation resistance by a single diffusion process in which both donor and acceptor impurities are introduced simultaneously. This technique makes use of the fact that acceptors diffuse more rapidly in silicon than donors.

The masking step, which is important in double diffusion, is relatively easy in silicon devices because silicon has a stable dioxide. It is more difficult to mask germanium, therefore, many germanium transistors are single diffused using an alloy-junction emitter. Where it is necessary to mask germanium, a silicon monoxide layer may be deposited.

POST-ALLOY DIFFUSION—Fig. 10B shows the cross section of a post-alloy diffused transistor by Amperex. This process starts with a slice of high resistivity *p* germanium. The slices are put into a furnace containing antimony vapor and an *n* region 10 microns thick is

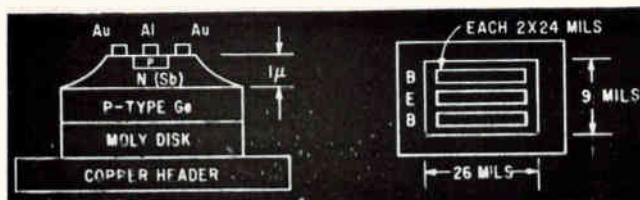
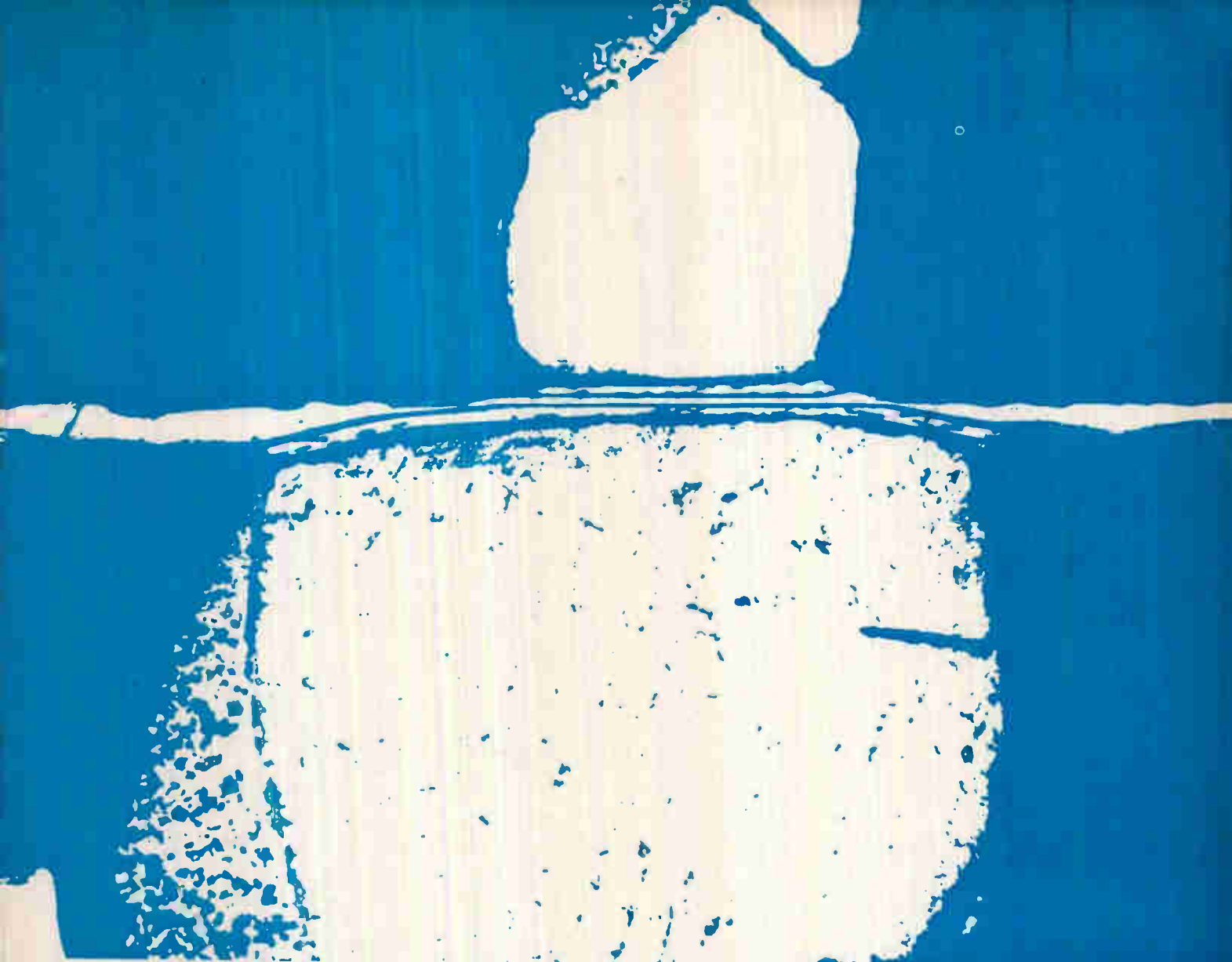

FIG. 11—Cross section and plan view of three-stripe alloy-diffused germanium mesa transistor



Cross section of npn silicon transistor for avalanche-mode operation (Raytheon)

formed around the slice. Next, two small pellets, one of n material (antimony) and the other of n and p material (antimony and aluminum) are alloyed on the top of a diffused slice. The n pellet alloys in and makes contact with the diffused n layer to form a base contact. The other pellet forms an emitter junction between the p material and the diffused n region. Since donors diffuse more rapidly than acceptors, the n material diffuses further in. As both pellets contain n material this material diffuses deeper into the p type slice as the pellets are alloyed pushing the diffusion layer in front of the alloying processes. The bottom of the substrate is etched away to remove the n layer and the collector is soldered to the p germanium region. A small area is masked around the base and emitter contacts and the crystal is etched to remove some of the n -layer giving the mesa effect.

MESA TRANSISTORS—In the development of high frequency and switching transistors the time constant $r_b C_c$ should be kept as low as possible. Quantity r_b is

the base lead resistance. This quantity can be kept small by controlling the impurity level and gradient in the base region. This control can be exercised easily in the diffusion process. Quantity C_c is the collector junction capacitance and may be reduced by keeping the junction area as small as possible.

One way of reducing the junction area is to use the mesa structure shown in Fig. 11. This is a cross section of a WE type 2N1645 pnp germanium diffused transistor. It has a 9 by 26-mil mesa. It uses two gold base stripes and an aluminum emitter stripe forming a rectifying junction. The base stripes are 2 by 24 mils. The base region is 12 microns thick and formed by antimony diffusion. The collector is soldered to a gold-plated molybdenum disk that is then attached to the copper header. The base region is heavily doped and very thin to provide an inherent protection against radiation.

This device gives a one-watt power output at 100 Mc with an efficiency of 50 percent. Typical turn-off and turn-on times under constant voltage drive are less than 5 nanosec. The device is used as a uhf power amplifier,

frequency multiplier and high-speed, high-current switch. It has switched 15 volts across a 50-ohm collector load with 6 nanosec rise time.

Some double-diffused germanium units have been made. The RCA TA1882 is a double-diffused *npn* germanium mesa for high-speed computer switching. It has a gain-bandwidth product of 1 Gc and a low-frequency beta of 40 to 60. It provides fast rise and fall times and can be used in complementary symmetry with *pnp* alloy-diffusion epitaxial germanium units. It can operate effectively to 100 milliamp. It has a 7 by 8-mil mesa and uses three stripes. The emitter stripe is 2 by 6 mils, base stripes are 1 by 6 mils and base width is 0.04 mil.

The *p* base region is produced by solid-state diffusion of a powdered germanium-indium or germanium-gallium alloy. The *n* emitter is produced by solid-state diffusion of a powdered germanium-arsenic alloy. It is important in germanium diffusion to control carefully the process to avoid alloying since diffusion occurs above the eutectic temperature of the materials.

Between diffusions surface areas are defined by silicon oxide masks obtained by deposition from a silane, a compound containing the SiH₃ radical.

SURFACE PASSIVATION — In high-frequency and switching transistors it would be desirable to have in addition to a low $r_b C_o$ product a low value of leakage current, I_{cbo} or I_{cbe} . It has been found that leakage current is largely a surface phenomenon. This has led to a great deal of work directed at passivating the surface to keep junctions free from contamination. Surface impurities increase leakage current because they form chan-

nels that effectively shunt the electrodes of the device. Furthermore, surface recombination can degrade the transport factor causing low gain. Surface recombination occurs when isolated potentials attract the minority carriers. The surface potentials can be strain potentials due to local damage during lapping. In mesa devices the etchant used to form the mesa may leave impurities.

There are several methods of cleaning transistors and removing surface damage. Surface damage introduced during lapping may be removed by polishing with aluminum oxide and etching off a layer of silicon with a hydrofluoric-nitric acid etch. Another technique is to form a silicon-dioxide coating on the surface and remove it with hydrofluoric acid. Still another technique is electrochemical polishing.

After etching it is important to wash the surface with deionized water to remove the etchant and to use some water miscible solvent such as acetone to dry. After the devices are cleaned and dried, they are packaged hermetically in a clean, dry ambient.

However, many manufacturers do not consider this to be sufficient and have gone further into surface passivation. To some manufacturers this means dipping the unit one or more times in a silicone varnish to build up a protective skin.

Other manufacturers have introduced into the case substances known as getters. The getters are there largely to soak up water molecules. Some getters have been calcium sulphate, calcium chloride and lead oxide. Other manufacturers use so-called molecular sieves. One type of molecular sieve is a long chain polymer that traps out impurities. However, many of these protection techniques tend to have a time-bomb effect. The efficiency of

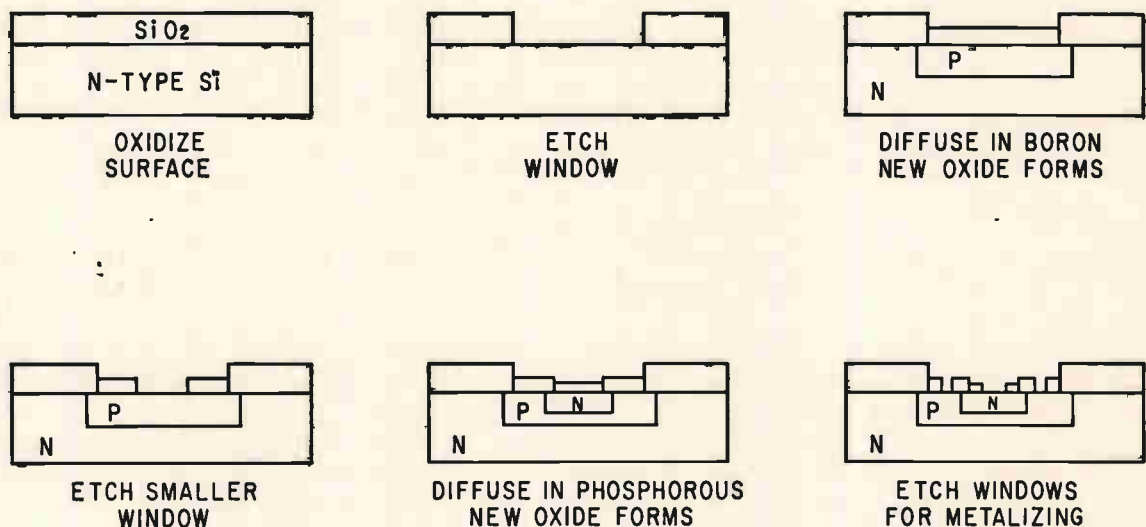

(A)

the getters decreases in service and eventually the device characteristics become degraded

A successful surface passivation technique is one in which the junction is never exposed during processing. This technique has resulted in the planar transistor, illustrated on the cover.

PLANAR TRANSISTORS—The technique for making planar transistors is illustrated in Fig. 12A. The starting point is an *n* silicon substrate. In the first step the substrate receives a silicon-dioxide coating. This may be produced by steam and oxygen.

Next a window is etched through the oxide by hydrofluoric acid. The surrounding area is masked against etching by a photolithographic technique. Boron is now diffused from a boric acid atmosphere. Note that the junction terminates under the silicon dioxide.

During the boron diffusion, silicon dioxide grows again. Where boron is used as a diffusant, the silicon dioxide may be converted to borosilicate glass.

It is necessary to etch another window in the oxide to diffuse the emitter region. The emitter is diffused from an atmosphere of phosphorus pentoxide. During this diffusion another oxide coating forms.

The base and emitter contact areas are etched through the oxide coatings but both junctions continue to terminate under the oxide coating. Aluminum is used for metalizing both junctions. Because of the high impurity concentration in the emitter region no rectifying contact is formed.

Figure 12B shows the cross section of the completed silicon planar transistor with collector soldered to the header and base and emitter leads attached.

Figure 12C illustrates a planar tetrode by Fairchild. In this device an additional electrode has been added on the top of the oxide coating that protects the emitter-base junction. The planar tetrode affords control of both majority and minority carriers by this external field-effect electrode or grid.

In the device shown the voltage applied between the grid and the emitter-base junction not only controls the characteristics of the emitter-base junction but also that fraction of total emitter current that reaches the collector junction which is, of course, h_{fe} or gain.

In a planar transistor the inherent surface passivation results in low leakage currents and relatively high alpha at low currents. High low-current alpha is important in micropower logic. Surface passivation in transistors hopefully may protect against ambients (naked or chip transistors) and they most certainly protect against contamination during manufacturing and thus increase yield.

General Instrument sells microdiodes of planar configuration encapsulated in epoxy for mechanical rigidity only.

Both the planar and mesa transistors are high-frequency devices. Both have low $r_b C_c$ products. A narrow base is obtained in both types by control of the diffusion process. In the mesa, the collector capacitance is kept low by etching the mesa while in the planar it is kept low by closely controlling the base diffusion.

MICROPOWER TRANSISTORS—Some computer designers are working on micropower logic circuits. The idea is that the logic operations of the computer may be performed within a micropower section with the input

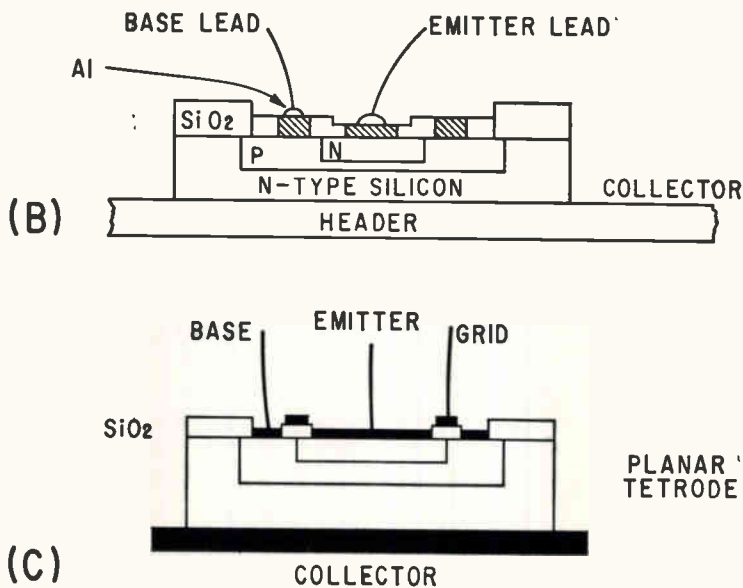

FIG. 12—Steps in making planar transistors (A); oxidized substrate, top left, window etched for base diffusion, top center, base diffused, top right, window etched for emitter diffusion, bottom left, emitter diffused, bottom center, and windows etched for metalizing, bottom right. Planar transistor with header and leads (B) and planar tetrode with grid on emitter-base junction (C)

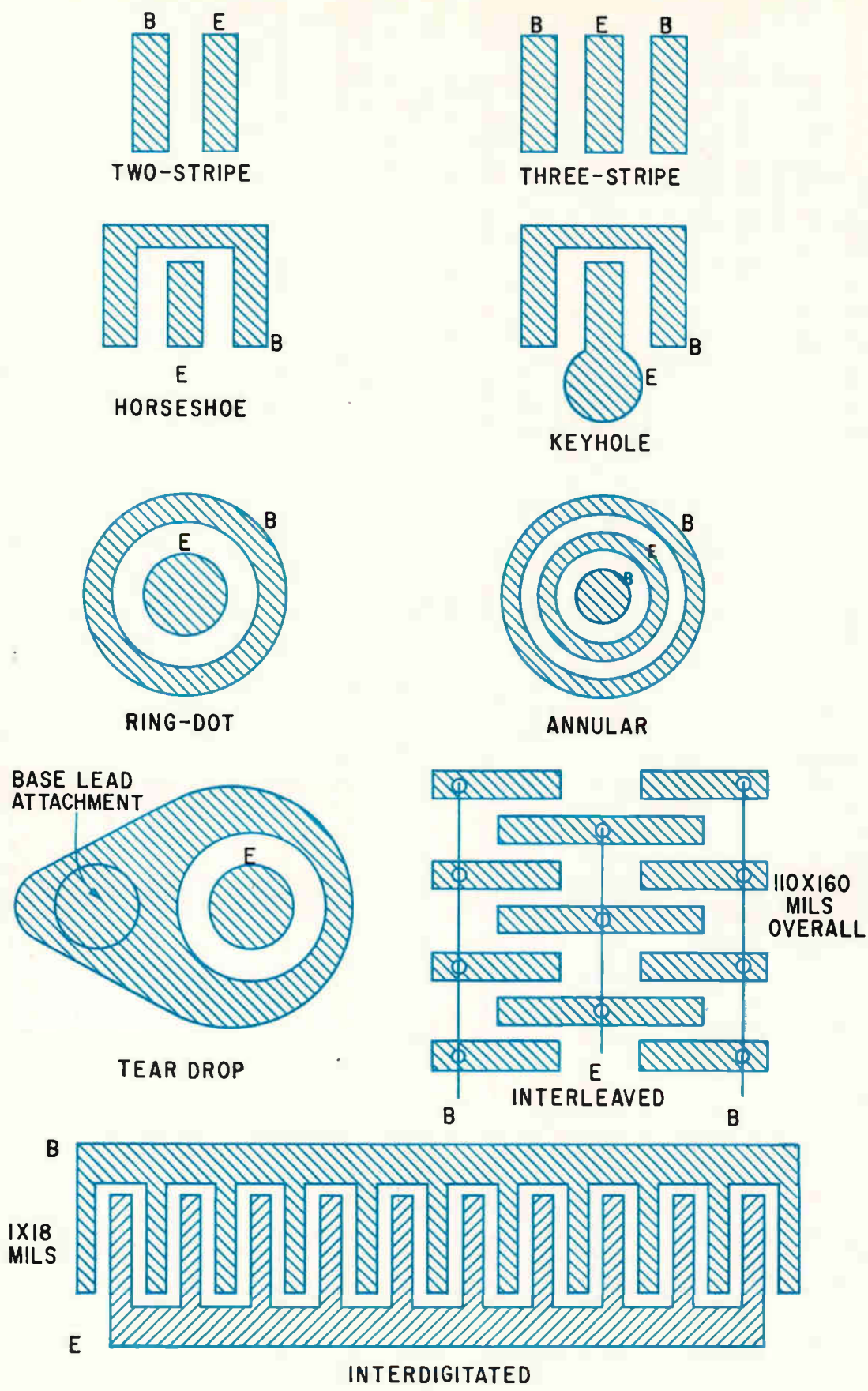

FIG. 13—Transistor junction geometries: two and three-stripe junctions are used with mesas; horse shoe and keyhole junctions may be used with mesas or planars; ring-dot and teardrop junctions are used with planars; annular, interleaved and interdigitated junctions are used with power transistors

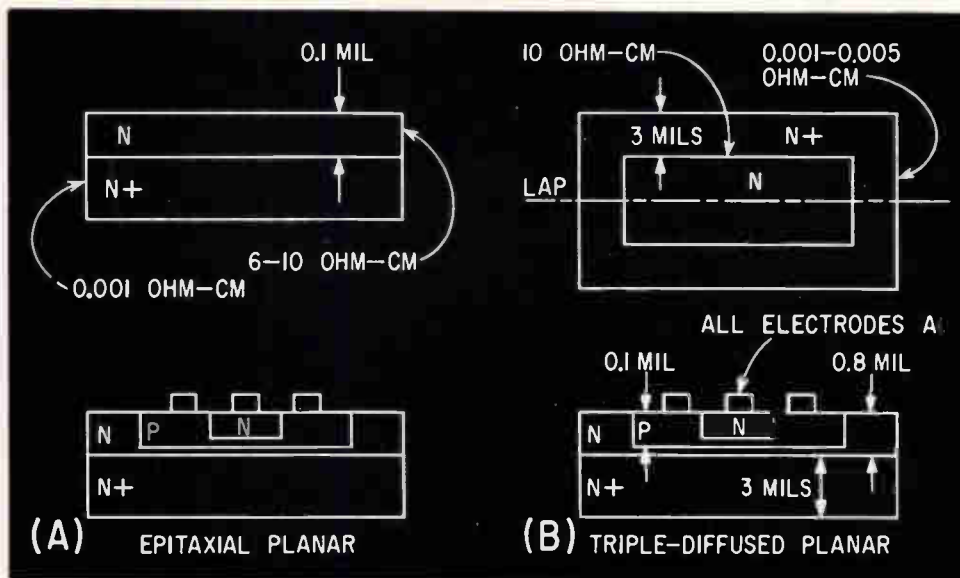

FIG. 14—Epitaxial planar transistor (A) showing epitaxial substrate and device cross section. Triple-diffused planar (B) showing diffused substrate and device cross section

and output signals transformed to normal power levels. The object would be to save power and reduce heat dissipation requirements.

It is important that collector cutoff current be low. In modern transistors, room-temperature collector cutoff current is measured in fractions of nanoamperes in silicon. It is measured in fractions of microamperes in germanium.

Some electrochemically etched transistors have proved useful in micropower applications. More recently, the 2N917 silicon planar by Fairchild operates with 10 microamperes and 3 volts at a 1-Mc bit rate. Another device, the 2N709, operates in saturated circuits at 100 Mc. A decimal counter has been built capable of counting bit rates of 100 Mc in a saturated circuit.

JUNCTION GEOMETRY—The geometry of the transistor junction has a great deal to do with the characteristics of the device. Several junction geometries are illustrated in Fig. 13. Transistors having base stripes may be considered garden-variety units. They are mostly mesas. The double-base-stripe units are almost always better than single-base-stripe units although the single-base-stripe units are generally cheaper to produce. The horse-shoe geometry may be considered a modified three-stripe and is midway in performance between the three-stripe transistor and the ring-dot or teardrop variety. The keyhole geometry is a modification of the horse shoe and is used in small units to get a larger area to which to attach the emitter lead.

The horse-shoe geometry may be used with mesa and planar transistors. The ring-dot and teardrop geometries are especially useful for high-frequency, fast-switching transistors. Many planar transistors are teardrop types. The teardrop is a modification of the ring-dot geometry and provides additional area for base-lead attachment.

The annular, interleaved and interdigitated geometries are used for high-power units.

EPITAXIAL TRANSISTORS—An ideal switch should

have zero impedance when turned on and infinite impedance when turned off. The latter characteristic is achieved by reducing the collector leakage current. The former is measured by the saturation-voltage drop across the device, V_{sat} . This is the collector to emitter drop across the device at some specified high-level current. A low saturation-voltage drop has been hard to achieve. High-gain and high-frequency operation usually implies increasing collector potential. But to do this requires a transistor having high resistivity in the collector region to prevent collector voltage breakdown. This means higher saturation resistance.

The happy solution to this dilemma is found in the epitaxial transistor. Here a low-resistivity substrate (0.001 ohm centimeter) may be used to reduce saturation resistance while the collector itself consists of a 0.1-mil film of 6 to 10-ohm centimeter resistivity, which gives high value of collector breakdown voltage.

In epitaxy, a thin film is grown on a smooth semiconductor substrate by depositing like semiconductor material that builds integrally upon the substrate crystal lattice-structure. The starting point of an epitaxial transistor is an n^+ substrate, highly doped with phosphorus or antimony. The epitaxial emitter is introduced in a carrier gas which may be either silicon tetrachloride or germanium tetrachloride.

Epitaxial devices have been made of both silicon and germanium. In germanium it is not hard to make a pn epitaxial transistor but an epitaxial npn germanium transistor is difficult to make because n impurities diffuse faster in germanium than p .

In silicon epitaxy the substrate is heated in a dry hydrogen atmosphere to 1,300 C for 10 minutes. The temperature is then reduced to 1,185 C while introducing the silicon tetrachloride. The film is allowed to grow long enough to get the desired layer thickness. The silicon tetrachloride is doped with phosphorus tetrachloride to get an n collector. An epitaxial planar transistor is shown in Fig. 14A.

One difficulty in making epitaxial devices is growing

a uniform layer on the slice. In making a large-area device there are a few units per silicon slice and the epitaxial layer must be perfect indeed. The WE 2N1841 is a three-stripe epitaxial silicon $n p n$ double-diffused junction transistor with a 30 by 70-mil mesa. It is a linear amplifier for the megacycle region. Its sustain voltage is 50 volts and $f_t = 90$ Mc. Sustain voltage is the collector potential at which alpha approaches unity. This occurs when collector multiplication makes up the loss in transport factor and emitter efficiency. If the sustain voltage is exceeded, the device gets into a non-linear region. To get a high sustain voltage, beta must be held to 120 or less. The epitaxial layer helps achieve a high sustain voltage, low saturation voltage and low collector capacitance.

TRIPLE DIFFUSION—The technique of triple diffusion presents many of the same advantages as epitaxy. Triple-diffused wafers may be more uniform than epitaxial wafers.

In the triple-diffusion process the starting point is an n silicon substrate of high resistivity. Into this is diffused from the solid phase an n^+ layer several mils thick of very low resistivity. The silicon wafers are prepared for diffusion by depositing phosphorus pentoxide on the surface. The concentration of phosphorus atoms at the surface is 2×10^{20} atoms per cubic centimeter. The slices are diffused for some 50 hours in a high-temperature furnace.

Some danger exists that such a long high-temperature diffusion may result in the formation of excessive recombination centers throughout the device due to the rapid diffusion of impurities. This is avoided by using utmost cleanliness in a silicon furnace that is rebuilt after each diffusion. Slow cooling is also used. This is an annealing operation that localizes the recombination centers. The n^+ layer in a triple-diffused device is graded in resistivity as opposed to the uniform n^+ region achieved in epitaxial devices.

In triple-diffused as in epitaxial devices the high resistivity or ν collector region contributes to high inverse breakdown voltage and high sustain voltage while the underlying n^+ region contributes to a low saturation-voltage drop. After diffusion the n^+ region is lapped off on one side. This leaves a very thin ν collection region. The substrate is now used to make a silicon planar transistor. Triple-diffused planars made by Pacific Semiconductors are known as Laminar transistors.

One interesting thing is that base spreading with high collector voltage in a triple-diffused unit is into the collector region which permits tightening the basewidth, without incurring the problem of punchthrough.

A triple-diffused planar transistor is shown in Fig.



Growing epitaxial layers in controlled-temperature furnace
(General Instrument)

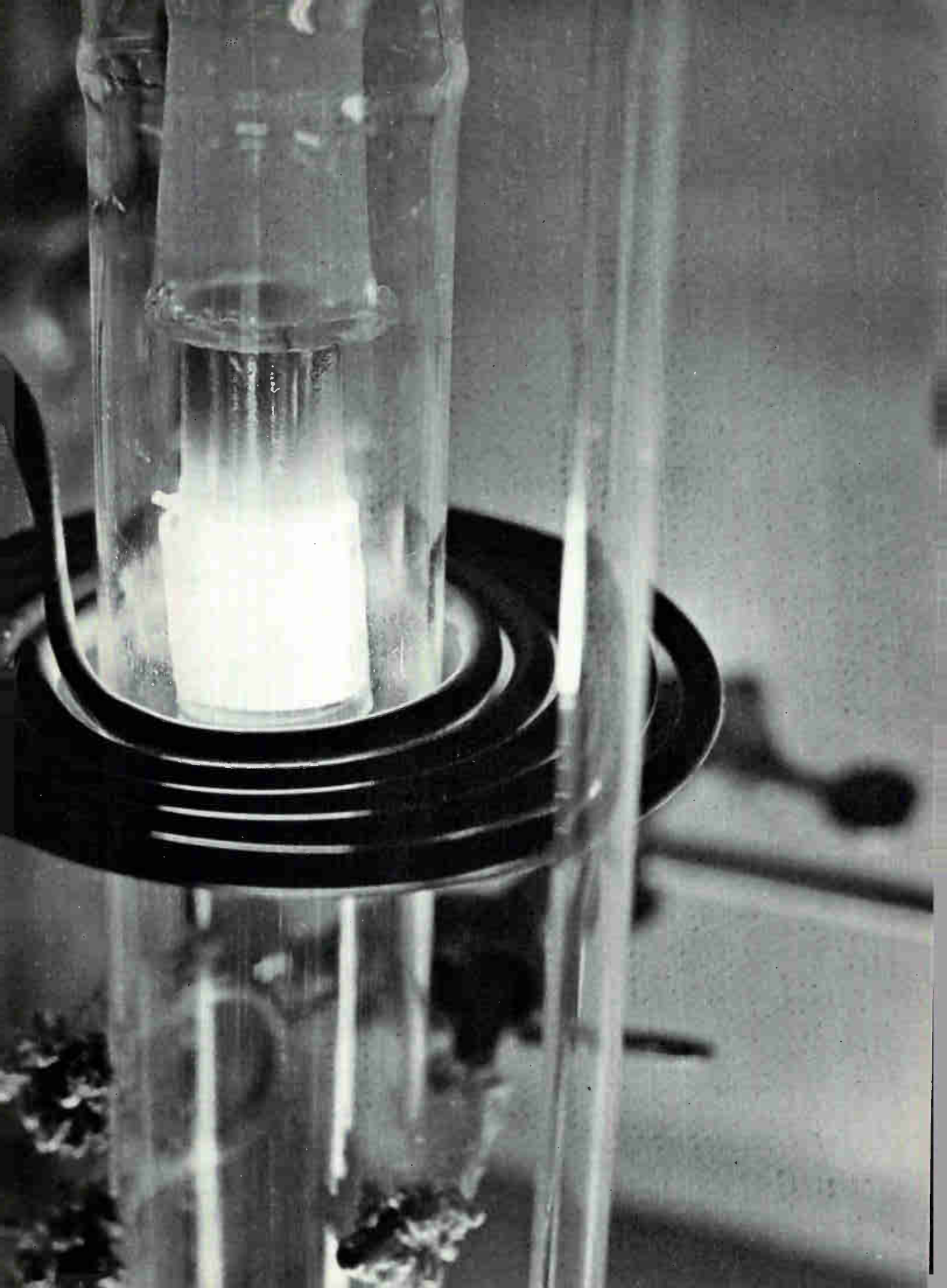

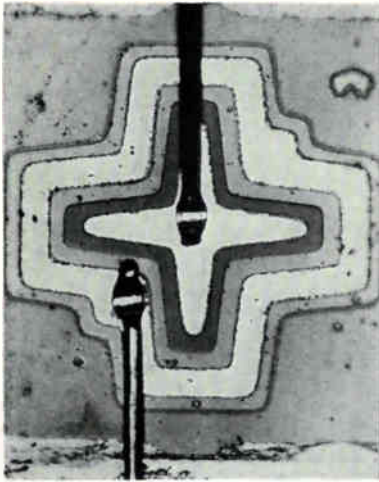

Plan view of planar epitaxial transistor with star geometry (Motorola)

14B. One example of a triple-diffused transistor is the RCA 2N2102. It provides a V_{ce} up to 200 volts; V_{ce} (high current) greater than 75 volts and V_{ce} of less than $\frac{1}{2}$ volt at 150 ma. It is useful as a general-purpose and medium-frequency linear amplifier. Useful beta range exceeds five decades, currents down to tens of microamperes.

COAXIAL TRANSISTORS—Germanium transistors find application in high-frequency circuits. One such device has been made by Bell Labs. The unit is a diffused base, alloy-emitter epitaxial-mesa, germanium transistor. It has a gain-bandwidth product up to 3 Gc. The Bell Labs device is illustrated in Fig. 15. It has an n base region 0.01-mil thick as against 0.02 to 0.04 mil for common high-frequency transistors. The base is arsenic diffused and the base contact is gold-antimony. The epitaxial collector is 0.1 mil thick while the substrate is

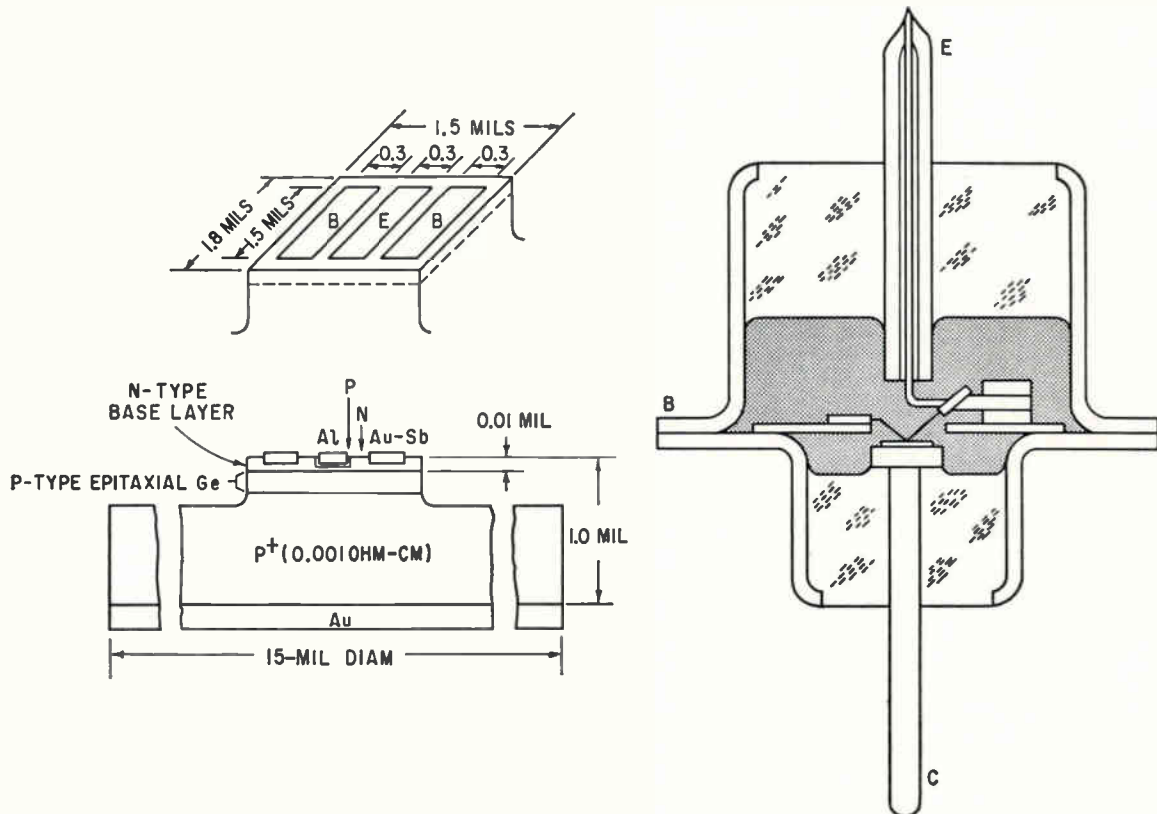

FIG. 15—Alloy-diffused three-stripe and epitaxial germanium mesa transistor designed for coaxial connection, plan view, cross section and package

Automatic electrochemical blank etching for transistors (Philco)

gallium doped to 0.001-ohm centimeter resistivity. The mesa is 2.2 mils square and the wafer is 1 mil thick overall. There are three stripes on the mesa each 0.3 by 1.5 mils with 0.15-mil spacing. The two outer stripes are gold antimony; the inner stripe is an aluminum emitter.

The wafer is mounted in a coaxial encapsulation. There are two code designations for the transistor, M2107 and M2174. The M2107 is a common-emitter transistor. The emitter is connected to the outer shell and the base is the input lead. The wafer is mounted on the output lead, making the collector contact. The device has input and output impedances near 50 ohms. It is intended for baseband amplifier applications where no impedance transformers are used between stages. Operating biases are 5 volts and 5 ma. The low-frequency value for current gain ($h_{f_{ec}}$) is nominally 20, and the cutoff frequency (f_c) is between 2 and 3 Gc.

The M2174 is a common-base transistor with basi-

cally the same wafer structure as the M2107. The emitter connected to the input lead of the coaxial package and the base lead is connected to the outer shell. It is intended for applications when impedance matching networks are used at the input and output. In an amplifier with tuned input and output with no external feedback, 12 db of gain has been obtained at 1,900 Mc with a 200 Mc bandwidth. As a power amplifier biased at 5 volts and 12 ma, 20-mw output at 1,000 Mc and 12-mw output at 2,000 Mc has been obtained. The drive power was 2 mw at both frequencies.

ELECTROCHEMICAL TRANSISTORS — Some of the earliest high-frequency transistors were the Philco surface-barrier units. In these devices transistor action is obtained when metal electrodes are plated on opposite sides of a thin slab of semiconductor material. A surface-barrier transistor is shown in Fig. 16A. Two small

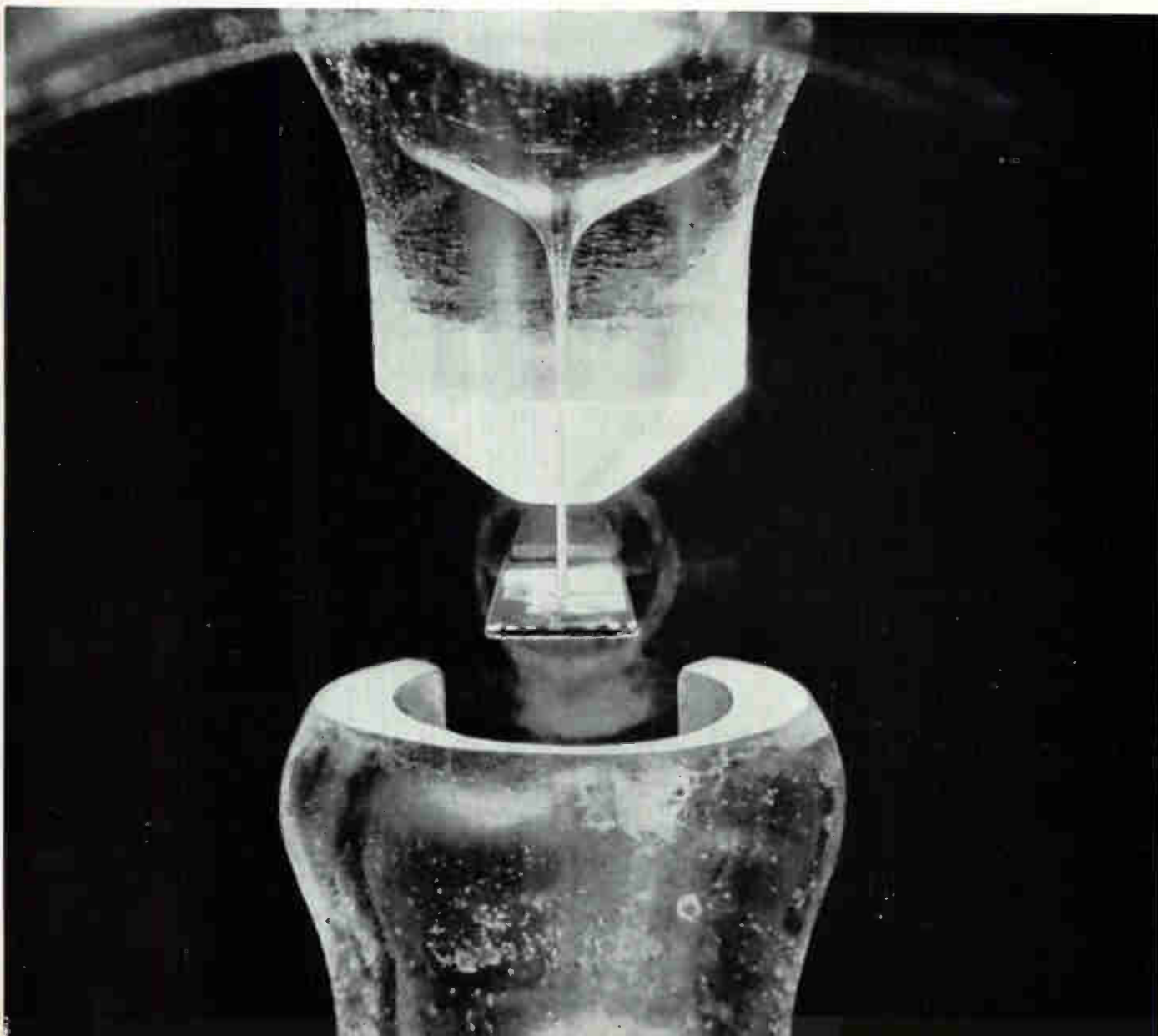

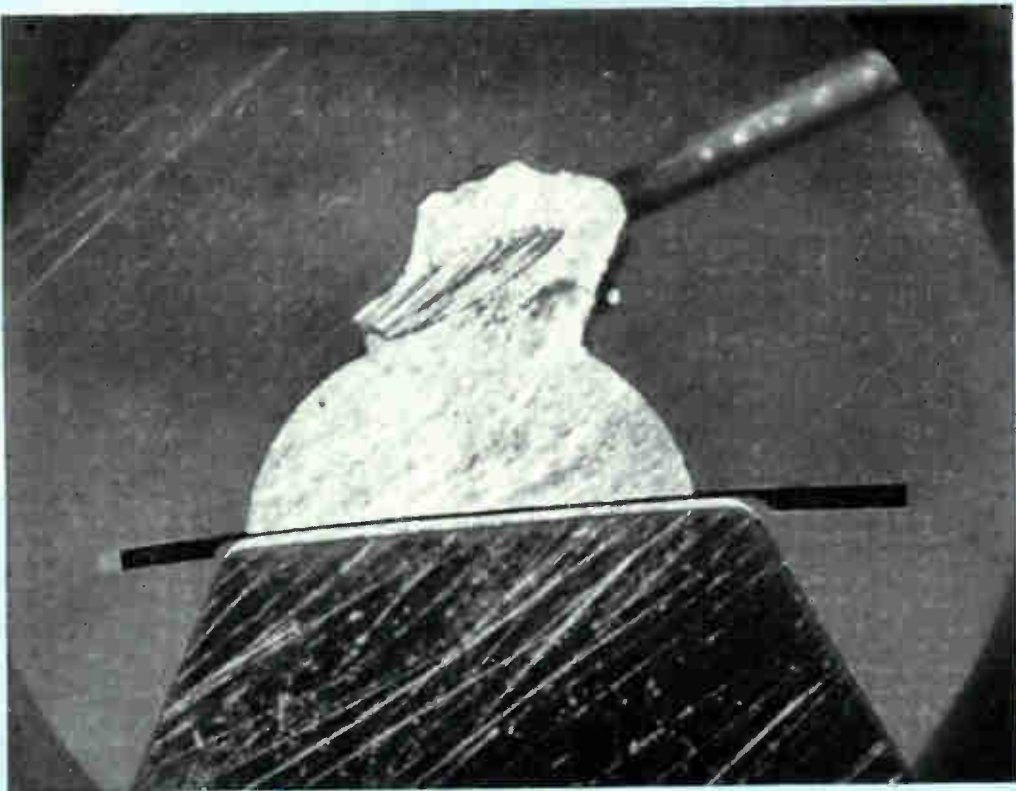

Cross section of microalloy-diffused transistor (Philco)

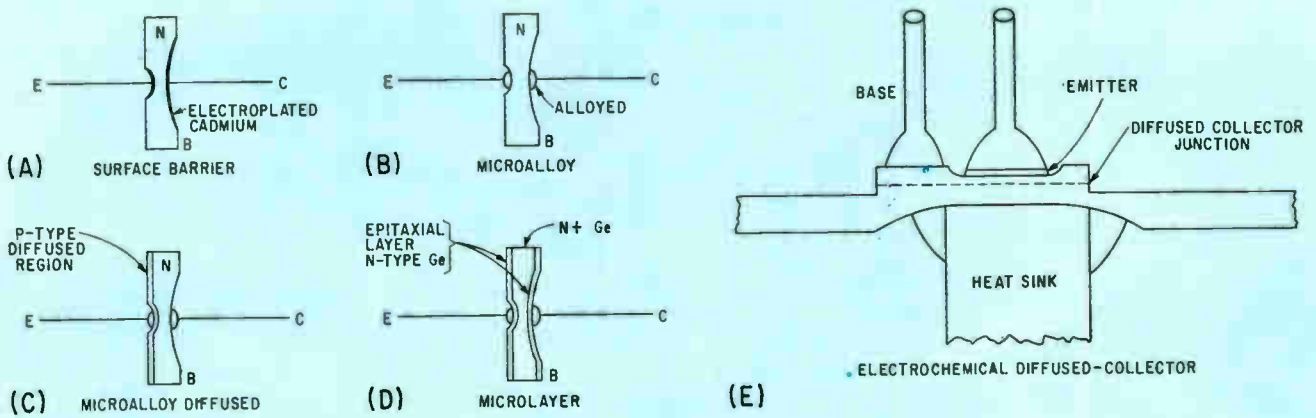

FIG. 16—Electrochemically etched transistor types: surface-barrier or SBT (A), microalloy or MAT (B), microalloy-diffused or MADT (C), microlayer or MLT (D) and electrochemically-etched diffused-collector or ECDC (E)

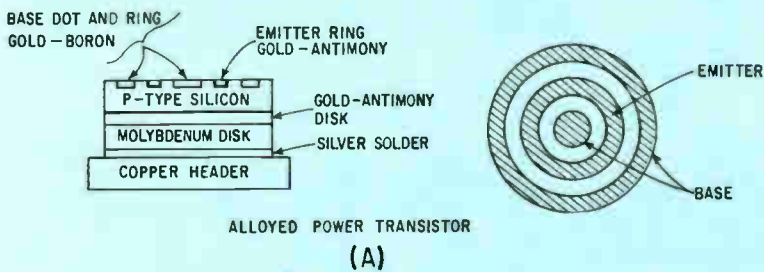
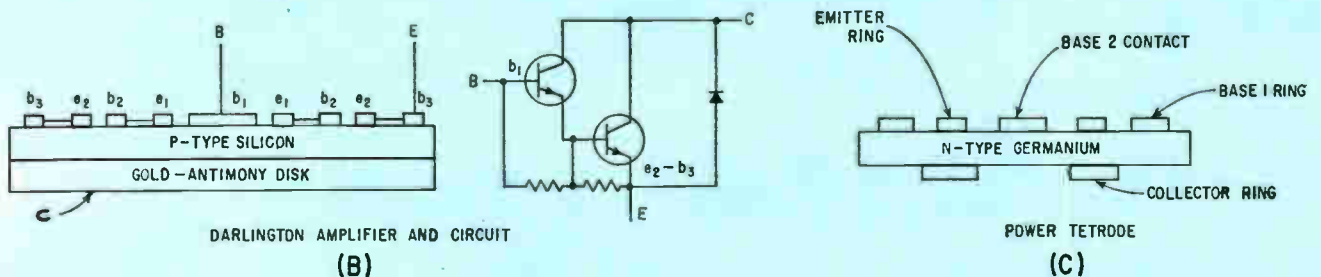

FIG. 17—Low-frequency power transistors: cross section and plan view of silicon alloyed unit (A); high-gain transistor or Darlington amplifier cross section with schematic (B) and germanium-alloy tetrode (C)



pits are etched on opposite sides of a semiconductor wafer by jets of an electrochemical solution. Then a dot of cadmium is plated in each of these pits by similar jets of electrolyte. Surface-barrier transistors have been made from both silicon and germanium.

Subsequently, the microalloying technique was combined with etching to manufacture the microalloy transistor shown in Fig. 16B. In this device the emitter and collector are alloyed to a slight depth into the germanium base material. The process increases gain while preserving the high-frequency capability afforded by the narrow basewidth.

The microalloy diffused transistor shown in Fig. 16C combines the techniques of electrochemical etching, microalloying and diffusion. It has a frequency capability about 10 times greater than that of the surface-barrier transistor.

A new type of electrochemical etched transistor shown in Fig. 16D combines electrochemical etching and epitaxial deposition. It is called the microlayer transistor and is expected to have a frequency capability in the 10-Gc range.

The microlayer transistor is fabricated by etching emitter and collector pits into heavily doped *n* germanium to form a base width on the order of 0.01 mil. Epitaxial layers of intrinsic germanium are deposited on opposite sides of the wafer and *p* electrodes are subsequently plated and microalloyed in the pits. A *pinip* structure is thus formed. The combination of extremely thin base with an intrinsic layer under the emitter and a *p*-layer of proper concentration under the collector permits a considerable increase in frequency capability.

The electrochemical diffused-collector (ECDC) transistor shown in Fig. 16E was developed by Sprague through the integration of electrochemical, microalloy and diffused-junction techniques. The electrochemical etch of the emitter pit allows the junction to be placed at proper resistivity for optimum breakdown and frequency response while still allowing the base to be placed on the extremely high conductivity surface. This high conductivity surrounds the emitter etch pit keeping the base resistance low and enabling the base contact to be placed a noncritical distance from the emitter. The electrochemical etch of the collector removes the unnecessary germanium and permits contact to be made close to the collector base junction. The result is low saturation voltage and low storage time as well as high breakdown voltage. Replacing the removed germanium with high conductivity metal keeps the collector-to-case thermal resistance low. Present ECDC transistors are germanium units equivalent in polarity to *pnp*.

HIGH POWER TRANSISTORS—Transistors for high power may be made both by alloying and diffusion.

A typical alloy power transistor is shown in Fig. 17A. This device starts with a *p* silicon substrate. The collector is formed by alloying a disk of gold antimony. The collector sits on a molybdenum disk that is silver soldered to a copper base plate. The ohmic base contact is a gold boron disk. It is surrounded by an annular ring of gold antimony to create the emitter. This in turn is surrounded by a second annular ring of gold boron

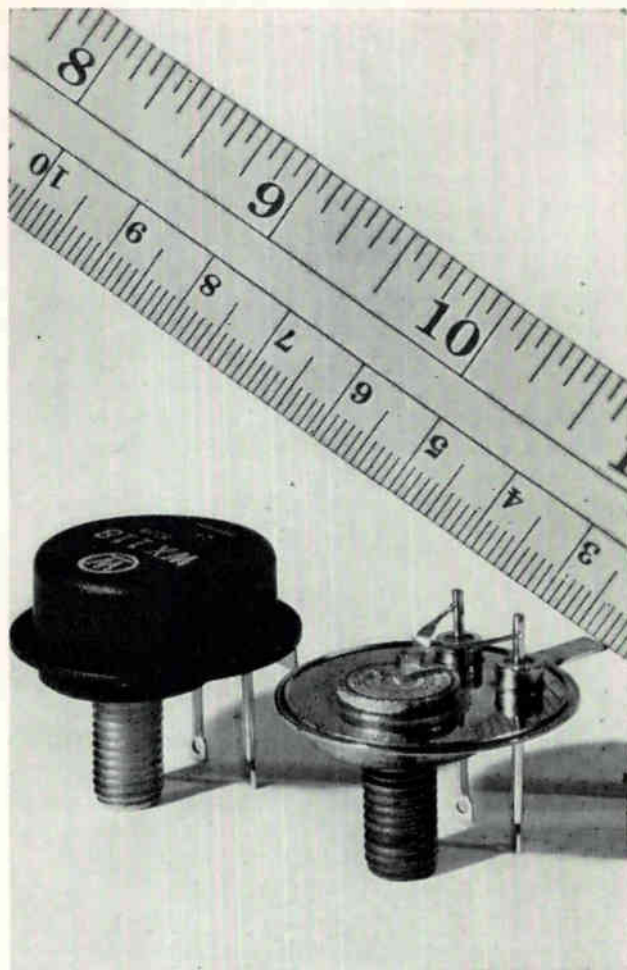

High-gain power transistor or Darlington amplifier (Westinghouse)

to create a second base contact concentric with the first.

These *npn* silicon power transistors are rated at 2 to 30 amperes and up to 200 volts. Power transistor ratings also include an h_{fe} range from 10 to 20 at currents up to 25 amperes. Saturation resistance, which is the emitter-to-collector drop with the transistor fully on, is less than $\frac{1}{4}$ ohm in 7-ampere devices, less than 0.1 ohm in higher power devices. A seven-ampere transistor can withstand collector voltages up to 200 volts. Higher power transistors can withstand 150 volts. Beta cutoff frequency, or the frequency at which h_{fe} has dropped to 0.707 of its midrange value, and ranges from 30 to 50 Kc.

The unit shown in Fig. 17B is a high-gain power transistor. It has an h_{fe} of up to 1,000 at 2 amp and 150 volts. It is actually a Darlington connection of two annular power transistors.

The transistor shown in Fig 17C is a power tetrode made by Minneapolis-Honeywell. This is a *pnp* germanium alloyed unit using annular geometry. The base 2 contact and the base 1 ring are not internally connected but are brought out as separate external electrodes. The two bases may be shorted to provide a high-gain triode. Base 1 may be shorted to the emitter to decrease switching time. Base 2 may be biased by

either an additional source or a diode and resistor combination to maximize linearity. A negative temperature coefficient element in the base 2 biasing network will improve stability of operating point against temperature changes. With base 2 reverse biased and input divided between base 1 and base 2, maximum linearity from a high-impedance drive source may be obtained.

High-power alloyed-junction transistors are low-frequency devices. However, high-power silicon diffused junction units provide high power handling capability and relatively high-frequency operation. For example, the WE 2N1675 is such a device. It is a double-diffused *pnp* transistor made by the diffusion of gallium and phosphorus. It has a 110 by 160-mil mesa and uses the interleaved junction structure illustrated in Fig. 13. There are eight separate base stripes. The transistor has a 4-micron base width and uses a molybdenum disk to connect to a copper header. Its thin base region is heavily doped. This contributes to minimize radiation sensitivity. The device is capable of dissipating 100 watts at 25 C. Typical gain bandwidth product (f_t) is 60 Mc. Turn on time is 250 nsec at 1 ampere collector current while turn off time is approximately 400 nsec. The unit is used in servo voltage regulators, servo amplifiers, d-c to d-c converters, high-power linear amplifiers, high-current and high-speed switching.

Triple diffusion is used to attain high-frequency high-power operation in the RCA TA2084 silicon diffused mesa. This is an experimental device that exists in several forms. One type has provided a 3-watt output from a one-watt input at 200 Mc (4.8-db gain) with 40-percent efficiency. It can also provide 12 watts output at 70 Mc; the f_t is 350 Mc; low-frequency beta is 40 at 1/2 ampere. The device has an 1,800-square-mil mesa with 0.02 to 0.04-mil base-width. The intrinsic region ranges from 0.2 to 3 mils wide. Typical value of $r_o C_o$ is 20. The substrate is soldered to its header with a gold-silicon alloy.

The device uses an interdigitated junction geometry

illustrated in Fig. 13. The fingers of this so-called "comb" junction are equivalent to 11 base stripes and 10 emitter stripes each 1 by 18 mils with a one-mil separation. This gives an effective junction length of 1/2 inch. Phosphorus and boron are the diffusants.

Some units have provided 500-w operation at 1 Kc. Twin-comb units have been made to dissipate 1 Kw at up to 5 Mc. Work on this transistor is being done for the Navy in a project whose object is to develop a transistor transmitter capable initially of operating at 1/2 megawatt and subsequently at 1 megawatt.

UNIPOLAR TRANSISTOR—The unipolar transistor is also known as a field-effect transistor. It is a majority carrier device. The unit illustrated in Fig. 18A is made by Crystalonics. It consists of an *n* silicon bar with ohmic anode and cathode contacts made to either end. Two *p-n* junctions built into the middle of the bar are connected in parallel as the grid. Negative bias applied to the grid projects a depletion layer from each junction into the silicon. This increases the effective resistance between the anode and cathode and creates a triode-type output characteristic.

In the annular unipolar transistor shown in Fig. 18B by Westinghouse, the substrate is *p* material. The cathode or source is the central disk. The grid or gate is the first annular ring while the anode or drain is the second annular ring. These devices give transconductances ranging from 1,500 to 5,000. They operate from 100 milliwatts to 5 watts. By adding rings, unipolar devices handling from 10 to 15 watts may be constructed. A unipolar transistor has been made using the bar geometry. The gate is alloyed in a channel between the source and the drain, while the base plate of the transistor forms a second gate electrode. Transconductance up to 1,000 has been achieved. In unipolar transistors transconductance is defined as the ratio of a change in drain current to a change in gate voltage with source voltage remaining constant.

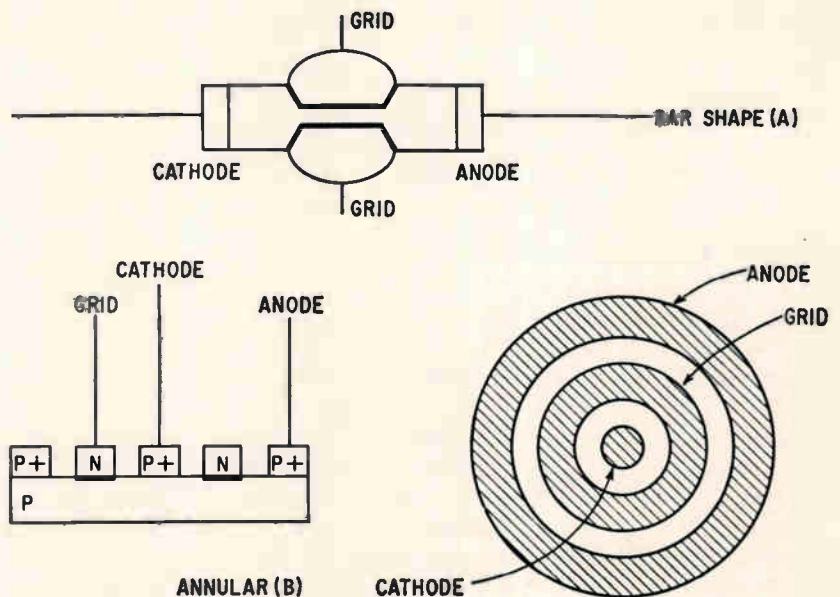
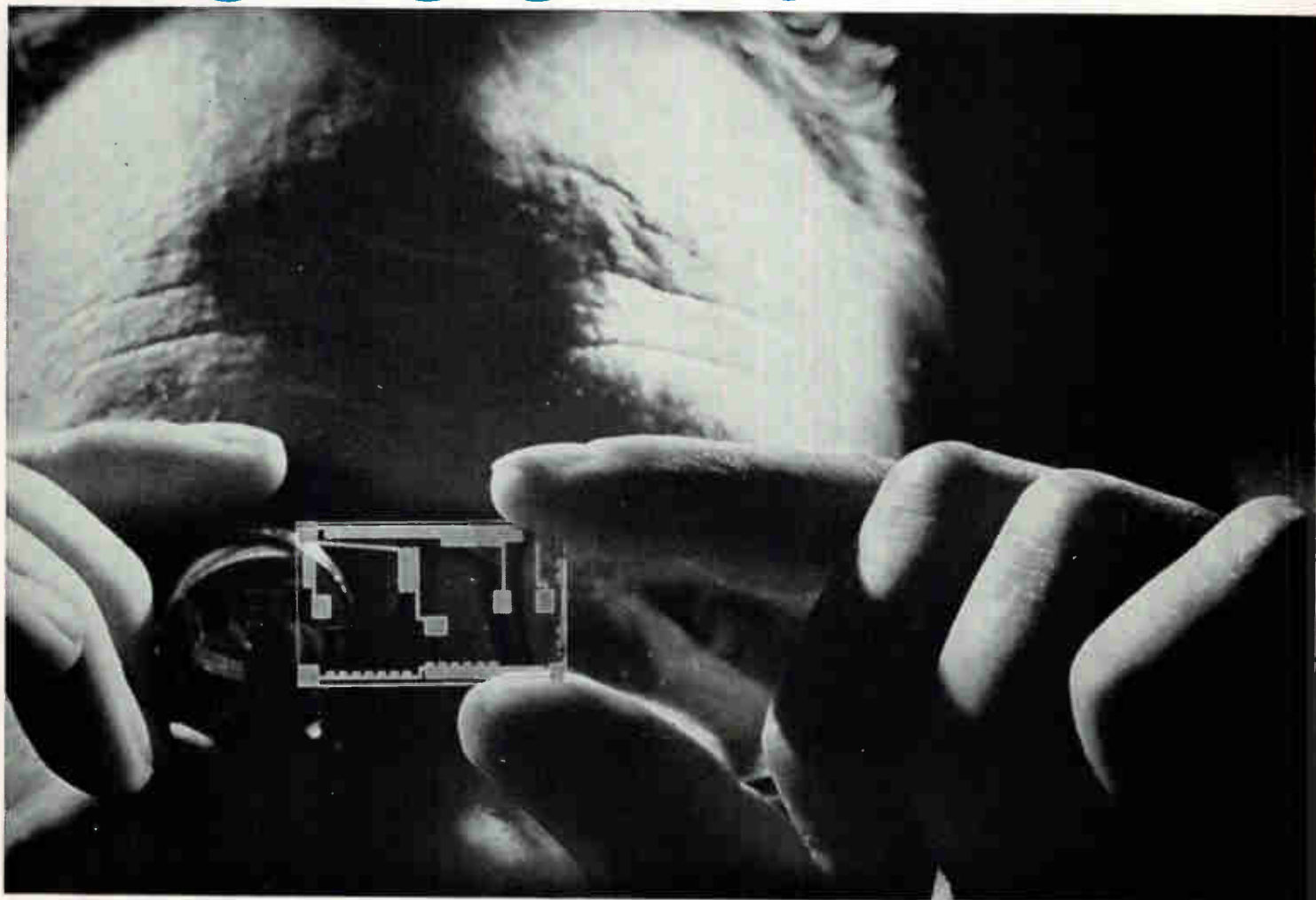

FIG. 18—Cross section of bar-type unipolar or field-effect transistor (A) and cross section with plan view of annular unipolar transistor (B)

MICROCIRCUITS



Single-crystal semiconductor film on dielectric substrate (Lear)

DEVELOPMENT of microcircuits has been going on under Defense Department auspices for several years. Many approaches have been tried but an interesting one is to construct the entire circuit, both active and passive components, on a single semiconductor substrate. There are perhaps as many approaches to this problem as there are manufacturers in the business, and the approaches range all the way from the most simple to the most complex. Multiple diodes are an approach to this problem.

General Instrument is assembling semiconductor devices on ceramic substrates within a transistor case. First the electrodes are evaporated then the devices

are mounted. The circuits are called nanocircuits. A typical one would be a flip-flop. In addition to diodes and transistors for nanocircuits, the company makes silicon-dioxide capacitors, silicon resistors and is working on a semiconductor inductance. A nanocircuit uhf transmitter is under development.

Lear is developing a process whereby transistors and diodes can be evaporated directly onto integrated microcircuits. The firm is evaporating single-crystal semiconductor films onto a dielectric substrate. Both *n* and *p* films are being evaporated and junctions have been produced. Elementary diode action has been observed. This technique permits the rest of the circuit such as

the resistors and capacitors to be evaporated on the same substrate, and reduces cross-couplings.

The single-crystal semiconductor films are deposited by high-vacuum evaporation. Both active and passive components are applied by the same process. The deposition process is a modified form of epitaxial crystal growth and can be controlled both in geometry and electrical characteristics. A portion of this work is being done by Battelle Memorial Institute.

Westinghouse calls their approach to the problem molecular electronics. One of their circuits provides a unipolar transistor input and conventional output to give the effect of voltage and power amplification in one package. Such circuit might be used as a preamplifier for an infrared detection system. Following is a list of 11 of more than 35 molecular electronic circuits under development: video amplifier (various levels), audio amplifier, tuned amplifier, detector, oscillator, mixer, AND gate, OR gate, multivibrators (bistable, monostable and astable), multiple switches, and NOR elements.

Fairchild calls their approach micrologic elements. First of these devices has been a flip-flop that looks externally like a transistor with eight leads. Five other devices: gate, half-shift register, buffer, half adder, and counter adapter will be available. A micrologic element uses direct-coupled transistor circuit design. The micrologic flip-flop is made by diffusing the transistors and resistors for many units onto a single slab of silicon. The metallic intraconnections are deposited on top of the slab and the slab is cut into individual elements. The circuit in Fig. 19A is representative of this approach.

Texas Instruments' approach is illustrated by the transistor-diode NOR gate shown in Fig. 19B. Their circuits are known as Solid Circuit semiconductor networks. A binary flip-flop and diode-resistor gate are also available. This approach uses circuit analogs to describe the conductance characteristics of semiconductor material. Thus circuit elements of resistors, capacitors, transistors and diodes can be used as design tools for forming the semiconductor network.

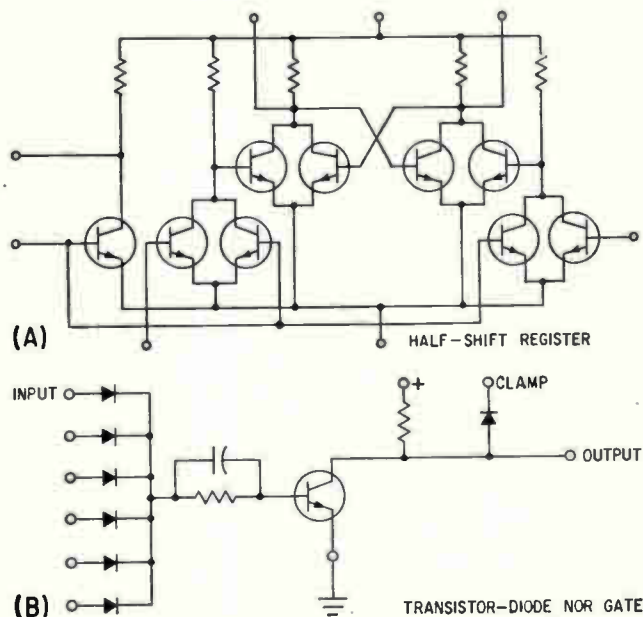
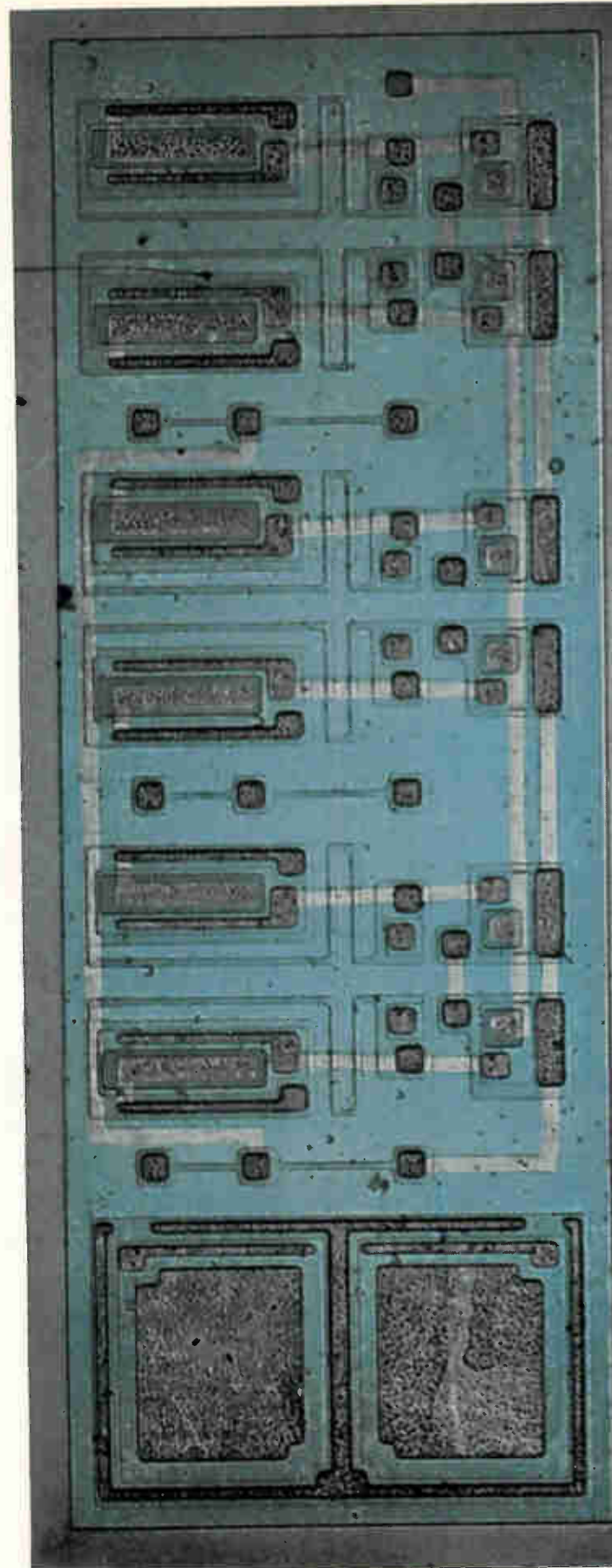
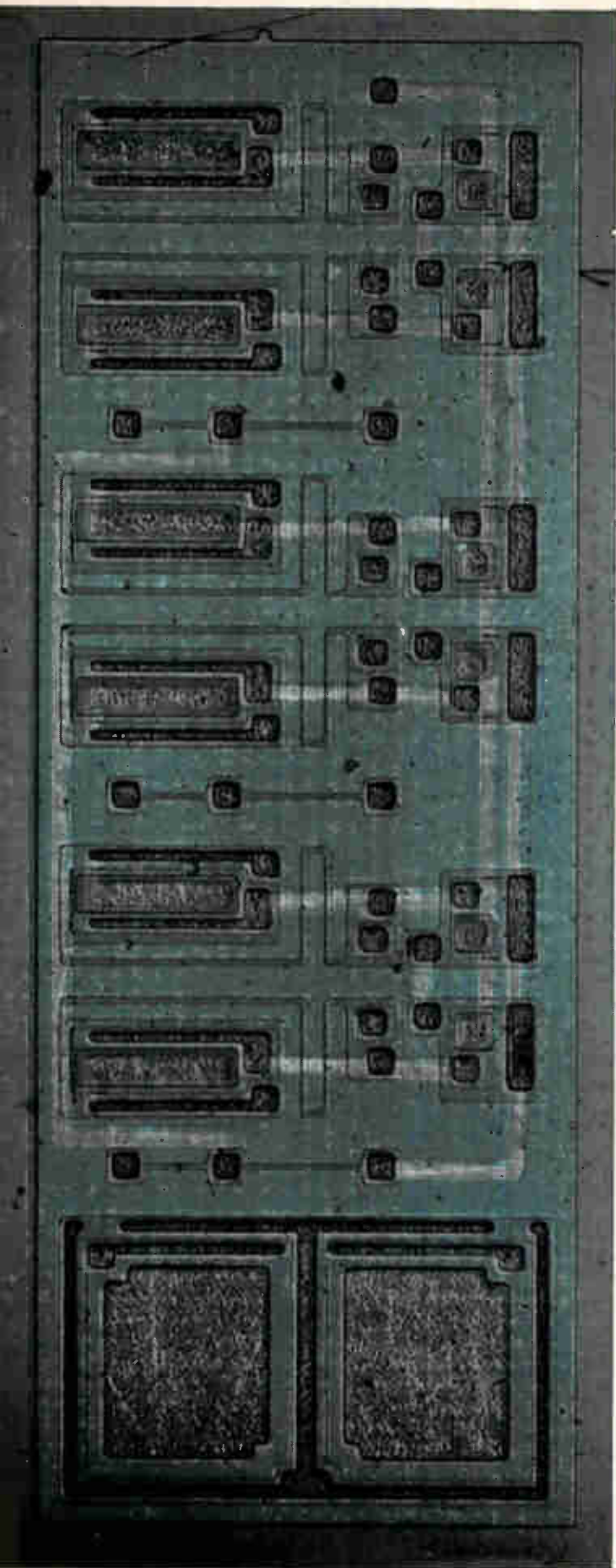

FIG. 19—Equivalent circuit of Micrologic half-shift register (A) and Solid Circuit transistor-diode NOR gate (B)



Two Solid Circuit semiconductor network elements in



semifinished state (Texas Instruments)

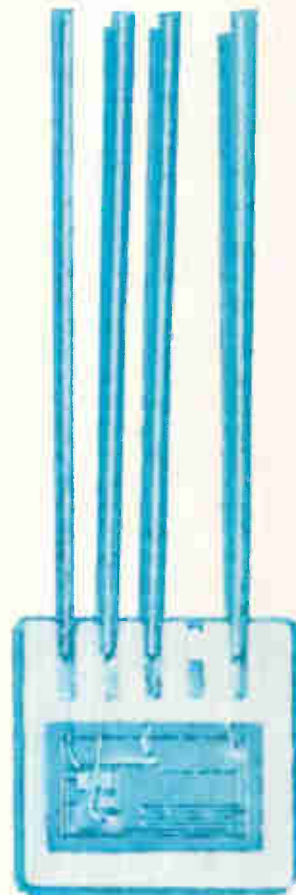

Molecular electronic multivibrator switch (Westinghouse)

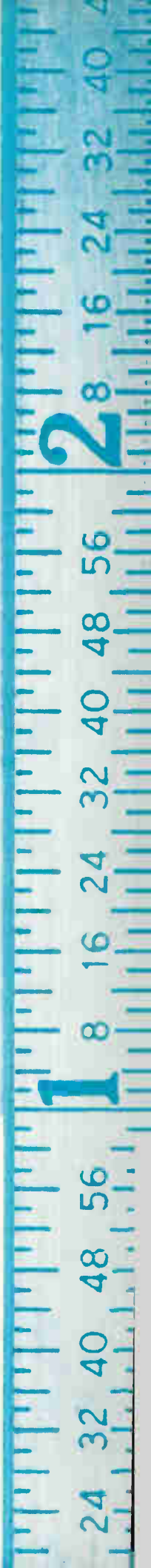

MAJORITY-CARRIER AMPLIFIERS

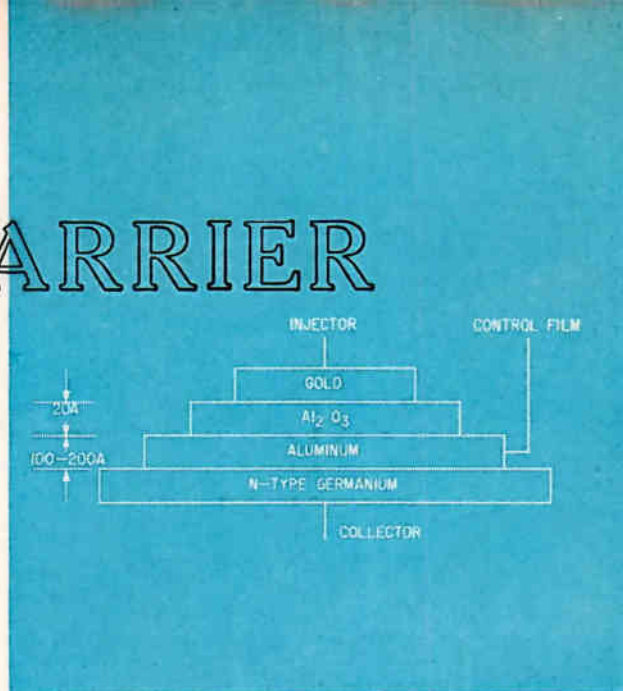

FIG. 20—Cross section of Metal Interface Amplifier

THE MAJORITY-CARRIER thin-film amplifier is an outgrowth of tunnel-diode technology. Several such devices are under development and they are known by various names. Philco calls theirs the Metal Interface Amplifier or MIA. RCA talks of evaporated thin-film triodes. Some workers talk about tunnel triodes.

Metal Interface Amplifier can be described as a third basic type of amplifier and a possible successor to the transistor in many applications. It may be contrasted with the vacuum tube, which uses one type of charge carrier, the electron, in a vacuum. It may also be contrasted with the transistor, which uses either positive or negative minority carriers in a solid. The MIA uses one charge-carrier type, the electron, in a solid. In the MIA the problem of ignoring majority carriers, that is, base recombination, does not exist. Furthermore, the device is not restricted to a limited range of materials of correct purities and crystal structure as is the transistor.

The device is illustrated in Fig. 20. Physically it is a four-layer sandwich. The substrate is an *n* germanium collector on which is evaporated an aluminum control film 100 to 200 angstroms thick. An aluminum-oxide film 20 angstroms thick is grown on the control film by thermal oxidation. A gold injector film is then evaporated on the aluminum oxide.

The germanium substrate is described as being non-critical; polycrystalline material could be used. The material used in experimental devices has been arsenic doped to a resistivity of one ohm centimeter. The aluminum and oxide layer characteristics are critical. Pinholes in the aluminum layer are said to increase the feedback voltage h_{re} and thereby degrade performance of the amplifier. Electrically the MIA is a three-terminal device corresponding roughly to an *npn* transistor. The injector is a source of electrons. The collector is the anode while the modulating voltage is impressed between the control film and the injector. Quiescent bias on the control film ranges from 0.5 to 1 volt. Collector

potential can range from zero up to forty volts.

Looking at the device as a four-pole network there is an input impedance h_{ie} of about 50 ohms; the reverse voltage feedback h_{re} as low as 0.001; forward current transfer ratio or alpha (h_{fe}) of 0.70 to 0.95 (alpha is measured as the ratio of a change in collector current to a change in injector current with control-film bias constant) and an output impedance h_{oe} of 10,000 to 15,000 ohms.

Beta or forward current transfer ratio in the common injector connection has varied from zero to 35 with a typical value of 20. Beta cutoff frequency has been measured at 100 Kc, but no limit is said to be in sight.

Power gains from 10 to 20 db have been measured with a typical value being 17. The device is a good thermal conductor, and should have good power-handling capability. From a physical point of view the MIA may be looked upon as a tunneling device having two barriers. The first barrier, the oxide layer, looks like a simple dielectric. Between the aluminum and the germanium, there is actually a back-biased surface barrier that has advantages over the alloyed junction of giving an abrupt junction right at the surface and a uniform depth over the whole junction. The potential difference between control film and injector creates an extremely high field and accelerates injector electrons.

Considering the electron as a wave, which is common in analysis of tunneling phenomena, there exists transmission coefficient at the oxide and at the junction barrier. Loss at the aluminum-oxide barrier ranges from 5 to 30 percent while there is nearly 100-percent transmission of energetic electrons at the aluminum-germanium interface.

Evaporated film triodes have been described by RCA. These are said to be field-effect transistors fabricated completely by deposition of thin films on glass plates. One such device is built around a cadmium-sulphide film several microns thick and conducting metals such as tellurium a few hundred angstroms thick.

New Bourns Precision Potentiometer Resolves the Quality-Price Dilemma!

NUMBER 18—NEW PRODUCT SERIES

Here is military reliability in a competitively-priced industrial potentiometer. Bourns wirewound 10-turn Model 3500 measures just $\frac{7}{8}$ " in diameter by 1" long—shorter by $\frac{1}{2}$ " than units available elsewhere—yet has a resistance element 20% longer than that of comparable potentiometers.

Fully meeting military requirements for steady-state humidity, Model 3500 can also be provided at a 10% premium to meet the cycling humidity specs of MIL-STD-202, Method 106. It's the only $\frac{7}{8}$ " 10-turn potentiometer guaranteed to meet this spec. Its published characteristics incorporate wide safety margins.

Reliability insurance is provided by the exclusive Bourns Silverweld® bond between terminal and resistance wire. Virtually indestructible under thermal or mechanical stress, this termination

eliminates a chief cause of potentiometer failure. In addition, a special close-tolerance rotor almost completely does away with backlash.

Model 3500 is also subjected to the rigorous double-check of Bourns' exclusive Reliability Assurance Program. In short, every possible step is taken to ensure that the performance you specify is the performance you get. Write for complete data.

Resistances	500 Ω to 125K, \pm 3%, std. (to 250K spl.)
Linearity	\pm 0.25% std.
Power rating	2w at 70°C
Operating temp.	-65° to +125°C
Mech. life	2,000,000 shaft revolutions



BOURNS

BOURNS, INC., TRIMPOT DIVISION
6135 MAGNOLIA AVE., RIVERSIDE, CALIF.
PHONE: OVERLAND 4-1700 • TWX: RZ 9222
CABLE: BOURNSINC.

Manufacturer: Trimpot® potentiometers; transducers for position, pressure, acceleration. Plants: Riverside, California; Ames, Iowa; and Toronto, Canada

THERE IS NO SUBSTITUTE

Specify **"MAG MOD"** *miniaturized*

For the ultimate in—
RELIABILITY
REPEATABILITY
SUPERIOR
PERFORMANCE

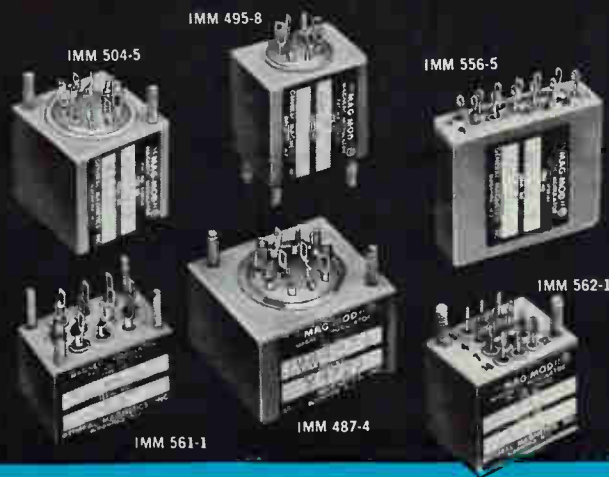

Designed for Subminiature
 Circuit Assemblies and Printed Circuit Card Configurations

New miniature designs of these reliable "MAG MODS"® make them ideal for incorporation into transistorized printed circuit assemblies. There is no sacrifice of dynamic response. They offer the engineer/designer the solution to problems involved in a wide range of data systems where analog circuit operations are encountered. To insure complete flexibility, the mechanical mounting on any "MAG MOD" may be modified to conform to your particular packaging requirements.

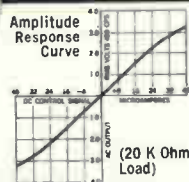

Input Magnetic Modulator
Type No. IMM 487-4

Subminiature "MAG MOD"® featuring high input signal sensitivity and high AC output impedance. Male or female mounting.

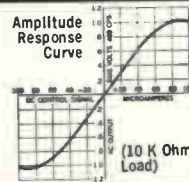

Input Magnetic Modulator
Type No. IMM 495-8

Subminiature "MAG MOD"® featuring wide band width, multiple signal input circuits, extreme zero stability from -65°C to $+135^{\circ}\text{C}$, low null amplitude or noise level. Mounting available male or female.

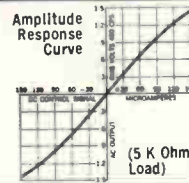

Input Magnetic Modulator
Type No. IMM 504-5

Subminiature "MAG MOD"® featuring low input and output impedance, resistance vs. temperature compensated input, extreme zero stability, repeatability and insignificant hysteresis. Supplied with male or female mounting.

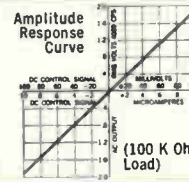

Input Magnetic modulator
Type No. IMM 562-1

Subminiature "MAG MOD"® featuring 4 KC carrier operation, wide frequency band width, high output impedance and voltage range. Mounting male or female.

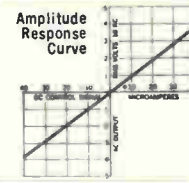

Input Magnetic Modulator
Type No. IMM 561-1

Subminiature "MAG MOD"® featuring low carrier energy level operation, very wide frequency band width, wide output operating range, minimum size and weight. Mounting male or female. May be mounted directly on printed circuit boards.

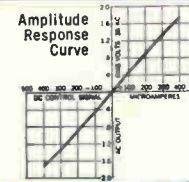

Input Magnetic Modulator
Type No. IMM 556-5

Subminiature "MAG MOD"® featuring high frequency carrier operation (35 KC), flat construction for printed circuit mounting, low output impedance and clean output fundamental frequency wave form. Mounting supplied male or female.

- 1% repeatability throughout entire service life
- Negligible hysteresis
- Faster response time
- Extreme stability over a wide temperature range
- Infinite service life
- Extremely lightweight — compact design

GENERAL MAGNETICS • INC



FOR RELIABILITY...

MAGNETIC MODULATORS



TYPE NUMBER	IMM 487-4	IMM 495-8	IMM 504-5	IMM 562-1	IMM 561-1	IMM 556-5
Excitation Carrier Voltage and Frequency	115 V @ 400 cps	115 V @ 400 cps	115 V @ 400 cps	2.5 V RMS @ 4 KC	3.0 V RMS @ 10 KC	6 to 10 V RMS @ 35 KC
Control Signal Winding DC Resistance	Winding No. 1 6200 ohms Winding No. 2 7400 ohms	Signal Winding No. 1 550 ohms Signal Winding No. 2 600 ohms	1000 ohms	Signal Winding 1300 ohms Feedback Winding 160 ohms	200 ohms	5000 ohms
Input Control Signal Range	0 to $\pm 40 \mu\text{a}$ Each Winding	0 to $\pm 100 \mu\text{a}$ (Both Sig. Windings in Series)	0 to $\pm 100 \mu\text{a}$	0 to $\pm 100 \mu\text{a}$ 0 to ± 1 V Bipolar	0 to $\pm 400 \mu\text{a}$	0 to $\pm 400 \mu\text{a}$
Amplitude Modulated AC Output Range	3 V RMS @ 400 cps Phase Reversing	0 to 1 V RMS @ 400 cps Phase Reversing	0 to 1.5 V RMS @ 400 cps Phase Reversing	0 to 6 V RMS @ 4000 cps Phase Reversing	0 to 3 V RMS @ 4 KC Phase Reversing	0 to 1.8 V RMS @ 35 KC Phase Reversing
Differential Gain RMS mv AC Out./ μa Signal In	100 mv/ μa	15 mv/ μa	10 mv/ μa	200 mv/ μa	10 mv/ μa	4.2 mv/ μa
Null Amplitude (Noise Level) mv RMS	25 mv RMS Maximum	5 mv RMS Maximum	10 mv RMS Maximum	30 mv RMS Maximum	10 mv RMS Maximum	20 mv RMS Maximum
Output Impedance	Approx. 30 K ohms	1600 ohms	1000 ohms	Approx. 70 K ohms	Approx. 40 K ohms	900 ohms Each Output Wind.
External Load (Suggested)	Approx. 20 K ohms	Approx. 10 K ohms	Approx. 5 K ohms	Approx. 100 K ohms	Approx. 100 K ohms	1000 ohms Each Output Wied.
Null Drift (in terms of Input Signal) -55°C to $+135^\circ\text{C}$	Less than $\pm 0.25 \mu\text{a}$ Over Temp. Range	Less than $\pm 0.25 \mu\text{a}$ Over Temp. Range	$\pm 1 \mu\text{a}$ Maximum Over Temp. Range	$\pm 0.5 \mu\text{a}$ Maximum Over Temp. Range	$\pm 1 \mu\text{a}$ Over Temp. Range	$\pm 2 \mu\text{a}$ Over Temp. Range
Hysteresis (% of Input Control Signal)	0.5% Maximum	0.5% Maximum	0.5% Maximum	Approx. 0.5%	0.5% Maximum	0.5% Maximum
% Harmonic Distortion in Output AC Modulated Envelope	Approx. 40% (3rd Harmonic)	Approx. 25% (3rd Harmonic)	Approx. 30% (3rd Harmonic)	Approx. 15% (3rd Harmonic)	Less Than 10% (3rd Harmonic)	Approx. 5% (3rd Harmonic)
Overall Dimensions (in inches)	$1\frac{1}{4} \times 1\frac{1}{4} \times \frac{3}{4}$	$\frac{3}{4} \times 1 \times 1$	$1 \times 1 \times 1$	$1 \times 1\frac{1}{16} \times \frac{3}{4}$	$1\frac{1}{16} \times 1 \times \frac{3}{4}$	$7/16 \times 1\frac{1}{4} \times 1\frac{1}{4}$
Type of Mounting	4-40 Studs or Inserts	4-40 Studs or Inserts	4-40 Studs or Inserts	4-40 Studs or Inserts	2-56 Studs	4-40 Tapped Holes or Studs
Weight in ounces	Approx. 1.25	Approx. 1	Approx. 1.1	0.75	0.6	1
Response Time (Band Width cps)	0.01 sec. for 15 K Sig. Source Imp. (12 cps Corner Frequency)	20 cps for 10 K Sig. Source Imp. 25 cps for 20 K Sig. Source Imp. (Both Sig. Windings in Series)	5 cps for 1 K Sig. Source Imp. 10 cps for 5 K Sig. Source Imp. 20 cps for 10 K Sig. Source Imp.	70 cps for 10 K Sig. Source Imp. (Time Constant Approx. 2 Milli- Seconds)	Corner Frequency 2 KC for Sig. Source Imp. of Approx. 6 K ohms	Corner Frequency 200 cps for 500 ohm Signal Source Imp. or 1000 cps for 5 K Source

Magnetic Multiplying Modulator Model MCM 515-1



Actual Size

The MAGNETIC MULTIPLIER is a miniaturized magnetic modulator specifically designed to deliver an analog output voltage which is the continuous product of two variable input voltages. One of these is an excitation voltage which varies over a pre-determined range; in this case, 0 to 1 VRMS 400 cycles per second. The other signal is a DC current which varies between 0 and $\pm 400 \mu\text{a}$. The output voltage is 400 cycles AC, and is always in phase or 180° out of phase with the variable excitation or fixed reference, i.e., in phase when the variable amplitude DC signal is positive, and 180° out of phase when the DC signal is negative. The relationship between variable alternating supply signal voltage E_s , variable direct current control signal E_c , and the alternating load voltage E_L having a sinusoidal wave shape is denoted by the equation—

$E_L = \text{Constant} \times E_s \times E_c$

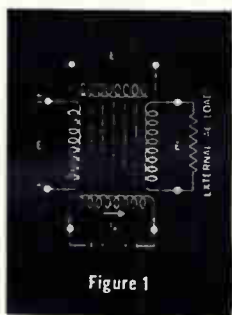

Figure 1

This expression, which defines the fundamental principle of the four quadrant MAGNETIC MULTIPLYING MODULATOR, can be clearly illustrated by linear transfer response curve families as shown at right, in Figure 2-A and Figure 2-B.

Illustrating:

- (1) Load voltage E_L as a function of alternating supply signal voltage E_s with control DC signal voltage E_c as a parameter.
- (2) Load voltage E_L as a function of control DC signal voltage E_c with alternating supply voltage, E_s as a parameter.

With linearity response curves held to within approximately 1 to 2% of theoretical straight lines, the product accuracy of the fundamental equation will be within 2 to 5% of the theoretical product.

SPECIFICATIONS MODEL MCM 515-1	
Variable Excitation Carrier Voltage and Frequency	Variable AC Signal 0 to 1 V RMS 400 cps
Control Signal Winding DC Resistance	DC Signal Winding Resistance 2650 ohms
Input Control Signal Range	Variable DC Signal 0 to $\pm 400 \mu\text{a}$
Amplitude Modulated AC Output Range	0 to 0.9 V RMS @ 400 cps Phase Reversing
Null Amplitude (Noise Level) mv RMS at Max. AC Excitation	5 mv RMS
Output Impedance	Approx. 3500 ohms
External Load (Suggested)	Approx. 25 K ohms
Null Drift (in terms of Input Signal) -65°C to $+135^\circ\text{C}$	$\pm 2 \mu\text{a}$ Over Temperature Range
Hysteresis (% of Input Control Signal)	0.5% Maximum
% Harmonic Distortion in Output AC Modulated Envelope	Less than 5%
Overall Dimensions (in inches)	$27/32 \times 27/32 \times 1\frac{3}{16}$
Type of Mounting	4-40 Insert or Stud
Weight	Approx. 1 Ounce

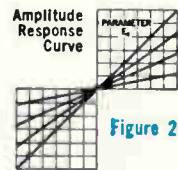

Figure 2-A

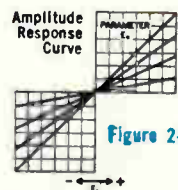

Figure 2-B

Typical "Mag Mod" Circuit Applications —

Include algebraic addition, subtraction, multiplying, raising to a power, controlling amplifier gain, mechanical chopper replacement in DC to fundamental frequency conversion, filtering and low signal level amplification.

Consult General Magnetics for magnetic amplifier components of proven reliability. These dependable instruments are widely employed in automatic flight systems, fire control, analog computers, guided missiles, nuclear equipment, antennas, gun turrets, commercial power amplifiers and complete control systems. Miniature, subminiature, standard and customized types available.

135 BLOOMFIELD AVE., BLOOMFIELD, NEW JERSEY



Call or write for new Brochure 102 on "MAG MOD" Miniaturized Magnetic Modulators and Magnetic Multiplying Modulators. Please address inquiries on company letterhead.



NEW MINIATURIZED LONG-LIFE COMMUTATION SWITCH



ACTUAL SIZE
Plate dia. only 1 3/4"

... but 1 3/4" plate diameter and 50% space savings* in a 180-channel switch are only the start of the story. This new electromechanical switch also gives the other advantages that have made MYCALEX® units the industry standard. Noise level of less than 1 millivolt when switching 5 volts into a 150-ohm load. Up-to-a 1000 megohm resistance between rectangular contacts. Speeds as high as 1800 RPM. Metal-to-metal wiping action that prevents graphite build-up. Super-hard, gold-plated contacts. SUPRAMICA® 555 ceramoplastic plate that withstands operating temperatures to 650° F., has total dimensional stability, locks contacts in place. Plus nylon-brush mountings of new design that eliminate bounce and deliver sharp, clean signal edges.

Whether you're looking for commutation plates or complete switches, it'll pay you to investigate both of these compact, new components which give you an additional degree of design latitude. (For example, other MYCALEX switches offer up to 540 contacts on a 3"-diameter plate.) Write today for our new, comprehensive technical bulletin.

*When compared with conventional Inter-Range Instrumentation Group Telemetering Switches.

General Offices and Plant: 120 Clifton Boulevard, Clifton, N. J.
Executive Offices: 30 Rockefeller Plaza, New York 20, N. Y.

EXCLUSIVE LICENSEE OF MYCALEX CORPORATION OF AMERICA

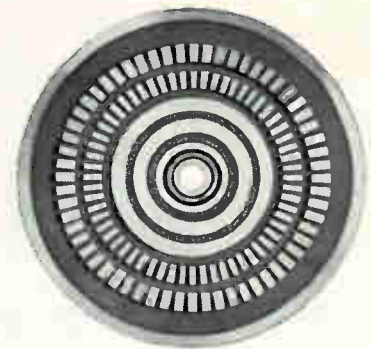

We are exhibiting at the N.E.C. Show
Booth 346-348 • Oct. 9-11 • Chicago, Ill.

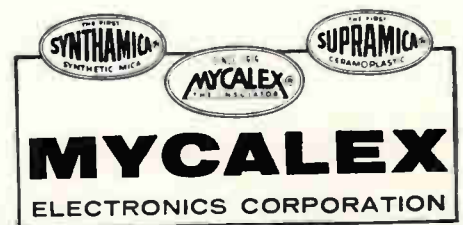

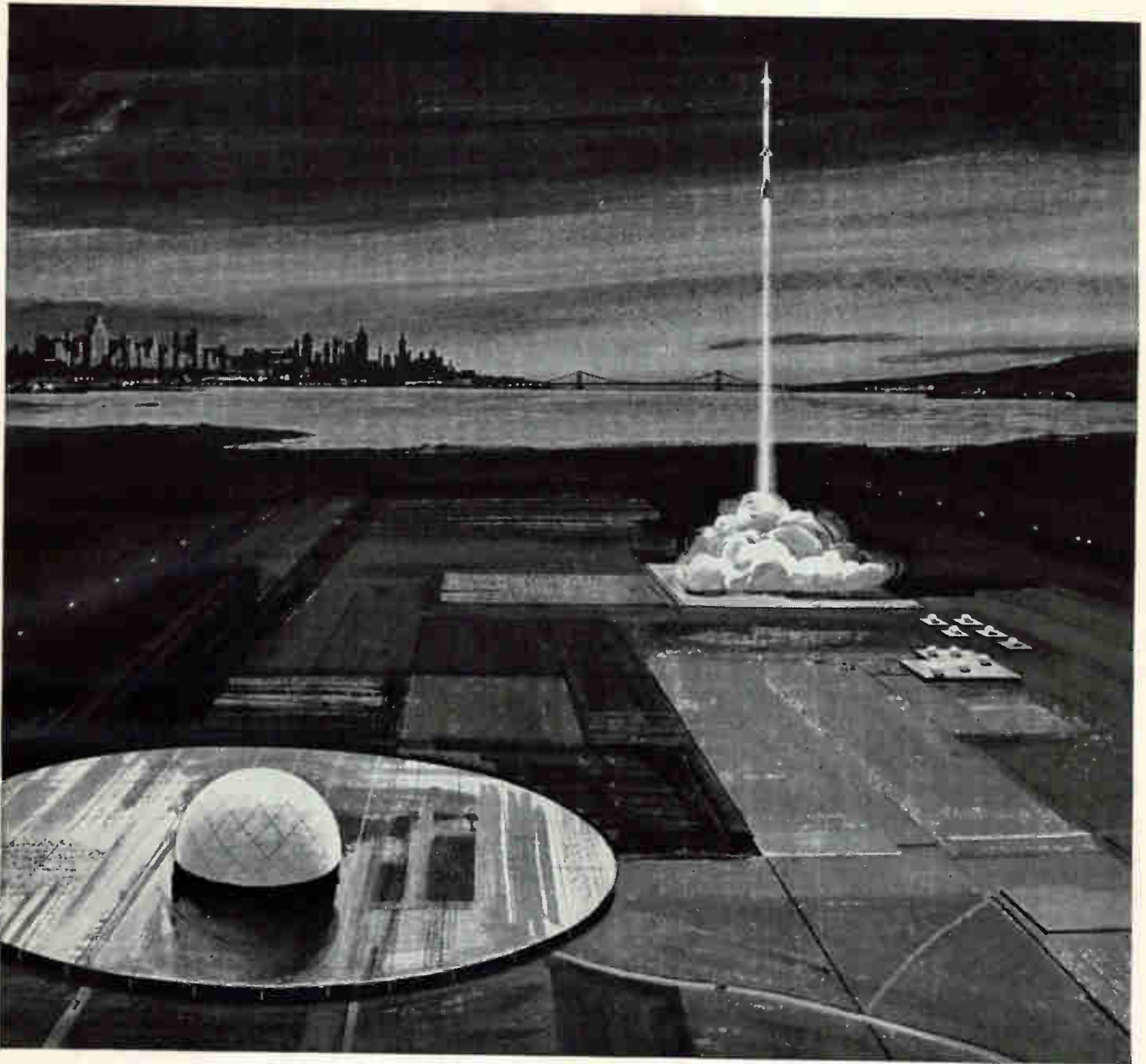

More than 450,000 pounds of thrust lifts the U. S. Army's Nike Zeus missile skyward in a cloud of vapor. The Nike Zeus missile being developed for the project by the Douglas Aircraft Company will be designed to intercept ballistic missiles traveling over 15,000 miles per hour, and destroy them at a safe distance from the defended area.

How do you stop an ICBM?

How do you detect, track, intercept—and destroy within minutes—an ICBM that is moving through outer space ten times faster than a bullet?

Bell Telephone Laboratories may have designed the answer: Nike Zeus, a fully automated system designed to intercept and destroy all types of ballistic missiles—not only ICBM's but also IRBM's launched from land, sea or air. The system is now under development for the Army Ordnance Missile Command.

Radically new radar techniques are being developed for Nike Zeus. There will be an acquisition radar designed to detect the invading missile at great distances. And a discrimination radar designed to distinguish actual war-

heads from harmless decoys that may be included to confuse our defenses.

The system tracks the ICBM or IRBM, then launches and tracks the Nike Zeus missile and automatically steers it all the way to intercept the target. The entire engagement, from detection to destruction, would take place within minutes and would span hundreds of miles.

Under a prime Army Ordnance contract with the Western Electric Company, Bell Laboratories is charged with the development of the entire Nike Zeus system, with assistance from many subcontractors. It is another example of the cooperation between Bell Laboratories and Western Electric for the defense of America.

BELL TELEPHONE LABORATORIES

World center of communications research and development





Low cost silicon voltage regulators



Help Yourself!

Help yourself to improved circuit performance at a new low cost with these Tarzian 1-watt units. Epoxy-enclosed, they combine:

1. sharp and instantaneous breakdown (avalanche) and instantaneous recovery
2. small size, inherent ruggedness, and physical simplicity that are distinct improvements over other types of regulators
3. low cost—less than a dollar in production quantities at the standard 20% tolerance. All standard tolerances available on request.

At these low prices, their regulating, clipping, limiting, and protecting functions and advantages can be used to improve the performance of more circuits than ever before.

Write for price and ordering information. Application assistance is available. For even faster service, contact the Tarzian Industrial Distributor near you.

Other Tarzian silicon voltage regulators are available in 1/4-, 1-, and 10-watt series, 31 units in each series, 5.6 to 100 Zener volts in 10% increments; standard tolerance 10%.

Specifications at 25° C

Tarzian Type	Zener Voltage (V)	Test Current (mA)	Dyn. Imp.(MAX) (Ohms)
VR6	6	25	4.0
VR7	7	25	5.0
VR8.5	8.5	25	6.0
VR10	10	12	8.0
VR12	12	12	10
VR14	14	12	11
VR18	18	12	17
VR20	20	4	20
VR24	24	4	28
VR28	28	4	42
VR33	33	4	50
VR39	39	4	70
VR47	47	4	98
VR56	56	4	140
VR67	67	2	200
VR80	80	2	280
VR90	90	1	340
VR105	105	1	400



Send for free SVR Catalog: includes data on all four Tarzian series of silicon voltage regulators, plus design and test information.



SARKES TARZIAN, INC.

World's Leading Manufacturers of TV and FM Tuners • Closed Circuit TV Systems • Broadcast Equipment • Air Trimmers • FM Radios • Magnetic Recording Tape • Semiconductor Devices

SEMICONDUCTOR DIVISION • BLOOMINGTON, INDIANA
In Canada: 700 Weston Rd., Toronto 9 • Export: Ad Auriema, Inc., New York



Manufacturers of glass silicon diodes
which meet the most challenging requirements of our industry's
high-temperature, low-leakage, fast-switching technology.

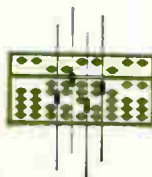

COMPUTER DIODE
C O R P O R A T I O N

250 GARIBALDI AVENUE • LODI, NEW JERSEY • PRESCOTT 3-2511 • CABLE ADDRESS: CODI LODI

September 29, 1961

CIRCLE 127 ON READER SERVICE CARD 127

NEW PHILCO SILICON CHOPPERS



T2357
Matched pair of
Philco type T2363
SPAT® Choppers, in
TO-18 Packages.



With SPAT* Matched-Pair Uniformity
Bring High Fidelity To Low Level Switching!

T2363 CHARACTERISTICS

Emitter Voltage, V_{ECC}	-30 volts
Collector Cutoff Current $I_{CBO}(V_{CB} = -10V)$	0.001 μ a max.
Emitter Collector Current $I_{EEO}(V_{EB} = -10V)$	0.001 μ a max.
Offset Voltage $V_{EC}(I_b = -200 \mu$ a, $I_c = 0)$	1.5 mv max.
Offset Voltage V_{EC} (T2357 Matched Pair, $I_b = -1$ ma at all temperatures from 25° to 85° C)	50 μ v max.

TYPICAL CHOPPER CIRCUIT

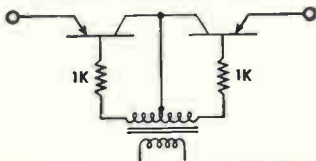

T2363: I-V CHARACTERISTIC (in above circuit)

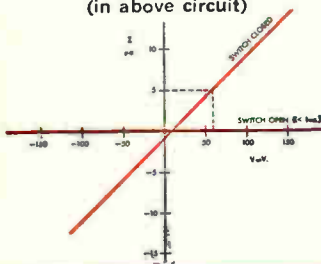

For low level switching applications, Philco now makes available *Silicon Precision Alloy Transistor Choppers—produced on industry's only fully-automatic chopper production line—to assure the uniformity so important to matched pairs.

Only Philco Choppers offer you all these advantages—made possible by the SPAT® process:

- Low offset current—1 nanoampere maximum;
- Low offset voltage—50 μ v maximum (for the matched pair);
- Guaranteed match over a temperature range—25° to 85° C;
- Guaranteed maximum offset voltage for a wide range of base current values;
- High gain-bandwidth product;
- Meet all requirements of MIL-S-19500B.

To assure ultra-high fidelity in multiplex systems for telemetry, multi-channel communications, analog computers, and other low level data handling applications, be sure to specify Philco SPAT® Choppers. For complete data, write Dept. E92961.

Philco SPAT®
Choppers are
immediately available
in quantities 1-999
from your Philco
Industrial Semiconductor
Distributor.

PHILCO®



Famous for Quality the World Over

LANSDALE DIVISION, LANSDALE, PA.



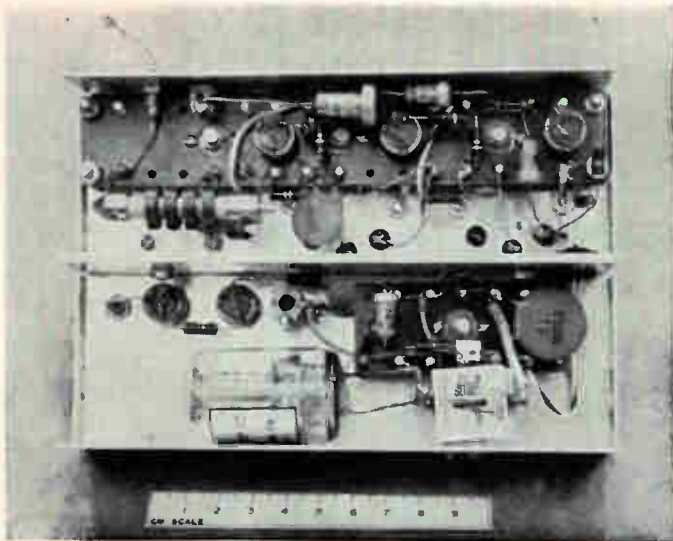

Tunnel Diodes Control Quartz-Crystal

Chronometer



Chassis in photos above is small enough to fit inside clock case, which additionally contains miniature batteries and clock motor. Frequency controlling crystal is vacuum enclosed for minimum value (500 ohms) of series resistance

Battery-powered clock runs for 6 months on one charging; 100-Kc crystal-controlled tunnel-diode oscillator provides basic stability; tunnel-diode dividers reduce frequency to 50 cps for clock motor

By R. L. WATTERS,
General Electric Research Laboratory,
Schenectady, New York

THE USE of a quartz crystal as the time base for a clock is well known¹. Basically such a clock consists of an accurate quartz crystal oscillator, a series of frequency dividers, and an output indicator. De-

velopment of tunnel diodes has made feasible a clock that is self-powered, simple, and accurate. Tunnel diodes can be used in simple oscillator circuits that operate with low power dissipation in the quartz crystal; they also permit simple frequency dividers of unprecedented stability. The number of dividers necessary depends upon

the frequency ratio of the oscillator, the stability of each divider, and also on the clock motor itself. Large division factors per diode can be reliably attained, making it feasible to use a 100-Kc oscillator where GT cut quartz crystals² are available. The frequency stability of such crystals can be a few parts per million for a temperature range

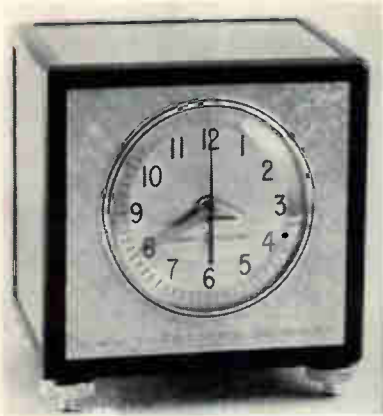

Clock has accuracy about 5 times better than maritime chronometers

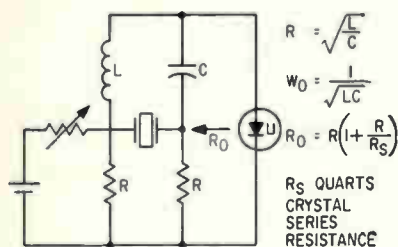

FIG. 1—Basic crystal-and-tunnel-diode oscillator circuit using a GT cut crystal

of 100 C (one part per million error is 32 seconds per year). Furthermore, since certain motors now available draw only 300 to 500 microwatts, the total power required for the complete clock is so low that it can be operated for about four months with one size D mercury cell. Lower current tunnel diodes could extend the battery life.

The active circuit elements in the clock are four 0.5-ma tunnel diodes, one transistor and the synchronous clock motor, with one of the tunnel diodes in a quartz crystal oscillator circuit. The crystal is a 100-Kc GT unit². The other three tunnel diodes are in frequency dividing circuits of ratio 10:1, 10:1, and 20:1, respectively. The transistor is a power amplifier for the 50-cps output of the divider unit, and drives the motor. The entire circuit is powered by a single 1.34-v mercury cell at a 1.5 ma current drain. The circuit tolerates a 15-percent drop in battery voltage with no loss of timing accuracy; an extra battery holder is installed so that the battery can be replaced

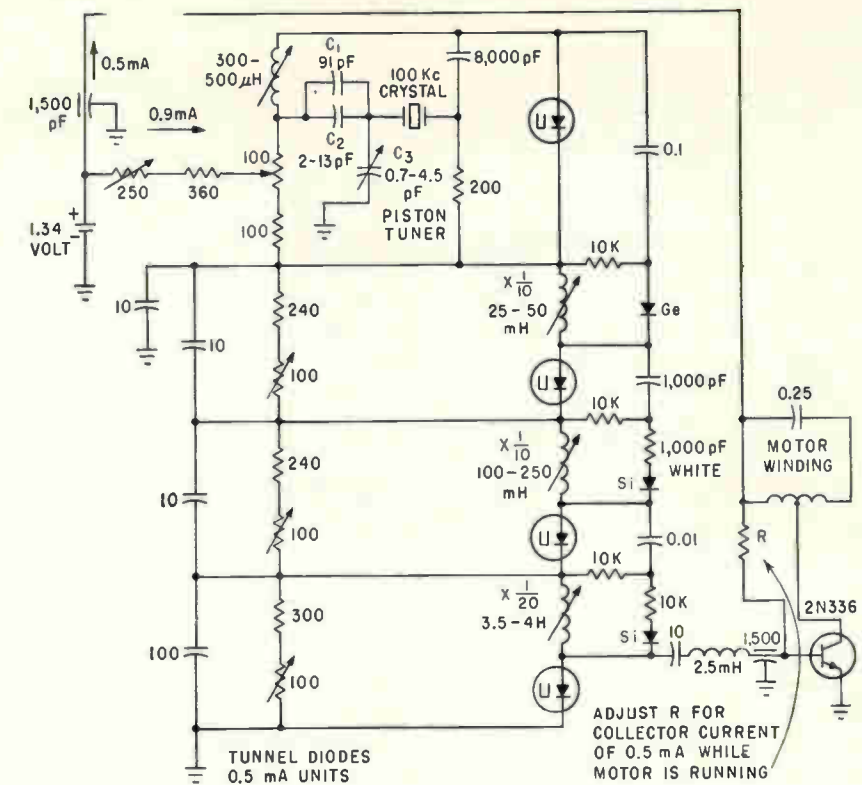

FIG. 2—Complete circuit incorporates trimmers that can adjust the timing of the clock by a few seconds per year. Three tunnel-diodes give overall division ratio of 2,000 to 1

without interrupting the timing. The clock measures 7½ by 7 by 6 inches overall.

The oscillator circuit of Fig. 1 uses a tunnel diode operating on the series resonant mode of a quartz crystal. The impedance, R_s , across the diode terminals is equal to R at all frequencies except the series resonance frequency of the crystal. R_s then becomes $R (1 + R/R_s)$, where R_s is the effective series resistance of the crystal. If R_s is larger than the absolute magnitude of the negative resistance of the tunnel diode, the circuit will oscillate. Although for oscillation to start, R_s must be larger than the negative slope of the tunnel diode current-voltage characteristic, oscillation will continue as long as R_s remains greater than the average negative resistance over one cycle. Therefore the circuit will remain oscillating reliably at bias voltages for which it will not start. For the particular clock under discussion, the diode minimum negative resistance is a little greater than the value of R , which is 200 ohms. To ensure oscillation over a suit-

able bias range, R_s should be less than about 250 ohms. The crystal is therefore vacuum mounted, because R_s for an equivalent air-mounted crystal would be about 1,000 ohms. It would be possible to obtain reliable oscillation for this larger value of R_s if one used lower current tunnel diodes and increased the value of R . The values of L and C would then also need adjustment according to the equations shown in Fig. 1.

Three extra capacitors in the oscillator circuit are shown in the complete circuit diagram of Fig. 2. The 91-pf C_1 and the 2-13-pf capacitor C_2 form the usual load capacitor for a quartz crystal operating in its series resonant mode; C_2 provides a slight adjustment for the operating frequency. The 0.7-4.5 pf piston capacitor C_3 is used for the final trimming of the frequency to 100 Kc. One clockwise revolution reduces the clock rate 45 seconds per year.

The frequency is not critical to small changes in the L and C values of the oscillator circuit. In a similar circuit using a DT crys-

tal having an R_c of 150 ohms, a 10-percent change in the 8,000-pf tuning capacitor resulted in a 4×10^{-7} change in frequency, or a clock rate change of 12 seconds per year.

The less expensive DT cut is probably the second choice for the quartz crystal. This cut has a frequency-temperature characteristic that is parabolic and concave downward. The point of zero slope can be positioned at room temperature by proper orientation of the original cut. Small changes can be made in either the frequency or in the frequency-temperature characteristic by selective grinding. A frequency variation of about 1 ppm over a temperature range of 25 degrees C has been obtained in DT plates⁵.

The frequency dividers are synchronized relaxation oscillators. The basic circuit and limit cycle for one unit are shown in Fig. 3. If the average bias is between points B and D, the circuit will oscillate. Assume the average bias is at point F and the diode operating point is at A. Because of the voltage difference between A and F the operating point will move up the curve toward B, limited in speed by the inductance L . At point B it will rapidly switch to C. Since the potential at C is higher than F, the operating point moves down the curve towards D, again limited in speed by the inductance, and then rapidly switches to A. The speed with which the operating point moves from A to B and from C to D depends on the inductance, the total series resistance, and the potential difference between the operating point and F. As the aver-

age bias is increased from its minimum value for oscillation, the repetition rate increases as well as the percentage of the period spent between C and D. Eventually a bias will be reached where the times spent from A to B and C to D will be equal and the repetition rate will reach a maximum. This is the proper bias for the most stable operation. Adjusting L then will establish the correct rate. To maintain a wide bias range in a frequency divider, it is desirable to feed the synchronizing signal through a rectifier diode. Due to the built-in bias of this rectifier diode, the synchronizing signal is effective only during one voltage state of the tunnel diode. In this case the low voltage state was selected. While the inherent stability of a tunnel diode is good enough to permit a division of 2,000, the requirements on bias stability are not met here. Three dividers are used, dividing by 10, 10, and 20, respectively. The bias range for proper operation is in excess of 15 per cent, and is limited by the last stage.

Referring again to Fig. 2, the 100-ohm variable resistors are adjusted to give a 50-percent duty cycle and the inductors are adjusted for the division ratio shown. The resistors in series with the silicon rectifier diodes reduce the synchronizing signal and incidentally, make them insensitive to temperature changes. Since the output of the crystal oscillator is low, a germanium diode is used in the first divider. Initially the total current is set with the 250-ohm variable resistor so that the frequency dividing diodes are in their high voltage state longer than the low. Proper operation is then maintained for a longer time as the battery discharges. The 100-ohm control apportions the d-c current taken by the oscillator circuit.

The 50-cycle output of the last divider is fed to an npn silicon transistor having a high h_{fe} . The bias resistor R is adjusted (about 39,000 ohms) to produce a d-c collector current of 0.5 ma while the motor is running. The 2.5-mh r-f choke in the base circuit prevents pickup in the timing circuits. Shielding the motor or the entire

clock mechanism might make this component unnecessary.

Circuit values must be set so that the clock will operate properly both with a fresh battery and as the battery discharges. The circuits should tolerate a drop of 15 percent in battery voltage, the limiting section being the final ($\times 1/20$) divider. As the circuits operate in series, the load currents have to be matched in addition to the usual adjustments of circuit elements.

The first model began operation in May, 1960. It was one second fast about five weeks later in June, 1960. Since the quartz crystal used had a frequency variation of 1 ppm per degree C, the conclusion is that the circuits were controlled by the crystal and the average temperature was nearly constant. Another model using a GT-cut crystal was also started, and eight weeks later it was $2\frac{1}{2}$ seconds fast. During the following month it gained about another half second. This error is probably due to the crystal's aging,⁶ since it is greater than that expected from temperature variations alone, and moreover the crystal was not aged before it was placed in operation. Since that time, another unit has been started, using a GT crystal that had been operating in a similar oscillator circuit at 50 C for a month. This unit gained 2 seconds in about five months, and still showed some evidence of aging.

The author is grateful to the GE Clock and Timer Department for supplying the low-power clock movements, to the Semiconductor Products Department for supplying the 0.5 ma high capacity tunnel diodes, and to E. A. Taft, G. W. Ludwig, and A. G. Tweet for their help in preparing this report.

REFERENCES

- (1) P. Vigoureux and C. F. Booth, "Quartz Vibrators and Their Applications," 12, H. M. Stationery Office, London, 1950.
- (2) W. P. Mason, New Quartz Crystal, Designated the GT, Which Produces a Very Constant Frequency Over A Wide Temperature Range, *Proc. IRE*, 28, p 220, 1940.
- (3) S. C. Hight and G. W. Willard, A Simplified Circuit For Frequency Substandards Employing a New Type of Low-Frequency Zero-Temperature-Coefficient Quartz Crystal, *Proc IRE*, 25, p 549, 1937.
- (4) A. W. Warner, Frequency Aging of High-Frequency Plated Crystal Units, *Proc IRE*, 43, p 790, 1955.

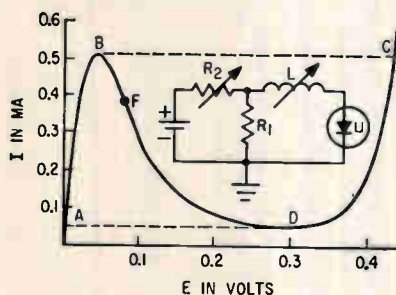

FIG. 3—Characteristic curve of tunnel diode with sequence of conditions superimposed. Operation follows path ABCDA

This miniaturized, all solid-state, low-power telemetering link lends itself also to upper atmosphere research. Mobile ground station can display, record and play back information telemetered from the airborne vehicle with an accuracy of plus or minus one-half percent



FIG. 1—Compact and transportable ground station

Pulse-Duration Telemetering for

By M. D. WILT,

Ling-Temco Electronics Inc.,
Dallas, Texas

THIS ARTICLE describes a miniaturized high-accuracy PDM telemetering link that will record data with an accuracy of $\pm\frac{1}{2}$ percent, exclusive of sensors, over a wide environmental range. The system was originally developed for an airborne weather drone to gather lower atmospheric data, but its small size makes it useful for instrument payloads for sounding rockets in upper air research. The airframe used in this application has been produced and successfully flown. It carries all sensors, power sources and data conversion equipment.

A static power supply converts primary power to the various voltage levels used in the airborne package. Primary power is supplied by a miniature, rechargeable nickel cadmium battery that can power the system for one-half hour of flight. The airborne circuits are

completely solid-state for light weight and low power consumption.

The ground receiving and recording station is a miniaturized, mobile, self-contained unit capable of receiving, displaying, recording and playing back PDM information telemetered from the airborne vehicle. Figure 1 shows the physical configuration of the ground station. This unit employs modular construction and is designed to be readily hand-carried or transported in a station wagon or similar vehicle. Primary power for the system is supplied by the vehicle storage battery. Readout of telemetered information is visual. Compared with other devices, the station cost is low.

The r-f data link consists of a 200-mw airborne transmitter operating at 27 Mc, and a ground receiver having a sensitivity of $3\mu\text{v}$. Both units are crystal stabilized and completely solid state. The ground receiver rise and fall time at $3\mu\text{v}$ is 12 μsec total. The airborne transmitter power is adequate for the application in which

the data link is normally used since the aircraft is controlled from the ground and tracked by visual means. A higher power airborne transmitter may be used for applications requiring greater range.

The airborne portion of the link, Fig. 2A, consists of a miniaturized, high accuracy PDM encoder and transmitter. The airborne telemetry encoder contains a commutator, a clock and keyer. The commutator is made up of a ring counter and diode bridge gate sequential circuit that allow the various transducer inputs to be sampled in a preset pattern. The diode gates are matched to prevent offset in the output. Sampling rate of the commutator is set by the clock frequency; in this application, sampling rate is 100 samples per second. This oscillator also supplies the signal that resets the keyer.

Figure 2B shows in detail the airborne keyer including circuit waveforms observed during a typical data sampling period.

The keyer is composed of an accurate voltage reference, integra-

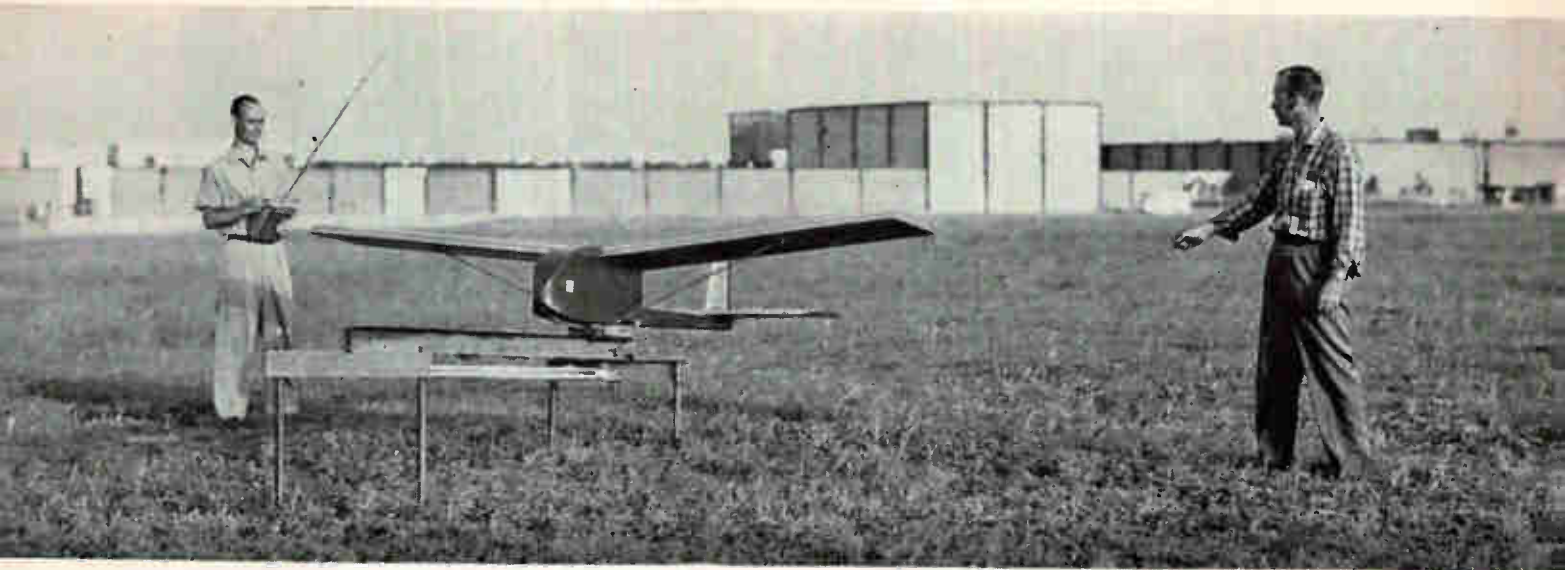

Airborne weather drone for gathering and telemetering data from the lower atmosphere is ready for launching

Lower Atmosphere Research

tor, voltage comparator and pulse-controlled switch. The keyer accepts the output of the commutator and converts this PAM information into PDM format. To make this conversion, the clock signal first resets an integrator. The output of this circuit is routed to a voltage comparator that emits a pulse when the integrator voltage reaches an accurate preset level. This pulse resets the keyer output. The integrator output slope is inversely proportional to the magnitude of the input voltage from the commutator. Therefore, the pulse duration of the keyer output between clock pulse and reset is directly proportional to the amplitude of the voltage output of the particular channel being sampled. Keyer output modulates the transmitter, which is solid-state. The airborne transmitter, which has an output of 200 mw and a carrier frequency of 27 Mc, feeds directly into a whip-type antenna.

The ground station, shown in Fig. 3, consists of a display, control and decoder unit, digitizer

unit and recorder unit.

The display, control and decoder unit contains the receiver, pulse

shaping circuits, quantizer and crt indicator. Information is displayed on the crt in two modes. In one

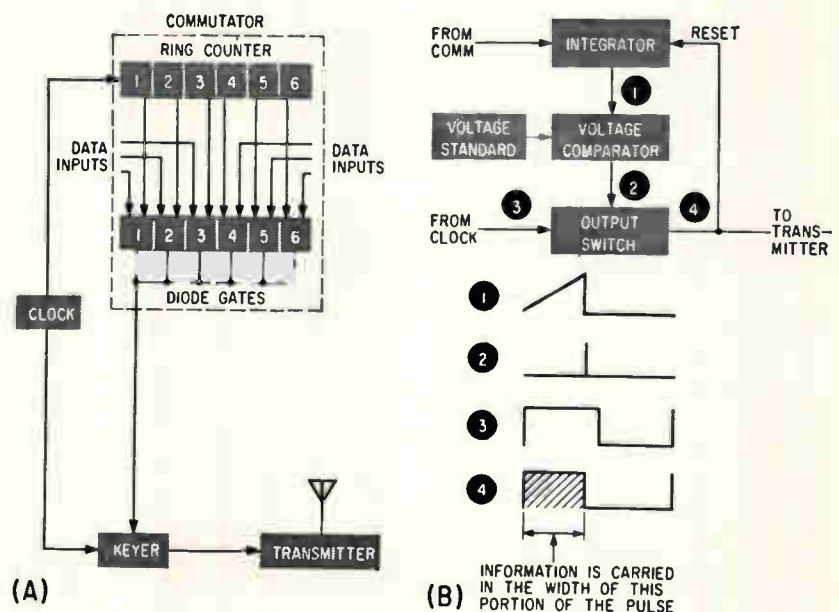

FIG. 2—Airborne encoder and transmitter (A), and airborne keyer (B) including typical circuit waveforms

mode a bar graph is presented. The height of each bar represents the magnitude of the parameter being measured on a particular channel. Calibration channels are also displayed. The values of the parameter being measured may be read directly by employing a calibrated reticule. The other mode presents the digitized output of the crt. One channel at a time may be monitored in this mode. The channel desired may be selected by a switch on the front panel. The function of this switch is to delay the start of the horizontal sweep. If the sweep were not delayed, it would trigger immediately upon receipt of the sync pulse which is designated as channel one. When the system is monitoring digital information, the horizontal sweep time is equal to the readout time for one channel of digital information. Therefore, to observe channel three, for instance, a time delay equal to two times the basic sampling time must be introduced into the system sync pulse to start the horizontal sweep at the time that digitized information from channel three is being transferred from the digitizer to the tape. The tape may be played back at any time and this same information displayed for checking the quality of recording. Binary information displayed on the crt either while recording or during playback may be read manually to determine the exact output of a particular channel. This method gives more accurate results than the bar-graph presentation but only one channel at a time can be read. Operation of the monitor does not interfere with the data being recorded.

Operation of the mode and channel selector switches may be followed on the detailed block diagrams of the ground station and digitizer. The crt display is fully automatic with respect to synchronization, sweep rate, blanking, and horizontal and vertical gain. When switching from one mode of readout to another, only the mode switch itself needs to be operated. Of course, when reading out a digital word, the proper channel must be selected with the channel selector switch.

Operation of the quantizing network is simple. A crystal-controlled oscillator which was developed

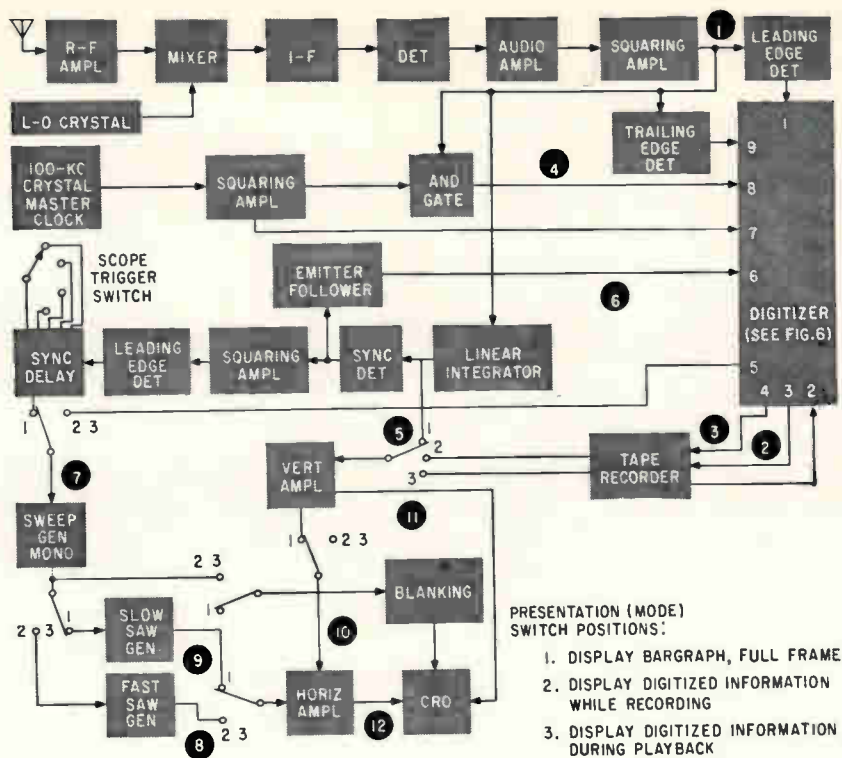

FIG. 3—Ground receiving station consists of a display, control and decoder unit, digitizer and recorder

especially for this application provides one input to an AND gate. The other input is provided by the incoming detected PDM information. This gate gives an output consisting of a series of bursts of high-frequency (100-Kc) square waves. This output goes to the digitizer along with a signal that tells the digitizer when the data pulse is beginning and one which says the data pulse is ending.

The method of presenting the PDM information on the crt in vertical line graph form is unique with this system. Refer to the ground-station block diagram and waveform chart, Fig. 4. The mode switch is in position one. The receiver output is shaped and sent to a linear integrator. Output of this device is fed to the vertical amplifier and to a circuit that detects the presence of the sync pulse, which is wider than any signal pulse. Following the sync pulse is a squaring amplifier and leading-edge detector which gives a fast rising pulse at the time the sync pulse is detected. This pulse is then delayed for almost a full frame. If this were not done, the sync pulse would be displayed in two pieces on the crt because the horizontal

amplifier would trigger at the time the sync detector decided that a sync pulse was present. This time is near the end of the passage of the PDM sync channel through the system. The horizontal sweep generator consists of two separate units, one of which generates a sweep of full frame duration, during bar-graph presentation, and the other generates a sweep of single-channel time length for displaying the digitized information.

The full frame sweep signal enters the horizontal amplifier along with a signal fed back from the vertical amplifier. The vertical amplifier supplies a signal that is the integrated PDM wave train. This signal is fed back so that the resulting sawtooth pulses in this wave train have a slope exactly equal in magnitude and opposite in sign to the slope of the horizontal sweep sawtooth. When these two pulses are added algebraically in the horizontal amplifier, the resultant wave shape is a horizontal sweep sawtooth with notches at points where pulses are being fed to the vertical amplifier. In other words, the horizontal sweep voltage remains constant during the time a sawtooth pulse is being received at

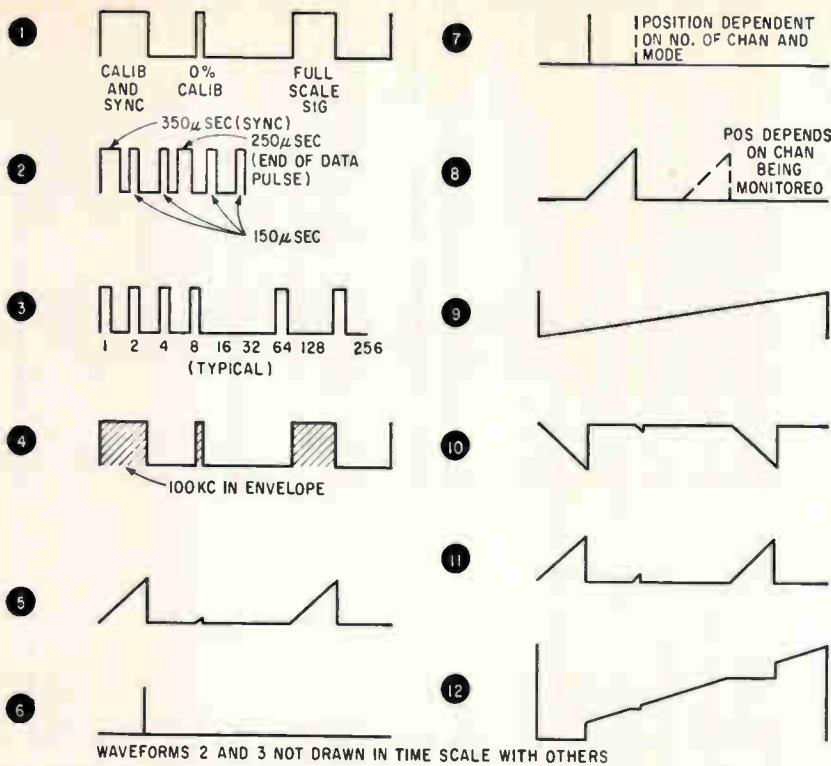

FIG. 4—Numbers on digitized waveforms shown here refer to the circled numbers in Fig. 3 ground station

the vertical amplifier and this causes the sawtooth to look like a vertical line on the crt face. A display generated in this way provides all the advantages of conventional PDM displays but with a saving in circuitry and expense. The crt display is shown in Fig. 5.

The signal path of the sync pulse in both digital monitoring modes, recording and playback, differs from the path in bar-graph presentation mode. In these modes the sync signal is derived from the digitizer. During playback operations the clock channel of the tape

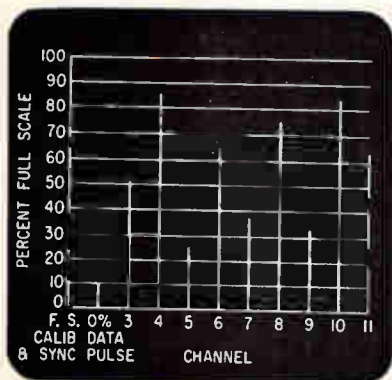

FIG. 5—This is what the crt display looks like

recorder is decoded in the digitizer and the sync pulse is derived from this source. When monitoring digital information during recording operations, the sync signal for the monitor system originates at the sync detector. It is then sent to the digitizer to be delayed and synchronized with the 2-Kc readout rate. The signal is then returned to the horizontal sweep generator where it triggers the fast sweep.

The digitizer unit is detailed in Fig. 6. The numbers on the input and output lines in this functional diagram correspond to the numbers in the digitizer on the complete ground station diagram (Fig. 3). The digitizer receives the quantized information from the quantizing gate and counts the number of 100-Kc pulses in each burst. At the end of a data pulse, the serial output gate reads out the information to the tape recorder. The transfer rate, 2 Kc, is synchronous with the 100-Kc master clock. A clock signal is also provided to a second channel of the tape recorder. This clock signal is a pulse-width-coded 2-Kc continuous wave train containing information for sync and channel selection. This two-channel format provides all the information

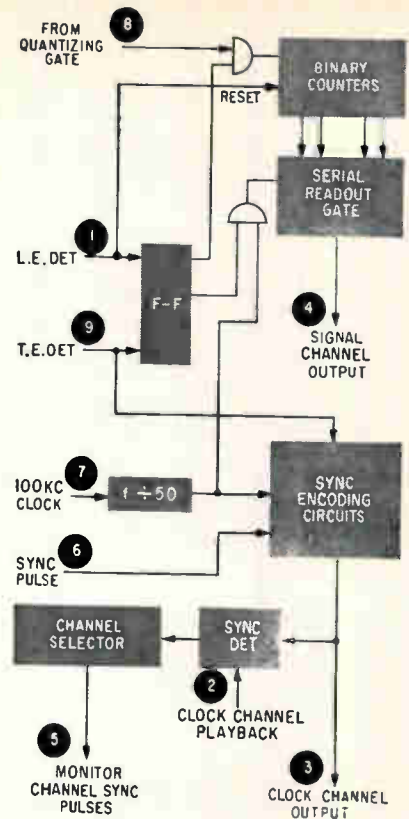

FIG. 6—Numbers correspond to those on the digitizer in Fig. 3

necessary to reduce data by computer methods. This feature is important where large amounts of information are recorded. A format change does not have to be made for automatic data reduction. One ground station can support operations of many flights during a day and data can be sent to the computer lab immediately.

The recorder unit used in the present model is a modified Magnecord Model 102.

The station is powered from a standard 12-v automotive battery for mobile use but can be easily modified for use with any power available at its place of operation. The maximum range of error of the recording path of the ground station with $3\mu\text{v}$ or more signal at the receiver is -0.25 percent to $+0.5$ percent of full scale signal. Readability of the existing crt is approximately ± 2 percent with greater accuracy possible by increasing the crt size. The station operates within these accuracies in the temperature range -30 to $+70$ C. A ten-channel PDM signal can be handled by the present design. However, the circuits can be readily modified to accept as many channels as other PDM systems.

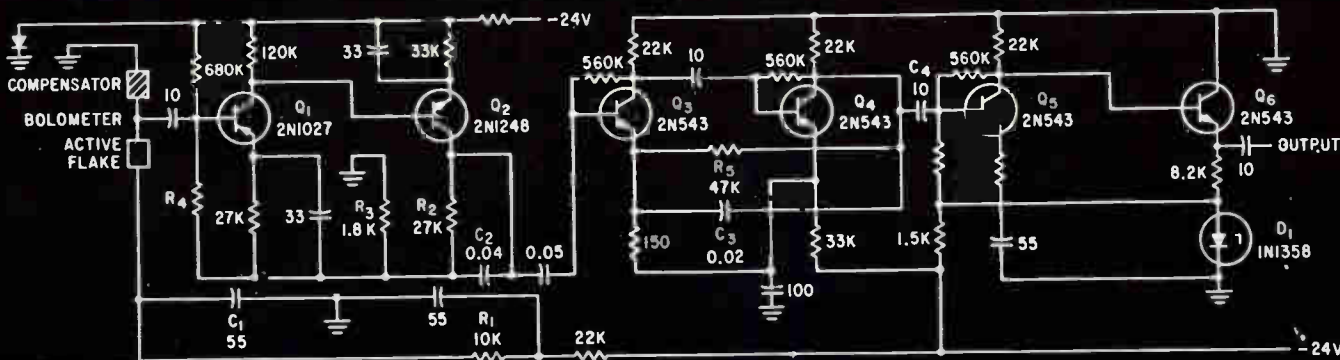

Fig. 1—Amplifier and detector for horizon sensor

INFRARED CIRCUITS IN

TIROS WEATHER SATELLITES

PART II—First part dealt with 5-channel radiometer, this part covers transient type horizon sensors to determine satellite spin rate and provide information on satellite attitude

By **FRANK SCHWARZ**
WAYNE CHOU,
 Barnes Engineering Co.,
 Stamford, Conn.

THE HORIZON SENSORS in NASA's Tiros series meteorological satellites served two functions:

(1) They supplied information on the spin rate of the satellite. The spin rate had to be maintained above a minimum value and could be increased by activation of small speed-up solid propellant rockets.

(2) By determining the period between earth pulses, the sensors provided information on the attitude of the satellite with respect to a radial line to the earth's center. This information was used to correct picture aspect and properly identify the target area as seen by the cameras and infrared radiometers in the satellite.

The first bit of information relayed when Tiros I went into orbit related to the spin rate of the satellite. Normal spin rate was approxi-

mately 10 rpm. Some ambiguous signal outputs were received from the sensors in Tiros I and II because of the sensor's ability to detect temperature differentials while scanning across cool cloud formations or warm solar reflections. However, once properly understood, the meaningful signals representing the discontinuities between earth and outer space could be identified and the necessary information extracted.

The sensor is mounted on the side of the satellite with its axis normal to the satellite's spin axis. It receives radiation from the earth whenever the spin of the satellite allows the detector's field of view to cross the discontinuity from space to earth. To translate the energy excitation into an electrical signal, a bias voltage is applied to the thermistor detector whose resistance drops when power is absorbed by its sensitive flake.

Although the detector is capable of d-c response and provides a negative output voltage until the field of view has again crossed the horizon

to view outer space, the transistor amplifier used responds to transients only. The detector signal is differentiated to obtain a negative pulse (positive at the amplifier output) in the transition from outer space to earth, and a positive pulse as the discontinuity is crossed in returning to view outer space.

The optical system for the horizon sensor consists of a germanium lens with good transmission from 1.8 microns to about 20 μ and an effective collecting area of about 1.3 cm², followed by a germanium immersed thermistor detector. Both elements are coated and provide an effective focal ratio f/0.21.

Embedding the detector into an optical material of high index of refraction without an intervening airspace of different index gives a large effective improvement in detectivity. The immersion lens, by converging the energy falling on its front surface, provides optical gain and makes it possible to use a smaller detector to cover the same field of view. Detectivity varies as the reciprocal of the square root

MODEL 13-200 SPECIFICATIONS

Sensitivity	approx 5 v/15 C (40-25 C)
Field of view	1.3 deg × 1.3 deg
Spectral passband	1.8–20 μ
Frequency response	(–3 db) 35-170 cps
Detector time constant	2.5 m sec \pm 20 percent
Output signal	\pm 6V. into 22,000 ohm load
Noise level (rms below peak signal)	better than –30 db
Output impedance	less than 1,000 ohms
Ambient temperature	–10 to +60C
Power requirements	4 ma at 26 v d-c \pm 10 percent
Size	4 $\frac{3}{8}$ × 1 $\frac{1}{2}$ × 1 $\frac{1}{2}$ -in.
Detector	0.1 × 0.1 mm germanium immersed

of detector area. Since the effective energy collecting area has been increased optically the detectivity may be increased by a factor of four (for a hemispherical lens with index of 4). Even greater gains may be obtained by hyperimmersion, an immersion process in which the detector is placed in contact with a plane surface at a distance greater than the radius of the sphere of the germanium spherical lens.

Specifications of the radially oriented transient horizon sensor, Model 13-200 are shown in the table.

Figure 1 is a schematic of the amplifier and detector. In the bolometer section, the compensator has the same temperature characteristics as the active flake but is not exposed to radiant energy. The compensator senses ambient temperature and provides for a constant bolometer bridge output in the absence of radiant energy on the active flake. Zener diode *D*, provides a low-impedance, constant-voltage source of bias to the detector, and *R*₁ and *C*₁ insure a low noise level in biasing the detector. The detector-amplifier combination is expected to operate at signal levels not greatly in excess of the thermal (Johnson) noise level of the detector. Low-noise design techniques are applied to minimize semiconductor noise in the low-frequency region.

The first two preamplifier stages, *Q*₁ and *Q*₂, consist of a common-emitter *pnp* silicon transistor direct coupled to a *npn* transistor. The d-c level of the second transistor

is set at the center of the supply voltage, permitting linear operation over a wide dynamic range. Negative feedback is applied to the first stage by returning the collector load resistor of *Q*₂ to a tap on the emitter of *Q*₁. The consequent degeneration gives increased input impedance and a decrease in the output impedance while stabilizing the voltage gain of this transistor pair. Voltage gain of this pair is approximately $R_2/R_3 = 27,000/1,800 = 15$. Additional increase in input impedance results from bootstrapping by returning base biasing resistor, *R*, to the unbypassed emitter resistor *R*₃. Capacitor *C*₂ with negative feedback resistor *R*₂ forms one of the two high-frequency break-points in the preamplifier. Since no significant signal components are expected be-

yond about 150 cps, the higher frequencies, which only contribute noise, are reduced.

Transistors *Q*₃ and *Q*₄ also constitute a cascaded negative feedback pair in the common emitter configuration. A second high-frequency break is produced by feedback resistor *R*₄ shunted by *C*₃. This transistor pair is followed by one more gain stage with local degeneration, *Q*₅, and a final emitter follower, *Q*₆.

Only one major low-frequency break is used. Coupling capacitor *C*₄ rolls off frequencies below 15 cps to limit excess noise. Additional low-frequency breaks would result in undesirable over-shoot of the transient signals.

A more recent version of preamplifier for a horizon sensor such as used in TIROS I and II, is considered the ultimate in low-noise, low-frequency, high-impedance amplifiers. It is finding application in other infrared instruments. Figure 2 shows the variation of noise figure as a function of frequency and source resistance. Characteristics of this newer preamplifier (known as Model DP5A) are: voltage gain = 7,000; $Z_{in} > 1.5$ megohms; $Z_{out} < 50$ ohms; frequency response of 5-2,000 cps (3-db points); power requirement of 24 to 30 v at 2 ma; size of preamplifier package in a sealed drawn steel can is 1 in × $\frac{3}{8}$ in × 4 in; and optimum source resistance of 100,000-200,000 ohms.

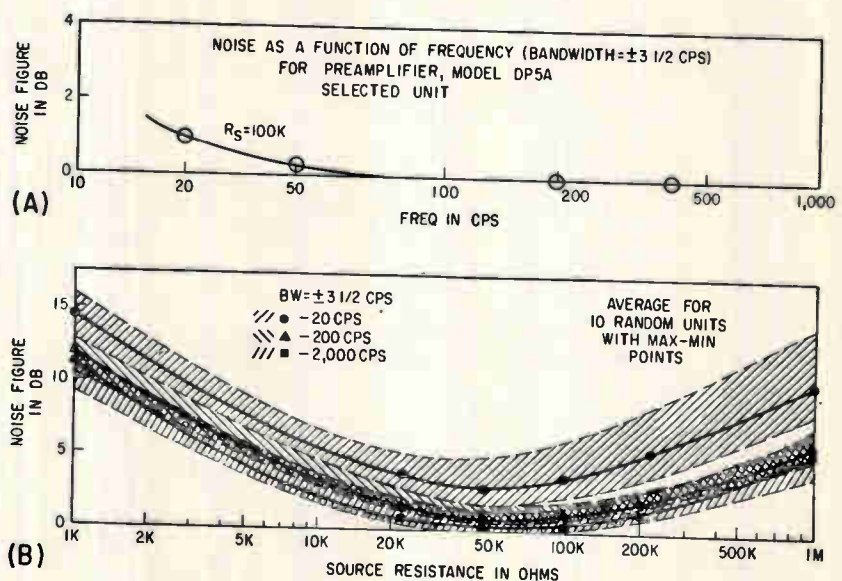

FIG. 2—Variation of noise figure with frequency (A) and source resistance (B) in DP5A preamplifier

OF ENVELOPE DELAY

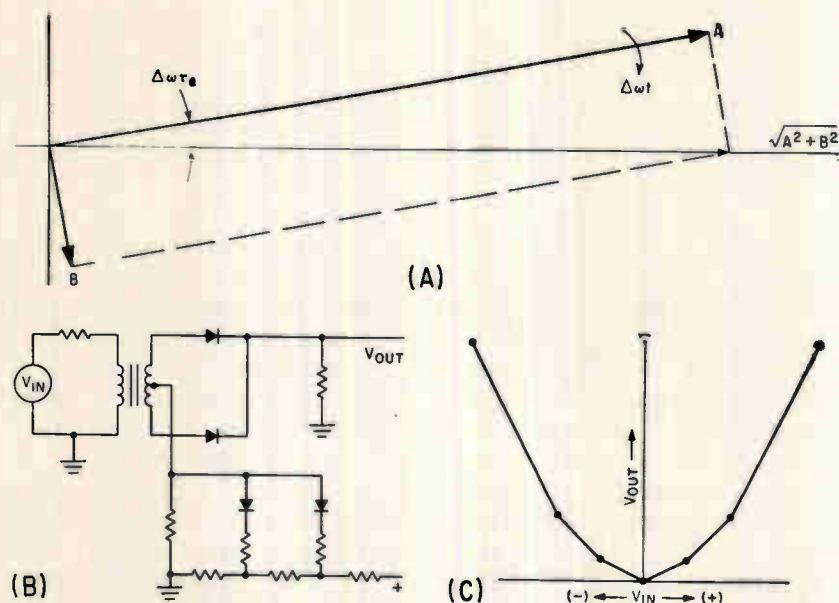

FIG. 2—Vector diagram (A) shows how an error voltage (vector B) can cause an apparent zero crossing of Δf (vector A). The square-law detector shown in (B) produces response shown in (C)

doesn't vary. Thus if β_2 and β_1 are measured at frequencies 50-cps apart, the envelope delay error resulting from a ± 0.1 -degree phase error in the worst case will be

$$\Delta\tau = \frac{\pm 0.2 \text{ deg}}{360 \text{ deg/cycle} \times 50 \text{ cps}} = \pm 11 \mu\text{sec} \quad (5)$$

Frequency increments greater than 50 cps would give less error produced by the phase readings, but the approximation to the phase slope would be less exact, especially at system cut-off frequencies.

The direct-reading method allows the ± 0.01 -deg accuracy over a 2-deg interval. Thus, if a frequency increment of 25 cps is used, envelope delay distortion can be measured over a 222- μ sec. period with an accuracy of $\pm 1.1 \mu$ sec. However, since the absolute level of envelope delay would depend on the ± 0.1 degree accuracy, overall accuracy would be $\pm 11 \mu$ sec. This accuracy could also be obtained for delay distortions greater than 222 μ sec.

The second advantage of the direct-reading method over measuring β_2 and β_1 independently is that direct-reading requires less time to make the measurements. If a phase meter which must be recalibrated

at each measurement frequency is used, the direct-reading method requires about 1/10 as much time as the independent-measurement method since only one frequency (Δf) is applied to the phase meter.

The two-frequency direct-reading method with square law detection is relatively insensitive to errors being produced by harmonics of the measurement frequency. This type error can be produced by harmonic groups consisting of nf_m , $nf_m \pm \Delta f$ or $nf_m \pm \Delta f/2$ ($n \geq 2$). These harmonic groups can be produced by the modulating equipment used to generate the fundamental tones, or by nonlinearities in the circuit. In passing through the circuit, these harmonic groups may receive an envelope delay much different from that of the measurement frequency. Upon detection, a Δf difference frequency produced by the harmonic tones will give an error in the phase reading. This error will depend on the relative amplitudes of the Δf signals produced by the test tones and by the harmonics and on the amount of phase difference between them. If these Δf signals have the form

$$e = A \sin \Delta \omega t + B \sin \Delta \omega t + \theta$$

where the second term is produced by harmonics, then the greatest error occurs when $\theta = 90$ deg. The error in phase-reading would be

$$\beta_{\text{error}} = \tan^{-1} B/A \quad (6)$$

For a Δf of 25 cps and a required error tolerance of 1 μ sec, Eq. 6 gives a ratio of B/A of 0.000157 or an error signal 76-db down. For this example, the harmonics producing the error signal would have to receive an envelope delay differing from that of the fundamental tones by about 10 millisecc. In a modulated-carrier measuring system employing envelope detection, the above considerations would impose an impossible harmonic specification or could result in reduced accuracy. In such a system, harmonics of the form nf_m , $nf_m \pm \Delta f$ are produced. If one of these harmonic groups produces a Δf error signal in direct proportion to its amplitude, it would have to be 76 db below the level of the f_m , $f_m \pm \Delta f$ tones to limit the maximum error to 1 μ sec.

The square-law detection process used in the two-frequency method alleviates the harmonic-distortion problem. For example, for one group of harmonics

$$e_o = A \cos \left[\left(\omega_m + \frac{\Delta \omega}{2} \right) t - \beta_2 \right] + A \cos \left[\left(\omega_m - \frac{\Delta \omega}{2} \right) t - \beta_1 \right] + B \cos \left[\left(2\omega_m + \frac{\Delta \omega}{2} \right) t - \beta_4 \right] + B \cos \left[\left(2\omega_m - \frac{\Delta \omega}{2} \right) t - \beta_3 \right] \quad (7)$$

After squaring, the resultant $\Delta \omega$ terms are

$$e_{\Delta \omega}^2 = A^2 \cos [\Delta \omega t - (\beta_2 - \beta_1)] + B^2 \cos [\Delta \omega t - (\beta_4 - \beta_3)] \quad (8)$$

Thus the ratio of the desired signal to the error signal is the square of the ratio of the test tones to the harmonics. This means that harmonics which are 40-db down will produce a Δf error signal which is 80 db down.

Readout of the $\Delta \beta$ value is accomplished using a phase meter. Since phase meters generally operate by producing a d-c signal proportional to phase angle, this integrating ac-

tion allows harmonic distortions in the order of 40-db down without affecting the readings noticeably.

An alternate method of obtaining readout is to make time-interval measurements with an electronic counter. This method is feasible, but is not without problems. One problem is in triggering the counter at precise zero-crossings of the reference and unknown Δf signals. The effects of harmonics of Δf and of noise in shifting the crossings of the signal applied to the time interval unit must be considered. Figure 2A shows a vector representation of a Δf signal (vector A) and an error signal (vector B). In this representation the resultant signal (horizontal vector) is passing through a zero crossing. The actual Δf signal passes through zero at an angle differing by

$$\Delta\omega\tau_e = \tan^{-1} B/A \quad (9)$$

For $\tau_e = 1 \mu\text{sec}$ and $\Delta f = 25 \text{ cps}$ the required ratio of A/B is 76 db. Thus a time-interval measurement requires considerable more filtering of Δf than the phase-meter measurement.

The two-frequency method of obtaining $\Delta\beta$ requires the generation of a pair of tones Δf apart. This is done by multiplying the measurement frequency f_m by the desired Δf frequency (Fig. 1). This multiplication can be readily achieved by using a Hall effect modulator.^{2,3} A Δf voltage could be applied to the magnetic-field winding and the measurement frequency to one pair of terminals of the semiconductor. The second pair of terminals would then have the required output. The

Hall-effect modulator can generate the required tones and limit harmonic components to the order of 60-db down. The near-perfect multiplication achievable with a Hall-effect modulator makes the use of this device appear attractive.

The square-law detector could also use a Hall-effect device. An alternate method would be to use a piecewise approximation to a parabolic curve. Figure 2B shows a circuit which approximates a curve (Fig. 2C) having the form $V_{\text{out}} = kV_{\text{in}}^2$ with six straight line segments. A larger number of segments can be used for a closer approximation. This technique can be used effectively when the input (V_{in}) to the square-law detector is held at a constant amplitude.

The most formidable problem encountered in implementing this system is filtering the Δf signal. Because of the low frequency involved, LC filters result in large inductors which change enough with level and temperature to cause the output phase to be unstable (phase must be stable to about 0.01 deg). Active filters employing twin-T feedback networks have a rapid phase-versus-frequency change at the center frequency, and are subject to phase changes for slight gain variations. In practice, a combination of passive R-C filtering and twin-T traps provide a workable arrangement. The traps attenuate frequencies close to Δf , for example, $2\Delta f$.

The filtering of Δf and the requirements of the phase meter impose a tolerance on the stability of Δf . This tolerance may be met by

dividing down from a stable source such as a tuning-fork oscillator, or from an electronic counter.

A phase shifter (Fig. 1) compensates for variations in phase between the reference and unknown channels. This control also allows one to offset the phase reading to use the range of greatest accuracy.

Extreme care must be taken in decoupling and in shielding. The problem of decoupling is aggravated by the low frequency of Δf . Also, it was found that large errors resulted when input and output test leads were allowed to run parallel for very short distances without shielding.

The direct-reading outlined has been used to measure envelope delay rapidly and accurately over the frequency range of 250 cps to 100 Kc. Figure 3A shows a measured delay curve of a delay equalizer along with the calculated curve, which assumed dissipationless reactive elements. Figure 3B shows the measured and calculated delay of a low-pass filter. In practice, a repeatability of within 3 μsec is typical, with most measurements repeating to within 1 μsec . The frequency range of the measurements is determined primarily by the transformers used in the modulator and demodulators.

REFERENCES

- (1) W. A. Codd, A Test Set for Measurement of Envelope Delay Distortion at Audio Frequencies with 1 μsec Precision, AIEE Conf Paper CP 60-46.
- (2) R. K. Jurgen, Hall Effect Devices, ELECTRONICS, Jan. 16, 1959.
- (3) W. P. Mason, W. H. Hewitt and R. G. Wick, Hall Effect Modulators and Gyrotors Employing Magnetic Field Independent Orientations in Germanium, *J Appl Phys*, 24, p 166, 1953.

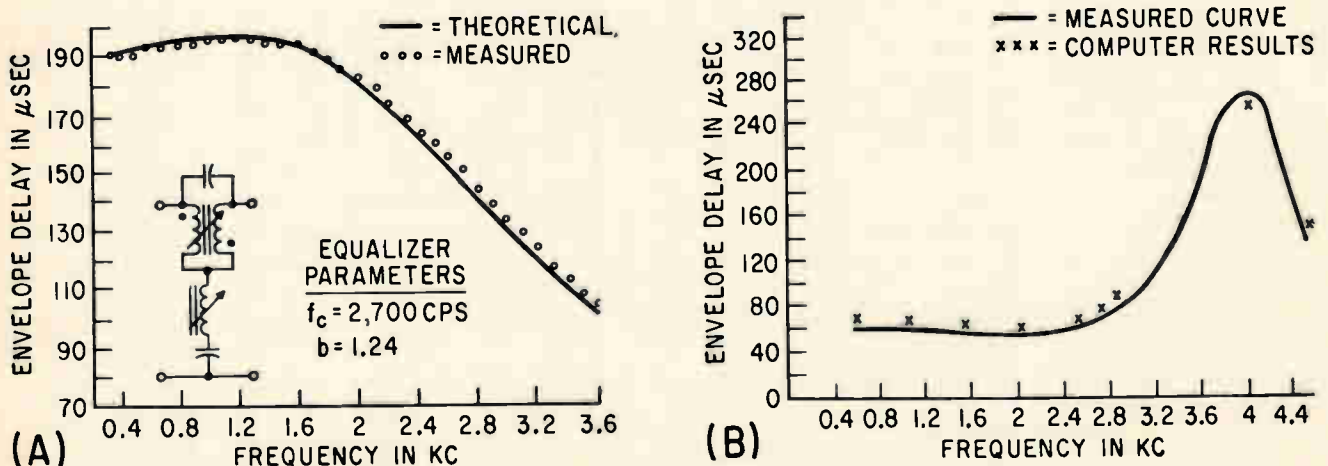

FIG. 3—Envelope delay of an equalizer (A) and delay produced by a low-pass filter (B)

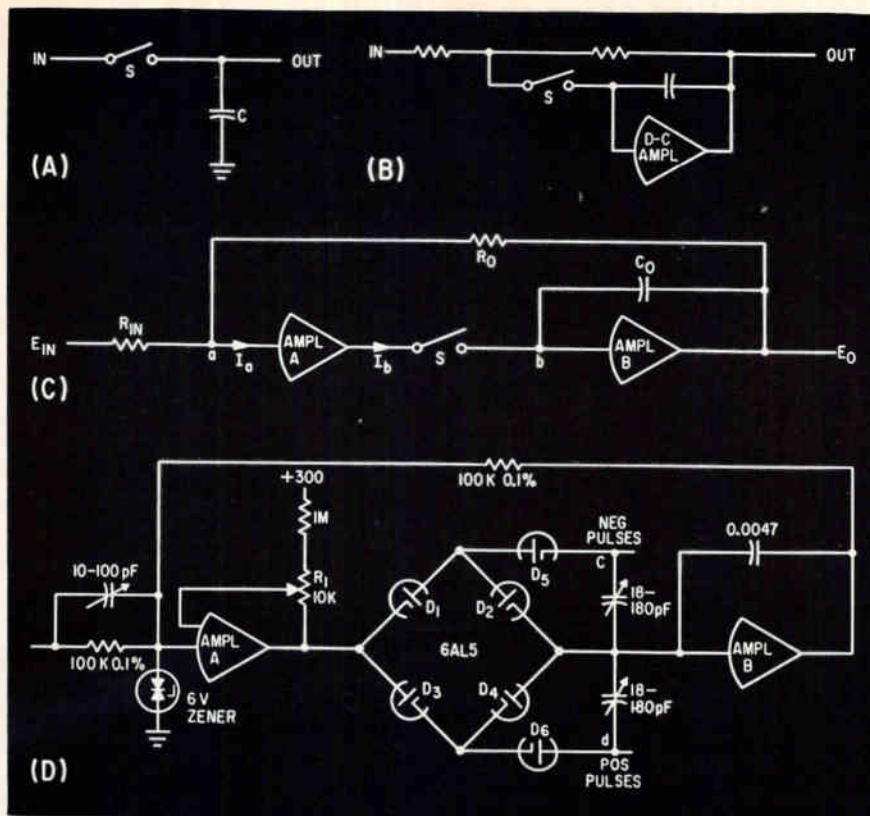

FIG. 1 — Elementary capacitor memory (A); sample-hold circuit using high-gain d-c amplifier (B); basic high-frequency sample-hold circuit (C); complete sample-hold circuit using diode-bridge as switching circuit (D)

Precision Analog Memory Has Extended Frequency Response

Used in analog circuits, the device has a dynamic range of ± 50 volts, holds within 0.02 volt for 100 milliseconds, and can track a 30-volt-peak sine wave with less than 2 degree phase shift at 20 Kc

By T. A. BRUBAKER,
 University of Arizona,
 Dept. of Electrical Engineering,
 Tucson, Arizona

THE STORAGE UNITS most often used in analog sample-hold circuits are capacitors that are switched in and out of the circuit to remember the capacitor voltage at the instant of switching (Fig. 1A). An analog-computer integrator in hold operation can replace a capacitor if the circuit is to drive a load (Fig. 1B). In low-frequency applications, mechanical relays may be used in the circuit of Fig. 1B, but audio-frequency applications require elec-

tronic switches, and these have the drawback that they tend to cause leakage into the holding capacitor when the switch is open.

The circuit to be described uses a relatively large holding capacitor to overcome leakage. The problem of driving the capacitor at high frequencies is solved with a d-c follower used as a current amplifier to supply current to the capacitor. The resulting circuit combines satisfactory holding ability with extended frequency response.

The analog memory circuit is used in random-process studies in conjunction with a fast repetitive computer. The amplifiers, which are on printed-circuit cards, are plugged

into a module containing two sample-hold circuits together with their switching electronics and an electronic comparator circuit. This module, which uses plug-in holding capacitors, is intended mainly for a new repetitive computer¹ permitting measurement of ensemble statistics. It is also useful for various instrumentation applications, notably amplitude-distribution analyzers,² where voltages must be held for 50 to 100 msec, and where the storage circuit must track signal components at frequencies as high as 20 Kc. Similar units serve as repetitive integrators.

The memory circuit is also useful in connection with slow electronic

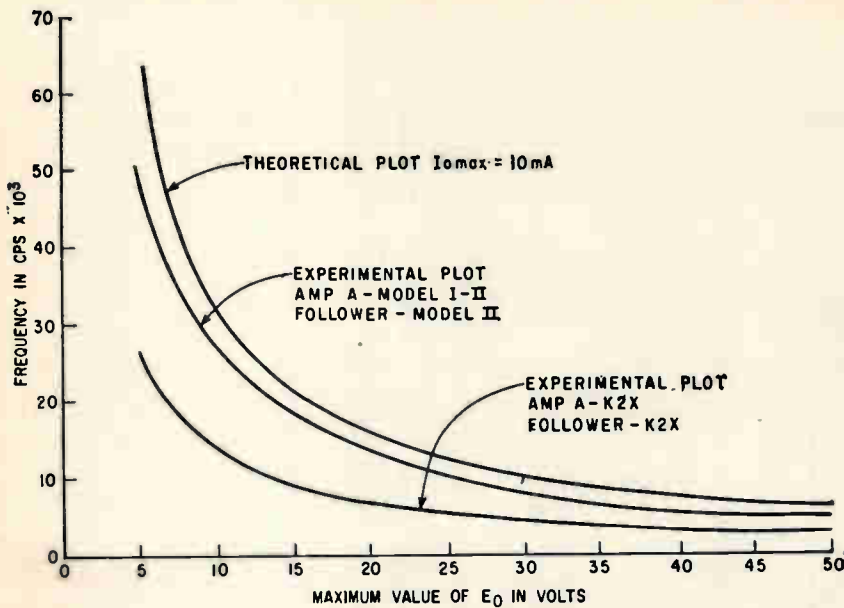

FIG. 2—Comparison between theoretical response and the actual response using various amplifier and follower types

analog computers incorporating analog storage and repetitive sub-routines³. Finally, if shorter holding times are required (as in multiplexing applications), a smaller holding capacitor can be used without loss of accuracy, improving the frequency response.

The basic sample-hold circuit is shown in Fig. 1C. If switch *S* is closed and the gain of the second amplifier is very high, point *b* will be at approximately zero volts. Thus, if the first amplifier is a true follower, point *a* will be at zero volts also.

Writing the node equation at point *a* gives

$$E_{in}(s)/R_{io} + E_o(s)/R_o = I_a(s) \quad (1)$$

The node equation at point *b* is

$$E_o(s)/(1/SC) + I_b(s) = 0 \quad (2)$$

If the current gain of amplifier *A* is *A*(*S*) then

$$I_b(s) = I_a(s) \times A(s) \quad (3)$$

Substituting Eq. 3 into Eq. 2 gives

$$E_o(s) SC + I_a(s) A(s) = 0 \quad (4)$$

Solving for *I_a*(*s*) in Eq. 4 and substituting into Eq. 1 yields the gain

$$E_o(s)/E_{in}(s) = -R_o R_{io} \times \frac{1}{1/R_o C_o s/A(s) + 1} \quad (5)$$

Thus, the effect of the current amplifier is to extend the frequency response by a value equal to the current gain of the amplifier.

The complete sample-hold circuit is shown in Fig. 1D. Input and feedback resistors are 100,000 ohms and give a gain of unity at d-c. The holding capacitor of 0.0047 μf compromises between frequency response and capacitor-charging-

through-leakage during the holding period. Note that addition of integrator-input resistors at the summing point of amplifier *B* would yield a complete repetitive-computer integrator.

Amplifier *A* used as a follower, is a University of Arizona Model II operational amplifier⁴ which can deliver a maximum current of 10 ma. Taking the input (grid) current, *I_a*, as approximately 10⁻⁴ amps, the maximum current gain of the follower is about 10⁷.

Amplifier *B* is the chopper-stabilized University of Arizona Model III operational amplifier⁴ which can deliver ± 100 volts at 10 ma. The follower amplifier was not stabilized, since its long-term drift (15-20 mv) is comparable to that of the electronic switch itself and does not affect the output in hold. Any initial offset is balanced by potentiometer *R_i* at the output of the follower. It was found after warmup that the total output drift is less than 0.02 volts.

For a sine-wave input *E_o* sin ω*t*, the output with the switch closed is -*E_o* sin ω*t*. The change in voltage across the capacitor is given by *dv/dt* = *i/c* = -*E_o* ω cos ω*t*. The current is therefore a maximum when cos ω*t* = 1 and *i_{max}* = -*E_o* *c*ω, giving an equation for the frequency at which the sample-hold circuit will overload. Figure 2 shows experimental and calculated voltages *E_o* as a function of frequency. Figure 2 also shows an experimental curve using Philbrick K2-X operational amplifiers as the follower and the main amplifier for purposes of comparison.

A six-diode bridge (Fig. 1D) in-

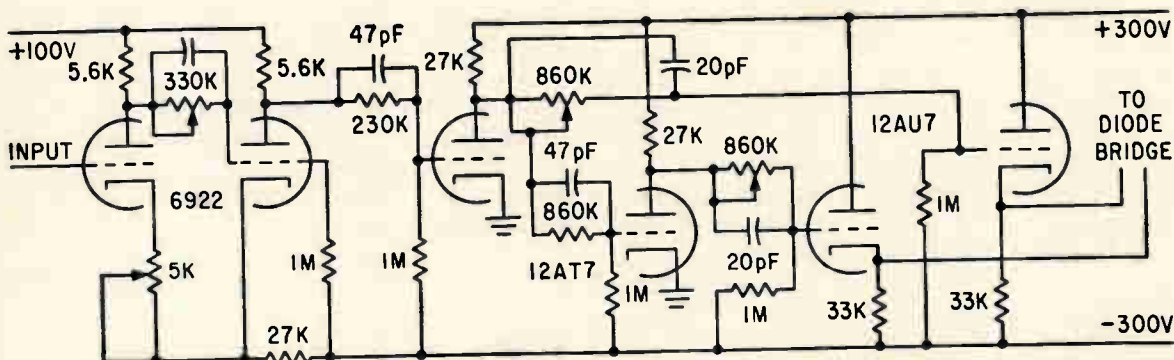

FIG. 3—Push-pull pulse amplifier for driving the diode bridge circuit. First stage of the pulse amplifier is a Schmitt trigger, whose input comes from an operational amplifier of gain 50

corporating 6AL5 diodes is used as the switch for the circuit. This type of circuit has a very high transfer impedance when off and is easily turned on and off with large or small push-pull pulses. When point *c* is positive and point *d* negative, diodes D_5 and D_6 are off and the bridge is on. Small offsets owing to differences in circuit resistance can be nulled, with the potentiometer at the follower output. When point *c* goes negative and *d* positive, diodes D_1 , D_2 , D_3 , and D_4 are turned off. However, there is a small amount of leakage through the diodes, and differences between diode characteristics produce a small current that flows into or out of the holding capacitor and cause a small charging or discharging effect. It was found that ± 10 volt and ± 100 volt gate pulses gave the same leakage-current difference. Errors due to this leakage current in the vacuum-type diodes are small compared to the effects of capacitor dissipation and finite amplifier gain. The small variable capacitors from points *c* and *d* to the summing point balance the rise and fall time of the push-pull gate pulses. When the input pulses are balanced, the change in voltage due to switching action is less than 5 mv. Stock 6AL5 diodes were used in the bridge, and there was no attempt to match them. The resulting output drift was less than 0.02 percent of 100 volts for a holding time of 100 msec.

The ± 50 -v push-pull pulses for turning the diode bridge on and off are obtained from the circuit shown in Fig. 3. The Schmitt trigger circuit acts as a comparator about zero volts and provides the input to two pulse amplifiers. Resistive networks combine the outputs of the two amplifiers with suitable bias voltages to provide the proper voltage levels, and the cathode followers furnish the push-pull output at the low impedance necessary to drive the diode bridge. Use of the Schmitt trigger permits two sample-hold circuits to be run as a memory pair in modern multipurpose analog computers (one sample-hold tracks, while the other holds)³. In this application, the Schmitt trigger is driven by an operational amplifier limited at ± 50 volts, with gain 50. The combination of the amplifier

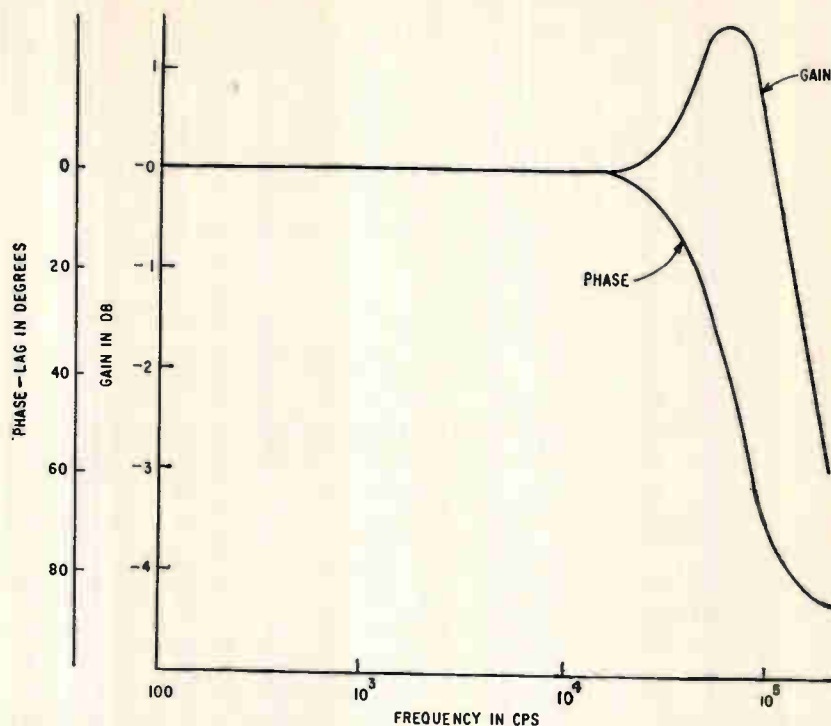

FIG. 4—Characteristics of phase and gain versus frequency, for the University of Arizona amplifier and follower

and Schmitt trigger forms a fast comparator. Note that the hysteresis and trigger level drift of the Schmitt trigger are effectively divided by the gain of the amplifier. If triggering about some d-c level is desired it is only necessary to add the d-c term at the comparator input.

If solid-state pulse circuits are used to drive the bridge, a low-voltage back-to-back Zener diode can be placed from the follower input to ground. This gives limiting-action when the switch is off and it is then possible to control the diode bridge with small push-pull pulses, such as those obtained from transistor logic modules, even though voltages as large as 50v are tracked and held.

The analog-storage circuit has a dynamic range of ± 100 volts d-c, with a static accuracy better than 0.1 percent essentially determined by the accuracy of the resistances R_{in} and R_{out} . The output is held within ± 20 mv for 100 msec with the switch off. Figure 2 shows the overload voltage as a function of frequency, and Fig. 4 shows the frequency response in the tracking mode. The recovery time after sampling is less than 100 μ sec for ± 50

volt steps. This recovery time limits the maximum sampling rate to 10,000 samples per second with the 0.0047 μ F holding capacitor shown. The plug-in holding capacitor can be changed to trade frequency response for holding time, or vice versa.

Since the University of Arizona Mod. J^r and III plug-in amplifiers (which were especially designed for fast analog computers) are not generally available, the circuit was also built using Philbrick K2-X amplifiers. The only result of the amplifier substitution is a reduction of the dynamic range at high frequencies, as indicated in Fig. 2.

The circuit was developed in the course of a repetitive analog computer project directed by G. A. Korn. Acknowledgment is due the Electrical Engineering Department of the University of Arizona and P. E. Russell.

REFERENCES

- (1) G. A. Korn, Repetitive Analog Computers at the University of Arizona. *Instruments and Control Systems*, Sept., 1960.
- (2) T. A. Brubaker and G. A. Korn, An Accurate Amplitude-Distribution Analyzer. *Review of Sci. Instr.*, 1961 (in print).
- (3) M. J. Andrews, The Dynamic Storage Analog Computer. *Instruments and Control Systems*, Sept., 1960.
- (4) H. Koerner, How to Extend Operational Amplifier Response, *ELECTRONICS*, Nov. 11, 1960.

Solid-State Devices for Electromechanica

Use of single-crystal strain gages and of tunnel diodes as pressure-sensitive transducers are among approaches leading to a new family of devices

By MAX BIALER, Electronic Technology Lab., USAF, Wright-Patterson AFB, Ohio

SOLID-STATE TECHNIQUES FOR ELECTROMECHANICAL APPLICATIONS

Technique	Output Parameters of Interest	Status	Performance
Single Crystal Devices Silicon, Germanium and Other Materials	Strain Piezo-resistance	Operational, with techniques and new materials being investigated	Linearity to 0.1 percent Hysteresis of 0.1 percent Resolution limited only by readout Friction undetectable Size approaching transistors
Diode	Strain Piezo-resistance Current/pressure function	In use and under investigation	<i>N</i> -type elements can be used to compensate <i>p</i> -type elements Broad temperature range Extremely small
Tunnel Diode	Strain Frequency/pressure function E-I curve is pressure sensitive	Under investigation	Sensitivity provides high accuracy potential Friction approaches zero Low power consumption Frequency output convenient for analog to digital conversion
Transistor Action	Strain Current gain beta varies with pressure	Recognized	Difficult to reproduce Gain provides for excellent sensitivity—high gage factor Resolution and friction affected only by readout equipment
Hall Effect	Position device Voltage output	Operational, and is also being investigated by many companies	Limited accuracy: 3 percent error Temperature sensitive Low friction, good resolution, highly versatile
Opto-Electronic	Position device Voltage, current. Simplified digital output	Operational Many approaches and uses for all types of measurements. Coherent light sources will increase accuracy by orders of magnitude	Extremely versatile instrumentation capability Performance limited by electroluminescence and photoconductivity and by light/electrical conversion efficiencies
Ferroelectric	Strain Piezo-resistance	Operational Many types of devices in use	Limited accuracy: 3 percent error Temperature sensitive
Nuclear Magnetic Resonance	Fixed Position (polarization) Frequency extremely sensitive to magnetic field	Being investigated by many companies for advanced devices	Accuracy limited only by instrumentation. Cryogenic temperatures and/or strong magnetic fields required for some applications
Mossbauer Effect	Coherent gamma rays with purity of about 10^{-12} Relative position, angular position and motion	Laboratory measurement Being investigated for advanced devices	Present device techniques are complicated Accuracy in excess of 1 part in 10^{10}

Applications

DEVICES BASED on solid-state techniques are already beginning to supplement and replace conventional electromechanical hardware such as potentiometers, synchros, accelerometers and strain gauges. Since the usable conversion of mechanical energy into calibrated electrical energy is generally accomplished in a solid-state lattice, the field can be called solid state electromechanics.

Strain and pressure measuring components, accelerometers, potentiometers, synchros and gyros represent an electromechanical family of components that are relatively large and complex assemblies. Their operation depends on critically machined and balanced parts, bearings, rubbing contacts, and power dissipating elements. During the past decade, performance gains have been realized as a result of new alloys, contact materials, using films to replace wire, magnetic material improvements, and closer mechanical balance and tolerance. Many of the advances are marginal and further improvement is increasingly difficult. Friction and machine-shop tolerances are predominant limiting factors and cannot be reduced much further.

An investigation was made of electromechanical hardware of all types that are used to measure motion such as roll, pitch and yaw, acceleration and change in motion, strain and pressure, and position in space. The devices all make use of one or more of the following three fundamental measurements: stress or strain; relative position of two bodies; and absolute maintenance and reference of a position in space. Strain gages, pressure indicators and accelerometers provide a calibrated electrical output as a result of stress or strain. Potentiometers, synchros and coded-disk analog-to-digital converters measure relative position of two bodies. Gyroscopes establish and maintain spacial reference.

Fortunately, the theoretical and

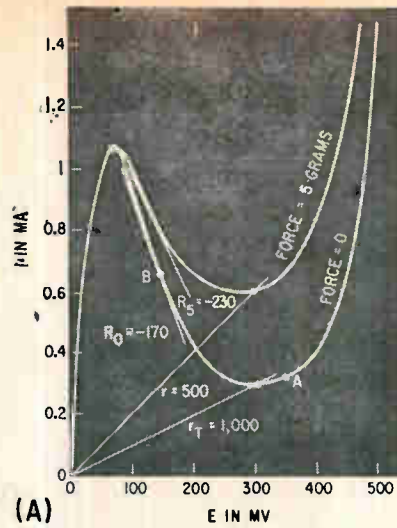

(A)

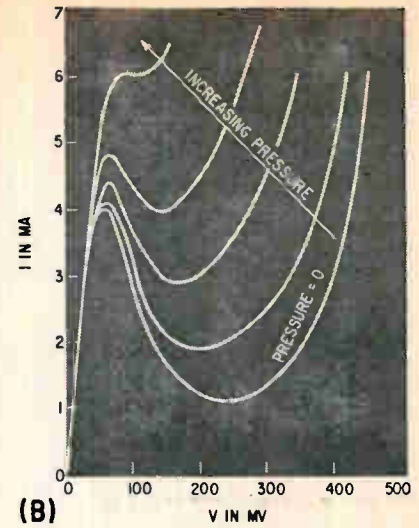

(B)

Tunnel diodes show a high sensitivity to pressure, are expected to provide strain and pressure transducers with gage factors of 1,000 or more

practical understanding of semiconductors, single-crystal behavior, and solid-state physics in general, has been greatly expanded during the past ten years. As a result, molecular or solid-state phenomena and techniques can be used to make all the fundamental measurements and to provide satisfactory sensor instrumentation for new systems. The table shows the output, status and performance expectation of the more promising energy-conversion mechanisms or techniques.

The instrumentation potential for each technique listed results from a calibrated electrical output, either as a result of pressure or strain for strain gages, pressure indicators, and accelerometers, or as a result of relative or angular position between two bodies for solid-state replacements for synchros, voltage-pickoff potentiometers and accelerometers. Gyroscopic instrumentation derives from techniques which produce an absolute reference position. The techniques have already provided some hardware but every approach listed is relatively new and is under investigation. Performances listed have either been realized or are projected possibilities made possible because the instrumented electrical output eliminates the limiting mechanical tolerances. Only performance items of principal importance to the application engineer are listed. Most of the techniques are dependent on molecular energy conversions, hence accuracy will be affected by nuclear radiation. Because most of the resulting devices are small, shielding for moderate

radiation may be designed into the transducers. Extremely high speed of response is inherent in most of the techniques, and this may require damping to make them suitable for many applications.

The single-crystal device provides an example of how the techniques work. In proper crystal orientation the strain gage factor of some semiconductors exceeds those of conventional strain gages by as much as 150. Gage factor is $(\Delta R/R_0)/\epsilon$, where ΔR is change in resistance caused by applied strain ϵ , and R_0 is the resistance of the element. For silicon, the high gage factor, coupled with low voltage input and relatively simple temperature compensation techniques, allows a transducer that ultimately will approach transistor size.

Tunnel diodes are extremely sensitive to pressure and should provide gage factors exceeding 1,000. Once problems of control, reproducibility and application are solved, tunnel diodes will provide a fundamental pressure or strain instrumentation suitable for many types of transducers. The curves in the drawing show the effect of pressure on tunnel diodes.

Nuclear magnetic resonance is a technique of extremely high potential accuracy. In paramagnetic materials electron resonance is $f(\text{Mc}) = K_1 H$ and proton resonance is $f(\text{Kc}) = K_2 H$, where H is in oersts. Constants K_1 and K_2 range from one to five. The output frequency is pure and sensitive to the magnetic field. This frequency is used as a time or frequency standard.

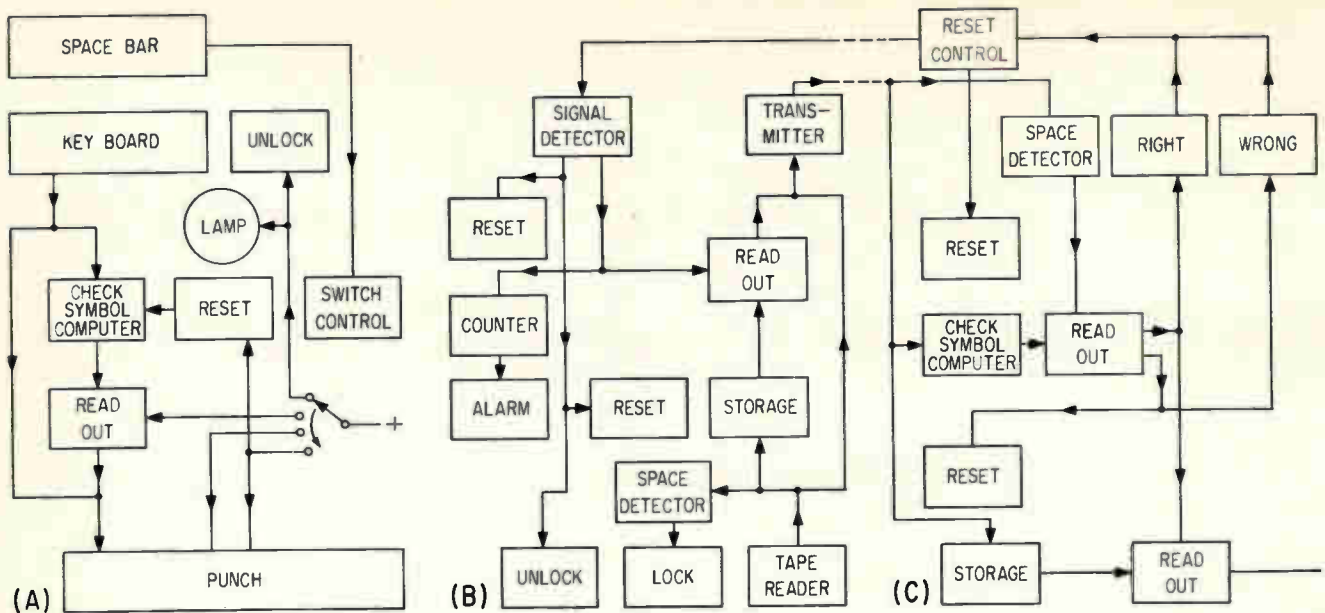

FIG. 1—System showing tape punching device (A), transmitting apparatus (B) and receiving equipment (C)

Automatic Symbol-Group Repetition

System adds check symbol to each symbol group, prior to data transmission. Computers calculate check symbol according to predetermined mathematical rule

By TH. REUMERMAN
 W. H. TH. HELMIG,
 Reumhelm Electronics N. V.,
 Amsterdam, Holland



Office application of basic error correction principles prevents transmission of wrong data

TRANSMISSION OF INTELLIGENCE by digital techniques implies that the intelligence received conforms exactly to that transmitted. This applies equally to teleprinter, radio, telegraph, telephone, direct wire and any other means of transmission. In transmitting data for high speed data processing, the computers must be fed correct data if accurate calculated data is to result.

Various methods have been proposed to accomplish errorless transmission. However, most of these methods restrict themselves to showing that an error (or several of them) has occurred during transmission; they neither locate the error, nor correct such errors. None check human input errors. For the correction of a detected error it is necessary to refer to the original document, and usually an inquiry must be sent to the transmitting end. The message or a considerable portion had to be re-

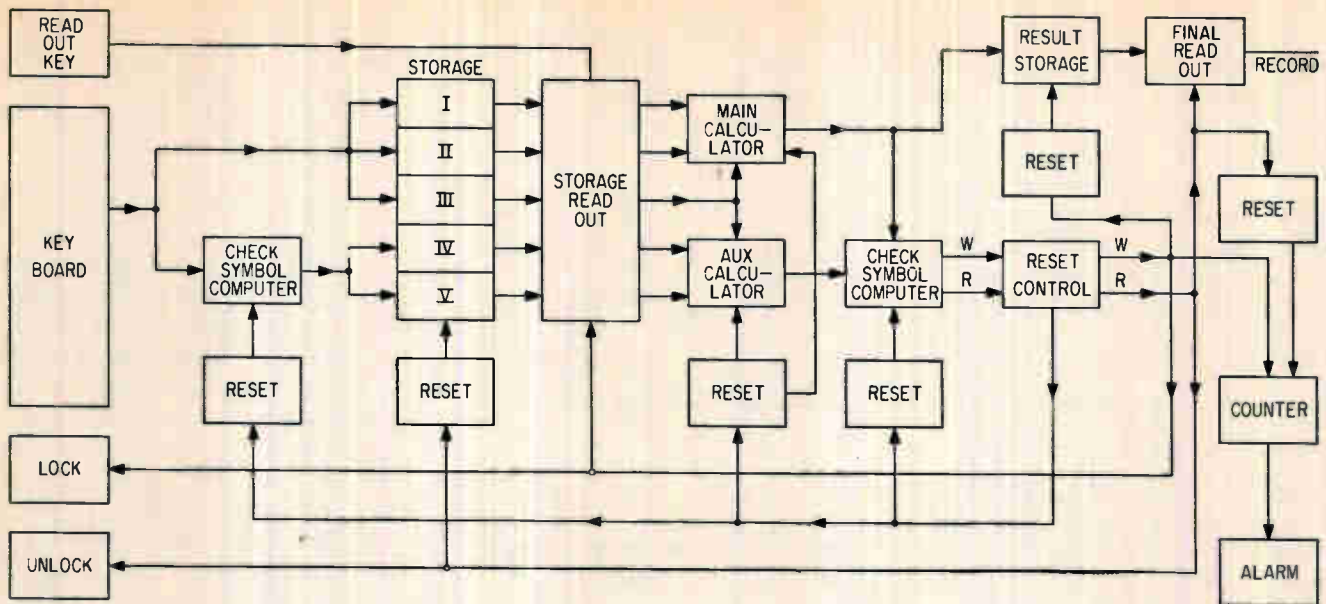

FIG. 2—System checks results of calculations and repeats calculations when necessary

Corrects Transmission Errors

peated. This is a costly, time consuming job, and with unmanned transmitters, it is impossible.

The system outlined in Fig. 1 provides means to automatically detect and correct transmission errors to give error-less output at the receiving end. It can be used with existing communication equipment and can be applied to any kind of data transmission.

In this system, the message may contain symbols of any kind, such as the full alphabet or all digits and auxiliary symbols for controlling machine operations. In practice, the symbols belong to a given series, determined by the apparatus involved in the transmission. For instance, the series may include all the symbols appearing on a keyboard, or all the symbols occurring in a telegraph code.

The system has input storage where the symbol group is stored. Then a computer automatically calculates a check digit for each symbol group according to a predetermined arithmetical rule (Fig. 1A). The symbol groups together with their check symbols are then trans-

mitted (Fig. 1B). At the receiver (Fig. 1C), the transmitted symbol groups are checked with the transmitted check symbols. If a symbol group is transmitted wrong it is not accepted and a warning signal is sent to the transmitter. On receipt of the warning signal, the symbol group mutilated during transmission is retransmitted from storage.

Thus, if a symbol group is mutilated, transmission is repeated until a correct symbol group is received at the output. The number of repetitions may be restricted by a stepping switch, actuated at each repetition, which stops the transmission entirely or switches on a second transmitting device.

In general, the check symbol is taken for the same series as the other symbols. Thus, the check symbol is not distinguishable as such from the other symbols of the group and means must be provided to indicate the moment at which a check must be made at the output.

If each symbol group consists of an arbitrary number of symbols,

a marker signal may be transmitted. In long distance transmission, the words of a message are generally separated by a space, and this symbol may serve as a marker signal to initiate the checking operation. If the number of symbols in a group is constant, the time for the checking operation may be determined by counting the symbols of the group.

There exists a checking system for long-distance transmission in which each symbol is separately checked. According to this system the symbols are transmitted by means of a seven-element code, in which each symbol is represented by a combination of four marking and three spacing elements. Upon receipt of a combination containing more or less than four marking elements, a signal is sent back to the transmitting end and the symbol is repeated. This system involves the amplification of the usual five-element code into a seven-element code, an increase by 40 percent of the time required for the transmission.

In the new system only one sym-

bol is added for each symbol group, (see editorial box) yet the efficiency of the checking, (the ratio of corrected to occurring errors) is at least of the same order.

The input storage means may be of any desired type: punched tape (Fig. 1A), magnetic tape, punched cards, electromechanical or electronic register, or a mag-

netic or electric memory device may be used.

If each symbol group or word of a message already contains a check digit then the new system will, besides correcting transmission errors, also automatically check the input for human errors and prevent their transmission.

Figure 2 shows how the system

can be used to check the results of arithmetical operations. The numbers (only two will be used in this description, although, in principle, an unlimited number could be used) and function signals are inserted by the keyboard. The first number is stored in compartment I, the second in II and the function in III. At the same time, the numbers are fed to the check symbol computer. Here, a check symbol for each number is computed and stored—the check symbol for the first number in IV, for the second number in V.

When the readout key is depressed, the numbers stored in I and II are fed to the main calculator, check symbols in IV and V are fed to the auxiliary calculator and the function signal in III is supplied to both calculators. Thus, the same arithmetical operation is performed on the numbers in the main calculator and the check symbols in the auxiliary.

Output of the main calculator goes to a second memory and a second check symbol computer. This second checking computer determines the check symbol of the result and compares it with the output of the auxiliary calculator. If the outputs agree, a voltage is applied to line R, if the results do not agree (indicating an error) a voltage is applied to line W.

A voltage on either line resets both calculators and both check symbol computers. The voltage appearing on line W in case of a wrong result resets the result memory and locks the keyboard. At the same time the storage readout re-supplies the numbers and function signals to the calculator, repeating the calculations.

If the result is right, the voltage on R will operate the final readout, clear the number and function memory and, if necessary, unlock the keyboard.

Each time a voltage appears on W a counter is operated; when the counter has operated a predetermined number of times, an alarm indicates the system is out of order. However a voltage on R will reset the counter, so that only consecutive failures are counted.

The system can be applied to many other applications where errorless data transmission is required.

CHECK SYMBOL CALCULATION

Assume that the information is to be transmitted in telegraph code and has been punched in a tape without any check symbols, and with a space symbol after each symbol group. In the transmitter, a check symbol is inserted between the last symbol of each symbol group and the succeeding space symbol. This check symbol is determined by the following arithmetical rule.

A numerical value (see cut) is assigned to each of the punch positions of the tape, 16 to the first, 8 to the second, 4 to the third, 2 to the fourth and 1 to the fifth. By adding together the values of the positions in which a hole appears, the numerical value of the symbol is found. For instance, the letter A (holes in positions 1 and 2) has the value 24, the letter B (Holes in positions 1, 4 and 5) has the value 19.

The numerical value w_q of the check symbol W_q of a symbol group $U_q, U_{q-1}, \dots, U_2, U_1$, in which the symbols U_1, U_2, \dots, U_q have the numerical values u_1, u_2, \dots, u_q is equal to $31 - R_{31}(2v_q)$, where $v_q = R_{31}(u_1 + 2u_2 + 4u_3 + \dots + 2^{q-1}u_q)$ and where R_{31} is an operator denoting the remainder obtained on division of the argument by 31.

This arithmetical rule has the advantage that, if the check symbol is added to the group, the complete group $U_q, U_{q-1}, \dots, U_2, U_1, W_q$ thus obtained has a check symbol of which the numerical value is 31, since $v_q + 1 = R_{31}/(w_q + 2u_1 + 4u_2 + 8u_3 + \dots + 2^q u_q) = R_{31}(31 - 2v_q + 2v_q) = 0$.

Hence, a symbol group received together with the appropriate check symbol may be tested at the receiving end by determining the check symbol of the complete group and verifying to see if it has a value of 31.

For the symbol group HEAD, the symbols have the numerical values 5, 16, 24 and 18, in this order.

$$v_q = R_{31}[18 + (2 \times 24) + (4 \times 16) + (8 \times 5)] = R_{31}(170) = 15, \text{ so that } w_q = 31 - R_{31}(30) = 1.$$

The numerical value 1 represents the letter T so that HEAD has the check symbol T. The transmitter will substitute HEADT for HEAD. In the receiver, if the group HEADT has been correctly transmitted,

$$v_{q+1} = R_{31}[1 + (2 \times 18) + (4 \times 24) + (8 \times 16) + (16 \times 5)] = R_{31}(341) = 0, \text{ so that } w_{q+1} = 31.$$

Say a mutilated group like HEEDT is received instead of HEADT, now

$$v_{q+1} = R_{31}[1 + (2 \times 18) + (4 \times 16) + (8 \times 16) + (16 \times 5)] = R_{31}(309) = 30, \text{ so that } w_{q+1} = 2.$$

The receiver sends back the right signal if w_{q+1} is equal to 31, and the wrong signal if it is not equal to 31. The check symbols are determined, both in the transmitter and receiver, by computer. After insertion of a symbol having the numerical value u , the computer calculates the value

$$v_1 = R_{31}(2v_{1-1} + u_1),$$

wherein v_{1-1} is the previously calculated value. Upon insertion of the first symbol of group, v_{1-1} is zero.

Again, if the group HEAD is inserted, the computer successively calculates the values $v_1 = 5$, $v_2 = R_{31}[(2 \times 5) + 16] = 26$; $v_3 = R_{31}[(2 \times 26) + 24] = 14$; and $v_4 = R_{31}[(2 \times 14) + 18] = 15$

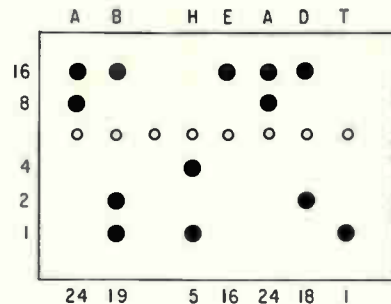

NEW FROM CINCH.

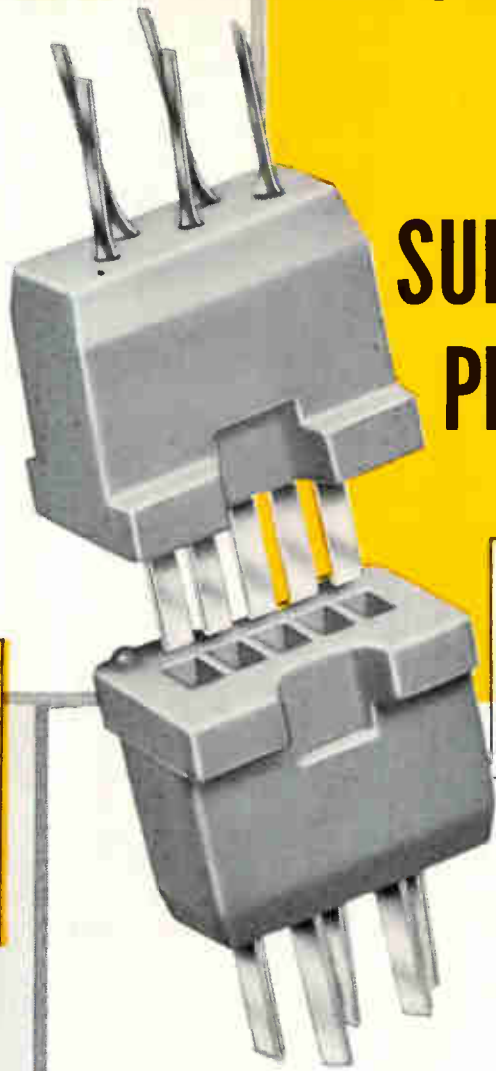
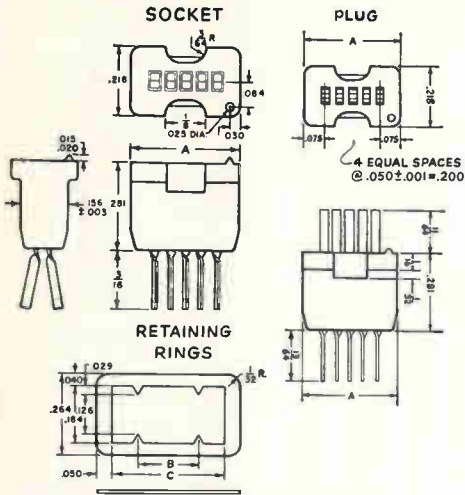

Low-Cost SUBMINIATURE PLUGS and SOCKETS for low-current circuits



ACTUAL SIZE

DIMENSIONS

No. of Contacts	A	B	C
3	.350 ± .003	.194	.360
4	.350 ± .003	.194	.360
5	.350 ± .003	.194	.360
6	.400 ± .003	.244	.410
7	.450 ± .003	.294	.460

NOMENCLATURE

PLUG	RECEPTACLE	RETAINING RINGS
3 contacts 204-92-03-047	131-13-12-095	441-00-11-082(105)
4 contacts 204-92-04-048	131-14-12-096	441-00-11-082(105)
5 contacts 204-92-05-049	131-15-12-097	441-00-11-082(105)
6 contacts 204-92-06-050	131-16-12-098	441-00-11-083(105)
7 contacts 204-92-07-046	131-17-12-099	441-00-11-084(105)

for interconnecting low current circuits where miniaturization is important... electrical ratings conform to EIA standards

Molded of low-loss, mica filled phenolic insulation (type MFE per MIL-4-14E) with beryllium copper contacts, .00003 Min. Sel-rex gold plated. Available also, with glass-filled Diallyl Phthalate insulation (type SDG per MIL-M-18794).

May be swaged into metal chassis, cemented into Bakelite chassis, mounted with retaining ring or potted.

ELECTRICAL RATINGS

Maximum Rated Voltage AC-RMS
 Contact to contact 300 volts
 Contact to ground 500 volts

Capacitance
 Measured from one contact to all other conducting parts... 1.5 m.m.f. (Max.)

Insulation loss factor
 Maximum 0.50 Dry

Insulation Resistance
 Measured from one contact to all other conducting parts 50,000 Megohms (Min.)

Contact Resistance 0.50 Ohms (Max.)

Safe Operating Temperature
 Maximum 80 C

Initial Insertion and Extraction Force

3 contact (Max.)	6 lbs.
4 contact (Max.)	7 lbs.
5 contact (Max.)	8 lbs.
6 contact (Max.)	9 lbs.
7 contact (Max.)	10 lbs.

Individual Contact Retension Force
 Minimum Gauge Weight... 1/2 ounce

WRITE FOR FULL INFORMATION TODAY! Complete engineering data and detailed specifications on this line of low cost plugs and sockets is available. Yours for the asking, or phone NE 2-2000.



Cinch
ELECTRONIC
COMPONENTS

CINCH MANUFACTURING COMPANY

1026 South Homan Avenue, Chicago 24, Illinois

Division of United-Carr Fastener Corporation, Boston, Massachusetts

Centrally located plants at Chicago, Illinois; Shelbyville, Indiana; City of Industry, California, and St. Louis, Missouri



Digital Q Meter Counts Damped Cycles

By T. F. HEITING,
Resident Engineer,
Aero-Space Div.,
The Boeing Co., Seattle, Wash.

QUALITY factor can be provided directly on a digital Q meter without digital or analog conversion. Measurements of Q can be made easily and quickly for production-line testing of tuned circuits, transformers, chokes, deflection yokes and similar components. Reading errors are minimized by the digital indication.

Operation of the meter involves counting the number of cycles of a damped oscillation between two specified levels of amplitude. Because the number of cycles is also quality factor Q, a simple counting method can be used to indicate values of Q greater than 10.

The theory of operation is based on the following relationships. Decrement $d = U_0/U_1 = U_1/U_2 \dots = U_{n-1}/U_n$, where $U_0, U_1 \dots U_n$ are the positive peak voltages of n successive cycles of the damped oscillation. Therefore, $d^n = U_0/U_n$ and

$$\ln d = \ln (U_0/U_n)/n. \quad (1)$$

Additionally, since $u = u_0 e^{-\alpha t} \sin \omega t$, $\alpha T = \ln (U_0/U_1) = \ln d$,

$$T = \ln d/\alpha \quad (2)$$

and $\alpha = r/2L$, (3)

it follows that $Q = \omega L/r = 2\pi L/rT = 2\pi L/[r(\ln d)/\alpha] = 2\pi L/[r(\ln d) 2L/r] = \pi/\ln d$ and

$$\ln d = \pi/Q. \quad (4)$$

Combining Eq. 1 and 4, $\ln(U_0/U_n) = n\pi/Q$, $U_0/U_n = e^{n\pi/Q}$. For $n = Q$, the ratio of the peak voltages $U_0/U_n = e^\pi = 23.14$.

The usefulness of this equation is indicated by assuming $U_0 = 100$ volts, in which case $U_n = 4.321$ volts. In terms of percentage, if amplitude of the individual cycles of a damped oscillation drops from an arbitrary reference level to 4.321 percent of that value (-27.30 db), the number of cycles is equal to Q.

This mathematical relationship, usually overlooked, makes possible the digital Q meter shown in the simplified block diagram. The free-running pulse generator ap-

plies pulses through a diode at a low pulse-repetition rate to the component under test. The diode is used to isolate the pulse generator from the component after oscillation has been initiated. Cathode-follower input to the amplifier avoids loading the component.

When amplitude of the induced damped oscillation has dropped slightly to a particular level, called the 100-percent level, the counter starts counting the clipped positive sinusoidal pulses. When amplitude has dropped to the 4.3-percent level, the counter stops. The number on the counter is the value of Q. The indication remains on the counter until erased by a reset pulse. The Q meter then recycles automatically. Capacitor C, with negligible losses, enables frequency of the damped oscillations to be adjusted.

Accuracy of the digital Q meter can be calculated assuming that error of the two level detectors is ± 1 percent and counter error is ± 1 count. The value of Q determines accuracy for a single wavetrain,

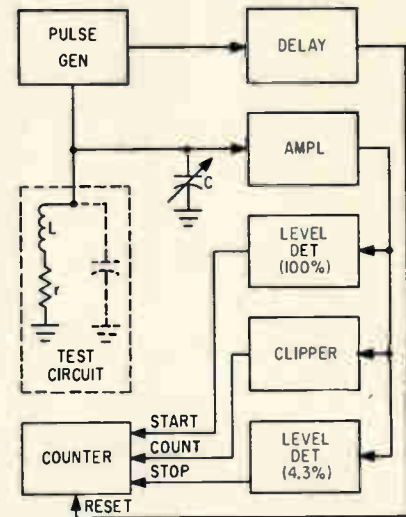

Counting cycles of a damped oscillation between two amplitude levels provides a direct digital reading of Q

which ranges from 12 percent for a Q of 10 to 2 percent for a Q of 1,000. However, by averaging measurements for many wavetrains, counter error approaches zero and overall accuracy approaches 2 percent.

Attenuator Controls Amplifier Gain

By L. C. BOWERS, Electronic Equip. Div., McDonnell Aircraft Corp., St. Louis, Mo.

TRANSISTOR circuit enables a-c amplifier gain to be controlled by d-c voltage. Response of the circuit to

control voltage can be made linear for control system applications by adding suitable feedback.

Variable gain capability has been obtained with vacuum-tube pentodes, as well as complex arrangements using transistors, usually in conjunction with avc and agc systems. A simpler method of providing variable gain is sometimes desirable particularly at servo system frequencies.

In the simplified schematic at the top of Fig. 1, the potentiometer functions as a variable attenuator by providing variable shunt resistance. The circuit at the bottom of Fig. 1 simulates the potentiometer, but the variable shunt resistance is controlled by the d-c input voltage.

When no d-c control voltage is applied at the base of Q_1 , both transistors are saturated and all tran-

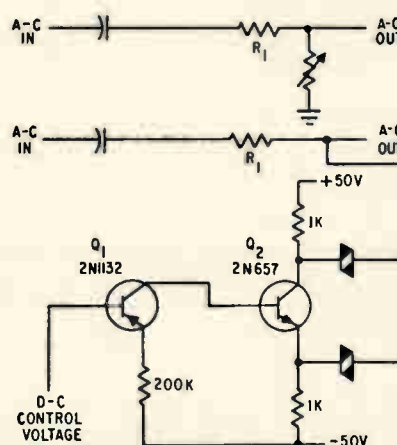
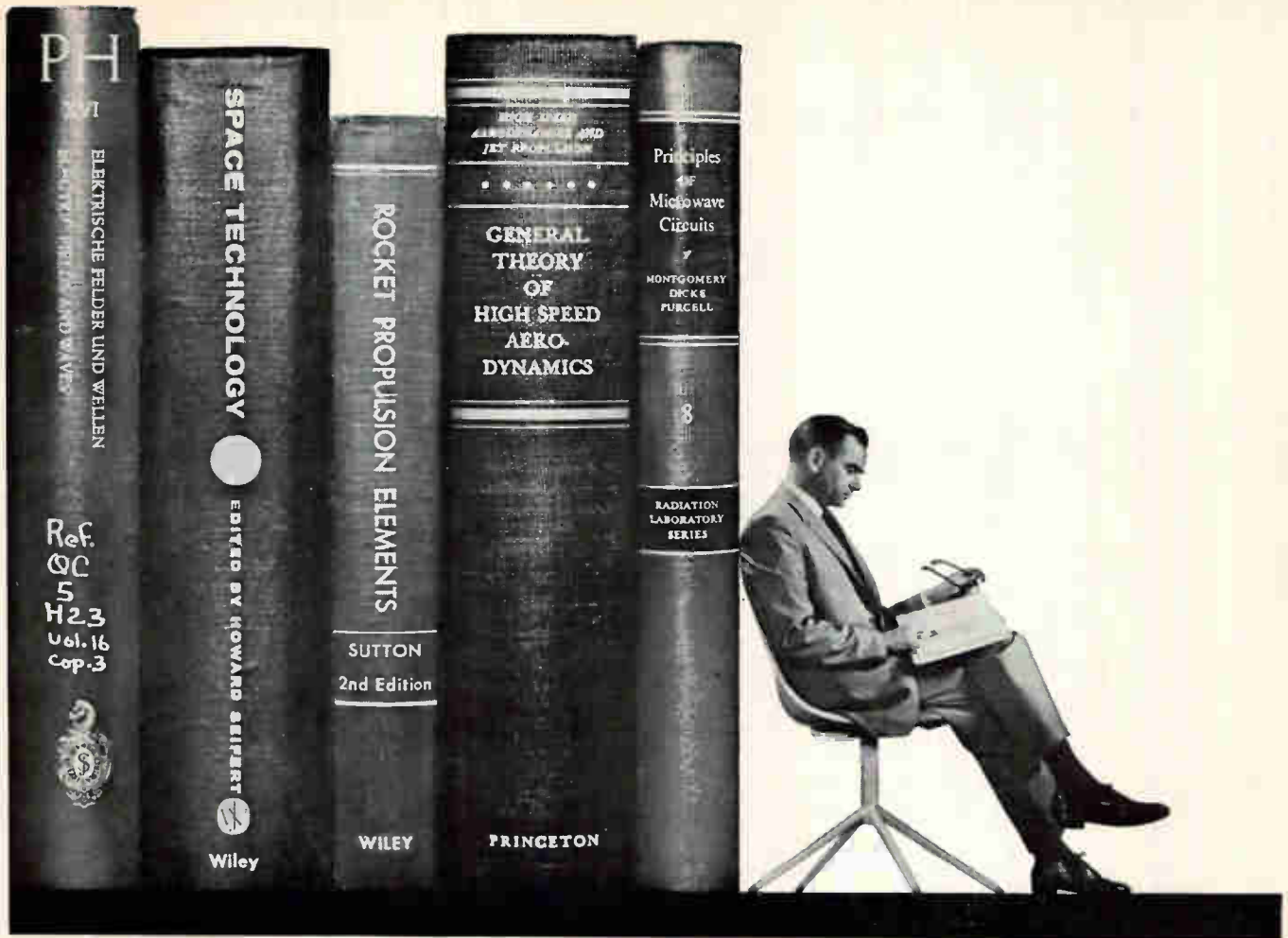

FIG. 1—Function of potentiometer in simplified schematic at top is simulated by circuit below



scientists and engineers in a unique leadership role

The frontiers of space science and technology are being expanded at Aerospace Corporation. The scientists and engineers of this leadership organization are the critical civilian link uniting government and the scientific-industrial team developing space systems and advanced ballistic missiles. In providing broad scientific and technical leadership to every element of this team, they are engaged in a balanced program of activities spanning the spectrum from basic research and forward planning through general systems engineering. Included in the latter are technical supervision, integration and review of the engineering, development and test operations of industry to the extent necessary to assure achievement of system concept and objectives in an economical and timely manner. These people are privileged to view both the state-of-the-art and system development in their totality. Now more men of superior ability are needed: highly motivated scientists and engineers with demonstrated achievement, maturity, and judgment, beyond the norm. Such men are urged to contact Aerospace Corporation, Room 110, P. O. Box 95081, Los Angeles 45, California.

*Organized in the public interest and dedicated to providing objective leadership
in the advancement and application of space science and
technology for the United States Government.*

AEROSPACE CORPORATION

September 29, 1961

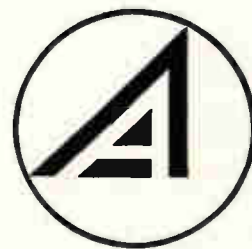

2N

**2N1015
2N1015A
2N1015B
2N1016
2N1016A
2N1016B**



150 Watt

**2N1212
2N1208
2N1616
2N1617
2N1618
2N1616A
2N1617A
2N1618A
2N1724**



85 Watt

NEC: Booth 116

SILICON TRANSISTOR CORP. ADDS 2 NEW SERIES. THE COMPLETE LINE OF HIGH POWER SILICON TRANSISTORS

The series ...

**2N1015 2N1016
2N1015A 2N1016A
2N1015B 2N1016B**

are 150 watt single-end stud types. With collector-emitter voltages of 100 volts. Saturation resistance of 0.5 ohms. Minimum beta of 10 at 5 amps.

The series

**2N1212 2N1616
2N1208 2N1617
 2N1618**

are double-ended 11/16" 85 watt hex stud types.

And ...

**2N1616A
2N1617A
2N1618A
2N1724**

are the most popular series in this package, with dramatic improvements from STC.

BVCEO of 80 volts. Saturation resistance of 0.5 ohms. Minimum beta of 10 at 5 amps.

Both STC series have the lowest leakage currents in the industry...high temperature stability...low thermal resistance and reliability at full power ratings. Write for Catalog listing complete line of STC's high and intermediate power silicon transistors and silicon diodes.

SILICON TRANSISTOR CORP.

CARLE PLACE, LONG ISLAND, NEW YORK Pioneer 2-4100





FOR IMMEDIATE DELIVERY CONTACT THESE STC DISTRIBUTORS

in Alabama:

MG Electronics & Equipment Co.
Birmingham—FA 2-0449

in Arizona:

Southwest Industrial Electronics
Phoenix—AL 2-1741

in California:

Finn Electronics Corp.
San Carlos—LY 1-4423

Hollywood Radio & Electronics, Inc.
Hollywood—HO 4-8321

Kierulff Electronics, Inc.
Los Angeles—RI 8-2444
San Diego—BR 6-3334

Shanks & Wright, Inc.
San Diego—BE 9 0176

in Connecticut:

N.E.E.D., Inc.
Danbury—PI 3 6844

Sun Radio & Electronics Co., Inc.
Stamford—WH 9-7715

in Florida:

Gulf Semiconductors, Inc.
Miami—MO 5-3574

Hammond Electronics, Inc.
Orlando—GA 5-0511

in Indiana:

Graham Electronics Supply, Inc.
Indianapolis—ME 4-8486

in Maryland:

Valley Electronics, Inc.
Towson—VA 5-7820

in Massachusetts:

Durrell Electronics, Inc.
Waltham—TW 3-7020

N.E.E.D., Inc.
Watertown—WA 6-1130

in New Jersey:

Sun Radio & Electronics Co., Inc.
Princeton—WA 1-2150

in New York:

Arrow Electronics, Inc.
Mineola, L.I.—PI 6-8686

Progress Electronics
New York—CA 6-5611

Stack Industrial Electronics, Inc.
Binghamton—RA 3-6326

Standard Electronics, Inc.
Buffalo—TT 3-5000

Sun Radio & Electronics Co., Inc.
New York—OR 5-8600

Valley Industrial Electronics, Inc.
Utica—RA 4-5168

in Pennsylvania:

Philadelphia Electronics, Inc.
Philadelphia—LO 8-7444

in Tennessee:

Electra Distributing Co.
Nashville—AL 5-8444

in Texas:

All State Electronics, Inc.
Dallas—RI 1-1295

Lenert Company
Houston—CA 4-2663

sistor electrodes are at ground potential. As d-c control voltage becomes positive, conduction in Q_1 is reduced and voltage at the collector of Q_1 and the base of Q_2 becomes negative. The resulting reduced conduction in Q_2 increases voltage across the varistors, which have a voltage-resistance characteristic as shown in Fig. 2.

Because of the symmetrical nature of the supply voltages and emitter and collector resistors associated with Q_2 , the junction of the varistors is always at a d-c potential of zero volts. This arrangement prevents a d-c component from being added to the a-c signal.

Effective shunt resistance with d-c control voltage at zero is about 500,000 ohms. As d-c control voltage is increased in the positive direction so that Q_1 is cut off, voltage at the emitter and collector of Q_2 is -50 volts and +50 volts, respectively, and effective shunt resistance is 2,000 ohms.

To obtain a shunt resistance ratio of 50:1, the required value of R_1 is $(500,000 \times R_1) / (50,000 + R_1) = 50 (2,000 \times R_1) / (2,000 + R_1) = 120,000$ ohms.

The equation relating a-c signal voltage to d-c control voltage is $V_{a-c} = K(1/V_{d-c}^2)$, over a specified range.

The feedback arrangement in Fig. 3 is suggested to obtain linear operation for control system appli-

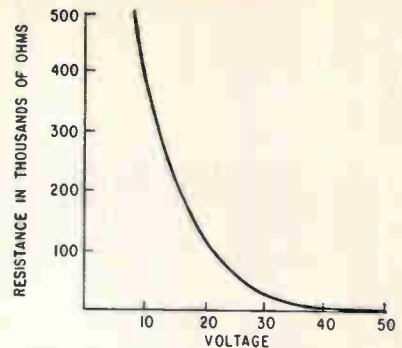

FIG. 2—Voltage-resistance characteristic is shown for varistors that change shunt resistance

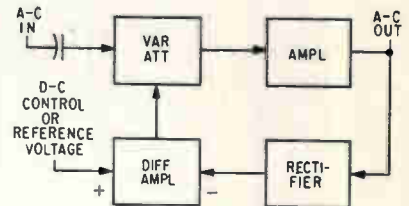

FIG. 3—Adding feedback loop provides linear response for use in control systems

cations. This configuration provides fast linear response to the d-c control voltage.

Higher ratios than 50:1 can be obtained by changing the value of R_1 and by increasing voltage of the positive and negative 50-volt supplies. For large ratios of gain, signal frequency is limited by frequency response of the varistors (50:1 at 5 Kc). Response to rapidly changing d-c voltage level is limited primarily by the type of filter used.

Re-Entry Simulator for R-F Studies

SPACE-VEHICLE re-entry simulator is expected to provide quantitative information about radio frequency transmission through the plasma sheath. Anticipated performance can actually be measured as parameters are varied without the cost and time of test firing.

The study is being conducted by Sylvania Electric Products, a subsidiary of General Telephone and Electronics Corp., and the Canadian Armament Research and Development Establishment (CARDE), Valcartier, Quebec.

Space vehicles re-entering the atmosphere of the earth at altitudes of 20 to 60 miles will be simulated.

Small free-flight models of the re-entry vehicles are used. Re-entry conditions are simulated by firing

the models at speeds up to 21,000 feet per second into a tank evacuated to have air pressures typical of those in the upper atmosphere.

A microwave receiver and a telemetering transmitter have been built into the projectile-type model. When fired down the ballistics range, the two-inch diameter model is subjected to shock loading of more than 150,000 g's.

Another phase of the study will be an investigation of the properties of the wake behind the vehicle, which is an efficient reflector of radio signals.

The program is sponsored by the Advanced Research Projects Agency, Department of Defense, by a contract from U. S. Army Rocket Guided Missile Agency.



Motorola shaves know-how on putting 23-inch color inside black and white tube. Faceplate preparation (left) includes washing in hydrofluoric acid solution, preparing panels for phosphor coating (center), and fitting shadow mask in position (right)

Bottling Up Color in Television Tube

TIMELY DISCOVERY of a special low-temperature fritting compound enabled a Motorola development team to produce a functioning 23-inch 92-degree rectangular color tv tube.

Successful frit seal for black and white tube was most troublesome problem faced by 40-man team who worked in round the clock shifts in company's new Franklin Park headquarters, reports Karl Horn, chief engineer, tv development.

Company has now opened color lab and is inviting tube makers in for study and discussion of frit seal know-how and other special techniques for depositing color phosphors, forming and positioning shadow masks and photosensitizing—hoping this will speed the day of mass production and volume sales for the color sets planned for the market. Motorola does not intend to make the color tubes but may interest one or more tube manufacturers to take over the job. Mass production of the color tube should be possible within a year at no greater cost than for present color designs, company predicts.

Project started mid-May when company management, feeling bulky tv tube was main stumbling block to public acceptance of color tv, called on Horn to study and list requirements for developing

23-in. 92-deg tube. Gathering a development team from within company, Horn started with the decision to put color hardware inside existing black and white envelope.

"Some tube people would have designed their new unit from the ground up," Horn told *ELECTRONICS*. "But this would have added significantly to our time and cost requirements."

As it turned out, choice of the black and white envelope still

brought persistent troubles: resealing the tube after phosphor dots had been deposited on its faceplate, reinstalling shadow mask, and inserting color guns.

Since annealing temperature of black and white tube is only four degrees above 400 deg at which glass solder melts (compared to 490 deg anneal temperature for color tubes) Horn's team constantly "walked the temperature tightrope" discarding tube after damaged tube while deadline for announcement of new unit closed in.

Last minute discovery that Kimball glass company, Toledo, could provide a 420 deg fritting compound led to delivery of first supply only two days before functioning tube was to be introduced.

Demonstrating process, step by step, to *ELECTRONICS*, Horn started with face plate sawed from end of regular 23-in black and white tube, after edges had been dressed smooth and special jig had guided drilling of tap holes to position steel shadow mask.

Panel, washed with 15 per cent solution of hydrofluoric acid, is then rinsed, positioned face up on tilt table, filled with barium acetate-distilled water solution and then it is left to stand until the



Completing blueprints of circuits required for new color tube

enjoy new design freedom with JFD differential and split stator trimmer capacitors

U. S. PATENT NO. 3,922,093 CANADIAN PATENT NO. 604,810

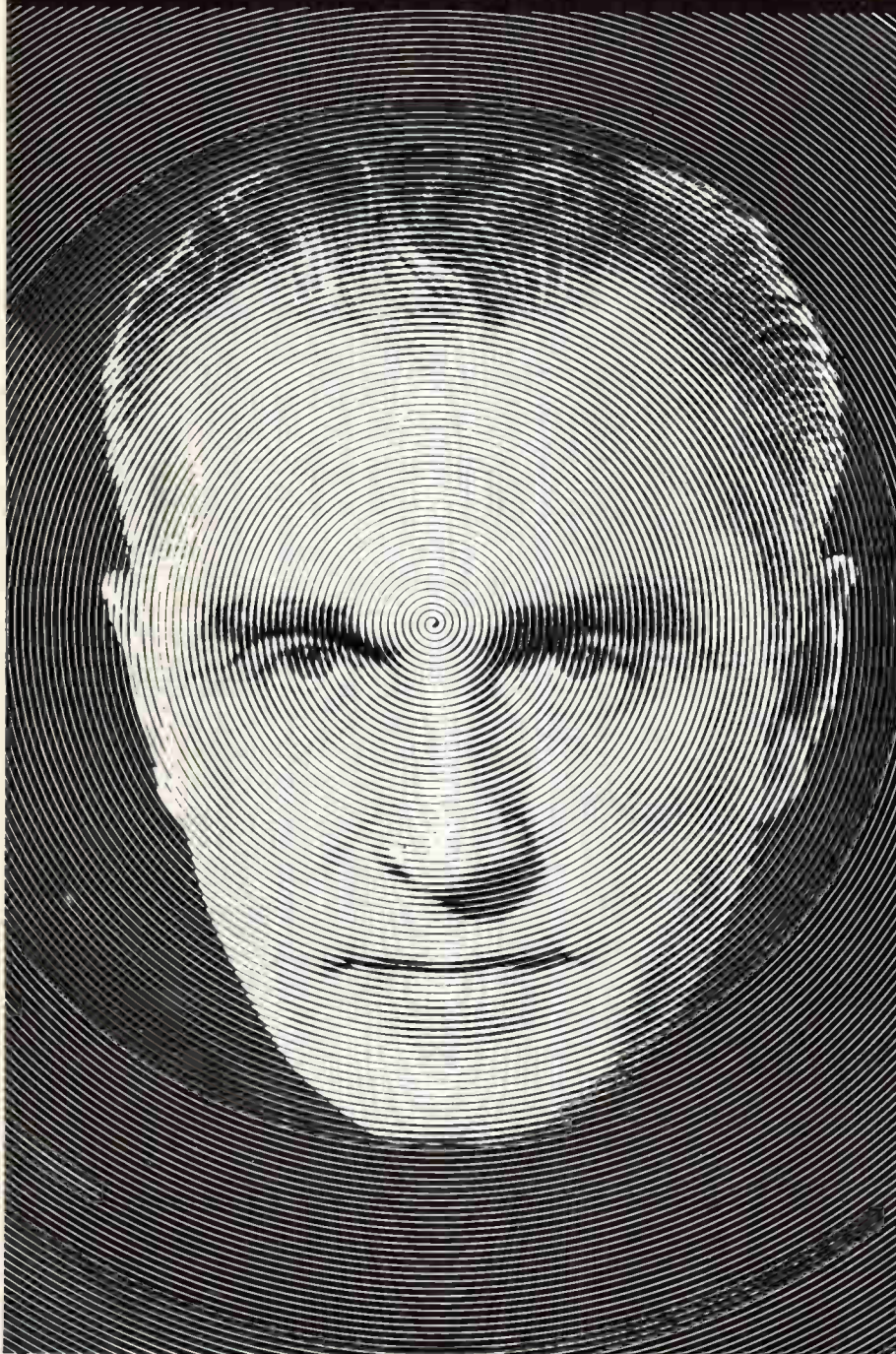

Whether you select the diminutive differential or split stator type JFD trimmer, you cut space, assembly and performance problems down to size.

These two versatile solid dielectric JFD trimmers provide excellent stability...extreme compactness... resist shock and vibration. Both employ the superior JFD rotating piston with patented telescoping adjust mechanism and anti-backlash assembly.

Result: velvet-smooth ultra linear tuning...much more capacitance per unit volume...and JFD trouble-free patented design simplicity adds to your product's reliability.

Write today for complete trimmer catalog C-61 or contact your local JFD field office. Quantities up to 299 pieces of one model are available from your local JFD franchised Industrial Distributor for fast, off-the-shelf delivery.



DIFFERENTIAL TRIMMER
MODEL DC413
Capacitance Range
0.8 to 8.0 pf section 1
2.5 to 8.0 pf section 2

Features capacity that increases in one gang as capacity decreases in the other gang. The sum of the capacitance of both gangs remains constant in the peak-to-peak area of the tuning curve. Low expansion invar and precision bore glass provides increased stability across a wide operating temperature range (from $-55^{\circ}\text{C}.$ to $+125^{\circ}\text{C}.$) 35 standard models available in panel mount and printed circuit types.



SPLIT STATOR TRIMMER
MODEL SP86G
Capacitance Range
0.8 to 4.2 pf plate to bushing
0.8 to 2.00 pf plate to plate

Features balanced electrode construction ideally suited for push-pull radio frequencies circuits, and similar networks where physical size is limited. When tuning, capacitance varies simultaneously from each plate to bushing, as well as plate to plate. 25 standard models are available in panel mount and printed circuit types.

Sliding piston differentials or split stators can be designed for use with cam or motor driven mechanisms. For these modifications or any special design to your requirements, please get in touch with one of our sales engineering offices or one of our 25 sales representative's organizations.

JFD ELECTRONICS CORPORATION

Components Division • 6101 16th Avenue, Brooklyn, New York • Phone DEwey 1-1000 • TWX-NY25040

JFD

JFD WESTERN
P. O. Box 3416
7311 Van Nuys Blvd.
Van Nuys, Calif.
Phone: STate 1-3530

JFD MIDWESTERN
6414 W. Higgins Ave.
Chicago, Illinois
Phone: SPring 4-4175

JFD NEW ENGLAND
Ruth Drive, P. O. Box 228
Marlboro, Mass.
Phone: HUrtle 5-7311

JFD CANADA
51 McCormack Street
Toronto, Ontario, Canada
Phone: ROger 9-1129

VARIABLE TRIMMER PISTON CAPACITORS • FIXED METALIZED INDUCTORS • LC TUNERS • DIPLEXERS
FIXED AND VARIABLE, DISTRIBUTED AND LUMPED CONSTANT DELAY LINES • PULSE FORMING NETWORKS

SEMICONDUCTING COMPOUNDS TO CUSTOMER SPECIFICATIONS

III-V INTERMETALLIC COMPOUNDS

Available in oriented single crystals or polycrystalline ingots.

GALLIUM ARSENIDE
INDIUM ANTIMONIDE

GALLIUM ANTIMONIDE
INDIUM ARSENIDE

Configurations: wafers down to 5 microns, ingots, matched pairs, grown pn junctions.

Special grinding and polishing available for specific applications.

THERMOELECTRIC MATERIALS

BISMUTH TELLURIDE

OTHER NEW MATERIALS

Configurations: rods down to .5mm, cubes, squares, rectangles, etc., as well as special shapes.

Semitronics, Inc. offers complete Research and Development services in semiconducting and infrared materials.

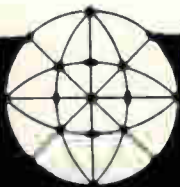

Semitronics . INC.
WINCHESTER, MASSACHUSETTS

CIRCLE 210 ON READER SERVICE CARD



Deflection yoke modification gets going over by Bob Hansen, chief project engineer, and Karl Horn

turbulence settles.

Meanwhile, first, green, phosphor powder mixed with distilled water and dilute potassium silicate is poured through funnel tipped with dispersion holes whose optimum position was determined experimentally—as were most critical requirements of process.

After mix stands 20 minutes, pneumatic control gradually tilts face plate 90 degrees, to vertical, during five minute period, causing liquid to drain off and leaving uniform phosphor coating—ideally one molecule thick—to be dried for five minutes at 100 F in special oven.

Photoresist application is then drained of excess and individual 6-7 mil thick steel shadow mask, perforated with 50,000, 10-mil diameter holes spaced 27 mil apart, is fixed in position above plate which must be protected from ultraviolet sources while being transferred to "Lighthouse".

Here sighting device calibrates angle of mercury light source, focused by quartz crystal into single point which is offset one degree so it corresponds to position of appropriate gun inside finished tube. Treated phosphor coating is exposed from four to ten minutes, depending on phosphor color. The shadow mask is then removed and a developer is used to wash off



BUD *Trans-aire*

NOW available in three sizes

BLOWERS

Two years of user acclaim of the B-25 fostered the development of two additional sizes. The Trans-aire Blowers are now available in three sizes with panel spaces of 3½", 5¼" and 7". Air displacement from 100 cfm to 700 cfm results.

Heat generated by tubes and semiconductors not only shortens their life-span, impairs their efficiency but also may cause operational breakdowns. Why take chances with delicate and expensive equipment; install Bud Trans-aire Blowers.

Bud Trans-aire Blowers are ideal for use where excessive heat is generated by equipment in an enclosed rack, cabinet or console. They draw in fresh air or exhaust heated air.

These blowers occupy less area, and a smaller panel space than others having similar air displacement capability. They are the lowest priced units of equal capacity and performance.

To prevent overheating they have thermal overload protection. Automatic reset.

See the Bud Trans-aire Blowers at your Authorized Bud Distributor or write for literature.



BUD RADIO, INC.

CLEVELAND 3, OHIO

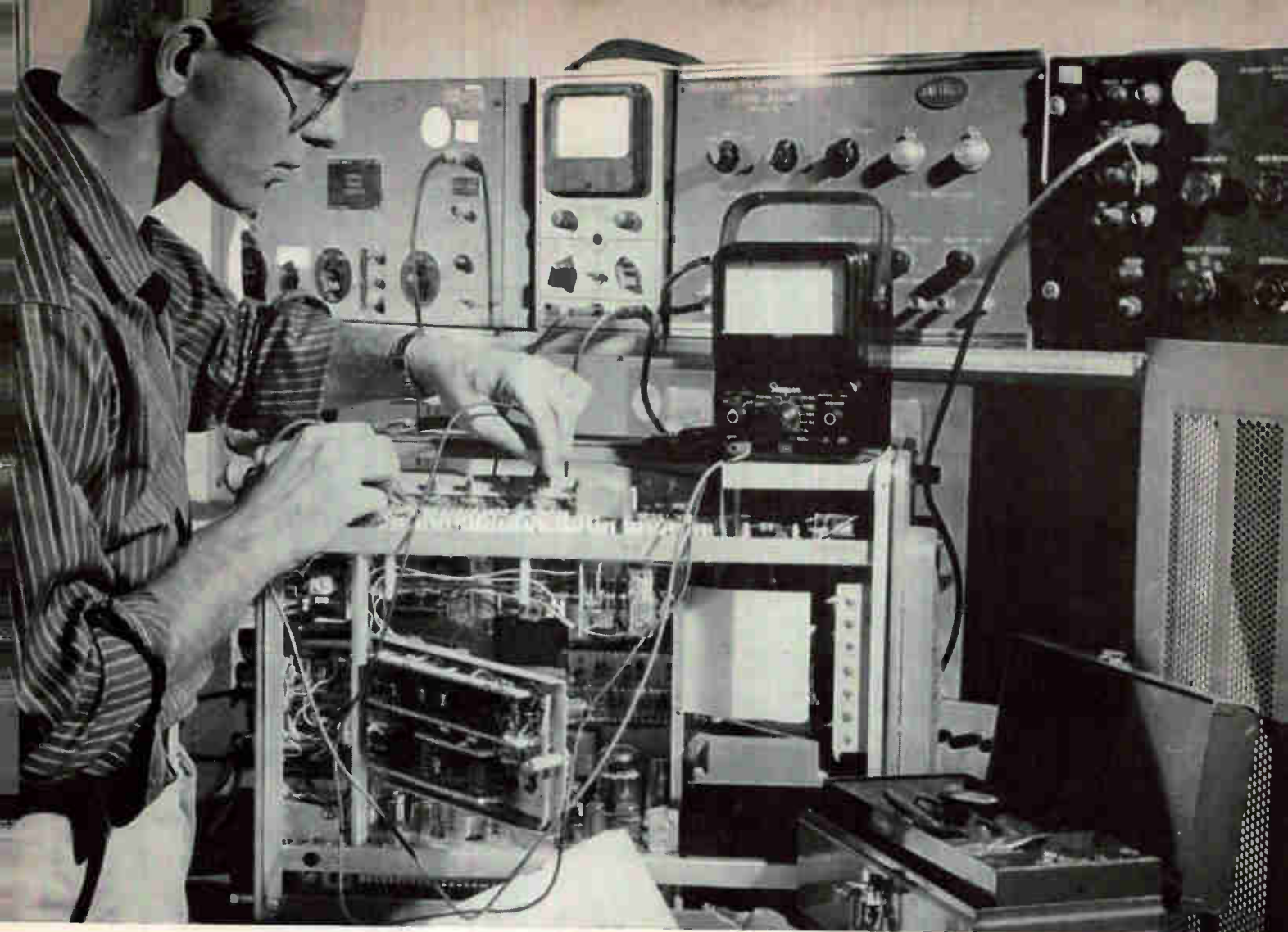

Every Electronics Manufacturer, Large or Small, Can Benefit from Raytheon's INSCAIR

INSCAIR is RAYTHEON'S "INSTRUMENT CALIBRATION AND INCIDENT REPAIR" service now available to manufacturers. It is a low cost basic program designed to insure time, frequency and voltage accuracy of electronic test equipment used by manufacturers or laboratories.

Through INSCAIR, Raytheon will carry out test equipment maintenance and calibration during your peak load periods. A complete year-round maintenance program is also available for your equipment on

a fixed cost basis. Return of the equipment in minimum time, restored to the original manufacturer's specifications, is assured. The INSCAIR program is under the direct supervision of experienced Raytheon electronic engineers, using measurement devices with traceability to NBS standards.

For brochure giving complete scope and capabilities of Raytheon's Electronic Services Division, write to Raytheon Company, Department 66, Lexington 73, Massachusetts, Attention: M. B. Curran.

RAYTHEON

RAYTHEON COMPANY

ELECTRONIC SERVICES DIVISION

Product Support and Customer Service — Field Engineering — Design Engineering — Site Surveys and Planning — Installation — Systems Management — Special Projects — Maintenance — Overhaul and Repair — Restoration and Retrofit Programs — Technical Training — Technical Publications.

6

DIFFERENT MEASUREMENTS ON THIS PART IN LESS THAN A MINUTE!

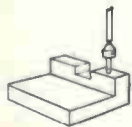

PIECE HEIGHT

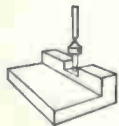

GROOVE HEIGHT

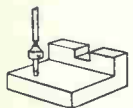

BOTTOM THICKNESS

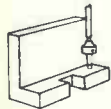

BACK THICKNESS

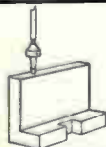

WIDTH



LENGTH



Fast? You bet your life . . . but that's only part of the story. Bausch & Lomb DR-25B Optical Gage gives you *direct* measurement to 0.0001" over a 3" range on a bright, magnified scale . . . to 0.000025" if required. Designed for shop use, no other instrument of this type, at any price, achieves such precision.

Fast, easy, accurate . . . and only \$875! Put the DR-25B to work in your shop and start savings of up to 85% in gaging time (job-proved by Aeroquip Corp., Taber Instrument Corp. and many others.)

Distributed in U.S.A. through the DoALL Company

BAUSCH & LOMB INCORPORATED
61421 Bausch St., Rochester 2, N. Y.

- I'd like an on-the-job demonstration of the DR-25B with no obligation.
- Please send Catalog D-285.

NAME TITLE

COMPANY

ADDRESS

CITY ZONE STATE

BAUSCH & LOMB

SINCE  1853

Made in America, to the world's highest standards.

areas that are unexposed.

Similar process is repeated for blue and then red phosphors before layer—ideally three molecules deep at overlap points—is covered by vacuum evaporated aluminized coat and shadow mask is installed permanently.

Low temperature frit, mixed with binder to consistency of tooth paste, is then applied to polished, sawed edges of tube. Both face plate and color gun sections are baked one hour at 100 C before special jig mates sections and assembly is placed on carborundum tip holders inside special oven for final firing. Program raises oven temperature 10 deg C a minute to 420, holds there for one hour and



Deposition of phosphor color triads on face of new color tube is inspected by Karl Horn and Garth Heisig, Engineering Director

then bakes down 2-3 deg a minute to 100 C, when oven door may be opened to speed cooling process.

Although willing to share all details of tube processing and construction—such as implosion tests which led to adoption of quarter-inch safety plate to handle additional mass of shadow mask—company draws line on sharing proprietary details of yoke deflection and convergence circuits derived from long standing basic company patents.

Horn points out that deflection circuitry draws 20 percent less power than other circuitry and that electronic parabolas provide convergencies equal to better than those in 70 deg color tube.

there's a beehive of activity at

Flair INDUSTRIAL PARK

AEROJET-GENERAL CORPORATION

acquires 73 acres for dynamic expansion



Flair INDUSTRIAL PARK—The new modern industrial center—prominently located along East-West Freeway at major intersection * (San Bernardino Freeway and Rosemead Blvd.) 10 minutes east of Los Angeles Civic Center. Finest residential communities and top engineering talent nearby... Cal-Tech of Pasadena just minutes away.

LEASING 5 TO 25 ACRE SITES AND BUILDING TO TENANTS REQUIREMENTS

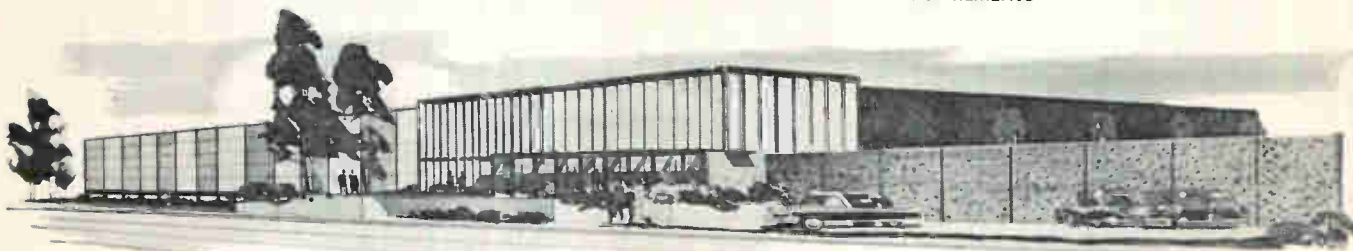

The above 121,000 sq. ft. concrete building on 14 acre site faces *San Bernardino Freeway; available for lease immediately. Planned elevation (illustrated) can be altered to suit tenant.

WRITE, WIRE OR PHONE

AJ

AJ LAND COMPANY a division of AJ INDUSTRIES NYSE-PCSE
6327 SANTA MONICA BLVD. • LOS ANGELES 38, CALIFORNIA

*ADVERTISING ADVANTAGE—California Division of Highway Statistics show 5,534,152 people pass this location monthly on San Bernardino Freeway.

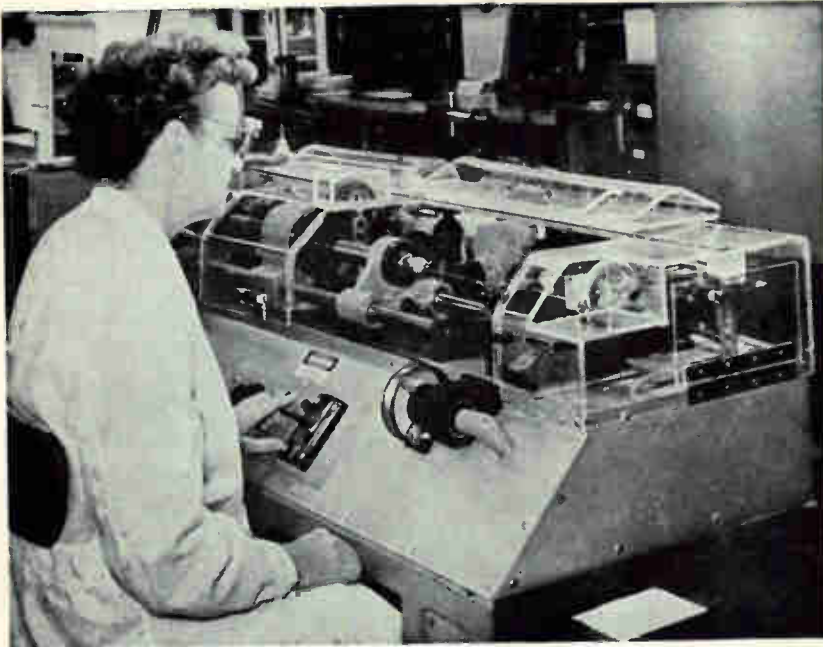

Precision helix winding machine puts locking turns at each end of the mandrel. Later in the process the locking turns are cut off and the coil unwinds slightly, allowing removal of the precision mandrel

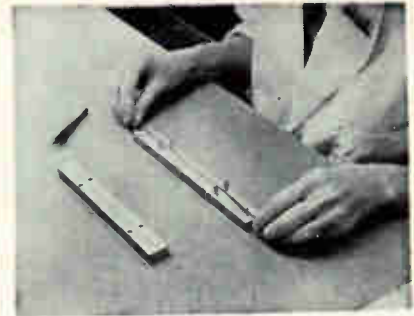

Helix, on mandrel, is placed in molybdenum fixture with ceramic support rods, antennas, and other parts, for firing to fix glaze on rods and to braze other parts



Mandrel is withdrawn after helix is attached to support rods

Manufacturing Precise Helices for TWTs

By C. W. COMO, Western Electric Co., New York, N. Y.

SUCCESSFUL MANUFACTURING of traveling-wave tubes requires special processes for fabricating helices in quantity, at reasonable cost and with the extraordinary precision vital to distortion-free amplification.

The typical helix made by Western Electric is a coil of wire with an "antenna" or coupler at each end. The helix and couplers are bonded by glass to three ceramic rods, making a rigid, self-supporting structure. Bonding the helix at every turn maintains its precision during axial and lateral vibration. Tubes with this type of helix assembly have survived 20-g vibration at 50 to 2,000 cps for extended periods and shocks as high as 80-g for two milliseconds.

Helices are wound on a mandrel or rod by a machine especially developed for twt helices. It will wind

2,000 turns in helices up to 12 inches long, or as many as 500 turns per inch in shorter lengths. Variable pitch matching turns are automatically wound at predetermined positions. Variation in pitch is less than 0.0002 inch and there is no discernible repeated error. Accuracy is built into the machine by the use of extremely precise ball bearings and carefully mated lead screw and nut.

The number of helix turns and the location of variable pitch matching sections is controlled by a programmer. The position of matching sections is determined by counting turns exactly. Matching turn pitch is controlled by a cam.

Helices for a 6784 low-noise, military service twt, for example, use 0.0070-inch-diameter molybdenum wire wound on a 0.0505-inch tungsten mandrel in the following

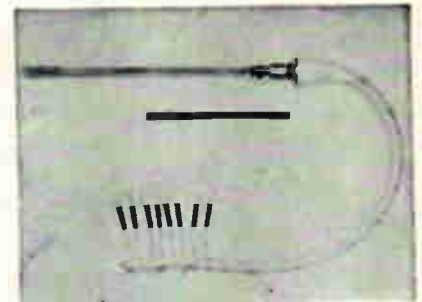

Complete type 6784 twt has noise figure of 5.9 db, operates in the S band

sequence: approximately 90 locking turns are wound at 0.0102 inch pitch; a six-turn variable pitch matching section with pitch decreasing exponentially from 0.085 to 0.0102; a gain section of 482 turns at 0.0102 pitch; another matching section with pitch increasing exponentially from 0.102 to 0.085; and 90 more locking turns at 0.0102 pitch.

Locking turns are wound over a flat portion of the mandrel and hold the helix in place until it is heat-treated. After winding, the

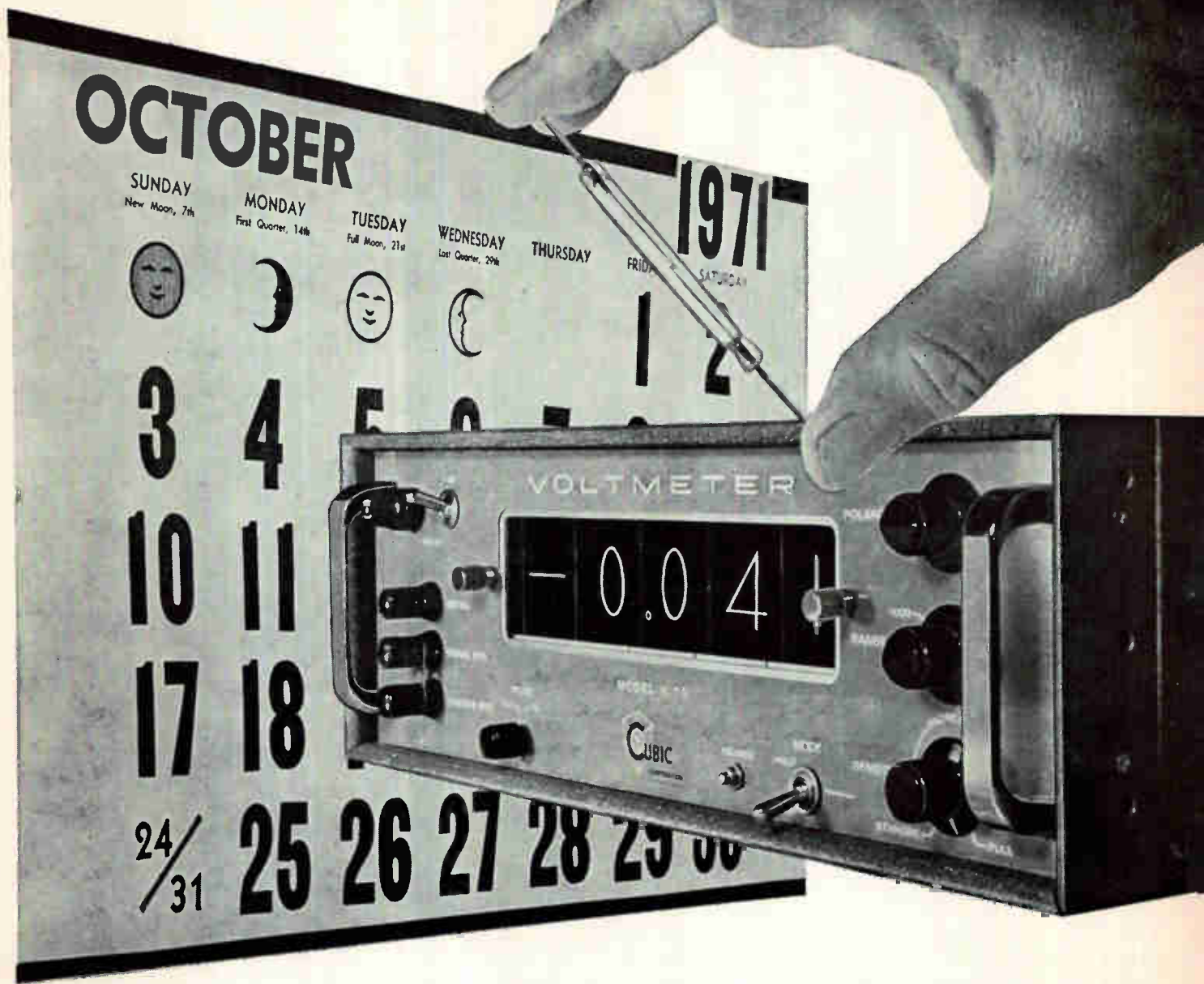

10 years without periodic maintenance!

The reed relays in the new Cubic V-70 series of digital voltmeters assure you of a decade of flawless service. These relays (which replace the stepping switches used in conventional DVMs) have been life-tested for 100 million operations—the equivalent of over ten years of normal operation. The V-70 covers the full DC range from 1 millivolt to 999.9 volts. Balance time is 500 milliseconds; maximum readout time, 750 milliseconds; absolute accuracy is 0.01% plus or minus 1 digit. The meter has no vacuum tubes or moving parts; it operates in any position and is heat and shock resistant; the relays require no maintenance. The V-70 series offers the highest operating speed available in its price range: V-70, only \$1,580; V-71 (with automatic ranging and polarity), \$2,200. For further information, write to Department E-109.



INDUSTRIAL DIVISION
 SAN DIEGO 11, CALIFORNIA • ROME, ITALY

PURITY PLUS!

UNIFORMITY PLUS!

"TRIANGLE RR"

99.7% PURE IMPERVIOUS
RECRYSTALLIZED
ALUMINA

PURITY PLUS! For temperatures to 1950°C (3542°F). Super refractories for the ever increasing high operating temperatures encountered in industry. High purity, and an impervious structure of interlocking corundum crystals, combine to resist chemical attack. Available in thin-walled crucibles and other laboratory ware, noble metal thermocouple insulators, pyrometer protection tubes for severe conditions and high temperature furnace tubes. Other Morganite Refractory products include "Triangle R" Porous Pure Alumina, "Triangle Z" Pure Zirconia and "Triangle H-5" Impervious High Temperature Mullite. Call or write for new catalog.



LABORATORY WARE



COVERS, DISCS, PLATES



FURNACE TUBES

"CRUSILITE" SILICON CARBIDE HEATING ELEMENTS

UNIFORMITY PLUS! Because Crusilite elements age at a uniform rate, furnace temperature profile remains uniform throughout the entire life of the elements. Ideal where night, weekend, end-of-run shut-downs or variations in furnace temperatures are desirable because cycling does not shorten the life of Crusilite. Available in standard, capped, hollow and single-end connection types. Some sizes available in *closely* matched sets. Request new Crusilite catalog.

FOR OVER HALF A CENTURY...

Morganite
INCORPORATED

MANUFACTURERS OF FINE CARBON GRAPHITE PRODUCTS INCLUDING MECHANICAL CARBONS, MOTOR AND GENERATOR BRUSHES, CURRENT COLLECTORS, ETC.

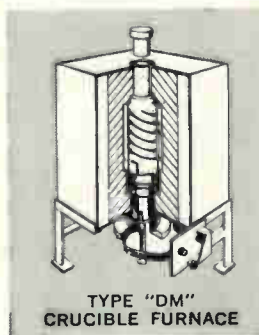

TYPE "DM"
CRUCIBLE FURNACE

3305 48th Avenue
Long Island City 1,
New York

Morganite Canada Ltd.,
49 Mobile Drive
Toronto 16, Canada

TRAVELING-WAVE TUBES

The heart of a traveling-wave tube is a coil of wire, the helix. The signal to be amplified progresses down the helix as an electromagnetic wave. Electrons, accelerated from a hot cathode by a high-voltage electrode and guided by magnetic fields, shoot down the axis of the helix in a narrow beam. Energy from the beam is transferred to the signal, increasing its strength many thousand times.

Providing high gain over wide bandwidths, traveling-wave microwave amplifier tubes are greatly increasing the capabilities of long-line telephony. With the 44A tube, the Bell System's TH Microwave Radio Relay System of six two-way channels will handle 11,000 telephone conversations simultaneously, or 12 tv channels and 2,500 conversations. This is approximately three times the capacity of the present TD-2 system. Among important military applications are the command guidance systems developed by Bell Laboratories for the Nike Hercules and Titan missiles.

accuracy of each lot is verified by microdeviometer¹ measurements.

The helix is heat-treated in a hydrogen atmosphere to partially anneal the wire and to remove oxidation. Then the locking turns are cut off and the winding is allowed to spring loose on the mandrel. In the 6784 helix, springback reduces the gain section turns by three and increases the internal diameter by 0.0005 inch. Although the winding is loose on the mandrel, allowing the mandrel to be removed later, dimensions are still well within specifications. Yield depends mostly on careful handling through succeeding operations to retain wound-in accuracy.

Three ceramic, centerless-ground support rods are spaced 120 degrees apart around the outside diameter of the winding. These are 0.0480 inch in diameter in the 6784 twt.

Before assembly, the rods are cleaned ultrasonically. Then a ribbon of glaze is sprayed the length of the rod. The glaze is finely powdered glass frit suspended in a vehicle of Acryloid and Cellosolve

Acetate. Since the shape and amount of glaze affects dielectric loading, geometry is carefully controlled by special design spray masks. Poor distribution and lumpiness will cause mechanical and electrical faults. The rods are heat-treated to fuze the glaze and drive off the binder.

Couplers are assembled to each end of the helix. In the 6784, molybdenum couplers are plated inside with copper and nickel. During heat-treating, the plated layers alloy and braze the antennas to the wires. Other types use a brazing eyelet or weld.

The helix couplers, rods and other parts are positioned in a fixture and the assembly is fired in forming gas to glaze the helix turns to the ceramic support rods and to braze the wires to the couplers. The molybdenum fixtures, machined to gage tolerances, can be used hundreds of times without deterioration. After firing, the assembly is removed from the fixture and the mandrel is withdrawn from the helix. Each of the glaze joints—as many as 1,500 in types such as the 6784—is mechanically sound and has the same approximate fillet geometry.

Glazed assemblies meeting straightness, dimensional and mechanical requirements are sprayed over part of the assembly length with Aquadag. The Aquadag, stabilized by vacuum firing, is an attenuator in the completed tube, providing r-f isolation between input and output circuits and thus preventing reflected waves from producing oscillations.

Helix match loss is measured to cull out assemblies with marginal electrical characteristics. The match test evaluates the ability of the helix to accept radio signals and release amplified signals at the tube operating frequency. The loss test evaluates the effectiveness of the attenuator. These tests also verify the accuracy of the helix pitch since the electrical characteristics depend largely on winding accuracy.

REFERENCE

(1) H. T. Closson, W. E. Danielson and R. J. Nielson, Automatic Measurement of Small Deviations in Periodic Structures, *Bell Telephone System Technical Publications*, Feb., 1959.

first from **triolab**...

a new standard of precision in
AC VTVMs

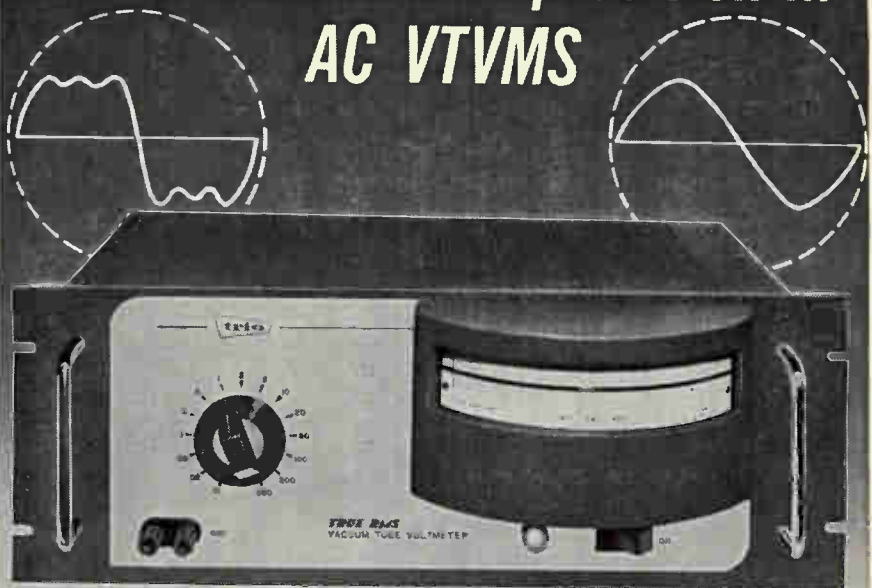

now measure both complex and sine waves with 0.25% accuracy

'Til now, no VTVM has been able to measure complex waves with high laboratory standard accuracy. Average-reading and peak-reading instruments are subject to significant distortions created by spikes and harmonics.

New triolab Model 120 achieves direct-reading, true RMS values of both sine and complex waves with deflection directly proportional to the square of the current—by use of a special dynamometer movement.



- **DIRECT-READING**
No knobs to twist or tedious balancing.
- **INSTANT MEASUREMENT**
No sluggish, thermo-couple response.
- **HIGHEST LEGIBILITY**
Full 7" custom-calibrated, mirror scale.
- **CONSTANT OVERALL GAIN**
For long life.
- **DIAMOND BEARINGS**
For perfect balance, smooth scale motion.

Ranges: 10MV to 500V rms, full scale. Input impedance: 1 meg. Fundamental freq. response: 50-2000 cps. Accuracy (above 50% electrical deflection): 1/4 % f.s. at 400 cps; 1/2 % f.s. at all other frequencies. Power: 115 VAC, 50-400 cps.

AVAILABLE RACK-MOUNTED OR PORTABLE

triolab other laboratory and build-in miniature precision instruments can help you. Write for Catalog E9-B.

triolab

TRIO LABORATORIES, INC., Plainview, L. I., N. Y.
Export Dept: EMEC, 127 Grace St., Plainview, N. Y.

New On The Market

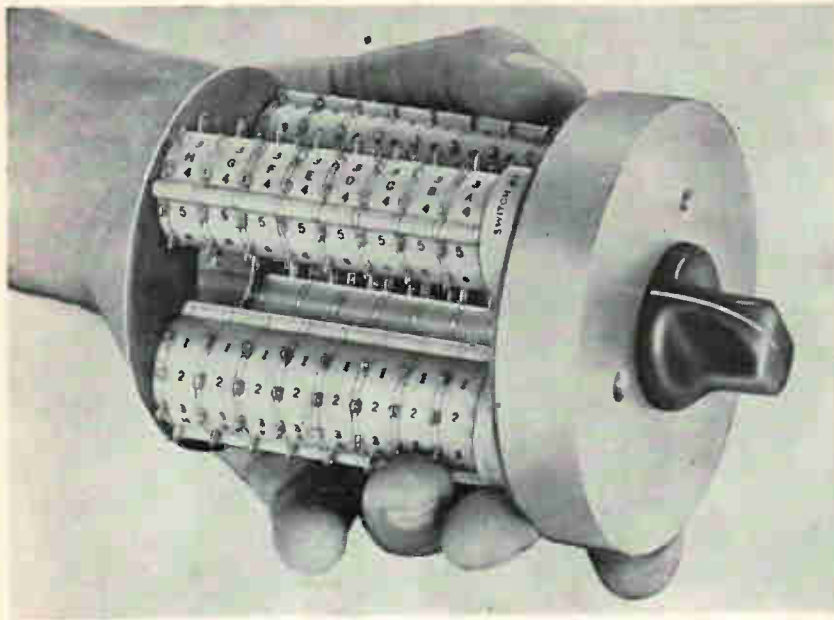

Missile Interrogation Switch ANY DEGREE OF INDEXING

JANCO CORP., 3111 Winona Ave., Burbank, Calif. Series 2000 missile interrogation switch is designed and built to exceed MIL-S-6807A. Being totally enclosed, it affords protection against adverse conditions. It is adaptable for dry circuit and signal level switching ap-

plications. Power handling capacities are up to 5 amp 115 v a-c and 3 amp 28 v d-c resistive, and 2 amp 28 v d-c inductive; contacts are for make, break, and carry. Price range is from \$100 up.

CIRCLE 301 ON READER SERVICE CARD

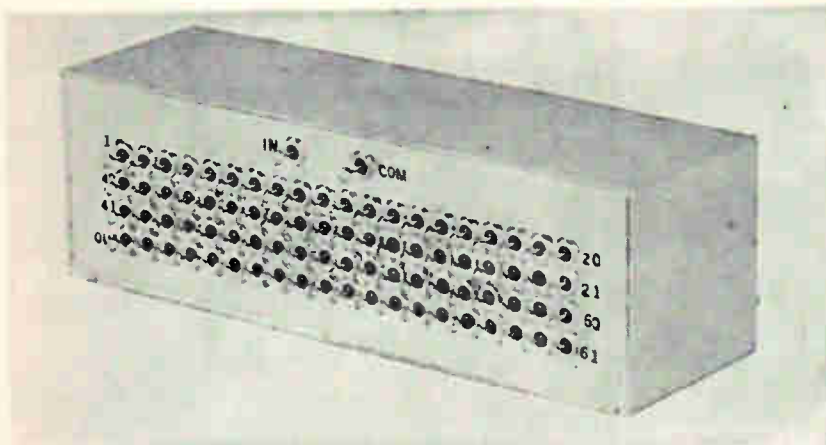

Delay Line MINIATURE, MULTIOUTPUT

VALOR INSTRUMENTS, INC. 13214 Crenshaw Blvd., Gardena, Calif. Model DL356 Porcupine delay line has 80 equally spaced taps arranged for easy identification and a wide variety of delay periods. It has a total delay of 4.0 μ sec and a tapped

output every 0.05 μ sec. It provides flexibility in delay selection for applications such as the proper phasing of multiple channel tape recorders.

CIRCLE 302 ON READER SERVICE CARD

Tuned Amplifier AND NULL DETECTOR

GENERAL RADIO CO., West Concord, Mass. A low-noise, transistor amplifier with 1- μ v full-scale sensitivity tunes continuously from 20 cps to 20 Kc, with additional fixed-tuned frequencies of 50 Kc and 100 Kc. Type 1232-A is intended as a bridge detector, but has other applications, including the detection of h-f modulated signals, approximate wave analysis at audio frequencies and as a preamplifier for transducers. Price is \$360.

CIRCLE 303 ON READER SERVICE CARD



Rotary Switch SOLID STATE

WHITE AVIONICS CORP., Terminal Drive, Plainview, N.Y. Rotary switch consists of a slotted disk passing a beam of light to photosensitive diodes, and can be provided with virtually any switching sequence with an angular accuracy of 0.25 deg. It is designed for military or other severe environmental applications at temperatures up to 100 C. Current capacity of 150 ma at 28 v d-c permits control of relays.

CIRCLE 304 ON READER SERVICE CARD

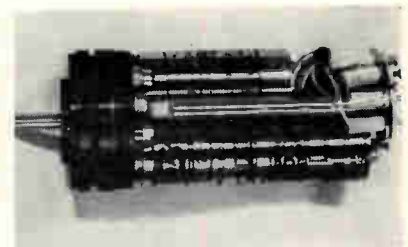

Integrated Assembly NO BULKY GEARBOX

DAYSTROM, INC., Transicoil Division, Worcester, Pa. Integrated servo assembly contains a size 5 motor, a size 5 synchro and precision gearing (gear ratios up to 875:1 are available). Output shaft is geared 1 to 1 with a size 5 control transformer. The output shaft positions

CIRCLE 165 ON READER SERVICE CARD →

The important advances in environmental testing come from MB

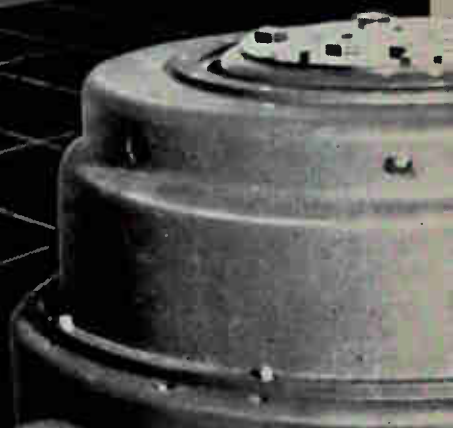
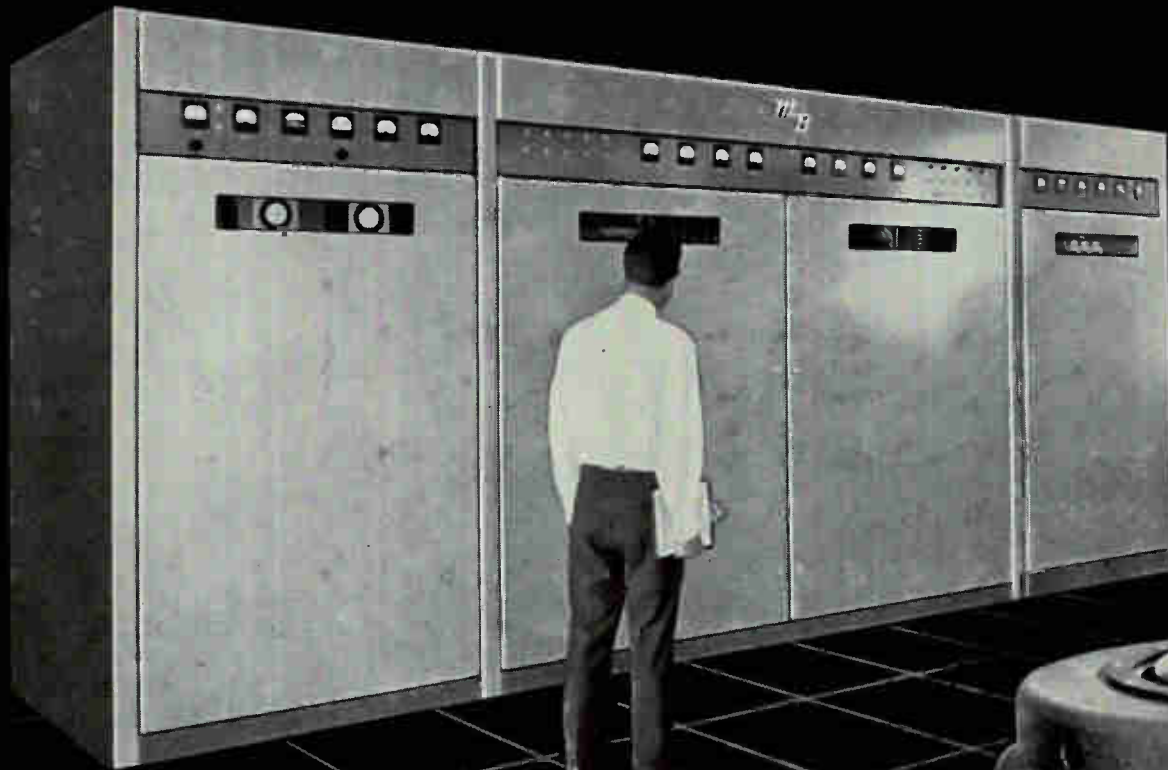

New 5140MB power amplifier improves reliability in sine wave and complex motion testing

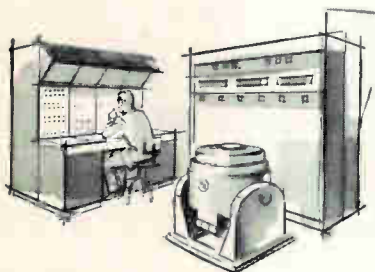

A pioneer and leader in the field of electrodynamic vibration systems, MB continually strives to improve the performance and reliability of vibration, shock and fatigue testing. The important advances in environmental testing come from MB.

MB Electronics has representatives in principal cities throughout the world.

The Model 5140MB Power Amplifier is designed to drive the Model (C210) 28,000 lb. force and Model (EL 10,000) 40,000 lb. force vibration exciters. Rated at 140,000 volt amperes output with plate dissipation of 240 kw, the amplifier offers the most conservative and reliable operation in the vibration testing field. It will readily handle all the adverse inductive and capacitive loading of the electrodynamic exciter.

These outstanding features are responsible for the greater reliability of the Model 5140MB amplifier:

1. 15 db negative feedback provides lowest source impedance and lowest distortion into the shaker load.
2. Oversized driver tubes for high random peaks.
3. Oversized amplifier with oversized output tubes.
4. Plate dissipation capabilities exceed vibration exciter requirements by a minimum of 33 $\frac{1}{3}$ %.
5. Compact water systems feature "water-miser" regulation of secondary water and a demineralizer insures low conductivity in primary coolant.

For additional information on the new 5140MB Power Amplifier, write for Bulletin 134.

MB ELECTRONICS

A DIVISION OF TEXTRON ELECTRONICS, INC., 1082 State Street, New Haven 11, Conn.

CIRCLE 165 ON READER SERVICE CARD

itself to agree with 3-wire electrical input data received from any synchro control transmitter. Com-

plete assembly is integrally housed in a size 11 configuration.

CIRCLE 305 ON READER SERVICE CARD

cps to 10 Kc. Featuring a minimum current gain of 1,000 at 100 μ a I_c, and a minimum current gain of 7,000 at 150 ma, the devices are suited for applications requiring high gain in a compact space.

CIRCLE 309 ON READER SERVICE CARD

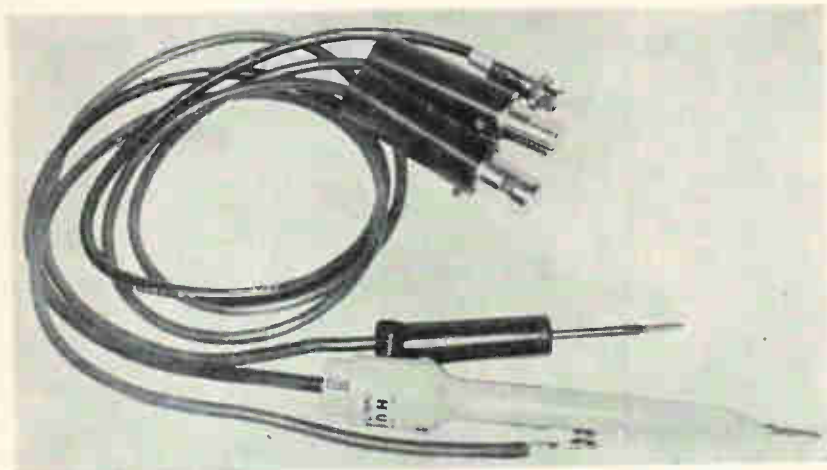

Welding Tool PENCIL PROBE TYPE

HUGHES AIRCRAFT CO., 2020 Short St., Oceanside, Calif. The VTA-43 pressure sensing pencil probe type welding handpiece facilitates small, pin-point welds entirely from one side of a work surface. Probe is adjustable to fire the weld energy

at preset pressures ranging from $\frac{1}{2}$ to 5 lb, permitting welds of consistent quality on hard-to-get-at thin metal applications. Price is \$75.

CIRCLE 306 ON READER SERVICE CARD



Discriminator PULSE HEIGHT

BECKMAN INSTRUMENTS, INC., Berkeley Division, 2200 Wright Ave., Richmond, Calif. Designed to drive high-speed electronic scalars, the model 2301 pulse height discriminator provides an output pulse only when the input signal is within a preselected amplitude range. With the ability to resolve paired-pulses spaced as close as 0.5 μ sec, it is suited for nuclear radiation or x-ray spectrum analyses.

CIRCLE 307 ON READER SERVICE CARD

Transponder Test Set VERSATILE UNIT

KEARFOTT DIVISION, General Precision, Inc., 1150 McBride Ave., Little Falls, N. J. Transponder test

set is built in accordance with ARINC 532 C. In conjunction with a suitable oscilloscope, it checks out any transponder—two pulse, three pulse, or combinations. Through amplitude control of each pulse in the interrogation train, the test set also checks out side-lobe suppression features of the system.

CIRCLE 308 ON READER SERVICE CARD

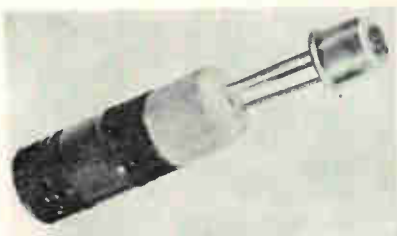

Transistor Element TWO IN ONE WAFER

TEXAS INSTRUMENTS INC., P. O. Box 5012, Dallas 22, Texas. The TI602 is a planar silicon device combining two transistors in one wafer—one driving the other to form a Darlington Pair, providing ultra-high gain at audio frequencies from 10

Pulsed X-Ray System

MB ELECTRONICS, a division of Textron Electronics, Inc., 781 Whalley Ave., New Haven 8, Conn. Multiple pulse x-ray system capable of charting the performance of totally enclosed moving parts creates a new dimension in environmental test studies.

CIRCLE 310 ON READER SERVICE CARD



Standard Instruments FOR THE EXPORT MARKET

WEINSCHEL ENGINEERING, 10503 Metropolitan Ave., Kensington, Md., has underway a product improvement program to make its instruments suitable for shipment to the export market. First two instruments available as a result of this program are the BA-1D bolometer preamplifier and model MO-1C, a highly stable 1Kc modulator.

CIRCLE 311 ON READER SERVICE CARD

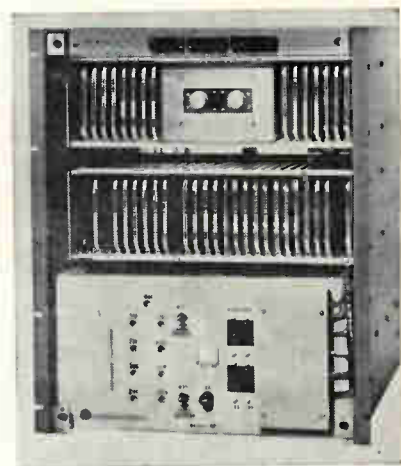

Core-Memory Systems HIGH SPEED, LOW COST

COMPUTER CONTROL CO., INC., 983 Concord St., Framingham, Mass. Transistorized random-access mag-

This slotted-blade vaneaxial fan design represents one of many special fan models available at Electric Boat Division for applications where small size, low airborne noise, low structure-borne vibration and long service life are important factors □ Turbo-slot vaneaxial fans are designed for lower speeds and with smaller tip diameters than the conventional vaneaxial fan, yet produce the same airflow and pressure rise □ Lower speeds extend the maintenance-free life of the fan and reduce airborne noise as well as structure-borne vibration levels □ The smaller tip diameters allow for light weight features and further contribute to lowering airborne noise levels □ Call New London, Conn. Hilltop 5-4321, Ext. 1933, or write Fan Department (E), Electric Boat, Groton, Connecticut.

ELECTRIC BOAT A DIVISION OF GENERAL DYNAMICS **G**



NEW FROM ELECTRIC BOAT
TURBO-SLOT FANS FOR ELECTRONIC COOLING

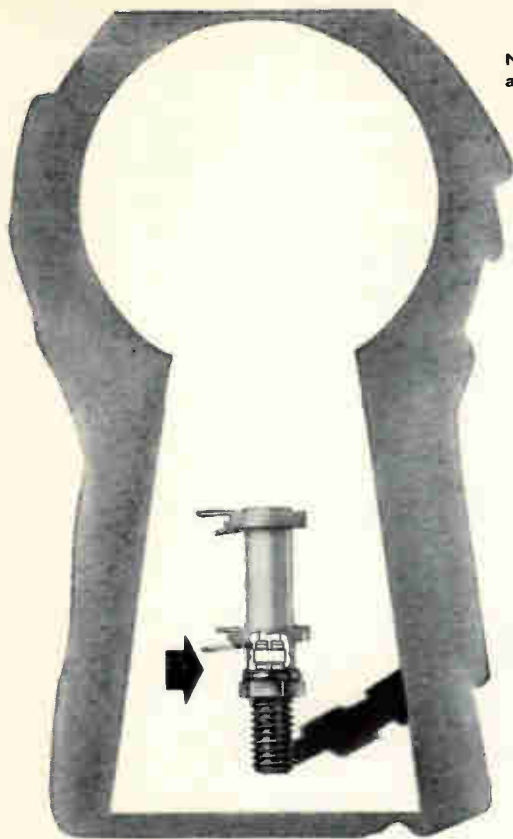

New advanced coil forms
and Internal PERMA-TORQ®

RELIABILITY... locked in and guaranteed

Working on the problems plaguing electronic systems design, CAMBION® engineers developed a new device to keep coils and coil forms in proper adjustment.

This exclusive development is the CAMBION internal PERMA-TORQ, a miniaturized, constant tensioning unit located completely within the CAMBION ceramic coil form. Allowing tuning cores to be locked while still tunable, it considerably reduces harmonics, provides increased stability and decreases oscillation in high gain IF strips. Reliability under all conditions keynotes the performance.

New Internal PERMA-TORQ is available in coil forms with the normal yellow, red, green and white slugs — (range: 0.2-300 MC) and with purple slugs (range: 2-40 MC) and blue slugs (range: 40-300 MC). Mechanically, PERMA-TORQ is very easy to adjust. Only a special tuning tool is needed.

CAMBION makes more than 1500 coil forms with varying collar-and-terminal arrangements — including ceramic, phenolic and shielded forms for conventional and printed circuits. All are guaranteed to meet your specifications.

The broad CAMBION line includes plugs and jacks, solder terminals, insulated terminals, terminal boards, capacitors, shielded coils, coil forms, panel hardware, digital computer components. For a catalog, for design assistance or for both, write to Cambridge Thermionic Corporation, 437 Concord Ave., Cambridge 38, Massachusetts. In Europe contact Maitland Engineering, Ltd., 50 Heaton Moor Rd., Stockport, England, or Uni-Office, N.V., P.O. Box 1122 Rotterdam, The Netherlands.

CAMBRIDGE THERMIONIC CORPORATION
CAMBION®
The guaranteed electronic components



netic-core memory systems have storage capacities ranging from 20,480 bits to 163,840 bits at cost as low as 25 cents per bit. Access times of 2.5-4.0 μ sec and read-write cycle times of 5-10 μ sec are obtained with specially developed 1 Mc S-PAC digital modules which feature high component density and high reliability.

CIRCLE 312 ON READER SERVICE CARD

Tiny Connector

NATIONAL CONNECTOR CORP., Science Industry Center, Minneapolis 27, Minn. High density micromodule connector has provision for more than 250 terminations within a block approximately 2 in. by 2½ in. Components may be mounted between 32 p-c boards.

CIRCLE 313 ON READER SERVICE CARD

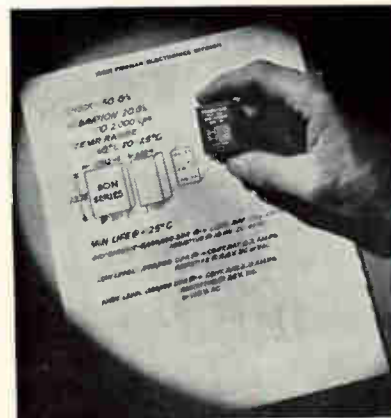

Microminiature Relays SENSITIVE DEVICES

IRON FIREMAN MFG. CO., 2838 S. E. 9th Ave., Portland, Ore., announces the 90N series of sensitive (80 mw) 4pdt, microminiature relays for dry circuit to high level switching. They conform to and exceed test specifications of MIL-R-5757D and feature bifurcated contact construction for long life and high reliability.

CIRCLE 322 ON READER SERVICE CARD

X-Y Recorder

HOUSTON INSTRUMENT CORP., P.O. Box 22234, Houston 27, Texas. Model HR-95 X-Y recorder designed for rack mounting is available with either 1 mv per in. or 10 mv per in. amplifiers.

CIRCLE 323 ON READER SERVICE CARD



P-C Connector

140 TERMINATIONS

VIKING INDUSTRIES, INC., 21343 Roscoe Blvd., Canoga Park, Calif. Connector provides two sets of twin receptacles to accommodate 1/16 in. p-c boards. It has a total of 140 terminations divided into two sets of 38 and 32 contacts. Unit has staggered, pierced terminations that facilitate soldering operations. Overall length is 8.63 in. with 0.100 in. contact spacing. Breakdown voltage is 2,200 v a-c at sea level and current rating is 3 amp.

CIRCLE 324 ON READER SERVICE CARD

Induction Motor

KEARFOTT DIVISION, General Precision, Inc., 1150 McBride Ave., Little Falls, N. J. The F-30-3 is a high output-to-weight ratio induction motor designed to drive an axial vane blower.

CIRCLE 325 ON READER SERVICE CARD



High-Power SCR's IN STUD PACKAGE

TEXAS INSTRUMENTS INC., P. O. Box 5012, Dallas 22, Texas. The TI-150 series of diffused silicon controlled rectifiers is rated for an average rectified forward current of 25 amp at 100 C, carrying a maximum d-c current of 35 amp at 95 C. Rated breakover voltages, both forward and reverse, for the series of five are 50, 100, 200, 300 and 400 v.

CIRCLE 326 ON READER SERVICE CARD

Digital Multimeter

ORTRONIX, INC., P.O. Drawer 8217A, Orlando, Fla. Model 5126A militarized solid-state digital multim-

recording history at the bottom of the sea

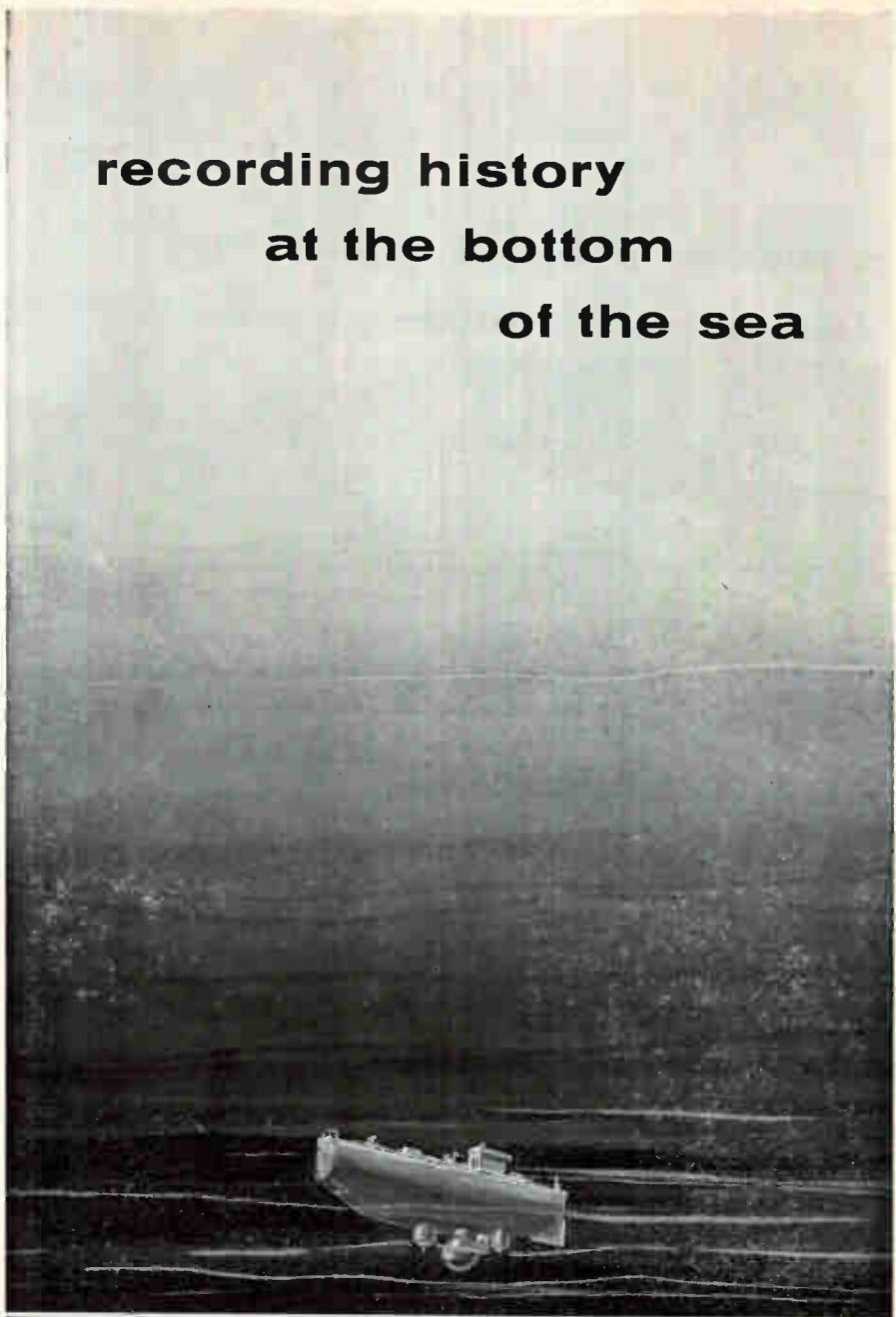

Far below the surface, in a sealed steel ball on the *Trieste* bathyscaph, a new chapter in undersea history is being recorded—on magnetic tape. Operating in an environment of 99% relative humidity, a high-performance instrumentation tape recorder captures a permanent record of depth, temperature, ambient noise, and voice.

The recorder, Precision Model PS-207 as shown at right, was modified for the application by Lockheed Aircraft Corporation, Sunnyvale, Calif., and supplied by them to the Naval Electronics Laboratory, San Diego, for the *Trieste* installation.

For details on Precision PS-200 series analog and digital recorders for other applications, write:



PRECISION INSTRUMENT COMPANY

1011 Commercial Street • LYtell 1-4441 • San Carlos, California

Cable: PRINCO, San Carlos, California • TWX: SCAR BEL 30

Representatives in principal cities throughout the world

THE *light* TOUCH

IN
AUTOMATION
AND
CONTROL

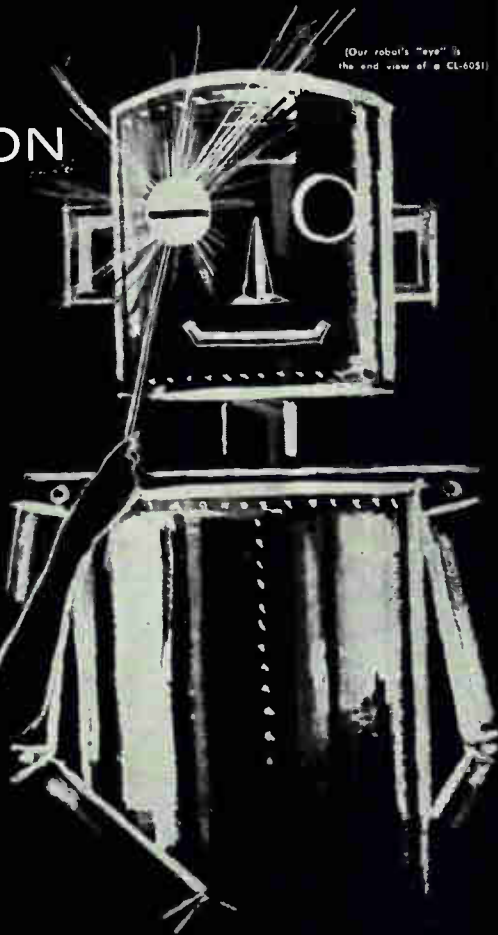

Clairex Photoconductive Cells, like the human eye, are "windows to the world" of control system design. Our continually expanding line now includes the S-1 series of hermetically sealed Cadmium Sulphide cells, employing a sensitive material formulation that matches the spectral sensitivity of the human eye! These are the first real "electronic eyes" and thus are particularly useful in applications involving human vision . . . such as Daylight Switches, Photography, and Automatic Brightness Control in Television Receivers.

CLAIREX
CORPORATION

and New Facilities . . . to meet Growing Needs
5 WEST 30 STREET, NEW YORK 1, N. Y. • MU 4-0940

eter offers high-speed automatic full scale ranging.

CIRCLE 327 ON READER SERVICE CARD



Servo Amplifier TRANSISTORIZED

MELCOR ELECTRONICS CORP., 48 Toledo St., So. Farmingdale, L. I., N. Y. Subminiature servo amplifier can drive a 40 v, 2 phase servomotor up to 3½ w input. Weighing 1 oz, the model 1035 employs silicon transistors and operates at 400 cps over a temperature range from -55 C to +125 C at the mounting base. Price: \$190-\$200 in sample quantities.

CIRCLE 328 ON READER SERVICE CARD



Frequency Detector SOLID STATE

AIRPAX ELECTRONICS INC., Fort Lauderdale, Fla. Frequency detection up to 20,000 cps is accomplished by the Magmeter at a linearity better than 0.25 percent. This detector may be used in tachometry, frequency measurement, instrumentation and telemetry. It is essentially a saturating transformer that has the inherent characteristic of providing output pulses of constant volt-sec area.

CIRCLE 329 ON READER SERVICE CARD

Multiple Diode

RAYTHEON CO., 150 California St., Newton, Mass. Multiple diode for logic circuit applications consists of three diodes packaged in a single TO-5 case.

CIRCLE 330 ON READER SERVICE CARD

SERVO IR Report

Bolometer Range Expanded By New Line of Standards

Expansion Based On Series
Approved For Army Signal Corps Use



Following rigid Army Signal Corps environmental tests, a broad new line of SERVOTHERM® infrared detectors is now being produced by Servo Corporation under an "Industrial Preparedness Contract" with the U.S. Army Signal Supply Agency.

The new line, now being offered for broad military, industrial, and laboratory use, includes a wide selection of infrared thermistor bolometer models with various window materials, flake sizes, and plain or flange mountings. Regular and immersed thermistor bolometers are offered, as well as stem types, with germanium and silver chloride windows as standard.

SERVOTHERM bolometers can also be supplied with SERVOFRAX® arsenic trisulfide glass, and conventional types of optical glass, calcium fluoride, silicon, KRS-5, and other infrared transmitting materials. Custom designs, including high-ambient and multi-element types, are available.

The further development of production techniques has resulted in reduced costs while improving performance and reliability.

From a simple infrared lens, to a complex infrared system . . . look to Servo



Infrared Optics

Standard and special optical shapes available in all sizes and transmitting

materials. Infrared wavelengths from less than 1 to more than 20 microns. Excellent refractive and reflective optics for research, laboratory, industrial, and military use.

IR detectors and associated circuitry

Uniformly sensitive thermistor detectors for fast, accurate, remote detection of radiation from visible through far infrared. Wide variety of time constants, capsule configurations, and window materials. SERVOTHERM® circuitry exploits speed, sensitivity, wide range, low noise, compactness, and flexibility of heat detector cells.



Call or write for further information...or a Servo applications engineer.



SERVO CORPORATION OF AMERICA

111 New South Road • Hicksville, Long Island, N.Y. • WE 8-9700

CIRCLE 211 ON READER SERVICE CARD

September 29, 1961



D-C Power Supply SHORT CIRCUIT-PROOF

PERKIN ELECTRONICS CORP., 345 Kansas St., El Segundo, Calif. Model MTR28-10 is a laboratory d-c power supply with a dynamic regulation of ± 0.1 percent line and ± 0.4 v load while providing 24-32 v at 10 amp. RMS ripple is only 2 mv. Unit features a magnetic amplifier for reliable steady-state regulation and a transistor series regulator to resist transient over-shoots.

CIRCLE 331 ON READER SERVICE CARD

D-C Amplifier

NEFF INSTRUMENT CORP., 1088 E. Hamilton Road, Duarte, Calif. Type 101B solid state differential d-c amplifier is designed to amplify low level signals in the 0-100 cps range.

CIRCLE 332 ON READER SERVICE CARD

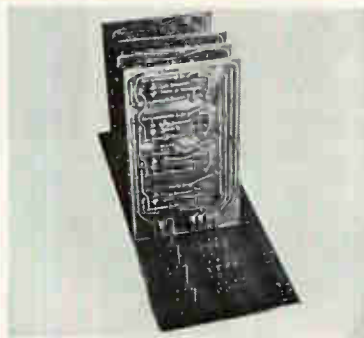

Miniature Connector FOR P-C BOARDS

COMPONENTS CORP., Denville, N. J. The Digi-Klip is a space-craft p-c board connector that can perform continuously at temperatures of more than 200 C without fatigue or contact failure. Incorporation directly into the etched board makes it possible to eliminate wiring for interconnection of circuit boards, such as decade counting units, etc.

CIRCLE 333 ON READER SERVICE CARD

Unit Oscillator

BURR-BROWN RESEARCH CORP., Box 6444 Tucson, Ariz. High purity sine waves of fixed frequency are pro-

Now your lab
can have
an accurate
temperature
chamber
for only \$735



Now, for the first time, Associated's new Econ-O-Line brings you an accurate low-high temperature chamber, priced within reach of your budget! Designed for test laboratory, research and quality control, it offers features never before available for so little money!

- Temperature range:
— 100° F. to + 350° F.
- Pull down to — 100° F. from ambient in less than 5 minutes
- Heat up to + 350° F. in 30 minutes
- Liquefied CO₂ refrigeration
- Plenum chamber, no direct gas injection into working space
- Accuracy $\pm 2^\circ$ F.
- Fan circulation with externally mounted motor
- United Electric indicating controller
- 14" x 14" x 14" stainless steel work area, heliarc welded
- Heavy gage steel exterior
- 2" port and plug for external connections

Complete specifications in Bulletin C-17-2. Write for your copy today.

Associated

ASSOCIATED TESTING LABORATORIES, INC.
(Manufacturing Division)
155 ROUTE 46 • WAYNE, NEW JERSEY • Clifflord 6-2800
TEST LABORATORIES
Wayne, N.J. • Winter Park, Fla. • Burlington, Mass.

CIRCLE 171 ON READER SERVICE CARD

171

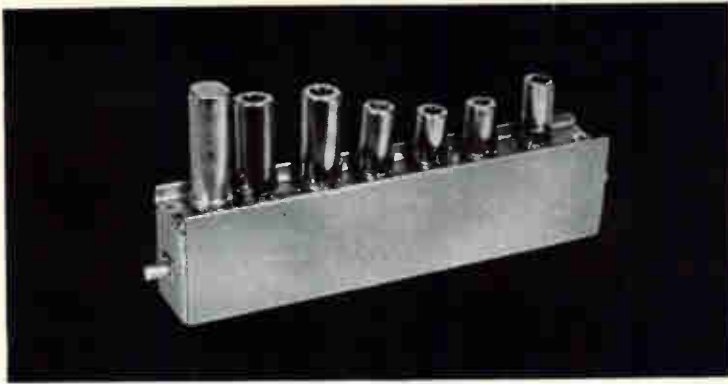

That "special" IF strip or

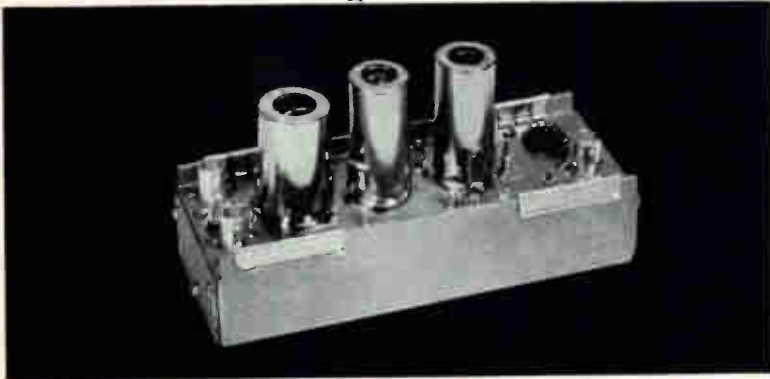

amplifier is probably an

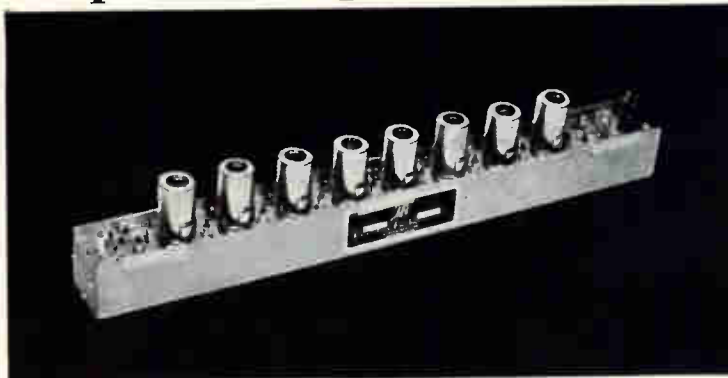

INSTRUMENTS FOR INDUSTRY standard

Check with IFI first for that IF strip or "special purpose" amplifier! Our work in designing and producing electronics systems has resulted in an array of IFI units that meet stringent specifications at lower cost than you'll find elsewhere... and most of them are available for immediate, off-the-shelf delivery. Just tell us your requirement. More than likely, we'll come up with the goods!



INSTRUMENTS FOR INDUSTRY, INC.

101 NEW SOUTH ROAD • HICKSVILLE, L. I., N. Y. • OV 1-7100

vided by the transistorized model 1391 unit oscillator.

CIRCLE 334 ON READER SERVICE CARD



Low Noise Amplifier

HIGH STABILITY

MELABS, 3300 Hillview Ave., Palo Alto, Calif. Model X-217 has a noise figure of less than 2 db. Operating range is 1,220 to 1,350 Mc, tuning being accomplished with only a single control. Gain is a minimum of 20 db over a nominal bandwidth of 15 Mc. Unit is a regenerative type with a pump frequency at 9,750 Mc.

CIRCLE 335 ON READER SERVICE CARD

Flash Lamp Pulser

SHAPIRO & EDWARDS, 1130 Mission St., S. Pasadena, Calif. Model 110 features high light output, high energy flashes, short flash duration and high repetition rate.

CIRCLE 336 ON READER SERVICE CARD

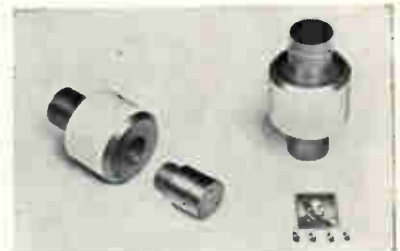

Power Varactors

HIGH Q UNITS

MICROWAVE ASSOCIATES, INC., Burlington, Mass., announced a series of 55 high Q silicon power varactors with a wide variety of breakdown voltage values from 6 v through 120 v. They are available in a subminiature "pill" case with axial prongs. Uses include high efficiency harmonic generation, radars, beacon transponders, microwave communications transmitters, and test equipment.

CIRCLE 337 ON READER SERVICE CARD

Time Delay Control

THE VICTOREEN INSTRUMENT CO., 5806 Hough Ave., Cleveland 3, O. Time delay control, with applica-

**IN LESS THAN
4 SECONDS**

FROM THIS

TO THIS

OR THIS

WITH THE REVOLUTIONARY
PRODUCTION AID TOOL!

"PIG-TAILOR"[®]

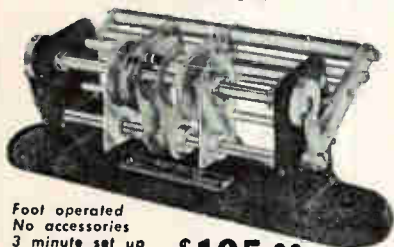

Foot operated
No accessories
3 minute set up

\$125.00

'PIG-TAILORING'

a revolutionary new mechanical process for higher production at lower costs. Fastest PREPARATION and ASSEMBLY of Resistors, Capacitors, Diodes and all other axial lead components for TERMINAL BOARDS, PRINTED CIRCUITS and MINIATURIZED ASSEMBLIES.

PIG-TAILORING eliminates:

- Diagonal cutters
- Long nose pliers
- Operator judgment
- 90% operator training time
- Broken components
- Broken leads
- Short circuits from clippings
- 65% chassis handling
- Excessive lead tautness
- Haphazard assembly methods.

PIG-TAILORING provides:

- Uniform component position
- Uniform marking exposure
- Miniaturization spacing control
- "S" leads for terminals
- "U" leads for printed circuits
- Individual cut and bend lengths
- Better time/rate analysis
- Closer cost control
- Invaluable labor saving
- Immediate cost recovery.

Pays for itself in 2 weeks

"SPIN-PIN"[®]

Close-up views of "SPIN-PIN" illustrate fast assembly of tailored-lead wire to terminal.

- No Training
- No Pliers
- No Clippings
- Uniform Crimps
- 22 Sizes

PAYS FOR ITSELF
THE FIRST DAY!

\$500

EACH



Write for illustrated book to Dept. E-8



BRUNO-NEW YORK INDUSTRIES CORP.

DESIGNERS & MANUFACTURERS OF ELECTRONIC EQUIPMENT
460 WEST 34th STREET • NEW YORK 1, N. Y.

CIRCLE 212 ON READER SERVICE CARD

September 29, 1961

tions in magnetic amplifier circuits, is independent of ambient temperatures up to 350 F and unaffected by external radiation and random noise.

CIRCLE 338 ON READER SERVICE CARD

H-F Sealing Machine

KAHLE ENGINEERING CO., 3322 Hudson Ave., Union City, N. J. No. 1243 is a high frequency sealing machine for making glass to metal seals (lighthouse tubes).

CIRCLE 339 ON READER SERVICE CARD



Delay Lines

MINIATURIZED

VANGUARD ELECTRONICS CO., 3384 Motor Ave., Los Angeles 34, Calif. Series of lumped constant delay lines features extremely compact design. They display low distortion, excellent thermal stability, and fast rise times. Units can be cascaded to obtain delays from 0.1 to 10 μ sec and beyond, and can be stacked in any required multiples. Units are completely sealed and said to be ideal for p-c applications.

CIRCLE 340 ON READER SERVICE CARD



Receiving System

FIELD INTENSITY

POLARAD ELECTRONICS CORP., 43-20 34th St., Long Island City 1, N. Y., has developed a mobile, transistorized, calibrated field intensity receiver, covering the 1,000 Mc to 10,000 Mc range. The entire com-

**Associated's
salt spray
chambers
let you see
your tests -
from all angles**

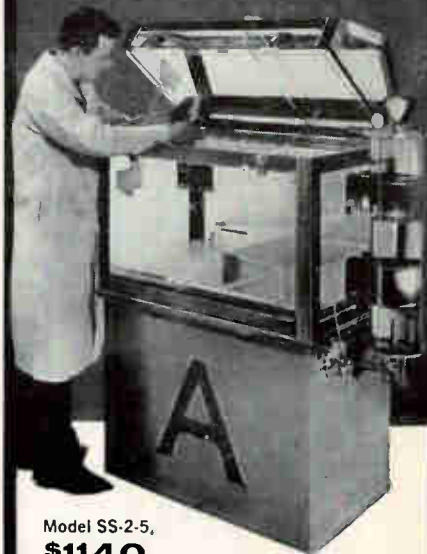

Model SS-2-5,
\$1140

All-lucite construction of Associated's salt spray chambers gives you all-angle visibility, long-term chamber life with complete freedom from salt fog effects. And the built-in design features meet every lab requirement for accurate, trouble-free testing:

- Performs all salt spray corrosion tests per MIL-E-5272C, MIL-S-19500B, Para. 40.9, QQ-M-151A, Mil-Std-202A.
- Operates from standard 115V AC line and low pressure air supply
- Lightweight lid for easy loading
- Lucite hanger rods and floor bars; test piece never contacts salt solution
- Dual seal prevents leakage of salt atmosphere

Standard models available with working area from 20" x 20" x 20" to 30" x 30" x 30"; larger sizes on special order. All models include temperature controllers and indicators for both chamber and saturation tower. For complete technical, price and delivery information, write today for Bulletin C-11-3.

Associated

ASSOCIATED TESTING LABORATORIES, INC.
(Manufacturing Division)
155 ROUTE 46 • WAYNE, NEW JERSEY • CLifford 6-2800
TEST LABORATORIES
Wayne, N.J. • Winter Park, Fla. • Burlington, Mass.

CIRCLE 173 ON READER SERVICE CARD

173

ANELEX®

Wherever
a data
processing
system is judged
by the quality
and volume of
document
production,
no other
equipment
has been able
to equal the
speed and
consistent
quality or the
reliability of
Anelex
High Speed
Line Printing
Systems.

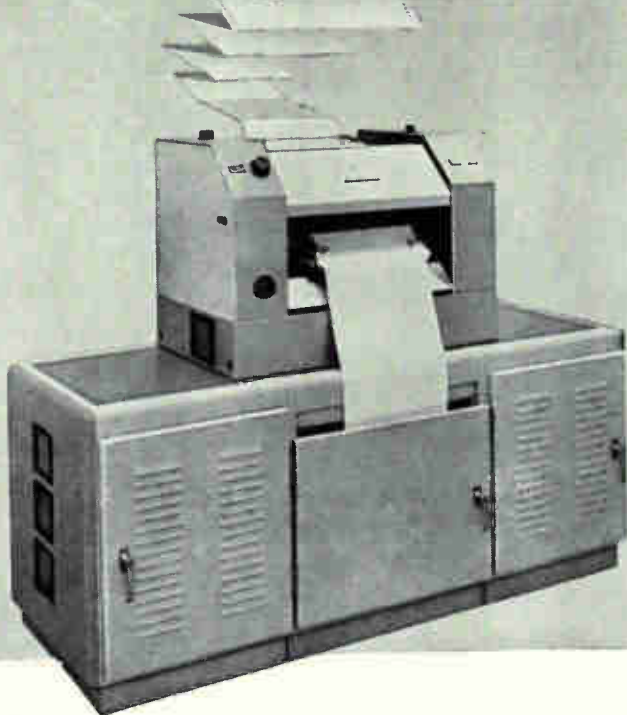

Further information available upon request

ANELEX CORPORATION

156 Causeway Street, Boston 14, Massachusetts

ANELEX

plement of equipment consists of a basic unit, four interchangeable r-f tuning units, an impulse calibrator, five antennas, and a tripod.

CIRCLE 341 ON READER SERVICE CARD



Power Supply DUAL-REGULATED

EMBREE ELECTRONICS CORP., 993 Farmington Ave., West Hartford 7, Conn. Model PS/200/3.5 is a dual-regulated chopper-stabilized power supply providing simultaneous outputs of 0-200 ma at both -300 v d-c and +300 v d-c from 117 v a-c input. It is designed for simulation, analog computing, and sensitive instrument applications. Hum, noise, and ripple are less than 200 μ v rms, while load regulation, line regulation, and drift are each within 0.001 percent.

CIRCLE 342 ON READER SERVICE CARD

Computer Transistor

RADIO CORP. OF AMERICA, Somerville, N. J. Miniature silicon transistor is designed for the logic or arithmetical sections of computers where it can help process data by switching coded signals on and off 40 million or more times per sec.

CIRCLE 343 ON READER SERVICE CARD



Microwave Receiver TRANSISTORIZED

POLARAD ELECTRONICS CORP., 43-20 34th St., Long Island City 1, N. Y. Model TR transistorized microwave receiver is equally at home as an a-m, f-m or field intensity receiver, or as a highly sensitive power-level

meter for both laboratory and field use. Frequency coverage is from 950 to 11,260 Mc using four interchangeable plug-in tuning units. The receiver is suited for quantitative analysis of microwave signals and the monitoring of most types of radio and radar communication.

CIRCLE 344 ON READER SERVICE CARD

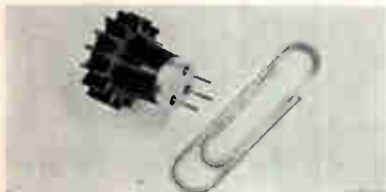

Radiator/Retainer

MULTIFIN DESIGN

THE BIRTCHEP CORP., Industrial Division, 745 So. Monterey Pass Road, Monterey Park, Calif. Kool-Tainers are a combination transistor heat radiator and retainer. They reduce heat up to 25 percent owing to increased surface area provided by their multifin design. Sides of mounting holes are slotted to accept a wide variance of case diameters.

CIRCLE 345 ON READER SERVICE CARD

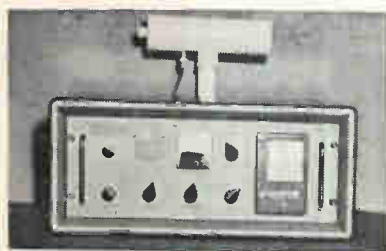

Receiver

FREQUENCY STANDARD

RMS ENGINEERING, INC., P. O. Box 6354, Station H, Atlanta 8, Ga. Model LF-18-20/A receiver is an all transistorized unit designed for standardizing the frequency (100 Kc) of a local secondary frequency standard by comparison with the Standard National Signals, 18 Kc of NBA and 20 Kc of WWVL. The receiver contains a strip recorder which provides a permanent record of the drift or error in the local standard.

CIRCLE 346 ON READER SERVICE CARD

Film Processor

OPTOMECHANISMS INC., 216 E. Second St., Mineola, L. I., N. Y., announces a six-second high-resolution camera-processor-projector for

NEW FROM T/I

CLOCK PULSE GENERATORS

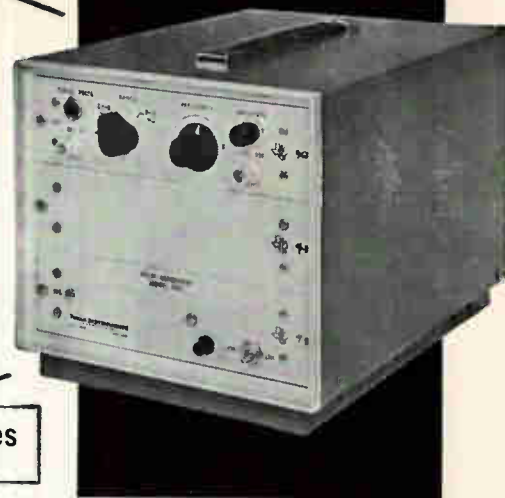

Very Fast Repetition Rates

(UP TO 100 MEGACYCLES)

Texas Instruments 6100 Series Clock Pulse Generators include models offering repetition rates from 100 cps to 100 MC. Provision is made for external drive input for single pulse and to permit operation of several generators from master source. All models have pulse width of less than 8 nanosec at one-half pulse height and rise times of 4 nanosec; 0-4 V continuously variable amplitude; 93-ohm output impedance.

Write for complete information.

APPARATUS DIVISION
PLANTS IN HOUSTON
AND DALLAS, TEXAS



TEXAS INSTRUMENTS

INCORPORATED
3609 BUFFALO SPEEDWAY
P. O. BOX 66027 HOUSTON 6, TEXAS

CIRCLE 213 ON READER SERVICE CARD

REMOTE DATA RETRIEVERS, EVENT AND DATA RECORDERS

117.50

121.00

122.99

127.99

PRINT AND PLOT SIMULTANEOUSLY

HOGAN FAXimile recorders are available with up to 2000 individual styli for simultaneous recording. A wide range of stylus spacings is offered—up to 100 to the inch for high-speed facsimile, television and radar recorders and high resolution printers and plotters. Chart widths to 30" and feed rates to 50" per second.

Hogan specializes in electrolytic techniques for event, spectrum analysis, oscillograph and facsimile recording, frequency time analysis and special purpose binary and gray scale record applications. Hogan electrolytic recording papers provide a permanent high contrast black on white record which is reproducible on most conventional office duplicators.

Whatever your recording problem may be—contact **HOGAN FAXimile**, a subsidiary of **TELAutograph Corporation**, 635 Greenwich Street, New York 14, N. Y.

HOGAN FAXimile Corporation • 635 Greenwich St., New York 14, N. Y.
A SUBSIDIARY OF TELAUTOGRAPH CORPORATION



Gates Radio Company Broadcast Transmitter utilizing Jennings type M-100 and M-750 Vacuum Fixed Capacitors.

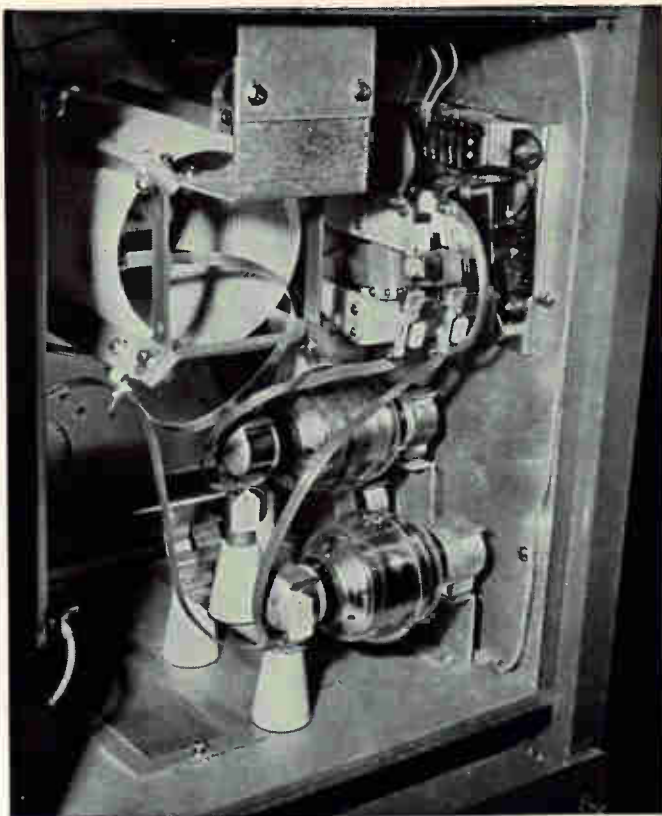

JENNINGS VACUUM CAPACITORS FOR ELECTRONIC ENGINEERS WHO WANT COMPACT EFFICIENCY

► OR HIGHER CURRENT RATING ► OR LOWER INDUCTIVE LOSSES

Witness how Gates Radio Company has created a smaller, more efficient transmitter through the use of these high voltage fixed vacuum capacitors. Vacuum dielectric results in very low dielectric losses thus making capacitors more efficient. All copper construction and large surface area permits high current ratings. And, most important, unlike other types of capacitors, vacuum capacitors are self healing after moderate overloads.

Jennings also manufactures a complete line of variable vacuum capacitors. Their vacuum dielectric permits a maximum amount of capacitance at high voltages to be packed into an extremely small physical space, thus reducing inductive losses. They also feature the lowest minimum capacities and highest maximum to minimum ratio of capacitance change attainable anywhere.

Catalog literature of Jennings complete line of vacuum capacitors is available upon request.

RELIABILITY MEANS VACUUM / VACUUM MEANS *Jennings*®

JENNINGS RADIO MFG. CORP., 970 McLAUGHLIN AVE., SAN JOSE 8, CALIF., PHONE Cypress 2-4025

use in electronic systems such as radar and sonar.

CIRCLE 347 ON READER SERVICE CARD

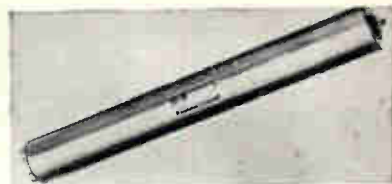

PPM T-W Tube LOW-NOISE

HUGGINS LABORATORIES, INC., 999 E. Arques Ave., Sunnyvale, Calif. The HA-54 is a periodic permanent magnet focused, low-noise twt operating in S-band. When operated from 2.4 to 3.4 Gc, it has a noise figure of 13 db max, small-signal gain of 27 db, and min saturation power output of 7 dbm.

CIRCLE 348 ON READER SERVICE CARD



Phase Meter DIRECT READING

AD-YU ELECTRONICS LAB., INC., 249 Terhune Ave., Passaic, N. J. Some features of the type 405 series are: (1) Meter reading independent of the ratio of input signal amplitudes from 1 to 700. (2) Equal accuracy for symmetrical waveforms of any shape. (3) Direct indication of phase angle in degrees from 500 Kc down to 1 cps. (4) No amplitude or frequency adjustment.

CIRCLE 349 ON READER SERVICE CARD



Miniature Amplifier TRANSISTORIZED

KEARFOTT DIVISION, General Precision, Inc., 1150 McBride Ave., Little Falls, N. J. The C70 3146 001 is a 5-w, 1-cu in. amplifier designed for use in an ambient temperature up to 125 C. Fabrication techniques, such as mounting standard and miniaturized component

elements in a high density, three-dimensional mass and interconnecting component leads by means of electrical resistance spot welding, assures high reliability.

CIRCLE 350 ON READER SERVICE CARD

Spark Gap

EDGERTON, GERMESHAUSEN & GRIER, INC., 160 Brookline Ave., Boston 15, Mass., announces a ceramic-metal, triggered spark gap with 70 Kv hold-off voltage.

CIRCLE 351 ON READER SERVICE CARD



Frequency Standard RUBIDIUM VAPOR

VARIAN ASSOCIATES, 611 Hansen Way, Palo Alto, Calif. A long-term stability of two parts in 10^{10} and short term stability of three parts in 10^{11} for a one second sampling time is provided by model X-4700 rubidium vapor frequency standard. A quantum electronic device based on optical pumping and transmission monitoring, the rubidium standard derives its stable output frequency from the rubidium -87 ground state hyperfine transition of 6834.86 Mc.

CIRCLE 352 ON READER SERVICE CARD



B-W Oscillator ELECTROSTATIC FOCUS

RAYTHEON CO., Foundry Ave., Waltham 54, Mass. The QKB830 bwo, a rugged X-band tube, operates over the 8,500-9,600 Mc range with no mechanical tuning. Minimum power output is 10 mw. Electrostatic beam focusing eliminates the need for a permanent magnet, re-

NEW FROM T/I

VARIABLE WIDTH PULSE GENERATOR

Continuously Variable
Pulse Width and Delay



The 6500 Series includes the features of Texas Instruments 6100 Series plus additional outputs with continuously variable delay from 0-1000 nanosec. All outputs provide controls for continuously variable pulse width from 20-1000 nanosec up to 90% duty cycle. Output amplitude is 0-5 V; rise times of 5 nanosec; repetition rates up to 25 MC.

WRITE FOR COMPLETE INFORMATION.

APPARATUS DIVISION
PLANTS IN HOUSTON
AND DALLAS, TEXAS



TEXAS INSTRUMENTS
INCORPORATED
3609 BUFFALO SPEEDWAY
P. O. BOX 66027 HOUSTON 6, TEXAS 462

CIRCLE 214 ON READER SERVICE CARD

AUGAT SPACESAVER SOCKET

Designed for the
Complete Series of
Clevite Spacesaver
Power Transistors

The Spacesaver Socket fastens beneath the chassis, allowing direct mounting of the transistor, with a mica insulator, to the chassis. In this way, the transistor is provided with maximum heat dissipation by conduction.

Three socket insulation materials available: black phenolic, melamine or diallyl phthalate.

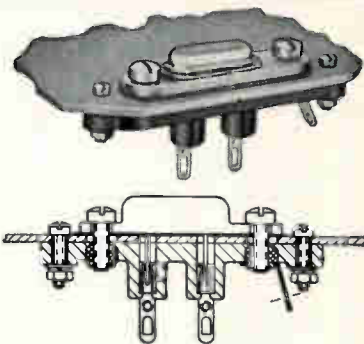

The socket's narrow width permits full utilization of the space saving size of its mating transistor.

For complete specifications, write for Data Sheet No. 760.

AUGAT BROS., INC.
30 PERRY AVENUE, ATTLEBORO, MASS.

OVERNIGHT OVERNIGHT DELAY LINES

TO FIT YOUR ELECTRICAL SPECIFICATIONS

OVERNIGHT



**A NEW
MARKETING
CONCEPT IN
DELAY LINES**

Here's the supermarket approach to your delay line problems. It's fast . . . versatile . . . accurate; really something new under the sun! Wee Lines are sectionalized delay lines, mounted on printed circuit boards that conform to MIL-P-13949B. Each section is a discreet value of delay time. The number of sections determines the overall delay time and the delay-to-rise time ratio. A quick computation tells the engineer how many sections are required; the problem is reduced to a simple ordering process; and the Wee Lines are shipped within 24 hours. An innovation designed and manufactured exclusively by Nytronics, Inc.

FEATURES

- Cut motion, time and costs
- Delay lines made from standard sections shipped in 24 hours
- Will fit 80% of requirements
- Uniform performance characteristics
- Sizes from 6 to over 200 sections
- Encapsulated to conform to MIL-C-15305B, Grade 1, Class B
- Solder lugs for connections; screw or rivet mounting
- Available in standard metal shields

WRITE TODAY FOR DESIGNERS DATA SHEET

NYTRONICS, INC.

550 SPRINGFIELD AVE., BERKELEY HEIGHTS, N. J. • Phone 464-9300 • TWX Summit, N. J. 533

ESSEX ELECTRONICS DIVISION, BERKELEY HEIGHTS, N. J.
AUTOMATION PRODUCTS DIVISION, LEXINGTON, KY.
ESSEX ELECTRONICS OF CANADA LTD., TRENTON, ONT.

sulting in a 6-in. long, light-weight tube. A control electrode is provided for 1-v pulsed or amplitude modulation.

CIRCLE 353 ON READER SERVICE CARD

Connector Devices

VECTOR ELECTRONICS CO., INC., 1100 Flower St., Glendale 1, Calif. Edge-Bord and In-Bord pins and cup receptacles allow the user to mount only the number of contacts required.

CIRCLE 354 ON READER SERVICE CARD

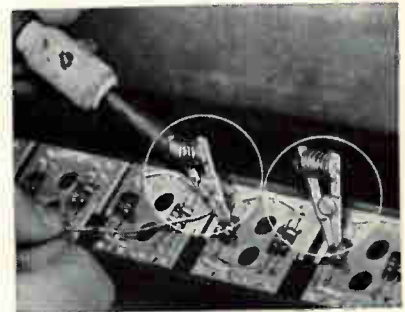

Heat Sink Clip

MADE OF ALUMINUM

AVTRON MFG., INC., 10409 Meech Ave., Cleveland 5, O. Heat sink clip is designed to protect semi-conductors during the soldering phase of electronics assembly. It fits around the wire running between the semiconductor and the joint to be soldered, and during the soldering operation it absorbs and dissipates the heat that runs up the wire toward the semiconductor. It reduces assembly time and costly rejects. List price, \$19.80 per 100.

CIRCLE 355 ON READER SERVICE CARD

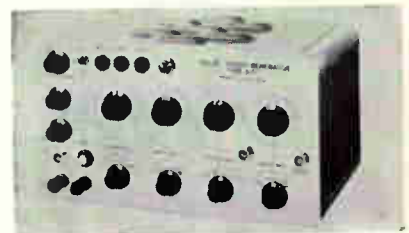

Pulse Group Generator

MANY APPLICATIONS

INSTRUMENT CORP. OF AMERICA, 516 Glenwood Ave., Baltimore 12, Md. Type 5101 provides a wide variety of pulse trains useful for testing computers and data handling equipment, and many other laboratory applications. Groups of pulses are generated at a repetition frequency variable between 1 and 10,000 groups/sec. Length of the groups

is adjustable between 20 μ sec and 0.2 sec, and within each group pulses are generated at a prf variable between 10 cps and 100 Kc.

CIRCLE 356 ON READER SERVICE CARD



D-C Voltmeter SERVO DRIVEN

HOUSTON INSTRUMENT CORP., P. O. Box 22234, Houston 27, Texas. Model HV-160 d-c servo voltmeter provides very high input impedance on all scales. Input is potentiometric (over 100 megohms) on ranges from 3 mv to 1 v, and is 10 megohms on ranges from 3 to 300 v. Servo gain is automatically adjusted for each scale by the range switch. Accuracy is 0.15 percent on 11 selectable scales. Double regulated Zener reference eliminates reference cell replacement.

CIRCLE 357 ON READER SERVICE CARD

Tungsten-Rhenium Alloys

HOSKINS MFG. CO., 4445 Lawton Ave., Detroit 8, Mich., offers ultra high temperature tungsten-rhenium refractory metal alloys in an expanded range of wire and strip sizes.

CIRCLE 358 ON READER SERVICE CARD

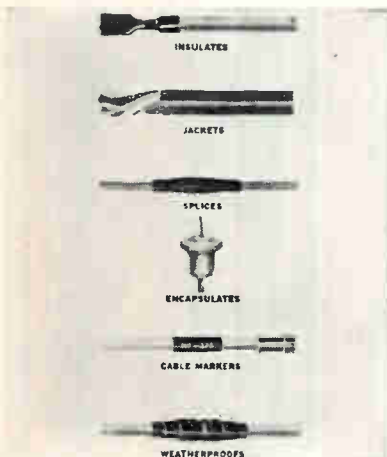

Heat-Shrinkable Tubing FORMS TIGHT BOND

ALPHA WIRE CORP., 200 Varick St., New York 14, N. Y. Alphlex shrinkable tubing is an irradiated, flame-retardant, thermally stable, modified polyolefin base product. It is

September 29, 1961

NEW FROM T/I

PROGRAMMED PULSE GENERATOR

Highest Repetition Rates
(UP TO 25 MEGACYCLES)

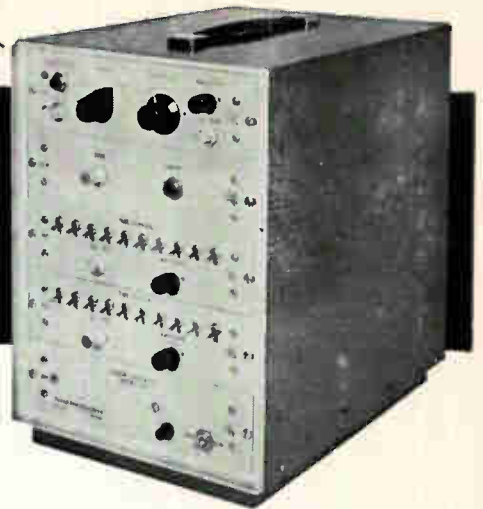

Texas Instruments 6200 Series provides signals at higher repetition rates than previously available, for applications in high speed logic circuit and memory system development. Ten pulse times are selectable in any combination for each of the two outputs by front panel controls. Other performance specifications similar to the 6500 Series. All TI Pulse Generators use solid state circuitry and modular construction for reliability and versatility.

WRITE FOR COMPLETE INFORMATION.

APPARATUS DIVISION
PLANTS IN HOUSTON
AND DALLAS, TEXAS



TEXAS INSTRUMENTS

INCORPORATED
3609 BUFFALO SPEEDWAY
P. O. BOX 66027 HOUSTON 6, TEXAS

469

CIRCLE 215 ON READER SERVICE CARD

FINE WIRE

for

- Semiconductors
- Resistors
- Potentiometers
- Thermocouples
- Electronic Tubes
- Other Electronic Applications

in

precious, base, exotic
and special metals
— bare or
insulated

Custom Melting, Complete Redrawing,
Strand and Vacuum Annealing Services
for fine wire processing to customers'
specifications.



WRITE for valuable
brochure contain-
ing fine wire com-
positions, perti-
nent properties
and applications.



CONSOLIDATED REACTIVE METALS, inc.

115 Hoyt Avenue — Mamaroneck, N. Y. — OWens 8-2300

CIRCLE 179 ON READER SERVICE CARD

179

NEW LEACH HALF-SIZE CRYSTAL CAN RELAY

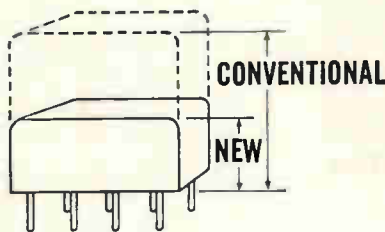

REVOLUTIONIZES PRINTED CIRCUIT PACKAGING

It's only .400 inches high. Weighs only .250 ounces. New Leach M-250 is so tiny it uses less than half the space needed by standard subminiature crystal can relays!

Space is saved on printed circuit boards because three M-250s will replace one ordinary, horizontally-mounted crystal can relay. And with its 0.2-inch terminal spacing and internal terminal connections, it is interchangeable with conventional crystal can relays.

Simplified design, mechanized production with minimum human contact, rotary balanced armature design and small space requirement—four reasons why you should specify Leach Half-Size Crystal Can Relays for your printed circuits (and that's just half the story!)

Available now:

Contact Ratings Low level to 2 amps.
Normal Coil Operating Voltages 6 to 26.5 VDC
Meets or exceeds all requirements of Mil-R-5757D.

Get the whole story. Write for complete technical specifications and application information.

LEACH CORPORATION

18435 SUSANA ROAD, COMPTON, CALIFORNIA
EXPORT: Leach International, S. A.

manufactured in an expanded form so that it may be easily slipped over wire and cables, hosing, terminals or conduit. When heat of approximately 135 C is applied, the material shrinks to a reduced, predetermined diameter forming a secure, tight-fitting bond.

CIRCLE 359 ON READER SERVICE CARD

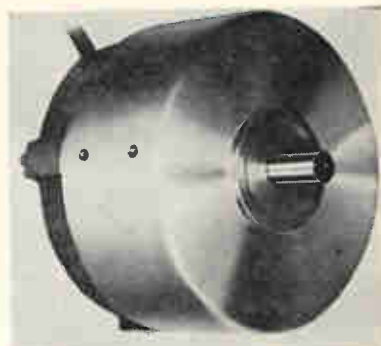

Induction Motor THERMALLY PROTECTED

KEARFOTT DIVISION, General Precision, Inc., 1150 McBride Ave., Little Falls, N. J. The E-10-1A is a 1/7 h-p rugged thermally protected induction motor. Power: 208 v, 400 cps, 3 phase. Unit conforms to the applicable portions of MIL-M-7969 and MIL-E-5272.

CIRCLE 360 ON READER SERVICE CARD



Multiplier-Modulator MINIATURIZED

TRANSMAGNETICS INC., 40-66 Lawrence St., Flushing 54, N. Y. Model 100 is a 2 percent accuracy low distortion unit for application as an analog multiplier or modulator in process control, analog computation, missile guidance and other automatic control systems. Inputs are d-c to 20 Kc, ± 1.5 v; output 100 to 20,000 cps, zero to 1.4 v rms. Output null is less than 10 mv (with one input zero).

CIRCLE 361 ON READER SERVICE CARD

PRODUCT BRIEFS

R-F ATTENUATORS for 75 ohm systems. Telonic Industries Inc., Beech Grove, Ind. (362)

SOUND LEVEL INDICATOR transistorized, covers 64 to 110 db. Dawe Instruments Ltd., Harlequin Ave., Great West Rd., Brentford, Middlesex, England. (363)

NUCLEAR AMPLIFIER transistorized, non-overloading. Lockheed-Georgia Co., Atlanta, Ga. (364)

PHASE METER measures from 0 to 360 deg. Industrial Test Equipment Co., 55 E. 11th St., New York 3, N. Y. (365)

WIRE-WOUND RESISTORS encapsulated. Kelvin Electric Co., 5907 Noble Ave., Van Nuys, Calif. (366)

BEACON TRANSMITTER transistorized. HRB-Singer, Inc., Science Park, State College, Pa. (367)

VARIABLE ATTENUATOR solid state. Merrimac Research and Development, Inc. Irvington, N. J. (368)

LOW VOLT D-C SUPPLY super regulated. Dynex Industries, Inc. 170 Eileen Way, Syosset, N. Y. (369)

LINEAR PULSE AMPLIFIER transistorized. Franklin Systems, Inc., 2734 Hillsboro Road, West Palm Beach, Fla. (370)

THREE-GUN CRT 5½ by 5½-in. square-face. Sylvania Electric Products, Inc., Seneca Falls, N.Y. (371)

SUBMINIATURE RESISTOR built-in heat sink. Marstan Electronics Corp., Roosevelt, L.I., N.Y. (372)

TRANSCEIVER with 4,800-bit speed. Hughes Aircraft Co., P.O. Box 90-902, Los Angeles 45, Calif. (373)

POWER TRANSISTOR with gain of 1,000. Westinghouse Semiconductor Depart. Youngwood, Pa. (374)

LINEAR AMPLIFIER 1 Kw unit. Plessey International Ltd., Ilford, Essex, England. (375)

ROSIN-CORE SOLDER up to ½ more spread. Alpha Metals, Inc., 56 Water St., Jersey City, N.J. (376)

MINIATURE CLUTCH-BRAKES direct-action. FAE Instrument Corp., 16 Norden Lane, Huntington Station, N.Y. (377)

NEW FROM T/I

HIGH SPEED A-D CONVERTER



1.5 μ sec per bit

Automatic Zero Stabilization

Texas Instruments Model 834 Analog-Digital Converter is a versatile, all solid state instrument combining high speed with high accuracy. Basic speed is 25 microseconds per conversion (40,000 12 bit conversions per second); accuracy is $\pm 0.05\%$ of full scale, $\pm 1/2$ the least significant bit. The instrument provides full scale ranges of ± 2.5 , ± 5.0 , and ± 10.0 volts with an input impedance of 200,000 ohms. Modular construction allows modification of output logic levels and digital code to suit various system requirements.

Write for complete information.

APPARATUS DIVISION
PLANTS IN HOUSTON
AND DALLAS, TEXAS



TEXAS INSTRUMENTS
INCORPORATED
3609 BUFFALO SPEEDWAY
P. O. BOX 66027 HOUSTON 6, TEXAS 478

CIRCLE 216 ON READER SERVICE CARD

MAKING ROOM AT THE TOP



EICO creates a new, professional lab quality test instrument series at moderate prices.

AC VTVM & AMPLIFIER #250

Kit \$49.95, Wired \$79.95

VTVM: 12 ranges from 1mv to 300v rms; response absolutely flat from 10 cps to 600 kc; input impedance 10M Ω shunted by 15 μ f; accuracy $\pm 3\%$ of full scale.

Note: Average responding meter calibrated in rms. Linear 0-1, 0-3 scales. Decibel scales based on 0db=1mv in 600 Ω with 10db interval between ranges.

AMPLIFIER: 60db gain on 1mv range; response +0, -3db from 8cps to 800kc; output to 5V rms undistorted, variable down to zero by attenuator control at output; input impedance 10M Ω , output impedance 5K Ω ; hum & noise -40db for signal inputs above 2mv.

DESIGN QUALITY: All frame-grid tubes; 60db frequency-compensated input attenuator ahead of cathode follower with 10db/step attenuator following; two-stage R-C coupled amplifier and full-bridge meter circuit in one overall feedback loop; no response adjustment required in amplifier circuit; single sensitivity adjustment; voltage-regulated power supply. 50/60 cycle operation.

EICO MODEL 255 AC VTVM identical to Model 250 described above, but less amplifier facility. 50/60 cycle operation. Kit \$44.95 Wired \$72.95

See the 41 additional EICO Instruments helpful for your lab and line work. Write for free catalog and name of neighborhood distributor.



Dept. 9B
3300 N. Blvd., L.I.C. 1, N. Y.
Export Dept.: Roburn Agencies, Inc.
431 Greenwich St., N. Y. 13, N. Y.

Add 5% in the West.

Literature of the Week

POWER FILTERS Polyphase Instrument Co., East Fourth St., Bridgeport, Pa. An engineering detail sheet contains data on the PF400 series of power filters that reduce harmonic distortion to less than 1 percent. (378)

VIBRATION CONTROL Lord Mfg. Co., Erie, Pa. "Lord vibration/shock/noise control" is the title of a 16-page capabilities brochure just published. (379)

LEAK DETECTORS General Electric Co., Schenectady 5, N. Y. Bulletin GEA-6817A describes type H line of portable, halogen sensitive electronic leak detectors for industry and research applications. (380)

MICROWAVE SIGNAL GENERATORS Strand Labs, Inc., 294 Centre St., Newton 58, Mass. Bulletin SDS3 contains condensed specifications for 17 different stabilized microwave signal generators. (381)

AUTOMATIC MACHINES Swanson-Erie Corp., 814 E. Eighth St., Erie, Pa. A facilities brochure shows a wide variety of automatic assembly and processing machines designed and built by the company. (382)

TRANSFORMER FINISHES James Electronics Inc., 4050 No. Rockwell St., Chicago 18, Ill., has available a catalog on standard miniature transformer finishes for military and commercial applications. (383)

QUARTZ CRYSTALS Texas Crystals, 1000 Crystal Drive, Ft. Myers, Fla., has available a catalog and price list No. 961 on quartz crystals for all uses. (384)

DISPLAY SYSTEM Philbrick Researches, Inc., 127 Clarendon St., Boston 16, Mass. A 12-page booklet on the operation and applications of model 5934 multichannel calibrated display system. (385)

FERRITE CORES Kearfott Division, General Precision, Inc., Little Falls, N. J., has issued a loose-leaf reference sheet on ferrite cores for magnetic recording heads. (386)

R-F POWER LEVELS Weinschel Engineering, 10503 Metropolitan Ave., Kensington, Md., has issued an illustrated brochure on precise methods of determining r-f power

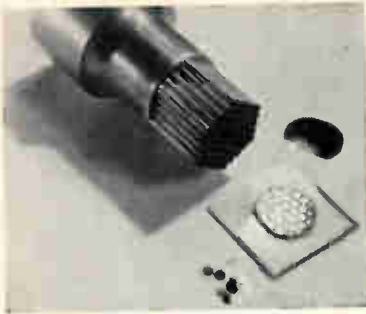

(1) SILICON

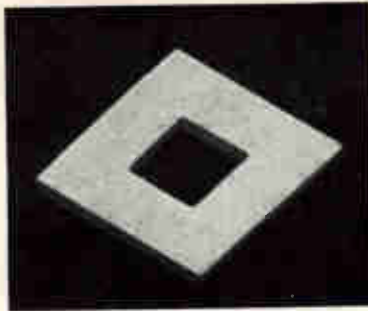

(2) FERRITES

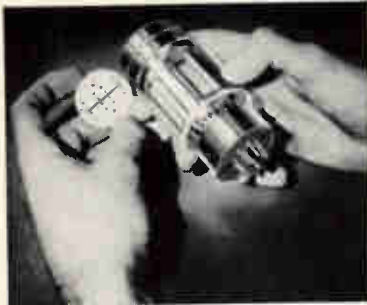

(3) CERAMICS

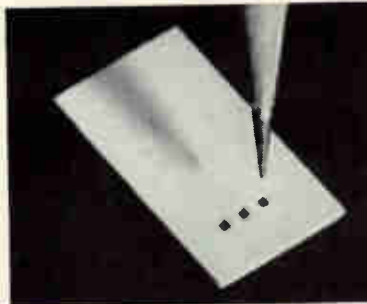

(4) ALUMINUM OXIDE

ULTRASONIC MACHINING: 1. dicing silicon wafers; 2. cutting ferrite cores; 3. cutting holes and slots in ceramic tube spacers; 4. drilling holes in aluminum oxides.

Low-cost, high-speed PRECISION MACHINING of hard or brittle materials with ULTRASONICS

The delicate cutting operations shown above were all performed with Impact Grinders—Raytheon's ultrasonic machines that drill, slice, engrave, trepan or shape hard and brittle materials.

Design, materials and production engineers who have tried this remarkable technique agree that it is the optimum method for machining such materials as silicon, germanium, ferrites, ceramics, carbides and glass.

In impact grinding the tool is made to vibrate ultrasonically as abrasives are introduced between tool and workpiece.

Find out how one of these cost-saving, high-production-rate units can solve your machining problem.

SEND FOR BROCHURE No. 2-300 today. Address Raytheon Company, Production Equipment Operations, Commercial Apparatus & Systems Division, Technical Information Service, Waltham 54, Massachusetts.



MODEL 2-332 Raytheon Impact Grinder

RAYTHEON

RAYTHEON COMPANY

COMMERCIAL APPARATUS & SYSTEMS DIVISION

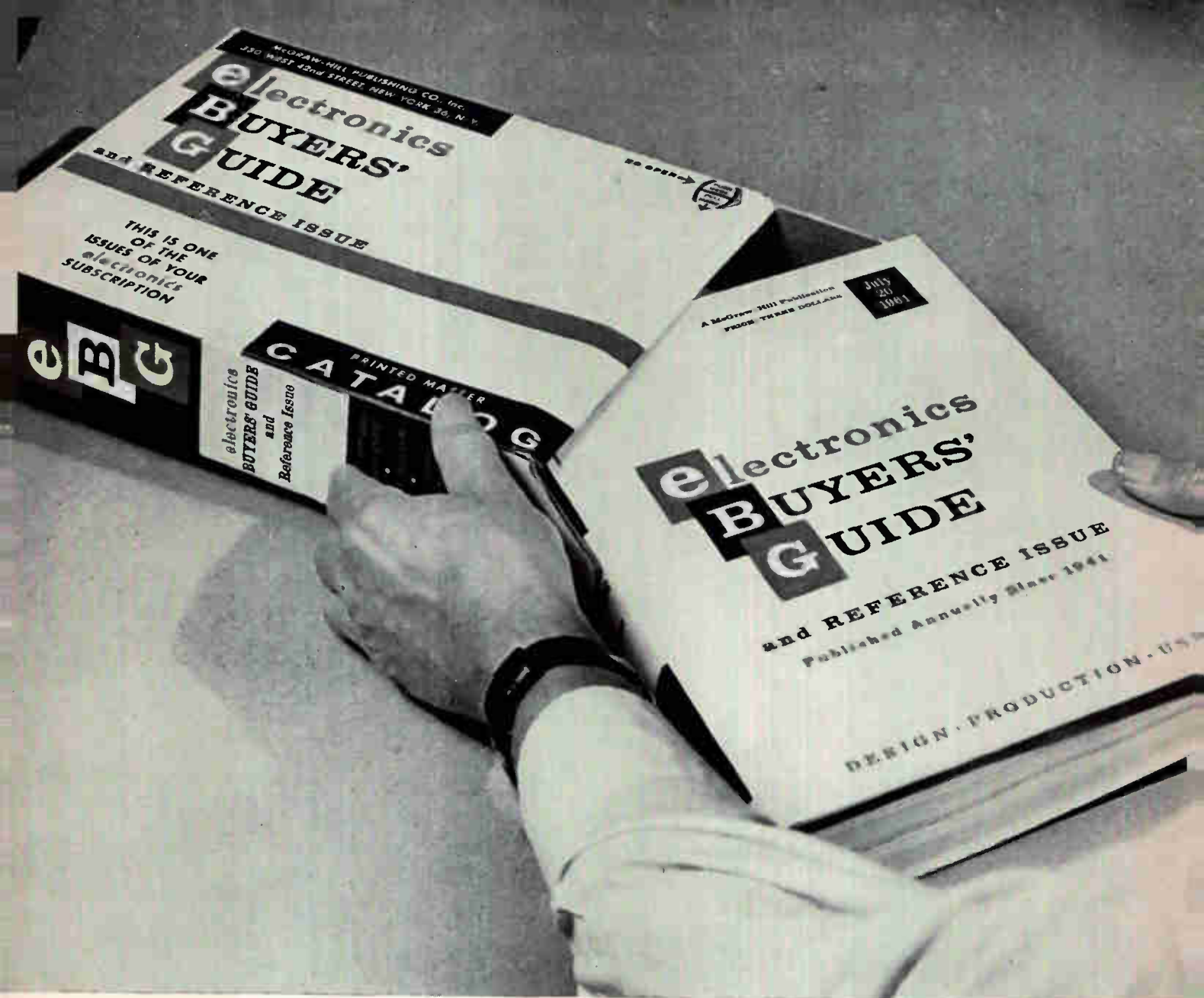

Look for new, time-saving IDEA INDEX in your new 1961 EBG!

NEW! Complete INDEX OF EDITORIAL ARTICLES, broken down by subject matter, that have appeared for a full year in electronics, published in EBG for the first time ... available nowhere else.

NEW! ABSTRACTS of all 1961 Feature Articles published to date in electronics, appears in EBG only. This makes the Index of articles fully meaningful for users and provides a quick summary of the editorial highlights of an entire year's effort.

4 MORE IDEAS THAT MAKE EBG THE MOST USED CATALOG-DIRECTORY IN THE INDUSTRY!

- *Specific Product Listing!* No matter how many products a company makes, each is listed under its specific heading, more than 3,000 are cross indexed. Listings are ACCU-

RATE, COMPLETE, AUTHENTIC. *Specially Edited Reference Section!* 64 pages of Data — an invaluable source of buying information about military electronic procurement, subcontracting, materials information centers, listing of industry organizations, government services, design data, extensive symbols dictionary. *Registered Trade Name Index!* If a product is known by trade name only, EBG quickly tells who makes it and where to buy it! *Local Sales Office Listing!* The nearest manufacturer's sales office, address, phone number is easily available.

These ideas make EBG the *most used* directory in the industry, make it the *most valuable catalog-directory medium* for electronic advertisers. Makes your advertising in electronics pay off 12 months a year, whenever your customers and prospects are ready to buy.

electronics BUYERS' GUIDE and Reference Issue



A McGraw-Hill Publication, 330 West 42nd Street, New York 36, N. Y.



The Basic Buying Book in Electronics



semiconductor products news

Give 'Em the Axe, the Axe, the Axial

It's usually safer to give 'em the axe when the other school has graduated its entire first team, lost its quarterback due to a leg injury, and comes into the game with a line that averages 50 lbs. less than yours. If you want that kind of an edge when you put your tunnel diodes into play, give 'em the axial. G-E's new "back" diodes for ultra high speed computer switching circuits are extremely small, unusually fast and consume very little power in the new axial package shown below. The regular line of general purpose-computer tunnel diodes is also available in this package, in addition to the TO-18 package which has always been popular. We can also supply them in racoon coats, but the cost is rather high.

AXIAL DIODE OUTLINE

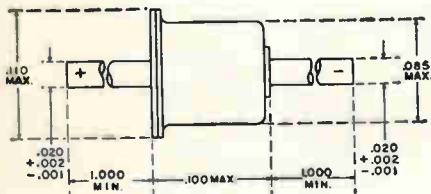

ALL DIMENSIONS IN INCHES. DIMENSIONS ARE REFERENCE UNLESS TOLERANCED.

Put PEP in your designs!

You May Suh, with a Mesa

... put industrial silicon transistors into your feedback and servo amplifier circuits (or any number of other medium power applications you might have in mind) at germanium prices. New low cost industrial silicon Mesas 2N2106, 07, 08 are like a refreshing hint of mint julep on a humid day if you want top performance at prices that will qualify you as an honorary Kentucky Colonel when the purchasing agent looks at the blueprint (not to mention the boss).

The servo motor drive circuit shown is just one example. Chapter 16 of the G-E Transistor Manual (5th edition) gives you many more feedback and servo amplifier circuit suggestions, and complete details. Don't be like Scarlett O'Hara and "think about it tomorrow." Read that chapter today ... the circuit you save may be your own!

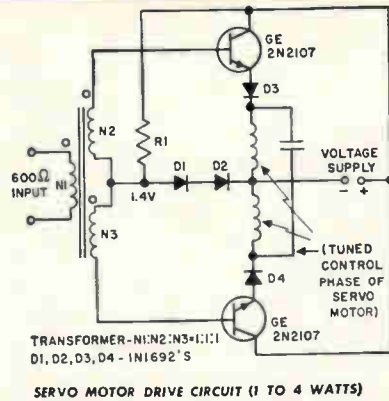

Put PEP in your designs!

If high speed is your problem

... give the car keys to your wife, lock the kid's bicycle in the garage, sink the outboard motor, break the skis, sell the horse and lock yourself in the lab. Frustrated? No need to be. You can satiate that high speed mania by designing a real hot rod switching circuit for industrial and military applications with the G-E 2N705 germanium PNP triode mesa transistor. Gain bandwidth product is 600 mcs, and that's without shaving the head or turning the cam shafts.

For low cost computer applications, and other lower voltage and lower cost circuits, the 2N710, 2N711, 2N725 and 2N1646 types offer all the speed you'll need. For complete details, write to Section 251106. You'll get your answer by return mail in nanoseconds (if the Post Office will cooperate).

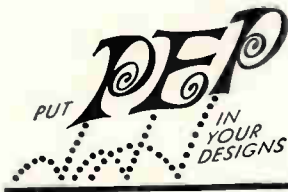

If you have any questions, write us at Section 251106. General Electric Company, Semiconductor Products Department, Electronics Park, Syracuse, New York. In Canada: Canadian General Electric, 189 Dufferin Street, Toronto, Ont. Export: International General Electric, 150 East 42nd Street, New York 17, New York.



GENERAL ELECTRIC

levels which discusses the sources of error. (387)

TORQUE POINTER-INDICATOR Baldwin-Lima-Hamilton Corp., 42 Fourth Ave., Waltham 54, Mass., has published a data sheet containing details on an automatic null-balance torque indicator. (388)

ANALYTICAL SERVICE Electronic Metals and Alloys, Inc., 60 Arsenal St., Watertown 72, Mass., has published a brochure discussing the analytical methods and processes used for control of materials in the electronics industry and describing its facilities and services. (389)

PLUG-IN POWER SUPPLIES Acopian Technical Co., 927 Spruce St., Easton, Pa. Bulletin No. 6 gives a detailed description of 19 models of plug-in transistorized power supplies. (390)

CERAMIC CAPACITORS Sprague Electric Co., 35 Marshall St., North Adams, Mass. Hypercon capacitors in 25-v ratings are described in engineering bulletin 6141C, available on letterhead request. (391)

DIFFERENTIAL PRESSURE GAGE Pall Corp., Glen Cove, N. Y. Bulletin E10 covers a leak-proof differential pressure gage that operates by a magnetic coupling. (392)

SILICONE FINISHES General Electric Co., Waterford, N.Y. A 16-page bulletin describing silicone-based industrial finishes and their capabilities is available. (393)

VERSATILE POTS Duncan Electronics, 2865 Fairview Road, Costa Mesa, Calif. A two-page bulletin covers the 3600 series of 5 to 600,000 ohm potentiometers. (394)

ELECTRONIC GENERATOR Industrial Test Equipment Co., 55 E. 11th St., New York 3, N. Y. A single-page bulletin illustrates and describes the Powertron model 150 precision 160 v-a electronic generator. (395)

MODULAR SUPPLIES Power Sources, Inc., Northwest Industrial Park, Burlington, Mass. Data sheets are available on modular transistor regulated power supplies. (396)

COMPOSITION ELEMENT POTS Clarostat Mfg. Co., Inc., Dover, N. H. A 16-page catalog provides description, specifications, dimensional drawings and photographs of eight series of composition element pots and their military versions. (397)

NEW BOOKS

Russian for the Scientist

By JOHN and LUDMILLA TURKE-VICH

D. Van Nostrand Co., Inc., Princeton, N. J., 252 p. \$5.95.

A TEXTBOOK designed to enable the engineer or scientist to read Russian technical publications. The book stresses the study of cognates, or Russian words that may be recognized from their similarity to English equivalents. In a series of lessons, the essential points of grammar are thoroughly covered, omitting, however, niceties like the diminutives that are not likely to occur in scientific language. Lessons and examples are taken from chemistry and physics, rather than the customary school language. From halfway through the book, the reading is taken from unsimplified texts such as Russian textbooks and encyclopedias.

The book accomplishes its purpose in providing a logical, easy-to-follow but solid grounding in the Russian language.—G.V.N.

Electrical Noise

By W. R. BENNETT

McGraw-Hill Book Co., Inc., New York, 280 p, \$10.

THIS book had its origin in a series of articles written for *ELECTRONICS* in 1956. It is written in clear, simple language for those who have an educational background equivalent to a bachelor's degree in electrical engineering.

The emphasis is on the qualitative aspects of electrical noise. The physical nature of thermal noise, shot noise, vacuum-tube and transistor noise, gaseous discharge noise, and noise from spontaneous emission of electromagnetic radiation is discussed. Noise generating equipment such as photoelectron multipliers, hot-cathode arcs, noise diodes and the positive column of a gas discharge is described. Noise measuring equipment and measurement techniques are clearly outlined. Included among these are techniques for measuring noise figures of single and cascaded networks.

The problem of designing equipment to convert a "too-weak signa"



Whether in the advanced laboratory, or on a production line the DATAPULSE 102 Pulse Generator continues to operate with maximum accuracy and high reliability.

The 102 is a quality test instrument designed for use on tomorrow's equipment today. Problem areas where the 102 will serve as a standard include logic and memory circuit development, magnetic material study, telemetry and navigation system test, and semiconductor evaluation.

With such outstanding features as high repetition rate and fast rise time, high output power, excellent resolution and accuracy, low jitter, and long term stability the critical scientist or engineer will be able to make significant use of this quality instrument.

Review the abbreviated specifications of the 102 Pulse Generator and more detailed information will be forwarded on request.

ABBREVIATED SPECIFICATIONS

REPETITION RATE: Variable 2cps to 3mc, or single shot, or externally triggered.

AMPLITUDE: Variable to ± 50 v peak into 50 ohms.

RISE TIME: Variable 10 to 500 nanosec.

PULSE DELAY: Variable 150 nanosec. to 10 millisecc.

PULSE DURATION: Variable 50 nanosec. to 10 millisecc.

DUTY CYCLE: Provides up to 225ma average output current, with fully automatic overload protection.

SIZE AND WEIGHT: 8 $\frac{3}{4}$ "h x 17"w x 15 $\frac{1}{4}$ "d, 45 lbs.

SALES REPRESENTATIVES

EASTERN SEABOARD STATES

George Gastenhofer and Associates, Inc.
Waltham, Mass. TWinbrook 4 9500 • Cheshire, Conn. BRowning 2 3091

G. Curtis Engel and Associates, Inc.
Ridgewood, N.J. GILbert 4 1400 • New York, N.Y. REctor 2 0001

Philadelphia, Penn. WAlnut 2 3270

Drimberg Associates, Inc.
Washington, D.C. District 7 4234 • Baltimore, Md. VAlley 3 0866

J. D. Ryerson Associates, Inc.
Syracuse, N.Y. GIBson 6 1371

CENTRAL SOUTH CENTRAL STATES

LeeMark Associates, Inc.
St. Louis, Mo. MIssion 5 1470 • Kansas City, Mo. HIgare 2 3313

Wallace Associates
Dallas, Texas FLEetwood 7 7080

WESTERN STATES

Mytronic Measurements, Inc.
Denver, Colo. PEarl 3 3701 • Salt Lake City, Utah INgerson 6 4924

Albuquerque, N.M. ALPine 5 0669

John Francis D'Halloran and Associates
Los Angeles, Calif. TRiangle 7 0173 • San Diego, Calif. BRoadway 3 5500

San Francisco, Calif. DAVenport 6 1493 • Phoenix & Tucson, Ariz. ENterprise 1200

DATAPULSE

DATAPULSE INCORPORATED

509 Hindry Avenue, Inglewood 1, California

Data Systems • Pulse Instrumentation

ORegion 1-7713 — ORchard 8-3983

Another "impossible" job done by the Airbrasive®...



...cutting semiconductors

abrading • cutting • deburring • stripping • drilling • cleaning • scribing

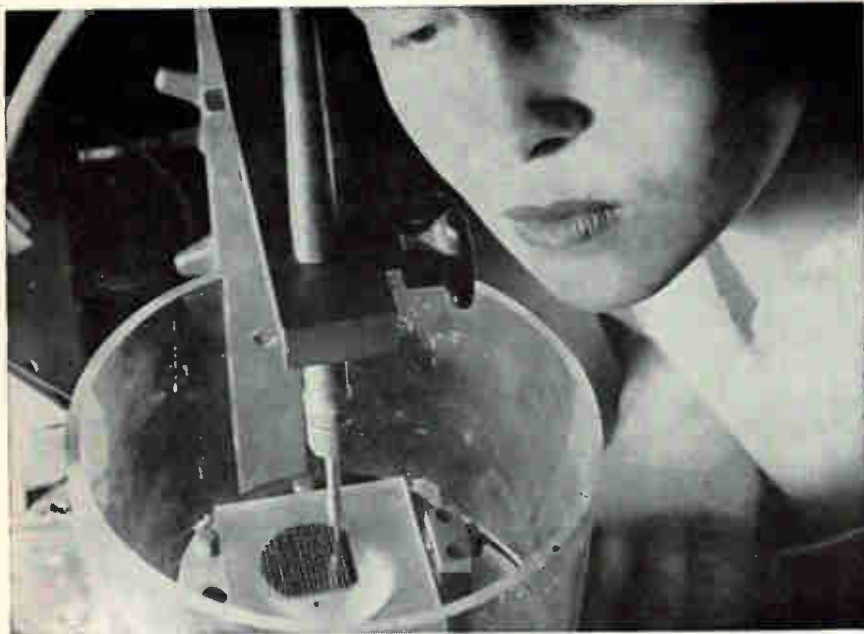

Hughes cuts fancy figures in silicon. Reports "Airbrasive is the only tool capable of handling the process!"

Hughes Aircraft uses the Industrial Airbrasive linked to a pantograph to cut intricate patterns and shapes in semiconductor wafers. And what's more they are doing it accurately and with *complete safety to the fragile part.*

The secret of this unique tool is a superfine jet of abrasive particles and dry gas, directed through a carbide nozzle. The resulting cutting action in hard brittle materials is cool, rapid, precise, and completely shockless.

The Airbrasive is being used to solve hundreds of seemingly impossible jobs... precision deburring... to remove surface deposits... form and adjust microminiaturized circuits... cut glass, germanium, tungsten, ferrites, and others.

Low in cost too. For under \$1,000.00 you can set up your own Airbrasive cutting unit!

Send us samples of your "impossible" jobs and we will test them for you at no cost.



SEND FOR BULLETIN 6006...complete information.

S. S. White

S. S. White Industrial Division
Dept. EU, 10 East 40th Street, New York 16, N. Y.

New dual
Model D1



into a satisfactory usable form without bringing in new noise not present in the original wave" is the subject matter of a 30-page chapter. Grounded cathodes, grounded-grid and cascode triode amplifiers are considered. Recent amplifying devices such as transistors, traveling-wave tubes and nonlinear-reactance amplifiers using semiconductor diodes are also included.

The next to the last chapter treats the mathematical methods of solving noise problems in a manner similar to that given in the author's paper in May, 1956 issue of the Proceedings of the IRE. The last chapter is devoted to the problem of electrical communication in the presence of noise. Attention is given to baseband systems, amplitude modulation systems—including single sideband, homodyne detection, phase and frequency-modulation systems—and several pulse modulation systems.

This book serves as an excellent introduction to the more detailed mathematical theories of electrical noise as well as a source of information for the practicing engineer. **ROBERT E. BEAM**, *Professor of Electrical Engineering, Northwestern University, Evanston, Illinois.*

Time Harmonic Electromagnetic Fields

By **ROGER F. HARRINGTON**

McGraw-Hill Book Company, Inc., New York, 1961, 480 p, \$13.50.

ELECTROMAGNETIC waves and their application to waveguides and scattering problems are covered in this book. It is directed to graduate level students as well as research scientists and engineers.

There are two major features to the book: it presents various mathematical techniques for handling electromagnetic engineering problems and it shows through numerous examples how to apply these techniques to the solution of specific problems.

The first part of the book covers fundamental concepts, basic theorems, and an introduction to wave propagation. Of particular interest is the chapter on basic theorems dealing with various well-known

electromagnetic theorems and principles such as the equivalence principle, the induction theorem, the reciprocity principle, and uniqueness theorems. Further along, wave functions are discussed in detail with application to waveguide propagation, radiation, and scattering. The study of wave functions covers plane waves, cylindrical waves, and spherical waves. The last two chapters cover perturbational and variational techniques utilized in solving cavity, waveguide, and scattering problems, model expansions, and micro-wave equivalence circuits.

There are a few appendices on mathematical techniques which the reader will find useful. Several tables throughout the book summarize the most important properties of wave functions. As an example, Table 5-1 has an excellent summary of the properties of cylindrical wave functions showing small and large argument formulas for Hankel's functions, Bessel's functions, and Newman's functions.

The book is a well-rounded exposition on the treatment of electromagnetic fields as applied to engineering problems. — H. HODARA, *Head of Space Communications, Research and Development Div., The Hallicrafters Co., Chicago, Ill.*

Numerical Methods for High-Speed Computers

By G. N. LANCE

Iliffe & Sons, Ltd., London, 166 p., \$5.88.

THE author seems to have attempted to combine a reference type presentation of numerical methods suitable for computer application with a scholarly treatment of these same methods. Unfortunately, he has not succeeded in doing either. Although a reasonable representation of method appears, the treatment is not sufficient for a good analysis of the application to a particular problem nor is it a concise list of proven infallible, plug-in formulas for all to use. Everything said in this book has been said better elsewhere.—W.E.B.

248A	1N595	1N1200	1N404	1N505	1N748	1N991A	1N1
249	1N599	1N1198A	1N482	1N903A	1N749	1N992A	1N2
249A	1N599A	1N1199A	1N482A	1N904	1N750	1N1518	1N2
250	1N600	1N1200A	1N482B	1N904A	1N751	1N1519	1N2
250A	1N600A	1N1201A	1N483	1N905	1N752	1N1520	1N2
332	1N601	1N1202A	1N483A	1N905A	1N753	1N1521	1N2
333	1N601A	1N1203A	1N483B	1N906	1N754	1N1522	1N2
334	1N602	1N1204A	1N484	1N906A	1N755	1N1529	1N1
335	1N602A	1N1205A	1N484A	1N907	1N756	1N1524	1N1
336	1N603	1N1206A	1N484B	1N907A	1N757	1N1525	1N1
337	1N604	1N1342	1N485A	1N908A	1N758	1N1526	1N1
338	1N604A	1N1343	1N485B	1N914	1N761	1N1527	1N1
339	1N605	1N1344	1N486	1N914A	1N762	1N1528	1N1
340	1N605A	1N1345	1N486A	1N916	1N763	1N1589	1N1
341	1N606	1N1346	1N486B	1N916A	1N764	1N1590	1N1
342	1N606A	1N1347	1N487	1N708	1N765	1N1591	1N1
344	1N607	1N1348	1N487A	1N709	1N766	1N1592	1N1
345	1N607A	1N1341A	1N488	1N710	1N767	1N1593	1N1
346	1N608	1N1342A	1N488A	1N711	1N768	1N1594	1N1
347	1N608A	1N1343A	1N625	1N712	1N769	1N1595	1N1
348	1N609	1N1344A	1N626	1N713	1N957A	1N1596	1N1
349	1N609A	1N1345A	1N627	1N714	1N958A	1N1597	1N1
140	1N610	1N1346A	1N628	1N715	1N959A	1N1598	1N1
141	1N610A	1N1347A	1N629	1N716	1N960A	1N1351	1N1
142	1N611	1N1348A	1N643	1N717	1N961A	1N1352	1N1
143	1N611A	1N1581	1N645	1N718	1N962A	1N1353	1N1
144	1N612	1N1582	1N645A	1N719	1N963A	1N1354	1N1
145	1N612A	1N1583	1N646	1N720	1N964A	1N1355	1N2
140B	1N613	1N1584	1N647	1N721	1N965A	1N1356	1N2
141B	1N613A	1N1585	1N648	1N722	1N966A	1N1357	1N2
142B	1N614	1N1586	1N649	1N723	1N967A	1N1358	1N2
143B	1N614A	1N1587	1N658	1N724	1N968A	1N1359	1N2
144B	1N1095	1N1692	1N659	1N725	1N969A	1N1360	1N2
145B	1N1096	1N1693	1N660	1N726	1N970A	1N1361	1N2
530	1N1100	1N1694	1N661	1N727	1N971A	1N1362	1N2
531	1N1101	1N1695	1N662	1N728	1N972A	1N1363	1N2
532	1N1102	1N1696	1N663	1N729	1N973A	1N1364	1N2
533	1N1103	1N1697	1N676	1N730	1N974A	1N1365	1N2
534	1N1104					1N1366	1N2
535	1N1105					1N1367	1N2
536	1N1191					1N1368	1N2
537	1N1192					1N1369	1N2
538	1N1193					1N1370	1N2
539	1N1194					1N1371	1N2
540	1N1195					1N1372	1N2
547	1N1196					1N1373	1N2
550	1N1197					1N1374	1N2

THE COMPLETE SILICON LINE



FOR

PGZ

POWER
RECTIFIERS
(low, medium, high)

GLASS
DIODES
(mesa, computer, general purpose)

ZENER
REFERENCE
DIODES
(glass, axial, stud)

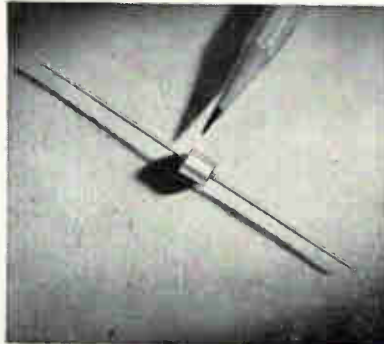

NEW!

One-amp "NoFlange"* rectifier

High temperature leakage ratings as low as 10 uA max. at 150°C. Up to 1000 PIV. No heat sink, yet smaller than a tophat. Hermetically sealed — double diffused junction. Case optionally insulated.

MORE POWER — LESS SPACE

*patent pending



Electronic devices, Incorporated

50 WEBSTER AVENUE • NEW ROCHELLE • NEW YORK

©1961—EDI



H-P Erecting Colorado Plant

HEWLETT-PACKARD CO. is building a new plant on an 84-acre site at the Loveland Industrial Park, a new industrial area south of Loveland, about 50 miles north of Denver, Colo. David Packard, president, said plans are eventually to provide more than 400,000 sq ft of engineering and manufacturing space.

Three buildings, each with 140,000 sq ft, are projected. The first unit, a single-story building, is already under construction, Packard said. Completion is expected early next year. The new plant will be operated by the company's Loveland division and will employ upwards of 500 people.

Hewlett-Packard, headquartered in Palo Alto, manufactures electronic measuring instruments. The company's Colorado operations date back to July, 1960, when it began operating a small manufacturing facility in Loveland. This interim plant of 13,000 sq ft is currently producing about a dozen different models of H-P instruments, including voltmeters, oscillators and power supplies.

Packard said the new plant will house complete research and development facilities as well as a large manufacturing operation. "We intend to increase our Loveland engineering staff considerably over the next several months and to make it a full-fledged research arm of the company," he said. "Initial emphasis will be on the development of new instruments in the audio-video field. We will, of course, continue to maintain our

central research and development department in Palo Alto."

Stan Selby, general manager of the Loveland Division, announced that the new plant's research activities would be directed by Marco Negrete, chief engineer. Donald Cullen has been appointed plant manager.

Hewlett-Packard now produces over 400 different types of precision instruments which are distributed throughout the U. S. and in 68 foreign countries. In addition to its Loveland facility, the company has two manufacturing plants in Palo Alto and one in West Germany. Total employment, including subsidiary companies, is approximately 3,500.



Irvine Moves Up At Avco Corp.

C. ROBERT IRVINE has been appointed general operations manager for the Richmond, Va., plant of Avco Corporation's Electronics and Ordnance division.

Irvine, who has completed 29 years with the company holding

many diversified positions, takes over the position vacated by J. D. Taylor, who has retired.

Burruano Sets Up Consulting Group

A NEW FIRM, specializing in the field of systems interference prediction, control and analysis, has been established in Westwood, N. J., by Samuel J. Burruano. It will be known as Burruano Associates, Inc.

Burruano was former manager of Systems Engineering Division of Filtron Co., Inc. in New York. He was also formerly associated with RCA in Camden for 13 years in radar design and there formed a company-wide RFI Group.



Perkin Electronics Names Ehlers

PERKIN ELECTRONIC CORP., El Segundo, Calif., has appointed Malcolm Ehlers as industrial engineering manager. He has been associated with Ryan Electronics, Hydraulics Specialties, and North American Aviation.



Assembly Engineers Appoints Possell

ASSEMBLY ENGINEERS, INC., Los Angeles, Calif., designer and manufacturer of precision missile and

MORE FROM PRD!



BROADBAND DIRECT-READING ATTENUATORS now available through K bands . . . up to 40 kmc. Compact, precision instruments feature 60 DB Attenuation Range, VSWR 1.15 Maximum, Accuracy to ± 0.1 DB, Insertion Loss as low as 0.5 DB, Spectrum Coverage from 3.95 to 40.0 kmc/s (nine models). Direct Reading. Send for data.

PRD ELECTRONICS, INC.
 202 Tillary St., Brooklyn 1, N. Y., ULster 2-6800;
 1608 Centinela Ave., Inglewood, Calif., OREGON
 8-9048 • A Subsidiary of Harris-Intertype Corp.

HARRIS
 INTERTYPE
 CORPORATION

CIRCLE 217 ON READER SERVICE CARD

PHAZOR
 PAT. PEND.

PHASE METER

MODEL
 200AB

PRICE
\$449.00



- 2° absolute accuracy
- Readings not affected by noise and harmonics
- Frequency range 15 CPS — 30KC
- Accuracy to .01 degree with simple circuit techniques
- High sensitivity on input & reference channels
- Can measure in-phase & quadrature voltage component

For further information contact your nearest representative or write for brochure



INDUSTRIAL TEST EQUIPMENT CO.
 55 E. 11th ST. • NEW YORK 3 • GR. 3-4684

Visit Booth #213, NEC SHOW, International Amphitheatre, Chicago, Oct. 9-11, 1961

CIRCLE 218 ON READER SERVICE CARD

September 29, 1961



SHIELD

your cables from Radio Frequency Interference with ZIPPERTUBING...

instant jacketing for all applications.

ZIPPERTUBING shields and jackets cables in a single, easy, economical operation. Available in a wide range of materials to meet extreme RFI and environmental conditions, including abrasion, extreme heat and cold.

Send for our free catalog and take advantage of our confidential consultation and design service.

INSTANT JACKETING FOR ALL APPLICATIONS

EVEN AFTER ASSEMBLY COMPLETED

PAT. AND PAT. APP. FOR

THE Zippertubing® CO.

Main Office and Plant:
 13000 S. Broadway, Los Angeles 61, Cal. • FA 1-3901
 Eastern Office and Warehouse:
 470 U. S. Hwy. 46, S. Hackensack, N. J. • HU 7-6261

Manufacturers of:

- PHASE METERS
- NULL DETECTORS
- IMPEDANCE COMPARATORS
- POWER OSCILLATORS
- FREQUENCY STANDARDS
- AUTOMATIC HI-POT

Other Electronic Test Equipment

CIRCLE 191 ON READER SERVICE CARD

143298

Core
Driver

Pacific Semiconductors, Inc.
A SUBSIDIARY OF THOMPSON RAMO WOOLDRIDGE INC.



12955 CHADRON AVE., HAWTHORNE, CALIFORNIA

aircraft devices, has appointed C. R. Possell as chief engineer.

Possell served previously as president and chief engineer of Propulsion Development Laboratories, Inc., El Segundo, Calif.



National Transistor Hires Whitney

LEONARD C. WHITNEY has joined the engineering staff of National Transistor Mfg., Inc., Lawrence, Mass., as manager, electronic engineering.

Prior to joining National Transistor, Whitney was senior engineer with Clevite Transistor Products Co. Before that he was an electronic consultant for a British engineering firm.

James Electronics Moves Division

JAMES ELECTRONICS INC. has moved its Magnetic Division to a new 12,000 sq ft building near the main plant in Chicago, Ill.

The new building, air-conditioned and dust free, is designed for the production of precision instrument transformers, subminiature transformers, reactors, transducers and other similar products.



Cox Joins ICF As Chief Engineer

MARCUS L. COX, authority on antenna systems, has joined Instrument

solid state information retrieval a problem?

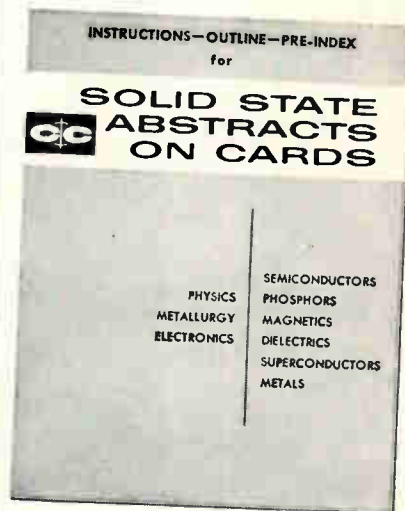

Let this FREE 120 page book show you how information retrieval is made easier, faster, more complete . . . with

SOLID STATE ABSTRACTS ON CARDS

the quick, cumulative reference to literature in the solid state field.

Send for your copy today

CAMBRIDGE COMMUNICATIONS CORPORATION

240 MAIN STREET
CAMBRIDGE 42, MASSACHUSETTS
Kirkland 7-1997

CIRCLE 219 ON READER SERVICE CARD
electronics

ANVAR™

Combination of electrical characteristics never before possible!
500mA @ .9V • RECOVERY 2.2 μsec • 7 pf CAP @ -9V
This remarkable silicon diode exhibits a forward spike of only 1.3V when subjected to a 500mA rise time pulse.
Ask for detailed specifications!

TELEMETRY BY TELE-DYNAMICS

1 and 2-watt Transistorized FM Transmitters



If you've a need for light—17 ounces—extremely compact—20 cu. in.—215 to 260 telemetry transmitters, specify Tele-Dynamic's Type 1053A and Type 1055A.

Providing one- or two-watt true FM output respectively, they employ dependable silicon transistors for high efficiency and offer better than 0.01% frequency stability. Type 1055A uses germanium transistors in the output stage. Each will operate reliably at any altitude and under any environment. Pressurized aluminum cases seal out the effects of altitude, humidity, salt spray, sand and dust.

These units, representative of Tele-Dynamic's latest creative effort in the complete telemetry field, are capable of being combined into various custom systems and are low in cost.

For detailed technical bulletins, call the American Bosch Arma marketing offices in Washington, Dayton or Los Angeles. Or write or call Tele-Dynamics Division, American Bosch Arma Corporation, 5000 Parkside Avenue, Philadelphia 31, Pa. Telephone TRinity 8-3000.

8412

TELE-DYNAMICS
DIVISION
AMERICAN BOSCH ARMA
CORPORATION

5000 Parkside Ave., Philadelphia 31, Pa.

CIRCLE 221 ON READER SERVICE CARD
September 29, 1961

20 to 200 D.P.

Send your prints
for quotations

- SPURS
- HELICALS
- WORM AND WORM GEARS
- STRAIGHT BEVELS
- LEAD SCREWS
- RATCHETS
- CLUSTER GEARS
- RACKS
- INTERNALS
- ODD SHAPES

We make gears like these for a wide variety of gages, meters, indicators, controllers, etc. Tell us your needs.

FOR AUTOMATIC
CONTROLS

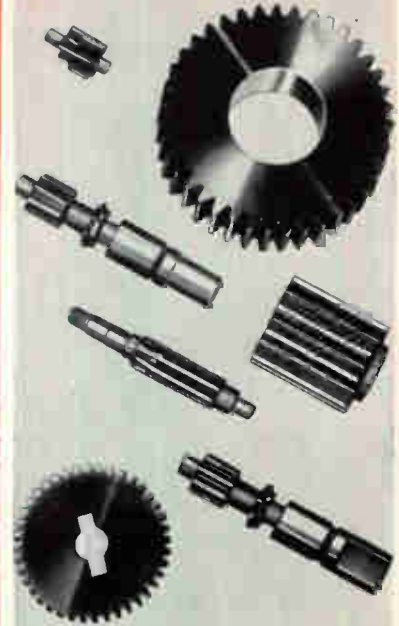

THE *Finest* IN GEARS

Beaver Gear Works Inc.

1021 PARMELE STREET, ROCKFORD, ILLINOIS



CIRCLE 220 ON READER SERVICE CARD

Acoustical Components of Superior Quality

JAPAN PIEZO supplies 80% of Japan's crystal product requirements. Here are a few examples of our capabilities.



MICROPHONE
Crystal—X-29

At 20°C, 1KC/s, Sensitivity is
—58 ± 5db. Impedence: 100KΩ.
Capacitance: 1,500 pF.



PHONOGRAPH MOTOR—DC
PM—31-1

9V, 2,500 RPM: No-load current,
35 mA; load current, 80 mA.
Starting torque, 13 g-cm; load
torque, 5g-m. Size: 2.4cm X 4.6cm.
Weight: 100 gm.

STEREO CARTRIDGE

Crystal—"PIEZO" Y-130
X'TAL STEREO CARTRIDGE
At 20°C, response: 50 to 10,000
c/s with a separation of 16.5db.
0.6V output at 50 mm/sec. Track-
ing force: 6 ± 1gm. Compliance:
1.5 × 10⁻⁶ cm/dyne. Termination:
1MΩ + 150pF.



Write for detailed catalog to :



JAPAN PIEZO ELECTRIC CO., LTD.

Kami-renjaku, Mitaka, Tokyo, Japan

CIRCLE 193 ON READER SERVICE CARD

data recorders expensive?



not any more

now, Mnemotron gives you a complete, easy-to-use 4-channel analog tape record/reproduce system with 0.2% precision for only **\$3,495**

Complete with 10½" reel tape transport, rack mounted.

Mnemotron offers a unique pulsed FM principle and fully transistorized, self-contained unit that records all analog data • data acquisition • storage, analysis and reduction • time scale contraction and expansion • programming • computer read IN and read OUT • dynamic simulation. With Mnemotron, you can do more with paper recorders . . . expanding frequency response and channel capacity, saving you from being deluged with data, permitting you to look at the same data at different time scales.

Model M204 features:

Any 2 adjacent speeds: 3¾, 7½, 15 ips.
Added low speed available on special order.

Frequency Response:

- DC—800 cps @ 15 ips
- DC—400 cps @ 7½ ips
- DC—200 cps @ 3¾ ips

Linearity: 0.2% full scale.

Noise: Less than -50 db full scale.

Crosstalk: below 70 db.

Extended range systems also available.

Write, wire, phone today for complete details.

MNEMOTRON
CORPORATION

precision analog data tape recorders and biological computers

37 South Main Street, Pearl River, N. Y.
• Pearl River 5-4015 (914)
• Cables: Mnemotron

CIRCLE 194 ON READER SERVICE CARD

Corp. of Florida, Melbourne, Fla., as chief engineer. Company designs and develops photogrammetric and electronic instrumentation.

Prior to joining ICF, Cox was a principal engineer and a member of the technical staff of the RF Division, Radiation, Inc. There he worked on the TLM-18 antenna systems and participated in Project Score.



John Vogt Takes New Position

JOHN N. VOGT has joined Temperature Engineering Corp, as vice president in charge of manufacturing.

For the past 15 years Vogt has served with General Electric Co., helping to pioneer notable advances in silicon rectifier manufacturing equipment and tooling, and in the establishment of quality control standards for the semiconductor industry.



CBS Laboratories Advances Heizman

CHARLES L. HEIZMAN has been promoted to manager of the exploratory circuitry section, solid state physics branch, CBS Laboratories, Stamford, Conn.

Before joining CBS Laboratories in April, Heizman spent four years

TELEFUNKEN SEMICONDUCTORS



GERMANIUM-
SILICON DIODES
TRANSISTORS
RECEIVING TUBES
CATHODE RAY
TUBES



SEND
FOR FREE
SEMICONDUCTOR
MANUAL
#4

AMERICAN ELITE INC.

4850 34th STREET,
LONG ISLAND CITY, N. Y.
Telephone: ST 6-8913

CIRCLE 222 ON READER SERVICE CARD

Various Types of Tamura's Zero-Reset Counters

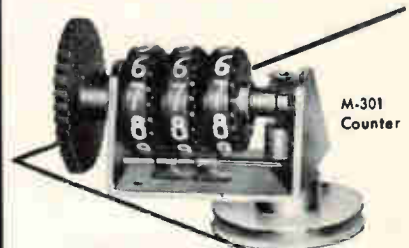

M-301
Counter

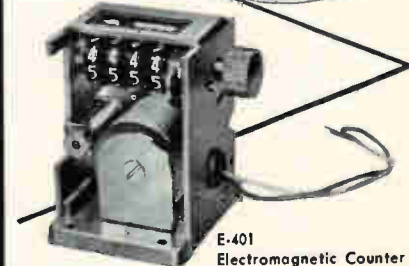

E-401
Electromagnetic Counter

Tamura Electric Works Ltd.

364, Shimomeguro-2, Meguro, Tokyo, Japon
Cable Address: TAMURAELEC TOKYO
Tel: Tokyo (491) 7101

CIRCLE 223 ON READER SERVICE CARD
electronics

with the research division of IBM Corp., where he worked on ultra-high speed switching circuits.



Oliva Organizes Consultant Group

JOSEPH A. OLIVA recently announced the opening of his own consultant organization in Red Bank, N. J.

His twenty-eight years of varied experience was spent in executive positions at International Rectifier Corp., Lockheed Aircraft Corp., Bendix Aviation Corp., Bureau of Naval Research, and the Signal Corps.



Dickson Electronics Hires Clark

O. MELVILLE CLARK has been named chief process control engineer at Dickson Electronics Corp., Scottsdale, Ariz.

Clark had previously been with Motorola, Inc., Semiconductor Products division for 5 years, where he held responsible positions in both development and productive engineering on Zener diode and rectifier products.

American Optical Forms Subsidiary

THE AMERICAN OPTICAL CO., Southbridge, Mass., has formed a new corporation, Laser Inc., to engage

September 29, 1961

FIRM FOOTING

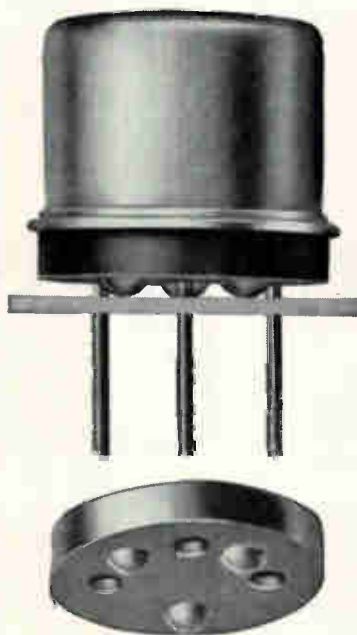

FOR TRANSISTORS

Transipads put a little extra security into printed-circuit assemblies. For a cost you count in pennies. A Transipad mounting is rock solid. It eliminates strain on delicate leads, provides vibration-proof separation between them. It isolates the transistor case from contact with printed conductors. And, perhaps most important, it provides a built-in air space to dissipate the heat of soldering (how many transistors have you lost lately through heat shock?). Transipads come in sizes and styles to fit most transistor types; some will convert lead arrangements from in-line to pin-circle, or vice-versa; others will widen lead spacing. Samples and drawings are yours for the asking. A note or a phone call will bring them.



THE MILTON ROSS COMPANY

238 Jacksonville Road, Hatboro, Pa. Phone: OSborne 2-0551

CIRCLE 195 ON READER SERVICE CARD

195

MICO Precision Apparatus

NEW HEAVY
DUTY 2 & 3
DIMENSIONAL
ENGRAVER



FOR
Engraving
Nameplates
Fine Routing Work
Profiling Small
Objects
Making Small Dies
and Molds



UHF COAXIAL
WAVEMETERS

2-75
Centimeter
Range

Send for Illustrated Catalogs.
MICO INSTRUMENT CO.
77 Trowbridge St. Cambridge 38, Mass.
CIRCLE 224 ON READER SERVICE CARD

Designers & Quality Controllers

TEST ELECTRICAL CONNECTORS

to military specifications with

"WEIGHT GAGE"



QUICK! • SURE! • ECONOMICAL!

"Weight Gage" certifies that connectors meet your requirements for electrical contact . . . that reliability will be maintained under conditions of vibration and shock. Testing by "Weight Gage" eliminates expensive remounting of faulty connectors in assembled packages. So simple and fast to use, "Weight Gage" can be employed for 100% checks on in-coming assemblies or as an in-line production control. "Weight Gage" is supplied with nominal diameter pins for checking both high and low limits at the same time . . . accurately . . . for all military specifications. "Specials" can be produced quickly to meet your specifications.

For full information and reference drawings, write:

ELECTRONIC CONNECTORS, INC.

connector specialists

84-45 ABINGDON ROAD
KEW GARDENS 15, NEW YORK

CIRCLE 225 ON READER SERVICE CARD

in fundamental research in the laser field. The new firm will be headed by E. Weldon Schumacher, president of American Optical.



Aircraft Radio Advances Post

APPOINTMENT of Richard F. Post as head of the military and industrial products department at Aircraft Radio Corp., Boonton, N. J., is announced. Post joined ARC in 1957.

PEOPLE IN BRIEF

Robert N. Lesnick, formerly with Stewart Warner Electronics and Beltone Research Labs, is now director of engineering operations for the western development labs of Philco Corp. Robert L. Kent promoted to manager, electronic systems engineering department, at Itek Electro-Products Co. Roy D. Jablonsky, Giannini Controls Corp. named manager of its servo component division. Thomas H. O'Brien advances to vice president-operations of PRD Electronics, Inc. Edward Bachorik moves up to executive v-p of Allied Control Co., Inc. Election of Lt. Gen. E. R. Quesada (U. S. A. F. Ret.) as a director of Edgerton, Germeshausen & Grier, Inc., is announced. Frederick M. Sawyer, ex-RCA, joins Secoa Electronics Corp. as manager of process engineering. R. E. Henning is named chief engineer of the Sperry Microwave Electronics Co. Marvin R. Emerson leaves United Aircraft to join MS&A, computer consultants. Paul W. Larsen resigns from the Tele-register Corp. to accept the presidency of Information Retrieval Corp. George V. Gerber, formerly with RCA, is named chief components engineer, military electronics division, Daystrom, Inc.

Coils for Contact Capsules

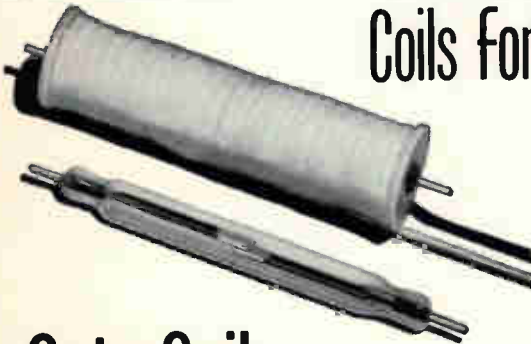

TYPE	DC-V	Ohms	Nom. Watts	Nom. Amp/TURNS
S	6	100	.40	250
	12	360		
	24	1400		
M	6	50	.70	250
	12	175		
	24	820		
T	6	100	.35	125
	12	400		
	24	1600		
	32	2800		
	48	4600		

Coto-Coils

COTO-COIL CO., INC.
65 Pavilion Avenue
Providence 5, R. I.

Write for Bulletin and Prices
CIRCLE 226 ON READER SERVICE CARD

Is your advertising selling the same four key buyers your salesmen call on? Competition demands it! Only advertising in electronics reaches and sells the electronics man wherever he is: in Research,

TODAY YOU MUST SELL ALL FOUR!

Design, Production, and Management. Put your advertising where it works hardest...

in **electronics**

electronics

WEEKLY QUALIFICATION FORM FOR POSITIONS AVAILABLE

ATTENTION: ENGINEERS, SCIENTISTS, PHYSICISTS

This Qualification Form is designed to help you advance in the electronics industry. It is unique and compact. Designed with the assistance of professional personnel management, it isolates specific experience in electronics and deals only in essential background information.

The advertisers listed here are seeking professional experience. Fill in the Qualification Form below.

STRICTLY CONFIDENTIAL

Your Qualification form will be handled as "Strictly Confidential" by ELECTRONICS. Our processing system is such that your form will be forwarded within 24 hours to the proper executives in the companies you select. You will be contacted at your home by the interested companies.

WHAT TO DO

1. Review the positions in the advertisements.
2. Select those for which you qualify.
3. Notice the key numbers.
4. Circle the corresponding key number below the Qualification Form.
5. Fill out the form completely. Please print clearly.
6. Mail to: D. Hawksby, Classified Advertising Div., ELECTRONICS, Box 12, New York 36, N. Y. (No charge, of course).

COMPANY	SEE PAGE	KEY #
BUTTRICK & MEGARY Philadelphia, Pa.	96*	1
ERIE ELECTRONICS DIV. Erie Resistor Corp. Erie, Pa.	199	2
ESQUIRE PERSONNEL Chicago, Illinois	96*	3
HUGHES AEROSPACE ENGINEERING DIV. Hughes Aircraft Company Culver City, California	73*	4
I B M CORP. New York, New York	27	5
JET PROPULSION LABORATORY Pasadena, California	198, 199	6
LITTON SYSTEMS INC. Data Systems Div. Canoga Park, California	32*	7
PERKIN-ELMER CORP. Norwalk, Conn.	96*	8
POLYPHASE INSTRUMENT CO. Bridgeport, Pa.	96*	9
REPUBLIC AVIATION CORPORATION Farmingdale, L. I., New York	95*	10
SCIENTISTS, ENGINEERS & EXECUTIVES INC. Washington, D. C.	199	11
TEXAS INSTRUMENTS INCORPORATED Apparatus Div. Dallas, Texas	202	12
P-7498	199	13

*These advertisements appeared in the 9/22/61 issue.

(cut here)

(cut here)

electronics WEEKLY QUALIFICATION FORM FOR POSITIONS AVAILABLE

Personal Background

NAME

HOME ADDRESS.....

CITY..... ZONE..... STATE.....

HOME TELEPHONE.....

Education

PROFESSIONAL DEGREE(S).....

MAJOR(S)

UNIVERSITY

DATE(S)

FIELDS OF EXPERIENCE (Please Check)

9291

- | | | |
|--|--|---------------------------------------|
| <input type="checkbox"/> Aerospace | <input type="checkbox"/> Fire Control | <input type="checkbox"/> Radar |
| <input type="checkbox"/> Antennas | <input type="checkbox"/> Human Factors | <input type="checkbox"/> Radio-TV |
| <input type="checkbox"/> ASW | <input type="checkbox"/> Infrared | <input type="checkbox"/> Simulators |
| <input type="checkbox"/> Circuits | <input type="checkbox"/> Instrumentation | <input type="checkbox"/> Solid State |
| <input type="checkbox"/> Communications | <input type="checkbox"/> Medicine | <input type="checkbox"/> Telemetry |
| <input type="checkbox"/> Components | <input type="checkbox"/> Microwave | <input type="checkbox"/> Transformers |
| <input type="checkbox"/> Computers | <input type="checkbox"/> Navigation | <input type="checkbox"/> Other |
| <input type="checkbox"/> ECM | <input type="checkbox"/> Operations Research | <input type="checkbox"/> |
| <input type="checkbox"/> Electron Tubes | <input type="checkbox"/> Optics | <input type="checkbox"/> |
| <input type="checkbox"/> Engineering Writing | <input type="checkbox"/> Packaging | <input type="checkbox"/> |

CATEGORY OF SPECIALIZATION

Please indicate number of months
experience on proper lines.

	Technical Experience (Months)	Supervisory Experience (Months)
RESEARCH (pure, fundamental, basic)
RESEARCH (Applied)
SYSTEMS (New Concepts)
DEVELOPMENT (Model)
DESIGN (Product)
MANUFACTURING (Product)
FIELD (Service)
SALES (Proposals & Products)

CIRCLE KEY NUMBERS OF ABOVE COMPANIES' POSITIONS THAT INTEREST YOU

1 2 3 4 5 6 7 8 9 10 11 12 13 14 15 16 17 18 19 20 21 22 23 24 25

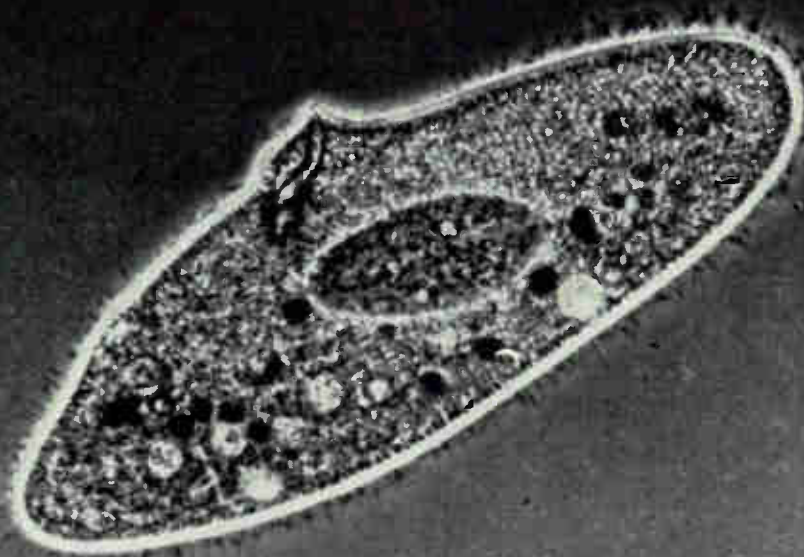

We don't want to put life on other planets

Just one living cell. The discovery of just one living cell in space would be one of man's greatest accomplishments. It would affirm the possibility that man-like civilizations could exist on other worlds.

But what if the life we found in space had been put there by our own spacecraft? What a tragic irony that would be!

To prevent this awesome mistake, Cal Tech's Jet Propulsion Laboratory is designing its spacecraft for the National Aeronautics and Space Administration to be 100% sterile before leaving our atmosphere.

The JPL Sterilization Program began even before the first Ranger shot. Different sterilization techniques are being tested in the JPL Lunar Program: heat soaking internal components at 125° Centigrade for 24 hours; coating all exposed surfaces of the spacecraft with ethylene oxide gas; using liquid sterilants during the spacecraft assembly.

By the time Mariner A makes the first "fly-by" to Venus, these tech-

niques will be perfected. Then, spacecraft will be free of any living organism that might upset our hopes of finding other life on other planets.

Spacecraft sterilization is only a small part of the work on JPL's Planetary Program and the job of space exploration as a whole. It's a job that requires the most creative, inventive minds this country has to offer. Minds that will only take know for an answer.

Write to us. Learn first-hand about the fascinating work our scientists and engineers do as America's leaders in space exploration. Learn how you can be part of this work...how your particular talent will be taxed to the limit in this, the greatest experiment of mankind.

JET PROPULSION LABORATORY
4814 Oak Grove Drive, Pasadena, California
Operated by California Institute of Technology for the National Aeronautics and Space Administration



All qualified applicants will receive consideration for employment without regard to race, creed or national origin. / U.S. citizenship or current security clearance required.



NEEDS SENIOR RESEARCH ENGINEERS AND SCIENTISTS

- To develop computer programs for solving engineering problems. Must have M. S. in mathematics or related field, knowledge of numerical analysis and ability to use a digital computer.
- To design and analyze ballistic and ion-propelled trajectories for lunar and interplanetary probes. Must have M. S. in Physics, Astronomy or Engineering Science and two to four years experience in celestial mechanics, trajectories and data analysis.
- To study space communications codes for efficiency, error correction, security, reliability, guidance and control. Must have Ph. D. with one year's experience or M. S. with three years' experience in discrete mathematics and applications to information theory, coding problems, and statistical communication theory.
- To study technical and economic feasibility of advanced facilities for vacuum technology, thermal and optical radiation, cryogenic and hydraulic flow systems. Must have at least a B. S. in Mechanical or Electrical Engineering and 6 to 8 years experience (some outside aviation industry) in broad engineering development and/or design.

Other opportunities exist for electronic engineers and physicists in many areas at JPL. Send complete qualification resume now for immediate consideration.

All qualified applicants will receive consideration for employment without regard to race, creed or national origin/U.S. citizenship or current security clearance required.

JET PROPULSION LABORATORY

California Institute of Technology
4814 Oak Grove Drive
Pasadena, California

POSITION VACANT

Sales Engineer/Manager with exp. in electronic instruments, delay lines. Excel. opportunity with well known Mfg. Ad-Yu Electronics Lab., Passaic, N. J.



**MANUFACTURERS'
REPRESENTATIVES**
IN THE ELECTRONIC INDUSTRY

SAMUEL K. MACDONALD, INC.

manufacturers representatives over 25 years
1531 SPRUCE STREET, PHILA. 2, PA.

Territory: Pennsylvania • New Jersey
Delaware • Maryland
Virginia • West Virginia
District of Columbia

Other Offices:
Pittsburgh
Baltimore
Washington, D.C.

EFFECTIVE ENGINEER RECRUITMENT ADVERTISING DEPENDS ON ENGINEERING READERSHIP

Where your recruitment program calls for qualified engineers in the electronics industry, there is no more efficient method of reaching them than through the pages of the publication they pay to read.

electronics

Classified Advertising Division

Post Office Box 12

New York 36, N. Y.

TRANSFORMER ENGINEER

With experience in the design and development of Hi-Frequency and Pulse transformers for commercial and military applications.

Ideal opportunity for ambitious man to develop full potential of present small department. Salary—open. Location—Erie, Pa. Call or send resume to Chief Engineer

Erie Electronics Division

Erie Resistor Corporation

645 West 12th Street Erie, Pa.
GL 6-8592

ENGINEERS — SCIENTISTS

MORE AND MORE COMPANIES

are continually coming to us for help!

WHY DON'T YOU?

S.E.E. client companies are wide in variety—large and small—with opportunities at all levels, as diverse as "the state of the art". Employers pay placement fee and relocation costs. If you are interested in advancement—

Send Resume to:

SCIENTISTS, ENGINEERS &
EXECUTIVES, Inc.

1026-17th St. N.W., Washington 6, D. C.

ASSISTANT RESEARCH DIRECTOR

This newly created position with a medium sized electrical—mechanical—electronic manufacturing organization, in a desirable New England location, has a key technical opportunity to assist in the organization, and ultimately head a new Research and Development Division.

Natural creative and imaginative ability are necessary to provide guidance and inspiration to a team of co-workers.

A Masters Degree in mechanical or Electrical engineering, and 5-10 years experience in research and development with an electrical—mechanical—electronic component manufacturer, are preferred.

Salary commensurate with experience.

Please submit resume in complete confidence to:

P-7498, Electronics
Class. Adv. Div., P.O. Box 12, N.Y. 36, N.Y.

SEARCHLIGHT SECTION

(Classified Advertising)

BUSINESS OPPORTUNITIES

EQUIPMENT - USED or RESALE

DISPLAYED RATE

The advertising rate is \$24.75 per inch for all advertising appearing on other than a contract basis. Contract rates quoted on request. AN ADVERTISING INCH is measured 1/8 inch vertically on one column, 3 columns—30 inches—to a page. EQUIPMENT WANTED or FOR SALE ADVERTISEMENTS acceptable only in Displayed Style.

UNDISPLAYED RATE

\$2.40 a line, minimum 3 lines. To figure advance payment count 5 average words as a line. BOX NUMBERS count as one line additional in undisplayed ads.

AUTO-TRACK & TELEMETRY ANTENNA PEDESTALS
3 & 10 CM. SCR 584 AUTOTRACK RADARS.
AN TPS-1D SEARCH. AN/TPS-10 HT. FINDERS.
AN/FPN-32GCA. AN/APS-10 NAVIG. & WEATHER.
AN/APS-15B PRECISION. AN/APQ-35B PRECISION.
AN/APS-31A SEARCH. DOZENS MORE.
.5-1.2 MEGAWATT HIGH POWER PULSERS.
MICROWAVE PLUMBING—TEST EQUIP.
LARGEST RADAR STOCK IN U.S.A.
RADIO RESEARCH INSTRUMENT CO.
550 Fifth Ave. New York Judson 6-4691

RADAR SYSTEMS & COMPONENTS / IMMEDIATE DELIVERY

CIRCLE 460 ON READER SERVICE CARD

\$10.95
Complete



Color Dial Telephones

Factory rebuilt Western Electric in white, beige, ivory, pink, green or blue. If 4 prong plug is required add \$2.00. Fully guaranteed. Write for free list. All shipments FOB.

SURPLUS SAVING CENTER

Waymart Dept. E-9291 Penna.

CIRCLE 461 ON READER SERVICE CARD

- Hewlett-Packard Company..... 15
- Hitachi, Ltd. 84
- Hogan Faximile Corp. 175

- Optical Gaging Products, Inc..... 87
- Optimized Devices Inc. 74

- Industrial Electronic Engineers, Inc... 74
- Industrial Test Equipment Co. 191
- Inland Motor Corp. 85
- Instruments for Industry, Inc..... 172
- International Business Machines..... 27
- International Rectifier Corp..... 75

- PRD Electronics, Inc. 191
- Pacific Semiconductors Inc..... 192
- Panoramic Electronics Inc..... 71
- Philco Corporation 128
- Polarad Electronics Corporation.... 66, 67
- Precision Instrument Co. 169

- JFD Electronics Corp..... 155
- Japan Piezo Electric Co., Ltd..... 193
- Jennings Radio Manufacturing Corp... 176

- Radio Corporation of America... 4th Cover
- Raytheon Company 2nd Cover, 157, 182

Kulicke & Soffa Mfg. Co., Inc..... 38

- Sarkes Tarzian, Inc..... 126
- Semitronics, Inc. 156
- Servo Corporation of America..... 171
- Sillion Transistor Corp..... 152, 153
- Sprague Electric Co. 5, 22, 45
- Stoddart Aircraft Radio Co. Inc..... 50
- Super Tool Company 7
- Swiss Air Worldwide 78
- Sylvania Electric Products, Inc.... 37, 38

- Lafayette Radio 28
- Lambda Electronics Corp..... 3
- Leach Corporation 180
- Lepel High Frequency Laboratories, Inc. 64
- Lionel Electronic Laboratories... 6
- Litton Industries 86

- Tamura Electric Works Ltd..... 194
- Tektronix, Inc. 57
- Texas Instruments Incorporated
Semiconductor-Components
Division 25, 175, 177, 179, 181
- Texas Instruments Incorporated
Apparatus Division 202
- Tinnerman Products Inc..... 68
- Transitron Electronic Corp..... 51
- Tri Metal Works, Inc. 63

- M B Electronics, A Division
of Textron Electronics, Inc..... 165
- Malayan Tin Bureau 34
- Melabs 42
- Melpar Inc. 13
- Mico Instrument Co..... 106
- Millen Mfg. Co., Inc., James..... 64
- Milton Ross Company 195
- Minnesota Mining & Mfg. Co.
Chemical Division 81
- Mnemotron Corp. 194
- Morganite Inc. 162
- Motorola Semiconductor Products Inc. 83
- Motorola Military Electronics Div.... 62
- Mycalex Corp. of America..... 124

- Trio Laboratories, Inc. 163
- Tung-Sol Electric, Inc. 21

- Varian Associates 3rd Cover
- Veeder-Root, Inc. 76, 77

- NRC Equipment Co. 44
- Nippon Electric Co., Ltd..... 54
- Nuclear Corporation of America..... 80
- Nytronics Inc. 178

- See Advertisement in the July 20, 1961 issue of Electronics Buyers' Guide for complete line of products or services.

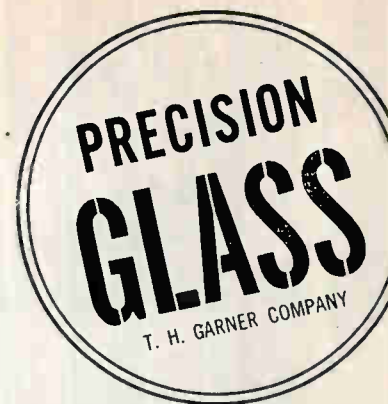

MANUFACTURED TO YOUR SPECIFICATIONS



One of a kind, or millions of parts . . . you get the closest tolerances from GARNER—tolerances which have led the field in the redrawn glass industry since 1953.

Large stocks of many different glass types and sizes—including the unusual. Available for immediate redraw.

Customer minded—We constantly upgrade equipment and techniques to keep ahead of your needs. You'll find us especially helpful on difficult requirements.

On-time deliveries—GARNER is geared for volume production to tight specifications—on a day-to-day basis. You get the parts you need . . . when you need them.

Send for complete data.



T. H. GARNER COMPANY

177 S. Indian Hill Blvd.
Claremont, Calif. • National 6-3526

ADVANCE WITH TI!

NEW GROWTH OPPORTUNITIES IN SYSTEMS AND COMPONENTS

RF DESIGN ENGINEER. To design new, completely solid state RF components for missile and space flight test equipment. Experience in VHF, UHF, and VHF transmitter design, with background in design and development of solid state RF circuitry, FM techniques, automatic frequency control. Thorough knowledge of miniaturized missile electronic packaging.

MICROWAVE DEVICE ENGINEER. To initiate advanced developmental programs involving broadband parametric amplifiers, radiometers, tunnel diode devices, ferrite phase shifters, switches, etc. Experience in microwave device design or microwave measurements with emphasis on solid state physics.

DIGITAL DESIGN ENGINEER. Experience in at least 3 of these areas: 1) logic design of digital computing equipment, 2) application of computers to real time systems, 3) circuit design with transistors and magnetic devices, 4) programming of general purpose computers.

TEST EQUIPMENT ENGINEER. For advanced work in high-speed switching and pulse circuitry for computer applications. Broad experience in industrial areas of component instrumentation design, in quality control work, with background in systems intergradation.

Advance your career with Texas Instruments. Send confidential resume to:

BOB BARRON, Dept. 11,

APPARATUS DIVISION
**TEXAS
INSTRUMENTS
INCORPORATED**

BOX 6015, DALLAS 22, TEXAS

An equal opportunity employer.

• Weinschel Engineering	14
Westinghouse Electric Corp.....	48, 49
White S. S.	188
Zippertubing	191

INDEX TO CLASSIFIED ADVERTISERS

Erie Electronics Div., Erie Resistor Corp.....	199
Jet Propulsion Laboratory.....	198, 199
• Radio Research Instrument Co.....	199
Scientists, Engineers & Executives Inc.	199
• Surplus Saving Center.....	199

• See Advertisement in the July 20, 1961 issue of Electronics Buyers' Guide for complete line of products of services.

MANUFACTURERS REPRESENTATIVES

MacDonald Inc. Samuel K.....	199
------------------------------	-----

CLASSIFIED ADVERTISING

F. J. Eberle, Business Mgr.

EMPLOYMENT OPPORTUNITIES	198, 199
--------------------------------	----------

EQUIPMENT (Used or Surplus New) For Sale	199
--	-----

This index and our Reader Service Numbers are published as a service. Every precaution is taken to make them accurate, but ELECTRONICS assumes no responsibilities for errors or omissions.

electronics



Audit Bureau
of Circulations



Associated Business
Publications

Audited Paid Circulation

JAMES T. HAUPTLI
Advertising Sales Manager

R. S. QUINT, Assistant Publisher Buyers' Guide and Business Manager; FRED STEWART, Promotion Manager; B. ANELLO, Marketing Service Manager; RICHARD J. TOMLINSON, Production Manager; GEORGE E. POMEROY, Classified Manager; HUGH J. QUINN, Circulation Manager.

ADVERTISING REPRESENTATIVES: NEW YORK (36) Donald H. Miller, Henry M. Shaw, George F. Werner, Robert M. Denmead, 500 Fifth Avenue, OXford 5-5959; BOSTON (16) William S. Hodgkinson, Donald R. Furth, McGraw-Hill Building, Copley Square, Congress 2-1160; PITTSBURGH (22) David M. Watson, Fair Gateway Center, Express 1-1314; PHILADELPHIA (3) Warren H. Gardner, William J. Boyle, 6 Penn Center Plaza, LOcust 8-4330;

CHICAGO (11) Harvey W. Wernecke, Martin J. Gallay, 645 North Michigan Avenue, Mohawk 4-5800; CLEVELAND (13) P. T. Fegley, 55 Public Square, Superior 1-7000; SAN FRANCISCO (11) T. H. Carmody, R. C. Alcorn, 255 California Street, Douglas 2-4600; LOS ANGELES (17) Marshall Freeman, Peter S. Carberry, 1125 W. 6th St., Huntley 2-5450; DENVER (2) J. W. Patten, Tower Building, 1700 Broadway, Alpine 5-2981; ATLANTA (9) M. H. Miller, 1375 Peachtree St. N.E., Trinity 5-0523; HOUSTON (25) Joseph C. Page, Jr., Prudential Bldg., Holcombe Blvd., Jackson 6-1281; DALLAS (1) Frank Le Beau, The Vaughn Bldg., 1712 Commerce St., Riverside 7-9721; LONDON W1, Dennis McDonald, 34 Dover St., FRANKFURT/Main, Stanley R. Kimes, 85 Westendstrasse; GENEVA, Michael R. Zeynel, 2 Place du Port.

HIGH-POWER LOW-FREQUENCY DUPLEXERS

1 Mw to 25 Mw

Bomac presents a state-of-the-art advancement in high-power, low-frequency duplexers. Applications include a wide variety of radar services and systems.

These duplexers are available in both waveguide and coaxial line configurations. Peak power ratings: 1 Mw to 25 Mw. Frequency range: 450 to 9600 Mc. Life expectancy: greater than 2000 hours.

Improved window design provides increased radar capability. Arc loss: much less than 0.1 db. Recovery time at high power is the fastest of any gas switching duplexer on the market. With increased power, recovery time increase is negligible.

Write for additional information, including power level and frequency desired.

Frequency (Mc)	Duplexer Type	Power		Max. Recovery Time @ 3 db (μ sec)	Arc Loss (db)	Transmitter to Receiver Isolation (db)
		Peak (Mw)	Average (kW)			
400-450	Branched Duplexer	2.5	300		< 0.1	74
400-450	Balanced Duplexer	5	40*	100	< 0.1	73
570-630	Balanced Duplexer	3	25	50	< 0.1	68
1250-1400	Balanced Duplexer	25	50	75	< 0.1	94
2700-3100	Balanced Pre-TR	10	25	100	< 0.1	50
5250-5750	Balanced Pre-TR	1	6.5	25	< 0.1	53
8400-9600	Balanced Duplexer	2	6	20	< 0.1	80

HIGH POWER WAVEGUIDE DUPLEXER LENGTH APPROX. 5'

*Short term tests have been successfully completed at 95 Mw peak, 150 kW average

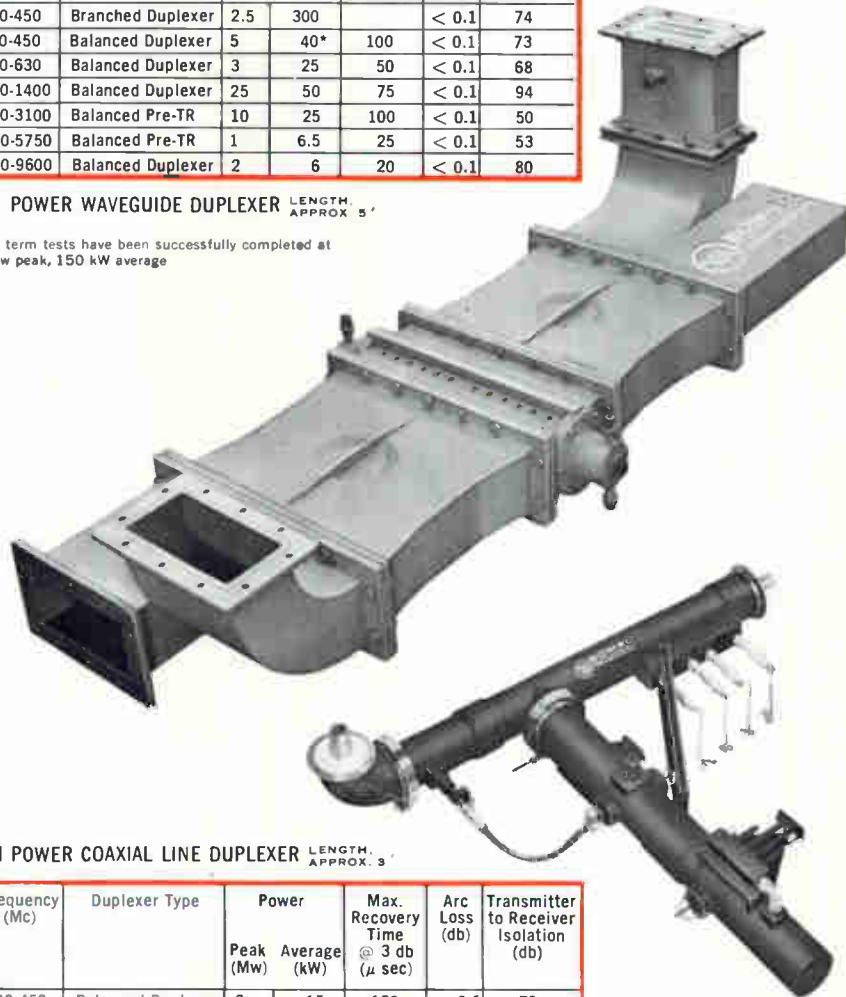

HIGH POWER COAXIAL LINE DUPLEXER LENGTH APPROX. 3'

Frequency (Mc)	Duplexer Type	Power		Max. Recovery Time @ 3 db (μ sec)	Arc Loss (db)	Transmitter to Receiver Isolation (db)
		Peak (Mw)	Average (kW)			
400-450	Balanced Duplexer	3	15	120	< 0.1	70
400-450	Branched Duplexer	3	5	100	< 0.1	60
850-950	Balanced Duplexer	2	15	100	< 0.1	70

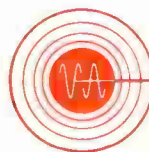

BOMAC laboratories, inc.

BEVERLY 1, MASSACHUSETTS
A Varian Subsidiary

Other Subsidiaries of Varian Associates:

S-F-D LABORATORIES, INC.
VARIAN ASSOCIATES OF CANADA, LTD.
SEMICON ASSOCIATES, INC.
SEMICON OF CALIFORNIA, INC.
VARIAN A.G. (SWITZERLAND)

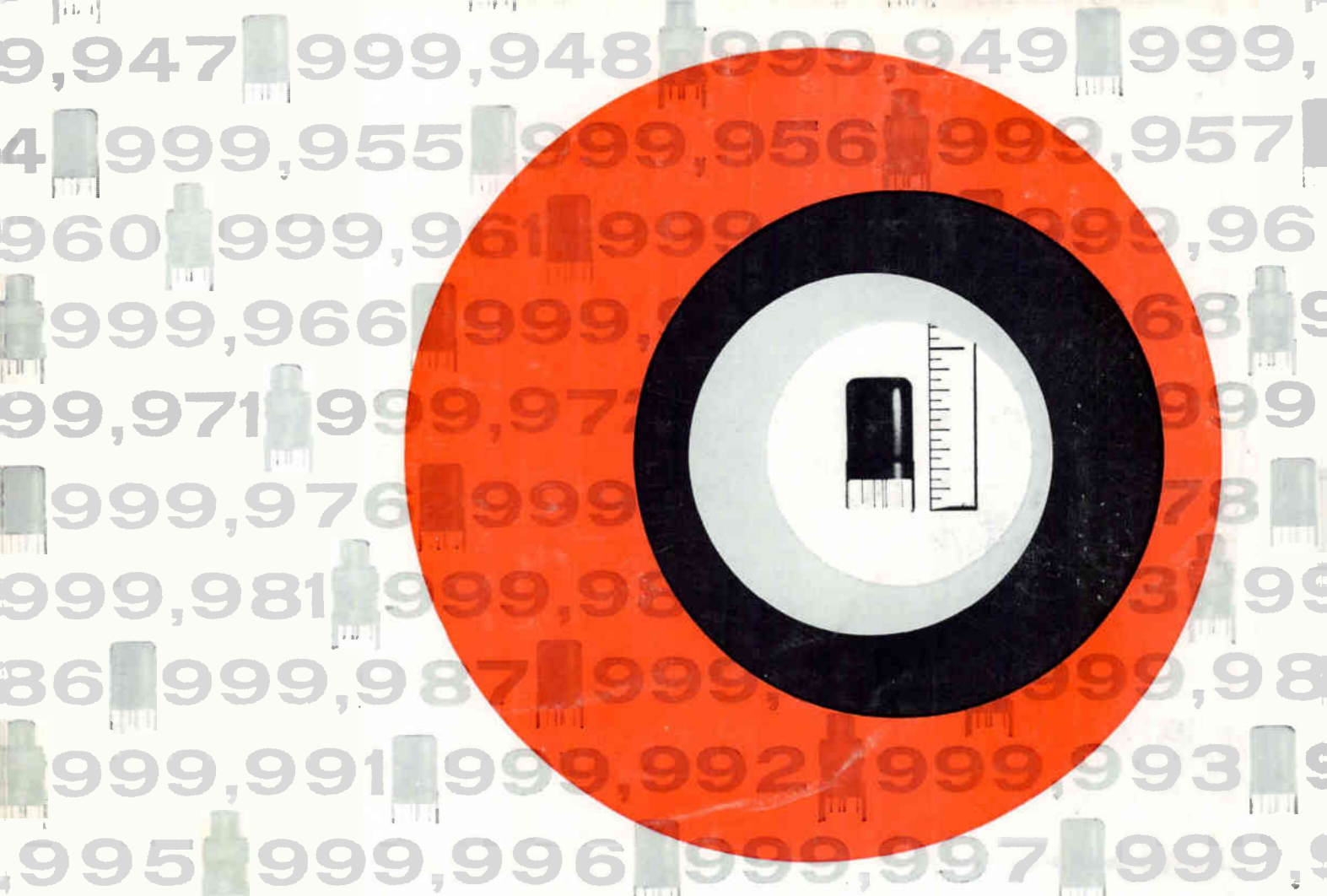

1,000,000 **nuvistors**

...and now the new RCA-6DS4 high-mu TV and FM tuner triode with semi-remote-cutoff characteristic to reduce cross-modulation distortion

In July, 1961 RCA produced its millionth nuvistor...evidence of the fast-growing popularity of this remarkable tube family.

Newest member of the nuvistor family is the RCA-6DS4, a high-mu triode for TV and FM tuner designs. In VHF TV tuners, the 6DS4 makes possible better reception in many difficult station areas. In addition, the semiremote-cutoff characteristic of the 6DS4 reduces cross-modulation distortion. The 6DS4 makes possible the design of compact TV and FM tuners with very low noise figure and high sensitivity.

This newest nuvistor triode owes its high gain and low-noise capabilities to very high transconductance and excellent transconductance-to-plate current ratio (12500 umhos at a plate current of 8 ma and plate voltage of 70 volts).

The 6DS4 is just one of 6 commercial nuvistors now

at your design command. The others are:

- RCA-7587 General-purpose sharp-cutoff industrial tetrode*
- RCA-7586 General-purpose medium-mu industrial triode*
- RCA-7895 High-mu industrial triode*
- RCA-6CW4 TV and FM tuner triode*
- RCA-2CW4 TV and FM tuner triode*

Inherent nuvistor design features include: low heater drain • exceptional mechanical ruggedness due to all ceramic and metal construction • exceptional uniformity of characteristics from tube to tube • extremely low interelectrode leakage • high sensitivity and stability • very small size and light weight.

Discover for yourself how much more you can expect from *nuvistorized* circuitry. See your RCA Field representative or write: Commercial Engineering, Section I-19-DE-5, RCA Electron Tube Division, Harrison, N. J.



The Most Trusted Name in Electronics