

electronics

A McGraw-Hill Publication 75 Cents

July 7, 1961

*Designing
microwave feed
system (right)
for 1,000-ft dish
aperture antenna
of Arecibo, P. R.
radar telescope, p 46*

*Recent progress
in semiconductor
purification.
See p 41*

*Scale model of
microwave feed
under test*

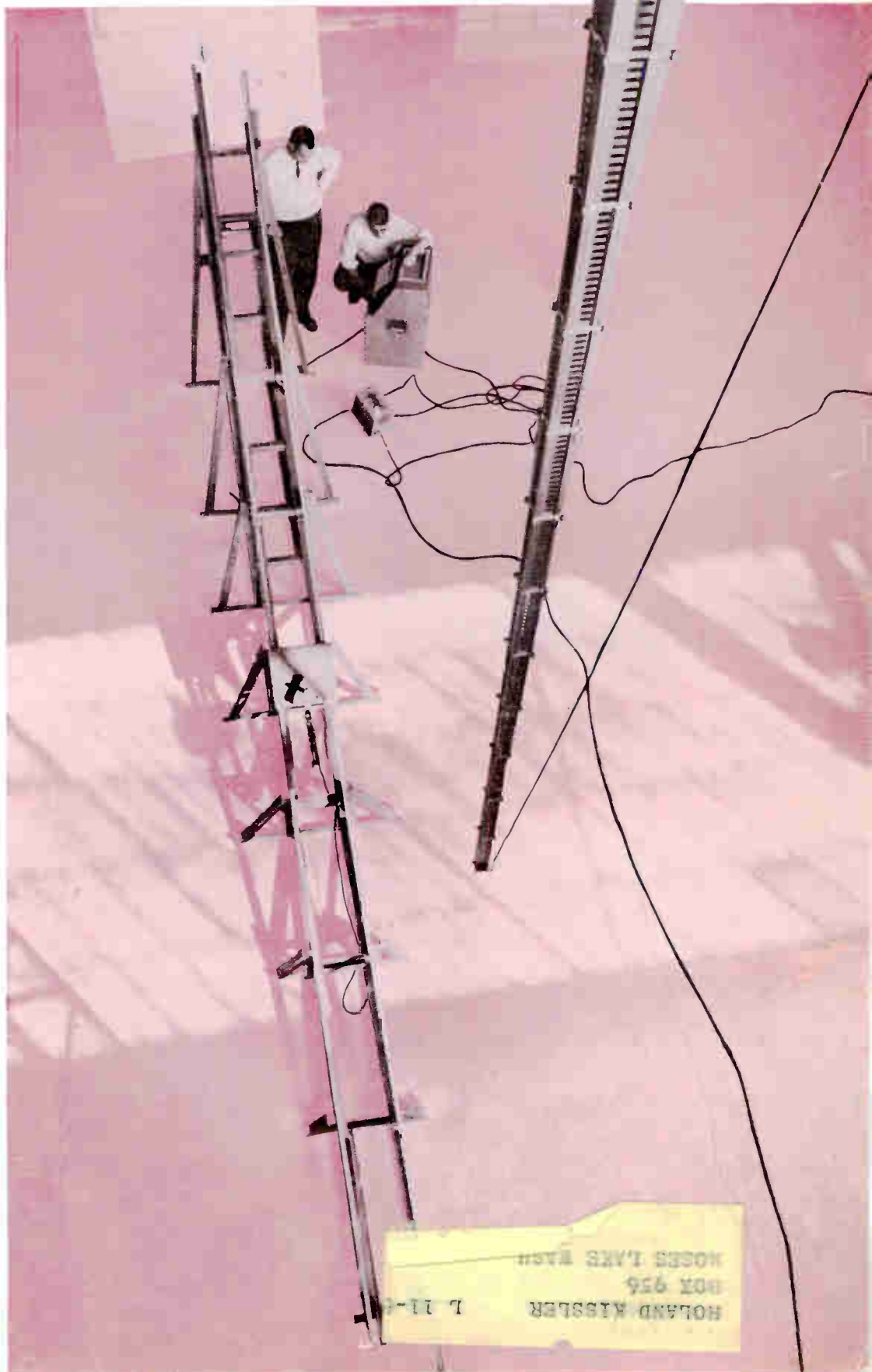

HOLAND KISSLER
BOX 956
MOSES LAKE WASH
7-11-61

ANOTHER ADVANCED MICROWAVE TUBE DEVELOPMENT
FROM RAYTHEON'S SPENCER LABORATORY

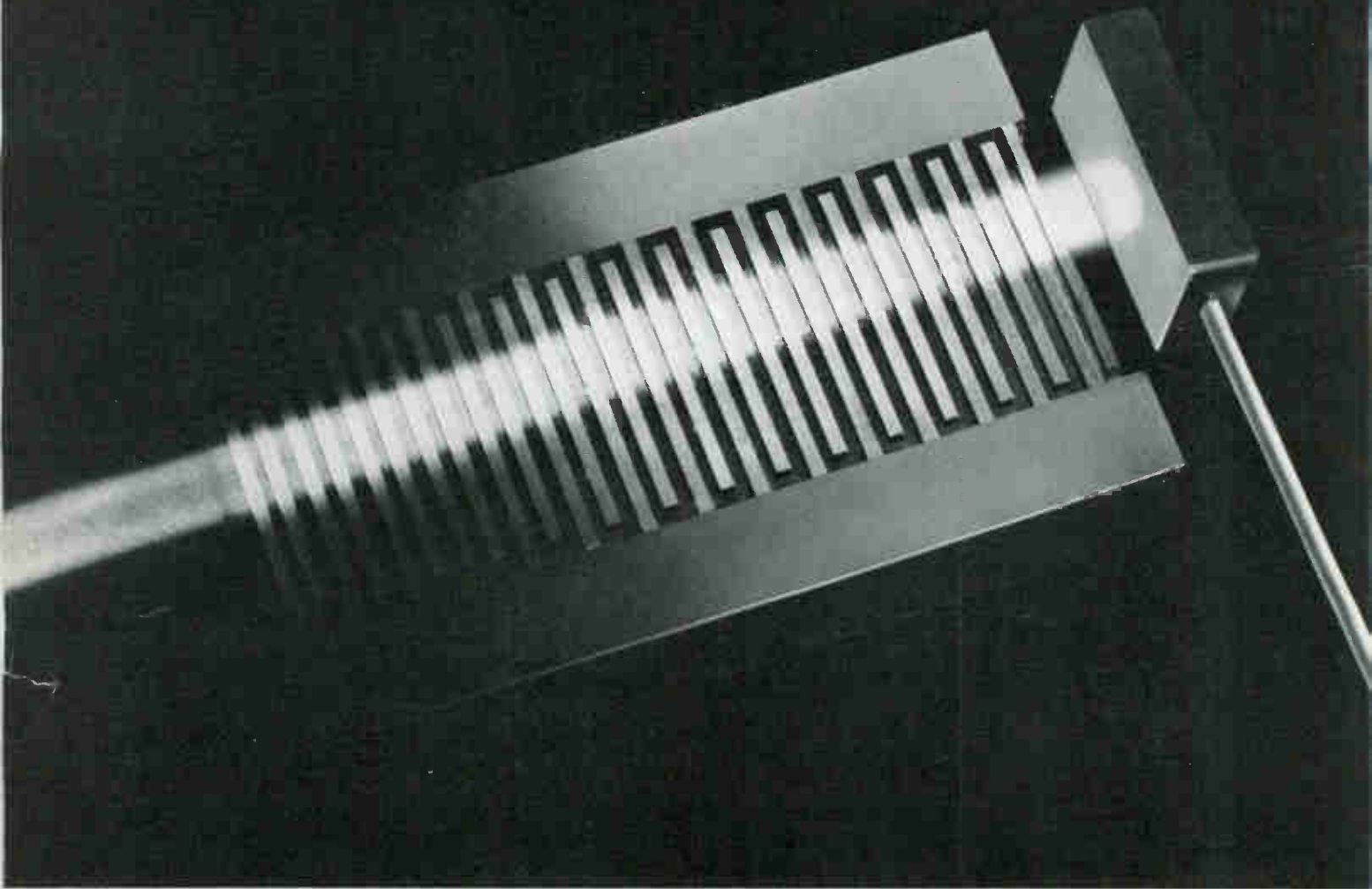

How new Raytheon "BEAM MISER" boosts efficiency in crossed field devices

Unique depressed collector greatly improves efficiency of "M" BWO's and crossed field amplifiers.

"Beam Miser" is Raytheon's newest advance in crossed field oscillator and amplifier design. With it are opened many new design possibilities for applications requiring voltage tunability or bandwidth plus high reliability and efficiency.

Incorporating the "Beam Miser" into existing crossed field tubes will yield improved performance and *will not require any mechanical or electrical changes in equipment.*

Write for further information on Raytheon developments in crossed field devices. Microwave & Power Tube Division, Raytheon Company, Waltham 54, Massachusetts. In Canada: Waterloo, Ontario.

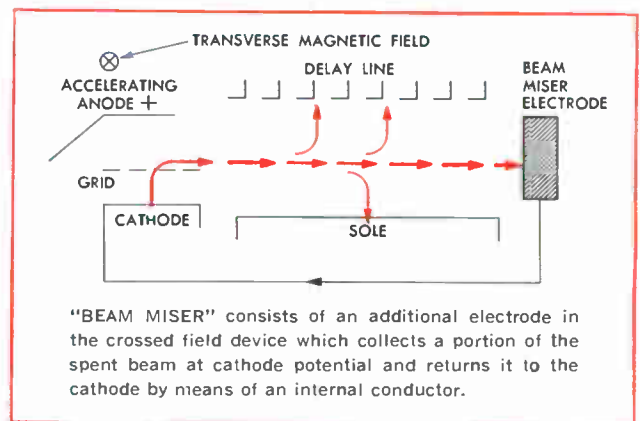

RAYTHEON COMPANY

MICROWAVE & POWER TUBE DIVISION

RAYTHEON

electronics

A McGraw-Hill Publication 75 Cents



W. W. MacDONALD, Editor

J. M. CARROLL, Managing Editor
 SENIOR ASSOCIATE EDITORS: Samuel Weber, Roland J. Charest. ASSOCIATE EDITORS: Michael F. Tomaino, George Sideris, Sylvester P. Carter, William P. O'Brien, John F. Mason, William E. Bushor, Thomas Emma, Sy Vogel, Leslie Solomon, M. M. Perugini, George J. Flynn.
 ASSISTANT EDITORS: Michael F. Wolff, Nilo Lindgren, Stanley Froud, Stephen B. Gray, Roy J. Bruun, George V. Novotny, Leon H. Dulberger.
 REGIONAL EDITORS: Harold C. Hood (Pacific Coast, Los Angeles), Thomas Maguire (New England, Boston), Cletus M. Wiley (Midwest, Chicago).
 ART DIRECTOR: Harry Phillips; Howard R. Berry. PRODUCTION EDITOR: John C. Wright, Jr. EDITORIAL ASSISTANTS: Gloria J. Meurer, Bernice Duffy, Lorraine Rossi, Virginia T. Bastian, Lynn Emery, Avis Pomeranz, Florence Hajaistran, Laura W. Smith, Bette H. Snyder.

JAMES GIRDWOOD, Publisher

Scale model of straight-line feed for 1,000-ft radio telescope being tested for electrical and mechanical performance. See p 46	COVER
Japanese Scope Business Gets Underway. But it faces obstacles	24
How Inventory Control Fits In. Now it's more technically oriented	26
F-M STEREO Dominates Conference. Decoder restores subcarrier	28
More U. S. Firms Going European. Over two dozen announce plans	30
Work Begins On Plan Probe Power Source	32
ULTRAPURE SEMICONDUCTORS: Boston conference report reveals new techniques for ultrapurification. By T. Maguire	41
Design of Line Feed for World's Largest-Aperture Antenna. Some of the problems encountered in building Arecibo 1,000-ft radio telescope dish. By A. F. Kay	46
TESTING HUMAN OPTICAL RESPONSE: Microflash and pulse stimulator tests color vision phenomena. By P. Scott	48
Positive and Negative Feedback Multiply Amplifier Input Impedance. Unity voltage gain from 5 cps to 10 Kc. By R. L. Willett	52
Pulse Comparator Circuit Measures Frequency Jitter. Simple counting and complementing. By K. Brackney and D. R. Gosch	54
Distortion Monitor Checks Linear Amplifier Characteristics. Does work of a spectrum analyzer. By G. H. Smith, Jr.	57
HIGH-SPEED MICROWAVE SWITCH. Employs both straight and circular-line couplers, measures power-phase for the oscilloscope display. By L. L. Oh and C. D. Lunden	60
Calculating Receiver Spurious Responses. Nomograph solves equation. By H. H. Jenkins	62

Crosstalk	4	Research and Development	64
Comment	6	Components and Materials	70
Electronics Newsletter	9	Production Techniques	74
Washington Outlook	14	New on the Market	78
Financial	20	Literature of the Week	87
25 Most Active Stocks	21	People and Plants	88
Meetings Ahead	34	Index to Advertisers	97

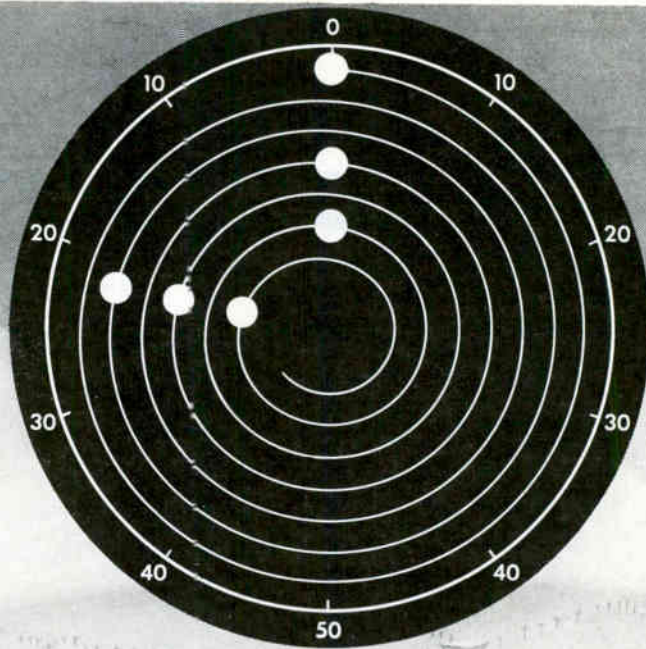

THIS TROUBLE HAS NO FUTURE!

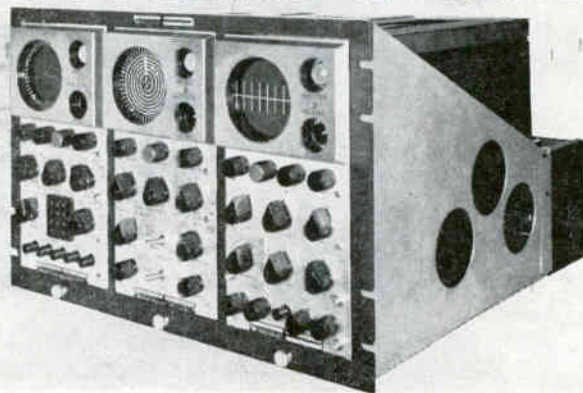

Radiation's TDMS anticipates circuit failure in telegraph and data transmission links without interrupting traffic

Radiation's Telegraph Distortion Monitoring System—TDMS—is a compact, self-contained unit for continuous on-line monitoring, testing and analysis of telegraph and data transmission links.

Its sensitivity to signal distortion is so acute that it can locate and describe equipment misalignment *before* it becomes an operational problem.

TDMS does its job without interrupting traffic and in a language that is easily interpreted by a nontechnical operator. Thus, in our illustration above, a line that is becoming increasingly capacitive can be located and rectified prior to circuit failure.

For detailed information on the TDMS, write Dept. EL-7, Products Division, Radiation Inc., Melbourne, Florida. Refer to Bulletin RAD-E-100B.



TDMS performs all of these *on-line* functions: 1. Distortion transmitter; 2. Test message transmitter; 3. Distortion analyzer; and 4. Linear wave-form analyzer.

Among available accessories are utility cart (shown above), portable power supply, and relay-test adapter.

All qualified applicants will receive consideration for employment without regard to race, creed, color, or national origin.



RADIATION
INCORPORATED

LAMBDA

Convection Cooled

Transistorized Regulated Power Supplies

LA SERIES

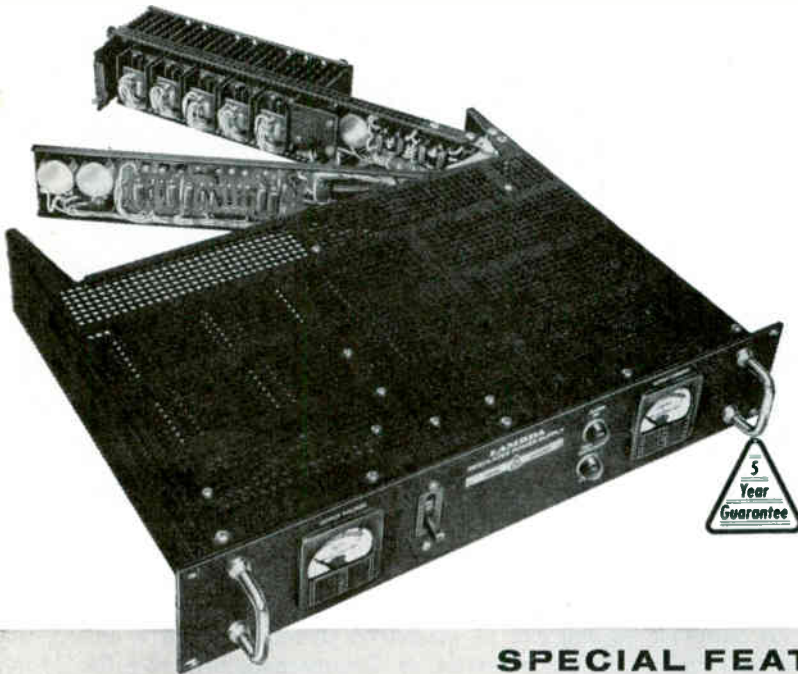

0- 34 VDC	5 AMP
0- 34 VDC	10 AMP
0- 34 VDC	20 AMP
20-105 VDC	2 AMP
20-105 VDC	4 AMP
20-105 VDC	8 AMP
75-330 VDC	0.8 AMP
75-330 VDC	1.5 AMP
75-330 VDC	3 AMP

SPECIAL FEATURES

- Convection Cooled—No internal blowers or filters—maintenance free
- Ambient 50°C
- No Voltage Spikes or overshoot on "turn on, turn off," or power failure
- Short Circuit Proof
- Remote programming over Vernier band
- Hermetically-sealed transformer designed to MIL-T-27A
- Easy Service Access
- Constant Current Operation—Consult Factory
- Guaranteed 5 years

CONDENSED DATA

DC OUTPUT (Regulated for line and load)

Model	Voltage Range ⁽¹⁾	Vernier Band ⁽²⁾	Current Range ⁽³⁾	Price ⁽⁴⁾
LA 50-03A	0- 34 VDC	4 V	0- 5 AMP	\$ 395
LA100-03A	0- 34 VDC	4 V	0-10 AMP	510
LA200-03A	0- 34 VDC	4 V	0-20 AMP	795
LA 20-05B	20-105 VDC	10 V	0- 2 AMP	350
LA 40-05B	20-105 VDC	10 V	0- 4 AMP	495
LA 80-05B	20-105 VDC	10 V	0- 8 AMP	780
LA 8-08B	75-330 VDC	30 V	0- 0.8 AMP	395
LA 15-08B	75-330 VDC	30 V	0- 1.5 AMP	560
LA 30-08B	75-330 VDC	30 V	0- 3 AMP	860

Regulation (line) Less than 0.05 per cent or 8 millivolts (whichever is greater). For input variations from 105-140⁽⁵⁾ VAC.

Regulation (load) Less than 0.10 per cent or 15 millivolts (whichever is greater). For load variations from 0 to full load.

Ripple and Noise Less than 1 millivolt rms with either terminal grounded.

Temperature Coefficient Less than 0.025% /°C.

(1) The DC output voltage for each model is completely covered by four selector switches plus vernier range.

(2) Center of vernier band may be set at any of 16 points throughout voltage range.

(3) Current rating applies over entire voltage range.

(4) Prices are for un-metered models. For metered models add the suffix "M" and add \$30.00 to the price.

(5) Except for LA50-03A, LA100-03A, LA200-03A which have AC input voltage of 100-130 VAC. 105-140 VAC available upon request at moderate surcharge.

AC INPUT 105-140 VAC, 60⁽⁵⁾ ± 0.3 cycle⁽⁶⁾

(6) This frequency band amply covers standard commercial power line tolerances in the United States and Canada. For operation over wider frequency band, consult factory.

Size

LA 50-03A, LA20-05B, LA 8-08B	3½" H x 19" W x 14¾" D
LA100-03A, LA40-05B, LA15-08B	7" H x 19" W x 14¾" D
LA200-03A, LA80-05B, LA30-08B	10½" H x 19" W x 16½" D

Send for new Lambda Catalog 61

LA118A



LAMBDA ELECTRONICS CORP.

515 BROAD HOLLOW ROAD, HUNTINGTON, L. I., NEW YORK 516 MYRTLE 4-4200

Published weekly, with Electronics Buyers' Guide and Reference issue, as part of the subscription, by McGraw-Hill Publishing Company, Inc. Founder: James H. McGraw (1860-1948).

Title registered U.S. Patent Office; Copyrighted 1961, McGraw-Hill Publishing Company, Inc. All rights reserved, including the right to reproduce the contents of this publication, in whole or in part.

Executive, editorial, circulation and advertising offices McGraw-Hill Building, 330 West 42nd Street, New York 36, N. Y. Telephone Longacre 4-3000. Teletype TWX N.Y. 1-1636. Cable McGrawhill, N. Y. Printed in Albany, N. Y.; second class postage paid.

OFFICERS OF THE PUBLICATIONS DIVISION: Nelson L. Bond, President; Shelton Fisher, Wallace F. Traendly, Senior Vice Presidents; John R. Callahan, Vice President and Editorial Director; Joseph H. Allen, Vice President and Director of Advertising Sales; A. R. Venezian, Vice President and Circulation Coordinator.

OFFICERS OF THE CORPORATION: Donald C. McGraw, President; Joseph A. Gerardi, Hugh J. Kelly, Harry L. Waddell, Executive Vice Presidents; L. Keith Goodrich, Vice President and Treasurer; John J. Cooke, Secretary.

Subscriptions are solicited only from those actively engaged in the field of the publication. Position and company connection must be indicated on orders. Subscription rates: United States and Possessions, \$6.00 one year; \$9.00 two years; \$12.00 three years. Canada, \$10.00 one year. All other countries \$20.00 one year. Single Copies, United States and Possessions and Canada 75¢; Buyers' Guide \$3.00; Single Copies all other countries \$1.50; Buyers' Guide \$10.00.

The Publisher, upon written request from any subscriber to our New York Office, agrees to refund that part of the subscription price applying to copies not yet mailed.

Subscribers: Please address all correspondence, change of address notices, subscription orders or complaints to Fulfillment Manager, Electronics, at above address. Change of address notices should provide old as well as new address, including postal zone number if any. If possible, attach address label from recent issue. Allow one month for change to become effective.

Postmaster: Please send Form 3579 to Fulfillment Manager, Electronics, 330 West 42nd Street, New York 36, New York.



Audited Paid Circulation

CROSSTALK



DEVICE SHOWN in the photo above is the breadboard of a frequency comparator described in this issue by K. H. Brackney and D. R. Gosch of General Electric's Heavy Military Electronics Dept. Frequency jitter of ± 64 counts a second can be measured through use of counting and complementing. For an explanation of this method, turn to p 54.

ULTRAPURE SEMICONDUCTORS. Desire to prepare semiconductors with purities of better than a part in a billion is spurring research in the preparation and purification of materials, impurity detection methods and measurement techniques. When New England Editor Maguire attended the Conference on the Ultrapurification of Semiconductors in Boston recently he heard a raft of papers on these topics. His conference roundup beginning on p 41 spotlights some of the new techniques for producing low-impurity materials. You'll also learn about recent work in activation analysis, emission spectroscopy and spark source mass spectroscopy.

SPURIOUS RESPONSE NOMOGRAPH. If you're looking for a convenient way to calculate receiver spurious responses, then you'll want to save the nomograph on p 62. Prepared by H. H. Jenkins of Radiation Inc., it provides a method of rapidly estimating the frequencies in order to reduce lengthy computation.

Coming In Our July 14 Issue

PLASMA. Since 1958 when we carried such articles as "Our Stake in Thermonuclear Power" (p 75, Dec. 19), ELECTRONICS has been paying close attention to the rapidly growing field of plasma research. The efforts to realize such alluring applications as controlled thermonuclear fusion involve widespread and varied work in generating and diagnosing plasmas. In order to bring you up to date on just what is being done to understand and utilize plasma, Assistant Editor Wolff has been preparing a comprehensive series on plasma engineering. His first article, on the devices and techniques for generating and heating plasma, appears next week. You won't want to miss it.

FILMISTOR® 'C'

METAL FILM RESISTORS OFFER 5 DISTINCT TEMPERATURE COEFFICIENTS TO MEET ALL CIRCUIT REQUIREMENTS

**RUGGED END-CAP
CONSTRUCTION
FOR LONG TERM
STABILITY**

• • •

**EXCEPTIONAL
RESISTANCE TO
MOISTURE AND
MECHANICAL DAMAGE**

• • •

**SURPASS MIL-R-10509
PERFORMANCE
REQUIREMENTS**

Providing close accuracy, reliability and stability with low controlled temperature coefficients, these molded case metal-film resistors outperform precision wirewound and carbon film resistors. Prime characteristics include minimum inherent noise level, negligible voltage coefficient of resistance and excellent long-time stability under rated load as well as under severe conditions of humidity.

Close tracking of resistance values of 2 or more resistors over a wide temperature range is another key performance characteristic of molded-case Filmistor "C" Resistors. This is especially important where they are used to make highly accurate ratio dividers.

Filmistor "C" Resistors are automatically spiralled to desired resistance values by exclusive Sprague equipment. The metallic resistive film, deposited by high vacuum evaporation, bonds firmly to special ceramic cores. Noble metal terminals insure low contact resistance.

The resistance elements, complete with end caps and leads attached are molded in dense, high temperature thermosetting material to form a tough molded shell for maximum protection against mechanical damage, moisture penetration and repeated temperature cycling.

Filmistor "C" Resistors, in 1/8, 1/4, 1/2 and 1 watt ratings, surpass stringent performance requirements of MIL-R-10509C, Characteristic C. Write for Engineering Bulletin No. 7025 to: Technical Literature Section, Sprague Electric Co., 35 Marshall Street, North Adams, Mass.

*For application engineering assistance write:
Resistor Division, Sprague Electric Co.
Nashua, New Hampshire*



SPRAGUE COMPONENTS

RESISTORS
CAPACITORS
MAGNETIC COMPONENTS
TRANSISTORS

INTERFERENCE FILTERS
PULSE TRANSFORMERS
PIEZOELECTRIC CERAMICS
PULSE-FORMING NETWORKS

HIGH TEMPERATURE MAGNET WIRE
CERAMIC-BASE PRINTED NETWORKS
PACKAGED COMPONENT ASSEMBLIES
FUNCTIONAL DIGITAL CIRCUITS

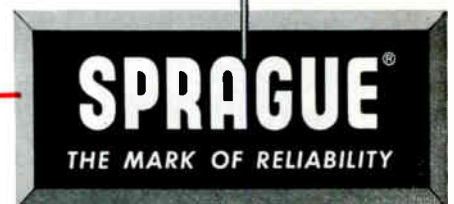

'Sprague' and '®' are registered trademarks of the Sprague Electric Co.



yes

**Gamewell made
a sector pot
with .0006"
wire**

This subminiature sector pot is wound with .0006" wire at over 1000 turns per inch. Required winding length tolerance is only .005". Here's one example of the hundreds of "special" pot design requests that Gamewell is answering with an unqualified YES. Find out what Gamewell YES service — Your Engineered Specials service — can do for you. Write for the facts.

Your
Engineered
Specials service**



THE GAMEWELL COMPANY, POTENTIOMETER DIVISION,
1411 CHESTNUT STREET, NEWTON UPPER FALLS 64,
MASS. A SUBSIDIARY OF E. W. BLISS COMPANY.

COMMENT

Electronics in Europe

Welcome home, and warm congratulations for the Europe piece (p 65, June 9). I hope you won't misunderstand me (as an old European ham from "way back") if I say that your personal notes gave as much pleasure and usable information as the stuff on electronics. Seriously, it was a most stimulating piece, and should give pause to many of our good friends over here who have not been able to keep up with affairs in the Old World.

JOHN JOSS

DECCA NAVIGATOR SYSTEM, INC.
WASHINGTON, D. C.

Magnetic Amplifier

I was much intrigued by the article "A-C Controlled Half-Cycle Magnetic Amplifier" in the April 14 issue of ELECTRONICS. Unfortunately my understanding does not equal my interest.

In Figure 1 on page 76, it appears that if an anti-phase pair of cores are both in the low-impedance state towards the end of a cycle of supply voltage, as the text seems to indicate, then the supply voltage will be short-circuited. Is this what is intended?

In Figure 2, the arrangement of the diodes appears to be such that only d-c can be delivered to the 150 ohms load resistance. D-c output is mentioned in the introductory paragraph of the article, but with reversible polarity.

I would really be most grateful if you could help to straighten me out on these points. Is the magnetic amplifier to be manufactured commercially by the Bendix Corporation?

PETER FELLGETT

ROYAL OBSERVATORY
EDINBURGH, SCOTLAND

Author's reply: The article had a typographical error. The 1N645 diodes in Figure 2 on page 76 should be connected as shown in Figure 1 on the same page.

With regard to your first question, the power supply is not short-circuited. Each power winding

has a resistance of 300 ohms. This is the minimum load impedance to which the 15-volt supply is subjected for a maximum time of one quarter cycle in each half cycle. This time is usually adjusted so that the null current is 60 milliamperes.

The magnetic amplifier has been made and sold by the Bendix Corp., Pioneer Central division, Davenport, Iowa, since February, 1957.

EDGAR W. VANWINKLE

THE BENDIX CORP.
TETERBORO, N. J.

Computers Today

We read with considerable interest the fine special report on "Computers Today" and would like to compliment you on this thorough piece of work. In connection with our company's data transceivers:

On p 68 there is a photo of a General Dynamics/Electronics magnetic tape data transmission terminal. Then on p 71 there is reference to the Stromberg-Carlson S-C 301 data transceiver—which is one component of the high-speed data transmission terminal in the photo. We regret that the renaming of our company, in which Stromberg-Carlson became General Dynamics/Electronics, was responsible for some of this confusion.

Incidentally, the S-C 301 can send or receive data from magnetic tape, punched cards, or punched paper tape, at 2,400 bits per second over a commercial telephone line—not a teletypewriter line, as stated on p 71. In addition, the data transmission terminals can take data directly from the buffer storage of a digital computer, and, operating into an S-C 3000 printer (mentioned on p 70), can print out data on-line with the data transmission system.

N. M. HOWDEN

GENERAL DYNAMICS/ELECTRONICS
ROCHESTER, N. Y.

... Got the copy of the special computer section today. A good job. Thank you for including some of LFE's accomplishments.

NORMAN P. TEICH

LABORATORY FOR ELECTRONICS
BOSTON, MASS.

PUT THE SQUEEZE
ON YOUR PUSHBUTTON PROBLEMS

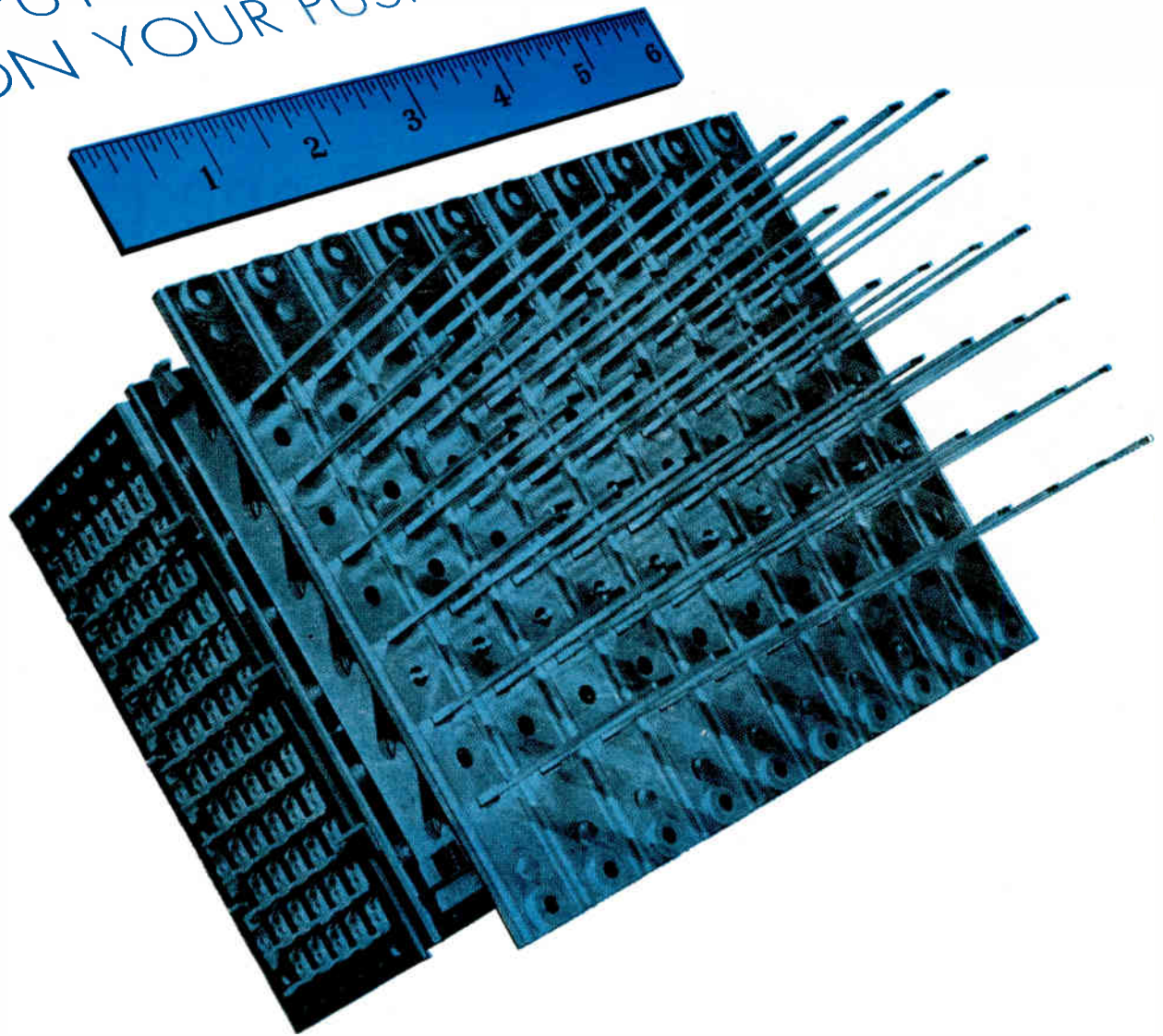

OAK TYPE 131 PUSHBUTTON SWITCHES will help you make the most of limited panel space. Only $\frac{5}{8}$ -in. thick, these switches can be mounted on $\frac{1}{16}$ in. centers; a stack of 10 separate gangs of switches requires only $6\frac{13}{16}$ -in. of panel space. Use Type 131 switches for handling low-power switching in computers, office equipment, communications devices, automatic coin-operated machines and many other military or commercial applications.

Available with from one to 12 buttons having up to 14 contacts per button. "Floating slider" design operates at lighter pressure per number of contacts than conventional push-button switches. Oak's vigorous research and testing, careful selection of materials, precision manufacture and quality control assure long operating life with minimum failure. Contact your local Oak sales representative or write for Oak's comprehensive 4th Edition General Switch Catalog.

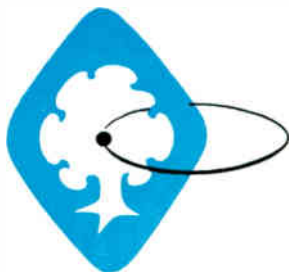

Creative Engineering • Quality Components

OAK MANUFACTURING CO.

CRYSTAL LAKE, ILLINOIS • telephone: Crystal Lake, 459-5000

OAK ELECTRONICS CORPORATION, (Subsidiary) Culver City, California

ROTARY AND PUSHBUTTON SWITCHES • TELEVISION AND FM TUNERS • SUBASSEMBLIES
APPLIANCE CONTROLS • CHOPPERS • ROTARY SOLENOIDS • VIBRATORS

New from Bendix

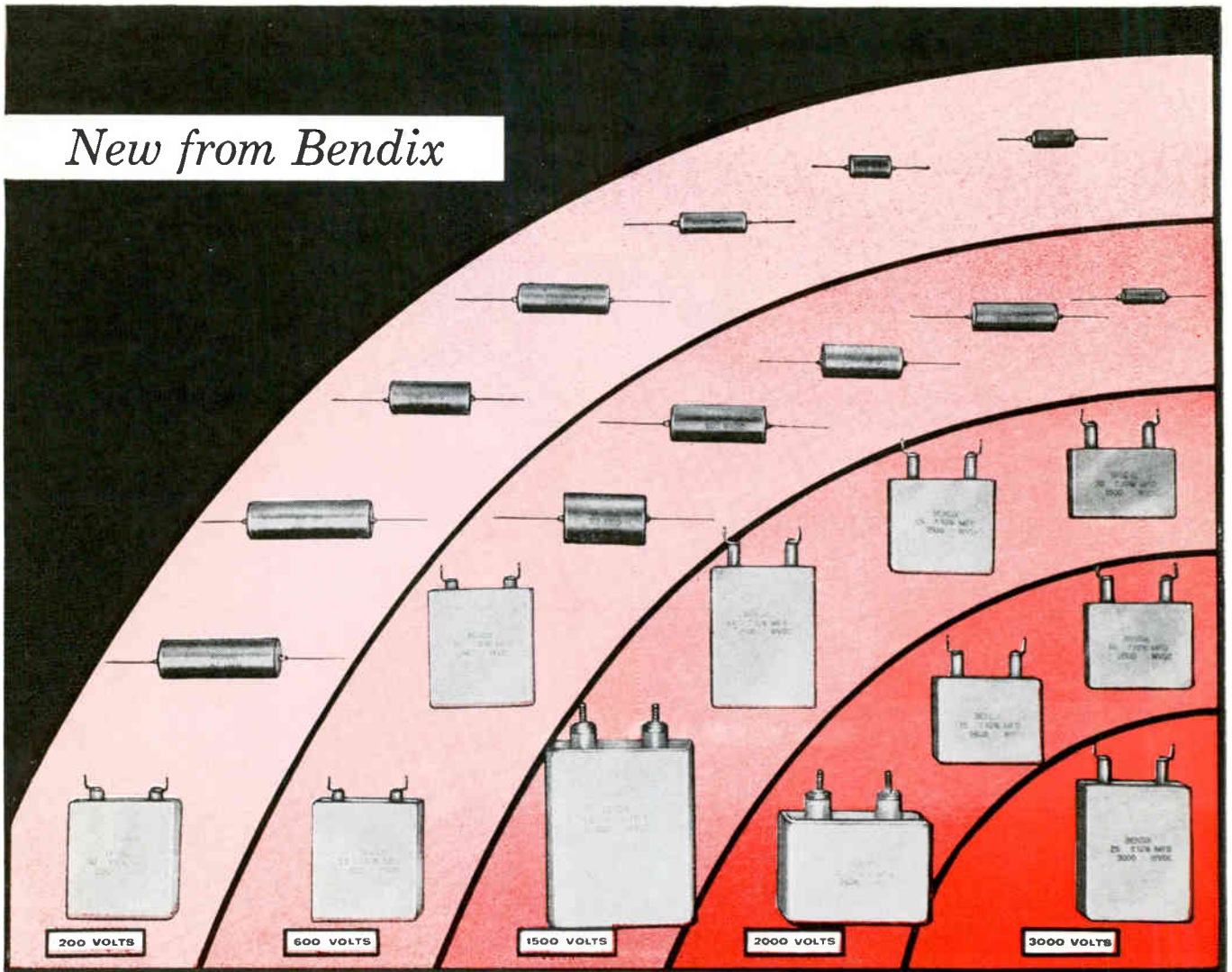

E-200 HIGH TEMPERATURE CAPACITORS

Operable to +200°C.

The Bendix® E-200 series of lightweight, small size capacitors is designed for installations requiring a high degree of component reliability at operating temperatures as high as 200°C.

High temperature capability and mica-like electrical characteristics enable the E-200 series to withstand extremely high orders of AC in small envelope size at all ambients under 200°C.

The new series is designed and manufactured

to a Bendix specification which is patterned after the high reliability specification MIL-C-14157B, proposed.

Hermetically sealed in tubular or rectangular housings, these capacitors offer superior resistance to mechanical and climatic environments.

E-200 CHARACTERISTICS: • Wound mica papers • Solid impregnants • Exceptional stability • High insulation resistance • Radiation resistance • Outstanding dependability

For full details, write

Scintilla Division
SIDNEY, NEW YORK



Canadian Affiliate: Aviation Electric, Ltd., 200 Laurentien Blvd., Montreal 9, Quebec. Export Sales & Service: Bendix International, 205 E. 42nd St., New York 17, N. Y.

ELECTRONICS NEWSLETTER

Fiber Optics Principle Getting New Attention

FIBER OPTICS (ELECTRONICS, p 92, Jan. 1, 1960) was in the news again last week: At Rome Air Development Center, Air Force scientists said the principle may have applications in computers and television.

If the fiber principle could be refined so controlled amounts of light could act as signals in a computer, instead of the conventional electrical impulse, many complexities of today's circuits could be eliminated, RADC said.

In television, scientists foresee a layer of fibers with their ends butted against the screen, resulting in a picture without a fuzzy look.

Meanwhile, Optics Technology, Inc., Belmont, Calif. says remote photographic inspection of the interior of a dangerously "hot" reactor—without dismantling—may be possible for the first time through fiber optics. A reactor probe now being built by the firm is scheduled for delivery this summer to Westinghouse at Pittsburgh under a \$60,000 contract.

In the ribbon-shaped, nine-foot probe are five aligned layers of optical fibers, each 1,500 strands wide (equivalent to three inches) and one strand thick, giving a total of 7,500 fibers. Three layers are used to transmit light from an outside source coldly into the interior; the other two layers pick up the reflection from the inspected surface and transmit it back to a film. The result is a picture of the surface as it would appear to the eye, with resolution to 2 mils.

Computer Makes Resistors And Also Controls Quality

AUTOMATIC MANUFACTURE of deposited carbon resistors, combined with statistical quality control—all under guidance of a digital computer—was demonstrated last week by Western Electric in its North Carolina works at Winston-Salem.

The computer also accepts a month's production schedule and automatically issues instructions to fabricating machines to make and package any or all of four basic sizes of resistors.

The machines work on a three-second cycle, producing a resistor per cycle. Maximum production rate is 1,200 finished resistors per hour. There are 11 machine stations, in addition to computer and control cabinets, on the 110-ft production line. Three of the stations are used only for testing.

Solid-State Microwave Transmitter 1/7th Size

GENERAL TELEPHONE & ELECTRONICS reports it has developed a solid-state microwave transmitter that occupies one-seventh the space and has 11 times life expectancy and 10 times frequency stability of conventional transmitters.

The announcement was made in Washington, D. C., last week at the

... And Then 15?

NEXT TWO YEARS will see accelerated race for survival in semiconductor business, says Raytheon president Richard E. Krafve. "And," he adds, "the race will go to the lean, the hungry, the tough, the flexible."

Krafve thinks that 10 to 15 companies will have survived after two to three years. He says tough competition will get tougher until industry stabilizes.

"Semiconductor business is increasing at a rate of 40 percent a year. Today there is twice as much production capacity as needed. Something has to give," he says.

5th National Convention on Military Electronics. The transmitter, smaller than a cigarette carton, was developed for the Air Force by Sylvania Electronic Systems, a GT&E division. Engineering model weighs 3.5 lb, has frequency stability of direct crystal control and operating life expectancy of more than 2½ years of continuous operation.

ACF Industries demonstrated its ABCD building block communications devices for high-speed simultaneous transmission of digital information from computers and other data equipment between remote locations. A single rack of interchangeable plug-in building blocks adapts all types of existing data equipment for transmission over a standard telephone line, company says.

The Diamond Ordnance Fuze Laboratories displayed its new arming programmer-timer for missiles. It works on an electronic digital principle using transistor binary logic. It is said to be one-fifth the size of anything previously used. It is 13 cubic inches and weighs 14 ounces. The unit was built by the Cleveland Metal Specialties Co.

Electromagnetic-Acoustic Probe Checks Air Speed

AN ELECTROMAGNETIC-ACOUSTIC PROBE is being used by the Carnegie Institute of Technology in a new concept for remote measurement of wind velocity from a helicopter.

The instrument measures air velocity in terms of the doppler frequency shift in an electromagnetic wave reflected from an acoustic disturbance propagating in the atmosphere.

Lightbeam Modulator Made for Space Use

SPERRY GYROSCOPE announced last week it has developed a compact lightbeam modulator for guidance and control systems for space exploration.

The modulator enables pencil-thin lightbeams to replace microwave radar beams as the heart of

advanced guidance and control systems, firm reports, modulating light at microwave frequencies.

The component, developed by the company's newly consolidated Infrared/Optics Laboratory in Great Neck, N. Y., will make it possible to obtain a stream of precise position information, firm says, and enable the vehicle's communications system to transmit vast amounts of information to other vehicles in space.

Semiconductor Neutron Counters Revealed

SEMICONDUCTOR neutron counters were revealed last week in Britain at the United Kingdom Atomic Energy Authority's Harwell Research Establishment.

The counters were prepared by a technique developed by AERE scientists. Called a "surface barrier" detector, an *n*-type silicon disk, after chemical etching, is allowed to oxidize, forming a *p*-type insulating layer spontaneously. Electrical contact is made by evaporating a thin gold film on the area to be sensitized. Contacts are secured with conducting cement.

A simple variation of the counter is also being used successfully for neutron flux measurement in the 2 to 6 Mev gap now existing. It measures recoil protons from hydrogen nuclei contained in a plastic foil placed on the face of the silicon counter.

Another variant is a multiple counter compound of many separate strips of gold evaporated onto a single silicon crystal.

Thin-Film Transistors Deposited in Arrays

EXPERIMENTAL thin-film transistors that can be laid down in large arrays by evaporation in successive layers on a glass surface have been developed by RCA in its Princeton, N. J. laboratories. The transistors, consisting of halogen-doped cadmium sulphide as the semiconductor or insulator material, and a

metal source and gate, are majority carrier devices.

RCA scientists said last week they have achieved g_m 's as high as 5,000 micromhos; for voltage gains they have amplification factors on the order of 50-60, with some as large as 100. Power gains are on the order of 5,000.

Although the experimental devices have been fabricated only a few at a time, the evaporation process will allow their production in large arrays, so they will be especially suitable for computer circuits. The thin-film transistors are so small that 20,000 of them could be formed in an area the size of a postage stamp.

The completed transistor is not only tiny but it also incorporates an important operating feature not now used in commercial transistors. In conventional transistors having comparable functions electrons flow more or less freely through the semiconductor material between two of the contacts and the third element provides control by reducing the flow in varying degrees. The operating principle of the experimental thin-film transistor is exactly opposite. The insulating property of the cadmium sulphide hampers the flow of electrons between two electrodes and the third element provides control by increasing the flow in varying degrees.

Low-Cost Unit Grows Tin, Zinc and Lead Crystals

SINGLE CRYSTALS of zinc, lead, tin metals, and silver chloride have been grown with an economical easily-operated, Bridgman-type apparatus, according to an Atomic Energy Commission report.

Costing approximately \$500 to construct, the apparatus passes the melt through a steep temperature gradient. It utilizes crystallizing crucibles made of quartz and graphite, all of which have 50 degree conical nucleating tips.

Removal of the single crystals is facilitated by tapered walls on the graphite crucibles. Sizes of the crystals produced with the equipment varied from $\frac{3}{8}$ to $\frac{3}{4}$ of an inch in diameter and up to $3\frac{1}{2}$ inches in length.

In Brief . . .

RAYTHEON COMPANY gets \$7-million contract to conduct feasibility study of ARPAT, new concept for ballistic missile defense. Supporting Raytheon in the program: Hughes Aircraft, Boeing, IBM and Bissett-Berman Co.

MAGNETOHYDRODYNAMIC propulsion for spacecraft may well win out over the ion engine, says G. S. Janes, principal research scientist for Avco-Everett Research Laboratories. Janes says a 30-Kw MHD unit might be ready by 1965.

LABORATORY FOR ELECTRONICS, INC. and Tracerlab, Inc. are planning to merge. Survivor: LFE; combined sales: more than \$60 million.

TEXAS division of Collins Radio Co. receives a \$4-million contract from Army Signal Corps for a large number of portable scatter communication terminals.

CAIRO UNIVERSITY is setting up a Graduate Institute of Outer Space. The University's Schools of Engineering Science and Medicine are drawing up a special curriculum.

ELECTRONIC ASSOCIATES, INC., Long Branch, N. J. gets a \$408,750 contract from GE for three "heat transfer" general purpose analog computers for studies relating to heat transfer problems of space vehicles.

GENERAL DYNAMICS/ASTRONAUTICS, San Diego, receives \$2.5-million Air Force contract to build three Atlas missile procedure trainers.

AEROJET-GENERAL combines its Spacecraft division and wholly owned subsidiary Space Electronics Corp. into a new subsidiary, Space-General Corp., situated in Los Angeles area.

SPACE CRAFT, INC., satellite systems and missile electronics design-development firm formed by seven NASA engineers and technicians at Redstone Arsenal, plans to begin operations next week.

Variable Delay Timing Circuit

Typical Applications

- Safety device for sequential application of signals
- Warm-up delay mechanism for starting complex machinery
- Automatic on/off control to facilitate adjustment of process machinery at irregular intervals
- Sequence control of signals as a function of time
- Delay mechanism for sequential sampling and measuring purposes at accurate intervals
- Element to provide required delays for computer or logic circuitry

Features

Time Delay From 25 milliseconds to 3 minutes
 Self Resetting or Externally Cycled
 Temperature Range -40°C to $+125^{\circ}\text{C}$
 ON/OFF Relay Actuator

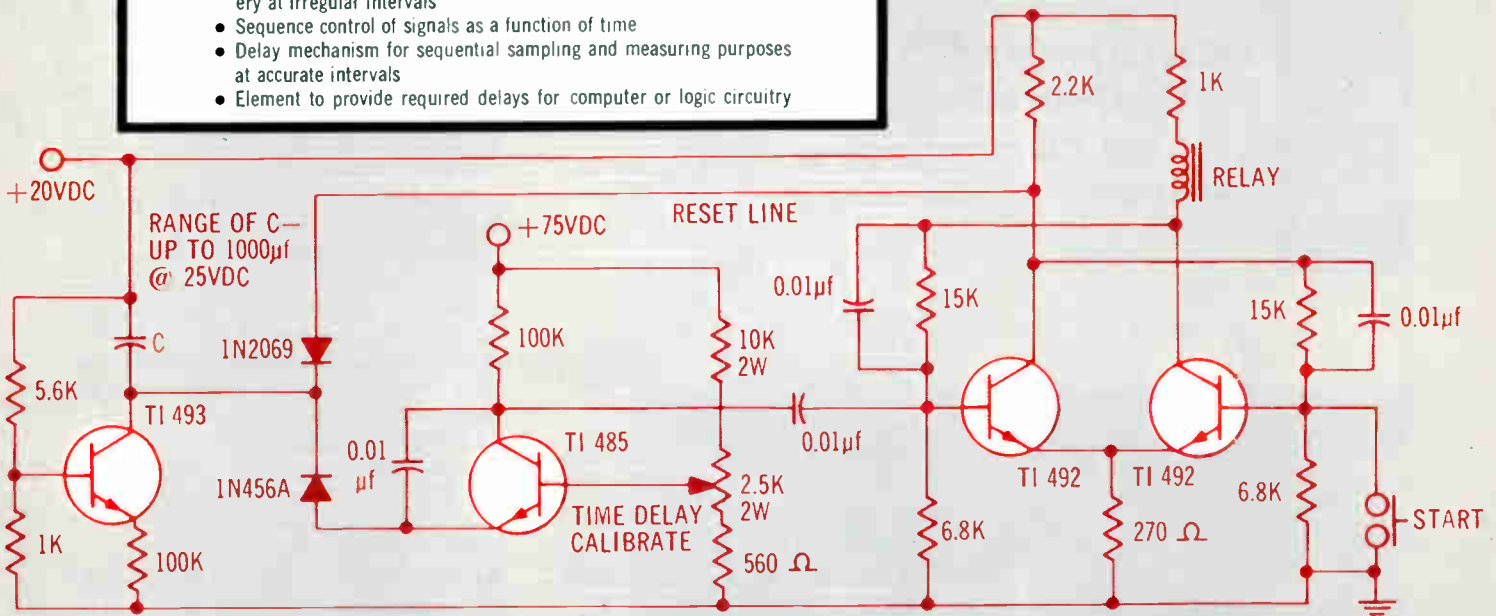

HOW TO GET HIGH TEMPERATURE STABILITY AND INDUSTRIAL ECONOMY

With New TI Low-Cost Silicon Industrial Transistors...

You can assure your customers optimum circuit performance up to 125°C when you design-in new, low-cost TI silicon industrial transistors. Priced comparable to lower-temperature industrial devices, these new TI silicon industrial units provide the high performance your industrial designs require.

Get greater margins of operational safety by applying these new silicon industrial transistors to your process control, communication, aviation system, electronic instrumentation, and computer applications today.

CHARACTERISTICS					APPLICATIONS					
TYPE	MIN BV _{CB0}	DC Beta Range	MAX I _{CB0} @ 100°C	f _{αb} (typ)	Serve and Relay Driver	Audio Amplifier Medium Speed Switches	Audio Amplifier Medium Speed Switches**	RF Amplifier (to 40 mc)	VHF Amplifier High Speed Switcher	NIXIE® Driver
TI 480	50 v	9—36* @ 5 ma	50 μa @ 30 v	1 mc	TI 480					
TI 481	80 v	9—36* @ 5 ma	50 μa @ 30 v	1 mc	TI 481					
TI 482	20 v	>20 @ 30 & 150 ma	50 μa @ 10 v†	60 mc			TI 482	TI 482		
TI 483	40 v	20—60 @ 150 ma	50 μa @ 30 v†	60 mc			TI 483	TI 483		
TI 484	40 v	40—120 @ 150 ma	50 μa @ 30 v†	60 mc			TI 484	TI 484		
TI 485	20 v	15—60 @ 10 ma	20 μa @ 15 v†	200 mc					TI 485	
TI 486	80 v	20—80 @ 200 ma	300 μa @ 60 v‡	15 mc			TI 486			
TI 487	80 v	20—80 @ 200 ma	300 μa @ 60 v‡	15 mc			TI 487			
TI 492	40 v	15—45* @ 1 ma	50 μa @ 30 v	8 mc		TI 492				
TI 493	40 v	15—45 @ 10 ma	50 μa @ 20 v	20 mc		TI 493				
TI 494	40 v	40—125 @ 10 ma	50 μa @ 20 v	20 mc		TI 494				
TI 495	40 v	120—250 @ 10 ma	50 μa @ 20 v	20 mc		TI 495				
TI 496	40 v "	>10 @ 3 ma	75 μa @ 40 v	1 mc						TI 496

*AC Beta † I_{CB0} @ 125°C ‡ I_{CB0} @ 150°C § 100 μa to 20 ma **20 ma to 500 ma // BV_{CEX} ® TRADEMARK OF BURROUGHS CORPORATION



SEMICONDUCTOR COMPONENTS
 DIVISION
 PLANTS IN DALLAS, TEXAS
 BEDFORD, ENGLAND
 AND NICE, FRANCE



TEXAS INSTRUMENTS
 INCORPORATED
 13500 N. CENTRAL EXPRESSWAY
 P. O. BOX 5012 DALLAS 22, TEXAS

ENGINEERED COMPONENTS

for the Electronics
Industry

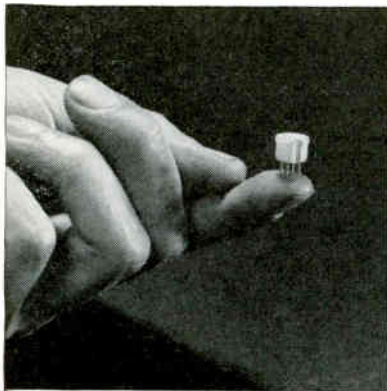

Now on hand for prompt
delivery — reliable Garlock
CHEMELEC* Miniature Sockets
(upper left), Insulators (upper
right), Connectors (right).

Now—Garlock Electronic Components are immediately available wherever and whenever needed!

Through a new, widespread distributor organization, Garlock now offers fast delivery of CHEMELEC Stand-off and Feed-Thru Insulators, Subminiature Tube and Transistor Sockets, and Connectors. Here, too, is an increased opportunity for close-at-hand assistance from Garlock distributors experienced in applying electronic products.

Take advantage of on-the-spot availability—specify these skillfully engineered Garlock electronic components. Reliable under the most severe conditions, they are ideal for high temperature, high voltage, high frequency service on missile guidance, fire control, tracking, and radar systems. Garlock has the technical personnel and modern facilities to produce components of all materials—Teflon† TFE and FEP, Nylon, Delrin‡, C.T.F.E.**—and in a range of sizes, designs, and tolerances to fit your exact needs.

At your disposal, too, for development of new electronic products, Garlock maintains complete electrical, chemical and physical laboratories staffed by top-flight engineers. Your Garlock Electronic Products representative will be glad to discuss specific products and service with you. Call him at the nearest of these locations:

ABBETT & HUSTIS
1245 Highland Ave.
Needham 92, Mass.

BOB BRAY
18 North Mentor Ave.
Pasadena, Calif.

CARL HOWER
340 N. Marshall Ave.
Scottsdale, Arizona

DON SMITH SALES CO.
2320 N. 45th St.
Seattle 3, Washington.

GEORGE A. KELLY
P.O. Box 222
Wayzata, Minn.

GRANT SHAFFER COMPANY
14241 Fenkel Ave.
Detroit 27, Michigan

HILL AND GRAY, INC.
821 Garfield St.
Oak Park, Illinois

J. P. DEARIE AND CO.
P.O. Box 66
Mountain Lake, New Jersey

J.Y. SCHOONMAKER CO., INC.
5328 Redfield Ave.
Dallas 35, Texas

LAKE ENGINEERING CO. LTD.
767 Warden Ave.
Scarborough, Ontario

NAUDAIN-BOHAKER & CO.
Suburban Sta. Bldg.,
Rm. 1032
Philadelphia 3, Pa.

NEWMAN, RUDAT & EWING
915 Terminal Way
San Carlos, Calif.

R. E. CATHEY CO.
1789 Fulton St.
Denver 8, Colorado

SCOTT & STEFFEN, INC.
1836 Euclid Ave.
Cleveland 15, Ohio

SOUTHERN SALES COMPANY
105 Lakeshore Drive
Angola, Indiana

STANLEY K. WALLACE
ASSOCS. INC.
P. O. Box 67
Lutz, Florida

You may also obtain more information by writing for Catalogs AD-169 and AD-171, Garlock Electronic Products, Garlock Inc., Camden 1, New Jersey.

G A R L O C K

ELECTRONIC PRODUCTS

Canadian Div.: Garlock of Canada Ltd.

Plastics Div.: United States Gasket Company

Order from the Garlock 2,000 . . . two thousand different styles of Packings, Gaskets, Seals, Molded and Extruded Rubber, Plastic Products.

*Registered Trademark **polychlorotrifluoroethylene
†DuPont Trademark

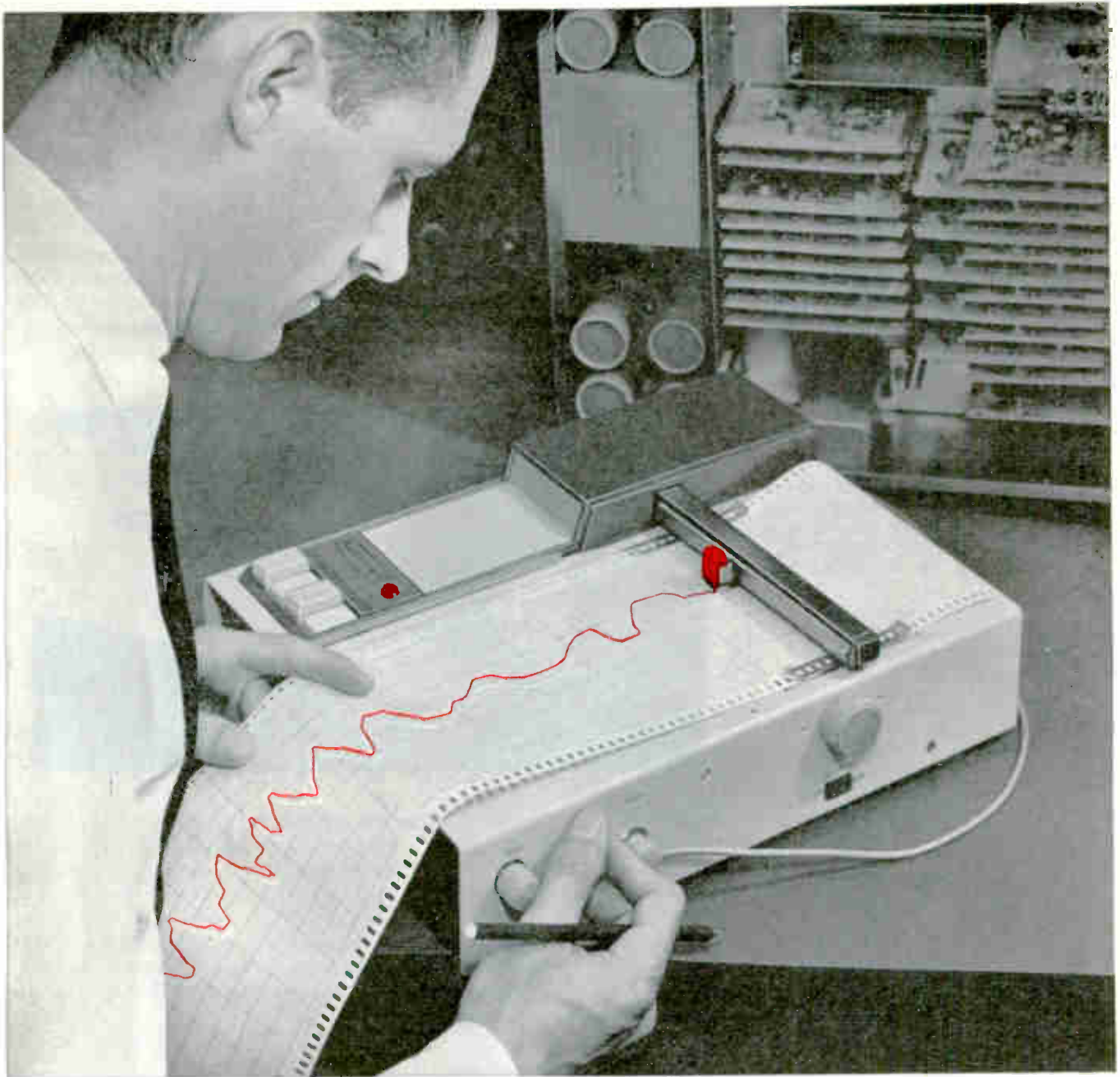

AWARD-WINNING* Beckman Potentiometric Recorder

Exclusive design features assure greatly improved performance and flexibility beyond any recorder in its price class. Pen movement, for example, is virtually free of backlash and maintenance because the drive is a toothed Nylon belt—instantly responsive, smooth and accurate. A wide variety of chart-drive speeds are obtainable with a simple flip-of-a-switch; or by just plugging-in small, auxiliary drive units. Centralized, pushbutton controls offer added convenience. Recorder is easily adaptable for use of special purpose strip or polar co-ordinate charts and is tailored for quick and easy addition of Limit Switch Controls without adding bulk.

PRICE \$500. For a comprehensive explanation, ask for Brochure A93500.



Recorder shown with compact auxiliary, outboard drive unit. Brief specs: Input 10-100 mv; limit of error 1% fs; response 1 second fs.

T40

Beckman®

INSTRUMENTS INC.
BERKELEY DIVISION
RICHMOND, CALIFORNIA

*Received Award of Excellence for design at 1960 WESCON.

July 7, 1961

CIRCLE 13 ON READER SERVICE CARD 13

WEINSCHEL ENGINEERING

announces substantial

PRICE REDUCTIONS ON PULSE GENERATOR & POWER BRIDGES

Increased sales combined with new developments in production material and techniques make possible a price reduction at a time when most companies are caught in the inflationary spiral.

The highly precise equipment for which Weinschel Engineering is well recognized requires extreme care in production, quality control and testing. An intensive program of research in production techniques has recently resulted in even greater efficiencies and savings than were formerly possible. These savings are reflected directly in new, reduced prices for these instruments:

WEINSCHEL PULSE GENERATOR

Model	Formerly	Reduced to*
PG-1A	\$2,150.00	\$1,150.00

WEINSCHEL POWER BRIDGE

Model	Formerly	Reduced to*
PB-1	\$2,500.00	\$2,100.00

WEINSCHEL THERMISTOR BRIDGE

Model	Formerly	Reduced to*
TB-2A	\$1,950.00	\$1,350.00

WEINSCHEL THERMISTOR BRIDGE

Model	Formerly	Reduced to*
TB-3	\$1,950.00	\$1,350.00

*Prices subject to change without notice.

Write today for more information on the instruments and for our new price list.

WEINSCHEL ENGINEERING COMPANY

PRECISION MICROWAVE MEASUREMENT
INSTRUMENTS AND SYSTEMS

KENSINGTON, MARYLAND

Phone: LO 4-0121

TWX: KENS 446

WASHINGTON OUTLOOK

THE NAVY may be ordered to cancel its big 600-ft. diameter radio telescope now under construction at Sugar Grove, W. Va. Navy denies the project is in trouble, but top sources here say it's very much up in the air.

Reasons: construction delays, spiraling costs, and a lesser requirement for the facility, which was to be the most powerful of its kind in the world. The telescope was originally slated for completion by next year. But the Navy still does not have a final design for the structure. Costs have spurted from an original estimate of about \$80 million to close to \$180 million. Need for the top-secret facility has reportedly been downgraded. But NRL, which is to operate the telescope, won't comment.



USE OF INFRARED to detect submerged submarines is being pushed under Navy's Project Clunker. Today's generation of nuclear subs, such as the *Robert E. Lee* (photo), which can remain silent underwater for long periods, still may be vulnerable in the future if infrared detection becomes a reality. Hughes Aircraft Corp. holds a major research contract, but other companies are also working on the same concept. The theory is that a submarine's movement through the water creates a temperature difference on the surface. Low-flying planes carrying infrared devices may be able to detect this and track the subs.

NASA PLANS to contract out over 80 percent of its estimated \$1.7-billion budget for the new year. Major electronic procurement will come out of the \$72 million earmarked for scientific satellites, \$38 million for tracking and data acquisition, \$94.6 million for communications satellites, and \$160 million for the Apollo spacecraft project.

PENTAGON will crack down on use of "open contracts" for procurement of electronic spare parts and other replacement components. These are contracts negotiated on an annual basis in which the military agrees to buy unspecified quantities of spare parts from a single supplier during the year. Prices are then set after individual purchase orders are placed.

Under an upcoming new rule, military agencies will have to justify in great detail purchases from a single-source supplier. Purpose: evaluate each case to see if competitive sources of supply can be developed.

HOUSE APPROPRIATIONS COMMITTEE added \$448.8 million to the Defense Dept.'s new budget for long-range bomber development or production and \$85.8 million to speed development of the Dyna-Soar spacecraft. On the other side of the ledger, the committee ordered a flat two-percent cut in all procurement projects to press the Pentagon into more economic and efficient contracting.

Use it on the bench—carry it anywhere!

New High Stability Oscillator

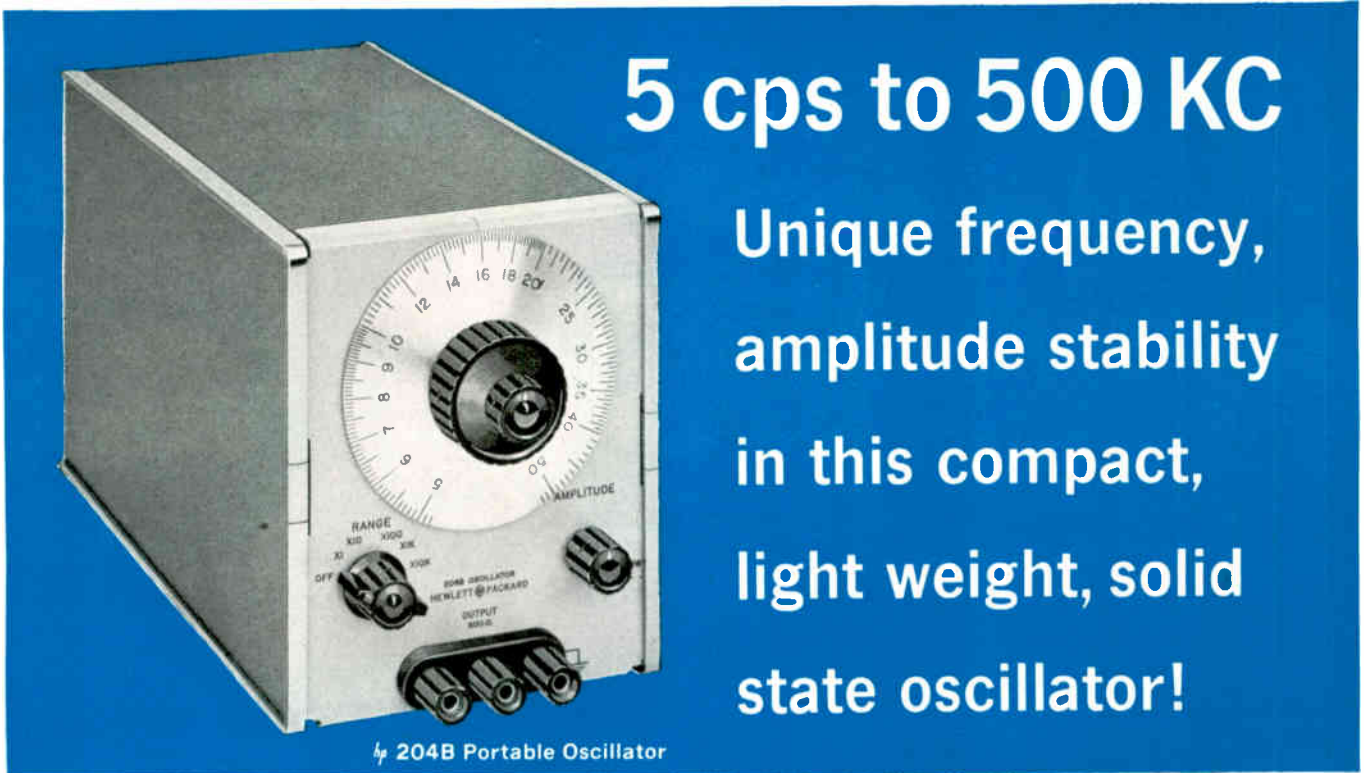

The unusual stability of the new  204B combines with solid state design and battery operation to give you one of the most useful, reliable, versatile oscillators available today. Because the 204B is fully transistorized, internal heat is small and warmup drift is negligible. In addition to battery operation, the 204B is operable on ac, with an ac power pack available at extra cost.



Frequency stability over the entire 5 cps to 500 KC range is better than $\pm 0.03\%/^{\circ}\text{C}$ from 0° to 55°C . Amplitude stability over rated frequency range and output levels is better than $\pm 0.1\%$ over 8 hours of operation at constant line voltage and temperature*; better than $\pm 0.2\%$ for line voltage changes of $\pm 10\%$; better than $\pm 0.1\%/^{\circ}\text{C}$, $0-55^{\circ}\text{C}$.

Output of the 204B is fully floating, isolated from both power line ground and chassis. Balanced and unbalanced loads, and loads referenced either above or below ground, can be driven by this versatile oscillator.

SPECIFICATIONS

Frequency Range:	5 cps to 500 KC, 5 ranges, 5% overlap, vernier control
Dial Accuracy:	$\pm 3\%$
Frequency Response:	$\pm 3\%$ with rated load
Output Impedance:	600 ohms
Output:	10 mw (2.5 v rms) into 600 ohms; 5 v rms open circuit
Output Control:	Continuously variable bridged "T" attenuator with at least 40 db range
Distortion:	Less than 1%
Noise:	Less than 0.05%
Power Source:	4 battery cells at 6.75 v each, 7 ma drain, life at least 300 hours
Power Accessory Available:	AC power supply can be installed in place of batteries. Optional at extra cost.
Dimensions:	6 - 3/32" x 5 - 1/8" x 8". 6 lbs.
Price:	 204B, \$275.00

Low impedance circuits drive the 600 ohm output, effectively isolating the oscillator stage.

Designed in the new  instrument module packaging, the 204B is only 6-3/32" high, 5 1/8" wide and 8" deep; weighs just 6 pounds! A new rack mount adapter holds three 204B oscillators or other  instruments of the new modular design.

*On battery operation, stability -1% during battery depolarization, less than 30 minutes.



HEWLETT-PACKARD COMPANY

1077A Page Mill Road
Cable "HEWPACK"

Palo Alto, California, U.S.A.
DAvenport 6-7000

Sales representatives in all principal areas

HEWLETT-PACKARD S. A.

Rue du Vieux Billard No. 1
Cable "HEWPACKSA"

Geneva, Switzerland
Tel. No. (022) 26.43.36

TRIPLET

Quality...
First to last

COMPLETE PANEL METER



BAR-RING TYPE MOVEMENTS (Exclusively Triplet)

- Self Shielded
- Not affected by magnetic panels or substantially by stray magnetic fields.
- More Torque
- Lower Terminal Resistance
- Faster Response
- Exceedingly Rugged and Accurate
- All Case Sizes

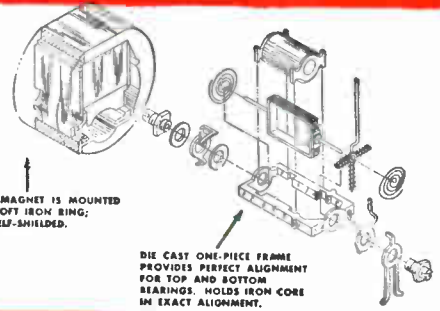

ALNICO MAGNET IS MOUNTED INSIDE SOFT IRON RING; FULLY SELF-SHIELDED.

DIE CAST ONE-PIECE FRAME PROVIDES PERFECT ALIGNMENT FOR TOP AND BOTTOM BEARINGS. HOLDS IRON CORE IN EXACT ALIGNMENT.



Round Flush Mounting (2 1/4")
Model: DC 221-T, AC 231-S, RF 241-T

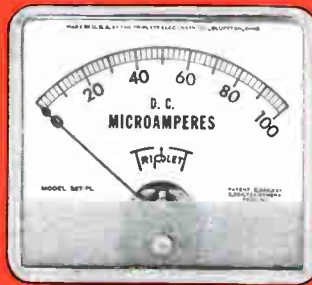

Rectangular Flush Mounting (3 3/4")
Model: DC 327-PL, AC 337-PL, RF 347-PL



Round Flush Mounting (3 1/2")
Model: DC 321-T, AC 331-S, RF 341-T, Dyn. 361

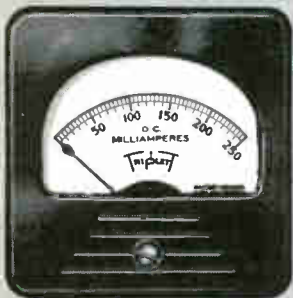

Rectangular Flush Mounting (2 3/4")
Model DC 227-T, AC 237-S, RF 247-T

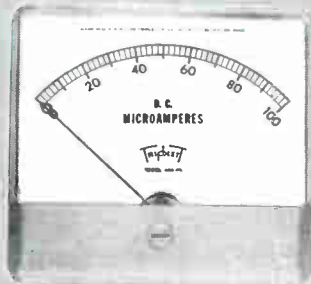

Rectangular Flush Mounting (4 3/4")
Model: DC 420-PL, AC 430-PL, RF 440-PL



Rectangular Flush Mounting (2 1/4")
Model: DC 227-PL, AC 237-PL, RF 247-PL

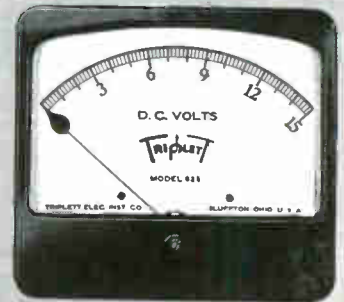

Rectangular Flush Mounting (6")
Model: DC 626, AC 636, RF 646



Ruggedized Instruments— 1 1/2", 2 1/4" and 3 1/4"
In addition to the popular commercial line of panel instruments, Triplet supplies a complete line of ruggedized and sealed instruments designed to meet government specification MIL-8-10304A.



Round Flush Mounting (2 1/4")
Model: DC 221-PL, AC 231-PL, RF 241-PL

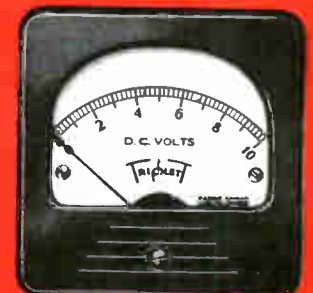

Rectangular Flush Mounting (3")
Model: DC 327-L, AC 337-S, RF 347-T, Dyn. 367-A

For complete details see your Electronic Parts Distributor, or write

LINE FULLY MEETS YOUR NEEDS

The name TRIPLETT has been on instruments of our manufacture for more than 55 years, and is regarded as a symbol of customer satisfaction to industrials and distributors in all parts of the world. Our instruments can be built to customer

specifications or provided from our large stocks of standard ranges in hundreds of sizes and types. We also carry in stock many semi-finished movements which can be converted readily to special customer needs.



Rectangular Flush Mounting (4 1/2")
Model: DC 420, AC 430, RF 440

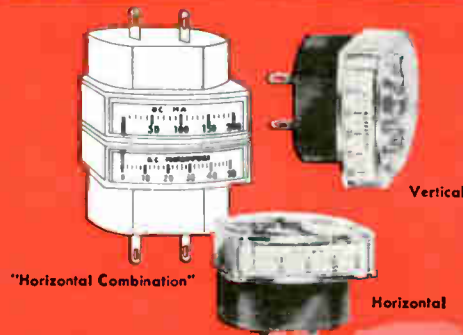

Miniature Edgewise Panel Meters
—Model 120



Model 327-U Unimeter 3 1/4"
Assembled



Model 354 Relay



Tilting Case Portable
Model: 325 (DC), 335 (AC)

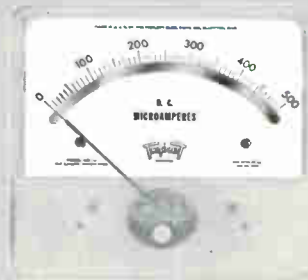

Model 420-U Unimeter 4 1/2"
with mirror scale



Model 234 Unimeter Stand

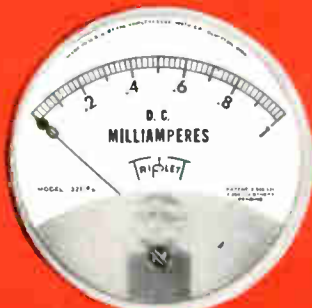

Round Flush Mounting (3 1/2")
Model: DC 321-PL, AC 331-PL,
RF 341-PL

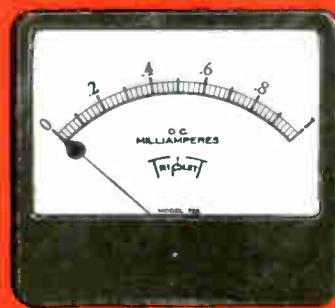

Rectangular Flush Mounting
(7 1/2")
Model: DC 724, AC 734, RF 744

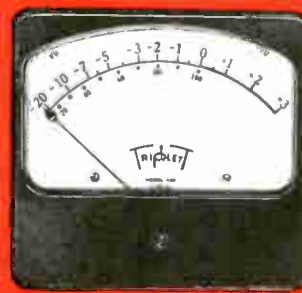

Model 420 VU Meter
Type A Scale



6 1/2" Molding Case 4.7" Scale Portables
Model: 615 (DC), 625 (AC),

TRIPLETT
Quality...
First to last

TRIPLETT ELECTRICAL INSTRUMENT COMPANY
BLUFFTON, OHIO

HIGH SENSITIVITY WIDE RANGE

*Varies from 1 ma. to 3 millimicroamperes
in 12 switch settings.*



LOW DRIFT

*Less than .01% per hour with overall
accuracy 1% of full scale.*

Elcor Current Indicator

The Model C309 Current Indicator is a wide-range, current-measuring instrument designed for measurement of electron or positive-ion beam current and for general lab use. Features high sensitivity and low drift. An auxiliary output is provided to drive a 1-ma recorder. Response time of less than 10 milliseconds makes it possible to use the Elcor Current Indicator as a low-drift D-C amplifier as well.



Write for full information: **ELCOR Incorporated**

*Subsidiary of Welx Electronics Corporation
Sales / R & D Laboratory / Manufacturing
1225 W. Broad Street / Falls Church, Virginia
JEfferson 2-8850*

General Instrument Silicon Planar Microdiodes



New from General Instrument: the only planar microdiode

This planar microdiode could help a designer make a new reputation. Here are the parameters of a "big" planar diode...but this is the first and only planar diode available in micro-size. • You get the high-reliability advantages of planar structure in a package 0.080" by 0.045"...microdiodes which have passed 10-day JAN humidity test cycles and ionic salt immersions with no degradation of electrical parameters...true surface passivation only available from General Instrument's unique Molecular Shield™ process. • Here is instant availability of a full line of planar microdiodes for computer and general purpose design, in any quantity, either as individual devices or pre-assembled as complete nanocircuits in standard TO-5 cans (up to six diodes per can). • For full information on General Instrument microdiode types MD 4, 6, 8 and 10 call the sales office or franchised distributor nearest you. In addition, the same reliability benefits of true passivation planars are available in General Instrument's microtransistors. Write today to General Instrument Semiconductor Division, 65 Gouverneur Street, Newark 4, New Jersey.

TYPICAL SPECIFICATIONS @ 25°C.

- Max. power dissipation: 250 mw.
- Reverse Recovery: JAN 256 ckt. 100 Kohms in 0.3 μ sec switching from 5 ma forward current to 40v reverse voltage.
- BDV: 100v; continuous working voltage: 80v.
- Average rectified current: 75 ma DC.
- Minimum forward current: 20 ma DC @ 1v DC.
- Reverse current: @ 80v DC: 0.005 μ a, 5 μ a @ 150 C.
- Storage and operating temperature range: -65°C to +150°C.

Typical Nanocircuit Assemblies Available in TO-5 Packages...

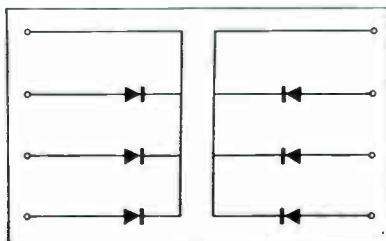

NC-1. Six Diode Assembly

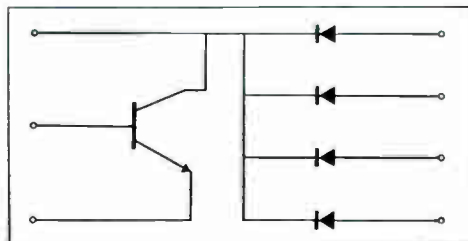

NC-3. Diode-Transistor Logic Assembly

GENERAL INSTRUMENT SEMICONDUCTOR DIVISION
GENERAL INSTRUMENT CORPORATION

ACTUAL SIZE

CIRCLE 19 ON READER SERVICE CARD

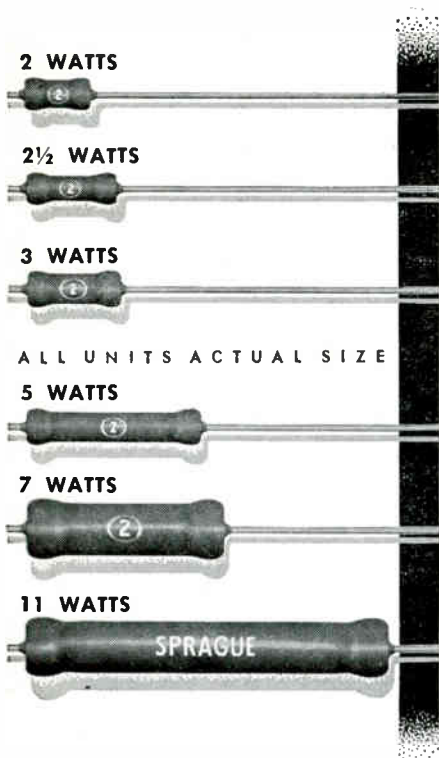

NEXT TIME ... USE TINY *Blue Jacket*[®] WIREWOUND RESISTORS

Sprague builds reliability ... efficiency ... economy right into minified Blue Jackets with these important features:

- * All-welded end-cap construction with special vitreous-enamel coating for total protection against humidity, mechanical damage, heat, corrosion gives long-term dependability under severe environmental conditions
- * Available in resistance tolerances as close as $\pm 1\%$
- * Low in cost ... quick and easy to install

Tiny axial-lead Blue Jackets are specially designed for use with conventional wiring or on printed boards in miniature electronic assemblies. Write for complete technical data in Sprague Engineering Bulletin 7410B.

SPRAGUE ELECTRIC COMPANY
35 Marshall Street, North Adams, Mass.



FINANCIAL

ITT Corp. Reports Increase in Sales

QUARTERLY REPORT from INTERNATIONAL TELEPHONE AND TELEGRAPH CORP. gives a preliminary survey of 1960's financial condition for the company. Systemwide sales and revenues totaled \$811 million, an increase of nine percent over 1959, excluding Cuban operations in both years.

Consolidated net income for 1960 was in excess of \$30 million, an increase of 11 percent over 1959 and equivalent to \$1.96 per share compared with 1959 earnings of \$1.80 per share (excluding 10 cents per share in 1959 attributed to Cuban properties).

First quarter earnings this year are \$6,640,000 or 42 cents per share on 15,698,524 shares. In the same period of 1960 earnings were \$5,871,152 or 38 cents per share on 15,534,307 shares.

HALLICRAFTERS CO., Chicago, reports nine-month earnings 73 percent higher for the period ended May 31, 1961 as compared with same period a year ago. The earnings figure for the interval this year were \$1,125,000, compared with \$650,000 a year before. This was equivalent to 51 cents a share this year as against 32 cents a share last year. The figures are adjusted for a two-for-one stock split in May 1961. Company backlog on May 31 this year stood at \$41,778,000, compared to \$24,557,000 on the same date in 1960.

COLLINS RADIO, Cedar Rapids, Ia., reports net income of \$2,700,117 for the nine months ended April 30, 1961. This is equivalent to \$1.22 per common share on 2,210,176 shares outstanding at the end of the period. In the comparable interval of 1960 net income of \$5,901,605 was reported, equivalent to \$2.85 per common share. Sales in the first nine months of the current year were \$164,145,046 as against \$138,991,830 in the corresponding period a year ago. Company president Arthur Collins said a moderate decline in sales and lower

margins of government business contributed to profit reductions in the latest three months of the period. He cited heavier spending for research and development and preproduction costs on new products as additional factors.

AMPEX CORP., Redwood City, Calif., announces consolidated sales for the fiscal year ended Apr. 30, 1961 were \$70,105,000, compared with the record high of \$73,434,000 in the preceding year (adjusted to include operations of Telemeter Magnetics Inc. which was merged with Ampex in Dec. 1960).

Although the fiscal year-end audit is not yet closed, company officials estimate the firm will show a consolidated net loss for the year, after tax adjustments, of approximately \$4 million as compared with earnings of \$3,959,000 for the preceding year.

George Long, Ampex president, says the projected loss is due to operating costs initially geared to support sales projected at higher

25 MOST ACTIVE STOCKS

	WEEK ENDING JUNE 23, 1961			
	SHARES (IN 100's)	HIGH	LOW	CLOSE
Transitron	3,946	28 ³ / ₈	22	26 ¹ / ₂
Lockheed	2,243	47 ³ / ₄	43 ¹ / ₈	47 ³ / ₈
Avco	1,617	21 ³ / ₈	19 ⁵ / ₈	20 ³ / ₄
Sperry Rand	1,373	29 ³ / ₈	26 ⁵ / ₈	29
Gen Dynamics	1,352	34 ³ / ₈	31 ¹ / ₂	33 ¹ / ₈
Ampex Corp.	1,222	22 ¹ / ₂	20 ³ / ₈	21 ⁷ / ₈
Gen Tel & Elec	1,174	26 ¹ / ₂	25 ³ / ₄	25 ⁷ / ₈
Gen Elec	1,087	64 ³ / ₈	62	62 ³ / ₈
U S Industries	1,012	15 ³ / ₈	13 ⁷ / ₈	15
Standard Kollsman	855	46 ³ / ₄	43 ³ / ₄	44 ³ / ₄
I T & T	806	55 ¹ / ₄	51 ¹ / ₂	53 ¹ / ₈
Elec & Mus Ind	703	6	5 ³ / ₈	5 ³ / ₄
Martin Co.	684	38 ³ / ₈	34 ³ / ₄	38
Univ Control	620	12 ³ / ₈	11 ³ / ₈	11 ³ / ₄
Westinghouse Elec	602	44	42 ¹ / ₂	42 ⁷ / ₈
Ling-Temco	520	39 ³ / ₈	34	38 ³ / ₈
Gen Inst	474	42 ¹ / ₂	39 ⁵ / ₈	41 ¹ / ₄
Burroughs Corp	453	30	29 ¹ / ₈	29 ³ / ₈
Dynamics Corp of Am	435	15 ³ / ₄	13 ⁵ / ₈	14 ⁷ / ₈
Avnet Elec	430	48 ³ / ₈	44	46 ³ / ₈
Lear Inc	361	24 ⁵ / ₈	21 ⁷ / ₈	23 ³ / ₄
Hycon Mfg	355	5 ¹ / ₄	4 ³ / ₄	5
Raytheon	348	40 ³ / ₈	38 ¹ / ₄	38 ⁷ / ₈
I B M	318	48 ² / ₂	47 ¹ / ₂	47 ¹ / ₂
Varian Assoc.	318	62 ¹ / ₂	54 ¹ / ₄	62 ¹ / ₄

The above figures represent sales of electronics stocks on the New York and American Stock Exchanges. Listings are prepared exclusively for ELECTRONICS by Ira Haupt & Co., investment bankers.

levels than were actually attained, the adverse impact of a strike in mid-April and the cumulative effects of special provisions for inventory revaluation and other non-recurring adjustments during the second half of the year.

DIGITRONICS CORP., Albertson, N.Y., reports an increase of 142 percent in sales and 190 percent in net income for the fiscal year ended March 31. Net sales were \$1,988,000 compared with \$821,000 the previous year. Research and development expenditures amounted to \$96,000 last year as compared with \$71,000 a year earlier. Net income in the fiscal year just ended was \$188,000 before taxes. Net earnings after taxes for the 1961 fiscal year were \$103,000 or 25.5 cents a share as compared with 10.2 cents and 7.5 cents in 1960 and 1959 respectively.

PERKIN-ELMER, Norwalk, Conn., announces net sales of \$18.4 million for the nine months ended April 30. This is a rise of 26 percent over the equivalent period a year ago when the figure was \$14.6 million. Net income for the period was \$730,868 compared with \$660,614 for the same period the year before. Earnings were equivalent to 58 cents a share in both the nine month periods because of the change in the number of common shares outstanding. At April 30, 1961, there were 1,252,460 shares out, and for the same date in the preceding year there were 1,146,350.

AIRPAX ELECTRONICS, Ft. Lauderdale, Fla., reports net earnings of \$27,420 for the three-month period ended Mar. 31, 1961. This is equal to 7 cents per share. In the same period of fiscal 1960 earnings were \$16,072 or 4 cents a share. Sales in this year's first quarter were \$1,056,979, compared with \$952,911 in the same quarter of 1960. This represents an approximate increase of 11 percent in sales and 72 percent in net income.

July 7, 1961

**square
peg**

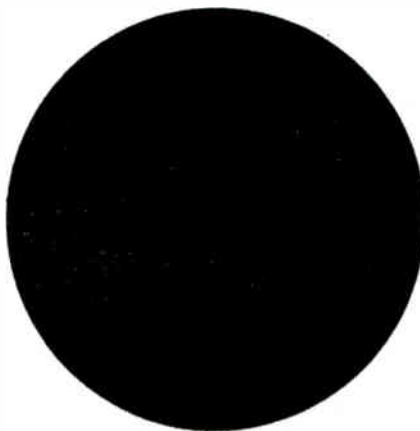

**round
hole**

You can't sell transistors to a short-order cook . . . nor a carload of frozen strawberries to a jewelry jobber.

And you don't have to waste advertising dollars trying to fit square pegs into round holes, either — not when the business publication you use is a member of the Audit Bureau of Circulations*.

Our ABC report, for example, helps you aim your advertising message directly to the audience you seek to sell . . . not only the specialized markets we reach and how well we reach them . . . but also the vocational identity of each subscriber in these markets — *who* and *how* many.

The phrase "Member of ABC" is significant to every advertiser who uses business publications. ABC reports provide him with a factual basis for reaching specialized markets . . . and the assurance that the people he wants to talk to will be there when the publication is delivered.

We are proud to be an ABC member.

electronics

A McGraw-Hill Publication

330 W. 42nd Street • New York 36, N.Y. 

* Through the reports issued by the Audit Bureau of Circulations, this publication, along with other publisher members of ABC, voluntarily and regularly give the buyers of advertising more verified factual information than is available for any other advertising media at any time.

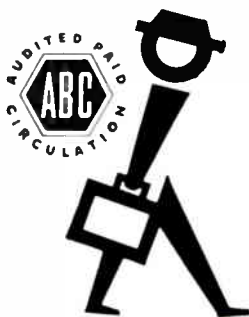

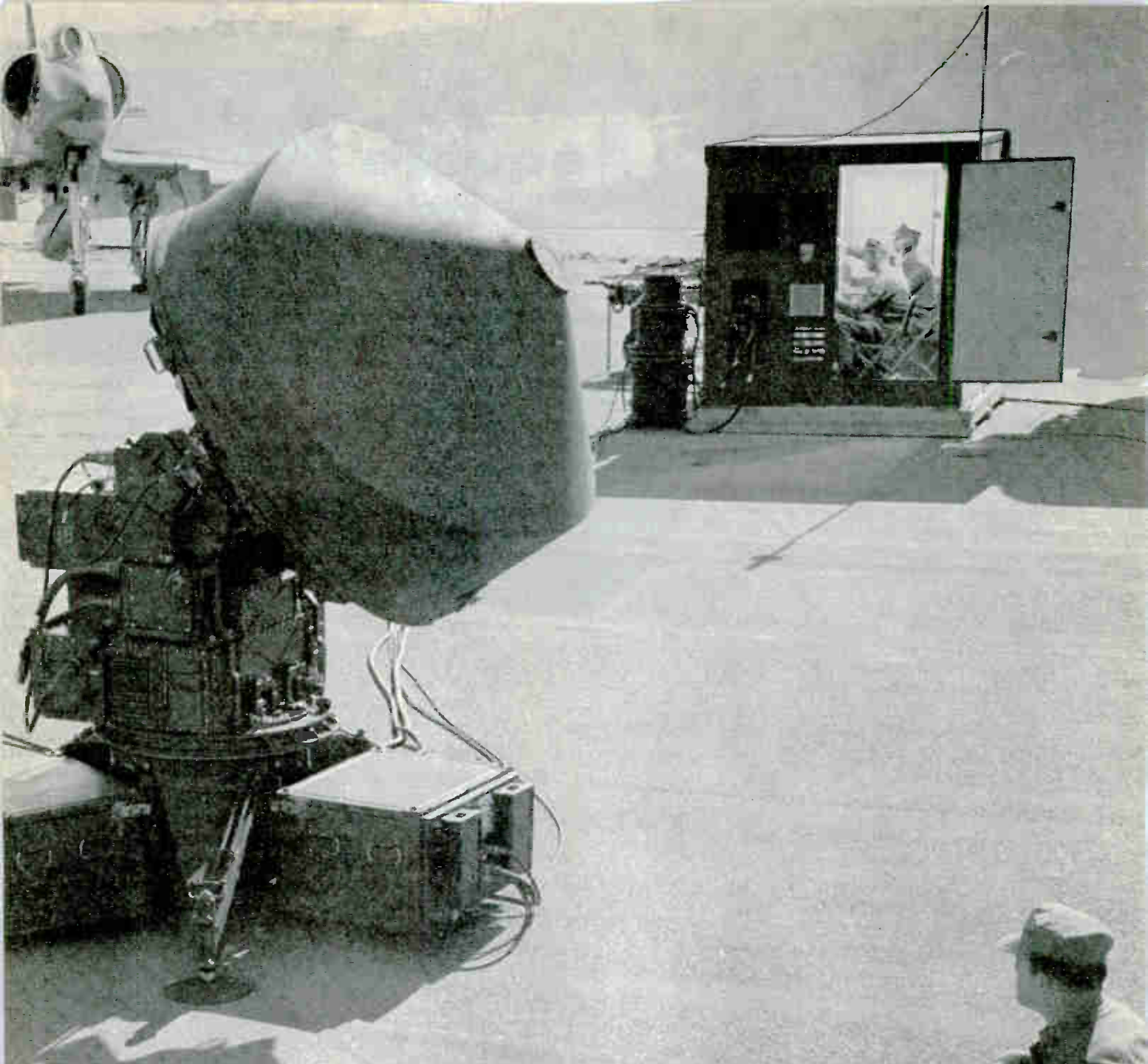

AN ACHIEVEMENT IN DEFENSE ELECTRONICS

New Transportable Radar Directs Precision Air Support

Front-line ground forces can now obtain all-weather, close air support, —when and where needed— with the new lightweight AN/TPQ-10. This is the first helicopter-transportable, high-accuracy control radar for precision air support. Developed for the U. S. Marine Corps by General Electric's Heavy Military Electronics Department, the versatile new system can also provide aircraft control for emergency supply airdrops, paratroop placements and aerial mapping.

176-07

HEAVY MILITARY ELECTRONICS DEPARTMENT
DEFENSE ELECTRONICS DIVISION • SYRACUSE, NEW YORK

Progress Is Our Most Important Product

GENERAL  ELECTRIC

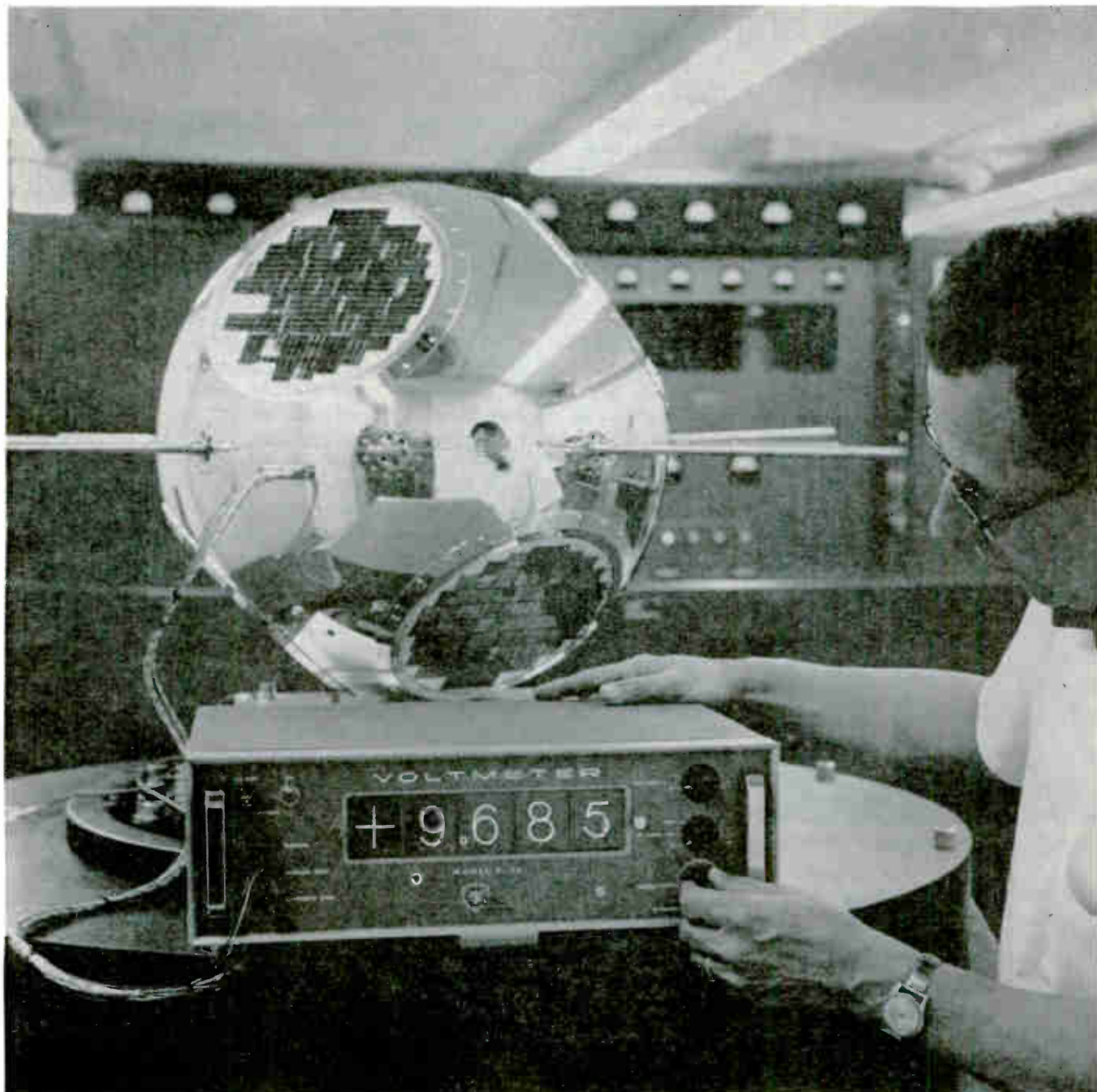

NEW DVM CONCEPT!

FAST: Two readings per second **ACCURATE:** 0.01% accuracy **LOW COST:** Only \$1,580

In the above test of a satellite's telemetry and solar cells, it was necessary to make 100 accurate measurements every minute. The job was done with the new Cubic V-70 digital voltmeter that reads out four times as fast as any instrument with stepping switches. The V-70 uses ultra-reliable reed relays hermetically sealed in glass for a life expectancy of at least 10 years. It has no moving parts, requires no maintenance, will operate in any position, and is resistant to thermal and physical shock. The V-70 is the only DVM offering 0.01% accuracy and less than 1 second balance time for less than \$2,000 (Model V-70, \$1,580; Model V-71 with automatic ranging and polarity, \$2,200). For details, write to Dept. E-106.



INDUSTRIAL DIVISION
SAN DIEGO 11, CALIFORNIA

OTHER OFFICES: LOS ANGELES, CALIFORNIA • ROME, ITALY (CUBIC EUROPA S.p.A.) • REPRESENTATIVES IN PRINCIPAL U.S. AND CANADIAN CITIES

Japanese Scope Business Gets Underway

TOKYO—Japanese oscilloscope manufacturers have obstacles to overcome before they can enter the world market. Although circuit design doesn't present a problem, marketing and problems in getting high-quality components at a competitive price are the stumbling blocks.

Many Japanese manufacturers are making the attempt to beat the admittedly superior U.S. instruments now being used as standard in Japan. One reason is to stimulate Japanese production, they want a 15-percent duty imposed on U.S. oscilloscopes thus raising their price. Because there are at present no Japanese equivalents of the high-quality American oscilloscopes, our devices now enjoy a duty-free status.

American manufacturers have little to fear at present. There are several reasons why Japanese manufacturers cannot compete on the international market in the near future . . . one being that the total number of different types of oscilloscopes required in the general electronics industry is large while the total number of these models that can be produced in Japan is small.

For example: Iwasaki, one of Japan's large oscilloscope manufacturers, is producing only 600 units total per month (of all types). Although the price of conventional electronic components is low, the price of high-quality components is high, even in Japan. Also, the cost of tooling up for limited production, or hand-producing parts for low-quantity production is high.

In addition, many components still have to be imported—Iwasaki imports certain Philips tubes, Hughes' Memotron and some British cathode-ray tubes.

The high cost of marketing in the United States is a serious problem for Japan. In Japan a manufacturer deals mostly with the retailer, and the profit to the manufacturer is great. If a Japanese manufacturer wishes to sell in the United States, he has more expenses—the cost of manufacturing, the exporter, trans-Pacific shipping, the

importer, import duty, the wholesaler, the retailer and then the customer. Either he reduces his price to be competitive, and suffers less profit, or he is priced out of the U.S. market.

Some Japanese oscilloscopes are seeing service in foreign countries. These were not exported as individual units, but as components of large systems such as tv or broadcast stations. This is another reason why most Japanese companies are getting into the oscilloscope race. Like many U. S. companies, Japanese companies are unhappy when they have to add another company's product to a system they build.

Many visitors to Japan, and the many engineers who have examined Japanese oscilloscopes on display in this country, have commented on the apparent similarity between Japanese and U. S. oscilloscopes. A representative of Iwasaki told ELECTRONICS:

"We set out to build the best oscilloscopes in the world. This always has been and always will be our aim. There is no getting around the fact that certain American companies are very far ahead of us and are considered as standards in Japan. We do not have the R&D budget of these companies neither do we have the equivalent resources of components and other manufacturers to draw on.

"Similarity in appearance is due to customer demand for panel layouts similar to the American oscilloscopes with which they are already familiar. Several large American manufacturers have made no effort to register any of their designs in Japan."

Some typical Japanese oscilloscopes and prices are: the SS-5302 synchroscope has a response from d-c to 30 Mc with a rise time of 12 nanoseconds. No price is given. The SAS-1001 samploscope is 3 db down at 1,000 Mc with a rise time of 0.35 nanosecond. It can be synchronized to 1,000 Mc and costs approximately \$5,000 without the delay circuit.

A transistor oscilloscope, the SS-3052, responds from d-c to 5 Mc

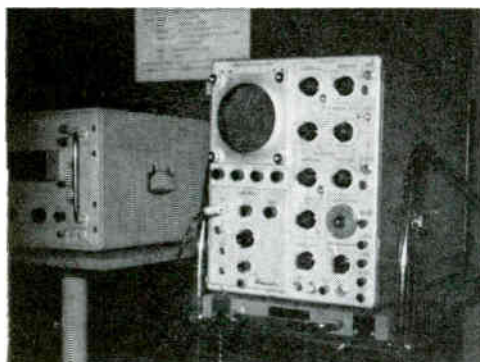

SS-5302 synchroscope, d-c to 30 Mc

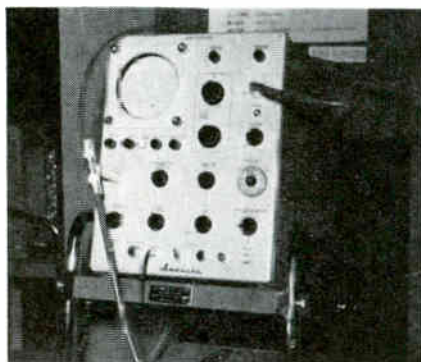

SAS-1001 Samploscope, to 1,000 Mc

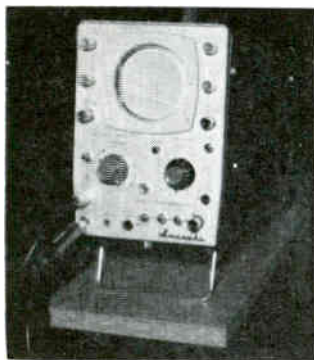

Transistor unit, d-c to 5 Mc

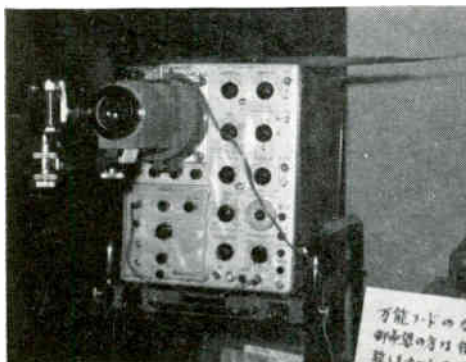

Typical camera hood

with a rise time of 0.07 μ sec. It can operate from conventional a-c power or for 20 minutes on internal flashlight batteries. It costs \$675. A camera hood costs about \$120.

An oscilloscope good to about 20 Mc costs around \$1,300 while one going to about 50 Mc runs to approximately \$1,600. Plug-in wide-band amplifiers costs about \$170 and a dual-trace wideband plug-in runs about \$250.

Drop Expected In Hiring Rate

THIS YEAR is likely to see a drop in hiring of engineers and executives by electronics companies.

According to survey information collected by Davies-Shea, Chicago personnel consultants, the amount of hiring is expected to be 70 percent of what it was during 1960.

A total of 385 electronics facilities were asked what their requirements would be this year for executive and engineering personnel.

Of the respondents, only 20 percent indicated plans to increase their hiring rate. Fifteen percent said they would not be changing their present activity in hiring, while the remaining 65 percent of the firms said they would reduce hiring activity between 10 and 85 percent.

Firms increasing their hiring rates, in the opinion of E. B. Shea, president of the Chicago company, are those which have so far not geared their personnel requirements to the faster growing areas of electronics. In this category he places semiconductors, thermoelectric devices, microelectronics and infrared.

G. J. McKorkle, manager of the agency's semiconductor division, predicts the greatest competition for key personnel will be in the semiconductor field which, he says, will see many mergers, consolidations and even a few failures this year.

These other specialized fields also will see demands for top manpower: inertial guidance, digital and analog computers, weapons systems, space systems, communications and undersea developments.

Taking Close Look at Memory Drum

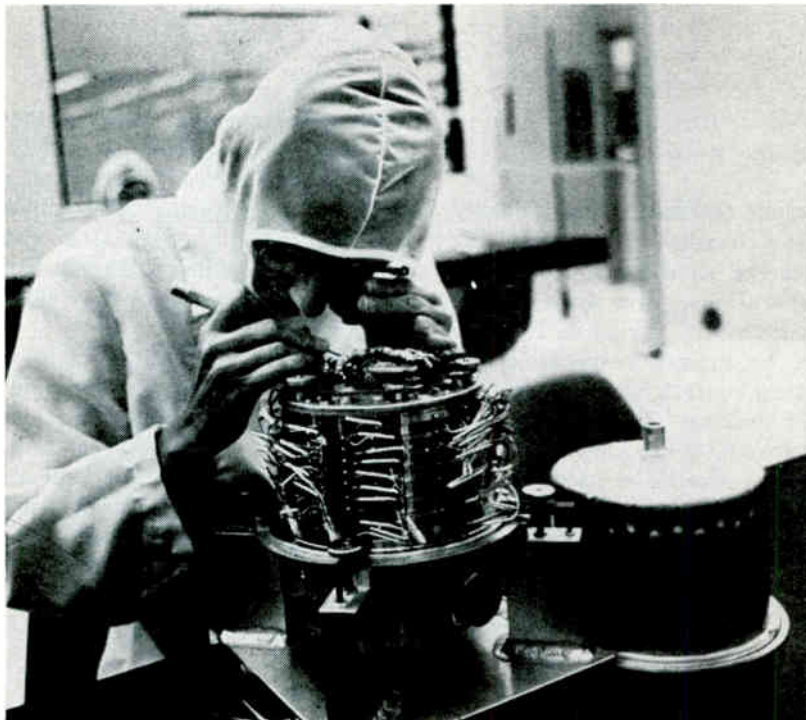

Memory drum for Titan 2 guidance computer is inspected by technician in clean room at IBM's Space Guidance center

As hardware stages are reached for equipment now in the design or development phase, there is likely to be an upturn in demand for manufacturing executives with experience in producing components and systems to military specifications. It's predicted 1961 will resemble 1960 in this way: demand will be great for high-level specialists able to deal in entire systems and draw up contract-winning proposals.

Navy Issues 3rd Group Of Laboratory Standards

THE THIRD GROUP of Navy Lab procedure standards is available this week from the U. S. Commerce Department's Office of Technical Services.

The group contains 41 new standards. The first group of 24 standards and the second group of 23 standards are still available. The remainder of approximately 300 Navy instrument standards will be published by OTS during the year.

Two new categories, *Technical Manual* and *Fabrication Instructions*, have been added to the three

previous ones, *Instrument Calibration Procedure*, *Measurement System Operation Procedure*, and *Cross-Check Procedure* which comprise the series, *Standards Laboratory Procedure*, prepared by the Bureau of Naval Weapons.

British May Use Wire Data Links

LONDON—British post office officials are studying the possibility of using 48-Kc bandwidth telephone circuits for data transmission. Despite considerations of expense and the need for repeaters, it is pointed out such a network would be able to provide direct computer input.

Work is now in process on design considerations for direct input and retrieval of computer data to telephone lines. Post office officials say the inland telephone circuits will be made available once studies are concluded. Specifications for the gear are being evolved.

Equipment adopted is likely to have a working speed to 1,000 bits per second, use f-m transmission in the 900- to 2,000-cps region.

Operations: How Inventory Control Fits In

By ROY J. BRUUN

Assistant Editor

INVENTORY CONTROL in our industry is being increasingly affected by engineering as well as by production operations. Five firms visited by *ELECTRONICS* varied as to: who should be mainly responsible for inventory control, where inventory control belongs in the company structure and what kind of control techniques should be used.

At RCA's Industrial Electronics Products Activity, inventory control is a staff function. The inventory control manager directly counsels and consults sales, engi-

neering, purchasing and production. He can thus develop analytical approaches for determining minimum engineering lead times that will permit purchasing and production schedules to supply end products at times specified by sales forecasts.

At IEP, the many product lines create such a large constant demand for standard components and materials that EOQ and other common techniques can be advantageously used to some extent. Adequate inventory turnover rate (twice a year) is thus promoted.

At Sperry Gyroscope Company's Air Armament Division the ma-

terials manager is directly responsible for making decisions on orders greater than \$50,000 for advanced components. If such an order is based on an engineering change, he may consult with the director of engineering and the chief engineer to ascertain whether the change is necessary. Final responsibility for the order is his.

In-process control of materials inventory at Air Armament, is delegated to production control, which reports to the materials manager. Immediate responsibility is assigned to a material control superintendent. He uses Sperry's Automatic Control Evaluation (ACE) data processing system to perpetually inventory all materials in production and those that will be in production within the three month lead time supplied by engineering. Every day there are 25,000 transactions in the \$20,000,000 inventory at Air Armament.

Under the ACE program, all of Sperry Gyro's Nassau (Long Island) divisions, including Air Armament, stock a total of 16,980 different standard parts such as resistors and capacitors with from 200 to 150,000 units stocked for one part. There are also 20,000 non-standard and high-priced items kept track of by ACE. ACE uses four computers, a Univac 1, Univac 2, Univac 120, and Univac solid-state 90. With ACE, the entire inventory can routinely be turned-over twice a year.

At Arma Division of American Bosch Arma, ultimate responsibility for inventory control resides with the Property Administrator, who heads the Property Accountability Section in the Controller's Department. Inventory control is part of property control which is concerned not only with the efficient use of materials in production but also with the effective employment of all equipment.

Effective property control enables Arma to avoid annual or semiannual inventories, saving \$50,000 per year. Surplus property that might otherwise have been disposed outside the company was

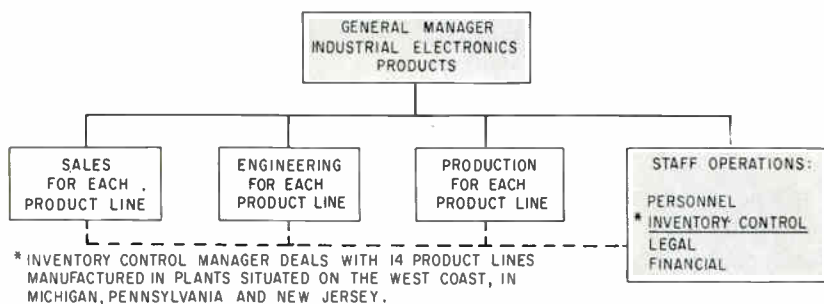

Inventory control is a staff function at RCA's Industrial Electronics Products Activity

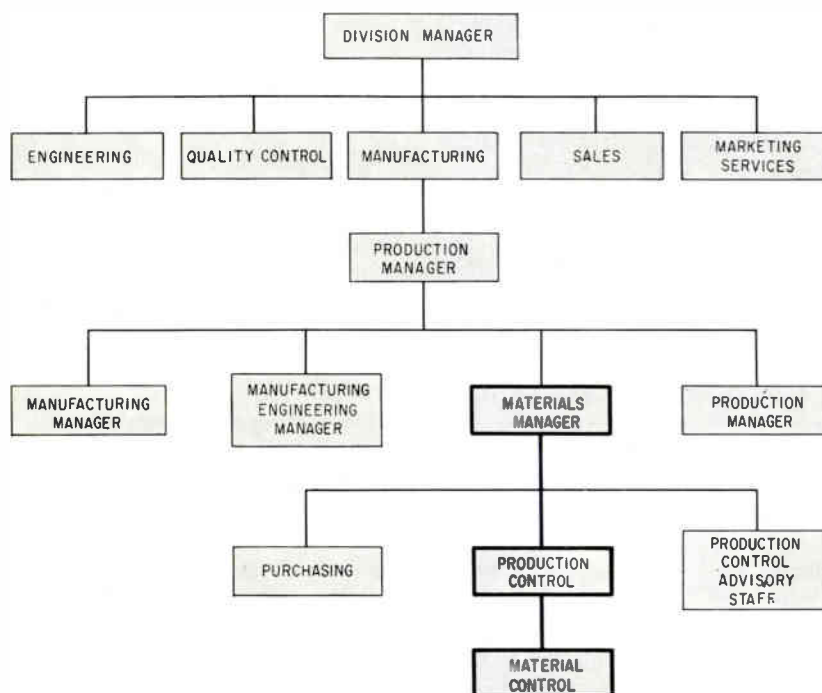

Inventory control organization at the Air Armaments Division of Sperry Gyroscope Company

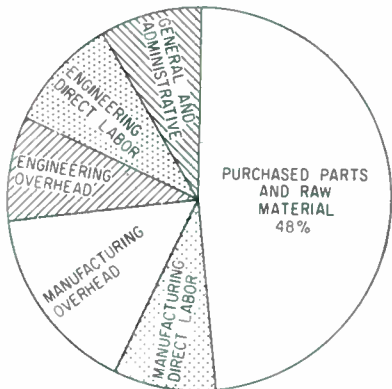

Distribution of expenditures at Arma indicates importance of good inventory control

distributed among various projects during 1959-1960 to realize a savings of \$500,000. Engineering and other departments are kept continually informed on available surplus.

More than 2,000 daily inquiries are made of the materials inventory at Arma. As yet, data processing has not been employed. Materials inventory at Arma may be roughly assessed at \$200,000,000—a missile guidance system requires 50,000 different parts.

Two smaller organizations, Huyck Systems Company and Amperex also have their inventory control problems.

Amperex in tube manufacturing is chained to the short-term commitment nature of the business.

Engineering design changes must be strongly justified once a tube design has gone into production. Management across-the-board, not just marketing or sales, makes the final decision.

Huyck operates inventory on a commitment basis and makes no attempt at large-scale economic ordering techniques except for standard components, only a small part of total dollar volume.

Since 40 percent of the sales dollar is tied up in purchased parts and materials, engineering changes are sent to production control for evaluation as to their effect on the inventory and on delivery schedules and price.

A materials control manager has overall responsibility for inventory control but works closely with engineering, production control and top management to balance engineering changes against materials and parts on hand.

TAPE TAMER



NEW EECO HIGH-SPEED MAG TAPE REWIND UNIT \$690, 6 WEEKS DELIVERY

Tame your tape rewind problems at the industry's lowest cost for all these features. Fast automatic stop when tape ends or power fails. Rewinds 101½" reel in 75 seconds. Constant tension for unusually even winding. Tension selector. Universal hub accepts NAB, UNIVAC or IBM reels. Precision guides handle ½", ¾" or 1" tape without adapters. Unit takes reels up to 14" diameter. Operates on 115v ac, 60 cps, 150 va. Initial availability 6 weeks. Send for Data File TR-300.



AUTOMATION DIVISION

Electronic Engineering Company of California

1601 E. Chestnut Ave. • Santa Ana, Calif. • KImberly 7-5501 • TWX: S ANA 5268

EE 1-32

F-M Stereo Dominates Chicago Conference

CHICAGO—Compatible stereo was the leading topic recently among 625 engineers attending the Second Annual Spring Conference on Broadcast and Television Receivers at the O'Hare Inn.

Four stereo papers featured Zenith engineers C. Eilers and A. Devries, outlining technical details of transmitter and receiver circuits developed for experiments leading to the recent FCC stereo ruling; A. Csicsatka, GE, discussing additional factors affecting overall receiver performance during preliminary tests; and Norm Parker, Motorola describing a decoder for restoring the subcarrier.

W. W. Watts, RCA executive vice president, said stereo multiplex is on threshold of an exciting era for the 60's. "New dimension—possibly the greatest that ever happened" he said in a luncheon talk.

Emphasizing challenge of consumer electronics for future while denying saturation of this field, Watts ranged from the challenge of global tv discussed in one conference paper to the 1,800,000-classroom future educational tv market, subject of another paper about the midwest program on airborne tv instruction.

Among consumer electronic challenges listed by Watts was the "limitless" tv market with a big color boom imminent (but no promise of substantial reduction in set prices) transistor tv and, eventually, 3-d tv. The U.S. could use uhf to pioneer education for backward and remote areas, he said. A mass market for citizens band equipment and the possibility of home computers, all these and more, should help double present market to more than \$2½ billion by 1970, he predicted.

First transatlantic communications satellite could be operational within next couple of years if a small relay system is satisfactory, S. Lutz, Hughes, said. More advanced nuclear-powered 24-hour satellite could relay programs to a 4 to 5½ foot dish atop homes by using a one-degree beam focused to serve homogenous cultural areas.

Quarter-second delay over the distance would be of no consequence

for one-way broadcast, Lutz said. Low-noise parametric receiver could be Peltier or thermoelectrically cooled.

Total of 8,000 to 10,000 teachers in six states are ready for airborne tv instruction.

The program will offer 10 hours of courses to five million students in 1,500 buildings, part of 5,000 school systems, starting next September. Programming will be from a plane broadcasting over channels 72 to 76 as it flies in a 10-mile orbit at 2,300 feet.

Technical details of subscription tv system to go on air in Hartford next fall was discussed by Norm Watters, Zenith. He said the system includes video coding which shifts horizontal segments of picture which has blacks and whites inverted and system for raising audio 2.6 Kc to destroy harmonic relationships. The receiver reverses these processes.

Feedback increases precision of easily tuned solid-state electronic tuned receiver discussed by E. Aupperle, University of Michigan. Crystal oscillator generates harmonic train spaced in 100-Kc steps. Chosen harmonic is locked on to selected signal in system which would be useful for scrambled communication systems, air navigation omnirange or two-channel stereo.

S. Talesnick, General Telephone

and Electronics Labs, discussed a solid-state oscilloscope display using a thin pizeoelectric panel with local fields interacting with a phosphor layer. Five-by-five inch experimental screen may eventually add colors and expand to become wall-panel tv, depending on the results of investigations now underway.

Small-sized pizeoelectric filters could prove important to solid-state circuits of future, according to H. Benzuly, Warwick, in a paper on applications of electromechanical and piezoelectric filters.

J. Gote, RCA, described a simple neutralization circuit for application of a nuvistor triode as a video i-f amplifier. A low-distortion transistor power amplifier for a low-cost stereo amplifier using a drift field power transistor was described by H. Kleinman, RCA. The company displayed the unit as part of exhibits that also included a transistor f-m tuner and stereo amplifier and three new transistors from Texas Instruments.

E. Boden, Sylvania, reported improvement in tube and receiver reliability in second progress report on tv receiver reliability since 1954. Set life is unaffected by use of double tubes, he reported. Series string circuits result in no significant difference in set life, compared to transformer power-supply circuits.

Checking Color Television Standards

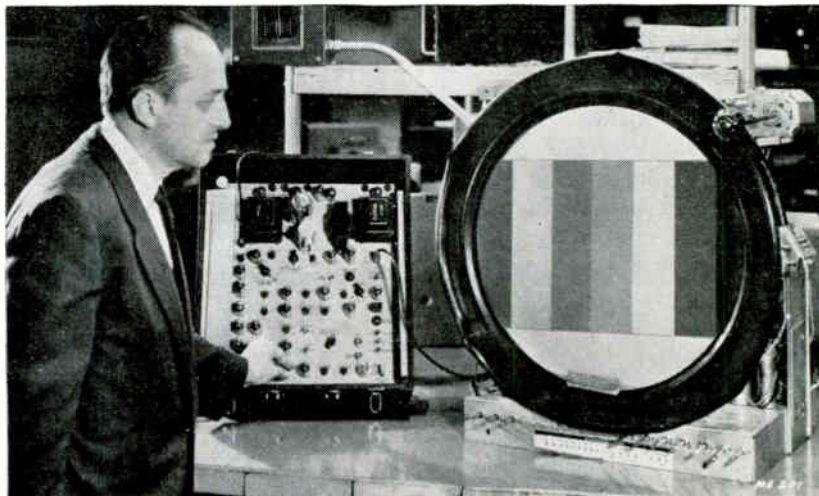

Color tv test gear by Hickok Electrical Instrument Co. generates the seven hues of NTSC standards: green, yellow, red, magenta, white, cyan and blue

WORKHORSE OZALID'S NEW PRINTMASTER 900



PRINTMASTER 900
Ht.—70½", Width—84¼", Depth—46½". Newest in Ozalid's family of whiteprinters...all designed to give you the finest reproduction at the lowest possible cost. Whatever your need there's an Ozalid whiteprinter to meet it.

Big volume of engineering prints? Put Ozalid's new Printmaster 900 to work. This new, heavy-duty whiteprinter is a workhorse for capacity, a thoroughbred for quality, a favorite for economy.

Fast! Top speeds up to 75 feet per minute. Versatile... processes any dry diazo material up to 42" wide without sticking. Develops both sides in one pass! Unique... new, sleeveless, scratch-proof developing and simplified control make it top performer in its price class.

Here, in truth, is a new concept in whiteprinting. New ideas, new designs from the leader in the industry that spell new efficiency, reliability, economy in engineering reproduction.

The coupon will bring you the facts on Ozalid's new "900". Facts that may save you thousands yearly. Mail it today.

OZALID®

Division of General Aniline & Film Corporation, Johnson City, New York
REMEMBER, FOR PEAK EFFICIENCY, ALL OZALID WHITEPRINTERS WORK BEST WITH OZALID SENSITIZED MATERIALS

Mr. James A. Travis, Mgr., Marketing
Ozalid, Dept. 221 Johnson City, New York
Please send information on New Printmaster 900.

Name _____

Firm _____

Address _____

City _____

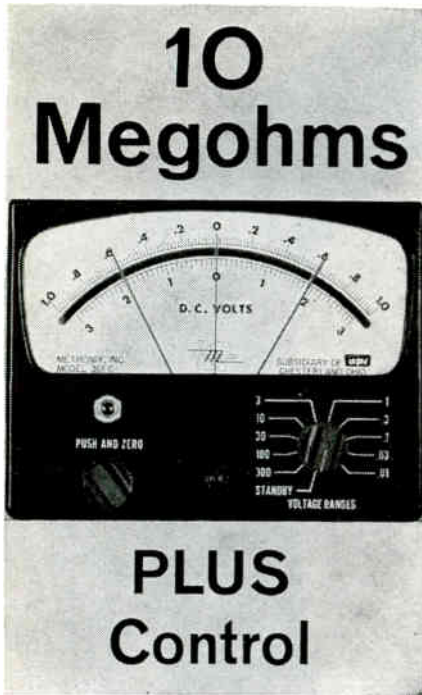

An electronic voltmeter with a meter-relay

This happy combination makes an extremely versatile and acute instrument.

It has critical measuring ability that goes with high input impedance, in space-saving panel-mounting style.

It also has the reliable, simple control of a locking contact meter-relay, with adjustable set points.

Many difficult functions can be easily controlled: conductivity cells, life testing of components or systems, production testing and sorting, automatic Go-No Go of missile circuits.

Ready When Needed

Metronix DC instruments such as Model 301-C-CMR (illustrated) have input resistances up to 10 megohms. AC input impedances go as high as 5 megohms. Like all Metronix panel-mounting electronic voltmeters (PMEV's), they are always connected—immediately available for continuous monitoring of critical parameters.

Send for data sheets describing Metronix PMEV's in single or multiple ranges, DC or AC, with either meter-relays or conventional indicating meters.

 **METRONIX, INC.**
a subsidiary of Assembly Products, Inc.
Chesterland, Ohio
Telephone: HAmilton 3-4440

More American Firms Going European

U. S. ELECTRONICS INDUSTRY'S interest in Western Europe continues high as 1961 passes the halfway mark.

Since this year started, more than two dozen electronics companies have announced plans to enter the European markets. New plants are being built, existing companies are being acquired and cross-licensing agreements are being signed.

A strong stimulus to these decisions is the increasing economic integration going on in Europe through the European Economic Community (EEC) and the European Free Trade Association (EFTA).

Improving tariff conditions within these two blocs of European countries is giving increased preference to goods produced within the groups. This means our products will stand a better chance of being sold there competitively if they are produced in Europe.

The Chase Manhattan Bank, in a report on some new developments in Europe, groups electronic equipment exports with electrical machinery and labels the two as one product category that could be displaced by European products.

Among firms establishing new European plants this year is Electronics Corp. of America, Cambridge, Mass. Already joint owner of an English factory, ECA is constructing a new factory in Belgium and expects to be producing and selling on the continent by year's end. Products will include electronic controls and infrared devices.

In Germany, Amphenol-Borg is constructing a factory with initial provision of over 3,000 sq ft of production and office space near Munich on a 10-acre site. The company already has access to the EFTA community through a wholly-owned British subsidiary making components.

Itek Corp., Waltham, Mass., entered the EEC last month by acquiring a complete facility in Munich, for cash. The company, Heinz Kilfitt Optische Fabrik, now makes a variety of specialized optical equipment and will include items reflecting its new parent

company's product lines later on.

In Switzerland, Reliance Electric and Engineering, Cleveland, O., and Schindler & Cie. AG, of Lucerne have jointly formed a new electronics company, Schindler-Reliance Elektronik, by investment of \$750,000 each. A new factory will be built in Lucerne to make both companies' products.

In Paris, C-E-I-R, Arlington, Va., has bought 42 percent of the assets of Centre Francais de Recherche Operationelle, and plans to make available consulting and data processing services.

In London, Dynamics Corp. of America is using its English subsidiary, Winston Electronics, as a base of operations for an acquisition program.

A number of new cross-licensing agreements have been concluded in the past 90 days:

Centralab Electronics has signed agreements with Plessey Co. Ltd. Centralab will give Plessey know-how in such fields as variable resistors, rotary switches, ceramic capacitors and packaging. In return Plessey will send information on aircraft electronics and automotive electrical systems here.

Also in England, technical exchange has been negotiated between Packard-Bell and Solartron Laboratory Instruments. From the

System Checks Tubes

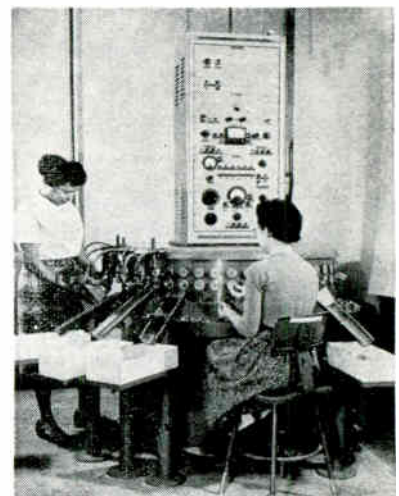

Automatic short and continuity checker by Sonotone tests 2,000 tubes an hour

agreement, P-B will be licensed to make and sell Solartron oscilloscopes in the U. S.

In Ivory, France, an agreement has been signed between Gultron Industries, Metuchen, N. J., and Schneider Radio-Tv S.A., in which the French firm will make and sell Gultron components and systems in France and the Benelux areas.

Collaboration in airborne radio and radar equipment has been agreed to by Marconi's of England and Wilcox Electronics, Kansas City, Mo. The two firms will jointly produce vhf and hf communications equipment, VOR, ILS and ADF systems for sale in the companies' respective market areas.

New operations in the period 1958-1961 in the electrical machinery and electronics industries saw 21 new starts in Italy. France came next during 11 new starts, followed by Britain with 10, Belgium with 8, Germany with 7. Six new starts were made in Switzerland and five in Holland.

U.S. Funds Supporting 76% of Our Engineers

SEVENTY-SIX PERCENT of all engineers and scientists employed in electronics are supported by government funds, according to a new survey conducted by EIA with Department of Defense cooperation. The remaining 24 percent are in commercially-supported activities.

There are 155,000 engineers and scientists performing electronics work in all areas. Eighty-three percent (128,000) are employed by industry, eight percent work for the federal government and five percent are doing research work for universities and nonprofit organizations. Remainder: independent consultants, engineers and scientists between jobs.

The survey was conducted to sufficiently inform officials of the Defense Department, military contractors, and other industry leaders as to the distribution of this technical manpower in order to avoid possible adverse effects of major shifts in defense programming. Distribution of the complete report is being restricted to manufacturers who provided information.

July 7, 1961



FLEXIBILITY

HYGRADE VF

vinyl-coated fiberglass sleeving

Feel it; flex it; it's sturdy, smooth, and responsive! It's the famous **HYGRADE VF INSULATING SLEEVING** in the *Markel Line of Excellence*. It perfectly combines supple *braided fiberglass* and tough *vinyl coating* for a superior class B sleeving to meet all these specifications:

- extreme flexibility without loss of dielectric strength • rated for continuous operation to 130°C with excellent stability • dielectric strength, 8000 v min (grade A) • non-migratory plasticizers: excellent resistance to transformer oils • non-flammable; non-corrosive; fungi-resistant • available in #24 to 1" sizes and all standard colors • meets MIL-I-3190B specifications and NEMA standards.

Like to handle some? For samples—and fast—call, write or wire today!

L. FRANK **MARKEL** & SONS
SINCE 1922



SOURCE for EXCELLENCE in
Insulating Tubings, Sleeveings, and Lead Wire

NORRISTOWN, PENNSYLVANIA

CIRCLE 31 ON READER SERVICE CARD

31

Work Begins On Planet Probe Power Source

PAYLOAD POWER SOURCE for Mariner-class planetary probes may be a solar energy thermionic conversion system (SET) now being developed by Electro-Optical Systems, Inc. for the National Aeronautics and Space Administration. The \$318,303 contract will be administered by the Jet Propulsion Laboratory.

SET will consist of a lightweight solar concentrator five feet in diameter which will focus solar radiation into a cavity used to heat several cesium vapor-filled thermi-

onic diodes. These diodes will transform heat into electrical current.

The thermionic generator will consist of an array of diodes arranged about the cavity. The generator will be developed under subcontract by Thermo-Electron Engineering Corp.

The system will generate 135 watts at a solar constant 40 percent of that available on earth. Total weight of the system will be approximately 25 lb. First prototype model is scheduled for completion in six months.

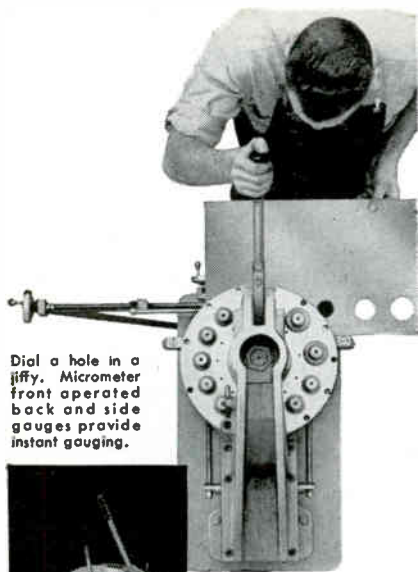

Dial a hole in a jiffy. Micrometer front operated back and side gauges provide instant gauging.

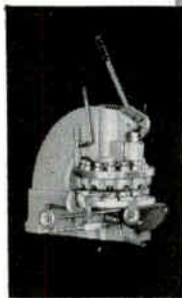

new Di-Acro* turret punch press

Accurate Burr-Free Punching at 12 Rotating Stations

The new Di-Acro 4 Ton Turret Punch Press provides rapid, close tolerance punching of round, square, oval and rectangular holes from $\frac{1}{16}$ " to 2".

Rotating turrets provide rapid indexing for single or sequence punching. Precision hole location quickly obtained with Micro-twin gauges. Punches sheet metals up to 16 gauge mild steel, fibreboard, asbestos, paper, cork, leather, rubber, plastic and other sheet materials.

Dies are mounted in turrets—always handy. Standard clearance between punch and die is .002". Choice of 6 other clearances at no charge. The Di-Acro Turret Punch Press is safe, simple to operate—requires little maintenance.



Consult the Yellow Pages of your phone book for the name of your nearest Di-Acro distributor or write us for catalog describing this and other Di-Acro machines.

*pronounced die-ack-ro



**DI-ACRO
CORPORATION**

formerly
O'Neil Irwin Mfg. Co.

437 8th Avenue Lake City, Minn.

EMC 'Game' Dramatizes Electronic Warfare Assets

AN ELECTRONIC COUNTERMEASURE "game" dramatizing capabilities and problems of modern electronic warfare is star attraction of Hallcrafters trailer exhibit which started last week at Dayton on six-month, 10,000 mile nationwide tour of military installations and industries in 41 cities, 21 states.

Electronic simulator's operator has seven seconds to detect and jam frequencies of radars through four successive zones while arriving at optimum program which allows model bomber to penetrate defenses and deliver bomb over target before defending missile can be triggered from launch site.

Successful jamming of all four radars brings plane over target to deliver bomb, completing mission. Hit causes mission failure message to flash on screen.

Simulator circuitry was adapted from audio visual teaching circuitry developed to train operators of Hallcrafters B-52 ecm equipment. Backlog of know-how could logically lead company into development of teaching machines for general education field.

Extending range of R&D, company is currently building our staff of 16 engineers plus team of 15 special field consultants from area colleges and universities as project engineers by end of year, says M. E. Krasnow, director.

Among fields currently under investigation are microminiaturization techniques for shrinking military communications center to pocket size for placement in squal level units and better electronic warfare receivers. Electronic medicine projects already involve company with 15 medical specialists in two medical schools.

Company is also working on lightweight transverse magnetic field generators capable of varying radar cross section of reentering nose cones at will and use of Van Allen belt as means of relaying communications from satellite to submarine cruising ocean depths.

X-Raying Parcels



Portable x-ray unit (Westinghouse) weighs 160 lb, checks suspicious parcels of various dimensions

hp 456A AC CURRENT PROBE

Converts ac current to
ac voltage directly
(1 amp = 1 volt)
for reading on your
scope or voltmeter



Just clamp around
and read:

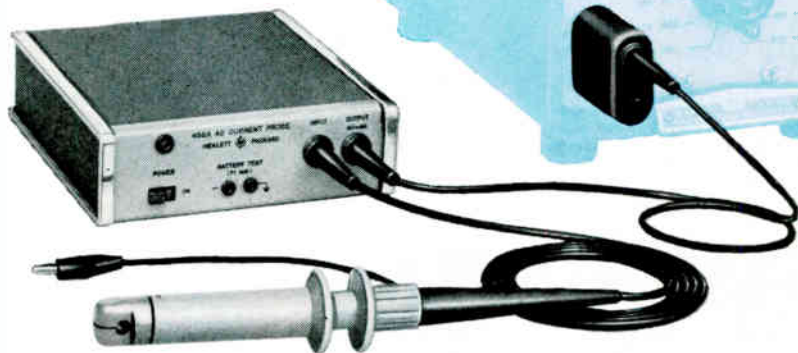

- Tube circuits** view current on your scope or measure it with a VTVM
- Transistor circuits** measure small signals dynamically, without clipping leads or circuit loading; study diodes at breakdown
- Logic circuits** measure ac current in presence of dc current
- Impedance measuring** . . with a dual-channel scope, measure current, voltage magnitude; phase angle
- Power measuring** with dual-channel scope read current, voltage directly, calculate power
- Frequency counting** . . . use 456A with counter for clip-on frequency access
- And, how about these?** . . phase comparisons of ac carrier waveforms; instrument fuse current ratings; cable identification, response of magnetic cores; magnetic field sensing; silicon rectifier peak currents

SPECIFICATIONS

Sensitivity: 1 mv/ma \pm 1% at 1 KC
Frequency Response: \pm 2%, 100 cps to 3 MC
 \pm 5%, 60 cps to 4 MC
-3 db at 25 cps and above 20 MC
Maximum Input: 1 amp rms; 1.5 amp peak.
100 ma rms above 5 MC
Maximum dc current: Dc up to 0.5 amp has no appreciable effect
Input Impedance: Probe adds to test circuit only approx. 0.05 ohms in series with 0.05 μ h
Equivalent Input Noise: Less than 50 μ a rms (100 μ a ac powered)
Power: 10 radio mercury cells; approx. 400 hours service normally supplied. Ac supply available
Size: 5" wide, 1 1/2" high, 6" deep, weight 3 lbs.
Price: \$190.00; for ac operation \$210.00.
hp 456-95A ac supply for field installation \$32.00
Data subject to change without notice
Prices F.O.B. Factory

Just clamp the hp 456A probe around a wire under test and view or read ac current directly on an indicating device. Model 456A's 1 mv to 1 ma unity conversion permits direct readings up to 1 ampere rms. The instrument's wide bandwidth permits use with oscilloscopes to view complex current waveforms with rise times to 0.017 μ sec. No direct circuit connection is required; there is no loading, no appreciable impedance change in the circuit under test, and the impedance of the test circuit is immaterial.

HEWLETT-PACKARD COMPANY

1014A Page Mill Road, Palo Alto, California, U. S. A.
Cable "HEWPACK" • Davenport 5-4451



HEWLETT-PACKARD S. A.

Rue du Vieux Billard No. 1, Geneva, Switzerland
Cable "HEWPACKSA" • Tel. No. (022) 26. 43. 36

hp offers almost 400 precision test instruments

6305

20 to 200 D.P.

Send your prints
for quotations

- SPURS
- HELICALS
- WORM AND WORM GEARS
- STRAIGHT BEVELS
- LEAD SCREWS
- RATCHETS
- CLUSTER GEARS
- RACKS
- INTERNALS
- ODD SHAPES

Quadrants and spindles with fine-pitch teeth are cut to close limits in our modern shop. Tell us your needs.

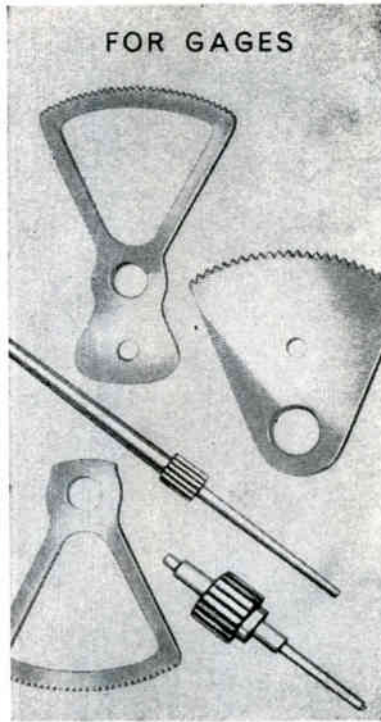

THE *Finest* IN GEARS

Beaver Gear Works Inc.

1021 PARMELE STREET, ROCKFORD, ILLINOIS



CIRCLE 200 ON READER SERVICE CARD

INFRASONIC VOLTMETER

0.01 cps to 30 kc

This peak to peak vtm has been designed to make accurate measurements from 30 kc down to 0.05 cps, or even to 0.01 cps with corrections. Square waves may be measured with the stated accuracy to 0.5 cps. Accuracy is better than 3 percent of reading regardless of voltage or frequency. Provision is made for speeding up measurements that might be delayed by severe overload or by a dc component on the input signal, or by a reduction of the voltage being measured. This instrument may be used for measurements of peak to peak voltages in such applications as automatic control systems involving low frequency servomechanisms, and in fields where infrasonic frequencies down to 0.01 cps are encountered, or in measuring voltages at very low frequencies at the output of signal generators. Flutter down to 0.05 cps is virtually eliminated, and is very small at 0.01 cps. Power line transients have negligible effect.

Price: \$330.

SPECIFICATIONS

Voltage Range..... 20 mV-200 V peak-to-peak
 Frequency Range..... 0.05 cps-30 kc
 (Down to .01 cps with correction)
 Accuracy..... 3% ENTIRE RANGE
 AT ANY POINT ON SCALE
 Input Impedance..... 10 M Ω shunted by
 17 pF or 40 pF



model 316



— Since 1932 —
BALLANTINE LABORATORIES INC.

Boonton, New Jersey

MEETINGS AHEAD

July 16-21: Conf. on Medical Electronics & Conf. on Elec. Tech. in Med. & Bio., IFME, JECMB, PGBME of IRE; Waldorf Astoria Hotel, New York City.

July 18-20: Western Plant Maintenance & Eng. Show; Pan Pacific Audit., Los Angeles.

July 20-21: Air Lines Comm. Admin. Council, AEEC, Saxony Hotel, Miami Beach, Fla. NOTE: this meeting was formerly scheduled for June 22-23.

July 24-26: Air Traffic Control Symposium, Electronic Maintenance Engineering Assoc. (EMEA); Mayflower Hotel, Washington, D. C.

Aug. 13-18: Magneto hydrodynamics Seminar, Penn State Univ., University Park, Pa.

Aug. 16-18: Electronic Circuit Packaging Symposium; Univ. of Colorado, Boulder, Colo.

Aug. 22-25: WESCON, L.A. & S.F. Sections of IRE, WEMA; Cow Palace, San Francisco.

Aug. 23-Sept. 2: National Radio & TV Exhibition, 1961 British Radio Show; Earls Court, London.

Aug. 23-25: Gas Dynamics Symposium, ARS, Northwestern Univ., Evanston, Ill.

Aug. 28-Sept. 1: Heat Transfer Conf., International; Univ. of Colorado, Boulder, Colo.

Aug. 30-Sept. 1: Semiconductor Conf., AIME; Ambassador Hotel, Los Angeles.

Sept. 11-15: Instrument-Automation Conf. and Exhibit, ISA; Sports Arena, Los Angeles.

Oct. 9-11: National Electronics Conf., IRE, AIEE, EIA, SMPTE; Int. Amphitheatre, Chicago.

Nov. 14-16: Northeast Research & Engineering Meeting, NEREM; Commonwealth Armory and Somerset Hotel, Boston.

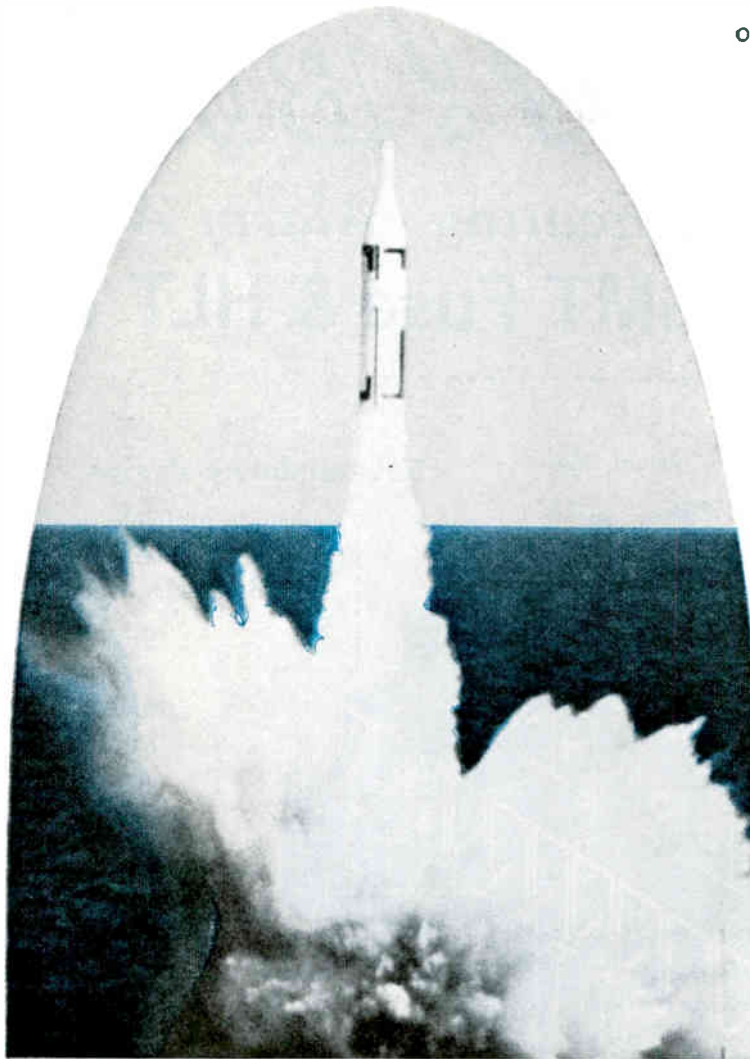

THE SUPREME TEST

Yesterday, Polaris was an idea on a drawing board—today, it is an accomplished fact. In the interim all of its components had to meet—and pass—the supreme test; **reliability of the highest degree.**

Metal film and carbon film resistors made by Electra meet the critical specifications of Polaris and other missiles because, continually improving resistor reliability is a standard procedure with us.

When unusual and extreme environments are encountered, select the new Electra Metal Film and/or Carbon Film **"High Reliability"** series.

Load life studies and other data available upon request.



Take a twenty-minute trip through our plant without leaving your office. "RESISTOR RELIABILITY," a 16 mm. color film with sound, is available for showing, upon request.

ELECTRA MANUFACTURING COMPANY, 4051 Broadway, Kansas City, Missouri

July 7, 1961

CIRCLE 35 ON READER SERVICE CARD 35

NEW! BUSS

Signal Indicating · Alarm Activating GMT Fuse & HLT Fuseholder

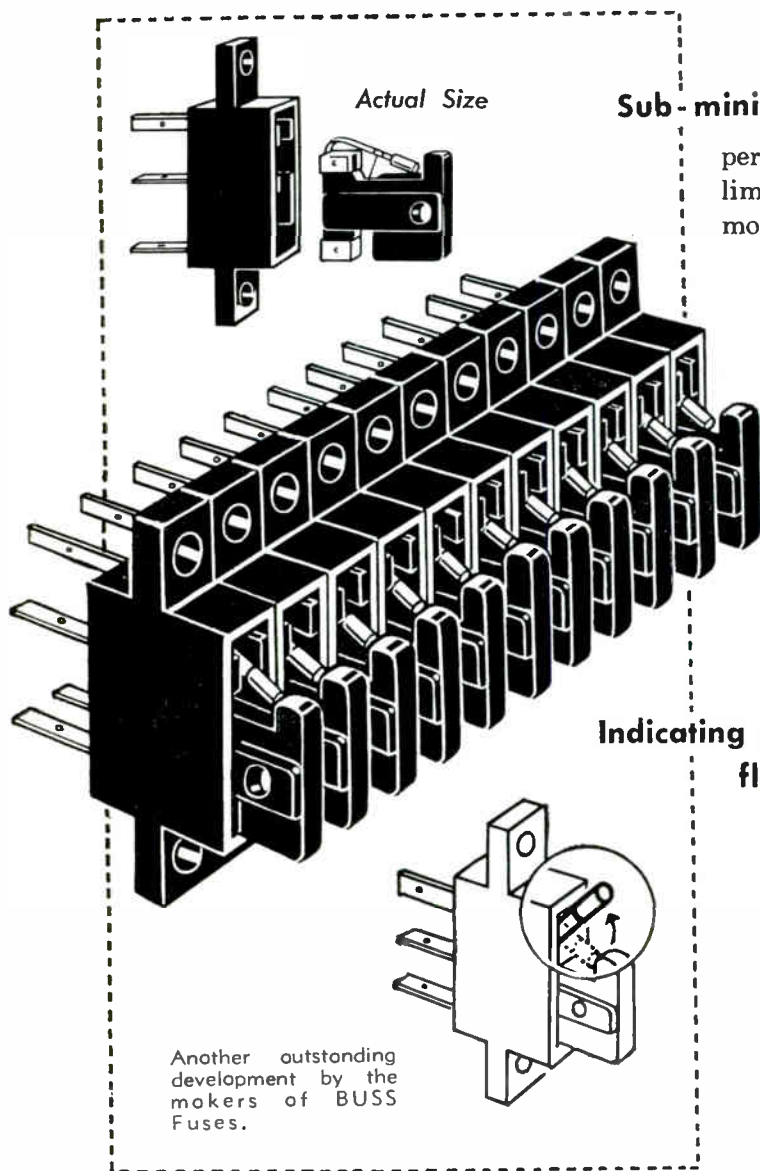

permits multiple mounting of fuses in limited space. Fuseholders can be mounted on $\frac{1}{4}$ inch horizontal centers.

Fuse and holder combination readily adaptable for use in equipment operating at 300 volts or less, such as: communication equipment, business machines, computers, control equipment or other multiple circuit apparatus where space is at a premium.

Indicating spring flashes color-coded flag when fuse opens

to give quick, positive identification of faulty circuit.

Indicator spring also makes contact with an alarm circuit so, it can be used to flash a light—or sound audible signal on fuse panel or at a remote location.

Ask for bulletin GMCS on BUSS GMT fuses and HLT holders.

In the BUSS line,

you'll find the type and size fuse to fit your every need
... plus a companion line of clips, blocks and holders.



BUSSMANN MFG. DIVISION, McGraw-Edison Co., UNIVERSITY AT JEFFERSON, ST. LOUIS 7, MO.





**gives you
fast delivery on custom
chokes and transformers**

Your needs for custom wound components at competitive costs get fast attention at EIC. Prototypes engineered to your specifications can be supplied within two weeks, and production runs in any quantity can follow immediately.



Write for our Representative Catalog of Custom Transformers, which gives specifications on input, interstage, output and power transformers, transistor power supply transformers, toroidal chokes, and geophysical reactors.

ELECTRODYNAMIC INSTRUMENT CORPORATION

Subsidiary of Reed Roller Bit Company

1841 Old Spanish Trail

Houston 25, Texas

CIRCLE 201 ON READER SERVICE CARD

*For Integrated
Communications
Systems*

BUDELMAN

*Microwave
and Carrier
Offers Greatest Value!*

- UHF and Multiplex Radio
- Systems Engineering

Write for free BEC Spec File Today!

BUDELMAN ELECTRONICS CORPORATION

375 Fairfield Avenue

Stamford, Connecticut

* Because Budelman equipment performs better, costs less to buy and maintain.

CIRCLE 202 ON READER SERVICE CARD

July 7, 1961

**NEW AND IMPROVED
RF CONNECTORS
THROUGH GREMAR**

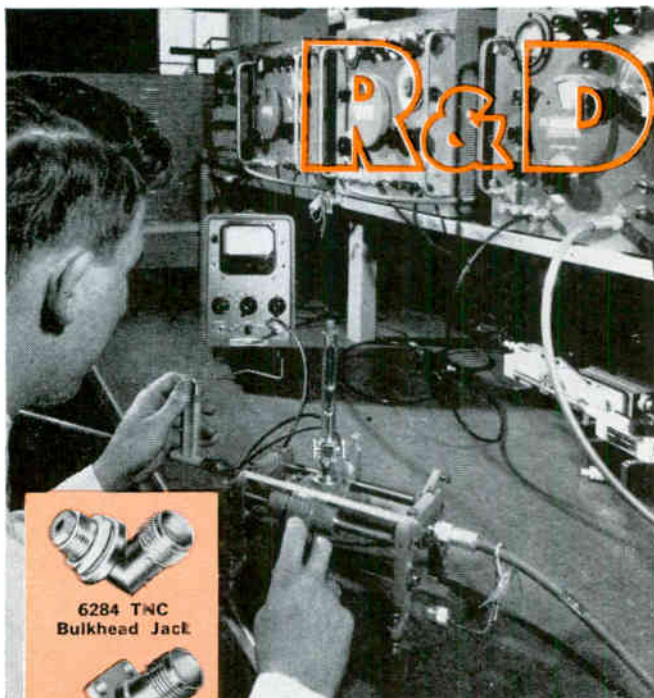

6284 TNC Bulkhead Jack



6171 TNC (F) Receptacle



6930 Tee Cable Termination



6195 TNC (M) Receptacle



7107 Adapter HN (M)-C(M)



5863 Adapter HN (F)-MHV(F)

Recent developments . . . all Greomar exclusives . . . are now extending the use of RF connectors. Power dividers and impedance transformers with integral connectors. Firewall connectors that withstand 2000° F. Red Line miniatures . . . half the size and weight of Greomar TNC connectors . . . for use with MIL-type subminiature coaxial cables. New subminiature connectors . . . half again as small as miniatures . . . soon to be announced. And many more!

What can Greomar R & D do for you? It costs nothing to inquire. Just name your problem. The answer may be already on hand or only hours away. For, Greomar *connectronics*®, by concentrating all resources on RF connectors only, offers R & D capabilities no other source can match. That's why designers of advanced RF circuits specify Greomar first

® Greomar Manufacturing Co., Inc.

Send for descriptive literature



GREMAR
MANUFACTURING COMPANY, INC.

RELIABILITY THROUGH QUALITY CONTROL

Dept. A

Wakefield, Mass., CRystal 9-4580

CIRCLE 37 ON READER SERVICE CARD 37

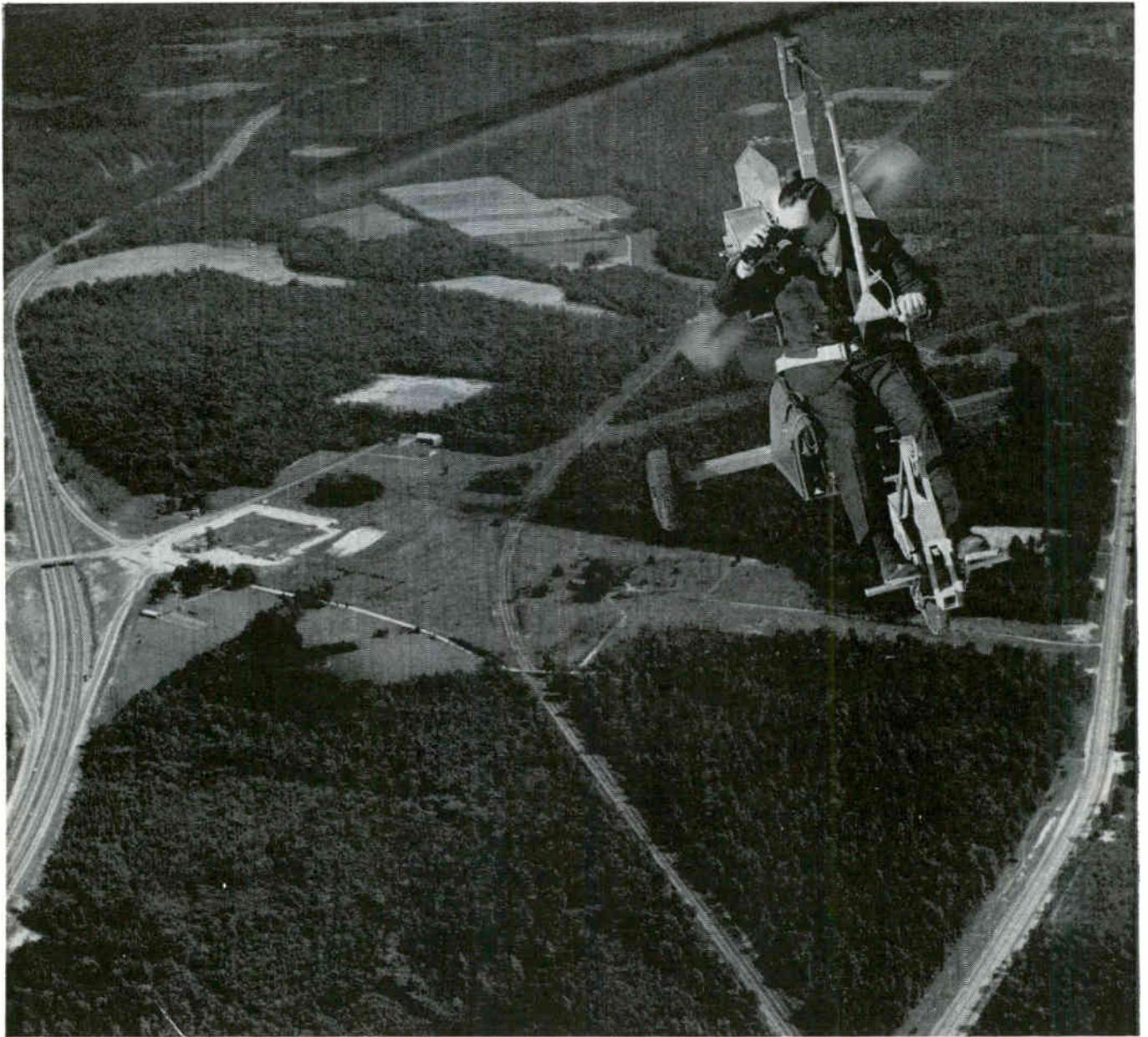

Single-Place Gyrocopter by Bensen Aircraft Corp.

Looking for production savings?

Look into Virginia's Capital Area

Every dollar saved on transportation brings down production costs. And you'll find many such savings in the Richmond-Petersburg-Hopewell-Colonial Heights area of Virginia. For here you can ship by six major railroads, plus 56 scheduled truck lines. You can enjoy excellent air service for both passengers and cargo. And there's a deep water channel for low-cost ocean freight. Ask VEPCO about other savings in Virginia's Capital Area. Write, wire or phone for site and economic data on its pleasant, conservatively-governed communities.



VIRGINIA ELECTRIC and POWER COMPANY

Clark P. Spellman, Manager—Area Development, Electric Building, Richmond 9, Virginia • MIlton 9-1411
Serving the Top-of-the-South with 2,086,000 kilowatts—due to reach 2,720,000 kilowatts by 1963.

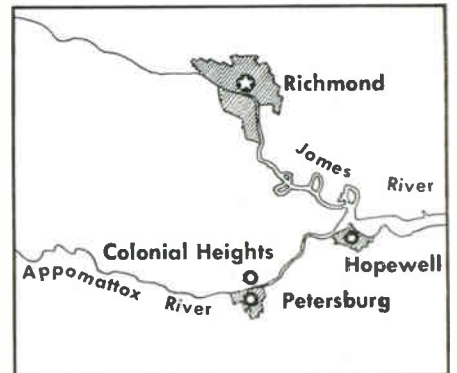

**your
invisible
employee . . .**

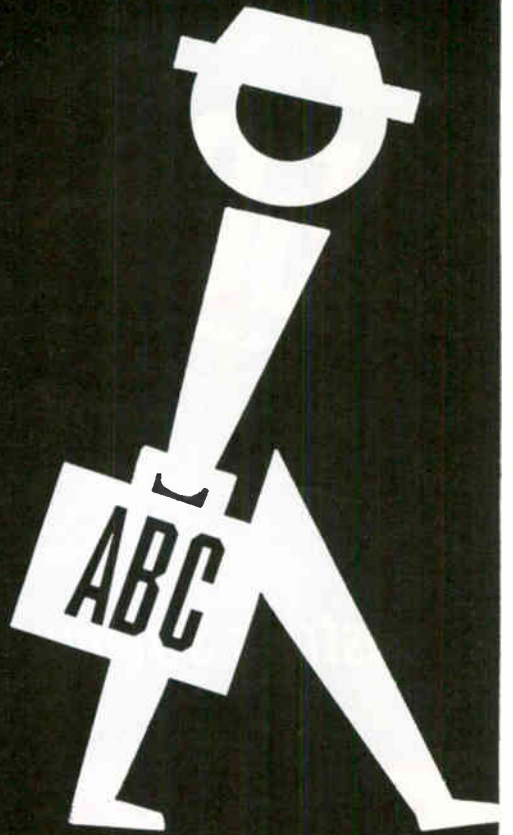

He's not on your payroll . . . he takes up no desk space in your office . . . and he doesn't hang around the water-cooler talking to your secretaries. But this man works for you — and for every other advertiser.

What does he do? He helps to safeguard your advertising investments in print media — by providing audited circulation facts and figures on 2,900 publication members of the Audit Bureau of Circulations*. Assuring an accurate accounting, he tells you how many people purchased the publication . . . where they live . . . how much they paid . . . and the answers to many other questions about the publications and your markets.

He gives you factual marketing information as the basis for your advertising investments. He walks into every ABC-member publication's office and audits its circulation — just as carefully and as objectively as a financial auditor might check your books.

When he is finished, the guesswork is gone! He gives you facts — no opinions, pleasant statistics, *maybe* projections, or fancy figures — just plain old fashioned circulation facts.

Who is he?

He is the ABC auditor — and he works for *you!*

electronics

A MCGRAW-HILL PUBLICATION • 330 W. 42nd ST. • NEW YORK 36, N. Y. 

* Through the reports issued by the Audit Bureau of Circulations, this publication, along with other publisher members of ABC, voluntarily and regularly give the buyers of advertising more verified factual information than is available for any other media at any time.

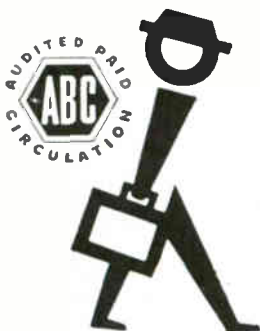

150 mw
POWER DISSIPATION

MADT

NEW LINK
in Industry's Strongest Chain of Transistor Performance

PHILCO
2N2048
GERMANIUM
SWITCH



ABSOLUTE MAXIMUM RATINGS

Storage Temperature.....	-65 to +100°C
Collector Voltage, V_{CB}	-20 volts
Collector Voltage, V_{CES}	-20 volts
Collector Voltage, V_{CEO}	-15 volts
Collector Current, I_C	-100 ma
Total Device Dissipation @ 25°C.....	150 mw

ELECTRICAL CHARACTERISTICS (@ 25° C)

Characteristics	Conditions	Min.	Max.	
Collector Cutoff Current, I_{CBO}	$V_{CB} = -5v$		3	μa
DC Current Amplification Factor, h_{FE}	$V_{CE} = -0.5v$ $I_C = -50 ma$	35		
DC Current Amplification Factor, h_{FE}	$V_{CE} = -0.5v$ $I_C = -10 ma$	50	300	
Collector Saturation Voltage, $V_{CE(SAT)}$	$I_C = -10 ma$ $I_B = -0.5 ma$.050	0.140	volt
Base Input Voltage, V_{BE}	$I_C = -10 ma$ $I_B = -0.5 ma$	0.25	0.35	volt
Time Storage Factor, K 's.....	$I_B = -2.5 ma$		100	nsec
Gain Bandwidth Product, f_T	$V_{CE} = -10v$ $I_E = -6ma$	150		mc

Philco's new 2N2048 is the forerunner of a broad line of 150 mw MADT switching transistors. The new power dissipation capability is available in uniformly reliable high-speed units, at surprisingly low cost, via proven MADT automation.

Intended for both saturated and non-saturated logic circuits, the Philco 2N2048 gives you more than comparably priced transistors—more drive per transistor, more switching speed per dollar invested in transistors, and the extra capability of extra power dissipation for applications that require it.

Philco 2N2048 features include minimum h_{FE} of 50, maximum $V_{(SAT)}$ of 0.14V., minimum f_T of 150 mc., and tightly controlled V_{BE} ranging from 0.25V. minimum to 0.35V. maximum. For complete information write Dept. E-7761.

Immediately available in quantities 1-999 from your Philco Industrial Semiconductor Distributor

PHILCO



Famous for Quality the World Over

LANSDALE DIVISION, LANSDALE, PENNSYLVANIA



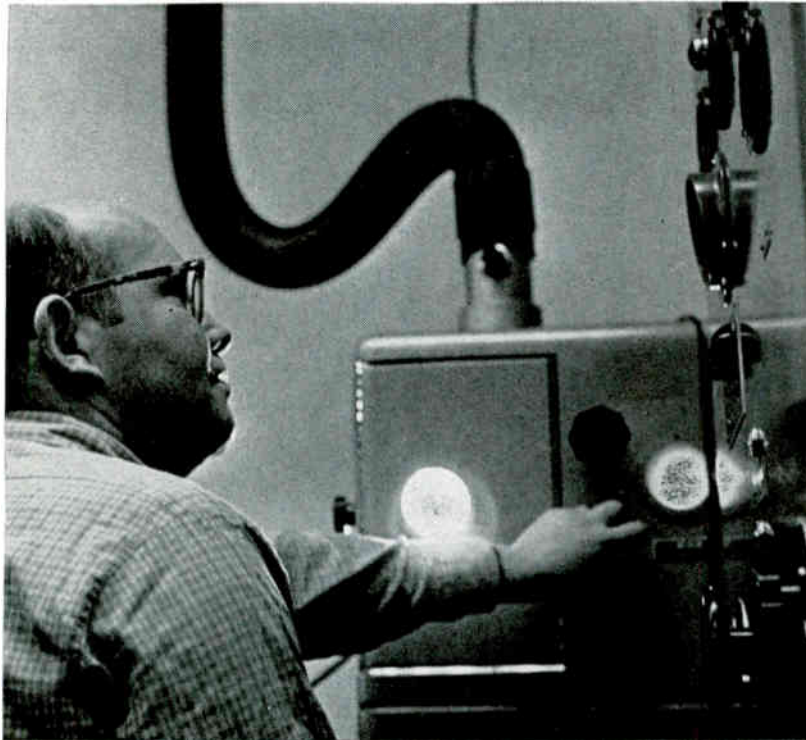

Emission spectrograph in operation. Sample of material placed on electrode is evaporated. Light passed through volatilized sample is diffracted by grating, and spectrum recorded on photographic plate

New Techniques for Producing Ultrapure Semiconductors

*Report from Boston conference reveals new techniques,
new demands for production of low-impurity materials*

By THOMAS MAGUIRE,
New England Editor

NEED FOR BETTER CONTROL of electrical properties of semiconductors is stimulating efforts for better understanding of chemical and physical phenomena involved in preparation and purification, impurity detection methods and measurement techniques.

A new kind of semiconductor researcher is needed, one who knows not only the electronic processes, but also the kinetics and thermodynamics of semiconducting materials, it was emphasized at the

recent Air Force-sponsored international conference in Boston on ultrapurification of semiconductor materials.

Some 500 delegates to the conference heard that a research team at MIT was investigating the thermodynamic properties of II-IV and V-VI compounds. B. W. Howlett and M. B. Bever have found that thermodynamic techniques can reveal and measure slight deviations from stoichiometry that alter electrical properties of semiconductors.

It was disclosed that a large producer of high-purity silicon is pur-

suing kinetics and thermodynamics research for broader-based understanding of the mushrooming field of new, special-purpose semiconductor materials.

Needed is more basic understanding of the chemical and kinetic phenomena that have direct bearing on device characteristics: lifetime, Hall coefficient, energy gap, mobility, resistivity, dislocation density, impurity concentrations and floating-zone characteristics.

Goal is preparation of materials with purities better than a part in a million, and processes to determine and stabilize this level of

purity for fabrication of reproducible devices with desired electrical properties.

No single material is likely to replace silicon, but diversification of materials has been undertaken to achieve semiconductor devices for special environmental and operating conditions, such as radiation or extreme heat.

Among periodic-table groups attracting attention are the rare-earth metals, whose characteristics depend on electron spin rather than conduction properties. They are chemically similar to other materials and also among themselves; therefore, sophisticated techniques are needed to separate and use them. These materials can be used with other elements to form semiconducting compounds with unusual electrical properties.

Need for a single crystal material of high purity—where concentrations of a few parts per billion are of significance—has made new demands on analysis.¹ Electrical measurements alone are not enough since the chemical identity and concentration gradient of both the intended and inherently present impurities remain unknown.

Also, compensation effects of donors and acceptors in the same

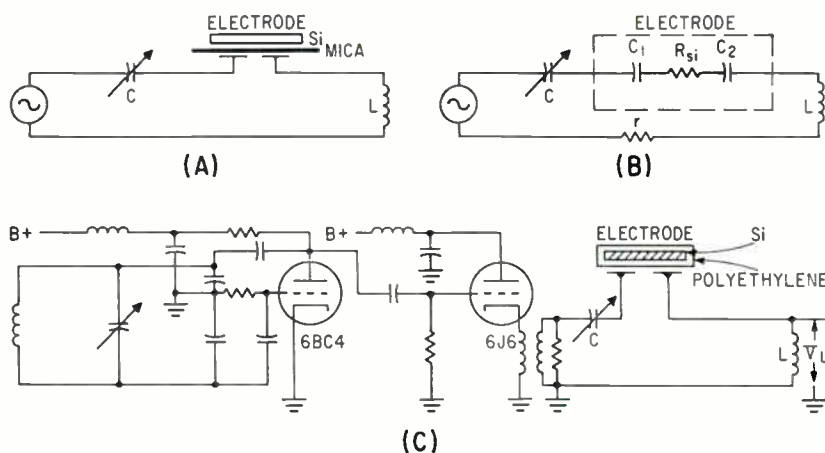

FIG. 1—For resistivity measurement, silicon crystal is wrapped in polyethylene or put on mica sheet, as in (A); equivalent circuit of electrode, (B). To measure resistivity, L-C-R circuit is coupled to 100-Mc source, (C)

sample interfere with the understanding, and eventually the engineering, of the semiconductor for solid-state devices.

Three techniques show promise in semiconductor impurity analysis at the parts-per-billion level: activation analysis, emission spectroscopy, and spark source mass spectroscopy.

Neutron activation analysis, with radio-chemical procedures, provides high sensitivity and freedom from contamination, since the species of interest are radioactive. Major role

of activation analysis in determination of ultratrace impurities is for more precise determination of a few specific elements rather than as a survey tool for general impurity content.

The technique is ideally suited to evaluation of removal of specific impurity elements and to the study of diffusion processes in device fabrication.

Value of emission spectroscopy has been recently increased by refinements in the technique of d-c arc excitation, so that sensitivity has been increased by two or three orders of magnitude. These have already benefited determination of impurities in silicon carbide in the parts-per-billion range, determination of boron in silicon down to 4 parts per billion and determination of impurities in gallium arsenide in the parts-per-billion range. The technique is suited to purification evaluation studies and control of large numbers of samples.

Emission spectroscopy, however, is highly matrix dependent, so that each material requires new quantitative methods. Sensitivities for some nonmetallic elements are poor, but research is improving the situation.

One of the most dramatic advances is development of the technique of spark-source mass spectrometry for determination of impurities in solids. Recently made available double-focusing mass-resolving instruments have made the technique an important trace analytical tool.

Samples are clamped into elec-

SILICIDES SYNTHESIZED AND REFINED ON COLD HEARTH

Silicide	Melting Point C	Crystal Structure	Final Impurity ⁽¹⁾ Content
Co ₂ Si	1,330		Sn*, Cu, Fe
CoSi	1,160	Cubic, B20	Al, Ca, Fe
CoSi ₂	1,326	CaF ₂ type	Ca, Mg
FeSi	1,110	Cubic, B20	Cu, Mg
FeSi ₂ (H)	1,220		Not analyzed
(L)	Dec. 995 C.		Mn*, Cu, Mg
CrSi	1,600	Cubic, B20	Cu, Mg, Fe
CrSi ₂	1,550	Hexagonal	
MnSi	1,275	Cubic, B20	Ca, Cu, Sn
MnSi ₂		Tetragonal	
VSi ₂	1,750	Hexagonal	
IrSi		MnP type, B31	Fe*, Cu
RhSi		B31	Fe*, Cu, Al

(1) All slight traces (1-10 ppm) except where marked * which contain trace quantities (10-50 ppm) of the elements so marked

(2) FeSi₂ (L) and CrSi were synthesized on the cold hearth but could not be zone refined owing to decomposition $\text{CrSi} \rightarrow \text{Cr}_2\text{Si}_3 + \text{CrSi}_2$
 $\text{FeSi}_2 \rightarrow \text{FeSi} + \text{FeSi}_2$ (H)

IrSi, RhSi were prepared only in small quantities and not zone refined

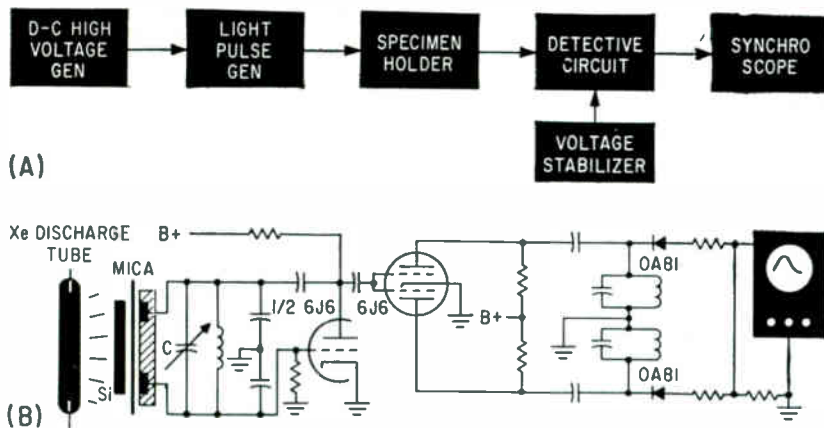

FIG. 2—Block diagram shows method for measurement of lifetime, (A); the detector circuit shown in (B) includes a modified Colpitts oscillator and the Travis circuit

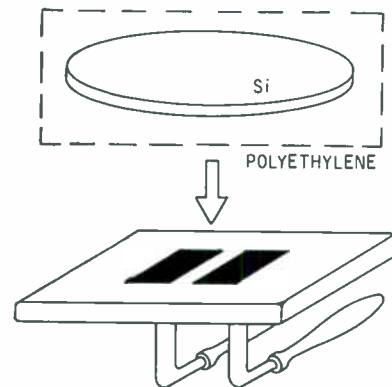

FIG. 3—Sketch of electrode used in the measurement of lifetime. Silicon is wrapped in polyethylene

trodes of the vacuum spark ion source at right angles. High-voltage r-f spark jumps between the two samples, sending ionized sample molecules into the mass resolving system, where they are separated and recorded either on a photographic plate or electrically. Attractive features are the ability to record the spectrum of the whole range of elements from lithium (mass 6-7) to uranium (mass 234-238) in a single exposure of the photographic plate. Present limitations include high cost and slow rate of sample handling because of the vacuum system. Technique can be used for a variety of semiconductor problems including analysis of raw materials, evaluation of zone refining, examination of crucible material and checking the dope of semiconductors.

Mass spectrometry, at present a research tool, can best serve as survey method for new materials, so that other more convenient methods can be prescribed for specific elements. Activation analysis provides greatest sensitivity and precision for certain elements; emission spectroscopy fulfills need for rapid and convenient multielement analysis for large numbers of samples.

In addition to their ability to analyze purified raw materials and high-purity semiconductor crystals, these highly sensitive techniques are useful in examination of micro-samples such as the final device, where concentration and distribution of minute amounts of specific elements can be determined.

Production-line measurement of

resistivity and lifetime of small slices of silicon is helping to speed manufacturing processes.²

Application of the Siemens method to measurements during refining, crystallizing and fabricating processes provides contamination-free measurements.

The series resonant circuit for measuring resistivity is based on the Q-meter principle (Fig. 1A, and B), consists of inductance L , capacitor C and the electrode on which a small slice of silicon is placed through a mica or polyethylene sheet and contacted capacitively.

The L - C - R series circuit is coupled to the 100-Mc source and is tuned to the source by adjusting a variable capacitor as shown in Fig. 1C. Then the maximum value of the voltage drop along the inductance L is measured. Resistivity of materials can be known by comparing with the calibrated curve of maximum voltage against resistivity.

Apparatus for measuring lifetime is based on the photoconductive-decay method. When a light pulse from a xenon lamp is applied on the surface of a small slice of silicon through a mica or polyethylene sheet, it modulates the bulk conductivity; the impulse is detected by an f-m detector and reproduced on a cathode-ray tube.

Difference between the d-c current method and this method is that cutting or soldering of specimen is not required, and the measurement can be done without contamination by contacting the specimen capacitively with the electrode. For the detector circuit, the electrode on

which the small slices are put is in parallel with the tank circuit of the oscillator. When the light pulse is applied on the small slices, output power is modulated by the variation in the conductivity in the semiconductor and frequency modulated at the same time.

The modulated signal is detected by a Travis circuit, and 100 Mc is used for coupling closely to a specimen with the electrode. Block diagram of this apparatus is shown in Fig. 2A. The light pulse was given to a slice by a xenon discharge tube to which the high d-c voltage is applied through the R-C blocking circuit.

Pulse interval is 10 microseconds and the prf is from 2 to 20 pps. The detector circuit for lifetime is shown in Fig. 2B. Center frequency is 116 Mc and bandwidth is 12 Mc.

The electrode indicated in Fig. 3 is 3 mm wide, 4 mm long and 2 mm in the spacing. To decrease error from recombination of silicon surface, only the light pulse through the silicon filter was applied to the crystal.

Decay pulses reproduced on the synchroscope are shown in Fig. 4. The lifetime is obtained by a reading on the horizontal scale as height is decayed to $1/e$.

Contamination of molten material by reactive crucibles has plagued materials men in many fields. As an alternative to the search for nonreactive crucible material, some researchers are keeping the walls of the vessel cool and thus avoiding chemical contamination.

Large-area silicon bars have

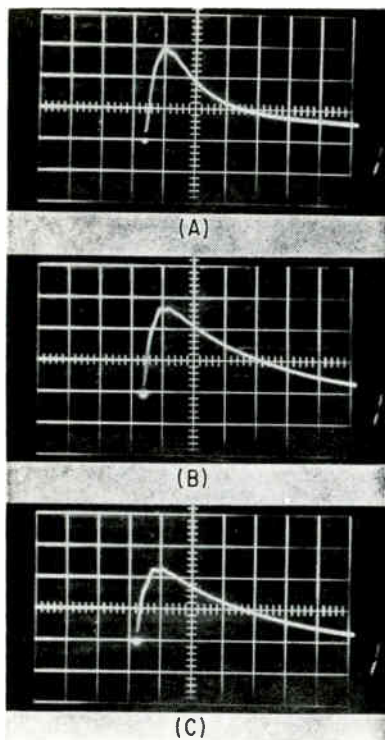

FIG. 4—Application of Siemens method to measure the resistivity and the lifetime of small slices of silicon. Oscilloscope trace shows modulating pulse in the lifetime measurement, with $t = 56 \mu\text{sec}$ (A), $64 \mu\text{sec}$ (B), and $74 \mu\text{sec}$ (C)

been zone-refined in such a receptacle, resulting in much improved quality.³

Zone-purification in cold-wall containers has produced large ingots of high-purity uncompensated silicon.

Techniques employed commercially in horizontal-zone melting of germanium have been generally satisfactory, but application of similar techniques to silicon has been beset with difficulties.

Since no material investigated—quartz, refractory carbides, nitrides—was suitable as crucible material because of reactivity with molten silicon, a workable method resolved itself into a technique for making the receptacle nonreactive.

It was discovered that if the vessel (quartz, copper, steel, tantalum) was maintained at a temperature substantially below that of molten silicon then no reaction took place.

Walls of the vessel were maintained in contact with a liquid coolant. First such vessel was a quartz test tube immersed in water. A charge of silicon was melted by an r-f coil also immersed in water.

When the melt was allowed to freeze, it did not wet nor adhere to the quartz, nor was there evidence of reaction with the vessel.

Series of experiments led to the design of a water-cooled silicon zone-refining system consisting of two concentric tubes, the outer one Pyrex and the inner one quartz, with water flowing in the annular space between. An r-f coil surrounded the outer tube. Molten zone movement was accomplished by moving the tube. Figure 5 shows prototype production equipment designed to zone-refine silicon in water-cooled quartz tubes. Use of double-pipe heat exchanger principle permitted high water velocity past the molten zone, thus eliminating formation of steam. Inert ambients such as argon, helium, or hydrogen were used successfully.

The same idea was extended to metal containers. First a water-cooled metal boat was constructed of a plurality of small-diameter copper tubes in the form of a small trough; each tube was individually cooled from its own water source. A charge of silicon was melted on the cooled tubes by r-f induction. There was no evidence of reaction or adhesion between the silicon and the cold metal. By virtue of its high surface tension, molten silicon remains within the container even though no seal is provided between the adjacent tubes defining the con-

tainer for the refining.

In development of thermoelectric materials, similar problem of attack upon crucible materials led to development of a water-cooled copper hearth for both synthesizing and zone-refining silicides.¹

Successful application of cold hearth zone-refining to a considerable number of silicides indicates that it should have general application to the purification of reactive materials, as an alternative to floating-zone refining. It is much simpler in practice, however, it may not be possible to grow single crystals due to nucleation at the copper surface. Considerable stresses are introduced in the specimen due to the thermal gradients involved. Thirdly, it is restricted to materials which do not wet copper, although cold hearths made of aluminum and silver have also been successfully operated.

First silicides prepared were those of cobalt. The method has been applied to several other transition-metal silicides including chromium, manganese, iron, nickel, rhodium, iridium, and appears to be generally applicable to the purification of reactive materials.

Cobalt silicides were prepared by melting the cobalt plate—previously purified by a chemical method—with pure silicon by induction heating on a water-cooled copper hearth. Isolation of the stoichiometric com-

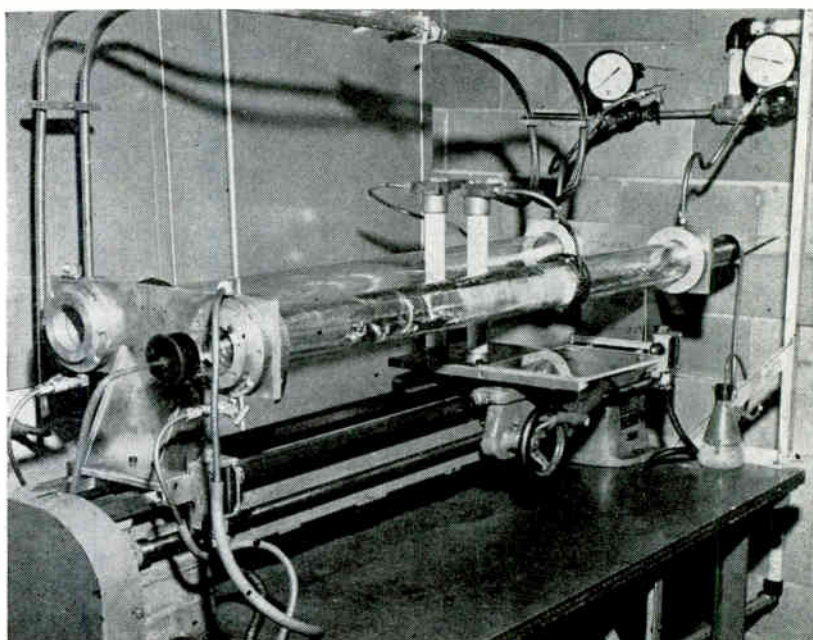

FIG. 5—Prototype production horizontal zone-purification machine for silicon

pounds and further purification were achieved by zone refining in the copper cold hearth.

The apparatus is illustrated in Fig. 6A; shape of the cold hearth can be seen in Fig. 6B. For zone refining, a single depression extends along the length of the hearth; for reactions, several small depressions are used, each 3 to 4 inches long, so a homogeneous melt can be obtained.

The material to be reacted or refined rests in the depression on upper surface of cold hearth. The cold hearth is copper, and the depression is highly polished. An inert atmosphere is maintained in the quartz outer tube. The induction coil is mounted on a small trolley and connected to the high-frequency generator by flexible leads. A motor and pulley can move the trolley along the silica tube. Generator has output of 7.5 Kw at 260 Kc.

This method has been successfully applied to large number of silicides, listed in the table. It was found impossible to purify CrSi by zone refining. Although the published phase diagram shows a maximum melting point, the compound seems to decompose on melting and zone refining produces a bar with Cr_2Si_3 at one end and CrSi_2 at the other.

Neither was it possible to refine IrSi and RhSi with the available equipment, since their melting points were too high for a stable molten zone to be formed.

Preparation of an atomically clean solid surface is a problem of great complexity, but important because of the electrical effects of impurity films.⁵

Surface contamination can arise from number of sources: a chemical film residual from etching, or gaseous adsorption from the ambient atmosphere. It can also be due to diffusion of impurities from the bulk to the surface or the unintentional result of a particular surface treatment.

Among techniques used for surface cleaning are high-temperature heating, evaporation, vacuum cleaving, vacuum crushing, and ion bombardment followed by annealing.

All must be applied under ultrahigh vacuum conditions. At a pressure of 10^{-6} mm Hg, sufficient atoms or molecules strike a surface per second to form an adsorbed mono-

layer if one assumes a sticking coefficient of unity. The work must therefore be carried out at pressures several orders of magnitude lower, so that enough time will elapse between the cleaning and the adsorption to allow for meaningful measurements.

When it was recognized that the chemical films due to the etching process were not removed from Ge by heating alone, ion bombardment or sputtering was tried. In this process—a combination of two old techniques, electron diffraction and cathodic sputtering—the energy of ions incident upon a solid is at least partially transformed into lat-

oxide of boron, transferred from the Pyrex walls to the sample by water vapor in the initial stages of evacuation. Some of this oxide remains on the crystal and is reduced when the sample is heated. Free boron thus released can diffuse into the crystal to form a *p*-type layer that extends several microns into the lattice. It has been shown that a total argon-ion bombardment of 10^{19} ions/cm² is required to remove such a film. The danger of using such large cumulative bombardments lies in the fact that excessive bombardment is known to produce surface etching.

For success, the solid must be

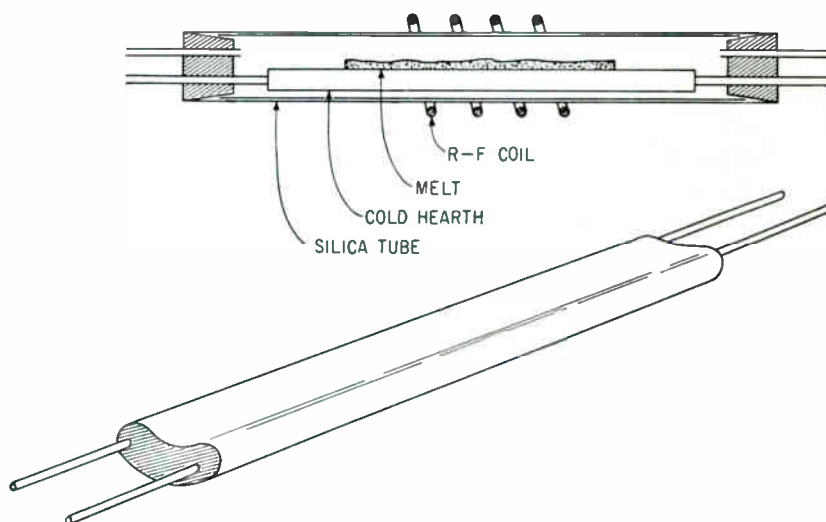

FIG. 6—Arrangement of water-cooled, induction-heated copper hearth (A); shape of the cold hearth (B)

tice vibrations in the solid. These vibrations can achieve such amplitudes that surface atoms are ejected. Electron-diffraction studies indicated that an ion-bombarded surface was broken up and that annealing in high vacuum was necessary to produce a clean, single-crystal surface. The annealing process also removed the gas atoms which had been occluded in the surface during the bombardment.

Ion-bombardment cleaning process has proven effective in removing impurities which diffuse either to or from the surface. Carbon can diffuse to the surface of some materials and remain there as a contaminant.

This technique is also of advantage in eliminating *p*-type films detected on both germanium and silicon samples heated in Pyrex systems. Contaminant here is an

thoroughly outgassed; proper operating conditions for each material must be observed by a method such as low-energy electron diffraction, and annealing conditions for the material must be predetermined.

REFERENCES

- (All papers delivered at Conference on the Ultrapurification of Semiconductor Materials, Boston.)
- (1) George H. Morrison, General Telephone and Electronics Laboratories, Determination of Ultratrace Impurities in Semiconductor Materials.
 - (2) Jun-ichi Nishizawa, Yuzo Yamaguchi, Naotoshi Shoji and Yoshio Tomimaga, Research Institute of Electrical Communication, Tohoku University, Application of Siemens Method to Measure Resistivity and Lifetime of Small Slices of Silicon.
 - (3) Duncan M. Lamb and John L. Porter, Sylvania, Horizontal Zone Purification of Silicon in Non-Reactive Crucibles.
 - (4) R. M. Ware, The Plessey Co. Ltd., Caswell Research Laboratories, Towcester, Northants, England, The Preparation and Purification of Transition Metal Silicides.
 - (5) J. A. Dillon Jr., Barus Research Laboratory, Brown University, Purification Methods in the Study of Semiconductor Surfaces.

Design of Line Feed for World's

This 96-foot feed compensates for the sphericity of the 1,000-ft Arecibo, P. R. dish and permits scanning without dish movement

APPLICATIONS OF RADAR and radio astronomy require the narrow beams of large aperture antennas to sweep through space, picking up and tracking targets or sources of interest. The world's largest aperture antenna or "radio telescope", a 1,000-foot spherical dish, will be finished early in 1962 in Arecibo, Puerto Rico. It is part of the Department of Defense Ionospheric Research Facility, an ARPA—Air Force project. The feed has been designed and will be built by TRG, Incorporated, under subcontract to Cornell University. The 18 1/2 acres of antenna reflector surface will have an accuracy of \pm one-tenth of a foot.

It would cost hundreds of millions of dollars to make such a reflector move physically to scan the beam in the same way as the 250-foot Jodrell bank paraboloid does; instead, the Arecibo dish will be fixed in a natural bowl in the ground (see Fig. 1) and scanning will be accomplished by moving the feed, rather than the dish.

The feed structurally is a 5-ton cantilevered aluminum box beam of square section, tapering from 40 in. at its root end to 14 in. at its free end 96 feet below. It is made of twelve 8-foot sections, and has the appearance of a thick needle when viewed in the huge scale of the dish. At the top is a 9 \times 9 \times 12-ft. carriage house containing the receiver, turnstile, duplexer, and test equipment. When the feed hangs vertically, the beam points to the zenith. To scan the beam in elevation, the feed is moved along a circular, radial track 155 feet long on the feed arm in such a way that the feed always points toward the true center of the reflector sphere, a point 870 feet above the reflector vertex (see Fig. 1). To scan the beam in azimuth the feed arm is rotated 360 deg about the vertical axis. 320 tons of steel truss work will support the

feed, drives, gears, etc.

Electrically the feed is a traveling-wave, waveguide slot array. An accurate X-band scale model is shown in Fig. 2 with some of the electrical testing hardware. The slots act as series impedances with an inductive reactive component. They are below resonant length and are spaced about $\lambda/5$ apart.

If a conventional paraboloidal dish and horn feed were used, the beam could not be scanned by feed motion for more than one degree from the zenith without pattern deterioration and a 3-db loss of gain. The line source feed corrects for the optical aberrations of the sphere and permits off-axis scanning to 20 deg. with less than 3 db loss of gain. This represents solid angle coverage improvement of better than 400 to 1, and is the reason for the use of a spherical rather than a paraboloidal dish.

The feed, however, is much more difficult to design than a simple horn. Figure 3 shows the rays from an incoming plane wave reflecting from the sphere. The rays are incident on the feed at an angle θ , which varies continuously from endfire at the root or generator end to 20 deg. from broadside at the free or load end. The guide wavelength λ_g of the feed must satisfy the traveling waveguide relationship $\lambda/\lambda_g = \cos \theta$. Guide wavelength λ_g is controlled primarily by the a dimension of the waveguide according to the dominant mode formula.

$$\frac{\lambda}{\lambda_g} = (1 - (\lambda/2a)^2)^{1/2} + \frac{\lambda X}{4\pi s}$$

where s is the slot spacing and X is the effective slot reactance. Limitation of the total phase error over the length of the feed to $\lambda/16$ imposes a tolerance on a that decreases to 0.010 in. at the load end. The coupling of the slots (or resistive component) is determined by (1) the geometrical optics ray density theorem, (2) the design

aperture taper (which was chosen to be 10 db Gaussian on the basis of a 90-percent aperture efficiency and 30.5-db side lobes) and (3) the amount of power dumped in the load (which is to be 1 percent).

The feed has perfect square symmetry. The slots in the N-S faces couple only to the polarization in the E-W plane and vice versa. This gives the system a dual polarization capability that is utilized by a turnstile at the feed input. A motorized adjustment of the turnstile shorting arms varies the polarization from circular, through elliptical, to linear. Purity of polarization will be maintained better than 30 db as measured at the peak of the beam. This requires a tight tolerance on the squareness of the waveguide. A rhombus effect, if maintained over an appreciable length of the feed especially near the cut-off end, can cause excessive cross-polarization coupling.

One novel design problem resulted from the failure of geometrical optics. Exact calculations showed that if the geometrical optics design theory were followed exactly, the side lobes would be about 10 db higher than those of the theoretical aperture distribution, the 10-db Gaussian with uniform phase. Considerable mathematical investigation¹ was undertaken to find a more exact theory than geometrical optics on which to base the design. A related problem is that the slot phase centers are not exactly on axis but displaced nearly to the waveguide walls. This causes an astigmatism error which reaches a maximum of $\lambda/4$ in the H plane in the aperture and produces some pattern degradation. This error could only be eliminated if the dual polarization feature were removed, as, for example, by replacing the square waveguide with flat rectangular guide with slots only on the broad

Largest Aperture Antenna

By ALAN F. KAY,
TRG Incorporated,
Somerville, Mass.

faces. Theory is useful only up to a point. Considerable empirical work was required to solve these problems.

Another interesting aspect is that the feed is both a structural and an electromagnetic device. To prevent excessive phase errors, a specification of 2 in. maximum departure from straightness was imposed on the feed under the combined loads of operational wind (up to 30 mph), gravity when cantilevered to 20 deg, solar heating, scanning acceleration, and fabrication tolerances.

Preliminary scale model tests showed that guy cable supports were electrically objectionable, and the feed was built as a simple cantilever even though the 2 in. stiffness requirement had to be relaxed by omitting the solar load from the specification. A design was obtained for optimum stiffness under the combined loads within the 10,000-lb weight limit from a special computer program. The optimum design has a high center of gravity and an extreme taper: the first 8-foot section will weigh 2,200 lbs, the last 40 lbs.

The scale model feed was hung from a roof truss of a large room with 35-foot ceiling height (see cover). A circular track was erected below supporting a receiving probe whose phase center was constrained to follow the surface of the scaled reflector with an accuracy of ± 0.035 in. Primary amplitude and phase patterns were obtained by a microwave bridge. The primary pattern data for a number of cuts was fed into a computer, which predicted the far field patterns.

The feed bandwidth for 3-db gain loss is 10 Mc. For operation in another frequency band the feed can be lowered and another erected in about 10 hours. Below about 50 Mc additional feeds may be used simultaneously for observing in different directions.

REFERENCE

(1) A. F. Kay, Design of a Line Source Feed for a Spherical Reflector, TRG-131-SR-4, AF19(604)-5532 Contract, May 15, 1961.



FIG. 1—Overall view of the Arecibo dish as it will appear when completed. Advantage is taken of natural dish-shaped valley

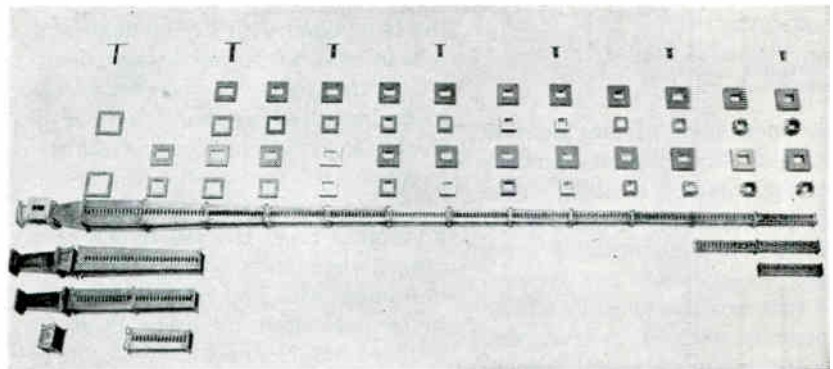

FIG. 2—Scale model of the feed, built for testing at X band frequencies. Slots act as inductive series impedances

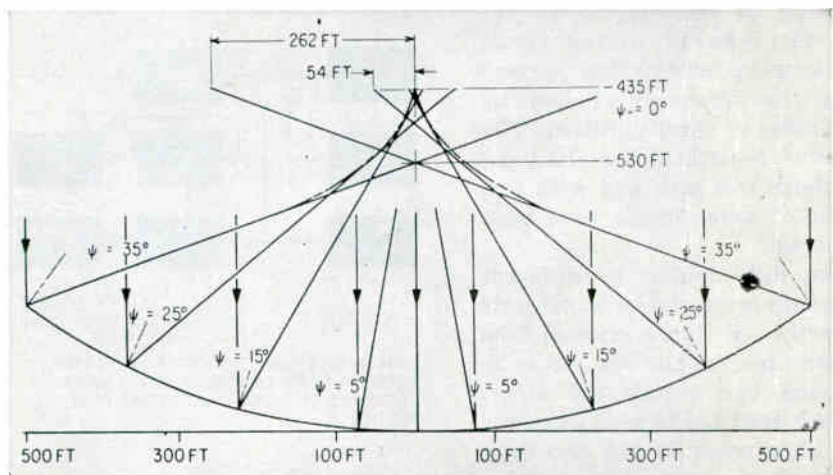
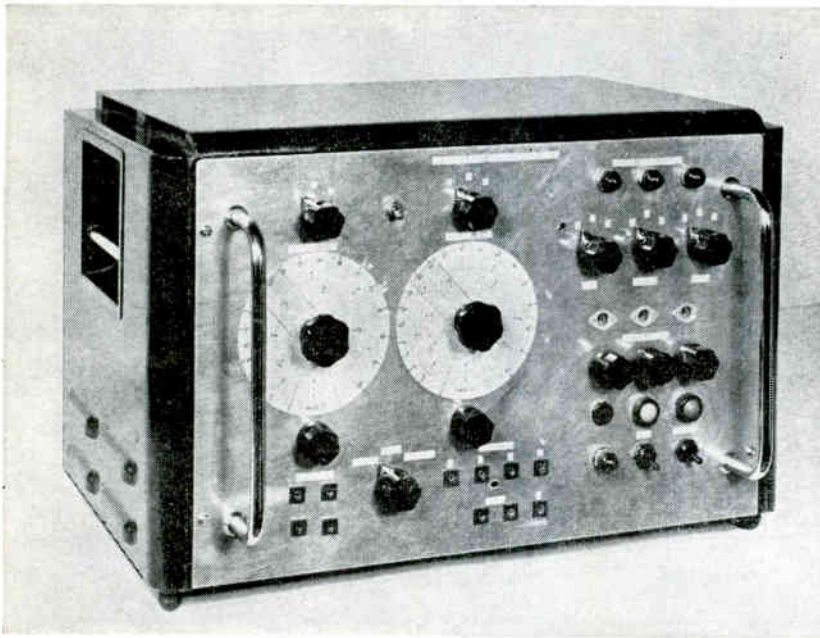

FIG. 3—Diagram of incoming rays reflected at different points on the antenna. Because the dish is spherical rather than parabolic, rays do not intersect at one point; line feed arrangement compensates for this

Microflash and Pulse Stimulator



Microflash and pulse stimulator control unit

By P. SCOTT,
Vickers Research Limited,
Sunninghill, Ascot,
Berkshire, England

DESPITE knowledge of the general behavior of the human nervous system, the complex activity called sensory perception remains unexplained. To help understand these processes, experiments can be performed that produce sensory effects not normally noticed in everyday life. A technique of visual perception uses microflash stimulation. Just as the expected performance of a control mechanism is analyzed by noting its response to an impulse, the behavior of the visual process can be investigated by comparing the responses elicited by light flashes of short duration. The apparatus described was designed to perform this task and with it a number of novel effects have been discovered.

When light flashes of different wavelength were shown to subjects at exactly the same moment, the subjects reported the two colors as appearing one before the other. This was most easily seen when the areas illuminated by the two light flashes were arranged to overlap slightly, the effect appearing as an apparent movement from one area to the other. By arranging to flash

the two colors at different instants, it was possible to get a time delay where there was no apparent movement between the two colors. For instance, with light flashes from the extremes of the visible spectrum, blue and red, there was apparent movement from the red to the blue areas when they were flashed simultaneously. The two flashes had to be separated by more than 10 millisecc before the apparent movement was reversed and occurred from the blue to the red.

A block diagram of the complete apparatus is shown in Fig. 1. The apparatus generates sequences of three pulses with spacing between them adjustable from 0 to 100 millisecc. These pulses trigger light sources, singly or grouped, to produce flashes of light at specified moments. An electronic counter measures the time spacing between pairs of pulses. Other features of the complete apparatus include a stimulator for exciting the retina electrically, a unit for producing single trigger pulses at random times, and a stop key and pulse generator so arranged that the subject can stop the counter in response to a pre-arranged stimulus pattern.

The flash-tube driving circuits and the circuits used to produce the sequences of direct and delayed trigger pulses are shown in Fig. 2. Each pulse unit (Fig. 2A) is a triggered blocking oscillator which gives a pair of output pulses with opposite polarity at the anode and cathode of V_1 . The negative-going pulse triggers the next adjustable delay unit and the positive pulse passes to the corresponding position of the pulse selector switch. Each delay circuit (Fig. 2B) is a suppressor-gated sanatron. In the idle state, gate V_1 is biased ON and sweep V_2 held OFF by the negative potential on its suppressor grid. A negative pulse from the pulse unit turns off the gate. This causes V_2

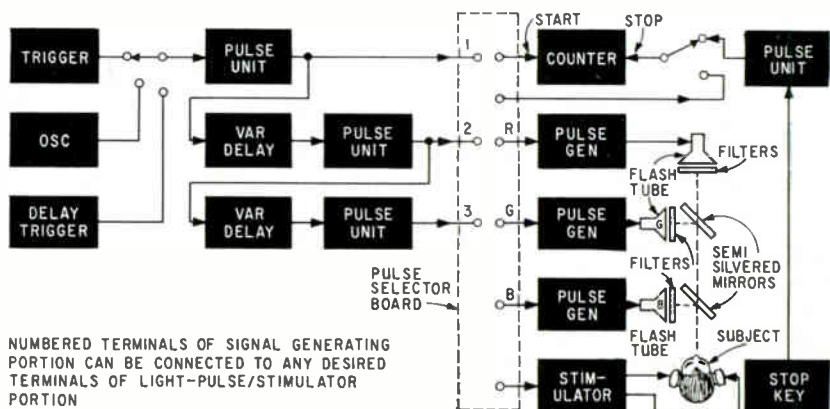

FIG. 1—Three different colors can be flashed simultaneously or in any chosen sequence, or subject's retina can be electrically stimulated with the test device. Subject can stop the counter in response to a prearranged pattern

Tests Human Optical Response

To test psychophysiological response to short flashes of colored light, this apparatus permits timing, spacing and control of flashes. Also described is a method of producing sensations of light when a small electrical current is passed near the optic nerve

to conduct, its anode potential running down at a rate decided by the selected sweep capacitor C_1 and grid return resistor R_1 . When it reaches the potential set by potentiometer R_2 , the run-down is terminated by diode V_2 . Rising grid bias turns on V_1 abruptly and a negative pulse appears at its screen grid. This pulse is used to trigger the next pulse unit.

The drive circuits (Fig. 2C) to the triode flash tubes generate low-impedance positive pulses of adjustable amplitude but constant duration. Each circuit is matched with its corresponding flash tube to produce light flashes with similar intensity/time characteristics. Buffer V_5 is turned ON by the incoming pulse from the pulse selector. The input network blocks unwanted low-frequency content and passes the sharp rising edge of the pulse. The falling potential on the V_7 anode is transferred via the pulse transformer to the grid of blocking oscillator V_6 , which conducts regeneratively. The setting of pulse am-

plitude potentiometer R_3 determines the voltage at V_7 cathode. The voltage appearing across the anode winding of the pulse transformer is available at 1:1 ratio at the output winding. Any over-swing is clipped by diode D_1 .

The output pulse is terminated after 2 μ sec by saturation of the transformer core and by capacitor C_2 so that V_6 ceases to conduct regeneratively. The duration of the output pulse is independent of the input triggering pulse.

Grid-controlled triode tubes with short-persistence blue, green and red phosphor screens produce the light flashes. Focus magnets, aperture screens and color filters are used to produce circular areas of light of maximum intensity, uniform brightness and with controlled spectral characteristics. Narrow pass-band filters were used to give light flashes with non-overlapping spectral characteristics and with peak light output at wavelengths of 4,700, 5,500, and 6,700 Angstrom units. The 2- μ sec duration driving

pulses produce flashes which last about 10 μ sec to the 10-percent level of intensity.

The flash tubes are placed relative to a pair of semi-silvered mirrors to give coplanar illuminated areas (Fig. 1). The mirrors can be positioned so that the flashes either overlap one another or are side by side. With $\frac{1}{2}$ -in diameter areas of each color, and with the colors partially overlapping, the complete stimulus field subtends a visual angle of 1 degree when observed by a subject at a distance of 4 ft.

In a typical application, the first pulse generator can be triggered to produce pulses at output 1 and causes pulses to appear at outputs 2 and 3 after predetermined delay times. This results in a single set of three pulses occurring either simultaneously or with delays up to 100 millisecc between them. The first pulse generator can also be driven by a square-wave oscillator for assessing the subjective brightness of the colors. Each flash tube in turn is triggered by the train of

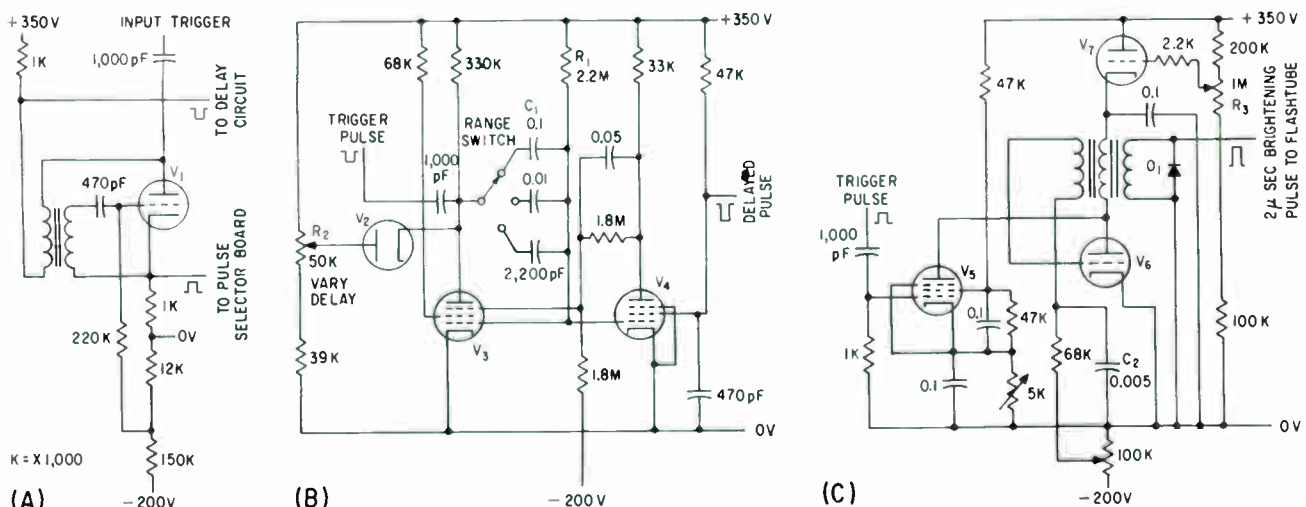

FIG. 2—Blocking oscillator pulse unit (A) uses negative pulse to trigger delay (B). Pulse regenerator (C) produces 2- μ sec flashtube-brightening pulse

output pulses and the brightness level of the tubes is adjusted to give the same flicker-fusion frequency for each color. After setting the brightness levels in this way, any further reduction in intensity can be achieved with neutral-density filters.

Besides being sensitive to light energy, the mosaic of nerve cells at the back of the eye called the retina can be excited by pressure, heat or electrical energy. Sensations of light produced by such means are called phosphenes. Of particular interest is the electrically-excited phosphene because it can be produced in a controlled fashion by the experimenter. Electrodes are attached to the surface of the skin near the eyes and a suitably shaped electrical pulse applied across the electrodes appears to the subject as a light flash of extremely short duration. This method of stimulation by-passes the photochemical processes of the retina and produces a more rapid response than a normal light-stimulus. If a subject is presented with a light stimulus and the retina is stimulated electrically at the same moment, the visual sensation due to the electrical stimulus will appear first. By flashing the light stimulus at a set time be-

fore applying the electrical stimulus the two responses can be made to appear together.

The electrical stimulator unit shown in Fig. 3 can be triggered by any pulse selected from the pulse generator and delay circuits of the main apparatus. It is isolated from these circuits by a pulse transformer. The incoming pulse triggers monostable multivibrator V_1 and V_2 . The resulting square pulse from V_2 switches charging transistor Q_3 and produces a pulse across capacitor C_1 ; this pulse has a rapid rise to 3 v followed by a gradual decay over the next 250 millise. Output resistors R_1 and R_2 assure that with a skin resistance at the subject of about 1,000 ohms the current will not exceed 300 μ amp. This means that the stimulator unit can be used with complete safety. The circuit is powered by three 1½ v cells. The shape of the output pulse had been decided by experiment to give a single light sensation with no apparent secondary effects such as a tingling of the skin due to the passage of current.

In experiments where the subject is instructed to respond to a stimulus as rapidly as possible (for instance when measuring reaction-time), if there is the slightest degree of regularity in the instant of presentation of the stimulus the subject will tend to anticipate the stimulus. This will produce a false measurement of the true reaction-time. To avoid such errors it is arranged for the light-source triggering pulse to appear at a random instant after the experimenter presses the switch. The circuit of the random-delay unit is shown in Fig. 4. Closing switch S_1 triggers monostable multivibrator V_1 and V_2 . The square pulse at the anode of

V_2 lasts for about 2 seconds. Its trailing edge triggers bistable multivibrator V_3 and V_4 . This alters the potential on the suppressor grid of V_5 and leaves it in a state to pass the next pulse from astable multivibrator V_6 and V_7 . The repetition rate of the astable multivibrator is one pulse approximately every 8 seconds, so that the first pulse to appear at the anode of V_5 occurs any time from 2 to 10 seconds after pressing the switch. The output pulse will occur at an unspecified instant during this period because the experimenter cannot know the precise state of the free running multivibrator at the moment the switch contacts close. The pulse unit returns the bistable multivibrator to its initial state.

The entire time scale of the several events is decided by the width of the square pulse from the monostable multivibrator and by the repetition rate of the astable multivibrator. The output pulse can be made to appear within any chosen interval by changing component values in these two circuits.

Because conventional switches quite often produce a noise when the contacts close, the subject might respond to this auditory signal instead of the visual stimulus. This results in a false reaction-time because the auditory response is usually more rapid than the visual response. Since the experimenter does not know the exact moment the stimulus will appear, he can be his own subject.

Several aspects of visual perception have been investigated with this apparatus. For example, experiments concerned with the transmission of visual information have been performed. The number of dots present in the random patterns

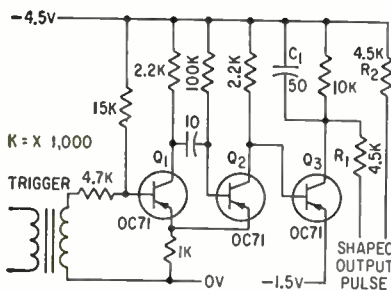

FIG. 3—Retina stimulator uses current-limiting resistors for complete safety

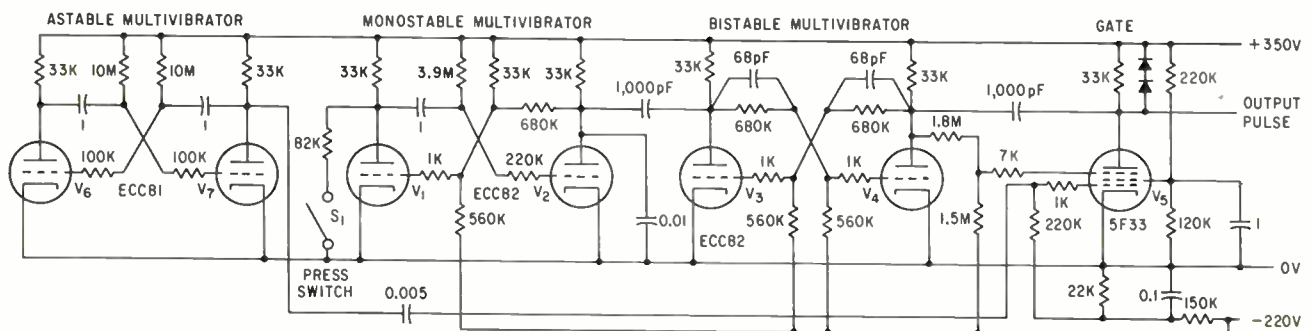

FIG. 4—Random delay unit uses multivibrators to generate a single pulse at an unspecified time 2 to 10 seconds after operating switch

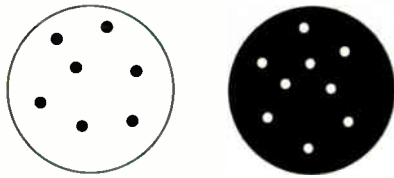

FIG. 5—Maximum number of dots perceived in random flash pattern lasting 1 μ sec

of Fig. 5 could be correctly assessed 50 percent of the time for flashes down to 1 μ sec duration. With illuminated dots on a dark background, the number was greater than with dark dots on an illuminated background. When different patterns followed each other in rapid succession, the relative brightness and time spacing between them decided whether the patterns were individually seen or were confused together.

In one series of experiments, subjects with normal color vision were asked to say which color appeared first when pairs of colors were flashed with time spacing between them which was altered in a non-regular fashion by the experimenter. An example of the responses with three color pairs is shown in Fig. 6 (results 1, 3 and 5). These results are representative of a normal subject and show that with these stimuli the latency of perception to red was shorter than that to blue; with red and green the effect was similar but less marked; while with blue and green a reverse result occurred, the latency to blue was shorter than that to green. This latter effect could be brought to the expected value, with the latency differences additive, by continuous illumination of the stimulus field with red light. This seemed to block the rapid response to the blue flash. When the other two color pairs were shown on a background field of the third color there were no significant latency changes (results 2, 4 and 6 of Fig. 6). In contrast, with subjects with abnormal color vision, the results were entirely different from the normal and even differed with the type of abnormality. The possible implications of these results have been discussed elsewhere¹.

Another series of experiments used the electrical stimulator to produce a reference response for

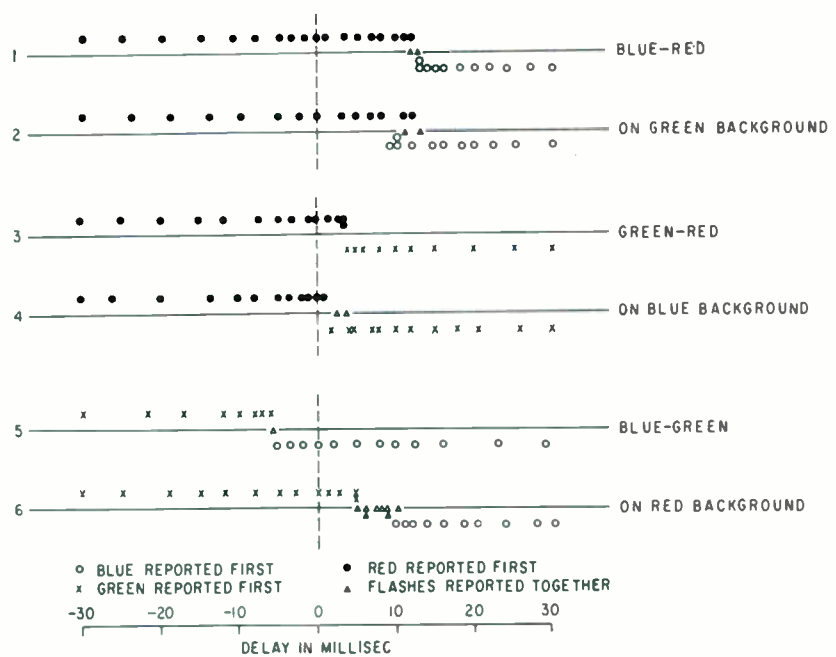

FIG. 6—Typical response of a subject with normal color vision

comparing latency differences with change in light stimulus parameters. Single flashes of blue, green and red light were presented to subjects with normal color vision. An instant later the retina was electrically excited. The time delay between the light stimulus and the electrical stimulus was adjusted until the subject reported that the two visual sensations appeared together. The time delay between the two stimuli had to be shortest for red, longest for blue and intermediate for green. The differences between the colors was of the same order as shown in the other results. The overall latency at the retina due to the photo-chemical processes was 50-60 millisecc.

When the apparatus was used for measuring reaction time, the experimenter selected a color and started the random-delay sequence. In the case of simple reaction-time, the subject would be instructed to respond to any stimulus as quickly as possible by operating the counter stop-key. With the complex reaction-time, where the subject has to discriminate between colors, he would be instructed to respond to a particular color and to ignore light flashes of any other color. The stimulus order would be decided from tables of random numbers. The results show no significant change in the simple reaction-time to different colors, but differences

were apparent with the complex reaction-time. The individual mean values of discriminative reaction-time were all longer than the corresponding simple reaction-time, with the mean value to red shortest, that to blue longest and with green between them.

The electrophysiological changes which accompany the visual process in animals have been extensively studied^{2, 3} and the anatomical structure of the visual centers in higher primates has also received attention⁴. Some of this other work suggests a latency effect associated with wavelength, an effect which may be related with the processes of color vision.

Acknowledgement is made to Dr. C. F. Bareford, the Directors of Vickers Research Limited and the I. E. E.,⁵ for permission to publish this article.

REFERENCES

- (1) P. Scott and K. G. Williams, Temporal Coding as a Mechanism in Sensory Perception, *Information and Control*, **2**, p 380, 1959.
- (2) H. T. Chang, Patterns of Organization in the Central Nervous System, *Research Publications, Association for Research in Nervous and Mental Diseases*, **30**, p 430, 1952.
- (3) M. A. Lennox and A. Madsen, Cortical and Retinal Responses to Colored Light Flash in Anesthetized Cat, *Journal of Neurophysiology*, **18**, p 412, 1955.
- (4) W. E. Le Gros Clark, The Laminar Pattern of the Lateral Geniculate Nucleus considered in relation to Colour Vision, *Documenta ophthalmologica*, **3**, p 57, 1949.
- (5) P. Scott, Microflash Stimulation in the Investigation of Visual Perception in Man, Third Int'l Conf on Med Electronics, July, 1960; to be published in *Proc IEE*.

Positive and Negative Feedback

By R. L. WILLETT,

The Martin Co., Baltimore, Maryland

USE of positive and negative feedback to alter the input parameters of a device has resulted in a stable amplifier with an input conductance adjustable to zero. This input characteristic may be achieved with almost any output load. The impedance multiplier provides an output voltage of ten volts peak-to-peak and an output current of one ma. Noise figure of the device is 15 db, permitting a total dynamic range of about 132 db.

The circuit is insensitive to changes in temperature and supply voltage and does not require selection of transistors. An input conductance of zero normally coincides with a voltage gain of exactly unity. The large amount of feedback, combined with unity gain, results in excellent linearity. Infinite input resistance and exact unity voltage gain can be proven only to the extent of measurement capabilities. Resistance measurements on the impedance multiplier were limited to 800×10^9 ohms.

Transistors Q_4 , Q_1 and Q_2 constitute a negative feedback loop. Transistors Q_2 and Q_3 comprise a positive loop, encompassed by the negative loop. Signal flow will be traced first without positive feedback, assuming the base of Q_3 to be grounded.

Transistor Q_4 is an emitter follower with a current monitor in the collector circuit. The change in Q_4 collector current, on a positive input signal, causes a negative excursion at the base of Q_1 . This signal appears with about the same amplitude and polarity at the base of Q_2 . The negative signal is inverted by Q_2 , closing the negative feedback loop and causing a positive signal at the output. Transistor Q_2 supplies most of the load current and the signal at the collector of Q_4 is small.

If positive feedback is inserted by adjusting R_6 , part of the positive signal at the output appears at the base of Q_3 . This signal is emit-

ter-coupled to Q_2 . No phase inversion occurs in Q_2 for the positive feedback signal, since emitter drive is used. Enhancement of the output waveform by the positive feedback causes the load conductance as seen by Q_4 to decrease, the signal level at the Q_4 collector to decrease and the input conductance of the entire device to decrease.

The positive feedback control may be varied so that the load conductance seen by Q_4 is positive, negative or zero. When the load conductance is negative, an increase in Q_4 base voltage as a result of an input signal causes a decrease in Q_4 collector current. This compensates for the internal collector resistance of the transistor. Infinite input resistance results when the apparent load conductance is equal in amplitude but opposite in polarity to the output conductance of Q_4 . When the circuit has been adjusted for infinite input resistance, the emitter-to-base voltage of Q_4 does not change with signal level, and unity voltage gain results.

An additional feedback path is from the output to the junction of biasing resistors R_2 and R_3 . Identical a-c signals at both ends of R_2 prevent current flow, regardless of the value of R_3 , and allow biasing the first stage without loading the input.

As the signal current flowing through Q_4 is reduced because of increased positive feedback, an operating point is reached where the sum of the signal currents in the base circuit of Q_4 and the collector circuit of Q_4 equals zero. The voltage waveform at the base of Q_4 nulls at this point and a further increase of positive feedback causes a signal polarity reversal. The polarity reversal occurs while the apparent load conductance is still positive, so that when the positive feedback has been increased sufficiently to provide infinite input resistance, all waveforms in the amplifier are in phase.

The positive feedback may be adjusted so that the input conductance

is negative and the voltage gain slightly greater than unity. Leakage resistance or any other undesirable shunting of the source may be avoided. A voltage gain is obtainable by inserting a resistor in series with the input signal and adjusting the negative conductance equal to the positive source conductances. The amplifier will remain stable as long as the absolute value of negative input impedance is not greater than the absolute value of positive source impedance.

Capacitors C_1 and C_2 provide high-frequency stability. Potentiometer R_1 adjusts the d-c operating point and need be set only when transistor Q_4 is changed. The collector voltage of Q_4 , base voltage of Q_2 and base voltage of Q_3 are about the same d-c level. This level is determined solely by resistance divider, R_7 and R_8 . Adjusting R_7 changes the d-c emitter voltage of Q_4 and the collector currents of transistors Q_2 and Q_3 .

An operating point for Q_4 should be selected carefully. The emitter-to-collector voltage must remain above the point where the collector resistance becomes nonlinear. When the quiescent operating level is chosen, the power-supply voltage may be varied from 14 to 30 volts without affecting the input impedance of the circuit.

Without positive feedback, the input impedance of the device is equal to the total current gain times the load resistance, in parallel with the product of the forward current transfer ratio and output resistance of Q_4 . As the apparent load conductance is driven negative, by positive feedback, extremely high input impedance values are encountered and the positive feedback ratio becomes the most important factor in determining the input characteristic.

The input resistance with large values of positive feedback is

$$R_{in} = h_{ie} + \frac{1 + h_{fet}}{h_{oe} + Y_L(1 - AB)} \quad (1)$$

where A is the voltage gain of the positive feedback loop and B the

Multiply Amplifier Input Impedance

feedback ratio of the positive loop.

To satisfy the condition for infinite input resistance, Y_L must be equal in amplitude but opposite in polarity to h_{oe1} . The approximate gain equation for the positive feedback loop is

$$A_v = 1 / \left[Z_{c1} \left(\frac{h_{oe1}}{h_{fe1}} + \frac{Y_L}{h_{fe1}h_{fe2}} \right) \right] \quad (2)$$

Impedance Z_{c1} is represented by R_1 , R_2 , R_3 and C_1 . If the positive feedback ratio, B , is set to

$$B = Z_{c4} \left(\frac{h_{oe4}}{h_{fe4}} + \frac{Y_L}{h_{fe4}h_{fe2}} \right) \left(1 + \frac{h_{oe4}}{Y_L} \right)$$

the product AB becomes $AB = 1 + h_{oe4}/Y_L$.

Substitution of this in Eq. 1 results in

$$R_{in} = h_{ie1} + \frac{1 + h_{fe1}}{h_{oe1} - h_{oe4}}$$

The zero in the denominator of the second term drives R_{in} to infinity.

Note that Z_{c1} appears in the gain Eq. 2. A decrease in Z_{c1} will increase the input resistance. Since C_1 is a part of Z_{c1} , it is necessary to match the roll-off characteristics at the base of Q_1 and the base of Q_3 so that the decrease in Z_{c1} with frequency is compensated by a decrease in the positive feedback ratio due to C_1 .

Matching of the R-C products at these two points provides an input resistance linear with frequency. Conversely, if an input resistance varying with frequency is desired, it is easily obtained. One version of the circuit had an input resistance that became more negative with an increase in frequency. The negative-going input resistance canceled the capacitive reactance at the input, permitting the absolute value of input impedance to become infinite.

In this mode of operation, infinite power gain is obtained. Cancellation of the reactance was accomplished over a frequency range of 5 cycles to 5 Kc, using a 2N104B transistor in the first stage. The input capacitance is approximately 24 pf with a 2N1613 in the first stage and 7 pf with a 2N104B.

A General Radio 716-C capaci-

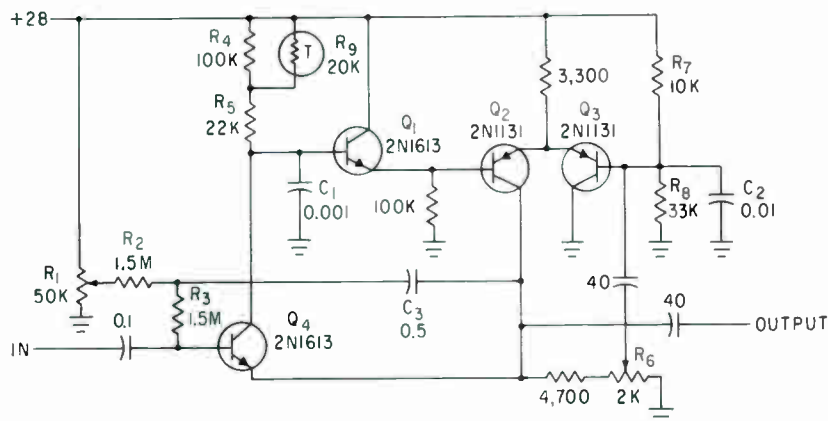

Schematic of amplifier, with transistors Q_1 , Q_2 and Q_3 in a negative feedback loop, and Q_4 and Q_5 in a positive loop inside the negative loop

tance bridge was used to measure input admittance over the frequency range of 100 cycles to 50 Kc. With the DF dial of the bridge set to zero, R_3 was adjusted for a null at a frequency of 1 Kc. Both DF and capacitance were then recorded over the entire band. The adjustment of R_3 was not critical and all readings were repeatable. Input conductance over a 5-cycle to 100-cycle range was measured by substitution of resistors in series with the input. A plot of G versus frequency shows the input conductance to be flat to about 10 Kc, where it begins to move negative.

A large part of the feedback has been degenerated from the circuit and the negative input conductance is similar to that in a conventional emitter-follower circuit. The input conductance remains negative up to a frequency of about 2 Mc, where the curve recrosses the zero line. The increase of input conductance after the zero crossing is extremely rapid. The circuit is stable over the entire range of negative conductance, since the absolute value of input admittance is always positive.

Equation 2 shows that the effects of transistor output conductance and forward current transfer ratio are opposite. Some compensation is achieved because both parameters have positive temperature coefficients. The d-c stability is maintained by thermistor R_9 . This also

affects the device input conductance, since it constitutes a part of Z_{c1} appearing in Eq. 2.

An attempt was made to measure the device gain by reducing the a-c value of R_3 and noting the effect on input resistance. Substitution of a 1,500-ohm resistor across R_3 yielded a gain-feedback ratio of 0.99994. The feedback ratio at 1 Kc was 0.998, due to the voltage drop across C_1 (0.5 μ f). This indicates a gain of 1.0019. Increasing C_1 would bring the gain closer to unity, as the tendency is for the gain-feedback ratio to approach unity when the input conductance is set to zero. Practical voltage gains of 1 ± 0.00005 should be attainable.

The circuit offers several advantages. High forward-current transfer ratios are not required in the transistors; hence the low gains usually associated with low current levels are not harmful. Also, high-value d-c bias resistors are not required to obtain high input resistance.

And the circuit configuration is compatible with nearly any voltage or current level, infinite power gain being obtainable with loads down to 200 ohms. Finally, the input impedance may be thought of as depending upon the relative values of two readily controllable impedances. These impedances, Z_{c1} and Z_{c4} , may be used to shape the device input characteristics as desired.

Pulse Comparator Circuit Measures

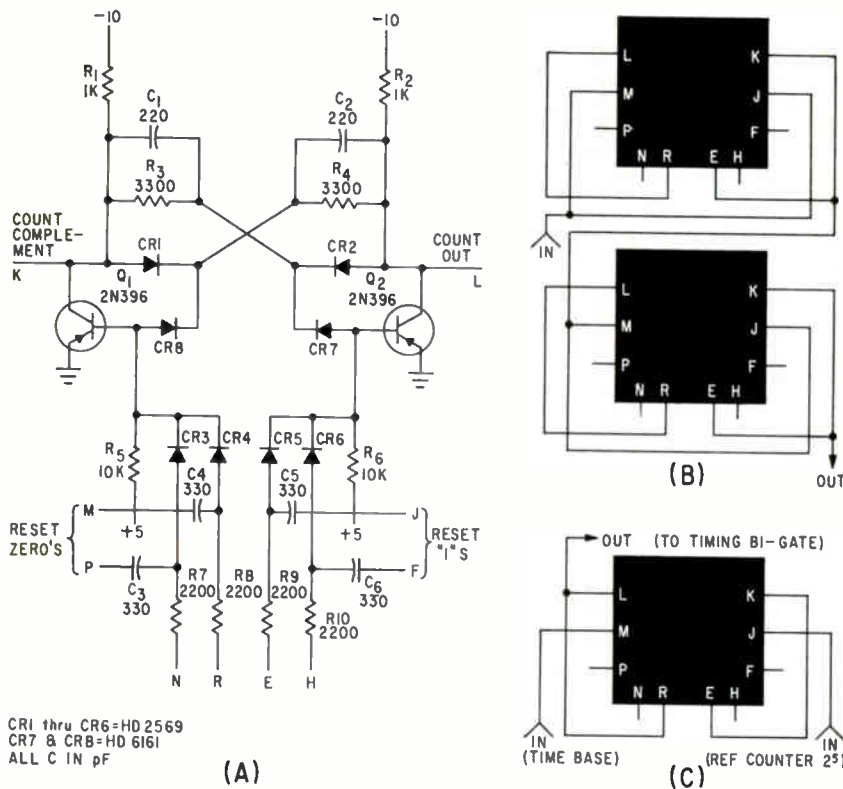

FIG. 1—Basic binary counting circuit (A) functions as flip-flop when connected as shown at (B), as bistable gate at (C)

Simple counting and complementing are used in this comparator to measure jitter to ± 64 counts a second.

Upper frequency limit of signals being compared is 130 Kc, but this can be increased by heterodyning

WHEN TWO SIGNALS are to be held near each other in frequency but are not locked together, a measure of the frequency variation, or jitter, is often desired. Typically, one of the signals will be a reference and the other the variable or jittery signal.

The frequency comparator will measure jitter of ± 64 counts a second. It uses two counters and averages counts over 0.5 second.

A simple method of measuring jitter is to mix the two signals and count the beat note, which would be zero if both signals have the same frequency. However, this scheme would indicate all plus and minus variations, even though such variations might average to zero. A binary subtraction can be used but requires dealing with many bits. The method used involves only counting and complementing.

The counting element is the binary circuit shown in Fig. 1A. When connected as in Fig. 1B, the circuit operates as a flip-flop. With the left collector potential at -8 v, the right collector will be -0.5 v. This state will be called the 0 state. If a position pulse is applied to terminals M and J (Fig. 1B), the flip-flop changes state to the 1 position.

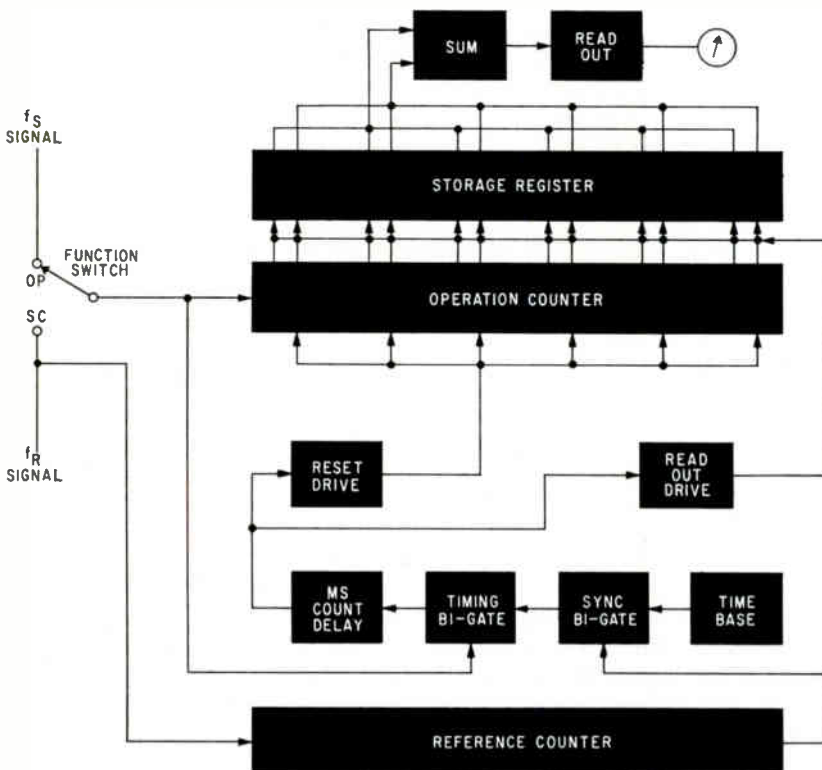

FIG. 2—Reference counter and operation or signal counter are used in the comparator

* Now with Bendix Radio Corp., Kansas City, Mo.

Frequency Jitter

By K. H. BRACKNEY*, D. R. GOSCH

Heavy Military Electronics Dept., General Electric Co., Syracuse, N. Y.

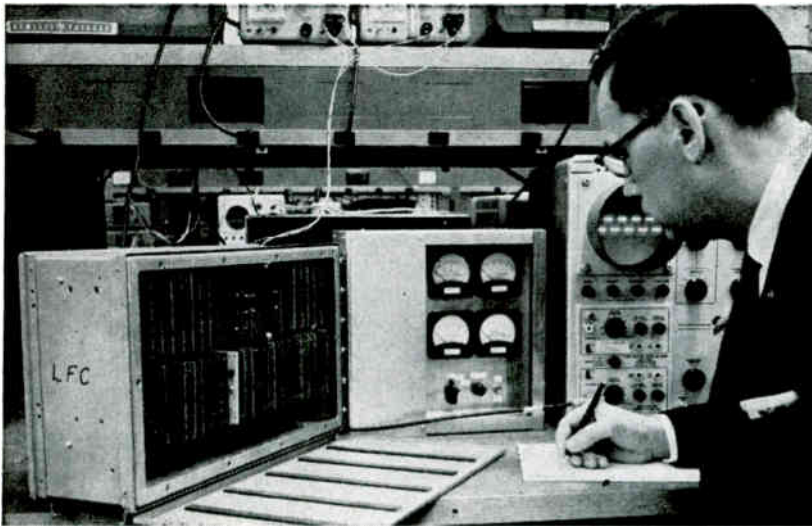

Output of frequency comparator is analog signal; readout is by meter. Circuit is shown in breadboard stage

As shown in Fig. 2, the comparator uses two small counters, storage register, and read out and timing circuits. If 32 counts are fed into both counters, as shown in Fig. 3A, and compared, the output of the first five stages would give a true difference of ZERO, as shown in Fig. 3B.

If 32 counts are fed in at A and 33 counts in at B, as shown in Fig. 3C, the true difference is one. If 32 counts are fed to A and 31 counts to B, as shown in Fig. 3D, the true difference is one, but the apparent difference is 31, as detected by the first five stages. If counter B is complemented as shown in Fig. 3E, and one count added as shown in Fig. 3F, the true difference is 1, as it should be.¹ The mechanism that determines whether or not the number should be complemented is the sixth bit of the storage register.

Binary digits are converted to analog form as show in Fig. 5A. Assume first that the storage register holds a ONE. This is the result of the signal being measured, f_n , being one count high over reference signal f_R during the sample period. The storage register holds 000001. Since binary unit 2^0 holds a ZERO, diode D_{20} is back biased. Since the binary unit 2^1 holds a ONE, diode D_1 is back biased. There is a current flow through D_1 and R_1 into the emitter of Q_1 and through the meter to the -10 v supply. If $R_1 = 2R_2$ and $R_2 = 2R_3$, a linear meter reading is realized.

When the operations counter is one count low, the storage register will hold 111111.

With binary unit 2^0 holding a ONE, diode D_{20} is back biased. Since the binary units $2^0, 2^1, 2^2, 2^3,$ and 2^4 are all holding a ONE, diodes $D_{10}, D_{16}, D_{20},$ and D_{22} are back biased.

The only current flow is that through R_n . Since $R_1 = R_n$, the meter will read the same as for the first condition. Resistors R_7 thru R_{11} have the same values as R_1 thru R_5 . This second operation is the complementing; R_n adds a ONE.

Assume that at time t_0 the storage register holds a ZERO, the operation counter a ZERO, and the reference counter a ONE.

At a time $t_0 + t$, the first positive-going edge of reference signal f_R triggers the reference counter. Assuming f_R has the same frequency and phase as f_n , the operation counter is triggered at $t_0 + t$. As time progresses the counters are filled and the excess counts run off the ends.

Excess counts from the reference counter are fed to the sync bigate, Fig. 2. This keeps the sync bigate in the 1 position as shown in Fig. 1C.

The time base generates a pulse t_0 once every 0.5 second which will place the sync bigate in the 0 position. The time interval determines how long comparison is performed, as shown in Fig. 5B.

When the sync bigate goes from the 1 to the 0 position, the left collector produces a negative pulse, which will not trigger the flip-flops used.

When the reference counter goes to zero a positive pulse will be generated out of the last binary unit.

The time base pulse t_0 sets the sync bigate in the 0 position. When the reference counter goes to zero, the positive pulse from the last binary unit sets the sync flip-flop to the 1 position, and the positive pulse from the sync flip-flop sets the timing flip-flop to the 0 posi-

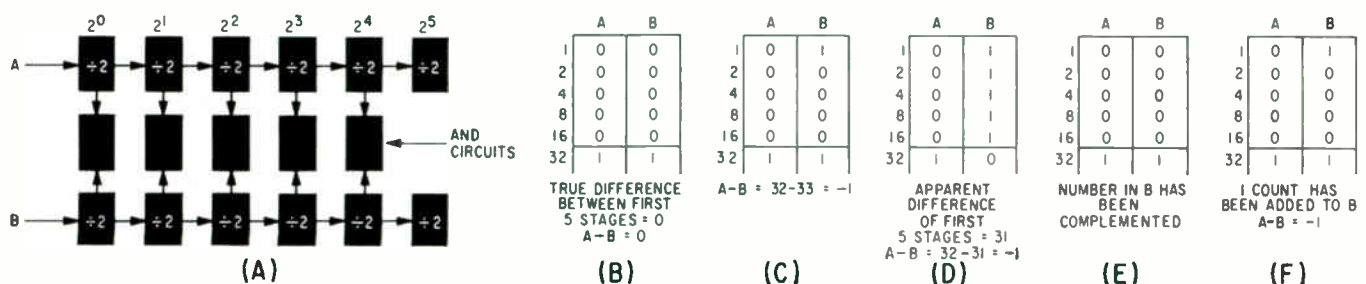

FIG. 3—Counter logic and operation is explained in text

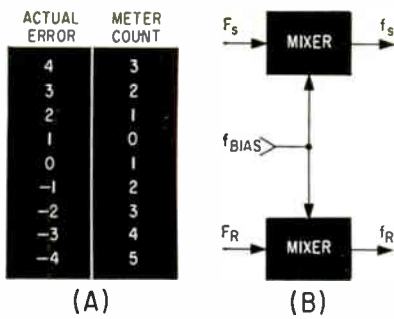

Fig. 4—Actual error vs meter count (A). Mixers (B) can be used to extend range of comparator

tion. If time base pulse t_b coincides with the positive pulse from the reference counter, the sync bigate is set to the 0 position. The time before the sync bigate goes to the 1 position will be $64(1/f_R)$.

At the time the timing bigate holds a 0, the reference counter holds a ZERO and the operations counter holds a count of 63.

The operation counter holds a 63 because at the time t_b , the reference counter holds a count of ONE, and for all time after t_b , the operation counter is one count behind the reference counter.

In binary notation, 64 is 1000000. Taking the last 6 digits, and sub-

tracting 1 gives 111111, which is 63.

Since no gating is performed on f_s or f_R , the next positive-going edge of f_s sets the timing bigate to a 1 and the timing bigate puts out a positive pulse. At the time the timing bigate is set to a 1, the reference and operation counter have a count placed in them making the operation counter hold a ZERO.

The read reset operation will now flow. However, a delay must be introduced to allow the last input pulse to propagate down the counter and the transients to die.

The positive pulse into the counter delay monostable triggers it, and a five-microsecond pulse is produced. The width of this pulse is determined by the delay time of a flip-flop multiplied by the number of flip-flops in the operation counter, plus the time interval of the maximum frequency that the flip-flop will divide. The negative pulse, when differentiated, will trigger reset and read-out drive.

The positive pulse out of the read-out drive when applied to the points M and J (Fig 5C) will read the information out of the operation counter and place what information it holds in the storage

register. Due to inherent flip-flop delay, the read out occurs before the flip-flops are reset to zero.

The positive pulse out of the reset drive resets all the flip-flops in the operation counter to zero.

The self-check position of the function switch places signal f_R in both counters, providing zero difference and, hence a self-check.

It is difficult to set a series of flip-flops to zero. Therefore the flip-flops are reset to 1s. Since the operation counter holds all 1s, instead of 0s, the error is 1. The read-out matrix (Fig. 5A) will give an error as shown in Fig. 4A.

To make the counting come out right, it is necessary to subtract 1 when the operation counter is below the reference counter, and add 1 when it is above. This is done by removing R_0 from the right and placing it on the left.

The upper frequency limit of the comparators is 130 Kc. However, by using mixers as shown in Fig. 4B the range can be extended.

REFERENCE

- (1) R. K. Richard, Arithmetic Operation in Digital Computers, Van Nostrand Pub. Co., 1955.

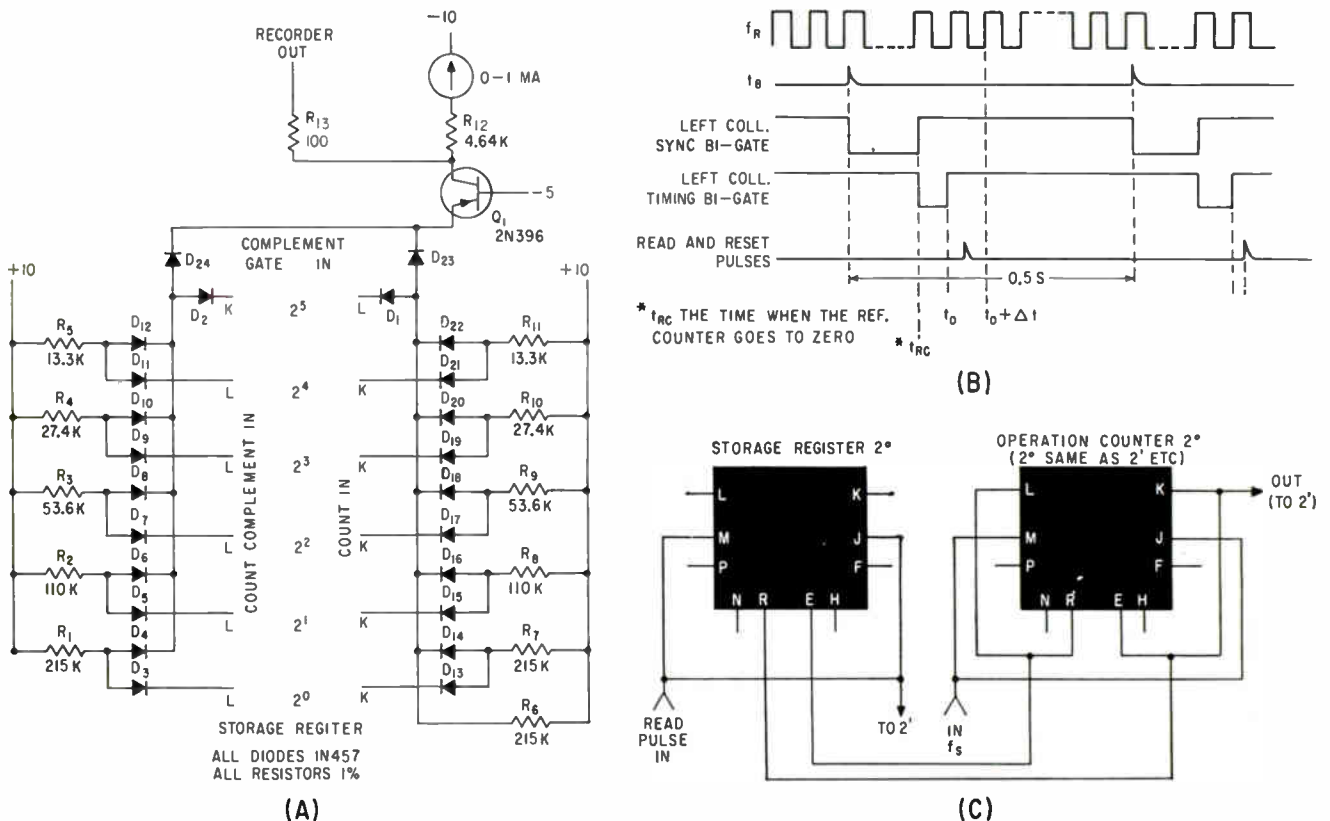
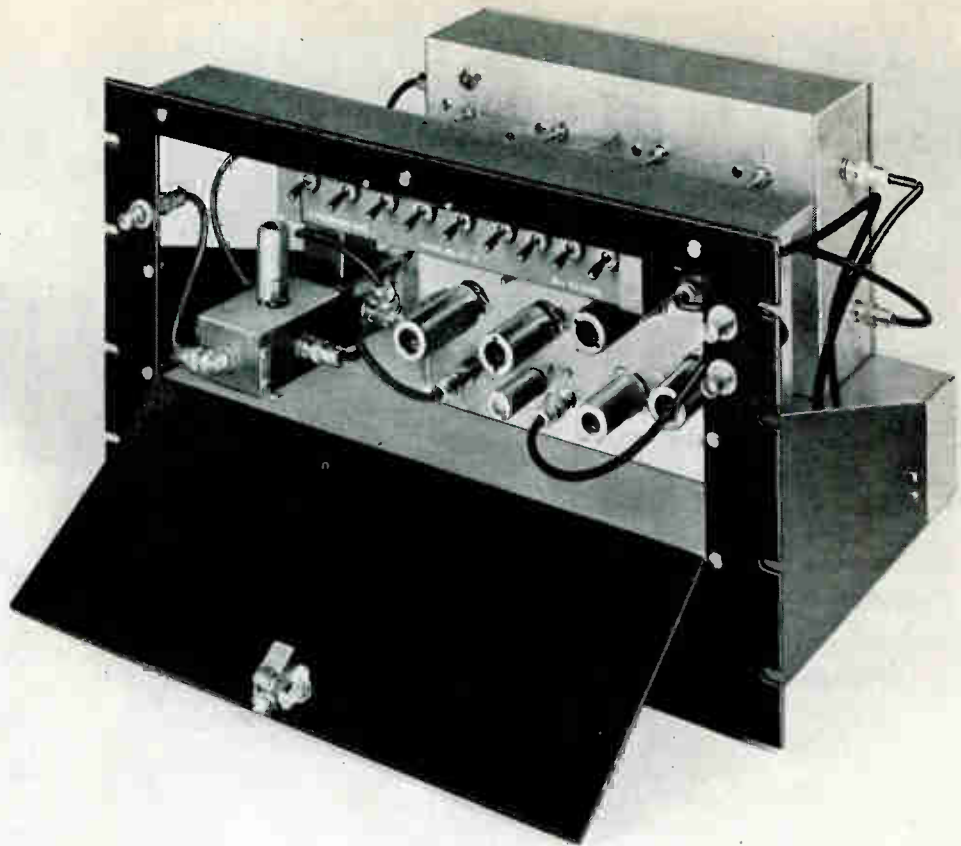

FIG. 5—Digital to analog converter (A), timing diagram of comparator (B) and readout interconnection of basic counting circuits (C)

Distortion monitor is simpler and more compact than a spectrum analyzer that would perform the same function



Distortion Monitor Checks Linear Amplifier Characteristics

Monitor determines control settings of linear amplifiers without the need for spectrum analyzers. Distortion is given by the ratio of two meter readings

By GUY H. SMITH, JR.,
 Research Assistant, Engineering
 Experimental Station, Georgia
 Institute of Technology, Atlanta, Ga.

OWING TO the advancement of single-sideband transmitting techniques, distortion in linear amplifiers has been raised in relative importance until now it has become one of the limiting factors in high-quality performance. Transmitters can now be constructed having overall third and fifth-order intermodulation distortion products 50 db below the level of the desired signal.^{1,2} In construction, assembly line production and field use of such amplifiers, there is a need for a device that will indicate the control settings for linear operation. This article describes a distortion monitor

that does not require a conventional spectrum analyzer. The block diagram of the experimental arrangement is shown in Fig. 1.

The distortion monitor separates the signal from intermodulation products at the output of a linear

amplifier, and displays these two signals (desired and intermodulation) on meters so that their ratio is proportional to the nonlinearity of the amplifier under test. This indication is accomplished by heterodyning the output of the ampli-

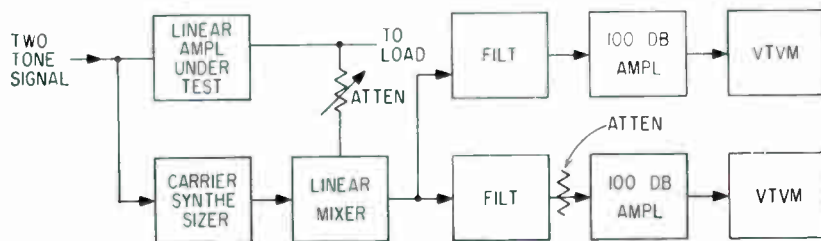

FIG. 1—Local oscillator signal midway in frequency between the two input frequency tones is generated in the carrier synthesizer. Local oscillator and amplifier outputs are mixed in the linear mixer

FIG. 2—Illustrations (A) through (D) show frequencies at various stages of the system while (E) and (F) are the filter characteristics of the two mixer output channels. Characteristics (G) and (H) show the actual frequencies of the post-mixer channels

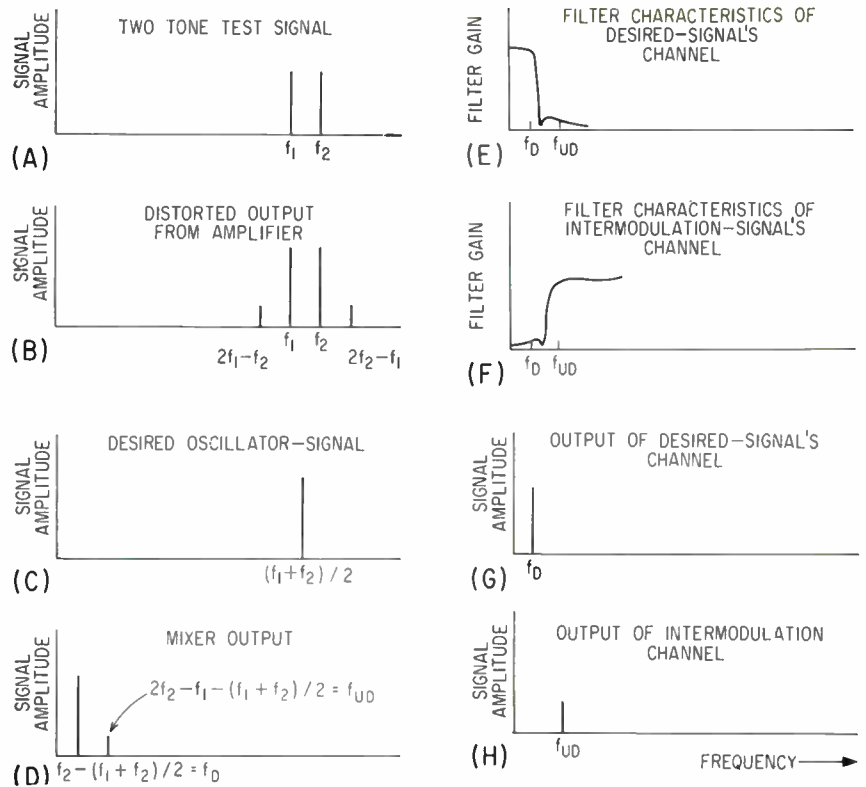
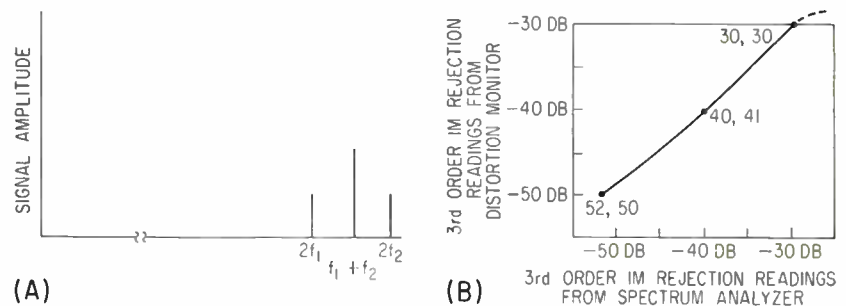

FIG. 3—Relative amplitudes of squared two-tone test signal (A) and comparison of a spectrum analyzer with the distortion monitor (B)



fier under test with a signal that is the average frequency $([f_1 + f_2] / 2)$ of the two-tone test signal used to drive the amplifier. This heterodyning converts the desired signal and its intermodulation products to low frequency signals that can be separated with filters. After separation, these converted signals are amplified and displayed on two vtvm's so that the ratio of two vtvm readings indicates the amplifier's distortion.

Applying a two-tone signal, Fig. 2A, to the test amplifier produces distortion as is shown in Fig. 2B; if this signal is mixed in a low-distortion mixer with the local oscillator signal, $(f_1 + f_2) / 2$, (Fig. 2C) and the output is low-pass-filtered, the result is the signal of Fig. 2D. If this signal is now split

into two channels, each with filters having characteristics shown in Fig. 2E and 2F, the outputs will be as shown in Fig. 2G and 2H. Both signals can then be amplified and displayed on separate vtvm's having scales calibrated in decibels.

The local-oscillator signal that heterodynes the distorted signal down to a low frequency is derived in the signal synthesizer and frequency-controlled by the two-tone $(f_1 + f_2)$ test signal.

The two-tone test signal is squared in the synthesizer and filtered, and the signal obtained consists of three spectral spikes centered about a frequency that is the mean of the second harmonics of the original two tones, Fig. 3A. Additionally, a signal of approximately correct frequency from a

local oscillator is squared, and its second harmonic is mixed with the squared two-tone test signal. Their product is low-pass-filtered and applied as a control signal to a reactance tube that controls the frequency of the oscillator. If the oscillator is tuned sufficiently close to the average frequency, $(f_1 + f_2) / 2$, of the original two-tone signal, the error signal reduces the frequency error of the oscillator. When the oscillator is locked by the error-signal to $(f_1 + f_2) / 2$, and if the gain of the servo loop is sufficiently large, there will be a constant phase angle of 90 degrees between the second harmonic of the oscillator signal and second harmonic of the mean frequency of the two-tone test signal. Thus the phase difference between the locked oscillator and

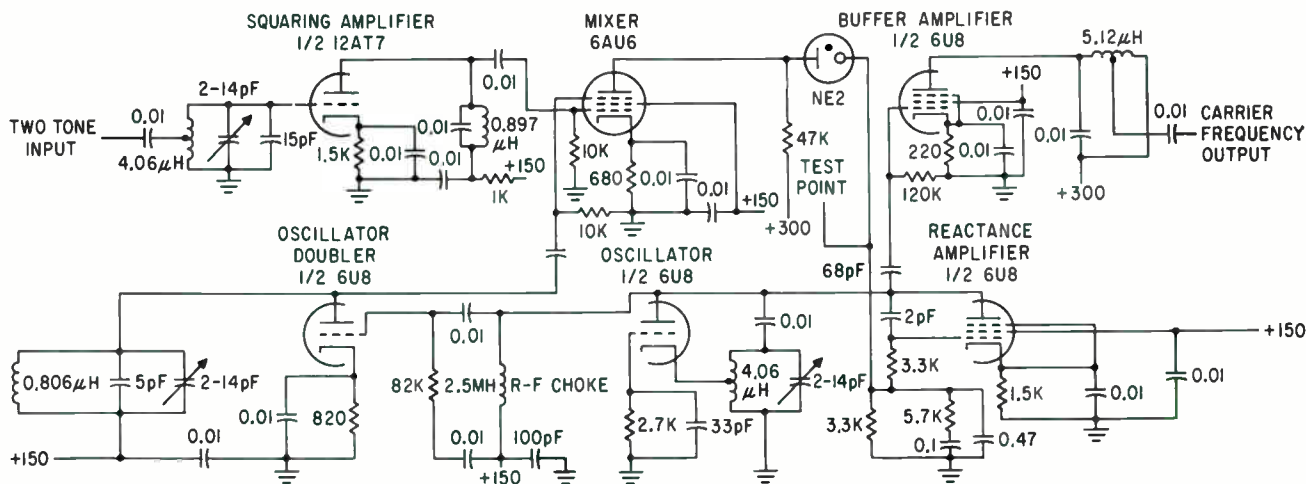

FIG. 4—Circuit shows how the local-oscillator frequency is adjusted to a value midway between the frequencies of the two-tone input

the missing carrier (that is, $D \cos t$ $[(\omega_1 + \omega_2)/2]$) is 45 degrees. This is desirable, for the distortion monitor is sensitive to both symmetric and antisymmetric distortion products. This would not be true if the resulting phase angle were either zero or ninety degrees.

This locked oscillator signal, after isolation and amplification, is now the local-oscillator input to the low-distortion mixer. The second mixer input is the attenuated output signal of the amplifier under test. Mixer output is low-pass-filtered and split into two channels. The two signals are then filtered individually, and after amplification are applied to separate vtvm's. When the amplifier under test is linear, the desired signal must be attenuated before amplification so as not to saturate the solid-state amplifier; this would result in a false reading. Curves showing the intermodulation readings of the distortion monitor and the corresponding readings obtained from a spectrum analyzer are shown in Fig. 3B. The signal synthesizer portion of the distortion monitor is shown schematically in Fig. 4.

The transistor amplifiers in the distortion monitor are shown in Fig. 5A. Each amplifier consists of three R-C coupled stages and has an overall gain of 100 db. The transistors used are general-purpose type 2N35. In this application there is no need for the phase characteristics of the two amplifiers to be the same. The low distortion

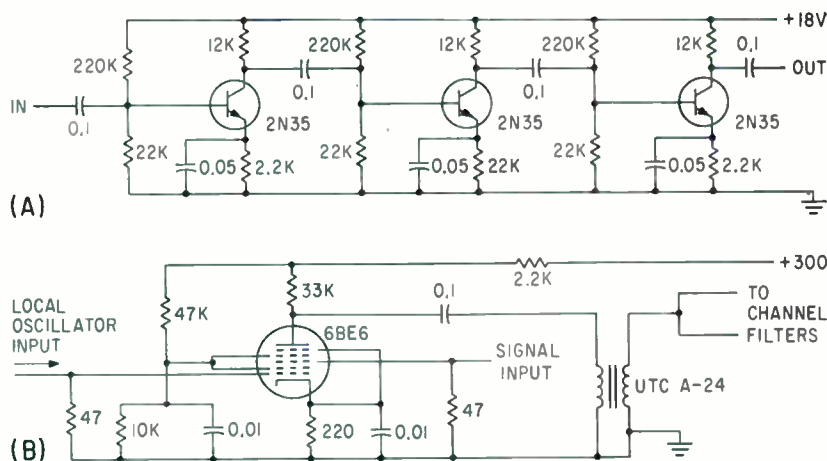

FIG. 5—Two amplifiers (A) are used, one in each channel; mixer circuit (B) combines local-oscillator and two-tone signals in a single envelope

mixer sacrifices gain for linearity and uses primarily grid swamping techniques. The low-distortion mixer is shown in Fig. 5B.

The distortion monitor, designed for use with a two-tone source requires no tuning adjustment of the filters, solid-state amplifiers or low-distortion mixer. This model of the distortion monitor, having been designed only to demonstrate feasibility, is capable of operation only in the 13 Mc range. The two tones of the test signal should have a separation of 22 Kc. This 22-Kc separation of the two tones is necessary because of the filter characteristics. If the separation is 22 Kc, then the desired signal will fall at 11 Kc and the third-order intermodulation products will fall at 33 Kc. The filter characteristics of Figs. 2B and 2C, where f_a is equal

to 11 Kc, and f_{ad} is equal to 33 Kc, shows the justification for a separation of 22 Kc.

When operating conditions are met, the difference in the readings of the two vtvm's will be the intermodulation distortion rejection. No attempt has been made to make this unit physically small; an operational prototype can be designed to be smaller.

This unit was designed and constructed under Air Force Contract No. AF 30(602)-2146 at the Engineering Experiment Station, Georgia Institute of Technology.

REFERENCES

- (1) Warren R. Bruene, Distortion Reducing Means for Single Sideband Transmitters, *Proc. IRE*, 44, p 1760, Dec. 1956.
- (2) R. E. Meek, G. H. Smith, W. M. Peacock, and H. L. McKinley, "Techniques for Linear Amplifier Tube and Circuit Design", Final Report, Contract AF 30(602)-2146, Feb. 1961.

*Rotary switch successfully samples power
on 24 antenna elements in
linear array for display on oscilloscope*

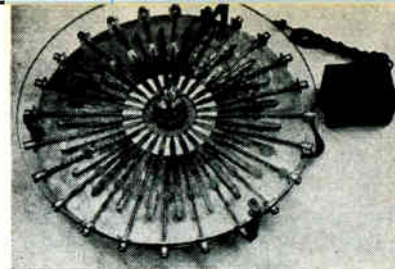

High-speed microwave power-sampling switch successively samples power of each antenna element in a linear array

STRAIGHT AND CIRCULAR-LINE COUPLERS FORM High-Speed Microwave Switch

By LUIS L. OH

C. D. LUNDEN,

Boeing Airplane Co., Transport Div.,
Renton, Washington

IN ELECTROMECHANICAL or electronic beam-scanning linear arrays, the phasing of each antenna must be known to obtain the desired beam formation, and the power distribution across the array aperture must be known to reduce sidelobe level. The high-speed, electromechanical rotary switch described here will successively sample the power of each antenna element in a linear array. These power measurements can be displayed on an oscilloscope as a series of pulses indicating the power in each element. The envelope of the pulses represents the power distribution across the array aperture.

This power-sampling switch was designed around two new noncontacting transmission-line couplers: a straight-line and a circular-line codirectional coupler. A helix coupler is a type of codirection coupler consisting of two helices concentric to each other. If the helix coil is compressed axially until the pitch becomes zero, the helix coil deforms into a cylinder or a one-turn helix. If the helix coil is stretched axially until the pitch becomes infinite, the helix coil deforms into a straight line. A helix coupler with either a helix pitch of zero or a helix pitch of infinity should exhibit some power coupler properties; experiments show that power-transfer efficiency above 95 percent over a 10-percent bandwidth can be obtained.

The experimental power-sampling switch was designed for a 24-element, uhf, electromechanical scanning array. It weighs 20 pounds and consists of one coaxial output terminal at the center of the 20-inch diameter circular switch and 24 coaxial input terminals along the periphery. Power sampled from each of the 24 antenna channels is sequentially coupled to the output terminal through a straight-line and a circular-line codirectional coupler (see photo). The center conductors of the input coaxial-line fittings (UG 58A/U) are connected to radially disposed straight-line conductors that represent one side of the straight-line couplers. The center conductor of the output coaxial-line fitting (UG 270/U) is connected to a circular-line conductor that represents one side of the circular-line coupler. Both the input and output assemblies are stationary. A lightweight rotating arm, consisting of the remaining portions of the two couplers in series, is in a plane between the plane containing the array of stationary straight-line conductors and the plane containing the stationary circular-line conductor. The air space between the rotating arm and the stationary lines is approximately half an inch.

A T-section elongated conductor between successively adjacent stationary straight-line conductors reduces cross coupling between channels and allows a sharp cutoff between each line. Individual channels are calibrated and adjusted by a screw that changes the dis-

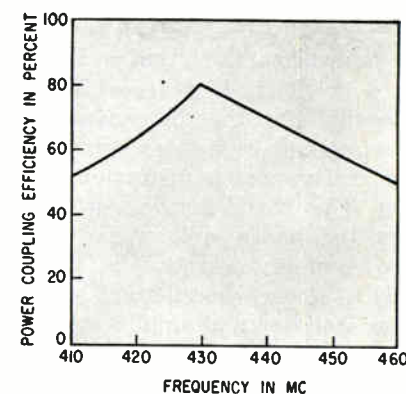

Switch power-coupling efficiency plotted against frequency

tance of the stationary straight-line conductor from the rotating arm. A one-db change can be easily achieved with this adjustment.

Because there are no r-f contacts between the couplers and because the rotating arm weighs about two ounces, the switch can scan at up to 5,000 rpm without deterioration in electrical properties. Although efficiency is not critical in monitoring devices, a power-coupling efficiency as high as 80 percent was obtained at 430-Mc (see plot). Operating frequency of the switch can be shifted either by making the length of the straight-line portion of the rotating arm adjustable or by using a different size rotating arm.

The switch can also be used (with caution) for measuring the instantaneous phase distribution across the array aperture and for sensitive receiver operations such as in doppler direction finding and angle-of-arrival measurements.



Cinch Hinge Connectors eliminate contact damage caused by the high insertion and extraction forces encountered with ordinary multi-contact (20-100) Connectors ... ideal for use in space-limited areas.

The exclusive Cinch Hinge Connectors are available with 20-100 contacts. Hinge Connectors are ideal for applications where a reliable multi-contact connector is needed for use in a limited area. The ingenious Hinge and Latch principle is foolproof and provides added reliability.

Use of this unique series of connectors eliminates damage to contacts caused by the excessive insertion and extraction forces encountered with ordinary connectors having large numbers of contacts. Only one finger is necessary to operate the latching device to open and close Cinch Hinge Connectors.

Another feature of the Cinch Hinge Connector is the design of the contacts. Positive Contact is always maintained because of the pressure action of the wiping contacts. This flexible contact design eliminates high insertion and extraction forces and provides added reliability.

In addition to the Standard Hood for use with 20-100 contact Hinge Connectors, Cinch now has a new space-saving shallow hood available for 20-50 contact hinge connectors. Both can be supplied with cable entry holes in top or end, with or without cable clamps and/or liners. For further information, contact the nearest Cinch Sales Office in your area.

...AN INGENUOUS CONNECTOR

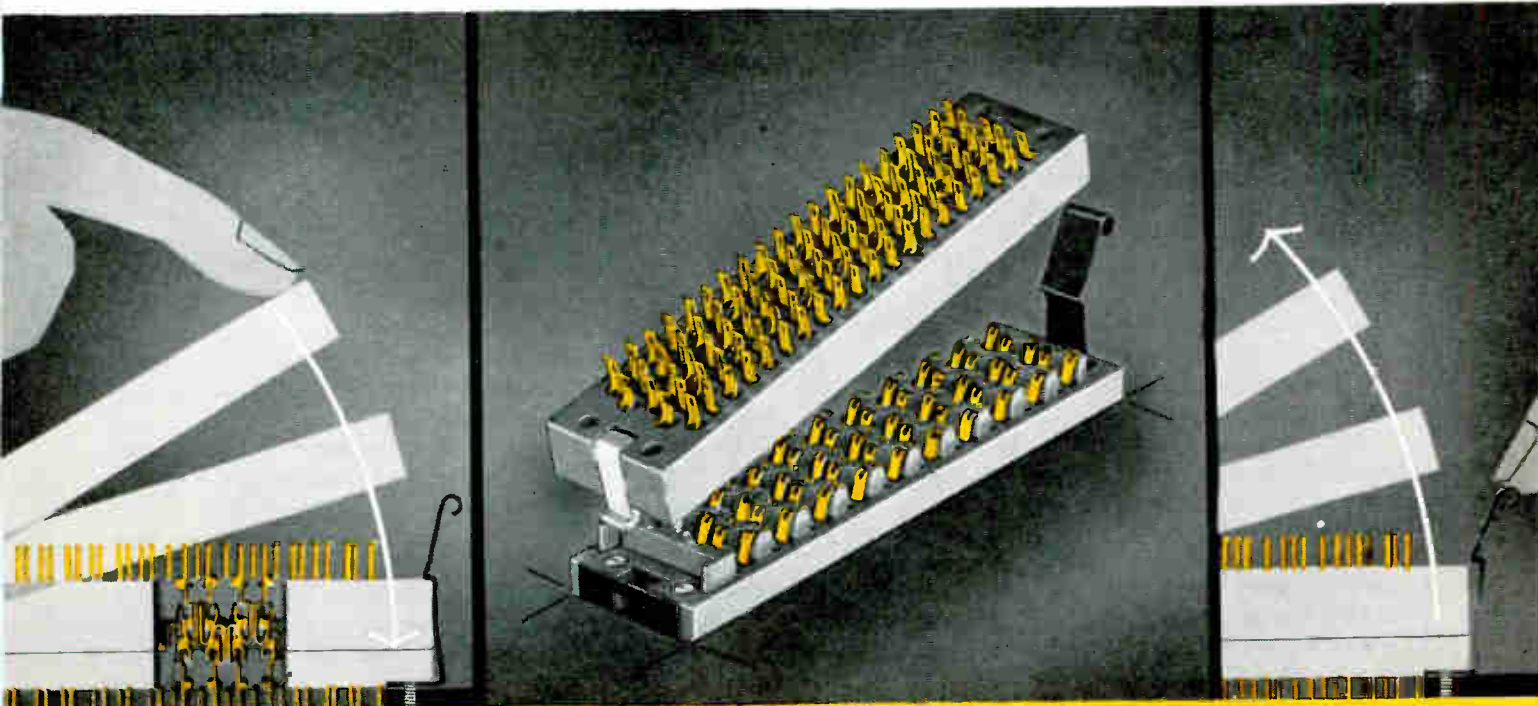

CINCH MANUFACTURING COMPANY

1026 South Homan Avenue, Chicago 24, Illinois

Centrally located plants at Chicago, Illinois; Shelbyville, Indiana;
City of Industry, California; St. Louis, Missouri.

CIRCLE 61 ON READER SERVICE CARD



A DIVISION OF UNITED-CARR FASTENER
CORPORATION, BOSTON, MASSACHUSETTS

CALCULATING Receiver Spurious Responses

By H. H. JENKINS, Sr. Engr.,
Radiation Inc., Melbourne, Fla.

A SUPERHETERODYNE RECEIVER may respond to signals at frequencies other than the tuned frequency. One common spurious response is that of a single signal being converted in the r-f stages to an i-f signal. These spurious responses are caused primarily by the fundamental or harmonics of the off-channel signal mixing with the fundamental or harmonics of the first local oscillator to produce a signal at the first i-f. Frequencies of these responses may be determined from

$$q f_s = p f_{lo} \pm f_{i-f} \quad (1)$$

where f_s = spurious response frequency, f_{lo} = local oscillator frequency, f_{i-f} = intermediate frequency, q = a nonzero integer, and p = any integer.

The nomograph provides a rapid solution of Eq. 1. Although any one of the five variables may be obtained if the other four are known, generally the unknown parameter is either f_s or f_{lo} because f_{i-f} is usually known and p and q are chosen.

Each axis on the nomograph has two scales. The left scale provides increased accuracy at frequencies below 20 Mc. The left (or right) scales are always used jointly.

Limits of $p \leq 5$ and $q \leq 5$ are used; with these limits, 50 solutions to Eq. 1 may be obtained. A large majority of the most deleterious responses are contained in these 50 responses.

Although the upper frequency limit on the nomograph is 100 Mc, f_{lo} and f_s values above 100 Mc may be used by normalizing Eq. 1. For example, suppose $f_{lo} = 1,000$ Mc and $f_{i-f} = 60$ Mc. Divide by 10 to obtain the equation $q f_s = p 100 \pm 6$ and solve for f_s , using the nomograph. The f_s values must be denormalized by multiplying by 10.

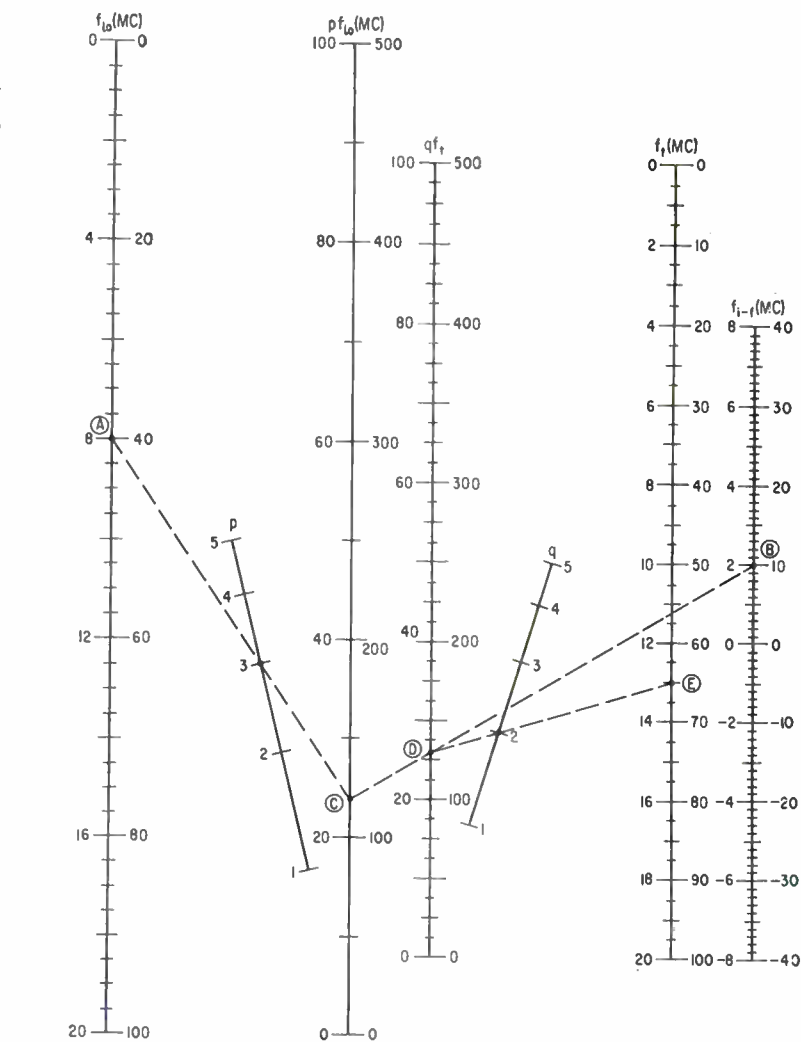

Nomograph solves $q f_s = p f_{lo} \pm f_{i-f}$, the spurious-response equation

A similar procedure may be used for low frequencies, for example, $f_{lo} = 40$ Mc, B at $+ f_{i-f} = 10$ Mc, f_{lo} and f_s values below 4 Mc. Draw a straight line between A and p -value 3 and note intersection C on the $p f_{lo}$ axis.

As an example: an f_{lo} value of 40 Mc, which corresponds to a tuned frequency of 50 Mc, and an f_{i-f} value of 10 Mc are used with p and q equal to 3 and 2, respectively. Only the positive sign for f_{i-f} is used. Determine f_{lo} and f_{i-f} for the known receiver tuned frequency, and establish the scale points corresponding to these values. Place scale points at A at

Draw a straight line between A and p -value 3 and note intersection C on the $p f_{lo}$ axis.

Draw a line between point C and B on the $+ f_{i-f}$ scale, and note intersection D on the $q f_s$ axis.

Draw a straight line between D and q -value 2 to spurious response frequency E on the f_s axis. The third harmonic of the 40-Mc local oscillator mixes with the second harmonic of a 65-Mc signal to produce the 10-Mc i-f.

FREE REPRINT

Single copy of this article available free by simply checking the READER SERVICE CARD of the month

Amperex[®]
announces
a significant
step
toward
instantaneous
electron
emission . . .



The
**HARP
CATHODE**

Amperex sought the best means of producing the world's fastest heating electron tube; found it in the Harp Cathode. As developed by Amperex, Harp Cathode tubes permit warm-up in as little as 100 milliseconds. This major advantage, combined with low cathode inductance, low operating voltage, and extreme ruggedness—make Harp Cathode tubes the logical choice for transistorized mobile and airborne communications, and any other application where instantaneous response is a necessity.

Described simply, the Harp Cathode is a flat rectangle, strung harp-fashion with many superfine wires. Its unique advantages are largely a function of this physical arrangement. Thus, the minute wire size provides a high surface-to-volume ratio, resulting in instantaneous availability of thermal energy at the emissive surface. The quantity of electrically parallel, directly heated wires assures low cathode inductance. The low (1.6V) filament voltage affords the closest approach to the "unipotential" cathode. Moreover, in actual tests, tubes incorporating the Harp Cathode have given longer service life than tubes with conventional cathodes.

The Amperex Harp Cathode Type 8042 RF power Amplifier (25 watts Diss.; 175mc ICAS) is available in pre-production quantities. It is the forerunner of an entire family of Amperex fast-heating Harp Cathode power tubes, which will include fast-heating versions of the type 6360 twin tetrode (12 w, 300mc); the 6939 miniature twin tetrode (7.5 w, 500mc); and the 6907 double tetrode (15 w, 450 mc).

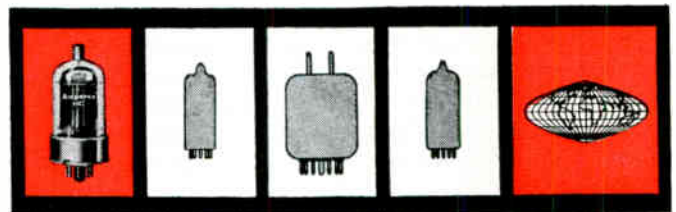

ask Amperex about the fast-heating tube best suited to your particular application.

AMPEREX ELECTRONIC CORPORATION • 230 Duffy Avenue • Hicksville, Long Island, New York
In Canada: Philips Electronics Industries Ltd., Tube, Semiconductor & Component Depts., 116 Vanderhoof Avenue, Toronto 17, Ontario

High-Accuracy Phase Standard Is Developed

MASTER standard shifts phase continuously from 0 to 180 degrees with an accuracy of 0.01 degree. It enables phase-angle comparisons of two 400-cps sine waves to calibrate laboratory standards. Similar phase shifters can also be designed for higher audio frequencies.

The phase-angle master standard was designed by the National Bureau of Standards to assist in precise determination of phase angle, which is required in computer and guidance system design. The phase shifter enables accurate measurements beyond the small phase angles and the 60-cps frequencies that usually receive most attention.

Absolute calibration of reference standards in standardizing laboratories can be accomplished conveniently by comparison with a master standard. A suitable master standard must contain phase-shift steps of several magnitudes with continuously variable fine control for phase angles between steps. The shift in phase produced by any control must be independent of all other control settings. It should also be possible to compute phase shift from measured resistance, capacitance and inductance.

The phase shifter has twelve 14.6-degree and three 4.3-degree pi sections. Switching permits connecting any desired combination of sections as a delay line. Ten capacitor steps that each provide 0.44 degree phase shift and a variable air capacitor for continuous fine control form part of an R-C network at the input of the delay line.

The input voltage to be shifted in phase is fed to a 4,000-ohm non-inductive resistor. The input resistor is shunted by a capacitance-remove type air capacitor of 1,100 to 100 pf, a decade set of mica capacitors covering 0.004 to 0.044 μf and a zero-adjusting capacitance.

A set of thirteen spdt mercury switches permits connecting any number of 14.6-degree pi sections and a set of four switches enables connecting any number of 4.3-degree pi sections into the line.

The delay line is terminated by a fixed impedance consisting of a 1,000-ohm resistor shunted by a 0.0021- μf capacitor. An experimental method was devised to adjust characteristic impedance of each pi section to be equal to the terminating impedance. All pi sections must have exactly the same impedance to prevent reflections and to make phase shift by the R-C circuit independent of number of pi sections.

When these conditions had been fulfilled, phase shift of each section was determined experimentally using an auxiliary phase shifter. A toroidal transformer was used

to check the 180-degree point. Phase shift was also computed from the measured inductance of each pi section. Phase shift obtained using the two methods agreed within 0.01 degree.

Similar phase-angle standards could be designed for higher frequencies. However stray capacitance introduced by connecting and switching leads might be troublesome beyond about 20 Kc. It might also be feasible to use the same master standard over a frequency range of about 2 to 1 with some adjustment of pi sections and termination for each frequency.

Magnetic Tape Changer Is Automatic

MAGNETIC tape cartridges are changed automatically in a newly developed magnetic recorder-reproducer. Standard quarter-inch tape is used in the cartridges, which are compatible with existing home recorders. The desired cartridge is selected by pushbutton, and the tape is threaded automatically.

The automatic magnetic tape system, which was developed at the Armour Research Foundation of Illinois Institute of Technology, is said to enable tape to compare favorably with long-play records on the basis of cost and convenience. Marvin Camras, who developed the innovation, adds that magnetic tape can be edited, erased and used again. It can also contain several channels for use with multiple-speaker systems.

The tape cartridges are kept in individual compartments in a magazine that can be seen in the photograph. The desired compartment is moved into place in response to a pushbutton selector, and the cartridge in the compartment is shifted into play position. When the cartridge has been inserted in a slot, a shaft is pushed through the hub.

The automatic threading operation requires about 3 seconds. The cartridge is rotated clockwise on

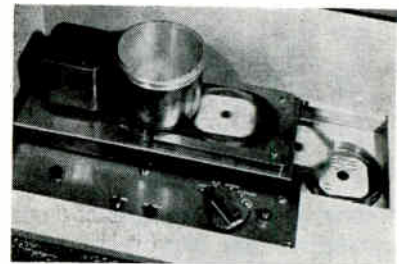

One model cartridge changer is moving cartridge into position for automatic threading operation while last cartridge is ejected

the shaft until a hook attached to a plastic leader in the machine is caught in a hole in the tape leader.

Manual operation using the tape cartridges is possible in the recorders now in existence in millions of homes. Operating speed, tape width and multiple-channel operation are standard, and the hub fits present recorders. All that is required is a take-up reel with a ball detent near the hub, which would cost about fifty cents.

An inexpensive adaptor to modify present home recorders would also permit semiautomatic operation. The cartridge can be inserted without directly manipulating the recorder or the hopper of an automatic changer.

The cartridge is designed to pro-

17 reasons why you get highest reliability with G-E Five-Star tubes

In industrial and communication equipment—critical sockets where there can be no compromise with electronic tube performance—you can depend on the proven reliability of G-E Five-Star tubes. Let these 17 features of a typical Five-Star tube tell you why:

- 1 Stem design minimizes welds—fewer points of possible failure—less chance of short-causing particles from weld splash.
- 2 Passive cathode alloys assure reliability and long life in low-duty cycle circuits where interface tends to develop.
- 3 Pins are annealed to prevent glass strain at socket insertion.
- 4 Short, sturdy cages increase rigidity of tube structure.
- 5 Two mica spacers, with additional anti-leakage slots, brace internal parts, provide superior inter-element insulation and improve vibration characteristics. 12 or 16 contact points give firmer fit between bulb and mount.
- 6 Highly efficient getter performs throughout tube life and guides flash to avoid inter-element leakage.
- 7 A getter flash shield improves initial leakage characteristics.
- 8 U-bolt construction through top and bottom micas firmly secures the cage assembly.
- 9 Folded heater design proved most reliable under shock, vibration and heater cycling conditions. Heater is temperature controlled to further improve reliability and lengthen life.
- 10 Cataphoretic coating of all heater bends after forming insures complete heater-cathode insulation.
- 11 Smooth grid legs prevent a “sawing” action on the mica, reducing grid vibration and microphonic noise.
- 12 Critical grids are plated with gold or silver to minimize grid emission.
- 13 Lead glass stems help ward off glass electrolysis.
- 14 Controlled inside diameter on bulbs improves vibration and microphonics.
- 15 Low thermo-conductivity cathode tab prevents terminal heat loss.
- 16 Outside diameter and density of cathode coating is statistically controlled.
- 17 Plate ears are embossed for added strength and improved mica fit.

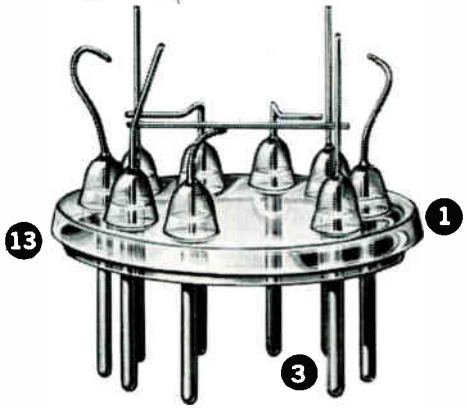
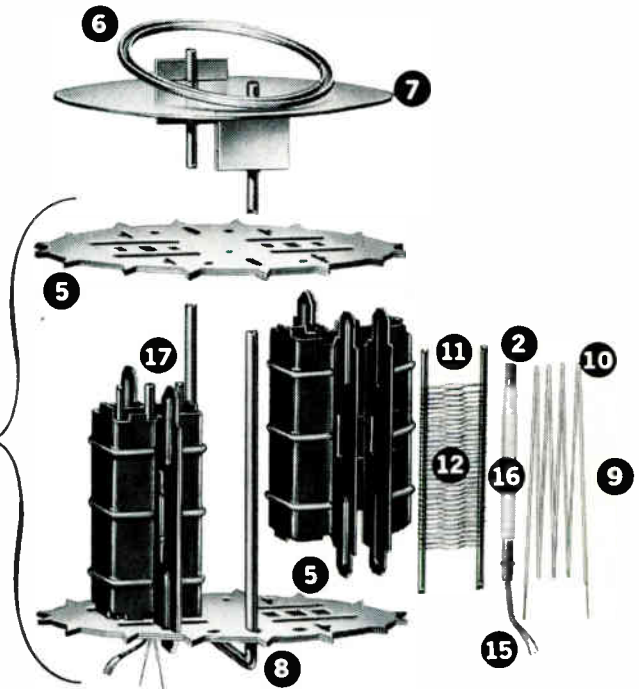

G-E Five-Stars are not tubes selected from standard receiving types. Their high reliability is a result of these special design features, special manufacturing processes, special tests, and stabilizing periods which may even exceed 200 hours of full-voltage operation. Order G-E Five-Star tubes from your General Electric tube distributor. He has them in stock. General Electric Company, Distributor Sales, Room 7150A, Owensboro, Kentucky.

Progress Is Our Most Important Product



WHEN QUALITY
IS A MUST
Stromberg-Carlson®
TELEPHONE-TYPE
COMPONENTS

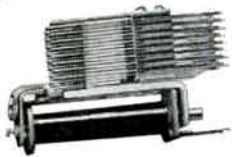

RELAYS: Wide range, for electro-mechanical switching. Send for Bulletin T-5000R2.



KEYS: Cam-type and push-button. Send for Bulletin T-5002R.

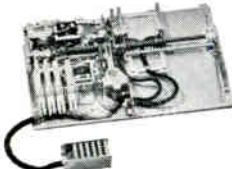

STEPPING SWITCHES. Fast and dependable. Bulletin T-5001R.



JACKS & PLUGS: For many electrical and electronic uses. Send for Bulletin T-5003.



TELEPHONE HANDSETS: Standard or with switch assemblies. Send for Bulletin T-5005.

For bulletins and more information contact the nearest Sales Branch office: Atlanta—750 Ponce de Leon Place N.E.; Chicago—564 W. Adams Street; Kansas City (Mo.)—2017 Grand Avenue; Rochester—1040 University Avenue; San Francisco—1805 Rollins Road.

**GENERAL DYNAMICS
ELECTRONICS**

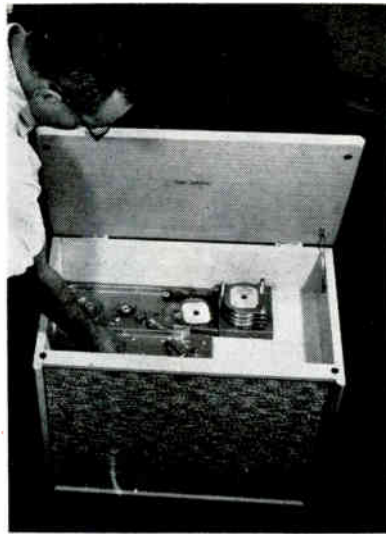

Selected cartridge is shifted toward position where shaft will be pushed up through hub

vide maximum protection to the recorded material. The leader on the quarter-inch magnetic tape is tapered from 0.25 to 0.34 inch. A bead is molded on the inner edge of each flange of the 3.75-inch diameter cartridge. The wide mylar end leader is held securely in place by the bead, sealing the inside to protect the tape from dust. The magnetic tape passes through the flanges with ample clearance. Another leader at the inner hub actuates automatic reverse.

To protect the tape from accidental erasure, a safety groove has been made in the bottom of the cartridge. Unrecorded cartridges are molded with the groove. When the machine is switched to record operation, a mechanical device enters the groove. If the groove is present, normal erasing and recording is permitted. However, recorded cartridges do not have the groove. The mechanical device is blocked and the machine is prevented from erasing or recording. A removable insert is provided so that this protection can be added.

Capacitors With Ceramic Dielectric Absorb Charge

By H. L. ARMSTRONG,
Dept. of Physics,
Queen's University, Kingston, Ontario, Can

APPLYING ceramic capacitors may require the same precautions as paper capacitors when used in circuits in which dielectric absorption can affect operation. This con-

BEEDE-E-25

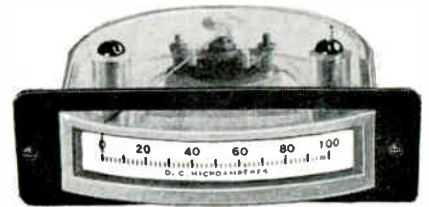

EDGEWISE METER

... can be used in either Horizontal or Vertical position—may be paired for comparative reading

Conserves space where panel area is limited



BEEDE
ELECTRICAL INSTRUMENT CO., INC.
PENACOOK, N. H.

CIRCLE 203 ON READER SERVICE CARD



WHO DROPPED THE BINOCULARS?

With everybody watching each other along the DEW line and the Iron Curtain these days, electronics has replaced binoculars.

What's happening in the giant markets for missile controls, radar and communications equipment?

electronics tells how things are going, keeps you informed of developments as they occur. This is a good time to subscribe or renew your subscription. Just fill in box on Reader Service Card. Easy to use. Postage free.

**FIND WHAT
YOU NEED IN...
electronics**

THE

ABC'S

OF ELECTRONIC PACKAGING



... using Building Block Techniques

Designed by and for engineers, Alden Plug-In Unit Construction is the only complete, standard packaging system available to the electronics industry. Here's how simple it is to solve your mounting and packaging problems . . .

A

MOVE FROM SCHEMATIC TO COMPLETED CIRCUITRY IN HALF THE TIME!

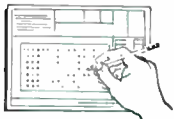

Lay out your circuitry on Alden full-scale planning sheets.

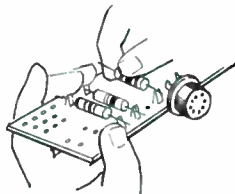

Snap component leads into ratchet jaws of Alden terminals.

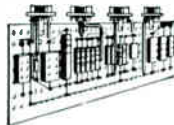

Make neat, component sub-assemblies organized into unit planes of circuitry.

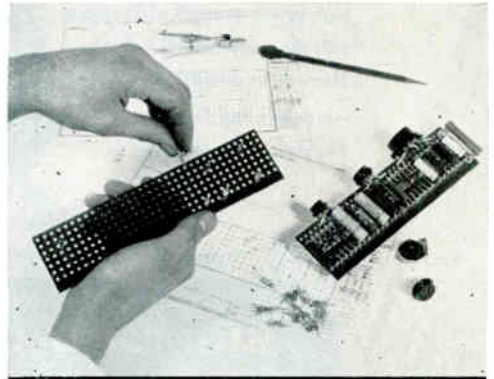

B

ORGANIZE YOUR CIRCUITRY BY FUNCTION FOR PLUG-IN FLEXIBILITY!

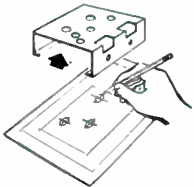

Indicate hole layout and sizes on full-scale planning sheets — complete chassis delivered to your specs.

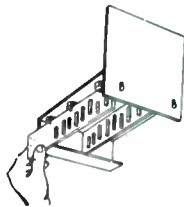

Snap-in circuit cards in vertical planes for a neat, accessible assembly.

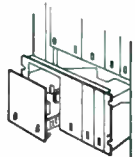

Sub-divide into modular, plug-in functions for true building block design.

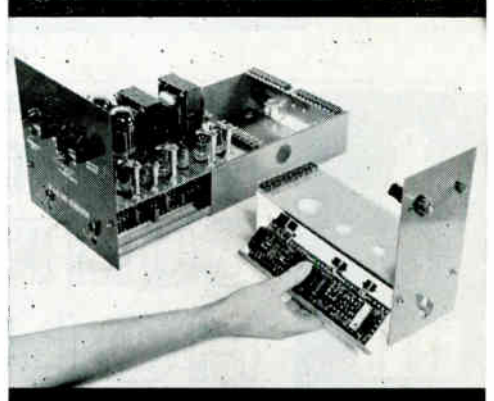

C

"DESIGN-IN" MAINTAINABILITY FOR THE REAL PAY-OFF!

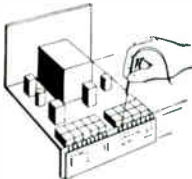

Provide an accessible point of check for all in/out leads with unmistakable graphic identification.

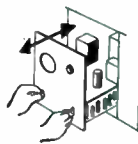

Get quick replacement/accessibility of plug-in chassis by simple half-turn of handle.

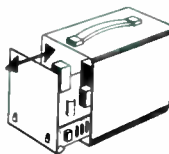

Modular chassis interchangeable with instrument case for dual function or as transport case for replacement chassis.



For FREE 250-page Alden Handbook, write on your company letterhead.

As the techniques of Alden Plug-In Unit Construction become more standardized throughout the world, those already designing to these standards will be setting the trends for equipment design in the rest of the industry.

You can get started now with any of the twelve Alden "Get-Started" KITS, ranging from \$11.25 to \$395.00. You can then evaluate — quickly—all or part of the Alden system in your particular application.



ALDEN

PRODUCTS COMPANY
7127 N. Main St., Brockton, Mass.

Electroplated WIRES

By our continuous process of electroplating wire, several metals may be plated one over the other, or two metals may be deposited simultaneously as an alloy... An interesting application is the Gold plating of Tungsten wire. This combines the extremely high tensile strength of Tungsten with the solderability of Gold. Many other combinations —such as using Tin plate or Platinum—are possible.

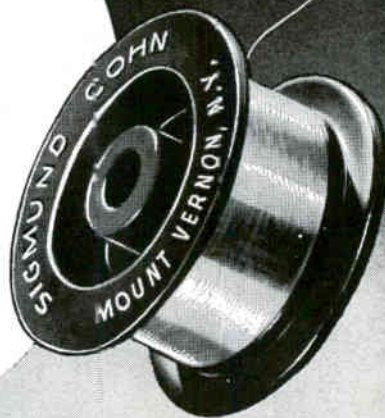

Write for Latest Brochure

SIGMUND COHN MFG. CO., INC.
121 SOUTH COLUMBUS AVENUE, MOUNT VERNON, N.Y.



CIRCLE 205 ON READER SERVICE CARD

MASTERITE COMPONENT HOLDERS

FOR YOUR MOST EXACTING REQUIREMENTS

Shock-resistant, vibration-free holding of transistors, diodes, capacitors, resistors, tube shields, etc. is assured with Masterite Component Holders. Highest precision quality in a wide range of types, sizes, metals, platings, coatings and coding. Also designed to your specs. Used by many leading electronics firms.

Immediate shipment from stock.



NEW 64 page catalog

Circle number shown below on reader service card to receive your copy.

MASTERITE INDUSTRIES

835 W. Olive Street, Inglewood, Calif. OR 8-2575
DIVISION OF HOUSTON FEARLESS CORPORATION



clusion resulted from experiments with dielectric absorption similar to those previously reported.^{1, 2}

Ceramic capacitors, which have become quite popular in recent years, offer small size and reasonable cost. The tests indicated no reason for not making use of these advantages in the many applications not affected by dielectric absorption, such as filtering, bypassing or coupling. In circuits in which absorption can affect operation, however, ceramic dielectric behaved similarly to paper.

Dielectric absorption can be observed by applying a voltage across a capacitor for a few seconds and then rapidly discharging the capacitor. After the capacitor circuit has been left open for a period of time, it is found that a charge reappears amounting to a small percentage of the total charge that had been applied to the capacitor at the original voltage. If the capacitor circuit had been completed through a galvanometer, current would have been observed for some seconds.

The small charge observed is said to have been absorbed by the dielectric and slowly set free as the capacitor circuit is left open after rapid discharge. Similarly current observed after discharge represents absorbed charge.

In the previous experiments, absorption, which depends on the dielectric, had been as much as 10 percent of the total charge in paper dielectric capacitors. However, most commonly used dielectric absorb much less charge.

The disk-shaped dielectric capacitors used in the present experiments ranged in capacitance from 0.05 to 1 μ f. Rated voltages ranged upwards from 3 volts.

The amount of charge absorbed ranged from 3 to 10 percent of the total charge at the voltage applied for different units and different times. The percentage of charge absorbed did not depend heavily on the level of the applied voltage. However, the amount of charge absorbed increased with time allowed for absorption and, if measured ballistically, with time allowed for it to be set free.

REFERENCES

- (1) Kurt Greene, Measuring Dielectric Absorption, *ELECTRONICS*, p 90, March 18, 1960.
- (2) H. L. Armstrong, Dielectric Absorption in Capacitors, *ELECTRONICS*, p 78, June 10, 1960.

Shallcross

precision
circuit
news

RESISTANCE NETWORKS

... the inside story
on quality

In reading ads for wirewound resistance networks, you sometimes find the superiority of one technical characteristic emphasized to a misleading degree. Desired accuracy, temperature coefficient, stability, and voltage division obtained in one type of network may be impossible to achieve in another.

Essentially, network quality is determined by the quality of its individual resistors. Beyond this, network performance improves or deteriorates depending on packaging and mounting techniques, AC layout and trimming methods, accuracy of measuring instruments, the manufacturer's production standards and his knowledge of the latest developments in network theory.

Shallcross offers a unique background of experience, reliability data, manufacturing and testing skills to minimize what few error factors remain in Shallcross precision wirewound resistors when the networks are sealed. For a sample of this ability, submit your next network requirement for evaluation by Shallcross engineers. Meanwhile, send for Bulletin A-2 for a practical discussion of proper network design.

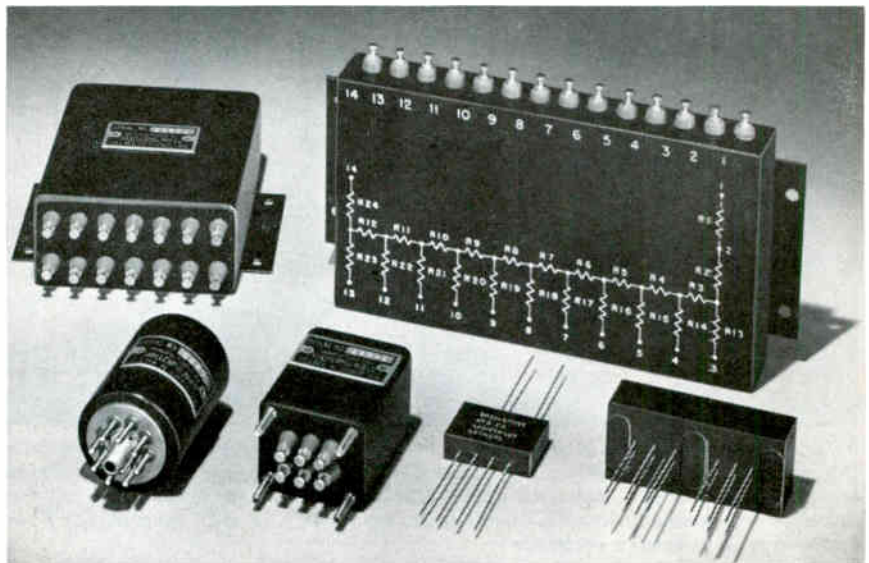

Temperature Stabilized COMPUTER NETWORKS

High reliability Shallcross P-Type precision wirewound resistors help these computer networks maintain close AC ratios over wide temperature ranges. To maintain these tolerances, Shallcross has refined resistor manufacturing techniques to provide TC tracking within ± 1 ppm in many cases. Individual resistor reliability is enhanced by stability "exercises" and by new tension relieving devices within each resistor. Beyond this, ex-

tremely accurate AC and DC measuring instruments help in final network design, trimming, packaging, and proof-of-performance testing.

From an extensive background of network engineering Shallcross offers analog to digital and digital to analog converters, voltage dividers, summing and integrator networks, and others to virtually any configuration.

WHY PACKAGE RESISTANCE NETWORKS?

Packaging does far more for resistor networks than provide convenient mounting and environmental protection. Some can also increase power dissipation, provide electrical shielding and increase network stability over extended temperature ranges. Principally however, enclosed networks maintain electrical performance by preventing "field introduced" errors brought about by improper mounting or damage to critical

AC layouts through improper resistor replacement during maintenance. Where unusually critical voltage division tolerances must be maintained, the design engineer should make provision for a packaged network in his application.

Shallcross regularly supplies networks in many hermetically sealed, encapsulated, and plug-in designs. For a discussion of when to use which style, write for Bulletin A-2.

Shallcross Manufacturing Co. Selma, North Carolina

Precision wirewound resistors, Switches, Instruments, Delay lines, Resistance networks, Audio attenuators.

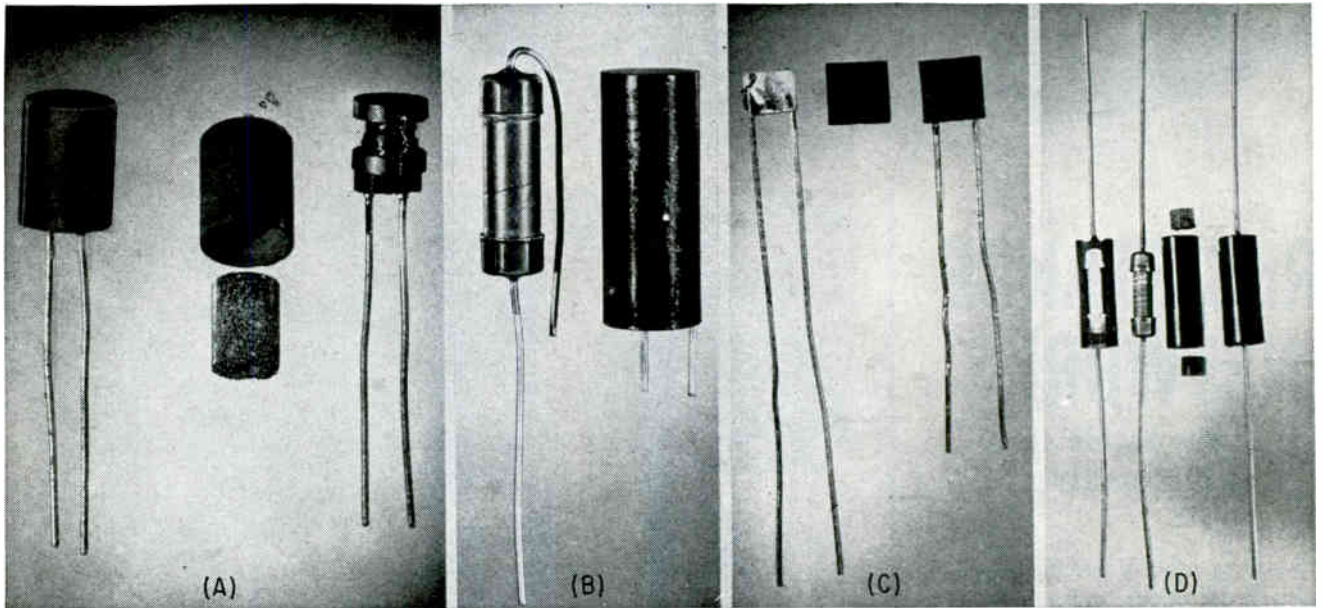

FIG. 1—Preformed shells, pellets and headers are available in a wide variety of standard shapes and sizes for packaging semiconductors, resistors, capacitors, and circuit modules. Inductor design (A) is pushed on top of melted pellet and completely sealed in epoxy. An epoxy shell (B) makes one resistor serve two purposes. Protection and support are provided by encapsulating the ceramic capacitor (C) in an epoxy shell. Tubular shell (D) provides the necessary air space around precision resistors

Epoxy Packages for Encapsulating Components

By SAMUEL RINGEL,

Epoxy Products Division,
Joseph Waldman & Sons, Irvington,
New Jersey

A KNOWLEDGE of what can be done with epoxy shells, pellets, liquid fillers, and pin-mounted headers for encasing components will help the designer evaluate the proper choice: should he specify preformed cases for his design, or should special casting and molding equipment be set up in his own plant?

When great quantities of components are involved, tooling for custom casting is not a major cost factor, and a custom shell design may be considered. But in many cases, cost of machining and storing large numbers of molds is often prohibitive. Encapsulating 1,000 components a day requires at least 500 molds, even with a fast four-hour cure. And components could be designed within standard epoxy shells, obtained from suppliers.

Unlike encapsulation by casting, epoxy cases do not require cleaning, either before or after encapsulation. They provide a smooth, at-

tractive component package which has excellent chemical and moisture resistance and can withstand continuous operating temperatures up to 400 F.

Cast parts often have a rough surface which may have to be machine polished to improve their appearance. Air bubbles, trapped during encapsulation produce air spaces which can lower electrical and shock resistance, and moisture

can creep in. A component cast in liquid epoxy must be carefully aligned in the mold. Any tilting will result in a thin epoxy coating which can be pierced by an air bubble. Practical problems involved in aligning components in the mold make casting a difficult operation in production quantities.

Some manufacturers encapsulate components and modules by direct transfer molding. For most elec-

CHARACTERISTICS OF MATERIALS USED IN PREFORMED SHELLS

Property and Units	Epoxy Mineral-Filled	Phenolic MFE	Diallyl Phtbalate MOG	Alkyd MAG
Compressive strength, psi.....	22,800	15,000	15,000	15,000
Dielect const, at 1 kv.....	5.33	6	5	6.2
Dielect strength, volts/mil.....	103	325	325	150
Dielect breakdown, kv.....	59+	15	35	40
Flexural strength face, psi.....	10,900	8,000	6,000	7,500
Tensile strength, psi.....	5,600	4,200	2,500	3,500
Water absorp, percent.....	0.035	0.1	0.5	0.5
Vol resist, megohms.....	2,200	2	1,000	
Surface resist, megohms.....	120,000	5	1,000	



Good base for a decade of dependability

All Sangamo Type TR High Reliability Electrolytic Capacitors have this highly effective end seal. It gives them an unusually long operating life... gives you dry electrolytics that you can depend on for at least ten years when operated within their ratings.

Available in ratings from 3 to 450 D. C., and designed to operate in a temperature range from -20°C to $+85^{\circ}\text{C}$, Sangamo Type TR capacitors are perfect for low-frequency filter, by-pass and coupling applications in communication systems, electronic industrial controls, laboratory test instruments, computers, and similar equipment. For more complete information write for Engineering Bulletin 2227.



ELECTRONIC COMPONENTS

SANGAMO ELECTRIC COMPANY

SPRINGFIELD, ILLINOIS
CIRCLE 71 ON READER SERVICE CARD



SHOWN 1/2 SIZE

HIGH-ACCURACY, WINDING COMPENSATED RESOLVERS

Kearfott precision resolvers are high accuracy units particularly applicable to analog computers and automatic control systems. The resolvers are capable of holding the angular arc error to accuracies within 20 seconds from electrical zero. A compensator winding provides feedback voltage for a resolver isolation amplifier. Unity gain from the amplifier input to resolver rotor output is made possible by adjustment of a resistor. Since compensator and rotor winding voltages vary with temperature and frequency in a parallel manner, the feedback loop is automatically adjusted to compensate for these variations.

TYPICAL PERFORMANCE DATA

Unit No.	R980-41D	T980-003	425506
Size	11	15	25
Accuracy (Max Error from E.2.)	5 minutes	5 minutes	20 seconds
Function Error	.1% max	.05% max	.01% max
Excitation (400 cps)	60 volts	60 volts	115 volts
Transformation Ratio (Rotor to Stator)	980±.020	980±.010	980±2%
Phase Shift	7.5 lead	8.5 lead	0°±1 min

Write for complete data



KEARFOTT DIVISION
GENERAL PRECISION, INC.

Little Falls, New Jersey

tronic applications, however, the high pressures and temperatures required for transfer molding may damage the components. With present techniques, it is difficult to transfer-mold fragile transistors, diodes or modules with solder connections. When new materials and better techniques are developed, direct-transfer molding should reduce encapsulating costs on large quantity items, since it will eliminate one step in encapsulation.

An epoxy shell, used with an epoxy potting compound, effects a strong chemical bond, in contrast to the mechanical bond formed with other conventional cases and potting materials. Epoxy and diallyl phthalate shells cost about the same. Shells made from alkyds and phenolics cost about two-thirds to three-quarters that of equivalent shells made of epoxy or diallyl phthalate. A comparison, in accordance with MIL-M-14E, of electrical and mechanical characteristics, of several shell materials is given the accompanying table.

The most convenient technique for filling the shell is with preformed epoxy pellets. A powdered mixture of epoxy resin and latent hardener are preformed into a pellet of exactly the right melted volume for the particular encapsulating application. The pellet is placed in the shell with the component, encapsulated and heated, and there is no messy runover.

By varying the resin-hardener formulation, pellets can be made with a variety of characteristics. With a silica filler, the encapsulant can be made resistant to 3×10^{15} ohm-cm; and with a silver filler, the pellet can be conductive to 0.001 ohm-cm. Thermal conductivity and thermal expansion can be varied over wide ranges by varying pellet formulation. Proper formulation can reduce the temperature rise per watt of an encapsulated component to one third the rise in air.

Pellets overcome the two most serious drawbacks of epoxy: they eliminate dermatitis, and each pellet contains the exact formulation for its application. Because of their solid form, pellets are well suited for automatic feeding on production lines.

Liquid epoxy can be used to fill the shell, but requires careful handling, and special mixing and meter-

ing equipment. For larger shells, however, liquid epoxy is more economical and has less tendency to produce bubbles from air entrapment. Headers with permanently mounted pins are available, or the actual component leads are utilized. A similar encapsulation for a single component is shown in Fig. 1A.

Environmental protection and insulation resistance were improved substantially by packaging the inductor, Fig. 1A, in an epoxy shell. The pellet is inserted, melted and the inductor is inserted on top of the melted pellet, completely sealing the unit.

A considerable saving in costs plus added protection for the unit were obtained by converting the axial lead resistor, Fig. 1B, to a printed circuit board resistor. Only one production line is needed to produce both configurations. For the printed circuit board configuration, the resistor is put through an extra step of encapsulation, but at a cost much less than a complete separate production line. Liquid epoxy is used in this case because of the large space to be filled.

The ceramic capacitor in Fig. 1C would be very difficult to mold because of its fragility. Here liquid is preferred because no heat is required for curing.

In precision resistors, nothing should come in contact with the carbon film or wirewound portions. An air space is essential, because at elevated temperatures a variation in coefficient of expansion will cause a resistance change. Fig. 1D shows an epoxy shell technique for protecting the resistor and yet leaving the air space. The air space between resistor and shell is seen in the cutaway view.

The fragile silicon diode shown in Fig. 2 needs both environmental protection and structural strength. The low moisture permeability makes epoxy ideal for this application. The pellet and diode are put inside the shell and the melted pellet completely encapsulates the diode.

The growing and widespread use of epoxy shells for packaging components is accounted for by circuit designers who seek increased protection for higher reliability, at low cost. Many military units are now going to this type of packaging for modules and components.

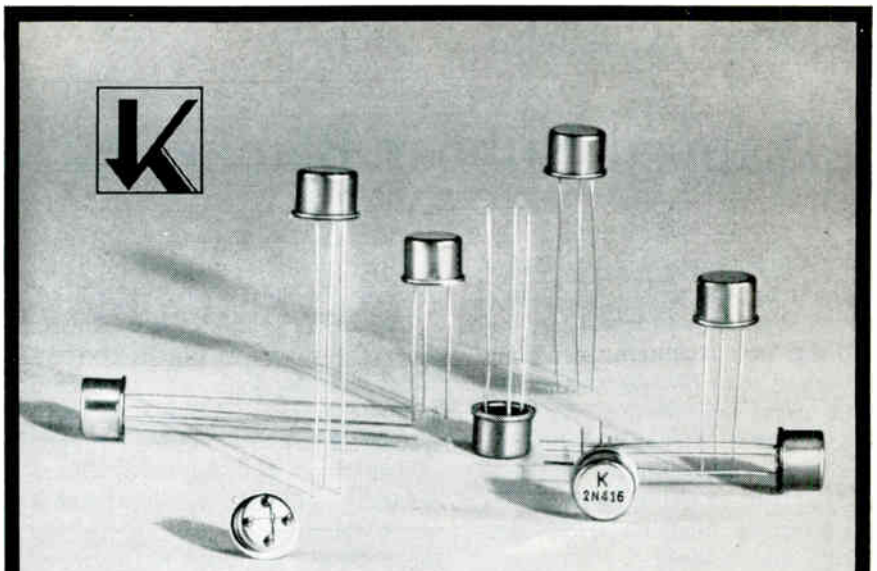

KEARFOTT TRANSISTORS PROVIDE HIGH RELIABILITY- CONSISTENT PERFORMANCE

HIGHEST POWER DISSIPATION OF ALL AVAILABLE GERMANIUM-ALLOY JUNCTION TRANSISTORS

Kearfott now offers a complete off-the-shelf series of TO-5 germanium-alloy PNP junction transistors. Their unexcelled electrical and mechanical reliability, precise electrical characteristics, and virtual insensitivity to temperature changes derive from Kearfott's intensive materials-and-methods control, plus complete, 100% functional testing. These factors add up to the consistent reliability, uniformity, extended service life, and repeatability of product performance which typify Kearfott semiconductors.

DESIGNED AND PRODUCED BY KEARFOTT SEMICONDUCTOR CORP. WEST NEWTON, MASS.

CHARACTERISTICS

Designed to meet or exceed requirements of NAVORD OS9669B (R-212 Series) and MIL-S-19500B

All transistors tabulated below are available with maximum collector power dissipation of 200 mw.

2N123	2N404	2N520A	2N653
2N315	2N404A	2N521	2N658
2N315A	2N413	2N521A	2N659
2N316	2N414	2N522	2N660
2N316A	2N414A	2N522A	2N661
2N317	2N416	2N523	2N662
2N317A	2N425	2N523A	2N1017
2N394	2N426	2N578	2N1303
2N395	2N427	2N579	2N1305
2N396	2N428	2N580	2N1307
2N396A	2N519	2N581	2N1309
2N397	2N520	2N582	

Write for complete data



KEARFOTT DIVISION
GENERAL PRECISION, INC.

Little Falls, New Jersey

Trapped Rubber Blanks Parts at Less Cost

SHEET METAL PARTS can be blanked by the trapped rubber or Guerin process at savings in lead time, tool build and manufacturing run time. Savings of some 50 percent for electronic parts are reported by Convair Division, General Dynamics Corp., San Diego, Calif. The firm also reports effective savings for such parts as small electrical components and holders.

Before using the process in production, Convair made a survey of current industry applications of the process and conducted a series of evaluation tests. The survey found only a limited number of

blanking applications, although the process is widely used for forming.

The basic setup for the Guerin process is shown in Fig. 1. Conventional crank, hydraulic or drop hammer presses capable of generating 2,500 psi in the trapped rubber head can be used. Shore hardness of the rubber should range from 45 to 90. An overlay sheet should be used to insure a smooth contact surface. The rubber will adapt itself to a die of any form.

Some sample dies are shown in the photos. Flat dies were generally made from "Speed Treat," a flame-

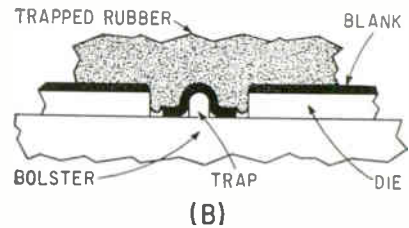
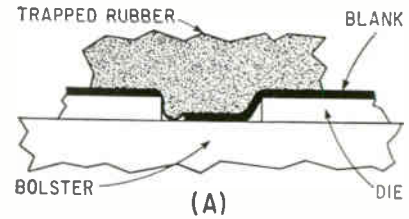
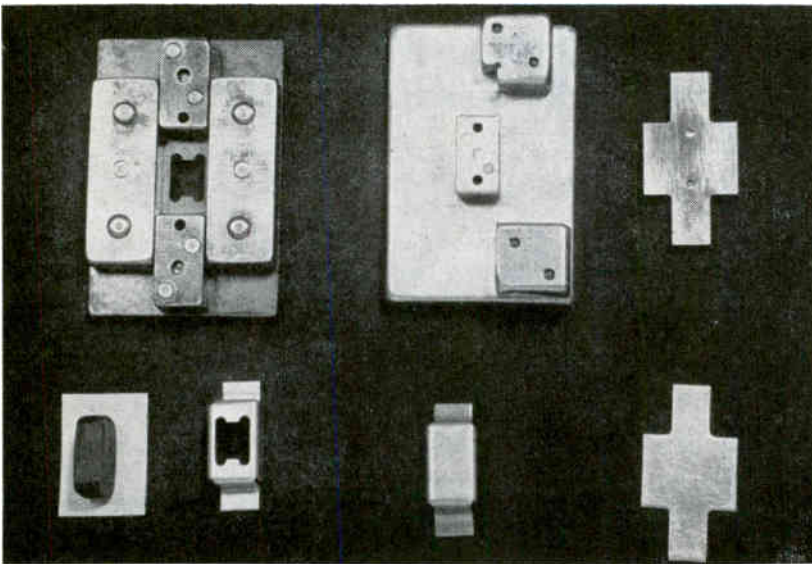

FIG. 2—Partial blanking of openings (A) is avoided by trap (B)



Manufacturing sequence for part about one inch long, made from 0.032-inch, 6061-T4 aluminum. At top (right to left) are blanking, forming and perforating dies. At bottom is the part as blanked from sheet, formed and perforated. The small rubber pad at left is used in perforating

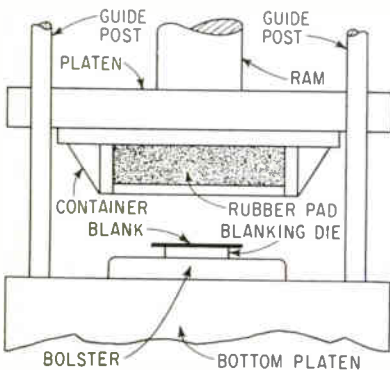
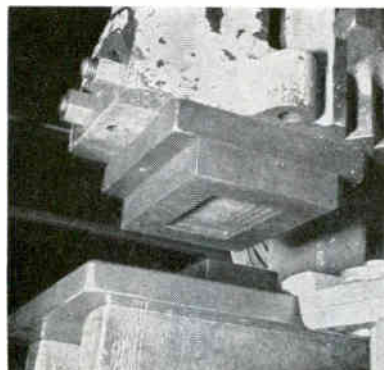

FIG. 1—Basic setup for process



Small head for crank press

hardening material. It is easily machined in the annealed condition and holds an edge well. If the die carries punches, rubber strippers must be at least 70 durometer. Sharp dies avoid deburring.

Recommended blanking material condition and thicknesses are: 2024 aluminum, 0.001-0.063 inch in 0 condition and 0.001-0.040 inch in T3; 6061 aluminum, 0.001-0.063 inch in 0 condition and 0.001-0.040 inch in T4 and T6; 7075 aluminum, 0.001-0.063 inch in 0 condition and 0.001-0.016 in T6; annealed stainless steel, 0.001-0.025 inch; commercially pure titanium, 0.001-0.020 inch, and annealed brass and copper, 0.001-0.025 inch. The smallest practical part size at present is approximately 0.5 square inch.

Minimum recommended width of notches from the edge of the part, for aluminum blanked by impact hammer, ranges from 0.25 inch for 0.20-inch sheet, to 0.625 for 0.060-inch sheet. Minimum hole diameters range from 0.25 inch to one inch. Holes should be 0.375 times diameter from the part edge. Blank overhangs range from 0.75 inch to 1.75 inch, for aluminum thicknesses ranging from 0.016-0.060 inch. The other metals require an overhang of 1.75 inch. Minimum die height should be nine times the blank thickness. External corners

NEW DIMENSIONS IN RELIABILITY...



Over a billion solderless wrapped connections without a reported failure

Gardner-Denver has added new dimensions to the reliability of electrical connections with a complete line of equipment for making solderless wrapped connections.

Proved superior by leading manufacturers of communication and computing equipment, these connections are easy and fast to make—take only three seconds. They are lastingly secure, conquer vibration failure and corrosion. Further proof of superiority: over a billion connections without a reported failure.

Included in the Gardner-Denver line of equipment are both air- and electric-powered "Wire-Wrap"® tools, and custom-designed, automatic "Wire-Wrap" machines for wiring modular boards. For details, contact your Gardner-Denver air tool specialist or write for bulletins.

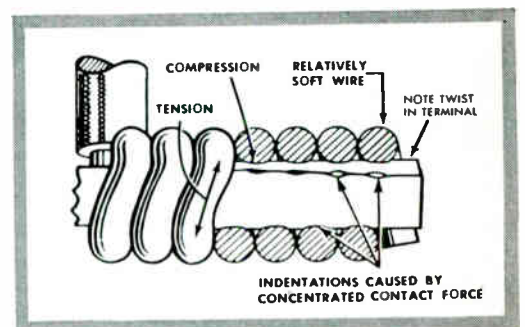

Sectional drawing of solderless wrapped connection. Indentations indicate clean, freshly exposed metal for permanent, air-tight, gas-tight connections which permit solid-state diffusion.



EQUIPMENT TODAY FOR THE CHALLENGE OF TOMORROW **GARDNER - DENVER**

Gardner-Denver Company, Quincy, Illinois—Offices in principal U.S., Canadian and Mexican cities
In Canada: Gardner-Denver Company (Canada), Ltd., 14 Curity Ave., Toronto 16, Ontario
International: Gardner-Denver International Division, 233 Broadway, New York 7, N.Y.
International Offices: Buenos Aires, Argentina; Artarmon, N.S.W. Australia; Brussels, Belgium; Rio de Janeiro, Brazil;
Santiago, Chile; Barranquilla, Colombia; Lima, Peru; Ndola, N. Rhodesia; Salisbury, S. Rhodesia; Johannesburg, Transvaal

July 7, 1961

CIRCLE 75 ON READER SERVICE CARD 75

ROHN

SELF SUPPORTING COMMUNICATION TOWER

NOW available up to 170 ft.!

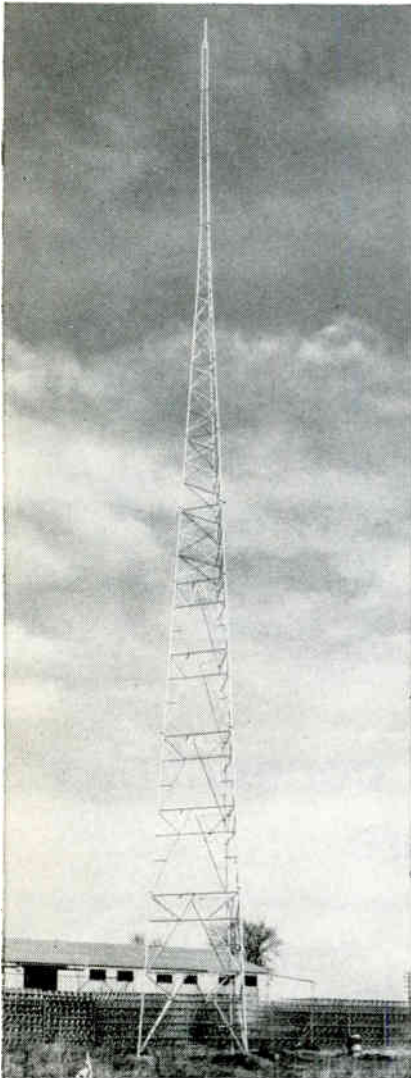

- ★ Fully self-supporting in heights up to 170 ft.
- ★ Rated a true HEAVY-DUTY steel tower, suitable for communication purposes, such as radio, telephone, broadcasting, etc.
- ★ Complete hot-dipped galvanizing after fabrication.
- ★ Low in cost—does your job with BIG savings—yet has excellent construction and unexcelled design! Easily shipped and quickly installed.

FREE details gladly sent on request.
Representatives coast-to-coast.

ROHN Manufacturing Co.

P.O. Box 2000
Peoria, Illinois

"Pioneer Manufacturers of
Towers of All Kinds"

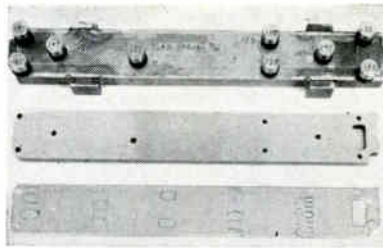

Pierce die (top) uses blanking tool (center) as base. Pierced blank is below

can be square, but inside corners should be radiused.

One of the problems encountered

was partial blanking of openings, caused by one side of the opening being sheared before the other (Fig. 2A). A trap will prevent loss of shearing pressure, allowing the second side to be sheared after the first side (Fig. 2B). Simultaneous blanking and forming operations are limited to combinations which employ shallow beads or embossing. When blanking tools are nested for simultaneous operations, die separations should be 0.375 inch for metal to 0.025 inch and 0.75 inch for metal to 0.063 inch.

Vaporizer Prepares Tube Pump Oil

ROTARY VAPORIZER distills oil for high-vacuum diffusion pumps used for the production of tv and special tubes at Tesla's Rosnov Division, Czechoslovakia. According to a report given McGraw-Hill World News, Vienna, the vaporizer produces high-quality oil at a fraction of the cost of the dropping film method.

Oil is fed to the inside surface of a heated, slightly conical vaporizer plate rotating in a vacuum chamber. The plate is electrically heated to a temperature corresponding to the vaporization temperature of the oil fraction being distilled. The oil is heated for only a few seconds, since the plate rotation spreads it to a thin film. The plate is 350 mm in diameter and rotates at 1,000 to 5,000 rpm, depending on oil viscosity.

The vapor passes to a cooled condenser with a polished, chrome-plated surface, a few centimeters from the vaporizer. The distillate flows down and through the outlet to a collector tank. Unvaporized residue is collected from the spinning vaporizer by a spoon and is returned to a tank.

The supply tank holds 20 liters in two sections. Initially, oil is loaded into the bottom and outgassed by drawing a vacuum. It is further outgassed by flowing it over the vaporizer, at a moderate temperature. The outgassed oil is returned to the tank via the collector spoon and residue outlet. During vaporization, the residue goes back to the upper part of the tank, where it is stored until all

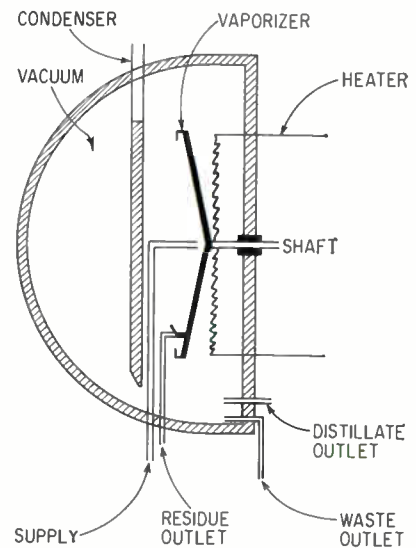

Setup within vacuum distillation chamber

of a fraction is distilled. Then the oil is released into the lower tank and the process repeated for the next fraction.

Welding Positioners Help Test Antennas

LARGE RADAR antennas can be maneuvered for testing by mounting them on heavy duty welding positioners, according to Ransome Company, Scotch Plains, N. J., a positioner manufacturer. The equipment is normally used to tilt and rotate large weldments. A unit is being used at Air Force Cambridge Research Center for load and wind tests on antennas weighing up to 10 tons, the firm reports.

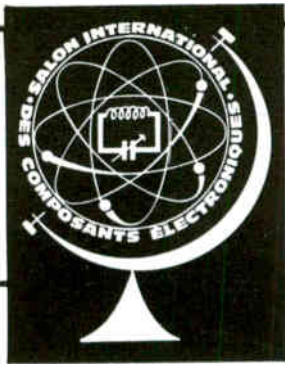

IN PARIS FORTE DE VERSAILLES
 FROM 14th TO 20th FEBRUARY 1962

5th INTERNATIONAL EXHIBITION OF ELECTRONIC COMPONENTS

The greatest world meeting in the field of electronics

FEDERATION FRANCAISE DES INDUSTRIES ELECTRONIQUES

23, rue de Lubeck, Paris 16, Phone: PAS 01.16

CIRCLE 206 ON READER SERVICE CARD

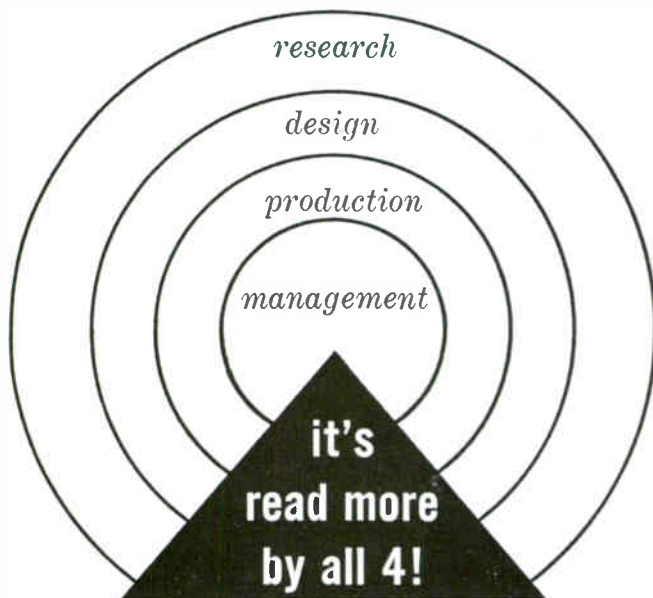

Get the technical facts in **electronics**, the magazine that features the latest engineering developments and technically interprets markets, business statistics, trends. Special issues on Electronic Markets and other reports you'll want to file and keep. Mail the reader service card (postpaid) and start your own subscription to **electronics**, the magazine that helps you to know and therefore to grow! Rates: three years for \$12, one year for \$6; Canadian, one year for \$10; foreign, one year for \$20. Annual **electronics** BUYERS' GUIDE (single issue price \$3) included with every subscription.

subscribe today to **electronics**

July 7, 1961

INSPECTION PROBLEMS?

This booklet is for you!



This comprehensive, elaborately illustrated booklet provides practical information on the use of the famous A. C. M. I. Borescope in various industries, for the inspection of interior areas or surfaces not otherwise visible—together with full data on the types of Borescope available, and on their care and maintenance. Have you received your copy?

Free on request

Fill in and mail today

To American Cystoscope Makers, Inc.

8 PELHAM PARKWAY PELHAM MANOR, N. Y.

Gentlemen: Please send me without obligation a copy of your booklet on Borescopes.

Name _____

Firm _____

Address _____

City _____ State _____

CIRCLE 77 ON READER SERVICE CARD 77

New On The Market

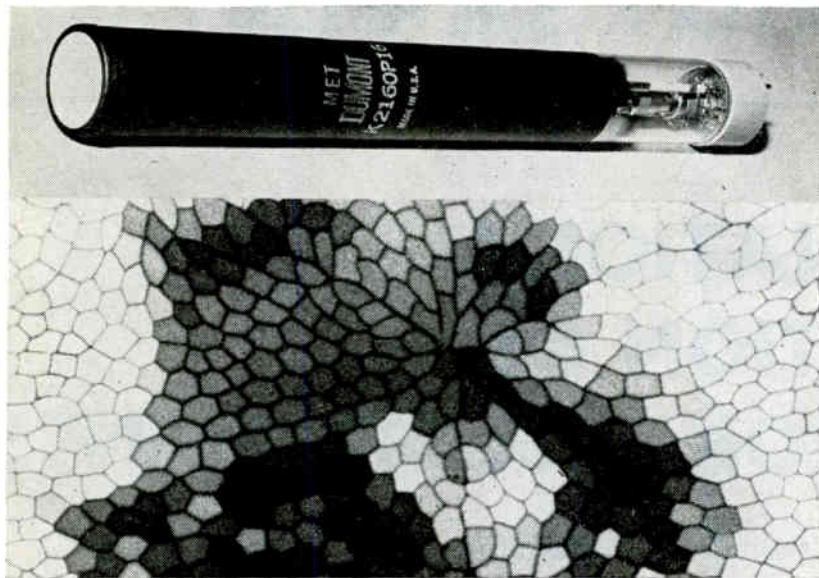

Fiber Optic CRT

10-MICRON GLASS RODS

ALL PARALLAX is eliminated in crt with glass fiber face plate. Normal light transmission efficiency of about 6.3 percent using a lens system is increased to 85 to 90 percent in crt by Allen B. DuMont Labs., 750 Bloomfield Ave., Clifton, N. J. Tubes are 1 $\frac{7}{8}$ inch diameter, but tubes to 5 inches in diameter can be provided and larger sizes can be developed.

Type K2160 has magnetic focus, magnetic deflection, a 1 mil line width. Other tubes are K2159 with combined magnetic and electrostatic deflection and electrostatic focus, and K2155 with magnetic de-

flection and low voltage electrostatic focus. Optics fibers (shown in microphotograph) are 10-microns, and more than six million individual glass fibers carry light from the phosphor screen to the tube surface. Fiber optics crt's are designed for flying spot scanning, direct photographic printing, coupling to other fiber optical systems. Because of the efficiency of light transfer, the tubes can utilize small beam currents and transistor drive circuits. Sample tubes are in \$900 range with delivery in four to eight weeks.

CIRCLE 301 ON READER SERVICE CARD

Transistorized Relay

MICROWATT INPUT

TRANSISTORIZED relay operates at input of 7 microamp at 50 mv.

Four pole, double throw relays are rated at 5 amps inductive (20 amp non-inductive); 120 v a-c; -50 to 80 C; and are supplied enclosed and potted (MIL-R-6106 Class "O").

Single unit price is \$115, appreciably lower in quantity. Manufacturer is Med-Tronics Manufacturing Co., 2019 Westchester Ave., New York 62, N. Y.

CIRCLE 302 ON READER SERVICE CARD

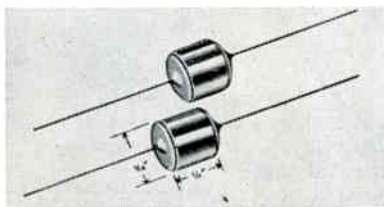

Ceramic I-F Transformer

SMALL SIZE, SOLID STATE

SOLID-STATE ceramic i-f transformer is replacement for conventional i-f transformers in transistorized circuits.

Type A10019C has preset tuning for life, reversible operation re-

gardless of the direction of flow, indefinite life expectancy, less than one-third the volume of the smallest conventional i-f transformer, shock and vibration resistance, and an overall gain equal to or better than many conventional transformers.

The transformer has an input impedance of 10,000 ohms, output impedance of 1,000 ohms, center frequency of 455 ± 1 Kc, and 1 db power loss at rated frequency. It is also available custom designed.

Price is comparable to conventional units, delivery is from stock, from U. S. Sonics Corp., 63 Rogers St., Cambridge, Mass.

CIRCLE 303 ON READER SERVICE CARD

Germanium Transistors

AUDIO, A-M AND F-M USES

TRANSISTORS designed especially for consumer products include GAM-1, with high gain in the broadcast band; GAM-2, a high-frequency series for f-m use, and the economy



power series for audio power applications.

Germanium Alloy-Mesa—GAM-1—units have h_{fe} of 32-40 db at 455 Kc and output impedance greater than 1 megohm. The d-c beta of all units is greater than 25 and the media value is approximately 40.

GAM-2 units are designed for f-m applications, have a high-frequency response (f_T) of 120 Mc. GAM-2 units have a fourth lead connected to the case to provide shielding.

The Economy Power transistors are designed for audio use. Specified parameters include dissipation of 25 watts and beta ranges from 30 to 150 at either 0.5 or 1 amp collector currents. Manufacturer is Texas Instruments, Inc., 13500 N. Central Expwy, Dallas, Tex.

CIRCLE 304 ON READER SERVICE CARD

Silicon Diodes

GUARANTEED RELIABILITY

SILICON DIODES PS4559 and PS4560 are general purpose diodes having

Highly Reliable

HITACHI "SEMI-CONDUCTORS"

For Industrial Use
Switching Transistors and Diodes

2SA18
2SA41
2SA42
2SA86
2SA208
2SA209
2SA210
2SB66
2SB67
2SB68
2SB81
2SB82
2SC89
2SC90
2SC91

Hitachi semi-conductors provide the basis for the excellent capacity of the Hitachi Electronic Computer HITAC 103.

1N34A
1N35
1N38A
1N56A
1N60
1S77
1S78
1S79
1S84



Back of HITAC 103.



Hitachi, Ltd.

Tokyo Japan

Cable Address: "HITACHY" TOKYO

a guaranteed failure rate less than 0.008 percent per thousand hours. Type PS4725 is a silicon diffused computer fast logic switch having a failure rate less than 0.004 percent per thousand hours. An integral part of the specification of each type is extensive failure definition, AQL and processing data.

The guaranteed reliability diode types are being shipped from stock. In 100 to 999 quantities prices are: PS4720, \$3.60; PS4560, \$3.55, and PS4559, \$3.15; Pacific Semiconductors, Inc., 12955 Chadron Ave., Hawthorne, Calif.

CIRCLE 305 ON READER SERVICE CARD

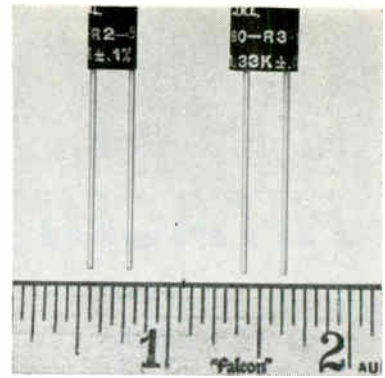

Resistor for Printed Circuits 0.005 PERCENT ACCURACY

TOP HAT encapsulated resistors have fifty ppm accuracy and long-term stability of 0.003 percent per year. The units are available at specified accuracy from 100 ohms to 1 megohm. Style RS26 is 0.28 inch in diameter and style RS36 is 0.4 inch in diameter; both are 0.37 inch long. Lower accuracies are available at lower costs. Manufacturer is Julie Research Labs., Inc., 603 West 130th Street, N. Y. 27, N. Y.

CIRCLE 308 ON READER SERVICE CARD

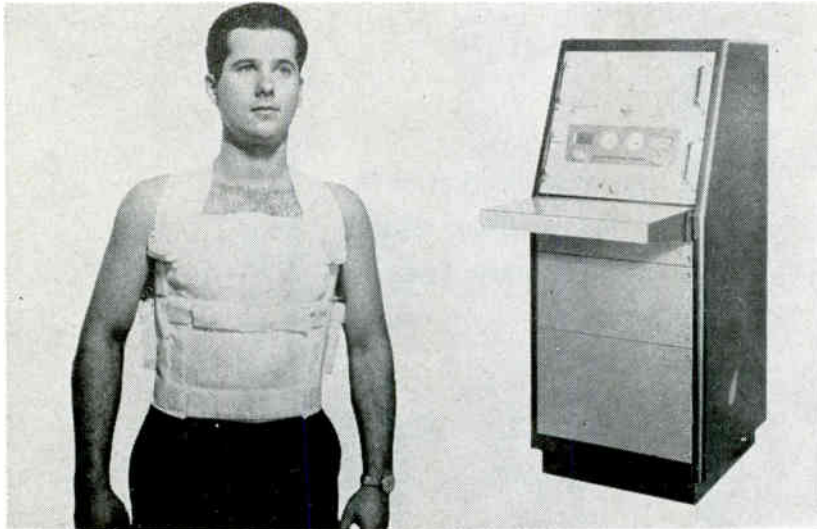

Six-Channel Telemetry BIOLOGICAL SIGNALS

BIOTELEMETRY system provides six channels of data while the test subject is completely unencumbered. Parameters available include electrocardiogram, respiration, temperature, galvanic skin response, electroencephalogram and voice. System is based on actual field use and is an outgrowth of work carried out for the USAF School of Aerospace Medicine. It is engineered for dynamic testing under severe

environmental conditions. Standard range is 200 yards with 10 hours of continuous transmission; it is adaptable to long range and airborne use. Vest unit, complete, weighs less than three pounds. Transmitter operates on IRIG standard frequencies. Model 99 Biotel is available for 90 day delivery, from Spacelabs, Inc., 15521 Lanark St., Van Nuys, Calif.

CIRCLE 306 ON READER SERVICE CARD

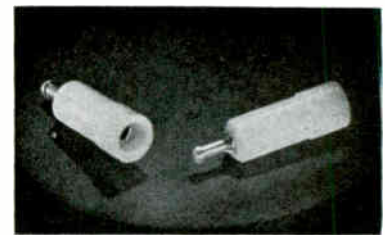

Test Jack LONG LEAKAGE PATH

SEAELECTRO CORP., 610 Fayette Ave., Mamaroneck, N. Y. Type SKT-27 test-point jack provides a leakage path of 0.187 in. or more and is rated at 2,000 v rms at sea level. It accepts a test probe 0.450 in. long by 0.093 in. in diameter. It may be used over a temperature range of -55 C to +200 C. It is quickly and easily mounted on a drilled or punched chassis by means of simple insertion tools available from Seaelectro.

CIRCLE 309 ON READER SERVICE CARD

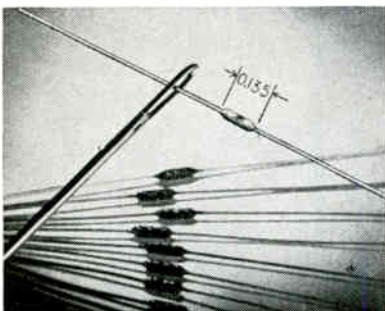

Miniature Resistors 25 TO 110,000 OHMS

RESISTORS ARE 0.135 x 0.05 inch in diameter. Type CE- $\frac{1}{8}$ are rated $\frac{1}{8}$

watt, 250 volts at ambient of 100 C, derate to zero load at 150 C. Range is from 25 to 110,000 ohms at ± 1 or ± 2 percent tolerance. The noble metal film resists oxidation, is impervious to moisture, can be cycled between -55 and 150 C. Temperature coefficients are 50, 100 or—on special order—25 ppm per degree C. Standard values are from stock at \$4 to \$1 each, depending on quantity. Manufacturer is American Components, Inc., 8th Ave. and Henry St., Conshohocken, Pa.

CIRCLE 307 ON READER SERVICE CARD

Pulse Generator ALL SOLID-STATE

EDGERTON, GERMESHAUSEN & GRIER, INC., 160 Brookline Ave., Boston,

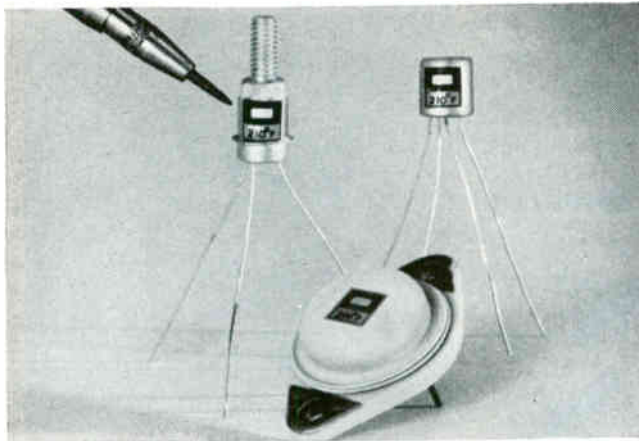

TEMP-PLATE®

DETECTS ELECTRONIC OVERHEATING

Overheating of transistors, diodes, resistors and transformers is detected by Temp-Plate in a positive, direct manner. Simple, easy to use, irreversible, Temp-Plate is the little plastic tab that sticks to the component, turns black when the temperature reaches any desired value between 100° and 1100°F. Impervious to ambient atmosphere and production line handling, Temp-Plate is accurate to ±1%, provides for absolute indication of heat damage. Write now for descriptive literature.

TEMP-PLATE/Pyrodyne, Inc.
11973 San Vicente Blvd.
Los Angeles 49, California



CIRCLE 207 ON READER SERVICE CARD

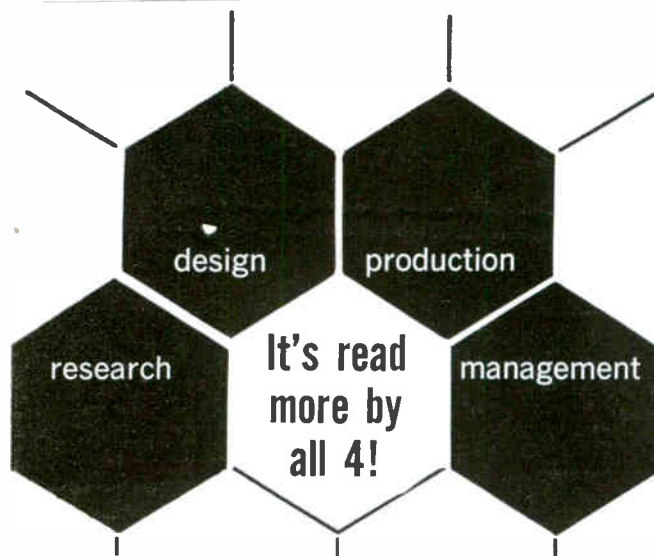

There's more data in **electronics**, the magazine that gives you the latest technical and engineering information every week *plus* business and government trends. Subscribe now. Mail the reader service card (postpaid) to **electronics**, the magazine that helps you to know and to grow! Rates: three years for \$12, one year \$6, Canadian, one year for \$10; foreign, one year for \$20. Annual **electronics** BUYERS' GUIDE (single issue price \$3.00) included with every subscription.

subscribe today to **electronics!**

July 7, 1961

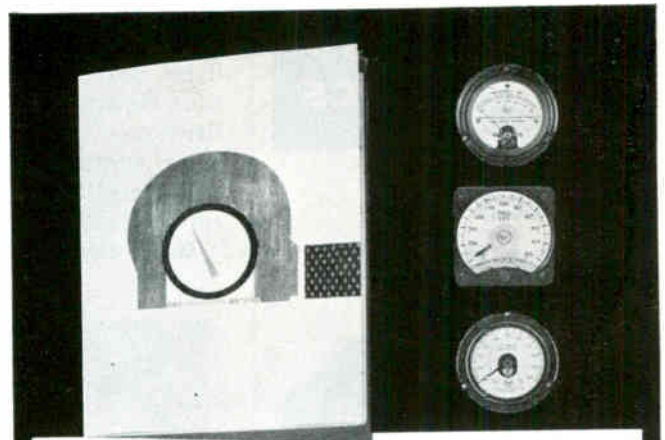

Catalog

AMF Precision Meters

If your operation demands accuracy to 1/10 of 1% you need this AMF Catalog, which includes specifications, sizes and weights of Frequency and Volt Meters for test, research, industrial, military and government use.

AMF Meters are rugged. They compensate for practically any temperature and environment. They can be tailored to your requirements—or are available immediately from stock. Send today for your Catalog! Address Department-S.



American Machine & Foundry Company

1101 N. Royal Street, Alexandria, Virginia

CIRCLE 208 ON READER SERVICE CARD

NEW DEPENDABLE SLIDE SWITCHES

from General Controls

Performance-proved by years of use in precision equipment!

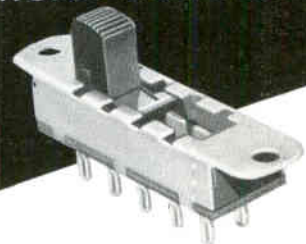

- Ideal for use where conventional slide switches have proved inadequate.
- Long flexure life, repeat accuracy and contact reliability assured.
- Positive make and break action.
- Less than 5 milliohms contact resistance.
- Choice of 2, 3 or 4 control positions.

Check the yellow pages for your nearest factory branch office or distributor.



AUTOMATION CONTROLS DIVISION

GENERAL CONTROLS

8080 McCormick Boulevard • Skokie, Illinois

CIRCLE 83 ON READER SERVICE CARD

83

TELEMETRY BY TELE-DYNAMICS

NEW Low Level Subcarrier Oscillator



The Type 1274A Low Level Subcarrier Oscillator is an outstanding member of Tele-Dynamic's new line of transistorized telemetry components for today's aerospace applications.

Designed to operate at unlimited altitudes, the 1274A can be activated by a ± 5 millivolt level differential signal. The input impedance is greater than 90 K ohms. It is extremely stable, has true differential floating input, and inherent deviation limiting which prevents over-deviation of greater than $\pm 22\%$ from center frequency. Common mode rejection is 110 db min. for a 10 volt peak to peak AC signal up to 2100 cycles. Silicon transistors allow operation over broad temperature ranges and latest packaging techniques reduce the volume of the 1274A to only 4.5 cu. in. and its weight to approximately 4 ounces.

For detailed technical bulletins, call the American Bosch Arma marketing offices in Washington, Dayton or Los Angeles. Or write or call Tele-Dynamics Division, American Bosch Arma Corporation, 5000 Parkside Avenue, Philadelphia 31, Pa. Telephone: TRinity 8-3000.

8410

TELE-DYNAMICS
DIVISION
AMERICAN BOSCH ARMA
CORPORATION
5000 Parkside Ave., Philadelphia 31, Pa.

Mass. Model 751 transistorized, high-speed pulse generator produces positive pulses of fast rise time (less than 1 millimicrosec). Repetition rate, 10 cps to 100 Kc. Output pulse width, 2 to 100 millimicrosec. Pulse amplitude, 20 v into 50 ohms (approximate).

CIRCLE 310 ON READER SERVICE CARD

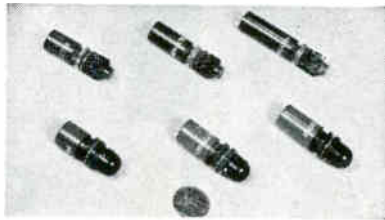

Lamp Assemblies HIGHLY VERSATILE

POLYTRONIX, P. O. Box 53, Manhattan Beach, Calif. Line of incandescent lamp assemblies is comprised of transistor and component assemblies and features extreme mechanical and electrical versatility. Features: replaceable lamps (both T 1 1/2 and cartridge types), wide operating temperatures, and 30 or more power supply values to choose from.

CIRCLE 311 ON READER SERVICE CARD

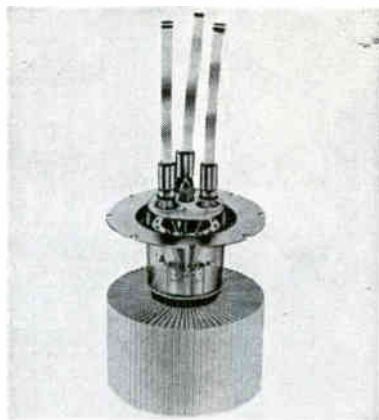

Power Amplifier Triode FORCED AIR COOLED

AMPEREX ELECTRONIC CORP., 230 Duffy Ave., Hicksville, L. I., N. Y. Type 7900 triode is designed for use in h-f transmitters, particularly tv at frequencies up to 220 Mc. It features a specially processed platinum grid which results in low drive power requirements. It has a 4 Kw plate dissipation rating and may also replace 2 1/2 to 3 Kw types, particularly in tv.

CIRCLE 312 ON READER SERVICE CARD



New operational amplifier 200 KC gain-bandwidth product

from unity to open loop

COMPACT . . . ALL SOLID STATE
FULL DIFFERENTIAL

RIG's new, transistorized Operational Amplifier Model A-2 is now your *one-best DC amplifier choice*: as a miniature, completely reliable instrument pre-amplifier . . . for versatile, multiple-unit use in complex data-handling and process control systems . . . and for customary analog computing applications.

Check and *compare* the A-2's unmatched combination of electrical, mechanical, and cost specifications:

OPEN LOOP GAIN — 100,000

RISE TIME — Less than 10 microseconds at unity gain, and at gain of ten; less than 100 microseconds at gain of one hundred.

DRIFT (referred to input) — Less than two millivolts over 75°F to 120°F change of ambient; less than 100 microvolts over eight-hour period at constant temperature.

COMMON-MODE REJECTION RATIO — Up to 500,000 to one at open loop.

OUTPUT LOADING CAPABILITY 10K at ± 10 volts.

LINEARITY — Within 0.1% in output swing of ± 10 volts.

SIZE — 5 1/4" x 2 1/2" x 1 1/4"

WEIGHT — 12 oz. COST — \$195.00

Request RIG-AMP Technical Bulletin for complete details.

ALSO AVAILABLE. Companion, plug-in Power Booster for use with Amplifier A-2 in driving heavy instrument systems, rotary amplifiers, and small DC servos.



**RIDGEFIELD
INSTRUMENT GROUP**

a Schlumberger division
Ridgefield, Conn., P.O. Box 337, IDlewood 8-6571

SPECIAL-PURPOSE ANALOG COMPUTERS FOR DATA HANDLING AND CONTROL, ELECTRONIC COMPONENTS, NMR AND ESR SPECTROMETERS, MAGNETIC RESONANCE ANALYTICAL SERVICES

CIRCLE 210 ON READER SERVICE CARD
electronics

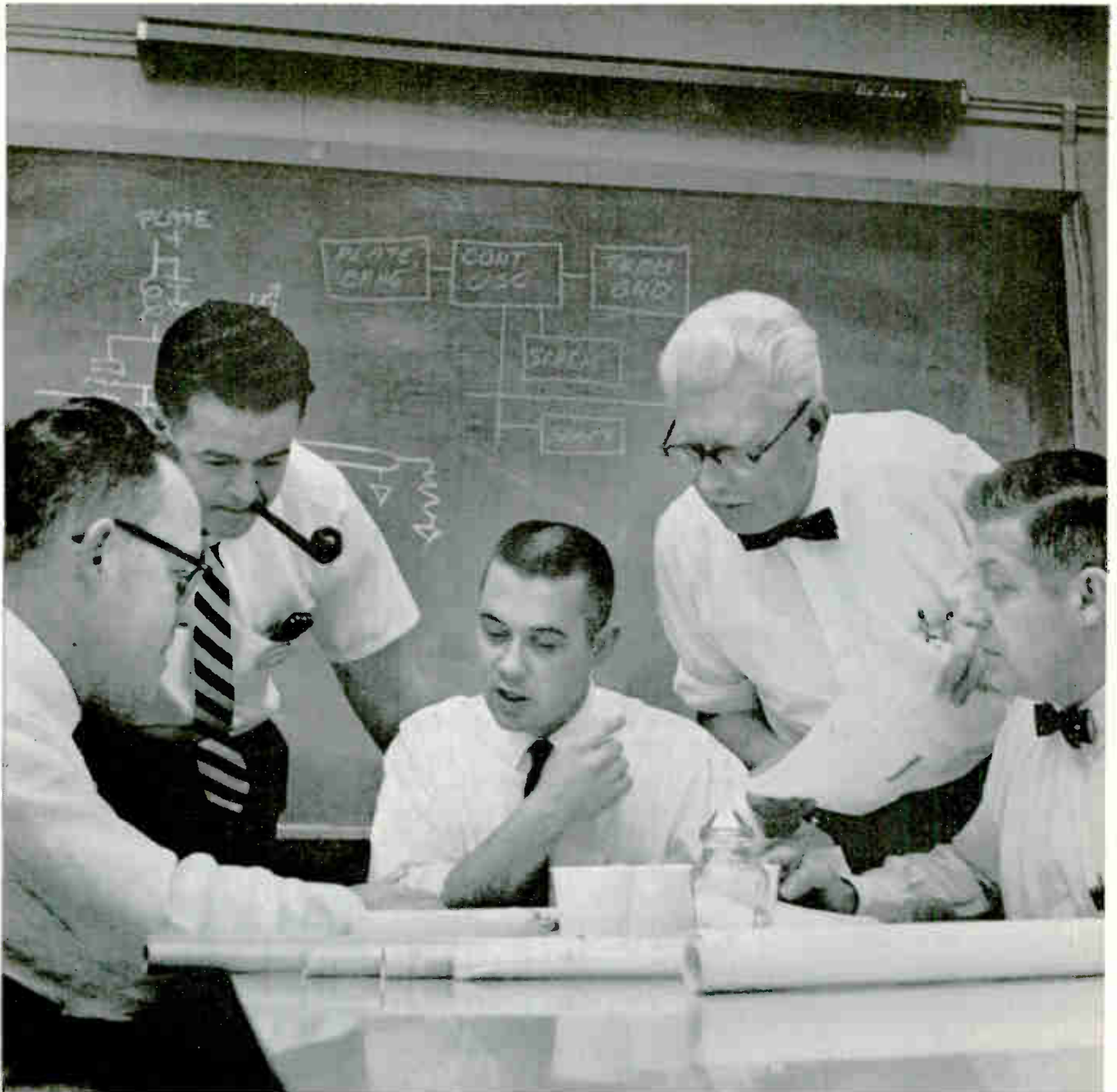

there's a young man on nearly every Collins team

At Collins, young men do not come up with *all* the new ideas, but they do create their fair share. A look at the technical progress being created at Collins is proof enough that Collins senior engineers encourage new men with new ideas.

At Collins, many great ideas come out of creative engineering teams like the one pictured above. The young man in the center, a relative newcomer at Collins, contributes materially to several new projects.

Other team members take pride in his accomplishments. They enjoy "showing him the ropes", but they consider *his* opinions, too. He belongs to their team.

A new Collins man is *new* for a very short time indeed. Collins steady growth creates a continuous need for EE's, ME's, mathematicians, technical writers and men with business training. Recent grads and experienced alumni may find Collins the ideal opportunity to build a satisfying and profitable career.

Learn more about a Collins career by writing for an illustrated brochure. To arrange a personal interview, send your qualifications to L. R. Nuss, Manager Professional Employment, Collins Radio Company, Cedar Rapids, Iowa, or E. H. Watkins, Manager, Employment, Collins Radio Company, 1220 North Alma Road, Richardson, Texas.



COLLINS RADIO COMPANY • CEDAR RAPIDS, IOWA • DALLAS, TEXAS • NEWPORT BEACH, CALIF.

ULTRASONIC DELAY LINES

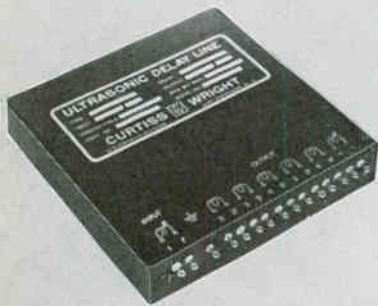

For:
Memory in computers
Coding in telemetering
and navigation
Range Marking in MTI Radar
Time Delay in precision
delayed sweeps

Magnetostrictive delay lines for missile, aircraft, marine and ground based equipment. Wide delay application — 5 to 10,000 microseconds — with stability over a broad temperature range.

Small size, low cost, rugged, lightweight construction. Pulse repetition rate to one megacycle. Wide range of input and output impedances. Standard and custom built models.

Write for latest complete components catalog #510

TIME DELAY RELAYS • DELAY LINES • ROTARY SOLENOIDS • SOLID STATE COMPONENTS • DUAL RELAYS • DIGITAL MOTORS • TIMING DEVICES

AD NO 4510

ELECTRONICS DIVISION

CURTISS  **WRIGHT**

CORPORATION
 EAST PATERSON, NEW JERSEY

PRODUCT BRIEFS

TEFLON-CLAD SLIP RINGS handle high voltages. Electro-Tec Corp., 10 Romanelli Ave., South Hackensack, N. J. (321)

BOOSTER AMPLIFIER dual channel. Melcor Electronics Corp., 48 Toledo St., So. Farmingdale, L. I., N. Y. (322)

COAXIAL MIXER DIODES high-burnout. Microwave Associates, Inc., Burlington, Mass. (323)

DIRECTIONAL COUPLERS miniaturized. Microlab, 570 W. Mt. Pleasant Ave., Livingston, N. J. (324)

AMPLIFIER ultra low-noise. Watkins-Johnson Co., 3333 Hillview Ave., Palo Alto, Calif. (325)

TRIMMING POTENTIOMETER $\frac{3}{4}$ in. square. Techno-Components Corp., 18232 Parthenia St., Northridge, Calif. (326)

STEEL MEMORY DRUM compact, low-cost. Hughes Aircraft Co., Florence Ave. & Teale St., Culver City, Calif. (327)

WIRE WOUND RESISTOR $\frac{1}{2}$ w at 137 C. International Resistance Co., 401 N. Broad St., Philadelphia 8, Pa. (328)

INPUT SCANNER PROGRAMMER push-button channel selection. Hewlett-Packard Co., 395 Page Mill Rd., Palo Alto, Calif. (329)

SIGNAL AMPLIFIER high gain. Stat-ham Instruments, Inc., 12401 W. Olympic Blvd., Los Angeles 64, Calif. (330)

MAGNETIC HEADS 7 tracks inline. Norton Associates, Inc., 240 Old Country Rd., Hicksville, L. I. (331)

SOLENOID SELECTOR ASSEMBLY hermetically sealed. Oak Manufacturing Co., Crystal Lake, Ill. (332)

POWER SUPPLY UNIT for plasma research. Duncan Electric Co., Inc., 2530-32 N. Elston Ave., Chicago 47, Ill. (333)

DIALYL PHTHALATE CASES for components. Industrial Electronic Rubber Co., 31945 Aurora Rd., Solon 39, Ohio. (334)

TRANSISTOR OSCILLATOR tuning fork control. Solid State Electronics Co., 15321 Rayen St., Sepulveda, Calif. (335)

PORTABLE REGULATED

DC POWER SUPPLY



Large
Capacity
Low-priced

model L3501
6" x 8" x 8"

only
\$199⁵⁰

- CONSTANT VOLTAGE 0-35v, 0-1A.
- CONSTANT CURRENT 0-30v, 0-1A.
- Transistor regulated—5mv. from no load to full load or for a 10% line change.
- Remote programming & current limiting.
- Two year guarantee
- Send for Bulletin P-61-1

Universal Electronics

COMPANY / 1720 Twenty-second Street
 Santa Monica, Calif. EXbrook 3-9219

CIRCLE 211 ON READER SERVICE CARD

ON PW BOARDS...

STOP COSTLY COMPONENT PREPARATION



WITH
DYNASERT



Cards or reels of components are loaded into self-feeding raceways and prepared for insertion *automatically*... The Dynasert Component Inserting Machine does all the work! Components are inserted accurately, uniformly at high rates of speeds. Operators are easily trained, changes made from one board or component type to another in seconds. Let us show you how Dynasert can actually pay for itself on only a few hundred insertions per week. Send for Facts. Dynasert Dept., United Shoe Machinery Corp., Boston, Mass.

United
DYNASERT

US1-72

CIRCLE 212 ON READER SERVICE CARD
 electronics

Literature of the Week

R-F HEATING Lindberg Engineering Co., 2450 W. Hubbard St., Chicago 12, Ill. Features and equipment of six models of radio-frequency heating units are described in a series of bulletins. (336)

SERVOMOTOR - GENERATOR Helipot Division of Beckman Instruments, Inc., 2500 Fullerton Road., Fullerton, Calif. A data sheet covers the size 5 motor generator, model 9005-1102-0. (337)

LOGIC MODULE Rese Engineering, Inc., A and Courtland Sts., Philadelphia 20, Pa. Technical bulletin 60-M describes a high-speed logic circuit plug-in. (338)

THERMOCOUPLES Harco Laboratories, Inc., 77 Olive St., New Haven, Conn. Four-page bulletin describes metal sheathed thermocouples that provide a flexible solution to temperature-sensing problems when precision data are mandatory. (339)

H-V COMPONENTS Universal Voltronics Corp., 17 S. Lexington Ave., White Plains, N. Y. Announces a 4-page bulletin that covers a line of standard high voltage terminations and provides information on anti-corona spheres, toroids, and cap nuts. (340)

MICROMINIATURE P-C CONNECTORS Continental Connector Corp., Woodside 77, N. Y. A catalog sheet illustrates and describes the series 600-2 p-c card receptacle for micro-electronic applications. (341)

T-W TUBE Ferranti Electric Inc., Industrial Park No. 1, Plainview, L. I., N. Y. Bulletin W169 describes the LY10, an X-band twt amplifier capable of supplying 20 Kw of pulse power at a maximum mean power rating of 30 w. (342)

VIBRATION METER Unholtz-Dickie Corp., 2994 Whitney Ave., Hamden 18, Conn. Bulletin introduces a line of Dial-A-Gain double integrating three-channel vibration meters. (343)

LEAK DETECTOR Consolidated Electrodynamics Corp., 360

Sierra Madre Villa, Pasadena, Calif. Details on the operation of type 24-510 Radiflo leak detector are available in an eight-page bulletin. (344)

NICKEL FERRITE Kearfott Division, General Precision, Inc., Little Falls, N. J. An advance technical data sheet describes KN201 nickel ferrite developed for use in microwave devices from C band and higher. (345)

TAPE CLEANER General Kinetics Inc., 2611 Shirlington Road, Arlington 6, Va., offers a brochure describing the model CT-2, which utilizes the Kinesonic transducer to obtain both sonic and ultrasonic cleaning of magnetic tape. (346)

HIGH DENSITY SYSTEM Potter Instrument Co., Sunnyside Blvd., Plainview, N. Y. A data sheet describes the characteristics and operating techniques of a contiguous double transition high density system. (347)

POTTED RECTIFIERS Solitron Devices, Inc., Norwood, N. J. A 10-page catalog gives specifications on a line of h-v potted rectifiers. (348)

SYSTEM BUILDING BLOCKS Digital Equipment Corp., Maynard, Mass. A 6-page folder covers the 4000 series 500 Kc, low cost system building blocks. (349)

FREQUENCY COUNTER General Radio Co., West Concord, Mass. Volume 35 No. 5 of the *Experimenter* illustrates and describes the type 1130-A digital time and frequency meter. (350)

SYNCHROS Vernitron Corp., 125 Old Country Road, Carle Place, L. I., N. Y., has issued a data sheet giving key specifications for size 11 MIL synchros. (351)

TEST INSTRUMENTS Hewlett-Packard Co., 1501 Page Mill Road, Palo Alto, Calif. The 220-page 1961 catalog of test instruments may be obtained by writing on company letterhead.

Instant Reset Voltage Compensated Vibration Resistant



Thermal Time Delay Relays

Precision-built Curtiss-Wright thermal time delay relays reset instantly when de-energized — provide the same delay period for each succeeding cycle. Compensated for wide voltage variations. Available in either 28V DC or 115V AC, 60 or 400 cps. Chatter-free operation, under severe shock and vibration conditions. Small sized, hermetically sealed, temperature compensated for precise, reliable operation and long life. Preset time delays from 10 to 180 seconds with SPST, SPDT or DPDT snap action contacts.



Write for latest complete components catalog #504

TIME DELAY RELAYS • DELAY LINES • ROTARY SOLENOIDS • DIGITAL MOTORS • TIMING DEVICES • DUAL RELAYS • SOLID STATE COMPONENTS

Electronics Division

CURTISS-WRIGHT CORPORATION
East Paterson, New Jersey

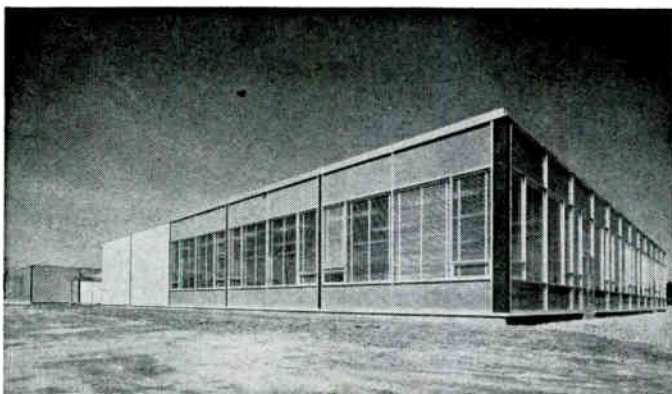

Mitre Expanding Bedford Complex

MEMBERS of The Mitre Corporation's computer programming department have moved into a new computer and office building in Bedford, Mass.

Mitre president C. W. Halligan described the facility as the computer building—C Building for short—and announced "this is a major step in a long-range program to consolidate company activities in Bedford."

The \$675,000 building, a single story and basement structure, is the second erected on the corporation-owned tract. Half of the 30,000-sq-ft first floor will be used as a computer facility. The other half will provide office space for approximately 100 people, including engineers and scientists of the computer programming department and related support functions. Another 8,000 sq ft in the basement will be used for storage of the computer's mechanical equipment and centralized communications equipment.

Heart of the installation is an IBM 7090 data processing system. It will eventually replace the IBM 704 which currently operates in facilities Mitre leases from MIT's Lincoln Laboratories at nearby L. G. Hanscom Field.

Companion equipment in the C Building includes two 1401's—small scale, multipurpose computers—which will be used for support functions and automatic machine-time accounting.

The facility contains a 75-ton cooling system necessary to maintain optimum temperature and hu-

midity control for 24-hour operation of the computer. Incorporated in the building design is a vinyl-tiled, raised aluminum floor which provides a completely pressurized sub-floor, called an air plenum. This feature eliminates the need for air conditioning ducts and also serves to conceal the miles of electrical cables necessary to inter-connect various units of the computing system.

Addition of the computer building provides a powerful tool for Mitre's work in design, development and evaluation of command and control systems for the Air Force's Electronic Systems division, Halligan said.

As system engineer for the Air Force's Sage (Semi-Automatic Ground Environment) system, Mitre also operates the prototype Sage computer at Hanscom Field. It is part of the Evaluation Sage Sector—the experimental center for development and evaluation of air defense techniques and experimental air traffic control systems.

An independent, nonprofit corporation, Mitre was formed in 1958 under sponsorship of MIT. The firm is chartered to serve the U. S. government as technical advisor in the broad area of electronic command and control systems.

At present, the firm employs 1,450 people. Most of its engineering and scientific activities are conducted in a 100,000-sq-ft facility completed in 1959. In addition, Mitre leases approximately 100,000 sq ft of office and engineering fa-

cilities in the Bedford Research and Office Park and in several other locations in the Bedford-Lexington-Burlington area.

McDonald Moves Up At Sola Electric

DONALD C. MCDONALD has been named vice president, engineering, by Sola Electric Co., Elk Grove, Ill. He has been director of engineering at Sola since he joined the company in January of this year.

McDonald had previously been vice president, engineering for the Cook Electric Co., and a consultant for the Bishop Freeman Co.



Hycon Names Cahill Manufacturing V-P

STARR W. CAHILL has been elected vice president of manufacturing with Hycon Mfg. Co. in Monrovia, Calif. He joined the engineering staff of Hycon in 1951 and was director of engineering operations before his new appointment.



Information Systems Appoints Bechard

HENRY L. BECHARD, formerly assistant to the general manager of



in the Air



in our elements



on the Sea



under the Sea



EDO, specialist in underwater electronics, designs and manufactures a wide range of echo-ranging and listening sonar equipments for the Navy's surface ships and submarines. Edo-built sonar "eyes"—looking upward, downward and ahead—have helped the nuclear submarines NAUTILUS, SKATE, SARGO and SEADRAGON navigate ice-surfaced polar seas. Edo sonar units give surface ships outstanding ASW capability. AN/UQN units—deep depth sounders in quantity production by Edo—are standard equipment on every class of Navy ship for precise bottom scanning, and are also in world-wide use commercially. For long range navigation, Edo also manufactures airborne and marine Loran that is standard equipment aboard airliners and surface vessels the world over.

Edo CORPORATION
College Point, N. Y.

Since
1925

Edo (CANADA) Ltd.
Cornwall, Ontario

LABORATORY PRODUCTION SERVO-PROGRAMMABLE

PRECISION

accuracy to 1/100,000 of a G

CENTRIFUGES

Genisco Centrifuges meet the most varied and critical demands for acceleration testing and calibration throughout missile, aircraft, and electronics fields . . . the extreme accuracy for critical calibration of inertial guidance systems . . . the ruggedness for routine product reliability tests and evaluation . . . capabilities for programmed servo control . . . many optional accessories.

Genisco's 931 Series G-Accelerators feature crystal-controlled oscillator to hold allowable drift to .001% from angular velocity of main rotating arm or outboard table . . . Calibration speeds preset to customer specifications within .5 to 30 g range . . . Direct-coupled synchronous drive motors . . . Loading maximums: 25 lbs. fixed platform; Model available with 10 lbs. outboard table . . . Varied modes including sinusoidal or spatial orientation.

The Genisco Model 460 Precision Centrifuge provides 0.25 to 25 g range, accuracy to 1/100,000 g in the range of 1 to 12.5 g's. Payloads are 400 lbs. (36" cube) on the environmental end of the boom; 50 lbs. (16" cube) on the precision end . . . Dynamic radius comparator.

Genisco
INCORPORATED

2233 Federal Ave., Los Angeles 64, California

CIRCLE 213 ON READER SERVICE CARD

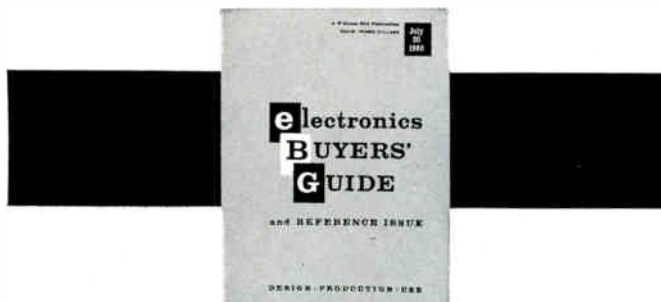

FIRST CHOICE OF ALL 4!

RESEARCH — DESIGN — PRODUCTION — MANAGEMENT

There is no mystery about who gets and uses the **electronics BUYERS' GUIDE**. It is part of the paid subscription to regular weekly issues of **electronics**, and is available and used by the more than 52,000 identified subscribers of the magazine.

Only the **electronics BUYERS' GUIDE** is compiled to satisfy the basic buying needs of all four key segments of the industry — research, design, production, management.

GIVES MORE TO ALL 4!

electronics BUYERS' GUIDE
and REFERENCE ISSUE

T.R.W. Computers, has been named director of engineering for the Systems Division of Information Systems, Inc., Los Angeles, Calif. In this capacity he will direct ISI's engineering and research and development efforts in the area of large and medium sized information and computer systems for industrial process control. He will also be responsible for engineering the company's line of computer products.



Wells Assumes New Position

APPOINTMENT of W. F. Wells as senior vice president and general manager of Midwestern Instruments, Inc., Tulsa, Okla., is announced. He had been manager of manufacturing engineering in the GE Computer Department in Phoenix, Ariz.



Sparton Electronics Names Stewart G-M

J. ALAN STEWART has been appointed general manager of Sparton Electronics, division of Sparton Corp., Jackson, Mich.

Stewart, who joined Sparton last year as operations manager, has been serving for the past several months as assistant general manager. He also is assistant secretary of Sparton Corp., and a director of

Opportunities for

circuit designers

Requirements of new and continuing projects, such as Surveyor and supersonic interceptor fire control systems have created new openings for circuit designers. The engineers selected for these positions will be assigned to the following design tasks:

- 1** the development of high power airborne radar transmitters, the design of which involves use of the most advanced components,
- 2** the design of low noise radar receivers using parametric amplifiers, solid state masers and other advanced microwave components,
- 3** radar data processing circuit design, including range and speed trackers, crystal filter circuitry and a variety of display circuits,
- 4** high efficiency power supplies for airborne and space electronic systems,
- 5** telemetering and command circuits for space vehicles such as Surveyor and the Hughes Communication Satellite,
- 6** timing, control and display circuits for the Hughes COLIDAR* (Coherent Light Detection and Ranging).

In addition, openings exist for several experienced systems engineers capable of analysis and synthesis of systems involving the type of circuits and components described above.

If you are interested and believe that you can contribute, please airmail your resume to:
Mr. Robert A. Martin, Supervisor, Scientific Employment, Hughes Aerospace Engineering Division, Culver City 51, California.

*Trademark H. A. C.

We promise you a reply within one week.

Creating a new world with electronics

HUGHES

HUGHES AIRCRAFT COMPANY
AEROSPACE DIVISIONS

AT HUGHES, ALL QUALIFIED APPLICANTS WILL BE CONSIDERED FOR EMPLOYMENT WITHOUT REGARD TO RACE, CREED, COLOR OR NATIONAL ORIGIN.

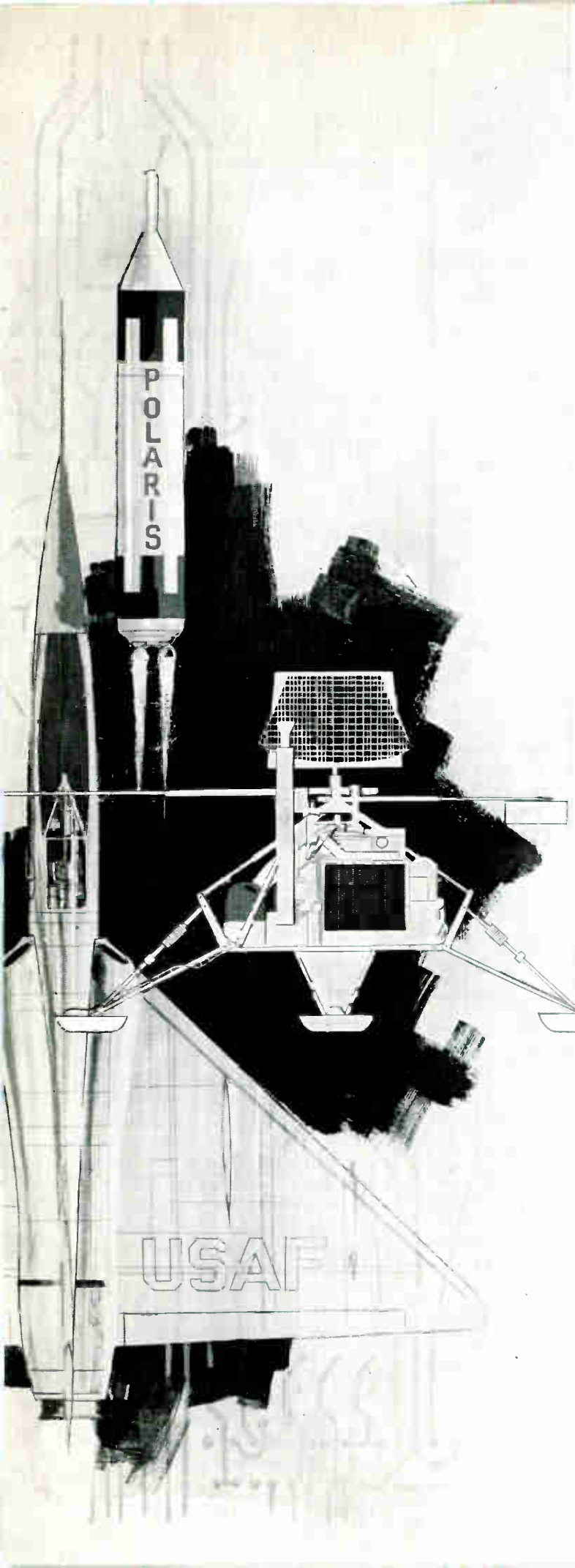



PRECISION - Square, Flat and Rectangular Wire with Controlled Edges

For WIRE-WRAP and PLUG or PIN type CONNECTORS for computers, control systems, missiles, etc., Also for springs, terminals, forms, fittings, prongs, contacts and clips.

Silvercote® Beryllium Copper — Brass — Bronze — ni-clad-ti Titanium — Aluminum — Hot Solder Dipped — Tinned — etc.

Square and rectangular shaped wires are frequently used in modern "wrapped" terminal and pin or plug type connectors. For this application the edges must be finished quite sharp (usually .003 radius corners or less) but without a burr or flashing. Also required are closely controlled dimensional tolerances and smooth finish. Uniformity of temper is essential. Therefore close control of all facets of wire manufacturing is of paramount importance.

LITTLE FALLS ALLOYS, INC. 194 CALDWELL AVENUE, PATERSON 1, NEW JERSEY

CIRCLE 214 ON READER SERVICE CARD

Coils for Contact Capsules



TYPE	DC-V	Ohms	Nom. Watts	Nom. Amp/Turns
S	6	100	.40	250
	12	360		
	24	1400		
M	6	50	.70	250
	12	175		
	24	820		
T	6	100	.35	125
	12	400		
	24	1600		
	32	2800		
	48	4600		

Coto-Coils

COTO-COIL CO., INC.
65 Pavilion Avenue
Providence 5, R. I.

Write for Bulletin and Prices
CIRCLE 215 ON READER SERVICE CARD

Is your advertising selling the same four key buyers your salesmen call on? Competition demands it! Only advertising in electronics reaches and sells the electronics man wherever he is: in Research,

TODAY YOU MUST SELL ALL FOUR!

Design, Production, and Management. Put your advertising where it works hardest...

in **electronics**

a subsidiary, Sparton Southwest, Inc., which is constructing a new military electronics facility at Albuquerque, N.M.

Linwood Advances At Stackpole Carbon

SIDNEY H. LINWOOD has been promoted to chief engineer of the ferrite engineering department, Stackpole Carbon Co., St. Marys, Pa. He had been assistant to the chief engineer.

PEOPLE IN BRIEF

Herman F. Zaiss, Jr., advances at General Electric's traveling wave tube product section to manager of engineering support. **Pat Tucciarone**, ex-RCA, joins PRD Electronics as applications engineer. **Thomas A. Holdiman**, formerly with the System Development Corp., appointed chief of systems controls by General Dynamics/Electronics military products division. **Robert L. Sink** leaves Consolidated Electroynamics Corp. to become manager of engineering at Burroughs Corp.'s military electronic computer division. **George A. Kahn** transfers from Maxson Electronics to REDM Corp. as director of engineering. **Walter Welkowitz**, director of Gulton Industries' R & D laboratory, accepts the additional post of general manager of the instrumentation division. **Arthur R. Burch**, previously with General Motors, named senior project engineer at Electro Nuclear Systems Corp.'s automatic controls division. **Alexander Elovic** of Indiana General Corp.'s general ceramics division promoted to manager of advanced development. **Joseph Reed** leaves General Precision Laboratories to join Adler Electronics' military products division as systems dept. executive engineer. **Ivor Brodie** of the Westinghouse electronic tube division accepts the post of fellow engineer. **Maurice S. Hartley**, ex-Polaroid Corp., appointed manager of the Cleveland engineering division of Brush Instruments.

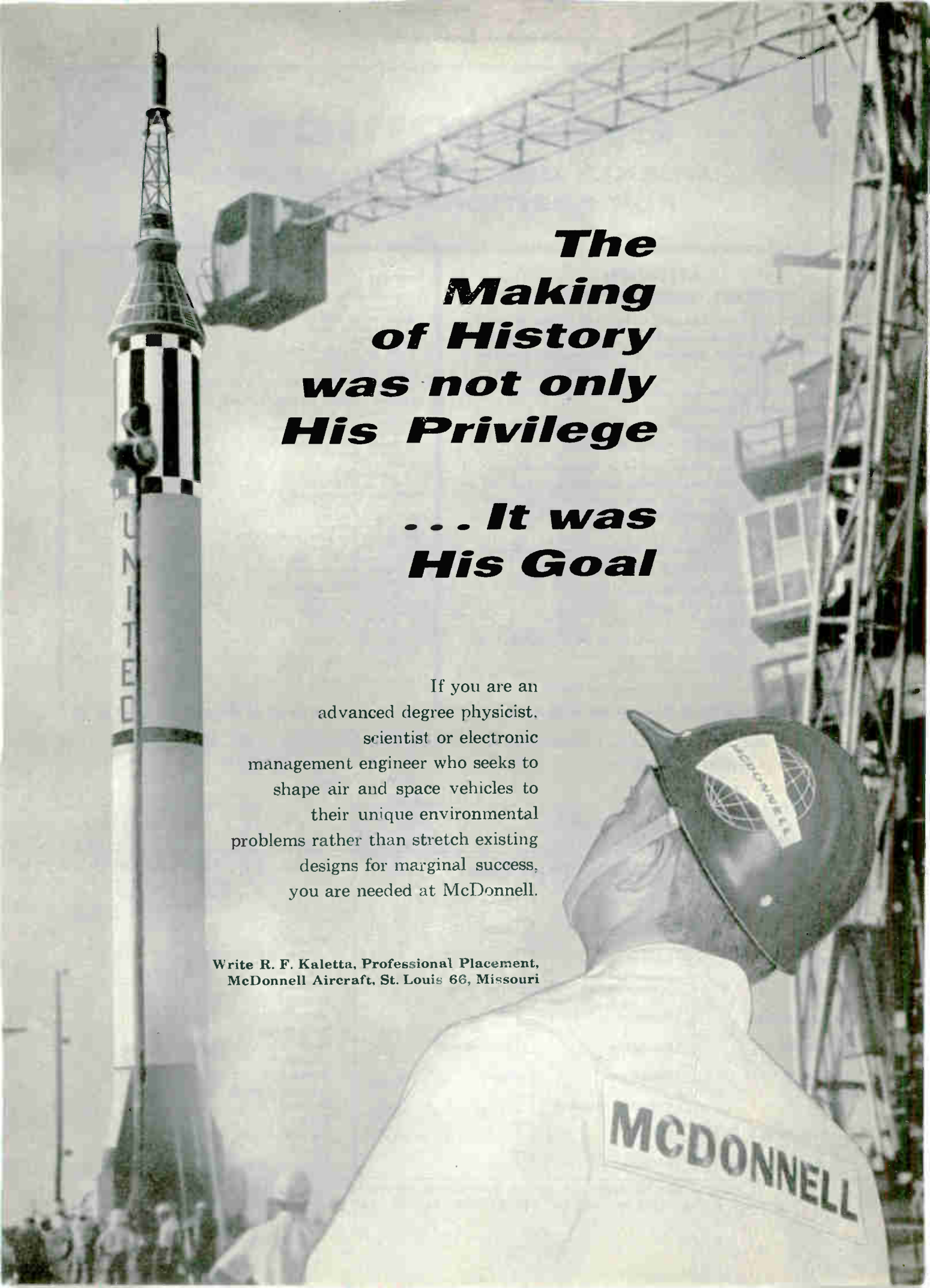

***The
Making
of History
was not only
His Privilege***

***... It was
His Goal***

If you are an
advanced degree physicist,
scientist or electronic
management engineer who seeks to
shape air and space vehicles to
their unique environmental
problems rather than stretch existing
designs for marginal success,
you are needed at McDonnell.

Write R. F. Kaletta, Professional Placement,
McDonnell Aircraft, St. Louis 66, Missouri

electronics

WEEKLY QUALIFICATION FORM FOR POSITIONS AVAILABLE

ATTENTION: ENGINEERS, SCIENTISTS, PHYSICISTS

This Qualification Form is designed to help you advance in the electronics industry. It is unique and compact. Designed with the assistance of professional personnel management, it isolates specific experience in electronics and deals only in essential background information.

The advertisers listed here are seeking professional experience. Fill in the Qualification Form below.

STRICTLY CONFIDENTIAL

Your Qualification form will be handled as "Strictly Confidential" by ELECTRONICS. Our processing system is such that your form will be forwarded within 24 hours to the proper executives in the companies you select. You will be contacted at your home by the interested companies.

WHAT TO DO

1. Review the positions in the advertisements.
2. Select those for which you qualify.
3. Notice the key numbers.
4. Circle the corresponding key number below the Qualification Form.
5. Fill out the form completely. *Please print clearly.*
6. Mail to: D. Hawksby, Classified Advertising Div., ELECTRONICS, Box 12, New York 36, N. Y. (No charge, of course).

COMPANY	SEE PAGE	KEY #
ALLEN ORGAN CO. Macungie, Pa.	96	1
COLLINS RADIO CORP. Cedar Rapids, Iowa	85	2
GENERAL ATOMIC Div. of General Dynamics San Diego, California	97	3
GENERAL ELECTRIC Missile & Space Vehicle Dept. Philadelphia, Pa.	125, 126, 127, 128*	4
GRUMMAN AIRCRAFT ENGINEERING CORP. Bethpage, L. I., New York	139*	5
HONEYWELL AERO Minneapolis, Minnesota	141*	6
LABORATORY FOR ELECTRONICS Boston, Mass.	36*	7
LOCKHEED California Div. Burbank, California	97*	8
MATERIALS RESEARCH CORP. Yonkers, New York	141*	9
MCDONNELL AIRCRAFT St. Louis, Missouri	93	10
PHILCO WESTERN DEVELOPMENT LABS. Palo Alto, California	140*	11
SANDERS ASSOCIATES, INC. Nashua, New Hampshire	96	12
SIKORSKY AIRCRAFT Div. of United Aircraft Corp. Stratford, Connecticut	95	13
SPACE TECHNOLOGY LABS., INC. A. Sub. of Thompson Ramo Wooldridge Los Angeles, California	15*	14
WLAC-TV INC. Nashville, Tenn.	141*	15

* These advertisements appeared in the 6/30/61 issue.

(cut here)

(cut here)

electronics WEEKLY QUALIFICATION FORM FOR POSITIONS AVAILABLE

Personal Background

NAME

HOME ADDRESS.....

CITY..... ZONE..... STATE.....

HOME TELEPHONE.....

Education

PROFESSIONAL DEGREE(S).....

MAJOR(S)

UNIVERSITY

DATE(S)

FIELDS OF EXPERIENCE (Please Check)

771

- | | | |
|--|--|---------------------------------------|
| <input type="checkbox"/> Aerospace | <input type="checkbox"/> Fire Control | <input type="checkbox"/> Radar |
| <input type="checkbox"/> Antennas | <input type="checkbox"/> Human Factors | <input type="checkbox"/> Radio—TV |
| <input type="checkbox"/> ASW | <input type="checkbox"/> Infrared | <input type="checkbox"/> Simulators |
| <input type="checkbox"/> Circuits | <input type="checkbox"/> Instrumentation | <input type="checkbox"/> Solid State |
| <input type="checkbox"/> Communications | <input type="checkbox"/> Medicine | <input type="checkbox"/> Telemetry |
| <input type="checkbox"/> Components | <input type="checkbox"/> Microwave | <input type="checkbox"/> Transformers |
| <input type="checkbox"/> Computers | <input type="checkbox"/> Navigation | <input type="checkbox"/> Other |
| <input type="checkbox"/> ECM | <input type="checkbox"/> Operations Research | <input type="checkbox"/> |
| <input type="checkbox"/> Electron Tubes | <input type="checkbox"/> Optics | <input type="checkbox"/> |
| <input type="checkbox"/> Engineering Writing | <input type="checkbox"/> Packaging | <input type="checkbox"/> |

CATEGORY OF SPECIALIZATION

Please indicate number of months
experience on proper lines.

	Technical Experience (Months)	Supervisory Experience (Months)
RESEARCH (pure, fundamental, basic)
RESEARCH (Applied)
SYSTEMS (New Concepts)
DEVELOPMENT (Model)
DESIGN (Product)
MANUFACTURING (Product)
FIELD (Service)
SALES (Proposals & Products)

CIRCLE KEY NUMBERS OF ABOVE COMPANIES' POSITIONS THAT INTEREST YOU

1 2 3 4 5 6 7 8 9 10 11 12 13 14 15 16 17 18 19 20 21 22 23 24 25

*pioneer and leading manufacturer
of rotary wing aircraft*

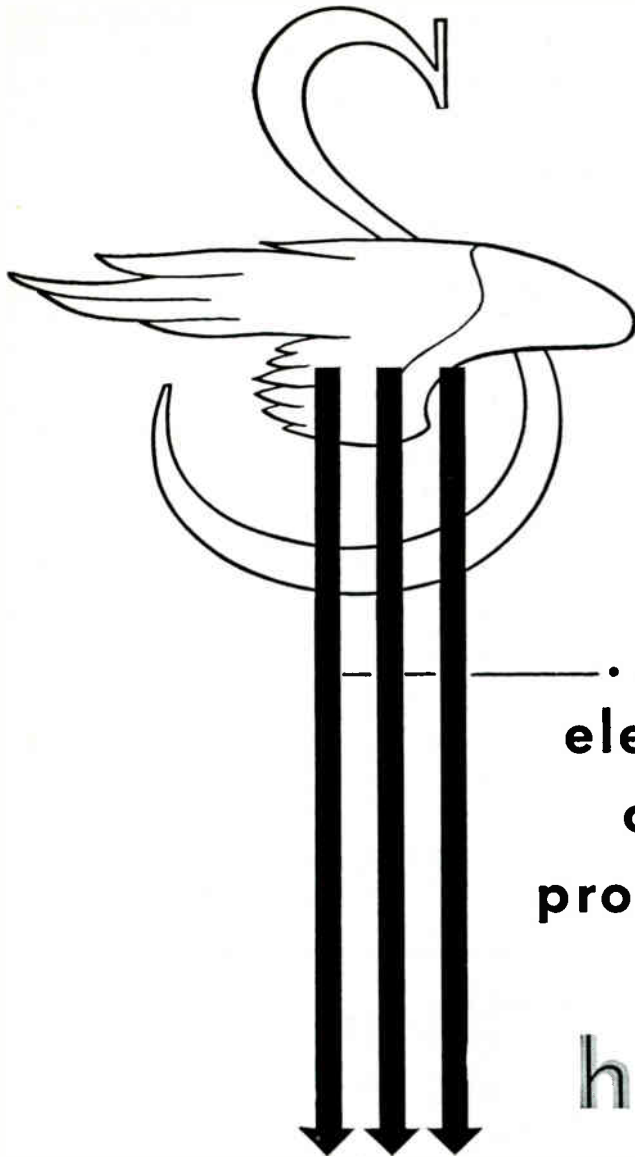

... at **SIKORSKY**
 electronic engineers
 can broaden their
 professional horizons
 in the field of
 helitronics

Today, as Sikorsky Aircraft's activities expand in significance and scope, particular emphasis is being directed to a sphere of activity which we term "helitronics". This area embraces a blending of two major technologies: *helicopters* and *electronics*. Specifically, helitronics means the integration of guidance and navigation systems, specialized electronic search and detection equipment to enhance the mission capability of the helicopter; specialized sensors and automatic controls to increase its versatility as an optimum military weapon system and a commercial carrier.

The need for more sophisticated electronic systems offers exceptional opportunities to competent electronic engineers with particular skills in: design • instrumentation • test • development • air-borne systems • production and service support equipment • trainers and simulators.

Unusually interesting openings as Avionics Instructors also exist for men with aircraft electronics experience and a desire to teach.

If you are interested in these career opportunities, please submit your resume, including minimum salary requirements, to L. J. Shalvoy, Personnel Department.

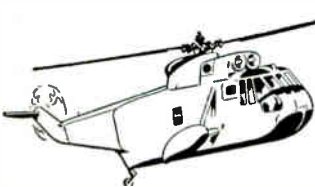

SIKORSKY AIRCRAFT STRATFORD, CONNECTICUT
 DIVISION OF UNITED AIRCRAFT CORPORATION

All qualified applicants will receive consideration for employment without regard to race, creed, color or national origin.

Join Sanders Associates in Nashua, New Hampshire

"The company is interested in NEW ways of doing things"... "work is carried on above the average level"... "circuit design here goes all the way from DC through microwave"—

—so say Engineers who have joined Sanders Associates in the past few months.

Such progressive philosophy has led to this young company's growth from 11 engineers to 1800 employees in only 10 years, with a current contract backlog of over \$50 million.

Still further expansion is planned for pioneering programs in many advanced areas including phased array radar, pulse doppler radar systems, space radar and communications systems.

If you are interested in working on the threshold of the state-of-the-art, untethered by conventional techniques, send a resume now to R. W. McCarthy.

All qualified applicants will receive consideration for employment without regard to race, creed, color or national origin.



SANDERS ASSOCIATES, INC.

NASHUA, NEW HAMPSHIRE

(In the New Hampshire hill country about an hour from downtown Boston)

KEEP YOUR LEARNING CURVE UP!

Opportunities are available now for:

MICROWAVE MANAGER

Requires extensive microwave systems design background and ability to direct engineering activities in microwave systems for radar and missile applications — standard components and stripline techniques including antenna systems and stripline modules. Must be capable of both technical and administrative supervision.

TRANSISTOR CIRCUITRY CONSULTANT

To provide technical guidance at the Corporate level on a wide variety of transistor circuit design problems. Requires ability to design detailed circuits rapidly.

RECEIVER DESIGN ENGINEERS

3 to 8 years experience. For design and development of receivers for military applications. Experience should include design of low noise front ends, IF strips, AGC circuitry and application of image rejection techniques. All transistorized. BS in EE or Physics.

TRANSMITTER DESIGN ENGINEERS

For design and development of transmitters, VHF-UHF and microwave frequency range, tubes, pulse modulators, power in excess of 1 kilowatt for military and airborne applications.

Electro-musical Engineers

Would you like to join the team that created and produces the Allen electronic organ—classic tone production through electronic means—and now the Allen electronic harpsichord? If you feel that you are qualified in this field and would like to join our engineering department, we would be pleased to hear from you. Excellent opportunities exist.

ALLEN ORGAN COMPANY

Dept. 2307
Macungie, Pennsylvania

ADDRESS BOX NO. REPLIES TO: Box No. Classified Adv. Div. of this publication. Send to office nearest you.
NEW YORK 36: P. O. Box 12
CHICAGO 11: 645 N. Michigan Ave.
SAN FRANCISCO 11: 255 California St.

POSITION VACANT

Position open, Antenna Engineer, experienced in antenna design and project work in the field of communications antenna systems. Write including complete resume and salary requirements to Roger Olson, Director of Engineering, Hy-Gain Antenna Products Corporation, 1135 North 22nd Street, Lincoln, Nebraska.

POSITION WANTED

Position Wanted: Recently Retired Signal Corps officer residing in Northern California will represent communications equipment or components manufacturers. Reply to PW-6987, Electronics.

"PINPOINT RECRUITING"

... most economical method of finding the engineers you need.

SEARCHLIGHT SECTION

(Classified Advertising)

BUSINESS OPPORTUNITIES

EQUIPMENT - USED or RESALE

DISPLAYED RATE

The advertising rate is \$24.75 per inch for all advertising appearing on other than a contract basis. Contract rates quoted on request. An ADVERTISING INCH is measured 3/8 inch vertically on one column, 3 columns—30 inches—to a page. EQUIPMENT WANTED or FOR SALE ADVERTISEMENTS acceptable only in Displayed Style.

UNDISPLAYED RATE

\$2.40 a line, minimum 3 lines. To figure advance payment count 5 average words as a line. BOX NUMBERS count as one line additional in undisplayed ads.

MOTOR GENERATORS GENERATORS—MOTORS

- ONE—20KW, 25 KVA, 60 to 50 Cycle M.G. INPUT: 60 HP, 220/440 Volt AC, 3 Phase, 1200 RPM. OUTPUT: 20 KW, 25 KVA, 120/208 volt AC, 3 phase adjustable to 220 volt, 50 cycle, 1000 RPM.
- ONE—M.G. SET WITH PANEL INPUT: 50 HP, 208/416 Volt AC, 3 Phase, 60 Cycle, 1714 RPM. OUTPUT: 30 KW, 37.5 KVA, 120/208 Volt AC, 400 Cycle.
- ONE—15 HP MOTOR 440 Volt, 60 cycle, 1200 RPM induction.
- ONE—71/2 HP MOTOR 440 Volt, 3 phase, 60 cycle, 1200 RPM induction
- ONE—1000 Watt, 110 Volt, Single Phase, 60 CYCLE, 1800 RPM GENERATOR.

FOR SALE

- ONE—BROWNING 42" AIR OPERATED COIL SPREADER equipped with air holders and air knuckle pickup attachments.
- ONE—HEWLETT-PACKARD 300 A WAVE ANALYZER.

KATO ENGINEERING COMPANY

1415 FIRST AVENUE, MANKATO, MINNESOTA

CIRCLE 460 ON READER SERVICE CARD

FOR INFORMATION

About Classified Advertising

Contact The McGraw-Hill Office Nearest You

- ATLANTA, 9
1375 Peachtree St. N. E. TRinity 5-0523
R. JOHNSON
- BOSTON, 16
Copley Square CONgress 2-1160
D. HICKS
- CHICAGO, 11
645 No. Michigan Ave. MOhawk 4-5800
W. J. HIGGINS—W. SONZSKI
- CLEVELAND, 13
1164 Illuminating Bldg. SUPERior 1-7000
W. B. SULLIVAN
- DALLAS, 2
1712 Commerce St., VAughn Bldg. RIVERSide 7-5117
J. GRANT
- DENVER, 2
1700 Broadway—Tower Bldg. ALPine 5-2981
J. PATTEN
- DETROIT, 26
856 Penobscot Bldg. WOODward 2-1793
P. HAMMOND
- HOUSTON, 25
Prudential Bldg., Holcombe Blvd., Rm. W-724 JACKson 6-1281
GENE HOLLAND
- LOS ANGELES, 17
1125 W. 6th St. HUNtley 2-5450
W. C. GRIES
- NEW YORK, 36
500 Fifth Ave. OXFord 5-5959
H. T. BUCHANAN—R. P. LAWLESS
T. W. BENDER
- PHILADELPHIA, 3
Six Penn Center Plaza LOCust 8-4330
P. PASCHALL—W. B. SULLIVAN
- PITTSBURGH, 22
4 Gateway Center EXpress 1-1314
- ST. LOUIS, 8
3615 Olive St. JEFFerson 5-4867
R. BOWMAN
- SAN FRANCISCO, 11
255 California St. DOuglas 2-4600

ENGINEERS and SCIENTISTS

Our newly expanded programs in the field of direct conversion of heat to electricity by thermoelectric means have created a number of openings for physicists, metallurgists, and engineers with a minimum of 3 to 5 years of applicable experience. Positions are available for individuals at all degree levels for the following types of assignments:

- Thermoelectric generators
- Generator stability testing
- Semiconductor applications
- Development of insulators
- Thermoelectric measurements
- Semiconductor-conductor bonds
- Thermoelectric converter testing
- Low temperature alloys
- Thermoelectric material fabrication

All qualified applicants will receive consideration for employment without regard to race, creed, color or national origin.

Please send a complete resume to Employment Manager,

Dept. 174, P. O. Box 608
San Diego 12, Calif.

**GENERAL ATOMIC
DIVISION**
of
GENERAL DYNAMICS



MANUFACTURERS' REPRESENTATIVES

IN THE ELECTRONIC INDUSTRY

SAMUEL K. MACDONALD, INC.
Manufacturers representatives over 25 years
1531 SPRUCE STREET, PHILA. 2, PA.
Territory: Pennsylvania • New Jersey
Delaware • Maryland
Virginia • West Virginia
District of Columbia
Other Offices:
Pittsburgh
Baltimore
Washington, D.C.

Your Inquiries to Advertisers Will Have Special Value . . .

—for you—the advertiser—and the publisher, if you mention this publication. Advertisers value highly this evidence of the publication you read. Satisfied advertisers enable the publisher to secure more advertisers—and more advertisers mean more information on more products or better service—more value—to YOU.

INDEX TO ADVERTISERS



Audited Paid Circulation

Alden Products Co.	67	Hewlett-Packard Company	15, 39
American Bosch Arma Corporation, Tele-Dynamics Division	84	Hitachi, Ltd.	79
American Cystoscope Makers, Inc.	77	Hoskins Mfg. Co.	21
American Machine & Foundry Co.	83	Hughes Aircraft Co.	91
Amperex Electronic Corp.	63		
		Kearfott Div. of General Precision Inc. 72, 73	73
Ballantine Laboratories, Inc.	34		
Beede Electrical Instrument Co., Inc.	66	Lambda Electronics Corp.	3
Beaver Gear Works, Inc.	34	Little Falls Alloys, Inc.	92
Beckman Instruments, Inc. Berkeley Division	13		
Bendix Corporation Scintilla Division	8	Markel & Sons, L. Frank.	31
Budelman Electronics Corporation	37	Masterite Industries, Division of Hous- ton Fearless Corp.	68
Bussman Mfg. Co.	36	McDonnell Aircraft	93
		Metronix, Inc.	30
Cinch Mfg. Corp., Div. of United Carr Fastener Corporation	61	Oak Mfg. Co.	7
Cohn Corp. Sigmund.	68		
Collins Radio Co.	85	Philco Corporation Lansdale Division	40
Coto-Coil Co., Inc.	92	Pyrodyne, Inc.	83
Cubic Corp.	23		
Curtiss-Wright Corp.	86, 87	Radiation Inc.	2
		Radio Corporation of America	4th Cover
Di-Arco Corporation	32	Ridgefield Instrument Group.	84
		Rohn Mfg. Co.	76
Edo Corporation	89		
Elcor Incorporated	18	Gamewell Co., The.	6
Electra Mfg. Co.	35	Gardner-Denver Company	75
Electrodynamics Instrument Corp.	37	Garlock Electronics Products, Inc.	12
Electronic Engineering Co.	27	General Aniline & Film Corp. Ozalid Div.	29
		General Controls	83
Federation Nationale Des Industries Electroniques	77	General Electric Co. Defense Electronics Division.	22
		Receiving Tubes	65
		General Dynamics Electronics.	66
		General Instrument Corp. Semiconductor Division	19
		Genisco Incorporated	90
		Green Instrument Co.	98
		Gremer Mfg. Co.	37
		Sangamo Electric Co.	71
		Security Devices	98
		Shallcross Mfg. Co.	69
		Sprague Electric Co.	5, 20
		Texas Instruments Incorporated Semiconductor-Components Division.	11
		Triplett Electrical Instrument Company 16, 17	17

GREEN PANTOGRAPH ENGRAVERS

● **ELIMINATE DELAYS!**

● **KEEP YOUR OPERATING COSTS WHERE THEY SHOULD BE!**



**PORTABLE
40-POUND
BENCH MODEL 106**

*You Make
Your Own
Engraved
Nameplates!*

Here is a speedy, economical 2 or 3-dimensional engraver used by thousands of dollar-conscious companies. It features 5 positive, accurate pantographic ratios; ball bearing spindle with 3 speeds up to 14,000 rpm. Is supplied with one copy carrier that accepts all standard master type sizes. Will actually work up to 10" by any width. Height of pantograph and position of cutter are continuously adjustable.

**MODEL D-2 HEAVY-DUTY
2-DIMENSIONAL**



Pantograph for milling, drilling and engraving.

Vertical adjustment of copy table automatic with Pantograph. Features: unobstructed on 3 sides to take large work; micrometer adjustment for depth of cut; ball bearing construction throughout; spindle speeds up to 26,000 rpm for engraving or machining; vertical range over 10"; ratios 2 to 1 to infinity — master copy area 26" x 10"

NEW

**MODEL D2-201
PNEUMATIC
ATTACHMENT**



for use with Model D2 Pantograph Engraver to rapidly drill holes in printed circuits by tracing templates. Drills as many as 100 holes per minute. Equipped with foot switch, spindle air cylinder; regulating valve and pressure gauge; filter and oiler. It's ready to use as soon as it's attached to an air compressor

Write or call for full details and prices.

**GREEN INSTRUMENT
COMPANY, INC.**

Dept. 63, 295 Vassar St.,
Cambridge 39, Mass. Tel. Eliot 4-2989

United Shoe Machinery Corp. 86
United Transformer Co. 2nd Cover
Universal Electronics Company. 86

Varian Associates 3rd Cover
Virginia Electric & Power Co. 38

Weinschel Engineering 14

MANUFACTURERS' REPRESENTATIVES
MacDonald Inc., Samuel K. 97

CLASSIFIED ADVERTISING
F. J. Eberle, Business Mgr.

EMPLOYMENT OPPORTUNITIES
95, 96, 97

EQUIPMENT
(Used or Surplus New)
For Sale 96

CLASSIFIED ADVERTISERS INDEX

Allen Organ Company. 96
General Atomic Div. of General Dynamics. . . 97
Kato Engineering Company. 96
Sanders Associates Inc. 96
Sikorsky Aircraft Div.,
United Aircraft Corp. 95

This index and our Reader Service Numbers are published as a service. Every precaution is taken to make them accurate, but electronics assumes no responsibilities for errors or omissions.

electronics



Audit Bureau
of Circulations



Associated Business
Publications

Audited Paid Circulation

BRUCE A. WINNER
Advertising Sales Manager

R. S. QUINT, Assistant Publisher Buyers' Guide and Business Manager; FRED STEWART, Promotion Manager; B. ANELLO, Marketing Service Manager; RICHARD J. TOMLINSON, Production Manager; GEORGE E. POMEROY, Classified Manager; HUGH J. QUINN, Circulation Manager.

ATLANTA M. Miller; HOUSTON Joseph C. Page; DALLAS Robert T. Wood, Frank LeBeau; LONDON Edward E. Schirmer; FRANKFURT Stanley R. Kimes; GENEVA Michael R. Zeynel.

ADVERTISING REPRESENTATIVES: NEW YORK Donald H. Miller, Henry M. Shaw, George F. Werner; BOSTON William S. Hodgkinson, Donald R. Furth; PITTSBURGH David M. Watson; PHILADELPHIA Warren H. Gardner, William J. Boyle; CHICAGO Harvey W. Wernecke, Martin J. Gallay; CLEVELAND P. T. Fegley; SAN FRANCISCO T. H. Carmody, R. C. Alcorn; LOS ANGELES Marshall Freeman, Peter S. Carberry; DENVER J. Patten;

BRANCH OFFICES: National Press Bldg., Washington 4, D.C.; McGraw-Hill Bldg., Copley Square, Boston 16; Four Gateway Center, Pittsburgh 22; Six Penn Center Plaza, Philadelphia 3; 645 North Michigan Avenue, Chicago 11; 55 Public Square, Cleveland 13; 255 California Street, San Francisco 11; 1125 West Sixth St., Los Angeles 17; 1740 Broadway, Denver 2; 1301 Rhodes-Haverty Bldg., Atlanta 3; 901 Vaughn Bldg., Dallas 1; Prudential Bldg., Holcombe Blvd., Houston 25; McGraw-Hill Publishing Co., Ltd., 34 Dover Street, London, England; B5 Westendstrasse, Frankfurt/Main; 2 Place de Port, Geneva.

for advanced systems...

$\frac{1}{4}$ WATT AT 70 kMc

Developing a space communication system? Working in advanced radar? Need a pump tube for an out-front parametric amplifier? Making advanced measurements in the laboratory? Varian's VA-99 reflex klystron oscillator will make new approaches possible.

The rugged new VA-99 is frequency stable from sea level to outer space, reliable in extreme environments. Frequency is fixed. Tube is factory preset to frequency ordered, between 68.0 and 72.0 kMc. Means are provided for subsequent fine trimming to exact operating frequency. The VA-99 is conduction cooled through waveguide flange. Excellent performance is also obtained at lower power levels. Base and leads are molded to permit high-altitude operation without pressurization.

Interested? Need a similar tube at a somewhat higher or lower frequency? For further information write Tube Division



VA-99 (shown actual size)

68.0-72.0 kMc / 250 mW Typical Power Output / Fixed Frequency, Trimmable



VARIAN associates

PALO ALTO 1, CALIFORNIA

Subsidiaries:

BOMAC LABORATORIES, INC.
VARIAN ASSOCIATES OF CANADA, LTD.
S-F-D LABORATORIES, INC.
SEMICON ASSOCIATES, INC.
SEMICON OF CALIFORNIA, INC.
VARIAN A. G. (SWITZERLAND)

HIGHEST RESOLUTION AVAILABLE IN A VIDICON.....

1200 LINES



with the New RCA-8051 1½-inch **vidicon**

for use with 35-mm optical systems

Never before has such resolution been achieved in a commercial vidicon! *Twelve hundred lines*—and without sacrifice of sensitivity or increase in lag.

The first vidicon designed expressly for 35-mm optical systems, the 8051 is ideal for high-quality B-&W film or live pickup, closed-circuit TV involving remote reading of documents or instruments and for color pickup in 3-vidicon cameras.

A photoconductive layer of precisely controlled thickness assures uniform output current and uniform dark current capability over the entire scanned area. Picture background is free of flare and other spurious signals. Precision-ground flat face-plate prevents optical distortion.

This new vidicon and its associated components (deflection, alignment and focusing coils) were designed and developed by RCA. For information on RCA Vidicons—check with your RCA Field Representative, or write: Commercial Engineering, Section G-19-Q-1, RCA Electron Tube Division, Harrison, N. J.

NOW—AN RCA VIDICON FOR EACH OF THESE STANDARD OPTICAL SYSTEMS

For 35-mm optics—RCA-8051
1½" vidicon, 1200 lines resolution.

For 16-mm optics—RCA-7735-A
1" vidicon, 900 lines resolution.

For 8-mm optics—RCA-4427
½" vidicon, 400 lines resolution.



The Most Trusted Name in Electronics

INDUSTRIAL PRODUCT SALES: NEWARK 2, N. J., 744 Broad St., HU 5-3900 • CHICAGO 54, ILL., Suite 1154, Merchandise Mart Plaza, WH 4-2900 • LOS ANGELES 22, CALIF., 6801 E. Washington Blvd., RA 3-8361 • BURLINGAME, CALIF., 1838 El Camino Real, OX 7-1620 • GOVERNMENT SALES: HARRISON, N. J., 415 South Fifth St., HU 5-3900 • DAYTON 2, OHIO, 224 N. Wilkinson St., BA 6-2366 • WASHINGTON 7, D. C., 1725 "K" St., N.W., FE 7-8500.