

# electronics

*Punched-tape-controlled machine (below) assembles welded-wire matrices for circuit modules designed by a computer. See p 108*  
*Outside-coil magnetic heads improve frequency response, p 89*

A McGraw-Hill Publication 75 Cents

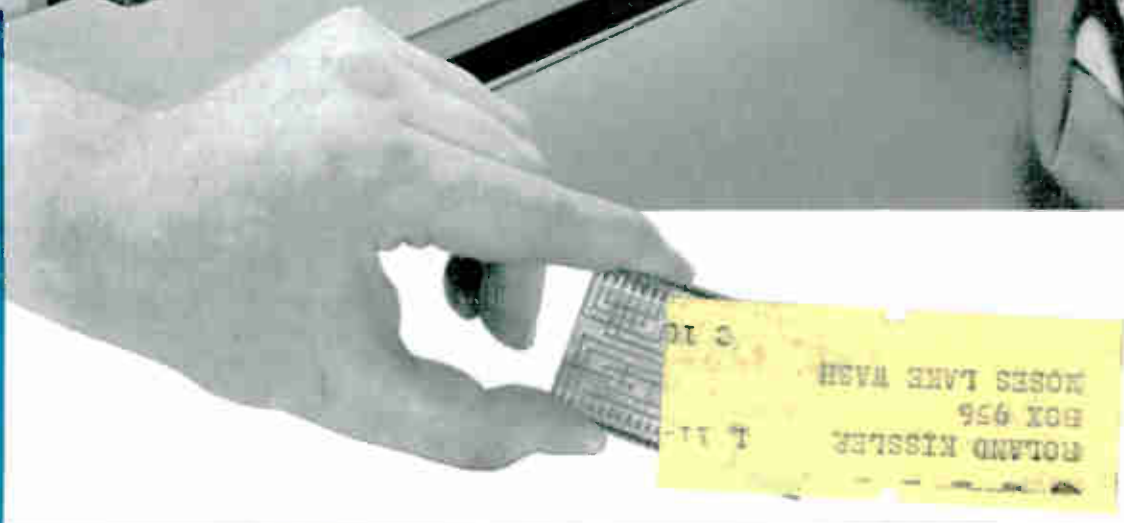

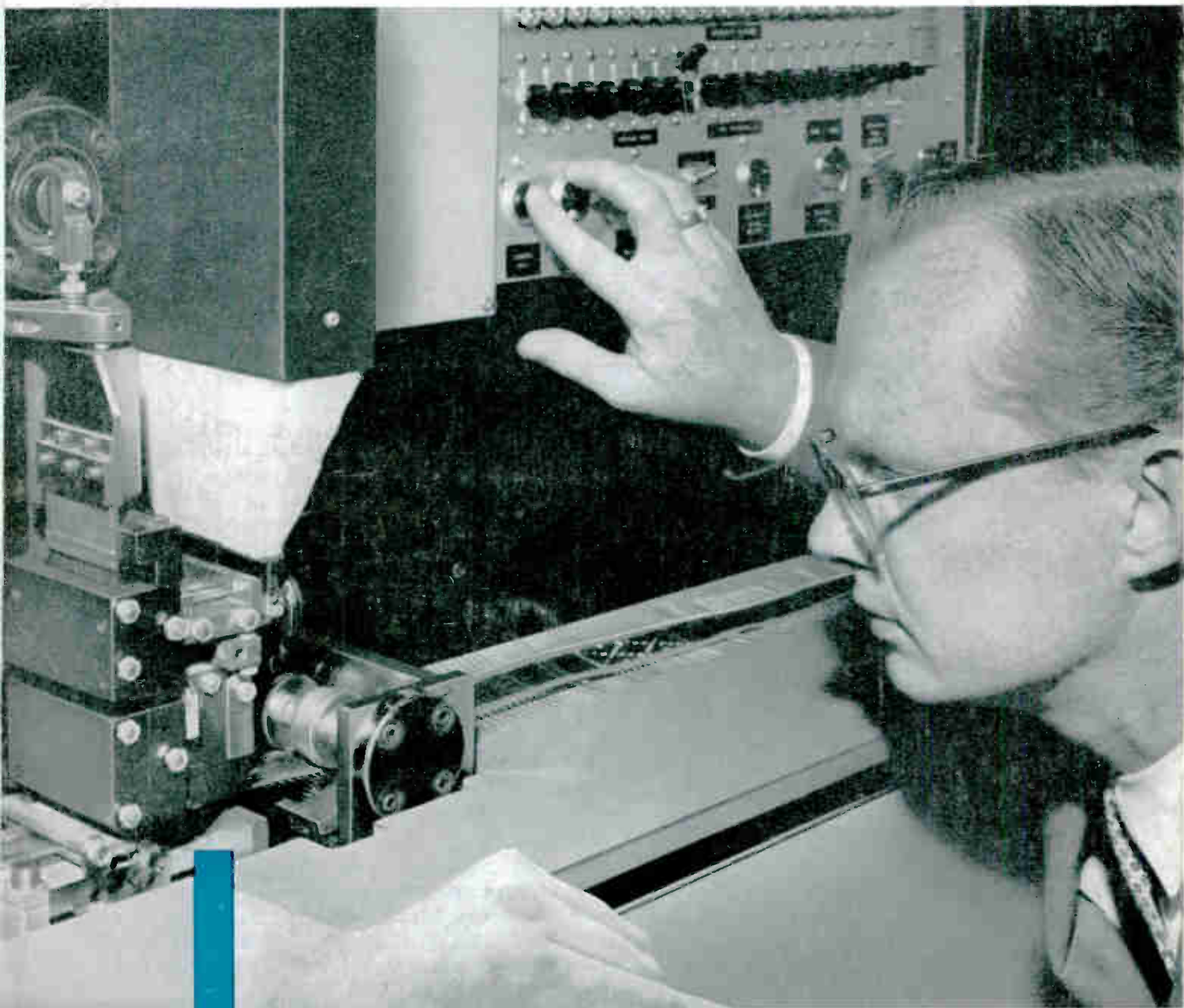
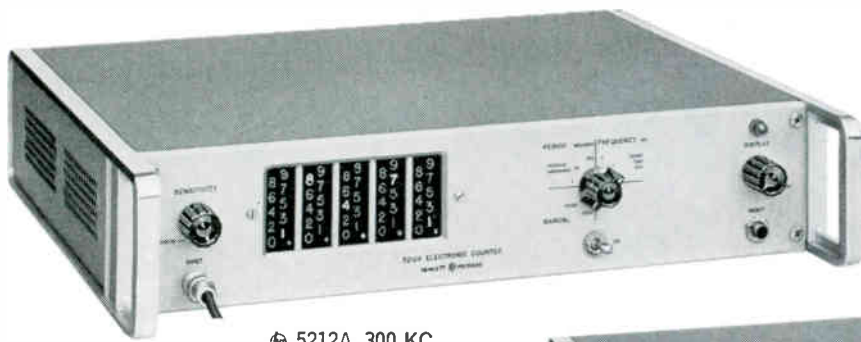

5212A, 300 KC

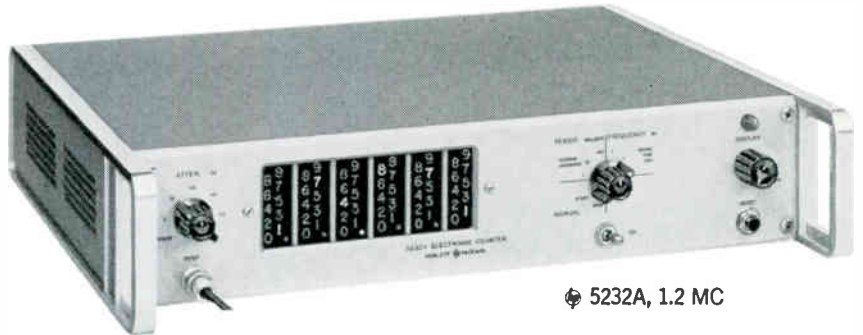

5232A, 1.2 MC



# COUNTERS!

sensitivity! Higher sampling rate! Unique low frequency accuracy! Operation  $-20^{\circ}$  to  $+65^{\circ}$  C! Prices comparable to vacuum tube counters!

Measurement		Frequency Measurement				Ratio Measurement			Price
Reads in	Periods Averaged	Range	Accuracy	Reads In	Gate Time	Reads	Range	Accuracy	
Milli-seconds with positioned decimal	1, 10, 10 <sup>2</sup> , 10 <sup>3</sup> , 10 <sup>4</sup> , 10 <sup>5</sup>	2 cps to 300 KC	$\pm 1$ count $\pm$ time base accuracy	KC with positioned decimal	10, 1, 0.1, 0.01 sec.	$(f_1/f_2) \times$ period multiplier	$f_1$ : 100 cps to 300 KC (1 v rms into 1,000 ohms) $f_2$ : same as period	$\pm 1$ count of $f_1 \pm$ trigger error of $f_2$	\$ 975.00
		2 cps to 1.2 MC					$f_1$ : 100 cps to 1.2 MC (1 v rms into 500 ohms) $f_2$ : same as period		1,175.00
Milli-seconds or micro-seconds with positioned decimal									1,300.00
									1,550.00

accuracy in lower frequency ranges, even for noisy signals. Self-check is provided for both frequency and period measurement modes.

Only  $3\frac{1}{2}$ " high, these counters are housed in the new  $\Phi$  modular cabinets ideal for both bench use and easy rack mounting. Routine maintenance is simple with snap-out decade/readout units and circuit cards. Readout drive directly from photoconductors eliminates a complete stage of complex circuitry, to effect genuine cost and reliability advantages. Compact design and construction and servicing ease are illustrated at the left.

Solid state design and construction gives you the advantages of low heat dissipation with minor heating effect on adjacent equipment, fast warm-up, low power consumption and new standards of reliability.

The new counters include a four-line BCD code output. This output, with assigned weights of 1-2-2-4, is available for systems use or to operate devices such as the  $\Phi$  562A Digital Recorder. Front panel controls include Input Attenuation, Display, Reset and Function.

Call or write your  $\Phi$  representative or call us today for information and a demonstration!

*Data subject to change without notice. Prices f.o.b. factory.*



## HEWLETT-PACKARD COMPANY

1081A Page Mill Road  
Cable "HEWPACK"

Palo Alto, California, U.S.A.  
DAvenport 6-7000

*Sales representatives in all principal areas*

## HEWLETT-PACKARD S. A.

Rue du Vieux Billard No. 1  
Cable "HEWPACKSA"  
Geneva, Switzerland  
Tel. No. (022) 26.43.36



- Easier reading continuous display
- Higher sampling rate
- Multi-period average
- Wide temperature range
- Low-frequency accuracy
- Versatile new modular design
- Measurement flexibility, moderate cost

# IN 4 NEW SOLID STATE COUNTERS!

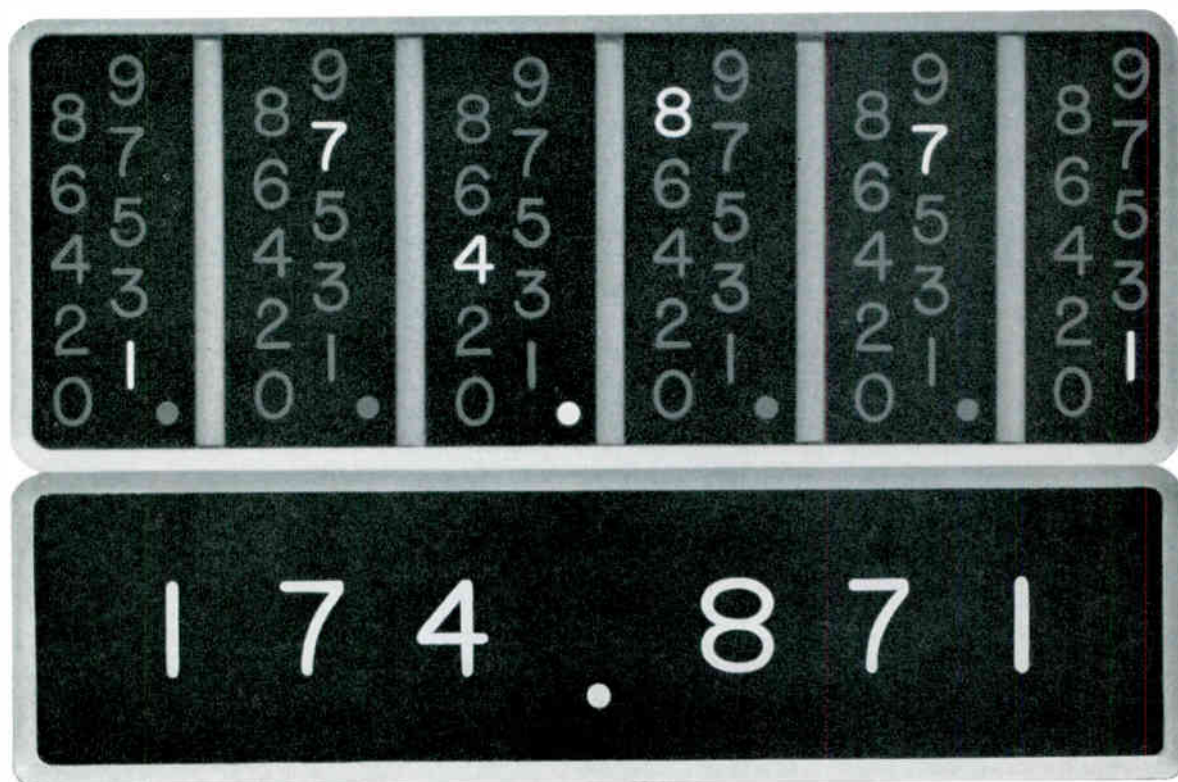

Turn the page to learn about new measuring convenience, dependability from .

a pleasure  
to measure  
with these...



5512A, 300 KC



5532A, 1.2 MC

# 4 NEW SOLID STATE

Measure frequency, period, ratio, quickly, accurately. Compact, easy-to-use instruments provide continuous display, no "blinking"! Solid-state dependability! 0.1 volt

All the advantages of solid-state design are now yours in these new  $\Phi$  solid state counters—offered at prices comparable to those of today's vacuum tube counters. And you get the *plus* advantages of greater readability, faster measurements, easier routine maintenance, rack-and-stack convenience of the new  $\Phi$  universal module instrument cabinets.

Offered in four models, these new counters have maximum counting rates of 300 KC or 1.2 MC, with a choice of Nixie or columnar readouts. The high-intensity neon readouts are stacked in compact columns for faster, easier reading. On the in-line readouts,  $\Phi$ -pioneered standard incorporation of the new long-life, wide-viewing Nixies gives you many extra hours of lamp life and heretofore unknown readability even at extreme angles. Polarized screen provides maximum readout brilliance with freedom from reflections.

A unique display storage feature of these new counters produces a continuous visual readout of the most recent measurement, even while the instrument is making a new measurement. Only if the new count differs from the previous count will the display change, in which case it will shift directly to the new reading. The fatigue and error possibility of a "blinking" display is eliminated. The storage feature may be disabled with a rear panel switch.

The counter's "inactive time" (when not making a new measurement) is independent of gate time and adjustable from 0.2 to 5.0 seconds, thus permitting a higher sampling rate.

Counter	Max. Counting Rate	Registration	Period	
			Range	Accuracy
5212A	300 KC	5 digits columnar	2 cps to 10 KC in single period; up to 300 KC in multiple period average	$\pm 10 \mu\text{s} \pm$ time base accuracy $\pm$ trigger error/periods averaged
5512A	300 KC	5 digits Nixie	2 cps to 10 KC in single period; up to 1 MC in multiple period average	$\pm 1 \mu\text{s} \pm$ time base accuracy $\pm$ trigger error/periods averaged
5232A	1.2 MC	6 digits columnar	2 cps to 10 KC in single period; up to 1 MC in multiple period average	$\pm 1 \mu\text{s} \pm$ time base accuracy $\pm$ trigger error/periods averaged
5532A	1.2 MC	6 digits Nixie	2 cps to 10 KC in single period; up to 1 MC in multiple period average	$\pm 1 \mu\text{s} \pm$ time base accuracy $\pm$ trigger error/periods averaged

High sensitivity permits low level measurement without accessories, and multiple period average measurement (to 100,000 periods) gives higher ac-



Note clean, compact, easy-to-service physical arrangement of new  $\Phi$  solid-state counters.

# electronics

A McGraw-Hill Publication 75 Cents



W. W. MacDONALD, Editor

J. M. CARROLL, Managing Editor  
 SENIOR ASSOCIATE EDITORS: Samuel Weber, Roland J. Charest. ASSOCIATE EDITORS: Michael F. Tomaino, George Sideris, Sylvester P. Carter, William P. O'Brien, John F. Mason, William E. Bushar, Thomas Emma, Sy Vogel, Leslie Solomon, M. M. Perugini, George J. Flynn.  
 ASSISTANT EDITORS: Michael F. Wolff, Nilo Lindgren, Stanley Froud, Stephen B. Gray, Roy J. Bruun, George V. Novotny, Leon H. Dulberger.  
 REGIONAL EDITORS: Harold C. Hood (Pacific Coast, Los Angeles), Thomas Maguire (New England, Boston), Cletus M. Wiley (Midwest, Chicago).  
 ART DIRECTOR: Harry Phillips; Howard R. Berry. PRODUCTION EDITOR: John C. Wright, Jr. EDITORIAL ASSISTANTS: Gloria J. Meurer, Bernice Duffy, Lorraine Rossi, Virginia T. Bastian, Lynn Emery, Avis Pomeranz, Florence Hajaistron, Laura W. Smith, Bette H. Snyder.

JAMES GIRDWOOD, Publisher

Welded wire matrix machine developed at General Electric is step forward in tape-programmed automatic circuit fabrication. See p 108 COVER

Cryotron Computers Approaching Reality But Production's A Problem. Trimmed in-line cryotron matches output impedance	26
"Real Time" Fax Controls Railroad Operations	28
New Research Studies Helping Electronics in Northern Ireland	30
Scan Converter Bandwidth Goes to 10 Mc. Air traffic control	33
Ion Rocket Engine Prototype Shown. 61-beam engine runs 175 hours	35
Radar-Computer Display Traces Alphanumeric Characters. Has 64 characters and 4,096 readout positions. By K. E. Perry and E. J. Aho	75
Replacing Sine-Wave Sources With Solid-State Inverters. Saturable reactor adjusts output waveshape. By D. Levy	80
Four-Layer Diode Triggers High-Voltage Pulse Generator. One-Kv pulses at 10,000 pps. By N. Hekimian and P. Schmitz	84
Testing Microwave Transmission Lines Using the Sampling Oscilloscope. Pulse reflection gives characteristic impedance directly. By H. Halverson	86
Outside-Coil Magnetic Head Improves High-Frequency Recording. Makes possible higher packing densities at low recording speeds. By M. Camras and R. Sears	89
Equations and Procedure for Designing Transistor or Zener Shunt Regulators. Single design equations. By M. Beebe	92
Graphical Design Procedure for Maximally Flat Microwave Filters. Valid for bandwidth of 10 percent. By M. Chomet	94

Crosstalk	4	Research and Development	100
Comment	6	Components and Materials	104
Electronics Newsletter	9	Production Techniques	108
Electronics Abroad	12	New on the Market	112
Washington Outlook	14	Literature of the Week	130
Financial	22	People and Plants	132
25 Most Active Stocks	23	Index to Advertisers	142
Meetings Ahead	36		



THE RAW MATERIALS OF PROGRESS

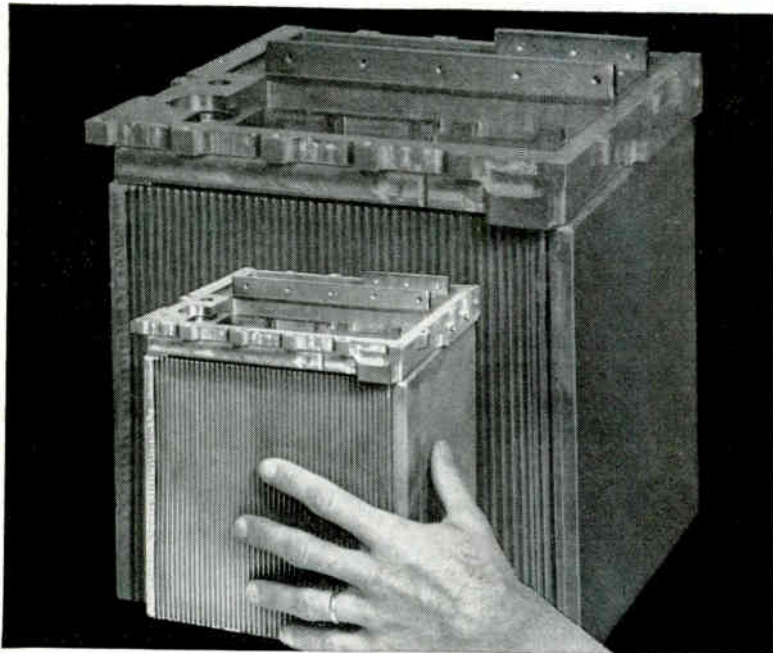

## Big help in thinking small:

7 times more cooling power with  
FC-75 and FC-43!

For substantial space-saving, weight-saving reductions in the design of electronic equipment, look to 3M Brand Fluorochemical Liquids FC-75 and FC-43! Their heat transfer capabilities are outstanding. Since these fluids boil at 100° C. (FC-75) and 180° C. (FC-43), their heats of vaporization can be used to effect heat removal by at least seven times the rate of non-volatile organic liquid coolants.

*Getting down to cases:* the heat removal capacity of FC-75 and FC-43 helped Hughes Aircraft designers to miniaturize the com-

munications power unit (shown above) by a factor of six. For Raytheon designers, a transformer was reduced by 4 to 1 in volume and by 2 to 1 in weight, without impairment of performance or power output.

*If you are designing* in the electrical, electronics, missile or jet aircraft fields, look into the miniaturization help that the dielectric strength, limited solubility, thermal stability, and low pour points of FC-75 and FC-43 can offer. After reading the "Properties Profile," write for further information . . .

### PROPERTIES PROFILE

#### on 3M Brand Inert Liquids FC-75 AND FC-43

These unique dielectric coolants possess unusual properties that can prove advantageous to the designer of electrical devices and instruments, as well as to the manufacturer. Increased range of operating temperatures, improved heat dissipation which permits miniaturization, and greatly increased protection from thermal or electrical overload are possible with their use.

FC-75 and FC-43 are non-explosive, non-flammable, non-toxic, odorless and non-corrosive. They are stable up to 750°F., and are completely compatible with most materials . . . even above the maximum temperatures permissible with all other dielectric coolants. Both are self-healing after repeated arcing in either the liquid or vapor state.

#### ELECTRICAL PROPERTIES

	FC-75	FC-43
Electrical Strength	35KV	40KV
Dielectric Constant (1 to 40 KC @ 75°F.)	1.86	1.86
Dissipation Factor (1000 cycles)	0.0005	0.0005

#### TYPICAL PHYSICAL PROPERTIES

	FC-75	FC-43
Pour Point	< -100°F.	-58°F.
Boiling Point	212°F.	340°F.
Density	1.77	1.88
Surface Tension (77°F.) (dynes/cm)	15	16
Viscosity Centistokes	0.65 min.	2.74
Thermal Stability	750°F.	600°F.
Chemical Stability	Inert	Inert
Radiation Resistance	25% change @ 1 x 10 <sup>8</sup> rads	25% change @ 1 x 10 <sup>8</sup> rads

FC-75 and FC-43 have nearly equivalent heat capacities in the liquid and gaseous states.

For more information on FC-75 and FC-43, write today, stating area of interest to: 3M Chemical Division, Dept. KAX-61, St. Paul 6, Minn.

CHEMICAL DIVISION

MINNESOTA MINING AND MANUFACTURING COMPANY

. . . WHERE RESEARCH IS THE KEY TO TOMORROW



# NEW! DIRECT READING FREQUENCY METER

a full octave and beyond  
3.95 to 11.0 KMc

## DELIVERY FROM STOCK



Model No. N414A Price: \$495.00

- Direct reading from 3.95 to 11.0 KMc
- Covers a full octave and beyond
- Reaction type with 0.1% absolute accuracy
- Non-contacting choke for long life and high Q
- Standard Type N Connectors for universal utilization

Meet the newest member of the FXR "family" of direct reading frequency meters. This coaxial type, Model No. N414A, has a range from 3.95 KMc to 11.0 KMc and by use of FXR Series 601 coax to waveguide adapters converts to waveguide set-ups. The unit covers "a full octave and beyond" with an absolute accuracy of 0.1% throughout its range. It is a perfect companion for the FXR Models No. C772 and X772 signal sources.

This newest direct reading frequency meter augments FXR's existing line, recognized as the largest in the industry. Direct reading, reaction type units are available for use up to 39.5 KMc while micrometer types extend FXR's coverage up to 220 KMc.

Write or call now for data sheets on Model No. N414A and other units in the integrated FXR family of precision frequency meters.

## FXR "FAMILY" OF DIRECT READING REACTION TYPE FREQUENCY METERS

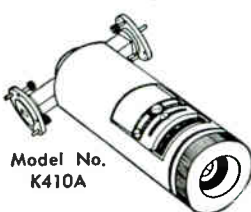
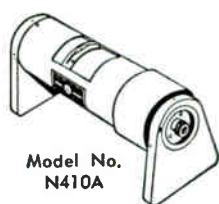

Model No.	Frequency Range (KMc)	Absolute Accuracy (%)	Approx. Q	Waveguide Type RG-( )/U	Flange Type UG-( )/U	Price (F.O.B. Woodside)
<b>COAXIAL TYPES</b>						
N410A	1.00- 4.00	0.10	3000	(3/8" Coax Type N)		\$495.00
N414A	3.95-11.0	0.10	500 to 1500	(3/8" Coax Type N)		495.00
<b>WAVEGUIDE TYPES</b>						
*H410B	3.95- 5.85	0.08	8000	49	149A	250.00
*C410B	5.85- 8.20	0.08	8000	50	344	180.00
*W410B	7.05-10.00	0.08	8000	51	51	165.00
*X410B	8.20-12.40	0.08	8000	52	39	150.00
Y410A	12.40-18.00	0.10	4500	91	419	210.00
K410A	18.00-26.50	0.10	4000	53	425	230.00
U410A	26.50-39.50	0.10	3000	96	381	250.00
C402A	5.85- 8.20	0.03	8000	50	344	1275.00
X402A	8.20-12.40	0.03	8000	52	39	1275.00

\* With transmission coupling probe.

**DELIVERY FROM STOCK**

### FXR M.M. TYPES (Micrometer Reading)

Model No.	Frequency Range KMc	Price (F.O.B. Woodside)
Q410X	33-50	\$325.00
M410X	50-75	300.00
E410X	60-90	500.00
F412A	90-140	750.00
G412A	140-220	750.00

**DELIVERY FROM STOCK**



**FXR, Inc.**  
Design • Development • Manufacture  
25-26 50th STREET • RA. 1-9000  
WOODSIDE 77, N. Y. • TWX: NY 43745

PRECISION MICROWAVE EQUIPMENT • HIGH-POWER PULSE MODULATORS • HIGH-VOLTAGE POWER SUPPLIES • ELECTRONIC TEST EQUIPMENT

Published weekly, with Electronics Buyers' Guide and Reference issue, as part of the subscription, by McGraw-Hill Publishing Company, Inc. Founder: James H. McGraw (1860-1948).

Title registered U.S. Patent Office; Copyrighted 1961, McGraw-Hill Publishing Company, Inc. All rights reserved, including the right to reproduce the contents of this publication, in whole or in part.

Executive, editorial, circulation and advertising offices McGraw-Hill Building, 330 West 42nd Street, New York 36, N. Y. Telephone Longacre 4-3000. Teletype TWX N.Y. 1-1636. Cable McGrawhill, N. Y. Printed in Albany, N. Y.; second class postage paid.

OFFICERS OF THE PUBLICATIONS DIVISION: Nelson L. Bond, President; Shelton Fisher, Wallace F. Traendly, Senior Vice Presidents; John R. Callahan, Vice President and Editorial Director; Joseph H. Allen, Vice President and Director of Advertising Sales; A. R. Venezian, Vice President and Circulation Coordinator.

OFFICERS OF THE CORPORATION: Donald C. McGraw, President; Joseph A. Gerardi, Hugh J. Kelly, Harry L. Waddell, Executive Vice Presidents; L. Keith Goodrich, Vice President and Treasurer; John J. Cooke, Secretary.

Subscriptions are solicited only from those actively engaged in the field of the publication. Position and company connection must be indicated on orders. Subscription rates: United States and Possessions, \$6.00 one year; \$9.00 two years; \$12.00 three years. Canada, \$10.00 one year. All other countries \$20.00 one year. Single Copies, United States and Possessions and Canada 75¢; Buyers' Guide \$3.00; Single Copies all other countries \$1.50; Buyers' Guide \$10.00.

The Publisher, upon written request from any subscriber to our New York Office, agrees to refund that part of the subscription price applying to copies not yet mailed.

Subscribers: Please address all correspondence, change of address notices, subscription orders or complaints to Fulfillment Manager, Electronics, at above address. Change of address notices should provide old as well as new address, including postal zone number if any. If possible, attach address label from recent issue. Allow one month for change to become effective.

Postmaster: Please send Form 3579 to Fulfillment Manager, Electronics, 330 West 42nd Street, New York 36, New York.



Audited Paid Circulation

# CROSSTALK

AUTHORS AND ELECTRONICS. Our 27-man editorial staff spends much of its time outside in manufacturing plants and research establishments and educational institutions, visiting engineers and scientists and talking about their work. This enables us to spot subjects that appear to have particular current significance, to point this out to people who may not be aware of the subject's importance and to encourage them to write technical articles. No "over the transom" editors, we.

When invited to write for ELECTRONICS, most men are interested, and their management, too, generally likes the idea. But even with such a unanimous expression of enthusiasm a substantial number of the encouraged articles never actually reach us, and the most common reason why is obvious: Time.

Now, management gives engineers their job assignments, which frequently include the writing of reports, and arranges their attendance at conferences and meetings. So these same men will often find the time to write for publication if management tells them to do so, or even if they know that management encourages it. They will find the time, in particular, if they think their advancement will be influenced. And where they simply cannot find the time it is often good business for management to find it for them, perhaps by temporary relief from other duties, instead of keeping their noses to a specific technical problem.

A good technical article, on an important subject, in ELECTRONICS, can do everybody involved a great deal of good. The work all around is worth it when contrasted with the questionable benefits of some so-called technical publicity.

## Coming In Our July 7 Issue

ULTRAPURE SEMICONDUCTORS. Continuing effort to improve the control of semiconductor electrical properties is stimulating research in preparation and purification of materials, impurity detection methods and measurement techniques. Progress in these areas was noted recently by New England Editor Maguire when he attended the Conference on the Ultrapurification of Semiconductor Materials in Boston.

In our next issue, his conference roundup spotlights some of the new techniques for producing low-impurity materials. You'll learn about three promising techniques for impurity analysis at the parts-per-billion level: activation analysis, emission spectroscopy, and spark source mass spectroscopy.

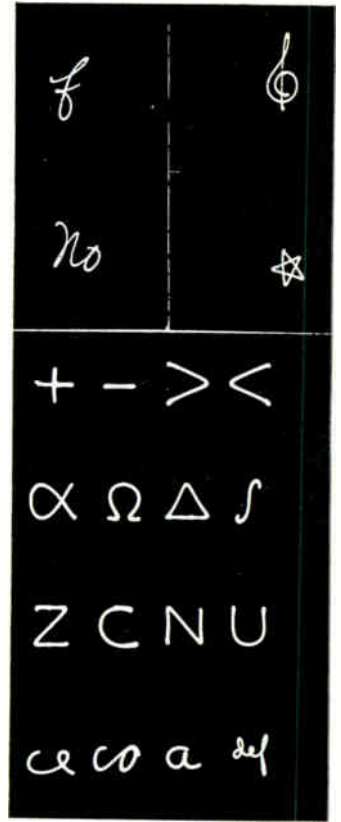

Symbols above can be traced on the radar computer output display described in this issue by K. E. Perry and E. J. Aho of MIT Lincoln Lab. Their article begins on p 75



# NOW...count and control precisely

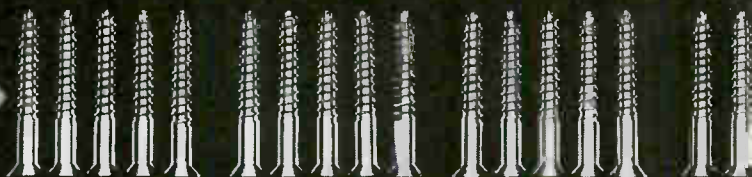

## with new decade counters from Raytheon



### RAYTHEON DECADE COUNTER TUBES

TYPES	CK6909 CK6910*	CK6476* CK6802	CK6476A* CK7978*
DC Supply	450 volts	425 volts	425 volts
Anode Resistor	0.27 meg ohms	0.82 meg ohms	0.82 meg ohms
Nominal Tube Drop	235 volts	187 volts	187 volts
Cathode Resistor	24 K ohms	100 K ohms	100 K ohms
Output (Across Cathode Resistor)	15 volts	30 volts	30 volts
Speed	to 100 kc	to 5 kc	to 5 kc
Maximum voltage between Electrodes (excluding Anode)	140 volts	140 volts	200 volts

\*All ten cathodes brought out independently for electrical readout.

More efficient equipment for precision counting and control of high-speed production machines can now be designed with Raytheon decade counter tubes. Because these tubes provide both visual and electrical readout, the functions of counting and stopping machinery at preprogrammed intervals can be combined with less circuitry and components.

The new Raytheon 13-pin CK7978 offers the advantages of small size, economical socket requirements, rugged construction, long life—and outstanding cost reductions both in lower initial purchase price and simpler circuitry requirements.

Frequency dividing, matrixing, telemetering, sampling, timing, and coding are other applications for Raytheon decade counter tubes. For full information please write: Raytheon, Industrial Components Division, 55 Chapel Street, Newton 58, Massachusetts.

*For Small Order or Prototype Requirements See Your Local Franchised Raytheon Distributor*

## RAYTHEON COMPANY

INDUSTRIAL COMPONENTS DIVISION



Stewart Ashton,  
our Chief Engineer,  
reports on  
the all-new . . .



## pHayes-master<sup>(TM)</sup>

**HERE AT LAST** is a simple, compact, space-saving package that provides *microsecond* response for controlling power to electric furnaces . . . and for numerous other applications and processes where temperatures must be precisely regulated.

**A TRANSISTORIZED UNIT**, the new Hayes pHayes-master now replaces costly and bulky saturable core reactors, tubes, magamps, powerstats, etc. — with *one*, small, smartly-designed control unit!

**VERSATILE, TOO . . .** pHayes-master can be used with most proportioning type temperature instruments . . . handles up to 70 amp. capacities at 220 volts, with stepless control over the full 0-100% range. Highly accurate, pHayes-master provides instantaneous, straight-line response . . . completely without lag or hunting.

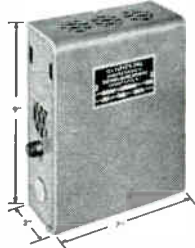

**ECONOMY** is another big advantage. The Hayes pHayes-master features a high power factor — expends only a fraction of the power source for control. Simple rugged construction and circuitry make it far easier and cheaper to install and maintain than conventional control devices.

These are just the highlights. If your equipment or process calls for close control of power for heat generation, get the *complete* facts on the all-new Hayes pHayes-master. Write for new Bulletin C-1, or tell

us about your application requirements. — C. I. HAYES, INC., 845 Wellington Ave., Cranston 10, R. I.



**C. I. HAYES, INC.**

Established 1905



It Pays To See Hayes for metallurgical guidance, lab facilities, furnaces, atmosphere generators, gas and liquid dryers, pHayes-master (TM) control units.

## COMMENT

### Electronics in Europe

In the past ten years I have made at least one and sometimes two trips a year to Europe. Only last Saturday I returned from a four-week trip to West Germany and England.

It was with extreme interest, therefore, that I read your story on "Electronics in Europe" which I found in the June 9th issue which was among the magazines that accumulated on my desk during my absence.

Needless to say, I concur 100 percent with your findings and observations. Of particular interest (in the fond memories aroused) were your marginal comments on personal observations.

JAMES MILLEN  
MILLEN MANUFACTURING CO.  
MALDEN, MASS.

. . . Your report "Electronics in Europe" is an interesting and informative publication, and should be very helpful to promoting an understanding of current economic developments in Europe, particularly in the field of electronics.

JOSEPH C. KOLAREK  
BUREAU OF EUROPEAN AFFAIRS  
DEPARTMENT OF STATE  
WASHINGTON, D. C.

. . . I just wanted to tell you that I enjoyed your "Electronics in Europe," appearing in the June 9th issue, especially your purely personal comments.

Having been an active radio amateur operator for many years I couldn't resist the temptation to write you. It sounds like you had a very interesting time in Europe; I wonder were you able to visit with the DX gang over there?

At your convenience, I would appreciate a reprint of your fine article for my files. We are just getting started in the European market and have found excellent response to our products there.

ROY T. STROMBERG  
CASWELL ELECTRONICS  
SAN JOSE, CALIF.

. . . Mr. Philip S. Fogg, chairman of Consolidated Electrodynamics forwarded me a copy of your excel-

lent publication "Electronics in Europe" dated June 9, 1961.

CHARLES C. SNIDER  
CONSOLIDATED ELECTRODYNAMICS  
PASADENA, CALIF.

In the special report "Electronics in Europe" in the June 9 issue, I was especially pleased to read the comments on technical support personnel. We have helped relieve this situation by establishing extension programs in electronic engineering technology and nuclear engineering technology through our European division with headquarters in London. Also, Oxford has accepted a grant from CREI to study secondary preparation for technical institutes and engineering programs. We have found expressed interest in such technical education programs in Greece, Austria, Germany and Switzerland.

CHARLES DEVORE  
CAPITOL RADIO ENGINEERING INSTITUTE  
WASHINGTON, D. C.

### Platinum Wire

We have noted a letter in *Comment* of your May 19 issue requesting a possible source for 5-10 mil platinum wire with a 200 C insulation. Sprague Electric has for some years been a source for custom coating on all types and shapes of conductors and I feel we can handle Dr. Sykes' requirement without undue delay. . .

H. F. WHITE  
SPRAGUE ELECTRIC CO.  
BENNINGTON, VT.

*Specification data sent by reader White was forwarded to Dr. Sykes.*

### Tunnel Diode Deterioration

Deterioration of tunnel diodes after several months of inactivity was reported in *Comment* (Mar. 17) and our question then: Were they gallium arsenide units? Reply from the researchers:

Tunnel diodes were RCA TD 100 germanium tunnel diodes. We have had no opportunity to work with gallium arsenide units nor have we been able to do further work with the germanium units.

CHARLES G. MASTERS  
JACK E. RATHMELL  
DUKE UNIVERSITY

## Crimp-type Connectors



These solderless, coaxial connectors are available in a variety of mounting configurations, including snap-locking versions. Male and female connectors may be mounted interchangeably. Mated length is  $1\frac{13}{16}$ ". Working voltages: 1,000 V. maximum, at sea level; 500 V. maximum, at 60,000 feet. VSWR; less than 1.2 up to 2,000 mc. Life; 5,000 matings, minimum, without electrical deterioration. Tensile strengths of the crimps exceed the breaking strength of the cable. Hard gold plated Beryllium copper and TFE plastic are extensively used to assure optimum reliability.

Microdot, Inc., 220 Pasadena Avenue, South Pasadena, California

**CIRCLE 9 ON READER SERVICE CARD**

## Coaxial Switch



SPDT miniaturized switch features a case volume of  $\frac{1}{2}$  cu. in. and weight of  $\frac{1}{4}$  oz. Design allows direct insertion into miniaturized circuit without cumbersome adapters. Toggle action is positive, rf characteristics are highly efficient. VSWR is less than 1.25 to 2.0 kmc. Insertion loss is 0.8 db at 2.0 kmc. Contact rating is  $\frac{1}{2}$  amp at 150 V. resistive. Operating is 50,000 operations, minimum. Special stripline manufacturing technique provides low loss, wide frequency band properties.

Microdot, Inc., 220 Pasadena Avenue, South Pasadena, California

**CIRCLE 7 ON READER SERVICE CARD**

## MICROMINIATURE COAXIAL CABLE



Microdot's Cable Facilities specialize in precise metallic braiding of micro-miniature coaxial cables. In a new, ultra-modern plant, special advanced techniques of cylindrical weaving are combined with the utilization of highest quality materials and rigid quality control methods, to produce a wide range of miniaturized RF frequency cables . . . cables designed and produced to yield the same matched impedance as required for larger cables.



"Mini-Noise" cable, a result of Microdot research, is specially processed to minimize self-generated noise—prevents noise interference with low strength signals. These cables also offer high performance in extreme temperature ranges.



Twinax cable produced by Microdot is a shielded, twisted pair of conductors utilizing prime dielectrics for low loss, featuring controlled capacitance and impedance. Shield is added after insulation and conductors are arranged in a balanced to ground configuration.



Triax cable by Microdot offers rf leakage below the level experienced with Double Shielded Coax. Three active conductors permit feedback to cancel a known noise source. Capacitance-cancelling hook-ups are possible for cathode followers.



Use reader service card in this publication, or write today for 4-page folder of performance charts, design characteristics, and specifications on the following cables: Coax 50, 70, 75, 93, 95 ohm. Twinax 125 and 160 ohm. Triax 50 and 93 ohm.

## MICRODOT INC.

220 Pasadena Avenue, South Pasadena, Calif.

MUrray 2-3351 SYcamore 9-9171



# YOU GET THIS MUCH MORE SELECTIVITY WITH A COLLINS MECHANICAL FILTER

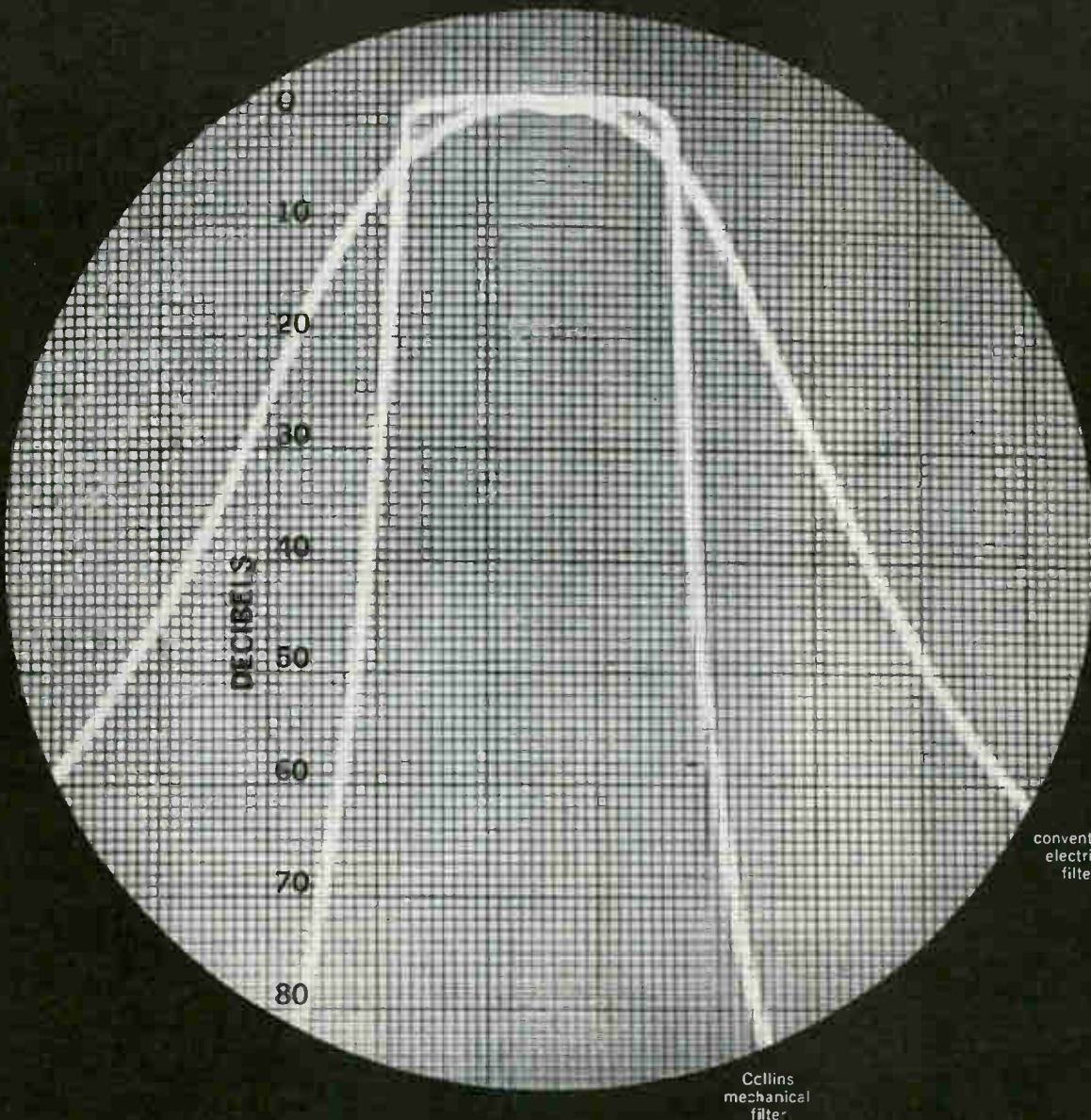

Choose Collins filters, and you don't have to choose between small size and selectivity. The steep, flat-topped curve above is the work of a few dime-size discs sealed in a case often smaller than a penlight battery. These resonant discs have Q's of 8,000-12,000, up to 150 times that of bulky electrical LC filter elements.

Collins mechanical filters also offer you unprecedented stability. Frequency shift can be held between 1.5 and 2 parts per million per degree centigrade over the range  $-25^{\circ}\text{C}$  to  $+85^{\circ}\text{C}$ , and there is no observable drift with age.

For carrier systems, single sideband equipment, bandpass filtering in high-

performance receivers—in fact, for any filtering job between 50 and 600kc, a Collins mechanical filter does a better job in less space.

Made to take it, Collins mechanical filters meet MIL-Spec requirements for humidity, corrosive environments, shock, vibration—the works. Literally hundreds of thousands now demonstrate their reliability throughout the world in communications equipment made by major electronic companies. A Collins filter may be your best answer, too.

Write for literature describing our line of more than 100 mechanical filters. Ask for Data File C-101A.



HALF SIZE

*Collins also offers a full selection of compact crystal filters, which cover the range of frequencies from below 10kc to as high as 30mc.*



**COLLINS RADIO COMPANY**  
19700 San Joaquin Road  
Newport Beach, California  
*World's Largest Producer of  
Mechanical Filters*

COLLINS RADIO COMPANY • NEWPORT BEACH, CALIFORNIA • DALLAS, TEXAS • CEDAR RAPIDS, IOWA

# ELECTRONICS NEWSLETTER

## Four Rumors, Three Unfounded

FOUR RUMORS have for some time been bandied about by Amateur and Citizens radio station operators. Three are without foundation. The fourth has some basis in fact. This is what ELECTRONICS has learned by interviewing Curtis B. Plummer, Chief of the Safety and Special Radio Services Bureau of the Federal Communications Commission:

*Citizens Banders have not proposed to the FCC that their 11-meter assignment be extended into the Amateur 10-meter band, and this subject is not under consideration at the Commission. There may soon be such a proposal, the most vocal proponents being a Citizens Band magazine published in California and a club in North Carolina.*

*Citizens Banders have not proposed to the FCC that their permissible input power be increased beyond the present five-watt limit, and this subject is not under consideration at the Commission. Same two primary sources of agitation.*

*No one has proposed to the FCC that amplitude modulation be eliminated from Amateur use and single-sideband be made mandatory, and this subject is not under consideration at the Commission. Source of rumor unknown.*

*FCC Chairman Minow has, in a recent speech, endorsed the idea that license fees might be required of stations, but if the proposal is eventually accepted it would probably apply to all classes of stations and not just to Amateurs or Citizens Banders. A rule-making proceeding was held in 1954 on this subject, and nothing came of it. It might eventually be revived.*

## Gallium Antimonide: Tunnel Diode Material

USE of gallium antimonide for tunnel diodes was revealed over the weekend by Micro State Electronics Corporation, Murray Hill, N. J. The material, firm says, makes possible an amplifier with a noise figure of only 2.5 db. (Common tunnel diode materials: gallium arsenide and germanium.)

Company announced development of a microminiature amplifier consisting of two gallium antimonide tunnel diodes. Practically noise-free amplifier is especially suited for satellite communications, firm says. Micro State is a subsidiary of Apollo Industries, headquartered in Pittsburgh.

Gallium antimonide has an energy gap of 0.68 electron volt. Electron mobility has been measured at 4,000 cm per volt-sec and hole mobility at 700. Quantity I<sup>2</sup>R, an inverse measure of noise figure in tunneling devices, is 35 to 40 milli-

volts in gallium antimonide as against 65 to 70 for germanium and 120 for gallium arsenide.

## Instrument Measures Blood Automatically

MEASUREMENT of blood volume—an important factor in serious operations where blood loss is high—can now be done automatically in 10 to 15 minutes with the Volemetron, a portable instrument developed by Atomium Corp. (an affiliate of Perkin-Elmer) and doctors at Beth Israel Hospital in Boston.

First announced and publicly demonstrated during the 110th Annual Meeting of the American Medical Association this week, the device actually is a mechanized version of the standard radioisotope-dilution technique now being used in many hospitals. The electronic approach improves accuracy and cuts measurement time. The device can be used by most person-

nel in or near the operating room.

The instrument has revealed that some blood loss estimates made by weighing surgical sponges and measuring blood content of surgical sponges with the electrolytic washing machines have been in error 30 percent. Now under or over-supplying of blood by transfusion can be quickly determined within five percent accuracy.

## Packs 19 Components In 1/4 in. Plastic Cube

REPLACEABLE circuit modules called "Logi-Mods," which average 19 electronic components fully encapsulated in a 1/4-in. cube of plastic material, are in Burroughs' ultra-miniaturized three-cubic-foot airborne computing system just delivered to the Navy.

System has the same computational ability as a room-size electronic "brain," firm says. Employing transistor circuits, the production prototype has high capacity and, company adds, was "packaged" by new techniques used to assure high reliability.

## EIA Finishes 3 New Technical Standards

THREE NEW technical standards dealing with receiver-type tube sockets, electronic component parts, and television transmitters are now available from EIA's Engineering Department in New York City.

The documents are: RS-167-A—Type Designation for Receiver-Type Sockets; RS-186-B—Standard Test Methods for Electronic Component Parts; RS-240—Electrical Performance Standards for Television Broadcast Transmitters Channels 2-6 (54-Mc-88-Mc), 7-13 (174-Mc-216-Mc), 14-83 (740-Mc-890-Mc).

## Japanese 3-color Tv Set Needs No Shadow Mask

IN TOKYO, these two items made news last week:

(1) The Toyo Electric Manufacturing Co. unveiled a less expensive yet reportedly superior three-color

system tv receiver. (Price details were not given.) The receiver requires no shadow mask. Toyo's stocks immediately soared out of clear sky more than eight times to \$1.15 dollar per share.

(2) Japan's foreign investment council approved an engineering tieup between Toshiba and General Electric for manufacture of large land radar parts. They will be used for the maintenance of the Japanese self-defense force's 12 radar installations manufactured by G.E. No further details were disclosed.

## Wescon '61 Program In Mails This Week

PRELIMINARY PROGRAM for the 1961 Western Electronic Show and Convention is in the mails this week.

It gives particulars on the technical convention, exhibitors, field trips and social events available in San Francisco during August 21-25.

More than 80,000 copies of the program are being mailed to western members of IRE and WEMA (co-sponsors), and to other IRE members, exhibitors and persons who have participated in recent Wescon shows.

The 16-page publication offers a first reading of the technical program, which is expected to attract upwards of 35,000 engineers and management men to Cow Palace. A total of 123 papers are listed under 41 sessions.

## True-Motion Radar For Nuclear Ship

NUCLEAR-DRIVEN cargo ship *Savannah*, nearing completion this week, has installed true-motion radar.

In addition to features in usual true-motion designs, the equipment gives "visually" true heading at all times. This avoids confusion caused by left-to-right reversal of objects displayed alongside the vessel, when heading is due south.

Instead of a downward moving bright-spot, the entire crt assembly rotates automatically, producing upward movement for south heading. Now in volume production, the radar, made by RCA in Camden, N. J., was announced last year.

Several units are in operation on conventionally-powered cargo ships.

In true-motion radar stationary objects remain fixed on the display while all moving objects, including the ship-mounted transmitter, move at their proper rates.

## Hanscom Buying Goes 'Central' Tomorrow

STARTING tomorrow, procurement at the Air Force's Hanscom Field in Bedford, Mass., will be centralized in a single office for both R&D and systems contracts.

Command-control and other AF electronic systems under development are managed by Electronic Systems division at Bedford. In the fiscal year now closing, \$500 million in contracts have been processed at Bedford. This figure will rise substantially in the new fiscal year.

## Studying 'Dehydrated' Digital Communications

PACKARD BELL ELECTRONICS this week has a contract from the George Marshall Space Flight Center, National Aeronautics and Space Administration, to determine feasibility of a digital communications concept proposed by firm's Advanced Technology Laboratory in Newbury Park, Calif.

Robert S. Bell, company president, says the technique would increase communications efficiency by eliminating redundant data prior to transmission, thereby allowing more information to be transmitted over existing facilities.

"It is similar to dehydration," Bell explains. "Data is compressed during transmission and expanded to its original form at the receiving end." Bell says the technique was conceived to reduce cost and weight in satellite and telemetry applications, but that it could be used for television.

"Theoretically, 10 different television programs could be sent from New York to Los Angeles over a single microwave channel, then distributed to 10 different stations," he says. Bell estimates the feasibility study will require six months to complete.

## In Brief . . .

GENERAL PRECISION, INC. receives an Air Force study contract for the guidance system to be used in the Space Logistic Maintenance and Rescue Vehicle (SLOMAR).

NASA invites these four companies to submit proposals on design, development, and production of Saturn S-II stage: Aerojet-General, Douglas Aircraft, General Dynamics-Astronautics division, and North American Aviation.

ELECTRONIC REPRESENTATIVES ASSOCIATION becomes a participant association of the National Electronics Conference.

GENERAL DYNAMICS/ELECTRONICS will supply the instrumentation and control systems for the 100-Kw nuclear mockup reactor being built for NASA at its Plum Brook, Ohio, nuclear facility.

TEXAS INSTRUMENTS INCORPORATED gets \$268,000 Air Force contract to design and develop an untended marine seismic monitoring system.

EIA reports April factory transistor sales decline, but annual totals far exceed last year's. The figures: April 1961—15,072,064 units worth \$27,388,278; March 1961—15,129,273 worth \$29,815,291; first four months of this year—55,655,696 transistors valued at \$105,858,361; to end of April last year—41,047,034 units valued at \$101,444,855.

LOCKHEED'S California division signs agreements with Italian government and industry officials establishing an F-104 fighter production program in Italy. F-104 carries an all-new electronics and fire control system.

GENERAL SERVICES ADMINISTRATION is selling 1,978 short tons of ground steatite talc useful for dies in production of electron tube insulators. The material will come out of the national stockpile.

MOTOROLA Semiconductor Products division in Phoenix receives \$1.4-million Air Force contract for a study of compatible techniques for integrated circuit functions through combined utilization of semiconductor processes and thin-film technology.

# EVERYONE TALKS **RELIABILITY** IN HERMETICALLY SEALED CONNECTORS BUT ONLY **CANNON** OFFERS **STATISTICAL PROOF**

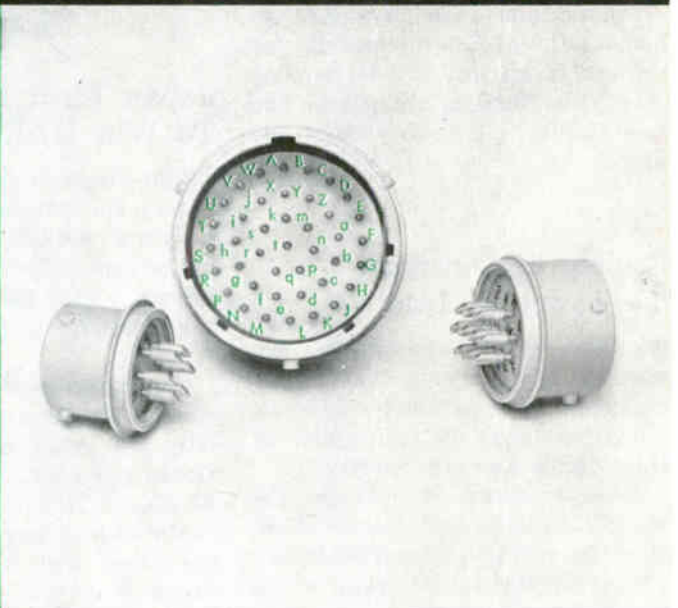
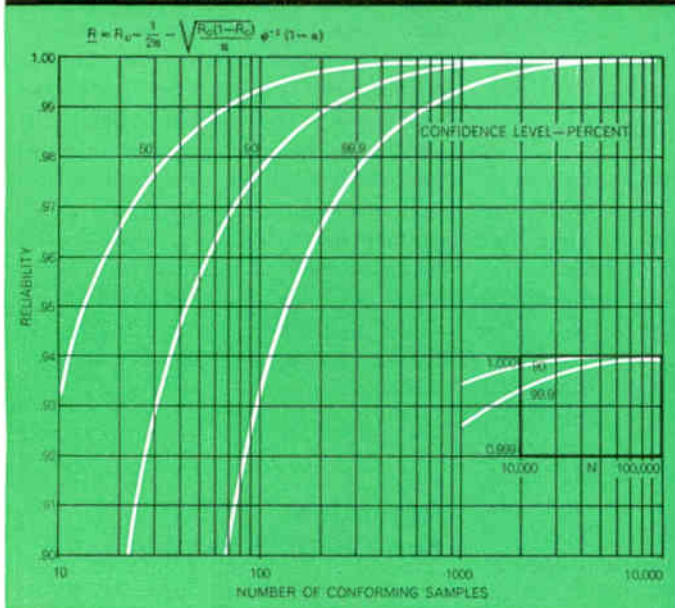

The Cannon KPT Hermetic line is designed to, and far surpasses all requirements of **MIL-C-26482**...has proven statistically reliable in leakage tests 200 times as severe as that required by MIL-C-26482. *Cannon offers you hermetic seals with a reliability coefficient of .999 at a confidence level of 95%.* Our rigid manufacturing controls and continued testing guarantee reliability at no added cost—and, in many instances, at lower prices than ordinary hermetic seals. Available for *off-the-shelf delivery* from Cannon stocking points and CAPS Distributors throughout the United States. ● **LEAD-FREE COMPRESSION GLASS** ● **EXCEPTIONALLY LEGIBLE CONTACT IDENTIFICATION FOR FASTER**

**TERMINATING AND CHECKOUT** ● **RELIABILITY ASSURANCE SUBSTANTIALLY REDUCES THE NEED FOR USER'S VERIFICATION TESTING** ● These are only a few of the many reasons why you should consult the world's most experienced manufacturer of electrical connectors for your hermetic sealing needs. For immediate delivery and quotations write, phone, or wire Customer Services Manager, PHOENIX DIVISION, 2801 AIRLANE, PHOENIX, ARIZONA. Phone BRidge 5-4792. Test report and complete KPT Catalog available upon request from:

**CANNON**  
**PLUGS**

**CANNON ELECTRIC COMPANY**, 3208 Humboldt Street, Los Angeles 31, California.

# ELECTRONICS ABROAD

## New Italian Plant To Make Components

MILAN—Siemens & Halske and Mial S. p. A. have formed a new stock company, Adriatica Componente Elettronici, to produce electronic components.

The new organization will be headquartered at Sulmona in a plant that will cover an area of about 1,076,000 sq ft. Italian spokesmen say the plant will be completed within a year, will cost about \$640,000.

They plan initial production of capacitors at a rate of about five million units per month. Initially, synthetic film capacitors will be manufactured. Sales, primarily for the export market, will be handled jointly by Siemens and Mial. The new facility will employ about 300 people.

## Soviets to Construct Tv Tower in Iraq

BAGHDAD—Iraqi newspapers are quoting Tass reports that Soviet engineers will construct a 1,058-ft. television tower in the capital of this Middle Eastern country.

Moscow claims it will be the world's tallest steel tower. Construction will be a nine-sided lattice prism for the initial stage which will be 769.9 ft. high.

The project is included in the Iraqi-Soviet Technical and Economic Cooperation agreement of March 1959 and is part of a program to expand and modernize the nation's radio and television facilities.

## British C-C Camera Selling for \$350

LONDON—New closed-circuit tv camera being produced in Britain is priced at \$350 without lenses. The unit is designed to operate with any standard UK tv receiver by using a coaxial feeder running from the camera output socket to the antenna input of the receiver.

The camera weighs 12 pounds,

measures 11½ by 5½ by 6¾ in. It is housed in a louvered steel case and includes a standard external tripod fitting. Normal transmission range of the camera is about 300 yards, but manufacturers say boosters give it a range that can extend four to five miles.

The photoconductive camera tube can be supplied with infrared or ultra-violet sensitive targets at extra cost. The manufacturer, Nottingham Electric Valve Co., Ltd., says hardware is available for remote control and for mixing and switching outputs from several of the cameras. Power consumption is about 50 watts.

## Japan Firm Likely To Win UAR Bid

TOKYO—Reports from Japan's capital say Matsushita Electric expects to win a \$10-million international bid to export 100,000 television receivers and 3,000 radio-television combinations to the United Arab Republic.

Conclusion of the deal hinges on whether the Japanese Finance Ministry will grant the three-year deferred payment plan stipulated by El Nasser, the UAR bid solicitor.

Matsushita was lowest bidder on one phase with a figure of \$69.30 per unit on a lot of 10,000 14-in. tv receivers. The firm came in sixth with a bid of \$106.97 per unit on 24,000 17- and 19-in. sets, and fifth on bidding for 60,000 23-in. receivers at a figure of \$125.60 per unit.

Despite the fact that Matsushita was not lowest bidder in all categories, Tokyo observers expect the entire award will go to the company because El Nasser is said to want to purchase the total complement from one company.

Matsushita is negotiating with the UAR organization to cut the three-year deferred payment term in half.

Also involved is Japan's Goshō Trading Company.

Some observers say the Japanese Finance Ministry may agree to a three-year term because in similar

negotiations last year Toshiba lost out on bidding in which it would have been successful except for disapproval of deferred payment terms by the Ministry.

## Egypt to Nationalize Dutch Company

CAIRO—Philips Orient is negotiating with the Egyptian government to sell 75 percent of its holdings here.

The Dutch-based company has several Egyptian facilities making light bulbs, radio receivers, television sets and home appliances. Presently these facilities are owned outright by Philips, but local observers say the company plans to vacate the holdings as soon as it is financially feasible to do so.

It is expected the Egyptian government-operated organization now being formed to manufacture electrical and electronic equipment in Egypt will take over the Philips facilities under a franchise agreement.

## Argentina Aiming For Color Television

BUENOS AIRES—Hopes are high here that Argentina will become the first country in Latin America to have color television facilities. An arrangement to this effect is currently being worked out between Argentine television stations and Nippon Television Network of Tokyo.

An Argentine spokesman says a technical and cultural agreement for developing color tv in Argentina would be signed between NTV and the Argentine stations when President Arturo Frondizi visits Japan late this year. The agreement is expected to incorporate exchange of technicians, program fare and performers between the two countries.

Nippon Television has a similar arrangement at work in France where color tv is still in the experimental stage.





**STATIC  
OR  
DYNAMIC  
TESTING**

**MINCOM  
SERIES G-100  
RECORDER-  
REPRODUCER**



FM and analog testing, RF or closed circuit data storage with Mincom reliability—all in the day's work for this superb, all-purpose general instrumentation system: the **Mincom G-100 Magnetic Tape Recorder/Reproducer**. Direct response is 200 cps to 300 kc at 60 ips. FM response at 60 ips is dc to 20 kc (broadband), dc to 10 kc (standard). Fourteen tracks in one rack. All-transistored card system record/reproduce modules, interchangeable for FM or analog. Greater dynamic range, built-in calibration, lower power requirements. Interested? Write for complete specifications.



... WHERE RESEARCH IS THE KEY TO TOMORROW

**MINCOM** DIVISION **MINNESOTA MINING AND MANUFACTURING COMPANY**

2049 SO. BARRINGTON AVE., LOS ANGELES 25, CALIFORNIA • 529 PENN BLDG., 425 13TH STREET N.W., WASHINGTON 4, D.C.

# **B** BARNSTEAD MIXED-BED

## DEMINERALIZERS

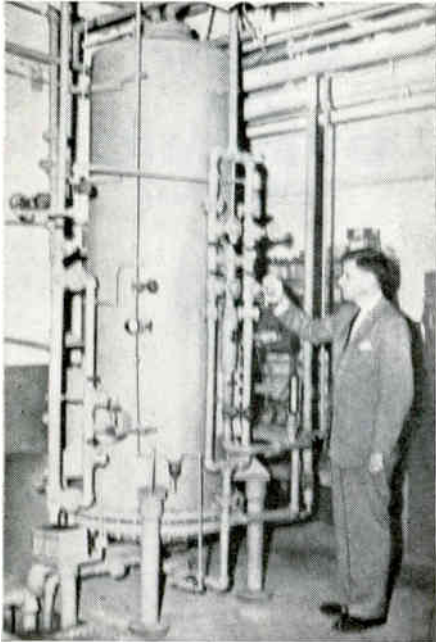

This Barnstead MM-5 Mixed-Bed Demineralizer (1500 g.p.h.) was installed at a semi-conductor plant for critical washing and rinsing of electronic sub-component parts. The purified water produced is of high electrical resistance and free of silica and CO<sub>2</sub>.

### FOR DEMINERALIZED WATER OF HIGH ELECTRICAL RESISTANCE AND CONSTANT pH

If your manufacturing operation makes demineralized water imperative . . . contact Barnstead, since 1878 the leader in water purification equipment. Barnstead Demineralizers hold ionizable content to a maximum of one-tenth of a part per million . . . producing water of high electrical resistance with pH of the demineralized water remaining constant between 6.8 and 7.2 throughout the purifying cycle.

Operation is simple since this single column unit employs one resin bed in which cation and anion resins are thoroughly mixed. A Barnstead Purity Meter constantly monitors the water being produced . . . red light shows when the water purity is below standard . . . and the demineralizer should be regenerated.

The unit comes completely equipped with Flow Meter, Purity Meter, Pressure Gage, and all connections in place to tap raw water supply. Easy to operate and easy to regenerate . . . can be equipped with automatic regeneration controls if desired.

Catalog #160 describes the complete line of Barnstead Demineralizers in capacities up to 2500 g.p.h. Where distillation of water is a must (removal of organics, bacteria, etc.) write for Catalog "G" on Barnstead Water Still.

**Barnstead**  
STILL AND STERILIZER CO.

84 Lanessville Terrace, Boston 31, Mass.

# WASHINGTON OUTLOOK

THE NAVY will set up an "Atlantic Underwater Test Evaluation Center" (AUTEK) near Andros Island in the Bahamas to check out new anti-submarine warfare equipment. Instrumentation work on a 100-mile by 20-mile ocean area will begin this year and run through the next three years or so. Costs will total about \$100 million.

Lockheed Aircraft Corp., which has a \$350,000 study contract to determine range requirements, is to submit its report to the Navy this summer. Some half-dozen other companies are now working under separate contracts to develop electronic instrumentation for the range.

THE PENTAGON is considering a new type of contract for development and initial production projects on which fixed-price terms are not feasible. Purpose is to furnish greater incentives for cost reduction with a lure of higher profit allowances. The contract would be known as a "cost-plus-award-fee" arrangement.

Under its provisions, contractors could be penalized 5 percent or earn fees as high as 15 percent of a project's cost depending on performance. (On current cost-reimbursable contracts, average gross profit runs from 5 to 8 percent.)

*The amount would be determined after the contract's termination, rather than during contract negotiations. It would be specified by an independent board of military officials who would evaluate a contractor's assumption of risk, technical breakthroughs, production quality and reliability, and the like.*

Initial industry reaction is critical of the plan's implication of more "overmanagement" by the military and the prolonged deferral of profit determinations.

P. E. HAGGERTY, president of Texas Instruments Incorporated, has proposed a shift from "cost-orientation to price-orientation" in military procurement. In effect, he urges more firm fixed-price contracts for development and initial production rather than cost-reimbursable types. He says the military should "pay for a product according to worth rather than cost".

THE WHITE HOUSE has stepped into the hassle over commercial ownership of a space communications system. Pres. Kennedy has dumped the sizzling issue on the National Space Council, headed by Vice Pres. Johnson. He wants the council to study the question and recommend the type of private ownership the government should sanction.

The study is aimed at resolving the controversy between FCC and the Justice Dept. on the type of joint ownership venture to be approved for a commercial communications satellite system. FCC favors limitation of ownership to international communications common carriers. Justice wants ownership diversified to include electronic equipment makers.

PENTAGON analysis of \$11.2-billion worth of defense orders placed during July-December 1960 shows that about 60 percent of the contracting was "non-competitive." Of this amount, 25 percent stemmed from "single-source solicitations," and 35 percent presented "follow-on" or second production-run contracts.

*Of the 40 percent described as competitive, only 13.3 percent was placed through formal advertising. About 6 percent was awarded under "technical and design competition" and 21 percent through "informal price competition"—small business set-asides, small-lot purchases, and such.*

Defense officials want to step up the volume of open advertised bidding which many Congressmen plump for as a means to expand competition. But the Pentagon feels formal bidding is "too artificial and rigid" to provide a complete remedy, says more competitive buying is possible even under negotiated contracting by bringing in more suppliers.

# Careers in a New Era of Space Technology Leadership

OGO • ADVENT • ATLAS

TITAN • MINUTEMAN

*Today Space Technology Laboratories, Inc., is engaged in a program of diversification and planned growth.*

**Programs.** Research, development, design, and construction of three Orbiting Geophysical Observatories for NASA. Systems engineering support and technical consulting services for the Army Advent program. Systems engineering and technical direction of the Atlas, Titan, and Minuteman weapon systems for the Air Force. Original and applied research in a broad spectrum of disciplines: particle physics, solid state theory, guidance, space physics, communication theory, propulsion and power, and electromagnetic systems in the infrared, ultraviolet and microwave regions.

**Facilities.** Presently under construction on a 110-acre site at Redondo Beach, near Los Angeles International Airport, is the STL Space Technology Center comprising ten buildings specially designed for research and development in missile and space systems, for the fabrication and environmental test of subsystems and components, and for the production of scientific and technical devices derived from STL's sustained research program. These new facilities will be augmented by the STL research and fabrication installation at Canoga Park, California.

**Immediate Opportunities** at STL exist for qualified engineers and scientists at all levels of experience, in the following activities:

**BALLISTIC MISSILE PROGRAM MANAGEMENT** (Los Angeles, Vandenberg AFB, Norton AFB—San Bernardino). Responsible for systems engineering and technical direction for the Air Force ICBM Weapon Systems Programs—Atlas, Titan, and Minuteman—including achievement of all technical objectives of these programs.

**MECHANICS DIVISION** (Los Angeles). Responsibilities of the Propulsion, Engineering Mechanics, and Aero-science Laboratories within this division include: analyzing and evaluating performance of rocket engines, propellants and propulsion subsystems and components; conception, design, development, and evaluation of ballistic missile and space vehicle systems; development and implementation of structural, dynamic, aerodynamic, and re-entry vehicle research and development concepts for both ballistic missile and space vehicle programs; and development of new subsystems for missile and spacecraft applications.

**SYSTEMS RESEARCH AND ANALYSIS DIVISION** (Los Angeles). *Systems Research Laboratory* activities include: management of complete space and missile systems studies including initial design; operations analysis; preliminary design in such areas as structures and aeromechanical and electromechanical systems; trajectory and error analysis; space navigation; and communication systems. *Computation and Data Reduction Center* performs the following functions: numerical analysis; applied mathematics; statistical analysis; scientific programming; computational systems programming; data processing analysis; and test evaluation programming and analysis.

**ELECTRONICS DIVISION** (Los Angeles). The Communication, Electromechanical, Guidance, and Space Physics Laboratories of this division are responsible for analysis, design, and development of advanced guidance, control, and communications systems for ballistic missiles and space vehicles—from applied research to electronic product and ground support equipment design. Disciplines include the physical, electronic, and electromechanical aspects of guidance, tracking, control, communication, and computer systems, geophysics, and space physics.

**RESEARCH LABORATORY** (Los Angeles and Canoga Park, California). Fields of interest include: physical studies of gaseous electronics, artificial meteors, reactor kinetics, microwave electronics; studies of quantum chemistry, thin film applications, electron and ion dynamics, and theoretical physics; heavy particle studies; ion propulsion research including neutralization and beam diagnostics, emitters, acceleration and ion optics, and engine design.

**FABRICATION, INTEGRATION & TEST DIVISION** (Los Angeles). Incorporates the areas of mechanical and electronic fabrication and assembly, environmental test, mechanical and electrical integration of spacecraft, integrated subsystems and systems checkout, and launch operations.

**ELECTROMAGNETIC SYSTEMS DIVISION** (Canoga Park, California). The Radio Physics and Signal Equipment Laboratories of this division are engaged in developing advanced communication, radio direction finding, electro-optical, and penetration and reconnaissance systems; and in investigating advanced signal processing, electronic and anti-submarine warfare techniques.

**FLIGHT TEST OPERATIONS** (Cape Canaveral). Responsible for directing systems test programs and for supplying technical leadership to contractors conducting flight testing of ballistic missiles, space programs, and vehicles modified for special development purposes.

**Resumes and Inquiries** from engineers and scientists, at all levels of experience, will receive prompt and careful attention. All qualified applicants, regardless of race, creed, color or national origin, are invited to communicate with Dr. R. C. Potter, Manager of Professional Placement and Development, for opportunities in Southern California or at Cape Canaveral.

SHARE IN THE GROWTH OF

SPACE TECHNOLOGY LEADERSHIP

SPACE TECHNOLOGY LABORATORIES, INC. P.O. BOX 95005J, LOS ANGELES 45, CALIFORNIA  
a subsidiary of Thompson Ramo Wooldridge Inc. P.O. BOX 4277J, PATRICK AFB, FLORIDA

Los Angeles • Vandenberg AFB • Canoga Park • Norton AFB, San Bernardino



Dayton • Cape Canaveral • Washington D.C. • Boston • Huntsville

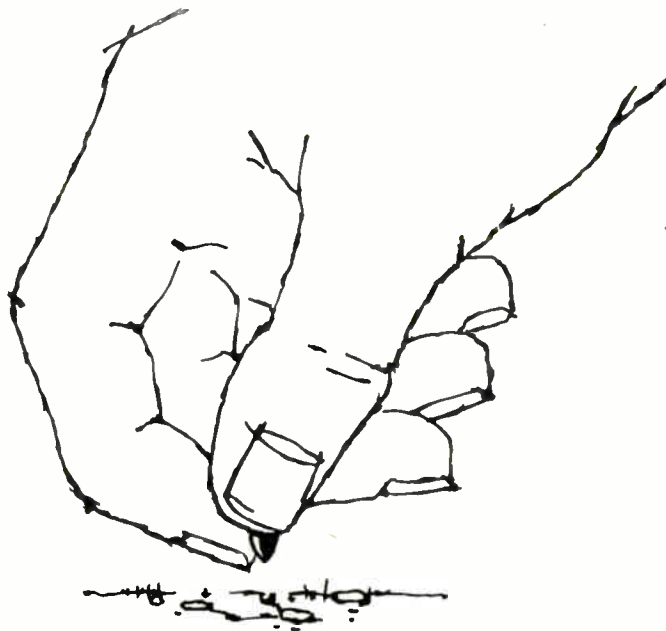

## planting for tomorrow

You've heard of the "hard sell" and the "soft sell" — but many of our advertisers are also interested in the "long sell".

This is *planned* advertising. You might call it "planting for tomorrow".

The sales seed in an advertising message bears abundant fruit if sown in fertile ground . . . readers of this publication, for example, who, in *buying* this issue, have demonstrated their interest in what we have to say.

As a member of the Audit Bureau of Circulations\*, our circulation records have been audited and the facts published — by this impartial organization of advertisers, advertising agencies, and publishers. These bedrock facts about our circulation audience can help you to plan more productive advertising.

Is your own planned selling based on circulation facts? You can be ABC-sure. Ask to see a copy of our latest circulation report.

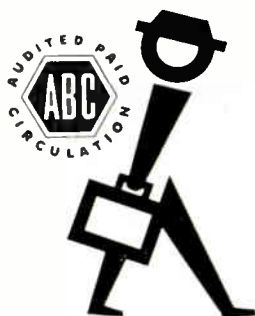

# electronics

A MCGRAW-HILL PUBLICATION • 330 W. 42nd ST. • NEW YORK 36, N. Y. 

\* Through the reports issued by the Audit Bureau of Circulations, this publication, along with other publisher members of ABC, voluntarily and regularly give the buyers of advertising more verified factual information than is available for any other advertising media at any time.

AVAILABLE NOW FROM SYLVANIA!

# PANELESCENT®



Sylvania AN-150, 1½" alpha-numeric, is diagrammed, right, to show the 14 segments that produce the complete English alphabet, 0-9 numerics and selected mathematical symbols.

# READOUTS

## • NUMERICS, ALPHA-NUMERICS

... wide range of patterns, sizes, mountings

## • X-Y GRID PANELS

... wide range of sizes, resolutions

PANELESCENT electroluminescent (EL) devices open a vast new future for creative design of readout displays. Outstanding features include: compact, flat area source of light • long life • absence of catastrophic failures, enabling planned maintenance • low power requirements • wide angle viewing • simplified circuitry.

Sylvania advances in EL techniques now make practicable character heights from ⅜" for numerics and ⅝" for alpha-numerics to 12". Multiple numerics or alpha-numerics are available formed on one substrate for in-line display. Sylvania techniques of packaging can provide several "plug-in" designs, to conform with your individual design requirements, offering optimum combinations of economy, compactness and ruggedness.

Sylvania X-Y Grid panels—for position-plotting displays—utilize conductive strips placed at right angles to each other. When the strips are excited a point of

light is produced at the intersection. This point of light is moved by selective excitation of the strips. Sylvania X-Y panels, using a green phosphor, provide contrast ratios in the order of 15:1. Panels with active areas of 2½" x 2½" are now available with resolutions of as high as 50 lines/inch. Larger panels are also available.

Contact your nearest Sylvania Sales Engineering Office for further information. They'll be pleased to discuss your individual readout requirement. Or, send for the descriptive brochure, "Sylvania Electroluminescent Display Devices." Write Electronic Tubes Division, Sylvania Electric Products Inc., Dept. EL, 1100 Main St., Buffalo 9, New York.

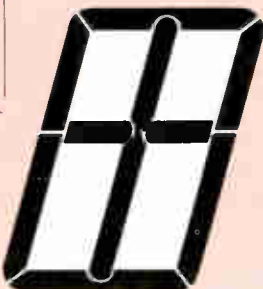

Sylvania NU-150, 1½" numeric, is diagrammed, right, in actual size to show the 9 segments that produce a display of 0-9 numerics. Numeric characters are also available with as few as 7 segments.

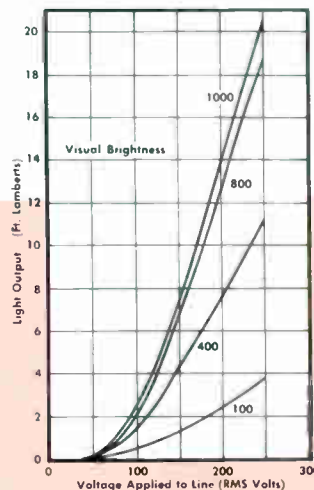

Curves illustrate variation of PANELESCENT lamp brightness with voltage at varying frequencies.

\* Panelescent is a registered trade mark.

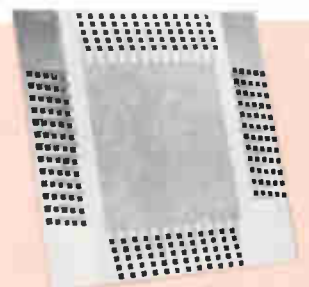

Sylvania X-Y Grid Panel, having a resolution of 50 lines/inch, is shown above.

# MICROWAVE DEVICE NEWS from SYLVANIA

**AVAILABLE  
IN  
QUANTITY!**



## BROADBAND FERRITE ISOLATORS

**COAXIAL DEVICES**

—from 1-11 GC

**WAVEGUIDE DEVICES**

—from 3.95-26 GC

Sylvania offers a comprehensive line of coaxial and waveguide isolators—12 types, in all—featuring extraordinary isolation to insertion loss ratios as high as 30 to 1. Designed for wideband applications in such end-products as ECM and laboratory test equipment, they're extremely well suited for the reduction of VSWR and the elimination of anomalies caused by long line effects in oscillator outputs.

Your Sylvania Sales Engineer will be pleased to tell you more about the full line of *competitively priced* broadband coaxial and waveguide isolators. Ask him. For technical data, write Electronic Tubes Division, Sylvania Electric Products Inc., 1100 Main St., Buffalo 9, N. Y.

BROADBAND COAXIAL ISOLATORS		Isolation (Min.) (db)	Insertion Loss (Max.) (db)	VSWR
Frequency	Types			
1.0-2.0	FD-1537	10	1.2	1.2
2.0-4.0	FD-151P	15	1.0	1.2
4.0-8.0	FD-1519	10	1.0	1.25
8.0-11.0	FD-1522W	30	1.0	1.4
BROADBAND WAVEGUIDE ISOLATORS				
3.95-5.85	FD-492	18	1.0	1.15
5.85-8.2	FD-502	20	1.0	1.15
7.05-10.0	FD-512	24	1.0	1.2
8.2-12.4	FD-522	30	1.0	1.15
10.0-15.0	FD-7530	30	1.0	1.15
12.4-18.0	FD-911	24	1.0	1.15
18.0-26.0	FD-531A	24	1.0	1.15
18.0-26.0	FD-531AF1	24	1.0	1.15

Typical performance characteristics of FD-522

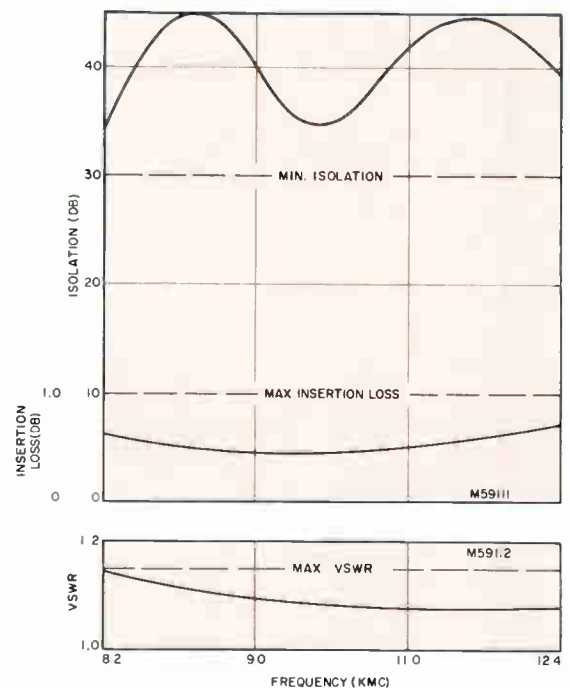

# SYLVANIA

SUBSIDIARY OF

**GENERAL TELEPHONE & ELECTRONICS**



From General Ceramics Division of  
**INDIANA GENERAL CORPORATION**

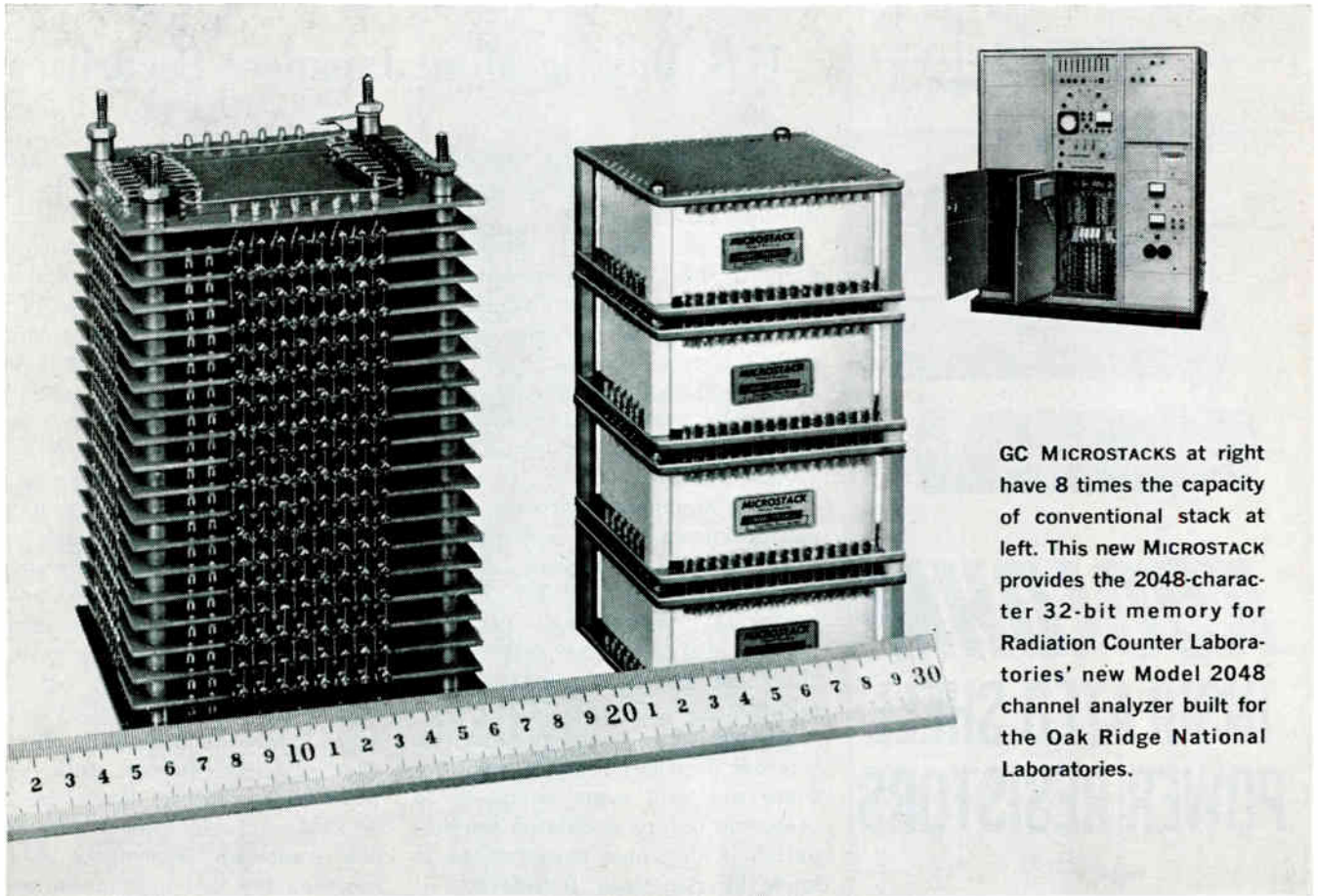

GC MICROSTACKS at right have 8 times the capacity of conventional stack at left. This new MICROSTACK provides the 2048-character 32-bit memory for Radiation Counter Laboratories' new Model 2048 channel analyzer built for the Oak Ridge National Laboratories.

## MICROSTACK® Memory Array Provides 8 TIMES MORE CAPACITY IN SAME SPACE

General Ceramics, the originator of the square loop ferrite memory core, has pushed back the "space barrier" in coincident current memory systems with the job-proved MICROSTACK.

GC's exclusive MICROSTACK design has not only cut memory plane space needs by 90%, but has made them more reliable by eliminating floating core mats and drastically cutting soldered connections. These units have successfully passed the severe vibration and shock tests outlined in MIL T-4708.

MICROSTACKS are available with up to 32,768 cores in a single matrix enclosure using any core material. Individual units may then be stacked to provide desired total memory capacity. Special temperature-controlled MICROSTACKS operate efficiently between  $-55^{\circ}$  C and

$+85^{\circ}$  C. GC can supply complete memory systems using MICROSTACKS and modular construction.

General Ceramics assures reliability with 100% quality control at all levels through automatic 12-per-second mechanical and electrical testing of each individual core . . . visual and electrical inspections at all assembly stages . . . and ultrasonic cleaning. These procedures, plus other electronic tests on specially designed equipment, give the extra quality edge that customers such as Radiation Counter Laboratories have come to expect from us.

Write for new Bulletins 25 and 26.



APPLIED LOGICS DEPARTMENT  
**GENERAL CERAMICS**

Phone VAlley 6-5100 • Direct Distance Dialing Code 201

KEASBEY, NEW JERSEY, U.S.A.

TECHNICAL CERAMICS, FERRITES AND MEMORY PRODUCTS

ALL UNITS ACTUAL SIZE

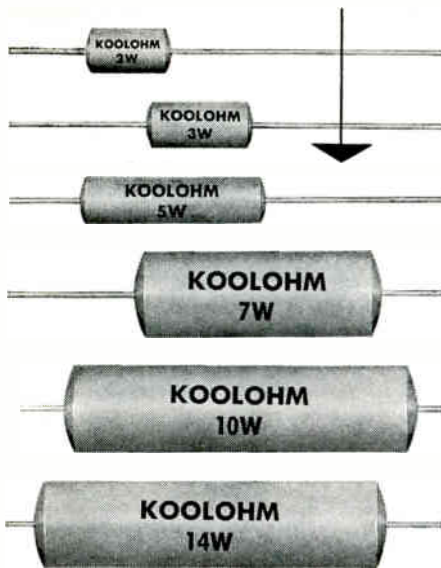

# KOOLOHM® INSULATED SHELL POWER RESISTORS

Sprague's Koolohm Resistors are designed to meet military and industrial requirements for insulated power wirewound resistors that will perform dependably.

New axial-lead Koolohm construction features include welded leads and winding terminations. Exclusive Ceron® ceramic-insulated resistance wire, wound on special ceramic core makes possible multilayer non-inductive windings and extra-high-resistance-value conventional windings. Dense, non-porous ceramic outer shells provide both humidity and mechanical protection for resistance elements. All resistors are aged-on-load to stabilize resistance value.

The advanced construction of these improved Koolohm Resistors allows them to operate at "hottest spot" temperatures up to 350°C. You can depend upon them to carry maximum rated load for any given physical size.

Send for Engineering Bulletin 7300A for complete technical data.

**SPRAGUE ELECTRIC COMPANY**  
35 Marshall Street, North Adams, Mass.



## FINANCIAL

# U.S. Buying More Japanese Securities

JAPANESE ELECTRONICS securities are making a bid for U.S. investor interest this quarter.

A recent Japanese electronics entry in the U.S. securities market was SONY CORPORATION'S offering of two million shares of common stock early this month. This followed by a few weeks a bond offering of \$20 million by NIPPON TELEPHONE AND TELEGRAPH. Both offerings have been successful.

Other Japanese electronics companies known to be interested in U.S. securities buyers include TOKYO SHIBAURA ELECTRIC, NIPPON COLUMBIA, YOKOGAWA ELECTRIC WORKS, SUMITOMO ELECTRIC INDUSTRIES and MATSUSHITA ELECTRIC INDUSTRIAL.

Despite this growing American interest, Japanese financial men say there are still some obstacles to overcome before maximum participation in Japanese corporations is made by American investors.

Mutsuji Nakano, president of Yamaichi Securities Co. of New York—the parent firm of the same name is one of Japan's largest brokerage firms—tells ELECTRONICS the Japanese currency exchange problem and the Japanese regulations on remitting dollars when

securities are sold are two factors that cause U.S. investors to hesitate.

To overcome some difficulties of remission time limitations and currency exchange, foreign stocks are often handled in the form of American Depositary Receipts. This ADR system is set in operation when the securities are deposited in a bank in the country where stock issue originates. U.S. purchasers of the securities are given receipts by the American branch of the bank indicating they have title to the shares on deposit abroad. Receipts are as negotiable as the stock certificates and may be traded readily here.

The offering brought out this month by Sony was handled in this way. It was the first public offering of a Japanese common stock registered under the U.S. Securities Act of 1933. Actually traded were 200,000 American Depositary Shares representing two million shares of Sony Common stock. Morgan Trust Company of New York was the depositary agent. Smith, Barney & Co. managed the underwriting group which included several other financial firms.

It's predicted the ADR system, long familiar to financial specialists,



Sony v-p A. Morita (r) signs stock sale documents as E. B. Schwartzbach of Smith, Barney and T. Kurata of Nomura Securities look on



## 25 MOST ACTIVE STOCKS

	WEEK ENDING JUNE 16, 1961			
	SHARES (IN 100'S)	HIGH	LOW	CLOSE
Lockheed	1,828	45 <sup>3</sup> / <sub>8</sub>	43 <sup>1</sup> / <sub>8</sub>	44 <sup>1</sup> / <sub>4</sub>
Avco	1,668	21 <sup>1</sup> / <sub>2</sub>	20 <sup>1</sup> / <sub>8</sub>	20 <sup>1</sup> / <sub>2</sub>
Gen Tel & Elec	1,305	27	26	26 <sup>1</sup> / <sub>8</sub>
Ampex	1,189	27 <sup>7</sup> / <sub>8</sub>	21	21 <sup>1</sup> / <sub>4</sub>
Gen Elec	1,184	67	63 <sup>1</sup> / <sub>2</sub>	63 <sup>3</sup> / <sub>8</sub>
Sperry Rand	1,124	30 <sup>3</sup> / <sub>4</sub>	27 <sup>1</sup> / <sub>2</sub>	27 <sup>3</sup> / <sub>4</sub>
Burroughs	1,020	31	29 <sup>7</sup> / <sub>8</sub>	30 <sup>3</sup> / <sub>8</sub>
Gen Dynamics	801	37 <sup>1</sup> / <sub>4</sub>	33 <sup>3</sup> / <sub>4</sub>	34 <sup>1</sup> / <sub>4</sub>
Raytheon	780	42 <sup>3</sup> / <sub>8</sub>	38 <sup>3</sup> / <sub>4</sub>	38 <sup>7</sup> / <sub>8</sub>
Westinghouse	721	45 <sup>3</sup> / <sub>4</sub>	43 <sup>1</sup> / <sub>2</sub>	44
Elec & Mus Ind	717	6 <sup>1</sup> / <sub>8</sub>	5 <sup>5</sup> / <sub>8</sub>	5 <sup>7</sup> / <sub>8</sub>
National Union Elec	658	4 <sup>1</sup> / <sub>4</sub>	3 <sup>7</sup> / <sub>8</sub>	4 <sup>1</sup> / <sub>8</sub>
Standard Kollsman	621	50 <sup>1</sup> / <sub>2</sub>	46 <sup>3</sup> / <sub>4</sub>	47 <sup>3</sup> / <sub>8</sub>
RCA	592	62 <sup>5</sup> / <sub>8</sub>	57 <sup>1</sup> / <sub>4</sub>	57 <sup>5</sup> / <sub>8</sub>
Waltham Precision	542	4 <sup>1</sup> / <sub>8</sub>	4	4 <sup>1</sup> / <sub>8</sub>
Transitron	539	28	24 <sup>1</sup> / <sub>4</sub>	24 <sup>1</sup> / <sub>2</sub>
Universal Control	506	12 <sup>7</sup> / <sub>8</sub>	12	12 <sup>1</sup> / <sub>4</sub>
Electro Industries	432	8 <sup>1</sup> / <sub>2</sub>	6 <sup>3</sup> / <sub>4</sub>	6 <sup>3</sup> / <sub>4</sub>
Dynamics Corp of Am	425	16	14 <sup>5</sup> / <sub>8</sub>	14 <sup>5</sup> / <sub>8</sub>
Martin Co	417	37 <sup>1</sup> / <sub>4</sub>	36 <sup>1</sup> / <sub>4</sub>	36 <sup>7</sup> / <sub>8</sub>
I T T	394	56 <sup>5</sup> / <sub>8</sub>	54 <sup>3</sup> / <sub>8</sub>	55 <sup>1</sup> / <sub>4</sub>
Zenith Radio	370	172	158	163 <sup>1</sup> / <sub>2</sub>
Avnet Elec	361	46 <sup>3</sup> / <sub>8</sub>	44	46
Hycor Mfg	352	5 <sup>3</sup> / <sub>8</sub>	5 <sup>1</sup> / <sub>8</sub>	5 <sup>1</sup> / <sub>8</sub>
Gen Instr	347	46 <sup>1</sup> / <sub>4</sub>	41 <sup>3</sup> / <sub>4</sub>	42 <sup>5</sup> / <sub>8</sub>

The above figures represent sales of electronics stocks on the New York and American Stock Exchanges. Listings are prepared exclusively for ELECTRONICS by Ira Haupt & Co., investment bankers.

will grow into a more commonly used investment mechanism for the ordinary investor. Yamaichi Securities says growing interest in ADR, plus the rising tide of investment in Japan, will stimulate trading in Japanese securities here and in his own country.

Increasing liberalization of Japanese remittance regulations may also spur American buying.

Further U.S. investor interest in Japanese electronics securities may come from the generally good financial performance these issues have shown over the past years.

Tokyo Shibaura, for example, had net sales of \$47,064,000 in the six-month period ended March 1956. In the same period of 1958 this figure rose to \$95,753,000. In the six-month period ending March 1961, the figure was \$166,271,000.

Nippon Columbia net sales in the six-month period ending March 1957 were \$6,874,200. In the same period three years later, the net sales had risen to \$9,730,000.

Yokogawa Electric Works Ltd. reported net sales of \$7,873,000 in the six-month period ended March 1957 rose to more than \$11,315,000 in the same period two years later.

Matsushita Electric Industrial net sales have increased more than four times in the period between 1955 and 1960.

## New Line of Precision Toroidal Inductors For Practically Every Application



Designed for use in commercial, industrial, and military apparatus, Sprague Precision Toroidal Inductors are customarily supplied to the close inductance tolerance of  $\pm 1\%$ . The broad line of Sprague inductors includes such styles as open coil, plastic-dipped, rigid encapsulated types with tapped or through-hole mounting, and hermetically-sealed inductors.

All styles, with the exception of the open-coil type, meet the requirements of Specification MIL-T-27A.

Several core permeabilities may be obtained in each of the five basic sizes of Sprague inductors to give the circuit designer the optimum selection of desired Q and current carrying abilities. Each of the core sizes is available with several degrees of stabilization. Inductors made with cores which have not been subjected to the stabilization process exhibit low inductance drift with time and have a low temperature coefficient of inductance. Where a greater degree of permanence of characteristics is required, cores with two different stabilization treatments can be used for most types of inductors.

Sprague toroidal inductors may be operated from  $-55^{\circ}\text{C}$  to  $+125^{\circ}\text{C}$ . Temperature cycling of finished inductors is a standard production procedure in order to equalize internal stresses and insure permanence of electrical characteristics.

For detailed information on Sprague Precision Toroidal Inductors, write on company letterhead for portfolio of engineering data sheets to Technical Literature Section, Sprague Electric Company, 35 Marshall Street, North Adams, Massachusetts.

## Foil-type Tantalum Capacitors Now Available in Ratings to 250 V

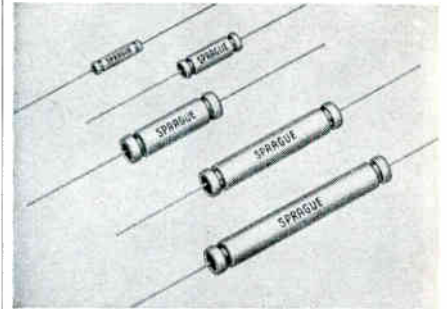

Sprague Electric Company has announced another major capacitor improvement. Higher voltage ratings, sorely-needed by circuit designers of military and industrial electronic equipment, are now available in Sprague's family of Tantalex® Foil-type Tantalum Capacitors.

Plain-foil 125 C types, previously limited to 150 volts, may now be obtained in 200 volt ratings. Plain-foil capacitors designed for 85 C operation, with a previous maximum of 150 volts, are now available in 250 volt ratings. Type numbers and pertinent characteristics are shown in the following table.

Capacitor Type	Polarity	Anode	D-C Voltage Range
<b>85 C Max. Operating Temperature</b>			
110D (MIL CL34, CL35)	polar	plain foil	3 to 250
111D	non-polar	plain foil	6 to 250
112D (MIL CL24, CL25)	polar	etched foil	15 to 150
113D	non-polar	etched foil	15 to 150
<b>125 C Max. Operating Temperature</b>			
120D	polar	plain foil	10 to 200
121D	non-polar	plain foil	10 to 200
122D	polar	etched foil	10 to 100
123D	non-polar	etched foil	10 to 100

Manufactured to meet or exceed the performance requirements of Specification MIL-C-3965B, this series of Tantalex Capacitors sets new standards of reliability for all types of military and industrial applications.

Tantalex Capacitors are available promptly in production quantities. For off-the-shelf delivery at factory prices on pilot quantities to 499 pieces, Sprague industrial distributors stock the more popular items in Types 110D, 111D, 112D, 113D, 120D, and 121D, as well as MIL Types CL24, CL25, CL34, and CL35.

For complete engineering data on the types in which you are interested, write Technical Literature Section, Sprague Electric Company, 35 Marshall Street, North Adams, Mass.



pacesetter in electron beam technology

**alloyd electronics**

## introduces the E-Beam Mark VI electron beam welder

The Mark VI electron beam welder makes possible what has previously been impossible in welding and brazing of refractory and reactive metals.

It utilizes electron bombardment heating, carried out in a high vacuum to make possible ductile welds in reactive metals and in super-alloys containing reactive elements. It makes possible narrow welds with controlled depth-to-width ratios. It makes it possible to weld thin-to-thick sections with highly accurate positioning of the beam. It produces welds in the new ultra-high strength materials that match or exceed the properties of the base material. It holds dimensional

change to a minimum. And the process is *fast*. It could hardly be otherwise at these temperatures.

The results: clean, crack free welds in even the most refractory and reactive metals... no contamination... optimum control and precision.

For complete information on the Mark VI welder, the Mark V evaporator, and Alloyd's engineering and custom services in electron beam applications, just write:

**alloyd electronics corporation**

An affiliate of Alloyd Corporation — 37 CAMBRIDGE PARKWAY, CAMBRIDGE, MASS.



**The electron beam at your service** — This Laboratory Welder is part of an advanced, complete facility for electron beam welding, brazing, evaporating, melting, and zone refining maintained by Alloyd to meet custom requirements. We also offer engineering, consulting and research and development services in system design and development. Ask us for complete information.



**Mark V Electron Beam Evaporator** — a reasonably priced, highly flexible unit for producing thin metallic and non-metallic films by vapor deposition through electron bombardment heating. Completely self-contained. An invaluable research and development tool for thin-film applications, including micro-miniaturized electronic circuitry, optical filters, resistors, capacitors, memory devices and countless other components.

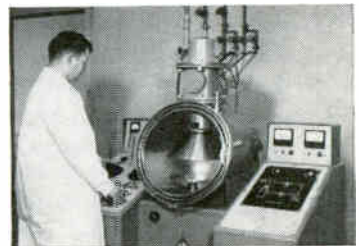

Newest...in the industry's  
most extensive line  
of rotary switches

# CENTRALAB SERIES 600

← 1 1/4" →

# DIAMETER SWITCH

WITH 1/32" STRUT CENTERS

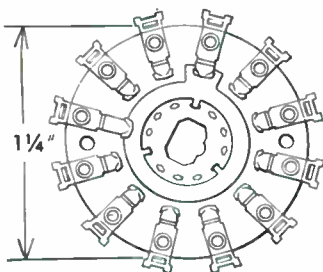

P-6129

#### SPECIFICATIONS

**INSULATION:** 1500V RMS, Steatite, Grade L-5A, MIL-I-10  
1000V RMS, Phenolic, Type PBE, MIL-P-3115  
1500V RMS, Mycalex, Grade L-4B, MIL-I-10

**TORQUE:** Per MIL-S-3786A.

**CONTACT RESISTANCE:** 3 milliohms.

**CURRENT RATING:** 5.5 amps at 12 VDC.  
450 ma at 115 VAC.

**LIFE TEST:** 25,000 cycles minimum.

Designed to meet MIL-S-3786A, this switch is available with ceramic, phenolic or Mycalex sections. It can be supplied with adjustable or fixed stops with 30° or 60° indexing. The Series 600 switch has up to 12 terminals on each side of the stator of which 8 can be insulated.

Sample delivery is seven days. Production delivery, 4-5 weeks.

For detailed specifications, write for EP-1152.

Many types in stock at CENTRALAB distributors as Series PA-6000 Switches.

# Centralab

THE ELECTRONICS DIVISION OF GLOBE-UNION INC.  
914F E. KEEFE AVENUE • MILWAUKEE 1, WISCONSIN  
In Canada: Centralab Canada Ltd., P.O. Box 400, Ajax, Ontario

ELECTRONIC SWITCHES • VARIABLE RESISTORS • CERAMIC CAPACITORS • PACKAGED ELECTRONIC CIRCUITS • ENGINEERED CERAMICS

# Cryotron Computers Approaching Reality But Production Problems Still Remain

By **GEORGE V. NOVOTNY**  
Assistant Editor

CRYOGENICS will become either a great practical success or a complete failure, and the next three or four years will show which.

Such was the feeling of scientists

at the recent symposium on superconductivity sponsored by IBM at Yorktown, N.Y. About 250 scientists from government, industrial and academic institutions all over the world heard 45 papers concerning fundamental research in the field (NEWSLETTER, p 9, June 23).

Professor A. B. Pippard of Cambridge University, England, said theoretical problems have now been largely solved, but production barriers have to be surmounted before cryotrons and similar devices are put to practical use.

William B. Ittner of IBM's Thomas Watson Research Center indicated his company is concentrating research on developing thin-film cryotrons, rather than tunneling devices.

The recently announced in-line cryotron, for instance, has resistance proportional to its length, and can be trimmed to match an output line impedance without affecting its other properties. This offers possibilities for an output element of an all-cryotron logic or memory unit.

Multilayer cryotrons have been built with two or more control layers. This makes them usable directly as "and" gates. Another development is biased-cryotron logic elements which can serve as "or" circuits.

Reliability and reproducibility in production are the main problems facing cryotron research today. The insulation layer between the superconducting layers of a cryotron is about 5,000 angstroms thick (usually silicon oxide) and this thickness has to be held within  $\pm 50$  angstroms.

This problem is much more severe in cryogenic tunneling devices, where an aluminum oxide film about 50 angstroms thick is used for insulation. This corresponds to only about 18 atomic diameters, and since the tunneling effect is critically dependent on it, the thickness must be controlled within two or three angstroms.

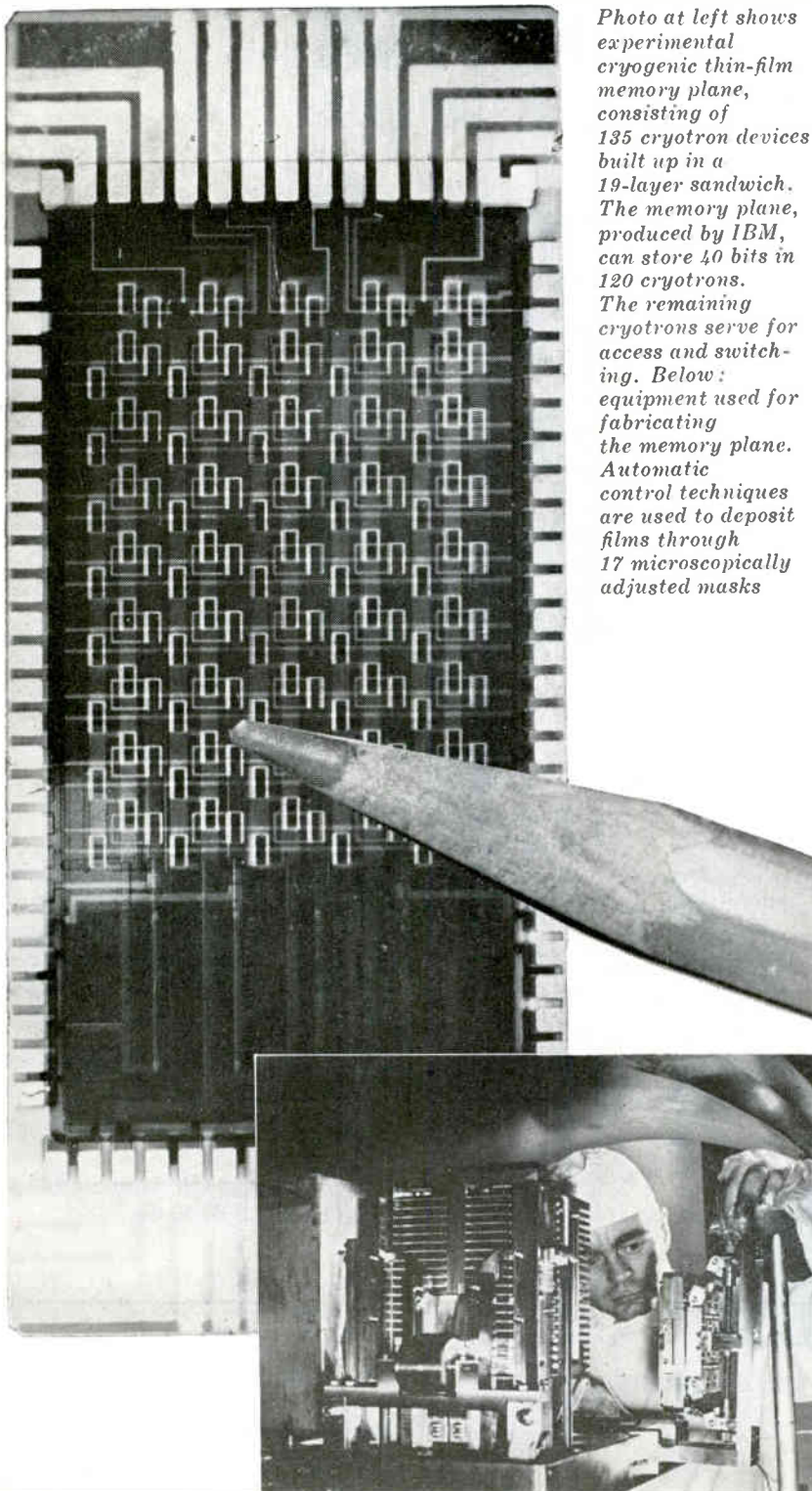

*Photo at left shows experimental cryogenic thin-film memory plane, consisting of 135 cryotron devices built up in a 19-layer sandwich. The memory plane, produced by IBM, can store 40 bits in 120 cryotrons. The remaining cryotrons serve for access and switching. Below: equipment used for fabricating the memory plane. Automatic control techniques are used to deposit films through 17 microscopically adjusted masks*

## 'Telespin' Device Relays 'Copter Blade Stress

A possible solution is that when the vapor-deposited layer reaches a certain thickness, surface oxidation stops; thickness may be adjusted by controlling ambient temperature, pressure, humidity.

However, the potential rewards are great. Cryotron computer units can be built with packing densities of the order of millions of components per cubic foot, and the mutual proximity of the components would greatly increase computer speed.

They dissipate no power except when being switched from one state to the other. They would save the cost of hand wiring of individual components, interconnections being vapor-deposited at the same time as the components.

Since one cryotron can drive another, an infinite number of stages could operate without intermediate amplification. And operation at liquid-helium temperatures would give almost unlimited operating life.

All this points to fast, complex and compact computers. The complexity must be great enough to justify a refrigerating apparatus and a helium bath; hence cryotron computers are not likely to be desk type. Since cryotrons operate at picawatt levels, signals will have to be amplified for readout.

An experimental 135-cryotron memory plane (photos) was successfully made by IBM last year, and can be duplicated by an automatic process.

Since a superconductor has no electrical resistance, large magnetic fields can be generated with very little power; this is another potentially useful application of cryogenics. Research in this area is concerned mostly with the metallurgy of superconducting metals; fields of 30,000 gauss have been generated with only 30 amperes per square centimeter, using titanium-molybdenum alloy wire. Among other alloys under investigation are molybdenum-rhenium and niobium-zirconium.

Superconducting magnetic field generators are of interest in nuclear fusion experiments and plasma applications. Another possibility is in large power transformers, where much power is wasted in magnetizing currents.

BEING PRODUCED this week is a tiny "telespin" telemetry transmitter for relaying information on stress in helicopter blades, high-voltage cables, temperature and stress in automobile tires, torque in turbine shafts, and data from other severe environment situations.

The manufacturer is Wiley Electronic Products Co., Phoenix, a subsidiary of Giannini Scientific Corp. The device is designed primarily for installation within rapidly revolving shafts. It measures  $1.75 \times 1.75 \times 3.25$  inches and weighs 6.2 ounces without power pack.

Latest f-m/f-m model consists of (1) battery pack; (2) f-m modulated, 70-Mc r-f transmitter; and (3) one to three subcarrier oscillator (sco) bridge driver units. The latter is a bridge-controlled f-m unit with center frequencies from 4 Kc to 70 Kc. Data has been reliably obtained up to 100 ft.

A recent refinement in high-speed rotating machinery applications, where maximum transmission distance requirements do not exceed a few inches, uses noncontacting, capacitive-coupled, concentric ring antennas, permits direct transmission of the sco frequency and elimination of the r-f carrier. A simple amplifier replaces the regular f-m receiver. Approximately 10 to 30

pf of capacitance between the rotating transmission ring and fixed receiving ring is needed.

Present operating limitations are 40,000 rpm and 100 g of vibration with the resistive and capacitive balancing potentiometers and the battery power supply being the critical components. Future operation at 200 g seems assured by replacement of the potentiometers with fixed resistors.

## Supplies Climate Data

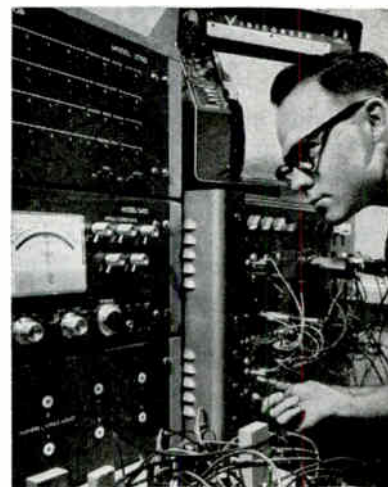

Analog computer used by Minneapolis Honeywell simulates outdoor temperatures, wind conditions, solar variations

## Predicts Zero-Cooled Transformer Windings

SUPERCONDUCTING TRANSFORMERS with windings cooled to near absolute zero where electricity flows without resistance are "feasible," said Richard McFee of Syracuse University.

Speaking at last week's AIEE meeting at Cornell University, he added:

"Such transformers will depend on operating the core at normal temperatures, to reduce refrigerator load, and with primary and secondary windings interleaved to prevent premature quenching of superconductivity by magnetic fields within the windings.

"Potential advantages of such transformers are small current loss,

high power ratings and low reactance factors," he said. The main drawback "seems to be the recooling interval required if the superconductor is permitted to quench on current surges."

This quenching can be prevented through the use of external reactors, but at a loss in power rating and power factor. Development of a fast-acting circuit breaker would furnish an ideal answer to this problem, he said.

A new refrigeration cycle promises "ultimately to give cryostats the same order of reliability as is now obtained with household equipment. The refrigeration outlook," he said, "is good."

# "Real Time" Fax Controls Railroad Operations

By CLETUS M. WILEY  
Midwest Editor

"REAL TIME" facsimile—so fast it takes full advantage of high-speed electronic central data collection and processing—is being pioneered this week by Denver and Rio Grande Western Railroad following a \$1½-million, four-year feasibility study.

The "Shipper Facts" system will go into full-scale operation July 1 from Denver headquarters.

Simultaneous six-second delivery of waybill copies to one or all of 18-station system, including six terminals and 12 repeaters along 715-mile microwave net serving 2,300 miles of track, will save road minimum of half-day to a day and often several times more than that in communications transit time.

Boosting speed 40 times over conventional facsimile, line can now locate specific car from among 50,000 passenger and freight units within 15 to 50 seconds instead of days or weeks often required before.

Videograph fax system offers instantaneous access to magnetic tape storage of master records, computes earnings and controls operating expenses on daily basis instead of monthly, keeps cars rolling while arrival times, interchanges and de-

parture lists are computed by central high speed electronic data processing.

Party-line hookup permits any one station to communicate with any or all others in net to produce local fax copy at rate of 15 linear feet of continuous information a minute, up to 15,000 8½-x-11-inch sheets a day.

A. B. Dick system illuminates original copy with 1,500-watt lamp, forming image of original on diaphragm containing 0.005 inch aperture. Rotating mirror moves image past aperture at rate of 120 scans per inch of paper movement. Variations in intensity of reflected light from copy are converted into pulse coded video signals.

Unique secondary scan circuit senses any change in contrast level between copy and background, automatically adjusting level of transmitted signal to compensate for tinted backgrounds or faint images.

Bright spot of light at side of scanning drum develops horizontal synchronizing pulse from beginning of each horizontal sweep of moving image, sending sync signal to transmitter amplifier.

Composite of 160 Kc bandwidth video and sync signals go out over microwave net to receivers which re-sort video from sync components.

Horizontal sync triggers saw-

tooth generator, amplified by a current feedback amplifier to drive deflection coils of specially-developed electrostatic printing tube. Linearity of current sawtooth for deflection coils of ept is provided by large amount of negative current feedback in sweep amplifier.

Sweep generator also provides clamping and gating signal automatically in sync with sweep applied to video processing amplifier. Sweep amplifier chassis includes ept focusing and circuits for horizontal and vertical centering.

Processed video signals go to modulator which is directly coupled to grid and cathode of ept to control electron beam. Fast-printing ept substitutes matrix of 0.001 inch stainless steel wires packed 62,500 to the square inch, extending through and sealed into faceplate 8½ inches wide by a quarter inch deep for conventional phosphor screen.

Character and symbol video signals applied to deflection system guide electron beam inside tube to retrace forms on inner side of wire matrix. Current passes through wires to contact coated paper web, delivering invisible electrostatic charge pattern of traced images on moving paper. Charges retain thermoplastic resin particles brushed against surface during pass through developer hopper. In-

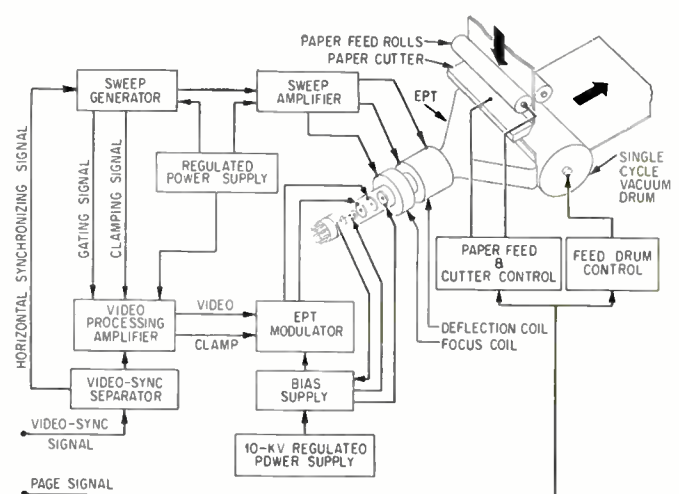
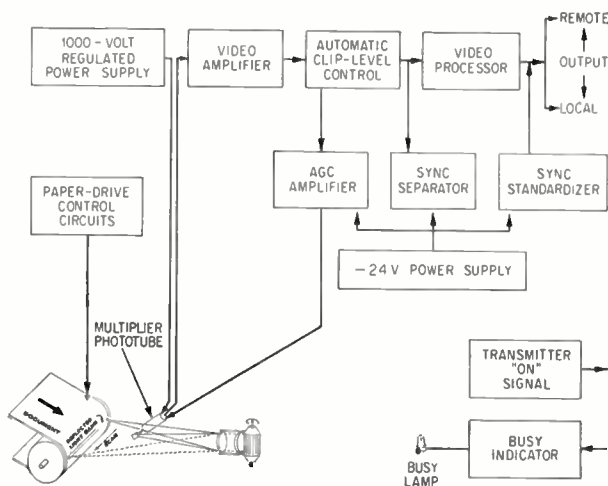

A. B. Dick's Videograph facsimile system scanner (left) and printer

frared heating elements then fuse powder, to fix image permanently.

Motorola, prime contractor, provides microwave links of system; Burroughs, central 220 computer and Western Union, telegraph facilities.

Microfilm modification of videograph system is being completed for CIA and information storage and retrieval applications are also under consideration by company.

Railroad application still under development will use specially developed tv scanner to read box car numbers from gray-scale images of moving cars passing through marshalling yards.

## Machine-Tool Computer Speaking 250 Words

PROGRAMMING LANGUAGE for a digital computer controlling a machine tool has been expanded from 100 words to more than 250 words, thereby enabling the production of more complex parts, Aerospace Industries Association reports.

This progress is reported on the APT (Automatically Programmed Tool) System being developed jointly by AIA and several member companies. Original research began in 1959. Phase III of developmental work now underway will be completed in December.

The progress report says the programming language is being rewritten into Fortran, so that with modifications the APT system can be used on many types of digital computers.

APT presently has five-axis capability, which means it can control cuts in all three dimensions plus rotation in two dimensions. Upon completion of APT III in December, the system will be made available to all APT III participants to utilize and develop further.

Participants in APT III include: Aerojet-General; General Motors; Bendix; Boeing, Chance Vought; Convair; Douglas; General Electric; Grumman; Lockheed, Marquardt; Martin; McDonnell; North American; Northrop; Republic; Rohr; Sperry Rand and United Aircraft. Cooperating on the project is IBM's Data Processing division.

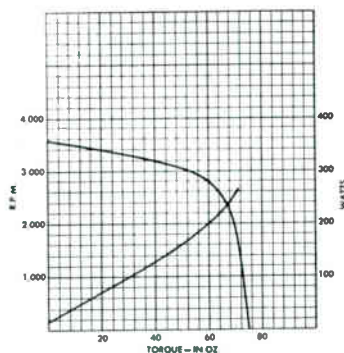

Typical curve on a  
"G FRAME" series  
2 pole 3  $\phi$  motor

### SPECIFICATIONS:

Dia.: 3 $\frac{1}{4}$ " (plain)  
3 $\frac{3}{4}$ " (finned)

H.P.: 1/400 to 1/4

Freq.: 60 cps

Phase: 1  $\phi$  or 3  $\phi$

Poles: 2 or 4

Ambient Temp.:  
-55 $^{\circ}$ c to +125 $^{\circ}$ c

Designed to military and industrial specifications the new "G FRAME" series motors are another addition to the wide line of AIR MARINE motors, blowers and fans.

A symbol of quality products... This trademark identifies the Air Marine line of carefully engineered products designed for military and industrial applications. 

**air marine** motors, inc.  
amityville, new york

los angeles, calif.



*Queen's University in Belfast (center: new Science and Technology Building) is receiving \$182,000 from U.S. Advanced Research Projects Agency. Aid is for electronics and space research, will continue at around \$56,000 annually for next seven years*

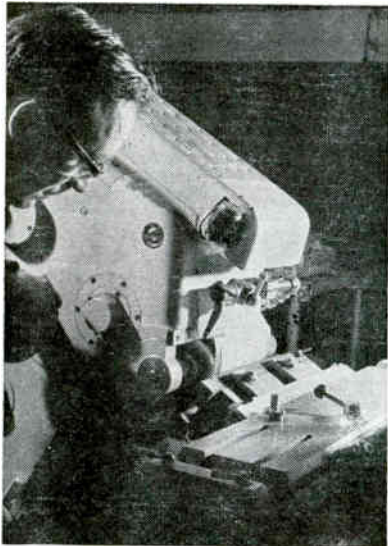

*Automatic rack-cutting machine*



## New Research Studies Helping Electronics In Northern Ireland

COMPUTERS and electronics research are the keys that may unlock a new industrial future for Northern Ireland.

Backed by United States government money, studies are going forward in Belfast in pure atom and space research, in the reactions of atom and molecule together and with electrons, in fields vital to missile and outer space progress. A digital computer is helping in these studies.

Northern Ireland governmental backing is given to the electronics industry, and one company in this field is pioneering complex computerization of production control method which could have far-reaching effects on industry.

To keep pace, computers and other electronic equipment are being produced, and steps are underway to create university courses for computer technologists.

Several manufacturers of electronic equipment are expanding. Among these are International Computers & Tabulators Ltd. of Castlereagh, Belfast; Short Bros. & Harland of Belfast; Pye Ltd. of Larne; Grundig Ltd. of Dunmurry;

and Plessey (Northern Ireland) Ltd. of Ballynahinch.

The Northern Ireland government is cooperating through its Aids to Industry Acts, whereby new firms can obtain from the government up to a third of the cost of plant, machinery and equipment and whereby the government provides ready-built factories on industrial estates at low rentals and with other inducements. The government's industrial diversification program has helped 155 firms of all kinds establish in Northern Ireland, adding 53,000 new jobs.

I.C.T., formerly the British Tabulating Machine Co., merged with Powers-Samas Accounting Machines Ltd. in January, 1959. In addition to computers and accounting machines, I.C.T. produces ancillary equipment including input/output machines which operate in conjunction with electronic devices. This company employs a team of men engaged in developing a system aimed at control of production in large plants through means of a digital computer.

The Castlereagh industrial estate, a 98,000-sq-ft plant employ-

ing 2,700 persons, is the largest of I.C.T.'s 23 manufacturing units in the United Kingdom. The company has a foothold in the Common Market through an agreement for exchange of experience, licensing and development with the German firm, Siemag Feinmechanische Werke Eiserfeld.

Short Bros. & Harland known in the aircraft industry for its Britannia and Canberra planes and more recently for the jet vertical takeoff and landing plane, the Short SC-1, has an important electronics group. The section produces five types of analog computers and electronic control devices for the guided missiles produced by this Belfast firm.

The company is now an important factor in the analog computer business. Its computers have proved of special value in aircraft studies. Other uses have included the search for new chemicals and processes for producing them; the design of nuclear power plant control systems, and the study of effects of changes in bank rates and capital investment control.

Short's newest product is the nu-



# TRANSISTOR/DIODE MULTIPLES FROM FAIRCHILD

Multiple PLANAR transistor and/or diode dice are packaged in a single TO-5-or TO-18-sized header with common or isolated electrical connections for a variety of circuit functions. PLANAR Multiples offer these advantages: ideal thermal matching, significant space reductions (up to 80%), fewer external soldered connections, reduced component- and circuit-assembly costs, superior device reliability.

## PLANAR makes it possible

Fairchild's PLANAR process provides the uniformity, parameter stability and high yield to make "multiples" economically and operationally practical.

## The Products

PLANAR Multiples can be produced in many device configurations. Some of the production units now available include:

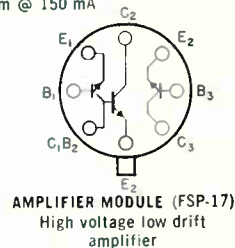
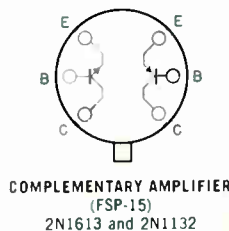
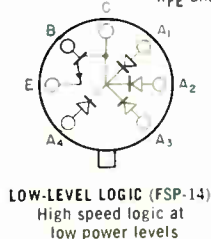
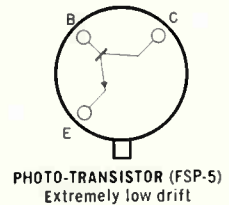
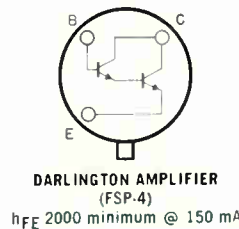
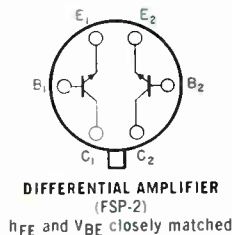
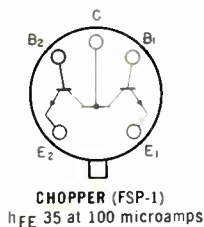

Special Products Handbook available on request.

# MATCHED PERFORMANCE / REDUCED SPACE / IMPROVED RELIABILITY

545 WHISMAN ROAD, MOUNTAIN VIEW, CALIF. · YORKSHIRE 8-8161 · TWX: MNVW CAL 853  
 A DIVISION OF FAIRCHILD CAMERA AND INSTRUMENT CORPORATION

**FAIRCHILD**  
 SEMICONDUCTOR



FSP-60 Triple Darlington  
 High Gain Low Noise Amplifier  
 TO-5 size header  
 3 - 2N1613 Planar Transistors  
 $h_{FE}$  typical = 100,000



ENGINEERING  
**REPORT**  
ON BENDIX COMPONENTS



## PRECISION SIZE 5 MOTORS NOW AVAILABLE FROM STOCK

Available for immediate delivery, these miniaturized Bendix® motors (type number CK 1066-40-A1) are designed for applications where space and weight requirements are at a minimum. So small that four can be packaged in a square inch, these motors are ideally suited for missile instrumentation and similar miniaturized applications. The motor has a tapered shaft; however, units may be obtained with other type shafts and with center tapped control windings.

### TYPICAL MOTOR CHARACTERISTICS

Voltage	
Fixed phase	26 volts
Control phase	26 volts
Frequency	400 cycles
Stall Current*	
Fixed Phase	100 ma
Control Phase	100 ma
Stall Impedance*	
Fixed Phase	$260 = 184.5 + j183.5$ ohms
Control Phase	$260 = 184.5 + j183.5$ ohms
Stall Power Input* (Total)	3.69 watts
Stall Torque	0.138 oz.-in.
No Load Speed	9900
Torque-to-Inertia Ratio	44,400 rad/sec <sup>2</sup> (Stall Acceleration)
Operating Temperature	
Range	-55°C. to +70°C.
Weight	0.88 oz.

\*With rated voltage applied to each phase.

For information on these motors — or similar motors in sizes B, 10, 11, 15, 20, and 28 — write:

**Eclipse-Pioneer Division**

Teterboro, N. J.



District Offices: Burbank, and San Francisco, Calif.; Seattle, Wash.; Dayton, Ohio; and Washington, D. C.  
Export Sales & Service: Bendix International, 205 E. 42nd St., New York 17, N. Y.

### AVERAGE PERFORMANCE CURVES

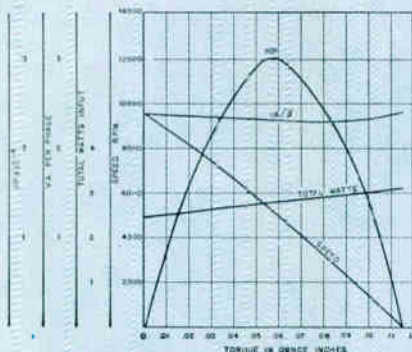

## Ireland . . .

clear power station simulator. It reproduces the characteristics of an atomic station and permits trainees to reach a high degree of proficiency in controlling reactors before going to work in actual stations. A 200-amplifier reactor simulator is being installed at the U.K. Atomic Energy Authority's Calder Hall Operations School in Cumberland.

Pye Ltd., which has joined forces with E. K. Cole Ltd. (Ekco), produces television and radio sets at a large modern factory at Larne, County Antrim. About \$500,000 is being spent by the Ministry of Commerce in providing extra storage space there.

Grundig Ltd., West German electronics group, has begun producing transistor tape recorders in a factory on the new Government Industrial estate of Dunmurry, about seven miles from Belfast. Grundig plans to extend its operations to a wide range of electronics equipment in which the West German group specializes. Within the first four weeks of operation at Dunmurry, Grundig had produced 8,000 Niki transistor tape recorders for the U.S. market.

Plessey (Northern Ireland) Ltd. is producing wiring sets for computers and other electronic equipment at Ballynahinch.

The U.S. Advanced Projects Research Agency has made available to Queen's University in Belfast about \$182,000 and aid will continue at around \$56,000 a year for the next seven years. Emphasis in pure electronic and space research will be on study of reactions and properties of atoms and molecules together and with electrons.

The study is expected to have value in upper atmosphere space exploration and will have a bearing on missiles and conditions in outer space.

Northern Ireland is also expanding the scope of higher technological education. Queen's University has established a course in computers. With the prospect of a designated College of Advanced Technology at Queen's University, Northern Ireland expects to take an increasingly important part in electronics developments.

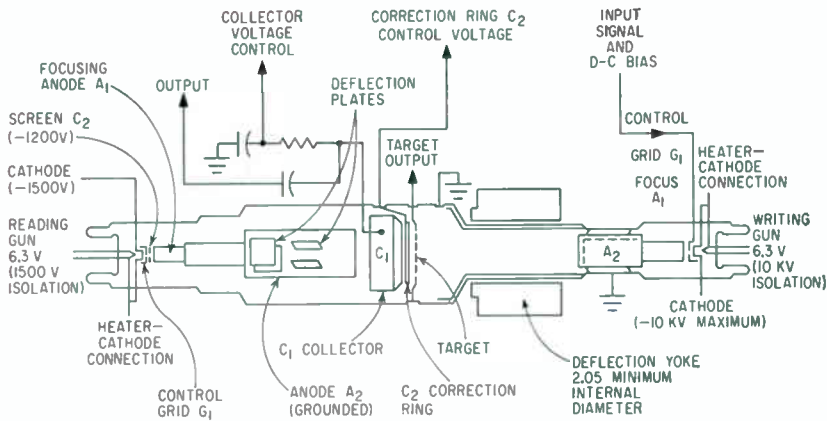

Video transformation tube reads radar information

## Scan Converter Bandwidth Goes to 10 Mc

SCAN CONVERSION equipment—radar to television—developed by INTEC and its French affiliate CSF has been around for quite some time (ELECTRONICS, p 135, Oct. 23, 1959). But this week there's news of a new system considerably improved in performance.

Range and resolution of the new INTEC Scan Converter, the TI-441, easily surpass the old TI-440 model. Maximum range is upped from 160 to over 300 nautical miles. Resolution is benefited by a tv bandwidth increase of 6 Mc to 10 Mc and goes from a previous maximum of 625 lines to 945 lines.

Transients in the tv video circuits have been reduced by use of crystals instead of vacuum diodes and additional clamping circuits.

Reliability has been improved by reducing the number of electrolytic capacitors in the equipment's circuitry from 30 to 6. Silicon rectifiers are used in the power supplies and the number of rectifier circuits has been decreased from five to two. Low voltage is reduced from 250 volts to 150 volts.

Use of photoelectric diodes instead of microswitches has improved reliability of angle mark generating circuits and high voltage protection circuits, company says.

Systemwise, the new equipment does not differ from the old version. The CSF-developed TMA 403X video transformation, or memory, tube provides the controllable link between radar and television equipment.

This tube is a two-gun cathode-ray tube that writes radar information on an internal target grid and independently reads this information with the television information beam.

## Propose Radiometers For Weather Checks

ACCURATE determination of weather variables 25 miles away is now possible, say scientists at Armour Reserve Foundation.

A study conducted by ARF for Army Signal Corps indicates two methods could be used in the surveillance system for measuring temperature by passive means: (1) a microwave radiometer which measures the emission from  $O_2$  in the 60 Gc region of the microwave spectrum and (2) a radiometer to measure the emission from  $CO_2$  in the 4.3 micron region of the infrared spectrum.

## Burroughs Opens Center To Show MICR Gear

BURROUGHS CORP. recently opened a permanent consultation center in Chicago for the financial industry's new electronic language—Magnetic Ink Character Recognition (MICR). Firm plans a \$150,000, 12,000-sq-ft expansion of its exhibit center to house equipment—including a data processing system—developed especially for the new technology.

## ENGINEERING REPORT

ON OTHER BENDIX COMPONENT PACKAGES



## AUTOSYN® SYNCHROS

Dependable in miniaturizing control circuitry

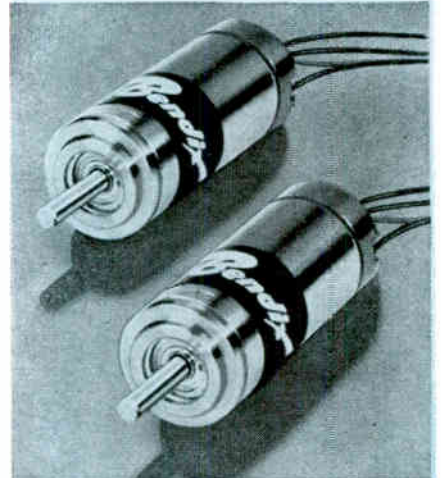

These Bendix® size 5 Autosyn synchros are well suited to the needs of missile instrumentation and similar applications requiring miniaturization and weight reduction. Typical characteristics are listed below. For additional information, including comprehensive data on transmitter, control transformer, and differential characteristics, write today.

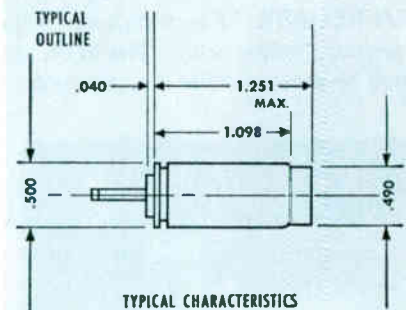

**TYPICAL CHARACTERISTICS**

Operating temperature range	-55°C. to 95°C.
Rotor moment of inertia	0.25 gm cm <sup>2</sup>
Weight	0.8 oz.
Accuracy	±15 minutes

Available as transmitter, control transformer and differential.

Manufacturers of

GYROS • ROTATING COMPONENTS  
RADAR DEVICES • INSTRUMENTATION  
PACKAGED COMPONENTS

Eclipse-Pioneer Division



Teterboro, N. J.

# When does it pay to pay more for a digital voltmeter?



**WHEN RELIABILITY** is of uncompromising importance, consider NLS Series 20 instruments with advanced transistorized logic and mercury-wetted relays. The M24, above, which measures DC voltage, DC voltage ratio or resistance in  $\frac{1}{3}$  second, has been selected by major missile manufacturers after thousands of hours of competitive life testing.



**WHEN SPEED**, in the order of 200 measurements per second, is required, specify the NLS V44 All-Electronic DVM. Here is an instrument specifically designed to solve the special problems encountered in high-speed measuring and data logging.



**WHEN ACCURACY**—full five-digit accuracy—is demanded by your application, use the NLS V35A. This instrument features resolution of 0.001% over the entire range, a result of mathematically perfect "No-Needless-Nines" logic.

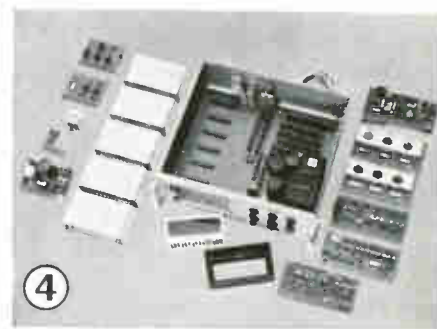

**WHEN EASE OF SERVICING** is of vital concern, you will find it in any NLS premium instrument. The higher-priced V44, M24, V24, R24 or the medium-priced V35A and V34A (shown above)—all feature 99% plug-in modular construction for spotting and correcting malfunctions in minutes instead of hours or days.



Originator of the Digital Voltmeter

**non-linear systems inc.**

DEL MAR, CALIFORNIA



**You can buy an NLS Digital Voltmeter for as little as \$1,125 . . .**

...but there are many times when it pays to pay much more! When accuracy, reliability, speed, servicing ease or versatility cannot be compromised, you'll gain far greater long-term economy by specifying one of these premium NLS instruments:

**1** M24 Multi-Purpose Instrument—Measures DC voltage from  $\pm 0.001$  to  $\pm 999.9$  and DC voltage ratio to  $\pm 9999$  ( $\pm 0.01\%$  accuracy), resistance from 0.1 ohm to 1 megohm...  $\frac{1}{3}$  second balancing time...with accessories, measures AC voltage or AC ratio, low-level DC... completely automatic...output for data logging. **\$5,650**

V24 Voltmeter-Ratiometer—Similar to M24 except it does not measure resistance. **\$4,950**

R24 Ratiometer—Measures DC ratio with ranges of  $\pm 9999/9.999$ . **\$4,650**

**2** V44 All-Electronic Voltmeter—200 readings per second...measures DC voltages from  $\pm 0.001$  to  $\pm 999.9$ ...output for data logging...input impedance 10 megohms on all ranges without internal or external preamplifiers...recommended for high-speed applications requiring maximum reliability and dependable  $\pm 0.01\%$  accuracy...there are no decade or amplifier potentiometers to trim; the V44's "NO POTS AT ALL" stability is designed in, not trimmed in. **\$6,150**

**3** V35A Transistorized Voltmeter-Ratiometer—This all-transistorized instrument is the fastest, most versatile, true 5-digit voltmeter with the Factual Fifth Figure, full 5-digit resolution of 0.001%...measures DC voltage from  $\pm 0.0001$  to  $\pm 999.99$ , DC voltage ratio from  $\pm 0.001\%$  to  $\pm 99,999\%$ ...with accessories, measures AC voltage, low-level DC...features No-Needless-Nines logic, plug-in oil bath stepping switches...output for data logging. **\$3,750**

**4** V34A Transistorized Voltmeter Ratiometer—4-digit quality and performance companion to V35A. **\$3,150**

NLS offers a complete line of digital voltmeters...both by purpose and by price. In addition to these premium instruments, six low-cost models in the Industrial Series are offered by NLS, pioneer of low-cost DVMs. To see any NLS instrument in action or receive more information, write NLS or contact any NLS office or representative.



CIRCLE 35 ON READER SERVICE CARD  
 ← CIRCLE 34 ON READER SERVICE CARD

## Ion Rocket Engine Prototype Shown

"THE LARGEST CESIUM ION engine successfully operated to date" was described by Electro-Optical Systems' M. P. Ernstene before a joint meeting of the Institute of Aerospace Sciences and the American Rocket Society in Los Angeles.

The 61-beam, three-thousandths-pound thrust, contact cesium ion engine has operated in a large vacuum chamber at EOS for as long as 175 consecutive hours with no failures, Ernstene said.

It produced specific impulses in the 5,000-to-8,000-second range and efficiencies as high as 65 percent. Power to thrust ratios were in the 280 Kw/lb range, and these are expected to decrease markedly in the near future.

As an indication of fuel economy provided by an ion engine, ESO estimates that a 4/10-lb-thrust ion rocket would require only 1,000 lb of fuel to make a 300-day trip from an earth orbit to an orbit around

Mars. A chemical engine would require 10 times this amount of propellant, company says.

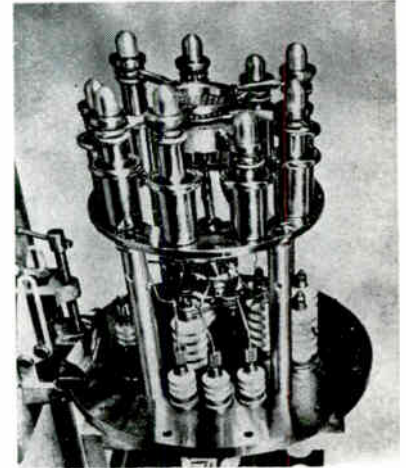

*Ion motor structure shows exit electrodes (left) and mountings. Behind exit electrodes are accelerating electrodes and porous tungsten ionizer. Porous ionizers are backed from a cesium vapor supply system controlled by a needle valve*

## Spectrometer Indicates Extraterrestrial Life

MASS SPECTROMETER operated by a team from Fordham University and Esso Research & Engineering

recently provided information to support the contention that life forms exist outside our own planet.

The instrument, built by Consolidated Electrodynamics, analyzed samples from a 97-year-old meteorite, produced data revealing the presence of paraffinic hydrocarbons. These molecules contain from 19 to 23 carbon atoms, are produced only by living matter.

Analyses were performed on solid particles and distillates of test samples vaporized in the heated inlet system of the spectrometer.

Uniform magnetic field for segregation of ions was produced by double-E electromagnet with a 2-in. gap having parallel faces. Field strength across the gap was variable from 800 to 6,000 gauss.

Ion accelerating voltage was provided by 4-Kv power supply. Automatic voltage scan can be started or stopped anywhere between 400 and 4,000 v, making possible a continuous scan, repeat incremental scan, or fixed voltage.

## Electronic Coach



*Radio-controlled pace-setter by Toshiba assists Japanese 1964 Olympic team. Unit has receiver and loudspeaker which broadcast instructions from coach*



# ENVIRONMENT FOR ACHIEVEMENT

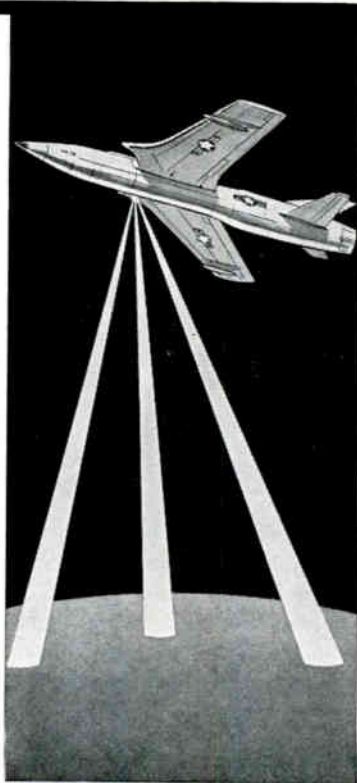

LFE's Airborne Doppler Navigation Systems are automatic, self-contained, and weigh as little as 75 pounds. They are supplied for any aircraft, from U. S. Navy helicopters to Air Force F-105D fighter-bombers. The systems operate anywhere in the world, without reference to ground aids, and independent of weather. They also operate at any speed, any altitude, even during radar silence.

The work environment that fostered this LFE achievement is close to ideal. It includes company-financed research, free inquiry, easy communications, and management that knows its technology. If you feel this environment would further your career, write us now about select new opportunities in:

## SYSTEMS, EQUIPMENT & COMPONENTS for

Airborne Navigation	Automatic Controls
Radar and Surveillance	Ground Support
Electronic Data Processing	

Excellent opportunities are also available  
at our Monterey, California Laboratory

Write in complete confidence to:



C. E. Fitzgerald  
**LABORATORY FOR ELECTRONICS**  
1079 Commonwealth Avenue  
Boston 15, Massachusetts

"All qualified applicants will be considered for employment  
without regard to race, color, creed or national origin."

## MEETINGS AHEAD

- June 26-July 1: International Measurement Conf. and Instrument Show, IMEKO, IMIS; Engineering Societies Bldg., Budapest.
- July 5-9: Radio Techniques and Space Research, British IRE; Univ. of Oxford, England.
- July 16-21: Conf. on Medical Electronics & Conf. on Elec. Tech. in Med. & Bio., IFME, JECMB, PGBME of IRE; Waldorf-As-toria Hotel, New York City.
- July 24-26: Air Traffic Control Symposium, Electronic Maintenance Engineering Assoc. (EMEA); Mayflower Hotel, Washington, D.C.
- Aug. 13-18: Magneto-hydrodynamics Seminar, Penn State Univ.; University Park, Pa.
- Aug. 16-18: Electronic Circuit Packaging Symposium; Univ. of Colorado, Boulder, Colo.
- Aug. 22-25: WESCON, L.A. & S.F. Sections of IRE, WEMA; Cow Palace, San Francisco.
- Aug. 23-25: Gas Dynamics Symposium, ARS, Northwestern Univ.; Evanston, Ill.
- Aug. 23-Sept. 2: National Radio & Tv Exhibition, 1961 British Radio Show; Earls Court, London.
- Aug. 30-Sept. 1: Semiconductor Conf., AIME; Ambassador Hotel, Los Angeles.
- Sept. 4-9: Analog Computation, International Conf., International Assoc., for Analog Comp., and Yugoslav Nat. Comm. for ETAN, Belgrade, Yugoslavia.
- Sept. 11-15: Instrument-Automation Conf. and Exhibit, ISA; Sports Arena, Los Angeles.
- Oct. 9-11: National Electronics Conf., IRE, AIEE, EIA, SMPTE; Int. Amphitheatre, Chicago.
- Nov. 14-16: Northeast Research & Engineering Meeting, NEREM; Commonwealth Armory and Somerset Hotel, Boston.

COPYRIGHT 1961

BRUSH INSTRUMENTS

DIVISION OF CLEVITE CORPORATION

CLEVELAND, OHIO

unmatched  
peak in  
penmanship...

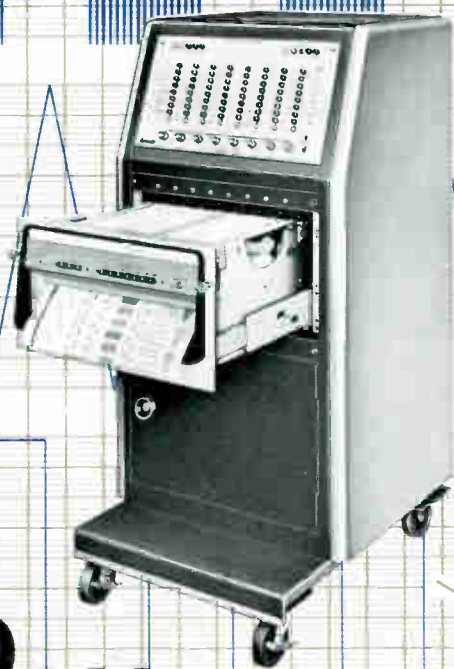

The totally new **Brush Recorder Mark 200** made these incredibly crisp tracings. No other recorder in existence can match them. Note the line width. It never varies . . . regardless of writing velocity, regardless of chart speed. The writing mechanism is electrically signaled by the position-seeking "Metrisite" transducer . . . no parts to wear, infinite resolution, verifiable dynamic  $\frac{1}{2}\%$  accuracy. Traces are permanent, high-contrast, reproducible . . . on low cost chart paper. The Mark 200 has but three standard controls . . . attenuator, pen position, chart speed. Such fidelity, simplicity and economy are possible with no other direct writing recorder. Write for details . . . they'll speak for themselves.

**brush** INSTRUMENTS

DIVISION OF

**CLEVITE**  
CORPORATION

37TH AND PERKINS

CLEVELAND 14, OHIO

# FREQ. STDS.



**TYPE 10**  
1 3/8" x 1 3/8" x 3/8"

This frequency standard (360 or 400 cycles) is accurate to  $\pm 50$  parts per million at 10° to 35°C. Aging has been greatly minimized.

External power of 1.4 volts at 6 microamperes powers the unit.

**TYPE 2007-6**



**TYPE 25**



**TYPE 2001-2**



## AND PRECISION FORK UNITS 1 TO 40,000 CYCLES

### TYPE 2007-6 FREQUENCY STANDARD

Transistorized, Silicon type  
Size, 1 1/2" dia., x 3 1/2" H., Wt., 7 oz.  
Frequencies: 360 to 1000 cy.

Accuracies:

2007-6  $\pm 0.2\%$  ( $-50^\circ$  to  $+85^\circ\text{C}$ )  
R2007-6  $\pm .002\%$  ( $+15^\circ$  to  $+35^\circ\text{C}$ )  
W2007-6  $\pm .005\%$  ( $-65^\circ$  to  $+85^\circ\text{C}$ )

Input: 10 to 30V DC at 6 ma.

Output: Multitap, 75 to 100,000 ohms

### TYPE 2001-2 FREQUENCY STANDARD

Size, 3 3/4" x 4 1/2" x 6" H., Wt., 26 oz.

Frequencies: 200 to 3000 cycles

Accuracy:  $\pm .001\%$  at  $+20^\circ$  to  $+30^\circ\text{C}$

Output: 5V at 250,000 ohms

Input: Heater voltage, 6.3 - 12 - 28

B voltage, 100 to 300 V, at 5 to 10 ma.

Accessory Modular units are available to divide, multiply, amplify and power this unit.

### TYPE K-5A FREQUENCY STANDARD

Size, 3 1/2" x 3" x 1 3/4"

Weight, 1 1/2 lbs.

Frequency: 400 cycles

Accuracy: .03%,  $-55^\circ$  to  $+71^\circ\text{C}$

Input: 28V DC  $\pm 10\%$

Output: 400 cy. approx. sq. wave  
at 115V into 4000 ohm load (approx. 4W)

### TYPE 25 PRECISION FORK

Size, 5/8" dia. x 2 3/4"

Weight: 2 ounces

Frequencies: 200 to 1000 cy.

Accuracies:

R-25T and R-25V  $\pm .002\%$  ( $15^\circ$  to  $35^\circ\text{C}$ )

25T and 25V  $\pm .02\%$  ( $-65^\circ$  to  $85^\circ\text{C}$ )

For use with tubes or transistors.

## INQUIRIES INVITED

For over 20 years we have made frequency standards and precision fork units for applications where consistent accuracy and rugged dependability are vital. Shown are just a few typical examples.

Some users integrate our products with instruments of their own manufacture. In other cases we develop complete assemblies to meet special needs.

You are invited to submit any problems within the area of our activity for study by our engineering staff.



## AMERICAN TIME PRODUCTS

DIV. OF BULOVA WATCH COMPANY, INC.

61-20 Woodside Ave., Woodside 77, L. I., N. Y.

WESTERN OFFICE, 234 N. LAKE AVE., PASADENA, CALIF.



# Now CBS MATs\* for Compact Computer Circuits

Wide Selection... Low Price...  
High-Frequency Performance

CBS Semiconductors provide a wide selection of Micro Alloy Transistors to give your compact computer circuits the economy and performance you've been seeking.

These transistors work well in a choice of circuits such as Pulse Generator, Flip-Flop, Resistor Transistor Logic and Binary Counter, to mention only a few.

Circuit design engineers can standardize their selection of high-frequency switching circuits by specifying CBS MATs.

Learn how the 13 types listed below can provide you with the advantages of high-frequency performance at low prices. Call or write today for complete technical data and delivery information from your local sales office or Manufacturer's Warehousing Distributor.

\*MAT, trade-mark of Philco Corp.

## ELECTRICAL CHARACTERISTICS

Suggested Application	Type	V <sub>CE</sub> V <sub>dc</sub>	I <sub>c</sub> mA <sub>dc</sub>	f <sub>r</sub> mc	P <sub>r</sub> mW	Min. h <sub>FE</sub> @ 1 kc
Pulse Generator	2N1122A	14	50	40	25†	35
	2N1122	12	50	40	25†	35
Flip-Flop	2N128	10	5	28	25	19
	2N240	6	15	25	30	16
	2N1427	6	50	50	25†	40
Resistor Transistor Logic	2N346	5	5	40	20	10
	2N393	6	50	25	25†	40
	2N1411	5	50	25	25†	—
	2N1750	14	5	20	15	—
Binary Counter	2N345	5	5	20	20	25-11
	2N344	5	5	20	20	11-33
	2N231	5	3	20	9	19-66
	2N232	5	3	15	9	9-39

†@45°C

Note: Suggested applications above indicate desirable uses for each type listed, based on transistor characteristics, economy and circuit requirements. CBS Micro Alloy transistors provide excellent performance in a variety of other computer circuit applications, in addition to these examples.

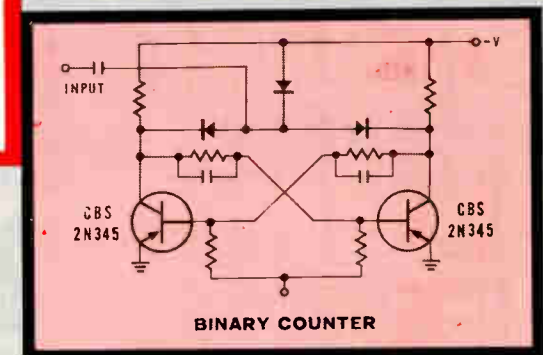
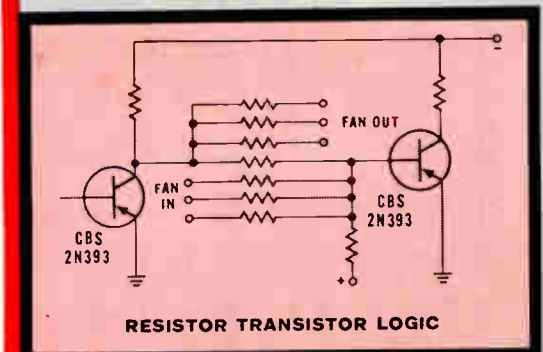
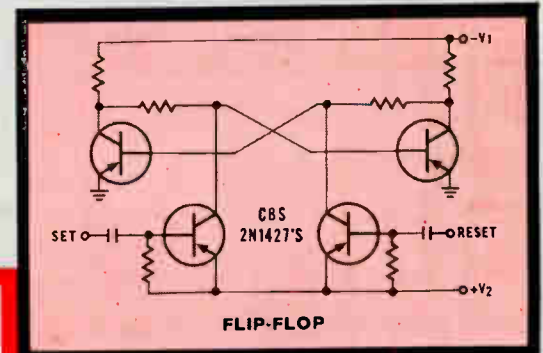
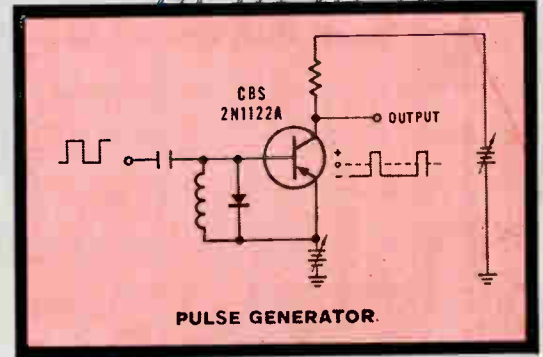

More Reliable Products through Advanced Engineering

**CBS ELECTRONICS, Semiconductor Operations, Lowell, Massachusetts**

A Division of Columbia Broadcasting System, Inc. • Semiconductors • tubes • audio components • microelectronics

Sales Offices: Lowell, Mass., 900 Chelmsford St., GLenview 2-8961 • Newark, N. J., 231 Johnson Ave., TAlbert 4-2450 • Melrose Park, Ill., 1990 N. Mannheim Rd., EStebrook 9-2100 • Los Angeles, Calif., 2120 S. Garfield Ave., RAYmond 3-9081 • Toronto, Ont., Canadian General Electric Co., Ltd., LEnnox 4-6311.

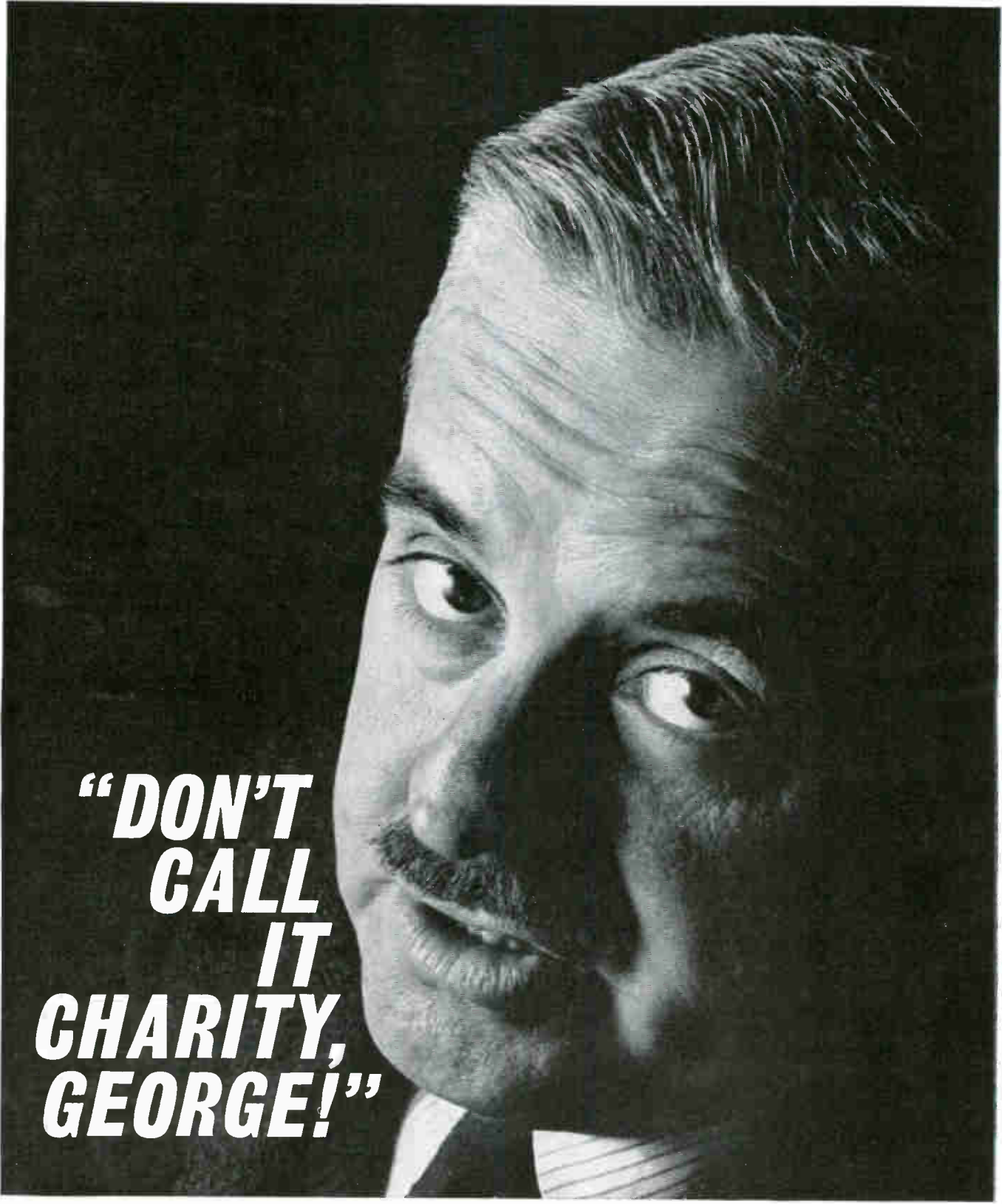

**“DON'T  
CALL  
IT  
CHARITY,  
GEORGE!”**

*“Contributions to the United Fund are really investments! Sure, charity takes the edge off hunger and misery. And that’s necessary. But the agencies of the United Fund go way beyond that. They give the help that gets people back on their feet, makes them productive members of the community again. So it makes good sense to give the United Way—as an investment in a stronger, more prosperous community. Besides, that’s the American way: to take care of our own, right at home. Our company makes a contribution, urges its employees to join in and makes it convenient through payroll payments. This once-a-year appeal cuts down the confusion of separate drives, too. It’s more than a charity, George. It’s an investment—and a duty—for your business and mine!”* **GIVE THE UNITED WAY**

# NEW DORSETT "20" SERIES

## MODULAR PACKAGING

provides maximum  
telemetry system flexibility!

- Requires Less Power
- Meets Most Rugged  
Environmental Conditions
- Die Cast Construction

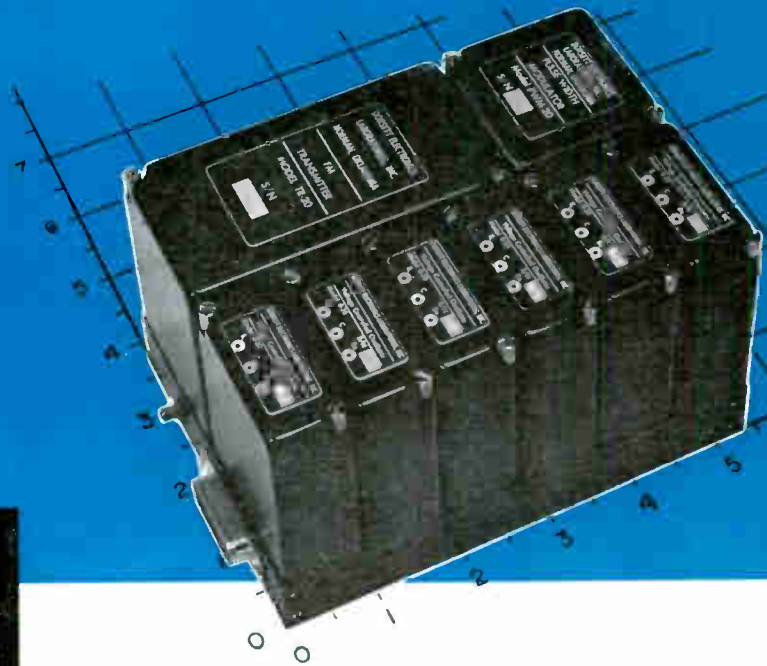

### SOLID STATE COMPONENTS AVAILABLE FOR "20" SERIES PACKAGING

- TR-20 2-watt FM Transmitter,  
225 - 260 mc.
- TR-21 2-watt FM Transmitter,  
136 - 137 mc.
- O-20 Subcarrier Oscillator
- MVO-20 Millivolt Subcarrier  
Oscillator
- ACA-20 Low Level AC Amplifier
- DCA-20 Low Level DC Amplifier
- PWM-20 Pulse Width  
Modulator
- PS-20 Regulated Power Supply

**MODULAR PACKAGING DESIGN** of the new "20" series line of telemetering components and systems lets you put more telemetering equipment in less space. Every system component has been packaged in compatible modules identical in height (2.25") and width (1.875"), with thicknesses of one, two, or four units (.875" per unit). These standard modules permit a wide range of system configurations, and make future modification of basic systems easy and economical.

**EVERY "20" SERIES COMPONENT** utilizes silicon semi-conductor circuitry—no tubes anywhere. The typical "20" series 12 channel system including transmitter, weighs less than 5 pounds, draws less than 20 watts from a 28 volt supply, and exceeds military specifications for reliability and performance throughout extreme missile environments.

**FOR YOUR NEXT TELEMETERING REQUIREMENT** let Dorsett take the problems out of system packaging with a "20" series telemetry system. Your inquiries or specifications will receive a prompt reply.

## DORSETT ELECTRONICS, INC.

P. O. Box 862, Norman, Oklahoma, Ph: Jefferson 4-3750



# Concerned about these radiation

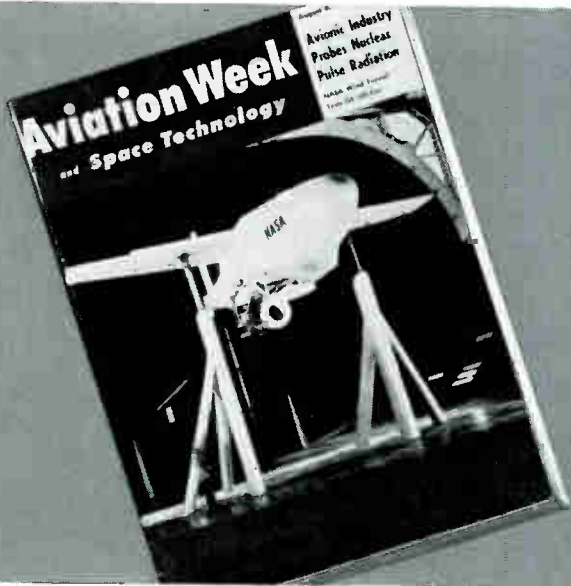

NEW YORK—Pulse nuclear radiation which could temporarily disable avionics controls in a weapon system and thus jeopardize the success of the weapon's mission is becoming the subject of serious military and industry concern.

The extremely brief, but very high intensity pulses of radiation that occur immediately following a nuclear explosion can produce disrupting transients or erratic operation of avionic equipment at distances from the detonation point that were once considered to be safe for equipment.

AVIATION WEEK, 8/8/60, Page 58

Increasing use of nuclear energy in propulsion systems and weapons, as well as the exposure of space systems to Van Allen and cosmic radiation, is causing growing interest in the effects of nuclear radiation on complex electronic systems. One of the more significant phenomena that occur under high-level nuclear radiation is the transient effect, leading to circuit malfunction as opposed to permanent damage. . . . shields or protective covers that surround typical electronic systems are almost completely transparent to these radiations.

ELECTRONICS, 2/10/61, Page 62

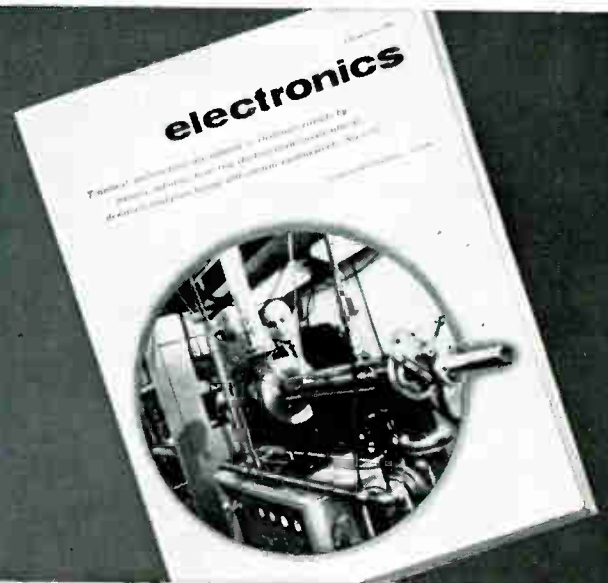

## G. E. OFFERS THREE ANSWERS TO

### 1. G-E 5-STAR TUBES



Special heavy-duty construction, highest quality materials, and low boron-content glass envelopes give G-E 5-Star tubes an increased tolerance to steady-state radiation and provide faster recovery time to pulsed gamma radiation. Integrated gamma dosage up to  $10^9$  roentgens and approximately  $10^{18}$  integrated fast neutron flux (NVT) can be sustained without permanent damage. For temperatures up to  $220^\circ\text{C}$ ., G-E 5-Star tubes offer the ultimate in high-output performance and reliability under the most adverse conditions of vibration and shock.

### 2. CERAMIC TUBES



Microminiature ceramic tubes, when adapted to your present circuitry, can increase steady-state radiation tolerance to as high as  $10^{11}$  roentgens and  $10^{19}$  NVT. In addition, the effects of pulse radiation are reduced considerably if the tubes are operated at higher temperatures. These reductions are proportionately greater as the tube operating temperature is increased to its maximum, up to  $500^\circ\text{C}$ .

Rigid, compact construction of ceramic tubes makes them extremely resistant to shock and vibration and provides the smallest equipment package using standard circuitry components.

# problems in the news?

 **ELECTRONICS**

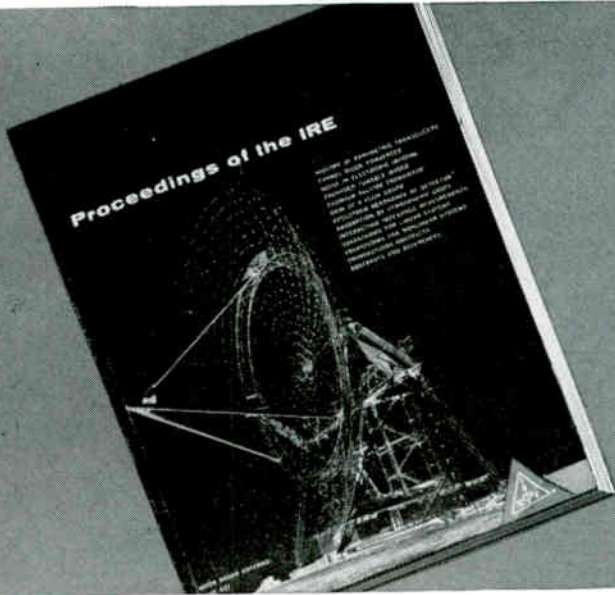

Frequently it is desirable to operate in a high radiation area and protect equipment by shielding. . . . preliminary considerations seem to rule out protection by shielding for present payloads. The range of a 100-mev proton is about 1.5 cm in lead; since about half of the damage is produced by the protons above 100 mev, it is clear that several cm of lead will be required to increase semiconductor lifetime significantly.

. . . cascade products are forward scattered in addition to other less preferentially radiated products, it appears that the use of thin shields may lead to an increase in damaging radiation.

Proceedings of the IRE, 5/60, Page 952

Researchers who recently uncovered a new radiation hazard are now searching for ways to counteract it. When transient radiation (gamma rays and neutrons) strikes electronic instruments, they act up, components don't function properly, and false data are sent out or received. Dose rates don't have to be high, and even "safe" radiation levels are unsafe for electronics, says the Defense Dept. Implications are serious because computers, missiles, and defense electronics systems are all susceptible.

MACHINE DESIGN, 8/18/60, Page 23

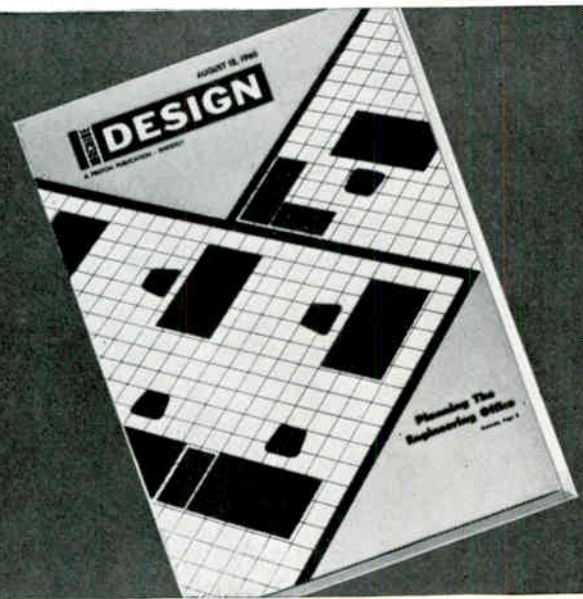

## NUCLEAR RADIATION PROBLEMS

### 3. TIMM CIRCUITS (Thermionic Integrated Micro Modules)

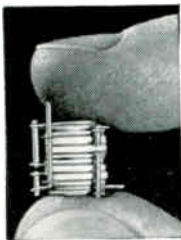

TIMM circuits, inherently resistant to radiation, are made of ceramic and titanium components which tolerate nearly 10,000 times the steady-state radiation of circuits employing solid-state devices, and more than 1,000 times greater high-intensity pulse radiation. No transients were produced in the output of a test TIMM during a  $5 \times 10^7$  R/sec. dose rate pulse.

TIMM circuits operate at 580° C., utilizing normal heat losses to increase efficiency; B+ power usage is no more than solid-state circuitry. High, constant temperature provides improved circuit stability. Rugged, micro-miniature construction is highly resistant to shock and vibration and allows component densities as high as one million parts per cubic foot.

Write for your free radiation file folder containing all the latest information on components and applications data. To:  
General Electric Co.  
Receiving Tube Dept.  
Room 7139 A  
Owensboro, Kentucky



*Progress Is Our Most Important Product*

**GENERAL  ELECTRIC**

CIRCLE 43 ON READER SERVICE CARD

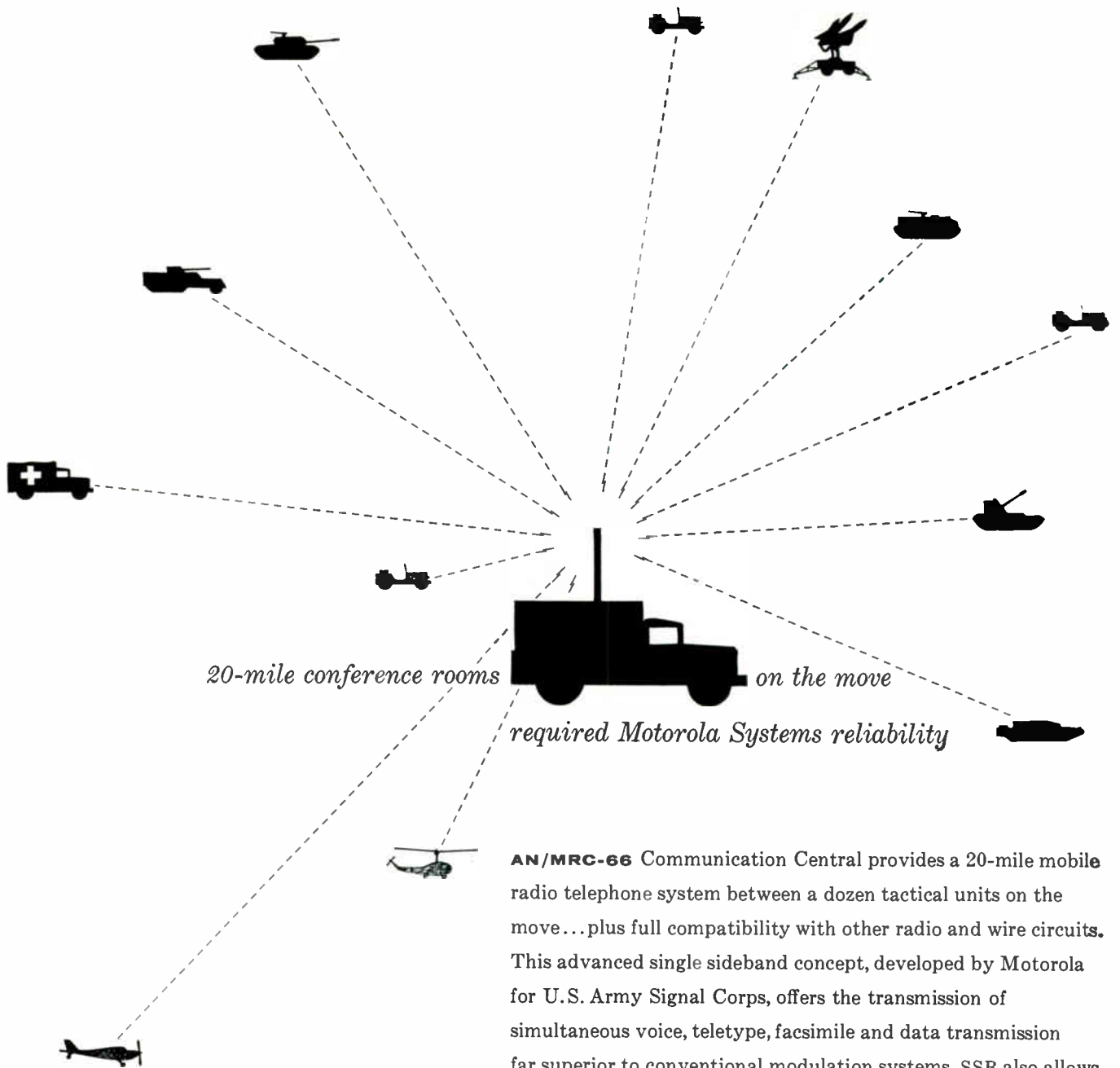

**AN/MRC-66** Communication Central provides a 20-mile mobile radio telephone system between a dozen tactical units on the move... plus full compatibility with other radio and wire circuits. This advanced single sideband concept, developed by Motorola for U.S. Army Signal Corps, offers the transmission of simultaneous voice, teletype, facsimile and data transmission far superior to conventional modulation systems. SSB also allows more channels in a given portion of the crowded RF spectrum and more systems in a given area. ☆ Automatic Output Control insures uniform signal reception regardless of whether vehicles are deployed 100 feet or 10 miles from the Central. Three operating modes—Normal, In-Channel Net and Emergency Net—enhance the basic system flexibility. ☆ Simplification inherent in Motorola's concept and modular design affords the highest possible degree of reliability and maintainability in the field. Detailed information is available on request.

**Military Electronics Division**



**MOTOROLA**

*Qualified technical personnel  
are invited to apply*

CHICAGO 51, Illinois, 1450 North Cicero Avenue  
SCOTTSDALE, Arizona, 8201 East McDowell Road  
RIVERSIDE, California, 8330 Indiana Avenue

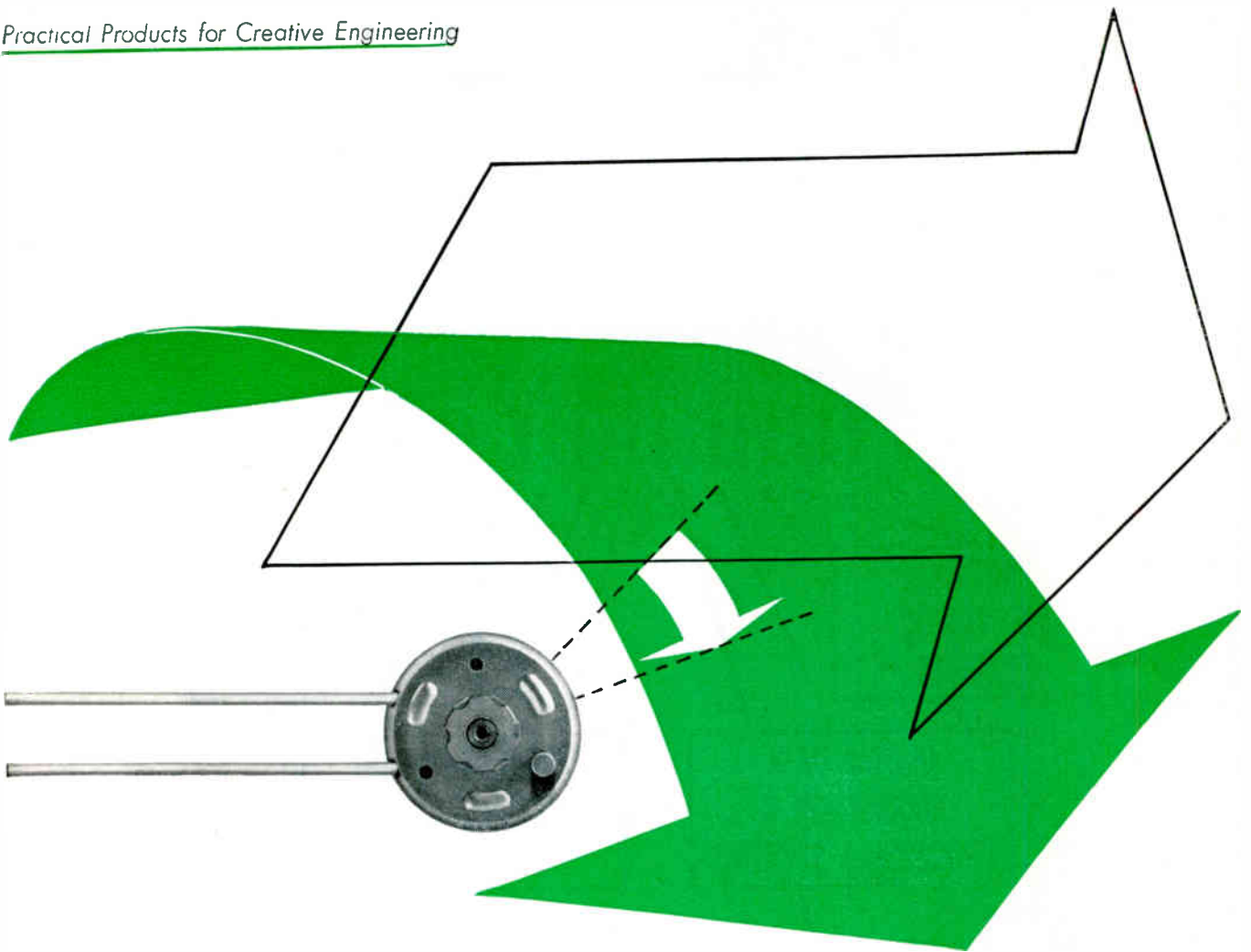

## PUT POWERFUL "DOWNHILL" TORQUE INTO YOUR REMOTE ACTUATION

**OAK ROTARY SOLENOIDS** provide high torque at the start of their actuation stroke—where and when it's needed most. Ordinarily, magnetic attraction of the solenoid coil is greatest near the end of the stroke. Oak engineers have solved this by inclining the ball races at a steeper angle near the top—or start—of the race. This "downhill" action levels off near the end of the rotary stroke. Since torque is inversely proportional to the length of stroke, a 2E solenoid that pro-

vides 6.4 inch-ounces of starting torque at 45° would offer almost twice as much torque when designed for a 25° stroke. You can obtain Oak Solenoids for stepping angles of 25°, 35°, 45°, and 67.5°—in right—or left-hand rotation. Because Oak Solenoids are custom-made to meet specific actuation and torque requirements, you can outline your needs with your local Oak sales representative. If you prefer, send a sketch of your design to our Applications Engineering department.

*Creative Engineering • Quality Components*

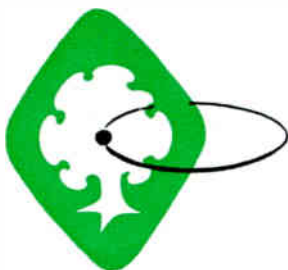

### OAK MANUFACTURING CO.

CRYSTAL LAKE, ILLINOIS • telephone: Crystal Lake, 459-5000  
OAK ELECTRONICS CORPORATION, (Subsidiary) Culver City, California

ROTARY AND PUSHBUTTON SWITCHES • TELEVISION AND FM TUNERS • SUBASSEMBLIES  
APPLIANCE CONTROLS • CHOPPERS • ROTARY SOLENOIDS • VIBRATORS

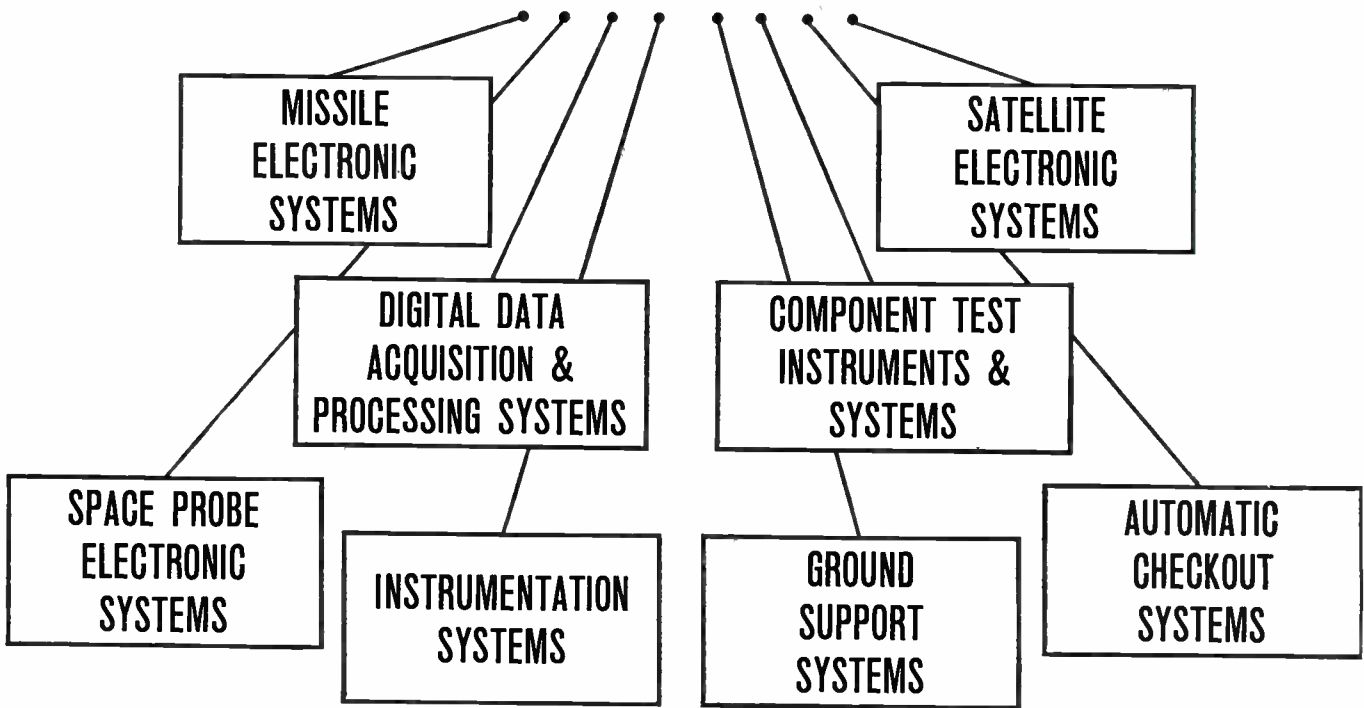
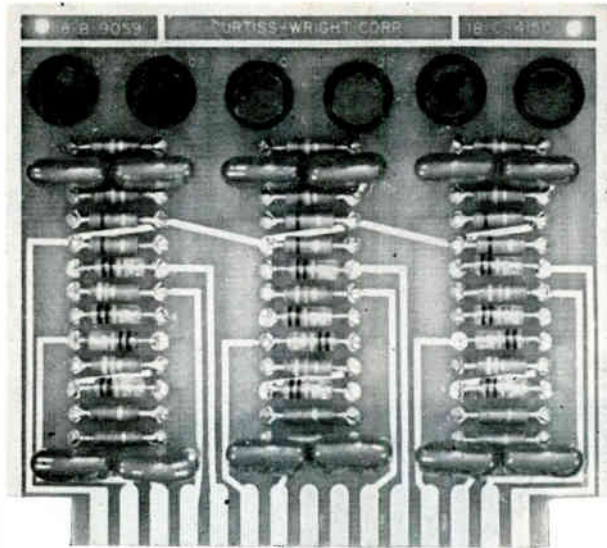

An example of Intermountain Solid State Circuit design capability...  
**SOLID STATE CIRCUITRY TAILORED TO YOUR SYSTEM NEEDS**



Intermountain Branch  
**CURTISS-WRIGHT**  
 CORPORATION  
 Electronics Division

P.O. Box 10044 Albuquerque, New Mexico  
 Telephone: 345-1661

You get built-in reliability . . . savings in design time . . . scheduled delivery — when your complex system circuitry is designed to your specifications and processed into Standard or Miniaturized Solid State Printed Circuit Cards by the Intermountain Branch of the Curtiss-Wright Electronics Division.

Whether it is a Printed Circuit Card tailored to your application . . . or one of the proven standard Intermountain Solid State Printed Circuit Cards — you can put Intermountain Solid State design capability to work for you in circuits . . . instruments . . . or systems. Write today for information and a quotation on your requirements.

AD NO. 4508



Another New High Order of Reliability!

**El-Menco**

# \* MYLAR-PAPER DIPPED CAPACITORS

TYPE  
**MPD**

**ASSURE A LOW FAILURE RATE OF**  
Only 1 Failure in 7,168,000 Unit-Hours for 0.1 MFD Capacitors \*

**14,336,000**

**Setting A New High Standard Of Performance!**

★ Life tests have proved that El-Menco Mylar-Paper Dipped Capacitors — tested at 105°C with rated voltage applied — have yielded a failure rate of only 1 per 1,433,600 unit-hours for 1.0 MFD. Since the number of unit-hours of these capacitors is inversely proportional to the capacitance, 0.1 MFD El-Menco Mylar-Paper Dipped Capacitors will yield **ONLY 1 FAILURE IN 14,336,000 UNIT-HOURS.**

**CAPACITANCE AND VOLTAGE CHART**

• Five case sizes in working voltages and ranges:

200 WVDC —	.018 to .5 MFD
400 WVDC —	.0082 to .33 MFD
600 WVDC —	.0018 to .25 MFD
1000 WVDC —	.001 to .1 MFD
1600 WVDC —	.001 to .05 MFD

**SPECIFICATIONS**

- **TOLERANCES:** 10% and 20%. Closer tolerances available on request.
- **INSULATION:** Durez phenolic, epoxy vacuum impregnated.
- **LEADS:** No. 20 B & S (.032") annealed copper clad steel wire crimped leads for printed circuit application.
- **DIELECTRIC STRENGTH:** 2 or 2½ times rated voltage, depending upon working voltage.
- **INSULATION RESISTANCE AT 25°C:** For .05MFD or less, 100,000 megohms minimum. Greater than .05MFD, 5000 megohm-microfarads.
- **INSULATION RESISTANCE AT 105°C:** For .05MFD or less, 1400 megohms minimum. Greater than .05MFD, 70 megohm-microfarads.
- **POWER FACTOR AT 25°C:** 1.0% maximum at 1 KC

These capacitors will exceed all the electrical requirements of E. I. A. specification RS-164 and Military specifications MIL-C-91B and MIL-C-25C.

Write for Technical Brochure

**MINIMUM LIFE EXPECTANCY FOR \*\* 1.0 MFD \* MYLAR-PAPER DIPPED CAPACITORS AS A FUNCTION OF VOLTAGE & TEMPERATURE**

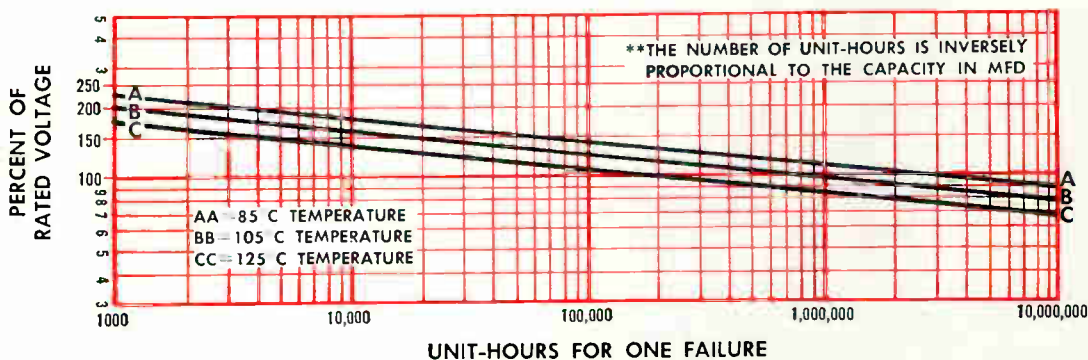

\*Registered Trade Mark of DuPont Co.

**THE ELECTRO MOTIVE MFG. CO., INC.**

Manufacturers of El-Menco Capacitors

WILLIMANTIC CONNECTICUT

- molded mica • mica trimmer • dipped mica • silvered mica films
- tubular paper • mylar-paper dipped • ceramic feed-thrus • ceramic discs

Also Electronics, Inc., Community Drive, Great Neck, L.I., New York  
Exclusive Supplier To Jobbers and Distributors in the U.S. and Canada

WEST COAST MANUFACTURERS CONTACT:  
COLLINS ELECTRONIC SALES, INC., 823 HIDDENFRED ROAD, PALO ALTO, CALIFORNIA

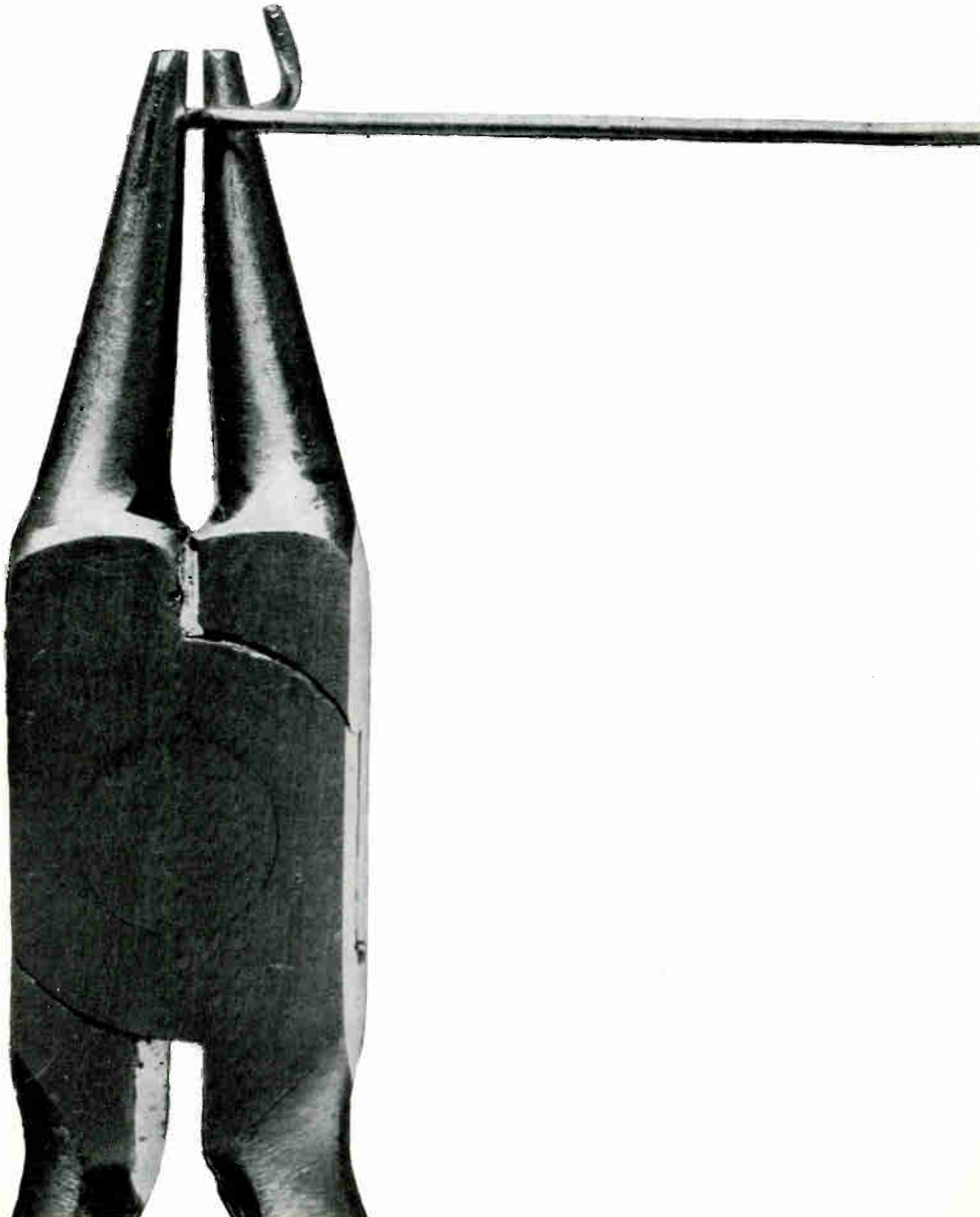

# Now! 100% power testing of 1N536-1N561 series rectifier cells gives greater reliability ...at no extra cost!

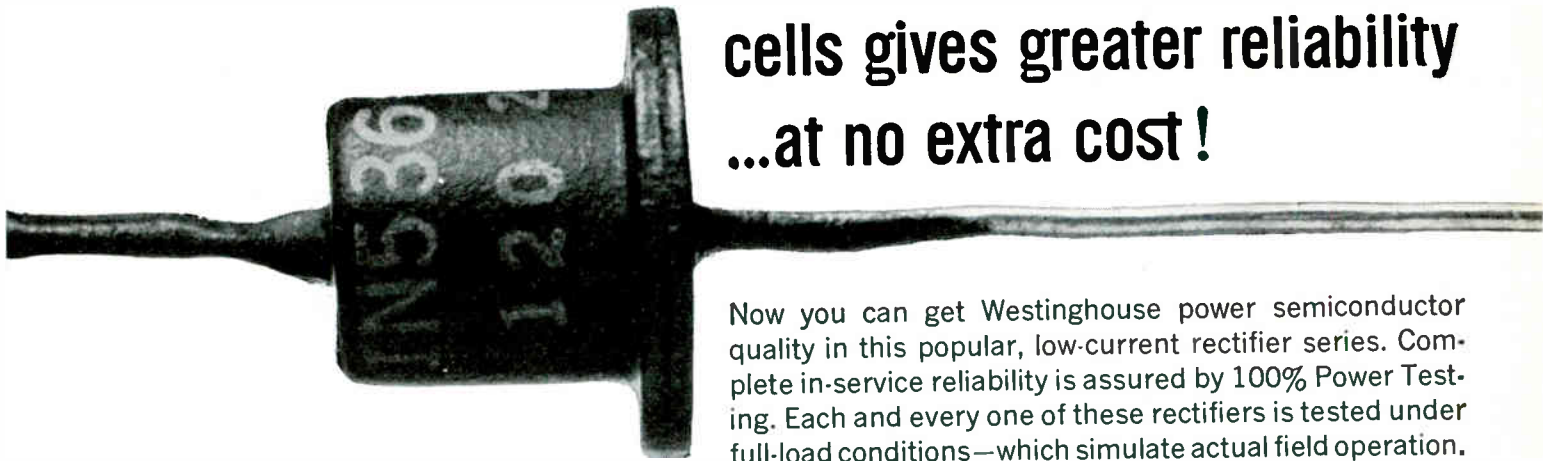

Now you can get Westinghouse power semiconductor quality in this popular, low-current rectifier series. Complete in-service reliability is assured by 100% Power Testing. Each and every one of these rectifiers is tested under full-load conditions—which simulate actual field operation. This exclusive Westinghouse procedure, developed through years of experience in high-power silicon rectifiers, has resulted in high reliability standards.

Each cell is completely tested under the severest combination of current, voltage, and temperature. Westinghouse gives this assurance of extra reliability, yet the Westinghouse 1N536-1N561 series rectifiers cost no more than other makes.

Features Include: ■ New fused, double-diffused construction ■ Ambient operating temperature minus 65°C to plus 165°C ■ Typical forward drop at 1 amp instantaneous at 25°C—.95 volts ■ Hermetically sealed encapsulation.

The 1N536-1N561 series rectifier cells are immediately available in quantities for all requirements. Why settle for less? Insist on rectifiers which have been 100% Power Tested. Whether the rectifiers you want are large or small . . . You can be sure . . . if it's Westinghouse. SC-1043

#### For "off the shelf" delivery, order from these Westinghouse Distributors:

##### EASTERN

ACK SEMICONDUCTOR, INC.  
Birmingham 5, Ala./FA 2-0588  
CAMERADIO  
Pittsburgh, Pa./EX 1-4000  
CRAMER ELECTRONICS, INC.  
Boston, Mass./CD 7-4700  
ELECTRONIC WHOLESALEERS, INC.  
Melbourne, Florida/PA 3-1441  
GENERAL RADIO SUPPLY CO., INC.  
Camden, N. J./WO 4-8560  
GENESSEE RADIO PARTS CO.  
Buffalo, N. Y./DE 9661  
KANN-ELLERT ELECTRONICS, INC.  
Baltimore, Md./TU 9-4242  
MILGRAY ELECTRONICS  
New York, N. Y./RE 2-4400  
RADIO & ELECTRONIC PARTS CORP.  
Cleveland, Ohio/UT 1-6060  
SCHWEBER ELECTRONICS  
Long Island, N. Y./PI 6-6520  
Silver Spring, Md./JU 5-7023

##### MIDWESTERN

ELECTRONIC COMPONENTS FOR INDUSTRY CO.  
St. Louis, Mo./WO 2-9917  
HALLMARK INSTRUMENTS CORP.  
Dallas, Texas/RI 7-8933  
INTER-STATE RADIO & SUPPLY CO.  
Denver 4, Colo./TA 5-8257  
LENERT CO.  
Houston, Texas/CA 4-2663  
RADIO DISTRIBUTING CO. Indianapolis, Ind./ME 7-5571  
SEMICONDUCTOR SPECIALISTS, INC.  
Chicago, Ill./NA 2-8860  
S. STERLING CO.  
Detroit, Mich./BR 3-2900  
UNITED RADIO, INC.  
Cincinnati, Ohio/MA 1-6530

##### WESTERN

ELMAR ELECTRONICS  
Oakland, Calif./TE 4-3311  
HAMILTON ELECTRO SALES  
Los Angeles, Calif./BR 2-9154  
NEWARK ELECTRONICS CO.  
Inglewood, Calif./OR 4-8440

Westinghouse Electric Corp., Semiconductor Dept., Youngwood, Pa.

# Westinghouse



CIRCLE 49 ON READER SERVICE CARD

# population -



Even in the most remote areas, wings aloft are guided on their way by Aerocom's new medium range N.D. Beacon Transmitter. This transmitter was designed and built to provide long, trouble-free service with no attendants...even where the total population is Zero.

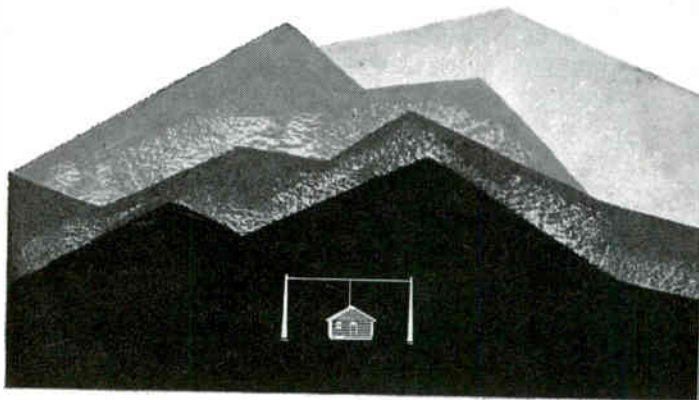

NOW — FCC type accepted — single or dual automatic—for carrier powers of 10, 12, 15, 20, 25, 50 and 100 watts.

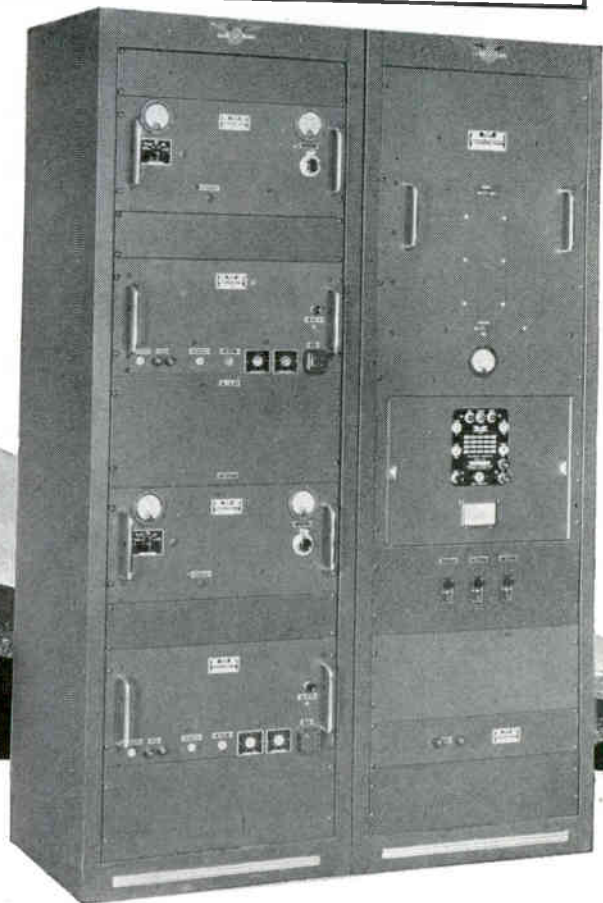

## **AEROCOM'S** **Dual Automatic** **Package-Type Radio Beacon**

for completely unattended service. This N.D. Beacon (illustrated) consists of two 100 watt (or 50 watt) transmitters with 2 keyers, automatic transfer and antenna tuner. (Power needed 110 or 220 volts 50/60 cycles, 465 V.A. for 50 watt, 675 V.A. for 100 watt.)

Frequency range 200-500 kcs.: available with either crystal or self excited oscillator coil. High level plate modulation of final amplifier is used, giving 97% tone modulation. Microphone P-T switch interrupts tone, permitting voice operation.

The "stand-by" transmitter is selected when the carrier or modulation level of main transmitter drops 3 db or more, in case of failure to transmit the identification signal or if carrier frequency changes 5 kcs. or more. Audible indication in monitoring receiver tells which transmitter is in operation.

Unit is ruggedly constructed and conservatively rated, providing low operating and maintenance costs.

Also available in 400 watt, 1 K.W. and 4 K.W. Models, 200-415 kcs.



3090 S. W. 37th AVENUE • MIAMI 33, FLORIDA

# 13 MOVES TO RELIABLE TRIMMING

**SPECTROL'S FULL LINE** of trimming potentiometers features 10 of the smallest square trimmers ever made, plus the only *transistor-size* units for solid state circuitry. This selection covers almost every conceivable application—a sure way to avoid checkmate when you need reliable trimmers.

**SQUARE TRIMMER DATA.** Models 50 and 60 measure  $\frac{3}{8}$ " and  $\frac{1}{2}$ " square respectively • humidity proofing a standard feature • available in resistances to 100K • greater surface contact between mandrel and aluminum case for better heat dissipation, no external heat sinks needed • dual wiper for positive contact under all conditions of shock and vibration.

**SINGLE TURN TRIMMER DATA.** Model 80 built into TO-9 transistor type case • measures less than  $\frac{1}{3}$ " in diameter, weighs 1 gram—smallest trimmer on the market • completely sealed against moisture and humidity • resistance element twice as long as ordinary trimmers • designed for complete package encapsulation with other printed circuit components • available in 3 case styles with resistance range to 20K.

**IMMEDIATE DELIVERY.** Your nearby Spectrol distributor stocks standard models of trimmers and miniature potentiometers as well as other standard Spectrol precision potentiometers and turns indicating dials. Prices are \$6 to \$8 in quantities of 1-9 for most styles and resistances.

*MORE DATA AVAILABLE. Contact your Spectrol engineering representative or drop us a line at the factory. Please address Dept. 42.*

ALL TRIMMERS SHOWN ACTUAL SIZE

## SPECTROL

**ELECTRONICS CORPORATION**

1704 South Del Mar Avenue • San Gabriel, California  
Phone: ATLantic 7-9761

Adams Court • Plainview, L. I., New York  
Phone: WElls 8-4000

NOW IT'S YOUR MOVE

MODEL 60



Printed circuit pins, top adjust

MODEL 50



Teflon insulated leads

MODEL 60



Teflon insulated leads

MODEL 80



Transistor size case

MODEL 80



Transistor size case, bushing mount

MODEL 50



Printed circuit pins from base

MODEL 60

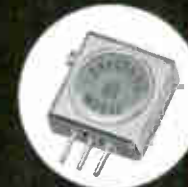

Printed circuit pins, side adjust

MODEL 50



Bushing panel mount

MODEL 50



Printed circuit pins, top adjust

MODEL 80



Transistor size threaded case

MODEL 50

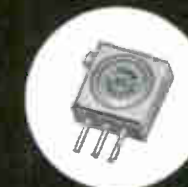

Printed circuit pins side adjust

MODEL 60



Printed circuit pins from base

MODEL 60



Bushing panel mount



#### TYPICAL APPLICATIONS

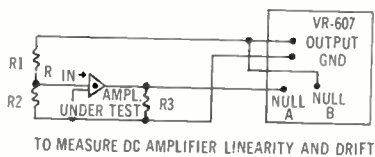
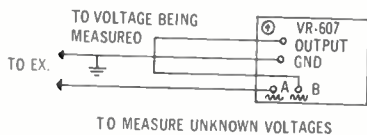
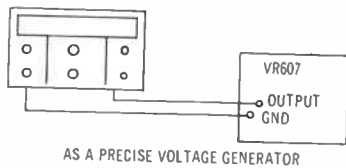

#### KEY FEATURES:

- 0.01% Absolute Accuracy • Long-Term 0.005% Stability... with drift of less than 0.02% per year
  - Selectable Output Voltage Ranges:  $\pm 111.112V$ , at  $\pm 15$  ma;  $\pm 211.112V$ . (Higher current outputs also available)
  - Adjustable in 1 mv increments
  - Microvolt resolution achieved through use of built-in calibrated divider
  - Output Impedance less than 0.005 ohm
  - Positive or Negative Polarity • Built-in Null Meter
  - Direct Reading: greater speed, fewer errors
  - Adjustment-Free, Temperature Compensated
  - Overall Dimensions:
- Portable:  
VR-607 and VR-607B 11 $\frac{1}{4}$ " w x 15 $\frac{1}{4}$ " h x 16 $\frac{1}{2}$ " d
- For rack mounting:  
VR-608 and VR-608B 19" w x 14" h x 16 $\frac{1}{4}$ " d

#### FOR CALIBRATING ALL TYPES OF DIGITAL VOLTMETERS OR CONVERTERS

## GENERATES, MEASURES VOLTAGES WITH .01% ACCURACY & .005% STABILITY

For over 6 years, Epsco's Secondary Standard Voltage References — VR-607/VR-608 series — have been used to calibrate virtually every type of digital

voltmeter or converter — in the laboratory — in quality control departments, in military checkout systems — wherever ultimate precision is demanded.

The VR-607/VR-608 generates a voltage accurately to .01% from 0-111.112 volts in 1 mv steps, with an output impedance of less than 0.005 ohms. The desired voltage is called up merely by the setting of five controls. The low output impedance and high accuracy make these precision sources ideal for calibrating any electronic equipment — since loading by the instrument under test has negligible effect on the VR-607/VR-608.

The built-in null meter permits external voltages to be measured to .01% accuracy using the potentiometric principle. The null meter is adequately protected against overload and cannot be damaged in the process.

The VR-607 B differs from the VR-607 in that the voltages may be set up directly in binary increments. This makes calibration and checking of binary reading instruments very convenient. Minimum increment for the binary model is 0.8 mv.

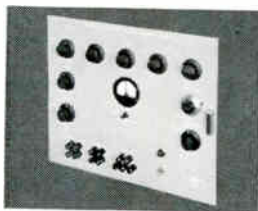

The VR-607/VR-608 may be used as a precision voltage divider. The low output resistance guarantees freedom from errors due to loading. Price, \$2275, FOB Cambridge, Mass. VRS-611 (portable "workhorse" model), \$625.

Please send for Bulletin #26001 for more information.

**Epsco**

**INSTRUMENTS**

A Division of Epsco, Incorporated, 275 Massachusetts Avenue, Cambridge 39, Mass. Telephone U Niversity 4-4950

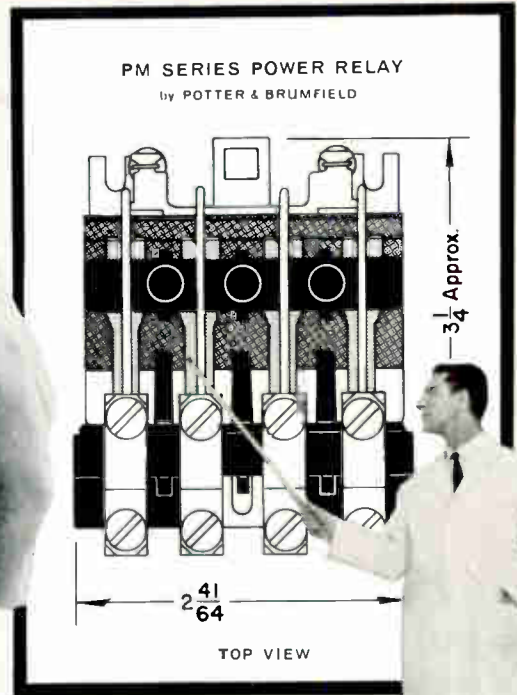
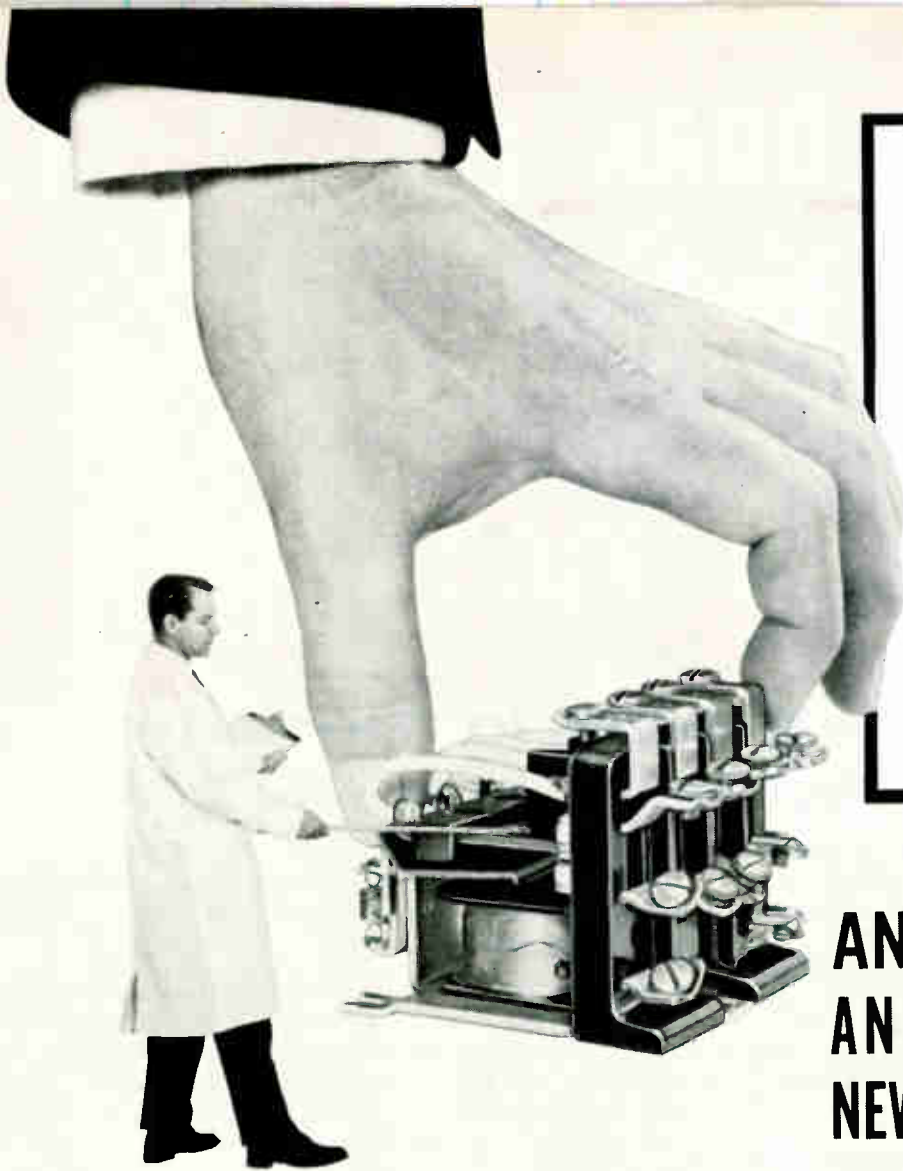

## ANNOUNCING AN IMPORTANT NEW SPACE SAVER

**P&B compact 4PDT power relay switches one H. P. per moveable arm**

Save panel space! This new 4-pole relay is only  $\frac{3}{16}$ " wider than our PR Series, America's most popular 2-pole power relay! Yet, it is engineered for reliable heavy-duty switching . . . and you can confidently expect 10 million mechanical operations.

PM Series relays are rated at 16 amperes (or 1 H.P.) at 115 volts, 50/60 cycles resistive . . . and special relays can be supplied for loads up to 25 amperes, at 220 volts, 50/60 cycles resistive. Heavy screw terminals are arranged for fast, easy hook up. An adapter plate is available for mounting PM relays in the same location used for 2-pole relays.

For full information, write today or call your nearest P&B representative.



PR Series



MR Series



AB Series

A whole family of power relays for a wide range of applications carry the P&B symbol of quality. Call P&B first for all your power relay requirements.

### PM ENGINEERING DATA

#### GENERAL:

Description: Heavy-duty AC power relay.

Insulating Material: Molded phenolic.

Insulation Resistance: 100 megohms minimum.

Mechanical Life: 10 million operations minimum.

Contact Life: 100,000 operations minimum at rated load.

Breakdown Voltage: 2,000 volts rms minimum between all elements and ground.

Ambient Temperature:  $-55^{\circ}\text{C}$  to  $+55^{\circ}\text{C}$ .

Weight: Approximately 14 ozs.

Pull-In: 78% of nominal voltage.

Terminals: Heavy-duty screw type with No. 8-32 BH screw.

#### CONTACTS:

Arrangements: 4PDT or 4PST—normally open.

Material:  $\frac{1}{4}$ " dia. silver-cadmium-oxide.

Rating: 16 amps @ 115 volts, 50/60 cps resistive.

8 amps @ 220 volts, 50/60 cps resistive.

1 H.P. per moveable, 115 or 220 volts AC single phase.

25 amps @ 220 volts, 50/60 cps resistive available on special order.

#### COILS:

Voltage: 6 to 230 volts AC 50/60 cycles.

Power: 14 volt-amps average at nominal voltage.

Duty: Continuous.

P&B STANDARD RELAYS ARE AVAILABLE AT YOUR LOCAL ELECTRONICS PARTS DISTRIBUTORS



**POTTER & BRUMFIELD**

DIVISION OF AMERICAN MACHINE & FOUNDRY COMPANY

PRINCETON, INDIANA

IN CANADA: POTTER & BRUMFIELD, DIVISION OF AMF CANADA LIMITED, GUELPH, ONTARIO

# PRODUCTION QUANTITY TI SIL

## MAXIMUM 12 nsec $t_{on}$

## MAXIMUM 40 nsec $t_{off}$

**$V_{CE(sat)}$  PRACTICALLY INSENSITIVE TO TEMPERATURE...  
CONSTANT 1 VOLT FROM  $-55$  to  $+170^{\circ}\text{C}$**

The fastest silicon switcher in the industry! Design today with Texas Instruments new 2N743 and 2N744 silicon epitaxial transistors and get *two-times faster switching than possible from any other commercially available silicon transistor!* This outstanding new epitaxial series gives you an optimum combination of ultra-fast switching times, temperature-stable  $R_{CS}$ , very low collector capacitance, and high  $f_T$ , to make the 2N743 and 2N744 *ideal for application in current ranges from 1 to 100 ma.*

Utilize the low  $R_{CS}$ /high current characteristics of these new epitaxial units to *replace large size medium-power transistors* and cut your overall switching times as much as two-thirds. Cut cost and reduce the complexity of your NOR logic designs with the new TI 2N743 series — these new epitaxial units give you

a guaranteed  $I_{CEX}$  of  $30 \mu\text{a}$  at a  $V_{CE}$  of 10 volts and  $V_{BE}$  of 0.35 volts to eliminate additional circuits previously required for an  $I_{B2}$  turn-off source in your computing systems.

Apply the new 2N743 and 2N744 to your designs today and get *guaranteed d-c betas at three current levels.* The 2N744 gives you a guaranteed  $h_{FE}$  of 20 at 1 and 100 ma and a 10-ma beta spread of 40 to 120, while the 2N743 features a minimum  $h_{FE}$  of 10 at 1 and 100 ma, and 60 maximum at 100 ma.

New TI 2N743 and 2N744 silicon epitaxial transistors are immediately available from distributor stocks or in mass production quantities at prices competitive with conventional silicon mesa and micro-alloy transistors.

### Compare the 2N743 and 2N744 with conventional transistors!

Parameter	Approx. Test Conditions	TI 2N743	TI 2N744	2N834	2N706B	2N708
$T_s$ (nsec)	$I_{B(1)} = -I_{B(2)} = I_C = 10 \text{ ma}$	14	18	25	25	25
$t_{on}$ (nsec)	$I_{B(1)} = 3 \text{ ma}$	11 (TYP)	10 (TYP)	35	40	35
$t_{off}$ (nsec)	$I_{B(2)} = -1 \text{ ma}$ $I_C = 10 \text{ ma}$	22 (TYP)	25 (TYP)	75	75	75
$t_{on}$ (nsec)	$I_{B(1)} = 40 \text{ ma}$	12 6 (TYP)	12 6 (TYP)	NO SPEC	NO SPEC	NO SPEC
$t_{off}$ (nsec)	$I_{B(2)} = -20 \text{ ma}$ $I_C = 100 \text{ ma}$	40 18 (TYP)	45 23 (TYP)	NO SPEC	NO SPEC	NO SPEC
$V_{CE(sat)}$	$I_B = 1 \text{ ma}$ $I_C = 10 \text{ ma}$ $T_A = +170^{\circ}\text{C}$	0.35 v	0.35 v	No High Temp. Guarantee (0.19 v MAX. @ $25^{\circ}\text{C}$ )	No High Temp. Guarantee (0.4 v MAX. @ $25^{\circ}\text{C}$ )	No High Temp. Guarantee (0.4 v MAX. @ $25^{\circ}\text{C}$ )
$I_{CEX}$	$V_{CE} = 10 \text{ v}$ $V_{BE} = +0.35 \text{ v}$ $T_A = 100^{\circ}\text{C}$	$30 \mu\text{a}$	$30 \mu\text{a}$	No Guarantee	No Guarantee	$10 \mu\text{a}$ (MAX.) @ $V_{BE} = +0.25 \text{ v}$ $V_{CE} = 20 \text{ v}$ $T_A = +125^{\circ}\text{C}$

NOTE: All limits are max. unless otherwise noted.



# ICON EPITAXIAL TRANSISTORS

# @ 100 ma

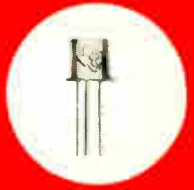

MAKE YOUR OWN COMPARISON FROM THESE TYPICAL CIRCUITS

### 50-ma SWITCHING CIRCUIT

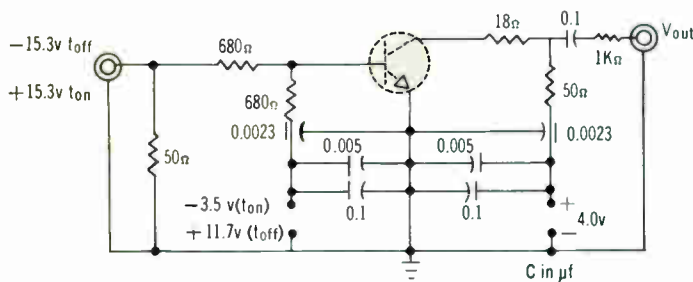

### USE THE TI 2N743 TO SWITCH IN 1/3 THE TIME!



2N706

$t_{on} = 10 \text{ nsecs}$   
 $t_{off} = \frac{50}{60} \text{ nsecs}$



2N743

$t_{on} = 7 \text{ nsecs}$   
 $t_{off} = \frac{15}{22} \text{ nsecs}$

### USE THE TI 2N743 TO DOUBLE POWER OUTPUT AND EFFICIENCY!



2N706

$P_{out} = 225 \text{ mw}$   
 $Eff = 32\%$   
 $P.G. = 6 \text{ db}$



2N743

$P_{out} = 500 \text{ mw}$   
 $Eff = 65\%$   
 $P.G. = 6 \text{ db}$

### 70-mc POWER AMPLIFIER

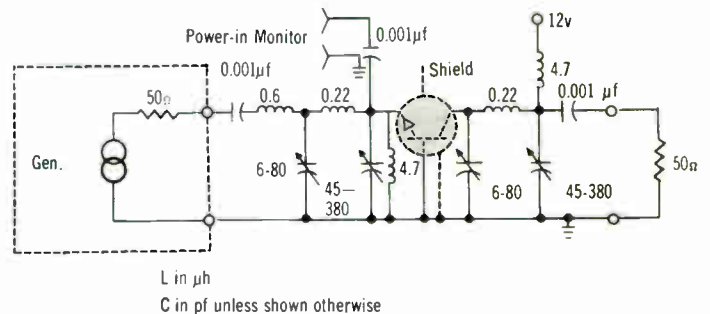

INDUSTRY'S BROADEST LINE OF TRANSISTORS  
 SEMICONDUCTOR-COMPONENTS DIVISION

**TEXAS**  **INSTRUMENTS**  
 LIMITED INCORPORATED  
 DALLAS ROAD • BEDFORD, ENGLAND P. O. BOX 5012 • DALLAS 22, TEXAS

CIRCLE 55 ON READER SERVICE CARD

KHAYSTACK  
 CKHAYSTACKHAYSTACK  
 HAYSTACKHAYSTACKHAYSTACKHA  
 YSTACKHAYSTACKHAYSTACKHAYSTACKHAYS  
 HAYSTACKHAYSTACKHAYSTACKHAYSTACKHAYSTACKH  
 AYSTACKHAYSTACKHAYSTACKHAYSTACKHAYSTACKHAYSTAC  
 ACKHAYSTACKHAYSTACKHAYSTACKHAYSTACKHAYSTACKHAYST  
 CKHAYSTACKHAYSTACKHAYSTACKHAYSTACKHAYSTACKHAYSTAC  
 STACKHAYSTACKHAYSTACKHAYSTACKHAYSTACKHAYSTACKHAYS  
 ACKHAYSTACKHAYSTACKHAYSTACKHAYSTACKHAYSTACKHAYSTA  
 KHAYSTACKHAYSTACKHAYSTACKHAYSTACKHAYSTACKHAYSTACKH  
 TACKHAYSTACKHAYSTACKHAYSTACKHAYSTACKHAYSTACKHAYSTACKH  
 TACKHAYSTACKHAYSTACKHAYSTACKHAYSTACKHAYSTACKHAYSTACKHAYS  
 KHAYSTACKHAYSTACKHAYSTACKHAYSTACKHAYSTACKHAYSTACKNEEDLE HAYSTACK  
 HAYSTACKHAYSTACKHAYSTACKHAYSTACKHAYSTACKHAYSTACKHAYSTACK  
 STACKHAYSTACKHAYSTACKHAYSTACKHAYSTACKHAYSTACKHAYSTACKHAYS  
 AYSTACKHAYSTACKHAYSTACKHAYSTACKHAYSTACKHAYSTACKHAYSTACKH  
 HAYSTACKHAYSTACKHAYSTACKHAYSTACKHAYSTACKHAYSTACKHAYSTAC  
 TACKHAYSTACKHAYSTACKHAYSTACKHAYSTACKHAYSTACKHAYSTACKHAYSTA  
 AYSTACKHAYSTACKHAYSTACKHAYSTACKHAYSTACKHAYSTACKHAYSTACKHAYST  
 CKHAYSTACKHAYSTACKHAYSTACKHAYSTACKHAYSTACKHAYSTACKHAYSTACKHAY  
 CKHAYSTACKHAYSTACKHAYSTACKHAYSTACKHAYSTACKHAYSTACKHAYSTACKHAYSTA  
 HOURS/MINUTES/SECONDS/HOURS/MINUTES/SECONDS/ HOURS/MINUTES/SECONDS

# TIME TRICK

**FIND A NEEDLE IN A 13-FOOT HAYSTACK IN 1 SECOND  
 WITH EECO's TIME-CODED  
 MAGNETIC TAPE SEARCH  
 AND CONTROL SYSTEMS**

That's searching 1200 feet of multi-channel tape in 90 seconds. This is the kind of performance that instrumentation and data reduction engineers are experiencing with EECO *time-code* referenced magnetic tape search-control systems. *Time-coded* for either binary or binary-coded decimal readout — Atlantic Missile Range, IRIG or NASA. EECO search-control systems automatically search, detect, and play back the type and quantity of data you designate in a matter of seconds to minutes. *Time-coded* EECO search-control systems end speed variation inaccuracies. Continuous display of time code to within 1 second of data location. Search-to-recording speed ratios to 64/1. No manual switching or plug changing to compensate for speed changes. Fully automatic with manual search options. Solid-state compactness. Broad compatibility. Low initial cost. Low maintenance cost. P.S. Found the needle yet?

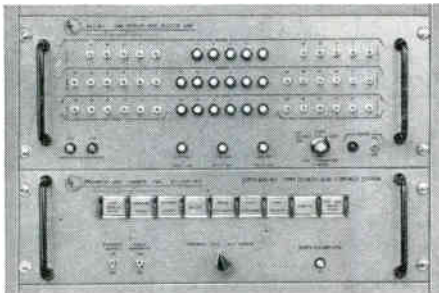

EECO 822 Tape Search and Control System  
Referenced for Atlantic Missile Code Ranges

**EECO SEARCH AND CONTROL SYSTEMS**

Automatic Systems	Price (f.o.b. Santa Ana)	Manual Systems	Price (f.o.b. Santa Ana)	Recorded Time Code Required For Search
EECO 821	\$10,200	EECO 841	\$5,100	24-Bit, 24-hour, BCD code as produced by TCG* EECO 801
EECO 822	9,500	EECO 842	4,750	17-Bit, 24-hour, Binary Code as produced by TCG* EECO 802 (Eglin AFB and Atlantic Missile Range codes)
EECO 823	10,200	EECO 843	5,100	20-Bit, 24-hour, BCD code as produced by TCG* EECO 803
EECO 830	12,500	EECO 850	7,500	36-Bit, 365-day, BCD code as produced by TCG* EECO 810 (NASA and IRIG codes)

\*Time Code Generator



**Electronic Engineering Company of California**

1601 E. Chestnut Ave., Santa Ana, Calif. KImberly 7-5501 • TWX: S ANA 5263

EE 1-31

Size—8, 10, 11,  
15, and 18.



## GEAR HEADS & SPEED REDUCERS

SUPERIOR Manufacturing and Instrument Corp. makes available a complete line of stock gearheads and speed reducers for demanding instrumentation and control applications.

Some of the important design and construction features:

- Standard units are designed to sustain up to 65 in. oz. for over 1,000 hours of continuous operation and max. momentary overload of up to 150 in. oz.
- Precision piloted plate and post construction. Bearing and pilot holes uniformly jig bored to  $\pm .0001$  tol.
- Low starting torque and inertia.
- A.B.E.C. precision class 7 ball bearings used throughout.
- All gearing is A.G.M.A. precision class 2 or 3.
- All units perform to applicable sections of MIL-E-5272-C.
- Models available with mechanical slip clutches.
- Optional designs to permit mounting inside extended motor housings or housing provided to adapt to Std. BuOrd. servo motors.

In addition to the standard types described in its catalog, SUPERIOR also provides complete design, fabrication and production facilities for fast delivery of special units to meet the most rigid customer specifications.

Detailed specifications of standard gearheads and speed reducers are presented in a new catalog. Data on modified or specials, designed to particular user requirements, will be supplied promptly upon request.



**FREE**

WRITE FOR YOUR CATALOG TODAY!

**superior**  
Manufacturing & Instrument Corp.

36-07 20th Ave., L. I. City 5, New York

# Raytheon Transformer Talk

New techniques reduce size of 2.5 megawatt

**AIRBORNE PULSE**

**TRANSFORMER**

to only .45 cu. ft.

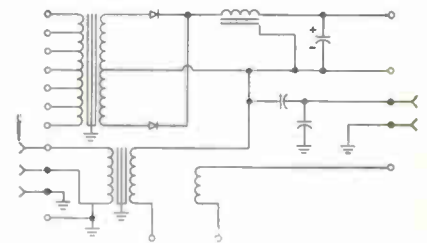

A high-voltage pulse transformer tested at 180kv and rated for pulsed operation at 90kv that measures just  $9\frac{1}{2} \times 9\frac{1}{2} \times 8\frac{3}{4}$  inches!

This ruggedized unit—typical of Raytheon's new compact pulse transformers—is designed to operate under the extreme environmental conditions encountered by high-speed aircraft. It contains an insulated DC filament supply and internal provision for  $-50^{\circ}$  to  $+100^{\circ}$  centigrade operation. For flexibility in mounting, it features a space-saving, bifilar-type, epoxy terminal that is eight inches shorter than previous models. Overall, the new .45 cubic-foot unit is 60% smaller than its predecessors.

Raytheon pulse transformers are designed to work with specific microwave tubes. Standard designs include open, resin encapsulated, enclosed, and oil-filled types.



WRITE FOR 16-PAGE BOOKLET on Raytheon transformers or for specific help on your particular requirements to Magnetics Operations, Microwave and Power Tube Division, Raytheon Company, Foundry Avenue, Waltham 54, Mass.

FEATURES of new Raytheon high-power pulse transformer include: (1) 2-inch-high truncated, bifilar-type klystron high-voltage terminal operating under external and internal liquid environment, (2) high-voltage primary input connector, double shielded to eliminate cable interference, and (3) 30kv traveling-wave-tube high-voltage output.

**RAYTHEON**

**RAYTHEON COMPANY**

MICROWAVE AND POWER TUBE DIVISION

## Better For Your SYSTEMS

MILLED GRID THYRATRONS

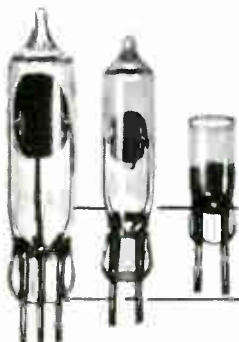

INFRA-RED CELLS



PHOTO CELLS



TRIODES



RECTIFIERS

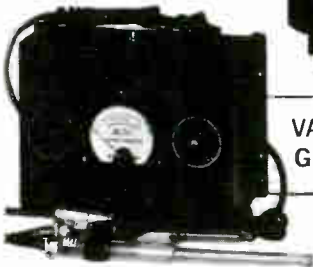

VACUUM GAUGES

No matter what systems circuitry you may be considering, check the broad line of dependable Cetron tubes for your requirements. You can be assured of their performance, dependability and long life. Cetron engineers are always at your service.

Write for literature today

**Be Certain with Cetron**

**CETRON**  
ELECTRONIC  
CORPORATION



715 Hamilton Street • Geneva, Illinois

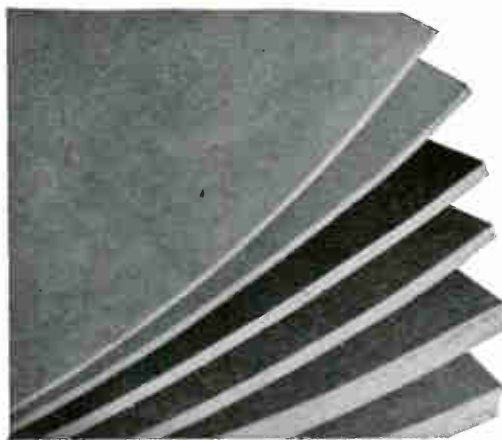

**SILICONE  
SPONGE  
RUBBER  
SHEETS**

**Flexible temperature range  
-100°F to 500°F**

COHrlastic R-10470 silicone sponge rubber sheets have a dense, uniform, non-absorbing closed cell structure highly suitable for soft gasketing, vibration dampening, fairing strips, pads, cushions and other applications where resiliency at extreme temperatures is required. It may be bonded to metals, plastics, fabrics or silicone rubber. COHrlastic R-10470 possesses superior compression set resistance, excellent dielectric properties, immunity to aging, ozone and weather hardening. Meets many specifications.

AVAILABLE FROM STOCK: in 12" x 12" sheets and 24" x 24" sheets — 1/16" through 1/2". Special thicknesses and sheet sizes up to 30" x 30" and 24" x 48" made to order. Sold nationally through distributors.

FREE SAMPLE and folder — write, phone or use inquiry service.

Leader in Fabrication of Silicone Rubber Products

**CHR CONNECTICUT HARD RUBBER CO.**

Main office: New Haven 9, Connecticut

CIRCLE 201 ON READER SERVICE CARD

Reliable products depend on reliable parts

The worldwide success of Japan's transistor radios is a tribute to their highly efficient yet minute components, of which the ultra-small Mitsumi IFT Poly-vari-con is typical. With other superb Mitsumi parts, it is being extensively used by leading radio manufacturers.

For Transistor Radio Parts



IFT

Intermediate  
Frequency  
Transformer



POLY-VARI-CON

Variable  
Capacitor



**Mitsumi Parts**

MITSUMI ELECTRIC CO., LTD.

1056-1, Koadachi, Komae-cho, Kitatama-gun, Tokyo, Japan

CIRCLE 202 ON READER SERVICE CARD  
CIRCLE 59 ON READER SERVICE CARD →

# intercept!



The U. S. Army's NIKE-ZEUS is the only anti-missile missile system under advanced development. It is designed to meet the threat of enemy Inter Continental Ballistic Missiles. Developing a gigantic 450,000 lbs. of thrust at launch, the NIKE-ZEUS missile rises almost instantly to intercept enemy ICBMs traveling faster than 20 times the speed of sound.

#### HEART AND BRAINS OF THE NIKE-ZEUS DEFENSE SYSTEM CONCEPT

Extremely powerful long-range acquisition radar is designed to pick up the enemy ICBMs far from the defended area. Target track radars use the information provided by the long-range acquisition radar to "lock-on" to an incoming missile, relaying precise target information to electronic computers. These computers determine the most favorable point of intercept, automatically firing a NIKE-ZEUS missile at the correct time, guiding it to the intercept point.

#### CONTINENTAL ELECTRONICS TRANSMITTERS

Working under sub-contract to Bell Telephone Laboratories and Western Electric Company, Continental Electronics is designing, manufacturing and installing the powerful acquisition radar transmitters used in the Research and Development model of the NIKE-ZEUS Defense Complex scheduled for full scale testing on Kwajalein Atoll in the Pacific.



## Continental Electronics

**MANUFACTURING COMPANY**

4212-South Buckner Boulevard • Dallas 27, Texas • Evergreen 1-1135

**☐** SUBSIDIARY OF LING-TEMCO ELECTRONICS

*Designers and Builders of the World's Most Powerful Radio Transmitters*

ENGINEERS . . . FOR STIMULATING WORK ON THE ELECTRONIC FRONTIERS OF TOMORROW  
WITH A DYNAMIC, CREATIVE ORGANIZATION, ADDRESS RESUME TO CHIEF ENGINEER.

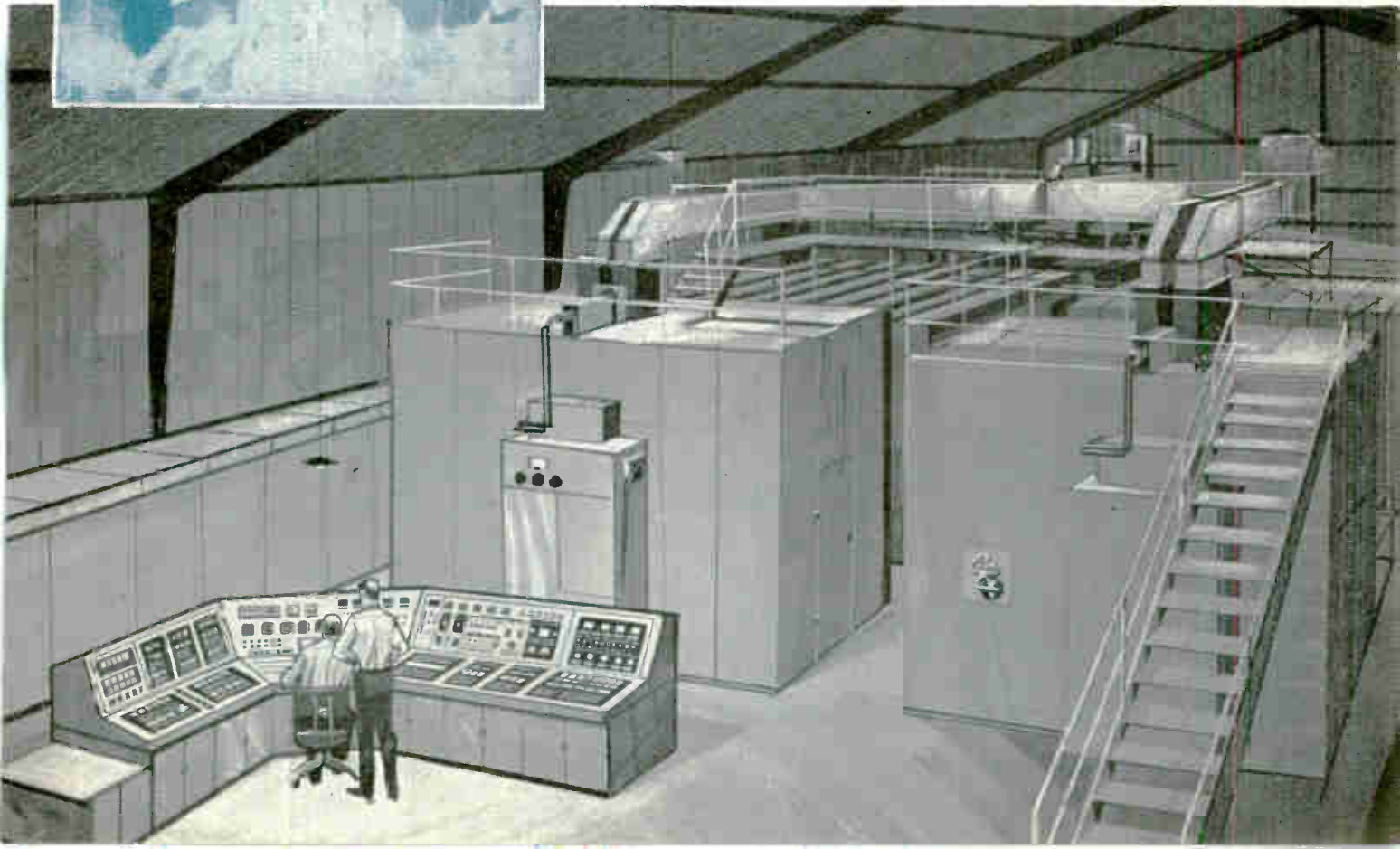

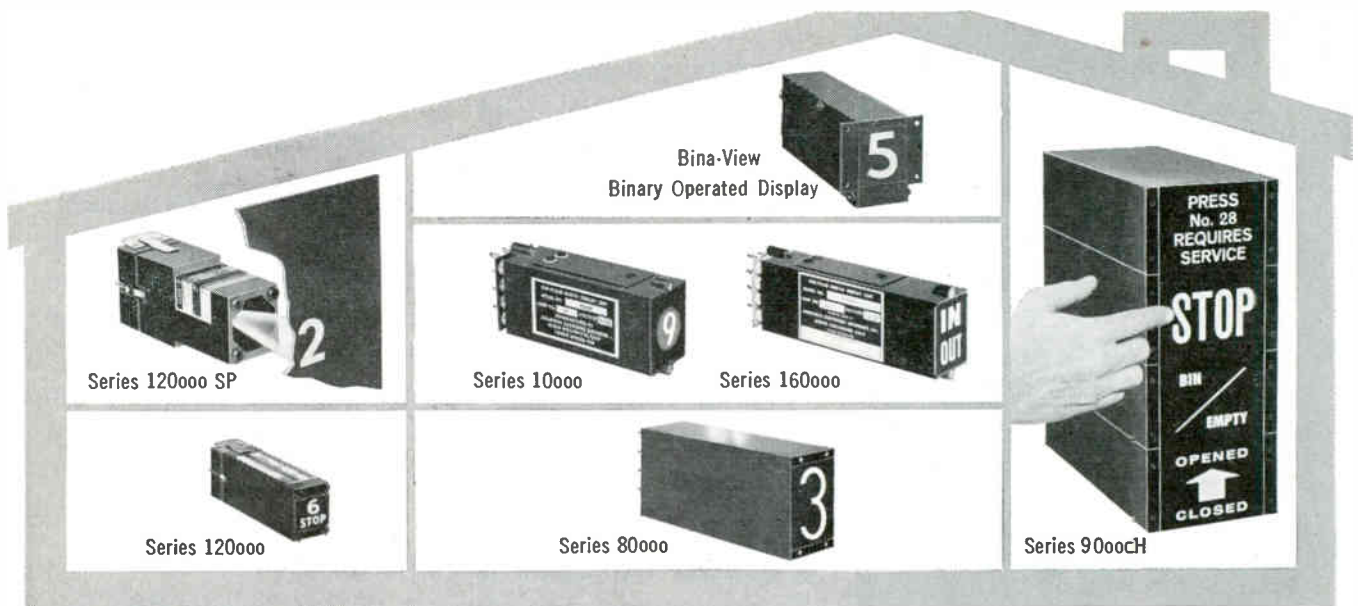

## READOUTS THAT DO MORE THAN DISPLAY NUMBERS

I.E.E.'s complete line of rear-projection readouts display words, numbers, symbols, and color. The alpha-numeric Bina-View readout is self-decoding and operates direct from binary output. And all can satisfy human factors requirements!

The engineering staff and facilities of Industrial Electronic Engineers, Inc. have approached the problem of readouts as one of visual communications, the case in point being that

complete!  
under  
the  
IE  
roof

numbers are only one form in a host of methods in visual communications. The engineering talent at I.E.E. work under the formula that the more forms of visual communications that are available the less chance there is for communicative breakdown. *In a word; complete.*

Your inquiry to complete readout visual communications is invited.

**IE INDUSTRIAL ELECTRONIC ENGINEERS, Inc.**  
5528 Vineland Avenue, North Hollywood, California

CIRCLE 203 ON READER SERVICE CARD

## IS DUST YOUR PROBLEM?

Then MIRACLE MAT is your answer . . . because MIRACLE MAT stands guard against walk-in dirt and dust . . . and is completely automatic!

Time-tested MIRACLE MAT meets rugged specifications of clean rooms across the nation.



## NEW!!! from GENALEX

**RATCHET-RELAY STEPPING SWITCH**  
for automatic switching,  
circuit selection,  
and timing control

- Occupies small mounting space.
- Does not overheat.
- Accurate, dependable, sturdy.

**Featuring:**  
36 steps per second on self-interruption.  
20 steps per second from external pulses.  
Operation on 75% nominal voltage.  
Life in excess of 50,000,000 steps.

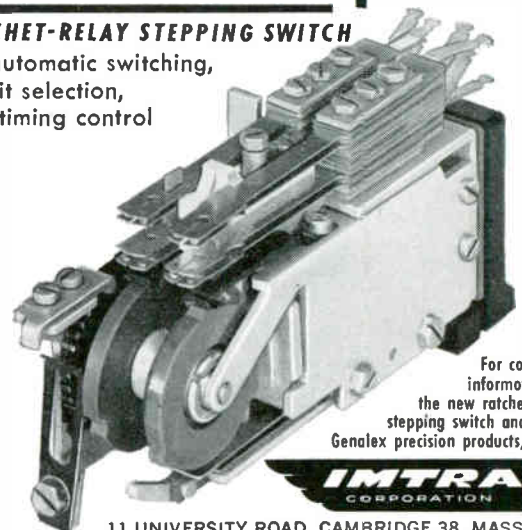

For complete information on the new ratchet-relay stepping switch and other Genalex precision products, write:



11 UNIVERSITY ROAD, CAMBRIDGE 38, MASS.

U. S. Sole Distributors for the General Electric Co., LTD. of England.

# TEFLON\* CABLES

**mil-w-16878C**

3 shielded cable constructions — furnished from stock with a Teflon outer jacket, a Teflon impregnated fiberglass outer covering, or with no covering over the shield.

All constructions available from 1 to 4 conductors in gauge sizes #24, #22, #20, #18.

# TEFLON\* HOOK-UP WIRE

**mil-w-16878C**

3 different types — E extruded, E wrapped, EE extruded. 30 different constructions, up to 19 stock colors.

# TEFLON\* TUBING

Complete range of inside diameters from #30 to #0. Up to 4 stock colors.

# TEFLON\* MAGNET WIRE

15 different gauge sizes from #44 to #30. Meets MIL-W-19583 Type III.

For additional information on our Teflon line, write for our all-new 52-page catalog of wire, cable and tubing products.

**ALWAYS  
IN STOCK**  
at your local electronics distributor



## ALPHA WIRE CORPORATION

Subsidiary of LORAL Electronics Corporation  
200 Varick Street, New York 14, N. Y.  
Pacific Division: 11844 Mississippi Ave., Los Angeles 25, California

\*T.M. DuPont

A large, bold red cross graphic is centered on the page. It consists of a vertical bar and a horizontal bar that intersect at their centers. The bars are thick and extend across most of the page width and height.

## TANTALUM CAPACITORS

- ... "wet slug," high temperature (to 200°C)
- ... "wet slug," microminiature to miniature
- ... solid electrolyte, metal case or encapsulated
- ... foil type, polarized and non-polarized
- ... Mallory has what you want. Industry's  
broadest line. 13 types, hundreds of ratings.  
Write for complete catalog.  
Mallory Capacitor Company,  
Indianapolis 6, Indiana.



TAF



TAS



TAP



MTF



TAH



XTL



XTK



XTV



XTH



TNT



XTM

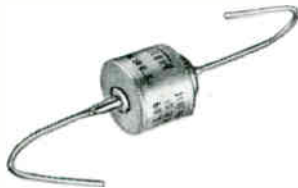

TAM



Complete line of aluminum and tantalum electrolytics, motor start and run capacitors

### Mallory Tantalum Capacitors Stocked by these distributors

- Arlington, Va.**  
Rucker Electronic Products
- Baltimore, Md.**  
Radio Electric Service
- Binghamton, N.Y.**  
Federal Electronics
- Boston, Mass.**  
Cramer Electronics, Inc.  
DeMambo Radio Supply Co.  
Lafayette Radio
- Bridgeport, Conn.**  
Westconn Electronics
- Buffalo, N.Y.**  
Wehle Electronics
- Chicago, Ill.**  
Allied Radio Corp.  
Newark Electronics Corp.
- Cincinnati, Ohio**  
United Radio
- Cleveland, Ohio**  
Pioneer Electronics
- Dallas, Texas**  
Engineering Supply Co.
- Dayton, Ohio**  
Allied Supply Co.
- Denver, Colo.**  
Denver Electronics
- Houston, Texas**  
Harrison Equipment Co., Inc.  
Lenert Company
- Indianapolis, Ind.**  
Graham Electronics
- Los Angeles, Calif.**  
California Electronics  
Electronic Supply Corp.  
Kierulff Electronics, Inc.  
Radio Product Sales
- Minneapolis, Minn.**  
Northwest Radio
- Montreal, Que.**  
Canadian Electrical Supply Co.
- Mountainside, N.J.**  
Federated Purchaser, Inc.
- Nashville, Tenn.**  
Electra Dist. Co.
- Newark, N.J.**  
Lafayette Radio
- New York, N.Y.**  
Harrison Radio Corp.  
Harvey Radio Co., Inc.  
Lafayette Radio  
Terminal Hudson Electronics
- Oakland, Calif.**  
Elmar Electronics, Inc.
- Orlando, Fla.**  
East Coast Radio
- Ottawa, Ont.**  
Wackid Radio-TV Lab.
- Palo Alto, Calif.**  
Zack Electronics
- Perth Amboy, N.J.**  
Atlas Electronics
- Philadelphia, Pa.**  
Herbach & Rademan  
Philadelphia Electronics
- Pittsburgh, Pa.**  
Radio Parts Co.
- St. Louis, Mo.**  
Olive Electronics
- Seattle, Wash.**  
F. B. Connelly Co.
- Tampa, Florida**  
Thurow Distributors, Inc.
- Toronto, Ont.**  
Alpha Aracon Radio Co.  
Electro Sonic Supply  
Wholesale Radio & Electronics
- Tucson, Ariz.**  
Standard Radio Parts
- Tulsa, Okla.**  
Engineering Supply Co.
- Washington, D.C.**  
Capitol Radio Wholesalers  
Electronic Industrial Sales
- White Plains, N.Y.**  
Westchester Electronic Supply Co., Inc.
- Winston-Salem, N.C.**  
Dalton-Hege Radio

# P. R. MALLORY & CO. Inc. MALLORY

# NEW ARRIVAL FROM ITT!



AND, NO DIAPER NEEDED! ITT WET-ANODE TANTALUM CAPACITORS NOW AVAILABLE IN NEW SHAPE WITH POSITIVE WEDGE SEAL, RATINGS FROM 1.7 TO 560 MFD.

Proud product of a two-year design effort: a unique, positive mechanical seal permits straight-wall construction in this new line of ITT wet-anode tantalum capacitors. No flange. Your most advanced circuit designs gain new compactness, new simplicity — plus new reliability and performance from high-purity tantalum dielectric and ITT's total process control during manufacture. This new line meets all the requirements of MIL-C-3965B and is now available in ratings from 1.7 to 560 mfd. Specify H-type for temperatures to 85°C; L-type for temperatures to 125°C.

COMPLETE SPECIFICATIONS on ITT wet- and solid-anode tantalum capacitors are available on request. Write, on your letterhead, please, to the address below. ENGINEERS: Your ITT representative has a complete set of qualifications and quality control tests for your inspection.



Phone these ITT-CD Capacitor Sales Offices:

Albuquerque . . . . . AX 9-8013	Los Angeles . . . . . RE 2-0145
Boston . . . . . CA 7-2980	Miami . . . . . MI 4-3311
Chicago . . . . . SP 7-2250	Minneapolis . . . . WE 9-0457
Cleveland . . . . . GR 5-3080	New York . . . . . LD 5-1820
Dallas . . . . . EM 1-1765	Philadelphia . . . . TR 8-3737
Dayton . . . . . BA 8-5493	Phoenix . . . . . WH 5-2471
Denver . . . . . KE 4-5091	Rochester . . . . . FI 2-1413
Detroit . . . . . TO 8-3322	San Francisco . . . . YO 7-5531
Fort Wayne . . . . . HA 0641	Seattle . . . . . PA 3-7310
Kansas City . . . . . JE 1-5236	St. Louis . . . . . EV 2-3500

## TRANSISTORIZED DIGITAL SYSTEMS BLOCKS

300 SERIES The completely compatible 300 Series transistor circuitry is operable from D. C. to 300KC and is packaged on 5" x 6" gold plated glass epoxy cards, with neon indicators and pull handles. There are five stage BINARY COUNTERS, SHIFT REGISTERS, etc. per card.

As many as 100 bits of logic circuitry may be contained in a single 19" relay rack housing. Gold taper pin connectors facilitate inter-unit wiring.

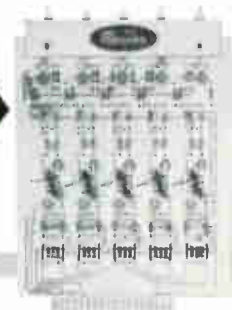

Creative engineering by NAVCOR has successfully developed the 100 Series transistorized modules for digital test equipment and prototype development, and the newer 300 Series card modules for constructing complete data handling systems. Delivered complete and attractively packaged, these economical systems modules are ready to operate with a minimum of inter-unit wiring.

NAVCOR can engineer and manufacture complete systems to your requirements. Years of experience, devoted exclusively to semiconductor digital systems design, have produced hundreds of thousands of operating logic stages.

### FREE

Send for complete data and specifications on the 300 Series systems blocks.



NAVIGATION COMPUTER CORP.  
VALLEY FORGE INDUSTRIAL PARK  
NORRISTOWN, PA.  
Glendale 2-6531

## PORTABLE KLYSTRON POWER SUPPLY 809-A

*featuring:* • New compact size: 8" x 12" x 15" • New low in reflector voltage ripple: less than 1 mv rms • New planetary gears to give finer adjustment of reflector voltage • New design including internal blower, built-in cabinet tilt stand, PRD expansion coil cord with polarized ac plug • Direct reading of beam voltage or current on front panel meter.

Regulated beam voltage 250 to 600 volts; regulated reflector voltage 0 to -900 volts; 6.3 volt ac filament supply. Reflector voltage available either unmodulated or internally modulated by square wave or sawtooth. Send for data! **PRD ELECTRONICS, INC.:** 202 Tillary St., Brooklyn 1, New York, ULster 2-6800; 1608 Centinela Ave., Inglewood, California, OREGon 8-9048. A *Subsidiary of Harris-Intertype Corporation.*

**HARRIS**  
**INTERTYPE**  
**CORPORATION**

# New from PRD!



*another Sarkes Tarzian  
production breakthrough!*



Specifications at 25° C			
Tarzian Type	Zener Voltage (V)	Test Current (MA)	Dyn. Imp.(MAX) (Ohms)
VR6	6	25	4.0
VR7	7	25	5.0
VR8.5	8.5	25	6.0
VR10	10	12	8.0
VR12	12	12	10
VR14	14	12	11
VR18	18	12	17
VR20	20	4	20
VR24	24	4	28
VR28	28	4	42
VR33	33	4	50
VR39	39	4	70
VR47	47	4	98
VR56	56	4	140
VR67	67	2	200
VR80	80	2	280
VR90	90	1	340
VR105	105	1	400

# Tarzian Silicon Voltage Regulators now at workday prices

- 1-watt
- Epoxy enclosed
- 6 to 105 volts, in 20% increments
- Standard tolerance is 20%  
(all common tolerances available on request)
- Immediate availability

Sarkes Tarzian did it in 1957 for silicon rectifiers and has done it again in 1961 for silicon voltage regulators...devised production methods that make it possible to offer quality silicon semiconductor devices at a price level that permits their use not only in Sunday circuits but also in workday circuits.

At the new low prices, more circuits can be better protected or improved in performance by the use of these small and inherently rugged devices as clippers, limiters, and regulators.

**Send for price and ordering information.**

*Where highest quality  
is in volume production*



## **SARKES TARZIAN, INC.**

World's Leading Manufacturers of TV and FM Tuners • Closed Circuit TV Systems • Broadcast Equipment • Air Trimmers • FM Radios • Magnetic Recording Tape • Semiconductor Devices

**SEMICONDUCTOR DIVISION • BLOOMINGTON, INDIANA**

*In Canada: 700 Weston Rd., Toronto 9 • Export: Ad Auriema, Inc., New York*

# Now—A High-Performance Potentiometer For As Little As \$3

NUMBER 15—NEW PRODUCT SERIES

Never before could you find a low price tag on this kind of potentiometer performance. Now—for as little as \$3 a unit in quantity orders—you can buy a single-turn  $\frac{1}{2}$ " wirewound rotary that meets the highest standards for computer and industrial control applications.

Weighing in at a scant .05 ounce, the  $\frac{1}{2}$ " dia. Trimpot® Model 3367 dissipates 0.5 watt, operates in 105°C heat, and holds residual end-setting resistance from 0 to 1.0%. It meets requirements for steady-state humidity and Mil Specs for sand, dust, salt spray and fungus. Designed for convenience too, it has index points that let you check your setting at a glance.

Reliability well beyond the expected is made possible by the exclusive Bourns Silverweld® termination. Alloyed with multiple turns of the resistance wire, Silverweld eliminates vulnerable single-wire terminations, is virtually indestructible under thermal or mechanical stress. Units are 100% inspected, and subjected to the rigid double-check of the Bourns Reliability Assurance Program.

Model 3367 is available immediately from factory and distributor stocks with resistances of 100Ω to 20K. Your choice of printed circuit pins (spaced for interchangeability with more expensive devices) or solder lugs with bushing mount. Write for complete data and list of stocking distributors.



**BOURNS**

BOURNS, INC. TRIMPOT DIVISION  
135 MAGNOLIA AVE. RIVERSIDE CALIF  
PLANT: RIVERSIDE CALIFORNIA  
LANS, IOWA TEL: 307-C CANADA

Exclusive designers and manufacturers of Trimpot® potentiometers. Pioneers in transducers for position, pressure and acceleration.

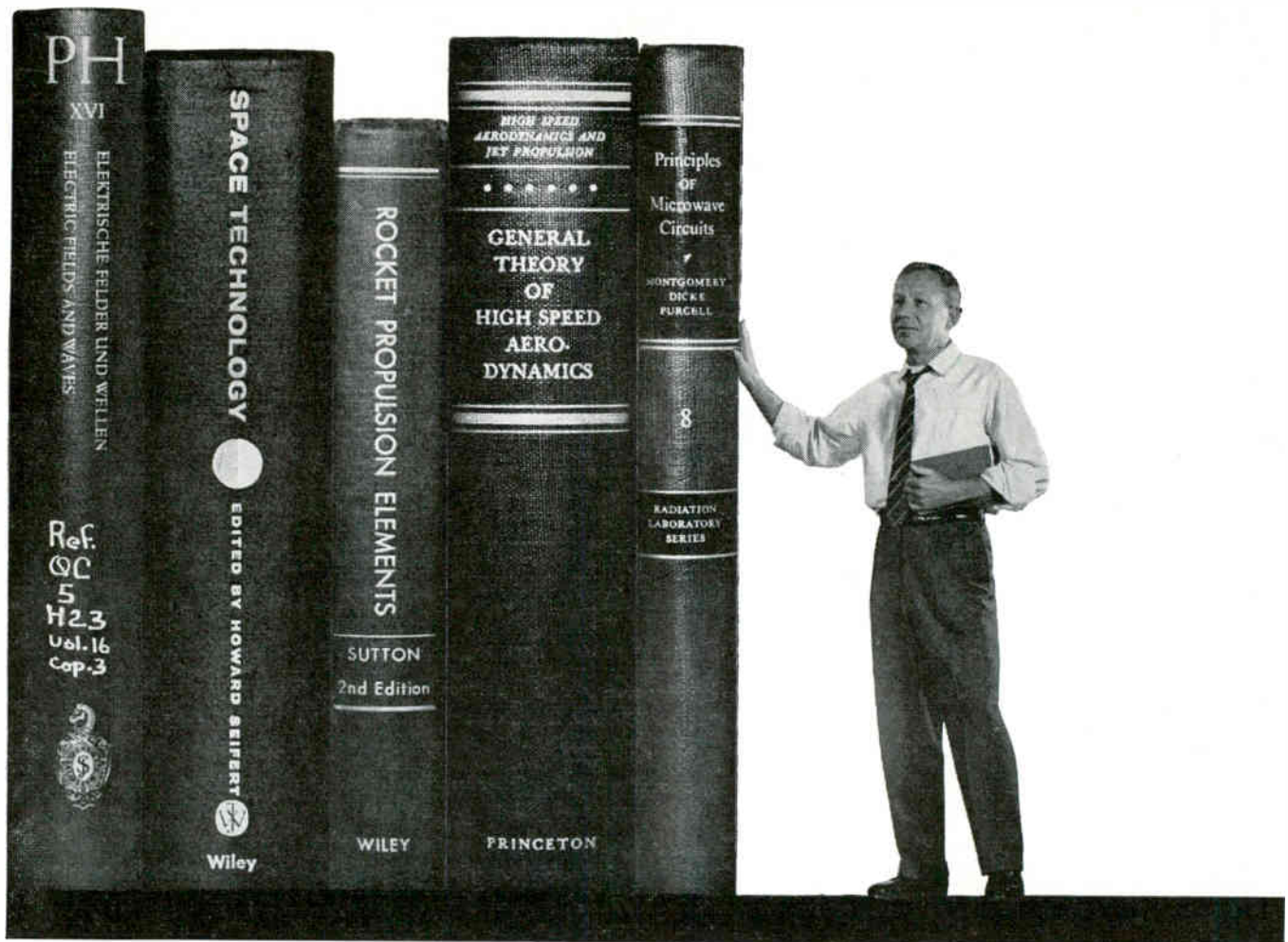

## ***space systems planning and engineering in a unique role***

The scientists and engineers of Aerospace Corporation are in the forefront of advanced planning and general systems engineering. Their unique role: critical civilian link uniting government and the scientific-industrial team developing space systems and advanced ballistic missiles. In providing broad scientific and technical leadership to every element of this team, they are engaged in activities spanning the spectrum from formulating new weapons systems concepts to technical supervision of the over-all industry team performing research, development, and test of missile/space systems. Specific activities include investigation of techniques for improving the state-of-the-art in propulsion, structures, guidance, communications and other engineering skills related to missile/space missions; feasibility studies of new weapons systems concepts and preliminary design of promising systems; formulation of development programs; conduct of critical experiments; technical supervision of the development and test program. Men with these backgrounds are invited to write to Mr. George Herndon, Aerospace Corporation, Room 110, P. O. Box 95081, Los Angeles 45, California.

*Organized in the public interest and dedicated to providing objective leadership in the advancement and application of space science and technology for the United States Government.*

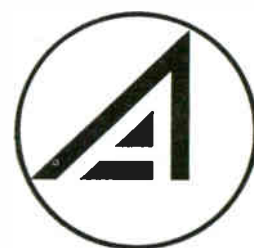

**AEROSPACE CORPORATION**



A T-Marked SPEED NUT Brand Fastener...

## SPEED CLAMPS® go on fast, trim weight and parts handling

Attachment of tubing is fast and simple with vibration-proof Tinnerman SPEED CLAMPS. They are available in a wide range of sizes and types, with or without attached SPEED NUTS or neoprene flame-resistant cushions. They make firm, secure attachments and allow substantial savings in weight, assembly time and costs.

The complete line of Tinnerman SPEED CLAMPS includes hose clamps, tube clamps, harness clamps, and an assortment of special types to meet various requirements.

When buying clamps or spring-steel fasteners, look for the T-mark... your assurance that you're putting Tinnerman quality and total reliability into your products. For samples, literature, prices call your local Tinnerman Sales Office... listed in the "Yellow Pages" under "Fasteners." Or write to: *Tinnerman Products, Inc., Department 12, Box 6688, Cleveland 1, Ohio.*



**TINNERMAN**  
*Speed Nuts®*  
Look for the Tinnerman "T"

### T-MARK ENGINEERED SPECIALS

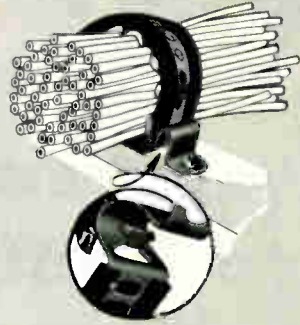

**TIME SAVING** was the benefit when this Tinnerman Harness Clamp was used to fasten wire bundles to an aircraft structure. Inset shows safe, interlocking tongue and slot that can't spring open accidentally, yet opens readily for servicing without removing clamp from bulkhead.

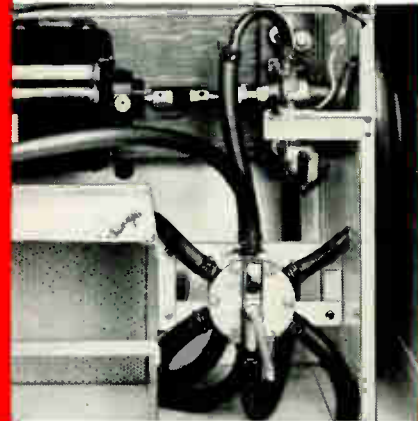

**ASSEMBLY SIMPLIFICATION** resulted from a switch to Tinnerman Hose Clamps in this oil changer. One-piece SPEED CLAMPS are easy to apply, quickly secured with standard pliers. Savings in time and labor are substantial, excessive weight and parts handling are eliminated.



**GREATER RELIABILITY** is attained by television manufacturers with Tinnerman Deflection Yoke Clamps. They eliminate the problem of misalignment and broken connections resulting from rough handling, cushion the tube assembly under live spring tension.

CANADA: Dominion Fasteners Ltd., Hamilton, Ontario.  
GREAT BRITAIN: Simmonds Aerocessories Ltd., Treforest, Wales. FRANCE: Simmonds S.A., 3 rue Salomon de Rothschild, Suresnes (Seine). GERMANY: Mecano Simmonds GMBH, Heidelberg.



1 1/2 kw switch  
capacity  
in 1/10 of a  
square inch!

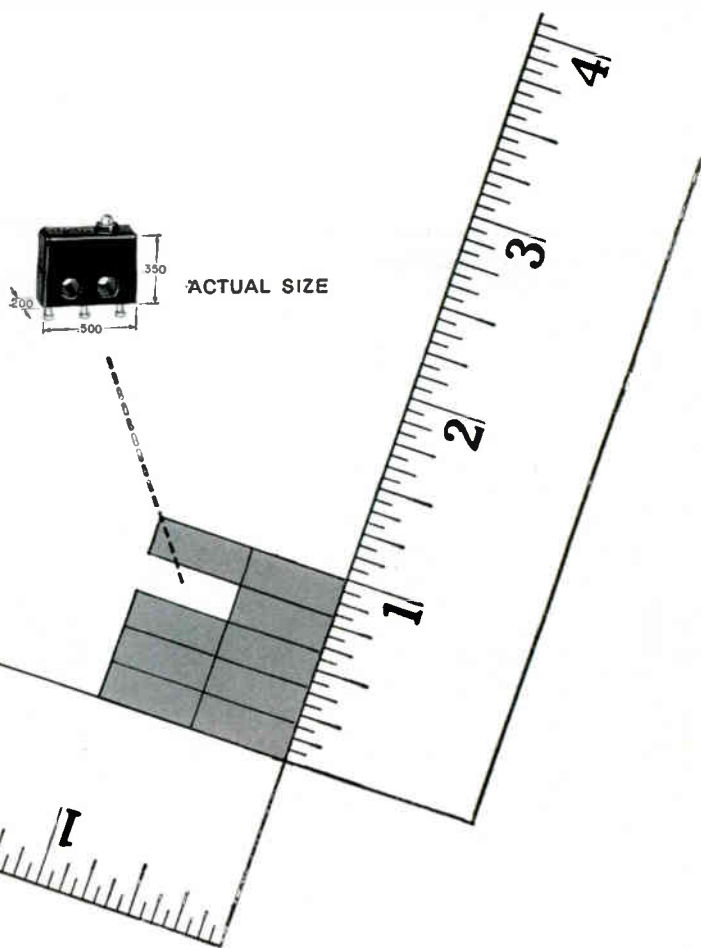

Choice of 6 switch actuators



Leaf actuator



Roller leaf actuator



Pivoted lever actuator



Reverse leaf actuator



Reverse roller leaf actuator



Pivoted roller lever actuator

THE MICRO SWITCH "1SX1" is the smallest single-pole double-throw snap-action switch made. It weighs only 1 gram. Yet, despite its tiny size, it performs millions of operations, in temperatures ranging from -65° F. to +250° F. And it handles precision switching jobs at capacities up to 1 1/2 kw.

The case, cover and plunger are made of high-strength plastic. Contacts are fine silver. The unique, snap-action spring is beryllium copper. The case has two mounting holes that accept No. 2 screws. One hole is slightly elongated to facilitate mounting. "1SX1" is designed to conform to MS24547-1.

MICRO SWITCH manufactures a complete line of small basic switches. See the Yellow Pages for your nearby MICRO SWITCH Branch Office. Or write for Catalog 63.

MICRO SWITCH... FREEPORT, ILLINOIS  
A division of Honeywell

In Canada: Honeywell Controls, Limited, Toronto 17, Ontario



**Honeywell**  
MICRO SWITCH Precision Switches

HONEYWELL INTERNATIONAL  
Sales and service offices in all principal cities of the world. Manufacturing in United States, United Kingdom, Canada, Netherlands, Germany, France, Japan.



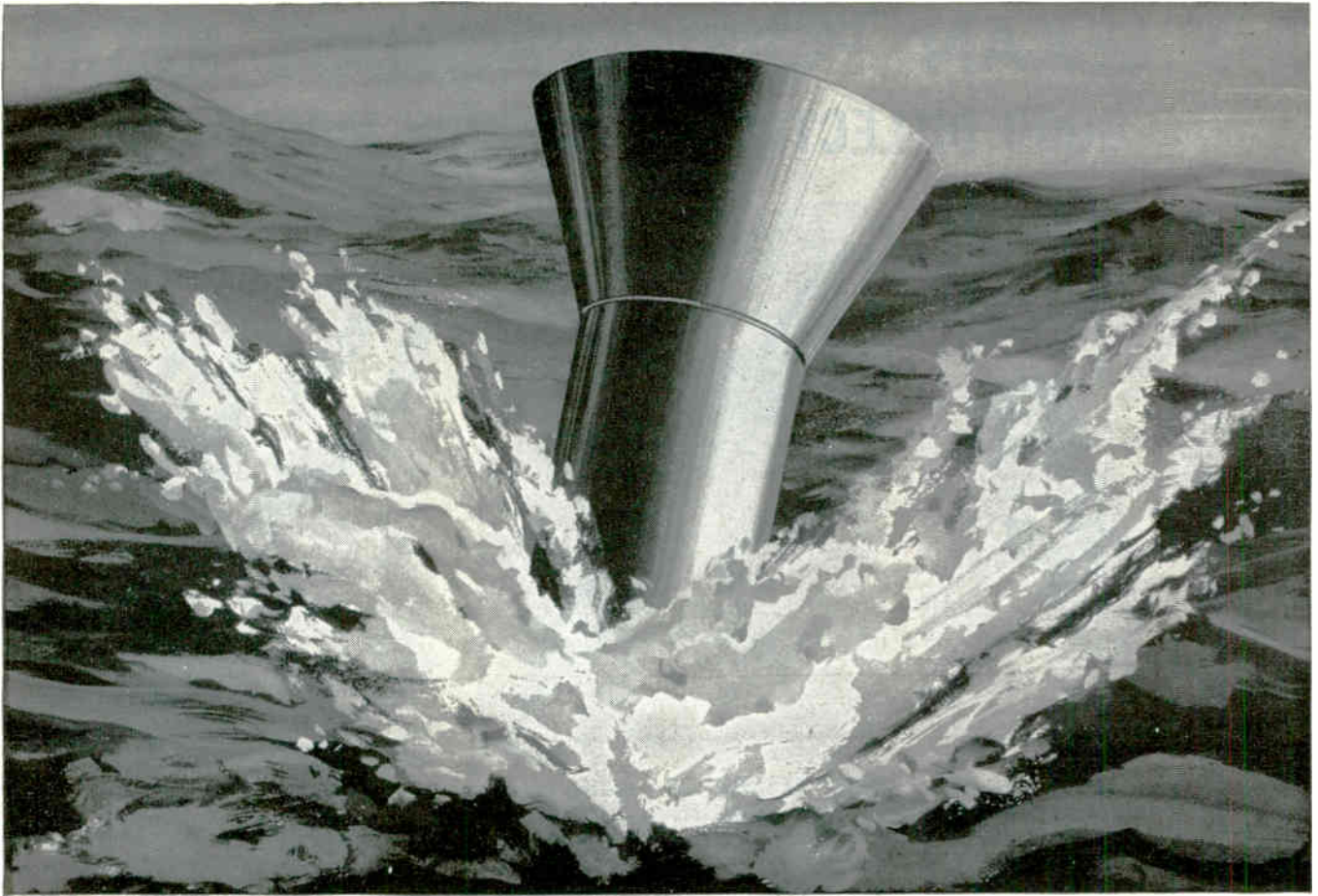

## HOW THE OCEAN GREW "EARS" TO PINPOINT MISSILE SHOTS

A quarter of the world away from its launching pad an experimental missile nose cone enters its ocean target area.

How close has it come to the desired impact point?  
Where actually did the nose cone fall?

To answer these questions quickly and accurately, Bell Laboratories developed a special system of deep-sea hydrophones—the Missile Impact Locating System (MILS) manufactured by Western Electric and installed by the U. S. Navy with technical assistance from Western Electric in both the Atlantic and Pacific Missile ranges. MILS involves two types of networks.

- One is a long-distance network which utilizes the ocean's deep sound channel. It monitors millions of square miles of ocean. The impacting nose cone releases a small bomb which sinks and explodes at an optimum depth for the transmission of underwater sounds. Vibrations from the explosion are picked up by hydrophones stationed at the optimum depth

and carried by cables to shore stations. Time differences in arrivals between these vibrations at different hydrophones are measured and used to compute location of the impact.

- The other is a "bull's-eye" network that monitors a restricted target area with extraordinary precision. This network is so sensitive it does not require the energetic explosion of a bomb but can detect the mere splash of a nose cone striking the ocean's surface—and precisely fix its location.

The universe of sound—above the earth, below the ocean—is one of the worlds of science constantly being explored by Bell Laboratories. The Missile Impact Locating System reflects the same kind of informed ingenuity which constantly reveals new ways to improve the range of Bell System services.

**BELL TELEPHONE LABORATORIES**

World center of communications research and development

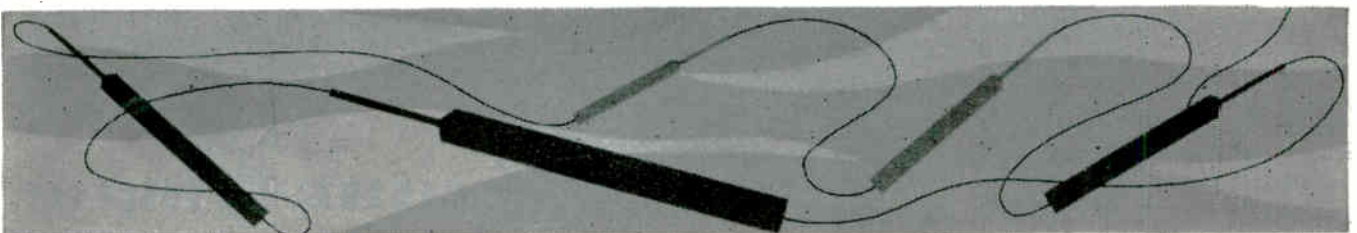

# G-E LEXAN<sup>®</sup> POLYCARBONATE RESIN

## GOOD DIELECTRIC—AND MUCH MORE!



**STABLE ELECTRICALS** Binding posts made of LEXAN resin retain electricals even under moist, hot conditions. They do not loosen, are molded in six attractive LEXAN colors for coding. Other features are: low loss and power factor, low dielectric constant, high voltage insulation, non-sink surfaces. (Superior Electric)

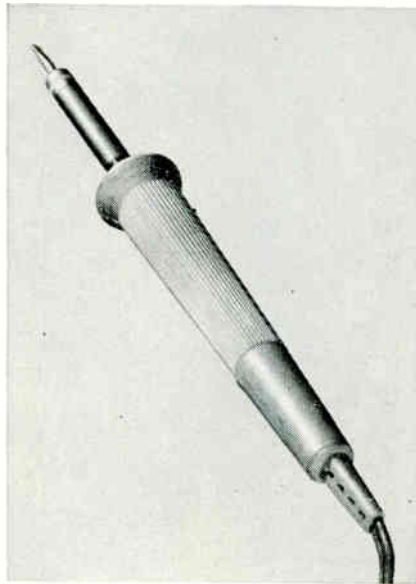

**HEAT RESISTANCE** Beautiful handles of LEXAN polycarbonate resin are used in rugged service on soldering irons. They resist the impact, heat and abrasion of daily bench work. The hard, glossy handles are light in weight. Molded in three pastel colors, they provide toughness and sales appeal. (Ungar Electric Tools)



**SELF-EXTINGUISHING** The self-extinguishing characteristic of LEXAN resin (ASTM-D635) is just one of several indispensable properties in this unique connector. Other important features are high dielectric strength, dimensional stability, moldability, good appearance, high impact strength. (Camblock Corp.)

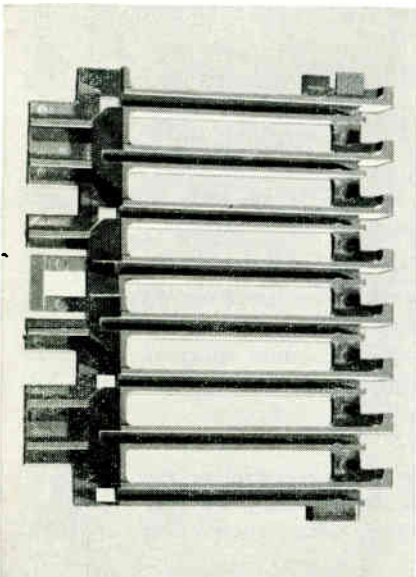

**DIMENSIONAL STABILITY** Card guide for business machines is molded to close tolerances . . . must undergo minimum change in dimensions during service. Parts show excellent dimensional stability under moist and high temperature conditions. LEXAN resin meets self-extinguishing requirement. (IBM)

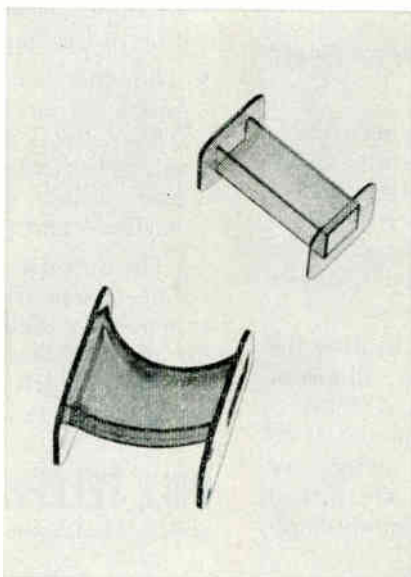

**STRENGTH** These coil forms can take temperatures above 200°F without deforming, despite stresses exerted by tightly wound wire. LEXAN resin is non-corrosive even when used with very fine Class F magnet wire. Coil forms have structural strength and stability . . . high oxidation resistance . . . stable electricals.

### HIGH-PERFORMANCE DESIGNS START WITH LEXAN THERMOPLASTIC

LEXAN resin is a stable and beautiful design material. It provides an outstanding variety of top qualities — from good electricals to the *highest impact strength of any plastic*. It has excellent high-temperature properties, including a high heat distortion point under heavy loads. The material is naturally transparent . . . has often been likened to a transparent metal. In fact, it offers the production advantages of both thermoplastics and non-ferrous metals. Its other advantages are too numerous to describe here: we urge you to refer to G-E's extensive literature on LEXAN resin. Send for details on price, properties, applications and G-E's technical assistance program today! General Electric, Chemical Materials Department, Section E-31, Pittsfield, Mass.

**LEXAN<sup>®</sup>**

Polycarbonate Resin

**GENERAL  ELECTRIC**

---

## A new concept in contact design

---



## New Wire-Form Contact Cuts Miniaturization Costs

As you can see, it's quite different from conventional solid pin and socket contacts—and for good reason.

Spring action of the beryllium-copper beam sections exerts an equalized force at 4 separate points on the wall of the socket contact. This eliminates the need for a costly and space-consuming spring member in the socket contact. Result: economical micro-miniaturization . . . with densities of 100 to 175 contacts per square inch. Tests show that Wire-Form Contacts retain consistently low resistance after 1,000 cycles of repeated insertions and withdrawals. And unlike solid pin contacts, Wire-Form Contacts can be easily realigned, even after severe bending.

The Wire-Form design makes possible a completely new series of AMPHENOL Micro-Miniature Connectors. Included are 52- and 104-contact Micro-Rac rack and panel connectors with integral body-dielectric construction. They provide up to 20% more contacts in an equivalent space—

at nearly half the "standard" cost. And with Wire-Form Poke-Home Contacts, assembly time is shortened, since all wire terminations are made independent of the connector.

Multi-Purpose Strip Connectors are also available. Applicable to a wide range of uses, they are especially suited for use as printed circuit, tape cable and modular connectors. Bulk Wire-Form Contacts are also supplied for use where it is desirable to plug in modules and components to printed circuit boards and other miniaturization devices.

A complete description of this new micro-miniaturization technique is available by writing: Vice-President, Marketing, Amphenol Connector Division, 1830 S. 54th Avenue, Chicago 50, Illinois.

**AMPHENOL** CONNECTOR DIVISION

*Amphenol-Borg Electronics Corporation*

Pat. applied for



# IN RACK AND PANEL CONNECTORS



## THIS MAKES THE DIFFERENCE!

Right here in the socket contact lies the heart of the **AMPin-cert Connector** line: the AMP cantilever spring. Seated in the slot of the socket to meet the pin shaft, it is your key to top connector reliability.

It provides you with positive wiping action . . . consistently sound electrical contact . . . firm pin grip . . . and stable resistance—yet has an extremely low, uniform insertion and withdrawal force. And, regardless of the metal plating you choose or the thickness you require, all pins and sockets are provided with an underplating of nickel to give long life reliability in all critical applications.

Add to this cantilever construction, many other plus features including AMP's industry proven solderless crimping technique to help you design and manufacture products of the highest reliability and lowest cost.

Take your pick: **AMPin-cert Connectors** in Series D, M and W as well as environmentally sealed or unsealed Series A—all tough enough to soak up heavy punishment while providing the dry circuit sensitivity you need for your most critical applications.



The complete story is available in catalog form. Write today for your copy.

# AMP INCORPORATED

GENERAL OFFICES: HARRISBURG, PENNSYLVANIA

AMP products and engineering assistance are available through subsidiary companies in: Australia • Canada • England • France • Holland • Italy • Japan • West Germany

# Radar-Computer Display Traces Alphanumeric Characters

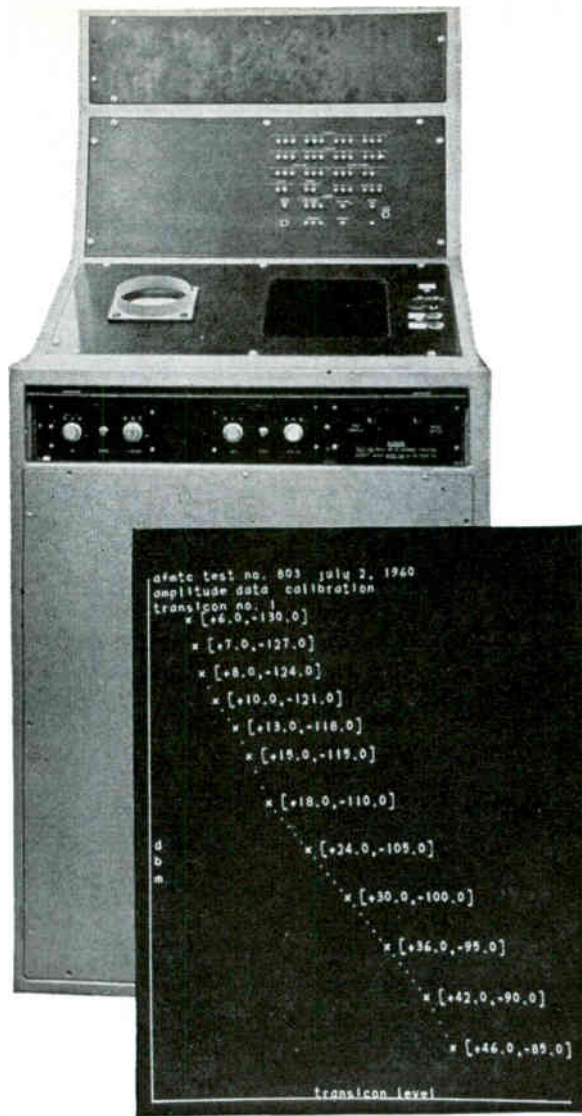

FIG. 1—Front view of calliscope shows display tube on right and camera tube without camera mount on left. The inset shows a radar amplitude curve as an example of point plotting and labeling of computer output data

By KENNETH E. PERRY  
EVERETT J. AHO

Lincoln Laboratory, Massachusetts  
Institute of Technology,  
Lexington, Mass.

A NEW high-resolution computer output display, the calliscope or calligraphic oscilloscope, is in operation with the CG-24 computer at the M.I.T. Millstone Hill radar site.

The calliscope (Fig. 1) is a point-plotting and alphanumeric digital display device using two cathode-ray tubes. A 17-inch rectangular crt with a resolution of 2,000 lines is used for viewing. The camera tube is a flat-face 5-inch circular crt with a 1-mil spot. A Polaroid print or transparency may be taken directly from this tube, making readily available copies of graphical or tabular computer output data.

An internally generated pattern displays the 64 available characters, which are produced by plug-in card circuits that are easily changed to provide different characters. The display rate is 13,500 symbols a second.

The point-plotting rate is 13,500 points a second (see Fig. 1 inset) and the resolution is one part in 4,096 across the tube face.

There are three methods for displaying alphanumeric characters on the face of a cathode-ray tube: (1) raster scanning as in monoscope systems, (2) the shaped electron beam as in the Charactron tube and (3) spot deflection, in which the character is traced out in a calligraphic manner by the moving electron beam. The calliscope uses spot deflection and generates the X and Y voltage waveforms by Fourier synthesis.<sup>1</sup>

Any character is made up of a segment or segments of a continuous closed curve. This curve can be described in Cartesian coordinates by the equation  $y = f(x)$ . In general  $y$  is a multivalued function of  $x$ , but the curve can also be represented by two parametric equations:  $y = f_1(t)$ ,  $x = f_2(t)$  where  $t_0 \leq t \leq t_{24}$ , and where  $f_1$  and  $f_2$  are single-valued functions of  $t$ . If  $t$  is time, these functions define the continuous motion of a point along the curve, and  $t_{24} - t_0$  is the time to trace the entire closed curve. Since the spot cannot be in two different positions at the same time, they must clearly be single-valued functions. If the tangential speed of the point is known at all times (specifically if it is constant), then the parametric equations are defined by the equation  $y = f(x)$ . Thus, if  $f_1(t)$  and  $f_2(t)$

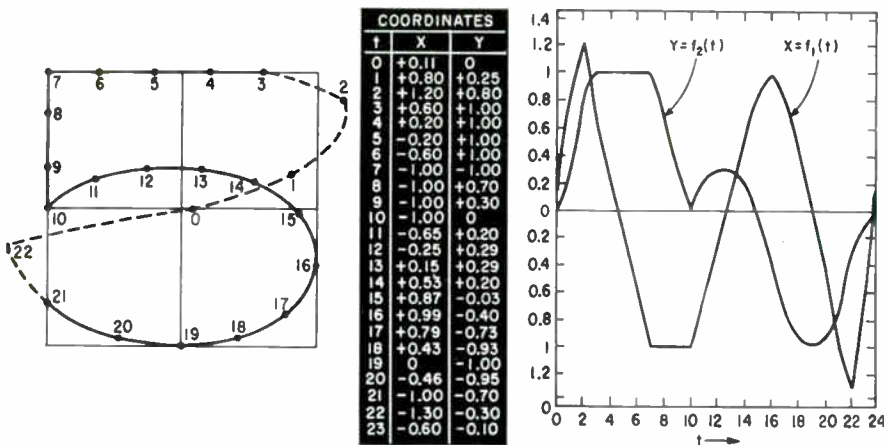
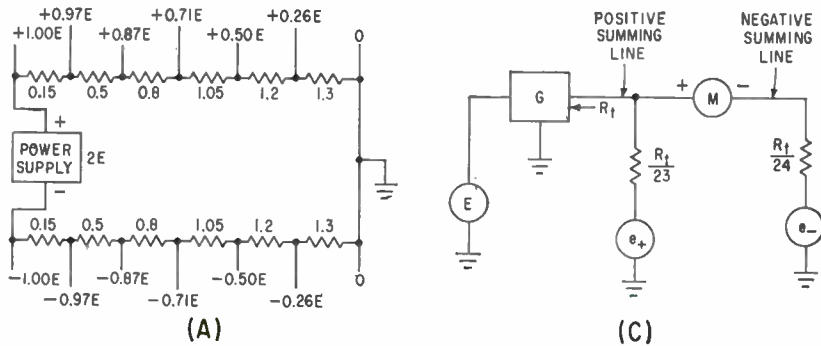

FIG 2—Waveforms at right, obtained by measuring coordinates of numeral five as at left, will generate this numeral when applied to X and Y inputs of oscilloscope



THE VOLTAGES ON TAP ON THE 24 WAFERS ARE PROPORTIONAL TO THE AMPLITUDE OF THE HARMONIC REPRESENTED AT THAT PARTICULAR TIME

THE POSITION OF THIS ROTOR (24-GANGED) DETERMINES WHICH COEFFICIENT IS BEING EXAMINED. THE SWITCH IS NOW LOOKING AT THE COSINE OF THE SIXTH HARMONIC

ETC. FOR A TOTAL OF 24 UNITS

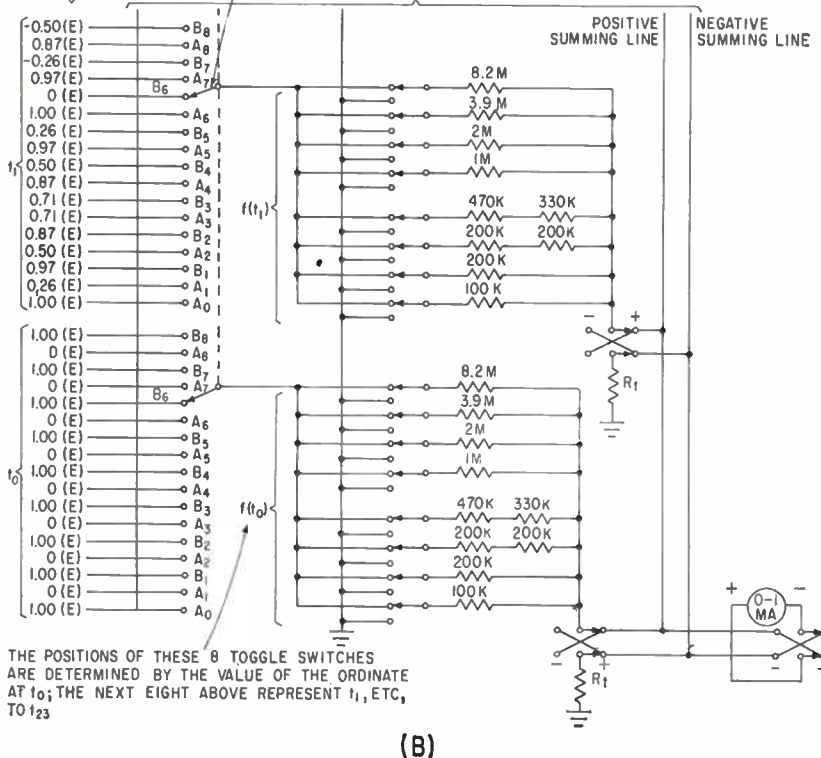

THE POSITIONS OF THESE 8 TOGGLE SWITCHES ARE DETERMINED BY THE VALUE OF THE ORDINATE AT  $t_0$ ; THE NEXT EIGHT ABOVE REPRESENT  $t_1$ , ETC., TO  $t_{23}$

(B)

FIG. 3—Low-resistance voltage divider (A) provides sine and cosine analog voltages for the harmonic analyzer (B), shown in equivalent circuit in (C)

represent the voltage waveforms applied to the Y and X deflection amplifiers, the curve will be traced on the oscilloscope. Since most alphanumeric symbols are not closed curves, an unblanking function must be provided to intensify the desired segment.

The functions  $f_1$  and  $f_2$  are defined in the interval  $t_0$  to  $t_{24}$ , and each has a value at  $t_{24}$  which equals that at  $t_0$ . A function of this type can be expanded according to Fourier's theorem into a series of sine and cosine terms:  $f_1(t) = A_0 + A_1 \sin \omega t + B_1 \cos \omega t + A_2 \sin 2\omega t + \dots$ , where  $\omega = 2\pi/(t_{24} - t_0)$  and  $t_0 = 0$ . In the equipment,  $(t_{24} - t_0) = 33 \mu\text{sec}$ , so the fundamental frequency is about 30 Kc.

The procedure for finding coefficients  $A_n, B_n$  is as follows (Fig. 2). The desired character is drawn on graph paper, including a retrace segment that closes the curve. Some characters are already closed but it is desirable, as far as possible, to use the same intensify function for all characters, so redundant retrace segments are tacked on these as an appendix. Some complex characters will require more than one retrace segment to close the curve and hence a more complex intensify function. Twenty-four points are laid off along the curve at roughly equal intervals. (The number of points used is arbitrary.) These points divide the time  $(t_{24} - t_0)$  into twenty-four equal intervals. The Y and X-coordinates of each point are tabulated, with  $t_0$  taken at the center of the retrace segment. These tabulated values represent the two functions  $f_1(t)$  and  $f_2(t)$ . These functions may be analyzed by a numerical or graphical technique to find the coefficients of the Fourier expansion.

A graphic technique<sup>2</sup> was used at first but later an electronic Fourier analyzer was developed to evaluate the 24-term expression

$$A_n \approx \sum_{i=0}^{23} x_i \sin n\omega t_i$$

It is a passive device using switches, resistors, a meter and power supply, to derive the coefficients of the Fourier series up to the eighth harmonic with 24-point analysis. Accuracy is limited only by component tolerance. The graphical method originally used required four hours a character;

with the new device, the time is reduced to fifteen minutes and the accuracy is considerably greater.

An external power supply, variable from 0 to 15 volts, feeds a very-low-resistance high-precision voltage divider (Fig. 3A) to generate voltages proportional to the sine and cosine functions of angles between 0 deg and 360 deg in 15-deg steps. These voltages are wired to the terminals of two 12-circuit 20-position rotary switches (Fig. 3B). The voltage on any terminal is determined by the wafer and position of the terminal. The first wafer represents  $t_0$ , the second wafer  $t_1$  and so on up to  $t_{23}$ . The first switch position represents unity value for calculating the  $A_n$  coefficient. The second position on each wafer represents  $\sin \omega t_i$ , where  $i$  is determined by the wafer under consideration. The third position represents  $\cos \omega t_i$ , the fourth position  $\sin 2\omega t_i$ , and so on up to  $\cos 8\omega t_i$ . Voltages proportional to these sine and cosine functions are connected to the terminals. For example, in the second position  $A_1$  is sought and wafer 1, position 2 is connected to (0)  $E$ ; wafer 2, position 2 is connected to  $+(0.26) E$ ; wafer 3, position 2 is connected to  $+(0.5) E$ , and so on.

The rotor of each wafer is connected to terminals on separate groups of eight toggle switches. To the rotors of the toggle switches are connected eight resistors, terminating together through a polarity toggle switch to one of two current-summing lines. The summing lines connect through a meter polarity reversing switch to the two sides of a precision milliammeter. Thus one summing line contributes positive current to the meter and one contributes negative current. The resistor  $R$ , equals the parallel combination of all eight resistors in a group and is switched in to ensure that each summing line sees a constant impedance to ground on its side of the meter. Figure 3C shows the equivalent circuit of the entire device as seen by one of the resistor groups  $G$  with the voltage  $E$  impressed upon it. The resistors of a group are arranged in a binary-decimal configuration. The values of the first four resistors are binary in relation to each other, and handle the

units in the decimal end result. The values of the last four resistors are also binary in relation to each other, and handle the tens in the decimal number. The relation between these two groups of four resistors is decimal. Each group of eight resistors, on their common sides, is then a sum of conductances. That is, in or out of the polarity switch,  $i = EG$ , where  $i$  is the total current into the summing line from one group of eight resistors,  $E$  is the sine or cosine proportional voltage, and  $G$  is the sum of conductances of the resistance in the circuit. This conduct-

cosine waves of the harmonic frequencies and combine them in the proportion to create the waveforms.

Figure 4 is a simplified block diagram of the calliscope system. A 323-Kc clock (3.1  $\mu\text{sec}$ ) increments the 5-bit status counter which generates the basic 74.4- $\mu\text{sec}$  character display cycle. During the first 40.3  $\mu\text{sec}$  of this period, the electron beam is positioned on the crt face. The last 34.1  $\mu\text{sec}$  are devoted to writing the character in this location. The timing matrix generates the 33- $\mu\text{sec}$  ring command which turns on the ten sine

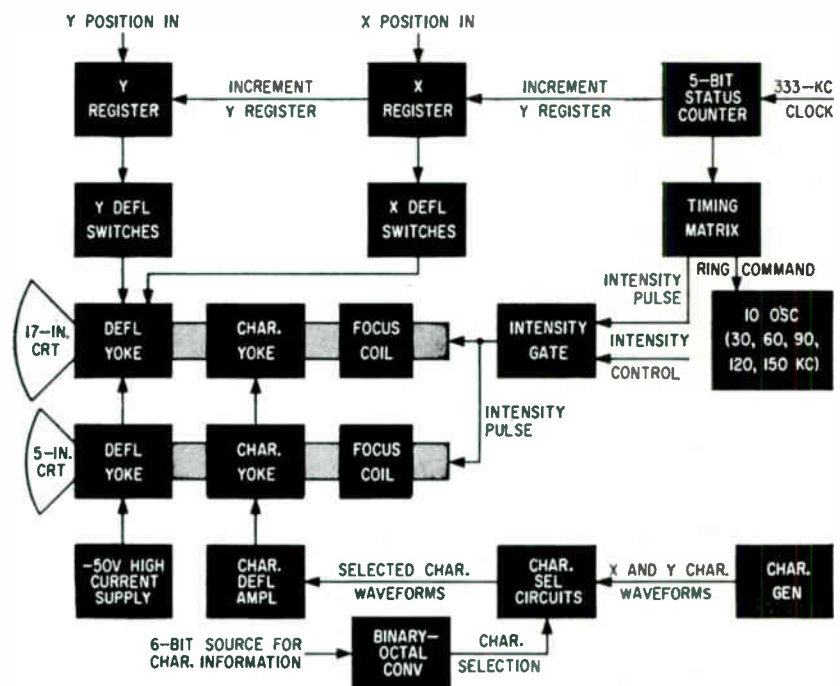

FIG. 4—Simplified block diagram of calliscope display shows at left the 17-inch high-resolution viewing crt with P-7 phosphor

ance is proportional to the ordinate at  $t_i$ , and the polarity switch is adjusted to conform with the polarity of this ordinate.

The outputs of all 24 groups of resistors are then summed in the two common lines and the net current read by a 0 to 1-ma meter. This current is proportional to the Fourier coefficient under consideration. The current through the meter is  $i_i = \pm E_0 (\pm G_0) \pm E_1 (\pm G_1) \pm \dots \pm E_{23} (\pm G_{23}) \pm E_{23} (\pm G_{23})$ .

When the coefficients of the Fourier components of the X and Y-functions have been computed, it remains to generate sine and

and cosine harmonic oscillators (five harmonic frequencies are used) and also generates the intensity pulse that brightens the desired part of the character curve. The outputs of the oscillators go to all the character generators that combine the sinusoidal signals to generate X and Y waveforms for all desired characters. All these waveforms go to the character selection circuits. A 6-bit character selection word is introduced from an outside source, such as the computer, and passes through binary-octal converter circuits to control the selection circuits for any one of 64 characters. The selected X

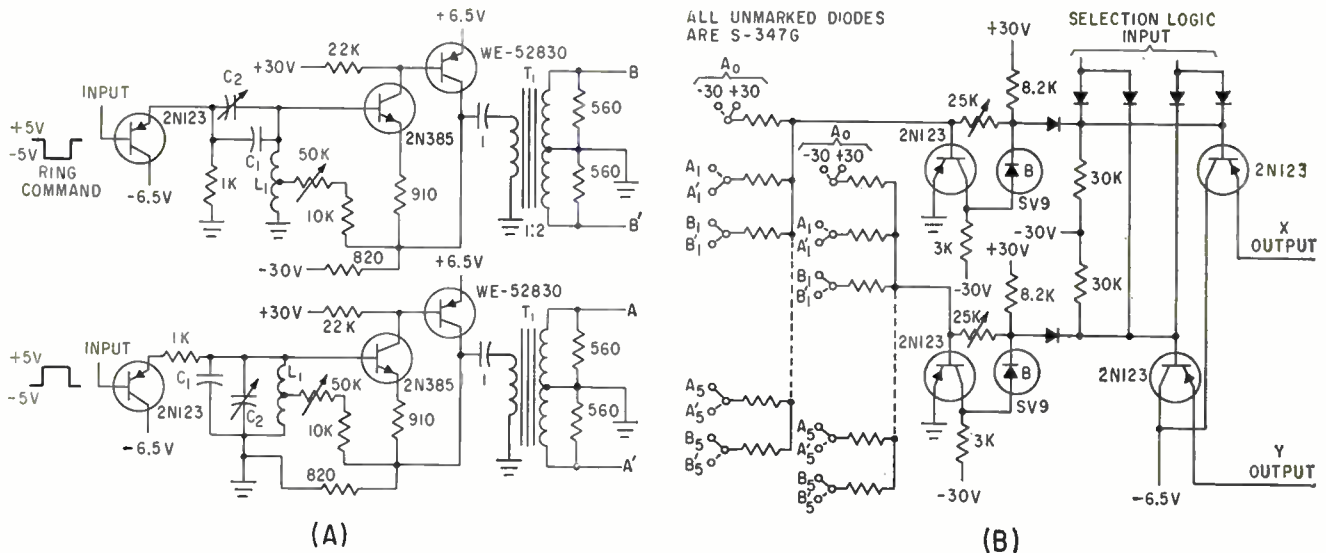

FIG. 5—Harmonic generators (A) for sine and cosine waves, which are combined in the symbol generator (B)

and Y-character waveforms go to character deflection amplifiers with high-current outputs, which drive a low-inductance character deflection yoke isolated from the main yoke. The low inductance and isolation of the character yoke ensures good frequency response up to the highest harmonic used. Maximum character deflection available is about  $\frac{1}{2}$ -inch peak-to-peak.

The X and Y registers are two 12-bit flip-flop counters that control the position of the electron beam. The X counter may be incremented by the output of the status counter in steps of any desired magnitude so that characters may be spaced at will across the tube face. In like manner the Y counter can be incremented in any desired steps from the carry output of the X counter to space lines of characters properly. Alternatively, the desired X and Y position may be parallel-transferred into the X and Y registers from an outside source. The outputs of the X and Y registers control the X and Y high-current deflection switches that drive the low-inductance main deflection yoke to position the electron beam rapidly on the scope face.

The sine- and cosine-wave oscillators are shock excited so that all ten waveforms will be initiated at the same time. They must be capable of being cut off and reduced to a quiescent state as soon as possible so that an identical set of oscillations can be started again within

a few microseconds. The frequency and amplitude must be stable. Finally, they must have low output impedance.

The circuit of Fig. 5A shows the cosine-wave oscillator above and the sine-wave oscillator below. Except for the  $C_1$  and  $L_1$  values, there are five identical cosine-wave and five identical sine-wave oscillator circuits. During the quiescent period, the input to the cosine-wave oscillator is at +5 volts and the input to the sine-wave oscillator is at -5 volts. These voltages are reversed for the oscillatory period by the 34.1- $\mu$ sec ring command, which shocks the tuned circuits into oscillation. The signal amplitude is about 10 volts peak-to-peak. At the end of the ring command, the ringing circuits are cut off at a point in the cycle exactly corresponding to the turn-on point, so there is no damping transient and the operation is not duty-cycle sensitive. At the instant of turn-off, the voltage on the capacitor and the current through the inductor are near the quiescent values.

The 50,000-ohm positive-feedback potentiometer is adjusted to compensate for circuit losses and the result is a flat envelope. The two-transistor output circuit is a negative feedback super-emitter-follower that provides unity voltage gain and a low output impedance. Output transformer  $T_1$  provides a positive and negative phase signal for each waveform. It must have a low-leakage inductance figure to

keep the output impedance low.

The values of  $L_1$  and  $C_1$  are determined by setting  $\sqrt{L/C} = R$ , where  $R$  is the critical damping resistor (the  $R$  value arbitrarily chosen as 1K) and  $L$  and  $C$  are unknown. By solving first for  $L$  in terms of  $C$  and substituting this result in the equation  $\sqrt{LC} = 1/2\pi f$  and solving for  $C$ ,  $L$  can be found from either equation. Trimmer capacitor  $C_2$  has a range of from 100 pf to 500 pf and can adjust the ringing circuit for any LC inaccuracies.

Figure 5B shows the method of combining harmonics to produce the X and Y waveforms. Resistors proportional to the reciprocals of the Fourier coefficients are tied from the frequency outputs to a common point at the base of a grounded-emitter transistor amplifier where current summing takes place. This is necessarily a low impedance point and it is made even lower by current feedback from the collector. It is held close to ground by the grounded emitter. The Zener diode is a d-c level adjustment, and the 25,000-ohm feedback potentiometer is a gain control. The  $A_0$  factor is controlled by the value of the resistor from  $\pm 30$  volts to the summing point.

Negative logic is used for the selection. The outputs of two binary-to-octal converters are ANDed together at the base of an emitter-follower transistor. The emitters of all the X transistors in all character circuits are tied together on



a common bus with a single 10,000-ohm resistor to +30 volts. Only the selected transistor is conducting, thus connecting the desired waveform to the bus. The Y waveform is selected in the same manner.

The voltage waveforms on the X and Y busses must be transformed into equivalent current waveforms of up to 0.5 amp peak-to-peak to drive the low-inductance character deflection yoke. This is done by the character deflection amplifier (Fig. 6A). The voltage waveform enters the amplifier circuit through a low-pass filter that has a cutoff frequency of about 500 Kc. This eliminates noise spikes coupled into the bus from the digital circuits and also suppresses a tendency toward high-frequency parasitic oscillations in the amplifier.

The *pn*p emitter-follower stage uses a Western Electric germanium transistor with a beta of over 100. This drives the base of an *npn* silicon power transistor with a 10-ohm degeneration resistor in the emitter circuit. The collector supplies

the current to the character deflection yoke.

The coarse deflection system consists of 32 power transistors used in a switching configuration, driving a low-inductance main deflection yoke. Sixteen switches control the X coarse deflection, and the other sixteen the Y coarse deflection. Each switch when ON contributes one ampere to its yoke winding. They establish sixteen discrete positions in X or Y or both. Full deflection current in the yoke is 8 amp. Figure 6B shows one complete switch and how it is connected to a yoke winding. Also indicated is the way the other fifteen switches are connected. The extra switch *H* bypasses the yoke and goes directly to the -50-volt supply, to maintain a constant load on the power supply. Since the current drain is a constant 16 amp, regulation of the -50-volt supply is not a problem.

When +5 volts are applied to the input of a switch, the output transistor saturates and contributes its one ampere to the yoke winding. An 8-ohm potentiometer in series

with the 50-ohm load resistor enables adjustment for variation in saturation resistance and leakage between the transistors.

When a method is considered for switching currents through a yoke from a 4-bit logic source to establish sixteen discrete levels, the natural first choice is a binary resistive ladder requiring only eight switches. This would be a poor choice, however, since the highest-order switch transistors would be required to contribute 4 amp and, furthermore, a small percentage error in the highest-order switch current would contribute a large absolute error in the spot position. Sixteen switches and a translation approach were decided upon.

The four high-order flip-flops have their binary outputs translated. The letters *L* through *Z* are the translator outputs that control the deflection switches. Outputs *L* through *S* cause deflection to the left (or down) and *T* through *Z* cause deflection to the right (or up). The least significant flip-flop is the load-equalizing function *H*.

The low-order fine positioning about the sixteen major points to achieve a 4,096-position capability is generated in binary fashion with pairs of deflection switches operating push-pull into the deflection yoke (Fig. 6C). The current contribution of each of these low-order switches is determined by  $R_n$ , determined by the binary bit represented. The currents in these eight pairs of switches will vary from 250 ma in the most significant to 1.9 ma in the least significant.

An intensity circuit provides the -70-volt bias to cut off the first grid ( $g_1$ ) of the crt, and provides positive intensity pulses of three different heights selectable by the three logic inputs. This provides for spot brightness of three different levels, automatically selectable by the outside source controlling the display.

The authors wish to acknowledge the contributions of Ronald Gagne, John Henry and other personnel of Millstone Hill.

#### REFERENCES

- (1) K. E. Perry and E. J. Aho, Generating Characters for Cathode-Ray Readout, *ELECTRONICS*, p 72, Jan. 1958.
- (2) T. C. Blow, Graphical Fourier Analysis, *ELECTRONICS*, p 194, Dec. 1947.

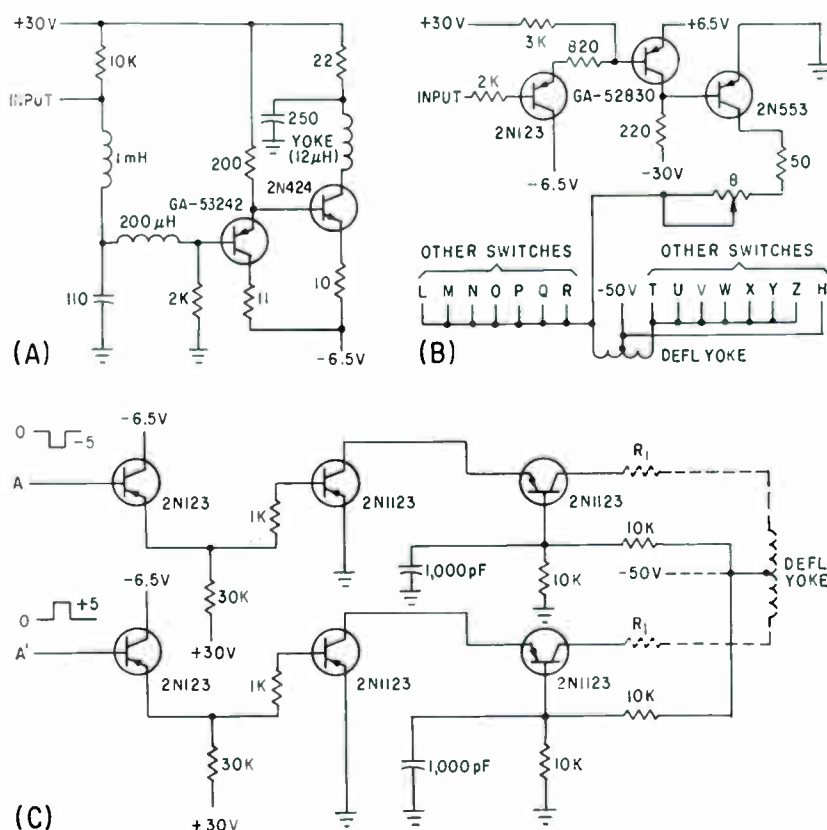

FIG. 6—Calliscope character deflection amplifier (A); coarse deflection switch (B); and fine deflection switch (C)

# Replacing Sine

An inverter can replace a sine wave source if its square wave output is modified to have the same rms and average values as a pure sine wave. A uniform method is presented here with a discussion of design problems

By DONALD LEVY

Section Head—Inverters,  
The Daven Co., Livingston, N. J.

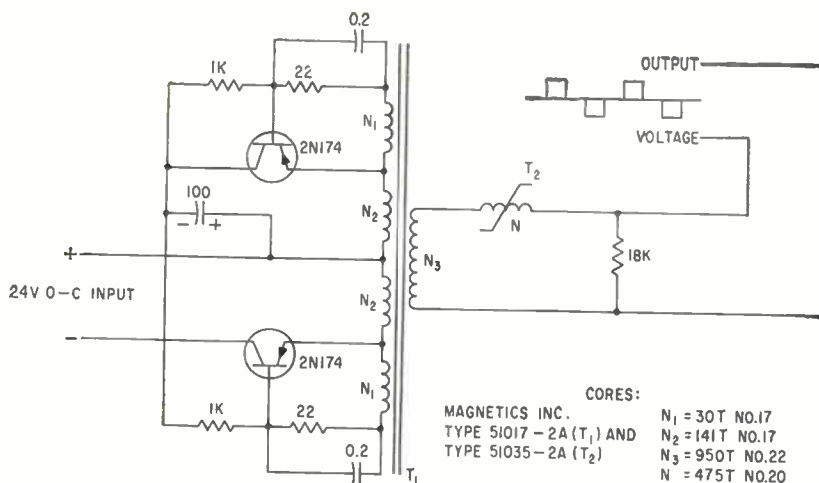
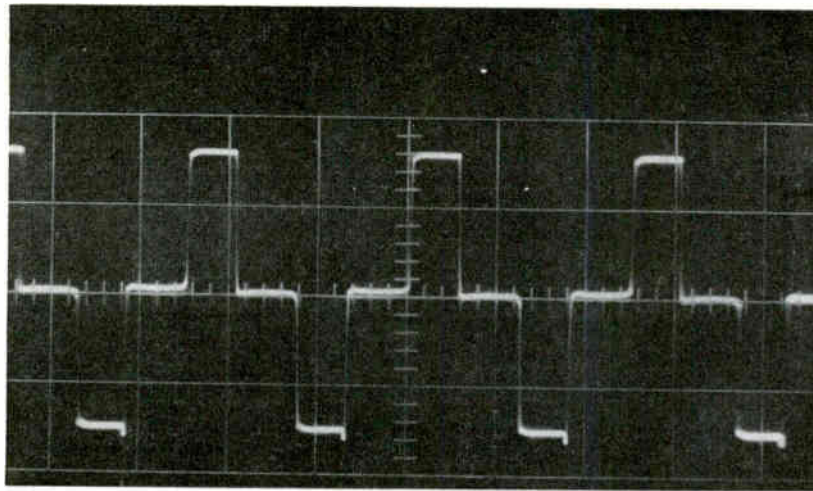

Schematic of an inverter circuit that uses the principles outlined in article, and typical inverter waveforms (above) with vertical scale of 100 v/cm and horizontal scale of 1 millisecond/cm

SOLID-STATE d-c to a-c inverters are frequently used to operate electronic equipment intended for conventional 60 or 400-cycle sinusoidal power sources from direct current sources. When inverters are used in such applications, consideration must be given to the output waveform if optimum or even useful performance is to be realized. Difficulty and expense can be avoided by proper design of the output stage; often, an improvement over sine wave operation can be realized through variations of the output waveform.

The output waveform for the most common type of inverter is the square wave (Fig. 1A). Such a waveform has the property  $V_{\text{peak}} = V_{\text{rms}} = V_{\text{rectified average}}$ . It is this relationship that causes most difficulty in the application of this type of inverter to electronic equipment designed for sinusoidal a-c. Such equipment, for example a conventional vacuum tube receiver operating from a-c, requires filament voltages and d-c voltages. These

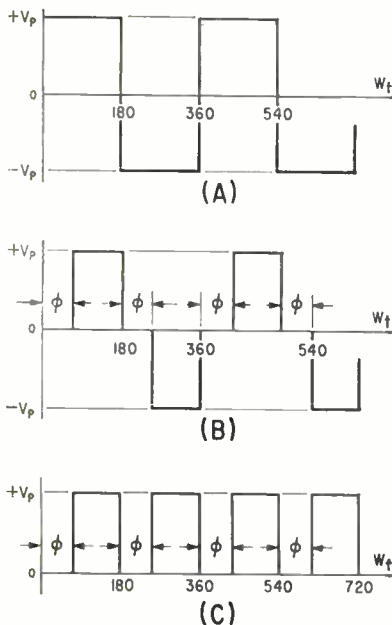

FIG. 1—Natural output waveform of transistor d-c to a-c inverter (A); and square wave modified (B), then rectified (C)

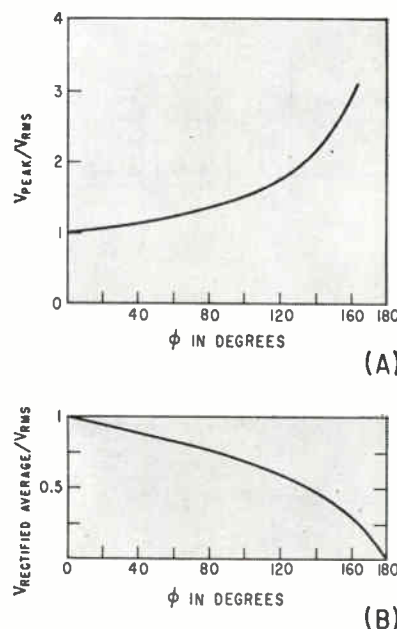

FIG. 2—Ratio of  $V_{\text{peak}}$  to  $V_{\text{rms}}$  plotted against  $\phi$  for Fig. 1B waveform (A), and ratio of  $V_{\text{rectified average}}$  to  $V_{\text{rms}}$  plotted against  $\phi$  (B)

# Wave Sources With Solid-State Inverters

voltages are obtained by passing the input power through a transformer, stepping down the input voltage for filaments and usually increasing the input voltage for the d-c requirements. Normally, for example, the input is 115 volts rms, the filament is 6.3 volts rms, the d-c is +300 volts. Typically, the +300 volts is obtained from a full-wave rectifier followed by a filter. If the filter is the capacitor input type, the B+ obtained corresponds to the peak voltage of  $\sqrt{2}$  times the rms value of the a-c voltage into the rectifier (neglecting rectifier losses). If the filter is the choke input type, the d-c output corresponds to the average voltage or 0.89 times the rms. The filament voltage corresponds to the rms value of input.

Consider the same receiver used with a square wave input of 115 volts rms. The filament voltage corresponds to the 115 volt rms and is correct. The B+ however will not be correct. If a capacitor input filter is used, the B+ corresponds to the peak of the square wave voltage into the rectifier, since peak and rms are equal. If a choke input is used, the B+ corresponds to the rectified average, and is also equal to the rms value. For the capacitor input filter the square wave operation results in approximately 29 percent reduction of B+, and the choke input operation gives approximately 11 percent increase in B+. Most equipments use the capacitor input filter. If the input rms voltage is adjusted to allow for the correct B+, the filament voltages will be incorrect.

To resolve this problem it is necessary to specify the rms input voltage as well as the peak or rectified average input voltage. This would be necessary for any voltage input waveform other than a sine wave. If capacitor input filters are used, the peak should be specified as  $\sqrt{2}$  times the rms voltage, and the rectified average voltage is not of first order importance. If choke input filters are used, the rectified

average voltage should be specified as 0.9 times the rms voltage, and the peak value is not of primary importance.

A uniform method for varying the peak or average to rms ratio is to modify the waveform of Fig. 1A to that of Fig. 1B by inserting a saturable reactor in series with the load. For the capacitor input filter, the peak voltage  $V_p$  of the converter output is chosen to equal  $\sqrt{2}$  times the rms value of the sine-wave voltage normally used. For example, assuming 115 volts rms,  $V_p = \sqrt{2} \times 115$  volts = 162 volts. The angle  $\phi$  can now be chosen so that the rms value of the waveform in Fig. 1B is correct (that is, 115 volts).

Instead of altering the converter  $V_p$ -to- $V_{rms}$  ratio by adjusting the series reactor's conduction angle, the higher harmonics of the square wave output could be removed by filtering leaving a conventional sinusoidal output. However, filters to do this are more bulky, expensive, and susceptible to load changes, than the series reactor.

The relationship between rms and peak voltage for the waveform in Fig. 1B is  $V_{rms} = V_p \sqrt{(180 - \phi)/180}$  where the value of  $\phi$  is in degrees. For  $V_{rms} = V_p/\sqrt{2}$  as is the case for a sine wave,  $\phi = 90$  degrees. Figure 2A shows the  $V_p/V_{rms}$  ratio plotted against  $\phi$  for the waveform of Fig. 1B. Figure 2A shows that by varying  $\phi$ ,  $V_p/V_{rms}$  can be made to vary from one to  $\infty$  with an upper limit of approximately three. For a choke input filter,  $V_{dc} = 0.9 V_{rms}$  where  $V_{dc}$  is the average full wave rectified voltage. The ratio of  $V_{dc}/V_{rms}$  as a function of  $\phi$  is  $V_{dc}/V_{rms} = \sqrt{(180 - \phi)/180}$ . For  $V_{dc}/V_{rms} = 0.9$ , corresponding to a rectified sine wave,  $\phi \approx 36$  degrees. Figure 2B plots the ratio  $V_{dc}/V_{rms}$  against  $\phi$ .

Substitution of the modified square wave for a sine wave is investigated with regard to ripple factor, harmonic content and con-

version efficiency. Ripple factor is a measure of the fluctuating components in the rectified output, and is defined as:  $r = (\text{rms value of the alternating components of waveform})/(\text{average value of waveform})$  or  $r = V'_{rms}/V_{dc}$ . Figure 1C is the waveform of Fig. 1B after rectification. For  $\phi = 0$ , the rms value of the alternating components of this waveform  $V'_{rms}$  are zero, hence,  $r = 0$ .

For  $\phi = 90$  degrees,  $V'_{rms} = V/2$ ,  $V_{dc} = V/2$ , hence,  $r = 1$ . The alternating components are equal to the d-c component. For single-phase sinusoidal full-wave rectified output, the ripple factor is 0.482. Figure 3A is a plot of  $r$  against  $\phi$ . For  $\phi = 90$  degrees, the value of  $r$  needed to make the peak-to-rms ratio equal to  $\sqrt{2}$  (corresponding to the sine wave) is slightly higher than twice the sine wave value of 0.482. For  $\phi = 36$  degrees, corresponding to the choke input filter case,  $r = 0.5$  and is close to the value obtained with sine wave input. For this value of  $\phi$  the 5th harmonic is approximately zero. For  $\phi = 90$  degrees, the ripple content is higher; however, the ripple components occur at higher frequencies than for a sine wave, and so the filtering is more effective. The simplest method of completely overcoming the additional ripple is to use a higher frequency so that the filtering is proportionately more effective. A 60-cycle receiver, for example, can be powered from a source having a frequency of 120 or 400 cycles or higher, provided there are no blowers or motors that depend on 60-cycle frequency.

The harmonic content of the waveform Fig. 1B is investigated as  $\phi$  is varied from 0 to 180 degrees. The Fourier expansion for this waveform is

$$\frac{4 V_p}{\pi} \cos \frac{\phi}{2} \sin \omega t + \frac{4 V_p}{3 \pi} \cos \frac{3 \phi}{2} \sin 3 \omega t + \dots + \frac{4 V_p}{N \pi} \cos \frac{N \phi}{2} \sin N \omega t$$

This waveform contains all odd

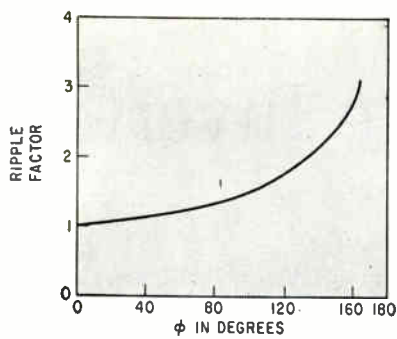

(A)

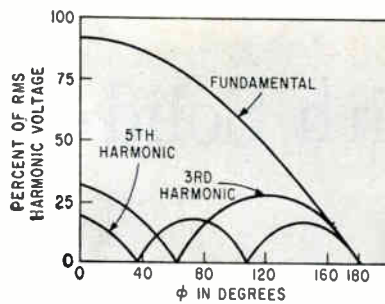

(B)

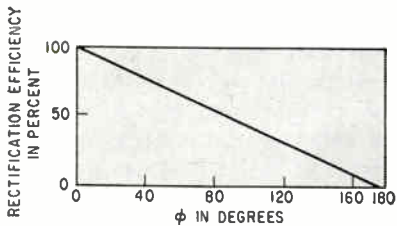

(C)

FIG. 3—Ripple factor plotted against  $\phi$  for Fig. 1C waveform (A); percent of rms harmonic voltage plotted against  $\phi$  for Fig. 1B waveform (B); and rectification efficiency plotted against  $\phi$  for Fig. 1B waveform (C)

### COMPARISON OF THREE CORE MATERIALS

Trade names <sup>®</sup> of core materials	Composition	Saturation flux density	Relative cost and use
Hypersil Silectron Orthosil Magnesil	iron 97% silicon 3% grain oriented	20,000 gauss typical	Low costs, high losses; least square hysteresis loop; use limited to 60 cps range
Orthonol Deltamax Orthonik	iron 50% nickel 50% grain oriented	15,500 gauss typical	Medium to high cost; medium loss; available 1, 2 and 4 mil tape thickness
Hy mu 80 Mo-Permalloy 4-79 Permalloy	iron 17% nickel 79% molybdenum 4% random grain structure	8,700 gauss typical	Medium to high cost; low loss; available 1, 2 and 4 mil tape thickness

harmonics. The angle  $\phi$  determines the amplitude of the harmonics present. Figure 3B plots the percentage of rms harmonic voltage for various harmonics against  $\phi$ . For  $\phi = 90$  degrees, corresponding to the capacitor filter case, the fundamental frequency is approximately 25 percent below the value corresponding to  $\phi = 0$ . For  $\phi = 36$  degrees, corresponding to the choke input filter, the 5th harmonic is approximately zero; however, the total harmonic content is practically the same as for the  $\phi = 0$  condition.

Conversion efficiency, or efficiency of rectification is  $\eta_r = (P_{dc}/P_i)$  (100%) where  $P_{dc}$  = d-c power to load, and  $P_i$  = total input power to rectifier. For a full-wave sinusoidal single phase rectifier,  $\eta_r$  has a maximum theoretical value of 81.2 percent. For the waveform of Fig. 1B, with  $\phi = 0$ ,  $\eta_r = 100$  percent. Figure 3C plots  $\eta_r$  against  $\phi$ . For  $\phi = 90$  degrees, corresponding to  $V_{peak}/V_{rms} = \sqrt{2}$ ,  $\eta_r$  is 50 percent, which is less than the sine-wave case. For  $\phi = 35$  degrees,  $\eta_r$  is approximately 80 percent, corresponding to the sine-wave case.

Two methods of changing the output waveform of Fig. 1A to that of Fig. 1B are considered. The first uses a series magnetic amplifier (Fig. 4A). This circuit, which has the characteristic of a variable angle  $\phi$  whose magnitude is approximately proportional to the d-c control current, can be designed so that  $\phi$  can be varied over the useful range. It can be made so that the d-c control current is just a few milliamperes. The second method uses a saturable reactor (Fig. 4B). This device has a fixed value of  $\phi$ .

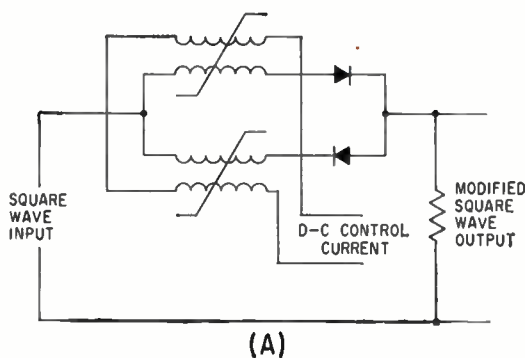

(A)

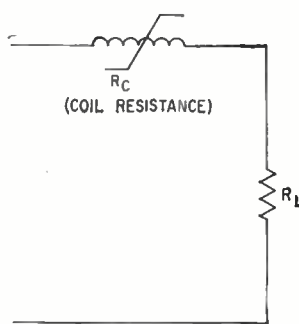

(B)

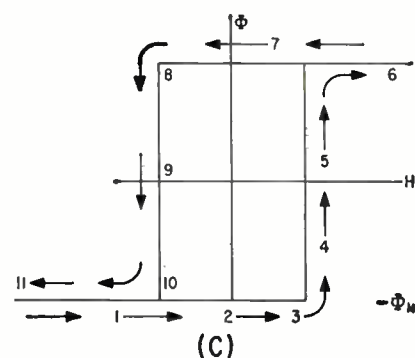

(C)

FIG. 4—Series magnetic amplifier (A), simple saturable reactor (B), and typical square loop characteristic (C)

Both methods exhibit the common characteristic that  $\phi$  will vary inversely with  $V_p$  and directly with frequency. If the square wave is taken from a standard unregulated semiconductor inverter, the frequency and output voltage are both proportional to the d-c input voltage and the value of  $\phi$  will be constant once it is set by the control current for the magnetic amplifier or set by the design in a series saturable reactor. The series magnetic amplifier is not treated as it is not advantageous in simplicity, size and expense compared to the simple reactor. The series saturable reactor uses a magnetic core exhibiting a square-loop hysteresis characteristic (Fig. 4C).

Consider a voltage step applied to the circuit of Fig. 4B. Assume that the core is initially at point 2 in Fig. 4C. The flux increases from  $-\Phi_m$  at point 2 to  $+\Phi_m$  along the path 2-3-4-5-6. The rate of change of flux with respect to time,  $d\phi/dt$ , is equal to  $V \times 10^8/N$  gauss/sec, where  $V$  is the voltage across the coil and  $N$  is the number of turns on the coil. The rate at which flux increases is independent of the core material as long as the voltage across the coil is maintained. Core characteristics and number of turns determine the current that will flow during the time of flux change according to  $I = HL/0.4 \pi N$  where  $H$  is the magnetic intensity in oersteds,  $N$  is the number of turns,  $L$  is the magnetic path length in centimeters, and  $I$  is the current in amperes.

For square-loop material,  $H$  is approximately constant over the range  $-\Phi_m$  to  $+\Phi_m$ . As the flux increases, current through the coil is approximately constant. Voltage across the coil equals  $V - HLR_L/0.4\pi N$  where  $R_L$  is the load resistance. If  $HLR_L/0.4\pi N \ll V$ , the voltage across the load is negligible and the voltage across the coil is approximately  $V$ . As  $\phi$  increases along path 1-2-3-4-5 the core saturates and  $H$  increases abruptly causing the magnetizing current to increase abruptly resulting in a rapid increase of voltage across the load and a decrease of voltage across the coil. This decrease of voltage across the coil causes  $d\phi/dt < 0$ . This continues until equilibrium when voltage across the coil is zero and current is de-

termined by load resistance. Coil resistance was neglected as it is generally small compared to load resistance. However, a small  $IR_c$  drop exists across this coil. When the input voltage reverses, the process is repeated in the reverse direction. Figure 5 presents graphically the current and voltage over several cycles. Rise and fall times can be computed; however, the non-linear behavior of the magnetic material at the instant of saturation as well as the second order effects make accurate computation complicated. For this application, the time is on the order of a few milliseconds for good square-loop material and resistive load. As the supply frequency is increased the core material must be chosen for squareness and core loss, as the rise time occupies proportionately more of the period, and the magnetizing current increases with increasing frequency.

The most important application of the waveform suggested is in the 60-cycle and the 400-cycle ranges. Information on core material is presented in the table. Two types of cores considered are toroidal tape wound cores and cut silicon steel cores. Toroidal cores are used at both frequencies, and the cut cores are used only at the low frequencies (60 cycles or less). Silicon steel is the poorest of the three types; however, for high power at 60 cycles the size of the cores results in a prohibitive cost for more expensive materials. Silicon steel should be considered for power outputs greater than 100-150 watts at 60 cycles. The material best suited is the 15,500 gauss flux density material given in the table. The 8,700 gauss material is used where it is desirable to have a large number of turns and low magnetizing current. The magnetizing current

should be less than 5 percent of peak load current for good performance; this material is applicable for low power loads in the 400-cycle range.

The method of design is outlined below. Generally initial design should be made with the 15,500 gauss material. Wire size can be chosen using approximately 1,000 circular mils wire area per ampere of peak current. In determining core size, consider the winding area needed to accommodate the wire, window area  $A_w$ , and the cross section iron area,  $A_{FE}$ , of the core. The relationship between  $A_w$  and  $A_{FE}$  is inverse, a large  $A_{FE}$  results in less turns, hence a small  $A_w$ . The product  $A_w \times A_{FE}$  may be determined using

$$A_{FE} A_w = \frac{V I_L \times 10^{10} \phi}{72 K f B_{max}} \text{ circular mils}$$

where  $V$  = peak voltage into reactor;  $I_L$  = peak current to load;  $K$  = (total copper area)/(total window area), for which assume 0.5;  $f$  = frequency of operation; and  $B_{max}$  = max flux density. With this value of  $A_{FE} A_w$ , the first core choice is made from a core manufacturer's catalog. The exact number of turns is determined by noting the cross section area  $A_{FE}$  and using  $N = V \phi 10^8 / 720 f B_{max} A_{FE}$ .

The design is checked to determine that the magnetizing current is less than 5 percent of  $I_L$  using  $I_M = HL/0.4\pi N$ . The value of  $H$  is dependent on frequency and core material. Manufacturers' catalogs list this information.

Here is a typical design example: frequency, 400 cps; power output, 100 watts; voltage output, 100 volts rms; crest factor,  $\sqrt{2}$ ; core material choice, 15,500 gauss material; peak load current, 1.4 ampere; wire size, 1,400 circular mils or #19;  $A_{FE} \times A_w = (141)(141)(10^{10})(90)/72(0.5)(400)(15,500) = 802,000$  circular mils; core choice is Magnetics Incorporated type 51035-2A;  $N = (141)(10^8)(90)/(720)(400)(15,500)(0.685) = 414$  turns;  $I_M = HL/0.4\pi N$ ;  $H = 0.3$  approx for 400 cycles;  $L = 11.85$  cm;  $I_M = (0.3)(11.85)/(0.4)(370)(3.14) = 7.6$  milliamperes. This value of magnetizing current is well within 5 percent of the load current. The author acknowledges the assistance of Joseph Palumbo in preparing the breadboard.

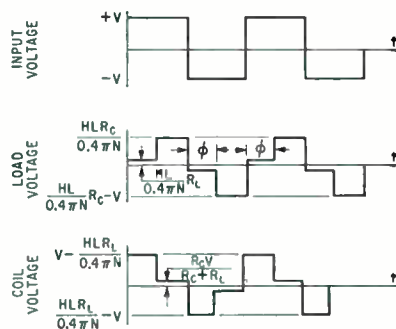

FIG. 5—Input, load and coil voltage waveforms

# Four-Layer Diode Triggers High-Voltage Pulse Generator

*Simple generator uses four-layer diode to discharge a capacitor.*

*Lockout circuit prevents diode from remaining in the conducting state, allows 1-Kv output of 10,000 pulses per second*

By N. C. HEKIMAIN and P. M. SCHMITZ, Department of Defense, Washington, D. C.

HIGH VOLTAGE PULSES of short duration are required in several processes. An application in electrographic recording required pulses at about one kilovolt amplitude and about 10 microseconds long, at a repetition rate of 10,000 per second or less, for which a simple, solid-state pulse generator with minimum peak-to-average power and negligible standby power was developed.

Since a large number of the circuits are to be pulsed at the same time, direct operation of pulse power amplifiers would put an excessive peak-to-average requirement on the power supply and distribution system. To average the power, a small capacitive energy reservoir is included in each pulser. Magnetic field storage in an inductor was considered but a voltage source was more attractive. Further, energy retention in capacitors is generally much more efficient than in inductors.

Because of the multiplicity of circuits, an inexpensive yet highly reliable design was required. This dictated the use of germanium transistors or silicon four-layer diodes, since other silicon trigger devices are relatively expensive and relatively unproved at this time.

The resulting circuit is simple, has high efficiency, minimal peak-

to-average power requirements, negligible standby power consumption and is easily triggered. The circuit is fail-safe since it prohibits current flow from the power supply during the pulse; thus it cannot stay in the conduction state. This is essential in high duty cycle operations since otherwise the charging current may maintain the trigger device on. With protection against this condition the charging current need not be restricted to less than the maintaining current of the trigger device, and repetition rates can be maximized for a given peak supply drain.

Upon uncontrolled loss of dynamic load impedance there is no danger of saturation of the pulse transformer and consequent sudden increase in power dissipation in the trigger. If load is lost completely, the reservoir drains rapidly and the trigger is quenched automatically, with total energy limited to  $\frac{1}{2} CE^2$ , that stored in the reservoir capacitor.

The basic circuit is shown at (A) in the figure. Capacitor  $C_1$  charges to the limit of the supply. This upper limit is set below the breakdown voltage of the four-layer diode and hence the diode does not conduct significant current. When a negative trigger is applied through  $C_2$ , the total voltage across the four-

layer diode exceeds breakdown and the diode switches rapidly to its high conduction state. It remains there until  $C_1$  cannot supply the maintaining current of the four-layer diode, at which time the diode turns off.

For a given repetition rate, the current to charge  $C_1$  can be kept to a minimum for a given energy storage. Letting  $E$  be the permissible supply voltage,  $W$  the required energy watt-seconds (with allowance for circuit and transformer losses), and  $t$  the minimum time between firings, the required average charging current is  $I=2W/Et$  amperes.

The control circuit must meet two requirements: the supply voltage must be disconnected during the pulsing period;  $C_1$  must be recharged between two consecutive trigger pulses. A constant current recharge requires less peak current than an exponential recharge but needs more complex circuits. Therefore a simple R-C charge with transistor switch was used.

The circuit, shown in (B), is simple but satisfies the requirements. Transistor  $Q_1$  is the supply inhibit which is normally forward biased through  $R_2$ . During the pulsed portion of the cycle the current  $I$ , flowing through diode  $D_2$ , reverse biases  $Q_1$ , by an amount equal to the voltage drop across  $D_2$ . Therefore

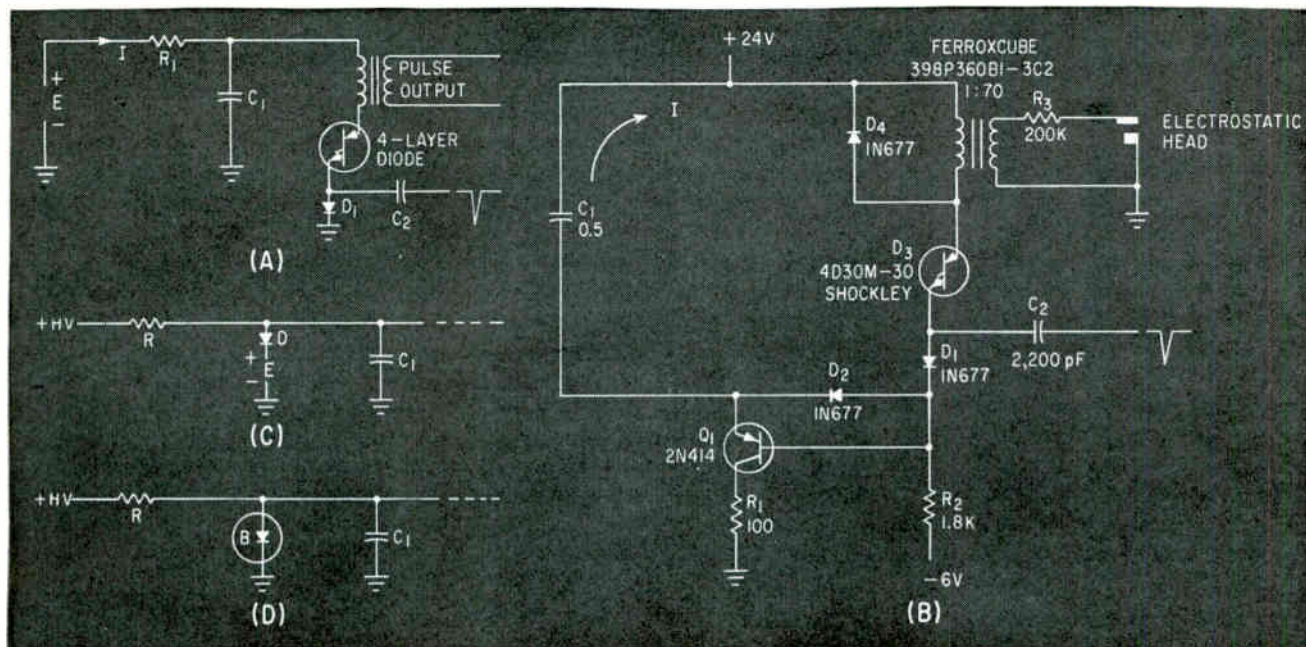

Basic circuit uses four-layer diode to discharge capacitor through pulse transformer primary (A). Complete circuit (B) uses transistor to keep diode from remaining in the conducting state. Possible variations of charging method at (C) and (D)

$C_1$  cannot begin to recharge until the pulse ceases, at which time the four-layer diode  $D_1$  returns to its high impedance state. Resistor  $R_1$  limits peak recharging current and is—within the limitations of the transformer—the element controlling the maximum repetition rate. At the same time  $R_2$  must supply enough base current to  $Q_1$  to saturate it during the recharge period.

Under quiescent conditions the maximum current which can flow through the four-layer diode is  $-V/R_2$ . This current is to be below the diode hold current even under the worst temperature and tolerance conditions.

Transistor  $Q_1$  can be any of several medium-speed switching *pnp* units. The initial current surge is 240 ma but succeeding pulses are about 100 ma. Likewise, the major limitation on the diodes is the magnitude of the current surges. The peak surge through  $D_1$ ,  $D_2$  and  $D_3$  is about 2.5 amp, which is within the rating of the Shockley diode 4D30M-30 and the one-cycle surge rating of the 1N677. At maximum repetition rate the duty cycle is only 2 percent, so average diode dissipation is well within limits. The transformer has 15 turns on the primary and a turns ratio of 1:70. The 24 volt supply is dictated by the  $30 \pm 4$  volt tolerance on the

four-layer diode.

To a trigger pulse the four-layer diode looks like a capacitor that must be charged to the breakdown point. The energy to do this must come from the trigger source. At the same time this capacitance tends to bypass the reverse biased *n-p* junction such that with a fast rise time trigger the breakdown voltage is reduced. Therefore, trigger power requirements can be exchanged for faster rise times on the trigger pulses. The pulse used to trigger the test circuits had a rise time of 0.3  $\mu\text{sec}$  and came from a 330-ohm, 10-volt source.

When the duty cycle is small it is possible to dispense with the supply inhibit and use a simple resistor. This is contingent on having the short-circuit charging current less than maintaining current for the four-layer switch, possible only for low duty-cycles.

Another possible modification is shown at (C). Here a clamped charging circuit achieves a rapid charge without exceeding the firing voltage. This is not as efficient as the basic system since the charging is from a high voltage and in addition has a stand-by drain. A Zener diode as in (D) for the low voltage clamp eliminates the need for a low voltage supply. Several circuits can share a common Zener diode by

using disconnect diodes as in (C). Capacitor size is determined by the load. The minimum time  $t$  between pulses is  $t = -RC \ln(1 - E/HV)$ , where  $E$ , supplied by battery or Zener diode, is just below the breakdown voltage of the four-layer diode, and  $HV$  is the high voltage toward which  $C_1$  charges before being clamped at  $E$ . Resistance  $R$  must be greater than  $HV/I_{h.o.i.d}$ , where  $I_{h.o.i.d}$  is the value of current below which the four-layer diode reverts to its high impedance state.

The circuit at (B) allows maximum repetition rate with minimum charging current and complete protection against maintaining a closed trigger. A rate in excess of 10,000 pps was achieved with a peak supply drain of 100 ma at 24 v. The peak pulse on the secondary, loaded with an air gap and a 200,000-ohm resistor, was 1,300 volts, with a width of 7  $\mu\text{sec}$ .

The circuit was developed for electrographic recording. Here ions are deposited on recording paper adjacent to the air-gap head at the time of the voltage breakdown. The process is completed by developing the latent electrostatic image with a dry "ink" that adheres to the charged areas. The circuit may also be used in a high-voltage, low-current power supply. One specific application is in a Geiger counter.

# Testing Microwave Transmission Lines

Pulse-reflection technique uses sampling oscilloscope to make direct readings of

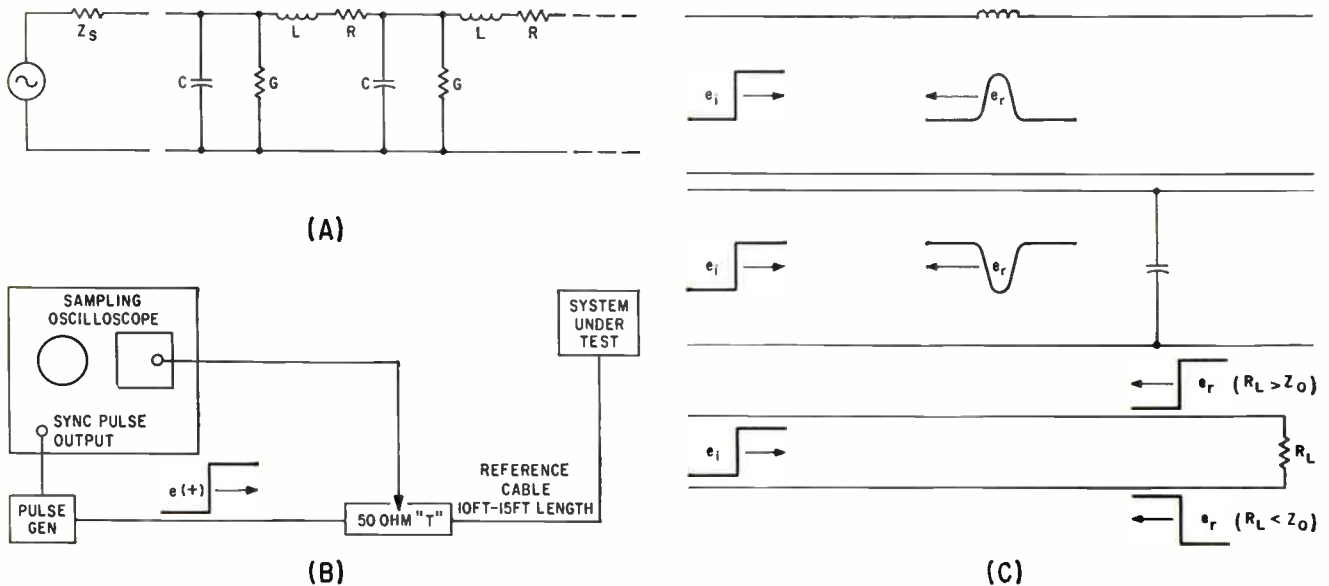

FIG. 1—Transmission line (A) and setup using HP-185 scope and 213A pulse generator to test transmission systems (B). Reflections from inductive, capacitive and resistive discontinuities (C)

By HARLEY HALVERSON,  
Hewlett-Packard Co.,  
Palo Alto, Calif.

SAMPLING OSCILLOSCOPES with rise times in fractions of nanoseconds, extremely wide dynamic range and horizontal sweep speeds approaching the velocity of propagation make possible a pulse-reflection technique to read characteristic impedance of transmission lines directly.

Impedance of lines as short as 1 ft may be measured to a few tenths of an ohm without connector discontinuities. Uniformity of characteristic impedance along the length of the line may be studied. The position and type of reactive discontinuities, relative attenuation between cables and velocity of propagation may also be determined.

From the low-frequency equivalent circuit of a transmission line, Fig. 1A, several characteristics can be determined.

If the line is infinitely long and  $L$ ,  $R$ ,  $G$  and  $C$  are defined per unit length, then

$$Z_{in} = \sqrt{\frac{R + j\omega L}{G + j\omega C}} = Z_0$$

where  $Z_0$  is the characteristic impedance of the line.

A voltage introduced at the generator will require a finite time to travel a unit distance. Phase of the voltage moving down the line will lag the voltage introduced at the generator by an amount  $\beta$  per unit length. Furthermore, the voltage will be attenuated by an amount  $\alpha$  per unit length by the series resistance and shunt conductance of the line. The phase shift and attenuation are defined by the propagation constant  $\gamma$  where  $\gamma = \alpha + j\beta = \sqrt{(R + j\omega L)(G + j\omega C)}$ ;  $\alpha$  is attenuation in nepers per unit length, and  $\beta$  is phase shift in radians per unit length. Velocity at which the voltage travels down the line is  $v_p = \omega/\beta$  unit lengths per second. Velocity of propagation approaches the speed of light,  $v_c$ , for transmission lines with air as dielectric. For the general case  $v_p = v_c/\sqrt{k}$  where  $k$  is the dielectric constant.

Propagation constant  $\gamma$  can define the voltage and the current at any

distance  $x$  down the line by

$$E_x = E_{in} e^{-\gamma x} \text{ and } I_x = I_{in} e^{-\gamma x}$$

Since the voltage at any point is related to the current by the characteristic impedance of the line  $Z_0 = E_{in} e^{-\gamma x}/I_{in} e^{-\gamma x}$ . When the transmission line is finite in length and is terminated in a load whose impedance matches the characteristic impedance of the line, the voltage and current relationships are satisfied by these equations.

If the load is different from  $Z_0$ , these equations are not satisfied unless a second wave is considered to originate at the load and to propagate down the line toward the source. This reflected wave represents energy that is not delivered to the load. Therefore, the quality of the transmission system is indicated by the ratio of this reflected wave to the incident wave originating at the source. This ratio is the voltage reflection coefficient,  $\rho_v$ , and is related to the transmission line impedance by

$$\rho_v = (Z_L - Z_0)/(Z_L + Z_0)$$

If the voltage along a line terminated in a load other than  $Z_0$  is



# Using the Sampling Oscilloscope

characteristic impedance. Discontinuities in impedance along line can be identified

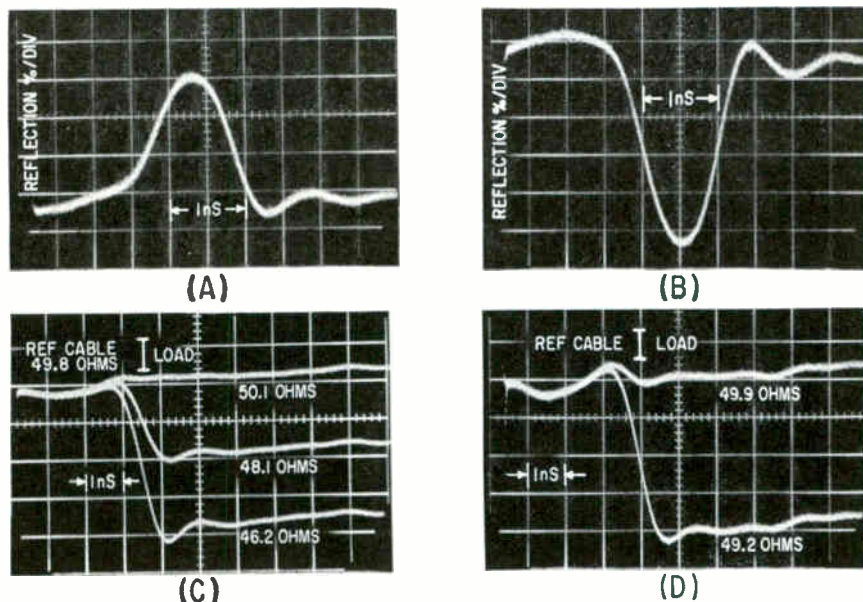

FIG. 2—Actual inductive (A), capacitive (B) and resistive (C) reflections. In maximum sensitivity test (D) sync output pulse of scope is used as source

examined, it is found to vary periodically between a maximum and minimum. This variation, called a standing wave, is caused by the phase relationship between the incident and reflected waves. Ratio between the maximum and minimum values of this voltage (called the voltage standing wave ratio  $\sigma$ ) is related to the reflection coefficient by

$$\sigma = \frac{E_{\max}}{E_{\min}} = \frac{1 + |\rho_v|}{1 - |\rho_v|}$$

Either of the coefficients can be measured with test equipment. But the value of these measurements to the design engineer is limited.

The measure of quality is good only for the one frequency at which the reflection coefficient is measured. Measurements must be taken at many frequencies, probably with several techniques, before it is known what system components are causing problems.

The high-frequency, high-sensitivity sampling oscilloscope has made available a simpler and more meaningful technique for testing transmission line systems (Fig. 1B).

A fast rise-time voltage step is launched down the transmission system. When the step encounters

a discontinuity, some of the voltage is reflected back. This reflection is measured with the oscilloscope. Since propagation along the system requires finite time, discontinuities separated in space produce reflections separated in time. Thus, each discontinuity in the system can be identified separately on the oscilloscope. The exact location of the discontinuity, and whether it is resistive, capacitive or inductive can be determined. This information is available at a glance and is independent of frequency, within the resolving power of the oscilloscope and the pulse.

Figure 1C shows the types of reflection from different discontinuities. The incident voltage step contains frequencies up to approximately  $0.35/t$ , Gc, where  $t$ , is the rise time in nanoseconds. Determining the exact magnitude of these frequencies would require analysis of the voltage step. The amount of each of these frequencies that is reflected from a specific reactive discontinuity would also take analysis. Thus it is not easy to relate the magnitude of the reflection from a reactive discontinuity to the value of the discontinuity. Much meaningful data can be obtained, however, by comparing the reflection from the discontinuity under test to that from a known discontinuity. Actual reflections from inductive and capacitive discontinuities are shown in Fig. 2A and B.

When the discontinuity is resistive and independent of frequency,

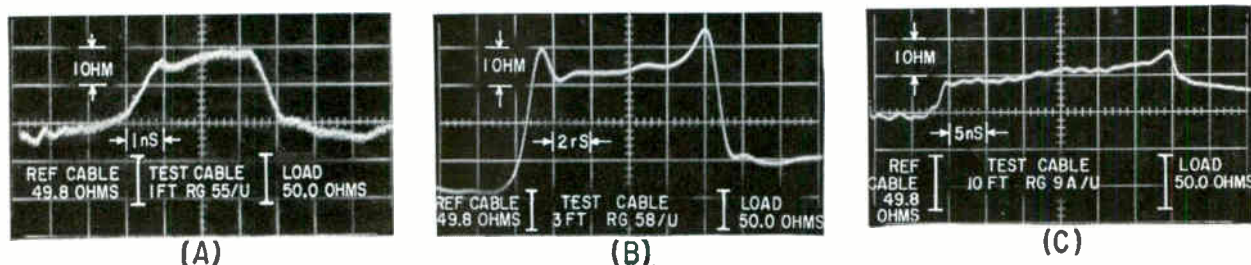

FIG. 3—Trace (A), for 1-ft cable, used 213A pulse generator as voltage source. Three-foot (B) and ten-foot (C) cable tests using sync output of scope as voltage source

an exact measurement can be made. Figure 2C shows the reflections from several type N loads whose resistances have been measured at d-c. Using these loads, the oscilloscope vertical sensitivity has been calibrated to equal 1 ohm per division. This measurement was used to calibrate the characteristic impedance of the reference cable at 49.8 ohms.

Figure 2D compares two loads with the oscilloscope at maximum sensitivity. Calibration is about 0.2 ohm per division. Vertical calibration will be linear as long as  $Z_L \cong Z_o$ . When this assumption is no longer valid, the exact expression  $\rho_r = (Z_L - Z_o)/(Z_L + Z_o)$  is used. This may be solved for  $Z_L$  to give  $Z_L = Z_o (1 + \rho_r)/(1 - \rho_r)$ . Figure 3 shows some examples of this technique when used to check the characteristic impedance and uniformity of both short and long coaxial cables. Figure 3B shows that large reactive discontinuities at the connectors of the cable do not affect accuracy of the measurement.

This technique is not limited to 50-ohm lines. The characteristic impedance of any line may be measured. Either the reference cable or the load may be used as a calibrating reference.

The gradual upward slope of the impedance shown in Fig. 3C is caused by losses in the cable. This slope may be understood by looking at the input impedance of a transmission line from the generator.

If the conductance  $G$  may be neglected

$$Z_{in} = \sqrt{\frac{L}{C} + \frac{R}{j\omega C}}$$

This may be reduced to

$$Z_{in} \cong \sqrt{\frac{L}{C} \left(1 - j \frac{R}{2\omega L}\right)} + \text{higher order terms}$$

This last expression may be treated as a lumped impedance attached to the source as shown in Fig. 4A.

Assuming  $Z_s = R'$ , the voltage input of the transmission line will step to one-half the source voltage, and then rise exponentially as shown in Fig. 4B. The initial slope  $m_i$  is

$$m_i = \frac{\epsilon_o \max}{4 R' C'} = \frac{\epsilon_o \max R}{8L} \text{ volts/sec}$$

Since the sampling oscilloscope

always sees the sum of the incident and reflected voltages, the apparent upward slope of the reflected voltage is caused by the rising incident voltage at the input of the transmission system.

The series resistance  $R$  is a function of the skin depth of the conductor and is not constant with frequency. It is difficult to relate the slope of the exponential with a value of  $R$ . However, magnitude of slope is useful in comparing cables of different loss.

Ability to differentiate between two closely spaced discontinuities is a function of the rise time of the oscilloscope and of the voltage step. Using an oscilloscope with a rise time of about 0.5 nanosecond, and a voltage step of about 0.2 nanosecond rise time, the reflection from a reactive discontinuity has a pulse width at the  $\frac{1}{2}$  voltage points of about 1 nanosecond (see Fig. 2A and B). Assuming a velocity of propagation in the line equal to the speed of light, the voltage step will

travel 30 cm in 1 nanosecond. Time between the reflections caused by two discontinuities is equal to the time required for the step to propagate down the line and back again. Thus, two discontinuities spaced 15 cm apart will be separated by 1 nanosecond on the oscilloscope. The reflections are still well defined. In cables with a velocity factor of 0.66, the 1 nanosecond spacing represents 10 cm.

The dynamic range of the oscilloscope probe sees at all times the sum of the incident and reflected voltages. These two voltages may have a ratio as great as 1,000 to 1. Thus, if the incident voltage step is 2 v, the reflection might be 2 mv. The oscilloscope must be able to look at the 2 mv reflection without saturating because of the 2-v incident step. The oscilloscope sweep speed must be great enough to properly resolve closely spaced discontinuities.

A synchronized dual-trace presentation oscilloscope also makes possible the direct comparison of two transmission systems. The electrical lengths of two long cables may be matched to within a few millimeters. This is done by setting up both probes as shown in Fig. 1B and driving them both from the same step output, with sufficient padding to keep the reflections from interacting. Figure 5 shows two cables whose delay differs by 0.1 nanosecond, or about 1 cm difference in electrical length.

The sampling oscilloscope technique in pulse-reflection testing is not limited to transmission lines. It has been used to measure the resistive impedance of a crystal mixer driven with a local oscillator voltage. The technique is also used on the production line to help reduce reflections in a step attenuator which consists of pressure-actuated switches, connecting wires and resistors as part of a 50-ohm system.

The author thanks L. Peregrino for assistance given in interpreting the results of this measuring technique.

## REFERENCE

- (1) Karakash, "Transmission Line and Filter Networks", MacMillan Company, New York, N. Y., p 29.

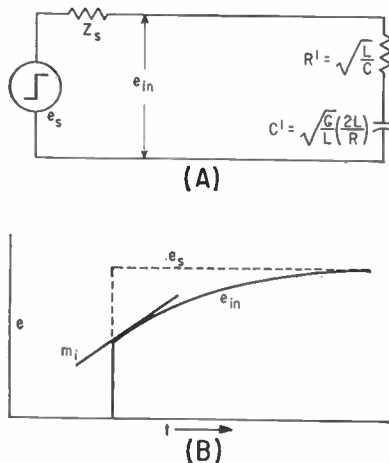

FIG. 4—Circuit (A) and graph (B) indicate how cable losses effect impedance slope

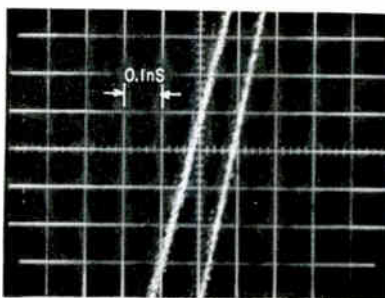

FIG. 5—Synchronized dual trace is used to compare cable lengths

# Outside-Coil Magnetic Head Improves High-Frequency Recording

*Configuration permits smaller air gap,  
higher magnetic tape packing densities*

By MARVIN CAMRAS,  
ROBERT SEARS,  
Armour Research Foundation,  
Chicago, Ill.

MAGNETIC-HEAD REQUIREMENTS have become stricter as a result of the trend toward better frequency response, higher packing densities and lower tape speeds. Gaps of 0.0005 inch were considered small a few years ago, but today's high-resolution heads have gaps five to ten times narrower.

Two adverse effects become noticeable with such small gaps: the shunting effect of gap-facing area reduces sensitivity during playback, and saturation of the head core may occur during recording before adequate biasing and recording levels are reached. Figure 1A shows a conventional tape head. The major portion of flux *A*, *B*, *C* from the coil is shunted across the gap, while only *D* threads the tape. To keep the gap facing area at working levels for gaps below 0.0001 in., depth *K* must be reduced to about 0.002 in., calling for accurate machining, and making the head sensitive to wear.

These difficulties are avoided in an outside-coil head, shown in Fig. 1B. This head uses the flux near the gap which is ordinarily lost, and suppresses most of the flux which ordinarily circulates through the pole pieces. The pole pieces defining the gap are formed independently of the windings, and tape is run over these pole pieces in contact with the gap. On the side of the tape opposite the gap is the recording and pickup coil.

A simple coil gives effective pickup, but better efficiency is

achieved if a ferrite core is used in the pick-up coil.

At low and medium frequencies, the flux is carried along paths *A*, *B*, and *C*. At frequencies in the megacycle range, eddy currents oppose flux penetration into the pole pieces, so that paths *B* and *C* become less important and path *A* assumes the major role. Decreasing distance *d* is beneficial, until dimensions of the order of the tape thickness are approached. Thinner tape backings and coatings are also helpful.

Best operating conditions occur when the magnetic circuit of the pole pieces is not completed at the rear of the head and when they are mounted in a copper block which acts as a short-circuited winding. These factors reduce pole-piece flux except near the gap and allow the outside coil to pick up that flux which ordinarily would be lost due to hysteresis and eddy currents.

Figure 1B illustrates the depth of the pole pieces and gap, an indication of their stability during tape wear. As the head wears, a new surface is exposed to carry high-frequency flux which is forced to the surface by the skin effect. Thus the head will continue to operate efficiently even when conventional shallow-gap heads must be replaced.

This head achieves better biasing throughout the tape layer because the coil is on the side of the tape opposite the pole pieces. This means that the bias required for low frequencies is more nearly the same as for high frequencies.<sup>1</sup> Also, better high-frequency response is obtained, since eddy currents in the pole pieces near the gap aid the

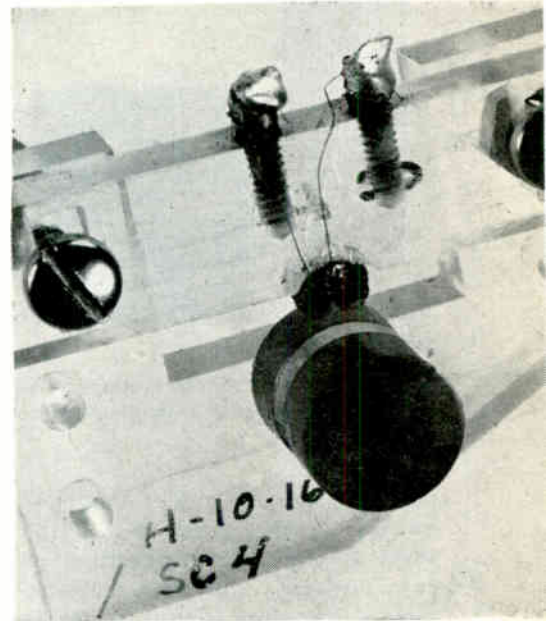

Photo shows one of the experimental outside-coil heads. Its performance figures are given in Fig. 3

high-frequency component of recording flux.

The effect of eddy currents or skin effects on this construction was analyzed. Experimental measurements confirm the analysis. The effect of gap length on theoretical response is critical, and there is no way to determine effective or magnetic gap as opposed to a well-defined mechanical gap, except by measuring the response. The data is somewhat ambiguous since a clear-cut magnetic null was observed on only one head. However, input and output response data for several heads are included.

The resistance analog of Fig. 2A describes the reluctances of gap, core, pole pieces, and tape of Fig. 1B by equivalent resistances,  $R_g$ ,  $R_c$ ,  $R_p$ , and  $R_t$ , respectively.

According to Bozorth<sup>2</sup> there is an effective skin depth,  $d_e$ , for an infinite thin sheet of thickness  $\delta$ , permeability  $\mu$ , resistivity  $\rho$ , and having an alternating magnetic field applied to its length, which is

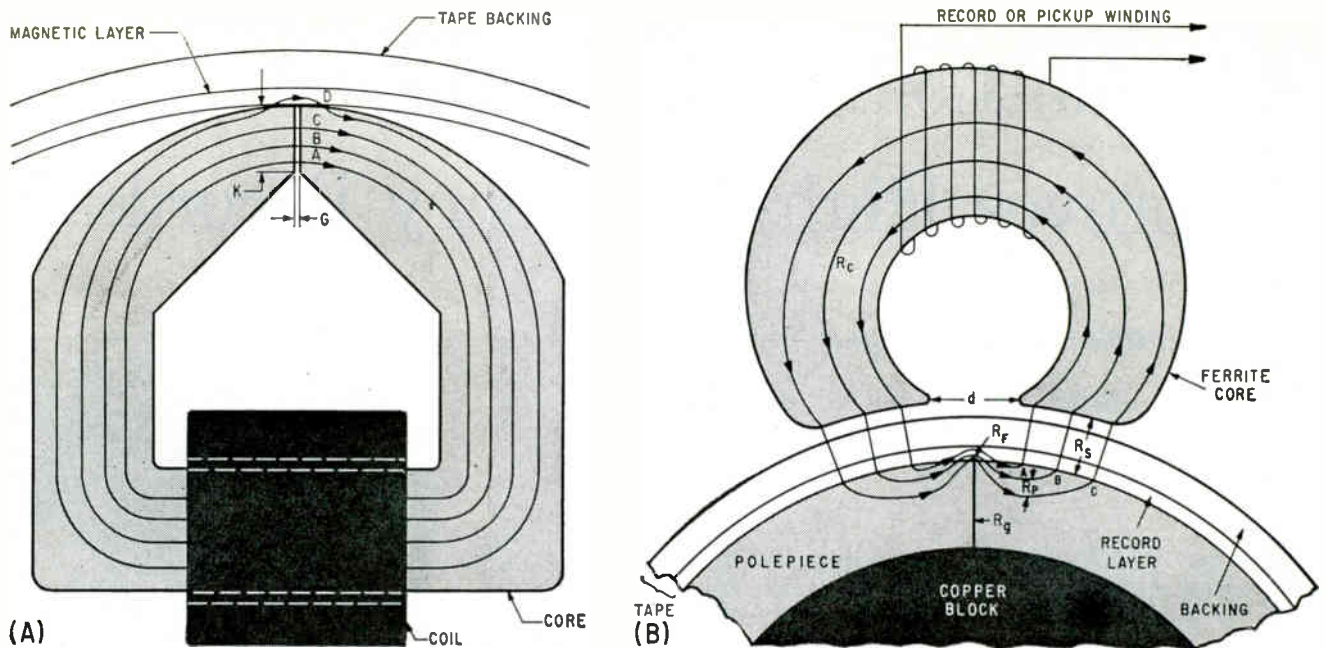

FIG. 1—Tape-head relationships in a conventional head are illustrated in (A); (B) shows the outside-coil head and resulting flux paths through ferrite core, pole pieces and tape

perpendicular to  $\delta$ . The depth of constant magnetization is  $d_o$  if the sheet is uniformly magnetized at two surfaces. The reluctance of such a thin sheet circuit would be  $R = L/\mu A$  where  $L$  = length of path, and  $A = d_o w$  is the area of the path,  $w$  being the width of the pole piece. The skin depth is a function of frequency  $d_o = d_o(f)$  and is  $d_o = 0.7/\theta$ , where  $\theta = 2\pi(f/\rho)^{1/2}$ . Let  $\mu = 10^4$ ,  $\rho = 40 \times 10^9$  (emu),  $L = 0.64$  cm,  $w = 0.32$  cm. The pole piece reluctance is then  $R_p = 8.9 \times 10^{-4} f^1$  cm<sup>-1</sup>. Choice of  $f$  is restricted by  $\theta$ , an approximation, which must be greater than 1. Thus  $f$  must be greater than  $10^4$ . The reluctance of the gap, if the depth is defined by the pole piece skin depth, is  $R_g = 1.8 \times 10^{-3} f^1$  cm<sup>-1</sup> for a gap of 50 microinches. Assuming a 2-mil spacing of pole piece to ferrite core, the reluctance of both spaces is  $R_s = 0.102$  cm<sup>-1</sup>. Calculations showed that the ferrite core reluctance  $R_c$  was low,  $R_c = 6.3 \times 10^{-8}$  cm<sup>-1</sup>.

Setting  $R_o = R_s + R_c + R_p$ , the proportion of useful flux through the pickup coil is found from  $\phi_o/\phi_T = R_T/R_o = R_o/(R_o + R_o)$  where  $R_T$  is effective reluctance of the circuit from the terminals in Fig. 2A,  $\phi_o$  is the flux through path  $R_o$ ,  $\phi_T$  is the total flux through all paths  $R_T$ . This is evaluated for different values of  $f$ :

$f$	$10^4$	$10^5$	$10^6$	$10^7$
$\phi_o/\phi_T$	0.48	0.60	0.65	0.66

Evaluating  $\phi_o/\phi_T$  at  $f = 0$ ,  $\phi_o/\phi_T = 0.21$ . From a graph of this function, a gradual rise in efficiency in playback operation from about 20 percent at low frequencies, 48 percent at  $10^4$  cps, and approaching 68 percent above 10 Mc might be expected.

A similar analysis can be made for recording with the head. A resistance analog, Fig. 2B, is set up. Again,  $R_c = 0.102$  cm<sup>-1</sup>,  $R_p = 8.9 \times 10^{-4} f^1$ ,  $R_g = 1.8 \times 10^{-3} f^1$ ,  $R_c$  is negligible, and a semicylindrical fringing path  $R_f = 12.18$  is considered to exist over the gap, after Roters.<sup>3</sup> The total flux through the circuit is determined by  $R_T = R_s + R_p + R_g R_f/(R_g + R_f)$ . The fraction of  $\phi_T$  passing through the fringing path is the flux,  $\phi_F$ , avail-

able for recording.  $\phi_F/\phi_T = R_o/(R_o + R_f)$ . Calculated values for  $f = 0$  and for  $f \geq 10^4$  cps are as follows, where  $\phi_F/\phi_T$  is fraction of total flux available for recording, and  $\phi_F/(NI)$  is the flux available for recording per ampere turn recording current

$f$	0	$10^4$	$10^5$	$10^6$	$10^7$
$\phi_F/\phi_T$	0.026	0.015	0.045	0.13	0.32
$1/R_T$	7.64	2.71	1.38	0.39	0.156
$\phi_F/NI$	0.2	0.04	0.06	0.05	0.06

$\phi_F$  is found by substituting  $\phi_T = 4\pi NI/R_T$  into  $\phi_F R_o/(R_o + R_f)$ , giving  $\phi_F = 4\pi NI R_o/(R_o + R_f)$ . Factor  $\phi_F/\phi_T$  increases with  $f$  from  $f = 0$  to  $f = 10^7$  cps. However, since the total reluctance decreases,  $\phi_F$  becomes less as frequency increases. The value of  $(\phi_F/NI)$  at  $f = 0$  must be considered more accurate than the values calculated for high frequencies, since large recording currents may cause the pole pieces to approach saturation, causing permeability to drop, and making the values given for high frequency erroneous. It is expected from this analysis that the overall efficiency will drop somewhat when going to higher frequencies, thus requiring higher recording currents.

At the outset the aim was to evaluate the high frequency characteristics of the head. Subsequent development of the analysis showed the characteristics to be

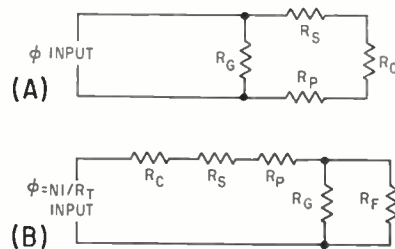

FIG. 2—Resistance circuits are electrical analogs of the playback magnetic circuit (A) and of the recording magnetic circuit (B)

sensitive to changes in several head parameters, namely gap width and magnetic condition of the pole piece material. According to analytic work, the skin depth at frequencies near 1 Mc is comparable to the surface roughness of the pole piece, making the skin effect calculations difficult to interpret.

A null in the frequency response curve, due to the magnetic gap was observed with only one head which had a 20-microinch physically defined gap, and no definite null was obtained with a head in which a 100-microinch spacer was placed. Figure 3A shows constant current output vs frequency curves for recording and replaying at 240-ips tape speed with three different sets of pole pieces, designated, SC2, SC3, and SC4. Head SC3 was an attempt to duplicate SC2. Head SC4 was constructed by gluing the pole pieces to the copper slug to see if absence of contact with the copper diminished the skin effect. Assuming from mechanical equivalence that the magnetic gaps in SC2, SC3, and SC4 are equal, then degradation of the SC4 head response relative to that of SC2, is due to the absence of contact to the copper backing. Considering Fig. 3B, which is the playback response of SC3 and SC4 relative to SC2, SC3 appears almost flat, and the SC4 curve drops off at higher frequencies. It can also be concluded that the recording efficiency of SC4 at 100 Kc equals that of SC2 and drops faster at higher frequencies than SC2. This again may be due to the insulation of the pole pieces from the copper backing, although as frequency increases, the effect of this contact is reduced. The 6 db

higher output at 100 Kc to 200 Kc is probably due to a larger effective gap, which would also contribute to the observed high-frequency degradation.

A better evaluation of head performance in light of theoretical predictions is made by changing the frequency and recording speed, allowing the recorded density to remain constant. This will show frequency-dependent effects most strongly, especially since the theory involves only  $f^2$  dependence. Again we compare SC2 and SC4 at 0.5 inches per second using a tape recorded by SC2, see Fig. 3C. A 60- $\mu$  inch roughness response degradation curve is included to illustrate the magnitude of roughness, that is effective tape-to-head spacing loss at these short wavelengths, which can be computed from loss equations found in Westmijze'. These curves match within experimental error ( $\pm 2$  db) at 1 Kc per inch just as at 240 inches per second. Note the jog in the SC2 response curve at about 12 Kc per inch indicating the expected magnetic-gap null effect.

Quantitative agreement exists between experimental data and the analytical results concerning the low frequency playback efficiency. At a recording speed of 7.5 ips and frequencies below 7.5 Kc a Brush BK 1250 was used to saturate the tape. Replaying, a Brush BK 1251 was compared to the SC2-OC 17 head. The low-frequency efficiency of the outside coil and Brush heads were corrected for the number of turns on each head, the matching transformer used with the outside coil, and the expected 6 db per octave rise in output. Output from

the outside coil was found to be an average of 3 db lower than that predicted, assuming the Brush head to be 100 percent efficient under these conditions. The response of an outside coil head could not be compared with the response of a ring type head at megacycle frequencies since all available ring heads had prohibitive coil resonances and losses in this region. All recordings were made with the outside coil head without bias.

The analysis shows the favorable high frequency characteristics of the outside coil head, particularly the slow change in output with increased frequency.

At 240 inches per second, frequencies up to 4 Mc have been recorded and replayed, and greater signal densities have been obtained at low speeds with very good reproducibility. Output degradation was caused throughout the experimental program more by tape roughness characteristics and mechanical system variations than by head vagaries.

The outside coil head is at its best in the megacycle region, retaining its efficiency as frequency is increased. High resolution is assured by the small gaps, and by the advantageous field configuration. The wear problems due to high tape velocities are minimized.

The authors are indebted to C. Christensen who constructed the heads.

#### REFERENCES

- (1) M. Camras, New Magnetic Recording Head, *Jour SMPTE*, V, 58, p 61, Jan 1952.
- (2) Bozorth, "Ferromagnetism", p 770, Van Nostrand, 1951.
- (3) Roters, "Electromagnetic Devices", Wiley, 1941.
- (4) Westmijze, Studies on Magnetic Recording, *Phil. Res. Repts*, 8, 1953.

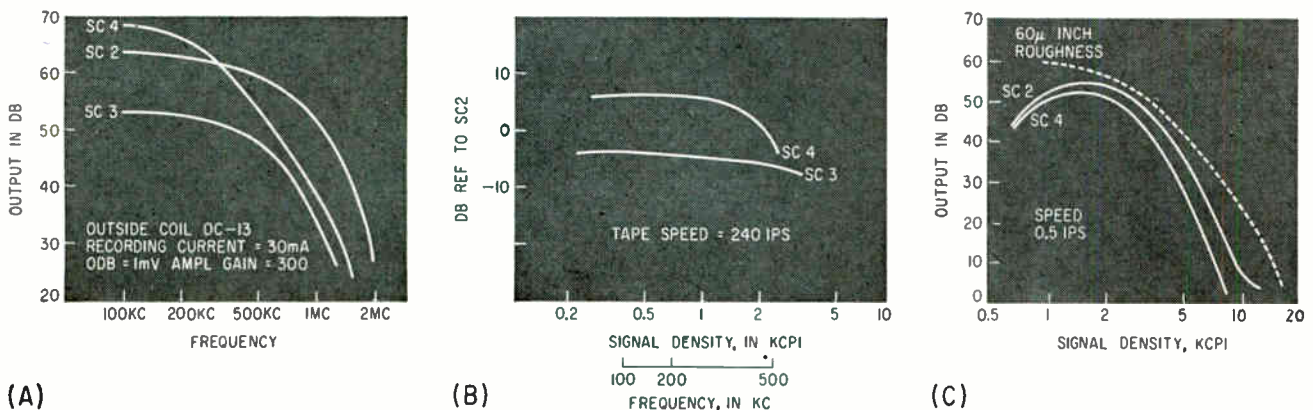

FIG. 3—Curves show response of outside-coil magnetic heads: frequency response of gap assemblies, (A); playback response of heads SC3 and SC4 compared to SC2, (B); and playback efficiency for heads SC4 and SC2

# Equations and Procedure for Designing Transistor or Zener Shunt Regulators

By MELVIN BEEBE,  
Senior Engineer,  
Industrial Products Div., ITT,  
San Fernando, California

ZENER DIODE reference or shunt transistor type voltage regulators require the designer to determine optimum input voltage and series current limiting resistor for minimum circuit power dissipation. In most practical cases, primary input voltage range, required output voltage (for some cases output voltage range) and minimum current to the load and regulating device are known.

In a Zener diode d-c reference regulator, output voltage is essentially constant and determined by other design criteria. Minimum load current and Zener reference current is a function of the external load and the Zener diode. Input voltage is often supplied by a transformer-rectifier combination, and it is possible to select any nominal value for the transformer output voltage. Since the primary source voltage may vary, it is the designer's problem to select the optimum regulator input voltage to minimize the total circuit power dissipation at maximum primary source voltage.

In a shunt regulator it may be desirable either to maintain a constant output load voltage or vary the output voltage. Minimum output current, input voltage variation, and output voltage variation and values are known.

These conditions can be expressed by referring to the figure. Here,  $V_{in}$  may vary from  $V_1$  up to  $V_2$  and  $V_L$  may vary from  $V_{L\ min}$  to  $V_{L\ max}$ . Define  $\alpha = V_2/V_1$ ,  $\beta = V_{L\ max}/V_{L\ min}$  and  $P_1$  (minimum allowable input power for circuit operation) as power dissipated when

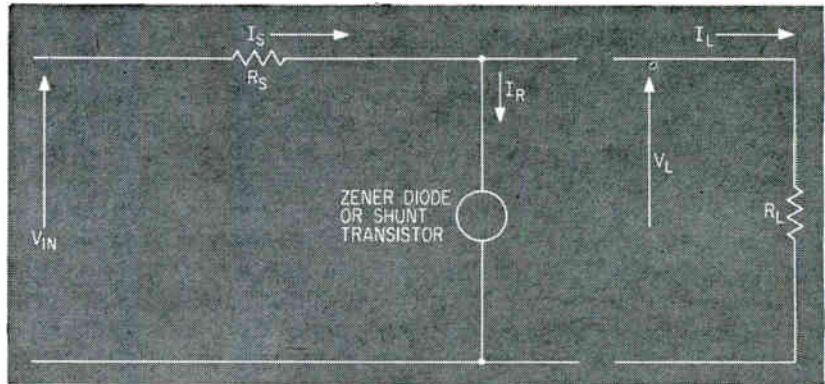

Circuit diagram is basis of equation derivation

$V_{in} = V_1$  and  $V_L = V_{L\ max}$ . Maximum input power to the regulator (worst possible condition) is  $P_2$ , the power dissipated when  $V_{in} = V_2$  and  $V_L = V_{L\ min}$ . Minimum power output  $P_o$  to the load and regulating device occurs when  $V_L = V_{L\ max}$  and  $V_{in} = V_1$ .

Design equations are

$$\begin{aligned} P_1 &= V_1 (V_1 - V_{L\ max})/R_s \\ P_2 &= V_2 (V_2 - V_{L\ min})/R_s \\ P_o &= V_L\ max I_{s1} \text{ where} \\ I_{s1} &= I_{R1} + I_{L1} = (V_1 - V_{L\ max})/R_s \end{aligned} \quad (1)$$

$$P_2/P_o = \frac{V_2}{V_{L\ max}} \left( \frac{V_2 - V_{L\ min}}{V_1 - V_{L\ max}} \right)$$

Letting  $P_2/P_o = P$  and differentiating  $dP/dV_1$ , then setting  $dP/dV_1 = 0$  to find the value of  $V_1$  which will make  $P_2/P_o$  a minimum, gives (after combining, rearranging and introducing  $\alpha$  and  $\beta$ )

$$V_1 = V_{L\ max} (1 \pm \sqrt{(\alpha\beta - 1)/\alpha\beta})$$

Since  $\alpha$  and  $\beta$  are always greater than one,  $(\alpha\beta - 1)/\alpha\beta$  will always be positive. Also,  $V_1$  must always be greater than  $V_{L\ max}$ , consequently

$$V_1 = V_{L\ max} (1 + \sqrt{(\alpha\beta - 1)/\alpha\beta}) \quad (2)$$

Using Eq. 1 and 2 it is possible to determine the optimum values of  $V_1$  and  $R_s$ .

EXAMPLES: Shunt Regulator—Given:  $V_2/V_1 = \alpha = 2$ ,  $V_{L\ max}/V_{L\ min} = \beta = 10$ ,  $V_{L\ max} = 10\ V_{d-c}$ ,  $V_{L\ min} = 1\ V_{d-c}$ ,  $I_{L\ max} + I_{R\ max} = I_{s1} = 10\ ma$ . Using Eq. 1 and 2

$$\begin{aligned} V_1 &= V_{L\ max} \left( 1 + \sqrt{\frac{\alpha\beta - 1}{\alpha\beta}} \right) \\ &= 10 \left( 1 + \sqrt{\frac{20 - 1}{20}} \right) = 19.5\ V_{d-c} \end{aligned}$$

$$\begin{aligned} \text{and } R_s &= \frac{V_1 - V_{L\ max}}{I_{s1}} = \frac{19.5 - 10}{10 \times 10^{-3}} \\ &= 950\ \text{ohms} \end{aligned}$$

Zener Diode Regulator—Given:  $V_2/V_1 = 2 = \alpha$ ,  $V_L = 10\ V_{dc}$ ,  $V_{L\ max}/V_{L\ min} = \beta = 1$ ,  $I_{L\ max} + I_{R\ max} = I_{s1} = 10\ ma$ . Using Eq. 1 and 2

$$\begin{aligned} V_1 &= V_{L\ max} \left( 1 + \sqrt{\frac{\alpha\beta - 1}{\alpha\beta}} \right) \\ &= 10 (1 + \sqrt{\frac{1}{2}}) = 17.07\ V_{d-c} \end{aligned}$$

$$R_s = \frac{V_1 - V_{L\ max}}{I_{s1}} = \frac{17.07 - 10}{10 \times 10^{-3}} = 707\ \text{ohms}$$

Knowledge of the input voltage range, output voltage range and total load current requirements under worst conditions is sufficient to determine the optimum design of shunt regulators. Power dissipation determines the actual devices to be used.



# Dependability PROVED!

**...in tests at 5 Times  
mil specs for  
shock, vibration  
and acceleration**



Potentiometers  
Type J and  
Type K



Potentiometers  
Type G and  
Type L



Adjustable  
Fixed Resistors  
Type R



Hermetically Sealed  
Ceramic Encased Resistors  
Type TS    Type CS    Type ES



## About the test

At the United States Testing Co., Inc.\* the above Allen-Bradley resistors and potentiometers were subjected to a constant acceleration of 300g, impact shock of 150g and vibration of 50g from 55 to 2,000 cps. All tests were conducted in accordance with procedures outlined in the latest Mil Specs.

\*Test Report #71801, Sept 1960

In these severe tests, Allen-Bradley resistors and potentiometers have demonstrated their complete dependability in environmental extremes.

The ruggedness of A-B fixed resistors is obtained through an *exclusive* process in which the resistance element and the insulating jacket are hot molded into an integral unit of unusual mechanical strength. This unit is then hermetically sealed in a ceramic tube. Also, please remember, A-B fixed resistors are *completely free from catastrophic failures*.

A-B potentiometers have the resistance elements molded into, and are an integral part of, the base; therefore, they are virtually indestructible. In addition, operation is quiet and smooth when the potentiometer is new, and these characteristics improve with use.

For maximum reliability under severe operating conditions, insist on Allen-Bradley *quality* electronic components.

Allen-Bradley Co., 110 W. Greenfield Ave., Milwaukee 4, Wis.  
In Canada: Allen-Bradley Canada Ltd., Galt, Ont.

# ALLEN - BRADLEY

**QUALITY  
ELECTRONIC  
COMPONENTS**

# Graphical Design Procedures for Maximally Flat Microwave Filters

*For filters requiring a bandwidth of ten percent or less, simplifications in design equations are permissible and lead to graphical solutions. Design method shows how to determine the number of resonators to fulfill a filter characteristic*

By MARC CHOMET, Airborne Instruments Laboratory, Deer Park, New York

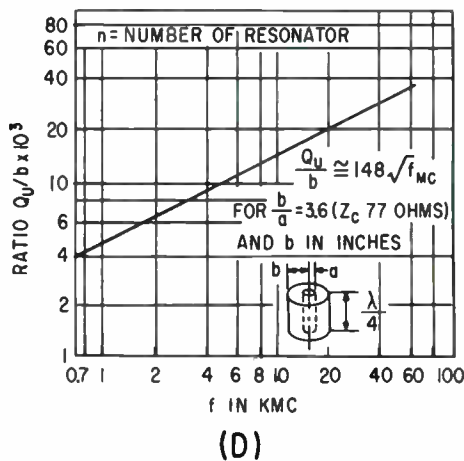
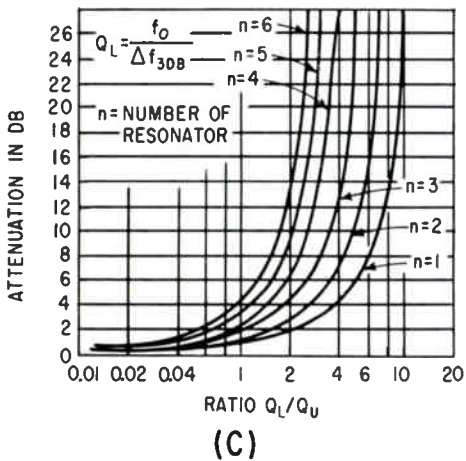
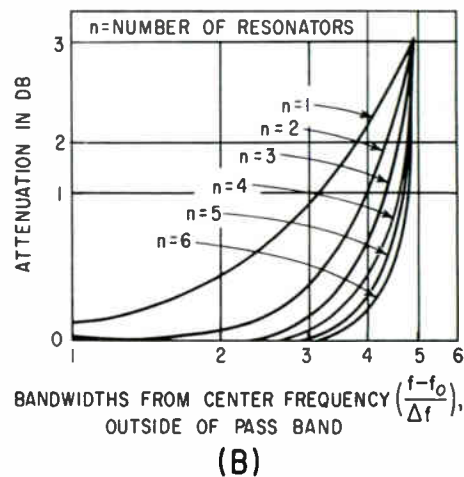
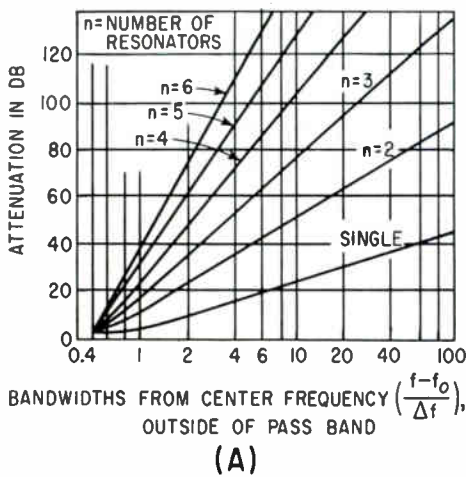
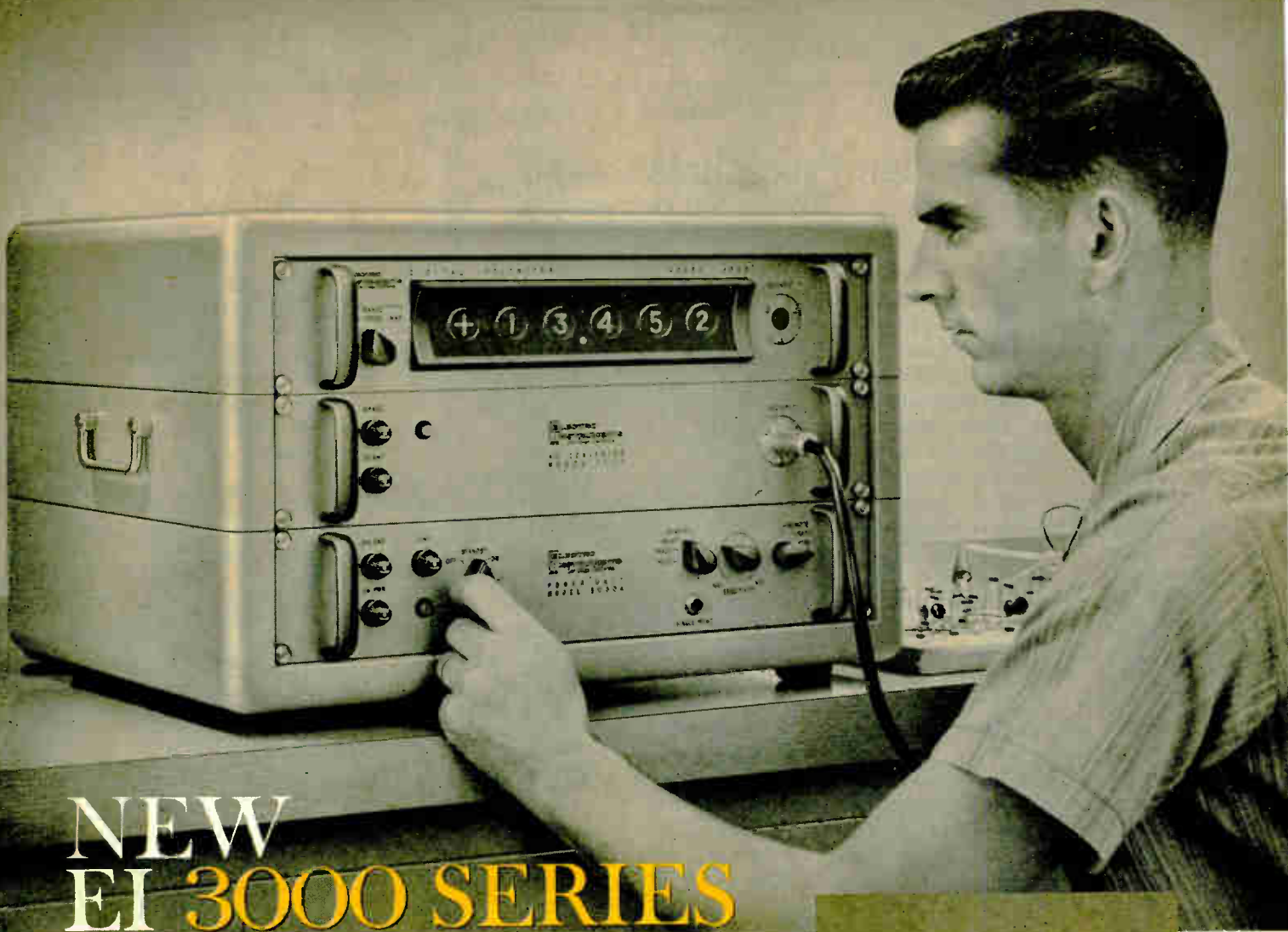

FIG. 1—Response curves for N resonators outside the passband (A) and complementary response curves inside the passband (B). Insertion-loss curves of maximally flat filters (C) and curves of unloaded Q for coaxial resonator (D)

(Text starts on p. 96)





# NEW EI 3000 SERIES

digital voltmeters and ratiometers feature...

- an 80 db input filter  
enables measurements of millivolts of DC in presence of volts of AC,
- a unique, 3-position, tilting readout with 10,000 hour readout life



and numerous other engineering improvements!

4 and 5-digit instruments to meet every application for precisely measuring AC/DC voltage, AC/DC ratios, and resistance. A variety of input-output modules are also available to give system capabilities to the basic measuring instruments.

Transistorized circuitry—gives exceptional reliability.

New temperature controlled, twin-bridge, Zener diode reference—0.005% stability for months.

1000 megohm input impedance

DC accuracy 0.01% of reading plus 1 digit.

AC accuracy 0.1% of reading plus 2 digits, from

30 to 10,000 cps—most stable AC digital voltmeter commercially available.

Easily floated—accomplished from front panel.

0.0001 volt sensitivity on both AC and DC.

Pre-Amp module increases sensitivity to one microvolt.

Automatic ranging on AC

Automatic polarity and ranging on DC

Remote operation—complete control of the instrument can be accomplished from remote locations.

Direct printer operation—no auxiliary equipment needed.

Ask for a demonstration

The high accuracies, simple operation, versatility and exceptional reliability of the 3000 Series instruments result from the unequalled experience of more than 10,000 EI digital instruments now in use. Your EI field engineer will be pleased to demonstrate their superior features. Call him today.

Engineers: Challenging opportunities now available. Contact Mr. Harvey Fleming.

## Electro Instruments, Inc.



8611 BALBOA AVE.  
SAN DIEGO 11, CALIF.

## Graphical Design Procedures (continued)

THE DESIGN of wide-band microwave filters can be complicated when considered in theoretical all-inclusive terms. However, many applications require filters having bandwidths of 10 percent or less with equal input and output loading. These filters are generally designed for a maximally flat or Butterworth response with a symmetrical distribution of interelement couplings, and they have a  $Q_u/Q_F \geq 10$ , where  $Q_u$  is the intrinsic Q of a single unloaded element and  $Q_F$  is equal to the ratio of  $f_0$  (the resonant frequency) to  $\Delta F_{3\text{db}}$ , the 3-db bandwidth of the filter<sup>1</sup>.

Design of filters that come within these restrictions can be simplified.

**Step 1:** Given the 3-db bandwidth and the selectivity, the number of resonators ( $n$ ) required can be determined from Figs. 1A and 1B. Then, solving for  $Q_1$  and  $K_{1(2)}, K_{2(3)}, \dots, K_{R(R+1)}$ , gives

$$\frac{Q_1}{(f_0/\Delta f_{3\text{db}})} = 2 \sin \frac{90}{n}$$

$$Q_2 \rightarrow (n-1) = \infty \quad (1)$$

where  $Q_1$  = the loaded Q of the input element, and  $f_0$  = the center frequency.

Furthermore

$$K_{R(R+1)} / (\Delta f_{3\text{db}}/f_0) = \frac{0.5 / \{(\sin [(2R-1)(90/n)])\}}{(\sin [(2R+1)(90/n)])^{1/2}} \quad (2)$$

where  $K_{R(R+1)}$  = the interelement coupling factor between the  $R$ th and  $(R+1)$ th resonators, and  $R = 1, 2, 3, \dots, n$ .

**Step 2:** Calculate the required unloaded Q ( $Q_u$ ) for the acceptable passband insertion loss from Fig. 1C. For a coaxial resonator; this is compared with the value of  $Q_u$  found from Fig. 1D. Figure 1D presents the equation

$$Q_u = 148 \sqrt{f} b \quad (3)$$

for  $b/a = 3.6$  ( $Z_c = 77$  ohms) where  $a$  = radius of inner conductor in inches,  $b$  = radius of outer conductor in inches,  $Z_c$  = characteristic impedance and  $f$  = frequency in megacycles. Formulas for other types of resonators or cavities can be found in reference 2.

The calculations show whether the design is feasible. The calculated  $Q_u$  (Fig. 1D) must exceed the  $Q_u$  shown in Fig. 1C. If the unloaded Q value cannot be achieved, the filter characteristics should be reexamined.

**Step 3:** Set up the equipment for testing as shown in Fig. 2.

**Step 4:** Detune resonators 2 through  $n$ .

**Step 5:** Tune resonator 1 at  $f_0$  (center frequency) for a peak indication on the detector output indicator. The detector probe in resonator 1 should be decoupled by at least 20 db so that its loading effect on the Q of resonator 1 is negligible.

**Step 6:** Change the generator frequency to obtain the -3-db points. This will give an  $f_1$  and  $f_2$  (Fig. 3A).

$$Q_1 = f_0 / (f_2 - f_1)$$

**Step 7:** Adjust the input coupling, and check until the desired  $Q_1$  is obtained by repeating steps 4 through 6.

**Step 8:** Lock resonator 1, leaving resonator 3 through  $n$  detuned. Tune resonator 2 until the indicator shows a dip, and set the resonator to the valley of the dip.

**Step 9:** Vary the frequency of the generator and obtain  $f_3$  and  $f_4$  as shown in Fig. 3B.

$$f_4 - f_3 = \Delta f_p$$

and if  $V_p/V_o \geq 20$  db then  $K_{1(2)} \cong 0.96 \Delta f_p/f_0$ .

**Step 10:** If  $K_{1(2)}$  is not as specified, change the interelement coupling mechanism and repeat steps 8 through 10 until proper interelement coupling is achieved.

**Step 11:** For two-element filters, turn the filter around so that the output becomes the input. Repeat steps 4 through 6. This design is now finished since  $Q_1 = Q_2$ . For three-element filters, turn the filter around and repeat steps 4 through 11, making  $K_{1(2)} = K_{2(3)}$  and  $Q_1 = Q_3$ . Here,  $Q_2$  needs no adjustment since  $K_{1(2)}$  and  $K_{2(3)}$  determine this adjustment.

**Step 12:** For filters with more than three elements, the non-resonant detector probe is moved to element 2 and steps 4 through 11 are repeated, but the element numbers given in the instructions are increased by 1. Tune element 3 for a dip on the indicator with a probe in element 2. Lock all tuning adjustments.

**Step 13:** Repeat steps 10 and 11.

**Step 14:** After all coupling parameters have been adjusted, the filter can be tuned. Place the probe back in element 1 and repeat steps 4, 5, and 8. Leaving the probe in element 1, tune element 3 for a peak, and lock; tune element 4 for a dip, and lock, and so on, until all elements are

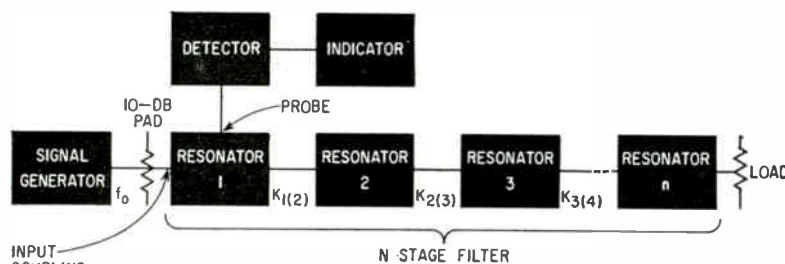

FIG. 2—Block diagram shows cascaded arrangement of filters in the test setup



**THERE IS SOMETHING NEW UNDER THE SUN**

Yes, there *is* something new under the sun. Science is proving this every day. With new discoveries. New explorations. New concepts.

Nowhere is this more evident than in the field of technology. For example: On the drawing boards of Lockheed Scientists and Engineers, new designs are constantly being born—designs in Spacecraft and Aircraft that will reinforce and enlarge our growing knowledge of Outer Space.

These new designs are rapidly developing. And their number is rapidly increasing. The pace is fast. Yet it needs to become faster. To keep pace, Lockheed needs more Scientists, more Engineers. Result? The future for Lockheed was never more promising—the opportunities never greater.

Lockheed feels that trained men will do well to examine thoughtfully the Company's current openings. Notable among

these are: Aerodynamics engineers; thermodynamics engineers; dynamics engineers; electronic research engineers; servosystem engineers; electronic systems engineers; physicists (theoretical, infrared, plasma, high energy, solid state, optics); hydrodynamicists; ocean systems scientists; physiopsychological research specialists; electrical-electronic design engineers; stress engineers; and instrumentation engineers.

**Scientists and Engineers:** To learn more about the opportunities at Lockheed, write Mr. E. W. Des Lauriers, Manager Professional Placement Staff, Dept. 1507, 2408 No. Hollywood Way, Burbank, California. All qualified applicants will receive consideration for employment without regard to race, creed, color, or national origin. U.S. citizenship or existing Department of Defense industrial security clearance required.



# Graphical Design Procedures (continued)

tuned. The filter is now synchronously tuned.

For example, find the  $Q_1$ ,  $Q_2$ ,  $K_{1(2)}$ , and the unloaded  $Q$  value for this filter:

The filter center frequency is to be 2,200 Mc with a 10-Mc half-power bandwidth (the 3-db bandwidth). Insertion loss is to be less than 2 db at the center of the passband. At 60 Mc away from the center frequency, this is the image response for a 30-Mc i-f receiver, the insertion loss shall be at least 40 db.

Refer to step 1. Figure 1A indicates that at six bandwidths (60 Mc/10 Mc) away from the center frequency the insertion loss of a maximally flat two-element filter is about 45 db. Therefore, a two-element filter will meet the image response requirement. Then, substituting nu-

merical values in Eq. 1

$$Q_1 = Q_2 = \frac{2 f_0}{\Delta f_{3db}} \times \sin 90/n$$

$$= (2200 \times 2 \sin 45)/10 = 310$$

and substituting in Eq. 2

$$K_{1(2)} = 3.214 \times 10^{-3}$$

Figure 1C shows that for an insertion loss of less than 2 db in the center of the passband for a two-element filter the  $Q_L/Q_u$  ratio should be 0.15. Since  $Q_L = f_0/\Delta f_{3db} = 220 Q_u = 1467$ .

Figure 1D shows that at 2,200 Mc,  $Q_u/b \times 10^3$  is equal to 6.9. When using coaxial cavities (a reasonable choice at these frequencies), the radius  $b$  is 0.213 inch. The theoretical  $Q_u$  is higher than the required  $Q_u$ . This indicates that coaxial elements can be used in the design of this filter. Now follow steps 3 through 11.

Figures 3C and 3D show some common microwave filter configurations.

The author thanks A. J. Hendler and K. S. Packard of AIL for their suggestions.

## REFERENCES

- (1) M. Dishal, Design of Dissipative Band-Pass Filters Producing Desired Exact Amplitude-Frequency Characteristics, *Proc IRE*, 37, p 1050, Sept. 1949.
- (2) Waveguides and Resonators, "Reference Data For Radio Engineers," 4th Edition, International Telephone and Telegraph Corporation, New York, N. Y., p 617.

## BIBLIOGRAPHY

- M. Dishal, Alignment and Adjustment of Synchronously Tuned Multiple Resonant-Circuit Filters, *Proc IRE*, 39, p 1448, Nov. 1951.
- S. Butterworth, On the Theory of Filter Amplifiers, *Experimental Wireless and Wireless Engineer*, July 1930.
- Selective Circuits and Filter Networks, "Reference Data for Radio Engineers," 3rd Edition, International Telephone and Telegraph Corporation, New York, N. Y., p 114.
- Filters, Modern Network Theory, Design, "Reference Data for Radio Engineers," 4th Edition, International Telephone and Telegraph Corporation, New York, N. Y., p 187.

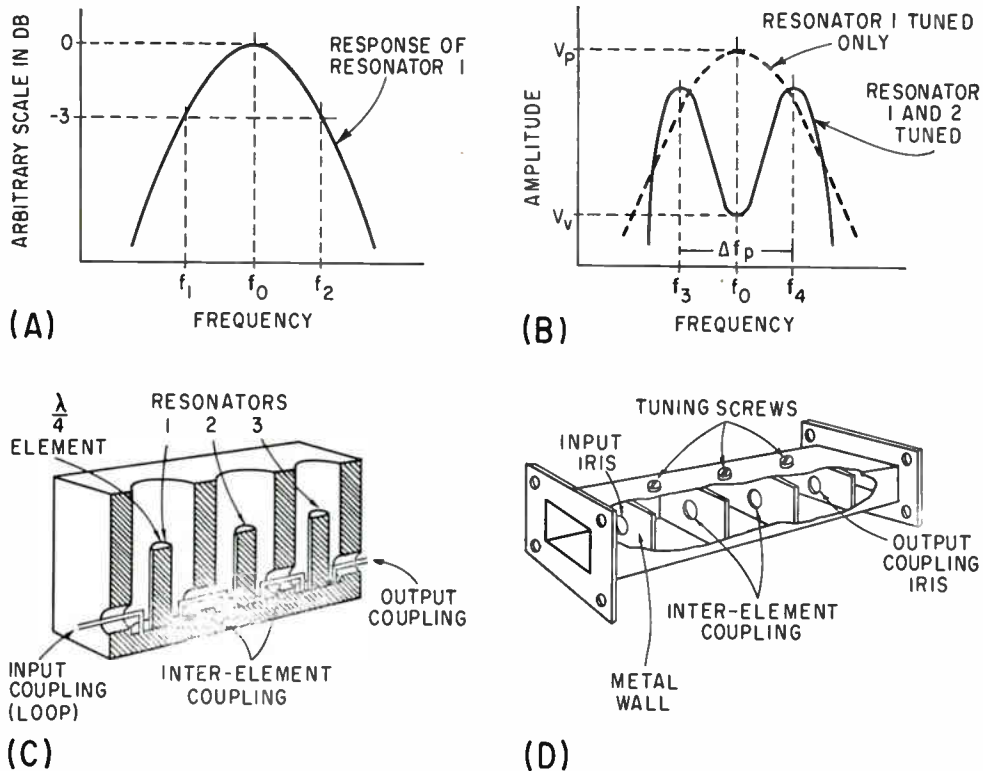
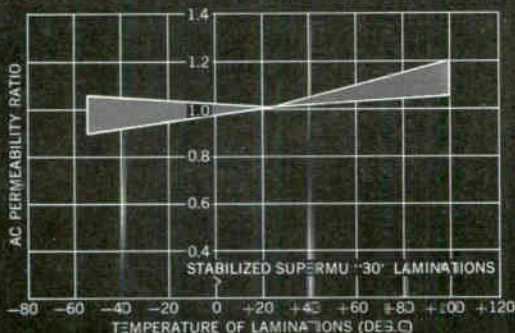
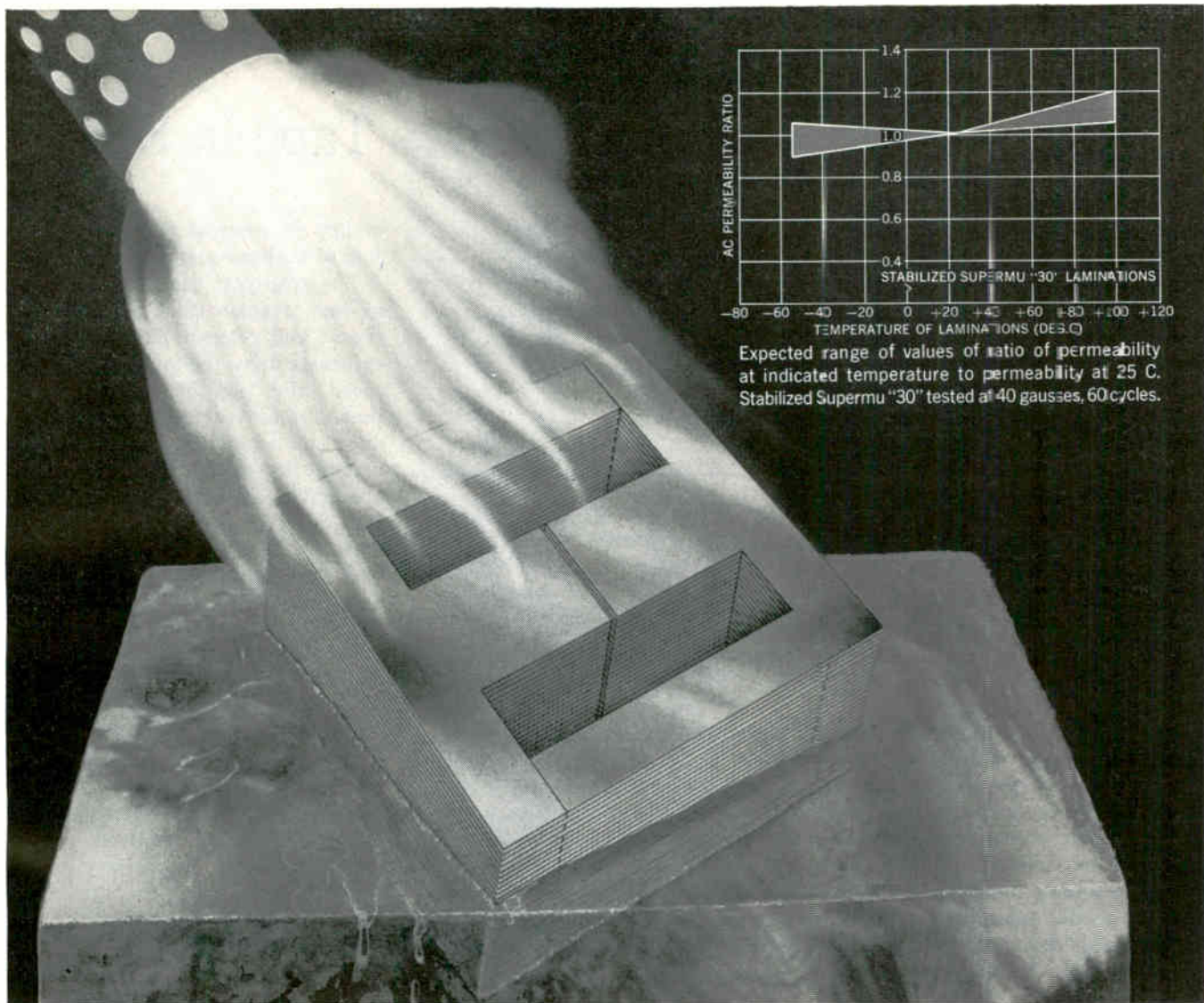

FIG. 3—Probe response (A) for one resonator tuned, and similar response (B) for two resonators tuned. Typical three-element coaxial filter (C) and typical three-element filter for waveguides (D)



Expected range of values of ratio of permeability at indicated temperature to permeability at 25 C. Stabilized Supermu "30" tested at 40 gauss, 60 cycles.

from Magnetic Metals . . .

## THERMALLY STABLE TRANSFORMER LAMINATIONS

If you're designing a transformer or reactor that must maintain constant inductance under the blazing desert sun or in the sub-zero cold of the Arctic or outer space, you need our thermally stable Supermu "30" laminations. They're the only temperature-stabilized laminations available anywhere.

Special composition and the ultimate in annealing control stabilize over a wide temperature range the permeability of thermally stable Supermu "30" laminations. Meticulous care in stamping eliminates burrs and preserves absolute flatness.

With performance characteristics effectively stabilized, thermally stable Supermu "30" offers the only available solution to thermal design problems, and is also of particular value where you want to miniaturize components.

Laminations of thermally stable Supermu "30" are made in all standard sizes and thicknesses. Count on two-week delivery. Custom designs are available on special order. Our engineers are ready and well qualified to help you make the most of this exceptional lamination material. Write or call today.

**M**MAGNETIC  
METALS



**MAGNETIC METALS COMPANY**

Hayes Avenue at 21st Street, Camden 1, N.J.

853 Production Place, Newport Beach, California

transformer laminations • motor laminations • tape-wound cores  
powdered molybdenum permalloy cores • electromagnetic shields



# Data Storage Transport Moves Tape in Steps

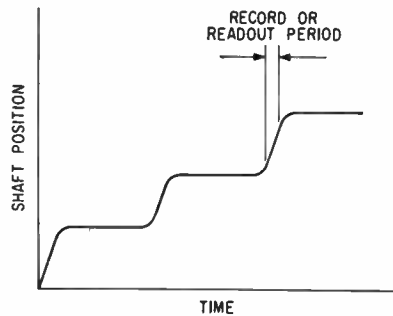
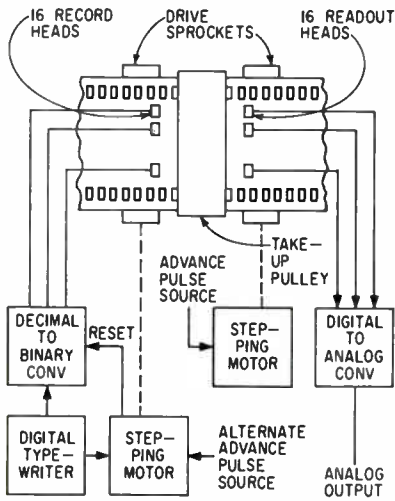

FIG. 2—Shaft velocity is constant during recording and readout periods

FIG. 1—Separately driven stepping motors permit variable delay between recording and readout

DIGITAL memory unit for analog computers uses a magnetic tape transport that moves the tape in small discrete steps rather than continuously. The storage system extends the capabilities of general purpose analog computers.

The digital data recording equipment was developed by Redifon, Ltd., Sussex, England. It enables analog computers to deal with problems such as partial differential equations, correlation analysis, stochastic function generation and finite variable time delays.

The transport mechanism shown in Fig. 1 uses 35-mm tape with sprocket holes. Two separately driven sprockets move the tape past the recording and readout heads, which permits independent variations of recording and readout speed.

Pulse-driven stepping motors drive the sprockets through speed-reduction gears. The drive system starts the tape quickly, drives it at constant speed past the head and stops it quickly. The constant rotational velocity throughout most of the period of movement can be seen in the plot of shaft position as a function of time in Fig. 2. The interval of constant-speed movement coincides with the record or readout period of one element of data.

The tape accommodates 16 par-

allel recording tracks and up to 1,000 ft of tape can be stored on reels. A continuous loop of tape up to 40 inches long can also be used for applications requiring it. Data elements can be recorded separately in the parallel tracks or several tracks can record simultaneously as many orders of digits or channels as required.

The recording heads are fed with current pulses from a decimal-to-binary converter. Converter input can be provided in decimal form from any suitable source, such as the digital typewriter shown in Fig. 1. An analog-to-digital converter can also be incorporated in the system so that analog inputs can be used.

When a digital data pulse arrives at the decimal-to-binary converter, an operating pulse is supplied to the stepping motor. As the tape is driven at constant speed, binary output from the converter is fed to the recording heads. After the motor stops, a clear-and-reset pulse is fed back to the decimal-to-binary converter. The original decimal data has been converted to binary form and recorded on the parallel tracks of the tape.

The readout heads feed a digital-to-analog converter. Analog output appears as a time-varying voltage as in Fig. 3. Each of the five voltage levels corresponds to one set of

binary data across the tape in one step of tape movement.

The transport permits variation in tape transit time between the record and readout heads. If both sprockets drive the tape at the same speed, the loop of tape between them remains at the same length and time delay between record and readout is constant. If the sprockets are driven at different speeds, the time delay varies accordingly. Tape between the driven sprockets is kept taut by a spring-loaded movable pulley.

The recording head stepping motor is energized by a variable frequency pulse generator in which pulse repetition frequency can be controlled manually or automatically. The readout head stepping motor can be driven by an independent pulse source if continuous data recording is required or the recording head stepping motor source can be used for the readout motor.

Maximum time delay between record and readout is limited only by the take-up mechanism of the movable tape pulley between the sprockets. Physical separation of the record and readout head limits minimum delay to 0.5 seconds.

This type recording system eliminates the need for recording pulses with a high-frequency carrier and flux-sensitive heads are not required. The system requires simple saturation recording with d-c pulses, and tape movement in relation to the readout heads is sufficient to induce output current.

A commutator system is avail-

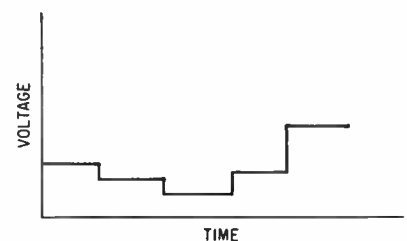

FIG. 3—Time-varying voltage represents one set of binary data at each of five levels



**8036 SMALL, RUGGED  
CERAMIC  
HYDROGEN THYRATRON  
SAVES VALUABLE SPACE**

Tung-Sol leads the way with a ceramic Hydrogen Thyatron that fills an important design need. An electrical equivalent of the popular Tung-Sol 5949A — only one third tube volume is required by this new member of the family.

Tung-Sol ceramic Hydrogen Thyatron 8036 has rugged environmental ratings. It is designed for flange mounting with flexible connectors to achieve a solid mounting with loss-free terminations. Grid connection is made to the flange through the grid ring clamp.

For full technical data, consult your Tung-Sol representative or write: Tung-Sol Electric Inc., Newark 4, N.J. TWX: NK193.



**HYDROGEN THYRATRON 6587A**

6587A, a glass thyatron, is a direct plug-in replacement for Tung-Sol 5C22. Valuable inches of overall height are saved by means of the ring-disk type of construction, which also provides the advantages of external (cool) anode and lower lead inductance. It is rated for higher voltages with higher currents than prototype tubes. Grid connection can be made through the grid ring or through the tube base pin. An internally-connected hydrogen reservoir promotes long life.

	<b>8036</b>	<b>6587A</b>	<b>5C22</b>
Overall height, Max	3.75"	6.	8.75
Peak forward voltage	25. KV	18.	16.
Peak current	500. Amps	365.	325.
Peak Pulse Power (Delivered to the load)	6.25Mw	3.25	2.6

TECHNICAL ASSISTANCE IS AVAILABLE THROUGH: Atlanta, Ga.; Columbus, Ohio; Culver City, Calif.; Dallas, Tex.; Denver, Colo.; Detroit, Mich.; Irvington, N.J.; Melrose Park, Ill.; Newark, N.J.; Philadelphia, Pa.; Seattle, Wash. In Canada: Abbey Electronics, Toronto, Ont.





*Highest  
performance,  
smallest  
size...*

## **CEC'S NEW HIGH-LINE, LOW-DIFFERENTIAL TRANSDUCER**



There's a port on each end of CEC's Type 4-351 Unbonded Strain Gage Pressure Transducer—and both are suitable for corrosive liquid or gas media. This new instrument is an ideal high-line, low-differential transducer for use in orifice-plate flow meter applications.

The 4-351 is the smallest unit of its type on the market and offers the highest performance of any comparable instrument. Look at some of its specs:

*Differential pressure range* —  $\pm 15$  psid through  $\pm 100$  psid. 10 X overpressure.

*Line pressure rating* — 5,000 psi.

*Sensitivity* —  $\pm 50$  mv.

*For complete information, call your nearest CEC sales and service office or write for Bulletin CEC 4351-X3.*

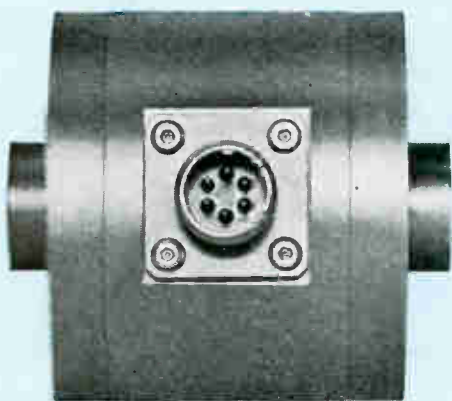

able for recording data from several different analog sources. The commutator is driven by the transport mechanism and samples the analog voltages synchronously with the stepping action. Each analog is sampled in a regular cycle, converted to binary form and recorded as a row of digits across the tape. As each analog voltage varies, the corresponding row of digits in the sequence recorded on the tape changes accordingly.

The commutation system is useful in computing cross correlation functions between one variable quantity and several other variables. The data recorded in binary form is read out with different time delays between the variable quantity and each of the other variables. After conversion back to analog form, the data is fed to an external analog computer to find the cross correlation functions.

Use of an external pulse source to control tape speed permits time-independent integration. The time delay between record and readout can be set by manual control on the equipment or it can be controlled externally.

The storage system can provide digital output signals if required to operate a digital typewriter or similar device.

### **Semiconductor Current Is Varied by Pressure**

ELECTRICAL conductivity in super-cooled semiconductors can be varied by a factor of 100 million with the application of not more than five pounds of pressure. This unexpected behavior in germanium semiconductors was reported by Hellmut Fritzsche, associate professor of physics at the Institute for the Study of Metals, University of Chicago.

The experiments in which the phenomenon occurred were conducted at temperatures lower than  $-450$  F. Two types of germanium semiconductors were used. In one type, arsenic was used as the impurity, while antimony was used in the other. Pressure was applied to the side or edge of the semiconductor.

Electrical conductivity was not only markedly affected by the pressure but the effect in the two simi-

Transducer Division

# **CEC**

**CONSOLIDATED ELECTRODYNAMICS** / pasadena, california

A SUBSIDIARY OF **Bell & Howell** • FINER PRODUCTS THROUGH IMAGINATION

←CIRCLE 102 ON READER SERVICE CARD



lar semiconductors was opposite. Conductivity in the two materials differed by a factor of  $10^{10}$ . Conductivity of the germanium semiconductor containing arsenic impurities increased  $10^7$  times with the application of pressure. In the antimony-doped germanium semiconductor, conductivity decreased by a factor of  $10^8$ .

Impurities in semiconductors have been assumed to enhance conductivity because they add free electrons to the crystal. However this theory does not explain the opposite results obtained with the two different impurities added to germanium crystals.

The results prompted Fritzsche to reconsider some basic assumptions about the effects of impurities on semiconductor behavior. He believes his explanation could have important implications for understanding semiconductors. It provides a clearer understanding of wave functions in semiconductors, which are the characteristics of impurities that determine the effects the impurities will have on conductivity.

According to this theory, the wave functions were distorted differently when pressure was applied. In the germanium semiconductor with arsenic impurities, the wave function swelled under stress. The increased size permitted more current to flow.

When antimony was used as the impurity in germanium crystal, the wave function collapsed from a spherical shape to a thin disk under pressure. As a result, current was reduced by a factor of  $10^8$ .

Conductivity in semiconductors at low temperatures could not be explained by the laws of classical physics before these experiments were conducted. The electrons would be so tightly frozen in holes at these temperatures that theoretically current could not flow.

Quantum physics provides an explanation for movement of electrons in semiconductors at extremely low temperatures. The electrons can tunnel through the barriers between holes even when they have insufficient energy to become free. Because of the tunneling electrons, the wave functions of the impurities are in close enough proximity for current to flow.

CIRCLE 103 ON READER SERVICE CARD →

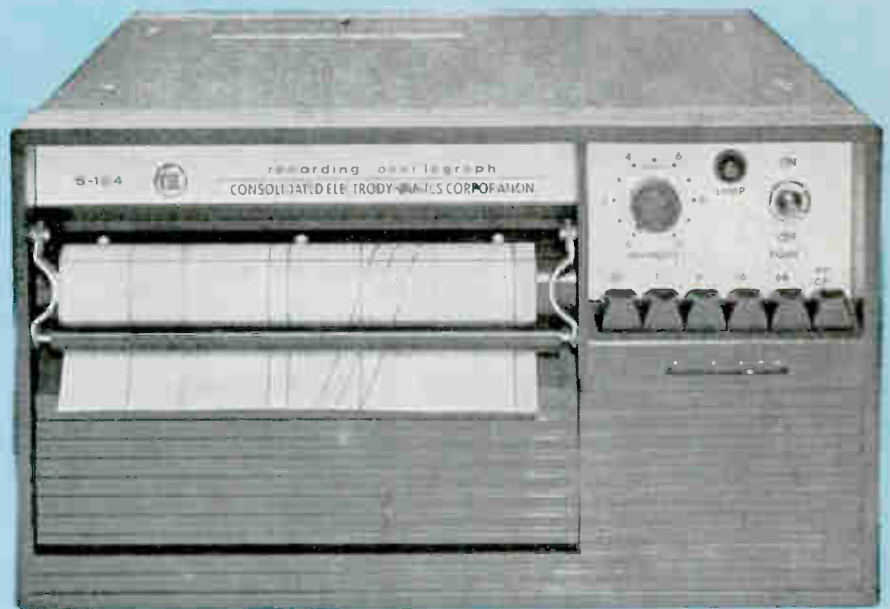

## Inside this portable recording oscillograph... **A FOCUSED PRECISION OPTICAL SYSTEM TO ASSURE HIGHEST TRACE RESOLUTION**

The high-efficiency optical system of CEC's 5-124 Recording Oscillograph concentrates more high actinic light on the record...permits a writing speed of 50,000 ips with trace widths of 0.010" or less.

Optics are specially treated for higher light transmissibility. This means "big" oscillograph capability in a portable, low-cost instrument. The 5-124 easily records and resolves phenomena occurring in intervals as short as 500 microseconds...boasts 18-channel capacity...delivers ready-to-read print-out records that eliminate processing problems.

Among the 5-124's standard features are pushbutton control, intensity control, unexposed footage indicator, individual input connectors and automatically regulated galvanometer lamp circuit. These optional features are available: grid lines (1/10" or mm), trace identification and numbering, full-width timing lines and galvanometer block heaters.

*For complete information, call your nearest CEC sales and service office or write for Bulletin CEC 5124-X16.*

Data Recorders Division **CEC**

**CONSOLIDATED ELECTRODYNAMICS** / pasadena, california

A SUBSIDIARY OF **Bell & Howell** • FINER PRODUCTS THROUGH IMAGINATION

# Devices to Harness the Sonic Spectrum

By WILLIAM K. FORTMAN,  
 Director of Research,  
 Astrosonics, Inc., Syosset, N. Y.

AN UNDERSTANDING of electroacoustical phenomena, and relationships occurring at the sonic and supersonic portions of the spectrum (see chart below), indicates a wave band that can be further explored for devices that may add new dimensions to earth and space electronics. This is being done at Astrosonics, Inc. with simple gas-driven sonic generators weighing but a few ounces<sup>1</sup>.

In such a sonic-wave generator, the energy source is derived entirely from compressed air, operating at pressures between 10 psi and 500 psi. The hot or cold gas is forced through a nozzle and into an oscillator. Vibratory energy is produced and controlled over a wide spectrum of frequency, intensity, amplitude and other complex phenomena, with efficiencies of over 20 percent. And there is virtually no limit to the number of sonic channels that can carry regulated signals to perform operations analogous to and complementing many

types of electronic equipment.

These waves, whether audible or ultrasonic, are fluctuations in the ambient pressure of the gas. The outstanding characteristics of these fluctuations are their magnitude and the frequency with which they occur. Associated with these waves there is a flow of energy, and the power flowing per unit area is the sound intensity.

Various levels of sound intensity acoustic power changes in frequency are determined by such factors as the velocity of the gas, design of the nozzle and resonator, the distance of the resonator from the jet nozzle, the depth of the cavity and its internal volume. This sound is then focused through various types of acoustic reflector lenses, depending on the required applications.

We therefore have a device which can generate a regulated signal in almost any gaseous environment, and transmit that signal to a receiver which can be set into vibration by the energy of the sonic and ultrasonic waves.

For specialized applications, these devices can be reduced to the size of an eraser on the end

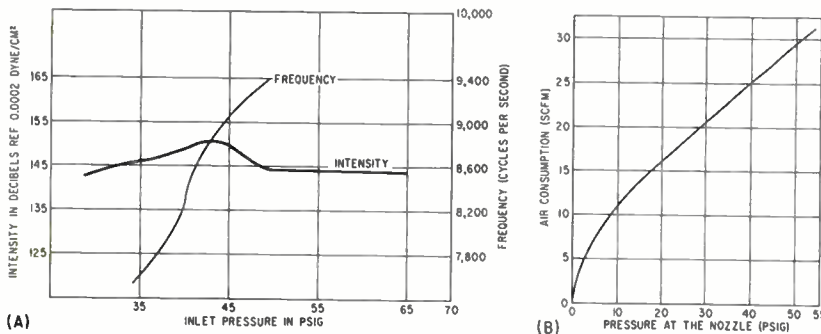
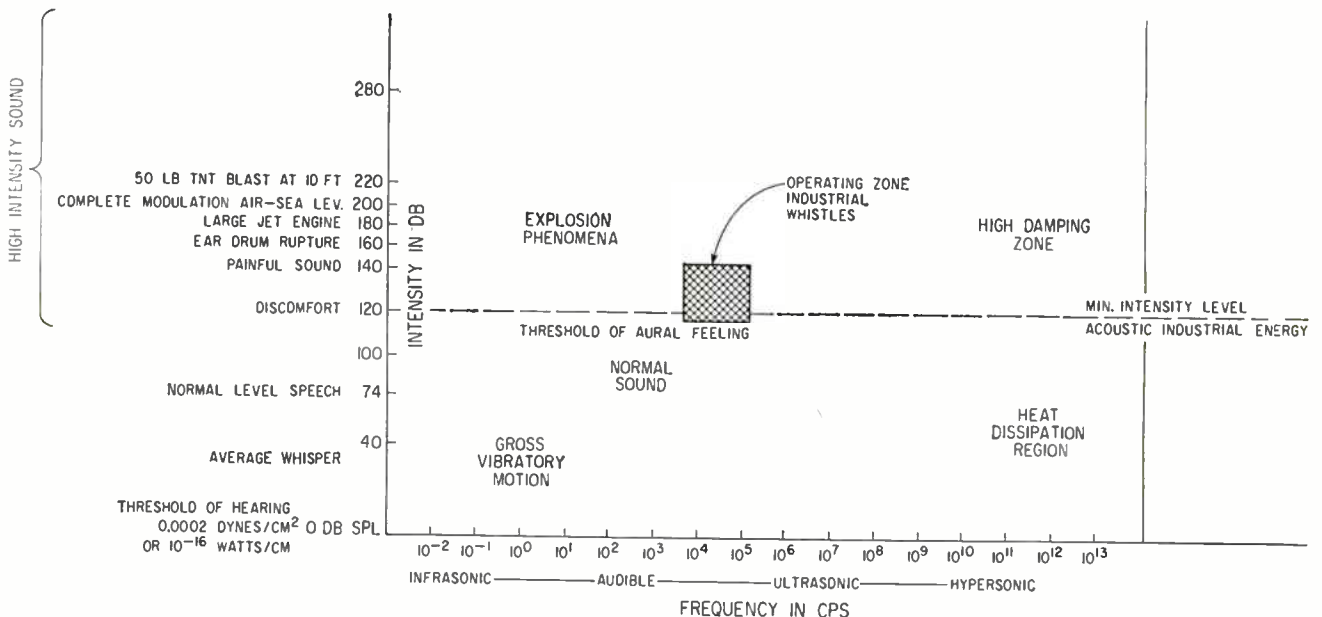
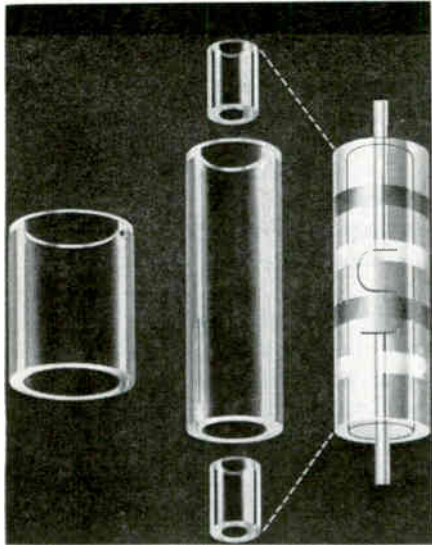

Fig. 1—Typical curves show frequency and intensity vs pressure (A), and air consumption vs pressure (B) of Astrobeam Transducer, Model 461. Measurements are taken 12-in. from sound source on vertical scale. Range of operation for similar units will be expanded to 18,000 cycles



Frequency and intensity relationships occurring in the sonic spectrum



glass for your diode packages... precision drawn to specifications

— GARNER provides tighter tolerances . . . improved roundness and concentricity . . . squarer and smoother end cuts.

Parts ultrasonically scrubbed, chemically cleaned, and rinsed in deionized water. Shipped ready for your production line.

Meeting your specifications is insured by continuous inspection, starting with raw material.

Fast dependable deliveries based on large stocks of redraw tubing . . . advanced production equipment, and the ability to move quickly.

Send for complete data.

**T. H. GARNER CO.**

Serving the semi-conductor industry since 1954

177 S. INDIAN HILL BLVD.  
CLAREMONT, CALIF. • NATIONAL 6-3526

CIRCLE 207 ON READER SERVICE CARD  
June 30, 1961

...and then there was...

**LIGHT** with a precision tensor work lamp

You can now have GLARE-FREE, CONCENTRATED light Where you want it . . . When you want it . . . and as much light as you want (enough to saturate the human eye) . . . at your finger tips. For sub-miniature wiring and sub-miniature assembly the Tensor Precision Work Lamp has been designed to give intense or subdued lighting in five pre-selected stages; logarithmically spaced (see chart). Three swivel joints and two 360 degree jack connectors cover every possible position use. Supplied with each lamp is a 7½' extension cord, with jack connector for remote controlled lighting within difficult working areas.

**ADDITIONAL FEATURES** of the Tensor Precision Work Lamp are: an independent electrical outlet, 2½" cork insulated light shade, weighted base; and each lamp comes supplied with 3 G.E. 1133 bayonet base bulbs. **FINISH:** Standard black wrinkle. Also available in flat white enamel for clean room and lab use. Chrome and epoxy finished model, for ultra sterile use @ \$76.50 ea. For further information and quantity prices write to:



Distance from lamp to meter 12"

(Volts) Line Voltage	(Volts) Lamp Voltage	Position	* Illumination F.C.
115	3.9	1	12.2
115	5.3	2	43.6
115	6.4	3	80
115	7.6	4	122
115	8.5	5	202

\* These figures are based on the use of a G.E. 1133 bulb.

MODEL 5900  
**PRECISION WORK LAMP**  
**\$46.50** ea.

**tensor**

**ELECTRIC DEVELOPMENT CO., INC.**  
1873 EASTERN PARKWAY, BROOKLYN 33, N. Y.

PROMPT QUOTATIONS ON SPECIAL FEATURES OR FINISHES TO CUSTOMER SPECIFICATIONS.

CIRCLE 206 ON READER SERVICE CARD



**GUDELACE**...

the lacing tape with a **NON-SKID** tread

You can't see it, but it's there! Gudelace is built to grip—Gudebrod fills flat braided nylon with just the right amount of wax to produce a non-skid surface. Gudelace construction means no slips—so no tight pulls to cause strangulation and cold flow.

But Gudelace is soft and flat—stress is distributed evenly over the full width of the tape. No worry about cut thru or harshness to injure insulation . . . or fingers.

Specify Gudelace for *real* economy—faster lacing with fewer rejects.

Write for free Data Book.

It shows how Gudelace and other Gudebrod lacing materials fit your requirements.



**GUDEBROD BROS. SILK CO., INC.**

ELECTRONICS DIVISION  
225 West 34th Street  
New York 1, New York

EXECUTIVE OFFICES  
12 South 12th Street  
Philadelphia 7, Pa.

CIRCLE 105 ON READER SERVICE CARD 105

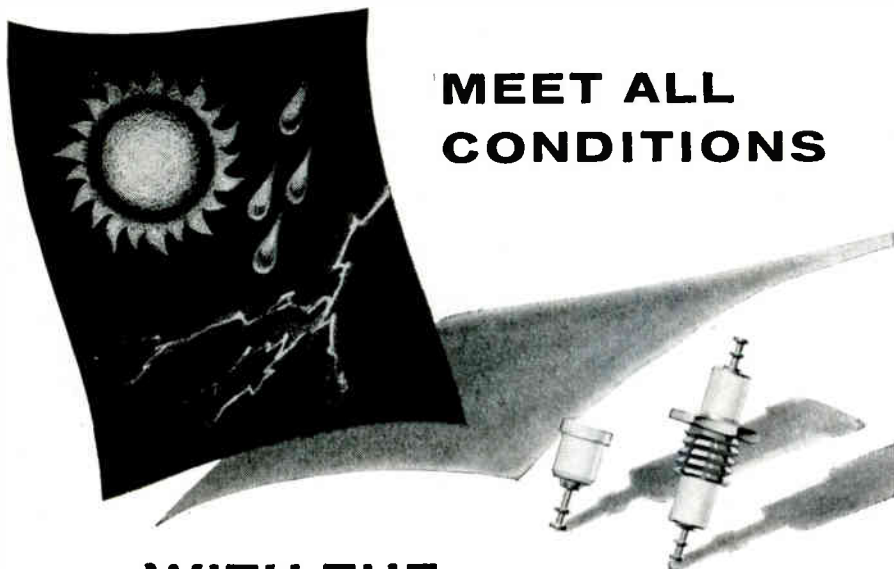

## MEET ALL CONDITIONS

## ...WITH THE RIGHT INSULATION

To give electronic circuits real protection against all hazardous service conditions—including temperature extremes, moisture, electric shock, mechanical shock and vibration—CAMBION® terminals are available with five different types of insulating materials.

These types—Ceramic, Teflon\*, Phenolic, Diallyl Phthalate and Melamine—bring you the most complete line of insulated terminals from any single source, plus the most complete, most positive protection.

All CAMBION insulated terminal machined parts are held to close tolerances and subjected to continuous quality control inspection... all are available in standoff and feed-through types... with internal or external thread mounts, press mounts or rivet mounts... with single turret, double turret or split terminals in gold, silver, electro-tin or custom plating. And like all CAMBION components they're quality guaranteed in lots of 1 to 1,000,000.

The broad CAMBION line includes plugs and jacks, solder terminals, insulated terminals, terminal boards, capacitors, shielded coils, coil forms, panel hardware, digital computer components. For a catalog, for design assistance or for both, write to Cambridge Thermionic Corporation, 437 Concord Ave., Cambridge 38, Massachusetts.

CAMBRIDGE THERMIONIC CORPORATION  
**CAMBION**®  
The guaranteed electronic components



\*Dupont Reg. T. M

of a lead pencil. Self-contained gas cartridges can supply the power, or the gas systems of air and space craft provide an available power source.

A typical frequency and intensity curve for one of these sonic generators is shown in Fig. 1A. Gas consumption is shown in Fig. 1B.

Electronic designers are familiar with ultrasonic devices for silent commands, cleaning, nondestructive testing, liquid level gauging, remote controls and signaling. These transducers convert electrical energy into ultrasonic acoustical energy and vice versa.

Transducers commonly in use today utilize magnetostriction, or piezoelectricity. The former causes a slight variation in the length of a metal rod due to an alternating magnetic field in the direction of the axis of the rod. The latter is

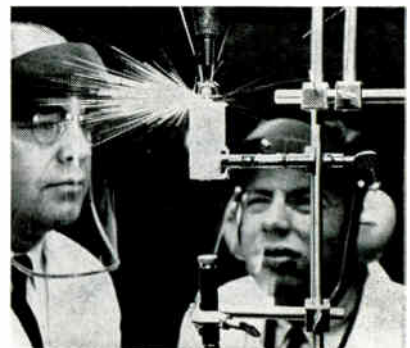

*William Fortman and Robert Soloff of Astrosonics watch captured sound waves melt steel wool. Ordinary compressed air forced through sonic generator at 43 lbs/sq in. generates frequency of 9,400 cycles. Significance: tremendous sound field available, possible applications include ignition for space vehicles*

literally pressure electricity which utilizes the property of a crystal to generate a voltage when mechanical force is applied, and conversely produces a mechanical force by expanding or contracting when a voltage is applied.

To operate, ultrasonic transducers of this sort require an r-f generator, and can have operating temperature limitations. Sonic generators, operating with compressed gas, do not have these limitations and are suggested for space circuits. These units could control the burning rate in solid fuel rockets, and utilize hot-gas systems of space craft that cannot tolerate

electronic components.

Astrosonics foresees manned space craft repairs with a miniature sonic beam welder that has a self-contained gas charge. In this application it is possible to beam acoustic wave energy by a simple sound-mirror system, attached to an airborne sonic transducer, which can remotely melt solder or metals. The melt flows over the surface of the junction and the sound fields disrupt the oxidation film, so that the metal gains access to a cleaned surface. This method precludes the use of flux or thermal element contact and is suited for microwork such as space capsule circuits.

The power effects of sound waves are appreciated by the fact that if 160 db sound pressure level strikes one square foot of material which is 100 percent absorbent to sound, 1,000 watts of heat are liberated. This force can be controlled and utilized in many areas of electronics.

In both laboratory and practical applications, sonic generators have achieved high power and intensity levels for given power inputs and frequency ranges. They are also highly efficient for transducing fluid dynamic energy into airborne oscillatory sonic fields.

The power of the pressure wave associated with sonic booms from supersonic aircraft has been well tabulated by its ability to shatter glass and cause structural damage at great distances. This force can be controlled and utilized in environmental testing to ensure that electronic components can withstand the shattering impact of continuous high-intensity low-frequency vibrations in high speed space craft.

Standard Astrobeam sound generators are normally fabricated in series 300 stainless steel. For special applications, the units can be made of any machineable metal, or ceramics, cermets, plastics or glass. The entire unit is machined out of the solid and is pressed fitted and pinned together to make an integral unit which requires no further adjustment. The device is virtually indestructible.

#### REFERENCE

(1) Astrosonics, Inc., 190 Michael Drive, Syosset, New York

**REQUIREMENT: RELIABILITY**—A U.S. Explorer Satellite and the revolutionary Bulova "Accutron" wrist timepiece have identical timing mechanisms... with accuracy guaranteed to within one minute per month in daily use... far more accurate than conventional fine-watch performance, yet impervious to the shock of rocket launching. Deemed best by Bulova is Diall Molding Compound 52-20-30, a Mesa developed and compounded product. The transistorized circuitry is mounted on two bright green Diall moldings, assuring highest insulation characteristics... extreme reliability under the most severe environmental and functional stress. Current Diall 52-20-30 applications range from micro-miniature moldings weighing a few grams to large mounting plates weighing as much as 60 pounds. If your requirements include positive reliability, absolute dimensional stability, versatile moldability, and/or write Mesa Plastics Company, 12270 Nebraska Avenue, Los Angeles 25, California.

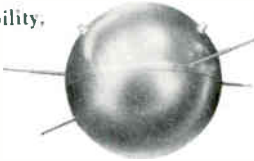

**OF ALL TESTED  
ONLY DIALL®  
MOLDING  
COMPOUND ACCEPTED**

# MESA



# Machine Produces Matrices for Modules

By W. A. MATTOX,

Advanced Manufacturing Development,  
Light Military Electronics Dept.,  
General Electric Co., Utica, N. Y.

WELDED WIRE MATRIX packaging concept is the basis for an automated circuit module production system now being developed at GE-LMED. Matrix design and fabrication has already been computer-programmed and automated. Within a year, we expect to accomplish complete automation, from drafting through circuit testing.

The matrices give almost unlimited flexibility in design and are suited to automated production in both small lots and long runs. Moreover, they are compact, low in cost and highly reliable. Modules can be produced as rectangles, arcs,

spirals and accordion folds. Components can be soldered or unsoldered without damaging the grid wire welds. The matrices can be encapsulated before or after components are soldered in place. Continuous in-process testing is practical.

Matrices are formed by two planes of parallel wires running in longitudinal and transverse directions in a one-tenth-inch grid. The two planes are insulated from each other by a thin film. Interconnections between wires are made by spotwelding through the film grid intersections. Wiring paths are isolated by punching out sections of the wires. Siderails are added for lead termination. The matrix is made rigid by encapsulation.

Automated module assembly will be handled in seven stages, several

of which are already operational: matrix layout is first designed by a computer programmed to translate circuit conditions into matrix topology; the layout is printed and approved or changed by the engineer; the computer prepares machine programming tapes; the matrix is fabricated; the module is assembled, tested and potted.

This system will yield a raw matrix 90 minutes after the schematic has been devised—about one-tenth the normal time. If the prototype is satisfactory (alternate prototypes can be prepared at the same time), it becomes the production model and production can commence without further lead time.

Computers have been used for some time at LMED to design matrices. Time required to produce a layout of a matrix with 79 components was, for example, 14 minutes. The machines required for matrix fabrication have also been developed and automatic testing equipment has been designed.

The standard one-tenth inch grid pattern is well-suited to computer programming. Unlike printed wiring, the wire grid gives the computer an extremely large and orderly choice of component locations, wiring paths and wiring crossovers.

Matrix fabrication is divided among three machines so that each machine is reasonably simple. Rails are first made on a supporting machine. A tape-programmed machine assembles, welds and trims the wires. Another tape-programmed machine punches out wire sections.

The rail machine coins two welding projections at each terminal position, slots the rail to provide electrical clearance between terminals and punches the holes which later become component lead soldering notches. A third welding projection is provided if component leads are to be welded to the rail.

Transverse wires are welded to one set of welding projections. The other set provides positive indexing in all assembly steps, assuring that positioning errors are not cumulative. The maximum deviation in

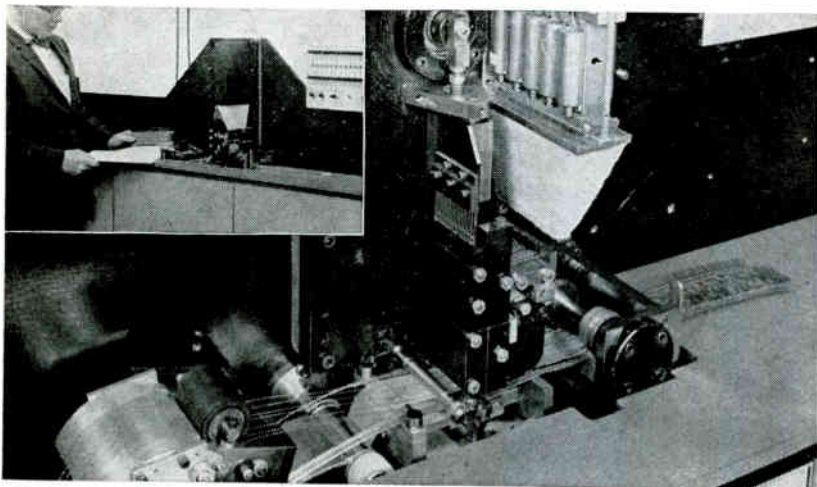

Closeup of rail, wire and film feeds, weld head and (insert) machine

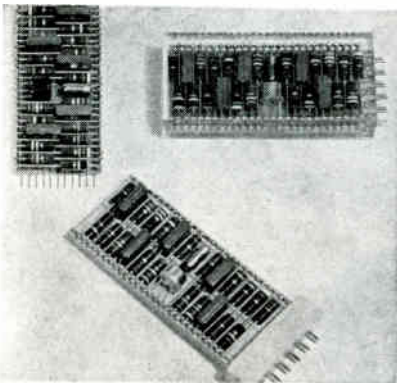

Module and encapsulations

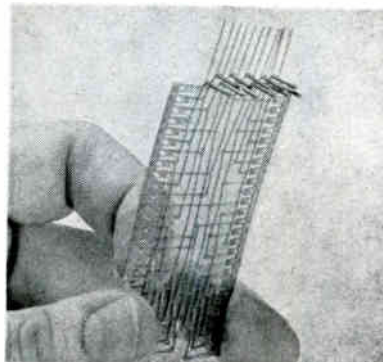

Matrix with connector pins

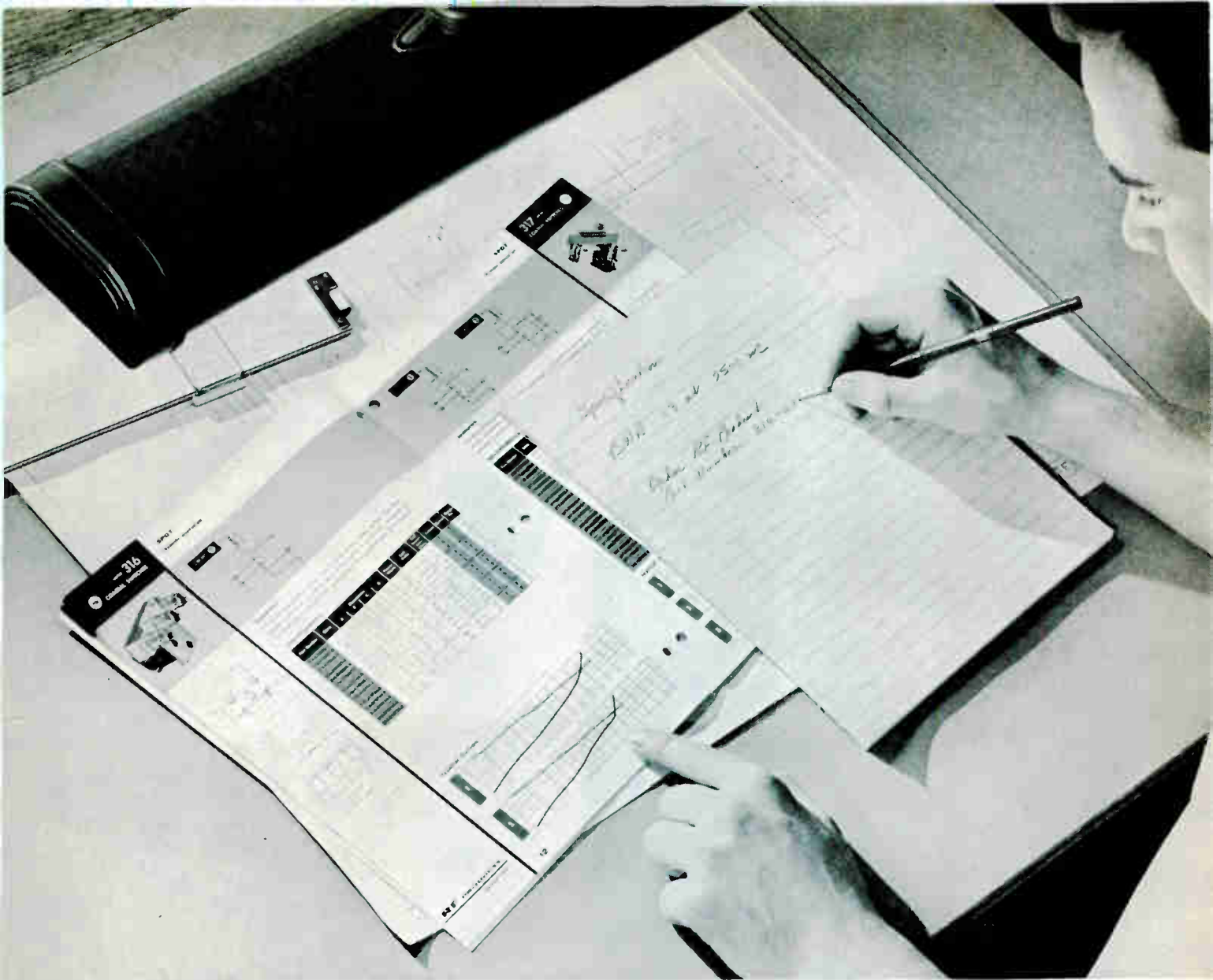

## Now, you can save time and insure reliability... by specifying DK Coaxial switches in your design

It's easy. DK Coaxial switches are available in scores of shapes, sizes, and functions *from factory stock*. RF Products' new DK Coaxial switch catalog lists over 130 variations of 16 basic coax switch designs, covering a proven 90% of all known applications. All the facts and figures on the industry's most complete line of coaxial switches are at your finger tips.

You'll also find that these switches successfully combine ruggedness with the highest standards of precision: spring-leaf switching blades, gold-plated silver contacts and impedance matched connectors keep insertion loss and VSWR (1.3 @ 4,000 MCs) low, Crosstalk high (in

decibels down); electro-mechanically actuated models operate and release in 8 to 20 milliseconds, depending on type and function, with a proven mechanical life of 1,000,000 cycles minimum when operated under 10 cps.

And, don't forget that RF Products, pioneers in the development of the coaxial switch, will continue to offer you design and engineering services whenever you need them. Whether you order a switch from the catalog or a switch designed to meet your exact specifications, you can be assured of the same high quality and service.

For details on our new line of standard switches, write for catalog DK 61.

# RF

# PRODUCTS



DIVISION OF AMPHENOL-BORG ELECTRONICS CORPORATION • 33 EAST FRANKLIN ST., DANBURY, CONN.

CIRCLE 109 ON READER SERVICE CARD

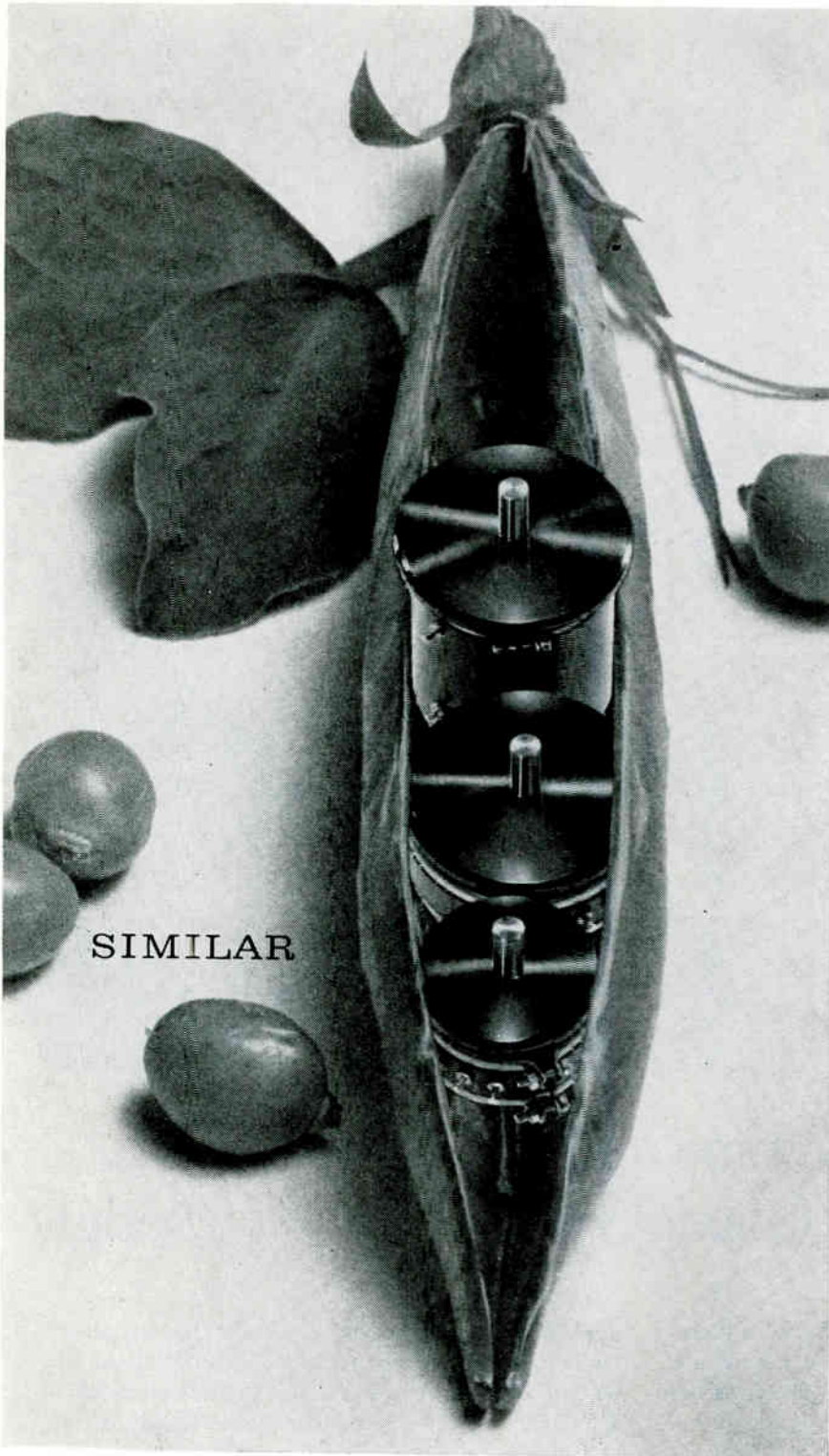

SIMILAR

Shell a basket of assorted Duncan potentiometers and you'll find a similarity that's more than skin deep. Designs have been standardized to yield higher reliability, lower production costs. It's a garden fresh approach that's paying off at the market place. Check over the Duncan crop yourself. They're all in season now! Send for our new Spring Catalog.

Vine ripening above top to bottom: 1-3/4" Model 3704; 1-3/4" 1602 and 1-7/16" 1502. All feature diallyl pthalate housing to withstand shock

and protect against fungus or attack by acids or alkali. Servo or bushing mountings and operating temperatures to 150° C are available.

DUNCAN ELECTRONICS, INC.  
2865 FAIRVIEW ROAD • COSTA MESA, CALIFORNIA

terminal spacing is 0.005 inch in 250 terminals (25 inches).

The weld and trim machine is fed the side rails, insulating film from a ribbon spool, up to 18 longitudinal wires from an array of individual spools, and the transverse wires, which are positioned and cut one at a time from a single spool. The wires are 20 mils in diameter. If a larger conductor surface is needed,

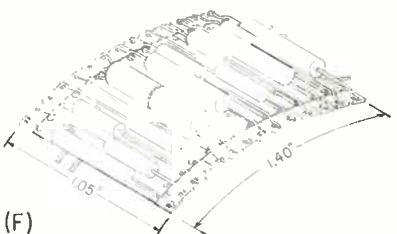
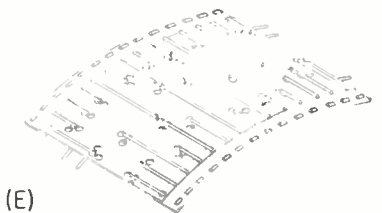
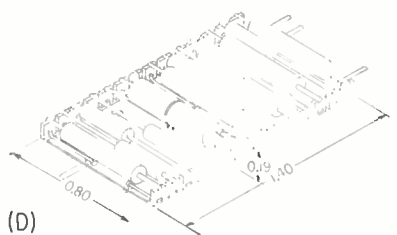
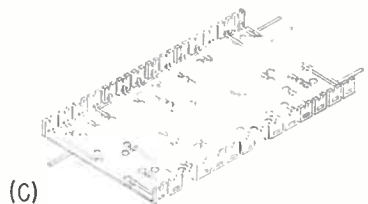
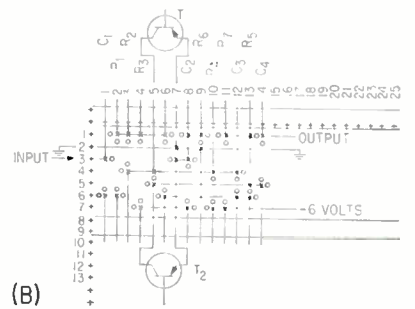
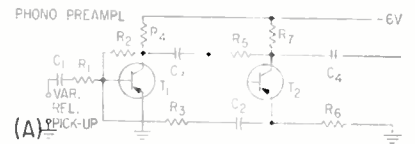

Diagram (A) and layout (B) of typical matrix; flat (C and D) and curved (E) matrices



for example for a ground plane, 0.150 by 0.020-inch strip can be substituted for two wires.

One length of transverse wire is positioned and welded per second. The power supply delivers three pulses, wire-to-wire, wire-to-rail, or wire-to-ground strip.

The lower electrode is common to all ground points and is flexure-mounted. The operator has a choice of three spring-loadings to correspond to the type of weld required. The upper part of the weld head is an array of 20 electrodes, each of which is selectively picked by solenoids and engaged with a mechanical ram which drives it against the lower electrode. The weld power pulse rate and the crankshaft speed are both 10 per second. Contacts on the upper weld head shaft deliver the power pulses to the electrodes at bottom dead center.

Measurable electrical parameters are monitored during the weld power pulse. Experience with this method of in-process monitoring has demonstrated that electrical parameters and weld strength have a fair degree of correlation.

Normally, excess transverse wire is trimmed at the rail weld points. However, the machine will leave the wire projecting beyond the rail where an input connection to the module is needed. Transverse wires can also be omitted at points where the matrix is to be folded.

The wire punch machine is similar to the weld and trim machine in mechanical operation. Punches and dies are located and programmed like the welding electrodes. The matrix is punched in two passes, longitudinal and transverse.

The matrix is then encapsulated and the side rails are trimmed to leave discrete terminals attached to the wires. This is now done by hand, but will be mechanized.

Data is punched into the control tapes in 10-line fields which are read photoelectrically. Each field defines all weld or punch operations and includes a parity check to insure the data is properly read.

Reliability of the modules is high. One group of assemblies containing some 23,000 welded joints and 5,000 solder connections were tested under simultaneous vibration and thermal cycling. During 600 hours of testing, not a single joint failed.

**KEEP IT RIGHT...**

**KEEP IT COOL**  
—economically

*with the New*  
**GOLD SEAL muffin® fan**



Gold Seal Muffin "SKELETON FAN"



Gold Seal Muffin "VENTURI FAN"



Gold Seal Muffin "GRILLED FAN"



Gold Seal Muffin "FILTER FAN"

Minimize component derating—increase life expectancy—assure top performance—KEEP IT COOL with a new Gold Seal Muffin Fan by Rotron.

The Gold Seal Muffin Fan offers "expensive" cooling performance at commercial-equipment prices. No longer is it necessary to settle for hap-hazard phono motor/blade assemblies. The Gold Seal Muffin Fan provides a completely integrated design of motor, blades, optional venturi, grille and filter in performance-matched assemblies.

100 CFM free delivery—quiet, quiet performance—1½" deep x 4-11/16" square small—version choice to fit every requirement—long, long life motor—looks like the quality it is!

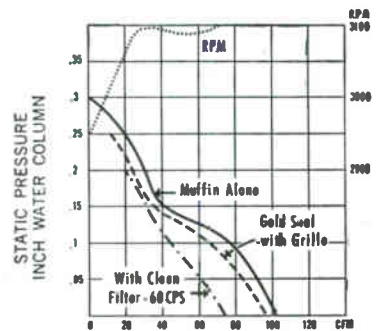

**VERSATILE...** If 100 CFM will cool it, the Gold Seal Muffin Fan will do it best! Reversible air-flow, filtered, grilled, or plain!

**STILL LESS THAN \$8.00 IN QUANTITY!**

Write For Complete Details Today...

*integrated*  
WITH *integrity*  
BY



**ROTRON** mfg. co., inc.

WOODSTOCK, NEW YORK • ORiole 9-2401

In Canada: The Hoover Co., Ltd., Hamilton, Ont.

# New On The Market

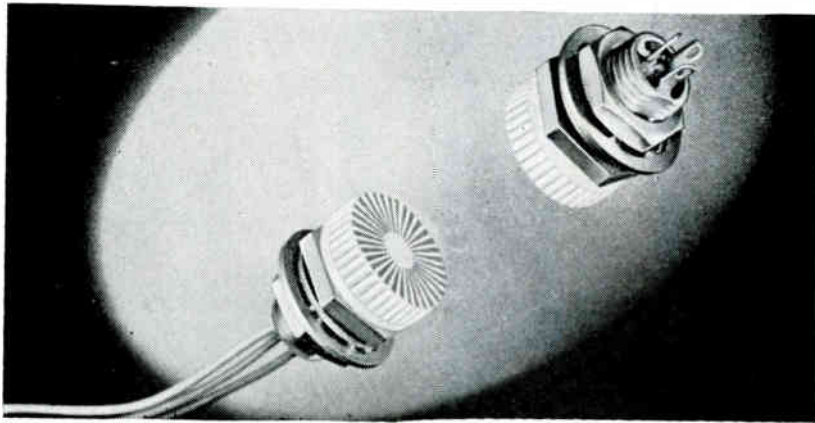

## Potentiometer in Knob

10 TO 10,000 OHMS

POTENTIOMETER design places the electrical element in front of the mounting panel, within the operating knob. The knob functions as a moisture and dust-proof housing, and terminations are brought out through the rear. Series 60M Cap-Pot is available from 10 to 10,000 ohms.

It is wire-wound, rated at  $\frac{1}{2}$  watt at 40 C; taper is linear; standard resistance tolerance is  $\pm 10$  percent. Suited to installations requiring weatherproofing, unit requires no additional gasketing or encapsulation. Manufacturer is Clarostat Mfg. Co., Dover, New Hampshire.

**CIRCLE 301 ON READER SERVICE CARD**



## Four Novar Tubes

9-PIN ALL-GLASS BASE

FOUR NOVAR receiving tubes, having integral 9-pin all-glass bases and a pin circle diameter of 0.687 inch, are announced by RCA Electron Tube Div., 415 5th St., Harrison, N. J. Types include RCA-6AY3, RCA-12AY3 and RCA-17AY3, half-wave vacuum-rectifiers designed as

damper diodes in horizontal deflection circuits. The tubes are rated at 5,000 piv, and supply a maximum peak plate current of 1,100 ma. The RCA-7868 is a high-perveance power pentode, for use in the output stages of high fidelity audio amplifiers, phonographs and radio receivers. The tubes use the new dark heater that functions efficiently at relatively low operating temperature.

**CIRCLE 302 ON READER SERVICE CARD**

## Low Temperature Zeners

TO 0.0005 PERCENT CHANGE

LINE OF highly stable, low temperature coefficient Zener diodes is announced by Pacific Semiconductors, Inc., 12955 Chadron Ave., Hawthorne, Calif. Units are designed especially for equipment with 10-volt full decimal readout, have low dynamic impedance and are not position-sensitive. Temperature coefficients and prices for 100 to 999

units are: PS1511 (0.01 percent) \$7.65; PS1512 (0.008 percent) \$8.95; PS1513 (0.006 percent) \$10.65; PS1514 (0.004 percent) \$13.20; PS1515 (0.002 percent) \$16.15; PS1516 (0.001 percent) \$23.80; and PS1517 (0.0005 percent) \$34.00. All are rated 500 mw and are immediately available.

**CIRCLE 303 ON READER SERVICE CARD**

## Noise Test Set

0 TO 15 DB, 5 TO 2,000 MC

NOISE TEST SET gives precise noise figures of 0 to 15 db at frequencies from 5 to 2,000 Mc. Noise temperature reference serves as the noise source. The temperature reference is a temperature modulated resistor having low vswr, negligible vswr variation during the temperature modulating cycle, and less than 0.1-db variation of excess noise over the frequency range. The

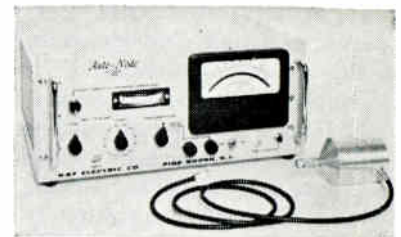

Auto-Node set gives direct readout and contains the equipment for noise-figure measurements. An i-f range of 7.5 to 150 Mc (with a required input noise level of -10 db to 0 dbm over a 3-Mc bandwidth) is provided. Prices and literature are available from Kay Electric Co., Dept. E, Maple Ave., Pine Brook, N. J.

**CIRCLE 304 ON READER SERVICE CARD**

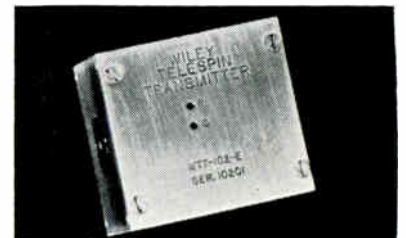

## Telemeter Transmitter

HIGH-SPEED ROTATION

TELEMETERING transmitter is for use in rotors of high-speed rotating

**CIRCLE 113 ON READER SERVICE CARD** →



## ***This label is your passport to priority on 10,000 flights daily***

*Ever wonder how the loading crews at the airport handle shipments bearing the red, white, and blue AIR EXPRESS label? Gently — with real kid-glove handling. Fast, too. In fact, of all packages, they're first on, first off. Special AIR EXPRESS trucks (there are 13,000 of them) come and go throughout the day. Their job is to pick up and deliver door-to-door at both ends of the flights. Does this give you any ideas about your own shipping problems? Then call AIR EXPRESS and find out how little it costs to put this skilled shipping team to work for your company. Once you do, you will always think AIR EXPRESS first! Call now.*

# **AIR EXPRESS**



CALL AIR EXPRESS DIVISION OF R E A EXPRESS • GETS THERE FIRST VIA U. S. SCHEDULED AIRLINES

machinery; it is designed for applications where the simplest possible system is desirable and the data transmission distance is short. Data is transmitted on the subcarrier oscillator frequency directly, with no r-f carrier, through capacitively coupled noncontacting slip rings. No f-m/f-m receiver is required, and subcarrier deviations of  $\pm 40$

percent are readily obtained. Model WTT-102 is 1.75 inches square  $\times$  2.25 inches long; WTT-103 with power pack is 1.25 inches in diameter  $\times$  3.1 inches long. Manufacturer is Wiley Electronic Products Co., 2045 W. Cheryl Dr., Phoenix, Arizona.

**CIRCLE 305 ON READER SERVICE CARD**

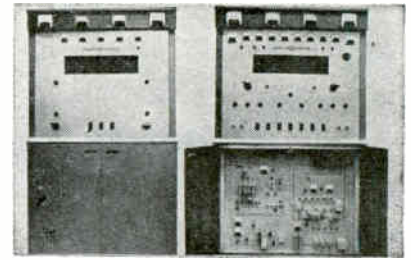

### Transmitter Cubicles SELF-CONTAINED

GENERAL ELECTRIC COMMUNICATION PRODUCTS DEPT., P. O. Box 4197, Lynchburg, Va. These two cubicles make up a 5,000-w vhf high-channel tv transmitter. Single cubicle is the 1,000-w transmitter, while the two cubicles can be used together as a 5,000-w driver for the company's 35,000-w vhf high-channel amplifier to form a 35,000-w transmitter for maximum-power commercial telecasting.

**CIRCLE 308 ON READER SERVICE CARD**



### Beta Computed AS CURRENT VARIES

TRANSISTOR test instrument provides oscilloscope display of beta as collector current varies from 0 to 500 ma. Test frequencies are 1 Kc and 10 Kc; plots to 1 Mc are possible with an external generator. Instrument has both linear and logarithmic sweep of collector current.

The T3A-2 Beta versus  $I_c$  Plotter has an inherent accuracy of 5 percent, exclusive of oscilloscope error. Price is \$1,125; manufacturer is Orbitec Corp., 512-30th St., Newport Beach, Calif.

**CIRCLE 306 ON READER SERVICE CARD**

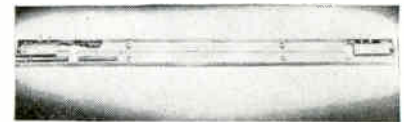

### Delay Line MAGNETOSTRICTIVE

ESC ELECTRONICS CORP., 534 Bergen Blvd., Palisades Park, N. J. Model 20M1 magnetostriictive delay line provides a time delay of 60  $\mu$ sec. Adjustment range of  $\pm 3 \mu$ sec, input impedance of 550 ohm and output impedance of 2,000 ohm; attenuation of 50 db and a signal to noise ratio of 12:1 are features.

**CIRCLE 309 ON READER SERVICE CARD**

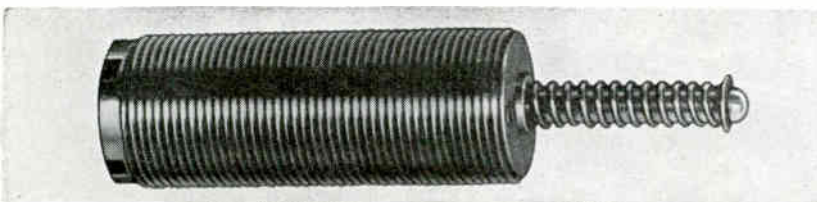

### Linear Potentiometer SHORT STROKE

SENSITIVE TO movements as small as 0.00006 inch, potentiometer can sense small deflections of structures, miniature valves or linkages. The spring loaded shaft drives a flexure supported wiper assembly that multiplies input motion without introducing friction or backlash errors. The static error band, including accuracy, repeatability

and interchangeability, is  $\pm 2$  percent.

Ranges are from 0.015 to 0.070 inch total travel, and resolution is as low as 0.00006 inch. The case is threaded with 9/16-18 threads. Model 150 potentiometer is available from Bourns Inc., 6135 Magnolia Ave., Riverside, Calif.

**CIRCLE 307 ON READER SERVICE CARD**

### Microvolt Meter

$\pm 100 \mu$  VOLT TO  $\pm 1,000$  V

ALL TRANSISTOR d-c microvolt/microammeter operated by an automatically recharged nickel-cadmium battery, Model 4072 has 15 full-scale ranges from  $\pm 100$  microvolts to  $\pm 1,000$  volts; current scales from  $\pm 10$  millimicroamperes to  $\pm 1$  ampere. Accuracy on all ranges is  $\pm 1$  percent of full scale. Overall protection circuit allows up to 100 volts on the microvolts ranges, and 1,000 volts on the upper ranges. Model 4072R is a rack-mounted version of the instrument; manufac-

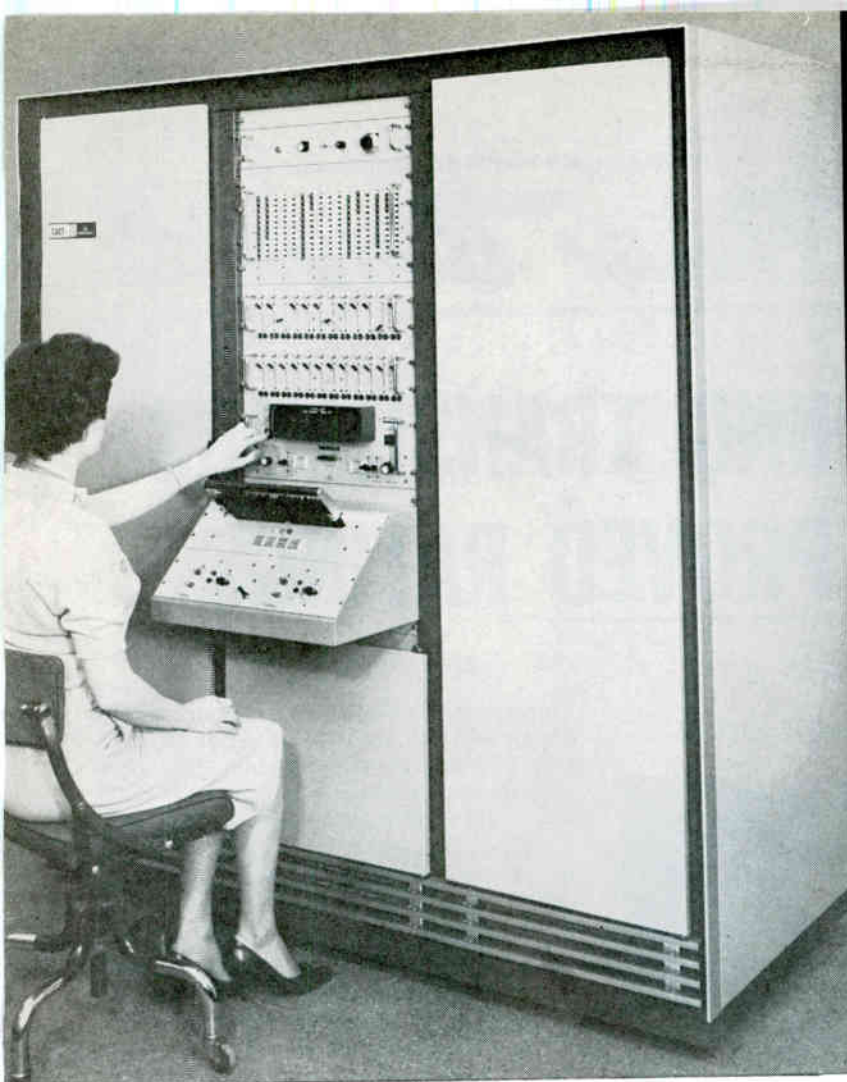

*new from TI*

# tact

TRANSISTOR AND COMPONENT TESTER



Fast, Simplified Programming  
With Punched Cards

MAXIMUM VERSATILITY *PLUS* ECONOMY

**tact** BUILDING-BLOCK DESIGN GIVES YOU BOTH!

TACT is a universally applicable transistor and component tester that will meet both present and future requirements without undue investment. It is a sequentially controlled system which advances through as many as 24 test parameters, applying pre-programmed test limits and visually reading out and/or recording measured results. Time-proved test circuitry is combined with punched-card programming to produce a highly accurate system of high sequential testing speeds.

TACT systems won't become obsolete—can be expanded to accommodate future tests or extended to testing printed circuit boards, modular circuits, etc.

**High Testing Accuracy** results from reduction of readout and signal cable leakage and interference. Test circuitry cabling has been reduced to approximately one-tenth of other designs offering similar testing capabilities.

**Repeatability of Testing** is maximized by punched-card programming and remote control of common test circuitry. Program cards can be retained and used indefinitely, assuring high repeatability and a permanent record of test conditions.

**Nontechnical Personnel** can operate TACT systems with minimum training. Reprogramming can be accomplished in minutes without circuit board or plug-in unit changes.

APPARATUS DIVISION  
PLANTS IN HOUSTON  
AND DALLAS, TEXAS



**TEXAS INSTRUMENTS**  
**INCORPORATED**  
3609 BUFFALO SPEEDWAY  
P. O. BOX 6027 HOUSTON 6, TEXAS

CIRCLE 115 ON READER SERVICE CARD

Extra quality at no extra cost with Bendix Semiconductors

# Bendix Bulletin

## POWER-SWITCHING TRANSISTORS THAT CARRY PROVED RATINGS

*Established parameter limits give engineers new reliable design base*

To help engineers achieve maximum circuit design reliability, Bendix series 2N1136 and 2N1137 power-switching transistors now come with absolutely defined and tested maximum performance ratings.

Electrical specifications are substantiated by actual dynamic tests which include both open base and shorted base breakdown voltage tests at high current.

This valuable testing is conducted at our new Holmdel, New Jersey, facility, devoted exclusively to semiconductor production. Here, also, our improved transistor processing reduces leakage currents, increases current gain linearity, increases transistor power rating by reducing thermal resistance, and controls high temperature (85°C.) ICBO to a maximum of 10 mAdc.

These 2N1136 and 2N1137 germanium PNP power transistors switch up to 400 watts as drivers for relays, relay replacements, solenoids, magnetic clutches, and have many other high current applications in DC-DC converter and DC-AC inverter circuits. Write for complete information on these series, and others in our complete line of Semiconductors.

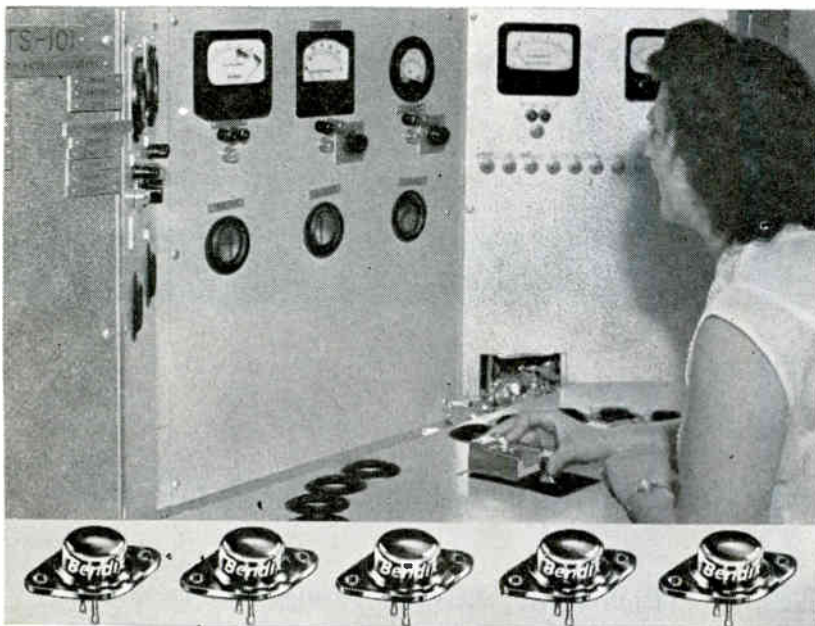

100% specification testing assures transistor rating.

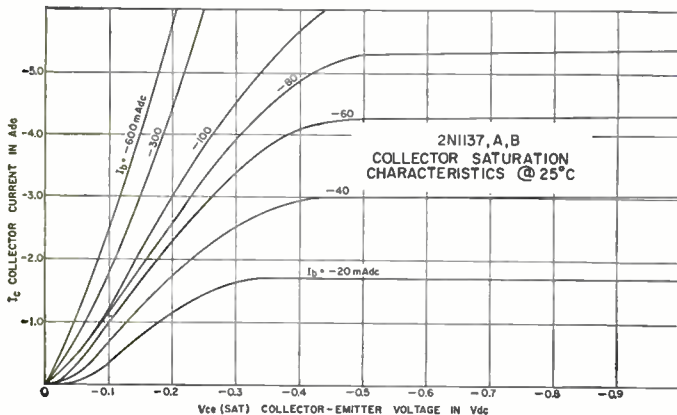

Low saturation means high efficiency

ABSOLUTE MAXIMUM RATINGS						CURRENT GAIN	
Type No.	Vcbo Vdc	Vces Vdc	Vceo Vdc	Ic Adc	Tj °C.	hFE	@ Ic
2N1136	60	40	30	6	100	50-100	3 Adc
2N1136A	90	70	55	6	100	50-100	3
2N1136B	100	80	65	6	100	50-100	3
2N1137	60	40	30	6	100	75-150	3 Adc
2N1137A	90	70	55	6	100	75-150	3
2N1137B	100	80	65	6	100	75-150	3



**Bendix**  
Semiconductor Division  
HOLMDEL, NEW JERSEY

Main Office: South Street, Holmdel, N. J.—Phone: SHadyside 7-5400—TWX HOLM 1388 • New England Office: 114 Waltham St., Lexington, Mass.—Phone: VOLunteer 2-7650  
 Detroit Office: 12950 West 8 Mile Rd., Detroit 37, Mich.—Phone: JORdan 6-1420 • Midwest Office: 2N565 York Rd., Elmhurst, Ill.—Phone: BRowning 9-5050—TWX ELM 393  
 West Coast Office: 117 E. Providencia Ave., Burbank, Calif.—Phone: VICToria 9-3961—TWX BRB 9808 • Canadian Affiliate: Computing Devices of Canada, P.O. Box 508, Ottawa 4, Ont.  
 Export Office: Bendix International, 205 E. 42nd Street, New York 17, N. Y.—Phone: MURray Hill 3-1100—TWX NY 1-4800.  
 Stocking Distributors—Contact nearest sales office for name of local distributor.

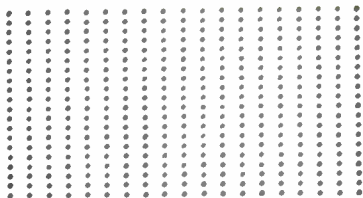

# Bendix

**SEMICONDUCTORS NOW  
AVAILABLE FROM  
DISTRIBUTOR STOCK IN  
QUANTITIES UP TO**

# 999

**FACTORY PRICES APPLY!**

**BALTIMORE, MD.**  
Electronic Wholesalers  
3004 Wilkens Ave.  
Wilkens 5-3400

**BOSTON, MASS.**  
Cramer Electronics  
811 Boylston St.  
COpley 7-4700

**BUFFALO, N. Y.**  
Summit Distributors  
916 Main St.  
TT 4-3450

**CHICAGO, ILL.**  
Newark Electronics  
223 W. Madison St.  
STate 2-2944

**DETROIT, MICH.**  
Rissi Electronic Supply  
14405 Wyoming Ave.  
TEXas 4-8420

**GLENDALE, CALIF.**  
R. V. Weatherford Co.  
6921 San Fernando Rd.  
VICTORIA 9-2741

**LOS ANGELES, CALIF.**  
Radio Product Sales  
1501 S. Hill St.  
RICHmond 8-1271

**MELBOURNE, FLA.**  
Electronic Wholesalers  
1301 Hibiscus  
PARKway 3-1441

**MIAMI, FLA.**  
Electronic Wholesalers  
61 Northeast Ninth St.  
FRanklin 7-2511

**NEW YORK, N. Y.**  
Milgray—New York  
136 Liberty St.  
REctor 2-4400

Milo Electronics  
530 Canal St.  
BEekman 3-2980

Terminal—Hudson  
236 W. 17th St.  
CHelsea 3-5200

**OAKLAND, CALIF.**  
Elmar Electronics  
140-11th St.  
HIGate 4-7011

**PHILADELPHIA, PA.**  
Radio Electric Serv. Co.  
701 Arch St.  
WAlnut 5-5840

**WASHINGTON, D. C.**  
Electronic Wholesalers  
2345 Sherman Way, N.W.  
HUdson 3-5200

Bendix Semiconductor Division



HOLMDEL, N. J.

**CIRCLE 117 ON READER SERVICE CARD**

June 30, 1961

turer is Dynamics Instrumentation Co., 583 Monterey Pass Rd., Monterey Park, Calif.

**CIRCLE 310 ON READER SERVICE CARD**

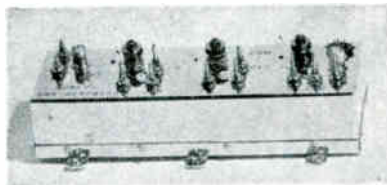

### Preamplifier FOR TELEMETERING

COMMUNITY ENGINEERING CORP., 234 E. College Ave., State College, Pa. Used for the transmission of meter or gage readings to remote locations, model 3010 telemetering preamplifier features very low noise and stable gain. Noise figure averages 4.5 db over the 35-Mc band from 225 to 260 Mc. Gain is 20 db minimum. Available in r-f chassis without power supply, rack and panel with power supply, or in a weatherproof enclosure.

**CIRCLE 311 ON READER SERVICE CARD**

### Missile Battery

ELECTRIC STORAGE BATTERY CO., P. O. Box 11301, Raleigh, North Carolina. Silver-zinc, 24 v battery, automatically activates in one second and has a discharge time of 0.83 min. at 10 amperes.

**CIRCLE 312 ON READER SERVICE CARD**

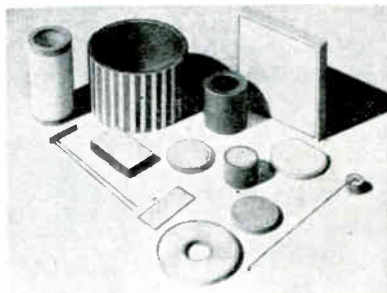

### Piezoid Ceramic Material FOR TRANSDUCER USES

CENTRALAB, The Electronics Division of Globe-Union Inc., 900A E. Keefe Ave., Milwaukee 1, Wisc. Composition KE-14 can be used in underwater sounding apparatus, ordnance systems, sensing gages, ultrasonic equipment and many other devices. The material is available in a wide variety of

shapes; disks, cylinders, tubes, plates and blocks can be supplied as well as unsymmetrical shapes. It has an extremely stable dielectric constant from 55 to 300 C.

**CIRCLE 313 ON READER SERVICE CARD**

### Beacon Transmitter

COOK ELECTRIC CO., 2700 Southport Ave., Chicago 14, Ill. Transistor radio transmitter for satellite location is battery powered and transmits amplitude modulated crystal controlled frequency.

**CIRCLE 314 ON READER SERVICE CARD**

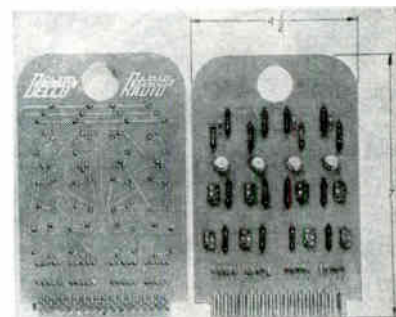

### Flip-Flop Card TWO CIRCUITS

DELCO RADIO DIVISION, General Motors Corp., 700 E. Firmin, Kokomo, Ind. Model CD200 dual flip-flop card can be used as shift register stages, binary computer stages, static storage and the implementation of other logic and control functions. Each flip-flop is transient gated through a five diode AND gate for both set and reset. Circuit will drive five loads and operate over a temperature range of -40 C to +71 C at a toggle speed of 200 Kc.

**CIRCLE 315 ON READER SERVICE CARD**

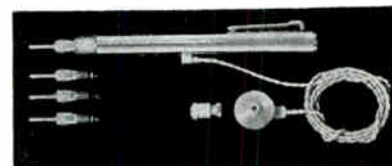

### Signal Tracer TRANSISTORIZED

DON BOSCO ELECTRONICS, INC., 56 Route 10, Hanover, N. J., announces the pen size Stethotracer for locating defective circuits and electronic components. In the absence of an oscilloscope, any low

## DESIGN FOR PERFORMANCE

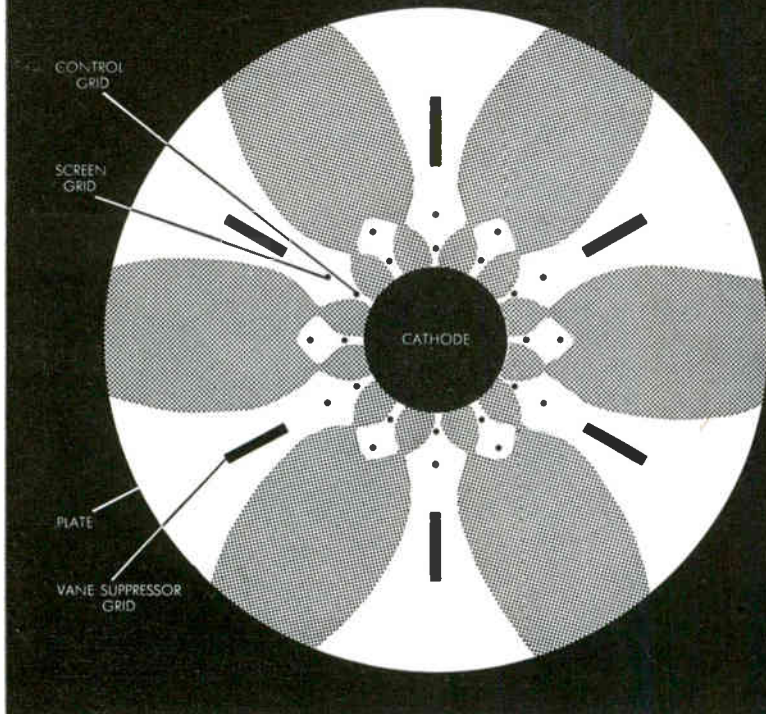

■ **HERE IS A STRAIGHTFORWARD** approach to the problem of preventing electrons from returning to the screen region of a transmitting tube. When channeled into beams like those above, electrons reach the anode, where they do their useful work. Penta's exclusive, patented vane-type suppressor grid does the trick.

■ **THE CHARACTERISTICS** of Penta tubes employing this electrode geometry approach those of the theoretically perfect beam tube. Plate current is practically independent of plate voltage. Kinks and wiggles are absent. Plate voltage can swing well below screen voltage without appreciable loss of current.

■ **THE RESULT IS OUTSTANDING LINEARITY,** efficiency, stability. Penta's PL-172, for example, delivers 1000 watts of Class AB<sub>1</sub> useful output at only 2000 plate volts... more than 1500 watts at maximum Class AB<sub>1</sub> ratings. Introduced in 1955, Penta tubes with vane-type suppressor grids are in important equipment the world over, and their use in high-quality linear amplifiers is growing daily.

■ **YOU TOO CAN ENJOY** the advantages of this years-ahead design by specifying the PL-177A, PL-175A or PL-172 for 100-watt to 1.5 kilowatt power output applications. Detailed, factual data sheets are available for the asking. Ask also for your copy of "Transmitting Tubes for Linear Amplifier Service," which explains how and why this exclusive Penta design provides outstanding performance.

**P. PENTA LABORATORIES, INC.**  
312 North Nopal Street, Santa Barbara, Calif.  
Trade Mark Reg U. S. Pat. Off.



level microwatt audio and modulated r-f signal can be detected or demodulated; then highly amplified (approximately 1,000 times) and reproduced through a high quality earphone device at the output stage. It can also be used as an oscilloscope or voltmeter preamplifier.

**CIRCLE 316 ON READER SERVICE CARD**

### Brush Blocks

ELECTRO-TEC CORP., 10 Romanelli Ave., South Hackensack, N.J. Brush block line provides dimensional stability to 400 F, and electrical stability above 10<sup>11</sup> ohm-cm.

**CIRCLE 317 ON READER SERVICE CARD**



### Power Supply SOLID STATE

DIGITROLS, INC., 8223 Old Philadelphia Road, Baltimore 6, Md. A solid state power supply unit, designed for use with thermoelectric cooling units, changes 115 v a-c 60 cps or 400 cps input to 1½ v d-c. It weighs 4½ lb and measures 3 by 4 by 5 in. Ripple content is less than 10 percent.

**CIRCLE 318 ON READER SERVICE CARD**

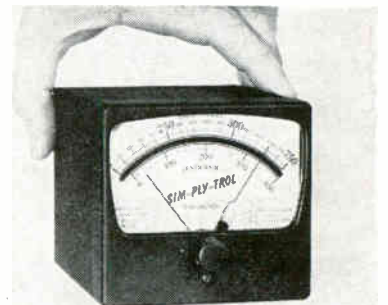

### Temperature Controls AUTOMATIC

ASSEMBLY PRODUCTS, INC., Chesterland, O. Series of small automatic temperature controls, only one-fifth as large as former units but capable of maintaining heat within ± 1 F. The Temp-Tendor controls, intended for panel mounting with



visual signal indication, are available in eight standard temperature ranges between 300 F and 2,500 F.

CIRCLE 325 ON READER SERVICE CARD

## TV Tube

RAYTHEON CO., 55 Chapel St., Newton 58, Mass. T6½ miniature pentode has a transconductance of 25,000 micromhos improves linear deflection.

CIRCLE 326 ON READER SERVICE CARD



## Interlock Switch

36 GANG

PEPCO INC., 2080 Placentia Ave., Costa Mesa, Calif. Switch is made up by using a 3 to 6 pdt unit in a 36 gang interlock assembly, mechanically operated with one reset button, common to all positions. No two buttons can be actuated at one time, and one will not actuate another without first depressing the reset button. It will withstand a shock test in excess of 50 g. Each switch has a low bounce rate of less than 500  $\mu$ sec.

CIRCLE 327 ON READER SERVICE CARD

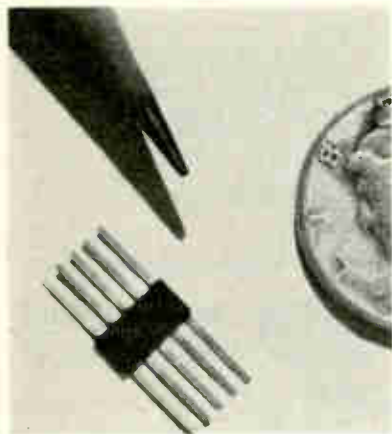

## Micrologic Circuits

MEET MIL SPECS

MICRO SEMICONDUCTOR CORP., 11250 Playa Court, Culver City, Calif., announces silicon micrologic circuits. Basic size for 4, 6 or 8 silicon diode configuration is 0.030 thick by 0.125 wide by 0.250 long. Leads are gold plated and ideally



... sign here!

If you want top-quality pots when you need them, you could make your own! Of course, you'll need Swiss screw machinery to produce the cases necessary to complete the job. So plunge right in — sign up for those highly precision screw machines . . . and hang the cost!

But before you deplete the family exchequer with a grand flourish of the pen, come to Ace! We've already taken the plunge, and it's paid off. These machines automatically deliver, at high speed, cases with mechanical tolerances closer than .0002. This also means the most flexible production operation in the industry. No subcontracted parts to wait for — we design our own cams to any special size and shape, and we run the cases ourselves, on a 24-hour day basis! So for dependable delivery, see your ACErep!



Here's one of our automatic-production cases, on a servo mount A.I.A. size 1-1/16" ACEPOT®. In-plant production on cases up to 6".

**ACE** ELECTRONICS ASSOCIATES, INC.  
99 Dover Street, Somerville 44, Mass.  
SOMerset 6-5130 TMX SMVL 181 West. Union WUX

Acepot® Acetrim® Acesel® Aceohm® \*Reg. Appl. for

**STANDING  
AT THE TOP**

**Westran  
TRANSISTORS**  
QUALITY - RELIABILITY

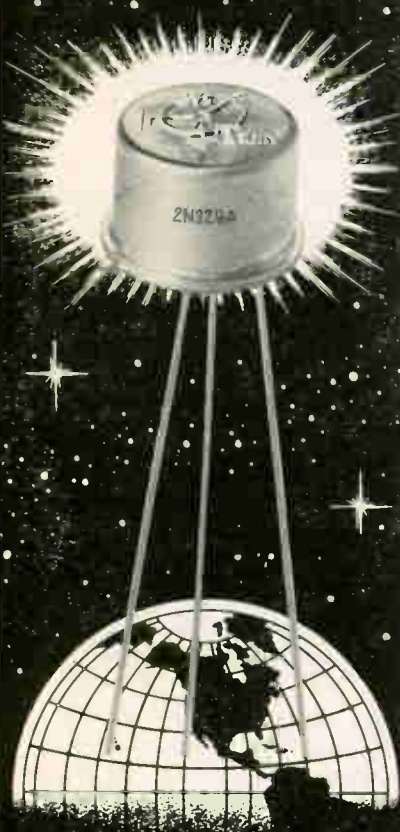

**Westran  
PNP SILICON  
ALLOY JUNCTION**

**TRANSISTORS**

TYPES - 2N327A - 28A - 29A  
2N1228-29-30-31-32-33-34

PROMPT DELIVERY ON ANY ORDER  
24 HOUR DELIVERY ON SMALL QUANTITIES  
CUSTOM DESIGN ENGINEERING SERVICES  
AVAILABLE

**Westran**  
**WESTERN TRANSISTOR CORP.**

13021 South Budlong Avenue  
Gardena, California  
FAculty 1-5741

EXPORT DEPT: Minthorne International Co.,  
15 Moore St., New York 4, N.Y.

Westcon Booth No. 4220

suited for welding and soldering techniques. Individual diode electrical parameters are available in excess of 2 nsec recovery and 2 pf capacitance.

CIRCLE 328 ON READER SERVICE CARD

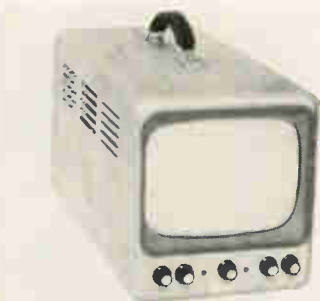

**C-C TV Monitor**  
SMALL SIZE

MIRATEL INC., Richardson St., New Brighton 12, Minn. The L8M, an 8-in. c-c tv monitor features: 10 Mc video bandwidth for better than 800 line resolution; 90 deg industrial quality aluminized kinescope; signal input 0.15 v to full contrast; internal-external sync switch; self-contained fan for extra cool operation.

CIRCLE 329 ON READER SERVICE CARD

### Conductance Diode

DELTA SEMICONDUCTORS, 835 Production Place, Newport Beach, Calif. Silicon computer diode features 4 nanosecond reverse recovery and 400 ma forward current at 1v.

CIRCLE 330 ON READER SERVICE CARD

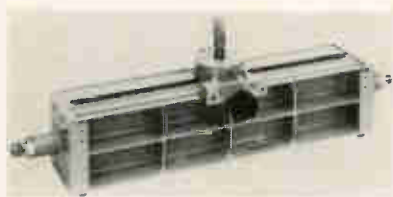

### Slide-Screw Tuner

PRECISE PROBE CONTROL

HEWLETT-PACKARD CO., 1501 Page Mill Road, Palo Alto, Calif. Independent phase and magnitude adjustments, high precision, easy probe insertion control and direct position readings are features of the model 872A coaxial slide-screw tuner. Operating in the 500 to 4,000 Mc range, it consists of a parallel-plane line and a precision

**IMMEDIATELY  
AVAILABLE**

FROM



### CERAMIC-METAL HYDROGEN THYRATRONS

Long-lasting, miniature thyratrons for compact modulator design in missile, airborne and ground-based applications. Ruggedly built . . . withstand severe shock, vibration and temperature extremes . . . functionally replace most glass-envelope tubes.



### CERAMIC-METAL HYDROGEN DIODES

High-power, high-voltage, hydrogen-filled diodes for use as grid-controlled rectifiers, hold-off diodes, inverse clippers and back-swing clippers. Compact, light, rugged . . . withstand severe shock, vibration and temperature extremes.



### CERAMIC-METAL, GLASS-METAL, TRIGGERED SPARK GAPS

Compact, low-cost spark gaps designed for electronic crowbar and high energy switching operations. Low trigger energy requirement, fast follow-through after trigger pulse, unaffected by atmospheric conditions, zero filament power requirement. Ruggedly built to withstand severe shock, vibration and temperature extremes.



### TRANSFORMERS, POWER SUPPLIES

EG&G is outstandingly well staffed and equipped to design and produce custom-built transformers, chokes, magnetic amplifiers, DC to DC converters, pulse transformers and power supplies for military or commercial use . . . and trigger transformers for all types of flash tubes.

Full technical information on all products available on request.



**Edgerton,  
Germeshausen  
& Grier, Inc.**

162 BROOKLINE AVENUE, BOSTON 15, MASS.

CIRCLE 208 ON READER SERVICE CARD

electronics

probe carriage. Unit is designed primarily for correcting discontinuities and for flattening waveguide and coaxial systems.

**CIRCLE 331 ON READER SERVICE CARD**

## Servo Amplifier

MELCOR ELECTRONICS CORP., 48 Toledo St., S. Farmingdale, L. I., N. Y. Transistorized servo amplifier provides 100,000 gain and an input impedance of 10,000 ohms.

**CIRCLE 332 ON READER SERVICE CARD**

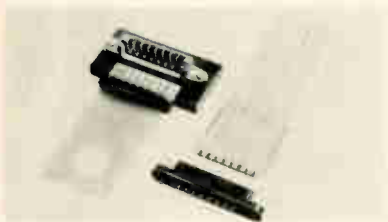

## P-C Connector

TAKES OVER 40 G

MATRIX SCIENCE CORP., 3311 Winona Ave., Burbank, Calif. The Fuz-Lok p-c connectors have female contacts similar to miniaturized fuse clips. In independent tests, they have sustained prolonged vibration of over 40 g from 5 to 2,000 cps without circuit discontinuity. Life cyclings of hundreds of insertions and withdrawals proved no resistance increase or contact wear. Positive pressure and moisture seals are provided. Design temperature is -60 F to +450 F. Male contacts with 0.156 in. spacing are staked to p-c boards or tape cable without soldering.

**CIRCLE 333 ON READER SERVICE CARD**



## Miniature Limit Stop

MULTITURN UNIT

REEVES INSTRUMENT CORP., Garden City, N. Y. Miniature servo-mounted limit stop is continuously variable from 0-42 turns. An external adjustment control permits the stop range to be varied without the need for disassembling the unit or removing it from its

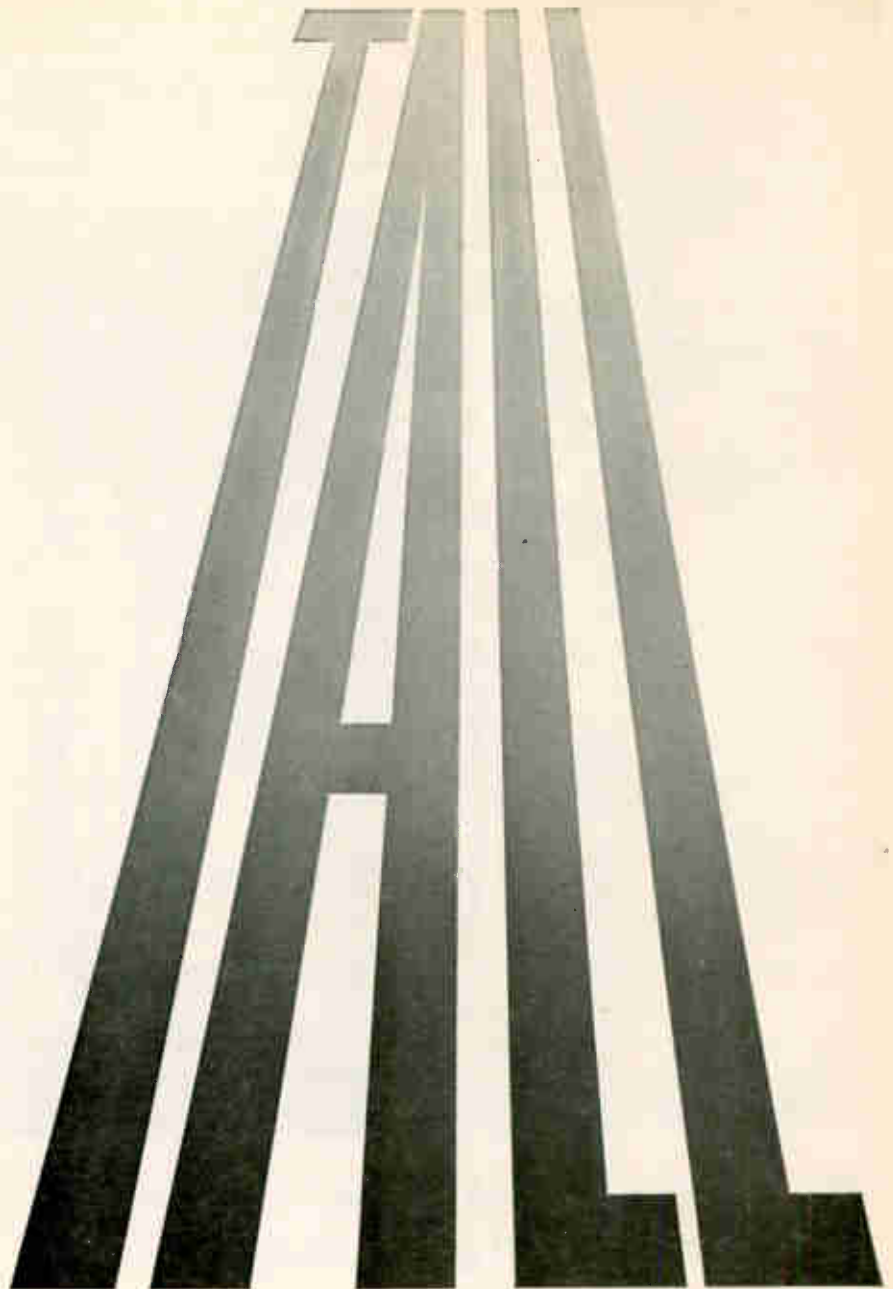

## in telemetry systems management

The ascendant position of Vitro Electronics in telemetry systems management and products stems from the facilities, experience, and talent it takes to produce *on time*. Vitro telemetry capability is demonstrated daily down the AMR and PMR ranges. Management versatility is reflected in our ground, mobile, shipboard, airborne, and space operations around the globe. ■ This specialty of Vitro's trusted electronic competence is founded on long and familiar experience in the functions of telemetry conception, design, engineering, procurement, production, testing, and installation. Where the utmost in exacting telemetry systems performance is demanded — Vitro is at work.

Outstanding opportunities for telemetry systems, RF and advanced development engineers.

**Vitro ELECTRONICS** A DIVISION OF VITRO CORPORATION OF AMERICA  
PRODUCERS OF NEMS-CLARKE EQUIPMENT  
919 JESUP-BLAIR DRIVE, SILVER SPRING, MARYLAND / 2301 PONTIUS AVENUE, LOS ANGELES 64, CALIFORNIA

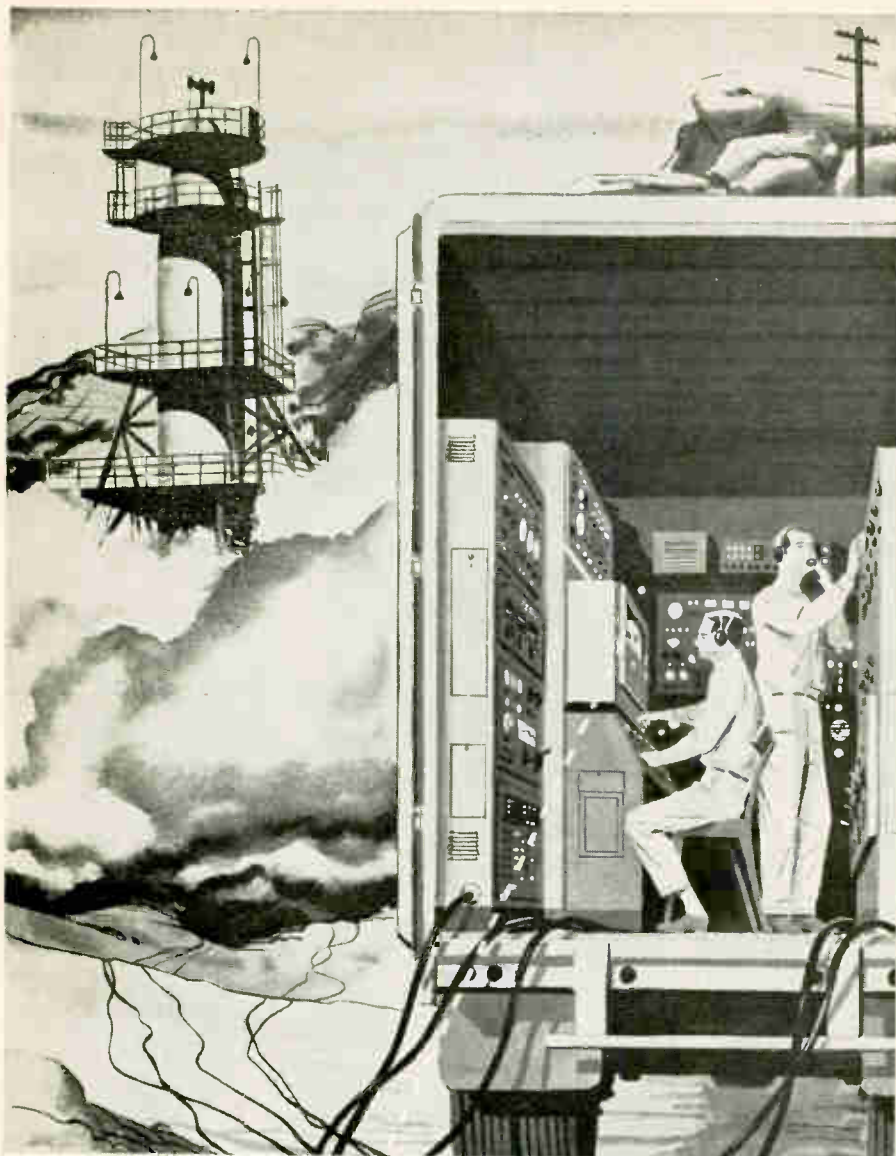

## PI "tape-centered" data handling systems

The difference between success and failure of a space-age project is often determined by the effectiveness of its data-handling system. Where magnetic tape recording is part of the system, you can insure higher performance levels and greater reliability by specifying a PI "tape-centered" data handling system. PI systems are engineered to effectively utilize all the advantages of magnetic tape. By specifying a PI integrated data system, you get the benefit of undivided responsibility from the transducer to the computer input. May we help you plan your next data system? Just drop a note or contact your local PI engineering representative.

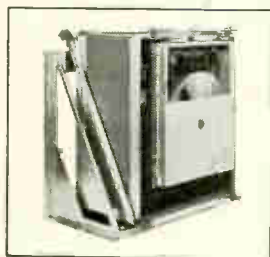

*All-solid-state Precision  $\pi$  Recorder provides doubled frequency response — high reliability for space-age data handling.*



**PRECISION INSTRUMENT COMPANY**  
 1011 Commercial Street • San Carlos, California  
 Phone: LYtell 1-4441 • TWX: SCAR BEL 30

REPRESENTATIVES IN PRINCIPAL CITIES THROUGHOUT THE WORLD

mount. The SR3341 limit stop has a torque rating of 40 oz-in., with a maximum starting torque of 0.04 oz-in.

CIRCLE 334 ON READER SERVICE CARD



## D-C Amplifier CHOPPER-STABILIZED

DYNAMICS INSTRUMENTATION CO., 583 Monterey Pass Road, Monterey Park, Calif. Model 4155 all-transistor amplifier has  $\pm 100$  ma,  $\pm 10$  v output for driving h-f galvanometers. It has voltage gain steps for 0.1 to 10.0 (continuously variable between steps), an input impedance of 100,000 ohms (constant over the passband), frequency response of d-c to 30 Kc, and d-c drift of less than  $\pm 0.1$  percent for any gain setting.

CIRCLE 335 ON READER SERVICE CARD

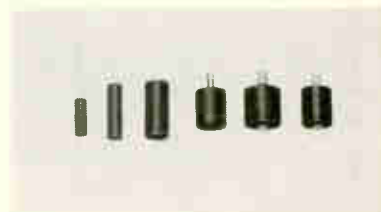

## Transient Suppressors SOLID STATE DEVICES

RELCOIL PRODUCTS CORP., Spring St. & Route 75, Windsor Locks, Conn. The TR series encapsulated transient suppressors are designed to protect electronic circuitry from damage caused by line transients and from transients caused by the switching of inductive current loads. These transients may vary from only a few volts to several thousand volts, and can vary from microseconds to many milliseconds in duration.

CIRCLE 336 ON READER SERVICE CARD

## PRODUCT BRIEFS

**ELECTRONIC CONTROLLER** three-mode. Plug-In Instruments, Inc., 1416 Lebanon Road, Nashville 10, Tenn. (337)

**VARIABLE INDUCTOR** for low audio range. Vari-L Co., Inc., 207 Greenwich Ave., Stamford, Conn. (338)

**HERMETIC SEALING GLASS** for components. Mansol Ceramics Co., Belleville, N. J. (339)

**P-C TRIMMING POT** meets MIL-R-27208. Aero Electronics Corp., 1745 W. 134th St., Gardena, Calif. (340)

**HEAT DISSIPATORS** natural convection. Vemaline Products Co., Franklin Lakes, N. J. (341)

**INDUCTANCE BRIDGE** for 0.4-20 Kc range. Boonton Electronics Corp., Morris Plains, N. J. (342)

**MINIATURE CAPACITORS** for missile use. Hopkins Engineering Co., 12900 Foothill Blvd., San Fernando, Calif. (343)

**AIRBORNE AMPLIFIERS** transistorized. Gulton Industries, Inc., 212 Durham Ave., Metuchen, N. J. (344)

**TELEPHONE-TYPE RELAY** extended coil length. Guardian Electric Mfg. Co., 1550 W. Carroll Ave., Chicago 7, Ill. (345)

**ULTRASONIC PROBE** many applications. Vibrasonics, Inc., 10 High St., Boston, Mass. (346)

**PRESSURE TRANSDUCER** for missile uses. Consolidated Electrodynamic Corp., 360 Sierra Madre Villa, Pasadena, Calif. (347)

**FREQUENCY STANDARD** subminiature. American Time Products, 61-20 Woodside Ave., Woodside 77, N. Y. (348)

**POWER OSCILLATORS** VHF-UHF. Microdot Inc., 220 Pasadena Ave., S. Pasadena, Calif. (349)

**COMPONENT HOLDERS** shock resistant. Masterite Industries, 867 W. Olive St., Inglewood, Calif. (350)

**CONVEYORIZED FURNACE** automated soldering. BTU Engineering Corp., Briar Hill Road, Waltham 54, Mass. (351)

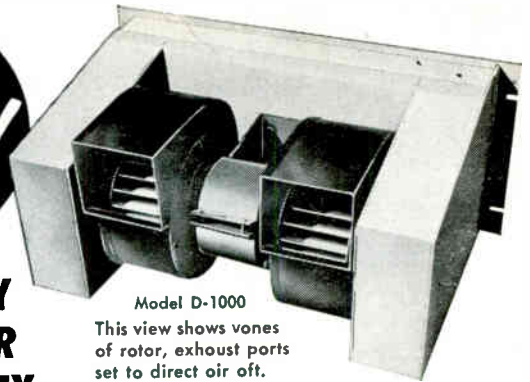

Model D-1000  
This view shows vanes of rotor, exhaust ports set to direct air off.

## A REVOLUTIONARY ALL-ANGLE BLOWER TO SAVE YOU MONEY

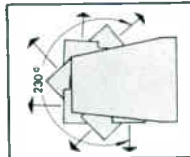

Air flow directed at any angle through 230°

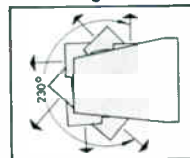

Motor-rotor assembly turned end-for-end gives this pattern

These remarkable new MIL quality All-angle blowers will not only do your cooling jobs more efficiently by more accurately directing air to your exact needs, but their inherent versatility can eliminate purchase of special blowers for many of your applications.

You can rotate their twin scrolls to the angle of your choice through 230°—or, by simply reversing the motor-rotor assembly end-for-end in its housing, create a new and equally diverse air flow pattern.

- Assured 400 CFM output • Mounts as 8 3/4" x 19" standard EIA rack panel—14" max. depth • MIL quality heavy duty construction and finish—or finish to Customer specs
- Easy maintenance without removal from cabinet • Interference-free operation per MIL-I-16910A • Cushion mounted for quiet operation • Sealed ball bearings for long life • Cleanable filter—disposable available.

Ask for complete data—our Bulletin D-1000

ORegon 8-7827

**ONE SOURCE . . .**  
for VENTILATED RELAY RACK CABINETS,  
CONTROL CONSOLES, BLOWERS, CHASSIS,  
CHASSIS-TRAK, RELATED COMPONENTS

**WESTERN DEVICES, INC.**

600 W. FLORENCE AVE., INGLEWOOD 1, CALIF.

CIRCLE 209 ON READER SERVICE CARD



it's read more  
by all 4!

electronics magazine gives you the latest engineering developments. Government trends, military applications, and markets are technically interpreted. Get it first with your own subscription. Mail the reader service card (postpaid) to electronics, the magazine that helps you to know and grow! Rates: three years for \$12, one year for \$6; Canadian, one year for \$10; foreign, one year for \$20. Annual electronics BUYERS' GUIDE (single issue price \$3.00) included with every subscription.

subscribe today to **electronics**

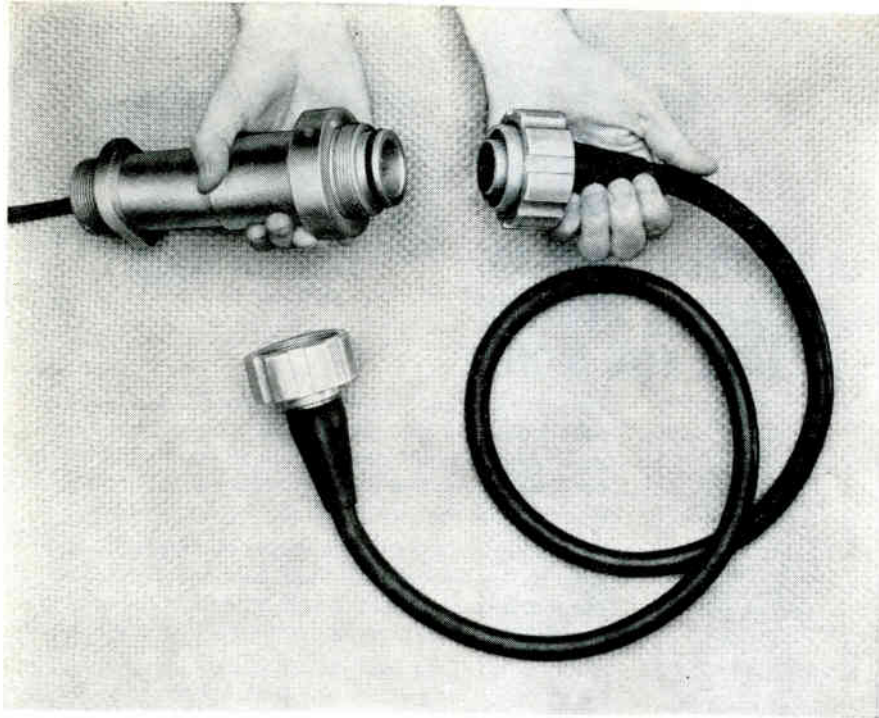

## PROTECT UNDERWATER CIRCUITRY WITH SPECIAL BENDIX CABLES AND CONNECTORS

Based on a concept developed by Portsmouth Naval Shipyard, special cable and connector assemblies offering maximum protection for underwater circuitry are now available from the Scintilla Division of The Bendix Corporation.

These watertight assemblies are available in a variety of configurations. The specification covering this design stipulates that the cable and connector assembly must be capable of operation, mated or unmated, at high pressures. Connector receptacle shells are fabricated of non-corrosive metal. Connector plugs are sealed to the cables by watertight, pressure-tight molding.

Bendix has a wealth of experience in fabricating cables and connectors for underwater applications. If you have needs in these areas—and want top quality at no premium in price—write today for complete information.

**BENDIX CONNECTORS**  
**BENDIX CABLES . . .**

*Designed together  
to work best together!*

**Scintilla Division**  
Sidney, New York



## Literature of

**MAGNETIC CORE TESTER** Rese Engineering, Inc., A and Courtland Streets, Philadelphia 20, Pa. Technical bulletin 60-L describes model 1300 magnetic core tester with maximal laboratory and production capabilities. (352)

**MICROWAVE CONTROL** Microwave Associates, Inc., Burlington, Mass. A six-page article discusses the applications of semiconductor diode devices that use varactors in microwave switching, phase-shifting, duplexing and limiting. (353)

**TV MONITORS** General Electric Communication Products Dept., P. O. Box 4197, Lynchburg, Va., has issued a series of 4-page bulletins on its 14, 17, and 21-in. monitors for c-c tv installations and broadcast station use. (354)

**COMPONENTS** Transistron Electronic Corp., 168 Albion St., Wakefield, Mass. A 12-page condensed catalog presents a cross-section of the company's diversified line of semiconductor devices. (355)

**SWITCHES** Clarostat Mfg. Co., Inc., Dover, N. H. A 4-page catalog includes dimensional drawings, specifications and photos on four types of switches. (356)

**POWER TRIODE** United Electronics Co., 42 Spring St., Newark, N. J., has issued a two-page specification sheet on its ruggedized power triode, type 572. (357)

**MEASUREMENT EQUIPMENT** Rohde & Schwarz, 111 Lexington Ave., Passaic, N. J. Data bulletin FNA covers an automatic recording a-f spectrograph analyzer and response plotter. (358)

**SEMICONDUCTOR PRODUCTION** Lindberg Engineering Co., 2450 W. Hubbard St., Chicago 12, Ill. A 20-page booklet in color is entitled "The Way to Better Semiconductor Production." (359)

**SHIELDING & BRAIDING** Alpha Wire Corp., 200 Varick St.,

# the Week

New York 14, N. Y. A 4-page catalog contains specifications for a line of flat, oval and tubular braid. Included is a glossary of shielding & braiding terms. (360)

**ELECTRONIC COMMUTATOR**  
Arnoux Corp., 11924 W. Washington Blvd., Los Angeles 66, Calif. Bulletin EC covers the -41 series electronic commutator designed for airborne, general-purpose telemetry. (361)

**GLASS-SEALED RESISTORS**  
The Victoreen Instrument Co., 5806 Hough Ave., Cleveland 3, O. Form 3140-61 is a 4-page brochure covering a line of quality glass-sealed resistors. (362)

**INDICATOR DATA** John Oster Mfg. Co., 1 Main St., Racine, Wis. Data sheet covers the type 9816-05 drift angle and ground speed indicator. (363)

**CHOPPER NOISE** James Electronics Inc., 4050 No. Rockwell St., Chicago 18, Ill. A technical report of test techniques and compiled data on residual noise present in chopper circuits is available. (364)

**FLEXIBLE COAXIAL CABLE**  
Andrew Corp., P. O. Box 807, Chicago 42, Ill., has published a 16-page catalog on Heliex, the flexible air dielectric cable. (365)

**MAGNETIC COMPONENTS**  
Applied Components Inc., 401 E. Beach Ave., Inglewood, Calif. Bulletin 561 illustrates and describes custom miniature r-f magnetic components. (366)

**RECORDING PAPER** Alfax Paper and Engineering Co., Inc., Westboro, Mass. An illustrated bulletin covers type A electro-sensitive recording paper that features high sensitivity and response. (367)

**TOROIDAL CORE DESIGN**  
Connolly & Co., 160 Gabarda Way, Menlo Park, Calif. A handbook on Genalex toroidal core design contains basic information tips and formulas. Request copies on company letterhead. (368)

a tube  
in this...  
fails 12  
times more  
often than  
in these!



Tubes, properly shielded with IERC Heat-dissipating Electron Tube Shields, instead of with harmful, obsolete JAN types, can extend tube life up to 12 times in new or retrofitted equipments.

For reliability and extended MTBF in your equipment, write for IERC's report, "Heat-dissipating Electron Tube Shields and Their Relation to Tube Life and Equipment Reliability." From it, you'll find the most effective, practical way to reduce bulb temperatures, neutralize critical environmental conditions, minimize down-time and tube failure-replacement costs!

**IERC**  **DIVISION**

International Electronic Research Corporation  
135 West Magnolia Boulevard, Burbank, California

Foreign Manufacturers: Europec, Paris, France. Garrard Mfg. & Eng. Co., Ltd., Swindon, England



## Motorola Expands Phoenix Division

MOTOROLA'S Semiconductor Products division has officially opened a new 315,000-sq-ft addition to its Phoenix, Ariz., plant. The expansion, doubling the size of the present plant, cost \$4.8 million with an estimated extra \$2 million for manufacturing and research equipment. Floor space is increased to a total of 575,000 sq ft. The facility houses 2,700 employees.

A new three-story office building of 24,000 sq ft is scheduled for the executive offices. The remainder of new space, a three-floor production building, is for manufacturing purposes.

Operating in its own facilities since 1956, the Semiconductor division manufactures mesa transistors for use in computers, missiles, communications, test equipment and radar; general purpose transistors for audio amplifiers, power supplies and electronic devices; industrial rectifiers; power transistors for all types of high power amplifiers and converters; automotive rectifiers; and Zener diodes for use in missiles, aircraft, computers, amplifiers and power supplies.

Under the system of product manager at Motorola, one person is responsible for the design, development and production of all products under his cognizance. Three individual product groups exist and they are responsible for approximately 2,000 devices produced. The groups include alloy transistor group, mesa transistor group and diode product group.

Projected for future investigation at the Semiconductor division is the elimination of interconnec-

tions between elements in electronic circuits by combining all components into one small piece of semiconductor material.

These integrated circuits would perform a complete function such as amplification, flip-flop circuitry and similar operations. Ultimately, no identifiable circuit could be traced in the material and certain forms of damage to the unit would only slightly impair its efficiency.

Daniel E. Noble, executive vice president, communications, Semiconductor and Military Electronic divisions, voices Motorola's view of the future of electronics art. He believes a transition from component electronics to solid state electronics is occurring.

"Our chief concern today", he says, "is with solid state electronics . . . and the semiconductor art is the heart of the revolution in the electronic industry.

"We are just beginning to expand our use of electronics to every phase and facet of modern life, and I venture to say we have not touched more than 10 or 15 percent of the potential and rewarding areas of application discernible in our modern civilization."

## Alpha Metals Opens European Division

ALPHA METALS, INC., Jersey City, N. J., has opened a sales and manufacturing division in London, England. The new plant, a leased property for the time being, occupies 2,000 sq ft.

Philip Baksh, resident European

representative of Alpha Metals, heads up this overseas operation.

The European division has been set up to supply semiconductor device manufacturers in the United Kingdom and on the Continent with the high purity microminiature metal forms used in transistors, diodes and other semiconductor devices.



## Appoint Charles Covey Manufacturing Manager

CHARLES R. COVEY has been appointed manager of manufacturing for Texas Research & Electronic Corp., Dallas, Texas.

For the past 10 years Covey has been associated with Texas Instruments Inc. as manufacturing superintendent in the semiconductor division.



## A. L. Chapman Joins Pacific Mercury

APPOINTMENT of Arthur L. Chapman as senior vice president of Pacific Mercury Electronics is announced. He will be active in overall management functions of the company, particularly in the area of manufacturing. He also will be in charge of marketing and distri-



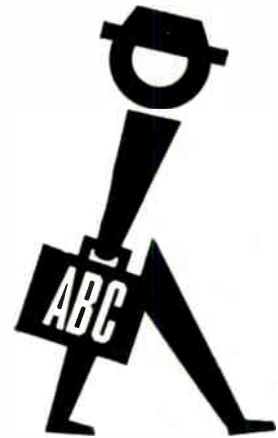
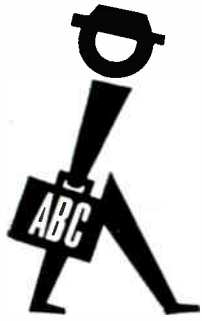

**here,  
there . . .**

## **almost everywhere**

Members of the specially trained, 70-man field auditing staff of the Audit Bureau of Circulations\* make regular calls on 2,900 publications . . . ours included . . . located in almost as many places.

The ABC auditor's call might last a day, a week, or even several months . . . just as long as it takes him to make a complete audit of our circulation records and obtain the information about our circulation audience that ABC will later publish.

Actually, he is working for you — our readers and our advertisers. Knowing full well that we will stay in business only so long as our publication continues to serve the interests of our readers, this audit of our *paid* circulation provides us with a regular and objective review of how well you think we are doing.

Knowing full well that sales messages must reach a responsive audience in order to be effective, our advertisers are also interested in the ABC auditor's call. The hard, and sometimes cold, facts he reports about our circulation provide you with an informed basis for investing your advertising money.

Yes, the ABC auditor has been here . . . and he will be here again, calling to check on how well we are doing our job and to provide the facts to help us *and our advertisers* do even better.

# **electronics**

A MCGRAW-HILL PUBLICATION • 330 W. 42nd ST. • NEW YORK 36, N. Y. 

\* This publication is a member of the Audit Bureau of Circulations, an association of nearly 4,000 publishers, advertisers, and advertising agencies. Our circulation is audited by experienced ABC field auditors. Our ABC report shows how much circulation we have, where it goes, how obtained, and other facts that tell you what you get for your advertising money when you use this publication.

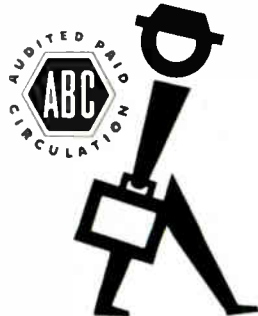

**IN LESS THAN  
4 SECONDS**

FROM THIS

TO THIS

OR THIS

**WITH THE REVOLUTIONARY  
PRODUCTION AID TOOL!**

**"PIG-TAILOR"®**

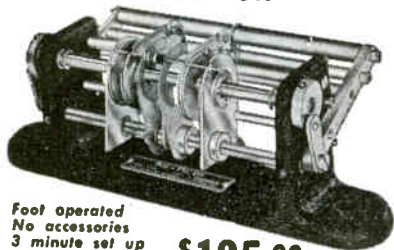

Foot operated  
No accessories  
3 minute set up

**\$125.00**

**'PIG-TAILORING'**

a revolutionary new mechanical process for higher production at lower costs. Fastest PREPARATION and ASSEMBLY of Resistors, Capacitors, Diodes and all other axial lead components for TERMINAL BOARDS, PRINTED CIRCUITS and MINIATURIZED ASSEMBLIES.

**PIG-TAILORING eliminates:** • Diagonal cutters • Long nose pliers • Operator judgment • 90% operator training time • Broken components • Broken leads • Short circuits from clippings • 65% chassis handling • Excessive lead tautness • Haphazard assembly methods.

**PIG-TAILORING provides:** • Uniform component position • Uniform marking exposure • Miniaturization spacing control • "S" leads for terminals • "U" leads for printed circuits • Individual cut and bend lengths • Better time/rate analysis • Closer cost control • Invaluable labor saving • Immediate cost recovery.

**Pays for itself in 2 weeks**

**"SPIN-PIN"®**

Close-up views of "SPIN-PIN" illustrate fast assembly of tailored-lead wire to terminal.

- No Training
- No Pliers
- No Clippings
- Uniform Crimps
- 22 Sizes

**PAYS FOR ITSELF  
THE FIRST DAY!**

**\$500**  
EACH

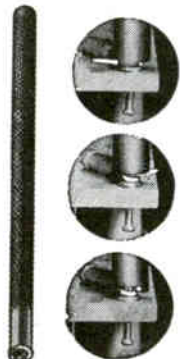

Write for illustrated book to Dept. E-6



**BRUNO-NEW YORK INDUSTRIES CORP.**

DESIGNERS & MANUFACTURERS OF ELECTRONIC EQUIPMENT  
460 WEST 34th STREET • NEW YORK 1, N. Y.

bution of electronic telemetering equipment for Pacific Mercury's Telemetering Corp. of America subsidiary.

For the past four years Chapman was associated with Columbia Broadcasting System, Inc. as president of CBS Electronics Division and was a vice president and member of the board of directors of the parent corporation.



**Dunn Engineering  
Elects Johnson**

LEONARD B. JOHNSON, a director and operations manager of Dunn Engineering Corp., Cambridge, Mass., has been elected a vice president of the company. He has been with Dunn since the firm was founded in 1951 to design and manufacture advanced electronics systems and inertial guidance and other missile program test equipment.



**Major Sperry Division  
Promotes Garbarini**

APPOINTMENT of Robert F. Garbarini as chief engineer of Sperry Gyroscope Company's Air Armament Division in Great Neck, N. Y., is announced. He joined Sperry as an assistant project engineer in 1941, and has held a number of positions since.

In his new post, Garbarini will

**Lepel**

**HIGH FREQUENCY  
Induction  
HEATING  
UNITS**



Lepel induction heating equipment is the most practical and efficient source of heat developed for numerous industrial applications

*Typical Induction  
Heating Applications*

**Glass to Metal Seals**

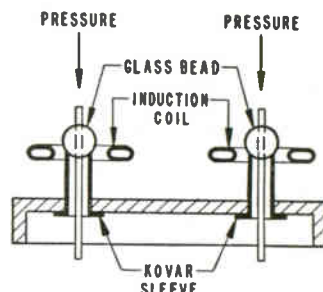

Induction heating is ideal for the assembly of glass beads to pre-oxidized Kovar metal sleeves for a header sub-assembly. The glass-Kovar joint area is brought to 1550° F while pressure is applied to the glass beads.

Our engineers will process your work samples and return the completed job with full data and recommendations without cost or obligation.

**Production Soldering  
Resistors With Long Pigtaills**

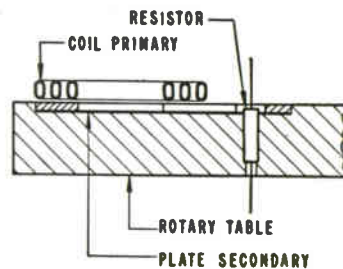

Heating occurs in small opening of plate secondary which is electromagnetically coupled to stationary primary. This produces highly localized heating while avoiding interference of pigtail with the coil. One turntable contains a number of loading positions.

WRITE FOR NEW LEPEL CATALOG

**Lepel HIGH FREQUENCY  
LABORATORIES, INC.**

55th ST. & 37th AVE., WOODSIDE 77, N. Y.  
CHICAGO OFFICE: 6246 WEST NORTH AVE.

be responsible for the engineering development of aeronautical, space and air armament equipment Sperry produces for commerce, industry and government.



### TIC of Acton Hires Richard Harris

RICHARD HARRIS has been appointed manager of the Instrument Division of Technology Instrument Corp. of Acton, Acton, Mass. He was formerly with Sanborn Co. as department manager of preproduction engineering for medical and industrial recording systems and transducers.

### Hughes Group Names Robert Veale

ROBERT J. VEALE has been appointed manager of radar applications engineering at Hughes Aircraft Company's ground systems group in Fullerton, Calif. He previously served as senior staff engineer and group head of an advanced radar project.



### Honeywell Names Noll Divisional V-P

W. T. NOLL, general manager of Minneapolis-Honeywell's Aeronautical division facilities in Minneapolis

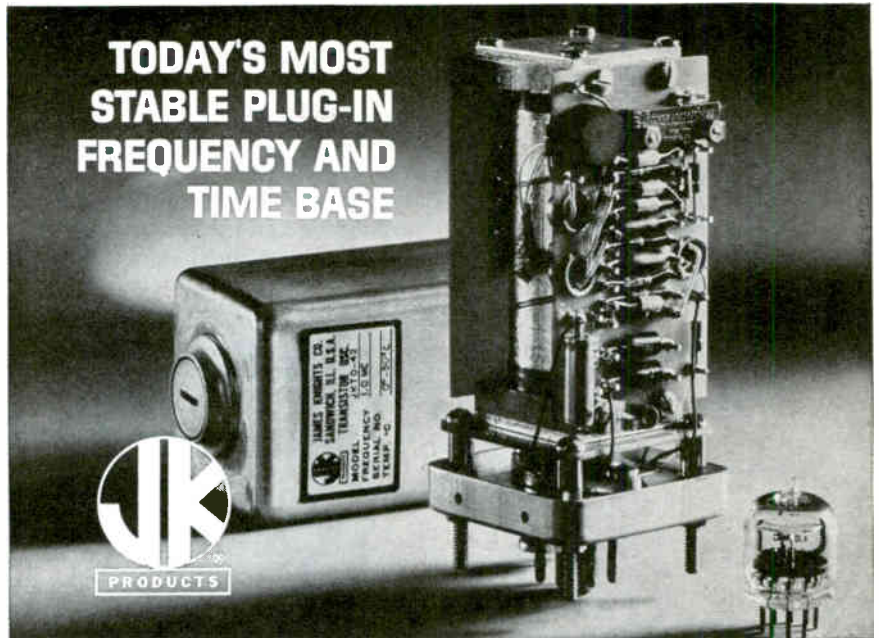

**Stability:**  $5 \times 10^{-9}$ /day. **Frequency:** 1 mc; available to 5 mc. **Oven:** AC type proportional control. **Temperature Stability:** .005°C at fixed ambient temperature; .01°C over ambient range of 0°C to 50°C. **Dimensions:** 2" x 2" x 4.5" seated height. **Power:** 28 volt input. For information write James Knights Company, Sandwich, Illinois.

## JKTO-42 Transistorized FREQUENCY STANDARD

Designed for Laboratory-  
Environment Service

CIRCLE 211 ON READER SERVICE CARD

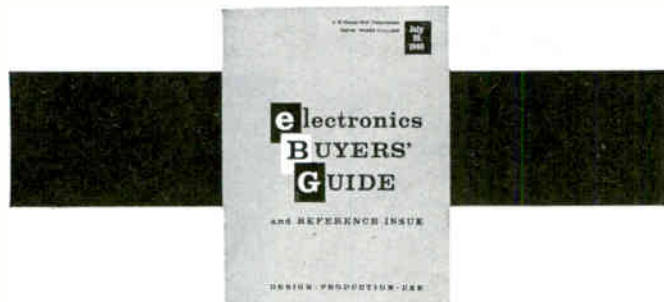

## FIRST CHOICE OF ALL 4!

RESEARCH — DESIGN — PRODUCTION — MANAGEMENT

There is no mystery about who gets and uses the **electronics BUYERS' GUIDE**. It is part of the paid subscription to regular weekly issues of **electronics**, and is available and used by the more than 52,000 identified subscribers of the magazine.

Only the **electronics BUYERS' GUIDE** is compiled to satisfy the basic buying needs of all four key segments of the industry — research, design, production, management.

## GIVES MORE TO ALL 4!

**electronics BUYERS' GUIDE**  
and REFERENCE ISSUE

## VARIAN Potentiometer RECORDERS

Preferred nationwide because  
you get . . .

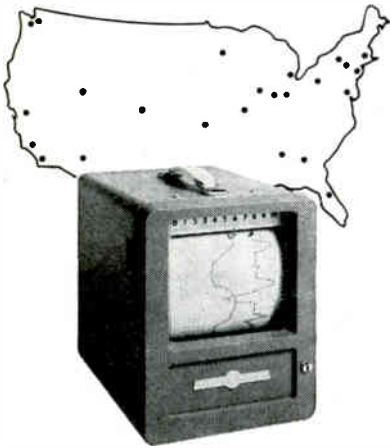

### COAST-TO-COAST SERVICE

Your Varian G-10, G-11A and G-22 need never stand idle for want of parts, service, accessories or supplies. Factory-trained service representatives in key U.S. locations are as near as your phone. Selected cities throughout the free world are represented.

Albuquerque, Bridgeport, Chicago, Dallas, Denver, Detroit, Houston, Kansas City, New York, N. Hollywood, Orlando, Phoenix, Pittsburgh, St. Louis, Sacramento, San Diego, Seattle, Syracuse. And Bombay, Cologne, Melbourne, Stockholm, Tel Aviv, Tokyo, Zurich.

Details from the Instrument Division



**VARIAN**  
**associates**  
PALO ALTO 1, CALIFORNIA

lis and Los Angeles, has been appointed a divisional vice president.

He joined Honeywell in 1940 as an inspector and has served in a variety of positions, including production control manager of the Aeronautical division, director of production for the division and assistant general manager.



### Erie-Pacific Hires Engineering Manager

GEORGE W. SPENCER has been named as engineering manager of Erie Resistor Corp., Hawthorne, Calif.

Prior to joining Erie-Pacific, Spencer was engineering supervisor of a Minuteman test requirements and evaluation group at North American Aviation's Autometrics Division in Downey, Calif.



### American Optical Appoints Brendle

THOMAS A. BRENDLE has been named to the new position of manager of electronic development by the American Optical Company's Instrument Division in Buffalo, N.Y. He was formerly product manager of nuclear systems for Curtiss-Wright Corp.'s Princeton Division.

### Announce Formation Of New Corporation

DONALD A. HOLDT, formerly executive vice president of Airpax Elec-

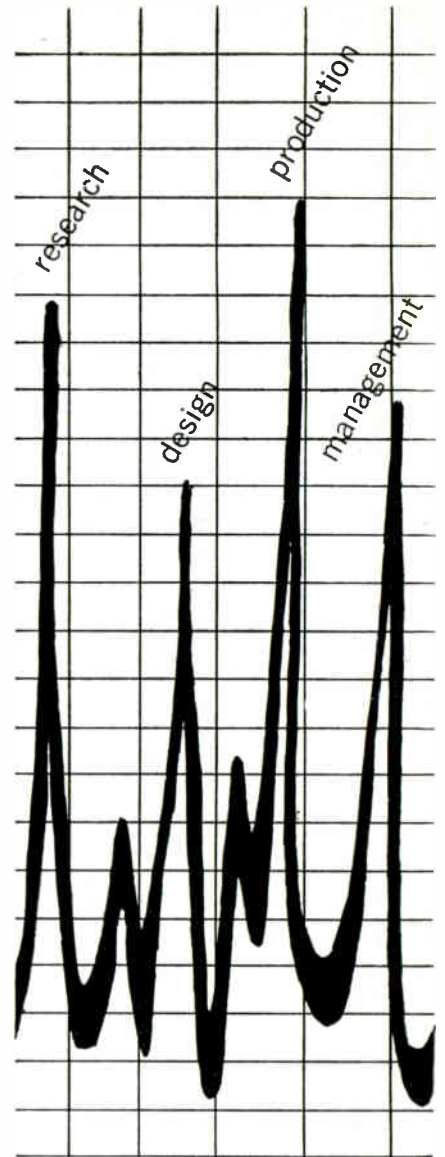

## IT'S READ MORE BY ALL 4!

**electronics** magazine interprets electronics for electronics men every week. The latest components, economic trends, military applications. Technical data you'll want to file and keep. Get the facts first with a personal subscription (don't be low man on a routing slip). Mail the reader service card (postpaid) to **electronics**, the magazine that helps you to know and to grow! Rates: three years for \$12, one year for \$6; Canadian, one year for \$10; foreign, one year for \$20. Annual **electronics** BUYERS' GUIDE (single issue price \$3.00) included with every subscription.

subscribe today to  
**electronics**

**NEW...COMPACT...  
TRANSMISSION & DELAY  
MEASURING SET  
TYPE 453-A**



**FEATURES:**

- ✓ Measures Attenuation and Relative Delay Characteristics of Transmission Systems with Impedances of 600 ohms
- ✓ 500 cps to 50 kc Carrier Frequency Range
- ✓ Accuracy =  $\pm 5$  microseconds

**TYPE 453-A MEASURES DELAY**

... by comparing the time relationship between the transmitted and received signals. The transmitter generates an amplitude modulated signal consisting of a variable carrier modulated at a constant 62.5 cycle rate. The receiver measures the change in relative phase of the 62.5 cycle envelope of the transmitted signal with respect to a common reference derived from the source which generates the 62.5 cycle modulation. Provisions are also made to measure the levels of the transmitted and received signals.

**SPECIFICATIONS:**

**Carrier Frequency:** Adjustable in two ranges from 500 cps to 40 kc.

**Modulation Frequency:** 62.5 cps derived through frequency dividing circuits from a tuning fork controlled oscillator.

**Transmitter Output:** Two output levels 0 dbm and -4 dbm, floating and balanced. Output impedance 600 ohms  $\pm 30$  ohms over range 500 cps to 50 kc. Frequency characteristics of output signal flat to  $\pm 5$  db.

**Receiver Input:** Balanced and floating with an input impedance of 600 ohms  $\pm 20$  ohms from 500 cps to 50 kc.

**Delay Measurements:** Indicated on a relative basis. Always read on the 0 to 0.2 M.S. full scale range. Coarse and Fine Delay switches and Fine Phase Control for precise adjustments.

**ALSO AVAILABLE:  
TYPE 451-A AND 452-A**

**Transmission and Delay Measuring Set.**

- Measuring Range 200 cycles to 24 kc.
- Accuracy  $\pm 50$  microseconds.
- Drift rate within  $\pm 50$  microseconds per 30 min.
- No loop back required.



For further information write

**TECHNOLOGY INSTRUMENT CORP.**

533 MAIN STREET, ACTON, MASS.

8530 WILSHIRE BLVD.  
BEVERLY HILLS, CALIF.

CIRCLE 213 ON READER SERVICE CARD

June 30, 1961

tronics, chopper manufacturer, has announced the formation of Cambridge Scientific Industries, Inc., in Cambridge, Md.

In making the announcement, Holdt defined the scope of activities of Cambridge Scientific to include the design and manufacture of electromechanical devices for the electronic and aircraft industries.

He said the company also has plans for the manufacture of several instruments for the medical profession.

**PEOPLE IN BRIEF**

Norman Milkman leaves Budd Electronics to join the data processing engineering dept. of Trak Electronics Co. as senior project engineer. Walter Stehle, formerly with Ryan Aeronautical Co., named manager of systems and procedures for the information technology div., General Dynamics/Electronics. Harley L. Bjeland of National Cash Register Co. advances to manager of engineering development for the military dept., electronics division. Frederick W. Mumma, ex-Remington Rand Univac, joins Auerbach electronics Corp. as technical staff member. James J. Carey chosen to head Caledonia Electronics & Transformer Corp.'s new pulse transformer dept. Donald A. Hurter transfers from Texas Instruments to Standard-Thompson Corp. as assistant to the president. Edward C. Puth promoted to selenium product line manager of ITT's components division. C. E. Flanagan leaves E. I. duPont de Nemours to join Muscle Shoals Electrochemical Corp. as director of research. Eugene K. Thornburn, formerly with Pacific Optical Corp., appointed to the senior technical staff of Perkin-Elmer Corp.'s electro-optical division. William P. Sharpe, Jr., of International Resistance Co.'s documented reliability dept. accepts the additional post of marketing manager for the plastic products division. William C. Giegold promoted to manager of quality control by General Electric's silicone products dept.

**NOW!**

**ELECTRONIC  
MEASUREMENTS  
HALF-RACK**

**Power Supplies  
are portable, too**

Talk about small size, this portable Electronic Measurements Power Supply measures just 7 $\frac{1}{2}$ " W x 5" H x 6 $\frac{1}{4}$ " D. Yet it has all the features of much larger E/M Semiconductor Power Supplies... vernier as well as main voltage control, continuous current limiting control, remote programming, 0.1% regulation, and more.

Ask for Catalog 1961-L

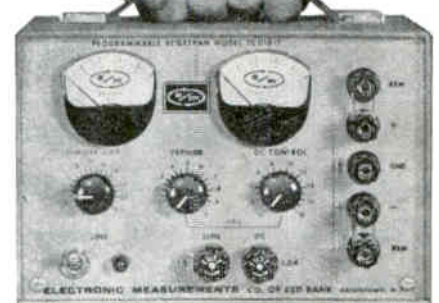

**BRIEF SPECIFICATIONS**

MODEL	VOLTS DC	CURRENT
TR018-1	0-18	0-1AMP
TR036-0.2	0-36	0-200MA
TR036-0.5	0-36	0-500MA
TR212A	0-100	0-100MA



**ELECTRONIC  
MEASUREMENTS  
COMPANY OF RED BANK**  
RED BANK, NEW JERSEY

CIRCLE 137 ON READER SERVICE CARD

137

# electronics

## WEEKLY QUALIFICATION FORM FOR POSITIONS AVAILABLE

### ATTENTION: ENGINEERS, SCIENTISTS, PHYSICISTS

This Qualification Form is designed to help you advance in the electronics industry. It is unique and compact. Designed with the assistance of professional personnel management, it isolates specific experience in electronics and deals only in essential background information.

The advertisers listed here are seeking professional experience. Fill in the Qualification Form below.

#### STRICTLY CONFIDENTIAL

Your Qualification form will be handled as "Strictly Confidential" by ELECTRONICS. Our processing system is such that your form will be forwarded within 24 hours to the proper executives in the companies you select. You will be contacted at your home by the interested companies.

#### WHAT TO DO

1. Review the positions in the advertisements.
2. Select those for which you qualify.
3. Notice the key numbers.
4. Circle the corresponding key number below the Qualification Form.
5. Fill out the form completely. Please print clearly.
6. Mail to: D. Hawksby, Classified Advertising Div., ELECTRONICS, Box 12, New York 36, N. Y. (No charge, of course).

COMPANY	SEE PAGE	KEY #
A C SPARK PLUG The Electronics Div. of G. M. Milwaukee, Wisconsin	37*	1
ESQUIRE PERSONNEL Chicago, Illinois	93*	2
GENERAL ELECTRIC Missile & Space Vehicle Dept. Philadelphia, Pa.	125, 126, 127, 128	3
GRUMMAN AIRCRAFT ENGINEERING CORP. Bethpage, L. I., New York	139	4
HONEYWELL AERO Minneapolis, Minnesota	141	5
LABORATORY FOR ELECTRONICS Boston, Massachusetts	36	6
LOCKHEED California Div. Burbank, California	97	7
MATERIALS RESEARCH CORP. Yonkers, New York	141	8
MONARCH PERSONNEL Chicago, Illinois	93*	9
PHILCO WESTERN DEVELOPMENT LABS. Palo Alto, California	140	10
RADAR DESIGN CORP. Syracuse, New York	93*	11
REMINGTON RAND UNIVAC Div. of Sperry Rand Corp. St. Paul, Minnesota	86*	12
SPACE TECHNOLOGY LABS., INC. Sub. of Thompson Ramo Wooldridge Los Angeles, California	15	13
WLAC-TV INC. Nashville, Tenn.	141	14

\* These advertisements appeared in the 6/23/61 issue.

(cut here)

(cut here)

## electronics WEEKLY QUALIFICATION FORM FOR POSITIONS AVAILABLE

### Personal Background

### Education

NAME .....

HOME ADDRESS.....

CITY..... ZONE..... STATE.....

HOME TELEPHONE.....

PROFESSIONAL DEGREE(S).....

MAJOR(S) .....

UNIVERSITY .....

DATE(S) .....

### FIELDS OF EXPERIENCE (Please Check)

6301

- |                                              |                                              |                                       |
|----------------------------------------------|----------------------------------------------|---------------------------------------|
| <input type="checkbox"/> Aerospace           | <input type="checkbox"/> Fire Control        | <input type="checkbox"/> Radar        |
| <input type="checkbox"/> Antennas            | <input type="checkbox"/> Human Factors       | <input type="checkbox"/> Radio—TV     |
| <input type="checkbox"/> ASW                 | <input type="checkbox"/> Infrared            | <input type="checkbox"/> Simulators   |
| <input type="checkbox"/> Circuits            | <input type="checkbox"/> Instrumentation     | <input type="checkbox"/> Solid State  |
| <input type="checkbox"/> Communications      | <input type="checkbox"/> Medicine            | <input type="checkbox"/> Telemetry    |
| <input type="checkbox"/> Components          | <input type="checkbox"/> Microwave           | <input type="checkbox"/> Transformers |
| <input type="checkbox"/> Computers           | <input type="checkbox"/> Navigation          | <input type="checkbox"/> Other .....  |
| <input type="checkbox"/> ECM                 | <input type="checkbox"/> Operations Research | <input type="checkbox"/> .....        |
| <input type="checkbox"/> Electron Tubes      | <input type="checkbox"/> Optics              | <input type="checkbox"/> .....        |
| <input type="checkbox"/> Engineering Writing | <input type="checkbox"/> Packaging           | <input type="checkbox"/> .....        |

### CATEGORY OF SPECIALIZATION

Please indicate number of months  
experience on proper lines.

	Technical Experience (Months)	Supervisory Experience (Months)
RESEARCH (pure, fundamental, basic)	.....	.....
RESEARCH (Applied)	.....	.....
SYSTEMS (New Concepts)	.....	.....
DEVELOPMENT (Model)	.....	.....
DESIGN (Product)	.....	.....
MANUFACTURING (Product)	.....	.....
FIELD (Service)	.....	.....
SALES (Proposals & Products)	.....	.....

CIRCLE KEY NUMBERS OF ABOVE COMPANIES' POSITIONS THAT INTEREST YOU

1 2 3 4 5 6 7 8 9 10 11 12 13 14 15 16 17 18 19 20 21 22 23 24 25

## ELECTRONICS AT GRUMMAN



## ...THE FIRST TEE

The first tee is hardly the place for a theoretical discussion on the relative merits of automated high resolution radar, but that's how it goes at Grumman. It's difficult to tell an engineer to turn his mind off at 4:30 when as so often happens, he heads for the nearby Bethpage golf course. While there is no supporting statistical data, it has been the Grumman experience that many first rate engineering ideas have been born away from work . . . even under the unprofessional auspices of the golf course. Total involvement with their work seems to be characteristic of Grumman engineers.

Engineers who would like to "tee off" on the many long range programs at Grumman are cordially urged to consider the following immediate openings.

**Digital Computer Systems Engineer**—BSEE with a minimum of 4 years experience in the analysis design and development of digital computers. Will participate in the integration of digital computer into a complex weapons system. A significant part of the effort will be devoted to extensive laboratory and flight development programs.

**Secondary Power Engineer**—EE or Physicist with understanding of electrical energy generation, thermodynamics and preferably some knowledge of direct conversion of electrical energy from heat and solar energy. To analyze and compare sizes, weights efficiencies of various means of obtaining electrical energy from solar nuclear and chemical energy; to perform preliminary design of secondary power systems for satellites and space vehicles; to participate in hardware development programs.

**Data Processing Engineer**—Background in digital data processing, logic circuit design, memory devices, R-F modulation techniques and related digital techniques required. Opportunity to participate in advanced design of systems concepts and hardware development. BSEE or BS in Physics with a minimum of 3 years' applicable experience.

**Laboratory Equipment Engineer**—BSEE with 5-10 years' experience in laboratory test programs of airborne electronics equipment. A working knowledge is required in a majority of the fields of airborne communication radar navigation and digital computers. Work will be conducted in our new Electronics Systems Center with the finest facilities and equipment available. Applicants must be willing to extend their technical capabilities to new challenging areas ranging from DC to microwaves.

To arrange an immediate interview, send your resume to Mr. W. Brown, Manager Engineering Employment, Dept. GR-76



# GRUMMAN

AIRCRAFT ENGINEERING CORPORATION  
Bethpage • Long Island • New York

All qualified applicants considered regardless of race, creed, color or national origin.

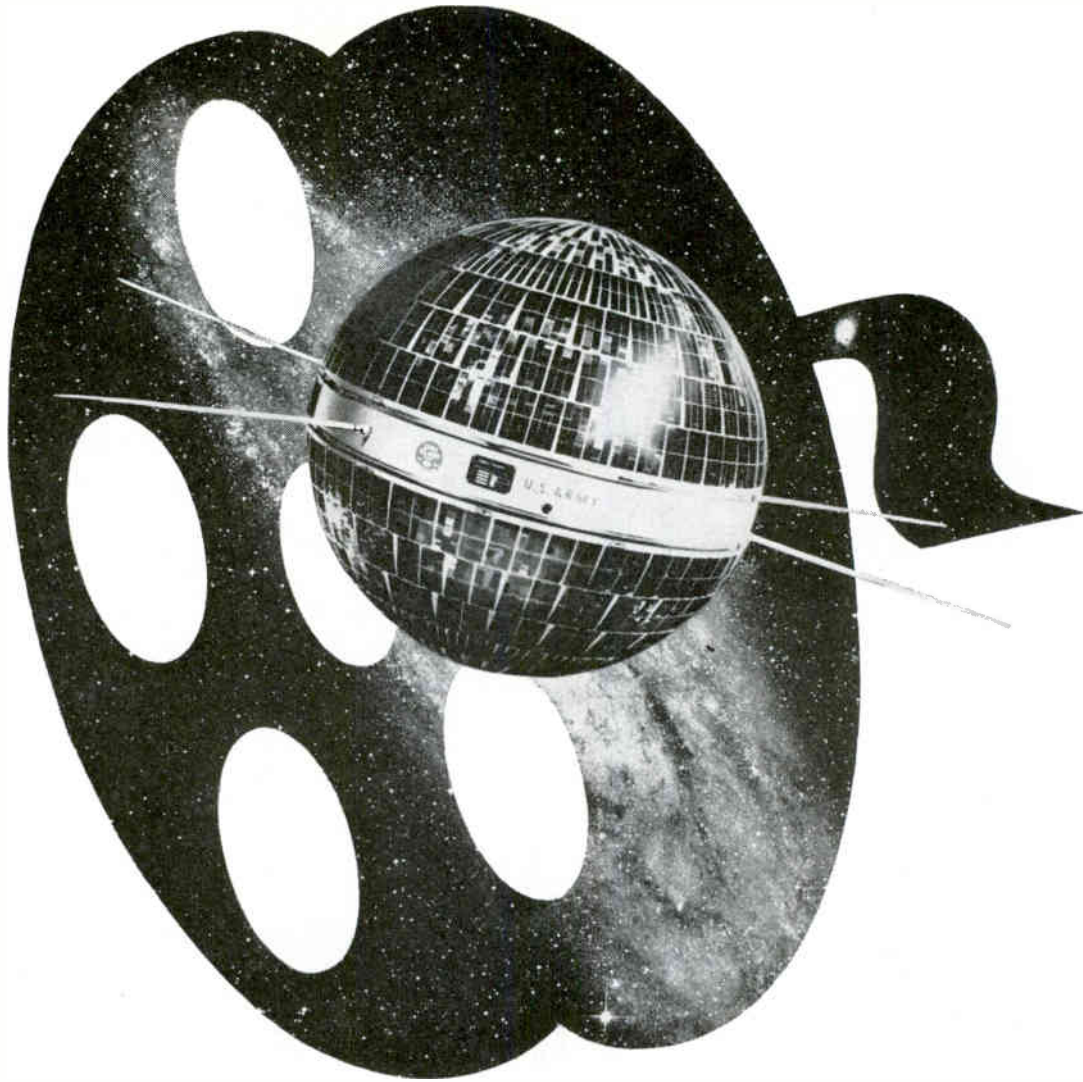

## LP Record—Stellar Style

The message from Courier is just one of the challenges offered to you at PHILCO Western Development Laboratories, whose long record in space communications achievement merely presages the adventure ahead.

From the earliest plans to invade space, PHILCO Western Development Laboratories has played a vital role in satellite vehicle instrumentation, still but *part* of its contribution to space communications. From this newest electronics center on the San Francisco Peninsula comes a continuing flow of advanced missile tracking, range and data processing instrumentation.

Added research projects and growing programs assure *you* a long and rewarding career as a member of the PHILCO Western Development Laboratories. What you think and what you do can be unhampered and uninhibited. Personal recognition and advancement promptly follow performance, with monetary rewards to match. Northern California provides an affluent climate for living, as PHILCO Western Development Laboratories provides a stimulating climate for working. For information on careers in electronic engineering, please write Mr. W. E. Daly, Dept. E-6.

All qualified applicants for employment will be considered without regard to race, creed, color, or national origin; U. S. citizenship or current transferable Department of Defense clearance required.

**PHILCO**  
 Famous for Quality the World Over<sup>®</sup>

**WESTERN DEVELOPMENT LABORATORIES**

3875 Fabian Way, Palo Alto, California

6317





**Are  
you  
this  
man?**

**SR. COMPUTER SCIENTIST:** Honeywell's Applied Research Group offers a challenging career opportunity to an individual qualified to conduct applied research in advanced digital computer organizations and computing methods for real time application. Work involves developing original concepts to take advantage of new and future digital components. Extensive experience in Logic Design, Computer organization, Digital Systems, Computer Program Analysis, Number Systems. All qualified applicants will receive consideration for employment without regard to race, creed, color or national origin. Send resumé to: Mr. Clyde W. Hansen, Technical Director, Honeywell Aero, 2656 Ridgway Road, Minneapolis 40, Minnesota.

**Honeywell**



**TELEVISION BROADCAST TECHNICIAN**

Seeking experienced, qualified television technician for maintenance and operation at commercial VHF station in growing market. CBS affiliate; progressive management with long broadcast experience. Station is well-equipped; maximum power: 1000 foot tower; two Ampex Videotape Recorders. Applicant must be ambitious, dependable, and have First-Class Phone License. Some formal schooling in electronics preferred. Salary commensurate with experience and ability. Replies treated in confidence.

**ASSISTANT CHIEF ENGINEER**

Seeking college graduate electronics engineer to assist Chief Engineer of commercial VHF television station in growing market. CBS affiliate; progressive management with long broadcast experience; good record of low personnel turnover. Majority of equipment RCA; two Ampex Videotape Recorders; maximum power: 1000 foot tower. Applicant should be capable of doing design and construction work, and should have some administrative ability. Salary commensurate with experience and ability. Replies treated in confidence. Write:

Chief Engineer,  
**WLAC-TV**  
Nashville, Tennessee

**SUPERVISORY POSITION**

In rapidly expanding scientific company for a qualified PhD—experienced in semiconductor solid state physics to direct projects in piezoelectric, thermoelectric, thermionic, and transistor materials. Send resume to:

**MATERIALS RESEARCH CORPORATION**  
47 Buena Vista Avenue  
Yonkers, New York



*it's read  
more  
by all 4!*

**electronics** is specially edited to keep you informed about the entire industry. With special issues on Electronic Markets, Modern Microwaves, Search and Probe Systems, and other reports you'll want to file and keep

*subscribe today to* **electronics**

Every Friday, **electronics** gives you the latest engineering developments and technically interpreted market trends. So don't wait till everyone on the routing slip has read it. Subscribe now and read **electronics** first. Mail the reader service card (postpaid) to **electronics**, the magazine that helps you to know and to grow! Rates: three years for \$12, one year for \$6; Canadian, one year for \$10; foreign, one year for \$20. Annual **electronics** BUYERS' GUIDE (single issue price \$3.00) included with every subscription.



## SQUARE-LOOP TAPE CORES TO MEET YOUR TOUGHEST SPECIFICATIONS

Speed your specs to Dynacor when you want square-loop tape cores to exact requirements—fast! Here you'll find a dependable combination of personnel, experience and facilities—the know-how to deliver parameters to your very tightest tolerance requirements for switching time, flux, and noise.

Dynacor Square-Loop Tape Cores are manufactured with the high permeability alloys—Grain-Oriented 50-50 Nickel Iron, 4-79 Molybdenum Permalloy, and Grain-Oriented 3% Silicon Iron . . . with fully guaranteed uniformity . . . under rigid standards of control and inspection.

Look to Dynacor for reliable production and swift delivery of your tape core requirements. For your convenience a full line of standard units are stocked for immediate off-the-shelf delivery—Send for bulletins DN 2000, DN 2001, DN 2002.



# DYNACOR

**DYNACOR, INC.**  
A SUBSIDIARY OF SPRAGUE ELECTRIC CO.

1006 Westmore Ave. • Rockville, Maryland

# INDEX TO ADVERTISERS



## Audited Paid Circulation

AMP Incorporated . . . . .	74	Collins Radio Co. . . . .	3
Ace Electronics Associates, Inc. . . . .	121	Connecticut Hard Rubber Co. . . . .	58
Aerocom . . . . .	50	Consolidated Electroynamics Corp. . . . .	102, 103
Aerospace Corporation . . . . .	68	Continental Electronics Mfg. Co. . . . .	59
Air Express . . . . .	113	Curtiss-Wright Corp. . . . .	46
Air-Marine Motors Inc. . . . .	29		
Allen-Bradley Co. . . . .	93	Dorsett Electronics, Inc. . . . .	41, 143
Alloyd Electronics Corp. . . . .	24	Duncan Electronics, Inc. . . . .	110
Alpha Wire Corp. . . . .	61	Dynacor, Inc., A Sub. of Sprague Electric Co. . . . .	142
American Machine & Foundry Co. Potter and Brumfield Div. . . . .	53		
American Time Products, Div. of Bulova Watch Co., Inc. . . . .	38		
Amphenol-Borg Electronics Corp., Connector Div. . . . .	73		
Barnstead Still & Sterilizer Co. . . . .	14	Edgerton, Germeshausen & Grier, Inc. . . . .	122
Bell Telephone Laboratories . . . . .	71	Electro Instruments Inc. . . . .	95
Bendix Corporation Eclipse Pioneer Division . . . . .	32, 33	Electro Motive Mfg. Co., Inc. . . . .	47
Scintilla Division . . . . .	130	Electronic Engineering Co. . . . .	56
Semiconductor Division . . . . .	116, 117	Electronic Instrument Co., Inc. (EICO) . . . . .	143
Bourns Inc., Trimpot Div. . . . .	67	Electronic Measurements Co., Inc. . . . .	137
Bruno-New York Industries Corp. . . . .	134	Epsco Inc. . . . .	52
Brush Instruments, Div. of Clevite Corp. . . . .	37		
		FXR Inc. . . . .	3
CBS Electronics . . . . .	39	Fairchild Semiconductor Corp. . . . .	31
Cambridge Thermionic Corp. . . . .	106		
Cannon Electric Co. . . . .	11		
Centralab, Electronics Div. of Globe-Union Inc. . . . .	25		
Cetron Electronic Corp. . . . .	58	Garner Co., T. H. . . . .	105

General Electric Co.....125-128	Minnesota Mining & Mfg. Co.	2
Chemical Materials Dept..... 72	Chemical Div. ....	13
Receiving Tube Dept.....42, 43	Mincom Division .....	58
Gudebrod Bros. Silk Co., Inc..... 105	Mitsumi Electric Co., Ltd.....	44
	Motorola, Inc., Military Electronics	64
	Div. ....	35
Hayes, Inc., C. I..... 6	Navigation Computer Corp.....	64
Hewlett-Packard Company	Non-Linear Systems, Inc.....34,	65
Inside Front Cover		
Imtra Corp. ....	Oak Mfg. Co.....	45
Indiana General Corp.		
General Ceramics Div..... 21	PRD Electronics, Inc.....	65
Industrial Electronic Engineers..... 60	Penta Laboratories, Inc.....	118
International Electronic Research	Potter and Brumfield, Div.	53
Corp. ....	American Machine & Foundry Co..	124
International Telephone and Telegraph	Precision Instrument Co.....	124
Corp., Components Div..... 64	Progressive Engineering Co.....	60
Kintel, A division of Cohu Electronics	R F Products, Div. of	109
Inc. ....	Amphenol-Borg Electronics Corp..	109
.....3rd Cover	Radio Corporation of America..4th Cover	
Knights Company, James..... 135	Raytheon Company .....	57
	Rotron Manufacturing Co., Inc.....	111
Laboratory for Electronics Inc..... 36	Sarkes Tarzian Inc.....	66
Level High Frequency Laboratories,	Space Technology Laboratories, Inc..	15
Inc. ....	Spectrol Electronics Corp.....	51
..... 134	Sprague Electric Co.....22,	23
Lockheed	Superior Mfg. & Instrument Co.....	56
California Div. ....	Sylvania Electric Products, Inc.	20
..... 97	Electron Tube Div.....17, 18, 19,	20

## BUILD-YOUR-OWN ELECTRONIC ORGAN

STEP UP TO AN

*Artisan*

GREATEST  
NAME IN  
ORGAN KITS

20TH CENTURY  
SUCCESSOR  
TO THE  
PIPE ORGAN



PIPE-LIKE  
TONE AND  
APPEARANCE  
DIRECT FACTORY  
TO OWNER  
SAVES 50%



PAY-AS-YOU  
BUILD  
STEP-BY-STEP  
INSTRUCTIONS  
HOME, CHURCH  
AND CONCERT  
MODELS  
2-3-4 MANUALS  
FROM  
\$1,750 to \$12,500



WORLD'S LARGEST SELECTION OF ORGAN KITS,  
ACCESSORIES AND CUSTOM-BUILT ORGANS

Send for FREE literature  
**DORSETT ELECTRONICS, INC.**  
ELECTRONIC ORGAN DIVISION  
4949 X YORK BLVD., LOS ANGELES 42, CALIF.

**CIRCLE 214 ON READER SERVICE CARD**

**EICO 1961**

**KITS AND WIRED**

STEREO  
AND MONO  
HIGH FIDELITY  
TEST INSTRUMENTS  
HAM EQUIPMENT  
CITIZENS TRANSCEIVERS  
RADIOS

LABORATORY PRECISION AT LOWEST COST  
Easy to assemble and to build

Send for  
**FREE**  
New 1961  
**EICO Electronics Catalog**

EICO, 3300 N. Blvd., L.I.C. 1, N. Y. E-6B  
 Send free 32-page catalog & dealer's name  
 Send new 36-page Guidebook to HI-FI for which I enclose 25¢ for postage & handling.

Name .....

Address .....

City ..... Zone ... State .....

**EICO** 3300 N. Blvd., L.I.C. 1, N.Y.  
...praised by the experts  
as BEST BUYS IN ELECTRONICS

**electronics** fills you in on every phase of the electronics industry each week featuring engineering and technical data every issue. Latest economic trends, technically interpreted, to help you make sound plans. Facts you'll want to file and keep. Subscribe now. Mail the reader service card (postpaid) to **electronics**, the magazine that helps you to know and to grow! Rates: three years for \$12, one year for \$6; Canadian, one year for \$10; foreign, one year for \$20. Annual **electronics** BUYERS' GUIDE (single issue price \$3.00) included with every subscription.

it's read  
more by  
all 4!



RESEARCH

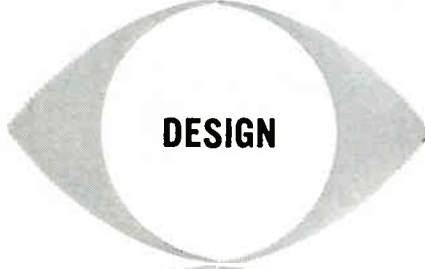

DESIGN

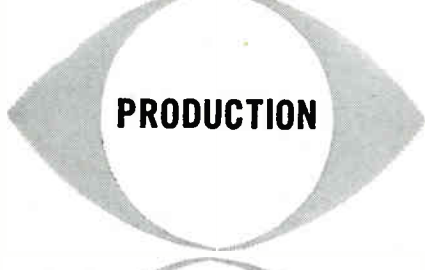

PRODUCTION



MANAGEMENT

SUBSCRIBE TODAY TO  
**electronics!**

TIC of Acton.....	137
Tensor Electric Development Co., Inc.	105
Texas Instruments Incorporated Apparatus Division .....	115
Semiconductor-Components Division .....	54, 55
Tinnerman Products, Inc.....	69
Tung-Sol Electric, Inc.....	101
Varian Associates .....	136
Vitro Electronics .....	123
Western Devices, Inc.....	129
Western Transistor Corp.....	122
Westinghouse Electric Corp.....	48, 49

CLASSIFIED ADVERTISING  
F. J. Eberle, Business Mgr.

EMPLOYMENT  
OPPORTUNITIES .....139-141

INDEX TO CLASSIFIED ADVERTISERS

Grumman Aircraft Engineering Corp.....	139
Materials Research Corp.....	141
Honeywell, Aero .....	141
Philco Western Development Labs.....	140
WLAC-TV Inc. ....	141

This index and our Reader Service Numbers are published as a service. Every precaution is taken to make them accurate, but **ELECTRONICS** assumes no responsibilities for errors or omissions.

**electronics**



Audit Bureau  
of Circulations



Associated Business  
Publications

Audited Paid Circulation

**BRUCE A. WINNER**  
Advertising Sales Manager

R. S. QUINT, Assistant Publisher Buyers' Guide and Business Manager; FRED STEWART, Promotion Manager; B. ANELLO, Marketing Service Manager; RICHARD J. TOMLINSON, Production Manager; GEORGE E. POMEROY, Classified Manager; HUGH J. QUINN, Circulation Manager.

ATLANTA M. Miller; HOUSTON Joseph C. Page; DALLAS Robert T. Wood, Frank LeBeau; LONDON Edward E. Schirmer; FRANKFURT Stanley R. Kimes; GENEVA Michael R. Zeynel.

ADVERTISING REPRESENTATIVES: NEW YORK Donald H. Miller, Henry M. Shaw, George F. Werner; BOSTON William S. Hodgkinson, Donald R. Furth; PITTSBURGH David M. Watson; PHILADELPHIA Warren H. Gardner, William J. Boyle; CHICAGO Harvey W. Wernecke, Martin J. Gallay; CLEVELAND P. T. Fegley; SAN FRANCISCO T. H. Carmody, R. C. Alcorn; LOS ANGELES Marshall Freeman, Peter S. Carberry; DENVER J. Patten;

BRANCH OFFICES: National Press Bldg., Washington 4, D.C.; McGraw-Hill Bldg., Copley Square, Boston 16; Four Gateway Center, Pittsburgh 22; Six Penn Center Plaza, Philadelphia 3; 645 North Michigan Avenue, Chicago 11; 55 Public Square, Cleveland 13; 255 California Street, San Francisco 11; 1125 West Sixth St., Los Angeles 17; 1740 Broadway, Denver 2; 1301 Rhodes-Haverty Bldg., Atlanta 3; 901 Vaughn Bldg., Dallas 1; Prudential Bldg., Holcombe Blvd., Houston 25; McGraw-Hill Publishing Co., Ltd., 34 Dover Street, London, England; B5 Westendstrasse, Frankfurt/Main; 2 Place de Port, Geneva.



KIN TEL's electronic galvanometer features

laboratory  
sensitivity

with test van  
ruggedness!



Here is a galvanometer that's functionally equivalent to sensitive suspension instruments, yet rugged enough for the test van.

*Here's how sensitive:* The current sensitivity of KIN TEL's Model 204A is  $2 \times 10^{-11}$  amperes per division. This is 20 times better than the  $4 \times 10^{-10}$  ampere-per-division of high-quality mechanical galvos. Full-scale power sensitivity is  $10^{-14}$  watts. This is several times better than moving coil galvos.

*Here's how rugged:* Chopper-stabilized all-transistorized circuitry makes the Model 204A insensitive to shock, vibration, microphonics, earth's magnetic field, stray pickup, sudden changes in temperature or humidity. It does not require leveling, has rapid response, and can

withstand severe overload with no offset on return to zero.

*Here's how to use it:* The 204A electronic galvo is a combination DC null detector, linear deflection indicator, microvolt-ammeter, and inverting DC amplifier. You can use it for production line testing; as a direct reading instrument for thermocouple, strain gage, and other measurements; to compare standard cells in low-level bridge and potentiometer circuits; to extend the range of recording instruments.

*Additional specification notes:* A built-in range switch provides seven decaded ranges from  $\pm 10 \mu\text{V}$  to  $\pm 10 \text{ V}$  full scale, from  $\pm 0.001 \mu\text{a}$  to  $\pm 1 \text{ ma}$  full scale. Input resistance is 10,000 ohms on all ranges. The input is floating. Drift is less than  $2 \mu\text{V}$ . Price \$425.

Write today for detailed technical information or demonstration.  
Representatives in all major cities.

5725 Kearny Villa Road, San Diego 11, California • Phone BRowning 7-6700

**KIN TEL**  
A DIVISION OF  
**COHU**  
ELECTRONICS, INC.

# TOP LEVEL PERFORMANCE ... LOWER COST

in TV horizontal and vertical oscillators  
with RCA-6FQ7 and RCA-8FQ7

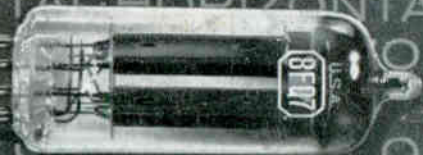

New RCA-6FQ7 and 8FQ7 medium-mu twin triodes are especially designed for use as vertical- and horizontal-deflection oscillators in TV receivers.

Use them in these circuit applications and you'll keep the top-level performance of your present equipment but you'll spend less to achieve it!

Both new tube types employ heaters with controlled warm-up time to insure dependable performance in TV receivers using series-connected heater strings. Mount structures of these tubes permit cool grid operation, thus help assure negligible grid emission.

But most important is the fact that *these are among the first commercially available tubes to use the revolutionary new RCA "DARK HEATER"*! The "DARK HEATER", by providing better heat transfer to the cathode, produces required cathode operating temperatures at heater temperatures about 350°K lower than conventional white heaters. Advantages of the "DARK HEATER" include:

Many times longer heater life • Increased heater-current stability on life • Reduced heater-cathode leakage and hum • Reduced heater growth on life • Reduced surge currents on cold starts, especially important for series-string applications. The new RCA-6FQ7 and 8FQ7 can cut the cost of TV set production with no sacrifice in quality. Get full details from your RCA Field Representative, or write Commercial Engineering, Section F-19-DE-5, RCA Electron Tube Division, Harrison, N. J.

**RCA ELECTRON TUBE DIVISION, HARRISON, N. J.**

#### RCA FIELD OFFICES

**EAST:** 744 Broad Street  
Newark 2, New Jersey  
HUmboldt 5-3900

**MIDWEST:** Suite 1154  
Merchandise Mart Plaza  
Chicago 54, Illinois  
WHitehall 4-2900

**WEST:** 6801 E. Washington Blvd.  
Los Angeles 22, California  
RAymond 3-8361



The Most Trusted Name in Electronics  
RADIO CORPORATION OF AMERICA