

April 28, 1961

electronics

A McGraw-Hill Publication 75 Cents

SPECIAL REPORT: *New components, advances in systems and logic, mean more powerful and economical computers*

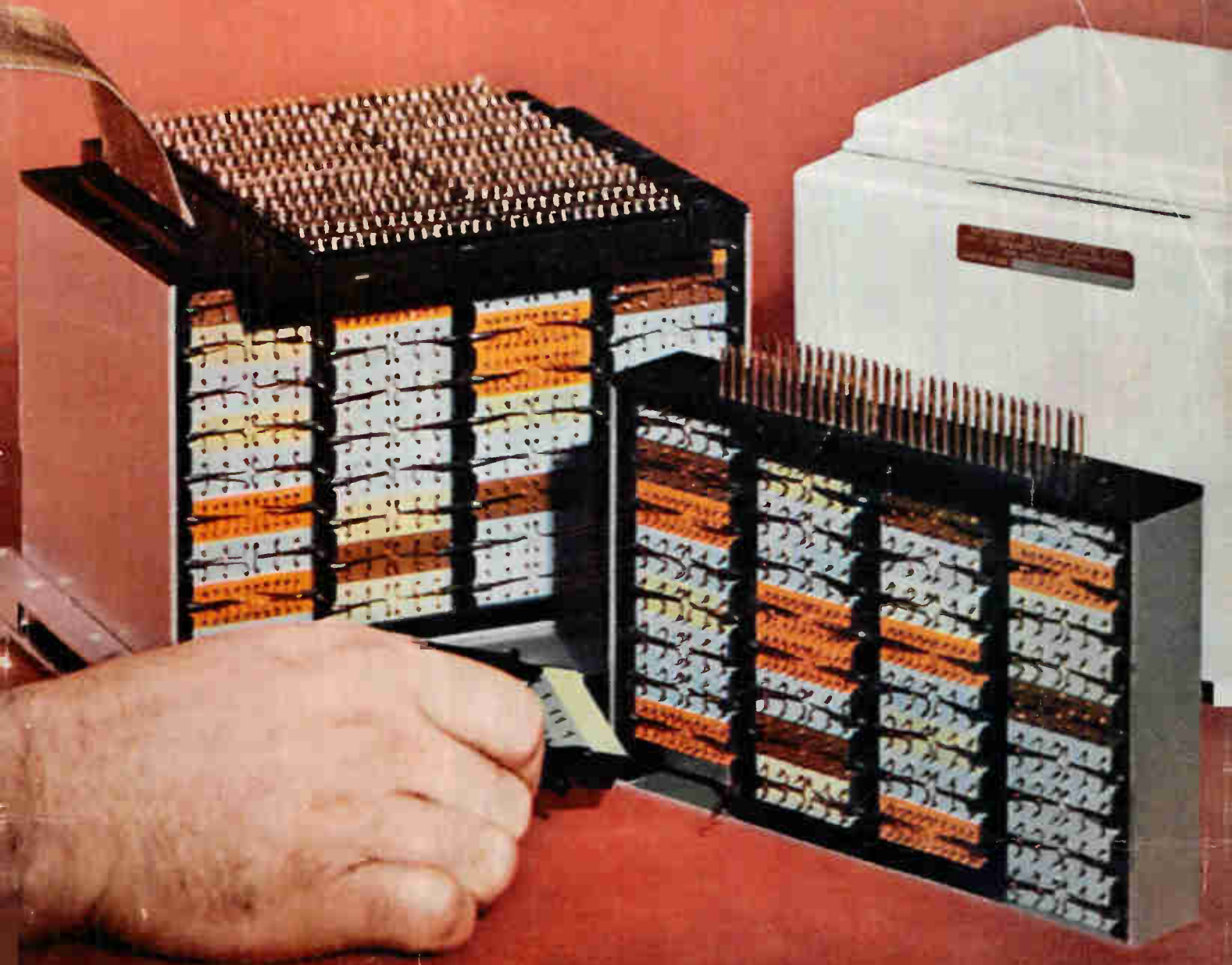

AY
ROLAND NISLER
BOX 520
ROSES LAKE WASH



SPECIAL PULSE TRANSFORMERS TO YOUR REQUIREMENTS

The pulse units illustrated below show a few of the thousands of special types designed and produced by UTC, to customers' requirements. Range covered on special pulse units is from a few microwatts to 10 megawatts. Rectangular pulse shapes are deliberately shown exaggerated to clarify parameters.

Almost thirty years of pioneering in the design and production of transformers plus exhaustive life testing programs and rigid quality control measures guarantee components of the highest reliability in the industry. . . . You can stake YOUR reputation on UTC products.

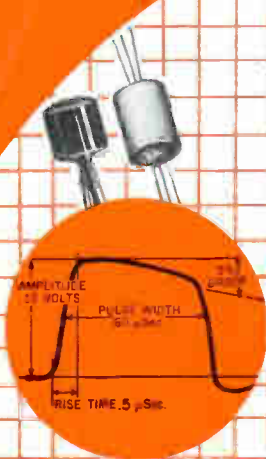

25 KC pulse transformer, DO-T or DI-T configuration. Pulse width 60 μSec. Rise time less than 0.5 μSec. Secondary C.T. balance each side to within 1% to ground. MIL-T-27A, GR 4. Size: DO-T, 3/8 dia. x 1 1/2", wt. 1/10 oz.; DI-T, 3/8 dia. x 1/4", wt. 1/20 oz.

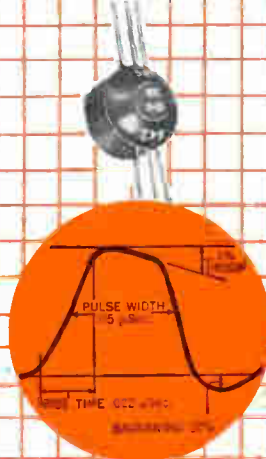

Special precision miniature pulse transformers. Designed in our standard stock mold to your specs. Checked and precisely adjusted in your tube or transistor blocking oscillator circuit. Sizes: 3/8 dia. x 3/8", 1 gram; 1/8 dia. x 3/8", 4 grams; 3/8 dia. x 5/8", 6 grams.

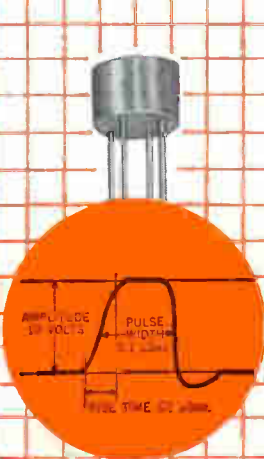

Ferrite core blocking oscillator transformer. 0.1 μSec. ±10% @ 200 KC PPS. 2 windings, rise time .01 μSec. Epoxy case. MIL-T-27A; 3/8 dia. x 1/4", .07 oz.



600 μSec. coupling transformer for printed circuit application. 3 windings, mu metal case for extreme shielding. Z=20 K Ω, 10 V. MIL-T-27A; standard UTC ML case; 3/8 x 1/4 x 1/8" h., .2 oz.

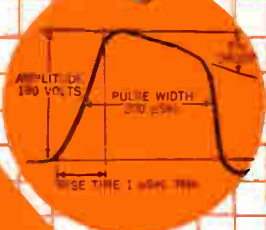

Toroidal pulse transformer, 150 V. 200 μSec. @ 400 PPS. Molded in epoxy. 3 windings, low leakage, less than 1 μSec. rise time; -40 C. to +85°C.; output voltage within 1%. MIL-T-27A; 1 1/2 sq. x 1 1/2", 1.5 oz.



Output to 2J42 magnetron. Input 1300 V.-50 ohms. Output 6.5 KV to 1200 ohms and 6A. bifilar filament winding. .15 μSec., 1000 PPS. Trigger winding. MIL-T-27A GR 5; 1 1/2 x 2 1/2 x 2 3/4", 10 oz.

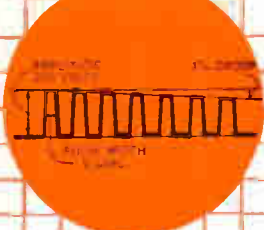

Output to Klystron, 5 μSec. pulses in groups of pulse trains at high rep rate. Droop 1% over pulse trains. 30 KV W.V., 43 KV hipot; -53°C. to +85°C.; MIL-T-27A; 4 1/4 x 5 x 6 3/4"; 11 1/2 lbs.

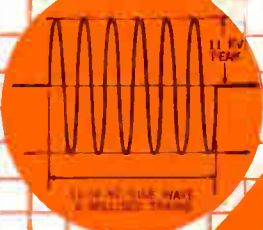

Sonar sine wave output transformer. PP 4-65A's, 11-14 KC rat. Pri. 11 KV; 28 KV hipot. Spark gap protected. Sec 1500 V. @ 800, 60 millisecon, 6% duty cycle. MIL-T-27A; -65 C. to +85 C.; 6 x 6 x 8 1/2", 13 lbs.

Plus over 1,000 STOCK ITEMS with UTC High Reliability from your local distributor



write for catalog

UNITED TRANSFORMER CORP.

150 VARICK STREET, NEW YORK 13, N. Y.

PACIFIC MFG. DIVISION: 4008 W. JEFFERSON BLVD., LOS ANGELES 16, CALIF.

EXPORT DIVISION: 13 EAST 40th STREET, NEW YORK 16, N. Y.

CABLES: "ARLAB"

electronics

A McGraw-Hill Publication 75 Cents



W. W. MacDONALD, Editor

J. M. CARROLL, Managing Editor
 SENIOR ASSOCIATE EDITORS: Samuel Weber, Roland J. Charest. ASSOCIATE EDITORS: Frank Leary, Michael F. Tomaino, Sylvester P. Carter, William P. O'Brien, John F. Mason, William E. Bushor, Thomas Emma, Sy Vogel, Leslie Solomon, M. M. Perugini, George J. Flynn. ASSISTANT EDITORS: Michael F. Wolff, Nilo Lindgren, Stanley Froud, Stephen B. Gray, Roy J. Bruun, George V. Novotny, Leon H. Dulberger.
 REGIONAL EDITORS: Harold C. Hood (Pacific Coast, Los Angeles), Thomas Maguire (New England, Boston), Cletus M. Wiley (Midwest, Chicago). BUYERS' GUIDE EDITOR: George Sideris. ART DIRECTOR: Harry Phillips; Howard R. Berry. PRODUCTION EDITOR: John C. Wright, Jr. EDITORIAL ASSISTANTS: Gloria J. Filipone, Bernice Duffy, Lorraine Rossi, Virginia T. Bastian, Lynn Emery, Avis Pomeranz, Florence Hajastron, Laura W. Smith, Bette H. Snyder.

JAMES GIRDWOOD, Publisher

BUSINESS

Japanese Engineers Seek Better Components. Big meeting	24
Field Engineering Spells Profits. Company groups grow	26
Infrared Sensor Ready for Mars Trip. Instrument weighs 20 lb	29
Management Appraises Organics at Semiconductor Conference	31
Scholars Urge Science Base for EEs. Cite 'sidetracking' risk	33
Crosstalk	4
Washington Outlook	14
Comment	6
Meetings Ahead	38
Electronics Newsletter	9

ENGINEERING

Subminiature components are used throughout to give Sperry general-purpose airborne computer high volumetric efficiency and high reliability. See p 63 **COVER**

Computers Today. Special Report on important trends in design and development of data-processing systems, increasing importance of communications and controls. By F. Leary	63
Designing Printed-Circuit Spiral Antennas. Shows how to design spiral antenna and its balun feed. By J. J. Wolfe and R. Bawer	99
Simulating War Games With Analog Computers. Computers simulate flights of attacking aircraft. By V. J. Caggiano	104
Improving Gain Control of Transistor Amplifiers. Each cascaded stage has an agc loop. By J. S. Brown	108
Transistors Drive Electromechanical Binary-to-Decimal Display. Provides accurate conversion. By R. J. Miller	111
Transistor Circuit Regulates Fluorescent Lamp. Continuous, precise dimming of light for photography. By L. L. Blackmer and A. T. Wright	114

DEPARTMENTS

Research and Development. Thermocouple Output	118
Components and Materials. Embedding Components	122
Production Techniques. Overlay Methods	126
New on the Market	130
Thumbnails	162
Literature of the Week	158
People and Plants	170
New Books	160
Index to Advertisers	182

Practical approach to compactness is demonstrated by this flame retardant, interphase insulating barrier for magnetic air circuit breakers. When the equipment was designed, CDF utilized its extensive knowledge of adhesives and post-forming to provide the barriers from a flame retardant, paper base phenolic laminate.

Result: two pieces bonded together to provide three channels in one unit, reducing size and cost, yet maintaining effective electrical insulating properties.

A few facts on the laminate:

Flame resistance: ASTM D-635
... self extinguishing
Water absorption, % 1.8
Flexural strength, psi 12,000
Specific gravity 1.38
Dielectric strength, parallel, kv . . . 40

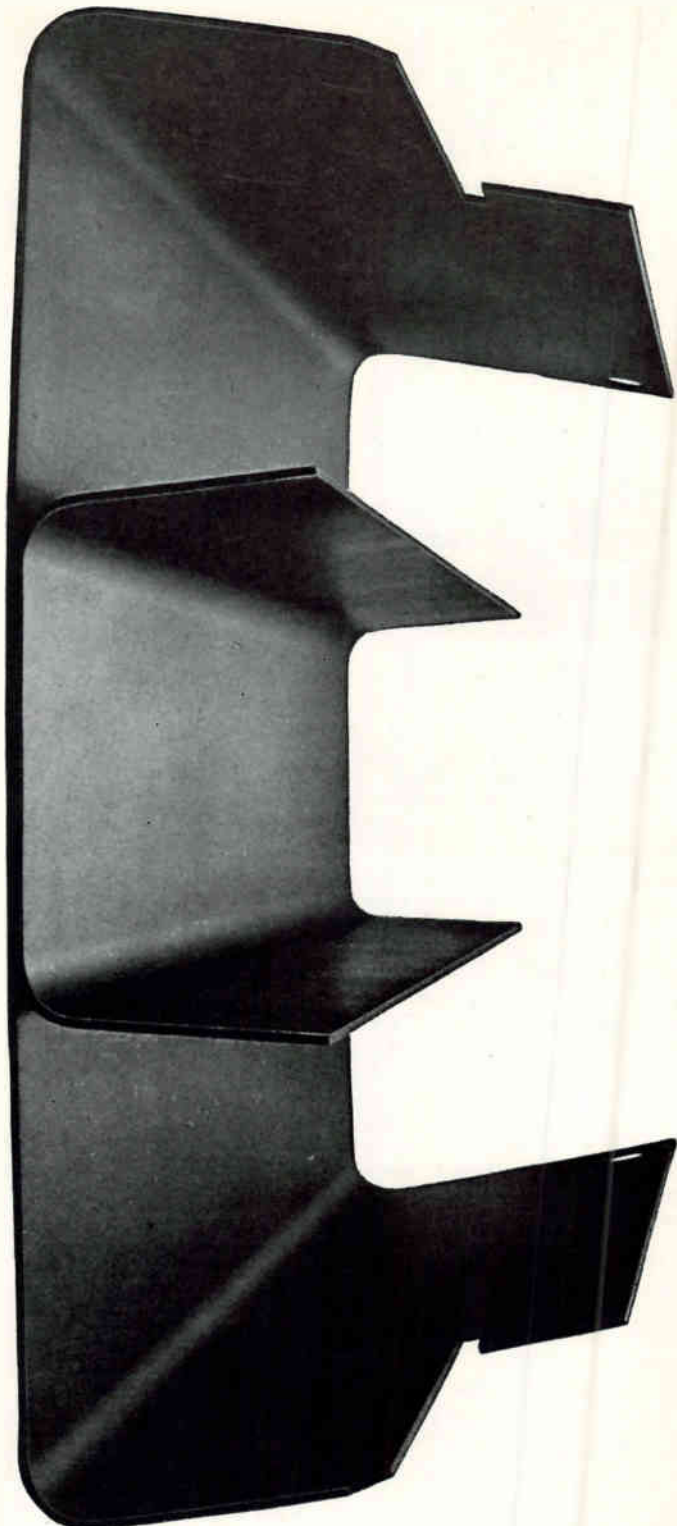

CONTINENTAL-DIAMOND FIBRE

CONTINENTAL-DIAMOND FIBRE CORPORATION, NEWARK, DELAWARE • A SUBSIDIARY OF THE *Bush* COMPANY

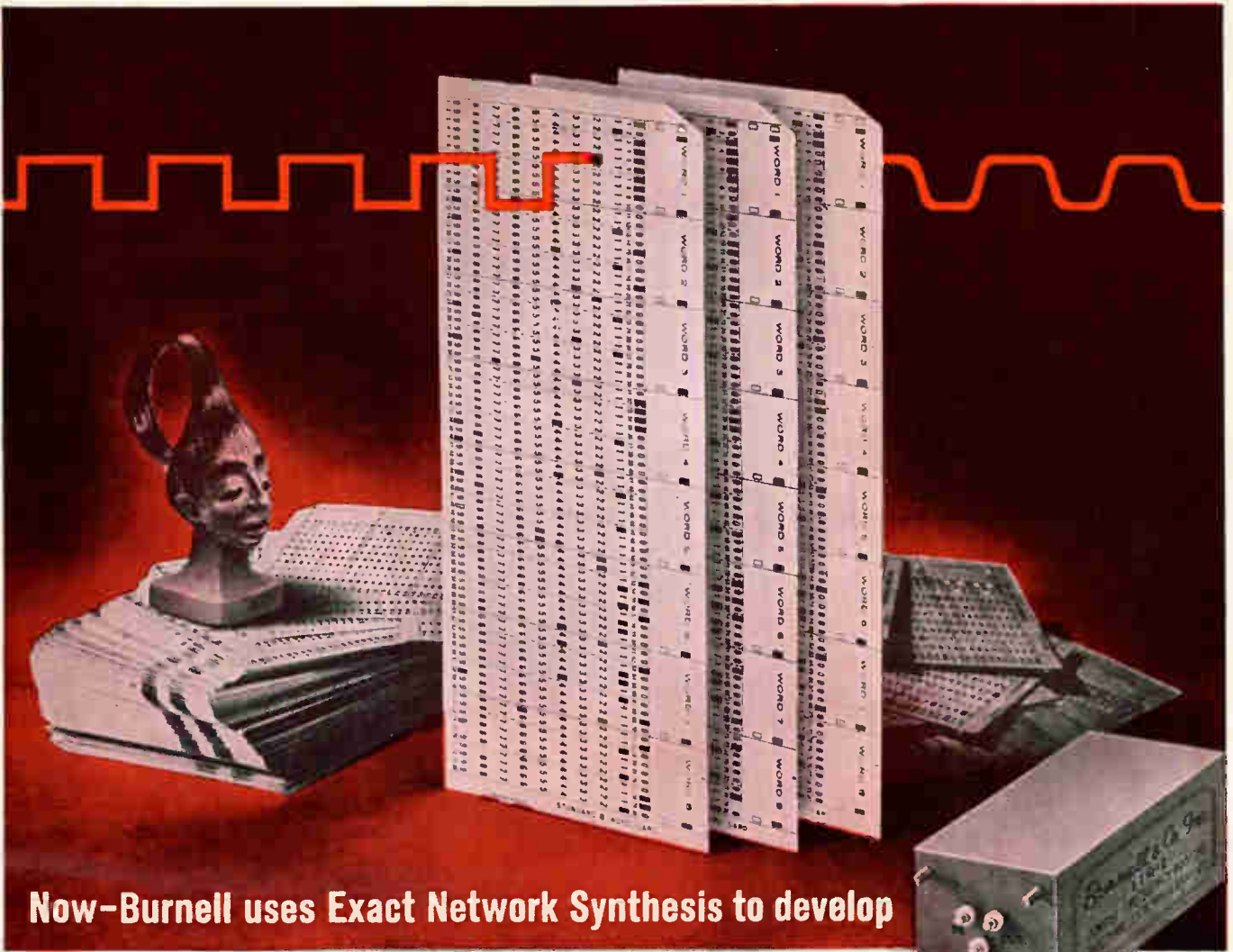

Now-Burnell uses Exact Network Synthesis to develop

New Low Transient Response Filters

New digital computer techniques for network synthesis have enabled Burnell & Co. to produce filters possessing the special time and steady state properties so essential to today's high precision, communication, data and guidance systems. An example of this achievement is the Burnell Type LTR-1 which overcomes problems formerly insoluble through the use of standard design procedure.

More than a linear phase band pass achievement, this new Burnell "low ringing" filter combines the center frequency, band width, rise time and attenuation characteristics that insure minimum phase distortion and low transient response. Hermetically secure, the LTR-1 easily shrugs off shock, vibration, acceleration and

other hazards encountered in extreme environments.

TECHNICAL DATA

Center frequency: 400 cps
 Pass band width: (3db) down +20%
 —16.5% of center frequency
 Attenuation: 30 db at one-half and twice center frequency
 Overshoot: ("low ringing") 1%
 Rise time: (1% to 99%) 6.25 ms.
 Meets MIL-F 18327A specifications.

If your circuit needs can not be met by the LTR class of filters or our stock of more than 15,000 specialized filter designs, Burnell engineers will, of course, manufacture to your specifications.

Write for Filter Bulletin.

With the aid of our new Guillemain Research Laboratory, we are now able to solve your network problems in an even wider range than ever before.

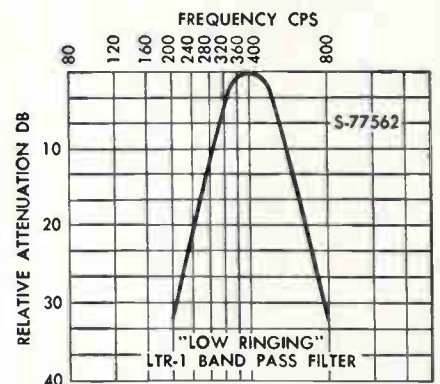

Write for your membership card in the Space Shrinkers Club.

COPYRIGHT 1961 • BURNELL & CO., INC.

Burnell & Co., Inc.

PIONEERS IN microminiaturization OF TOROIDS, FILTERS AND RELATED NETWORKS

EXECUTIVE OFFICE
 AND PLANT
 DEPT. E-34
 PELHAM, NEW YORK
 PELHAM 8-5000
 TELETYPE PELHAM 3633

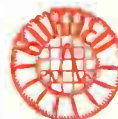

PACIFIC DIVISION
 SOUTH PASADENA, CAL.
 MFD. IN CANADA
 BY EDO (CANADA) LTD.
 CORNWALL, ONT.
 WELLINGTON 2-6774

Published weekly, with Electronics Buyers' Guide and Reference issue, as part of the subscription, by McGraw-Hill Publishing Company, Inc. Founder: James H. McGraw (1860-1948).

Title registered U.S. Patent Office; Copyrighted 1961, McGraw-Hill Publishing Company, Inc. All rights reserved, including the right to reproduce the contents of this publication, in whole or in part.

Executive, editorial, circulation and advertising offices McGraw-Hill Building, 330 West 42nd Street, New York 36, N. Y. Telephone Longacre 4-3000. Teletype TWX N.Y. 1-1636. Cable McGrawhill, N.Y. Printed in Albany, N. Y.; second class postage paid.

OFFICERS OF THE PUBLICATIONS DIVISION: Nelson L. Bond, President; Shelton Fisher, Wallace F. Traendly, Senior Vice Presidents; John R. Callahan, Vice President and Editorial Director; Joseph H. Allen, Vice President and Director of Advertising Sales; A. R. Venezian, Vice President and Circulation Coordinator.

OFFICERS OF THE CORPORATION: Donald C. McGraw, President; Joseph A. Gerardi, Hugh J. Kelly, Harry L. Waddell, Executive Vice Presidents; L. Keith Goodrich, Vice President and Treasurer; John J. Cooke, Secretary.

Subscriptions are solicited only from those actively engaged in the field of the publication. Position and company connection must be indicated on orders. Subscription rates: United States and Possessions, \$6.00 one year; \$9.00 two years; \$12.00 three years. Canada, \$10.00 one year. All other countries \$20.00 one year. Single Copies, United States and Possessions and Canada 75¢; Buyers' Guide \$3.00; Single Copies all other countries \$1.50; Buyers' Guide \$10.00.

The Publisher, upon written request from any subscriber to our New York Office, agrees to refund that part of the subscription price applying to copies not yet mailed.

Subscribers: Please address all correspondence, change of address notices, subscription orders or complaints to Fulfillment Manager, Electronics, at above address. Change of address notices should provide old as well as new address, including postal zone number if any. If possible, attach address label from recent issue. Allow one month for change to become effective.

Postmaster: Please send Form 3579 to Fulfillment Manager, Electronics, 330 West 42nd Street, New York 36, New York.



Audited Paid Circulation

CROSSTALK

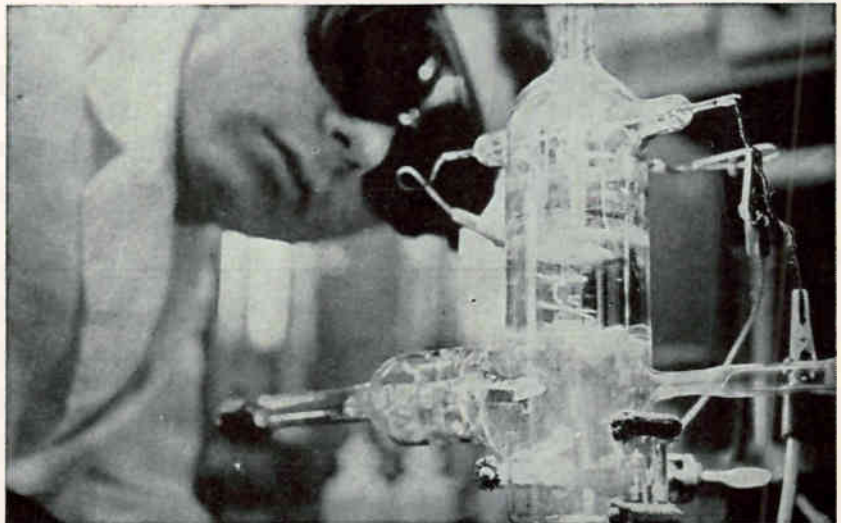

SPECIAL REPORT. Photo above shows an IBM engineer checking out apparatus for evaporating niobium thin films by electron bombardment. Niobium films are of great interest in cryogenics, one of three critical research areas in computer technology. For a comprehensive view of these and other developments in the rapidly growing computer industry, turn to Associate Editor Leary's special report on p 63.

JAPANESE ENGINEERS. More than 2,500 engineers and physicists met a short while ago in Osaka, Japan. They represented manufacturers, government laboratories, and universities, and they assembled at Osaka University for the annual joint meeting of Japan's four electrical institutes.

It was quite a meeting. In all, 1,668 individual papers were read. Each was only eight minutes long. Time for questions? Two minutes per paper. Even so, the disclosures were many, including double-base tunnel diodes, an epitaxial transistor, silver-bonded diodes, solid-state networks, indium antimonide tunnel diodes and metal-card memories. Our story starts on p 24.

Coming In Our May 5 Issue

ALL-MAGNETIC LOGIC. As brought out in a recent **ELECTRONICS** report (p 81, Jan. 13), all-magnetic logic circuits have been receiving more serious attention recently. In our next issue, U. F. Gianola of Bell Labs in Murray Hill, N.J. surveys the general problems of magnetic logic and discusses some of the methods for designing such circuits. His informative article points out a number of ways in which the basic requirements of synchronous sequential logic circuits can be achieved and some areas in which future developments can be anticipated.

Something
NEW
in counting
techniques!



Sprague type 73Z1 core-transistor **DECADE COUNTERS**

Here is a simple yet versatile, low-cost yet reliable component for counter applications. Counting to speeds of 10 kc, the 73Z1 decade counter provides an output signal for every 10 input pulses, then resets in preparation for the next cycle. For higher counting, two or more counters may be cascaded. Typical characteristics are shown below.

CHARACTERISTIC	INPUT	OUTPUT
Amplitude	1.5 to 8 volts	6.5 volts
Pulse Width	1 μ sec min.	35 μ sec
Impedance	100 ohms	20 ohms

Utilizing two rectangular hysteresis loop magnetic cores and two junction transistors to perform the counting operation, the 73Z1 counter is encapsulated in epoxy resin for protection against adverse environmental conditions. It has five terminals -B+ (12v \pm 10%), input, output, ground, and manual reset.

The 73Z1 counter is available as a standard item. However, "customer engineered" designs can be supplied when other counting cycles, speeds, and package configurations are required for special applications.

For complete technical data or application assistance on the 73Z1 counter or other Sprague components, write to Special Products Division, Sprague Electric Co., 35 Marshall St., North Adams, Mass.

SPRAGUE[®]
THE MARK OF RELIABILITY

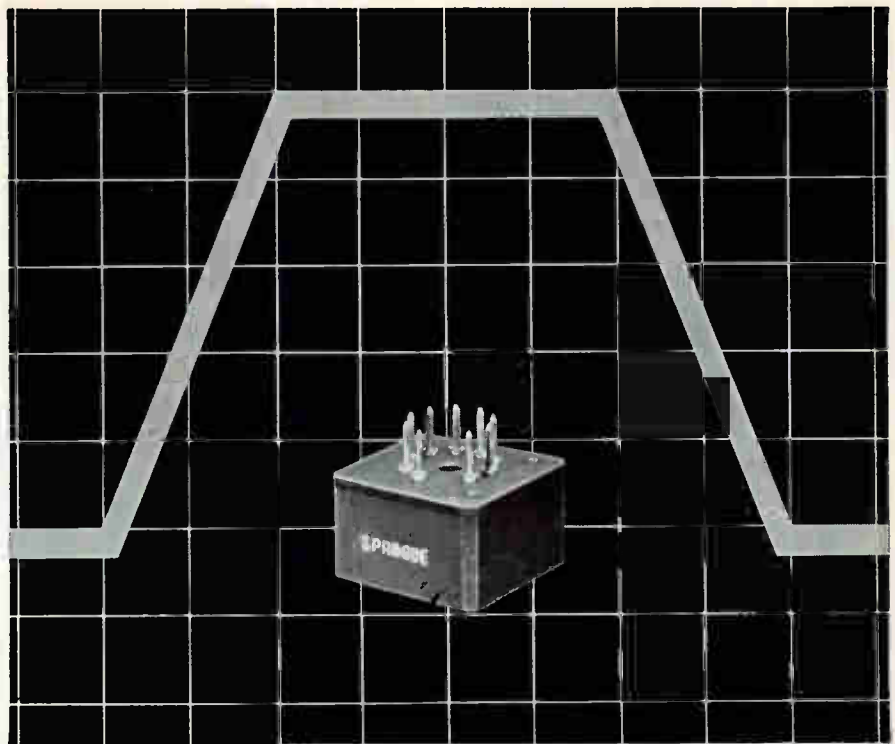

MAGNETIC SHIFT REGISTERS NOW AVAILABLE AT SENSIBLE PRICES!

Sprague Electric Company's SPECIAL PRODUCTS DIVISION has scored another *first* by breaking the "\$5.00-per-bit" barrier. Magnetic Shift Registers for industrial control applications may now be obtained for less than the proverbial \$5.00 figure!

Inherently more reliable, more stable than costlier semi-conductor alternates, these new encapsulated shift registers permit substantial savings in the design and production of your equipment without sacrificing quality, reliability, performance.

Available in single-bit and multi-bit assemblies with or without bit drivers to meet your individual packaging requirements, Sprague Magnetic Shift Registers may well be the answer to some of your design problems.

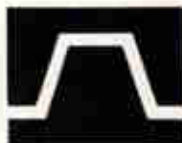

Sprague SPECIAL PRODUCTS DIVISION application engineers will help you without obligation. Call MOhawk 3-5311, Extension 977 or 954, for speedy information.

Sprague Electric Company
Special Products Division
North Adams, Mass.

SPRAGUE[®]
THE MARK OF RELIABILITY

'Sprague' and '®' are registered trademarks of the Sprague Electric Co.

CAN YOU ALWAYS FORECAST PEAK WORKLOADS?

Anticipating peak loads is difficult . . . variables are involved. Even so, once they're forecasted—how do you cope with them? Overloading skilled manpower can reduce efficiency and endanger reliability within any technical organization.

A good solution is to utilize specialized assistance such as provided by the RCA Service Company. Depending on your requirements, RCA's service arm can assign one . . . five . . . 100 or more specialists to assist you. This reserve of stable technical talent is familiar with complex electronic equipment and systems. It's a ready-made back-up support you need to handle unanticipated workloads and special assignments.

Highly skilled personnel are available in these specialized areas:

- Electronics
- Electrical Engineering
- Reliability Analysis
- Maintainability Prediction
- Space Environmental Chambers

It makes good business sense to utilize qualified manpower customized to assist you in specific assignments. RCA Service Company has been providing this type technical support for almost two decades to the U. S. Armed Forces, governmental agencies and prime contractors.

Look to RCA for ingenuity and excellence in technical support services. You can meet your requirements during peak loads and still maintain the quality of your in-plant capabilities.

For complete information, contact J. R. Corcoran, Location 206-2, RCA Service Company, Camden 8, N. J.



The Most Trusted Name
in Electronics

RADIO CORPORATION OF AMERICA.

COMMENT

Who Should Teach Math?

Your issue of March 17 ("Engineering Math—In Whose Hands?" in *Academically Speaking*, p 22) reported on a recent seminar held in Paris, in which it was recommended that instruction in mathematics for engineers should be taken out of the hands of mathematicians, and that math topics be introduced as tools useful in science and engineering.

I question the wisdom of this recommendation. Mathematics is playing an even greater role in the newer fields of engineering, and the engineer needs to have free scope in his mathematical thinking to be most effective. A thorough understanding of the applicable mathematics, its potential and limitations, ought to be a prerequisite for the future engineer. I therefore believe that mathematics should be taught as a separate subject by one who is primarily a mathematician.

A. G. GANZ

BELL TELEPHONE LABORATORIES
WHIPPANY, N. J.

There seem to be two—perhaps more—sides to this question. We can applaud the urge to make math a more practical tool for the engineer, but perhaps reader Ganz is right in suggesting that the mathematician instructor can do more to extend the uses of mathematics in engineering. Perhaps too the pragmatic approach of some math instructors and the theoretical approach of others can be merged into some more felicitous middle ground.

Non-Newtonian Color Tv

Some years ago it was announced that there had been developed in Mexico a method of stereo television in which alternate stereo frames were observed with goggles bearing electric shutters, permitting only the proper frame to be observed with the proper eye.

More recently, E. Land has proposed a two-print method of seeing color photographs. Scientific journals have carried communications from psychologists indicating that the two prints do not

have to be viewed by the same eye for color vision to be experienced. One eye views the scene through a monochromatic filter, while the other eye views the black-and-white view through an adjustable variable-density filter.

Combining the two principles of two-print color vision and electrically shuttered goggles would seem to make possible reception of color television from regular sets equipped with adapters.

The entire proposed idea assumes that the Land principle will work even when both eyes do not experience light at the same instant. This may or may not be a valid assumption.

Such a system may require an electrical circuit producing a negative image of light intensities for the frames received by one or both eyes . . .

ROBERT B. NELSON
LA PUENTE, CALIF.

Several non-Newtonian color-television concepts have been proposed in the last year, and reported in this publication.

Converting Volts to Digits

I would appreciate it if you would publish a correction of an error in a circuit diagram in my article "Voltage-to-Digits Conversion with Relays" (p 96, Jan. 13). In Fig. 2A, normally closed contacts are shown on relays S_1 and S_2 . All contacts on these two relays should normally be open . . .

THOMAS L. GREENWOOD
HUNTSVILLE, ALA.

Fast-Switching Tunnel Diodes

It was recently called to my attention that I had been quoted in your Feb. 17 issue, p 38 ("Shockley Explains Four-Layer Diode"). The sentence to which I have reference reads: "Hybrid circuitry using TDs with vacuum tubes promises to become the most effective way to use (fast-switching tunnel diodes) . . ."

The hybrid circuits to which I was referring were those which would couple TDs to transistors, not vacuum tubes. I do not know where the error originated, but I do think that I should clarify my position.

JAMES P. SHIPLEY
TEXAS INSTRUMENTS
DALLAS

NOW... stretch your **rustrak** to *UNLIMITED CAPABILITIES* with the addition or combination of any of these **rustrak** accessories



(a)

(a) 1 MA RECORDER

Basic 1 MA DC unit with standard 1 MA scale, one inch per hour, supplied with one Style A chart and detachable connector, portable or panel mounting.

Price: **\$79.50**



(b)

(b) DUAL CHANNEL RECORDER

The Rustrak dual channel recorder contains two individual galvanometers, yet retains the same overall dimensions as the famous Rustrak single channel recorder. When recording, a smooth, dual, high resolution line is made on the chart paper without the requirement for ink, heated stylus, or voltage sensitive paper.

Price: **\$124.50**



(c)

(c) 98 DC AMPLIFIER

Chopper stabilized, vacuum tube type completely isolates recorder from signal source, for use with 1 MA or 100 μ a recorder. Overall amplifier sensitivity is increased ten times when used with 100 μ a recorder.

Maximum sensitivity: 1 millivolt full scale (with 100 μ a recorder)
Full scale sensitivity: 10 Mv, 100 Mv, 1 volt
10 volts, 100 volts,
or 1, 10, 100 μ a

Price: **\$109.50**



(e)

(d) 111-A MULTI-RANGER

Ranges: 1-5-10-50-100-500-
1000 volts or MA DC

Price: **\$44.50**



(d)

POSSIBLE COMBINATION UNITS*

- (e) Type 98 DC Amplifier connected to a standard 1 ml. Recorder. This illustrated combination provides a multitude of measurements which can be made, including temperature with low output thermocouples.
- (f) Dual channel Recorder with a type 110 decade amplifier and a 111-A multi-ranger. This combination allows simultaneous measurements of two individual signals,



(f)

For complete information write:



130 Silver Street
Manchester, N.H.

*Many combinations can be used with the Rustrak Recorder using the accessories shown.

Extra quality at no extra cost with Bendix Semiconductors

Bendix Bulletin

ANOTHER BENDIX FIRST! 120-VOLT, 110°C. DAP TRANSISTORS

Exclusive! Available with Cerameterm terminals that set new reliability standards*

Here's important news for you if you're a design engineer. New Bendix 10- and 25-amp DAP[®] diffused alloy power transistors switch high currents *in microseconds*. They also offer low input resistance for increased circuit stability over a temperature range from -60°C. to +110°C.

That's not all you get with these new DAP transistors. They're also available with new Cerameterm (ceramic-metal terminal) bases specially developed by Bendix for extra reliability in severe applications demanding high performance.

Only Bendix brings you all these advantages . . . plus many more . . . that open the door wide to new design ideas and applications. Write for full details.

*TRADEMARK

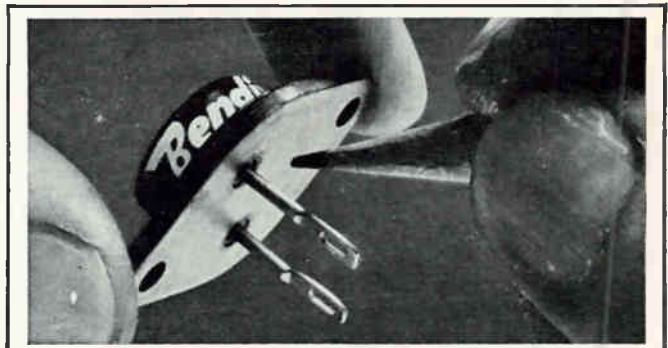

Type Number	Absolute Maximum Ratings				Electrical Characteristics	
	V _{ce} Vdc	I _c Adc	P _c W	T _J °C.	h _{FE}	β _{Ic}
2N 1073	40	10	60	110	20-60	5 Adc
2N 1073A	80	10	60	110	20-60	5
2N 1073B	120	10	60	110	20-60	5
*BC 1073	40	10	60	110	20-60	5
*BC 1073A	80	10	60	110	20-60	5
*BC 1073B	120	10	60	110	20-60	5
B 1274	40	10	60	110	50-120	5 Adc
B 1274A	80	10	60	110	50-120	5
B 1274B	120	10	60	110	50-120	5
*BC 1274	40	10	60	110	50-120	5
*BC 1274A	80	10	60	110	50-120	5
*BC 1274B	120	10	60	110	50-120	5
**2N 1430	100	10	60	110	20 min. 30-120	10 Adc 5
2N 1651	60	25	100	110	20 min.	25 Adc
2N 1652	100	25	100	110	20 min.	25
2N 1653	120	25	100	110	20 min.	25

*The BC DAP transistor series uses Cerameterm ceramic-metal terminals for increased reliability.
**Designed to meet SCL 7002/25A.



NEW BENDIX SEMICONDUCTOR PLANT situated on 118 acres at Holmdel, N.J., is devoted exclusively to research, engineering, and manufacture. A big reason you can continue to look to Bendix Semiconductors for extra quality at no extra cost.

SEMICONDUCTOR PRODUCTS
Red Bank Division
HOLMDEL, NEW JERSEY



Main Office: South Street, Holmdel, N.J.—Phone: SHodyside 7-5400—TWX Holmdel NJ 1388 • New England Office: 114 Waltham, Lexington, Mass.—Phone: VOlunteer 2-7650.
Detroit Office: 12950 West 8 Mile Rd., Detroit 37, Mich.—Phone: JOrdan 6-1420 • Midwest Office: 2N565 York Rd., Elmhurst, Ill.—Phone: BRowning 9-5050—TWX Elmhurst Ill 393.
West Coast Office: 117 E. Providencia Ave., Burbank, Calif.—Phone: VI. 9-3961—TWX BRB 9808 • Canadian Affiliate: Computing Devices of Canada, P.O. Box 508, Ottawa 4, Ont.
Export Office: Bendix International, 205 E. 42nd Street, New York 17, N.Y.—Phone: MUrray Hill 3-1100—TWX NY 1-4800.
Stocking Distributors—Contact nearest sales office for name of local distributor.

ELECTRONICS NEWSLETTER

FCC Approves System For F-M Stereo

FEDERAL COMMUNICATIONS COMMISSION last week named General Electric and Zenith as the two winners in the stereo radio sweepstakes that have been in progress two years.

After poring over the findings of the National Stereophonic Radio Committee for several months, FCC decided that both GE and Zenith must modify their specifications slightly, compromise on one identical system. Managements at both companies await final FCC specifications to begin production.

FCC is allowing broadcasters to start stereo on or after June 1. Manufacturers want to start turning out adapters for existing f-m consoles, as well as new table models and consoles with the stereo feature. GE put a plug for a stereo adapter on its most recent line of console radios. With exact figures not yet fixed, it appears that production costs for the adapters will run to about \$8, involve a single tube and some associated circuits. List price will probably be somewhere under \$15.

Communications Satellite May Loft by Christmas

BELL SYSTEM is prepared to deliver the first of several experimental communications satellites by Christmas if the National Aeronautics & Space Administration will give prompt permission, AT&T president Frederick R. Kappel says. Intervening months would be used to test and perfect traveling-wave tube and solar battery to be used in the satellite.

Kappel figures continuous service to Europe could be provided with 20 to 25 active repeater satellites, with full-scale worldwide service possible in three or four years. AT&T wants to put a test unit up as soon as possible. Kappel noted difficulties of working with a stationary (24-hour orbit) satellite, including degradation of signal on the 22,000-mile hop and 0.6-second delay in conversations. Bell's immediate plans are for a family of

repeaters in relatively low orbits (about 6,000 miles up).

Meanwhile, AT&T is rushing work on its ground station near Rumford, Me., now being carved out of 1,000 acres of virgin forest. The site is out of the way of most interference, is shielded by a surrounding range of hills 3,000 ft high. One radome will go up at first; ultimately there will be five towers, each with tracking radar and computer plus communications transmitters and receivers in the common-carrier bands.

Alkali Halides Tested As Optical Masers

STUDIES at Armour Research Foundation at Illinois Institute of Technology indicate that the alkali halide group of materials exhibit characteristics that may make them useful in optical masers. (The group is made up of halide compounds—fluorides, chlorides, bromides, iodides—of the alkali metals: sodium, potassium, calcium, and so forth.)

Armour researchers propose to build a maser operating in the infrared region using thallium-activated potassium chloride. Mechanism of operation uses the so-called Stokes shift, the quantum-mechanical shift toward the low end of the spectrum caused by absorption and luminescence from point imperfections in solids. This differs from the mechanism that operates in a ruby maser, could result in considerably reduced requirements for pumping power, also make c-w operation possible.

USAF Asks 17 Companies To Bid on Norad Center

AIR FORCE has invited proposals from 17 companies for a development and production contract for project 425L, the combat operations center for the North American Air Defense Command's new headquarters in Colorado. Proposals will be opened June 1.

The 17 firms are: Aeronutronics (Ford Motor Co.), Bendix, Bur-

roughs, General Dynamics, General Electric, General Telephone & Electronics, Hughes, International Business Machines, International Telephone & Telegraph, Lockheed, Martin, Philco, Raytheon, Radio Corp. of America, Sperry Rand, Thompson Ramo Wooldridge, Western Electric (AT&T).

Japanese Competition Grows In Instruments, Not Computers

U. S. OBSERVERS currently in Japan with the Department of Commerce trade mission told ELECTRONICS last week that Japan is a coming international competitor in the instrument market, but would not become an exporter of computers to U. S. and other foreign markets in the near future.

Charles Schwarzler, vice president of Foxboro, said he fears the Japanese position in instruments is "explosive," because of the country's orientation toward increased production. "My concern is that they will overproduce and won't have the sales techniques to sell what they make," he commented. "Then they may resort to price cutting."

As far as computers are concerned, Japan represents no threat unless they "tie up with one of the major American companies," said A. F. Draper of Remington Rand Univac. "I don't expect to see them exporting computers otherwise," he said. Many Japanese firms reflect a reluctance to use technological advances not developed in their own labs, he pointed out, adding that this restricted effective collaboration of Japan's industry with U. S. and European technology.

Kennedy's Tax-Reform Plan Encourages Capital Spending

KENNEDY ADMINISTRATION's tax-reform plan has a provision encouraging capital spending through special tax incentives. Industry looks on the plan as favorable for growth industries such as electronics.

Manufacturers would be allowed to subtract from their tax liability these credits: 10 percent of the first \$5,000 of spending on new plant and equipment, without regard to

normal depreciation allowances; 6 percent of plant and equipment spending in excess of 50 percent of depreciation allowances but not more than 100 percent; and 15 percent of any spending beyond that.

Maximum reduction in tax liability would be 30 percent. Expenditures made after Jan. 1, 1961, for new equipment situated in the U. S. and having a tax life of at least six years qualify under the plan.

Autonomous Tape Control Added to Computer

TECHNOLOGICAL ADVANCES aimed at freeing high-speed computing circuits from input-output housekeeping continue to mark computer progress (see also Special Report "Computers Today," p 63). Philco last week announced an input-output processor, the Philco 2400, which is designed for use with the high-speed Philco 2000 computer system. The 2400 can run various input and output units, handle magnetic-tape functions such as editing, search and select, sorting and data translation. It can be programmed to do most computer work that does not require calculation. Peripheral system rents for \$7,800 monthly.

Overseas Television Burgeoned During 1950s

TREMENDOUS SURGE in growth of tv overseas during the past decade is reported in a U. S. Information Agency study released last week. Agency report says that the number of sets in use has grown from about a million in 1951 to 43 million today. Number of transmitting stations grew in the same period from 28 to 1,488. Total of 62 countries outside the U. S. and Canada now have local tv; steady expansion in Western Europe, the Far East and Latin America is reported, with slower progress in Near and Middle East and South Asia, and with Africa only beginning.

Transmitting stations in the Communist Bloc now number 264; in non-Bloc countries outside North America, 1,224. Sets in use in the Bloc number 7.4 million; in non-Bloc countries, 35.5 million. Growth

during 1960 was about 40 percent in both transmitters and receivers in the Bloc, about 36 percent in transmitters and 33 percent in receivers outside the Iron and Bamboo Curtains.

Sage Sites Getting Improved Search Radar

IMPROVED search radars are being installed at 12 Sage sites around the country. First system is nearing completion at Selfridge AFB, Michigan.

Sperry Gyro built the system, which is almost jamproof, can handle fast jets and airbreathing missiles. Radar will also serve Army's Missile Master, which controls area-defense Nike missiles. Antenna for the improved system is 125 ft wide, 40 ft high, is mounted on an 85-ft tower housing the transmitting and receiving systems, includes identification-friend-or-foe equipment and countermeasures subsystems.

Soviets Developing Automatic Programming

AUTOMATIC PROGRAMMING using algorithmic techniques to define and state scientific problems has been disclosed in the Soviet technical press. System, dubbed ACS, apparently combines analyzer and compiler techniques, including interpretive and assembly subroutines. ACS is not yet fully finished, according to V. A. Fedoseyev, who disclosed the development.

Hybrid Antenna Array Has High Resolution

ELECTRONICS RESEARCH Directorate of USAF's Cambridge Research Laboratories is investigating a high-resolution antenna system using interferometer and slot antennas together with data-processing circuits such as phase-shifters, multipliers and filters.

Total aperture in a scale model built for 9,375 Mc is partially filled by 16 antenna elements spaced according to a mathematical progression instead of 80 elements half

a wavelength apart. As more interferometers are added, even greater reductions in elements are possible. Analog multipliers and a synchronous detector effectively double the aperture.

Synthesis of desired radiation patterns is accomplished by proper channel selection, according to an ERD report.

System can be used only for receiving, could be employed for locating point sources in space or to map incoherent self-luminous sources in radio astronomy.

Biochemical Fuel Cell Uses Living Microorganisms

LIVING BACTERIA are being used to generate electricity directly from chemical fuels. J. A. Welsh of Joseph Kaye & Co., Cambridge, Mass., describes the novel approach to fuel cells as similar to conventional concepts but with faster energy conversion because of enzymatic action in living organisms.

Speed increase can be of the order of a million times.

Development work is proceeding on systems for closed-cycle environmental control and power for space vehicles, extraction of minerals from seawater, and others. Welsh says bacteria commonly found in sewage can be used; he's using bacteria found inside the human intestines.

Biochemical batteries made to date reportedly yield as much power as fuel cells, give 0.5 to 1.0 v per cell, do not require high temperatures or pressures or other unusual environment.

Desk Calculators Go Solid-State

TRANSISTOR CIRCUITS are beginning to replace gears and motors in small desk-calculators. Electro-solids Corp., Los Angeles, last week announced a transistorized calculator expected to enter the market in 1961. Company figures the desk adder market at \$60 to \$75 million annually, expects to sell its calculator at about \$500, compared with about \$700 for ten-column (full-keyboard) electromechanical calculators.

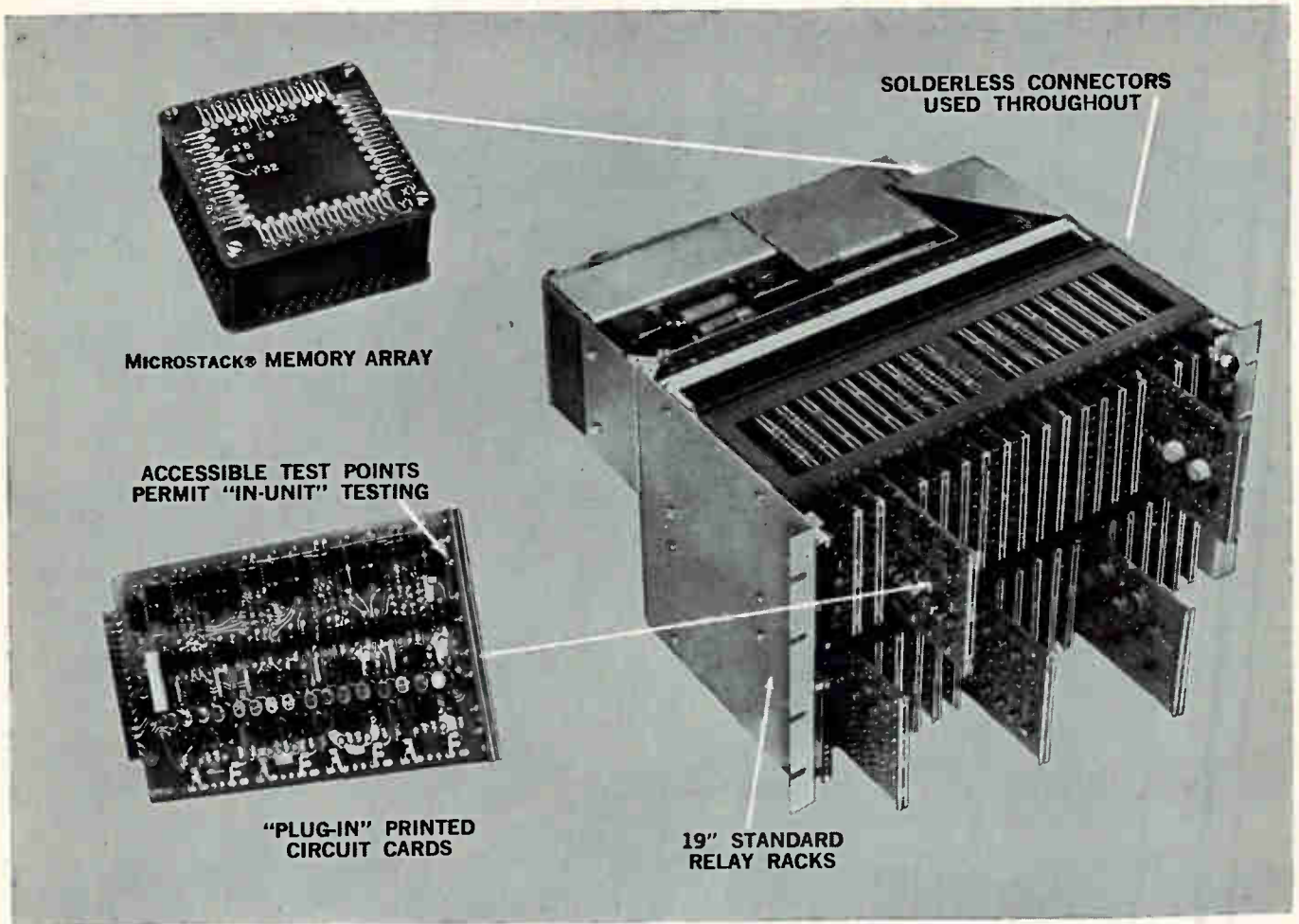

Customized, Modular-Built Memories **ENGINEERED FOR MAINTAINABILITY**

4 BASIC SERIES AVAILABLE				
Memory Series	M	K	L	J
Cycle Time — μ Sec.	10	6	5	3.3
Data Access Time — μ Sec.	4	2.5	3.5	2
Word Capacity Note: any bit length desired	32 to 32,000	32 to 32,000	32 to 32,000	32 to 32,000
Standard Types 1) Random Access	(See Note Below) X			
2) Sequential Interlaced	X	X	X	X
3) Sequential Non-Interlaced	X	X	X	X

NOTE: A combination of Random Access and either Sequential Interlaced or Non-Interlaced types are available in the "K" and "M" Series.

New GC modular design concept using standardized circuitry and in-stock modules speeds up deliveries of customized buffer and random access memory systems while improving reliability, cutting space requirements and simplifying maintenance.

Once again from General Ceramics, originator of the square loop Ferrite, comes a significant advance in the science of data handling — memory units that provide unequalled design flexibility.

A new brochure (Bulletin 26) provides descriptive data. For more complete information in regard to your specific project, write, wire or call today to:



APPLIED LOGICS DEPARTMENT
GENERAL CERAMICS

Phone VALley 6-5100 • Direct Distance Dialing Code 201

KEASBEY, NEW JERSEY, U. S. A.

TECHNICAL CERAMICS. FERRITES AND MEMORY PRODUCTS

THE PASSIVATED SURFACE, an integral silicon oxide coating completely protecting the junctions against contamination during manufacture and against change with time.

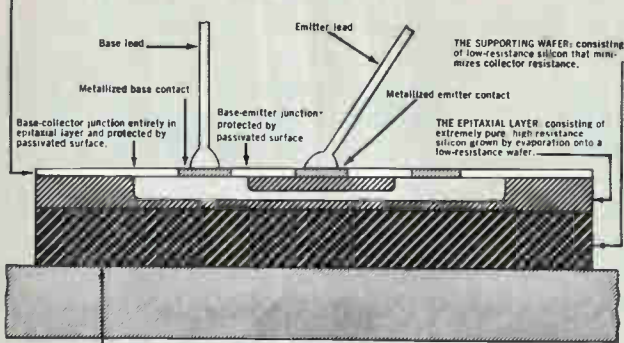

Soldered attachment to metal header (conducts collector current)

Silicon PLANAR epitaxial cross section

PLANAR

- GREATEST RELIABILITY, STABILITY AND UNIFORMITY
- LOWEST GUARANTEED I_{CBO}

EPITAXIAL

- LOWEST GUARANTEED $V_{CE(sat)}$
- HIGHER MAXIMUM I_C
- NO SACRIFICE IN VOLTAGE BREAKDOWN

COMBINED IN ONE TRANSISTOR FAIRCHILD SILICON 2N914

This combination means extremely fast propagation time in digital circuits, excellent high-frequency response in amplifiers, high-speed performance in current drivers. Typical f_T is 300 mc.

To the EPITAXIAL advantages, PLANAR adds extreme stability, reliability, low leakage and low noise figure. PLANAR and EPITAXIAL TOGETHER achieve usable current gain over a broader current range than either alone.

ELECTRICAL CHARACTERISTICS AT 25°C—2N914

	Min.	Max.	Conditions
h_{FE}	20	80	$I_C = 10mA, V_{CE} = 1.0V$
BV_{CBO}	40V	—	$I_C = 10\mu A, I_E = 0$
BV_{EBO}	5.0V	—	$I_E = 10\mu A, I_C = 0$
$V_{CE(sat)}$	—	0.18V	$I_C = 10mA, I_E = 1mA$
$V_{CE(sat)}$	—	0.7V	$I_C = 200mA, I_B = 20mA$
h_{fe}	3	—	$I_C = 10mA, f = 100mc$
C_{ob}	—	6pf	$V_{CB} = 10V, I_E = 0$

Write for full specifications.



545 WHISMAN ROAD, MOUNTAIN VIEW, CALIF.-YORKSHIRE 8-8161-TWX: MN VW CAL 853
A wholly owned subsidiary of Fairchild Camera and Instrument Corporation

JERROLD

R. F. Test Equipment

Quantitative Measurements Using Sweep Frequency Techniques



Model 900A—THE MOST VERSATILE SWEEP GENERATOR \$1,260.00

CENTER FREQUENCY—VHF 0.5 to 400 MC
UHF 275 to 1000 MCS—SWEEP WIDTH—
up to 400 MCS—FLATNESS— ± 0.5 db over
widest sweep!



Model 707—ULTRA FLAT SWEEP GENERATOR \$795.00

Featuring $\pm 5/100$ db flatness—Plug-in osc. heads*; variable sweep rates from 1/min. to 60/sec.; all electronic sweep fundamental frequencies; sweep width min. of 1% to 120% of C.F.

*Heads available within the spectrum 2 to 265 MCS

Models 601/602—PORTABLE GENERAL PURPOSE \$295.00

COVERAGE—Model 601—12 to 220 MCS. Model 602—4 to 112 MCS—FLATNESS— ± 0.5 db
OUTPUT—up to 2.5 V RMS
WIDTH—1% to 120% of C.F.



Model FD-30 \$165.00

High speed DPDT coaxial switch permitting oscilloscope measurements without calibration—all measurements referenced continuously against standard attenuators.



Model AV-50 Variable Precision Attenuator \$150.00

Long life rotary wiping switches; dual wiping silver contacts on "Kel-F" dielectric. 0-62.5 db in $\frac{1}{2}$ db steps; DC to 500 MCS.

Write for catalog and technical Newsletter series on measurements using sweep frequency techniques. Prices and data subject to change without notice.

JERROLD ELECTRONICS CORPORATION
Industrial Products Division Dept. ITE-97
The Jerrold Building, Philadelphia 32, Pa.
Jerrold Electronics (Canada) Ltd., Toronto
Export Representative: Rocks International, N. Y. 16, N. Y.

WASHINGTON OUTLOOK

THE RECENT budget revisions were just the first round in what's likely to be a full-scale overhaul of the defense program by the Kennedy administration. Military electronics contractors take note: another series of policy changes appears to be shaping up. Look for changes in production schedules, procurement rules, defense strategy and deployment of new weapons systems.

The tipoff comes from an order by Defense Secretary McNamara for 104 formal staff studies by top-level Pentagon officials on just about every defense problem. McNamara had a penchant at Ford Motor Co. for ordering surveys to help make crucial decisions. He has carried the custom over to the Defense Department.

The surveys range widely over fields of direct interest to the electronics industry. Defense Research and Engineering Director York, for example, is making an extensive review of command and control facilities for strategic forces, studying whether to continue or phase out the Sage system, determining the potential of advanced manned strategic systems other than the B-70 bomber and reassessing all anti-ICBM projects.

Under McNamara's orders, Assistant Defense Secretary Morris is bird-dogging the new Defense Communications Agency, studying a plan to pay special premiums to production contractors for exceptional performance, reviewing policy on inventory stock levels and reorder of major operational hardware items and preparing a year-by-year forecast of aircraft and missile project impact on regional employment.

Defense Comptroller Hitch is working up guidelines for the fiscal 1963 defense budget and a five-year projection of military spending. Defense General Counsel Vance is studying a proposal to merge the Army Signal Corps and other Army technical services into a single contracting agency and a scheme to centralize supply functions under one agency.

Air Force Secretary Zuckert is reviewing a plan to replace still more scheduled Titan II output with additional Minuteman ICBMs and to slash F-105 fighter output (assuming work on the new TFX tactical fighter plane design can be rushed).

Navy Secretary Connally is studying whether additional aircraft carrier construction should be authorized and whether antisubmarine research and development can be effectively expanded. Gen. Lemnitzer, chairman of the Joint Chiefs of Staff, is reviewing long-range requirements for competing strategic weapon systems and a proposal to set up a unified limited-war command integrating Air Force tactical planes and Army ground forces.

Some of the studies have been completed, and show up in recent budget changes. The other surveys are to be finished from now on into early Fall and will be reflected in upcoming Pentagon decisions. Officials are reluctant to talk about the surveys, but the scope and significance of the studies make it look like important changes are in the works.

Says a McNamara aide: "The Secretary has set up the surveys to get clear-cut answers to all the questions which have occurred to him since he's come to the Pentagon. He hasn't been satisfied with some of the responses he's gotten so far, and wants to stimulate thinking."

LABOR SECRETARY Goldberg last week announced his intention to set up an Office of Automation & Manpower in the Labor Department to cope with the problems of changing U.S. industry to automatic controls.

In the Secretary's words, the OAM will "examine employment and unemployment by industry, occupation and area, to follow current and anticipated technological changes . . . Consider and develop educational and guidance programs to allow workers who may be displaced by automation to find employment without suffering a long period of unemployment . . . (and) Develop proposals for both training and retraining, for both placement and replacement of workers coming into the new economy, and those who must change their places within it."

Transitron

SILICON CONTROLLED RECTIFIERS

augmenting the industry's broadest line

With the addition of the 50-Amp Silicon Controlled Rectifier, Transitron now offers the industry the broadest line of Controlled Rectifiers available on the market today.

Research and development efforts during the past year have already produced an impressive array of types which include the following series:

TSW31S SERIES (TO-18 package).....operating current range to 200mA
 TCR251 SERIES (TO-5 package).....operating current range to 1 amp
 2N1595 SERIES (TO-5 package).....operating current range to 1 amp
 2N1600 SERIES (7/16" hex package)...operating current range to 3 amps
 TCR505 SERIES (7/16" hex package)...operating current range to 5 amps
 TCR510 SERIES (11/16" hex package) operating current range to 10 amps
 TCR520 SERIES (11/16" hex package) operating current range to 20 amps

NOW AVAILABLE — NEW 50-AMP CONTROLLED RECTIFIER

The latest addition to the Transitron line — the 50 Amp Silicon Controlled Rectifier — is a three-terminal, four-layer device designed to control very large load currents with small gate current signals. A mechanically rugged and electrically stable device, the new Controlled Rectifier is provided in the 1 1/16" hex base stud-mounted package and is hermetically sealed. Wherever high power handling ability is required, the 50-Amp Silicon Controlled Rectifier will find wide application ranging from frequency changing to welding control.

TCR550 SERIES (1 1/16" hex package)
operating current range to 50 amps

Type	Min. Peak Reverse Volt. and Min. Forward Breakover Volt. (volts)	Max. Average Forward Current at 90°C case (amps)	Package Configuration
TCR4050	400	50	1 1/16" hex
TCR3050	300	50	1 1/16" hex
TCR2050	200	50	1 1/16" hex
TCR1050	100	50	1 1/16" hex
TCR550	50	50	1 1/16" hex

Requires 50mA to turn on 50 Amp



For information on any or all of Transitron's line of Controlled Rectifiers, call or write today for Bulletin TE-1356.

WHY BIAS CONTROLLED RECTIFIERS?

THE
BIASING
OF SILICON
CONTROLLED
RECTIFIERS
AND
SWITCHES

Pioneering in *new* application techniques, Transitron application engineers have assembled information which demonstrates how "gate biasing" will improve the circuit reliability of the SCR. This informative booklet, entitled "The Biasing of Silicon Controlled Rectifiers and Switches," deals individually with *each* of Transitron's Controlled Rectifiers and Switches. It is an indispensable aid to the design engineer seeking *longer life* and *greater stability* in higher temperature applications . . . It's yours for the asking.

Transitron



electronic corporation
wakefield, melrose, boston, mass.

SALES OFFICES IN PRINCIPAL CITIES THROUGHOUT THE U.S.A. AND EUROPE • CABLE ADDRESS: TRELCO

FREQ. STDS.

TYPE 10, ACTUAL SIZE



SIZE, 1-3/8" x 1-3/8" x 3/8"

This frequency standard (360 or 400 cy.) is accurate to ± 25 parts per million at 10° to 35°C . The tuning fork is made from Iso-elastic alloy and is approximately 1 inch long. Fork aging has been greatly minimized. Compensation in the circuit provides a minimum rate change throughout the useful life of the power cell (over a year). External power of 1.4 volts at approximately 6 microamperes can also power the unit. An hermetically sealed model, Type 15, is also available.

TYPE 2007



TYPE 15

For more than 20 years, this company has made frequency standards and fork oscillators within the range of 30 to 30,000 cycles for applications where consistent accuracy and rugged dependability are demanded. A few examples are shown and described here.

Some users integrate these units into instruments of their own manufacture. Others rely on our experience and facilities to develop complete operating assemblies to meet their special needs.

You are invited to submit any problems within the area of our activities for study by our engineering staff.

AND TUNING FORK OSCILLATORS

TYPE K-5A FREQUENCY STANDARD

Size, 3 1/2" x 3" x 1 1/4"

Weight, 1 1/2 lbs.

Frequency: 400 cycles

Accuracy: .03%, -55° to $+71^{\circ}\text{C}$

Input: 28V DC $\pm 10\%$

Output: 400 cy. approx. sq. wave
at 115V into 4000 ohm load (approx. 4W)

TYPE 2007-6 FREQUENCY STANDARD

Transistorized, Silicon type

Size, 1 1/2" dia., x 3 1/2" H., Wt., 7 oz.

Frequencies: 360 to 1000 cy.

Accuracies:

2007-6 $\pm .02\%$ (-50° to $+85^{\circ}\text{C}$)

R2007-6 $\pm .002\%$ ($+15^{\circ}$ to $+35^{\circ}\text{C}$)

W2007-6 $\pm .005\%$ (-65° to $+85^{\circ}\text{C}$)

Input: 10 to 30V DC at 6 ma.

Output: Multitap, 75 to 100,000 ohms

TYPE 25 PRECISION FORK

Size, 5/8" dia. x 2 1/4"

Weight: 2 ounces

Frequencies: 200 to 1000 cy. (specify)

Accuracies:

R-25T and R-25V $\pm .002\%$ (15° to 35°C)

25T and 25V $\pm .02\%$ (-65° to 85°C)

For use with tubes or transistors.

TYPE 15 FREQUENCY STANDARD

Similar to Type 10 (illustrated) except with silicon transistor, hermetically sealed and vibration resistant.

Size, 1" x 2" x 2" high

Tolerance, $\pm .01\%$ from -40°C to $+71^{\circ}\text{C}$

Output: .1V at 50,000 ohms source impedance.



AMERICAN TIME PRODUCTS, INC.

61-20 Woodside Ave., Woodside 77, L.I., N. Y.

NEWEST ULTRA HIGH SPEED

saturated logic switching

TRANSISTORS FROM PSI

2N919

(formerly PT706)

MEDIUM h_{FE}

2N920

(formerly PT706-1)

HIGH h_{FE}

- Low $V_{CE(sat)}$
- Low T_s
- High Power
- High Current

LAMINAR
TM

CONSTRUCTION

Meet or exceed all epitaxial characteristics . . . and delivery now!

TECHNICAL DATA								
TYPE	V_{CBO}	V_{CER}	V_{CEO}	V_{EBO}	h_{FE}^*	$V_{CE(sat)}^*$	$T_s \text{ max.}^*$	Pkg.
2N919	25	20	15	5	20-60	.2	25 ns	TO-18
2N920	25	20	15	5	40-120	.2	25 ns	TO-18

NOTE: GUARANTEED 15 ns Max. T_s available in both types. Specify "A" versions.
*See data sheet for exact test conditions.

Phone, wire or write a nearby PSI field office for full details, delivery schedules and quantity prices.

Off-the-shelf delivery from PSI distributors everywhere.



Pacific Semiconductors, Inc.



A SUBSIDIARY OF THOMPSON RAMO WOOLDRIDGE INC.

12955 CHADRON AVENUE, HAWTHORNE, CALIFORNIA

2 NEW TRANSISTORS

for 3 SPECIAL APPLICATIONS

- Newest Core Driver
- Medium Power Switch
- Clock Pulse Generator

PT 600

Medium h_{FE}

PT 601

High h_{FE}

- Low $V_{CE(sat)}$
- High Current
- Fast Switching
- Controlled h_{FE}

TRIPLE DIFFUSED MESA CONSTRUCTION

TECHNICAL DATA

TYPE	V_{CB0}	V_{CEr}	V_{EB0}	h_{FE}^*	$V_{CE(sat)}^*$ max	$t_{on typ.}^*$	$P_C 25^\circ C$	Pkg.
PT600	60	45	4	15-45	1.0	40 ns	13w	T0-8
PT601	60	45	4	30-90	1.0	30 ns	13w	T0-8

*Measured at 1 Amp collector current. See data sheet for exact conditions.

Phone, wire or write a nearby PSI field office for full details, delivery schedules and quantity prices.

Off-the-shelf delivery from PSI distributors everywhere.



Pacific Semiconductors, Inc.



A SUBSIDIARY OF THOMPSON RAMO WOOLDRIDGE INC.

12955 CHADRON AVENUE, HAWTHORNE, CALIFORNIA
OR 8-4711, OS 9-2281 • TWX: HAW CAL 4270 • Cable Address PSISOCAL

SALES OFFICES

NEW YORK — 870 Broadway, Newark 4, New Jersey •
Humboldt 4-5616 • TWX: NK 1010
Boston — 471 Washington Street, Wellesley 81, Mass. •
CEdar 5-0171
Syracuse — 4455 E. Genesee Street, De Witt, New York •
Gibson 6-4600
CALIFORNIA — 8271 Melrose Ave., Los Angeles 46, Calif.
OLive 3-7850
San Diego — 2223 El Cajon Blvd.—Room 211 •
CYpress 7-3951
Palo Alto — 701 Welch Road — Suite 205, Palo Alto, Calif.
• Davenport 1-2240

ILLINOIS — 6957 West North Avenue, Oak Park, Illinois •
Village 8-9750 • TWX: OKP 1547
Dallas — P.O. Box 6067, Dallas, Texas • Riverside 7-1258
Detroit — 1204 No. Woodward Ave., Royal Oak, Michigan
• Lincoln 8-4722
St. Paul — 1602 Selby Ave., St. Paul 4, Minn. • Midway
5-9351
PENNSYLVANIA — No. 4 Township Line Road, Philadel-
phia 17, Pa. • Pilgrim 2-8089
Baltimore — 1811 North Rolling Road, Baltimore 7, Md.
• Windsor 4-3622

DISTRIBUTORS IN MAJOR ELECTRONIC CENTERS COAST-TO-COAST

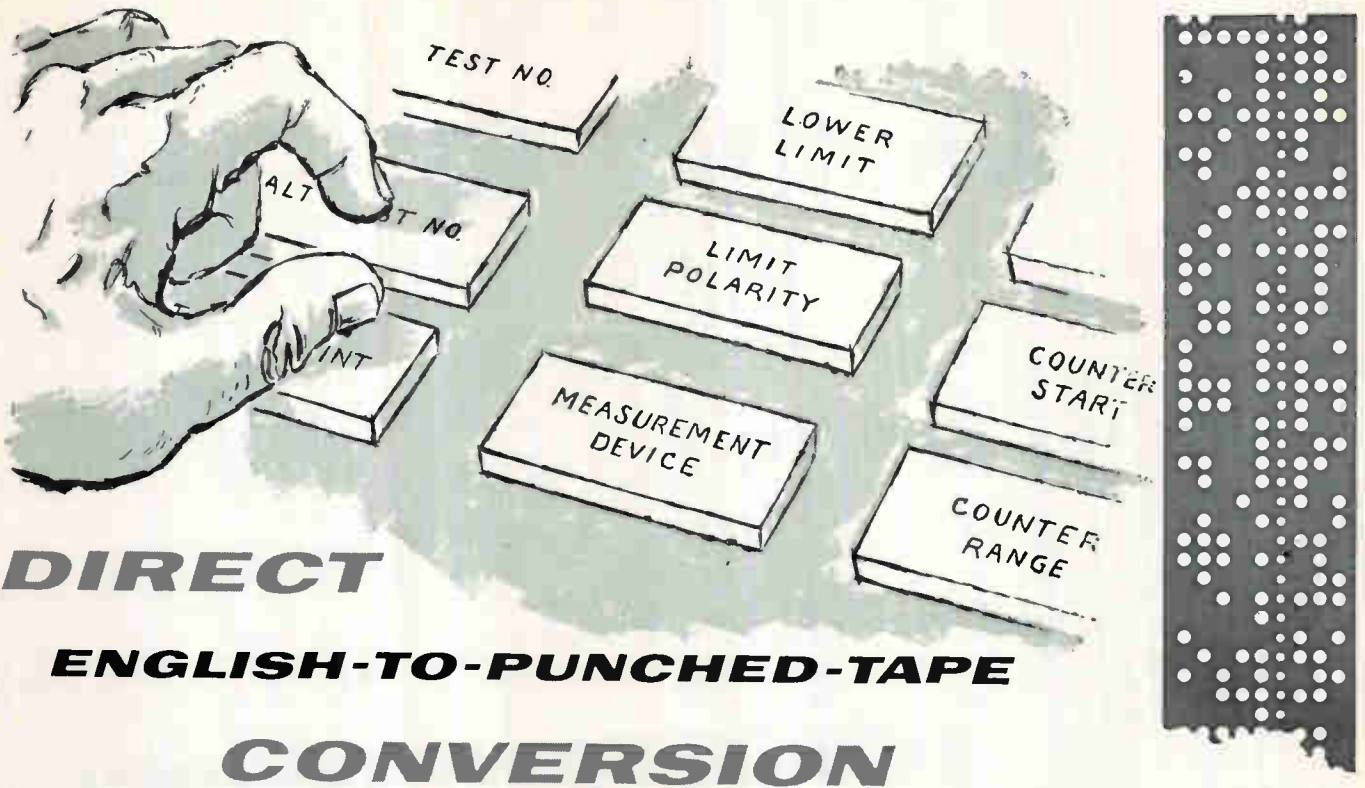

DIRECT ENGLISH-TO-PUNCHED-TAPE CONVERSION

The McDonnell TAPE* automatically prepares punched tape. TAPE's logic circuitry electronically analyzes word-group and numerical keyboard commands and converts them to complete coded programs. Punching mechanisms instantly deliver the finished tape. Editing, verifying, duplicating or correcting is accomplished quickly and automatically.

TAPE Slashes Time and Costs

Programming time, operator training, schedule delays, as well as large computers, key punches and other peripheral equipment are eliminated. Small size permits installation in laboratories or wherever finished tape is used. Unskilled operators learn to use TAPE in minutes. The

McDonnell TAPE has demonstrated the capability to prepare 25,000 feet of perfect tape at less than half the cost and in less than one-third the time required to prepare the same tape with the best standard computer preparation method available.

A prototype McDonnell TAPE is operating which prepares tape for the AN/GJQ-9 missile and aircraft automatic checkout system. Minor modification readily adapts the keyboard and logic circuitry to tape preparation requirements of other industrial and military operations.

Whatever your punched tape requirements, you are invited to visit McDonnell and operate TAPE.

**Tape Automatic Preparation Equipment*



For descriptive literature, write:

Electronic Equipment Division
Dept. 952
McDonnell Aircraft, St. Louis, Missouri

MCDONNELL ELECTRONIC EQUIPMENT DIVISION

*Airborne Antennas • System Trainers • Simulators •
Radio Beacons • Telemetry • Specialized Digital Computers • Microwave Components •
Automatic Flight Control Systems • Automatic Checkout Equipment*

MCDONNELL AIRCRAFT • ST. LOUIS

What the specs say,

 dependable automatic

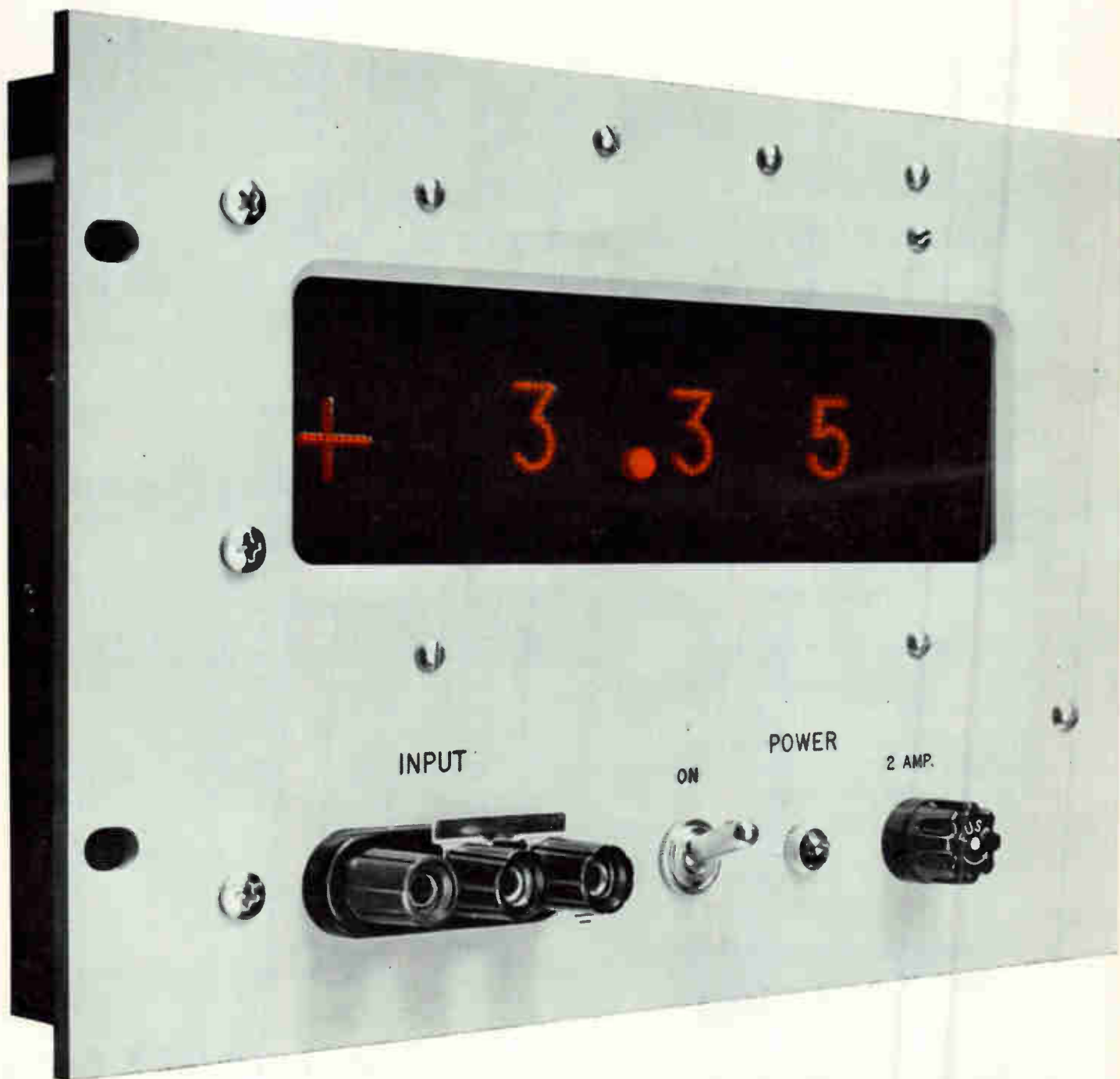

you get—day after day!

digital voltmeters for lab,
production line, systems!

Simple touch-and-read dc voltage measurements—

Automatic range and polarity selection—

Easily used by inexperienced personnel—

Bright, clear in-line Nixie readout—

Command, recorder outputs*

AUTOMATIC
DC DIGITAL VOLTMETER
MODEL 405CR
HEWLETT PACKARD
PALO ALTO CALIFORNIA

SAMPLING

INCREASE RANGE

EXT

CALIBRATE

SET RANGE SWITCH TO AUTO
INT. STD.

+7.12v

RANGE

AUTOMATIC

HOLD

MANUAL STEP

⊕ 405BR/CR Automatic DC Digital Voltmeters automatically zero-set themselves, choose the proper voltage range and polarity and present an accurate reading in bright clear numerals. ⊕ 405BR and CR are identical except that ⊕ 405CR offers unique systems versatility—provisions for external sampling command and recording outputs, plus reading hold-off capability, print command when overranging, and remote readout.

Both instruments feature well known ⊕ reliability, with superior components, circuit design and broad-range environmental dependability, all at moderate price.

Brief Specifications, ⊕ 405BR/CR

Range: 0.001 to 999 v dc; 4 ranges
Presentation: 3 significant figures, polarity indicator
Accuracy: $\pm 0.2\%$ full scale ± 1 count
Ranging time: 0.2 sec to 2 sec
Input impedance: 11 megohms to dc, all ranges
Response time: Less than 1 sec
AC rejection: 3 db at 0.7 cps; min. 44 db at 60 cps
Recorder output: Digital recorder output, ⊕ 405CR only
Price: ⊕ 405BR, \$850.00; ⊕ 405CR, \$925.00
(both rack mount)

*Model 405CR only.

HEWLETT-PACKARD COMPANY

1068A Page Mill Road Palo Alto, California, U.S.A.
Cable "HEWPACK" Davenport 6-7000

Sales representatives in all principal areas

HEWLETT-PACKARD S.A.

Rue du Vieux Billard No. 1 Geneva, Switzerland
Cable "HEWPACKSA" Tel. No. (022) 26.43.36



Highly Reliable

HITACHI "SEMI-CONDUCTORS"

For Industrial Use
Switching Transistors and Diodes

2SA18
2SA41
2SA42
2SA86
2SA208
2SA209
2SA210
2SB66
2SB67
2SB68
2SB81
2SB82
2SC89
2SC90
2SC91

Hitachi semi-conductors provide the basis for the excellent capacity of the Hitachi Electronic Computer HITAC 103.

1N34A
1N35
1N38A
1N56A
1N60
1S77
1S78
1S79
1S84

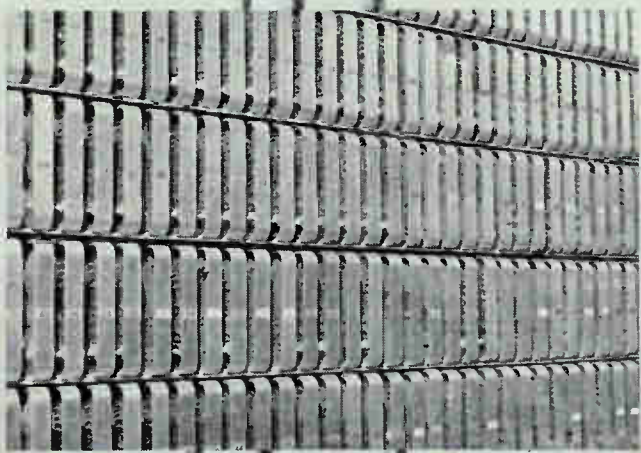

Back of HITAC 103.



Hitachi, Ltd.

Tokyo Japan

Cable Address: "HITACHY" TOKYO



RCA AIRBORNE SINGLE SIDEBAND

Performance proven in Operation "Deep Freeze"

RCA's single sideband modification of the 618S-1 high frequency communication equipment has demonstrated proven capability under actual flight operations during Operation "DEEP FREEZE," now being conducted by the U. S. Navy with the support of the U. S. Air Force and MATS.

The RCA concept of modifying proven, existing equipments, such as the AN/ARC-65, has resulted in the most economical approach to the utilization of single sideband performance capabilities. The 618S-1/MC and AN/ARC-38A SSB modifications are the latest additions to the family of RCA Communications Equipments now providing extra capability to meet present and future military and civil operational communications requirements.

Several thousand RCA Airborne Single Sideband Equipments are now in flight operation.



For further information on the 618S-1/MC, AN/ARC-38A, and other airborne communication equipments write: Marketing Dept., Airborne Systems Division, Defense Electronic Products, Radio Corporation of America, Camden 2, New Jersey.



The Most Trusted Name in Electronics
RADIO CORPORATION OF AMERICA

Japanese Engineers Seek Better Components

By CHARLES L. COHEN,
McGraw-Hill World News

OSAKA, JAPAN—More than 2,500 engineers and physicists representing manufacturers, government laboratories and universities gathered at Osaka University recently for the annual joint meeting of the four electrical institutes of Japan.

Many top engineers expressed a desire for more stable, uniform and reliable components.

Zenemon Abe of Hitachi Central Research Laboratories observed that in one of the sessions over one-third of the papers dealt with skillful methods of using inferior components and that much of this work would lose all of its value as soon as better components became available.

One thing that distinguishes the Japanese convention from similar American conventions is the large number of papers. The papers are subject to virtually no review and many papers of dubious quality are mixed in with the good ones.

Also, many Japanese engineers have a compulsion to publish everything they do and many detailed analyses that represent excellent work but are of little use to anyone else are given.

At this year's convention 1,668 individual papers were read, nine symposiums were held and four special lectures given. The papers were only eight minutes long with two minutes for questions.

The larger lecture halls at Osaka University were equipped with a wireless microphone and a loud-speaker system which enabled everyone to hear the lectures distinctly.

In the session on semiconductor devices, Toshio Misawa of Sony described an experimental epitaxial diffused transistor. This transistor can operate at currents up to 10 amperes and is suitable for tv horizontal sweep circuits. Other Japanese companies are also reported working on epitaxial transistors.

Yasuo Tarui of the Electrotechnical Laboratory, a government re-

search and standards laboratory, described a free-running solid-state multi-vibrator. He used the wafers on which the circuit is built as the bases of the transistors. Special features include the use of the back resistance of diodes for resistors and use of zinc sulphide coatings to form capacitors.

Toshiya Hayashi of the Electrocommunication Laboratories, the research laboratories of the semi-government telephone company, fabricated a three-terminal esaki diode. The construction is similar to that of a unijunction transistor except that a lower resistivity bar is used. Biasing allows the characteristics to be shifted along either the current or voltage axis. It is possible to make the ratio of the peak to the valley current as large as desired. However, the device needs separate biasing batteries for each diode and the added ohmic resistance of the germanium bar is several ohms.

A silver-bonded diode developed for computers was described by Shoichi Kita of the Electrocommunication Laboratories. Over half of the capacitance of this diode, which is a modified version of his parametric amplifier diode, is that of the pigtail-lead glass enclosure. This diode is also used as a 70-Mc i-f amplifier by Nippon T & T. Although the reverse breakdown voltage is comparatively low, the forward voltage drop is also low enabling efficient switching.

This diode, which is characterized by gradual forming, has backward characteristics similar to a point-contact diode and may not be an actual bonded diode. It is mechanically weak unless suitably mounted. Reverse recovery characteristics are good. A U. S. company is reported negotiating to build this and the original parametric-amplifier diode.

Two papers describing work with indium antimonide were given. Hiroshi Akiyama of Osaka Institute of Technology experimentally produced dendrites. Takichi Hashimoto of the Electrical Communica-

tion Laboratories fabricated Esaki diodes that show tunnel characteristics only at temperatures lower than -40°C .

Takeo Miura of Hitachi Central Research Laboratories described a transistorized analog-to-digital converter with an accuracy of 0.1 percent, clock pulse frequency of 150 Kc, conversion time of 80 μsec and a conversion repetition rate of 12.5 Kc. Input impedance is 10,000 ohms and output is a negative-positive code and a binary 10-bit signal. Operating temperature is $25 \pm 10^{\circ}\text{C}$. A Peltier element stabilizes the temperature of the Zener diode in the power supply.

Kitsutarō Amano of the K.D.D. Laboratories described an extremely high speed a-d converter with a sampling speed of 10 Mc using comparators of Esaki diode pairs. The buffer, encoder and output circuits use ungrounded Esaki diode pairs in a parametron circuit with a 10-Mc three-phase power supply. The maximum number of sampling levels with presently available diodes is about 75. This converter was designed for use with ultrahigh-speed real-time computers and for encoding television signals.

Hideo Shimura of the Electrical Communication Laboratories described the supratron, a logical element for computers which uses super-conductivity. The supratron consists of a ring with four leads spaced 90 degrees apart on its circumference. One pair of leads is for the signal while the other pair is for bias. A three-phase power supply similar to that used with parametrons is required. Temperature of operation is 3.7 K. A slightly modified supratron is suitable for memory circuits.

Semipermanent metal-card memories of two different types were described. One type, developed by the Electrical Communication Laboratories, consists of two printed-circuit coil boards with one-turn coils printed in the centers of the squares formed by an imaginary rectangular grid drawn on the coil

Annual meeting discloses double-base tunnel diodes, epitaxial transistor, silver-bonded diodes, solid-state networks, indium antimonide tunnel diodes and metal-card memories as well as new circuit and equipment designs

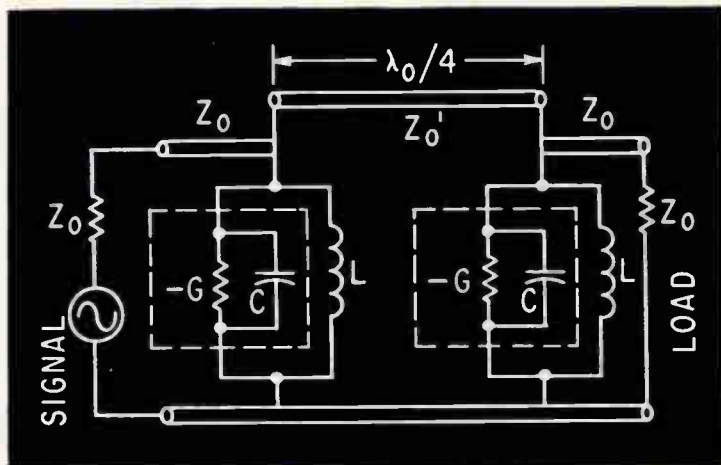

Four-terminal microwave amplifier uses two tunnel diodes

boards. The position of the coils on both boards is identical. All coils in each vertical column on one board are connected in series and all coils in each horizontal row on the other board are connected in series. A metal card with holes punched only at the intersections where a one is to be stored is inserted between the two coil boards. When a read current is sent through one horizontal group of coils, a voltage appears in those vertical columns where there is a hole in the metal card at the crosspoint. The stored information may be changed by changing metal cards. The other type, developed by the Electrotechnical Laboratories, is similar but operates by capacitive coupling.

Professor Ei'ichi Goto of Tokyo University described the PC-2 parametron computer. This computer has a clock rate of 100 Kc and an add time of 40 μsec with a fixed decimal point and 40 to 300 microsec with a floating decimal point. Memory access time is only 60 μsec and the speed of the computer is limited by the speed of arithmetical operations and not by the access time.

Shigeru Takhasi of the Electrotechnical Laboratories described the ETL Mk-6 computer now under construction. This computer will have a 5 Mc two-phase clock frequency, an adding speed of 400 nanosec and a multiplication speed of 3.4 μsec. Approximately 10,000 transistors and 40,000 diodes will be used.

Joji Hamasaki of the Industrial

Production Research Laboratory of Tokyo University developed a four-terminal negative-resistance amplifier that needs neither a circulator nor hybrid circuit. Two Esaki diodes, whose capacitances have been tuned out by inductors, are connected at either end of a quarter-wave transmission line. The signal input is connected to one end of the quarter-wave transmission line and the output is taken from the other end by transmission lines terminated with their characteristic impedance. It is assumed for sim-

plicity that the input and output circuits have the same impedance. If

$$-1 < GZ_0 < 0 \text{ and } \frac{Z'_0}{Z_0} = 1 / \sqrt{1 - (GZ_0)^2}$$

A stable four-terminal amplifier with bidirectional characteristics will be obtained.

The gain at the center frequency is

$$A = (1 + GZ_0) / (1 - GZ_0)$$

A gain of 6 db was realized at 1,300 Mc using two Sony IT1103 diodes.

Dictating While Nuclear Sub Cruises



Nuclear submarine Seadragon uses magnetic tape dictating machine in attack center for on-the-spot reports. DeJur-Grundig unit (rear, middle) is later brought to ship's office for transcription of day's tapes



Sleds and muscles help field engineer bring equipment to snowy mountaintop military station



Field engineer uses Indian oxcart to bring weather radar gear to station site at Raytheon installation

FIELD ENGINEERING SPELLS PROFITS

By THOMAS EMMA,
Associate Editor

FIELD ENGINEERING departments are expanding and operating at a growing profit, according to a number of companies.

Manufacturers say the main reason for this is the increasing complexity of today's electronic systems and equipment. Their biggest volume of field service business is done with the military.

Industry estimates are that somewhere between 30,000 and 40,000 people are now employed by field service divisions of U.S. electronics companies. Roughly one-quarter of these people are engineers.

Military men say the electronic field service organization supplies continuity very difficult for them to achieve with uniformed personnel. "Just as we have a man trained well enough to maintain complicated equipment, his enlistment expires and he leaves the service," says an Air Force spokesman.

Some idea of the amount of electronics servicing the military needs may be formed from estimates by Radio Corp. of America that about 25 percent of the cost of a modern jet fighter plane is for electronics. Ten years ago the figure was

closer to 10 percent.

Up to 35 percent of the cost of a missile firing ship is for electronics, while nearly half the expenditures for the missiles themselves go for electronics. All these systems require a high degree of technical skill to install and maintain.

In addition to military income for field service operations, there is a growing commercial market in automation and computer gear.

Burroughs Corp., for example told *ELECTRONICS* some 500 of its field engineers work exclusively on medium and large-scale commercial and industrial data processing systems, while a substantial additional number of men work on electronic accounting gear and small computers.

Field engineers are most often either young men who are single and free to travel, or men over forty with grown up families, according to Raytheon's Electronic Services division. This general grouping in two age areas is typical within the industry and most field engineering departments boast of a grandfather or two.

In the younger age group, a good many field service engineers are former members of the armed services. "With all other qualifications

equal," said a spokesman of Federal Electric Corp., ITT's field service subsidiary, "we prefer ex-service people."

Since civilian engineers working at military installations simulate military rank for billeting purposes while on the job, the ex-service man's knowledge of military etiquette and protocol is helpful. Says one field supervisor: "They have to know how to walk that fine line between the commissioned officer and the noncom specialist, and to work equally well with both."

A good field engineer, in addition to travel and variety in his work, is usually able to see a considerably larger income than the inside engineer. Although base pay for the field man is at a par or a little below other engineers, overseas allowances ranging from 20 to 30 percent of base pay are not unusual. In addition to this, expense allowances and lower living costs, coupled with income tax advantages, add to take-home pay. A field man with about five years' experience can make \$20,000 a year.

In contrast to the plant specialist, who works fairly continuously with one type of equipment, the field man is often called on to deal with an entire communications system, an



entire data processing network or the total instrumentation of a jet aircraft.

Travel is also seen as a stimulus to field engineering. Personnel people for many field engineering departments say younger men respond easily to the idea of living and working in foreign lands. Not all field engineering means assignment overseas, however.

Burroughs, for example, has responsibility for maintaining Sage systems throughout the U. S. Field engineers in this project have area responsibility and service equipment on a regional basis, making their rounds somewhat like a traveling sales representative working in a "territory".

Field assignments can mean servicing computers in a number of local banks, or month after month on the DEW line, or isolation in some eastern European mountain region working on communications gear.

The average field engineer has something like one and one-half to two years of formal education and from two to five years of experience, military or industrial.

The present trend in field engineering education is training within an entire system. A company with a contract to service a system is often called on to deal with equipment it has not manufactured. Some companies, such as Federal

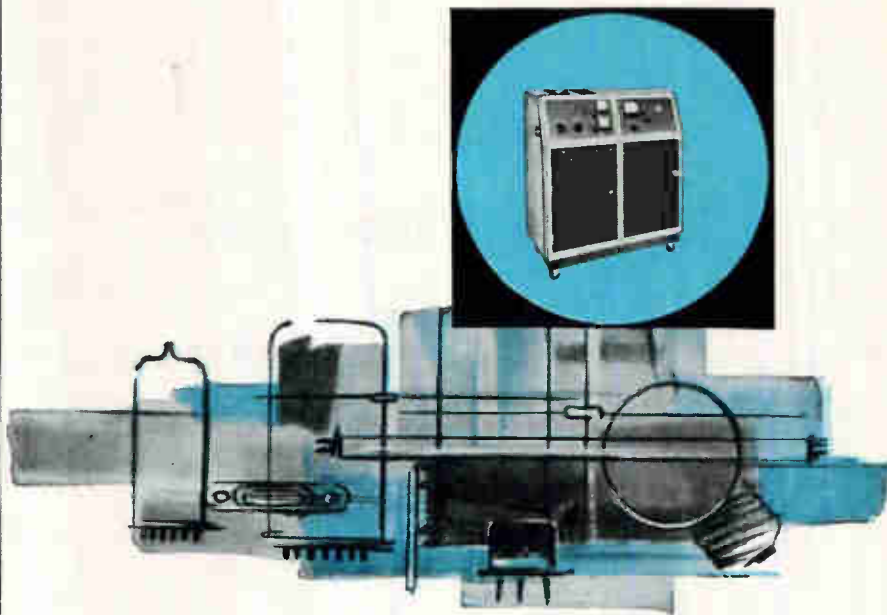

MASS SPECTROMETER

LEAK DETECTOR*

... 100 TIMES MORE SENSITIVE
THAN OTHER HELIUM
ACTUATED UNITS

Sensitivity of 10^{-12} cc/sec. (S.T.P.) permits critical vacuum testing, providing an important increase in operating reliability and shelf life of hermetically sealed and pressurized devices. The competitively-priced Crosby-Teletronics Model 600, an outgrowth of the recently-introduced ultra sensitive Model 700 (sensitivity of 10^{-13} cc/sec), incorporates a double magnetic analyzer and a newly developed ion source and detector unit. This new machine takes its place with other advance-design hardware developed by Crosby-Teletronics, a leader in test equipment, long range communications and

vacuum research



Crosby-Teletronics Corporation • 54 Kinkel Street • Westbury, Long Island, New York

*pat. pend.

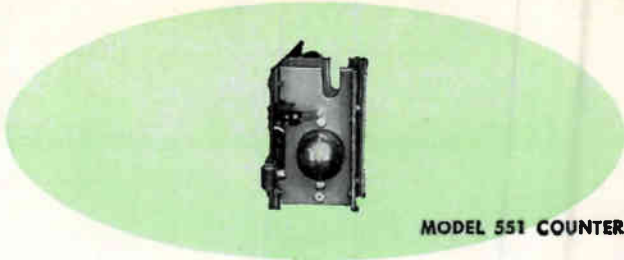

MODEL 551 COUNTER

meet the new counter that made the new
FRANKLIN
 Model 550 Digital Voltmeter possible



*MODEL 550, ALL-ELECTRONIC DIGITAL VOLTMETER, \$1370

One third the number of parts of previous counters. . . that's just one of the reasons why the new Franklin Model 550 Digital Voltmeter guarantees a reliability never before possible. Add to this Franklin's use of the new Beam-X tube and long-life Nixie indicator . . . and you know its reliable. And speaking of the New Franklin Model 550 all-electronic Digital Voltmeter, there are other benefits besides the new counters . . . effectively infinite input impedance on all ranges through 120 V dc . . . reads from 100 microvolts to 1200 V dc . . . 0.1% absolute accuracy . . . all electronic . . . self-contained calibration cell . . . handsome, rugged construction for rack or bench use . . . 7" high panel . . . and more . . . For all the new facts, ask for Bulletin 311.

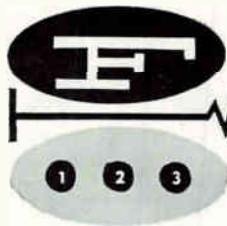

FRANKLIN

electronics, inc.
 BRIDGEPORT • PENNSYLVANIA

*Beam-X and Nixie are trademarks of the Burroughs Corp.

Electric Corp. or Page Communications Engineers, manufacture little or no equipment. Field engineers spend time on the manufacturer's premises watching the equipment being developed and assembled before going into the field.

In addition, the field engineer must be thoroughly familiar with equipment through instruction manuals and other literature. Most field engineering departments employ a substantial number of technical writers and maintain large publications sections to produce these manuals.

Almost all companies maintain schools for specialized training. Raytheon, for example has some 90 locations in the U. S. for field engineer training, as well as 18 locations abroad.

The field services division of General Electric, nicknamed "the Foreign Legion", maintains a training unit in Syracuse that handles some 275 men a year.

The basic education here is built around four courses, electronic systems, operations, field maintenance and shop repair theory and practice. GE's Heavy Military Electronics division spent about \$1 million last year on recruiting and training field engineers.

Page, as part of its communications field work, maintains training facilities in U. S. field stations and also operates a special systems school in Hawaii to train field engineers for Pacific scatter systems.

Field engineers often have contractual obligations to train military and other personnel as part of their regularly scheduled work day in the field. In many cases on-job-training is conducted in a regular classroom situation where attendance is mandatory and homework assignments and other schoolroom practices are part of the job.

Other subjects besides electronics are sometimes handled by field service departments. RCA, for example, has field men conducting courses in nuclear physics, chemistry and electrodynamics for the Air Force Air Training Command. Some electronics courses the group conducted recently include studies of the BMEWS, F-108 fighter plane and B-52 bomber systems.

AN INFRARED spectrophotometer is scheduled to study Martian organic molecules from a Mariner spacecraft in 1962.

Design concepts of the device may be important in the evolution of future infrared sensors that will later explore other planets in our solar system and beyond.

Perkin-Elmer is providing the gear under subcontract from the Jet Propulsion Laboratory, delegated by the National Aeronautics and Space Administration to direct lunar and planetary space exploration programs.

The 20-lb instrument package is expected to give a sharp spectral scan concurrent with a geographical scan of the Martian surface. At a 9,300-mile distance from Mars, the surface projection of the spectrophotometer is designed to define an area of the planet about 40 mi by 400 mi.

While the spacecraft is within analytical range of Mars, about 300 geographical picture elements are expected to be generated. Information storage capacity is 324,000 bits. If the space vehicle's trajectory is imperfect, the device's scan rate can be varied electronically by signals from on-board radar equipment.

For collection of infrared energy, the spectrophotometer uses a reflecting telescope. Energy from the field of view (0.25 by 2.50) is imaged on the entrance slit of the instrument's scanning monochromator.

A resonant reed chopper immediately in front of the entrance slit modulates the incoming radiation. The reed is driven by electromagnetic coupling to a pole piece energized by a transistor feedback oscillator. Reed modulation frequency is 300 cps.

To achieve a four-micron sensitivity, a lead selenide detector is radiation cooled to -78 C. An umbrella protects one side of the detector against heat from the sun; the other side is open to the cold of deep space.

The grating monochromator configuration, an Ebert optical path, is ideal for containment in a small



Working model of device that will study life on neighboring planet

sealed package, according to Perkin-Elmer. Use of a grating technique allows high spectral resolution; at the same time, it permits use of a small area dispersion plate.

In signal processing, a keyed automatic gain control loop accommodates a wide dynamic range of signals without saturation or distortion.

Quality of the data sent to earth for analysis is more important than quantity. The most intimate details of chemical mechanisms can be exhaustively evaluated, provided the important identification signatures of the absorption components are preserved with fidelity. Determining the precise wavelength of peak absorption calls for spectral calibration accuracy. A 0.02-micron shift might completely invalidate a life-process theory. Also, the absorption width of the band, and the depth of the absorption must be preserved.

Wales Gets Its First Community Tv Network

NEWPORT — Community television service begins this month in the Welsh town of Cwmbran where some 1,000 homes have hitherto been unable to get adequate tv reception because of severe ghosting due to hilly terrain.

Perennial Favorites

Eldema
Miniature
Pilot Lights
and
Indicators
(Genus: Eldeminiata
Californium)

By inbreeding, cross-pollinating and the introduction of new strains, Eldema has produced a multitude of miniature and sub-miniature pilot lights and indicators to meet requirements from super-complex reliability to mass production economy. They range from the common garden variety of low cost neon or incandescent lamps (neonium/incandescentium simplex economicus) to multiple lamp holders and lamps for display of special circuit functions . . . from switchlites with separate but related lamp and switch circuits (grow-no grow) to the new hybrid Logic Lites (Eldeminiata Logicum) with internal driver circuitry for use in transistorized circuits. New strains can be developed to your specifications, hardy enough for any environment. Eldema lights are available in a riot of lens colors and shapes with a variety of root structures, and permanent or replaceable lamps (perennial or annual). Send for our new catalog of bulbs and stuff now.

ELDEMA CORPORATION
1805 BELCROFT.
EL MONTE, CALIFORNIA



Phone Used With Tv



One piece phone facilitates closed circuit tv communication in Philadelphia bank

Soviets Revamp R&D Planning

MOSCOW—The Kremlin is apparently moving to strengthen central control over research and development activities, according to observers here.

Recent newspaper stories have quietly announced that the State Scientific and Technical Committee has been abolished and is being replaced by the new State Committee of Coordination of Scientific Research.

This new group, like its predecessor organization, is directly under the Soviet Council of Ministers. The older group had the task of coordinating research and speeding application into industry. It is not clear how the new group will differ in its aims and functions.

Some upgrading is predicted because the new committee will be headed by M. V. Krumichev. Although announcements do not otherwise identify him, he is apparently Mikhail Vasilevich Krumichev, sixty-year-old veteran of Soviet industrial planning bodies.

He is a member of the Central Committee of the Communist Party and was one of its first deputy chairmen.

Observers here note the Soviet press has carried frequent complaints about the slowness of bringing research technology into actual production, but say such complaints have been standard for years.

Management Appraises Organics At Semiconductor Conference

CHICAGO—High-level research executives, representing major electronics and chemical firms, comprised a significant percentage of the serious-minded attendees at the Inter-Industry Conference on Organic Semiconductors, held here last week. The conference was co-sponsored by ELECTRONICS and Armour Research Foundation.

While interest in the invited and contributed papers for their own sake was high, the management representatives were attempting to appraise the future of organic semiconductors for applications in electronic systems.

As one research executive put it: "We're here to evaluate the state of the art, so we can make recommendations to management on which way to jump."

As reported in ELECTRONICS (p 22, April 21) some companies have already jumped to the extent of supporting substantial internal research programs in organic semiconductor investigations.

Other companies are adopting a watchful attitude, unwilling to commit themselves in an area in which a definite breakthrough is needed before practical devices are forthcoming.

Some of these firms have indi-

cated interest in joint sponsorship of a research program at private institutions. Armour is considering offering a nonproprietary interest in an organic semiconductor program to several industry participants, for a relatively modest fee.

An electronics research executive who listened carefully to the highly esoteric papers presented at the conference might have come to these conclusions about the state of the art:

- The organic material about which the most is known is anthracene. The mechanism of conduction in this material is now well defined, and understood, as delineated in papers on the subject by R. G. Kepler of E. I. duPont de Nemours and Company, and G. E.'s Oliver H. LeBlanc, Jr. Anthracene may be roughly characterized as resembling silicon in its conduction characteristics. Both hole and electron conduction are possible.

- At present, no junctions with organic semiconductors have been made. Preliminary experiments with point contacts on anthracene crystals have been unsuccessful from the standpoint of observation of rectification.

- The next step to be taken is investigation of suitable doping agents for anthracene. As Dr. James J. Brophy, Armour's assistant director of physics research, told ELECTRONICS: "Someone has to go through the periodic table element by element to find materials best suited for doping, as was done for germanium and silicon."

- The class of organics known as polymers is probably where the real promise for devices of the future lies. The infinite variety of semi-conductive plastics coupled with synthesis techniques might make possible tailor-made devices with capabilities unheard of today.

The presence of more than 15 foreign visitors to the conference testified to interest in the subject abroad. Among the foreign visitors was Zdnick Louda, scientific and engineering attache of the Czechoslovakian embassy in Washington, D. C.

Low Mass Gage



Ionization gage by Westinghouse has low mass elements that withstand space acceleration forces

a New Hybrid

ELDEMA
MINIATURE
LOGIC LITES

(Genus:
Eldeminiata
Logicum)

Planting indicator lights in transistor circuitry has always meant extra work in adapting light operation to limited power and space availabilities. Eldema answers these problems with its new strain of Logic Lites, by grafting much of the associated lamp driver circuitry within the lamp case itself. Neon or incandescent readout is combined with networks consisting of diodes, transistors and other associated components for customer specified control of lamp operation. Especially suited for relay control, memory (forget-me-not) circuitry, switching, voltage toggles, process control and more, in low voltage/low current and very close tolerance applications. Available in a

brilliant host of lens shapes and colors, terminal setups, with permanent or replaceable lamps. Plant your limited systems acreage more effectively.

Send for our new Logic Lites catalog now, or ask for one of our local botanical experts to call and discuss your specific requirements.



Eldema

ELDEMA CORPORATION
1805 Belcroft, El Monte,
California

AMPHENOL **TASK FORCES** **FAST RESPONSE!**

Three regional AMPHENOL Connector Divisions offer industry a new kind of service. Each Division is a fast-response facility, staffed by creative engineering and production specialists, equipped to meet any requirement in interconnecting devices and assemblies. Your needs give these technical task forces their directives on design, prototypes and delivery. And delivery is the fastest ever available!

If you are in a hurry, call AMPHENOL!

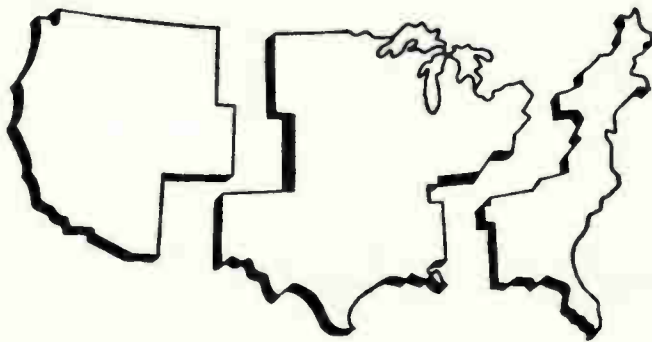

AMPHENOL—WESTERN
CONNECTOR DIVISION
9201 Independence Ave.
Chatsworth, California
Telephone: Diamond 1-0710
TWX: CNPK-5406

AMPHENOL—MIDWESTERN
CONNECTOR DIVISION
2837 South 25th Avenue
Broadview, Illinois
Telephone: COlumbus 1-2000
TWX: MAY-1192

AMPHENOL—EASTERN
CONNECTOR DIVISION
Fair Lawn Industrial Park
Fair Lawn, New Jersey
Telephone: SWarhmore
1-0303

AMPHENOL CONNECTOR DIVISION—CENTRAL OPERATIONS supports its three regional Divisions with nationwide engineering and manufacturing service.



AMPHENOL

AMPHENOL CONNECTOR DIVISION

AMPHENOL-BORG ELECTRONICS CORPORATION

1830 South 54th Avenue
Telephone: Blshop 2-1000

Chicago 50, Illinois
TWX: CIC-2294

Scholars Urge Science Base for EEs

EMPHASIS on fundamental science is the best preparation for engineering careers despite possible sidetracking of engineering students into science, according to an international group of experts on technological education.

As part of the MIT Centennial celebration in Cambridge, Mass., some 30 scholars tackled the problem of scientific and engineering education in countries with more advanced technologies.

Reporting on the closed conference, MIT Physics Prof. Martin Deutsch said there was unanimous agreement the most valuable subject matter for engineering students is that which is fundamental to the widest range of specialized engineering advancement.

Whether referred to as "Engineering Science" or "Pre-Engineering Education," it is taking over in developed countries from more specialized forms of education.

But this trend creates new problems. The student's first contacts with teachers come now in science, not engineering. "And many are induced unwittingly into careers as scientists or into the scientific mode of work in the engineering field, even when their talents and natural bent would better flourish in a genuine engineering career," said Prof. Deutsch.

Best solution, the educators

agreed, is early introduction of contact with real work situations for engineering students—with teachers who are working engineers.

At MIT and other U.S. schools, Deutsch said, this is effected by a "vigorous research and development activity. Students participate with teachers as a team."

The "project approach" at MIT, he said, involves creation of interdisciplinary centers where rigid departmental boundaries are broken up and disciplines are merged to attract first-rate professionals.

Deutsch warned that the cross-fertilization of education and technology is being threatened by the number of large laboratories being started or expanded outside the educational milieu.

He cited both governmental laboratories and industrial laboratories which are being encouraged by public policy. He said these labs are increasingly undertaking work of a kind which has been traditionally carried out in education institutions, and has benefited education of engineers and also made R&D more fruitful in the long run by the continuous infusion of new ideas and fresh approaches at all levels.

Deutsch said the threat is one which should be dealt with as a matter of conscious national and industrial policy, "not on the basis of expediency."

Data Transcriber Checks Exams

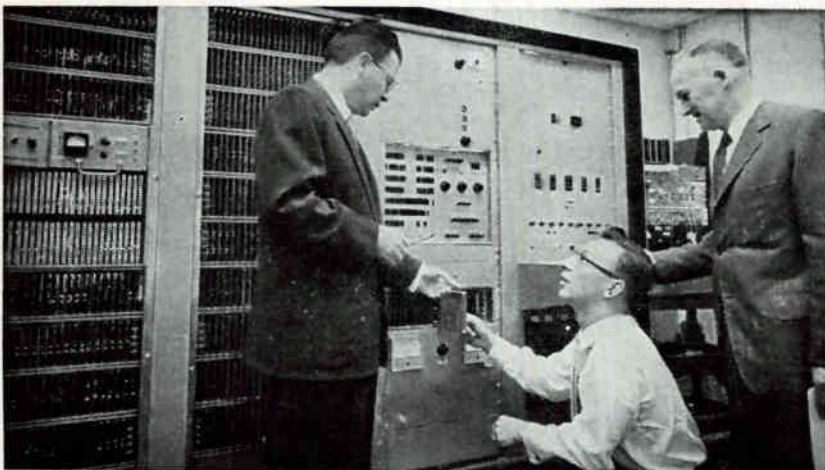

One hundred educational tests per minute are scored by new Norden transcriber which also produces student records. Delivery is due this year

PERMASEAL[®]

PRECISION WIRE-WOUND RESISTORS FOR 85C AND 125C AMBIENTS

A COMPLETE LINE OF DEPENDABLE ENCAPSULATED RESISTORS

Permaseal resistors are designed for extreme stability and long life in military and commercial applications requiring highly accurate resistance values in small physical sizes. To achieve this, winding forms, resistance wire and embedding materials are carefully matched. The completed resistors are then aged by a special Sprague process for long-term stability.

They're plastic embedded for mechanical protection and humidity resistance, meeting exacting requirements of MIL-R-93B and MIL-R-9444A (USAF).

Permaseal Resistors are available in close resistance tolerances down to 0.05%. Permanent identification marking is available to withstand all environmental conditions. Write For Engineering Bulletins 7500 and 7501 to: Technical Literature Section, Sprague Electric Company, 35 Marshall Street, North Adams, Mass.

SPRAGUE[®]
THE MARK OF RELIABILITY

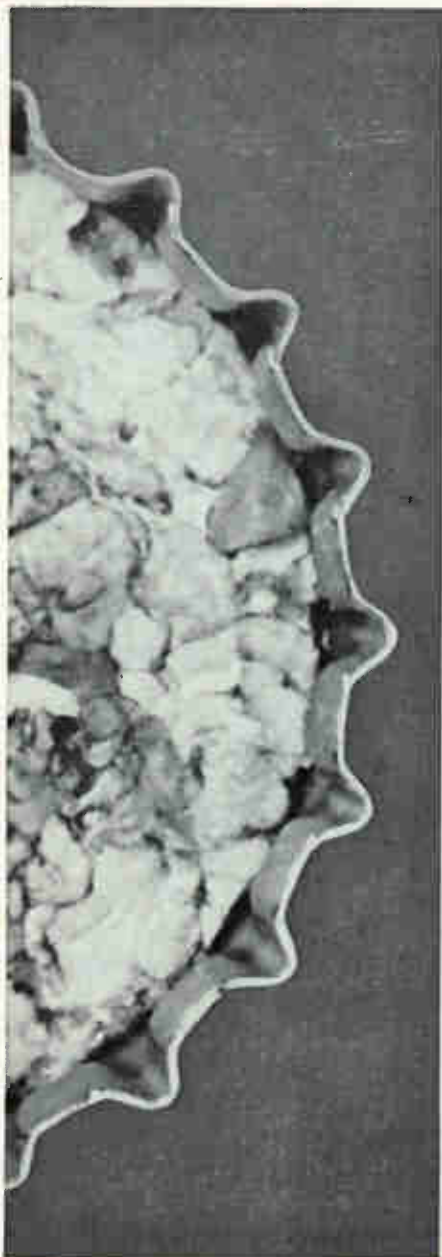

Counting bottle caps, pills or tiles . . . Veeder-Root electronic counters with photo-electric input record up to a surprising 300,000 units per minute.

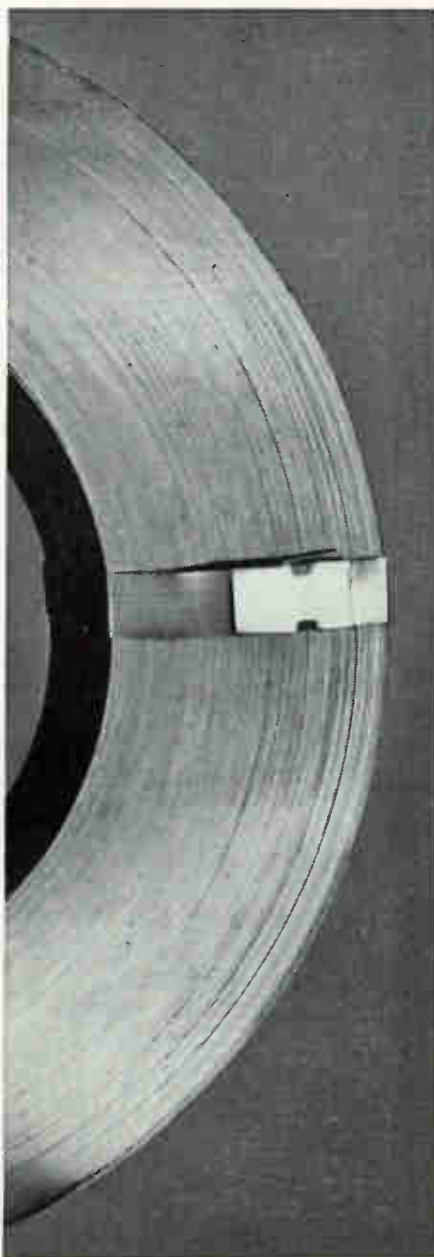

Operators in the remote control booth of high-speed strip mills get automatic readings of steel production on Veeder-Root electrical counters.



In industrial automation systems, Veeder-Root remote digital readout coordinates control, makes operating data instantly, constantly available.

Indicate, coordinate, automate...with Veeder-Root counters!
Now get facts fast—facts you can use for stepping up your operation, for integrating parts of it, for activating other equipment, automatically. Veeder-Root makes facts like these surprisingly economical to come by. For details, write Veeder-Root Inc., Hartford 2, Conn. count on...Veeder-Root



VISUAL MICROWAVE ANALYSIS 10 to 44,000 mc

MODEL TSA DIRECT-READING SPECTRUM ANALYZER

10 to 44,000 mc with
five plug-in tuning
units



0.4 μ SEC PULSE

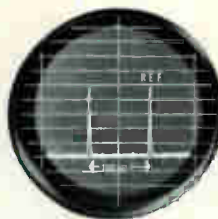

STANDARD SIGNAL



DECODED MULTIPULSE
SPECTRUM

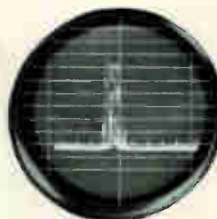

INCIDENTAL
FM ANALYSIS

MODEL TSA-S COMBINATION SYNCHROSCOPE- SPECTRUM ANALYZER

10 to 44,000 mc with
five plug-in tuning
units



10 μ SEC PULSE

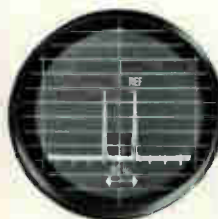

STANDARD SIGNAL

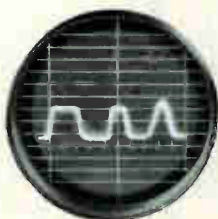

ANALYSIS AS A
FUNCTION OF TIME

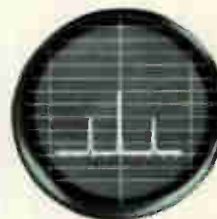

IDENTIFICATION OF
AMPLITUDE MODULATION

MODEL TSA-W WIDE DISPERSION SPECTRUM ANALYZER

10 to 40,880 mc with
five plug-in tuning
units—80 mc disper-
sion

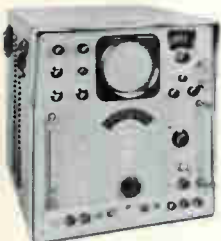

0.1 μ SEC PULSE

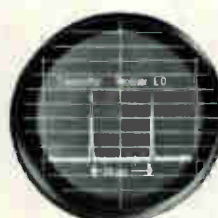

AFC ACTION

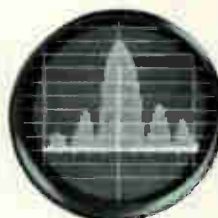

LOG DISPLAY

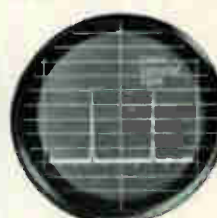

SIGNAL STABILITY
MEASUREMENT

MODEL SA-84 UNIVERSAL SPECTRUM ANALYZER

10 to 40,880 mc in
one integrated self-
contained unit



4 μ SEC PULSE

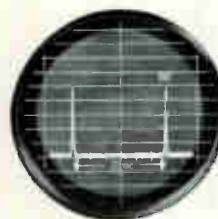

STANDARD SIGNAL

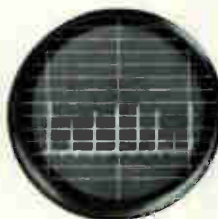

FM SIGNAL
ANALYSIS



LEAKAGE AND
RADIATION MEASUREMENT

MODEL SA-84W WIDE DISPERSION UNIVERSAL SPECTRUM ANALYZER

10 to 44,000 mc in
one integrated self-
contained unit—fea-
tures over 80 mc dis-
persion

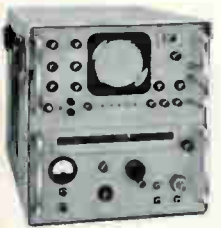

0.08 μ SEC PULSE

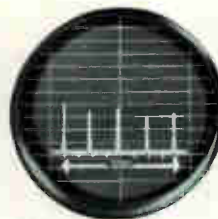

CRYSTAL HARMONICS

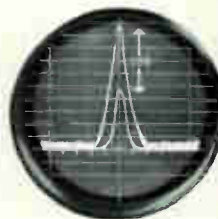

PRECISION
ATTENUATION

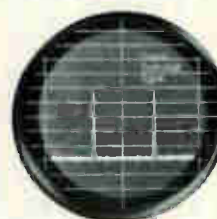

ACCURATE DETERMINATION
OF FREQUENCY

The scope displays shown opposite each Polarad Spectrum Analyzer serve two basic purposes—first, they illustrate the significant analysis capability of each instrument; second, they demonstrate the many microwave parameters that can be measured and displayed visually on Polarad's versatile analyzing equipment.

**FREE LIFETIME
SERVICE**

**MAIL THIS
COUPON** 
for specifications. Ask your nearest Polarad representative (in the Yellow Pages) for "Handbook of Spectrum Analyzer Techniques."

POLARAD ELECTRONICS CORPORATION: 123456789

Please send me information and specifications on:

- Model TSA
- Model SA-84
- Model TSA-S
- Model SA-84W
- Model TSA-W
- Model SA-84W Universal Spectrum Analyzer (See reverse side)

My application is _____

Name _____

Title _____ Dept. _____

Company _____

Address _____

City _____ Zone _____ State _____

POLARAD

ELECTRONICS CORPORATION

43-20 34th Street, Long Island City 1, N. Y.
Representatives in principal cities.

© P.E.C.

NEW UNIVERSAL SPECTRUM ANALYZER



Polarad Model SA-84W being used to make pulse analysis of radar aboard a Pan American Boeing 707, Jet Clipper®

MODEL SA-84W 10 to 44,000 MC in a single unit

FEATURES:

- A** Over 80 mc dispersion
1 mc to over 80 mc for narrow pulse analysis.
100 kc to 7 mc for wide pulse analysis.
- B** Crystal controlled markers from 10 to 44,000 mc.
- C** Provision for use with a multi-pulse spectrum decoder (Polarad Model SD-1)
- D** Log-linear amplifiers
- E** Expanded, direct-reading, slide rule dial.
- F** Accurately calibrated IF attenuator

The Polarad Model SA-84W is the most accurate universal microwave analyzer to measure nearly all parameters — Pulse, CW, FM, VSWR, antenna patterns, bandwidths and filter characteristics.

Postage
Will be Paid
by
Addressee

No
Postage Stamp
Necessary
If Mailed in the
United States

BUSINESS REPLY CARD

First Class Permit No. 18, Long Island City 1, N.Y.

POLARAD ELECTRONICS CORP.
43-20 34th St., Long Island City 1, N.Y.

POLARAD

MAIL THIS CARD
for specifications.
Ask your nearest
Polarad representa-
tive (in the
Yellow Pages) for
a copy of "Notes
on Microwave
Measurements."

FREE LIFETIME
SERVICE

POLARAD
ELECTRONICS CORPORATION
43-20 34th Street, Long Island City 1, N.Y.
Representatives in principal cities.

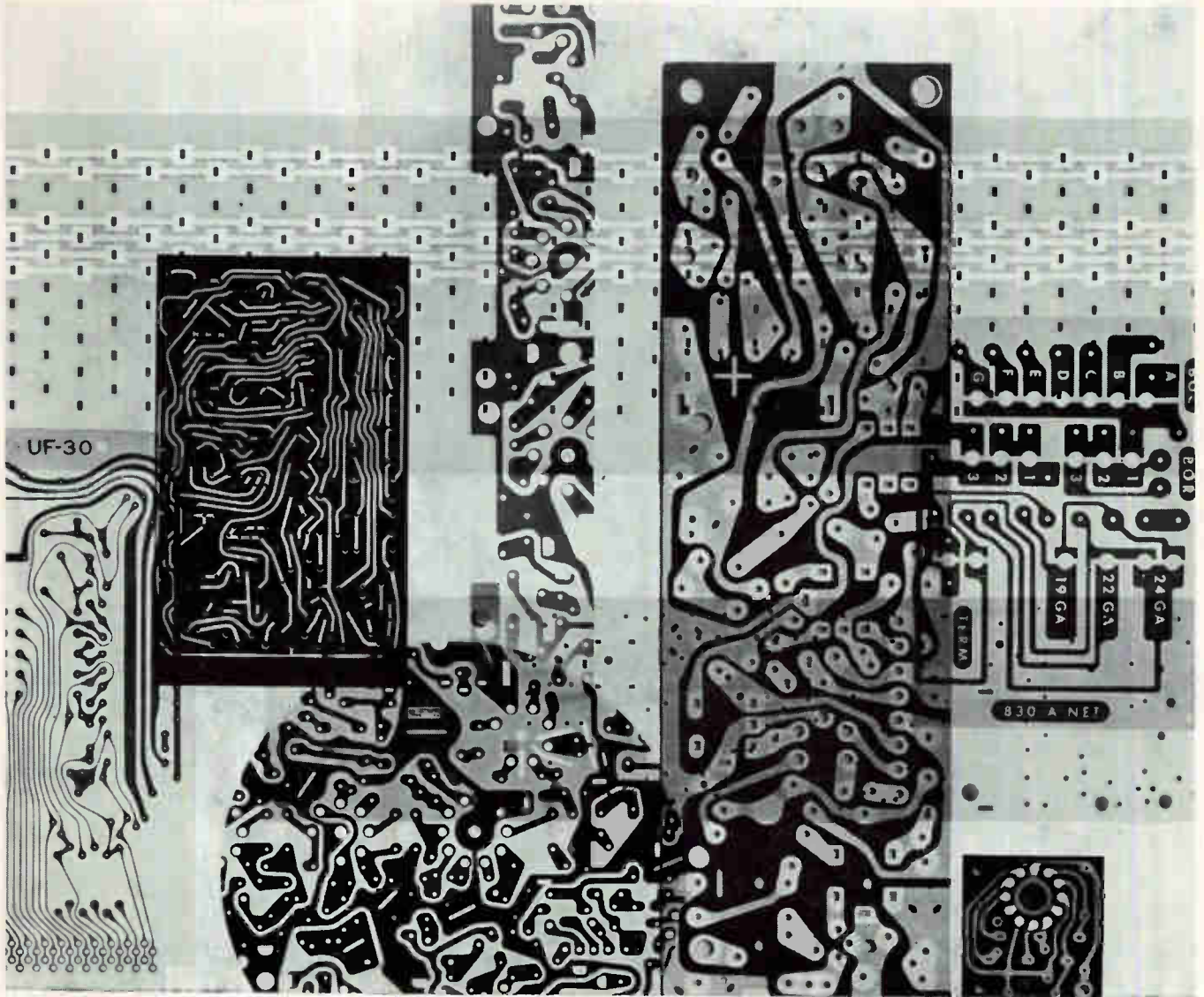

Your profits suffer for the pennies you pinch on printed circuits

Normally, the cost of the copperclad laminate in a printed circuit is peanuts compared to the cost of the product in which it is used.

So whether you produce your own boards, or buy them already punched and etched for assembly, a review of the specific laminates you are now using could uncover an important new benefit.

Perhaps a dollar benefit . . . fewer rejects due to poor cold-punching qualities, unsatisfactory foil bond strength, poor dip soldering performance, or dimensional instability. Or perhaps dollars saved in reduced servicing of circuit failures in installed equipment. Keep in mind, the laminate is only a fraction of your loss.

You might turn up a new product benefit. Greater reliability, and assurance for your customer that your equipment will measure up to the trouble-free performance he expects. Maybe you will find that a *flame retardant* printed circuit will give your product a selling edge, or reduce the danger of fire and severe damage to expensive equipment.

Start a review of your copperclad laminates with a call to the nearby NVF Sales Office, or write for samples and literature. Dept. HH-4, Wilmington, Delaware.

116 Choices: One Source This is the latest count of the different plastics and grades NVF can offer in your search for the *one best material*. Add to this total *the one special grade* that can be developed from scratch to meet your particular need. This full range of materials is backed by complete engineering services . . . from application assistance up to and including the delivery of 100% usable, precision-fabricated parts . . . in any quantity, on time! Call the NVF Sales Office near you. It's a direct line to single-source help on your current materials problem.



NATIONAL VULCANIZED FIBRE COMPANY
WILMINGTON 99, DELAWARE
In Canada: NATIONAL FIBRE COMPANY OF CANADA, LTD., Toronto 3, Ontario

MEETINGS AHEAD

Apr. 30-May 4: Electrochemical Society; Claypool Hotel, Indianapolis.

Apr. 30-May 4: Aero-Space Instrumentation Symposium, ISA; Adolphus Hotel, Dallas.

May 1-4: International Scientific Radio Union (URSI), IRE; Georgetown Univ., Wash., D. C.

May 2-4: Electronic Components Conf., PGCP of IRE, AIEE, EIA, WEMA; Jack Tar Hotel, San Francisco.

May 4-5: Human Factors in Electronics, PGHFE of IRE; Marriott-Twin Bridges Motor Hotel, Arlington, Va.

May 6-9: Symposium on Circuit Theory, PGCT of IRE; Allerton Park & Urbana Campus, Univ. of Ill., Urbana, Ill.

May 7-11: Broadcast Engineering Conf., NAB; Wash., D. C.

May 7-12: Society of Motion Picture and TV Engineers, Semi-annual; King Edward Hotel, Toronto, Ontario.

May 8-10: Natl. Aeronautical Electronics Conf., NAECON, PGANE of IRE; Miami & Dayton-Biltmore Hotels, Dayton, O.

May 9-11: Western Joint Computer Conf., PGEC of IRE, AIEE, ACM; Ambassador Hotel, Los Angeles.

May 15-17: Microwave Theory & Tech., National Sym., PGMTT of IRE; Sheraton Park Hotel, Wash. D. C.

May 22-25: Electronic Parts Distributors Show, Electronic Industry Show Corp.; Conrad Hilton Hotel, Chicago.

Aug. 22-25: WESCON, L. A. & S. F. Sections of IRE, WCEMA; Cow Palace, San Francisco.

Sept. 11-15: Instrument-Automation Conf. and Exhibit, ISA; Sports Arena, Los Angeles.

Oct. 9-11: National Electronics Conf., IRE, AIEE, EIA, SMPTE; Chicago.

Nov. 14-16: Northeast Research & Engineering Meeting, NEREM; Commonwealth Armory and Somerset Hotel, Boston.

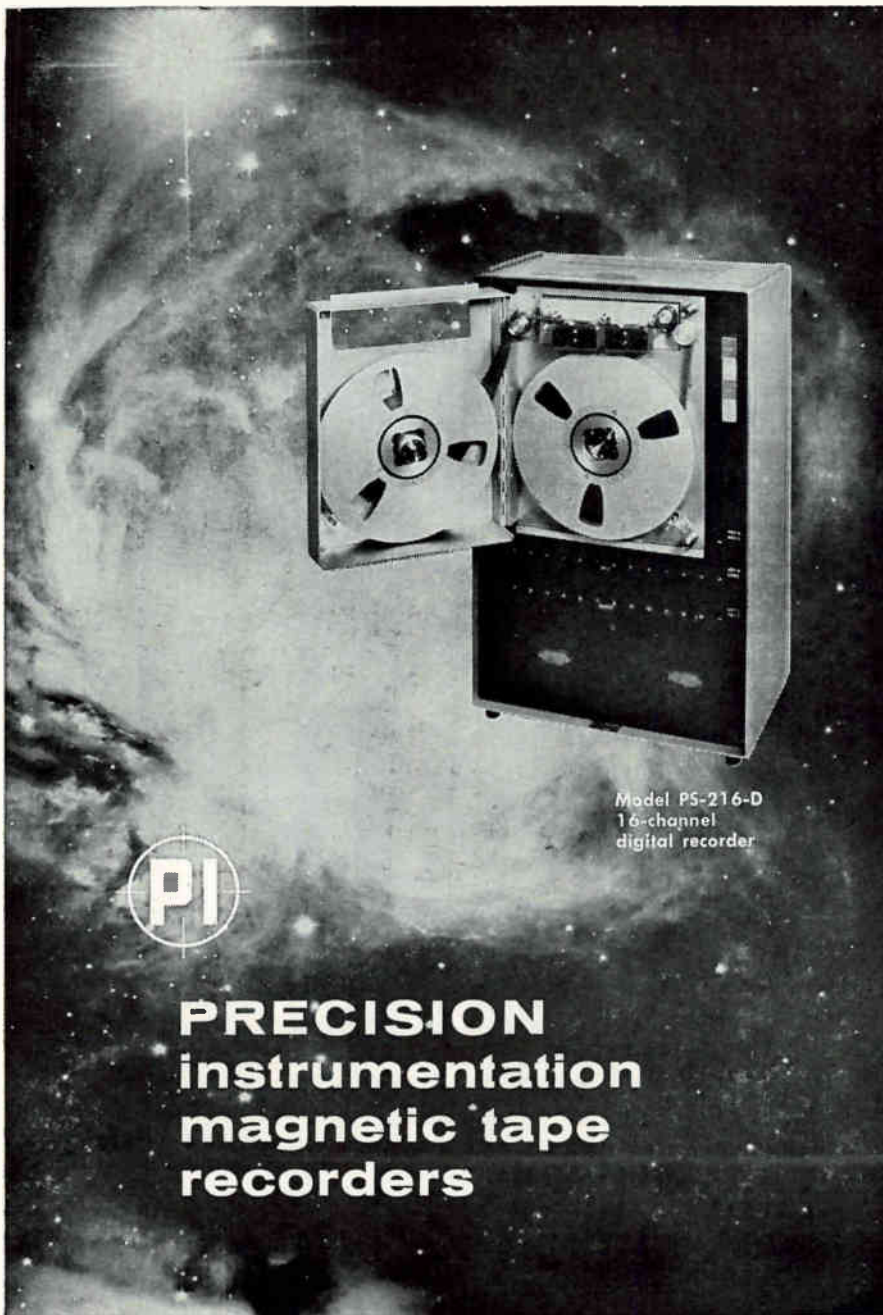

Model P5-216-D
16-channel
digital recorder



PRECISION instrumentation magnetic tape recorders

for space-conscious applications

PRECISION recorders are fast becoming the standard for the most critical and demanding applications in the age of space. Advanced mechanical concepts and solid-state circuitry provide full-size performance in less than $\frac{1}{4}$ the space required by conventional recorders. Up to 14 channels of analog or 16 channels of digital recording in a wide range of models for rack mounting or portable use. Write for detailed new brochure #55A.



Two
complete
14-channel
P.I. recorders
require
only 51"
of rack
space

P.I. Invites Inquiries from senior engineers seeking a challenging future.



PRECISION INSTRUMENT COMPANY
1011 COMMERCIAL STREET • SAN CARLOS, CALIFORNIA
Phone: LYtell 1-44 41 • TWX: SCAR BEL 30

REPRESENTATIVES IN PRINCIPAL CITIES THROUGHOUT THE WORLD

Accutron...*

new electronic timepiece
uses **ALLEN-BRADLEY**
Type TR Miniature
Composition Resistors



A-B Type TR
Resistor
Actual Size

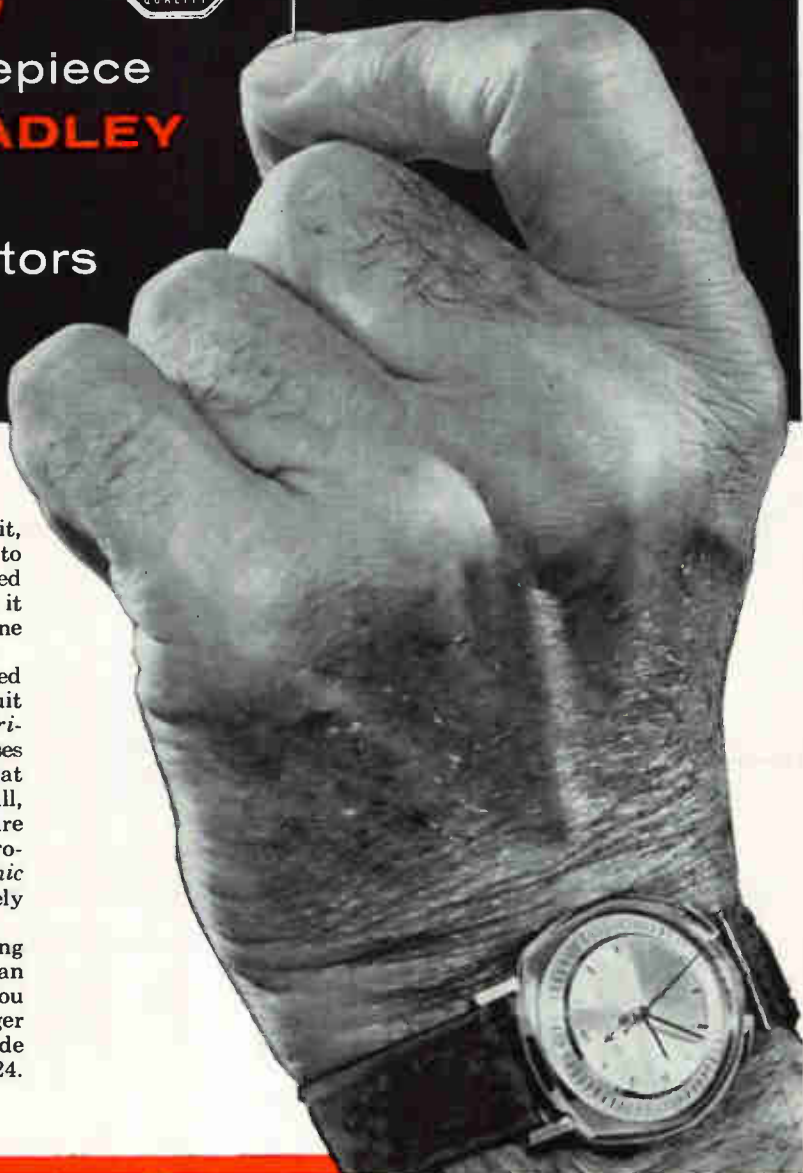

With its miniature tuning fork and electronic circuit, Accutron introduces an entirely new principle to timekeeping—one which promises unprecedented wrist timepiece accuracy. Strapped to your wrist, it is guaranteed not to gain or lose more than one minute a month.

Allen-Bradley Type TR tiny resistors enabled Accutron designers to achieve the required circuit miniaturization for a wrist timepiece—without sacrificing reliability. This circuit controls the 360 pulses of power each second—31 million per day—that drive the tuning fork. Although incredibly small, these Type TR miniature composition resistors are made by Allen-Bradley's exclusive hot molding process that guarantees complete freedom from catastrophic failures! A-B Type TR resistors are conservatively rated 1/10 watt at 70°C.

There are also other Allen-Bradley space-saving potentiometers, capacitors, and h-f filters that can help solve your miniaturization problem. And you obtain the same reliability for which the larger Allen-Bradley components have earned a world-wide reputation. For full details, send for Publication 6024.

* TRADEMARK BULOVA WATCH CO., INC.

A-B HOT MOLDED COMPOSITION RESISTORS

Type TR 1/10 Watt		MIL TYPE RC 06
Type CB 1/4 Watt		MIL TYPE RC 07
Type EB 1/2 Watt		MIL TYPE RC 20
Type GB 1 Watt		MIL TYPE RC 32
Type HB 2 Watts		MIL TYPE RC 42

DRAWING OF ACCUTRON SHOWS BASIC MECHANISM

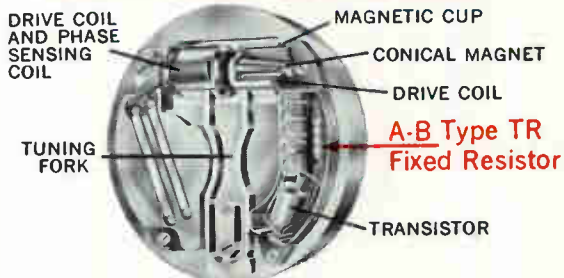

ALLEN-BRADLEY

Quality
Electronic Components

Allen-Bradley Co., 110 West Greenfield Avenue, Milwaukee 4, Wisconsin • In Canada: Allen-Bradley Canada Ltd., Galt, Ontario

CIRCLE 39 ON READER SERVICE CARD

CIRCLE 40 ON READER SERVICE CARD →

WHAT TI'S 50-100 h_{FE} @

IN AMPLIFIER CIRCUITS

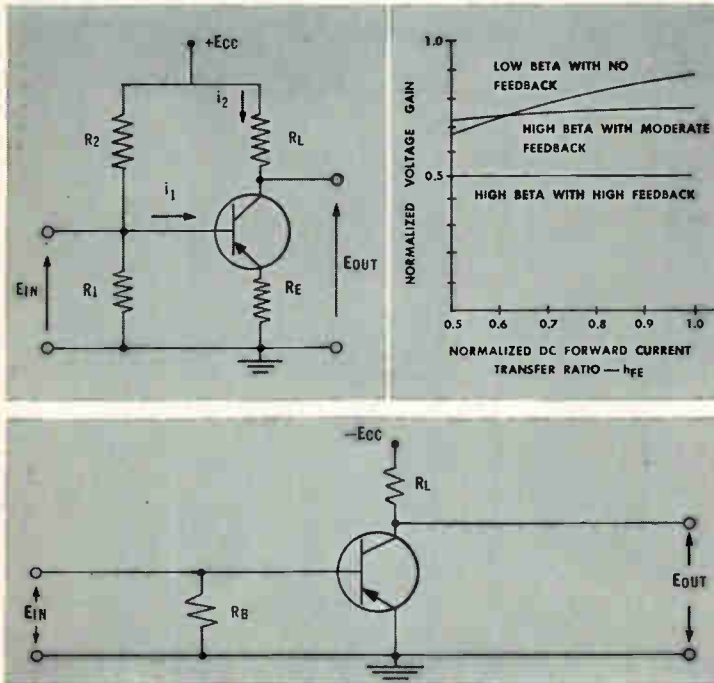

In a common emitter amplifier, with emitter feedback, *high-beta* transistors offer the following advantages:

1. Comparing high and low beta transistors in an identical operating circuit with typical beta spreads of 2 to 1, the use of high-beta transistors provides reduced loading on the bias network thereby reducing the shift in the DC operating point.

2. The voltage gain of the circuit is: $A_v = -\frac{i_2 R_L}{E_{IN}}$

$$\cong + \frac{R_L}{\frac{r_b + r_e + R_E}{\beta} + r_e + R_E}$$

dependent on beta as beta is increased: $A_v \cong -\frac{R_L}{r_e + R_E}$.

3. The input impedance, R_{IN} , excluding the bias network is $R_{IN} = \frac{E_{IN}}{I_L} \cong r_b + (r_e + R_E)(1 + \beta)$. Thus, the input impedance is much higher if *high-beta* transistors are utilized.

IN SWITCHING CIRCUITS

Higher h_{FE} offers the following switching circuit advantages:

1. Less power required from the driver circuit. Eliminates one driver circuit stage or gives a much greater design margin.
2. Shorter rise time if high h_{FE} unit is substituted for low h_{FE} in identical circuits.

TEXAS INSTRUMENTS 2N1980



Now get maximum circuit economy with Texas Instruments 2N1980 series *high-beta* germanium power transistors. Increased power gain gives you: fewer components for same circuit results; or equal components for better circuit results — either way, your circuits give increased performance at *less cost*.

With TI 2N1980, 2N1981, 2N1982 *high-beta* power transistors you get more power gain than any standard TO-36 device available today. You also get industry's lowest profile TO-36 package for more compact designs. TI's exclusive 2N1980 series manufacturing process assures you *constant — predictable — guaranteed* high beta performance.

Call your local TI Sales Engineer or TI Distributor today for immediate price and technical information... including applications assistance.

Send today for your personal copy of the new TI 2N1980 Application Note, "Circulation Stabilization Using High Beta Transistors."

SEMICONDUCTOR COMPONENTS
DIVISION
PLANTS IN DALLAS, TEXAS
BEDFORD, ENGLAND
AND NICE, FRANCE

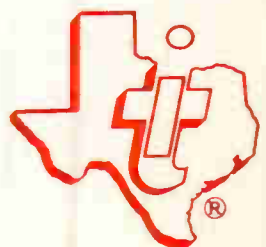

5 amps CAN DO FOR YOU

IN SQUARE CORE OSCILLATORS

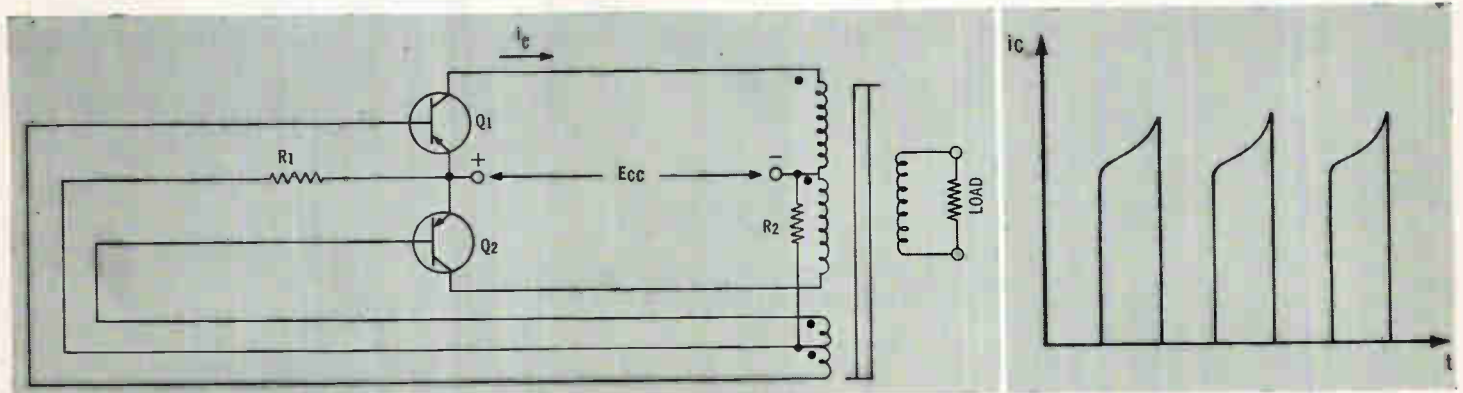

The starting bias depends on the voltage divider R_1 and R_2 . With a typical V_{BE} of 0.4 volts to start oscillations, appreciable power is lost in R_2 when R_1 is small. For low beta transistors R_1 must be small to provide enough feedback current to guarantee collector saturation. This results in high bias power loss in R_2 . By using high-beta transistors, R_1 and R_2 may be increased in value — resulting in lower signal and bias power losses.

The peak collector current (shown in the above figure) in a square core oscillator can vary with a change of V_{BE} . For a given spread

of transistors, V_{BE} can vary as much as 1.0 volt. High beta transistors may be used to reduce the effect of changes in V_{BE} on peak collector current. The maximum current spike for a given spread of transistors occurs in the highest beta units under conditions of peak base current.

Peak base current and peak collector current vary inversely with V_{BE} . Therefore, by using high-beta transistors, R_1 and the base winding voltage may be increased, minimizing the effects of V_{BE} .

GERMANIUM POWER SERIES

Immediate Circuit Improvement . . . with TI 2N1980 Series

	I_{CBO}	$V_{CE(sat)}$ @ 5 amp	h_{FE} @ 5 amp	BV_{CBO}	BV_{CEO}	I_c
2N1980	6 ma @ 50V	0.5V	50—100	50	30	15A
2N1981	6 ma @ 70V	0.5V	50—100	70	40	15A
2N1982	6 ma @ 90V	0.5V	50—100	90	50	15A

TEXAS INSTRUMENTS
INCORPORATED
 13500 N. CENTRAL EXPRESSWAY
 P. O. BOX 5012 DALLAS 22, TEXAS

MEET THE DCS FAMILY OF



THE MOST COMPLETE LINE IN THE INDUSTRY **FROM THE INDUSTRY'S TECHNOLOGICAL LEADER**

Includes the famous *Runyan-designed* Model GFD-3 solid-state discriminators that will operate within specifications at carrier frequencies as high as 300 kc and accommodate intelligence spectra up to 35 kc! Compare the other features below—exclusive with DCS—Complete literature on the entire family of DCS Discriminators. Address: Dept. E 1

COMPARE THESE DCS FEATURES:

- THE BEST PERFORMANCE SPECIFICATIONS AVAILABLE
- ADJUSTABLE VARIABLE-LOOP TRACKING FILTERS
- GUARANTEED MEAN-TIME-TO-FAILURE DATA
- AUTOMATIC AMPLITUDE AND PHASE TAPE SPEED COMPENSATION
- HIGH-FREQUENCY PREDETECTION RECORDING CAPABILITY
- INDIVIDUAL CHANNEL POWER SUPPLIES
- PLUG-IN PRINTED CIRCUIT BOARDS COMMON TO SEVERAL SUBASSEMBLIES SIMPLIFIES SPARES PROVISIONING
- FRONT PANEL ACCESS TO MODULAR COMPONENTS
- WIDEST VARIETY OF ACCESSORIES
- OFF-THE-SHELF DELIVERY OF STANDARD ITEMS
- NATION-WIDE FIELD SERVICE AND ENGINEERING CONSULTATION
- USED IN EVERY MAJOR MISSILE AND SPACE PROGRAM
- COMPLETE SPARE PARTS KITS AVAILABLE FOR REMOTE INSTALLATIONS

DATA-CONTROL SYSTEMS, INC.

Los Angeles • Palo Alto • Washington, D. C.
Home Office: E. Liberty St., Danbury, Conn. Pioneer 3-9241



Raytheon Transformer Talk

New techniques reduce size of 2.5 megawatt

AIRBORNE PULSE TRANSFORMER

to only .45 cu. ft.

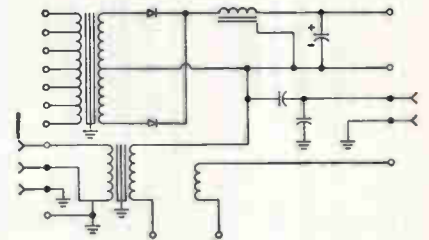

A high-voltage pulse transformer tested at 180kv and rated for pulsed operation at 90kv that measures just $9\frac{1}{2} \times 9\frac{1}{2} \times 8\frac{3}{4}$ inches!

This ruggedized unit—typical of Raytheon's new compact pulse transformers—is designed to operate under the extreme environmental conditions encountered by high-speed aircraft. It contains an insulated DC filament supply and internal provision for -50° to $+100^{\circ}$ centigrade operation. For flexibility in mounting, it features a space-saving, bifilar-type, epoxy terminal that is eight inches shorter than previous models. Overall, the new .45 cubic-foot unit is 60% smaller than its predecessors.

Raytheon pulse transformers are designed to work with specific microwave tubes. Standard designs include open, resin encapsulated, enclosed, and oil-filled types.



FEATURES of new Raytheon high-power pulse transformer include: (1) 2-inch-high, truncated, bifilar-type klystron high-voltage terminal operating under external and internal liquid environment, (2) high-voltage primary input connector, double shielded to eliminate cable interference, and (3) 30kv traveling-wave-tube high-voltage output.



WRITE FOR 16-PAGE BOOKLET on Raytheon transformers or for specific help on your particular requirements to Magnetics Operations, Microwave and Power Tube Division, Raytheon Company, Foundry Avenue, Waltham 54, Mass.

RAYTHEON

RAYTHEON COMPANY

MICROWAVE AND POWER TUBE DIVISION

pacesetter in electron beam technology

alloyd electronics

introduces the E-beam mark V electron beam evaporator

The Mark V Electron Beam Evaporator is a reasonably priced, highly flexible unit for producing thin metallic and non-metallic films by vapor deposition through electron bombardment heating.

Completely self-contained and free of any radiation hazard, it is an invaluable research and development or limited-production tool for thin-film applications, including micro-miniaturized electronic circuitry, optical filters, semiconductors, magnetic tapes, and countless other components.

Vacuum system, electron gun, power supply and controls are conveniently arranged for maximum accessibility and simplicity of operation and maintenance.

Only cooling water, electrical power, and low pressure air are needed to make the unit completely operative.

Flexibility is built in: modular design allows for interchangeable chambers, permitting the Mark V to be converted into a welder or a melter by substituting a modified chamber.

For complete information on the Mark V evaporator, the Mark VI welder, and Alloyd's engineering and custom services in electron beam applications, just write:

alloyd electronics corporation

AN AFFILIATE OF THE ALLOYD CORPORATION,
37 CAMBRIDGE PARKWAY, CAMBRIDGE, MASSACHUSETTS



Mark VI Electron Beam Welder — for clean, crack-free welds in even the most refractory and reactive metals by electron bombardment. High vacuum eliminates contamination. Ultra-narrow heating zone permits optimum control and precision in handling very thin pieces or welding thin-to-thick sections.



AMEBA — Alloyd Modular Electron Beam Apparatus is part of an advanced, complete facility for thin film evaporation, welding, brazing, melting, and zone refining maintained by Alloyd to meet custom requirements. We also offer engineering, consulting, and research and development services in system design and development. Ask us for complete information.





10,000 VARIATIONS...

all stamped with the T-MARK of total reliability

Other spring fasteners may *look* like Tinnerman SPEED NUTS. But only those stamped with the T-mark really *are* SPEED NUTS, made to Tinnerman's high, precise standards of reliability. Tinnerman quality controls are the most stringent in the industry. And only Tinnerman stocks a *half-billion* SPEED NUTS . . . is tooled to turn out 10,000 variations . . . develops 25 *new* designs each week. Protect your product's good name by insisting on genuine SPEED NUTS. Stamped with the Tinnerman "T"—the mark of total reliability. *Tinnerman Products, Inc., Department 12, Box 6688, Cleveland 1, Ohio.*

CANADA: Dominion Fasteners Ltd., Hamilton, Ontario.
GREAT BRITAIN: Simmonds Aerocessories Ltd., Treforest, Wales.
FRANCE: Simmonds S.A., 3 rue Salomon de Rothschild, Suresnes (Seine).
GERMANY: Mecano Simmonds GMBH, Heidelberg.



TINNERMAN

Speed Nuts®

Look for the Tinnerman "T"

RESEARCH LEADERSHIP...

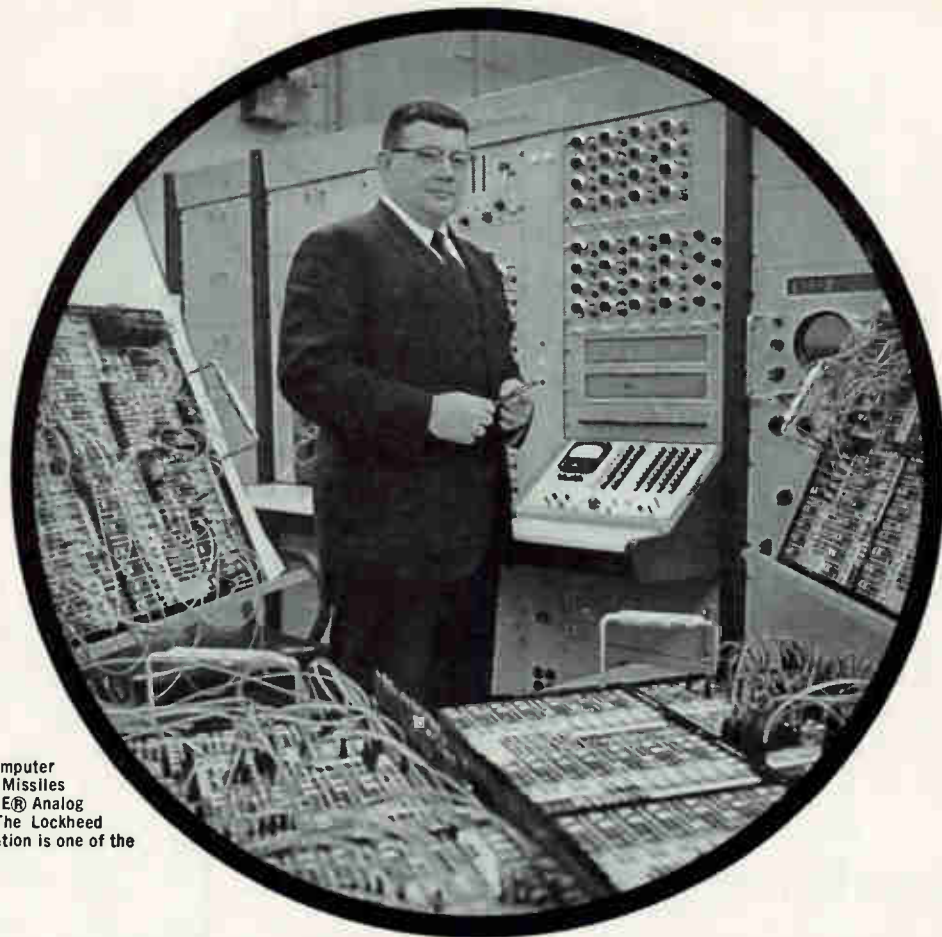

J. E. Sherman, Analog Computer Manager, at Lockheed's Missiles and Space Division's EASE® Analog Computer Installation. The Lockheed Analog Computer Installation is one of the largest in the world.

pays off for Lockheed and Beckman

Lockheed Missiles and Space Division, Sunnyvale, California, leading research and development organization, beat its own schedule by three years and surpassed its own performance goals by wide margins to provide the Free World with the most important operational deterrent to aggression: the Navy's POLARIS Fleet Ballistic Missile. • Lockheed has actually just crossed the threshold of space and defense programs. Future development of Polaris and other Lockheed space and missile programs will be more complex, intricate and demanding—will require research computation of a level and complexity never even envisioned. The problem-solving capacity of Beckman EASE Analog Computers meets this challenge.

LOCKHEED-EASE History EASE Analog Computers have participated in Lockheed success for over 5 years at the Lockheed-Georgia Division where the new Jet-Star executive jet transports and C-130 Hercules are manufactured and for over 2 years at Lockheed-California Division, famous for the Air Force F104 Interceptor and Navy P3VI Electra.

BERKELEY DIVISION
of Beckman Instruments, Inc.

INSTRUMENTAL
• **Beckman**
IN YOUR FUTURE

Richmond, California



10,000 VARIATIONS...

all stamped with the T-MARK of total reliability

Other spring fasteners may *look* like Tinnerman SPEED NUTS. But only those stamped with the T-mark really *are* SPEED NUTS, made to Tinnerman's high, precise standards of reliability. Tinnerman quality controls are the most stringent in the industry. And only Tinnerman stocks a *half-billion* SPEED NUTS . . . is tooled to turn out 10,000 variations . . . develops 25 *new* designs each week. Protect your product's good name by insisting on genuine SPEED NUTS. Stamped with the Tinnerman "T"—the mark of total reliability. *Tinnerman Products, Inc., Department 12, Box 6688, Cleveland 1, Ohio.*

CANADA: Dominion Fasteners Ltd., Hamilton, Ontario.
GREAT BRITAIN: Simmonds Aerocessories Ltd., Treforest, Wales.
FRANCE: Simmonds S. A., 3 rue Salomon de Rothschild, Suresnes (Seine).
GERMANY: Mecano Simmonds GMBH, Heidelberg.



TINNERMAN
Speed Nuts®
Look for the Tinnerman "T"

NEW FROM WESTINGHOUSE AT YOUNGWOOD



New Westinghouse High Gain Transistor simplifies circuitry, increases reliability, eliminates driver stage components, reduces cost of assembly.

NEW WESTINGHOUSE SILICON POWER TRANSISTOR PROVIDES

GAIN OF

Westinghouse introduces a complete new family of High Gain Silicon Power Transistors providing a gain of 1000 or more at 2 amps . . . with guaranteed minimum gain of 400 at 10 amps (WX118X series) . . . a guaranteed minimum gain of 100 at 10 amps (WX118U series). These devices can substantially reduce circuit components, increase reliability, save space and weight.

They're ideal for application in high power, high efficiency regulators, amplifiers and switching circuits. For example, 1500 watts of power can be easily controlled with a 50 milliwatt signal! For full information call your nearest Westinghouse representative or write to Semiconductor Dept., Youngwood, Penna. You can be sure . . . if it's Westinghouse.

SC-1025

OTHER FEATURES INCLUDE

- True Voltage Ratings to 150 volts
- Power dissipation of 150 watts
- Collector current—10 amperes
- Operating temperature to +150°C.
- Low thermal impedance: .5°C/watt

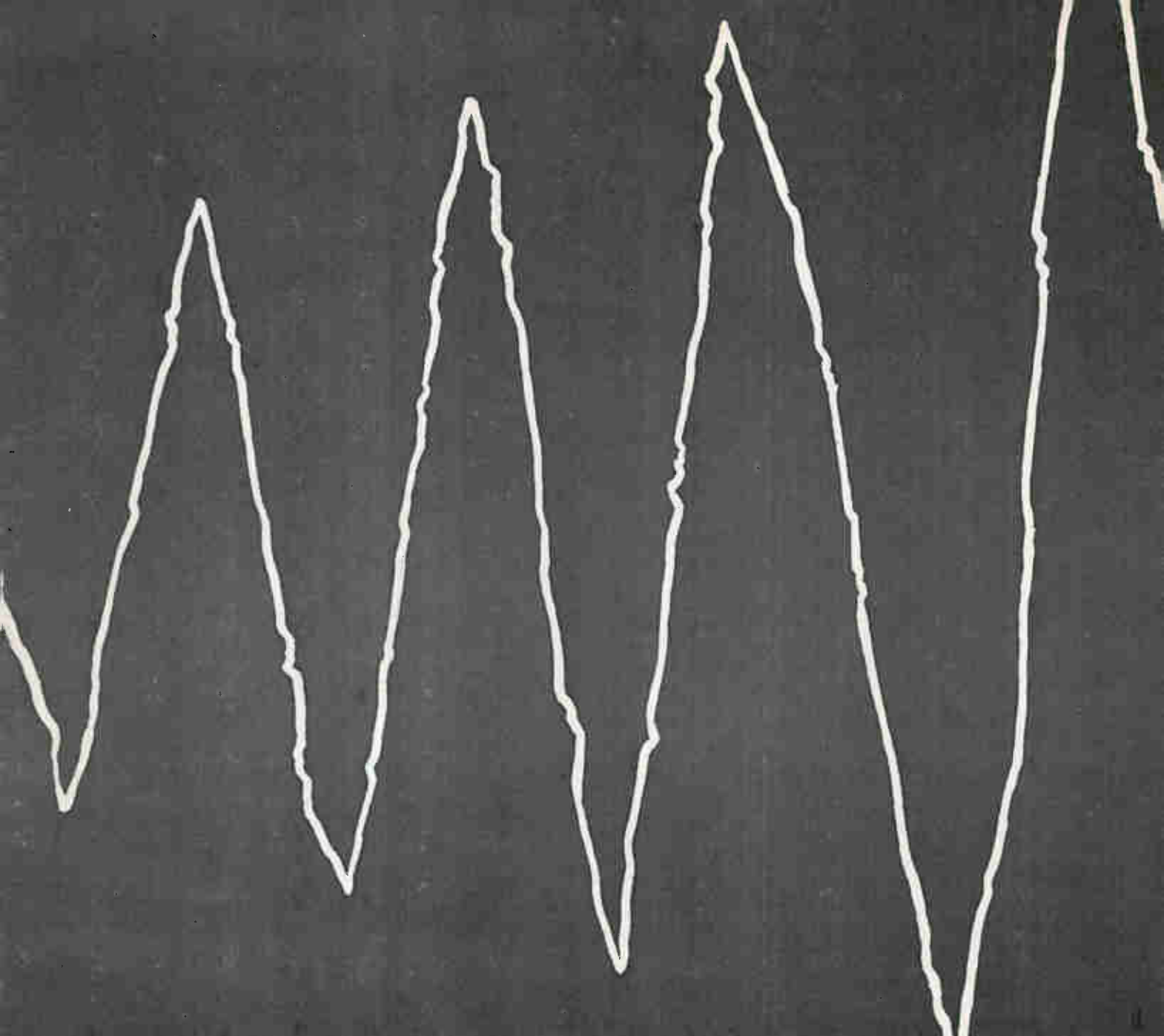

1000 AT 2 amps!

Prototype quantities now available. Order from these Westinghouse Distributors.

EASTERN

ACK SEMICONDUCTOR, INC.
Birmingham 5, Ala./FA 2-0588
CAMERADIO Pittsburgh, Pa./EX 1-4000
CRAMER ELECTRONICS, INC.
Boston, Mass./CO 7-4700
ELECTRONIC WHOLESALERS, INC.
Melbourne, Florida/PA 3-1441
GENERAL RADIO SUPPLY CO., INC.
Camden, N.J./WO 4-8560
GENESEE RADIO PARTS CO.
Buffalo, N.Y./DE 9661
KANN-ELLERT ELECTRONICS, INC.
Baltimore, Md./TU 9-4242

MILGRAY ELECTRONICS

New York, N.Y./RE 2-4400
RADIO & ELECTRONICS PARTS CORP.
Cleveland, Ohio/UT 1-6060
SCHWEBER ELECTRONICS
Long Island, N.Y./PI 6-6520
Silver Spring, Md./JU 5-7023

MIDWESTERN

**ELECTRONIC COMPONENTS FOR
INDUSTRY CO.**
St. Louis, Mo./WO 2-9917
HALLMARK INSTRUMENTS CORP.
Dallas, Texas/RI 7-9385
INTER-STATE RADIO & SUPPLY CO.
Denver 4, Colo./TA 5-8257
LENERT CO. Houston, Texas/CA 4-2663

RADIO DISTRIBUTING CO.

Indianapolis, Ind./ME 7-5571
SEMICONDUCTOR SPECIALISTS, INC.
Chicago, Ill./NA 2-8860
S. STERLING CO.
Detroit, Mich./BR 3-2900
UNITED RADIO, INC.
Cincinnati, Ohio/MA 1-6530

WESTERN

ELMAR ELECTRONICS
Oakland, Calif./TE 4-3311
HAMILTON ELECTRO SALES
Los Angeles, Calif./BR 2-9154
NEWARK ELECTRONICS CO.
Inglewood, Calif./OR 4-8440



Westinghouse

CIRCLE 47 ON READER SERVICE CARD

RESEARCH LEADERSHIP...

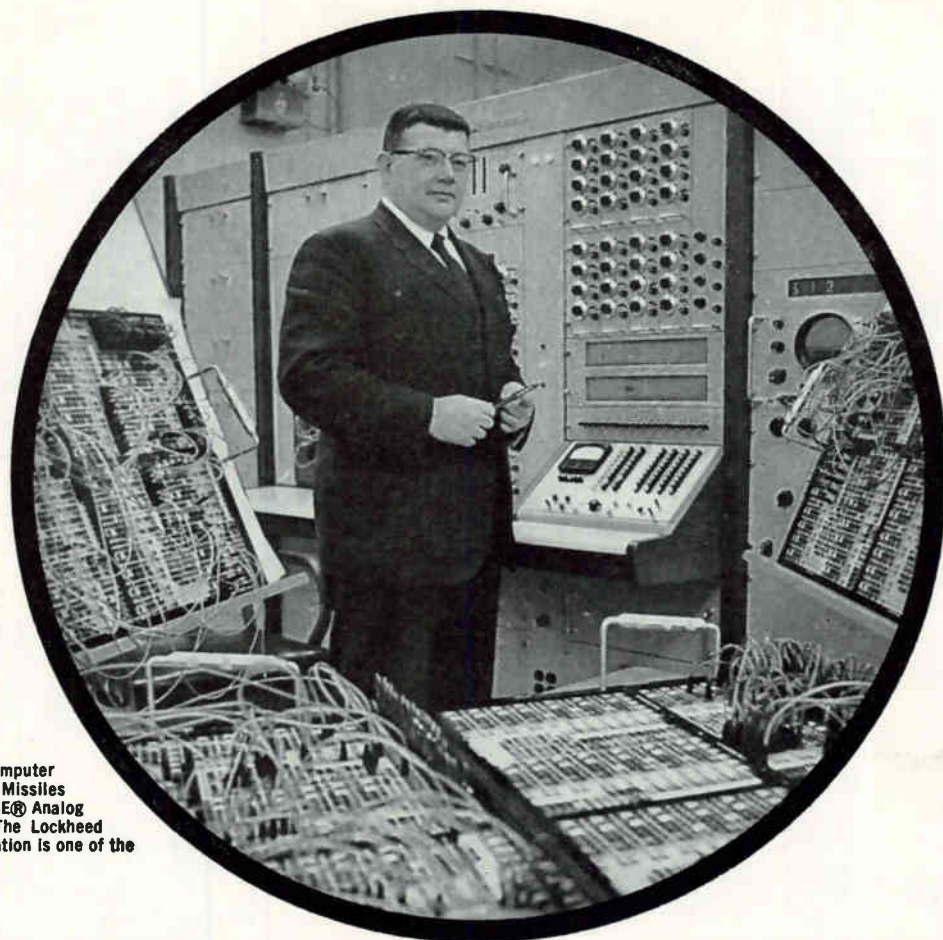

J. E. Sherman, Analog Computer Manager, at Lockheed's Missiles and Space Division's EASE® Analog Computer Installation. The Lockheed Analog Computer Installation is one of the largest in the world.

pays off for Lockheed and Beckman

Lockheed Missiles and Space Division, Sunnyvale, California, leading research and development organization, beat its own schedule by three years and surpassed its own performance goals by wide margins to provide the Free World with the most important operational deterrent to aggression: the Navy's POLARIS Fleet Ballistic Missile. • Lockheed has actually just crossed the threshold of space and defense programs. Future development of Polaris and other Lockheed space and missile programs will be more complex, intricate and demanding—will require research computation of a level and complexity never even envisioned. The problem-solving capacity of Beckman EASE Analog Computers meets this challenge.

LOCKHEED-EASE History EASE Analog Computers have participated in Lockheed success for over 5 years at the Lockheed-Georgia Division where the new Jet-Star executive jet transports and C-130 Hercules are manufactured and for over 2 years at Lockheed-California Division, famous for the Air Force F104 Interceptor and Navy P3VI Electra.

BERKELEY DIVISION
of Beckman Instruments, Inc.

INSTRUMENTAL
• Beckman
IN YOUR FUTURE

Richmond, California

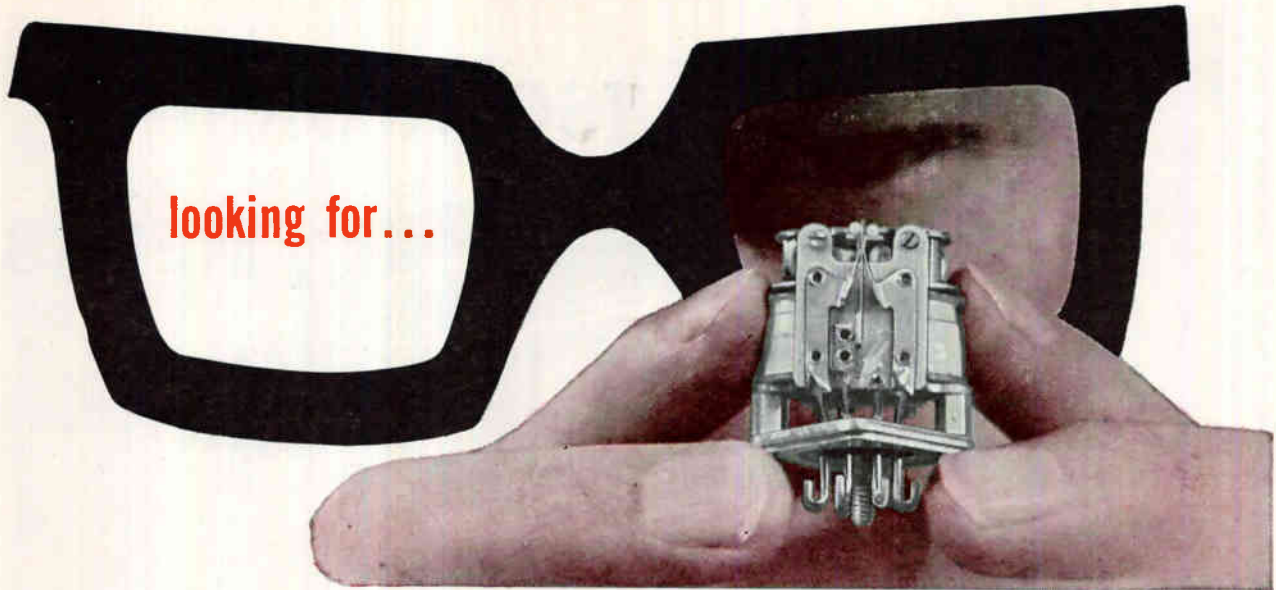

looking for...

RELIABLE RELAYABILITY?

specify the **VG and VGS series**

Elgin's hermetically sealed VG and VGS miniature rotary relays provide high sensitivity and high contact rating in less than one cubic inch. The VGS Series operates on the power of a single transistor.

another example of



relayability

VG AND VGS SPECIFICATIONS

contact arrangement	DPDT (2 form C)
contact rating	5 amps @ 26.5 VDC or 115 VAC 60 CPS resistive load
min. oper. power @ 25°C	VG: 340 milliwatts VGS: 125 milliwatts
max. oper. time @ nom. oper. power	VG: 6 milliseconds VGS: 20 milliseconds
max. release time	10 milliseconds
duty	continuous
shock	VG: 100G VGS: 50G (MIL-R-5757C, shock test II)
vibration	10-55 CPS total max. excursion of 0.060 in.; 15G, 55-2000 CPS
amb. temp. range	-65°C to +125°C
life	100,000 operations @ rated resistive load (MIL-R-5757C)
enclosure	evacuated @ 2.5 in. HG ABS, degassed @ 10 microns and 170°C, dry nitrogen filled & hermetically sealed
dimensions	H—0.875"; W—0.875"; L—1.125"
weight	1.5 ounces

send for



latest data

ELGIN advance RELAYS 

THE ELECTRONICS DIVISION OF ELGIN NATIONAL WATCH COMPANY
2435 NORTH NAOMI STREET, BURBANK, CALIFORNIA

NONE smaller

ISOLATORS from MELABS



ACTUAL
SIZE

Ultra-miniature isolators at low cost!

S Band models are typical: 1.1" x 1.1" x 3.5"
(incl. connectors), 6 Oz.!

Model	Frequency	Isolation
X-173A	2.6-3.25 KMC	> 10 db (18 db at frequency center)
X-173B	2.7-2.9 KMC	> 14 db
X-173C	2.95-3.25 KMC	> 14 db

Insertion loss, > 1 db, all models; VSWR, 1.2:1
Power, all models, 5 kw peak, 5 w average

PRICE:

\$155, B & C models; \$175, A model
S. Band models available from stock, similar models available for C and L bands. Special frequency models available on request. TNC connectors can be furnished for special requirements.

7011



Engineers and Physicists, careers in advanced research programs are unlimited at Melabs.

3300 Hillview Avenue, Palo Alto, California

CIRCLE 200 ON READER SERVICE CARD

ALL DIGITS
CAN BE
READ FROM
ANY ANGLE

IN-LINE DIGITAL READOUT

featuring
ONE-PLANE PRESENTATION
Series 10000



Over 1000
firms throughout
the world in just a
few years prove
unprecedented
acceptance of
IEE digital
readouts.

The IEE digital readout puts the digit right up front, visible from any angle. Vision is unimpaired by stacked characters and sharp, clear-white digits provide high-contrast, error-proof reading. Use of words, color, and multiple projections offer utmost versatility.

Binary-To-Decimal Decoders Available.
Representatives in Principal Cities

PRICE **\$1800**
COMPLETE
QUANTITY PRICES ON REQUEST
WRITE TODAY FOR
COMPLETE SPECIFICATIONS.



INDUSTRIAL ELECTRONIC ENGINEERS, INC.
Engineers and Manufacturers of Fully Automatic Systems and Digital Readouts
5528 Vineland Avenue, North Hollywood, California



Wrapped up in a sticky TEFLON tape problem?

Joclin's 16 basic types of Fluorolin® pressure-sensitive Teflon tapes are the broadest line available. When you need a non-stick surface with chemical resistance, rated at 1000 to 4000 v/mil, that withstands

temperatures of -100° to +500°F., there's a Joclin tape ideal for your application.

Johnny Joclin sez:

Send for 6 pg. brochure
loaded with engineering data
on 16 basic Teflon tapes!

JOCLIN

SPACE-AGE PLASTICS

COlony 9-8708



JOCLIN MFG. COMPANY, INC. • LUFBERY AVE. • WALLINGFORD, CONN.

CIRCLE 201 ON READER SERVICE CARD
CIRCLE 51 ON READER SERVICE CARD →

New Improved CBS PNP Power Transistors

2N538(A) • 2N539(A) • 2N540(A)

**FEATURE MORE POWER,
LESS WEIGHT, LESS SPACE**

The CBS 2N538(A), 2N539(A) and 2N540(A) have a maximum dissipation of 30 watts at a base mounting temperature of 25 deg. Centigrade. Yet, each transistor weighs less than 5 grams and requires only 1/3 square inch of chassis space.

Compact and rugged, these hermetically-sealed CBS PNP Germanium Power Transistors are ideal for military and industrial power applications demanding high reliability. They are especially suited for servo motor controls, power amplifiers, converters, power supply regulators and low-speed power switches.

Note the major characteristics and advantages. Call or write today for complete technical data and delivery information from your local sales office or Manufacturer's Warehousing Distributor.

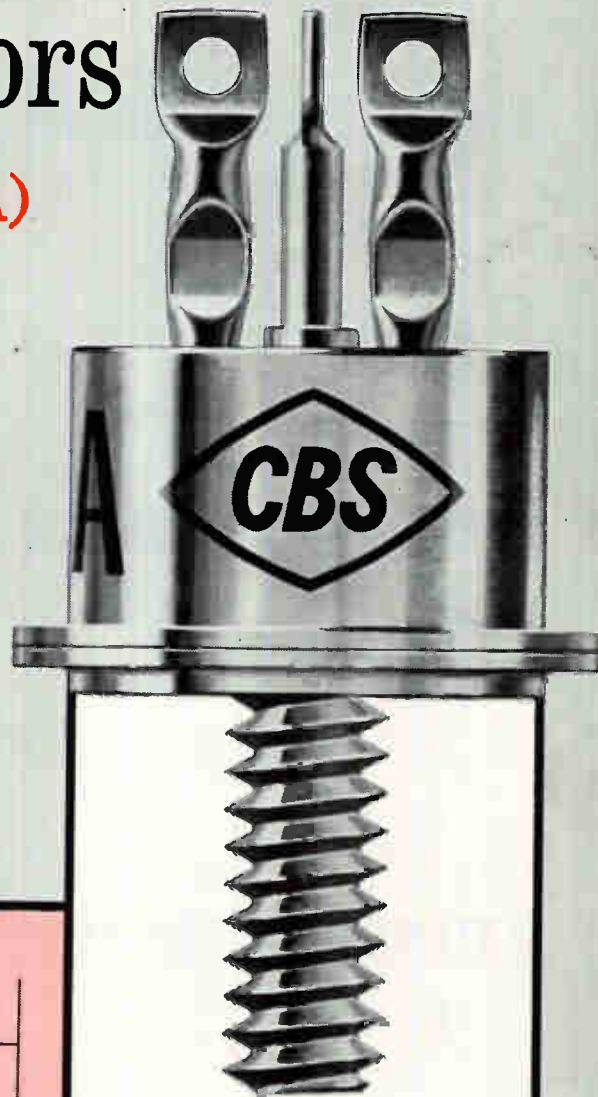

ELECTRICAL CHARACTERISTICS

Type	Max. VCBO	Min. VCE (d=1)	hFE (IC=2A, VCE=-2V)		VBE (IC=2A, VCE=-2V)		Gp (mhos) (IC=2A, VCE=-2V)	
			Min.	Max.	Min.	Max.	Min.	Max.
2N538	-80	-55	20	50	1.33	3.33		
2N538A	-80	-55	20	50	1.33	3.33	17.5	52
2N539	-80	-55	30	75	1.00	2.50		
2N539A	-80	-55	30	75	1.00	2.50	35	105
2N540	-80	-55	45	113	0.75	1.88		
2N540A	-80	-55	45	113	0.75	1.88	71	213

All types have: Max, collector current, 3.5 amps; junction temperature, -65 to +95°C; max, saturation voltage 0.6 volts (IC=2A, IB=200 mA). Minimum alpha cutoff frequency is 200 KC (IC=100 MA, VCE=-4 volts); max, thermal resistance, 2.2°C/W.

CBS PNP Power Transistors with an improved industrial male package offer:

- Single, sturdy 8-32 mounting stud
- Matched glass-to-metal seal for greater mechanical strength and resistance to thermal shock
- Rugged welded construction through the selection of matched materials having excellent welding properties
- Typical leakage three to five times lower than specification limits.
- High dissipation with minimum size
- High collector-to-base voltage
- High collector-emitter breakdown voltage
- Wide range of operating and storage temperatures



semiconductors

More Reliable Products through Advanced Engineering

CBS ELECTRONICS, Semiconductor Operations, Lowell, Massachusetts

A Division of Columbia Broadcasting System, Inc. • Semiconductors • tubes • audio components • microelectronics

Sales Offices: Lowell, Mass., 900 Chelmsford St., GLenview 2-8961 • Newark, N. J., 231 Johnson Ave., TALbert 4-2450
Melrose Park, Ill., 1990 N. Mannheim Rd., EStebrook 9-2100 • Los Angeles, Calif., 2120 S. Garfield Ave., RAymond 3-9081
Toronto, Ont., Canadian General Electric Co., Ltd., LENnox 4-6311.

The industry's most thoroughly characterized and medium power silicon Mesa transistors...2N497A,

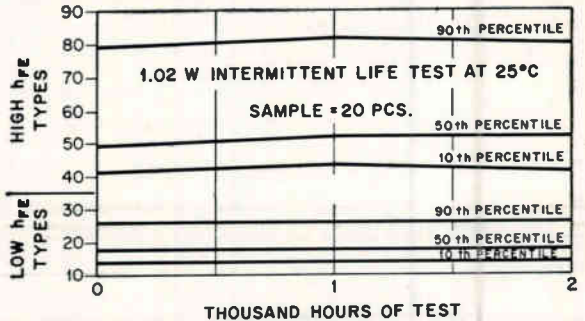
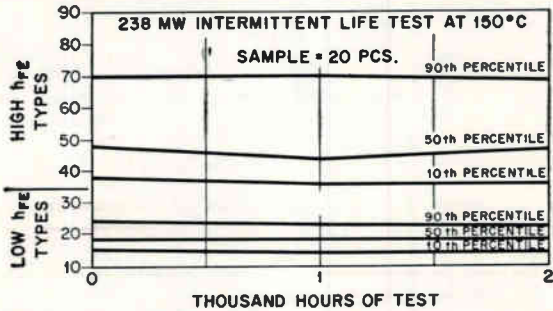
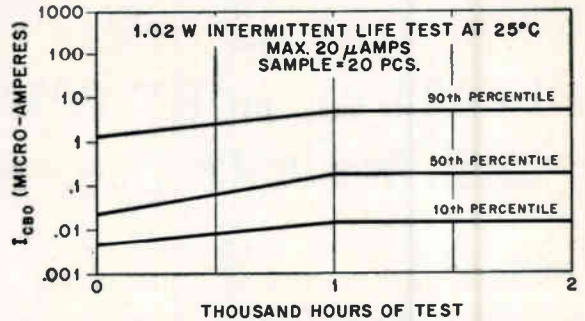
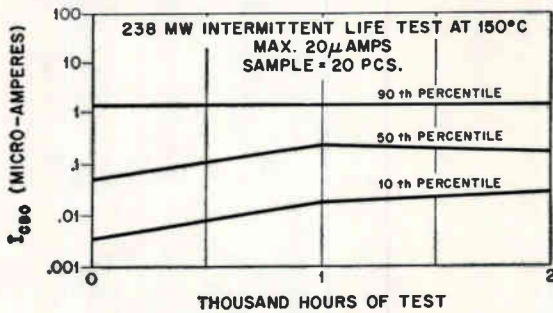

Absolute Maximum Ratings (25°C)

	2N497A	2N498A	2N656A	2N657A		
Voltages						
Collector to Base	V _{CB0}	60	100	60	100	volts
Collector to Emitter	V _{CE0}	60	100	60	100	volts
Emitter to Base	V _{EB0}	8	8	8	8	volts

Temperatures	T _{STG}	T _J
Storage		-65 to 200°C
Operating Junction		-65 to 200°C

Total Dissipation
Free Air @ 25°C - 1 watt*
Case Temperature @ 25°C - 5 watts**

*Derate 5.72 mw/°C increase in ambient temperature above 25°C
**Derate 28.6 mw/°C increase in case temperature above 25°C

Electrical Characteristics (25°C)

unless otherwise specified

D-C Characteristics

	2N497A		2N498A		2N656A		2N657A		
	Min.	Max.	Min.	Max.	Min.	Max.	Min.	Max.	
Collector to Base Voltage (I _C =100 μa, I _E =0)	V _{CB0}	60	100	60	100	60	100		volts
Collector to Emitter Voltage (I _C =250 μa)	V _{CE0}	60	100	60	100	60	100		volts
Collector to Emitter Voltage (I _C =16 ma)	V _{CE0}	60		60		60			volts
Collector to Emitter Voltage (I _C =10 ma)	V _{CB0}		100			100			volts
Emitter to Base Voltage (I _E =250 μa, I _C =0)	V _{EB0}	8	8	8	8	8	8		volts
Forward Current Transfer Ratio* (I _C =200 ma, V _{CE} =10V)	h _{FE}	12	36	12	36	30	90	30	90
Base Input Resistance* (I _B =8 ma, V _{CE} =10V)	h _{IE}		200		200		200		ohms
Saturation Resistance* (I _B =40 ma, I _C =200 ma)	r _{CE(sat)}		10		10		10		ohms
Cutoff Characteristics									
Collector Current (I _E =0, V _{CB} =30V)	I _{C0}		10		10		10		μa
Collector Current (High Temperature) (I _E =0, V _{CB} =30V, T _A =150°C)	I _{C0}		250		250		250		μa

*Pulse Test: 300 μsec. 2% Duty Cycle

Specifications also available for 2N497,498, 2N656,657 mesa transistors

tested

98A, 2N656A, 57A...come from General Electric

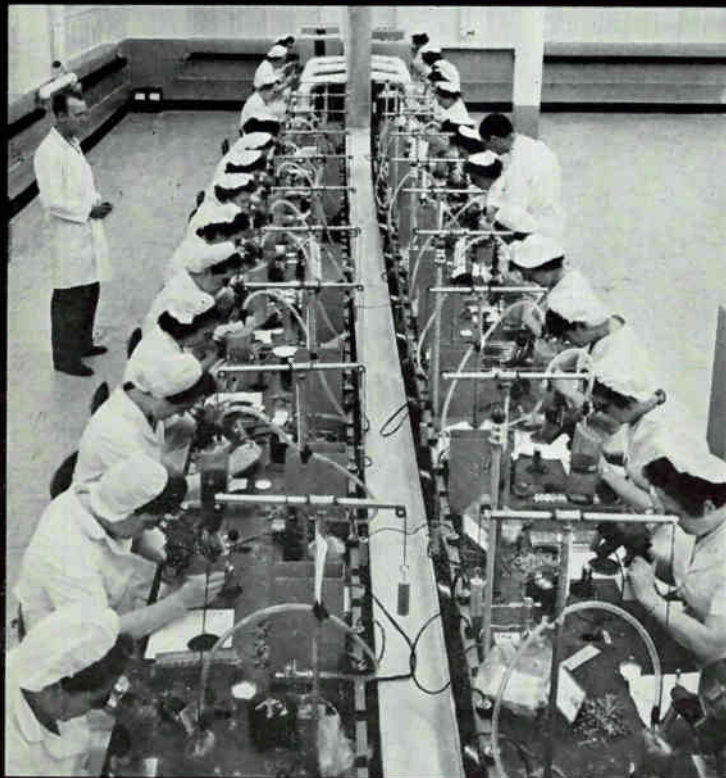

All assembly is done on a super-clean, super-reliability line similar to that which produces transistors for missile applications.

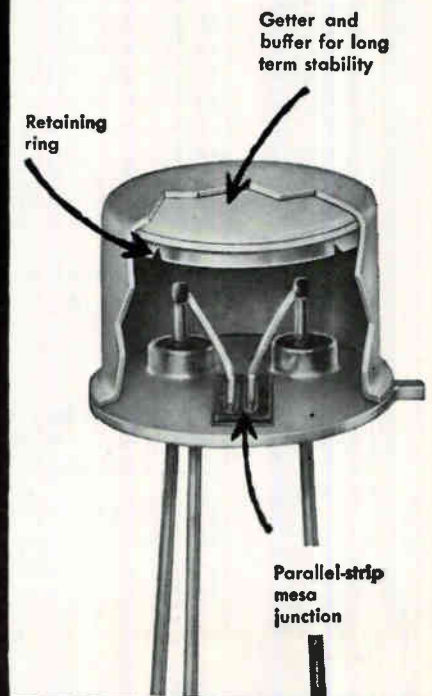
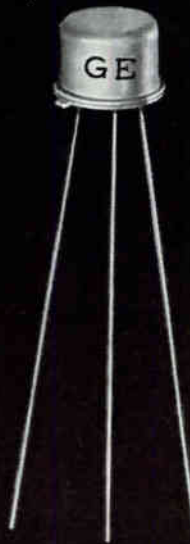

Positive internal atmospheric control achieved through the use of General Electric's buffered-sieve encapsulation technique, higher power dissipation with lower saturation resistance and lower input impedance are important features of this line of top quality one to five watt audio switches. Especially well suited for either high level linear amplifier or switching applications, these are the industry's most thoroughly characterized and tested medium power silicon double diffused NPN transistors available today. Just take a look at the extended life test charts illustrated for convincing evidence of long term stability and reliability.

Semiconductor Products Department, Section 25E96, Electronics Park, Syracuse, New York.

For fast delivery of medium power Mesa transistors at factory-low prices in quantities up to 999 call your G-E semiconductor distributor.

Progress Is Our Most Important Product

GENERAL  **ELECTRIC**

Shaped to the hand . . . General Electric

Midget irons give:

FASTER TIP AND HEATER CHANGE

General Electric's Midget soldering irons are now better than ever before. New clip arrangement saves time on your assembly line by making it easier to change the tip and heater. They're more streamlined and shaped to fit the operator's hand for maximum comfort.

Look at some other reasons why the G-E Midget iron is better:

- Low handle temperature for added operator comfort
- Tip and heater assembly will not "loosen up".
- Variety of long-life, ironclad tip sizes — 1/8 in. to 1/4 in.—with 6-volt, 18- to 35-watt ratings.

For more information on General Electric's full line of industrial soldering irons see your G-E Distributor, or call your nearby G-E Sales Office.

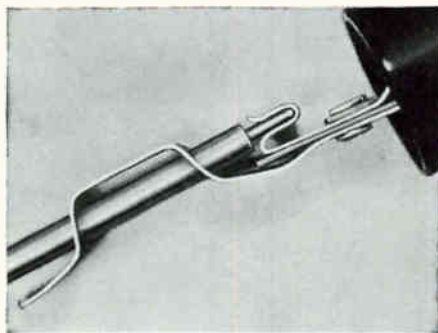

Simple clip arrangement makes it even easier to change the tip and heater on General Electric Midget soldering irons. Simply pull the entire assembly out of the handle, slip out the tip and heater assembly, replace it, and push assembly back into the handle. The iron is ready to go.

758-04

ACTUAL SIZE

Progress Is Our Most Important Product

GENERAL  ELECTRIC

New... LOW COST

PRODUCTION EYELET MACHINES

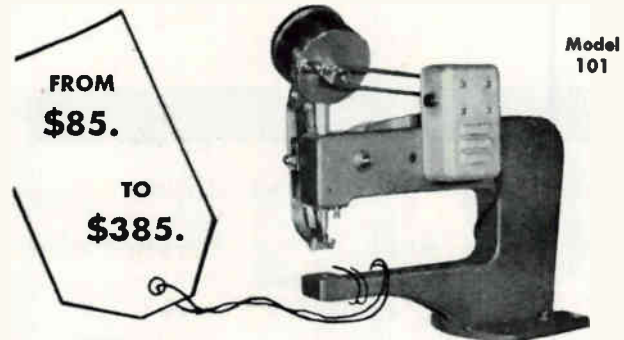

FROM
\$85.

TO
\$385.

Model
101

We specialize in production machines for electrical and electronic needs. Used by leading makers of PW boards for setting funnel flange, standardized, and special eyelets, from smallest sizes to 3/8". Best value on the market.

Model 101 air-operated machine automatically adjusts to various thicknesses. Cuts damage when setting plastics, ceramics, PW boards, glass, leather, etc.

FREE BULLETIN NO. AE100

Solve your eyelet machine problems fast — Write today.



EYELET TOOL CO.
INCORPORATED

31 Carleton Street, Cambridge, Mass.

CIRCLE 202 ON READER SERVICE CARD

Lepel

High Frequency Induction

HEATING EQUIPMENT

For Hardening • Annealing • Soldering
Brazing • Zone Refining • Crystal Growing

ELECTRONIC TUBE GENERATORS:

1 kw; 2 1/2 kw; 5 kw; 10 kw;
20 kw; 30 kw; 50 kw;
75 kw; 100 kw.

SPARK GAP CONVERTERS:

2 kw; 4 kw; 7 1/2 kw;
15 kw; 30 kw.



WRITE FOR THE NEW LEPEL
CATALOG 36 illustrated pages
of valuable information.

**Lepel HIGH FREQUENCY
LABORATORIES, INC.**

55th ST. & 37th AVE., WOODSIDE 77, N. Y.

CHICAGO OFFICE: 6246 WEST NORTH AVE.

CIRCLE 203 ON READER SERVICE CARD

electronics

NOW REACH OPERATING PRESSURES FASTER

... with the NRC Model HS4-750
4" Fractionating Diffusion Pump

Highest speed over the widest range
of any 4" diffusion pump available today.*

The only fractionating 4" diffusion pump of its type, the Model HS4-750 starts pumping at 400 microns — delivers 750 liters/sec. from 1 micron down and reaches ultimate pressures in the 10^{-10} Torr range. Regardless of variations in water temperature and fluctuations in voltage, performance is assured with only a 6 cfm mechanical backing pump. This outstanding performance is made possible by a completely new boiler and heater plus the new 4-stage fractionating jet design.

Check these additional features:

FIRMLY ANCHORED JET

cannot be hurled into the manifold by accidental release of air through the foreline.

SILVER SOLDERED COOLING COILS

cannot slough off even when pump is operated without cooling water.

FLUID-RETAINING FORELINE BAFFLE

keeps fluid in the pump, even when it is incorrectly air-released.

LONG HEATER LIFE

"cast-in" unit assures good heat transfer to the boiler while keeping watt density low.

LOW BACKSTREAMING

less than $0.02 \text{ mg./cm.}^2/\text{min.}$

QUICK HEAT-UP AND COOL-DOWN

reduces operating time and use of power.

MINIMUM CLEANING

stainless steel body stays clean... entire unit disassembled in 15 sec.

This NRC pump combines all the features which add up to the ideal diffusion pump... offers you both top performance and reliable, trouble-free operation. Write for our free catalog containing speed curves... see why Model HS4-750 is the best 4" pump you can find anywhere.

*Immediately available at \$395.00 F.O.B. Newton, Mass.

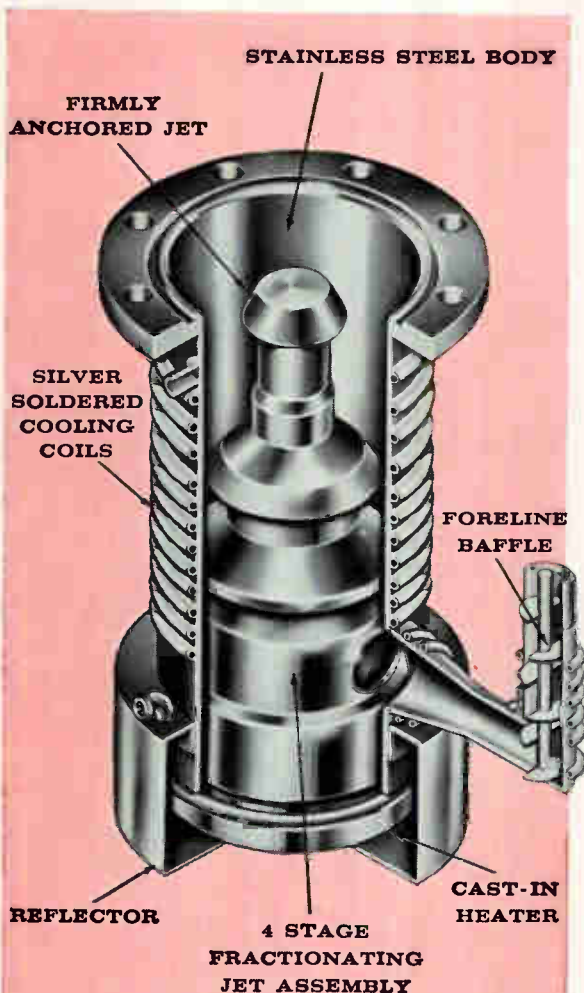

MODEL HS4-750



A Subsidiary of National Research Corp.
160 Charlemont Street, Dept. 4D
Newton 61, Massachusetts

RECENT RAYTHEON DEVELOPMENTS
IN MICROWAVE FERRITE DEVICES



HIGH-POWER CW CIRCULATOR,
Model CXH2 covers 9.4 to 10.8 kMc.

Versatile X-band circulators handle cw power in excess of 10kW

New high-power ferrite device provides over 20 db isolation; can be used as isolator with suitable auxiliary loads.

An advanced line of Raytheon high-power circulators keeps abreast of new X-band tube developments.

Typical of these compact units is the CXH2 covering 9.4 to 10.8 kMc with a continuous power rating of 10kW. Isolation is 20 db minimum, insertion loss is 0.2 db maximum and VSWR is 1.15 maximum.

Used as an isolator—in conjunction with suitable auxiliary loads—the CXH2 will handle continuous power levels to 10 kilowatts with a back-to-front ratio greater than 100:1. Similar units are available for use at high peak power levels.

For complete details on this and other significant developments in high-power microwave ferrite devices, please write to Special Microwave Devices Operation, Raytheon Company, Waltham Industrial Park, Waltham 54, Massachusetts.

TYPICAL SPECIFICATIONS • MODEL CXH2

Frequency	9.4—10.8 kMc
Power	10kW (cw)
Isolation	20 db min.
Insertion loss	0.2 db max.
VSWR	1.15 max.
Length	9 3/16 in.
Flanges	UG 39/U
Waveguide	RG 52/U
Weight	Less than 4 lbs.
Water cooled	0.75 gpm.

RAYTHEON

RAYTHEON COMPANY

SPECIAL MICROWAVE DEVICES OPERATION

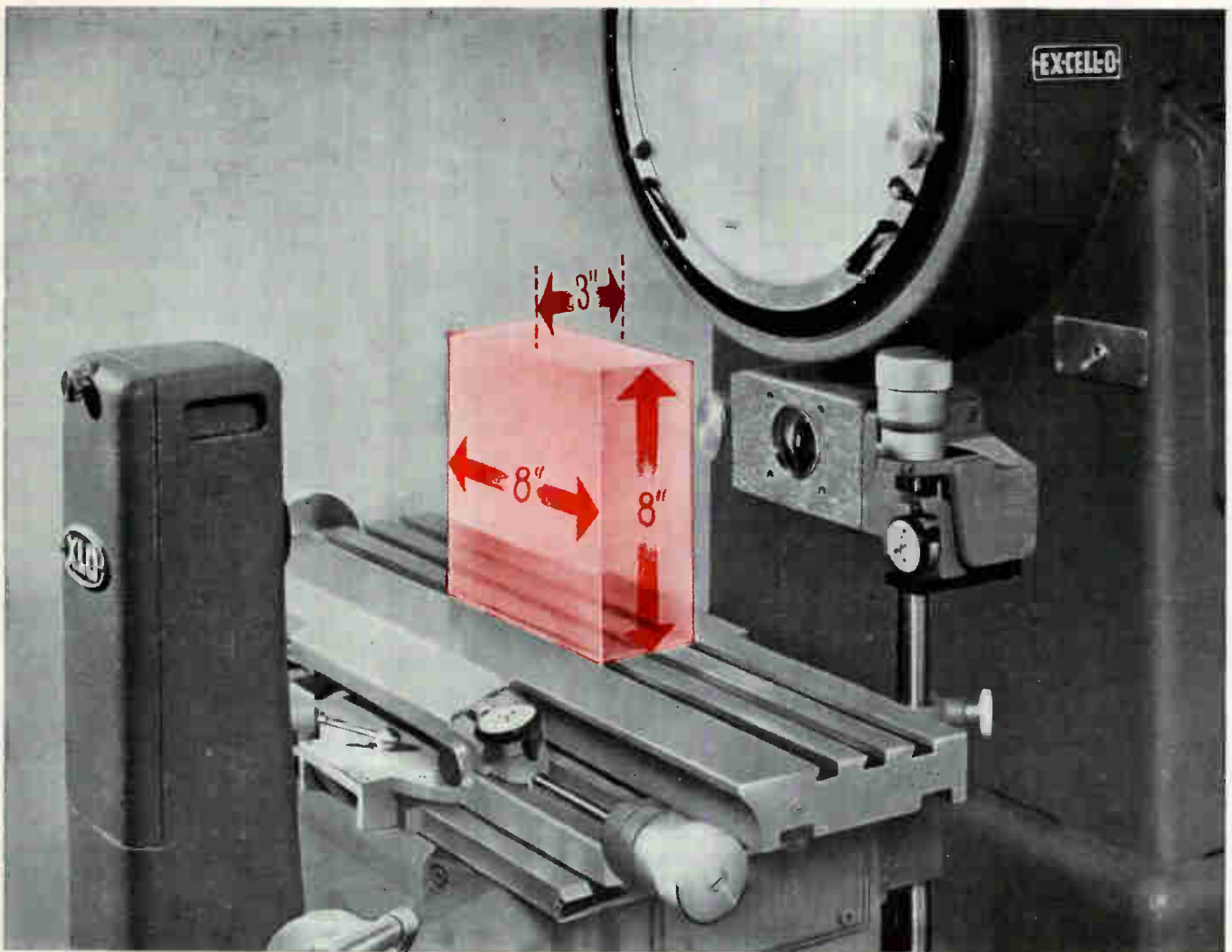

EX-CELL-O Contour Projectors Give You 98% More Capacity

Ex-Cell-O Models 14-5 and 30 give you capacity to accept and optically gage much larger parts than is possible with other contour projectors,—and without repositioning on the table!

A full 8" of table travel in both horizontal and vertical planes, together with 3" of focusing travel is standard on these Ex-Cell-O Models. Every point within this "block" can easily be brought into focus on the screen.

Here is real capacity,—192 cubic inches,—98% more than the nearest standard model! Enables users to stage shafts 16" in diameter, (and larger in some cases), and 16½" in length on the standard work table with standard centers. Any point along the part contour can be optically gaged with convenient table movement.

"Cubage" isn't the only Ex-Cell-O capacity Plus! You get constant 8" of working distance (lens to focal plane) —20% more than other standard projectors. Full 8" of vertical measuring travel. Constant throat clearance, (collimator lens to front projection lens), of 17½" on the Model 14-5; 16" on the Model 30;—and Ex-Cell-O's rugged, heavy duty tables enable you to stage parts weighing up to several hundred pounds.

When you are ready to talk about Contour Projectors, compare feature for feature! There is an OGP Representative near you to demonstrate Ex-Cell-O's many PLUS values. Call or write. In the meantime, let us send you "43 Reasons Why EX-CELL-O Contour Projectors are the First Choice of Industry."

You Can Purchase Ex-Cell-O Contour Projectors on Conventional Terms . . . Deferred Payment Plan . . . or Lease With or Without Purchase Option. Select the Plan Best Suited to Your Needs.

Manufactured by EX-CELL-O Corporation at Detroit, Mich.
SOLD AND SERVICED BY

OPTICAL GAGING PRODUCTS, INC.

26 FORBES STREET

ROCHESTER 11, N. Y.

(A subsidiary of EX-CELL-O Corporation)



now from **Clary**

*a digital arithmetic center
that works with: -process control*

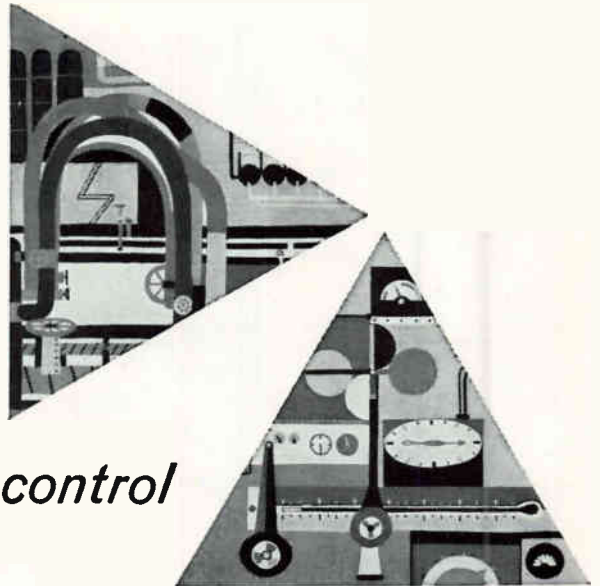
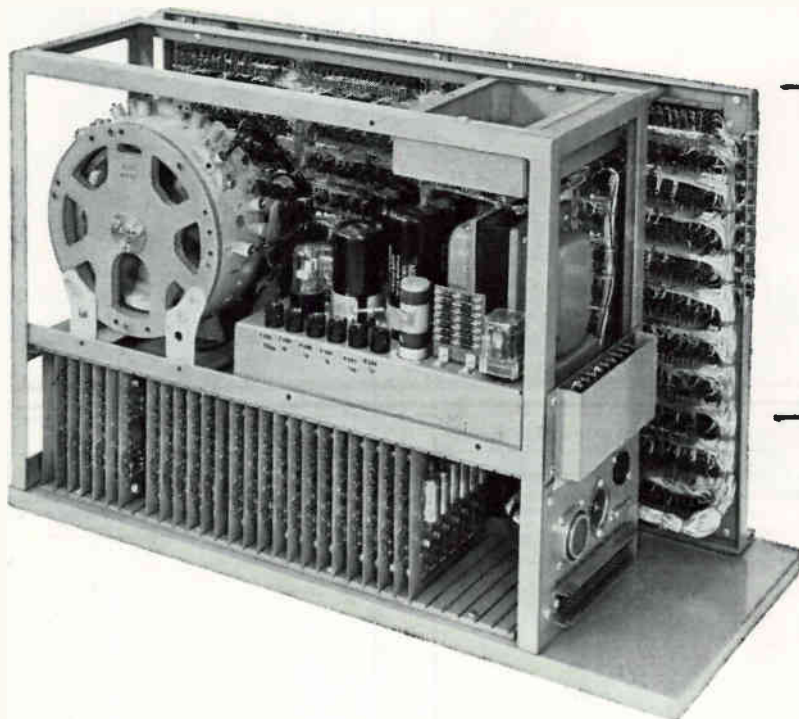

-instrumentation

-test equipment

-data-processing systems

Important specifications include:

Number System...Decimal
Word Length...18 decimal digits and sign
Storage...Magnetic Drum
Storage Capacity...16 words per channel, non volatile
10 channels are available
2 channels are supplied as standard equipment
Instructions...Multiple Address
Input of Data...Unique pulse per digit or binary coded decimal
Input of Instructions...DC voltage to proper connector pin(s)
Output...Unique pulse per digit or binary coded decimal
Size...Length 28", height 19", width 13"
Weight...97 lbs.
Power...117 VAC \pm 10%, 150 watts maximum, 60 cycle, single phase
Construction...Modularized, solid state, plug in components

You name the application, and Clary's new arithmetic center—the DAC-2500—will fit it.

FLEXIBLE. This unit performs arithmetic, logical, and memory functions with electronic speed and accuracy...works with punch card and tape devices, analog to digital converters, X-Y plotters, printers, and other input and output equipment.

PROVEN. This is an off-the-shelf item. It has been proven in actual applications. Production-line quality makes it low-in-cost, insures prompt delivery, reduces maintenance and repair problems.

RELIABLE. Clary's long experience in quality controls and the use of solid state electronics insure exceptional reliability.

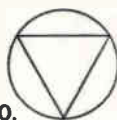

Clary

CORPORATION,
COMPUTER DIVISION
San Gabriel, California

For information on how you can use the DAC-2500, write direct for Engineering bulletin SS-4.

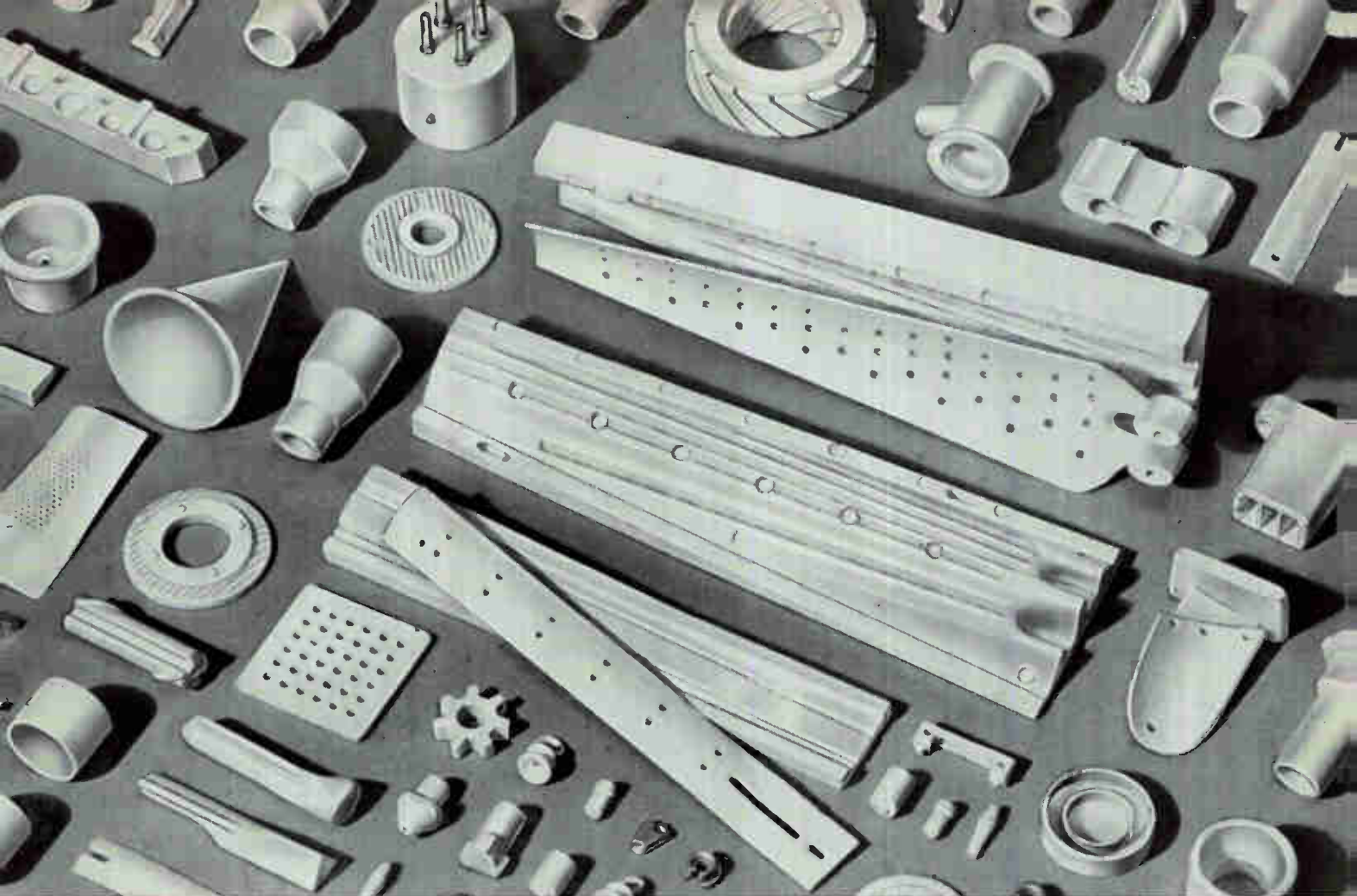

Highly complex shapes,

internal and external, formed in one operation to close tolerances in

ALSiMAG CERAMICS

NEW SHAPES NOW PRACTICAL

Technical ceramic parts formerly impossible or available only by expensive machining and grinding are now practical and can be produced in volume to close tolerances and with great uniformity. They include complex and compound curves, thin walls and other difficult design features. This injection molding process is particularly suited to volume production which readily permits amortization of initial tooling costs.

MATERIALS

ALSiMag 614 (High Alumina) and
ALSiMag 704 (Porous and Leachable)

have found widest use. Other ALSiMag ceramic compositions are available. See Property Chart, sent on request.

APPLICATIONS

include but are not limited to:

Electronic and Electrical, such as conical micro-wave tube windows, envelopes, complex internal insulators, cups, encapsulating devices, semi-conductor assembly boats and plugs.

High Temperature, Mechanical and Heat Shock uses such as welding nozzles.

Precision Investment Casting cores of great dimensional accuracy.

Guides for wire and textile machinery.

The use of these ALSiMag ceramics is indicated when high frequencies, high temperatures, heat shock, chemical attack or mechanical wear are involved.

EXPERIENCE

More than two years of steadily increased production from this equipment has given us practical experience which enables us to promptly and accurately answer most inquiries involving complex and difficult shapes. Send blue prints or sketches. Chances are that your "impossible" designs are now practical in ALSiMag ceramics.

A Subsidiary of
Minnesota Mining and
Manufacturing Company

AMERICAN LAVA CORPORATION

CHATTANOOGA 5, TENN.

60TH YEAR OF CERAMIC LEADERSHIP

For service, contact American Lava representatives in Offices of Minnesota Mining & Manufacturing Co. in these cities (see your local telephone directory): Boston: Newton Center, Mass. • Chicago: Bedford Park, Ill. • Cleveland, Ohio • Dallas, Texas • Los Angeles, Cal. • New York: Ridgefield, N. J. • Philadelphia, Pa. • St. Louis, Mo. • St. Paul, Minn. • So. San Francisco, Cal. • Seattle, Wash.
All other export: Minnesota Mining & Manufacturing Co., International Division, 99 Park Ave., New York, N. Y.

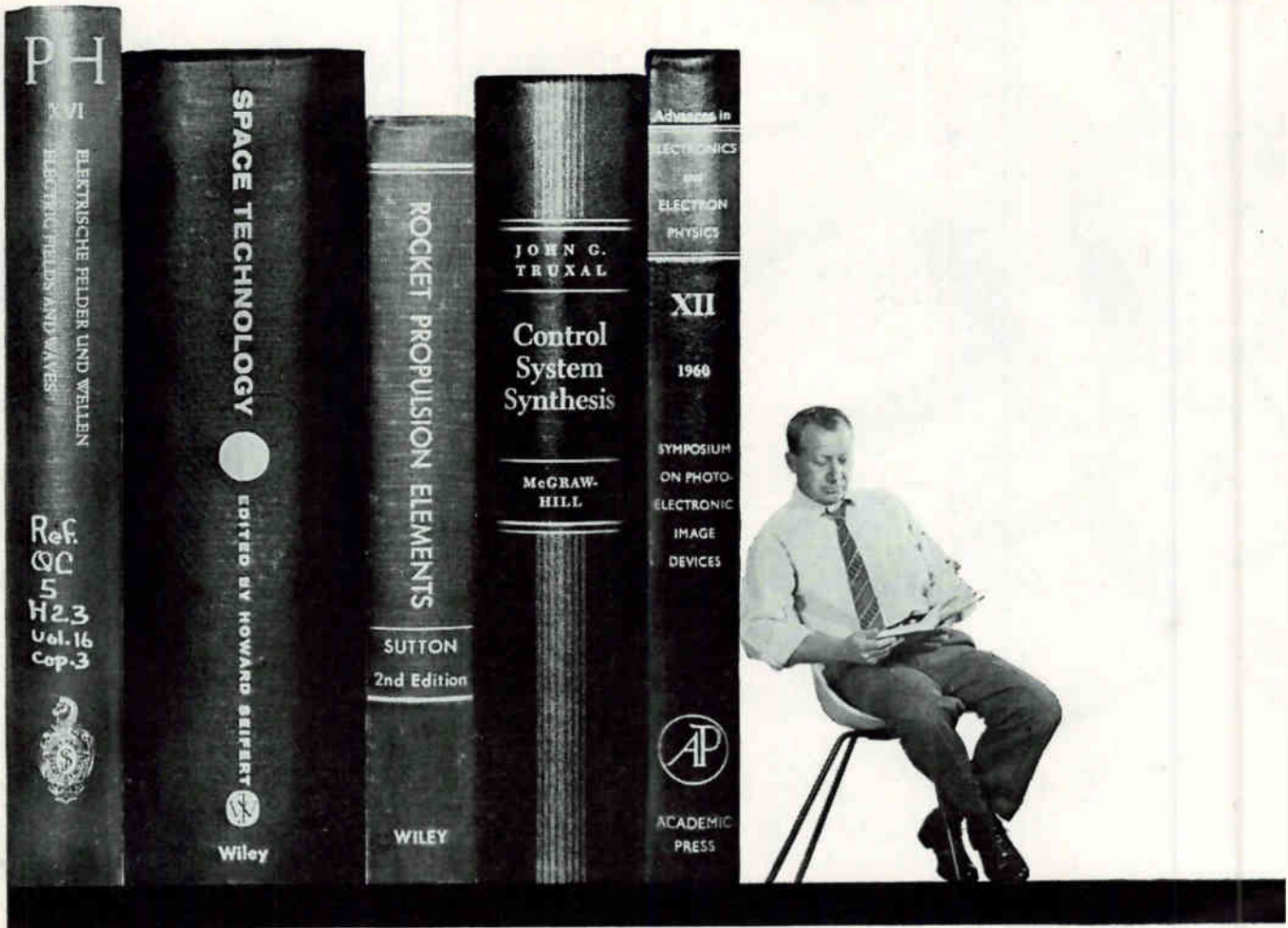

electronic and electromechanical engineers in a unique role

The engineers and scientists of Aerospace Corporation are in the forefront of a rapidly advancing state-of-the-art in sensing and information systems. Their unique role: a critical civilian link uniting government and the scientific-industrial team responsible for development of space systems and advanced ballistic missiles. In providing scientific and technical leadership to every element of this team, they are engaged in a broad spectrum of activities, from formulation of new concepts to technical review and supervision of hardware development by industry. Specific areas of interest include inertial and radio guidance, automatic control, communications, instrumentation, space- and ground-based computing, telemetering, tracking, auxiliary power, infrared, television, optics, and photography. Now more men of superior ability are needed; highly motivated engineers and scientists with demonstrated achievement, maturity, and judgment, beyond the norm. Such men are urged to write Mr. George Herndon, Aerospace Corporation, Room 116, P. O. Box 95081, Los Angeles 45, California.

Organized in the public interest and dedicated to providing objective leadership in the advancement and application of space science and technology for the United States Government.

AEROSPACE CORPORATION

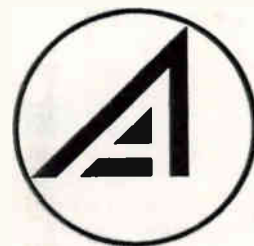

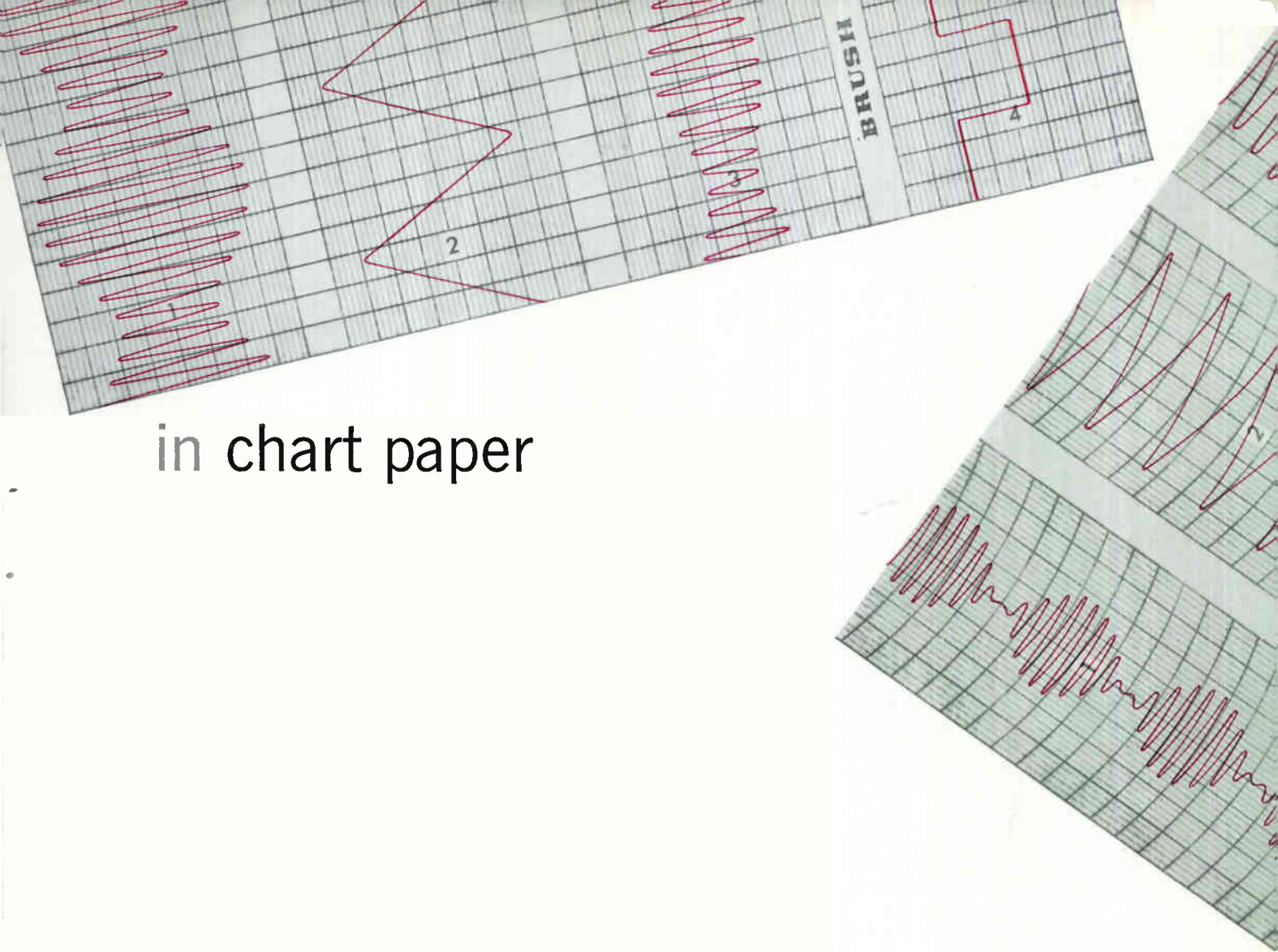

in chart paper

there
is
a
difference

brush INSTRUMENTS
DIVISION OF
CLEVITE CORPORATION
37TH AND PERKINS CLEVELAND 14, OHIO

Only Brush Chart Paper is designed as an integral component of precisely engineered Brush Direct Writing Recording Systems. The full potential of these systems cannot be realized unless *all* of the original components are utilized. They're engineered as a *total* entity. Imitation papers cannot match the precision ruling, dimensional stability and super-smoothness of Brush Chart Paper. Take no chances—specify *Brush* and you can rely on your records being accurate, permanent, easily read and easily reproduced. Stocks available from strategically located branches and sales representatives throughout the United States and Canada.



Write for samples
of actual tracings on
Brush Chart Paper.
Ask for
"Brush Engineered
Recording Supplies".

The VISICORDER records transistor torture

Transistors often have to work under incredibly severe environmental conditions. Production-testing them gave engineers at Honeywell's Semiconductor Division a chance to exploit the great versatility of the 36-channel Visicorder oscillograph Model 1012.

A certain order of transistors had to withstand vibrations of 10G at 10 to 2,000 cps without failing during the test or as a result of it. A standard test had been to measure the transistor's performance, next subject it to non-active vibration (not in any circuit), and then re-measure. This approach was obviously deficient as it did not reveal *operating* characteristics during test, nor did it disclose *intermittent*-type failures.

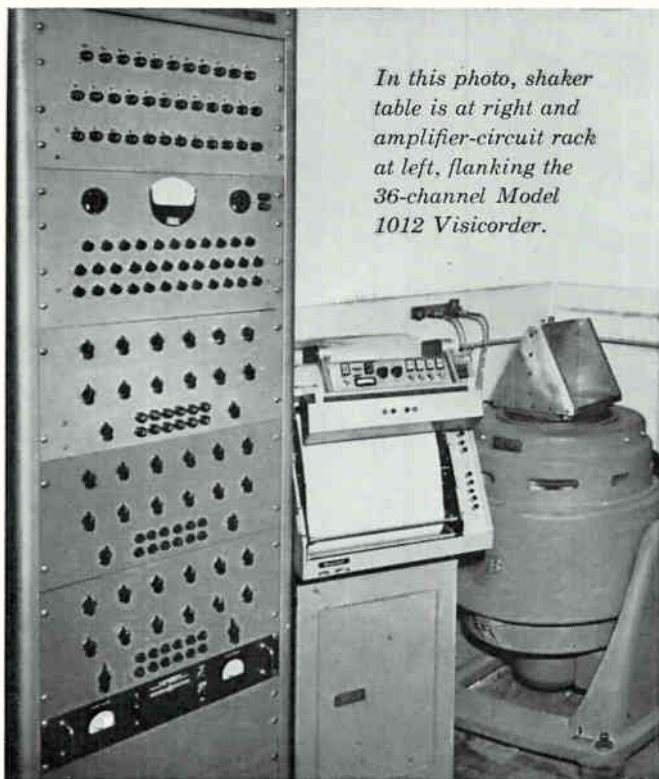

In this photo, shaker table is at right and amplifier-circuit rack at left, flanking the 36-channel Model 1012 Visicorder.

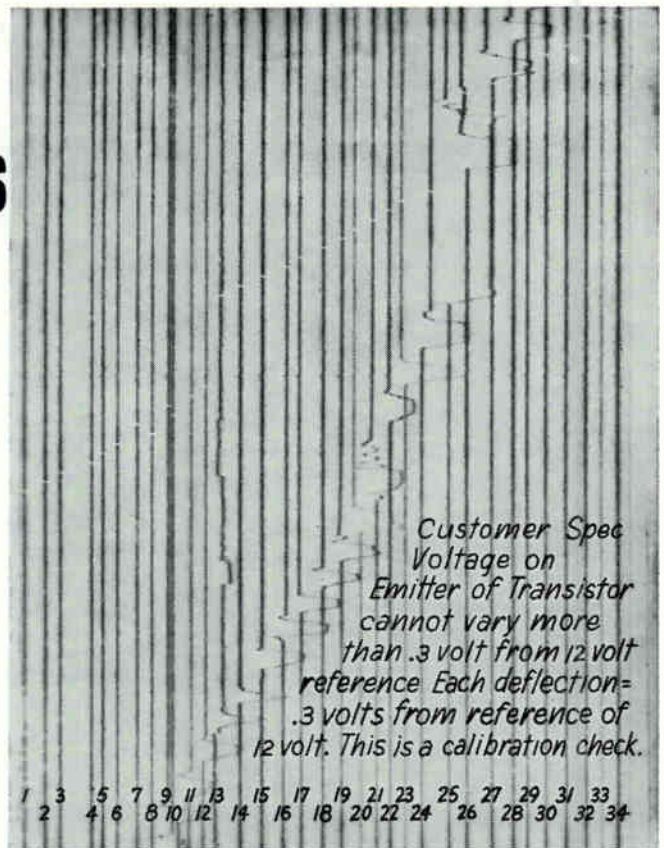

Unretouched record of vibration test on 36 transistors, each active in its own circuit during test.

The customer's quality requirements were stringent (AQL = .4%) and the large test sample required ruled out the use of an oscilloscope. The 3-hour test would have made a battery of scopes and operators necessary; transient defects would be missed due to eyestrain, fatigue, etc.

The Model 1012 Visicorder was chosen for the task as it simultaneously measures and records 36 channels of test information throughout the test period. The Visicorder instantly and directly records transients, no matter how random.

A Visicorder record like this is always a welcome supplement to your test data—your customer will be able to read it quickly and with full understanding. And it is a *permanent* record which he can show to *his* customer, if necessary.

For further information on how Visicorders can help to solve your instrumentation problems, contact your nearest Honeywell sales office without delay. Or write for Catalogs HC 906, 1012, 1108 and 1406, to:

Minneapolis-Honeywell, Heiland Division, 5200 East Evans, Denver 22, Colorado, SK 6-3681—Area Code:303

HONEYWELL INTERNATIONAL

Sales and Service offices in all principal cities of the world.

Honeywell



Industrial Products Group

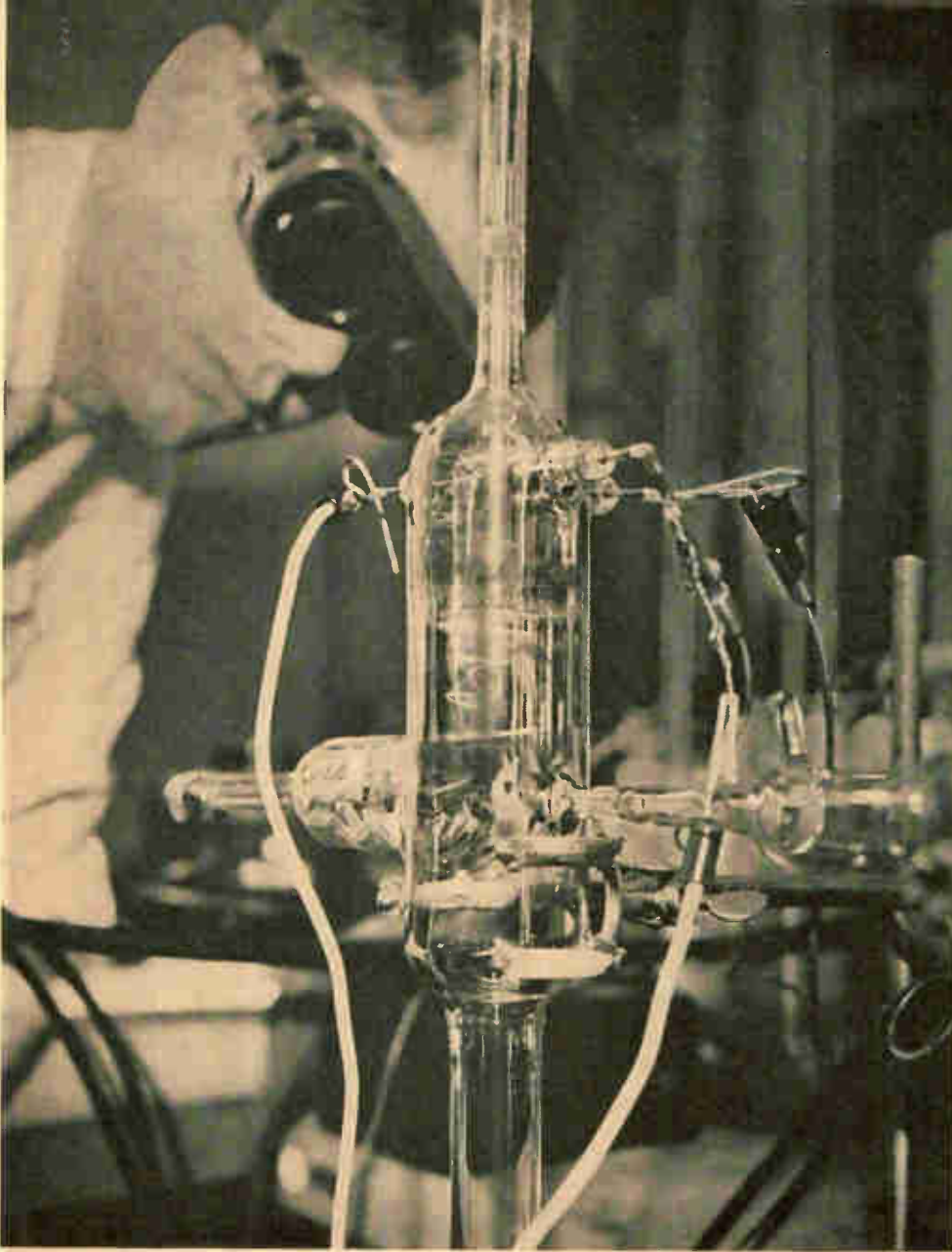

Apparatus used by
IBM for evaporating
niobium films by
electron bombardment

COMPUTERS TODAY

By FRANK LEARY, Associate Editor

*Research into new materials
is the foundation of
expanding technology*



REPRINTS
AVAILABLE
SEE
READER SERVICE CARD

© ELECTRONICS, a McGraw-Hill Publication

TRENDS IN COMMERCIAL DATA-PROCESSING

Electronic data-processing is entering a new era of communications that heralds far greater realization of full computer potential than has ever before been possible.

Until quite recently, punched cards and paper tape, together with the console keyboard, were the major means man had of communicating with, or putting information into, commercial data-processing systems. In effect, all data had to be manually prepared for the input operation. An even more limiting factor has been the inability of computers to engage in on-line communications with each other.

Today all this is changing. Developments such as optical scanning, magnetic-ink character recognition, and various techniques using returnable media are destined to increase input efficiency while at the same time extending the versatility of commercial data-processing systems.

The new data-communication techniques for on-line computer-to-computer communications over long distances will have even greater implications for the future expansion of data-processing. An example of such developments is the recently announced Honeywell data-communications system; using this system, Honeywell computers can not only communicate with

each other over existing communications facilities, but can also talk with non-Honeywell machines.

The new input devices, together with long-distance data transmission directly from computer to computer, will bring a new standard of efficiency to computer operations — and in the long run will open up many applications that never before were practical. Large billing operations, through returnable-media applications, will become more completely automatic. Decentralized companies with extensive selling organizations will be able to establish data-processing networks that will eliminate large areas of slow and costly manual handling and transcription of data. Such networks, for example, could very well make possible faster delivery of goods on order without the expense of increasing inventories.

And looking further ahead, it is not stretching the imagination too far to foresee vast computer networks between banks and business organizations that in effect would amount to electronic banking systems.

WALTER FINKE

*President, Datamatic division
Minneapolis-Honeywell Regulator Co.*

THE FRONT COVER — MINIATURE COMPUTER



A GENERAL-PURPOSE digital computer is contained in the Sperry Gyroscope unit on the cover. It is a guidance and control computer with 4,096 words of core storage and can perform 250,000 operations a second. Digital circuit blocks made up of encapsulated subminiature components with welded interconnections are assembled into functional modules; wiring harness uses wire-wrap connections from module to module. Twelve types of building block are used, with function identified by color coding. Module assembly contains up to 68 blocks. Heat-exchanger baseplate is the mounting for the computer; the exchanger can adapt to air, liquid or cold-plate cooling. Modern production techniques all contribute to reliability. Design is compatible with newer components — molecular circuits, and so forth. Volumetric efficiency is 40 percent including cooling



Larc, here being tested at the Navy's David Taylor Model Basin, is among today's giant computer systems

COMPUTERS TODAY— PART I

the industry today

IT HAS BEEN just over fifteen years since the ENIAC—electronic numerical integrator and calculator—was dedicated at the Moore School in Philadelphia. The fifteen years have seen the growth of an impressive and promising technology.

In 1953, sales of stored-program general-purpose digital computers grossed \$10 million; in 1956, the Radio-Electronics-Television Manufacturers Association reported that sales reached \$100 million. Last year, sales of general-purpose computers topped \$500 million, and the computer industry as a whole grossed over a billion dollars.

Now a new phase of computer activity is underway. Transistor systems are now going in—the population of solid-state computers trebled in the last six months of 1960, going from about 200 at midsummer to about 700 now. Meanwhile, the older vacuum-tube systems are being superseded, although there are still about 4,000 of them.

Since 1956 the number of computer manufacturers has almost doubled. The influx of new talent has materially shifted the industrial patterns in the computer

business; it has also brought new insights to bear on the technology.

TODAY'S SYSTEMS—The distinctions once valid in the computer business—distinctions of size such as large-, medium- and small-scale systems, or of type, such as scientific and commercial systems—are gradually fading. Solid-state design permits modular construction, so that systems can be built up in almost any configuration from small to very large. Furthermore, the amount of peripheral equipment is frequently the key to system capability. Small systems in their basic capability become medium-sized when outfitted with multiple tape units or other bulk storage. Distinctions of type are today largely dependent on input-output capability and a few refinements such as floating-point arithmetic.

The average price or monthly rental is a guide to system capability. Large systems are considered to be those whose average price runs in excess of \$1 million, with rentals varying upward from \$12,000 a month. Of these systems, most use magnetic tape. Most have add times in the range of tens of microseconds; a few are

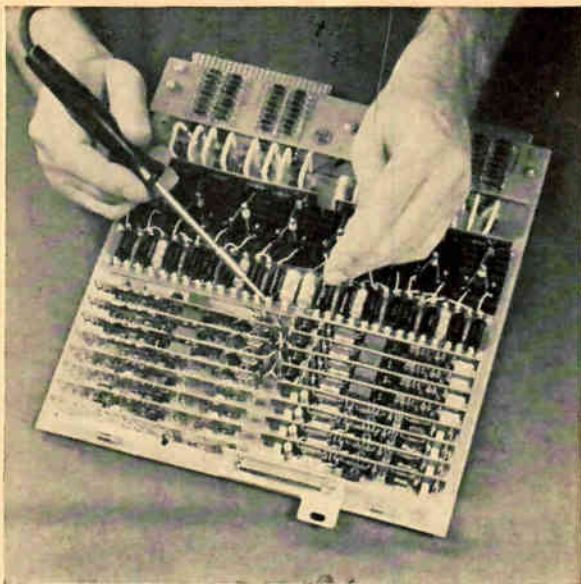

Component packing densities are increasing, with rise in volumetric efficiency. This is circuit board from Philco 2000

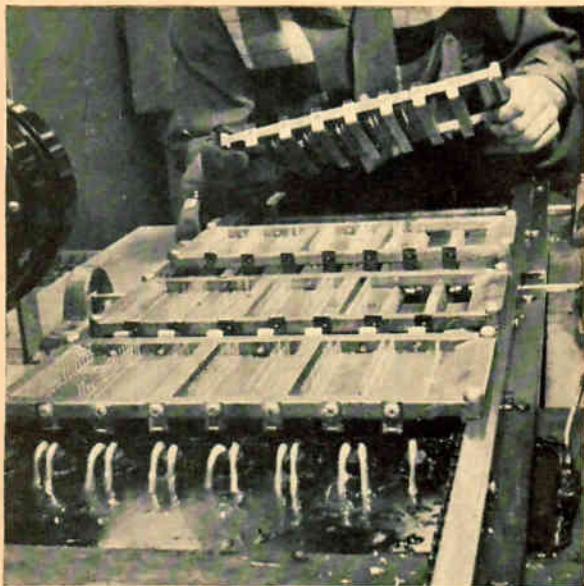

Jet soldering used by Honeywell makes uniform joints of high quality as boards ride across fountains of solder

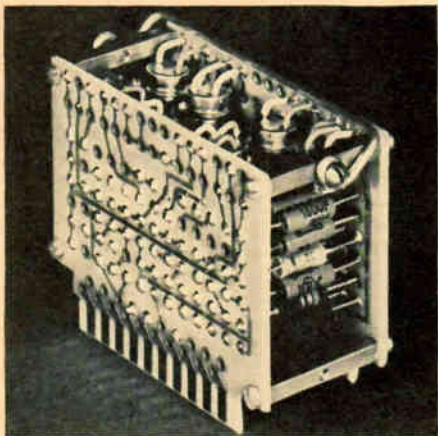

High-speed logic of the FX-1 computer being built at MIT's Lincoln Laboratory to evaluate new circuit and logic techniques. The FX-1 has thin-film memory of 0.2-microseconds cycle time, uses 325 modules of 13 different types

in the hundred-microsecond range, and some are fewer than ten.

Medium-sized systems sell for less than \$1 million, but generally more than \$200,000 or \$300,000. They use magnetic-tape units, but generally measure add times in the milliseconds or tens of milliseconds. Small systems are those which do not use tapes, but are internally programmed, and which rent for less than \$2,000 a month on the average. These divisions overlap and are becoming less distinct.

GIANT SYSTEMS—At the apex of systems capability and cost stand IBM's Stretch and Remington Rand's Larc, joined with the Muse model of Ferranti's Atlas computer now abuilding at the University of Manchester in England, and the Japanese Mark VI. Stretch and Larc were both built for the Atomic Energy Commission, and both are being merchandised to other customers. Stretch sells for about \$13 million, rents for about \$200,000 a month; Larc is about two thirds as expensive.

Stretch has a basic 16,000 words of core storage with 1-microsecond access time; word length is 64 bits. It can add two 15-digit numbers in 2 microseconds. Stretch can use 32 input or output channels, can read 62,000 characters a second, performs multiple read-write-compute operations simultaneously. It can interrupt an operation to handle a problem of higher priority, has a semi-independent controller that relieves the computer of input-output housekeeping. Up to 256 tape units can be used in the system. Stretch's ability to look a few steps ahead in a program helps it make optimum use of its fast internal speeds.

Larc has a basic 10,000 words of core storage with 2-microsecond access time; word length is 12 digits; add time is nominally 4 microseconds. The system has 10 input or output channels, can read 133,000 alphanumeric or 200,000 decimal characters a second, writes at 25,000 characters a second. The input-output processor handles up to 60 tape units in multiple read-write operations while the arithmetic and logical unit continues with computing operations. The semi-independent processor can also handle simple data manipulations not requiring computation.

MUSE—The Manchester-Ferranti Atlas, also called Muse, will be completed about yearend. It will use a fast-carry adder and a core-storage unit in which two cores are employed per bit. The memory is built in 4,096-word sections with consecutive addresses in different sections; memory operations will be capable of overlap, with one section accessible while another is cycling. Since cycle time is 2 microseconds, the effective access rate will be in excess of a megacycle. Average time to extract and execute a complete single-address floating-point addition instruction is expected to be 1.1 microseconds, but actual time will depend on the amount of possible overlap with adjacent operations. Summing a polynomial will take about 5 to 7 microseconds per term.

Fixed memory for constants will be a woven-wire mesh in which ferrite slugs will represent binary ONES.

The fixed memory will also contain routines for initiating and controlling external transfers, for monitoring programs, for routine engineering tests, and to control

time-sharing between programs. Word length of the system is 48 bits, with numbers represented in floating-point octonary form.

A technique for interpreting the address digits uses an 11-bit floating label for a 512-word block of information, and a page-address register in which the address of the transfer instruction is interpreted. Without limiting the rate of transfers to and from the storage unit, the Muse thus can recognize a symbolic address for complete blocks of information, simplifying the problems of time-sharing between programs and allocation of the two-level (cores and drums, plus tapes) storage.

MARK VI—Electrotechnical Laboratory of Japan's Ministry of International Trade & Industry began work last summer on a computer to be designated Mark VI. Using microalloy diffused transistors, ETL expects to attain an add time of 0.5 microsecond, with floating-point add to be accomplished in 1.5 microseconds, multiplication in 5 microseconds. Mark VI will use a three-phase 3-Mc clock. Memory will be 8,192 words of core storage, 52 bits per word, with a cycle time of 2 microseconds. Supplementary high-speed storage unit for scratchpad purposes will be a tunnel-diode matrix operating on a 0.2-microsecond cycle. Eight magnetic-tape units, a line printer, and paper-tape devices will be among the peripheral gear. R&D cost of the Mark VI was originally estimated at \$236,000.

Atomic Energy Commission, Office of Naval Research, and the University of Illinois are currently supporting the development and construction of a new computer at the Illinois campus that will be operational late in 1961. The Illinois computer will use *pnp* germanium mesa transistors in nonsaturating circuits to attain a floating-add time of 1.5 to 2.5 microseconds, multiply time of 5 to 7 microseconds. Core storage of 2-microsecond cycle time will hold 8,192 52-bit words; a drum store of 65,536-word capacity will be accessible in 17 milliseconds maximum (8.5 milliseconds average), and, once accessed, with a word-transfer rate of 7 microseconds per word.

A speed-independent control contains logical circuits that can react to an input change after an indefinitely long time without affecting the result. The control helps ensure correct operation even if signal-transmission time exceeds circuit-operation time. Arithmetic and memory-access operations are overlapped; a look-ahead control reads operands and instructions into a fast-access transistor-register scratchpad store in advance.

OTHER LARGE SYSTEMS—Among commercial computers, IBM's 7090 is a very fast system with 4.4-microsecond add time and 32,000 words of core storage, can use up to 80 tape units on 8 input-output channels, reads data at 62,000 characters a second. The 7080 has a memory capacity of 80,000 words, but each is one alphanumeric character. IBM is testing the usefulness of variable-word-length systems in the very-high-speed class of computers designed to operate with the new breed of data-processing compiler routines, which can make more efficient use of variable-length memory than manually programmed systems. RCA is doing the same thing with its 601.

Simultaneous multiple read-write-compute capabilities are built into IBM's 7090, 7080 and 709, Control Data's

1604, Remington Rand's Univac III and 1107, the Bendix G-20 and Honeywell 800. Add times of less than 10 microseconds are found in the 7090, Univac III and 1107, CDC 1604, RCA 601; while core cycle times of the order of microseconds or less are found in the 7090, 7080, Univac 1105, 1107, and III, CDC 1604, RCA 601, Philco 2000 (unusual in being an asynchronous computer), Honeywell 800, and in the 7074 configuration of IBM's 7070.

Overlap—or interlace, as it is sometimes called—in the memory, limited look-ahead and look-behind capability, simultaneous operation, sophisticated error-detection and correction, variable-length and packed instructions with the ability to flexibly modify instructions—all these and other departures in the technology are filtering downward among systems offered in the competitive market for commercial and industrial sale.

COMPONENTS AND MATERIALS—Systems entering the market today have mostly settled on transistors and diodes for logic and arithmetic circuits and magnetic cores for memory systems. Surface-barrier, microalloy diffused transistors (MADT), diffused transistors in both mesa and planar configurations, and, more recently, epitaxial transistors have permitted substantial increases in computational speed without requiring logical schemes different from those using slower transistors.

Magnetics continues to hold its own in memory design and as an input-output medium, and is making slow progress in processing circuits. Since the limits on switching rates for ferrite cores are set by hysteresis, emphasis has been on reducing core size.

Cores with an inner diameter of 0.005 to 0.01 in. and an outer diameter of 0.01 to 0.02 in. have been employed successfully by RCA in experimental memories with cycle times in the 10-nanosecond range, three orders of magnitude faster than most commercial core memories now employed. One-microsecond memories using a core with 0.03-in. outer diameter are being produced in quantity by Ampex Computer Products.

Tape and drum coating materials have been consistently improved so that high-density recording—1,000 and 1,500 bits to the inch—is now a realized concept. Base materials have been improved; much digital tape is now Mylar-based, is consequently less susceptible than formerly to dimensional instabilities introduced by temperature, humidity or tension.

CIRCUITS AND SUBSYSTEMS—Smaller and more reliable solid-state components have given engineers a wider latitude in design of computer circuits, resulting in designs that would never have been economically feasible with vacuum tubes. At the same time, the inherent reliability of solid-state devices has permitted the elimination of many of the redundant circuits needed in vacuum-tube computers to ensure correct operation. Thus Binac, built in 1948, was duplicated in its entirety; later systems were as much as 30 and 35-percent redundant; today's equivalent system may have a redundancy level lower than 10 percent.

Computing and logic circuits are becoming more sophisticated. For example, the first computers multiplied the way a desk calculator does: by repeated addition of the multiplicand to itself under control of the multiplier digits. Systems today employ an algorithmic tech-

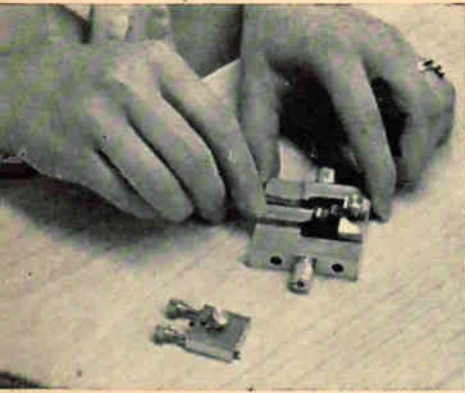

Assembly of flying head for the Telex disk file

Videograph output unit built by A. B. Dick translates magnetic tape into edited output for an electrostatic label printer



Data communications are important to data-handling. Here a technician prepares to receive data over General Dynamics/Electronics transceiver



nique, or form multiples of the multiplicand to reduce the number of iterations. IBM's Naval Ordnance Research Calculator has a complex multiplier in which nine multiples of the multiplicand are formed as it is read out of storage, and the multiplier controls a wholesale summing of the correct number of each multiple; multiplication in the NORC takes only twice as long as addition. Recomp II, Gamma 60, Ferranti's Mercury, the ER56 of Intelx, Stretch, Nippon Electric's 2203, the Philco 2000, RCA 601, and Larc are among today's systems that employ an algorithmic or matrix-lookup multiplier method.

Development of wired-core and other fixed but alterable types of storage has made feasible the introduction of compiling and autocoding capabilities in machine hardware. The Gamma 60 of France's Compagnie des Machines Bull was among the first to include this capability; instructions for the 60 are prepared in a high-level pseudocode, or macrocode, and broken down into component machine orders by the computer itself.

The multiple computer—or polymorph, as Thompson-Ramo-Wooldridge calls its RW-400—is one development of relatively recent date that has already had a pronounced effect on the technology. Gamma 60, RW-400 and the Honeywell 800 are among computers which can subdivide themselves to operate on different parts of a program or different programs in parallel. So, of course, can Larc and Stretch and others of the giant systems. All systems with multiple read-write-compute capabilities at least have autonomous input-output housekeeping controls and buffers.

Self-correcting circuits appear in systems now on the market. In the Orthotronic control in the Honeywell

800, not only is the information augmented by a redundant transverse check or parity bit for each character, but each record is summed modulo-2 to form a pair of redundant Orthotronic words which constitute a longitudinal parity check. The Orthotronic word and parity bits work together to detect dropped or picked-up pulses with a high degree of reliability and low ambiguity. The system can reconstitute any twelve adjacent characters.

MEMORY SYSTEMS—There are now four general classes of magnetic memory in general use: core systems for high-speed randomly accessible internal storage and for buffer devices; drum systems for storage of bulk data in either basic memory or backup file where serioparallel accessibility in the millisecond range is adequate; disk systems for bulk data, generally of a predominantly unchanging character (as in a permanent file) where serioparallel accessibility in hundreds of milliseconds is adequate for major file items; and tape systems, now predominantly considered as input-output transfer media and master file storage where essentially serial access to ordered and sequenced data in tens or hundreds of milliseconds is acceptable.

Cost per bit of memory systems today is roughly proportional inversely to the access or cycle time and the storage capacity. A core memory of moderate size—a thousand words or so—with a cycle time in the range of 10 microseconds costs about a dollar a bit. Drum memory systems cost about 10 cents a bit or less; disk systems, a fraction of a cent, and tape storage—especially considering the possibility of changing tapes—costs even less.

COMPUTERS IN INDUSTRIAL CONTROL

The advent of the modern electronic data-processing system as a tool of industry marks the beginning of the final stage in the industrial revolution which began two centuries ago. At the end of this final stage lies automation in its full sense, linking the processes of management, production and distribution from beginning to end in the single integrated enterprise of the future.

The bases for this dramatic advance are the digital memory and the mathematical logic circuit, applied by the electronic systems engineer to the problems of both management and manufacturing. In the production tasks of industry, the new systems provide the means for preprogramming and actuating machine operations in any desired number and order. With the added feature of electronic communications, such systems permit the automatic control from a central location of widely dispersed production facilities.

Applied to the manufacturing phases of the business, these modern techniques offer the early

prospect of gains in efficiency and operating reliability, leading in turn to higher profits and returns on investment. Over the longer range, their importance is even greater in forging a vital link in the ultimate automated and integrated enterprise.

Even now, the parallel introduction of management data-processing systems is starting to revolutionize many of the methods of management itself in planning and controlling the operations of the business. The simultaneous growth of automated production techniques by industrial-control computers opens a channel through which both management and production systems will soon interact on a growing scale to provide an ever-greater degree of comprehension, sensitivity and speed in management's control of the enterprise.

ELMER W. ENGSTROM

*Senior executive vice-president
Radio Corporation of America*

Early core units had to be temperature-controlled within ± 10 F. Most present units operate from 0 to 40 C and some operate from -20 C and even -55 C to 100 C. Mean error-free operating times in excess of 1,000 hours are commonly obtained with 0.5-percent maintenance time.

Improved magnetic coatings and dispersions have permitted the design of drums and disks with information packed at high densities; parallel developments in head design have reduced the head gap and increased recording efficiency, thus making high-density recording even more achievable. Some recording heads use beaten gold to shim the two halves of the recording head apart. Heads also are commonly floated on the airstream that forms on the surface of the drum, keeping 0.0005-in. displacement to maintain a sharp and unspread signal.

Most high-speed tape drives use long free-floating loops whose length is sensed in vacuum chambers to servo the reel motors for feed and takeup; mass of tape actually engaged by the capstan is of the order of a few grams. Instead of using friction or pinch-roller drives, many tape units today gently clutch the tape to the capstan pneumatically. Most heads make contact with the tape during recording only slightly if at all.

The volumetric inefficiency of drums for bulk storage of data has led to the development of several tape-loop devices. A data file produced by Burroughs several years ago used a tubful of continuous loops of tape. Ampex is working on a tape-file system. Royal Precision now markets, with its RPC 9000 system, a tape-storage unit using a continuous loop of 35-mm tape in a removable cartridge; on each cartridge can be stored 10,000 blocks of 96 alphanumeric characters

each. The cartridges are considered as permanent files. During operation, the tape passes continuously through a reading station at 120 ips. Records can be searched for content in accordance with 8 or 16 keys entered into the 9000 prior to search.

Laboratory for Electronics has developed a random-access storage and display system using multiple (up to 33) high-density magnetic file drums with 300 tracks on each drum, a symbol generator which can form numbers, letters, map symbols or other abstract shapes, and a viewing unit with a 21-in. television-type storage-tube display. The drums can store 1.7 million alphanumeric characters. A complete display contains a maximum 12,800 characters (100 lines of 128 characters), can also be a map or drawing with amplifying data, either fixed or variable. The storage-display subsystem is designated RD-900; one has been delivered to Army's Corps of Engineers. Drum read-write rate is 20,000 characters a second. About two seconds are required to interrogate the drum.

Disk files, introduced as computer storage systems with IBM's Rmac, are now commercially produced by Bryant Chucking Grinder and Telex Inc., among other suppliers. Access time of the Telex disk is 150 milliseconds. Read-record heads are mounted in opposed pairs on a two-prong positioning arm, with one pair serving the upper side of a disk and the other the underside. Positioning arms are driven by a motor; track-locating dimensional references are built into the fields of the motors. Heads are held to the disk by air at 10 psi pumped through the arm, float 0.0005 in. from the disk. Each disk has its own recording arms. The disks are 31 in. in diameter with a 10-in. center

hole. Recording is serial by bit at 400 bits per linear inch average; recording on the outer tracks is at 500 Kc, on the inner, 250 Kc; 64 disks can store 617.6 million bits, or about 100 million alphanumeric characters.

Laboratory for Electronics has developed a disk file which uses a flexible Mylar disk rotated close to a smooth backplate into which the read-record heads are set flush. When the disk is at rest, it falls away from the backplate; in motion, it is flattened to conform to the backplate at a small distance introduced by the airstream. The unit can store 40,000 bits at 1,024 per track, at a typical bit rate of 140 Kc; highest bit rate is 400 Kc.

Refinements of drum storage techniques now employ the moving-head principle borrowed from the disk concept. Remington Rand's Randex file, for example, uses one mobile head unit with two heads on it to read from two drums. The drums are parallel with each other, and the head unit darts back and forth in the valley between them tangent to both. Gross and fine lateral positioning devices operate simultaneously to slide the head unit into place. Average access to randomly chosen data in the 24-million-digit file is 375 milliseconds; serial access to successive 48-word (480-digit) records is 35 milliseconds.

INPUT-OUTPUT SYSTEMS—Data-processing systems cannot tap the vast reservoir of useful knowledge unless procedures are set up to feed it into the system. Input-output transfer for most of today's computers is by magnetic tape; in the smaller systems paper-tape devices or punched-card systems are commonly used. Type-writer keyboard and adding-machine keyboard inputs are also used, in the smaller systems for data entry, in larger systems for occasional operator intervention or interrogation.

Off-line peripheral equipment such as high-speed printing systems are now common; commercially available line printers operate in the range from 500 to 1,200 lines a minute. Xerographic printers, such as the Stromberg-Haloid S-C 3000 printer, and electrostatic printers like the ones built by Burroughs for weather computation and A. B. Dick for magazine labeling, promise even greater speeds.

Input-preparation equipment to translate from cards or paper tape to magnetic tape are fairly common; devices to type directly onto magnetic tape have been around since 1952, but are not widely used outside of the Univac systems.

An important development in offline peripheral equipment has been the gradual standardization of machine languages and codes. This has made possible a class of devices to translate between machine codes, so that cards, paper tapes and magnetic tapes for specific systems can be routinely converted for input to other systems. The growing number of large corporations who use computers from more than one manufacturer has provided the pressure for this standardization.

DATA COMMUNICATIONS—Advent of powerful computer systems has increased the interest in computer-compatible data communications. Large decentralized corporations have given much thought to using a central computer facility tied by data circuits to outlying divisions.



Engineers at Philadelphia Electric receive Honeywell computer-control system that assigns power generation requirements, provides cost data on grid interchanges

The telephone and telegraph common carriers have developed moderate-speed facilities for transmitting data. Computermakers have responded by building the terminal data-handling equipment. Makers of communications equipment have produced high-speed transceiver equipment that presumes wideband transmission lines.

IBM1009 data-transmission unit is used to connect IBM1401 systems in direct memory-to-memory communications through Bell System modulating-demodulating subsets and voice-grade telephone circuits. Data flows at 150 characters a second.

Wide bandwidths permit transmission of data at computer-compatible rates and at low cost per bit; AT&T has figured out that the cost per bit decreases rapidly when wider, more expensive channels are used. Motorola and Collins Radio are among communications companies that have built data-transmission multiplex equipment. Motorola equipment can handle 62,000 characters a second—the nominal data-transfer rate of an IBM7090 tape unit—on a single wideband carrier. Another Motorola system uses parallel transfer on several sub-carriers; systems in use can handle 15,000 characters a second.

One Collins Kineplex system transmits 300 characters a second from one magnetic-tape or punched-card unit to another many hundreds of miles away over commercial telephone lines. Another will be used by Westinghouse to keep its IBM7090 busy in Pittsburgh with work from a Philadelphia division. Kineplex transmits 2 bits per tone on a four-tone scale, effectively an 8-bit parallel transfer. Overall speed is thus 2,400 bits per second on voice-grade telephone lines.

Telautograph Corp. installed an interrogation system using teletypewriter lines to 20 remote locations from an IBM Ramac computer installed at Lockheed's big plant on the West Coast. Avco/Crosley's Comex system handles transfers between paper-tape units of Westinghouse's computer network at Mansfield, O., and Springfield, Mass. Data is read at 75 bits per second into a magnetic-tape recorder in the Comex unit; transmission is over high-grade lines at 750 bits per second.



Automatic wire-wrap machine used at Honeywell's computer plant cuts, positions and connects a wire every six seconds. Device is punched-card controlled

Stromberg-Carlson has developed a data transceiver, the solid-state S-C 301, which passes 2,400 bits per second over teletypewriter lines on a modulated subcarrier. The transceiver stores up data on a magnetic tape prior to transmission, can convert card-punched data to tape format as a routine process.

Teletypewriter and voice-grade telephone lines are commonly used for data-transfers among subsystems of airline and hotel reservation systems, and savings-bank bookkeeping systems, which use centrally located drum storage and computing facilities and remote subsets for interrogating the central facility. Most such remote subsystems have an upper speed limit of 1,000 or so bits per second, well within the capabilities of teletypewriter and telephone circuits.

RCA's DaSpan communications equipment likewise works within the limitations of common-carrier lines. Punched paper tape in the 7-level code recognizable by RCA's computer systems is the information medium for DaSpan; other paper-tape codes at 5, 6 and 8 levels can also be recognized by DaSpan auxiliaries.

Minneapolis-Honeywell has developed data-communication units which pass 150 characters a second. Equipment now being developed will operate over microwave links at speeds closer to the internal processing speeds of the Honeywell 800 and 400 computer systems, will work as on-line auxiliaries, automatically verifying and correcting transmission errors with Orthotronic control.

Western Union's data-transmission system, being developed to handle the equivalent of 100 million words daily for USAF's portion of Comlognet (combat logistics network), uses speeds ranging from 100 to 3,000 words a minute, can run at 20 times this rate if necessary. Electronics were developed by RCA.

Control Data is testing a high-speed communications link between core memory units in a CDC1604 in Minneapolis and a small CDC160 several miles away. The transmissions are running at 1.2 million bits a second through a Motorola 12-Gc broadband microwave system. CDC likes the idea of employing the desk-sized 160 as a satellite in multiple installations under control

of centrally located large-scale 1604 system.

RCA last month announced a differential diphasic transmission technique capable of sending data at 50,000 bits a second over conventional two-wire direct cable circuits. A simple crystal-controlled clock generates timing information; two-phase transmission renders the data pulses relatively immune to amplitude variations induced in the line. System was developed for Minuteman ICBM communications.

INFORMATION SYSTEMS—Although the distinctions between commercial data-processing equipment and scientific or engineering computer systems have become largely a matter of peripheral equipment, other classes of computing systems have grown. Information-retrieval systems are one kind on which much research has already been done; information processing is a further refinement now being researched. Monitor and control systems form a whole separate class now growing, perhaps more rapidly than any other group.

The computer in commercial and scientific processing, as it is presently conceived, handles batches of work at a time. On-line commercial processing is rarely undertaken. When it is—as with the simple processing of flight reservations or savings-bank accounts in some of the systems by Teleregister, IBM (American Airlines' Sabre system), and Remington Rand (which supplied the flight-reservations system used by United Air Lines)—it is usually closer to being a primitive information-retrieval problem: the account or reservation schedule is retrieved, interrogated, adjusted and returned to storage. But the nature of present-day processing is mostly batch handling of aggregate masses of information.

SYSTEM-ORIENTED COMPUTERS—Another class sees the computer as a part, albeit a central and critical part, of a physical system. Into this class fall vehicle-guidance computers, automatic navigation-intercept-bombing-attack systems, industrial process control computers and a whole host of related systems. Here the emphasis must be on reliability of operation. A commercial computer can stall on the detection of an error; a process-control computer dare not, but must quickly correct the error, eliminate its cause, and meanwhile continue to control the process to an acceptable degree.

Speed will be important in some cases, but programming flexibility and mass storage will generally not be required. System-oriented computers mostly must perform a fixed program over and over with little or no operator intervention. Most such systems now in existence satisfy the definition of a general-purpose computer (even including some of the programmable digital differential analyzers), although a wired or plugged program may substitute for more sophisticated program means. A Ferranti process-control computer, for instance, uses a pinboard to set in the plant program; it can hold up to 512 instructions, can be expanded to handle 4,096; a separate pinboard is used for setting in 128 production constants.

Such systems also require a flexible input-output system. In an industrial control job, inputs may range from digital entries on a keyboard through incremental readings from digital devices and a-c resolver data, to analog d-c voltages or other analog quantities of various orders of magnitude. Some common scale must be applied to

all these, and they must all be capable of transcription into the internal scheme of the central controller or processor. Effector outputs are less problematical, since voltages in a common order of magnitude can generally be readily translated into various effector requirements.

Many techniques for ensuring reliability have been developed. Solid-state circuits have helped substantially. In 1956, an 85-percent figure of computer useful time was about par for a system in use 168 hours a week; recently Packard-Bell's PB250 ran 1,250 hours—just about seven weeks—without interruption or error, was still going strong when the word went out. The PB250 also can operate during a power failure: a drop in line voltage below operating level connects a built-in battery on which the computer can operate until power is restored.

The Verdan computer, built by Autonetics for airborne use (as a bomb-nav computer or flight controller) contains a special circuit to protect the program against information loss on power failure. When line or operating voltages fluctuate beyond a safe limit, the contents of all control flip-flops are read off into the magnetic-disk memory and stored until power comes back up; at that time the flip-flops are restored and the computer picks up where it left off.

INDUSTRIAL CONTROLS—Interest in the problems of industrial control is growing all over the industry. Computers are now used to direct and monitor petrochemical processes; computer-based techniques are increasingly used for design and manufacture of machine tools; the continuous-process industries, from cement-making to power generation, have evinced great interest in computers.

The Los Angeles division of North American Aviation, for example, uses eight automatic metal-cutting machines run by computer-produced magnetic tape to



Western Electric computer to be used on Ascension Island for missile and antisubmarine work was itself built entirely from information furnished by another computer

make parts for the B-70 bomber. An RW-300 has been installed to run a Texaco refinery in Port Arthur, Tex. A GE system employing 1,100 inputs was designed to control a steam-generating plant for Southern California Edison. Another GE system was set up to run a hot-strip mill for Jones & Laughlin.

Computers have been considered for startup and shutdown controls and system monitoring in power-generating plants; for scheduling and fuel flow in open-hearth furnaces and control of furnace-charging in Bessemer blast furnaces. Other systems handle pipeline scheduling and dispatching. A Librascope computer is used by Public Service of Colorado for natural-gas dispatching.

Many manufacturers are going ahead with design work and setting up experimental installations. Thompson-Ramo-Wooldridge and Packard-Bell are in this area. Minneapolis-Honeywell's horizontal corporate organization and natural orientation to controls thrusts it into the business. IBM is beginning to move in the direction of controls. RCA and Philco have set up joint ventures with controls companies, the former with Foxboro and the latter with Leeds & Northrup. Remington Rand Univac has adapted some of the technology that went into its work on the AN/USQ-20, the submarine-transportable computer in the Naval Tactical Data System, and is making a computer adapted to realtime control work, the Univac 490. The General Precision complex can tap both computer capabilities (Royal Precision, and more recently General Precision Laboratories) and control capabilities (Librascope and Kearfott), and last month signed a cross-licensing agreement with German controls manufacturer Schoppe & Faeser. General Electric recently formed an industrial controls organization at its Phoenix, Ariz., computer division.

ANALOG-DIGITAL INTERPLAY—Emphasis on industrial controls has produced an interesting interplay between analog and digital techniques. Most processes can be represented in analog form, while general-purpose computers can most easily be made with digital techniques. The interface between the two is now gradually being broached.

Instrumentation recording and data-acquisition systems are being made which work into analog sensors at one end and digital systems at the other. The analog computer itself—with its own independent line of development, and a market which last year ran about \$30-million—is now considered as an integral part of some types of digital system. Techniques for quickly recognizing and developing the digital equivalents of analog signals are receiving greater attention.

And in the analog-computer field, some of the techniques of the digital computer are being employed. Where the memory function has been highly developed in digital computers, it has traditionally remained in a fairly primitive stage in analog systems. But some analog computers now are being made with memories. Computer Systems Inc., of Monmouth Junction, N. J., makes a Dystac computer which can perform high-speed repetitive operations at frequencies up to 2,000 cps and store intermediate results; it can also time-share its circuits.

It is inevitable that the two technologies shall merge and flow into each other more and more. What were once separate lines of development—communications, computers and controls—have become a related family.

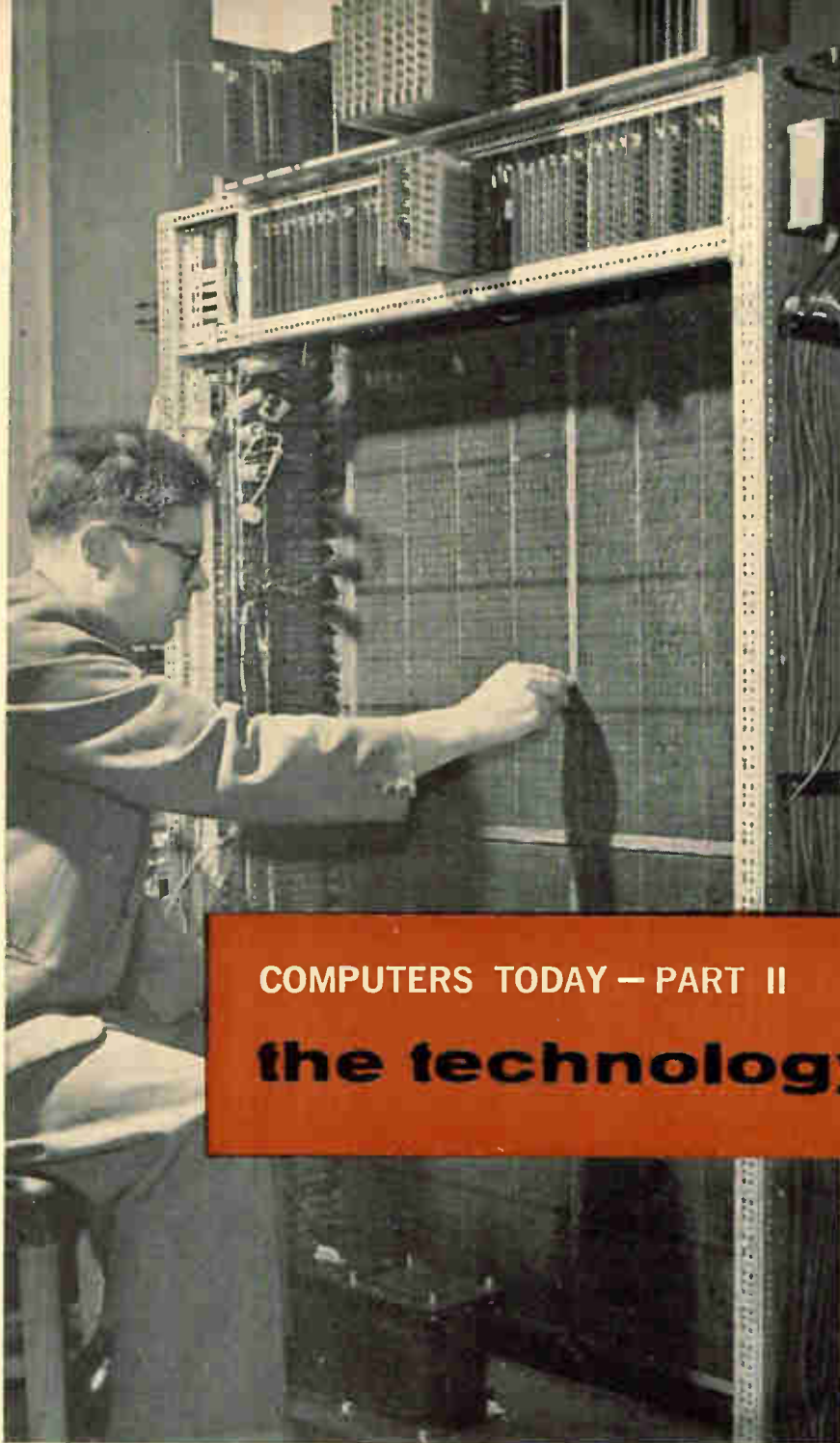

Rods of magnetic material inserted in this wire mesh permanently store binary ONEs. Magnetic-rod fixed memory in Manchester-Fer-ranti Atlas stores constants, special routines

COMPUTERS TODAY — PART II

the technology today

DIGITAL COMPUTER CIRCUITS divide into several categories, some classes of which are unique to the computer technology. Amplifiers are included in computers wherever their function is required.

The logical and arithmetic functions of a computer are fulfilled by other circuits, generically referred to as buffers and gates, but more specifically classified by their functions. A gate circuit which passes a signal when one or more other signals are present is called an AND circuit. One that passes a signal when and only when its control inputs are absent is called a NOT circuit, or sometimes a NAND (not AND) circuit. A circuit that will produce an output when any of its several inputs is present is called an OR circuit. There are sixteen different

kinds of Boolean functions possible with two input signals, of which OR, AND, exclusive-OR, NOT and NOR are probably the most important in computer circuits.

Patently, these considerations approach the circuit by considering the input in a certain sense; in some computers, the sense of a signal is positive, in many, negative. Thus an AND gate to negative-going signals, producing a negative-going signal only when all inputs are present, is an OR circuit to positive signals; any positive-going signal will remove a negative output, or to look at it conversely, will cause a positive output.

Systems designers have generally attempted to keep all logic circuits in a computing system operating from the same phenomena (all gears, all relays, all vacuum

tubes, all gas tubes, all diodes, all transistors, all magnetic circuits), since signals from one element do not then need to be logically interpreted to another. Elements producing at least enough gain to drive two or three other elements have been most fruitfully employed. Where elements that do not produce gain have been used—semiconductor diodes, for example—they have required amplifiers periodically to reshape the pulses to workable levels.

Within the framework of phenomena requiring a minimum of reshaping and amplifying circuits, designers have attempted to use phenomena that could be transmitted from input to memory to computer logic to memory to output with minimum translation. Thus magnetic tape became an early favorite for electronic computers because of its electromagnetic character and consequent compatibility with electron devices. A relay calculator works more compatibly from punched cards. Use of ferrite-core memories has led to a substantial

amount of research in magnetic elements for logic and computing that might provide adequate gain.

Reliability has also been a vital criterion in design, as it must be in a system employing so many thousands of components as a computer. So has speed. The high speeds in today's computers rely on the parallel operation of many reliable components. Parallel mode of operation would not be a manageable feature of commercially competitive systems without the reduction in size made possible by reliable transistors.

Work on the analysis of phenomena to determine their capability of realizing logic requirements efficiently is now being done, at Stanford Research Institute particularly. This analytical research is especially important in the development of extremely small components and circuits and the design of devices with multiple functions.

LOGIC CIRCUITS—Original electronic computing devices used Eccles-Jordan trigger circuits in metastable

TRENDS IN COMPONENT RESEARCH

Since the first solid-state computers began to be produced about seven years ago, component research has been practically synonymous with solid-state science. This technology has resulted in greatly increased speed, packing density, and reliability of computer components, and has provided the computer user with greater performance per dollar. The trends in component research today are aimed at the goals of higher speed and lower cost. Usually a balance must be struck between these criteria to satisfy the particular purpose of the system in question.

The well-proved magnetic core is still the basic element of most computer memories; modern systems are capable of million-bit storage, and cycle times of a few microseconds. Refinements are being pushed both in the configuration of this device, such as smaller dimensions and change of shape (e.g., multi-aperture plate), and in the ferrite materials involved (e.g., change of shape of hysteresis loop). Such developments will probably keep magnetic devices in production for the next five years.

There are three newer technologies which are presently being investigated by the industry for memory applications: magnetic thin films, cryogenic devices, and tunnel diodes. The possibility of evaporating arrays of either magnetic or cryogenic thin films will be conducive to the formation of very large memories at reasonable cost. For example, IBM has fabricated a cryogenic memory plane consisting of 135 cryotrons in the area of a postage stamp, and has developed automatic techniques to control the process. Present investigations on the switching behavior of magnetic films

show that 100-nanosecond cycle times will probably be attainable and that this technology is amenable to nondestructive readout. A number of laboratories are attempting to attain uniformity of magnetic characteristics in thin films. Tunnel diodes show promise for relatively small (about 1,000 words), very fast (less than 100 nanoseconds) memories.

Semiconductor devices have been, and are continuing to be, thoroughly investigated to improve their application in logic functions. The basic phenomena and device limitations of transistor action are now well understood, and attention is being focused on other physical effects, such as tunneling, and on fabrication techniques.

At the present time, circuit designers working with transistors seem to be facing a switching-speed barrier in the region of 1 to 10 nanoseconds. The tunnel diode, although a two-terminal device, has a very high gain-bandwidth product (10^{10} cps or higher), which may permit faster switching.

Considerable effort is being spent on devising new methods of fabricating semiconductor devices. The handling of semiconductor materials themselves is being scrutinized in many laboratories with goals of better control of dopant concentrations and gradients, and ultimately of fabricating complex integrated devices. One new technique that looks very promising in this regard is vapor growth; IBM scientists have used this process to produce a variety of epitaxial structures and devices, including tunnel diodes. It is hoped that such methods may be used to produce functional circuit building blocks for future computers.

EMANUEL R. PIORE

*Vice-president, research & engineering
International Business Machines Corp.*

and bistable configurations for storage, to provide gating signals, and, in conjunction with blocking oscillators and differentiators, to produce pulses. One researcher compiled some 30 variations on the basic Eccles-Jordan circuit that were used by some 50 organizations. Logical AND and OR functions were performed in multigrid tubes, diodes, and in some cases by combinations of passive components.

DIODE LOGIC—Diodes—thermionic and semiconductor—have proved flexible for realizing various logical schemes. The circuit in Fig. 1 buffers two pairs of signals together into a gate. If either *A* or *B* appears at the input terminals, D_1 or D_2 will conduct and a negative pulse will appear across R_5 . Similarly, *C* or $D will cause a negative-going signal to appear across R_6 . If the resistors R_1 through R_4 are substantially larger than the output impedance of the preceding stages, the output amplitude will be nearly the same as the input.$

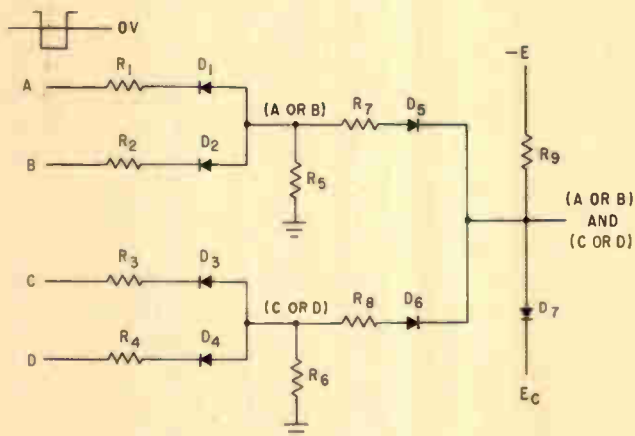

FIG. 1—Diode level logic; two OR circuits provide input to one AND circuit

Diodes D_5 and D_6 form an AND circuit, or gate. Normally the two diodes conduct because of the negative potential $-E$ applied to both cathodes. The value of E_c is set so that the currents through the diodes are larger than the current through R_5 , and D_7 establishes the level at which the output is clamped in the quiescent state. If a negative signal appears at either D_5 or D_6 , it back-biases the diode and cuts it off; but since the other diode continues conducting, the output remains clamped at E_0 .

If both diodes receive an input and are cut off, then D_7 will also be cut off and a negative pulse of amplitude $-E$ will develop at the output. The current-carrying capacity of D_7 effectively limits the number of inputs that can fan into the gate.

The circuit in Fig. 1 is simplified. In practice, upper and lower clamps are applied to signal lines to maintain pulse levels, and balancing networks are frequently added. The logic and storage circuits of the Bureau of Stand-

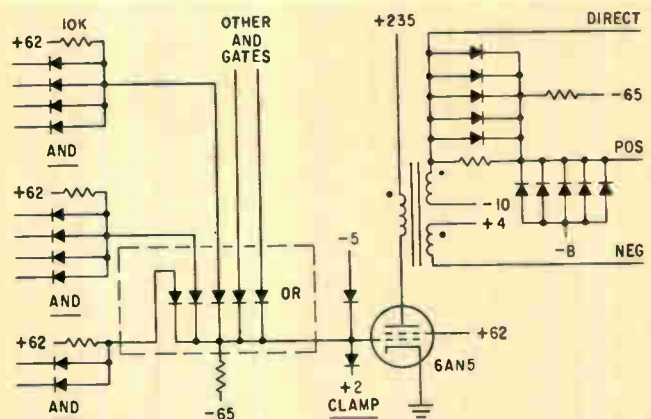

FIG. 2—Logic circuits of SEAC. The reshaping amplifier has clamped input, complementary outputs

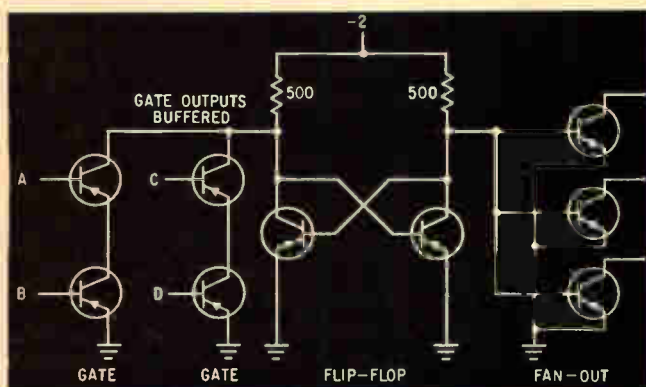

FIG. 3—Direct-coupled transistor logic. NOR gates share a common buffered output line to trigger the flip-flop

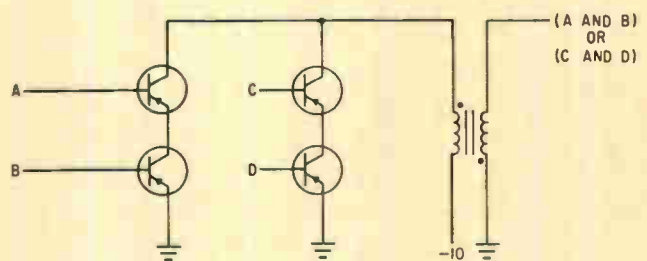
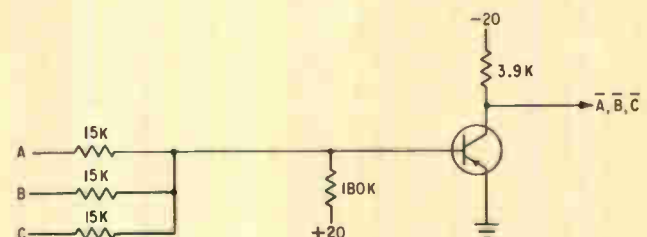

FIG. 4—Transformer-coupled output from DCTL input permits inversion flexibility

FIG. 5—Resistor-transistor NOR circuit can take up to nine inputs, fan out up to seven outputs



ards' eastern automatic computer (SEAC) illustrate some of the refinements (Fig. 2). Similar circuits have been developed using all solid-state components.

TRANSISTORS—Solid-state technology resulted in many new logic circuits. The junction transistor is capable of replacing triode logic elements, and in many cases has permitted combination of logic and amplifying or inverting functions in a single circuit. In logic circuits, transistors have been used in several coupling configurations: through inductive or capacitive elements, through diodes, by resistive connection only, and in direct coupling.

Direct-coupled transistor logic is fast, uses a low power level (about 2 v) and a large population of identical components: usually one type of transistor and one type of resistor. Collector outputs are directly coupled to base inputs, and level-changing networks are unnecessary. Two- and three-input AND circuits can be constructed by stacking transistors in series.

The DCTL circuit in Fig. 3—two gates buffered into a flip-flop and fanned out into three output lines—represents the type of circuit in the Philco 2000, Larc, Stretch and some other extremely fast systems. In this circuit, the input pulses are presumed negative going, are about 200 mv in amplitude. Current division in the fan-out circuit requires that the emitter-base diode characteristics of the output units be carefully matched. Stacked AND gates must be limited to two or three inputs because the voltages add, and the product of the saturation voltage (about 50 mv) times the number of inputs to the AND gate must be below the base threshold.

Hybrid circuits using stacked AND inputs and transformer coupling have been developed; a circuit is shown in Fig. 4. The pulse transformer is used for impedance matching and to permit sense inversion. Coincidence of inputs to the AND circuits is critical.

RESISTOR COUPLING—Direct-coupled transistor logic places some fairly severe restrictions on the components. Resistor-transistor circuits use fewer transistors and at a less demanding level of excellence; power levels are higher however, and the circuits are not generally as fast as DCTL circuits.

The resistor-transistor NOR circuit shown in Fig. 5 can take as many as nine inputs, although each additional negative-going input signal drives the transistor deeper into saturation. The extreme negative swing of the input signal is usually set at about -15 v signifying a ONE. Binary ZERO is 0 v. The positive potential on the 180,000-ohm resistor ensures that the transistor will be turned off when the inputs go to 0 v. Two of these NOR circuits may be formed into a loop to function as a flip-flop.

A diode OR circuit and an R - C coupled inverter can be used to perform NOR functions with a low impedance to ground corresponding to a ONE and a high impedance corresponding to ZERO. In this circuit, shown in Fig. 6A, current through the 1,000-ohm resistor supplies the transistor base if none of the input diodes is grounded through an input signal. The 27,000-ohm resistor to +6 v turns the transistor off. The 56-pf capacitor provides transient overdrive.

To avoid saturating the transistor in this circuit, the combination of the 56-pf capacitor and 4,000-ohm

resistor can be replaced by the biasing diodes D_3 , D_2 , and D_1 in Fig. 6B, with a feedback diode D_4 to clamp the collector to the bias voltage (about a volt) produced by D_3 and D_2 . The collector-base equivalent diode is then effectively backbiased. Diode D_1 is an additional bias circuit to ensure that any -1 v signal on an input diode will turn off the transistor. For higher voltage drops, the biasing diodes are silicon units.

Emitter-follower OR circuits are widely used in direct-coupled logic for isolation and to drive multiple outputs. The circuits require separate inverter and level-regeneration circuits.

DIODE-TRANSISTOR LOGIC—Transistors and diodes form a bistable device in the circuit in Fig. 7. This Bell Labs circuit uses a transistor with current gain of more than unity; R_1 is the feedback path for bistable operation. Diode level logic buffers the input signals in.

Symmetrical circuits (with respect to the voltage supply) can be made using n pn and p np transistors together, as shown in Fig. 8. The flip-flop in the drawing will have two transistors conducting in the ONE state (negative output at point 2), and two nonconducting in the ZERO state. Each transistor amplifier inverts the sense of the input signal, but this is not interpreted as logical inversion when complementary pairs drive each other.

Researchers estimate that a one-tenth-microsecond gate can be built with hybrid diode-transistor logic at less than a fifth the cost of an equivalent DCTL circuit; the hybrid circuit can also operate substantially faster. Diode-transistor circuits were disclosed by Burroughs in 1958; the Lincoln Lab CG-24 computer, used with the Millstone and Haystack radars, uses this type of logic circuit.

DIODE CURRENT SWITCHING—Diode fan-in circuits have been used with emitter-followers and current-switching circuits in relatively recent fast circuits with delays under 5 nanoseconds. Besides being cheap and fast, these circuits permit high component packing density.

Current-switching circuits have an advantage at high speeds because they operate away from the saturation level, with high sensitivity to small signal levels, fast rise and fall times, and either direct or inverted outputs. Use of diodes to fan in to current-switching circuits eliminates an extra transistor normally required for each logical input, but requires a high-current driver such as an emitter-follower as an output to drive other diodes. Thus one transistor on the output eliminates several on the input.

The circuit in Fig. 9 has a negative AND followed by a negative OR driving a current-switching amplifier and inverter into complementary emitter-followers. The delay across the emitter-followers and diodes is about 2 nanoseconds. Zener diodes are used in the current-switching circuits as class A d-c translators to eliminate the problem of different d-c levels at input and output. The current-switching circuit can be eliminated and the diode stages coupled to the emitter-followers, if inversion is not required and the signal level and shape are well preserved at the diode outputs.

FOUR-TERMINAL SWITCHING TRANSISTOR—Fairly fast switching times—of the order of 100 nanoseconds—have been obtained using four-terminal

germanium *pnpn* switching transistors. The device is switched on with a negative signal and off with a positive signal, and maintains state in the absence of the appropriate signal.

In the circuit in Fig. 10A, a voltage biases both emitter junctions forward and the central collector junction backward. A load resistor is connected to the *p*-type base-collector and a much larger feedback resistor to the *n*-type emitter. The equivalent two-transistor circuit, Fig. 10B, is a regenerative circuit with the *npn* section as a grounded-base amplifier and the *pnp* section as an emitter follower. A negative signal to the *n*-base will turn the circuit on and drive both sections to saturation if the current amplification of the *pnp* section is high enough and the feedback resistance not too large. The switch then stays on with the signal removed. A positive signal will withdraw some of the current to the *n*-base; if the feedback resistance is large enough, the holding current through the feedback resistance will be small compared to the load current and a small input will cut the transistor off. Switching gain is available in both directions. Load resistance of about 1,000 ohms and feedback resistance between 50,000 and 100,000 ohms have been successfully employed; a load current of 20 ma at 20-v supply was switched on and off with 5-v, 2-ma pulses in 60 nano-seconds—a delay of 20 nsec and rise time of 40 nsec. Switchoff time totaled 120 nsec.

CORE-DIODE LOGIC—The use of ferrites in memory systems sparked a number of research projects in logic schemes using cores for logic functions. Many of these schemes use cores in combination with semiconductor elements.

Two general classes of core-diode logic elements have grown, one from a half-wave amplifier disclosed by R. A. Ramey in 1953, and another from a magnetic shift register discussed by A. Wang and W. D. Woo in 1950.

The basic core shift circuit, shown in Fig. 11A, places a transmitting core S_T and a receiving core S_R in series with a signal source. A fixed amount of volt-seconds tends to drive the transmitter to the ZERO state and the receiver to the ONE state (the receiver is assumed to be at ZERO). If the transmitter is at ZERO, it cannot switch, but presents a small impedance in the loop so that almost all the voltage is applied to the receiver, which is switched to ONE. If the transmitter is at ONE, both cores tend to switch, but the turns ratios are such that the loop current required to switch the transmitter is below the receiver threshold; the applied volt-seconds are absorbed in resetting the transmitter core, and the receiver cannot be set. At the termination of the transfer, the complement of the transmitter quantity is in the receiver core, and the transmitter is at ZERO.

Loops must be open-circuited when adjacent loops are switching; sine sources in alternating phases, as shown in Fig. 11B, are used to accomplish this. A diode placed in the loop ensures that no reverse current flows. Fig. 11B is the Ramey series transfer circuit. Figure 12 shows an adaptation of the Ramey circuit as used by Librascope. Fan-in and fan-out are accomplished by diode logic; the circuit is a positive-signal transfer element operating from a three-clock source so as not to require inverting devices for general logic. The receiver

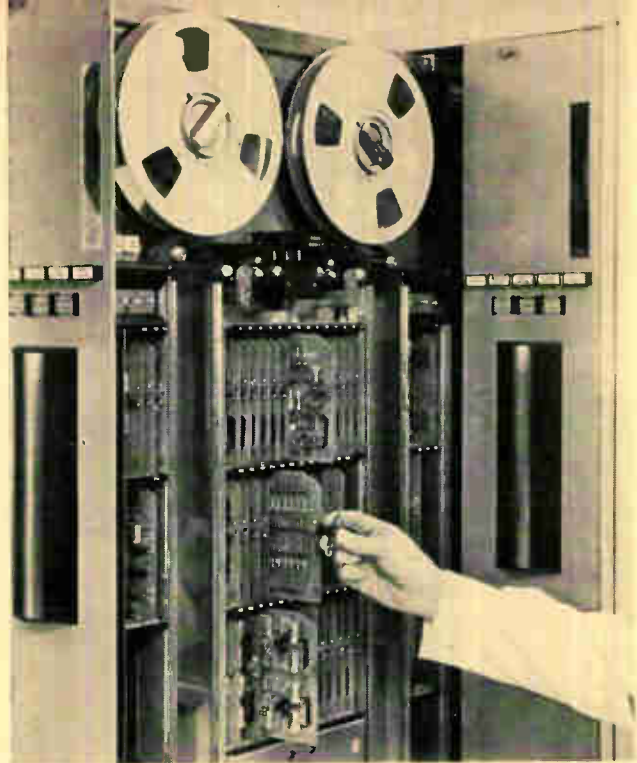

Etched-circuit cards of epoxy-glass in this Army Fielddata tape transport built by Ampex are typical of computers today. Solid state technology has meant more reliable computers

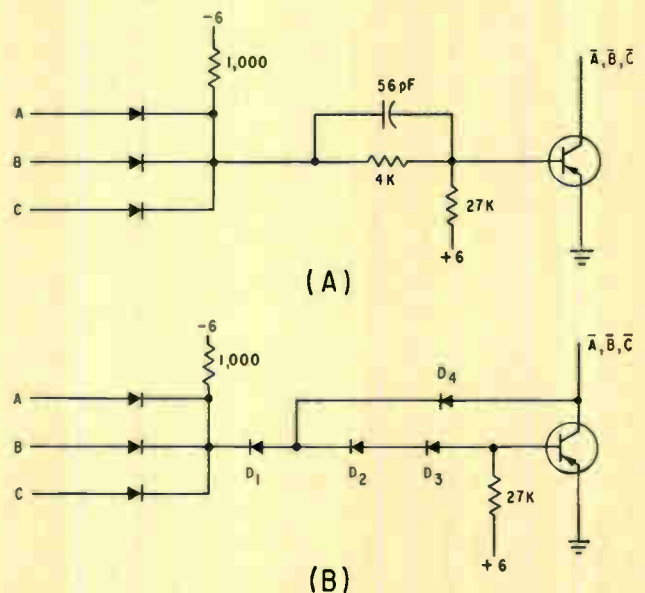

FIG. 6—(A) Direct-coupled transistor NOR circuit; (B) Clamped-diode equivalent; silicon diodes are used for high voltage drops

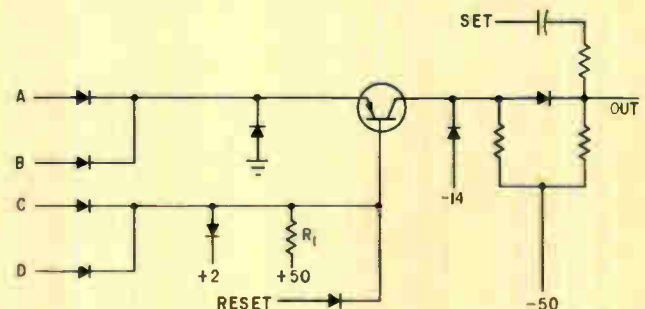
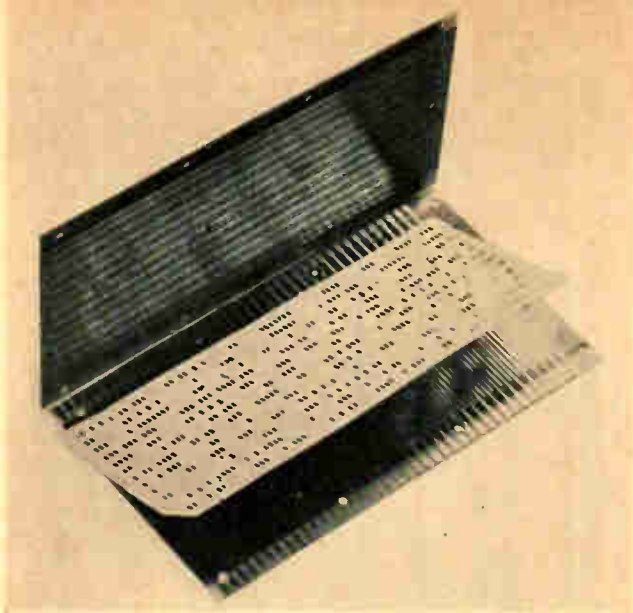

FIG. 7—Circuit from Bell Labs' Tradic using diode level logic and transistor amplifier-storage unit



Experimental IBM read-only memory senses capacitance change where holes are punched in the foil-sandwich card

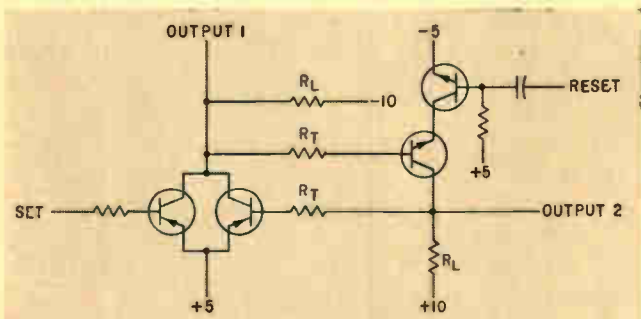

FIG. 8—Dual-range symmetrical flip-flop using npn and pnp transistors and producing simultaneous outputs

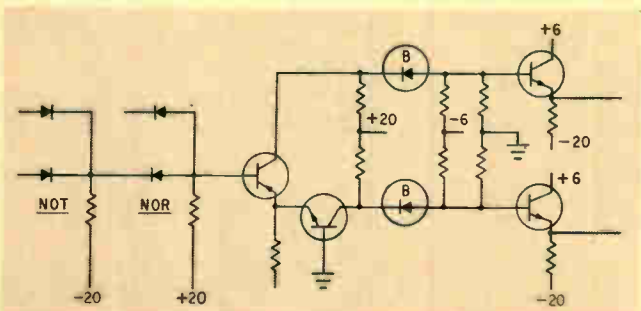

Fig. 9—Current-switching amplifier with NOT and NOR diode inputs

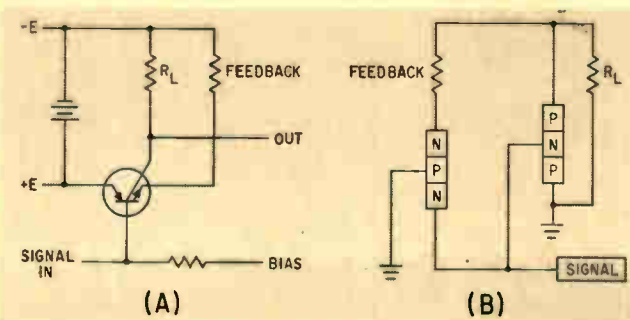

FIG. 10—(A) Elementary version of fast switching circuit using four-terminal transistor; (B) equivalent two-transistor circuit

is set to ONE only if the transmitter is at ONE; the ZERO RESET operates off a reset clock between inputs.

In the Westinghouse circuit in Fig. 13, the variable signal and its complement are provided at every gate. R_1 and D_1 clip the output current; R_2 and D_2 limit the current when switching is completed.

The Remington Rand circuit in Fig. 14 uses sine-wave current limiting and adds a ZERO bias drive E_2 which clamps the receiver core (S_2) to ZERO when the power signal E_1 is absorbed in the transmitter. Diodes D_1 and D_2 pass unwanted reverse currents.

The Burroughs circuit using split windings in Fig. 15 descends from the older Wang-Woo circuit. When the transmitter core does not switch, the equal branch resistance splits the transfer current I equally, with no effect on the receiver core; only loop currents caused by transmitter switching have any effect on the receiver core. Signals are fanned in at the cathodes of the input diodes; separate output windings are used for fan-out.

The Raytheon delay circuit in Fig. 16A adds an $R-C$ delay network in the loop. Assuming that all cores contain information, a transfer pulse will switch all cores that are ONE to ZERO, charging the next capacitor down the line. When the capacitor discharges through the resistor, the current switches the core to ONE. Fig. 16B shows a similar RCA-developed circuit in which the capacitor discharge loop is opened while the shift out pulse is applied by backbiasing diode D_A . A separate shift-in pulse permits those capacitors storing ONES to discharge through their receiver cores.

In many of these circuits, the input and output diode can be replaced by transistor emitter-followers, with resultant increase in operating margin, fan-out isolation and drive sensitivity.

OTHER CORE LOGIC SCHEMES—Combination of transistors and cores in Fig. 17 use the square-loop core as a feedback loop for a blocking oscillator. The transistor is arranged as a triggered blocking oscillator so that a minimum shift pulse produces one cycle of regeneration, yielding a parallel output pulse equal in amplitude to the supply voltage. If the core is at ZERO when the shift pulse arrives, regeneration does not take place.

The National Cash Register core-logic circuit in Fig. 18 uses a negative SET pulse to probe core S_1 for the presence of A or B and S_2 for the presence of C or D . The logic of the circuit is that either signal will inhibit the core from responding to the SET pulse; if both are absent, the core will be set to ONE. Positive DRIVE pulse

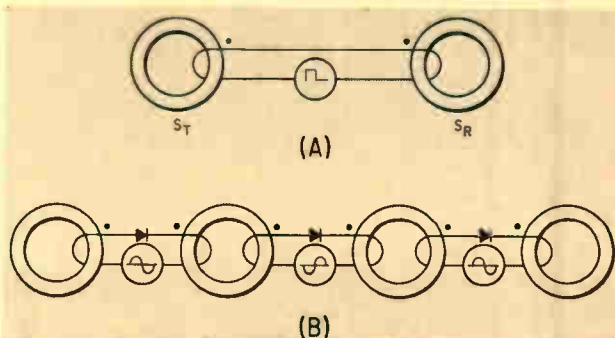

FIG. 11—(A) Basic series transfer loop using cores; (B) Ramey's circuit using alternating sine phases for shifting

will tend to restore both cores to ZERO; if either core had been set, its restoring will set the next flip-flop. Through the use of inhibit logic, in which the flip-flop outputs do not need to supply a switching current to the core, a large number of gates can be controlled by a single flip-flop.

In the Bell Labs Laddic element, Fig. 19, the legs start with magnetic flux saturating in alternate directions, as shown. A set pulse flips leg 1; the flux lines will try to close through leg 2 unless signals *A* or *B* inhibit the path, in which case they will try to close through leg 4. If that leg is also inhibited (by *C* or *D*) only leg 6 will be left for a return flux path (legs 3 and 5 are already saturated).

A reset pulse would restore all legs; if the flux had closed through 4, flip-flop *FF*₁ would be set, meaning *A* or *B* was present but neither *C* nor *D*; if *FF*₁ received a set input, meaning that flux had closed through leg 6, it would mean *A* or *B* and *C* or *D* had been present.

A flux logic element developed by IBM, shown in Fig. 20, can be used as a half-adder. When reset, 1, 2 and 3 are parallel flux paths one way and legs 4, 5 and 6 are parallel the other. Since flux will tend to switch around the shortest possible path, an input on one or more lines will switch leg 4; on two or more, leg 5, and on all three, leg 6. When the reset pulse comes in, windings threading the output legs will sense the resetting of legs that switched; 4 or 6, but not 5, will produce a sum; 5 will produce a carry.

TRANSFORMER LOGIC—IBM has suggested using transformers—among the most reliable of components—to increase the potency of transistor circuits. The circuits make use of the fact that transformers can not only serve as output coupling devices from flip-flops to transistor pulse circuits, but also perform logical functions.

The gate circuit in Fig. 21 uses a linear pulse transformer to apply a flip-flop output to a pulse circuit. With the emitter of the gate at -9.5 v, an output level of 9.5 v from the flip-flop results in a gate supply of zero; a flip-flop level of zero volts conditions the transformer gate to pass the pulse input. The circuit is designed to fan out onto four lines. Standard pulse input is less than 50 nanoseconds; minimum and maximum levels are 2.2 v and 4.0 v. Circuit can be operated at 6 Mc, and has a

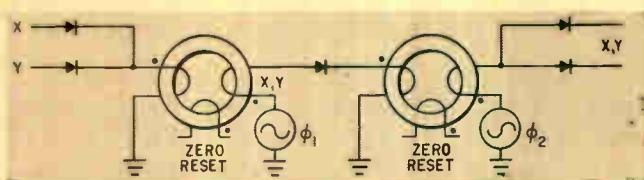

FIG. 12—Positive transfer in core-diode circuit by Librascope

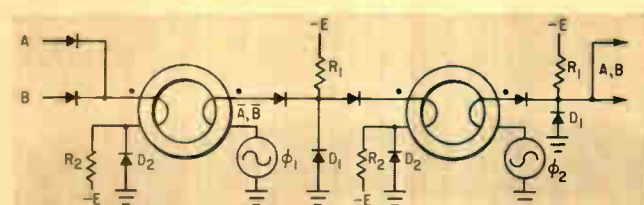

FIG. 13—Inverting circuit used in Westinghouse Cypak provides input variable or its complement

delay of from 11 to 22 nanoseconds.

Base network on the pulse input gives a noise rejection of 1.2 volts; the regenerative feedback transformer increases the sharpness of the transfer characteristic.

The double gate in Fig. 22 uses a second transformer with intervening diodes for isolation. Only one transistor is required. The transformers pass the input pulse on opposite senses of the flip-flop setting.

The register gate in Fig. 23 uses only one transistor for the equivalent of six gates or three double gates. Six transformers are required with diode isolators. The register gate can drive only one unit of load.

Register gates can be used in association with transformer networks for decoding, shifting and so forth. A 10-input diode OR fan-in can be used with these gates. Diode AND fan-ins can be included in the base networks of the transistor in any of these circuits; an AND input at a more negative potential than the emitter backbiases the emitter-base equivalent diode of the pulse circuit and prevents an output.

PHASE-LOCKED OSCILLATORS—Aside from the parametron, the phase-locked oscillator, well described as it has been in the literature, has not been widely adopted in computer systems. The consensus gleaned by *ELECTRONICS* is that these circuits will probably not be widely used until the advent of microwave computers.

The PLO circuit requires a nonlinear reactive element whose reactance varies at some frequency f' which is an even multiple of the characteristic or operating frequency f of the tank circuit of which it is a part. The frequency f' is usually set at $2f$ and is referred to as the pump or pumping frequency.

When the correct relationship exists between f and f' , the tank presents an effective negative resistance at its characteristic frequency f . The nonlinear element will oscillate parametrically at its frequency f' with the result that it will pump the tank much as a child pumps on a swing, at twice the frequency of the swing oscillations.

PLO's are bistable in phase; the oscillations can be made to start on the upswing or downswing by majority logic (noise in the tank will determine the starting phase at the time pump power is applied in the absence of a controlling signal). Successive stages of PLO require successive overlapping applications of phase-related clock sources in order for information flow to be unilateral; three phase-displaced clock sources are normally sufficient to control information flow.

The parametron, developed by E. Goto and M. Taka-

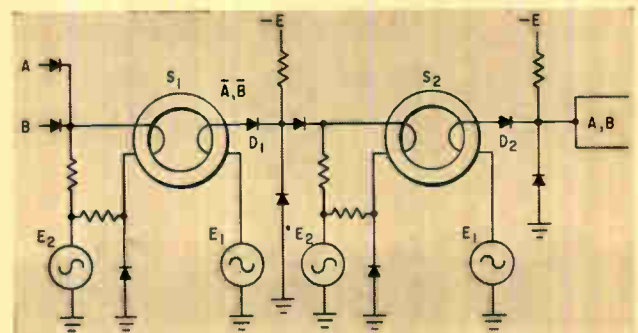

FIG. 14—Ferractor inverting circuit of the type used in the Univac SS80 and the Cambridge Research Calculator

hashi at Tokyo University, uses a nonlinear inductance as the parametric oscillator. The circuit in Fig. 24A is the basic parametron equivalent circuit employed in many Japanese computers. The device in Fig. 24B is the parametron component itself; and Fig. 24C is a suggested refinement of the button-sized parametron. The capability of the smaller unit of operating at substantially greater information rates than the tens of kilocycles now practical with the parametron have made it attractive to computer engineers in this country.

PLOs can be forced into one or another mode by a locking signal of desired phase injected into the tank. The locking signal must be able to quench previous oscillations and restart the tank in the desired place. A tank can rise to full output from no output in about 8 cycles even at $f = 4$ Gc; this can be reduced to 2 cycles if a low-level locking signal is continuously supplied to the tank.

PLOs possess a zone of ambiguity between the pump-power level adequate to cause the tank to respond and the slightly higher level at which the tank must respond; in this zone the PLO can also be jammed off. This state, plus the two possible phases of oscillation, makes it possible to employ the PLO in certain sophisticated techniques requiring tristability.

MICROWAVE CIRCUITS—RCA has demonstrated a microwave PLO subsystem that operates on a 3.7-Gc pump and uses a varactor diode as the oscillating parameter. The three-phase power source was modulated at 30 Mc, giving an interlogic interval of 11 nanoseconds. Information rate was 1.85 Gc; logical operations involved majority decisions on the three inputs. The subsystem included a three-phase ring, two majority gates, and their majority-logic drivers, for a total of seven oscillators; it occupied 0.16 cu in. of volume but required an elaborate power supply and involved high engineering design cost.

In Fig. 25, if the admittances of the diodes in the modulator arms are equal, the modulator is in effect a balanced bridge; r-f power at C will pass into the output when either A or B but not both are present. If the diode admittances are not equal, the modulator is unbalanced and the output is the OR function of A or B .

Gate circuits have been formed from hybrid stripline in rings of multiple half-wave lengths. These gates use the nonlinear response of certain diodes to open or short a quarter-wave stub, closing or opening the output line onto which the stub opens.

Similar circuits have evolved for half- and full-adders and other logical computer functions. Besides microwave diodes and plumbing (or stripline), microwave circuits require traveling-wave tubes for amplifiers or dynamic bistable elements, klystrons and microwave circulators.

NEW LOGIC TECHNIQUES—Besides the many sophistications in logical realization of information-handling through new or improved components, there have been some departures in the logical organization of computers.

Designers have expressed interest in majority-rule logic, in which any three inputs would produce only one output, determined by the state of two or more of the inputs. These systems of logic are valuable for ambiguous decisions not easily represented by YES and NO answers; they are also handy in systems that must not stall on error.

In many of today's systems, redundant circuits perform

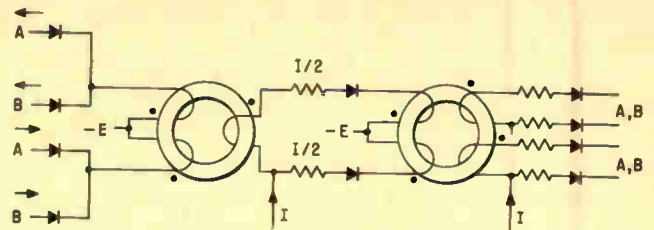

FIG. 15—Burroughs' split-winding circuit cancels out transfer current I , switching only significant bits

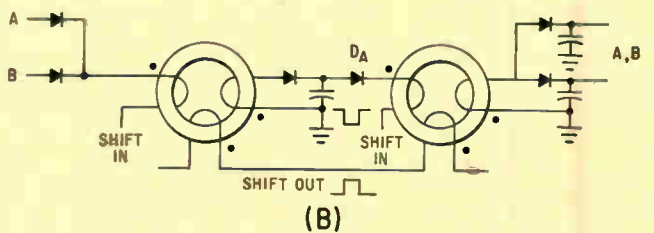
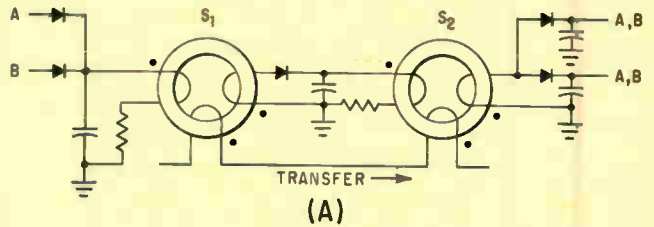

FIG. 16—(A) Raytheon delay circuit with R-C delay network; (B) similar RCA-developed circuit

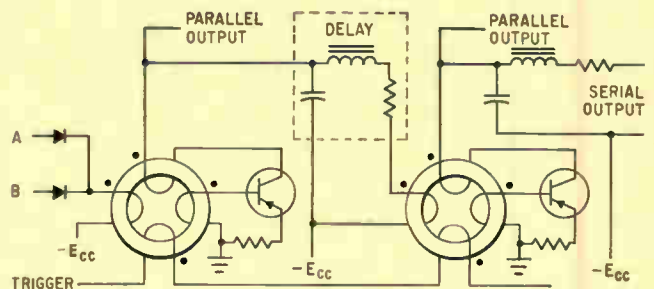

FIG. 17—Regenerative core-transistor circuit can be operated as bistable blocking oscillator

parallel operations, with one checking the other; if a discrepancy occurs, it causes the computer to stall or reject the answer. Statistically, if three circuits were performing the operation, the majority rule would be correct; the probability that two circuits would fail in exactly the same way at exactly the same time is infinitesimal except for catastrophic failure (such as power failure).

The diode-core circuit shown in Fig. 26 in exploded form is used in taking majority decisions on inputs 1, 2 and 3. W is the write-bias winding, S the reset-current winding. Reading currents are applied to terminals $-R$ and $+R$, and the output reads into load Z . The majority rule is stored in the cores when a write current is applied. When reading currents are applied, current goes through the load from A to B if the result is positive, from B to A if negative. Average power is about 250 mw at 250 Kc operating frequency.

Tunnel diodes are also peculiarly adaptable to majority-

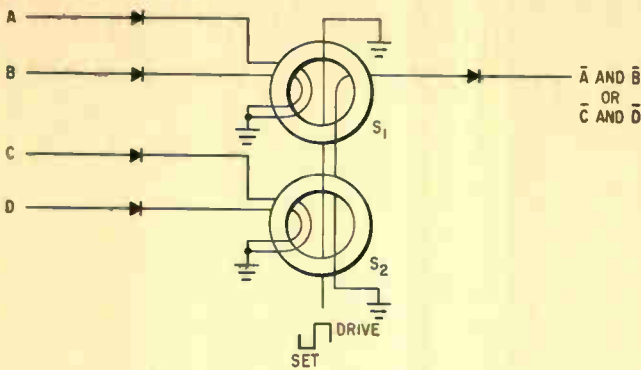

FIG. 18—Inhibit logic lessens load on signal sources in this circuit by NCR

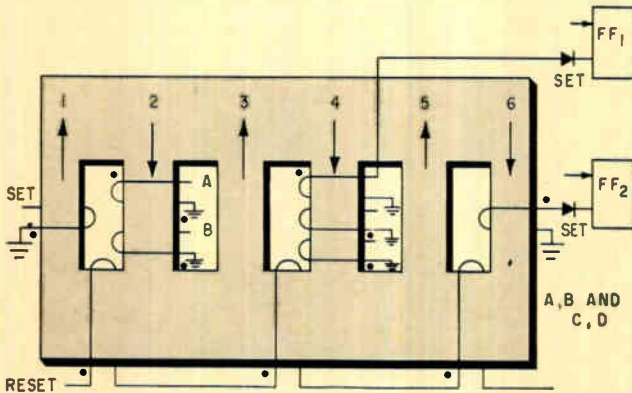

FIG. 19—Bell Labs' Laddic performs logical functions by inhibit logic

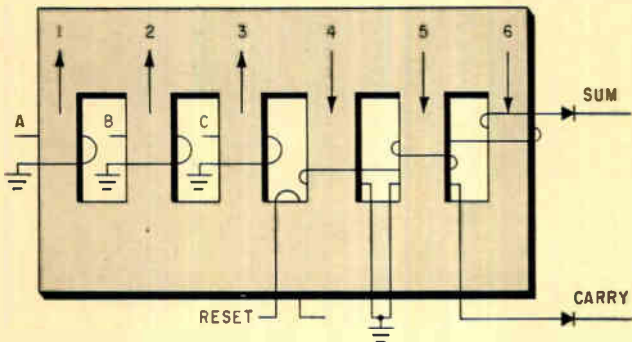
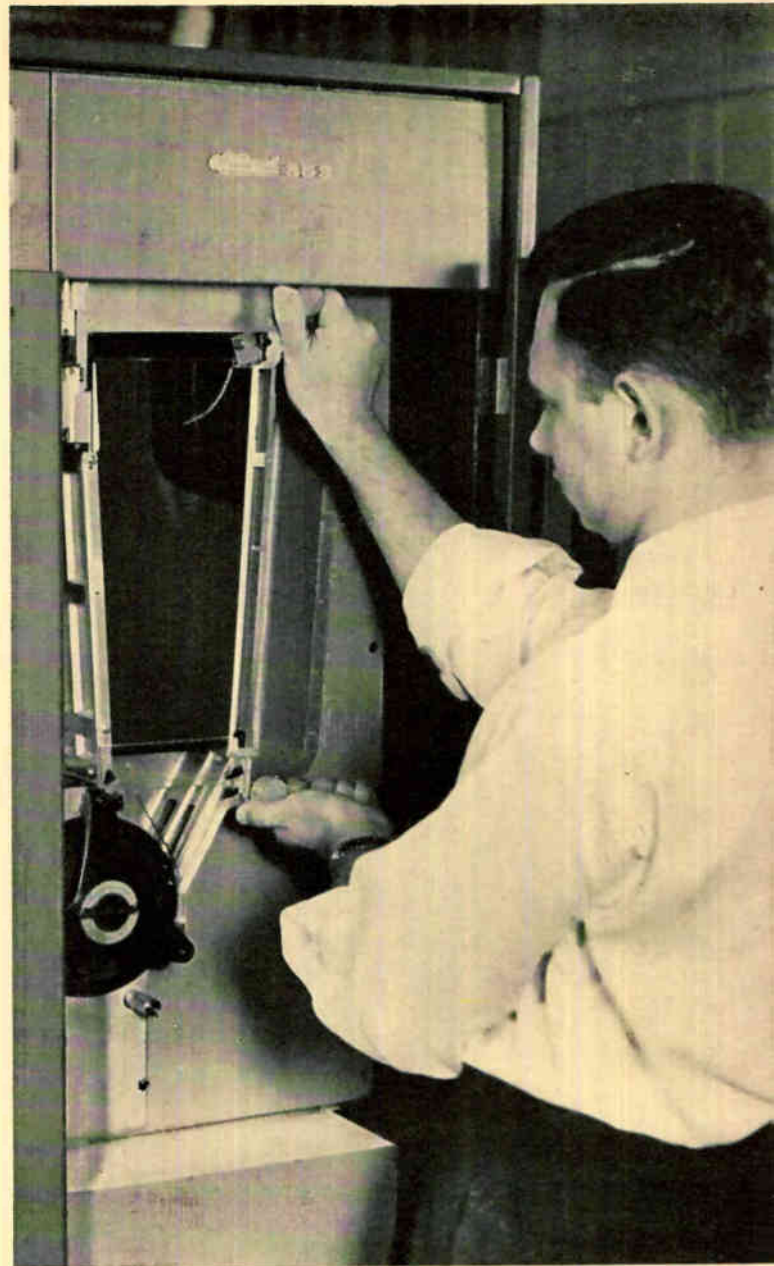

FIG. 20—Multiple-aperture device suggested by IBM can function as a half-adder

decision circuits, with a tunnel twin being used to fan in each signal and a second twin to take the logical decision. Phase-locked oscillators in both kilocycle and megacyclogigacycle ranges are also being used in such circuits.

Most important among advances in logical organization have been developments that make addition and shifting independent of the number of bits added or shifted. Delays in these circuits are functions only of component response characteristics.

An adder-accumulator that adds any number of bits in one bit time plus the delay in the circuit is shown in Fig. 27. Each half-adder receives a bit from the augend and a bit from the addend; the outputs are the sum and carry. The sum signal from all but the least-significant bit, and the carry signal, are applied to a detector complex which is a cascade of interrelated exclusive-OR circuits. It produces a signal—designated V in the drawing—whenever the sum of a pair of bits must be added to the carry



Card random-access memory of NCR puts tape strips on a cart-ridge. Drum at lower left reads the data

from a preceding pair. Thus a ONE sum on S_2 might need to be added to a carry C_1 . The signal C_1 would pass as V_2 to the quarter-adder and reverse the sense of the other input S_2 , so that Z_2 would be ZERO. Signal V_2 would also condition the next exclusive-OR circuit to produce V_3 . If sum S_2 were ZERO, its sense would be changed to form a ONE on Z_2 , and no V_2 would be produced; if it were a ONE, its sense would be changed to a ZERO by V_2 and a V_3 signal would be produced.

Using high-frequency transistors—in the 10-Mc range—would mean a delay of about 100 nanoseconds in the circuit. The exclusive-OR cascade is all diode level logic.

An n -place shifter has been developed whose shift time is independent of number of input bits or number of places shifted. The circuit, shown in Fig. 28, requires a multiple-secondary pulse-transformer as one input to a matrix selector. Signals enter the shifter in parallel.

For each of n possible shifts there is a transformer

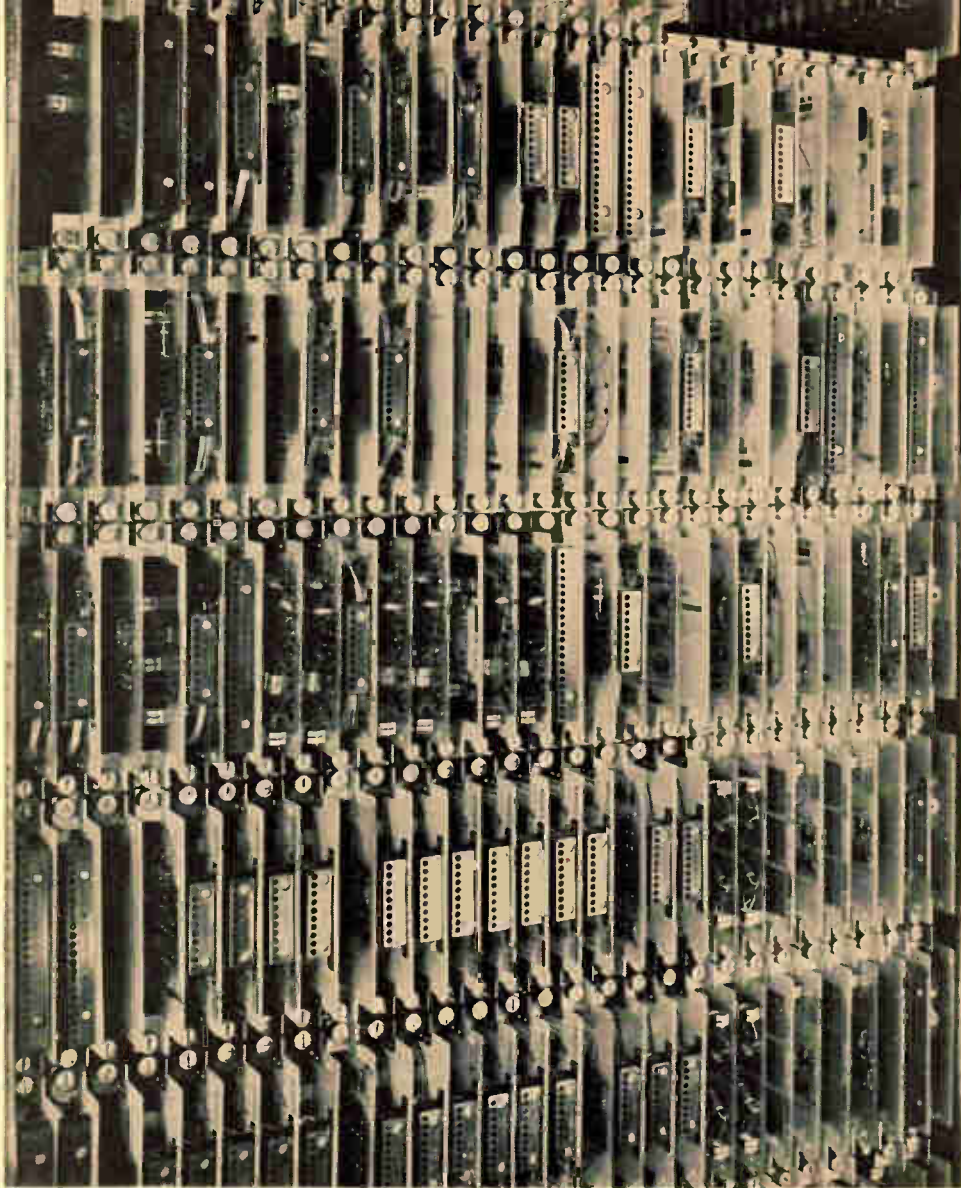

Backboard of computer that directs Asroc weapon. Mk 38 system, built by Librascope, is digital fire-control computer, contains 243 circuit cards

with m secondary windings, where m is the number of bits in the number to be shifted. The collector for each transistor connects to one secondary winding of each transformer. (Transformers with up to 40 secondaries, representing 40-bit words on the input, have been successfully employed).

A power pulse is applied to the primary of one of the transformers, selected to indicate the number of places the input is to be shifted. When the primary is pulsed, diodes on the secondary windings gate out the word. Outputs from all transformers are whiffletreed into a single output register of $m + n$ positions; the 4th bit from an unshifted word goes into the same register position as the 3rd from a word shifted one place or the 2nd from a word shifted two places, and so forth.

Sophisticated multiplier techniques use such a shifter and adder to great advantage. The multiplier word is scanned for ONES and ZEROS; the ZEROS are added up, and the position of the ONES in relation to each other is sensed. An isolated ONES bit causes the shifter to shift the multiplicand as many times as there were ZEROS, plus one place, and add it to the partial product in the accumulator. Successive ONES bits cause the same shifting operation

and then subtraction, followed by a count of ONES, shift and addition. Average multiply time is $n/4$ bit times where n is the number of bits in the multiplier.

Some computer makers are beginning to consider separating multiplication and division (the operation least amenable to a computer) so that they can be performed autonomously while other work goes forward. The large-scale Ferranti Perseus computer has a separate multiplier accumulator and associated registers, for example, to handle these chores; the added circuitry makes up for a fairly long add time—234 microseconds—in this system.

ADDRESSING TECHNIQUES—Methods of addressing computer memories have become more sophisticated. Conventionally, words are addressed by a unique number which represents one set of cores or one strip on a drum. (Some computer makers even address their tapes, partly to make certain bad tape spots will not be recorded on, partly to permit rapid search for particular tape records.)

In some of today's computers, a single bit in an instruction is used to address certain index or logic registers where the instruction must make use of several registers or memory locations. Other instructions have implicit

addresses; for example, a multiply instruction conventionally leaves its product in the accumulator, which is thus implicitly addressed. Search-and-compare instructions permit a memory location to be addressed by content, as does the tape memory system of the RPC9000. Associative memories now in development will be directly accessed in terms of content.

Indirect and relative address systems are especially valuable in automatic programming, but are used even in manual coding when the storage area for a block of data may not be determined in advance. The indirect address stores, not an operand, but the address of an operand, which may turn out to be the address of still another operand, and so forth. Nested iterative operations, for example, usually terminate with a series of these jumps to jumps to further jumps. A relative address is given with relation to a fixed address, usually the one now in the control register, sometimes another address stored elsewhere.

The ability to form addresses from data is a further refinement included in some systems. A basic sector address might be provided in an instruction, for instance; data arrived at in the course of a computation would be added to it to form a specific address in the sector.

Repeat instructions have been included in some systems, permitting an automatic iteration controlled by reduction to zero of an index value in the instruction, or by

comparison of the index value, changed every iteration, with some stored value. These have increased manifold the speed of performing simple repeating routines of one or two instructions.

Program-interrupt features have increased the operating efficiency of many systems. The increasing autonomy of input-output operations, coupled with the trend toward realtime control systems, has stimulated the use of program-interrupt.

MICROPROGRAMMING—A technique for using set-up bits in the instructions, working with small, fast, read-only memories to directly control gates in the computer, has been a powerful innovation in executing instructions. Microprogramming, in its purest form, uses the set-up bits for direct control of the gate paths; an improved technique employs ordinary operation codes operating by table look-up on a fast memory which sends out the signals to execute the operation and open the gates.

Both systems are most advantageous with inexpensive memory components, where the greater use of memory capacity is justified by the elimination of the welter of logical circuits associated with instruction decoding and command-line encoding matrices. The microprogram also, since it deals directly with the logical paths in the computer, permits a programmer to overcome

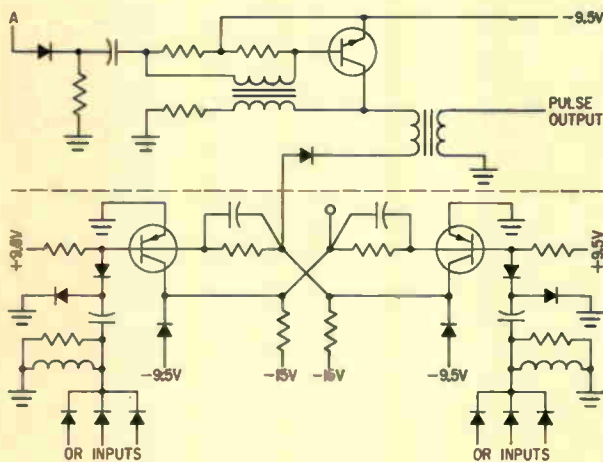

FIG. 21—Transformer logic circuit designed by IBM is alerted by zero-volt output from flip-flop to pass pulse input A

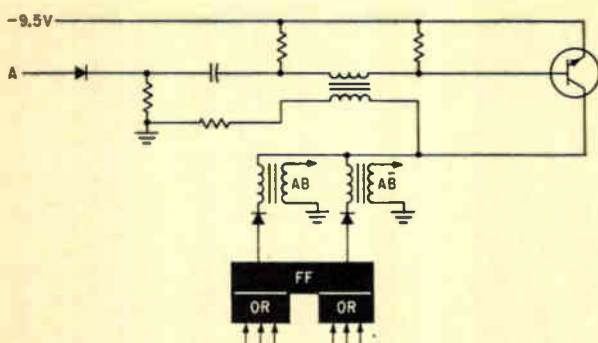

FIG. 22—In transformer logic scheme, double gate uses one transistor for input isolation; transformers drive output

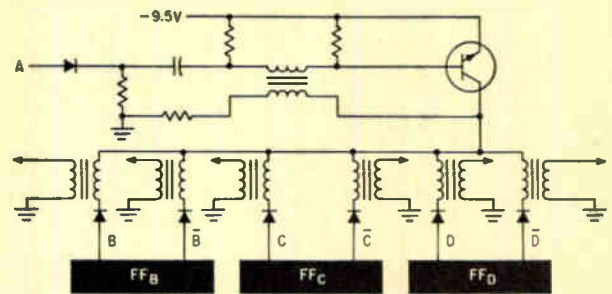

FIG. 23—Multiple-gate functions for register control and decoding can be performed by transformers

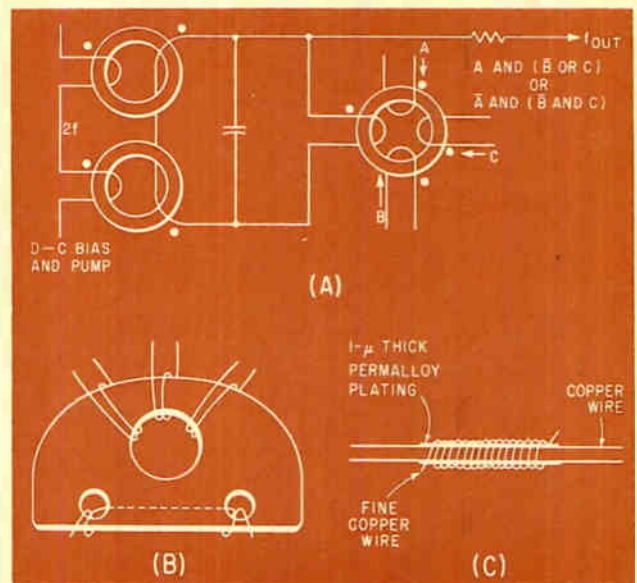

FIG. 24—(A) Parametron equivalent circuit; (B) configuration of parametron component; (C) improved high-frequency version will be made by continuous-process etch

oversights of the designer in the instruction code; the microprogram can be exactly as flexible as the computer paths will permit.

Programming developments constitute an important collateral research area. Compiler routines now available for almost all large general-purpose systems and many of the medium-scale and small computers have made it unnecessary for users to be familiar with either the hardware capability or the instruction code of the computer which they use. Pseudocoded instructions in a language quite close to business English (in the case

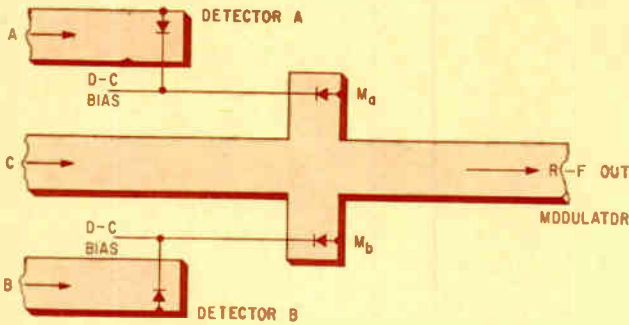

FIG. 25—Diode-waveguide AND or OR circuit. Modulator operates as a bridge, reacting to detector outputs. Diode bias is from constant-current source

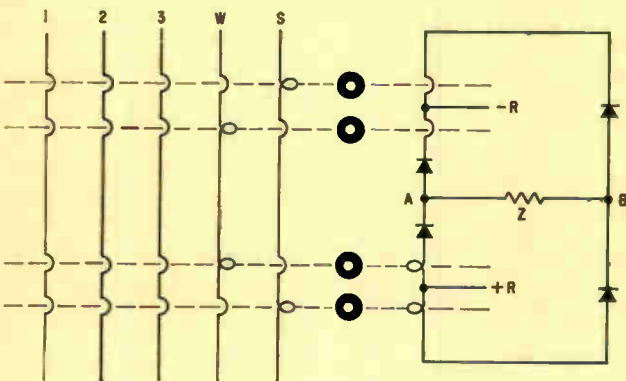

FIG. 26—Diode-core circuit for majority-decision logic

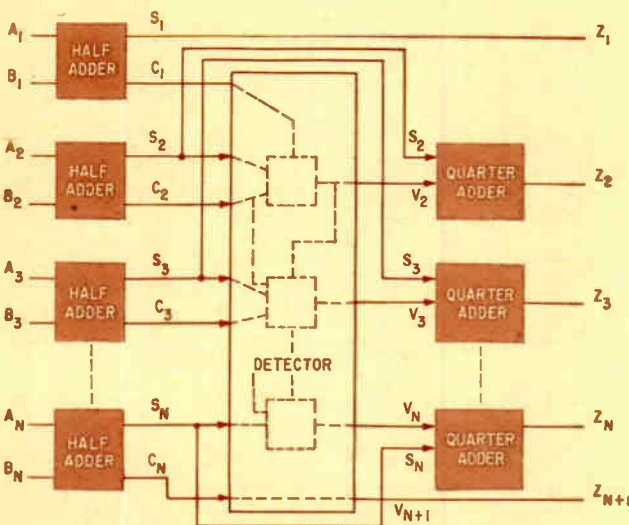

FIG. 27—Adder circuit has a total delay of one bit-time plus circuit lag. Fast components could produce n-bit addition in 100 ns

of commercial compilers) or mathematical jargon (in the case of scientific compilers) are interpreted by the compiler routine into component subroutines and assembled into a running program with memory addresses, tape units, and all other working parameters figured out and in place in the program.

Such routines nipped fairly well in the bud any tendency that might have been present at one time to build macrocircuits into computers, such as sine or square-root hardware that would be triggered by a single instruction. Some computers do have such hardware—the RW-400, LN-3000 of Leeds & Northrup, PB-250, and Honeywell 290, among others, have special square-root hardware; the systems cited are all designed as control computers—but such hardware is mostly included either where analytical compilers were not available or where speed is an essential requirement. The AN/FSQ-7 used in Sage, for instance, can automatically perform spatial coordinate transformation on two-dimensional coordinates.

NEW MEMORY DESIGNS—Novel designs in storage systems continue to be incorporated in computer systems. Improvements in core storage have been made. Systems now in being are made for low drive currents at moderate, fast, and very fast speeds, and for buffer storage.

Partial-flux word-select memories have received considerable attention because of the higher speeds such a technique makes possible. In this technique, only a small amount of the total flux available in the core is required for operation; less heat is generated and permissible switching times are raised. The relative amounts of flux switched in word-select and coincident-current systems are shown in Fig. 29A; the winding configuration for a word-select memory is shown in Fig. 29B.

All the bits for a word are arrayed on the same read-write line; each bit position has a separate sense winding. A read pulse through a selected word puts out a signal on the sense winding for any ONE-state cores. During writing, a write pulse of polarity opposite to the read pulse will not disturb any ZEROS; coincidence of a digit pulse and the write select signal will put selected cores on a minor loop. The ONES-digit pulses cannot disturb ZEROS already recorded in other nonselected words, because ZERO is a position on the major loop; it can only serve to drive nonselected ONES cores farther into minor-loop saturation.

Cores designed specifically for word-select operation do not switch as much flux as coincident-current cores, even if the latter are operated on a minor-loop word-select mode. Major disadvantage of the partial-flux technique is that more access drivers are required; but the cost-per-bit-per-second is less due to the higher speeds at which the word-select cores can be driven.

Core memories for severe environments—above 70 C and below 10 C—have been developed by attention to materials and to matrix design aimed at a uniform stack temperature.

Buffer stores differ from ordinary storage units in their ability to take and order information at one speed and put it out at another. Thus information may come in from tape at intervals of tens or hundreds of milliseconds, be stacked in the buffers in sequenced locations, and then read out into a computer storage unit at 100 Kc.

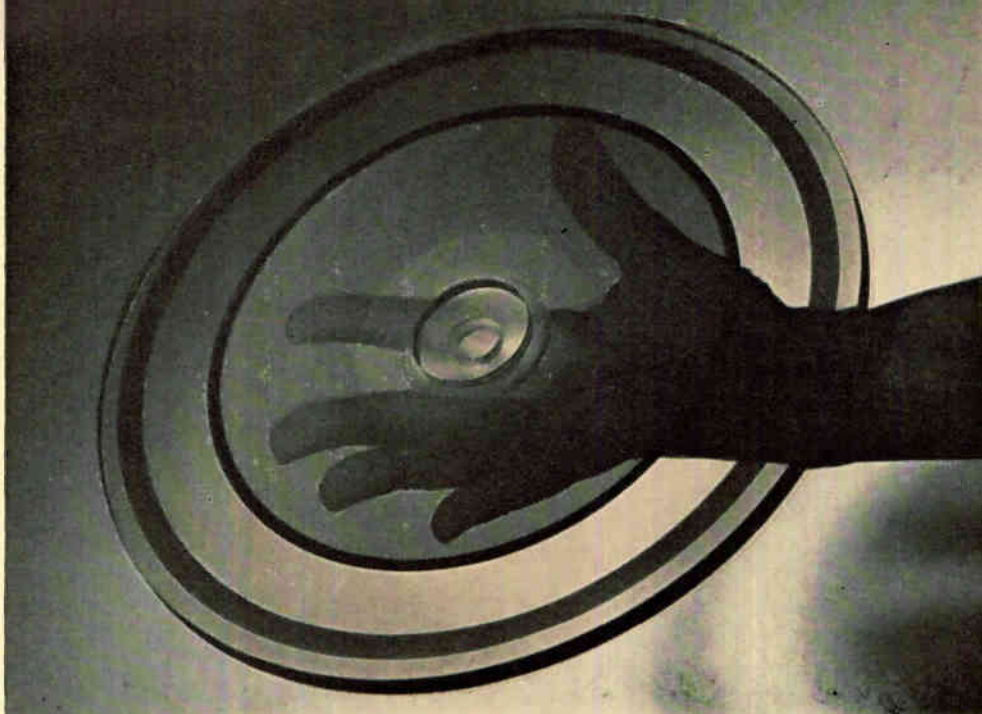

Glass disk of IBM's language translator holds code for 55,000 Russian words, is optically scanned

Such units are a necessity for autonomous input-output control, and are routinely included in most of today's large and medium-scale computers.

Speed increases over conventional core memories have been achieved with multiple-aperture devices using a cadmium-manganese formulation with moderate retentivity and low coercivity. The configuration, shown in Fig. 30, permits nondestructive readout. All legs are equal in cross-section. A bias current I_b sufficient to ensure saturation is maintained on the center hole, and another of twice the value is maintained on the outer hole. Read and write currents are half-select values. Information is stored in leg 4 and sensed on the line through the slot next to that leg.

When a ONE is written, the half-select write current overcomes the outer bias and reverses flux in both legs 1 and 4. A ZERO is stored if the write input is inhibited with current I_b applied to the outer hole to reinforce the outer bias; this added bias cancels one of the half-select write fields. Half-select currents for readout, summing to twice I_b , reverse the flux in leg 4 if a ONE has been stored, but provide only a small shuttle flux if a ZERO has been stored. The core can switch in less than a millisecond.

Twistor memories, developed by Bell Labs and now used in several military computers, use a thin narrow tape or wire of anisotropic magnetic material (4-79 molybdenum permalloy), wrapped in the form of a spiral on a conductor. The device derives its name from the fact that originally a nickel wire was twisted to make the device. The anisotropy of the wrapping tape puts the easy direction of magnetization in the direction of its length. The wrapped twistor is the warp of a woven mesh; a copper conductor is the weft. Current applied to the twistor produces a circumferential field; current in the transverse solenoid wire produces an axial field. Neither field alone can change the state of the tape material, but coincident fields add vectorially at their

common junction and shift the state of the twistor at that point. A large reading field shifts all ONES to ZERO, and the center conductor is used as a sense wire to read the changes in flux.

An experimental read-only memory recently developed by IBM uses a matrix-coded punched card as input for capacitive readout. Readout device provides random access to any of 960 possible bits on the card, which is considered as an 80 by 12 matrix for binary data. The cards are formed from sandwiches of aluminum foil between sheets of paper. Twelve vertical and 80 horizontal conductors in separate layers of the readout device sense a shift in capacitance at intersections where holes have been punched.

Other read-only memories in use include wired-core and magnetic rod systems, more commonly found in computers of European design than in the U.S.

A magnetic filing system disclosed last month by National Cash Register is made of tape on cards 14 in. by $3\frac{1}{4}$ in., and serves as a card random-access memory of moderate speed and high volumetric efficiency. CRAM cards are notched and suspended on rods 256 to a cartridge. Electromechanical selection drops the cards one at a time onto a drum to which they are held by vacuum. A single card holds 21,700 alphanumeric characters; a cartridge can hold 8.3 million decimal digits or 5.5-million alphanumeric characters. Access time to data on a card already on the drum is 14 milliseconds; acquisition time for a card is of the order of tenths of a second. Serial transfer rate is about 100,000 characters a second.

Other novel external storage devices of moderate speed and fairly high volumetric efficiency are the Carousel memory of Facit in Sweden, which uses 64 reels of 8-channel tape mounted in two concentric circles on a wheel which is used for gross selection; and the K-10 tape-loop memory of Standard Elektrik Lorenz in Germany.

English Electric Valve is marketing a bistable storage

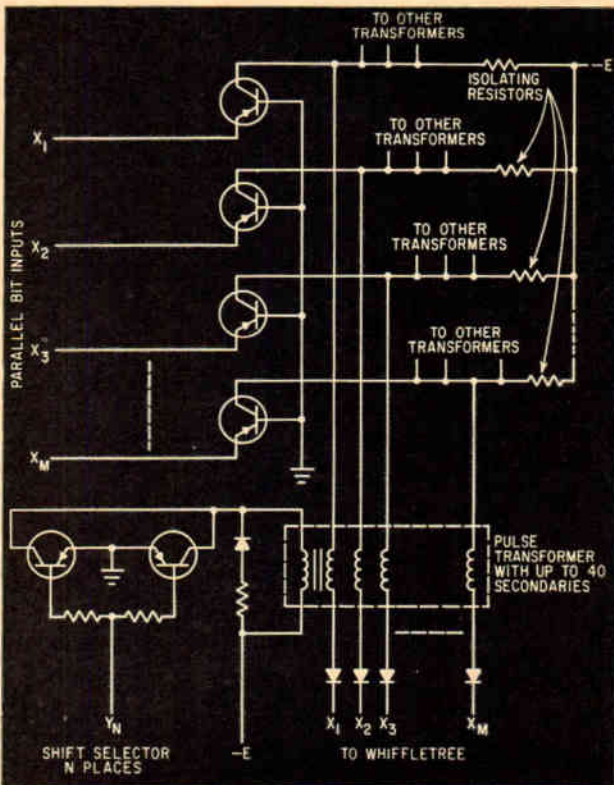
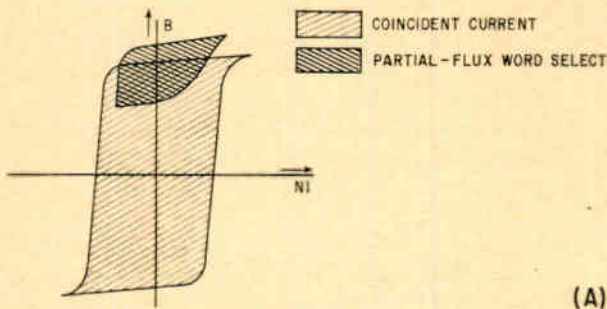
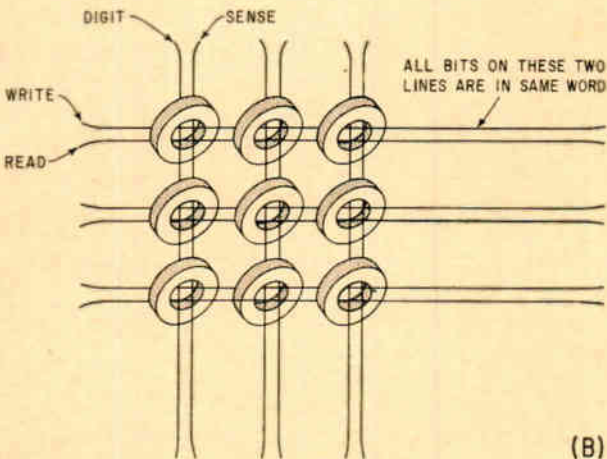

FIG. 28—Shifter can handle n -place shift with shift time independent of number of bits or number of places shifted



(A)



(B)

FIG. 29—(A) Partial-flux word-select memories use minor loop with only small flux change; (B) wiring configuration of word-select memory

tube that will store information indefinitely and permit the continuous or intermittent display of stored signals. A writing gun puts 0.001-in. spots on the storage mesh; a second holding gun washes the entire storage area with a weak holding signal to maintain the display. Barrier-grid and other electrostatic storage tubes have also been the subject of a flurry of resurgent research interest recently.

A high-density memory device may emerge from work currently being undertaken by National Cash Register and others in photochromic devices. The photochromic dyes, similar to the pressure-sensitive dyes in use in carbonless carbon papers, can be made to change color under light stimulus, with the area of change entirely dependent on the fineness of the light beam. Cells of memory could theoretically be arrayed as close together as 10,000 to the linear inch; with available optics, packing densities of a million to the square inch are not unfeasible. The change in color state is a quantum-mechanical phenomenon, whose speed is dependent on the strength of the light beam. With electronically controlled switching and strong and coherent light sources, access times in the fractional microsecond range are feasible.

ADVANCED APPLICATIONS—Several new classes of problems have become amenable to computer solution relatively recently, as a result either of the standardization of a system or the development of new devices.

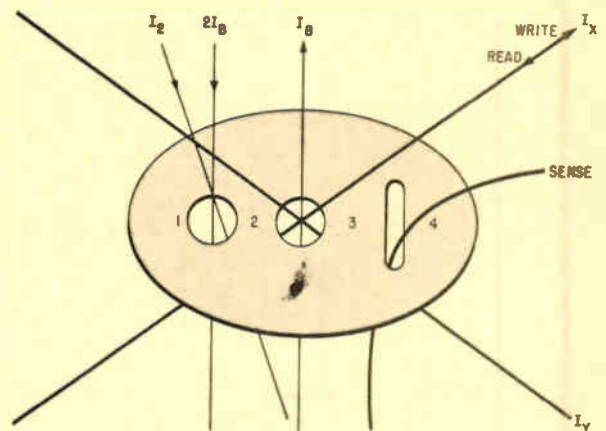

FIG. 30—Multiple-aperture device has complex wiring, permits fast nondestructive readout

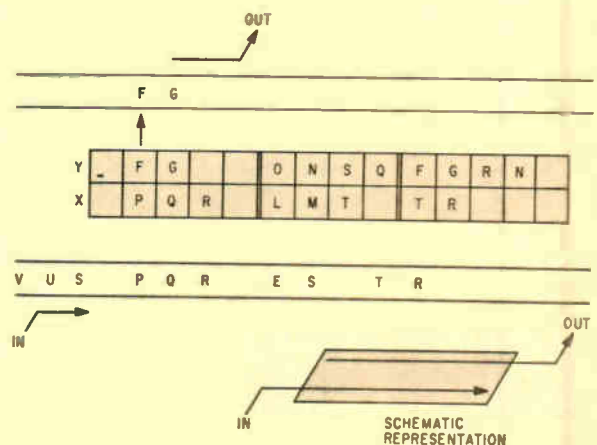

FIG. 31—Lamellar storage and retrieval techniques use complete or partial keys to retrieve associated material

In the former category is the special class of bank demand-deposit bookkeeping. This required the banking community to standardize on a record which banks could accept as a check and which could be used as a unit record by data-handling devices. Once the American Bankers Association had settled on magnetic-ink characters in a specified format, the character-recognition systems rapidly followed. Magnetic-ink character readers have been developed as input to the IBM7070, 1410, 1401 and 1620, Honeywell 800 and 400, NCR 304 and 315, GE 210 and 225, the CDC 160 and the RCA 301. Most of the nation's big banks are converting or preparing to convert to mechanized bookkeeping systems.

The integration of industrial systems is being considered as the logical next step after introducing industrial-control computers. Integrated systems will combine the tasks of commercial processing with process controls in a coordinated computer complex for management.

Recent developments in programming are leading to the standardization of a pseudocode language, probably a Cobol (common business-oriented language) for commercial compiling and an Algol (algorithmic language) for scientific compiling. This will tend to make programming somewhat less an art. The widespread use of compilers of the Algol and Cobol type has already relieved the programmer of the need to deal with machine codes; and computermakers are more and more tending to design their systems to make direct use of compilers.

Burroughs' recently announced medium-scale B5000 derives its efficiency from its having been built from the ground up to work with compilers instead of straight programming. Systems capable of being macroprogrammed, and systems with variable word-length and individually accessible memory cells, also in part assume the existence of compilers.

But for all the work done in programming, there is still much ground unexplored, especially in business data-processing. Analyzers capable of determining the general class of scientific problems have been in existence for a decade; but business methods and procedures are not so universal. Every administrator is prepared to demonstrate that his system is superior to someone else's. Standardizing these systems is the next thing to impossible. More basic scientific thought is needed to broaden the use of computers even in technological problems.

Among novel uses to which computers are being put at least to a limited degree are medical diagnosis and simulation; building design and other civil engineering; flood control by simulation of river systems; language translation; information retrieval, and for many military uses.

Probably the most advanced computer systems made are used by security agencies for rapid analysis of crypt, and by such organizations as the Rand Corp. to play retaliatory strategies. Air Force uses a powerful IBM computer with a fixed optical memory containing a 55,000-word vocabulary to translate *Pravda* daily into rough but readable English, and to keep up with what's going on in other Soviet journals. The system translates at about 1,800 words a minute.

Some military systems are entirely logic computers. Sperry's AN/ALQ-27, a countermeasures analyzer, needs no arithmetic capability, merely performs logical analysis of its several inputs. Others such as Melpar's giant Finder (which includes a Burroughs 220 as a subsystem) use both logic and calculation for analysis of ferreted reconnaissance data.

In the USSR, Soviet planners, with several excellent computers at their command, are thinking of developing a computer model of the entire Soviet economy to reflect the statistical interdependence of its branches. Ultimately the academicians there would like to turn over the management of the entire economy to computers, according to *Moscow Komsomol*. They estimate that they'll need a system capable of 200,000 computations a second to handle the job.

HEURISTIC RESEARCH—A major exercise that should widen the computer's usefulness has been research—in both programming and hardware—aimed at improving the problem-solving performance of the computer. The problem-oriented approach, referred to as heuristic, would turn over to the computer the chore of determining the method of solution to a problem, now mostly done by human analyst-programmers.

Heuristic procedures involve searching through a possible spectrum of approaches and recognizing optimum approaches when they show up. This procedure, coupled with a learning or multiple-associative ability, can permit the computer to make and exploit generalizations from experience accumulated in solving prior problems. Planning a search to cover only the small set of approaches that seem to fit the problem may be another

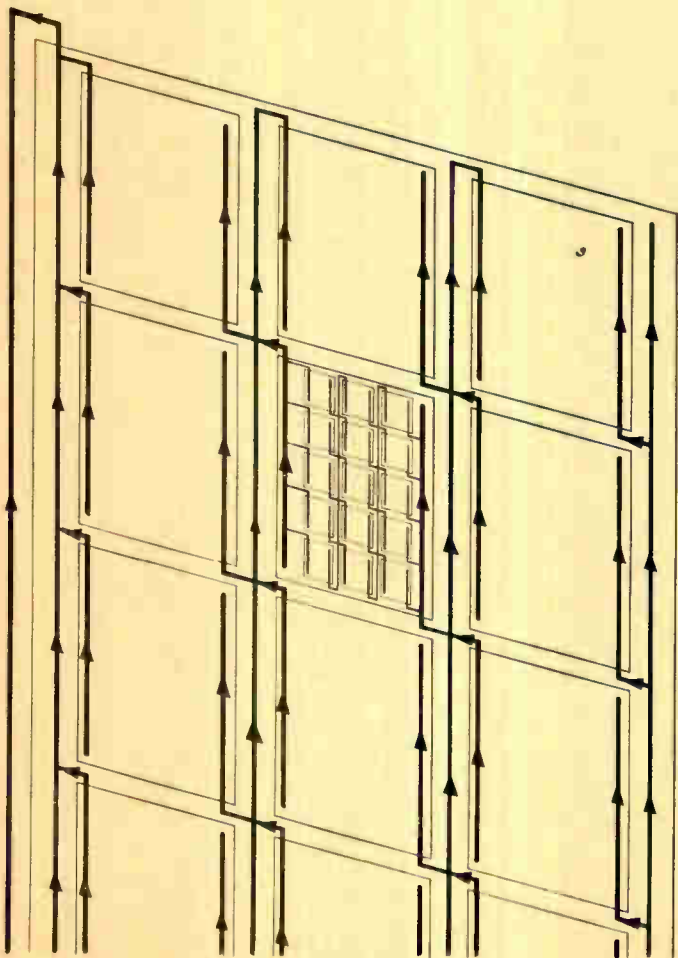
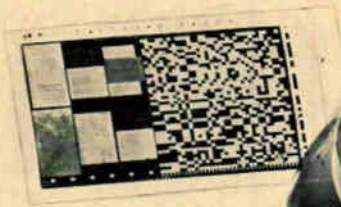

FIG. 32—Recursive lamellar structure permits multiple associations with single powerful input



Eastman-Kodak Minicard record with 6 legal-length documents, coded index data

desirable capability. An inductive ability, permitting computers to construct models of the problem environment, will further broaden the problem-solving performance.

Much of this work has stressed programming thus far, since it is substantially less expensive to construct and try a program empirically than it is a machine. But certain machine developments are leading in the same direction.

Large randomly accessible memory systems have led many designers to postulate a computer that would be a machine version of an *idiot savante*, a creature with total recall of everything ever entered, and addressable by partial and incomplete—or even analogous—index. With fast enough memories adequately cross-indexed and cross-referenced, as the human memory seems to be associatively cross-indexed, this sort of system might be quite useful.

INFORMATION RETRIEVAL—The masses of information being accumulated in not easily machinable form have forced the development of information-retrieval systems. All these rely on storage systems capable of holding the information without necessarily converting it to machine format. Among the earliest of this class of machines was Eastman-Kodak's Minicard.

The Minicard system stores documents as micro-filmed records on high-resolution film cut into 16 × 32-mm cards. One film record can hold up to 12 legal-length documents plus 294 bits—49 alphanumeric characters—of indexing information. Fewer documents can be stored per card, with more room for coded data. Up to 2,730 bits, or 455 alphanumeric characters, can be stored on the Minicard. The code is set up as clear and opaque areas on the film by an encoding mechanism in the camera at the time a record is first made. All kinds of document material—maps, drawings, printing, handwriting—can be microfilmed on the cards.

Minicards are duplicated and the masters stored. Duplicate cards are racked on file sticks. Peripheral equipment sorts and selects cards; other gear is used for analysis viewing and for printing copies. The Minicard sorter works at 1,000 cards a minute.

Documents are indexed by all possible cross-references and can be retrieved by partial reference if the reference code is cleverly organized. A computer-duplicator can determine needs of a particular installation and make copies as needed at the rate of 120 cards a minute as data are entered; the duplicates are then used to make referenced prints for users of the system.

There are two failings of Minicard, one inevitable, the other not so. The input process is extremely slow. The best camera made as part of the system can record only

90 documents an hour—which at maximum packing density is something less than 8 Minicards. This is the slowest link in the system (film is processed at 100 cards a minute), and certainly limits system efficiency. The other failing is that the system is not an integrated one; it is an assembly of discrete parts. If an item, once entered, were left under machine control permanently in mobile files accessible from a control console, the system's efficiency might be improved.

LAMELLAR MEMORY—Another approach to retrieving information is embodied in the work being done at MIT by M. Barnett in string transformations. A string, to this research group, is a linear arrangement of signals from some finite alphabet of symbols which evokes a response. The process of causing the string to evoke its correct response is the string transformation. Providing a specific person-number-gender of a French verb given the infinitive is one example; compiling a subroutine from a pseudocoded input is another.

Barnett envisages a lamellar storage device, illustrated in Fig. 31 in which the input string *PQR* pops up the output *FG* when it matches the *PQR* stored in the *X* channel. He further envisages a recursive structure, as in Fig. 32, in which a single input could fan out to other lamellae to form a set of associations. Such a recursive structure would be useful in dealing with nested parentheses in algebraic expressions, or nested iterative subroutines in a compiler library. It would also be valuable in dealing with multiple associations in recall or retrieval procedures, where a single nontrivial input would trigger outputs that might ramify all through the system.

ABSTRACTING—The problem of retrieving information from volumes of stored data is less serious than the related problem of abstracting meaningful intelligence from printed text. In using Minicard, for instance, the indexing codes must be assigned by a human operator; it would be more reliable and certainly faster if this could be done by machine, but as yet there is no sure way to abstract the necessary index data. Both retrieval and abstracting may prove to be more susceptible to heuristics approaches than to the straightforward empiric approaches applied heretofore to which neither problem has gracefully responded.

Research to develop programs and techniques for abstracting the intelligence from text—which will permit automatic evaluation and indexing of materials—is now underway in several universities and corporations. The techniques employ statistical count methods and the elimination of trivial words and particles, but many of the methods are highly specialized; no valid generalized solution has yet been elucidated.

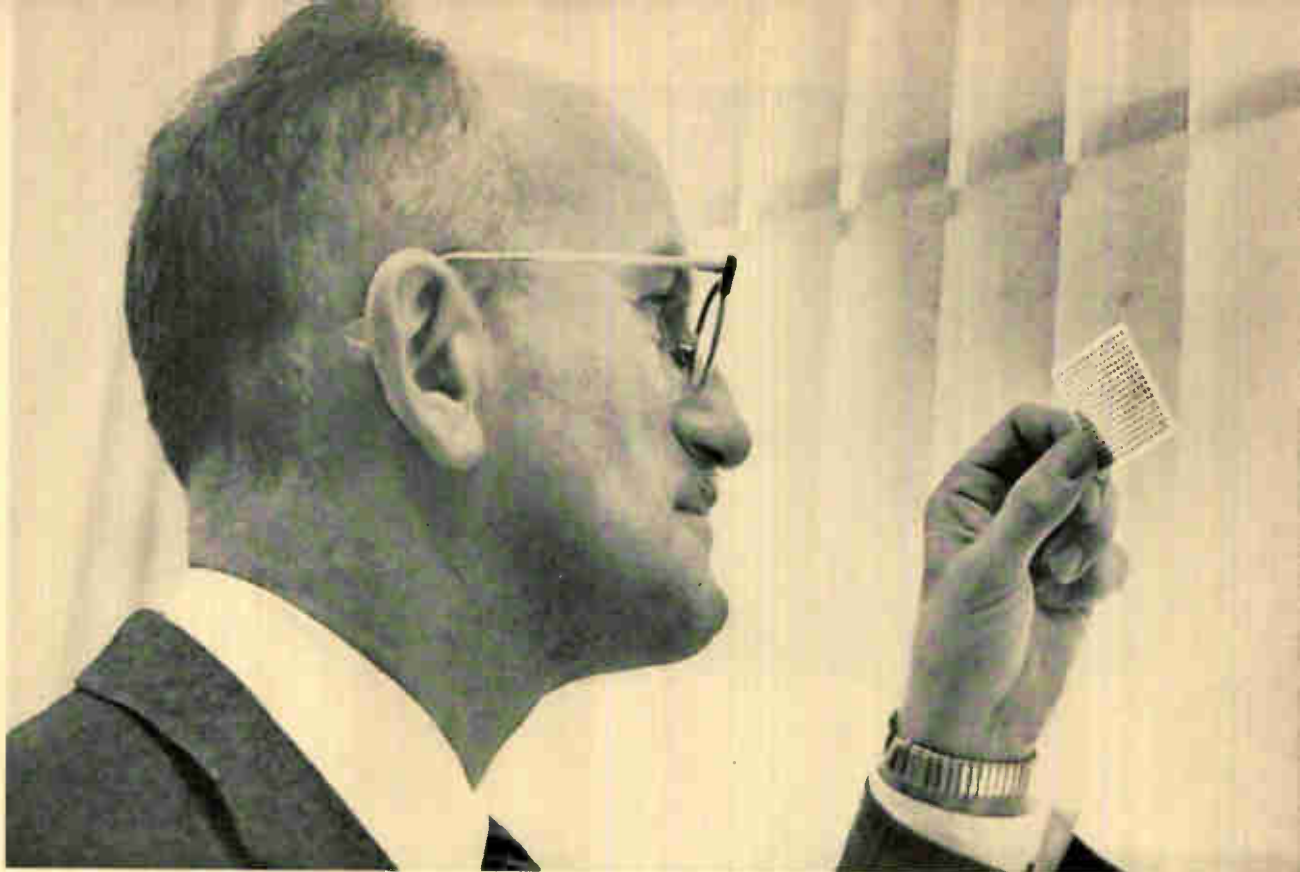

Magnetic thin films deposited on glass substrate are now being used as memory components (Sperry Rand photo)

COMPUTERS TODAY — PART III

trends and developments

FOUR WELL-MARKED TRENDS exist in the development of computer components. One of these is magnetic devices; during the last year or so the development of all-magnetic logic using single cores and multiple-aperture devices has been noteworthy.

Among newer devices, cryogenics, thin magnetic films and tunnel diodes have been searchingly investigated. All three demonstrate substantial usefulness in computer design. Another collateral development effort has been in the design of microelectronic or molecular electronic circuits, and still another has sought ways of programming logical and data-handling operations using signal levels of microwatts.

MAGNETIC CIRCUITS—The biased-core magnetic circuit in Fig. 33 uses cores as unilateral coupling elements in transfer loops. Loop currents flowing counterclockwise tend to switch cores S_0 to ONE, providing a high loop impedance. Clockwise currents do not switch the cores, and a low impedance is present in the loop. The unilateral flow characteristics allow the replacement by these cores of the diodes usually needed in coupling loops. Reset currents reestablish the ZERO state in all S_0

cores. Resetting the coupling cores is done slowly so that loop currents do not pass the threshold of the information cores S_1 , S_2 , and S_3 . Another version of the same circuit uses the coupling cores as transformers with clock-current control over signal transmission.

All-magnetic circuits developed at Stanford Research Institute use large and small toroids or multiaperture devices (MADs) with no nonmagnetic components. The sequence detector in Fig. 34, when a pulse is shifted down the MAD chain, will detect the sequence COMPUTE no matter how that sequence of letters is interrupted or interspersed so long as it arrives on the lines in the correct order. Thus it would detect the sequence C-C-L-O-M-R-P-U-T-R-R-E-E-R as COMPUTE since neither repeated inputs nor inputs on unused lines can affect the switching of the cores. As the ONES signal advances from core to core, the previously set cores remain set. A common clearing pulse restores them all.

Modification of the circuit can be used to detect sequences hidden in statistical noise. An experimental technique using a direction-sensitive stylus has been used for interpreting handwriting; as the stylus moves, it puts out five inputs (four horizontal directions and

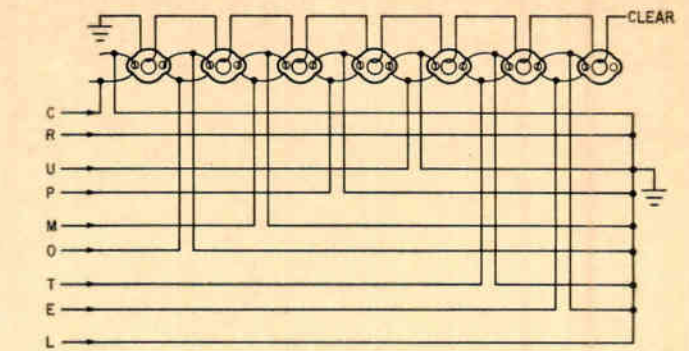
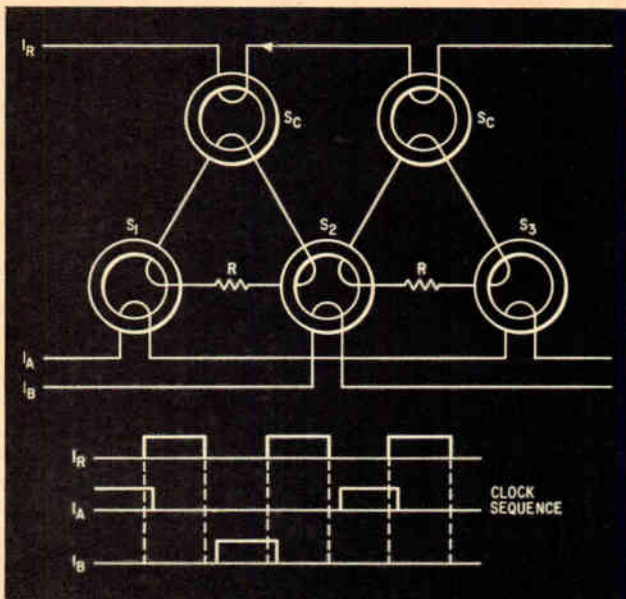

Fig. 34—Multiple-aperture core sequence detector will recognize the sequence **C-O-M-P-U-T-E** no matter how it is interspersed with other signals

Fig. 33—Biased-core magnetic circuit uses cores only. Cores S_C are unilateral-transfer controls

THE LAG IN COMPUTER USE

Our welfare as a nation requires the best possible utilization of all our resources. Prime concern is properly directed toward our educational system, which can develop or stifle the human creative talents on which all else must depend.

In the area of information-handling technology there is also an educational frontier bearing directly on our national welfare. The equipment now at our command has far surpassed the visions of 1950. Our ability to use that equipment, however, has not kept pace. We are far short of obtaining the major benefits which could be ours through effective application of existing systems.

The gap between what could be done and what is being done shows no signs of closing. In the next ten years, the inherent capacity and potential abilities of data-processing equipment may well be advanced a millionfold. The challenge is enormous, and so are the rewards which come to those who face it.

No pedestrian or stereotyped approach will meet this challenge. Clearly, we must outreach our current ideas as to what can or cannot be done by computers. Nor is lip service enough: we must give solid support to the exploration and development of new frontiers of technique and application.

Research on general problem-solving (heuristic techniques), on linguistic theory, on management

systems for scheduling, decisionmaking and control, on simulation schemes and forecasting methods — all these are but a beginning, a sketchy forecasting of the directions in which much more remains to be done than has so far been done.

How well or how badly we use the information-processing facilities of the next ten years is a most important question. With a conviction of urgency, schools of business and industrial management are training their students for a new generation in which these new tools will play a key role. The engineer, too, should be prepared to learn more and teach more, so that he can help guide the community around him in the effective use of the systems he is helping develop.

To await the arrival of the new troops being bred up in the schools before facing the problem can bring a heavy penalty. To recapture a lost competitive advantage, whether financial, social or political, is sometimes impossible. We must learn now to use what we already have, and we should now be developing the knowhow that will be needed if we are to derive even a small fraction of the potential profits from the hardware to come.

JOHN W. MAUCHLY

President, Mauchly Associates, and visiting professor of systems engineering, Carnegie Institute of Technology

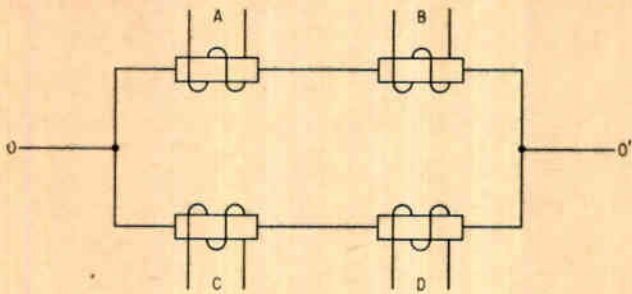
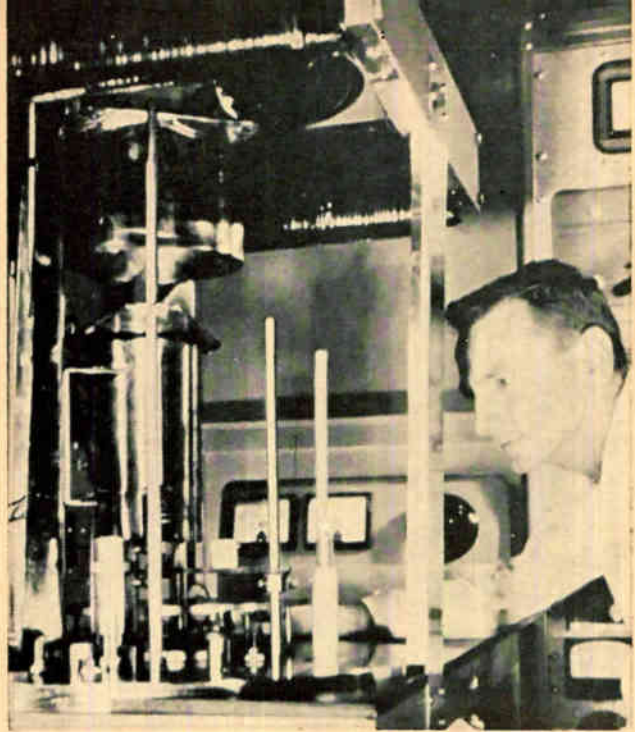

FIG. 35—Basic cryotron gate. Path resistance from 0 to 0' is zero so long as A and B or C and D are not present to quench superconductivity

Metal bell jar in which films are evaporated has been removed for inspection in this picture at RemRand's St. Paul plant. Permalloy crucible is at bottom; substrate goes behind metal mask at top. Evaporation temperature is 1,700 C



one vertical) which are matched in multiple networks of the type discussed. As with all ferrites, hysteretic heating limits the switching rate.

Other important developments in magnetics include Curie-point writing, in which direction of magnetization in premagnetized films is reversed by temporarily and locally elevating the temperature above the Curie point. A focused electron beam is used to write at very high speeds and densities. Electron-mirror microscopic methods would be used for readout. Polarized light has also been suggested for reading from films.

CRYOGENICS—Parallel line of research is exploring the usefulness of superconductive elements. Simple cryogenic loops containing two drive cryotrons and a number of sensing cryotrons have been constructed. IBM has successfully built up film planes containing 135 cryotrons using automatically controlled techniques.

The cryotron is a switching device in which current through a superconductive material is controlled by a magnetic field induced in a surrounding or overlying conductor. When the magnitude of the magnetic field is great enough, it overrides the superconductive phase and makes the zero-resistance path a high-resistance one. Ring cryotrons in the superconductive phase can retain a circulatory current indefinitely, making excellent memory devices.

Cryotrons used in logic circuits must be active devices with current gain greater than one. In switching networks and memories, they can be driven from external transistor circuits and may thus have less than unity gain. L/R time constant severely limits the speed of the high-gain cryotrons; in a low-gain circuit, the time constant is independent of the length or width of the unit, where these parameters affect the internally driven high-gain device.

The basic cryotron gate is shown in Fig. 35. The construction details of a cryotron flip-flop are given in Fig. 36. Besides these basic logic circuits, persistent-current memory devices have been built up; the diagram of a memory circuit appears in Fig. 37A in schematic form, and a wiring diagram for the same circuit is shown in Fig. 37B.

The thin-film cryotron circuit in Fig. 37A is the unit device of IBM's 135-cryotron memory plane. It is a persistent-current cell containing three cryotrons. The plane consists of 19 thin-film layers of lead, tin and silicon monoxide deposited in sequence through 17 masks.

A persistent current is set up in the loop (heavy line)

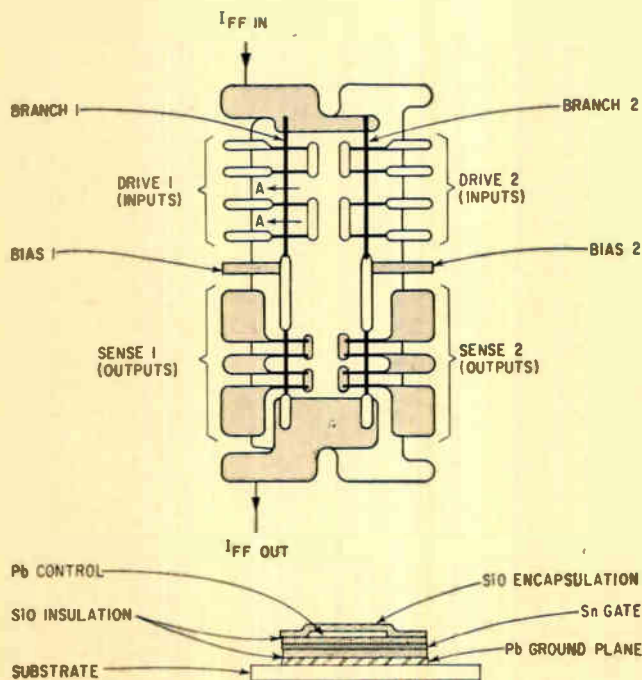
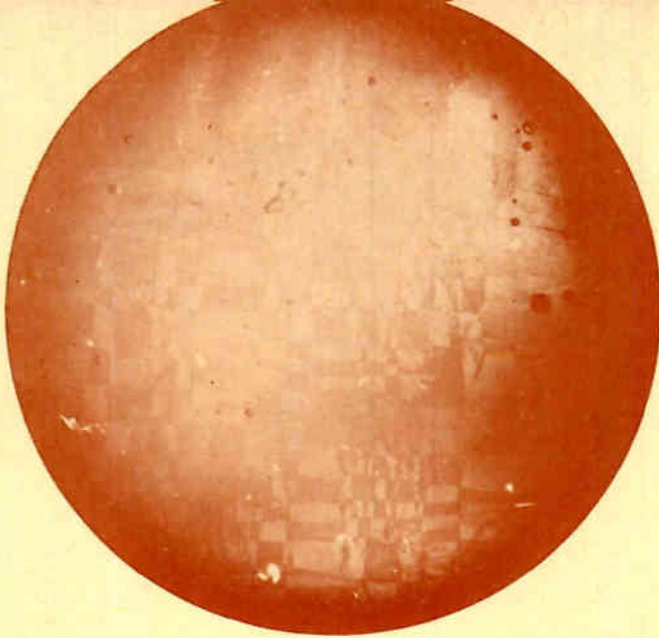

Fig. 36—Construction detail of cryotron flip-flop



Microscopic view (magnified about 25X) of thin film under polarized light shows random magnetized areas

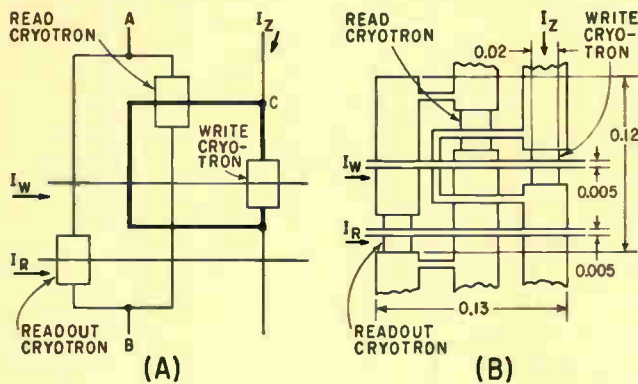

Fig. 37—(A) Schematic of persistent-current memory cell; (B) wiring diagram

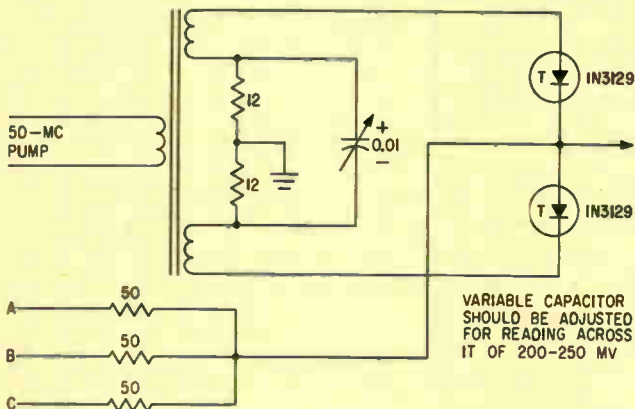
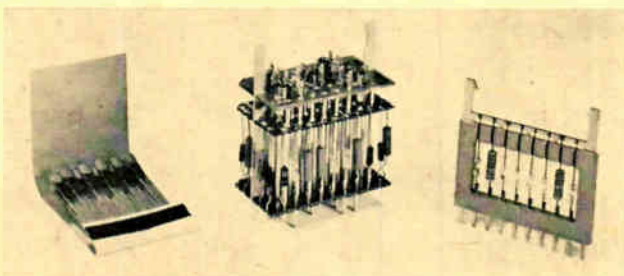

Fig. 38—Majority-decision tunnel-diode logic designed by RCA. Circuit is a 50-Mc phase-locked tank



Miniature transistor packages use low power levels in Burroughs 5000 computer

when a writing current is applied to the WRITE cryotron to hold its gate normal and an information signal is injected at C; the WRITE gate is then opened and the current circulates. It continues to circulate until the WRITE gate is made resistant by application of a writing current.

THIN FERROMAGNETIC FILMS—Thin films possess an easy or preferential axis of magnetization, and thus exhibit a bistable characteristic useful in information-handling. A small film spot can control at least one other film spot. Logic circuits have been postulated, but the major effort at the moment appears to be in thin-film memory devices.

Remington Rand Univac is making a computer in which 128 words of ultrahigh-speed thin-film memory are included as an interpretive scratchpad, working with a main store of 2-microsecond cores. The relatively high input-to-output current ratio which characterizes thin films is militating against their present use as bulk storage devices. Other problems being investigated in computer labs are noise levels and spurious pulses introduced by domain switching.

MIT's Lincoln Laboratory will shortly place in operation its FX-1 system, which will use microalloy diffused transistors for logic in the 50-Mc range, and will have a memory composed entirely of thin ferromagnetic films. Aeronautical division of Minneapolis-Honeywell is also designing thin-film hardware for special-purpose airborne computers, as is Hughes.

Fabrication of thin films is a problem several solutions to which seem to be emerging. The Remington Rand St. Paul laboratories are vacuum-depositing films 1,000 Å thick in the presence of a strong magnetic field to control the anisotropy. Other laboratories are investigating electroplating, chemical-bath plating (without electrodes) and other processes, some of which may produce more repeatable batches of thin-film components than vacuum evaporation.

Most thin films are prepared as spots, either circular, oval or rectangular. Burroughs is investigating the possibility that a flat sheet of thin-film material will prove even more efficient and not place as many strictures on the fabrication of the reading and writing sandwiches.

Mu-metal shields are needed on thin-film memory planes. The earth's magnetic field and stray fields in the ordinary industrial environment significantly affect the behavior and noise-levels in thin-film devices.

TUNNEL DIODES—New development which has not had to await the solution of unusual fabrication problems has been the tunnel diode. Here the principal research effort has been expended in developing logic which would at once be compatible with existing devices and still cope with the bilateral characteristics of the tunnel diode.

First circuits using tunnel diodes were twin or balanced-pair types, exemplified in the majority-decision circuit in Fig. 38. The gate in this illustration is a phase-locked tank operating on a 50-Mc pump.

More recently, Boolean logic functions have been realized without using matched pairs. The OR and AND circuits in Fig. 39A and B use resistance-coupled inputs to operate the tunnel diodes. Since the gate in Fig. 39B is open when the 1N3129 is on its negative-resistance

slope, a reset pulse must be applied to close it. Set and reset pulses of this type must be considered as logic inputs in tunnel-diode circuits.

MICROMINIATURIZATION—The continuing drive to reduce the size of computers puts constant pressure on research in microminiature components, molecular electronics and similar developments. The high cost of molecular circuits and microminiature units is the principal barrier to their acceptance at present.

Burroughs has developed a technique for making extensive diode arrays cheaply at densities as high as 2,500 to the square inch at a cost of a few cents per diode. The matrices are made in place from a single circular wafer of silicon, lapped and polished, ultrasonically machined and etched, then mounted between circuit plates bearing the two sets of contacts. Diodes are 0.01 in. in diameter on 0.02-in. centers.

One major trend is toward reducing the amount of power consumed in the computing system. Engineers in the data-processing technology today speak of micro-power circuits which will use signals in the millivolt range driving currents in the milliamperere range, for resultant power in microwatts. Cryogenic circuits will surpass this aim, as will molecular-electronic circuits, when they become practical. But even now, in dealing with miniature components, the aim is to hold power per logic or amplifier stage down to a few microwatts.

COMPUTERS AND THE CHALLENGES OF MAN

We see man as a creature of certain attributes and abilities. Facing him is the universe of problems — the host of things to be done, or of things he wishes, the accomplishment or attainment of which he regards as a challenge. His whole history has been characterized by the invention or development of tools which match him to the environment so that he can more efficiently or enjoyably cope with these challenges. Of these tools, the computer is one of the most potent.

Considered this way, with man "here" and his challenges represented as a remoter "there," the question becomes: What needs to be done to get there from here?

Researchers postulate a possible future in which computational power will be available in a wall socket, like electrical power; or where every man who wants one can buy a small computer as he may one day buy his own nuclear generator for power. Perhaps the computer builder of 1961 finds it hard to comprehend the development of individually available computer power. He might concede that we could develop suitable equipment and effective means for intercommunication between human and helper; but can he imagine all the changes this would cause in our everyday environment and ways of doing things? Can he visualize the tremendous upsurge in intellectual mobility and power that we might experience, and its potential good? Such a development might be

CHARACTER RECOGNITION—In attempting to solve the problem of getting information into the computer, a tremendous engineering effort is being put into recognition of patterns, with especial emphasis on recognizing the printed, written or spoken word.

IBM recently disclosed development of a device which can recognize the spoken digits from zero to nine. The device uses fewer than 100 transistors, can recognize vowel sounds, selected voiced consonants, the necessary fricatives. The digits have the advantage—save "7"—of being monosyllabic.

At USAF's Electronics Research Directorate, studies of speech bandwidth compression and analysis have resulted in a digital evaluation technique by which a small vocabulary of spoken words—about fifty so far—can be recognized and matched by the computer. The computer figures a template of characteristics for a word by hearing it spoken several times, then matches inputs to the template "vocabulary." Reliability is high when the same speaker makes both template and test, drops to 80 to 90 percent when another speaker makes the test.

Systems for recognizing the printed word are farther along. The magnetic-ink systems can handle the ten digits and selected special code symbols. Optical systems have been developed for recognizing simple and complex alphabets of printed characters. The optical scanning devices designed by Intelligent Machines Research, a division of Farrington Corp., are already widely used

inevitable; intelligent effort could hasten it and direct it into desirable channels.

Another line of machine history from which I like to extract fortifying considerations is the harnessing of automotive engines for transportation. When these engines first became available, their application to the transportation of goods and people was in the large-machine, formal-schedule class. Ships and railroads provided tremendous service if your problem happened to be amenable to their capabilities and programming. The impact of such machines was great; but I wonder if the people who celebrated them as the acme of human progress saw the huge potential of automotive machines designed to help individuals? Our cars, trucks, fork-lifts, bulldozers, have had an impact on society that would have confounded the engine builder of 1861.

Could he have accepted that ordinary people could learn the rules and skills needed to operate a car in heavy traffic, or that ordinary communities would put up the capital for today's road systems, or that children would learn the complex skills of operation as a natural part of their cultural inheritance? Probably not; and our computer-makers today are in the same spot.

DOUGLAS C. ENGELBART
Senior research engineer
Stanford Research Institute

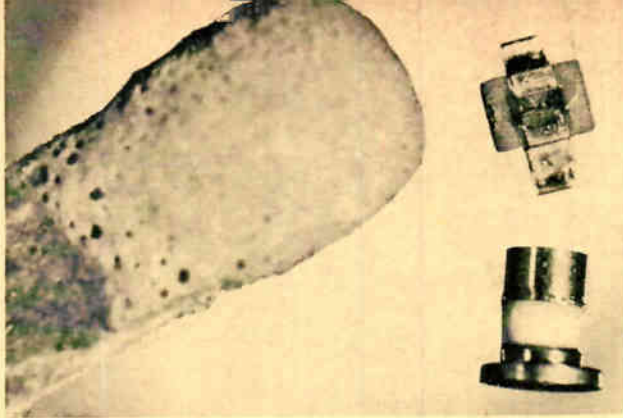

Rivet-type and wedge-type tunnel diodes developed by IBM are dwarfed by matchhead. Junction is less than 0.0005 in. wide. Rivet diode needs no additional connectors, is inserted directly into circuit board

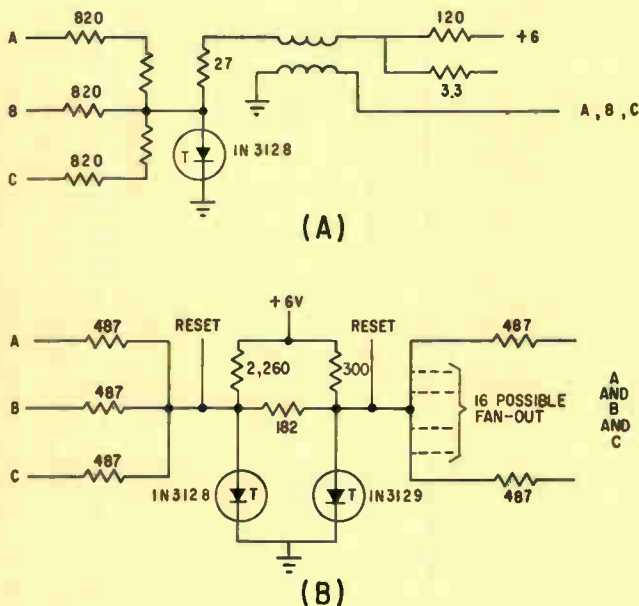

Fig. 39—(A) Tunnel-diode monostable OR circuit; (B) tunnel-diode threshold logic: bistable AND circuit with reset

to read credit-card data, also work for the government in sorting mail and transcribing typed data for computer input. IMR machines work on both a complete truth-table comparison and interpretation of data letter by letter, and on a topological recognition basis. Address-detecting equipment used for macrosorting mail recognizes the topology of major urban addresses; the credit-card data are interpreted digit by digit.

RCA and IBM have developed their own optical scanning systems to read special fonts of numerical type of their own devising. Both are continuing research in the generalized field of recognition of all fonts, of hand-printed characters, and of handwriting. GE and NCR have also developed optical systems; GE's makes a hybrid correlation of samplings taken of the character outline.

ASSOCIATIVE MEMORY—Two dramatic developments may completely overhaul the logical approach to data-handling. One is the associative memory, or distributed-response memory, of which the most well known hardware example is probably Cornell Aeronautical Lab's perceptron. The other, the development of machine learning, is related and in many ways depends on the

development of associative memory.

In the perceptron, sensory devices translate a stimulus pattern into discrete sets of electrical signals. These are relayed to associative units; in the initial machine organization, negative or positive associative units may be randomly made to receive a given stimulus input as excitation or inhibition, and each associative unit has an arbitrarily selected threshold. If a stimulus exceeds the associative-unit threshold, it puts out a signal to a response unit to which the associative unit is connected. The response units, themselves randomly interconnected, also transmit reinforcement signals to the source-set of stimulus inputs, each to its own associative unit.

Stimuli and correct responses are related and the responses enforced by adjustment of stored threshold values. The feedback from response unit to associative unit adjusts this threshold. Experiments have established that a perceptron, however primitive, will ultimately arrive at a solution to any given response-association problem, provided only that there is an acceptable terminal state of the system which represents a solution. The efficiency of more highly organized perceptron systems is greater than that of the simpler type of perceptrons.

Other associative memory systems are being investigated in computer labs. IBM is pursuing a magnetic associative memory that can be addressed by content, and would then search on partial association, reinforcing when it got "warm."

Sylvania, RCA and Honeywell are also known to be developing associative memories. Sylvania's work relies heavily on multiple-layer electroluminescent-photoconductive systems with visual-pattern inputs. The CAL perceptron, which also takes visual inputs, uses a photore-sistive matrix for stimulus conversion.

Result of these lines of development would be a memory system in which no coded or classified lists of experience or data exist. All data would be indefinitely cross-referenced whenever experience produced the necessary associative reinforcement. Elaborate search and comparison routines would be needless, and the system could retrieve data merely in terms of reference to the content.

A system organized on such lines, with the ability to establish the thresholds for its own logical paths, would be capable of learning from experience, and therefore would not need the meticulous instruction which computers now receive. Furthermore, operating at the speeds now projected for computers, it would have a capability increased by several orders of magnitude over today's systems.

In order to make full use of the capabilities of such sophisticated organization, a computer would need a far greater population of one or two types of logic circuits—say NOR circuits—randomly interconnected. It is this requirement, with its obvious demand for a high percentage of redundancy and the concurrent need for manageable size, which causes computer engineers to await with great impatience the advent of commercially competitive cryotrons or molecular circuits. For these might conceivably be thrown together just so randomly by the millions, allowed to form their own associative patterns, and thus form a computer far beyond the abilities of the systems designed from fixed logic today.



MICRO/G* diode lying on the head of a pin illustrates the extreme smallness—0.040" diameter, 0.060" body length—of the glass hermetic package.

FIRST

IN A NEW GENERATION OF SILICON DIODES TI-2 AND TI-6

MICRO/G*

MESA DIODES FOR YOUR COMPUTER APPLICATIONS

New MICRO/G diodes — smaller in diameter than the head of a pin — give you electrical characteristics equal or superior to those of conventional-size computer diodes... in 1/50 the volume! ● The TI-2 and TI-6 capitalize on diffused silicon mesa wafers whose surfaces are *oxide-passivated* for optimum stability and reliability. The solid construction and extreme simplicity of the smallest hermetic computer microdiodes in the industry represent a revolutionary achievement in high-density packaging. ● MICRO/G diodes are priced competitively with their larger counterparts... contact your authorized Texas Instruments distributor or nearest TI Sales Office for evaluation samples today.

*Trademark of Texas Instruments

MAXIMUM RATINGS	TI-2	TI-6	UNITS
V_F Fwd. Voltage Drop at 25°C	1 at $I_F=10$ ma	1 at $I_F=5$ ma	v
C Capacitance at $V_R=0$ Vdc at 25°C	4	10	μmf
I_R Reverse Current at 10 v at 25°C	0.025	1.0	μa
t_{rr} Reverse Recovery Time (10 ma I_F , 10 ma I_R Recovery to 1 ma reverse)	10	100	nsecs
V_R Reverse Voltage	40	20	v

Wide usage in potting compounds is made possible by hermetically sealed glass case which concentrically encapsulates the silicon wafer.

Rapid conduction of heat away from junction is provided by round leads with 30% greater cross-sectional area.

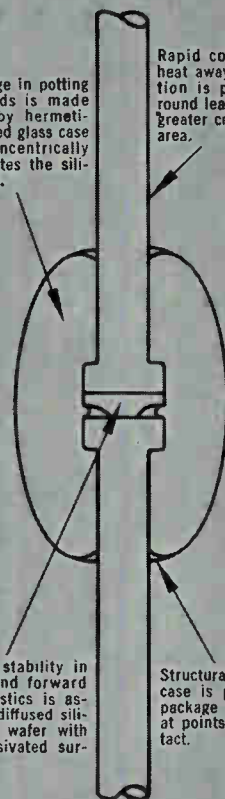

Optimum stability in reverse and forward characteristics is assured by diffused silicon mesa wafer with oxide-passivated surface.

Structural damage to case is prevented by package configuration at points of lead contact.

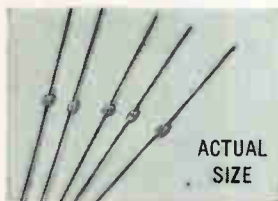

SEMICONDUCTOR-COMPONENTS DIVISION

TEXAS INSTRUMENTS

LIMITED

INCORPORATED

DALLAS ROAD • BEDFORD, ENGLAND

P. O. BOX 5012 • DALLAS 22, TEXAS

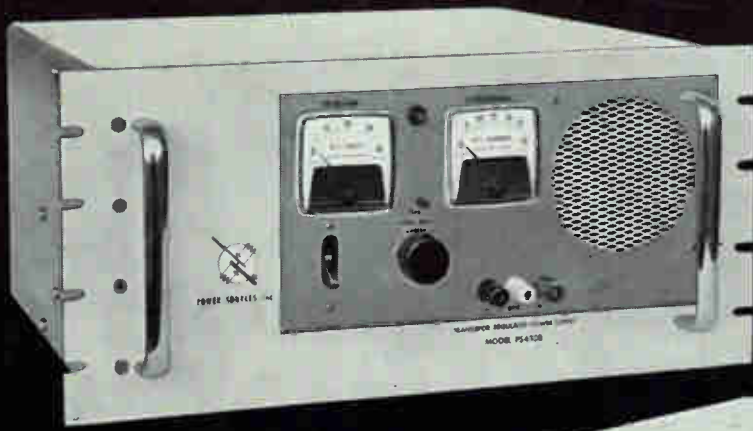

Model PS4330M
0-36 volts DC out
at 30 amps maximum

Model PS4232M
115-325 volts DC out
at 1.5 amp maximum



**NOW
priced
up to**

**20% LESS than comparable
power supplies**

CONSIDER . . . POWER SOURCES two new lines of power supplies . . . one high and one low voltage. *Both* lines feature the exclusive POWER SOURCES, INC., regulator circuit that fully protects transistors *without* DC fuses or circuit breakers. This means total protection for supply and load without limiting current.

WEIGH . . . the importance of a warranty that covers both lines for *five full years*. And this includes all semiconductor components.

ADD UP . . . other POWER SOURCES advantages such as Transient-Free Output . . . Cooling Systems designed for long life, trouble-free operation . . . Compactness . . . New low prices. And . . . 10-day delivery!

ASK YOURSELF . . . "Aren't these the benefits I've been looking for in a transistor-regulated power supply?" Then . . .

WRITE OR PHONE . . . today, for complete specifications on POWER SOURCES high and low voltage solid state power supplies.

SPECIFICATIONS	LOW VOLTAGE			HIGH VOLTAGE		
	MODEL PS4305M	MODEL PS4315M	MODEL PS4330M	MODEL PS4222M	MODEL PS4230M	MODEL PS4232M
Voltage Range (VDC)	0-36	0-36	0-36	32-215	90-300	115-325
Current Range (amps)	0-5	0-15	0-30	0-1.5	0-1.5	0-1.5
AC Input (Volts)	105-125	105-125	105-125	105-125	105-125	105-125
AC Input (CPS)	50-60*	50-60*	50-60*	50-60*	50-60*	50-60*
Regulation-Line (105-125V)	0.025%	0.025%	0.025%	0.1%	0.1%	0.1%
Regulation-Load (0 to full load)	0.05%	0.05%	0.05%	0.1%	0.1%	0.1%
Cooling	Free Air Convection	Forced Air	Forced Air	Forced Air	Forced Air	Forced Air
Ripple (RMS) in Millivolts	1	1	1	3	3	3
Panel Height	3½"	5¼"	8¾"	5¼"	5¼"	5¼"
Price (Note: If meters not desired deduct \$30 and drop "M" from model number)	\$525	\$825	\$1375	\$685	\$710	\$750

*400 cps available on order

Specify POWER SOURCES BY

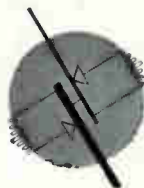

POWER SOURCES, INC.
BURLINGTON, MASSACHUSETTS

* ACTUAL SIZE



These unique features show why Daystrom 341 Series Potentiometers have zero backlash and maximum resistance to shock and vibration.

Three things make these rotaries unique. (1): our patented V-guide design which eliminates backlash. (2): the use of our patented *double wipers* effectively doubles resolution. And (3): impossible to see with the naked eye, is the winding; the resistive element is wound tightly in a precision groove cut into the mandrel by a tiny diamond tool. As a result, each turn always stays securely in position, despite severe shock and vibration.—Only Daystrom 341 Series rotaries offer these features. Available in values from 1K to 600K, rated at 2.5 watts in *still air*, they are only ½" in diameter and 1" long, with or without our patented clutch for servo use. They meet or exceed all applicable MIL specs.—Start solving your potentiometer problems now: contact your Daystrom Representative (or the factory) for more information on specifications, prices, fast delivery.

DAYSTROM, INCORPORATED
POTENTIOMETER DIVISION
ARCHBALD, PENNSYLVANIA • LOS ANGELES, CALIFORNIA



FOR
MILITARY
 REQUIREMENTS

BE SURE OF MAXIMUM
 RELIABILITY...SPECIFY

PHILCO
TRANSISTORS

Look to the pioneer producer of *many millions of Military transistors* for your critical applications. Philco has been the symbol of reliability from one of the industry's first JAN types (2N128) to the present broad Military line.

The enviable record of ultra-reliable performance has resulted in the use of Philco transistors in many Military programs. The following types are available to existing Military specifications:

TYPE NO.	APPLICATION	MILITARY SPEC. NO.
2N128	High frequency amplifier	MIL-T-19500/9A
2N240	High speed switch	MIL-S-19500/25A
2N393	High speed switch	MIL-S-19500/77A (Sig C)
2N495	Medium frequency amplifier (Silicon)	MIL-T-19500/54A (Sig C)
2N496	Medium speed switch (Silicon)	MIL-S-19500/85 (Sig C)
2N499	VHF amplifier	MIL-S-19500/72A (Sig C)
2N501A	Very high speed switch	MIL-T-19500/62 (Sig C)
2N502A	VHF amplifier	MIL-S-19500/112 (Sig C)
2N599	Medium speed switch	MIL-S-19500/166 (Navy)
2N1118	Medium frequency amplifier (Silicon)	MIL-S-19500/138 (Sig C)
2N1119	Medium speed switch (Silicon)	MIL-S-19500/139 (Sig C)
2N1158A	VHF oscillator	MIL-S-19500/113 (Sig C)
2N1199A	High speed switch	MIL-S-19500/131 (Sig C)
2N1200	HF amplifier (Silicon)	MIL-S-19500/105 (Sig C)
2N1201	HF amplifier (Silicon)	MIL-S-19500/101 (Sig C)
2N1411	High speed switch	MIL-S-19500/133 (Sig C)
2N1499A	High speed switch	MIL-S-19500/170 (Sig C)
2N1500	Very high speed switch	MIL-S-19500/125 (Sig C)

For information on any of the above types, write Dept. E42861.

PHILCO[®]

 Famous for Quality the World Over

LANSDALE DIVISION • LANSDALE, PENNSYLVANIA



OFFICIAL U.S. AIR FORCE PHOTO

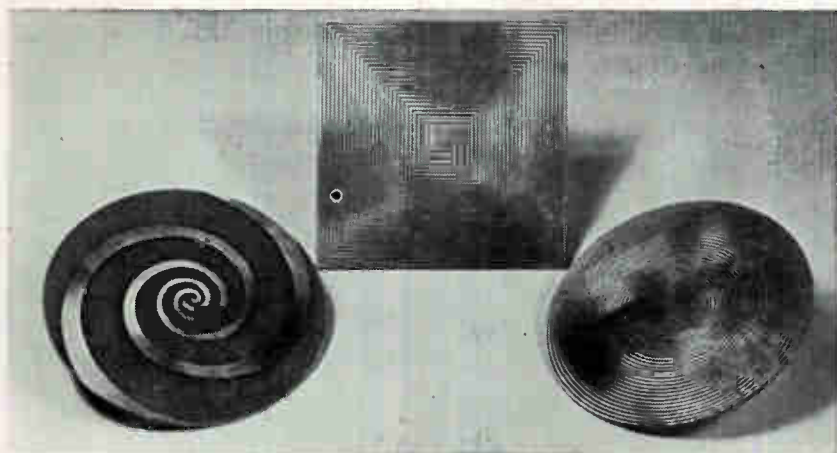

These logarithmic, square-Archimedean and Archimedean spirals (left to right) are of the dual-arm, rather than the single-arm, type of spiral

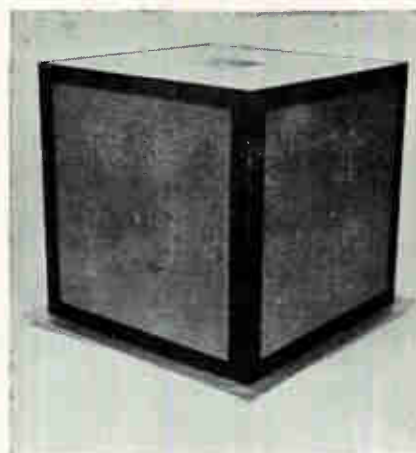

Antenna structure comprises square-Archimedean spirals

DESIGNING

Printed-Circuit Spiral Antennas

Describes design considerations such as effects of spiral and cavity diameters, spiral rate of growth, type of spiral and antenna-feed structure. Shows how to design a balun for feeding spiral antennas and lists performance criteria of these antennas

By J. J. WOLFE and R. BAWER, Aero Geo Astro Corp., Alexandria, Va.

THE SPIRAL ANTENNA is a two-dimensional structure that is fabricated by photoetching the geometric configuration on copper-clad laminate. Only three of the variety of possible spiral configurations have received wide attention; these are the logarithmic or equiangular spiral, the Archimedean or arithmetic spiral, and the rectangular counterpart of the Archimedean spiral. All these show broadband characteristics with respect to input impedance, radiation pattern and circular polarization of the radiated field. Since the dual-arm Archimedean spiral has the greatest symmetry, only this form is discussed. Many of the results,

however, are applicable to the other configurations.

An Archimedean spiral antenna, whose two arms are excited by currents having a 180-degree phase relationship will radiate from a band of mean diameter equal to λ/π . This follows directly from the band theory,¹ which provides a heuristic description of the radiation mechanism of the spiral antenna. The radiation pattern is bidirectional and circularly polarized according to the winding sense of the spirals. This is the normal mode and is the one in which nearly all spiral antennas are intended to operate. Refer to reference 2 for a detailed discussion of

higher-order radiating modes.²

This article discusses those aspects and parameters that significantly affect the operation of spiral antennas and clarifies some uncertainties in the design of these antennas.

Applications of spiral antennas are most common where flush mounting, large bandwidths, circular polarization and small size are needed. In nearly all of these uses the bidirectional radiation pattern of the spiral element is undesirable and, for this reason, the most familiar configuration is of a spiral element mounted at the mouth of a closed-back cavity. The problem is to establish the opti-

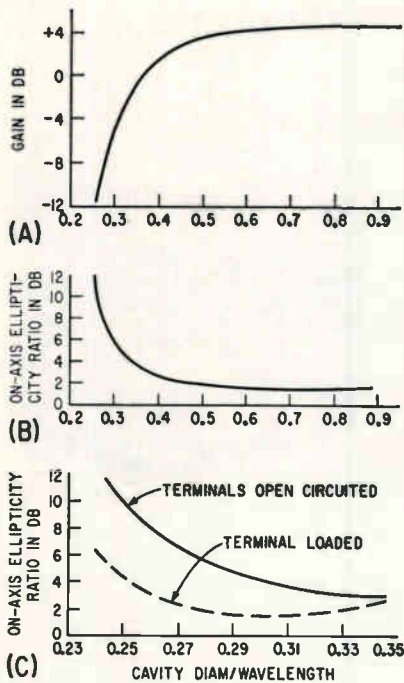

FIG. 1—Effect of cavity diameter on gain (A) and axial ratio (B). Effect of loading conductors (C)

imum parameters for spiral diameter, cavity depth, spiral rate of growth, dielectric material, conductor width and spacing, type of spiral and feed structure.

Band theory shows that antenna gain will be low for spiral diameters smaller than λ/π . Gain will increase with diameter and asymptotically approach some upper limit for diameters much greater than λ/π . This is illustrated in Fig. 1A, which plots the absolute on-axis spiral antenna gain against various cavity-diameter (D) over wavelength (λ) ratios. The curve represents a compilation of data taken on a large number of spiral antennas operating over the frequency range of about 200 to 4,000 Mc. The gain is relative to that of a linear isotropic source and is normalized to the average axial ratio, that is, to the average on-axis ellipticity ratio. The axial ratio is the ratio of the E_z and E_θ vectors along the axis of the antenna, these vectors being at right angles to each other.

When the spiral's outer terminals are short-circuited or left open-circuited, the axial ratio becomes progressively larger as the spiral diameter is reduced, approaching linear polarization as the spiral degenerates to a simple dipole (Fig. 1B).

Consider the effect of terminating the spiral's outer ends with resistors or absorbing material. The most dramatic result is the improvement in axial ratio for small D/λ ratios (Fig. 1C). Antenna gain is unaffected by the loading, a result primarily due to normalizing the gain to the average axial ratio.

The cavity diameter must be equal to or greater than the spiral diameter. Nearly all spiral antennas are built with equal spiral and cavity diameters. If the cavity diameter is too large, higher-order coaxial and/or waveguide modes may be excited in the cavity that would cause pattern deterioration near the cavity resonances.

Gain of the cavity-backed spiral antenna follows the behavior of a dipole over a ground plane, being a maximum when the cavity depth is about λ and dropping off rapidly for depths greater than λ . The effect of cavity depth on gain is illustrated in Fig. 2A; the measured gain has been normalized to the average axial ratio and is corrected for input voltage standing wave ratio (vswr).

It would seem that for an annular ring of given width and mean diameter equal to λ/π , an increased percentage of input power is radiated from this ring as the number of turns is increased. Less power is then available at the outer terminals of the spiral and, consequently, the total energy in the radiated field having a reversed

sense is reduced. The axial ratio should, therefore, be reduced as the spiral is wound more tightly. The reduced axial ratio has been experimentally verified. The chief question remaining relates to the effect of increasing the number of turns on the antenna gain; the reduced axial ratio could also be attributed to the additional loss associated with the increase in the electrical length of the antenna. Measurements made on several spirals having different rates of growth have not shown sufficiently different gains to warrant a positive conclusion. A conclusion compatible with intuitive reasoning can be drawn from the data shown in Fig. 2B. These curves were obtained by probing the electric field along the surface of two spiral antennas. For a given radial distance, more energy is associated with the spiral having the greatest number of turns; therefore, the reduction in axial ratio is not associated with a corresponding reductions in gain.

There has been conjecture as to the characteristics of the dielectric base material that should be used for these printed-circuit antennas. For a given aperture size and number of turns, lower axial ratios are obtained using epoxy fiber glass ($\tan \delta = 0.02$) as opposed to Teflon fiber glass ($\tan \delta = 0.002$). However, the Teflon fiber glass antenna has 1 db more gain than the epoxy unit. Thus, best results are obtained using a

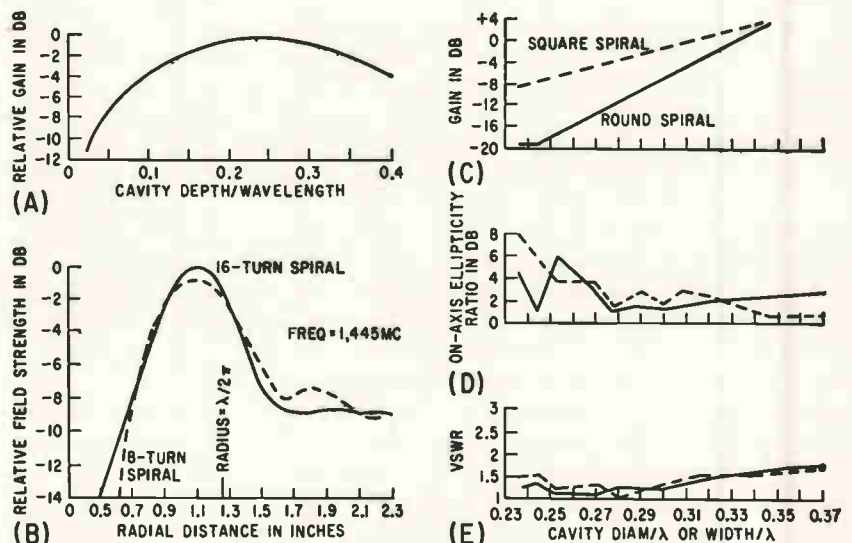

FIG. 2—Effect of cavity depth on gain (A) and of two windings on field distribution (B). Comparison of square and round spirals (C), (D) and (E)

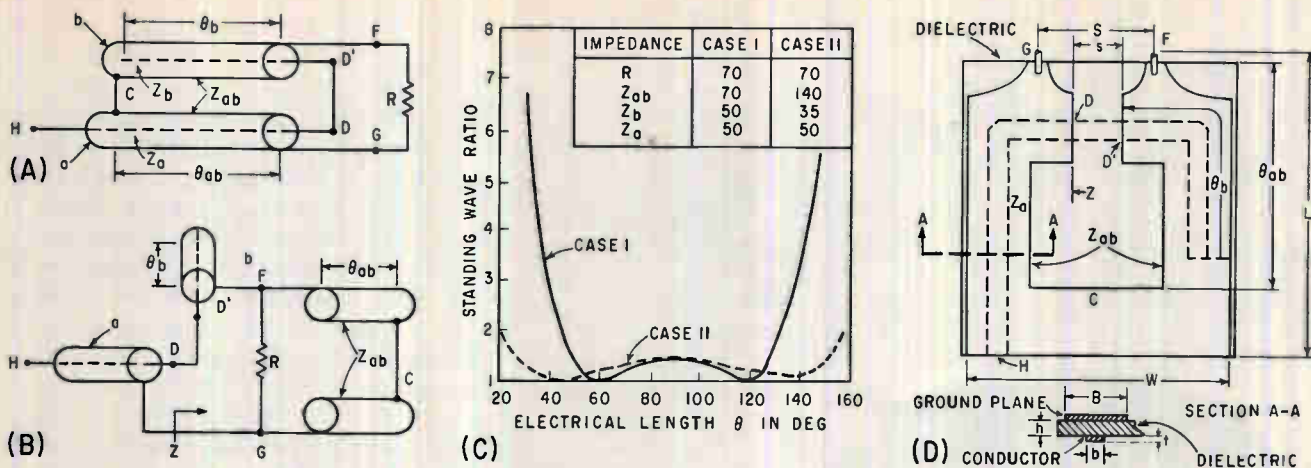

FIG. 3—Schematic (A) and equivalent circuit (B) of wide-band balun. Comparison of vswr for two balun designs (C). Details of printed-circuit balun (D)

low-loss base material and terminating the spiral outer ends with resistors or absorbing material.

Of all the spiral antenna parameters, conductor width and conductor spacing appear to be the least critical, the major consideration being to obtain the maximum number of turns within the allocated space. In general, spirals are constructed so that the ratio of conductor width to conductor spacing is unity, that is, the antenna is self-complementary. This choice is based on precedent, probably because the input impedance of this class of antennas has been calculated to be about 180 ohms. Since the antenna is generally fed from a 50-ohm line, a ratio other than unity would be more desirable. The impedance matching problem might be greatly simplified if the input impedance of the spiral antenna were reduced by making the ratio of conductor width to conductor spacing somewhat greater than unity.

In the previous discussions only the conventional Archimedean or round spiral was considered. However, similar arguments can be used to describe the behavior of the square counterpart of the Archimedean spiral. Figures 2C to 2E compare square and round spiral antennas. The difference in measured gains may be explained by recalling that the first radiation band occurs when the circumference of the spiral is one wavelength, corresponding to a diameter $D = \lambda/\pi$ for the circular spiral and a width $W = \lambda/\pi$ for the

TABLE I— Z_b^a of Unshielded Strip Transmission Line^b

b/h	G-10 ^c	GB-112 ^c
	Z_b (ohms)	Z_b (ohms)
0.75	90	125
1	80	112
1.5	65	89
2	53	74
2.5	46	64
3	41	55
4	33	46

(a) Characteristic impedance; (b) $B > b$, $l = 0$; (c) material

square spiral. When space is at a premium, the square spiral is preferable; however, for large D/λ ratios better results have been obtained with the round units.

The entire operation of the spiral antenna in its normal mode use postulated on the basis of an ideal, balanced, two-wire feed structure. Improper excitation of the spiral antenna causes pattern dissymmetry and pattern squint. Squint occurs if the feed lines themselves radiate or if the two-wire feed line is not balanced.

There are numerous devices⁵⁻⁷ suitable for transforming a balanced to an unbalanced transmission line over a wide frequency range. However, the balun to be described is well suited for use with spiral antennas or similar uses where space is at a premium.

Figure 3A and B show the schematic drawing and equivalent circuit of a coaxial balun. The terms Z_a and Z_b represent the characteristic impedance of transmission

lines a and b , respectively. The term Z_{ab} is the characteristic impedance of the balanced transmission line that is composed of the outer conductors of lines a and b .

From the equivalent circuit, the impedance looking into the terminals D - G is

$$Z = -jZ_b \cot \theta_b + \frac{jRZ_{ab} \tan \theta_{ab}}{R + jZ_{ab} \tan \theta_{ab}} \quad (1)$$

On letting $\theta_b = \theta_a = \theta$ and rationalizing,

$$Z = \frac{RZ_{ab}^2 + j \cot \theta [R^2(Z_{ab} - Z_b \cot^2 \theta) - Z_b Z_{ab}^2]}{Z_{ab}^2 + R^2 \cot^2 \theta} \quad (2)$$

Two interesting cases have been treated in the literature. Roberts⁵ imposes the conditions that $Z_b = Z_a = R$. For this case

$$Z = R \sin^2 \theta + j(\cot \theta)(R \sin^2 \theta - Z_a) \quad (3)$$

and the input impedance becomes perfectly matched at two widely separated frequencies given by

$$\sin^2 \theta = Z_a/R \quad (4)$$

These frequencies are symmetrically disposed about a center frequency corresponding to $\theta = 90$ degrees.

Using the same prototype balun, McLaughlin⁴ obtained a greater bandwidth by minimizing the imaginary term in Eq. 2. Again, θ is chosen to be 90 degrees at mid-band, Z_b is chosen according to

$$Z_b = R^2/Z_{ab} \quad (5)$$

and Z_{ab} is made as large as possible.

To compare the two approaches, the standing-wave-ratio curves shown in Fig. 3C were calculated for a balun transforming a 50-ohm unbalanced load to a 70-ohm bal-

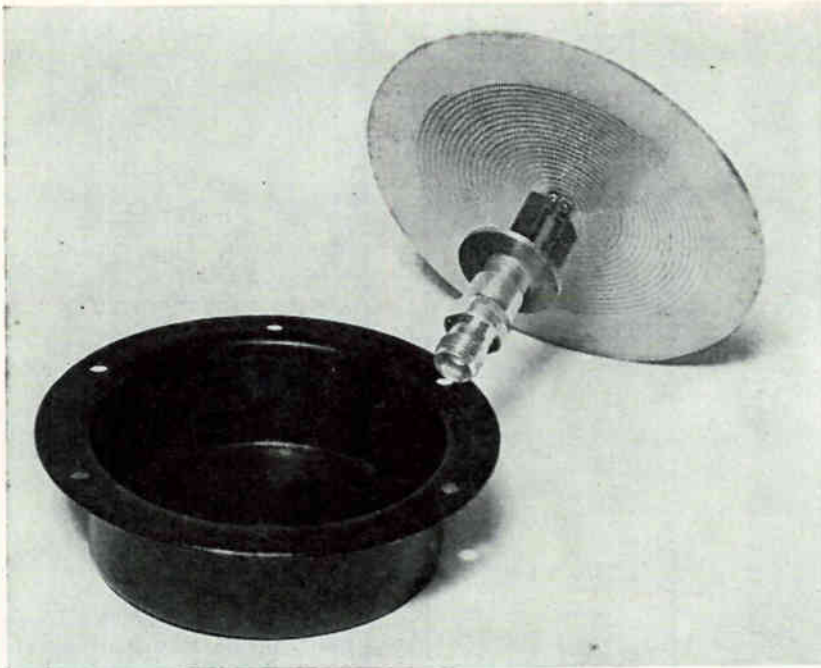

FIG. 4—Exploded view of spiral-antenna assembly

anced load. The advantage of the second approach would be offset by the increased complexity of a coaxial realization; however, this argument is not valid for the printed-circuit balun.

Figure 3D illustrates the construction of the printed-circuit balun. The coaxial line of Fig. 3A and 3B has been replaced by unshielded strip transmission line and that the corresponding balanced transmission line now consists of the two ground planes.

For a given load and generator impedance, Eq. 2, 4 or 5 can be used to calculate the parameter values. If however, the mismatch corresponding to the ratio of load-to-generator impedance is greater than can be tolerated, an independent transforming section must be used. This can be done by tapering the input transmission line.

Two types of transmission line are involved in the balun shown in Fig. 3D. The first type is the conventional unshielded strip transmission line consisting of a thin conductor over a ground plane (section A-A). The second type consists of a balanced transmission line made up of two flat, thin conductors of characteristic impedance Z_{ab} and length θ_{ab} .

The characteristic impedance and phase velocity of unshielded

strip transmission line have been the subject of numerous articles.^{8,9} Virtually all of the field is confined within a region of about three conductor widths. If the ground plane width is taken equal to or greater than three times the conductor width ($B > 3b$), the transmission line is nonradiating.

Dimensions for typical characteristic impedances are given in Tables I and II. Consult the references and bibliography for more complete data than in Table I. The data given in Table II is approximate, but should be sufficiently accurate for most balun designs.

The physical length of the transmission line depends upon the effective dielectric constant of the printed circuit line. For a non-homogeneous dielectric surrounding the lines

$$\theta = 2\pi Lf(\epsilon_e)^{1/2}/c \quad (6)$$

where c is the velocity of light in free space, ϵ_e is the effective dielectric constant of the medium, and f is the center frequency.

As a first approximation, the effective dielectric constant for the unbalanced line can be taken as

$$\epsilon_e = 0.75\epsilon \quad (7)$$

where ϵ is the dielectric constant of the base material. Equation 6 can then be used for the initial calculation of θ_{ab} , and the final length

may be obtained by trimming the line length.

For the balanced transmission line the effective dielectric constant does not significantly depart from that of free space, that is, $\epsilon_e \cong 1$.

Note the following points: (1) The impedance of the spiral antenna was estimated to be in excess of 100 ohms; consequently, the input conductor was tapered to provide a characteristic impedance of about 50 ohms at the balun input and an impedance of about 150 ohms at the center line of the balun. The line continues at this impedance to the open circuit. (2) At the upper end of the frequency band, obscuration of the spiral by the balun resulted in an increased axial ratio. This effect was virtually eliminated by trimming the corners of the ground plane, as shown in Fig. 4. (3) Final results were obtained by systematically varying a number of the parameters. The major change involved the length of the open-circuited line θ_{ab} , which was adjusted to give a vswr curve that is roughly symmetrical about the center frequency. The characteristic impedance and length of balanced line Z_{ab} and of θ_{ab} were found to have only a second-order effect.

Use the following procedure to design spiral antennas. Select the spiral diameter according to the minimum allowable gain of the lowest operating frequency (Fig. 1A and B). If space is a premium, use a square spiral (Fig. 2C to 2E). With the conductor width equal to the conductor spacing, select a dimension to give approximately 16 turns. Choose the cavity diameter equal to the spiral diameter. The cavity depth should be equal to $\lambda/4$ at the mid-operating frequency (Fig. 2A).

TABLE II—Characteristic Impedance of Printed Balanced Transmission Line

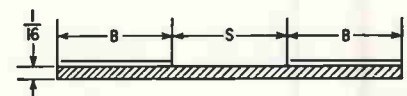

B/S	Z_{ab} (OHMS)
2	220
4	185
6	170
8	160
10	155

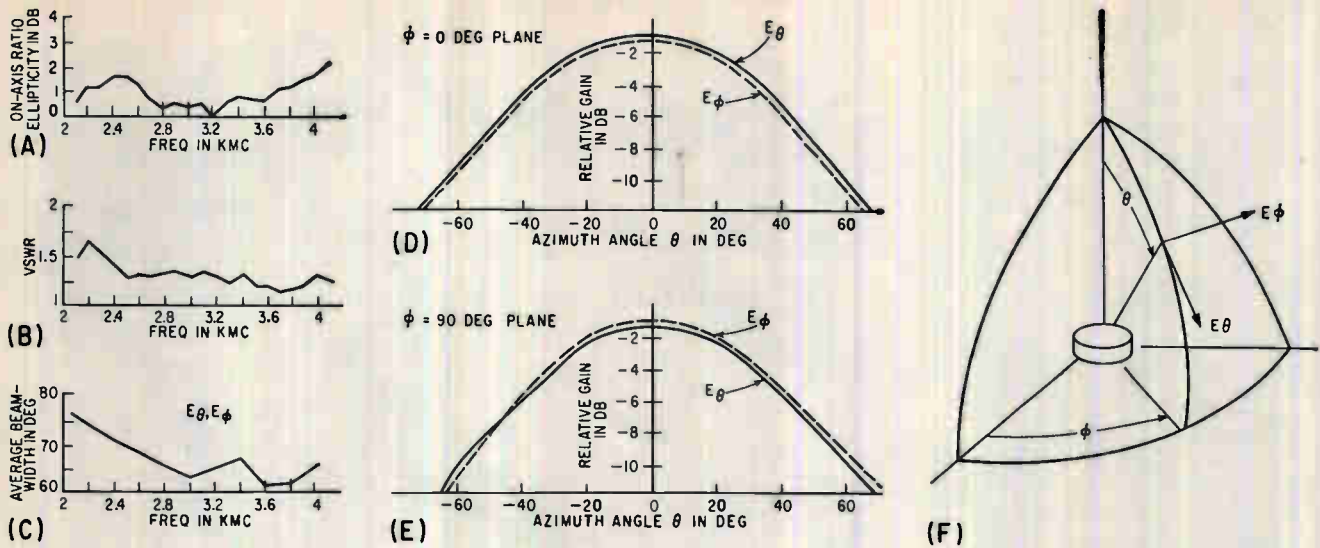

FIG. 5—Axial ratio (A), vswr (B) and beamwidth (C) of spiral antenna. Geometry of radiation-pattern measurements (D) and (E) is indicated in (F)

For the balun, choose W (Fig. 3D) to be $\ll \lambda/4$ at the high end of the frequency band; choose $L \leq$ cavity depth. Assume spiral impedance to be approximately 150 ohms and use Eq. 2, 3 and 4 to obtain balun parameters. Taper the printed line from D to H to obtain the desired input impedances. Trim line length θ_0 to obtain desired vswr.

An exploded view of an S-band spiral antenna is shown in Fig. 4. This unit is three inches in diameter and one inch in depth. The spiral has twelve turns and a conductor width equal to the conductor spacing, and is printed on $\frac{1}{8}$ in. thick epoxy fiber glass NEMA G-10. The balun is photoetched on $\frac{1}{8}$ in. epoxy fiberglass. It measures 0.750 in. wide (W) by 0.938 in. tall (L) and is attached to a GRFF 175 connector at the rear of the cavity.

Data showing the frequency dependence of the axial ratio, input impedance, and beamwidth of this spiral antenna are given in Fig. 5A, B and C. Over the octave range the on-axis ellipticity ratio is less than 3 db, the input vswr is less than 2:1 and the beamwidth varies between 60 and 80 degrees. These values represent a goal for the antenna designer and a specification for system design. More stringent requirements can be met, but further improvement would require greater mechanical tolerances and uniformity of the dielectric base material. Figure 5D to

5F illustrate the radiation patterns. Data were taken for two orthogonal planes with the antenna immersed in microwave absorbing material to simulate free-space. The data presented are typical of that obtained testing many different antennas at frequencies ranging from 140 Mc to 6,000 Mc, all frequency bands being on the order of two-to-one.

Consider the range of azimuth angles over which the ellipticity ratio (E_θ/E_ϕ) remains comparable to the on-axis ratio; for the case illustrated, the ellipticity ratio remains less than 1 db over an azimuth angle of greater than ± 60 degrees.

In most literature dealing with circularly polarized antennas, axial ratio is taken as one of the primary criteria for judging the quality of the antenna; reference is seldom made of the corresponding figure for off-axis angles. On-axis data alone can be misleading when applied to the flush-mounted spiral antenna. It is common to observe a low on-axis ratio while having excessively high ellipticity ratios for off-axis angles well within the usable antenna beamwidth. Improper feed, higher order band radiation, or a combination of the two will contribute to this effect.

Consider also the symmetry of the patterns about the axis of the antenna; the beam is aligned with the antenna boresight axis. The importance of a well-designed balanced feed in minimizing boresight

cannot be overemphasized. Without a well balanced, nonradiating balun, it is virtually impossible to achieve zero boresight error.

The work reported in this paper was sponsored by the Airborne Instruments Laboratory, P. O. No. 6468, under Air Force Contract No. AF33(600)-37829.

REFERENCES

- (1) B. H. Burdine, The Spiral Antenna, M.I.T., Research Laboratory Technical Report, April 1955.
- (2) R. Bawer and J. J. Wolfe, The Spiral Antenna, 1960 IRE International Convention Record, Part 1, p. 84-95.
- (3) W. K. Roberts, A New Wide-Band Balun, *Proc IRE*, 45, p. 1,628; Dec. 1957.
- (4) J. W. McLaughlin, D. A. Dunn, and R. W. Grow, A Wide-Band Balun, *IRE Trans on Microwave Theory and Techniques*, MTT-6, p. 314-316, July 1958.
- (5) E. G. Fubini and P. J. Sutro, A Wide-Band Transformer From An Unbalanced to a Balanced Line, *Proc IRE*, 33, p. 1,163; Oct. 1947.
- (6) E. M. T. Jones and J. K. Shimizu, A Wide-Band Strip-Line Balun, *IRE Trans on Microwave Theory and Techniques*, MTT-7, p. 128; Jan. 1959.
- (7) R. Bawer and J. J. Wolfe, A Printed Circuit Balun for Use with Spiral Antennas, *IRE Trans*, MTT-8, No. 3, p. 319; May 1960.
- (8) M. Arditi, Characteristics of Microstrip for Microwave Wiring, *IRE Trans on Microwave Theory and Techniques*, MTT-3, p. 31, Mar. 1955.
- (9) F. Assadourian and E. Rimal, *Proc IRE*, 40, p. 1,651, Dec. 1952.

BIBLIOGRAPHY

- J. A. Kaiser, Spiral Antennas Applied to Scanning Arrays, Electronic Scanning Symposium, Air Force Cambridge Research Center, April 1958.
- E. M. Turner, The Impact of the Spiral Antenna and Its Derivatives on the Design of Antennas and the Weapon System, National Conference on Aeronautical Electronics, Dayton, Ohio, 1958.
- W. L. Curtis, Spiral Antennas, M.S.E.E. Thesis, University of Washington, June 1958.
- V. H. Rumsey, Informal Presentation given at the URSI International Symposium on Electromagnetic Theory, University of Toronto, June 1959.

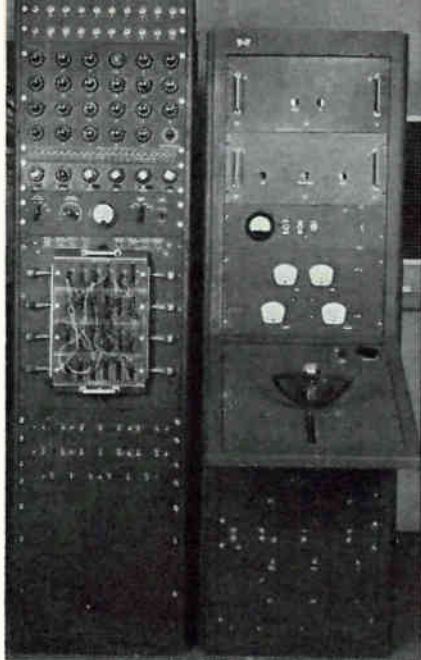

Two racks in left-hand photo make up most of a single-target generator of the attacker. Other photo shows part of defense system. Attacker and defender are situated in separate rooms

SIMULATING WAR GAMES

Analog computer simulates a flight of airplanes maneuvering to attack a target, while defense command responds to simulated radar information about the attackers. Attack, defense and a battle umpire comprise battle-simulation system for war games

By VINCENT J. CAGGIANO,

Applied Physics Laboratory,
The Johns Hopkins University,
Silver Spring, Maryland

IF WAR GAMES are to be carried out successfully, attacking aircraft must be free to maneuver independently. That is, the enemy operator must operate in a coordinate system that is not known to the defenders. However, to integrate the enemy targets into a unified battle simulator, provision must be

made for the defender's radar to pick up the enemy and track him in the defender's radar coordinates. Therefore a conversion must be made from enemy coordinates to the defender's coordinates.

Figure 1 indicates a complete battle-simulation system, as well as the enemy target generator. The enemy directs the attack of its aircraft from a command post. The battle umpire, which is the only station that has data from both the enemy and defenders, determines hits, duds, and who wins the battle.

The following specifications (see Fig. 2) apply to the target generator: slant range (R_s) should be precise to 1 part in 600 and range jitter should be less than the equivalent of 0.1 g target maneuver; target altitude (h) should have the same precision as range; speed should be controlled and variable as a cockpit control; azimuth angle (ϕ) and elevation angle (θ) should be precise to 1 part in 360; maximum angle jitter should be less than 0.1 deg. Parameters R_s , θ and ϕ are to appear as a radar would see a target in search or track mode.

In addition, the target generator must simulate six aircraft in

an attacking formation, again to appear as they would when being detected by a search radar and tracked by a tracking radar. These specifications, and the design of the additions to the single target generator which create a generator of six targets, are not discussed.

Since a target simulator is an analog computer with a specific problem, many techniques may be used to generate target parameters.

Figure 3 shows one method for generating the target path. Here a stick motion generates maneuver velocities $\bar{\alpha}$ and $\bar{\beta}$ (see Glossary) by moving potentiometers to pick off a portion of the reference voltage. These velocities are integrated to obtain α and β . The α and β outputs control servos which drive sine-cosine potentiometers R_1 and R_2 . Since the reference voltage on the sine-cosine potentiometers is scaled to represent the velocity, the velocity control being manipulated by the operator, the sine output of R_2 results in V_x ; Fig. 2 indicates that $V_x = V \sin \beta$. Voltage V_{xy} is the output at the cosine tap since $V_{xy} = V \cos \beta$. Similarly V_z and V_y are obtained by positioning R_1 by the α servo and referencing R_1 with V_{xy} ; Fig. 2 shows that $V_z =$

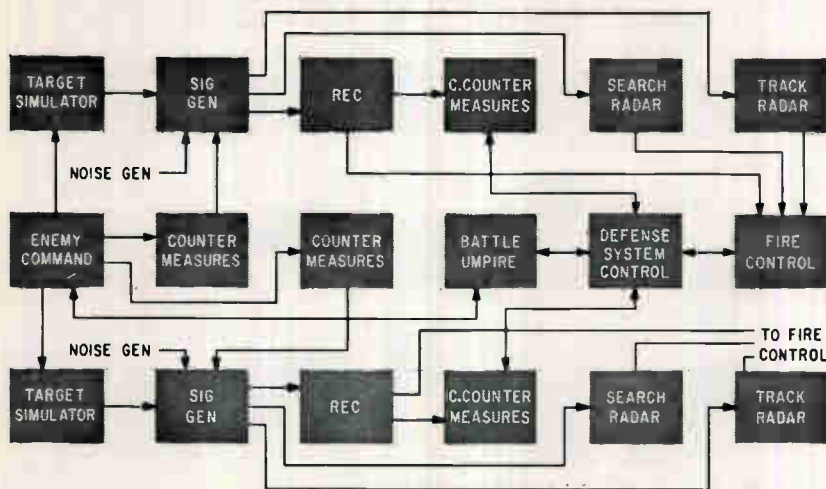

FIG. 1—Target simulators (generators) comprise but two blocks of battle-simulation system. Among tasks of umpire are making decisions, observing displays, and committing targets

GLOSSARY

V	velocity
V_h	velocity in vertical direction
V_x	velocity in x direction
V_y	velocity in y direction
V_{xy}	velocity in xy plane
V_{R_g}	velocity along ground-range component
V_{R_s}	velocity along slant-range component
h	altitude
x	distance in x direction
y	distance in y direction
R_g	ground range
R_s	slant range
ϕ	azimuth angle
θ	elevation angle
$\dot{\theta}$	rate-of-change of elevation angle
$\dot{\phi}$	rate-of-change of azimuth angle
$\dot{\alpha}$	lateral rate of turn
$\dot{\beta}$	rate of climb or dive
α	heading angle of target
β	angle of climb or dive

WITH ANALOG COMPUTERS

$V_{xy} \sin \alpha$ and $V_x = V_{xy} \cos \alpha$. After these velocities are obtained in cartesian coordinates they are integrated to obtain x , y and h , position data in cartesian coordinates. This is indicated by

$$\begin{aligned} h &= -\int V \sin \beta dt + h_0 \\ x &= \int V_{xy} \sin \alpha dt + x_0 \\ y &= -\int V_{xy} \cos \alpha dt + y_0 \end{aligned}$$

Since these outputs must be used as radar outputs the cartesian coordinates must be resolved into spherical coordinates. Assume the angle output of the servo is an unknown ρ . The inputs to the servo amplifier can be summed since the outputs of the sine-cosine potentiometers are known. Thus $y \sin \rho - x \cos \rho = 0$ is the necessary

condition for the servo to null. Solving for ρ : $y \sin \rho = x \cos \rho$ and $\sin \rho / \cos \rho = \tan \rho$. Figure 2 shows that the angle whose tangent is x/y is ϕ . Therefore the servo must null at an angle position equivalent to ϕ . Similarly, from Fig. 2

$$x \sin \phi + y \cos \phi = R_g$$

Note that no attempt has been made to consider proper polarities or scaling. The ϕ servo should be summing $y \sin \phi - x \cos \phi = 0$ to produce a positive angle ϕ . This is taken care of by inverting one of the inputs to the ϕ servo amplifier. Also potentiometer R_s should be scaled with the proper reference voltage. Using the same techniques, θ and R_s can be found since $\theta = h/R_s$, and $h \sin \theta + R_s \cos \theta = R_s$.

With this method the outputs are obtained from servo-driven potentiometers which may be a source of trouble. For instance, if the target is at a ground range of 300 miles and an altitude of 5 miles, the elevation angle, θ , is only about 1 degree. If the jitter due to the servo and potentiometer is 1 degree in magnitude this appears as if the target dove into the water and jumped out. Even if the jitter can be held to an acceptable value, the

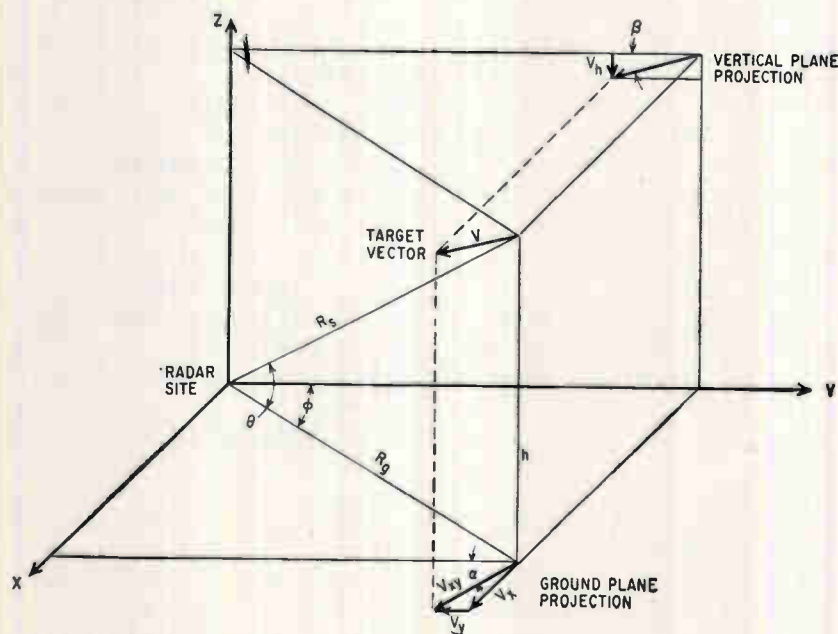

FIG. 2—Single-target geometry

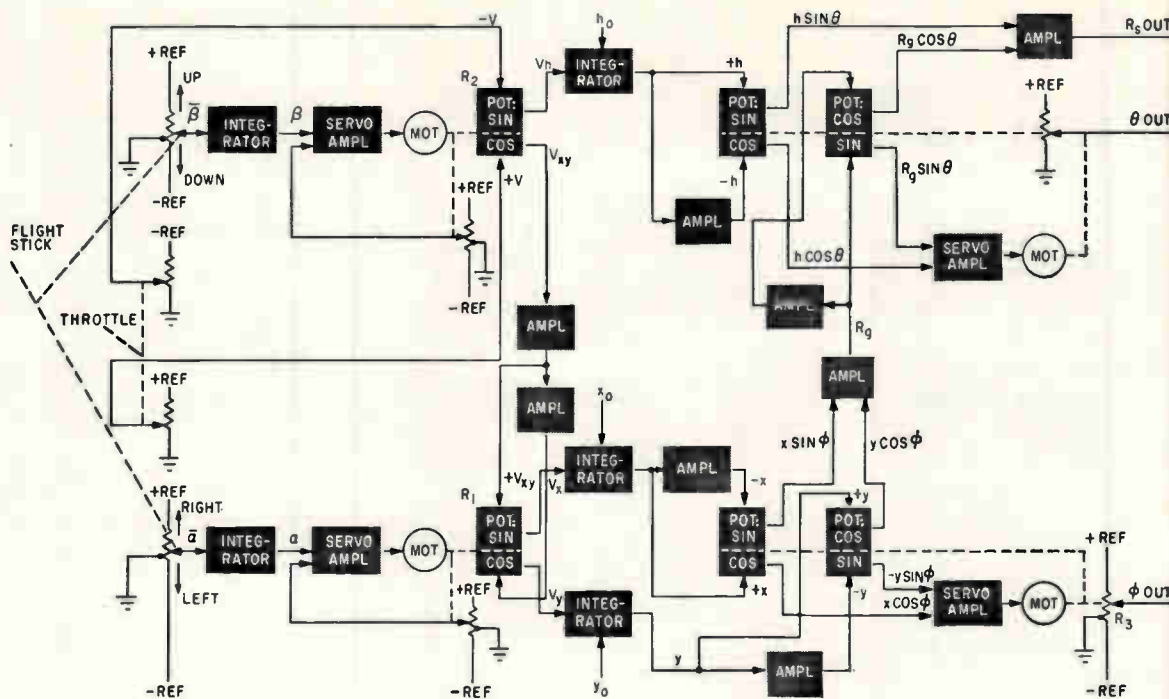

FIG. 3—Single-target generator uses position coordinate conversions

rate-of-change of jitter would indicate violent maneuvers. This problem may be diminished by filtering the outputs, but then there is a filter problem to solve.

The problem of jitter suggests that the coordinate resolutions should be done primarily with rates to obtain a position output from an integrator. Such a system is illustrated in Fig. 4 and 5. The geometrical representation in Fig. 2 largely applies. Figure 5 indicates the vector manipulations to derive the equations, which are instrumented in Fig. 4. Voltage V_{xy} is resolved into these two components: 1) along R_θ , being $V_{R\theta} = V_{xy} \cos(\alpha + \phi)$ and 2) perpendicular to R_θ , being $R_\theta \phi = V_{xy} \sin(\alpha + \phi)$. Voltage $V_{R\theta}$ is resolved into these two components: 1) along R_x , being $V_{R\theta} \cos \theta$ and 2) perpendicular to R_x , being $V_{R\theta} \sin \theta$. When V_h is resolved into its two components we get $V_h \sin \theta$ along R_x , and perpendicular to R_x , $V_h \cos \theta$. When these components are summed: $R_\theta \phi = V_{xy} \sin(\alpha + \phi)$, in ground plane; $V_{R\theta} = V_h \sin \theta + V_{R\theta} \cos \theta$, along R_x ; $R_x \dot{\theta} = -V_h \cos \theta + V_{R\theta} \sin \theta$, perpendicular to R_x .

Figure 4 shows that the instrumentation is similar to Fig. 3 in that a servo positions a sine-cosine

potentiometer to resolve V_{xy} into the appropriate components. In Fig. 3 this servo is driven by α whereas in Fig. 4 the servo is driven by $(\alpha + \phi)$ since ϕ is fed into the servo amplifier as a closed loop feedback system.

After $V_{R\theta}$ is obtained it is integrated to obtain R_θ , which is used to drive the division servo. This division process can be explained by referring to Fig. 6. The servo is a simple position servo and its output shaft position represents X . By defining the unknown output of amplifier 2 as E_n , the references on the second potentiometer are defined as $-E_n$ and $+E_n$. Hence the output of the second pot is $X E_n$. All that remains is to sum the inputs of amplifier 1, set this equal to E_n , and solve for E_n : $-E_n X + Y + E_n = |E_n|$; hence, $E_n = Y/X$. If $Y = R_\theta \phi$ and $X = R_x$, the resultant is $E_n = \phi$. Note that in the division servos of Fig. 4 polarities have not been considered and R_x is the input to the division servo and the input to the amplifier is $R_\theta \phi$. The only requirements are that ϕ does not get larger than the reference and R_x cannot be 0.

The same process is used to generate θ as to generate ϕ . The divi-

sion servo used to derive θ is driven by R_x (the divisor). The input to the amplifier is $V_{R\theta} \sin \theta - V_h \cos \theta$, which is equal to $R_x \dot{\theta}$. The R_x voltage is generated by summing $V_{R\theta} \cos \theta$ and $V_h \sin \theta$ (which is $V_{R\theta}$) and integrating the result. Terms θ and ϕ are also integrated to obtain θ , ϕ and R_θ .

One disadvantage of this system is that integrators tend to drift, and since it is anticipated that each simulation will last approximately one-half hour, the drift for that period must be small enough so that the target is within the required error band. Commercial integrators are available that are rated conservatively at 0.006 percent per minute maximum; this rating is better than required. Figure 4 appears to be best from the standpoint of reliability, accuracy, dependability, and cost. The cost of this system appears to be only slightly more than the cheapest method.

The computations required in the vertical plane and horizontal plane for Fig. 4 were simulated on a general purpose analog computer that indicated excellent results. The system in Fig. 3 was also simulated; the best conditions produced a jitter in the output servos of

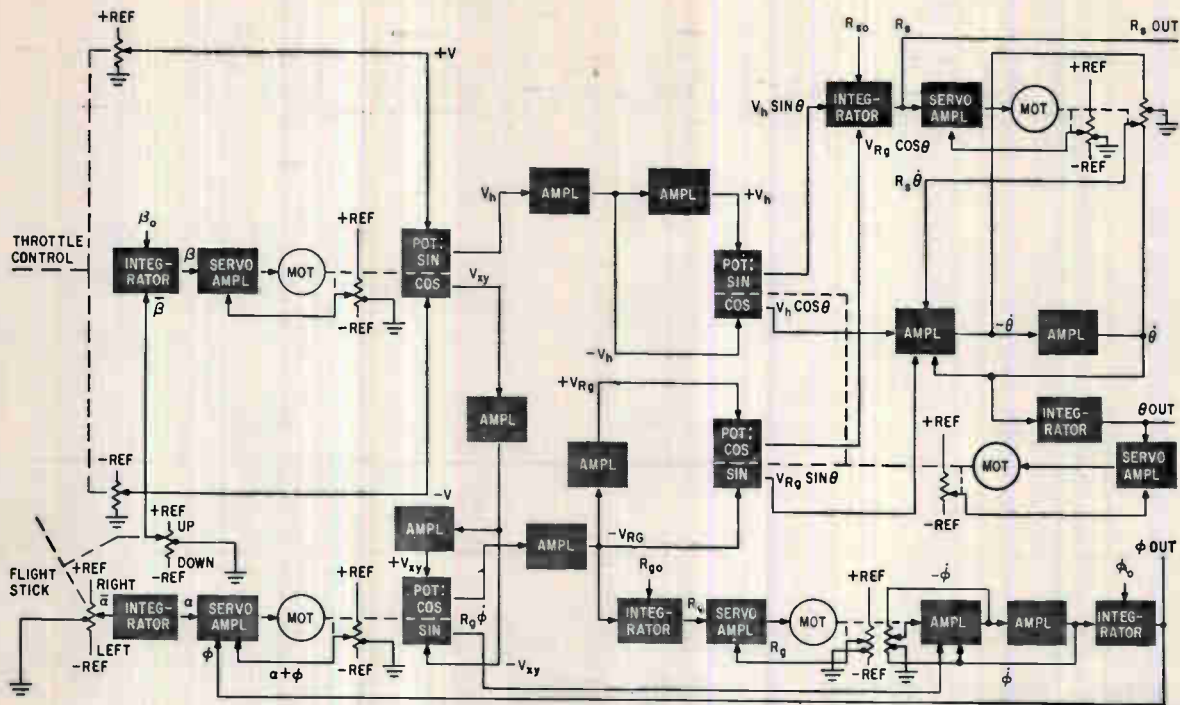

FIG. 4—Single-target generator uses velocity coordinate conversions

± 0.3 degree. The worst conditions indicated jitter of approximately ± 0.5 to ± 0.6 degree. The basic problem to be solved in order to eliminate the jitter is one of servo design. Since the servo used in the tests was representative of a good servo, it would appear that considerable time and effort could be spent in designing a smoother servo. Therefore, the system used is that shown in Fig. 4, in which coordinate resolutions are done on a velocity basis.

Figure 4 illustrates the system where angular rates ($\dot{\theta}$ and $\dot{\phi}$) are derived which are integrated to obtain the angles θ and ϕ . The simulation tests performed illustrate the filtering qualities of an integrator in that the output rate ($\dot{\theta}$) contained the same magnitude of jitter as the angle θ in the position resolution tests of Fig. 3, but output angle θ in the velocity resolution tests of Fig. 4 was almost smooth.

Circuit additions to the target generator allow simulation of a formation of as many as six aircraft (more may be added) flying in a formation that may be formed in many different configurations. The system that has been built and operated is contained in four standard racks, one a power-supply rack.

The second rack contains 20 general-purpose amplifiers, 20 general-

purpose attenuators used for scaling and a patch panel. These 20 (used for all integrators) amplifiers are of a higher quality than those contained in the third rack. The third rack contains cheaper amplifiers, servos and filament power supplies. This rack primarily contains components for the multiple-target instrumentation. The fourth rack is the main control panel. It consists of flight meters such as air speed, heading angle climb or dive meter, the throttle control, flight stick and other accessories associated with manning an attack aircraft. Also included are the pots with which the formation configuration is controlled. All the general control circuits are in the fourth rack.

A correction in θ due to the curvature of the earth has not been considered here since the effects are very small. This can be handled by summing a small fraction of R_{θ} with $\dot{\theta}$ to obtain an accurate approximation.

Two such systems have been built and incorporated into the battle simulator. These systems are used independently except that the two operators have a voice connection to allow a unified attack plan by two formations.

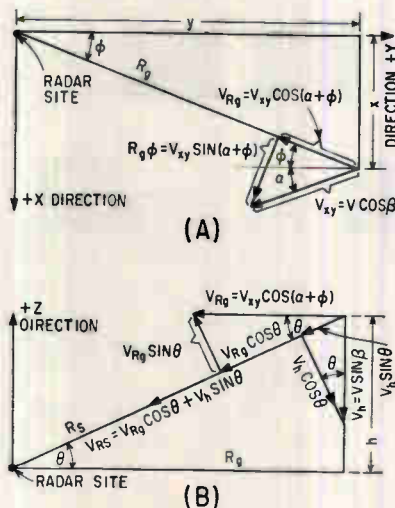

FIG. 5—Velocity projections on X-Y plane (A) and radar plane (B)

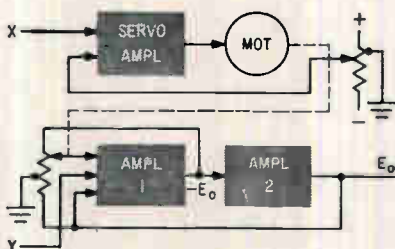

FIG. 6—Simplified diagram of bipolar division servo

IMPROVING GAIN CONTROL

Giving each cascaded stage an agc loop provides better temperature

By J. S. BROWN,
General Electric Co., Syracuse, N. Y.

USING agc with transistor amplifiers is difficult because of the characteristics of transistors.¹ The absence of a remote cutoff characteristic results in problems in controlling gain. Among these are signal-handling ability, range of control, and the sharpness of the transistor characteristic change as a function of control current. These factors are interrelated. Another factor is the low level of power in the control circuits. Since transistors are temperature sensitive, there are additional problems involving all of the factors.

Some problems can be circumvented by operating the transistors with fixed operating points and controlling the gain by electrically controlled attenuators² having low minimum insertion loss. Many of these circuits are critical and while good results have been obtained from them when a number of attenuators in one high-gain amplifier have been operated under the same conditions, difficulties have arisen where it was desired to control the gain in parts of the amplifier in a different manner at different signal levels.

Such a situation is an i-f amplifier having a low-noise-figure input amplifier and designed to operate over a large input signal range without overloading. This last requirement makes it necessary to attenuate the signal at high signal levels after the first stage. This attenuation must be done with care. At low signal levels the introduction of attenuation after the first stage could have a significant effect on the amplifier noise figure. If the attenuator does not provide constant impedance this too could degrade the overall amplifier noise figure. It is desirable then to delay the application of agc at the front

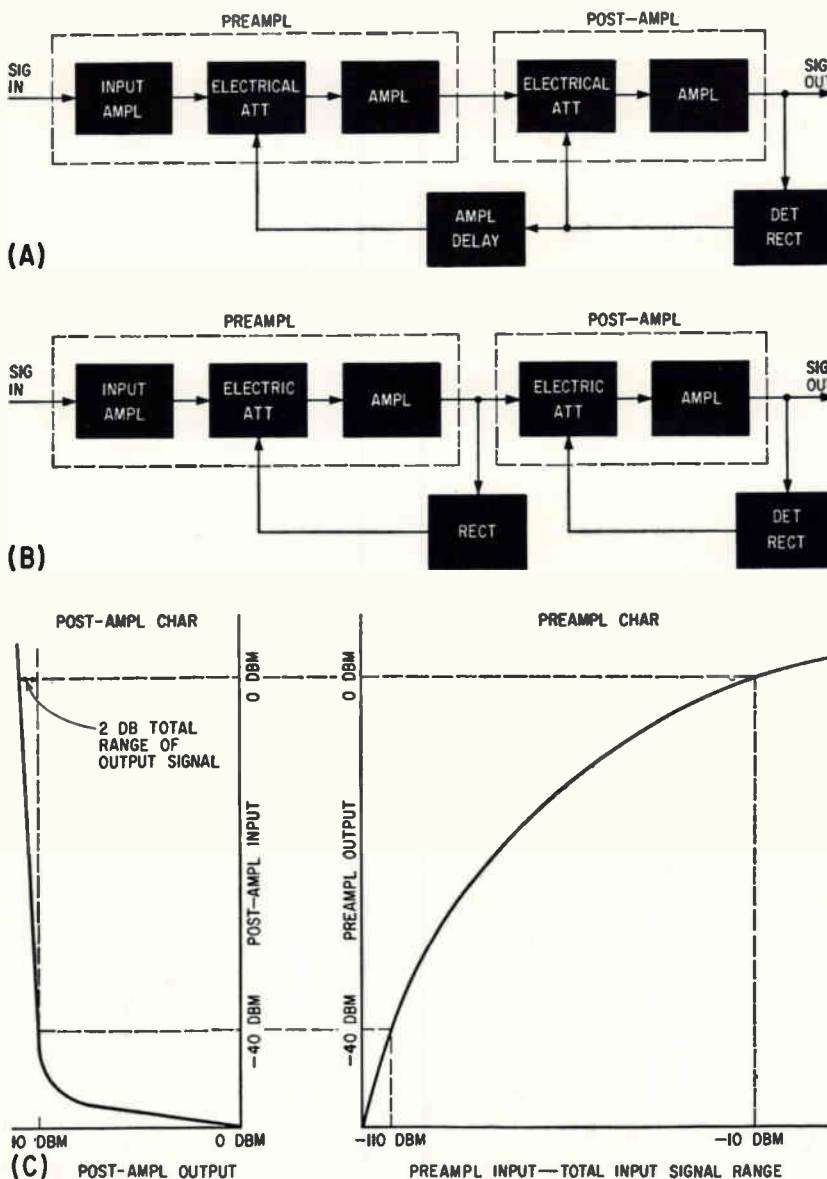

FIG. 1—Standard delayed agc system (A). Cascaded system with two agc loops (B). Transfer curves (C) show agc compression with cascaded system

OF TRANSISTOR AMPLIFIERS

stability and lower noise figure than possessed by amplifiers with overall agc loops

end of the amplifier until the input signal level is high enough so that any degradation of noise figure will not significantly affect the signal-to-noise ratio of the amplifier output.

This can be done with present semiconductor devices, providing operation is over a restricted temperature range. When, however, the temperature range over which operation is anticipated increases, for example, -40°C to $+60^{\circ}\text{C}$, difficulties arise. Consider Fig. 1A, a block diagram for a high gain-low noise i-f amplifier. The block marked *amplitude delay* is extremely important because it determines the input signal level at which the pre-

amplifier attenuator begins its action. Where the agc action is good, the control signal applied to the input of the amplitude delay circuit will show little variation, as it will be related to the amplifier output. Critical adjustment of a threshold circuit is necessary to enable the agc control voltage to act on the preamplifier attenuator only when the signal level exceeds a particular value. The combination of amplitude delay circuits and attenuator circuits could produce many difficulties in -40°C to $+60^{\circ}\text{C}$ operation unless high-gain d-c amplifiers were used. Direct-coupled amplifiers, particularly those using transistors, produce problems of

longterm constancy as well as temperature stability. The problem then becomes one of tracking referred to the temperature and time characteristics of the attenuators, delay circuits and any d-c amplification.

A way around these problems is illustrated in the block diagram of Fig. 1B, where two separate agc's are used; one for the preamplifier and one for the post-amplifier. Each of the agc's operates independently. The post-amplifier agc can be designed to maintain the output within a predetermined range. This would require only one threshold in a single-loop agc: the amplitude delay threshold. The

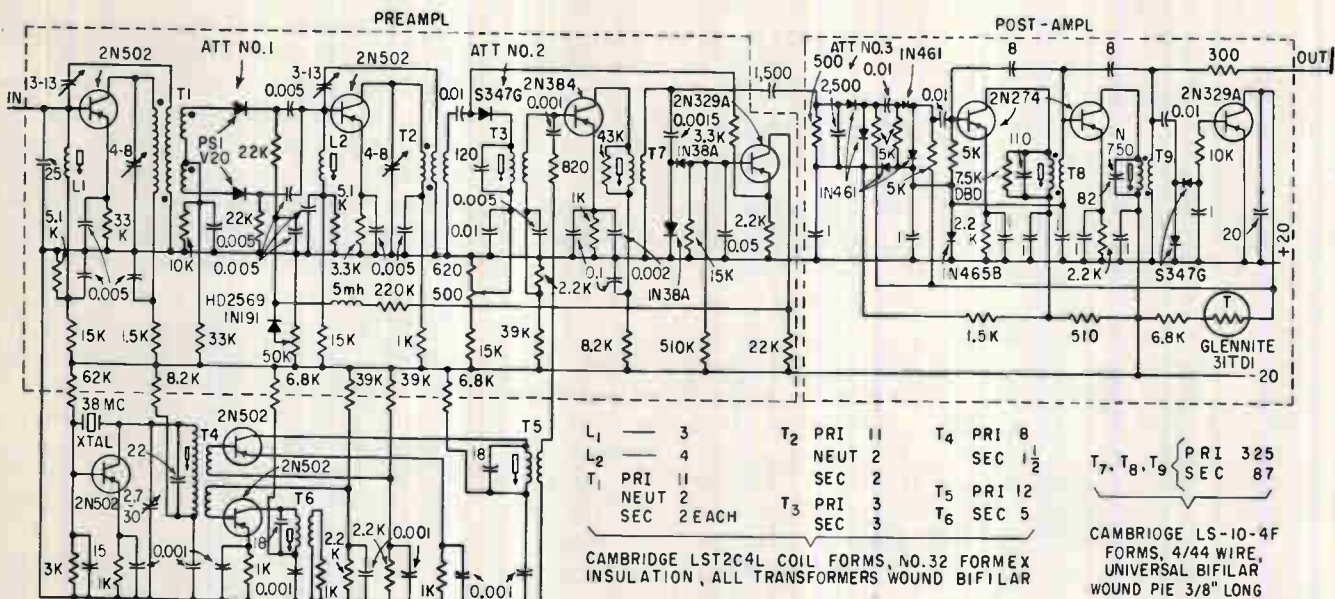

FIG. 2—Schematic of double-conversion i-f amplifier using cascaded agc

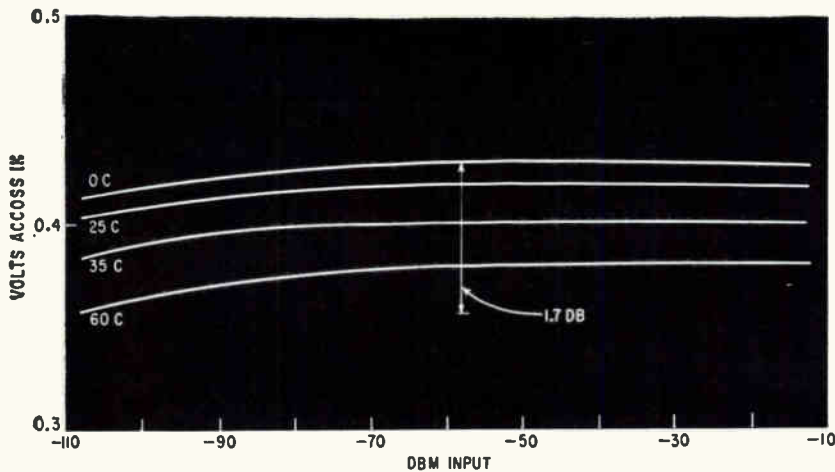

FIG. 3—Overall age characteristic of double-conversion i-f amplifier

preamplifier agc would then have only the one function of restricting the preamplifier output so that it would not overload the post-amplifier.

The overall agc flatness characteristic would be determined principally by the agc of the post-amplifier. This is illustrated in Fig. 1C where the preamplifier agc characteristic is shown as having an almost indifferent control characteristic in restricting the output variation to a small value. It should restrict its output to where the post-amplifier is not overloaded for the range of input signal.

The other significant point about using two separate agc amplifiers is the signal ranges over which they would act and their effect on signal-to-noise ratio at the amplifier output. Consider that the total gain of the amplifiers of Fig. 1B is 120 db, evenly divided between the preamplifier and the post amplifier. Also assume the noise power at the input is -100 dbm. If the preamplifier input and output impedances are equal and 100 ohms, a gain of 60 db would produce an rms noise output of 3.16 millivolts available to the agc detector. This voltage would be too small by a factor of at least 30 db to produce any output from a germanium rectifier. The preamplifier agc would therefore not act until the signal level was -70 to -60 dbm. At this level the preamplifier agc would begin its action and restrict its output so that at large inputs, say -10 dbm, its out-

put would be no more than 0 dbm. Assuming no signal input and with the gain wide open (60 db), the post-amplifier noise output would be 3.16 volts rms (20 dbm into 100 ohms) which would be enough to activate the post-amplifier agc system. If the design output for this amplifier was 1 volt into 100-ohm load (10 dbm) then the noise would already have initiated about 7 to 15 db of agc action in the post-amplifier. The 8-db additional range is specified to include the differences introduced by the agc rectifier, which could be a peak, average or rms detector.

The range of gain in excess of the amount needed would, in combination with the post-amplifier agc, compensate for changes in gain of the amplifier due to temperature changes and variations in the individual transistors. Since the noise input to the post-amplifier would be 3.16 millivolts and its maximum input would be restricted to 0.316 volt, it would have to handle an input signal range of only 40 db. The design of an agc to restrict an amplifier output variation to a predetermined small amount, say 1 to 2 db for a 40-db range of input signal is considerably easier than where the joint range is the total of 90 db (-100 dbm to -10 dbm). The ranges are illustrated in Fig. 1C.

Figure 2 is the schematic of an agc system. This applies to an i-f amplifier for a double-conversion superheterodyne receiver. The high-frequency portion up to and in-

cluding the output of the mixer was the preamplifier. The first electronic attenuator (*Att. No. 1*) was chosen because of its signal handling ability. The second attenuator (*Att. No. 2*) was included to extend the range of the gain control of the preamplifier. The remainder of the gain control circuit consists of the two 1N38A germanium diodes used as half-wave voltage doubling rectifiers at the 500 Kc output of the converter and the 2N329A silicon transistor that amplifies the rectifier output to drive the two electronic attenuators. The two 2N-502's are high-frequency amplifiers and the 2N384 is a converter.

The post amplifier uses a single attenuator (*Att. No. 3*) to handle its input signal range. The rectifier consists of two 347-G germanium diodes also in a voltage-doubling rectifier followed by a 2N329A silicon transistor that amplifies the rectifier output to drive the agc attenuator. The two 2N274's amplify the signal at 500 Kc.

Figure 3 shows the overall agc behavior of the amplifier shown in Figure 2. The signal levels on this characteristic go down into the noise, indicating that the noise of the input stage has pushed the agc action of the post-amplifier beyond the knee of its input-output characteristic. The total range of the output, including the effects of temperature, is restricted to 1.7 db. This temperature behavior is due to a thermistor in the collector circuit of the post-amplifier's 2N329A d-c amplifier. Better temperature correction could have been obtained had the d-c amplifier consisted of a common-emitter balanced amplifier with a temperature-compensated potential applied to the balancing transistor. The circuit shown in Fig. 2 was chosen because it was adequate and simpler than a balanced circuit.

The author acknowledges the contributions of A. Brandli and L. E. Boyd.

REFERENCES

- (1) W. F. Chow and A. P. Stern, Automatic Gain Control of Transistor Amplifiers, *Proc. of IRE*, 43, p 1,119, Sept. 1955.
- (2) W. F. Chow and H. Lazar, An AGC for UHF and VHF Transistor Circuits, Solid State Circuits Conference, Philadelphia, Feb. 1958.

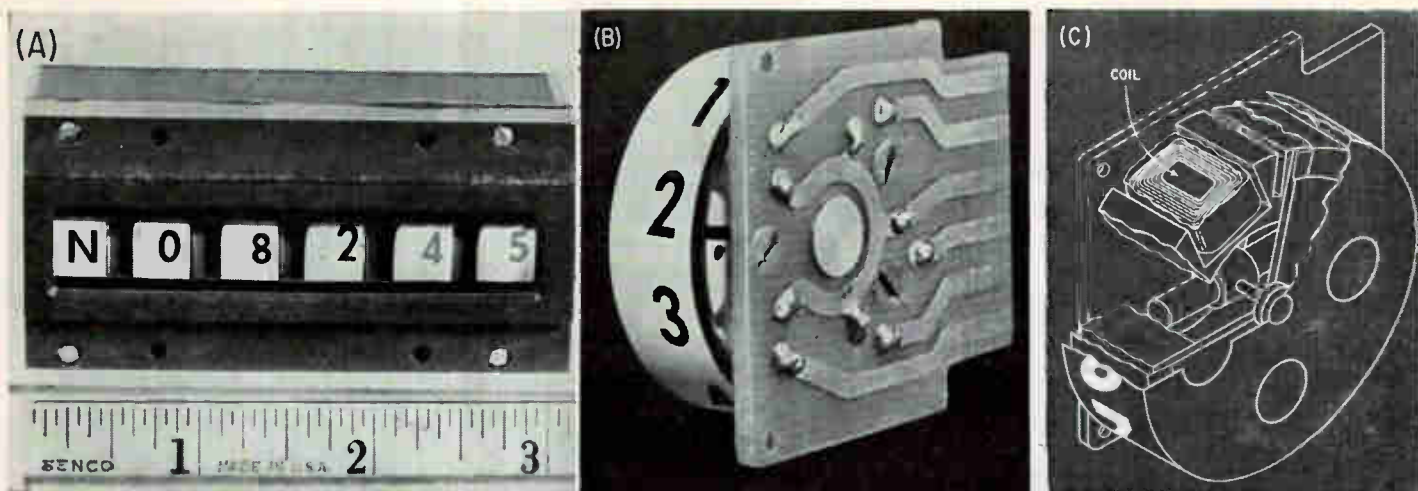

FIG. 1—This 5-digit display (A) comprises 5 display wheels such as shown in (B). Cutaway (C) indicates fixed coils, movable bar magnet

Binary-to-Decimal Display Uses Magnetic Stepping

By RAYMOND J. MILLER,
Advanced Electronics Center,
General Electric Co., Ithaca, N. Y.

Shows how to achieve an accurate conversion of a binary code to the final decimal display. Features an electromechanical indicator of decimals

DIRECT binary-to-analog conversion has several disadvantages. Accuracy is limited to about one part per thousand, and extreme care must be taken in choosing components and operating parameters to achieve and maintain this accuracy. Environmental conditions must also be tightly controlled, thus adding to equipment complexity. Where higher orders of accuracy are required in converting from a straight binary to a decimal output, other means of conversion must be sought.

The technique described in this article (whose development was sponsored by the Air Research and Development Division, USAF) permits conversion of any number of binary digits to their scaled decimal equivalent. Key to achieving this conversion is first to perform a conversion from straight binary code to a 4-bits-per-decade code. After this conversion, the binary-coded information can be handled

in many ways, requiring only moderate accuracy in the final stage to retain a high overall conversion accuracy. This is accomplished by independent handling of each digit of the final decimal number, resulting in only ten possible selections within each decade of the binary-coded number. Thus, the incremental spacing between the possible output selections is great enough so that a one or two-percent conversion error will not affect the overall conversion accuracy.

The electromechanical decimal display shown in Fig. 1A works with the straight binary-to-binary coded decimal converter to form a complete converter-display package. Figure 1B shows a single decade counter wheel of the decimal display, while Fig. 1C is a cutaway drawing of the counter wheel. The wheel may be plugged into the display housing, thus permitting a high degree of flexibility in the

overall display. All electrical connections are brought out through the individual counter-wheel plugs, resulting in a flexible package.

Figure 2 is a block diagram of the complete converter-display package. This package converts a 16-digit serial binary number input to a 5-decimal digit output. The electronics package is designed to be time shared among a number of the electromechanical decimal displays. Because of its time-sharing ability the electronics package is suited to work with a central time-shared digital computer such as used in modern aircraft.

The electromechanical display presents a decimal output in a single plane with small, easy-to-read numbers that can be read under ambient lighting. Slewing speed is a function of the driving circuits and the electromechanical design of the display. The display can be slewed through its entire range just as quickly as it can be

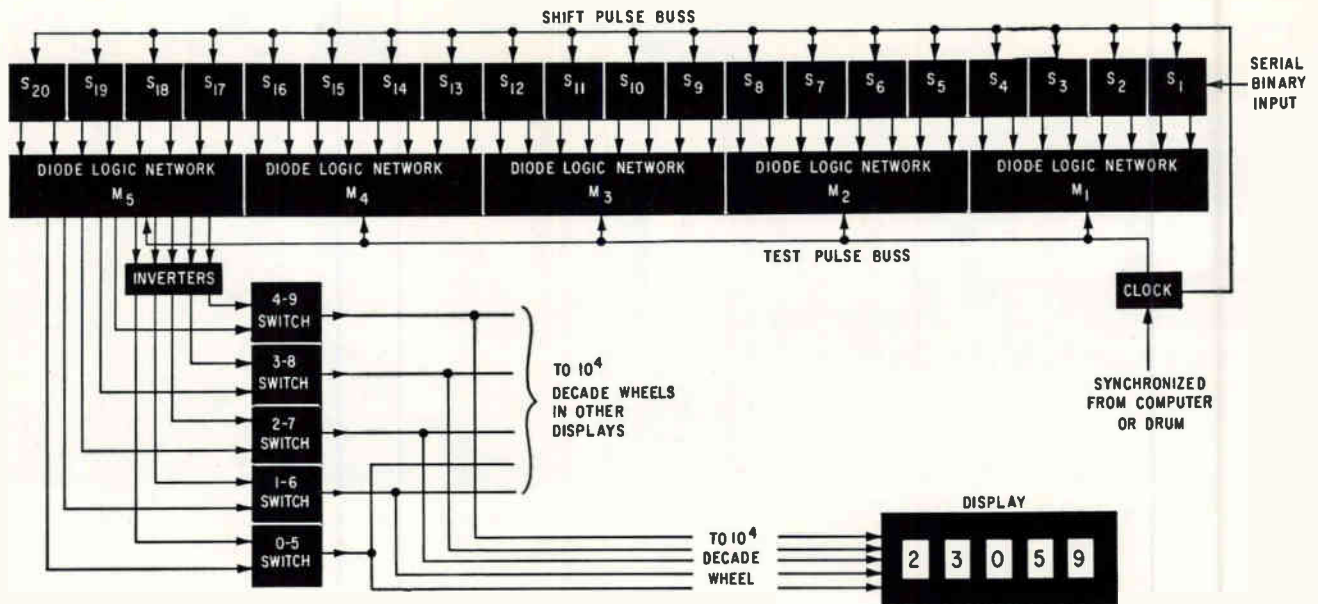

FIG. 2—Binary-to-decimal conversion and display system. Networks M_1 to M_5 have same inverter and switching circuits as shown for M_1 , these circuits driving the other decades

changed by its smallest increment since each decade wheel is set independently. Also, it is unnecessary to run through all intermediate numbers when resetting from one number to another. From one setting of the display to the next, each digit of the display number is reset independently.

Diode logic networks M_1 to M_5 are dual purpose in that they are used in the conversion process from straight binary to binary-coded decimal, and also to convert the stored binary-coded decimal numbers to decimal output numbers. Ten output lines are obtained from each diode matrix. A plus voltage on one of these lines is the desired output, and only one of the ten output lines from each matrix can have a plus voltage on it at any time. The inverter stages are used to invert the matrix output 5 through 9.

The electromechanical display wheels are essentially small synchronous motors. The voltage inversion process permits the reduction of motor windings in each display wheel from ten to five by driving each of the five windings with current of one polarity or the other. Consider the 0-5 switch shown in Fig. 3A. If the diode matrix dictates that a zero is the proper output, the 0 line will have a +6-volt potential; otherwise it will be at 0 volts. If the diode matrix dictates that a 5 is the proper output,

the 5 line will have a -6-volt potential (the matrix will put a +6-volt potential on the 5 line but the inverter will change this to -6 volts); otherwise the 5 line will have a 0-volt potential.

Thus, the possible inputs to the circuit are: 5 equals 0v and 0 equals +6v; 5 equals -6v and 0 equals 0v; 5 equals 0v and 0 equals 0v.

Figure 3B illustrates the operation of the display wheels. The bar magnet is free to pivot about an axis normal to the coil axis. When the coil is energized, the magnet pivots about its axis to align itself with the magnetic field. By reversing the current through the coil, the magnet could be forced to take a position exactly 180 degrees away from the position shown in the drawing.

Expanding Fig. 3B to include five equally spaced coils about the periphery of an imaginary circle produces the picture in Fig. 3C. By sequentially energizing each of the coils with a unidirectional electric current, five separate magnetic fields can be set up. Then by reversing the current through the coils, five more magnetic fields of the opposite polarity can be generated, each of which will be 180 degrees out of phase with the field previously generated by a coil.

Thus, ten separate magnetic fields can be generated with the five equally spaced coils, and the direc-

tions of the fields will be displaced at equal intervals of 36 degrees about the periphery of the imaginary circle. The permanent-magnet rotor will always align itself with the impressed field. Therefore, by energizing any one of the five coils with one polarity of voltage or the other, the rotor can be made to align itself in any one of ten discrete positions. This is the basis for the decimal display wheel. The same technique could be expanded by increasing the number of poles and driving lines so that more characters, such as the alphabet, could be displayed, even though this discussion is limited to the decimal display.

In the display, an address signal must first be obtained to indicate which display is to receive the information to be transmitted by the computer. This signal energizes a relay or closes a switch grounding the five field coils of each decade counter wheel in the selected display. From one of the input lines to each decade of the display, a non-zero voltage will appear, causing one of the motor coils to be energized. The permanent magnet in the numerical rotor will align itself with the magnetic field and the decimal digit will be displayed.

The second requirement to be satisfied is the physical retention of the counter wheels in their set positions until the next updating. The permanent-magnet rotor works

with a magnetic field pole piece having a moderate retentivity of field magnetism. This is a magnetic detent locking device.

When resetting the display, additional driving torque must be added to overcome the holding effect of the magnetic detent. The worst case is when the setting of the display called for requires that a counter wheel be rotated 180 degrees from its position. This worst case has been alleviated by 5 field coils and dual-polarity driving voltages. To reset a counter wheel to a position displaced 180 degrees the same field coil is energized with an opposite polarity voltage. Thus, the magnetic detent is destroyed and then reset to hold the display in its new position.

Figure 4 shows how the five field coils of a display digit are interconnected. At any time, nine of the ten transistors are turned off and one is conducting. When the setting switch or relay for a display is not energized, the path to ground for the field coils of this display is open-circuited; thus no magnetizing current can flow. Therefore, only the display that receives an address signal from the digital computer will be reset during any setting period.

Figure 4 is not complete in that each emitter has a number of field coils tied in parallel to it; the total number of field coils tied to each emitter is the same as the number of displays being driven.

Although the field coils of each counter wheel share a single common lead to the grounding switch, it is not possible to interconnect the common leads of all counter wheels in the same display. Therefore, the grounding or setting switch must provide for independent grounding contacts for each of the counter wheels in that display. Interconnection of the common field coil leads among different decimal digits of a single display would result in circulating currents through the field coils if opposite-polarity driving voltages were present on the different digit output lines. This is not possible when only those coils for a single counter wheel are connected in common, since only one of the driving transistors can be conducting at a time and all of the emitters assume a common voltage of ± 6 volts.

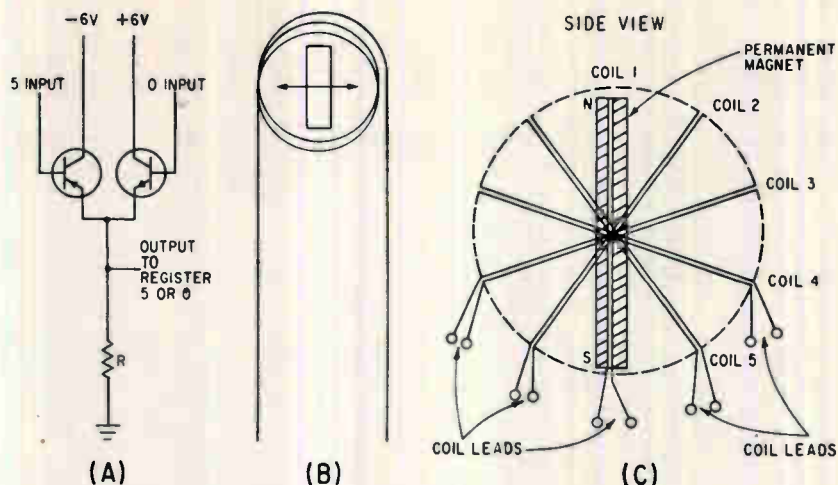

FIG. 3—Switch (A) controls the 0-5 coils. Rotor aligns itself with single coil (B) and with one of 5 coils (C)

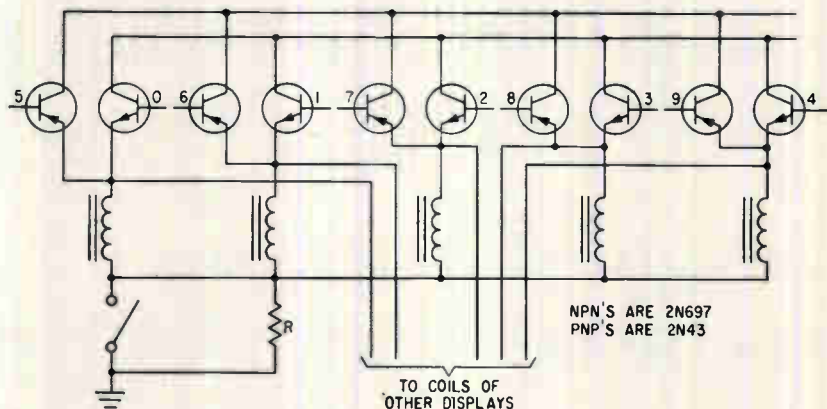

FIG. 4—Interconnections of display coils and drivers

Connecting the field coil terminals in common results in all of the emitters being at the same voltage, so that instead of a nonconducting emitter of a nonselected display being at zero volts, it will be at either +6 or -6 volts. This causes a back voltage of 12 volts across some of the base-emitter diodes, which they must withstand without breaking down.

When a display is being set, its setting switch is energized by an address signal from the computer that grounds the common leads of all field coils in that display. During this time, the selected transistors conduct heavily through field coils, causing a strong magnetic field to be set up in each digit of the display, thus positioning each counter wheel. The emitters of all the nonconducting transistors (excepting the mates to the conducting transistor for each decimal digit) assume a potential of zero

volts during the setting period.

The setting time of any display can be made less than one second by design of the driving circuits and counter wheels of the display. The relatively long time required to set a display does not hold up the central digital computer since the information being displayed is temporarily stored in the converter register. Thus, when a display is being set, the digital computer may continue to compute the succeeding output for the same display or for another display being driven by the same converter.

Using modular construction, the converter's volume is approximately 125 cubic inches. This volume can be reduced by micro-miniaturization.

BIBLIOGRAPHY

J. F. Couleur, BIDEC—A Binary-to-Decimal or Decimal-to-Binary Converter, *IRE Trans on Electronic Computers*, Dec. 1958.

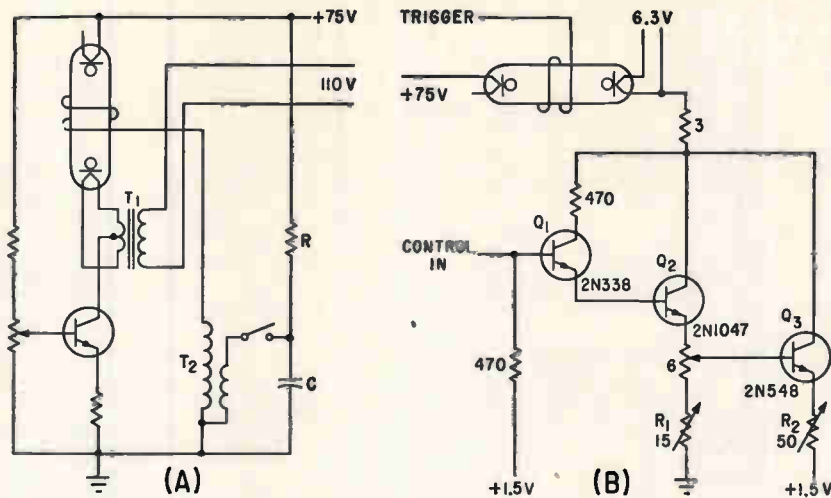

FIG. 1—Basic circuit for transistor dimming is shown in (A); additional amplification has been added in (B)

Tandem-Transistor Circuit Regulates Fluorescent Lamp

By L. L. BLACKMER
 A. T. WRIGHT
 Research Laboratories,
 Eastman Kodak Company,
 Rochester, N. Y.

FLUORESCENT LAMPS can be used with advantage in photographic applications because of their high efficiency, low running temperature, and their variety of shapes and spectral emissions. However, special equipment is needed to control their luminance.

Several techniques exist for dimming fluorescent lamps on a-c,^{1, 2, 3, 4} and some of these have been adapted to commercial equipment. The range of luminance control is about 200 to 1, but modulation rates are limited. With d-c vacuum-tube circuits,⁵ the modification rate is limited only by the response time of the phosphor, or the time constant of the discharge. The chief disadvantage is that the control tube consumes excessive power, and requires a power supply larger than that used by the lamp itself. These difficulties can be overcome by regulating unidirectional lamp current with a power transistor.

To control the luminance of a hot-cathode fluorescent lamp, sev-

eral conditions must be met: (1) the cathode must be kept hot enough to emit enough electrons regardless of lamp current; (2) there must be enough series impedance to stabilize the negative resistance of the gaseous discharge; (3) the voltage across the electrodes must be high enough to maintain the discharge; and (4) there must be means of starting the lamp.

The circuit in Fig. 1A meets these conditions. Forward bias, applied to the transistor base, controls the lamp current and also serves as the series stabilizing impedance. Transformer T_1 maintains the cathode-end heater of the lamp at emission temperature, and conventional photoflash trigger circuit R, C, T_2 gives reliable starting for lamp currents down to 1 ma. The high-voltage trigger pulse is applied to the lamp by a foil strip cemented to the lamp envelope, or by a wire loop placed a few inches from the lamp.

The nearly constant potential drop across the lamp permits a low collector voltage throughout the dimming range. This low operating voltage and current feedback in the common emitter resistor help stabilize I_{co} . With sili-

con transistors, currents less than 1 ma can be reliably controlled.

The d-c current gain of power transistors ranges from 10 to 50; it is thus advantageous to have additional current amplification. The tandem circuit in Fig. 1B needs less than 0.4 ma at 8 volts to drive a 15-watt T-8 lamp at its rated 300 ma. As shown in Fig. 2A, the combination is linear over this range.

Germanium transistors, generally *pn*p type, can be used in the same circuit if the polarities of power source and base signal are reversed. However, I_{cbo} can exceed several milliamperes and inverse biasing is required to obtain low lamp current.

Increasing lamp temperatures decreases conversion efficiency, and this makes the luminance-current characteristic nonlinear at high currents. This may be compensated for by the feed-forward action of transistor Q_3 (Fig. 1B).

Fixed emitter biasing keeps Q_3 at cutoff for base inputs below about 2 volts. So long as Q_3 is cut off, the lamp current is nearly the same as Q_2 emitter current. As lamp current rises above 100 ma, the increased voltage drop across the Q_2 emitter resistor gives an increasing forward bias to the base

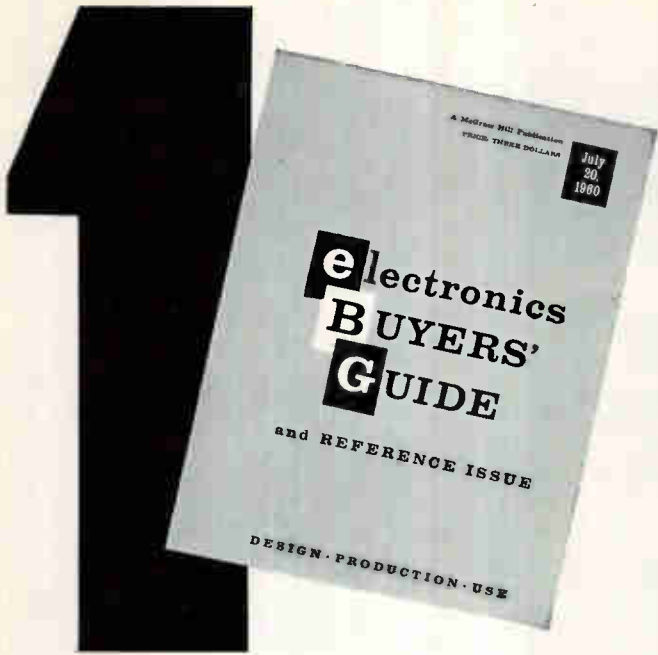

FIRST CHOICE OF ALL 4!

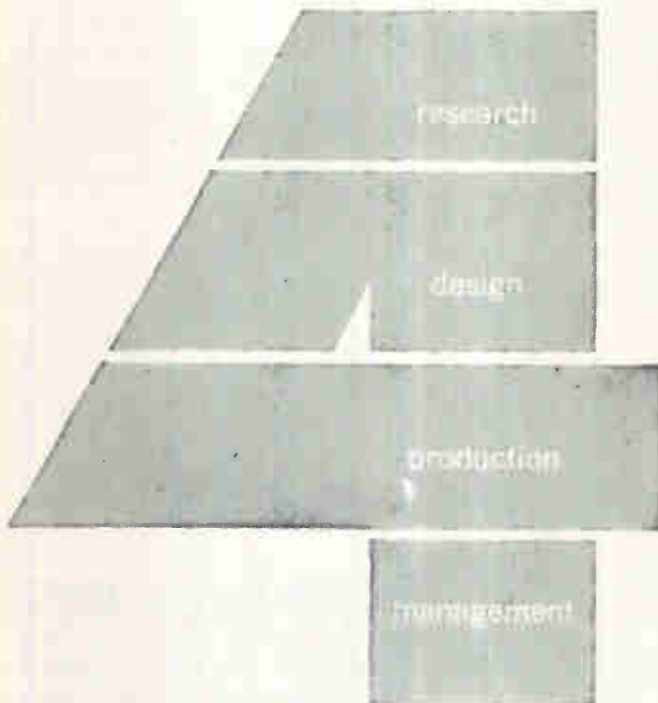

Edited and refined by the daily experience of users for 20 years. Unmatched for accuracy and completeness. Major corporations frequently order extra copies in addition to the hundreds of copies already received by employees who are regularly paying subscribers to **electronics**. The **BUYERS' GUIDE** is equally useful to men in research, design, production and management. Gives more information in less space.

gives more to all 4!

electronics BUYERS' GUIDE
and REFERENCE ISSUE

April 28, 1961

MEET THE N. E. I. POTENTIOMETER FAMILY

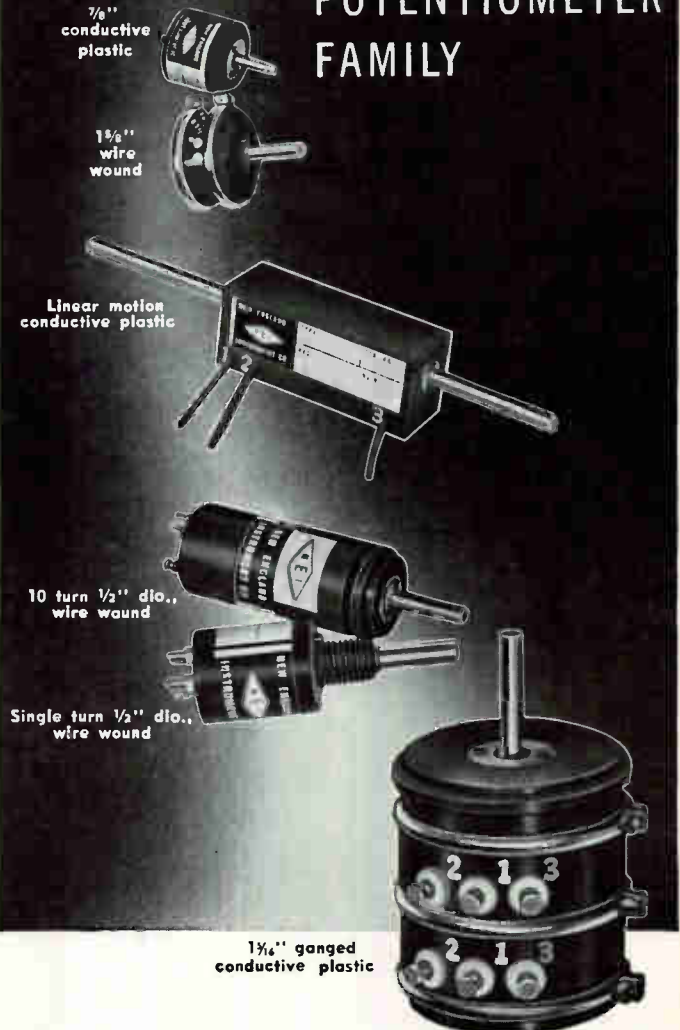

Their reliability assures your products performance. N.E.I. precision potentiometers, both Conductive Plastic and Wire Wound, embody every desirable design and engineering feature known to potentiometer manufacture. Because we manufacture both types, our engineers can analyze your specific requirements from both sides and produce the proper solution. Remember, N.E.I. precision potentiometers are unsurpassed for reliability.

Conductive Plastics

- Infinite resolution
- Unsurpassed reliability
- Negligible noise level
- Standard resistance values 1K, 2K, 5K, 10K, and 20K, 0.5% linearity.
- Specials from 500 ohms to 1 megohm — 0.1% linearity

Wire Wound

- Meet performance specs of MIL5272A, NAS710 and applicable portions of JANR-19
- Maintain excellent characteristics from -55° to 150°C
- Available from $\frac{1}{2}$ " single and 10 turn types to 3"
- Standard resistances from 1K to 100K, special designs from 25 ohm to 25 OK



Send for complete catalog

New England Instrument Company
39 Green Street, Waltham, Massachusetts

CIRCLE 115 ON READER SERVICE CARD

115

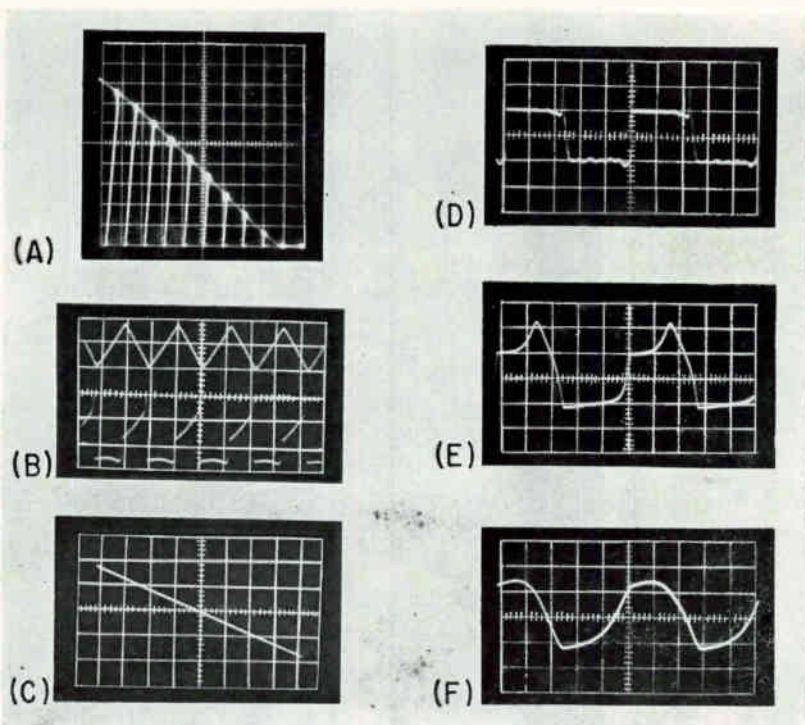

FIG. 2—Current amplification of transistors in tandem circuit, plotted as collector current against base current (A). Circuit modulated with triangular wave (B, upper) produces a-c component potential drop in lamp (B, lower); relative light output against lamp current (C). Circuit modulated with square-wave input at 0.1 Kc (D); 1 Kc (E); 4 Kc (F) Note: All time bases are right to left

of Q_3 , driving it into conduction. As a result the lamp current, which is the sum of Q_2 and Q_3 collector currents, increases more rapidly than the input signal.

Figure 3 plots the relative light output against base input for uncompensated, correct, and overcompensated circuits. The Q_3 collector current for correct compensation is also shown. The break point D is determined by the emitter bias and the setting of R_1 (Fig. 1B). Resistor R_2 determines the degree of compensation. For more precise control, additional stages can be added to the circuit.

The light output of hot-cathode fluorescent lamps can be sinusoidally modulated at rates up to several kilocycles, depending on the phosphor. Blue and daylight-type phosphors have faster response than those that radiate longer wavelengths.

If a step input of current has a short enough rise time, the radiant output waveform shows an overshoot on its leading edge. The oscillograms of Fig. 2D to Fig. 2F show the modulated light output of a 15-watt lamp in the circuit of

Fig. 1B, for a square-wave input between 5 and 300 ma. As the input repetition rate increases, the overshoot takes up more of the radiation period until, at 4 Kc, the light output is derived entirely from the overshoot.

The overshoot originates in the variation of dynamic impedance of the discharge. To a fair approximation, steady-state current i is proportional to voltage gradient V along the tube and inversely proportional to the number of charge carriers, n .⁹ Then $dv/dt = c [(1/n) (di/dt) - (1/n^2) (dn/dt)]$, where c is a constant related to tube geometry, gas filling and temperature. The term dn/dt introduces a lag effect, so that for rapid changes in current the degree of ionization is out of phase with the current. This amounts to an increasing dynamic resistance during the period of positive current change; power consumption and light output also rise. When the discharge returns to a stable state during the flat portion of a square wave, the light output drops to the value predicted by the steady-state characteristic.

The overshoot may be eliminated by increasing either the rise time of the input signal or the response time of the control circuit. Figures 2B and 2C show the result of driving a 15-watt lamp with a triangular input at 300 cps. The current range was 150 ma, centered about an average current of 150 ma.

As the current reverses from a decreasing to an increasing direction, both positive, the voltage across the lamp rises abruptly. After recovery from the initial surge, the lamp potential falls with increasing current. In this region the gas discharge has a negative dynamic impedance. When current is reversed from an increasing to a decreasing direction, the lamp potential falls abruptly and then slowly rises to the value at the beginning of the cycle.

This is the same situation as with a square-wave input, except that the rate of current change and magnitude of overshoot in lamp potential are both reduced to a point where the power increase during the overshoot is negligible. Hence the light output, Fig. 2C, is linear with current and shows practically no hysteresis.

REFERENCES

- (1) K. W. Hess and F. H. deJong, *Philips Tech Rev* 12, p 83, 1950.
- (2) J. W. Strange, *Trans Illum Eng Soc (London)* 15, p 111, 1950.
- (3) J. E. Campbell, H. E. Schultz and W. H. Abbott, paper presented at Illum. Eng. Soc., Sept. 1953.
- (4) D. D. Kirshaw, *Elec Eng* 74, p 378, 1955.
- (5) L. L. Blackmer and D. J. Stone, Jr., *Phot Sci and Eng*, 1, p 172, 1958.
- (6) V. J. Francis, *Fundamentals of Discharge Tube Circuits*, Methuen and Co., Ltd., London, p 39, 1948.

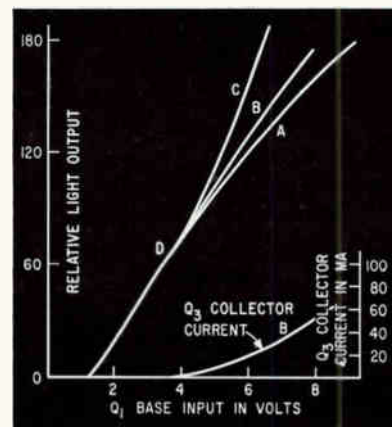

FIG. 3—Relative light output plotted against base input for uncompensated (A), correct (B), and overcompensated (C), circuits

**NUCLEAR
SPECTROSCOPY**

**LABORATORY
RESEARCH**

**INSTRUMENTATION
AND TESTING**

**RADAR
SYSTEMS**

**TELEMETRY
SYSTEMS**

**HIGH SPEED
DATA PROCESSING**

Model AD-50A. This series includes a new Raytheon A-D Converter providing up to 10 bit outputs at 1 megasample rate.



RAYTHEON'S NEW A-D CONVERTER: UP TO 5.0×10^6 INDEPENDENT 8 BIT WORDS PER SECOND!

Faster than any other available, Raytheon Analog-Digital Converter's 25-nanosecond aperture time allows digitizing of pulses less than $\frac{1}{2}$ -microsecond in width. With multiplexed input, its applications encompass any product or process requiring digitized analog voltages in continuous or intermittent form.

About the size of an office typewriter, Model AD-50A is readily integrated with established systems: its flexible design allows acceptance of variable input as well as wide variations in output format and logic. Its almost unlimited systems applications offer industry, government and the

military a basic, solid state tool that revolutionizes the present state of the art.

All of its outputs are usable, every readout is valid, and it can be operating in your system in less than 90 days.

MAIL COUPON TODAY FOR BROCHURE

Raytheon Company, Dept. 31B, Lexington 73, Massachusetts
Attention: M. B. Curran

Please mail me Specifications on:

- Model AD-50A 8 Bit Converter
 New 10 Bit, 1 megasample Converter

I'm interested in possible applications to the following type system(s):

Name & Title _____

Company _____

Address _____

City & State _____

RAYTHEON

RAYTHEON COMPANY

EQUIPMENT DIVISION

Two Hot Junctions Up Thermocouple Output

By F. W. BRANDS, Asst. Prof.,
Dept. of Elec. Engineering,
Wash. State Univ., Pullman, Wash.

HEATING both junctions of an experimental thermocouple produced more net voltage than when one of the junctions was cooled. The junctions for this unusual thermoelectric generator were made of materials having nonlinear voltage-temperature characteristics. If semiconductor materials with the desired properties could be found for the junctions, conversion efficiency could be significantly increased.

Because the thermocouple effect has been used so extensively in thermometry, investigators have sought materials with highly linear voltage-temperature characteristics. Materials with nonlinear characteristics and the temperature ranges at which nonlinearities occur have often been avoided.

Total voltage developed in a typi-

cal thermocouple can be shown schematically as at (A) in the figure. Temperature gradients are assumed to be confined to the vicinity of the junctions and any voltage developed along the temperature gradient (Thomson effect) is lumped with junction voltage.

Voltage at the hot junction exceeds that at the cold junction. Because polarities oppose each other, net loop voltage is the difference between the two. Net voltage is increased if either the hot junction is made hotter or the cold junction is made colder.

If current is flowing but the heat generated by resistance to its flow ($I_s R t$) is neglected, the junction with a voltage that aids current flow is doing work. Therefore either junction temperature is lowered or heat must be provided to it. The junction with a voltage that opposes current flow however is being worked upon. Either its temperature is increased or it expels heat.

To maintain steady-state conditions, heat must be provided to the hot junction and removed from the cold junction. However, removing heat from the cold junction, which is at a low temperature, seriously limits efficient generation of electrical power.

If polarity at one junction could be reversed, both junctions would supply electrical energy when current was flowing and heat would have to be supplied to both junctions to maintain steady-state conditions. Both junctions would be converting thermal energy into electrical energy, whereas one junction in the conventional thermocouple converts electrical energy into thermal energy. The two hot junctions need not be kept at the same temperature and in actuality they are not.

Evidence of the desired characteristic appears as two intersections of the voltage-temperature curve of the two materials, as for the hypothetical material at (B) in the figure. If this material were used with a reference material with one

junction kept at temperature T_1 and the other at T_2 , relative polarity of the two junction voltages would be additive. When the circuit is closed and current is flowing, both junctions are doing work and therefore require heat to maintain steady-state conditions.

The device does not violate the second law of thermodynamics. In an electrical circuit, $I^2 R$ losses are analogous to friction losses in a mechanical device and ultimately some of the input energy is rendered unavailable. Also, for thermal energy to be imparted to the junctions, temperature of the energy source must be higher than temperature of the junctions. Therefore, the over-all system would have a net increase in entropy.

An iron-copper thermocouple was built to determine feasibility of the concept. It was first tested in the usual manner with the cold junction kept at a temperature of 0 C in an ice-water bath and the hot junction inserted into an electric furnace. The curve at (C) in the figure clearly indicates one intersection at 0 C and a second one at 531 C.

When the hot junction was then held at a temperature of 800 C and the cold junction removed from the bath, voltage increased. The cold junction was then inserted into a second electric furnace and voltage continued to increase until junction temperature reached 250 C. When either junction was removed from its furnace, voltage dropped, indicating that heat was being converted into electrical energy at both junctions.

Because of the close relationship between the Peltier and Thomson effects, it might be concluded that the voltage is not developed at the junction but along the temperature gradient in the conductor. However, when current flows in the circuit, the primary temperature anomalies occur at the junctions. A lesser effect is distributed along the conductor in the region of the

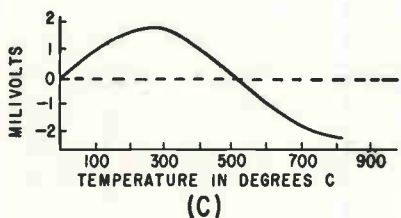
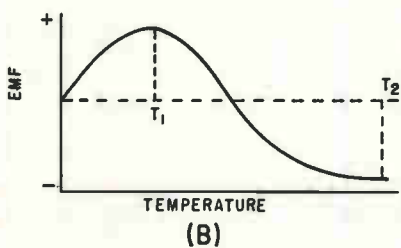
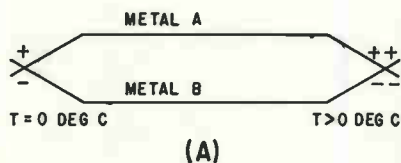

Junctions of usual thermocouple (A) are at opposing polarities, while hypothetical material (B) and test material (C) permit additive junction voltages

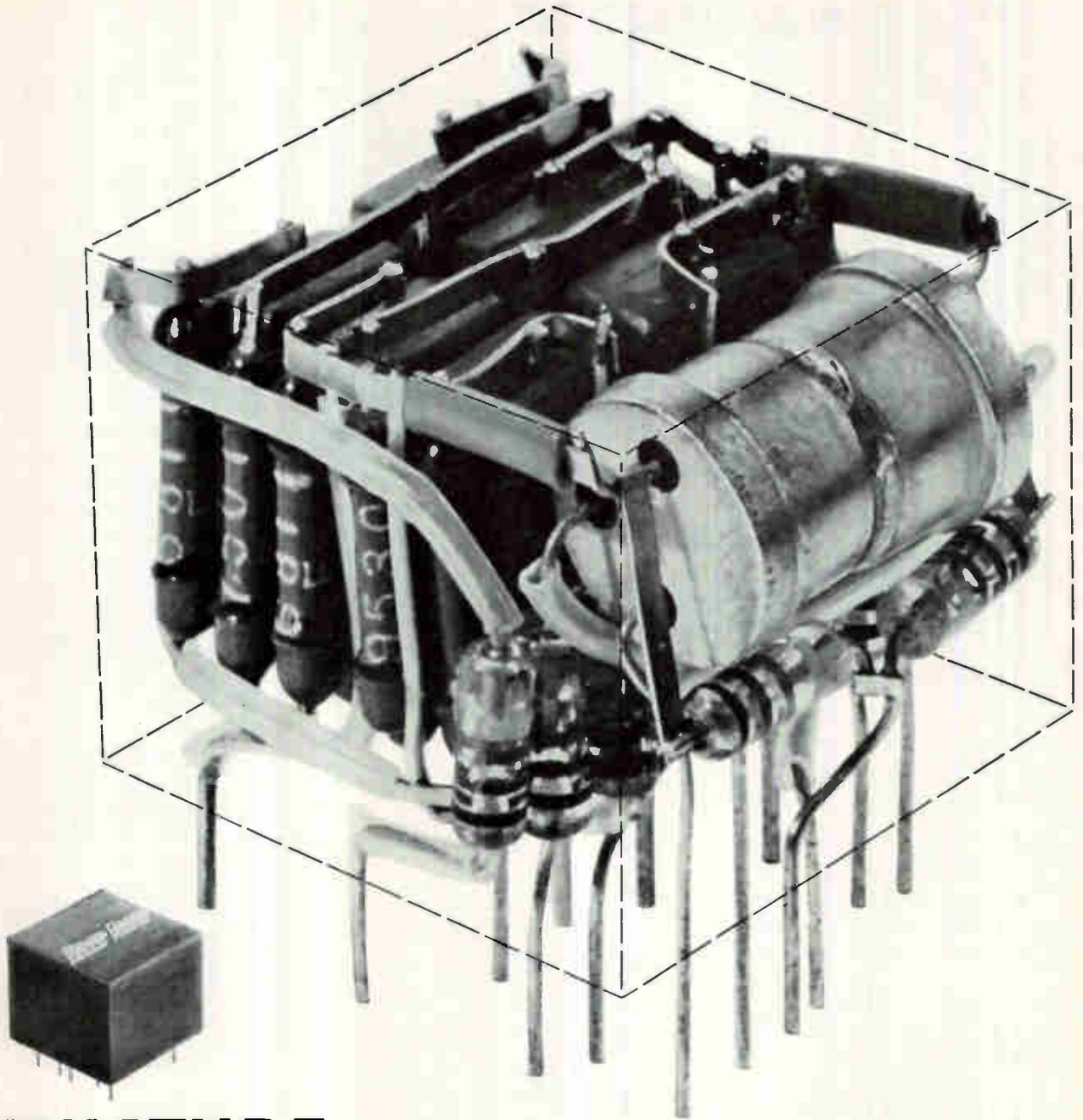

MINIATURE BUILDING BLOCK MODULES

5 times actual size to better show
the 28 standard-sized components

Delco Radio's high density packaging of reliable standard components utilizes the unique three-dimensional welded wiring technique. These miniature modules are available off the shelf in 16 basic types. Or with them, Delco Radio can quickly build for you a compact, reliable digital computer for airborne guidance and control or any other military application. Vacuum encapsulated with epoxy resin, the modules perform all the standard logic functions. They meet or exceed all MIL-E-5272D (ASG) environmental requirements, and operate over a temperature range of -55°C to $+71^{\circ}\text{C}$. Too, these same reliable digital circuits are available packaged on plug-in circuit cards. And we can also supply circuits to meet your specific needs. For complete details, just write our Sales Department. *Physicists and electronics engineers: Join Delco Radio's search for new and better products through Solid State Physics.*

PIONEERING ELECTRONIC PRODUCTS THROUGH SOLID STATE PHYSICS

**DELCO
RADIO**

Division of General Motors • Kokomo, Indiana



UL AND CSA APPROVED

PROBLEM:

Jamming of gears at low temperature operation

AREA OF APPLICATION:

Oil field telemetering instruments

The Foxboro Company, a leading manufacturer of telemetering instruments, experienced continuous difficulties with synchronous motors operating metering and transmission equipment. Many such installations were in the field where extreme climatic conditions made reliability of the timing motors a prime requisite.

TESTING:

Over a 6-year period various timing motors, including Hansen SYNCHRON motors, were subjected to constant testing for dependability of operation. Tests included: continuous operation . . . as long as one and one-half years; gear noise check . . . initially, and after extended running; synchronous torque tests . . . motors had to deliver 0.9 in.-oz. of torque at 30 rpm; a 1500-volt shock to check breakdown rating between leads and cases to meet UL and CSA approval; starting ability . . . motors were packed in dry ice (-40°F) for one hour, then had to start within five minutes; three hours continuous running in dry ice . . . again at -40°F ; five hours uninterrupted operation in an oven at 140°F .

If you must have performance in a synchronous motor . . . investigate Hansen SYNCHRON motors. Over 200 different types of output available. Hansen engineers will work with you to find a satisfactory solution to special application or design problems. For further information or assistance, contact the nearest Hansen representative or write direct to:



IN-PLANT TESTING
Shown is a test rack, where some of the more than 50 tests are given to every Hansen SYNCHRON motor before shipment to customers.

- **RESULT:**
- Only Hansen SYNCHRON timing motors met all the exacting requirements!
- Hansen SYNCHRON timing motors were incorporated in all telemetering instruments produced, and singled out to replace motors on all applicable equipment now in use in the field. Foxboro is also reviewing over-all operations — to use Hansen SYNCHRON motors where possible on other instruments and controls.



HANSEN REPRESENTATIVES: The Fromm Co., 5150 W. Madison St., Chicago, Ill.; Winslow Electric Co., New York, N.Y.; Chester, Conn.; Philadelphia, Pa.; Cleveland, Ohio; Electric Motor Engineering, Inc., Los Angeles (OLive 1-3220) and Oakland, Calif.; H. C. Johnson Agencies, Inc., Rochester, Buffalo, Syracuse, Binghamton, and Schenectady, N.Y.

temperature gradient.

Some semiconductors have proved superior to metals in conventional thermocouples because of their high thermoelectric power and low thermal conductivity. If two such semiconductors could be found with the required nonlinear characteristics, they would be valuable for the type thermocouple described.

Lack of access to facilities for semiconductor fabrication and impurity control prevents an effective search for such semiconductor materials by the author. However, it is hoped that such materials can be found, and it is expected that a substantial increase in thermocouple efficiency will result.

Character Counter Aids Teletypewriter Routing

By R.E. PAFENBERG,
Arlington, Va.

CHARACTER detection and counting unit provides basic information related to teleprinter traffic volume, flow and routing. The simple, low-cost circuit was designed to provide reliable data to permit the most effective use of military and commercial communications channels and plant facilities.

Usually estimates of traffic volume are derived from a group count obtained by statistical sampling of each cut-through and terminated teleprinter channel. The estimates are used to develop routing procedures and as a basis for expansion or curtailment of allocated channels and plant facilities.

A variety of methods have been used to derive group count data. Techniques range from accurate mechanical or manual counting of teleprinter characters to rough approximations derived from measurements of monitor tape or page copy.

Accurate information can be obtained from the circuit in the figure. It senses the presence of keying impulses in the signal loop and indicates total time in traffic on a power-line operated clock. Because transmission rate is known, total group count can be readily determined from total time in traffic.

The primary of low-inductance audio transformer T_1 is connected in series in the teleprinter signal loop. When keying interrupts loop current, the voltage induced in the transformer secondary and rectified is used to charge capacitor C_1 . When voltage across the capacitor reaches a predetermined level, current through the coil of polar relay K_1 energizes it. The relay in turn provides power to the clock.

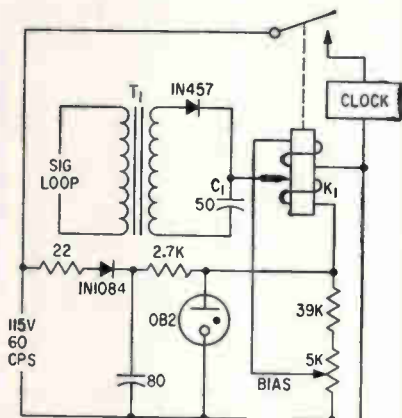

Allocation of teleprinter channels and facilities is aided by circuit that switches on timer in the presence of teleprinter keying impulses

When the teleprinter loop is normally or abnormally closed, no voltage is induced in the transformer secondary. Also, momentary interruptions of current or occasional transient impulses do not charge the capacitor sufficiently to energize the relay.

The breadboard unit used to verify the concept was made using available components. The polar relay permits precise adjustments. Careful setting of relay bias current and correct selection of the value of C_1 provide the required immunity to transient impulses and permit compensation for starting lag and coasting of the commercial clock used for the tests.

Validity of the design and fulfillment of operational requirements have been demonstrated by the circuit. However, selecting optimum component values and matching relay and clock characteristics would probably permit use of a conventional relay. Replacing the more expensive polar relay would also eliminate need for the relay bias supply.

**FROM
EVERY
POINT
OF
VIEW...**



**The AIRPAX
INDUSTRIAL
CIRCUIT BREAKER**

EXCELS IN -

-  **RELIABILITY**
-  **COMPACTNESS**
-  **VERSATILITY**

Ask for Bulletin B-14



CAMBRIDGE DIVISION, CAMBRIDGE, MARYLAND

Embedding Components for Uses Above 300 C

A COMMERCIAL SILICIC ACID GEL-BONDED SYNTHETIC MICA ORGANIC FOR EMBEDDING^a

Cure cycle	16 hrs at 120 C
Specific gravity	1.8
Flex strength, psi	1,000
Diel const (10 ² to 10 ¹⁰ cps)	approx 4.2
Diss fact (10 ² to 10 ¹⁰ cps)	0.004
Vol resist, ohm—cm., 70 F	10 ⁸
500 F	2 × 10 ⁶
after 120 hrs at 90% R.H., 70 F	10 ⁶
Elec strength, vpm, 100 mil sample	100
Thermal shock of embedments without cracking	between +2000 F and -70 F
Apparent porosity, volume %	approx 27

^aSM25, Emerson and Cuming, Inc.

THE DEMANDS ON electronic equipment for space age applications are resulting in ever increasing requirements for higher temperature operation in the 300 C-500 C range. Embedded packaging for this temperature range presents particularly acute problems, since in general, inorganic embedding materials must be used. Application problems with these materials are normally quite severe primarily due to their brittleness and cracking tendencies, their porosity and subsequent high moisture absorption, and the generally poor flow or pouring properties of the solvent or liquid dispersions at low solvent content. Increasing the proportion of the solvent or dispersing liquid to improve flow properties usually results in increased porosity and

shrinkage problems.

The types of inorganic materials used for embedded electronic packaging above 300 C are usually low melting, high lead content glasses, cements, bonded inorganic fillers or powders, castable refractories and ceramics, and the like. Lists of some materials and their sources, some inorganic fillers and binders, and the properties of a commercial silicic acid gel-bonded synthetic mica inorganic embedding compound are shown in the tables¹.

Typical ceramic embedding materials are the aluminum phosphate compounds. Aluminum phosphate is capable of reacting with materials such as asbestos, magnesium silicate, calcium silicate, aluminum oxide, zinc oxide, lead oxide, and others. The reaction

TYPICAL INORGANIC EMBEDDING MATERIALS AND SUPPLIER

Supplier	Material(s)
Sauereisen Cements Co.	Sauereisen Cements
Pennsylvania Salt Mfg. Co.	Synar Cements
Aluminum Company of America	Calcium aluminum cement
U. S. Gypsum Co.	Keene cement and plaster of paris
Orell, Inc.	Temporell Compounds
Russel Manufacturing Co.	Rusco adhesive compounds
Monsanto Chemical Co.	Alkophos aluminum phosphates
The Carborundum Co.	Fiberfrax Castable insulation
Corning Glass Works	Thermal setting solder glass
Duramic Products, Inc.	Sur-Braze "S" compound
Emerson and Cuming, Inc.	Eccoceram
Plibrico Company	Pli-Tab trowel mix
Philadelphia Quartz Co.	Kasil compounds
National Lead Co., Titanium	
Alloy Manufacturing Div.	Electrical cements

INORGANIC FILLERS AND BINDERS FOR EMBEDDING

Fillers	
Flake Type Mica	Natural and Synthetic
Fibers	Glass, Silica, Asbestos, Alum. Silicate
Expanded Types	Vermiculite, Perlite
Bubble Types	Hollow Glass Microspheres Hollow Clay Spheres Alumina Spheres
Massive Types	Silica, Alumina, Titania
Binders	
Alkali Silicates	Sodium, Potassium
Silica Aquasols	
Organic Silicates	Ethyl Silicate
Calcium Silicate	Portland Cement
Calcium Aluminate	Lumnite Cement
Calcium Sulfate	Plaster of Paris
Clay	
Glass	
Oxychloride	
Cement	
Oxyphosphate	Aluminum Phosphate
Cement	
Inorganic	
Polymers	

AN ALUMINUM PHOSPHATE COMPOUND FOR EMBEDDING

Composition	
Material	Parts by Weight
Magnesium Oxide	1
Silicon Dioxide	1
Alkophos C aluminum phosphate	1
Curing Cycle ^a	
25 C	for 2 hours
70 C	for 4 hours
125 C	for 4 hours
500 C	for 4 hours
Properties	
Thermal shock	Good
Dielec breakdown strength	250 vpm at 25 C
Low temp storage	No visible effect after 24 hours at -65 C.
Modulus of rupture	700 psi
Set time	30 minutes in small amounts, less in larger amounts due to exothermic heat of reaction generated.

^aApprox times; actual times will depend on thickness and composition

MIL type rectifiers from General Electric

The industry's FIRST MIL type Medium Current Silicon Rectifiers...



Type	MIL Spec	Max. Single Phase PRV (volts)	Max. Single Phase I _{oc} @ Temp.
USA 1N249B	MIL-S-19500/134	125	20 A @ 150°C case
USA 1N250B	MIL-S-19500/134	250	20 A @ 150°C case
USA 1N2135A	MIL-S-19500/134	500	20 A @ 150°C case

The industry's FIRST MIL type Silicon Controlled Rectifiers...

Type	MIL Spec	Max. Single Phase PRV (volts)	Max. Single Phase I _{oc} @ Temp.
USN 2N681	MIL-S-19500/108	25	25 A @ 57°C Stud
USN 2N682	MIL-S-19500/108	50	25 A @ 57°C Stud
USN 2N683	MIL-S-19500/108	100	25 A @ 57°C Stud
USN 2N684	MIL-S-19500/108	150	25 A @ 57°C Stud
USN 2N685	MIL-S-19500/108	200	25 A @ 57°C Stud
USN 2N686	MIL-S-19500/108	250	25 A @ 57°C Stud
USN 2N687	MIL-S-19500/108	300	25 A @ 57°C Stud
USN 2N688	MIL-S-19500/108	400	25 A @ 57°C Stud



and a complete line of Low Current Rectifiers...

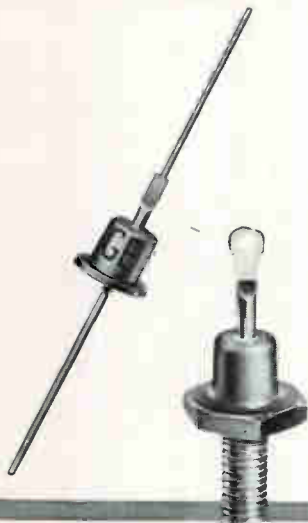

Type	MIL Spec	Max. Single Phase PRV (volts)	Max. Single Phase I _{oc} @ Temp.
<i>Germanium</i>			
USN 1N93	MIL-E-1/895B	300	75 ma @ 55°C
USAF 1N315	MIL-E-1/1088	100	100 ma @ 85°C
<i>Silicon</i>			
JAN 1N253	MIL-E-1/1024A	100	1 A @ 135°C case
JAN 1N254	MIL-E-1/989B	200	400 ma @ 135°C case
JAN 1N255	MIL-E-1/990B	400	400 ma @ 135°C case
JAN 1N256	MIL-E-1/991B	600	200 ma @ 135°C case
JAN 1N538	MIL-E-1/1084A	240	250 ma @ 150°C amb.
USAF 1N538	MIL-E-1/1089	200	250 ma @ 150°C amb.
JAN 1N540	MIL-E-1/1085A	480	250 ma @ 150°C amb.
USAF 1N540	MIL-E-1/1089	400	250 ma @ 150°C amb.
JAN 1N547	MIL-E-1/1083A	720	250 ma @ 150°C amb.
USAF 1N547	MIL-E-1/1089	600	250 ma @ 150°C amb.

For complete information call your Semiconductor District Sales Manager or write to Rectifier Components Department, Section 25D12, General Electric Company, Auburn, New York. In Canada: Canadian General Electric, 189 Dufferin St., Toronto, Ont. Export: International General Electric, 150 East 42nd Street, New York 17, N. Y.

For Factory-Low Prices on Selenium, Germanium and Silicon Rectifiers in Quantities up to 999
Call Your Local G-E Semiconductor Distributor.

GENERAL  ELECTRIC

TOWER FOOTING
INSULATORS FOR
SELF-SUPPORTING
RADIATORS

LAPP ANTENNA TOWER INSULATORS

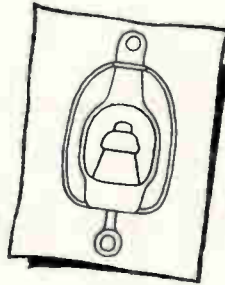
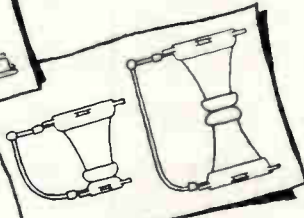
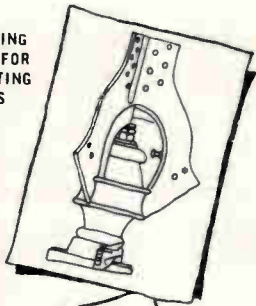

MAST BASE
INSULATORS

RADIO GUY
INSULATOR



We at Lapp are mighty proud of our record in the field of tower insulators. Over 30 years ago, the first insulated broadcasting tower was erected—on Lapp insulators. Since then, most of the large radio towers in the world have been insulated

and supported by Lapp insulators. Single base insulator units for structures of this type have been design-tested to over 3,500,000 pounds.

A thorough knowledge of the properties of porcelain, of insulator mechanics and electrical qualities has been responsible for Lapp's success in becoming such an important source of radio insulators. Write for description and specification data on units for any antenna structure insulating requirement. Lapp Insulator Co., Inc., Radio Specialties Division, 178 Sumner Street, LeRoy, N. Y.

Lapp

products are solid, non-water soluble compounds. They are somewhat porous, however. The composition and properties of one aluminum phosphate composition are given in the table.

In cases where the electronic package is placed in an integral container and can be potted and hermetically sealed, dry powders can sometimes be used as high temperature potting materials. Bell Telephone Laboratories has reported using this approach in the potting of electronic power transformers (see *ELECTRONICS*, p 92, Dec 18, 1959). The material used in this application was spherical particles of aluminum oxide, whose diameters ranged from five to fifteen mils.

REFERENCE

(1) C. A. Harper, *Electronic Packaging With Resins*, McGraw-Hill Book Co., Inc., Apr. 1961. Acknowledgement is made for information and data to W. R. Cuming, Emerson and Cuming, Inc.; Technical Publications, Inc.; and L. W. Kirkwood and R. S. Key, Bell Laboratories.

Taping Magnetic Coating To Nonmagnetic Surfaces

PUNCHED CARDS, slabs, discs or cylinders can be rendered sensitive to magnetic pulses by two self-adhering magnetic tapes that can be stuck on any nonmagnetic surface. These tapes have the quality and properties of recording tapes.

The self-adhering tapes are available in two types: one, of acetyl cellulose, has a total thickness of about 70 microns. The second, of polyester foil, is 35 microns thick. Both tapes have an adhesive coating and are shielded by a backing strip that is peeled away before they are stuck in place. The tapes are 6 mm wide, but can be supplied in widths up to 60 mm.

Facing tape is 15 microns thick with a synthetic resin adhesive coating 3 microns thick. The magnetizable coating is carried on a polyester foil. The tape becomes adhesive at 120 C, and is completely dry at room temperature. It can be applied with a hot pressing iron or a heated roller and the carrier layer is peeled off.

REFERENCE

(1) Agfa A. G., Leverkusen-Bayerwerke, Germany.

Fused Salt Program Studies Conductivity



Infrared absorption spectra of fused alkali nitrate and nitrite salts are detected by L. J. Hallgren of Minneapolis-Honeywell Research Center, Hopkins, Minn. Significance: electrical resistance variations of molten salts may be the basis of completely new design concepts for electronics. For instance, solid sodium chloride is an insulator; but in molten state, its electrical resistance decreases by 6 or 7 orders of magnitude

Clear Potting Material



Cushioning protection is provided by new flexible, clear potting and embedding compound developed by the Silicone Products Department of the General Electric Company. Called LTV-602, (low temperature vulcanizing) clear silicone potting compound, the material is designed for electronic components and assemblies and protects against moisture, dust, ozone, corona and other hazards of the space age. The material cures to a flexible, resilient solid at temperatures of 70 C to 80 C

IT FLOATS!

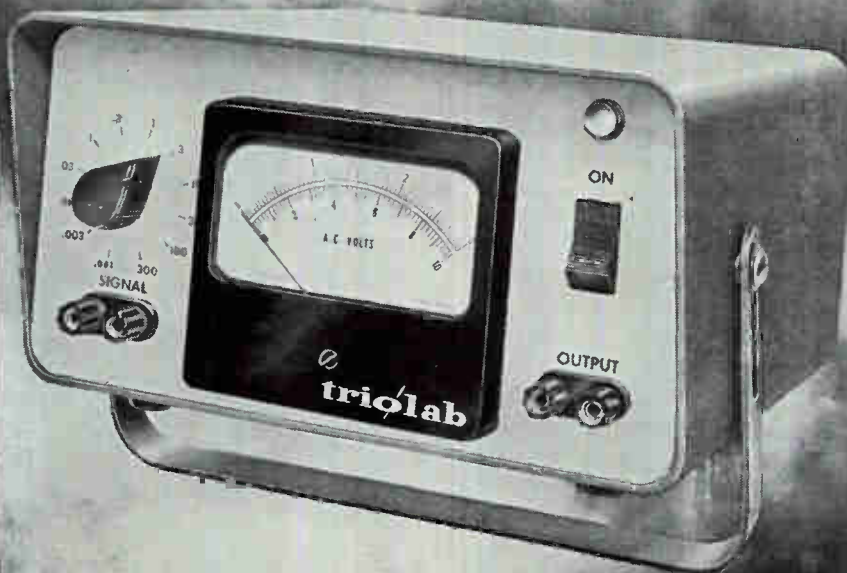

In Trio Labs' new Standard Laboratory AC VTVM... the signal circuits are isolated from case and power circuits, to provide

- floating measurements previously impractical
- accurate voltage measurements to 5 cps
- shock safety: case isolated from circuit under test

The new Model 109-2 has 12 voltage ranges calibrated to RMS value of a sine wave: 0.001 to 300 VAC full scale, with frequency range of 5-200,000 cps. Accuracy is $\pm 2\%$ full scale. Can measure accurately to 20 microvolts. Input impedance 10 megohms. Low distortion amplifier output voltage can be externally shorted without internal damage. Power: 105-125 VAC, 50-420 cps, 25 watts. Price: \$220.00

For free 36-page Engineering Guide, write to Dept. E-4

... Precision electronic instruments for measurement and control.

triolab

TRIO LABORATORIES, INC.
Plainview, Long Island, New York
Overbrook 1-0400 • TWX HKVL 1166

© 1961, Trio Laboratories, Inc.

Export Dept: EMEC, 127 Grace St., Plainview, N.Y.

Overlays Produce Multilayer Circuits

MULTILAYER PRINTED CIRCUIT boards have received considerable attention from equipment designers recently. Being three-dimensional, they can reduce wiring volume as much as 10:1 while simplifying interconnections, shielding and component placement in complex or miniature equipment. Each layer is environmentally protected by encapsulation resulting from lamination.

Production techniques developed by Hazeltine Corp., Little Neck, N. Y., for their "multiplanar" boards are described below. Hazeltine is producing them as interconnection boards or tray cards for printed circuit modules of large military data systems. Boards range up to 25 inches long, carry as many as 43 44-pin connectors and contain up to 20 layers. The boards are also being produced under license by Photocircuits Corp., Glen Cove, N. Y., and Precision Circuits, New Rochelle, N. Y.

The boards are built up with layers etched from thin laminate (two-ounce copper on epoxy-glass four mils thick, or heavier). These are aligned and laminated between cover boards. Holes are drilled where required and are plated through to provide interlayer connections to connector pins or component leads. Corresponding land

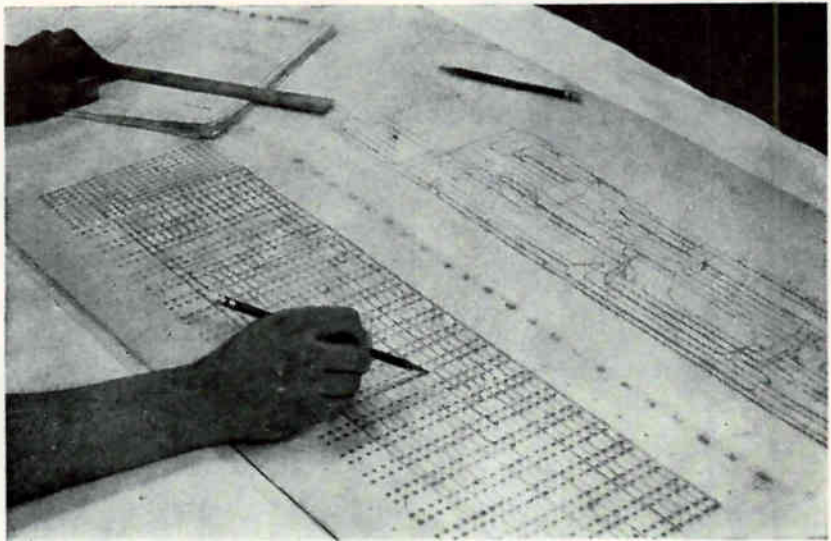

Artist uses wiring list to prepare color-coded rough layout

or pad positions in the layers must be in precise vertical registration to prevent shorts or missed connections. Registration is assured by an overlay method of preparing the artwork for each layer.

A layout of the top cover, containing all available connector pin and land positions is made at 4:1 or other suitable scale on stable film. A wiring list identifies each path from pin to pin. Each item on the list is underlined in a color indicating circuit function.

Gridded prints of the top cover are used as layout forms for the layers. The rough layout is made on tracing paper placed over the forms. Circuit paths are sketched on the top layer, in the function colors, until a crossover problem arises. The paths are then continued on the second layer, and so on. Whenever an interconnection between layers is needed, a path will end in a land at a pin position. Otherwise, the paths go around the pin positions.

All wiring for a function is kept on a single layer if possible. If there are no pickup problems, more than one function may be placed on a layer. If shielding is required, provision is made for shielding foil between layers. The color coding

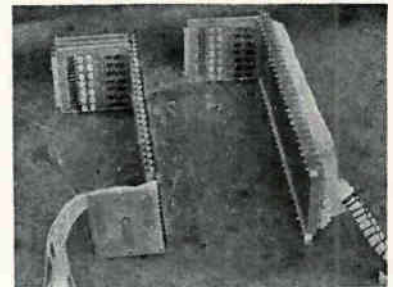

Volume of multilayer board (left) is one-tenth that of wired tray card

during layout makes it easy to identify pickup problems and areas needing shielding. Foil can be cut to fit and inserted between layers. Or, if double-sided laminate is used, the shielding pattern can be etched on the bottom of the layer above the shielded area.

A few spare pin positions are usually provided for each function as insurance against future circuit modifications. Jumper wiring can be used for modification after lamination.

When all wiring is laid out, layouts are checked against the top cover to make sure all paths end at a pin position and unwanted connections will not be made when holes are plated. The color coding, visible through overlaid layouts,

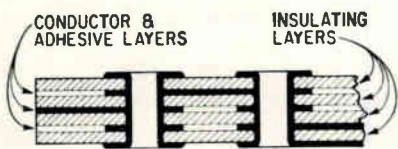

Typical cross-section of multilayer board

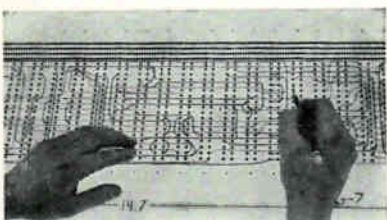

Overlaid artwork is checked against top cover



515 feet long, this cargo terminal office building at Zurich connects with warehouse, storage and cargo-handling building to the rear.



Daily DC-8 service and all-cargo flights from New York take advantage of the jet age's fastest, most efficient transshipping handling.



Large door, all-cargo aircraft fly to Zurich, too! A key cargo hub, Zurich is served by 27 airlines flying to all parts of the world.



Terminal's facilities range from free trade zone areas to refrigerator rooms, from guarded vaults to high speed conveyors.

Zurich's new all-cargo terminal: 120,000 square feet of facilities designed from the ground up for cargo. Here, transshipping takes minutes, not hours.

Zurich, in the heart of Europe, served by 27 airlines, took a giant step into the jet cargo age late last year with the opening of its new two-building cargo terminal. Key cargo gateway to Southern Europe, Mid-East and Orient, Zurich now offers you the world's most complete, most advanced cargo facilities.

Here you'll find high-speed conveyor systems to rush documents along... cold storage rooms offering a variety of temperatures... animal hostels... 9,000 square feet of free trade zone facilities... radiation storage rooms... guarded vaults. And here, to save valuable time, all forwarders, agents and airline offices are located under one roof, within easy reach of one another.

From New York, daily Swissair DC-8 flights plus all-cargo services connect with Swissair Caravelles and other aircraft flying to 55 cities on five continents. In addition, a full schedule of connecting flights is offered by 26 other airlines flying from Zurich to every part of the world. Swissair will shortly add Convair "Coronado 990" jets to the Near and Far East. Take advantage of Zurich's unique facilities on your next shipment to Switzerland, Southern or Eastern Europe, the Mid-East, Orient or Africa. Just call your IATA cargo agent or any Swissair office.

SWISSAIR
 SWISSCARE • WORLDWIDE
 10 West 49th Street, New York 20, New York. FAculty 2-8600.



**GLASS FILLED
DIALLYL PHTHALATE
MOLDING COMPOUNDS**

APPROVED

**UNDER U. S. MILITARY
SPECIFICATIONS
FOR THE ELECTRONIC AND
ELECTRICAL INDUSTRY**

**ACME
ACME
ACME**

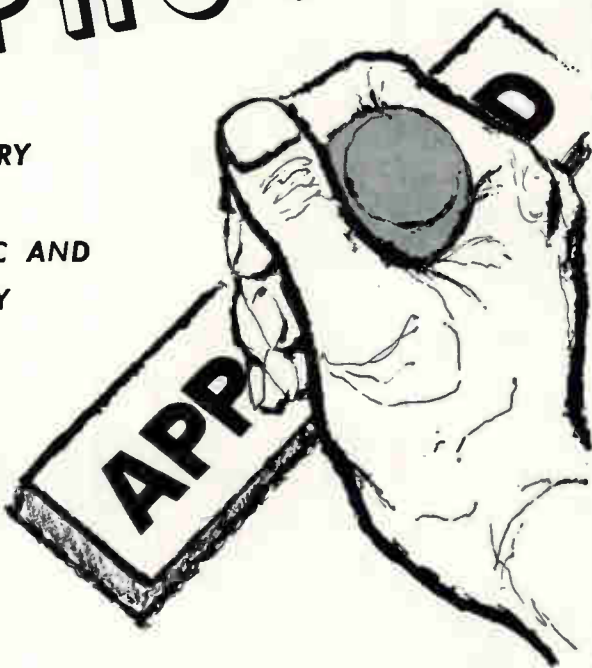

GLASS FILLED COMPOUNDS

**Approved Under
MIL-M14-F
Type SDG
1-520 Short-Fibre Glass Filled
2-520 Heat Resistant
3-520 Flame Resistant**

**Approved Under
MIL-M-19833
(SHIPS)
Type GDI-30
1-530 Long Fibre Glass Filled
2-530 Heat Resistant**

MINERAL AND SYNTHETIC FIBRE COMPOUNDS

**Approved Under
MIL-M14-F
Type MDG
1-501 Mineral filled
1-501A Mineral filled—reinforced
1-510 Mineral filled—reinforced**

**Approved Under
MIL-M14-F
Type SDI-5
1-503 Orlon Filled**

Acme, through rigid control, inspection and testing, insures in their Diallyl Phthalate Molding materials, the ultimate in fine electrical properties, dimensional stability and molding reliability.

We invite your request for complete data sheet describing Acme D.A.P. Molding Materials.

ACME RESIN CORPORATION
1401 CIRCLE AVENUE • FOREST PARK, ILLINOIS
(Suburb of Chicago)

speeds up the checking procedure.

Art work for etching the layers is prepared conventionally. Registration hole positions are added to guide mechanical processing. All unused land areas are masked out (the top cover has all available land positions and is used as a printing master) to prevent blind lands



Layers are stacked for laminating



Saw trims edges of lamination

from creating excess copper buildup and possible layer-to-layer slippage in the laminating press. Artwork is also checked by overlays.

The artwork is reduced photographically. Layer-to-layer registration of 0.005 inch or better is obtained from glass negatives and photoresist etching. A silk screen can be used if the layout is relatively open and tolerances are greater.

Registration holes are drilled after etching. If the laminate is single-sided, the blank side must be free of silicone or other mold release to insure good adhesion upon laminating. Copper paths are oxidized after etching to promote adhesion. The layers are stacked in a laminating jig, with film or liquid adhesive between layers. The jig is two ground steel plates. The registration holes are used to pin the layers between the plates. The assembly is laminated in a press and cured to set the adhesive.

Foils on the top and bottom cover boards are then etched to leave a land at each pin position. Holes

are drilled, the boards are cleaned by sand-blasting and the holes are plated through. The lands give the plating good adhesion to the cover boards. Plating is relatively uniform through the holes since internal conductors provide additional current paths.

Board edges are trimmed by shearing, if the laminate is thin, or by sawing and routing if it is thick. The first board of a run is usually cut apart across a series of pin positions so internal registration and plating can be checked under a microscope. While thinner boards are translucent, normal visual inspection would not suffice.

In addition to being used as tray cards, the board can be used to interconnect components stacked like cordwood between boards, Photocircuits reports. The firm is making multilayer boards under the trade name "Encapsulayer". Hazeltine is investigating methods of using the boards to promote automatic assembly. Removing restrictions imposed by monoplane crossovers and component polarities can permit all components of a type to be inserted in a straight line on the board. Stable impedance lines for high-frequency applications can be designed into the boards by adjusting wiring size and dielectric thickness through the layers.

The boards are reported to pass all military specifications (SCL-750 3A is the tentative specification). They have, for example, been undamaged by a 15-second dip in wax at 500 F, a test for delamination during dip soldering. Connectors and leads can also be secured in boards by hand soldering.

Chemical Process Puts Tin Coating on Metals

CHEMICAL PROCESS for depositing a protective tin coating on metal surfaces has been announced by Shipley Co., Inc., Wellesley, Mass. The company says it is a relatively low-temperature process that does not require electricity and contains no cyanide. The coating is thick enough for a solder base and does not form on non-conductive surfaces, so it can be used for printed circuits and electronic hardware.

More than 107 types standard
solder terminals



WEBSTER KNOWS

In fact, his definition certainly applies to CAMBION® Standard Solder Terminals. As parts which terminate plenty of trouble in electronic circuitry construction, they've gained universal approval from manufacturers, professional technicians and hams.

Starting with top quality brass, each CAMBION solder terminal is precision machined, quality inspected, electroplated with silver, electro-tin or gold — or to your own plating specifications. Close quality control is maintained, and inspections made at each successive manufacturing step to assure that each terminal meets or exceeds applicable MIL specifications, such as MIL-Q-5923C.

That's why, as with all components in the broad CAMBION line, top quality is guaranteed for the more than 30,000,000 CAMBION Solder Terminals in stock . . . in more than 107 different types: single, double and triple turret; feed-through, double-ended, hollow and split.

The broad CAMBION line includes plugs and jacks, solder terminals, insulated terminals, terminal boards, capacitors, shielded coils, coil forms, panel hardware, digital computer components. For a catalog, for design assistance or for both, write to Cambridge Thermionic Corporation, 437 Concord Ave., Cambridge 38, Mass.

CAMBRIDGE THERMIONIC CORPORATION
CAMBION®
The guaranteed electronic components



New On The Market

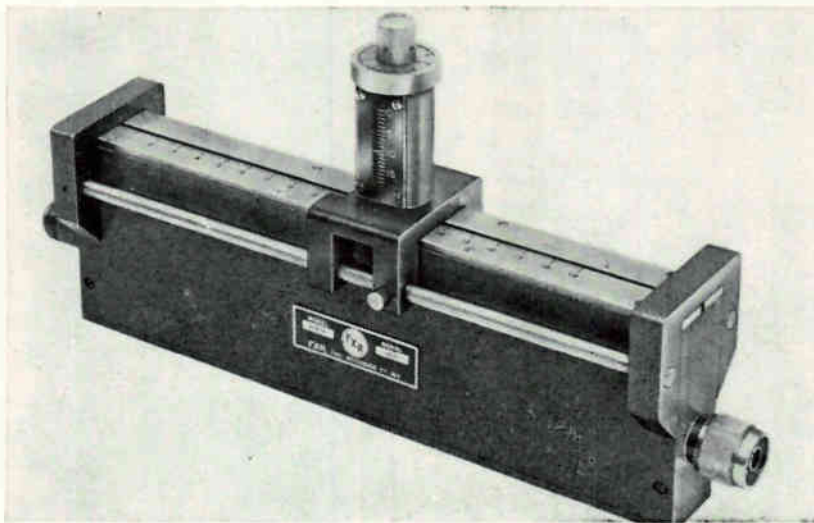

Broadband Coaxial Slide Screw Tuner

COVERS 1 TO 10 GC

COAXIAL slide screw tuner operates from 1 to 10 Gc. Matching of vswr's as high as 10 to 1, of any phase, can be accomplished to 1.00; r-f leakage has been minimized by special poly-iron choke and insertion loss is less than 1 db when a mismatch of 3 to 1 is corrected.

The N311A coaxial tuner consists of a strip line section with a rail guided carriage upon which the adjustable probe is mounted.

Two JAN connectors, equivalent to the Type N UG-21B/U plug and the UG-23B/U jack, are provided for universal use.

Length of the tuner is 11½ inches, carriage travel is 7½ inches. Price is \$190.00; delivery is from stock, from FXR Inc., Microwave Div., 25 50th St., Woodside 77, New York.

CIRCLE 301 ON READER SERVICE CARD

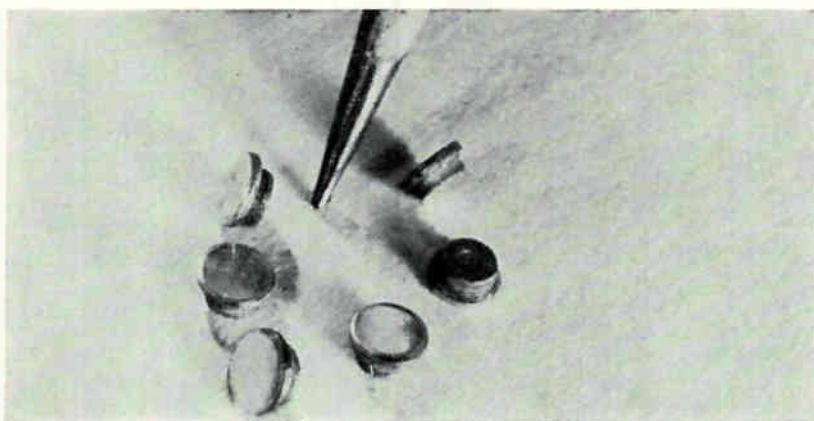

Microwave Tunnel Diodes

OSCILLATE AT 10 GC

MINIATURE tunnel diodes oscillate at frequencies of 10 Gc and above. Designated D-4168-D, the p-type germanium tunnel diode has peak currents of approximately 3.5 ma and minimum peak to valley ratios

of 5 to 1. Characteristics of the diode include: negative resistance of 30 to 40 ohms, series resistance of 7 to 10 ohms, capacity of 1 pf, inductance of 0.25×10^{-9} henry.

The unit may have ultimate fre-

quency capability to 12 Gc and can be made with higher current to capacity ratios. Unit prices are: D-4168-C, \$300 (range up to 8 Gc); D-4168-D, \$400, (range up to 10 Gc).

Diodes are available from Sylvania Electric Products Co., 100 Sylvan Rd., Woburn, Mass.

CIRCLE 302 ON READER SERVICE CARD

Heart Condition Tester

SCOPE READOUT

LINE of cardiovascular equipment for precision physiological measurements is available from Dallons Laboratories, 5066 Santa Monica

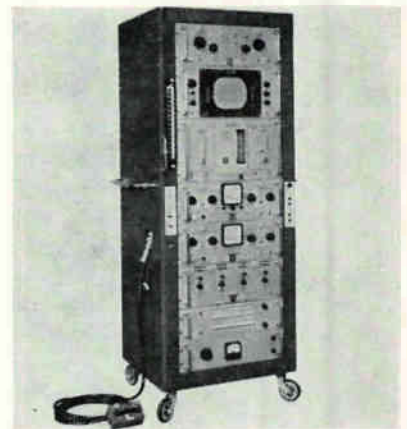

Blvd., Los Angeles 29, Calif.

The apparatus offers two to four simultaneous intracardiac pressures for left and right heart catheterization. Intracardiac electronic pressure transducers, plus intracardiac phonocardiography and blood samplings are available in a single catheter.

Up to eight oscilloscopes with high intensity trace can be furnished, giving visualization of pressure curves, sound amplitude and frequency of murmurs, plus provisions for scg, eeg or pneumograph.

CIRCLE 303 ON READER SERVICE CARD

Shock Accelerometer

IMPACT TRANSIENTS

SHOCK accelerometer Model 2225 can measure shock and impact transients because of its high resonant frequency of 80 Kc. Dynamic range

YOU ARE LOOKING AT THE WORLD'S SMALLEST PISTON CAPACITOR THE *tiny-trim**

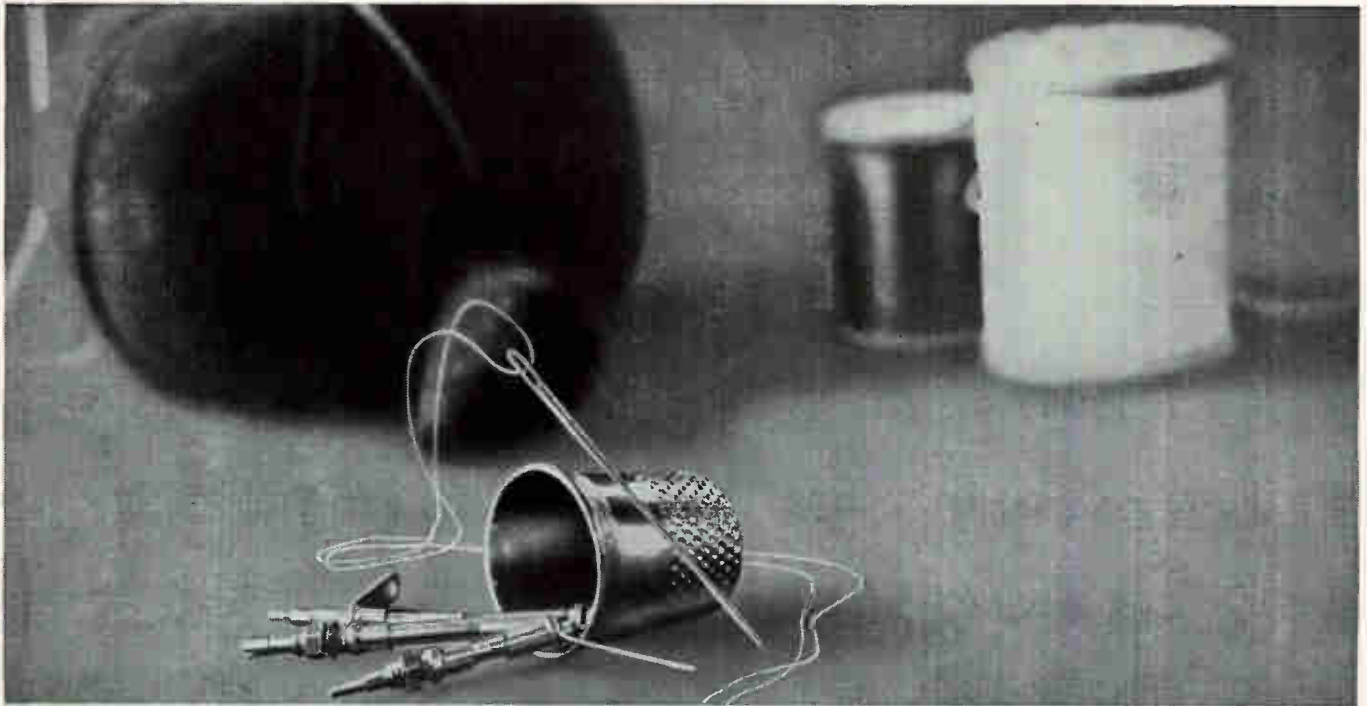

A major advancement in variable piston capacitors developed and offered exclusively by JFD

New from JFD—the *Tiny-Trim*—so small, so slim, that you can carry a dozen of them in a thimble!

One-fourth the weight and less than *one-half* the diameter of JFD miniature trimmer capacitors, the *Tiny-Trim* is JFD's answer to the exacting demands of sub-miniature design. It delivers *more* capacitance per cubic inch than any other conventional variable piston capacitor — plus the advantages of premium reliability, unique adaptability, and unprecedented sensitivity.

JFD *Tiny-Trim* capacitors are available in panel mount and printed circuit board types that meet or exceed applicable performance requirements of MIL-C-14409A. Write today for complete data of this dramatic new development and how it can help you solve your space, weight and reliability problems.

- Overall diameter: 1/8 inch. Overall length above panel: 35/64 inch to 1-1/64 inch.

- Double the sensitivity of JFD standard trimmers. Special adjust mechanism provides 102 turns per inch for extra fine adjustment.

- Increased maximum to minimum capacitance ratio per unit (minimum: 0.5 pf.).

- Operating temperature —55° to +125°C.

- Low temperature coefficient of capacitance.

- Anti-backlash design for precise tuning resolution.

- Low inductance for high frequency use.

- Ultra linear tuning assures accurate alignment—absolute repeatability.

- Rugged shock and vibration resistance.

- 500 V. DC working voltage.

- 10⁹ megohms insulation resistance.

- Q factor of 500 (measured as per JFD #5178).

- 0.5 inch ounce tuning torque.

Model*	Capacitance Range MMF Measured Per JFD #5177		D.C. Working Volts	Dielectric Strength Measured For 5 Seconds at 50% R.H. at Max. Rated Cap.	Insulation Resistance Measured After One Minute at 500V. D.C. and 50% R.H.	Q Factor Measured Per JFD #5178	Unit Weight Grams	Dimen.**
	Min.	Max.						Max. ±1/32 K
TT901	0.5	2.0	500	1000	10 ⁶ Megohms	500	0.62	25/64
TT902	0.5	3.0	500	1000	10 ⁶ Megohms	500	0.64	33/64
TT903	0.5	5.0	500	1000	10 ⁶ Megohms	500	0.79	49/64
TT904	0.5	7.0	500	1000	10 ⁶ Megohms	500	0.94	1-1/64

*These units are also available in the same capacitance values for printed circuit boards in models TT911, TT912, TT913 and TT914. **Length front of panel.



(Shows actual size) Model TT902
*Trademark

Order from your local JFD Component Distributor who can supply your requirements up to 299 pieces or order direct for production quantities.

JFD

JFD ELECTRONICS CORPORATION

Components Division • 6101 16th Avenue • Phone DEwey 1-1000 • TWX-NY25040

JFD WESTERN
P. O. Box 3416
7311 Van Nuys Blvd.
Van Nuys, Calif.
Phone STate 1-3530

JFD MIDWESTERN
6414 W. Higgins Ave.
Chicago, Illinois
Phone: SPring 4-4175

JFD NEW ENGLAND
Ruth Drive
Marlboro, Mass.
Phone: HUNtley 5-7311

JFD CANADA
51 McCormack Street
Toronto, Ontario, Canada
Phone: ROger 9-1129

VARIABLE TRIMMER PISTON CAPACITORS • FIXED METALIZED INDUCTORS • LC TUNERS • DIPLEXERS
FIXED AND VARIABLE, DISTRIBUTED AND LUMPED CONSTANT DELAY LINES • PULSE FORMING NETWORKS

is 10,000 g (sinusoidal), and a maximum shock of 20,000 g with a 75 μ sec half-sine pulse. Nominal sensitivity is 0.6 pk-mv/pk-g, with 300 pf external capacitance. Unit is 0.52 in. high, and has a $\frac{1}{8}$ in. hex

base. Price is \$175.

Accelerometer is manufactured by Endevco Corp., 161 East California Blvd., Pasadena, Calif.

CIRCLE 304 ON READER SERVICE CARD

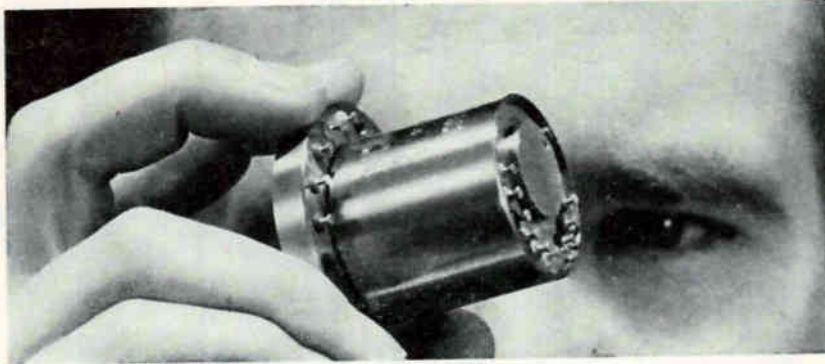

Ten-Circuit Slip-Ring

BRUSHES LIFT MANUALLY

SEALED, ten-circuit miniature slip-ring for general purpose use has manually operated brush lifter. Applications include strain gage, thermocouple and vibration measurements.

The unit, Model SR10M, made by Michigan Scientific Corp., 730 Bellevue, Milford, Mich., is 2 inches in diameter by 1 $\frac{1}{8}$ inches long, can

operate in presence of oil, water, dust and other contaminants. Manual rotation of the brush lifter about 90 degrees raises the brushes from the slip rings. Solder terminals on the rotor and stator are color coded. Noise is insignificant at speeds up to 6,000 rpm.

CIRCLE 305 ON READER SERVICE CARD



Trimmer Capacitor

FOR P-C BOARDS

DIRECT TRAVERSE trimmer capacitor has one wire lead and one tab lead, is made in four models with capacitance ranges from 1 to 8 pf. With fixed cavity tuning and linear tuning curve, the Mini-Trimmed is for printed circuit boards and custom applications.

Capacitors have low inductance at high frequencies, thermal stabil-

ity and ruggedness. Samples are available from stock, from Corning Electronic Components, 550 High St., Bradford, Pa.

CIRCLE 306 ON READER SERVICE CARD

Dual Coaxial Couplers

HIGH DIRECTIVITY

DUAL coaxial couplers designed for coaxial reflectometer setups, featuring high directivity and a four-to-one frequency range, have been an-



nounced by the Narda Microwave Corp., Mineola, L. I., N. Y. Directivity of the couplers, models 3020

and 3022, is held to 35db and 30 db minimum, respectively, assuring a maximum error of only 1.035 vswr, for the Model 3020.

CIRCLE 307 ON READER SERVICE CARD

Microwave System

TRANSISTORIZED PACKAGE

TRANSISTORIZATION of all stages except the transmitter klystron is a feature of microwave system operating in 6,000 Mc region. Designed for use by railroads, utilities, government and industry, the equipment uses modular construction and etched circuit cards.

The MR-50 equipment includes r-f unit MR-50, multiplex MC-50, telegraph carrier MT-50, and alarm

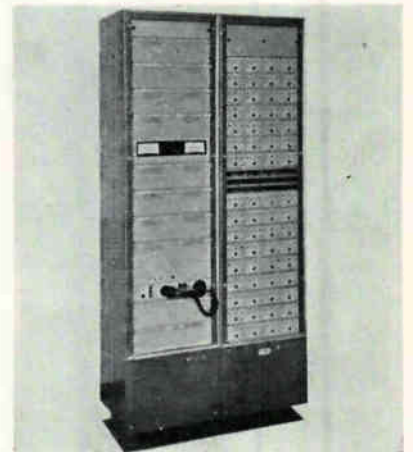

MA-50. Klystron tube in the transmitter has one-watt output and life expectancy of 20,000 hours.

Frequency stability is ± 0.005 percent, to conform to proposed FCC standards. The equipment is available in nonstandby, standby, frequency diversity and space diversity models. A maximum of 600 channels cover band from 60 to 2,540 Kc with 4-Kc channel spacing. System is manufactured by Motorola, Inc., 4501 West Augusta Blvd., Chicago 51, Ill.

CIRCLE 308 ON READER SERVICE CARD

Power Computer

HALL-EFFECT DEVICE

POWER COMPUTER of high accuracy has been developed by Ohio Semiconductors, 1205 Chesapeake Ave.,

light up time...

AND TIME TO LIGHTEN UP!

An ISOLATOR

only 4 ounces light! Only 3½" long, including connectors!

Your every isolator problem involving size and weight is solved with this Melabs Model X-205: 5.4 to 5.9 GC • max. insertion loss (at band ends) 1.0, typical center, 0.8 • isolation (min. at band ends) 18.0 (typical center, 25.0) • input

VSWR max. 1.25:1 • power, 5 W av. • TNC connectors —all this... and magnetically shielded!

Delivery, specified quantities, available from stock: Melabs X-205 Isolator, \$320.00.

Data subject to change without notice. Price f.o.b. factory

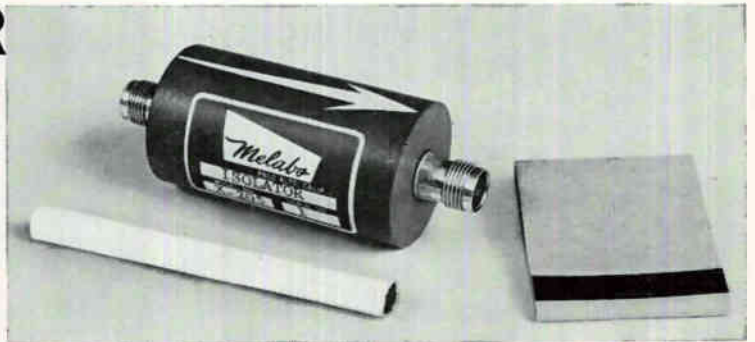

Ambitious engineers are offered unlimited opportunities for career advancement at Melabs. Write today.

7118

3300 Hillview Avenue • Palo Alto, California • Davenport 6-9500 • Area Code 415

CIRCLE 215 ON READER SERVICE CARD

Did you know that your 1960 **electronics BUYERS' GUIDE** includes... Missiles in Production — p. R5, List of Military Procurement Locations and Personnel — p. R7, Characteristics of Plastics — p. R34, Characteristics of Laminates — p. R36, Wire, Tape and Foam Specifications — p. R38, Symbols Dictionary — p. R42, List of Industry Organizations, Services and Standards — p. R47, Military Standards — p. R50, Military Nomenclature — p. R53.

The only directory in the electronics industry with a Reference Section. It contains Market Data, Materials for Components, Specifications and Services, Design Data.

First choice of all 4!

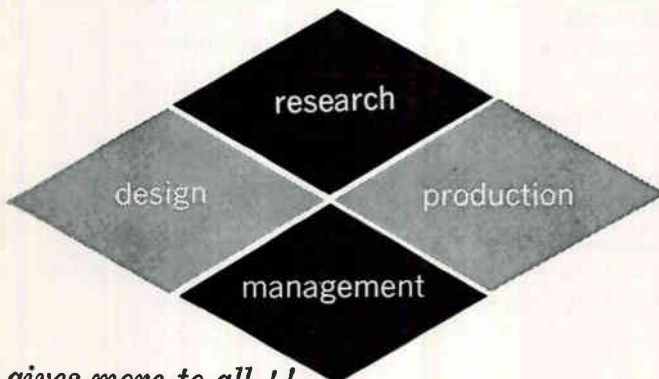

gives more to all 4!

electronics BUYERS' GUIDE
and REFERENCE ISSUE

April 28, 1961

BINARY OPERATED READOUT

Operates Direct — No Buffers or Translators Required

New!

ALL DIGITS CAN BE READ FROM ANY ANGLE

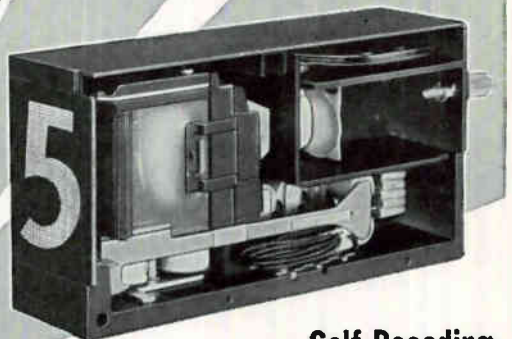

Self-Decoding
Alpha-Numeric Readout

Price Complete from \$50.00

Applications... May be connected directly into computers, teletype, other electronic equipment.

Features... Electro-magnetic operation, low power (10 milliwatts), accepts BCD code to 6 bits, does own translating and displays proper character.

Specifications . Speed: 20 characters per sec. Character Size: 1½" high. Dimensions: 1¾" x 3¼" x 6¾".

WRITE TODAY FOR COMPLETE DETAILED INFORMATION.

Representatives in principal cities.



INDUSTRIAL ELECTRONIC ENGINEERS, Inc.
5528 Vineland Avenue, North Hollywood, California

CIRCLE 133 ON READER SERVICE CARD

133

**Phil
Greenstein
can
show
you...**

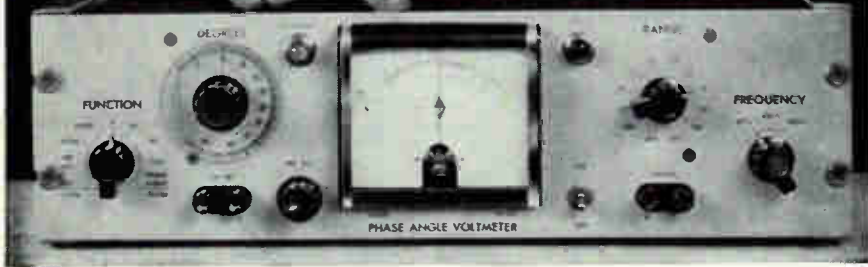

**how North Atlantic's
Phase Angle Voltmeters solve
tough ac measurement problems
... in the lab or in the field.**

Designed for critical tasks in circuit development, production and testing, North Atlantic's Phase Angle Voltmeters provide direct reading of phase angle, nulls, total, quadrature and in-phase voltages—with proven dependability even under field conditions. Your North Atlantic engineering representative can quickly demonstrate how they simplify ac measurement jobs from missile checkout to alignment of analog computers—from phasing servo motors to zeroing precision synchros and transducers.

Shown below are condensed specifications for single-frequency Model VM-202. Other models include high sensitivity, three-frequency and broadband types.

Voltage Range.....	1 mv to 300 v f.s., 12 ranges
Voltage Accuracy.....	±2% f.s.
Phase Accuracy.....	dial: ±1°; meter: ±3% of F.S. degrees
Signal Frequency.....	1 Freq., 30 cps—10 kc
Input Impedance.....	10 megohms
Reference Input.....	100 K, 0.25 v min.
Meter scale.....	3-0-3, 10-0-10 linear
Phase Angle Dial.....	4 scales, 90° (elec.) apart
Nulling Sensitivity.....	2 microvolts (phase sensitive)
Harmonic Rejection.....	55db (with filters)
Dimensions.....	5¼" h. x 19" w. x 7⅞" d.

The North Atlantic man in your area has full data on standard and special models for laboratory, production and ground support. Call today for his name, or request Bulletin VM-202.



NORTH ATLANTIC industries, inc.
TERMINAL DRIVE, PLAINVIEW, L. I., NEW YORK • Overbrook 1-8600

Columbus 12, Ohio.

Model PC-500 is for use as a power meter, power recorder, and power monitor and demand indicator. Rugged Hall-effect device produces a d-c output proportional



to true power. Output voltage is a linear function of power from -5 to 75 C, and is proportional to instantaneous power. Output may be recorded, or displayed on an oscilloscope, to check waveforms, transients and system irregularities.

Frequency response is within 0.5 percent from 50 to 1,000 cps, within 3 percent to 2,500 cps. Delivery is 2 weeks and unit price is \$143.50.

CIRCLE 309 ON READER SERVICE CARD

Magnetometer

TEXAS INSTRUMENTS INC., 6000 Lemmon Ave., Dallas 22, Texas. Metastable helium magnetometer features insensitivity to temperature and orientation changes.

CIRCLE 310 ON READER SERVICE CARD



**Radar TO Simulator
IN 5.4-5.9-GC RANGE**

RANTEC CORP., Calabasas, Calif. A monopulse antenna pattern simu-

lator in the 5.4-5.9 Gc range will perform a checkout or system analysis on monopulse circuitry and computers without the use of expensive range equipment. It provides adjustable electrical line lengths in both signal and local oscillator branches, and includes branching circuits with ferrite isolators and three balanced mixers.

CIRCLE 311 ON READER SERVICE CARD

Inverters

BERGEN LABORATORIES INC., 60 Spruce St., Paterson 1, N. J. Three phase sinusoidal inverters range in power from 15v-a to 300v-a. Distortion is held to below 5 percent.

CIRCLE 312 ON READER SERVICE CARD



Fluxless Solder

LOW TEMPERATURE

METALS FOR INDUSTRY INC., 299 Pavonia Ave., Jersey City 2, N. J. A fluxless solder, Tin-A-Lum, which melts at very low temperature, thus eliminating the danger of metal destruction under heat, has been developed for use on aluminum and its alloys, zinc, tin, pewter, magnesium and other metals as well as castings. The all-purpose aluminum solder has proven to be of such tensile strength that it can even replace welding or brazing in many instances and at much lower cost and less time.

CIRCLE 313 ON READER SERVICE CARD

Pressure Transducer

RUGGED DEVICE

CENTURY ELECTRONICS & INSTRUMENTS, INC., Tulsa, Okla. Rugged, low-cost pressure transducer, of bonded silicon strain-gage construction, requires no amplifier or associated equipment. It is available in pressure ranges from 20 to 10,000 psig and can be overpres-

DURANT

Your answer
to an infinite number of
variable demands for
**PRECISION
CONTROLS**



Model "D" SERIES
Wheel diameter: 1"
Figures: 3/4" high

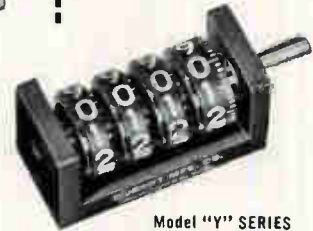

Model "Y" SERIES
Wheel diameter: 3/4"
Figures: 3/16" high

Many stock variations, easily adapted for MISSILE TRACKING, RADAR CONTROLS, COMPUTERS, NAVIGATION INSTRUMENTS, GAUGING INSTRUMENTS, and ANY other indicator applications.

- Standardized in two basic families to cut costs, save time, and simplify installation.
- Meet rigid military specifications.
- Component parts may be purchased separately to meet design requirements.
- High speeds, lower torque, and lower moment of inertia for long operating life.
- Non-corrosive, one piece precision molded pinions and wheels, large legible figures.
- One piece aluminum die cast frame.
- Single, 1 1/2 or double width wheels; right or left hand drive; clockwise or anti-clockwise rotation.
- Base mounting. Threaded mounting holes may be in frame top or ends.
- "Y" Series, single or double bank types.
- In addition, Durant can develop designs for any special counter requirements.

Send for Catalog Number 400

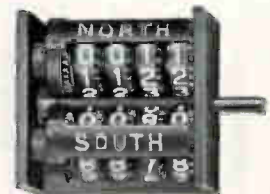

MODEL "Y" 9425
DUAL BANK SERIES



MODEL "Y" 8831
DUAL BANK SERIES

DURANT MANUFACTURING CO.

dependable since 1879

1912 North Buffum St.
Milwaukee 1, Wisconsin
12 Thurbers Ave.
Providence 5, R. I.

DURANT

COUNTING INSTRUMENTS

Accurately Count Everything . . . EVERYWHERE



MODEL "YE"
ELECTRIC
HIGH SPEED
QUICK RESET



COUNTER
FOR TRUE
AIRSPEED
INDICATOR



INSTRUMENT
COUNTER WITH
LUMINESCENT
FIGURES



HIGH SPEED
COUNTER FOR
NAVIGATING
INSTRUMENT



DEGREES AND
MINUTES
INSTRUMENT
COUNTER



INSTRUMENT
COUNTER FOR
INCREMENTAL
OSCILLATOR

REPRESENTATIVES IN ALL PRINCIPAL CITIES

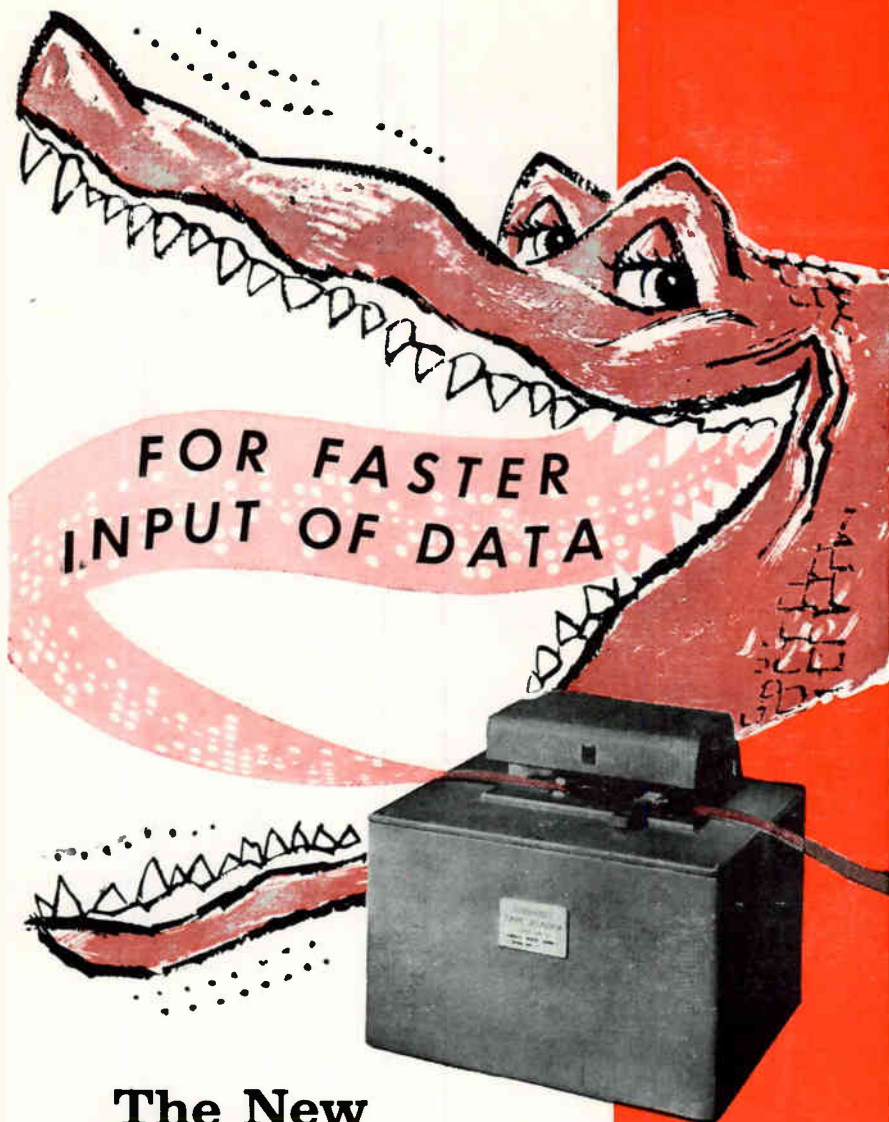

The New **FERRANTI TR5** Transistorized Tape Reader

This is an advanced design embodying broad experience gained from earlier Ferranti tape reader models.

It employs new transistorized circuits and a photoelectric system of reading . . . offers the advantage of speedier input of data, compactness, light weight.

Many design features to meet practical requirements of the user. Power supply is self-contained.

Write for detailed information.



FERRANTI
ELECTRIC, INC.
ELECTRONICS DIVISION
PLAINVIEW, NEW YORK

TAPE WIDTHS:
5, 6, 7 or 8 level, all types and colors.

SPEED:
Any speed up to 330 chars/sec, under external control.

ELECTRONICS:
All solid state, including solar cell reading head, signal amplifiers, logical circuits, control circuits and power supplies.

INPUTS:
115V 60 cps 115 Watts power, -2 V 100 micro-amp start signal.

OUTPUTS:
8 signal outputs, -1.5 to -3.5 V 5 milliamps plus reader ready signal.

SIZE:
9 1/4" x 11 1/2" x 10"
Weight 32 lbs.

FINISH:
Gray wrinkle.

sured by a factor of 10 without requiring calibration. Its accuracy and zero-shift are comparable to wire-gage types.

CIRCLE 314 ON READER SERVICE CARD



Data Processing Units FULLY TRANSISTORIZED

SMITH-CORONA MARCHANT INC., 410 Park Ave., New York 22, N. Y., has introduced two data processing units, the Typetronic 2215 (illustrated) and the Typetronic 6615. The 2215 is a business document writing system consisting of an electric typewriter with electronic components which automatically process forms upon activation by punched tape or edge punched cards. Unit reproduces standard repetitive data at more than 100 wpm and entering of variables is the only manual operation required. The 6615 is an electronic computer with electric typewriter input-output which speeds and simplifies preparation of business forms requiring calculation.

CIRCLE 315 ON READER SERVICE CARD

Regulator

PERKIN ELECTRONICS CORP., El Segundo, Calif. A completely static, a-c line regulator has a 0.05 second response and an accuracy of ± 0.1 percent.

CIRCLE 316 ON READER SERVICE CARD

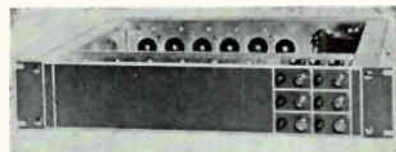

Computer Building Block FIXED PROGRAM

EMBREE ELECTRONICS CORP., West Hartford, Conn., introduces a sta-

bilized operational "six-pack", a fixed program analog computer building block designed to be incorporated as original equipment for machine tool and process control instrumentation and simulation. Unit accommodates 6 pairs of plug-in amplifiers (of a variety of types) to provide 6 channels of high gain, drift-stabilized analog computation.

CIRCLE 317 ON READER SERVICE CARD

Recording Heads

APPLIED MAGNETICS CORP., P. O. Box 368, Goleta, Calif. Digital read-write magnetic heads provide 8 in line tracks for each $\frac{1}{4}$ inch of tape.

CIRCLE 318 ON READER SERVICE CARD

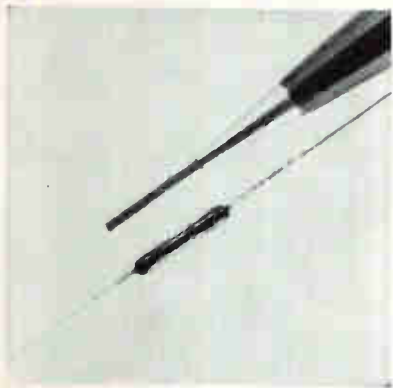

Wirewound Resistor VITREOUS ENAMELED

OHMITE MFG. CO., 3657 Howard St., Skokie, Ill., announces a 1-w, wirewound, vitreous enameled, axial lead power resistor measuring $\frac{1}{8}$ in. max length by $\frac{1}{4}$ in. max diameter. Watt rating is based on 300 C temperature rise. Units are particularly adaptable for p-c and modular wiring applications. Resistance range, 1 to 600 ohms; resistance tolerance, ± 5 percent.

CIRCLE 319 ON READER SERVICE CARD

Precision Pot MULTITURN

LITTON INDUSTRIES POTENTIOMETER DIVISION, 200 E. Third St., Mt. Vernon, N. Y., announces a multiturn pot of infinite resolution and linearity of ± 0.005 percent. Model MJ20-10 measures 2 in. in diameter, and MJ30-10, 3 in. Both can accommodate taps in any location. They have the added capability of



**No
moving
parts in**

FERRANTI Magnetostriction Delay Lines



Ferranti engineers have a depth of experience unmatched in this specialty.

We can provide stock units that have been proved in performance — or custom design to your special applications.

Features that characterize Ferranti Delay Lines:
Temperature stable . . . wide temperature operating range . . .
High digit rates up to 1 Mc/s for delays up to 3 milliseconds . . .
Small size, light weight . . . No moving parts . . . Low cost, highly reliable elements for delay, storage and correlation — fixed and variable.

Write for detailed literature

FERRANTI ELECTRIC, INC.

ELECTRONICS DIVISION

PLAINVIEW

NEW YORK



DOUBLE TALK!

**MAKES SENSE WITH
EECo ALL SOLID-STATE
DATA CONVERTERS
FOR OFF-LINE DUTY**

One data language in. Another out. Fast, accurate performance and long service life, at new, low cost. Off-line operation to conserve valuable computer time.



EECo-753 3-Way Tape Data Converter

for business or scientific use

• Paper-to-Magnetic Tape • Magnetic-to-Paper Tape • Paper-to-Paper Tape — 5-, 6-, 7-, or 8-level paper tape in any coding in or out. IBM 704 or IBM 705 magnetic tape in or out. Selectable block lengths up to 720 characters stored in ferrite core memory. Manual-visual check of code conversion and memory.

PRICE \$62,500 fob Santa Ana



EECo-752 Data Converter

for business or scientific use

Converts 5-level Teletype paper tape to magnetic tape for IBM 704 or IBM 705. Manual-visual check of code conversion and memory. 128-character ferrite core memory.

PRICE \$36,500

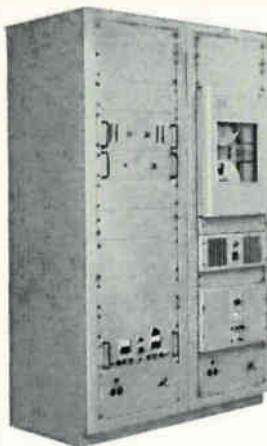

EECo-751 Format Control Buffer

for scientific use

For entry into IBM 650, IBM 704, IBM 705, IBM 709. Or can be furnished for other computers. Accepts digitized data in parallel form at random rates.

PRICE \$38,500-\$45,000

SEND FOR DATA FILE 751-3. All converters employ Engineered Electronics Co.'s all-solid-state plug-in circuits throughout.



Electronic Engineering Company of California

1601 E. Chestnut Avenue • Santa Ana, California • KImberly 7-5501 • TWX: S Ana 5263
MISSILE & AIRCRAFT RANGE INSTRUMENTATION • DIGITAL DATA PROCESSING SYSTEMS • TIMING SYSTEMS •
COMPUTER LANGUAGE TRANSLATORS • PAPER TAPE PROGRAMMERS EE 0-16

relatively high-accuracy load compensation and high power dissipation.

CIRCLE 320 ON READER SERVICE CARD

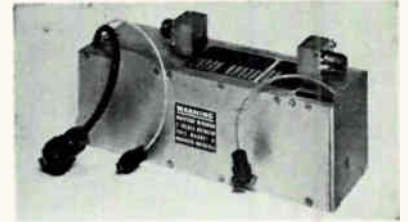

Low-Noise TWT RUGGEDIZED

GENERAL ELECTRIC CO., Schenectady 5, N. Y., has developed a twt for use in the 7 to 11 Gc range for input service in radar receivers. The Z-3103 metal-ceramic tube has a noise figure less than 10 db, minimum gain of 25 db, and power output of 5 mw across the entire band. It withstands shock at 50 g and vibration at 5 g. Additional uses include applications in radio astronomy, radiometry, countermeasures and microwave relay systems. Price is \$2,850.

CIRCLE 321 ON READER SERVICE CARD

Titanium Cladding

SUPERIOR TUBE CO., Norristown, Pa. A cladding of A-nickel tubing permits production use of titanium in brazing metal stems to ceramics.

CIRCLE 322 ON READER SERVICE CARD

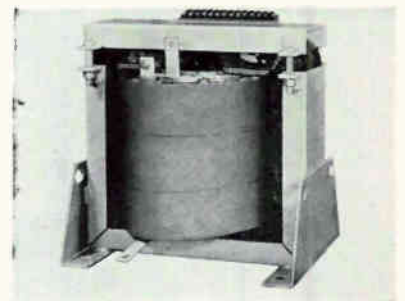

Magnetic Amplifiers HIGH-CAPACITY

VICKERS INC., Electric Products Division, 1815 Locust St., St. Louis 3, Mo., introduces a series of high-capacity magnetic amplifiers in seven sizes from 75 h-p to 400 h-p. The Mega-Power 1310 series are recommended for applications requiring high capacity controlled

d-c power for variable-speed d-c motor drives. Other suggested uses are for controlled d-c power in plating, electrochemical processes, accelerator magnets and other d-c applications.

CIRCLE 323 ON READER SERVICE CARD

Ceramic Magnet

D. M. STEWARD MFG. CO., Chattanooga, Tenn. A 3000 oersteds minimum coercive force ceramic magnet, developed for use in periodic magnetic stacks for tvwt applications, is announced.

CIRCLE 324 ON READER SERVICE CARD

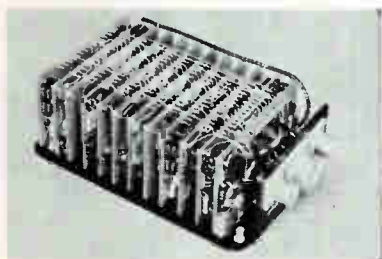

Converter

ANALOG-TO-DIGITAL

TOWSON LABORATORIES, INC., 200 E. Joppa Road, Baltimore 4, Md. The Capcoder is an analog-to-digital converter utilizing the technique of capacitive charge transfer. The unit has 45 transistors in a total of only 512 components. Analog-to-digital converters using this charge transfer technique can be engineered for the full spectrum of encoding speeds up to and including megacycle rates. The Cap-coder is designed for pcm telemetering applications.

CIRCLE 325 ON READER SERVICE CARD



Frequency Meter AND COUNTER

WESTPORT ELECTRIC, 149 Lomita St., El Segundo, Calif. The WE-140 is a 4-decade electronic frequency meter and counter with a frequency

NOW

for the first time...

IDL offers

"STANDARD" TELEMETERING COMMUTATORS

which can satisfy 98%* of PAM and PDM System Requirements

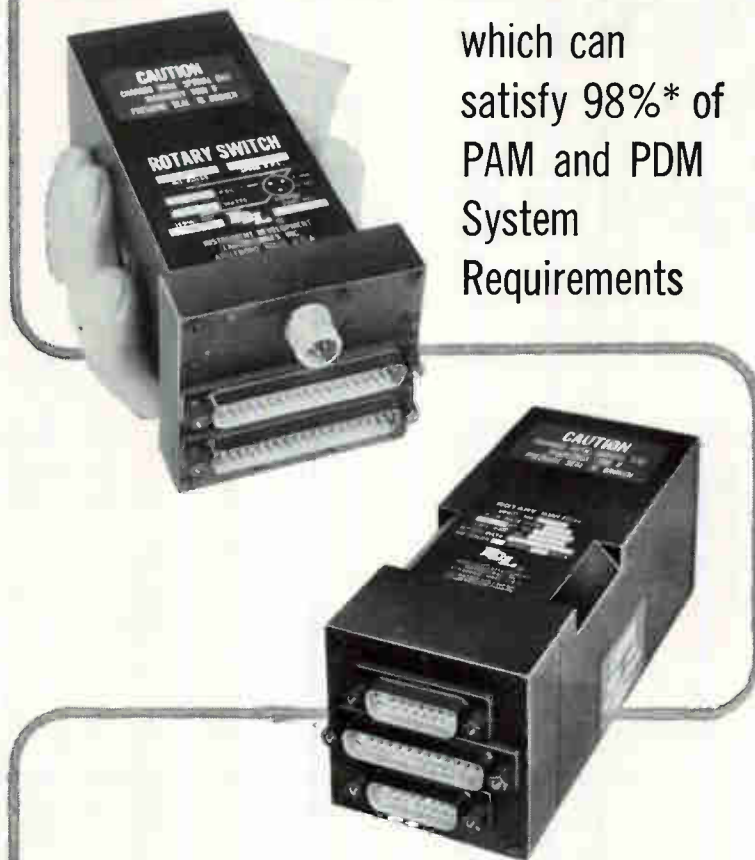

Within these two case configurations, IDL will provide sampling rates, channel density, low noise level operations and motor characteristics specified by IRIG requirements in telemetering systems. The possible combinations offered by this production plan are so numerous that most telemetering requirements can be met.

To the systems designer, these "Standard" Telemetering Commutators offer tremendous advantages:

1. Uniform installation requirements
2. Shorter delivery schedules
3. Uniform quality and workmanship
4. Long, service-free unattended life
5. Missile reliability
6. Uniform pricing
7. Unlimited production capacity for follow-on

**We try, but we can't satisfy everybody.*

For complete information, write for IDL brochure "New 'Standard' Telemetering Commutators".



INSTRUMENT DEVELOPMENT LABORATORIES, INC.

Subsidiary of Royal McBee Corporation

51 MECHANIC STREET, ATTLEBORO, MASSACHUSETTS, U.S.A.

RECMF

RADIO and ELECTRONIC COMPONENT SHOW



exhibits include ...

components, valves, tubes,
semi-conductors, chassis, cases,
fittings, wires, cables, assemblies
and other associated products for:

- Telecommunications equipment
- Radio and television receivers
- Tape recorders, gramophone reproducers
and film equipment
- Amplifiers, "hi-fi" equipment
- Electronic computers
- Radar and navigational aids
- Measuring instruments and scientific
apparatus
- Medical electronic and allied apparatus
- Process control and automation equipment
- Civil and military aeronautical purposes
- Guided missiles and military equipment

RECMF

OLYMPIA, LONDON, ENGLAND
30 May - 2 June, 1961

Admission: Free Season Ticket for Overseas Visitors

Further details and personal invitation from the organisers:

INDUSTRIAL EXHIBITIONS LTD,

9 ARGYLL STREET, LONDON, W.1. ENGLAND

range of 75 Kc, crystal controlled time base in a 15 lb package 6½ by 11½ by 9½ in. Decade glow transfer tube counting and indication are used with reliable and simplified circuitry. These tubes are used for both counting and time base division. Display of results is variable from 0.5 to 5 sec or can be manually controlled and held indefinitely.

CIRCLE 326 ON READER SERVICE CARD

Discriminator Cavity

WESTINGHOUSE ELECTRIC CORP., Box 2278, Pittsburgh 30, Pa. Dual-mode transmission type discriminator cavity has been developed for use as a frequency stabilizing device.

CIRCLE 327 ON READER SERVICE CARD



Ultrasonic Cleaner TRANSISTORIZED

ACOUSTICA ASSOCIATES, INC., 10400 Aviation Blvd., Los Angeles 45, Calif., offers a line of self-tuned transistorized 20-Kc ultrasonic cleaners. Model SC-520 is designed to clean completely assembled p-c boards, potentiometers, ball-bearings, gyros and many other complex items. Units are light and compact, have choice of selectable power levels.

CIRCLE 328 ON READER SERVICE CARD



Modulator SOLID STATE

SIERRA RESEARCH CORP., 240 Cayuga Rd., Buffalo 25, N. Y. Model SSM101 solid state modulator employs a technique that allows any reference supply voltage fluctuation or distortion to be transformed to the output, thereby per-

mitting cancellation of these effects. It has an input voltage of 0 to ± 2 v d-c, input impedance of 100,000 ohms, output voltage of 0 to 3 v rms at 0 or 180 deg phase, and output impedance of 500 ohms.

CIRCLE 329 ON READER SERVICE CARD

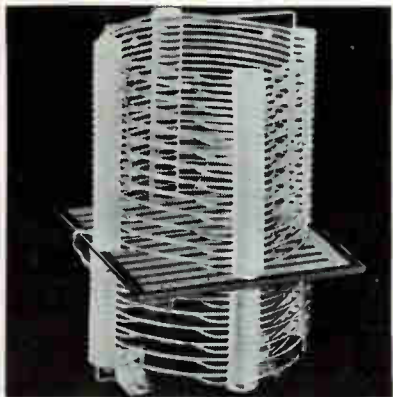

Air Wound Coils ELECTROSTATIC SHIELD

ILLUMITRONIC ENGINEERING CORP., 680 E. Taylor St., Sunnyvale, Calif. Introduction of electrostatic shielding in air wound coils with Q's as high as 500 is announced. The Faraday shield is employed where two coils are to be electromagnetically coupled but electrostatically shielded from each other. The Faraday shield is a printed circuit with a group of parallel conductors which takes the form of a comb. It is available for use with any of the company's special design or 67 standard Air Dux coils.

CIRCLE 330 ON READER SERVICE CARD

Silicon Mesas

SYLVANIA ELECTRIC PRODUCTS INC., 730 Third Ave., New York 17, N. Y. Two watt transistors handle 500 ma of collector current in a total switching time of 105 nsec.

CIRCLE 331 ON READER SERVICE CARD



Potentiometer HIGH-FREQUENCY

REON RESISTOR CORP., 155 Saw Mill River Road, Yonkers, N. Y. Model

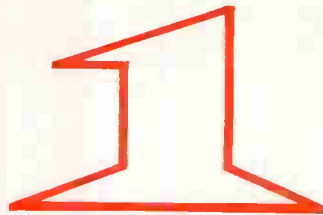

TRANSPORT CAN NOW DO THE WORK OF



WITH POTTER HIGH DENSITY RECORDING



With the revolutionary new Potter High Density Recording System, one tape transport has the capacity of 5 or more conventional transports.

For highly reliable computer applications, Potter High Density Recording can give you data transfer rates of 360,000 alpha-numeric characters per second, at densities up to 1500 bits per inch on 1-inch tape. Sixteen parallel channels can be accommodated on one-inch tape. Because Potter has made the information channels self-clocking, no separate clock channel is needed, and multichannel data can be read out in true parallel form, despite interchannel time displacement.

In production units delivered by Potter for the BENDIX G-20 COMPUTING SYSTEM at the Carnegie Institute of Technology, this dramatic new technique makes recording so reliable that in 40 hours of continuous operation less than 2 seconds re-read time are required to recover information lost through transient error. Dropouts are fewer than 1 bit in 10 billion at 1100 alpha-numeric characters per inch. More than 20,000 passes of the tape can be made without losing information or significantly increasing the reading error rate.

Tested and proven in computer systems, Potter High Density Recording is presently available in the Potter 906II High Speed Digital Magnetic Tape Handler, and will be available in other Potter Tape Systems.

Write today for details on how High Density Recording can be applied to your data handling problem.

POTTER INSTRUMENT COMPANY, INC. • SUNNYSIDE BOULEVARD, PLAINVIEW, NEW YORK

a tube
 in this...
 fails 12
 times more
 often than
 in these!



Tubes, properly shielded with IERC Heat-dissipating Electron Tube Shields, instead of with harmful, obsolete JAN types, can extend tube life up to 12 times in new or retrofitted equipments.

For reliability and extended MTBF in your equipment, write for IERC's report, "Heat-dissipating Electron Tube Shields and Their Relation to Tube Life and Equipment Reliability." From it, you'll find the most effective, practical way to reduce bulb temperatures, neutralize critical environmental conditions, minimize down-time and tube failure-replacement costs!

IERC  **DIVISION**

International Electronic Research Corporation
 135 West Magnolia Boulevard, Burbank, California

Foreign Manufacturers: Europelec, Paris, France. Garrard Mfg. & Eng. Co., Ltd., Swindon, England

R potentiometer can be applied to circuits with frequencies as high as 10 Mc with a minimum of distortion. It has a rotational life of 100,000 cycles and is operable in ambients from - 55 C to 125C. An improved design and extensive use of non-metallic materials have practically eliminated inductance in the unit and reduced capacitance to 8 $\mu\mu\text{f}$.

CIRCLE 332 ON READER SERVICE CARD

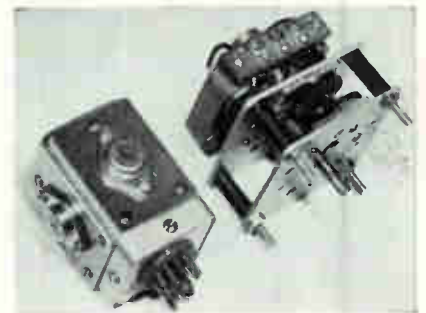

Servo Amplifier SOLID STATE

SOLAR ELECTRONICS CO., 5909 Melrose Ave., Hollywood 38, Calif. Model 6102 solid state servo amplifier with its associated reversible nonsynchronous motor comprises a system adaptable to a wide variety of industrial control and automation applications with either a-c or d-c control systems. Servo system is plug-in, inexpensive and reliable; has two d-c and one a-c input signal. Price: amplifier, \$124.50; motor, approximately \$50, depending on gear ratio.

CIRCLE 333 ON READER SERVICE CARD

Digital Computer

HARVEY-WELLS ELECTRONICS, INC., 14 Huron Drive, Natick, Mass. Solid state computer uses separate program and data memories to obtain real time speeds.

CIRCLE 334 ON READER SERVICE CARD



Thermostat NON-OVERHEATING

VALVERDE LABORATORIES, 252 Lafayette St., New York 12, N.Y. For the reliability program pro-

duction schedules where rejects are costly, the Dualstat serves where an overrun of even one cycle cannot be tolerated. A snap action with only 3 F or better differential. Capacity 2 amp 28 v, 150 w 120 v a-c/d-c; 500,000 one minute cycles; dimensions 0.372 deep by 1 3/4 in.; weight 0.3 oz; preset up to 300 F, hermetically sealed.

CIRCLE 335 ON READER SERVICE CARD

Transistor

HOFFMAN ELECTRONICS CORP., 1001 North Arden Drive, El Monte, Calif. The USA2N697 silicon mesa transistor, which meets the reliability required in Signal Corps tests, is available.

CIRCLE 336 ON READER SERVICE CARD



AGC Amplifier TRANSISTORIZED

MELCOR ELECTRONICS CORP., 48 Toledo St., So. Farmingdale, L. I., N. Y. Model 1020 has an automatic gain control range up to 250:1. When used with a variable gain servo, the 400 cps unit maintains constant loop gain. It weighs 6 oz, has simplified mounting, and operates over ambient temperature range of - 55 C to + 125 C. Price: \$270-\$310.

CIRCLE 337 ON READER SERVICE CARD



Servo Pot WIREWOUND

MAUREY INSTRUMENT CORP., 7924 South Exchange Ave., Chicago 17, Ill., announces the 50-M52 1/2 in. servo precision pot. Wirewound element with resistance range of 50 to 100,000 ohms. Linearity up

April 28, 1961

BIRD



82-A
(500 Watts)

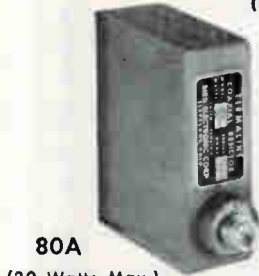

80A
(20 Watts Max.)



81
(50 Watts)



81-B
(80 Watts)

"Termaline" 50 ohm Coaxial Line LOAD RESISTORS

SERIES 80-82

- Frequency Range: DC to 4000 mc
- Power Range: 20 to 2500 Watts
- Non-Radiating
- VSWR: 1.1 max. to 1000 mc.

APPLICATIONS

Accurate termination for 50-ohm coaxial systems, as dummy antennas, during adjustment, alignment and testing.

SPECIFICATIONS

MODEL	MAXIMUM POWER (In Still Air)	FREQUENCY RANGE	MAX. VSWR	INPUT CONNECTOR	WEIGHT	MAXIMUM DIMENSIONS		
						HEIGHT	LENGTH	WIDTH
80-A	20 W	0-1000 mc	1.1	"N" Female	2 lbs.	4 1/4"	4 5/8"	1 1/2"
81	50 W	0-4 kmc	1.2	"N" Female	4 lbs.	4 1/2"	9 3/4"	2 1/32"
81-B	80 W	0-4 kmc	1.2	"N" Female	4 lbs.	6 1/32"	9 3/8"	3 1/16"
82-A	500 W	0-3.3 kmc	1.2	Coplanar Adapter to UG-21 B U Supplied. RG-17, RG-19 cable assemblies available.	17 lbs.	8 7/16"	18 1/2"	5 1/16"
82-AU	500 W	0-3.3 kmc	1.2	LC Jack mates with UG-154 U plug on RG-17 U cable.	17 lbs.	8 7/16"	19 1/8"	5 1/16"
82-C	2500 W Water cooled	0-3.3 kmc	1.2	Coplanar Adapter to UG-21 B U Supplied. RG-17, RG-19 cable assemblies available.	26 lbs.	8 7/16"	20 13/16"	5 1/16"

OTHER BIRD PRODUCTS



"ThruLine"
Directional
RF Wattmeters



Coaxial
RF Filters



Coaxial
RF Switches.



"Termaline"
RF Absorption
Wattmeters



BIRD

ELECTRONIC CORP.

Churchill 8-1200
30303 Aurora Road, Cleveland 39, Ohio
Western Representative:
VAN GROOS COMPANY, Woodland Hills, Calif.

CIRCLE 143 ON READER SERVICE CARD

143

*magnetic
controls
company*
has made

**6147
GYRO
TEMPERATURE
CONTROLS**

*for these
missiles*

ATLAS
POLARIS
MACE
THOR
MATADOR
BOMARC
REGULUS
SNARK

Missile manufacturers demand light, accurate, reliable gyro temperature controls—delivered on time. Magnetic Controls Company pioneered this field in 1952. Since then we have reduced the weight and size of these controls by 90% while *increasing* accuracy and reliability. This is why so many missile makers rely on Magnetic Controls Company. For experienced advice and detailed facts on specific applications, phone or write:

MAGNETIC CONTROLS COMPANY
6411 CAMBRIDGE STREET • MINNEAPOLIS 26, MINN. • WE. 9-4691
Heat Control Systems • Static Inverters • Voltage Monitoring Systems

to 1.3 p.p.m. Wattage 2 w at 80 C derated to zero at 125 C. Built to environmental specs NAS710, Mil-R-19A, Mil-R-27208, Mil-R-12934B and Mil-E-5272A. Standard torque of 0.05 oz-in.

CIRCLE 338 ON READER SERVICE CARD

Reference Block

CIRCO CORP., 51 Terminal Drive, Clark, N. J. For use in the calibration of ultrasonic flow detection equipment, the reference block can verify refracted angles and determine beam characteristics.

CIRCLE 339 ON READER SERVICE CARD



Tubular Capacitors SUBMINIATURE UNITS

JOHN E. FAST & CO., 3598 N. Elston Ave., Chicago 18, Ill., announces series 60T subminiature tubular capacitors in hermetically sealed metal cases. Suitable for operation from -55 C to 125 C, they meet MIL-C-25A requirements. Variations are available with impregnations of stabilized wax, mineral oil, and synthetic oil.

CIRCLE 340 ON READER SERVICE CARD

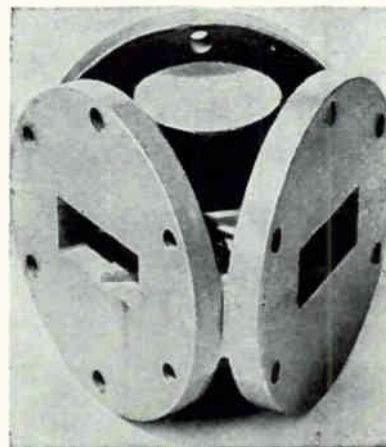

Y Circulators FOR MICROWAVE USE

HUGHES AIRCRAFT CO., Florence & Teale, Culver City, Calif. The 20-20 circulator is suited for microwave

AUGAT

SPACESAVER SOCKET

Designed for the
Complete Series of
Clevite Spacesaver
Power Transistors

The Spacesaver Socket fastens beneath the chassis, allowing direct mounting of the transistor, with a mica insulator, to the chassis. In this way, the transistor is provided with maximum heat dissipation by conduction.

Three socket insulation materials available: black phenolic, melamine or diallyl phthalate.

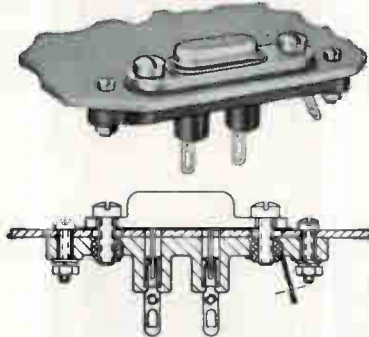

The socket's narrow width permits full utilization of the space saving size of its mating transistor.

For complete specifications, write for Data Sheet No. 760.

AUGAT BROS., INC.

30 PERRY AVENUE, ATTLEBORO, MASS.

CIRCLE 204 ON READER SERVICE CARD

GUDELACE® . . .

the lacing tape with a NON-SKID tread

You can't see it, but it's there! Gudelace is built to grip—Gudebrod fills flat braided nylon with just the right amount of wax to produce a non-skid surface. Gudelace construction means no slips—so no tight pulls to cause strangulation and cold flow.

But Gudelace is soft and flat—stress is distributed evenly over the full width of the tape. No worry about cut thru or harshness to injure insulation . . . or fingers.

Specify Gudelace for *real* economy—faster lacing with fewer rejects.

Write for free Data Book.

It shows how Gudelace and other Gudebrod lacing materials fit your requirements.



GUDEBROD BROS. SILK CO., INC.

ELECTRONICS DIVISION
225 West 34th Street
New York 1, New York

WEST COAST OFFICE
2833 S. Olive Street
Los Angeles 7, Calif.

EXECUTIVE OFFICES
12 South 12th Street
Philadelphia 7, Pa.

CIRCLE 205 ON READER SERVICE CARD

April 28, 1961

ENGINEERS
PHYSICISTS
MATHEMATICIANS

S SYSTEMS EVALUATION POLARIS SYSTEM

The Applied Physics Laboratory of The Johns Hopkins University has responsibilities in the evaluation of the Polaris Missile System. We invite you to consider the following career appointments:

Senior Mathematicians

Duties will involve statistical analysis of complex test data for performance, reliability and operation evaluations. A background in physics or electrical engineering is desirable.

Project Engineers

For field test operations involving a team effort of Contractor, Navy and APL Personnel. Work will include launch and flight data acquisition analysis and monitoring of shipboard activities related to the Polaris Missile System. Prefer engineers with considerable background of project level responsibilities.

Systems Engineers

APL has several positions available on the associate and senior levels for men with experience in electrical engineering, physics, mechanical engineering, dynamics, or computer engineering. Will perform systems work related to fire control, navigation, missiles, and submarine controls. Assignment involves field work and contact with the Navy and Contractor Personnel.

Systems Analysts

Respondents must have heavy theoretical background and ability to read and understand telemetry records. Will perform basic analysis of systems related to fire control, navigation, missiles, and submarine controls. May also be required to simulate and solve orbit and doppler equations. Associate and senior level appointments.

Data Requirements, Instrument Engineers

Positions require a physicist or electrical engineer with experience in evaluation, data acquisition and testing of instrumentation installations. Will analyze sub-systems such as guidance, propulsion, controls, boosters, and inertial systems individually and as integral parts of over-all systems to derive data requirements and instrumentation. Duties involve some field work.

APL will provide you with a professional atmosphere conducive to creative effort as well as the tools and technical support required to tackle these and related problems. Our facilities are located in Silver Spring, a residential suburb of Washington, D. C., offering you a choice of country, suburban or city living.

For additional details,
direct your inquiry to:
Professional Staff Appointments

The Applied Physics Laboratory The Johns Hopkins University

8633 Georgia Avenue, Silver Spring, Md.

CIRCLE 379 ON READER SERVICE CARD

145

Another **FIRST**
 by **TODAY'S LEADER**
 in frequency calibrators
 standards, counters
 and meters



Model 14-31
 with dust cover removed

A FREQUENCY CALIBRATOR

NOW QUALIFICATION TESTED:

- TEMPERATURE MIL-E-005272B
- ALTITUDE 35,000 ft.
- HUMIDITY MIL-E-005272B
- SHOCK MIL-E-4970
- VIBRATION MIL-E-4970

IMMEDIATE DELIVERY FROM STOCK

- INPUT POWER 115 V, 60 cps
- POWER SUPPLY Self contained high voltage rectifier and regulator circuit; and low voltage filament.
- HIGH STABILITY OSCILLATOR 1 MC • Stability of 1 part 10⁸/day; 5 parts 10⁸/wk. Aged 1,000 hrs. before shipment.
- CRYSTAL OVEN Operates at 75°C with mercury switch-transistor control.
- DIVIDER 10:1 cathode-coupled LC locked oscillator.
- BUFFER AMPLIFIER Isolates 100 KC output of locked divider and provides a low impedance output.

Price \$770.00 (Bench or Rack Mount)

Sold and serviced by leading sales reps throughout the U. S.

EXPORT DIVISION • FRAZAR & HANSEN LTD.
 301 Clay St., San Francisco 11, Calif.



NORTHEASTERN ENGINEERING, INC.
 MANCHESTER, N. H.

An Affiliate of Atlantic Research Corp.

reception and transmission applications. Specifications for any frequency band within the 2.6-12.4 Gc range are: isolation, 20 db (minimum); bandwidth, 20 percent of center frequency; insertion loss, less than 0.5 db; vswr, less than 1.2. Price is about \$375.

CIRCLE 341 ON READER SERVICE CARD



Power Supply VOLTAGE REGULATED

KEPCO INC., 131-38 Sanford Ave., Flushing 55, N. Y. Model SM 36-10M delivers 0-36 v d-c, 0-10 amperes, 0.1 percent regulation. Stability is 0.1 percent or 6 mv, whichever is greater, over 8 hr period; ripple, less than 1 mv rms; temperature coefficient, less than 0.05 percent per deg C; recovery time, 50 μsec; output impedance—0.005 ohm from d-c to 1 Kc, 0.05 ohm from 1 Kc to 100 Kc.

CIRCLE 342 ON READER SERVICE CARD

Alternator

THOMPSON RAMO WOOLDRIDGE, INC., 1845 East 30th St., Cleveland 14, Ohio. High-speed, brushless alternator features one-piece rotor design that has no rotating windings, rectifiers or slip rings.

CIRCLE 343 ON READER SERVICE CARD



Reference Junction THERMOCOUPLE TYPE

PACE ENGINEERING CO., 13035 Saticoy St., No. Hollywood, Calif., announces a miniature thermocouple

for fast, expert
electronic supply
at **factory prices**



call your man . . .

at **ALLIED**

Semiconductors
Connectors
Relays
Capacitors
Transformers
Controls
Switches
Resistors
Industrial Tubes
Test Equipment
Wire & Cable

He's your electronic supply specialist, an expert on your needs. He serves you best because he's backed by the world's most complete stocks—all major lines, all types available—at *factory prices*. For complete supply, for expert help, for *same-day shipment*—“call your man at Allied.”

Taylor 9-9100

TWX: CG-2898



Always refer to your 576-page Allied Catalog—the most complete electronics supply source for industry. We stock everything we list . . .

ALLIED RADIO

100 N. WESTERN AVE., CHICAGO 80, ILL.

LOS ANGELES, CALIF.: Murray 1-5291 • INDIANAPOLIS, FT. WAYNE, MISHAWAKA, SOUTH BEND, IND.: Enterprise 6866 • GRAND RAPIDS, MICH.: Enterprise 7566 • MINNEAPOLIS, ST. PAUL, MINN.: Zenith 6866 • ST. LOUIS, MO.: Enterprise 6866 • MILWAUKEE, WISC.: Hilltop 4-8320

One Order to Allied Fills the Whole Bill

Environmental conditioning for detection systems

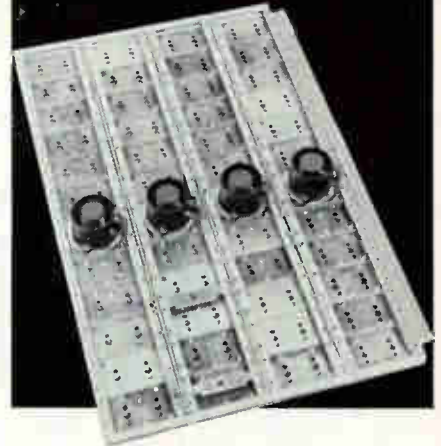

AiResearch cooling of airborne detection systems is accomplished by an extremely reliable, compact unit which is both an air-cooled cold plate and mounting structure for the detection system's transistorized power supply.

This lightweight package weighs 7.2 lb., and has a heat rejection of 500 watts. It consists of four AiResearch Minifans and an all-aluminum structure with 44 separate modules. Each module is electrically isolated and may be removed individually for quick, easy replacement.

AiResearch is the leading designer and manufacturer of such advanced electronic conditioning equipment and systems. This production unit is one example of the broad production-proven capability of AiResearch in providing extremely reliable, lightweight, compact cooling packages for aircraft, missile, space and ground support applications.

Environmental conditioning equipment has been produced for the following electronic systems:
Detection • Communication • Control • Ground Support • Guidance

Write for literature today.



AiResearch Manufacturing Division
Los Angeles 45, California

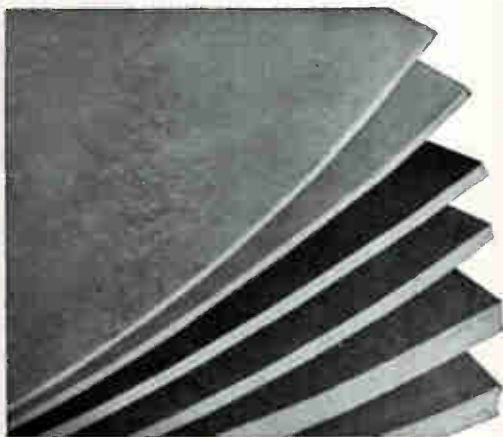

SILICONE SPONGE RUBBER SHEETS

Flexible temperature range -100°F to 500°F

COHRLastic R-10470 silicone sponge rubber sheets have a dense, uniform, non-absorbing closed cell structure highly suitable for soft gasketing, vibration dampening, fairing strips, pads, cushions and other applications where resiliency at extreme temperatures is required. It may be bonded to metals, plastics, fabrics or silicone rubber. COHRLastic R-10470 possesses superior compression set resistance, excellent dielectric properties, immunity to aging, ozone and weather hardening. Meets many specifications. AVAILABLE FROM STOCK: in 12" x 12" sheets and 24" x 24" sheets — 1/16" through 1/2". Special thicknesses and sheet sizes up to 30" x 30" and 24" x 48" made to order. Sold nationally through distributors.

FREE SAMPLE and folder — write, phone or use inquiry service.

Leader in Fabrication of Silicone Rubber Products

CHR CONNECTICUT HARD RUBBER CO.

Main office: New Haven 9, Connecticut
CIRCLE 207 ON READER SERVICE CARD

NEW!

Solid State DISPLAY ASSEMBLY



for decimal display
and storage of
binary coded
decimal data

accepts up to 24 bits of parallel BCD data

Hermes' new Solid State Display Assembly, Model 2060, is designed for use in any system requiring presentation in decimal display of a BCD parallel signal. For example, Model 2060 permits direct reading of Angular Shaft Encoders with BCD parallel output. Model 2060 accepts up to 24 bits of parallel BCD information in any of the following 4-bit Codes: Binary Code Decimal (1-2-4-8); Gray Code (Cyclic Code); Decade Counter Code (1-2-2-4) or (1-2-4-2); Binary Complement Coded Decimal; Binary Two Out of Five Code; Binary (1-2-4-7).

These signals are converted to 60-line decimal display using Burroughs-type Nixie tubes. Binary input to Model 2060 may be either static or parallel pulses.

Storage capability which can conveniently be retrieved through a multi-pin connector is provided in the converting circuitry. Converter Boards can be furnished which accept up to six bits of parallel information, converting to two decimal displays. Write for Technical Bulletin 2060.

Hermes



ELECTRONICS CO.

75 CAMBRIDGE PARKWAY, CAMBRIDGE 42, MASS.
A DIVISION OF

Itek

reference junction for in-flight applications. Series FRJ provides a precise temperature reference for multichannel thermocouple systems with minimum space, weight and power consumption. The instruments are designed to meet the environmental requirements of MIL-E-5272 for acceleration, vibration, altitude and humidity.

CIRCLE 344 ON READER SERVICE CARD

All Angle Blower

WESTERN DEVICES, INC., 600 W. Florence Ave., Inglewood 1, Calif. Panel-mounting blowers, the twin scrolls of which can be rotated and set at any angle through 230 deg, are announced.

CIRCLE 345 ON READER SERVICE CARD

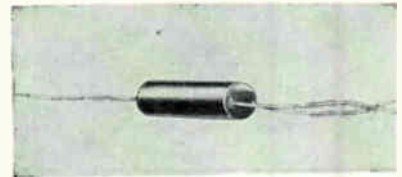

Meter Protector

AUTOMATIC RECOVERY

DYNATRON LABORATORIES, 71 Glenn Drive, Camarillo, Calif., has developed a new meter protector. Company says it is not a fuse and will keep degradation and current overload ratios constant. Unlike a fuse, it provides instant overload protection to any D'Arsonval meter movement between zero and 1 ma. When the overload is removed, the protector automatically recovers, rendering the meter operable. Device measures 1½ in. long, ⅜ in. diameter.

CIRCLE 346 ON READER SERVICE CARD



Sweep Drive

AUTOMATIC UNIT

HEWLETT-PACKARD CO., 1501 Page Mill Road, Palo Alto, Calif. Model

ANALYZE NOISE

WITH AN
ALLISON FILTER



Allison 2B Filter

You can evaluate the amount of a noise and its frequency characteristics with an Allison Filter. You can make this evaluation regardless of whether the noise is continuous or intermittent, or whether it has sharp peaks. *Allison Filters do not ring on transient noises.* This analysis can be very important in testing equipment, preventing hearing loss, and controlling harmful or irritating industrial noises.

Allison Filters have been in constant use for a wide range of laboratory and industrial applications for nearly a decade.

ALLISON SERIES 2 FILTER SPECIFICATIONS

- Continuously variable passive network — no power supply
- Frequency range: 2A, 15 to 10,080 cycles; 2B, 60 to 20,160 cycles; 2C, 9 KC to 670 KC
- Designed for use in 600 OHM circuit and with transformers for other impedances
- Low loss — approximately 2db in pass band
- Attenuation rate — 30 db per octave
- Size: 14" high, 7" deep, 5 1/4" wide
- Portable and rack models available

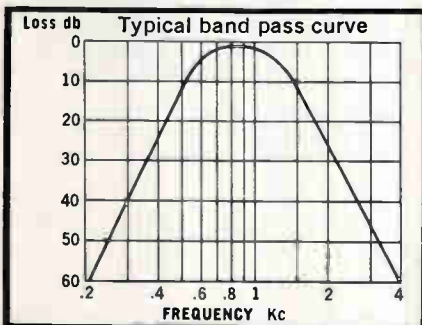

Write today for complete literature and prices

Allison Laboratories, Inc.
CIRCLE 226 ON READER SERVICE CARD

April 28, 1961

FINE WIRE

for

- Semiconductors
- Resistors
- Potentiometers
- Thermocouples
- Electronic Tubes
- Other Electronic Applications

in

precious, base, exotic and special metals — bare or insulated

Custom Melting, Complete Redrawing, Strand and Vacuum Annealing Services for fine wire processing to customers' specifications.



WRITE for valuable brochure containing fine wire compositions, pertinent properties and applications.



CONSOLIDATED REACTIVE METALS, inc.

115 Hoyt Avenue — Mamaroneck, N. Y. — OWens 8-2300

CIRCLE 227 ON READER SERVICE CARD

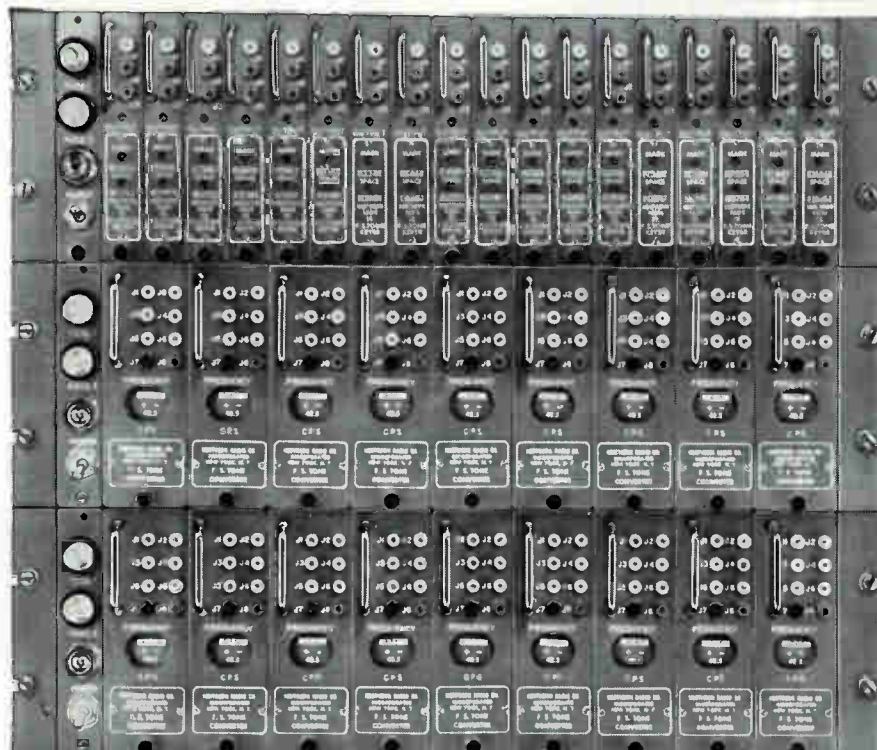

Northern Radio
ALL-TRANSISTOR VF Carrier Telegraph System

18 CHANNELS in 15 3/4" panel space

Write on your letterhead
for literature to Dept. E-4



NORTHERN RADIO COMPANY, INC.

147 W. 22nd Street, New York 11, N. Y.

Pace-Setters in Quality Communications Equipment

In Canada: Northern Radio Mfg. Co., Ltd., 1950 Bank St., Billings Bridge, Ottawa, Ontario

CIRCLE 149 ON READER SERVICE CARD

149

- MACHINING
AND
PROCESS
CONTROL
- COUNTING
- BATCHING
- SORTING
- MIXING

- WINDING
 - PACKAGING
- ... or any other
physical process
that can be
electrically
digitized.

NEW!

HIGH-SPEED, SOLID-STATE, PRESET COUNTER



MODEL 300T-4S
\$495.00

The completely transistorized Model 300T industrial counter is rugged, dependable and low-cost control instrumentation that is ideal for every use requiring a preset counting device. Modular design minimizes maintenance time and steel construction permits mounting directly on controlled machine. Modules can be easily modified for special applications. The 300T is a truly remarkable instrument that deserves your serious consideration.

Send today for complete technical information.

SPECIFICATIONS

Speed: 6,000,000 counts per minute
 Range: 1 to 9,999 standard. 5 to 8 decades available
 Reset: Automatic, manual, local or external
 Size: 3½" high; 9½" wide; 14" deep (standard model)
 Weight: Approx. 10 lbs.

Quality Where It Counts



ERIE PACIFIC DIVISION • ERIE RESISTOR CORPORATION
 12932 S. Weber Way, Hawthorne, California
 Phone: ORegon 8-5418

AC-97C sweep drive automatically sweeps oscillators and other tunable devices through their frequency ranges. It is a useful motor accessory for H-P's model 302A wave analyzer. It sweeps through the entire range of the wave analyzer for automatic plots of harmonics, spurious responses or intermodulation products with an X-Y recorder. Price is \$275.

CIRCLE 347 ON READER SERVICE CARD



Fixed Coaxial Pad HIGH POWER

MERRIMAC RESEARCH & DEVELOPMENT, INC., 517 Lyons Ave., Irvington, N. J., has available a fixed coaxial attenuator featuring high power performance. It provides attenuation of 1.5 db \pm 0.1 db in the uhf range and successfully accepts up to 200 w of c-w power. Size is 10 in. by 1½ in. by 1½ in.

CIRCLE 348 ON READER SERVICE CARD

Mobile Antenna

ANTENNA SYSTEMS, INC., Hingham, Mass. Thirty-foot mobile scatter antenna, mounted on a steel flat-bed trailer, can be erected by winch or hydraulic lifting device.

CIRCLE 349 ON READER SERVICE CARD



Frequency Standard RUBIDIUM CELL

STL PRODUCTS, a division of Space Technology Laboratories, Inc., P. O. Box 95001, Los Angeles 45, Calif. Atomic frequency standard, using optically pumped rubidium cell as basic frequency reference, has stability of two parts in 10 billion, and maintains accuracy of less than 1 sec of error in 750 years. Device has application in terrestrial and

HIGH PERFORMANCE MICROMINIATURIZED

COMPUTER MEMORY

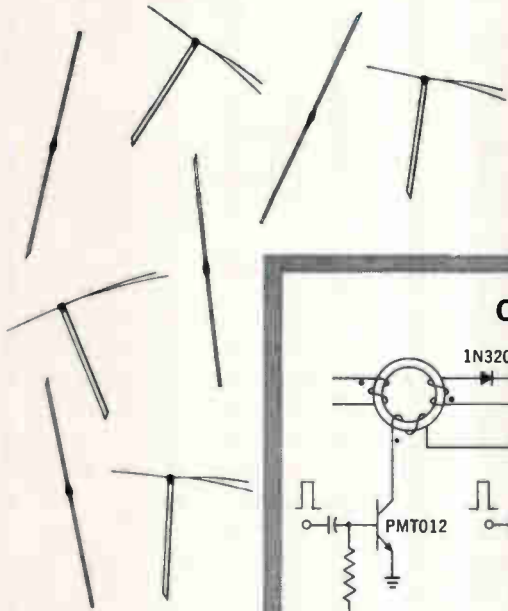

ACTUAL SIZE

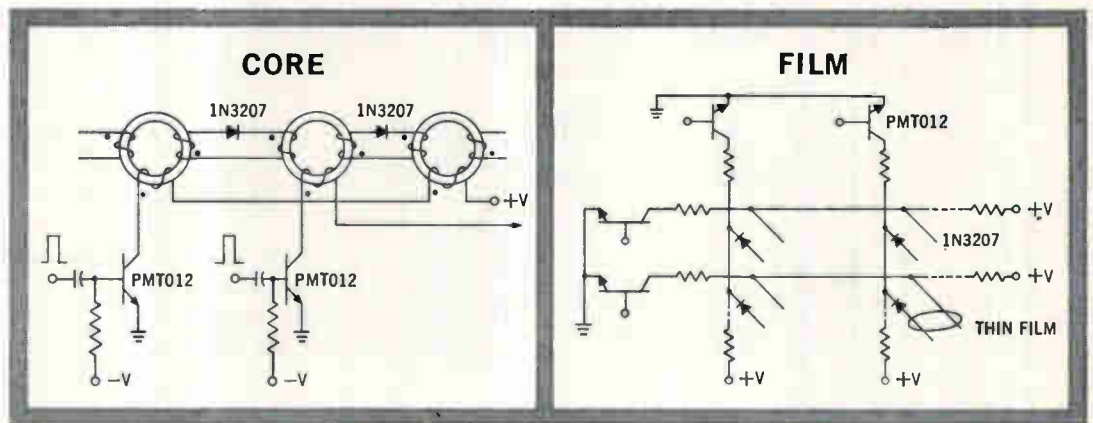

1N3207

(formerly PD400)

HIGH CONDUCTANCE MICRO-DIODE

I_F 150mA (min) @ 1 VDC • t_{rr} 6 nanosec (max) @ 10mA to -6V • Stored charge 20 pico coulombs per mA.

PMT012

LAMINAR TRANSISTOR

V_{CE} (sat) 0.3 volts @ 50mA • h_{FE} 30min/90 max @ 150mA and 10V • Linear Beta • Pico configuration

These outstanding silicon devices...companions in size, performance, reliability and ease of assembly...open the way to a whole new concept of computer design.

All PSI Micro Components are available now and in production quantities!

For detailed specifications, prices and delivery schedules call a PSI field office near you. Prototype quantities available at authorized PSI distributors everywhere.



Pacific Semiconductors, Inc.



12955 CHADRON AVENUE • HAWTHORNE, CALIFORNIA
A SUBSIDIARY OF THOMPSON RAMO WOOLDRIDGE INC.

Completely Redesigned

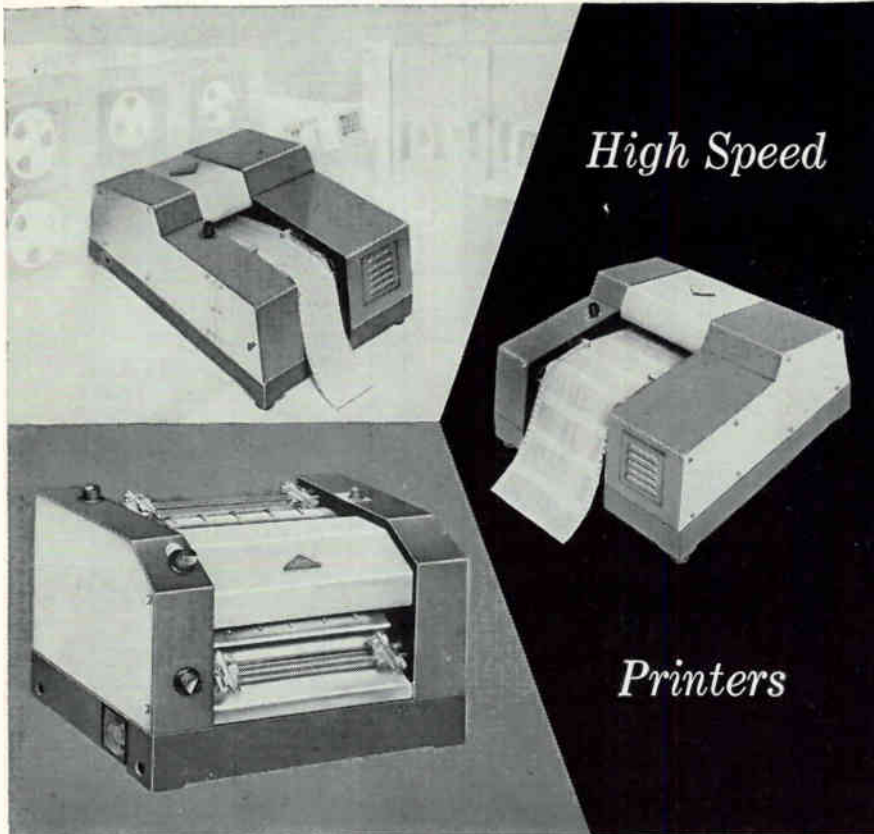

by

ANELEX[®]

... of course

Data processing systems builders* . . . and users expect this from Anelex. And for good reason. Most new developments associated with high speed line printing for EDP systems . . . even to high speed printing using machine-recognizable characters . . . have originated with Anelex.

The highly specialized skills acquired by Anelex engineers in the creative development of advanced systems enables them to best design mechanical, electro-mechanical and electronic out-put equipment. In all probability the techniques required for your particular system have already been accomplished. This group, with their extensive knowledge and experience, is available for a discussion of your requirements.

*Anelex High Speed Printers are supplied as standard equipment by 22 major computer and systems builders.

*Anelex printers will be displayed in Booth 93-94
Western Joint Computer Conference.*



ANELEX CORPORATION
150 CAUSEWAY ST., BOSTON 14, MASS.

space navigation, and as a standard for calibration of instruments for advanced technology.

CIRCLE 350 ON READER SERVICE CARD



Latch Relay

SPDT & DPDT

HI-G, INC., Bradley Field, Windsor Locks, Conn., has introduced a micro-miniature sensitive relay featuring a magnetic latch system that maintains an actuated condition without continuous power drain, utilizes rotary balanced armature construction, allowing the relay to meet extremes of vibration and shock.

CIRCLE 351 ON READER SERVICE CARD

Capacitor

GULTON INDUSTRIES, INC., 212 Durham Ave., Metuchen, N. J. Miniature, high-temperature tubular capacitor has a temperature range of -55 C to 150 C and a 50 v d-c working voltage.

CIRCLE 352 ON READER SERVICE CARD



Ferrite Modulators

BROAD-BAND

MICROMEGA CORP., Venice, Calif., has introduced a line of broad-band ferrite modulators. They are available in frequency ranges from S-band to Ku-band. Specifications for the X-band model XL400 are: frequency range, 8,200 to 10,000 Mc; attenuation-dynamic range, 40 db minimum; insertion loss, 0.6 db maximum; vswr, 1.25 maximum;

NEW PANDUCT



ROUNDED EDGES

TYPE E OPEN-SLOT PLASTIC WIRING DUCT WITH ROUNDED EDGES

Write for samples, literature, prices

STANDARDIZE ON PANDUIT WIRING COMPONENTS

PANDUIT CORP. 17301 Ridgeland Ave.
Dept. E, Tinley Park, Ill.
CIRCLE 210 ON READER SERVICE CARD

Multiple Circuit PLUG & RECEPTACLE

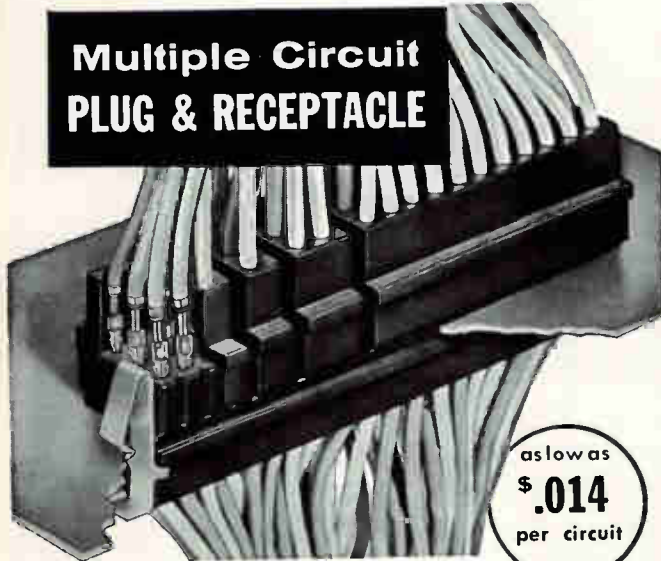

as low as
\$.014
per circuit

Cut
to your
specifications

- Low cost—from 3 to 60 circuits
- Positive polarity
- Fast simple assembly
- Snap-lock terminals
- Terminals automatically crimp to wires

RATED: 6½ amps per connection
125/250 V a-c

Call or Write



MOLEX PRODUCTS CO.

9515 Southview Ave. • Brookfield, Ill.
HU nter 5-5881

CIRCLE 211 ON READER SERVICE CARD

April 28, 1961

“Black CRYSTOLON*” grain

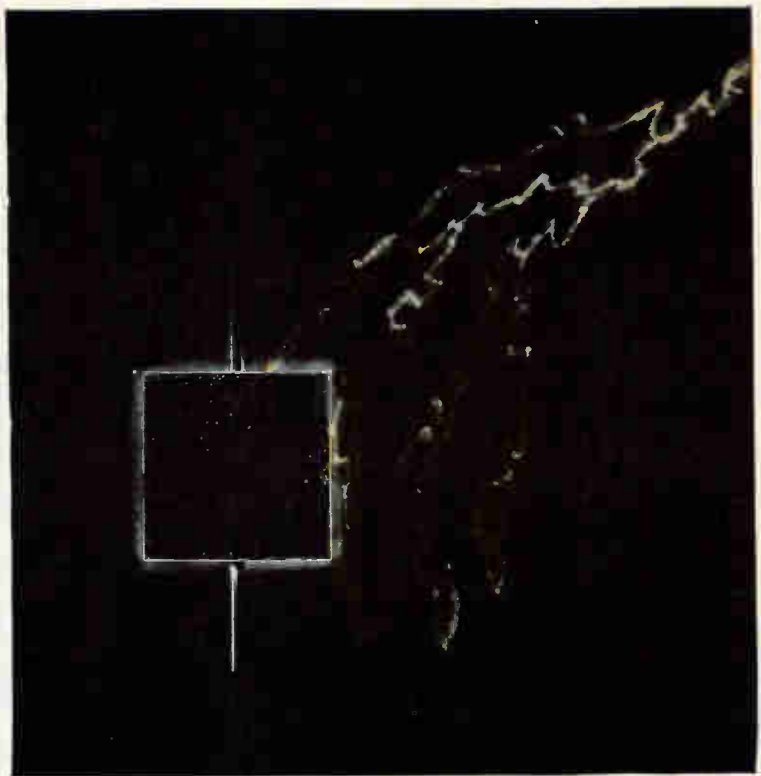

...crystals that master lightning

Often referred to as “Black CRYSTOLON”, Norton E 179 CRYSTOLON Electrical Grade silicon carbide grain is widely used in lightning arrestors — and in a steadily increasing variety of other nonlinear resistor applications in the electrical-electronics field.

These applications include protection of coils from overvoltage, protection of relay contacts, and general voltage stabilization . . . with voltage or surge control requirements ranging from thousands of amps to microamps . . . in resistors ranging in volume from thick arrestor blocks to paper-thin varistors.

To control its semiconduction properties, E 179 differs from regular CRYSTOLON silicon carbide grain by the addition of alumina. But the most important control of E 179 is constant control through each step of manufacture, from electric furnace to shipping drum. Accurate, duplicable grain impedance (resistivity) is assured by careful furnacing, grain processing, sizing, blending and surge testing.

In loose pack or ceramic bonded form, E 179 CRYSTOLON grain has the nonlinear current-voltage relation $I = AE^n$, where “A” and “n” are constants. For loose grain “n” may be as high as 10; for bonded grain it is usually between 3 and 7.

For surge tests, standard 280 ampere pulses are passed through a column of compressed E 179 CRYSTOLON grain, 1” diameter x 1” long. Voltage across the cell is measured in kilovolts per inch. E 179 CRYSTOLON grain is available in sizes of 60 to 240 mesh, covering a surge test range of 1.6 to 13.0 KV/inch.

For further facts, contact NORTON COMPANY, Refractories Division, 683 New Bond Street, Worcester, Mass.

*Trade Mark Reg. U. S. Pat. Off. and Foreign Countries.



Crystallizing ideas into products

CIRCLE 153 ON READER SERVICE CARD

153

9 NEW RAYTHEON WELD-PAK STANDARD DIGITAL MODULES

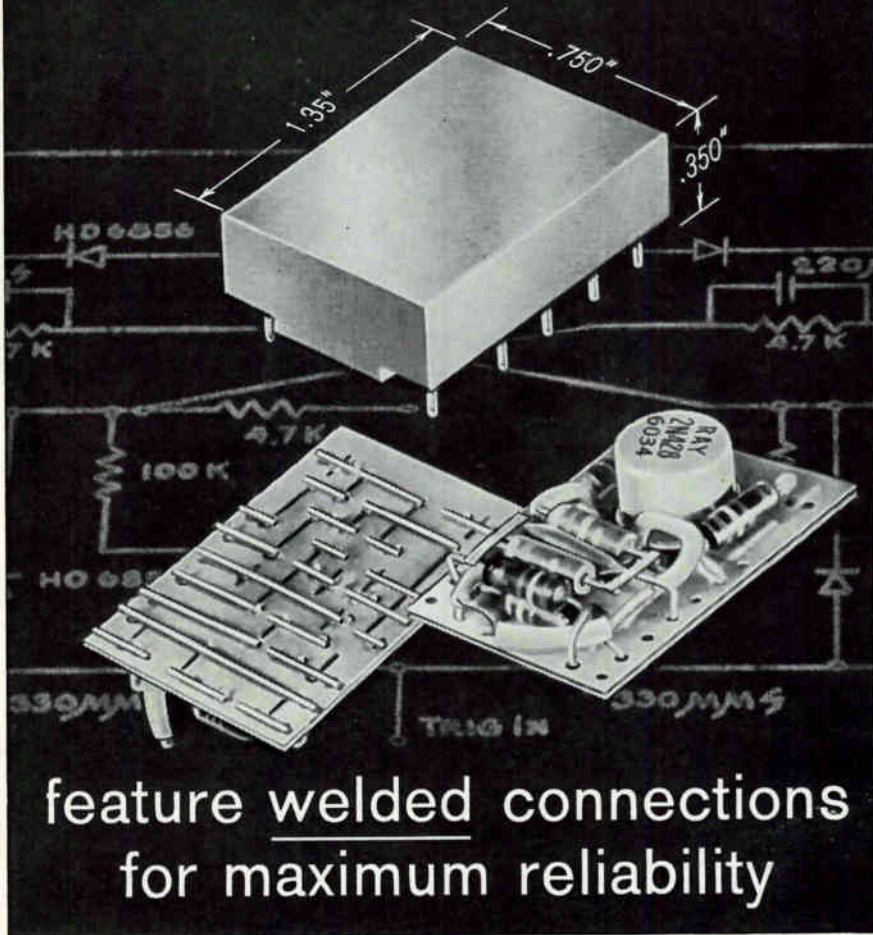

feature welded connections
for maximum reliability

New Weld-Pak standard digital circuit modules provide extreme compactness and unequalled mechanical ruggedness. Nine standard modules featuring Raytheon-developed welding techniques and three-dimensional packaging are now available.

NOR Gate, NOR Gate and Emitter Follower, Flip-Flop, Self-gated Binary, Emitter Follower, Diode AND, Diode OR, Clock-Variable, and Inverter circuits are offered in this new group of color-coded Weld-Pak modules. Stand-

ard components, conservatively operated, are used throughout. Accurately programmed welding, with short weld cycles and very low heat, is used to insure reliable connections. Thorough quality control measures and Raytheon-engineered reliability assure long and trouble-free operation.

For full details and technical data on Weld-Pak standard digital circuit modules please write: Raytheon, Industrial Components Division, 55 Chapel Street, Newton 58, Massachusetts.

*For Small Order or Prototype Requirements
See Your Local Franchised Raytheon Distributor.*

RAYTHEON

RAYTHEON COMPANY

INDUSTRIAL COMPONENTS DIVISION

modulation frequency, 100 Kc; solenoid field, 0 to 50 gauss.

CIRCLE 353 ON READER SERVICE CARD

Microminiature Lamps

KAY ELECTRIC CO., 14 Maple Ave., Pine Brook, N. J. Type 13-7 consumes 0.009 w at 1.35 volts. Type 30-30 provides approximately 250 millilumens at 3 volts.

CIRCLE 354 ON READER SERVICE CARD



Choppers

HIGH TEMPERATURE

AIRPAX ELECTRONICS INC., Cambridge, Md. Extremes of temperature over a -65°C through $+125^{\circ}\text{C}$ range will not alter the performance of the series 310 choppers. Reliability is assured by elimination of materials that could volatilize or deteriorate at high temperatures. Drive is 6.3 rms v, 400 cps; dwell time, 147 ± 18 deg; phase angle, 65 ± 15 deg; noise, $200 \mu\text{v}$, average, or less; contacts spdt bbm. Priced at \$49 each in quantities 1-6.

CIRCLE 355 ON READER SERVICE CARD

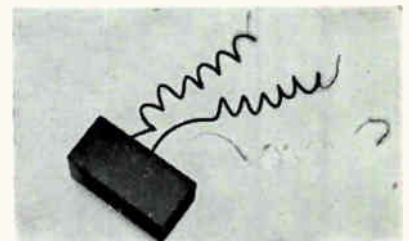

Telemetering Filters ENCAPSULATED

CONTROL ELECTRONICS CO., INC., 10 Stepar Place, Huntington Station, N. Y. Line of encapsulated telemetering filters meet requirements for missile or airborne telemetering systems. Units measure $\frac{3}{16}$ in. by $\frac{3}{16}$ in. by $1\frac{1}{2}$ in. long and weigh 1 oz. They are available with center frequencies from 1.7 Kc to 70 Kc with an impedance of 51,000 ohms. Attenuation characteristics are less than 3 db at $\pm 7\frac{1}{2}$ percent and more than 20 db at ± 27 percent of the

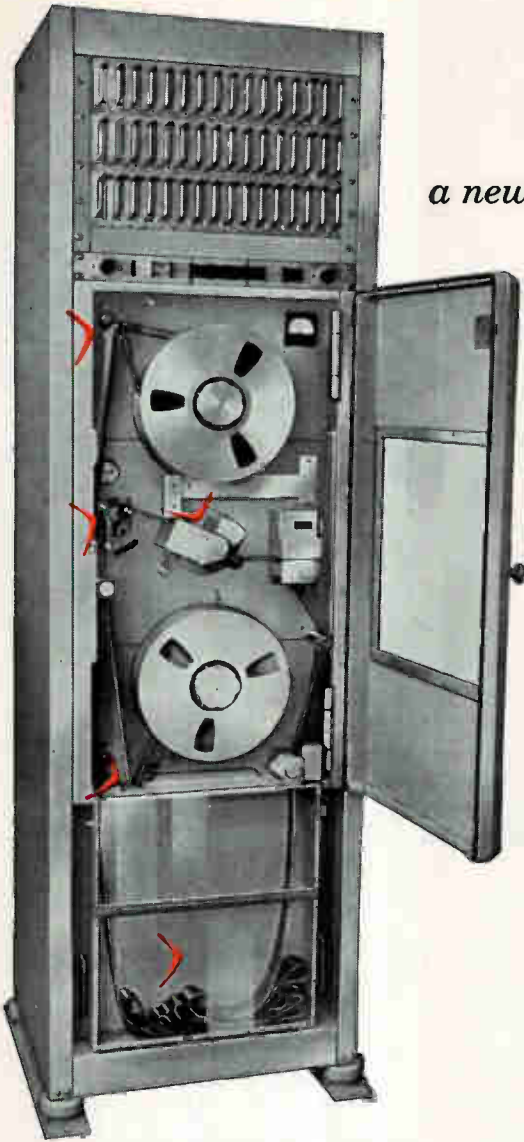

a new concept in tape handling

SANGAMO 460-SERIES MAGNETIC TAPE INSTRUMENTATION

Now, one recorder/reproducer—the Sangamo 460-Series can be changed instantly from reel to loop operation without rehandling the tape or making any changes in the transport. It can be programmed for reels only, reels and basket, or basket only simply by means of a selector switch. It will handle up to 2-inch wide tape. Other standard tape widths can be utilized by changing head and guides. The Sangamo 460-Series is a fully transistorized magnetic tape recorder/reproducer for application in direct analog, wide band, FM, PDM, and PCM instrumentation systems.

The tape is threaded from feed reel to take-up reel through the storage basket. Data can be recorded while up to 250 feet of tape is fed directly into the basket. After recording, the tape can be cut, and spliced for immediate data reproduction in loop operation. Where pre-recorded tapes are to be played back, and the data is contained on a relatively short length of tape, the same unique transfer from reel to loop operation is possible. The Series-460 feed and takeup reel servos operate with a tape tension between 6 and 8 ounces. Additional tension necessary to insure continuous head-tape contact is provided by a vacuum pad which also cleans the tape before it passes the head. In turn, the head is mounted almost in contact with the drive capstan. This results in a very short span of tape that requires precise positioning. Differential flutter and weave is reduced to the point where inter-channel time displacement error between outside tracks on one inch wide tape is less than ± 2.0 microseconds at 60 IPS.

The 460-Series has exclusive wide-range, fast-response, Hare Tape Synchronized servo speed control. This control reduces instantaneous and long-term record-playback speed deviations to a level several times lower than other speed control systems. You get magnetic tape instrumentation system accuracies heretofore considered unattainable.

The tape transport and fourteen (14) tracks of Record/Reproduce electronics are contained in a single standard 19" W x 71" H cabinet. This unusual compactness is achieved through transistorized electronic circuitry. The solid state circuitry means greater reliability, reduced weight, lower heat dissipation, and lower power consumption.

For the name of the technically qualified Sangamo representative nearest you, and for complete details on the Sangamo 460-Series, please write for Bulletin 3400.

SANGAMO 460-SERIES PERFORMANCE and CHARACTERISTICS

Start Time: 1.0 second to synchronism @ 60 ips with servo speed control and 1" wide tape.

Stop Time: 0.2 seconds from 60 ips.

Instantaneous Time Displacement Error: Less than 25.0 microseconds (including flutter) @ 60 ips.

Long Term Time Displacement Error: $\pm 0.01\%$ standard. Higher accuracies available.

Interchannel Time Displacement Error: ± 2.0 microseconds @ 60 ips between outside tracks on 1" tape.

Servo Speed Control Range: $\pm 15\%$ nominal tape speed.

Servo Speed Control Response: $\pm 15\%$ speed change per second.

Tape Widths: Standard sizes from $\frac{1}{4}$ to 2".

Reel Sizes: 14" or smaller.

Mounting: 1 standard 19" equipment rack for a complete 14 track record/reproduce system with power supplies and servo speed control.

Power Requirements: 117 volts, 60 cps $\pm 10\%$ single phase. All D C drives. 7.0 amperes load for 14 track system.

Weight: Approximately 500 pounds for 14 track system.



SANGAMO ELECTRIC COMPANY

SPRINGFIELD, ILLINOIS

ES61-2

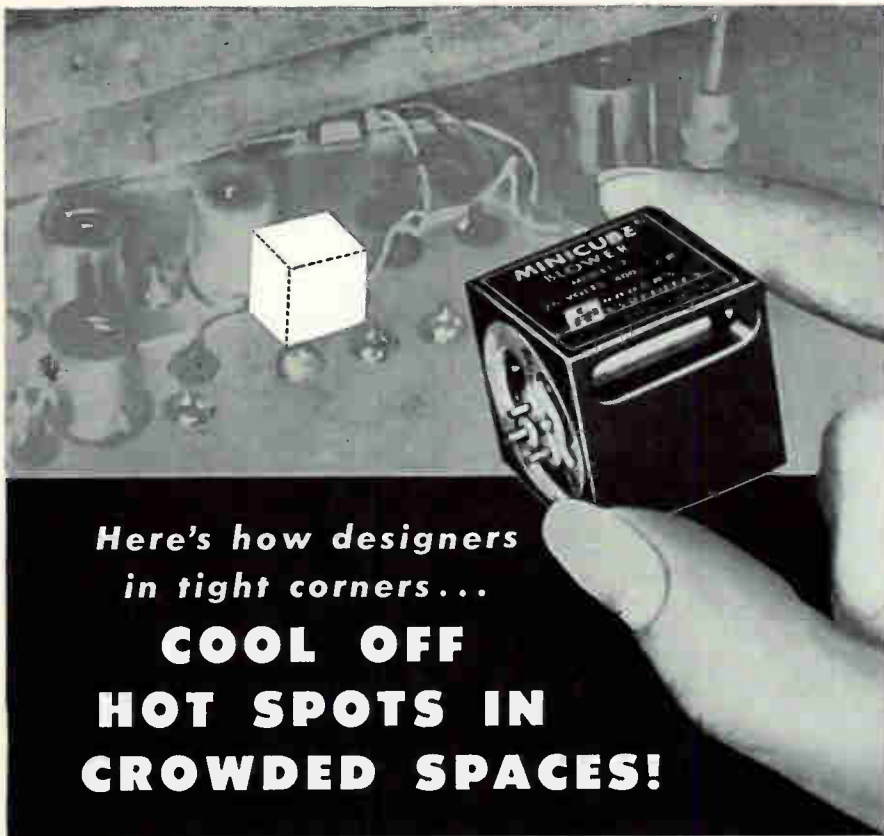

Here's how designers
in tight corners...
**COOL OFF
HOT SPOTS IN
CROWDED SPACES!**

SANDERS MINICUBE® BLOWER

integrates fan and motor in a
rugged 1" package!

It's the busiest cubic inch in cooling today! Even if you've designed yourself into a corner but have a cubic inch to spare, it will mount easily into your equipment. Lowering ambient temperature in miniaturized airborne equipment was its original job. Now, it's also eliminating hot spots around klystrons and other electronic tubes and devices... preventing fogging of lenses and mirrors... and solving other heat problems in a wide variety of military and industrial applications.

It's a reliable performer! Each Sanders MINICUBE® Blower is ruggedly built to withstand acceleration, shock and vibration requirements of military specifications for missile and aircraft applications. So, you can depend on it to do any cooling or ventilating job you assign to it within its scope.

Want more facts? To get the whole story on conformance to military specifications, flow-pressure ratings, delivery schedules and prices, attach the coupon below to your letterhead and mail it today.

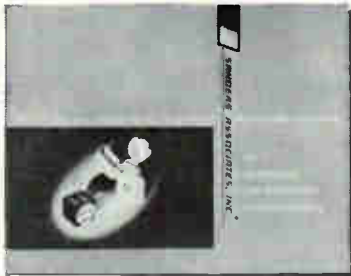

© Sanders Associates, Inc.



SANDERS ASSOCIATES, INC.

NASHUA, NEW HAMPSHIRE

Please send literature, delivery schedule and prices on Sanders MINICUBE® Blowers.

Name _____ Title _____

Firm _____

Address _____

City _____ Zone _____ State _____

center frequency. Operating temperature range is -30 C to +90 C.
CIRCLE 356 ON READER SERVICE CARD



Toggle Switch MINIATURIZED

MILLI-SWITCH CORP., Gladwyne, Pa., has developed a 3-position toggle switch with dimensions of 0.78 in. by 0.656 in. by 1.356 in. The B-T1-3P is supplied with a keying tab 0.025 in. thick. The terminals are shielded by flexible insulation. Electrical rating is 5 amp at 120/240 v a-c; 3 amp at 30 v d-c inductive at sea level; 4 amp at 30 v d-c resistive at sea level.

CIRCLE 357 ON READER SERVICE CARD

Microvoltmeter

DYNAMICS INSTRUMENTATION CO., 583 Monterey Pass Rd., Monterey Park, Calif. The d-c microvoltmeter combines an automatically recharged nickel-cadmium storage battery with a chopper-stabilized all transistor microvoltmeter.

CIRCLE 358 ON READER SERVICE CARD



Power Supply HIGH CURRENT

EDER ENGINEERING CO., INC., 1568 S. First St., Milwaukee 4, Wisc. Model 4025 power supply delivers high current output at variable voltage from 0 to 150 a-c or 0 to 200 d-c. An isolation transformer provides protection from the line voltage. Output impedance of 15 ohms, recovery time of 30 milliseconds for half-current step changes, are other features.

CIRCLE 359 ON READER SERVICE CARD

Cool Operation
Medium Power
Linear Beta
4. Minimum Space

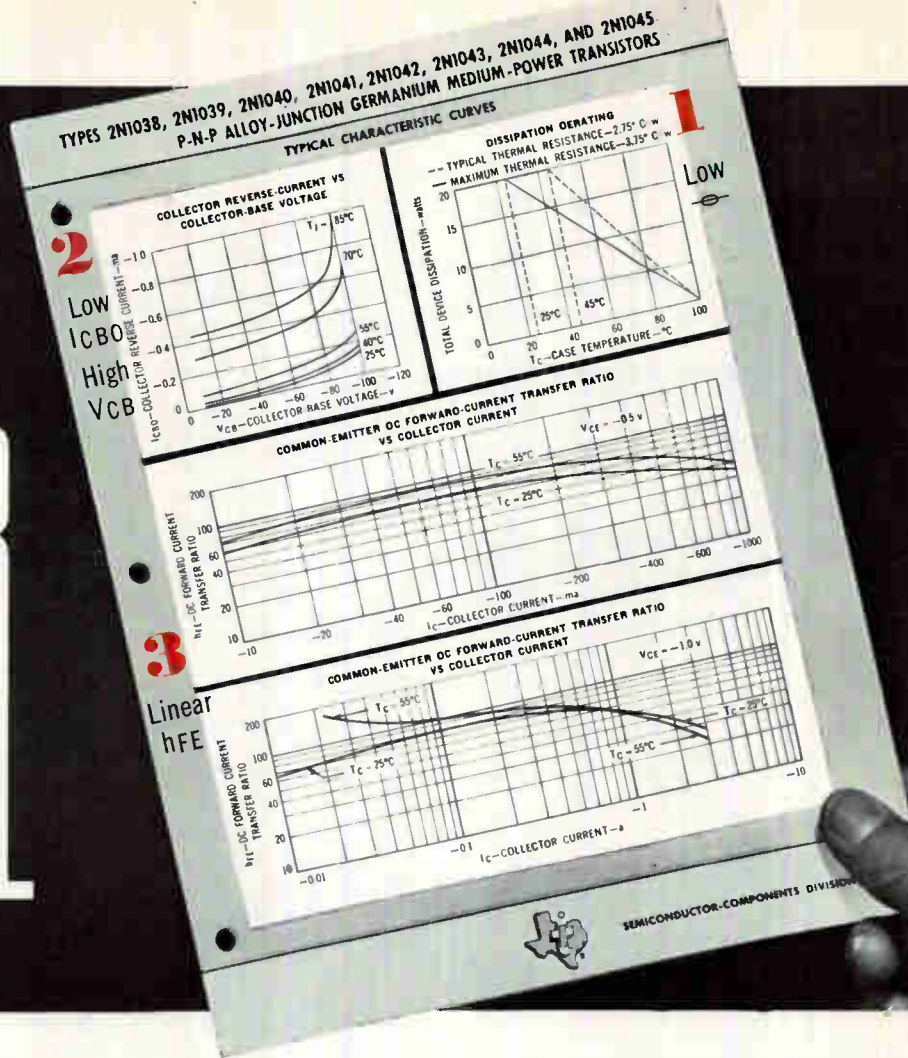

ALL IN ONE TO-11* PACKAGE—TI 2N1038 SERIES

- 20 w dissipation in a TO-11 package (with flange or stud heat sink) — maximum heat transfer for greater circuit economy and longer, more reliable component life.
- Guaranteed maximum I_{CBO} as low as $-125 \mu a$ and minimum V_{CB} as high as $-100 V$ — in a TO-11 package to give you the useable power you need for the widest range of driver requirements.
- Linear h_{FE} over a wide range of current conditions ($-10 ma$ to $-3000 ma$) increases P_{IN} vs. P_{OUT} ratio — extending design flexibility.
- Highest power/size ratio devices available today — Texas Instruments 2N1038 germanium transistors give you *useable* power, *economical* circuits, *compact* designs — all with a TO-11 package. Plus, mechanized production processes assure you *constant-predictable* performance and immediate large quantity availability.

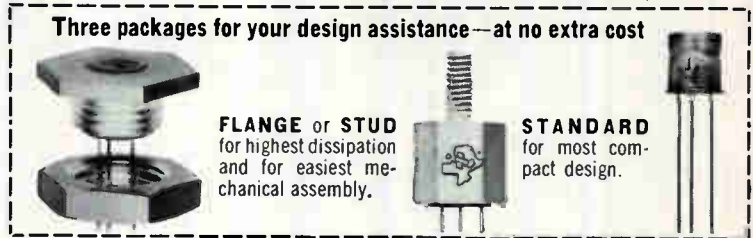

■ Use-proved in sustained satellite power supply operations.

■ Less than 7.8 grams and 0.59 square in. Less than 0.39 in. high. ■ Up to 20 watt dissipation in flange or stud heat sink.

*with 0.025 in. diameter lead

Device	2N1038	2N1039	2N1040	2N1041	2N1042	2N1043	2N1044	2N1045
I_C	1 amp	1 amp	1 amp	1 amp	3 amp	3 amp	3 amp	3 amp
BV_{CBO}	40	60	80	100	40	60	80	100

Write today or call your local TI Sales Engineer or TI Distributor for price and technical information, including applications assistance.

SEMICONDUCTOR COMPONENTS DIVISION

PLANTS IN DALLAS, TEXAS
 BEDFORD, ENGLAND
 AND NICE, FRANCE



TEXAS INSTRUMENTS
 INCORPORATED
 13500 N. CENTRAL EXPRESSWAY
 P. O. BOX 5012 DALLAS 22, TEXAS

Engineers! Designers!
**THERE IS NO SUBSTITUTE
 FOR RELIABILITY!**

Specify—
**PERFORMANCE
 PROVEN "MAG MOD"**

MAGNETIC MODULATORS



**GM
 INC.**
 For complete specifications and application data on "Mag Mod" Miniature and Standard Components, call or write.

Miniaturized design permits engineers to employ these new components in transistorized printed circuit assemblies and wafer type structures. All models offer maximum reliability, fully ruggedized construction and conform to MIL-T-27A specifications.

- COMPLETE RELIABILITY
- INFINITE LIFE
- FASTER RESPONSE TIME
- NEGLIGIBLE HYSTERESIS
- EXTREME STABILITY (Ambient Temp. Range from -75° to $+135^{\circ}\text{C}$)
- COMPACT SIZE
- LIGHTWEIGHT

Typical circuit applications for Magnetic Modulators are algebraic addition, subtraction, multiplying, raising to a power, controlling amplifier gains, mechanical chopper replacement in DC to fundamental frequency conversion, filtering and low signal level amplification.

GENERAL MAGNETICS • INC

135 BLOOMFIELD AVENUE
 BLOOMFIELD, NEW JERSEY
 Telephone: Pilgrim 8-2400

CIRCLE 212 ON READER SERVICE CARD

For Production

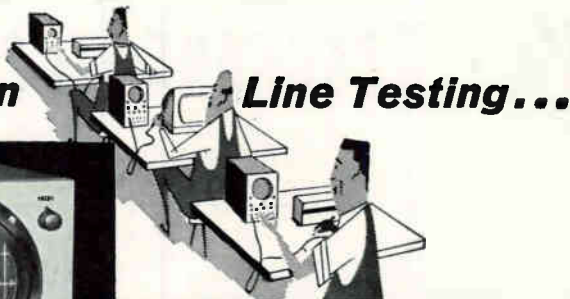

EICO SCOPES

give you:

- professional performance
- reliability
- ruggedness
- versatility

... at moderate cost

EICO's high quality standards and low initial cost add up to true economy: EICO units outperform scopes selling for two or three times EICO's prices.

With kits, the initial cost is even lower. And the experience each operator gains in building his own, increases his efficiency, and enables him to keep his scope in better condition, with less "down" time.

	prices		freq. resp. (sinusoidal)		sensitivity (rms)	
	kit	wired	vert.	horiz.	vert.	horiz.
5" Push-Pull Scope #425	\$44.95	\$79.95	5 cps to 400 kc	5 cps to 400 kc	75 mv/in	0.1V/in
5" DC-4.5 MC Scope #460	79.95	129.95	DC-4.5 mc/flat	1 cps to 400 kc flat	25 mv/in	0.6V/in



See the 41 additional EICO test instruments helpful for your lab and production work. Write for free Catalog & name of neighborhood Distributor.

3300 NORTHERN BOULEVARD, Dept. E-4D, L. I. C., 1, N. Y.

Literature of

CAPACITORS General Electric Co., Schenectady 5, N. Y. Catalog offers technical information on film dielectric capacitors rated 100 through 600 in tolerances of ± 20 , ± 10 , and ± 5 percent.

CIRCLE 360 ON READER SERVICE CARD

ANGLE MEASURING SYSTEMS Datex Corp., 1307 So. Myrtle Ave., Monrovia, Calif. Bulletin covers digital data systems and antenna positioning and control systems.

CIRCLE 361 ON READER SERVICE CARD

ANODIZED NAME PLATES Anodyne Inc., North Shore Nameplate Div., 1270 N.W. 165th St., N. Miami Beach 69, Fla. "Operation Palm Tree," a company facilities bulletin, discusses the manufacture of anodized multicolor panels using deep etch Zincography.

CIRCLE 362 ON READER SERVICE CARD

CAVITY AMPLIFIERS Resdel Engineering Corp., 330 South Fair Oaks Ave., Pasadena, Calif. Miniature cavity amplifiers designed for vhf-uhf receivers, transmitters or special radio frequency equipment are described in a single data sheet.

CIRCLE 363 ON READER SERVICE CARD

PHASE METERS Ad-Yu Electronics Lab., Inc., 249 Terhune Ave., Passaic, N. J. Bulletin gives technical data on three precision phase meters which feature meter reading independent of the ratio of input signal amplitudes.

CIRCLE 364 ON READER SERVICE CARD

CUP CORE General Ceramics Corp., Keasbey, N. J. Engineering bulletin covers three types of temperature stable cup cores for filter networks and delay lines.

CIRCLE 365 ON READER SERVICE CARD

POTENTIOMETERS Daystrom Inc., Archbald, Pa., has published a short form catalog on standard sub-miniature Squaretrim precision potentiometers.

CIRCLE 366 ON READER SERVICE CARD

TAPE READER Westrex Corp., 6601 Romaine St., Hollywood 38,

the Week

Calif. A single data sheet describes a punched tape reader that operates at the rate of 1500 characters per second.

CIRCLE 367 ON READER SERVICE CARD

DECADE SCALER Harvey-Wells Electronics, Inc., 14 Huron Drive, Natick, Mass. Technical specifications are available in a 2-page bulletin on a 10 Mc decade scaler digital system building block.

CIRCLE 368 ON READER SERVICE CARD

BOBBIN CORES Dynacor, Inc., 10431 Metropolitan Ave., Kensington, Md. Engineering bulletin gives performance characteristics of the Preferred series 300 bobbin cores for computer applications.

CIRCLE 369 ON READER SERVICE CARD

POWER SUPPLY Sola Electric Co., Elk Grove Village, Ill. A CVQ transistorized static-magnetic d-c power supply in the 100 w range is described in an 8-page brochure.

CIRCLE 370 ON READER SERVICE CARD

SWITCHES Technology Instrument Corp. of Acton, 533 Main St., Acton, Mass. A brochure on silent switching with a commutator designed for rocket and satellite telemetry systems is available.

CIRCLE 371 ON READER SERVICE CARD

WIRE BONDER Kulicke & Soffa, 401 North Broad St., Philadelphia 8, Pa. Bulletin covers a thermo-compression wire bonder designed primarily for the manufacture of mesa-type transistors.

CIRCLE 372 ON READER SERVICE CARD

MOTOR CONTROLS Electric Machinery Mfg. Co., Minneapolis 13, Minn., has made available a data sheet on low voltage, synchronous motor controls for motors rated 600 v and below.

CIRCLE 373 ON READER SERVICE CARD

TUNNEL DIODE SOURCE Electronic Research Associates, Inc., 67 Factory Place, Cedar Grove, N. J. Catalog sheet No. 121 describes the model TD6M tunnel diode power source.

CIRCLE 374 ON READER SERVICE CARD

Another reliable GENERAL MAGNETICS "MAG MOD" Miniature

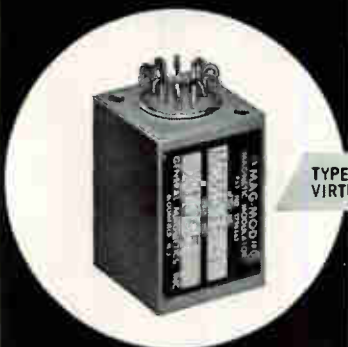

Continuous Accuracy within $\pm 5\%$ of Theoretical Product over the entire Ambient Temperature Range

TYPE MCM 515-1 SHOWN ACTUAL SIZE. COMPLETELY RUGGEDIZED, VIRTUALLY SHOCK AND VIBRATION PROOF. WEIGHS ONLY ONE OZ.

THERE IS NO SUBSTITUTE FOR RELIABILITY!

Specify "MAG MOD" miniature components for infinite life, faster response time, negligible hysteresis and extreme stability. Call or write for new Brochure 102 on "MAG MOD" Miniaturized Magnetic Modulators and Magnetic Multiplying Modulators.



General Magnetics • Inc



135 BLOOMFIELD AVENUE
BLOOMFIELD, NEW JERSEY
Telephone: Pilgrim 8-2400

CIRCLE 213 ON READER SERVICE CARD

BLACK OR
GREY WRINKLE
GREY
OR BROWN
HAMMERTONE

REMOVABLE
ROUNDED
CORNER
MOULDINGS

LOOSE
JOINT
HINGES and
CHROME
HANDLE

16 GAUGE
STEEL
BOTTOM

12 GAUGE
STEEL
BOTTOM

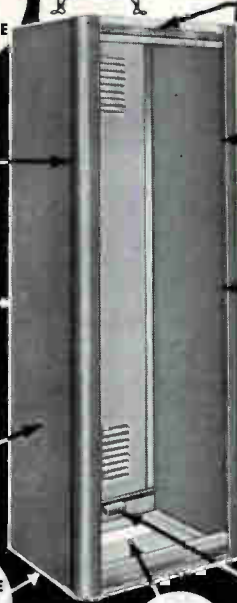

RM
SERIES

CUT-OUT
FOR
LEADS,
ETC.

DUPLEX
RECEPTACLE
AND
OUTLET
BOX

RUGGED RACKS... TO DO A RUGGED JOB! PREMIER

HEAVY DUTY
TRANSMITTER RACKS
18" and 24" DEEP
FOR 19", 24" and
30" RACK PANELS

- Available in 15 sizes.
- Louvers on sides available at no additional cost.
- Also available with adjustable panel mounting angles (RMA series).

CONTACT YOUR LOCAL
DISTRIBUTOR OR SEND
FOR COMPLETE CATALOG

PREMIER METAL PRODUCTS COMPANY
337 MANIDA STREET, NEW YORK 59, N. Y.

WESTERN SALES OFFICE: 1667 Laurel St., San Carlos, California
EXPORT DEPARTMENT: EMCC, 127 Grace Street, Plainview, New York
MFD. IN CANADA by PREMIER METAL HOUSINGS, Ltd., 5810 Smart Ave., Montreal



*High selectivity,
attenuation and precision matching of . . .*

NEW HILL FILTERS ASSURE FAST, PRECISE MEASUREMENT OF INTER-MODULATION DISTORTION

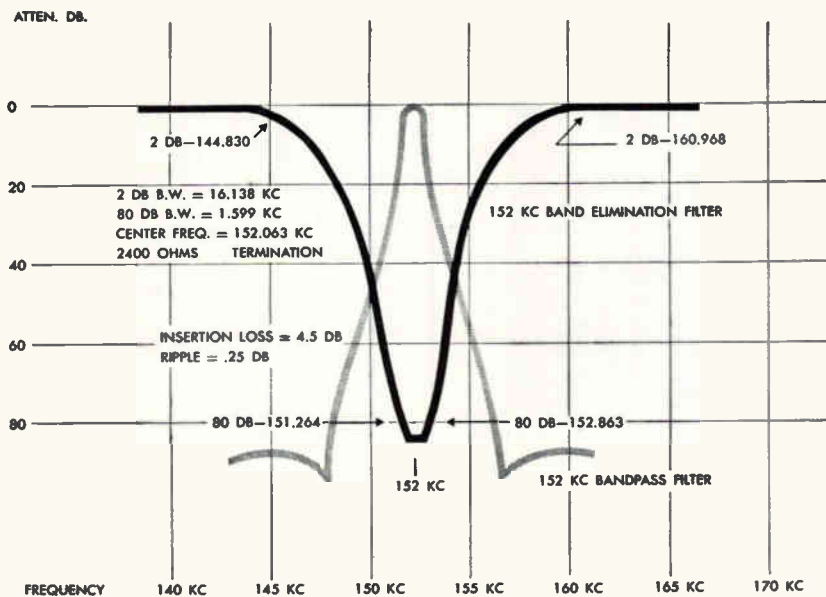

Actual operational curves, obtained from point-to-point readings, from Hill 34900 and 34800 filters developed to fulfill customers' specific requirements.

These two highly stable, precision-matched Hill Electronic filters permit fast, exceptionally accurate measurement of inter-modulation distortion in communications systems. A band elimination filter places a narrow, deep notch in the white noise being passed through the equipment under test. Distortion generated in the notch is then isolated for measurement by the narrow band filter.

The high degree of selectivity and attenuation of these filters, and the excellent alignment of one within the other are demonstrated in the actual operational curves shown above. Used together, these filters provide 80 db attenuation from 6 to 252 kc.

This is a typical example of Hill's creative engineering that develops outstanding solutions to customers' specific problems involving LC and crystal control filters as well as precision frequency sources and other crystal devices.

WRITE FOR BULLETINS 34800/900

They contain details and specifications concerning the filters described above.



HILL ELECTRONICS, INC.

MECHANICSBURG, PENNSYLVANIA

NEW BOOKS

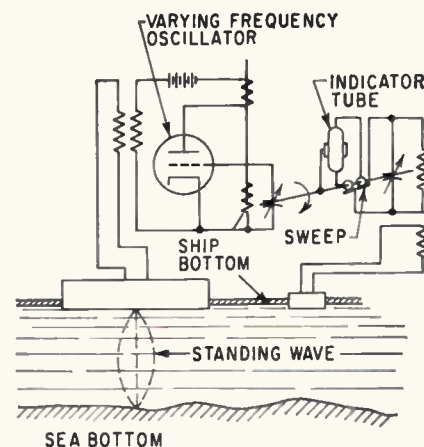

Fig. 8-23. Depth-finding apparatus.

Ultrasonics

By BENSON CARLIN

McGraw-Hill Book Co., N. Y., 309 p., \$11.50.

This second edition carries considerably more information than the first edition, which was published in 1949. It describes ultrasonic theory in some detail, crystal and magnetostrictive transducers in considerable detail, and has excellent and comprehensive treatments of high-power and low-power applications of ultrasonics. Coverage of nondestructive-testing applications is particularly comprehensive.

The book is well organized and provides a good survey of ultrasonics. Much of the practical information it contains could do a good job of supplementing ultrasonics books whose approaches are more theoretical and provide more mathematically-rigorous analysis.—S.V.

Electromagnetic Fields and Waves

By R. V. LANGMUIR

McGraw-Hill Book Company, Inc., New York, N. Y. 1961, 227 p., \$9.75.

This book is a concisely written treatment of electrostatics, magnetism, and electrodynamics. It is written for courses at the senior or first year graduate level in electrical engineering or applied phy-



Wide Range PULSE and SQUARE WAVE GENERATOR PSG-1

Broad Range of Frequencies and Pulse Widths

- Frequency—1 cycle to 1 mc
- Pulse Width—.1 μ sec. to .3 seconds
- Rise and Fall Time—.02 μ sec. for 10 v, 100 ohm output
- Rise and Fall Time—.1 μ sec. for 50 v, 500 ohm output

DOUBLE PULSE ADAPTER • PSG-1/DG Price \$135.00

Pulse and Square Wave Generator— Rack Mounted PSG-1/RM Price \$740.00

Double Pulse Adapter— Rack Mounted PSG-1/DG/RM Price \$145.00

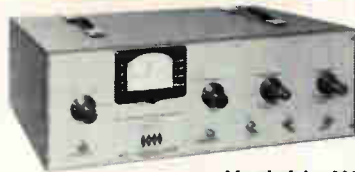

Variable Width PULSE GENERATOR PG-10

The Pulse Generator, PG-10, generates variable width pulses in the frequency range 1 megacycle per second to 20 megacycles per second. It is especially useful where high repetition rates and narrow pulses are required.

- Frequency range: 1-20 mcps (3 overlapping ranges)
- Rise and fall time less than .006 μ sec.
- Minimum pulse width approximately .02 μ sec. at 50% amplitude
- Can be externally synchronized

Very Low Frequency SPECTRUM ANALYZER SA-11

This analyzer system is designed for use wherever real time, accurate, high-resolution analysis of the very low frequencies is required. Some typical fields of application are:

- Seismology
- Underwater acoustics
- Heartbeat analysis
- Speech analysis
- Shock and vibration analysis

Frequency range—
0.0025-1000 cps
(real time basis)
seven scales

Analysis time—
1.6 seconds for maximum
selectivity

3DB Selectivity
1 cycle scale: 0.0037 cps
1000 cycle scale:
3.75 cps

Transistorized models SA-12 and SA-14 will provide frequency ranges up to 5000 cps and, with GASL auxiliary equipment, offer power density and normal density capability

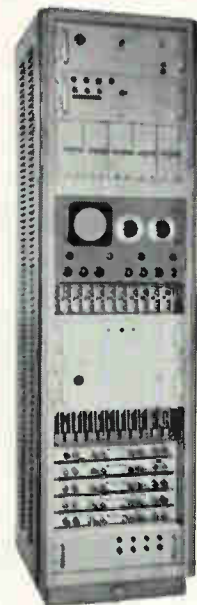

Visit us at our plant for a demonstration, or call our Marketing Department at EDgewood 3-6960 to arrange for analysis of one of your sample tapes

All prices subject to change without notice.

CIRCLE 218 ON READER SERVICE CARD

GENERAL APPLIED SCIENCE LABORATORIES INC.

GASL

Merrick & Stewart Avenues
Westbury, N.Y.
EDgewood 3-6960



Transistorized LOGIC MODULES

For systems containing dynamic and static type digital logic as well as analog computation devices.

FMS-1	High Speed Flip Flop (2)	\$82	MG-1	Multiplexer Gate (6 gates)	\$59
FMS-1	Dual Medium Speed Flip Flop (2)	69	OA-1	Summing Amplifier	71
DG-1	Digital Gate (4)	51	SA-1	Servo Amplifier	87
DM-1	Delay Multivibrators (3)	62	CDX-1	Card Extender	30
ND-1	Nixie Driver	58	BCP-1	Bucket—27 card capability—wired for power	357
BO-1	Blocking Oscillator (3)	88	BC-1	Bucket—27 card capability—not wired for power	241
OS-1	Clock Oscillator	77	TLG-1	2 Leg Gate (8 gates)	69
CPA-1	Clock Pulse Amplifier (4)	105	LD-1	Light Driver (4)	42
AE-1	Active Element	61	ST-1	Schmidt Trigger (2)	68
DL-1	Delay Line Card	89	MSC-1	Special Circuit Card	25
CG-1	Computer Gate Card	49			
MDL-1	Magnetostrictive Delay Line	522			

Powdered Iron Toroids

APPLICATIONS

High Q circuits for

- Transformers — I.F., etc.
- Precision filters
- Delay lines
- Linear Networks

TOROIDAL FEATURES

- 1 Reduces stray fields and proximity effects to obtain better stability.
- 2 Permits small coil construction
- 3 Higher effective permeability
- 4 Coupling not affected by tuning circuit
- 5 High stability with temperature and time
- 6 Low harmonic distortion
- 7 Improved insulation results in high Q
- 8 Manufacturing methods permit close control of permeability and Q
- 9 Finishes of tough thermosetting resins minimize moisture absorption and provides insulation suitable for winding enameled wire directly on the core.

CORE SIZES

Cores are available in diameters from 9/32 OD to 2" OD

Permeability: From 8 to 45

Recommended frequencies:

Materials are available which will provide good Q from 0.1 to 25 MC

Write for samples and further information.

Radio Cores, Inc.

9540 South Tully Avenue
Oak Lawn, Illinois

Phone:

GArden 2-3353



CIRCLE 223 ON READER SERVICE CARD

NOW! CONTINUOUS PRODUCTION

permits a
PRICE REDUCTION
\$229⁵⁰
F.O.B. NEW YORK



SEMICONDUCTORIZED POWER SUPPLY

MODEL **5015**

1-50 V.D.C. • 0-1.5 AMP

WITH • .05% regulation—500 μ V ripple.

over 10,000 in use!

- ROBOTEC short circuit protection.
- HEATRAN electronic heat transfer.

IMMEDIATE DELIVERY

Power Designs inc.

1700 SHAMES DRIVE, WESTBURY, NEW YORK
EDgewood 3-6200 (LD Area Code 516)

CIRCLE 161 ON READER SERVICE CARD 161

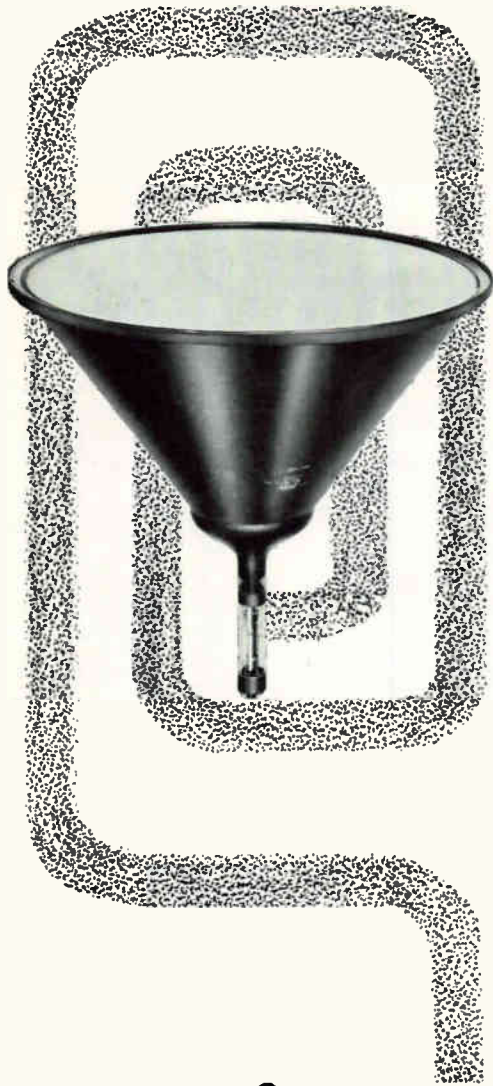

CRT OF THE MONTH

New! Large-area, bright display—22" magnetic deflection, electrostatic focus, radar display tube, ETC Type M1003.

Pattern distortion is minimized through rigid production controls that permit holding a nominal 165" radius of curvature on the large flat face of this new metal shell display tube. Designed for unusually high brightness, the tube produces up to 95 foot-lamberts with excellent light output linearity at 18 Kv, while maintaining a high 1500 to 2000 line resolution over the useable screen area.

Similar new ETC display tubes are available in glass up to 16" in diameter or in glass-to-metal in 12", 16", 19", and 22" sizes with either magnetic or electrostatic focus.

paceing trends

IN CATHODE RAY TUBE DESIGN

...since 1937

Over 100 standard types . . . many specials . . . produced for oscilloscopes and critical display instrumentation. 1 to 10 guns; square, round, or rectangular faces; high resolution; spiral band for radar, fire control, counter-measures, guidance—where quality control counts most. Submit your application details for an engineering review.

electronic tube corporation

1200 E. MERMAID LANE, PHILADELPHIA 18, PENNA.

sics. Its purpose is to train the student in the mathematical methods as well as the basic physics of the field. A number of problem examples and their solutions are given to aid the student in developing an understanding of the subject matter. At the end of each chapter practice problems are given to test the students understanding and to further develop the subject matter. Emphasis is placed on such subjects of modern electrical engineering as waveguides, resonant cavities, antennas and wave propagation.—DR. ROBERT E. BEAM, *Professor of Electrical Engineering, Northwestern University, Evanston, Ill.*

THUMBNAIL REVIEWS

Electrical Principles of Electronics. By Angelo C. Gillie, McGraw-Hill Book Co., Inc., New York, 1961, 532 p, \$10. The basic physics of electricity presented on a level suitable for technical institutes, high-school seniors or first year college. Gives a thorough introduction (with many examples and exercises) to circuit elements, elementary circuit analysis and waveform analysis, including passive filters and transformers. Semiconductor devices are taken into account throughout, but no treatment of transistors or vacuum tubes is attempted.

Resistance and Resistors. By C. L. Wellard, McGraw-Hill, 272 p, \$8.50. Tables include most manufacturers' data of given types of resistors. Useful information is given on power and voltage ratings, materials used, construction, and applications. This is a quite adequate treatment of subject for circuit designers and components men, and a practical reference. Short sections presented on precision film resistors include bibliographies.

NAB Engineering Handbook. Editor-in-Chief A. Prose Walker, McGraw-Hill Book Co., New York, 1,664 p, \$27.50. Revised and brought up to date, this fifth edition provides comprehensive reference to the latest methods, facts and data for every phase of radio and tv broadcast engineering from tower maintenance to compatible single sideband for standard broadcasting.

Retaining the same practical ap-

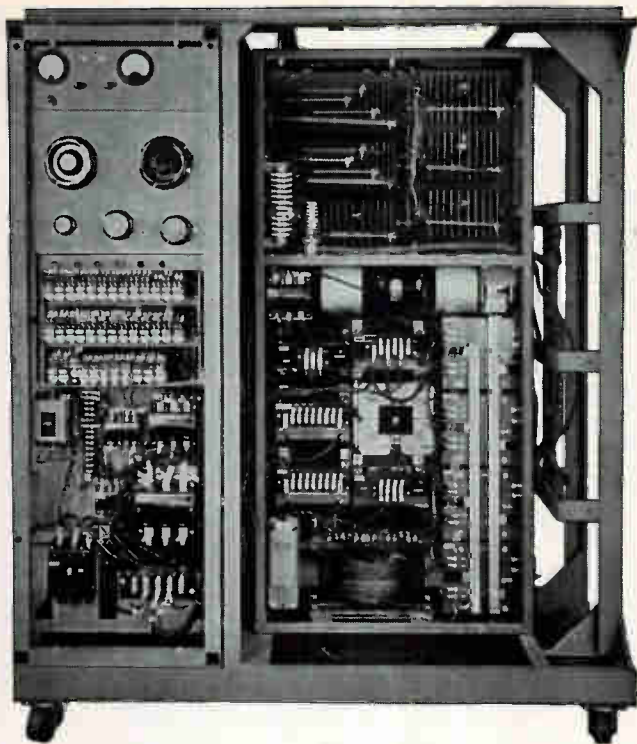

Regulated, multiple voltage output +250 volts, +150 volts, +70 volts, +70 volts, +250 volts, -35 volts, -50 volts, -60 volts, -70 volts, -250 volts D.C. 6.3 volts, 115 volts, A.C. Total power capacity approx. 15 KW

EXPERIENCE and SKILL
are an inherent component
of every ACME ELECTRIC built
POWER SUPPLY

"Know your supplier" is pertinent advice as it applies to the design, engineering and construction of power supplies. Acme Electric not only knows the state of the art but is a recommended supply source. That's why you can expect specific advantages based on engineering experience, and backed-up by manufacturing facilities and trained manpower. If power supplies are an important part of your products, it will pay you to investigate the part Acme Electric can play in your procurement program.

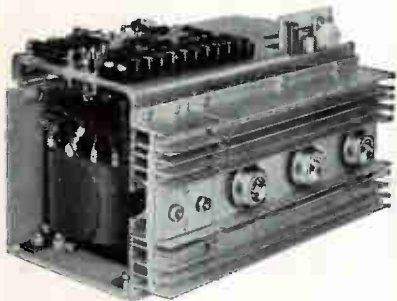

Series regulated
Output 120, $\pm 1\%$ dc
@ 0-6 amps.

ACME ELECTRIC CORPORATION

314 WATER ST.

CUBA, N. Y.

In Canada: Acme Electric Corp. Ltd., 50 Northline Rd., Toronto, Ont.

SAE 3420/1872

Acme ACME Electric
TRANSFORMERS

CIRCLE 216 ON READER SERVICE CARD

April 28, 1961

if you are

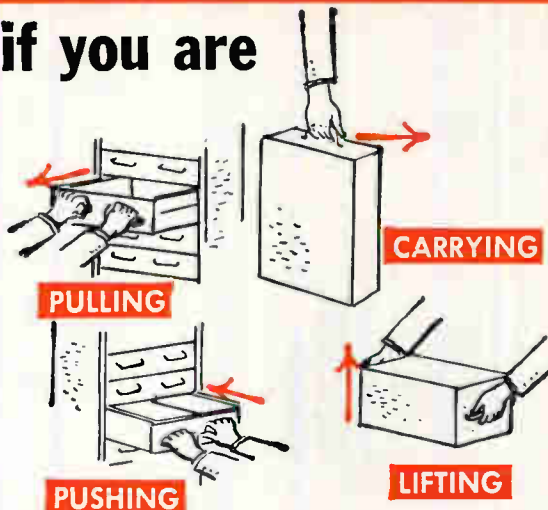

you need

BUD HANDLES



● Here are the handles you can depend on regardless of the object to be moved or the direction of the motion. In addition to being attractively symmetrical, Bud Handles are precision made... some of brass, others of steel and many of aluminum. There are 29 styles and sizes from which to choose. Every one will enhance the utility and appearance of the equipment or instrumentation to which it is attached. The safety of movement, too, is greatly increased.

If handles are a standard part of the equipment you produce or if you wish to achieve greater mobility of the equipment you already have, it will pay you to see these outstanding Bud Handles at your Bud Distributor or write us for Bulletin S-6060.



BUD RADIO, INC.

Cleveland 3, Ohio

CIRCLE 163 ON READER SERVICE CARD

163

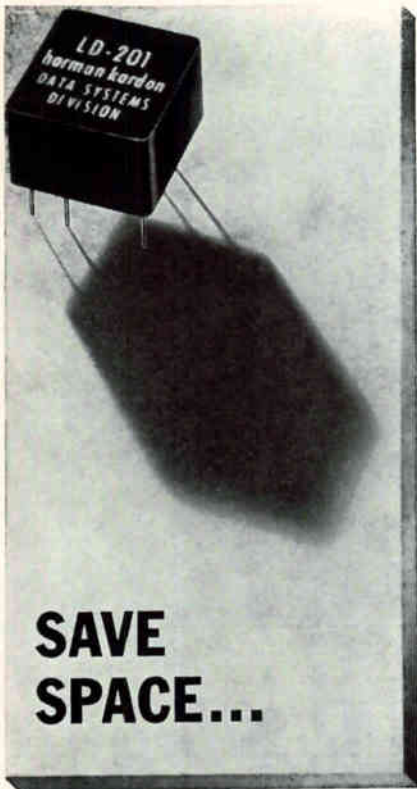

**SAVE
SPACE...**

INCREASE RELIABILITY

with
Harman-Kardon encapsulated
digital logic modules...
proven components...proven
circuits...proven packaging

These fully encapsulated modules offer increased reliability—afford a high density, fully protected package with better heat dissipation. And, you will find the cost competitive with open card construction.

The modularized Series 200 logic circuits are available now—from stock—in a variety of logic configurations for operation up to 250 Kc. Higher speed units, too, are on the way!

The application engineering staff of the Data Systems Division stands ready to serve you in the implementation of your system block diagrams.

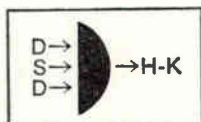

Data Systems Division

harman kardon

INCORPORATED
Plainview, N.Y.

proach and method of arrangement which helped establish it as a reference for broadcasters, this new enlarged edition updates the broadcaster to latest techniques in such typical areas as transistor applications, tv translators and boosters, remote control of transmitters and directional antennas, automatic logging techniques, stereo broadcasting, video tape recording and field strength measurements.

This book is designed to meet the needs of engineers, technicians, management personnel and others concerned with the effective and economical solution of broadcast engineering problems. Over 1,300 diagrams, photographs, charts, graphs and tables add to the practical value of the handbook.

The Theory and Design of Inductance Coils. By V. G. Welsby, MacDonald, London. 232 p, \$4.20. In this second edition the author presents a new concept in inductor designs by approaching the analysis from the standpoint of electromagnetic radiation theory, rather than the purely electromagnetic one that tends to regard the co-existing electric field as incidental. This fresh approach is particularly useful at microwave frequencies where propagation theory presents a better picture of what is going on than does circuit analysis alone. In general, the book contains a wealth of information, but by modern standards, its style is somewhat stilted.

Problems in Electronics with Solutions (Second edition). F. A. Benson; E. & F. N. Spon Ltd, London, 1961, 249 p, \$6. This unique book is a collection of engineering problems ranging through the entire field of electronics, accompanied by solutions. Problems range in difficulty from simple circuit analysis to graduate-level topics in electron physics. Solutions given are complete enough to have considerable instructive value.

Tin and Its Alloys. By E. S. Hedges, St. Martin's Press, Inc., New York, 423 p, \$27.50. The author and his collaborators are all associated with the Tin Research Institute of England which has done much pioneering work in tin processes and their commercial applications. The data on the metallurgy of tin and tin-bearing alloys, plating, tinning and soldering are extensive and well-referenced. Much of the information can be applied to the needs

HOW RED IS A BLUSH?

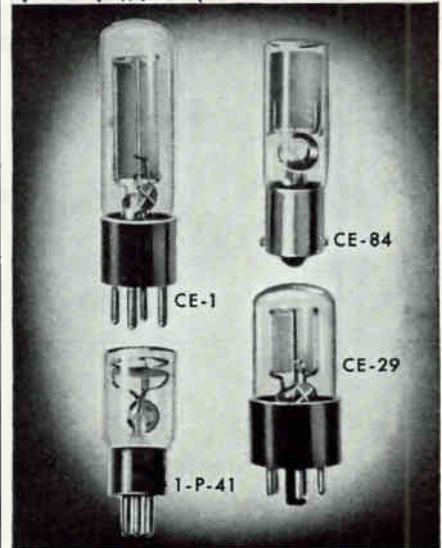
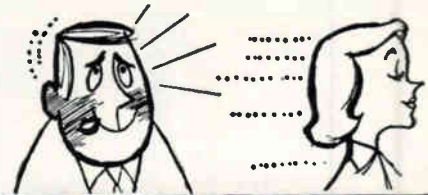

CETRON

PHOTO CELLS DO HUNDREDS OF JOBS

How red is red! How bright is a light! These answers, and hundreds of others are all possible—instantly with the use of Cetron Photo Cells.

For counting, color sorting, color registration, light intensity, Cetron Photo Cells do the job fast and accurately. Wherever circuitry for automation requires energy from changing light or color . . . you can be certain with Cetron.

Cetron Photo Cells are used in:

- Sound Reproduction
- Facsimile
- Counting and Sorting
- Burglar Alarms
- High Speed Color Registration
- Spectroscope Reproduction

Cetron Photo Tubes are available to meet requirements of JAN Specifications.

Cetron Engineers are always available to help in your tube requirements—just write, wire or phone.

YOUR DEPENDABLE SOURCE FOR
RECTIFIER, THYRATRON AND PHOTO TUBES

CETRON

ELECTRONIC CORPORATION



715 Hamilton Street • Geneva, Illinois

CIRCLE 217 ON READER SERVICE CARD

electronics

In PRECISION POTENTIOMETERS

if it's news, expect it first from IRC

DIALLYL PHTHALATE ROTOR
WITH INTEGRAL STOP ARM

ROTOR BEARING

WELDED
TERMINATIONS

SEAL

DIALLYL PHTHALATE HOUSING
WITH MOLDED-IN STOP

PRECISION
WIREWOUND ELEMENT

PRECIOUS METAL
WIPER

PRECIOUS METAL CONTACT

EXPOSED...a new simplified trimmer design increased reliability...added economy



The new IRC $\frac{1}{2}$ " round Circuitrim trimmer with its unique mechanical design (depicted above) simplifies the complex mechanical linkage used for adjustment in most trimmers making it more reliable and less costly. This round trimmer design employs the same fine electrical assembly found in IRC's popular square trimmer. Available in twelve standard ranges from 10 ohms to 50K ohms, 1 watt. Higher power rating available.



Set it and forget it is the paramount feature of IRC's new square trimmer, made possible by an exclusive self-locking, antibacklash spiroid drive gear. Square Circuitrim has superior moisture, shock and vibration characteristics, and is interchangeable with earlier designs. Teflon leads and seals standard. Printed circuit terminals available. 10 ohms to 50K ohms, 1 watt. Write for technical bulletins. International Resistance Company, 401 N. Broad St., Philadelphia 8, Pa.

COMPLETE LINE OF PRECISION POTENTIOMETERS • STOCKED BY IRC MAJOR INDUSTRIAL DISTRIBUTORS
Standard Single and Multi-turn • Moisture Sealed and High Temperature • Hermetically Sealed • Servo Potentiometers • REVODEX 10-turn Dials



Leading supplier to manufacturers of electronic equipment



NOW IN PRODUCTION



M 3000

**MIDWESTERN
REPLACES THE
WEAKEST LINK
IN AUTOMATIC
DATA
PROCESSING
SYSTEMS
with the
M-3000
DIGITAL TAPE
TRANSPORT SYSTEM**

WRITE OR CALL FOR
LATEST SPECIFICATIONS: M-3000-4361

**MIDWESTERN
INSTRUMENTS**
manufacturers of  magnecore
"professional" tape recorders
P. O. Box 7509 / PHONE NATIONAL 7-1111
TULSA 18, OKLAHOMA

of electronics manufacturing and quality control. However, the greatest emphasis on applications and production equipment is given volume applications such as pewter, molding, plumbing and tinplate. Specific applications in electronics are discussed only briefly.

Transistor Substitution Handbook. Howard W. Sams & Co., Inc., Indianapolis, Indiana, 1961, 96 p, \$1.50. Contains listing of over 6,500 direct substitutions for transistors made in the US and six other countries, a tabulation of over 600 Japanese-American transistor substitutions, and a crystal diode substitution guide. Manufacturer's name, polarity, and lead arrangement are given for the transistors.

International Transistor Substitution Guidebook. By Keats A. Pullen, Jr., John F. Rider Publisher, Inc., New York, 1961, 64 p, \$1.50. Lists direct substitutions for transistors made in the US and six other countries, giving EIA case style numbers for both original and substitute transistors. An appendix gives dimensions and lead arrangements of the case styles. No manufacturers' names are given.

Ed. Note: There is not much agreement on transistor substitution between the above two books.

Logic Machines and Diagrams. Martin Gardner, McGraw-Hill Book Co., New York, 1961, 157 p, \$2.25. A fascinating story of the graphic and mechanical ways in which men have represented the logic of their time, this book ranges from the medieval mystic diagrams of Ramon Lull to modern computers and predictions for the future. An excellent book for anyone with a practical or theoretical interest in logic.

Basic Transistors. By Alexander Shure, John F. Rider Publisher, Inc., New York, 1961. 152 p, \$3.95 (soft cover). \$5.50 (cloth binding). The large number of excellent illustrations is the best feature of this introductory text. The first half of the volume deals with the basic electronics of transistors, and the rest is concerned with amplifiers, except for a short chapter on oscillators and a brief mention of the tetrode transistor. The price seems high for the limited coverage, but the illustrations may be worth it to some readers.

ENGINEERS
PHYSICISTS

RELIABILITY . . . the effect

of space environment on electronic hardware

As part of its Transit Satellite Program, The Applied Physics Laboratory is establishing a group of scientists and engineers to study the effect of space environments on the electronic instrumentation used in satellites and to design and develop electronics possessing a long life in space. To qualify for assignment to this group, responding reliability engineers must be able to assume responsibilities such as the development of experiments, establishing techniques of quality control on a laboratory scale, and analysis of electronic instrumentation.

The Applied Physics Laboratory will provide you with a professional atmosphere conducive to creative effort as well as the tools and technical support required to tackle these and related problems. Our modern laboratory is located an equal distance between Washington, D. C. and Baltimore, offering you a choice of country, suburban or city living.

For additional details about this position or other interesting career opportunities, direct your inquiry to:
Professional Staff Appointments

The Applied Physics Laboratory
The Johns Hopkins University

8633 Georgia Avenue, Silver Spring, Md.

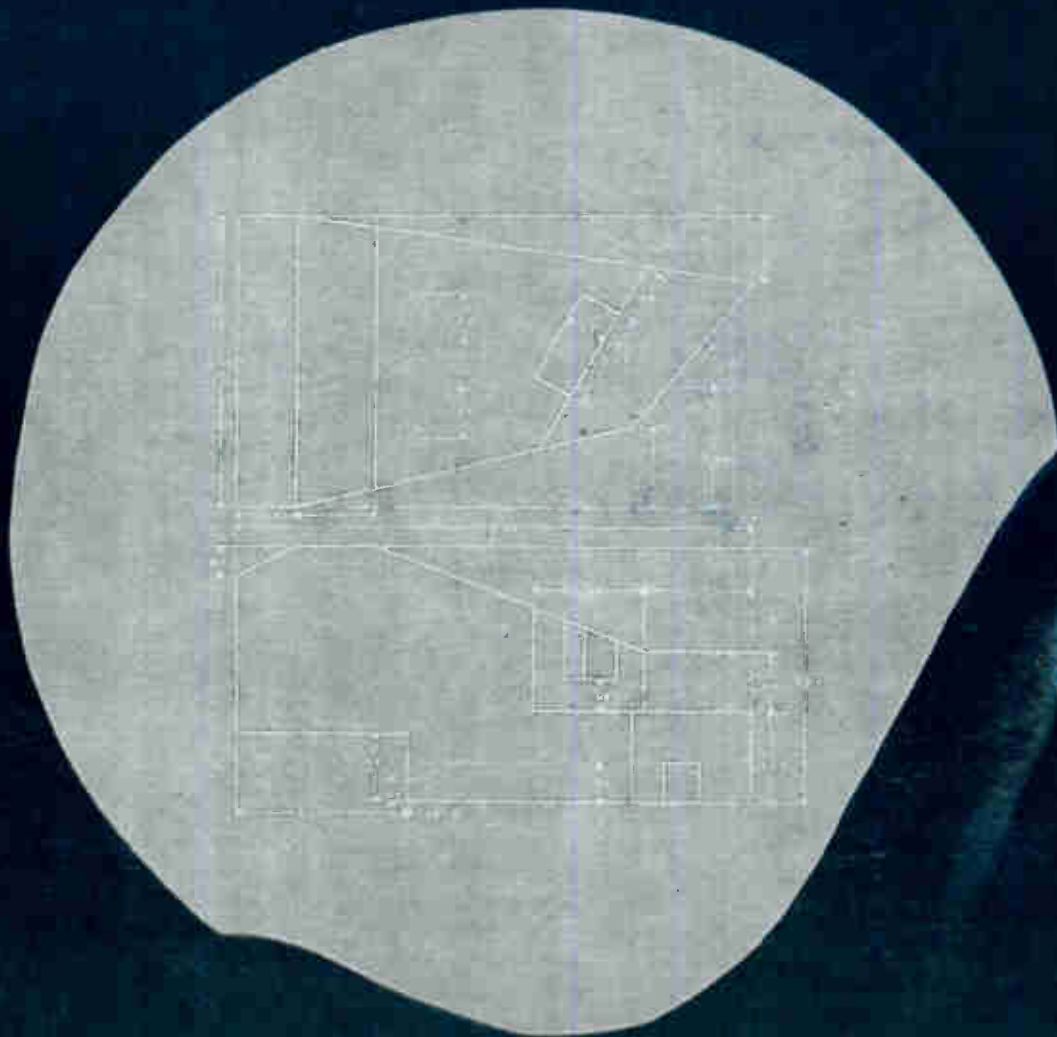

DRAWN IN

1/2 SECOND!

You are looking at the face of a CHARACTRON® Shaped-Beam Tube, heart of the remarkable S-C 4020 High-Speed Microfilm Recorder. The part drawing you see was made by electron beams from computer logic and recorded on 35-mm film in a fraction of a second! After the design has been approved, output of the computer can be used to operate an automatically programmed tool and produce the part. In addition to the S-C 4020's capabilities for automatic drafting and numerical control tool path drawings,

the system can be utilized as a computer printer, recording data at 6000 lines per minute, or as a graph plotter, recording highly-accurate curves at 12,500 points per second. Write for details to General Dynamics/Electronics, Information Technology Division, Dept. B-32, P. O. Box 2449, San Diego 12, California.

GENERAL DYNAMICS | ELECTRONICS



CIRCLE 169 ON READER SERVICE CARD



Bourns Begins Expansion Project

GROUND BREAKING ceremony for the first unit of the new Bourns, Inc., plant took place recently on a 45-acre site in Riverside, Calif. The property was purchased last year. Bourns said then the new plant probably wouldn't be ready before early 1963.

Acceleration of this schedule was brought about by the need for more manufacturing facilities due to sales increases. Since 1955, sales of Bourns products have gone up almost six times from approximately \$2 million in 1955 to about \$12 million in 1960.

In announcing the construction schedule speed-up, Marlan Bourns said: "Based on our projected growth, it would be desirable to move into the new plant as soon as possible. Therefore, we have adopted a rather ambitious time schedule calling for initial occupancy of the building prior to the end of the year by a portion of the Trimpot division manufacturing operations. As soon as possible thereafter, the remaining Riverside Trimpot operations and the corporate offices will move. The Instrument division will consolidate in the present main building and adjacent new buildings."

Scheduled as the first unit of a 568,000-sq-ft plant, to be built over a period of several years, is the 130,000-sq-ft north wing. This building will have more floor space than all the Bourns buildings in Riverside; Ames, Iowa, and Canada combined.

At present, there are two major divisions of Bourns:

The Trimpot division is a high

volume, mass production operation responsible for the design, manufacture and sale of leadscrew actuated potentiometers. These devices are sold under Bourns registered trademarks of Trimpot, Trimit, Twinpot and others.

The Instrument Division is engaged in the design and manufacture of potentiometer transducers, a-c transducers and instrument/systems. These instruments are designed to sense physical phenomena such as an angular and linear position, pressure and acceleration and provide input signals to telemetering systems, control systems and data processing systems.



AIL Names Fromm Division Director

AIRBORNE INSTRUMENTS LABORATORY, Deer Park, L. I., N. Y., has appointed Winfield E. Fromm to the position of director, research and systems engineering division. Prior to this appointment he was in charge of AIL's space technology and research department.

Fromm succeeds Eugene G. Fubini who was recently appointed

to the position of Director of Research, Department of Defense, Research and Engineering.

Rescon Augments Engineering Staff

RESCON ELECTRONICS CORP., Waltham, Mass., has appointed Charles E. Brackett as research engineer and F. A. Epsom to the position of senior engineer in its data processing division.

Both men come from Mitre Corp., Lexington, Mass., where they were active in the design of SAGE radar data processing equipment.



Appoint Beadling Plant Manager

DAVID A. BEADLING has been named manager of the Fairchild Semiconductor Corp., diode plant in San Rafael, Calif. Prior to accepting the new position he was Fairchild's Minuteman program manager.

Glushyn Announces New Division

WILLIAM GLUSHYN, president, Glushyn's Precision Tool Corp., El Monte, Calif., announces the formation of an electronic materials processing division.

The new division provides the electronics industry with a facility for the machining of materials in the ferromagnetic and ceramics field, as well as the usual semiconductor materials.

Hubert R. Smith, formerly of Roygen Ferrite Processing Co., will direct the shop operations. For the past eight years, while with the

SILICON TRANSISTOR CORPORATION

85 Watts



2N389
2N424

**THE COMPLETE LINE
OF INTERMEDIATE AND HIGH
POWER SILICON
TRANSISTORS**

60 Watts



2N1069,70
2N1487,8,9,90

40 Watts



2N1050
2N1049
2N1048
2N1047

15 Watts



2N1486
2N1485
2N1484
2N1483

Silicon Transistor Corporation also manufactures a Complete Line of Silicon Glass Diodes including JAN Types 1N457, 1N458, 1N459 and Sig. C. Types 1N643, 1N658, 1N661 & 1N663.

FOR IMMEDIATE DELIVERY, CONTACT THESE STC AUTHORIZED DISTRIBUTORS: **Ala:** MG Electrical Equipment Co., Birmingham. **Calif:** Brill Semiconductor Corp., Oakland; Hollywood Radio Supply, Inc., Hollywood; Peninsula Electronic Supply, San Jose; Shelley Radio Co., Inc., Los Angeles; Wesco Electronics, Pasadena; Shanks & Wright, Inc., San Diego. **Fla:** Hammond Electronics, Inc., Orlando; Leader Distributors, Inc., Tampa. **Mass:** Durrell Distributors, Inc., Waltham. **Md:** Valley Electronics Inc., Towson. **New York:** Arrow Electronics, Inc., Mineola, L. I.; Progress Electronics Co., Inc., New York City; Summit Distributors, Buffalo. **Penna:** Philadelphia Electronics, Inc., Phila. **Texas:** Lenert Company, Houston; Central Electronics, Dallas.



For transistor and diode specification sheets, write to

SILICON TRANSISTOR CORPORATION / CARLE PLACE, LONG ISLAND,
NEW YORK. PIONEER 2-4100

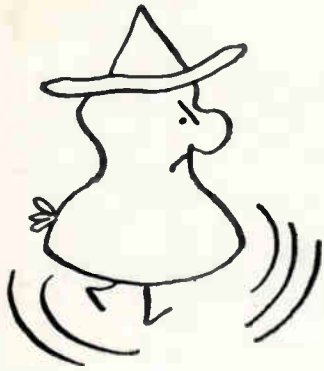

There once was a young engineer
 Who walked 'round with a permanent sneer
 An Electro-Mec Pot
 Has helped him a lot
 Now he yodels while sipping his beer!

Even if you can't yodel
 You can depend on **Electro-Mec Potentiometers***.



*Write for data sheets and further information about our complete line of **SUPERPRECISION potentiometers**. Certified calibration data, including recordings of output function are supplied with each instrument. If **RELIABILITY** is your goal, always specify **ELECTRO-MEC potentiometers**.

ELECTRO-MEC

Division of **WALTHAM Precision Instrument Company, Inc.**
 47-51 33RD STREET, LONG ISLAND CITY 1, N. Y.

CIRCLE 219 ON READER SERVICE CARD

research and development laboratory of Hughes Aircraft Corp., he handled the machining of the entire range of ferrites and ceramics.



Goodwin G. Mills Joins National Radio

APPOINTMENT of Goodwin G. Mills as executive vice president and general manager of National Radio Co., Inc., Melrose, Mass., has been announced. He was formerly with Allied Radio Co. in Chicago, where he was vice president and general manager of Allied's subsidiary, Knight Electronics Corp.



MicroSemiconductor Appoints Spector

MURRAY SPECTOR has been named diode plant manager at MicroSemiconductor Corp., Los Angeles, Calif. He previously served as manager of processing in the reliability division of Pacific Semiconductors, Inc., and as process engineer at Clevite Transistor Products.

Kidde Establishes Laboratories

FORMATION of the Kidde Electronics Laboratories by Walter Kidde & Co., Inc., has been announced. The Laboratories, combining the

6,000 ELECTRONIC WIRE AND CABLE PRODUCTS

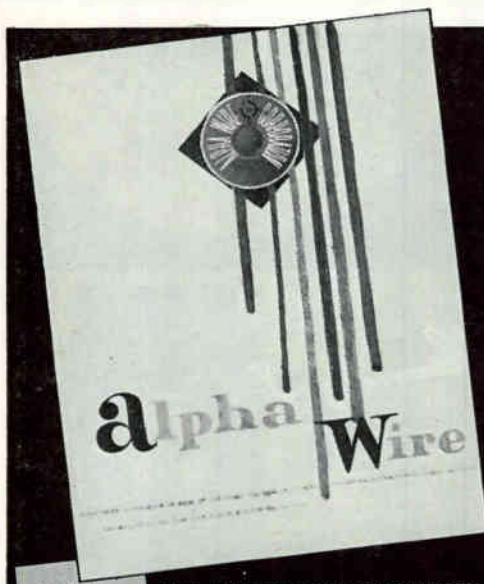

6 NEW WIRE & TUBING LINES

- **HEAT SHRINKABLE TUBING** — An irradiated tubing with controlled shrinkage; that, when heated, shrinks in seconds to form a tight-fitting mechanical bond.
- **RETRACTILE COIL CORDS** — A quality line of test leads, power cords, power cord sets and communication cords with the maximum retractility and durability.
- **TEFLON CABLES** — 48 different cables. Available from one to four conductors.
- **ZIPPER TUBING** — New constructions, new techniques with complete data on five tubing types.
- **TEFLON TUBING** — All new tubing for high temperature application (260°C.).
- **SHIELDING AND BRAIDING** — 3 different types including new round shielding to QQ-B-575.

NEW
 ALPHA
 WIRE
 CATALOG

YOUR COMPLETE GUIDE TO ELECTRONIC WIRE AND CABLE 52 pages of information

Write



ALPHA WIRE CORPORATION
 Subsidiary of **LORAL Electronics Corporation**
 200 Varick Street, New York 14, N. Y.
 PACIFIC DIVISION:
 1871 So. Orange Dr., Los Angeles 19, Calif.

BUILD-YOUR-OWN ELECTRONIC ORGAN

STEP UP TO AN

Artisan

GREATEST
NAME IN
ORGAN KITS

20TH CENTURY
SUCCESSOR
TO THE
PIPE ORGAN



PIPE-LIKE
TONE AND
APPEARANCE

DIRECT FACTORY
TO OWNER
SAVES 50%



PAY-AS-YOU
BUILD

STEP-BY-STEP
INSTRUCTIONS
HOME, CHURCH
AND CONCERT
MODELS
2-3-4 MANUALS
FROM
\$1,750 to \$12,500



WORLD'S LARGEST SELECTION OF ORGAN KITS,
ACCESSORIES AND CUSTOM-BUILT ORGANS

Send for FREE literature

DORSETT ELECTRONICS, INC.

ELECTRONIC ORGAN DIVISION

4949 X YORK BLVD., LOS ANGELES 42, CALIF.

CIRCLE 214 ON READER SERVICE CARD

IS YOUR
ADVERTISING
SELLING

THE BIG 4

?

Tough competition and smart selling demand that the electronics man be reached and sold wherever you find him: *Research, Design, Production, and Management.* Only electronics is edited to interest and influence all four key buyers. Put your advertising where it works *hardest*

in **electronics**

April 28, 1961

METALS for ELECTRONIC APPLICATION

rolled ULTRA THIN

by **OUR SPECIAL ROLLING
TECHNIQUE**

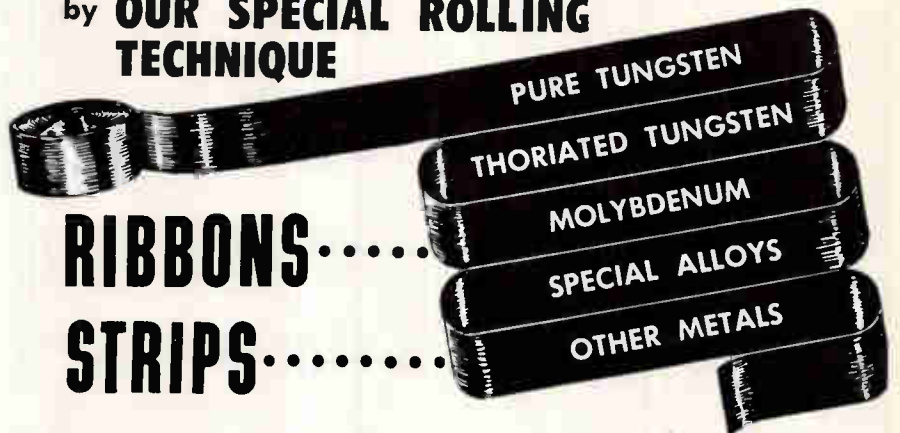

**RIBBONS.....
STRIPS.....**

TOLERANCES CLOSER THAN COMMERCIAL STANDARDS

Note: for highly engineered applications—strips of TUNGSTEN and some other metals can be supplied

rolled down to .0003 thickness

- Finish: Roll Finish—Black or Cleaned
- Ribbons may be supplied in Mg. weights if required

Developed and Manufactured by

H. CROSS CO.

3229 BERGENLINE AVE., UNION CITY, NEW JERSEY

Tele: Union City, N. J.: UN. 3-1134

N. Y. C., N. Y.: BR 9-4425

CIRCLE 220 ON READER SERVICE CARD

Computer Circuit Performance enhanced by Kelvin Series "O" precision resistors

**GUARANTEED STABLE
...NOW AND LATER!**

Kelvin's new high performance Series "O" resistors, designed and manufactured under laboratory conditions, are specifically intended for applications requiring long term electrical stability of the highest order.

Guaranteed stability: .003% per year max. under reasonable environmental conditions; Temperature coefficient range: .001%/°C max., .0001%/°C min.; Standard accuracies: to ±.005%; Matching or ratio accuracies: to ±.002%; Rise time characteristics: as low as .05 micro-seconds for 100K ohm range; Wattage range: .15 watt to 2.50 watts; Resistance range: .1 ohm to 15 meg-ohms; Physical size range: .187 dia. x .375 length to 1.000 dia. x 2.125 length.

These units feature "relaxed," pre-aged windings, all welded terminations and unique encapsulation techniques which ensure accuracy both now and later!

Your inquiry is also invited concerning RESISTIVE NETWORKS in prototype or production quantities available in virtually any arrangement of values and physical configurations to meet the most exacting specifications.

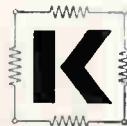

Representatives in
principal cities

**KELVIN
ELECTRIC COMPANY**

5907 Noble Ave., Van Nuys, Calif., TRiangle 3-3430
New York: Yonkers, 916 McLean Ave., BEverly 7-2500

CIRCLE 173 ON READER SERVICE CARD

173

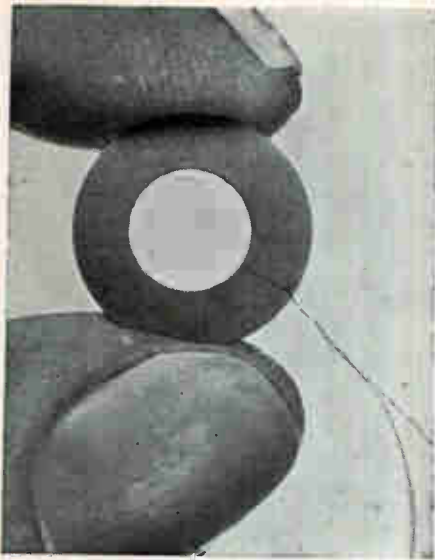

In the Remington Rand Univac physics laboratory, 5 mil. diameter holes are ultrasonically drilled in ferrite cores, then threaded with fine wire in the examination of domain structure. Such experiments prove that a series of alternate-polarity pulses of diminishing amplitude result in concentric rings of alternately directed magnetization. Much smaller cores (80 mil. o.d.) were then studied by means of residual magnetization curves for flux distribution under various modes of partial switching.

Opportunity for personal progress has never been greater than it is today at Remington Rand Univac.

In addition to an attractive salary, you will work with engineers and scientists who have made significant advances in solid state development and computer reliability. Immediate openings include:

RESEARCH ENGINEERS

Attractive positions are now available for Research Engineers. These permanent assignments include circuit development work and the logical design of high speed computer elements.

- TRANSISTOR CIRCUIT DESIGNERS
- ELECTRONIC PACKAGING ENGINEERS
- SERVO-ENGINEERS
- ELECTROMECHANICAL ENGINEERS
- QUALITY CONTROL ENGINEERS
- PRODUCTION ENGINEERS
- RELIABILITY ENGINEERS
- STANDARDS & SPECIFICATIONS ENGINEERS

Send resume of education and experience to:
R. K. PATTERSON, DEPT. T-4

Remington Rand
Univac

DIVISION OF SPERRY RAND CORPORATION
2750 West Seventh St., St. Paul 16, Minn.

There are also immediate openings in all areas of digital computer development at our other laboratories. Inquiries should be addressed to:

F. E. NAGLE, Dept. C-1
REMINGTON RAND UNIVAC
1900 West Allegheny
Philadelphia 29, Pa.

D. CLAVELOUX, Dept. C-1
REMINGTON RAND UNIVAC
Wilson Avenue
South Norwalk, Conn.

technical assistant to the vice president in charge of research and engineering for Sylvania Electronic Systems.



MSI Elects Kent V-P, Engineering

LEONARD I. KENT has been elected vice president-engineering and a member of the board of directors of Microwave Semiconductor & Instruments Inc. MSI, which was recently formed to enter the field of microwave components and equipments, leased 6,200 sq ft in Richmond Hill, N. Y.

Kent was formerly director of engineering at Narda Microwave Corp.



Harris-Intertype Names Merrill V-P

HARRIS-INTERTYPE CORP., Cleveland, O., recently elected Grayson Merrill to the new corporate post of vice president-electronics. He joined the firm after resigning as general manager of the Astrionics Division of Fairchild Engine and Airplane Corp., L. I., N. Y.

Merrill will have corporate responsibility for the company's two electronics divisions—PRD Electronics, Inc., Brooklyn, N. Y., and Gates Radio Co., Quincy, Ill., pro-

*OPTISYN

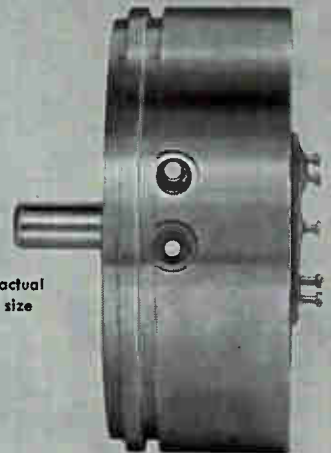

actual size

a unique optical shaft position encoder for servomechanisms, data reduction, navigation systems, programmed control systems

*Miniature size (2.312 dia. by 1 5/8") with no sacrifice in resolution

*Instantaneous interrogation

*Low torque — will not load shaft

*Reliable — low power photocircuit and absence of moving contact insure long life and high reliability

*Economy — moderate cost, extensive life, and lack of required maintenance reduce overall control system costs

For details on standard OPTISYNS get Bulletin #604.

SPECIAL DESIGNS

OPTISYN Gimbal Angle Readout Encoder — the first digital transducer specifically for inertial guidance or navigation platforms. Provides direct digital readout. Lightweight. Convenient shape and size will fit available space. For details get Bulletin #606.

OPTISYN Incremental Pickoff for readout of integrating accelerometers. High reliability and basic versatility make it ideal for this very exacting requirement. Available for size 35, 25 and 16 accelerometers. For details get Bulletin #605.

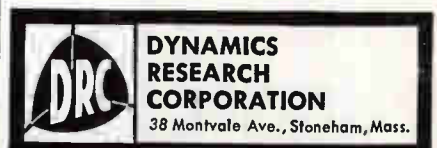



Time Tested Quality



MINIATURE Electrolytic CAPACITORS

- Wide range of capacities and voltages.
- Excellent low temperature characteristics.
- Stable, low leakage, high temperature characteristics.
- Rugged, excellent under severest operating conditions.
- Non-polarized types available for audio, cross-over, and other AC applications.

SMT and SMTU

Aluminum case with patented construction, molded bases with thermoset plastic and silicone rubber seals. Hermetic sealing for wide temperature applications. Supplied with transparent plastic insulating sleeves.

SMT-AXIAL LEAD



SMTU Upright Mounting

Temperature:
 -30°C to +65°C
 -40°C to +85°C
 -30°C to +105°C

Types SMTU and BMTU are available in multiple section units in common cathode and common anode. We invite your inquiry.

BMT and BMTU

Plastic cased with thermoset resin end fill; available in two temperature ranges. Economically priced.

BMT-AXIAL LEAD



Temperature:
 -30°C to +65°C
 -40°C to +85°C



BMTU Upright Mounting

ILLINOIS

CONDENSER COMPANY

1616 N. Throop Street Chicago 22, Illinois
 Telephone: EVerglade 4-1300
 Export: 15 Moore St New York 4 New York

"Foremost manufacturers of Electrolytic Capacitors for almost 30 years"

CIRCLE 222 ON READER SERVICE CARD

PHAZOR

PHASE METER

MODEL 200AB

PRICE \$449.00



- 2° absolute accuracy
- Readings not affected by noise and harmonics
- Frequency range 15 CPS - 30KC
- Accuracy to .01 degree with simple circuit techniques
- High sensitivity on input & reference channels
- Can measure in-phase & quadrature voltage component

For further information contact your nearest representative or write for brochure



INDUSTRIAL TEST EQUIPMENT CO.
 55 E. 11th St. • NEW YORK 3 • GR. 3-4684

Manufacturers of:

PHASE METERS

NULL DETECTORS

IMPEDANCE COMPARATORS

POWER OSCILLATORS

FREQUENCY STANDARDS

AUTOMATIC HI-POT

Other Electronic Test Equipment

ducers of microwave and broadcasting equipment respectively.

Precision Electronics Plans Expansion

PRECISION ELECTRONICS, INC., Rockville Centre, N.Y., manufacturer of transformers, coils, and inductive components for military and industrial uses, announces plans to further increase its plant capacity by leasing the building immediately adjacent to its present plant.

This expansion, which will double the existing facility, will mark the third increase in space for the company in the past year.

PEOPLE IN BRIEF

Charles W. Curtis advances at Hughes Aircraft to manager of the company's ground systems group radar lab. John F. Richard leaves D. S. Kennedy & Co. to join Antenna Systems, Inc. as product manager of the r-f components division. Imre Farkass, formerly with the National Research Corp., appointed director of applied physics by Ilikon Corp. Walter H. Cobbs, Jr. transfers from E. I. duPont de Nemours Co. to Orr Industries Co., a division of Ampex Corp., as manager of research and development. G. Harry Ashbridge of the Bryant Computer Products Div., Ex-Cell-O Corp., promoted to manager of the product planning dept. Edward C. Jones leaves Cutler-Hammer Inc. to become sales engineering manager of Vectrol Engineering, Inc. Warren G. Abbott, ex-Farrington Manufacturing Co., joins Conductorlab, Inc., as sales manager. G. U. Sorger of Weinschel Engineering Co. appointed assistant professor at the Institute of Measurement Science of George Washington University. Jack Pinner, previously with the John Oster Manufacturing Co., chosen director of engineering by Rotating Components Inc., precision instrument division. Harlan A. James advances at Pacific Automation Products to manager of the manufacturing division.

electronics

WEEKLY QUALIFICATION FORM FOR POSITIONS AVAILABLE

**ATTENTION:
ENGINEERS, SCIENTISTS, PHYSICISTS**

This Qualification Form is designed to help you advance in the electronics industry. It is unique and compact. Designed with the assistance of professional personnel management, it isolates specific experience in electronics and deals only in essential background information.

The advertisers listed here are seeking professional experience. Fill in the Qualification Form below.

STRICTLY CONFIDENTIAL

Your Qualification form will be handled as "Strictly Confidential" by ELECTRONICS. Our processing system is such that your form will be forwarded within 24 hours to the proper executives in the companies you select. You will be contacted at your home by the interested companies.

WHAT TO DO

1. Review the positions in the advertisements.
2. Select those for which you qualify.
3. Notice the key numbers.
4. Circle the corresponding key number below the Qualification Form.
5. Fill out the form completely. (PLEASE PRINT CLEARLY)
6. Mail to: D. Hawksby, Classified Advertising Div., ELECTRONICS Box 12, New York 36, N. Y. (No charge, of course).

COMPANY	SEE PAGE	KEY #
AC SPARK PLUG The Electronics Div. of G. M. Milwaukee, Wisconsin	49*	1
APPLIED PHYSICS LABORATORY The Johns Hopkins University Silver Spring, Maryland	145, 166	2
BAUSCH & LOMB INC. Rochester, New York	180	3
BENDIX-PACIFIC DIV. The Bendix Corp. North Hollywood, California	48*	4
BOEING AIRPLANE CO. Seattle, Washington	37*	5
BRENTEN EMPLOYMENT AGENCY Newark, New Jersey	180	6
GENERAL ELECTRIC Defense Systems Dept. Syracuse, New York	178	7
GENERAL ELECTRIC Heavy Military Electronics Dept. Syracuse, New York	181	8
HORIZONS INC. Cleveland, Ohio	180	9
HOUSTON INSTRUMENT CORP. Houston, Texas	178	10
IBM CORP. New York, New York	179	11

Continued on page 178

(cut here)

(cut here)

electronics WEEKLY QUALIFICATION FORM FOR POSITIONS AVAILABLE

Personal Background

NAME
HOME ADDRESS.....
CITY..... ZONE..... STATE.....
HOME TELEPHONE.....

Education

PROFESSIONAL DEGREE(S).....
MAJOR(S)
UNIVERSITY
DATE(S)

FIELDS OF EXPERIENCE (Please Check)

4281

- | | | |
|--|--|---------------------------------------|
| <input type="checkbox"/> Aerospace | <input type="checkbox"/> Fire Control | <input type="checkbox"/> Radar |
| <input type="checkbox"/> Antennas | <input type="checkbox"/> Human Factors | <input type="checkbox"/> Radio-TV |
| <input type="checkbox"/> ASW | <input type="checkbox"/> Infrared | <input type="checkbox"/> Simulators |
| <input type="checkbox"/> Circuits | <input type="checkbox"/> Instrumentation | <input type="checkbox"/> Solid State |
| <input type="checkbox"/> Communications | <input type="checkbox"/> Medicine | <input type="checkbox"/> Telemetry |
| <input type="checkbox"/> Components | <input type="checkbox"/> Microwave | <input type="checkbox"/> Transformers |
| <input type="checkbox"/> Computers | <input type="checkbox"/> Navigation | <input type="checkbox"/> Other |
| <input type="checkbox"/> ECM | <input type="checkbox"/> Operations Research | <input type="checkbox"/> |
| <input type="checkbox"/> Electron Tubes | <input type="checkbox"/> Optics | <input type="checkbox"/> |
| <input type="checkbox"/> Engineering Writing | <input type="checkbox"/> Packaging | <input type="checkbox"/> |

CATEGORY OF SPECIALIZATION

Please indicate number of months experience on proper lines

	Technical Experience (Months)	Supervisory Experience (Months)
RESEARCH (pure, fundamental, basic)
RESEARCH (Applied)
SYSTEMS (New Concepts)
DEVELOPMENT (Model)
DESIGN (Product)
MANUFACTURING (Product)
FIELD (Service)
SALES (Proposals & Products)

CIRCLE KEY NUMBERS OF ABOVE COMPANIES' POSITIONS THAT INTEREST YOU

1 2 3 4 5 6 7 8 9 10 11 12 13 14 15 16 17 18 19 20 21 22 23 24 25



**DEFENSE SYSTEMS DEPARTMENT
PROFESSIONAL
EMPLOYMENT
BULLETIN APRIL, 1961**

On a regular basis, General Electric's Defense Systems Department publishes opportunities of special importance to experienced Systems Engineers and/or degree Engineers interested in developing their skills to the point of Systems Engineering in its broadest sense.

**ANALYTICAL
SYSTEMS ENGINEERS**

To apply mathematical and engineering techniques to creative analysis of physical systems, modular development, classic mechanics, statistical analysis, non-linear systems analysis. Investigations are both analytical and numerical.

Areas of effort encompass Upper Atmospherics, In-Orbit Trajectory Corrections, Redundant Measurements (real-time and post flight), Error Analysis Studies (pertaining to redundant time and position measurements), Acquisition and Evaluation Studies, Probe Tracking, Planetary-Terminal-Midcourse Guidance, Space Tracking (analytical determination studies), and In-Orbit Corrections.

**ELECTRONIC SYSTEM
TEST ENGINEERS**

To establish test objectives and accomplish planning and scheduling for test programs . . . implement programs, evaluate results and initiate required corrective action as a result of gross analysis.

Your response to this Bulletin will be expedited to the appropriate technical managers at DSD for prompt, personal attention and a confidential reply, generally within one week. Address:
Mr. E. A. Smith,
Box 4-E



GENERAL ELECTRIC

Northern Lights Office Bldg., Syracuse, New York

CIRCLE 382 ON READER SERVICE CARD

CHIEF ELECTRONICS ENGINEER

An excellent opportunity is available for a competent engineer with proven creative ability. Applicant must have a B.S. or M.S. degree in electrical engineering from a leading university and must have at least five years experience in the design of commercial electronic laboratory instruments.

This opening is ideally suited for an independent type of engineer who can supervise but who requires minimum supervision. It is an excellent ground floor opportunity in a small but rapidly growing and financially healthy company. (Stock option participation plan would be negotiated to obtain the right man. This plus participation in management is the next best thing to having your own company.) All work will pertain to developing a line of new products with many novel features. Applicant should be capable of adding new, technically sound, and salable ideas of his own over a reasonable period of time.

Our interest also extends to small undercapitalized companies with promising products who may wish to consolidate with us.

Write to: E. V. Hardway, Jr., President



houston instrument corporation

P. O. BOX 22234 • Houston 27, Texas

PLANT: 4950 TERMINAL AVE., BELLAIRE, TEXAS

MOhawk 7-7405 • CABLE: HOINCO • TWX: 28

CIRCLE 383 ON READER SERVICE CARD

electronics
**WEEKLY QUALIFICATIONS FORM
FOR POSITIONS AVAILABLE**

(Continued from page 177)

COMPANY	SEE PAGE	KEY #
LOCKHEED MISSILES & SPACE DIV. Sunnyvale, California	34*	12
McGRAW-HILL PUBLISHING CO., INC. New York, New York	180	13
NATIONAL CASH REGISTER CO. Electronics Division Hawthorne, California	174	14
REMINGTON RAND UNIVAC Div. of Sperry Rand Corp. St. Paul, Minnesota	175	15

* These advertisements appeared in the 4/21/61 issue.

A Reminder to Engineers:

The electronics Weekly Qualification Form is your passport to advancement in the electronics industry.

When you use the form, PLEASE PRINT all information clearly. Legibility assures that your qualifications and background are submitted as you intend to the personnel executives of the various companies you select.

FOR INFORMATION

About Classified Advertising

Contact The McGraw-Hill
Office Nearest You

ATLANTA, 9 1375 Peachtree St. N. E. R. JOHNSON	TRinity 5-0523
BOSTON, 16 Copley Square D. HICKS	COngress 2-1160
CHICAGO, 11 520 No. Michigan Ave. W. J. HIGGENS—W. SONZSKI	MOhawk 4-5800
CLEVELAND, 13 1164 Illuminating Bldg.	SUperior 1-7000
DALLAS, 2 1712 Commerce St., Vaughn Bldg. Riverside 7-5117	J. GRANT
DENVER, 2 1700 Broadway—Tower Bldg.	ALpine 5-2981
DETROIT, 26 856 Penobscot Bldg. P. HAMMOND	WOodward 2-1793
HOUSTON, 25 Prudential Bldg., Holcombe Blvd., Rm. W-724 JACKSON 6-1281	GENE HOLLAND
LOS ANGELES, 17 1125 W. 6th St. W. C. GRIES	HUNtley 2-5450
NEW YORK, 36 500 Fifth Ave. H. T. BUCHANAN—R. P. LAWLESS T. W. BENDER	OXford 5-5959
PHILADELPHIA, 3 Six Penn Center Plaza P. PASCHALL—W. B. SULLIVAN	LOcust 8-4330
PITTSBURGH, 22 4 Gateway Center	EXpress 1-1314
ST. LOUIS, B 3615 Olive St. R. BOWMAN	JEfferson 5-4867
SAN FRANCISCO, 11 255 California St.	DOuglas 2-4600

This four-cryotron flip-flop can be switched in *two billionths of a second*. It was developed by an IBM team investigating the possibilities of low-temperature devices for basic binary storage in digital computers.

IBM scientists and engineers designed the flip-flop around a primary law of low-temperature physics: A superconductive metal loses its superconductivity in the presence of a magnetic field. In the IBM device, a small control current is used to destroy the superconductivity of one of two parallel lines. This sets up a resistance in the first line and causes current to switch to the second.

The new flip-flop offers another advantage in addition to speed. Its eight layers of thin metallic and insulation films operate in a temperature range where chemical deterioration is nonexistent. As a result, the device should have an unusually high degree of reliability.

Creative careers start here. A good deal of this project's success came from the creative interplay of different technical areas. IBM physicists and mechanical and electrical engineers worked together to develop new films, improved vacuum equipment and more reliable test circuits.

Perhaps you'd like to work . . . and grow . . . in a professionally stimulating atmosphere like this. You may be interested in the progress IBM is making in such areas as solid state, magnetics or IBM Tele-Processing.* If you have a degree in engineering, mathematics, or one of the physical sciences, plus experience in your field, write, briefly describing your background, to:

Manager of Technical Employment
IBM Corporation, Dept. 554D4
590 Madison Avenue
New York 22, New York

IBM
*Trademark

**cryogenic switching
in 2 billionths
of a second**

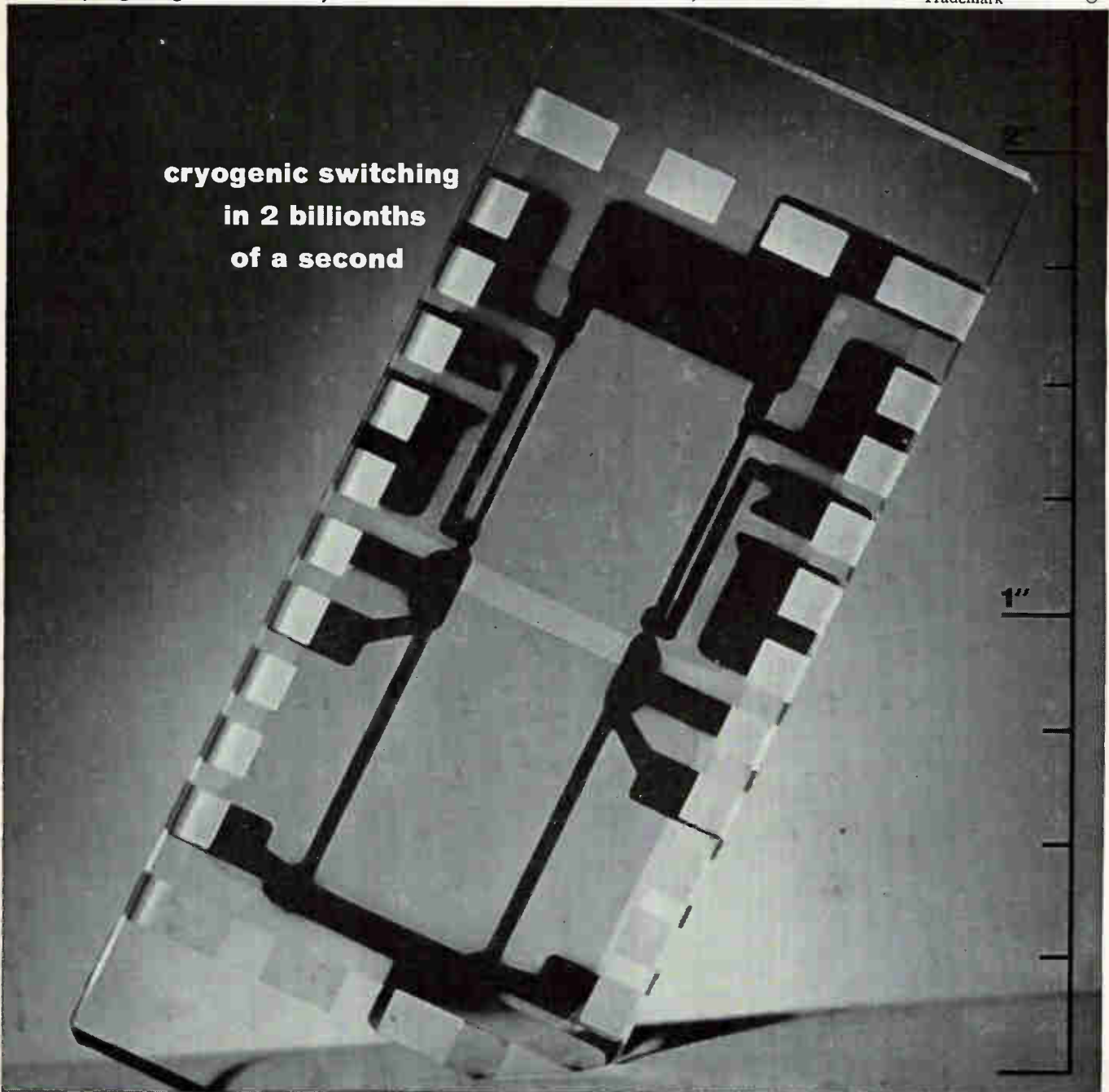

NEW OPENINGS at Bausch & Lomb

MECHANICAL ENGINEERS

Several openings are available in the Mechanical Design Section where an engineer has project responsibility from specifications to a saleable product. The products involved are mechanical—electrical—optical in nature. These positions require board design, inter-plant engineering coordination, drafting supervision and production assistance.

PROJECT ENGINEERS

The Military Products Department has several challenging openings for Project Engineers. These men will have broad project responsibility in the area of optical and electro-optical systems. Should be familiar with Military R.&D. Specific optical experience not required. Educational background may be in either Electrical or Mechanical Engineering or Physics.

MATHEMATICIAN

M.S. or Ph.D. to be responsible for basic research in the Thin Film area. Also openings for Mathematicians with an interest in Computers and Programming and in Lens Design.

OPTICAL ENGINEERS

Section Head with mature background in optical, mechanical, electro-optical or related systems for military projects, with primary emphasis on optical system design and hardware follow-through. (Career opportunities also available for qualified optical engineering section personnel.)

PRODUCTION ENGINEER

Department Head for machine and tool design with broad experience in mechanical and electro-mechanical manufacturing. Several openings also available for Production Engineers in the areas of Time Study, Process Engineering, and Quality Control.

LIVE IN ROCHESTER

... in the heart of upstate New York vacation country. Rochester is noted for its fine schools and the University of Rochester (with its Institute of Optics), beautiful homes and gardens, outstanding cultural advantages, and high ratio of professional residents.

Please send resume to: H. A. FRYE, Professional Employment
20 Bausch Street, Rochester 2, N. Y.

Bausch & Lomb Incorporated

ME's, CHEM E's, EE's plus CIVILS

When you think of **INTEREST**
think of your job

When you think of **GROWTH**
think of your job

When you think of **CHALLENGE**
think of your job

When you think of your **job**
think of McGraw-Hill

If you like to write, and engineering is your profession, consult with us about a career in engineering-journalism. For additional information, write: Mr. Jack Coyne, Room 506, McGraw-Hill Publishing Company, 330 West 42nd Street, New York 36, New York.

CIRCLE 385 ON READER SERVICE CARD

ELECTRONICS \$16-19,000 MANAGERS NEW JERSEY

All Fees & exp. paid by client Co.
5-10 yrs. exp. in one or more of the following:

Digital Computer Programming
Digital Logic Circuits
Digital Systems
Modules & Transistor Circuits
Anti-Submarine Warfare
Advanced Tech'l Planning
Inertial Systems Engineering
Airborne Analog Computer
Infra-Red
Analog Systems Controls
Electronic Modules Amplifier
Projects
Electronic Test Equip't To \$14,000
Gyro Axis Components To \$14,000
Digital Power Supplies To \$14,000

To meet these top quality New Jersey Co. managements phone or write J. Albert or A. Brenten (New Jersey) Market 2-0915 or Mitchell 3-2141, please send 1 resume in complete confidence.

ENGINEERS PLACE ENGINEERS



BRENTEN EMP. AGENCY

786 Broad St., Newark, N. J.

CIRCLE 386 ON READER SERVICE CARD

SEARCHLIGHT SECTION

WANTED

Wanted: Microscopic particles opaque or chromophilic 5 to 40 microns in size by 5 micron increments. Needed by research project. Funds available. Write Murco Research, Inc., P. O. Box 6006, Jacksonville 5, Florida.

CIRCLE 384 ON READER SERVICE CARD

A SUPERVISORY RESEARCH POSITION

is open in our Physics Dept. It presents an unusual opportunity for advancement and learning. Present research activity is in areas including ultra-sonic inspection systems, molecular electronic components and photo conductors.

If you are experienced in physics and electronics and are interested in research and development work with a small progressive, independent, laboratory, please contact R. A. Fottland, Head, Physics Dept.

HORIZONS INCORPORATED

2905 E. 79th Street Cleveland 4, Ohio

CIRCLE 387 ON READER SERVICE CARD



MANUFACTURERS' REPRESENTATIVES

IN THE ELECTRONIC INDUSTRY

SAMUEL K. MACDONALD, INC.

manufacturers representatives over 25 years
1531 SPRUCE STREET, PHILA. 2, PA.

Territory: Pennsylvania • New Jersey
Delaware • Maryland
Virginia • West Virginia
District of Columbia

Other Offices:
Pittsburgh
Ballimore
Washington, D.C.

CIRCLE 388 ON READER SERVICE CARD

Your Inquiries to Advertisers
Will Have Special Value . . .

—for you—the advertiser—and the publisher, if you mention this publication. Advertisers value highly this evidence of the publication you read. Satisfied advertisers enable the publishers to secure more advertisers and—more advertisers mean more information on more products or better service—more value—to YOU.

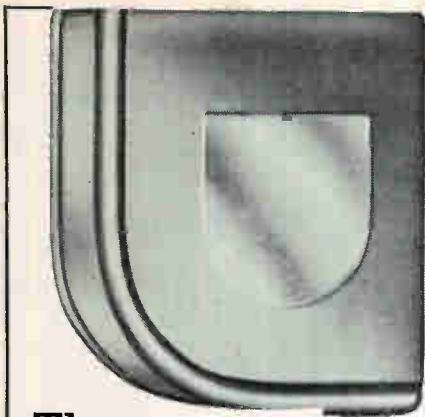

The
Effectiveness
of your
Engineer
Recruitment
Advertising
is
Measured
by the
Calibre
and
Quantity
of the
Experienced
Engineers
it Reaches.

The man you
need
is the man who
reads

electronics
CLASSIFIED ADVERTISING
DIVISION
POST OFFICE BOX 12
NEW YORK 36, N. Y.

Engineers

MEMO FROM: W. M. JENKINS
Manager, GEECS Systems Engineering

TO: George B. Callender
Engineering Administration

SUBJECT: Manpower Requirement, Amplification:
Project Management Teams

Re: Your inquiry about my last memo* and the fifteen Project Management Team members I need. These men will develop operational requirements for systems which will accomplish specified missions within given environments. Will then evolve system concept and specifications. To obtain assistance, team members will generate Work Statements for consulting units specializing in related technologies (data acquisition, communications, data processing, etc.) Example: "We need combination sector-searching-range on given target type. Analyze and specify type of radar needed. Reply will be performance and environmental spec for sub-system component which my Project Management Team can incorporate into systems specifications."

Need help here, too—more in next memo!

Few compromises as possible

WMJ

Engineers with experience in most of the following fields:

physics (including nuclear) / circuit theory & design / radar theory / communications theory / computer programming & utilization are invited to forward their resumes to: George Callender, Division 69-WE.

HEAVY MILITARY ELECTRONICS DEPARTMENT

GENERAL  ELECTRIC

Court Street, Syracuse, New York

* SEE ELECTRONICS—MARCH 3, 1961

Kelvin Electric Company..... 173

*Lapp Insulator Co. Inc..... 124
 Lepel High Frequency Labs Inc.... 54

*Magnetic Controls Company..... 144
 McDonnell Aircraft 19
 Melabs50, 138
 Midwestern Instruments 166
 *Minneapolis-Honeywell Reg. Co.
 Heiland Div. 62
 Molex Products Co..... 153

National Cash Register Company... 174
 National Research Corp..... 55
 National Vulcanized Fibre Company 37
 New England Instruments Company 115
 *North Atlantic Industries, Inc..... 134
 *Northeastern Engineering Inc..... 146
 *Northern Radio Inc..... 149
 Norton Co., Refractories Div..... 153

Optical Gaging Products, Inc..... 57

Pacific Semiconductors, Inc. 17, 18. 151
 Panduit Corp. 153
 *Philco Corp., Lansdale Tube..... 98
 *Polarad Electronics Corp.....35, 36
 Potter Instrument Co..... 141
 *Power Designs, Inc..... 161
 Power Sources, Inc..... 96
 Precision Instrument Co..... 88
 *Premier Metal Pmts. Co..... 159

*Radio Cores, Inc..... 161
 *Radio Corp. of America .23, 4th Cover
 *RCA Service Company..... 6
 *Raytheon Company...43, 56, 117, 154
 Remington Rand Univac, Division of
 Sperry Rand Corp..... 175
 Rustrak Instrument Company Inc.. 7

*Sanders Assocs, Inc..... 156
 Sangamo Electric Co..... 155
 *Silicon Transistor Corp..... 171
 Sprague Electric Co.....5, 33
 Swissair Worldwide 127

* See Advertisement in the July 20, 1960 issue of Electronics Buyers' Guide for complete line of products or services.

April 28, 1961

1,000,000

DC OUTPUT COMBINATIONS

Select the outputs you need from D/B's line of modular supplies; we will assemble them into the appropriate Rack Mounting Kits as listed below:

Kit Model	Kit Size	Kit Price*
71	19x3 $\frac{1}{2}$ x8	15.00
72	19x5 $\frac{1}{4}$ x9	17.00
73	10x7x9	17.50
74	19x7x14	24.00
75	19x8 $\frac{3}{4}$ x14	24.50

*Add \$5 for switch, pilot light and fuse combination. Prices are f.o.b. Pasadena, Calif.

FREE!

A 90-SECOND GUIDE TO OVER 1,000,000 ELECTRICAL COMBINATIONS OF MODULAR SUPPLIES ASSEMBLED IN RACK MOUNTING KITS

DRESSEN-BARNES ELECTRONICS CORPORATION
 250 NORTH VINEDO AVENUE PASADENA, CALIFORNIA

CIRCLE 224 ON READER SERVICE CARD



Coils for Contact Capsules

TYPE	DC-V	Ohms	Nom. Watts	Nom. Amp/Turns
S	6	100	.40	250
	12	360		
	24	1400		
M	6	50	.70	250
	12	175		
	24	820		
T	6	100	.35	125
	12	400		
	24	1600		
	32	2800		
	48	4600		

Coto-Coils

COTO-COIL CO., INC.
 65 Pavilion Avenue
 Providence 5, R. I.

Write for Bulletin and Prices
 CIRCLE 183 ON READER SERVICE CARD

Is your advertising selling the same four key buyers your salesmen call on? Competition demands it! Only advertising in electronics reaches and sells the electronics man *wherever* he is: in *Research,*

TODAY YOU MUST SELL ALL FOUR!

Design, Production, and Management. Put your advertising where it works *hardest...*

in **electronics**

HIGHEST PURITY PRECISELY DEFINED

to meet critical
electronic manufacturing
needs

J. T. Baker ELECTRONIC CHEMICALS

'Baker Analyzed' *Reagents*

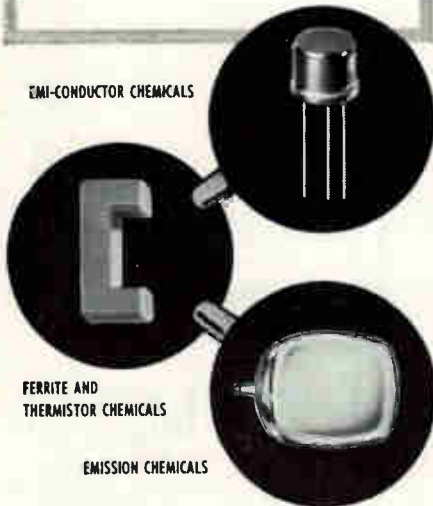

SEMI-CONDUCTOR CHEMICALS

FERRITE AND
THERMISTOR CHEMICALS

EMISSION CHEMICALS

J. T. Baker electronic chemicals offer you the highest standards of purity in the industry—proved by the Actual Lot Analysis and Actual Lot Assay on the label. Your variables are minimized... rejections are fewer... product performance is improved.

IMPORTANT. 'Baker Analyzed' Reagents have consistently met or exceeded the requirements of the electronics industry. Through a continuing program of establishing additional and more stringent specifications, the 'Baker Analyzed' label consistently defines a degree of purity so high that special electronic labeling is unnecessary.

YOURS FOR THE ASKING—

Important Guide to Electronic Chemicals

Describes J. T. Baker chemicals of exceptional purity for semi-conductors, vacuum tubes, ferrites, thermistors, etc. Also includes specification sheets that define the high standards for 'Baker Analyzed' Reagents. Write for your copy today.



J. T. Baker Chemical Co.

Phillipsburg, New Jersey

*Technology Instrument Corp. of Acton	182
*Texas Instruments Incorporated Semi-conductor Components Div.	40, 41, 95, 157
Tinnerman Products, Inc.	45
*Transitron Electronic Corp.	16
*Trio Labs, Inc.	125

*United Transformer Corp.2nd Cover

*Veeder-Root Inc. 34

Westinghouse Electric Corp.46, 47

* See Advertisement in the July 20, 1960 issue of Electronics Buyers' Guide for complete line of products or services.

Manufacturers' Representatives
MacDonald Inc., Samuel K. 180

CLASSIFIED ADVERTISING
F. J. Eberle, Business Mgr.

EMPLOYMENT OPPORTUNITIES.178-181

ADVERTISERS INDEX

Bausch & Lomb Inc.	180
Brenten Employment Agency	180
General Electric, Defense Systems Dept.	178
General Electric, Heavy Military Electronics Dept.	181
Horizons Incorporated	180
Houston Instruments Corp.	178
International Business Machines Corp.	179
McGraw-Hill Publishing Co.	180

This index and our Reader Service Numbers are published as a service. Every precaution is taken to make them accurate, but ELECTRONICS assumes no responsibilities for errors or omissions.

electronics



Audit Bureau
of Circulations



Associated Business
Publications

Audited Paid Circulation

BRUCE A. WINNER
Advertising Sales Manager

R. S. QUINT, Assistant Publisher Buyers' Guide and Business Manager; FRED STEWART, Promotion Manager; B. ANELLO, Marketing Service Manager; RICHARD J. TOMLINSON, Production Manager; GEORGE E. POMEROY, Classified Manager; HUGH J. QUINN, Circulation Manager.

ATLANTA M. Miller; HOUSTON Joseph A. Page; DALLAS Robert T. Wood, Frank LeBeau; LONDON Edward E. Schirmer; FRANKFURT Stanley R. Kimes; GENEVA Michael R. Zeynel.

BRANCH OFFICES: National Press Bldg., Washington 4, D.C.; McGraw-Hill Bldg., Copley Square, Boston 16; Four Gateway Center, Pittsburgh 22; Six Penn Center Plaza, Philadelphia 3; 520 North Michigan Avenue, Chicago 11; 55 Public Square, Cleveland 13; 255 California Street, San Francisco 11; 1125 West Sixth St., Los Angeles 17; 1740 Broadway, Denver 2; 1301 Rhodes-Haverty Bldg., Atlanta 3; 901 Vaughn Bldg., Dallas 1; Prudential Bldg., Holcombe Blvd., Houston 25; McGraw-Hill Publishing Co., Ltd., 34 Dover Street, London, England; B5 Westendstrasse, Frankfurt/Main; 2 Place de Part, Geneva.

ADVERTISING REPRESENTATIVES: NEW YORK Donald H. Miller, Henry M. Shaw, George F. Werner; BOSTON William S. Hodgkinson, Donald R. Furth; PITTSBURGH David M. Watson; PHILADELPHIA Warren H. Gardner, William J. Boyle; CHICAGO Harvey W. Wernecke, Martin J. Galloway; CLEVELAND P. T. Fegley; SAN FRANCISCO T. H. Carmody, R. C. Alcorn; LOS ANGELES D. A. McMillan, Marshall Freeman; DENVER J. Patten;



The **smallest rotary switch** ever made!

Daven's New Series G Sub-Miniature Switch...1/2" Diameter!

A new sub-miniature rotary selector switch, developed by DAVEN, is specifically suited for application in missiles, aircraft, handy talkies, field pack sets, frog-man communication equipment, and all types of mobile apparatus. This explosion-proof, waterproof switch has the same reliability as its bigger brothers . . . but in a fraction of the space. It meets applicable military specifications on temperature, humidity, corrosion, vibration, acceleration, shock and immersion.

This unit is available as a single pole, 10 position switch and can be obtained with up to four poles on a single deck.

Contact Resistance: Less than .008 ohm.

Contact Rating: 1 ampere, 250V D. C. into resistive load.
350 MA, 100V D. C. into inductive load.

Insulation Resistance: 200,000 megohms between any two terminals or between any terminal and shell.
Measured at 25° C., 50% RH, at sea level.

Life Expectancy: 50,000 cycles minimum
Shaft and case: Stainless steel
Panel and hub: Glass filled epoxy
Contacts and terminals: Silver alloy
Rotors: Rhodium plated beryllium copper

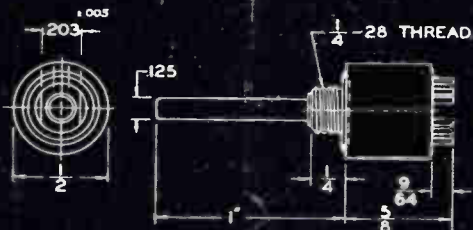

THE **DAVEN** CO.

LIVINGSTON, NEW JERSEY

*Write today for comprehensive technical report
on the new Series G Sub-Miniature Rotary Switch.*

TODAY, MORE THAN EVER, THE DAVEN © STANDS FOR DEPENDABILITY!

Now in 2 Case Sizes for
Your Computer Designs

TO-5



NOW SMALLER
IN TO-18 CASE

RCA Adds To The 2N1301 Family

THREE NEW MESAS IN THE TO-18 CASE

- Minimum Betas of 30, 40, 50
- Typical G-BP* of 40, 60, 80 Mc.
- Pulse Repetition Rates Up to 10 Mc.

NEW IN TO-18 CASE: RCA 2N794, 2N795, 2N796. IN TO-5 CASE: RCA 2N1300, 2N1301, 2N1683

Once again RCA meets the stringent demands of the dynamic computer industry with new high-speed switching transistors specifically designed for today's military and industrial data processing applications. Here are some of the outstanding features of these high performance types:

- **High Power-Dissipation Capability**—150 mw (max.) at 25°C.
- **High Gain-Bandwidth Product***—40 (2N1300, 2N794), 60 (2N1301, 2N795), 80 (2N1683, 2N796). (Typical Values).
- **High Beta (h_{FE})**—30 min. (2N1300, 2N794), 40 min. (2N1301, 2N795), 50 min. (2N1683, 2N796).
- **Low Total Stored Charge In Saturating Circuits**—400 $\mu\text{coulombs}$ (2N1300, 2N794), 325 $\mu\text{coulombs}$ (2N1301, 2N795), 160 $\mu\text{coulombs}$ (2N1683, 2N796). (Max. Values).
- **Rugged Mesa Structure**
- **Economy Performance**—Top Performance at Low Cost.

Contact your RCA Representative now for complete price and delivery information. For additional technical information, write RCA Semiconductor and Materials Division, Commercial Engineering, Section D-19-NN-4, Somerville, N. J.

Field Offices

EAST: Newark, N. J., 744 Broad St., HU 5-3900 • Erlton, N. J., 605 Marlton Pike, HA 8-4802 • Syracuse 3, N. Y., 731 James St., Room 402, GR 4-5591 • **NORTHEAST:** Needham Heights 94, Mass., 64 "A" St., HI 4-7200 • **SOUTHEAST:** Orlando, Fla., 1520 Edgewater Drive, Suite 1, GA 4-4768 • **EAST CENTRAL:** Detroit 2, Mich., 714 New Center Bldg., TR 5-5600 • **CENTRAL:** Chicago, Ill., Suite 1154, Merchandise Mart Plaza, WH 4-2900 • Minneapolis, Minn., 5805 Excelsior Blvd., WE 9-0676 • **WEST:** Los Angeles 54, Calif., Box 54074, RA 3-8361 • Burlingame, Calif., 1838 El Camino Real, OX 7-1620 • **SOUTHWEST:** Dallas 7, Texas, 7905 Carpenter Freeway, FL 7-8167 • **GOV'T.:** Dayton 2, Ohio, 224 N. Wilkinson St., BA 6-2366 • Washington, D. C., 1725 "K" St., N.W., FE 7-8500.

Available Through Your
RCA Distributor



The Most Trusted Name in Electronics
RADIO CORPORATION OF AMERICA