

electronics

*Transistor life test racks (below) are divided into modules
with independent power supplies and fail-safe protection, p 72
Designing sensing circuits with semiconductor strain gages, p 43*

A McGraw-Hill Publication 75 Cents



0 11 c
L
HOLAND KISSLER
BOX 956
MOSES LAKE WASH

BASIC



because...

It Measures

VOLTAGES

from 0.5 mv to 10v, dc

CURRENTS

from 0.005 μ a to 1 ma, dc

RESISTANCES

from 0.3 M Ω to 500 MM Ω

... it can also be used as a d-c amplifier with a current gain of over 16×10^9 ... use it as a "front end" to drive recorders and other instruments

- ✓ True direct-coupled amplifier design — no choppers, vibrators, or reeds to give mechanical trouble or get out of adjustment.
- ✓ High input resistance: 100 mega-megohms — does not load down sensitive circuits. Input resistance can also be set by switch to other values from 10^4 to 10^{11} ohms.
- ✓ Constant low voltage across unknown (9.1v) — no need for voltage coefficient corrections when making high resistance measurements.
- ✓ Output for 5-ma recorders.



**Type 1230-A D-C Amplifier
and Electrometer... \$440**

Write For Complete Information

GENERAL RADIO COMPANY

WEST CONCORD, MASSACHUSETTS

*The Best Instruments
In Electronics*

NEW YORK, WOrth 4-2722
NEW JERSEY, Ridgefield, WHitney 3-3140

CHICAGO
Oak Park
Village 8-9400

PHILADELPHIA
Abington
HAncock 4-7419

WASHINGTON, D.C.
Silver Spring
JUniper 5-1088

SAN FRANCISCO
Los Altos
WHitecliff 8-8233

LOS ANGELES
Los Angeles
HOLlywood 9-6201

IN CANADA
Toronto
CHerry 6-2171

electronics

A McGraw-Hill Publication 75 Cents



W. W. MacDONALD, Editor

J. M. CARROLL, Managing Editor
SENIOR ASSOCIATE EDITORS: Samuel Weber, Roland J. Charest. **ASSOCIATE EDITORS:** Frank Leary, Michael F. Tomalno, Sylvester P. Carter, William P. O'Brien, John F. Mason, William E. Bushor, Thomas Emma, Sy Vogel, Leslie Solomon, M. M. Perugini, George J. Flynn. **ASSISTANT EDITORS:** Michael F. Wolff, Nilo Lindgren, Stanley Proud, Stephen B. Gray, Roy J. Bruun, George V. Novotny, Leon H. Dulberger.
REGIONAL EDITORS: Harold C. Hood (Pacific Coast, Los Angeles), Thomas Maguire (New England, Boston), Cletus M. Wiley (Midwest, Chicago). **BUYERS' GUIDE EDITOR:** George Sideris. **ART DIRECTOR:** Harry Phillips; Howard R. Berry. **PRODUCTION EDITOR:** John C. Wright, Jr. **EDITORIAL ASSISTANTS:** Gloria J. Filipone, Arlene Rudd, Bernice Duffy, Lorraine Rossi, Virginia T. Bastlan, Lynn Emery, Avis Pomeranz, Florence Hajaistron.

JAMES GIRDWOOD, Publisher

BUSINESS

Market Growing for Space-Tracking Gear. What's needed	20
How Value Analysis Cuts Costs. Organizational guidelines	23
Mutual Funds Buy More Electronics Stocks. Suvey shows rise	26
Scanner Translates Tape Data to Film. New processing unit	28
Biomedical Engineering Course Set Up. Educational news	33
Crosstalk	4
Washington Outlook	14
Comment	6
Meetings Ahead	34
Electronics Newsletter	11

ENGINEERING

Locks and interlocks prevent fluctuations in power or unauthorized changes in test conditions in transistor life test racks. See p 72	COVER
Semiconductor Strain Gages Offer High Sensitivity. Gage factors of nearly 200 obtainable. By R. E. Talmo	43
Phantastron Circuits Using Transistors. They require more than one transistor to do the job. By N. C. Hekimian	46
Measuring Thickness of Paramagnetic Coatings. New technique measures plating thickness By P. Dick	48
Simulator Tests Radar Tracking Systems. Checks performance under dynamic target conditions. By O. B. Mitchell	51
Medical Electronics Part III: Therapeutic Devices. Equipment and techniques for treating diseases and alleviating pain. By W. E. Bushor	54
Common-Mode Rejection in Wideband D-C Systems. Differential amplification with data signal amplifiers. By J. L. Kimball	61

DEPARTMENTS

Research and Development. Missile Provides Wind Profiles	64
Components and Materials. Applying Insulated Wires	68
Production Techniques. Design Upgrades Transistor Tests	72
New on the Market	78
People and Plants	84
Literature of the Week	83
Index to Advertisers	91

A clear, solventless liquid, General Electric clear LTV-602* cures at 75-80°C to form a resilient compound with excellent electrical properties. Even thick sections are perfectly transparent. Useful from -65 to 175°C, this self-supporting material provides protection against thermal shock, vibration, moisture, ozone, dust and other hazards.

*Low Temperature Vulcanizing

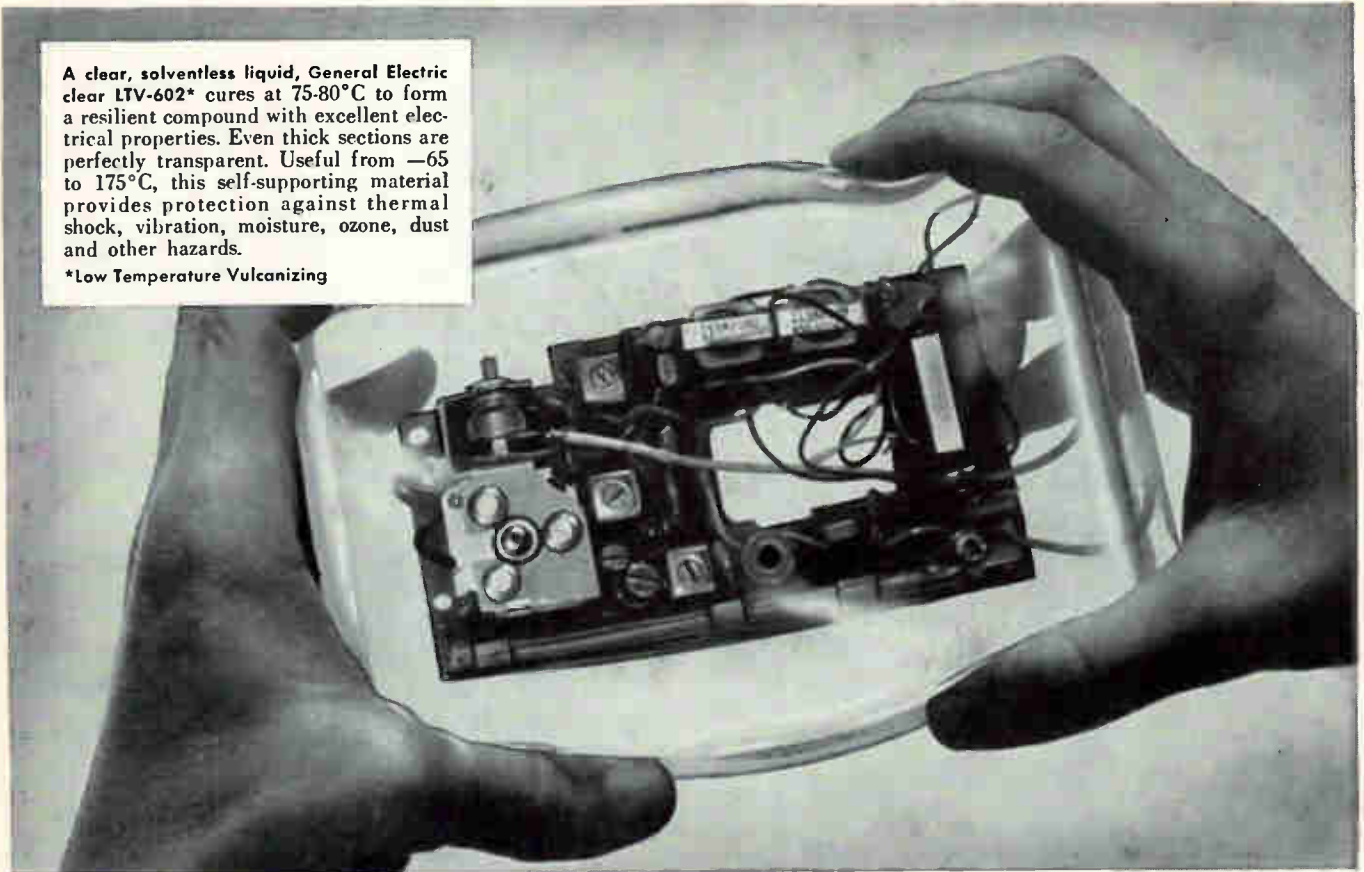

General Electric clear LTV silicone compound for potting and embedding

Transparent, resilient, self-supporting and easy to repair

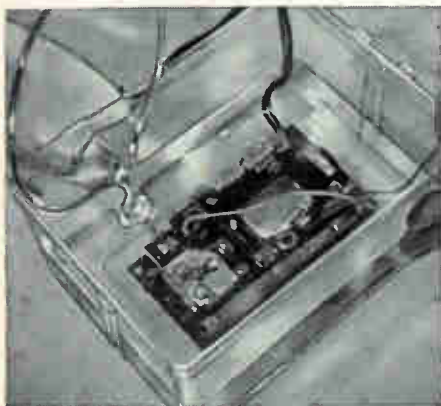

LTV-602 is easily applied, flows freely in-and-around complicated parts. Having a low viscosity in the uncured state, 800-1500 centipoise, LTV is ideal for potting and embedding of electronic assemblies. Unlike "gel-like" potting materials, LTV-602 cures to a flexible solid. Oven cure is overnight, or from 6 to 8 hours at 75 to 80°C.

LTV-602 is easy to work with and easy to repair. To repair parts embedded in LTV, merely cut out and remove section of material, repair or replace defective part, pour fresh LTV into opening and cure. Pot life, with catalyst added, is approximately 8 hours and may be extended with refrigeration. When desirable, LTV may also be cured at room temperature.

Resiliency offers excellent shock resistance. LTV-602 easily meets thermal shock tests described in MIL-STD-202A test condition B which specifies five temperature cycles from -65 to 125°C. Tests indicate that LTV retains protective properties even after 1800 hours aging at 175°C. Other tests confirm LTV's resistance to moisture and water immersion.

LTV-602 is the newest addition to the broad line of G-E silicone potting and encapsulating materials which also include the RTV silicone rubbers. For more information, write to General Electric Company, Silicone Products Department, Section N240, Waterford, New York.

GENERAL  ELECTRIC



73720

*Arnold Pulse Transformer
Cores are individually tested*

under actual pulse conditions

Here's
technical data on

**ARNOLD
SILECTRON
CORES**

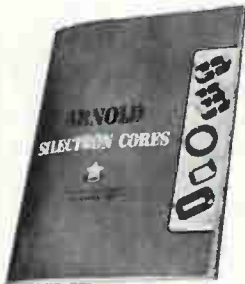

Bulletin SC-107 A

... this newly-reprinted 52-page bulletin contains design information on Arnold Tape Cores wound from Silectron (grain-oriented silicon steel). It includes data on cut C and E cores, and uncut toroids and rectangular shapes. Sizes range from a fraction of an ounce to more than a hundred pounds, in standard tape thicknesses of 1, 2, 4 and 12 mils.

Cores are listed in the order of their power-handling capacity, to permit easier selection to fit your requirements, and curves showing the effect of impregnation on core material properties are included. A valuable addition to your engineering files—write for your copy today.

The inset photograph above illustrates a special Arnold advantage: a 10-megawatt pulse-testing installation which enables us to test-prove pulse cores to an extent unequalled elsewhere in the industry.

For example, Arnold 1 mil Silectron "C" cores—supplied with a guaranteed minimum pulse permeability of 300—are tested at 0.25 microseconds, 1000 pulses per second, at a peak flux density of 2500 gauss. The 2 mil cores, with a guaranteed minimum pulse permeability of 600, receive standard tests at 2 microseconds, 400 pulses per second, at a peak flux

density of 10,000 gauss.

The test equipment has a variable range which may enable us to make special tests duplicating the actual operating conditions of the transformer. The pulser permits tests at .05, .25, 2.0 and 10.0 microsecond pulse duration, at repetition rates varying anywhere from 50 to 1000 pulses per second.

This is just another of Arnold's facilities for better service on magnetic materials of all description.

● Let us supply your requirements.
*The Arnold Engineering Company,
Main Office & Plant, Marengo, Ill.*



ARNOLD
SPECIALISTS in MAGNETIC MATERIALS

BRANCH OFFICES and REPRESENTATIVES in PRINCIPAL CITIES
Find them FAST in the YELLOW PAGES

ADDRESS DEPT. E-2

Published weekly, with Electronics Buyers' Guide and Reference issue, as part of the subscription, by McGraw-Hill Publishing Company, Inc. Founder: James H. McGraw (1860-1948).

Title registered U.S. Patent Office; Copyrighted 1961, McGraw-Hill Publishing Company, Inc. All rights reserved, including the right to reproduce the contents of this publication, in whole or in part.

Executive, editorial, circulation and advertising offices McGraw-Hill Building, 330 West 42nd Street, New York 36, N. Y. Telephone Longacre 4-3000. Teletype TWX N.Y. 1-1636. Cable McGrawhill, N.Y. Printed in Albany, N. Y.; second class postage paid.

OFFICERS OF THE PUBLICATIONS DIVISION: Nelson L. Bond, President; Shelton Fisher, Wallace F. Traendly, Senior Vice Presidents; John R. Callahan, Vice President and Editorial Director; Joseph H. Allen, Vice President and Director of Advertising Sales; A. R. Venezian, Vice President and Circulation Coordinator.

OFFICERS OF THE CORPORATION: Donald C. McGraw, President; Joseph A. Gerardi, Hugh J. Kelly, Harry L. Waddell, Executive Vice Presidents; L. Keith Goodrich, Vice President and Treasurer; John J. Cooke, Secretary.

Subscriptions are solicited only from those actively engaged in the field of the publication. Position and company connection must be indicated on orders. Subscription rates: United States and Possessions, \$6.00 one year; \$9.00 two years; \$12.00 three years. Canada, \$10.00 one year. All other countries \$20.00 one year. Single Copies, United States and Possessions and Canada 75¢; Buyers' Guide \$3.00; Single Copies all other countries \$1.50; Buyers' Guide \$10.00.

The Publisher, upon written request from any subscriber to our New York Office, agrees to refund that part of the subscription price applying to copies not yet mailed.

Subscribers: Please address all correspondence, change of address notices, subscription orders or complaints to Fulfillment Manager, Electronics, at above address. Change of address notices should provide old as well as new address, including postal zone number if any. If possible, attach address label from recent issue. Allow one month for change to become effective.

Postmaster: Please send Form 3579 to Fulfillment Manager, Electronics, 330 West 42nd Street, New York 36, New York.



Audited Paid Circulation

CROSSTALK

FRENCH PLASMA RESEARCH. Continuing his engineer's tour of Europe, **ELECTRONICS'** Editor W. W. MacDonald (left) discusses new developments in plasma research with Pierre Guenard. Guenard is technical director of the Centre d'Etudes de Physique Electronique et Corpusculaire, one of the major research establishments operated by France's largest electronics manufacturer, the Compagnie Generale de Telegraphie sans Fils, more commonly known as CSF.



The center is located at Corbeville, about ten miles southwest of Paris overlooking the valley of the Chevreuse. A chateau built in 1585 serves as the administrative building for the center. Pascal is reputed to have stayed at the chateau, thus anticipating by several centuries the arrival of CSF's electronic physicists.

MEDICAL ELECTRONICS. Part III of Associate Editor Bushor's series on medical electronics (p 54) covers therapeutic devices. Oldest application of electronics to medicine is, of course, the x-ray. Wilhelm Roentgen delivered a paper reporting on his discovery on Dec. 29, 1895; the world was informed on Jan. 6, 1896. Just one day later the technique was put to use diagnostically by another scientist in locating a needle in a patient's hand. Exactly one month after Roentgen's announcement, Emil Grubbe used x-rays to treat a woman patient for breast cancer. These events probably represent the shortest discovery-to-application time in the history of science. The fact that x-rays could cause burns was observed immediately after their discovery, but it was Oct. 2, 1902 before the cancer on the back of the right hand of a man working in an x-ray tube factory in Germany was attributed to x-ray exposure. It was 1928 before the International Commission on Radiological Protection was established to deal with the problem of protection from x-ray exposure.

Coming In Our March 3 Issue

THIN FILM MEMORIES. Thin ferromagnetic films offer many advantages in the fabrication of digital computer memory planes operating in the nanosecond range. Use of thin films in high-speed memories was described by E. E. Bittmann of Burroughs Corp. in our issue of June 5, 1959 (p 55). Next week, Bittmann discusses the design of thin film memories, pointing out that new vapor deposition techniques have overcome uniformity problems. The memory planes use nickel-iron films 2,000 angstroms thick, and have cycle-time capabilities of 0.2 microsecond.

Incidentally, recent **ELECTRONICS** articles dealing with magnetics and thin film memories include: p 78, Sept. 9, 1960; p 81, Jan. 13, 1961; and p 126, Feb. 17, 1961.

TUNNEL DIODE-TRANSISTOR LOGIC. Isolation is a problem in the use of tunnel diodes in high-speed logic circuits. In our next issue, R. W. Lade of Marquette University in Milwaukee describes a logical building block termed tunnel diode-transistor logic that combines the high switching speed of the tunnel diode with the isolation properties of conventional transistor circuits. Lade reports that switching speeds of 0.7 nanosecond have been observed.



On the ground, or high in the sky, Raytheon's line of rugged diode rectifiers gives dependable arc-free operation.

Example: Raytheon 583, one of seven Raytheon half-wave rectifier types. Operating as a clipper diode at altitudes to 36,000 feet, maximum ratings are 15,000 volts PiV, 8 amperes peak plate current. Arc-free clipping action makes sure a magnetron can be fired once *without* re-firing automatically or uncontrollably!

The reliability of Raytheon diode rectifiers is the result of exceptional care in design and manufacture . . . with no compromise in quality control. Gold-plated plates and zirconium coatings assure reliable operation at high voltages. Cathodes are heliarc welded. Higher exhaust temperatures mean less gas and longer life. For more information on Raytheon's growing line of dependable diode rectifiers, please write: Raytheon, Industrial Components Division, 55 Chapel Street, Newton 58, Massachusetts.

**GET PEAK
POWER
WITH
RAYTHEON
RUGGED,
ARC-FREE
DIODE
RECTIFIERS**

For Small Order or Prototype Requirements, See Your Local Franchised Raytheon Distributor

RAYTHEON COMPANY

INDUSTRIAL COMPONENTS DIVISION

RAYTHEON DIODE RECTIFIERS

TYPE	SERVICE	HEATER		MAX. PLATE RATINGS		
		VOLTS	AMPS	PEAK INVERSE (VOLTS)	PEAK CURRENT (AMPERES)	AVERAGE CURRENT (AMPERES)
583*	H. W. RECT. (to 36,000 ft.) CLIPPER DIODE (to 36,000 ft.)	2.5	4.9	17,000	0.250	0.065
		2.5	4.9	15,000	8.0	0.240
3B24W } 3B24WA }	H. W. RECT. (HALF FIL.) (FULL FIL.)	2.5	3.0	20,000	0.150	0.030
		5.0	3.0	20,000	0.300	0.060
3B26	CLIPPER DIODE	2.5	4.75	15,000	8.0	0.020
3B29	H. W. RECT. (OP. 1) (OP. 2) (OP. 3) CLIPPER DIODE	2.5	4.9	16,000 7,700 5,000	0.250 0.300 0.300	0.065 0.080 0.095
		2.5	4.9	10,000	8.0	0.018
4B31*	H. W. RECT. CLIPPER DIODE	5.0	5.0	16,000	0.470	0.150
		5.0	5.0	16,000	12.0	0.060

*Mil-Std-200E Preferred Type



DYNASERT

**Installs Small
or Large Components
up to
10 Times Faster**

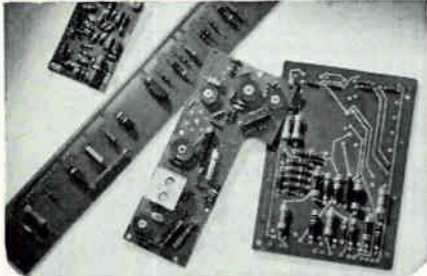

Components in PW boards as small as .032" diameter can be installed with Dynasert machines. If your production is as little as a few hundred insertions a week you should consider Dynasert. Components can be inserted with leads bent to follow circuit in any direction. Obtain superior quality through precise insertions with Dynasert. Write for descriptive 12 page booklet.

United

UNITED SHOE MACHINERY CORPORATION
140 Federal Street, Boston, Mass.

CIRCLE 200 ON READER SERVICE CARD

DYNASERT

**HELPS SPEED
MODEL
CHANGEVER
IN PW BOARDS**

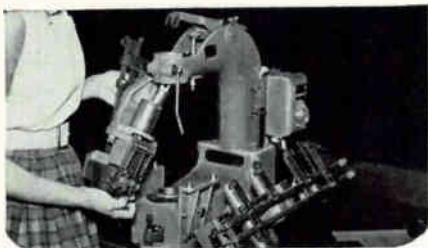

In a matter of minutes, you can get a new production run under way with Dynasert. Little or no re-tooling costs are involved.

Only Dynasert machines give you that extra flexibility you need to keep pace with today's fast moving, ever changing PW board applications. Even sample runs can be made economically. Send for the complete story on machines available. Write for descriptive 12 page booklet.

United

UNITED SHOE MACHINERY CORPORATION
140 Federal Street, Boston, Mass.

6 CIRCLE 6 ON READER SERVICE CARD

COMMENT

Academically Speaking

I am writing to propose a new project for ELECTRONICS to tell the electronics world about the work of the universities and especially about their openings for teachers.

Most professors nowadays go into teaching direct from school, with the result that the schools tend to be inbred. A professor of electrical engineering really ought to have industrial experience. There is a tremendous difference between engineering as she is taught and as she is practiced. But once a man goes into industry he is lost to us. Even if we can pay him a salary that is attractive, we cannot attract his attention.

The proposal is that you establish a department, coequal with your Research and Development department and the others, devoted to what the schools are doing and to their openings. Carry brief articles by professors and department heads or by your staff.

As things go now, industry is rich and we are poor. Yet industry needs the universities. We are going to have to look to industry for some pretty concrete help if we are to continue with our job.

JOHN G. TRYON

UNIVERSITY OF ALASKA
COLLEGE, ALASKA

Since Nov. 20, 1959, we have run a department called Academically Speaking from time to time (see p 33). This department carries some of the material reader Tryon suggests, although it is not a weekly event, and although it does contain other matter.

Actually, the situation doesn't seem to be universally bad as far as recruiting and keeping university professors is concerned. In fact, some industrial employers have told us that they are concerned about losses from their engineering staffs to universities.

We are thoroughly in accord with reader Tryon's opinions and will continue to support them.

Comment on Comment

It would be helpful if persons using the Comment columns of

ELECTRONICS were to identify the article they are commenting about. A case in mind is the column of Jan. 27 (p 6), which refers to the effects of microwave interaction with the human body. A search of back issues did not disclose whether the writer was merely commenting in general, or if he had a specific issue at hand.

ROBERT L. FARROW

OHIO STATE UNIVERSITY HEALTH
CENTER
COLUMBUS, OHIO

If we may presume to speak for H. R. Meahl—who wrote the letter cited by reader Farrow—we can say that his note referred to no specific article in this or any other publication, but rather to the whole literature, dating back to our "Researching Microwave Health Hazards" (p 49, Feb. 20 '59), and more specifically to his own excellent work in the field.

Medical Electronics

I have found your recent Medical Electronics articles (p 49, Jan. 20, and p 46, Feb. 3) of great interest, in particular the applications of ultrasonics in medicine. I would especially like to know what has been done in the field of treatment of mineralized deposits—gall-bladder and kidney stones—with ultrasonic energy.

It seems that the problem is one of the destruction of the deposits without harm to the intermediate tissue. Possibly gallstones are particularly susceptible to one frequency or band, selective enough to limit exposure to other organs. We might find a combined diagnostic and treatment device which first locates stones by sonar-type reflections, then analyzes the echoes, selects the appropriate frequency, and finally tunes or focuses the radiating probe to the correct depth.

Perhaps such techniques lie very close in the future—or are even now in use.

FRED W. CHESSON

M B ELECTRONICS
NEW HAVEN, CONN.

The third in the series of Medical Electronics articles (p 54) covers this subject, but not quite from reader Chesson's viewpoint.

for the first time in air tool history Cleco offers--



Trademark

EXCLUSIVE ONE YEAR WARRANTY

... on Clecomatic screwdrivers
and nutrunners!

New Cleco warranty—the first one year warranty ever offered—is effective now on CLECOMATIC Golden Circle Air Tools

Performance Superiority Leads to Warranty. Extensive tests and industry usage have proved that CLECOMATIC screwdrivers and nutrunners assure the operator of trouble-free performance in the most rigorous and exacting jobs. In view of these outstanding performance results, Cleco management and engineers offer this unprecedented one year warranty—fully confident that CLECOMATIC screwdrivers and nutrunners will continue to provide trouble-free operation for all industries.

Look For The Golden Circle. For quick identification of trouble-free CLECOMATIC screwdrivers and nutrunners, Cleco will designate these tools Golden Circle Air Tools, a new symbol for quality workmanship. At present, No. 6 and No. 10 Series CLECOMATIC non-angle head screwdrivers and nutrunners will carry the one year warranty of Golden Circle Air Tools.

CLECOMATIC screwdrivers and nutrunners included in this line are the No. 6 SA, 6 RSA, 6 SAP & 6 RSAP (in speeds of 1000, 2000 & 3000 rpm); and the No. 10 SA, 10 RSA, 10 SAP & 10 RSAP (in speeds of 500, 1000, 1500 & 3000 rpm).

What One Year Warranty Means. Cleco's exclusive one year warranty assures the buyer that Golden Circle Air Tools are guaranteed for one year from date of purchase to be free from defects in workmanship and material under normal operating conditions. Warranties are included with each product purchased. To redeem your warranty simply return the tool to your nearest Cleco division or branch office, or direct to the factory in Houston, Texas.

Why Is CLECOMATIC The Best? • Positive, completely automatic torque control. • Air is automatically turned on when work is engaged. • Air is automatically cut off at pre-set torque. • Lowest air consumption of any air tool of comparable size and capacity because motor can run only while on work. • Non-friction clutch and no-drift locking device maintains constant torque. • Practically no torque reaction. • Built-in automatic oiler on pistol grip handles.

Call your nearest Cleco office or representative for complete information. In your next air tool order, be sure to specify Clecomatic Golden Circle Air Tools.

"quality tools engineered for industrial progress"

A Division of Reed Roller Bit Company • P. O. Box 2541/Houston 1, Texas, U. S. A.

IN CANADA: Cleco Pneumatic Tool Company of Canada, Ltd., 927 Millwood Road, Leaside (Toronto), Ontario

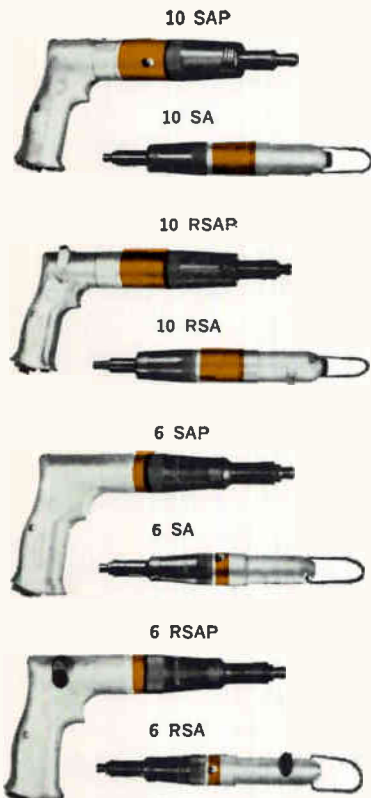



Complete RF Detector





Ⓜ R422A



Two new  developed mounts offer unique combination of wide band-width, low SWR and high sensitivity for general-purpose and reflectometer uses!

Flat frequency response and excellent sensitivity for rf detection are yours with the new  K422A (18 to 26.5 GC) and R422A (26.5 to 40 GC) Waveguide Crystal Detector Mounts.

These broadband instruments cover the frequency range 18 to 40 GC, and provide the same excellent square-law detection characteristics as lower frequency  crystal mounts. The unique advantages of the 422A are made possible by  design and production of the internal crystal and the detector mount as an integrated unit.

 422A extends the coverage of  coaxial and waveguide rf signal detectors while maintaining low SWR and high detection efficiency. General-purpose rf detector uses include mixer applications. Excellent frequency response (± 1 db maximum full range) and true square-law characteristics make the  mounts ideal for swept-frequency reflectometer applications extending to 40 GC.

SWR: Less than 2.5. Sensitivity: .05 v per mw. Square law characteristics: ± 1 db (-3 dbm to -40 dbm).

 K422A, 18.0 to 26.5 GC, \$200.00;  R422A, 26.5 to 40 GC, \$200.00.



Ⓜ K422A



WORLD LEADER IN PRECISION WAVEGUIDE INSTRUMENTATION!

Coverage to 40 GC!



hp 420A Coaxial Crystal Detector Mount, 10 MC to 12.5 GC

Detects rf signals over a three decade frequency range from 10 MC to 12.5 GC. Sensitivity is approximately $0.01 \sqrt{0.1 \text{ mw}}$, and frequency response is $\pm 3 \text{ db}$ over the full range. Maximum SWR is 3:1.

Ⓢ 420A, \$50.00.

hp 420B Coaxial Reflectometer Mount

Identical to the Ⓢ 420A in frequency range, the Ⓢ 420B is available in pairs matched to within $\pm 1 \text{ db}$ over the range 1 to 4 GC.

Ⓢ 420B, \$75.00; \$150.00 per matched pair.



hp 485 Waveguide Barretter Mounts, 2.6 to 12.4 GC

Reflectometer Mounts—characterized by flat frequency response, low SWR, true square-law characteristics and high sensitivity, the broadband 485D Waveguide Barretter Mounts are supplied with factory selected barretters for maximum accuracy in reflectometer applications.

Ⓢ S485D, 2.6 to 3.95 GC, \$185.00; Ⓢ G485D, 3.95 to 5.85 GC, \$170.00; Ⓢ J485D, 5.2 to 8.2 GC, \$170.00.

General Purpose Mounts—Ⓢ S485A, 2.6 to 3.95 GC Fixed Tuned Barretter Mount, \$165.00; Ⓢ 485B Tunable Detector Mounts, covering 3.95 to 12.4 GC, use either barretters for lowest SWR or silicon crystals for highest sensitivity. (Detectors not supplied.) Ⓢ G485B, 3.95 to 5.85 GC, \$95.00; Ⓢ J485B, 5.85 to 8.2 GC, \$90.00; Ⓢ H485B, 7.05 to 10 GC, \$85.00; Ⓢ X485B, 8.2 to 12.4 GC, \$75.00.



hp 421A Waveguide Crystal Detector Mounts, 7.05 to 18.0 GC

Silicon diodes are employed in these mounts for better SWR characteristics at higher waveguide frequencies. Frequency response $\pm 2 \text{ db}$ maximum over full range, square-law characteristic $\pm 1 \text{ db}$.

Matched pairs are available for reflectometer applications. Ⓢ H421A, 7.05 to 10 GC, \$95.00 each, \$210.00 per matched pair; Ⓢ X421A, 8.2 to 12.4 GC, \$75.00 each, \$170.00 per matched pair; Ⓢ M421A, 10.0 to 15 GC, \$125.00 each, \$270.00 per matched pair; Ⓢ P421A, 12.4 to 18.0 GC, \$130.00 each, \$280.00 per matched pair.

hp 440A Detector Mount

For use in coaxial or waveguide systems, the Ⓢ 440A covers 2.4 to 12.4 GC. The mount uses either 1N21 or 1N23 silicon crystal, 1/100 amp instrument fuse or Sperry 821 barretter. (Detector element not furnished as part of instrument.) With the Ⓢ 442B Broad Band Probe (not shown), the 440A becomes a sensitive, easily tuned detector for slotted waveguide sections. Ⓢ 440A, \$85.00; Ⓢ 442B, \$40.00.



HEWLETT-PACKARD COMPANY

1064A Page Mill Road Palo Alto, California, U.S.A.
Cable "HEWPACK" Davenport 6-7000

Sales representatives in all principal areas

HEWLETT-PACKARD S.A.

Rue du Vieux Billard No. 1
Cable "HEWPACKSA"

Geneva, Switzerland
Tel. No. (022) 26. 43. 36

Data subject to change without notice. Prices f.o.b. factory

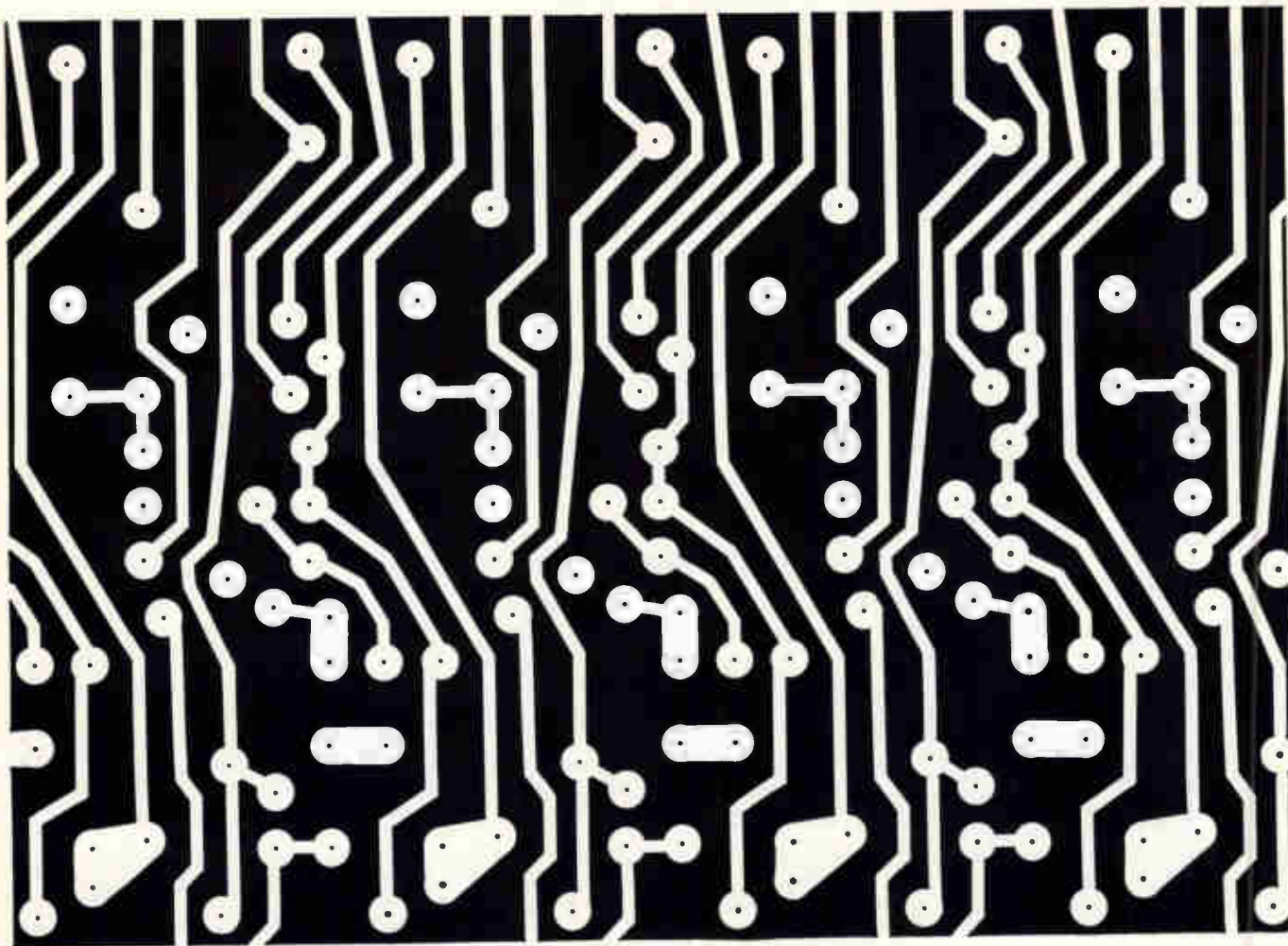

Now Electralab circuits on DIELOX base can take 900° F.

Your printed circuits with Electralab's new Dielox Process* will have these impressive advantages:

1. Withstand continuous temperatures in excess of 900° F.
2. Bond strengths available in excess of 100 pounds.
3. Dielox does not smash, crack, scratch, craze or fracture in any size or thickness.
4. Dielox has superior thermo-dimensional stability; exacting fabricating dimensions can be maintained.
5. No warpage.
6. Dielox can be formed for three-dimensional circuitry.
7. Exceptionally high dielectric strength and insulation resistance.
8. Dielox base can be color-coded for identification.
9. With Dielox, the entire base can be utilized as a heat sink and ground.

With the new Dielox base, Electralab offers a versatile range of printed circuit services. Manufacturing facilities are flexible, allowing long or short production runs, and fabrication of limited quantities. Electralab is geared to produce virtually every type of printed wiring board with related printed circuit assemblies. For further information and literature, write: E. P. E. C., a Farrington affiliate.

See DIELOX at the I. R. E. Show,
March 20 through March 23,
Booth 2130.

Electralab Printed Electronics Company
NEEDHAM HEIGHTS 94, MASS.

A SUBSIDIARY OF

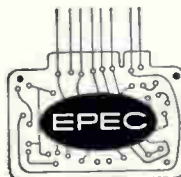

* Letters Patent Pending

ELECTRONICS NEWSLETTER

Defense Research Stresses Materials

RECENT REPORTS from Defense Department research organs show continued interest in materials research. Air Force, for instance, has sponsored investigations of new high-temperature semiconductors, including compounds of cadmium-sulfur, cadmium-selenium, zinc-tellurium, and mixed crystals of cadmium-sulfur and cadmium-selenium. Compounds of metals and tungsten trioxide were also studied. Discovery that aluminum boride is a semi-conductor with large activation energy is one result of one of the programs.

Another report recommends expansion of ceramics research because ceramics are expected to fill in the research area beyond refractory metals.

A new group of materials with ferroelectric properties — called ferrielectrics—has been discovered. First member of the new group was found in the mixed crystal of two antiferroelectric materials—sodium niobate and sodium vanadate. The material exhibits high nonlinearity, appears to have a switching field similar to that of magnetic materials, shows a Curie point of 375 C. Ferrielectrics may be useful as computer elements at high temperatures.

Soviet Venus Probe Measures Space Conditions

SOVIET UNION'S successful Venus probe is measuring the parameters of space in several ways. Tass reports that scientific equipment aboard is designed to study cosmic radiation, magnetic fields and interplanetary matter, and to count micrometeorite collisions. A temperature-control system is keeping cabin ambient at workable levels for the instruments.

Radio gear measures the movement of the probe relative to the earth, according to Tass, and relays the results of the measurement, and of other experiments, to listening posts in the Soviet Union. Operation of the instruments is

also checked and reported.

Records are kept on magnetic tape. During playback—on interrogation—the instrument package is fed by chemical power cells which are recharged constantly from solar cells. A solar orientation system keeps the sunpower pickups turned always to the sun. The instruments had been interrogated twice prior to Feb. 14; all systems were reported operating as planned. Schedule calls for communication every five days.

The probe, launched from a 6-ton satellite, weighs 643.5 kilograms (over 1,400 lb), transmits on 922.8 Kc on command.

Heavy gag put by Washington on space surveillance centers tracking the probe has dried up information that had trickled out. What apparently scared the Pentagon was that if the 6-ton midspace launching platform could fire a 1,400-lb probe out from the earth to intercept Venus in May, it could fire it the other way with far less difficulty. A Soviet academician pointed out this capability last week.

Competition Widens For Magnetic-Tape Market

IN A MOVE that the industry has been expecting for a couple of years, Eastman Kodak announced last week that it will manufacture and sell magnetic recording tape, beginning later this year.

Kodak Pathe, the firm's French affiliate, has been producing and selling tape in European markets for 12 years.

Initially, Kodak will supply sound-recording tape on triacetate base in quarter-inch rolls. Research is going forward on instrumentation and digital quality tapes. Kodak will use its regular distribution organization to sell tape products.

Tunneling Observed In Titanium-Dioxide Film

RESEARCHERS at Republic Aircraft report tunneling in thin-film microcircuit sandwiches at room

temperature. Experiments have resulted in development of a tunnel diode of thin-film dimensions which does not require supercooling.

Thin-film sandwich is made by capturing titanium vapor on a strip of glass. Special oxidation technique deposits a film less than a millionth of an inch thick.

Tunneling had previously been reported in supercooled lead and aluminum thin-film sandwiches using aluminum-oxide as a dielectric layer. When the dielectric layer is less than a millionth of an inch thick, charge carriers in other than forbidden energy states can tunnel through the barrier.

Japanese Develop Small Videotape Recorder

JAPAN'S fast-moving Sony Corp. has announced completion of a videotape recorder, dubbed Videocorder, which is about a fourth the size of standard units.

Videocorder uses 2,400 ft of standard 2-in. videotape which travels at 7½ inches a second and can record 66 minutes worth of video information. Recorder unit is about 3 x 3 x 2 ft, weighs 440 lb, consumes 500 w. Unit uses 96 transistors, 101 diodes.

Standard 525-line signal on 60-cycle interlace is accepted as input. Sony claims a resolving power of 280 lines. Video carrier is 2.8-3.5 Mc, recording is flat ±2 db from 0 to 2.5 Mc, and signal-to-noise ratio is 36 db. The equipment will be seen in this country at the International IRE Show next month.

Demonstrate Pulse-Code Television System

NATIONAL BUREAU OF STANDARDS researcher W. C. Coombs demonstrated a system for coding tv picture information in digital-pulse form to the Washington, D. C., chapter of the Institute of Radio Engineers last week.

Coombs pointed out that digitizing the information and transmitting it in coded form extends transmission range, since the pulse data can be reconstituted at the receiver. His system will find application in transmitting pictorial

data from space.

At the IRE meeting, Coombs described methods achieving creditable fidelity without usual bandwidth expansion.

See \$100-Billion Business In Space Communications

SPEAKING IN WASHINGTON last week, Lloyd V. Berkner, new president of the Institute of Radio Engineers, predicted that worldwide communications using space satellites would be a \$100-billion-a-year business within ten to fifteen years. He also said that business methods will change radically with "cheap and unlimited radiotelephonic and telegraphic communications by this method."

Berkner added that the time for engineers to work toward ensuring an adequate technical underpinning for forthcoming regulation is now. When a business reaches such giant size, he said, "watch out for international disagreements on surveillance."

Imports From Britain Decline Moderately

U. S. IMPORTS of electronic products from the United Kingdom in the first nine months of 1960 totaled \$13.7 million, a 3-percent drop from the equivalent period of 1959.

Data supplied the Business & Defense Services Administration by British Radio Equipment Manufacturers Association show sharp declines in shipments of record-players and parts, moderate declines in electron tubes and radio receivers. Gains were chalked up in the areas of commercial electronics, test equipment, medical electronics, recording tapes.

Soviet Rockets Study Solar Eclipse

SOVIET SCIENTISTS launched a series of geophysical rockets last Wednesday to investigate the total eclipse of the sun. The rockets carried high-altitude automatic "geophysical stations" to study radiation from the solar corona in the various parts of the spectrum,

and dispersion of solar radiation in the atmosphere. Telemetry gear radioed the data to earth; photographs and spectographs were recovered from parachuted capsules.

Instruments lofted in the rockets included spectrograph, spectrometers, photometers, electrophotometers, proton counters, X-ray quantum counters and other radiation gages.

Rockets were launched before, during and after the eclipse to obtain profiles of the effect of the solar and coronal radiation.

Telemetry System Trebles Prior Transmission Range

MISSILE AND SPACE VEHICLE department of General Electric has completed an experimental version of a telemetry system that is expected to be able to beam signals from space three times as far as systems now flying. System is one of a family dubbed Synchrolink; Synchrolink gear uses pulse-code modulation with phase-shift keying, contains error-correction codes, is said to require far less power than conventional systems of equivalent range.

Double-sideband suppressed-carrier r-f signal is received in a synchronous receiver followed by a correlation detector. Use of the threshold-free synchronous receiver permits detection of signals at signal-to-noise ratios of about -10 db.

Vote-at-Home System Would Use Computers

MICHIGAN STATE UNIVERSITY political scientist R. M. Goldman suggested last week that the "antiquated technology of our voting procedures" be replaced with a system in which the voter would telephone his ballot to a computer central which would verify and count his ballot.

The voter would dial a special code number, listen for a signal that the computer was ready, and, by dialing additional codes, enter his vote. At the end, he would dial a terminating code; up until this point, he could alter or correct his vote. The system would read back

to him—before he dialed the terminating code—how his ballot had been cast.

"All that is needed," Goldman says, "is a well constructed and well instructed computer plus a simple system of codes for dialing the vote."

Electronic Dust-Smasher Keeps Walls Clean

ELECTRONIC SYSTEM to bombard dust particles overlooked in conventional air-conditioning systems was introduced last week at Chicago's Heating & Air-Conditioning Exposition.

System was developed by CRS Industries, Philadelphia, uses screens carrying a strong static charge working with an ion generator. Ion bombardment shatters dust particles; aerosols discharged under negative ionization then mingle with the dust particles dislodged by local air currents to ionize them before they can be attracted to wall surfaces.

Moon-Bounce Delayed By Frigid Weather

UNSEASONABLE temperatures in the northeastern U. S. delayed a moon-bounce experiment. MIT's Lincoln Laboratory was planning to bounce some millimeter-wave signals off the moon; severe cold cracked a 28-ft spuncast parabolic reflector (**ELECTRONICS**, p 41, Jan. 6).

For next optimum periods—last two weeks of March and April—a new spuncast dish is being fabricated. Meanwhile, Lincoln has borrowed from MITRE Corp. an antenna which "with luck" may give adequate gain. Researchers are using 50-w K-band transmitter and 8-mm maser developed at the Lab, will try the bounce at night to avoid attenuation in the atmosphere.

In another moon-bounce experiment, National Aeronautics & Space Administration deputy chief Hugh Dryden talked from Washington to an Australian government minister in Woomera, Australia. Moon-hop used the Goldstone, Calif., and Woomera space-tracking antennas as terminals.

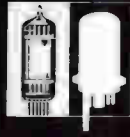

Bendix Craftsmanship at work for you

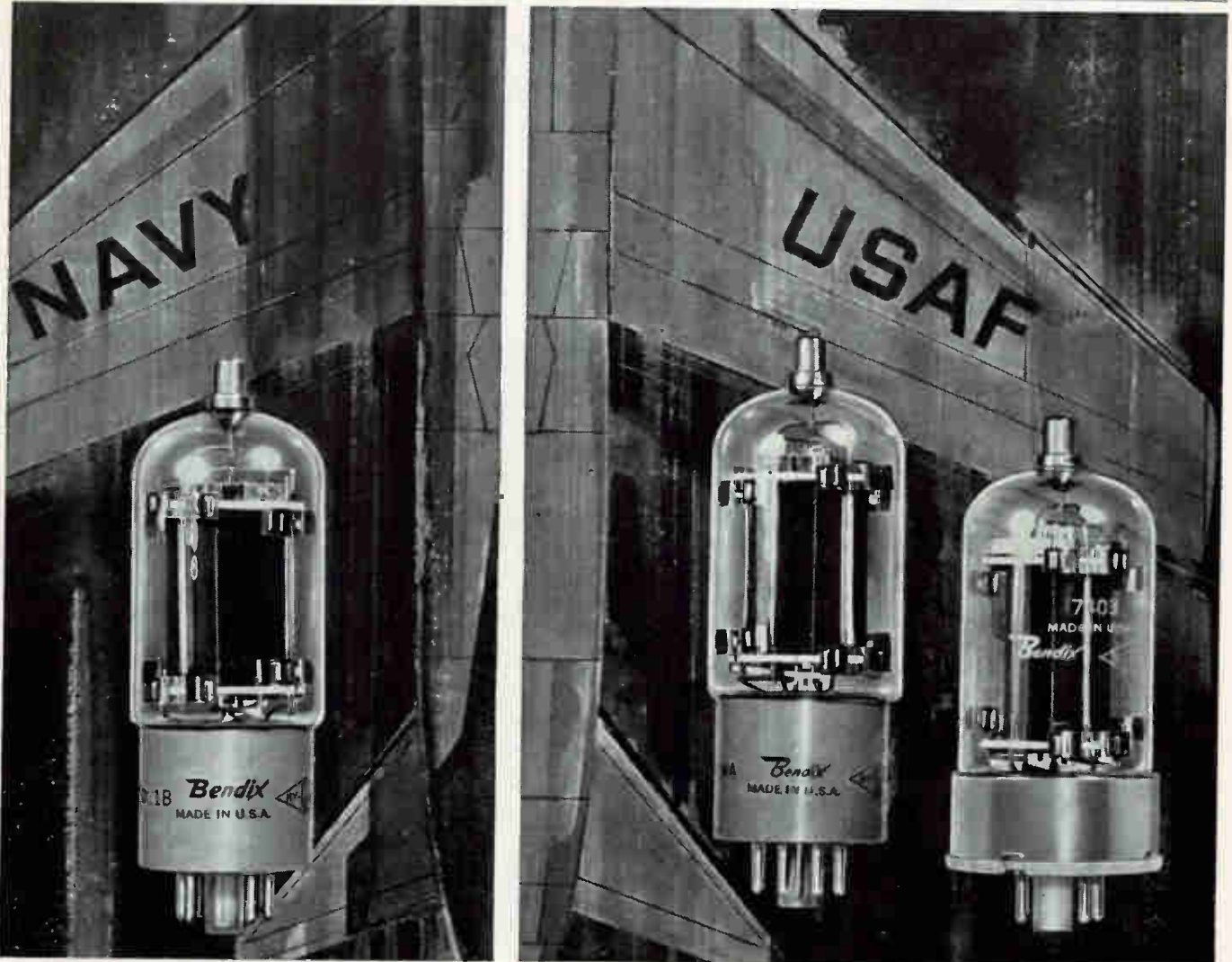

BENDIX® HIGH-ALTITUDE, ARC-FREE, PULSE POWER TUBES

are reliable, hard glass beam tetrodes. These high-perveance beam amplifier tubes are part of the Bendix Hy-G-300® line. Types 3D21B (designed to Navy specifications), 3D21WA (designed to Air Force specifications), and their specially ruggedized counterpart, type 7403, are dependable in high-current, high-voltage pulse service. Type 7403, designed to Air Force specifications, is compact and specially constructed to function durably in high-altitude jet aircraft. For further information, write . . .

ELECTRON TUBE PRODUCTS

Red Bank Division

EATONTOWN, NEW JERSEY



SPRAGUE PIEZO- ELECTRIC CERAMIC ELEMENTS

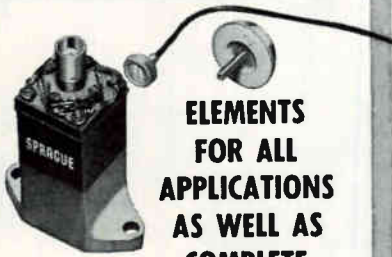

**ELEMENTS
FOR ALL
APPLICATIONS
AS WELL AS
COMPLETE
TRANSDUCER ASSEMBLIES
FOR MOST APPLICATIONS,
SUCH AS UNDERWATER
SOUND AND
VARIOUS ORDNANCE AND
MISSILE DEVICES.**



Sprague-developed mass production and quality-control techniques assure lowest possible cost consistent with utmost quality and reliability. Here too, complete fabrication facilities permit prompt production in a full, wide range of sizes and shapes.

Look to Sprague for today's most advanced ceramic elements—where continuing intensive research promises new material with many properties extended beyond present limits.



**YOUR INQUIRIES
ARE INVITED**

**WRITE FOR
LITERATURE**

SPRAGUE ELECTRIC COMPANY
35 Marshall Street, North Adams, Mass.

SPRAGUE®
THE MARK OF RELIABILITY

WASHINGTON OUTLOOK

SLIGHT DECLINE in imports of electronic goods—notably transistor radios from Japan—is predicted by government economists. This will be part of a general trend in which overall shipments of foreign products here are expected either to level off or to drop.

They predict a \$14-billion level in imports this year, \$600 million under the 1960 volume. But they're not ready to give precise figures on specific commodities. The major factor in their forecast: the domestic recession. The general rule of thumb used is that in times of recession, imports tend to drop; in times of economic boom, imports usually rise. There are always exceptions, however, depending on country and product.

Washington also believes the economy of Western Europe has nearly peaked, that the boom will begin leveling off in West Germany and Japan. Officials also cite rising labor costs overseas that will force up prices of many import goods.

In transistor radios, officials here feel U. S. producers are building lower-cost sets that will dent the large demand for the Japanese product in this country.

But some industry estimates of overall imports exceed the government forecasts. The National Foreign Trade Council, for instance, predicts about \$15 billion in imports this year, slightly higher than 1960. The major difference in the estimates lies in interpretations of the current business recession.

A STUDY TO HELP electronics companies find new plant sites has been started for the Commerce Dept. by Arthur D. Little, Inc. It's part of a general project to aid growth industries to relocate. The study will include data on markets, raw materials, transportation and labor. It is to be completed by midsummer.

AIR FORCE'S drive to force contractors to cut costs is paying off. Lt. Gen. Mark E. Bradley, Jr., Deputy Chief of Staff for Material, reports that a study of major contractors shows tangible cost reductions of over \$500 million over a period of two or three years. These have been accomplished through better pricing and subcontracting, use of value analysis, overhead cost reductions, and improved cost control.

Still, the Air Force is dissatisfied with the results. Of some 400 suppliers surveyed, going into first and second-tier subcontractors, 67 percent of source selections were said to have been made on a sole source basis—too many of them not documented. The Air Force wants more competition on subcontract awards and better documentation where primes consider sole sources necessary.

The survey also alleges that 65 percent of the companies inadequately analyzed the costs and prices of subcontractor proposals.

SHAKEUP in Post Office Dept. research and development programs, which are geared to electronic controls, is in the works. J. Edward Day, the new Postmaster General, says his department will trim financing of R&D. New equipment will still be sought, he says, but only after it has been developed privately.

The Eisenhower budget for fiscal 1962 earmarks some \$12 million for postal R&D, \$2 million more than this year. Day is studying individual projects closely. Guessing is that this will mean cutbacks in the budget. The department's R&D director, Wade S. Plummer, has already resigned.

Development of the facsimile speed-mail program may be dropped. Reports are that industry is pressuring hard against the system. Little has been done on the project since the Fall when test transmissions were made between Washington, D. C., Chicago, and Battle Creek, Mich.

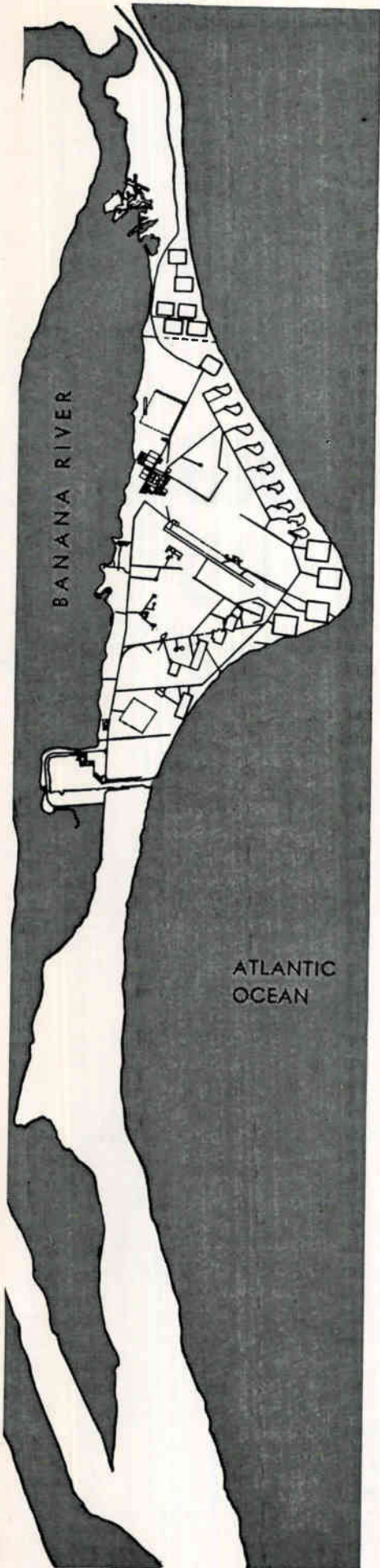

“INTERDICT”

Silencing the Skies at Canaveral

... and what it means to you

Cape Canaveral, a serious r-f interference problem, and a group of experienced Capehart engineers. This was one salient phase in the operation we call “INTERDICT,” for Interference Detection and Interdiction by Countermeasures Team. The exact nature and reason for this operation, and the engineering service that is now available to all r-f installations, comprise our story...

You probably already know of the r-f interference experienced at the Cape: the large number of radiating and receiving equipments there were creating undesirable field conditions. Origin of these conditions was unknown. Capehart's engineers were asked to analyze all the site's r-f sources—radars, telemetry links, communications equipment, etc.—and to predict and determine the interference sources. What they found is now history. Many of the spurious signals stemmed from higher harmonics of radar and communications systems. Once these had been defined and located, and other sources of rfi also isolated, the engineers of INTERDICT recommended ways to still the noise, so that the skies over Canaveral could be silenced.

Next: Vandenberg. After their mission at Cape Canaveral, the Capehart engineers were called to Vandenberg Air Force Base. Once again, r-f radiation was causing interference and hazard problems. Once again, the Capehart INTERDICT team went to work: performed field measurements, analyzed spurious signals for carrier frequency and source, analyzed instrumentation and all r-f equipments functioning at Vandenberg. As a result of Capehart's recommendations and countermeasures, the noise could be silenced at Vandenberg, too.

If you have site problems or r-f interference on any military or industrial communications-electronics equipments, the engineers from Operation INTERDICT are at your service. Their background in this field is unparalleled, and their experience and knowledge of all current types of equipment can now be offered to all. This is the first such service we know of, and we're proud to make it available.

Note: As you well know, interference and noise can come from a variety of sources. Spurious transmitter and receiver signals are close to inevitable in electronics installations of any complexity. Our function is to determine what is interfering with what, and to take the correct remedial action. We also perform diagnoses as to possible electromagnetic radiation hazards to personnel, squibs, ammo or fuel, and suggest the proper remedies for these hazards.

In short, Capehart's INTERDICT service is performed in compliance with all applicable MIL Specifications and systems requirements. INTERDICT, under the direction of Dr. Joseph H. Vogelmann, offers you complete, world-wide, packaged services for the prediction, detection and elimination of r-f interference, personnel and material hazards. To learn more about these services contact:

CORPORATION

INTERDICT GROUP, Dept. C, CAPEHART CORPORATION
87-46 123rd Street, Richmond Hill 18, New York • HIckory 1-4400

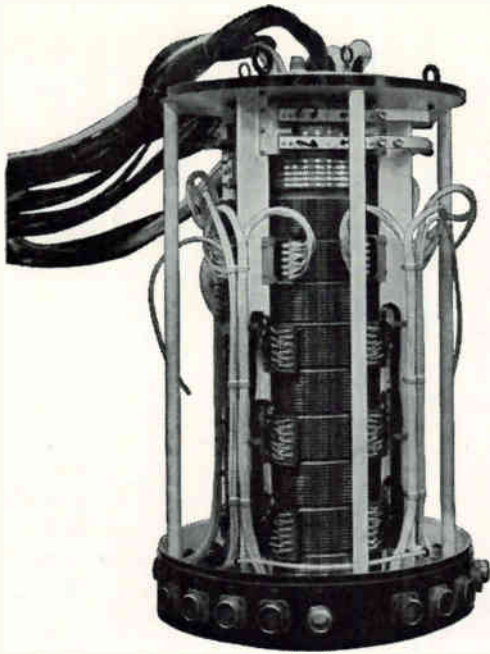

SEND FOR A COPY OF 28-PAGE CATALOG 66SR WHICH PROVIDES OPERATING DATA ON BREEZE CUSTOM UNITS AND DRAWINGS AND SPECIFICATIONS OF ALL STANDARD SLIP RING ASSEMBLIES.

COMBINING CUSTOM AND STANDARD SLIP RING ASSEMBLIES

FOR LOWER COSTS—FASTER DELIVERY

This slip ring assembly controls, powers and monitors the centrifuge arm of a motion simulator. Its production required the combination of highly creative engineering skills, well-equipped manufacturing facilities and diversified production methods available to you at Breeze.

The unit, having a duty cycle of 2000 amps, is only 48" high, yet contains 425 slip rings. These include both standard rings and rings engineered for this application. There are rings of flat and cylindrical design, electroplated rings and rings of fabricated construction in the assembly.

Whatever your slip ring requirement, it can be met without compromise at Breeze.

For general applications, Breeze offers a line of field-proven standards with ring envelope diameters from 1" through 10½". These are flat, fabricated assemblies built from off-the-shelf components to insure rapid delivery at reduced costs.

For custom applications including general purpose control and power, radio frequency and video, high voltage, high speed instrumentation and switching, Breeze produces flat, cylindrical or concentric assemblies using all standard construction methods, fabricated, electroplated and plastic molded.

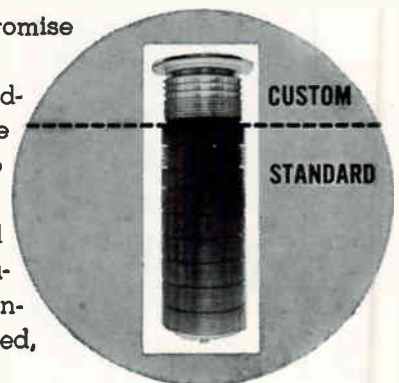

BREEZE CORPORATIONS, INC.

700 Liberty Avenue, Union, New Jersey • Telephone: MURdock 6-4000

Manufacturers of electrical, electro-mechanical and hydro-mechanical components and systems and fabricated metal products.

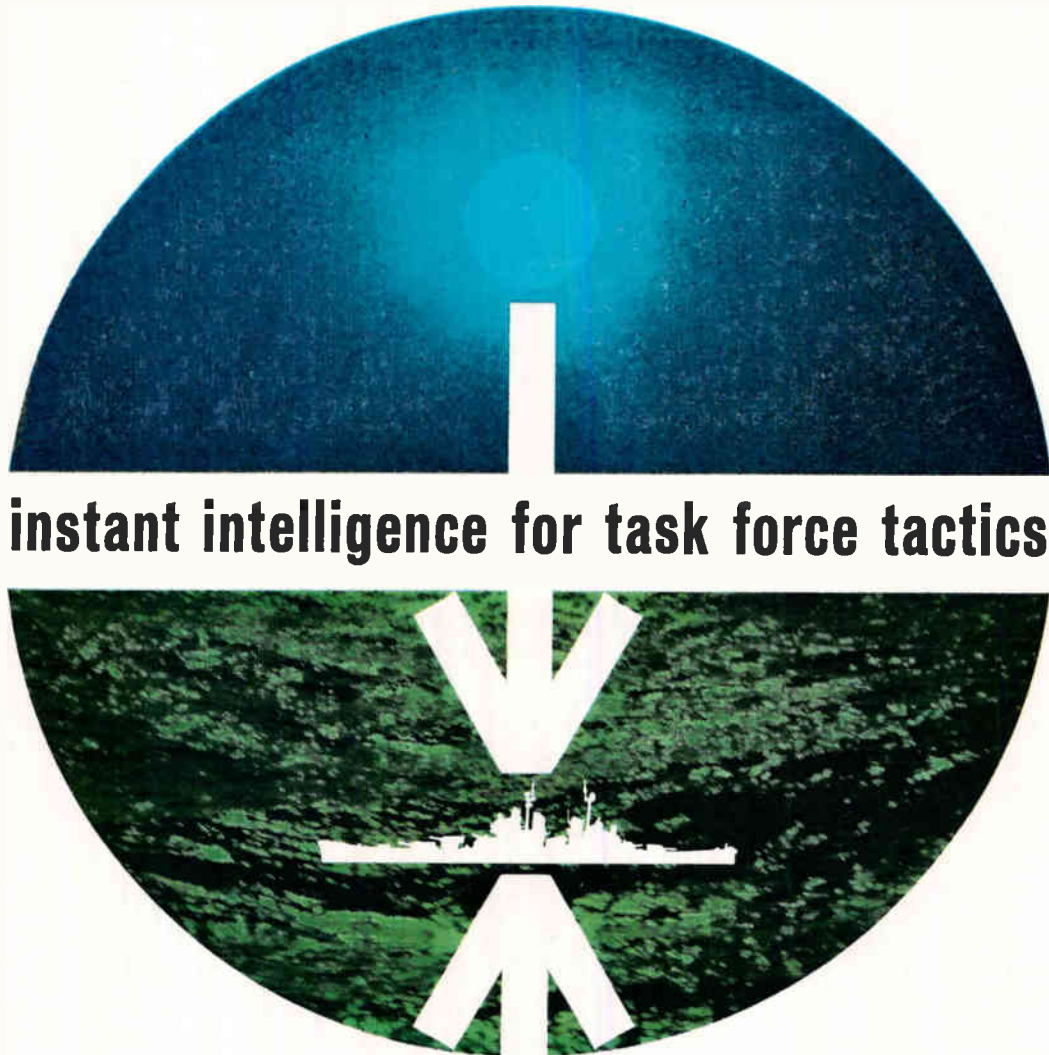

instant intelligence for task force tactics

New Data Interchange System Tightens Naval Fleet Coordination The new Naval Tactical Data System will permit a task force, dispersed over a 300 mile area, to be operated by its commander with the same flexibility and tactical control he exercises over his flagship. Information from radar, sonar and other sensing sources gathered by all surface and airborne elements of the task force will be continuously displayed, providing intelligence for directing missile-launching functions, reconnaissance operations and tactical maneuvers.

Alpha is providing system engineering and management for the channeling of the intelligence data from each unit's computer and the transmitting by single sideband radio to like computers in each other unit of the force. This computer-to-computer instant sharing of intelligence is the heart of NTDS.

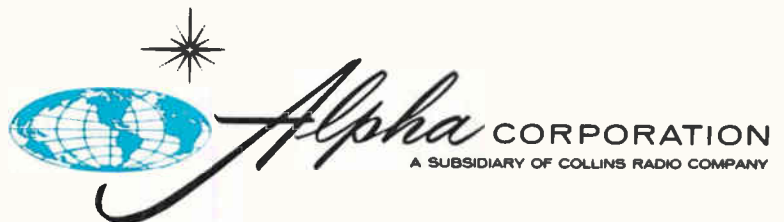

SYSTEMS DESIGNERS, ENGINEERS, CONSTRUCTORS, WORLD - WIDE • RICHARDSON, TEXAS • TELEPHONE DALLAS ADams 5-2331

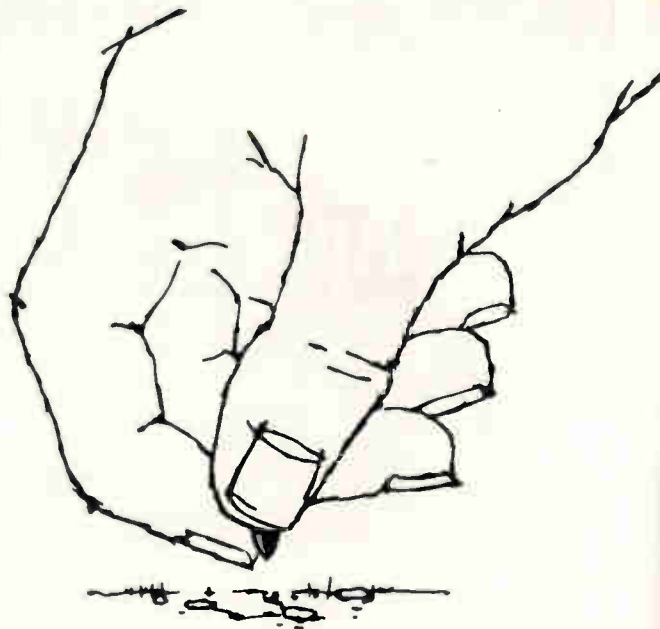

planting for tomorrow

You've heard of the "hard sell" and the "soft sell" — but many of our advertisers are also interested in the "long sell".

This is *planned* advertising. You might call it "planting for tomorrow".

The sales seed in an advertising message bears abundant fruit if sown in fertile ground . . . readers of this publication, for example, who, in *buying* this issue, have demonstrated their interest in what we have to say.

As a member of the Audit Bureau of Circulations*, our circulation records have been audited and the facts published — by this impartial organization of advertisers, advertising agencies, and publishers. These bedrock facts about our circulation audience can help you to plan more productive advertising.

Is your own planned selling based on circulation facts? You can be ABC-sure. Ask to see a copy of our latest circulation report.

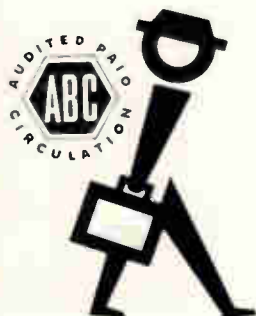

electronics

A MCGRAW-HILL PUBLICATION • 330 W. 42nd ST. • NEW YORK 36, N. Y. 

* Through the reports issued by the Audit Bureau of Circulations, this publication, along with other publisher members of ABC, voluntarily and regularly give the buyers of advertising more verified factual information than is available for any other advertising media at any time.

How To Design High Performance Voltage Regulator For Military Applications

TRANSISTORIZED DC REGULATOR

NOMINAL CHARACTERISTICS:

Input - 75 volts DC
 Output - 50 volts DC - 0 to 400 ma
 Output Impedance - less than 0.25 ohms
 Operating Temperature - -55°C to $+125^{\circ}\text{C}$

REGULATION CHARACTERISTICS:

0.01% output change per 15% input change
 0.2% output change from no load to full load
 0.5% output change from -55°C to $+125^{\circ}\text{C}$

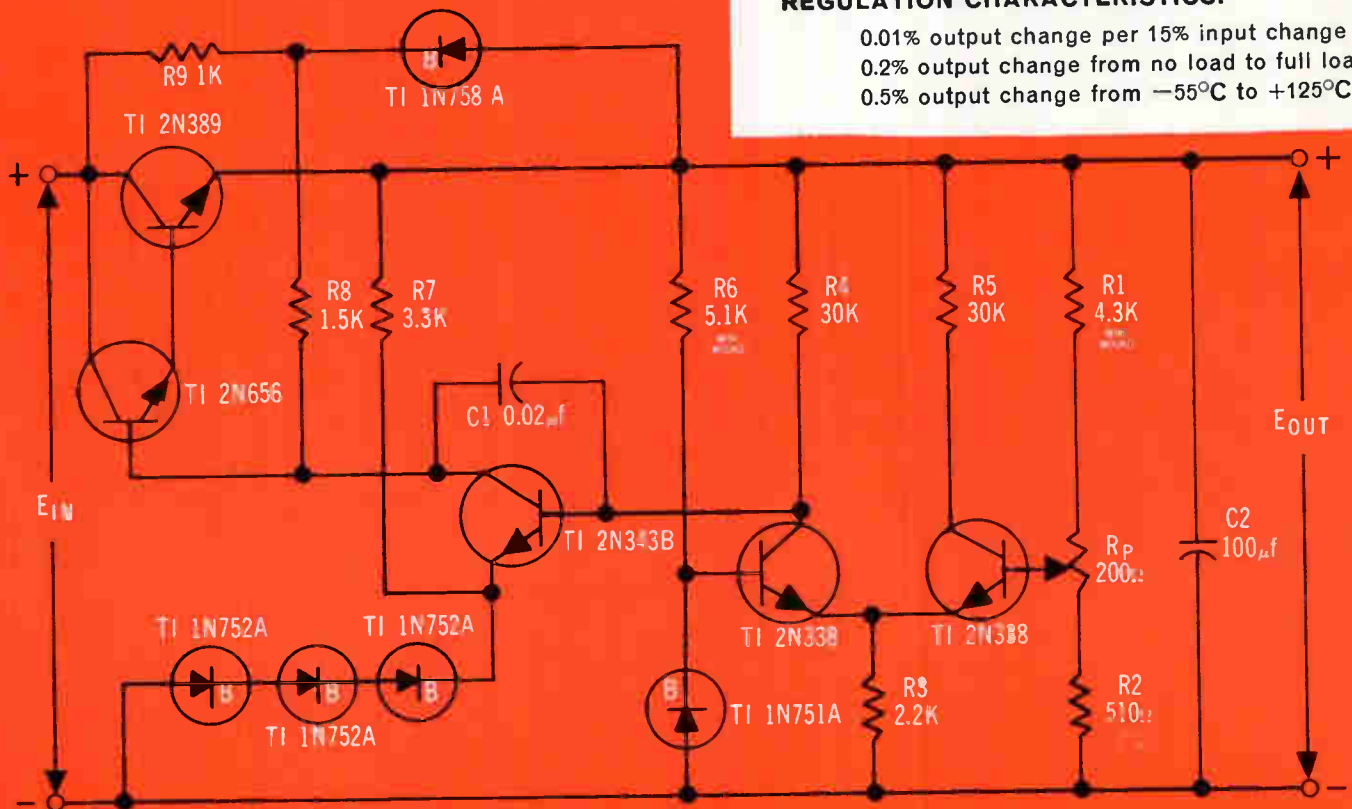

NOTE: All composition fixed resistors are TI MIL-LINE precision carbon film types, RN65B or RN70B.

...with TI MIL-TYPE Semiconductors & Components

You can depend on your circuits to give the high performance/high reliability/low maintenance you demand when you design-in TI semiconductors and components. The DC regulator circuit above contains... transistors which meet or exceed MIL-S-19500B... diodes which meet or exceed MIL-E-1/1258... resistors which meet or exceed MIL-R-10509C. ■ Your TI sales engineer is qualified to assist you in selecting TI devices and components to meet your particular military design requirements. ■ Get your personal copies of TI Application Report, "DC Regulator Power Supply Design" and TI Application Note, "Silicon Transistor Voltage Regulator Overload Protection" by writing on your company letterhead to Military Marketing, Dept. M-1, Texas Instruments Incorporated, P. O. Box 5012, Dallas 22, Texas.

TI MIL-TYPE semiconductors and components are immediately available "off-the-shelf" from TI's national distributor network.

SEMICONDUCTOR-COMPONENTS DIVISION
TEXAS INSTRUMENTS
 LIMITED
 DALLAS ROAD • BEDFORD, ENGLAND
 INCORPORATED
 P. O. BOX 5012 • DALLAS 22, TEXAS

MARKET

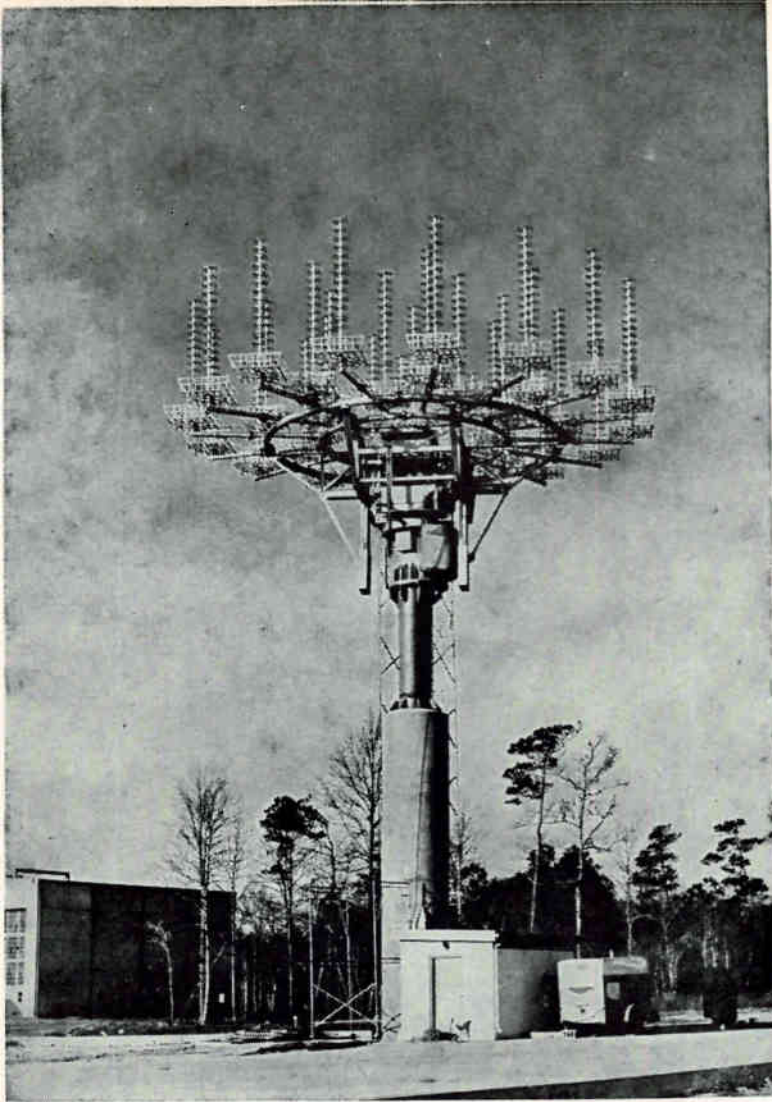

New 40-ft, 33-element end-fire antenna at NASA's Wallops Island receives signals from test rockets

This article reports on today's and tomorrow's needs, both in quantity and in new-equipment design

By JOHN F. MASON, Associate Editor

DURING THE 1960's, the increased activity in space will require a corresponding buildup in ground equipment facilities. Existing systems will be retrofitted and new networks built. R&D and production contracts for tracking, data collection, communications, command control and computation equipment will be a growing business.

The 32 or more pieces of hardware orbiting the earth today (ten of them are transmitting) may increase to 150 to 200 (with at least 40 of these sending data back to earth) by the 1965 to 1970 period.

Main buyers of equipment are the National Aeronautics and

Space Administration and the Defense Department.

NASA's ground networks are needed for vertically fired sounding or research rockets, earth satellites, manned earth satellites and deep space probes. NASA estimates it will need \$38,650,000 for R&D and \$16,811,000 for construction of ground tracking facilities in new fiscal year 1962 appropriations. If this amount materializes, NASA will have received about \$176½ million for ground tracking and data acquisition facilities during the three-year period, 1960-1962.

Control center for computing, data reduction and communications for all of NASA's networks is the

Goddard Space Flight Center, Greenbelt, Md. The communications links tying the stations together are leased commercial facilities and military networks. The annual bill is about \$8 million.

Besides NASA's ground facilities for sounding rocket firings at Wallops Island, Va., the agency uses four space tracking networks all of which are continuing markets for equipment:

(1) Minitrack, a north-south fence of 14 interferometer-type stations, tracks unmanned earth satellites orbiting in an east/west direction. The system measures a satellite's angular position by radio signals from a small beacon transmitter on the satellite. Data are recorded and transmitted to Goddard. The system requires several hours to determine a satellite's orbital pattern. Total cost of Minitrack to date is about \$16 million.

NASA plans to equip all Minitrack stations with an automatic data read-out system to permit transmitting digital tracking data directly from the tracking station to Goddard. This will increase station tracking capabilities by 50 percent.

New large dishes will be added to Minitrack to accommodate the Orbiting Astronomical Observatory satellite (OAO) scheduled for launching between 1963 and 1965. (ELECTRONICS, p 36, Oct. 28, 1960.)

NASA will also install an 85-ft antenna next to the Fairbanks, Alaska station for polar orbiters such as the Nimbus meteorological satellite.

(2) Under technical direction of the Smithsonian Astrophysical Observatory, NASA contracts for a second network composed of 12 Baker-Nunn camera sites that photograph a satellite against a star background. Though more accurate than radio, optical systems have two disadvantages: First, tracking is limited to certain periods of the day, dependent upon twilight conditions which vary with the latitude and time of year; this restriction might be alleviated by

GROWING FOR SPACE-TRACKING GEAR

adding a flashing light on the satellite. Second, data processing is time consuming. The solution here is in making procedures more automatic.

Design of a photoelectric optical tracking system has begun which, NASA says, is more sensitive than existing photographic systems and provides data instantaneously.

(3) The Mercury man-in-orbit project will track with an 18-site radar tracking network installed by Western Electric. It has cost over \$53 million to date.

Major equipment consists of tracking radars, telemetry and vehicle communication facilities, and a ground communications and data transmission system. (ELECTRONICS, p 30, Oct. 7, 1960).

(4) For deep space probes, the Jet Propulsion Laboratory has established the Deep Space Instrumentation Facility (DSIF) for NASA. This network consists of a station in Goldstone, Calif.; Woomera, Australia; and Krugersdorp, South Africa, to be operational this spring; and a mobile station. Capital cost \$17 million.

The fixed stations are designed to provide continuous coverage for spacecraft at altitudes above 10,000 mi. The mobile station fills in from low-altitude injection to the 10,000 mi altitude.

The present network uses 85-ft parabolic antennas and 890/960-Mc phasecoherent transmission.

NASA also uses, under contract, the 250-ft parabola at Jodrell Bank, England which tracked Pioneer V out to 23 million miles.

The low frequency used by Jodrell, as well as other radio telescopes (100 to 400Mc), is not the most desirable for long-range space communications. JPL has contracted Hughes, Blaw-Knox, North American and Westinghouse to design a parabolic reflecting surface for a 250-ft dish to an accuracy of $\frac{1}{4}$ in for transmissions in the 2,300-Mc band. Given the same power source and antenna on a spacecraft, a 250-ft antenna would increase the information rate

returned by a factor of 10 over the present 85-ft antenna. Designs are to be completed by late spring. Production contract should be awarded in fiscal year 1962. NASA would like one of the big dishes at each of its three deep-probe sites.

Eberhardt Rechtin, JPL's director of the program, foresees a continuing opportunity for business in the following areas: modulators and demodulators (phase-coherent synchronous f-m, or synchronous binary); ground antenna angle servo and control systems; microwave optics (spacecraft and ground); transmitters (spacecraft, transistorized, 2,300 Mc, 1-25 w radiated; ground 2,100 Mc, 20-100 Kw); and receivers (phase-locked low temperature, 2,300 Mc, 10 Mc bandwidth); wideband telemetry (1-10 Mc); velocity equipment (high-precision digital readouts); general test equipment.

Rechtin also cites equipment needed for which there is at present only limited industrial capability: (1) coders (pseudo-noise, digital, transistorized, 1-Mc rate), precision ranging; (2) logic circuits (acquisition, verification data se-

lecting, replacement), ranging, command, data; (3) unique spacecraft antennas (arrays, unfurlable, accurate - $\frac{1}{8}$ -in., 30-ft diameter or equivalent); (4) transponders (transistorized, except, probably, for the final r-f power amplifier, reliable acquisition, extremely long life); must outlast almost all other equipment aboard; (5) ranging equipment (coders range tally equipment, search and acquisition circuits); (6) quick-reaction equipment (flexibility, quick change, simple tuning, general purpose recording, intended to exploit unexpected events or to increase capability in short bursts); automatic checkout and calibration of DSIF stations; (7) advanced ground antennas.

Areas which could lead to hardware a few years from now, Rechtin says, include: giant antennas, digital telemetry, secure coded digital command systems, automatic radar acquisition, telemetry from very deep space, adaptive nonlinear control systems for large ground antennas and optical communications (only limited applications are seen at the present time).

Pulsed X-Ray Permits Microsecond Exposures

DEVELOPMENT of a pulsed x-ray system capable of making cineradiographs with microsecond exposure times only 1/4,000th second apart was announced recently by Zenith Radio Research Corp.

System produces visible images that can be viewed directly, monitored on closed-circuit tv, or photographed on conventional film. Stop-motion photos of a bullet in flight taken at inch intervals were shown.

Major component of the system is a new hot-cathode x-ray tube developed by Zenith. Tube has a life in excess of a million shots, can repeat pulse length and shape, can produce 30 pulses of high power x-ray per second continuously for

serial photography. System uses an image-intensifier tube developed by Rauland Corp., a Zenith subsidiary.

Philippines to Get Troposcatter Net

AIR FORCE will install a tropospheric scatter radio telephone network in the Philippine Republic.

The system, developed by Dynamics Corporation of America, will be able to carry 72 telephone conversations, will be relatively impervious to the static and fading of the western Pacific's tropical storms.

The troposcatter net was developed under a \$1-3-million contract from Air Research & Development Command, will connect four U. S. air bases in the Philippines.

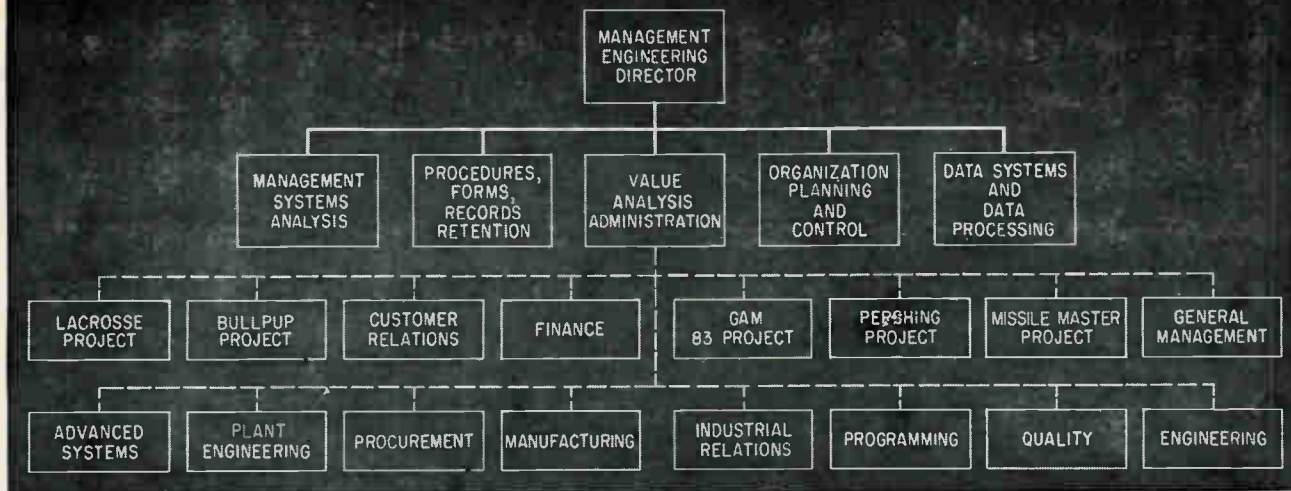

Value engineering organization at Martin's Orlando division

HOW VALUE ANALYSIS CUTS COSTS

VALUE ENGINEERING is doing things from a cost standpoint that under normal circumstances would not be done economically.

So said George T. Willey, vice president and general manager of Martin Orlando at the Value Analysis-Engineering Seminar for Missile Systems held at Redstone Arsenal, Huntsville, Ala. late last year.

Some 400 persons representing missile contractors and government agencies attended the seminar, which was sponsored jointly by the Army Ballistic Missile Agency and Martin.

Close study of recently-released details of the proceedings of the conference reveals interesting techniques in value engineering and significant results attained.

For example: at GE's Heavy Military Equipment department, four annual value analysis seminars are conducted. Participants work in four-man groups each including an electrical engineer, mechanical engineer and two non-technical people representing marketing, finance, personnel or the like.

The groups work on actual engineering projects, get drawings, tooling and planning data, specs and costs.

Recommendations coming out of these seminars in one year saved \$150,000 on projects worth \$700,000.

One team examined the voltage-standing-wave-ratio tripout chassis

for high-powered acquisition radar developed for the Nike-Hercules. This unit protects the radar's klystron transmitter from power reflected from the antenna. The team recommended changes such as designing one full-wave bridge rectifier to replace two, using four diodes in place of eight, eliminating one filter network, modifying connectors to allow direct mounting on the chassis.

These changes resulted in a reduction from 132 components to 80, and a reduction in shop cost from \$288 to \$129. Complexity was reduced to facilitate maintenance.

Another project at GE resulted in the revamping of a radio-frequency envelope viewer, the basic part of which was a lighthouse diode. The filament transformer, chassis and terminal board of the old design was eliminated by mounting the diode cavity on an existing chassis and obtaining filament power from a transformer already on the chassis.

Redesign of the diode cavity itself resulted in a parts reduction from 40 to 4. Conventional parts were used instead of special ones. Overall cost of the cavity was reduced from \$81.79 to \$8.76.

Value engineering, said Martin D. Willey, must be actively supported by top management. At the Orlando division, the director of management engineering is responsible for value analysis administration.

The groups that have prime responsibility for engineering economy (solid line) report directly to him in his capacity as director of management engineering. Groups composing the operational engineering staff report to him in his role of value analysis administrator. Thus, one man with two hats is at the heart of the division's operating efficiency and this man reports directly to Willey who is vice-president and general manager of the division.

Furthermore, a control council consisting of top management people evaluates and directs the effort of the value analysis administrator.

Sputnik VII Carry Man Or Spy-In-Sky Devices?

SHORTLY AFTER Sputnik VII was launched earlier this month, American tracking stations found that at least three, and maybe four, vehicles were in orbit.

In addition to the 7-ton satellite and the last-stage rocket, one additional vehicle and possibly two were detected.

Unlike Sputnik IV, which included numerous "pieces" which kicked off in varied orbits, the sections of Sputnik VII appeared to have had identical orbits at first.

Radar returns showed a gradual discrimination among the vehicles,

and the separation of orbits gave rise to theories that the Russians were trying to bring back to earth one or more of the vehicles in orbit and were having trouble doing so. Theories also were expressed that one of the vehicles may have been a man-carrying capsule.

A Swedish scientist, meanwhile, voiced the belief that the Russians were altering the sputnik's orbit in an attempt to prevent anyone from accurately tracking it. And in Norway, an engineer reported shifts in frequency over a three-day period. Orbit switching and frequency shifts would be consistent with another theory, that the sputnik was actually a spy-in-the-sky type satellite.

Despite its low period and a prediction of one Russian scientist that the satellite would accordingly burn up in the atmosphere within a few days, U. S. trackers believed it would last for as much as two weeks because of its mass.

The giant sputnik was launched Friday night, Feb. 3 (U. S. time), and the U. S. knew about it almost immediately from its network of radar and optical observatories around the world. But the Pentagon forced tracking stations to keep quiet about it until the Soviet announcement about 16 hours later, around noon on Saturday (U. S. time).

Say Dutch Firm Plans \$12-Million Swiss Loan

AMSTERDAM—Financial sources here say Philips of Eindhoven is contemplating a loan in Switzerland of 50 million Swiss francs (\$12 million).

According to Dutch financial circles the loan rate will be 4½ percent. The disclosure is said to have touched off considerable surprise here.

What one financier describes as Philips' excellent liquidity is seen as being a favorable factor in having the loan go through and paving the way for the Dutch corporation to enter the Swiss capital market when the time is ripe.

According to reports, the loan proposal will be submitted to Philips stockholders at an early March meeting.

BRAND NEW!

Almost everything's new at Duncan Electronics.
Fresh design approach, modern equipment, new facility.
Everything's new — except experience. Only carefully candled,
Grade A talent here. More than 300 years of potentiometer
experience in the design group alone. And they've all been
egged into designing a line of pots
unequaled for precision, quality and reliability.
We'd like to send you the unscrambled
details in our new catalog.

de
DUNCAN
electronics, inc.

P. O. Box 1953, 1305 Wakeham Ave., Santa Ana, California

RAYTHEON DISTRIBUTORS

in **57** cities offer immediate delivery of

RAYTHEON DIODE RECTIFIERS

for dependable, arc-free operation

... at no penalty in price

ALABAMA

Birmingham
Forbes Distributing Company
AL 1-4104
MG Electrical Equipment Company
FAirfax 2-0449

Mobile
Forbes Electronic Distributors, Inc.
HE 2-7661

ARIZONA

Phoenix
Radio Specialties & Appl. Corp.
AL 8-6121

Tucson
Standard Radio Parts, Inc.
MA 3-4326

CALIFORNIA

Burbank
Valley Electronic Supply Co.
Victoria 9-3944

Glendale
R. V. Weatherford Co.
Victoria 9-2471

Hollywood
Hollywood Radio & Electronics, Inc.
HO 4-8321

Inglewood
Newark Electronics Company
ORchard 4-8440
OREgon 8-0441

Los Angeles
Federated Purchaser
BRadshaw 2-8771
Graybar Electric Company
ANGelus 3-7282
Kierulff Electronics, Inc.
RiChmond 8-2444

Oakland
Brill Electronics
TE 2-6100
Elmar Electronics
TEmplar 4-3311

Palo Alto
Zack Electronics
DA 6-5432

San Diego
Radio Parts Company
BE 9-9361

San Francisco
Fortune Electronics
UN 1-2434

Santa Ana
Airtronic Sales, Inc.
KImberly 5-9441

Santa Monica
Santa Monica Radio Parts Corp.
EXbrook 3-8231

COLORADO

Denver
Ward Terry Company
AMherst 6-3181

CONNECTICUT

East Haven
J. V. Electronics
HOBart 9-1310

DISTRICT OF COLUMBIA

Electronic Industrial Sales, Inc.
HUdson 3-5200

FLORIDA

Miami
East Coast Radio & Television Co.
FRanklin 1-4636
Electronic Equipment Co., Inc.
NEwton 5-0421

West Palm Beach
Goddard Distributors, Inc.
TEmpLe 3-5701

ILLINOIS

Chicago
Allied Radio Corporation
HAYmarket 1-6800
Newark Electronics Corp.
STate 2-2944

INDIANA

Indianapolis
Graham Electronics Supply Inc.
MElrose 4-8486

LOUISIANA

New Orleans
Columbia Radio and Supply Co.
TW 7-0111

MARYLAND

Baltimore
Wholesale Radio Parts Co., Inc.
MUIberry 5-2134

MASSACHUSETTS

Boston
Cramer Electronics, Inc.
COpley 7-4700
DeMambro Radio Supply Co., Inc.
AL 4-9000

Graybar Electric Co.
HUbbard 2-9320
Lafayette Radio Corp. of Mass.
HUbbard 2-7850

Cambridge
Electrical Supply Corp.
UNiversity 4-6300

MICHIGAN

Ann Arbor
Wedemeyer Electronic Supply Co.
NORMandy 2-4457

Detroit
Ferguson Electronics, Inc.
UN 1-6700

MISSISSIPPI

Jackson
Ellington Radio, Inc.
FL 3-2769

MISSOURI

Kansas City
Burstein-Applebee Company
BALtimore 1-1155

St. Louis
Graybar Electric Company
JEfferson 1-4700

NEW HAMPSHIRE

Concord
Evans Radio
CAPital 5-3358

NEW JERSEY

Camden
General Radio Supply Co.
WO 4-8560 (In Phila.: WA 2-7037)
Mountainside
Federated Purchaser Inc.
AD 8-8200

NEW YORK

Binghamton
Stack Industrial Electronics, Inc.
RA 3-6326

Buffalo
Genesee Radio & Parts Co., Inc.
DElaware 9661
Wehle Electronics Inc.
TL 4-3270

Elmira
Stack Industrial Electronics, Inc.
RE 3-6513

Ithaca
Stack Industrial Electronics, Inc.
ITHaca 2-3221

Mineola, Long Island
Arrow Electronics, Inc.
Pioneer 6-8686

New York City
H. L. Dalls, Inc.
EMpire 1-1100

Milo Electronics Corporation
BEekman 3-2980

Sun Radio & Electronics Co., Inc.
OREgon 5-8600
Terminal-Hudson Electronics, Inc.
CHelsea 3-5200

OHIO

Cincinnati
United Radio Inc.
CHerry 1-6530

Cleveland
Main Line Cleveland, Inc.
EXpress 1-4944
Pioneer Electronic Supply Co.
SUPERior 1-9411

Columbus

Buckeye Electronic Distributors, Inc.
CA 8-3265

Dayton
Sreppo, Inc.
BALdwin 4-3871

OKLAHOMA

Tulsa
S & S Radio Supply
LU 2-7173

OREGON

Portland
Lou Johnson Company, Inc.
CAPital 2-9551

PENNSYLVANIA

Philadelphia
Almo Radio Company
WALnut 2-5918
Radio Electric Service Co.
WALnut 5-5840

Pittsburgh
Marks Parts Company
FAirfax 1-3700

Reading
The George D. Barbey Co., Inc.
FR 6-7451

TENNESSEE

Knoxville
Bondurant Brothers Company
3-9144

TEXAS

Dallas
Graybar Electric Company
Riverside 2-6451

Houston
Busacker Electronic Equipment Co.
JACKson 6-4661
Harrison Equipment Company
CAPitol 4-9131

UTAH

Salt Lake City
Standard Supply Company
EL 5-2971

VIRGINIA

Norfolk
Priest Electronics
MA 7-4534

WASHINGTON

Seattle
Western Electronic Company
AT 4-0200

WEST VIRGINIA

Bluefield
Meyers Electronics, Inc.
DAvenport 5-9151

WISCONSIN

Milwaukee
Electronic Enterprises, Inc.
GR 6-4144

SEE PAGE 5 FOR FURTHER INFORMATION.

RAYTHEON DISTRIBUTOR PRODUCTS DIVISION • 411 PROVIDENCE TURNPIKE • WESTWOOD, MASS.

RAYTHEON COMPANY

DISTRIBUTOR PRODUCTS DIVISION



inter-industry conference on

ORGANIC SEMICONDUCTORS

*April 18 and 19, 1961
The Morrison Hotel, Chicago, Illinois*

co-sponsored by

ARMOUR RESEARCH FOUNDATION

of Illinois Institute of Technology

and electronics

a McGraw-Hill publication

Technical sessions of invited and contributed papers on the present state and future potential of organic semiconductors in the electronics, chemical, and semiconductor industries.

Invited papers will cover the following areas:

David Fox, State University of New York

Theoretical Aspects of Electrical Transport

R. G. Kepler, E. I. DuPont de Nemours and Company

Conductivity in Anthracene Single Crystals

Jan Kommandur, National Carbon Research Laboratories

Characteristics of Charge-Transfer Complexes

Oliver Le Blanc, General Electric Research Laboratories

Interpretation of Conductivity in Molecular Crystals

Herbert A. Pohl, Princeton University

Electrical Properties of Pyrolyzed Polymers

Marvin Silver, Office of Ordnance Research

Surfaces and Contacts in Organic Semiconductors

For further information contact James J. Brophy, Co-Chairman, Physics Division, Armour Research Foundation, Technology Center, Chicago 16, Illinois.

VARIAN
Potentiometer
RECORDERS

The logical "first choice"

because . . .

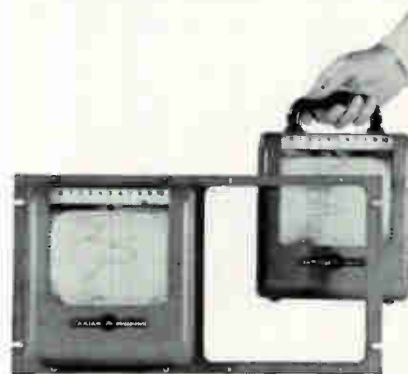

TOTAL DESIGN IS

FUNCTIONAL

Carry it anywhere — put two side-by-side in a rack. Its shape is ideal for both. And its performance is multi-purpose too: wide choice of ranges, accessories, options and plug-ins. Chances are it has the capability to record for you in a variety of assignments.

The Varian G-11A is 10" high, 8 $\frac{1}{4}$ " wide, 7 $\frac{3}{4}$ " deep; 15 lbs.; 1% accuracy; ranges from 10 mv to 100 v d. c. full scale; wide choice of charts and chart speeds for millivolt, milliamp and direct temperature recording from thermocouples. Write for full specifications to Instrument Division.

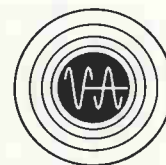

VARIAN
associates
PALO ALTO 1, CALIFORNIA

Mutual Funds Buy More Electronics Stocks

MUTUAL FUNDS today hold combined assets in excess of \$18 billion and handle about 3,500 different stocks. They are an important factor in the behavior of stock values.

Discussing effects of mutual funds on electronics stock behavior, a spokesman for the National Association of Investment Companies, which has 186 firms on its rolls, says that virtually every one of its members has some holdings in electronics.

In some cases this equity is quite limited. In others, however, holdings are almost exclusively in electronics or related fields.

A 10-year survey of NAIC's 20 leading members shows a rapid climb in electronics and related holdings from 1949 to 1959.

In 1949 those holdings amounted to \$28,907,000, represented only 2.8 percent of all holdings of the companies. By 1954, the dollar value was \$179,007,000 and represented almost 5 percent of total holdings. The final year, 1959, showed a total of \$461,545,000—5.4 percent the collective portfolios—was electronic. (See chart for detailed breakdown.)

NAIC's membership accounts for 95 percent of all investment companies. Today about six member firms specialize in electronics and related stocks. Four years ago only two did.

Over a dozen mutual funds now report holdings between 5 and 10 percent in electronics, as compared with nine when a study was made in 1958. Electronics holdings ranging from 10 to 20 percent are in the portfolios of more than half a dozen mutual funds. Electronics holdings by remaining funds range from three to 40 percent.

In many cases, the early years of the electronics industry saw all but a few giant corporations shunned by mutual funds as being too speculative. In time, fund managers realized two things: the high level of financial potential of many new electronic stock issues and the vital need to gain technological evaluation. So increased attention was given to technical developments, aspects of research and develop-

INVESTMENTS IN ELECTRONICS

Year end	Value of Holdings of Electronics and Related Stocks (thousands)	% of Total Common Stock Holdings of 20 Investment Cos.
1959	\$461,545	5.4%
1958	274,885	3.7
1957	189,914	3.8
1956	178,599	3.5
1955	188,596	4.0
1954	179,007	4.9
1953	107,601	4.5
1952	93,848	4.2
1951	63,410	3.6
1950	42,377	3.1
1949	28,907	2.8

Note: Assets of 20 companies in this study represented 67 percent of the assets of all 155 open-end investment company members of the N.A.I.C. on December 31, 1959.

ment and other factors within the electronics industry.

Today talks with many mutual fund officers are sprinkled with technical jargon and comments indicating a high degree of familiarity with manufacturing processes, plant operations and research work at advanced levels.

Speaking on the value of technical analysis, Donald C. Samuels, president of Energy Fund, which specializes in technically-oriented stocks, told ELECTRONICS: "The problem of analysis becomes far more complicated when a fund specializes in the science fields. In view of the high degree of scientific technology in electronics, it is vital to have access to scientific counsel."

His fund, said Samuels, has among its principal advisers a number of individuals and research organizations with formal training in electronics. Financial analysts specializing in electronics also form part of the team.

Decisions by a mutual fund to drop or purchase a stock can have considerable effect on the stock's subsequent decline or rise in value. For this reason, most acquisitions or divestments are made with care and in small quantities.

In buying a stock, the mutual fund usually begins by taking a small position and increasing its holdings as the company progresses.

Specialized funds like Energy and Television-Electronics Fund say they prefer to look to smaller companies for technological ad-

vances. Big companies announcing breakthroughs are not as likely to see as large a percentage in appreciation of their stock as small firms, fund spokesmen point out. Where demonstrated earning power and stability by a larger company will add stability to a portfolio, such stocks are also acquired. A mutual fund often will acquire stock with a predetermined set of expectations. Once these are met, the fund will sell the holdings to gain capital for other investments. A change for the worse in company outlook will usually cause a fund to sell its holdings.

To detect such a change, funds keep a close tab on company operations. Sometimes a lack of adequate information may lead a fund to sell its holdings. A watch is also kept on firms in competing areas to anticipate losses of technical advantages.

Fund managers say companies gain in prestige when their shares are held by a fund. Funds publicize new commitments and list them in annual reports. Other members of the financial community keep an eye on fund acquisitions and divestments and are often influenced accordingly.

Antenna Puffs Up

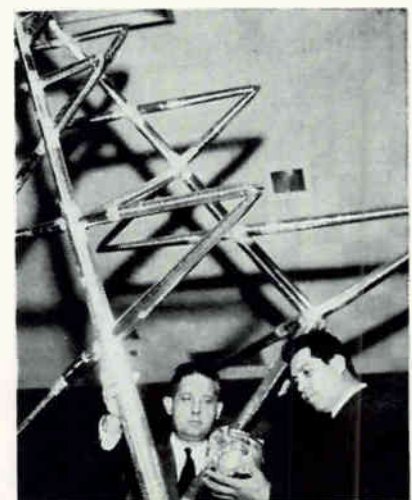

Once in space, Lockheed log-periodic antenna of aluminum foil and Mylar film inflates from small package (foreground) to full 3-ft size

intercept!

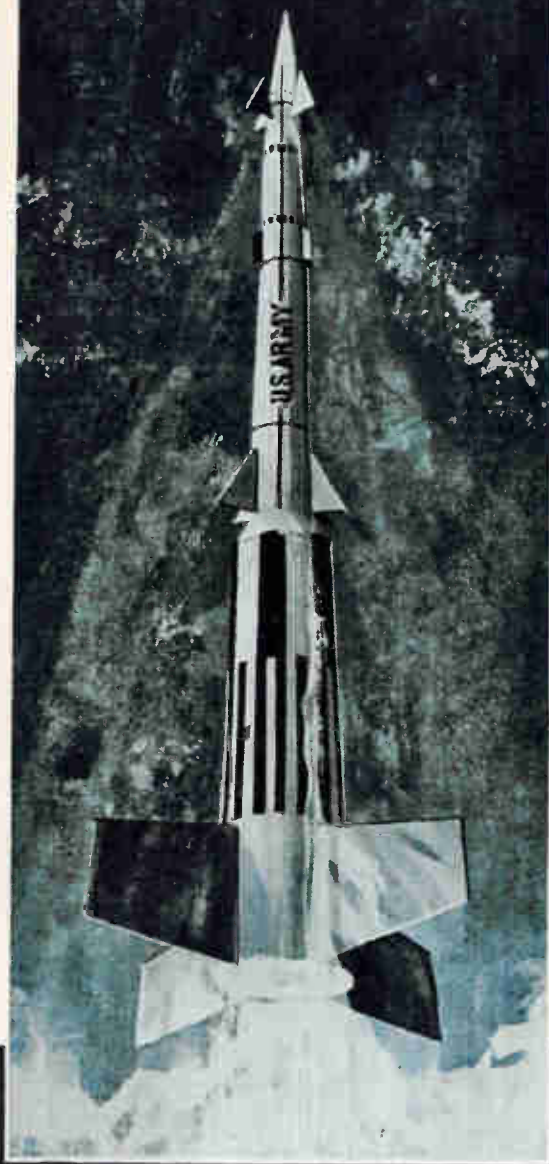

The U. S. Army's NIKE-ZEUS is the only anti-missile missile system under advanced development. It is designed to meet the threat of enemy Inter Continental Ballistic Missiles. Developing a gigantic 450,000 lbs. of thrust at launch, the NIKE-ZEUS missile rises almost instantly to intercept enemy ICBMs traveling faster than 20 times the speed of sound.

HEART AND BRAINS OF THE NIKE-ZEUS DEFENSE SYSTEM CONCEPT

Extremely powerful long-range acquisition radar is designed to pick up the enemy ICBMs far from the defended area. Target track radars use the information provided by the long-range acquisition radar to "lock-on" to an incoming missile, relaying precise target information to electronic computers. These computers determine the most favorable point of intercept, automatically firing a NIKE-ZEUS missile at the correct time, guiding it to the intercept point.

CONTINENTAL ELECTRONICS TRANSMITTERS

Working under sub-contract to Bell Telephone Laboratories and Western Electric Company, Continental Electronics is designing, manufacturing and installing the powerful acquisition radar transmitters used in the Research and Development model of the NIKE-ZEUS Defense Complex scheduled for full scale testing on Kwajalein Atoll in the Pacific.



Continental Electronics

MANUFACTURING COMPANY

4212-South Buckner Boulevard • Dallas 27, Texas • EVergreen 1-1135

 SUBSIDIARY OF LING-TEMCO ELECTRONICS

Designers and Builders of the World's Most Powerful Radio Transmitters

ENGINEERS . . . FOR STIMULATING WORK ON THE ELECTRONIC FRONTIERS OF TOMORROW WITH A DYNAMIC, CREATIVE ORGANIZATION, ADDRESS RESUME TO CHIEF ENGINEER.

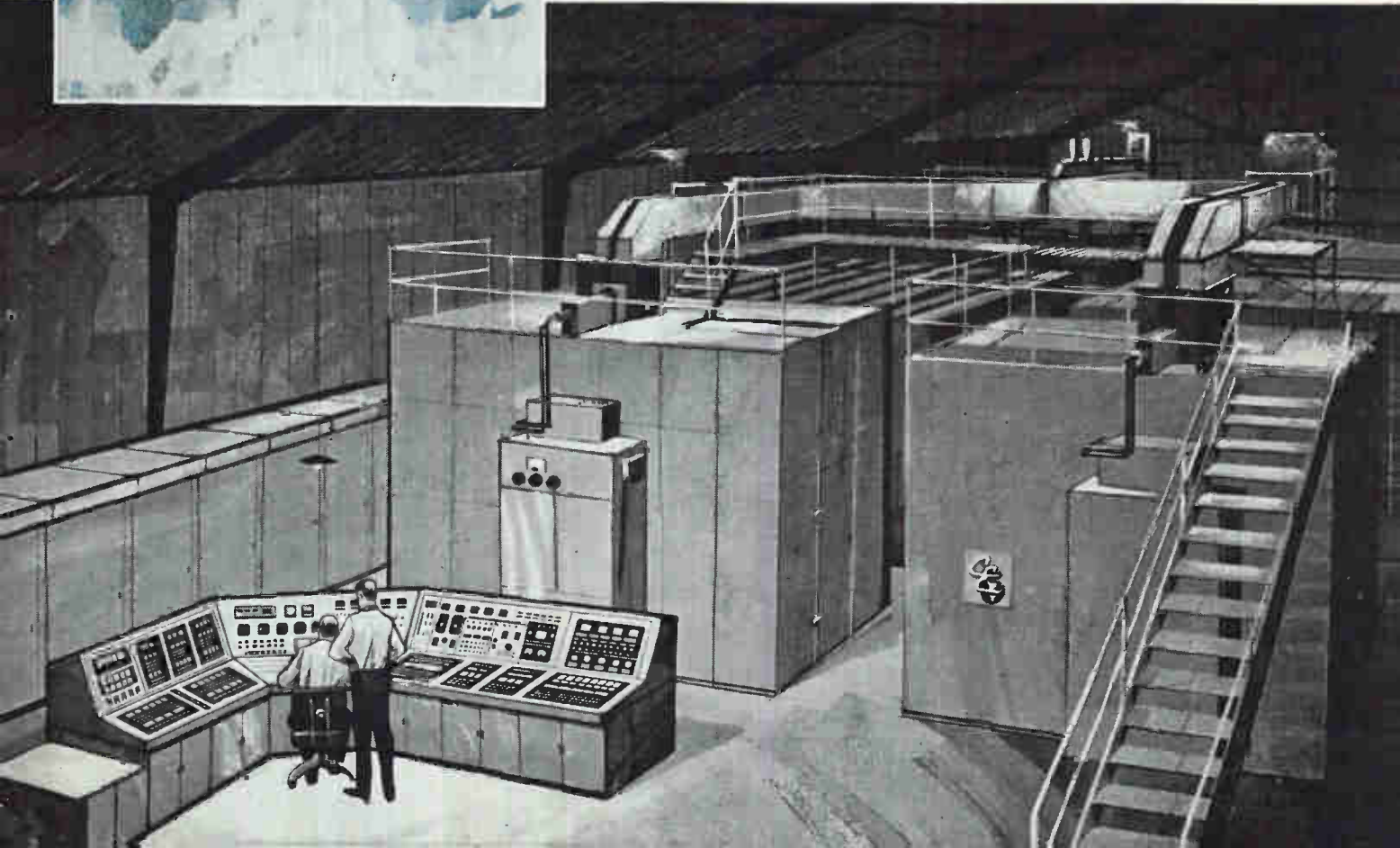

SPRAGUE[®]

MODEL 500

INTERFERENCE LOCATOR



This versatile instrument is a highly sensitive interference locator—with the widest frequency range of any standard available unit! Model 500 tunes across the entire standard and FM broadcast, shortwave, and VHF-TV spectrums from 550 kc. to 220 mc. in 6 bands.

It's a compact, portable, rugged, versatile instrument—engineered and designed for most efficient operation in practical field use. It features a transistorized power supply, meter indications proportional to carrier strength as well as sensitivity of 5 microvolts minimum for 5% meter deflection over entire tuning range.

For full details, send for brochure IL-106.

SPRAGUE ELECTRIC COMPANY
35 Marshall Street, North Adams, Mass.

SPRAGUE[®]
THE MARK OF RELIABILITY

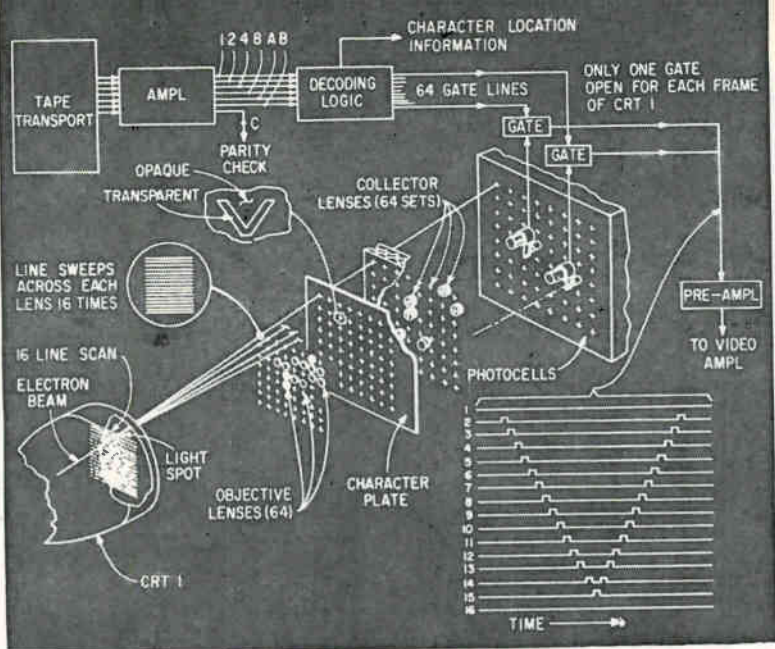

Operation of Dacom flying spot character generator

Scanner Translates Tape Data to Film

DIGITAL SIGNALS on magnetic tape are translated to 64 alphanumeric symbols on 16-mm film in new processing unit by Recordak Corp., a subsidiary of Eastman Kodak Co. Readout from the magnetic tape occurs at 15,000 characters a second and the filming rate is variable up to 20 frames a second, with various page format overlays such as bank statements and insurance forms. After exposure, the film is processed conventionally, then used for viewing or for producing paper copies.

Called Dacom, the processor simulates typewriter readout and also plot graphs, with 1,024 points along each axis without overlap. The processor is a random access device, which means data can be printed on any part of the page regardless of its position on the magnetic tape.

A cathode-ray tube generates a light spot that sweeps a 16-line raster 15,000 times a second. Each

of 64 objective lenses directs the 16-line pattern onto a character-shaping plate, then through collector lenses onto multiplier phototubes. Although all characters are scanned simultaneously, a video output signal is passed only for the character whose output gate has been opened by the decoding logic; in the illustration, V. The video signal is amplified, then reproduced on a second crt. Film makes a permanent record of the readout trace.

Location of a character on the readout page or plot is determined from information on the magnetic tape. The dummy bank statement shows the quality of the digital conversion system.

The first prototype model, which was displayed in New York City recently, uses vacuum tubes for all circuits. Design of equivalent transistor circuits—except for power supplies—is said to be well along, however, and these circuits are ex-

CHECKS PAID		DATE	DEPOSITS	BALANCE
S. P. WILLIAMSON 669 CALDWELL STREET NEW YORK 11, NEW YORK				05-60045
Statement of Account WITH THE FIRST RECORDAK BANK ANYWHERE, U.S.A.				
BALANCE FROM LAST STATEMENT 10-00			JUN 30 60	9,501.07
16.10		JUL 1	42.00	9,526.97
15.10		JUL 5		9,493.77
25.00		JUL 10		9,468.77
4.60	8.30	JUL 15	70.00	9,538.77
44.00		JUL 20	30.00	9,518.77
		JUL 25		9,548.77

Dummy bank statement shows quality of machine output

pected to be used in the first production lot. Delivery of the processor is 18 to 24 months away.

Tracking System Uses Analog Techniques

ANALOG instead of digital techniques are featured in a new automatic tracking device developed by Servonics, Inc. of Alexandria, Va.

Servonics says the system can be added to existing track-while-scan radars at a cost of approximately \$1,000 a tracking channel and requires a space allotment of only 3 by 7 by 22 inches per channel. Module circuits are used. As many tracking channels as needed can be added with a practical limit of around 18 an operator.

Basically, the system functions by comparing computed target position with actual target position as the scanning radar operates. After it determines that the computed position agrees with the target's actual position, it generates a video identification and places it on the radar indicator at computed and actual target position.

Operation of the equipment can be initiated in two ways: by manual entry and by barrier mode.

In manual entry, the operator selects the target to be tracked, positions a video dot over the target to give the equipment the initial target information, then puts the equipment into automatic tracking. By initially positioning the video dot over the target, the operator is in effect surrounding the target with a five-mile square electronic fence. This area is automatically reduced to a one-mile square area with succeeding sweeps of the radar scan.

A desirable feature of the manual entry track method is that the radar operator can update the tracking information or reposition the tracking tag in the event that lock-on is lost because of high noise, extended fade conditions, or enemy jamming.

However, because radar operators cannot always detect and place each target in an automatic tracking channel at the first instant a target appears, the barrier mode method was devised to automatically assign a channel.

(Advertisement)

New Nanosecond* Pulse Transformers for Ultra-miniature, Ultra-high Speed Applications

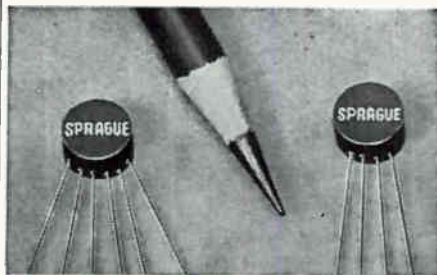

Digital circuit designers will find the new Sprague Type 43Z Nanosecond Pulse Transformers of considerable interest. These tiny transformers have been carefully designed for the all-important parameter of minimum rise time at high repetition rates up to 10 mc.

The new Type 43Z series is comprised of a broad line of 72 pulse transformers in 10 popular turns ratios. They are Sprague's latest addition to the most complete listing of pulse transformers offered by any manufacturer for use in digital computers and other low-level electronic circuitry.

Type 43Z Pulse Transformers are designed so that the product of leakage inductance and distributed capacitance is at a minimum. They are particularly well suited for transformer coupling in transistor circuits since transformers and transistors are very compatible low impedance devices. Nanosecond transformers are equally suitable for transmission line mode of operation, in twisted-pair transmission line coupling, and in regenerative circuits.

The epoxy-encapsulated "pancake" package is excellent for both etched wire board or conventional chassis mounting. To simplify etched-board design, these ultra-miniature pulse transformers are available with leads terminating at the side or the bottom of each unit.

For complete technical information on Type 43Z Nanosecond Pulse Transformers, write for Engineering Data Sheet 40235 to Technical Literature Section, Sprague Electric Co., 35 Marshall St., North Adams, Mass. *millimicrosecond

Now! super-speed MADT[®] TRANSISTORS

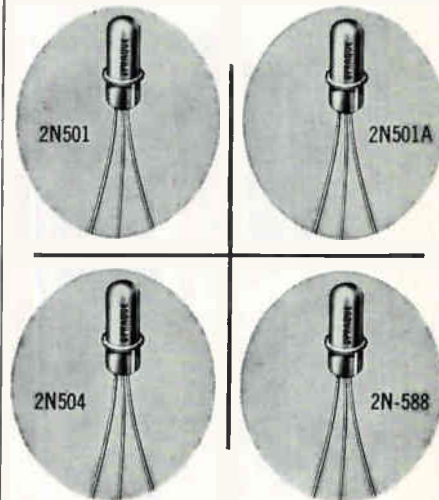

...at sensible prices
and fast deliveries!

Sprague Germanium Micro-Alloy Diffused-Base Transistors are priced below other transistors with comparable electrical characteristics. Perfected mass production techniques enable shipment of quantity orders on short notice. Add to this their dependable vhf performance, and you have three good reasons why Sprague MADT Transistors have achieved their high level of acceptance.

These ultra-fast transistors now permit circuits in vhf amplifiers and oscillators to operate with collector currents to 50 ma . . . with power dissipation to 50 mw . . . with collector-to-base voltages to 15 v.

For complete engineering data on the types in which you are interested, write to Technical Literature Section, Sprague Electric Company, 35 Marshall Street, North Adams, Massachusetts.

You can get off-the-shelf delivery at factory prices on pilot quantities up to 999 pieces from your local Sprague Industrial Distributor.

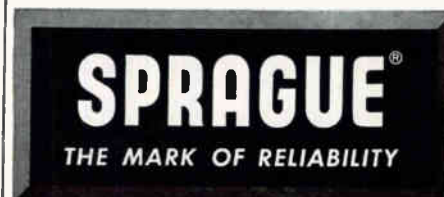

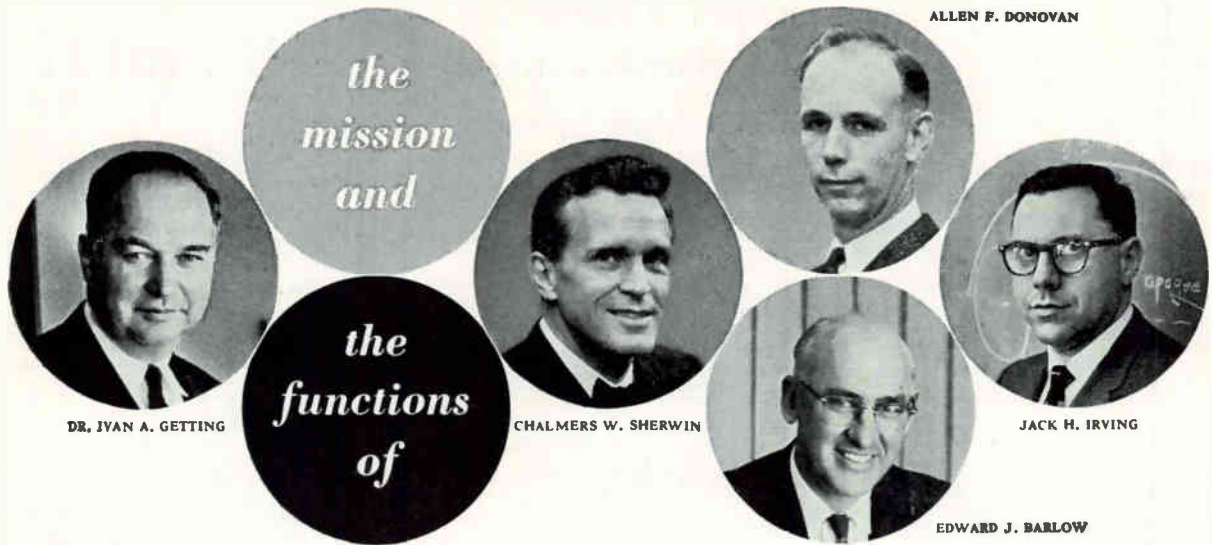

AEROSPACE CORPORATION

*present genuine challenge to scientists
and engineers of demonstrated competence*

"To preserve our free institutions, it is absolutely essential that the United States find the most effective means of advancing the science and technology of space and also of applying them to military space systems. This is the mission of Aerospace Corporation."

IVAN A. GETTING
PRESIDENT
AEROSPACE CORPORATION

In accomplishing its mission, this non-profit public service organization performs the unique role of space systems architect. Aerospace Corporation provides scientific and technical leadership to the science/industry team responsible for developing complete space and ballistic missile systems on behalf of the United States Air Force.

Specific responsibilities of the new corporation include advanced systems analysis, research and experimentation, initial systems engineering, and general technical supervision of new systems through their critical phases.

The broad charter of Aerospace Corporation offers its scientists and engineers more than the usual scope for creative expression and significant achievement, within a stimulating atmosphere of dedication to the public interest.

Aerospace Corporation scientists and engineers are already engaged in a wide variety of specific systems projects and forward research programs, under the leadership of scientist/administrators including corporation president Dr. Ivan A. Getting, senior vice president Allen F. Donovan, and vice presidents Edward J. Barlow, William W. Drake, Jr., Jack H. Irving, and Chalmers W. Sherwin.

Aerospace Corporation is currently seeking scientists and engineers capable of meeting genuine challenge and with proven ability as:

- **SENIOR ELECTRONICS ENGINEERS**
Communications systems
Guidance electronics
Data processing systems
Radio techniques
Electromechanical design
Information theory
Sensing systems
- **SPACE VEHICLE SPECIALISTS:**
Senior power systems engineer
Sr. flight performance analyst
Re-entry aerodynamicist

Those qualified and experienced in these and related fields are urged to direct their resumes to:

Mr. James M. Benning, Room 110
P.O. Box 95081, Los Angeles 45, Calif.



A new and vital force

AEROSPACE CORPORATION

engaged in accelerating the advancement of space science and technology

ACTUAL



SIZE

20 TO 30 VOLTS DIRECT CURRENT

TIMING FOR RELIABILITY of systems, sub-systems and modules is accurate, dependable with Houston Fearless "Alert" sub-miniature Elapsed Time Indicators. Measure life expectancy, provide operational warnings to prevent overuse failure. Tested for severe environmental use. Exceeds MIL-E-5272C. 1,000 and 10,000 hour models. Weight, 2 oz., 1" dia., 1 1/4" depth. Write for specifications.

HF **HOUSTON FEARLESS**
DIVISION OF HOUSTON FEARLESS CORPORATION
11801 West Olympic Blvd., Los Angeles 64, California

CIRCLE 217 ON READER SERVICE CARD

AO TRACEMASTER PRODUCES SUPERIOR DEFINITION AND UNIFORMITY OF TRACE

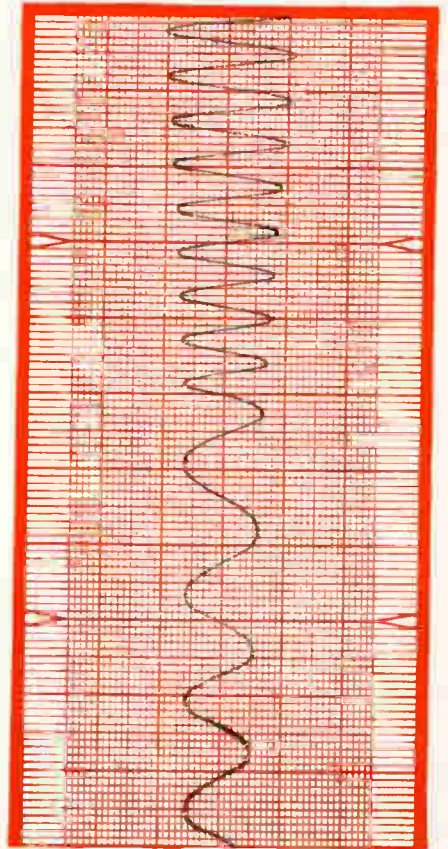

The unique carbon transfer writing method of AO's TRACEMASTER 8-channel recorder provides a trace that is a minimum of 2-3 times finer than that of any other direct writing recorder. The trace shown above, taken from a TRACEMASTER record, is an excellent example of the fine trace ... each line is separate and distinct, and reveals significant detail with great clarity.

This allows twice as many lines per millimeter, or twice the definition, possible with any other recorder. Notice, also, how the line width and line contrast remain uniform through a chart speed change of 5:1, and through the coincident amplitude change. You continue to see complete signal information.

Superior definition—due to uniform, fine line and excellent contrast—is just one of the many reasons why the AO TRACEMASTER is the world's finest direct writing recorder. Write for complete information, now!

American Optical Company

Instrument Division • Buffalo 15, New York

CIRCLE 31 ON READER SERVICE CARD 31

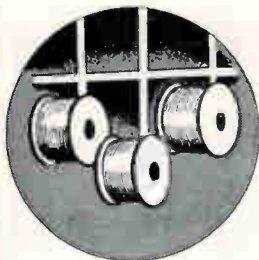

Measures Footage in Stock

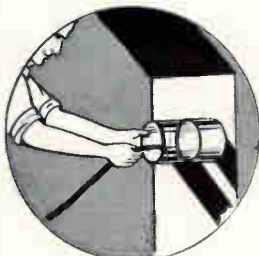

Measures Footage used

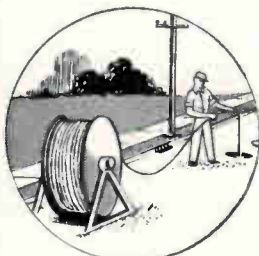

Measures Footage Needed



**Foot-Marked
every
2 feet**

**HICKORY
BRAND®
Coaxial Cable**

Sequential marking, available only on Hickory Brand Coaxial Cable, lets you accurately measure the footage you need, the footage you use and the footage you have left...and guarantees the footage you get! Saves time and cable!

Every two feet, numbers are permanently stamped in sequence on Hickory Brand Coaxial Cable... means better inventory control, eliminates waste in estimating installation requirements.

The conductor insulation and dielectric material used on Hickory Brand RF Cables is polyethylene, making these cables especially adaptable to applications requiring high, very high and ultra-high frequencies.

For economy and efficiency, order Hickory Brand!



*Write for complete information
on the full line of*

**HICKORY BRAND
Electronic Wires and Cables**

Manufactured by
SUPERIOR CABLE CORPORATION, Hickory, North Carolina

3491

North Atlantic Series RB500 Ratio Boxes



Model RB-504
Bench mount

**Measure A.C. Ratios
From -0.1111
To +1.1111...with
accuracy to 1 ppm**

With any of North Atlantic's RB500 Ratio Boxes you can now measure voltage ratios about zero and unity—without disrupting test set-ups.

And—a complete range of models from low cost high-precision types to ultra-accurate ratio standards—in portable, bench, rack mount, binary and automatic stepping designs—lets you match the model to the job.

For example, characteristics covered by the RB500 Series include:

- Frequency: 25 cps to 10 kc.
- Accuracy: 10 ppm to 1.0 ppm
- Input voltage: 0.35f to 2.5f
- Input impedance: 60 k to 1 megohm
- Effective series impedance: 7.5 ohms to 0.5 ohms
- Long life, heavy duty switches

Name your ratio measurement and its probable there's a North Atlantic Ratio Box to meet them—precisely. Write for complete data in Bulletin 11X.

Also from North Atlantic
...a complete line of
complex voltage ratio-
meters...ratio test sets...
phase angle voltmeters

**NORTH ATLANTIC
industries, inc.**
Terminal Drive, Plainview, L. I., N. Y.
Overbrook 1-8600

Biomedical Engineering Course Set Up

BIOMEDICAL ENGINEERING is being established at the University of Rochester under a five-year National Institutes of Health grant totaling \$254,407. The research graduate training program will be operated by the College of Engineering in cooperation with the School of Medicine and Dentistry. It will lead to the Ph. D. degree in engineering with special application to the fields of medicine and the life sciences. According to Dr. John W. Graham, Jr., Engineering Dean, the program is being developed because of the growing usefulness of modern engineering techniques in biological and medical research and the resulting need to have engineers trained in the specialized biological and medical applications of engineering. The University of Pennsylvania and John Hopkins University have also received NIH grants for this purpose.

WORK STUDY programs leading to doctorates in electrical engineering, chemistry, and physics will be inaugurated next September by Northeastern University. Students will alternate periods of study and actual service in industry.

ENGINEERING COURSES are among those being added to the 1961 correspondence program of University of California Extension. Other areas include business administration, economics, education, English, foreign languages, philosophy and sociology. Information is available from University Extension, University of California, Berkeley 4, California. During the past year, nearly 15 thousand persons from every state and 56 foreign countries were enrolled in the home study courses.

NEW ENGINEERING SCHOOL on the Santa Barbara campus of the University of California will appear next fall. The Regents of the University recently authorized the school which will offer the bachelor of science degree in engineering with graduate degrees added at a later date. Also provided for the

Santa Barbara campus by the Regents was the establishment of a college of letters and science. This merges the present separate divisions of the applied arts and the letters and science into one academic unit. Liberal arts courses will be given by the college of letters and science to students in the new engineering school.

SPIRAL CLOVERLEAF design of a new cyclotron developed by UCLA allows continuous acceleration of protons, the nuclei of hydrogen atoms. Present synchro-cyclotrons accelerate the protons in bursts. Called the spiral ridge cyclotron, it can perform an experiment a hundred times faster than other cyclotrons in the same energy range, according to J. R. Richardson one of its designers. Energy potential is 50 million electron volts so that particles can be accelerated to speeds of 62,000 miles a second. Without introducing any new design principles, the energy potential can be extended up to 600 Mev, claims Richardson. The atom smasher will enable scientists to extend nuclear physics experiments involving the scattering of particles and polarization processes.

857 Words Per Minute

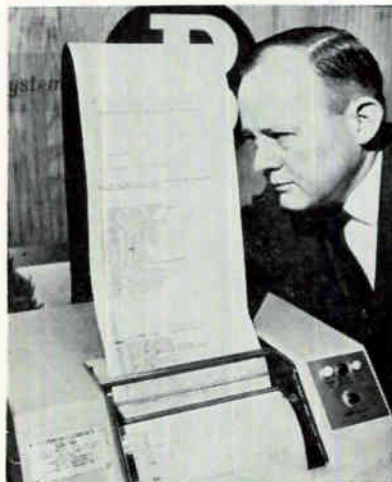

Nationwide weather information at 857 words per minute is recorded by Burroughs' ADIS system

CAN YOU ALWAYS

FORECAST

PEAK

WORKLOADS?

Anticipating peak loads is difficult . . . variables are involved. Even so, once they're forecasted—how do you cope with them? Overloading skilled manpower can reduce efficiency and endanger reliability within any technical organization.

A good solution is to utilize specialized assistance such as provided by the RCA Service Company. Depending on your requirements, RCA's service arm can assign one . . . five . . . 100 or more specialists to assist you. This reserve of stable technical talent is familiar with complex electronic equipment and systems. It's a ready-made back-up support you need to handle unanticipated workloads and special assignments.

Highly skilled personnel are available in these specialized areas:

- Electronics
- Electrical Engineering
- Reliability Analysis
- Maintainability Prediction
- Space Environmental Chambers

It makes good business sense to utilize qualified manpower customized to assist you in specific assignments. RCA Service Company has been providing this type technical support for almost two decades to the U. S. Armed Forces, governmental agencies and prime contractors.

Look to RCA for ingenuity and excellence in technical support services. You can meet your requirements during peak loads and still maintain the quality of your in-plant capabilities.

For complete information, contact J. R. Corcoran, Location 206-2, RCA Service Company, Camden 8, N. J.



The Most Trusted Name
in Electronics

RADIO CORPORATION OF AMERICA.

**C
S
C**

ALL-TRANSISTORIZED WHEATSTONE BRIDGE

**GALVANOMETER,
POWER SUPPLY
AND BRIDGE ...
IN 1 PACKAGE
for \$495.***



**MODEL WB-100A
PRECISION WHEATSTONE BRIDGE**

The unique CSC Model WB-100A offers a highly accurate, ultra-sensitive Wheatstone Bridge, transistorized chopper readout amplifier, and bridge voltage power supply... all packaged together in a single, compact, portable unit... priced at what you'd expect to pay for the Bridge alone! High resolution of 5-digit readout is provided over the full range. Check some of these typical specifications:

ACCURACY: $\pm 0.05\%$ + .005 ohms absolute
RANGE: 1 ohm to 100 megohms
SENSITIVITY: 1 mv for full scale
WEIGHT: 8 lbs.
SIZE: 8" w., 7" h., 6" d.

The Model WB-100A is one of a comprehensive, all-transistorized line of CSC precision voltmeters, volt-amp meters, wheatstone bridges and regulation monitors. For complete information and technical specifications, contact any of the CSC Representatives (shown at right), or write directly to CSC for technical bulletin E-1320-1A.

* P. O. B. ALHAMBRA, CALIF.
PRICES SUBJECT TO CHANGE WITHOUT NOTICE

**C Calibration
S Standards
C Corporation**

a subsidiary of ROYAL INDUSTRIES, INC.
1025 Westminister Ave., Alhambra, Calif.

MEETINGS AHEAD

Feb. 26-Mar. 1: Pacific Electronic Trade Show; Great Western Exhibit Center, Los Angeles.

Mar. 1-2: Instruments Show, ERA; Elks Club, Palo Alto, Calif.

Mar. 1-2: Society of Vacuum Coaters, Thin-Film Structures; Conrad Hilton Hotel, Chicago.

Mar. 6-8: Data Processing Conf. & Exhibit, AMA; Statler-Hilton Hotel, Wash., D. C.

Mar. 9: National Federation of Science, Abstracting & Indexing Services; Manger Hotel, Cleveland.

Mar. 9-10: Engineering Aspects of Magnetohydrodynamics, PGNS of IRE, AIEE, IAS; University of Penn., Philadelphia.

Mar. 11: Quality Control, American Society for; Hart House, Univ. of Toronto, Ontario.

Mar. 14: Defense Planning Seminar, EIA; Statler-Hilton Hotel, Wash., D. C.

Mar. 15-19: High-Fidelity Show, Magnetic Recording Industry Assoc.; Cow Palace, San Francisco.

Mar. 20-23: Institute of Radio Engineers, International Convention, All PG's; Coliseum & Waldorf-Astoria Hotel, New York City.

Mar. 21-22: Institute of Printed Circuits, Annual; New York City.

Mar. 27-31: Temperature, Its Measurement and Control, ISA, AIP, NBS; Veteran's Memorial Auditorium, Columbus, O.

Mar. 28: Rochester Soc. for Quality Control, ASQC; Univ. of Rochester, Rochester, N. Y.

Mar. 28-29: Nuclear Aspects of Atmospheric and Space Systems, ANS; Statler-Hilton Hotel, Dallas.

Apr. 4-6: Electromagnetics and Fluid Dynamics of Gaseous Plasma, IRE, IAS, U. S. Defense Research Agencies; Engineering Societies Bldg., N. Y. C.

**C
S
C**

ALL-TRANSISTORIZED REGULATION MONITOR

**VOLTAGE
REGULATION
STABILITY
MEASUREMENT
for \$325.***



**MODEL RM-2A
PRECISION REGULATION MONITOR**

The CSC Model RM-2A is specifically designed to measure voltage stability and to final-check D.C. regulated power supplies. As such, it provides a compact, highly sensitive and stable package that eliminates the need for specially constructed, involved test set-ups... substitutes instead an easily portable, inexpensive instrument with straightforward circuitry and easy readout.

VOLTAGE: 2-500 Volts DC
SENSITIVITY: .1% F.S., 1% F.S., 10% F.S.
STABILITY: 5 PPM/°C from 10-40°C
WEIGHT: 7 lbs.
SIZE: 8" w., 7" h., 6" d.

Complete information is available from any of these CSC Representatives:

QED Electronic Sales, Inc.....Mt. Vernon, N.Y.
 Holdsworth & Company.....Lansdowne, Pa.
 Stanley Enterprises.....Seattle 8, Wash.
 Smith-Dietrich Sales Co.....Inglewood, Calif.
 Lawrence L. Hill.....Wichita, Kans.
 The Jay Company.....Arlington, Va.
 Charles Winick Company.....Schenectady, N.Y.
 EMF Associates...Denver, Colo. & Salt Lake City
 George Gostenhofer & Assoc., Inc., Waltham, Mass.
 Frazer & Hansen (Export)...San Francisco 11, Calif.

Or write directly to CSC for technical bulletin E-1320-1B.

* P. O. B. ALHAMBRA, CALIF.
PRICES SUBJECT TO CHANGE WITHOUT NOTICE

**C Calibration
S Standards
C Corporation**

a subsidiary of ROYAL INDUSTRIES, INC.
1025 Westminister Ave., Alhambra, Calif.

AN EXTRAORDINARY PUBLISHING ACHIEVEMENT OF OUR TIME!

Here Are the Many Fields Covered:



- ACOUSTICS
- AERONAUTICAL AIRFRAMES
- AGRICULTURE & SOILS
- ANIMAL ANATOMY
- PLANT ANATOMY
- ANIMAL SYSTEMATICS
- ASTRONOMY
- ATOMIC, MOLECULAR AND NUCLEAR PHYSICS
- BIOCHEMISTRY
- BIOPHYSICS
- CHEMICAL ENGINEERING
- ANALYTICAL CHEMISTRY
- INORGANIC CHEMISTRY
- ORGANIC CHEMISTRY
- PHYSICAL CHEMISTRY
- CIVIL ENGINEERING
- COMMUNICATIONS
- CONSERVATION
- CONTROL SYSTEMS
- CYTOLOGY
- ANIMAL ECOLOGY
- PLANT ECOLOGY
- ELECTRICAL ENGINEERING
- ELECTRICITY
- ELECTRONICS
- FLIGHT SCIENCE
- FOOD ENGINEERING
- FORESTRY
- GENETICS & EVOLUTION
- GEOCHEMISTRY
- PHYSICAL GEOGRAPHY
- SURFICIAL AND HISTORICAL GEOLOGY
- GEOPHYSICS
- GRAPHIC ARTS
- GROWTH AND MORPHOGENESIS
- HEAT
- INDUSTRIAL AND PRODUCTION ENGG.
- LOW TEMPERATURE PHYSICS
- MACHINE DESIGN
- MATHEMATICS
- MECHANICAL POWER
- CLASSICAL MECHANICS
- METALLURGICAL ENGINEERING
- METEOROLOGY AND CLIMATOLOGY
- MICROBIOLOGY
- MEDICAL MICROBIOLOGY
- MINERALOGY AND PETROLOGY
- MINING ENGINEERING
- NAVAL ARCHITECTURE AND MARINE ENGG.
- NUCLEAR ENGINEERING
- OCEANOGRAPHY
- OPTICS
- PALEONTOLOGY
- ANIMAL PATHOLOGY
- PLANT PATHOLOGY
- PETROLEUM CHEMISTRY
- PETROLEUM ENGINEERING
- GENERAL PHYSIOLOGY
- PLANT PHYSIOLOGY
- SOLID STATE PHYSICS
- THEORETICAL PHYSICS
- PLANT TAXONOMY
- PROPULSION
- PHYSIOLOGICAL AND EXPERIMENTAL PSYCHOLOGY
- INVERTEBRATE ZOOLOGY

The Entire Span of Today's Scientific, Engineering and Technical Knowledge Encompassed in a Monumental Reference Work Containing 8,500 pages of Text, 800 Index Pages, 7,200 Articles and 9,700 Illustrations

Includes developments so recent they are still major news!

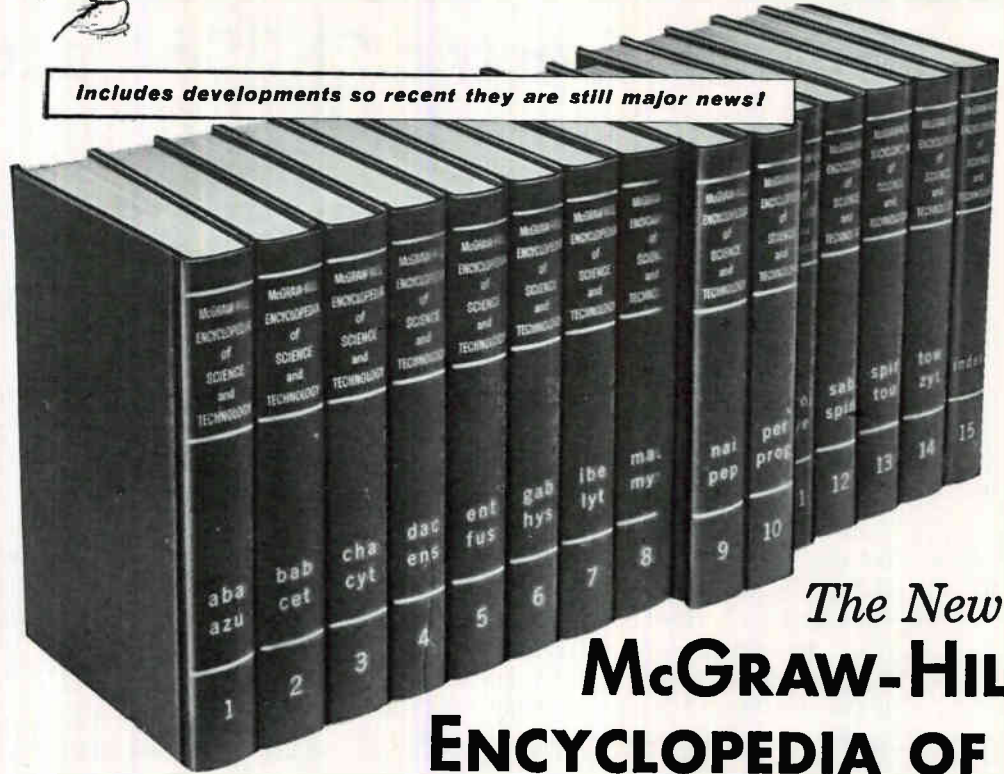

The New
McGraw-Hill
ENCYCLOPEDIA OF
SCIENCE and TECHNOLOGY

2,015 Contributors, including Nobel Prize Winners, Respected Leaders of Research and Industry . . . Over 6,000,000 Words — from Concise Articles to Amazingly Comprehensive Treatments . . . 100,000-Entry Index . . . a Wealth of Maps, Charts, Diagrams, Drawings, Photographs . . . many more than in any comparable work of reference.

An epoch-marking publishing venture — providing up-to-date, authoritative information on all the sciences of our day — is now completed. The new MCGRAW-HILL ENCYCLOPEDIA OF SCIENCE AND TECHNOLOGY makes readily accessible within its 15 volumes a vast fund of knowledge covering hundreds upon hundreds of subjects dealing with the whole spectrum of the physical sciences, life sciences, earth sciences, and engineering.

This major work fulfills a prime need of the scientist, the engineer, the technician — whether concerned with pure research or practical applications — whether his work is of a design or operating nature — whether he wants to review or keep abreast of the vastly enlarged knowledge of his own field or must bridge the gap between his specialty and unfamiliar areas into which his work leads him.

Unequaled in Timeliness, Clarity, Depth

This unique library makes it possible for you to have as near as your office, laboratory, plant, or home an all-knowing corps of specialists to which you can turn for precise, authoritative information. You can get answers to specific questions raised through daily professional activities or simply explore in a random way the universe of today's scientific, engineering, and technical knowledge — distilled into 7,224 comprehensive articles. Whatever your own field, whatever field your work is related to, you will find it here.

A Work of Unsurpassed Authority

The names of the contributors read like a "Who's Who" of the world's scientific community. All are recognized specialists — in many instances, articles

were written by the very person credited with new discoveries and developments in a given field. Among them are Nobel Prize Winners and others who have distinguished themselves for their original and significant work.

Nothing comparable in breadth of conception, in authority, in usefulness, has ever before been offered in a reference work of this kind. As an all-embracing general reference or a practical working tool, this Encyclopedia belongs in the home and professional library of everyone with an interest in science and engineering. An annual Supplement Volume keeps it always up to date.

You are cordially invited to examine all fifteen volumes. There is, of course, no obligation on your part. Mail the coupon below for full details.

MAIL THIS COUPON

McGraw-Hill Book Company Dept. L-2-24
327 West 41 Street, New York 36, N.Y.

Please send me without obligation your pre-view brochure on the new MCGRAW-HILL ENCYCLOPEDIA OF SCIENCE AND TECHNOLOGY in 15 volumes; also detailed information about the convenient time-payment plan I may use to purchase this set.

Name.....

Address.....

City & Zone.....

State.....

L-2-24

General Electric 2N396A and 2N526 transistors feature guaranteed maximum high temperature I_{CO} and minimum low temperature h_{FE}

A WELL-CHARACTERIZED SWITCH AND AMPLIFIER FOR MILITARY USE WITH EXTREME STABILITY PROVED BY 10,000-HOUR LIFE TESTS

These two do the tough jobs—a fact demonstrated by their use in dozens of different missiles. Reliability and uniformity of parameters are enhanced by a 100°C bake on 100% of all manufactured product. All units also undergo a hydraulic pressure test to insure against leaks. Gettering guards against entrapped moisture and provides unusual stability of parameters.

USN 2N396A

Method B life-test of MIL-S-19500 assures exceptional reliability for General Electric's USN 2N396A. Life-test reliability is the highest for any transistor now covered by military specifications. The G-E USN 2N396A is guaranteed to have extremely low failure rates,

being required to meet acceptance criteria roughly equivalent to 0.65 AQL. Compare this with the AQL's of 4.0 and 6.5 generally used for life assurance in MIL specs.

JAN 2N526

The JAN specification for General Electric's 2N526 reflects the outstanding characteristics of this transistor type. Among the features which contribute to its superiority are high dissipation (225 mw), 100°C maximum storage temperature and h_{FE} from 53 to 90.

See your General Electric Semiconductor District Sales Manager for complete specifications. General Electric Company, Semiconductor Products Dept., Electronics Park, Syracuse, New York.

2N396 EXTENDED LIFE TEST STABILITY

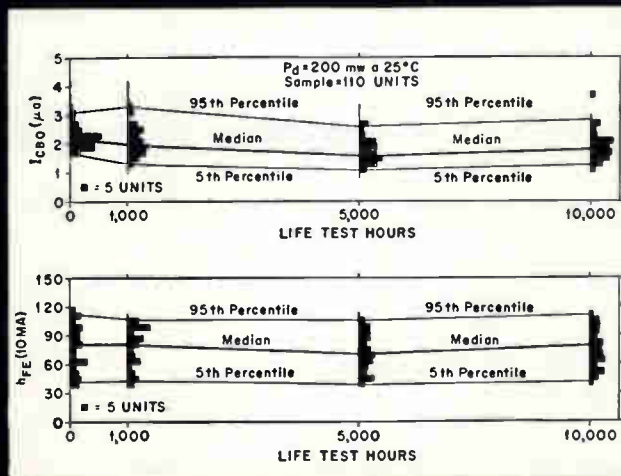

2N526 EXTENDED LIFE TEST STABILITY

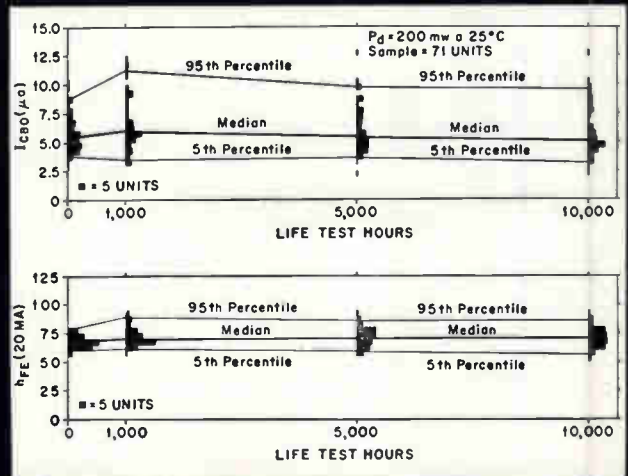

Scope at left shows high-temperature I_{CO} trace with transistor immersed in mineral oil at $+70^{\circ}\text{C}$. Scope at right shows low-temperature h_{FE} with transistor packed in dry ice at approximately -55°C . Scales: I_{CO} — vertical scale 10 microamps./cm., voltage scale 2 volts/cm.; h_{FE} — base drive 50 microamps./step, vertical scale 1 millamp./cm., horizontal scale 2 volts/cm.

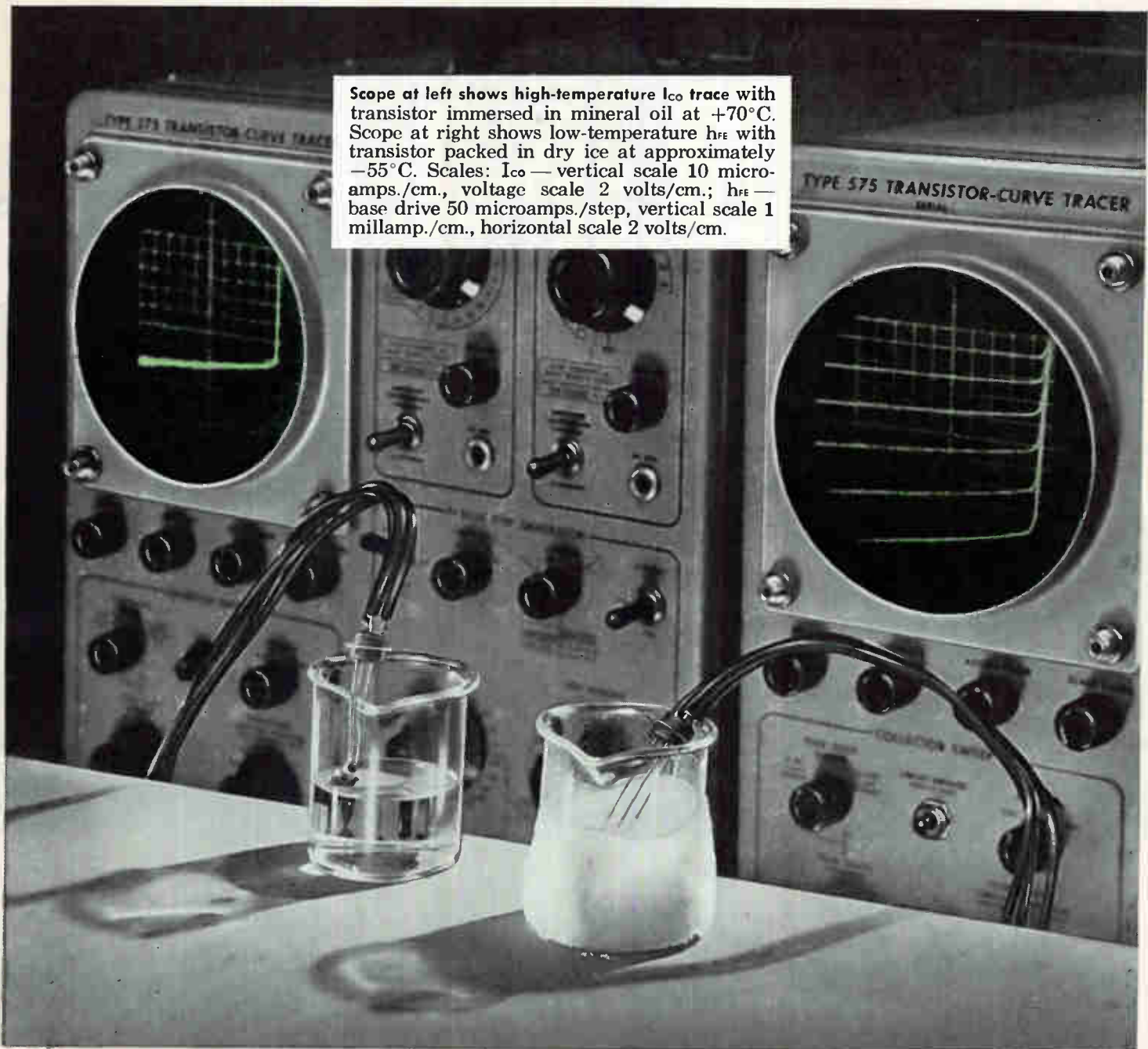

TYPE	MAXIMUM RATINGS (25°C)				ELECTRICAL CHARACTERISTICS				
	V _{CEO}	V _{CER}	V _{EB0}	P _T	25°C Max. I _{CO}	70°C Max. I _{CO}	25°C h _{FE} min.	25°C h _{FE} max.	h _{FE} min.
2N526	-45***	-30	-15	225 mw	-10μa @ -30V	-220μa @ -30V	53	90	27 (-25°C)
2N396A	-30	-20*	-20	200 mw**	-6μa @ -20V	-120μa @ -20V	30	150	20 (-55°C)

*V_{CEO}
 Mil Version 150 mw *Mil Version -30V

For fast delivery at factory low prices, call your authorized General Electric Distributor.



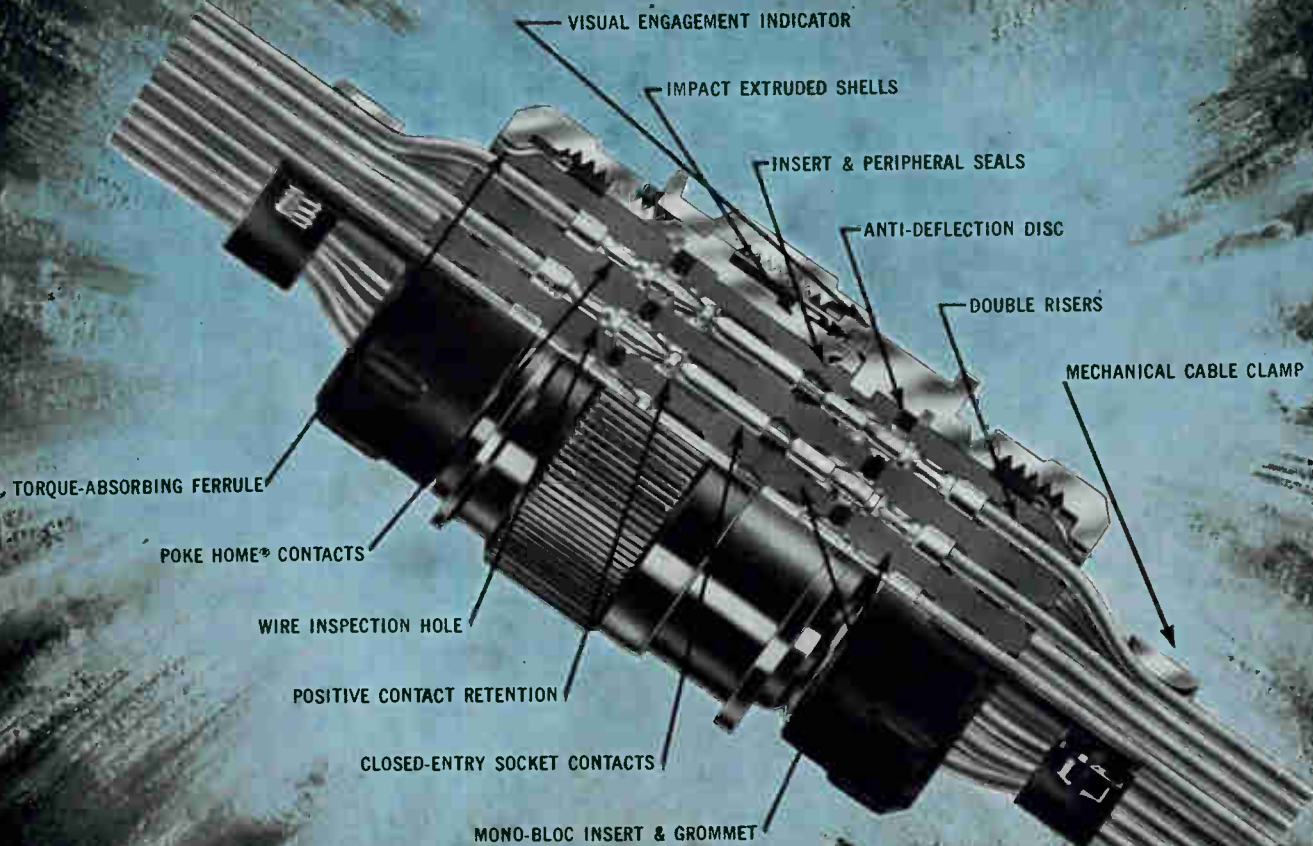

MIL-C-26500 (USAF)

the Future is here!

**AMPHENOL
48 SERIES CONNECTORS
TO MIL-C-26500
provide you with these
performance features:**

- Performance not affected by maximum operating temperature life of 800 hours at 200°C (392°F), simultaneously conducting current on all contacts.
- Performance not affected by Thermal shock of 260°C (500°F) to -55°C (-67°F).
- Supports 1500 volts RMS at high altitudes (Sea level to 350,000 feet) fully mated.
- Altitude immersion resistant after 10 contact removal and insertion cycles on all contacts. (Maintains 5000 megohms I.R. after three altitude cycles.)
- Environmental and electrical integrity is maintained during and after vibration, 0 to 2000 CPS, 15 g's during exposure to 200°C and -55°C.

Plus Outstanding Design Features — **WRITE FOR DATA**

AMPHENOL

AMPHENOL CONNECTOR DIVISION

1830 S. 54TH AVE. • CHICAGO 50, ILLINOIS

Amphenol-Borg Electronics Corporation

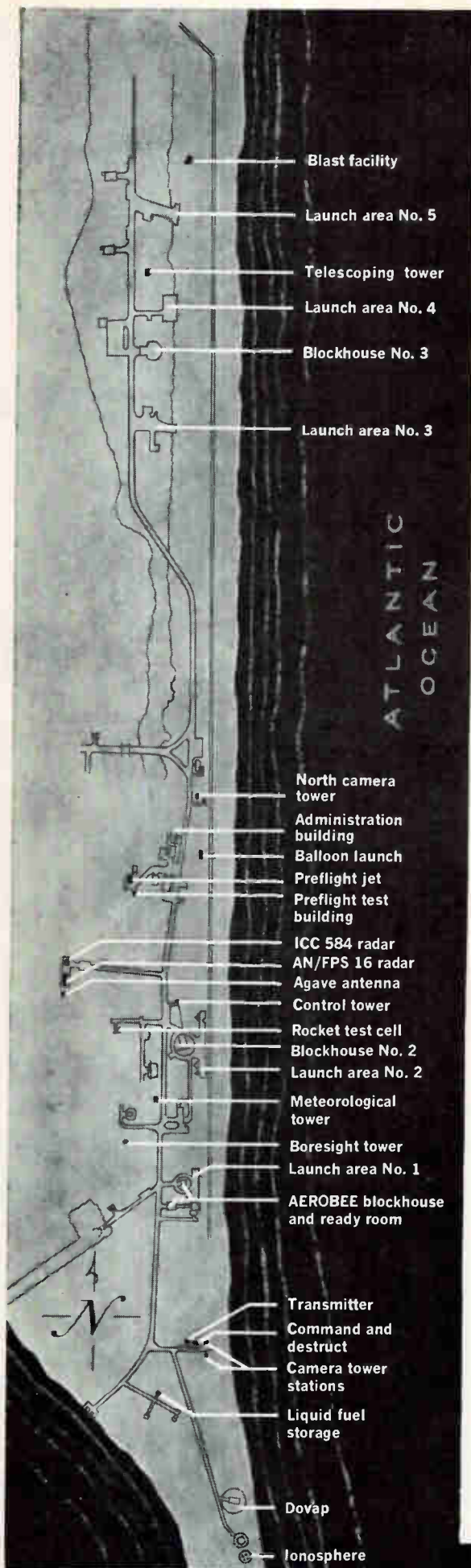

Blast facility
 Launch area No. 5
 Telescoping tower
 Launch area No. 4
 Blockhouse No. 3
 Launch area No. 3

ATLANTIC
 OCEAN

North camera tower
 Administration building
 Balloon launch
 Preflight jet
 Preflight test building
 ICC 584 radar
 AN/FPS 16 radar
 Agave antenna
 Control tower
 Rocket test cell
 Blockhouse No. 2
 Launch area No. 2
 Meteorological tower
 Boresight tower
 Launch area No. 1
 AEROBEE blockhouse and ready room
 Transmitter
 Command and destruct
 Camera tower stations
 Liquid fuel storage
 Dovap
 Ionosphere

this is NASA

WALLOPS

AMERICA'S SCIENTIFIC ROCKET RANGE FOR THE SPACE AGE

Wallops Space Flight Station is located on Virginia's historic Eastern Shore a scant 120 air miles from the Nation's Capital. Here on the beaches, where the famed wild ponies of Chincoteague run free, the mysteries of the cosmos are explored.

A part of the NASA complex, Wallops is a complete launching facility equipped with tracking and data collection systems. More than four hundred launchings are planned for 1961, ranging from small ARCON sounding rockets probing the outer edges of the atmosphere to powerful SCOUT rockets orbiting scientific satellites.

You can be sure to play an important role in the nation's space effort when you join NASA. For detailed information about outstanding professional opportunities, address your inquiry to the Personnel Director.

NASA Wallops Space Flight Station, Wallops Island, Va.—
 NASA Ames Research Center, Mountain View, Calif.—NASA Flight Research Center, P.O. Box 237, Edwards, Calif.—NASA Goddard Space Flight Center, Greenbelt, Md.—NASA Langley Research Center, Hampton, Va.—NASA Lewis Research Center, Cleveland 35, Ohio—NASA Marshall Space Flight Center, Huntsville, Ala.



**NATIONAL AERONAUTICS
 AND SPACE ADMINISTRATION**

TANTALUM CAPACITORS

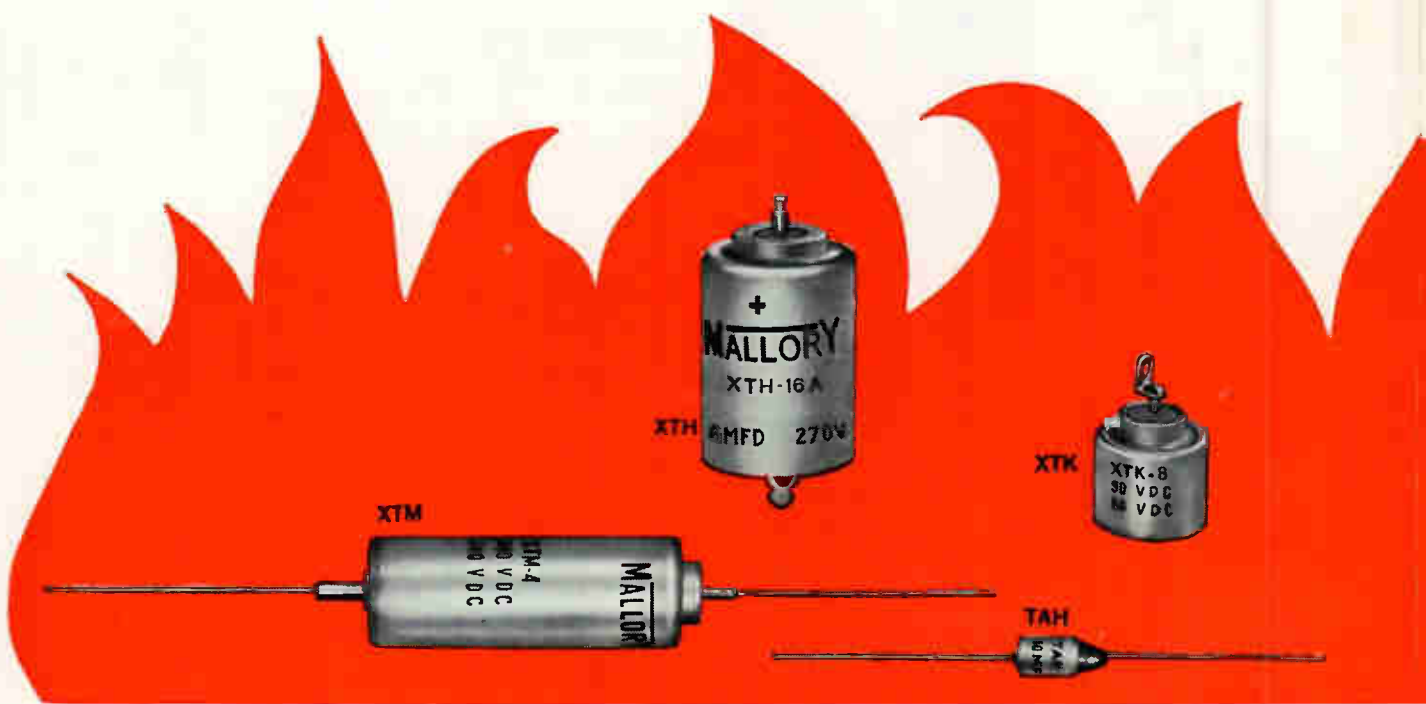

from the industry's widest selection...

the highest temperatures—up to 200°C . . . the highest capacitances—up to 2250 microfarads . . . the smallest sizes—new 125°C miniature TAH . . . many terminal arrangements are available in the XT series.

seven different high temperature types . . . with the

sintered pellet anode pioneered by Mallory for extreme environments.

. . . plus seven other tantalum capacitor types—including foil, solid electrolyte, encapsulated, miniature, microminiature. Write for catalog and consultation. Mallory Capacitor Company, Indianapolis 6, Indiana.

FOR THE HOTTEST JOBS

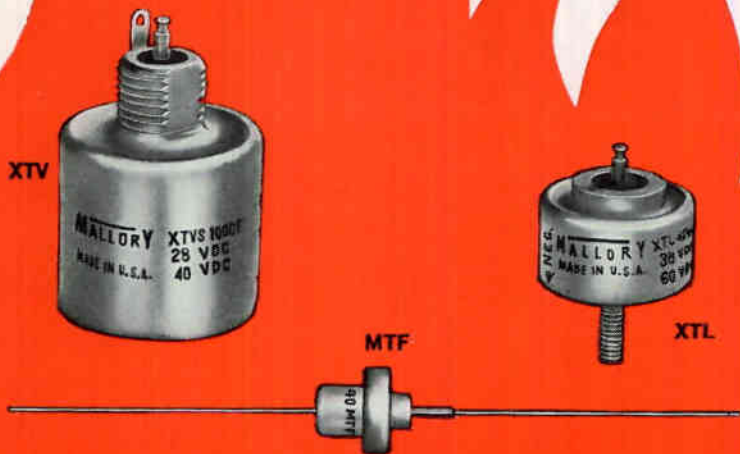

P. R. MALLORY & CO., Inc.
MALLORY

Mallory Tantalum Capacitors Stocked by these distributors

Arlington, Va.
 Rucker Electronic Products

Baltimore, Md.
 Radio Electric Service

Boston, Mass.
 Cramer Electronics, Inc.
 DeMambro Radio Supply Co.
 Lafayette Radio

Bridgeport, Conn.
 Westconn Electronics

Buffalo, N.Y.
 Wehle Electronics

Chicago, Ill.
 Allied Radio Corp.
 Newark Electronics Corp.

Cincinnati, Ohio
 United Radio

Cleveland, Ohio
 Pioneer Electronics

Dallas, Texas
 Engineering Supply Co.

Dayton, Ohio
 Allied Supply Co.

Denver, Colo.
 Denver Electronics

Houston, Texas
 Harrison Equipment Co., Inc.
 Lenert Company

Indianapolis, Ind.
 Graham Electronics

Los Angeles, Calif.
 California Electronics
 Kierulff Electronics, Inc.
 Radio Product Sales

Minneapolis, Minn.
 Northwest Radio

Montreal, Que.
 Canadian Electrical Supply Co.

Mountainside, N.J.
 Federated Purchaser, Inc.

Nashville, Tenn.
 Electra Dist. Co.

Newark, N.J.
 Lafayette Radio

New York, N.Y.
 Harrison Radio Corp.
 Harvey Radio Co., Inc.
 Lafayette Radio
 Terminal Hudson Electronics

Oakland, Calif.
 Elmar Electronics, Inc.
 Zack Electronics

Orlando, Fla.
 East Coast Radio

Ottawa, Ont.
 Wackid Radio-TV Lab.

Palo Alto, Calif.
 Zack Electronics

Pasadena, Calif.
 Electronic Supply Corp.

Perth Amboy, N.J.
 Atlas Electronics

Philadelphia, Pa.
 Herbach & Rademan
 Philadelphia Electronics

Pittsburgh, Pa.
 Radio Parts Co.

St. Louis, Mo.
 Olive Electronics

Seattle, Wash.
 F. B. Connelly Co.

Tampa, Florida
 Thurow Distributors, Inc.

Toronto, Ont.
 Alpha Aracon Radio Co.
 Electro Sonic Supply
 Wholesale Radio & Electronics

Tucson, Ariz.
 Standard Radio Parts

Tulsa, Okla.
 Engineering Supply Co.

Washington, D.C.
 Capitol Radio Wholesalers
 Electronic Industrial Sales

White Plains, N.Y.
 Westchester Electronic
 Supply Co., Inc.

Winston-Salem, N.C.
 Dalton-Hege Radio



A complete line of aluminum and tantalum electrolytics, motor start and run capacitors

RESOLVERAMP

The Compatible Marriage of a

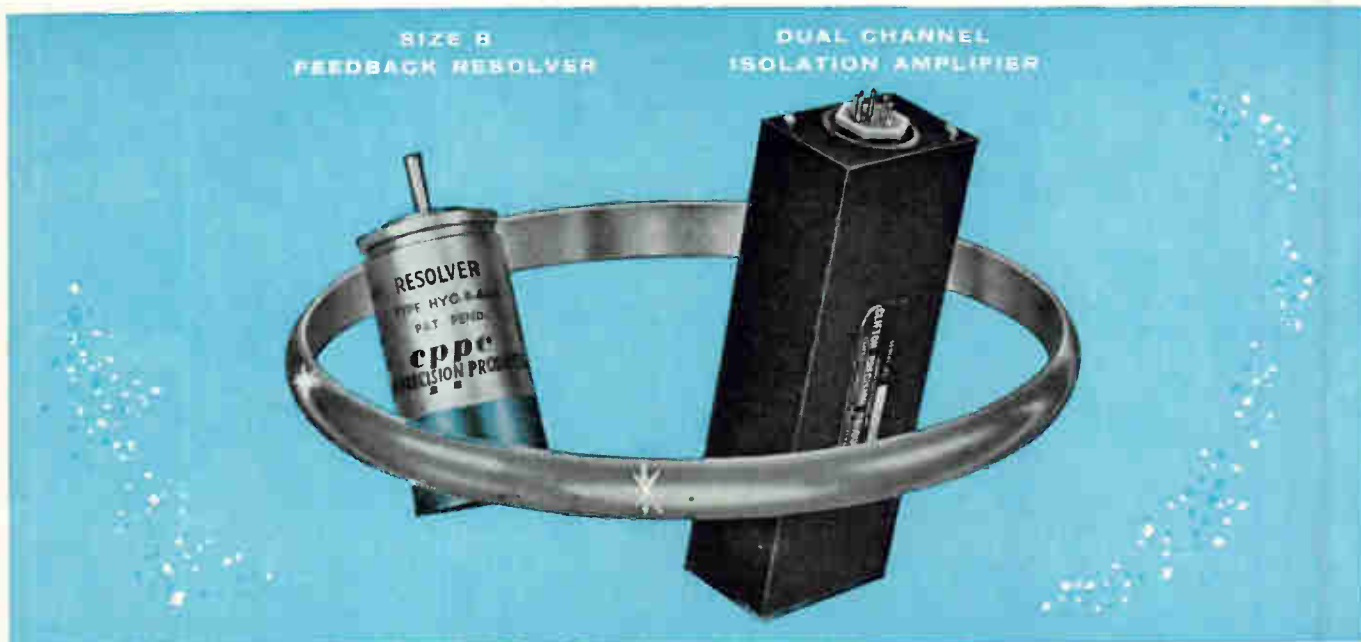

**Highest Feedback Factor
Guaranteed 1:1 T.R. ($\pm 0.05\%$)
Off-Shelf Delivery**

A truly compatible marriage! As a further advantage, save gear plate area by mounting these size 8 components rather than size 11's or 15's.

A typical application in which four dual channel amplifiers and 5 resolvers solve a spherical triangle is shown below. More complex trigonometric functions as well as systems involving coordinate axis transformation can be generated.

Our Systems Division can engineer to your specifications assemblies utilizing these components.

SIZE 8 FEEDBACK RESOLVERS

- Feedback factor of 66 db. (2000 to 1)
- Unity transformation ratio $\pm 0.05\%$
(Other transformation ratios accurate to $\pm 0.05\%$ available on special order)
- 0.05% functional accuracy over all environmental extremes
- $\pm 5'$ or $\pm 3'$ resolvers to meet your most exacting specifications
- 0° phase shift

DUAL CHANNEL ISOLATION AMPLIFIER

- 10,000 ohm amplifier input Z
- Two complete and separate amplifiers per module
- Size 1" x 1 1/16" x 4 1/4"
- Supply voltage 28v dc
- Encapsulated construction

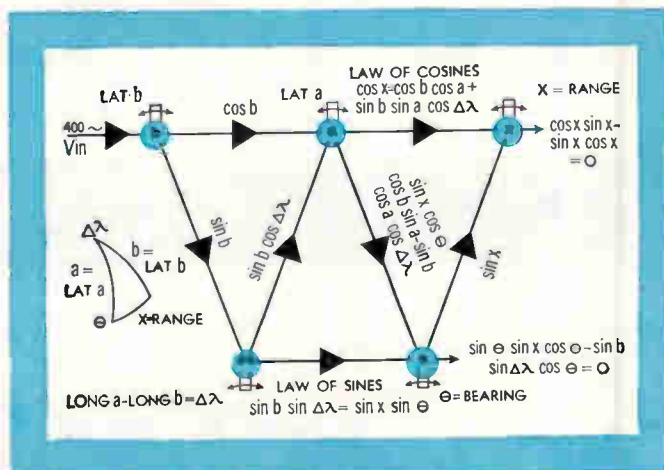

For Further Information Telephone or Write:

MAdison 2-1000, TWX LNSDWN, PA. 1122(U)—or our Representatives

CLIFTON PRECISION PRODUCTS CO., INC.
Clifton Heights, Pennsylvania



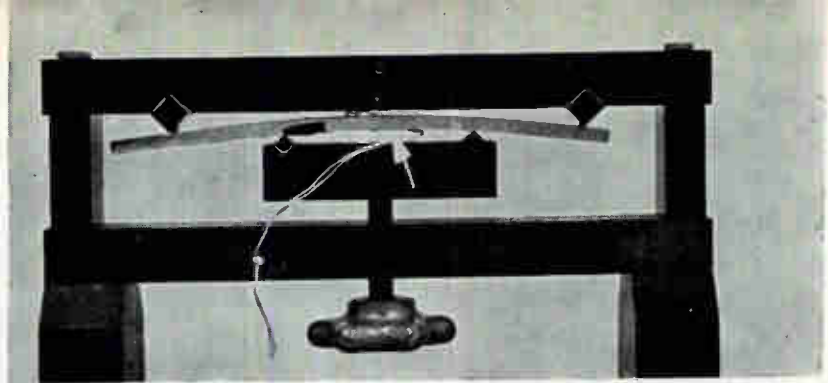

Sensor bonded to aluminum beam is undergoing 5,800 microinch per inch strain test in constant moment bending test fixture

Semiconductor Strain Gages Offer High Sensitivity

By **ROBERT E. TALMO**

Chief Engineer, Micro Systems Inc., San Gabriel, Calif.

Single crystal silicon structures provide sensitivity nearly two orders of magnitude greater than their metal counterparts. Devices are adaptable to small area strain measurements

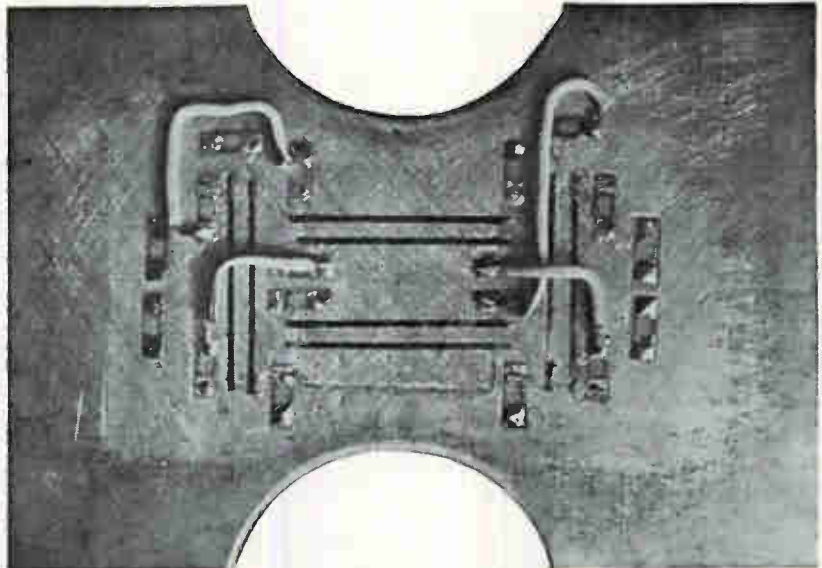

Strain measuring application shows eight semiconductor elements (Micro-Sensors) connected as two full bridges

MEASURING INDUCED stress or resulting strain in materials is commonplace in structural work as well as in electromechanical transducers. Until recently this has been accomplished almost solely by wire or metallic foil gages. While these gages possess desirable characteristics their usefulness is limited by lack of sensitivity in certain applications. Sensitivities 10 to 100 times greater than those available from present metallic devices can be obtained by using semiconductor strain gages.

Semiconductor strain sensors can detect extremely low strain levels. In many applications signal ampli-

fiers can be eliminated. With appropriate semiconductor element geometry, bonding to a surface of small radius of curvature is possible. Because of repeatable temperature characteristics, compensation of zero and sensitivity shift is practical.

All materials exhibit some piezoresistance—that is, a change in resistivity due to applied stress. To compare the degree of piezoresistance or sensitivity of various materials, a figure of merit known as gage factor is used. Gage factor

is defined by $GF = \frac{\Delta R/R}{\Delta L/L}$ where

R is the unstrained resistance, ΔR the change in resistance due to applied strain, L the unstrained length and ΔL the change in length due to applied strain.

The gage factor is a dimensionless scaler quantity. A positive value denotes an increase in resistance with increasing strain (tension). Gage factor for metallic wires varies from two to twelve. In certain semiconductors, gage factors approach two hundred.

Due to the anisotropic nature of single crystal semiconductors it is necessary to define the crystallographic orientation when referring to gage factor. The conductivity

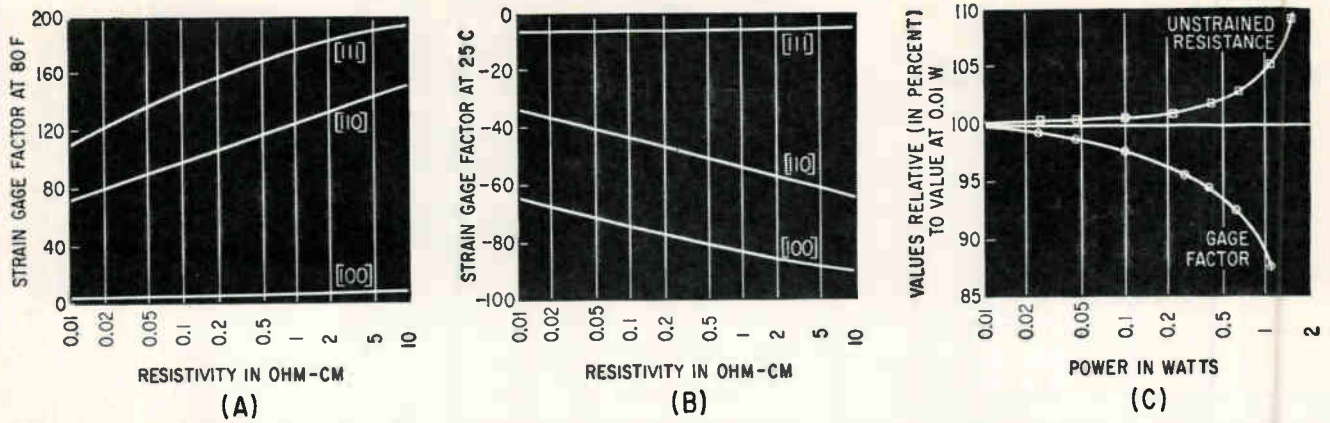

FIG. 1—Strain gage factor for three orientations of p-type (A) and n-type (B) silicon. Effect of power dissipation is indicated in (C)

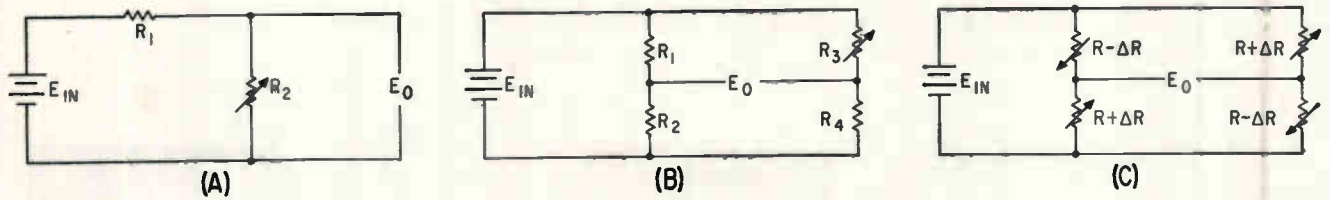
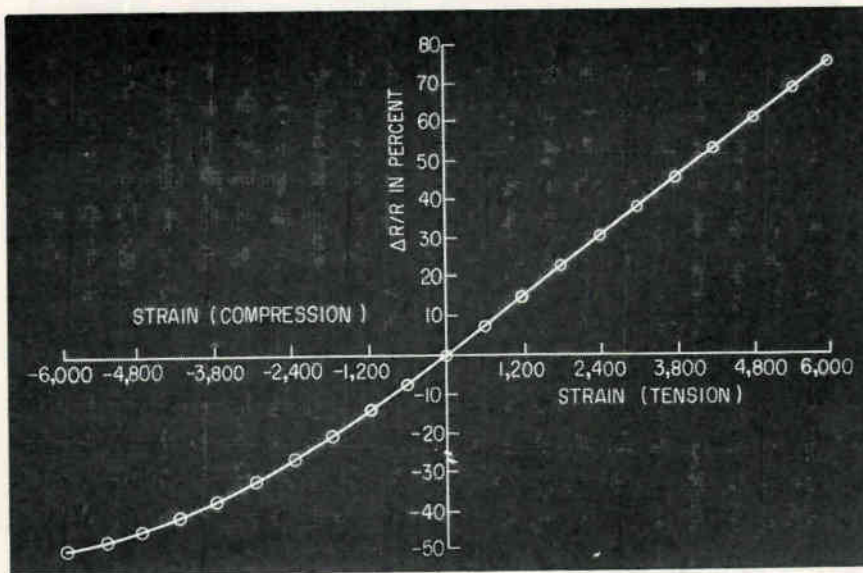

FIG. 2—Basic circuit (A) is modified to provide temperature compensation (B) and increased output (C)



Single-Crystal Silicon Properties

Density	0.087 lbs/in ³
Young's Modulus	27.3 × 10 ⁶ psi [111] 20.3 × 10 ⁶ psi [100] 25.1 × 10 ⁶ psi [110]
Thermal Coefficient of Expansion	1.39 × 10 ⁻⁴ /F
Melting Point	2,590F

FIG. 3—Sensitivity and linearity of silicon strain gage varies with tension and compression

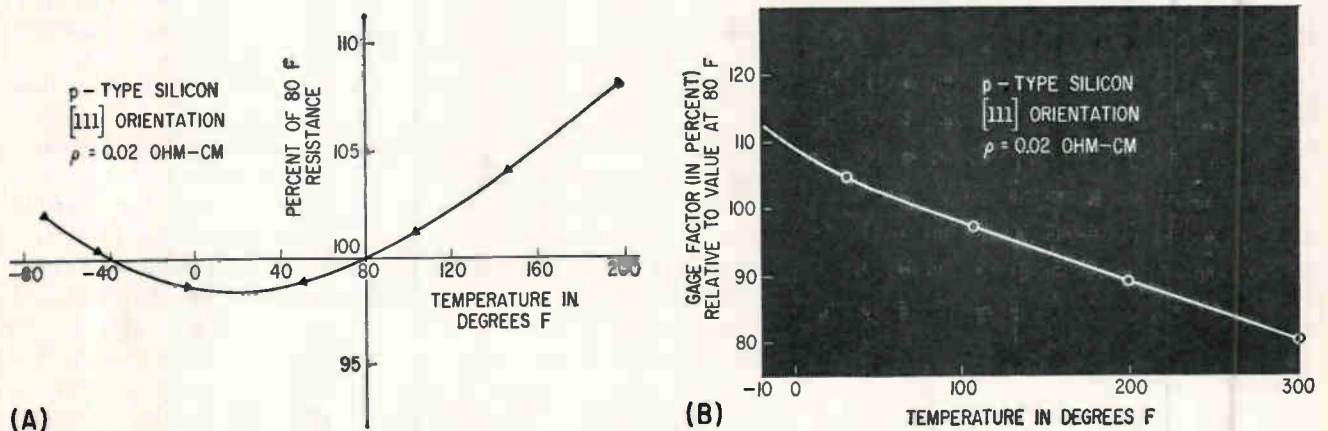

FIG. 4—Resistance (A) and gage factor (B) are influenced by temperature

type (p or n) and resistivity for a semiconductor material also effect the degree of piezoresistance. Figures 1A and B show the effect of these parameters on gage factor.

A quantitative expression for the gage factor of a semiconductor piezoresistance element is

$$GF = \frac{\Delta R/R}{\Delta L/L} = 1 + 2\sigma + Y\pi_e$$

where σ = Poisson's ratio, Y =

$$\text{Young's modulus and } \pi_e = \frac{\Delta R/R}{F/A}$$

Factor F is the applied longitudinal force and A the element cross sectional area.

In addition to gage factor, other properties must be known to use these semiconductor elements in an optimum manner. The table lists a number of physical and electrical properties.

Inasmuch as the semiconductor strain gage element is a single crystal device it exhibits a nearly ideal stress-strain characteristic—that is, no plastic deformation below 900 F. This means hysteresis is absent. For small cross-sectional areas, maximum strain level of 3,000 to 6,000 microinch per inch is possible. The active portion of a typical element is 0.5 inch long, 0.20 inch wide and 0.0007 inch thick. The device is flexible and easy to apply and can be bonded to surfaces whose radius of curvature is as small as 0.1 in.

Resistance is controlled by the amount of impurity doping used to make the ingot from which the elements are cut. For elements 0.5 inch long by 10^{-5} square inch cross sectional area, resistances in the range of 100 to 10,000 ohms are readily made. Because the output signal obtainable with these devices is from one to two orders of magnitude greater than their metallic counterparts, the signal-to-noise ratio is enhanced by the same factor, assuming equal generator impedance.

It is expected that this sensor will find widespread application in stress analysis and electromechanical transducers. In stress analysis, measurements heretofore impossible because of signal to noise considerations for a metallic strain gage become a reality. Strain levels of a fraction of a microinch per inch can be resolved.

Strain elements made from these sensitive materials can be used in either a bonded or unbonded manner. Bonded applications assure the availability of a heat sink which allows the application of greater input voltage which in turn produces a proportionally larger output signal. Figure 1C shows the power handling capability for bonded elements. Unbonded elements of the same geometry can be used to approximately 10 percent of the bonded power rating. The extremely small mass of the elements prevents loading of a transducer force summation unit, thereby preserving the frequency response of the sensor. If output is traded for frequency response, it is possible to raise the natural frequency of a transduction system by a factor of ten while still obtaining normal metallic strain gage output. Zero shift with temperature must be accounted for in this case as the element is being used at a small fraction of its full-scale capability.

Semiconductor strain gages can be used in both d-c and a-c excited circuits due to the resistive nature of the device. A sample circuit for the use of a single element is shown in Fig. 2A. If this circuit is arranged for constant current conditions ($R_1 \gg R_2$), then $E_o = KR_2$ where $K \cong E_{in}/R_1$. For the constant current case the output is a linear function if R_2 changes in a linear manner. Linearity of the Micro-Sensor is shown in Fig. 3. For improved linearity in cases involving both tension and compression, pretensioning of the compression elements is recommended.

Although simple, the circuit in Fig. 2A suffers from lack of temperature compensation. This disadvantage can be overcome by the bridge circuit of Fig. 2B. To gain temperature compensation, R_3 and R_4 must have the same resistance versus temperature curve and both must be at the same temperature. Further improvement can be made by making R_3 and R_4 both active legs of the bridge if an equal and opposite strain can be seen by these two elements. In this instance the output signal will increase by a factor of two along with the cancellation of first order zero shift with temperature. A four active arm bridge will yield four times

the output and provide temperature compensation if the elements are arranged as in Fig 2C.

Figure 2C is the most frequently used bridge configuration for transducer applications. Output from this circuit is

$$E_o = E_{in} \Delta R/R \quad (1)$$

Bridge output can also be determined from $E_o = E_{in} \times \epsilon \times GF \times N/4$ where ϵ = strain level ($\Delta L/L$), GF = gage factor and N = number of active arms.

In the case of a four active arm bridge: $E_o = E_{in} (\epsilon \times GF)$ which has the same form as Eq. 1. Thus, $\Delta R/R = \epsilon \times GF$ and since $\epsilon = \Delta L/L$, then

$$GF = \frac{\Delta R/R}{\Delta L/L}$$

Figures 4A and B show the effect of temperature on unstrained resistance (zero shift) and gage factor (sensitivity). Low resistivity material shows a relatively flat characteristic over a moderate temperature range. Of equal importance in bonded applications is the coefficient of linear expansion of the base material. Where half or fully active bridges can be used, the circuit configuration will cause a first-order correction to zero shift. If closer control of zero shift is required, standard compensation networks can be applied. Sensitivity shift with temperature can be corrected by using an appropriate thermistor compensation network in either the input or output leads.

BIBLIOGRAPHY

- J. C. Sanchez, The Micro-Sensor, A New Tool for the Experimental Stress Analyst; Paper presented at Society for Experimental Stress Analysis, Oct. 12, 1960, Meeting of Southwest Chapter.
- E. D. Padgett and W. V. Wright, Silicon Piezoresistive Devices; Paper (Preprint number 42-NY60) presented at Instrument Society of America Conference, New York, N. Y., Sept. 1960.
- C. Perry and H. Lissner, "The Strain Gage Primer", McGraw-Hill, New York, N. Y., 1955.
- W. P. Mason and R. N. Thurston, Use of Piezoresistance Materials in the Measurement of Displacement, Force and Torque, *Jour. of Acoustical Society of America*, Oct. 1957.
- L. E. Hollander, G. L. Vick and T. J. Diesel, The Piezoresistive Effect and its Applications, *The Rev of Sci Inst*, March 1960.
- C. S. Smith, Piezoresistance Effect in Germanium and Silicon, *Physical Review*, April 1, 1954.
- E. M. Conwell, Properties of Silicon and Germanium, *Proc IRE*, 40, p 1327, 1952 and 46, p 1281, 1958.
- W. P. Mason, J. J. Forst and L. M. Tornillo, Recent Developments in Semiconductor Strain Transducers, Paper (Preprint number 15-NY60) presented at Instrument Society of America Conference, New York, N. Y., Sept. 1960.
- F. J. Morin, T. H. Geballe and C. Herring, Temperature Dependence of Piezoresistance of High Purity Silicon, Germanium, *Physical Review* 105, 1957.

PHANTASTRON CIRCUITS

By N. C. HEKIMIAN,
Department of Defense,
Washington, D. C.

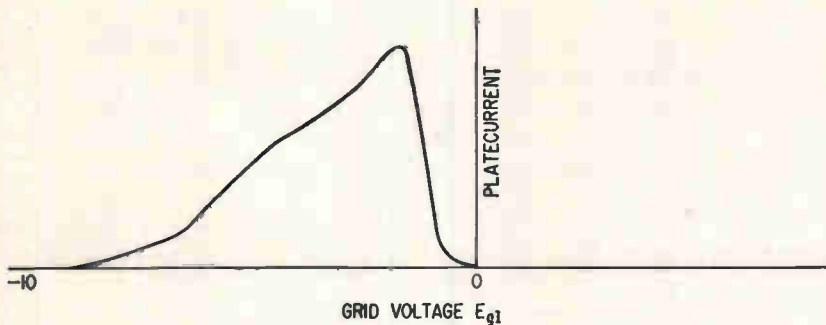

FIG. 1—Characteristic of vacuum-tube phantastron exhibits a region of negative slope, which is the key to the circuit's regenerative action

THE CONVENTIONAL vacuum-tube phantastron depends for its action on partition of cathode current between the screen grid and plate of a multigrid tube. Using a suppressor grid between the screen and plate, it is possible to control the proportion of cathode current that is diverted to the screen. With feedback signal coupled to this grid, it is possible to obtain a normal amplification over a certain range of grid bias, and, over another region, an inverted relationship in which the plate current diminishes as the grid bias becomes increasingly positive.

Since this latter region corresponds to amplification with uninverted phase, the operation can be made regenerative. Figure 1 shows a sketch of the I_p - E_{g1} (plate current-control grid voltage) relation for a typical phantastron characteristic. The region to the left of the maximum I_p is conventional in behavior, that is, I_p and E_{g1} are in phase, while to the right of the maximum, I_p is reversed in phase with respect to E_{g1} . It is this dual capability that makes the phantastron attractive as a self-contained linear amplifier and regenerative circuit.

Both regions of operation are used in the phantastron sweep generator and its modifications. The regenerative region acts as a switch to reset the circuit at the end of a cycle, while the linear region provides a negative feedback integrator, thus giving a highly linear sweep.

The utility of the phantastron makes it desirable to apply the principle to transistor circuits. However, at present no direct transistor equivalent to the controlled partitioning of the space-charge current is available so that an exact dupli-

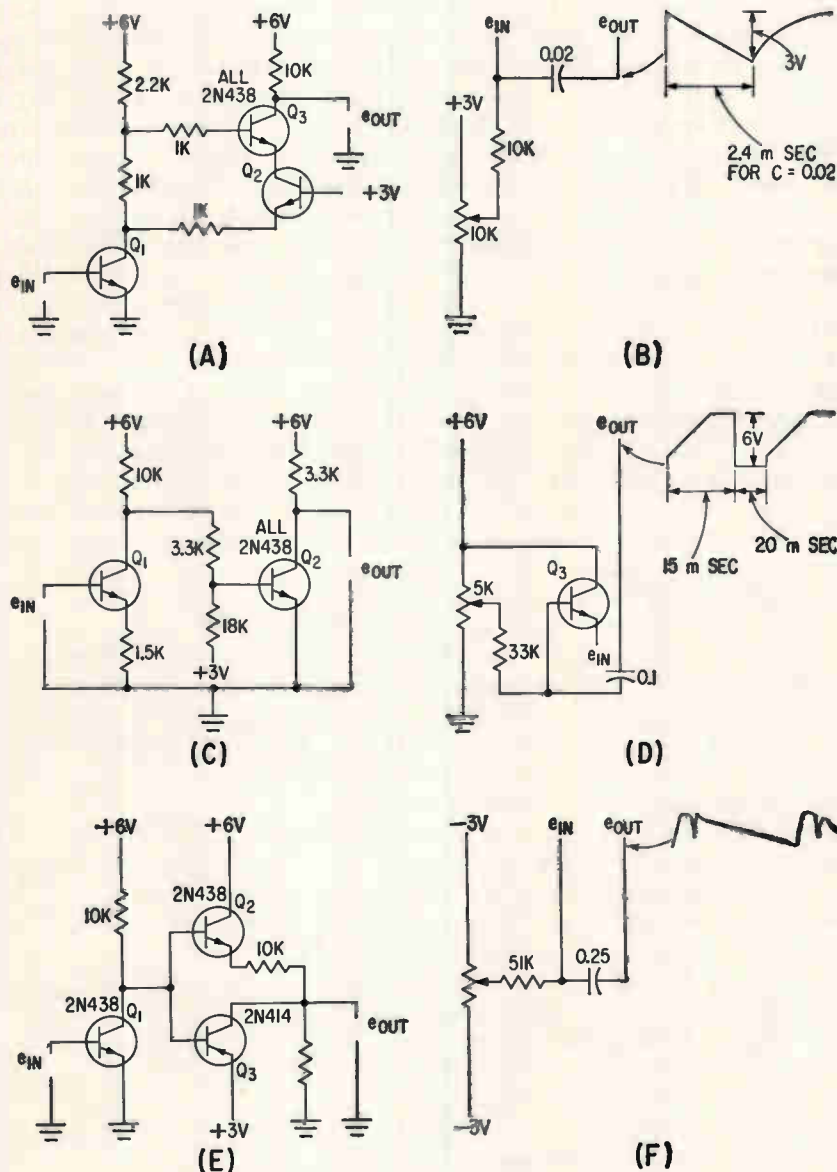

FIG. 2—Method of introducing partition of emitter current from Q_1 (A) and bias and feedback arrangement (B). Partition of current in (C) is provided by saturation, and feedback by schematic (D). Use of both pnp and npn transistors in (E) give the desired current partition, while feedback is obtained through arrangement (F)

USING TRANSISTORS

Three transistors are required to produce characteristics equivalent to those of pentode vacuum-tube phantastron circuit. The pentode circuit uses feedback to give regeneration and amplification within one envelope

ation is out of the question. It is necessary instead to simulate phantastron action using more than one transistor.

Figure 2A shows a circuit to simulate the current partitioning action. Consider an input signal slowly rising from some negative voltage towards positive, with transistor Q_1 initially cut off (Collector voltage of Q_1 will be at its maximum positive value). Transistor Q_3 base is forward-biased but Q_2 emitter is reverse-biased, thus cutting off the emitter current of Q_2 . Since the emitter current of Q_2 is essentially zero, the collector current is also zero, despite the forward bias of the base.

As the applied signal crosses zero, the base of Q_1 is forward-biased and Q_1 starts to conduct, causing its collector voltage to drop. Next in sequence is the forward biasing of Q_2 as the collector of Q_1 drops below +3 v, permitting emitter current flow into Q_2 . (This flow of Q_1 collector current may be considered to be split between its collector load resistance and the emitter of Q_2 , whence it flows through the emitter-collector path of Q_2 to the 10,000-ohm load at the output.) The output voltage drops, and is thus 180 degrees out of phase with the input signal.

As the input signal is further increased, collector voltage of Q_1 is further depressed until the voltage at the junction of the split collector load of Q_1 is about +3 v. At this point, Q_3 base current has decreased to a small value, and Q_3 goes to cutoff. Again the output voltage rises, this time being in phase with the input signal E_{in} . The rise is considerably faster in terms of input signal increment, since, the signal to Q_3 being to the base rather than the emitter, the current gain

is approximately β instead of α . The collector current of Q_1 is now split between its collector load resistors and the emitter of Q_2 , but the portion flowing to the Q_2 emitter is completely diverted to the +3 v supply instead of to the output.

By introducing the correct bias and feedback, phantastron sweep is achieved. Adjustment of the potentiometer allows for triggered or free-running operation. Linearity and recovery time can be improved by providing added loop gain and emitter-follower drive to the time-constant capacitor.

Another phantastron equivalent is shown in Fig. 2C. This circuit achieves the two distinct regions by introducing transistor saturation. When Q_1 is nonsaturated, normal common-emitter operation prevails; that is, the output voltage is in phase with the input voltage, and hence may be regeneratively connected by a network, as in Fig. 2D. However, when Q_1 is driven hard, the collector will bottom and any further increase in input signal will force the collector to be in phase rather than reversed. Transistor Q_1 must have some external emitter-load resistance, since in saturation the collector must be able to follow the input, and hence be not clamped

to ground. By choice of base bias on Q_2 , it can be ensured that Q_2 is not saturated, and is preferably near cutoff when Q_1 is saturated. This will allow Q_2 to be saturated, or at least heavily conducting, when Q_1 is driven by either a large negative or a large positive signal, thus providing both regions required for phantastron behavior. Since the input impedance is low, especially when Q_1 saturates, linearity can be improved by emitter-follower Q_3 as shown in Fig. 2D.

Figure 2E shows a circuit using both *pnp* and *npn* transistors. Here the change in operation is obtained by using Q_2 as a common-emitter amplifier when the collector of Q_1 is below, say, +3 v, and using Q_2 as a common-collector (emitter-follower) amplifier when the collector of Q_1 is above +3 v.

The resistor in the emitter of Q_2 allows a large output voltage, since the conduction of Q_2 causes reset to +3 v, from a level determined by the division of 3 v across this emitter resistance and the resistance to ground.

Figure 3 is a development dual to Fig. 2E. Here current and voltage functions are reversed, and voltage output is a first derivative of the sawtooth current sweep.

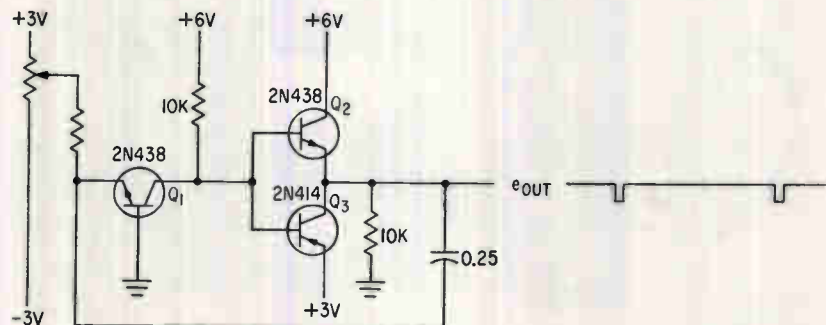

FIG. 3—Development of circuit in Fig. 2D has an output that is a derivative of the sawtooth sweep, resulting in the pulses shown

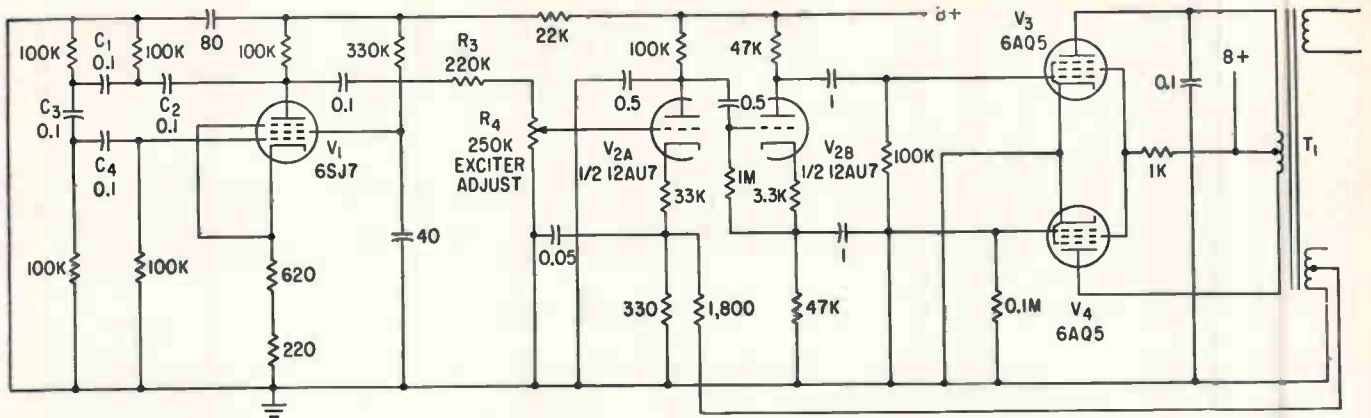

FIG. 1—Type I circuit contains, from left to right, oscillator, amplifier, phase splitter, push-pull amplifier, trans-

Measuring Thickness of

Method uses magnetic flux to determine thickness of paramagnetic plating layer on nonmagnetic base

By PAUL DICK,

Missile and Space Vehicle Dept.,
General Electric Company,
Philadelphia, Pennsylvania

THICKNESS OF COATINGS on nonmagnetic materials must often be measured quickly and accurately, but nondestructively. Examples of such coatings are nonconductive, conductive, and paramagnetic material coatings and platings.

Plastic coatings on nonmagnetic materials have been successfully measured by low-frequency eddy-current techniques, and high-frequency eddy-current methods are used for conductive coatings on nonmagnetic bases. This article describes two techniques for meas-

uring the thickness of a paramagnetic material coating on a nonmagnetic base, without leaving any permanent effects on either. Paramagnetic materials have permeability greater than one.

Type I instrument is an inspection and laboratory tool with range from zero to 0.040 inch of coating, and accuracy of ± 2 percent of the scale reading. It consists of a transducer, control leads and a cabinet containing the electronic components, as shown in photo.

The device operates on a magnetic reluctance principle: the surface of a paramagnetic material, brought within the field of a balanced transducer, will unbalance

the transducer and cause an output voltage proportional to the thickness of the coating. The voltage is amplified, rectified and displayed on a meter. Figure 2 illustrates the meter's operation.

A schematic diagram of the instrument is shown in Figure 1. The exciter signal generator produces a 10-cps signal in phase-shift oscillator V_1 , with high gain. The signal from V_1 is attenuated in voltage-divider network R_3 - R_4 in the grid circuit of amplifier-phase splitter V_2 . The double-ended output of V_2 drives the push-pull power amplifier output stage, V_3 and V_4 , whose output excites the transducer coils. A degenerative feedback voltage developed in the output of V_3 and V_4 is applied back to V_{2a} to reduce signal distortion. The output signal, a stable 10 cps, is variable by potentiometer R_1 , between 0 and 5 volts. Meter M_1 , across the secondary of transformer T_1 , monitors the signal amplitude.

The transducer contains an electromagnet with two differentially wound exciter coils and a pickup coil. When the signal generator output is applied to the exciter coils, they show a balanced expanding and collapsing flux pattern. The transducer is placed away from all other magnetic fields, and balanced by the control potentiometer R_1 , so that no voltage exists in the pickup coil.

The transducer is then applied to the paramagnetic surface at

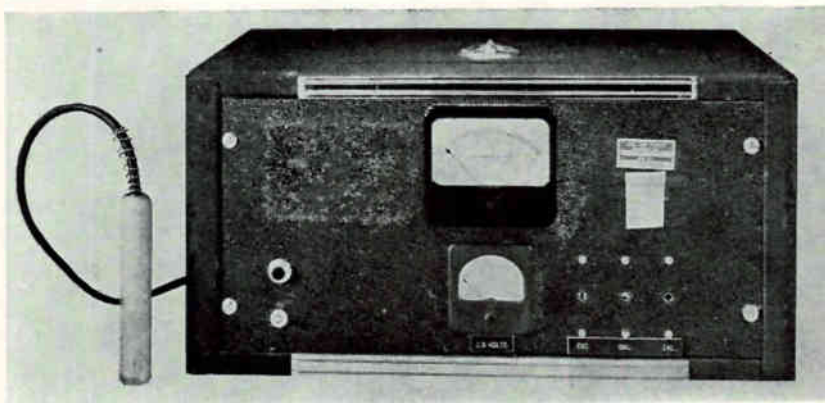

Laboratory instrument reads plating thickness directly on meter when probe, left, is applied to coating

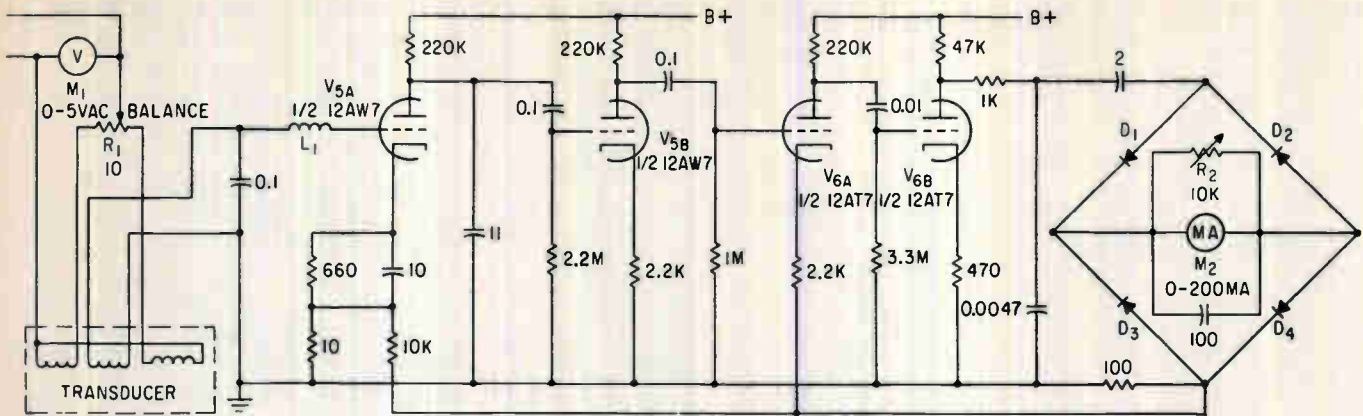

ducer, four-stage high-gain amplifier, and bridge with meter

Paramagnetic Coatings

right angles. The reluctance of the external path in the material causes a proportional unbalance between the transducer exciter coils. Total magnetic reluctance of the material is inversely proportional to the coating thickness.

Change in the flux pattern about the exciter coils induces a voltage in the pickup coil. The amplitude of the output signal is proportional to the paramagnetic material thickness. The output is applied to a four-stage high-gain amplifier V_5 - V_6 , through r-f filter network consisting of C_5 , choke L_1 , and the input interelectrode capacitance of V_{5A} .

The amplified voltage from V_{6B} is rectified in bridge circuit D_1 - D_4 . The output d-c current flows through milliammeter M_2 and causes a deflection proportional to its amplitude. The coating thickness can be read directly. The a-c voltage across the bridge rectifier circuit is applied as negative feedback to V_5 and V_6 , to reduce overall amplifier gain and thus regenerative oscillation within the cascaded amplifier stage. Rheostat R_2 is the meter sensitivity adjustment. As much as 200 microamperes is available from this circuit for recorder or plotter.

The power supply consists of two full-wave rectifiers. One supplies $B+$ and screen voltages for V_5 and V_6 ; the other supplies all other $B+$ and screen requirements. To increase accuracy, a line-voltage regulator provides adjustable regulated power between 110 and 125

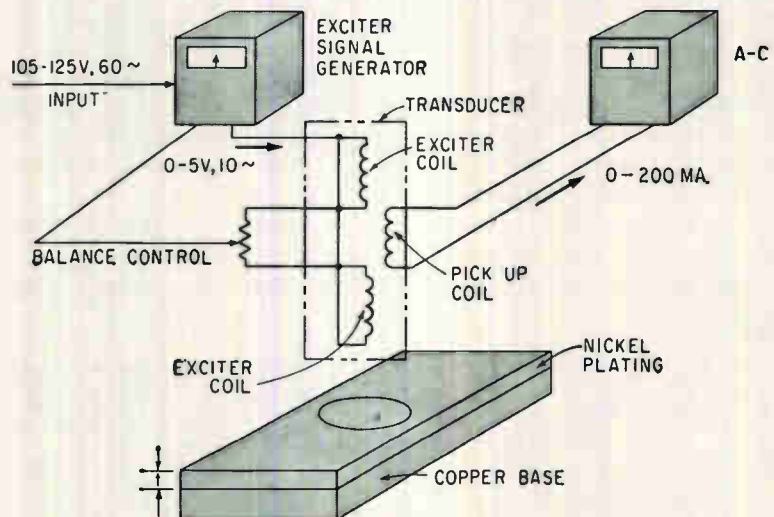

FIG. 2—Principle of instrument is balanced magnetic field. Amount of unbalance, proportional to plating thickness, is sensed by pickup coil

volts when line voltage varies between 95 and 130 volts.

The signal generator phase-shift oscillator, V_1 , operates on the 180-degree phase-shifted feedback principle. Frequency stability is improved by using four capacitors C_1 , C_2 , C_3 and C_4 in the feedback circuit. The use of a subsonic frequency minimizes the effect of eddy-current losses in the metallic base material.

Unlike the type I instrument, the type II paramagnetic coating thickness tester is a portable device designed for field use. It weighs less than 40 pounds, compared to the 78 pounds of type I. It has a range from zero to 0.020 inch and the reading is accurate to approxi-

mately ± 5 percent. No regulated power supply is required.

The probe contains a U-shaped electromagnet, positioned so that the pole faces are slightly within the bottom of the case. The pole faces are covered with a protective mylar film. Coaxial cable connects the probe with the instrument case.

This device uses magnetic saturation to measure the thickness of a paramagnetic coating. The probe acts as a transformer with an open magnetic circuit. Placing the two poles on a paramagnetic surface completes the magnetic circuit and produces a voltage in the secondary, proportional to the plating thickness. This voltage is first attenuated, then amplified, rectified

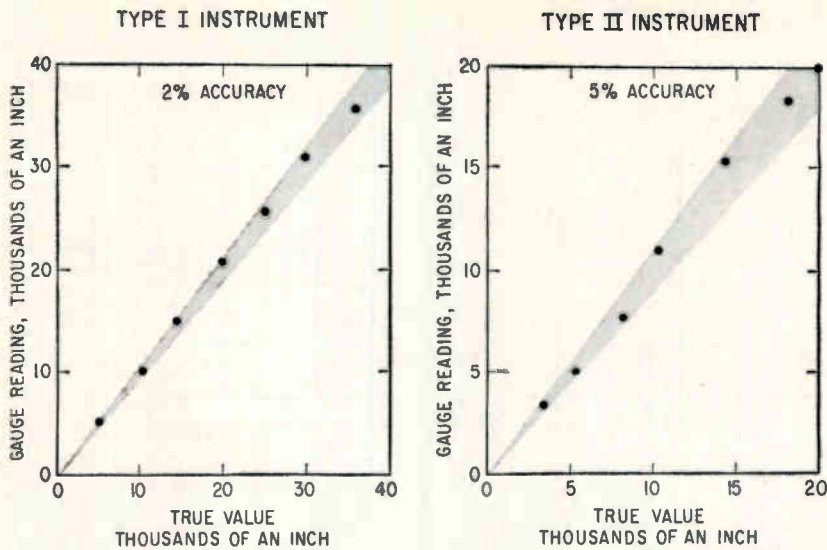

FIG. 3—Instrument readings are plotted against true values of coating thickness, showing accuracy spread

and displayed on a direct-reading meter.

Line voltage is applied to the primary of voltage stabilization transformers T_2 and T_3 (Fig. 4). Transformer T_2 feeds the power supply transformer T_1 , and T_3 supplies two filament transformers T_4 and T_5 , whose secondaries, connected in series, feed voltage to the probe exciter coil. This cur-

rent is adjusted by potentiometer R_1 , set at about 4 ohms, making its impedance large compared with that of the probe coil. This combination of T_4 , T_5 and R_1 constitutes a constant-current generator, as seen by the probe exciter coil.

Since the probe input impedance is a function of the thickness of the material, the constant-current source has to maintain a constant

magnetomotive force in the probe. This keeps a linear relationship between the average voltage induced in the probe pickup coil, and the measured paramagnetic material thickness.

The probe output is coupled to a three-stage amplifier through a resistance-capacitance attenuator network, modified by the addition of resistor R_2 and potentiometer R_3 .

The amplifier consists of pentodes V_1 , V_2 and V_3 . This circuit remains stable under varying input voltages from 105 to 125 volts and provides a maximum voltage gain of 70 db. The output of V_3 is rectified by dual diode V_4 , connected in parallel. The rectified signal drives indicator meter M_1 .

To compensate for residual meter deflection, a constant equal and opposite cancelling voltage is applied to the meter. This voltage is derived from the power supply and controlled by potentiometer R_4 .

Figure 3 shows typical values measured by the instruments, plotted against values obtained by optical and mechanical destructive test methods, for specimens of nickel plating on a nonmagnetic (copper) base.

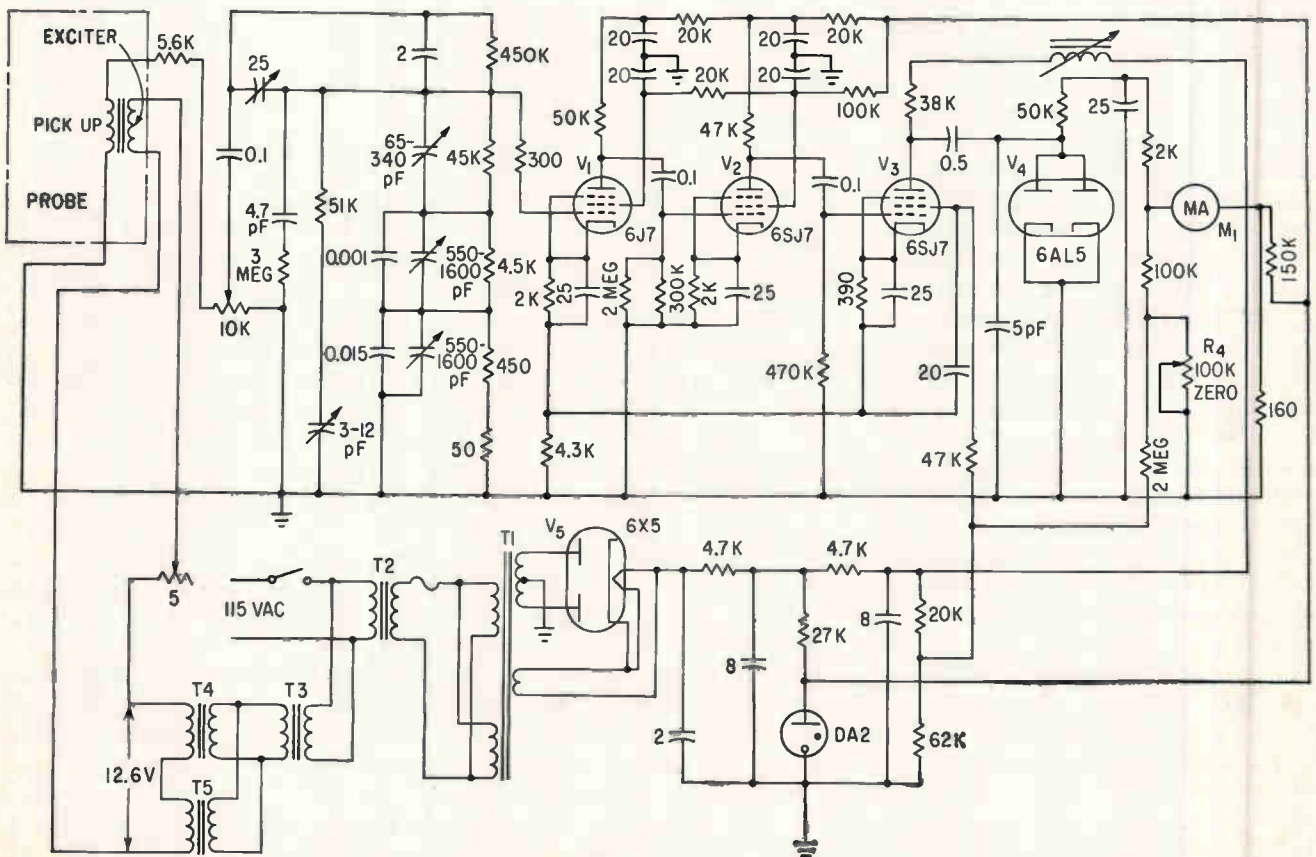

FIG. 4—Schematic diagram of type II portable instrument

Simulator Tests Radar Tracking Systems

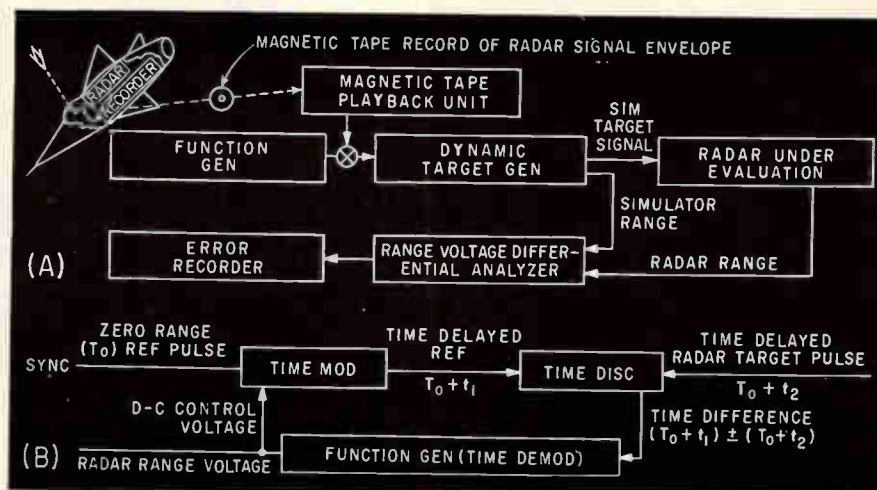

FIG. 1—Diagram shows how in-flight recording of radar signals can be played back through simulator for analysis of dynamic range errors (A). Pulse radar automatic range-tracking loop (B)

This simulation technique allows precise evaluation of radar range performance of airborne equipment under dynamic target conditions

By O. B. MITCHELL, Head, Radiation Systems Analysis, Emerson Electric Mfg. Co., St. Louis, Mo.

FIRE CONTROL and missile guidance applications often demand precise continuous target range information from automatic tracking radar systems. Static range calibration of these systems can be done with simulated fixed range marks or surveyed radar targets; however, dynamic ranging errors can result when the equipment is used against missiles and high-performance manned aircraft. Here the velocity and acceleration characteristics of the range-tracking device, as well as the effects of target modulation, can reduce the system accuracy predicted by static calibration.

Radar target fluctuation can result from antenna pattern modulation in angle tracking systems that use conical scan or sequential lobeing and also from antenna servo jitter. It is often desirable to reproduce these and other dynamic effects by simulation during the early testing phase of a system design program. Relative target velocity characteristics and normal variations in system parameters are readily predicted from a knowl-

edge of the expected tactical situation and by system analysis. The effects of these conditions on dynamic ranging performance can then be evaluated by reproducing the time and amplitude modulation characteristics on a simulated signal which is used as an input to the radar.

Target glint and fading noise, which can further deteriorate the dynamic performance of a tracking radar system when used against real targets, are difficult to predict and simulate. A target presents a time fluctuating echo signal to a radar. Since the amplitude relative to time of reflected signals is different for various classes of radar targets, it is often difficult to evaluate these target-generated noise effects except under operational conditions. Where the radar equipment being evaluated is airborne, considerable time and expense can result when extensive flight tests must be resorted to.

To be most useful, a radar target simulator should be capable not only of reproducing kinematics of

the expected tactical situations, but should also generate simulated radar signals that closely resemble those from typical targets.

A simulation and evaluation technique allowing the precise evaluation of dynamic radar ranging performance of airborne equipment within these requirements is shown in Fig. 1A. A feature is the technique for target data acquisition and playback. A portable airborne magnetic tape recorder obtains a permanent record of the radar signal modulation envelope generated during flight test while tracking targets. In most tracking radars, the target modulation envelope can be obtained from the output of the third detector or at the stretched video point before the radar signal is applied to system angle tracking circuits. The recorded tape of the target modulation envelope can then be played back through a ground-based unit into a target simulator for a more detailed examination of dynamic signal effects.

In addition to the recorder and

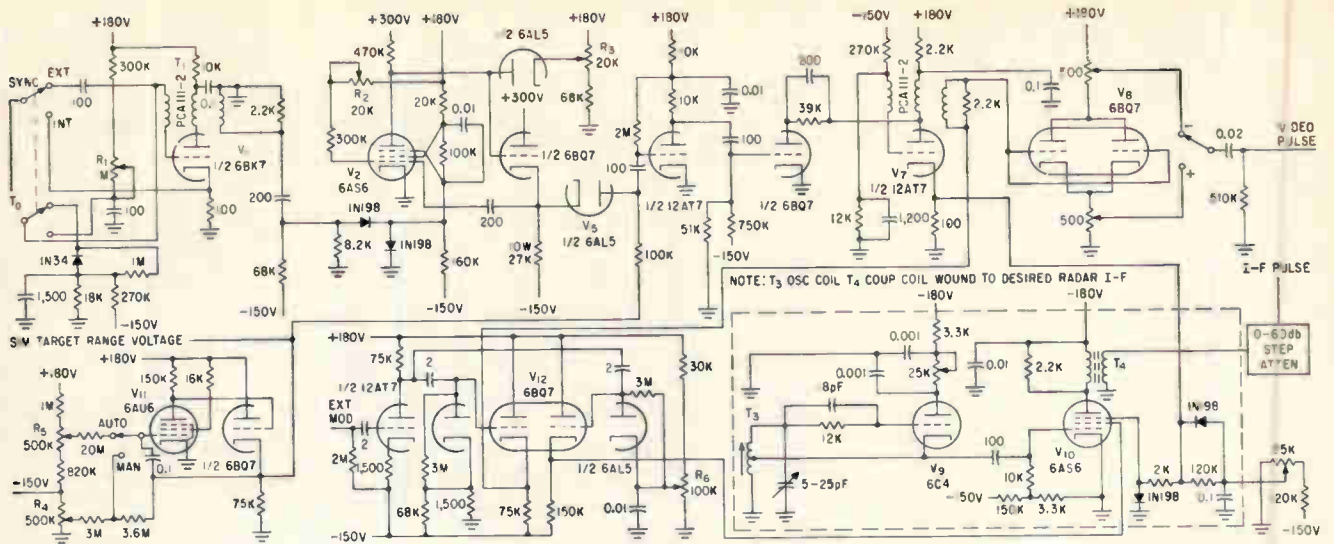

FIG. 2—Complete schematic of dynamic target generator that independently generates time-delayed fixed or moving target pulses with respect to its own or an external sync (T_s) pulse

playback unit, the simulator and range-tracking analyzer includes a dynamic target generator, range differential analyzer and ink paper-strip error recorder. The simulation and analysis techniques have been useful in the early evaluation of automatic tracking pulsed radar systems where extensive flight test time has not been available.

The automatic range-tracking configuration most often used by pulsed radars employs reversible processes of time modulation and demodulation (Fig. 1B). The reflected radar signal arriving at the receiver at time $T_s + t_r$ is compared by a time discriminator with a locally generated sync pulse that usually represents zero range (T_0). The time difference between the two signals is demodulated to generate a d-c control voltage. The control signal fed back in turn, time-modulates the sync pulse

to cause coincidence tracking of the radar signal in closed-loop fashion. The d-c control signal or radar range voltage is an analog representation of the range to the target.

The dynamic target generator shown in Fig. 1A accepts locally generated target velocity and angle modulation characteristics along with played-back target-generated noise recorded during in-flight tracking runs. These inputs modulate a simulated radar target pulse. Time modulation of the simulated target is done in a manner similar to the radar technique shown in Fig. 1B. The time modulation base of the target simulator can be calibrated to have range slope and intercept characteristics identical to those of the time modulator of the radar. A d-c voltage, the analog of simulated target range from the simulator, is compared with the

radar range voltage and the difference or error recorded. This recorded difference voltage provides a precise measure of the magnitude and direction of the radar's ranging errors under the dynamic target conditions programmed during the test.

The simulator unit will produce relative target rates in excess of Mach 3, and the simulated target video signal may be inserted directly into the video input of the radar or used to modulate or synchronize a microwave pulse generator. A simulated target pulse is also generated at 30 Mc for insertion at the i-f level of the radar receiver.

The circuits of the target simulator is shown in Fig. 2. Internal or external synchronization is provided by the prf blocking oscillator V_1 . The internal pulse repetition frequency is adjustable by R_1 . With the component values shown, the repetition frequency is adjustable about a rate of 2,000 pulses a second. A highly linear time modulation base is generated by the screen-coupled phantastron V_3 , which is triggered by the prf blocking oscillator.

The waveforms of the synchronizer and linear time base generator are shown in Fig. 3A. The output waveform of V_2 is a linear negative-going sawtooth whose slope is controllable by R_2 . The potential at time zero (zero range), from which the linear waveform runs down, is adjustable by range zero potentiometer R_3 . A diode

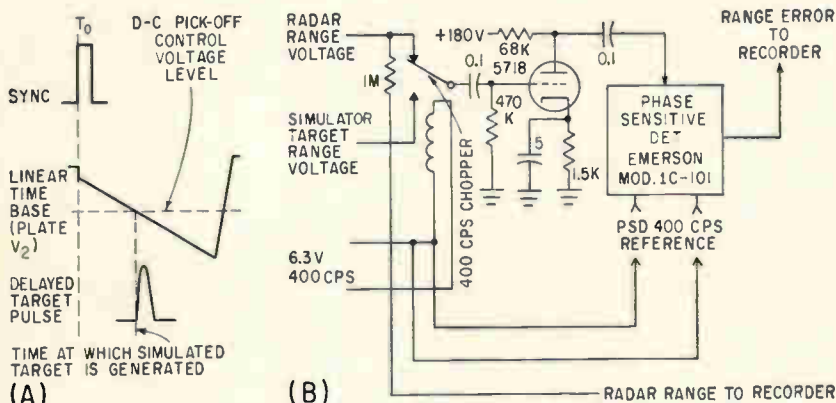

FIG. 3—Time relationship of simulator waveforms (A), and range-error analyzer (B)

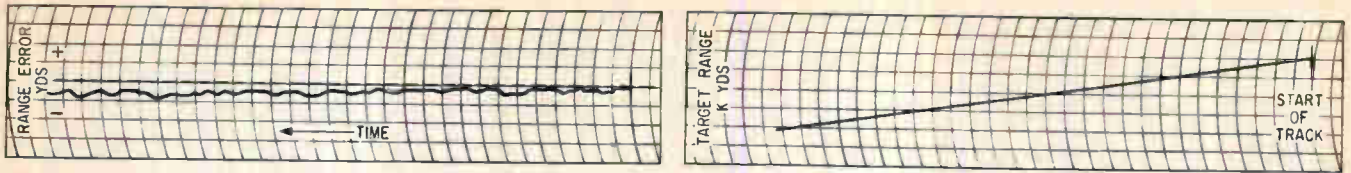

FIG. 4—Dynamic range error-recording illustrates the effect of severe fading on tracking accuracy

comparator V_5 generates a target trigger that is delayed from the sync reference until the instant of coincidence between the linear sawtooth and the pick-off control voltage. This time-delayed pulse is shaped and triggers the simulated-target blocking oscillator V_7 . Positive and negative simulated video pulses are provided at an output impedance of less than 500 ohms by paraphase amplifier V_8 .

The target blocking oscillator also generates a range delayed pulse for gating the output of a 30 Mc oscillator V_{10} . The pulsed 30 Mc target may be applied to the input of the i-f amplifier through a 0 to 60-db step attenuator.

Operational amplifier V_{11} generates the range delay control voltage applied to comparator V_5 . In the manual target ranging mode the circuit operates as a d-c feedback amplifier. The fixed range of the simulated target is controlled by range set potentiometer R_4 . With the component values shown, the range of the simulated target can be varied from approximately 0 to 100 microseconds.

In the automatic track mode of operation, V_{11} functions as a Miller integrator to provide an output control potential that can be adjusted to the desired output volts-per-second rate. The direction and magnitude of the integrator output voltage rate, and the velocity of the simulated target, is controlled by range rate control R_5 . With the range of input voltage indicated, target rates in excess of 6 microseconds a second, or 1,000 yards a second, are provided.

Modulation of the simulated radar video signal and the i-f signal is accomplished by modulator V_{12} . Control-grid modulation is applied to the video paraphase amplifier, while the 30-Mc oscillator is modulated with the screen and suppressor gated amplifier V_{10} . External modulation input is provided to allow wide flexibility in target

modulation characteristics. This target modulation input can be supplied from function generators and/or from a tape playback recorded under operational conditions (Fig. 1A).

Initial static calibration is performed by manually positioning the simulated target to several points over the tracking range. Under conditions of radar lock on at each point, the time modulation base of the simulator is adjusted by slope and zero controls (in Fig. 2, R_2 and R_3 , respectively) to provide a null at the output of the phase sensitive detector (Fig. 3B). With the desired amplitude modulation input, the simulated target can then be automatically accelerated through the range interval.

The simulator d-c range control voltage and the range voltage of the radar under evaluation provide the two inputs to the differential range analyzer (Fig. 3B). The two signals are sampled by a 400 cps chopper, amplified and fed to a phase-sensitive detector.

The 400-cps chopper excitation voltage provides the reference signal for the phase-sensitive detector, whose output is a measure of the direction and magnitude of the dynamic radar range tracking error that is fed to a Brush-type recorder. A second input is provided to the recorder from the radar range voltage which allows the range tracking error to be plotted as a function of range. A multiple-channel recorder allows simultaneous recording of other pertinent radar information which may be desirable to evaluate under dynamic tracking conditions.

Dynamic radar range tracking errors are recorded as shown in Fig. 4. The deviation of the error signal about the zero reference axis is a measure of dynamic range tracking velocity errors.

The effects of simulated target fading, as well as velocity errors on a range tracking servo, are

shown in Fig. 4. Discontinuities in the recorded error signal result when the simulated error signal fades below the noise level.

The dynamic target generator can be adapted to meet requirements. Pulse repetition rate and maximum target range can be altered by modifying the control grid time constants of V_1 and V_2 . The output pulse width is a function of blocking oscillator transformer T_2 . As indicated in Fig. 2, the i-f output signal can be generated at any normal radar intermediate frequency by the use of proper inductances for T_3 and T_4 .

The effects of jamming on the radar under test can be examined by the injection of c-w through the gated amplifier V_{10} . The carrier level and the magnitude of c-w injection for various types of external modulation inputs are adjustable by means of potentiometers R_6 and R_7 respectively. The range of velocity and acceleration characteristics of the simulated target signal can be expanded by modification of the input circuit of operational amplifier V_{11} .

More realistic evaluation of dynamic target characteristics on tracking radar performance is often accomplished by generating the simulated target at the radar's microwave frequency for signal insertion through the system antenna or directional coupler, rather than the i-f or video levels. The video output pulse of the simulator triggers a fixed or moving microwave pulsed generator. If more complex modulation than that provided by the dynamic range characteristics is desired at the microwave level, ferrite modulation techniques can be employed in the output waveguide of conventional microwave generators.

Recognition is given to E. Kuehner, J. Hammond and J. Weakly for their contributions to the equipment developments and techniques described.

MEDICAL ELECTRONICS

Part III: THERAPEUTIC DEVICES

Radiation, diathermy and ultrasonic apparatus, electrical stimulators, and analgesic devices used in treatment of disease and injury are discussed

By WILLIAM E. BUSHOR,
Associate Editor

TREATMENT which effects a cure for, controls the spread of or alleviates the symptomatic pains from a disease is termed therapy. Electronic techniques used in radiation, surgical, stimulation and medicinal therapy are described together with electronic analgesics.

Low-voltage X-ray Therapy—The two important characteristics of x-rays in therapy are their penetrating ability and their interaction with matter through which they pass. The former is significant in treating deeply situated tumors, the latter in selectively destroying certain malignant growths.¹

Ultrashort distance therapy (often incorrectly referred to as contact therapy) uses a small, low-voltage, shockproof x-ray tube that is placed nearly in contact with the skin or introduced into body cavities. The soft x-rays produced have low penetrating power and are generally used to treat small areas. Voltages commonly used are 200,000 to 400,000 electron volts in a range of 1 to 10 Angstrom units.

Supervoltage Radiation Therapy—High-energy beams produced by supervoltage accelerators are being used to treat deep-seated cancers. As of the middle of 1960, there were about a dozen linear accelerators and betatrons in the U. S., all located at large laboratories, universities or medical centers.² Supervoltage therapy offers more deeply penetrating radiation than other techniques while also reducing radiation sickness and damage to intervening tissue.

Disadvantages are the cost of initial installation, precision required in localizing tumors, accuracy with which the beam must be directed and the difficulty in effectively immobilizing the patient.

A relatively new development is the use of high-frequency excitation voltage to produce hard x-rays (0.1 to 1 Angstrom units). High-frequency generators developed by Picker and GE convert the usual 60-cps excitation voltage to 1,200 cps. The resulting x-ray beam has high intensity and a wide range of penetrating ability.

Normally continuous exposures are used in x-ray therapy as opposed to the short exposure bursts used in diagnostic work. Re-

searchers at the Charles F. Kettering Foundation are studying the possibility of using pulse techniques in therapeutic work. The studies are being conducted with a specially built x-ray generator to determine the effect of x-ray bursts on normal and malignant tissue. It is hoped that a pulse repetition rate which is most destructive to cancerous tissue and least destructive to normal cells can be found.

Linear accelerator produced x-rays give better penetration than conventional x-ray equipment, but it is difficult to control the depth of penetration. Either x-rays or beta rays produced by betatrons can be used in therapy of deep tumors without damage to skin and

GLOSSARY OF RADIATION TERMS*

Types of Radiation—electromagnetic wave (gamma- and x-rays) and corpuscular (streams of particles including alpha particles, beta particles, neutrons, positrons and the like)

X-rays—originate from energy change of orbital electrons or with sudden slowing down of electrons (as when accelerated electrons strike a target)

Gamma rays—originate from changes in nuclear energy levels. Behavior similar to x-rays except energies are usually higher

Alpha particles—high-speed particles (each consisting of two protons and two neutrons) carrying a positive electric charge

Beta particles—high-speed electrons or positrons

Thermal Neutron—a neutron with an energy of 0.025 electron volt

Curie—measure of quantity of a radioactive substance in which there are 3.700×10^{10} disintegrations per sec

Roentgen—measure of quantity of gamma- or x-ray radiation received, not direct measure of energy lost in matter

Rad—measure of absorbed dose or energy absorbed per unit of material for all kinds of ionizing radiation

Relative Biological Effectiveness (RBE)—biological effect of different kinds of radiation varies even when absorbed doses in rads are equal. Gamma- and x-rays are used as comparative reference. For same absorbed dose positrons and electrons have nearly same biological effect as x-rays, thus their RBE is 1. Heavy ionizing particles (protons and neutrons) produce much greater biological effect than x-rays for same dose, thus their RBE is greater than 1.

RBE Dose—product of absorbed dose in rads and RBE. Roentgen equivalent man (rem) is unit of RBE dose.

(a) taken in part from *Nucleonics Fundamentals* by D. B. Hoisington, McGraw-Hill Publishing Co., New York, 1959



Woodcut (left) shows stomach operation technique used in 1497. Anesthetic was an often fatal narcotic potion. By contrast, modern surgery often does not require an incision. Patient in photo is undergoing radiation treatment for cancer from cobalt-60 machine at the Veterans' Administration Hospital in the Bronx, N. Y. Camera (right in photo) is part of DuMont's closed-circuit tv system used to observe patient in closed treatment room

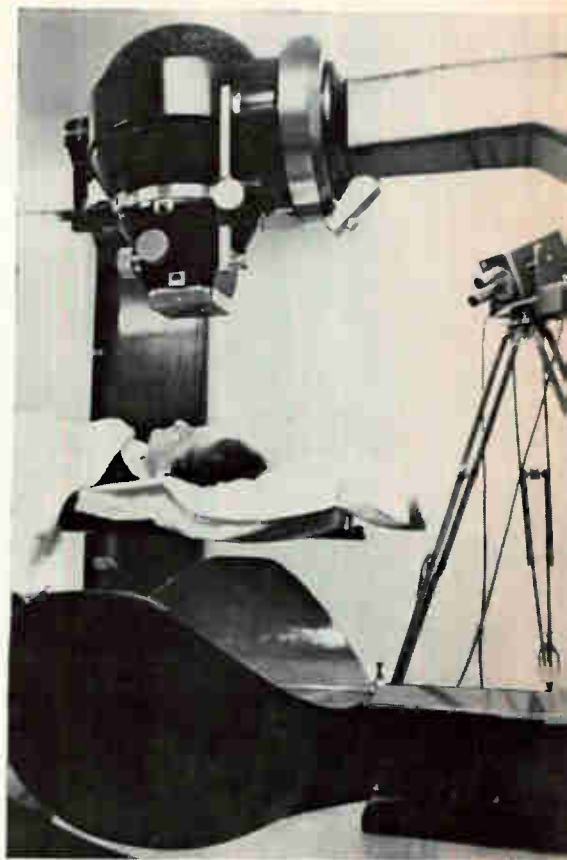

with less constitutional disturbance than with other techniques. Radiation is not selectively absorbed by bone, thus tumors that lie close to a major bone can be irradiated with no permanent damage to the patient. Also, electrons can be concentrated into a thin beam and applied directly to a tumor mass with less damage to the surrounding tissue. Beta particles are particularly useful in treating introral cancers with neck nodes, breast tumors and bladder cancer.

Neutron Capture Therapy—This form of radiation treatment uses a nuclear reactor as the energy source. A suitable target (or capture isotope) is first situated in a diseased site. The reactor is then used to produce a stream of slow neutrons that are directed through the site causing a thermal neutron reaction to take place in the target. Disintegration of unstable nuclei in the target results in the release of heavy particles which give up

millions of electron volts of nuclear energy.³ Main advantages of this type of therapy are that radiation can be localized, exposure can be maintained at a minimum, no residual environmental hazards exist and heavy particle radiation has high relative biological effect.

Slow neutrons with energies of but a fraction of an electron volt are required. These are obtained from the reactor by using a graphite reflector to moderate the fast neutrons, which have energies of many millions of electron volts. Although slow neutrons have virtually no effect in passing through tissue, the radiation from the short-lived radioisotope target they stimulate is effective in destroying tissue.

Although gamma rays are also produced by the fission process, reactors are not useful as a fundamental source because they are expensive and cumbersome—cobalt or cesium teletherapy is preferable. Supervoltage accelerators could be used for neutron capture therapy,

but are not as reliable in operation and probably would cost more to develop for this application than a reactor costs.⁴

The first device of this type built solely for medical purposes is the Medical Research Reactor (MRR) placed in operation in March 1959 at Brookhaven National Laboratory. Enriched uranium-235 is used as the fuel. Nominal full power is one megawatt and 7×10^{10} thermal neutrons per sq cm per sec are delivered to the treatment room.

Atomics International division of North American Aviation recently built a 50,000-watt nuclear reactor for Walter Reed Army Hospital. Fuel used is an uranyl sulphate solution highly enriched in uranium-235. Installations of medical reactors are currently underway at MIT, U. of Buffalo and Georgia Institute of Technology.

It has been suggested that a limited duty cycle flash-type reactor could be constructed to provide a large charge of 10^{18} neutrons

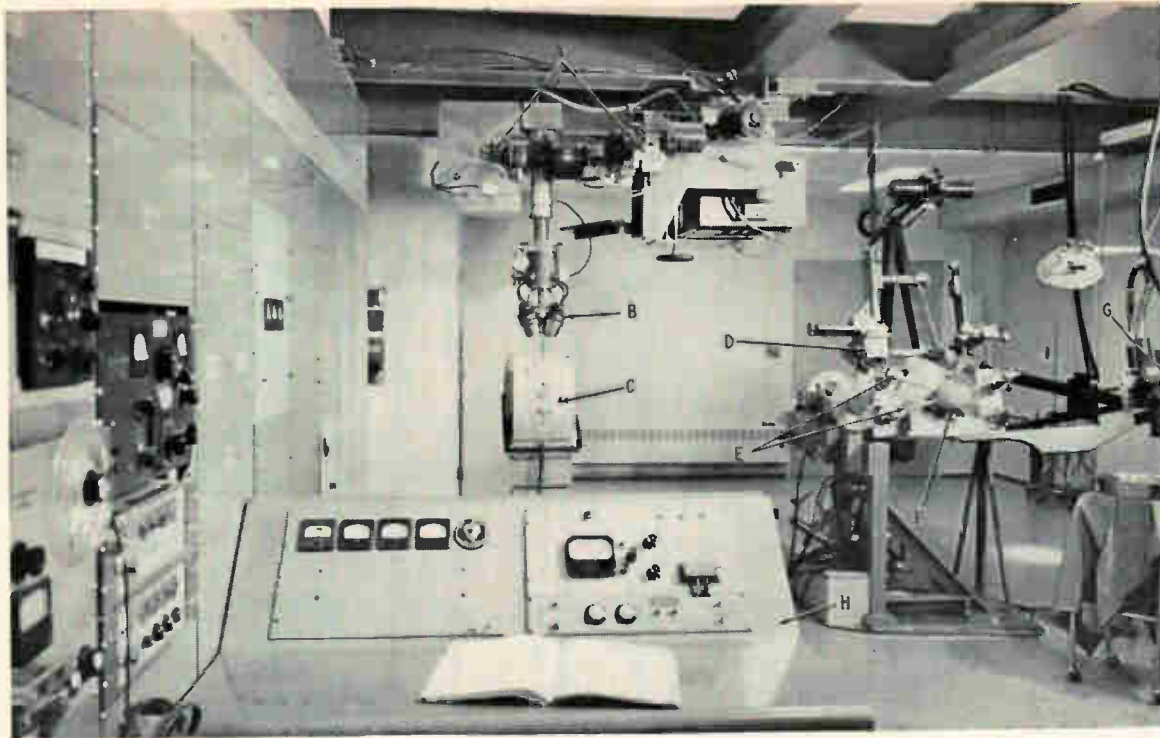

Irradiation room at University Hospitals, Iowa City, Iowa, where ultrasonic neurosurgery is performed showing irradiator positioning system (A), irradiator (B), calibration tank (C), pointer positioning system (D), head holder (E), patient (F), x-ray tubes (G) and control console (H)

per sq cm in millisecond bursts.⁴ Such a device may be useful for more general application than the present type.

Radioisotope Therapy — When a powerful source of gamma rays is placed over the skin to treat deep-lying tumors, the procedure is described as teletherapy (or telecurie therapy). Radium was the first source used, but radioisotopes are now widely used especially cobalt-60 and cesium-137. Over 240 teletherapy units made by nine different manufacturers are currently in use in the U. S. The U. S. Atomic Energy Commission reports that more than 2,000 research projects supported by the federal government are using radioisotopes to study disease processes in cancer, leukemia, heart failure, arteriosclerosis, virus infections, multiple sclerosis, arthritis, anemia, gout and nutritional deficiencies.⁵

Radium, x-ray and radioisotope treatment supplement each other well, each eventually establishing its own advantageous role for certain disease conditions. Some therapeutic uses of radioisotopes, particularly cancer treatment, follow x-ray and radium principles—that is, the diseased tissue is exposed to radiation from sources

distributed in the body or from a source outside the body (teletherapy). Radioisotopes can also be given by vein or mouth to concentrate the radioactivity in the regions to be treated.

Radiocobalt (cobalt-60) is the major isotope in use because it emits high energy radiation while being extremely compact. Biochemical placement of radioisotopes is another therapeutic measure. Radiophosphorus has been used to treat excess formation of red corpuscles and leukemia, and radioiodine has been used for thyroid tumors and intractable heart disease. Teletherapy in the form of radioactive cobalt and cesium is being used extensively as a substitute for massive 1 to 2 million electron volt x-ray generators.

A new way of loading steel needles with radioactive sources after implantation of the needle in cancerous tissues was described late last year.⁶ The conventional technique is to preload rigid needles containing radium or cobalt-60; however, high radiation levels to the therapist and other hospital personnel during implantation and the limitation inherent in having available only a few lengths and activities of needles are disadvantages. Once implanted

in chest, mouth or neck cancer sites, the hollow, stainless steel needles are loaded with radioactive wires by inserting the wires into the needles. Iridium-192 and cobalt-60 wires have been used thus far.

Ultraviolet Radiation — High-intensity ultraviolet in the black light region (3,660 Angstrom units) is being used to selectively remove malignant areas. Mercury-vapor lamps are the most widely used, the Kromayer lamp being used for intensive local treatment or in conjunction with quartz applicators for introduction of rays into body orifices. A system of direct ultraviolet radiation that reduces post-operative infection is being offered hospitals by Westinghouse's Lamp division.

Diathermy—Passage of r-f current or ultrasound through a part of the body of a patient is used to produce deep heating that relieves various types of physical distress. Frequencies of 500 to 3,000 Kc are used for conventional diathermy and of 10,000 to 100,000 Kc for short-wave diathermy. Metal plates placed on either side of subject or coils placed around the subject are used to apply r-f to tissue. In the first case, heat is caused by dielectric losses;

TABLE I—CHARACTERISTICS OF SUPERVOLTAGE PARTICLE ACCELERATORS USED IN THERAPY

Device	Operation	Particles Accelerated	Maximum Energies Now Produced	Remarks
Van de Graaff generator	Electric charges are collected on an endless moving belt made of insulating material and delivered to a hollow metal electrode at a high potential	Electrons Protons Deuterons Alpha particles	3 Mev (High-Voltage Engineering Corp.) 8 Mev readily attainable 16 Mev readily attainable	Electron beams at 2.5 Mev are being used to treat skin lesions. Energies of particles can be easily and accurately controlled
Linear accelerator (traveling wave type)	High-power uhf pulsed waves generated by magnetron are applied across ring-shaped electrodes arranged along a straight line. High velocity electrons from an electron gun are accelerated to multimillion-volt level	Electrons Protons	630 Mev (Stanford U.) 2 Bev probable upper limit 140 Mev (U. of California)	No magnets required. Electrons are injected from a Van de Graaff accelerator at velocity slightly less than velocity of light
Cyclotron	Low-voltage r-f electric fields successively accelerate charged particles traveling in two hollow semicircular metal boxes which are caused to follow expanding spiral path by a constant magnetic field	Protons Deuterons Alpha particles Oxygen nuclei	12.5 Mev } 25 Mev } 50 Mev } 200 Mev }	Nobel Institute for Physics in Stockholm Neutron beams are being used experimentally in therapy. This device also is source of artificial radioisotopes
Synchrocyclotron (f-m cyclotron)	A type of cyclotron using frequency modulated r-f electric field to induce phase stability which keeps charged particles in step with field variations	Protons Deuterons Alpha particles He ³ isotopes	740 Mev } 460 Mev } 915 Mev } 1,110 Mev }	(U. of California) Ions are accelerated in bundles, thus average current is much less than in cyclotron but energies are high
Betatron	Rapidly varying magnetic fields accelerate electrons traveling in evacuated, ceramic doughnut-shaped tube to high velocities after large number of electron revolutions	Electrons	310 Mev (U. of Illinois) 500 Mev probable upper limit	Produces extremely penetrating x-rays which are used to treat deep seated tumors. Beta rays produced are being used experimentally, may be choice for therapy in future ^a
Electron synchrotron	Similar to betatron except electrons are accelerated by r-f electric field whose frequency is in synchronism with rotational time of the electrons. Modulated magnetic field is required to determine electron orbit	Electrons	6 Bev (Harvard U. and Mass. Institute of Tech.)	Has never produced x-rays of high enough intensity to be entirely satisfactory for medical use ^b
Proton synchrotron	Same as electron synchrotron except protons are accelerated and both r-f accelerating and magnetic orbiting fields are modulated	Protons	10 Bev (Veksler's Institute in Russia) 25 Bev (Brookhaven National Laboratories) ^c	Frequency of accelerating voltage must be increased as particles gain energy

(a) Paper by M. Sempert, A Betatron for Cancer Therapy and Material Testing (unpublished) (b) L. E. C. Hughes, Electronic Engineers' Reference Book, The MacMillan Co., New York, p 353, May, 1960 (c) D. B. Hoisington, Nucleonics Fundamentals, McGraw-Hill Book Co., New York, p 106, 1959

in the latter heat, is caused by circulating eddy currents.

A pulsed r-f unit developed by Diapulse Manufacturing Corp., unlike the conventional r-f diathermy equipment, does not product heat.⁷ The theory is that the high energy pulses stimulate the general defense mechanism of the body. Frequency used is 27.12 Mc, pulses are 50 to 60 seconds in duration and are produced at a rate of from 80 to 600 a second. Maximum peak power is 1,333 watts with average operating power about 36 watts. Energy is radiated from a coil antenna with the patient becoming a part of the radiating system. Good results have been reported in treating ear infections, upper respiratory infections, rheumatic ailments, pelvic inflammations and urinary tract infections.

Ultrasound produces heating pressure and cavitation effects in the human body that have therapeutic properties. This technique has been widely used in Europe and is becoming more widely used in the U. S. Intensity of the ultrasound must be carefully controlled to avoid harmful effects.⁸ The margin that separates the range of harmless and harmful effects for ultrasound is narrower than for diathermy or microwave therapy, but larger than for x-ray therapy.⁹ Ultrasonic energy, when properly applied can be completely transmitted to the human body giving ultrasonics an advantage over microwave therapy where the power produced cannot be simply related to energy absorbed by the patient.¹⁰ The effect of cavitation on the dark-brown oxidized form

of hemoglobin has been investigated by the National Heart Institutes at 100 times the power used in ultrasonotherapy (or several hundred watts per sq cm). It was found that sonochemical oxidation takes place causing the loss of ability to transport oxygen reversibly.¹¹

Surgical diathermy—Electrocoagulation using a metal electrode, of which Ford Instrument's Ophthalmic-Electrome is an example, is a form of therapy used to reattach eye retinas and to treat retinal cysts, tissue tears and certain forms of degeneration. Electric current passed through an electrode establishes a firm union between the weakened tissues and surrounding normal structures thus preventing spread of the disease.

The U. of California Los Angeles

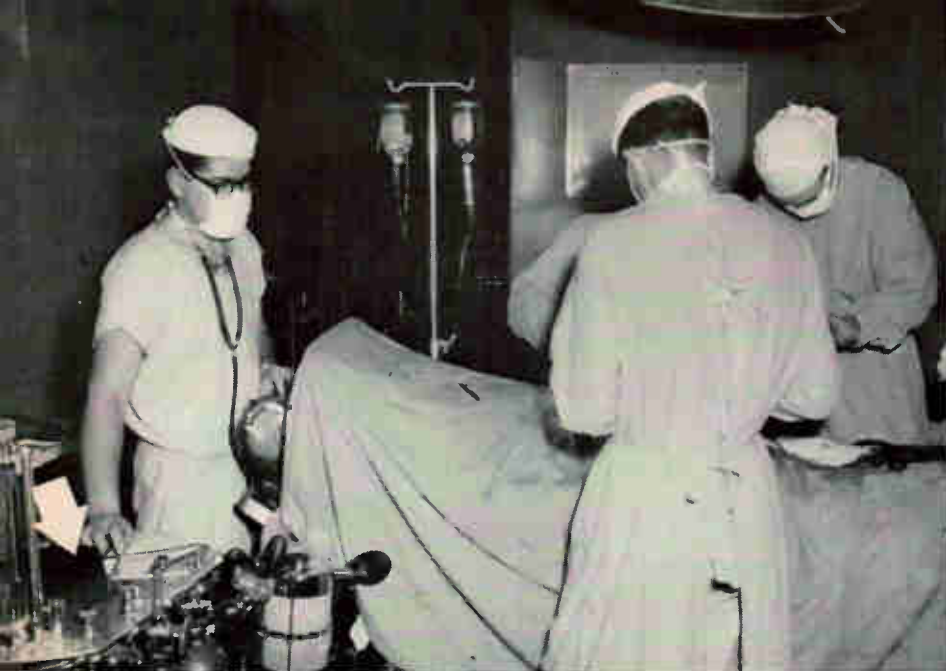

Operating room application of General Atronic's artificial pacemaker (in front of anesthetist's right hand) as a defibrillator. Work was carried out in cooperation with Dr. Samuel Bellett of Philadelphia Hospital

Medical School announced the development early this year of a liquid electrode technique for performing eye surgery. Advantage of the liquid over the metal electrode is that in the former case optimum and uniform contact with the tissue can be established and maintained, in the latter it can't. This situation permits careful control of the electrical current and makes possible accurate measurement of the electrical properties of the treated tissues. The technique is used to treat retinal detachment and certain types of glaucoma.

A glass tube containing a saline solution and electrolytically coated wire make up the instrument. Current is passed through the silver wire and the saline solution to the eye. Uniform contact pressure is maintained by a fluid reservoir.

A light coagulator developed by the Carl Zeiss Co. in Germany is being used to reattach retinas and dry up eye tumors. A ray of highly magnified light is focused on the affected area generating up to 100 C of heat with six times the brightness of the sun which coagulates the tissue. The physician uses a weakly illuminated diaphragm to center the firing arm of the instrument directly over the area to be treated. Four half-second exposures are required for an operation.

Ultrasonic Neurosurgery—High-intensity focused ultrasound is be-

ing used to produce lesions in deep brain structures of patients suffering from various neurological disorders. To date permanent changes confined to arbitrarily specified regions of predetermined shape, size and orientation can be produced at almost any site in the brain without disrupting intervening tissue. Also by choice of parameters of irradiation, it is possible to produce either reversible (temporary) or irreversible (permanent) changes in tissue.¹² Blood vessels within the region in which the changes are produced can be left intact and functioning even when all neural elements are destroyed.

Ultrasonic human neurosurgery of deep brain structures has been in progress for the past two years as a collaborative effort between the Biophysical Research Laboratory of the U. of Illinois and the Division of Neurosurgery of the State U. of Iowa.¹³ In this system four sound beams are focused on the spot being irradiated. By moving the focus of the beam, lesions of complex shape and large size can be made. Wavelength of the sound and angle of convergence of the beams determine minimum size of the area affected. Most neurosurgical work has been accomplished at frequency of 1 Mc, involving a couple of cu mm of tissue; however, 2.5 and 4 Mc have also been used involving less than 0.05 cu mm of tissue.

One type of irradiator uses four individually focused x-cut quartz crystal transducers. A polystyrene lens in front of the transducer focuses the beam, castor oil serving as the coupling medium. A pointer arrangement permits beams to be given a common focus at desired sites. Ultrasound energy is conducted from irradiator to the brain through a degassed saline solution. Multiple interfaces in the brain reflect only a small portion of the incident acoustic energy. Maximum intensity used is 8 Kw per sq cm.

Four stainless steel rods are used to support the head after the skull is accurately positioned with respect to three mutually perpendicular reference planes. The rods fit into previously prepared indentations in the skull. Two x-ray units are used to provide physicians with brain landmarks for positioning focus, one takes a lateral view and the other an anterior-posterior view of the ventricular system. A positioning system moves tungsten crosshairs in directions parallel to the axes of the head holder. By measuring distances between brain landmarks and the tungsten crosshair on the roentgenogram, transformation of coordinates for positioning the focus of the multibeam transducers can be computed.

Bone flap is removed earlier and the skin and underlying tissue sutured back in place. Irradiation then takes place directly through skin. Thus, any number of exposures can be made and the progress of the treatment followed over a considerable length of time.

To date, 48 patients have been treated for tremor and rigidity of Parkinson's disease, nonpatterned involuntary movements of cerebral palsy origin, nonpatterned involuntary movements of unclassified hyperkinetic disorders, intractable pain following cerebral vascular accidents, phantom limb pain and image following amputation, hypersensitivity to stimulation of peripheral sense receptors and discomforting sensations of a variety of types in addition to those already listed. Although decided improvement in the condition of patient has taken place, no histological results are available as yet.

Another type of transducer used is a crystal plate whose vibrations

are reflected with a uniform angular distribution in all directions at right angles to the axis of the irradiator by a cone with an apex angle of 90 deg. A parabolic reflector is used to focus the energy. This technique suppresses side lobes appearing in multibeam irradiators; however, it is more difficult to prepare skull openings to admit the converging sound when deep structures are to be irradiated. A hybrid transducer can be designed wherein the advantages of short focal length of the multibeam arrangements and low sidelobe generation by the reflector method can be combined. This could be done by designing transducers that use a single lens with an aperture and cone of convergence equal to that of the multibeam instrument. The transducers would have to be formed in a multicrystal array. A new lens material will be required for higher intensity instruments because plastics overheat and develop mechanical flaws.

Selective damage of tumor cells by ultrasonic irradiation can be accomplished, in fact a malignant growth of the bone cells of a rabbit has been removed by the Department of Orthopedics at the Mayo Clinic working with the U. of Illinois.¹⁴ The Russians report they have used intense ultrasound on tumors and that the controlled application of high level sound constitutes a means of selectively destroying at least some types of malignant growths in humans.¹⁵ Sound levels of 500 watts per sq cm with uniform beams of 50 sq cm are used. Since transplantation of the same type of tissue to an irradiated animal could not be accomplished, perhaps even a type of immunity to cancer has been produced. Work is proceeding in this country at the Mayo Clinic and Mayo Foundation to use ultrasound to inhibit growth of bone tumors.¹⁶

Ultrasonotherapy—Stones in the bile and urinary tracts have been dislodged by an ultrasonic technique developed by H. Lampert.¹⁷ Ultrasonic energy is applied directly to the stone with a drill tip connected to flexible, flat ribbons of Monel metal encased in a catheter (hollow tube). The length of the Monel metal strips is critical—it

must be precisely related to wavelength of ultrasound energy to get maximum energy transfer. A magnetostriction generator operating at 20 Kc is used as the power source. High-frequency sound probes have been used during open-heart surgery to fragment, by direct contact, calcium deposits in a diseased cardiac valve.¹⁸

Ultrasound has also been used to treat Meniere's disease, a waterlogging or swelling of the balancing mechanism in the labyrinth of the ear. An Italian physician, Dr. M. Arslan, has perfected a technique that consists of surgically opening the ear drum and inserting the tip of an ultrasound generator until it contacts the labyrinth. This extremely delicate operation is reportedly 94 percent effective in relieving the symptoms of ear-ringing, nausea, deafness and dizziness.

A technique of indicating accurately the intensity of ultrasound during this treatment has been developed.¹⁹ It was concluded that by using ceramic piezoelectric transducers, impedance variation with frequency even during an operation can give information on the character of the contact made by the probe. Thus, power can be electronically computed from input voltage and current, and frequency. Efficiency of three transducers used for ultrasonic surgery of the labyrinth has been surveyed.²⁰

Stimulators — Electronic instruments are used to apply to the human body by way of electrodes d-c, square wave or sinusoidal currents having known and controllable amplitude, duration and time variations. These currents are used in physiotherapy to stimulate muscles to make them contract, in psychiatry for inducing convulsion by electric shocks to the brain, interruption of fibrillation and reestablishment of correct heart beat during operations, and inducing respiration in new born infants.²¹ Defibrillators are used to interrupt fibrillation and reestablish correct beating of the heart during heart operations. Electrical counter shocks are applied directly to the ventricles—the sooner after onset of fibrillation, the more successful the results. Medtronic has developed a defibrillator that has an out-

put of 2½ kilowatts capable of placing 7 amperes through the lowest resistance heart loads known.

An artificial pacemaker developed by Atronic Products, Inc. is intended for emergency use either in a medical ward or in surgery.²² Extraneous stimulation is controlled through direct application of electric stimulus to the myocardium. The instrument is a current source generating pulses of 3.5 milliseconds. Rate control ranges from 25 to 120 impulses a minute. Atronics is currently developing a new defibrillation technique that reportedly will decrease by about one-half the concentration of current applied by existing defibrillation methods, thus eliminating burning of the cardiac patient.

Ultrasonic Aerosol Therapy—Work on using ultrasonic atomizers to produce aerosols for inhalation therapy has been investigated and some units have been developed.²³ Although ultrasound can disrupt large molecular compounds, substances such as aureomycin hydrochloride, digitalis and penicillin have been atomized ultrasonically without diminution of their pharmacological properties. Cavitation and vibratory processes occurring at the surface of the liquid when ultrasound is focused at the surface intensify the formation of a fog. A focused ultrasound ray is produced with an emitter of ceramic barium titanate shaped into a concave disk. Frequencies used have varied from 800 Kc to 2.7 Mc in a power range of 20 to 54 watts. A rubber-bottomed, covered vessel with liquid to be atomized is placed in the water ultrasound bath. This device shows promise for both individual and group inhalation therapy, prophylaxis of occupational disease and disinfection of living quarters. High efficiency permits battery operation, thus transportable units could be developed. A 60-watt unit, termed Gearsol, has been built by Sophya in Belgium for home use.

Electronic Analgesics—Electronics is being used as an analgesic in at least three different areas—sleep induction, tissue cooling and dentistry. The Russians have reportedly developed a cigarette-pack-

age size transistor device that causes normal sleep by passing a monotonous steady wave analogous to the brain's natural alpha rhythm (about 10 cps) through the head. By conditioning the patient over an extended period—30 or 40 minutes is initially required—time required to induce sleep can be reduced. The Japanese are testing a device to aid insomnia victims. Sleep results within five minutes after passing a weak current through the head and a special pillow.

Surgeons at the U. of Mississippi Medical Center recently used electricity to anesthetize a woman patient during an abdominal operation. Current from a 700-cps oscillator is amplified and then passed to the patient's brain through temple electrodes. The patient is asleep within a minute of current application and awakens within a minute after current is removed. There apparently are no side effects. This type of analgesia is desirable because it works directly on the nervous system without involving the blood stream or other organs. There is the danger in using this technique, however. Careful control of the frequency and voltage applied must be maintained to prevent the patient from going into convulsions.

Solitron Devices' Sounvister, announced early this year, is capable of producing random noise across a white noise spectrum. A white noise generator using the Sounvister has been built that provides an 18-volt output. It is believed that white noise can be used in a system similar to U. of Mississippi Medical Center's unit.

Cooling of blood required during some of the more difficult modern operations can be done using thermoelectric effects. Although a considerable amount of refrigeration capacity is required, dependable and silent functioning could well offset the initial price differential between the thermoelectric unit and a vapor compression system.²⁴

The principle used is the Peltier effect—that is, by controlling the direction of current through a couple of dissimilar materials, the junctions can either be heated or cooled. Advantages of this device are that it is absolutely silent thus cannot annoy patient, physician or

researcher, has no moving parts that can wear or fail, and can be sized according to refrigeration capacity required thus providing a lighter weight, more economical unit than possible with conventional vapor compression systems. Cost of the thermoelectric system is higher, except for hot-cold pad applications where cost is lower.

Audio analgesics, wherein controlled volume of tape-recorded stereo music selected by the patient applied through high-quality earphones desensitizes oral areas during both filling and extraction of teeth, are being used by dentists. Although not much is known for certain as to how this technique works, it is generally believed that if enough noise is put into the ear,



Portable defibrillator being marketed by Medtronic. Paddles in foreground have concave surfaces for maximum contact, insulated backs to limit application area and nylon handles to protect surgeon

the brain doesn't receive pain messages. Some devices permit the patient to control the level of the music, louder levels being required as pain becomes more intense. If pain persists at full musical gain, some units have provision for switching over to a high pitched masking hiss of a thermal or white noise spectrum.²⁵

Solitron's Sounvister can also be used in this application to provide white noise. The white noise spectrum presently being used is a compromise between pleasurable low-frequency sound and more effective analgesic sounds with strong high-frequency components. All these devices are also useful in canceling out the noise of the drill, espe-

cially if the dentist uses a high-speed air turbine drill that produces annoying high-pitched whine. Using the sound techniques, dentists do not have to wait for the analgesic to take effect.

REFERENCES

- (1) J. Selman, *The Basic Physics of Radiation Therapy*, Charles C. Thomas, publisher, Springfield, Ill., 1960.
- (2) Comments by B. Roswit of the Bronx Veterans Administration Hospital to *Medical Focus*, a monthly bulletin issued by the Medical Department of Knoll Pharmaceutical Co., Apr 1960.
- (3) E. E. Stickley, *Neutron Capture Therapy: Slow Neutron Depth Distribution Measurement in Tissue*, paper given at *Thirty-Sixth Ann Meet of Am Radium Soc.* March, 1954.
- (4) L. E. Farr, *Radiation Biology and Medicine*, Addison Wesley Publishing Co., Reading, Mass. Ch 21, p 522, 1958.
- (5) P. C. Aebersold, remarks prepared at dedication of the Picker X-Ray Corp Research Center, Cleveland, Ohio, June, 1959.
- (6) H. D. Suit, R. J. Shalek, E. B. Moore and J. R. Andrews, *New Method of Radioactive Loading of Therapy Needles in Radiation Treatment*, paper given at *46th Ann Meet of Radiological Soc of N. Am.* Dec. 1960.
- (7) *Pulsed Energy Goes in Clinics*, *ELECTRONICS*, p 42, July 31, 1959.
- (8) S. Vogel, *Ultrasonics in Industry*, *ELECTRONICS*, p 54, Jan 27, 1961.
- (9) V. T. Tomberg, *Ultrasonic Dosimetry for Medical Use*, *IRE Nat Conv Rec*, part 4, p 80, March, 1957.
- (10) H. P. Schwan, *Absorption of Ultrasound by Tissue and Biological Matter*, *Proc IRE*, 47, p 1959, Nov 1959.
- (11) A. Weissler, *Effects of Ultrasonic Irradiation on Hemoglobin*, *Dig of Tech Papers, 12th Ann Conf on Elect Tech in Med and Bio.* Nov 1959.
- (12) W. J. Fry and F. J. Fry, *Fundamental Neurological Research and Human Neurosurgery Using Intense Ultrasound*, *IRE Trans on Med Electronics*, ME-7 July, 1960.
- (13) F. J. Fry, *Instrumentation, Techniques and Mechanism of Action of High-Intensity Ultrasound in Fundamental Neurological Investigations and in Human Neurosurgery*, *Dig of Tech Papers, 12th Ann Conf on Elect Tech in Med and Bio.* Nov, 1959.
- (14) W. J. Fry, R. Meyers, F. J. Fry, D. F. Schultz, L. L. Dreyer and R. F. Noyes, *Topical Differentia of Pathogenetic Mechanisms Underlying Parkinsonian Tremor and Rigidity as Indicated by Ultrasonic Irradiation of the Human Brain*, *Trans Am Neurological Ass*, p 22, 1958.
- (15) W. J. Fry, *Biological and Medical Acoustics*, *Jnl Acoust Soc Am*, 30, p 287, May 1958.
- (16) J. F. Herrick, *Introduction: Medical Ultrasonics*, *Proc IRE*, 47, p 1957, Nov. 1959.
- (17) H. Lampion et al, *Second Int Conf on Med Electronics*, July, 1959.
- (18) E. Watkins, H. P. Hovarian, A. C. Hering and T. A. Brennan, *Ultrasonic Fragmentation of Calcific Valve Deposits*, *Third Int Conf on Med Electronics*, July, 1960.
- (19) G. Bradfield, *The Direct Indication of the Radiated Power of Surgical Ultrasonic Probes in the Presence of Contact Imperfections*, *Third Int Conf on Med Electronics*, July, 1960.
- (20) D. Gordon, *The Performance of an Ultrasonic Transducer for Surgery of the Labyrinth*, *Third Int Conf on Med Electronics*, July 1960.
- (21) L. E. C. Hughes, *Electronic Engineer's Reference Book*, The McMillan Co., New York, 1960.
- (22) D. G. Kilpatrick and S. Bellet, *Cardiac Pacing/Stimulation by Very Portable Equipment*, *IRE Nat Conv Rec*, 1959
- (23) A. R. Livenson, *The Use of Ultrasonic in Aerosol Therapy*, *Meditsinskaya Prom. SSSR*, No. 1, p 17, Jan. 1959.
- (24) J. D. Meess, *Thermoelectric Applications in Medicine*, *AIEE Conf Paper*, 1960.
- (25) W. J. Gardner, *Use of Audio Analgesia in Dentistry*, *Thirty-Sixth Ann Session, Greater NY Dental Meet*, Dec. 5-9, 1960.

Differential amplification channel with high common-mode rejection is obtained by two wideband d-c amplifiers. The second d-c amplifier suppresses the common-mode signal as much as 130 db



Author makes final adjustment on one of two wideband d-c amplifiers used to reject common-mode during differential amplification

Common-Mode Rejection In Wideband D-C Systems

By JAMES L. KIMBALL,
Kin Tel, a division of Cohu Electronics,
San Diego, Calif.

NOISE AND HUM frequently mask low-level data signals originating in grounded thermocouples and other transducers. This noise is usually caused by the difference in ground potential between the signal source and a remote amplifier. It is called common-mode voltage because it appears on both signal and signal return lines as shown in Fig. 1A; it is frequently of the order of several volts—usually at power-line frequency.

Differential d-c amplifiers were developed to cope with common-mode noise, but these units are usually narrowband—d-c to 100

cps or less—and limited in output, as well as being more expensive than chopper-stabilized wideband d-c amplifiers.

Figure 1B shows two wideband d-c amplifiers in a common-mode rejection circuit for differential amplification. One amplifier, $-K_2$, has a fixed gain and injects a common-mode cancellation voltage into a second variable gain amplifier, $-K_1$. The degree of cancellation depends on the accuracy of matching the resistances, but there is no difficulty in obtaining a rejection of 80 db and a short-term rejection of 130 db has been demonstrated. Amplifier frequency response is maintained at normal bandwidth; variable gain, output capability and impedance, linearity and other

performance characteristics remain unchanged.

Both amplifiers for the scheme shown in Fig. 1B must be high-gain inverting units (a positive input signal results in a negative output) and stabilized by feedback to the point that amplification is determined solely by the values of the feedback and input resistances. In amplifier $-K_2$, resistors R_3 and R_2 fix the gain to produce an output of $-R_3 E_{CM}/R_2$.

Output of $-K_2$ is injected through R_4 into signal amplifier $-K_1$. The amplified common-mode current is $I_2 = -R_3 E_{CM}/R_2 R_4$. Signal current at the input to $-K_1$ is $I_1 = (E_s + E_{CM})/R_1$.

The composite signal to $-K_1$ is then $I_1 + I_2 = E_s/R_1 + E_{CM}/R_1$

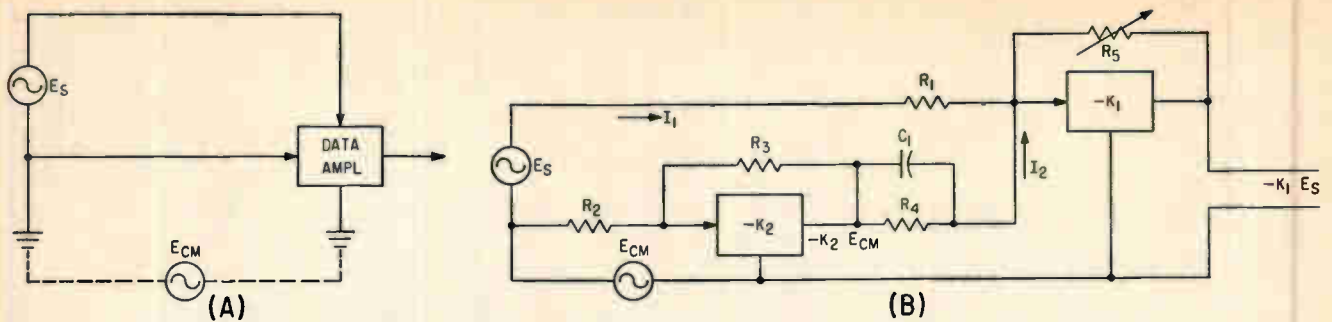

FIG. 1—Common-mode voltage appears on both leads to the data amplifier (A). Rejection circuit (B) can achieve a common-mode rejection of 130 db

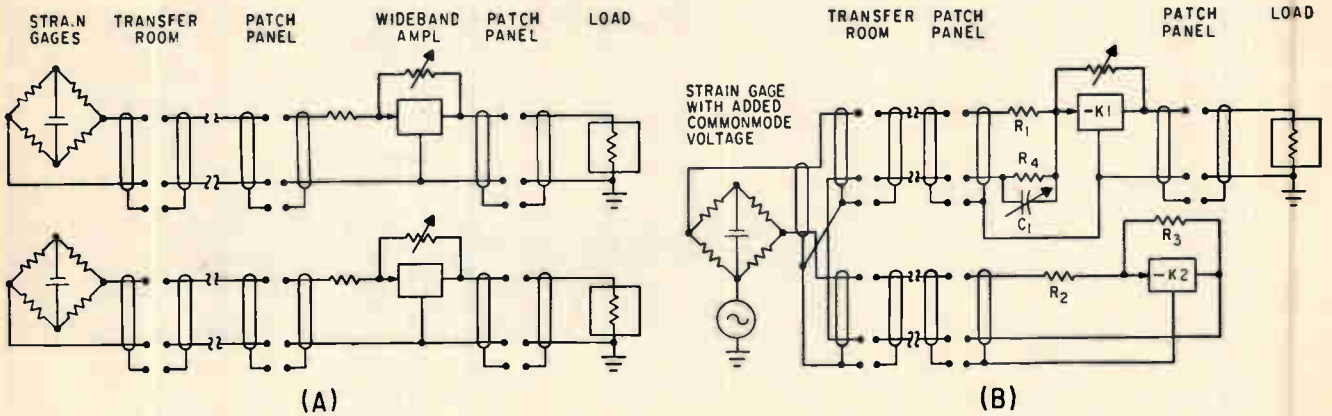

FIG. 2—Two wideband d-c amplifiers in a typical data-acquisition system (A) are converted into a single differential channel by inserting amplifier plug-in units and modifying wiring connections in transfer room (B)

$-R_2 E_{CM} / R_2 R_1$. For R_1 equal to absolute value of K_2 multiplied by R_1 (or $R_3 / R_2 = R_1 / R_1$), common-mode voltages cancel and the sum of the currents is $I_1 + I_2 = E_s / R_1$. A reactive balance is obtained by shunting R_1 with a capacitor; $C_1 = 1 / R_1 \omega_c$, where ω_c is the cutoff frequency of the amplifier formed by $-K_2$, R_2 and R_3 .

The circuit was set up with two amplifiers that use plug-in units to establish fixed or variable gain. Resistors R_2 , R_3 and R_1 were all made 100,000 ohms to match the R_1 input resistor in the variable gain ($-K_1$) amplifier, and C_1 was a variable capacitor of 7 to 42 pf. Space enclosed by the loop of R_1 , R_3 , R_2 and E_s was kept physically small by using a shielded twisted pair for the leads, thus minimizing electromagnetically induced voltages. For the same reason, the loop area of R_1 and the two amplifiers was minimized. A conventional variable-gain amplifier insert was modified by installing a 100,000 ohm resistor (R_1) and variable capacitor (C_1) within the plug-in enclosure. Resistors R_2 and R_3 were installed in a plug-in in-

sert. Changes were made in the input and output signal return wiring of both amplifier inserts. Since the impedance of the input lines form a part of R_1 and R_3 , both lines were made the same length and kept in the same environment.

A common-mode voltage of 35 volts, 60 cps, was placed in series with a +0.001-volt d-c signal to evaluate the arrangement. A rejection of 80 db was observed almost immediately; adjusting the resistances and C_1 gave an additional 50 db for a total rejection of 3×10^6 . The rejection held for any gain of the $-K_1$ amplifier. Substituting a 0.005-volt a-c signal from 20 to 20,000 cps showed that the amplifier frequency response was not impaired. No waveform distortion or modulation was observed, even in the vicinity of 60 cps, and increasing the signal level showed that the output capability was not affected.

Although R_1 , R_2 , R_3 and R_4 were all 100,000 ohms in the demonstration circuit, other values can be used as long as the relationship $R_1 / R_1 = R_3 / R_2$ is maintained. Input resistance R_1 in the amplifier can

remain 100,000 ohms for most situations, while R_1 , the injection resistance, is changed as required by the R_3 / R_2 ratio. Amplification of $-K_2$ should be adjusted by the ratio R_3 / R_2 to cancel the common-mode voltage in the installation; ideally, the circuit will give a $-K_1$ output close to amplifier capability, typically about 40 volts.

For a common-mode noise level of approximately three volts, a fixed gain of 10 is desirable for $-K_2$. Resistor R_1 would then be increased to 1 megohm (which is close to the practical upper limit for a precision resistor), while C_1 would be decreased and R_2 changed to 10,000 ohms; R_1 and R_3 remain 100,000 ohms. The input impedance of $-K_2$ would be decreased by an order of magnitude—an unimportant change since only the common-mode voltage is amplified by this unit.

An application of the circuit is in data acquisition systems. Two wideband amplifier channels may be converted rapidly and easily to a single wideband differential channel, as shown in Fig. 2 for a strain gage application.

Circuit Designers...

GET
150 WATTS
 IN **TO-3 PACKAGE**
 FROM
TI

... TI germanium power  5 through 25 amp series

■ Lowest thermal resistance available... 0.5°C/watt ■ Highest total dissipation available... 150 watts ■ Get 150-watt dissipation with your present circuit designs... TO-3 package ■ Longer battery life in DC circuits... Low I_{CBO} ■ Immediately available from Texas Instruments distributors' shelves... 1-999 units at factory prices.

DESIGNED FOR POWER SUPPLIES/AMPLIFIERS/GENERAL PURPOSE SWITCHES

Replace your low dissipation units with TI 150-watt devices now! Call your nearest TI sales engineer for price, delivery and application information.

TI Type Numbers	2N250	2N251	2N456A	2N457A	2N458A	2N1021	2N1022	2N511	2N511A	2N511B	2N512	2N512A	2N512B	2N513	2N513A	2N513B	2N514	2N514A	2N514B
I_C	5a	5a	7a	7a	7a	10a	10a	10a	10a	10a	15a	15a	15a	20a	20a	20a	25a	25a	25a
BV_{CBO}	30v	60v	40v	60v	80v	100v	120v	40v	60v	80v	40v	60v	80v	40v	60v	80v	40v	60v	80v

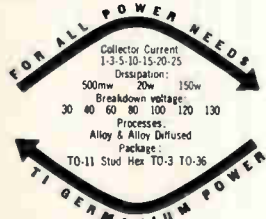

SEMICONDUCTOR-COMPONENTS DIVISION

TEXAS  **INSTRUMENTS**

LIMITED

INCORPORATED

DALLAS ROAD • BEDFORD, ENGLAND

P. O. BOX 5012 • DALLAS 22, TEXAS

Missile Provides Wind Profiles to Aircraft

PROFILES of horizontal wind velocity and direction over a wide range of altitudes are provided within a few minutes by an inertial wind-measuring system. It includes a missile that is dropped from an aircraft, airborne data-processing equipment and recorders. Wind information obtained by the missile is telemetered back to the aircraft, eliminating need for ground stations. Equipment in the aircraft makes the data immediately applicable to other airborne gear as well as recording it for future use.

The wind-profiling system, called Wind Sonde, was developed for the Air Force by Allied Research Associates, a fully owned subsidiary of Boeing Airplane Company. The wind-vector data is expected to improve accuracy of bomb-navigation systems.

Among a wide variety of other possible applications, the system could be used to study wind characteristics of hurricanes and other storms, measure high-altitude winds and provide data quickly to weapons test ranges and missile launching sites. It can provide information to prediction computers that could determine fallout patterns of aerial releases of chemicals, bacteria or radioactive materials. The system is also being considered for potential use in exploring the atmospheres of other planets.

Because no ground stations are required, wind profiles can be obtained over uncharted areas, large bodies of water and politically controversial or even hostile regions. Altitudes at which measurements can be made are limited only by aircraft capabilities. Several missiles can be released simultaneously from separate aircraft to develop a comprehensive picture of horizontal winds over a wide area.

Before release, a gyro in the 27-inch long missile is spun about the vertical axis using a vertical reference in the aircraft. The gyro, encased in an evacuated housing, has relatively large angular momentum.

After release, the coasting gyro provides a short-term (2-minute) horizontal inertial platform for an accelerometer and an azimuth magnetometer.

Roll and pitch gimbals allow two-degree-of-freedom movement of the gyro relative to the missile case when the gyro is uncaged. The roll gimbal frame provides primary support for the two gimbals.

The back plate of the aerodynamically neutral missile supports a parachute assembly. As the missile falls, the two-stage parachute system orients the missile within 10 degrees of gyro vertical. The parachute system is then jettisoned and the gyro is caged to begin the wind-tracking phase. With the gyro locked to the missile, the entire missile functions as a gyro, which is acted on by small aerodynamic moments.

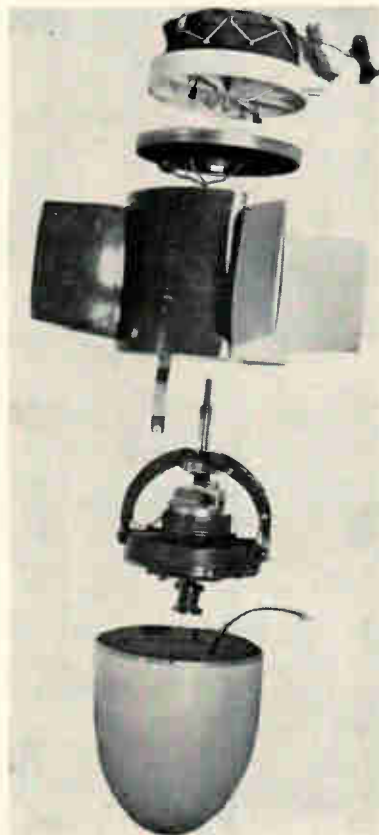

Inertial wind-measuring system gets telemetered data from missile shown in exploded view

The 13-inch diameter cylindrical missile is equipped with four slightly canted fins that increase its diameter to 26 inches. The fins cause the missile to spin at about 3 cps. By spinning the missile, a single accelerometer can detect horizontal wind velocity in two directions.

During the free-fall tracking phase, outputs from the accelerometer, a spinning-coil magnetometer and a signal generator are used to modulate subcarrier oscillators. A 70-Kc precision linear voltage-controlled oscillator and two standard voltage-controlled oscillators are used in the f-m/f-m telemetry link. A 403-Mc transmitter is used to relay the information back to the aircraft. Power for the electronic equipment is provided by a battery pack in conjunction with a d-c to d-c converter.

A slot-type antenna is used for the system that is an integral part of the nose structure. It is formed from two metallic sections of the nose cone that are separated by a Teflon insert and fed in phase. The resulting pattern is torus-shaped in the horizontal plane with major lobes extending to the rear of the missile.

The signals received at the aircraft are fed to data-processing equipment. The processed information in turn is recorded and provided to other equipment as required. As a precaution, the raw data received is also recorded directly to prevent its loss should the airborne data-processing equipment not function properly.

Vertical Sensor Devised To Limit Shock Effects

By F. W. KEAR, Supervisor, R & D Lab., Lytle Corp. Albuquerque, New Mexico

VERTICAL-SENSING device has been developed for applications in which equipment will be subjected to mechanical shock. Performance of the vertical-sensing gyro switch has

SM GROUP

Optional 0.1% or 0.01% regulation:

3 1/2" PANEL HEIGHT

0.1% REGULATION MODELS	DC OUTPUT RANGE		0.01% REGULATION MODELS
	VOLTS	AMPS	
SM 14-7M	0-14	0-7	SM 14-7MX
SM 36-5M	0-36	0-5	SM 36-15MX
SM 75-2M	0-75	0-2	SM 75-2MX
SM 160-1M	0-160	0-1	SM 160-1MX
SM 325-0.5M	0-325	0-0.5	SM 325-0.5MX

5 1/4" PANEL HEIGHT

SM 14-15M	0-14	0-15	SM 14-15MX
SM 36-10M	0-36	0-10	SM 36-10MX
SM 75-5M	0-75	0-5	SM 75-5MX
SM 160-2M	0-160	0-2	SM 160-2MX
SM 325-1M	0-325	0-1	SM 325-1MX

8 3/4" PANEL HEIGHT

SM 14-30M	0-14	0-30	SM 14-30MX
SM 36-15M	0-36	0-15	SM 36-5MX
SM 75-8M	0-75	0-8	SM 75-8MX
SM 160-4M	0-160	0-4	SM 160-4MX
SM 325-2M	0-325	0-2	SM 325-2MX



SM GROUP

Precise, reliable performance in a wide choice of output ranges.

Three rack sizes: 8 3/4" H, 5 1/4" H, and 3 1/2" H. Impervious to operational damage: circuit protection is an inherent function of input transformer and regulator characteristics.

kepco

makes

power

supply

news

for

'61

HB GROUP

Optional 0.1% or 0.01% regulation:

3 1/2" PANEL HEIGHT

0.1% REGULATION MODELS	DC OUTPUT RANGE		0.01% REGULATION MODELS
	VOLTS	MA	
HB 2M	0-325	0-200	HB 20M
HB 4M	0-325	0-400	HB 40M
HB 6M	0-325	0-600	HB 60M
HB 8M	0-325	0-800	HB 80M



HB GROUP

Exceptional performance: delivers 0-325 v dc at 200, 400, 600 or 800 ma from one standard 3 1/2" H rack-mounting package.

Incorporates many "special" features as standard: constant current mode, remote programming, remote dc on-off control.

PR GROUP

7" PANEL HEIGHT

MODEL	DC OUTPUT RANGE	
	VOLTS	AMPS
PR 15-30M	0-15	0-30
PR 38-15M	0-38	0-15
PR 80-8M	0-80	0-8
PR 155-4M	0-155	0-4
PR 310-2M	0-310	0-2



PR GROUP

A flexible new general-purpose line of semi-conductor power supplies. Adjustable wide-range outputs.

± 1% line regulation; semi-regulated for load. Many standard modifications available.

FOR DETAILED SPECIFICATIONS ON MORE THAN 150 STANDARD MODEL POWER SUPPLIES, SEND FOR KEPSCO CATALOG B-611

kepco inc.

131-48 SANFORD AVENUE

FLUSHING 52, N. Y.
IN 1-7000 • TWX #NY4-5196

The Finest in Dynamic Rectifier Analyzers for Under \$900



MODEL 170

- Incoming Inspection
- On-Line Inspection
- Evaluates Heat Sink Design
- Measures Rectifier's Dynamic Characteristics

Here is a completely self-contained dynamic rectifier test set that is the ultimate in testing any semi-conductor rectifier UNDER ACTUAL OPERATING CONDITIONS. The unique design eliminates the need for bulky external load resistors and permits testing rectifiers at any combination of ratings up to 20 amperes and 1000 volts peak with ease. This Wallson Model 170 dynamic rectifier analyzer meets and exceeds the proposed JEDEC specifications.

Mirror scaled 1% meters combined with functional design assures minimum operator error and continuous accurate testing. Front panel terminals provide direct output for oscilloscope display of forward and reverse characteristics.

FEATURES

- Average Forward Current: 1/5/20 amperes DC full scale
- Reverse Voltage: 250/1000 volts peak
- Measures Average Forward Voltage Drop: 0-1, 0-5 volts
- Measures Average Reverse Current from 1 μ a to 50 ma in four ranges

\$855.00

Price

Delivery is from stock
(2 weeks)

Coming Soon "Companion 600 ampere SURGE TESTER"



WALLSON

ASSOCIATES, INC.

912-914 Westfield Avenue, Elizabeth, New Jersey

FLanders 1-0700

See our full line of Semiconductor Test Equipment at Booth 3006 IRE Show

proved to be equal to that of mercury vertical-sensing switches.

A basic requirement in a wide variety of guidance and navigation equipment is that of sensing the vertical direction. In some gyro applications, however, existing vertical-sensing transducers were found to be unsatisfactory because they were adversely affected by shock. Splashing and oscillations can result in high-inertia mercury vertical-sensing switches. Pendulum-type sensors can also respond to shock.

The new vertical-sensing switch shown in the figure has a cylindrical case completely filled with fluid.

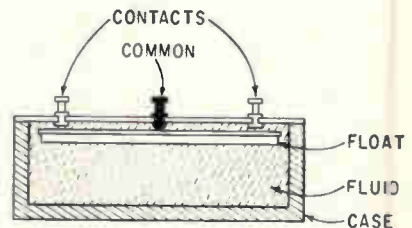

Float in completely filled cylinder tends to remain horizontal

A cover plate is attached to the case with a water-tight seal. A common terminal is mounted at the center of the non-conducting cover plate, and contact terminals are mounted at equal distances from the center of the plate.

The key part of the assembly is a float suspended in the completely filled container. The material used for the disk-shaped float is buoyant. A second disk attached to the top of the buoyant disk is made of electrically conductive material. This conductive float surface is in constant contact with the center common terminal.

In operation, the float tends to remain in a horizontal position. If the switch casing is rotated away from vertical, a contact is brought below horizontal and into contact with the float surface. Thus a circuit is completed between the terminal of that contact and the common terminal.

Although accuracy is dependent on a number of dimensional tolerances, the most important single factor is that buoyancy of the float is equal at all points around its

circumference. To assure this balance, precision machining is used to form the float. Final inspection of the switch float is made using a precision dynamic balance tester. After this it is checked for buoyancy balance.

Thermoelectric Power For Microwave Relay

ONE-HUNDRED watt thermoelectric generator will be used for cathodic protection of pipelines and for charging batteries used to power a microwave relay communications system. Total power output is obtained by stacking two 50-watt sections one on top of the other.

The power-generating system was designed by Westinghouse Electric for use by Northern Illinois Gas Company. The thermoelectric generator was needed at some remotely located pumping stations where electrical power is not available. Thermoelectric generators are ideally suited for this application because they provide all power required by a station, including that for meters, valve control and microwave relay equipment.

Electrical energy is produced by propane gas burned in an assembly at the base of the unit. Hot gases pass through a central insulated chimney. Thermocouples mounted around the outside of the chimney generate the electrical power. The hot side of the thermocouples is kept at about 400 C, with heat being dissipated through anodized aluminum fins to the surrounding air.

Basic generator output is 11 volts d-c at about 10 amp. A static converter operating at about 88 percent efficiency changes this output to 48 volts d-c at about 2.1 amp.

The unit, weighing about 75 pounds, was designed and constructed at Westinghouse's semiconductor department plant at Youngwood, Pennsylvania. It will be used as part of a research program by Northern Illinois Gas in which additional industrial applications of thermoelectric power generators will be investigated.



Lapp

ANTENNA STRAIN INSULATOR

The Lapp porcelain rod insulator shown at the top of the illustration develops 12,000 lb. strength, and is suitable for the most severe electrical and mechanical duty. It is available with rain shield and/or corona rings. All hardware is silicon aluminum alloy. Smaller insulators, in porcelain or steatite, are suited to lighter duty for strain or spreader use. Lapp engineering and production facilities are always ready for design and manufacture of units to almost any performance specification. Write for Bulletin 301, with complete description and specification data. Lapp Insulator Co., Inc., Radio Specialties Division, 176 Sumner Street, LeRoy, N. Y.





Photomicrographs, enlarged 5.5 times, illustrate the three powders used in the fabrication of TFE tape-wrapped and extruded wires. Particle sizes of TFE-1 (left); TFE-5 (center); and TFE-6 (right) are the key to the basic characteristics of the insulated wire

How To Apply Teflon-Insulated Wires

By J. W. HOLLAND, Vice President,
Cable Designs, Inc., Westbury, N. Y.

ACCEPTANCE AND INCREASING use of tape-wrapped Teflon, and extruded Teflon wire in wire and cable systems for guided missiles, radar, telemetering, and computers have given rise to many queries regarding the uses of these wires. And this article was prepared especially for this column to help the systems designer better understand his materials, and choose their best applications.

With proper fabrication, wire insulated with either tape-wrapped Teflon, or extruded Teflon, conforms to MIL-W-16878; Types E (600-v) and EE (1,000-v). Certain differences in performance characteristics are generally an outgrowth of the insulation and method used for insulating the conductor.

The generic term TFE has been adopted for the tetrafluoroethylene resins used in this connection. The resins are made by Du Pont.

The two major types of Teflon tape-wrapped insulating wire presently used are a presintered tape fabricated from a film skived from a molded cylinder of TFE-1 or TFE-5; and an unsintered, extruded and calendered film of TFE-6. The latter, also extruded directly onto wire, has the greater equivalent dielectric strength due to its structure and particle size (see photos).

Wire insulated with a presintered skived film consists of multi-

layers of tape either heat-sealed under pressure, or contained within an outer covering such as glass-fiber braid. This construction prevents the taped insulation from unraveling during use. To overcome interface problems between layers of tape, some wire manufacturers use a Teflon dispersion between layers. This acts as a binder.

Dielectric material such as this generally requires additional layers of tape in order that the electrical properties of the insulated wire conforms to MIL-W-16878. This causes the diameter of the finished wire to exceed the maximum limits of the spec. This is particularly true for Type E, the 600-v wire.

Most Teflon striping inks are fabricated from Du Pont's TD-30 dispersion. This ink, due to particle size, makes good adherence possible with the TFE-6 wire; is a problem with TFE-1 or TFE-5. The particle size of the Teflon striping ink is much smaller than that of TFE-1 or TFE-5, tending to prevent proper adhesion of the striping ink to the substrate.

Because of its lower cost, the skived tape is often used as a moisture barrier on high-temperature coaxial cables (per MIL-C-17) that have a nonhomogeneous outer covering, such as silicone-impregnated glass-fiber braid. Another common application for skived tape is for fabricating high-temperature air-frame wire (per MIL-C-7139). Here the skived tape is interlayered with

Teflon-coated glass fiber, and covered with an outer glass-fiber braid.

Skived-tape hook-up wire has good flexibility, can be fabricated in longer lengths than extruded wire, and has a lower cost factor.

Wire insulated with TFE-6 extruded and calendered tape very closely parallels Teflon insulation that has been extruded directly onto the wire. Films as thin as three mils can be made with very few pin holes. Unlike the presintered skived tape, the unfused TFE-6 film, after being wrapped on the wire, can be sintered into a homogeneous cross-section. Pigmentation and ink-striping characteristics of the TFE-6 taped-wire construction are equal to that of extruded insulation. The colored tape stripes will not scrape off or flake off when the wire surface is abraded. This is important where positive prevention of contamination of delicate electronic equipment is essential.

The density and durometer of homogeneous taped insulation is not as high as extruded wire insulation. This gives the wire flexibility, but not as good abrasion resistance as extruded insulation. In many cases taped insulation strips better than extruded Teflon. Extruding pressures force the insulation down into the interstices of the stranded wire, hindering easy striping. On the other hand, unfilled interstices tend to lower the corona initiating level. Any type of Teflon insulated wire is known

For that 

NEW IDEA

visit the

IRE SHOW

March 20-23, 1961 New York
 Coliseum and Waldorf-Astoria Hotel
 Members \$1.00, Non-members \$3.00 Age limit—over 18

CIRCLE 204 ON READER SERVICE CARD

Reliable products depend on reliable parts

The worldwide success of Japan's transistor radios is a tribute to their highly efficient yet minute components, of which the ultra-small Mitsumi FT Poly-vari-con is typical. With other superb Mitsumi parts, it is being extensively used by leading radio manufacturers.

For Transistor Radio Parts



IFT
Intermediate
Frequency
Transformer



POLY-VARI-CON
Variable
Capacitor



Mitsumi Parts

MITSUMI ELECTRIC CO., LTD.
 1056-1, Koadachi, Komae-cho, Kitatama-gun, Tokyo, Japan
 TEL: (416) 2619 2692 2219

CIRCLE 205 ON READER SERVICE CARD

February 24, 1961

Lepel

HIGH FREQUENCY
Induction
**HEATING
 UNITS**

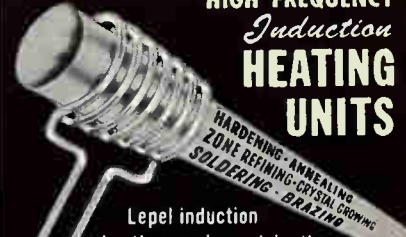

Lepel induction heating equipment is the most practical and efficient source of heat developed for numerous industrial applications

Typical Induction Heating Applications

Glass to Metal Seals

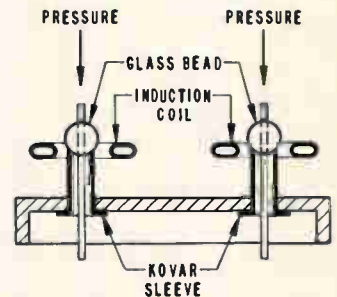

Induction heating is ideal for the assembly of glass beads to pre-oxidized Kovar metal sleeves for a header sub-assembly. The glass-Kovar joint area is brought to 1550° F while pressure is applied to the glass beads.

Our engineers will process your work samples and return the completed job with full data and recommendations without cost or obligation.

Production Soldering Resistors With Long Pigtaills

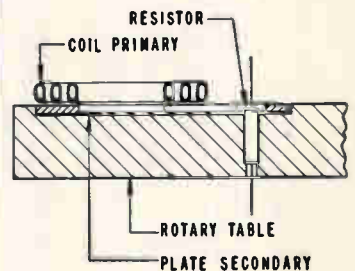

Heating occurs in small opening of plate secondary which is electromagnetically coupled to stationary primary. This produces highly localized heating while avoiding interference of pigtail with the coil. One turntable contains a number of loading positions.

WRITE FOR NEW LEPEL CATALOG

Lepel HIGH FREQUENCY LABORATORIES, INC.

55th ST. & 37th AVE., WOODSIDE 77, N. Y.
 CHICAGO OFFICE: 6246 WEST NORTH AVE.

CIRCLE 69 ON READER SERVICE CARD 69

WHAT'S YOUR TRANSISTOR COOLING PROBLEM?

Whatever it is, you can probably find the solution with a Birtcher Radiator. Available in sizes and designs to most efficiently cool all popularly used (and many special) transistors. Test reports show up to 27% more transistor efficiency!

AVAILABLE FROM AUTHORIZED BIRTCHER DISTRIBUTORS

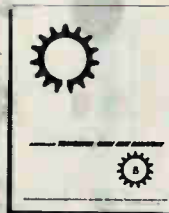

NEW!

TRANSISTOR
RADIATOR
CATALOG 1-HR

Just off the press — write for it

B

THE BIRTCHER CORPORATION

INDUSTRIAL DIVISION

745 S. MONTEREY PASS ROAD, MONTEREY PARK, CALIFORNIA

CIRCLE 206 ON READER SERVICE CARD

WIDE BAND FM DEVIATION...

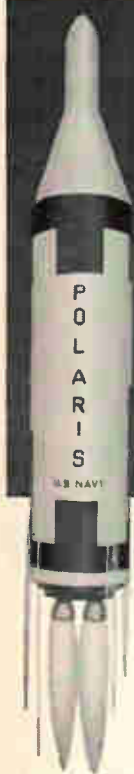

... is measured to 3% accuracy with 928 and 928/2. Like all Marconi FM Deviation Meters they have direct readout, xtal standardization and ease of use. They include demodulated output for transmitter noise and distortion measurements.

Most Missile Makers Measure Modulation with Marconi Meters.

	Model 928	Model 928/2
Carrier Freq.	10-500Mc.	215-265Mc
Deviation	to 400 kc	to 150kc
Modulation	50cps-120kc	50cps-120kc
Construction	Shock Resistant, ruggedized,	waterproof.
Price	\$1450	\$1600



MARCONI
INSTRUMENTS



111 CEDAR LANE • ENGLEWOOD, NEW JERSEY

MAIN PLANT: St. Albans, England

to have poor corona resistance.

The dielectric strength of TFE-6 tape is equal to the extruded type, and in the larger conductor sizes (12 AWG through 8 AWG) the taped insulation is superior to the extruded. Because of the manufacturing limitations of extruding, taped wire can be fabricated in much longer continuous lengths.

Proper sintering of the TFE-6 tape is a critical phase of good manufacturing, and close control is required. Overfused tape will be too soft (but will not unravel), and in many cases will crack after being subjected to the cold-bend test of MIL-W-16878. Underfused taped insulation will also be too soft, and will unravel easily. Generally, underfused insulation can be detected by a high-voltage spark test, which is a 100 percent test.

The grain of the extruded and lubricated tape is unidirectional. Therefore, after the tape is applied spirally, the grain runs in a helix. Once a tear is established, the tape can be torn spirally. This is not unraveling, for the tear is between two seams.

Jackets over shields and multi-conductor constructions is an ideal application for the TFE-6 tape.

Indications point to TFE-6 taped wire as having superior heat resistance over the extruded insulation (especially over 250 C for a short duration). However, further investigation is regarded as necessary to substantiate this claim.

Extruded wire made by extruding unlubricated TFE-1 or TFE-5 on a conductor with a reciprocating ram is a slow process, generally confined to heavy-wall thicknesses over 40 mils. Cores for large high-temperature coaxial cables are usually fabricated in this way. This is just about the scope of this type of extruding for wire insulation.

Lubricated TFE-6 is extruded on hook-up wire in thin-wall thicknesses by straight ram extrusion. Although this method offers relatively slow manufacturing output and limitation of finished wire lengths, the high pressures used obtains a very dense cross section which gives the finished wire good abrasion resistance, but not as good flexibility. Proper sintering eliminates pressure splits, or longitudinal cracks. Because of manufacturing limitations, extrusion is

confined to primary insulation.

Smooth, uniform surfaces obtained by extrusion is important when wire leads are to be inserted into a hermetically-sealed unit. Properly extruded wire strips better than taped Teflon, particularly when automatic strippers are used.

The price advantage of extruded wire over the equivalent taped construction is not as great with manufacturers that produce their own TFE-6 tape.

BIBLIOGRAPHY

Test data illustrating the flexibility of these wires is available from Cable Designs, Inc., 66 Rushmore St., Westbury, N. Y. These tests were conducted on a stiffness tester made by Taber Instrument Corp., North Tonawanda, New York.

Thin Magnetic Films For Computer Memories

A NEW LINE of ultra-high purity alloys, used as source material (evaporants) to produce magnetic thin films for computer memories, are now available from the Precision Metals and Electronics Division of the Hamilton Watch Co., Lancaster, Penn. Called Vapalloys, these materials can be tailored to any composition required for computer applications.

Hamilton's Vapalloys are in use in the UNIVAC 1107 Thin-Film Computer, and give memory access time of one billionth of a second.

The Vapalloys are produced by vacuum induction melting under careful control. These magnetic alloys are compounded using highest purity iron, nickel, and cobalt as raw materials. Because the subsequent application for Vapalloys is in ultra-high vacuum systems in which the thin films are deposited, the vacuum melting practice is designed to keep residual gas content at a minimum: hydrogen and nitrogen are usually less than one part per million; oxygen runs slightly higher since solid deoxidizers are avoided. Amounts of other trace impurities in parts per million are Ca 1-10, Si 1-10, Mg 3-30, Al 1-3, Mn 3-30 and C 5-40.

Selection of raw materials and exacting composition control of the alloys is the key to reproducible magnetic properties. Vapalloys can be alloyed to any composition required for computer applications.

THIS "BABY" CAN REALLY TAKE IT!

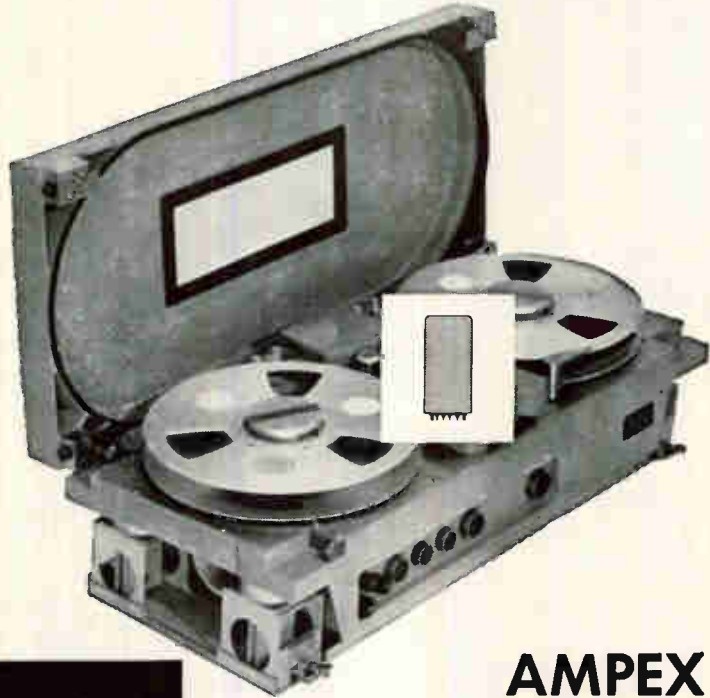

AMPEX

specifies Hill signal generators for use in the AR-200 magnetic tape recorder because of their high reliability under extreme environmental conditions. The compact Hill units generate a precision 60-cycle frequency which is power amplified to operate the recorder's capstan drive motor. While paralleling the qualities of advanced laboratory recorders, the sturdy Ampex AR-200 will withstand shock up to 15 G's, operate at altitudes of 100,000 feet, function under excessive temperature changes and in up to 100% humidity. It displaces only 1.6 cubic feet.

BULLETIN FS 17900

fully describes Hill's Signal Generator used in this application. Write for your copy.

Hill Electronics manufactures precision, crystal controlled frequency sources, filters and other crystal devices for operation under all types and combinations of conditions.

HILL ELECTRONICS, INC.

MECHANICSBURG, PENNSYLVANIA





Interlock bar cuts off power before adapters can be inserted or removed

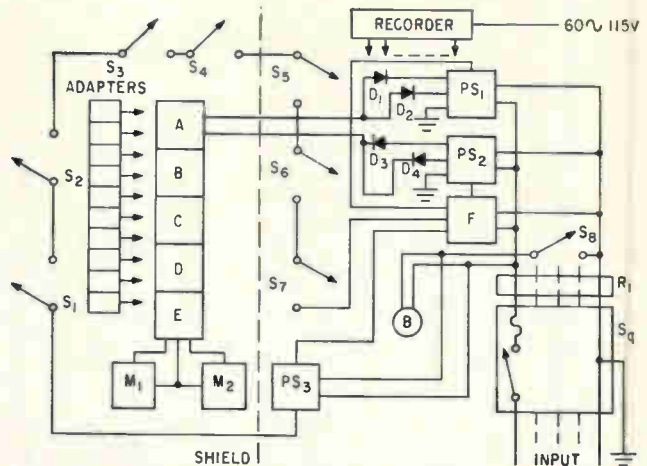

FIG. 1—Wiring diagram of 100-transistor module. Each rack contains four modules

Fail-Safe Design Upgrades Transistor Tests

FAIL-SAFE LIFE TEST racks have been developed by Philco Corp. as part of a long-range program, called Project Virtue, to upgrade transistor test equipment and procedures. A major aim is avoiding human and equipment errors which could be more numerous than actual transistor failures in a test run of several thousand unit.

The racks at Philco's Landsdale, Pa., division are designed to prevent fluctuations in transistor operating power and temperature. The number of times the transistors are turned on and off and the hours of on-time are automatically counted. The counters, in addition to providing test records, accumulate data that help assess equipment performance and the effect of interruptions on life testing reliability.

The complete rack is actually a series of modules, each testing 100 transistors. Each module has two individual power supplies, a separate control circuit, interlock system and cycling instrumentation.

Transistors are put into magazine adapters which are inserted in the test sockets. The original adapters hold 10 transistors. Equipment now being installed uses 20-transistor adapters. The newer adapters can be used for higher-temperature testing and also incor-



Portion of life test area, showing four-module units



Magazine adapters. Newly-designed units at left hold 20 transistors

porate a frangible device which precludes further testing if it is dropped or if the transistors are otherwise subjected to shock.

Each group of transistors is locked into the module by an interlock bar. When the interlock is opened, power is shut off. This eliminates accidentally switching transistors in or out of a powered circuit during insertion or removal of samples.

Transistor operating conditions are established by plug-in printed circuit boards, containing zener diode clamp circuits as an additional safeguard against power fluctuation. Condition boards are locked in the rear of the cabinets. Power supply controls are recessed and locked behind the front panels of the modules. Opening a cabinet operates an interlock which removes

power to the transistor.

If there should be a failure of power to a rack, a circuit breaker closes it down. All power supplies must be reset and turned on manually after power is restored. Thermostats monitor rack temperature and shut down the rack if temperature exceeds limits. Power cannot be restored until temperature returns to normal.

Each power interruption actuates a counter, indicating the number of interruptions during any given test. In addition, elapsed time meters and voltage and temperature recorders maintain a continuous record of test activity.

Fig. 2 illustrates a single module. Four modules are stacked in a rack with a common power input (three-phase, 208 v, four-wire, 115 v to neutral). The test chassis at the

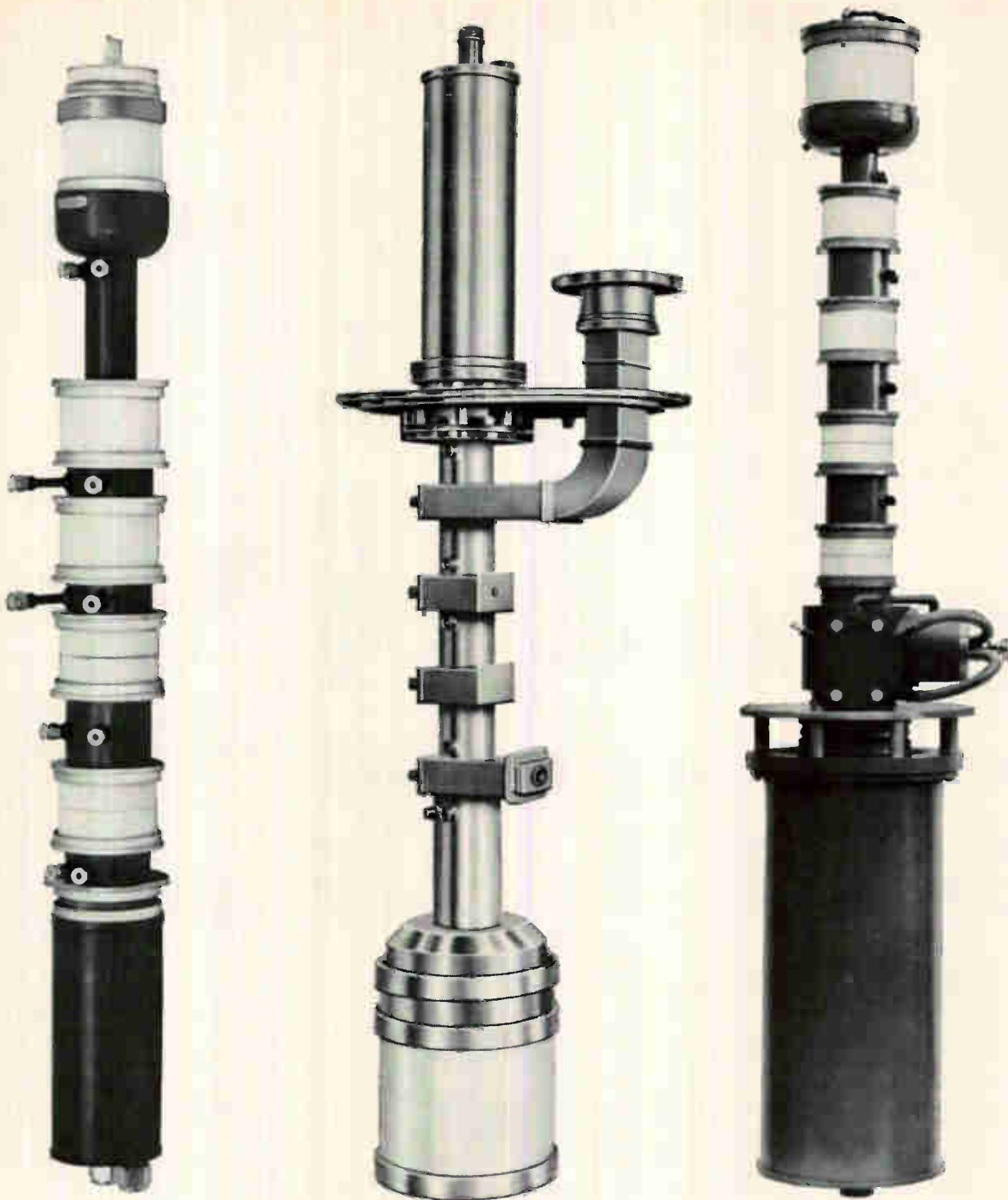

There are 3 ways to design a klystron. Which is best?

The answer: there is no *one* best way. The design of a klystron must vary to meet specific performance requirements. For instance:

For the 4K50,000LQ, left, *external-cavity* design is best for producing 10 kw power output at 755-985 Mc. (Proof: more than 25,000 hours of near unattended service in troposcatter systems!)

For the 4KP40,000SQ, center, *internal-cavity* design is best for developing 10 Mw pulse output power at 2845-2865 Mc. (Proof: better than 2,500 hours in continuous rf service!)

For the 5K210,000LQ, right, a *combination* of internal and

external design is best for achieving 75 kw minimum average power output at 755-985 Mc. (Proof: tested to 100 kw!)

Where will you find klystrons designed all three ways? Where will you find *every* klystron always shaped the best way to meet specific needs? *Only* at Eimac... where unmatched tube-making skills permit complete design flexibility. For more facts, more figures, get your free copy of "Advancing Klystron Performance Through Design Freedom." Write: Eitel-McCullough, Inc., San Carlos, California.

Power Tubes • Microwave Tubes • Amplifier Klystrons



UP-DATE Your File!

Announcing
DRESSEN-BARNES
 New 1961 Catalog
 Over 150 DC Power
 Supplies
 Over 50 New Modular
 Supplies
 Many New Modular
 Kit Arrangements
 Modified Standard
 Power Supplies
 Many New Mil-Spec
 Power Supplies
 Power Supply Selector
 Charts

NEW 24-PAGE CATALOG

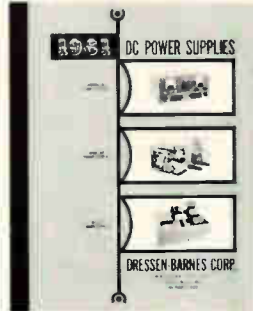

SEND FOR YOUR FREE
 COPY NOW

DRESSEN-BARNES CORP.

250 N. Vinedo Avenue
 Pasadena, Calif. • MU 1-0643

CIRCLE 207 ON READER SERVICE CARD

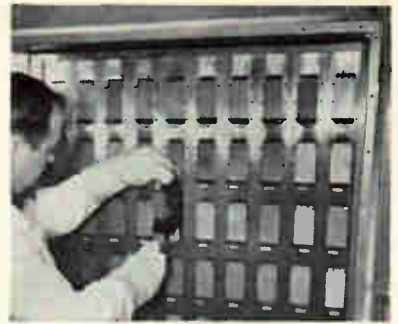

Adapters go into storage oven modules

left is shielded to isolate transistors and test circuits from a-c fields and higher temperatures in the power supply portion.

S_1 is the interlock bar, S_2 the cabinet rear door interlock, S_3 and S_4 are high and low ambient temperature switches, S_5 power supply cabinet rear door interlock, S_6 power supply high temperature limit switch, S_7 power supply cover panel interlock, S_8 the filtered air blower switch, and S_9 a safety disconnect switch and fuse box. R is a relay circuit which detects input power failure and turns off power.

A , B , C , D , and E are the life test circuits, anti-oscillation components, diode clamp overvoltage protectors, constant power dissipation circuits and non-circuit-breaking voltage and current monitoring circuits, respectively. M_1 and M_2 are remote meters. Shorting the meter leads has no harmful effect on the transistors.

PS_1 and PS_2 are collector and emitter power supplies. They are adjustable from zero to 36 v-d-c, 3 amp, and will not overshoot. The diodes are for polarity assurance. F is the module control panel, containing a cycle timer, a running time meter which cannot be reset and a cycle counter which can be reset with a key. The remote 24-point strip chart recorder records each power supply output. PS_3 supplies low voltage d-c to the interlocks. B is a filtered air blower for the power supply cabinet.

Other developments in the program include modular high-temperature storage ovens and a variety of automatic test equipment also designed to eliminate programming, operating and handling errors. Fig. 2 is a flow diagram showing how the racks fit into the total procedure.

The ovens hold 2,000 transistors,

electronics

SPELLMAN HIGH VOLTAGE POWER SUPPLIES



MODEL RG-30

Continuously
 Variable 15-30 KV
 Regulated DC
 Power Supply with
 Regulated Focus
 Voltage Tap

A continuous duty DC supply with highly filtered outputs and regulations better than 0.5% at 1 ma.—no load to full load. A variable focus tap 4-6 KV for use with 5WP11, 5TP4 and flying spot tubes. Dimensions: 19" wide x 10 1/2" high x 13" deep.

With HV meter \$375 Net Less meter \$325 Net
 MODEL RG-40 is a 20-40 KV unit with same specifications as RG-30 except .7 ma. at 40 KV.
 With meter \$375 Net Less meter \$325 Net

MODEL 4575 5 KV-1ma. DC POWER SUPPLY

For an output voltage of 5 KV DC at 1 milliamperes, the low voltage input requirement is 250 V at 50 milliamperes. By varying the DC input the output voltage can be varied from approx. 1 KV to 7 1/2 KV. Dimensions: 5 3/4" high x 3" deep x 4 1/2" wide. In completely enclosed metal housing.



MODEL 4575-2. Same as above with 2 ma. output at 5 KV. \$42.50 Net
 MODEL 4575PN—Reversible polarity. High voltage secondary floating or can be grounded. 1 ma. at 5 KV. \$42.50 Net
 MODEL 4575-2PN—Reversible polarity. 2 ma. at 5 KV. \$52.50 Net

SPELLMAN HIGH VOLTAGE
 COMPANY
 1930 Adee Ave., Bronx 69, N. Y.
 Kingsbridge 7-0306

for fast, thorough production
 cleaning of small parts and
 sub-assemblies — for
 process evaluation —
 and for general ultra-
 sonic studies —



the NEW SOLID-STATE ULTRASONIC CLEANER SONOGEN® LG-75

Compact, efficient, fully transistorized, 75 Watt generator drives a two-gallon cleaning tank. For extremely difficult jobs, the one-gallon high-intensity tank is recommended. Equipment is backed by a nationwide factory-trained service organization. Bulletin S-628. Two-gallon system, \$395, FOB Stamford.

Since 1946 — The Respected Name In Ultrasonics

Branson ULTRASONIC

DIVISION OF BRANSON INSTRUMENTS, INC.
 68 BROWN HOUSE RD. • STAMFORD, CONN.

CIRCLE 208 ON READER SERVICE CARD

74 CIRCLE 74 ON READER SERVICE CARD

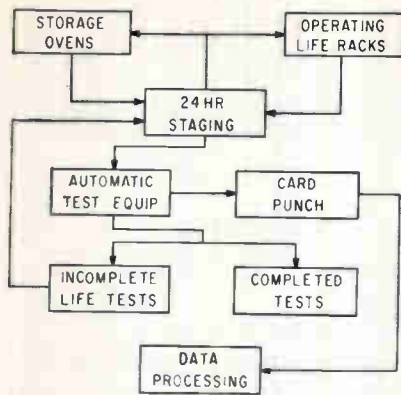

FIG. 2—Quality control and reliability test program

in adapters, at temperatures to 300 C. Temperature is controlled within one degree. One adapter can be removed from the oven with a minimum disturbance of the temperature of the others. Fail-safe features similar to the racks are provided.

Testing is performed without removing transistors from the adapter. Programming is accomplished by interlocking a pre-punched "test condition" card with the adapter, which in turn contains a similar code built into the adapter contacts. When all codes are compared and satisfied, testing can proceed. Data is presented in direct digital form and transposed into unit record cards for subsequent tabulation.

Harness Assembly



Wiring and components for a navigational computer made by Lear, Inc., are assembled on blueprints on a flat board. This procedure eliminates the necessity of soldering as well as tying in tight quarters. Wire ends are temporarily tied down by inserting them into coil springs

MODULAR TELEMETRY RECEIVER FEATURES MULTIPLE BANDWIDTH SELECTION

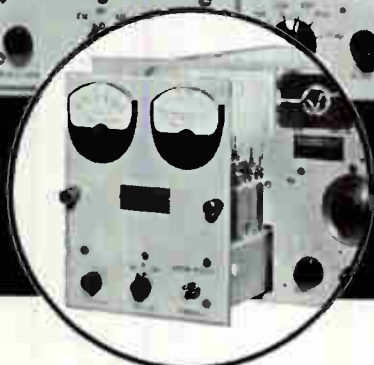

The CENTAUR Receiver
used by NASA
Nems-Clarke Model 1455

Designed to provide a selectable bandwidth capability for PCM, the 1455 most nearly approximates a "universal" telemetry receiver. IF/Demodulator Modules are available in bandwidths ranging from 100 KC to 1.5 MC. Each module contains 3 independent demodulators. Selectable by a front panel switch, they are: Foster-Seeley Discriminator, Phase-Lock Detector, and AM envelope detector. As a further refinement in signal-to-noise ratio enhancement, the video amplifier incorporates a video bandwidth filter having a 6 db per octave roll-off adjustable from 20 KC to 1.2 MC by means of a front panel switch. This receiver is capable of optimum reception of any known type of telemetry signal. Features: 5 MC pre-detection recording output, playback input terminals, and integral VFO, automatically actuated by a micro-switch on the crystal socket. The modulation sensitivity and deviation meter scales provide output voltages and meter deflections which are essentially the same percentage of bandwidth in all modules.

Available as an accessory unit is the Nems-Clarke IFC 1400 Pre-Detection Converter which permits use of the 1455 with stationary-head instrumentation tape recorders for pre-detection recording.

See the 1455 Receiver at the I.R.E. Show, Booths 3917-3919.

Vitro ELECTRONICS A DIVISION OF VITRO CORPORATION OF AMERICA
PRODUCERS OF NEMS-CLARKE EQUIPMENT
819 JESUP-BLAIR DRIVE, SILVER SPRING, MARYLAND / 2301 PONTIUS AVENUE, LOS ANGELES 64, CALIFORNIA

New On The Market

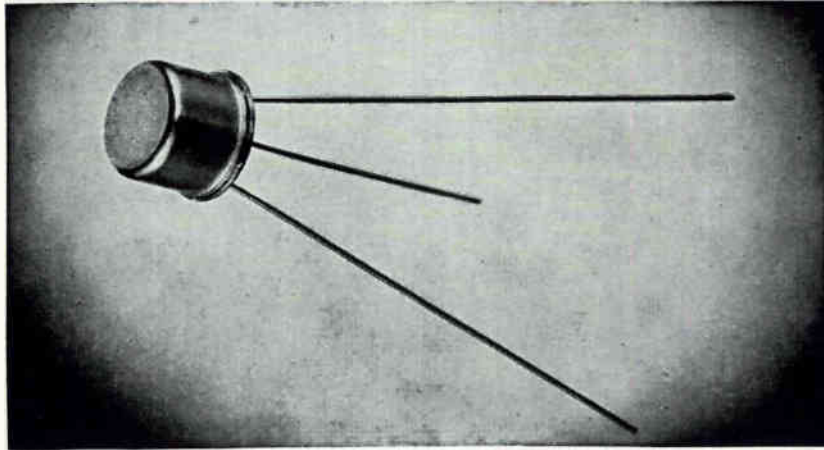

Silicon Mesa Transistor HIGH BREAKDOWN VOLTAGE

RHEEM SEMICONDUCTOR CORP., Mountain View, Calif., has announced a silicon mesa transistor with 175-volt collector-base breakdown. The device (RT5202) V_{CBO} is claimed to be 50 percent higher than any other silicon mesa type. Designed to replace high-voltage relays, it is recommended for high-voltage avalanche operation and for use in constant current generators.

Other features include 5-watt power dissipation and a guaranteed I_{CO} less than 10 nanoamp typical and $2\mu a$ max at 100 volts. Emitter-

base breakdown is 8 volts and maximum collector capacitance is 15 pf at 10 v. Alpha cutoff is 30 Mc and small signal beta range is from 20 to 100.

The unit can be operated in common base with a constant current characteristic to its maximum rated voltage and switches up to 250 volts in avalanche condition. Available in either TO-5 or TO-18 packages, the transistors are priced at \$33 each in quantities of 100-999 and are available from stock.

CIRCLE 301 ON READER SERVICE CARD

Resistance Bridge FOR TEMPERATURE

A RESISTANCE BRIDGE featuring suppression of the effects of variable and unknown lead resistance has been announced by Rosemount Engineering Co., Minneapolis, Minnesota.

A variation of the basic Wheatstone bridge, the instrument is designed for use in temperature measurement with variable resistance temperature probes. In conventional 3-wire and 4-wire bridge circuits, variable and unknown lead resistances can cause prominent errors, particularly in unbalanced conditions. Rosemount's triple-bridge suppresses lead resistance effectively both at null and when unbalanced. Lead variation from 0 to 5 ohms affect readings by less than 0.1 percent of full scale.

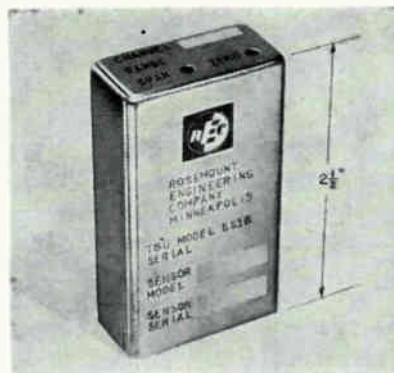

Being a plug-in unit, the triple-bridge permits convenient change of full-scale temperature and allows correcting known calibration errors of the temperature probe. The basic 10-channel Triple-bridge unit contains sockets and interconnecting wiring for 10 probes and 10 plug-in units providing 10 temperature ranges for each probe. Optional equipment includes a pre-

cision regulated power supply and calibration devices.

CIRCLE 302 ON READER SERVICE CARD

10-Mc Counter-Timer IS TRANSISTORIZED

A MILITARIZED all-transistor 10-Mc universal counter-timer, only 5 1/2 inches wide, has been announced by Computer Measurements Co., Sylmar, Calif. The unit, model 1144A, couples increased reliability with reduced power consumption, size and weight. Heterodyning techniques are not used in this direct reading unit. It is available with

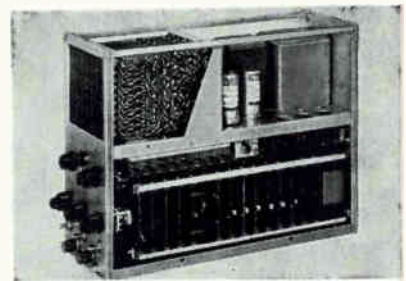

standard vertical decade number panels or with in-line Nixie readout. Power consumption is 50 w and weight is only 22 lb.

Offered with a two-year free service warranty, the 1144A combines the functions of a counter, time interval meter, and frequency/period meter. Its ranges are d-c to 10 Mc for frequency; 0.1 microsecond to 10^7 seconds for time interval and 0.1 microsecond for period.

CIRCLE 303 ON READER SERVICE CARD

Microwave Varactor Diodes MADE EPITAXIALLY

MICROWAVE silicon varactor diodes, with cutoff frequencies as high as 150 Gc at minus 45 v breakdown voltage, have been developed through epitaxial techniques by Sylvania Electric Products, Inc., Woburn, Mass.

These high Q diodes exhibit frequencies as high as 100 Gc and capacitance as low as 0.15 pF at minus 6 v.

As harmonic generators, the new devices are said to feature exceptional power handling capabilities.

MAX/MIN *a message of economy to electronic engineers*

SHOULDN'T YOU SPECIFY A NEW

SF IRE METER

INSTEAD...

...of purchasing three separate instruments to do the work of only one versatile Smith-Florence Model 810 IRE meter?

This flexible new instrument combines all the desirable functions of a multimeter, vacuum tube voltmeter, and exceptionally wide range AC and DC ammeter in one space-saving, easy-to-use package.

The Model 810 is a case in point of the Smith-Florence max/min concept. Here is an instrument that makes a maximum number of measurements and delivers a maximum number of features at minimum cost.

Measure

I AC and DC 10⁻⁹ to 10 amps
±2% DC, ±3% AC.

R 10 ohms to 10 megohms
±5% center scale.

E AC 1 mv to 1 kv ±3%,
20 cps to 1 mc.
DC 1 mv to 1 kv ±2%.

Use the IRE Meter To—

Measure power consumption, both dc and ac * Calibrate ac and dc shunts * Check transistor diode leakage currents * Measure transducer outputs directly * General ac and dc voltage, resistance, current and db measurements.

FEATURES

Simultaneous two function insertion through separate input terminals on the front panel permit voltage or current

measurements to be made while leaving the other probe connected.

Automatic scale selection by means of a unique mechanical design is incorporated into the function switch.

Two calibrating output voltages: 1 v dc and 1 v ac rms square wave controlled by a zener reference circuit to an accuracy of 1%.

Scope and recorder output provides 1 v dc ±20%, ac 400 cps. 1 mc db scale for audio work.

OTHER SPECIFICATIONS

Input Impedance
10 megohms

Power Requirements
117 vac ±10%, 50-60 cps

Dimensions
13" W x 7½" H x 13" D (cabinet);
19" W x 7" H x 13" D (rack)

Weight
16 lbs.

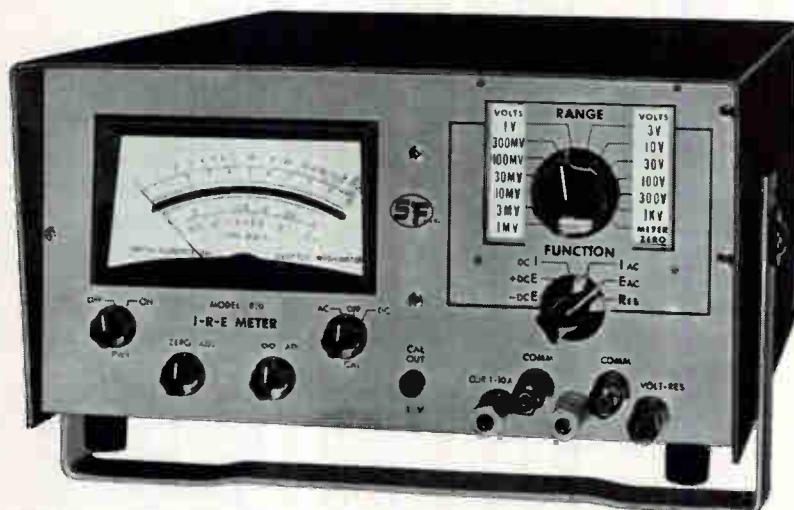

Model 810 IRE meter. Price \$445, rack or cabinet.

For more information and a copy of our new 4-page bulletin on the Smith-Florence 810 IRE meter, call your nearby S-F engineering representative or write directly to:

SF inc.

SMITH-FLORENCE, INC.

4228-36 23rd West
Seattle 99, Washington
Phone: ATwater 4-0170

*Your S-F rep wants to show you the versatile 810. Why not give him a jingle today?

In tests as doublers at L-band, they show conversion efficiencies as high as 70 percent.

Small quantities are available for customer sampling.

CIRCLE 304 ON READER SERVICE CARD

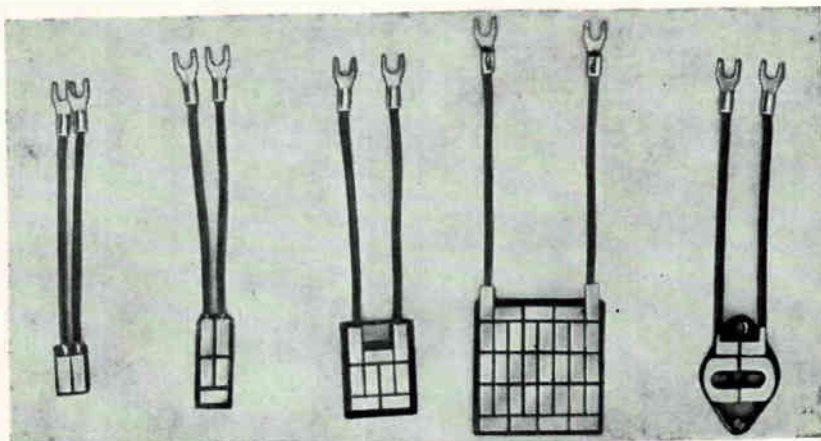

Thermoelectric Cooling Modules 80 C TEMPERATURE DIFFERENTIAL

A COMPLETE line of standard thermoelectric solid state cooling modules for application to military, scientific and industrial needs has been announced by General Thermoelectric Corp., Princeton, N. J., a joint subsidiary of General Devices Inc. and Needco Cooling Semiconductors, Ltd.

The F1, F4, F8 and F32 Frigistors, designated by a number corresponding to the number of thermocouples in the module, are in quantity production. Heat pumping capacity is about one watt per couple; for example, the F8 Frigistor which contains eight thermocouples, pumps up to 8 watts.

Thermocouples made from a new form of Neelium can produce a no-load temperature difference as high as 80 degrees C when measured with its hot junction at 27 deg C. This makes possible low temperatures when the devices are connected in thermal cascade. This se-

ries operates with currents in the region of 10 to 15 amperes. The couples of all modules are electrically connected in series, each requiring about 0.1 to 0.3 volt. The encapsulated modules in this series feature mechanical strength without appreciable deterioration of cooling properties.

Typical uses of these devices are: component cooling, temperature stabilized enclosures below ambient, small refrigerators and air conditioning equipment, fluorescent tube cooling, and scientific and medical instruments requiring reduced temperatures. These devices also have application in the processing industries, in the cooling of military vehicles and in high density electronic packages where normal cooling techniques cannot be used.

In addition to the standard form factors, assemblies are available in a variety of shapes and sizes.

CIRCLE 305 ON READER SERVICE CARD

Sweep Oscillators MICROWAVE RANGES

FOUR microwave sweep oscillators with leveled power output are available from Hewlett Packard Co., 1501 Page Mill Rd., Palo Alto, Calif.

Model 682C covers 1.0 to 2.0 Gc; model 683C, 2.0 to 4.0 Gc; model 684C, 4.0 to 8.1 Gc; and model 686C, 8.2 to 12.4 Gc. All provide

either c-w or swept r-f output. A wide range of sweep speeds allows measurements such as reflection,



attenuation and gain to be displayed on scope or recorded. Sweep range is continuously adjustable and independently variable; sweep rate is selected separately.

The units contain an open-loop leveler, which provides less than ± 1.5 db variation in output. The oscillators are priced from \$2,900 to \$3,090. Delivery is from stock on most models.

CIRCLE 306 ON READER SERVICE CARD

Drive Amplifier FOR D-C TORQUE MOTORS

CONTROL TECHNOLOGY CO., INC., 1186 Broadway, New York 1, N. Y. Model 910 is a fully transistorized amplifier for driving d-c torque motors. It will deliver 2 amps d-c differential current into a two-terminal torquer. The input into the amplifier can be either d-c or 400 cps. Gain is 200 mv per 1 amp d-c output current. Current feedback minimizes the effects of torquer inductance on servo response.

CIRCLE 307 ON READER SERVICE CARD

Thin-Film Memories NiFe FILM ON GLASS

STORAGE elements in high-speed memory planes are 80-20 Ni-Fe alloy films 2,000 angstroms thick on a glass substrate. The film is vapor-deposited.

Type BIP-1000 thin-film memory planes can store 20 words of 8 bits each. Cycle time is 0.2 μ sec or less. The thin-films remagnetize predominantly by a spin-rotational mechanism (further discussed in a technical story in next week's issue) rather than by domain wall movement. Spin-rotational switching occurs in nanoseconds. The film memory planes have a large tolerance with respect to drive requirements.

The memories are available on printed circuit boards 4 x 3 $\frac{1}{4}$ x 0.070 inch, and have standard printed circuit receptacles. The memories are immediately available at \$175 each in small quantities, from Burroughs Corp., Electronic Tube Div., P. O. Box 1226, Plainfield, N. J.

CIRCLE 308 ON READER SERVICE CARD

YEO

Miniature Transformers for Transistor Circuits

For application wherever high efficiency and wide frequency response is needed. Consistently high quality and low prices.

Full details, and quotations for units to your own specifications gladly provided on request.

Write for brochure.

YUTAKA ELECTRIC MFG. CO., LTD.

1-1253, Yutaka-cho, Shinagawa-ku, Tokyo, Japan
Cable Address: EDOYUTACO TOKYO

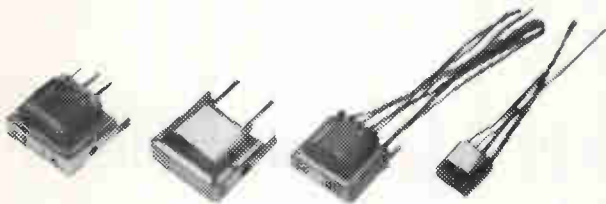

CIRCLE 209 ON READER SERVICE CARD

NEW! MINITAN SOLID TANTALUM NON-POLAR CAPACITORS

for transistorized equipment

- Check these advantages . . . Smaller than any comparable 50 V capacitor. (Actual size .090 x .100 x .065) . . . Low leakage . . . Low dissipation loss at high frequencies . . . Capacity range — .001 to .047 MFD . . . Excellent frequency and temperature stability . . . Available immediately.

For complete technical data and performance curves write:

COMPONENTS, INC.
SMITH STREET, BIDDEFORD, MAINE

CIRCLE 210 ON READER SERVICE CARD

February 24, 1961

OTHER FUSE POSTS MAY LOOK LIKE THESE . . . BUT ONLY LITTELFUSE HAS **PIQ***

A Fuse Post to meet every application—every requirement.

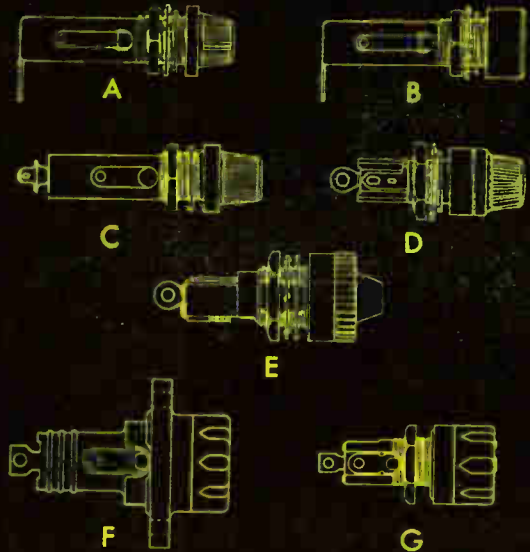

EXTRACTING FUSE POST! Fuse is held in end of removable knob for quick, safe and easy replacement of blown fuse. Safe "dead front" fuse mountings assured. U/L Approved.

- A—3AG Fuse Post (finger operated knob)—No. 342001
- A—8AG Fuse Post (finger operated knob)—No. 372001
- B—3AG Fuse Post (Screwdriver Slot)—No. 341001
- B—8AG Fuse Post (Screwdriver Slot)—No. 371001
- C—4AG Fuse Post (Finger Operated Knob)—No. 442001
- D—3AG Miniature Fuse Post (Finger Operated)—No. 342012

E—NEW INDICATING 3AG FUSE POSTS! (344,000 series) It Glows When The Fuse Blows. Long life incandescent bulb for low voltage ranges — 2½-7V; 7-16V; 16-32V. New high degree vacuum neon lamp for high voltage ranges for greater brilliance and visibility—90-125V; 200-250V.

WATERTIGHT FUSE POSTS Specially designed for use where excessive moisture is a problem.

- F—5AG Watertight Fuse Post. Has flange mounting.—No. 571004.
- G—3AG Watertight Fuse Post—No. 342006
- G—4AG Watertight Fuse Post—No. 442006

For complete details on these items and quotations on special application requirements, write to:

*Precision Engineering
Design Know-how
Quality Craftsmanship

LITTELFUSE
DES PLAINES, ILLINOIS

CIRCLE 81 ON READER SERVICE CARD



Individuality

alone is not a true measure
of an engineer's creativeness

Of course, it helps a bit.

But we're not asking you to jog around the neighborhood in Bermuda shorts or a souped up Model A to prove you can think for yourself. If, however, this somehow stimulates your thinking process, be our guest.

The main point is, RCA West Coast does not believe an engineer's creative abilities fit a specific pattern. Some of our engineers are conformists. Some are not. Some are individualists. Some are not. But *these* prime creative qualities they all share—courage, competence, optimism, and the ability to work together as a team. Solving difficult engineering problems. Right now we're looking for these able additions to this group:

Advanced Systems Engineers, Development and Design Engineers, and Project Engineers, with experience in these areas: Electronic Countermeasures, Data Processing and Computer Systems, and Missile Ground Support Systems.

Interested in the brightness of your future at RCA West Coast? If so, check the box at the right.

RCA
WEST COAST

Call collect or write:
Mr. O. S. Knox
EMpire 4-6485
8500 Balboa Blvd.
Dept. 361-B
Van Nuys, California



RADIO CORPORATION OF AMERICA
WEST COAST MISSILE AND SURFACE RADAR DIVISION

The name you know is the place to grow!



Literature of the Week

SPECIFIC OPENINGS AT RCA WEST COAST ARE:

SENIOR COMPUTER SYSTEMS ENGINEERS

To lead studies in new organizational concepts, pattern recognition and machine learning. Will be a member of high level Research and Development team working on RCA Sponsored Programs.

SENIOR COMPUTER ENGINEERS

To lead applied research studies on kilomegacycle computer circuits. Will work with advanced R & D team.

DIGITAL SYSTEMS ENGINEERS

For design and application of digital data processing equipment to military systems. Also for conceptual design, synthesis, and analysis of military systems utilizing digital techniques.

ECM ENGINEERS

For project equipment utilizing new and unique high frequency and video circuit techniques.

SYSTEMS OPTIMIZATION ENGINEERS

For application of operation analysis and other analytical techniques. Advanced degree.

OPERATIONS ANALYSTS

For development of large scale systems concepts. Familiarity with logical and/or mathematical models for data processing systems necessary. Advanced degree in Mathematics preferred.

DESIGN AND DEVELOPMENT ENGINEERS

For control equipment, display equipment, and design of analog and display circuits.

SENIOR LOGIC DESIGN ENGINEERS

To design entire computer systems. Advanced degree preferred.

SENIOR ENGINEERS

For relay logic and relay switching design and application to advanced digital techniques.

PROJECT ENGINEERS

For technical project management of development and design engineering and customer liaison and manufacturing. Responsibilities include project direction, control and proposals for improvement and extension of digital system capabilities.

PROJECT ENGINEERS

For visual data handling and analog data processing, employing direct view storage techniques, alphanumeric readout devices and projection systems.

For complete details on these positions contact Mr. O. S. Knox at RCA West Coast.

OSCILLATORS Stewart Engineering Corp., Santa Cruz, Calif. Ten backward wave oscillator types in the frequency range from 1,000-18,000 Mc described in a 6-page brochure.

CIRCLE 309 ON READER SERVICE CARD

RESISTANCE FILAMENTS DATA GOW-MAC Instrument Co., 100 Kings Road, Madison, N. J. Single data sheet describes type 9225 high positive coefficient resistance filaments.

CIRCLE 310 ON READER SERVICE CARD

MOLDING COMPOUND The Polymer Corp., Molding Resins Division, Reading, Pa., has published a 4-page product bulletin on Nylatron GS, a molding compound of nylon and molybdenum disulfide.

CIRCLE 311 ON READER SERVICE CARD

C-C TELEVISION Television Utilities Corp., a division of Nord, 300 Denton Ave., New Hyde Park, L. I., N. Y. A 2-color folder introduces the Scan-a-graph "500", a closed circuit instrument that operates without camera or light and provides communications with up to 500 locations in an area.

CIRCLE 312 ON READER SERVICE CARD

INSTRUMENTS FOR MEASUREMENT General Radio Company, West Concord, Mass., offers an illustrated catalog, 18 pages, that discusses the use of measurement instruments for the evaluation and control of sound, noise and vibration.

CIRCLE 313 ON READER SERVICE CARD

ENCAPSULATED RESISTORS Reon Resistor Corp., 155 Saw Mill River Road, Yonkers, N. Y., has available a two-page bulletin describing a complete line of encapsulated printed-circuit type resistors.

CIRCLE 314 ON READER SERVICE CARD

MECHANICAL FILTERS Collins Radio Co. 2700 West Olive Ave., Burbank, Calif. A four-piece catalog package on mechanical filters for communications and navigation equipment, data transmission systems, etc., has been released. Included are general and short form

catalogs, a sheet on ferrite filters, and data on filter installation.

CIRCLE 315 ON READER SERVICE CARD

VARIABLE INDUCTOR COILS Delevan Electronics Corp., 77 Olean Road, East Aurora, N. Y., announces a 20-page catalog for design engineers that graphically illustrates electrical parameters under various conditions for variable inductor coils.

CIRCLE 316 ON READER SERVICE CARD

TRIMMER RESISTORS CTS Corp., Elkhart, Ind. Two data sheets illustrate and fully describe series 170 and 180 metal-ceramic trimmer resistors.

CIRCLE 317 ON READER SERVICE CARD

TRANSDUCER Electric Regulator Corp., Pearl St., Norwalk, Conn. "Mechanical-To-Electrical Transducer" is the title of a descriptive treatise on the Regohm transducer. It summarizes a new design approach in a component used for the control of such quantities as position, tension, speed, weight and others.

CIRCLE 318 ON READER SERVICE CARD

FERRITE DEVICES Microwave Associates, Inc., Burlington, Mass., has available a series of 21 engineering data sheets on high power ferrite circulators and broadband, low-power ferrite isolators.

CIRCLE 319 ON READER SERVICE CARD

COAX CABLE CONNECTORS Phelps Dodge Copper Products Corp., 300 Park Ave., New York 22, N. Y. An illustrated eight-page brochure describes new connectors for aluminum sheathed, high frequency Styroflex and Foamflex coaxial cables.

CIRCLE 320 ON READER SERVICE CARD

CONVERTERS Epsco Inc., 275 Massachusetts Ave., Cambridge 39, Mass. Brochure describes militarized, high speed, solid-state, programmable analog to digital converters for measuring a-c and d-c volts resistance. Units covered are designed for use in automatic checkout systems.

CIRCLE 321 ON READER SERVICE CARD



GE Expands Military Electronics

GENERAL ELECTRIC'S latest addition to the defense arsenal of the Free World—an ultramodern 465,000-sq-ft engineering and manufacturing facility—was recently dedicated in Syracuse, N. Y.

When completely equipped, the \$8-million plant will be used primarily for the design, development, production and testing of the wide variety of radar and underwater detection equipment being manufactured by GE's Heavy Military Electronics Department for the Army, Navy, Air Force and major defense contractors.

The new facility consists of two large buildings, and is situated on a 185-acre parcel of land. Building 1, including 159,000 sq ft of office and laboratory space, has been completed and is partially occu-

piated. The second building is scheduled for completion in March.

Approximately 2,500 employees will occupy the two buildings. The 306,000-sq-ft manufacturing area will house defense production work currently being done in two of the company's other Syracuse plants. This includes such high-priority programs as the FPS-24 high power search radar, HIPAR acquisition radar for the improved Nike-Hercules weapon system, the FPS-7 multibeam, three-dimensional radar, and the SQS-26 anti-submarine sonar.

The building of this new facility is typical of the growth of GE's Heavy Military Electronics Department since its inception in 1953. The department has grown from about 3,600 to 8,400 employees.

Radiation Inc. Names Board Chairman

HOMER R. DENIUS, president, was recently elected chairman of the board of Radiation Inc., Melbourne, Fla. He will also retain the presidency of the corporation.

Denius and George Shaw founded Radiation Inc. in 1950 as an electronic research and development firm. Denius previously was vice president and chief engineer of Melpar, Inc., Alexandria, Va.

During the past 10 years the company's activities have been broadened to include the design and manufacture of advanced data processing, telemetry and test equipment. The firm is also known for its tracking antenna systems and communications antennas used in missile and space programs.



CBS Electronics Advances Smith

WILSON R. SMITH has been named plant manager, semiconductors for CBS Electronics, manufacturing division of the Columbia Broadcasting System, Inc. In his new position he will be responsible for the manufacture of all transistors, diodes, parts and materials; and for

industrial and factory engineering.

Previously, Smith was chief engineer and prior to that, manager of engineering for CBS semiconductor operations. He joined CBS Electronics in 1958.

Loral Selects Two Division Managers

THE APPOINTMENTS of Boris Cohen as division manager, antisubmarine warfare division, and Santo Scibilia as division manager, passive detection division, have been announced by Loral Electronics Corp., New York, N. Y.

Cohen, previously staff manager, production and test, joined the company in 1952.

Scibilia, with Loral since its establishment in 1948, was most recently division manager, tactical computers division.



TRE Names D. R. Fewer Officer-Director

D. R. FEWER has been appointed vice president, research and engineering of Texas Research and Electronic Corporation and was also named as a director of the firm.

Prior to joining TRE, Fewer had been associated with Texas Instruments as branch manager in the research and engineering department. He was formerly with Bell Telephone Laboratories.

Applied Technology Elects Board Member

APPOINTMENT of John L. Grigsby to the board of directors of Applied Technology, Inc., is announced by

A NEW SERVICE

▼
**NOTICE
TO
READERS**

▲
**FREE
REPRINT
OF THE
MONTH**

Each month the editors of *electronics* are selecting a significant article and offering it in reprint form —FREE—to readers.

The February reprint is an article by Dr. Joseph H. Vogelman — Graphical Method Predicts Radio Interference. Serious r-f interference problems have arisen with the introduction of new electronic equipments and systems into crowded spectrum. Dr. Vogelman's article presents a step-by-step prediction procedure which eliminates a great deal of the work involved in calculating interference in areas jammed with mutually - interfering equipment.

Order your free copy now by checking the appropriate box on the Reader Service Card in this issue.

electronics

Another "impossible" job done by the Airbrasive®..



... Micromodule circuits

abrading • cutting • deburring • stripping • drilling • cleaning • scribing

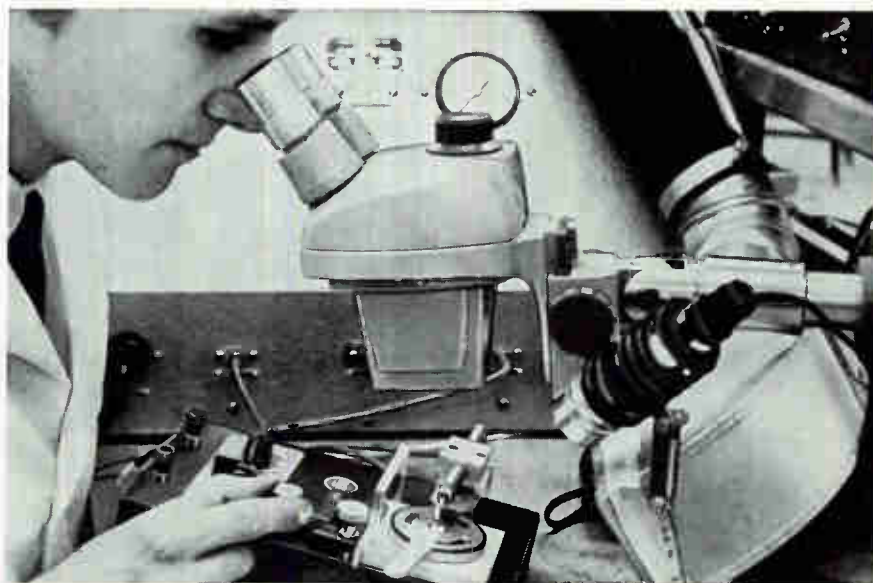

Key to fabrication in RCA Basic Micromodule Laboratory...The Airbrasive cuts and adjusts micro-miniaturized components

S. S. White's Industrial Airbrasive is the key to rapid construction of Micromodules by the new RCA Basic Micromodule Laboratory.

Faster and more reliable and flexible than photo-etching methods, the Airbrasive forms circuits and adjusts resistors and capacitors by abrading away controlled portions of deposited conducting surfaces and terminations.

Every day the Airbrasive is solving problems that once appeared impossible. Its precise stream of superfine abrasive particles, gas-propelled at supersonic speeds, quickly slices or abrades a wide variety of hard brittle materials... fragile crystals, ceramics, thin films, tungsten... and others. No shock, no heat damage. There is no contact between the tool and the work.

Note this too. The Airbrasive is not expensive... for under approximately \$1,000 you can set up your own unit.

Send us samples of your "impossible" jobs and we will test them for you at no cost.



SEND FOR BULLETIN 6006
... complete information.

New dual
Model D!



S. S. White

S. S. White Industrial Division
Dept. EU, 10 East 40th Street, New York 16, N. Y.

For that 

NEW IDEA

visit the

IRE SHOW

March 20-23, 1961 New York
 Coliseum and Waldorf-Astoria Hotel
 Members \$1.00, Non-members \$3.00 Age limit—over 18

CIRCLE 212 ON READER SERVICE CARD

William E. Ayer, president of the Palo Alto advanced systems firm.

Grigsby will continue in his present position of chief engineer where he is responsible for the direction of the company's expanding engineering activities in reconnaissance receiving systems, active electronic countermeasures and special instrumentation for ionosphere and radio astronomy studies.



Ortho Filter Corp.
Hires Senior Engineer

ORTHO FILTER CORP., a division of Ortho Industries, Inc., Paterson, N. J., manufacturer of electric wave filters, toroidal transformers, magnetic amplifiers, delay lines, equalizers and attenuators, announces that J. P. Smith, Jr. has joined the company as a senior engineer.

Smith was previously associated with The Daven Co. for over 25 years as chief engineer and director of engineering.



Siegler Appoints
Group G-M

H. P. ROBERTS has been named general manager of The Siegler Cor-

Precision Grinding

Quartzite offers skilled manpower plus specialized facilities for fabricating and finishing hard materials . . . to assure you the maximum in speed, economy and accuracy.

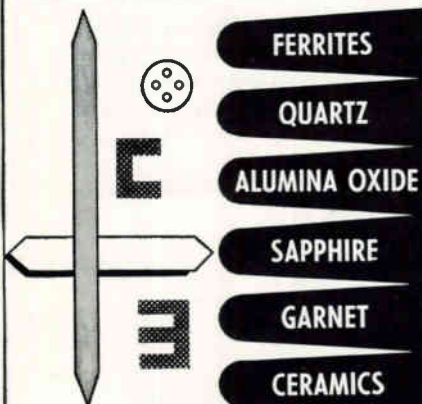

Write for Free Brochure

QUARTZITE

PROCESSING, INC.

6 HOLYOKE ST., MALDEN 48, MASS.
Tel. DAVenport 2-1380 : 2-5400

LAND AUCTION!

HAMILTON FIELD INDUSTRIAL PARK

(M-3) Near San Francisco

SALE BY ORDER OF TRUSTEE

ON THE SITE AT 2 P.M.

MONDAY, MAR. 13

67 acres next to Hamilton Air Force Base to be sold in 3 equal parcels; on U.S. Hwy. 101, 17 mi. north of Golden Gate Bridge in beautiful Marin County. Excellent for electronics and similar plants. Easy commuting makes plants here attractive to high-caliber personnel in Bay Area cities.

For illustrated brochure & terms of sale, contact the Auctioneers:

MANNIE FEIGENBAUM & ASSOCIATES

8161 W. 3rd St., Los Angeles 48
Telephone WEBster 8-2701

CIRCLE 213 ON READER SERVICE CARD

poration's space systems technology group, Inglewood, Calif.

The group, made up of senior engineers, mathematicians and scientists, was recently established to offer specialized technical services in missile and space systems test operations and test range planning, and to further strengthen and coordinate the defense systems capabilities of Siegler's divisions.

Before coming to Siegler, Roberts was manager of the test support department, systems engineering division of Space Technology Laboratories, Los Angeles, Calif.

PEOPLE IN BRIEF

George B. Kistiakowsky, formerly special assistant for science and technology to President Eisenhower, appointed chairman of a newly created Itek science board and elected a director of Itek Corp. **David B. Young** of General Electric chosen military applications engineer for the GE Ordnance Dept. **Edward F. O'Brien** of Motorola Aviation Electronics advances to assistant chief engineer. **Arie Slikkerveer**, from the Netherlands Telephone and Telegraph Administration, joins the marketing division of Lynch Communications Systems. **Robert Foncell** promoted by Philco Corp. to production manager of the Sierra Electronic Division. **Willard F. Bates**, formerly of Ryan Electronics, chosen director of manufacturing for the data recorder division of Consolidated Electrodynamics Corp. **Herbert H. Rickert** leaves General Precision to become chief engineer of the Douglas Research Corp. **Marvin Kaplan** promoted to manager of industrial engineering at Loral Electronics. **Jack D. Wilson** advances at Hughes Aircraft to manufacturing manager of the Santa Barbara Research Center. **R. K. Lockhart**, RCA, chosen to head a development engineering group for the company's Navy computer project. **Jack McCoy** leaves Collins Radio to take the post of applications engineer at the Controls Company of America, electron division.

APL offers
unusual opportunities
in

microelectronics

A new group of scientists and engineers has been formed at the Applied Physics Laboratory of the Johns Hopkins University to perform highly advanced research and development work in solid state microelectronics. The objective: to explore new techniques and methods to produce reliable microelectronic functions for wide application in missiles, satellites, radar, adaptive computers, etc.

■ **Solid State Theory** The position requires a Ph.D. with two or more years of experience in solid state theory. You will apply the principles of dielectrics, conducting materials, and semi-conductors to the analysis of integrated electronic circuits. This is a new area of activity with unusual opportunities for rapid personal and professional advancement.

■ **Semi-Conductor Devices, Prototype Production** An opening with exciting possibilities. You will establish a semi-conductor laboratory and work freely within broad policy directives. Funds have been allocated for the laboratory. Duties include making integrated semi-conductor electronic circuits on a laboratory basis. B.S. plus three years of experience in this field desirable.

■ **Circuit-Systems Analysis** Position involves micro-electronic system and circuit analysis and design, as well as maintaining close working relationship with prototype fabricator and user groups. Applicant must have a B.S. in electronics or physics and approximately five years of experience in system and/or circuit analysis.

For details about these positions,
direct your inquiry to:
Professional Staff Appointments

The Applied Physics Laboratory
The Johns Hopkins University

8633 Georgia Avenue, Silver Spring, Md.
(Suburb of Washington, D.C.)

Reliability assured!

**H-H "Gray Line"
RHEOSTATS
and
RESISTORS**



**Ruggedized Components for
All Types of Commercial and
Military Applications**

"Gray Line" precision-built components feature special H-H design and construction advantages that assure the engineer/designer maximum dependability in the most severe environments. Standard types are available to meet a wide range of electrical and mechanical requirements; "specials" can be custom designed for unusual applications.

"GRAY LINE" RHEOSTATS



Standard types from 5 to 1000 watts. MIL types and customs to 'specs.'



"GRAY LINE" RESISTORS



• Wide Range of Fixed Resistors



• Flat and Stack Mounting Power Resistors



• Axial-lead Types from 2 to 10 Watts



• Adjustable Resistors from 10 to 200 Watts

"Gray Line" ... Stocked by Authorized H-H Distributors Nationwide!



**HARDWICK
HINDLE • INC**

40 Hermon Street
Newark 5, New Jersey



The Mark of Quality since 1924

Old Fashioned?

See what **Ungar** does to soldering tools next month!

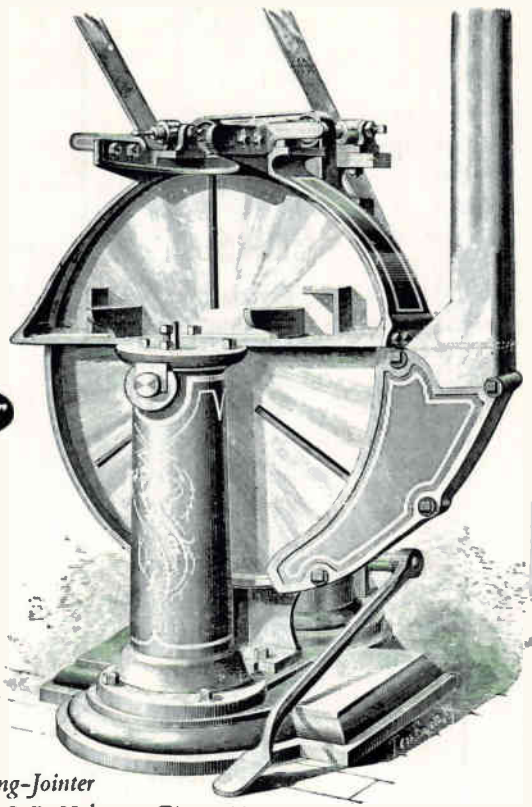

Combined Fan, Heading-Jointer and Dowel-Borer • E. & B. Holmes • Circa 1885

CIRCLE 214 ON READER SERVICE CARD

METALS for ELECTRONIC APPLICATION

rolled ULTRA THIN

by **OUR SPECIAL ROLLING TECHNIQUE**



**RIBBONS.....
STRIPS.....**

TOLERANCES CLOSER THAN COMMERCIAL STANDARDS

Note: for highly engineered applications—strips of TUNGSTEN and some other metals can be supplied

rolled down to .0003 thickness

- Finish: Roll Finish—Black or Cleaned
- Ribbons may be supplied in Mg. weights if required

Developed and Manufactured by

H. CROSS CO.

3229 BERGENLINE AVE., UNION CITY, NEW JERSEY

Tele: Union City, N. J.: UN. 3-1134

N. Y. C., N. Y.: BR 9-4425

CIRCLE 215 ON READER SERVICE CARD

Immediate Openings

OVERSEAS
AND IN THE
UNITED STATES
FOR

ENGINEERS

- TELEPHONE ENGINEERS, SYSTEM DESIGN
- TELEPHONE INSIDE PLANT ENGINEERS
- TELEPHONE OUTSIDE PLANT ENGINEERS
- TELEPHONE TRAFFIC ENGINEERS
- RADIO RELAY SYSTEMS ENGINEERS
- RADIO RELAY ENGINEERS
- RADIO ENGINEERS
- TELETYPE ENGINEERS
- MULTIPLEX ENGINEERS
- MICROWAVE TECHNICIANS
- POWER ENGINEERS
- SPECIFICATION ENGINEERS
- TRAINING SUPERVISORS

U. S. CITIZENSHIP REQUIRED

(FAMILIES MAY ACCOMPANY)

Submit detailed resume of schooling and experience and definite basic salary requirements to:

P6163 Electronics
520 N. Michigan Ave., Chicago 11, Ill

CIRCLE 383 ON READER SERVICE CARD

ELECTRONIC ENGINEER

Inductive devices. Established and experienced company has an excellent opportunity for a capable engineer to organize and manage the design and manufacture of low-pass, high-pass, hand-pass filter and electro-magnetic delay lines. Salary in line with training, experience and ability to manage. Write President, Vanguard Electronics, 338 Motor Ave., Los Angeles 34, Cal.

CIRCLE 384 ON READER SERVICE CARD

COMMUNICATION ENGINEER

A college graduate with several years' experience and good technical background, including radio system application or installation. Consulting engineering firm in New York City.

P-6035--Electronics
Class. Adr. Div., P. O. Box 12, N. Y. 36, N. Y.

CIRCLE 385 ON READER SERVICE CARD

Put Yourself in the Other Fellow's Place

TO EMPLOYERS - TO EMPLOYEES

Letters written offering Employment or applying for same are written with the hope of satisfying a current need. An answer, regardless of whether it is favorable or not, is usually expected.

Mr. Employer, won't you remove the mystery about the status of an employee's application by acknowledging all applicants and not just the promising candidates.

Mr. Employee you, too, can help by acknowledging applications and job offers. This would encourage more companies to answer position wanted ads in this section.

We make this suggestion in a spirit of helpful cooperation between employers and employees.

This section will be the more useful to all as a result of this consideration.

Classified Advertising Division

McGRAW-HILL PUBLISHING CO., INC.

330 West 42nd St., New York 36, N. Y.

Career opportunities at

Motorola in Phoenix

*are awaiting you now,
along with a wealth of
warm winter sun*

The sun spends more time in Phoenix than in any other major city in the United States. That's why golfing, gardening, picnics, boating and fishing can be enjoyed around the calendar. World-famed scenery and the freedom of wide open spaces are yours to enjoy. You're 90 minutes from pine-forested mountains; just four hours to Mexico; six hours to incomparable deep-sea fishing.

These advantages add considerable meaning to opportunities for personal and professional growth at Motorola. Here, you'll be given the opportunity to express your ideas in an atmosphere that encourages initiative and independence. As a member of a project team, you become a key figure at every level of creative engineering — from preliminary conception, design, into production, then final evaluation. And in addition you'll get a bonus in better living in the sunniest, healthiest climate in the United States.



IMMEDIATE OPPORTUNITIES FOR:

- Systems Test Equipment Design
- Communications and Navigation
- Systems Analysis and Preliminary Design
- Digital Circuitry Design
- Microwave and Radar
- Missile and Space Guidance and Control
- Reliability and Components



Write Phil Nienstedt, Dept. 205

MOTOROLA

MILITARY ELECTRONICS DIVISION — WESTERN CENTER
P.O. Box 1417, Scottsdale, Arizona

Motorola also offers opportunities at
Chicago, Illinois, and at Culver City and Riverside, California

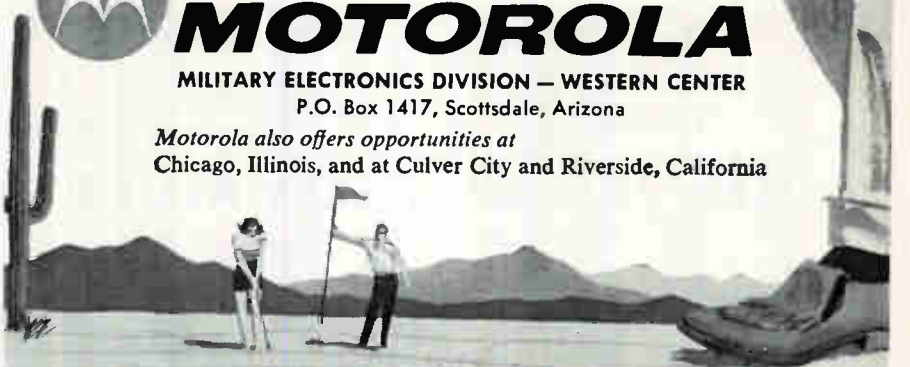

CIRCLE 382 ON READER SERVICE CARD

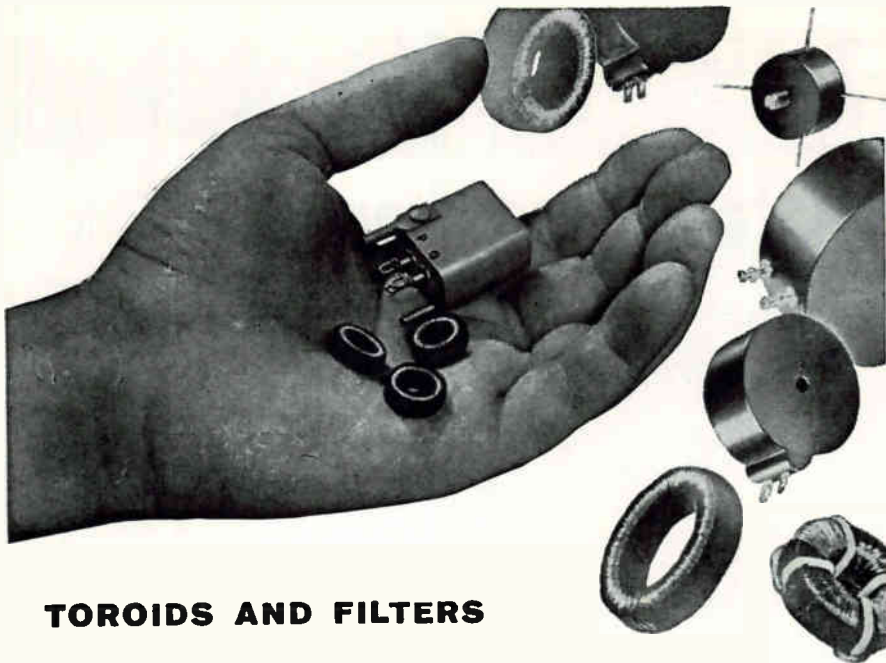

TOROIDS AND FILTERS

... TAILOR MADE ... DELIVERED IN DAYS

Need quick delivery on *special* toroidal components?

We can usually design and deliver samples of toroidal coils and filters to your exact specifications on short notice.

We are equipped to produce toroids and toroidal filters with outstanding temperature stability to either commercial or military requirements.

Whether your application is communications, missiles or data reduction systems, our facilities backed by a quarter of a century of service to industry assure you of a solution . . . fast. Many engineers find our folder "Toroids and Filters" helpful in developing specifications. A copy is yours for the asking.

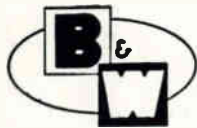

Barker & Williamson, Inc.

Beaver & Canal, Bristol, Pa.

Specialists in designing and building equipment to operating specifications

A few other B&W products: I. F. TRANSFORMERS • COMMUNICATIONS EQUIPMENT • AUDIO PHASE SHIFT NETWORKS • TEST EQUIPMENT • and many types of standard and special electronic components and equipment.

CIRCLE 216 ON READER SERVICE CARD

Is your advertising selling the same four key buyers your salesmen call on? Competition demands it! Only advertising in electronics reaches and sells the electronics man wherever he is: in Research,

TODAY YOU MUST SELL ALL FOUR!

Design, Production, and Management. Put your advertising where it works *hardest*...

in **electronics**

SEARCHLIGHT SECTION

(Classified Advertising)

BUSINESS OPPORTUNITIES

EQUIPMENT - USED or RESALE

DISPLAYED RATE

The advertising rate is \$24.75 per inch for all advertising appearing on other than a contract basis. Contract rates quoted on request. AN ADVERTISING INCH is measured $\frac{7}{8}$ inch vertically on one column, 3 columns—30 inches—to a page. EQUIPMENT WANTED or FOR SALE ADVERTISEMENTS acceptable only in Displayed Style.

UNDISPLAYED RATE

\$2.40 a line, minimum 3 lines. To figure advance payment count 5 average words as a line.

PROPOSALS, 2.40 a line an insertion. BOX NUMBERS count as one line additional in undisplayed ads.

DISCOUNT OF 10% if full payment is made in advance for four consecutive insertions of undisplayed ads (not including proposals).

TRANSCO "Y" Type Coaxial Switch SPDT

Miniature Light weight CoAx switch with low VSWR and broad band width. Works to 11 KMC. Separate actuator coils for each circuit. Type "N" connectors. 50 Ohm nominal impedance. Actuator voltage 28 volts DC, 6 Watts each coil.

TRANSCO Number 11100 Our price \$20.00 each. LARGE QUANTITY AVAILABLE.

TRANSCO "A" Type Coaxial Switch SP4T

Same action and specs. as the above "Y" type but has 4 solenoids to operate the contacts, allowing complete control over make-before-break or break-before-make and contact of all positions simultaneously. TRANSCO Number 14100. Our Price \$30.00 each.

SAGE Broadband Coaxial Crystal Holders

Type 101BDJ 150 to 4000 MCS.

Uses SYLVANIA TRIPOLAR CRYSTAL IN358A

Type N Male to BNC output (female) With DC Return Our Price \$18.00 Complete

IN358A Crystal only \$10.00

Sage Mount only \$9.00

10,000 Coax Cable Assemblies

Write for complete list of cables with BNC and UHF connectors.

All of the above Merchandise New, and clean from Lockheed Aircraft Spare parts Mfg. in 1958.

"RED" JOHNSON ELECTRONICS

3311 PARK BLVD., PALO ALTO, CALIF.
Davenport 6-6085

CIRCLE 460 ON READER SERVICE CARD

LOOKING FOR USED/SURPLUS ELECTRONIC EQUIPMENT/COMPONENTS?

For an up-to-date listing of such equipment see Searchlight Section of February 10th

INDEX TO ADVERTISERS



Audited Paid Circulation

Aerospace Corporation	30	National Aeronautics and Space Administration	89
Alpha Corporation	17	*North Atlantic Industries, Inc.	82
*American Optical Co.	31	*Philbrick Researches, Inc., George A.	91
*Amphenol-Borg Electronics Corp. Connector Division	38	Quartzite Processing, Inc.	86
Applied Physics Laboratory, The	87	*Radio Corporation of America. ... 88, 82	88, 4th Cover
*Arnold Engineering Co., The	3	*Raytheon Company	5, 24
Barker & Williamson, Inc.	90	Smith-Florence, Inc.	79
*Bendix Corporation		*Spellman High Voltage Co.	74
Red Bank Division	13	Sprague Electric Co.	14, 28, 29
*Bircher Corporation, The	70	Superior Cable Corp.	82
Branson Ultrasonic Corp.	74	Telemetrics, Inc.	92
Breeze Corporations, Inc.	16	*Texas Instruments, Incorporated Semiconductor-Components Div. ... 19,	68
Calibration Standards Corp.	84	Ungar Electric Tools	88
Capehart Corp.	15	United Shoe Machinery Corp.	6
Cleco, Division of Reed Roller Blt Co.	7	*Varian Associates	25
*Clifton Precision Products Co., Inc. Components, Inc.	42	Vitro Electronics	77
Continental Electronics Mfg. Co.	27	*Wallson Associates, Inc.	66
*Cross Co., H.	88	White S. S.	85
Dressen-Barnes Corp.	74	Yutaka Electric Mfg. Co., Ltd.	81
Duncan Electronics, Inc.	28		
*Eitel-McCullough, Inc.	78		
Farrington Electralab Printed Electronics Company	10		
*General Electric Co. Semiconductor Pdts. Dept. 86, 37			
Silicone Pdts. Dept.	2		
*General Radio Co.	2nd Cover		
Hardwick-Hindle, Inc.	88		
*Hewlett-Packard Company	8, 9		
*Hill Electronics	71		
Houston Fearless Corp.	81		
Institute of Radio Engineers. 89,	86		
*Kepco, Inc.	65		
*Kintel, A division of Cohu Electronics Inc.	3rd Cover		
*Lapp Insulator Co., Inc.	67		
*Lepel High Frequency Laboratories, Inc.	69		
Littlefuse	81		
Mallory and Co., Inc., P. R. 40,	41		
Mannie Fiegenbaum & Associates ...	86		
Marconi Instruments, Ltd.	70		
McGraw-Hill Book Co.	85		
Mitsumi Electric Co., Ltd.	69		

CLASSIFIED ADVERTISING
F. J. Eberle, Business Mgr.

EMPLOYMENT OPPORTUNITIES ... 89

EQUIPMENT
(Used or Surplus News)
For Sale

ADVERTISERS INDEX

Motorola Military Electronics Div., Western Center

This index and our Reader Service Numbers are published as a service. Every precaution is taken to make them accurate, but ELECTRONICS assumes no responsibilities for errors or omissions.

A familiar shape to DC amplifier devotees



WIDELY RECOGNIZED ...
WIDELY ACCEPTED ...
K2 OCTAL PLUG-INS FROM PHILBRICK

FAST DC: K2-W is an efficient, foolproof high-gain operational unit for all feedback applications, fast and slow. The K2-W features balanced differential inputs for low drift, high input impedance, low output impedance, and economy of operation. Its range of operation is from d-c to above 100 kc depending on external circuitry. **\$24***

SLOW DC: K2-P gives to other dc amplifiers, such as K2-W and K2-XA, drift stability well under 1 millivolt, long term. This chopper stabilized unit has the same case structure and octal base as the K2-W and sells for **\$60***

HOT DC: K2-XA, a new amplifier of improved reliability, is primarily useful in operational circuits where an output voltage range from minus to plus 100v (at 3 milliamperes) is required. Its pass band extends to beyond 250 kc depending on external circuitry. **\$28***

- * • Military equivalents available
- OEM's: write wire or phone for quantity prices
- 24 page Applications Manual available on request

GEORGE A. PHILBRICK RESEARCHES, INC.

127 Clarendon St., Boston 16, Mass.
Commonwealth 6-5375, TWX; BS 1032, FAX; 6SN
Representatives in principal cities
Export Office: 240 West 17th St., New York 11, N. Y.
Tel. CHelsea 3-5200, CABLE: TRILRUSH

from
added
&

TELEMETRICS PRECISION FLEXIBILITY



Model 301

THE NEW SERIES 300 PULSE SIMULATORS SOLID STATE PAM, PDM PAM/NRZ

The Telemetrics 300 Series of Solid state Electronic Signal Simulators offers a selection of PAM, PDM, and PAM/NRZ units with extreme flexibility for precision calibration and checkout of telemetry ground stations, data transmission systems, and data reduction equipment . . . in the field . . . in the laboratory. The four models in the series: ESS-301, with PAM, PAM/NRZ only, 8-channel subcommutation; ESS-302, with all the PAM features except subcommutation; ESS-303, with PAM, PAM/NRZ, PDM, subcommutation; ESS-304 with PDM only, and subcommutation. In all models, "pre-programmable" patch panels provide complete flexibility to create any form of signal output within the unit's design limits. Standard plug-in digital logic units simplify maintenance. Standard rack mounting; 7" front panel height.

SPECIFICATIONS, ESS-301

INPUT	115v, 3 amp
OUTPUT	0 to +10v variable 0 to -10v variable 0 to +1v fixed
BASE LINE	Reference level: 0 Adjustable -2v to +2v
MASTER PULSE	IRIG Standard 2 or 3 full scale or absence of 2 pulses.
CALIBRATION	Switchable in steps of 0, 50%, 100% Continuously variable 0 to 100%
OUTPUT WAVE TRAIN	PAM, PAM/NRZ, optional PDM
FRAME LENGTH	Any number of pulses, up to 1054 channels per frame by patching
SUBCOMMUTATOR	8 Channels
RATES	10 pps to 60,000 pps
ACCURACY	Selectable information accurate within $\pm 1.5\%$ full scale.

Telemetrics, Inc.

12927 SOUTH BUDLONG AVENUE, GARDENA, CALIFORNIA

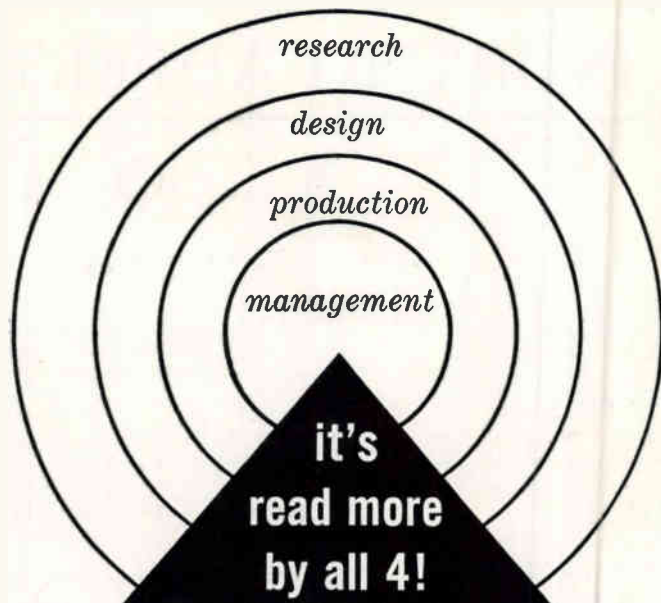

Get the technical facts in **electronics**, the magazine that features the latest engineering developments and technically interprets markets, business statistics, trends. Special issues on Electronic Markets and other reports you'll want to file and keep. Mail the reader service card (postpaid) and start your own subscription to **electronics**, the magazine that helps you to know and therefore to grow! Rates: three years for \$12, one year for \$6; Canadian, one year for \$10; foreign, one year for \$20. Annual **electronics** BUYERS' GUIDE (single issue price \$3) included with every subscription.

subscribe today to **electronics**

electronics



Audit Bureau of Circulations



Associated Business Publications

Audited Paid Circulation

BRUCE A. WINNER,
Advertising Sales Manager

R. S. QUINT, Assistant Advertising Sales Manager and Buyers' Guide Manager; FRED STEWART, Promotion Manager; RICHARD J. TOMLINSON, Production Manager; GEORGE E. POMEROY, Classified Manager; HUGH J. QUINN, Circulation Manager.

Robert T. Wood; LONDON Edward E. Schirmer; FRANKFURT Stanley R. Kimes; GENEVA Michael R. Zeynel.

ADVERTISING REPRESENTATIVES:
NEW YORK Donald H. Miller, Henry M. Shaw, George F. Werner; BOSTON William S. Hodgkinson, Donald R. Furth; PITTSBURGH David M. Watson; PHILADELPHIA Warren H. Gardner, William J. Boyle; CHICAGO Harvey W. Wernecke, Martin J. Gallay; CLEVELAND P. T. Fegley; SAN FRANCISCO T. H. Carmody, R. C. Alcorn; LOS ANGELES D. A. McMillan, Marshall Freeman; DENVER J. Pat-ten; ATLANTA M. Miller; DALLAS

BRANCH OFFICES: National Press Bldg., Washington 4, D.C.; McGraw-Hill Bldg., Copley Square, Boston 16; Four Gateway Center, Pittsburgh 22; Six Penn Center Plaza, Philadelphia 3; 520 North Michigan Avenue, Chicago 11; 55 Public Square, Cleveland 13; 68 Post Street, San Francisco 4; 1125 West Sixth St., Los Angeles 17; 1740 Broadway, Denver 2; 1301 Rhodes-Haverly Bldg., Atlanta 3; 901 Vaughn Bldg., Dallas 1; McGraw-Hill Publishing Co., Ltd., 34 Daver Street, London, England; 85 Westendstrasse, Frankfurt/Main; 2 Place de Port, Geneva.

NOW!

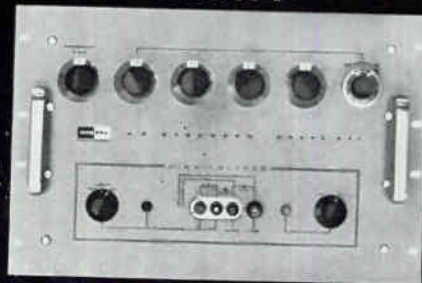

**A 0.1% ACCURACY
AC SOURCE!**

**KINTEL's New AC Voltage Standard is
Ideal For Use in Calibrating AC Instruments...
Evaluating Magnetic Properties...
Designing Servo and Gyro Equipment**

The KINTEL Model 601A is an exceptionally stable and accurate source of AC voltage. It needs no external oscillator, contains no electromagnetic servos. Simply dial the desired frequency—60, 400, or 1000 cps—and adjust the RMS output in tenth-volt steps between 1 and 501 volts. Use a multi-turn control to set the voltage between steps to a resolution of 100 microvolts.

You can draw up to 25 watts from the output at any voltage between 5 and 501—up to 5 amperes below 5 volts—without distortion or loss of accuracy. Short term stability is within $\pm 0.01\%$, and the effective output impedance is on the order of 0.001 ohm. The output is completely guarded, floating, and isolated from the AC line and chassis ground. Write for detailed literature or demonstration. Representatives in all major cities.

OUTPUT VOLTAGE	1 to 501 volts RMS, adjustable in 0.1 volt steps and by multi-turn potentiometer to resolution of 100 μV
OUTPUT FREQUENCY	60, 400, or 1000 cps within 1%
VOLTAGE ACCURACY	Within ± 0.005 volt or 0.1% of dial reading
VOLTAGE STABILITY	0.01%
WAVEFORM DISTORTION	<0.3%
OUTPUT CAPABILITY	5 amperes up to 5 volts, 25 watts above 5 volts
OUTPUT IMPEDANCE	On the order of 0.001 ohm (with constant load)
PRICE	\$4500.

5725 Kearny Villa Road
San Diego 11, California
Phone: BRowning 7-6700



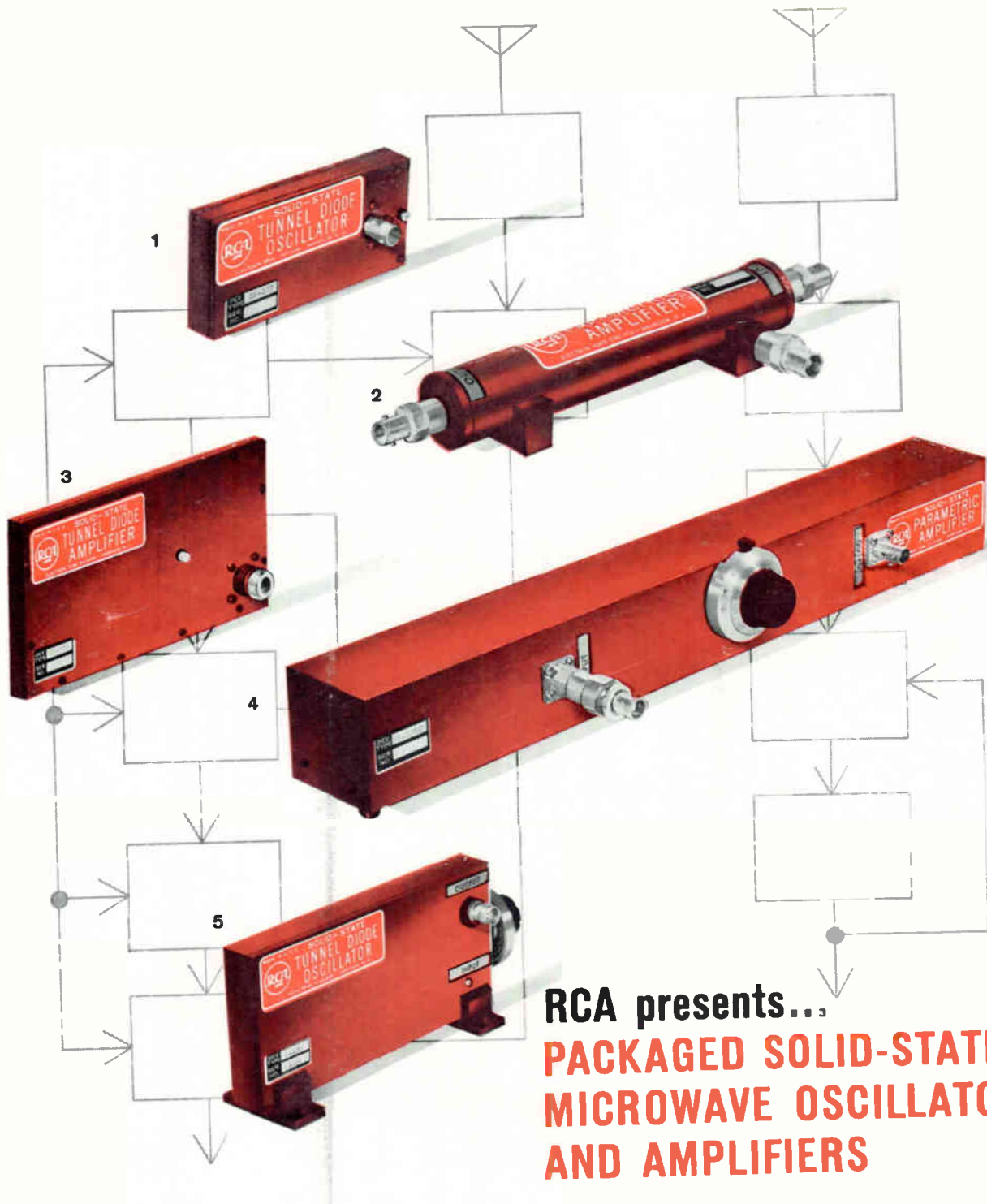

RCA presents... PACKAGED SOLID-STATE MICROWAVE OSCILLATORS AND AMPLIFIERS

Now, RCA takes a major step ahead in microwave technology—to integrate packaged microwave circuits with RCA developed solid-state diodes and provide an important, new line of components for the needs of microwave designers. Low power requirements, and compact packaging using RCA Semiconductor and Materials Division's latest tunnel and varactor diodes open new possibilities for miniaturization, improved systems reliability, and systems cost reduction. Here are the first members of a growing family of packaged microwave circuits.

In addition to the performance characteristics of the packaged circuits shown here, RCA Solid-State Microwave Oscillators and Amplifiers can be designed to meet your special requirements for gain, power, frequency, and noise characteristics. For delivery quotations and technical data on circuits to meet your needs, contact the RCA Field Office nearest you. Or write: Microwave Marketing, RCA Electron Tube Div., Harrison, N. J.

- 1. Fixed-Tuned Tunnel-Diode Oscillator** (Dev. No. SS-107) Delivers a minimum power output of 1 milliwatt at your specified frequency between 500-2000 Mc. DC input: 180 ma at 0.40 volt.
- 2. Helix Parametric Amplifier** (Dev. No. SS-1000) Stable minimum gain of 15 db from 2200-2300 Mc with a 5-7.5 db noise factor. Typical saturated power output of 1 milliwatt; with 300 milliwatts pump power at 3000 Mc.
- 3. Tunnel-Diode Amplifier** (Dev. No. SS-500) Stable minimum gain of 15 db from 1275-1325 Mc with 6 db max. noise factor, including typical circulator loss. Saturated power output of 30 microwatts. DC input; 10 ma at 0.1 volt.
- 4. Tunable Low-Noise Parametric Amplifier** (Dev. No. SS-1002) Tunable with 5 Mc bandwidth from 1250-1350 Mc, with stable minimum gain of 15 db. Max. noise factor, 3 db. Saturated power output of 0.5 milliwatt, with 60 milliwatts pump power at 10,800 Mc.
- 5. Tunable Tunnel-Diode Oscillator** (Dev. No. SS-100) Delivers a minimum power output of 0.3 milliwatt from 1050-1400 Mc. Coax. output. DC input: 30 ma at 0.2 volt.

RCA Electron Tube Division Field Offices INDUSTRIAL PRODUCTS SALES

Detroit 2, Michigan, 714 New Center Building, TR 5-5600 • Newark 2, N. J., 744 Broad St., HU 5-3900 • Chicago 54, Illinois, Suite 1154, Merchandise Mart Plaza, WH 4-2900 • Los Angeles, California, 6801 East Washington Boulevard, RA 3-8361 • Burlingame, California, 1838 El Camino Real, OX 7-1620.

GOVERNMENT SALES

Harrison, N. J., 415 South 5th St., HU 5-3900 • Dayton 2, Ohio, 224 North Wilkinson St., BA 6-2366 • Washington 7, D. C., 1725 "K" St., N.W., FE 7-8500.



The Most Trusted Name in Electronics
RADIO CORPORATION OF AMERICA