

# electronics

*Infrared rapid-scanning system in foreground may help identify missiles by their plumes. Assembly is mounted below ROTI (Recording Optical Tracking Instrument)*

A McGraw-Hill Publication 75 Cents

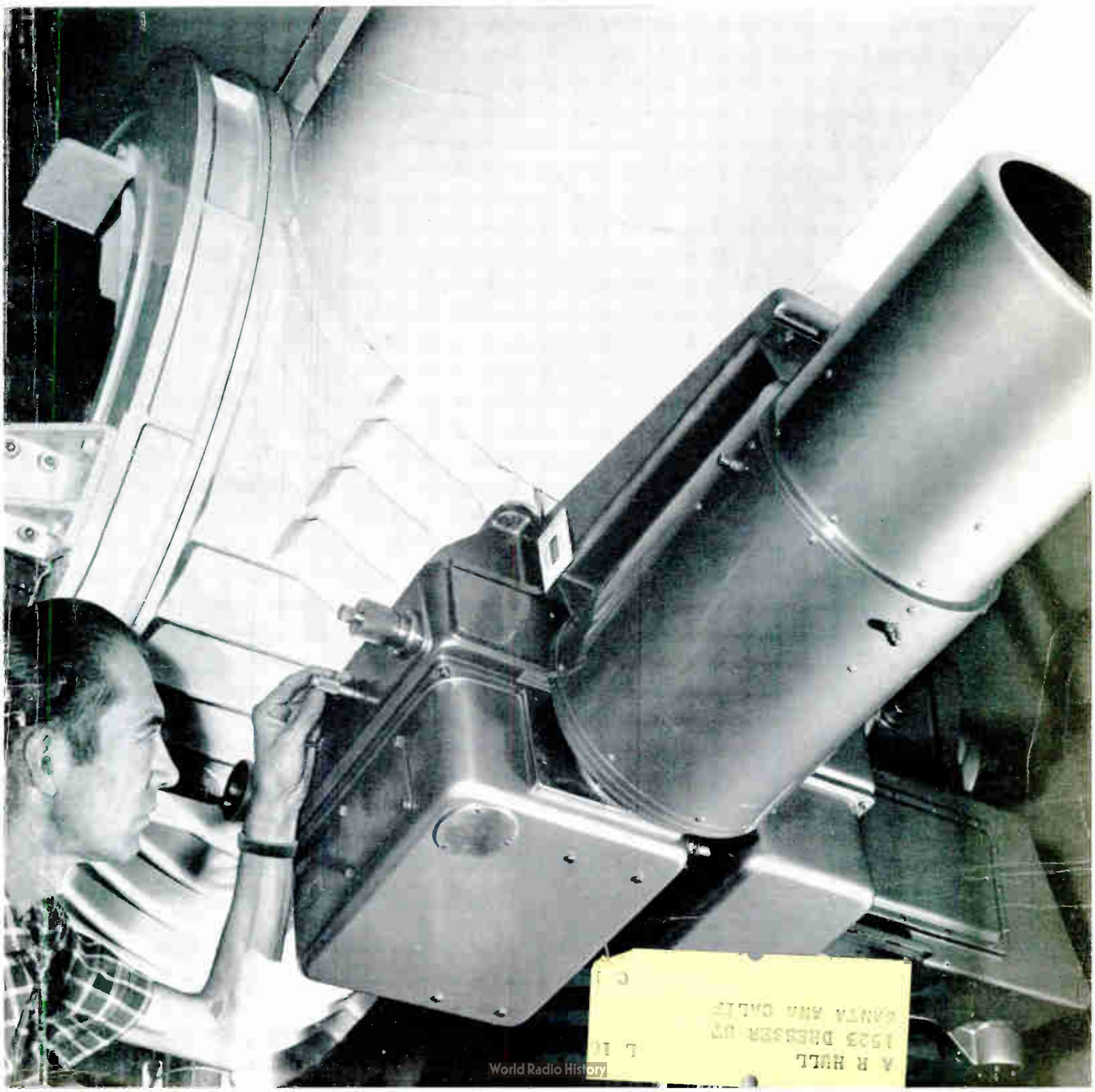



# FILTERS FOR ALL APPLICATIONS FROM STOCK

HERMETICALLY SEALED TO MIL-T-27A & MIL-F-18327 SPECS.



## MINIFILTERS

New Minifilters provide almost the same characteristics (with attenuation only slightly less) as the industry's standard interstage and line filters immediately below.

BPM band pass units are 10K input, output to grid; 2:1 gain. Attenuation is approximately 2 db  $\pm$  3% from center frequency, then 35 db per octave.

HPM high pass units; loss of less than 6 db at cut-off frequency; attenuation of 30 db at 67 cut-off frequency, 40 db at .6 cut-off frequency. Input and output 10K.

LPM low pass units; loss of less than 6 db at cut-off frequency; attenuation of 30 db at 1.5 cut-off frequency, 40 db at 1.65 cut-off frequency. Input and output 10K.

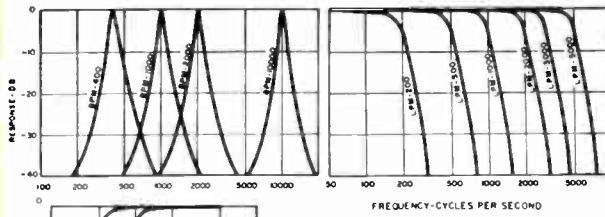

STANDARD STOCK FREQUENCIES  
(number in figure is cycles)

BPM-400	BPM-10000	LPM-1000
BPM-750	HPM-500	LPM-2000
BPM-1000	HPM-1000	LPM-3000
BPM-1500	LPM-200	LPM-5000
BPM-2000	LPM-500	

Write For  
NEW Catalog



BPM case  
(MIL AF)  
3/8 x 3/8 x 1 1/4"  
Weight...1 oz.

HPM and LPM  
case (MIL AG)  
1 x 1 x 1 3/4"  
Weight... 2 1/4 oz.

## INTERSTAGE & LINE

These six basic types cover most popular filter applications and frequencies.

BMI band pass units are 10K input, output to grid; 2:1 gain. Attenuation is approximately 2 db at 3% from center frequency, then 40 db per octave.

HMI high pass units are 10K in and out. Attenuation is less than 6 db at cut-off frequency and 35 db at .67 cut-off frequency.

LMI low pass units are 10K in and out. Attenuation is less than 6 db at cut-off frequency and 35 db at 1.5 cut-off frequency.

HML high pass filters are same as HMI but 500/600 ohms in and out.

LML low pass filters are same as LMI but 500/600 ohms in and out.

BML band pass units are same as BMI but 500/600 ohms input, output to grid, 9:1 gain.

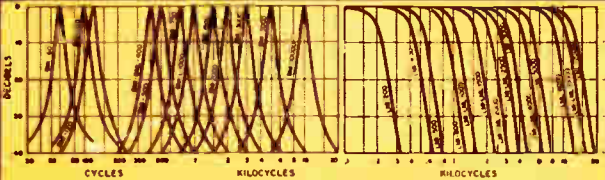

STANDARD STOCK FREQUENCIES  
(number in figure is cycles)

BMI-60, 100, 120, 400, 500, 750, 1000, 1500, 2000, 3000, 4000, 5000, 10000
BTI-60, 100, 120
HMI-200, 400, 500, 800, 1000, 2000, 3000
LMI-200, 400, 500, 800, 1000, 1500, 2000, 2500, 3000, 4000, 5000, 10000
BML-400, 1000
HML-200, 300, 500, 1000
LML-1000, 1500, 2000, 2500, 4000, 8000, 10000, 12000



Base ..... 1 3/8 x 1 1/4"  
Height, BMI, LMI, BML ..... 1 1/2"  
Height, HMI, HML, LML ..... 2 1/4"  
Weight ..... 6 oz. and 9 oz.

## TELEMETERING BAND PASS

UTC standard telemetering filters provide extreme miniaturization with maximum stability, a complete set of 18 filters taking 19 cubic inches. They are 100K in and out and have an insertion loss of less than 6 db, 4 pin header for small Winchester socket.

TMN units are within 3 db at  $\pm$  7.5% of center frequency . . . down more than 18 db at  $\pm$  25% . . . more than 40 db beyond 1.75 and .58 center frequency.

TMW are within 3 db at  $\pm$  15% of center frequency . . . down more than 20 db at  $\pm$  50% . . . more than 40 db beyond 2.5 and .4 center frequency.

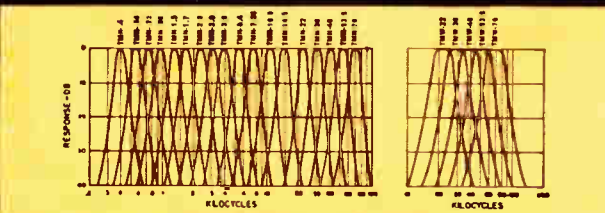

STANDARD STOCK FREQUENCIES  
(number in figure is KC)

TMN-4	TMN-1.7	TMN-5.4	TMN-30	TMW-22
TMN-.56	TMN-2.3	TMN-7.35	TMN-40	TMW-30
TMN-.73	TMN-3.0	TMN-10.5	TMN-52.5	TMW-40
TMN-.96	TMN-3.9	TMN-14.5	TMN-70	TMW-52.5
TMN-1.3	TMN-22			TMW-70



TMN-2.3 thru  
TMW-70  
3/8 x 3/8 x 1 3/4"  
Weight...1.2 oz.

TMN-4 thru  
TMN-1.7  
1 1/2 x 1 1/2 x 2"  
Weight...3.5 oz.

## TELEGRAPH TONE CHANNEL

These band pass filters for multiplex transmitting and receiving provide maximum stability in miniature sizes. Both receiving and transmitting types are 600 ohms in and out, and employ 7 terminal header for sub-miniature 7 pin socket.

TGT transmitting filters are within 3 db at  $\pm$  42.5 cycles from center frequency . . . down more than 16 db at  $\pm$  170 cycles . . . down more than 7.5 db at adjacent channel cross-over.

TGR receiving filters are within 3 db at  $\pm$  42.5 cycles from center frequency . . . down more than 30 db at  $\pm$  170 cycles . . . down more than 15 db at adjacent channel cross-over.

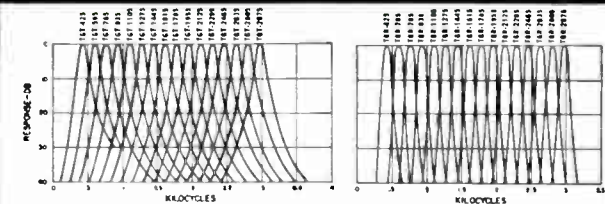

TRANSMITTING

TGT-425	TGT-1785
TGT-595	TGT-1955
TGT-765	TGT-2125
TGT-935	TGT-2295
TGT-1105	TGT-2465
TGT-1275	TGT-2635
TGT-1445	TGT-2805
TGT-1615	TGT-2975

STANDARD STOCK FREQUENCIES  
(number in figure is cycles)

RECEIVING

TGR-425	TGR-1785
TGR-595	TGR-1955
TGR-765	TGR-2125
TGR-935	TGR-2295
TGR-1105	TGR-2465
TGR-1275	TGR-2635
TGR-1445	TGR-2805
TGR-1615	TGR-2975



TGT CASE  
1 1/2 x 1 1/2 x 2 1/2"  
Weight...8 oz.

TGR CASE  
1 1/2 x 1 1/2 x 4 1/4"  
Weight...15 oz.

And Special Units to  
Your Specifications

## UNITED TRANSFORMER CORP.

150 Varick Street, New York 13, N. Y.

PACIFIC MFG. DIVISION: 4008 W. JEFFERSON BLVD., LOS ANGELES 16, CALIF.  
EXPORT DIVISION: 13 EAST 40th STREET, NEW YORK 16, N. Y. CABLES: "ARLAB"

# electronics

A McGraw-Hill Publication 75 Cents



MacDONALD

**JAMES GIRDWOOD**, Publisher  
**W. W. MacDONALD**, Editor  
**J. M. CARROLL**, Managing Editor  
**SENIOR ASSOCIATE EDITORS:** Samuel Weber, Roland J. Charest.  
**ASSOCIATE EDITORS:** Frank Leary, Michael F. Tomaino, Sylvester P. Carter, William P. O'Brien, John F. Mason, William E. Bushor, Thomas Emma, Sy Vogel, Leslie Solomon, M. M. Perugini, George J. Flynn. **ASSISTANT EDITORS:** Michael F. Wolff, Nilo Lindgren, Stanley Froud. **REGIONAL EDITORS:** Harold C. Hood (Pacific Coast, Los Angeles), Thomas Macquire (New England, Boston). **MARKET RESEARCH EDITOR:** Edward DeJongh. **BUYERS' GUIDE EDITOR:** George Sideris. **ART DIRECTOR:** Harry Phillips; Howard R. Berry. **PRODUCTION EDITOR:** John C. Wright, Jr. **EDITORIAL ASSISTANTS:** Gloria J. Filippone, Arlene Schilp, Bernice Duffy, Patricia Martine, Dolores A. Fornaro, Lorraine Rossi, Virginia T. Bastian, Ruth Ayres.  
**BRUCE A. WINNER**, Advertising Sales Manager. R. S. Quint, Assistant Advertising Sales Manager and Buyers' Guide Manager. Fred Stewart, Promotion Manager. Richard J. Tomlinson, Production Manager. George E. Pomeroy, Classified Manager. Hugh J. Quinn, Circulation Manager. **ADVERTISING REPRESENTATIVES:** New York: Donald H. Miller, Henry M. Shaw, George F. Werner. Boston: William S. Hodgkinson. Pittsburgh: David M. Watson. Philadelphia: Warren H. Gardner, William J. Boyle. Chicago: Harvey W. Wernecke, Martin J. Gallay. Cleveland: P. T. Fegley. San Francisco: T. H. Carmody, R. C. Alcorn. Los Angeles: Carl W. Dysinger, D. A. McMillan, Marshall Freeman. Denver: J. Patten. Atlanta: M. Miller. Dallas: Gordon L. Jones, Robert T. Wood. Frankfurt: Stanley Kimes. Geneva: Michael R. Zeynel.

## BUSINESS

Korea: On Guard 10 Years After Invasion. New systems active	40
Circuit Synthesis: New Trend in Design. A progress report	44
Rocket to Take Photos of Mars. Round trip requires 2 to 3 years	49
Field Men Belong On the Team. How to hold top engineers	52
Rice Develops Computer Plans. News from educational centers	59
Crosstalk	4
Comment	6
Electronics Newsletter	11
Washington Outlook	14
Financial Roundup	25
25 Most Active Stocks	25
Market Research	28
Current Figures	28
Meetings Ahead	62

## ENGINEERING

Spectrometric studies of missile flights are being made with this ROTI-mounted infrared rapid-scan system See p 86	COVER
Signal Transmission Through Ionized Media. How man-made ionization affects communications By W. A. Greenhow	81
Spectrometric Analysis of Missile Flights. Rapid-scan spectrometer provides function-of-time chart By J. N. Day, Jr.	86
Achieving Stable Discriminator Levels With a Biased Input Diode. Circuit helps count nuclear pulses By F. S. Goulding and L. B. Robinson	89
Designing Reciprocal Computer Circuits. For analog computers and control systems By A. Gill	92
Production Line Checker for Relay Contact Chatter. Relays are tested on a go: no-go basis By Eugene H. Kopp	94
Method for Simplifying Filter Design. Network has minimum elements by K. Lichtenfeld	96
Transmission Line Analogy for Sandwich Propagation. Aids computation of characteristics needed by designers By H. F. Mathis	100

## DEPARTMENTS

Research and Development. Ferrite Films in Logic and Storage	104
Components and Materials. Tuning Fork for High-Q Resonance	108
Production Techniques. Evacuate Tubes Before Stems Are Sealed	114
New On the Market	120
Literature of the Week	170
People and Plants	172
Index to Advertisers	180

New temperature controlled MICROSTACK® meets

# -55°C to +85°C

## MILITARY REQUIREMENT

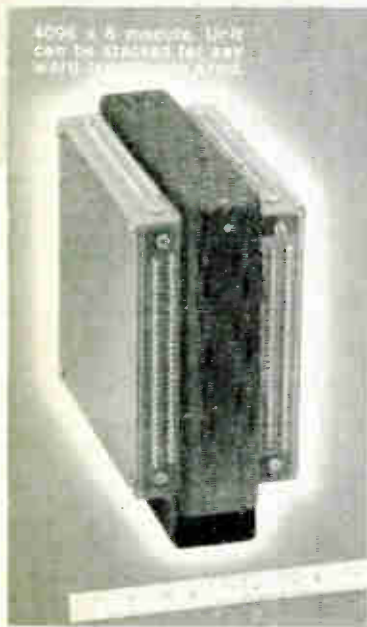

The General Ceramics MICROSTACK, one of the most important advances in memory core packaging, now operates in a temperature range of from  $-55^{\circ}\text{C}$  to  $+85^{\circ}\text{C}$ . Core characteristics remain constant. By maintaining temperature stability inside the MICROSTACK unit, General Ceramics engineers have developed a memory core package that is smaller, more rugged, requires no external cooling or heating, and meets MIL shock and vibration specifications.

For additional information, please write on company letterhead. Address inquiries to Section E.



APPLIED LOGIC DEPARTMENT  
**GENERAL CERAMICS**  
KEASBEY, NEW JERSEY, U. S. A.

TECHNICAL CERAMICS, FERRITE AND MEMORY PRODUCTS



actual size

## NOW—Two important contributions to printed circuit design—

The Microminiature Kernel

ATE-34 Adjustoroid® and a New Line  
of Miniature Encapsulated Adjustoroids

Newest addition to the Burnell Adjustoroid line is the microminiature Kernel® ATE-34 and the miniature ATE-11, ATE-0 and ATE-4. One of the unique features of these new Adjustoroids is a flush slotted head providing for ease of adjustment and economy in height.

The new microminiature Kernel ATE-34 Adjustoroid and the miniature ATE-11, ATE-0 and ATE-4 are variable over a 10% range of their inductance. Fully encapsulated, they will withstand high acceleration, shock and vibration environments. All of the above meet MIL-T specifications, 27 Grade 4 Class R and MIL-E 15305 A. Write for Stock Sheet AT-34.

	Length/ Dia.	Hgt.	Wt.	Useful Freq. Range	Max. Q	Max. I. in hys
ATE-0	1 1/16"	1"	1 1/2 oz.	1 kc to 20 kc	10 kc	5 hys
ATE-4	1 3/16"	1 3/16"	3.5 oz.	1 kc to 16 kc	5 kc	15 hys
ATE-6	1 1/16"	1"	1 1/2 oz.	10 kc to 100 kc	30 kc	.75 hys
ATE-10	1 3/16"	1 3/16"	.1 oz.	3 kc to 50 kc	20 kc	.75 hys
ATE-11	3/4"	1 3/16"	.75 oz.	2 kc to 25 kc	15 kc	5 hys
ATE-12	3/4"	1 3/16"	.75 oz.	15 kc to 150 kc	60 kc	1 hy
ATE-34	2 1/4"	2 1/32"	.1 oz.	3 kc to 30 kc	55 kc	1 hy

PAT. 2,762,020

If you haven't already done so—send for your free membership in the Space Shrinkers Club.

*Burnell & Co., Inc.*

PIONEERS IN MICROMINIATURIZATION OF  
TOROIDS, FILTERS AND RELATED NETWORKS

Eastern Division  
Dept. E-34  
10 Pelham Parkway  
Pelham, N. Y.  
PELham 8-5000  
Teletype Pelham 3633



Pacific Division  
Dept. E-34  
720 Mission St.  
South Pasadena, Cal.  
MURray 2-2841  
Teletype Pasadal 7578

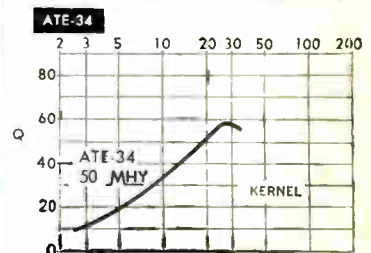
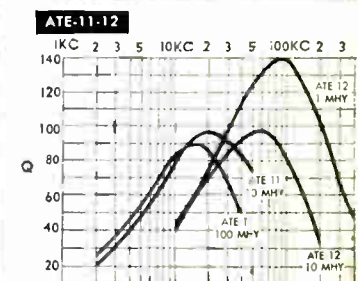
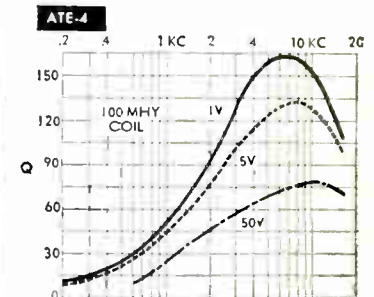
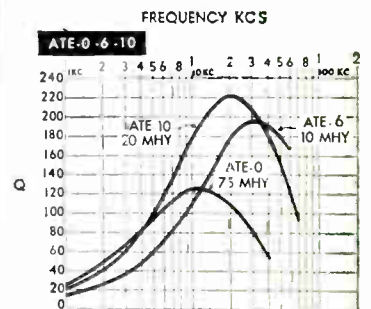

## CROSSTALK

Published weekly, including the ELECTRONICS BUYERS' GUIDE and REFERENCE Issue in mid-July as part of the subscription, by McGraw-Hill Publishing Company, Inc., James H. McGraw (1860-1918) Founder.

Executive, Editorial, Circulation and Advertising Offices: McGraw-Hill Building, 330 W. 42 St., New York, 36, N. Y. Longacre 4-3000. Publication Office: 99-129 North Broadway, Albany 1, N. Y. See panel below for directions regarding subscriptions or change of address.

OFFICERS OF THE PUBLICATIONS DIVISION: Nelson L. Bond, President; Shelton Fisher, Wallace F. Traendly, Senior Vice Presidents; John R. Callahan, Vice President and Editorial Director; Joseph H. Allen, Vice President and Director of Advertising Sales; A. R. Venezian, Vice President and Circulation Coordinator. OFFICERS OF THE CORPORATION: Donald C. McGraw, President; Joseph A. Gerardi, Hugh J. Kelly, Harry L. Waddell, Executive Vice Presidents; L. Keith Goodrich, Vice President and Treasurer; John J. Cooke, Secretary.

Subscriptions are solicited only from persons engaged in theory, research, design, production, management and use of electronic equipment. POSITION and COMPANY CONNECTION must be indicated on subscription orders. Subscription rates for individuals within the field of the Publication: United States and United States Possessions, \$6.00 one year; \$9.00 two years; \$12.00 three years. Canada, \$10.00 one year. All other countries \$20.00 one year. Single Copies, United States, United States Possessions and Canada 75¢; Buyers' Guide \$3.00; Single Copies all other countries \$1.50; Buyers' Guide \$10.00.

Our primary aim is to provide subscribers with a useful, valuable publication. Your comments and suggestions for improvement are encouraged and will be most welcome. The publisher, upon written request from any subscriber to our New York Office, agrees to refund the part of the subscription price applying to copies not yet mailed.

Second class postage paid at Albany, N. Y. Printed in U.S.A. Copyright 1960 by McGraw-Hill Publishing Co., Inc.—All Rights Reserved. Title registered in U. S. Patent Office.

BRANCH OFFICES: 520 North Michigan Avenue, Chicago 11; 68 Post Street, San Francisco 4; McGraw-Hill House, London E. C. 4; 85 Westendstrasse, Frankfurt/Main; National Press Bldg., Washington 4, D. C.; Six Penn Center Plaza, Philadelphia 3; 1111 Henry W. Oliver Bldg., Pittsburgh 22; 55 Public Square, Cleveland 13; 856 Penobscot Bldg., Detroit 26; 3615 Olive St., St. Louis 8; 350 Park Square Bldg., Boston 16; 1301 Rhodes-Haverly Bldg., Atlanta 3; 1125 West Sixth St., Los Angeles 17; 1740 Broadway, Denver 2; 901 Vaughn Bldg., Dallas 1.

ELECTRONICS is indexed regularly in The Engineering Index and annually in a December issue.

Subscriptions: Send subscription correspondence and change of address to Fulfillment Manager, Electronics, 330 West 42nd Street, New York 36, N. Y. Subscribers should notify Fulfillment Manager promptly of any change of address, giving old as well as new address, and including postal zone number, if any. If possible, enclose an address label from a recent issue of the magazine. Since copies are addressed one to two issues in advance, please allow one month for change of address to become effective.

Postmaster: please send form 3579 to Electronics, 330 W. 42nd St., New York 36, N. Y.



Audited Paid Circulation

**NETWORK SYNTHESIS.** Network theory began in 1827, when Georg Simon Ohm published his paper on the relationship between current, voltage and resistance. The paper had the forbidding title "Die Galvanische Kette Mathematisch Bearbeitet" and was so coolly received by the scientific community that Ohm quit his professorship at the Jesuit's college in Cologne. The only immediate result of this hasty action was that he was unemployed for several years.

For almost a hundred years after Ohm's paper appeared, network theory meant network analysis—synthesis was largely neglected. It wasn't until the 1920's that the first important steps were taken in synthesis problems. Network synthesis is thus a relatively new approach to circuit problems and while much has been accomplished, especially in the past ten years, much more remains to be done, particularly with active elements, nonlinear devices and time-varying systems. Strong stimulation to this and related subjects has been given by Brooklyn Poly's series of symposia that began in 1952 and have since been held annually. News about the latest meeting appears on p 44.

**KEEPING GOOD MEN.** Manufacturers' representatives have been long plagued with the problem of how to hold good men. The traits that make them good also make them want to set off on their own. Burlingame Associates, a major rep firm, has taken a good look at this problem. This company has instituted a series of important incentive plans to keep the men they know are valuable. To learn what a major rep organization does to hold its top men, see p 52.

### Coming In Our May 27 Issue

**ELECTRONICS IN JAPAN.** For about two years, it has been growing clearer and clearer that the U.S. electronics industry has a serious competitor in the resurgent industrial strength of Japan. Small and economical transistor radios, tape recorders, and components are among the areas where pressure has already been felt, but they aren't alone. Instruments, made in Japan, are now also entering the market. And controls.

Last year, an American group of electronics manufacturers appealed for protection from this competition to the Office of Civil & Defense Mobilization. This served to focus attention on the problem. The magnitude of the problem, however, was not clearly understood; distance and the barriers of language block good communications between the Japanese industry and us.

Believing that direct on-the-spot observation is worth multitudes of speculation, we sent Associate Editor Frank Leary over to look. He spent some two months going up and down the Japanese islands, touring production facilities, asking questions about research and development, and talking to engineers, bankers, lawyers, traders, students, executives, people in every phase of the electronics industry and technology. He came back with what we believe is an accurate picture of the strength and the weakness of Japan's industry.

The report on Japan's electronics development which appears next week discusses the status of the business and the industry, and explores the frontiers of the technology as it exists today. It covers the whole picture, from recent advances in materials research through new transistor fabrication techniques to the attitude of Osaka traders toward trade liberalization.

It's one of the longest articles this magazine has ever run, but we believe that everybody whose future is staked in the electronics industry will want to read "Electronics in Japan," an ELECTRONICS Special Report coming in our May 27 issue.

# Tubular Sintered-Anode **TANTALEX<sup>®</sup>** Capacitors

## Pack High Capacitance In Small Volume

Now designers can get the reliability and performance of Sprague's Type 109D and 130D Tubular Sintered-Anode Tantalex Capacitors *in ratings up to 560  $\mu$ F*. A new "T" case size permits more ratings in every working voltage. Type 109D capacitors can be operated up to 85 C without voltage derating and up to 105 C with a voltage derating of only 15%; Type 130D to 125 C without derating.

*Designed to MIL-C-3965B*

These Tantalex Capacitors are designed to meet vibration (2000 cycle), shock, and all other environment requirements of MIL-C-3965B. Outstanding mechanical features include a specially-treated cathode; a double-spun, missile-proven fluorocarbon elastomer high temperature seal; and a special porous sintered tantalum anode developed to give unusually high capacitance per unit volume.

*No Shoulders; No Chassis Slots Required*

The clean, shoulder-less shape of these capacitors was pioneered by Sprague to simplify printed wiring layout and assembly. It eliminates the need to punch mounting slots of the type required for older shouldered cup designs. Wiring boards can also be stacked more compactly.

**NEW**

**"T"** Case Size  
**BOOSTS**  
**RATINGS TO**  
**560  $\mu$ F**



SPRAGUE "T" Case  
45 to 560  $\mu$ F

SPRAGUE "F" Case  
18 to 270  $\mu$ F

"C" Case  
3.6 to 68  $\mu$ F

Actual Sizes

For more information on Type 109D and 130D Tubular Sintered-Anode Tantalex Capacitors, write for Engineering Bulletin 3700D and Bulletin 3701 to Technical Literature Section, Sprague Electric Company, 35 Marshall Street, North Adams, Massachusetts.

#### SPRAGUE COMPONENTS:

CAPACITORS • RESISTORS • MAGNETIC COMPONENTS • TRANSISTORS • INTERFERENCE FILTERS • PULSE NETWORKS  
HIGH TEMPERATURE MAGNET WIRE • CERAMIC-BASE PRINTED NETWORKS • PACKAGED COMPONENT ASSEMBLIES





## with a DI-ACRO ROL-FORM DIE

Workmarking from forming sheet materials in press brakes and punch presses is greatly reduced and in many metals completely eliminated when formed with the Di-Acro Rol-Form Die. Hardened and precision ground rolls pivot smoothly in the die block to fold material without strain. You save costs by discarding elaborate and time consuming preparation and work methods, reducing polishing time, eliminating scrap parts. You also cut costs in press brakes and punch presses by reducing the number of dies needed and the set-up time.

One Di-Acro Rol-Form Die with a 60° upper die forms any angle to 60° and any thickness of metal to 1/8" just by adjusting the ram or bed of the brake. Where ultra-high finish material is to be formed, nylon inserts can be used in the die block to further reduce the possibility of work marks.

The Rol-Form Die is offered in five styles and in lengths from 6 inches to 12 feet for use in all sizes and models of press brakes and punch presses.

For ordinary press brake forming ask about Di-Acro Standard Press Brake Dies.



Consult the yellow pages of your telephone book under Machinery-Machine Tools for the name of your nearest Di-Acro distributor or write us.

pronounced die-ack-ro



**O'NEIL-IRWIN  
MFG. CO.**

321 Eighth Avenue  
Lake City, Minnesota

## COMMENT

### Unity-Gain Amplifier

Your article "Unity-Gain Amplifier Offers High Stability" (p 66, Feb. 26), describes the double cathode follower as "new." This circuit is hardly novel. It is shown in *Electron Tube Circuits*, by Samuel Seely (McGraw-Hill, 1950), page 120, which references an MIT Radiation Lab report of 1943. It has also been attributed to E. L. C. White and to G. A. Head of Bell Telephone Laboratories.

Can't we do better?

LAWRENCE T. FLEMING  
PASADENA, CALIF.

Authors Davidson and Brady say:

In reply to Mr. Fleming's parting query, we feel that we have "done better"! The article referred to does not describe "the" double cathode follower as new, but does describe two new precision isolation amplifiers. These new circuits were claimed to offer greatly improved transmission accuracy and gain stability over that of the normal cathode follower.

The circuit referred to in "Electron Tube Circuits" by Seely is "the" double cathode follower. If Mr. Fleming had checked a little more closely, he would have found, as is shown below, that it does not offer the gain stability or transmission accuracy of the new circuits.

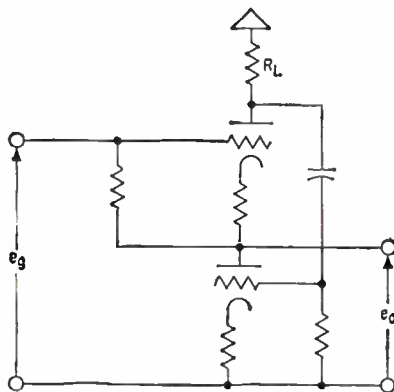

The above figure shows Seely's double cathode follower circuit.

The gain of the circuit is given by Seely as:

$$K = \frac{\mu^2 + \mu r_p / R_L}{(\mu^2 + \mu + 1) + (\mu + 2) r_p / R_L}$$

For simplicity assume the ideal case such that  $r_p = 0$

$$\therefore K = \frac{\mu^2}{\mu^2 + \mu + 1}$$

Hence the gain stability factor  $\delta$  is equal to:

$$\delta = \frac{dK}{d\mu} = \frac{\mu + 2}{\mu^2 + \mu + 1}$$

If  $\mu \gg 2$ , then

$$\delta \approx \frac{1}{\mu}$$

Which is the same as that of the normal cathode follower.

### Polaris

"Where Polaris Stands Today," p 32, Apr. 15, is an excellent story and very factual.

W. F. RABORN

REAR ADMIRAL

DIRECTOR, SPECIAL PROJECTS

U. S. NAVY

WASHINGTON, D. C.

### An International View

Just scanning your May 6 issue at random, I see articles like "European Combine to Produce Hawk," "Japan Ponders Export Policy," "Israel Forms Electronics Group," "Sequential Receivers for French Color Tv System," and an article on pulse-amplifier design by a British author.

It seems as if your magazine ought to have a fair-sized job on its hands reporting the results of U.S. engineering, research and production without giving all this publicity to foreign developments.

I note in the same issue your Market Research department carries the headline "Exports \$415 Million, Down 3 Percent." No wonder.

E. R. CARROLL

CHATHAM, MASS.

We do not give publicity to anybody's work; we merely select, to the best of our ability, the developments most worthy of reporting from among the work that is known to us. Electronics is an international industry, and science has no nationality. This magazine tries always to remember that; we would be doing less than our job if we forgot it.



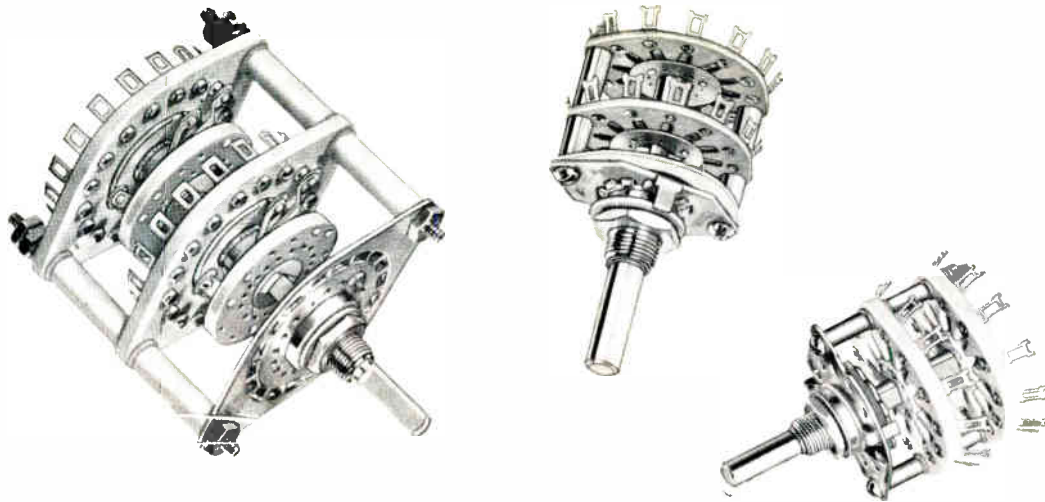

**for switches quick**



**make a quick switch to Centralab**

The switch you need is available *fast* from CENTRALAB. From the simplest general purpose units to the most highly specialized, you get speedy service on samples, quotations, and production.

In fact, on a wide variety of standard switches you can get immediate local delivery, in industrial quantities, at factory prices — from your near-by CENTRALAB distributor.

Write today for CENTRALAB's unique Switch Visualizer (which simulates actual switch operation). Used in conjunction with our detailed layout sheet, it simplifies and speeds up switch design—for you, and for us. We'll also send along a copy of Catalog 42-405, listing detailed electrical and mechanical specifications on all CENTRALAB switches and including a complete listing of all standard types available for immediate delivery.



The Electronics Division of Globe-Union Inc.  
914E E. Keefe Avenue • Milwaukee 1, Wisconsin  
In Canada: P. O. Box 400, Ajax, Ontario

Measure impedance and other system characteristics,

500 MC to 40 KMC

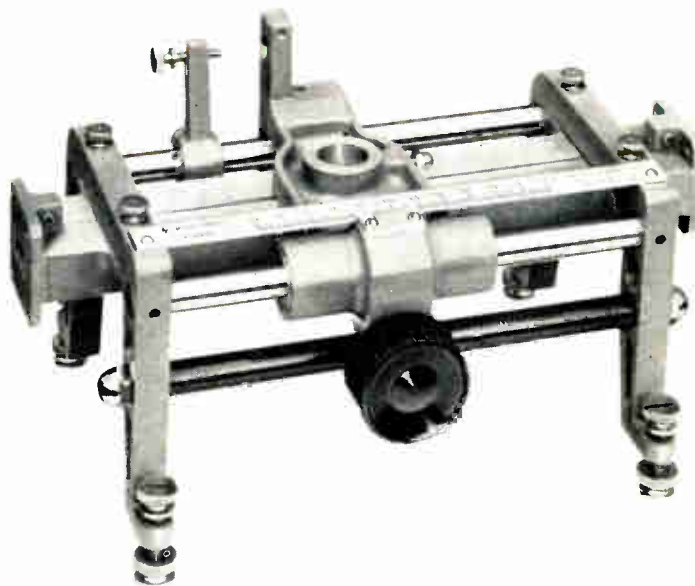
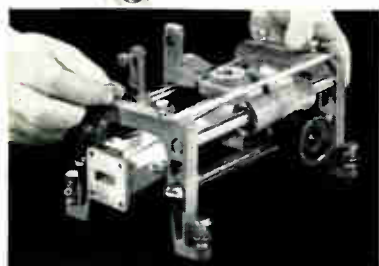
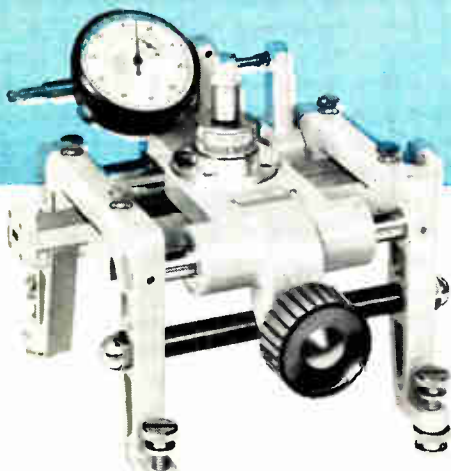

**hp 809B and 814B  
UNIVERSAL PROBE CARRIAGES**

- Coverage 3 to 40 KMC
- Sections interchange in 30 seconds
- Dial gauge accuracy, highest stability

Models 809B and 814B are rugged, precision Universal Probe Carriages designed for use, respectively, with 810B and 815B waveguide slotted sections. The 809B/810B combination covers frequencies 3.95 to 18.0 KMC, and the 814B/815B combination covers frequencies 18.0 to 40.0 KMC. For waveguide measurements involving several bands, the

cost of a special probe and carriage assembly for each band is eliminated and much engineering time is saved since waveguide sections can be changed in 30 seconds. Model 809B has a vernier scale reading to 0.1 mm and can be fitted with a dial gauge for greater accuracy. Model 814B is equipped with a dial indicator reading to 0.01 mm.

**Specifications**

**809B Universal Probe Carriage**

**Carriage:** Mounts 810B Slotted Sections and 806B Coaxial Slotted Section (not shown: 3 to 12 KMC, 50 ohms impedance, Type N connectors).

**Probe Required:** 442B Broadband Probe plus 440A Detector or 444A Untuned Probe.

**Probe Travel:** 10 centimeters.

**Accuracy:** With waveguide sections, 1.02 SWR easily read. Slope error eliminated by adjustment.

**Price:** \$160.00.

**814B Universal Probe Carriage**

**Carriage:** Mounts 815B Slotted Sections.

**Probe Required:** 446B Untuned Probe.

**Accuracy:** SWR of 1.02 easily read.

**Price:** \$200.00.



**WORLD'S MOST COMPLETE LINE OF PRECISION,**

quickly, accurately, with these low cost, precision instruments!

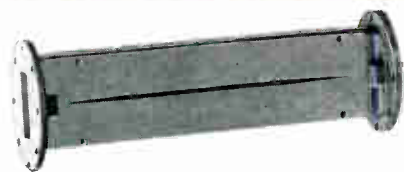

Ⓢ 810B Waveguide Slotted Sections—  
3.95 to 18.0 KMC.

These accurately machined sections of waveguide have a small, tapered, longitudinal slot, and fit the 809B Universal Probe Carriage in a precisely indexed position. A traveling probe mounted on the carriage samples the electric field along the slot, and permits precise plotting of variations. Slot reflection is less than 1.01 SWR. For prices, list of 810B waveguides available, see Table 1 below.



Ⓢ S810A Waveguide Slotted Section—  
2.6 to 3.95 KMC.

This instrument is a conventional slotted waveguide complete with a probe carriage mounted directly on the section. It is available in the S-band only and will operate with Ⓢ 442B or 444A probes. SWR less than 1.01. \$450.00.

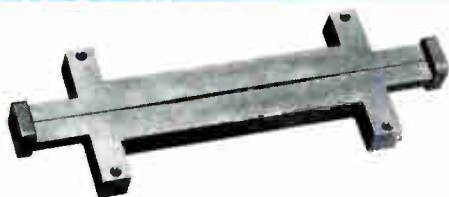

Ⓢ 815B Waveguide Slotted Sections—  
18.0 to 40.0 KMC.

Available in K and R band sizes, these waveguide slotted sections are similar to 810B sections and, like 810B units, are accurately machined from precision castings to insure a uniform cross-section. Prices and details below.



Ⓢ 805A/805B Coaxial Slotted Lines—  
500 MC to 4 KMC.

For SWR, wavelength, impedance and system flatness measurements in coaxial systems. Exclusive Ⓢ parallel-plane design for higher accuracy, stability. Negligible slope, SWR less than 1.04, reads in cm and mm to 0.1 mm. Ⓢ 805A, for 50 ohm lines, Type N connectors, \$450.00. Ⓢ 805B, for 46.3 ohm lines, UG-45/U male and UG-46/U female connectors, \$450.00.

Table 1—Ⓢ 810B/815B Slotted Sections.

Model	Frequency Range KMC	Fits Waveguide Size (in.)	Overall Length (in.)	Price
G810B	3.95 - 5.85	2 x 1	10¼	\$110.00
J810B	5.20 - 8.20	1½ x ¾	10¼	110.00
H810B	7.05 - 10.0	1¼ x ⅝	10¼	110.00
X810B	8.20 - 12.4	1 x ½	10¼	90.00
M810B	10.0 - 15.0	.850 x .475	10¼	110.00
P810B	12.4 - 18.0	.702 x .391	10¼	110.00
K815B	18.0 - 26.5	.500 x .250	4½	265.00
R815B	26.5 - 40.0	.360 x .220	4½	265.00

## HEWLETT-PACKARD COMPANY

5427A PAGE MILL ROAD • PALO ALTO, CALIFORNIA, U.S.A. • CABLE "HEWPACK" • DAVENPORT 5-4451

FIELD REPRESENTATIVES IN ALL PRINCIPAL AREAS

HIGH VALUE MICROWAVE MEASURING EQUIPMENT

# Bourns Trimpot® Puts the Proof in Humidity-Proof

NUMBER 5 — RELIABILITY SERIES

Plunging a potentiometer into near-boiling water is just one of the ways Bourns puts the proof in humidity-proof. Every Trimpot unit made takes this 60-second bath with the water simmering at 90°C. Air expanded by the heat creates four pounds of pressure inside the potentiometer—enough to cause bubbles—if it leaks. Only if the unit is completely leak-free does it pass the test.

Bourns humidity proofing starts at the beginning—with original design and selection of materials. The plastic chosen for Trimpot cases, for example, displays the unusual properties of high insulation resistance and extremely low moisture absorption.

Further protection against humidity results from manufacturing procedures, such as internal potting of the resistance element and sub-components. Finally, Bourns samples all production for compliance to MIL-STD-202A, Method 106 as a routine part of a Reliability Assurance Program. As a result, Trimpot does more than "resist" moisture; it keeps moisture out.

For more information about the industry's largest selection of humidity-proof adjustment potentiometers—wirewound and carbon in a variety of sizes, power ratings, operating temperatures, etc.—write for new Trimpot summary brochure and list of stocking distributors.

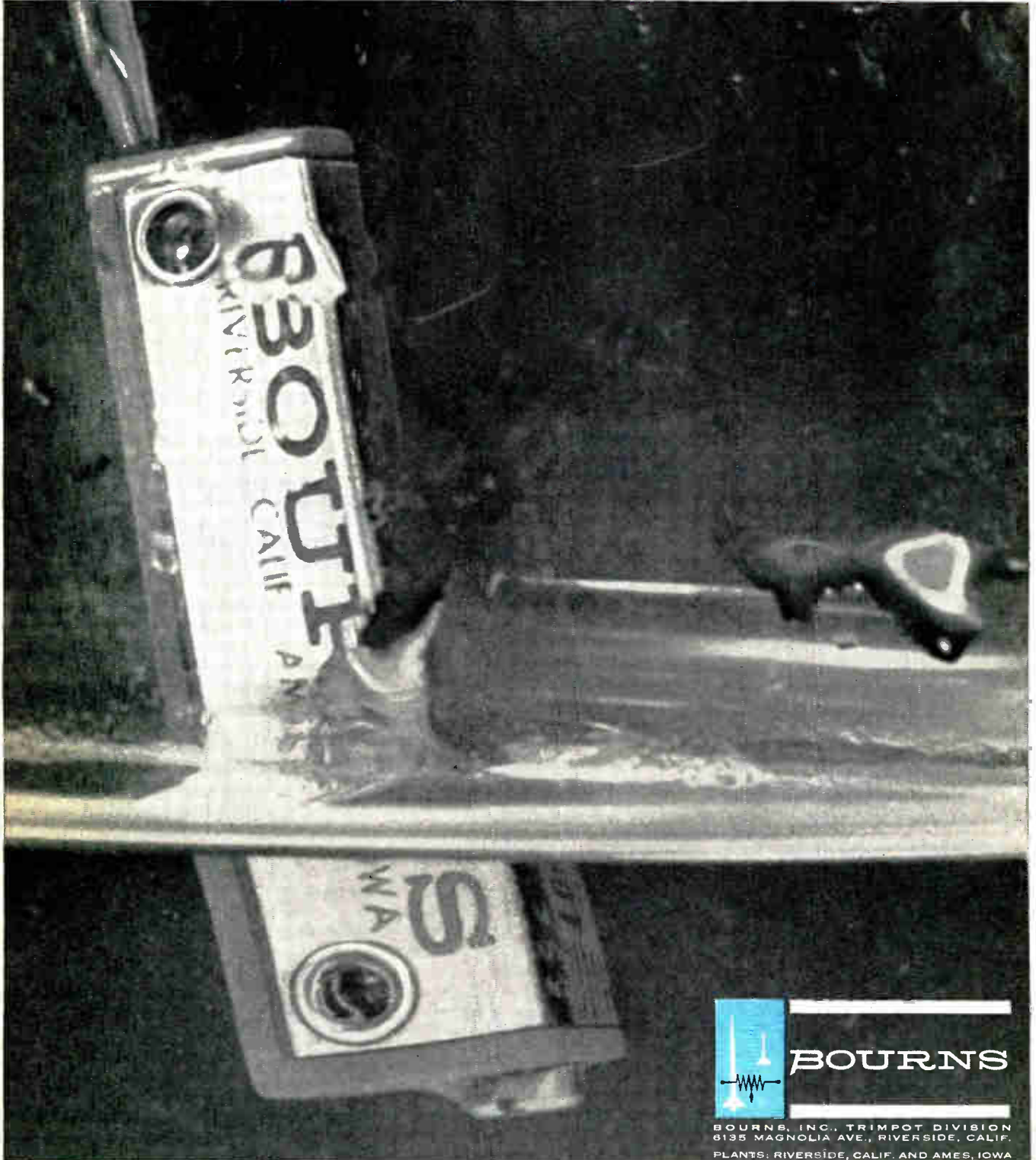

**BOURNS**

BOURNS, INC., TRIMPOT DIVISION  
6135 MAGNOLIA AVE., RIVERSIDE, CALIF.  
PLANTS: RIVERSIDE, CALIF. AND AMES, IOWA

Exclusive manufacturers of Trimpot®, Trimit®, and E-Z-Trim®. Pioneers in transducers for position, pressure and acceleration.

# ELECTRONICS NEWSLETTER

## Radiation Damage Is Major Research Task

REASONS why radiation damage to semiconductor materials often occurs in isolated cluster areas of the lattice structure will come under close investigation at the Radiation Physics Lab, nearing completion at AF Cambridge Research Center, Bedford, Mass. Slated to be completed in July, the facility will have a 3 Mev Van de Graaff generator, a 1.5 Mev Dynamitron and a 10,000-Curie cobalt 60 source.

Preliminary studies by AF research groups have pinpointed the cluster phenomenon, but additional studies are required to determine size of the cluster and how many clusters develop in a given area before breakdown. Goal of the research project is creation of new materials to withstand radiation environments, but studies to date have also hinted at a new possibility: radiation "damage" may, in some cases, result in enhanced electrical properties.

## Efficiency of Capacitors Draws Attention

MORE USE OF TANTALUM and columbium for capacitors to achieve high capacitance in increasingly smaller packages gained considerable attention at the recent Electrochemical Society meeting in Chicago.

Also at the meeting, General Electric revealed work is being done with an anodic oxide film which permits capacitors to operate at 500 C.

## Electromagnets Being Explored by MIT Lab

SUPERCONDUCTING electromagnets are being explored at MIT Lincoln Lab for use with masers and other devices and in solid-state research requiring cryogenic temperatures and a magnetic field. A small magnet, energized by superconducting coils, fits directly inside a dewar flask.

This technique has advantages of

compactness and practically negligible power requirements, contrasted with the conventional arrangement in which the apparatus is inside vacuum flasks which are then placed between the pole-faces of an electromagnet. Lincoln Lab is experimenting with both air-core solenoids and isemagnets (iron-ore superconducting electromagnets).

## Transistors Flush With Circuit Boards

TRANSISTORS which are almost flush with printed circuit boards have been developed by Sylvania Electric Products. The so-called pancake design has been applied to germanium alloy pnp and npn transistors. Shortly, the company will be making pnp drift transistors and diffused-base germanium and silicon transistors using the new design.

Sylvania also announces two other developments: One is a technique for packaging microminiature electronic circuits on a series of stacked wafers, and the other is a new cathode-ray tube capable of high resolution photographic recording at altitudes up to 70,000 feet.

## Remington Rand Adds Large-Scale Computer

NEWEST ADDITION to Remington Rand's line of large-scale computers is the Univac III, a solid-state machine with a processing speed nine times faster than Univac II and an operating efficiency 25 percent higher.

The system rents for between \$15,000 to \$30,000 monthly, depending on the user's requirements. Peripheral equipment can be operated on-line or off-line at the option of the user. This "program interrupt" feature automatically tells the computer when ancillary equipment has finished a task and allows sections such as sorters, printers or card punchers to be put to work on new tasks. Reading and writing at the rate of 20,000 digits

a second can be carried out simultaneously with computing functions. The computer operates from magnetic tape or punch cards. Its card reader operates at 700 cards a minute.

## AF Develops High Speed Russian Translator

AN ELECTRONIC translator which converts Russian into English at the rate of 35 words a second has been developed by the Air Force. Heart of the translator is a 10-inch transparent disk that can store 550,000 Russian-English words in an area the size of a postcard.

Words appear around the edge of the disk in concentric tracks of binary code. As a Russian word is fed into the translator by a punched tape, it is read by the machine and converted into electrical signals. These are matched with the coded equivalents on the glass disks. English translation is transmitted over an electrical typewriter.

Tape containing the Russian text is prepared manually and is limited to 40 words a minute. However, a special input machine is being developed that will raise the input rate to 2,400 a minute. The translator is the work of Gilbert W. King of International Business Machines Research Center, Yorktown Heights, N. Y.

## NASA Plans 25 Major Launchings Each Year

THE National Aeronautics and Space Administration plans to launch 25 to 30 major vehicles and 100 sounding rockets each year for the next three years. This information was divulged by Maj. Gen. Don R. Ostrander, USAF, director of the launch vehicle programs of NASA.

He pointed out, however, that after this three-year period the rate of launchings is expected to decline—mainly because of the greater complexity and considerably higher cost of the vehicles scheduled for launchings.

# FULL LINE OF HIGHEST BETA GER

## New TI high-efficiency emitter gives you high beta germanium power transistors!



Now minimum and maximum betas are guaranteed from 20 to 60 at the maximum current rating

of  $I_C = 25$  amps in new TI 2N514 series transistors. New high efficiency emitter makes possible greatly improved specifications for TI 2N456, 2N511, 2N512, 2N513, 2N514, and 2N1021 series alloy-junction germanium power transistors.

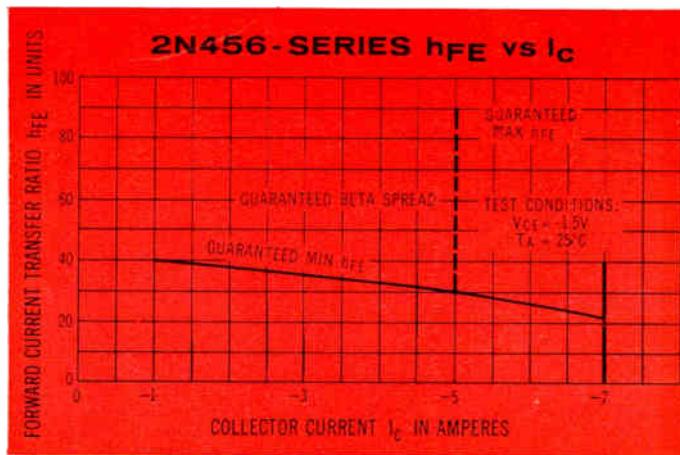

### TI gives you design leadership in quality germanium power transistors

#### INCREASED BETA THROUGH HIGH-EFFICIENCY EMITTER

Emitter efficiency can be improved by increasing the ratio of resistivities between the emitter and base region. For example, when a 10 ohm-centimeter resistivity germanium wafer is used as the base material, it is advantageous to have less than a .01 ohm-centimeter resistivity emitter regrowth region. Since initial doping of the germanium crystal establishes base resistivity, the ratio can be changed only by varying the emitter material. TI utilizes an emitter material that results in a lower emitter resistivity and an increased emitter efficiency, plus providing the higher beta at high currents.

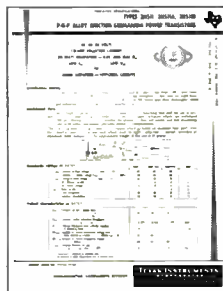

Optimum reliability for all TI germanium power transistors is assured by . . . 100% testing . . . 100% temperature cycling . . . 100% hermetic seal testing . . . continuous and intensive quality assurance program. Write on your company letterhead for germanium power transistor specifications.

#### GERMANIUM

**POWER/SWITCHING/DEFLECTION CIRCUIT**

#### TRANSISTORS

# TEXAS



# INSTRUMENTS INCORPORATED

SEMICONDUCTOR-COMPONENTS DIVISION  
13500 N. CENTRAL EXPRESSWAY  
POST OFFICE BOX 312 · DALLAS, TEXAS

# MANIUM POWER TRANSISTORS

New high current 2N1046-A-B give you high frequency/dissipation/voltage with high beta!



New TI 2N1046B germanium power transistors give you 10 amp  $I_C$  with typical 18 mc  $f_T^*$  . . . 130 volt  $BV_{CBO}$  . . . guaranteed beta of 10 at 10 amp  $I_C$  . . . 30 watt dissipation . . . high frequency/high current operating characteristics. The 2N1046 series alloy-diffused P-N-P transistors provides maximum reliability for your core driving, hi-fi amplification, and other high frequency power applications.

$f_T^*$  Frequency at which common emitter current gain of the device is unity.

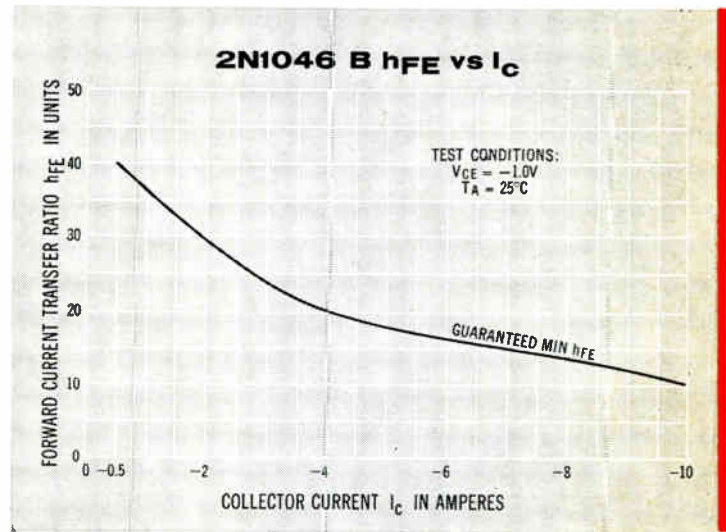

Call on your nearest TI distributor or sales office for immediate delivery of TI germanium power transistors including the 1-amp 2N1038 series and the 3-amp 2N1042 series power transistors.

## TI GERMANIUM POWER TRANSISTOR CHARACTERISTICS AT 25°C

Type	Dissipation at 25°C watts	Collector to Base Voltage-v max	Collector to Emitter Voltage min $BV_{CEO}$	Emitter to Base Voltage-v min $BV_{EBO}$	Collector Current Amps max	$h_{FE}$ @ $I_C$		Collector Reverse Current $I_{CO}$ max		Typ $R_{CS}$ @ $I_C$ ohms	Internal Cutoff Frequency avg $f_T$
						min	max	ma	v		
2N456A	50	-40	-20	-20	-7	30 @ 5a	90	-0.5	-20	0.040 @ 5a	430 kc
2N457A	50	-60	-30	-20	-7	30 @ 5a	90	-0.5	-30	0.040 @ 5a	430 kc
2N458A	50	-80	-40	-20	-7	30 @ 5a	90	-0.5	-40	0.040 @ 5a	430 kc
2N1021	50	-100	-50	-20	-7	30 @ 5a	90	-0.5	-50	0.040 @ 5a	430 kc
2N1022	50	-120	-50	-20	-7	30 @ 5a	90	-0.5	-60	0.040 @ 5a	430 kc
2N511	80	-40	-20	-30	-25	20 @ 10a	60	-2	-20	0.025 @ 10a	260 kc
2N511A	80	-60	-30	-30	-25	20 @ 10a	60	-2	-30	0.025 @ 10a	260 kc
2N511B	80	-80	-40	-30	-25	20 @ 10a	60	-2	-40	0.025 @ 10a	260 kc
2N512	80	-40	-20	-30	-25	20 @ 15a	60	-2	-20	0.033 @ 15a	280 kc
2N512A	80	-60	-30	-30	-25	20 @ 15a	60	-2	-30	0.033 @ 15a	280 kc
2N512B	80	-80	-40	-30	-25	20 @ 15a	60	-2	-40	0.033 @ 15a	280 kc
2N513	80	-40	-20	-30	-25	20 @ 20a	60	-2	-20	0.038 @ 20a	300 kc
2N513A	80	-60	-30	-30	-25	20 @ 20a	60	-2	-30	0.038 @ 20a	300 kc
2N513B	80	-80	-40	-30	-25	20 @ 20a	60	-2	-40	0.038 @ 20a	300 kc
2N514	80	-40	-20	-30	-25	20 @ 25a	60	-2	-20	0.040 @ 25a	350 kc
2N514A	80	-60	-30	-30	-25	20 @ 25a	60	-2	-30	0.040 @ 25a	350 kc
2N514B	80	-80	-40	-30	-25	20 @ 25a	60	-2	-40	0.040 @ 25a	350 kc
2N1038	20	-40	-30	-20	-3	20 @ 1a	60	-125 $\mu$ a	-20	0.150 @ 1a	8.0 kc $f_{oe}$ min
2N1039	20	-60	-40	-20	-3	20 @ 1a	60	-125 $\mu$ a	-30	0.150 @ 1a	8.0 kc $f_{oe}$ min
2N1040	20	-80	-50	-20	-3	20 @ 1a	60	-125 $\mu$ a	-40	0.150 @ 1a	8.0 kc $f_{oe}$ min
2N1041	20	-100	-60	-20	-3	20 @ 1a	60	-125 $\mu$ a	-50	0.150 @ 1a	8.0 kc $f_{oe}$ min
2N1042	20	-40	-30	-20	-3	20 @ 3a	60	-125 $\mu$ a	-20	0.167 @ 3a	8.0 kc $f_{oe}$ min
2N1043	20	-60	-40	-20	-3	20 @ 3a	60	-125 $\mu$ a	-30	0.167 @ 3a	8.0 kc $f_{oe}$ min
2N1044	20	-80	-50	-20	-3	20 @ 3a	60	-125 $\mu$ a	-40	0.167 @ 3a	8.0 kc $f_{oe}$ min
2N1045	20	-100	-60	-20	-3	20 @ 3a	60	-125 $\mu$ a	-50	0.167 @ 3a	8.0 kc $f_{oe}$ min
2N1046	30	-100	-50	-1.5	-10	40 @ 0.5a		-1	-40	0.500 @ 1a	15 mc min
2N1046A	30	-140	-50	-1.5	-10	20 @ 4a		-1	-40	0.125 @ 4a	15 mc min
2N1046B	30	-140	-50	-1.5	-10	10 @ 10a		-1	-40	0.050 @ 10a	15 mc min

# WASHINGTON OUTLOOK

THE STRATEGIC AIR COMMAND will get a modified version of the IBM-built solid-state computer originally designed for the North American Air Defense Command's Super Sage underground combat control centers.

*SAC will use the computer for its modernized command control system at Offutt AFB, Omaha, Neb.*

The new transistorized computer was scheduled as a follow-on to NORAD's current AN/FSQ-7 computer now being installed in about 15 Sage sites scattered throughout the country.

The solid-state follow-on was to be set up in eight so-called Super Sage installations to be built underground. The Pentagon's recent budget reshuffle, however, knocked out funds for construction and installation of these NORAD facilities.

NEW BUSINESS for f-m multiplexing will be opened up by FCC's approval of sub-channel broadcasting to private groups. This service is intended for business, professional, educational, religious, trade, labor, agricultural and other special groups of subscribers. Example: medical news and information piped into doctors' offices at certain hours.

The order extends to remote cueing, order circuits, remote control telemetering for internal station operations and program relaying. Other f-m stations will now copy KDKA-FM's recent relay operation in Pittsburgh by which baseball games have been transmitted to other f-m and a-m stations in the area without disturbing KDKA's own music programming.

*Incentive to go into doctor-casting, stockbroker-casting and such is restrained, however, by f-m stations' potential interest in stereo-casting, since a station cannot do both.*

Decisions on multiplexing for education f-m stations and remote pickup facsimile have been put off to a later date.

THE FCC STAFF is hard at work on technical studies looking toward vhf drop-ins—stations sandwiched in by shortening the transmission range of existing vhf stations. The Commission is asking for comments by June 20 on newly revised propagation curves.

WASHINGTON'S DRAMATIC ADMISSION of U. S. aircraft flights on intelligence missions over Soviet territory was official confirmation of what has long been an open secret: that specially-designed Lockheed-built, high-altitude U-2 aircraft have been performing reconnaissance on strategic Soviet facilities for about four years.

*ELECTRONICS magazine reported on the flights on July 10, 1959 (p 22), following the Soviet interception of an unarmed U. S. aircraft near the Turkish frontier.*

There is a political furor here over the administration's ineptitude in disclosing the U-2 aircraft's operations—the initial denial and the references to weather observation activities. The upshot is sure to be a searching inquiry into U. S. intelligence operations and an overhaul of policy in this sensitive field.

*Few if any responsible people here challenge the requirement for such flights. The aerial reconnaissance missions over the Soviet Union have provided SAC with the latest data for preparation of up-to-date targeting schedules.*

The Russians, of course, can gather comparable information on U. S. target areas through the normal channels of information existing in a democratic society. The locations of latest ICBM sites, for instance, are routinely announced by the Pentagon.

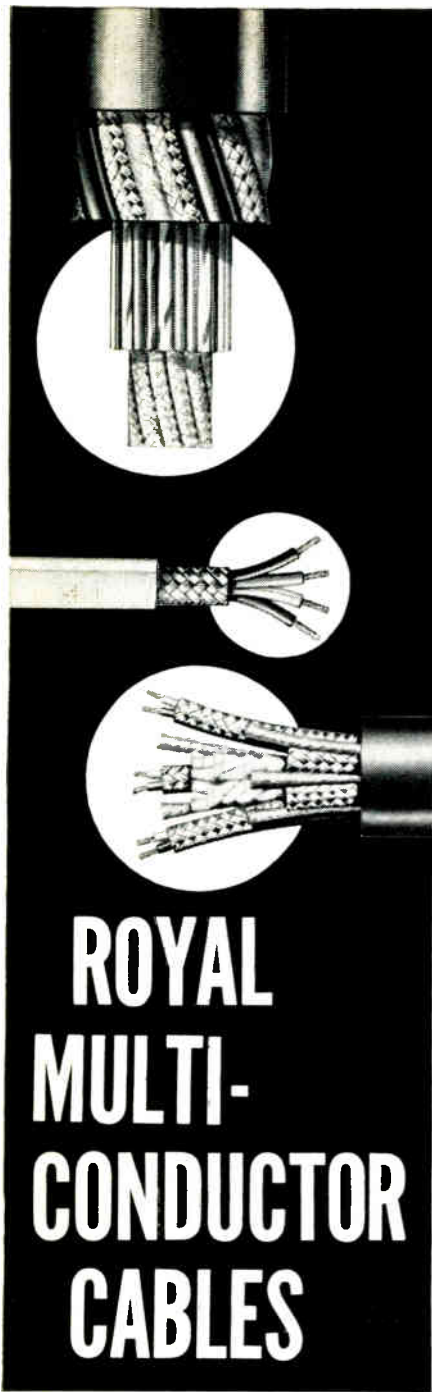

## ROYAL MULTI- CONDUCTOR CABLES

For simple or complex constructions, Royal has the know-how and capacity to fill your multi-conductor cable requirements. Royal Multi-Conductor Cables are designed, made, and quality-controlled to give you the cable characteristics you want most on the job — easy workability, foot-after-foot quality, topmost dependability. Send us your cable specifications . . . or ask to have our representative call.

**ROYAL ELECTRIC CORPORATION**  
301 Saratoga Avenue  
PAWTUCKET, RHODE ISLAND

In Canada: Royal Electric Company (Quebec) Ltd.,  
Pointe-Clair, Quebec

**ROYAL**  
ELECTRIC  
... an associate of **ITT**



# TO BE SURE

Specify the Finest Digital Voltmeter Made

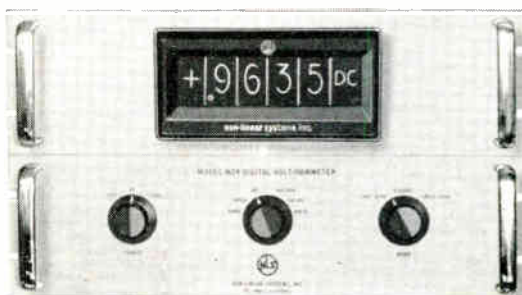

## NLS SERIES 20

When the combination of reliability, speed and accuracy is of uncompromising importance — you can't afford to gamble on "second best" digital measuring equipment! NLS Series 20 instruments are field-proven in the most critical applications — missile and electronic systems checkout, automatic process monitoring, sophisticated laboratory research. Be sure — specify time-tested NLS Series 20 instruments, the M24 multi-purpose instrument or the V24 voltmeter ratiometer.

*Some reasons why: M24 measures DC voltage, voltage ratio or resistance in a third of a second, V24 measures DC voltage and voltage ratio at same speed . . . both instruments feature advanced transistorized circuitry and mercury-wetted relays with life in excess of 3 billion readings . . .  $\pm$ one digit accuracy on DC voltage and voltage ratio . . . completely automatic operation . . . plug-in modular construction . . . AC or low level measurements with plug-in accessories . . . output connectors for continuous data logging, remote ranging. Ranges: DC voltage  $\pm$ .0001 to  $\pm$ 999.9; DC voltage ratio to  $\pm$ .9999; resistance .1 ohm to 1 megohm.*



Originator of the Digital Voltmeter

**non-linear systems, inc.**

DEL MAR (SAN DIEGO), CALIFORNIA

NLS — The Digital Voltmeter That Works . . . And Works . . . And Works . . .

# SUPRAMICA® 560 ceramoplastic

from the family of the world's  
most nearly perfect insulation

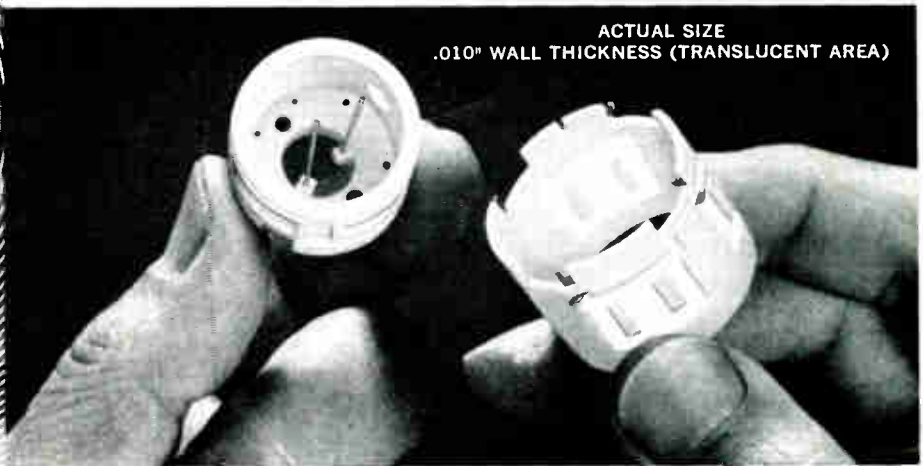

## helps to maintain peak gyro efficiency

Leading gyro producers design parts made of precision-molded SUPRAMICA 560 ceramoplastic, an *exclusive formulation of MYCALEX CORPORATION OF AMERICA* capable of retaining absolute dimensional stability at a maximum temperature endurance up to +932°F (unstressed) . . . in complex but lightweight designs. These small parts function as vital components of miniature gyros . . . critical applications where the highest standards for precision accuracy must be met.

SUPRAMICA 560 ceramoplastic having the same thermal expansion coefficient of many insert metals, can tightly bond and permanently anchor gold leads, stainless steel contacts and stainless steel threaded inserts . . . in parts with wall thicknesses of only .010".

SUPRAMICA 560 ceramoplastic offers premium insulating properties with excellent economy in production scale runs. SUPRAMICA 560 ceramoplastic is but one of a family of versatile electrical and electronic insulating materials produced by MYCALEX CORPORATION OF AMERICA . . .

- MYCALEX® glass-bonded mica, maximum temperature endurance (unstressed)—up to +700°F heat distortion temperature \* —up to +850°F
- SUPRAMICA® ceramoplastic, maximum temperature endurance (unstressed)—up to +1550°F heat distortion temperature \* —up to +1360°F
- SYNTHAMICA® synthetic mica, maximum temperature endurance (unstressed)—up to +2000°F

\*ASTM test method D 618 (modified) at stress of 261 psi.

Write for technical information today.

General Offices and Plant: 120A Clifton Blvd., Clifton, N. J.  
Executive Offices: 30 Rockefeller Plaza, New York 20, N. Y.

World's largest manufacturer of glass-bonded mica, ceramoplastic and synthetic mica products.

See Us At Booth 1400, 1960 "Design Engineering Show", New York Coliseum, May 23 to 26

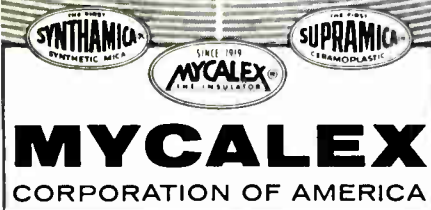

# FROM PHILCO

## TRANSISTOR CENTER U.S.A.

COMES THE WORLD'S MOST  
COMPLETE LINE OF TRANSISTORS  
... TO MEET YOUR CIRCUIT  
REQUIREMENTS

These three ultra-modern plants produce a full line of high quality transistors, covering the entire useful frequency spectrum. World-famous for reliability and uniformity, Philco Transistors are manufactured on the first and only fully-automatic transistor production lines, developed by Philco and used exclusively by Philco and its licensees. On the following 3 pages are charts showing the Philco Transistor types suitable for most major applications and their typical performance in practical circuit design. These charts, used with the Philco Reference Chart and individual data sheets, will help you select the proper Philco Transistor for most circuits. More detailed information on specific types and applications will be sent to you upon request.

*PULL OUT THIS 4-PAGE SECTION and KEEP IT HANDY FOR REFERENCE*

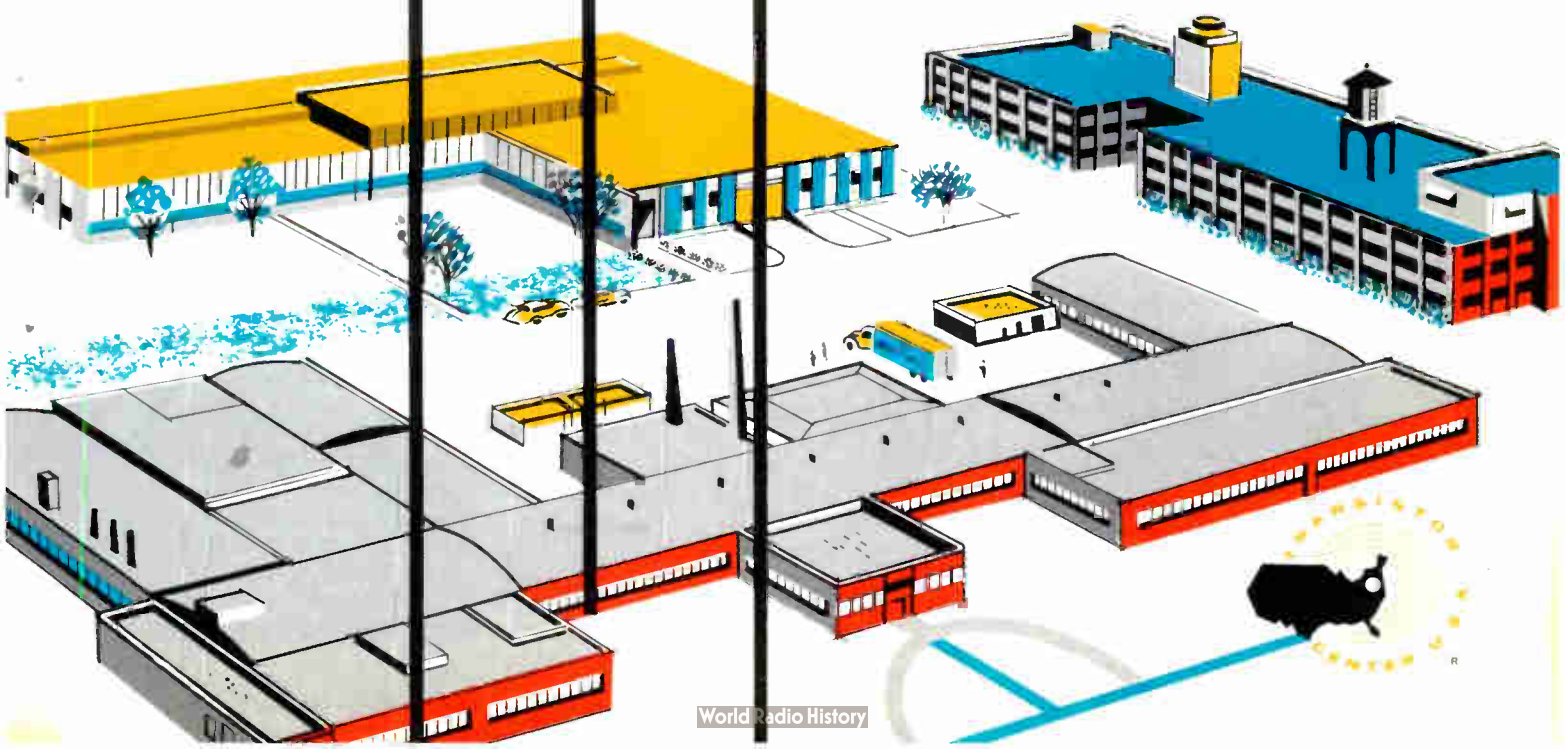

POWER GAIN (db)

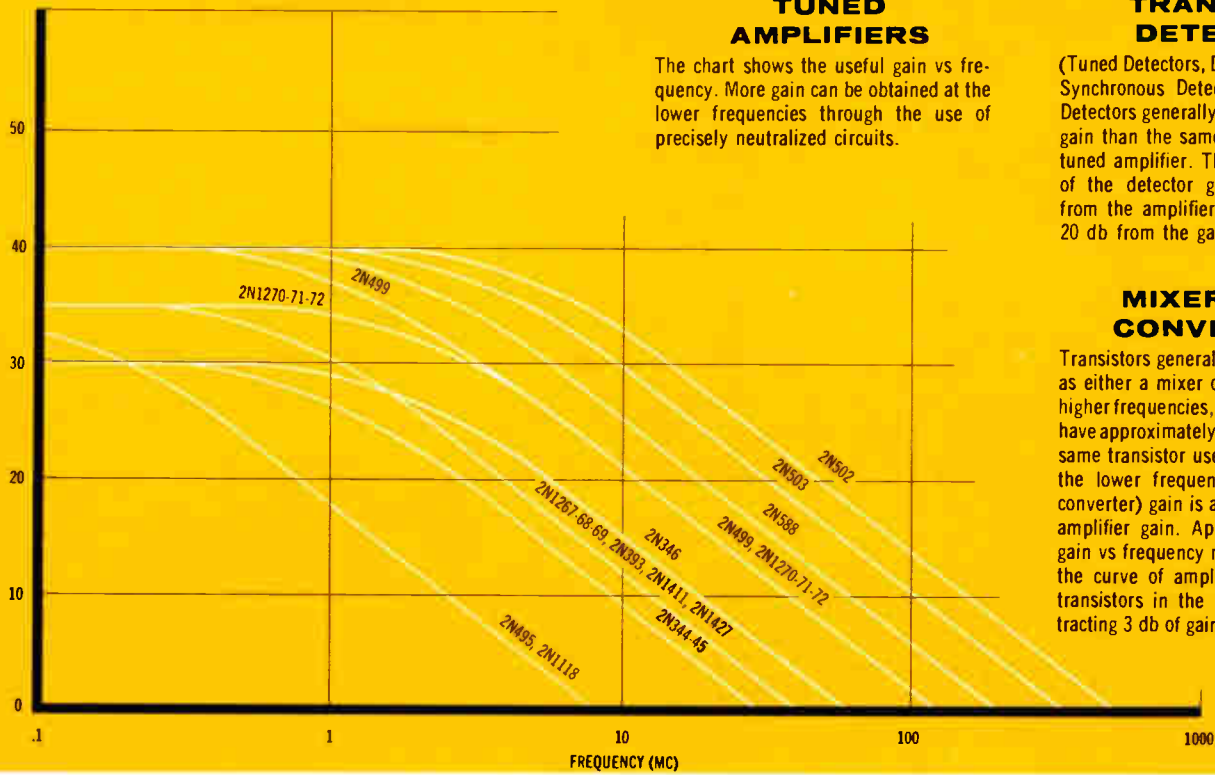

### TUNED AMPLIFIERS

The chart shows the useful gain vs frequency. More gain can be obtained at the lower frequencies through the use of precisely neutralized circuits.

### TRANSISTOR DETECTORS

(Tuned Detectors, Dynamic Detectors and Synchronous Detectors.)  
Detectors generally have about 20 db less gain than the same transistor used as a tuned amplifier. The approximate value of the detector gain can be obtained from the amplifier chart by subtracting 20 db from the gains given.

### MIXERS AND CONVERTERS

Transistors generally have the same gain as either a mixer or a converter. At the higher frequencies, mixers and converters have approximately 3 db less gain than the same transistor used as an amplifier. At the lower frequencies the mixer (and converter) gain is about the same as the amplifier gain. Approximate conversion gain vs frequency may be obtained from the curve of amplifier gain for various transistors in the product line by subtracting 3 db of gain.

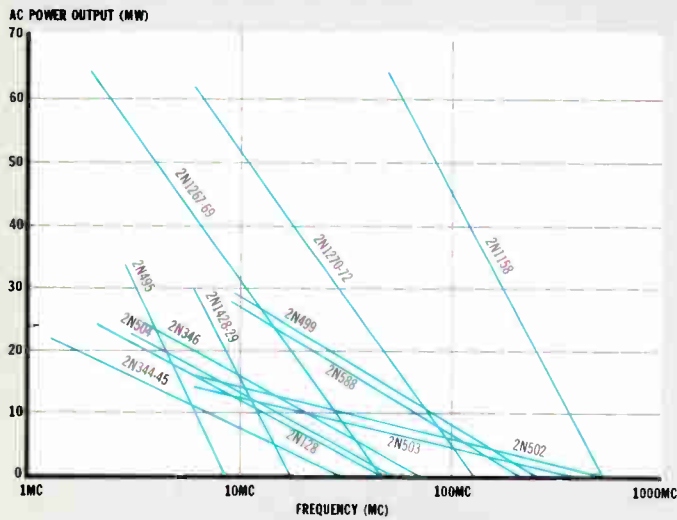

### OSCILLATORS

The chart shows the maximum power output that could be obtained in a matched oscillator. For low level oscillators as used in the front end of receivers the transistor will operate satisfactorily up to 80% of the frequency given for 0 power output.

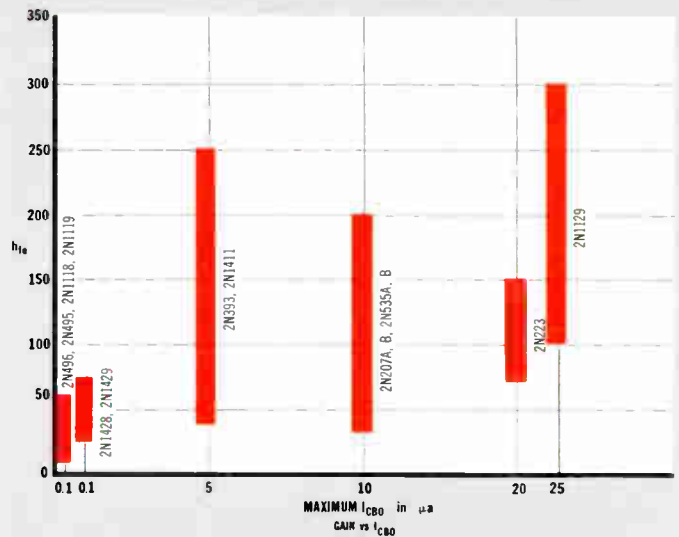

### DC AMPLIFIERS

Two parameters of the transistor are important in the DC amplifier. The gain of an individual stage is determined by the beta and the temperature drift is primarily determined by the  $I_{CBO}$ . A chart of beta range vs  $I_{CBO}$  (maximum) is given for the types which are particularly useful for DC amplifier design.

### AUDIO AMPLIFIERS

- |  |   |  |  |
|--|---|--|--|
| <p>1. LOW POWER (Less than 50 mw)</p> <p>2N207, A, B<br/>2N534<br/>2N535, A, B<br/>2N536</p> | <p>2. MEDIUM POWER (Less than 500 mw)</p> <p>2N223 2N1125<br/>2N224 2N1128<br/>2N226 2N1129<br/>2N1124 2N1130</p> | <p>3. HIGH POWER (Up to 30 watts)</p> <p>2N386<br/>2N387</p> | <p>4. SPECIAL PURPOSE</p> <p>LOW NOISE<br/>2N207A, 2N207B<br/>2N535A, 2N535B</p> |
|--|---|--|--|

**SILICON** High frequency transistors for high temperature applications:

SAT <sup>®</sup> (PNP)	SADT <sup>®</sup> (NPN)
2N495 2N1119	2N1199 2N1270
2N496 2N1428	2N1267 2N1271
2N1118, A 2N1429	2N1268 2N1272
	2N1269 2N1472

# PHILCO<sup>®</sup>



Famous for Quality the World Over

TO USE CHART BE SURE TO LOCATE TYPE NUMBER ON BOTH AXES.

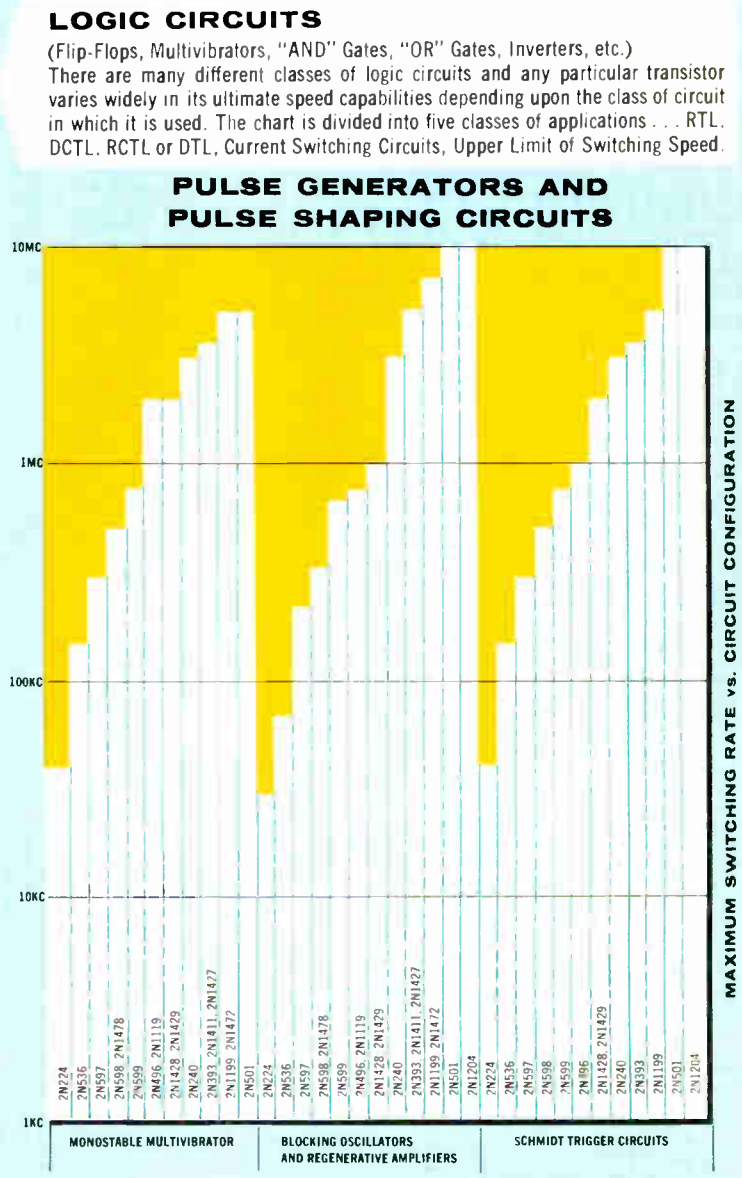
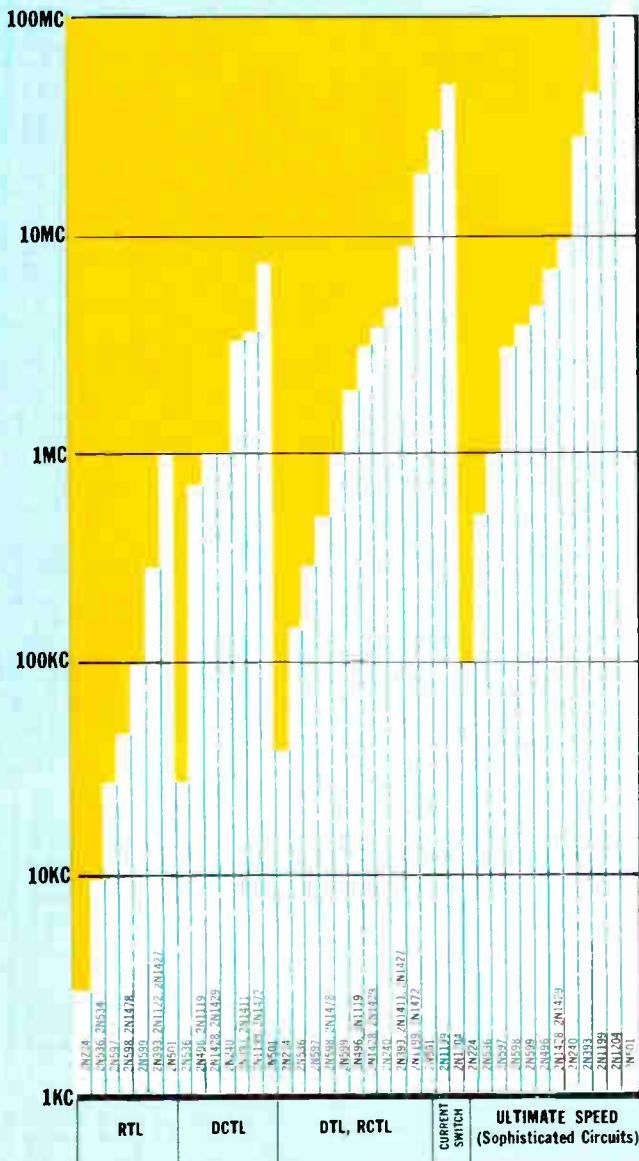
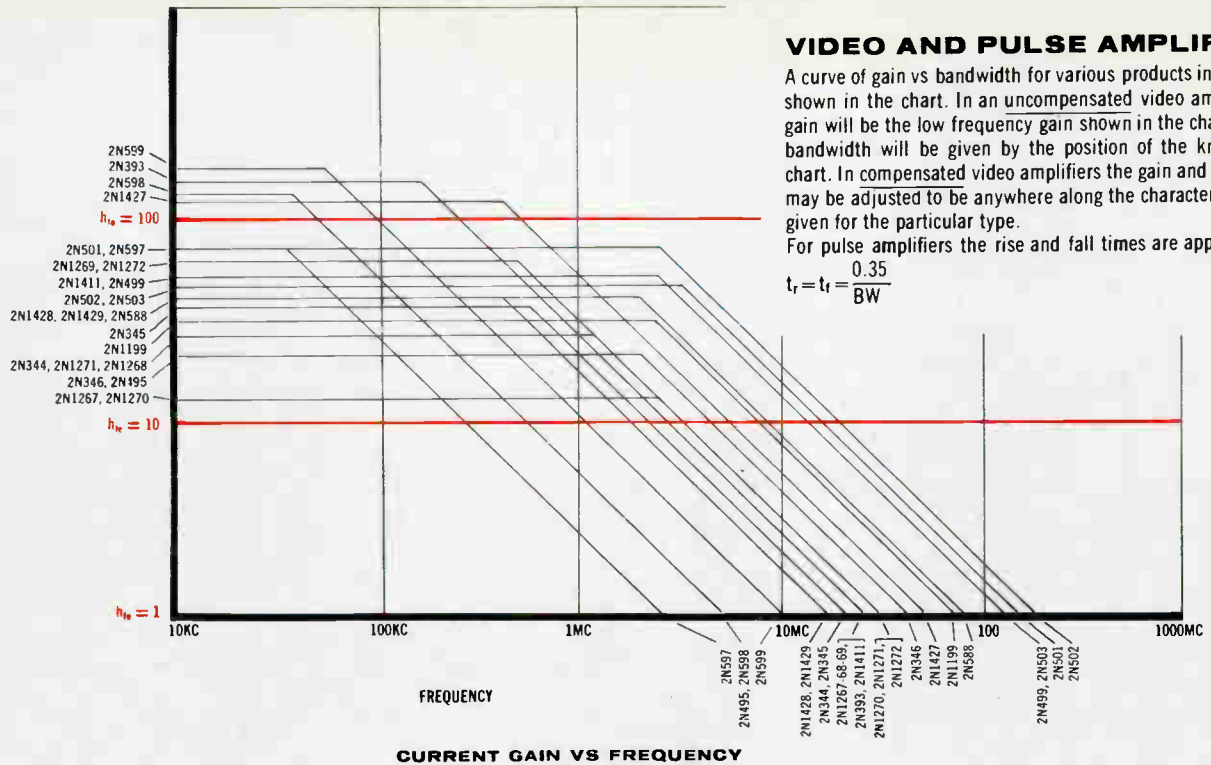



## CHOPPERS (Synchronous Switches)

The following transistors are specifically recommended for chopper circuits:

### Germanium.

2N224, 2N536 General purpose low frequency chopper.  
 2N393, 2N1411, 2N1427 Very low offset voltage, high frequency response. (Use 2N1122 and 2N1122A for high voltage applications.)

### Silicon.

2N495 General purpose chopper.  
 2N1428-2N1429 Low offset voltage—low offset current—high frequency response. Recommended for general purpose chopper applications.

### Silicon Units with Chopper Specifications

T1452-T1581 Medium level choppers with offset voltage guaranteed to be less than 3 mv.  
 T1453-T1582 Matched pairs of the above units for symmetrical chopper applications.  
 T1507-T1558 Special units for very low level chopper applications. Offset voltage guaranteed to be less than 1 mv.

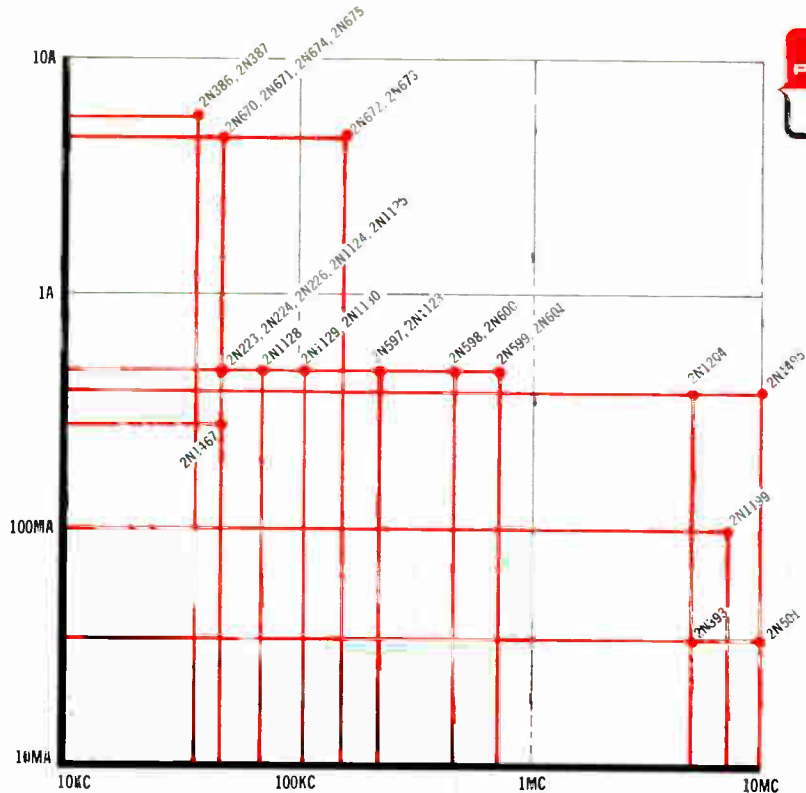

## HIGH CURRENT PULSE AMPLIFIERS

(Line Drivers, Core Drivers, Read-Write Amplifiers, etc.)  
 The chart shows the peak current that may be switched as a function of the upper switching rate. The switching rates given are for reasonable circuit design. For most types higher switching rates can be obtained through the use of complex circuitry or through reduction in stage gain.

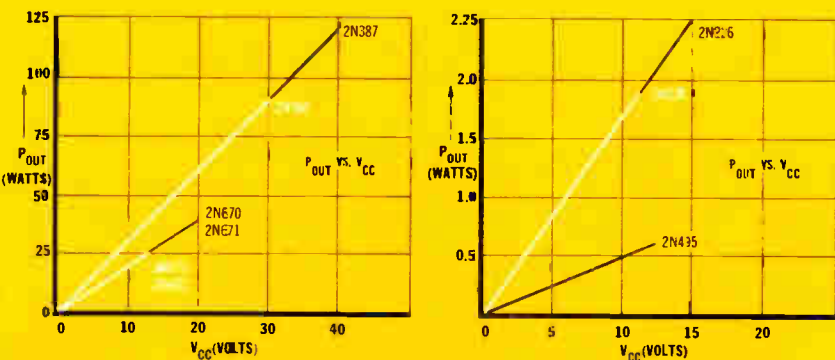

## POWER CONVERTERS

(DC to DC Converters, DC to AC Converters, Inverters, etc.)  
 The chart shows the total power output which may be extracted from the converter as a function of the supply voltage for products which are particularly applicable to this service.

## SOLENOID, RELAY CURRENT

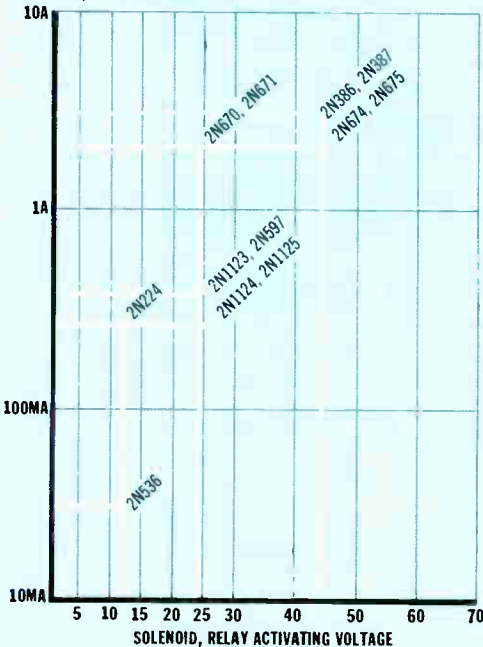

## RELAY DRIVERS

(Solenoid Drivers, Motor Drivers, Actuator Drivers and other low Frequency High Current Circuits)  
 These circuits are generally used to drive loads operating at 6, 12, 18, 24, 28 or 36 volts. The chart shows the peak load current which may be handled vs the supply voltage in the above categories for types particularly applicable to this class of circuits.

## WRITE FOR THESE HELPFUL BOOKLETS

Philco's Reference Chart lists all major Philco Transistor types; shows their most important characteristics and primary applications. Used in conjunction with the charts in this lift-out insert, the reference chart is invaluable in selecting the right transistor for your circuit.

Another useful aid in choosing the proper transistor is this complete index of Laboratory Application Notes, listing all reports available to date.

Write for your copies of both booklets . . . without cost or obligation. Address: Dept. S-1.

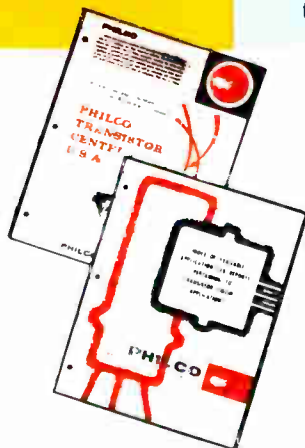

All types immediately available in quantities 1-999 from your local Philco Semiconductor Distributor.

**PHILCO**®

*Famous for Quality the World Over*

LANSDALE DIVISION  
 LANSDALE, PENNSYLVANIA

# SOLVED

## Circuit Design Reliability Problems

**New** tool for the Reliability Engineer ... the AIL Type 90 is designed to test low frequency (audio, video and computer) circuits by the "extreme values" or "worst case" technique. Circuits may be tested for all combinations of anticipated low and high values for as many as 16 parameters. Up to 6000 tests per minute may be conducted.

Digital read out permits determination of circuit combinations which produce unacceptable performance. The total number of parameters available combined with the total number of parameters successfully tested to their extremes, provide a measure of the reliability factor of the circuit under test.

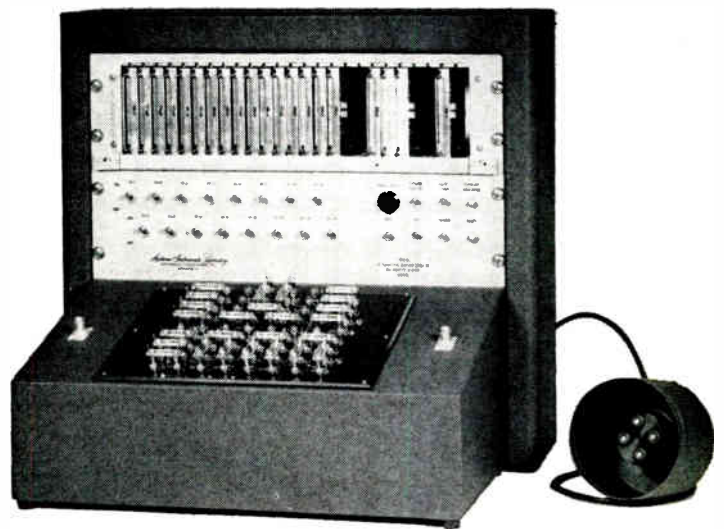

*6000 tests a minute*

**AIL Type 90 Circuit Design Reliability Tester \$3600.00**

*Write for full details*



**AIRBORNE INSTRUMENTS  
LABORATORY**  
DEER PARK, LONG ISLAND, NEW YORK  
**A DIVISION OF CUTLER-HAMMER INC.**

# MANSON CUSTOM ENGINEERING IN MODULATORS

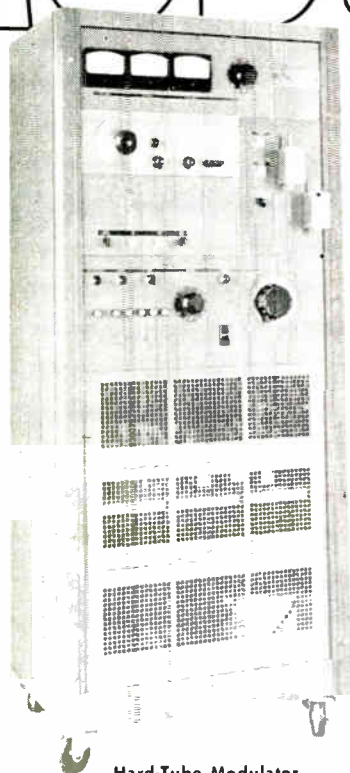

Hard-Tube Modulator,  
350-Kilowatt Unit #240

- **POWER (peak):** 350 kilowatts
- **VOLTAGE (peak):** 17 kilovolts
- **CURRENT (peak):** 20 amps.
- **PULSE WIDTHS:** 1.0 to 10.0 microseconds, continuously variable
- **PULSE REPETITION FREQUENCY:** 20 to 10,000 pps, continuously variable, internally controllable by means of a built-in audio oscillator. In addition, a trigger input jack allows modulator to be operated from an external trigger source, at lower repetition frequencies.
- **MAXIMUM AVERAGE POWER:** 1400 watts
- **T.U.T. FILAMENT SUPPLY:** 0 to 15 volts AC @ 10 amps.

**Advanced engineering at modest cost is Manson's outstanding achievement in the field of pulse techniques. If you have a problem touching on this field, call for MANSON CUSTOM ENGINEERING to help you solve it . . . it may be the most important help you have ever had!**

Soft-Tube Modulator,  
30-Megawatt Unit #237

- **POWER (peak):** 30 megawatts
- **VOLTAGE (peak):** 200 kilovolts into 1300 ohms
- **CURRENT (peak):** 150 amps.
- **PULSE WIDTHS:** 1, 1, 2, 4, 6 and 8 microseconds, measured at 90% voltage points
- **PULSE REPETITION FREQUENCY:** 50 to 1800 pps, continuously variable with higher PRFs at reduced power
- **MAXIMUM AVERAGE POWER:** 60 kilowatts
- **MONITORING:** Current-viewing resistor for T.U.T. primary; capacitance voltage dividers for viewing (1) primary of auxiliary pulse transformer, (2) primary of T.U.T., (3) secondary of T.U.T. and (4) grid drivers to thyatrons

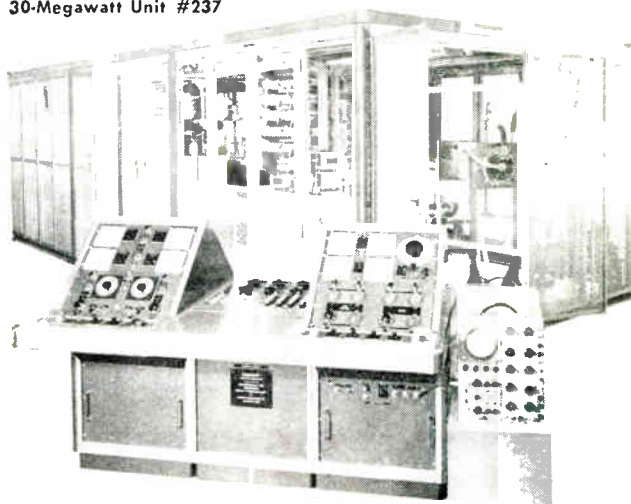

MANSON



LABORATORIES, INC.

375 FAIRFIELD AVENUE, STAMFORD, CONNECTICUT • DAVIS 5-1391



Reliability comes  
in **3** small  
packages...

# Sylvania Silicon Rectifiers

Small in size, giants in performance—Sylvania Silicon Rectifiers are quality-controlled for applications in *industrial power supplies* and *magnetic amplifiers*.

SYLVANIA offers *excellent availability at competitive prices* of all registered 1N-types with p.i.v. to 1000-Volts and forward current ratings to 1-ampere.

ALL 3 packages conform to military requirements

**Top Hat package**  
offers mechanical versatility of  
"wire-in" or "clip-in" design.



**Epoxy-Bullet package**  
offers extraordinary compactness for volumetric efficiency, and 100% case insulation against external short circuiting. The encapsulating material is fire-resistant.



**Stud package**  
with integral threaded mounting lug offers excellent heat-sink plus a fixed "top" terminal lug.

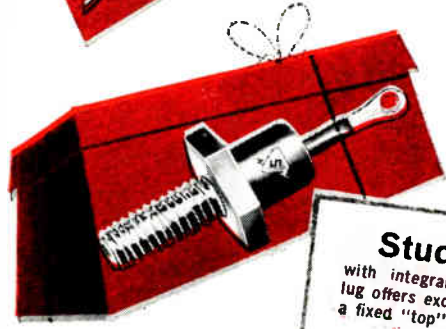

for environment. Modern production techniques, stringent test procedures, careful controls of purity of materials and surface cleanliness minimize contaminants, result in units that feature low leakage, promise long life operation.

Contact your Sylvania Field Office or your Local Sylvania Franchised Distributor for sales information. For technical data on specific 1N-types, write Semiconductor Division, Sylvania Electric Products Inc., Dept. 225B, Woburn, Mass.

# SYLVANIA

Subsidiary of **GENERAL TELEPHONE & ELECTRONICS** 

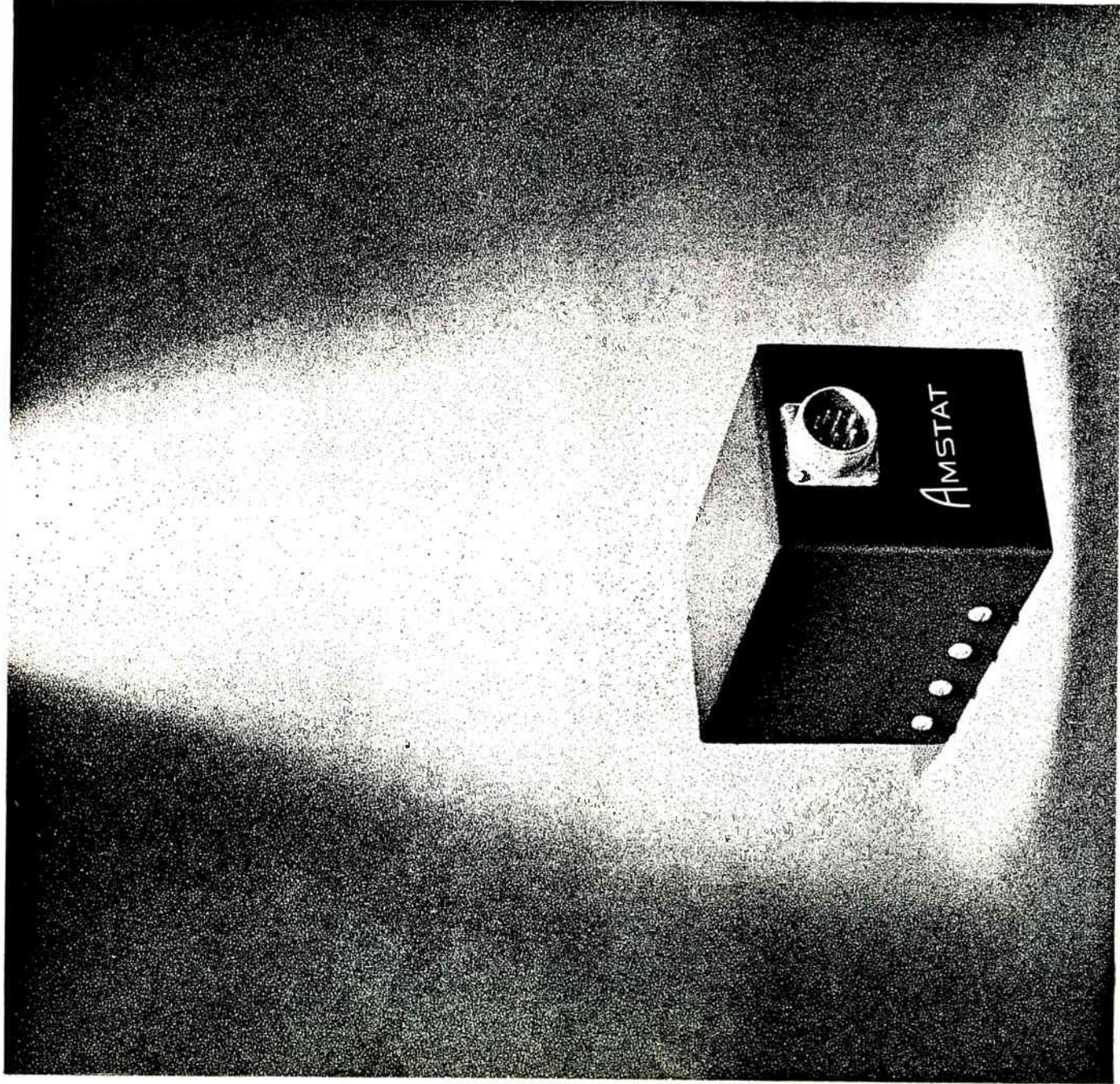

### **The black box that caused a revolution in power conversion**

AMSTAT Inverters, Converters and Frequency Changers — American Electronics' revolutionary new designs in static power conversion equipment now feature the use of Silicon Controlled Rectifiers offering greater reliability and wider systems applications. • AEI's Precision Power Division, long a leader in rotary and solid state power conversion, has pioneered the use of Silicon Controlled Rectifier units that provide simplified component circuitry while maintaining safety margins in both temperature and voltage fluctuations. • These new AMSTAT designs offer fail-safe protection for your systems with longer life, unmatched reliability and resultant lowered costs. For the full AMSTAT story on power conversion, please write for the AMSTAT brochure, or contact your nearest Precision Power Division representative.

**A** **AMERICAN ELECTRONICS, INC.**  
**E** **PRECISION POWER DIVISION**

9705 KLINGERMAN STREET, EL MONTE, CALIFORNIA  
 CUMBERLAND 3-7721

## New Sales Rises Reported

HIGHEST EARNINGS in company history are reported by **Transitron Electronic Corp.**, Wakefield, Mass., for the 13 weeks ended Mar. 26 this year. Sales totalled \$13,128,611 compared with \$11,829,026 in the previous quarter. Net income for the 13 weeks was \$2,154,216 or 29 cents a share on 7,502,500 shares, compared with a figure of \$2,030,213, or 27 cents a share on the same number of shares in the previous quarter.

**General Transistor Corp.**, Jamaica, N. Y., announces net sales of \$3,060,200 in the first quarter of 1960. This is an increase of 38 percent over the \$2,218,400 recorded in the first quarter of 1959. Net income after taxes in the 1960 first quarter was \$181,900, a rise of 12 percent over the \$162,300 earned in the comparable 1959 period. Earnings per share this year for the quarter ended Mar. 31 were 20½ cents.

**International Rectifier Corp.**, El Segundo, Calif., reports passage of a vote by its directors to split the common stock of the company on a two-for-one basis subject to approval by shareholders. Earnings for the company for the nine months ended Mar. 31, 1960 increased 65.1 percent. Sales rose 26.1 percent over the equivalent period a year ago. Net sales for the period ended last March were \$9,934,386 compared with \$7,876,452 for the period ended in Mar., 1959. Net income after taxes for this year's period was \$924,248, or 81 cents a share.

**Houston Fearless**, Los Angeles, reports sales of more than \$15 million in 1959 compared with \$4.2 million in 1958. Three new divisions acquired during 1959 were all reported to be profitable. Company shareholders have approved the authorization of common shares to be increased to 7,500,000, with 250,000 shares authorized for a restricted employee stock option plan.

**Textron Electronics**, Providence, R. I., announces first quarter sales of \$6,355,000, net income before federal taxes of \$425,000 and net income for the 1960 period of \$226,000. This is equivalent to 8 cents per share on about 2,890,000 shares now outstanding. The company's business backlog as of Mar. 31 this year stood at \$5 million.

**Siegler Corp.**, Los Angeles, reports net earnings of \$2,467,000 for the nine-month period ended Mar. 31, 1960. This is equal to \$1.50 per share on the 1,644,402 shares currently outstanding. These figures represent a 42.4 percent increase over the comparable period a year ago—\$1,732,080 or \$1.11 per share. Net income this year before taxes amounted to \$4,841,175 as compared with pre-tax profits of \$3,186,922 for the like period a year ago.

### 25 MOST ACTIVE STOCKS

	WEEK ENDING MAY 6			
	SHARES (IN 100's)	HIGH	LOW	CLOSE
Int'l Tel & Tel	1,321	42¾	38¾	42
Ampex	982	34	30½	32¾
RCA	977	74½	69½	73½
Univ Controls	737	15¾	12¾	14¾
Sperry Rand	607	21¾	20½	21¾
Temco Aircraft	596	14¾	12¼	14¼
Gen Electric	553	90¾	87½	89¾
Electronics Capital	540	19½	14	15
Westinghouse	482	55	52½	54¾
Burroughs	481	33¾	31¾	33¼
Lockheed Aircraft	472	22	20½	20¾
Fairchild Camera	472	166	150¾	154½
Philco Corp	462	31¼	28½	31
Gen Inst	455	31½	29¼	30¼
Collins Radio	439	54½	48	52¼
Siegler Corp	405	39¼	36¾	38¾
Raytheon	398	39¼	35½	37
DuMont Labs	395	9½	7¾	7¾
Int'l Resistance	394	23¾	20½	22¾
Gen Dynamics	386	40	38	38¾
Texas Inst	382	218	201¼	214½
Litton Ind	349	75¾	70½	73
Gen Tel & Elec	339	83¼	81½	81½
Beckman Inst	334	80	74¼	80
Republic Aviation	317	25	23¼	24¼

The above figures represent sales of electronics stocks on the New York and American Stock Exchanges. Listings are prepared exclusively for ELECTRONICS by Ira Haupt & Co., investment bankers.

### DIVIDEND ANNOUNCEMENTS

	Amount per Share	Date Payable
Consolidated Electronics Ind.	\$.25	Jun. 1
Marcus Transformer	5%	Jun. 6
Stewart-Warner	.35	Jun. 11
Tv-Electronics Fund	.04	May 31

# MAGNETRON CONNECTORS



Specify JETTRON for all types of magnetron connectors for vital military or commercial equipment. Complete facilities for the design and production of "specials" and other precision components including sockets and cable assemblies.

Magnetron Input Connector Cat. 9000-C

Fits 4J52A and similar Magnetrons. Features floating heater contact, eight prong heater-cathode contact of silver plated, heat treated beryllium copper. Molded silicone encloses metal body.



Magnetron Input Connector Cat. 9005-C



Fits 4J52A and similar Magnetrons. Features identical to Cat. 9000-C. In addition has 75 mil thick silicone insulated cables for higher potential applications. Made with 4700 µf built-in capacitor.

Magnetron Input Connector Cat. 9040

One of the many "Specials" Jettron has made. Basic Input Connector with floating heater contact. Supplied with or without bypass capacitor. Normally potted to the magnetron input end.



Magnetron Input Connector Cat. 9050



Fits Miniature Magnetrons such as L-3028B. Beryllium copper heater and cathode contacts assure dependable contact. Silicone cup fits snugly over magnetron input end. Leads insulated with silicone.

Magnetron Input Connector Cat. 9060

Fits Miniature Magnetrons such as L-3028B. Features similar to Cat. 9050 but supplied less silicone enclosure. Leads extend axially from body of connector. Normally potted to magnetron input end.



Call or write for bulletins on special sockets, magnetron and other connectors

## JETTRON PRODUCTS • INC

56 Route 10, Hanover, New Jersey  
Telephones: TUCKER 7-0571-0572

Sales Engineers in Principal Cities



## At The Ramo-Wooldridge Laboratories... integrated programs of research & development of electronic systems and components.

The new Ramo-Wooldridge Laboratories in Canoga Park provide an environment for creative work in an academic setting. Here, scientists and engineers seek solutions to the technological problems of today. The Ramo-Wooldridge research and development philosophy places major emphasis on the imaginative contributions of the members of the technical staff. ■ There are outstanding opportunities for scientists and engineers. *Write* Dr. Richard C. Potter, Head, Technical Staff Development, Department 21-D.



**THE RAMO-WOOLDRIDGE LABORATORIES**

8433 FALLBROOK AVENUE, CANOGA PARK, CALIFORNIA

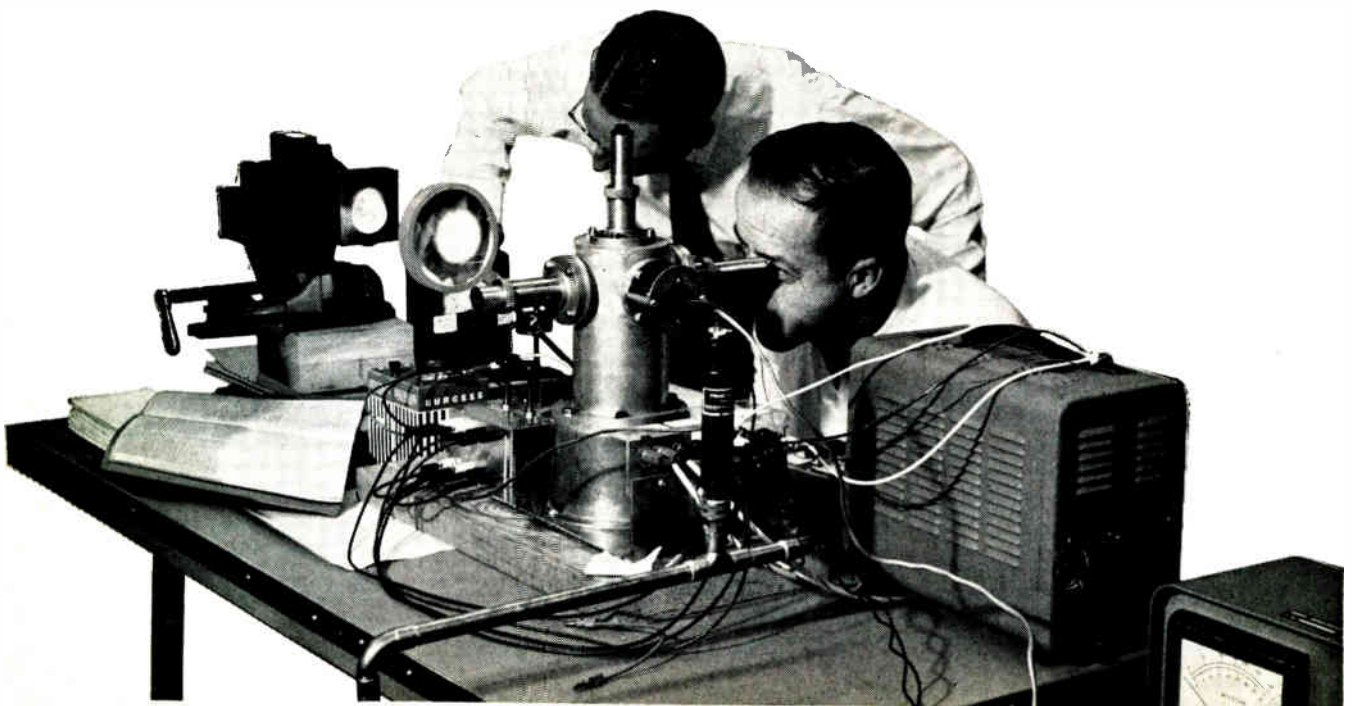

An electron device permits scientists to study the behavior of charged dust particles held in suspension.



*the science of*  
**rotation...**

**SIZE 8—SERVO  
TACHOMETER  
TYPE SJ7HLZ7-4**



High Performance  
plus Low Tachometer Power

This small motor tachometer features high torque output per watt input and excellent signal to noise ratio. It is an ideal choice for those applications where space is limited yet the high performance and reliability of a precision damping, motor generator is required. Other BuOrd Size 8 motors, tachometers and gearhead units are available, built to E.A.D.'s high standards as well as to meet specific customer requirements.

**TYPICAL CHARACTERISTICS**

**GENERAL:** Frequency, 400 c.p.s. • Rotor Inertia, 1.2 gm.cm.<sup>2</sup> • Torque at Stall, 0.34 oz. in. • Oper. Temp. Range, -55° to 150° C • Weight, 2.8 oz.

**MOTOR:** Motor Voltage (fixed & control phases), 26 • Power (Stall), 2.5 Watts

**GENERATOR:** Excitation, 26v, 400 c.p.s. • Power (Stall), 1.5 Watts • Output at 0 RPM, 0.010 V.R.M.S. • Output Voltage, 250 Mv/1000 RPM • Signal to Null Ratio, 25/1 at 1000 RPM

Write for complete Technical Data

*Eastern Air Devices' contribution to systems design is the science of rotation. This concept represents the basic engineering and production approach of a company whose products are specified everywhere to meet the critical performance and reliability requirements of today's systems . . . tomorrow's designs. Eastern Air Devices' product line — the most complete and diversified in the industry today — and the company's new developments in bearing life, high temperature insulations, oxidation protection . . . reflect the technical confidence developed during 18 years in the application of the many sciences of rotation. At Eastern Air Devices you are assured of a 1960 scientific approach to the application of rotating electrical components . . . whether you select from the standard line or order special designs.*

**EASTERN AIR DEVICES, INC.**



*Subsidiary of Norbut Corporation • Dover, New Hampshire*

**INDUCTION MOTORS • SERVO MOTORS • HYSTERESIS MOTORS  
INTEGRATING TACHOMETERS AND MOTOR TACHOMETERS • BLOWERS  
INERTIALLY DAMPED SERVO MOTORS • TORQUE MOTORS • FANS  
DAMPING MOTOR TACHOMETERS • GEAR MOTORS • ALTERNATORS**

VARIAN  
Potentiometer  
RECORDERS

A preferred size for many  
uses because . . .

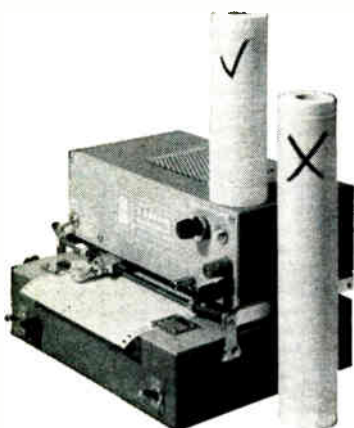

8. FIVE-INCH CHARTS ARE  
**ECONOMICAL.**

A 50% savings in paper can mean hundreds or thousands of dollars in the life of a recorder. Five-inch charts are handier too for notebooks, reports or files. And in round-the-table conferences, smaller charts can be set side by side, giving more data and less clutter.

1 & 2 channel versions use same 5-inch chart paper; 1% limit of error and 1 or 2½ second full-scale balancing time; chart speeds from ½ inch per hour to 16 in./min.; prices from \$365; numerous options described in Varian literature. Write the Instrument Division.



**VARIAN**  
**associates**

PALO ALTO 1, CALIFORNIA

Sonic Cleaning Gear Sales Up 30%

ULTRASONIC CLEANING EQUIPMENT market is mushrooming. It has been a popular subject of market investigation in recent months.

Hank Osterman, sales manager of Branson Instruments, a leading manufacturer of ultrasonic cleaning equipment, estimates 1960 sales will total \$15 million, up from about \$11 million in 1958. He figures sales will continue to increase at rate of about 30 percent over the next five years, and will mount to \$50 to \$60 million by 1965.

Ultrasonic cleaning is an accepted fact today for small, expensive parts used in electronic equipment. However, it is being increasingly used in high-volume, low-cost applications such as pickling of metal, wire and high-speed degreasing of sheet metal and wire. It is in this area of general industry use, particularly metal finishing firms, where greatest future sales growth is expected, says Osterman.

Individually engineered systems using relatively high-priced custom-designed cleaning equipment are augmenting sales to mass-production industry users.

Development of company salesmen and electronics manufacturers' reps who can talk to customers on economic values in addition to technical values has been an important factor in opening up the general industry market, says Osterman. Most of these customers don't understand the "black box" approach but have a ready understanding of cost reduction and quality improvement, he says.

Electronic Industries Association issues its 1960 Fact Book, the handy summary of electronics industry statistics and trends. It is supplied to non-members at a charge of 75¢.

Electronics industry factory sales in 1959 totaled \$9.2 billion. This included equipment sales to the military worth \$4.7 billion, industrial and commercial sales of \$1.6 billion, consumer sales of \$2 billion, plus replacement parts worth \$900 million.

Industry trends highlighted in the report are:

1. During the next decade over \$14 billion will be authorized for space program spending, and about one-third of this sum will be for electronics. New commercial and public service markets will evolve from the application of space technology to electronics production for commerce, industry and the consumer.

2. Space era has already induced a strong trend toward "smallness" in electronic systems. Research programs in many firms are oriented by concepts of microminiaturization. As a result, entirely different concepts are in prospect for the construction of missiles, space vehicles and a variety of conventional equipment.

3. Electronics share of military production and procurement plus military R&D rose from 7 percent in 1955 to 11 percent in 1959.

4. Latest military budget reflects trends toward increased spending for research, development, test and evaluation of new improved weapons systems and equipment.

5. Electronic control and processing instruments are improving operations in major industries in terms of cost, quality, safety, reliability.

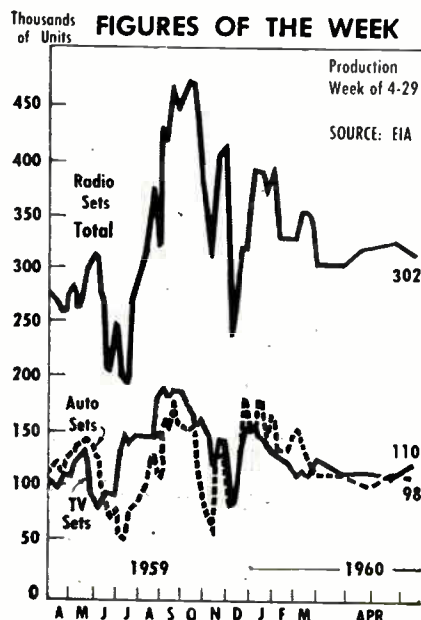



*You get an extra measure of design freedom with*  
**... POWDERED PERMALLOY FILTOROID® CORES\***

The high permeability and low core loss of powdered permalloy Filtoroid cores can remove design roadblocks for you. You can build extra frequency stability into filter networks with these cores. Their permeability *remains* stable with changes in time and flux levels. Distortion factors are held to a bare minimum. Temperature coefficient of inductance is tightly controlled.

There's extra design flexibility for you, too, in

the broad range of Filtoroid cores available. They're made in three standard permeabilities—150, 125 and 60—in sizes up to 1.570" O.D., all carried in stock for immediate shipment.

Our engineers are ready right now to help you select the proper Filtoroid core for your filter circuits. Write or call for a discussion of your needs, or send for Bulletin G-1.

\*MADE UNDER A LICENSE AGREEMENT WITH WESTERN ELECTRIC COMPANY

**M**MAGNETIC  
 **M**ETALS

transformer laminations • motor laminations • tape-wound cores  
 powdered molybdenum permalloy cores • electromagnetic shields

MAGNETIC METALS COMPANY • Hayes Avenue at 21st Street, Camden 1, N. J.



(Actual Size)

One kilowatt power in a compact ceramic package is now available to 400Mc., with the Eimac 4CX1000A radial-beam power tetrode.

The new, expanded frequency range coverage of the versatile 4CX1000A makes it ideal for AM, FM and SSB operation in the important government communication band, 225-400Mc., and for FM and VHF-TV broadcasting.

An excellent linear amplifier tube,

the 4CX1000A has low voltage, high current, high gain characteristics. It achieves maximum rated power output in Class AB<sub>1</sub>, SSB service without grid drive.

Illustrated here, actual size, it is easy to see why this compact, rugged ceramic tetrode is ideal for tight space, high power situations.

A companion air-system socket to meet your specific requirement is available with the 4CX1000A.

**TYPICAL OPERATION 4CX1000A (400Mc FM Amplifier)**

DC Plate Voltage	3000 volts
DC Screen Voltage	250 volts
DC Plate Current	750 ma
DC Screen Current	45 ma
Driver Power Output	15 watts
Useful Output Power	1100 watts

**EITEL-McCULLOUGH, INC.**



San Carlos, California



# CHRISTIE

Specialists in Power Supplies for 30 Years

# D-C POWER



WITH ENGINEERED AND CONTROLLED

## RELIABILITY

- Static-Tubeless
- All Silicon
- Built to MIL-E-4970
- Overload and Short Circuit Protection
- 500% Overload Capability

Write for new D-C Power Supply Bulletin AC-60

**CHRISTIE ELECTRIC CORP.**

3400 W. 67th Street, Los Angeles 43, California

### 300 AMP. POWER SUPPLY

Model MH32-300KP4

#### Electrical Specifications:

NOMINAL D-C OUTPUT:  
28 v. @ 300 amp. (continuous)  
VOLTAGE ADJUSTMENT RANGE:  
22 to 32 v. d-c

VOLTAGE REGULATION:  
±0.5% — combination of rated  
load and a-c input variations  
(Sensing: local or remote)

VOLTAGE RIPPLE:  
1% rms. (—20°C to +55°C)

VOLTAGE RECOVERY (63%):  
0.1 sec.— full load application  
or removal

D-C CURRENT OVERLOAD  
CAPACITY:  
125% for 5 min. every 20 min.  
250% for 5 sec. every 20 sec.  
350% for 1 sec., 500% peak

A-C INPUT:  
400-490 v., 3-ph., 57-63 cps.  
(other voltages available)

A-C CURRENT AT 440 V.:  
25 amp.

AMBIENT TEMPERATURE RANGE:  
Operating: —55°C to +55°C  
Storage: —62°C to +70°C

ENVIRONMENT, SHOCK,  
VIBRATION:

Built to MIL-E-4970

RADIO INTERFERENCE:  
Built to MIL-I-26600

#### Mechanical Specifications:

CABINET STYLE: STATIONARY  
Also other styles below

SIZE & WEIGHT:  
19" W x 19" D x 31" H.— 355 lbs.

#### Standard Features:

VOLTMETER & AMMETER:  
3½" ruggedized (MIL-M-10304)  
Recessed behind removable panel

OVERLOAD PROTECTION:  
Magnetic & thermal

PARALLEL OPERATION:  
Includes load sharing provision

OTHER FEATURES:  
Input Contactor, Pilot Light, Fan,  
Fan Failure Protection.

Over 200 Models in  
6 Cabinet Styles



Stationary



19" Rack



2-Wheel



Caster



Lab Cabinet



3-Wheel



Air-powered Gardner-Denver "Wire-Wrap" tool being used by Kellogg Switchboard and Supply Company, Division of International Telephone and Telegraph Corporation.

## Put your electrical connections on a 3-second production schedule

**Permanent** electrical connections in only three seconds. That's the solderless wrapping method—proved superior by leaders in communications and electronics. These connections are lastingly secure . . . conquer vibration failure and fight corrosion.

And only at Gardner-Denver will you find a complete line of equipment to make these connections. Gardner-Denver Wire-Wrap® tools get the job done fast . . . bring you these profit-building benefits:

**GREATER PRODUCTION** Only three seconds total time per solderless connection. Actual connecting time, 1/10 second.

**LOWER PRODUCTION COSTS** You can eliminate the expense of precise inspection required by other methods.

**REDUCED LABOR COSTS** More connections per operator, with less fatigue. No faulty connections that require expensive hand repair work.

**HIGHER QUALITY** Solderless wrapped connections are mechanically strong and electrically stable—proved most reliable in the industry.



EQUIPMENT TODAY FOR THE CHALLENGE OF TOMORROW

# GARDNER - DENVER

Gardner-Denver Company, Quincy, Illinois

In Canada: Gardner-Denver Company (Canada), Ltd., 14 Curry Avenue, Toronto 16, Ontario

**INCREASE DIE LIFE**

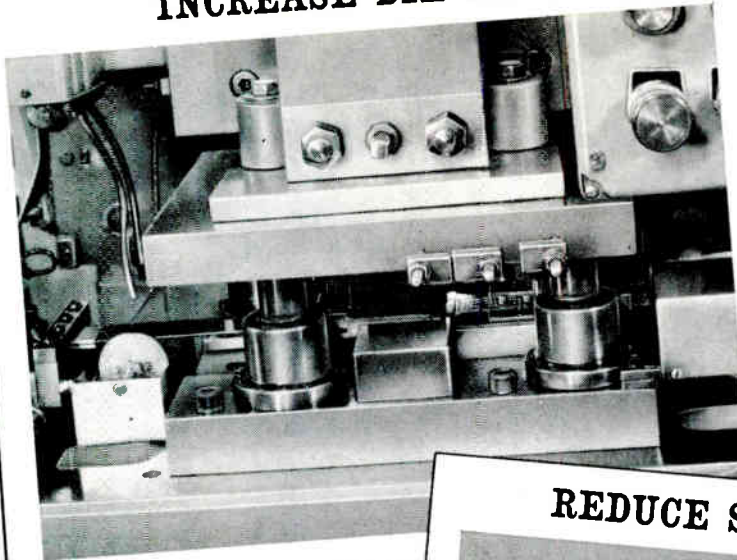

**REDUCE SEALING REJECTS**

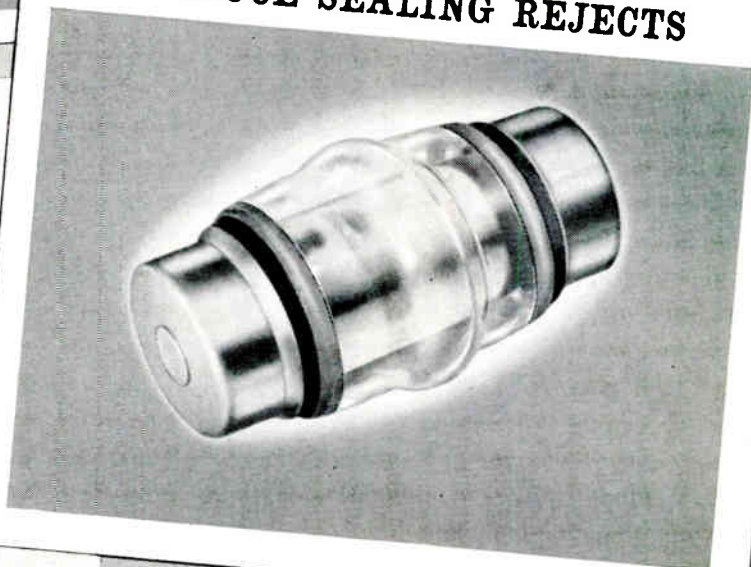

**Now get these 2 glass-sealing economies**

with **THERLO**\* **The only commercial vacuum melted glass sealing alloy available...No price increase.**

Therlo—now a commercially vacuum melted alloy made *only* by Driver-Harris—is such a metallurgically cleaner metal that it has *greater ductility* and a *better surface* than any other alloy used for the same glass-to-metal sealing applications.

For this reason it is more easily formed into desired shapes and increases die life 25-50% between sharpenings. And Therlo produces a permanent vacuum tight seal with negligible leakers on the production line.

\*T.M. Reg. U.S. Pat. Off.

Therlo matches such commercially hard glasses as Corning #7052 and #7040 in expansivity from 80° C to the annealing point. In every case where Therlo has been specified the resulting reduction in rejects both in fabrication and glass-sealing production have cut production costs impressively.

Therlo is one of four D-H alloys developed for glass-to-metal sealing of both hard and soft glass in most every sealing operation. For more information write to Dept. G.

**DRIVER-HARRIS\* COMPANY**

HARRISON, 32 NEW JERSEY

Distributors: ANGUS-CAMPBELL, INC., Los Angeles, San Francisco  
J. M. TULL METAL & SUPPLY CO., INC., Atlanta

BRANCHES: Chicago, Detroit, Cleveland, Louisville)

In Canada: The B. GREENING WIRE COMPANY, Ltd., Hamilton, Ontario

**MAKERS OF THE MOST COMPLETE LINE OF ALLOYS FOR THE ELECTRICAL, ELECTRONIC, AND HEAT-TREATING INDUSTRIES**



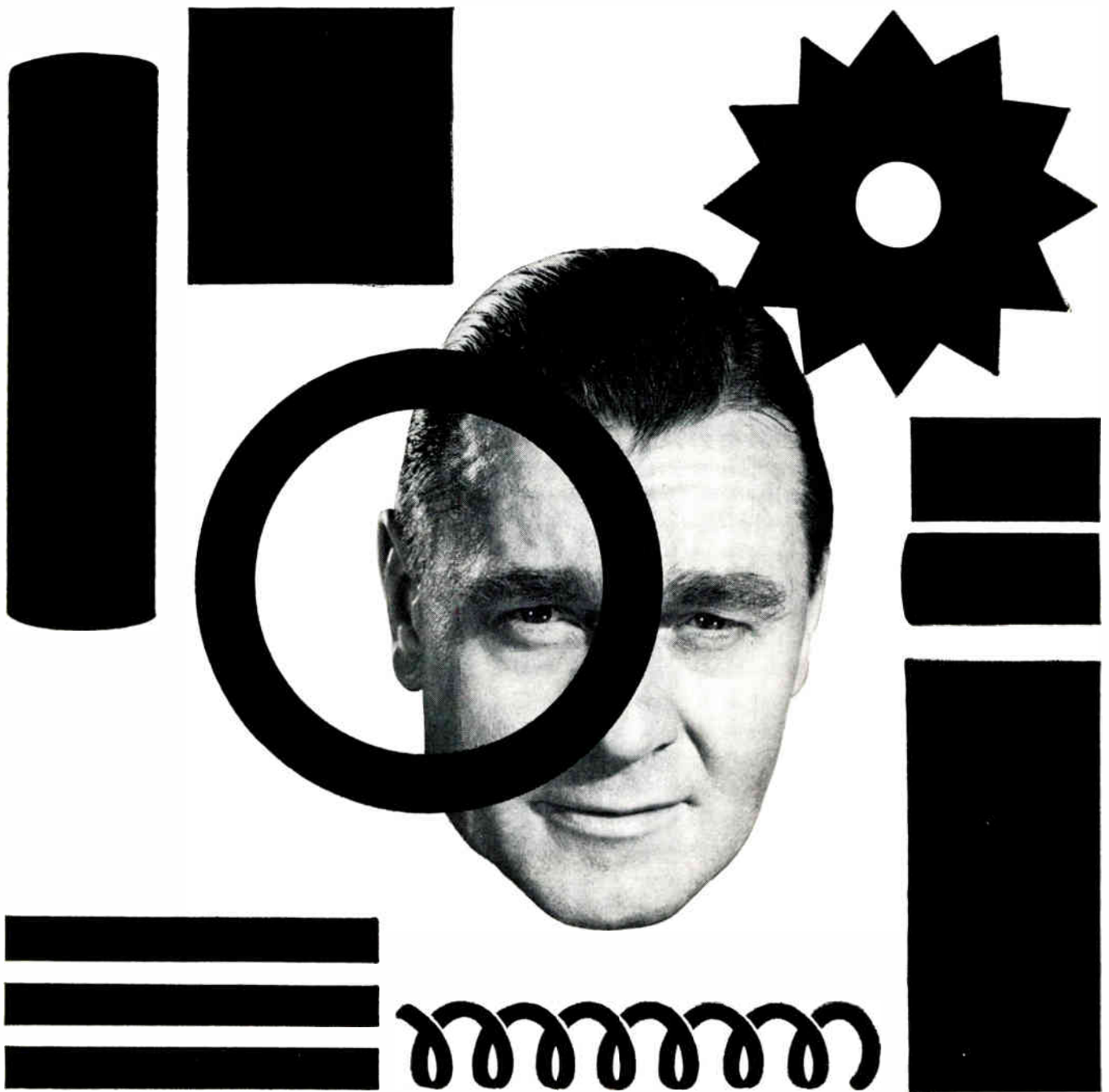

## What's the shape of your future?

Now, with greater uses of plastic laminates being found every day, Panelyte® can offer you a *complete* range of sheets, tubes and rods for whatever shape or size the part in your engineering drawing calls for. Remember: Panelyte comes in NEMA and Military Grades. *What do your specifications call for?* High dielectric strength? Low moisture absorption? Minimum cold flow under high humidity? Excellent machining characteristics? There is a Panelyte grade to fit any of these require-

ments! You can have Panelyte *copper-clad*, too, for use in the manufacture of printed circuits.

Specify Panelyte for the best in "laminated thermo-setting resinous plastics"—the accepted high-quality product! For specification sheet, write Panelyte, St. Regis Paper Co., 150 E. 42nd St., New York, N. Y.



—and here's where to call the  
**PANELYTE distributor nearest you!**

**ALABAMA**

Marine Specialty Company  
Mobile, Alabama

**ARIZONA**

Electrical Specialty Company  
Phoenix, Arizona

**CALIFORNIA**

Cadillac Plastics  
Los Angeles, California  
Electrical Specialty Company  
Los Angeles, California  
Cadillac Plastics  
San Francisco, California  
Electrical Specialty Company  
San Francisco, California

**COLORADO**

Electrical Specialty Company  
Denver, Colorado  
\*Regal Plastic Supply  
Englewood, Colorado

**CONNECTICUT**

Modern Plastic & Glass Company  
Bridgeport, Connecticut  
\*New England Non Metallics Co., Inc.  
Milford, Connecticut  
Industrial Safety Supply  
W. Hartford, Connecticut

**DELAWARE**

Brandywine Fibre Company  
Wilmington, Delaware  
Kaufman Glass Company  
Wilmington, Delaware

**FLORIDA**

Commercial Plastics Supply Corp.  
Miami, Florida

**GEORGIA**

AAA Brands Plastic Supply Co.  
Atlanta, Georgia  
Commercial Plastics & Supply Corp.  
Atlanta, Georgia

**ILLINOIS**

Cadillac Plastics  
Chicago, Illinois  
Colonial Kolonite  
Chicago, Illinois  
Insulating Manufacturing Corp.  
Chicago, Illinois

**INDIANA**

\*Hyaline Corporation  
Indianapolis, Indiana  
Cadillac Plastics  
Indianapolis, Indiana

**KANSAS**

D & O Products  
Wichita, Kansas

**LOUISIANA**

Drake-Thompson and Company  
New Orleans, Louisiana

**MARYLAND**

Gilbert Plastics and Supply Company  
Baltimore, Maryland

**MASSACHUSETTS**

Plastic Supply Co. (Hub Stamping)  
Boston, Massachusetts  
\*Insulation Products Company  
Chicopee, Massachusetts  
H&P Spool & Bobbin Company  
Lawrence, Massachusetts  
\*Laminated Sheet Products  
Norwood, Massachusetts

**MICHIGAN**

Cadillac Plastics  
Detroit, Michigan

**MINNESOTA**

Arrowhead Plastics  
Minneapolis, Minnesota  
Service Tool & Engineering  
Minneapolis, Minnesota  
\*Minneapolis Manufacturing Co.  
Minneapolis, Minnesota  
Special Parts, Inc.  
Minneapolis, Minnesota

**MISSOURI**

Regal Plastics Supply Co.  
Kansas City, Missouri  
Cadillac Plastics  
Kansas City, Missouri

Plastic Sales  
Kansas City, Missouri  
Cadillac Plastics  
St. Louis, Missouri

**NEW JERSEY**

\*Insulating Fabricators, Inc.  
East Rutherford, New Jersey  
\*Allied Plastics Supply Corporation  
Elizabeth, New Jersey  
\*Insulating Specialties, Incorporated  
Hillside, New Jersey  
Kennedy Lumber Company  
Trenton, New Jersey  
\*Rummel Fibre Company  
Union, New Jersey  
Commercial Plastics & Supply Corp.  
Newark, N. J.  
Robert McKeown Co., Inc.  
Livingston, N. J.  
\*Delta Plastics  
Bellmawr, N. J.  
\*Phirus Products  
Newark, N. J.

**NEW MEXICO**

\*Jay-Grear, Incorporated  
Albuquerque, New Mexico

**NEW YORK**

\*Thomas J. Long, Inc.  
Long Island, N. Y.  
\*Aircraft Specialties Company, Inc.  
Hicksville, New York  
\*Allied Plastics Supply Corporation  
New York City, New York  
Commercial Plastics & Supply Corp.  
New York City, New York  
\*Comco Plastics  
Ozone Park, New York  
The Plastic Center  
Rochester, New York  
\*The Frank Products Corporation  
Wesbury, New York

**NORTH CAROLINA**

\*Engineered Plastics, Incorporated  
Gibsonville, North Carolina

**OHIO**

Cadillac Plastics  
Cincinnati, Ohio  
Cadillac Plastics  
Cleveland, Ohio  
\*Dayton Plastics, Incorporated  
Columbus, Ohio  
\*Dayton Plastics, Incorporated  
Dayton, Ohio

**OKLAHOMA**

Oenton's Glass & Plastics  
Oklahoma City, Oklahoma  
Tulsa Gasket Mfg.  
Tulsa, Oklahoma  
Industrial Gasket & Packing Company  
Oklahoma City, Oklahoma

**OREGON**

Electrical Specialty Company  
Portland, Oregon

**PENNSYLVANIA**

Commercial Plastics Supply Corp.  
Philadelphia, Pennsylvania  
\*Herschel Engineering & Supply Co.  
Philadelphia, Pennsylvania  
Commercial Plastics Supply Corp.  
Pittsburgh, Pennsylvania  
\*Wood Plastics  
Wayne, Pennsylvania

**TEXAS**

Cadillac Plastics  
Dallas, Texas  
Cadillac Plastics  
Houston, Texas  
Cadillac Plastics  
Fort Worth, Texas

**WASHINGTON**

Electrical Specialty Company  
Seattle, Washington

**WISCONSIN**

Rahrs Engineering  
Manitowoc, Wisconsin  
Cadillac Plastics  
Milwaukee, Wisconsin  
\*Asbesto Fab  
Milwaukee, Wisconsin  
\*General Plastics  
Milwaukee, Wisconsin

new way to make  
products better,  
more efficient...

**ACE** PRECISION  
**NYLON BALLS**

Precision manufactured from DuPont Nylon Resin to close tolerance of  $\pm .001$  on diameters and  $.001$  on sphericity, Ace Nylon Balls give design flexibility and production economy. Light in weight... tough at low temperatures... stable at high temperatures... resistant to corroding chemicals such as sulphuric acid, etc... almost abrasionproof... these mass-produced balls have hundreds of industrial applications. Come in 14 standard sizes from  $\frac{1}{8}$ " to  $\frac{3}{4}$ ".

Complete facilities for fabrication of plastic parts for all industries. Estimates submitted promptly on receipt of blueprints or specifications.

EXTRUSION MOLDERS  AND FABRICATORS

**ACE PLASTIC COMPANY**

91-33 Van Wyck Expwy., Jamaica 35, N. Y., JAMAICA 3-5500

CIRCLE 201 ON READER SERVICE CARD

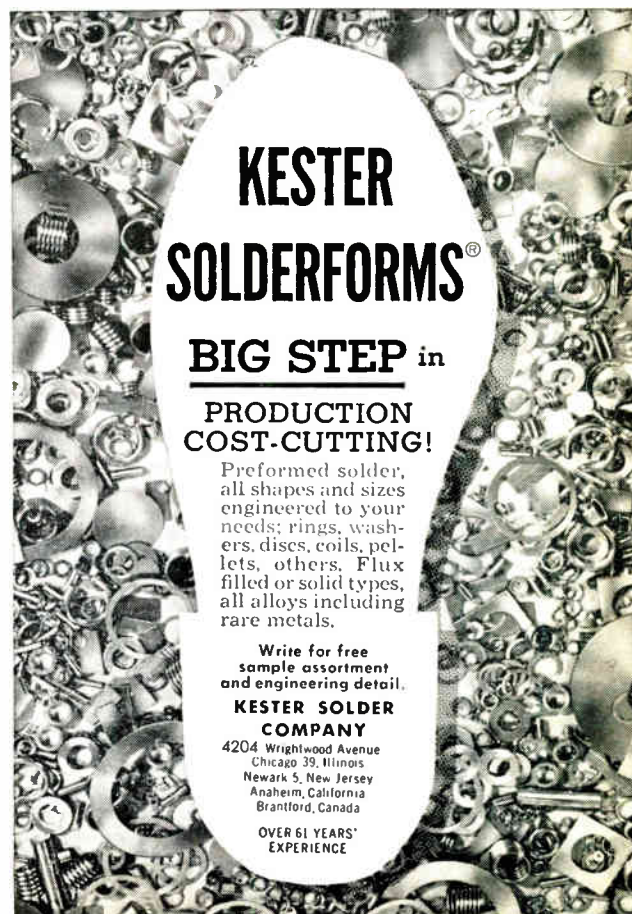

**KESTER**  
**SOLDERFORMS®**

**BIG STEP** in  
**PRODUCTION**  
**COST-CUTTING!**

Preformed solder, all shapes and sizes engineered to your needs; rings, washers, discs, coils, pellets, others. Flux filled or solid types, all alloys including rare metals.

Write for free sample assortment and engineering detail.

**KESTER SOLDER COMPANY**  
4204 Wrightwood Avenue  
Chicago 39, Illinois  
Newark 5, New Jersey  
Anaheim, California  
Brantford, Canada

OVER 61 YEARS' EXPERIENCE

\*Distributor-Fabricators who can give special attention to your fabrication needs.

CIRCLE 200 ON READER SERVICE CARD



**Get much more information in the ...**



## **new electronics BUYERS' GUIDE**

When designs call for products in the field of electronics, the Guide solves problems *in advance*.

There's a 64-page reference section with up-to-the-minute data on markets, materials, components and applications to make product selection easier.

You'll find detailed facts about the products of nearly 700 advertisers — that's 42% more than you'll find in

any other similar guide.

Also local sales offices of manufacturers . . . the names, addresses, and phone numbers of representatives . . . complete lists of manufacturers . . . registered trade names . . . and, of course, the most complete list of electronic and related products. Tells you what you need to know *when you are ready to buy*.



A McGraw-Hill Publication • 330 West 42nd Street, New York 36, New York

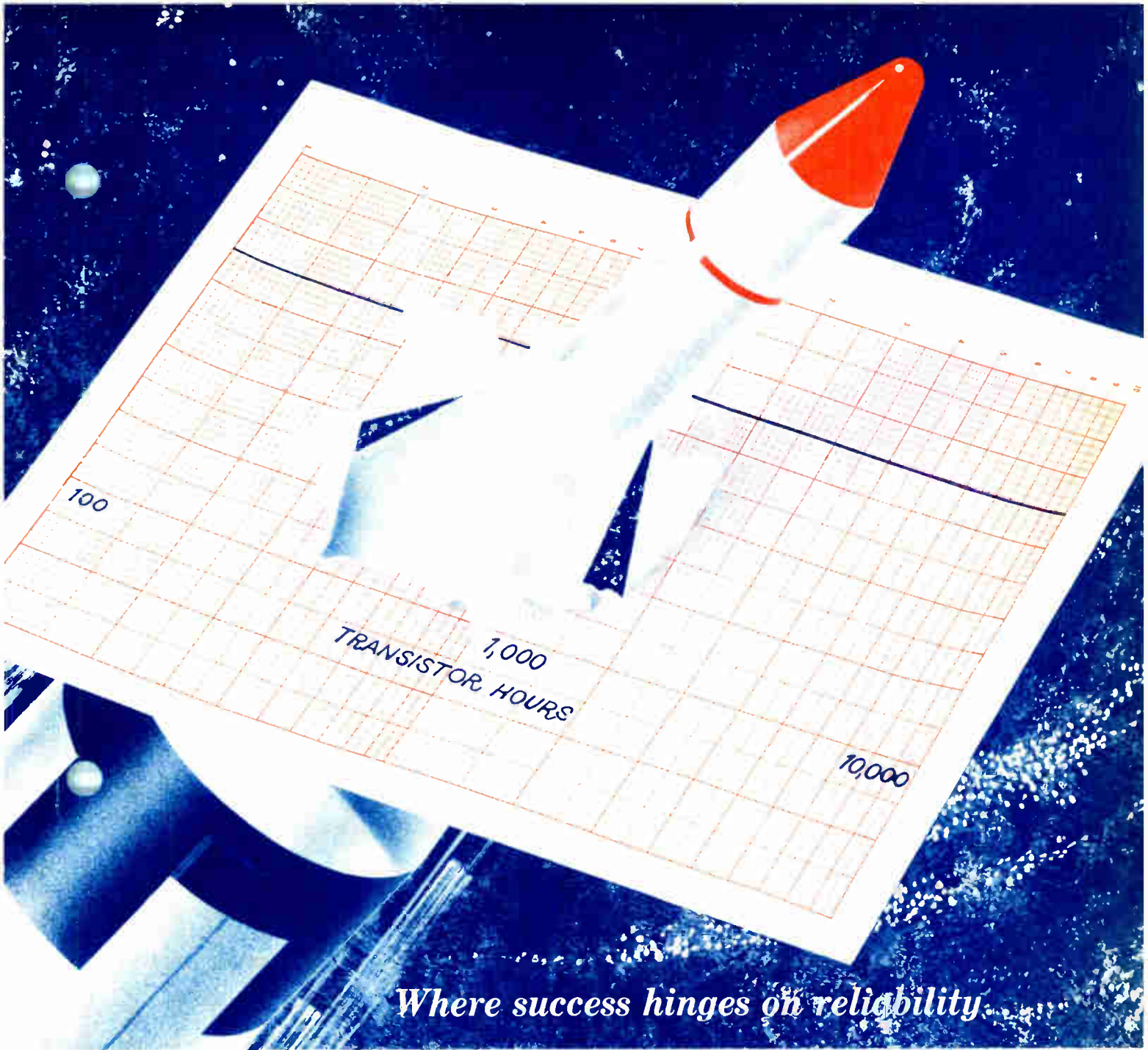

*Where success hinges on reliability.*

## Turn to Raytheon silicon transistors

The broad Raytheon line of fusion alloy silicon transistors provides the ultimate in reliability. More than six years of experience in the manufacture of these devices has led to a level of reliability unsurpassed in the industry.

You will want to use Raytheon silicon transistors in your most critical applications. For example, consider commonly used chopper circuits. Designed around these Raytheon transistors, choppers provide high speeds and meet the highest standards of reliability even at high temperatures. With Raytheon silicon transistors you

can design your own choppers to fit your specific circuit requirements. Or, if you prefer, you can obtain these circuits encapsulated in the famous Raytheon Circuit-Pak for maximum protection against heat and shock.

Your own circuit requirements will suggest numerous applications for these high-performance transistors. The important characteristics and technical details are tabulated on the following page.

Semiconductor Division, Raytheon Company, 215 First Avenue, Needham Heights 94, Massachusetts.



# RAYTHEON SEMICONDUCTORS

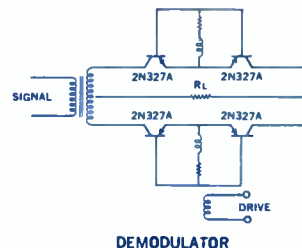
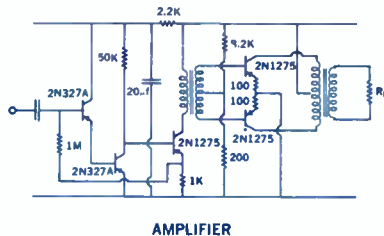
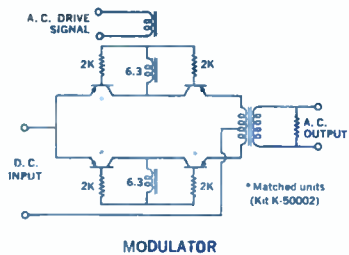

## Put These Raytheon PNP Fusion Alloy Transistors to Work in Your Critical Circuits... Get High Reliability and High Performance too

Immediate Availability in Production Quantities!

**2N327A, 2N328A, 2N329A:** Your choice of medium, high or very high gain PNP silicon transistors . . . intended for use in high temperature switching and DC amplifier circuits: . . . featuring low saturation voltage, close parameter control throughout the rated temperature range ( $-65^{\circ}\text{C}$  to  $+160^{\circ}\text{C}$ ), and exceptionally good current gain at collector levels up to 50 milliamperes.

**2N1034, 2N1035, 2N1036, 2N1037:** A useful range of medium, high, or very high gain silicon fusion alloy devices designed for high temperature audio circuits, featuring low noise and low leakage current.

**2N1275, 2N1654, 2N1655, 2N1656:** Dependable high temperature — high voltage transistor for use in DC amplifiers and related applications where low leakage current and high collector-emitter and emitter-base breakdown voltage are required.

Your local authorized Raytheon Distributors carry in-stock inventories for immediate delivery.

Type	$I_{EO}$ or $I_{CO}$ at 20 Vdc Average $\mu\text{amps}$	$V_{CE}$ max. Volts	$H_{FE}$ ave.	$r_b$ ohms	Noise Figure max. db	$C_{ob}$ $f=100\text{Kc}$ ave. $\mu\mu\text{f}$	$f_{ab}$ ave. Kc
2N327A	0.005	-40	15*	1200	30	65	200
2N328A	0.005	-35	30*	1400	30	65	300
2N329A	0.005	-30	60*	1500	30	65	400
2N1034	0.005	-40	15**	3000	30	65	200
2N1035	0.005	-35	30**	3000	30	65	300
2N1036	0.005	-30	60**	3000	30	65	400
2N1037	0.005	-35	30**	3000	15	65	250
2N1275	0.005†	-80	15**	3000	30	65	200
2N1623/ CK942	0.005	-20	25**	3000	30	65	200
2N1654	0.005†	-80	30**	3000	30	65	300
2N1655	0.005††	125	15**	3000	30	65	200
2N1656	0.005††	125	30**	3000	30	65	300

\* $I_C = -3.0\text{ ma}$ ;  $V_{CE} = -0.5\text{V}$  †At 60 Vdc.  
\*\* $I_C = -1\text{ ma}$ ;  $V_{CE} = -6\text{V}$  ††At 60 Vdc.

A-6760



# SEMICONDUCTOR DIVISION RAYTHEON COMPANY

SILICON AND GERMANIUM DIODES AND TRANSISTORS • SILICON RECTIFIERS • CIRCUIT-PAKS

ENGLEWOOD CLIFFS, N. J., LOwell 7-4911 (Manhattan Phone, Wisconsin 7-6400) • BOSTON, MASS., Hillcrest 4-6700 • CHICAGO, ILL., NAtional 5-4000 • LOS ANGELES, CAL., NOrmandy 5-4221 • ORLANDO, FLA., GArden 3-0518 • SYRACUSE, N. Y., GRanite 2-7751 • BALTIMORE, MD., SOuthfield 1-0450 • CLEVELAND, O., Winton 1-7716 • SAN FRANCISCO, CAL., Flreside 1-7711 • CANADA: Waterloo, Ont., SHerwood 5-6831 • GOVERNMENT RELATIONS: Washington, D. C., METropolitan 8-5205



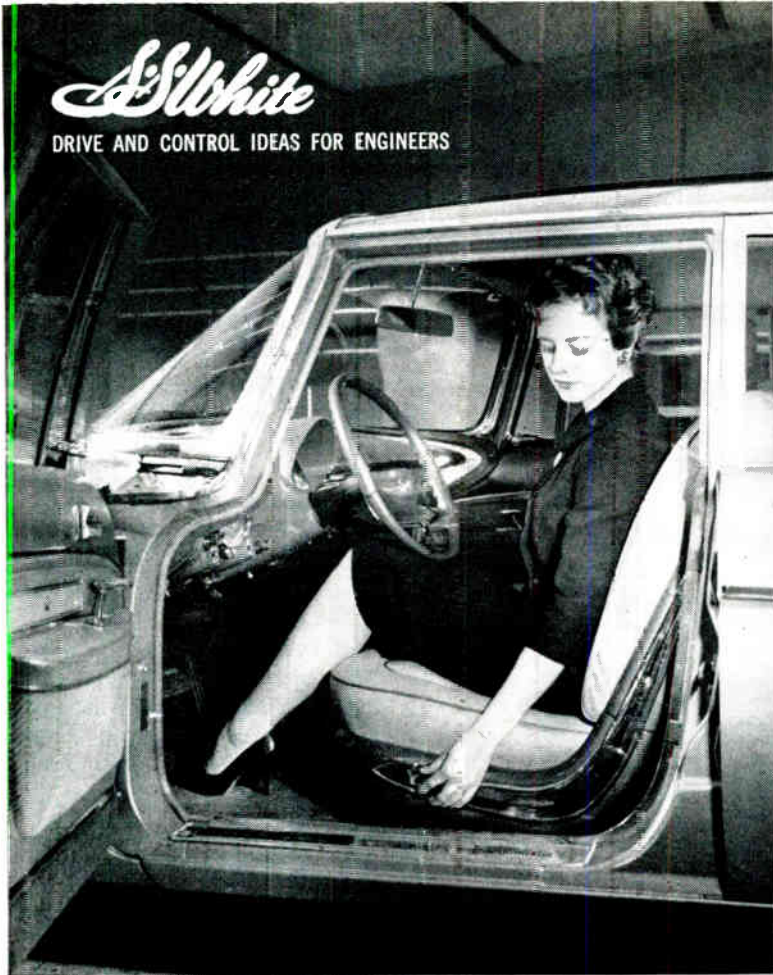

**HEART OF THE POWER-SEAT MECHANISM...** Two slave units, on the left and right sides of seat, are driven by flexible shafts to provide three-way motion. A single ¼-hp motor attached to a geared drive unit is the power source. Flexible shafts rotate at 1250 rpm, carry 9 in.-lbs. of torque at running load (three persons) and 15 in.-lbs. at full stall speed.

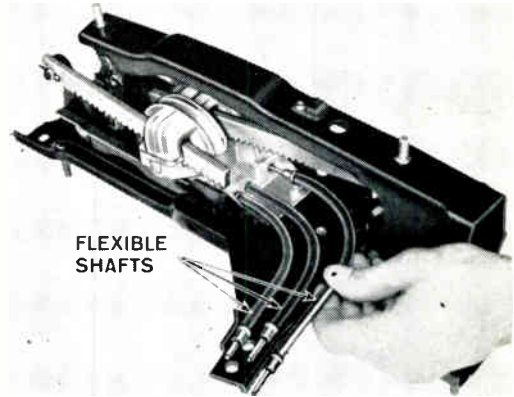

## Flexible Shafts Solve Space Problems in Chrysler Power-Seat

Chrysler Corporation faced a design challenge in its power-operated seat adjuster. Six-way motion was called for: fore and aft, up and down, and tilt. Yet there was limited space under the seat for the mechanism. After much Chrysler testing and development, a design submitted by subcontractor Ferro Stamping Company was approved, utilizing flexible shafts.

According to Chrysler, the decision to go to flexible shafts was based on the following advantages:

**1. SPACE ECONOMY...** "flexible shafts provided means to transmit power from a single elec-

tric motor, without compromising seat design."

**2. REDUCED STRESSES...** "flexible shafts act as torsion bars to reduce motor armature stresses induced when the mechanism was stopped or stalled suddenly."

**3. RELIABILITY...** "not a single shaft fatigue failure reported from the field to date."

**4. LOW COST...** "flexible shafts definitely represented savings without sacrificing design advantages."

Investigate for yourself how flexible shafts can solve many of your design problems and at the same time reduce costs!

S. S. White Industrial Division Dept. E, 10 East 40th Street, New York 16, N. Y.

1098



**THE S. S. WHITE FLEXIBLE SHAFT HANDBOOK**  
New 4th Edition... Send for your free copy!

This authoritative handbook has been recently revised to include new selection and application data for S. S. White Standard... Pre-engineered... Custom-designed flexible shafts.



# KOREA: On Guard

By FRANK LEARY  
Associate Editor

SEOUL—ON JUNE 25, it will be 10 years since the Communist North Korean Peoples Army first struck across the 38th parallel, which divided Communist North Korea and the Republic of Korea in the World War II aftermath of the Japanese occupation. The three-year war ended with an armistice that no one who has seen this land could call a peace.

Now, to keep the uneasy armistice from breaking into renewed war, four nations man the southern side of the demilitarized zone that divides the Korean peninsula. Major burden of patrolling this frontier falls on the First Republic of Korea Army, and the U.S. 7th Infantry and First Cavalry divisions (which now constitute the bulk of the Eighth Army).

A heavy part of this burden is carried by electronic equipment—by the gear which forms the links in the longest supply line currently maintained by the United States. The line stretches through Japan and Hawaii to the continental U.S., some 10,000 miles overall. But it is the barren, rocky terrain of Korea that demands the most ingenious communications engineering.

## Korean Communications

Backbone of communications on the Korean peninsula since the '20s has been the Mukden cable. The cable originates at Fukuoka, Japan, as a 14-quad undersea line to Pusan on Korea's southern tip. From Pusan north to Seoul it is 10-quad 16-gage. At the present time it has been cut at the demilitarized zone and capped on the southern side of Panmunjom.

Originally, the Japanese laid it as an ordinary wire link, but during the '30s they added Han 3 and 4 carrier equipment on each quad, giving a capability of 7 voice channels per quad (8 teletypewriter channels per voice channel)—for a total of 70 voice or 560 teletype-



*This cluster of antennas is atop Namsan Mountain, near Seoul, where microwave communications network center is situated*

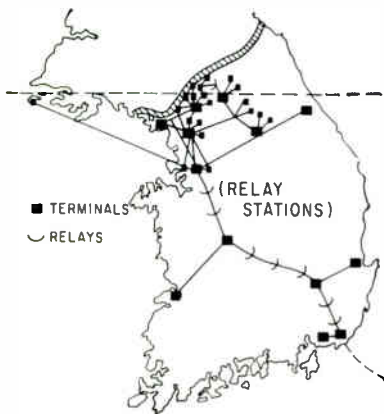

*Map above shows hf relay links installed in South Korea. On right, the proposed tropo transmitters and the microwave system*

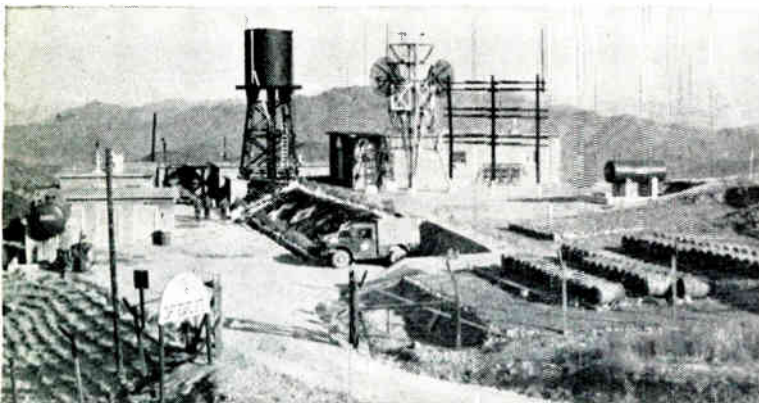

*At this relay point between Taegu and Pusan in hills of Korea TRC 29 antennas are installed. A 120-channel microwave system goes in soon*

# 10 Years After Invasion

New radar and communications systems help protect Republic of Korea from Communist threat almost seven years after UN and Reds signed armistice

writer channels from Pusan to Seoul.

Most of these channels are used by the South Koreans. There are several coexistent communications facilities operated by the ROK government, all of which use parts of the cable. Several auxiliary systems built since 1945 with U.S. aid funds are also being used mainly by the ROK's.

The Ministry of Communications operates the national telephone system, which makes the heaviest demands on the cable. The Ministry of Transportation operates its own radio and wire communications to service the rail system.

The national police, run by the Home Ministry and an object of public scorn in the student-led uprising that overthrew President Syngman Rhee, operates another radio network, along with some wire lines. In many villages, the police chief's radio—rather than a general-store telephone—is the only contact with the other parts of the country.

Finally, the Ministry of Public Information operates the Korean Broadcasting System, a fairly complex radio net by comparison with other national facilities, and built partly with U.S. aid. The system does not yet include a television station.

## Army Communications

The Army has backed up the overworked cable facility with radio links. Radio communications in Korea present unusual problems arising from both terrain and the composition of the soil. The high ferrous content of the clay soil "drinks up" a radio signal almost before it leaves the antenna; the complex chemical makeup of the clay makes a good earth-ground next thing to impossible; high acid content ruins counterpoise metals and makes it necessary to replace the ground sections of antenna sys-

tems twice a year or oftener. The mountainous terrain makes frequent repeater stations a must; r-f communications backing up the cable between Pusan and Seoul rely on 13 mountaintop relays, whereas the cable itself needs only 10.

The first network to go in was made up of AN/TRC-1 carrier gear, a 4-channel vhf system built in the early '40s. This was rapidly backed up or replaced by AN/TRC-24, a more up-to-date 12-channel vhf relay system.

Third and newest system is now starting operation. This is a microwave system designated AN/TRC-29; a 24-channel system fudged by double carrier to serve 45 channels. As the TRC-29 (supplied by IT&T and Radio Receptor Corp.) comes into use, the TRC-1 systems are being retired and TRC-24's are finding their way into the "fingers" of the communications network in tactical outposts.

Elements of a GE-built microwave system AN/FRC-23 are also installed alongside the TRC-29. The fixed-station FRC-23 is augmented

by AN/FRC-34 relay equipment to get the signals over the mountains.

In addition, there is a plan to lay in legs of a 120-channel microwave system designed by Nippon Electric. This system, ELECTRONICS learns, will work into a proposed 60-channel tropo scatter link from the mainland cable terminal near Pusan to Itazuke AFB near Fukuoka, Japan.

For Army units just behind the demilitarized zone, AN/GRC-26 teletypewriter equipment provides input to the microwave network, together with truck-mounted AN/MRC-46 systems capable of handling both radioteletype and voice. Patrols along the front are tied to headquarters by AN/GRC-19 radio systems.

## Missiles and Early Warning

U.S. ground forces include the 4th Missile Command, equipped with Honest Johns. Units of the Fifth Air Force are, of course, missile-armed, and nearby cruisers and carriers include Talos missiles in their armament. Many facilities being built into Korea's communications network could conceivably be used for transmission of missile data.

Air warning is generally in the hands of the ROK Air Force, with backup from USAF and with small USAF advisory groups on forward sites. The two forward sites are quite near Communist territory, one on the east side of the island, the other on Paeng-yong-do, an isolated island.

Air early warning and aircraft control equipment is a ground-transportable 250-mi radar, AN/GPS-4, with a portable height-finder, AN/PPS-14.

These remote outposts relay information to USAF Korean headquarters at Osan by way of AN/TRC-24 systems, maintained and serviced jointly by ROKAF and Eighth Army.

---

## VIGIL AGAINST AGGRESSION—

*FROM Paeng-yong-do, an island just 6 miles away from the sullen coastline of North Korea, a ROK Air Force early-warning radar stares out over North Korea, parts of Manchuria and a piece of China's Shantung peninsula to watch for signs of air activity that could mean another Communist attack.*

*A tiny American detachment—9 men and 4 officers—serves as advisory group. Island commander is a ROK Marine colonel, and it's the ROK Marines who guard against infiltrating "wetbacks."*

*Stand on the cliffside and look three miles out into the channel; a battery of Red 90-mm guns stares back. Step inside the plotting center and watch the air activity over North Korea. Then you get a fair idea of what the Korean armistice means. Here, at the last ROK outpost, you can see how vital electronics has become to South Korean defenses in monitoring a precarious armistice*

---



a new pattern

SHOCKLEY TRANSISTOR UNIT - STANFORD INDUSTRIAL PARK, PALO ALTO, CALIFORNIA



in semiconductor progress . . .

## SHOCKLEY TRANSISTOR JOINS CLEVITE

In keeping with its program of advancement in semiconductors, Clevite has acquired the Shockley Transistor Corporation of Palo Alto, California.

Dr. William Shockley, noted solid state physicist and co-winner of the 1956 Nobel Prize for his work in the development of the transistor joins Clevite, together with his research and development organization.

### NEW PRODUCTS

In addition to Clevite Transistor's broad line of diodes and transistors, the corporation now offers to the industry Shockley devices which represent new advances in the semiconductor art. The Shockley 4-layer diode is a nearly ideal switch for pulse generation, pulse counting and high power switching in such applications as computers, telephone and control circuits. A new plant in Palo Alto, California, is underway to fill the growing demand for these new devices.

### NEW PLANTS

Besides the new plant for the Shockley organization in California, Clevite Transistor is nearing completion of its new \$4,000,000 Waltham, Massachusetts facility which will employ 2,000 people. The present Waltham plant will continue as a supplementary operation. Clevite's overseas operation, Intermetall G.m.b.H., now employs 1,000 people in a new plant at Freiburg, West Germany to serve the European market.

*To find out more about our progress and our products, write:*

*Reliability In Volume . . .*

**CLEVITE TRANSISTOR**

254 Crescent Street Waltham 54, Mass. Tel: TWinbrook 4-9330

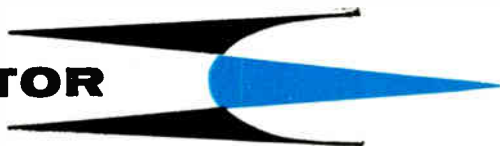

# Conference Highlights CIRCUIT-SYNTHESIS

Three armed services participate in sponsoring three-day meeting on active networks and feedback theory. It is part of a major trend away from circuit analysis, towards circuit synthesis. Microminiaturization is one spur

THE NEW TREND towards circuit synthesis rather than circuit analysis was the catalyst at the Conference on Active Networks and Feedback Systems held recently by Polytechnic Institute of Brooklyn.

About 150 engineers and scientists attended the three-day meeting that was sponsored by Brooklyn Poly, its Microwave Research Institute and three military scientific agencies: Air Force Office of Scientific Research, Office of Naval Research and Army Signal Corps. The Institute of Radio Engineers Professional Group on Circuit Theory cooperated.

## Active Networks

In circuit analysis, the circuit is given and its frequency response determined. In circuit synthesis, the desired response is known and a circuit that will meet the requirements must be found. The papers presented at the conference were mostly abstract and generalized, with active networks receiving the major share of the attention.

Long-range goal in circuit theory is a more complete understanding of networks; immediate goal is a practical way of including active elements so that circuit synthesis becomes practical for complex net-

works and systems. This is important in microminiaturization, where complete circuits, including active elements, are constructed as units. Cut-and-try methods are expensive and time consuming, and a synthesis technique is needed. Better synthesis techniques will also improve conventional electronic circuits as well as other dynamic systems such as rockets and missiles.

The first conference in this series on modern network synthesis, organized by Brooklyn Poly, was held in 1952; it was restricted to passive circuits.

If the desired response of a circuit needs only passive, linear circuit elements, and meets some other restrictions, a circuit can be found that will meet the requirements. However, there is no general technique that will insure that the minimum number of components have been used or that the circuit is optimum. Typically, more than one circuit can be found that will suffice. The problem then must be resolved by considering other factors. It might be desirable to eliminate inductors, for example, or to use the circuit that gives minimum cost. No specific progress was reported on this important problem in synthesis.

Several circuits were presented by H. J. Carlin of the Microwave Research Institute. One of these was a two-terminal single-port circuit that is both a short circuit and an open circuit at the same time. Another circuit, shown in Fig. 1, is a two-port active device, with one port, A, open and a short at the same time, while the other port, B, can have any current flowing with any impressed voltage. The voltage and current are not related. It is assumed in the circuits that the components are ideal; how the devices would work in actual practice was not disclosed. No practical use is known for the circuits.

## Negative Resistance

One subject receiving much attention is the concept of negative resistance. Since positive resistance always produces losses, a negative resistance can be considered an active element and a source of energy. A number of papers presented were concerned with ways to use negative resistance elements in circuit synthesis.

A talk was given by H. W. Bode on the history of feedback, from its invention in the early 1930's to its place in electrical theory today. Feedback was originally devised to

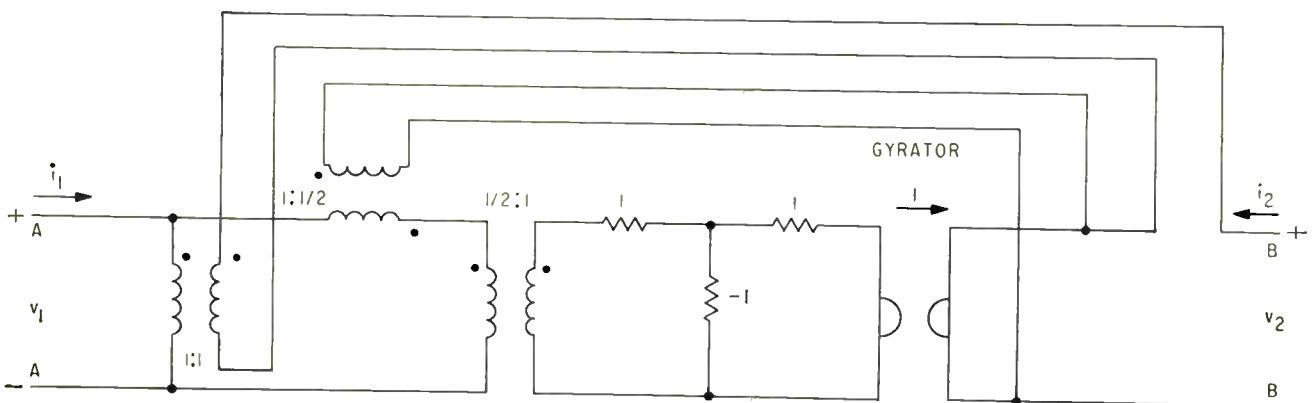

FIG. 1—Active two-port network is open and shorted at A terminals; voltage current at B terminals are unrelated

# TREND

solve the problems of equalizing gain of telephone channels. If a chain of amplifiers are strung across the country, with a total open-circuit gain of about 30,000 db, a high level of gain stability is necessary. Negative feedback was able to solve this problem and was then incorporated into control theory. Much of the communication theory in which negative feedback was enmeshed was also taken over for use in the control field.

## Probing the Universe Is Conference Theme

DAYTON, O.—Twenty papers on the theme "Electronics Probes the Universe" were read at the 12th Annual National Aeronautical Electronics Conference held here recently. Attendance at the conference, which also featured more than 100 exhibits, was estimated at 4,000.

A new wrinkle to the annual event was a session on scientific education under the direction of Raymond Ewell, of the University of Buffalo.

Other sessions covered energy conversion systems, solid-state devices, radio astronomy, magneto-hydrodynamics and plasma propulsion, space systems integration, interplanetary environment, electric propulsion and managing space systems.

Winners of Pioneer Awards this year were J. H. Dellinger, radio authority and consultant, and the late Wilbur L. Webb, who was affiliated with Bendix Aviation Corp. until his death in 1957.

Dellinger was cited for work in systems for aircraft guidance during approach and landing, and Webb for design and production of early airborne automatic direction finder equipment and ground controlled approach radar sets.

The advertisement features a dark background with several electronic instruments and accessories. At the top, there is a small airplane icon. Below it, a large rectangular instrument with a circular dial and a probe is shown. To its right is another rectangular instrument with a circular dial and a probe. Below these, there is a smaller rectangular instrument with a circular dial and a probe. At the bottom, there is a small car icon. The text "Termaline" 50 ohm coaxial line Load Resistor, "ThruLine" Directional RF Wattmeter, "Termaline" RF Absorption Wattmeter, Coaxial RF Switches, and Coaxial RF Filters is displayed. A large black oval with the text "... a need filled" is positioned in the center.

"Termaline" 50 ohm coaxial line Load Resistor  
"ThruLine" Directional RF Wattmeter  
"Termaline" RF Absorption Wattmeter

... a need filled

Coaxial RF Switches  
Coaxial RF Filters

Since 1942 the Bird Electronic Corporation has met the challenge of a constantly growing electronic industry. Today, enlarged engineering facilities demonstrate our intention to maintain leadership in our field. A wide range of coaxial line instruments and accessories are being designed to meet a variety of specifications; and new applications are continuously being sought.

In addition to experience and established leadership, Bird has the physical facilities to produce and dependably deliver coaxial line instruments and accessories meeting your highly exacting requirements.



# BIRD

## ELECTRONIC CORP.

CHurchill 8-1200 (Cleveland)  
30303 Aurora Road, Solon, Ohio  
Western Representative:  
VAN GROOS COMPANY, Woodland Hills, Calif.



Give your  
"spec" cables  
the protection  
they deserve ...

# Resinite EP-145<sup>®</sup> jacketing

To protect your cables from the rough treatment and extreme climatic conditions encountered in missile, aircraft, and ground control applications, we suggest Resinite EP-145 vinyl jacketing.

**TOUGHER**—EP-145 has greater tear strength and abrasion resistance . . . exceeds all important specs of MIL-R-6855 (for synthetic rubber) and MIL-I-3930.

**LONGER LIFE**—EP-145 does not deteriorate when exposed to gasoline or oil. There's no cracking, no ozone embrittlement.

**PERMANENT FUNGUS AND FLAME RESISTANCE**—EP-145 will not rot. And it has outstanding self-extinguishing characteristics.

Your Resinite Distributor has complete information on EP-145 and other Resinite materials (including Resinite vinyl tape filler). For samples and performance data write:

#### RESINITE EP-145

- Abrasion resistance is 11 to 31 times better than neoprene at varying test cycles.
- Lighter, stronger, easier to handle. Allows thinner walls, less material.
- Resists exposure to gasoline and oil. No deterioration. Exposure increases tensile strength.
- Superior cold bend and impact properties (lower than -100°F).
- Smooth, glossy surface does not rub off or smudge.
- Fungus resistant. Flameproof.
- Color: Black. Other sizes and colors on special order.
- Readily applied by standard methods.

*Resinite<sup>®</sup>—specialists in vinyl sleeving and tubing for the aircraft, electronics, electrical and pharmaceutical fields.*

*\*Available as a resin. Ask for Borden 5410.*

Resinite Department, The Borden Chemical Company, 1 Clark St., North Andover, Mass., and P. O. Box 430, Compton, Calif.

IF IT'S A **Borden**  **Chemical** IT'S GOT TO BE GOOD!



**NEW THUMB INDEX  
FOR FAST FINDING**

Telephone Types
Midget Telephone Enclosed Plug-In
General Purpose
Antenna & Ceramic Terado
Power AN, MS, RBM
Collins Chopper D.D.S.
Automatic Electric Steppers
Clare Stepping Switches
"211" Stepping Switches
Mercury Wetted
HGS
"11"
Advance Relays
Potter & Brumfield
GV Controls
Struthers Dunn
Ebert Mercury
Leach Relays
Phillips Control Corp.
American Monarch
Guardian Electric
Kurman Electric
Electro Mechanical Specialties



**Buy** All these leading lines of  
*Relays*

**From this ONE catalog**

*Immediate delivery from stock  
Factory Prices*

**Write for your personal copy  
of this catalog TODAY!**

**RELAY SALES, INC.**  
P. O. BOX 186-A, WEST CHICAGO, ILL.



Electro Mechanical Specialties



R-B-M  
Div. Essex Wire



Automatic Electric



C. P. Clare



Ebert Electronics Corp.



Collins Electronics Mfg. Corp.



Guardian Electric



Phillips Control



G-V Controls



Kurman Electric Co.



Leach Relays



Potter & Brumfield



Terado



American Monarch Corp.



Advance Relays



Monitor Relays Inc.



Struthers

New dimensions in design flexibility

# HUDSON PRECISION DRAWN CLOSURES

Leading electronic/electrical manufacturers specify HUDSON closures for *total* reliability in commercial equipment and vital military programs. HUDSON precision-drawing is an industry standard... standardized tooling reduces cost and production time... HUDSON "know-how" turns out specials quickly for unusual applications. Call Hudson for complete, reliable service — *every time!*



A complete  
Range of Standard  
Cases and Covers from  
Transistor Caps to  
Transformer Housings

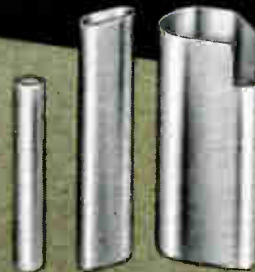

Hudson Standardized Closure Designs include —

- RELAY CLOSURES
- TRANSFORMER HOUSINGS
- INSTRUMENT CASES
- TRANSISTOR AND DIODE CLOSURES
- NICKEL-SILVER CRYSTAL CASES
- COVERS WITH INSTALLED TERMINALS

Commercial and Military Closures in —

- MU METAL
- NICKEL-SILVER
- ALUMINUM
- BRASS
- COPPER
- STEEL AND STAINLESS STEEL

— all finishes available

Ask for the  
HUDSON  
CATALOG  
— contains  
complete data  
on HUDSON  
Standard  
Closures  
including MIL  
types. Please  
make request  
on company  
letterhead.

**Hudson Tool & Die Company • Inc**

18-38 Malvern Street, Newark 5, New Jersey

*Precision Metal Components for Electronics, Nucleonics, Avionics and Rocketry*

Telephone: MArket 4-1802  
Teletype: NK 1066

## OBJECTIVE: Photos of Mars

MIT interplanetary space probe would take three years collecting data on solar system

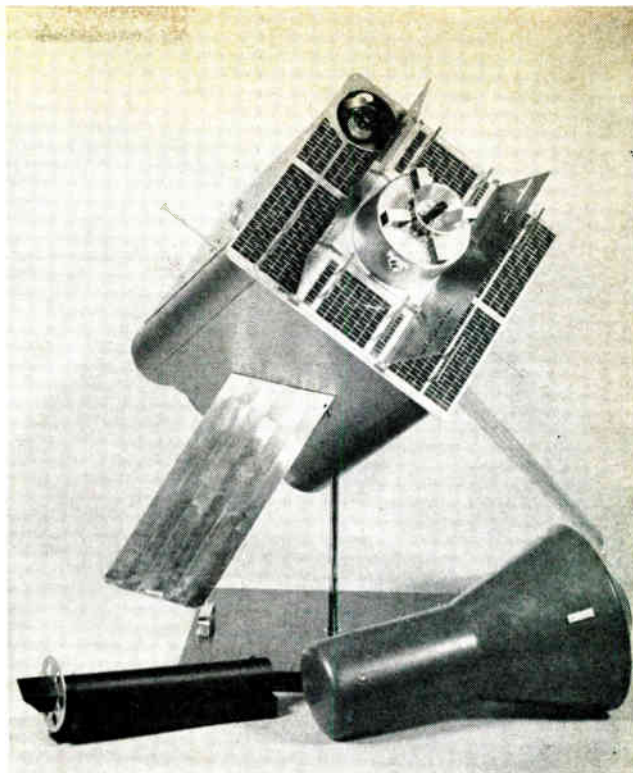

Proposed vehicle for trip to Mars (above). In it, space sextant (left) would gather solar system data for navigational aids. Reentry vehicle is at right

CAMBRIDGE, MASS.—The feasibility of launching a recoverable space vehicle to pass within 5,000 miles of Mars and photograph 40 percent of the planet's surface has been investigated by the Massachusetts Institute of Technology. Such a launching could take place within the next few years.

The round-trip from Earth to Mars would take two to three years. The craft could be expected to pick up a billion bits of information, according to scientists and engineers at the MIT Instrumentation Laboratory.

Details of the projects were revealed, after clearance with the Air Force Ballistic Division, ARDC, in an 810-page, four-volume technical document entitled "A Recoverable Interplanetary Space Probe."

### Size of Table Tv Set

The vehicle itself would weigh 340 pounds and be about the size of a table model tv set. The time it would take on its contemplated trip to Mars would depend on the launch velocity used. The craft could be launched by a rocket booster from a site such as Cape Canaveral, Fla.

The major technical problem, according to the MIT research scientists, is expected to be achieving high reliability in the final vehicle. The instruments must remain in working order 2 to 3 years.

What scientists are now shooting for is programming of an elaborate digital computer and making exhaustive orbital calculations. The proposed project now involves the latest techniques in navigation, control communication, corrective propulsion and reentry, including the use of the pressure of sunlight to control torque on the vehicle.

The report describes a hypothetical flight to Mars with June 17, 1962 set as the launching date. Using a slow trajectory, the flight would take 3.2 years during which the craft would travel one and one-half billion miles around the solar system. Several minutes after launching, wide field-of-view sun finders would be used with flywheels to position the probe's energy-collecting face toward the sun. This face would have solar cells for power and thermal control shutters to maintain reasonable temperature within the vehicle.

Each week a 20-second prepared message would be sent to earth. Data would enable scientists to evaluate performance of the vehicle. Also, once each week solar vanes would automatically emerge from the side of the probe to eliminate any angular momentum the vehicle might accumulate.

The weekly communications would continue until Jan. 21, 1963, on which date the vehicle would sight two stars, the sun and planets

to measure angles to determine its position. Nearly two years after this date, during which time checks would be made to determine velocity, course and other data, another fix would be made four days before the vehicle reaching the vicinity of Mars.

The final fix would be made on Nov. 17, 1964, several hours before passing Mars. Just before the time of photographic exposure, the vehicle would track the sun and a star to determine the direction of Mars. Then the camera would be automatically pointed toward the planet and the picture is taken.

### Recovery Aids

Three days after leaving the vicinity of Mars, the return flight would begin. The reentry vehicle, which is a small projectile-like apparatus, would be instrumented with a radio beacon and flashing light which are to be used as recovery aids.

The MIT project has been in the works for two years and has involved collaboration with Avco Corp., MIT's Lincoln Laboratory and Reaction Motors Division of Thiokol Chemical Corp.

Although laboratory officials say that no government agency now has specific plans to try the experiment, they feel the probe is feasible and that it can be attempted within the next few years.



**FIRST  
IN  
CLASS**

CHANCE **VOUGHT CRUSADER**  
DALLAS, TEXAS

Operating from fast, far-ranging carriers, the new F8U-2N Crusader adds even greater strength to the U. S. Fleet. This all-weather fighter is fully instrumented and equipped to deliver the deadliest of air-to-air missiles . . . at speeds approaching Mach 2.

Chance Vought again specified Hitemp Teflon\* wire and cable for use in the F8U-2N—their fourth operational version of this fighter to be delivered to the U. S. Fleet.

Hitemp Wires, Inc., as the leading specialist in high temperature insulated wire and cable, is justifiably proud of its contributions to the defense of our nation's shorelines.

**HITEMP WIRES, INC.**

1200 SHAMES DRIVE, WESTBURY, NEW YORK



\*Registered trademark for Du Pont fluorocarbon resins.

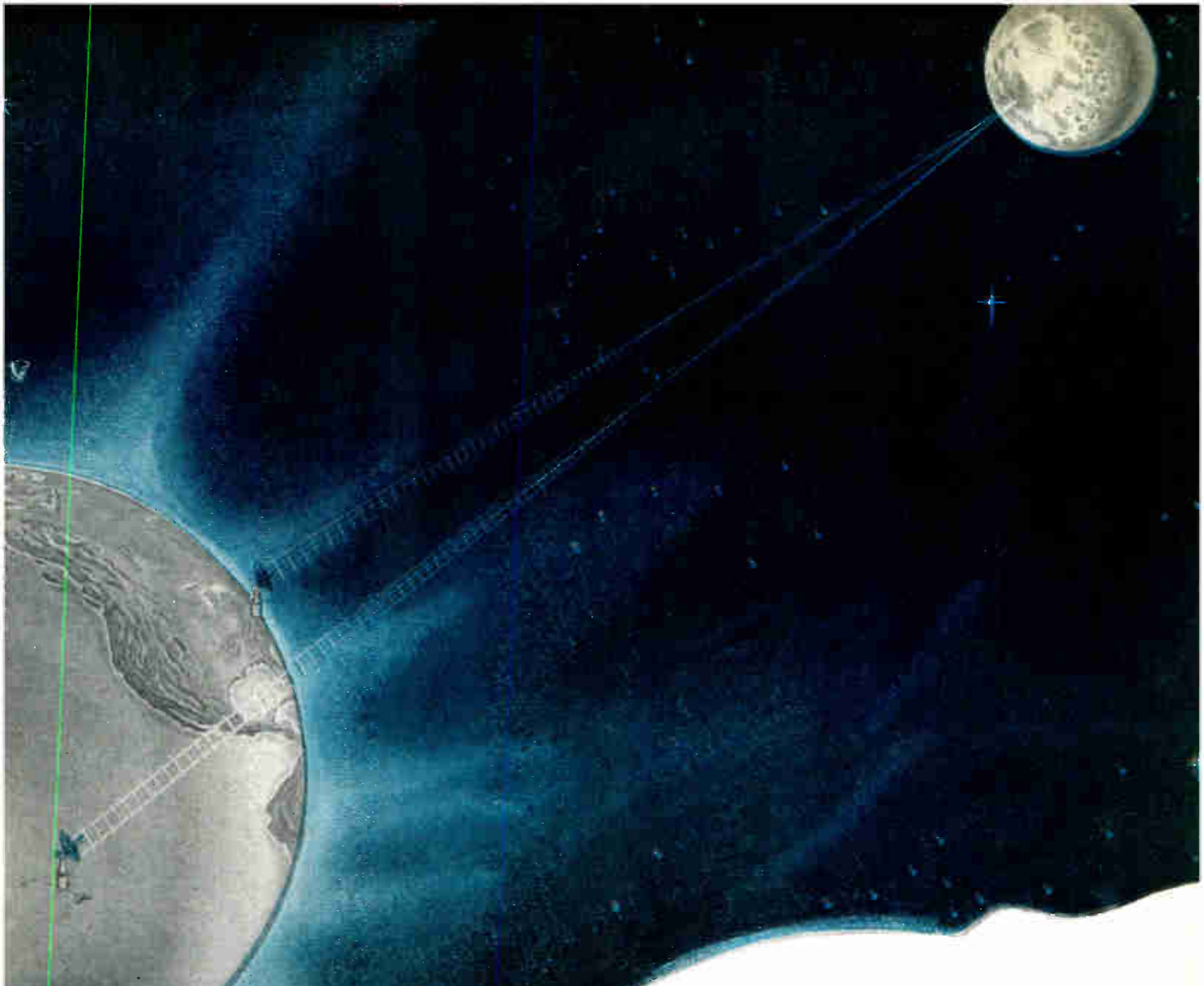

## WASHINGTON TO HAWAII VIA OUTER SPACE!

Right now the Navy's "moon bounce" transmitter is operational . . . virtually jamproof against enemy and immune to ionospheric storms.

Essentially, the Navy's "Communications Moon Relay" is a multi-channel multiplexed teletypewrite-facsimile circuit between Washington and Pearl Harbor via the moon. The narrow beam, highly directionalized L-Band signal pulses travel to the moon and bounce back to the receiver in  $2\frac{1}{2}$  seconds . . . utilizing a half million mile signal path to span 5,000 miles!

Continental Electronics' transmitter is 100 KW, conventional transmission, and is unusual for the high level of continuous power used. Each Transmitter-Receiver site uses an equatorially mounted, high gain, fully steerable dish-type antenna 84 feet in diameter, aimed at the moon by astronomical data.

When fully developed, this communications system opens a whole new spectrum of radio communications for our overcrowded Long Range Communications: the number of channels that can be carried by time-sharing on a single antenna is readily expanded.

*Another  
Continental Electronics  
Contribution  
in Super Power Radio*

*A Subsidiary of  
Ling-Altec Electronics, Inc.*

**Continental Electronics**  
MANUFACTURING COMPANY

World Radio History 4212 S. Buckner Blvd. • Dallas 27, Texas

EVERETT 1-1125

CIRCLE 51 ON READER SERVICE CARD



# NOW 10 CASE SIZES

in plain and etched  
tantalum foil  
electrolytic capacitors



No more need to over-specify! **iei** offers 10 case sizes—twice as many as other manufacturers.

- Smaller sizes are available for most ratings.
- Low voltages (to 3 WVDC)—both plain and etched foil.
- Extremely close tolerances, down to  $\pm 10\%$  on plain foil if desired.
- Plain and etched  $-55^{\circ}\text{C}$  to  $85^{\circ}\text{C}$ .

All electrical connections welded. Lead wires have high resistance to stresses, bending. Cases fit tightly, for maximum vibration resistance, high reliability.

#### Prompt service on special capacitors.

Engineering service available for adapting standard capacitors or designing new ones to meet special needs. **iei** also offers a full line of miniature and sub-miniature aluminum foil electrolytic capacitors.

Write for bulletin 41858. International Electronic Industries, Inc., Box 9036-L, Nashville, Tennessee.

# iei

AN **SPS** COMPANY

where reliability replaces probability

## Field Men Belong on the Team

One manufacturers' representative organization taps three veteran sales engineers for posts on company management council

RECENT SURVEY of factors that cause field engineers in electronic manufacturers' representative organizations to leave their companies reveals that money is in third place.

Most of the men interviewed said they resigned their jobs mainly because they felt they weren't getting enough management experience. In second place was the feeling that their jobs weren't giving them a sense of control over their own future.

"The very qualities of personality that mark the first rate field engineer are precisely those which lead him, at maturity, to consider embarking on an independent career of his own."

This comment by Harold Bogin, president of Burlingame Associates throws into sharp focus a major problem that most high-level electronic representative organizations are being forced to face.

In an industry where specialized knowledge in the sales arm of business is worth its weight in gold, new approaches to the problems and aspirations of the sales engineer must be outlined, evaluated and put into action.

Status incentives, long-term security and an active voice in the company policy are some of the factors the rep organization is now emphasizing.

The new approach to sales management promotes veteran field men to a position similar to that of the junior partner in other professional organizations. Some examples of how this new concept is being applied may be seen by what lies ahead for three veteran field engineers newly appointed as district supervisors in three of the company's principal sales areas.

The men, Richard Bullock in Washington, D. C., Delaware and Maryland; Robert Crane in Long Island and New York City and Martin Malloy in North and Central New Jersey, will form part of a management council. Together with company officials they will meet

frequently to shape sales policy, they will participate in the direction of the company's retirement fund, and they will ultimately be entitled to acquire company stock in amounts proportional to their length of service.

In addition to taking part in these areas of company activity, the supervisors will continue to serve former accounts and to advise and support other company field engineers in their areas.

In many cases, the support will come as the personal experience the supervisors have in solving instrumentation problems, in advising on specifications for system compatibility and in general, drawing on the backlog of previous problems solved for the benefit of younger men.

#### Benefits of System

Company officials see in these factors the means of ensuring continuing activity, loyalty and personal development both for the firm and for the manufacturers it represents.

Uninterrupted continuity of service is seen by the company as being one of the most valuable assets a representative organization can claim for its field men. The com-

## Rescue Beacon Floats

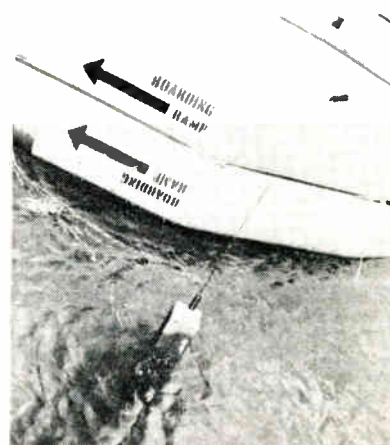

Airliner liferafts are being equipped with this self-releasing unit developed by Granger Associates, Palo Alto, Calif.

pany has always been fortunate in enjoying a low employee turnover.

Other areas where attention must continue to be focused should be continuous factory training where the field men can learn their product lines inside out, and thorough basic training in new technical developments. In addition to supplying both these needs, the representative organization can further maintain the value of its field men by sponsoring formal education and training courses.

## Engineers Cite New Needs in Measurement

INCREASED concentration on electronic components and systems of high reliability is sending standards and measurements engineers back to a review of the most fundamental parameters, inductance and capacitance.

Measurement of these basic units with an accuracy of about .01 percent is required, an order of magnitude more precise than has been considered in the past.

At General Radio Co. in West Concord, Mass., recently, standards engineers from laboratories throughout the country reviewed basic standards and measurement techniques in inductance and capacitance at a four-day calibration seminar consisting of workshops and lectures.

Types of inductors covered were fixed and variable standards with air core and fixed semi-standards with dust core. Wanted particularly in the field of inductance standards are high stability, low resistance, low temperature and voltage coefficients, small external field.

Capacitor types included fixed and variable standards with air dielectric, fixed standards with mica dielectric, and fixed semi-standards with mica or polystyrene dielectric. Wanted are high stability, low dissipation factor, low temperature and voltage coefficients.

New developments cited included the method of deriving the unit of capacitance from length measurements only. Also discussed were transformer-ratio-arm bridges developed for calibrating other capacitors and showing promise of increased accuracy.

CIRCLE 53 ON READER SERVICE CARD→

# WHAT'S THE BEST WAY TO LEAK-CHECK ELECTRONIC COMPONENTS?

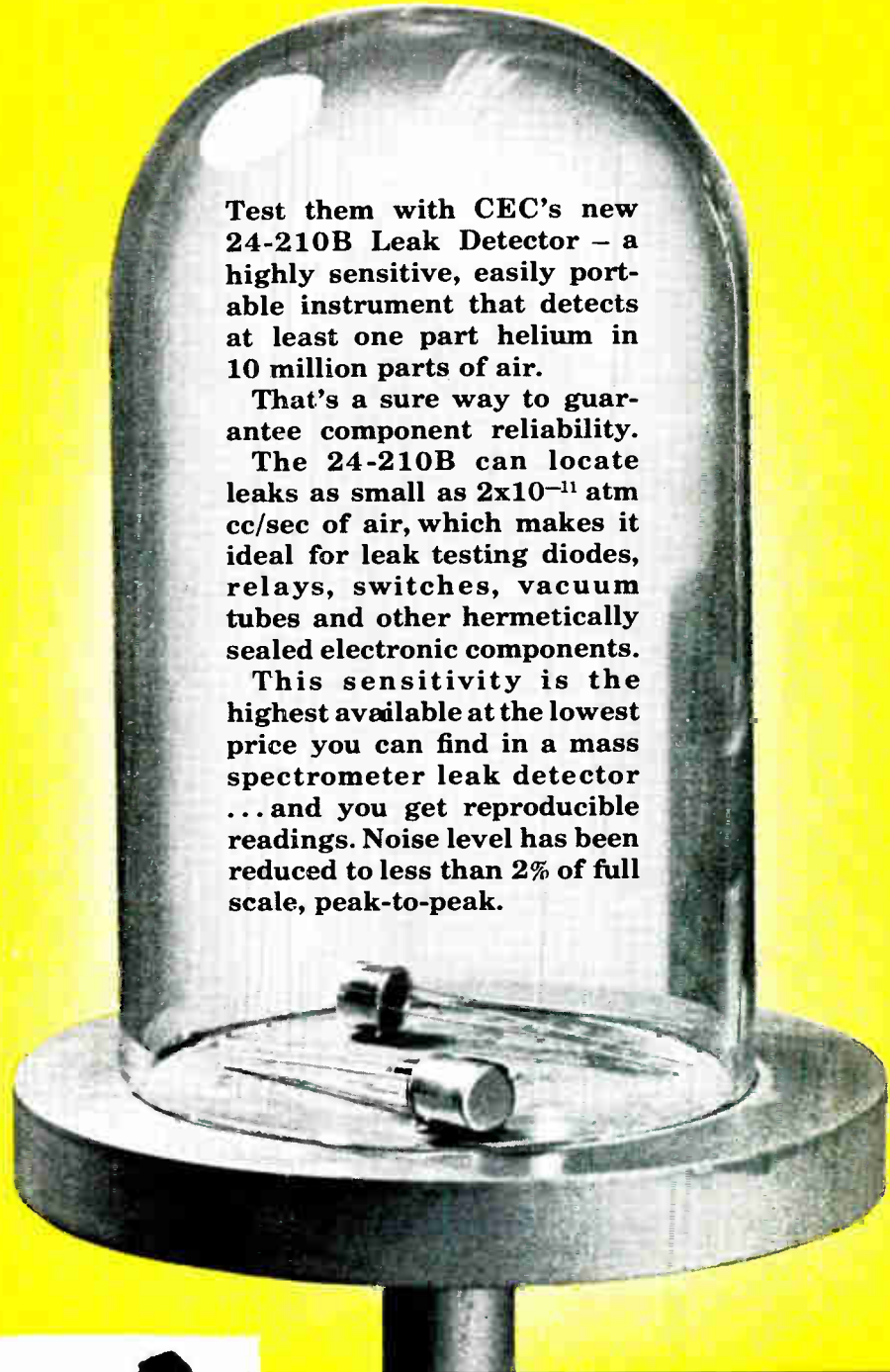

Test them with CEC's new 24-210B Leak Detector – a highly sensitive, easily portable instrument that detects at least one part helium in 10 million parts of air.

That's a sure way to guarantee component reliability.

The 24-210B can locate leaks as small as  $2 \times 10^{-11}$  atm cc/sec of air, which makes it ideal for leak testing diodes, relays, switches, vacuum tubes and other hermetically sealed electronic components.

This sensitivity is the highest available at the lowest price you can find in a mass spectrometer leak detector ... and you get reproducible readings. Noise level has been reduced to less than 2% of full scale, peak-to-peak.

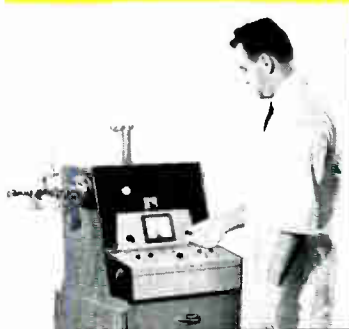

For complete information, write for Bulletin CEC 1830-X5.

The 24-210B, available with mobile workstand, operates without maintenance for as long as six months. CEC provides installation and instructs operators at no extra cost. Instruments and parts are available from stock, delivery two weeks from receipt of order.

Analytical & Control Division

# CEC

CONSOLIDATED ELECTRODYNAMICS / pasadena, california

A SUBSIDIARY OF Bell & Howell • FINER PRODUCTS THROUGH IMAGINATION

## Nickel leads, welded directly to tantalum, boost capacitor ruggedness

DALLAS, TEX. — For maximum reliability, new Texas Instruments *tau-TI-cap*\*\* capacitors depend on leads of Electronic Grade "A" Nickel. This strong, tough nickel wire, welded soundly and easily to the tantalum stubs, helps provide the good connections needed to withstand mechanical and thermal shock.

Electronic Grade "A" Nickel is highly resistant to oxidation and corrosion. What's more, it provides tight hermetic seals (note figure below) and speeds unit installation.

\*T. M. of Texas Instruments Incorporated

Pertinent Literature: Write for Technical Bulletin T-15.

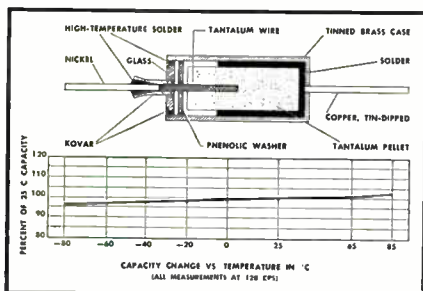

Lead wires of Electronic Grade "A" Nickel strengthen this new *tau-TI-cap* Solid Tantalum Electrolytic Capacitor.

## Nickel materials keep electrons "in line" in new linear accelerator

WALNUT CREEK, CALIF. — Intense electron, neutron and X-ray beams are generated by this new ARCO linear electron accelerator. In order to operate at very high vacuums  $-10^{-7}$  to  $10^{-8}$  mm Hg —its vacuum envelope must be de-gassed by baking out at  $400^{\circ}\text{C}$ . ARCO designers specify Electronic Grade "A" Nickel for the envelope because it provides the excellent vacuum properties required. This metal also resists oxidation, corrosion and retains its strength at operating temperatures well above  $400^{\circ}\text{C}$ .



# ALLOY PRODUCTS

## FIRST COMMERCIAL ATOMIC CLOCK... WAVEGUIDES OF LOW PERMEABILITY MONEL "403" HOLD DOWN SIGNAL DISTORTION

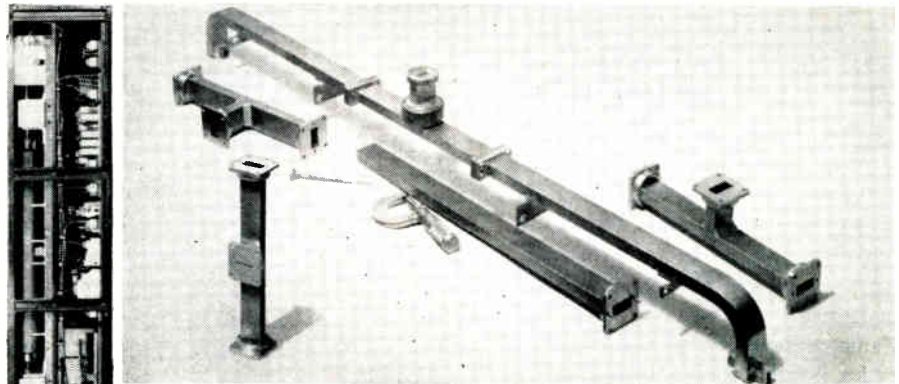

No problem fabricating these waveguides of Monel "403" low permeability alloy, reports National. The intricate tubes carry microwaves in the Atomichron atom-regulated frequency standard.

Heart of the "clock" — a cesium beam tube—Monel "403" alloy provides the tube's pole assemblies with excellent mechanical properties plus low magnetic permeability. Manufactured by National Company, Inc., 61 Sherman Street, Malden 48, Mass.

... clock generates frequencies accurate to 5 parts in 10 billion!

MALDEN, MASS. — You can now tell time accurately down to 100 millionths of a second with the Atomichron†, first commercial atom-regulated "clock."

### How it works

Waveguides feed a tuned microwave signal through a stream of cesium atoms. As signal reaches the atoms' resonant frequency, it changes some atoms in internal structure. This change is sensed by a detector and signalled to a servo system, which regulates the frequency of a basic oscillator at precisely the atomic resonance value. By means of electronic multipliers and dividers, this oscillator produces standard output frequencies of 0.1, 1.0, 5, 10, and 100 megacycles — the required "clocking" action.

Designers chose Monel "403"\* low permeability nickel-copper alloy for the waveguides, radio frequency sections and magnet pole assemblies, because it provides magnetic permeability so low that atomic resonance remains free from distortion. Monel "403" alloy offers excellent vacuum and mechanical properties, is readily machined and formed into intricate shapes.

Like all nickel alloys, Monel "403" alloy is freely available.

Pertinent Literature: Write for "Basic Data-Monel '403' Low Permeability Nickel-Copper Alloy."

†T. M. of The National Company, Inc.

HUNTINGTON ALLOY PRODUCTS DIVISION

The International Nickel Company, Inc.  
Huntington 17 West Virginia

### Nickel improves seals

All metal surfaces of the envelope's metal-ceramic seals are nickel-covered. Nickel is easily brazed, protects parts from oxidation. Its purity facilitates the elimination of all organic products from the vacuum envelope, permitting excellent radio-frequency operation.

Pertinent Literature: Write for "Nickel Alloys for Electronic Uses."

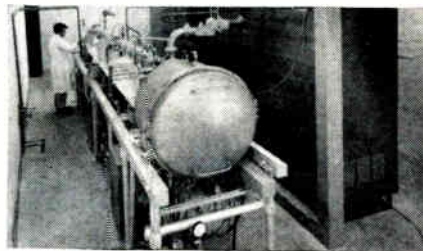

For outstanding vacuum properties, key parts of the Mark 1-T4 accelerator are made of Electronic Grade "A" Nickel. Built by Applied Radiation Corp., Walnut Creek, Cal.

\*Inco trademark



# Electron Tube News

...from **SYLVANIA**

**NOW AVAILABLE!**



**FIRST TV  
DAMPER TUBE  
WITH  
SARONG  
CATHODE**

...Sylvania-6AU4-GTA

Sylvania has "beefed up" the heart of 6AU4-GTA — added life to its service, increased its stability and improved its over-all performance. 6AU4-GTA's bright future results directly from the use of the new concept in cathode coating for electron tubes—Sylvania *Sarong Cathode*.

An exclusive Sylvania development, *Sarong Cathode*

is a thin film of cathode material made to precise measurements for uniformity and *wrapped* on an ultrasonically cleaned cathode sleeve. This provides greater control of density and smoothness of the cathode emissive material, greater control of the coating process, and provides high uniformity of electrical characteristics from tube to tube.

**Sarong Cathode** significantly minimizes plate-to-cathode arcing. Surface of **Sarong** is virtually free of "peaks and valleys," provides uniform spacing between cathode and plate.

**Sarong Cathode** eliminates "hot spots." Control of density of **Sarong** coating assures uniform temperature and emission over the entire cathode surface.

**Sarong Cathode** reduces heater-to-cathode arcing. Wrap-around cathode eliminates possibility of cathode emissive particles adhering to the inside of the cathode sleeve during the coating process.



# SARONG ADDS LIFE TO TV DAMPER TUBE

*Sylvania-6AU4-GTA* illustrates the advantages attainable with the use of *Sarong Cathode*. It is the first TV damper tube to receive this specialized treatment. Other Sylvania types soon to utilize *Sarong* include 6AX4-GTA and 6DE4. This vital development plus several individual tube-type improvements combine to produce highly reliable TV damper tubes deserving of a place in your designs. Your Sylvania Sales Engineer will gladly give you complete technical data and delivery information. Ask him.

## NEW! TWO HIGH-VOLTAGE RECTIFIERS FOR TV PROVIDE "COOL" OPERATION, IMPROVED RELIABILITY



Sylvania-1N2 and -1AU3 feature improved structural design for greater reliability, longer life expectancy. Utilizing a large anode within a T-12 bulb, 1N2 and 1AU3 offer improved heat dissipation for "cool" operation and a reduced voltage gradient. Too, increased anode-to-filament spacing reduces electrostatic field forces that cause filament pulling and resultant plate-to-filament arcing.

Sylvania-1N2 has a tube drop of 100V @ 7mA Ib and a DC inverse plate voltage of 24KV. Sylvania-1AU3 has a tube drop of 225V @ 7mA Ib and a DC voltage of 26KV. Further, 1AU3 incorporates a helical shield as an additional safeguard against electrostatic charges. For complete technical data, see your Sylvania Sales Engineer.

For further information, contact the Sylvania Field Office nearest you. Or, write Electronic Tubes Division, Sylvania Electric Products Inc., 1740 Broadway, New York 19, N. Y.

ELECTRICAL CHARACTERISTICS	1N2	1AU3
Filament Voltage	1.25V ± 0.2V	1.25V ± 0.2V
Filament Current	200mA	200mA
Tube Drop for Ib = 7mA	100V	225V

RATINGS (Design Max. System)	1N2	1AU3
Inverse Plate Voltage		
Total DC and Peak	28,000V	30,000V
DC	24,000V	26,000V
Peak Plate Current	50mA	50mA
Average Plate Current	0.5mA	0.5mA

# SYLVANIA

Subsidiary of **GENERAL TELEPHONE & ELECTRONICS** 

## SOLVING MATERIAL DESIGN PROBLEMS HEAT RESISTANCE

A 5000° flame has not penetrated a one-quarter-inch piece of CDF's new Dilecto RD-105 laminate after ten minutes. The same thickness of cold-rolled steel is pierced in less than forty seconds.

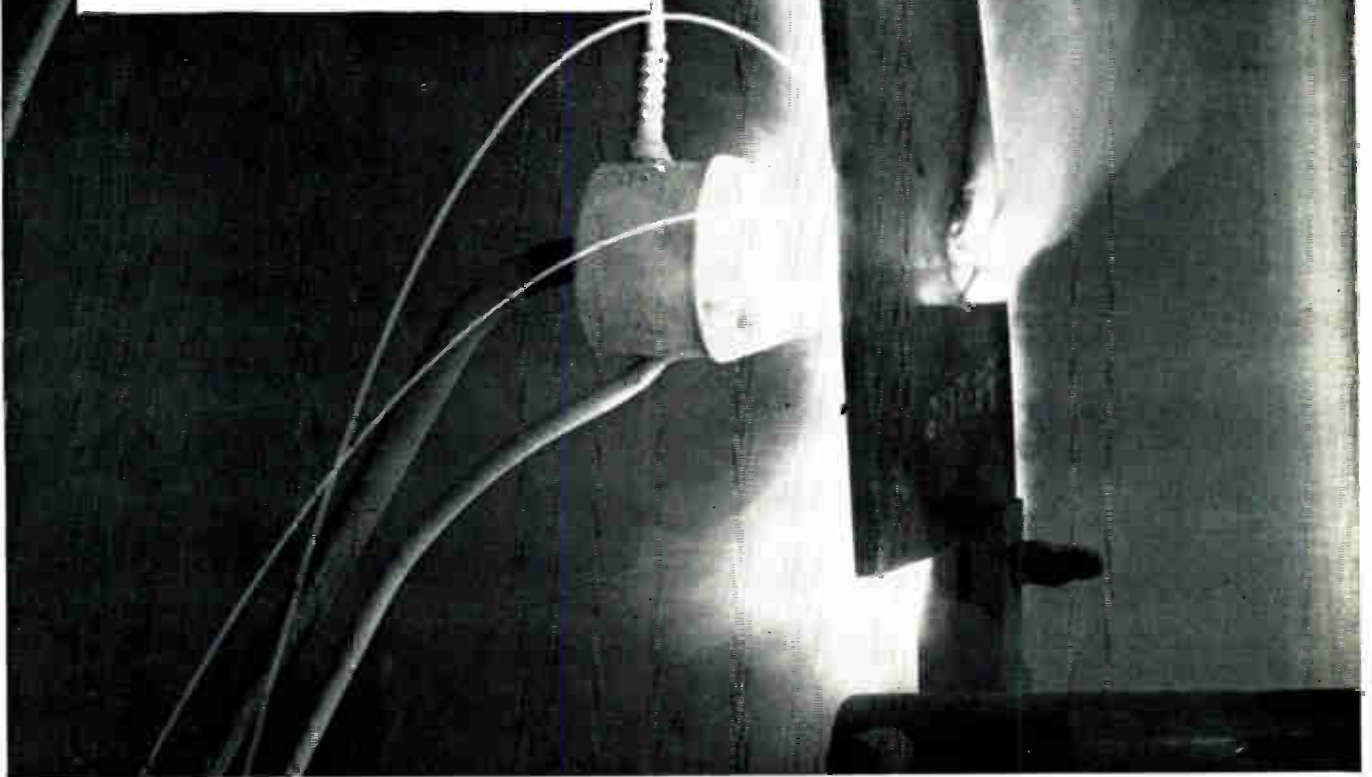

Molded from graphite fabric impregnated with a heat (ablation)-resistant phenolic resin, new CDF grades RD-105 and RD-115 are being evaluated in solid propellant rocket motors.

Dilecto laminates are only one family of products from industry's largest selection of non-metallic

structural materials and electrical insulations. Vulcanized fibre, silicone rubber, mica, Teflon\*, and thermosetting moldings are also supplied by CDF.

CDF can provide both quality and true economy in selecting plastic materials best suited to your needs. Refer to SWEETS PD file or write to us for General Folder 60.

\*DuPont trademark



# CONTINENTAL-DIAMOND FIBRE

A SUBSIDIARY OF THE *Boill* COMPANY • NEWARK 16, DEL.

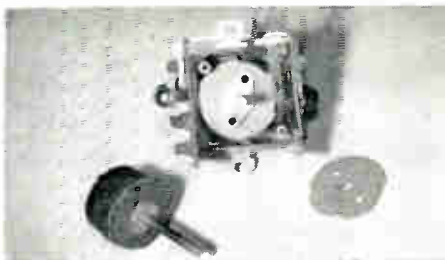

Moisture-resistant and low cost Dilecto cams for automatic washer and dryer controls.

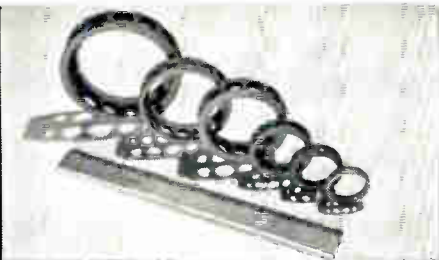

Dimensionally stable, light weight, oil-resistant Dilecto ball bearing retainer rings.



Easily fabricated paper-base, punching grade Dilecto precision switch insulators.

*Another new Hydro-Aire product  
for the aircraft, missile support,  
missile and electronics industries*

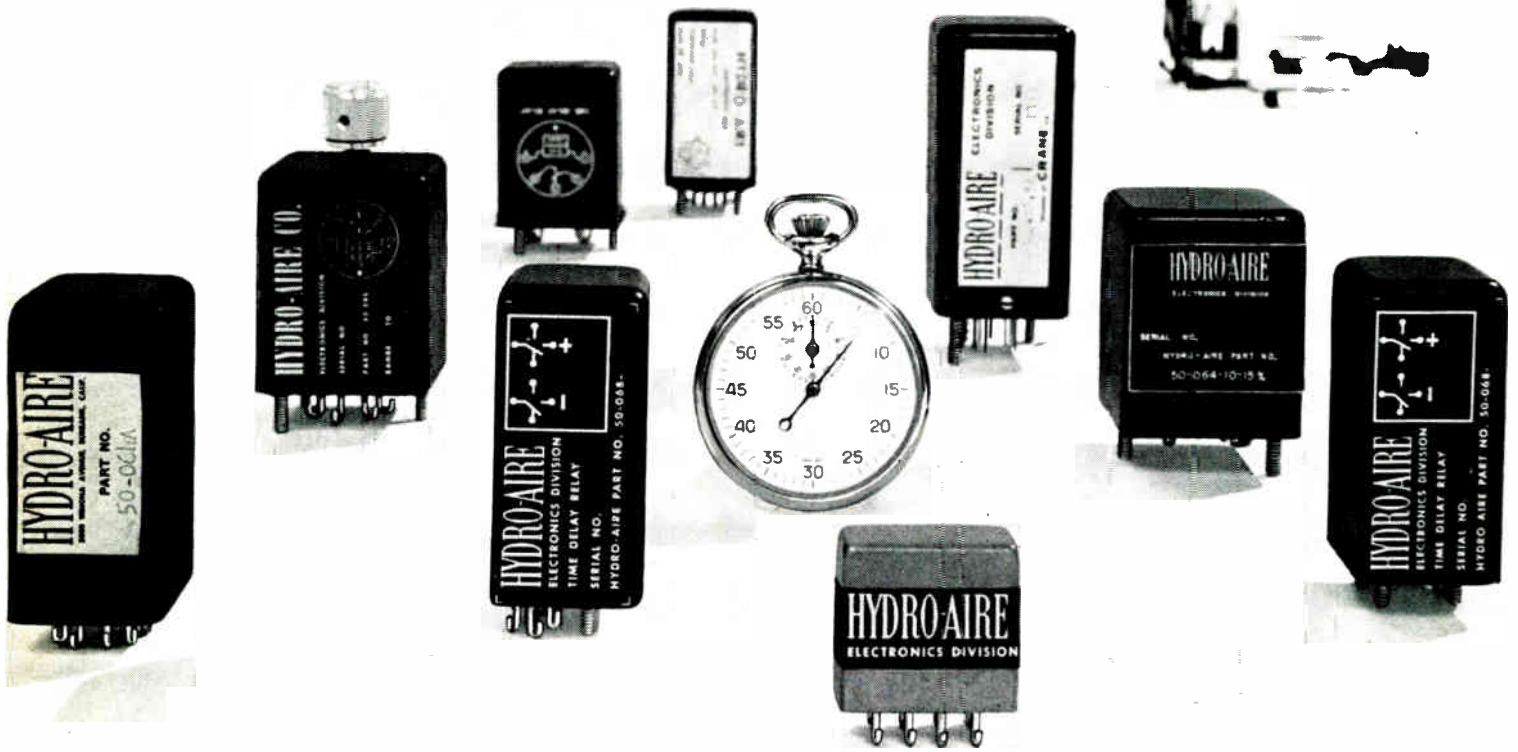

## Ready Now! A Reliable Family of Transistorized Time Delay Devices — available on time from Hydro-Aire

These fully-transistorized time delay devices are but nine of a widely diversified family including relays, sequence timers, computer timing modules and time-programmed, system supervising units—all custom-designed, built and on-time delivered by Hydro-Aire. Perhaps one of these proven designs meets your specifications. If not, we will custom-design to your requirement. All of our time delay devices are compactly designed, available for AC or DC operation, and conform to applicable Mil Specs. These devices typify the many reliable electronic products being designed, developed, produced and on-time delivered by Hydro-Aire.

CHARACTERISTICS: TIME DELAY RELAY MODEL 50-085

Size— $2\frac{3}{8}$ " x  $1\frac{1}{2}$ " x  $1\frac{1}{2}$ "

Weight—4 oz.

Time delay range—adjustable over one decade; 6 to 60 seconds with  $\pm 5\%$  accuracy

Life: 100,000 operations at rated contact load

Maximum power required: 50 ma at 24-31 VDC

Temperature range:  $-55^{\circ}\text{C}$  to  $+71^{\circ}\text{C}$  as standard; to  $+125^{\circ}\text{C}$  available on special request

WRITE FOR ELECTRONICS CATALOG. A note on your letterhead brings a free copy, containing detailed facts and specifications. If you have a time delay device requirement, include your specifications for a prompt quote.

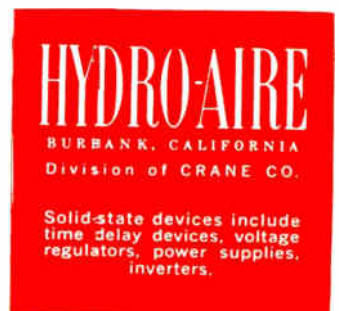

## Rice Develops Computer Plans

COLLEGES AND UNIVERSITIES currently find themselves deeply involved in research and scientific projects of all sorts as they approach the half-year mark. A sampling of what is going on at several of the schools follows:

**Rice Institute**—A computer project, which began in 1957, is continuing. Sponsored by the Atomic Energy Commission and the Shell Development Co., the project is due almost entirely to original work done by members of the project staff. An 8,192 word-barrier grid tube memory bank is now in operation, and is expected to be expanded after the machine is in use to 32,000 words. Word length is 56 bits, including two tag bits. Forty-eight bit mantissa and six bit exponent is used for number representation, and one instruction per word for orders. Input will be by punched paper tape at 40 words per second, and output on a fast-line printer at ten 108-character lines per second. Magnetic tape units are buffered and will transfer information to or from the main memory at over 4,000 words per second. The computer is expected to be placed in routine operation within one year.

**University of Michigan**—Astronauts will have to keep track of two kinds of time during their flight to Mars, according to a report prepared by the University of Michigan for the Air Force. The two types involve reference to astronomical time and reference to some event during the course of the flight. The report points out that the space pilots will require an extremely accurate, compact, and dependable timepiece calibrated in microseconds for computations. The timepiece will also have to supply the crew with information on the passage of hours, days and months.

**Johns Hopkins University**—The Martin Co. has established a Project Vanguard annual graduate fellowship here. Predoctoral candi-

dates in engineering or the physical sciences are eligible. Under the program, \$5,000 will go each year to the university. Of this amount \$3,000 will go directly to the successful candidate, \$1,200 will go toward tuition, and the remainder is provided to the university for administrative purposes.

**Stanford Research Institute**—Last year Stanford Research Institute reported a volume of more than \$22 million in contract research. In the previous year, the total was \$18 million. About two-thirds of the research in 1959 was performed under government sponsorship; the remainder was financed by business, industry, foundations and individuals.

**Joint Effort**—Eighteen areas in six midwestern states have been designated as a communications network for the new Midwest Program on Airborne Television Instruction. Beginning in February, 1961, educational courses on video tape will be telecast from an airplane flying over north-central Indiana. The telecasts will be received in the classrooms of the various colleges throughout the telecasting area. The MPATI telecasts will cover a circular area of 150 to 200 miles in the states of Illinois, Indiana, Kentucky, Michigan, Ohio and Wisconsin. Beginning in September, 1961, courses will be telecast on two channels six hours a day, four days a week. The \$7-million project is supported by the Ford Foundation and private industry. The groups involved are Northern Illinois University, Northwestern University, University of Illinois, Ball State Teachers College, Butler University, Indiana State Teachers College, Indiana University, Notre Dame University, Purdue University, University of Kentucky, University of Louisville, Michigan State University, Bowling Green State University, Miami University, Ohio State University and the University of Wisconsin.

# LOW-LOSS



## KEL-F SOCKETS

For high power transmitting tubes such as: 4X150A; 4X150D; 4X250B; 4CX250B; 7034; 7035; 4X250F

Molded of low dielectric loss-factor Kel-F plastic, these popular Johnson sockets are designed to handle a wide selection of high power transmitting tubes. Sockets are available in several designs—with or without screen grid by-pass capacitors. Control grid contact "guide" is machined for greater alignment accuracy—all contacts are low-resistance, silver-plated beryllium copper. Tube pin contacts are heat treated to provide positive contact pressure as well as extended life—annealed soldering tabs may be easily bent or formed. High quality, heat resistant, steatite chimney also available to direct air flow through tube cooling fins.

For complete specifications, write for Data Sheet 755 . . . or our newest components catalog, described below.



Basic socket with silver-plated brass mounting saddle.



Socket with mounting ring and screen grid by-pass capacitor.

### New Catalog

Write today for our newest electronic components catalog—complete specifications, engineering prints and current prices on:

• Capacitors • Tube sockets • Connectors • Pilot lights • Insulators • Knobs, Dials • Inductors • Hardware



### E. F. JOHNSON CO.

1809 2nd Ave. S.W. • Waseca, Minn.

**In science ...**

This "diary" of an airframe in wind-tunnel flight is an instantly-readable record taken on a Model 906A Visicorder by ARO, Inc., at the USAF Arnold Engineering Development Center, Tullahoma, Tennessee, the ARDC wind tunnel facility. This record measures damping-in-pitch derivatives for a clipped-delta-wing-body configuration over a Mach number range of 2.0 to 5.0 so that these measurements could be compared with Mach number trend predicted by theory. The values discovered through this experiment showed discrepancies from theoretical values because the theory pertained to simpler bodies than that used in the tests. The new set of Visicorder data will result in more accurate predictions for future design.

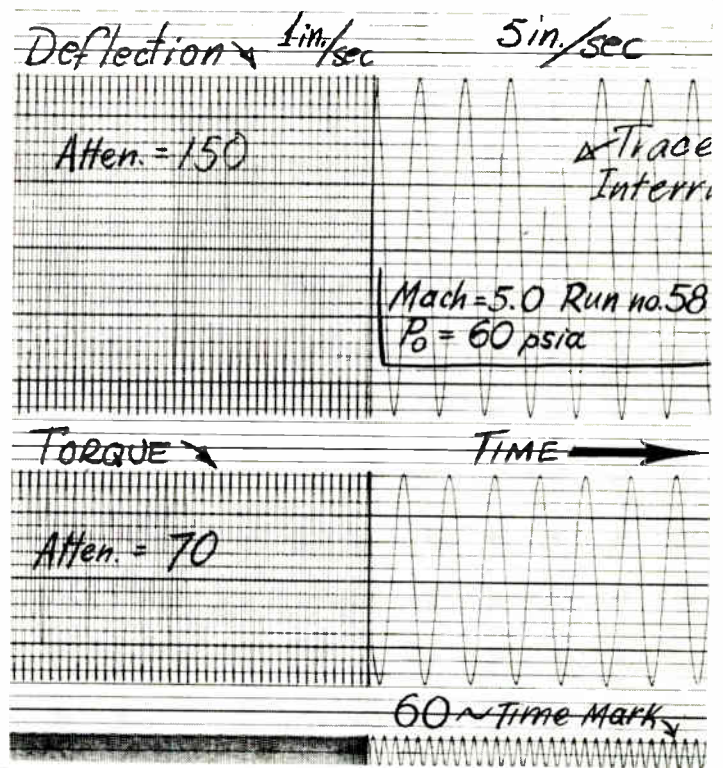

**these are records of leadership**

**In industry ...**

This "cardiogram" of a diesel engine was taken on a Model 906 Visicorder by research engineers at the Worthington Corporation. It is a directly-recorded chart of pressure variations in the exhaust manifold, cylinder, and intake manifold of a Worthington Tripower diesel operating at 450 RPM and developing 265 HP per cylinder. These pressure-variation studies enable Worthington engineers to determine optimum valve timing and engine configuration, and led to changes in the Tripower engine for best performance. In these and in hundreds of other scientific and industrial applications, Visicorders are bringing about new advances in product design, computing, control, rocketry, nucleonics, and production.

For information on how to apply the unlimited usefulness of the Visicorder to your specific problems, phone your nearest Honeywell Industrial Sales Office.

The Honeywell Visicorder provides instantly-readable, high-sensitivity data at frequencies from DC to 5000 CPS. There are models with 8, 14, 24, or 36-channel capacities.

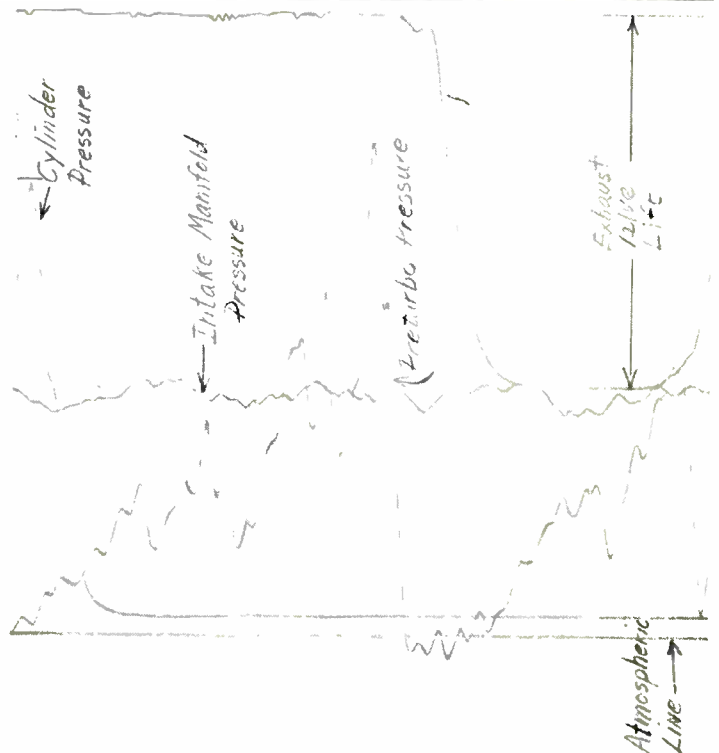
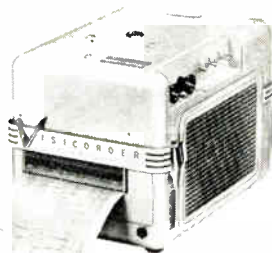

Visicorder records 2/3 actual size.

**Honeywell**



Industrial Products Group

Reference Data: Write for specifications on Visicorders 906B, 1108 and 1012.

Minneapolis-Honeywell Regulator Co., Industrial Products Group, Heiland Division, 5200 E. Evans Ave., Denver 22, Colorado

CIRCLE 60 ON READER SERVICE CARD

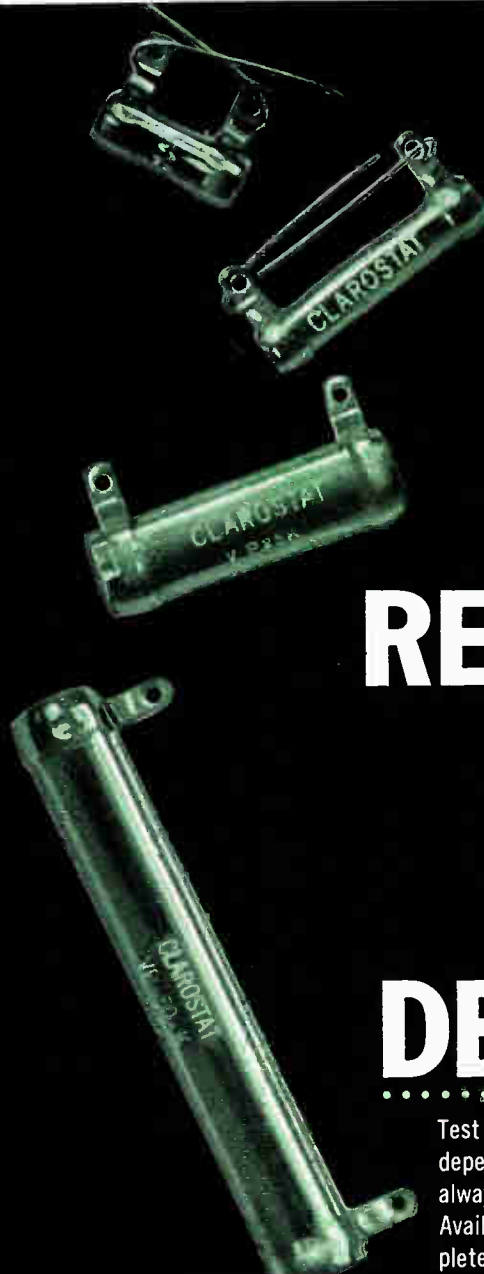

# NO VITREOUS ENAMEL POWER RESISTOR EVER OFFERED GREATER DEPENDABILITY!

Test after test by independent evaluation laboratories have proved the outstanding dependability of Clarostat Greenohm "V" vitreous enamel resistors. Be sure to always specify this **proved dependability**. Available in all popular wattages, ohmages, adjustable or fixed... Write for complete information.



*Write for complete details*



**CLAROSTAT MFG. CO., INC.**  
DOVER, NEW HAMPSHIRE  
In Canada: CANADIAN MARCONI CO., LTD., Toronto 17, Ont.



*direct  
line  
service*

Your local Clarostat Distributor stocks Greenohm "V" resistors in depth—call him for fast delivery...

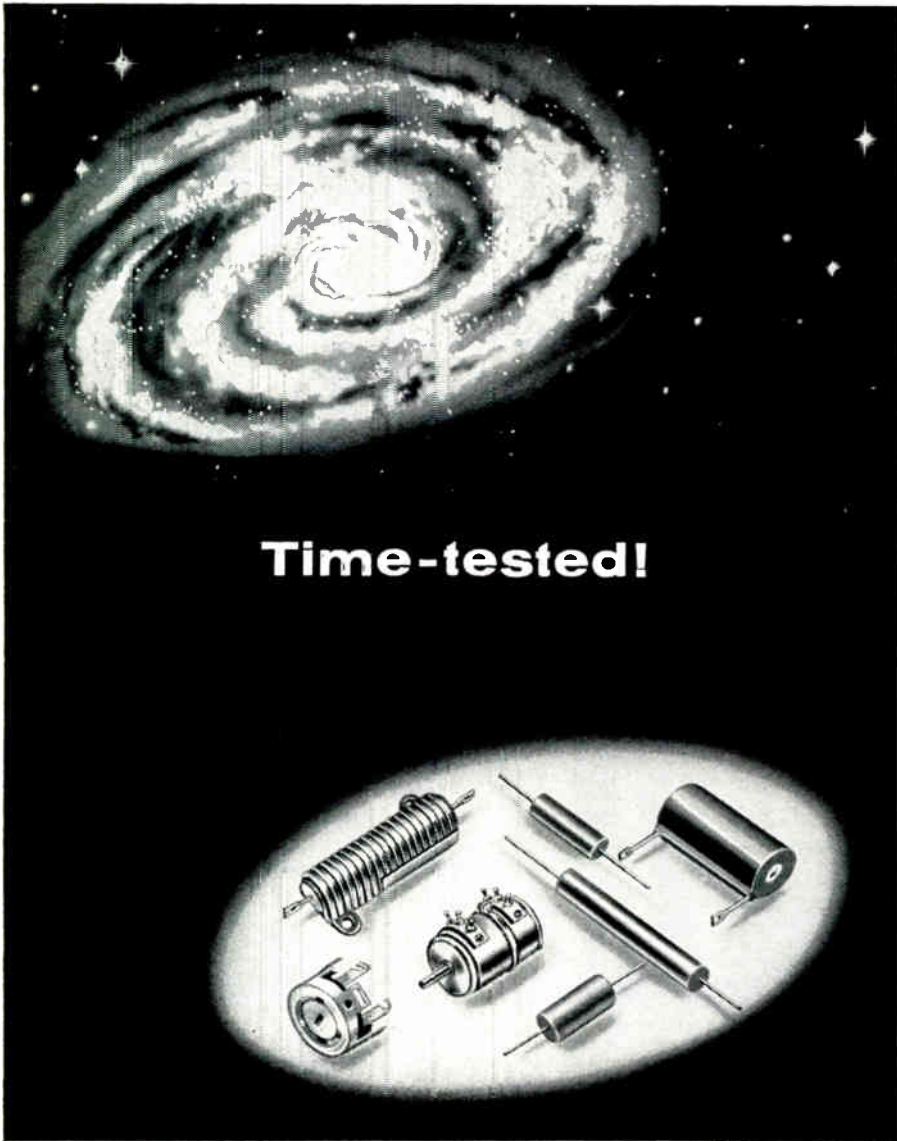

**Time-tested!**

— the time-tested standard of the resistor industry

# **Evanohm\***

## **RESISTANCE ALLOY**

— for resistors and precision instruments

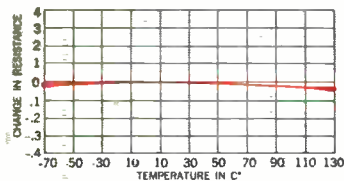

Percent change in resistance of an ideal sample of Evanohm. Normal production material (.002" and finer) is supplied within the range  $\pm 10$  ppm  $-65^{\circ}$  to  $25^{\circ}$  C. and  $25^{\circ}$  to  $125^{\circ}$  C. referred to  $25^{\circ}$  C.)

Wherever exceptional stability over a wide temperature range is essential, EVANOHM is the accepted standard of performance. This high-reliability resistance alloy provides high specific resistance, low temperature coefficient, low thermal EMF to copper. EVANOHM is especially recommended for use in resistors, aircraft instruments, for guided missiles, rockets and other precision equipment. Available in bare wire, enamel, formvar, polyurethane, silk, cotton, nylon and glass insulation. Write for complete electrical and mechanical data and recommendations on your specific application.

\*Patents 2,293,878-2,638,425 — Tradename Registered

**WILBUR B. DRIVER CO.**  
Main Office: NEWARK, N. J. — Tel. HUmboldt 2-5550



Branch Offices and Warehouses in Principal Cities. Manufacturing Plants: 1875 McCarter H'way, Newark 4, N. J.; 2734 Industrial Way, Santa Maria, Calif. Canadian Wilbur B. Driver Co., Ltd., Rexdale (Toronto). Subsidiary: Western Gold and Platinum Co., 525 Harbor Blvd., Belmont, Calif.

## MEETINGS AHEAD

May 23-25: Telemetry Conf., Annual, West Coast, ISA with ARS, AIEE, IRE, IAS Miramar Hotel, Santa Monica, Calif.

May 23-26: Design Engineering Conf., Coliseum, N. Y. C.

May 23-28: I.E.A. Exhibition, Instruments, Equipments & Components, Olympia, London.

May 24-26: Technical Conf. and Trade Show, Seventh Regional, IRE, ISA, Olympic Hotel, Seattle, Wash.

May 31-June 2: Frequency Control Symposium, USA Signal Research & Devel. Lab., Shelbourne Hotel, Atlantic City, N. J.

June 1-3: Analysis Instrumentation, Latest Advances, ISA, Queen Elizabeth Hotel, Montreal, Canada.

June 1-3: Radar Symposium, Willow Run Laboratories, Univ. of Michigan, Ann Arbor, Mich.

June 9-12: Society of Women Engineers, Annual Convention, Ben Franklin Hotel, Seattle, Wash.

June 10-26: British Exhibition, Electrical and Electronic Equipment, Coliseum, N. Y. C.

June 12-15: American Nuclear Society, Annual, Palmer House, Chicago.

June 14-16: Railroad Communications, Assoc. of Amer. Railroads, Communications Section, Sheraton-Cadillac Hotel, Detroit.

June 20-24: American Institute of Electrical Engineers, Summer General, Chalfont-Haddon Hotel, Atlantic City, N. J.

Aug. 23-26: Western Electronic Show and Convention, WESCON, Memorial Sports Arena, Los Angeles.

Oct. 10-12: National Electronics Conf., Hotel Sherman, Chicago.





*Avnet is Quick!*

*Quicker* than any other major source of supply in America. A verbal order from an Avnet customer puts the gears in motion. To meet customer requests, 75% of all orders are received by Avnet, processed, assembled and shipped before written confirmation arrives.

Electronic Designers, Engineers and Purchasing Men rely on Avnet's speed of shipment.

Speed of delivery is available to you from Avnet Service Centers and Stocking Facilities in: Los Angeles, Cal., Sunnyvale, Cal., Chicago, Ill., Dayton, Ohio, Westbury, L. I., Waltham, Mass.



**AVNET**  
AVNET ELECTRONICS CORP.

Avnet distributes from most stocking facilities: BENDIX SCINTILLA CONNECTORS, SPERRY SEMICONDUCTORS, ROBERTSON SPLICE & CONNECTOR CASES, VIBREX FASTENERS BY GENERAL TIRE & RUBBER CO., U. S. SEMCOR SEMICONDUCTORS, SANGAMO CAPACITORS, SPRAGUE CAPACITORS.

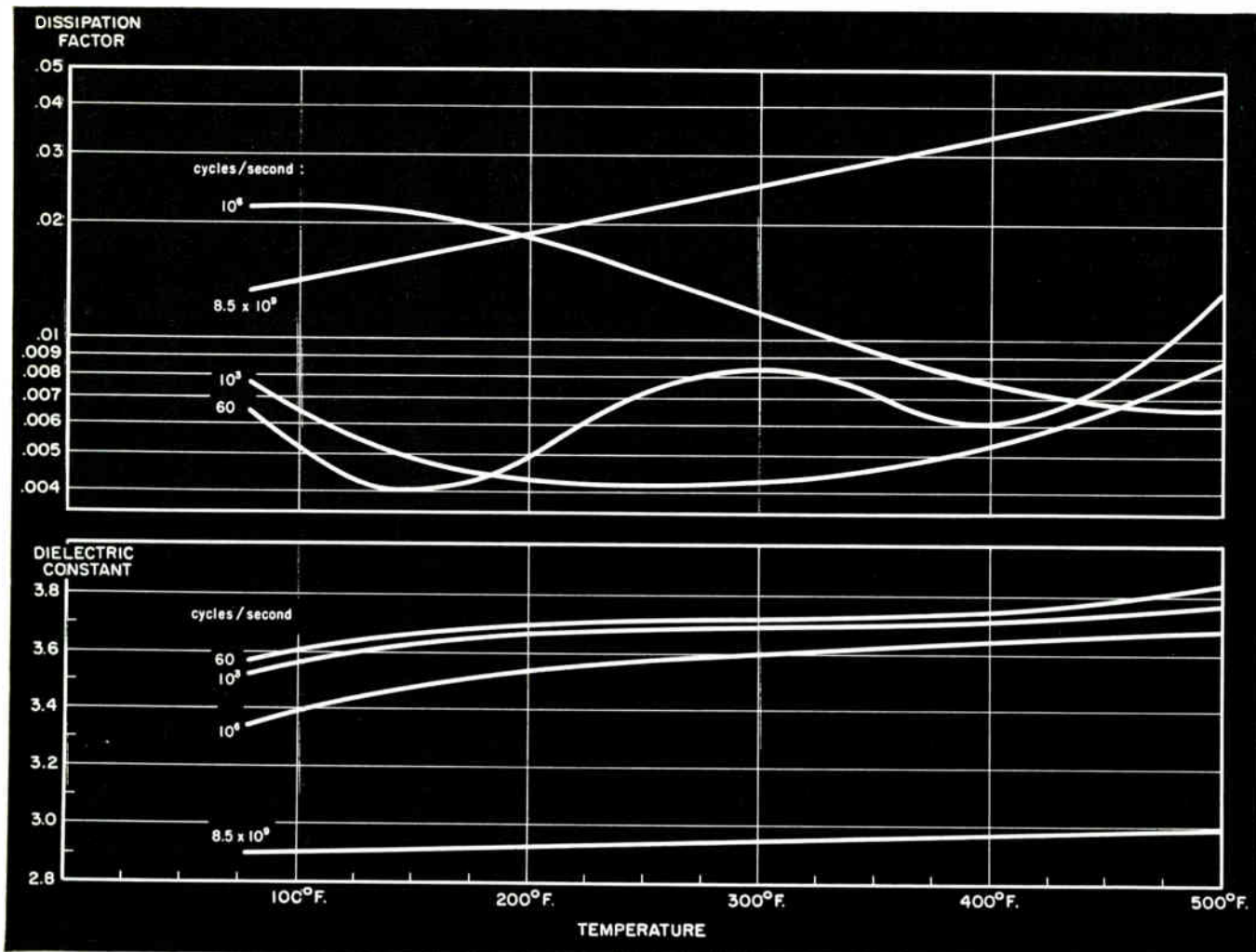

## Good electrical properties at H.D.T.'s\* above 500°F. now possible in epoxy resin potting systems

Turn an appraising eye on the chart above. These data were assembled in tests of epoxy resin systems which had been cured with Du Pont's pyromellitic dianhydride (PMDA).

Note the unusual stability of electrical properties at elevated temperatures.

Had we the space, we could also display equally exciting graphs showing excellent thermal resistance.

PMDA is now available in commercial quantities, to help you add these exceptional thermal characteristics to your epoxy resin potting, encapsulating, and laminating systems.

### Other advantages

There's more. PMDA provides several advantages in addition to high heat resistance.

You get all the usual benefits of an anhydride curing

agent, including low toxicity and good chemical stability.

If you wish, you can get long pot life—up to 2 days at room temperature or 6 hours at 165° F. On the other hand, if you want a quick cure—say, 15 minutes at 355° F.—you can get it by simply changing the formulation.

### Now available

You can turn these test results into product improvements *now*, because PMDA is being delivered in quantity from Du Pont's new multimillion-pound plant. Recent price reduction to only \$1 per pound also makes this a practical means of improving your epoxy resin systems.

For more details or for samples of PMDA, write to Du Pont, Explosives Department, 6539 Nemours Bldg., Wilmington 98, Delaware.

\*(H.D.T.—Heat Distortion Temperature)

**DU PONT** PMDA (PYROMELLITIC DIANHYDRIDE)  
REG. U.S. PAT. OFF.

BETTER THINGS FOR BETTER LIVING...THROUGH CHEMISTRY

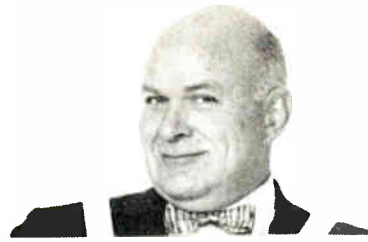
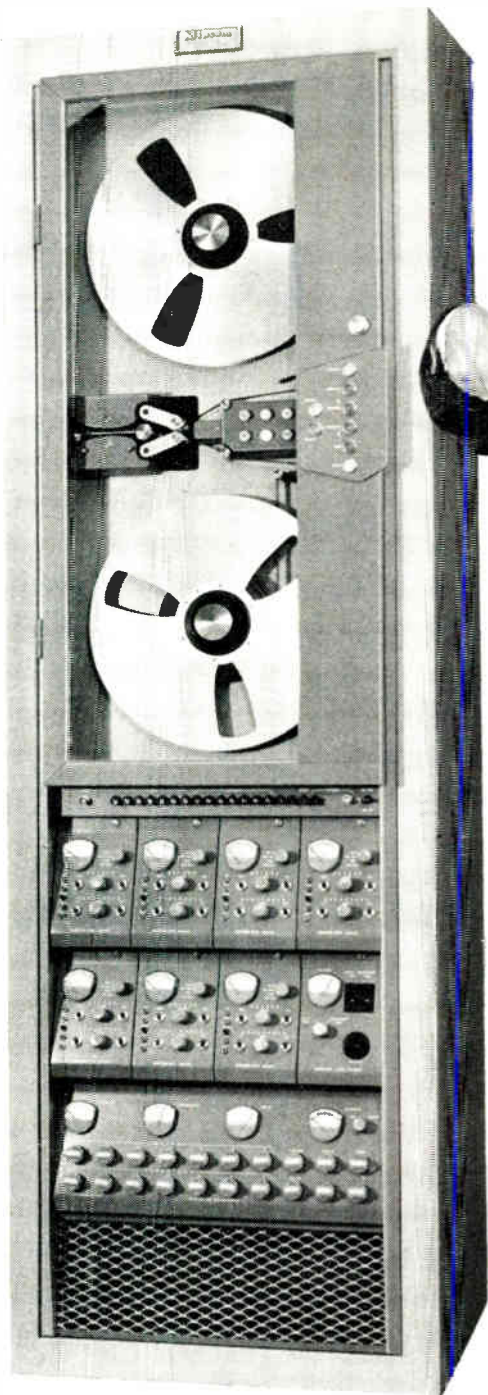

The Newest from  
**MINCOM**  
the **CM-100**

records & reproduces **6 SPEEDS**

**62.5 kc - 7½ ips - 192 min.**  
**100 kc - 12 ips - 120 min.**  
**125 kc - 15 ips - 96 min.**  
**250 kc - 30 ips - 48 min.**  
**500 kc - 60 ips - 24 min.**  
**1 mc - 120 ips - 12 min.**

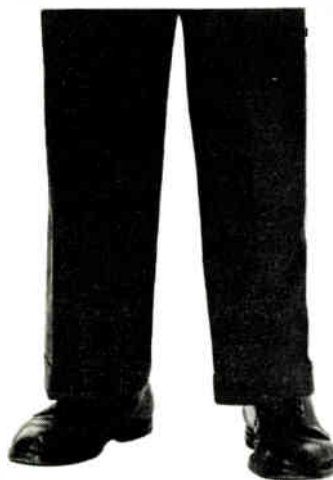

Greater bandwidth at a given speed — in six words that's the story of Mincom's newest system, the **Mincom Model CM-100 Magnetic Tape Instrumentation Recorder / Reproducer**. There's more, too: one-rack compactness, no belt changes, dynamic braking, complete compatibility, modular construction. For versatile and reliable performance in any instrumentation application, the CM-100 stands alone. Interested? Write today for brochure.



... WHERE RESEARCH IS THE KEY TO TOMORROW

**MINCOM** DIVISION **MINNESOTA MINING AND MANUFACTURING COMPANY**

2049 SOUTH BARRINGTON AVENUE • LOS ANGELES 25, CALIFORNIA • 425 13th STREET N.W. • WASHINGTON 4, D. C.

*After 31 years of continuous growth and*

*We're changing*

# The Bendix

To reflect our dynamic growth in such fields as electronics, missiles and space, automotive, weapons systems, computers, machine tools, instrumentation, nuclear technology, hydraulics, meteorology, electrical, marine and others, we are dropping "Aviation" from our corporate name on June 1, 1960. We do not wish to convey the impression that our products and skills are limited to the field of aviation alone, although aviation products accounted for billings of \$388,700,000 in 1959.

Today Bendix—through 25 divisions and 16 subsidiary and affiliate companies around the world—serves many fields.

Our success in the rapidly expanding age of aviation has long obscured the fact that the Bendix® automobile starter drive was the company's first major product. Bendix introduced the type of four-wheel brakes that over the years has been used on most makes of cars. Bendix also pioneered automotive power brakes and power steering. Our automotive business in 1959 totaled \$114,300,000.

A notable trend in Bendix' recent history is the utilization of electronics in many of our major fields of activity. These range from automobile radios to

aircraft and industrial communications and automatic flight controls . . . from electronic computers and data processing to numerical tape control systems for machine tools . . . and from transistors and ship-to-shore telephones to sonic cleaning and undersea sonar detection equipment. Approximately 40% of Bendix products are electronic, including air defense radar which today guards 25 million square miles of the earth's surface.

Missile and space equipment accounted for \$103,000,000 of our total business of \$689,692,312 in 1959. In addition to being the prime contractor for two important missiles, Talos and Eagle, we are also a supplier of components and sub-systems

*diversification as Bendix Aviation Corporation . . .*

*our name to*

# Corporation

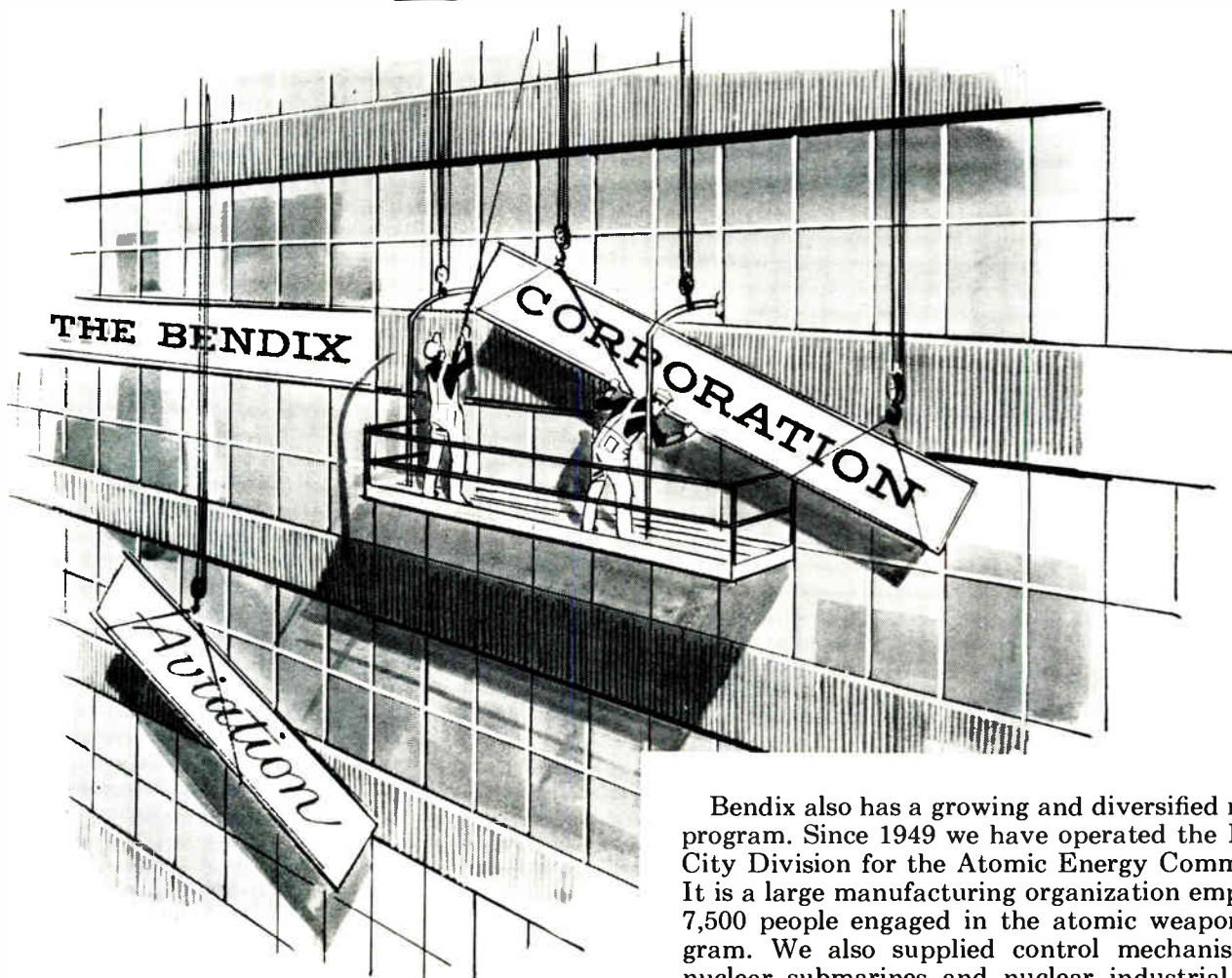

for most U. S. missiles. Bendix is likewise taking an active part in Project Mercury and in satellite communications. The first is the program to put a man into space. The second will mark a new era in communications by using a satellite in orbit as a relay station for global radio messages between earth stations and aircraft.

Bendix also has a growing and diversified nuclear program. Since 1949 we have operated the Kansas City Division for the Atomic Energy Commission. It is a large manufacturing organization employing 7,500 people engaged in the atomic weapons program. We also supplied control mechanisms for nuclear submarines and nuclear industrial power plants, and we are playing a part in developing the newest U. S. atomic power plants for aircraft, missiles and space vehicles.

Thus, as we drop "Aviation" from our corporate name, but not from our programs, we face a tomorrow where the range of our opportunities is broadening at a breathtaking rate.



*A thousand diversified products*



TW-956H—1/2 ACTUAL SIZE

# Now...solve TWT space and temperature problems

**Magnetically shielded,  
temperature compensated TWTs**

Sylvania research offers you two new S-band traveling-wave tubes of the permanent magnet focused type—TW-4002F and TW-956H—which give you these unique advantages:

**Magnetically shielded**—not affected by proximity to magnets and magnetic materials such as other TWTs, solenoids, and hardware. This permits close packing without hazard of performance loss.

**Temperature compensated**—they operate from  $-65^{\circ}\text{C}$  to  $+72^{\circ}\text{C}$  with minimum degradation of performance, and without requiring heater blankets.

**Periodic PM focusing**—they do not require weighty, space-and-power consuming solenoids.

**Broad band**—they have a relatively flat frequency response over an octave, from 2.0 to 4.0 KMC.

**Electrically superior characteristics**—at room temperature they have the following specifications:

**TW-4002F**—small signal gain is 37 db minimum; CW rf power output (saturation) is 10 milliwatts minimum

**TW-956H**—gain with 0.1 milliwatt input is minimum 37 db; CW rf power output (saturation) is 2 to 5 watts

**COMPACTNESS**—they are about 15" long, have 1.4" capsule diameter, weigh 3 pounds

**RUGGEDNESS**—specially designed for airborne and missile applications

Sylvania Electric Products Inc.—Special Tube Operations  
500 Evelyn Ave., Mountain View, Calif.

# SYLVANIA

Subsidiary of **GENERAL TELEPHONE & ELECTRONICS**

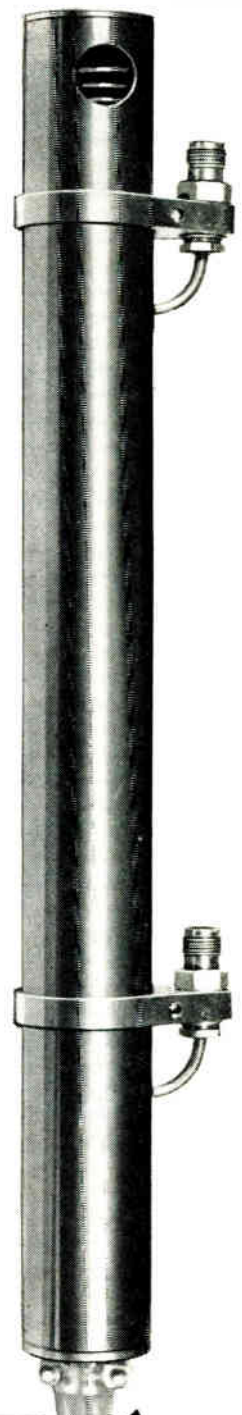

The important advances in environmental testing come from MB



## NEW line of MB hydraulic shaker systems to broaden scope of vibration/shock/fatigue testing

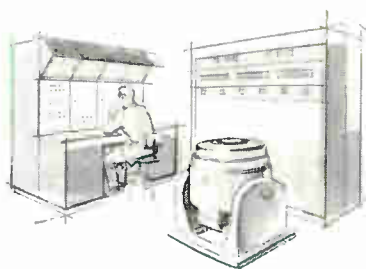

Pioneer and leader in the field of electrodynamic vibration systems, MB now adds a new dimension to environmental engineering with a complete line of hydraulic shaker systems. Operating in the low to intermediate frequencies, these systems—27 models in all—will provide vibratory forces from 1000 to 100,000 pounds, strokes as long as 9' D.A., and practical test load capacity from 5 pounds to 15 tons.

ENGINEERING's long recognized need for test equipment with far greater forces and longer strokes than heretofore available is now successfully fulfilled with MB's new line of hydraulic shaker systems.

Compact, efficient, reliable—and above all, *conservatively rated*—these new shaker systems will perform as specified and promise to enlarge radically the scope of vibration, shock and fatigue testing.

Over four years in development and already service-proved, these new test systems are the result of MB's unparalleled experience in the field—plus its keen understanding of the needs of the environmental test engineer.

They are another reason why engineers everywhere recognize that . . . *the important advances in environmental testing come from MB.*

### **MB ELECTRONICS**

A DIVISION OF TEXTRON ELECTRONICS, INC., 1102 State Street, New Haven 11, Conn.

**BASIC  
BUILDING  
BLOCKS  
FROM KEARFOTT**

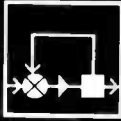

**20 SECOND  
SYNCHRO**

This synchro, just one of a broad line offered by Kearfott, provides the extreme accuracy required in today's data transmission systems. Kearfott synchro resolvers enable system designers to achieve unusual accuracy without the need for 2-speed servos and elaborate electronics. By proper impedance, matches up to 64 resolver control transformers can also operate from one resolver transmitter.

**TYPICAL  
CHARACTERISTICS**      **SIZE 25**

	Transmitter	Control Transformer
Type Resolver	Z5161-001	Z5151-003
Part Number		
Excit. Volts (Max.)	115	90
Frequency (cps)	400	400
Primary Imped.	400/80°	8500/80°
Secondary Imped.	260/80°	14000/80°
Transform. Ratio	.7826	1.278
Max. Error fr. E.Z.	20 seconds	20 seconds
Primary	Rotor	Stator

Write for complete data.

**BASIC  
BUILDING  
BLOCKS  
FROM KEARFOTT**

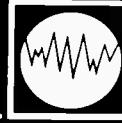

**PRECISE  
ANGLE  
INDICATOR**

Consisting of an angle position indicator, motor and servo amplifier, this small, versatile, rack panel mounted unit provides angular position indications for laboratory, production and field use. Input signals proportional to unknown angular position of synchro device being measured are resolved as an error voltage, which is amplified and used to drive an internal servo loop to null. Counter mechanism then provides direct visual readout of angular position.

**TYPICAL  
CHARACTERISTICS**

Input Signal: S<sub>1</sub>, S<sub>2</sub>, and S<sub>3</sub> of external synchro transmitter.  
 Repeatability: Within 0.6 minute in either a clockwise or counterclockwise direction for any angular position.  
 Readability: 0.5 minute through full range from zero to 360° Rotation is continuous.  
 Accuracy: ± 6 minutes in the standard unit. Other accuracies available on request.  
 Sensitivity: 0.5 minutes maximum.  
 Slewing Speed: Phase sensitive, 180° in 7 seconds.  
 Input Voltages: 115 volts, single phase, 400 cycles, 23 VA max.  
 Size: Standard Rack Mounting—1 3/4" x 9 1/2" x 8 1/2"

Write for complete data.

**BASIC  
BUILDING  
BLOCKS  
FROM KEARFOTT**



**FLOATED RATE  
INTEGRATING  
GYROS**

Specifically designed for missile applications, these Kearfott miniature gyros operate efficiently at unlimited altitudes. Their outstanding accuracy and performance make them superior to any comparably-sized units on the market. Hermetically sealed within a thermal jacket, these gyros are ruggedly designed and completely adaptable to production methods. Performance characteristics that are even more precise can be provided within the same dimensions.

**TYPICAL CHARACTERISTICS**

Mass Unbalance:  
 Along Input Axis: 1.0°/hr maximum untrimmed  
 Standard Deviation (short term):  
 Azimuth Position: 0.05°/hr  
 Vertical Position: 0.03°/hr  
 Drift Rate Due to Anisoelectricity  
 Steady Acceleration:  
 .015°/hr./g<sup>2</sup> maximum  
 Vibratory Acceleration:  
 .008°/hr./g<sup>2</sup> maximum  
 Damping:  
 Ratio of input angle to output angle is 0.2  
 Characteristic Time:  
 .0035 seconds or less  
 Weight: 0.7 lbs.  
 Warm-Up Time:  
 10 minutes from -60°F  
 Life: 1000 hours minimum

Write for complete data.

Tachometers



Servo Valve



Ferrites



**Engineers:** Kearfott offers challenging opportunities in advanced component and system development.

**KEARFOTT DIVISION**  
**GENERAL PRECISION INC.**  
 LITTLE FALLS, NEW JERSEY

Midwest Office: 23 W. Colendar Ave., Lo Grange, Ill.  
 South Central Office: 6211 Denton Drive, Dallas, Texas  
 West Coast Office: 253 N. Vinado Avenue, Posedeno, Calif.



For Airborne Equipment

# MORE POWER LESS WEIGHT LESS SPACE

with new  
**CBS PNP Power Transistors**

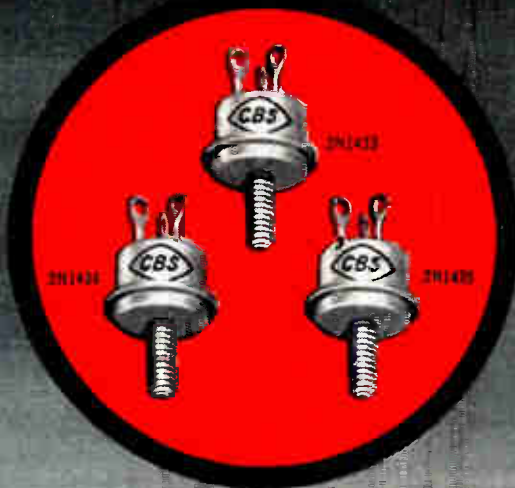

Compact, lightweight servo amplifier employing CBS 2N1434 10-watt push-pull output stage.

In a typical servo amplifier, a pair of these CBS PNP germanium power transistors delivers 10 watts output. Yet each transistor weighs less than 5 grams . . . and requires only  $\frac{1}{3}$  square inch of chassis space. Put the compact CBS 2N1433, 2N1434, 2N1435 to work in your military or industrial equipment — airborne, mobile or portable. Check advantages and basic data. Write for complete technical bulletin E-370. Order from your Manufacturers Warehousing Distributor.

### NOTE THE ADVANTAGES

These improved versions of the 2N538, 2N539A and 2N540 offers:

- Single, sturdy 10-32 mounting stud
- Compact male-industrial TO-10 welded package
- High dissipation with minimum size
- High collector-to-base voltage
- High collector-emitter breakdown voltage
- Wide range of operating and storage temperatures

### CHECK THE CHARACTERISTICS

Type	Max. W Diss.*	Max. $V_{CB0}$	Min. $BV_{CBO}$	$(I_C=2A, V_{CE}=-2V)$		$(I_C=2A, V_{CE}=-2V)$		Max. Thermal Res. °C/W
				Min.	Max.	Min.	Max.	
2N1433	35	-80	-50	20	50	—	3.3	2
2N1434	35	-80	-50	45	115	—	1.8	2
2N1435	35	-80	-50	30	75	1.0	2.5	2

All types have: Max. collector current, 3.5 amps; junction temperature, -65 to +95°C; max. saturation voltage, 0.6 volts ( $I_C=2A, I_B=200mA$ ). Minimum alpha cutoff frequency is 200 KC ( $I_C=100mA, V_{CE}=-4$  volts). \*25°C base mounting temperature.

More reliable products  
through Advanced Engineering



**semiconductors**

**CBS ELECTRONICS**, Semiconductor Operations • A Division of Columbia Broadcasting System, Inc.

Sales Offices: Lowell, Mass., 900 Chelmsford St., GLenview 4-0446 • Newark, N. J., 231 Johnson Ave., TAibot 4-2450 • Melrose Park, Ill., 1990 N. Mannheim Rd., EStebrook 9-2100 • Los Angeles, Calif., 2120 S. Garfield Ave., RAYmond 3-9081 • Atlanta, Ga., Cary Chapman & Co., 672 Whitehall St., JACkson 4-7388 • Minneapolis, Minn., The Heimann Co., 1711 Hawthorne Ave., FEderal 2-5457 • Toronto, Ont., Canadian General Electric Co., Ltd., LEEnox 4-6311

# Take a close look at today's foolproof termination method...

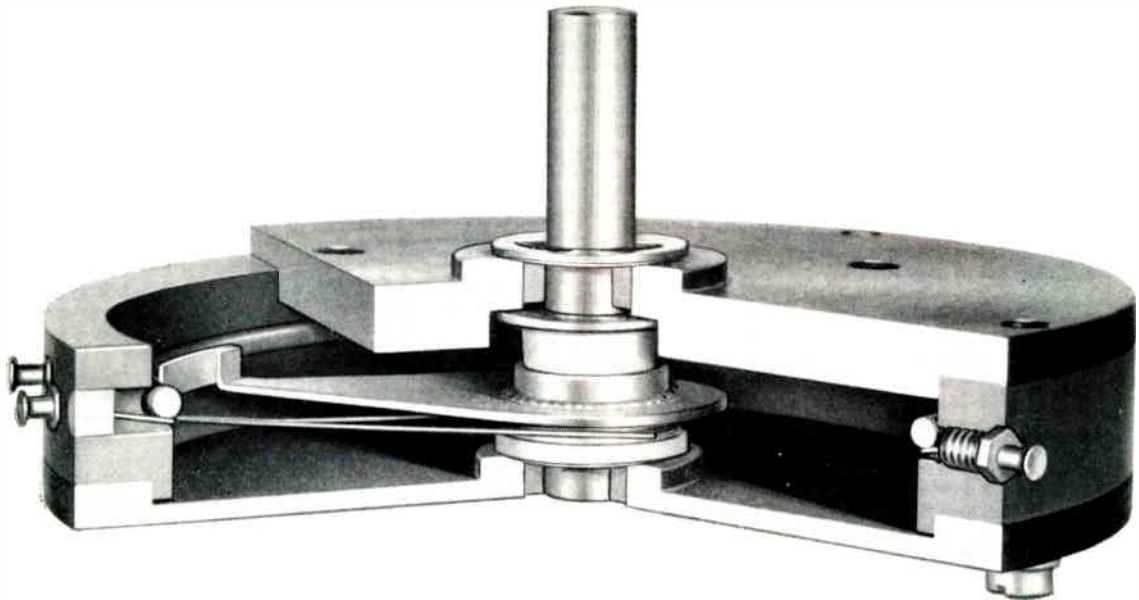

## Then put it to the test!

This blow-up of the unique GAMEWELL High Pressure Spring Contact Potentiometer Design tells the story. It's shockproof, shake-proof, foolproof!

Precious metal spring contacts with unit pressure in excess of 10,000 pounds per square inch assure *positive, troublefree* contact at both tap and terminal. This advanced High Pressure Spring Contact Design provides extremely *low end resistance* . . . *without* excessive linearity distortion at taps. In addition, pressure is well within the spring's elastic limit . . . and there are none of the fatigue factors inherent in welded joint construction. It's truly a *long-life* design . . . and meets MIL specifications.

Thousands of GAMEWELL Pots incorporating this High Pressure Spring Contact Design are operating in all kinds of service. Exhaustive GAMEWELL and user tests have confirmed the superiority of this design under severe environmental conditions of shock and vibration . . . over temperature ranges from  $-65^{\circ}\text{C}$  to  $+200^{\circ}\text{C}$ . Put this method to the test in your lab.

For applications requiring utmost dependability, specify GAMEWELL High Pressure Spring Contact Design. Write for additional information and send specification requirements to THE GAMEWELL COMPANY, 1387 Chestnut Street, Newton Upper Falls 64, Mass.

GAMEWELL Series RL-270A Potentiometers are available with High Pressure Spring Contacts. They also feature dimensionally stable housings, closer tap spacing, advanced design shaft-and-slip ring for low noise and minimum wear.

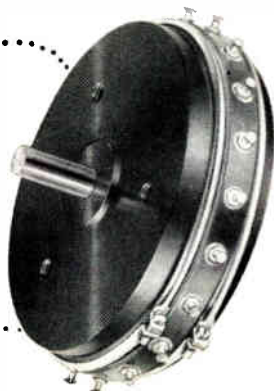

**Gamewell**<sup>®</sup>

**PRECISION POTENTIOMETERS**

INTEGRALS OF  
HIGH PERFORMANCE

For the ultimate in — **RELIABILITY**  
**REPEATABILITY**  
**SUPERIOR PERFORMANCE**

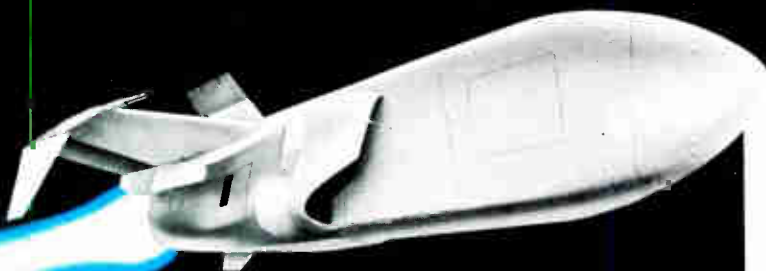

Specify —  
**"MAG MOD"®**  
*miniaturized*  
**MAGNETIC**  
**MODULATORS**

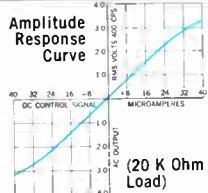
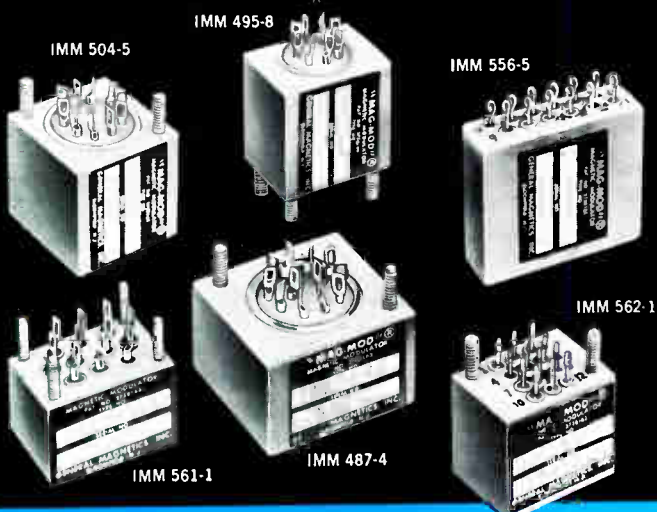

**Input Magnetic Modulator**  
**Type No. IMM 487-4**  
 Subminiature "MAG MOD"® featuring high input signal sensitivity and high AC output impedance. Male or female mounting.

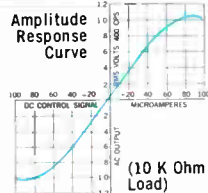

**Input Magnetic Modulator**  
**Type No. IMM 495-8**  
 Subminiature "MAG MOD"® featuring wide band width, multiple signal input circuits, extreme zero stability from -65°C to +135°C, low null amplitude or noise level. Mounting available male or female.

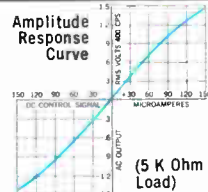

**Input Magnetic Modulator**  
**Type No. IMM 504-5**  
 Subminiature "MAG MOD"® featuring low input and output impedance, resistance vs. temperature compensated input, extreme zero stability, repeatability and insignificant hysteresis. Supplied with male or female mounting.

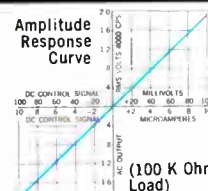

**Input Magnetic Modulator**  
**Type No. IMM 562-1**  
 Subminiature "MAG MOD"® featuring 4 KC carrier operation, wide frequency band width, high output impedance and voltage range. Mounting male or female.

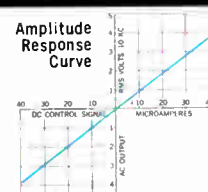

**Input Magnetic Modulator**  
**Type No. IMM 561-1**  
 Subminiature "MAG MOD"® featuring low carrier energy level operation, very wide frequency band width, wide output operating range, minimum size and weight. Mounting male or female. May be mounted directly on printed circuit boards.

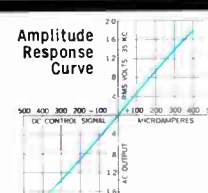

**Input Magnetic Modulator**  
**Type No. IMM 555-5**  
 Subminiature "MAG MOD"® featuring high frequency carrier operation (35 KC), flat construction for printed circuit mounting, low output impedance and clean output fundamental frequency wave form. Mounting supplied male or female.

Designed for Subminiature  
 Circuit Assemblies and Printed Circuit Card Configurations

New miniature designs of these reliable "MAG MODS"® make them ideal for incorporation into transistorized printed circuit assemblies. There is no sacrifice of dynamic response. They offer the engineer/designer the solution to problems involved in a wide range of data systems where analog circuit operations are encountered. To insure complete flexibility, the mechanical mounting on any "MAG MOD" may be modified to conform to your particular packaging requirements.

- 1% repeatability throughout entire service life
- Negligible hysteresis
- Faster response time
- Extreme stability over a wide temperature range
- Infinite service life
- Extremely lightweight — compact design

**GENERAL MAGNETICS • INC**  
 135 BLOOMFIELD AVENUE, BLOOMFIELD, NEW JERSEY, U. S. A.



See reverse side  
 for specifications

# "MAG MOD" Miniaturized MAGNETIC MODULATORS

TYPE NUMBER	IMM 487-4	IMM 495-8	IMM 504-5	IMM 562-1	IMM 561-1	IMM 556-5
Excitation Carrier Voltage and Frequency	115 V @ 400 cps	115 V @ 400 cps	115 V @ 400 cps	2.5 V RMS @ 4 KC	1.0 V RMS @ 10 KC	6 to 10 V RMS @ 35 KC
Control Signal Winding DC Resistance	Winding No. 1 6200 ohms Winding No. 2 7400 ohms	Signal Winding No. 1 550 ohms Signal Winding No. 2 600 ohms	1000 ohms	Signal Winding 1300 ohms Feedback Winding 160 ohms	200 ohms	5000 ohms
Input Control Signal Range	0 to +40 $\mu$ a Each Winding	0 to +100 $\mu$ a (Both Sig. Windings in Series)	0 to +100 $\mu$ a	0 to +100 $\mu$ a 0 to $\pm$ 1 V Bipolar	0 to +400 $\mu$ a	0 to $\pm$ 400 $\mu$ a
Amplitude Modulated AC Output Range	3 V RMS @ 400 cps Phase Reversing	0 to 1 V RMS @ 400 cps Phase Reversing	0 to 1.5 V RMS @ 400 cps Phase Reversing	0 to 6 V RMS @ 4000 cps Phase Reversing	0 to 3 V RMS @ 4 KC Phase Reversing	0 to 1.8 V RMS @ 35 KC Phase Reversing
Differential Gain RMS mv AC Out/ $\mu$ a Signal In	100 mv/ $\mu$ a	15 mv/ $\mu$ a	10 mv/ $\mu$ a	200 mv/ $\mu$ a	10 mv/ $\mu$ a	4.2 mv/ $\mu$ a
Null Amplitude (Noise Level) mv RMS	25 mv RMS Maximum	5 mv RMS Maximum	10 mv RMS Maximum	30 mv RMS Maximum	10 mv RMS Maximum	20 mv RMS Maximum
Output Impedance	Approx. 30 K ohms	1600 ohms	1000 ohms	Approx. 70 K ohms	Approx. 40 K ohms	900 ohms Each Output Wind.
External Load (Suggested)	Approx. 20 K ohms	Approx. 10 K ohms	Approx. 5 K ohms	Approx. 100 K ohms	Approx. 100 K ohms	1000 ohms Each Output Wind.
Null Drift (in terms of Input Signal) -65°C to +135°C	Less than $\pm$ 0.25 $\mu$ a Over Temp. Range	Less than $\pm$ 0.25 $\mu$ a Over Temp. Range	$\pm$ 1 $\mu$ a Maximum Over Temp. Range	$\pm$ 0.5 $\mu$ a Maximum Over Temp. Range	$\pm$ 1 $\mu$ a Over Temp. Range	$\pm$ 2 $\mu$ a Over Temp. Range
Hysteresis (% of Input Control Signal)	0.5% Maximum	0.5% Maximum	0.5% Maximum	Approx. 0.5%	0.5% Maximum	0.5% Maximum
% Harmonic Distortion in Output AC Modulated Envelope	Approx. 40% (3rd Harmonic)	Approx. 25% (3rd Harmonic)	Approx. 30% (3rd Harmonic)	Approx. 15% (3rd Harmonic)	Less Than 10% (3rd Harmonic)	Approx. 5% (3rd Harmonic)
Overall Dimensions (in Inches)	1 1/4 x 1 1/8 x 3/4	3/4 x 1 x 1	1 x 1 x 1	1 x 1 1/16 x 7/8	11/16 x 1 x 3/4	7/16 x 1 1/4 x 1 1/4
Type of Mounting	4-40 Studs or Inserts	4-40 Studs or Inserts	4-40 Studs or Inserts	4-40 Studs or Inserts	2-56 Studs	4-40 Tapped Holes or Studs
Weight in Ounces	Approx. 1.25	Approx. 1	Approx. 1.1	0.75	0.6	1
Response Time (Band Width cps)	0.01 sec. for 15 K Sig. Source Imp. (12 cps Corner Frequency)	20 cps for 10 K Sig. Source Imp. 25 cps for 20 K Sig. Source Imp. (Both Sig. Windings in Series)	5 cps for 1 K Sig. Source Imp. 10 cps for 5 K Sig. Source Imp. 20 cps for 10 K Sig. Source Imp.	70 cps for 10 K Sig. Source Imp. (Time Constant Approx. 2 Milli- Seconds)	Corner Frequency 2 KC for Sig. Source Imp. of Approx. 6 K ohms	Corner Frequency 200 cps for 600 ohm Signal Source Imp. or 1000 cps for 5 K Source

## Magnetic Multiplying Modulator Model MCM 515-1



The MAGNETIC MULTIPLIER is a miniaturized magnetic modulator specifically designed to deliver an analog output voltage which is the continuous product of two variable input voltages. One of these is an excitation voltage which varies over a pre-determined range; in this case, 0 to 1 VRMS 400 cycles per second. The other signal is a DC current which varies between 0 and  $\pm$ 400  $\mu$ a. The output voltage is 400 cycles AC, and is always in phase or 180° out of phase with the variable excitation or fixed reference, i.e., in phase when the variable amplitude DC signal is positive, and 180° out of phase when the DC signal is negative. The general schematic is illustrated in Fig. 1. The relationship between variable alternating supply signal voltage  $E_s$ , variable direct current control signal  $E_c$ , and the alternating load voltage  $E_L$  having a sinusoidal wave shape is denoted by the equation—

$E_L = \text{Constant} \times E_s \times E_c$

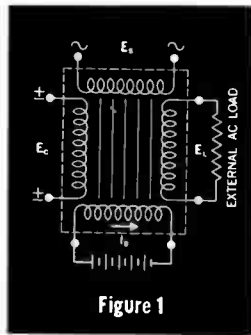

Figure 1

This expression, which defines the fundamental principle of the four quadrant MAGNETIC MULTIPLYING MODULATOR, can be clearly illustrated by linear transfer response curve families as shown at right, in Figure 2-A and Figure 2-B.

- Illustrating:
- (1) Load voltage  $E_L$  as a function of alternating supply signal voltage  $E_s$  with control DC signal voltage  $E_c$  as a parameter.
  - (2) Load voltage  $E_L$  as a function of control DC signal voltage  $E_c$  with alternating supply voltage,  $E_s$  as a parameter.

With linearity response curves held to within approximately 1 to 2% of theoretical straight lines, the product accuracy of the fundamental equation will be within 2 to 5% of the theoretical product.

### SPECIFICATIONS MODEL MCM 515-1

Variable Excitation Carrier Voltage and Frequency	Variable AC Signal 0 to 1 V RMS 400 cps
Control Signal Winding DC Resistance	DC Signal Winding Resistance 2650 ohms
Input Control Signal Range	Variable DC Signal 0 to $\pm$ 400 $\mu$ a
Amplitude Modulated AC Output Range	0 to 0.9 V RMS @ 400 cps Phase Reversing
Null Amplitude (Noise Level) mv RMS at Max. AC Excitation	5 mv RMS
Output Impedance	Approx. 3500 ohms
External Load (Suggested)	Approx. 25 K ohms
Null Drift (in terms of Input Signal) -65°C to +135°C	$\pm$ 2 $\mu$ a over Temperature Range
Hysteresis (% of Input Control Signal)	0.5% Maximum
% Harmonic Distortion in Output AC Modulated Envelope	Less than 5%
Overall Dimensions (in Inches)	27/32 x 27/32 x 1 3/16
Type of Mounting	4-40 Insert or Stud
Weight	Approx. 1 Ounce

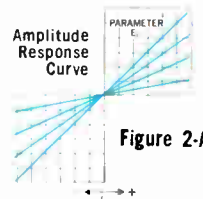

Figure 2-A

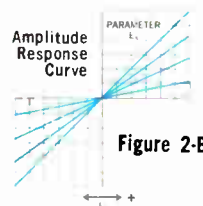

Figure 2-B

Typical "Mag Mod"® Applications—Circuit applications for MAGNETIC MODULATORS include algebraic addition, subtraction, multiplying, raising to a power, controlling amplifier gain, mechanical chopper replacement in DC to fundamental frequency conversion, filtering and low signal level amplification.

Consult General Magnetics—For magnetic amplifier components of proven reliability. These dependable instruments are widely employed in automatic flight systems, fire control, analog computers, guided missiles, nuclear equipment, antennas, gun turrets, commercial power amplifiers and complete control systems. Miniature, subminiature, standard and customized types available.



Call or write for new Brochure 102 on "MAG MOD" Miniaturized Magnetic Modulators and Magnetic Multiplying Modulators. Please address inquiries on company letterhead.



**GENERAL MAGNETICS • INC**

135 BLOOMFIELD AVENUE, BLOOMFIELD, NEW JERSEY, U. S. A.

One of a Series

## New "White Room" Assembly Insures Accuracy, Reliability of Instrument Counters

This special facility has been designed to provide positive environmental control for ultra-precision assembly and test of Veeder-Root Instrument Counters. Temperature and humidity are constant and electrostatic filtering and pressurization maintain air purity.

This is the latest step taken by Veeder-Root to insure top reliability and accuracy in counters and readout devices used for instrumentation, aircraft and navigational applications. Veeder-Root offers an extremely varied line of these instrument type counters; and also does extensive design and prototype work to develop new devices for all types of readout problems. Whatever your needs for precision counting devices, Veeder-Root can provide that extra margin of dependability by supplying a single counter or complete counting package or system. Your specifications will receive prompt attention.

### Veeder-Root Precision Gearing Provides Long Life, Accuracy at High Speeds

The secret of Veeder-Root precision counter performance is the close tolerance manufacturing and inspection of gearing, typified by the strip chart record shown here. This Veeder-Root experience with all types of intricate gearing, to Precision Class 2 tolerances, assures accuracy and dependability in readout devices and counting packages.



Send for More Information . . . or advise your precision counter requirements. Application assistance is available from Veeder-Root Counting Engineers or write.

# Veeder-Root



HARTFORD 2, CONNECTICUT

*'The Name that Counts'*

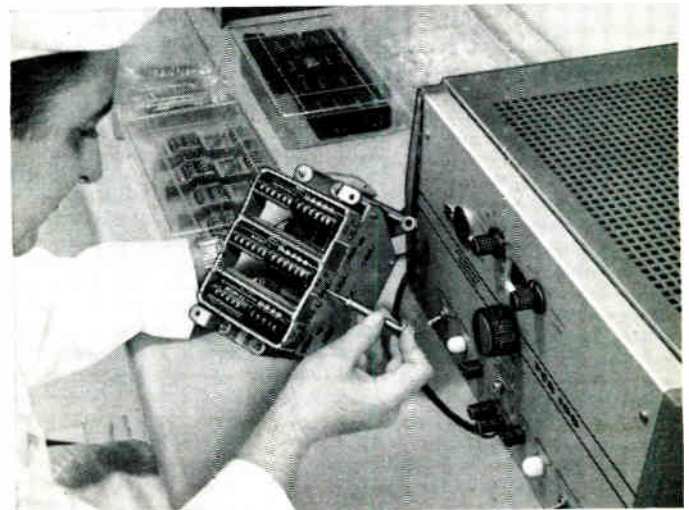
New York • Chicago • Los Angeles • San Francisco • Seattle  
St. Louis • Greenville, S. C. • Altoona, Pa. • Montreal  
Offices and Agents in other principal cities



This is a Veeder-Root Counting Package developed for airborne navigational systems. It is being assembled and tested in the new "white room".

 <p><b>Series 1597 Miniaturized Counter</b></p> <p>designed for readout of navigational data. Features maximum figure size on 1/2" wheel, plus small overall dimensions and light weight. For high speed counting.</p>	 <p><b>Series 1698 Internal Pinion Counter</b></p> <p>developed for aircraft instrumentation such as alt meters, fuel readout and manifold pressure. Wheels are only 0.672" in diameter.</p>
 <p><b>Series 1392 Open Frame Counters</b></p> <p>for navigational computers. Has extremely low torque, wheels are ball-bearing mounted, and counter is available with various frame styles for mounting into "packaged" systems.</p>	 <p><b>Series 1666 Precision Internal Pinion Counter</b></p> <p>available with 3 or 4 figure wheels, in single or tandem styles. Minimum size, maximum readability.</p>
 <p><b>Series 1387 and 1388 Concentric Drum Counter</b></p> <p>for latitude and longitude readout. These counters offer compact digital presentation, speeds to 300 rpm, and unusually long counting life.</p>	

**Veeder-Root, HARTFORD 2, CONNECTICUT**

- Please send Precision Counter Data Sheets
- Please have Counting Engineer call

Name.....

Title.....

Company.....

Address.....

City..... State.....

VR0-3

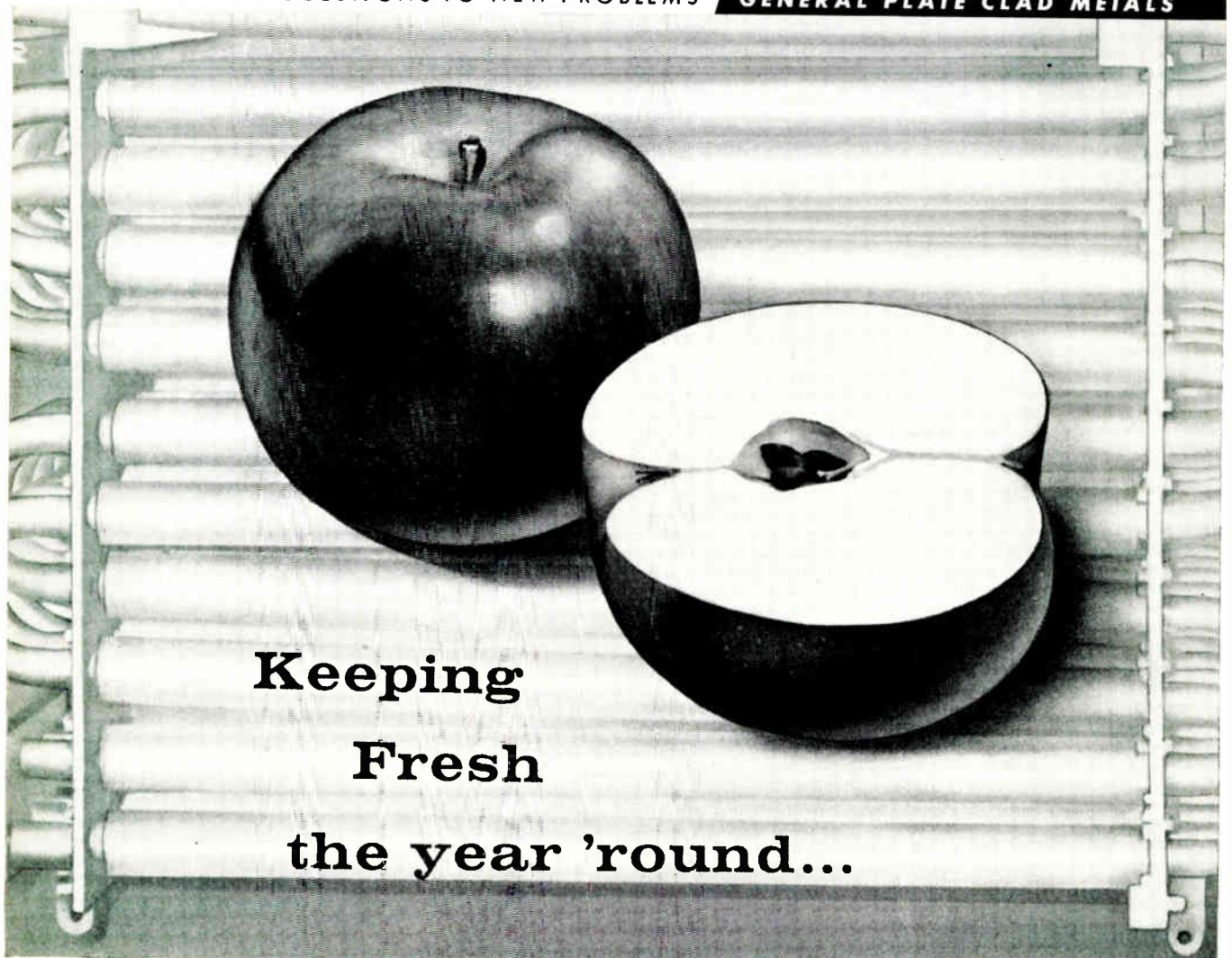

**Keeping  
Fresh  
the year 'round...**

One of series illustrating how General Plate Clad Metals help uncover new horizons in one of many fields of engineering accomplishments: REFRIGERATION

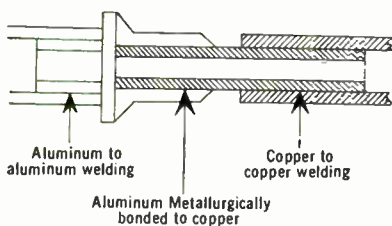

*New Products made with New Materials...  
New Processes...*

**USED IN NEW AND DIFFERENT WAYS**

ALCUPLATE® (aluminum clad copper) fabricated into tubing connector solves mechanical joining problem. Aluminum and copper are metallurgically bonded and permit aluminum to aluminum and copper to copper welding for a corrosion-free seal.

fabricated into a tubing connector. In this small part composed of clad metal, the advantages of welding copper to copper and aluminum to aluminum are combined to create a perfect corrosion-free seal. This makes it possible to eliminate galvanic corrosion and subsequent leakage resulting from bonding copper and aluminum tubing using cold welding techniques.

Among the important contributions to the success of refrigeration is the use of ALCUPLATE® (aluminum clad copper)

General Plate Alcuplate is but one of over 400 different combinations of clad metals available which are finding wide use in industry after industry. New combinations are being developed constantly.

No matter what your metal problem, it will pay you to consult with Metals & Controls Division Engineers. Their vast experience in cladding precious to base or base to base metals can overcome your metals engineering problems with multiple property requirements . . . often reduce costs, too. Write today.



**TEXAS INSTRUMENTS**  
INCORPORATED  
METALS & CONTROLS DIVISION  
1305 FOREST STREET • ATTLEBORO, MASS.

General Plate Products: Clad Metals • Electrical Contacts • Truflex® —Thermostat Metal • Gold, Silver, Platinum and other Precious Metal Products

# new

MICRO-MINIATURE CERAMIC CAPACITORS  
OFFER A PACKAGE DENSITY  
OF 432,000 PARTS PER CUBIC FOOT  
excellent for complete assembly encapsulation



actual size

The reliability built into the "VK" Capacitor is a hard, tested fact — backed by the name and reputation of the company that made the "VITRAMON" monolithic porcelain capacitor a synonym for capacitor reliability.

A minutely controlled process, continuous life and environmental testing, plus 100% tests for Dissipation Factor, Insulation Resistance and Capacitance guarantee that each "VK" Capacitor in your circuit will perform as predicted. Pre-production lot-by-lot qualification tests on all materials used, craftsmanship of the highest order and ten years of experience dedicated exclusively to the manufacture of high-reliability capacitors assure that these tiny units will function predictably under the most punishing conditions to which a component of this type is subject.

**Vitramon**<sup>®</sup>  
INCORPORATED

P.O. BOX 544 • BRIDGEPORT 1 CONNECTICUT



## micro-miniature CAPACITORS

47-10,000 mml  
200 vdc without derating  
-55° C to 150° C operation

Square precision molded cases in only two sizes and a single standard 0.2" lead spacing for all values simplify circuit design, guarantee uniformity, facilitate handling, give greater mechanical stability.

The DAPON\*\* resin used in "VK" Capacitor cases assures environmental reliability through every stress to which such components are susceptible.

### ENVIRONMENTAL CHARACTERISTICS

**Moisture Resistance:** Operational in 95% relative humidity at 200 vdc. When tested in accordance with MIL-STD-202A, Method 106, with rated voltage applied, Insulation Resistance is greater than 10,000 megohms at 95% relative humidity. Dissipation Factor is less than 2.5%, and capacity change less than 10% at 25°C and 50% relative humidity.

**Temperature and Immersion:** When tested in accordance with MIL-STD-202A (with maximum temperature extended to 150°C), Method 102A (test condition C) and Method 104A (test condition B), Insulation Resistance is greater than 10,000 megohms, Dissipation Factor is less than 2.5% and capacity change is less than 10%.

**Temperature Shock:** "VK" Capacitors show no evidence of electrical damage when subjected to 10 cycles of alternate immersion in silicone oil at 160°C and water at 0°C (±10°C) for a minimum duration of ½ minute each bath.

**Vibration:** No evidence of physical damage has been found when tested per MIL-STD-202, Method 204 (test condition B) when ¾ in. lead mounted and vibrated for four hours in each of three mutually perpendicular planes (10 cps to 2,000 cps) at 15 G's. **Shock:** When ¾ in. lead mounted and subjected to 3 shocks of one milli-second duration in each of 3 mutually perpendicular planes at 100 G's per Method 202A of MIL-STD-202, "VK" Capacitors show no evidence of physical damage.

**Altitude:** When tested in accordance with MIL-STD-202, Method 105A (test condition D) requiring a minimum of 100,000 feet, "VK" Capacitors suffer no electrical breakdown at 150% of rated voltage.

**Life:** Following 1,000 hours at 150°C and 200% of rated voltage, measurements at 1 kc and 25°C show a Dissipation Factor less than 2.5% and an Insulation Resistance greater than 10,000 megohms.

Conforms to requirements of MIL-C-11015B

\*Trade Mark

\*\*Trade Mark of Food Machinery and Chemical Corp.

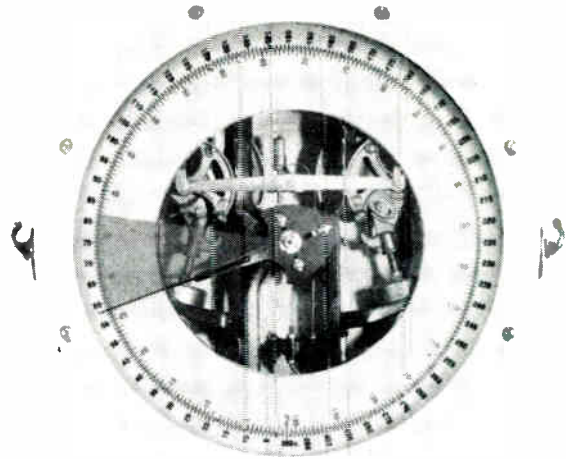

# 42% HEAVIER IN ADVERTISER CONFIDENCE!

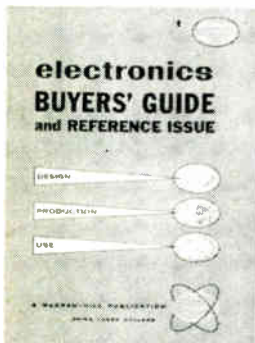

Advertisers, being practical, like things that work! That's why the **electronics BUYERS' GUIDE** and Reference Issue has 42% more advertisers than the nearest competition. With the "GUIDE" advertisers reach more of the right people . . . readers

get a correspondingly bigger choice of products and services to select from. Clear evidence that the "GUIDE" carries the most weight in advertiser confidence and acceptance.

**Exclusive!** 64-page Reference Section that gives buyers basic market, materials, and design data that buyers refer to again and again. The only directory in the field that contains this valuable reference data, Accurate, authoritative, easy to read.

9.62

**electronics Buyers' Guide** and Reference Issue

THE ELECTRONICS MAN'S BASIC BUYING BOOK

A McGRAW-HILL PUBLICATION

330 West 42nd St., New York 36, N. Y.



1960 Issue Closing Dates: Published July 20; Complete Plates May 1



## TRANSFORMER COILS OF



**±0.01%**  
HIGH PRECISION AC VOLTAGE REGULATORS

*are insulated with*

**NATVAR ISOGLAS®**

Sorensen high precision AC regulators hold 60 cycle line voltage to  $\pm 0.01\%$  for use in standards laboratories, for meter calibration and for other applications demanding a voltage source of highest accuracy and stability. Natvar Isoglas, used to insulate transformer coils has excellent thermal stability up to 155°C continuous operating temperatures.

Sorensen & Company, Inc., a subsidiary of Raytheon Company, manufactures a widely accepted line of controlled power equipment for research and industry — electronic and magnetic regulated AC and DC power supplies, regulators, stabilizers, frequency changers and inverters.

Materials are carefully selected, and must pass rigid inspection before they are accepted for production. Natvar Isoglas, a glass fabric coated with an isocyanate reacted resin, is used as interlayer insulation because of its excellent physical and electrical properties. It is strong mechanically and is resistant to transformer oils, Askarel, and other non-flammable insulating liquids, and to all solvents commonly used in electrical applications.

If you need insulating materials with good physical and electrical properties, and exceptional uniformity, it will pay you to specify Natvar, and get in touch with your wholesaler, or with us direct.



Eight coils are wound at a time on this multiple coil winder. Operators find Isoglas easy to use because it is always pliable, yet tough and scuff resistant.



### Natvar Products

- Varnished cambric—sheet and tape
- Varnished canvas and duck—sheet and tape
- Varnished silk and special rayon—sheet and tape
- Varnished papers—rope and kraft—sheet and tape
- Varnished, silicone varnished and silicone rubber coated Fiberglas\*—sheet and tape
- Slot cell combinations, Aboglas®
- Teraglas\*\*
- Isoglas® sheet and tape
- Isolastane® sheet, tape, tubing and sleeving
- Vinyl coated and silicone rubber coated Fiberglas tubing and sleeving
- Extruded vinyl tubing and tape
- Styroflex® flexible polystyrene tape
- Extruded identification markers

\*TM (Reg. U.S. Pat. Off.) OCF Corp.

\*\*Trademark applied for.

We will be very happy to supply information on any of our products on request.

**NATVAR CORPORATION**

FORMERLY THE NATIONAL VARNISHED PRODUCTS CORPORATION

Telephone

TWX

Cable Address

FULTON 8-8800

RAHWAY, N.J., RAH 1134

NATVAR: RAHWAY, N.J.

RANDOLPH AVENUE • WOODBRIDGE, NEW JERSEY

# NEW...

**® Regatron Programmable**

# CONSTANT-CURRENT-POWER SUPPLIES

Extremely low ripple... 0.1% load regulation\*... wide operating range... the well-known Regatron features are incorporated in these new constant-current power supplies. Transient response time is less than a millisecond. A modulation input is a standard feature. A vernier permits continuous zero-to-maximum coverage throughout each of 16 current ranges. These c-c supplies are programmable too. Current output can be controlled by means of a remote resistor at any convenient location. Shunt the programming terminals with the resistor and the Regatron delivers a precise value of constant-current to your load. Voltage compliance, or load voltage capability, rises above the minimum values cited in the brief table below, with decreasing current settings.

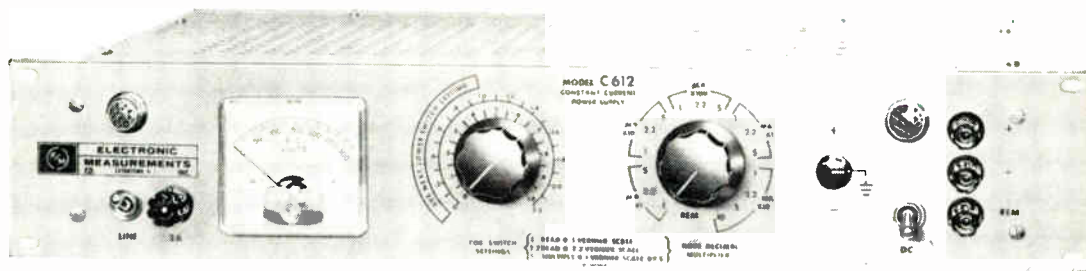

## BRIEF SPECIFICATIONS

105-125 V, 50-60 CPS LINE  
(Prices are F.O.B. Eatontown, New Jersey)

MODEL	OUTPUT	VOLTAGE COMPLIANCE (MINIMUM)	DIMENSIONS			PRICE
			H	W	D	
C612A	1 $\mu$ A to 100 ma	100 V	3½	19	9¼	\$289
C624A	2.2 $\mu$ A to 220 ma	100 V	3½	19	9¼	\$364
C621A	5 $\mu$ A to 500 ma	100 V	5¼	19	15	\$479
C620A	5 $\mu$ A to 500 ma	50 V	5¼	19	15	\$449

\* Load regulation is 0.1% for all models except 0.2% on 1 and 2.2  $\mu$ A ranges of Models C612A and C624A.

You'll find the programming feature, voltage compliance, and other performance data fully detailed in four-page Specification Sheet 3072A. Ask your local E/M representative or write...

® Registered U.S. Patent Office. Patents issued and pending.

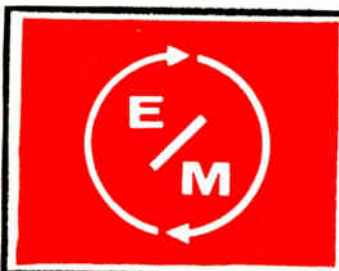

**ELECTRONIC MEASUREMENTS COMPANY, INCORPORATED**  
EATONTOWN • NEW JERSEY

# Signal Transmission THROUGH IONIZED MEDIA

Nuclear-powered, rocket-powered, and space-reentry vehicles produce ionized regions that can tangle up communications. This article details the problems

By **WILLIAM A. GREENHOW**,  
Nuclear Engineering and Physics,  
Vought Aeronautics,  
Dallas, Texas

COMMUNICATIONS may be hampered as well as helped by ionization in the atmosphere. This analysis will first discuss ionization processes and their effects on signal transmission, and then discuss ionization effects produced by nuclear vehicles, hypersonic reentry vehicles, rocket-motor exhausts and nuclear explosions.

An atom or molecule can be ionized by nuclear radiation or by thermal decomposition. In this article, ionization describes not only the formation of positive and negative ions, but also the formation of free electrons. This analysis is concerned only with the free-electron concentration; the generally accepted theory of wave propagation in an ionized medium considers only the effects of free electrons since they are more effective than the relatively inert ions in removing energy from the system.

The principal mechanisms by which swift charged particles such as protons, electrons, positrons, alpha particles and mesons lose their kinetic energy involve elastic or inelastic collisions with atomic electrons or nuclei. In an absorbing material, a charged particle is slowed down and finally brought to rest by the combined action of all of these processes, the particular interaction being described by the laws of probability.

Inelastic collision with atomic electrons is the predominant mechanism by which swift charged particles lose their kinetic energy in an absorber. As a result of each inelastic collision, one or more bound atomic electrons experiences a transition to an excited state (excitation) or to an unbound state (ionization). In many cases the ejected electron has enough energy to be called a swift charged particle and can produce secondary ionization while being brought to rest.

When an atom or molecule is ionized, the free electron and the residual ionized atom are said to constitute an ion pair. The energy necessary to free an electron is called the ionization potential of that atom and is defined as the difference in energy levels of the most stable configurations of the atom and the ion. Since charged particles lose energy by other mechanisms which do not produce free electrons, a more useful quantity is the average energy for the formation of an ion pair.

The average energy for the formation of an ion pair does not vary by more than a factor of 2 and is 32.5 ev (electron volts) for air. The average energy for the formation of an ion pair is not strongly influenced by the type or energy of the charged particle; hence, the free electrons produced when a charged particle is brought to rest approximate the energy of the particle divided by the average energy for the formation of an ion pair.

Swift charged particles have high specific ionizations; therefore,



*It's up in the air, but as it comes down will they be able to communicate with it?*

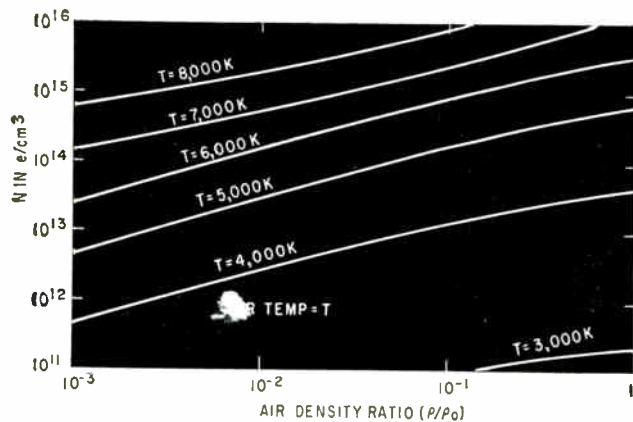

FIG. 1—Free-electron density ( $N$ ) in heated air

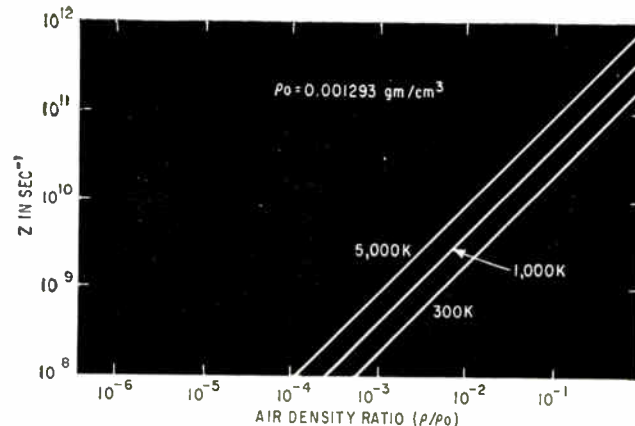

FIG. 2—Collision frequency ( $Z$ ) versus air density

charged particles are effective only in producing ionization along short path lengths. The range-energy equations for charged particles are well known; however it is not necessary to refer to these equations because the ranges of these charged particles are only a few centimeters for energies which would be expected from nuclear sources, and antennas can easily be placed more than this distance from all sources of nuclear radiation.

Neutrons and gamma rays, unlike charged particles, are capable of producing ionization at great distances from sources of nuclear radiation, and consequently have a greater effect upon the transmission of em (electromagnetic) energy. The process of absorbing neutrons and gamma rays is exponential; the distance required to reduce their intensity to  $\frac{1}{2}$  of the original intensity is about 3,000 ft for gamma rays and about 600 ft for neutrons in air under standard conditions. The relaxation length is inversely proportional to the air density ratio and is affected by the energy of the radiation.

The mechanisms by which a neutron loses its kinetic energy are: elastic collisions with a nucleus, inelastic collisions with a nucleus (re-

sulting in emission of a gamma ray and a neutron with degraded energy), and absorption processes (resulting in emission of a gamma ray or a charged particle). Neutrons do not produce any primary ionization, but the secondary particles which result from neutron interactions are capable of producing free electrons by the mechanisms previously discussed. Neutrons are only about one-half as effective in producing free electrons as charged particles of the same energy; however the neutron will produce ionization at great distances from the source.

Gamma rays are quanta of em energy of short wavelength and the primary mechanisms by which they lose their energy are: the Compton Effect (results in ejection of an atomic electron and a gamma ray of degraded energy), the photoelectric effect (results in emission of a high-energy electron), and pair production (results in formation of an electron and a positron, but can only occur when the gamma ray has an energy greater than 1.1 Mev). The gamma rays produce approximately the same number of ion pairs as a charged particle of the same energy, but are capable of producing ionization at

great distances from the source.

In the nuclear engineering field it is customary to speak of the gamma flux at a point in roentgens (R) where the absorption of one R produces  $2.09 \times 10^9$  ion pairs per cubic centimeter of dry air. The total number of free electrons produced by one R is proportional to the air density ratio and is inversely proportional to the average energy for the formation of an ion pair.

In addition to nuclear ionization, air or any other medium can also be ionized by intense heating such as in the shock wave of hypersonic reentry vehicles or in the exhausts of jet engines and rocket motors. Gilmore has evaluated the extent of this decomposition to more than 20 products of decomposition. The equilibrium free-electron concentration as determined in his study is shown in Fig. 1.

The mechanisms by which free electrons are removed from a system are attachment to neutral molecules and volumetric recombination with positive ions. Since negative ions do not remove em energy from the system, electron attachment is just as effective as recombination in decreasing transmission losses through an ionized region.

Electron attachment to neutral molecules or atoms to form negative ions is a common occurrence for gases whose outer electronic shells are nearly filled. Energy of formation is called the electron affinity, and is defined as the difference in potential energy between the ground state of the atom with a free electron at infinity and the ground state of the negative ion. The higher the electron affinity, the greater the probability of an electron attaching itself to the atom.

TABLE I—Transmission Losses Due To Hypersonic Reentry Vehicles

Mach No.	Altitude ( $\times 10^3$ ft)	Air Temp in Shock ( $^{\circ}$ K)	$\rho/\rho_0$ in Shock	$N$ ( $\text{cm}^{-3}$ )	$Z$ ( $\text{sec}^{-1}$ )	Transmis. Freq. (Mc)	Atten. Loss (db)
10	2	5,500	0.0297	$1.5 \times 10^{14}$	$10^{10}$	10	5.1
10	2	5,500	0.0297	$1.5 \times 10^{14}$	$10^{10}$	10,000	108.7
10	1	5,200	$3.22 \times 10^{-6}$	$1 \times 10^{11}$	$6 \times 10^6$	10	2.8
10	1	5,200	$3.22 \times 10^{-6}$	$1 \times 10^{11}$	$6 \times 10^6$	10,000	$7.9 \times 10^{-4}$
15	2	12,100	$6.69 \times 10^{-2}$	$1 \times 10^{17}$	$10^{11}$	10	50.1
15	2	12,100	$6.69 \times 10^{-2}$	$1 \times 10^{17}$	$10^{11}$	10,000	57.5
15	1	11,500	$7.24 \times 10^{-6}$	$7 \times 10^{16}$	$2 \times 10^7$	10	7.250
15	1	11,500	$7.24 \times 10^{-6}$	$7 \times 10^{16}$	$2 \times 10^7$	10,000	7.19

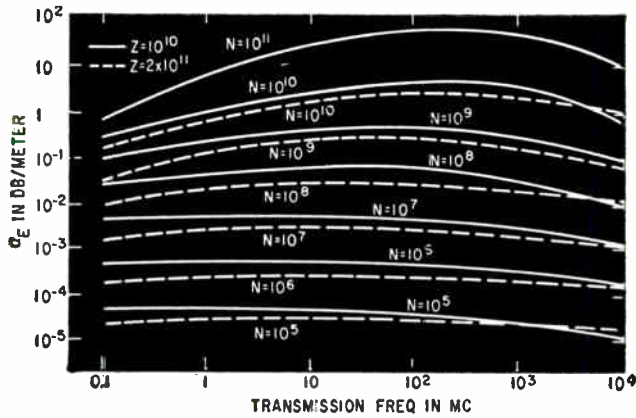

FIG. 3—Attenuation coefficient at various frequencies

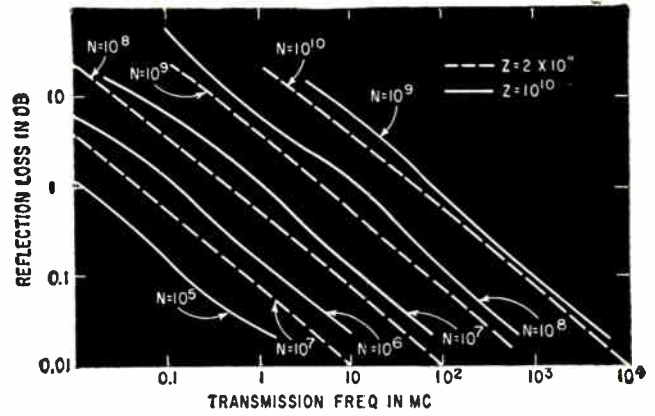

FIG. 4—Reflection loss at various frequencies

If the atmosphere is composed of atoms or molecules having closed shells such as H<sub>2</sub>, He, or N<sub>2</sub>, electron attachment can be neglected when computing the electron removal rate because these molecules do not exhibit electron attachment.

Electron attachment can occur by several mechanisms. Free electrons can be captured by atoms in the presence of a third body. Since this is a three-body collision process, it can only be important if the free-electron density and gas density are large. Free electrons can be captured by molecules with subsequent dissociation of the molecule. Free electrons can be captured by molecules followed by vibration but no dissociation. This can only occur with low energy electrons.

Charge neutralization occurs by volumetric recombination of negative ions and electrons with positive ions. The mechanisms of electron positive-ion recombination are different than the negative-ion positive-ion recombination mechanisms. Thus, the recombination coefficients are several orders of magnitude different for the two types of recombination processes. The most common type of electron positive ion recombination mechanism is a radiative recombination process in which an electron coming within the field of a positive ion drops into a low-lying electronic orbit and radiates its excess energy.

The mechanisms of electron-positive ion recombination have been investigated by microwave techniques.

The continuity equation for the free-electron concentration is

$$dN/dt = P_i - \alpha_n N^2 - (1/\tau)N - \text{grad } J \quad (1)$$

where  $P_i$  is the rate at which electrons are being formed,  $N$  is the

free-electron density in electrons/cm<sup>3</sup>,  $\alpha_n$  is the electron positive-ion recombination coefficient,  $(1/\tau)$  is the collision frequency for attachment to neutral molecules, and  $\text{grad } J$  is the gradient (vector-analysis operator) of  $J$ , the electron-current distribution.

If the medium is air or some other gas which exhibits electron attachment, the volumetric recombination and gradient terms can usually be neglected. The solution to the continuity equation can then be approximated as  $N = P_i \tau$ .

If the medium is air, the electrons are removed primarily by attachment to O<sub>2</sub> molecules. The collision frequency for electron attachment in oxygen can be expressed as  $1/\tau = \sigma n^2$  for pressures between 7 and 54 mm Hg. Where  $\sigma$ , the coefficient for oxygen attachment, is  $2.8 \times 10^{-30}$  cm<sup>2</sup>/sec and  $n$  is the density of oxygen molecules. If it is assumed that the density of air is 0.00129 gm/cm<sup>3</sup> STP (standard temperature and pressure) and it contains 21 percent by weight of oxygen, the density of oxygen molecules can be expressed as

$$n = 5.6 \times 10^{19} (\rho/\rho_0) \text{ molecules/cm}^3$$

where  $\rho/\rho_0$  is the ratio of air density to air density at STP. Therefore,

$$1/\tau = 8.8 \times 10^7 (\rho/\rho_0)^2 \text{ (between 7 and 54 mm Hg)}$$

This expression will also be applied to other pressures since its extrapolation to STP checks with the accepted collision frequency of attachment at STP ( $10^8$  sec<sup>-1</sup>). Thus, in air,  $N = 1.13 \times 10^{-6} (\rho_0/\rho)^2 P_i$ .

If the atmosphere is composed of atoms or molecules which do not exhibit electron attachment, the attachment term and the gradient term of Eq. 1 can be neglected. Thus, the first order solution to the

continuity equation can be approximated as  $N = (P_i/\alpha_n)^{1/2}$  where  $\alpha_n$  is the electron positive-ion recombination coefficient.

Ionization changes the electrical properties of the medium and thus affects the transmission of em energy. There are losses by reflection from the boundaries of the region and also by the refraction and absorption of energy as the wave is being transmitted through the ionized atmosphere.

The following analysis of reflection and absorption losses is based on the propagation of a sinusoidal plane wave of angular frequency  $\omega$  through an ionized region in which the free electron concentration is  $N$  free electrons per cu cm. The analysis is generalized for the condition where the particle density is so large that the free electron experiences  $Z$  collisions/sec with air molecules and neglects magnetic effects on the electron; these effects need not be considered unless the free electrons are in a strong magnetic field. Collision frequency  $Z$  is equal to the product of the concentration of air molecules, the cross section of the average air molecule for scattering, and the average electron velocity. If the electron energy distribution is Maxwellian and the radius for scattering for the average air molecule is assumed to be  $1.4 \times 10^{-9}$  cm,  $Z$  under standard conditions will be about  $2 \times 10^{11}$  collisions/sec. The electron collision frequency is about the same for most atmospheres under the same conditions; but, it is influenced by temperature and air density (Fig. 2).

When an em wave is transmitted through an ionized region, energy is lost from the electric field to the free electrons. A free electron in a

vacuum, when placed under the influence of a high-frequency em field, oscillates with its velocity 90 deg out of phase with the field and hence does not derive any power on the average from the electric field. However, if the free electron is in a gaseous medium it will collide with the atoms of the gas and its motion will change from an ordered motion to a disordered motion, thus absorbing energy from the electric field.

The free electrons in this ionized region are assumed to be vibrating in an inertial manner under the influence of this electric field, their motion being damped by a frictional force which is caused by the collisions that the electrons make with the molecules of the gas. This frictional factor is assumed to be equal to  $mZ$  where  $m$  is the mass of the electron. By applying Maxwell's equations to the original conditions, using vector analysis we arrive at the wave equation  $\text{grad}^2 \mathbf{H}_e = k^2 \mathbf{H}_e$  where  $\mathbf{H}_e$  is the magnetic-field vector and  $k$  is the wave constant. Turner defined the wave constant as  $\alpha + j\beta$ , where  $\alpha$  is the attenuation factor and  $\beta$  is the phase constant, and expressed the solution in terms of the original conditions.

$$\alpha = \left\{ \frac{\omega^2 \mu}{2} \left[ \sqrt{\left( \frac{Nq^2}{m(\omega^2 + Z^2)} - \epsilon \right)^2 + \left( \frac{Nq^2 Z}{m(\omega^2 + Z^2)} \right)^2} - \left( \frac{Nq^2}{m(\omega^2 + Z^2)} - \epsilon \right) \right] \right\}^{1/2} \quad (2)$$

$$\beta = \left\{ \frac{\omega^2 \mu}{2} \left[ \sqrt{\left( \frac{Nq^2}{m(\omega^2 + Z^2)} - \epsilon \right)^2 + \left( \frac{Nq^2 Z}{m(\omega^2 + Z^2)} \right)^2} + \left( \frac{Nq^2}{m(\omega^2 + Z^2)} - \epsilon \right) \right] \right\}^{1/2} \quad (3)$$

where  $\omega$  is the angular transmission frequency,  $\mu$  is the permeability of the region,  $\epsilon$  is the dielectric constant,  $N$  is the electron density,  $Z$  is the electron collision frequency,  $m$  is the mass of the electron and  $q$  is the charge of the electron. All terms are expressed in the cgs system of units. The power loss ( $\alpha_r$ ) in db per meter is  $-8.68 \alpha$ .

To facilitate calculation of transmission losses, this equation was programmed for a computer which produced the parametric curves of Fig. 3. Here electron-collision frequencies of  $2 \times 10^{11}$  and  $10^{10}$  collisions per sec correspond to altitudes

of sea level and 100,000 ft.

Due to the decreased index of refraction of an ionized region, there will also be some losses due to reflection of em energy. The following analysis of reflection losses assumes that there is a sharp discontinuity in the index of refraction at the boundary of the ionized region which causes a complex-impedance mismatch. In most cases, since the boundary is not a sharp discontinuity but a gradual transition, energy reflection will not be as severe as in this analysis.

If we define reflection loss as the ratio of the transmitted electric-field vector to the incident electric-field vector, the power loss can be expressed with reference to the incident voltage as

Reflection loss (db) =  $20 \log [1 / (1 - \alpha_r)]$  where  $\alpha_r$  is the reflection coefficient of the region.

Transmitted, incident and reflected waves are not in phase when considered from a free-air to an ionized region.

To facilitate determination of these reflection losses, the above equation was programmed for a computer; Fig. 4 shows results.

In examining reflection problems it is sometimes convenient to define a term called the critical frequency of the ionized region  $f_c$ ;  $f_c = (N / 1.24 \times 10^6)^{1/2}$  (Mc). Frequencies lower than the critical frequency will be reflected from the region irrespective of angle of incidence. Frequencies greater than the critical frequency may be partially reflected or refracted if the angle of incidence is large.

Critical frequency is shown in Fig. 5 as a function of the free electron concentration.

Now for specific cases of energy-transmission problems. The first case to be considered is transmission through the ionized cloud surrounding an airborne reactor.

The air surrounding a nuclear-powered vehicle is ionized by the radiation from the reactor. This ionization changes the electrical properties of the air, and consequently causes attenuation and mismatch of radar waves propagated through this ionized atmosphere.

Ionization produced by radiation escaping from a reactor is determined not only by the type of reactor and its characteristics, but also by the time and history of op-

eration. Ionization can be produced by fission-product release, activated air, beta radiation, neutron radiation and gamma radiation. Preliminary calculations indicate that only the ionization produced by gamma rays need be considered.

This discussion assumes that the reactor can be approximated as a point source and that the gamma-dose rate is proportional to the power level. Neglecting the attenuation of gamma energy in the vicinity of the reactor, the gamma-dose rate ( $D$ ) is about

$D = 2.7 \times 10^6 / r^2$  with  $2 < r < 300$  m. Here  $D$  is in R/hr/Mw and  $r$  is the distance from the center of the reactor in m (meters).

The free-electron concentration can be expressed as

$$N = (1.8 \times 10^{11} / r^2) (\rho_o / \rho)$$

in electrons/cm<sup>3</sup>/Mw, with  $2 < r < 300$  m. If reactor power and antenna location are known, the transmission and reflection losses due to this ionized region can be determined. The free-electron concentration is not constant along the transmission path; hence, the attenuation loss in the ionized region must be determined by integrating the attenuation coefficient (Fig. 3), along the propagation path.

Assuming a power level of 800 Mw and an antenna placement 2 m from the reactor, losses at sea level will be less than 0.1 db due to attenuation and reflection for most telemetry frequencies. However, at 100,000 ft, the losses will be considerably higher and could be as high as 8 db for frequencies less than 20 Mc, but would be less than 2 db for frequencies greater than 500 Mc. Losses could be reduced further by placing the antennas further away from the reactor.

The major conclusion reached, subject to many uncertainties, is that transmission of telemetry signals to and from an airborne reactor vehicle will not involve any excessive reflection or attenuation losses. Thus, power requirements for communications equipment will not be affected appreciably. It should be emphasized that the calculated losses are only approximate; however, if more exact data is available, the losses can be determined accurately by the equations and methods employed. These losses are frequency sensitive, and under cer-

tain conditions, it may be wiser to change transmitting frequency rather than design equipment with higher power requirements. The factor which influences the losses the most is the altitude because the losses are proportional to the concentration of neutral molecules available for electron attachment.

The next case to be considered is transmitting em energy to and from a hypersonic reentry vehicle.

When a hypersonic vehicle, such as the nose cone of a ballistic missile, reenters the atmosphere, the temperature of the air in the shock wave rises to several thousand deg K, and the air becomes ionized. Signals probably will be attenuated and possibly blacked out during portions of the reentry flight due to this thermal ionization.

The major problem in analyzing the ionization problems associated with a hypersonic reentry vehicle is the inability to describe accurately the temperature and pressure distributions inside the shock wave. For the purposes of this analysis, assume that the perfect gas relations hold in a normal wave and the gas directly behind the stagnation point of the bow shock wave has come to chemical equilibrium. Assume also that the temperature and pressure between the nose of the vehicle and stagnation point are constant. By making these assumptions, the temperature and pressure in the shock wave as well as the thickness of the shock wave can be calculated for any altitude and Mach number. Knowing the temperature and pressure in the shock wave, Fig. 1 and 2 can be used in conjunction with Eq. 2 to determine the transmission losses.

The effect of Mach number, altitude, and transmission frequency upon transmission losses can be illustrated by examining Table I which was calculated for a nose cone of 0.5-meter radius. Since the thickness of the shock is directly proportional to the radius of the nose cone, losses for nose cones of other radii can be determined.

These losses are only approximate because of the many assumptions which were employed; however, their magnitude indicates that the transmission losses will seriously attenuate telemetry signals and in certain phases of reentry, the signal will be completely blacked out.

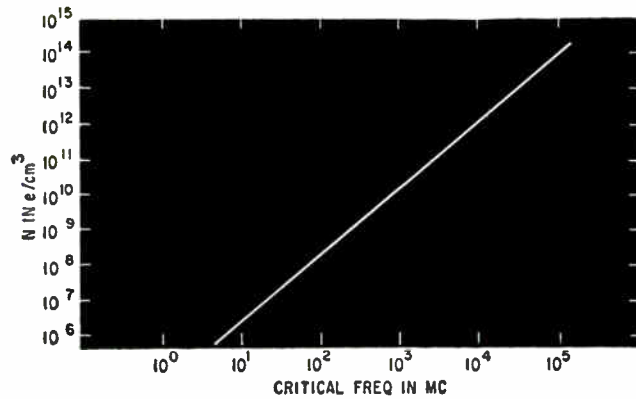

FIG. 5—Critical frequency for reflection increases with  $N$ , the free-electron concentration

In addition to attenuation losses, there will also be a reflection problem. Since the electron-collision frequency is small in the shock wave, reflection properties of the region can be investigated by referring to the  $f_c$  of the region (Fig. 5) which is of the order of 1 to 100,000 Mc for Mach numbers between 10 and 15. This means that for communications between ground and missile, the signal frequency must be above this value or it will be reflected. One of the most promising methods of transmitting information to and from a hypersonic reentry vehicle is by delayed broadcasting after the electron plasma has subsided.

The next case to be considered is em transmission through the region affected by a rocket-motor exhaust.

Effects of rocket-motor exhaust can be analyzed in the same manner as for the reentry vehicle, and the major problem again is in determining the free-electron distribution inside the exhaust plume. The  $N$  is influenced by the following: temperature distribution in flame, pressure distribution in flame, types of fuel and combustion products, reaction-motor back pressure and nozzle configuration, and the presence of additives which enhance electron recombination.

The exhaust problem may be serious since  $N$  may be as high as  $10^{10}$  electrons/cm<sup>3</sup> in some portions of the exhaust plume. The malfunctioning of the missile-ground radio link in some rocket firings has been attributed to attenuation of the radio signals by the ionized gases in the motor flame. Attenuation losses as high as 15 db have been measured and ascribed to the ionized exhaust plume. The propagation of

em energy through propellant gases of reaction motors is accompanied by absorption of energy; however, the problem of determining the physical nature of these losses is difficult because the quantity measured is usually the insertion loss and includes the effect of the impedance mismatch at the air-flame boundary.

Determining losses requires experimental determination of the thermodynamic and physical properties of the exhaust plume. From practical considerations it seems that the best methods of minimizing the flame effects are careful placement of radio antennas and by the use of chlorine additives which enhance free-electron recombination.

The next case to be considered is em transmission in the vicinity of a nuclear explosion.

A nuclear explosion releases a large number of gamma rays which produce ions. This ionization causes some transient effects in electronic equipment, particularly equipment sealed in an inert atmosphere. No energy can be propagated through the fireball at any frequency. Ionized air in the vicinity of the radioactive cloud will have the greatest effect on em transmission because it is of fairly high intensity and persistency. Propagation will involve losses of several db; however, losses should not be prohibitive unless the energy is being propagated towards the fireball, or the size of the nuclear burst is several megatons.

#### BIBLIOGRAPHY

W. A. Greenhow and D. G. Abshier, Transmission of Electromagnetic Energy Through Ionized Media, AIEE paper 60-333, 1950.

# Spectrometric Analysis

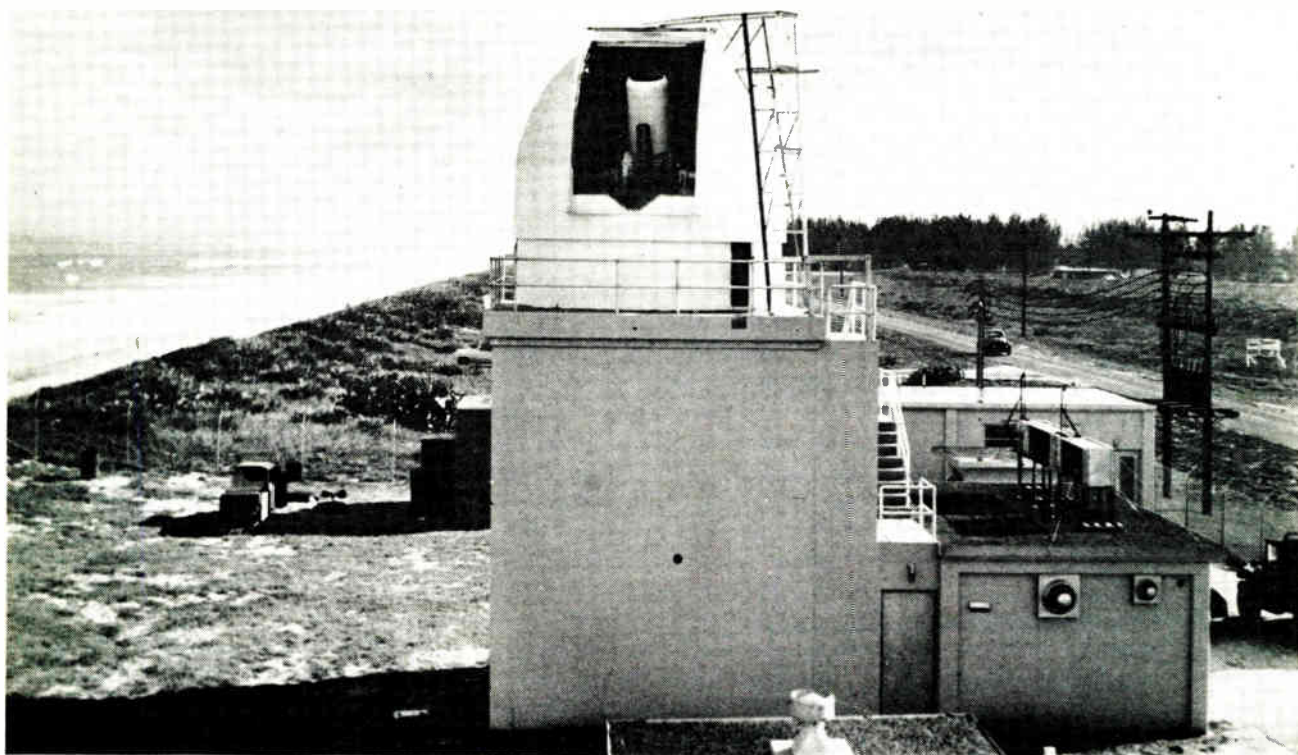

**THE FRONT COVER**—Infrared rapid-scan equipment mounted underneath Recording Optical Tracking Instrument makes spectrometric studies of missile flights at the Air Force Missile Test Center in Florida

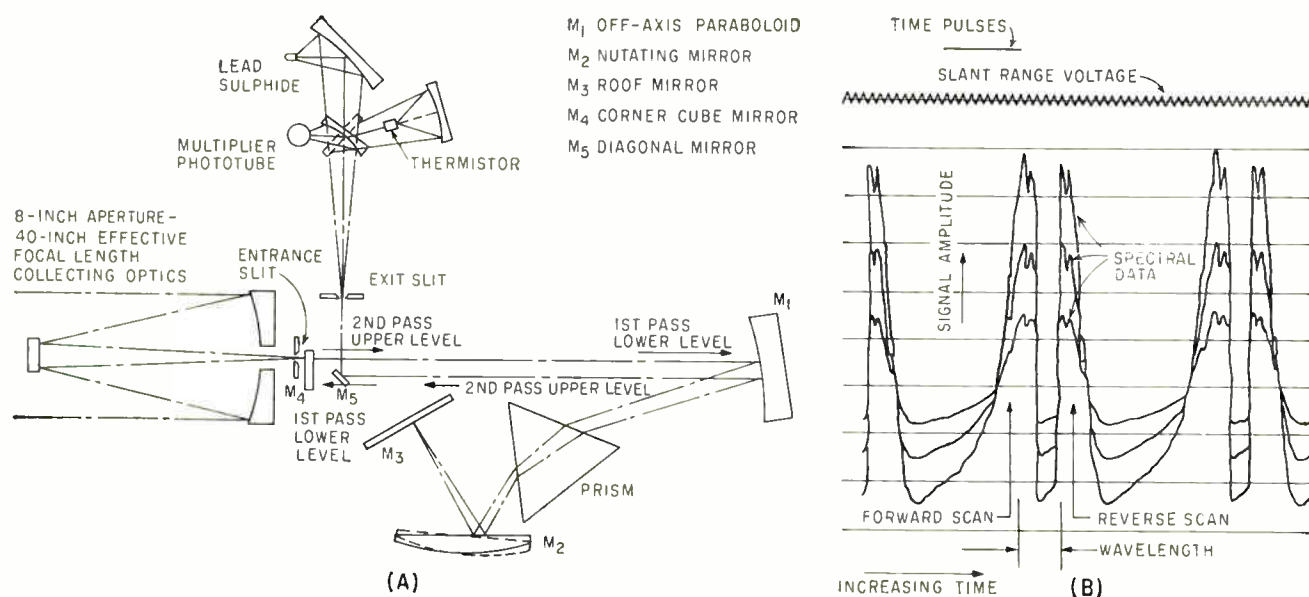

**FIG. 1**—Modified double-pass Littrow system with effective aperture of  $f/5$  (A) sends energy to detector whose signal is then used to produce function-of-time plot (B)



# Of Missile Flights

By JOSEPH N. DAY, JR.,  
Resident Engineer, Perkin-Elmer Corp., Norwalk, Conn.

Does each missile have its own signature? This infrared scanning system is trying to find out. One reason: Identify missiles by their plume traits

INFORMATION gained from infrared measurements of missile plumes, midcourse projectiles and reentry vehicles may lead to developing distinct missile signatures. Although still in the early developmental stage, the analysis of inflight plume characteristics could yield data pertinent to development of more efficient fuels and engines. Data may also be used for missile detection, advanced infrared homing systems for antimissile-missiles, development of decoy tactics, improvement of reentry vehicles and so forth.

The rapid-scan spectrometer described in this article records the distribution and time variation of the spectral wavelengths of the energy radiated during the power-flight portions of missile firings from Cape Canaveral. Mounted under a 24-inch-aperture optical telescope (Perkin-Elmer's Recording Optical Tracking Instrument), the rapid-scan spectrometer consists of a rapid-scan monochromator, a radiation detection system and appropriate readout and recording equipment.

Radiant energy from the missile plume is imaged by the collecting optics, shown in Fig. 1A, on the entrance slit of the monochromator. The energy is chopped by a rotating shutter blade (driven in synchronism with the spectral wavelength scanning nutator or wobbler), dispersed by a prism into its various wavelength components which are imaged on the exit slit and, from there, sent to the detector.

The detector sees an alternating signal whose frequency is the chopped frequency; within each half cycle the signal amplitude varies in accordance with the radiant spectral energy. End product is a plot of the spectrum of the source repeated at the chopping frequency. This plot, known as a function-of-

time plot, shows spectral wavelength in microns against relative amplitude (or magnitude of the radiant energy) and is shown in Fig. 1B. If the scan rate of the monochromator is set for 10 scans a second, then 10 spectra would be recorded in one second.

If the source being analyzed is constant in composition, then all spectra would be identical. However, if the source varies with time either in composition, rate of burning or for any other reason, then each spectrum will differ from the preceding one. Thus, the rapid-scan monochromator can detect and record not only the distribution of the spectral wavelengths of the radiant energy but its variations with time. Variation in energy level due to a changing distance between source and monochromator can be corrected by the inverse square law from knowledge of the distance variation with time. This information would be provided with instruments such as radar.

The monochromator scanning system, which scans the selected spectral region, is basically composed of a plane mirror spinning on an axial shaft. To create a scanning motion, the mirror surface is not perpendicular to the shaft, and the turning mirror reflects incident light in a conical pattern. This nutating mirror system functions as a Littrow mirror, but reflected light components are moving in two directions—both parallel and perpendicular to the dispersion plane. It is therefore necessary to translate rotary light motion into a purely lateral motion which is parallel to the dispersion plane. This is done by reflecting a light beam from a roof mirror that has its edge parallel to the dispersion (horizontal) plane. This roof mirror thus acts as a plane mirror for light motion in the dispersion

plane, but eliminates light motion in the vertical plane by sending light back on itself.

The nutating mirror tilt angle determines wavelength interval of scan, while the roof mirror angle determines the wavelength scan midpoint. Thus, instantaneous wavelength is a function of both these angles.

In the rapid-scan system, all forms of mechanical reciprocating motion are avoided, the elements moving only rotationally. There is no limitation of scan frequency because of mechanical resonance, and dynamic balance is maintained at all times regardless of tilt angle. The scanning frequency is adjustable from 2.5 to 180 cycles a second. The interval of the sinusoidal wavelength scan is continuously adjustable from essentially zero to the complete wavelength range, with center of scan adjustable anywhere within the wavelength range.

In conventional double-pass systems, beam chopping occurs in the second pass region only, there being a carrier frequency separation of first and second passes. Data frequencies are clustered in a small band about this carrier frequency. In rapid-scanning systems, spectral information lies in a wide band of frequencies, the lowest frequency being one-half the scan frequency. Consequently, due to detector time-constant limitations, it is not possible to use carrier frequency separation of first and second passes.

The problem of beam chopping and signal detecting is solved by physically separating the first and second passes. Referring to Fig. 1A, energy from the source is imaged at the entrance slit and collimated by an off-axis paraboloid mirror,  $M_1$ , onto the prism. The energy beam is then refracted to nutating mirror  $M_2$ , reflected to roof mirror  $M_3$  (where the vertical com-

ponent of light motion is eliminated) and then fed back through the prism system. The returned beam is brought to focus by mirror  $M_1$  at the corner of cube mirror  $M_2$  where it is displaced up and across to the paraboloid mirror. It then passes through the monochromator for the second time. The second pass is one inch higher than the first and is the only pass intercepted by mirror  $M_3$  and focused on the exit slit.

The present mode of operation calls for continuous spectral coverage of all ballistic types from visible (0.35 micron) to 2.9 microns in the infrared. To obtain maximum usable data, this is done in three overlapping bands, using a combination of two detectors and prisms. A IP21 multiplier phototube and glass prism are used in the visible, with a combination of lead sulphide detector and sodium chloride prism being used in the near infrared and infrared. A thermistor bolometer is also available for infrared. Detectors are permanently mounted and brought into use by simple interchange of prefocused mirror assemblies.

The electrical signal generated by the monochromator detector as a result of the energy impinging upon the detector from the monochromator is amplified in a preamplifier located on the monochromator base. As shown in Fig. 2, the preamplifier is a two-stage dual triode, R-C coupled voltage amplifier. This pre-

amplifier is used with either the multiplier phototube detector or the lead sulphide detector. The thermistor bolometer has its own preamplifier which is not shown. A wafer switch is used to switch from one detector to another.

When the lead sulphide detector is used, the signal is fed to the grid of the first triode stage and, from there, to the second stage whose output goes through an R-C high-pass network and then to the recording mechanism. Bias for the lead sulphide detector is provided by a 5651 regulator tube across the B+ supply for the amplifier. The first triode stage of the preamplifier is battery biased to maintain the operating point and gain of the triode despite varying signal levels. To achieve good low frequency response for low chopping frequencies (which may be selected to as low as 5 cps) large coupling capacitors are used between stages. An R-C high-pass filter sets the upper frequency limit. This upper limit is adjustable in steps via a wafer switch. The high-frequency cutoff used is dependent upon the detector in use and its inherent time constant. For the lead sulphide this is about 6,000 cps. A higher frequency cutoff than this serves no purpose in increasing information content of the signal and would only increase the noise seen by the recording medium. When the multiplier phototube is used, a high-frequency cutoff at 100,000 cps is

selected to take advantage of the shorter time constant of this detector.

A test voltage is introduced into the cathode of the preamplifier first stage whenever gain calibration of the overall electronic system is desired. Although there is no gain control within the preamplifier itself, the preamplifier output is fed to an oscillograph recorder by way of the oscillograph amplifier which has a variable gain control. To ensure that the overall system gain is the same from day to day, the test signal is fed into the preamplifier prior to each measurement run, and the oscillograph amplifier gain adjusted to give a fixed standard signal displacement on the oscillograph paper. The test signal is removed just prior to a measurement activity.

Since a multiplier phototube has a much higher gain than the lead sulphide detector only one stage of voltage amplification is required with the multiplier phototube. The wafer switch for selecting detectors accomplishes this by taking the multiplier phototube signal from the plate of the first preamplifier triode. A separate high-voltage supply for the multiplier phototube dynodes is used.

Read-out and data-recording can be accomplished in several ways. One method is to present data on the oscilloscope and photograph the pattern with a movie camera. The most desirable data recording system uses a multichannel direct-writing oscillograph. Five channels are used to record range timing, slant range and spectral data. Each spectral channel is at a different gain setting to prevent data loss in event of excessive signal strength.

In instances where large quantities of data are to be collected and reduced, magnetic tape will be used for data recording so that reduction may be simplified by direct input to an electronic computer.

The classified infrared studies of missile exhaust plume characteristics are being made under contract from Air Force Cambridge Research Center as part of the Interservice Radiation Measuring Program (IRMP 59/60) which is sponsored by ARPA.

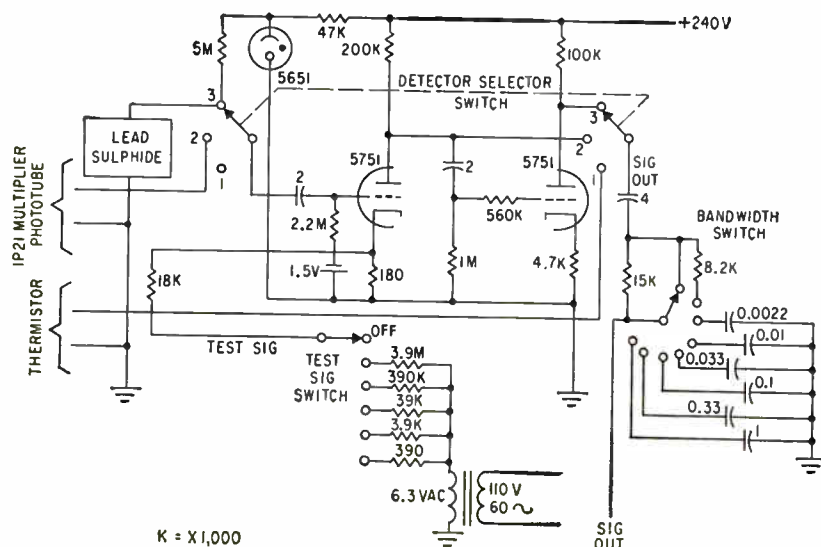

FIG. 2—Detector preamplifier is used with either multiplier phototube detector or lead sulphide detector

# Achieving Discriminator Levels

## WITH A BIASED INPUT DIODE

Triggering thresholds of this highly-accurate and stable pulse-height discriminator are set by adjusting bias of a diode

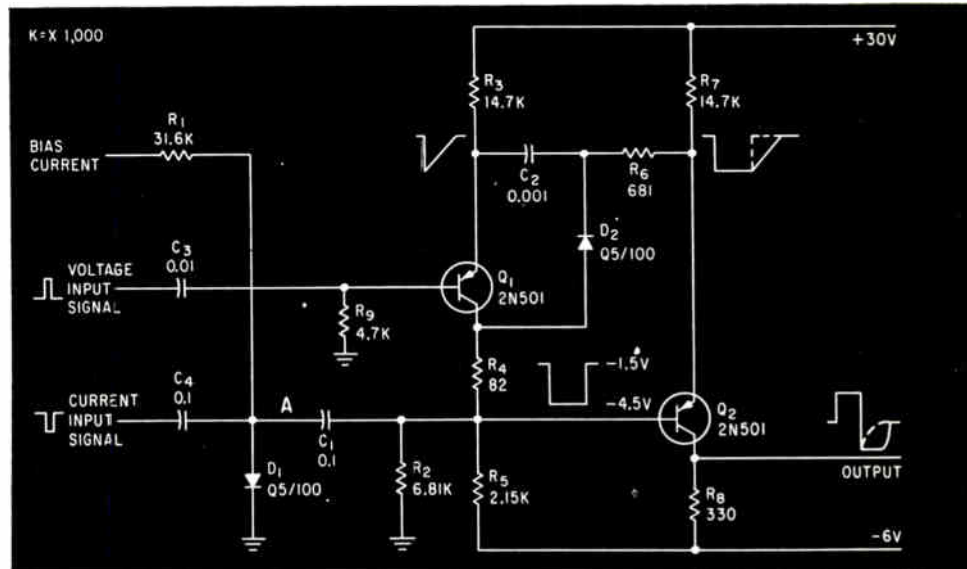

FIG. 1—In operation, only one type of input signal is present at a time

By F. S. GOULDING  
and L. B. ROBINSON,

Electronics Branch, Physics Division,  
Atomic Energy of Canada,  
Chalk River, Ontario, Canada

PULSE-HEIGHT DISCRIMINATORS are widely used to determine whether a voltage or a current input pulse is above or below a predetermined level. The circuit to be described is a highly accurate and stable amplitude discriminator which has been successfully used in nuclear-physics work. Stability of its triggering threshold is achieved by using a forward-biased shunt diode in its input circuit ( $D_1$ , Fig. 1).

Kandiah<sup>1</sup> originally suggested the use of a forward-biased shunt diode in a trigger circuit to produce a stable triggering threshold. Since diode impedance depends on current flowing in the diode, this impedance, hence trigger-circuit loop gain, may be varied by changing diode current. Thus the signal

to be measured reduces a standing (or bias) current in the shunt diode, increasing the shunt-diode impedance, and increasing the loop gain of the trigger circuit. If the signal is large enough to make the loop gain exceed unity, the discriminator triggers.

The advantage of this circuit is that variations in the voltage drop across the diode have little effect on the discrimination level; thus a considerable improvement in stability is possible compared with using the same diode as a biased voltage discriminator.

The circuit described here has a discrimination stability of  $\pm 1 \mu\text{a}$  at a  $50\text{-}\mu\text{a}$  triggering level, or  $\pm 0.4\text{-mv}$  stability at a  $10\text{-mc}$  triggering level, over a range of  $\pm 10\text{ C}$ .

Figure 1 shows the discriminator waveshapes for current-input triggering. The circuit to the right of point A is basically an oscillator with a high gain in the loop formed by  $R_3$ ,  $C_2$ ,  $Q_1$ ,  $R_1$ , and  $Q_2$ . Diode  $D_1$ ,

which has an effective impedance of about 250 ohms at a bias current of  $100 \mu\text{a}$ , provides a shunt load at the collector of  $Q_1$ , and holds the loop gain of the circuit well below unity.

If a negative current input signal to the anode of  $D_1$  reduces the bias current sufficiently, the effective impedance of  $D_1$  rises to the value that decreases its shunting action on the oscillator feedback loop enough to start a regenerative action. This article will first discuss the waveforms and triggering levels of the current discriminator and show how stability and sensitivity are obtained. A voltage discriminator is described later.

Consider the waveforms which will be produced when a short input current signal reduces the current through  $D_1$  to the point where the circuit triggers. (For this analysis we may assume that  $D_2$  is open circuited). The reduction in current through  $D_1$  increases

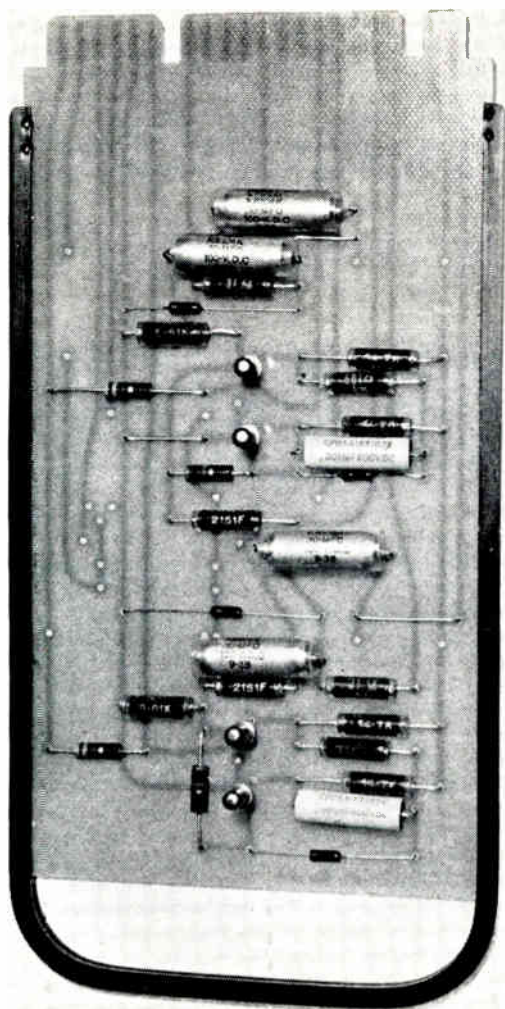

This 4-in by 7-in printed plug-in card holds two discriminators

the incremental resistance of  $D_1$ , thus increasing the loop gain of the trigger circuit from below unity to above unity. The reduction in current also provides a small negative-voltage change at the anode of  $D_1$ , which, for fast signals, is coupled by  $C_1$  to the base of  $Q_2$ . Since  $Q_2$  is in conduction, the emitter resistance of  $Q_2$  is very low, and almost exactly the same voltage change appears at the emitter of  $Q_2$  as at the anode of  $D_1$ . This voltage change causes current to flow via  $C_1$  and  $R_6$  into the emitter of  $Q_2$ , so that the  $Q_2$  emitter current is slightly increased and the  $Q_1$  emitter current is slightly decreased.

Decrease in emitter current to  $Q_1$  decreases the current from  $Q_1$ 's collector to  $R_3$ ; the voltage across  $R_3$  drops, and removes more current from  $Q_1$  via  $Q_2$ ,  $R_6$  and  $C_2$ . Since  $C_1$  has low impedance, the

negative signal also appears on the anode of  $D_1$ , reverse biasing it. The collector of  $Q_1$  and the base and emitter of  $Q_2$  fall about 3 v. The emitter of  $Q_1$  is pulled down enough to cut  $Q_1$  off. During the next  $1\mu\text{sec}$ , all the current supplied by  $R_3$  and  $R_7$  is fed to the emitter of  $Q_2$ , producing a positive output pulse across  $R_5$ . This action continues until the voltage across  $C_2$  recovers enough to bring  $Q_1$  back into conduction. A reverse trigger action then occurs, with the collector of  $Q_1$  rising rapidly, while the emitter

TABLE I—Rise Time of Output Pulse

Input-Pulse Excess (%)	Time ( $\mu\text{sec}$ )
1	0.15
2	0.10
4	0.08
8	0.06
16	0.04

of  $Q_2$  rises more slowly at a rate determined by the recharging of  $C_2$ . The collector of  $Q_1$  rises above its original level due to the recovery current being supplied from  $C_2$ . However,  $D_1$  provides a clamp via  $C_1$ , so that the voltage rise above the original level will be only about 0.1 v during the  $1\mu\text{sec}$  recovery time. The circuit then returns to its original stable condition, if the original input-current signal has been removed.

It is now possible to calculate the current in  $D_1$  at which the circuit will just trigger. The calculation is done in two steps; first find the critical diode impedance, and then calculate the diode current necessary to produce that impedance.

The critical diode impedance is such that the effective impedance at the collector of  $Q_1$  is just large enough to give a gain of unity in the feedback loop. Neglecting emitter impedances, assume a large transistor current gain and denote the critical effective impedance at the collector of  $Q_1$  by  $R_c$ . A sudden change in voltage ( $\Delta V$ ) at the collector of  $Q_1$  produces a current change at the emitter of  $Q_1$  of  $\Delta V/R_c$ , and hence a current change at  $Q_1$ 's collector of  $\Delta V/R_c$ . For a loop gain of unity,  $(\Delta V/R_c) \times R_c \approx \Delta V$ , or  $R_c \approx R_3$ . Thus the critical diode impedance  $R_d$  is the impedance that makes the parallel combination of  $R_3$ ,  $R_7$  and  $R_d$  equal to  $R_3$ .

The critical diode current is obtained from

$$I = I_0[\exp(eV/(nKT) - 1)] \quad (1)$$

where  $I_0$  and  $n$  are diode parameters,  $e$  is electron charge,  $K$  is Boltzmann's constant,  $T$  is the absolute temperature, and  $I$  is the current through the diode junction for voltage  $V^2$ . Differentiating leads to the relation

$$R_d = nKT/eI \quad (2)$$

where  $R_d$  is the diode incremental impedance.

Substituting numerical values,  $R_d = (n/I) \times 25.9$  ohms where  $I$  is the current in ma. The diode parameter  $n$  is usually between 1 and 1.4.

In Fig. 1, the parallel combination of  $R_d$ ,  $R_7$  and  $R_3$  is equal to  $R_3$  when  $R_d$  is 1,160 ohms. Assuming  $n = 1.2$ , the critical diode current is about 27  $\mu\text{a}$ .

The general case, in which a dis-

crimination level must be calculated for any given bias level, is more complicated and has been treated elsewhere<sup>3</sup>.

Figure 2 shows a plot of bias current versus pulse discrimination level for three different values of  $R_6$ .

The stability and reproducibility of the discrimination level is almost completely determined by the characteristics of shunt diode  $D_1$ . In particular, the temperature stability of the discriminator depends on the temperature stability of the diode incremental-impedance curve. In Eq. 2, the numerator varies linearly with temperature but an exponential temperature dependence of  $I_s$  in the denominator complicates the temperature dependence of  $R_6$ . In silicon diodes where  $I \gg I_s$ ,  $R_6$  is proportional to  $T$ . In germanium diodes, where  $I_s$  is significant (that is, above 1 percent of  $I$ ), negative or positive temperature coefficients may be measured, depending upon the actual value of  $I_s$ . Germanium and silicon diodes of several types have given satisfactory results.

Because of the limited frequency response of the elements forming the trigger circuit, application of an input pulse exceeding the threshold value does not immediately trigger the circuit into its new state. The first part of the current waveforms in  $Q_1$  and  $Q_2$  are of positive exponential form and the initial parts of the waveforms are slow. Any excess of input pulse over the threshold value tends to speed up the rise (or fall) in the current waveforms in the circuit. Table I shows experimental values of the time required after the start of the input pulse for the output across  $R_7$  in Fig. 1 to rise to 50 percent of its maximum amplitude. The percentage figures indicate input-pulse amplitudes above the 100- $\mu$ a threshold.

The experimental measurements of Table I were made with input-pulse widths exceeding the times measured. If input-pulse width is reduced enough, the circuit will just fail to trigger, since, at the time corresponding to the back edge of the input pulse, the circuit is not yet removing sufficient current through  $C_1$  from  $D_1$  to maintain the unstable condition. Since the cur-

rent rise has a positive exponential form, the rise is fast at the 50-percent-amplitude point and the time values in Table I correspond roughly to the minimum input width at the specified amplitude.

The dead time of the circuit may also be calculated. Recovery time of the circuit depends on the value of  $C_2$  and on the currents supplied by  $R_6$  and  $R_7$ . With the values given in Fig. 1, the voltage across  $C_2$  must change by about 2 v after triggering before  $Q_1$  starts to conduct again. Since  $C_2$  is charged by an approximately constant current of 2 ma from  $R_6$ , the time required is about 1.0  $\mu$ sec. After  $Q_1$  again starts to conduct, a similar time would be required before  $C_2$  is recharged to its original condition if  $D_2$  were not in the circuit. Diode  $D_2$  reduces the second half of the dead time by a factor of 10 or more. This diode is normally nonconducting, but when the collector of  $Q_1$  starts to rise towards its original level,  $D_2$  becomes forward biased

last of its charge through  $Q_1$ . Diode  $D_2$  plays an important role here, for if it did not shorten the recovery period, 2 ma would flow into  $C_1$  during a 1.0- $\mu$ sec recovery period, causing part of the bias current to be diverted to restore  $C_1$ . This effect would reduce the discrimination level at high count rates, and could produce self-oscillation of the circuit; thus,  $D_2$  is necessary.

To determine the stability which may be expected a number of diodes were tested for temperature dependence. Of the diodes tested, one with the highest positive-temperature coefficient (hptc), one with a low-temperature coefficient (ltc), and one with the highest negative-temperature coefficient (hntc) were used for  $D_1$ . At almost constant room temperature, the triggering level changed by less than 0.2  $\mu$ a in 24 hours. Increasing temperature from 25 C to 45 C produced these changes in triggering circuit: for the hptc diode, -2.7  $\mu$ a; for the ltc diode, -1.9  $\mu$ a; for the hntc diode, -0.2  $\mu$ a.

From these results it appears that a long-term stability of  $\pm 1 \mu$ a can be obtained if the ambient temperature is maintained within a range of  $\pm 10$  C around normal room temperature.

The discriminator circuit of Fig. 1 may be used as a voltage discriminator by feeding positive pulses to the base of  $Q_1$ . Here the discriminating action is similar to that of the current discriminator. Instead of a negative current pulse being fed to diode  $D_1$ , a positive pulse of voltage to the base of  $Q_1$  reduces the collector current of  $Q_1$  by  $V/R_6$ . Since the current in  $R_7$  remains almost constant, the current in diode  $D_1$  is reduced by  $V/R_6$ . As in the current discriminator, the triggering level can be adjusted by varying the bias current to  $D_1$ .

Using the voltage discriminator circuit configuration, a discrimination level of 10 mv remains stable to  $\pm 0.4$  mv for a  $\pm 10$  deg C range of temperature.

#### REFERENCES

- (1) Kandiah, *Proc IEE*, 101, Pt. II, No. 81, p. 239.
- (2) Sah, Noyce and Shockley, *Proc IRE*, 45, p. 1,228, 1957.
- (3) F. S. Goulding and L. B. Robinson, CREL-778, Chalk River, Ontario.

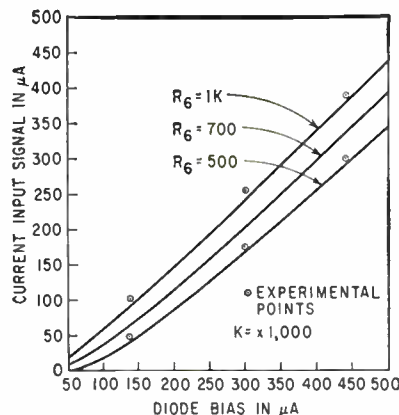

FIG. 2—Effect of bias on triggering levels for various values of  $R_6$

and  $C_2$  can discharge through the low-impedance path provided by  $D_2$  and  $Q_1$ . Thus a dead time of less than 1.2  $\mu$ sec is achieved.

Storage of charge on  $C_1$  also affects recovery time. At high repetition rates, charge storage on  $C_1$  provides a possible cause of shift of discrimination level. However, the charge stored on  $C_1$  tends to be removed after each pulse, for the bias current charges  $C_1$  during the time that  $Q_1$  is nonconducting, and a pulse of current charges  $C_1$  through  $D_1$  in the other direction during the instant that  $C_2$  discharges the

## PROCEDURE FOR DESIGNING

# Reciprocal Computer Circuits

Circuits with outputs inversely proportional to their inputs can be constructed with diodes, resistors and d-c voltage supplies.

Element values and computation range and accuracy are presented

By ARTHUR GILL

Dept. of Engineering, Div. of Electrical Engineering, University of California, Berkeley, Calif.

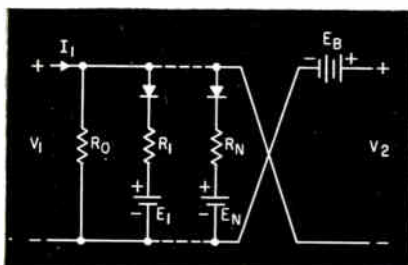

FIG. 1—Reciprocal-computing circuit

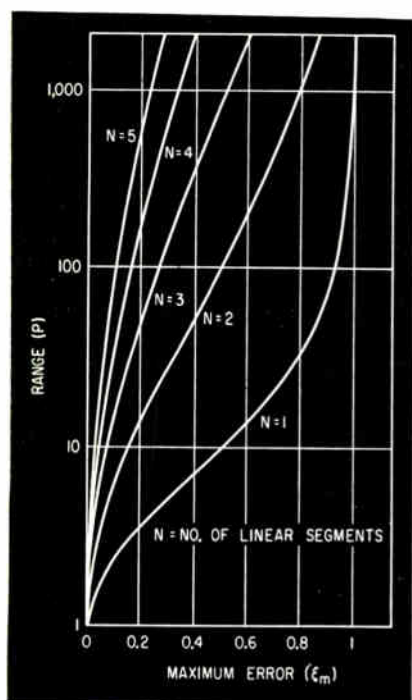

FIG. 2—Operating range as a function of accuracy and number of diodes

A circuit whose output is inversely proportional to the input is often desired in analog computation devices as well as in various control systems. Such a circuit can be constructed from diodes, resistors and d-c voltage supplies to yield transfer characteristics that constitute a piecewise-linear approximation of a hyperbolic curve.

Relationships between the element values of such a circuit and the prescribed values of computation range and accuracy are presented in this article.

The circuits considered are unidirectional; that is, their characteristics approximate only one branch of a hyperbola. A complete approximation, however, can be realized by connecting two circuits in parallel, such that one will be operative with positive inputs only and the other with negative inputs.

The general structure of a reciprocal-computing circuit is shown in Fig. 1. Design of this circuit requires specifying the following quantities: the constant multiplier,  $k$ , of the approximated function  $y = k/x$ , the minimum input current  $I_m$ , to the circuit, the computation range,  $P$ , (ratio between the highest and lowest value of  $x$  in the computed function) and the maximum allowable fractional error,  $\epsilon_m$ .

The  $V_2 - I_1$  characteristics of the circuit shown approximate  $y$ ,

subject to the given specifications, provided it is constructed according to the formulas listed in Table I. The number of diodes,  $N$ , in the circuit also equals the number of linear segments employed in the approximation of the hyperbolic curve. The relationship between  $P$  and  $\epsilon_m$  is plotted in Fig. 2 for various values of  $N$ .

Figure 3A shows the given hyperbola, the piecewise-linear approximation and the realized circuit for  $k = 1$ ,  $I_m = 10$  ma,  $P = 15.4$  and  $\epsilon_m = 0.1$ .

To minimize the dependence of the circuit on diode characteristics, and thus assure the fullest correspondence between the specified and actual responses, the  $R_n$  resistors should be considerably larger than the operating forward resistances of the associated diodes. On the other hand, these resistors cannot be made too high, since this may impair the current-generator character of the input source. For optimal operation the  $R_n$  resistors should be of the same order of magnitude as the zero-signal incremental resistance of the diodes. This resistance, which roughly equals the geometric mean of the diodes' forward and reverse resistances, is between 10 and 100 kilohms for most semiconductor diodes.

Although this choice of resist-

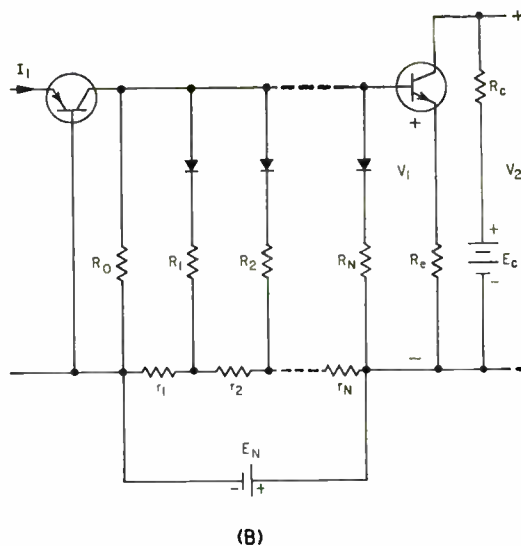
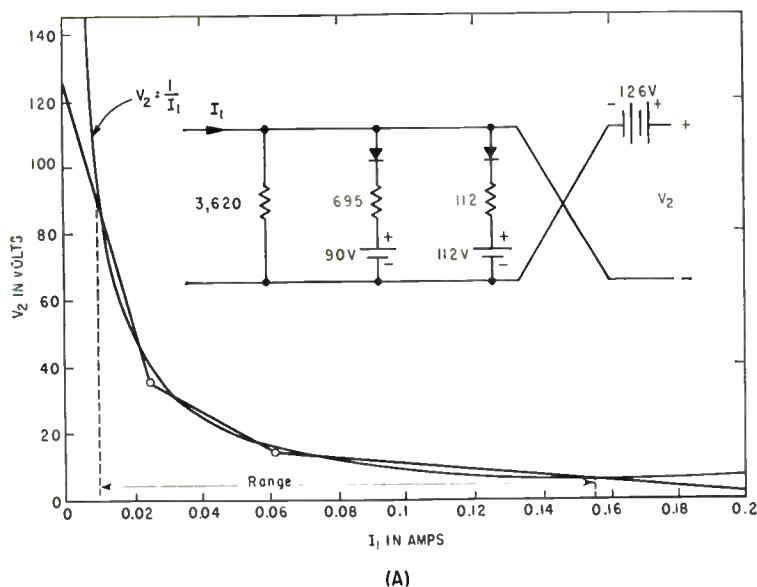

FIG. 3—Circuit is designed from given hyperbola (A). Transistorized input and output stages are used for a practical reciprocal-computing circuit (B)

ance maximizes the stability in most of the operating range, it emphasizes the effect of the diode characteristics in the breakpoint regions. This effect, however, is usually beneficial since it tends to round off the breakpoint corners and, therefore, reduces the error at these points.

As seen from Table I, the resistance level of the circuit can be conveniently controlled by the constant multiplier  $k$ . However, changing  $k$  effects a proportional change in all the bias voltages. The result is that higher stability is usually obtained at the expense of higher voltages.

When higher voltages are en-

countered, the reverse leakage through the diodes becomes appreciable. In such cases silicon diodes may be preferred because of their high reverse resistance (on the order of 100 megohms).

A practical reciprocal-computing circuit, employing transistorized input and output stages, is shown in Fig. 3B. The input  $pnp$  transistor, connected in the common base configuration, has a current amplification factor of approximately unity and a high output impedance (1-10 megohms), as required. The output  $npn$  transistor has an input impedance  $\beta R_e$ , which is sufficiently high when  $R_e$  is of the order of 10 kilohms.

The individual batteries in the piecewise-linear circuit are replaced by a single power supply and a voltage divider. This modification is permissible if the individual resistors in the divider are chosen according to the formula

$(E_n - E_{n-1})(r_1 + r_2 + \dots + r_n)/E_N$  where  $r_1 + r_2 + \dots + r_N$  is arbitrary, as long as  $r_N \ll R_N$ . If  $E_c$  is chosen such that

$$E_c = \beta R_e E_B / (\beta + 1) R_e$$

the output of the circuit is given by

$$V_2 = [\beta R_e k / (\beta + 1) R_e] I_1$$

Thus, the ratio  $R_e/R_c$  can be utilized to control the effective constant multiplier of the computed function.

TABLE I—Design Formulas for Reciprocal Circuits

$$N = \frac{\log P}{\log \left( \frac{(\epsilon_m + 1)^{1/2} + (2\epsilon_m)^{1/2}}{(\epsilon_m + 1)^{1/2} - (2\epsilon_m)^{1/2}} \right)}$$

$$E_B = \frac{2k}{I_o} \left( \frac{1 - \epsilon_m^2}{P^{2/N}} \right)^{1/2}$$

$$E_n = E_B - \frac{k(1 - \epsilon_m)}{P^{n/N} I_o} \quad n = 1, 2, \dots, N$$

$$R_o = \frac{k(1 - \epsilon_m)}{P^{1/N} (I_o^2)}$$

$$R_n = \frac{R_o}{P^{(2n-2)/N} (P^{2/N} - 1)} \quad n = 1, 2, \dots, N$$

$N$  = Number of diodes

$P$  = Computation range

$\epsilon_m$  = maximum allowable fractional error

$I_o$  = minimum input current

$k$  = constant multiplier of the approximated function

$E_B, E_n, R_o, R_n$  = as defined in Fig. 1

# Production Line Checker For Relay Contact Chatter

Thyratron timer operates a reject indicator when relay contacts are forced open by vibration for longer than a prescribed interval. Converse applies to relays that should remain open but are momentarily closed by vibration

By EUGENE H. KOPP  
Assistant Professor of Engineering,  
Los Angeles State College,  
Los Angeles, Calif.

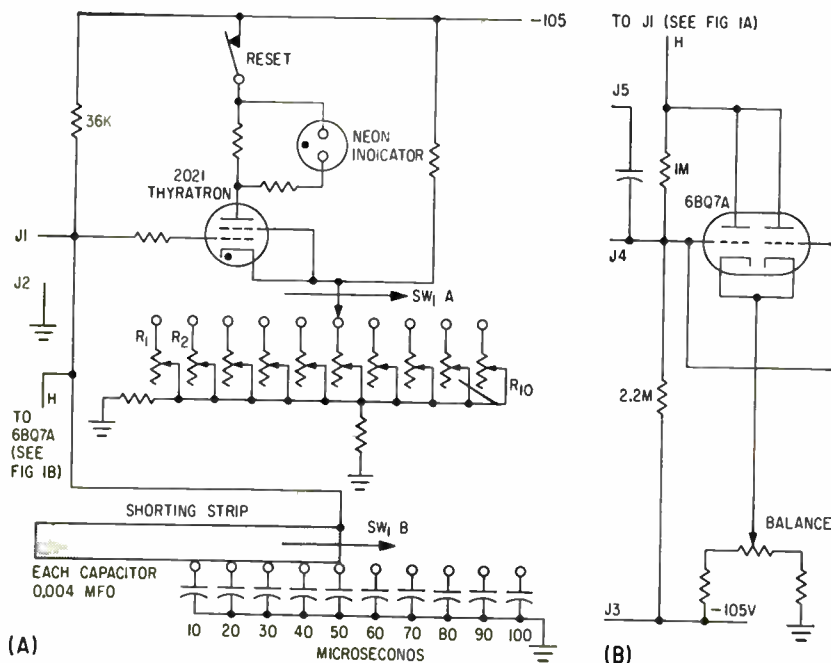

FIG. 1—Time constant is set by multiposition switch, thyatron conducts if relay contacts remain open (or closed) longer than the timed interval (A); Inverter triggers thyatron timer during testing of contacts that should remain open (B)

TODAY'S electronic control systems require increasingly reliable components. The electromagnetic relay has long been one of the basic control system elements, and recent developments have significantly increased its reliability. One of these developments is thorough and systematic test procedures for relays, permitting the manufacturer to specify certain relay characteristics to a degree previously unattained.<sup>1</sup>

One of the most difficult characteristics to test is relay chatter. Chatter is defined<sup>2</sup> as a sustained rapid opening and closing of contacts caused by variations in the coil current, mechanical vibrations, shock or other causes. In applications in which the relay may be subject to severe shock and vibration, it is often impossible to eliminate this chatter. In such cases, the associated circuits may be designed to function properly providing the relay chatter interval does not exceed a designated time. That is, the circuit will still function properly providing that contacts which should be closed do not open for longer than a designated time before reclosing and that contacts which should be open do not close for longer than this designated time.

Testing for chatter requires only the determination of an unwanted contact condition, and is not concerned with the relay state to produce that condition. Therefore, the term "a contact that should be closed" means *either* a normally closed contact on a deenergized relay, or a normally open contact on an energized relay. The converse is true for an open contact.

Because of its transient and unpredictable nature, special test techniques must be used in checking for chatter and in measuring the duration of the chatter interval. One common laboratory procedure is to connect the relay and a suitable voltage source to a high-speed oscilloscope with a triggered sweep, so that opening (or closing) of the relay contacts—as a result of chatter—triggers the sweep. The displayed waveform then gives the duration of the chatter interval. Although this setup is useful and necessary for a quantitative evalua-



tion of developmental improvements, it is not suitable for production testing.

A circuit has been developed to permit production testing of contact chatter on a simple GO NO-GO basis.<sup>3</sup> The circuit as originally proposed had the disadvantage that it could be used only to monitor the unwanted openings of closed contacts, and had only a single interval (10 microseconds) that could be used as the basis of a GO NO-GO test. This circuit has been revised and improved so that it may serve to monitor either open or closed contacts, for intervals from 10 to 100 microseconds in 10 microsecond increments. The improved circuit is also easier to calibrate than the original, and has been made available in a single, compact assembly.

The basic timing circuit uses a 2D21 thyatron. A simplified schematic of this portion of the circuit is shown in Fig. 1A. When testing a pair of contacts that should be closed, these contacts are connected to terminals  $J_1$  and  $J_2$ , thereby maintaining the thyatron grid at ground potential. The cathode is at a positive potential determined by the setting of one of the potentiometers  $R_1$  to  $R_n$  (depending on the setting of  $SW_1$ ). This positive bias is sufficient to cut the tube off.

If contact chatter is present, the contacts open. As soon as this occurs, the thyatron grid begins an exponential rise toward +105 volts, at a rate determined by the time constant of the 36,000-ohm resistor and whichever capacitors are connected in the circuit by  $SW_1$ . This switch determines the time interval of the GO NO-GO operation; it permits testing the relay for chatter intervals between 10 and 100 microseconds, in increments of 10 microseconds. Electrically,  $SW_1$  adds 0.004  $\mu$ f of capacitance to the R-C timing circuit for every additional 10 microsecond increment of time interval.

As long as the contacts remain open, the grid potential rises. If the contacts remain open for longer than the prescribed interval, the grid potential rises to the point at which conduction begins (determined by the setting of the cathode potentiometer); the thyatron then ionizes, and the warning light goes

on. Since, in a thyatron, the grid loses control of conduction as soon as the tube conducts, the relay contacts may reclose without affecting the circuit. If a single chatter interval exceeds the preset value, the warning light will go on and stay on.

This basic circuit is useful only for monitoring contacts which should be closed, and which chatter open. To monitor OPEN contacts for undesired closures, it is necessary to perform a polarity inversion. That is, as long as the contacts under test are open, a short-circuit should exist between  $J_1$  and  $J_2$ , and as soon as these contacts become shorted,  $J_1$  and  $J_2$  should be open circuited.

Polarity inversion may be accomplished in an active element, such as a tube, a transistor, or an auxiliary relay. For this application the operate time of commercially available relays is too long. A similar consideration rules out transistors, which are also hampered by the requirement of d-c stability discussed below. A vacuum tube was therefore chosen as the inversion element.

To perform this inversion, the vacuum tube must alternately be an open circuit, then a low-resistance short-circuit, the resistance of the short being low compared to the 36,000 ohm charging resistor of the R-C timing circuit. Although a vacuum tube is an excellent open-circuit when it is non-conducting, most tubes are poor short-circuits when conducting. To achieve the low-resistance necessary, a tube with a low plate resistance (6BQ7A) was chosen, and both sections of the tube operated in parallel to halve the plate resistance. Voltage feedback also decreases the output impedance of a circuit, and is used here. The feedback circuit consists of the resistive divider from the plate to the grid of the 6BQ7A. Effective resistance of the circuit when conducting is about 5 percent of the charging resistance.

Additional circuits used for testing contacts that should remain open are shown in Fig. 1A. The contacts under test are connected to terminals  $J_3$  and  $J_4$ . Before the test is begun, a voltmeter is placed between terminals  $J_1$  and  $J_2$ , and the

BALANCE potentiometer is adjusted so that there is zero potential difference between these terminals. The test then begins, and any contact closure immediately cuts-off the 6BQ7A and permits the thyatron grid potential to rise exponentially, as in the preceding case. If the contact closure exceeds the predetermined interval, the thyatron will ionize and the warning light will light.

To insure that the normal plate voltage of the 6BQ7A remains at ground potential, the operating point must be highly stabilized. The negative feedback helps to accomplish this, along with the regulation of the power supply. The 6BQ7A was also selected because of its good d-c stability.

The polarity-inversion circuit may also be used to re-calibrate the instrument when necessary. A pulse generator is connected to feed a negative pulse of known and adjustable duration to the 6BQ7A grids. Pulse duration is matched to the particular setting of  $SW_1$ , and the potentiometer in the thyatron cathode is adjusted to make the thyatron fire at that pulse duration. Each potentiometer is calibrated in turn.

In use, the monitor is set at the longest chatter interval that can be tolerated in a given application. At the conclusion of the test the operator checks the condition of the warning light; if off, there was no chatter interval exceeding the specified duration—if on, at least one interval exceeded this specification. The relay is accordingly accepted or rejected and the instrument is then reset, ready for another test. The complete equipment consists of the two circuits described, plus power supplies and switches to perform the monitoring function.

The author wishes to express his appreciation to Maurice Coplan of Coplan Electronics for sponsoring this project.

#### REFERENCES

- (1) Relay Testing Procedures, National Association of Relay Manufacturers, 1959
- (2) Definition of Relay Terms, National Association of Relay Manufacturers, 1955
- (3) A Circuit to Monitor Relay Chatter, WCRE Technical Memorandum Report 55-15, Wright Air Development Center
- (4) J. Millman, "Vacuum Tube and Semiconductor Electronics", McGraw-Hill, New York

## METHOD FOR

# Simplifying Filter Design

For a specified stopband attenuation, design procedure for Zobel filters is made straightforward by use of Caueer parameters. Design procedure results in network with minimum number of elements

By KURT LICHTENFELD

Airborne Systems Laboratories,  
Hughes Aircraft Co., Culver City, Calif

THE ZOBEL image-parameter method of designing wave-filters offers a faster and easier way to arrive at a practical network than methods based on modern synthesis techniques if the transfer function has zeros as well as poles.<sup>1</sup> The disadvantage of the Zobel method, as compared with insertion loss synthesis, is that the calculation of attenuation versus frequency response of a network consisting of several cascaded M-sections is not straightforward. The design is a cut-and-try process with no assurance that the filter is optimally designed and contains the minimum number of elements necessary to produce a desired attenuation; also, there is no assurance that the specified attenuation will be obtained throughout the stopbands.

Cauer has shown that by Tschebyscheff approximation for a specified value of the minimum attenuation in the stopband, and a given number  $n$  of cascaded M-sections of a Zobel filter, the range of the stopband as well as the design parameters of the normalized filter can be determined.<sup>2</sup> By tabulation of these values for  $n$  sections the design

procedure of Zobel filters can be made straightforward and will result in a network that has the minimum number of elements. Filter design is optimized in the sense that with the smallest amount of network elements the largest possible attenuation in the stopband will be obtained; computational time is minimized due to the elimination of the cut-and-try process and by using impedance and frequency normalization. Tables of the Caueer parameters and the elements of two section low-pass, high-pass, bandpass, and band elimination filters are presented here.

For low-pass filters, referring to the characteristic shown in Fig. 1A,  $\omega_c$  is the highest frequency in the passband in rps;  $\omega_s$  is the lowest frequency in the stopband in rps;  $\omega_{x1}$  is the first frequency of peak-attenuation in rps; and  $\omega_{x2}$  is the second frequency of peak-attenuation in rps. From Fig. 1A, the attenuation in the stopband is equal to or greater than  $A$ , in db. Let

$$\omega_1 \omega_2 = \omega_c^2 \quad (1)$$

Frequency normalization is obtained by setting  $\omega_c = 1$  rps. The normalized frequencies, corresponding to  $\omega_1, \omega_2, \omega_{x1}, \omega_{x2}$ , are

$$\begin{aligned} \kappa &= \omega_1 / \omega_c; & k &= \omega_2 / \omega_c; \\ \Omega_{\infty 1} &= \omega_{\infty 1} / \omega_c; & \Omega_{\infty 2} &= \omega_{\infty 2} / \omega_c \end{aligned} \quad (2)$$

From (1) follows  $k = 1/\kappa$ . With numerical values for  $A$ , and  $\omega_s$  specified, we find in Table I the parameters  $k, \Omega_{x1}, \Omega_{x2}$ , and from (2) follows

$$\begin{aligned} \omega_c &= \omega_s / k; & \omega_1 &= \omega_c / k; \\ \omega_{\infty 1} &= \omega_c \Omega_{\infty 1}; & \omega_{\infty 2} &= \omega_c \Omega_{\infty 2} \end{aligned} \quad (3)$$

With the values for  $m_1, m_2, \Omega_{x1}, \Omega_{x2}$  from Table I, we obtain from Table II the normalized elements of the two networks A and B (Fig. 1B) which have identical attenuation characteristics.

The last step is the removal of the frequency and impedance normalization. For a source and load resistance of  $R$  ohm all capacitances are multiplied by  $1/R\omega_c$  and all inductances by  $R/\omega_c$ .

Example: A low-pass filter shall provide at least 40-db attenuation at 5,000 cps and above and will be inserted between 600-ohm source and load resistances.

We find in Table I:  $k = 1/\kappa = 1.35$ ;  $\Omega_{x1} = 1.43$ ;  $\Omega_{x2} = 2.94$ ; and from (3) it follows, with  $f_s = \omega_s/2\pi = 5,000$  cps, that  $f_c = f_s/k = 5,000/1.35 = 3,700$  cps;  $\omega_c = 2\pi f_c = 23,220$  rps;  $f_1 = f_c/k = 2,740$  cps;  $f_{x1} = f_c \Omega_{x1} = 5,290$  cps;  $f_{x2} = f_c \Omega_{x2} = 10,850$  cps. With  $m_1 = 0.715$ ,  $m_2 = 0.940$ ,  $\Omega_{x1} = 2.04$ , and  $\Omega_{x2} = 8.63$  from Table I, we find the normalized values of the networks A and B of Fig. 1B from the third column of Table II. These values appear in column four, Table II.

Normalization is removed by multiplying the capacitances by  $1/R\omega_c = 0.0717 \times 10^{-6}$  and the inductances by  $R/\omega_c = 25.8 \times 10^{-3}$  with  $\omega_c = 23,230$  rps and  $R = 600$  ohms. The resulting element values for the two filter networks are shown in Fig. 1B (C's in  $\mu\text{f}$ ).

For high-pass filters, referring

TABLE I—Caueer Parameters

$A_s$ (db)	$k = 1/\kappa$	$\Omega_{\infty 1}$	$\Omega_{\infty 2}$	$m_1$	$m_2$	$\Omega_{x1}^2$	$\Omega_{x2}^2$
20	1.035	1.06	1.72	0.332	0.814	1.12	2.95
25	1.075	1.11	1.96	0.434	0.86	1.23	3.84
30	1.135	1.175	2.22	0.525	0.893	1.38	4.92
35	1.205	1.265	2.53	0.612	0.919	1.6	6.40
40	1.35	1.43	2.94	0.715	0.94	2.04	8.63
45	1.5	1.59	3.5	0.777	0.958	2.52	12.2
50	1.67	1.785	3.97	0.828	0.968	3.18	15.7
55	1.87	2	4.6	0.866	0.976	4	21.2
60	2.08	2.22	5.2	0.893	0.98	4.92	27

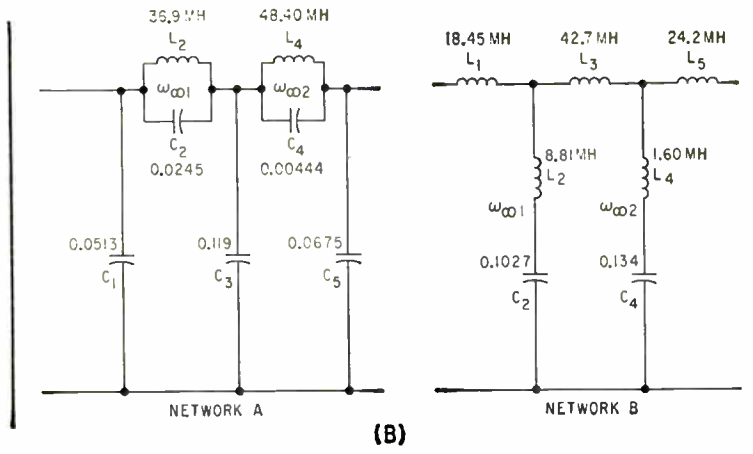
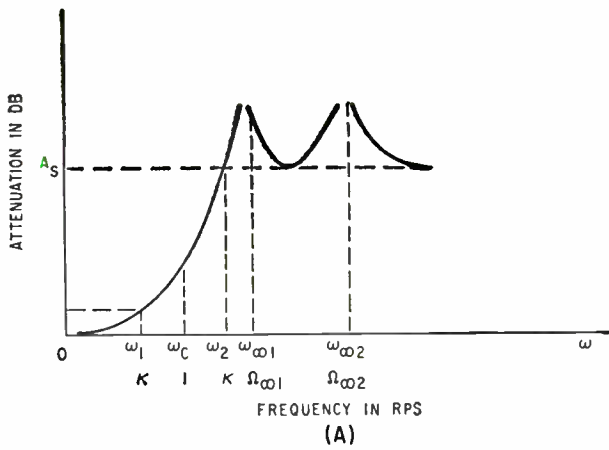
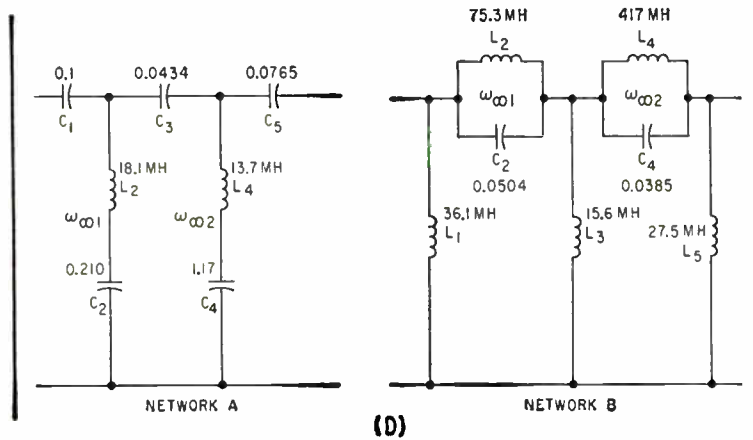
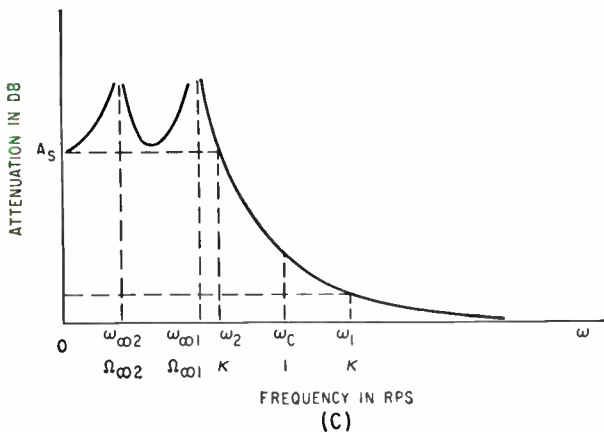

FIG. 1—Low-pass filter characteristics (A)

and low-pass filter network (B)



high-pass filter characteristic (C)

and high-pass filter network (D)

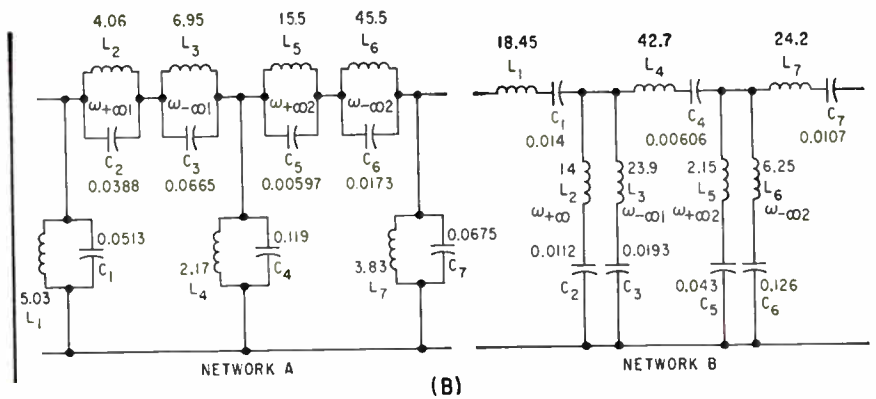
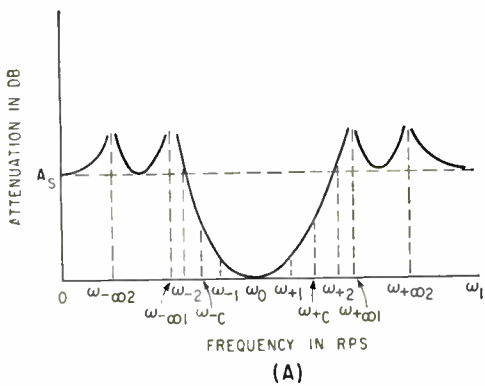
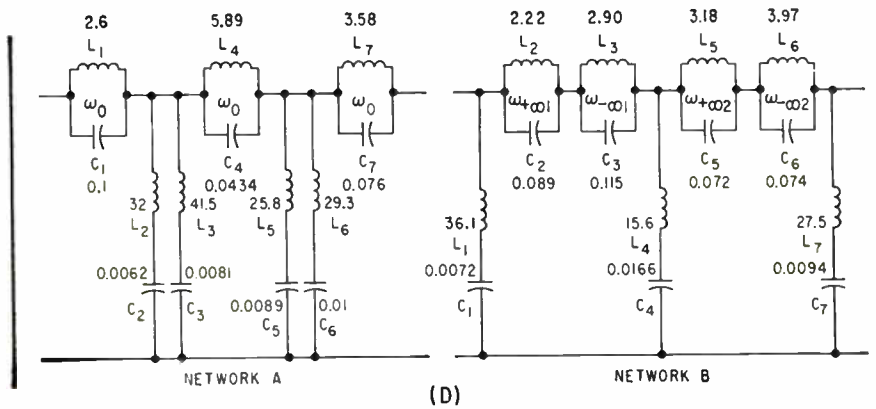
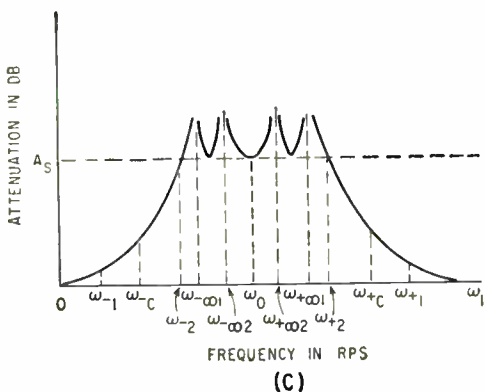

FIG. 2—Bandpass filter characteristic (A)

and bandpass filter network (B);



band elimination filter characteristic (C)

and band elimination filter network (D)

TABLE II—Element Values For Normalized Low-Pass Filter

Network		Values	Normalized Values
A	B	(henries or farads)	for Example
$C_1$	$L_1$	$m_1$	0.715
$L_2$	$C_2$	$2m_1$	1.43
$C_3$	$L_3$	$1/2m_1\Omega_{\infty}^2$	0.342
$L_4$	$C_4$	$(m_1 + m_2)$	1.655
$C_5$	$L_5$	$2m_2$	1.88
		$1/2m_2\Omega_{\infty}^2$	0.062
		$m_2$	0.94

TABLE III—Element Values For Normalized High-Pass Filter

Network		Values	Normalized Values
A	B	(henries or farads)	for Example
$C_1$	$L_1$	$1/m_1$	1.4
$L_2$	$C_2$	$1/2m_1$	0.7
$C_3$	$L_3$	$2m_1\Omega_{\infty}^2$	2.92
$L_4$	$C_4$	$1/(m_1 + m_2)$	0.605
$C_5$	$L_5$	$1/2m_2$	0.532
		$2m_2\Omega_{\infty}^2$	16.15
		$1/m_2$	1.065

to the characteristic shown in Fig. 1C,  $\omega_1$  is the lowest frequency in the passband in rps;  $\omega_2$  is the highest frequency in the stopband in rps;  $\omega_{r1}$  is the first frequency of peak attenuation in rps; and  $\omega_{r2}$  is the second frequency of peak attenuation in rps. The attenuation in the stopband is equal to or greater than A, db. We let

$$\omega_1\omega_2 = \omega_c^2$$

Frequency normalization is obtained by setting  $\omega_c = 1$  rps. The normalized frequencies, corresponding to  $\omega_1, \omega_2, \omega_{r1}, \omega_{r2}$  are

$$\kappa = \omega_c/\omega_1; \quad k = \omega_c/\omega_2; \\ \Omega_{\infty 1} = \omega_c/\Omega_{\infty 1}; \quad \Omega_{\infty 2} = \omega_c/\Omega_{\infty 2} \quad (4)$$

From (1) follows  $k = 1/\kappa$ . With numerical values for A, and  $\omega_2$  specified, we find in Table I the parameters,  $k, \Omega_{r1}, \Omega_{r2}$ , and from (4) follows

$$\omega_c = k\omega_2; \quad \omega_1 = k\omega_c; \\ \Omega_{\infty 1} = \omega_c/\Omega_{\infty 1}; \quad \Omega_{\infty 2} = \omega_c/\Omega_{\infty 2} \quad (5)$$

With the values for  $m_1, m_2, \Omega_{r1}, \Omega_{r2}$  from Table I, we obtain from Table III the normalized elements of the two networks A and B illustrated in Fig. 1D, which have identical attenuation characteristics.

The last step is the removal of the frequency and impedance normalization. For a source and load resistance of R ohm, all capacitances are multiplied by  $1/R\omega_c$  and all inductances by  $R/\omega_c$ .

Example: A high-pass filter, complementary to the previously designed low-pass filter, shall have at least 40-db attenuation at and below 2,740 cps. The source and load resistances are 600 ohms.

The parameters in Table I are the same as in the first example. From (5) it follows, with  $f_2 = 2,740$  cps, that  $f_c = kf_2 = 3,700$  cps, and  $\omega_c = 23,220$  rps;  $f_1 = kf_c = 5,000$  cps;  $f_{r1} = f_c/\Omega_{r1} = 2,580$  cps;  $f_{r2} = f_c/\Omega_{r2} = 1,255$  cps.

Normalized values of networks A and B (Fig. 1D) are obtained

from the third column of Table III. Values appear in fourth column. When normalization is removed the values of the elements of the two networks are as shown in Fig. 1D.

For bandpass filters, referring to the characteristic of Fig. 2A, frequencies smaller than the center frequency,  $\omega_0$ , have a negative subscript, and frequencies larger than  $\omega_0$  have a positive subscript. The definition of  $\omega_{-1}, \omega_{-2}, \omega_{r-1},$  and  $\omega_{r-2}$  is equivalent to that of the low-pass filter, and the definition of  $\omega_{-1}, \omega_{-2}, \omega_{r-1},$  and  $\omega_{r-2}$  is equivalent to that of the high-pass filter. The bandpass filter described here is symmetrical and, therefore, satisfies the condition

$$\omega_{+x} \times \omega_{-x} = \omega_0^2 \text{ or } \omega_{+x}/\omega_0 = \omega_0/\omega_{-x} \quad (6)$$

with equal attenuation at  $\omega_{+x}$  and  $\omega_{-x}$ . This is valid in the special cases for  $x = 1, 2, \infty 1,$  and  $\infty 2$ . We define  $\Delta\omega_1 = \omega_{-1} - \omega_{r-1}$  as the bandwidth limiting the passband in rps;  $\Delta\omega_2 = \omega_{+2} - \omega_{r-2}$  as the bandwidth limiting the stopband in rps;  $\Delta\omega_{r1} = \omega_{r+1} - \omega_{r-1}$  as the first bandwidth for peak attenuation in rps; and  $\Delta\omega_{r2} = \omega_{r+2} - \omega_{r-2}$  as the second bandwidth for peak attenuation in rps. Let

$$\Delta\omega_1 \times \Delta\omega_2 = \Delta\omega_c^2 \quad (7)$$

Frequency normalization is obtained by setting  $\Delta\omega_c = 1$  rps. The normalized frequencies, corresponding to  $\Delta\omega_1, \Delta\omega_2, \Delta\omega_{r1}, \Delta\omega_{r2}$ , are

$$\kappa = \Delta\omega_1/\Delta\omega_c; \quad k = \Delta\omega_2/\Delta\omega_c; \\ \Omega_{\infty 1} = \Delta\omega_c/\Delta\omega_{\infty 1}; \quad \Omega_{\infty 2} = \Delta\omega_c/\Delta\omega_{\infty 2} \quad (8)$$

From (7) follows  $k = 1/\kappa$ . With numerical values specified for A, and  $\Delta\omega_2$ , we find in Table I the parameters  $k, \Omega_{r1}, \Omega_{r2}$ , and from (8) follows

$$\Delta\omega_c = \Delta\omega_2/k; \quad \Delta\omega_1 = \Delta\omega_c/k; \\ \Delta\omega_{\infty 1} = \Delta\omega_c/\Omega_{\infty 1}; \quad \Delta\omega_{\infty 2} = \Delta\omega_c/\Omega_{\infty 2} \quad (9)$$

From (6) follows, for  $x = 1, 2, \infty 1, \infty 2$ :

$$\omega_{+x} = \sqrt{\omega_0^2 + (\Delta\omega_x)^2/4} + \Delta\omega_x/2 \quad (10) \\ \omega_{-x} = \sqrt{\omega_0^2 + (\Delta\omega_x)^2/4} - \Delta\omega_x/2$$

$$\text{For } \Delta\omega_x/2 \ll \omega_0; \quad \omega_{+x} \approx \omega_0 + \Delta\omega_x/2 \\ \omega_{-x} \approx \omega_0 - \Delta\omega_x/2 \quad (10A)$$

With the values for  $m_1, m_2, \Omega_{r1}, \Omega_{r2}$  from Table I and  $\omega_{-1}, \omega_{r-1}, \omega_{r-2}, \omega_{+2}$  from (10) or (10A), we obtain from Table IV the normalized element values of the two networks A and B, illustrated in Fig. 2B, which have identical attenuation characteristics. Then we remove the frequency and impedance normalization of these elements by multiplying all capacitances by  $1/R\Delta\omega_c$  and all inductances by  $R/\Delta\omega_c$ , with R equal to the source and load resistance, and add the values of elements listed in Table V which are determined by the resonance frequencies of their series or parallel branch circuits,

$$L_n = 1/C_n\omega_r^2 \text{ or } C_n = 1/L_n\omega_r^2; \\ n = 1, 2, \dots, 7 \quad (11)$$

Example: A filter shall have at least 40 db attenuation at 7,500 cps and below, and at 12,500 cps and above. Source and load resistance is 600 ohms.

We have  $f_{-2} = 12,500$  cps;  $f_{-2} = 7,500$  cps;  $\Delta f_2 = f_{-2} - f_{-2} = 5,000$  cps. The center frequency is, from (6),  $f_0 = (7,500 \times 12,500)^{1/2} = 9,690$  cps and  $\omega_0 = 2\pi f = 60,800$  rps.

The parameters from Table I are the same as in the first and second example,  $k = 1.35, \Omega_{r1} = 1.43, \Omega_{r2} = 2.94$ . From (9) we obtain  $\Delta f_1 = 2,740$  cps,  $\Delta f_c = 3,700$  cps,  $\Delta f_{r1} = 5,290$  cps,  $\Delta f_{r2} = 10,850$  cps. From (10) we have  $f_{+1} = 11,150$  cps;  $f_{-1} = 8,410$  cps;  $f_{r+1} = 12,690$  cps;  $f_{-1} = 7,400$  cps;  $f_{r+2} = 16,520$  cps;  $f_{-2} = 5,670$  cps.

From the third column of Table IV we obtain the values of the normalized elements of the networks A and B, Fig. 2B, by using the parameters from Table I and the above listed values of the peak frequencies. These values appear in fourth column of Table IV.

Multiplying the capacitances by

TABLE IV—Element Values For Normalized Bandpass Filter

Network		Values	Normalized Values
A	B	(henries or farads)	for Example
$C_1$	$L_1$	$m_1$	0.715
$C_2$	$L_2$	$(1/2m_1\Omega_{\infty 1}^2)(1 + \omega_{-\infty 1}/\omega_{+\infty 1})$	0.542
$C_3$	$L_3$	$(1/2m_1\Omega_{\infty 1}^2)(1 + \omega_{+\infty 1}/\omega_{-\infty 1})$	0.927
$C_4$	$L_4$	$(m_1 + m_2)$	1.655
$C_5$	$L_5$	$(1/2m_2\Omega_{\infty 2}^2)(1 + \omega_{-\infty 2}/\omega_{+\infty 2})$	0.0833
$C_6$	$L_6$	$(1/2m_2\Omega_{\infty 2}^2)(1 + \omega_{+\infty 2}/\omega_{-\infty 2})$	0.242
$C_7$	$L_7$	$m_2$	0.94

TABLE VI—Element Values For Normalized Band Elimination Filter

Network		Values	Normalized Values
A	B	(henries or farads)	for Example
$C_1$	$L_1$	$1/m_1$	1.4
$L_2$	$C_2$	$(1/2m_1)(1 + \omega_{-\infty 1}/\omega_{+\infty 1})$	1.24
$L_3$	$C_3$	$(1/2m_1)(1 + \omega_{+\infty 1}/\omega_{-\infty 1})$	1.61
$C_4$	$L_4$	$1/(m_1 + m_2)$	0.605
$L_5$	$C_5$	$(1/2m_2)(1 + \omega_{-\infty 2}/\omega_{+\infty 2})$	1
$L_6$	$C_6$	$(1/2m_2)(1 + \omega_{+\infty 2}/\omega_{-\infty 2})$	1.135
$C_7$	$L_7$	$1/m_2$	1.065

TABLE V—Element Values For Bandpass Filter

Network		Resonance Frequency, $\omega_r$
A	B	
$L_1$	$C_1$	$\omega_0$
$L_2$	$C_2$	$\omega_{+\infty 1}$
$L_3$	$C_3$	$\omega_{-\infty 1}$
$L_4$	$C_4$	$\omega_0$
$L_5$	$C_5$	$\omega_{+\infty 2}$
$L_6$	$C_6$	$\omega_{-\infty 2}$
$L_7$	$C_7$	$\omega_0$

TABLE VII—Element Values Band Elimination Filter

Network		Resonance Frequency, $\omega_r$
A	B	
$L_1$	$C_1$	$\omega_0$
$C_2$	$L_2$	$\omega_{+\infty 1}$
$C_3$	$L_3$	$\omega_{-\infty 1}$
$L_4$	$C_4$	$\omega_0$
$C_5$	$L_5$	$\omega_{+\infty 2}$
$C_6$	$L_6$	$\omega_{-\infty 2}$
$L_7$	$C_7$	$\omega_0$

$1/R\Delta\omega_r = 0.0717 \times 10^{-6}$  and the inductances by  $R/\Delta\omega_r = 25.8 \times 10^{-3}$  we remove the normalization, to obtain the values of the capacitors in network A (in  $\mu\text{f}$ ) and the inductors in network B (in mh). From Table V and Formula (11), we obtain the remaining element values: the inductors in network A and the capacitors in network B. All these values are shown on Fig. 2B.

For band elimination filters, referring to the characteristics of this filter type, as shown in Fig. 2C, we notice that the definition for frequencies with positive subscript is equivalent to that of the high-pass filter, and the definition for frequencies with negative subscript is equivalent to the low-pass filter. The definitions for bandwidths, center frequency, and the expressions (6), (7), (10), and (11) are the same for the bandpass as for the band elimination filter. The expressions (8) and (9), however, have to be reversed

$$\kappa = \Delta\omega_r/\Delta\omega_1; \quad k = \Delta\omega_r/\Delta\omega_2; \\ \Omega_{\infty 1} = \Delta\omega_r/\Delta\omega_{\infty 1}; \quad \Omega_{\infty 2} = \omega_r/\Delta\omega_{\infty 2} \quad (12)$$

and  $k = 1/\kappa$ . And for specified values of  $A_s$  and  $\Delta\omega_s$ , using the parameters of Table I.

$$\Delta\omega_r = k\Delta\omega_2; \quad \Delta\omega_1 = k\Delta\omega_r; \\ \Delta\omega_{\infty 1} = \Delta\omega_r/\Omega_{\infty 1}; \quad \Delta\omega_{\infty 2} = \Delta\omega_r/\Omega_{\infty 2} \quad (13)$$

The use of Tables VI and VII for obtaining the elements of networks A and B of Fig. 2D, and the removal of the normalization follows the same procedure as in the case

of the bandpass filter.

Example: A filter shall have at least 40 db attenuation between 8,410 cps and 11,150 cps. Source and load resistance is 600 ohms. This filter is complementary to the bandpass filter in the previous example.

From Table I:  $k = 1.35$ ;  $\Omega_{r1} = 1.43$ ;  $\Omega_{r2} = 2.94$ ; and  $f_{r2} = 11,150$  cps;  $f_{r1} = 8,410$  cps;  $\Delta f_{r2} = 2,740$  cps (specified);  $\Delta f_r = 3,700$  cps, from (13);  $f_s = 9,690$  cps, from (6). From (13) and (10):  $\Delta f_1 = 5,000$  cps,  $f_{s1} = 12,500$  cps,  $f_{r1} = 7,500$  cps;  $\Delta f_{r1} = 2,590$  cps,  $f_{r1} = 11,060$  cps,  $f_{r1} = 8,470$  cps;  $\Delta f_{r2} = 1,260$  cps,  $f_{r2} = 10,330$  cps,  $f_{r2} = 9,070$  cps.

Normalized elements of the two networks from third column of Table VI are shown in the fourth column of Table VI.

Final values of elements after removal of normalization, obtained from Table VI and Table VII, appear on Fig. 2D.

The image impedance of a normalized filter varies in the passband between 1 ohm and  $1/s$  ohm for networks with shunt impedance termination such as in Fig. 1B (network A), Fig. 1D (network B), Fig. 2B (network A), and Fig. 2D (network B), and between 1 ohm and  $s$  ohm for networks with series impedance termination such as in Fig. 1B (network B), Fig. 1D (network A), Fig. 2B (network B), and

Fig. 2D (network A), where  $s = (1 - \kappa^2)^{1/2}$ .

The average value of the image impedance in the passband of a normalized filter is:  $r_s = (1 + s)/2s$  for shunt impedance termination; and  $r_s = (1 + s)/2$  for series impedance termination.

Replacing  $R$  by  $R_s = R/r_s$  for shunt impedance termination and  $R_s = R/r_s$  for series impedance termination when we remove the normalization, where  $R$  is equal to the source and load resistance, we match the average image impedance to source and load, and by minimizing the reflection loss in this way, we make the response in the passband as flat as possible. This is only valid, however, when the effect of dissipation is neglected as pointed out above.

In the four examples,  $\kappa = 1/1.35$ ,  $s = 0.67$ ,  $r_s = 1.245$ ,  $r_s = 0.835$ . For the networks A in Fig. 1B, B in Fig. 1D, A in Fig. 2B, and B in Fig. 2D, we replace  $R = 600$  ohms by  $R_s = R/r_s = 480$  ohms; for the networks B in Fig. 1B, A in Fig. 1D, B in Fig. 2B, and A in Fig. 2D, by  $R_s = R/r_s = 720$  ohms when we remove the normalization for the element values.

REFERENCES

(1) Otto J. Zobel, Theory and Design of Uniform and Composite Electric Wave-Filters, *Bell Syst Tech Jour.*, v. 1, Jan. 1923.  
 (2) Wilhelm Cauer, "Synthesis of Linear Communication Networks," 2nd Ed, McGraw-Hill, New York, 1958.

# TRANSMISSION LINE ANALOGY FOR Sandwich Propagation

Equivalent transmission line circuits are given for sandwiches of dielectric sheets and conducting films or grids

By H. F. MATHIS,  
Goodyear Aircraft Corp., Akron, Ohio

SANDWICHES consisting of various combinations of dielectric and metal sheets and conducting films and grids are used for antennas, radomes, polarization converters, r-f shields and the like.

The transmission-line analogy for wave propagation has been discussed elsewhere.<sup>1</sup> This analogy can be applied to the transmission of plane electromagnetic waves through sandwiches consisting of plane, homogeneous, isotropic dielectric and metal sheets of infinite extent and with uniform thickness, and conducting grids which are of infinite extent and have a regular pattern. Although sandwiches are generally curved in practical applications, characteristics computed for ideal conditions are satisfactory for most cases.

Since the transmission characteristics are different for parallel and perpendicular polarization, it is necessary to consider these two polarizations separately. When the polarization of the wave is neither parallel nor perpendicular to the plane of incidence, it is necessary to divide the wave into parallel and perpendicular components.

A dielectric sheet is analogous to a section of transmission line with the length equal to the thickness of the sheet. The propagation constant for this sheet is  $\gamma = \alpha + j\beta = j(2\pi/\lambda_0) \sqrt{\mu\epsilon - \sin^2\theta_0}$ , the characteristic

impedance is  $\eta_{\parallel} = \sqrt{\mu\epsilon - \sin^2\theta_0}/\epsilon$  for parallel polarization, and the characteristic impedance is  $\eta_{\perp} = \mu/\sqrt{\mu\epsilon - \sin^2\theta_0}$  for perpendicular polarization where  $\lambda_0$  is the wavelength in air,  $\theta_0$  is the angle of incidence in air,  $\mu$  is the relative permeability of the sheet and  $\epsilon$  is the relative dielectric constant. (A lossy dielectric is characterized by either the dielectric constant or the permeability, or both, being complex.) The air on each side of the sandwich is equivalent to transmission lines having the previously discussed characteristics with  $\mu = \epsilon = 1$ . An example of how circular transmission line charts, that is Smith ( $R-X$ ) and Carter ( $Z-\theta$ ) charts, can be used to compute the transmission characteristics of a sandwich of dielectric sheets has been given.<sup>2</sup>

A metal sheet is analogous to a section of transmission line with the length equal to the thickness of the sheet expressed in meters with  $\gamma = (1 + j)(1.987 \times 10^{-3}) \sqrt{f\mu\sigma}$ , and  $\eta_{\parallel} = \eta_{\perp} = (1 + j)(5.274 \times 10^{-4}) \sqrt{f\mu/\sigma}$  where  $f$  is the frequency in cps,  $\mu$  is the relative permeability, and  $\sigma$  is the conductivity expressed in mhos/meter. (It is not permissible to express the thickness in centimeters or inches and the conductivity in mhos/cm or mhos/in. without changing the above expressions for  $\gamma$  and  $\eta$ .) The values of  $\gamma$  and  $\eta$  are independent of the polarization and angle of incidence; however, the values of these quantities for the sections

of transmission line representing the dielectric layers of the sandwich and the air outside are functions of these parameters.

A conducting film is defined as a metal sheet having negligible thickness compared to the wavelength. The section of transmission line representing the sheet reduces to a shunt conductance  $G$  across the appropriate junction of transmission lines. The value of  $G$  is 377 times the surface conductivity, that is  $G = 377\sigma d$ , where  $d$  is the thickness of the film.

It is assumed that the conducting grid consists of parallel elements, or wires, which lie in a plane. Thickness and width of elements are small compared to wavelength and separation between elements is uniform and small compared to wavelength. Since the grid is not isotropic, direction of current flow must be along the elements. In general, a grid acts as a polarization converter and it is necessary to consider both polarizations.

Let  $\tau$  denote the angle between the elements of the grid and the plane of incidence. An equivalent circuit for a grid is shown in Fig. 1A. The sections of transmission line shown in this figure represent the adjacent layers of the sandwich or air with the propagation constants and characteristic impedances given by the equations presented previously.

When  $\theta_0 = 0$ ,  $\tau$  is not defined. In this case, let  $\tau$  denote the angle between the elements of

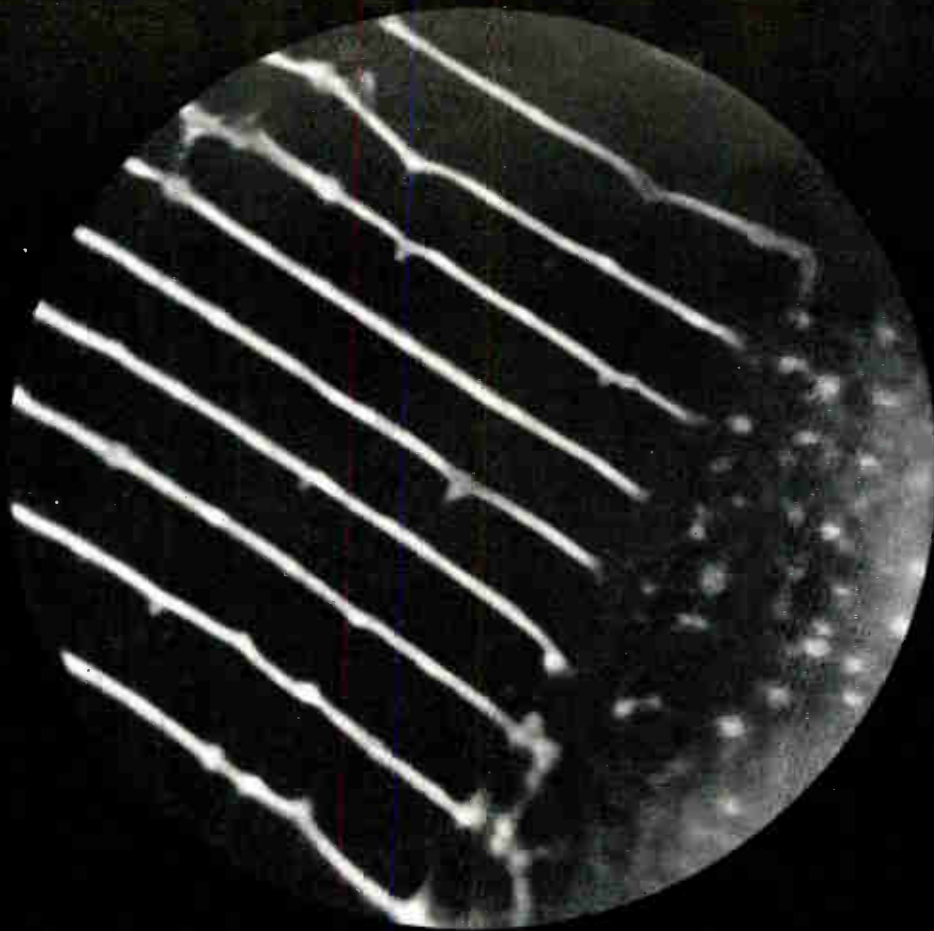

*Bit densities are revealed by the electron mirror microscope through the behavior of electrons reflected by the magnetic fringe fields of recorded data.*

## Reflections from an Electron Mirror

The photograph is a representation of the magnetic fringe fields above a small portion of a recording surface. Behind these magnified tracks of recorded data is the story of a device now decades old in principle, but which has only recently been applied to the study of high-density magnetic information storage.

The electron mirror microscope was constructed by IBM scientists as a laboratory instrument. Based on the excellent resolution capabilities of an electron beam, the electron mirror principle has its primary application in the observation of tiny magnetic fringe fields.

In the operation of an electron mirror microscope, an electron beam is acceler-

ated down a tube toward a specimen mounted on a conductive plate with a negative potential relative to the cathode. At the zero equipotential surface in the tube, the electrons traveling toward the specimen change their directions and are reflected in somewhat the same way light rays are reflected by a mirror. By controlling the potentials of the cathode and the conductive plate, the "mirror" can be placed at any height above the magnetic surface. When the mirror is set close enough to the surface to be in the fringe fields of recorded information, these fields distort the return paths of electrons in the beam. Passing the return beam through a magnetic lens results in a magnified repre-

sentation on a phosphor viewing plate, capable of resolving bit densities far greater than those in use in present systems.

It is well known that the "writing" abilities of present magnetic recording transducers exceed their "reading" abilities. The mirror microscope produces accurate evidence of all-but-undetectable recorded information. Thus the magnetic recording process is no longer limited to verification by velocity-dependent readback capabilities. By the same token, the mirror microscope serves both as the spur to, and the measure of progress toward further refinements in the art of magnetic recording.

**IBM RESEARCH**

*Investigate the many career opportunities available in exciting new fields at IBM. International Business Machines Corporation, Dept. 554Q3, 590 Madison Avenue, New York 22, New York.*

the grid and the direction of polarization. In Fig. 1A, the words *parallel polarization* should be replaced by *incident polarization* and *perpendicular polarization* by *cross polarization*.

For example, if a parallel polarized wave is incident upon the grid from the left, this is equivalent to a wave traveling from left to right on *line 1*. Some power is reflected in the same polarization and this is equivalent to a wave traveling from right to left on *line 1*. Some power is transmitted in the same polarization and this is equivalent to a wave traveling from left to right on *line 2*. Some power is reflected with perpendicular polarization and this is equivalent to power being transmitted from right to left on *line 3*. Some power is transmitted with perpendicular polarization and this is equivalent to power being transmitted from left to right on *line 4*. Let  $Y_2$ ,  $Y_3$ , and  $Y_4$  denote the input admittances to *lines 2, 3 and 4*, respectively. In this case, terminating admittance  $Y_1$  of *line 1* is

$$Y_1 = Y_2 + K \cos^2 \tau - \frac{K^2 \sin^2 \tau \cos^2 \tau}{Y_3 + Y_4 + K \sin^2 \tau}$$

To determine  $K$  experimentally, measure the complex transmission coefficient  $T$  of the grid alone with  $\theta_o = \tau = 0$ . Let  $E_i$  denote the incident electric field and  $E_t$  denote the transmitted electric field at the surface of the grid. Let  $t = 1/T$ , where  $T = E_t/E_i = T/\phi$ . The point  $Y_k$  is plotted on a Smith chart, as shown in Fig. 1B, so that the distance from  $Y = 0$  to  $Y_k$  is  $t$  times the radius of the chart and the line from  $Y = 0$  to  $Y_k$  makes the angle  $-\phi$  with the  $B = 0$  line. Now  $K = Y_k - 1$ .

More complex grids can be considered in much the same way as parallel-wire grids. A reference line should be selected for the grid in the direction of maximum admittance. Let  $\tau$  denote the angle between the reference line and the plane of incidence. An equivalent circuit for a grid is shown in Fig. 1C. When  $\theta_o = 0$ , let  $\tau$  denote the angle between the reference line and the direction of polarization and make the

same substitution of words in Fig. 1C as in Fig. 1A. The values of  $K_1$  and  $K_2$  can be determined experimentally using the technique described previously. First,  $K_1$  is determined with  $\theta_o = \tau = 0$ , then  $K_2$  is determined with  $\theta_o = 0$  and  $\tau = 90$  deg.

An example is given using two dielectric sheets separated by a thin conducting grid (Fig. 1D). Parameters for this sandwich are  $\epsilon_1 = 4 (1 - j0.05)$ ,  $\mu_1 = 1$ ,  $d_1 = 0.2$  in.,  $\epsilon_2 = 3 (1 - j0.03)$ ,  $\mu_2 = 1$ ,  $d_2 = 0.3$  in.,  $K_1 = K_2 = -j0.5$ ,  $\lambda_o = 1.26$  in.,  $\theta_o = 30$  deg., and  $\tau = 0$ . The voltage transmission and reflection coefficients were computed and found to be  $T_{||} = 0.767 / -248.5$  deg.,  $T_{\perp} = 0.508 / -163.7$  deg.,  $\Gamma_{\perp} = 0.677 / -250.0$  deg., and  $\Gamma_{||} = 0.633 / -165.5$  deg. The increase  $\phi$  in phase retardation due to the sandwich is  $\phi_{||} = 124.8$  deg. and  $\phi_{\perp} = 126.3$  deg.

REFERENCES

- (1) Ramo and Whinnery, "Fields and Waves in Modern Radio", Revised Edition, John Wiley and Sons, New York, Ch 7, 1953.
- (2) H. F. Mathis, Transmission Characteristics of Sandwiches, *Trans IRE, MTT-3*, p 57-8, Oct. 1955.

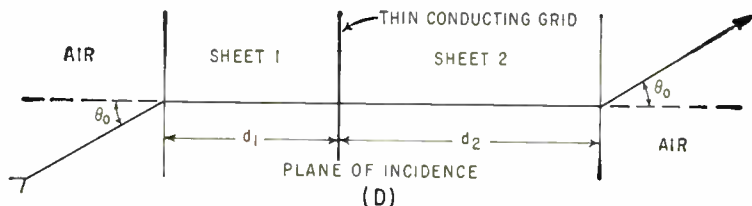
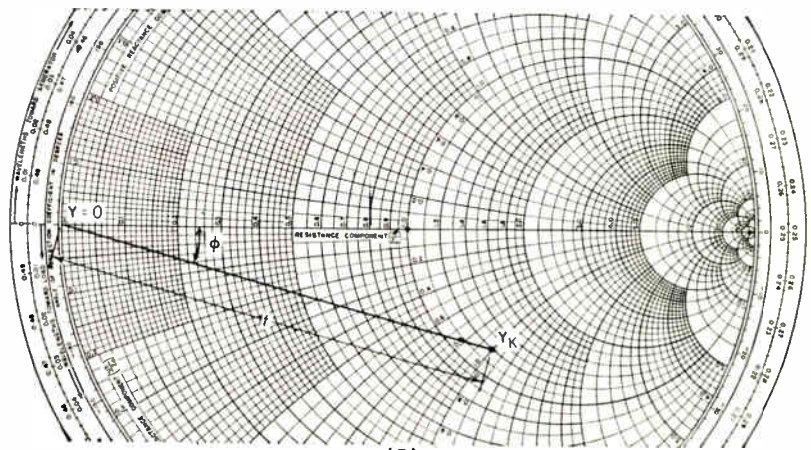
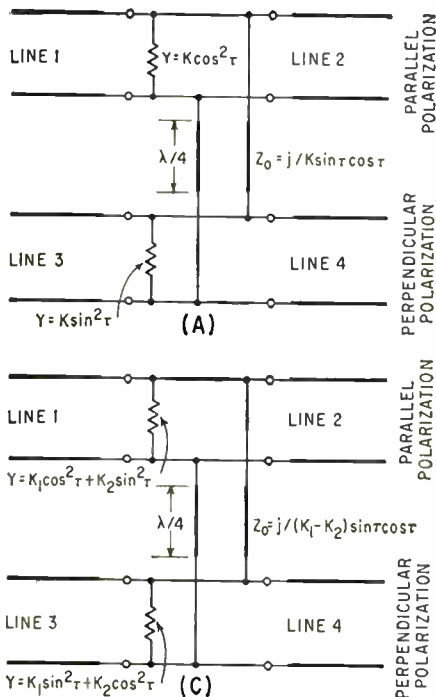

FIG. 1—Equivalent circuit for parallel-wire grid (A), graphical determination of  $K$  using Smith chart (B), equivalent circuit for grids in general (C) and construction of sandwich used in example (D)



CHART NO. 501

PROPERTIES	SEATITE										FORSTERITE		ZIRCON	TITANIA	CORDIERITE		LAVA		READS BOTH LEFT AND RIGHT		ALUMINA	
	ALSiMAG 33	ALSiMAG 40	ALSiMAG 100	ALSiMAG 110	ALSiMAG 120	ALSiMAG 130	ALSiMAG 140	ALSiMAG 150	ALSiMAG 160	ALSiMAG 170	ALSiMAG 180	ALSiMAG 190	ALSiMAG 200	ALSiMAG 210	ALSiMAG 220	ALSiMAG 230	ALSiMAG 240	ALSiMAG 250	ALSiMAG 260	ALSiMAG 270	ALSiMAG 280	ALSiMAG 290
Water Absorption	0.00	0.00	0.00	0.00	0.00	0.00	0.00	0.00	0.00	0.00	0.00	0.00	0.00	0.00	0.00	0.00	0.00	0.00	0.00	0.00	0.00	0.00
Specific Gravity	3.80	3.80	3.80	3.80	3.80	3.80	3.80	3.80	3.80	3.80	3.80	3.80	3.80	3.80	3.80	3.80	3.80	3.80	3.80	3.80	3.80	3.80
Life Temperature of Component Part	1500	1500	1500	1500	1500	1500	1500	1500	1500	1500	1500	1500	1500	1500	1500	1500	1500	1500	1500	1500	1500	1500

**AMERICAN LAVA CORPORATION**  
 A SUBSIDIARY OF MINNESOTA MINING AND MANUFACTURING COMPANY  
 For service, contact American Lava representatives in Offices of Minnesota Mining & Mfg. Co. in these cities (see your local telephone directory):  
 Philadelphia, Pa. • St. Louis, Mo. • St. Paul, Minn. • San Francisco, Cal. • Seattle, Wash.

**SELECTION CHARTS**  
 EACH CHART ARRANGED ACCORDING TO PROPERTY VALUES

DIELECTRIC MATERIALS		POROUS MATERIALS		MHO SCALE MATERIALS	
201 Alumina	0.0001	201 Alumina	0.0001	201 Alumina	0.0001
202 Alumina	0.0002	202 Alumina	0.0002	202 Alumina	0.0002
203 Alumina	0.0003	203 Alumina	0.0003	203 Alumina	0.0003
204 Alumina	0.0004	204 Alumina	0.0004	204 Alumina	0.0004
205 Alumina	0.0005	205 Alumina	0.0005	205 Alumina	0.0005
206 Alumina	0.0006	206 Alumina	0.0006	206 Alumina	0.0006
207 Alumina	0.0007	207 Alumina	0.0007	207 Alumina	0.0007
208 Alumina	0.0008	208 Alumina	0.0008	208 Alumina	0.0008
209 Alumina	0.0009	209 Alumina	0.0009	209 Alumina	0.0009
210 Alumina	0.0010	210 Alumina	0.0010	210 Alumina	0.0010

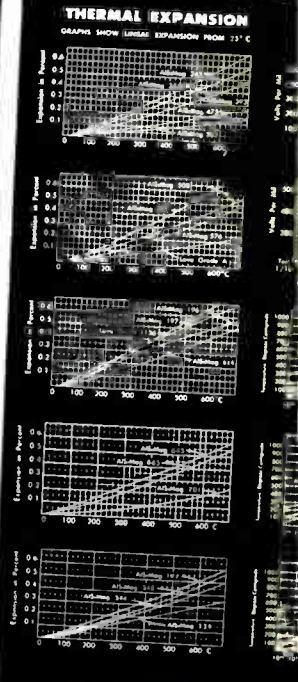

**NEW**  
**PROPERTY CHART OF**  
**ALSiMAG®**  
**TECHNICAL CERAMICS**

**WHAT ALSIMAG IS**  
 The ALSiMag trade mark includes the widest variety of technical ceramics available from any single source... backed by the most inclusive custom manufacturing facilities in the industry. Now well into its second half century of leadership in technical ceramics, this is the place you are most apt to get what you want, when you want it.

**WHAT THE CHART TELLS**  
 The chart gives principal physical and electrical characteristics of the most frequently used ALSiMag compositions. If your work includes design, production or purchasing you will find this chart valuable. It is completely factual and is of convenient file size.

*Yours on Request!*

**WHERE ALSIMAG IS USED**  
 ALSiMag ceramics are unexcelled in electronic and electrical applications because of their superior dielectric properties, especially at elevated temperatures. They have many mechanical and chemical applications. You may choose compositions from this chart which have various combinations of these characteristics. Permanently rigid. Chemically inert. Withstand high temperatures. Hard (up to 9 on Mohs' scale) and abrasion resistant. Non-magnetic. Will not rust, oxidize or corrode. Do not deteriorate with time. Metal-ceramic combinations can be accomplished. Materials are available with expansion coefficients varying over a wide range. Precision tolerances can be maintained. The chart, sent on request, gives details, saves you valuable time.

A Subsidiary of  
 Minnesota Mining and  
 Manufacturing Company

**AMERICAN LAVA CORPORATION**

**CHATTANOOGA 5, TENN.**  
 58TH YEAR OF CERAMIC LEADERSHIP

For service, contact American Lava representatives in Offices of Minnesota Mining & Manufacturing Co. in these cities (see your local telephone directory): Boston: Newton Center, Mass. • Chicago: Bedford Park, Ill. • Cleveland, O. • Dallas, Texas • Los Angeles, Cal. • New York: Ridgefield, N. J. • Philadelphia, Pa. • St. Louis, Mo. • St. Paul, Minn. • San Francisco, Cal. • Seattle, Wash.

# Ferrite Films in Logic and Storage

MAGNETIC devices for storage and switching applications in digital computers have been made in the form of open flux path elements. Geometry is that of a planar film from 5 to 50 microns thick, and other dimensions in the fractional inch range. They have the advantages of ferrite composition and open flux paths. For storage systems, they possess excellent squareness characteristics and have coincident selection times comparable with ferrite toroidal devices.

Advantages of thin magnetic films as computer elements have been described<sup>1</sup> but practical devices have been unrewarding. Although operable matrices of thin films have been used in very small memories<sup>2</sup>, there are difficulties associated with obtaining film arrays for practical storage systems. Problems include uniformity of easy axis alignment and switching threshold, and transmission or drive and sense line problem, although more subtle, may be more serious<sup>3</sup>. Detrimental effects in films include stress sensitivity, disturb sensitivity and aging.

Until recently, thin magnetic films for computer components were composed only of metals, but now ferrite films have been successfully made. The objective is to obtain the advantages of open flux path elements and to take advantage of some ferrite device characteristics. The detrimental effects of stress, disturb sensitivity, and aging have been virtually eliminated for some time for many ferrite toroidal devices.

## Magnetic Properties

The ferrite elements were planar structures about 10 microns thick and other dimensions in the fractional inch range. A ferrite with  $B_s$  of 2000 gauss (compared to 10,000 gauss for nickel iron) allows a proportionately greater thickness for a given demagnetizing field and sample dimensions. Circular elements 10 microns thick and a quarter inch in diameter have a demag-

netizing field of about 0.1 oersteds.

The squareness characteristics of ferrite films are very similar to ferrite in a bulk toroidal geometry. From 60-cps hysteresis loop measurements, squareness ratios of 0.95 and loop shear of 0.2 oersteds were found to be typical of many ferrite samples. Coercive forces are from 1 to 10 oersteds.

A plot of inverse of switching time versus amplitude of applied field pulse is shown in Fig. 1. The sample is 8 microns by 0.1 by 0.3 inch. Switching time for an applied field equal to twice the wall motion threshold field is 0.25  $\mu$ sec. For this curve, exciting fields were applied parallel to the easy axis of magnetization, which was determined by shape anisotropy. A study of the influence of transverse fields on switching curves is not conclusive at this time. Comparison of the switching curves of materials in bulk and in film structures shows the following similarities: Over the range of switching times where  $T_s > 0.1 \mu$ sec there are two linear regions of the curve. The slopes for these regions are nearly the same for film and bulk. The lower field region is described by a domain wall motion process, and the higher field region ( $> 4$  oersteds in Fig. 1) by a rotational process. A difference between the curves for film and bulk

materials is observed, such that for the film samples, the region of the switching curve attributed to a wall motion process is smaller than for bulk material. Fig. 1 shows that the application of fields of amplitude twice the threshold field is sufficient for the flux reversal process to be dominated by a rotational mechanism.

The switching threshold is well defined for the ferrite film samples. If the threshold field is measured as the amplitude of a succession of ten 1- $\mu$ sec pulses required to switch a small (about 5) percent of the magnetic flux, then this value agrees with that measured using d-c current. This characteristic differs from the threshold behavior of many nickel-iron films; it is common to find a significant difference between the threshold values measured using d-c and using a series of pulses. This leads to problems of disturb sensitivity in multi-dimensional selection of storage devices.

Because of the favorable geometry of a thin film, heating effects due to pulse repetition frequencies of at least a few megacycles are negligible. It is expected that ohmic losses in selection lines would account for most of the energy dissipation in a storage array.

As mentioned earlier, the lower magnetization of ferrite allows a greater thickness of material when other dimensions and the demagnetizing field are not changed. This results in an element of greater mechanical strength. Handling of unsupported elements does not ordinarily harm the device properties.

Ferrites are chemically stable. The problem of aging or of reaction with normal atmospheres is as negligible with ferrite films as with ferrite toroids. Aging effects observed with square-loop metallic films are nonexistent in ferrite structures.

## Applications

For storage applications, a mode of operation similar to that employed with toroidal cores may be

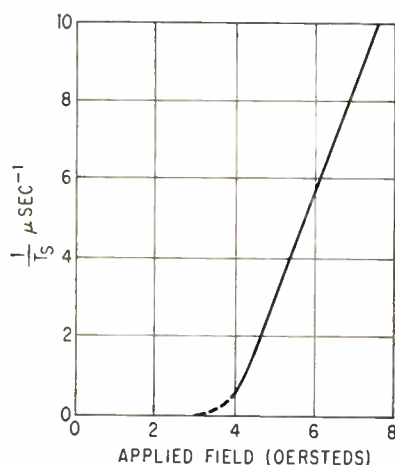
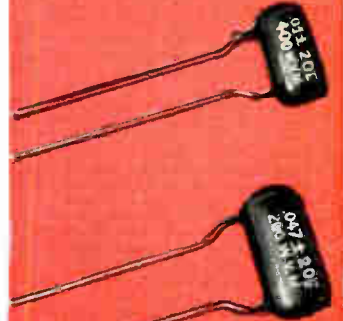
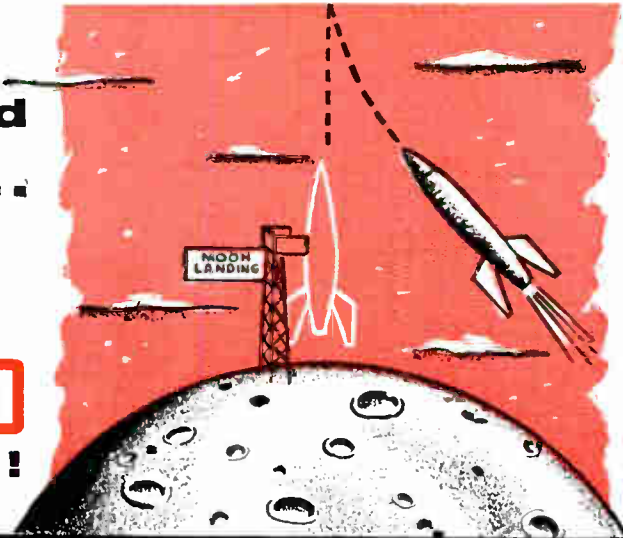

FIG. 1—Switching curve for ferrite film

It could  
happen...

with

**El-Menco**  
CAPACITORS!



**NEW**

*Mylar-Paper Dipped*

**CAPACITORS**

**TYPE  
MPD**

**INSURE FAILURE-PROOF PERFORMANCE!**

**Only 1 Failure In 7,168,000 Unit-Hours for 0.1 MFD Capacitors \***

**Setting a new standard of reliability!**

\*Life tests have proved that El-Menco Mylar-Paper Dipped Capacitors — tested at 100°C with rated voltage applied — have yielded a failure rate of only 1 per 716,800 unit-hours for 1 MFD. Since the number of unit-hours of these capacitors is inversely proportional to the capacitance, 0.1 MFD El-Menco Mylar-Paper Dipped Capacitors will yield **ONLY 1 FAILURE IN 7,168,000 UNIT-HOURS.**

**SUPERIOR FEATURES!**

• Five case sizes in working voltages and ranges:

200 WVDC —	.018 to .5 MFD
400 WVDC —	.0082 to .33 MFD
600 WVDC —	.0018 to .25 MFD
1000 WVDC —	.001 to .1 MFD
1600 WVDC —	.001 to .05 MFD

Write for Technical Brochure Giving Complete Information on the El-Menco Tubular Dur-Paper Line.

THESE CAPACITORS WILL EXCEED ALL THE ELECTRICAL REQUIREMENTS OF E.I.A. SPECIFICATION RS-164 AND MILITARY SPECIFICATIONS #MIL-C-91A AND MIL-C-25A.

FOR FAILURE-PROOF PERFORMANCE... COUNT ON EL-MENCO MYLAR-PAPER DIPPED CAPACITORS... FROM MISSILE GUIDANCE SYSTEMS TO DATA PROCESSING EQUIPMENT!

\*Registered Trade Mark of DuPont Co.

**SPECIFICATIONS**

- **TOLERANCES:** ±10% and ±20%. Closer tolerances available on request.
- **INSULATION:** Durez phenolic resin impregnated.
- **LEADS:** No. 20 B & S (.032") annealed copper-weld crimped leads for printed circuit application.
- **DIELECTRIC STRENGTH:** 2 or 2½ times rated voltage, depending upon working voltage.
- **INSULATION RESISTANCE AT 25°C:** For .05MFD or less, 100,000 megohms minimum. Greater than .05 MFD, 5000 megohm-microfarads.
- **INSULATION RESISTANCE AT 100°C:** For .05MFD or less, 1400 megohms minimum. Greater than .05MFD, 70 megohm-microfarads.
- **POWER FACTOR AT 25°C:** 1.0% maximum at 1 KC.



**El-Menco**  
*Capacitors*

**THE ELECTRO MOTIVE MFG. CO., INC.**

WILLIMANTIC CONNECTICUT

Manufacturers of El-Menco Capacitors

- molded mica • dipped mica • mica trimmer • dipped paper
- tubular paper • ceramic • silvered mica films • ceramic discs

Arco Electronics, Inc., 64 White St., New York 13, N. Y.  
Exclusive Supplier To Jobbers and Distributors in the U.S. and Canada



## 50 & 100 contact CONNECTORS

AMPHENOL Series 115 connectors, used primarily for circuit analyzing and cable testing, were engineered to provide top efficiency and built for rugged field use. The connectors accommodate 50 or 100 No. 16 wires and are nominally rated at 750 volts RMS 60 CPS at sea level. They represent maximum efficiency in the utilization of space for all applications where a large number of circuits must be broken quickly and conveniently.

The connectors incorporate simple, reliable knife blade contacts, "free floating" for easy alignment in mating. Three different contact terminations may be ordered: Crimp-on, Extended Solder Cup or Taper Pin.

The photo to the right illustrates the DIT-MCO Model 850 Multiplier used in conjunction with their Model 200 Circuit Analyzer. Because of their outstanding capabilities, AMPHENOL 115 Series connectors were used in both units manufactured by this Kansas City firm . . . AMPHENOL's 50 contact connectors and 100 contact connectors in both DIT-MCO's Model 200 Circuit Analyzer and Model 850 Multiplier . . . proof that quality equipment consists of quality components.

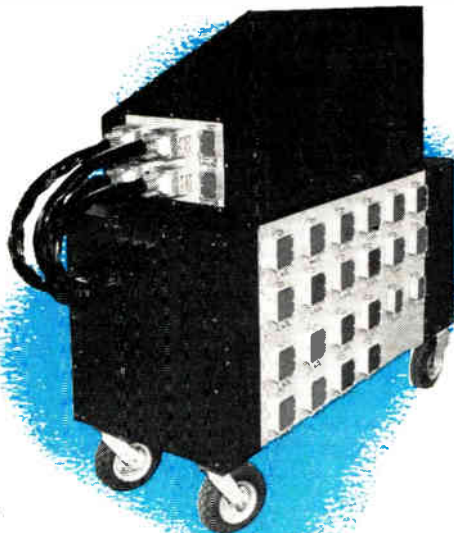

FOR MORE INFORMATION ON THIS VERSATILE, RUGGED CONNECTOR, AND OTHER CONNECTORS, WRITE FOR CATALOG "A."

**AMPHENOL**

**CONNECTOR DIVISION**

CHICAGO 50, ILLINOIS

Amphenol-Borg Electronics Corporation

World Radio History

used. Only fields parallel to the easy axis are applied and the response is typified by Fig. 1. Since selection ratios as low as 1.5 have been obtained, the elements are capable of three dimensions of selections as in a bit-organized memory. In a 2-dimensional system, the use of bias allows selection times of less than 0.1  $\mu$ sec for full switching. Another reduction in switching time results when using partial switching.

The effects of transverse fields are being studied. Modes of operation similar to those proposed for metallic film devices are expected to result.

The samples employed up to now have dimensions of about 0.1 to 0.4 inch. Bit density using these elements would be smaller than for some toroidal core arrays. However, it is expected that a decrease in sample size would result in information density as great as with core or metallic film arrays. Such a decrease eases the drive problem in some respects but at the expense of the available information signal from a storage location.

The ferrite films were described by J. M. Brownlee, W. L. Shevel, and O. A. Gutwin of IBM Research Center. The authors acknowledge the assistance of K. R. Grebe and N. J. Mazzeo.

### REFERENCES

- (1) D. O. Smith, *ELECTRONICS*, p 44, June 26, 1959
- (2) J. I. Raffel, *Jour Appl Phys*, 30, p 4, 1959
- (3) J. S. Eggenberger, AIEE Magnetism and Magnetic Materials Conference, Nov. 18, 1959

## Radar Finds Meteor Showers Are Frequent

WORLD'S space-weather report can now be revised from "occasional" to "frequent" showers of meteors on the strength of new radar investigations by Stanford University scientists.

Some modification of ideas about the origin and lifetime of interplanetary matter may also result, according to P. B. Gallagher and V. R. Eshleman of the Stanford Radioscience Laboratory. Their work marks the first extension of radar astronomy into the field of micrometeors. Such space particles are too small to be seen before they

burn up in the earth's atmosphere.

New Stanford equipment enabled the investigators to detect meteors 100 times smaller than any detected previously by radar—down to the microscopic size of one millionth of an inch and a ten-millionth of a gram in weight. The radar signals are reflected by the ionized trails of such meteors, not by the tiny meteors themselves.

Space has been pictured previously as being sprinkled with small meteors orbiting independently through the interplanetary regions. This postulated background of small particles is punctuated now and then by large particle showers which are well known and predictable. These large particles are big enough to produce visible light, and are often erroneously called shooting stars.

Upon closer examination with the more sensitive new radar equipment, the background particles have proved to be bunched into great numbers of orbiting clouds of very fine dust-like micrometeors. There must be millions of meteoric clouds that cross the earth's path and produce short-lived showers.

On the average, the earth is immersed in about 11 of these clouds at a time. Their number is so great, and the earth encounters a given cloud so rarely, that it would be practically impossible to predict their occurrence. The occasional showers of large particles remain predictable, but the dust-cloud micrometeor showers are likely to occur at any time of day or night. They last for only a matter of hours. There appears to be no pattern of recurrence on an annual basis.

Most meteoric material in the solar system is believed to be associated with present or past comets. Thus these showers may indicate the presence of a large number of very small, invisible comets. If so, it may be necessary to alter present theories about the origin, dynamics and lifetime of interplanetary matter.

The work used a pulsed high-power transmitter. Antennas were 96 tv-type Yagis mounted in two rows, each 2,000 feet long. The work was sponsored by the Air Force Cambridge Research Center.

# MARK TIME

## TO AN ACCURACY OF 1 SECOND A MONTH

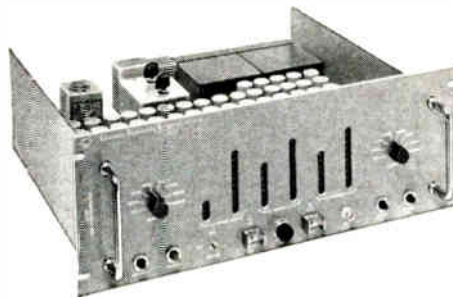

You time-correlate data within 3 parts in  $10^8$  per day...when you design your instrumentation timing system around an EECo Time Code Generator.

**More accuracy per dollar...** Use Model ZA 801 for BCD output (24 digits), \$7650<sup>00</sup>...Model

ZA 802 for Binary Coded output (17 digits), \$7050<sup>00</sup>...both with accuracy and stability equal to a secondary standard. Other minor code format variations available.

**Compact...** sized for standard rack mounting...complete unit including power supply measures 7" x 19" x 16".

**Furnishes as output** both time-of-day code (24-hour recycling) and any two of eight pulse rates. Suitable for oscillographs, strip chart, recorders, magnetic tape, or driver for neon flash lamps.

**Applications** in lab or field. Use an EECo TCG as a clock, for time correlation. Use it as the heart for your own system...incorporate it wherever you need time pulses. Or call on EECo's specialized experience in developing complete timing and synchronization systems.

For benefits and full specs write for Data Sheet ZA 801/802.



**Electronic Engineering Company of California**

1601 E. Chestnut Ave., Santa Ana, Calif. • Klmbury 7-5501 • TWX: S ANA 5263

EE 0-1

MISSILE AND AIRCRAFT RANGE INSTRUMENTATION • DIGITAL DATA PROCESSING SYSTEMS  
COMPUTER LANGUAGE TRANSLATORS • SPECIAL ELECTRONIC EQUIPMENT

# Tuning Fork for High-Q Resonance

By W. J. HOLT, President and Chief Engineer, Gyrex Corp., Santa Monica, Calif.

NARROW-BAND electromechanical filters operating in the audio-frequency range can utilize tuning forks as ideal high-Q resonant elements. Input impedance can be relatively high, and output impedance low if desired. Transmission loss can be held to a minimum, usually 6 db or less, for equal input and output impedances.

Conventional tuning forks are driven electromagnetically with a coil and magnet assembly mounted close to one tine of the fork. The second coil and magnet assembly, mounted closely to the other tine, serves as a pickup which generates

a voltage proportional to the amplitude of motion of the tine. With this geometry, the drive and pickup coils can be separated and shielded sufficiently to attenuate unwanted frequencies over a fairly wide band. The main disadvantage of this geometry is that it is sensitive to

external vibrations. Since the pickup coil generates a voltage proportional to the motion of only one tine, external vibrations causing this tine to move will generate unwanted signals.

A balanced geometry which tends to nullify unwanted vibratory signals is one in which the magnetic circuit associated with the drive coils is arranged to drive both tines of the tuning fork simultaneously and 180 deg out of phase.

In a similar fashion, the pickup coils generate a voltage proportional to the combined motion of both tines. An external vibratory motion would tend to move both tines in the same direction, rather than 180 deg out of phase, in which

case the net motion of both tines with respect to the pickup coil would be zero and no vibratory voltage would be generated.

While the balanced drive and pickup system is good from a shock and vibration standpoint, it is generally difficult to shield the drive and pickup assemblies sufficiently to prevent transformer coupling outside the passband.

A geometry which employs the desirable features of both balanced and unbalanced drive systems is shown in Fig. 1.

This resonant element is a dual tuning fork assembly with all four tines attached to a common base and tuned to the same frequency. The drive coil and magnet assembly is located between one pair of tines, the pickup coil between the other pair of tines. This affords maximum physical separation between the drive and pickup coils and the common base serves as an excellent magnetic shield between the input and output.

Since the pickup coil is located between the tines and generates a voltage proportional to the net change in air gap between the tines and pickup magnet, the effects of external vibration are greatly reduced.

A typical 1,600 cps unit has the

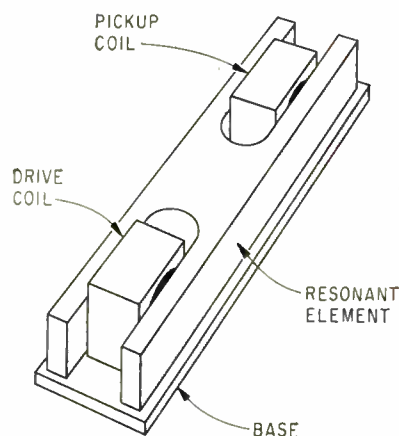

FIG. 1—Balanced geometry of dual fork tends to nullify unwanted vibratory signals

following characteristics: input and output impedance, 1,500 ohms; input voltage, 2 v rms; transmission loss, 6 db; relative attenuation (20 cps-20 Kc), 60 db; operating Q at 1,600 cps, 5,000; center frequency stability,  $\pm 0.01$  percent; operating temperature, zero to 70 deg C. With temperature stabilized oven, center frequency may be held to  $\pm 0.001$  percent.

Using this geometry and by proper coil placement, there are no spurious resonances in the 20 cps to 20 Kc range. The attenuation remains essentially constant at 60 db. The resonant element is temperature compensated and temperature coefficients less than one part per million per deg. C may be obtained.

The Gyrex Corporation has used this patented dual fork geometry to advantage in precision frequency standards as well as filters. One of the units currently in production provides the precision 400 cps timing signal for the Northrop Snark missile guidance system.

An accuracy of  $\pm 0.001$  percent is maintained while operating in a vibration environment from 5 to 2,000 cps at 15 g, and constant acceleration up to 20 g. Since the accelerating forces act oppositely on the two fork elements, the effects of acceleration and vibration are reduced greatly over that of a single tuning fork resonator.

## Ga Phosphide Diodes

AT THE USA Signal Research and Development Laboratory, Fort Monmouth, N. J., an investigation of the potentials of gallium phosphide used in point contact devices points to gallium phosphide diodes as ultimately competitive with silicon in performance and far exceed silicon in temperature range.

The material used in the investigation, as reported by Joseph Mandelkorn was thin platelets pre-

# NOW—Ketay “packaged” Gyro components

- safeguard system accuracy
- save testing and machining



Norden's Ketay Department, an acknowledged leader in the rotating component field, is now able to deliver gyro component "packages" tailored to your specifications . . . ready for installation. This precision pre-assembly saves you expense and problems because:

**TESTING**, simulating *your* application, is handled by Ketay.

**MACHINING** of mounts and fittings is accomplished at Ketay . . . saving you machine time and engineering time.

**RELIABILITY** is further ensured, for the gyro "package"

is an entity wholly tailored to a pre-determined function . . . not an assembly of individually modified components. In addition, sets of such packages can be perfectly matched.

Components shown above—Synchro, Torquer and Spin Motor—are typical. Their specifications are tabled below. Other Ketay gyro component "packages" are Induction Pickoffs, Pancake Resolvers, D.C. Spin Motors and a unique D.C. Voice Coil Torquer giving a linear force of .55 grams per milliamper of current.

## TYPICAL SPECIFICATIONS

### SYNCHRO TRANSMITTER TYPE SP-152

Input Voltage (to Rotor)— 400 cps—volts.....	26
Input Power—watts.....	1.0
Input Impedance (stator shorted)....	110+j 36
Input Impedance (stator open).....	89+j 230
Transformation Ratio.....	.454
Output Impedance (Rotor open)—ohms.....	27+j 44
Output Voltage—volts (line to line).....	11.8
Voltage Gradient—volt/degree.....	0.206
Total Null Voltage (mv. max.).....	30
Electrical Accuracy (Max. Error from E.Z.)—minutes....	±3.0

(Tighter accuracy tolerances available for applications requiring limited ranges of rotation.)

### A. C. TORQUER MOTOR TYPE SP-170

	Fixed Phase	Control Phase
Rated Excitation Voltage—volts	26	40
Frequency (cps).....	400	400
Current—(mv.).....	230	226
Power—watts.....	3.1	4.6
Power Factor.....	.517	.505
Resistance—ohms.....	58.5	89.3
Reactance—ohms.....	85.5	152.5
Impedance—ohms.....	113	177
Effective Resistance—ohms...	218	348
Capacitor for Unity Power Factor—mfd.....	1.35	2
Torque at stall (min.)—oz.in.	1.0	

Operating Temperature Range—minus  
55°C to plus 125°C

### A. C. SPIN MOTOR TYPE SP-167

Input Voltage (line to line)—volts....	26
Frequency—(cps).....	400
Input Line Current (mv.) at stall condition.....	350
Total Input Power (watts) at stall condition (max.).....	10
Input Line Current (mv.) at 24,000 rpm.....	300
Total Power (watts) at 24,000 rpm. (nominal).....	5.5
Stall Torque—(min.) in.oz.....	.34
No-load Speed (rpm.)—(in air).....	24,000
Run-up time with rated voltage (in air) to NLS—sec. max.....	90
Moment of Inertia Gm.Cm <sup>2</sup> .....	190
Angular Momentum Gm.Cm <sup>2</sup> /Sec. at 24,000 rpm.....	475,000
Dynamically balanced to within 10x10 <sup>-6</sup> oz.in. max. unbalance	
Coasting time (in air) (min.).....	2½
Total weight—gms.....	151

Ambient Temperature Range—  
Minus 55°C. to Plus 125°C.



## KETAY DEPARTMENT

NORDEN  
DIVISION OF UNITED AIRCRAFT CORPORATION  
Commack, Long Island, New York

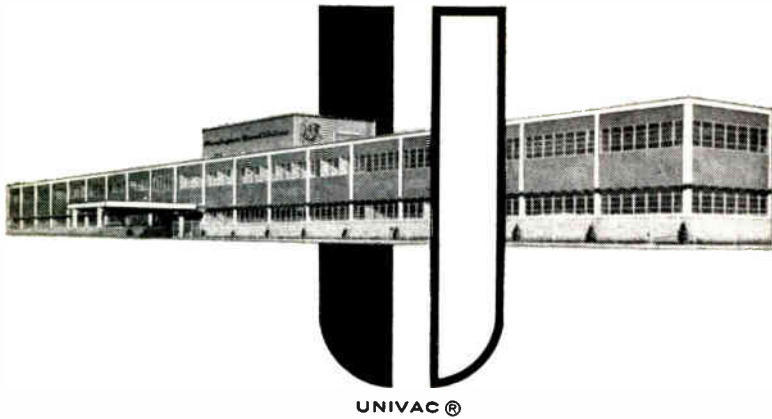

UNIVAC®

# Opportunities at UNIVAC...

Investigate these immediate opportunities at Remington Rand Univac. In addition to an attractive salary, you will work with techniques that have made significant advances in solid-state development, ultra-reliable military computers and other challenging programs.

If you are interested in advancing beyond your present position, be sure to investigate these openings.

#### STANDARDS AND SPECIFICATIONS ENGINEERS

To prepare engineering standards and component specifications for electronic equipment. Engineering or Science degree with experience in military specifications for electronic equipment.

#### COMMUNICATIONS ENGINEERS

Electrical Engineering degree with experience in HF transmission, network theory and antenna design.

#### SERVO-ENGINEERS

Electrical Engineering degree with experience in servo-amplifiers, servo-mechanisms and airborne electronics.

#### DEVELOPMENT ENGINEERS

To develop advanced techniques in high speed memory circuits, switching circuits, and other data processing requirements. Engineers are also required for work on communications systems, antenna couplers, and servo mechanisms.

#### RELIABILITY ENGINEERS

Engineering or Science degree with experience in design, quality control, and manufacturing processes relating to electronic equipment. This is a relatively new field with exceptional growth possibilities.

#### SYSTEMS ENGINEERS

Engineering, Mathematics, or Physics degree with experience in weapons and missile guidance systems involving digital control, digital conversion, radar and communications information processing, and display and output equipment.

#### QUALITY CONTROL ENGINEERS

Electrical Engineering degree with experience in reliability, statistical methods, and test procedures for electronic equipment.

#### PRODUCTION ENGINEERS

Engineering or Science degree with production engineering experience on electronic equipment or electro-mechanical business machines.

Send complete resume of education and experience to:

R. K. PATTERSON, Dept. T-5

## Remington Rand Univac

DIVISION OF SPERRY RAND CORPORATION  
2750 West Seventh Street, St. Paul 16, Minnesota.

There are also immediate openings in all areas of digital computer development at our other laboratories. Inquiries should be addressed to:

#### F. E. NAGLE

Department T-5  
REMINGTON RAND UNIVAC  
Division of Sperry Rand Corporation  
1900 West Allegheny,  
Philadelphia 29, Pennsylvania

#### R. F. MARTIN

Department T-5  
REMINGTON RAND UNIVAC  
Division of Sperry Rand Corporation  
Wilson Avenue,  
South Norwalk, Connecticut

pared by the method described by Wolf, Keck, and Broder.<sup>2</sup> Indium gallium was ultrasonically applied to one surface of the platelets and a tungsten probe brought to bear on the opposite (top) surface. In some cases the top surface was previously subjected to chemical treatment. Platelets which appeared to have good diode characteristics under the above conditions were then encased in the 1N23C diode package and performance tested.

Diodes made in this fashion had to be biased in the forward direction for approximately 50  $\mu$ a of current flow for the best performance. Some of these diodes had detection sensitivities of -40 dbm and mixer noise figures of 13 db at a frequency of 10,000 mc.

These diodes are capable of being formed with subsequent improvement in performance until optimum forming is exceeded. A preliminary check of performance of one of these diodes as a reactance amplifier yielded a gain of 9 db at 400 mc in a down-converter circuit.

Diodes of this nature were subjected to temperature tests in argon atmosphere and several showed rectification at a temperature of 800 C. Rectification ratios in the order of 10<sup>7</sup> were obtained at 500 C.

These performance figures were obtained in test equipments designed for silicon microwave diodes and using crudely made unoptimized diode packages.

#### REFERENCE

- (1) J. Mandelkorn, Gallium Phosphide Point-Contact High-Frequency Diodes, U. S. Army Signal Research and Development Laboratory, Fort Monmouth, N. J. Paper given at Electronic Components Conf., Wash. D. C., 11 May, 1960.
- (2) G. A. Wolf, P. H. Keck and J. D. Broder, Preparation and Properties of the III V Compound, Phys. Rev vol 94 p 753, May 1951.

## Beryllia Heat Sink

AN R-F TELEMETRY power amplifier which amplifies two watts to 25 watts posed the problem of heat removal developed in the tube anode. At first a blower was used, the smallest that could be found for the application. The blower had a life rating of only 200 hours which was a limiting factor.

The unit required cooling fins on



# NOW — CONTOUR PROJECTORS FROM EX-CELL-O!

## FORMER KODAK<sup>®</sup> OPTICAL PROJECTORS ADDED TO PRECISION GAGING LINE

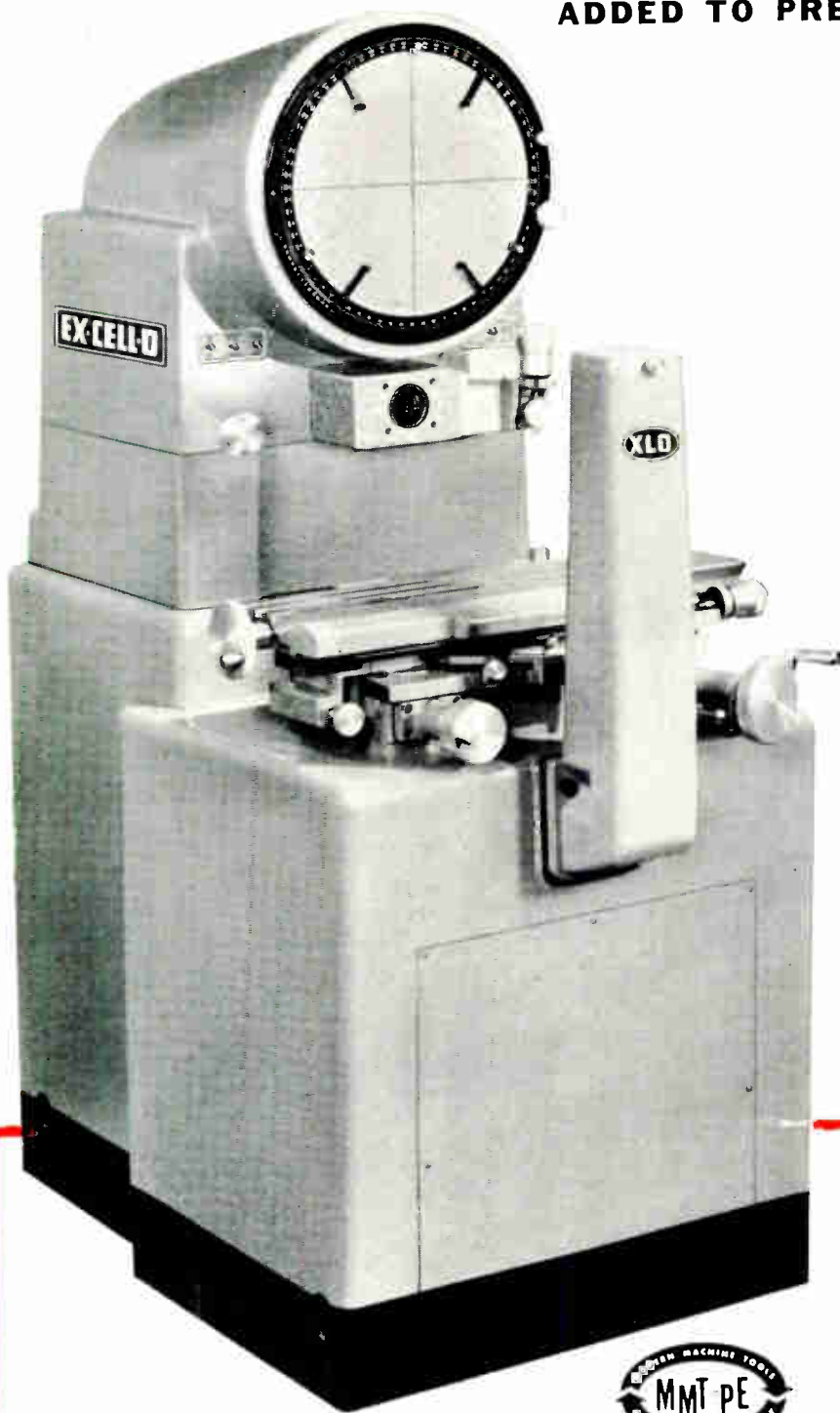

Precision Contour Projectors, formerly manufactured by Eastman Kodak Company, have been added to an expanded line of gaging and inspection equipment from Ex-Cell-O. They are sold and serviced by Ex-Cell-O's subsidiary, Optical Gaging Products, Inc.\*

Ex-Cell-O Contour Projectors are available in six table and console models for measuring and inspecting parts ranging in size from the smallest watch springs to huge breech blocks, with accuracy to .0001".

Features: Kodak Ektar<sup>®</sup> highest quality optics; finger-tip controls; vertical or horizontal projection; wide selection of lenses; maximum staging space and table travel; screen sizes from 8" to 30"; and rugged, precision construction.

Contact your Optical Gaging Products, Inc. Representative.

©Kodak and Ektar are registered trademarks of Eastman Kodak Co.

\*26 Forbes Street, Rochester 11, N. Y.

Illustrated Model 14-5 is designed for large, heavy parts. Standard features include:

- 14" screen with full-width brilliance.
- Extra-large, 26" x 8" heavy-duty work table.
- Built-in helix table.
- Full 17½" throat clearance.
- Six magnifications from 10X to 100X.
- Protractor ring for measuring image angles.
- Vertical and horizontal measuring attachments, each with dial indicator and .0001" micrometer.



### EX-CELL-O FOR PRECISION

EX-CELL-O PRECISION PRODUCTS INCLUDE: MACHINE TOOLS • GRINDING AND BORING SPINDLES • CUTTING TOOLS • RAILROAD PINS AND BUSHINGS • DRILL JIG BUSHINGS • TORQUE ACTUATORS • GAGES AND GAGING EQUIPMENT • GRANITE SURFACE PLATES • ATOMIC ENERGY EQUIPMENT • AIRCRAFT AND MISCELLANEOUS PRODUCTION PARTS • DAIRY EQUIPMENT

*Machinery Division*

**EX-CELL-O**  
CORPORATION  
DETROIT 32, MICHIGAN

60-50



*NEW Time Delay Relays*

# INSTANTANEOUS RESET... VOLTAGE-TEMPERATURE COMPENSATED

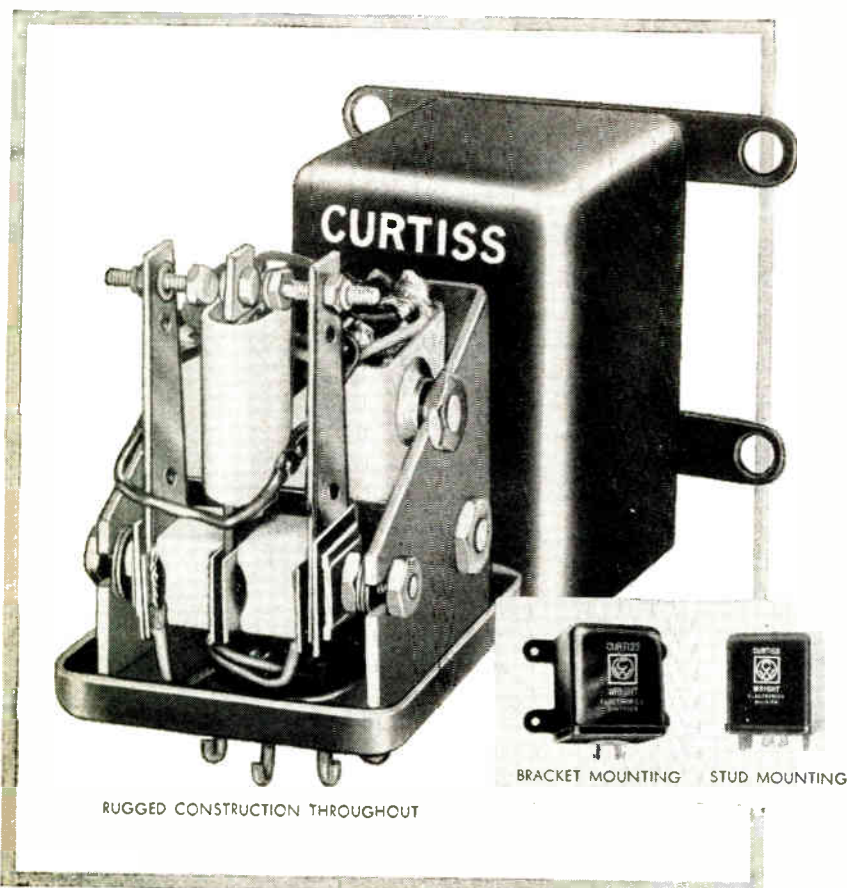

Designed with an instantaneous reset feature, these relays provide the same time delay for a series of cycles when temperature and voltage vary.

They are pre-set from 3 to 180 seconds, are chatter-free and will withstand severe shock and vibration. Because of this unique combination of features, these relays are now being used in such new circuit applications as:

- Sequential timing for missiles
- Automatic reset on digital readout equipment
- Oscillator stabilization
- Overload protection
- Computer sequencing

### "DM" SERIES STEPPING MOTORS



Curtiss-Wright Stepping Motors convert digital pulses into mechanical work or motion. Units are bi-directional with high starting torque.

Write for complete Components Catalog 260 to help you select Curtiss-Wright electronic components for use where dependability is of prime importance.

COMPONENTS DEPARTMENT • ELECTRONICS DIVISION

**CURTISS WRIGHT**

CORPORATION • EAST PATERSON, N. J.

TIME DELAY RELAYS • DELAY LINES • ROTARY SOLENOIDS • DIGITAL MOTORS • TIMING DEVICES • DUAL RELAYS • SOLID STATE COMPONENTS

112 CIRCLE 112 ON READER SERVICE CARD

the anode tube, power to operate the blower, and—in some applications—pressurizing of compartments to have a supply of cooling air in the vacuum environment encountered by missiles.

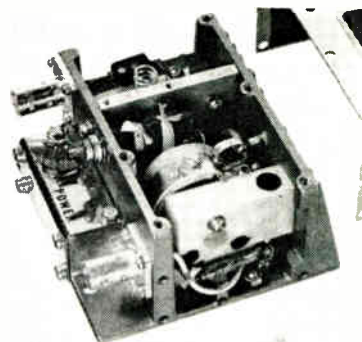

*Telemetry amplifier PA-11 as redesigned to eliminate anode cooling fins and blower. The beryllium oxide ceramic anode base is the white block in the foreground. It provides a thermal path to the amplifier chassis to dispose of heat generated in the anode.*

An amplifier was designed which incorporated the blower. Although remarkably small, this design was considered too large.

A beryllium oxide block solved this problem for United ElectroDynamics. This base for the anode was developed with National Beryllia Corp., North Bergen, N. J. BERLOX was chosen for its excellent thermal conductivity and good insulating properties at high radio frequencies.

The beryllia component provides a thermal path from the anode into the mounting plate, equivalent to that obtained by cold plate techniques, yet also isolates the anode electrically from the chassis.

By eliminating the blower and tube fins the resulting amplifier required only 12.5 cu in. The ceramic base is roughly 1 x 1.5 x 0.5 in and includes several through holes and blind holes. Blanks can be ground to within 0.001 in. Holes are core drilled, though they will be formed in the blank, then finished by grinding, when the piece goes into quantity production. The hard-fired surface is immune to normal abrasion, so that in its assembly operations United ElectroDynamics is free of concern about toxic dust.

**IT'S  
WHAT'S  
IN  
HERE  
THAT  
COUNTS**

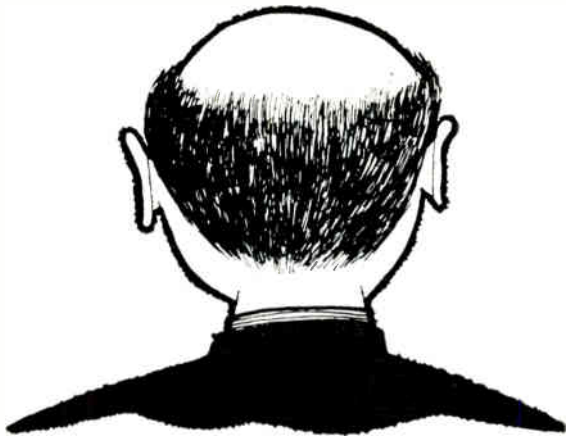

Do you know, for instance...which electronic stocks are hottest? Who's in the news and why? About "Three Approaches to Microminiaturization"? About the newest product ideas hitting the market? What's up in production? Opportunities overseas? What's going on in Washington?

It pays to know more than the next man! The questions above are just 6 reasons why you should subscribe to *electronics*.

IF YOU'RE ON THE TAG END OF A ROUTING SLIP, get your own subscription. Knowing what's going on is the first step to going up.

Fill in the coupon below right now...it will pay big dividends.

**FIND WHAT YOU NEED IN...  
electronics**

\_\_\_\_\_ Renew my subscription for 3 more years.  
\_\_\_\_\_ Enter my new subscription.

U.S. Subscription Rates: \_\_\_\_\_ 3 years \$12. \_\_\_\_\_ 1 year \$6  
Canadian rates \$10 for 1 year. Foreign rates \$20 for 1 year.

Name \_\_\_\_\_

Street \_\_\_\_\_

City \_\_\_\_\_ Zone \_\_\_\_\_ State \_\_\_\_\_

Company \_\_\_\_\_

Street \_\_\_\_\_

City \_\_\_\_\_ Zone \_\_\_\_\_ State \_\_\_\_\_

Your Title \_\_\_\_\_ Department \_\_\_\_\_

Product Manufactured or Service Performed \_\_\_\_\_

Mail reply to: *electronics*, 330 West 42nd Street, New York 36, N.Y.

**For System Applications**

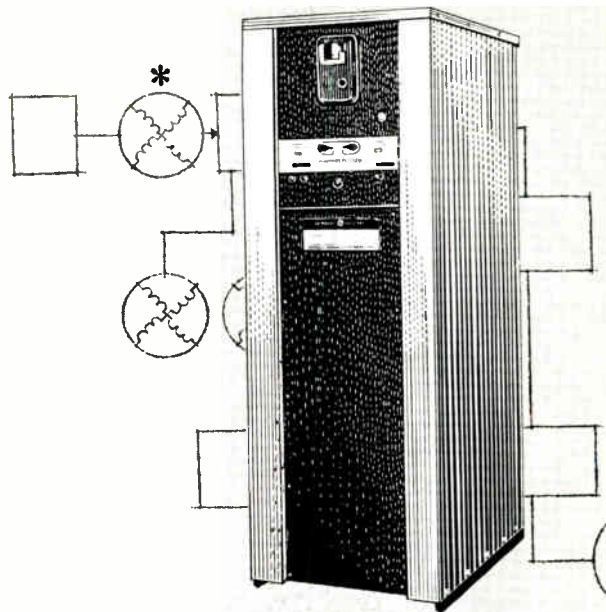

\*SYMBOL FOR INDUCTROL VOLTAGE REGULATORS

**NEW**

**Complete Line of General Electric  
400-cycle Inductrol<sup>†</sup>  
Voltage Regulators**

Induction regulation is the only reliable answer to many system control problems

Ratings, 1000 kva and above—120 to 600 volts, single- and three-phase.

**FEATURES**

- Built to meet MIL specifications
- No brushes
- No harmful waveform distortion
- Drift-free tubeless controls
- Voltage adjustment up to 100%
- Automatic, motor-driven, or hand-operated
- Compact—high capacity
- Temperature, power factor, and frequency compensated
- Highly reliable

FOR MORE INFORMATION about G.E.'s complete line of Inductrol regulators, contact the General Electric voltage regulator representative at your nearby G-E Apparatus Sales Office, or write to Section 457-02, General Electric Company, Schenectady 5, N. Y.

<sup>†</sup>Registered Trademark of General Electric Co.

*Progress Is Our Most Important Product*

**GENERAL  ELECTRIC**

# Evacuate Tubes Before Stems Are Sealed

SEALING TECHNIQUE adapted from optical polishing is reported to significantly improve the reliability and life of glass envelope electron tubes. Polishing the mating edges of stems and bulbs allows them to bond on contact, permitting the tube to be evacuated during bake-out and while the stem is sealed to the bulb.

The technique was demonstrated recently by Chatham Electronics, division of Tung-Sol Electric Inc., and U.S. Army Signal Supply Agency, at Chatham's plant in Livingston, N. J. The firm has completed an evaluation and laboratory production program for USASSA. Work began in 1956 with a process developed by CSF, of France.

Chatham now has a new USASSA contract to study process variations. Efforts will be made to reduce costs through mechanization

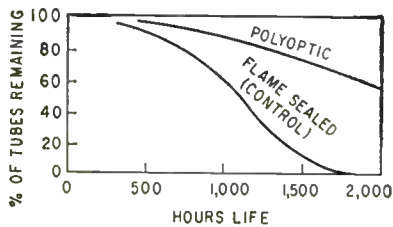

FIG. 1—Results of life tests on miniature hydrogen thyratrons



Ball lap used for polishing bulb edge

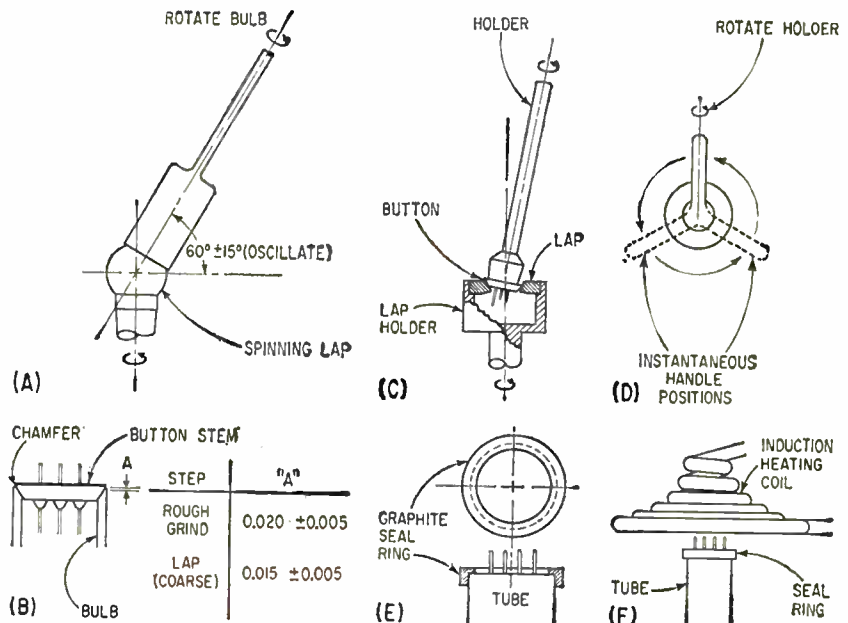

FIG. 2—Bulbs and stems are lapped so they bond before seal is made

and new techniques. The process is estimated to add 15 percent to the cost of premium tubes.

Called polyoptic sealing, the process uses r-f heating, avoiding several problems associated with conventional gas flame sealing. Advantages of polyoptic sealing, according to Ward Watrous, power tube department manager, are:

### Advantages of Process

There is no measurable oxidation of tube elements; products of gas combustion cannot enter the bulb; gaseous products and metallic vapors driven from the glass are exhausted; the glass is heated to the softening point for only 15 seconds; glass temperature during the sealing period is lower than in flame sealing; the seal is annealed under vacuum; the seal is made without distortion of the mount due to softening; premature breakdown of the cathode binder is unimportant as decomposition occurs in vacuum.

The initial study was restricted to tube type 1258, a miniature hydrogen thyratron made of hard glass with a mount structure close to the seal zone. Fig. 1 shows reported life test results for 38 of

these tubes made by the polyoptic process and 50 made by gas flame sealing. The process follows:

### Bulb Preparation

Molded bulbs are preferred for outside diameter control and to avoid double cutting. After tubulating, the bulb is cut to length with a diamond wheel. The cut edge is smoothed and flattened on a wetted, flat, cast iron lap plate.

The mating edge is rough ground with abrasive slurry on a cast iron ball (Fig. 2A). Coarse lapping is similar. A standard button stem is used to gage seated height (Fig. 2B); the button should protrude from the bulb the amount indicated in the table. Curvature of the lapped surface is checked periodically by the water drop method.

Fine lapping is done in a separate room to prevent coarse abrasive from contaminating the fine lapping slurry. The fine lap is a brass ball. Lapped surface curvature is frequently checked to avoid tedious corrections in the polishing stage. When curvature deviates excessively from standard, laps are re-shaped.

The polishing lap is a ball made

# TAILOR-MADE TELEMETRY WITH BENDIX-PACIFIC SERIES 300

These revolutionary Series 300 Telemetry components offer you a quick, easy "building block" method of assembling a system to meet your instrumentation requirements. • Besides this extreme flexibility each Series 300 unit is sub-subminiature in both size and weight (approximately 1.6 cu. in. and 2 oz.) Performance is guaranteed to exceed that of old-style components. Phone or wire for complete specification and prices.



Instrumentation Facility  
7250 Laurel Canyon Blvd.  
North Hollywood, California

TRE—300 VOLTAGE REGULATOR

TOE—300  
SUBCARRIER  
OSCILLATOR

TAA—301  
AUDIO VOLTAGE AMPLIFIER

TAA—300  
COMPOSITE  
SIGNAL AMPLIFIER

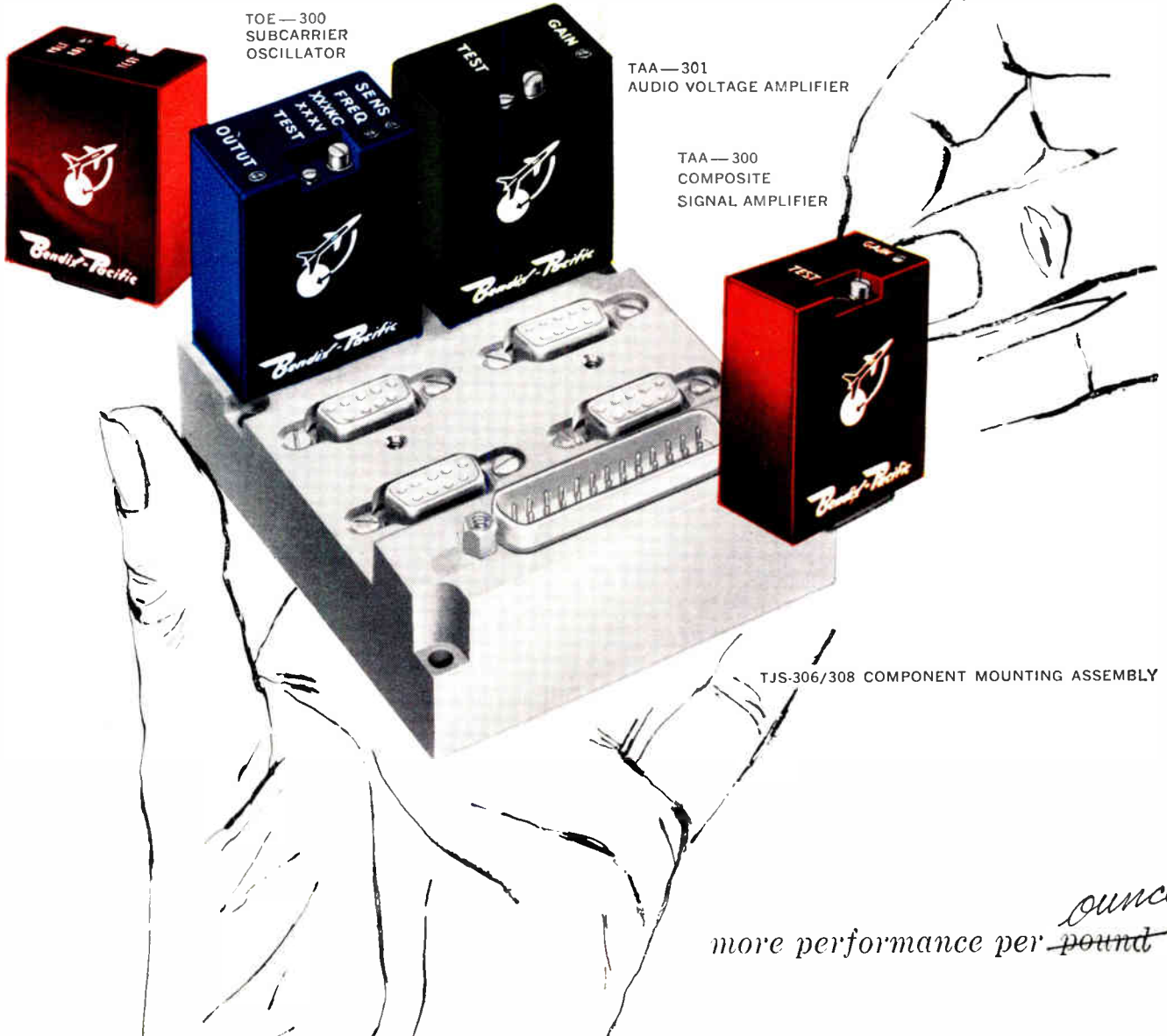

TJS-306/308 COMPONENT MOUNTING ASSEMBLY

more performance per *ounce* ~~per pound~~

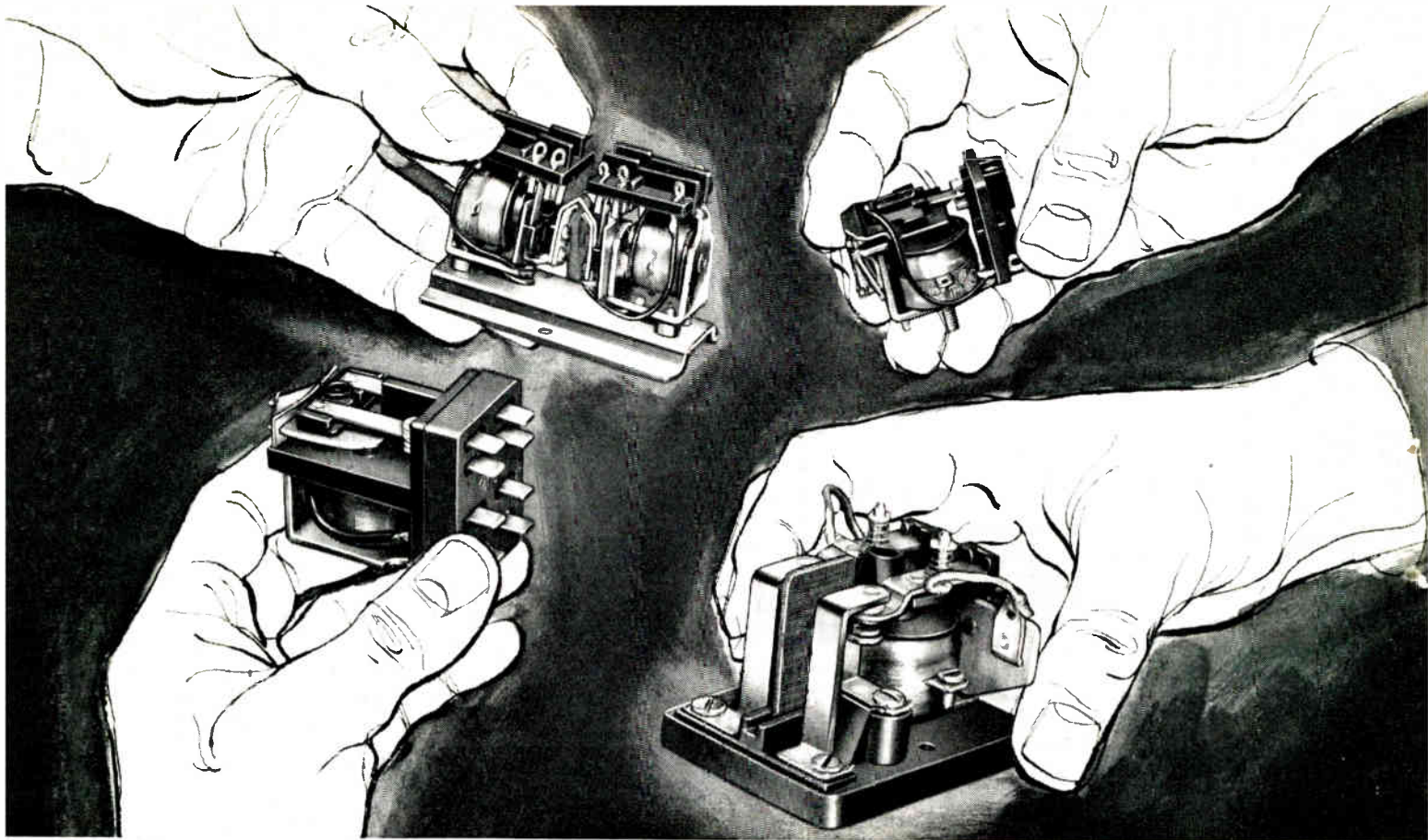

# save time! save money! call your parts distributor for P&B RELAYS



These important savings are yours when you order—from your Electronic Parts Distributor—P&B relays listed with Underwriters' Laboratories, Inc. and Canadian Standards Association:

**SAVE TIME.** You get fast, off-the-shelf delivery. Usually your order is shipped the day after it is received. And no waiting for U/L or CSA clearance . . . this has been done for you. Thus you get your project—and your product—off to a fast start!

**SAVE MONEY.** You save the cost of getting relays listed with U/L or CSA . . . and you need have no big investment in shelf inventory, either. Remember, you pay no premium over factory prices in quantities to 249.

More than 40 different standard P&B relays in 450 different coil voltages and contact arrangements are available from the leading Electronic Part Distributors in your area. For special applications, call your nearest P&B sales engineer.



**PR Series**

Type	Contact Arrangement*	Type	Contact Arrangement*
PR1AY	SPST-NO	PR5AY	SPDT
PR3AY	SPDT-NO-DM	PR7AY	DPST-NO
		PR11AY	DPDT

These relays are available in any of the following operating voltages: 6, 12, 24, 115, 230 volts 50/60 cycles AC.

Contacts are rated at: 25 amps, 115/230 V. AC 1 phase, 1 hp for 115/230 volt AC motors 1 phase.

\*Read: NO normally open, NC normally closed, DB double break, DM double make.

U/L File E22575

CSA File 15734

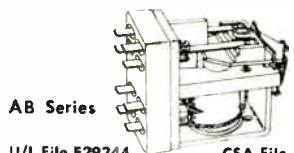

**AB Series**

U/L File E29244

CSA File 15734

For appliance and general purpose operations requiring long life and quiet operation. Quick connect terminals. Screw terminal adapters also furnished with each relay. Contact arrangement: DPDT. Rated at 10 amps, 115 V., 5 amps, 230 AC non-inductive by U/L and CSA.



**ABC Series**

U/L File E29244

CSA File 15734

Medium duty power relay in dust cover. For small motors, industrial controls and similar applications. Contact arrangement: DPDT. Rated at 10 amps, 115 V., 5 amps, 230 AC non-inductive by U/L and CSA.



**KA Series**

U/L File E29244

CSA File 15734

Small, low cost, general purpose relay for handling automation work, small motors, solenoids, other relays. Contact arrangements: SPDT, DPDT and 3PDT. Rated at 5 amps, at 115 V., AC non-inductive by U/L and CSA.

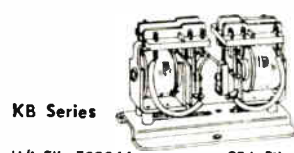

**KB Series**

U/L File E29244

CSA File 15734

Compact latch relay ideal for memory work and overload applications. Operates on momentary impulse to either coil. Contact arrangements: 4PDT and 6PDT. Rated at 5 amps at 115 V., AC non-inductive by U/L and CSA.



## POTTER & BRUMFIELD

DIVISION OF AMERICAN MACHINE & FOUNDRY COMPANY, PRINCETON, INDIANA  
IN CANADA: POTTER & BRUMFIELD CANADA LTD., GUELPH, ONTARIO



KB Series  
Latching Relay

let  
**NEWARK**  
carry your  
**P&B RELAY  
INVENTORY**

We're Relay Specialists—Over 400 types of P&B relays are available right off of our shelves.

Fast Delivery—Orders received today are shipped tomorrow.

Factory Prices—You pay no premium for Newark's super-service. Newark offers Quantity O.E.M. Prices that are competitive with Potter & Brumfield's own selling price!

FREE Newark Catalog No. 70.

Order your copy today! Check your P&B relay needs, then write or call . . .



Dept. PB-2 • 223 West Madison Street  
Chicago 6, Ill. nois  
StAtE 2-2944 • TWX: CG1401

Dept. PB-2 • 4747 West Century Blvd.  
Inglewood, California  
ORchard 4-8440 • ORegon 8-0441  
TWX: INGL: 4043



**POTTER & BRUMFIELD**  
Princeton, Indiana

of rolled canvas-Micarta and the rouge is Zerex-C mixed with water to a thin paste. Shape and maintenance of the lap is critical. Fit of the bulb with a standard gage (a carefully polished button stem) is determined by interference bands seen under a monochromatic helium light source. If more than 2 fringes occur along the circumference of the polished surface, contour is corrected. Polishing a bulb takes 3 to 6 minutes.

*Stem Preparation*

Button fabrication is conventional except that edges are molded in the specified arc to minimize grinding. Leads are inspected and cleaned before grinding to protect the polish given the edge.

The coarse lap is a ring of cast iron (Fig. 2C and top view Fig. 2D) with a concave shape. The holder is a tube socket, machined and attached to the end of a plastic rod. The button is ground until surface texture is uniform, about 2½ minutes. Button fit with a standard



*Fit between mating bulb and stem edges is indicated by fringes seen under monochromatic helium light*

bulb is checked periodically by the water drop method to monitor lap curvature.

The button is chamfered to remove sharp edges, which could crack during sealing. Chamfering is done by reversing the button in the holder and grinding the edge until the chamfered edge (Fig. 2B) is about 0.020 inch wide.

For fine lapping, the lap is made of brass and a fine abrasive is used. The motion of the lap rotates the button, so the fingers are used for

**RUGGED**

**BUT PRECISE**

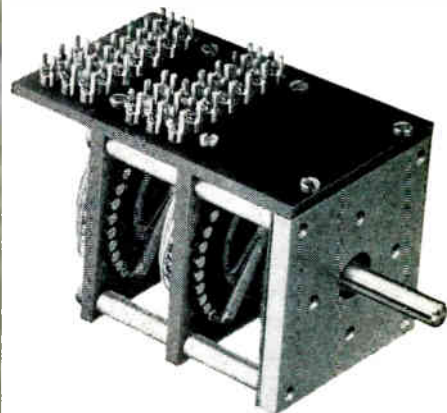

**CINEMA**

**INSTRUMENT SWITCHES**

- ★ Long Life
- ★ Rugged Construction
- ★ Low Circuit Resistance
- ★ Meet Military Specifications

Cinema Engineering offers a complete range of instrument switches to meet practically every application and all the requirements of critical circuitry and precision performance.

Switches feature contacts of one homogenous material to provide minimum EMF and to insure positive metal-to-metal wiping contact and continuous low electrical resistance for long-life operation. Advanced engineering and construction techniques provide permanent precision alignment and elimination of field failures. Available in 1 to 8 deck styles for operation up to 100KC and for all DC circuits. 2 to 16 decks are available on a single shaft through the use of a unique Cinema precision gear drive.

Choice of Contact Arrangement—shorting (make-before-break) or non-shorting (break-before-make); Contact Material—solid nickel silver or Coin Silver for lower switch circuit resistance; Deck Material—fine linen base phenolic or glass epoxy for extremely high insulation resistance.

Write for your free copy of our all-new Precision Switch Catalog.



**CINEMA  
ENGINEERING**

DIVISION AEROVOX CORPORATION  
1100 Chestnut, Burbank, California

# do you know what's expected from semi-conductor materials?

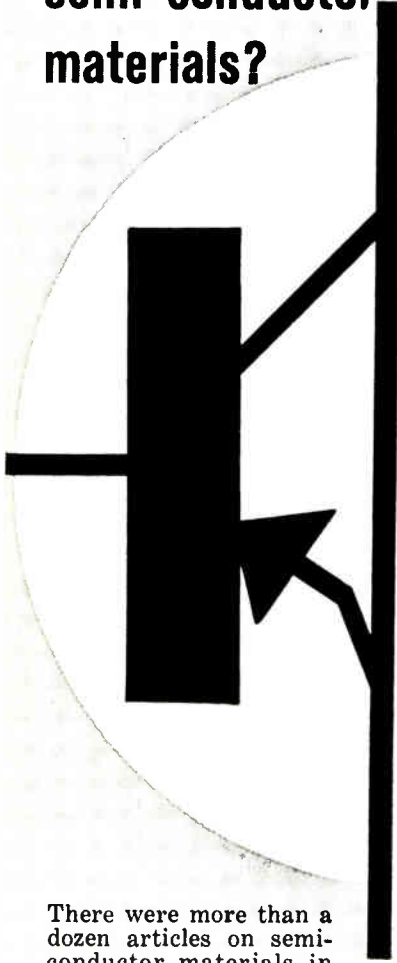

There were more than a dozen articles on semi-conductor materials in **electronics** in recent months. Each was specially edited to give you all key facts, ideas or trends—and there's more coming! Accurate **electronics'** reporting tells you what's happening now... what's *expected* in materials and components. Don't miss dozens of articles on basic subjects edited to keep you informed, help make your research, development, sales and marketing plans pay off. It pays to subscribe to **electronics** (or renew). Fill in box on Reader Service Card now. Easy to use. Postage free.

## FIND WHAT YOU NEED IN electronics

braking. The polishing is done on a lap of rolled canvas-Micarta with Zerex-C. Polished buttons are inspected for fringe lines under helium light.

All the laps are rotated at 1,000 rpm. Stems and bulbs are thoroughly washed in water between each step. After polishing, stems are also dipped in pure alcohol, wiped with lint-free cloth and stored in lint-free tissue paper until used.

### Sealing

Although a spherical seal shape is used for tube type 1258, the mating surfaces can also be flat or conical. If soft glass is used, low melting point enamels can be fused to mating surfaces before polishing.

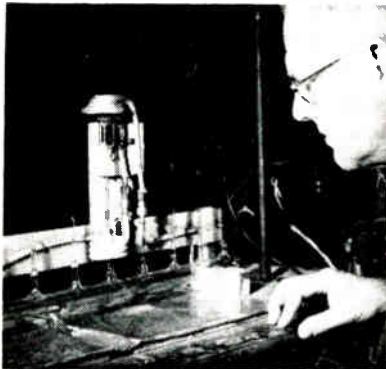

*Tubes are baked out and sealed on this prototype setup. Bakeout oven has been raised*

Sealing steps are: connect the exhaust tubulation to the exhaust system; align the mount within the bulb; position the graphite sealing ring (Fig. 2E); evacuate; bake at 450 C; heat graphite ring by induction to 950 C for 15 seconds (Fig. 2F); resume exhaust, which from this point on is conventional.

With polishing accuracies of a few millionths of an inch, vacuums as low as  $2 \times 10^{-4}$  mm Hg are obtained before sealing. Graphite used to date for the sealing ring wears relatively rapidly; an even ring cross section is necessary to prevent uneven heating and faulty seals. An oven is lowered over the tube during bakeout. A sealing time of 15 seconds was found to be optimum. Shorter times may yield leaky seals and longer times may overheat the glass causing it to be distorted by atmospheric pressure.

## FAIRCHILD

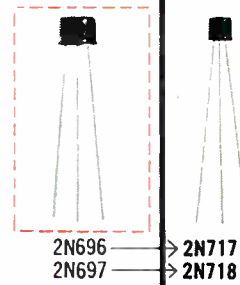

### NEW NUMBERS SAME CONVENIENT SOURCES

The new Fairchild 2N717 and 2N718—like other new Fairchild types—are available for immediate delivery from distributors at announcement. For quantities 1 to 999, call your nearest distributor. For quantities of 1,000 and over, contact your local Fairchild office.

#### EAST

CRAMER ELECTRONICS INC.  
811 Boylston St., Boston 16, Massachusetts  
Copley 7-4700, WUX: FAX Boston, Mass.

PHILA. ELECTRONICS, INC.  
1225 Vine St., Philadelphia 7, Pennsylvania  
LOcust 8-7444

SCHWEBER ELECTRONICS  
60 Herricks Road, Mineola, L. I., New York  
Pioneer 6-6520, TWX: G CY NY 580

VALLEY ELECTRONICS INC.  
1735 East Joppa Road, Towson, Maryland  
Valley 5-7820, TWX: TOWS 564

VALLEY INDUSTRIAL ELECTRONICS,  
INCORPORATED  
1417 Driskany Street W., Utica, New York  
RAndolph 4-5168, WUX: FAX Utica, New York

#### EASTERN SALES OFFICES

JENKINTOWN, PENNSYLVANIA  
100 Old York Road, Turner 6-6623  
TWX: JENKINTOWN PA 1056

WASHINGTON 6, D. C.  
1027 Cafritz Building, National 8-7770

GARDEN CITY, L. I., NEW YORK  
600 Old Country Road, Pioneer 1-4770  
TWX: G CY NY 5391

SYRACUSE, NEW YORK  
731 James Street, Room 304, Granite 2-3391  
TWX: SS 94

MARBLEHEAD, MASSACHUSETTS  
19 Preston Beach Road  
NEptune 1-4436

#### SOUTH

SCHWEBER ELECTRONICS, FLORIDA  
P. O. Box 1491, Melbourne, Fla.  
Parkway 3-4461

#### CENTRAL

SEMICONDUCTOR DISTRIBUTOR  
SPECIALISTS, INC.  
5706 West North Avenue, Chicago 39, Illinois  
National 2-8860

#### CENTRAL SALES OFFICE

OAK PARK, ILLINOIS  
6957 West North Avenue, Village 8-5985  
TWX: OAK PARK 2820

#### WEST

HAMILTON ELECTRO SALES  
12308 Wilshire Blvd., Los Angeles 25, Calif.  
EXbrook 3-0441, BRadshaw 2-8453  
TWX: W LA 66 37

KIERULFF ELECTRONICS INC.  
820 West Olympic Blvd., Los Angeles 15, Calif.  
RiChmond 7-0271, TWX: LA 46

SCHAD ELECTRONIC SUPPLY, INC.  
499 South Market St., San Jose 13, Calif.  
CYpress 7-5858

#### WESTERN SALES OFFICES

LOS ANGELES 46, CALIFORNIA  
8833 Sunset Boulevard, OLeander 5-6058  
TWX: BV 7085

MOUNTAIN VIEW, CALIFORNIA  
545 Whisman Road, Yorkshire 8-8161  
TWX: MOUNTAIN VIEW CAL 853



CIRCLE 203 ON READER SERVICE CARD  
MAY 20, 1960 • electronics





2N696

2N697

→ 2N717

→ 2N718

**NEW NUMBERS**  
**SAME POPULAR TRANSISTORS**  
**SMALL PACKAGE OPTION**

## THE FAIRCHILD

2N696 and 2N697 are the world's most copied transistors. We have now copied them ourselves in scaled down versions. The 2N717 and 2N718 are exactly the same as these popular types but packaged in the TO-18 case. They occupy  $\frac{1}{3}$  the volume of the standard TO-5, making them ideal for high-density equipment designs.

With maximum power dissipation of 0.4 watt at a free air temperature of 25°C (or 1.5 watts at a 25°C case temperature), the small packaging still gives more than adequate power handling capability for the majority of applications. All other specifications are identical to those given in the 2N696 and 2N697 data sheets.

These new types are options. Fairchild, as the originator of the 2N696 and 2N697, remains your best source for these most reliable types.

For specification sheets, write Dept. A.

A wholly owned  
subsidiary of Fairchild Camera  
and Instrument Corporation



545 Whisman Road • Mountain View, California • Yorkshire 8-8161 • TWX MTN VIEW 853

# New On The Market

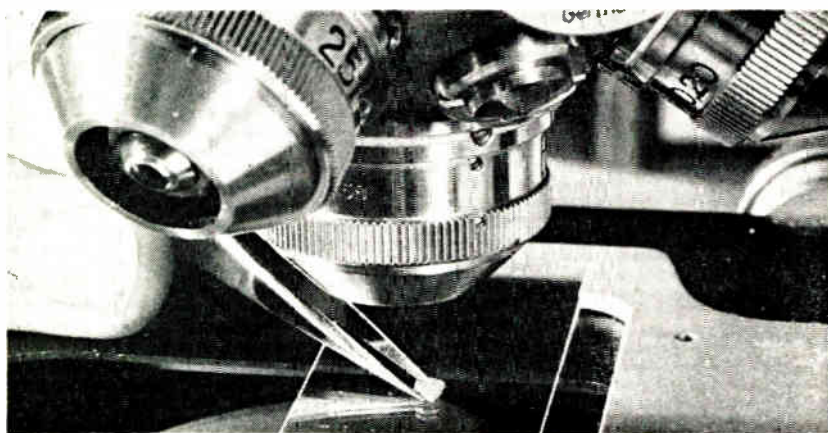

## Miniature Tunnel Diode

OSCILLATES AT 4,000 MC

DEVELOPMENT of miniature germanium tunnel diode that can oscillate up to 4,000 Mc has been announced by Sylvania Electric Products Inc., a subsidiary of General Telephone & Electronics Corp., 730 3rd Ave., New York.

The 4,000-Mc units will be available in a few weeks. Engineering samples are available of tunnel diode type D4115 that oscillates above

2 Gc and type D4115A that oscillates above 3 Gc.

The new tunnel diodes have a peak-to-valley ratio of 5 to 1, a peak current of up to 4 ma at approximately 50 mv and minimum current at approximately 350 mv.

The diodes are packaged in a ceramic case designed for microwave strip transmission line application.

**CIRCLE 301 ON READER SERVICE CARD**

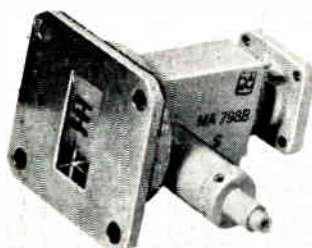
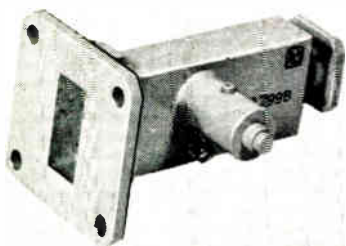

## Harmonic Generators

WORK UP TO 80 GC

TEN harmonic generators providing second, third, fourth and fifth harmonics with output frequencies ranging from L-band (1.30 to 1.43 Gc) to V-band (53.0 to 80.0 Gc) are available from Microwave Associates, Inc., Burlington, Mass.

The units are broadband, fixed-tuned and have filters to eliminate unwanted harmonics. They have coaxial, waveguide and strip-transmission-line packaging and incorporate solid-state elements.

Using high-voltage varactors, harmonic power of 100 to 150 mw has been generated at third harmonic in the 6-Gc region with a conversion loss of 8 to 10 db.

In addition to the models available new units converting 1 w at 2,000 Mc to 100 mw or more at 4,000 and 6,000 Mc are under development. Another model converts 1 watt at 3,000 Mc to 250 mw at 6,000 Mc.

**CIRCLE 302 ON READER SERVICE CARD**

## High-Voltage Voltmeter

CAN MEASURE 200,000 V

DIRECT potentials up to 200,000 volts can be measured with a voltmeter consisting of a high-voltage multiplier resistor in a tall phenolic-resin tube and a separate indicating instrument in a metal cabinet at ground potential. The instrument is made by Peschel Electronics, Inc., Patterson, New York.

The model M200DC kilovoltmeter has an input resistance of 2,000 megohms, a 4½-in. meter and will withstand a 150-percent overload. The multiplier circuit is connected



to ground through a neon bulb so that high voltage cannot appear on the meter even if the multiplier resistor should open.

**CIRCLE 303 ON READER SERVICE CARD**

## Transistor Code Generator

PRODUCES 43 CHARACTERS

A TRANSISTORIZED code generator that produces 43 Morse code characters in real time has been designed for emergency operations,



military reconnaissance and manual entry of data into data-processing or telemetry systems. The device can also produce other outputs such

# BAKE IT!

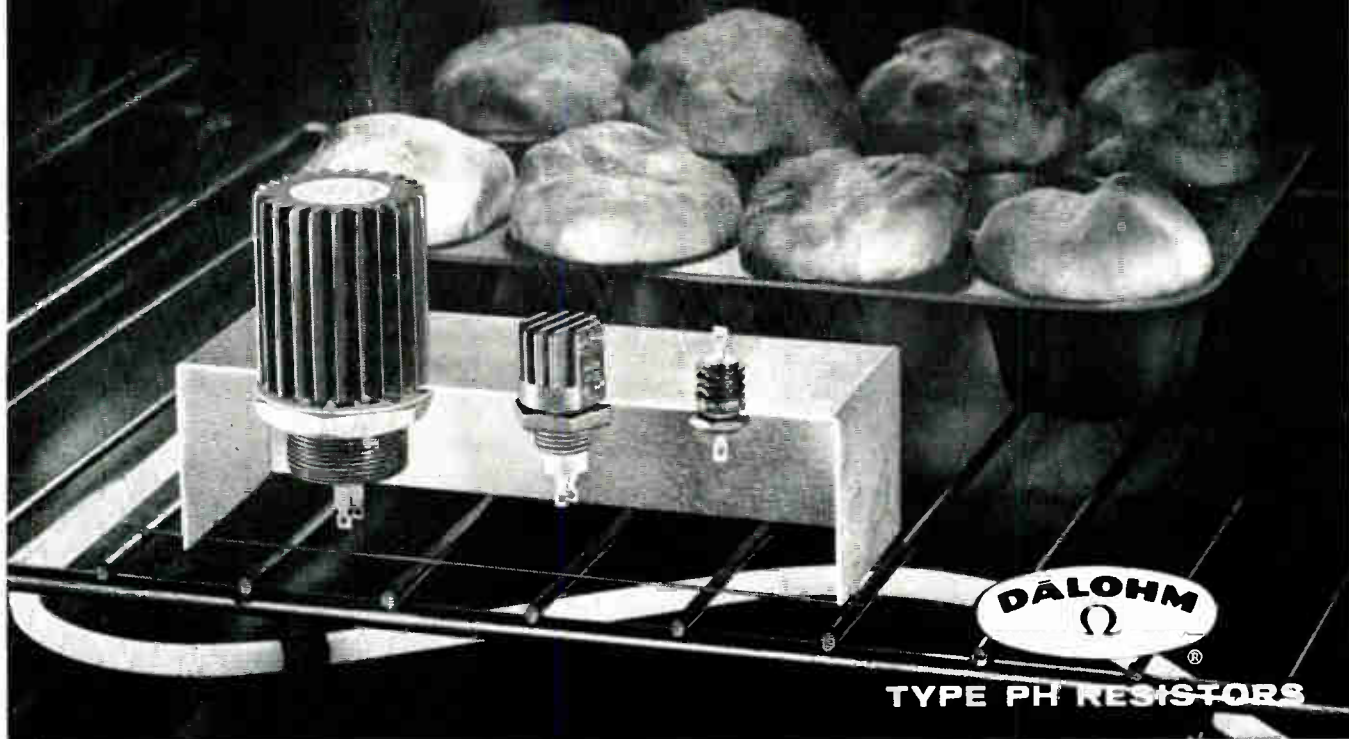

## INHERENT STABILITY Assured in a DALOHM PH Resistor

Neither bake-oven heat nor bone-chilling cold causes a deviation from the inherent stability that is standard in Dalohm resistors.

Stored on the shelf for months... or placed under continuous load... operating in severe environmental, shock, vibration and humidity

conditions... Dalohm precision resistors retain their stability because it has been "firmly in-fixed" by Dalohm design and methods of manufacture.

For all applications demanding resistors that meet or surpass MIL specifications, you can depend on Dalohm.

### HIGH POWER • WIRE WOUND • MINIATURE DALOHM TYPE PH RESISTORS

Designed for primary application of high power requirements, coupled with precision tolerance. Mount through hole in chassis for maximum heat dissipation.

DERATING DATA		
A.I. resistors dissipate rated wattage at 25° C. and derate to 0 at 275° C.		
	Mounted on Heat Sink	Free Air
PH 10-1	10 watts	6 watts
PH 25	25 watts	12.5 watts
PH 100	10 watts	50 watts

Write for Bulletin R-36, with handy cross-reference file card.

- **Rated at** 10, 25, and 100 watts
- **Resistance range** from 0.1 ohm to 60K ohms, depending on type
- **Tolerance**  $\pm 0.05\%$ ,  $\pm 0.1\%$ ,  $\pm 0.25\%$ ,  $\pm 0.5\%$ ,  $\pm 1\%$ ,  $\pm 3\%$
- **Temperature coefficient** 20 P.P.M.
- **Operating temperature range** from  $-55^{\circ}$  C. to  $275^{\circ}$  C.
- **Smallest in size**, ranging from  $1/2" \times 3/4"$  to  $1 3/4" \times 2-31/32"$
- **Ruggedly housed**; sealed in silicone and inserted in radiator finned aluminum housing.
- **Complete welded construction** from terminal to terminal
- Made in accordance with MIL-R-26C and MIL R-18546B (Ships).

### SPECIAL PROBLEMS?

You can depend on DALOHM, too, for help in solving any special problem in the realm of development, engineering, design and production. Chances are you can find the answer in our standard line of precision resistors (wire wound, metal film and deposited carbon); trimmer potentiometers; resistor networks; collet-fitting knobs; and hysteresis motors. If not, just outline your specific situation.

from **DALOHM**  
Better things in  
smaller packages  
**DALE PRODUCTS, INC.**  
1300 28th Ave., Columbus, Nebr.

as binary-coded decimal. The unit is made by R. W. Johnson Co., 9372 Hillview Road, Anaheim, Calif.

Called the Codemite, the unit measures only 6½ by 5½ by 2½ in. and is powered by self-contained rechargeable batteries. The unit includes a 10-bit magnetic-core mem-

ory. Rate of transmission is adjustable from 5 to 40 words a minute.

Each time a key is depressed, the corresponding code character is formed as a relay closure and side tone. High-impedance earphones are supplied.

**CIRCLE 304 ON READER SERVICE CARD**



### Impedance Comparator HAS 3-PERCENT ACCURACY

RESISTORS, capacitors and inductors may be compared with a standard sample using the type 1605-AS2 impedance comparator made by General Radio Company, West Concord, Mass. The instrument indicates magnitude and deviation of impedance difference and phase-angle difference directly on panel meters.

The device is accurate enough to allow sorting high-quality silvered mica films. Other applications include checking temperature coefficients, making environmental reliability tests and measuring small

dielectric-constant changes in gases and dilute solutions.

The instrument comprises a signal source, bridge and detector. The internal oscillator provides 100 cps, 1, 10 and 100 Kc signals all accurate to plus or minus 3 percent. Full-scale ranges are plus or minus 0.1, 0.3, 1.0 and 3.0 for impedance magnitude and 0.001, 0.003, 0.01 and 0.03 for phase angle. Accuracy is 3 percent of full-scale value.

The instrument is available for relay-rack or bench mounting. Panel is 19 by 8½ in.; depth is 12 in.

**CIRCLE 305 ON READER SERVICE CARD**

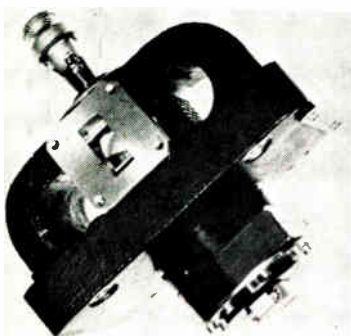

### Tunable Magnetron HYDRAULIC ACTUATOR

FREQUENCY diversity and higher definition for airborne radar and countermeasures equipment is of-

fered with the L-3305 hydraulically tunable magnetron made by Litton Industries, Electron Tube Division, 960 Industrial Road, San Carlos, Calif.

The magnetron can be tuned at rates up to 100,000 Mc over the frequency range from 8,600 to 9,500 Mc. Pulse stability at peak power output in excess of 65 Kw is maintained while the tube is tuned.

The hydraulic actuator is an integral part of the tube design. The hydraulic control valve can be attached directly to the actuator. The power supply and reservoir may be remotely located.

**CIRCLE 306 ON READER SERVICE CARD**

### Tiny Trimmer Capacitor

VARIES 0.4 PF A TURN

USE in airborne transmitters, computers and communications receivers is seen for a miniature trimmer capacitor line made by Corning Electronic Components, a department of Corning Glass Works, Corning, N. Y.

Four models designed for panel mounting have capacitance ranges of 1 to 4.5, 1 to 8.5, 1 to 12 and 1 to 18 picofarads. Behind panel lengths are ¾, 1, 1½ and 1¾ in. Linear tuning is provided at rate of 0.4 picofarad a turn.

A nontraversing 0-80 adjusting screw provides fixed cavity tuning.

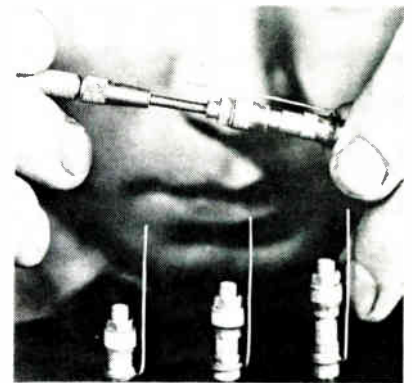

The core has positive stops at both ends of the tuning stroke.

Metal parts are made of invar and brass to achieve a temperature coefficient of plus or minus 50 parts per million per deg C. Silver plating provides minimum corrosion resistance and a minimum Q of 500 at 50 Mc.

**CIRCLE 307 ON READER SERVICE CARD**

### Multipurpose Voltmeter COVERS 3 TO 600-KC

COMMUNICATIONS carrier measurements, wave analysis and general laboratory use are foreseen for a frequency-selective voltmeter avail-

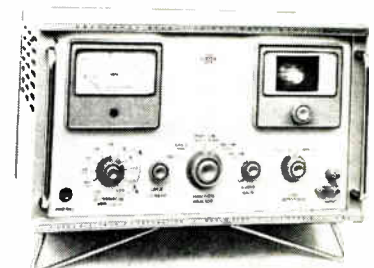

able from Sierra Electronics Corp., a division of Philco Corp., 3885

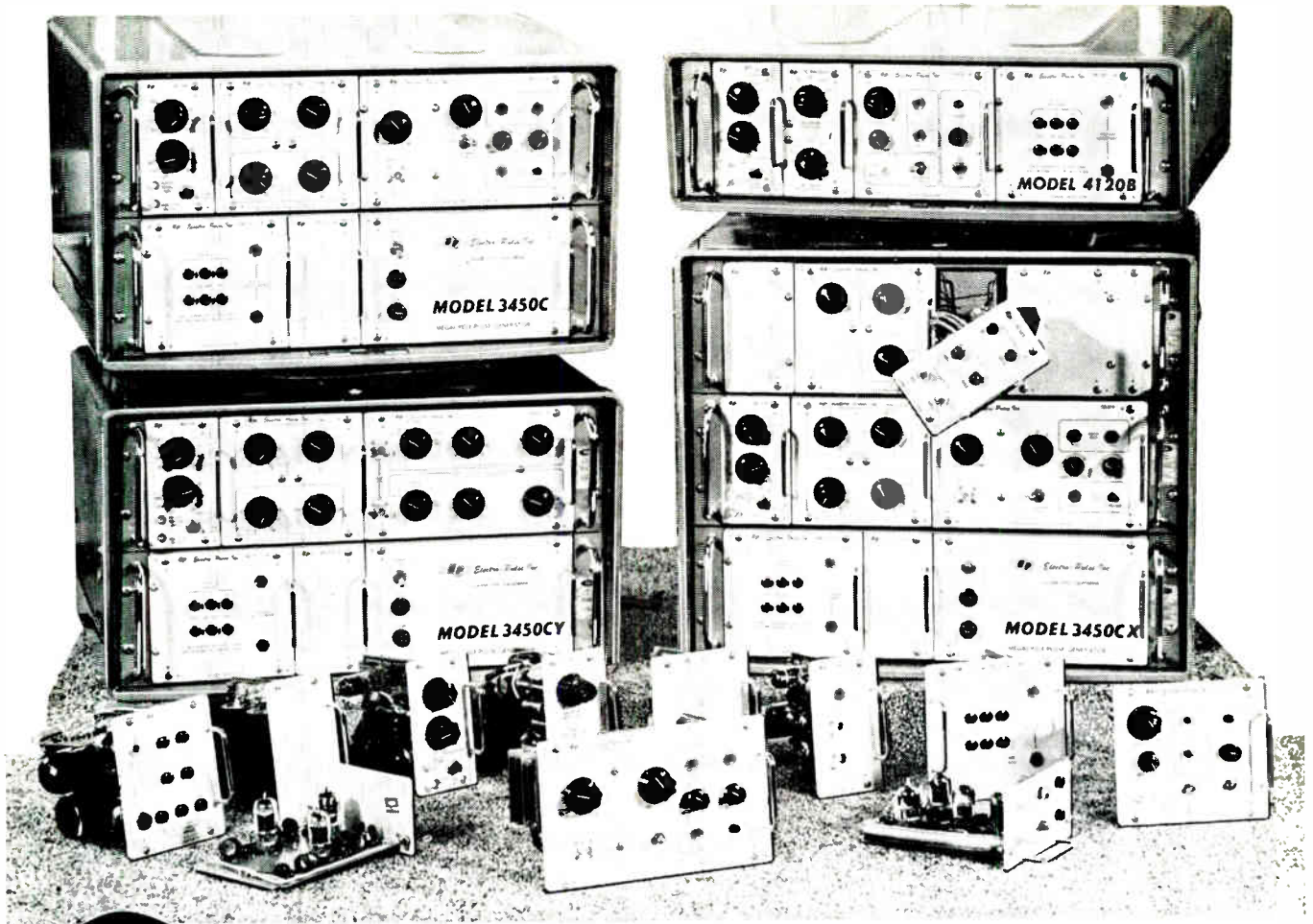

**NOW!**

## **FULL coverage in Pulse Instrumentation through MODULAR CONSTRUCTION**

Modular plug-in construction adds unparalleled versatility and serviceability to proven EP circuit quality, allows extension of standard instruments to special requirements, and provides the key to rapid, economical fabrication of simple or complex pulse and digital instrumentation systems.

Electro-Pulse currently manufactures 137 standard pulse and digital circuit modules (both tube and transistor types). Over 90 catalog instruments are offered to save you time and money in the generation of fast-rise pulses, pulse pairs, pulse trains, gates, time delays, digital words, programmed current pulses, PPM and PCM codes, etc. Our current comprehensive catalog is yours for the asking.

Various combinations of only eleven basic pulse circuit modules,\* when plugged into wired rack frames, make up the four standard pulse generators shown above—

3450C—0.015  $\mu$ s rise single pulses, 50v into 50 ohms to 2MC, variable durations, delay and waveform.

3450C/X—Adds pulse pair and pulse train capabilities to 3450C.

3450C/Y—Fast rise, power flip-flop (45v into 470 ohms, Pos. and Neg. outputs), duration to 1 sec., rep rate to 1.7MC.

4120B—Economical fast-rise pulses to 500KC, 35v into 100 ohms.

Write for complete data: Bulletins 3450 and 4120

Representatives in Major Cities

# *Electro-Pulse, Inc.*

11861 TEALE ST., CULVER CITY, CALIF. • Phone: UPTon 0-9193 or EXmont 8-6764

\*Basic modules in photo above:

Time Base, Delay and Width Control, Pulse Forming, Flip-flop, Trigger Amplifier, 2 Output Amplifiers, 2 Power Regulators, Rectifier-Filter, and Gating Control, with variations. Also available: Counters, And/Or Gates, Crystal Oscillators, Precision Time Delays, Blocking Oscillators, Mixers, Inverters, Attenuators, Input Amplifiers.

Note, in above photo of 3450CX, the ease with which a single module may be extended on plug-in adapter for service.

*Pulse and Digital Circuit Engineers:  
Rapidly expanding Systems activity and  
New Product development at Electro-Pulse  
have created several attractive openings  
for qualified engineers. Please send resume  
to T. C. Ridgway, Personnel Manager.*

Dependability  
Reliability  
Stability

are the key words for

# THERMAL Time Delay RELAYS

designed and produced by

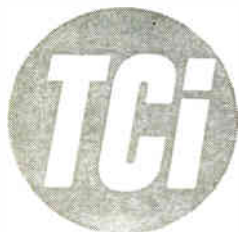

WRITE FOR FREE LITERATURE

# THERMAL CONTROLS, INC.

and O.K. ELECTRONICS

41 RIVER ROAD  
NORTH ARLINGTON, N. J.

124 CIRCLE 124 ON READER SERVICE CARD

Bohannon Drive, Menlo Park, Calif. The instrument covers the frequency range 3 to 600 Kc and operates with both narrow and wide selectivity settings plus a flat voltmeter position.

The voltmeter's range in the tunable modes is -90 dbm to plus 32 dbm and from -30 dbm to plus 32 dbm in the flat mode. The narrow-selectivity bandwidth is 250 cps at the 3-db points and 600 cps at the 30-db points. The broad selectivity bandwidth is 2.5 Kc at the 3-db points and 6 Kc at the 30-db points.

Accuracy on both bandwidths is plus or minus 1 db in level measurements. Accuracy of frequency measurement is plus or minus 1 Kc from 3 to 100 Kc and plus or minus 2 Kc from 100 to 600 Kc. The instrument is designated the model 125A and is of modular construction with etched glass epoxy circuit boards.

CIRCLE 308 ON READER SERVICE CARD



## Proximity Switch

MAGNETIC OPERATING

A PROXIMITY switch for rotating cam timers has been developed by Tann Corp., 3750 Outer Drive, Detroit. The switch consists of a single beam that rocks on a single pivot. The beam is held in place by a magnetic field and is released when a ferrous mass approaches. The unit features snap action and repeatability within 0.001 in. Differential between on and off position is approximately 0.008 and the unit is shock resistant. Contacts are rated for 6 amp at 110 v resistive and 3 amp at 220 v. Life ratings are in millions of cycles. The switch is 13/16 in. in diameter and 2 1/2 in. long. Price is \$17.50.

CIRCLE 309 ON READER SERVICE CARD

## Silicon Rectifiers

SIX-AMPERE DEVICES

CORNELL-DUBILIER ELECTRIC CORP.,  
Norwood, Mass., is producing sili-



# ENGINEERS work on these rewarding projects

### THE OPPORTUNITIES:

Designing the "Lifeguard Station" for Project Mercury (opposite page) is just one of the challenging projects at Stromberg-Carlson-San Diego. Others include development of high-speed electronic printers that print up to 1 1/2 million magazine labels daily, microfilm printers that print out data from major computers, and display consoles for jet-age air traffic control.

### THE COMPANY:

Stromberg-Carlson is a division of General Dynamics Corporation.

### THE LOCATION:

San Diego, California is a world-famous resort area on the Pacific Ocean, adjacent to Mexico. It offers the finest year-around climate in the U.S.

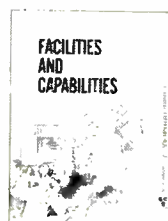

LEARN THE  
STROMBERG-  
CARLSON-  
SAN DIEGO STORY!  
SEND FOR THIS  
FREE BOOKLET!

Dept. D-45, 1895 Hancock Street, San Diego, Calif.

# STROMBERG CARLSON SAN DIEGO

CIRCLE 204 ON READER SERVICE CARD

MAY 20, 1960 • electronics

# LIFEGUARD STATION

## for a man in space

The vital Cape Canaveral nerve center for Project Mercury, the U.S. program to put a man in space, is being designed and built by Stromberg-Carlson-San Diego. Display information about the flight will be fed to the operations room from computers and from a world-wide network of tracking and telemetry stations. One wall of the 40 by 60 ft. operations room will be a large map display, visually summarizing all pertinent information about the flight. It will show the capsule moving along its orbital flight path around the earth and will also show the location, range and status of all ground based equipment and communications links. The operations room will contain display consoles presenting information to the Flight Director, Chief Flight Surgeon, Capsule Communicator, Flight Dynamics Officer and other decision-making personnel. For information on how Stromberg-Carlson-San Diego can help solve your data/display problems, write to Department A-45, 1895 Hancock Street, San Diego 12, Calif. Telephone CYPRESS 8-8331.

**STROMBERG-CARLSON - SAN DIEGO**  
A DIVISION OF **GENERAL DYNAMICS CORPORATION**





## Heart of the Control System

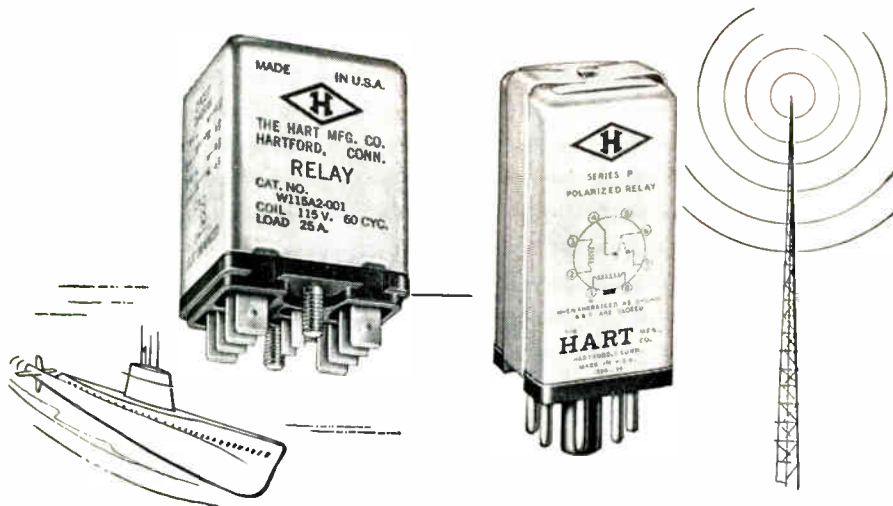

## "DIAMOND H" Relays

Look into the heart of the control system for a missile, a computer, a nuclear submarine, or a great many other critical applications. You might be surprised how often you'll find "Diamond H" relays.

Unless, of course, you're one of the increasing number of engineers who've already selected "Diamond H" relays for a spot where they just have to work despite all sorts of adverse conditions.

Hart makes relays of three basic types: miniature, hermetically sealed, aircraft-missile relays (Series R/S); high speed, sensitive, polarized relays (Series P), and general purpose AC, DC relays (Series W).

Technical literature outlining the wide range of characteristics available with each type relay is yours for the asking. You'll find "Diamond H" engineers uncommonly adept at working out a variation of the basic designs to meet your set of specific requirements.

Tell us your needs . . . by phone, wire or letter.

**THE HART MANUFACTURING COMPANY**

202 Bartholomew Ave., Hartford 1, Conn.

con rectifiers for medium power applications up to a maximum of 6 amperes. The rectifiers, available in  $\frac{1}{2}$  in. hex ceramic insulated or  $\frac{3}{8}$  in. hex styles, are offered in eight piv ratings from 50-600 v. Complete electrical and mechanical characteristics are described in bulletin SC1006.

**CIRCLE 310 ON READER SERVICE CARD**

## Decade Counter ADD-SUBTRACT

ROBOTOMICS, INC., 4624 E. Garfield, Phoenix, Ariz. A new transistorized 100 Kc add-subtract decade counter features simple switching control. Grounding one of two control lines determines whether decade will add or subtract. Available in single voltage model 1303 requiring + 100 v at 40 ma; or lower dual voltage model 1203 requiring + 30 v at 35 ma, and 60 v a-c at 1 ma. Bright, ten number display, electrical zero reset, and optional coincidence output. Plugs into standard 10-pin p-c connector. Size: 3 $\frac{1}{2}$  in. high by 1 in. wide by 3 $\frac{1}{4}$  in. deep.

**CIRCLE 311 ON READER SERVICE CARD**

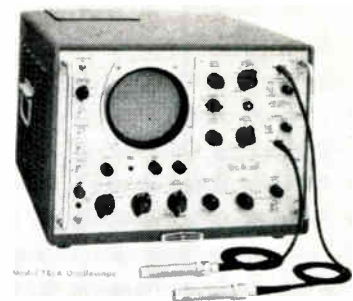

## Sampling Scope SINGLE PACKAGE

HEWLETT-PACKARD CO., 275 Page Mill Road, Palo Alto, Calif. Model 185A is a 500 Mc oscilloscope which provides viewing of repetitive millimicrosecond pulses. It has a rise time of less than 0.7  $\mu$ sec. It is useful wherever pulse analysis of fast circuits can speed engineering, research, design or performance testing—as with transistors, diodes, memory units, fast computer circuits and surveillance radars. It has a full 10 cm vertical display and high vertical amplifier sensitivity. A fast rise sync pulse, suitably delayed from the start of the oscilloscope trace, is available for trigger-



# 17 FACTS



about  
**ALLEN-BRADLEY**  
Hot Molded Composition  
**RESISTORS**

... to assist you in the design of  
more stable, more reliable circuits

Circuit reliability is determined by the quality of the components and the understanding with which they are applied. A-B hot molded resistors are universally recognized for their quality and reliability. Here are 17 facts that will assist you with your design and development work.

- 1** Resistance changes due to humidity are temporary, but Allen-Bradley resistors can be returned to their original value by proper conditioning or "loading."
- 2** Resistance changes due to increase in moisture content are always positive.
- 3** Resistance change due to humidity varies with the resistance value and is less in the lower values.
- 4** Resistance change which has occurred due to humidity may be returned to the original value by conditioning the resistor at 100°C for 48 hours.
- 5** Resistors operating at 1/10 rated wattage load are hardly—if at all—affected by humidity.
- 6** Hermetically sealed resistors do not change because of humidity.
- 7** Resistance change due to "load life" is permanent and ultimately negative.
- 8** Resistance change due to "load life" can be minimized—on the order of 1% to 2% in many thousands of hours of service by derating the resistor approximately 50%.
- 9** This same result can be attained by limiting the maximum operating surface temperature of the resistor under load to 100°C.
- 10** Resistance change due to soldering is positive; but if the resistor is dry, it will return to its original value in a matter of hours.
- 11** The temperature characteristic of the Allen-Bradley resistor is positive above and below room temperatures between +10°C and +80°C ambient.
- 12** The temperature characteristic of the Allen-Bradley resistor is negligible from +10°C to +80°C ambient.
- 13** The voltage characteristic of the Allen-Bradley resistor is negative. It is less at elevated temperatures than at room ambient (+10°C to +80°C).
- 14** The voltage characteristic is less in low-value resistors than in high-value units—it is linear.
- 15** The voltage characteristic and the temperature characteristic tend to cancel one another in an Allen-Bradley resistor under average operating conditions where both voltage and temperature are present.
- 16** The "heat sink" to which a resistor is connected affects its rating. Resistors operated in parallel should be derated unless an adequate "heat sink" is provided.
- 17** The quality and reliability of Allen-Bradley resistors are exactly the same regardless of the "tolerances" for which the resistor is listed.

Allen-Bradley Co., 110 W. Greenfield Ave, Milwaukee 4, Wis. In Canada: Allen-Bradley Canada Ltd., Galt, Ont.

## ALLEN-BRADLEY

Quality  
Electronic Components

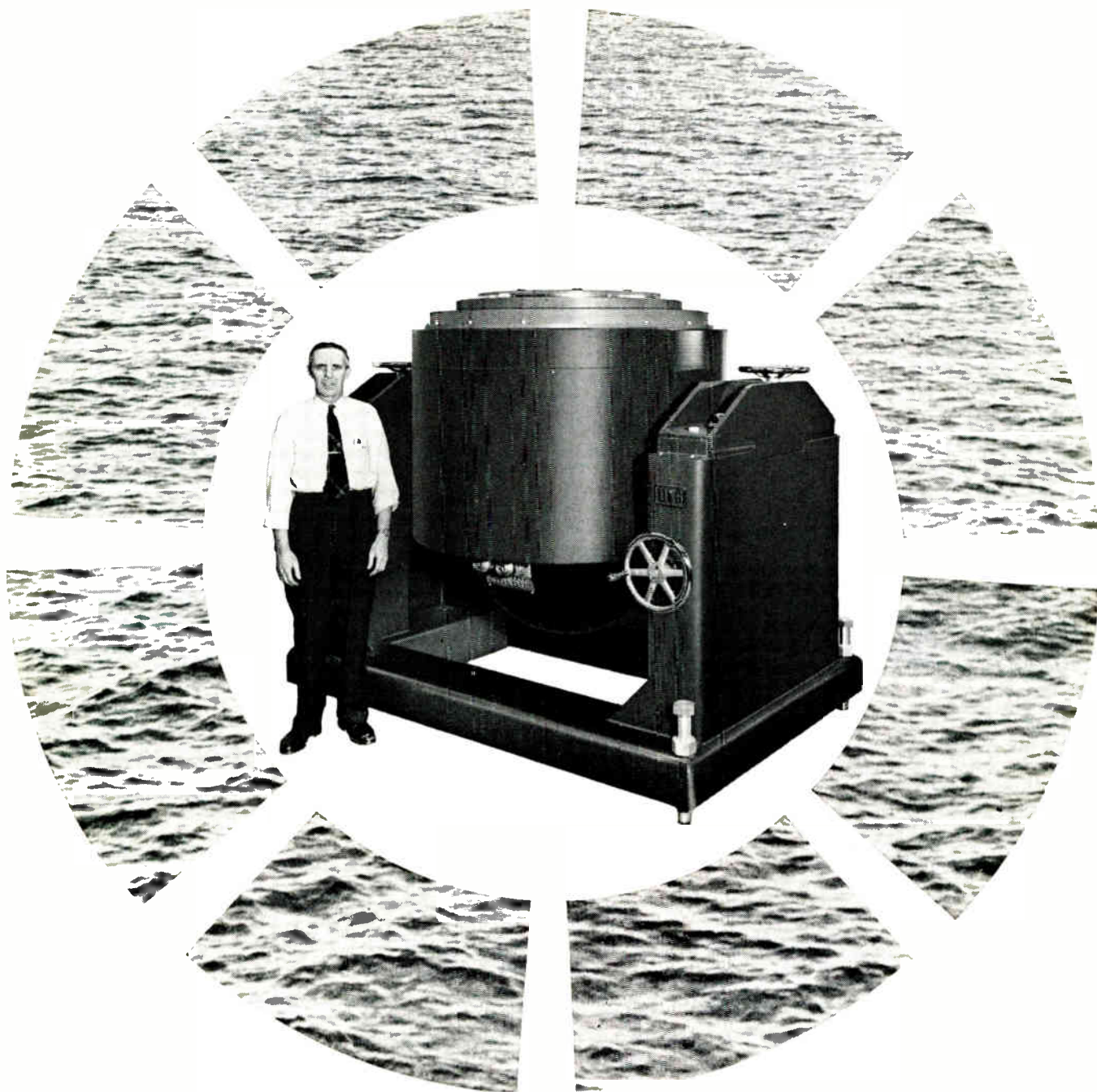

## LING'S LIQUID-COOLED SHAKERS DISSIPATE HEAT FAST WITH WATER

Improved system efficiency goes with the improved design of Ling's new series of liquid-cooled shakers. For instance, Model 249 shown above not only offers an impressive 28,000 pound force rating, but a number of other advantages. The new closed-loop cooling system, employing clean raw or distilled water, dissipates heat so efficiently that less is dumped on the testing site. The series also features a new web-design armature of lightweight aluminum. Force is transmitted to the table with maximum rigidity. Finally, special construction details make these liquid-cooled shakers adaptable for environmental chamber testing without special accessories. Tests can be conducted from  $-100^{\circ}\text{F}$  to  $300^{\circ}\text{F}$  at any altitude. Field and armature coils are designed to help eliminate corona at altitudes; special thermal barriers can be supplied which control heat flow from the shaker to the chamber. This built-in adaptability and high efficiency grow from Ling research; For details on the liquid-cooled shaker series, write Dept. EL-2 at either address below.



**L I N G**  
E L E C T R O N I C S

A DIVISION OF LING-ALTEC ELECTRONICS, INC. • 1515 SOUTH MANCHESTER, ANAHEIM, CALIFORNIA • 120 CROSS STREET, WINCHESTER, MASSACHUSETTS

## LING ELECTRONICS

The shaker at the left is just one of many design improvements to grow out of Ling's continued research and development program. Its high 28,000 pound force rating—one of the highest force ratings available—is another result of Ling's constant search for better equipment and better methods of vibration testing.

In addition to the special advantages offered by the efficient liquid-cooling system, this new series offers other important features which it has in common with the air-cooled shaker series.

Ling's dual magnetic field structure provides a low stray field and improved force-current linearity. Ling shakers are engineered to operate continuously at maximum force on low input, feature simplified compensation over wide bandwidths.

Check the ratings on the entire liquid-cooled series. The performance of the series is just one more proof that whatever your needs in high power electronics—vibration testing, acoustics or sonar—you can rely on Ling for the most advanced design and practical engineering.

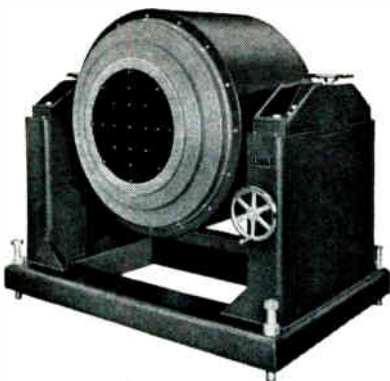

**LING'S LIQUID-COOLED SHAKERS** cover this useful range of force ratings:

Model 245—2,000 lb. force rating  
Model A246—7,500 lb. force rating  
Model 275—10,000 lb. force rating  
Model 249—28,000 lb. force rating

# L I N G

E L E C T R O N I C S

HIGH-POWER ELECTRONICS FOR  
VIBRATION TESTING • ACOUSTICS • SONAR  
CIRCLE 205 ON READER SERVICE CARD  
electronics • MAY 20, 1960

ing external circuits. In situations where the test circuit will respond to this trigger, a delay line is unnecessary.

CIRCLE 312 ON READER SERVICE CARD

### Servomotor Gearheads 400-CYCLE UNITS

GUIDANCE CONTROLS CORP., 110 Duffy Ave., Hicksville, L. I., N. Y., introduces a line of rugged 400 cycle servomotor gearheads for application in computer, control and servo positioning systems or where size/weight ratio is critical and ultrareliability is paramount. Units are 2½ in. long and weigh 6 oz. Series 11 are available in over 1,000 ratios, from 5:1 to 78125:1. Stock ratios range from 5:1 to 2,000:1 and all ratios are designed to a maximum recommended load torque of 100 oz in. Maximum backlash does not exceed 30 minutes as measured with a 1 oz in. load on the output shaft. No-load speed of the units is 6700 rpm and torque at stall is 0.63 oz in. Operating temperature range is from -54 C to as high as +120 C.

CIRCLE 313 ON READER SERVICE CARD

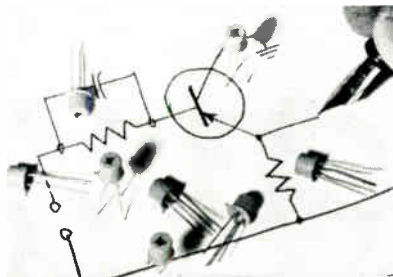

### Switching Mesa ULTRA-HIGH SPEED

MOTOROLA INC., Semiconductor Products Division, 5005 E. McDowell Road, Phoenix, Ariz. The 2N705 millimicrosecond switching mesa transistor features a maximum power rating of 300 mw at 25 C case temperature. It is suitable for high speed counters, flip-flop circuits, logic circuits, and a wide variety of computer pulse and switching circuits, both saturating and nonsaturating. A germanium pnp diffused base transistor, it is housed in a TO-18 (3-lead, 0.100 in. pin circle) package with collector connected to case. To assure maxi-

## AL TYPE 335-A ultra-low frequency

### PHASE METER

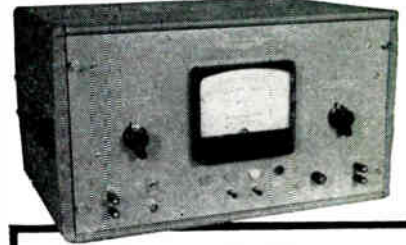

#### FEATURES:

- Direct Reading from 0 to 360° in 6 Ranges of 60° each
- 0.0001 cps to 1.0 cps in Decade Ranges
- Phase Accuracy ±1° from 0.0C01 cps to 0.1 cps; ±2° from 0.1 cps to 1.0 cps

This unit measures the phase angle in degrees between two sinusoidal or non-sinusoidal voltages within the frequency range from 0.0001 cps to 1 cps. A wide variety of applications are offered in the field of: servomechanisms, vibration studies and other low frequency phenomena. Readings of phase angles are indicated directly on a large 5" meter which has 6 full scale ranges of 360°, 300°, 240°, 180°, 120°, and 60°.

#### SPECIFICATIONS...

**Amplitude Range:** 1 to 30v rms sine wave with no d-c component.

**Input Impedance:** Not less than 100k ohms.

**Wave Form:** Will measure all sine waves and complex wave forms provided that the applied signals have no d-c component. The applied signals should not have more than one positive-going or one negative-going zero-axis crossing per cycle.

**Dimensions:** 19" x 10-½" x 13-½"

**Cabinet:** Aluminum with gray wrinkle finish. Gray baked enamel front panel.

For full details write or call:



**ACTON  
LABORATORIES, INC.**

A Subsidiary of

**TECHNOLOGY INSTRUMENT CORP.**

517 MAIN STREET, ACTON, MASS.  
Telephone: COlonial 3-7756



# SORENSEN power rides the weather satellite!

The new weather satellite, TIROS, is one of the most remarkable space vehicles yet to take to the skies. For TIROS carries a complete TV transmitting system into space.

Built by RCA for the National Aeronautics and Space Administration, under technical direction of the U. S. Army Signal Corps, its mission is to televise cloud formations and transmit the pictures back to earth to aid weather forecasters.

Among the advanced electronic equipment in TIROS is a Sorensen dc-to-dc converter that transforms the output of the satellite's solar cells to voltages necessary for the satellite's complex electronic gear. Of course, this converter is both miniaturized and transistorized (weighs only 20 oz.) and its reliability is vital to success of the project.

## MORE THAN 130 MODELS

Read about the more than 130 different models of dc-to-dc converters offered by Sorensen in our new 32-page catalog . . . plus a complete line of highly regulated d-c supplies, a-c line-voltage regulators, high voltage supplies to 600,000 volts, frequency changers . . . plus valuable reference data. Write for your copy to Sorensen & Company, Richards Avenue, South Norwalk, Conn.

0 23



A SUBSIDIARY OF RAYTHEON COMPANY

## CONTROLLED POWER PRODUCTS

... THE WIDEST LINE MEANS THE WISEST CHOICE

imum reliability, this transistor undergoes an in-process vacuum bake-out at 200 C and is welded into a vacuum tight enclosure. The device also receives a stabilization bake for a minimum of one week at temperatures in excess of 100 C.

CIRCLE 314 ON READER SERVICE CARD

## Phase Shift Control

### INHERENTLY FAILSAFE

VEC TROL ENGINEERING, INC., P.O. Box 1089, Stamford, Conn., announces the Silicontrol, an inherently failsafe full range phase shift control for silicon controlled rectifiers of all makes and ratings. It provides complete control of one or two scr's in one small, compact, ready-for-use package, eliminating additional involved circuitry. A super-sensitive phase shifting network applies 60-cycle steep pulses of constant amplitude to rectifier gates and varies their phase angle over a full 180 deg to control the rectifier output from zero to maximum. Pulse rise time is only a few  $\mu$ sec. The constant amplitude output which is a feature of the Silicontrol technique is of vital importance because any gate overdrive, however transient, can and usually does destroy the rectifier.

CIRCLE 315 ON READER SERVICE CARD



## Silicon Rectifiers STACK MOUNTED

TRANS-SIL CORP., 55 Honeck St., Englewood, N. J. Developed to provide high power in a minimum of space, the type 7D stacked rectifiers are hermetically sealed high power silicon cells for all types of power applications. They will deliver up to 2,000 amperes in full wave cir-



An achievement in  
defense electronics

NEW THERMOPLASTIC RECORDING DISPLAY ACHIEVES

## Detection to Projection in Less than a Second

Large-screen display of radar signals can be recorded and projected in less than a second. This advanced technique in information display is an example of one application of the new thermoplastic recording system developed by General Electric.

The grainless, thermoplastic film eliminates processing delays and permits, with higher resolution, much greater enlargement than is practical with high-speed photographic film. Target delineation is also significantly improved by optical filtering used to increase the signal-to-noise ratio.

Now undergoing final development in General Electric's Electronics Laboratory, the "thermoplastic display" is expected to find maximum application in the high-speed radar systems of the future.

176-03

*Progress Is Our Most Important Product*

**GENERAL  ELECTRIC**

DEFENSE ELECTRONICS DIVISION  
HEAVY MILITARY ELECTRONICS DEPARTMENT  
SYRACUSE, NEW YORK

**ANOTHER REASON WHY PARAGON-REVOLUTE QUALITY PAYS OFF FOR YOU!**

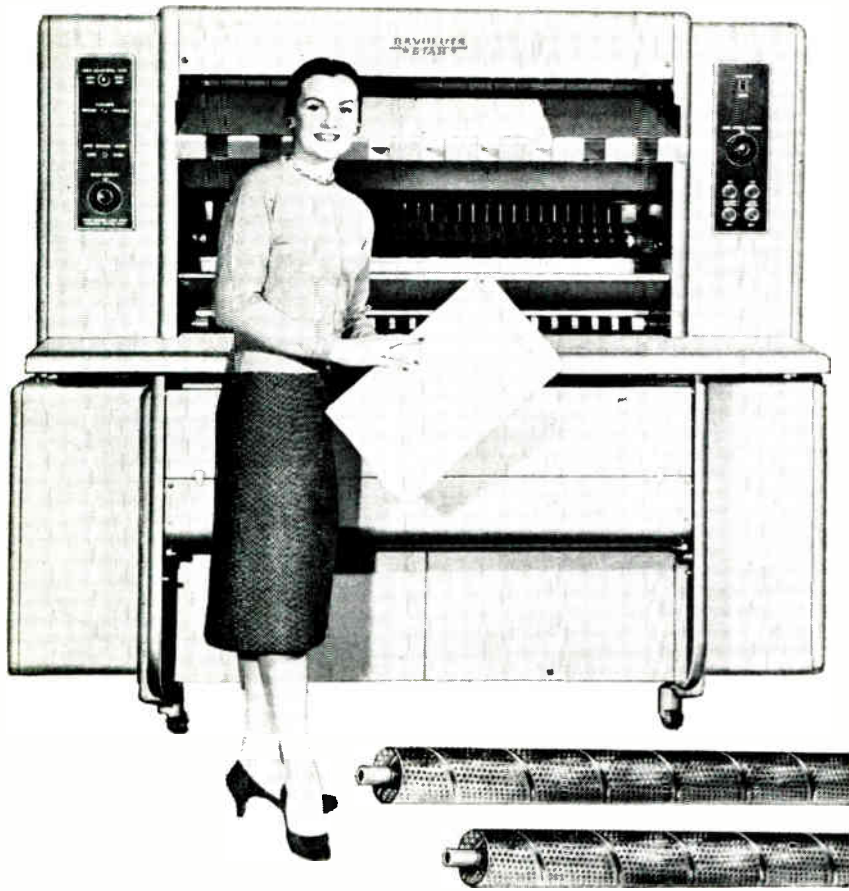

*Better Prints Due to Perforated Rollers!*

Better, faster, more economical prints are what you get as a result of these perforated stainless steel rollers . . . a patented exclusive feature you'll find only in Revolute whiteprinters. The holes allow practically 100% exposure to the developer—at high speeds, low speeds, or fluctuating speeds. Prints travel a shorter route, come through clearer, faster, and there's 1/4 to 1/2 less ammonia consumption than in other designs.

This is just one of the many im-

portant advantages in a Revolute Star that pays off for you in more efficient, economical performance. Moreover, you'll find a Star model to meet your printing needs exactly. Printing widths of 24", 42" or 54"; top speeds of 45 or 75 fpm.

If you're in the market for a whiteprinter right now . . . or if you expect to be soon . . . it will pay you to investigate the Star. Why not drop this coupon in the mail and we'll send you full details.



DIVISION OF CHARLES BRUNING CO., INC.



77 South Avenue • Rochester 4, New York

Paragon-Revolute  
Advertising Department, Dept. P5-Z  
1800 Central Rd., Mt. Prospect, Illinois

Please send me information on your Star whiteprinters.

Name \_\_\_\_\_ Title \_\_\_\_\_

Company \_\_\_\_\_

Address \_\_\_\_\_

City \_\_\_\_\_ County \_\_\_\_\_ State \_\_\_\_\_

ports. Capable of operating at temperatures up to 150 deg ambient, the assemblies are available in all circuit configurations and are available for either forced or natural convection cooling. All assemblies use copper fins, melamine insulation and other materials to insure satisfactory performance in high ambient temperatures.

**CIRCLE 316 ON READER SERVICE CARD**

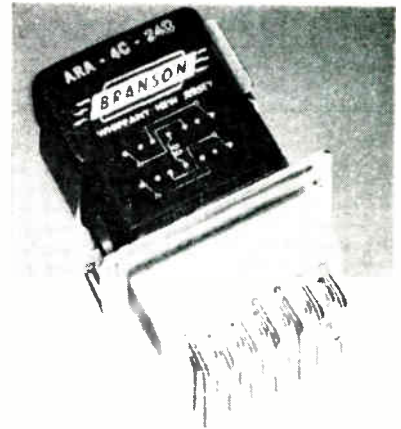

**Plug-In Relay  
FOUR-POLE**

BRANSON CORP., 41 S. Jefferson Road, Whippany, N. J. Now the four-pole crystal can relay is available for use in a printed circuit socket. At ambient temperatures up to 125 C the relay meets the requirements of military specifications including 50 g shock and 20 g vibration at frequencies up to 2,000 cps. It features full 2 ampere contact ratings. The addition of the plug-in mounting style makes the relay useful in many new applications.

**CIRCLE 317 ON READER SERVICE CARD**



**Frequency Monitor  
SOLID STATE**

VOI-SHAN ELECTRONICS, 13259 Sherman Way, N. Hollywood, Calif. These solid state frequency mon-

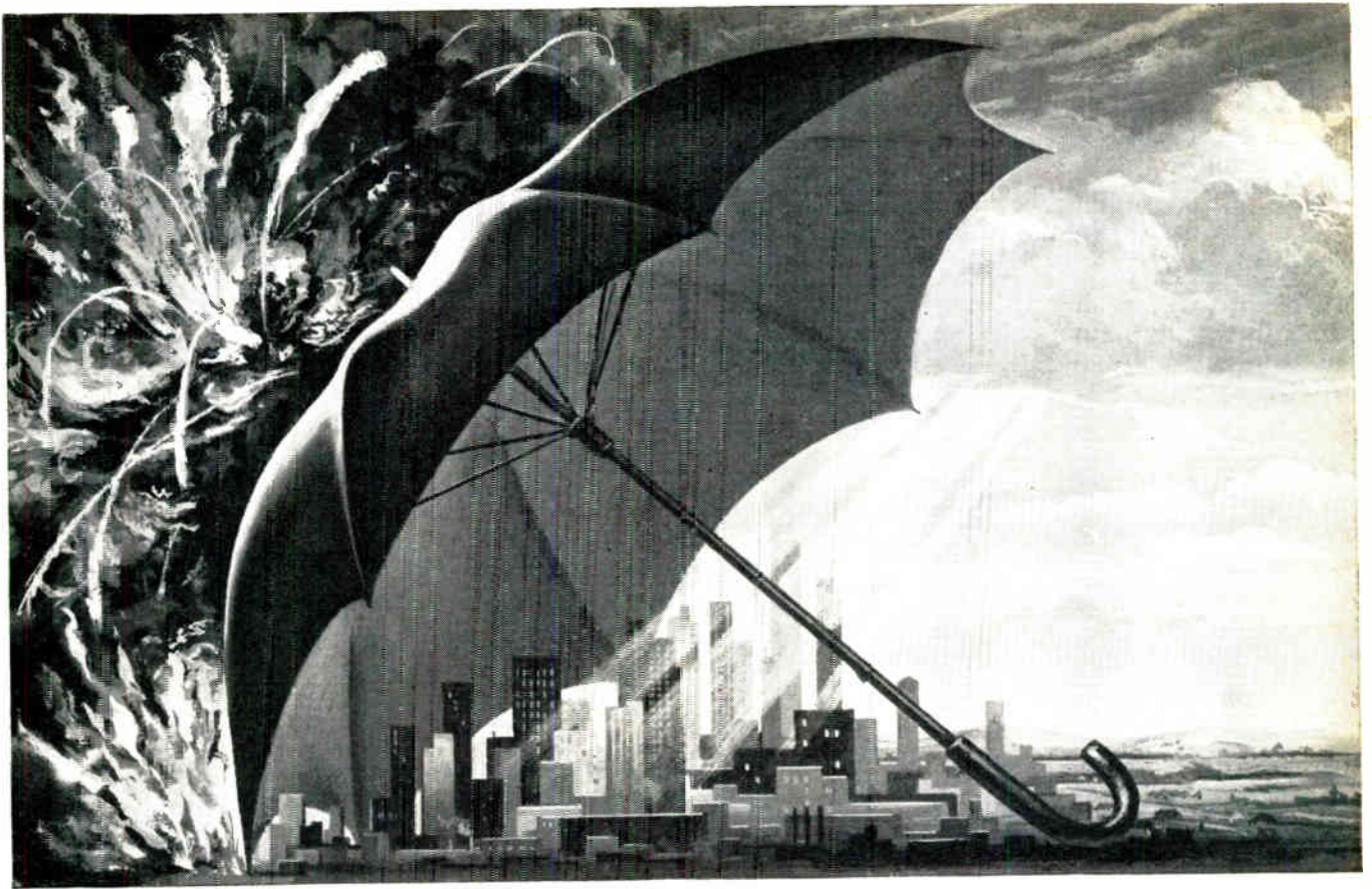

Helping to guarantee a vital  
 "something" for a rainy day



# hallicrafters \* QRC

The effectiveness of America's defense "umbrella"—today and tomorrow—depends on *instant availability of superior electronics weapons.*

For over seven years, the Hallicrafters company has been answering this urgent need with \*QRC—Quick Reaction Capability.

For your electronic requirements . . . from single circuit to complete system . . . for application on land, sea, air or space . . . Hallicrafters QRC can provide you with this unique design and production service in electronics.

**ENGINEERS:** Join our rapidly expanding QRC team now. For complete information address your inquiry to: William F. Frankart, Director of Engineering.

## hallicrafters company

MILITARY ELECTRONICS DIVISION

CHICAGO 24, ILLINOIS

U R G E N T P R O B L E M S R E L I A B L Y S O L V E D

electronics • MAY 20, 1960

CIRCLE 133 ON READER SERVICE CARD 133

## CABLE-bility



## ENGINEERING service when you need it!

AMPHENOL Cable & Wire Division makes over 140 RG-/U coaxial cables, but even this large selection cannot meet all the needs of the electronics industry. Here are recent examples of AMPHENOL engineering Cable-bility, cables designed and produced to special customer needs:

1. *Low Capacitance*, low loss cable using Polyfoam® dielectric—to maintain excellent electrical properties under adverse mechanical conditions.
2. *Low Loss*, high power, flexible Teflon-tape cables for electronic counter-measures equipment.
3. *Semi-solid* Teflon version of RG-63/U for use in a production ICBM.
4. *Pressurized* cable with flexible metal-hose jackets.
5. *Ultra-high Temperature* cables, including one design that operates at 1000°F continuously.

*Assistance in design problem areas is another way in which AMPHENOL Cable & Wire Cable-bility can help you!*



## CABLE & WIRE DIVISION

S. HARLEM AVE. at 63rd ST., CHICAGO 38  
AMPHENOL-BORG ELECTRONICS CORPORATION

itors provide accurate indication and/or control of phenomena associated with varying frequency. Related functions such as time delays for opening or closing contacts and activating warning or control devices, may be incorporated in the basic frequency monitor. Operating within frequency ranges of 400 cps to 10 Kc at  $\pm 1$  percent accuracy, these units have input supply voltage of 28 v d-c, with a minimum input signal of 900 mv. Output is spdt, or to customer specification. The devices have temperature range of  $-55$  to  $+125$  C, shock, vibration, and altitude to requirements of MIL-T-5422C.

**CIRCLE 318 ON READER SERVICE CARD**

## Survey Meter PORTABLE UNIT

FRANKLIN SYSTEMS, INC., 2734 Hillsboro Road, West Palm Beach, Fla. Model 15-2 portable nuclear radiation survey meter is a reliable, self-contained beta-gamma ray responsive instrument designed for survey and monitoring purposes. Unit is an ultrasensitive transistorized scintillometer. Typical applications are: (1) rapid low level background monitoring; (2) field survey from moving vehicle; (3) rapid location of contaminated or tagged material.

**CIRCLE 319 ON READER SERVICE CARD**

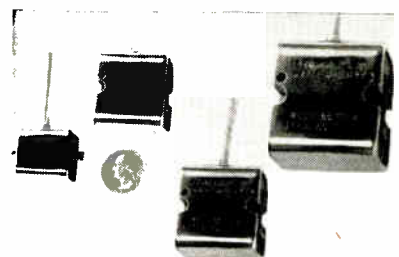

## Torque Motors UNITIZED CONSTRUCTION

Servotronics, Inc., 190 Gruner Rd., Buffalo 25, N. Y. Model 20 series torque motors in four models are characterized by their unitized construction which completely contains and affixes pole pieces, magnets and armature to a nonmagnetic stainless steel frame. This construction completely eliminates such problems as pole pieces or magnets shifting position or breaking away from the assembly in either shock or vi-



bration. Stroke (in.) ranges from  $\pm 0.006$  to  $\pm 0.015$ ; output radius, 0.593 to 0.906; midposition force (lb), 2.5 to 13.0; hysteresis, 2 percent for all; resonant frequency (cps), 400 to 940; maximum power required (watts), 1.6 to 5.2; weight, 2.8 to 18.5 oz.

**CIRCLE 320 ON READER SERVICE CARD**

## Converter ANALOG-TO-DIGITAL

PACKARD BELL COMPUTER, 1905 Armacost Ave., Los Angeles 25, Calif. New solid-state analog-to-digital converter has a speed of 10,000 conversions per sec at 0.05 percent accuracy and is priced at \$4,500. Either 11-bit binary or 3-digit BCD plus sign is available. It is also available in 4 decimal digits plus sign on special order. Power requirements of the Multiverter M3 are 115/230 v a-c, 50-400 cps, with a maximum consumption of 35 w. Input impedance is operational and therefore absolutely specified at 10,000 ohms per v. Reliability is extremely high due to a low component count, solid-state design, and the absence of eyelets and etched circuit connectors.

**CIRCLE 321 ON READER SERVICE CARD**



## Distributed Amplifier WIDE BAND

Community Engineering Corp., P. O. Box 824, State College, Pa. Capable of amplifying sine waves, symmetrical signals or fast pulses, the model 1004 incorporates a specially designed and constructed p-c board holding inter-wire capacitances to a minimum and assuring long life and trouble free operation. This rack mounted amplifier features careful shielding to eliminate radiation, and easily removable dust covers to protect circuiting. Bandwidth is 10 to 90 Mc and phase response is substantially linear within the pass band. Gain is 40 db, nominal, with a noise figure of better than 8.5 db at 85 Mc. Amplifier delay is approximately 0.03

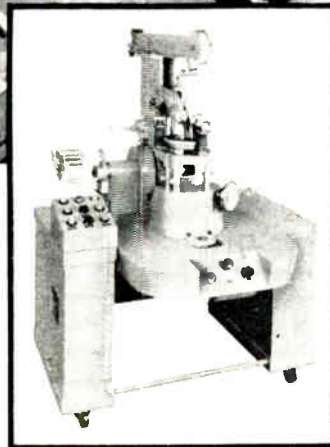
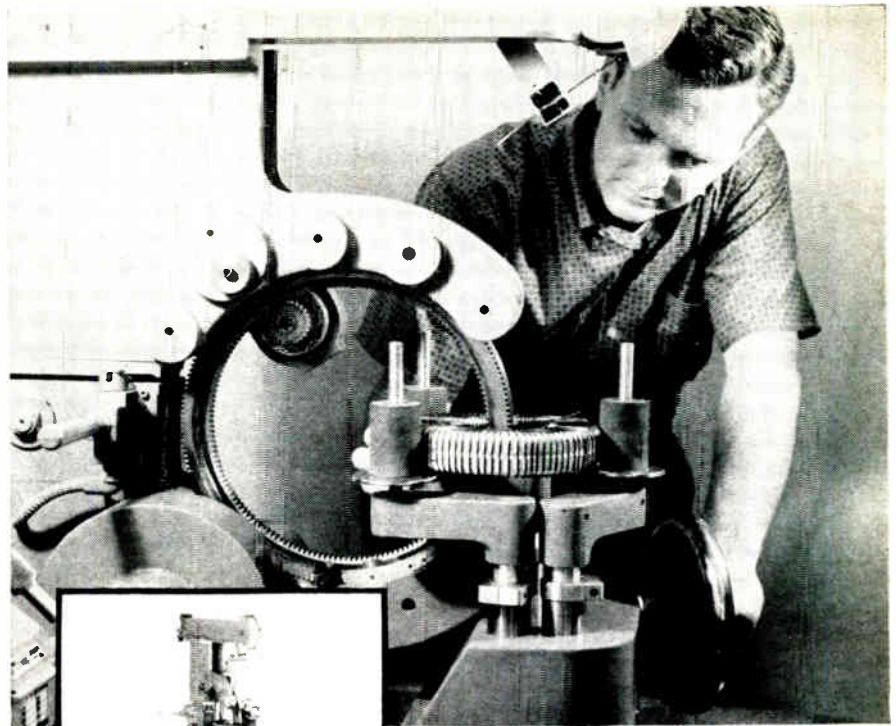

## NEW BOESCH MAXITOR

*winds toroids from #40  
to #7 wire . . . using  
3 interchangeable heads*

Boesch's new MAXITOR Toroidal Coil Winding Machine covers a wide range of applications, including exceptionally large diameter, heavy wire gauge winding jobs. The coil shown above is typical. It is being wound with #10 wire on a MAXITOR machine using Boesch's HW-200 winding head and continuous-winding core holder. Segmental-winding holder is also available.

Two other interchangeable heads are available which make MAXITOR a really versatile machine. The HW-300 head winds wire gauges as large as #7 to finished O.D. as much as 14". HW-100 handles gauges from #40 to #22 to maximum O.D.'s of 10".

And MAXITOR is packed with "dream" features. Pushbutton drive ring and magazine positioning saves set up time. A dial control on the operator's panel provides micrometer brake settings for easiest variable speed tension control. Turn spacing is infinitely variable at the turn of a knob. And the range of winding applications for MAXITOR is apparent in the table below.

Head Type	Min. Final I.D.	Max. Final O.D.	Max. Final Height	Wire Range AWG #
HW-100	1/2"	10"	6"	40 to 22
HW-200	1"	10"	6"	24 to 10
HW-300	2"	14"	10"	20 to 7

WRITE TODAY for complete specifications, prices and delivery information.

**B** **BOESCH MANUFACTURING  
COMPANY, INCORPORATED**  
BOESCH DANBURY, CONNECTICUT

# THERMISTORS

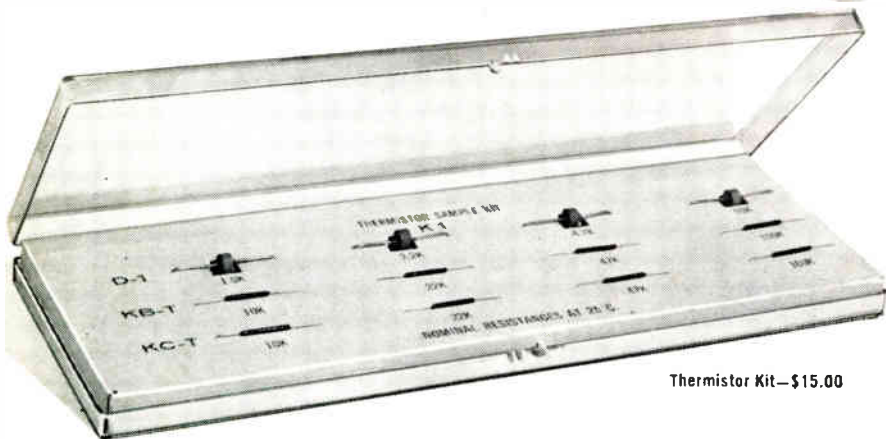

Thermistor Kit—\$15.00

## Now—Kidde experience sets the standard for quality and performance!

**Kidde experience.** For more than ten years, Kidde has manufactured thermistors for use in sensitive aircraft fire detectors. Now, by using the experience gained in this demanding field, Kidde makes available a complete selection of thermistor components for general use.

**Kidde performance.** First developed to meet the rigid specifications of the military, Kidde thermistors have been *proven in performance*. In temperature control, compensation, time delay or voltage regulation, you can be sure of the stabilized characteristics and high temperature capabilities of Kidde thermistors.

**Kidde quality.** By utilizing unique automated manufacturing techniques in the production of thermistors, Kidde can now offer the utmost in thermistor uniformity and quality at the lowest possible price. And, in addition to a wide off-the-shelf selection, Kidde also offers engineering help in the application of thermistors toward the solution of special problems. For more details on Kidde thermistors, and their application to special problems, write today.



ELECTRONICS DEPARTMENT

## Kidde Aero-Space Division

Walter Kidde & Company, Inc., 550 Brighton Road, Clifton, N. J.

CIRCLE 136 ON READER SERVICE CARD

# NEW IDEAS FOR SALE!

Words and pictures tell you about the top new product ideas each week in "On the Market". Who makes 'em and what they'll do for you. Easy way to keep in touch with the latest and best.

Another reason why it will pay you to subscribe to *electronics* (or renew your subscription) right now. Fill in the box on Reader Service Card. Easy to use. Postage free.

FIND WHAT  
YOU NEED IN...

# electronics

$\mu$ sec. Input and output impedance is 300 ohms, type N connectors. Power supply is self contained.

CIRCLE 322 ON READER SERVICE CARD

## Readout System

TEMPERATURE/PRESSURE

TEXAS INSTRUMENTS INC., Geosciences and Instrumentation Division, 3609 Buffalo Speedway, Houston 6, Texas. New digital temperature and pressure readout system reads out from resistance temperature bulbs in the 0-1,400 F range and from resistance pressure transducers ranging from 0-10,000 psi. System reads out combinations both of temperature and pressure. Capable of accuracy in the magnitude of  $\frac{1}{2}$  percent to 2 percent absolute (depending upon range and transducers), the system offers significant cost reduction through the use of copper wiring to transducers in lieu of more expensive thermocouple wiring. In addition to the local readout feature, the system is capable of remote interrogation because information is encoded for telemetering. Temperature and pressure may be monitored from as many as 99 different points.

CIRCLE 323 ON READER SERVICE CARD



## Leak Valve

ADJUSTABLE

VACTRONIC LAB. EQUIPMENT, INC., 21 Monmouth Court, East Northport, N. Y., has available an adjustable leak valve for precise, uniform pressure regulation in the high vacuum region. The Vari-Vac, Cat. VV-40, affords fingertip micrometer control of leak rates ranging from 0.02 to 2 standards ccs per sec. The Vari-Vac valve body contains a sealed stem which has a precise machined groove along its axis. The machined

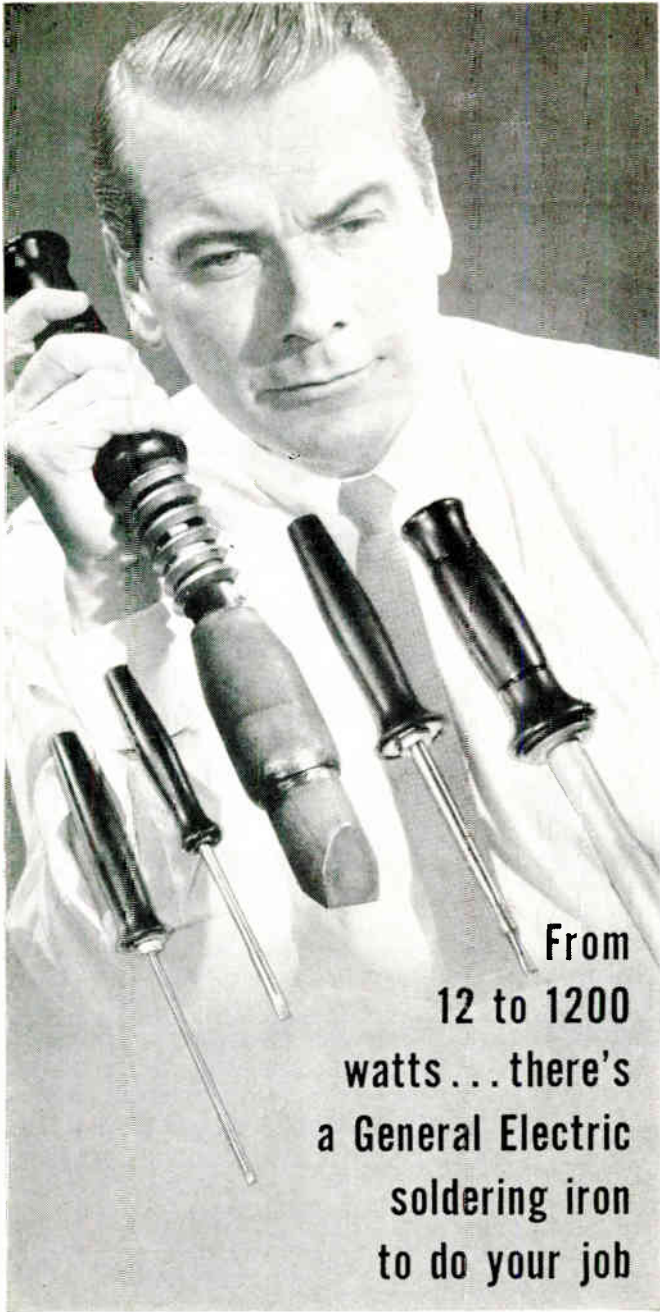

From  
12 to 1200  
watts ... there's  
a General Electric  
soldering iron  
to do your job

... AND GENERAL ELECTRIC WILL HELP YOU  
CHOOSE THE EXACT IRON YOU NEED

Whatever your soldering requirements may be—from complex miniature electronic sub-assemblies to heavy-duty industrial uses—one of the high-speed soldering irons in General Electric's complete line will do the job. The G-E irons shown above include (left to right):

**MINIATURE** for production-line soldering of sub-miniature assemblies.

**MIDGET** for pinpoint soldering of hard-to-reach joints.

**EXTRA HEAVY-DUTY** for industrial high-wattage soldering.

**LIGHTWEIGHT** for soldering of most electronic components.

**INDUSTRIAL** for general industrial soft-solder applications.

For expert assistance in choosing the exact iron you need, contact your General Electric distributor or local G-E Apparatus Sales Office; or write Section 758-03, General Electric Co., Schenectady 5, N. Y.

*Progress Is Our Most Important Product*

**GENERAL  ELECTRIC**

CIRCLE 206 ON READER SERVICE CARD

electronics • MAY 20, 1960

World Radio History

## Fine Laboratory Instrumentation

*designed for easy operation*



Cubic Model 701-B

# Klystron Power Supply

A compact unit providing all electrode and modulation potentials necessary for AM, FM and CW operations in:

- Development work
- Microwave research
- Production test
- VSWR determination
- Attenuation measurement

The 701-B offers these advantages:

- Extended beam voltage operation to 600 V
- CW or square wave operation without re-adjustment of the reflector voltage
- Greater voltage stability
- Switch voltage overlap for proper vernier control operation
- Minimum FM modulation of the klystron
- Human-engineered for convenience

Cubic Corporation for the ultimate in precision electronic equipment:

- Microwave instrumentation
- Test equipment
- And a complete line of digital instrumentation

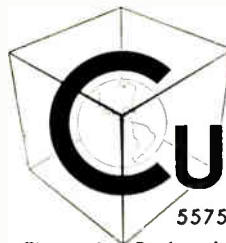

INDUSTRIAL DIVISION

**CUBIC CORPORATION**

5575 Kearny Villa Road, San Diego 11, Calif.

Electronic Engineering With a Dimension for the Future

CIRCLE 137 ON READER SERVICE CARD

137

**NOW!** a new concept in graphic recorder design sets a new standard of

**Versatility, Accuracy, Reliability and Economy!**

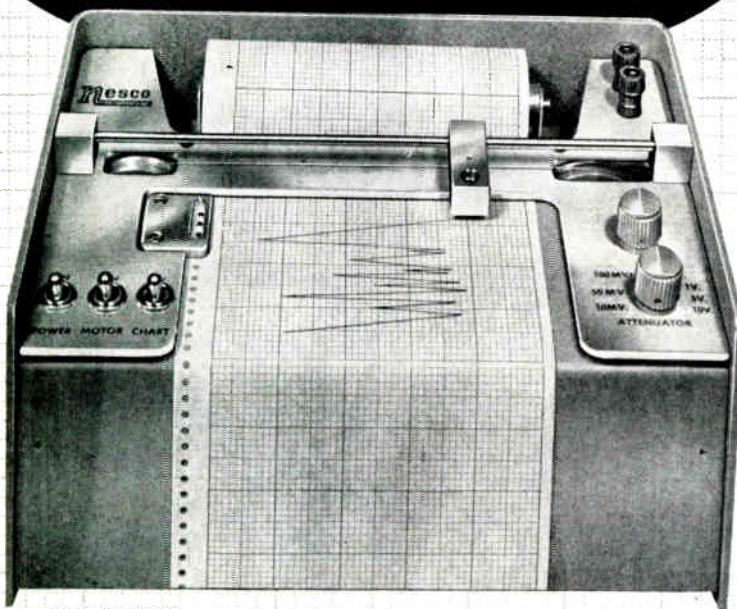

MODEL JY-100

*Engineered specifically for modern laboratories with all the features you've wanted... now only \$320.*

**SOME OUTSTANDING FEATURES**

- Null balance servo type.
- Response time  $\frac{1}{2}$  second full-scale in standard model.
- Sensitivity  $\frac{1}{4}\%$  of span with zero adjustment anywhere on chart.
- $\frac{1}{2}\%$  accuracy.
- Available with step attenuator to max. 100 v.
- 10 mv full scale sensitivity.
- Floating input
- Max. signal source resistance of 100K on 10 mv position.
- Multiple chart speeds from 1 in/hr to 16 in/min.
- 5 inch chart.
- Designed to serve a wide variety of recording needs, for addition of special accessory and optional equipment, and for adaption to special applications.
- Compact cabinet and rack mount models.

WRITE FOR COMPLETE SPECIFICATIONS

**NESCO**  
INSTRUMENTS, INC.

DESIGNERS AND MANUFACTURERS OF PRECISION INSTRUMENTS  
638 WEST 17TH STREET, COSTA MESA, CALIFORNIA

groove varies in depth at a controlled rate per unit length. A vernier drive causes this stem to pass along a sealing surface. By this means, the Vari-Vac provides reproducible leak rates, which may be varied linearly.

CIRCLE 324 ON READER SERVICE CARD

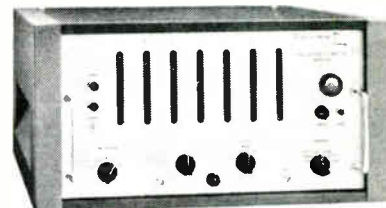

Frequency Meter  
DIGITAL TYPE

BECKMAN INSTRUMENTS, INC., Berkeley Division, 2200 Wright Ave., Richmond, Calif. Model 7175 creates a digital indication of any frequency from 10 cps to 110 Mc. It occupies  $8\frac{1}{2}$  in. of rack space. Meter consists of a 10 Mc counter closely integrated with a simple heterodyne frequency converter. Frequencies up to 10 Mc are measured by the counter alone. Frequencies above 10 Mc are beat against a selected reference frequency to create a difference frequency below 10 Mc. Accuracy far exceeds FCC requirements over communications range. Possible error is said to be only 0.00004 percent or less from 1 Mc to 110 Mc. Sensitivity is 100 mv rms. Input impedance is 1 megohm up to 10 Mc, 100 ohms above 10 Mc. Price is \$1,895.

CIRCLE 325 ON READER SERVICE CARD

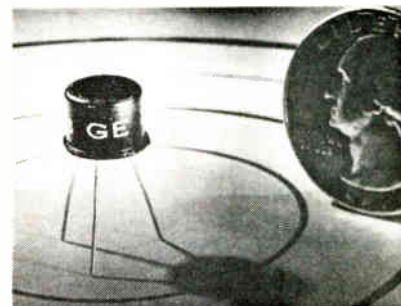

Transistors  
GERMANIUM NPN

GENERAL ELECTRIC CO., Syracuse, N. Y. Types 2N1288 and 2N1289 high speed germanium npn switch-

ing transistors are capable of operation at a frequency of 60 Mc. The computer circuit designer can use them to complement his *pnp* transistor circuits and thus simplify the overall circuitry. In logic circuits the new transistors have a constant gain bandwidth. It is the same at 5 ma at 1 v, collector to emitter, as it is at 1 ma at 5 v, collector to emitter. The 2N1288 and 2N1289 have guaranteed collector to emitter voltage ratings of 10 v and 15 v respectively; both have emitter to base guaranteed ratings of 5 v, and collector to base guaranteed ratings of 15 v and 20 v respectively. All are rated for operation from - 55 C to + 85 C. Typical d-c beta at - 55 C is greater than 70 at a collector current of 10 ma.

**CIRCLE 326 ON READER SERVICE CARD**



### Insulating Varnish SILICONE BASE

MELPAR, INC., 3000 Arlington Blvd., Falls Church, Va. Melvar A-100 silicone base varnish reduces moisture absorption and acts as an insulator. It is particularly well suited for protectively coating transformers, coils, capacitors, resistors, and p-c boards. It protects against electrical leakage caused by contaminants, and provides additional protection against breakdown at high altitudes. Under tests specified in MIL-V-173A, the varnish shows satisfactory fungicidal properties after being exposed to temperatures well in excess of 400 F, its maximum recommended operating temperature. Water-thin and transparent, it can be applied by dipping,

electronics • MAY 20, 1960

computer  
racks,  
consoles,  
& cabinets

CAN  
BREATHE!



## FLUSHING FANS

Models MF, NF and HF fans, with propeller diameters of 5½", 6½" and 8" respectively, are produced to fulfill such design criteria as: high output, light weight, compactness and self-contained construction.

Power requirements are 50-60 or 400 cps, 1Ø or 3Ø. The fans can be mounted with their shafts in any position. Motors can run in both high and low ambient temperatures and require no maintenance. Venturi ring permits simple mounting to a dust filter housing or cabinet wall. Push or pull air-flow available. Mil specs are met.

Write for complete catalog information for the fan that best meets your particular requirements.

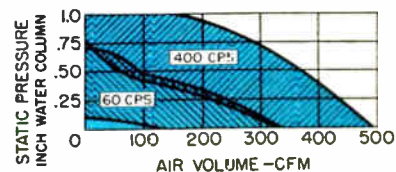

Motors are covered by U.S. Pat. Design No. 174,148. Other U.S. and Foreign Pats. Pend.



**ROTRON** mfg. co., inc.

WOODSTOCK, NEW YORK

In Canada: The Hoover Co., Ltd., Hamilton, Ont.

CIRCLE 139 ON READER SERVICE CARD 139

4-4- 4-4- 4-4- 4-4-

the number to remember

4-4- 4-4- 4-4- 4-4-

for faster soldering!

# KESTER "44" RESIN-CORE SOLDER



You get the fastest possible soldering action with Kester "44" Resin-Core Solder, created for today's high speed requirements. "44" Resin meets all applicable MIL and Federal specifications, latest amendments, Army, Navy, Air Force. Flux-residue non-corrosive and non-conductive. All alloys, cores and diameters... on 1 lb., 5 lb. and 20 lb. spools.

**FREE. WRITE** for 78-page Technical Manual "SOLDER... Its Fundamentals and Usage."

# Kester Solder COMPANY

4204 Wrightwood Avenue, Chicago 39, Illinois  
Newark 5, New Jersey • Anaheim, California • Brantford, Canada

Over 61 Years' Experience in Solder and Flux Manufacturing

140 CIRCLE 140 ON READER SERVICE CARD

brushing, vacuum impregnating or spraying without obliterating component markings.

**CIRCLE 327 ON READER SERVICE CARD**

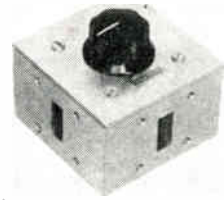

## Waveguide Switch FOR X-BAND

WAVELINE INC., Caldwell, N. J. Model 678-E is a manually operated four part waveguide switch for use over the full range of 8,200 to 12,400 Mc. It is designed for laboratory use or for systems application to make alternate connections between two waveguide inputs and two waveguide outputs. Vswr is less than 1.05 over the range, and crosstalk or isolation between ports is greater than 45 db. Attenuation through any channel of the switch is negligible and power handling capacity is approximately the same as the waveguide itself. Switch measures 3 by 3 in. and flanges are equivalent to UG-135/U with No. 8-32 tapped mounting holes.

**CIRCLE 328 ON READER SERVICE CARD**

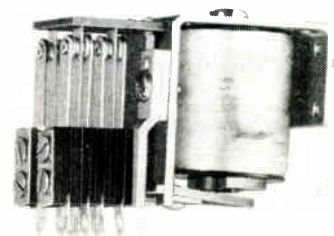

## Medium Power Relay TELEPHONE TYPE

LINE ELECTRIC CO., 229 River St., Orange, N. J. Series TW medium power telephone type relay is available with contact arrangements up to 4 pdt, in voltages from 6 to 220 v a-c and d-c  $\frac{1}{2}$  diameter contacts made of fine silver and gold flashed are rated at 5 amperes at 115/60 noninductive. Coil resistance is 10 K as standard, higher upon request. Applications include: communications equipment, computers, industrial programming devices and

MAY 20, 1960 • electronics

many other applications requiring a small fast-acting multicontact relay. Price is \$5.50 to \$8.05.

**CIRCLE 329 ON READER SERVICE CARD**

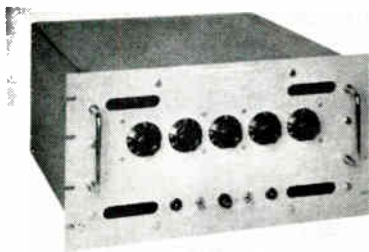

### Current Governor PROGRAMMABLE

NORTH HILLS ELECTRIC CO., INC., 402 Sagamore Ave., Mineola, L. I., N. Y. Model CS-12 current governor is designed especially for meter calibration, transistor and diode forward testing, and as a filament current source. It furnishes currents from 10  $\mu$ a to 1 ampere for load voltages from 0-7 v. The current is set to five places by decade knobs arranged to provide a digital in line read-out. Accuracy at any current setting is 0.05 percent  $\pm$  1  $\mu$ a. Line and load regulation are better than 0.01 percent. Unit is 19 in. by 10 $\frac{1}{2}$  in. by 18 in. and weighs 45 lb. Price is \$995.

**CIRCLE 330 ON READER SERVICE CARD**



### Velocity Indicator VERTICAL TYPE

KEARFOTT DIVISION, General Precision Inc., 1150 McBride Ave., Little Falls, N. J. The T8614-11 servoed vertical velocity indicator is primarily designed to be utilized in submarine and aircraft applications to measure vertical velocity as a function of an a-c input voltage. "Rate of climb" information is presented in feet per sec and displayed on a dial illuminated according to

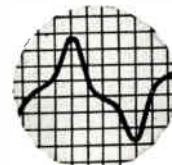
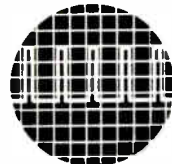
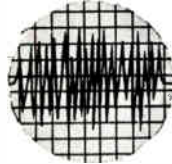
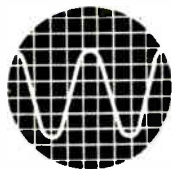

measures  
from

# 100 MICROVOLTS to 320 VOLTS

regardless  
of  
waveform

Price:  
\$445.

# TRUE RMS

frequency range 5 to 500,000 cps

#### FEATURES

Built-in calibrator . . . easy-to-read 5 inch log meter . . . immunity to severe overload . . . useful auxiliary functions

#### SPECIFICATIONS

**VOLTAGE RANGE:** 100 microvolts to 320 volts

**DECIBEL RANGE:** -80 dbv to +50 dbv

**FREQUENCY RANGE:** 5 to 500,000 cycles per second

**ACCURACY:** 3% from 15 cps to 150KC; 5% elsewhere. Figures apply to all meter readings

**MAXIMUM CREST FACTORS:** 5 at full scale; 15 at bottom scale

**CALIBRATOR STABILITY:** 0.5% for line variation 105-125 volts

**INPUT IMPEDANCE:** 10 M $\Omega$  and 25  $\mu$ f, below 10 millivolts; 10 M $\Omega$  and 8  $\mu$ f above 10 millivolts

**POWER SUPPLY:** 105-125 volts; 50-420 cps, 75 watt. Provision for 210-250 volt operation

**DIMENSIONS:** (Portable Model) 14 $\frac{1}{8}$ " wide, 10 $\frac{1}{8}$ " high, 12 $\frac{3}{8}$ " deep—Relay Rack Model is available

**WEIGHT:** 21 lbs., approximately

Write for catalog for complete information

## BALLANTINE VOLTMETER Model 320



— Since 1932 —



**BALLANTINE LABORATORIES INC.**

Boonton, New Jersey

CHECK WITH BALLANTINE FIRST FOR LABORATORY AC VACUUM TUBE VOLTMETERS, REGARDLESS OF YOUR REQUIREMENTS FOR AMPLITUDE, FREQUENCY, OR WAVEFORM. WE HAVE A LARGE LINE, WITH ADDITIONS EACH YEAR. ALSO AC/DC AND DC/AC INVERTERS, CALIBRATORS, CALIBRATED WIDE BAND AF AMPLIFIER, DIRECT-READING CAPACITANCE METER, OTHER ACCESSORIES.

BECAUSE  
IT'S DIGITALLY  
PROGRAMMABLE—  
NEW  
CON AVIONICS  
DC POWER  
SOURCE...



...INSTANTLY PROVIDES ON COMMAND ANY VOLTAGE  
FROM 0.1 TO 50 VOLTS DC — UP TO 15 AMPERES

Another first by Con Avionics, this digitally programmable power source translates manual push-button setting or output of your program device into the selected voltage. It can be made to respond to any digital code from sources such as paper or magnetic tape readers, punched card readers, or keyboards. Voltages may be changed from any setting to any other within 300 milliseconds. Voltage is stable and accurate within  $\pm 0.1\%$  of the selected value. Ripple is less than 0.05% rms.

The completely self-contained design of the Con Avionics DC Power Source eliminates external rheostats, step switches and other devices. This unit reduces equipment complexity in data systems, automatic checkout equipment or precision testing applications.

Outstanding results are obtained both in the lab and on production work.

**CONSOLIDATED AVIONICS CORPORATION**

A SUBSIDIARY OF CONSOLIDATED DIESEL ELECTRIC CORPORATION

800 Shames Drive • Westbury, L. I. • EDgewood 4-8400

the lighting specifications of MIL-L-25467A. Unit contains a transistorized servo amplifier, and incorporates design features meeting applicable portions of MIL-I-983B. The indicator operates reliably even under the environmental extremes specified in MIL-E-5400.

**CIRCLE 331 ON READER SERVICE CARD**



**D-C Power Supply**  
PLUG-IN TYPE

PLUG-IN INSTRUMENTS, INC., 1416 Lebanon Road, Nashville, Tenn. Model SPS-2011-P is a transistorized plug-in regulated d-c power supply. With input of 105-125 v a-c, 60 cps, it is capable of delivering 24 v d-c at 0-90 ma. A trimming adjustment is included. Line regulation is  $\pm 0.01$  percent. Short term load regulation is  $\pm 0.05$  percent (no load to full load) and long term load regulation is  $\pm 0.1$  percent (no load to full load). Ripple is less than 1 mv-rms. With the top cover removed, all critical circuitry is readily accessible for easy maintenance.

**CIRCLE 332 ON READER SERVICE CARD**



**A-F Circuit Aligner**  
L-F INSTRUMENT

KAY ELECTRIC CO., 14 Maple Ave., Pine Brook, N. J. Model M Sona-Sweep is a complete measurement



system for alignment of audio-frequency circuits without tedious point-by-point frequency response checks. The ultrastable unit makes possible continuously adjustable center frequency sweeps—20 cps to 200 Kc, adapting accepted techniques of r-f swept frequency alignment for sonic and ultrasonic design and test work. Continuously variable, narrow sweep range covers 500 cps to 20 Kc, and continuously variable wide sweep widths of 2 Kc to 200 Kc—both linear and logarithmic. The logarithmic 30-cycle sweep, extremely useful for studying audio and video low-pass circuits, provides an expanded view of the low-frequency end, while showing overall frequency characteristics.

**CIRCLE 333 ON READER SERVICE CARD**



## Magnetic Amplifiers 400-CPS UNITS

AIRPAX ELECTRONICS INC., Seminole Division, Fort Lauderdale, Fla. With thermocouple, strain gage, photocell or other low-level input, these amplifiers can deliver 0 to  $\pm 5$  v output into a 50 K load at accuracies of 0.1 percent in a single stage of amplification. Series 5800 PREAC amplifiers feature built-in temperature compensation, a filtered output and inherent high gain and reliability. These d-c amplifiers are applicable to ground multi-channel data amplification and airborne instrumentation and are employed as high reliability and flexible building blocks in instrumentation and control systems. Applications also include linear amplification, null and error detection, summing with electrical isolation,

Multi-turns?

We got 'em!

Multi-turn potentiometer connoisseurs...the men who buy them...turn to Helipot to succeed their circuits.

They make their choice from the nineteen separate and distinct series of HELIPOT multi-turns, each with a myriad of models, scaled from 7/8" dia. x 1-1/2" up to 3-5/16" dia. x 6".

They find it easy to pick the pot that suits their circuit...linear or non-linear... high temperature or standard range... with resolution from a three-turn 0.164% up to a forty-turn 0.00073%...and linearities to  $\pm 0.01\%$ !

Join the well-informed 7 out of 10\* who turn to Helipot. Get the complete story on this profusion of multi-turns (plus a delineation of the HELIPOT single-turn line). Write for Data File A212.

\*Based on a well-known national trade publication's own survey of thousands of pot specifiers and buyers.

Beckman®

/

Helipot®

Helipot Division of Beckman Instruments, Inc., Fullerton, California  
Engineering representatives in 29 cities

60010 © 1959 B. I. I.

potentiometers: dials: delay lines: expanded scale meters: servomotors: breadboard parts



## INSTRUMENTS FOR PRECISION CIRCUIT ANALYSIS

Proved in every type of service, these quality instruments are used by experts for FCC "proof-of-performance" tests and supplied as original equipment with many broadcast station installations.

**Matchmaster.** This versatile test equipment combines three instruments in one self-contained unit. Built in dummy antenna standing wave ratio indicator, direct reading RF watt meter, Model 650 (for 52 ohm line) and Model 651 (for 73 ohm line) indicate transmitter output power up to 125 watts directly. Model 52-500 gives direct readings up to 600 watts and is designed for permanent connection into 50 ohm coaxial lines such as RG-8/U.

**Model 404 Linear Detector.** Combined RF detection and audio bridging circuits for use with any distortion meter, 400 kc to 30 mc range with 20-30 volt RF carrier. Essentially flat frequency response from 20 to 50,000 cps.

**Model 300 Frequency Meter.** Measures audio frequencies to 30,000 cps in 6 ranges. Integral power supply and input level control.



**MODEL 200 AUDIO OSCILLATOR**

- Frequency Range: 30 to 30,000 cycles.
- Frequency Response: Better than -1 db, 30 to 15,000 cycles with 500 ohm load.
- Stability: Better than 1%
- Calibration:  $\pm 3.0\%$  of scale reading
- Voltage Output: 10 volts into 500 ohm load.
- Distortion: Less than .2% at 5 volts output.



**MODEL 400 DISTORTION METER**

- Frequency Range: Fundamentals from 30 to 15,000 cycles. Measures Harmonics to 45,000 cycles.
- Sensitivity: .3 volts minimum input required for noise and distortion measurements.
- Calibration: Distortion measurements  $\pm .5$  db. Voltage measurements:  $\pm 5\%$  of full scale at 1000 cycles.
- Residual Distortion: .05%—30—15,000 cycles.
- Residual Noise: .025% or less.

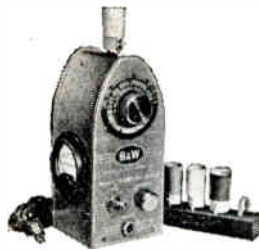

**MODEL 600 DIP METER**

- Covers 1.75 to 260 mc in 5 bands.
- Monitoring jack & B + OFF switch.
- Shaped for use in hard-to-get-at places.
- Sturdy, color coded, plug-in coils.
- Adjustable 500 microamp meter.

integrating, microvolt and micro-ampere measurement.

**CIRCLE 334 ON READER SERVICE CARD**

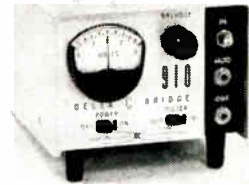

### Capacitance Bridge BATTERY POWERED

**THE DECKER CORP.,** Forty-Five-Monument Road, Bala-Cynwyd, Pa. Model 910-1 a-c capacitance bridge is a general purpose dimensional measurement tool for non-contact or capacitive gaging. The portable transistorized unit has provisions for 60 cps or 400 cps modulation of the carrier. It has a frequency response of 13 Kc. Available with two 10-ft cables providing a sensitivity of  $3.5\text{v}/\mu\text{mf}$  or 30-ft cable with sensitivity of  $0.9\text{v}/\mu\text{mf}$ . Cables up to 50 ft in length may be used between the electronics and point of measurement.

**CIRCLE 335 ON READER SERVICE CARD**

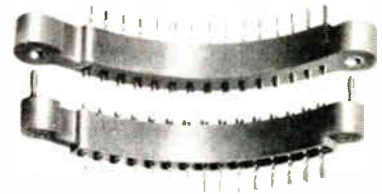

### Radial Connector

**HIGHLY RELIABLE**

**ELCO CORP.,** "M" St. below Erie Ave., Philadelphia 24, Pa. Radial connector illustrated has 15 contacts at approximately 5 deg spacing; guide pins and bushings; set-screw locking device which permanently secures connector in mated position. Connector employs Varicon mating principle; contacts are from Elco series 5000. The forklike Varicon contacts, with 4 mating coined surfaces, assure low contact resistance, high current rating, complete reliability after thousands and thou-

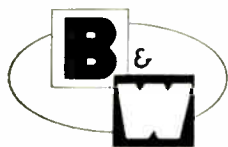

*Barker & Williamson, Inc.*

Canal Street & Beaver Dam Road, Bristol, Penna.

Specialists in Designing and building equipment to operating specifications

B&W also design and manufacture filters for: ANTENNAS • RADIO INTERFERENCE • RADIO RANGE • UHF and VHF as well as many special types designed to performance specifications. Available to commercial or military standards.

**CIRCLE 207 ON READER SERVICE CARD**

# NEW IDEAS FOR SALE!

Words and pictures tell you about the top new product ideas each week in "On the Market". Who makes 'em and what they'll do for you. Easy way to keep in touch with the latest and best.

Another reason why it will pay you to subscribe to *electronics* (or renew your subscription) right now. Fill in the box on Reader Service Card. Easy to use. Postage free.

**FIND WHAT  
YOU NEED IN...**

# electronics

sands of insertions and withdrawals.

**CIRCLE 336 ON READER SERVICE CARD**

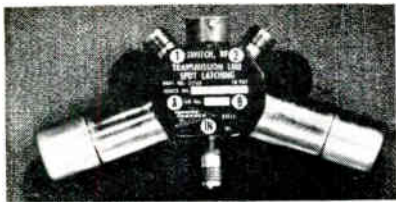

### Latching Switch COAXIAL TYPE

TRANSCO PRODUCTS, INC., 12210 Nebraska Ave., Los Angeles 25, Calif., has available a solenoid actuated coaxial latching switch which requires no holding power. Newly designed solenoids operate from 28 v d-c and draw only 3.2  $\mu$ a/hr—switching time of 10 millisecc. The 50 ohm switch is make-before-break. Weight is 8.7 oz. Frequency range extends to 11,000 Mc with typical specifications at 7,000 Mc of: vswr 1.4; insertion loss 0.4 db; crosstalk 30 db. Type N and TNC connectors presently available—others can be supplied.

**CIRCLE 337 ON READER SERVICE CARD**

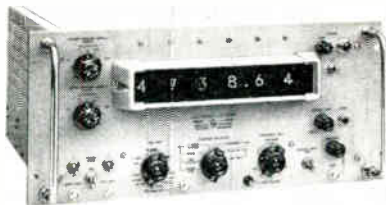

### Electronic Counters ALL-PURPOSE

HEWLETT-PACKARD CO., 275 Page Mill Road, Palo Alto, Calif. Models 523CR and 523DR directly measure frequencies from 10 cps to 1.2 Mc, time intervals from 1  $\mu$ sec to 10<sup>6</sup> sec and periods from 0.00001 cps to 100 Kc. Stability is 2/1,000,000 per week. The 523CR has an in-line readout. Readout of the 523DR is by six columnar neon indicators. The counters have an accuracy of  $\pm 1$  count  $\pm$  crystal stability. Gate times of 0.001, 0.01, 0.1, 1 or 10 sec are selected with a front panel switch. The versatile and self-contained counters also measure phase delay, random events, ratios and—when used with transducers—such

**FOR DEPENDABLE  
HIGH-INTENSITY ILLUMINATION**

**KEMLITE LABORATORIES  
USES "LINDE"**

# XENON

Lighting the way to safer aircraft landings is only one of many important uses for Kemlite Laboratories' new xenon-filled lamps. They are also used in missile-tracking, stroscopic equipment, and the graphic arts, producing light intensities approximating zenith-position sunlight!

LINDE is a leading producer of rare gases which include xenon, krypton, argon, and neon. These are extracted through a unique liquefaction process pioneered by LINDE to meet the most rigid standards of purity for highly critical applications. For example, LINDE produces xenon of highest purity available, yet this gas exists as only one part in 12 million in atmosphere!

LINDE was first to produce many of the rare gases in wide use today. These are available in pure or mixed form. Mixtures can also be supplied with the radio-active isotope Krypton-85 as an additive.

For information, write Linde Company, Division of Union Carbide Corporation, Rare Gases Dept. E-53, 30 East 42nd Street, New York 17, N.Y. In Canada: Linde Company, Division of Union Carbide Canada Limited, Toronto 7.

*"Kemlite"*  
Flash Lamp  
Type S-471

**Linde**  
TRADE MARK

**UNION  
CARBIDE**

"Linde" and "Union Carbide" are registered trade marks of Union Carbide Corporation.

## Important facts to know about laminated plastics

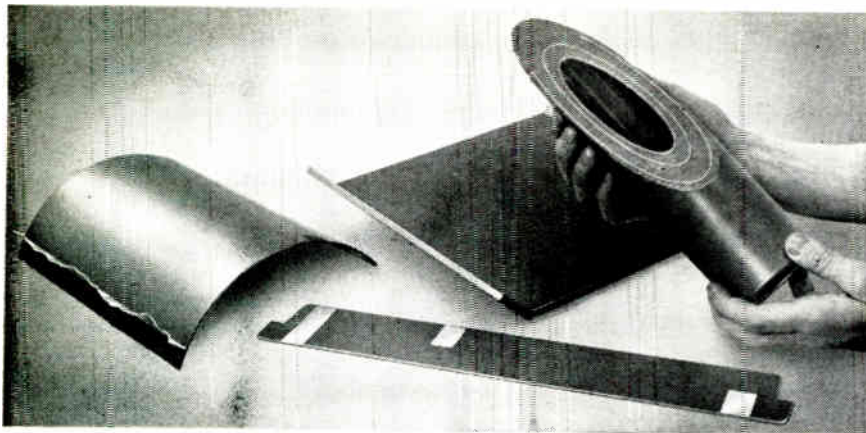

A few Taylor composite laminates (left to right): copper-clad section; sandwiched copper component; Taylorite vulcanized fibre-clad part; laminated tube, copper inserts.

## Composite Laminates Open Up New Design Opportunities

While the great variety of commercially available laminated plastics satisfy most electrical and mechanical requirements, there are applications that can benefit from the combination of properties provided by composite laminates. Recent advances in bonding techniques have made it possible to bond virtually any compatible material with a laminate. These can be supplied as clad or as sandwiched materials. And they can be molded into many shapes to fit design requirements. Taylor is presently supplying to order the following composite laminates:

- **Copper and laminated plastics.** Clad for printed circuits and formed shapes. Sandwiched for special applications.
- **Taylorite® vulcanized fibre-clad laminates.** These combine the high strength of laminated plastics with the superior hot-arc-resistance of vulcanized fibre. They are being used in both high and low-voltage switchgear applications. Also in applications where the high impact strength of vulcanized fibre may be advantageous.
- **Rubber-clad laminates.** Almost any type of natural or synthetic rubber may be used as the cladding material. These laminates are widely used for condenser tops in wet condensers to protect the laminate against highly alkaline electrolytes. They also have application in any part where sealing or chemical resistance is needed.
- **Asbestos-clad laminates.** For applications where high heat- and arc-resistance are required.
- **Laminate-clad lead.** Lead sheets sandwiched between Grade XX pa-

per-base laminates have been used for X-ray shields. The laminate provides strength and contributes to the high shielding properties of the lead.

- **Aluminum-clad laminates.** These have been used extensively for engraving stock. They also offer possibilities as printed-circuit material and as plate holders for X-ray machines.
- **Beryllium copper-clad laminates.** Beryllium copper is nonmagnetic and a good conductor—properties that give these laminates possibilities in many applications.
- **Stainless steel-clad laminates.** Applications where nonmagnetic properties are required. Also in certain corrosive environments where the resistance of stainless steel to attack is an asset.
- **Magnesium-clad laminates.** These laminates have been produced in 108-in.-long sheets for use as screens for X-ray operators. Weight was a factor.

Our design and production engineers are constantly developing new materials, new applications, and new procedures for fabricating laminated plastics. Our experience is yours for the asking. And if you have a problem requiring assistance or more information on composite laminates, write us. Also ask for your copy of Taylor's new guide to simplified selection of laminated plastics. Taylor Fibre Co., Norristown 40, Pa.

**Taylor**  
LAMINATED PLASTICS VULCANIZED FIBRE

physical variables as speed, weight, pressure, temperature and flow.

CIRCLE 338 ON READER SERVICE CARD

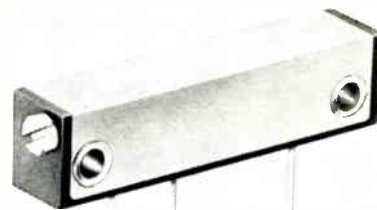

## Potentiometer

### TRIMMER TYPE

CTS CORP., Elkhart, Ind., has developed a trimmer potentiometer with MIL-R-94 type carbon element, a contact mechanism with long spring arms for adequate spring range in limited space, and a 25 turn lead screw with clutch stops. Series 140 is also available with 18 turn lead screw with fixed stops. Power rating is 0.2 w at 70 C with maximum operation up to 125 C. Infinite resolution is provided by the extremely stable carbon resistance element. Resistance range is 500 ohms through 1 megohm (linear taper) and case size 1 1/2 in. by 1/2 in. by 3/4 in. Available with insulated leads or p-c pins.

CIRCLE 339 ON READER SERVICE CARD

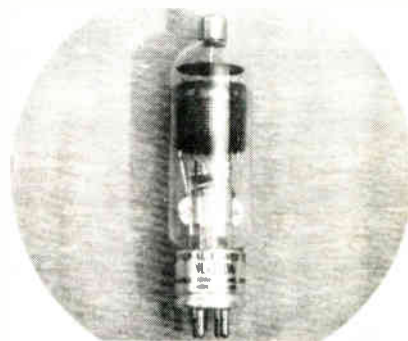

## H-V Thyatron

### 2.5-AMPERE UNIT

NATIONAL ELECTRONICS, INC., Geneva, Ill. The NL-710A is a 2.5 ampere, 2,500 peak inverse and forward voltage thyatron designed especially for the higher voltages encountered in the new spike welding applications. Other ratings are the same as the NL-710/6011: filament volts, 2.5; filament current, 9 amperes; peak anode current, 30 amperes; average anode current, 2.5

amperes; and condensed mercury temperature limits of - 40 to + 80 C.

**CIRCLE 340 ON READER SERVICE CARD**



### Ceramic Capacitors RESIN-DIPPED

SPRAGUE ELECTRIC CO., North Adams, Mass., has available Monolithic capacitors using high dielectric constant Formulation 23 body. Into a small rectangular block  $\frac{1}{2}$  in. by  $\frac{1}{2}$  in. by  $\frac{1}{8}$  in. thick, it is possible to pack a capacitance of as much as 2.2  $\mu$ f at 25 v d-c or 0.47  $\mu$ f at 50 v d-c. The new capacitors are made by spraying alternate layers of ceramic dielectric material and metallic electrodes until the desired capacitance is achieved, using automatic machinery especially made for the purpose. The resultant capacitors are solid homogeneous blocks. They are then protected against moisture and mechanical damage by a resin dip.

**CIRCLE 341 ON READER SERVICE CARD**



### Delay Lines HIGH DENSITY

VALOR INSTRUMENTS, INC., 13214 Crenshaw, Gardena, Calif. Revolutionary network and construction developments led to a delay line series which offers a 10:1 size and weight reduction over conventional lines. The high density of 150 lumped constant sections per cu in. is achieved by using unique design and construction approaches plus subminiature toroidal inductors and special disk capacitors. Units with delays of 0.1 to 20  $\mu$ sec, 100 to 2,000

# Double Duty in Space



THE NEW Nems-Clarke 1906 AM/FM/CW Receiver has been reduced in height from 8 $\frac{3}{8}$ " to 3 $\frac{1}{2}$ " with no sacrifice of performance. With a tuning range of 30-260mc it gives more information while using less space. The 1906 Receiver has wide application in surveillance, countermeasures, direction finding and similar specialized military functions.

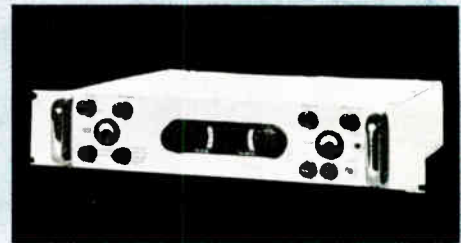

### 1906 RECEIVER

Tuning Range ..... 30-260mc (two bands: 30-60mc, 60-260mc switched)  
 Noise Figure ..... 6db maximum  
 Input Impedance ..... 50 ohms unbalanced to Type N connector on rear apron  
 IF Rejection ..... 65db minimum  
 Image Rejection ..... 60db minimum  
 IF ..... 21.4mc  
 IF Bandwidths: 300kc, 20kc (switchable from front panel)  
 Power Input: 115/230v AC, 50/60 cycles, 100w approx.  
 Size ..... 19" wide, 3 $\frac{1}{2}$ " high, 15" maximum depth

## NEMS-CLARKE CO.

A DIVISION  
OF VITRO  
CORPORATION  
OF AMERICA

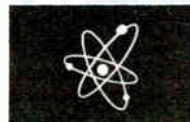

919 JESUP-BLAIR DRIVE  
SILVER SPRING  
MARYLAND

PRECISION ELECTRONICS SINCE 1909

# MORE NEWS ABOUT SILICON POWER RECTIFIERS

The **NEW**  
Fansteel  
**35**  
**AMP.**



## 1N SERIES TYPE 4B

1N 1183	1N 1185	1N 1187	1N 1189
1N 1184	1N 1186	1N 1188	1N 1190

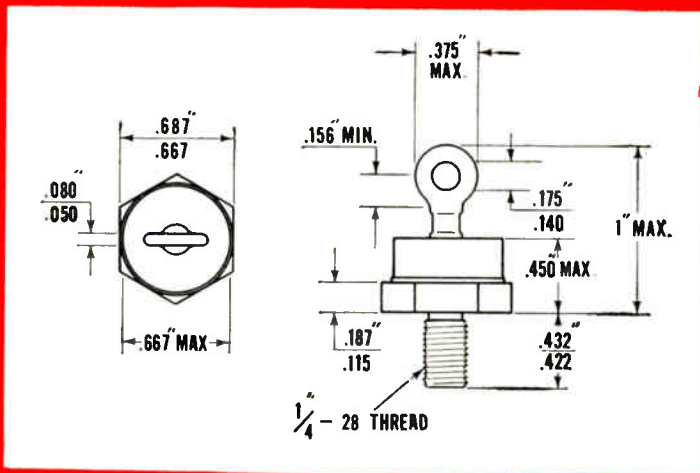

Full 35 amp. load in half-wave circuits; up to 105 amps in bridges. Operating temperatures up to 190°C junction temperature. Peak reverse voltages 50 to 600 V. Storage temperatures from -65°C to +175°C.

Also available to meet Military Specifications MIL-E-1/1135 (USAF)

Write for complete technical data



where reliability  
dictates standards

FANSTEEL METALLURGICAL CORPORATION North Chicago, Ill., U.S.A.

ohms impedance, 100:1 delay to rise time ratios and attenuations as low as 0.008 db (1 percent) are available.

CIRCLE 342 ON READER SERVICE CARD

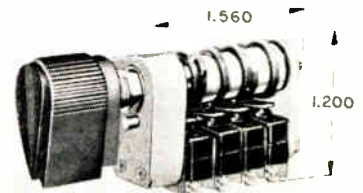

## Rotary Switches

### DECIMAL-BINARY

MICRO SWITCH, Freeport, Ill., announces ten new decimal-to-binary rotary switches which convert decimal constants to a positional number code. Primarily for computer control consoles, the switches are available keyed to various binary code combinations (straight binary; excess 3; 2-4-2-1 or gray). Selectors are available with 8 or 10 detented positions, yet only 1.3 sq in. of mounting surface is required. Double turret terminals allow easy wrap-around solder connections, with all wiring on one plane. Each plastic-enclosed precision switch is spdt, with gold contacts for reliable long life. Electrical rating is 0.5 ampere inductive, 1 ampere resistive at 30v d-c.

CIRCLE 343 ON READER SERVICE CARD

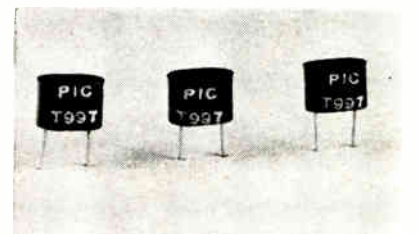

## Components

### MINIATURIZED

POLYPHASE INSTRUMENT CO., East Fourth St., Bridgeport, Montgomery Co., Pa., announces a new line of transformers, filters and inductors called PICO Tran, PICO filters, PICO Ductors, and PICO coils. Typical of these miniature units is a precision inductor for delay lines or filters; a PICO Ductor with specs as follows: inductance 13

microhenries  $\pm 1$  percent; Q is 125 at 2.5 Mc; temperature stability, inductance constant within  $\pm 0.5$  percent over  $-20$  C to  $75$  C; epoxy encapsulated  $\frac{3}{8}$  in. by  $1$  in. by  $1$  in.; shielding is provided by a well closed magnetic circuit.

**CIRCLE 344 ON READER SERVICE CARD**

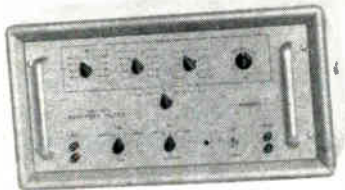

### Band-Pass Filter SELECTIVE UNIT

DYTRONICS CO., P. O. Box 3676, Columbus 14, Ohio. Model 720 is a narrow bandpass selective filter for operation over a frequency range from 1.0 cps to 10,000 cps. Frequency is selected by a digital selection technique using a set of four dials. A three-position gain selector switch permits gain settings of either  $-20$  db,  $0$  db, or  $+20$  db. The filter selectivity is adjustable with a maximum selectivity of  $\pm 2.3$  percent to the 3 db down points. The filter offers 38 db rejection to 3rd harmonic with a maximum attenuation rate near the center frequency of 250 db/octave. Filter is ideally suited for separation of closely spaced frequency components that are not necessarily harmonically related.

**CIRCLE 345 ON READER SERVICE CARD**



### Magnetic Pickups HIGH TEMPERATURE

ELECTRO PRODUCTS LABORATORIES, INC., 4500 N. Ravenswood Ave., Chicago 40, Ill. The 3100 series of magnetic pickups are capable of operating at temperatures as high as 800 F. They are wound with a special copper and nickel magnet wire

electronics • MAY 20, 1960

# PROOF!

THAT FANSTEEL'S SHOULDER  
AND CURL DESIGN\* PROVIDES  
THE BEST METHOD OF  
SEALING A TANTALUM  
ELECTROLYTIC CAPACITOR

\*Pat. No. 2,744,217

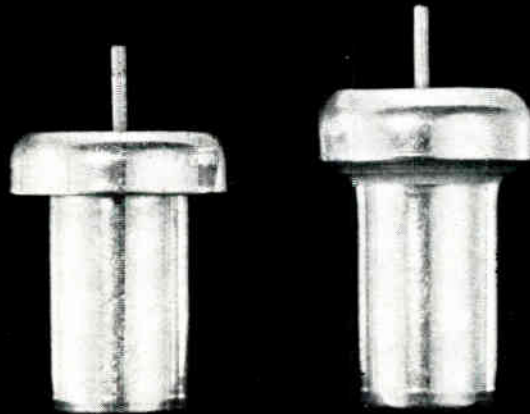

BEFORE TEST

AFTER TEST

This unretouched photo (twice actual size) shows a Fansteel "PP" type tantalum capacitor before and after being subjected to internal pressures of 600 psi. As shown, the test resulted in a stretching and deformation of the silver case, but no failure or leakage whatsoever in the seal.

## What Every Designer and Engineer Should Know About This Seal



The shoulder and curl design of the silver case results in a spring action on the seal assembly at all times... and this downward pressure and tension remains constant throughout the capacitor's temperature range. Two gaskets—one above, one below the tantalum disk—create an air space, the only effective barrier against capillary action. Part of the upper gasket is formed into the curl for a perfect seal between case and gasket unaffected by varying temperatures. All gasket materials are carefully selected and controlled in their parameters so as not to interfere with the curl's spring action. There can be no loosening of this seal due to compression set. This is a perfect tantalum capacitor seal; it is a part of every Fansteel tantalum electrolytic capacitor.

Write for latest technical bulletins

**FANSTEEL®**

where reliability  
dictates standards

C5044

**FANSTEEL METALLURGICAL CORPORATION** North Chicago, Ill., U.S.A.

CIRCLE 149 ON READER SERVICE CARD 149

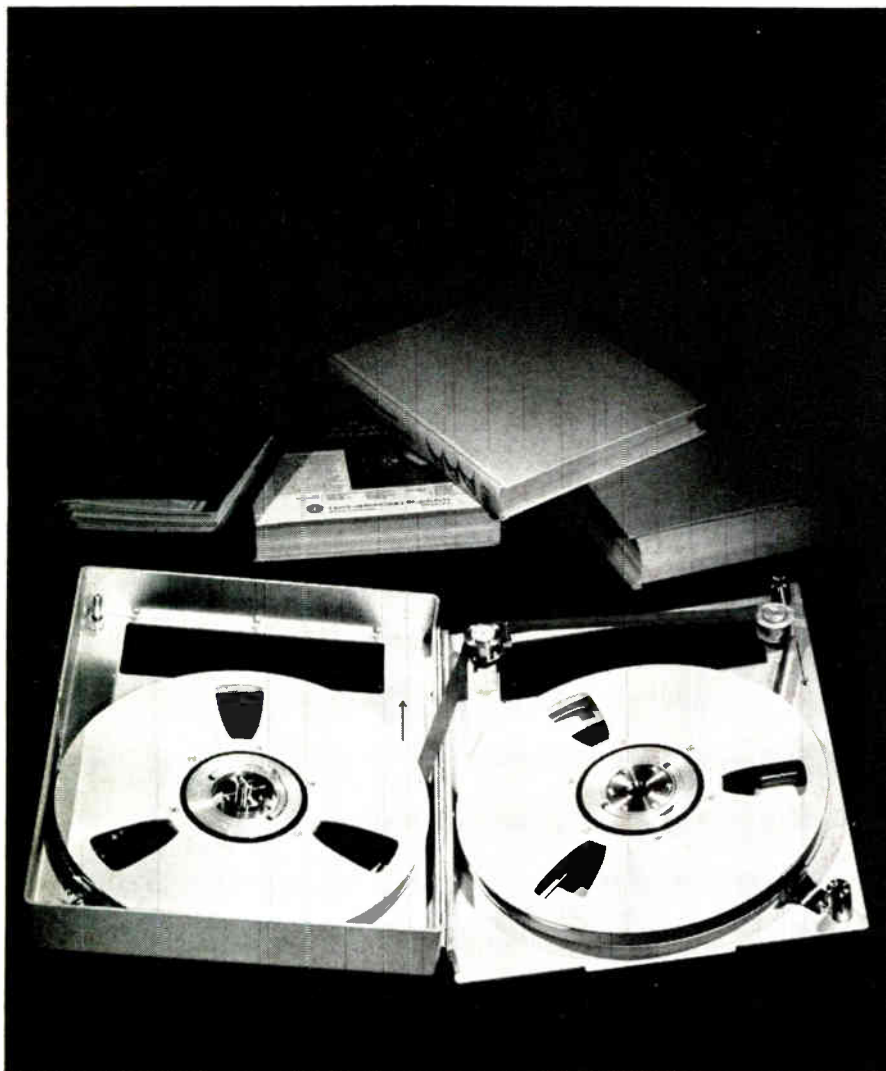

## P. I. tape recorder secret is an open book

A unique stacked-reel tape magazine is one of many space-saving secrets which enable Precision instrumentation recorders to out-perform conventional magnetic tape instruments many times their size. Other design secrets are push-button selection of function and speed, light beam end-of-tape sensing, front panel calibration and testing, interchangeable tape loop magazines, and all-solid-state plug-in electronics.

All the secrets of these recorders are unveiled in detailed new brochure 55B. Write for your copy today.

*P. S. - Here's an installation secret - two complete 14-channel analog (or 16-channel digital) recorders mount in only 5 1/2" of vertical rack space.*

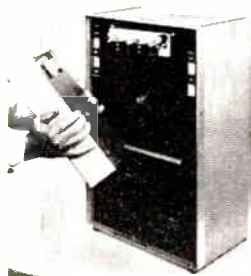

14-CHANNEL  
PRECISION RECORDER  
Loaded magazines can be  
interchanged in 5 seconds.



**PRECISION INSTRUMENT COMPANY**  
1011 Commercial Street • San Carlos • California  
Phone LYtell 1-4441 • TWX: SCAR BEL 30

REPRESENTATIVES IN PRINCIPAL CITIES THROUGHOUT THE WORLD

150 CIRCLE 150 ON READER SERVICE CARD

and insulated with a ceramic material to permit operation at high temperatures. The pickups are mounted in a 3-in.-18 internally threaded hole. Connections can be made by means of silver brazing to lugs or by means of a special 1000 F mating connector. Stocks are available in both lug and connector forms and semi-rigid 1000 deg cable can be supplied on special order. They have no moving parts, and make no contact with the equipment that activates them. They do not require auxiliary bearings, shafts, or special housings.

**CIRCLE 346 ON READER SERVICE CARD**

## D-C/D-C Converter MEETS MIL-E-5272C

POWER INSTRUMENTS CORP., 235 Oregon St., El Segundo, Calif. New transistorized d-c/d-c converter features 0.1 percent regulation for  $\pm 10$  percent line change as well as 100 percent load change. Nominal input is 28 v d-c and the output is 150 v d-c, 0-250 ma. Ripple is 0.5 percent pp. Size of the unit is 3.75 in. by 4.5 in. by 3.75 in. and it weighs 3.2 lb. It meets all requirements of MIL-E-5272C.

**CIRCLE 347 ON READER SERVICE CARD**

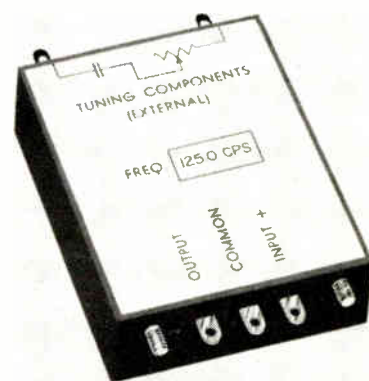

## Audio Oscillator TRANSISTORIZED

ALLEN ORGAN CO., Components Division, Macungie, Pa. Type C transistorized oscillator provides a frequency adjustment range of  $\pm 2$  percent by means of two external components. An input of 12 v d-c at 3 ma will produce up to 4 v rms into a 200 K ohm load with a choice of either sinusoidal or peaked waveform. Frequency drift is less than

MAY 20, 1960 • electronics



0.27 percent from 22 to 50 C. Unit is encapsulated with typical dimensions of 3½ in. by 2½ in. by 1 in. for a frequency of 125 cps.

**CIRCLE 348 ON READER SERVICE CARD**

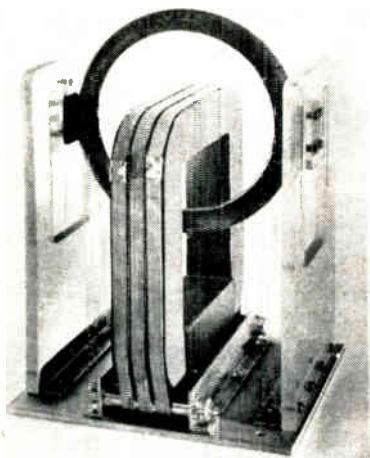

### Filament Transformer LOW CAPACITANCE

PEARSON ELECTRONICS, INC., 707 Urban Lane, Palo Alto, Calif. Low capacitance high voltage insulated filament transformer is rated at 300 Kv pulse immersed in oil or 30 Kv pulse, a-c, or d-c in air. Variety of output voltages and currents available including the common heater voltages for high power klystrons, twt's, hydrogen thyratrons, high voltage diodes, magnetrons, etc.

**CIRCLE 349 ON READER SERVICE CARD**

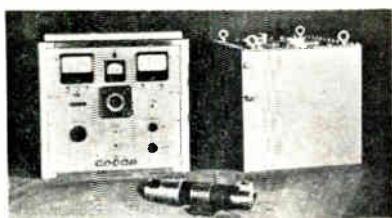

### X-Ray Generator HIGH INTENSITY

BRACKE-SEIB X-RAY CO., INC., 16 Pelham Bay Park West, Pelham Manor, N. Y. Model 60-50-FW-IP x-ray generator produces high intensity soft x-rays for environmental or other studies requiring radiation in the range from 5 to 50 Kv at intensities ranging to the order of 10<sup>6</sup> R/min. Water cooling of the x-ray tube and transformer unit permits continuous operation at maximum rating of 50 Kv at 50

electronics • MAY 20, 1960

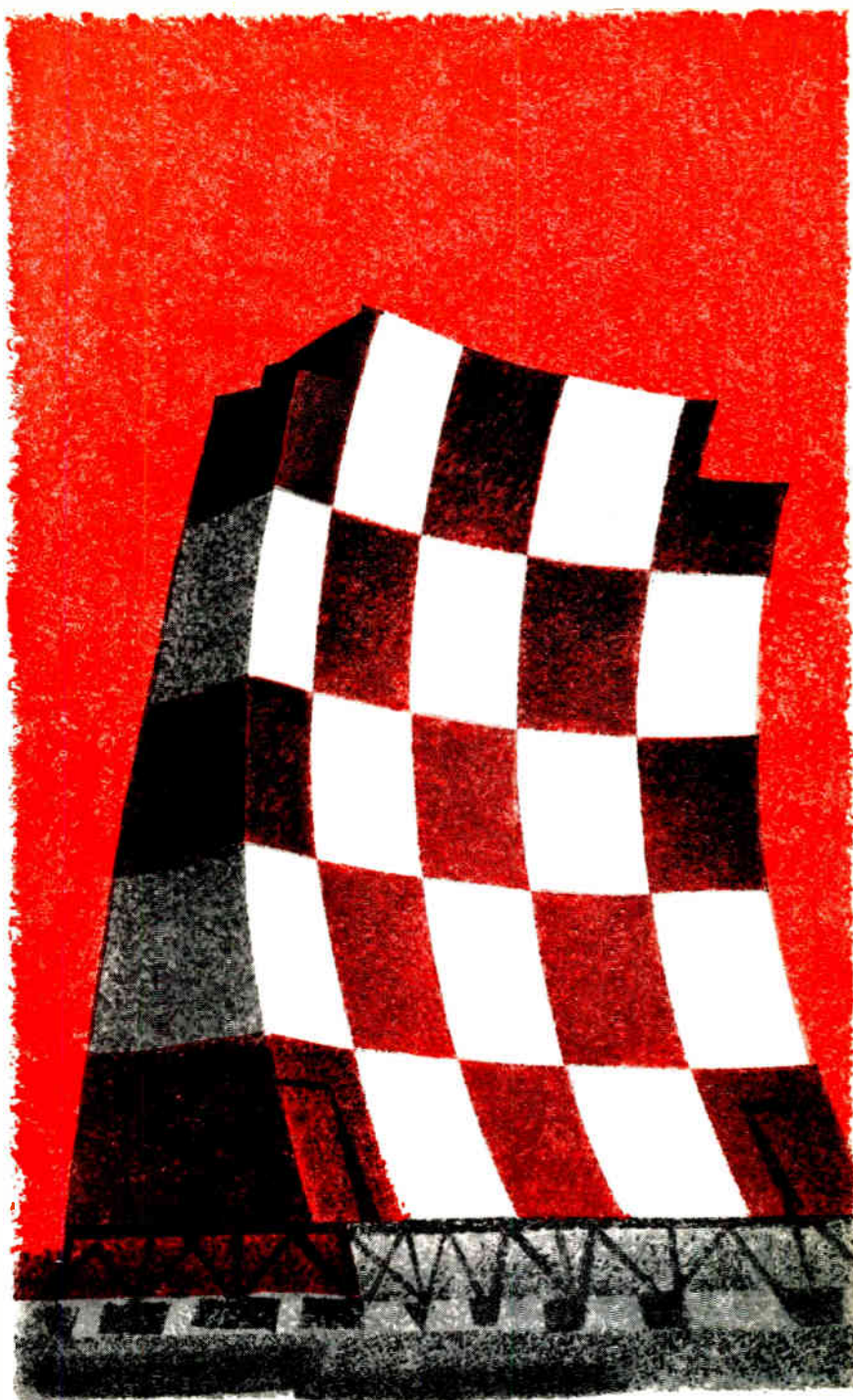

**ADVANCED ENGINEERING  
PRECISION FABRICATION**  
to convert your antenna concepts  
into reliable structures. For information,

contact the Blaw-Knox Equipment Division, Pittsburgh 38, Pa.

**BLAW-KNOX**  
ANTENNAS

CIRCLE 151 ON READER SERVICE CARD

151

# TWO POTS

## for missile pressure measurement

Here's a rugged pair—  
one for low pressures and  
one for high pressures—  
that can really take shock  
and vibration. That's why  
*accurate* in-flight missile  
pressure measurement is  
their particular specialty.

**THE HIGH-PRESSURE 4-383**  
comes in gage and absolute  
models that measure  
pressure from 600 to 3500  
psi. It's a helical Bourdon  
tube instrument, oil filled  
and featuring welded  
construction of 304  
stainless steel (no gaskets  
or O-rings)... fail-safe  
case that takes 5000 psi  
...vibration resistance  
to 35 g's.

**THE LOW-PRESSURE 4-380A**  
uses a force-summing  
pressure capsule and a  
pot to measure absolute,  
gage, or differential  
pressures from 0 to 100  
psi. It features a balanced  
dual flexure pivot for  
extreme resistance to the  
effects of shock and  
vibration.



ma. The x-ray tube features a low  
absorption beryllium window and  
is available in a variety of target  
materials.

**CIRCLE 350 ON READER SERVICE CARD**

## Instrument Wire

### ULTRA-THIN

MECHTRON DIVISION of Tensolite  
Insulated Wire Co., Inc., 1000 N.  
Division St., Peekskill, N. Y. A line  
of instrument wire in unlimited  
lengths offers stranded silver plated  
copper conductors from Awg 28  
(7/36 stranding) down to Awg 36  
(7/44 stranding) with extremely  
thin (1 mil to 6 mil) Teflon insula-  
tion walls. Solid silver plated cop-  
per conductors from Awg 20 to  
Awg 36 are also available with the  
ultra-thin insulation. The wire is  
rated for 300 v at temperatures  
from -90 to +250 C, and is avail-  
able in 12 colors.

**CIRCLE 351 ON READER SERVICE CARD**

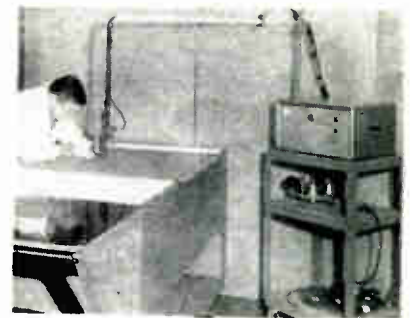

## Splice Welder

### HIGH-SPEED

HEXCEL PRODUCTS INC., 2332  
Fourth St., Berkeley, Calif. New  
splice welder was specifically de-  
signed for high-speed precision  
splicing of structurally critical  
honeycomb core materials. It can  
average 12 to 15 welds per sec—  
compared to one weld per sec for  
comparable hand welders. Elec-  
tronically, the unit is composed en-  
tirely of transistors and other solid  
state devices with the exception of  
one premium quality electron tube.  
No thyatrons, ignitrons or similar  
devices are used. Solenoid valve  
life is estimated at over 10 million  
operations. In addition to normal  
heat setting, both welding fre-  
quency and interval spacing are  
completely adjustable. High quality  
node welds in materials ranging

**←CIRCLE 152 ON READER SERVICE CARD**

*You'll want more information on these pot pressure transducers  
that operate in a range of -65°F to +200°F—with resistance of  
5000, 7500, and 10,000 ohms. Write for Bulletins CEC 1604-X29  
and 1625-X4, or provide us with your exact requirements for a  
custom-engineered instrument.*

Transducer Division

# CEC

**CONSOLIDATED ELECTRODYNAMICS / pasadena, california**

A SUBSIDIARY OF **Bell & Howell** • FINER PRODUCTS THROUGH IMAGINATION

from 0.001 in. up to and including 0.010 in. thicknesses are possible.  
**CIRCLE 352 ON READER SERVICE CARD**

### Copper Coating FOR PRINTED CIRCUITS

ETCHOMATIC, INC., 182 Newton St., Waltham, Mass. "Conduct-a-Coat" is an electrically conductive copper coating for a new, simple, positive and economical way to plate through-holes in printed circuits. It is applied by dipping, removing excess, oven-drying, light sanding and copper strike. Manufacturer claims this process fills and levels irregularities, contributing to a smoother, precision plated hole. Unlike chemical deposition processes, "Conduct-a-Coat" does not require expensive equipment or laboratory controls. Price for a 6 oz sample kit is \$5.95.

**CIRCLE 353 ON READER SERVICE CARD**



### Life-Test Oven FOR COMPONENTS

ITT, COMPONENTS DIVISION, 815 San Antonio Road, Palo Alto, Calif., introduces an elevated-temperature thermostatically controlled life-test oven with complete internal power supply and test-facility circuitry. Unit handles 660 bipolar components or 330 tripolar devices. Standard units are rated at 125 C maximum. Components are carried in low-resistance electrical clips on mounting racks of expanded metal. These have self-mating connectors on their rear surfaces and the related circuitry permits either connection of all racks to a common power supply or each to an individual one. This Teflon-insulated wiring terminates in a patch panel above the oven, by means of which electrical checking of the components under test can be performed

**CIRCLE 153 ON READER SERVICE CARD** →

# A UNIVERSAL RECORDING OSCILLOGRAPH

*with 3-process capability*

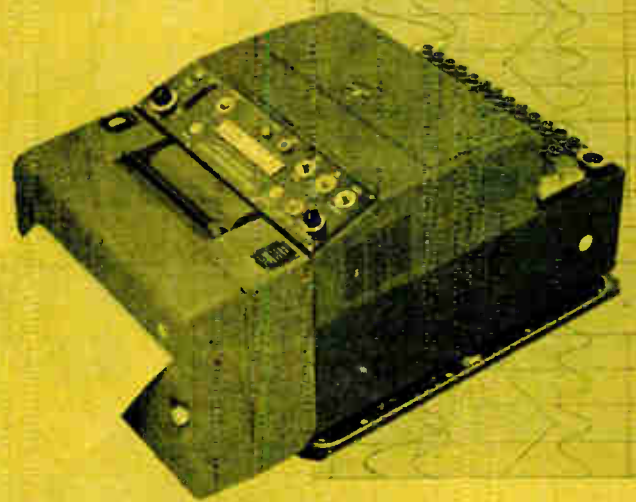

It's a print-out oscillograph...an automatic processing rapid-access oscillograph...a conventional oscillograph. It's a single engineering research tool with directly interchangeable magazines that precisely records up to 50 channels of static or dynamic data—simultaneously.

CEC's 5-119V Recording Oscillograph is designed with twin recording banks of individual magnet blocks, each with its own galvanometer light source. This lets the test engineer record low-speed data with low light intensity and high-speed data with high light intensity—simultaneously.

The 5-119V converts quickly to:

A *print-out oscillograph* with a high-actinic light source and a slot-exit magazine that clearly resolves writing speeds in excess of 50,000 ips...reproduces records on standard print-out papers without chemical processing.



An *automatic processing rapid-access oscillograph* that processes standard photographic papers... provides ready-to-read test results in 0.8 second after exposure at 25 inches per second.

A *conventional oscillograph* using 12-inch recording films or papers that are processed after the record run.

For complete details on the 5-119V and its accessories, call your nearest CEC sales and service office or write today for Bulletin CEC 1536-X15.



Electro Mechanical Instrument Division

# CEC

**CONSOLIDATED ELECTRODYNAMICS / pasadena, california**

A SUBSIDIARY OF **Bell & Howell** • FINER PRODUCTS THROUGH IMAGINATION  
 World Radio History

As tall as a  
7-story  
building...  
but it uses  
tiny BRISTOL  
CHOPPER

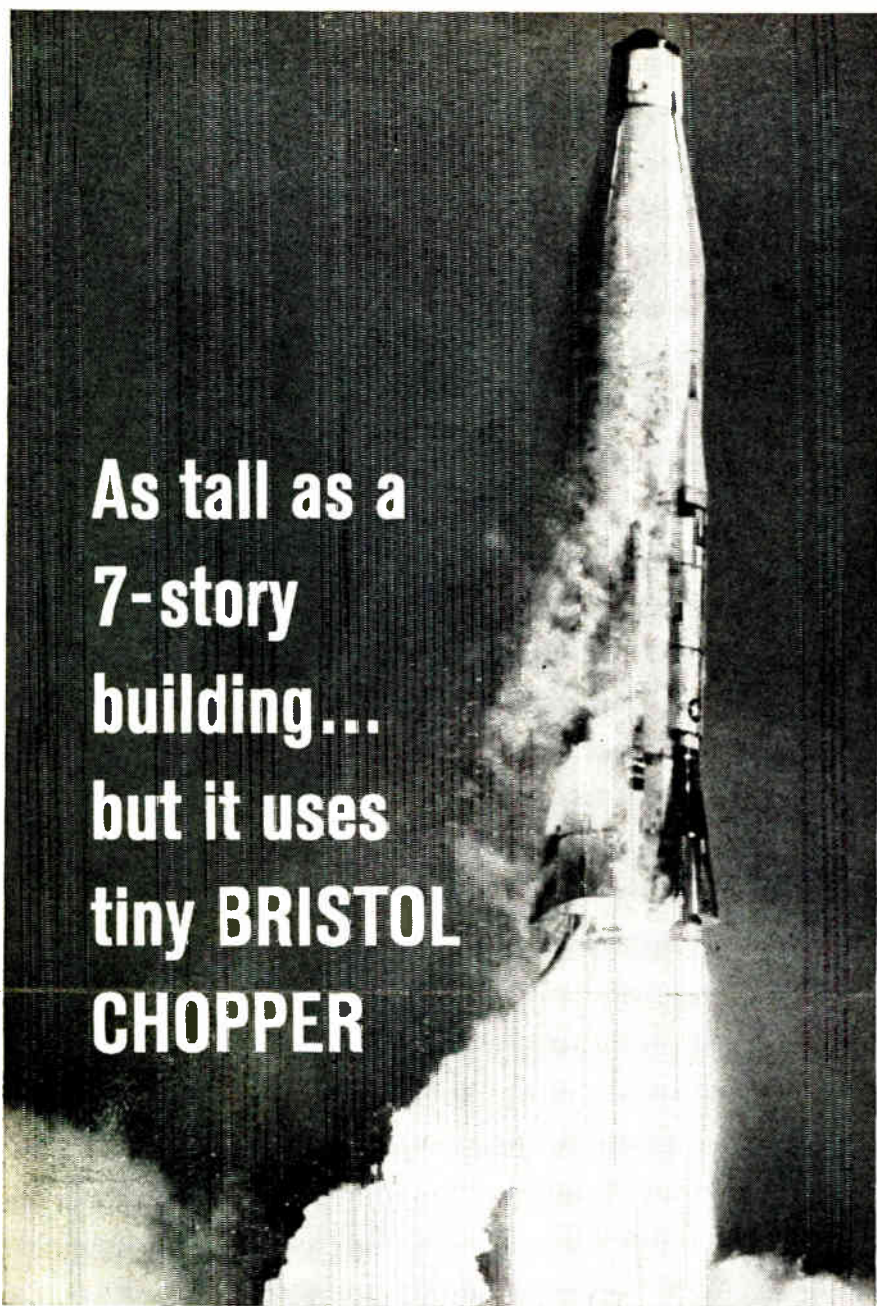

More than 40,000 parts, each of which must meet the most stringent reliability standards, make up the U. S. *Atlas* intercontinental ballistic missile, built by prime contractor Convair (Astronautics) Division, General Dynamics Corporation.

Among these parts is the Bristol Syncroverter\* chopper . . . adding to its record of service in U. S. guided missile systems of almost every type since their very beginnings.

**Billions of operations.** To insure the reliability so necessary in aircraft and missile operations, Bristol Syncroverter choppers are constantly under test at Bristol, with and without contact load. One example: We've had five 400-cycle choppers operating with 12v, 1ma. resistive contact load, for more than 26,000 hours (2.96 years) *continuously* without failure—over 37-billion operations!

Many variations of Bristol Syncroverter choppers and high-speed relays are available—including external-coil, low-noise choppers. Write for full data. The Bristol Company, Aircraft Equipment Division, 152 Bristol Road, Waterbury 20, Conn.

.09

\*T.M. Reg. U. S. Pat. Off.



actual size

**BRISTOL** FINE PRECISION INSTRUMENTS FOR OVER SEVENTY YEARS

154 CIRCLE 154 ON READER SERVICE CARD

externally without disturbing the internal temperature by opening the oven. Test circuitry is rated at 750 v and 5 amperes with resistance less than 0.5 ohm. Prices start at approximately \$4,000.

CIRCLE 354 ON READER SERVICE CARD

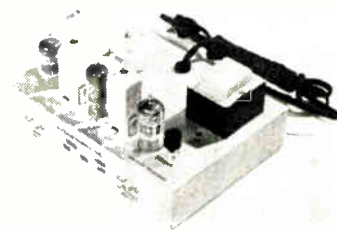

## Multiplex Converter

TUNABLE 23KC-70KC

AUTOELECTRONICS, INC., 6207 Breamore Road, Indianapolis, Ind., announces a new Neophonic multiplex converter unit that is completely tunable from 23 Kc to 70 Kc with an average audio recovery of 1 volt. Crosstalk is controlled to a 60 db or better with a sensitivity of 0.1 v for 30 db quieting. The converter has a self-contained power supply and a relay controlled squelch. Unit is said to perform excellently with all types of f-m receivers now on the market.

CIRCLE 355 ON READER SERVICE CARD

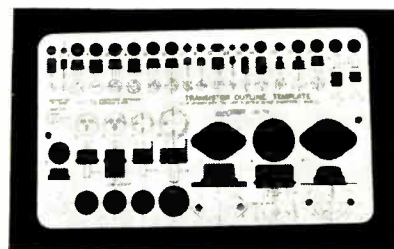

## Outline Template

FOR TRANSISTORS

RAPIDESIGN, INC., P. O. Box 429, Burbank, Calif. Based on the standards registered by manufacturers with JEDEC, the No. 319 transistor outline template has cut-outs for 27 sizes of transistors, using the registered designating numbers, sizes and specifications. Outlines are of both top view and side elevation, allowing immediate ascertainment of space requirements of transistors in layouts of wiring diagrams and printed circuits. Made of 0.030 matte finish

MAY 20, 1960 • electronics

mathematical quality plastic, actual size of the template is 9½ in. by 5½ in. Price is \$3.00.

CIRCLE 356 ON READER SERVICE CARD

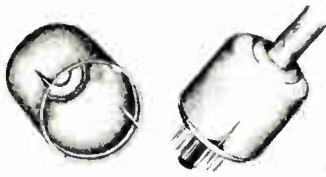

## Octal Plug Caps

### ONE-PIECE UNITS

BEAUCHAINE AND SONS, INC., Lakeport, N. H., has available Beaucaps molded in four standard NEMA colors. Material is rugged linear polyethylene. They have high resistance to physical damage and excellent dielectric characteristics. They are designed to replace the drawn metal cap, which employs fish paper insulation and a rubber grommet. Colors are red, blue, green and black. Cable openings of ⅜ in. and ½ in. in either top or side are standards, but other locations and sizes are available. Also offered is a cable clamp for top openings.

CIRCLE 357 ON READER SERVICE CARD



## Power Supply Modules

### SOLID STATE

SOLIDYNE, 7460 Girard Ave., La Jolla, Calif. Model PS202 is an inexpensive, compact d-c supply with dual output up to 150 ma at ±18 v or a single output at ±36 v. Line and load regulation is ±1 percent with less than 6 mv of ripple. The 8 in. by 3 in. by 3 in. unit weighs 2 lb and is convenient for bench work as well as the building block of transistor equipment. It is a highly stable well regulated d-c supply primarily used where a reference source is required. Line regulation from 95 to 135 v a-c input to 0.1 percent with continuously variable d-c output of 2 to 24 v. Load regulation is 0.1 percent with loading of 0 to 100 ma. Tem-

The bat's keen hearing enables it to pick up sounds beyond the range of the human ear. The high pitched cries it continuously emits are reflected by obstacles and guide the bat in its flight path.



False Vampire  
(Lasiurus frons)

## MILLENNIUMS of DESIGN DEVELOPMENT

Here's an antenna that's survived severe environmental testing through several thousands of years. Design factors, if we can believe Darwin, were purely empirical.

Dorne and Margolin has designed hundreds of specialized antennas for every major aircraft manufacturer in the country. With less time at our disposal than the bat, we've had to evolve ingenious solutions to antenna design problems. We've never failed an assignment.

If you have a problem involving antennas, it's more than likely that our background of design and production experience can provide a speedy, economical solution.

Write for illustrated catalog.

Excellent positions in a growing organization affording opportunities for stock participation, as well as many other benefits, are offered to engineers. Contact R. E. Anderson, Chief Engineer.

ANTENNAS



# DORNE & MARGOLIN, Inc.

WEST COAST:  
1434 Westwood Boulevard  
Los Angeles 24, California

EAST COAST:  
29 New York Avenue  
Westbury, L. I., New York

# SOMETHING NEW IN A SUITCASE...

## ... Complete transistorized EECO Digital System Breadboard

Designers who want to go places fast systemswise can be sure of getting there on time with an EECO suitcase. It's packed with a complete and integrated breadboarding system designed around mutually compatible EECO T-Series Germanium circuit modules, N-Series transistorized decades, and R-Series Minisig® sensitive indicators.

Standard 19" amateur-notched panels have the necessary permanent wiring to accommodate any standard EECO Germanium circuit module, and all other circuit interconnections are made by patch cords or plugs, with unique, prepunched circuit cards to guide you. No soldering is required, and experimental arrangements of T-Series circuits can be quickly patched up, changed, or taken down without waste of time or materials.

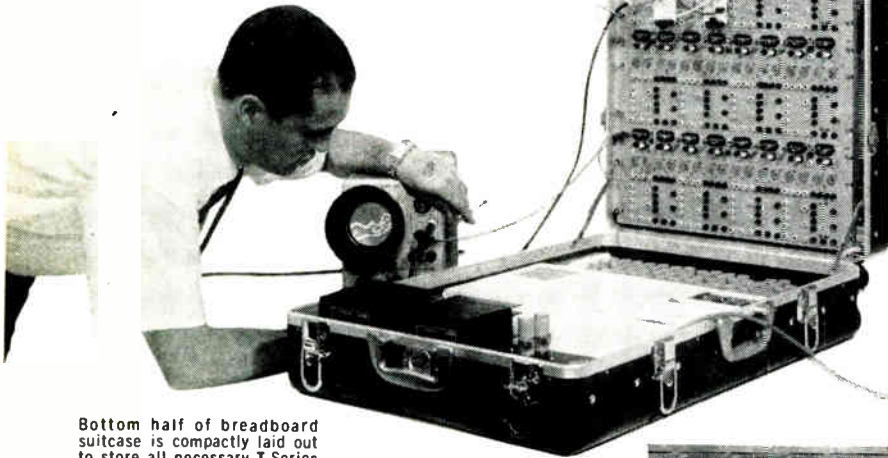

Bottom half of breadboard suitcase is compactly laid out to store all necessary T-Series circuit modules, circuit cards, patch cords, and compatible power supplies.

EECO T-Series breadboard equipment is available in both suitcase and rack-mounted types. Breadboard Kits of any degree of complexity can be built up in stages, according to the specific panels and number of circuits incorporated. Compatible interconnections between racks or suitcases further enable the designer to expand the equipment into a complete systems development console. Compatible solid-state, convection-cooled power supplies are also available in two different models: ZA-720 is a dual 12-volt, 5-amp supply; ZA-721 is a 12-volt, 1-amp plug-in power supply.

### FEATURES

- Permits rapid formulation of digital electrical systems.
- System may be operated slowly to permit inspection of its mode of operation, or over-speed to indicate system derating.
- Operation may be analyzed with a minimum of test equipment.
- Provides a means for rapidly building and testing alternate ways of formulating a system.
- Minimizes wiring errors and the inclusion of defective parts.
- Circuit cards provide a means for rapidly visualizing the system, and facilitate drawing a circuit diagram.
- Circuit cards enable the designer to determine the elements involved, as well as the cost of the system.

A request, on your company letterhead, will bring detailed information on the flexibility of the EECO T-Series Breadboarding equipment, and a demonstration if desired.



**ENGINEERED ELECTRONICS COMPANY**

1441 East Chestnut Avenue • Santa Ana, Calif.

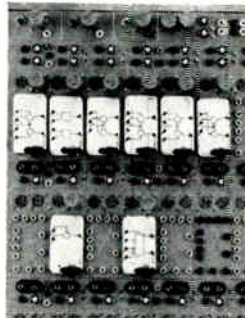
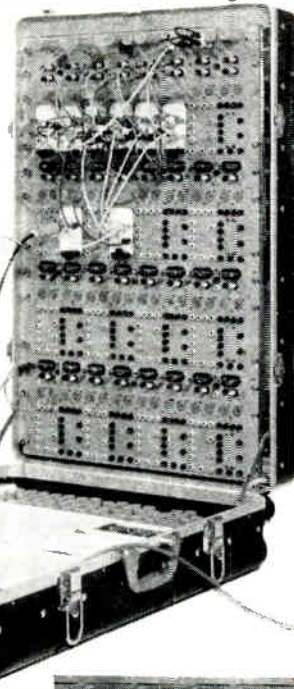

Circuit cards are selected according to the system it is desired to breadboard and placed on the panel in alignment with the jack pattern. Corresponding T-Series circuit modules are plugged in above each card.

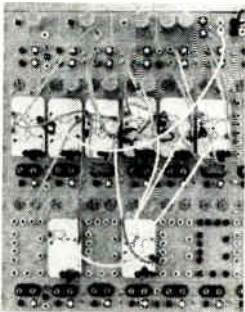

Circuit interconnections are made by patching through holes in the circuit cards. Resulting pattern of symbol cards and patch cords shows a schematic and bill of materials for the system, once it is checked out.

perature stability is 50 parts per million per deg F in the range of 40 to 120 F. Line-load isolation is in excess of 10,000 megohms. Module dimensions are 7.5 in. by 3.5 in. by 2.5 in. Unit finds wide application in the strain-gage instrumentation field.

**CIRCLE 358 ON READER SERVICE CARD**

## Casting Resin MOISTURE RESISTANT

EMERSON & CUMING, INC., Canton, Mass. Stycast TPM-5 polyethylene copolymer casting resin is a one part system and when cured can be used well above 325 F. Cured castings have physical and electrical properties similar to that of high density polyethylene. Manufacturer claims it is unsurpassed in moisture resistance as compared with conventional casting resins. It also exhibits extremely low loss, low dielectric properties, making it useful as insulation material in microwave, waveguide and coaxial components.

**CIRCLE 359 ON READER SERVICE CARD**

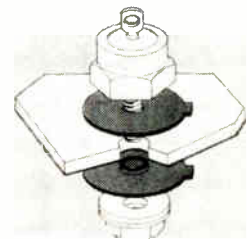

## Insulator Wafers FOR DIODES

MONADNOCK MILLS, subsidiary of United-Carr Fastener Corp., San Leandro, Calif. Hard-anodized insulator wafers for stud mounted diodes provide outstanding dielectric insulation and thermal conductivity. Installed between diode and chassis and between hex jam nut and chassis. Extruded center hole insulates stud from chassis and eliminates necessity for separate insulating bushing. Five diameters for stud sizes 8-32, 10-32 and 1-28 now in stock; additional sizes soon

available. Wafers designed for use with semiconductors of other configurations also available.

**CIRCLE 360 ON READER SERVICE CARD**



### Servo Amplifier HIGH TEMPERATURE

WESTAMP, INC., 11277 Massachusetts Ave., Los Angeles 25, Calif. Model A419 servo amplifier has been developed for operation in the temperature range from - 55 C to + 150 C. Features of the new amplifiers are the operation of motors up to size 15 at temperatures up to 150 C and the self-contained power supply for operation directly from 400 cps power source.

**CIRCLE 361 ON READER SERVICE CARD**

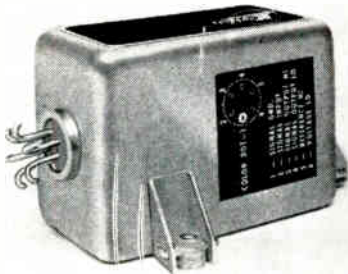

### Rejection Circuit QUADRATURE TYPE

KEARFOTT DIVISION of General Precision Inc., 1150 McBride Ave., Little Falls, N. J. The D4816-01 quadrature rejection circuit is designed to operate from a preamplifier or gain controlled amplifier into a transistor servo amplifier. Small, lightweight, and rugged, this device rejects the component of the input wave which is 90 deg from the reference input. The component of the input wave which is in-phase with the reference will produce a square wave whose magnitude is proportional to the load and the magnitude of the in-phase signal. Unit is designed to

# T HIRTEEN I NDISPENSABLE C HARACTERISTICS

## FOR *Precision* SERVO POTS



### PRECISION SERVO POTENTIOMETERS HAVE ALL 13 FEATURES

*Your Assurance  
of Superior System  
Performance*

A few of the many applications of TIC Precision Servo Potentiometers are as input-output transducers in servo systems for airborne navigation and flight control, fire control, fuel control, shipboard gun directors, missile aiming and flight control, analog computing, air traffic control and telemetering.

TIC Precision Servo Potentiometers are available in 21 types with diameters from 1/2" to 3", giving design engineers a wide range from which to select. Included are single and multi-turn types with either wirewound or infinite resolution metallic film resistance elements, as well as types designed for ganging without a shaft.

And TIC Precision Servo Potentiometers are engineered to withstand the severe environmental conditions imposed by military equipment operation.

- 1 High Reliability
- 2 Low Torque
- 3 High Accuracy
- 4 Low Inertia
- 5 High Resolution (or Infinite in Film Type)
- 6 Wide Resistance Range
- 7 Low Phase Shift Over Wide Frequency Range
- 8 Low Noise Level
- 9 Highly-Precise Non-Linear Functions
- 10 Can Be Ganged
- 11 Long Life
- 12 Close Mechanical Tolerances
- 13 Withstand Extreme Environmental Conditions

Write or call for this new catalog on the TIC line of Precision Potentiometers - the most complete line on the market.



**TECHNOLOGY INSTRUMENT CORP.**  
569 MAIN STREET, ACTON, MASS.

SUBSIDIARIES: ACTON LABORATORIES, INC., ACTON, MASS. • ALTMAC CORP., CANTON, MASS.  
TECHNOLOGY INSTRUMENT CORP. OF ARIZONA, TUCSON, ARIZ.  
TECHNOLOGY INSTRUMENT CORP. OF ILLINOIS, FRANKLIN PARK, ILL.  
TECHNOLOGY INSTRUMENT CORP. OF CALIFORNIA, NEWBURY PARK, CALIF.



FREQUENCY

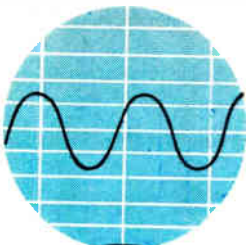

FLOW

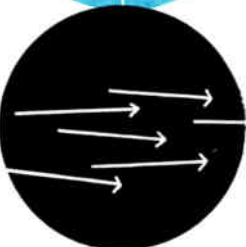

RPM



# NEW

## low cost multi-purpose electronic counter



with  
in line  
NIXIE  
readout

Model 720 events-per-unit-time counter is specially designed for industrial and laboratory uses where unusual flexibility is required. The unique modular construction permits the measurement of virtually any physical variable, such as rate of flow, RPM, frequency or time interval. NIXIE in-line readout is easy to read and reduces operator fatigue and the chance for error. Simplified construction permits operation by relatively unskilled personnel. Low Cost starts at \$475 for the 3-decade model. Send for complete technical literature.

<b>DECADES:</b>	3, 4, 5 or 6
<b>FREQUENCY RANGE:</b>	0 to 120,000 pulses/sec.
<b>SENSITIVITY:</b>	50 Millivolts RMS
<b>ACCURACY:</b>	± one count ± time base error
<b>DISPLAY TIME:</b>	0.2 to 6 sec. or infinite
<b>SIZE:</b>	19" x 5 1/4" x 12"
<b>WEIGHT:</b>	25 lbs.

ERIE-PACIFIC manufactures a complete line of digital counting and timing instruments and systems for military or commercial use.

# ERIE

INSTRUMENTATION

ERIE PACIFIC DIVISION  
ERIE RESISTOR CORPORATION  
12932 S. Weber Way, Hawthorne, California  
Phone: ORegon 8-5418

operate in an ambient temperature range of - 55 C to + 115 C at altitudes from 0 to 100,000 ft.

**CIRCLE 362 ON READER SERVICE CARD**

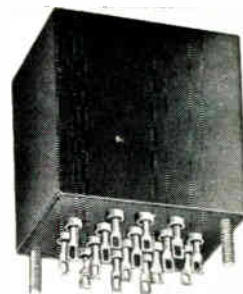

**Magnetic Modulator**  
12,000 OHMS LOAD

FREED TRANSFORMER CO., INC., 1718 Weirfield St., Brooklyn 27, N. Y. This unit is essentially a low-power level magnetic amplifier. The modulator shown has an input of 115 v at 400 cps and an output of from 0 to 3 v and 0 to 2.5 v with a reversible phase. The d-c signal input is 0 to = 100  $\mu$ a, with a 20 percent maximum distortion of output. The load of the unit is 12,000 ohms.

**CIRCLE 363 ON READER SERVICE CARD**



**Test Adapters**  
COMPACT UNITS

LAIK ELECTRONICS CO., 311 Hickory St., Kearny, N. J., announces adapters designed to simplify the work of the engineer as well as production line testing of electronic equipment. Units are made as small as possible for use in crowded places. The adapter is inserted into the vacuum tube socket and the vacuum tube is plugged into the adapter so that it becomes an integral part of the electronic circuit. At this point it can be used as any ordinary adapter for taking voltage and resistance measurements. Breaking into the circuit is accomplished by loosening the screw in the circuit or circuits under test



# THE ELECTRONICS MAN

IDENTIFICATION

R  
D  
P  
M

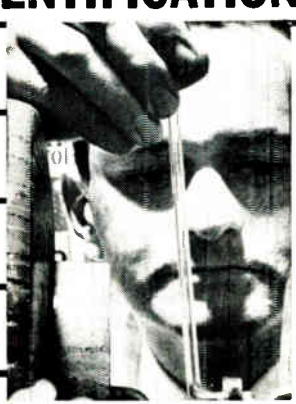

6XK-5XKW
S Q

## WHERE TO FIND HIM

The electronics man may be found in any or all of the areas of research, design, production, management.

Your problem: sell him (wherever he is) and keep him sold all year long. Here's the simplified key to this job!

Use **electronics** to arouse his interest and create acceptance for your products in the magazine's weekly issues.

Use the **electronics BUYERS' GUIDE** and Reference Issue to be there all year long whenever he is ready to buy.

This is the best selling combination in the electronics industry... and the one that carries the *most* weight!



THE ELECTRONICS MAN  
"BUYS" WHAT HE READS IN ...

## electronics

 A MCGRAW-HILL PUBLICATION   
330 West 42nd Street, New York 36, New York

electronics • MAY 20, 1960



NOW  
there are  
4

high-performance Series F

### Tarzian Silicon Rectifiers

The addition of Type 2F4 expands the Tarzian F Series to cover a current range from 200 to 750 milliamperes dc (to 85° C). Characteristics of the complete F Series are shown below, in condensed form.

#### COMPARE THESE ADVANTAGES:

- **Small Size**... diameter  $\frac{3}{16}$ " max; length  $\frac{5}{16}$ " max.
- **Low Cost**...and high quality resulting from Tarzian production methods
- **Insulated Body**...no mounting problems
- **High Efficiency**...oversize junction and low voltage drop
- **Available**...now from stock

In addition to providing good operating efficiency at low temperature rise, thereby increasing reliability, the *oversize* junction also handles inrush currents far beyond normal circuit requirements. Careful selection of materials increases stability and improves thermal characteristics.

For additional information about Series F rectifiers, call your Sarkes Tarzian sales representative, or write Section 4887A. Sarkes Tarzian is a leading supplier of silicon, tube replacement, and selenium rectifiers. Practical application assistance is always available.

Tarzian Type	Amps. DC (85° C)	PIV	Max. RMS Volts	Max. Amps.	
				Recurrent Peak	Surge (4MS)
2F4	.20	400	260	2.0	20
F-2	.75	200	140	7.5	75
F-4	.75	400	280	7.5	75
F-6	.75	600	420	7.5	75



### SARKES TARZIAN, INC.

World's Leading Manufacturers of TV and FM Tuners • Closed Circuit TV Systems • Broadcast Equipment • Air Trimmers • FM Radios • Magnetic Recording Tape • Semiconductor Devices  
**SEMICONDUCTOR DIVISION • BLOOMINGTON, INDIANA**  
 In Canada: 700 Weston Rd., Toronto 9 • Export: Ad Auriema, Inc., New York

CIRCLE 159 ON READER SERVICE CARD 159

# A NEW CONCEPT IN MINIATURE CHOPPERS

by **JAMES**

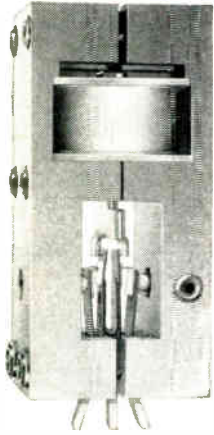

## A MINIATURE CHOPPER WITH ALL MODELS OF INSTRUMENT QUALITY!

- All with center pivot armatures
- All models for 100°C
- Low Mechanical noise
- Low residual noise

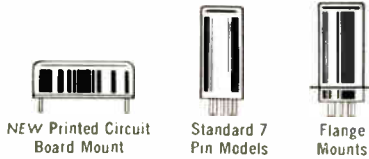

WRITE FOR CATALOG AND TECHNICAL DATA Dept. E-5

**JAMES ELECTRONICS INC.**  
4050 N. Rockwell, Chicago 18, Illinois  
CO 7-6333

CIRCLE 208 ON READER SERVICE CARD

# METALS for ELECTRONIC APPLICATION

## rolled ULTRA THIN

by OUR SPECIAL ROLLING  
TECHNIQUE

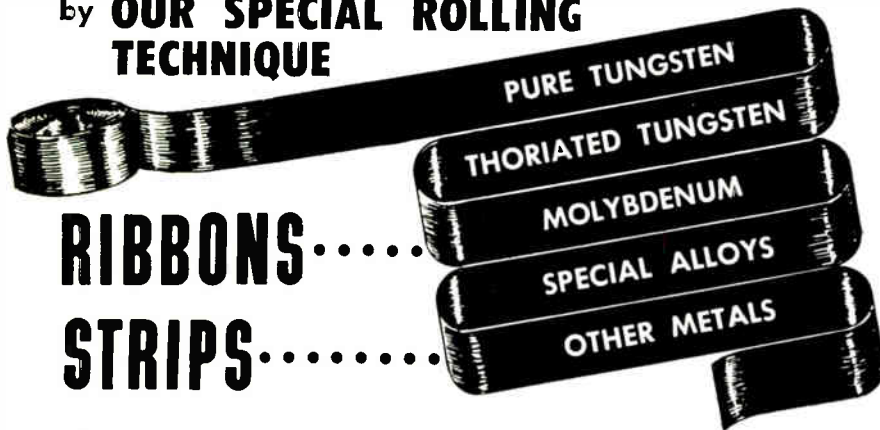

TOLERANCES CLOSER THAN COMMERCIAL STANDARDS

Note: for highly engineered applications—strips of TUNGSTEN  
and some other metals can be supplied

*rolled down to .0003 thickness*

- Finish: Roll Finish—Black or Cleaned
- Ribbons may be supplied in Mg. weights if required

Developed and Manufactured by

**H.CROSS CO.**

15 BEEKMAN ST., N. Y. 38, N. Y.  
TELEPHONE: WOrth 2-2044  
COrtlandt 7-0470

160 CIRCLE 160 ON READER SERVICE CARD

and inserting meters or components between the upper and lower lugs. This may be done by means of any small clips (such as alligator clips). No special leads, jacks or plugs are necessary.

CIRCLE 364 ON READER SERVICE CARD

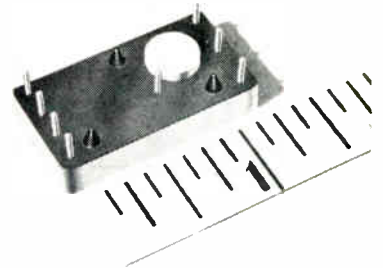

## Logic Circuit Unit ENCAPSULATED

DALE PRODUCTS, INC., Columbus, Neb. The SPR-76 Dalohm balanced resistor network measures 1½ by 1½ by 1. Network contains five precision wire wound resistors and one transistor incorporated into a NOR logic circuit. The complete circuit is encapsulated in a rigid epoxy compound. The network is designed to withstand tough moisture, temperature cycling, vibration and life tests. Termination is ideal for printed circuit or plug mounting.

CIRCLE 365 ON READER SERVICE CARD

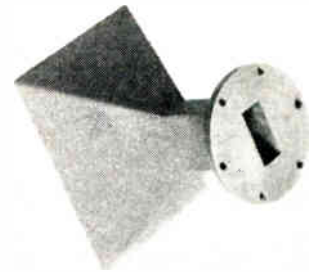

## Standard Gain Horns FIVE GUIDE SIZES

RADAR DESIGN CORP., Pickard Drive, Syracuse 11, N. Y. The RDH series of 15 db standard gain horns contains a horn for each of the waveguide sizes from ½ in. by ½ in. to 3 in. by 1½ in. Each horn covers the full AN-rated frequency band. The horns are designed on optimum gain principles and feature cover type flanges and vswr below 1.1 over the entire applicable frequency range. A curve of gain-vs-fre-

MAY 20, 1960 • electronics

## new, high-speed micro- microammeter



The new Keithley Model 415 micro-microammeter offers high speed of response, accuracy, and zero suppression.

A speed of response of less than 600 milliseconds to 90% of final value at  $10^{-12}$  ampere is possible where external circuit capacity is  $50\mu\text{f}$ . Accuracy is  $\pm 2\%$  of full scale on  $10^{-3}$  through  $10^{-8}$  ranges and  $\pm 3\%$  on ranges below. Zero suppression permits full scale display of one per cent variations of a signal.

The 415 is ideal for use with ion chambers, ionization gages, gas chromatography, mass spectrometry.

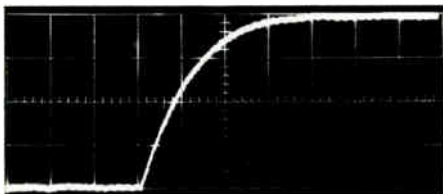

Response to a current step of  $10^{-12}$  amp. Input capacity is  $35\mu\text{f}$ . One major horizontal division equals 200 milliseconds.

### SPECIFICATIONS

**Ranges:**  $10^{-12}$ ,  $3 \times 10^{-12}$ ,  $10^{-11}$ ,  $3 \times 10^{-11}$ , etc. to  $10^{-3}$  ampere f.s.

**Accuracy:**  $\pm 2\%$  f.s.  $10^{-3}$  thru  $10^{-8}$  amp;  $\pm 3\%$  f.s.  $3 \times 10^{-9}$  thru  $10^{-12}$  amp.

**Zero Drift:** Below 2% of f.s. per day.

**Input:** Grid current below  $5 \times 10^{-14}$  amp.

**Output:** 1 v f.s. up to 5 ma. Noise less than 20 mv.

**Rise Time:** On  $10^{-12}$  amp range — at 50, 150, 1500  $\mu\text{f}$   $C_{in}$  — rise time is .6, .8, 2.5 sec. respectively to 90% of final values; decreasing to .001 sec. on all ranges at  $3 \times 10^{-9}$  amp and above for stated input capacitances.

**Price:** Model 415 . . . . . \$750.00

For full details, write:



**KEITHLEY  
INSTRUMENTS**

12415 EUCLID AVENUE  
CLEVELAND 6, OHIO  
CIRCLE 209 ON READER SERVICE CARD

electronics • MAY 20, 1960

quency is supplied. Price is \$95 to \$170 dependent on guide size.

CIRCLE 366 ON READER SERVICE CARD



### Pressure Switch MINIATURE DEVICE

CENTURY ELECTRONICS & INSTRUMENTS, INC., 1333 North Utica, Tulsa, Okla. Originally designed for use in the Polaris missile program, the 58600 series rugged, all-metal miniature pressure switch is  $1\frac{1}{2}$  in. long,  $\frac{3}{4}$  in. in diameter, and weighs only 2 oz. It can be factory set from 30 to 500 psi gage or absolute. It is environmental proof for missile applications.

CIRCLE 367 ON READER SERVICE CARD

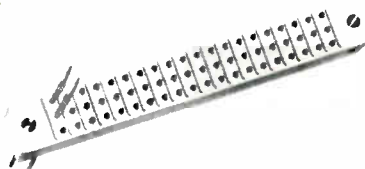

### Terminal Blocks SHOCK RESISTANT

PRECISION CONNECTORS, INC., P. O. Box 96, Mineola, N. Y. Series 100-53 solderless terminal blocks feature molded-in taper pin receptacles for complete immobility and maximum resistance to vibration and shock. Receptacles are precision reamed to accommodate standard "AMP53" solderless taper pin wiring terminals with high mechanical bond and low contact resistance. Any desired combination of feed-through individual or shorting circuitry is available, in protected, molded-in internal connections between terminals. Electrically common adjacent receptacles in groups of two or more can be shunted internally to produce any desired terminal circuit configurations. Horizontal and vertical mounting holes allow for diverse stacking applications. Vari-

looking for...

# ignitrons

...or any major brand industrial electron tube and semi-conductor? TRANSITUBE... the distributors' supplier... will fill your order... immediately... at great savings... from the well-stocked shelves of 3 modern warehouses.

Address your inquiry to:

## transitube

114 LIBERTY ST., NEW YORK • WO 4-0252-3-4

CIRCLE 210 ON READER SERVICE CARD

send for this

# FREE

## EICO Electronics Catalog



you save 50% on Top-Quality  
**Test Instruments**  
**Hi-Fi • Ham Gear**  
**KITS AND WIRED**  
for professional and home use

**TEST INSTRUMENTS**  
battery eliminators  
bridge testers  
bridges  
decade boxes  
electronic switch  
flyback tester  
oscilloscopes  
probes  
signal and sweep generators  
tube testers  
transistor tester  
vacuum tube voltmeters  
volt-ohm-milliammeters

**HI-FI**  
stereo and monaural tuners  
preamplifiers  
power amplifiers  
integrated amplifiers  
speaker systems

**HAM GEAR**  
cw transmitter  
modulator-driver  
grid dip meter

**OVER 2 MILLION**  
EICO instruments in use throughout the world.

LIFETIME service and calibration guarantee.  
IN STOCK at your neighborhood EICO dealer.  
Send now for FREE catalog E-5

**EICO** 33-00 N. Blvd., L. L. C. 1, N. Y.  
... praised by the experts  
as BEST BUYS IN ELECTRONICS

CIRCLE 161 ON READER SERVICE CARD 161

# BEST TIP MILEAGE!

Outlasts Copper Tips 20 to 1  
Doubles the Life of Clad Tips

**HEXAACON XTRADUR**  
LONG-LIFE SOLDERING TIPS

82 SIZES AND SHAPES

FIT ALL MAKES

## TOP PERFORMANCE, TOO!

Multicoated for extra long wear by a new exclusive process. Solder adheres only to working surface at point of tip — prevents solder dropping on components or creeping into tip hole. Eliminates costly tip maintenance.

SEND FOR CATALOG—  
showing the most complete  
line of Industrial Soldering  
Irons and Long-Life Tips.



**HEXAACON ELECTRIC CO.**  
130 WEST CLAY AVENUE  
ROSELLE PARK, NEW JERSEY

SERVING INDUSTRY FOR A QUARTER OF A CENTURY  
CIRCLE 211 ON READER SERVICE CARD

ous combinations of standard and special terminal blocks are available for every application.

CIRCLE 368 ON READER SERVICE CARD



### Connector RACK-AND-PANEL

CONSOLIDATED ELECTRODYNAMICS CORP., 360 Sierra Madre Villa, Pasadena, Calif. The 500L series rectangular rack-and-panel connector is available in 48- or 63-contact configurations. The 63-contact connector has 59 size 20 snap-in contacts and four size 16 contacts. The 48-contact unit has 43 size 20 and five size 16 snap-in contacts, and two standard RG58/U coaxial contacts. The individual snap-in contacts, made for crimped-on attachment of conductors, are designed to meet MIL-C-26636 specifications.

CIRCLE 369 ON READER SERVICE CARD

## NEW SOLUTION TO RELAY TESTING PROBLEMS

### SCHMELING MODEL 140 UNIVERSAL RELAY ANALYZER

Quantitatively checks relay  
operation under actual contact  
current



...FOR FAST,  
ACCURATE,  
TESTING OF  
RELAYS

- Precise Check of Pull-in and drop-out Voltage
- Exact Measurement of Contact Make and Break Time
- Accurate Evaluation of Contact Bounce
- Overlap Time on Make Before Break and Break Before Make Contacts
- Contact Resistance Measurement under Both Load and Dry Current Conditions

AUTOMATIC MODELS AVAILABLE — Call or write for complete information on standard and automatic models, today!

## Schmeling Electronics

DIVISION OF RARITAN INDUSTRIES CORP.

20 FIRST STREET, KEYPORT, NEW JERSEY, U.S.A.

DESIGNERS AND MANUFACTURERS OF QUALITY TEST EQUIPMENT



### Rectifier Trigger ALL SOLID-STATE

HANSON - GORRILL - BRIAN, INC., 85 Hazel St., Glen Cove, N. Y. Series 351 Recti-Pulse generates a steep wave front signal for controlling the firing angle of silicon controlled rectifiers or Trinisitors. The ser power output is thus varied in proportion to low level control signals which can be a-c, d-c, or varying resistance. Response time is 1 cycle or less. Multiple isolated control windings allow great freedom in circuit design. Models are available for both full wave and half wave circuits from 50 to 400 cps. The all solid-state circuit compo-

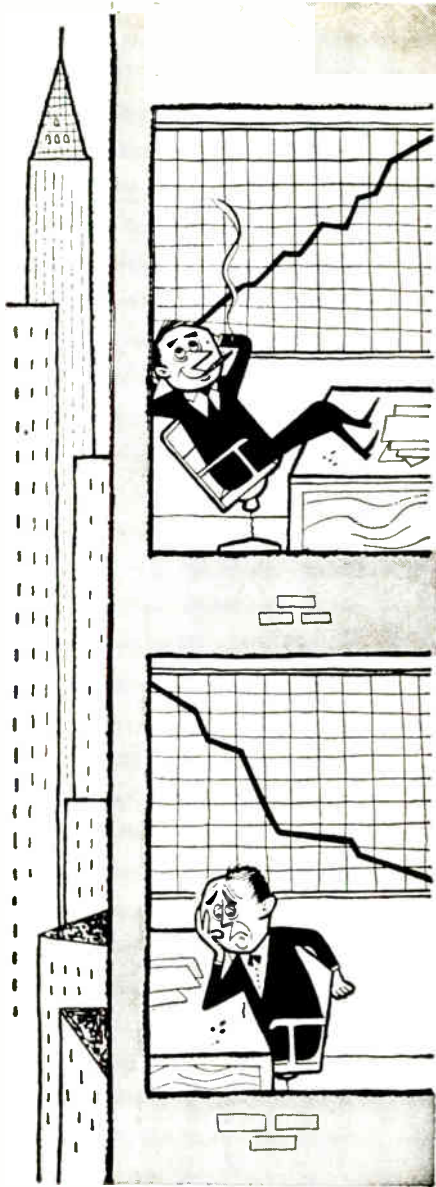

## WHO'S MAKING OUT BEST?

A quick, 3-minute Financial Round-up that names electronics companies that have achieved substantial financial gains. Tells where they are and what they make.

Fast visual summary of active stocks each week in the electronics industry. New public issues. Stock price averages.

This highly readable score card helps keep you informed on what counts most on the financial front. This is just one more reason why you should subscribe to electronics (or renew your subscription). Fill in box on Reader Service Card. Easy to use. Postage free.

## FIND WHAT YOU NEED IN... electronics

electronics • MAY 20, 1960

nents are hermetically sealed and suitable for use to 100 C.

**CIRCLE 370 ON READER SERVICE CARD**



### Pulse Transformers MINIATURIZED

ATLAS TRANSFORMER CO., 1839 Moore St., San Diego 1, Calif., announces a new line of miniature pulse transformers designed for printed circuit board mounting and available for various voltage ratios. Dimensions are 0.62 in. deep by 0.31 in. high and all units are designed to MIL-T-27 requirements.

**CIRCLE 371 ON READER SERVICE CARD**

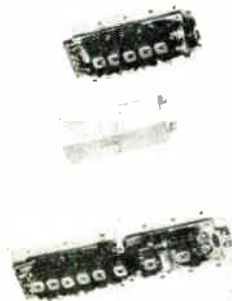

### I-F Amplifiers TRANSISTORIZED

RS ELECTRONICS CORP., P. O. Box 368, Station A, Palo Alto, Calif. New transistorized i-f amplifiers are designed for use where severe environments, minimum size and lower power drain are required. Models 83003H and 83003D (illustrated), using silicon transistors, operate with a center frequency of 30 Mc and a bandwidth of 3 Mc. Model 83003H has a gain of 100db and uses one subminiature tube in

looking for...

# thyratrons

...or any major brand industrial electron tube and semi-conductor? TRANSITUBE... the distributors' supplier... will fill your order... immediately... at great savings... from the well-stocked shelves of 3 modern warehouses.

Address your inquiry to:

## transitube

114 LIBERTY ST., NEW YORK • WO 4-0252-3-4

**CIRCLE 212 ON READER SERVICE CARD**

**YOU CAN SAVE  
UP TO 50% ON  
SMALL PARTS LIKE THESE**

by using  
TRADEMARK

## BEAD CHAIN Multi-Swage PRODUCTS

Every year Bead Chain produces billions of tubular metal parts for electronic and mechanical applications. Multi-Swage eliminates costly turning, drilling, stamping and forming—automatically swages from flat stock into strong precision forms with positive, tight seams. If you're a volume user of such parts, in any metal, up to 1/4" diam. x 1 1/2" long, find out how much Multi-Swage can save you. Send sketch or standard parts for prompt estimate. Write for catalog today.

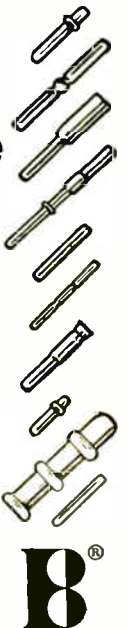

**THE BEAD CHAIN MANUFACTURING CO.**  
88 Mountain Grove St., Bridgeport, Conn.

**CIRCLE 163 ON READER SERVICE CARD 163**

**SET IT DOWN!  
HOOK IT UP!**

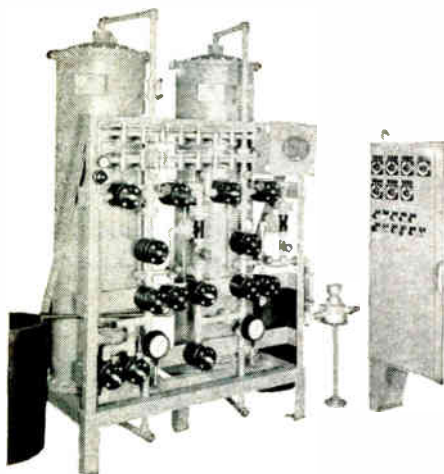
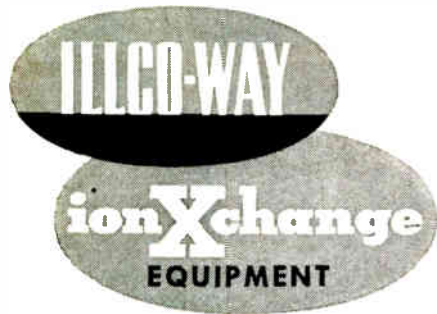

**COMPLETE  
AUTOMATIC  
DE-IONIZER**

Here is a complete, loaded, fully-instrumented, automatic ionXchange unit in a neat, compact, and ready-to-operate "package." It is equipped with our own Ilco/Matic, all-plastic, air-actuated valves, which have been specially developed for ionXchange service. The Control Panel, also our own design and manufacture, provides all necessary quick-adjustment features, and requires only electrical hook-up to the terminal box on the frame. The only other connections required are to plant service.

**FULLY ASSEMBLED AND  
READY TO INSTALL**

All structural assembly of elements, all piping, all wiring, and all installation of air lines is done in our factory by men of long experience. Then the unit is tested for proper operation of all circuits, loaded with the proper supporting beds and resins, painted, bolted to a skid, and crated for delivery to the exact spot it will be used. *This is the quickest, easiest, and surest way for you to get a reliable, ready-to-go ionXchanger*—arranged and instrumented to suit your special needs, whatever they are.

Write for Particulars



**ILLINOIS WATER  
TREATMENT CO.**  
840 Cedar St.  
Rockford, Ill.

NEW YORK OFFICE: 141 E. 44th St., New York 17, N.Y.  
CANADIAN DIST.: Pumps & Softeners, Ltd., London, Can.

164 CIRCLE 164 ON READER SERVICE CARD

the input for minimum noise figure. Model 83003D, completely transistorized, has a gain of 60 db. Both units incorporate gain control.

CIRCLE 372 ON READER SERVICE CARD



**Thermal Wells  
HIGH PRESSURE**

FENWAL INC., Pleasant St., Ashland, Mass. Pressures up to 3000 psi at 600 F, or 2000 psi at 700 F. can be handled by new thermal wells. Wells are available in three styles: coupling head, hex head, and with a moisture-sealed, tamper-proof cover. All are type 316 stainless steel with heliarc welded functions.

CIRCLE 373 ON READER SERVICE CARD

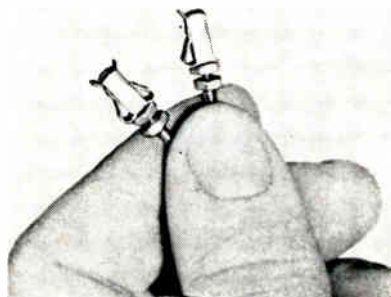

**Miniature Test Clip  
SINGLE OR DOUBLE**

GRAYHILL, INC., 561 Hillgrove Ave., La Grange, Ill., announces a miniature, single or double, spring tension test clip, with hex nut for adjustment of tension to suit conditions of use. It assures simplified, rapid testing of resistors, transistors, capacitors and other pig-tail type components, as well as for single wire connections and for bread-board work. They are designed to allow rapid connection and positive contact without manually opening and closing jaws. Panel area required by the single unit (2-41) is approximately 3/8 in. by 1/2 in., while the area required by the double unit (2-42) is approxi-

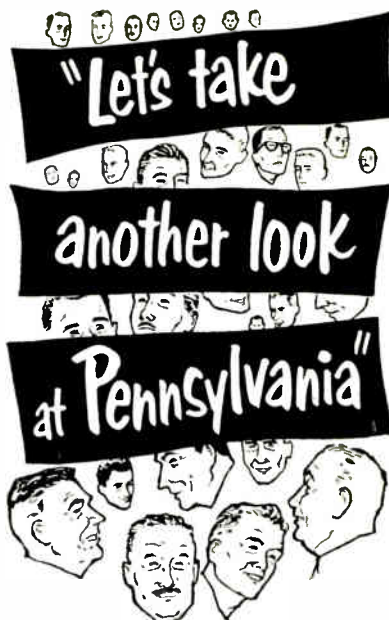

**...that's what a  
growing number  
of industrial  
executives are  
saying and doing!**

In the past four years  
they announced:

- 389** NEW PLANTS
- 391** RE-OPENINGS  
OF IDLE PLANTS
- 788** PLANT EXPANSIONS

(Send for the list—address below)

**They are finding:**

Surplus of industry-minded workers . . . Strategic locations in the great Eastern market with access to major trunk line railroads, and modern highway and Turnpike networks . . . Ports on the Atlantic, St. Lawrence Seaway and Ohio River system . . . All types of industrial raw materials and components . . . 100% low-interest plant financing in labor surplus areas . . . Choice of industrial "parks" and individual plant sites.

**Excellent "tax climate"**

No state personal income tax—no machinery or inventory taxes—no graduated state tax rates—no direct state property tax—manufacturing activities in Pennsylvania are exempted from capital stock, franchise, and sales taxes.

For free copy of "Plant Location Services" pamphlet, or for details on 100% financing, write or call:



**Pennsylvania Department of Commerce**  
South Office Building  
803 State St., Harrisburg, Pa.  
Phone: CEdar 4-2912

CIRCLE 213 ON READER SERVICE CARD  
MAY 20, 1960 • electronics

# electronics READER SERVICE

Use these handy prepaid

**READER SERVICE POST CARDS**

for more detailed information on:

**PRODUCTS ADVERTISED**

**NEW PRODUCTS "On the Market"**

**LITERATURE OF THE WEEK**

Circle the number on the READER SERVICE post card at the right that corresponds to the number at the bottom of Advertisement, New Product item, or the Literature of the Week selection in which you are interested.

Please print clearly. All written information must be legible in order to be efficiently processed.

**ALL FOREIGN INQUIRIES** that cannot reach electronics before the expiration dates noted on the Reader Service Post card, must be mailed directly to the manufacturer.

Correct amount of postage must be affixed for all foreign mailings.

**TO SUBSCRIBE TO OR TO RENEW electronics** — Fill in the "For Subscriptions" area on the card if you desire to subscribe to or renew your present subscription to electronics. Send no money. electronics will bill you at the address indicated on the Reader Service post card.

**\*MULTI-PRODUCT ADVERTISEMENTS —**

For information on specific items in multi-product advertisements note area marked by asterisk (\*) on post card. Print circle number of advertisement and name of product(s) in which you are interested.

Name \_\_\_\_\_ Title \_\_\_\_\_

Company \_\_\_\_\_

Address \_\_\_\_\_

INSIDE	FRONT COVER											INSIDE	BACK COVER						
1	21	41	61	81	101	121	141	161	181	201	221	241	261	281	301	321	341	361	381
2	22	42	62	82	102	122	142	162	182	202	222	242	262	282	302	322	342	362	382
3	23	43	63	83	103	123	143	163	183	203	223	243	263	283	303	323	343	363	383
4	24	44	64	84	104	124	144	164	184	204	224	244	264	284	304	324	344	364	384
5	25	45	65	85	105	125	145	165	185	205	225	245	265	285	305	325	345	365	385
6	26	46	66	86	106	126	146	166	186	206	226	246	266	286	306	326	346	366	386
7	27	47	67	87	107	127	147	167	187	207	227	247	267	287	307	327	347	367	387
8	28	48	68	88	108	128	148	168	188	208	228	248	268	288	308	328	348	368	388
9	29	49	69	89	109	129	149	169	189	209	229	249	269	289	309	329	349	369	389
10	30	50	70	90	110	130	150	170	190	210	230	250	270	290	310	330	350	370	390
11	31	51	71	91	111	131	151	171	191	211	231	251	271	291	311	331	351	371	391
12	32	52	72	92	112	132	152	172	192	212	232	252	272	292	312	332	352	372	392
13	33	53	73	93	113	133	153	173	193	213	233	253	273	293	313	333	353	373	393
14	34	54	74	94	114	134	154	174	194	214	234	254	274	294	314	334	354	374	394
15	35	55	75	95	115	135	155	175	195	215	235	255	275	295	315	335	355	375	395
16	36	56	76	96	116	136	156	176	196	216	236	256	276	296	316	336	356	376	396
17	37	57	77	97	117	137	157	177	197	217	237	257	277	297	317	337	357	377	397
18	38	58	78	98	118	138	158	178	198	218	238	258	278	298	318	338	358	378	398
19	39	59	79	99	119	139	159	179	199	219	239	259	279	299	319	339	359	379	399
20	40	60	80	100	120	140	160	180	200	220	240	260	280	300	320	340	360	380	400

* Circle No.	Product	Circle No.	Product	Searchlight Section							
460	463	466	469	472	475	478					
461	464	467	470	473	476	479					

**MAY 20 • 60**  
Card Expires  
**JUL. 20 • 60**  
For Foreign Mailings  
**JUL. 10 • 60**

**FOR SUBSCRIPTIONS**

Check One Box

- New  
 Renewal

Check One Box Below

**DOMESTIC**

- 3 yrs. - \$12.00  
 1 year - \$ 6.00

**CANADA**

- 1 year - \$10.00

**FOREIGN**

- 1 year - \$20.00

Product(s) M't'd \_\_\_\_\_

Service(s) \_\_\_\_\_

Name \_\_\_\_\_ Title \_\_\_\_\_

Company \_\_\_\_\_

Address \_\_\_\_\_

INSIDE	FRONT COVER											INSIDE	BACK COVER						
1	21	41	61	81	101	121	141	161	181	201	221	241	261	281	301	321	341	361	381
2	22	42	62	82	102	122	142	162	182	202	222	242	262	282	302	322	342	362	382
3	23	43	63	83	103	123	143	163	183	203	223	243	263	283	303	323	343	363	383
4	24	44	64	84	104	124	144	164	184	204	224	244	264	284	304	324	344	364	384
5	25	45	65	85	105	125	145	165	185	205	225	245	265	285	305	325	345	365	385
6	26	46	66	86	106	126	146	166	186	206	226	246	266	286	306	326	346	366	386
7	27	47	67	87	107	127	147	167	187	207	227	247	267	287	307	327	347	367	387
8	28	48	68	88	108	128	148	168	188	208	228	248	268	288	308	328	348	368	388
9	29	49	69	89	109	129	149	169	189	209	229	249	269	289	309	329	349	369	389
10	30	50	70	90	110	130	150	170	190	210	230	250	270	290	310	330	350	370	390
11	31	51	71	91	111	131	151	171	191	211	231	251	271	291	311	331	351	371	391
12	32	52	72	92	112	132	152	172	192	212	232	252	272	292	312	332	352	372	392
13	33	53	73	93	113	133	153	173	193	213	233	253	273	293	313	333	353	373	393
14	34	54	74	94	114	134	154	174	194	214	234	254	274	294	314	334	354	374	394
15	35	55	75	95	115	135	155	175	195	215	235	255	275	295	315	335	355	375	395
16	36	56	76	96	116	136	156	176	196	216	236	256	276	296	316	336	356	376	396
17	37	57	77	97	117	137	157	177	197	217	237	257	277	297	317	337	357	377	397
18	38	58	78	98	118	138	158	178	198	218	238	258	278	298	318	338	358	378	398
19	39	59	79	99	119	139	159	179	199	219	239	259	279	299	319	339	359	379	399
20	40	60	80	100	120	140	160	180	200	220	240	260	280	300	320	340	360	380	400

\* Circle No. \_\_\_\_\_ Product \_\_\_\_\_ Circle No. \_\_\_\_\_ Product \_\_\_\_\_

Searchlight Section \_\_\_\_\_

460 463 466 469 472 475 478  
461 464 467 470 473 476 479  
462 465 468 471 474 477

**MAY 20 • 60**  
Card Expires  
**JUL. 20 • 60**  
For Foreign Mailings  
**JUL. 10 • 60**

**FOR SUBSCRIPTIONS**

Check One Box

- New  
 Renewal

Check One Box Below

**DOMESTIC**

- 3 yrs. - \$12.00  
 1 year - \$ 6.00

**CANADA**

- 1 year - \$10.00

**FOREIGN**

- 1 year - \$20.00

Product(s) M't'd \_\_\_\_\_

Service(s) \_\_\_\_\_

FIRST CLASS  
PERMIT NO. 64  
NEW YORK, N. Y.

**BUSINESS REPLY MAIL**

NO POSTAGE STAMP NECESSARY IF MAILED IN THE UNITED STATES

6¢ Postage Will Be Paid By

**electronics**

**Reader Service Dept.  
330 West 42nd Street  
New York 36, N. Y.**

FIRST CLASS  
PERMIT NO. 64  
NEW YORK, N. Y.

**BUSINESS REPLY MAIL**

NO POSTAGE STAMP NECESSARY IF MAILED IN THE UNITED STATES

6¢ Postage Will Be Paid By

**electronics**

**Reader Service Dept.  
330 West 42nd Street  
New York 36, N. Y.**

## THE ELECTRONICS MAN... A SPECIAL BREED

In most industries the management man went to business school and doesn't concern himself with design problems.

In most industries the design engineer doesn't concern himself with management problems.

The electronics man is different.

He is many things. He is in Research-Design-Production-Management. His interests are in any or all of the four areas.

No matter where you find the electronics man his engineering background enables him to influence the purchase of electronic components and equipment. Your advertising must reach him if you are to sell electronic goods.

This is the strength of electronics, the one magazine published weekly and edited to reach this engineering oriented electronics man, wherever he is.

THE ELECTRONICS MAN  
"BUYS" WHAT HE READS IN...

## **electronics**

and in the  
**electronics BUYERS' GUIDE**

A McGRAW-HILL PUBLICATION  
330 West 42nd St., N.Y. 36, N.Y.



mately 1/4 in. by 1/4 in., exclusive of tension adjusting nut. Mounting stud extends 1/2 in. below the adjusting nut.

CIRCLE 374 ON READER SERVICE CARD

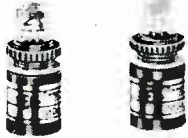

### Indicators WIRE WRAP TERMINALS

TRANSISTOR ELECTRONICS CORP., 3357 Republic Ave., Minneapolis 26, Minn., announces that wire wrap terminals are now available on its complete line of indicators. These terminals are available on all of Tec-Lites neon or incandescent indicators with either permanent or replaceable lamps, standard or transistor driven, and are offered at no increase in price over standard solder or taper pin terminals.

CIRCLE 375 ON READER SERVICE CARD

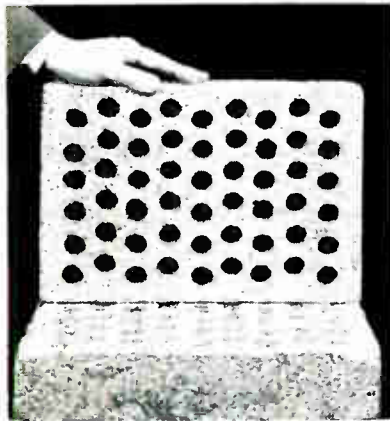

### High Loss Foam LOW WEIGHT

EMERSON & CUMING, INC., Canton, Mass. High loss, low weight ceramic foam block is useful in constructing vhf high power loads. Suitable designed loads made with Eccosorb WG are capable of average power dissipation in excess of 2,000 w without forced air or water cooling. Operating temperatures up to 1,000 F are possible without permanent deterioration. Each block has holes drilled through it so that a large surface area is available for

## 20 to 200 D.P.

Send your prints  
for quotations

- SPURS
- HELICALS
- WORM AND WORM GEARS
- STRAIGHT BEVELS
- LEAD SCREWS
- RATCHETS
- CLUSTER GEARS
- RACKS
- INTERNALS
- ODD SHAPES

We make gears like these for a wide variety of gages, meters, indicators, controllers, etc. Tell us your needs.



FOR AUTOMATIC  
CONTROLS

THE *Finest* IN GEARS

*Beaver Gear Works Inc.*

1021 PARMELE STREET, ROCKFORD, ILLINOIS



CIRCLE 214 ON READER SERVICE CARD

For the latest advances in data illumination, read:

# “PILOT LIGHTS” that Enlighten<sup>®</sup> by DIALCO



The only Brochure devoted especially to visual indication by means of read-out lights, data display, placard lights, word and number discs, lenses-with-legends, etc. Applications: data processing, computers, automation, motor-controlled devices, automatic merchandising... Comprehensive, colorful For a free copy, mail coupon now.

DIALIGHT CORP. E-5-20-60

60 Stewart Ave., Brooklyn 37, N.Y.

Please send \_\_\_\_\_ copies of "lights that Enlighten".

Name \_\_\_\_\_

Position \_\_\_\_\_ Dept. \_\_\_\_\_

Company \_\_\_\_\_

Address \_\_\_\_\_

City \_\_\_\_\_ Zone \_\_\_\_\_ State \_\_\_\_\_

Foremost Manufacturer of Pilot Lights

**DIALIGHT**  
CORPORATION

60 STEWART AVE., BROOKLYN 37, N.Y.  
HYACINTH 7-7600

## North Atlantic Series RB500 Ratio Boxes



Model RB-504  
Bench mount

Measure A.C. Ratios  
From -0.1111  
To +1.1111...with  
accuracy to 1 ppm

With any of North Atlantic's RB500 Ratio Boxes you can now measure voltage ratios about zero and unity—without disrupting test set-ups.

And—a complete range of models from low cost high-precision types to ultra-accurate ratio standards—in portable, bench, rack mount, binary and automatic stepping designs—lets you match the model to the job.

For example, characteristics covered by the RB500 Series include:

- Frequency: 25 cps to 10 kc.
- Accuracy: 10 ppm to 1.0 ppm
- Input voltage: 0.35f to 2.5f
- Input impedance: 60 k to 1 megohm
- Effective series impedance: 7.5 ohms to 0.5 ohms
- Long life, heavy duty switches

Name your ratio measurement and its probable there's a North Atlantic Ratio Box to meet them—precisely. Write for complete data in Bulletin 11K

Also from North Atlantic  
...a complete line of  
complex voltage ratio-  
meters...ratio test sets...  
phase angle voltmeters

**NORTH ATLANTIC**  
industries, inc.  
Terminal Drive, Plainview, L. I., N. Y.  
OVerbrook 1-8600

heat dissipation. Supplied in blocks 10 in. by 15 in. by 3 in., weighing less than 3 lb, Eccosorb WG has a useful frequency range from below 100 Mc to about 1,000 Mc.

**CIRCLE 376 ON READER SERVICE CARD**

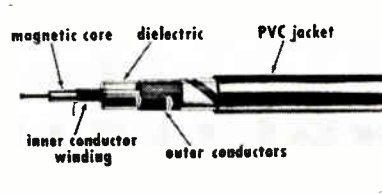

### Delay Cable MAGNETIC-CORE

COLUMBIA TECHNICAL CORP., 61-02 Thirty-First Ave., Woodside 77, N. Y. Type HH-1500A (RG-266/U) delay cable features an impedance of 1,500 ohms and a delay of 0.08  $\mu$ sec per ft with delays on the order of several microseconds. Ratios of delay-to-rise time of 100:1 can be achieved. The delay cable has an o-d of 0.400 in. It is very flexible and can be easily installed in electronic equipment. It can be supplied in 100 ft bulk lengths or in calibrated sections with molded PVC end caps and tinned leads.

**CIRCLE 377 ON READER SERVICE CARD**

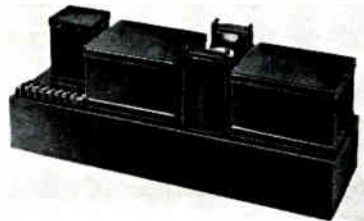

### Regulated Supply TUBELESS UNIT

FREED TRANSFORMER CO., INC., 1718 Weirfield St., Brooklyn 27, N. Y. New tubeless regulated supply contains a Freed reactor and a hermetically sealed constant voltage transformer. Featured in the supply is a time delay relay adjustable from 30 sec to 3 minutes to allow for warm-up. Input is 95 to 130 v a-c at 60 cycles; output is 155 v d-c at 150 ma regulated to  $\pm 1$  percent. Ripple is less than 10 mv. Also built in is a 6.3 v a-c, 60 cycle supply regulated to  $\pm 1$  percent against line variations of 95 to 130 v.

**CIRCLE 378 ON READER SERVICE CARD**

## PRECISION DEFLECTION WITH COSSOR YOKES

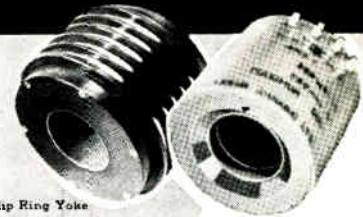

Slip Ring Yoke

Two Axis Fixed Yoke

### Component Development Engineering at its BEST!

- ADVANCED ELECTRICAL DESIGN
- PRECISION MECHANICAL DESIGN
- ACCURATE PRODUCTION METHODS

Custom Built to the most  
Exacting Specifications  
by Cossor Engineers

In Mumetal Cores for Optimum Geometry  
In Ferrite Cores for Speed and Sensitivity  
In Non-magnetic Cores for Perfection of Response

Any of Cossor's Three Core Types can be made in single or double axis with single or push-pull windings, and encapsulated for fixed or slip ring (rotating) use

Normal characteristics of yokes for 1-1 2 in neck tubes are:

- Positional accuracy: the spot position will conform to the yoke current co-ordinates within 0.25% of tube diameter. For deflection angles less than  $\pm 25^\circ$  better accuracy can easily be achieved.
- Memory: 0.5% max without over swing  
0.1% or less with controlled overswing

Complete encapsulation in epoxy (stycast) or silicone resins is standard for all Cossor deflection yokes, and is done with special moulding tools ensuring accurate alignment of the yoke axis. When slip rings are added, solid silver rings are mounted in encapsulating resin. The finished slip ring yoke is precision turned to centre bore, and can include bearing mounting surfaces with dimensional tolerances approaching those associated with high quality metal parts.

- Settling Time (Micro sec.) =  $120 \sqrt{\text{Inductance in Henries}}$
- Sensitivity degrees/milliampere =  $0.095 \sqrt{\frac{\text{Inductance} \cdot \text{millihenries}}{\text{Accelerator Voltage} \cdot \text{KV}}}$



Complete Rotational Systems

COMPONENTS DIVISION

**E.M.I  
COSSOR**  
Electronics Limited

WOODSIDE, DARTMOUTH, N. S.  
2005 Mackay St., Montreal, Que.  
3077 Bathurst St., Toronto, Ont.  
Corporation House, 160 Laurier West, Ottawa, Ont.

**CIRCLE 215 ON READER SERVICE CARD  
MAY 20, 1960 • electronics**



actual size  
Model HCM 7/16

## MINIATURE 7/16" INDICATOR

Micro-miniature moving coil, core magnet indicator; 7/16" diameter, 31/32" length. Weight 10 grams; sealed. Available with a pointer or flag display in a wide variety of electrical sensitivities and functions. Data on request. Marion Instrument Division, Minneapolis-Honeywell Regulator Co., Manchester, New Hampshire, U.S.A. In Canada, Honeywell Controls Limited, Toronto 17, Ontario.

# Honeywell



PIONEERING THE FUTURE



First in Control  
SINCE 1896

CIRCLE 216 ON READER SERVICE CARD



## There's going to be a meeting

Who's going to get together and *what* are they going to talk about?

Electronics men are meeting all over the country to talk about everything from ultrasonics to quantum electronics.

*electronics* tells you where and when "Meetings Ahead" ... gives you the highlights later on.

Another reason why it will pay you to subscribe to *electronics* (or renew your subscription) right now. Fill in the box on Reader Service Card. Easy to use. Postage free.

FIND WHAT YOU NEED IN...

# electronics

electronics • MAY 20, 1960

# PRICES HAVE DROPPED!

on high voltage transistor regulated power supplies

- for critical commercial and military applications
- full five year warranty includes *all* components
- guaranteed to meet published specs.
- short circuit protected
- fit standard 19" rack



Specifications	Model PS4221M	Model PS4231M	Model PS4222M	Model PS4232M
Voltage Range (VDC)	30-210	120-330	30-210	120-330
Current Range (Amps)	0-1	0-1	0-1.5	0-1.5
Regulation Against 20% Line change 0 to full load	0.1% 0.1%	0.1% 0.1%	0.1% 0.1%	0.1% 0.1%
Impedance (Ohms) DC to 100KC	.4	.4	.2	.2
Ripple (RMS) in Millivolts	2	3	2	3
Panel Height	5 1/4"	5 1/4"	5 1/4"	5 1/4"
Price: (See Notes)	\$555	\$620	\$580	\$645

Note 1: If meters not desired deduct \$30 and drop "M" from model number.  
Note 2: If fixed output desired ( $\pm 5$  volts) deduct \$40 and add "F" to model number followed by nominal output voltage desired.

Write for complete specifications



Specify POWER SOURCES BY

POWER SOURCES, INC.  
Burlington, Massachusetts

CIRCLE 169 ON READER SERVICE CARD 169

for maximum reliability

## PREVENT THERMAL RUNAWAY

Prevent excessive heat from causing "thermal runaway" in power diodes by maintaining collector junction temperatures at, or below, levels recommended by manufacturers, through the use of new Birtcher Diode Radiators. Cooling by conduction, convection and radiation, Birtcher Diode Radiators are inexpensive and easy to install in new or existing equipment. To fit all popularly used power diodes,



## with NEW BIRTCHER DIODE RADIATORS

**B**

Birtcher cooling and retention devices are not sold through distributors. They are available only from the Birtcher Corporation and their sales representatives.

### THE BIRTCHER CORPORATION *industrial division*

4371 Valley Blvd. Los Angeles 32, California

Sales engineering representatives in principal cities.

**CIRCLE 217 ON READER SERVICE CARD**

**FOR CATALOG**

and  
test data write:



## RF PROJECT ENGINEERS SENIOR DESIGN ENGINEERS VHF-UHF MICROWAVE

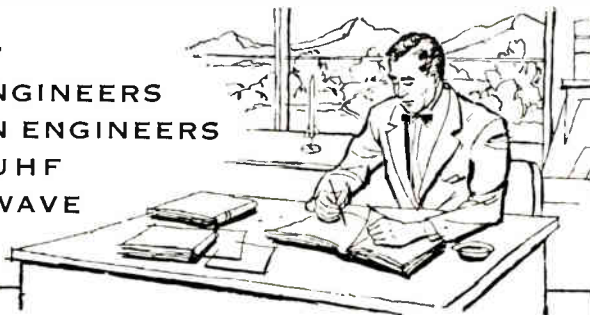

Positions now open for engineers experienced in management of radio frequency projects, and for engineers experienced in radio frequency design. Our long range programs in lunar and interplanetary communications offer challenging assignments in an academic atmosphere.

Current projects include advanced development of precision radio tracking systems, digital telemetry and command systems, and terminal landing instrumentation.

Minimum B. S. degree and five years related design experience required. 10 to 15 years desired.

Immediate "on lab" interviews arranged for qualified applicants.

*Send resume and qualifications today to*



CALIFORNIA INSTITUTE OF TECHNOLOGY  
**JET PROPULSION LABORATORY**  
PASADENA, CALIFORNIA

A Research Facility operated for the National Aeronautics and Space Administration

## Literature of

**SUB-SUBMINIATURE SWITCH** Micro Switch, Freeport, Ill. Data sheet 169 describes the 1XE1 environment-free sub-subminiature switch.

**CIRCLE 380 ON READER SERVICE CARD**

**TACHOMETERS** The Electro-Mechano Co., 241 E. Erie St., Milwaukee, Wisc., has available a bulletin covering portable and hand tachometers for general shop and lab testing of rotational speeds on most any type of equipment.

**CIRCLE 381 ON READER SERVICE CARD**

**INSULATING MATERIAL** Westinghouse Electric Corp., Benolite Plant, Manor, Pa. Eight-page booklet MB-1908-A describes the properties and uses of Limitrak surface-coating insulating material.

**CIRCLE 382 ON READER SERVICE CARD**

**QUARTZ CRYSTAL TRANSDUCERS** Kistler Instrument Corp., 15 Webster St., North Tonawanda, N. Y., has published a well-illustrated brochure showing a full line of natural quartz crystal transducers for pressure, force, acceleration and vibration measurements.

**CIRCLE 383 ON READER SERVICE CARD**

**ELECTRONIC COUNTER** Hewlett-Packard Co., 275 Page Mill Road, Palo Alto, Calif. A loose-leaf data sheet describes model 521G electronic counter. Advantages, uses, and specifications are listed.

**CIRCLE 384 ON READER SERVICE CARD**

**CAPACITORS** General Electric Co., Schenectady 5, N. Y. Bulletin GET-3032 provides detailed information about a wide range of standard commercial, MIL-C-25A, and Permafil capacitors used for such a-c/d-c applications as blocking and bypass service, power supply filters and other general purpose military and commercial applications.

**CIRCLE 385 ON READER SERVICE CARD**

**SENSING DEVICES** Consolidated Electrodynamics Corp., 360 Sierra Madre Villa, Pasadena, Calif. Design details and applications of pressure instrumentation, force-balance instruments, unbonded

# the Week

strain-gage and potentiometer pressure transducers, vibration transducers, galvanometers, and ceramic and precision optical products are featured in a 16-page general catalog.

CIRCLE 386 ON READER SERVICE CARD

**WINDING MACHINES** Boesch Mfg. Co., Danbury, Conn. Catalog 60 is a 40-page booklet on a line of winding machines and accessories for the electronics industry.

CIRCLE 387 ON READER SERVICE CARD

**FASTENERS** Deutsch Fastener Corp., 14504 So. Figueroa St., Los Angeles 61, Calif., offers a new, profusely illustrated two-color brochure featuring four new concepts in special-purpose fasteners, including the Pawl-Loc, Zip-Loc, Pres-Loc and Deutsch blind rivets. The devices described increase design freedom for engineers concerned with missile, rocket, aircraft or ground-equipment fastener applications.

CIRCLE 388 ON READER SERVICE CARD

**R-I FILTERS** Sprague Electric Co., North Adams, Mass. Engineering bulletin No. 8100A illustrates and describes a line of small and light cylindrical style radio interference filters.

CIRCLE 389 ON READER SERVICE CARD

**VOLTAGE LIMITERS** Clevite Transistor, Waltham, Mass. Bulletin B220A covers a line of voltage limiters which are subminiature glass diodes designed to have a maximum ratio of d-c to a-c impedance in the region of 1 to 10 ma and 0.25 to 0.75 v.

CIRCLE 390 ON READER SERVICE CARD

**PULSE TRANSFORMERS** Technitrol Engineering Co., 1952 E. Allegheny Ave., Philadelphia 34, Pa. Bulletin PT-201 describes the company's complete line of standard miniature pulse transformers and includes a full page of application notes showing circuits and design formulas of interstage coupling applications and vacuum tube and transistor blocking oscillator applications.

CIRCLE 391 ON READER SERVICE CARD



Parts shown 2/3 actual size.

25 years of progress in tiny parts

## BRAND NEW! GRC GUIDE BOOK for SMALL GEAR USERS

Full Specs for Hundreds of Combinations of One-Piece Die Cast Zinc Alloy—spur gears, gear clusters, pinions, cup gears—with hubs, shafts, spacers, or special features—at little or NO tool cost.

If you use small gears and pinions it will pay you to keep this valuable guide book at your fingertips. It shows parts made by GRC's interchangeable unit die systems and exclusive single cavity casting techniques; new design flexibility, new assembly shortcuts—reduced production and material costs. Maximum sizes: 1-5/16" O.D. by 1/16" face width—wider faces with smaller diameters.

Send TODAY for your  
GRC Gear Guide Book



**GRIES REPRODUCER CORP.**

World's Foremost Producer of Small Die Castings

151 Beechwood Ave., New Rochelle, N. Y., New Rochelle 3-8600

See us at the Design Engineering Show—Booth #2435

CIRCLE 218 ON READER SERVICE CARD



**YOU HAVE TO BE THE  
BEST TO STAY ON TOP**



**ELECTRON GUN MOUNTS**

In every industry there's a leader that earns and maintains its position through its ability to produce a better product than its competitors.

Superior Electronics Corporation, oldest and largest exclusive manufacturer of electron gun mounts in the world, continues to hold this position of leadership through consistent and complete application of its talents and skills in electron gun mount research, engineering and production techniques.

For standard gun mounts, prototypes or special purpose mounts for any application call on Superior Electronics Corporation.

SAMPLES, CATALOGS, PRICES AVAILABLE ON REQUEST

**SUPERIOR ELECTRONICS CORP.**

DEPT. FEEL • 208 PIAGE AVENUE • CLIFTON, N. J. • GREGORY 2-2500



## Hitemp Opens Western Plant

Hitemp Wires, Inc., producer of high temperature insulated wires, cables and cable assemblies, has increased its production capacity 25 percent with the recent opening of an integrated manufacturing facility in Monrovia, Calif. The new plant is operated by Hitemp, Inc., a newly formed, wholly owned subsidiary.

George F. Rolfe, president of Hitemp Wires, said the West Coast move became necessary when the company's present manufacturing facilities in Westbury, N. Y., had difficulty in meeting increased demands from western companies.

The trend today, he said, is toward highly specialized wires and cables. "We constructed a fully equipped, modern installation in Monrovia to provide the experienced engineering service and fast delivery of finished products required by the growing list of electronics, missile and aircraft pro-

ducers in the western states."

The new plant represents an investment of approximately \$250,000. It contains enough space and provisions for ultimately increasing the company's over-all production as much as 50 percent, Rolfe added.

The eight-year-old company, which supplies some 1,500 users with high temperature wiring products, was an early pioneer in the mass production of Teflon-insulated wires. Hitemp's research and development department recently developed a ceramic-insulated wire for applications at temperatures up to 1,000 F. Flat ribbon cables and bondable Teflon wires were also perfected in the company's laboratories and are now widely used.

Another recent development by Hitemp researchers is thin-walled tubing of Teflon made in large diameters. The tubes are fabricated with continuous windings of Teflon tape material.

## Company Formed In Pittsburgh

A NEW FIRM, Norbatrol Electronics Corp., has started operations in Pittsburgh.

The company, using facilities formerly occupied by Westinghouse's Collins Avenue plant, manufactures magnetic amplifiers and electronic controls, components, assemblies and systems.

Thomas H. Nimick, Jr., is presi-

dent and Roland W. Roberts, executive vice president. The company employs about 50 persons, mostly women.

Nimick handles the financial and administrative phases of the business. Roberts handles sales.

Harry J. Abrams and Ronald C. Blackmond, engineers with manufacturing and design experience, have joined the company. Abrams is vice president in charge of manufacturing and Blackmond is chief

design engineer at the plant.

All four men are stockholders in the corporation.



## Shortess Takes WacLine Post

EDWIN S. SHORTESS has joined WacLine, Inc., Dayton, Ohio, as general manager of its Meter Division.

Prior to coming with WacLine, he was associated with Hickok Electrical Instrument Co. as director and as administrative engineer for 7 years, and he was chief engineer and a director of Burlington Instrument Co. from 1945 to 1953.

WacLine specializes in military panel meters and special meters and indicators of many types.

## Hughes Aircraft Names Five Lab Managers

F. P. ADLER, director of advanced projects laboratories at Hughes Aircraft Co., Culver City, Calif., announces the appointment of five laboratory managers.

They are R. L. Roderick, ballistic missile and ballistic missile defense systems; J. W. Ludwig, space systems; Leonard Mautner, special systems; R. K. Ausbourne, tactical missile systems, and L. J. Money, tactical aircraft systems.

The advanced projects laboratories are responsible for invention

magnetic phase modulators for defense application

# Transmitter circuitry can be simplified

MPM'S compact design does it — with fewer multiplier stages

The Magnetic Phase Modulator, an innovation in G.E.'s Electrically Variable Delay Line family, now combines small size with increased time delay, linearity and reliability. Improved phase shift capability permits use of oscillators operating to a frequency of 18 mc. By eliminating one or more transmitter multiplier stages, both circuit complexity—and total cost—are greatly reduced. Designed to withstand extreme conditions of humidity, shock and vibration, this magnetically stable device finds ready application in portable and semi-portable military equipment, with particular use in FM communications.

Magnetic Phase Modulators, developed to defense specifications, are available for high and low frequency transmitters, and are suitable for printed wire board mounting, transistorized circuitry and chassis miniaturization. For complete specifications write to: Defense Industries Programs, Section 176-51.

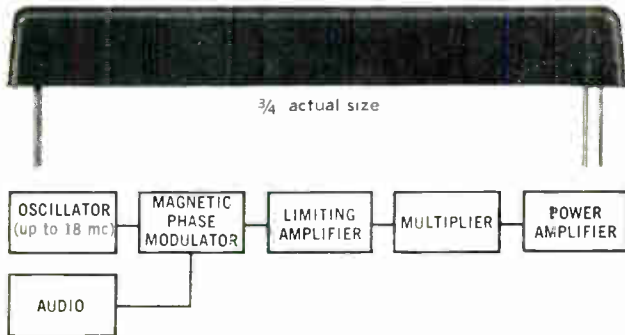

Block diagram shows how MPM replaces the reactance tube in a basic transmitter circuit to permit higher frequency operation. De-emphasis network and unnecessary multiplier stages are now eliminated.

# GENERAL ELECTRIC

DEFENSE ELECTRONICS DIVISION  
HEAVY MILITARY ELECTRONICS DEPARTMENT, SYRACUSE, NEW YORK

CIRCLE 219 ON READER SERVICE CARD



## BENDIX-PACIFIC

*in Southern California*

*needs* ENGINEERS *with*  
DOCTORS' - MASTERS' - BACHELORS'  
DEGREES

*for electrical, mechanical and systems work in fields of  
Instrumentation — Telemetry  
Anti-Submarine Detection Systems/Operations Research  
Missile and Aircraft Fluid Controls.*

Please send resume to MR. RALPH LAMM,  
DIRECTOR OF ENGINEERING

*Other High-Level Electronic  
Engineering Positions Available*



11602 SHERMAN WAY  
NORTH HOLLYWOOD, CALIFORNIA

CO-AX

4 mmf/ft



capacitance & attenuation

★ **ULTRA LOW**

WE ARE SPECIALLY ORGANIZED TO HANDLE DIRECT ORDERS OR ENQUIRIES FROM OVERSEAS

SPOT DELIVERIES FOR U.S.

BILLED IN DOLLARS—  
SETTLEMENT BY YOUR CHECK  
CABLE OR AIRMAIL TODAY



TYPE	$\mu\text{mf/ft}$	IMPED. $\Omega$	O.D.
C 1	7.3	150	.36'
C 11	6.3	173	.36'
C 2	6.3	171	.44'
C 22	5.5	184	.44'
C 3	5.4	197	.64'
C 33	4.8	220	.64'
C 4	4.6	229	1.03'
C 44	4.1	252	1.03'

**NEW** 'MX and SM' SUBMINIATURE CONNECTORS  
Constant 50 $\Omega$ -63 $\Omega$ -70 $\Omega$  impedances

TRANSRADIO LTD, 138A Cromwell Rd, London SW7 ENGLAND CABLES: TRANSRAD, LONDON

CIRCLE 220 ON READER SERVICE CARD

**TEST THE SUPER ACCURATE  
AVOMETER 8**  
WITHOUT COST, WITHOUT OBLIGATION  
Guaranteed Long-Term Accuracy 1%

We invite you to test the world-famous AvoMeter 8 for one month. No cost. No obligation. Thousands in use wherever accuracy and dependability are required. Closer to a laboratory standard than to a conventional test meter! Accuracy guaranteed, 1% DC current, 2% DC voltage, 2 1/4% AC current and voltage. Sensitivity: 20k $\Omega$ /v DC, 1k $\Omega$ /AC. Hand Calibrated • Mirrored Scale • Automatic Overload Protection • AC Current Ranges • Reversing Switch • 3 Zeroing Controls • Accessories Extend Ranges. Moderate Price is \$89.01



**BRITISH INDUSTRIES CORP.**  
Use Coupon or Letterhead

BRITISH INDUSTRIES CORPORATION 22 E 160  
Scientific Instruments Division  
Port Washington, New York

We wish to test the AvoMeter without cost or obligation.

firm name \_\_\_\_\_  
address \_\_\_\_\_  
city \_\_\_\_\_ zone \_\_\_\_\_ state \_\_\_\_\_  
your name \_\_\_\_\_  
title \_\_\_\_\_

**INCOME  
TAXES  
are going  
DOWN**

for everybody in  
**MISSISSIPPI**

- ↓ Executives will weigh this mandatory tax reduction program in their future plans.
- ↓ Top Income Tax bracket will be reduced 50%, graduated over a six-year period.
- ↓ Personal Exemptions are increased \$1,000; individuals now \$5,000, married couples \$7,000.
- ↓ Main Street merchants view tax reduction as a very real incentive to industrialization.

For Further Information Contact  
MISSISSIPPI AGRICULTURAL AND INDUSTRIAL BOARD  
Jackson, Mississippi

CIRCLE 221 ON READER SERVICE CARD

and preliminary design of missile, space and electronic systems.



**Telemeter Magnetics  
Appoints Englert**

ROBERT ENGLERT has joined Telemeter Magnetics, Inc., Components Division, Culver City, Calif., as applications engineer. He will provide engineering assistance for customers' problems involving magnetic data storage components.

Englert was formerly with Telecomputing Corp. where he served as western manager of field engineering, a position he held for 4 years. Prior to this he was with Western Electric Co.



**Stromberg-Carlson  
Hires Lawrence**

WILLIAM LAWRENCE has been appointed director of operations for the Electronics Division of Stromberg-Carlson, Rochester, N. Y.

Prior to joining S-C, Lawrence was assistant general manager of the Avionics and Automation Divisions of Bell Aircraft Corp. From 1953 to 1956 he was manager of manufacturing of the Radio Condenser Corp., Camden, N. J. Pre-



viously he had been manager of operations at Magnavox Corp., Greeneville, Tenn., and plant manager for General Electric Co. at Syracuse, N. Y.



### Mallory Board Elects Officers

The board of directors of P. R. Mallory & Co. Inc., Indianapolis, Ind., has elected G. Barron Mallory (picture) to the office of president, succeeding Joseph E. Cain, who has been president since 1946 and prior to that was executive vice president from 1935 to 1946.

Philip R. Mallory was re-elected chairman of the board of directors with J. E. Cain elected co-chairman. Cain was also elected chairman of the executive committee, succeeding J. F. Riley who remains a member of the executive committee together with C. Harvey Bradley and G. B. Mallory.

G. Barron Mallory, son of company founder and board chairman, P. R. Mallory, has been administrative vice president since October 1958. Active in Mallory company affairs for many years, he was a director of the company before his election as administrative vice president.

The Mallory board also announced four other executive promotions. Charles A. Barnes, formerly vice president-controller, was elected vice president-finance; Leon Linn, who heads the Metallurgical and Mechanical Group, was elected vice president of P. R. Mallory & Co. Inc.; Kenneth W. Shearer, formerly assistant to the controller, was elected controller; and Paul M. D. Harrison was elected assistant secretary.

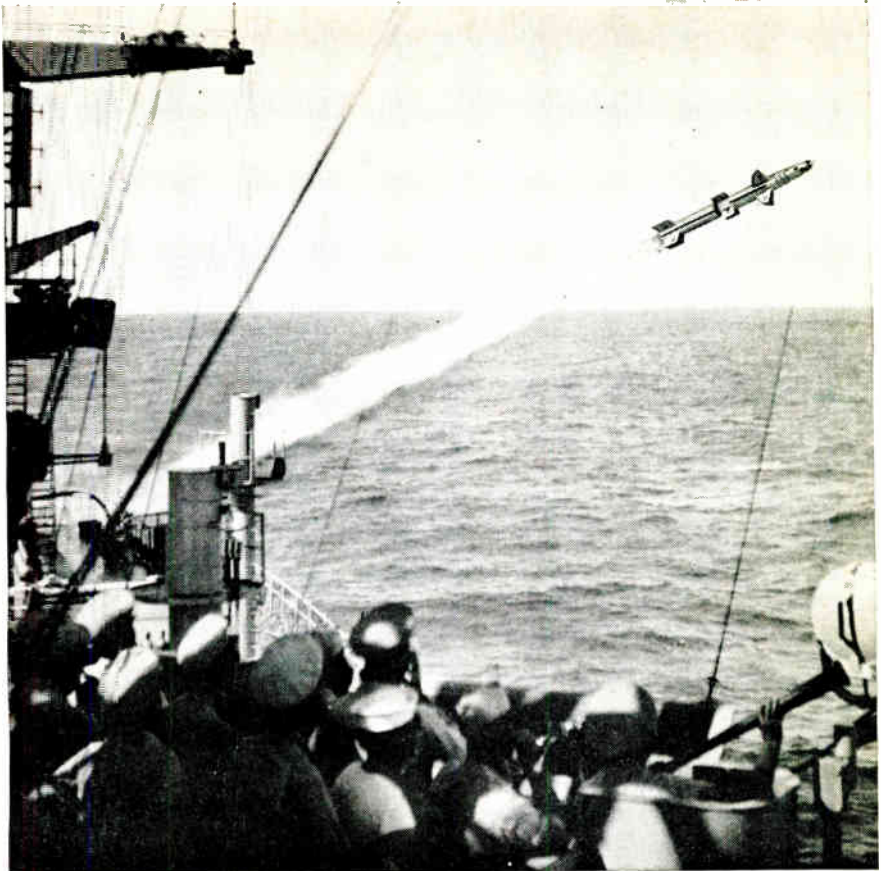

Talos missile, prime armament of the missile-age cruisers, blasts off from the U.S.S. Galveston.

## Bendix Talos— on target for your future!

Talos was on target from the start. The Navy credits it with consistently high accuracy and effectiveness. As a result, Talos was installed directly aboard first line cruisers, rather than auxiliary ships.

The established success of Talos by Bendix Missiles, its prime contractor, not only assures permanence to the present program but has opened the door to other advanced missile projects that offer new and challenging job opportunities in design, development, testing, and manufacturing.

Bendix Missiles, in addition to its direct responsibility for Talos and other advanced missile projects, is a key

division of Bendix Aviation Corporation. The corporation-wide activities of Bendix cover practically every phase of advanced technology with particular emphasis on systems design and development. Participation in this highly diversified corporation effort is your further assurance of a more secure future.

Enjoy living in the Midwest and find unmatched job opportunities with Bendix Missiles. Grow professionally as well as financially. Take the first step today. Mail the coupon for your copy of the interesting booklet "Opportunities Abound at Bendix Missiles."

**Bendix** PRODUCTS DIVISION **Missiles**



PRIME CONTRACTOR FOR THE TALOS MISSILE



**Bendix Products Division—Missiles**

402E So. Beiger St., Mishawaka, Ind.

Gentlemen: I would like more information concerning opportunities in guided missiles. Please send me the booklet "Opportunities Abound at Bendix Missiles."

NAME \_\_\_\_\_

ADDRESS \_\_\_\_\_

CITY \_\_\_\_\_ STATE \_\_\_\_\_

# The future ... from your point of view

A good day's growth for a hard day's work.

A position to suit your talents, experience and ambition.

Opportunity to exercise full initiative in Research, Radar, Doppler Navigational Systems, Magnetic Memory Systems, Microwave and Computers.

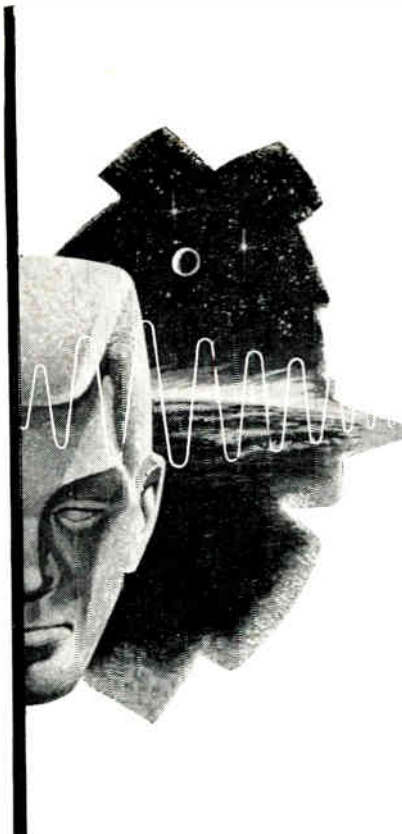

## PLUS

Management awareness encouraging exploration beyond the range of present knowledge.

## APPOINTMENTS NOW AVAILABLE:

### SENIOR ENGINEER

#### Air Traffic Control Systems

Experienced in problems involving the relation of overall ground-air environment to such elements as Navigation, Data Acquisition, Processing and Display.

### SENIOR ENGINEER

#### Radar Systems & Techniques

Thoroughly grounded in existing systems, philosophies and techniques. To study, design and plan advanced programs for varied applications.

### SENIOR ENGINEER

#### Airborne Electronic Weapon Systems

Experienced in existing systems and requirements. To plan the optimum integration of such various subsystems as radar, navigation, central data computers, communications, etc.

*For a confidential discussion, please write:*

Eugene Rust  
Laboratory for Electronics  
75 Pitts Street, Boston 14, Massachusetts



**LABORATORY FOR ELECTRONICS**

## CONTACTS

FOR THE FIELD OF  
ELECTRONICS

**LIFSCHULTZ**  
**FAST FREIGHT**

FASTEST TO BOTH COASTS!

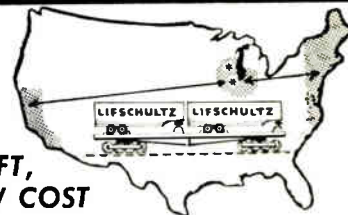

SWIFT,  
LOW COST

TRUCKLOAD SHIPMENT via  
**LIFSCHULTZ PIGGYBACK**

Between Middle West and  
Atlantic Seaboard Points

Specify **LIFSCHULTZ**  
and Be Sure It's On Time!



## WHO DROPPED THE BINOCULARS?

With everybody watching each other along the DEW line and the Iron Curtain these days, electronics has replaced binoculars.

What's happening in the giant markets for missile controls, radar and communications equipment?

electronics tells how things are going, keeps you informed of developments as they occur. This is a good time to subscribe or renew your subscription. Just fill in box on Reader Service Card. Easy to use. Postage free.

**FIND WHAT  
YOU NEED IN...  
electronics**

FROM AN ENGINEER'S NOTE PAD



## "You plot your own curve at HMED"

ENGINEERS ARE a curious lot: a breed apart. Their natural preferences for facts, their talents for logic have been trained and disciplined.

The result many times...an uncommon, refreshing way of expressing the well known...a direct, succinct method of stating the complex.

Here is an actual example. It is a composite of sketches made by one of our Engineering Supervisors

during a discussion of General Electric's unique Salary Administration Program.

Circuit engineers will have little trouble in reading it. Others may have more difficulty. All may wish additional detail. For this, as well as other information regarding the unusual professional and outstanding personal opportunities awaiting you at General Electric's Heavy Military Electronics Department, write in confidence to George B. Callender.

HEAVY MILITARY ELECTRONICS DEPARTMENT

**GENERAL  ELECTRIC**

Div. 69-WT Syracuse, New York

There are openings for graduate engineers at intermediate (3 or more years) and high levels of experience in the following areas: Weapons Systems Analysis; Mathematical Analysis of Engineering Problems; Military Communications Systems; Radar Systems; Weapons Control Systems; Electronic Circuitry; Experimental Psychology—Human Factors; Instrumentation.

SYSTEMS  
ENGINEERS



ENGINEERS  
ELECTRONICS

**CHALLENGING R & D OPPORTUNITIES**

Fundamental and applied research in the fields of hydrodynamics, acoustics, electronics, network theory, servomechanisms, mechanics, information theory and noise reduction. Also design of electronic instrumentation for underwater ordnance and application of analogue and digital computers.

Opportunities for Graduate Study  
Faculty Appointments for Qualified Applicants  
Excellent Working and Living Conditions

Send Resume to

ARNOLD ADDISON, PERSONNEL DIRECTOR  
ORDNANCE RESEARCH LABORATORY  
THE PENNSYLVANIA STATE UNIVERSITY  
BOX 30, UNIVERSITY PARK, PA.

**DESIGN  
ENGINEERS**

*check these openings in  
advanced gyro and electrical  
components design*

In 1949, Honeywell developed and flight tested the floated gyro for control systems. Since then, its Gyro Design Group has become the focal point for a multi-million dollar component development program, supporting the inertial navigation industry. This is, perhaps, the most advanced program of its kind. It has expanded rapidly and now has openings for additional top level engineers.

This group is involved in all fields of gyro design. It works in such areas as *precision gyro and accelerometer design, hydro-dynamic bearings, vibratory mechanisms, precision electric suspension techniques and gyro magnetics.*

The men needed to fill these positions should be capable of developing advanced concepts for gyros and of following through on their projects. They should have a minimum of two years' (and up to twenty years') experience in such areas as *precision gyro mechanics, servo techniques, digital data handling, electronics packaging, advanced instrumentation, or magnetic component design.*

*To discuss these or other openings, write Mr. Bruce D. Wood, Dept. 614B, Aeronautical Division, 1433 Stinson Blvd., Minneapolis 13, Minn.*

**Honeywell**



To explore professional opportunities in other Honeywell operations coast to coast, send your application in confidence to H. K. Eckstrom, Minneapolis 8, Minnesota.

**LENKURT  
ENGINEERS**

has opportunities for

in the following fields:

- MICROWAVE RADIO DESIGN ENGINEERS
- TELEPHONE CARRIER DEVELOPMENT ENGINEERS
- SALES ENGINEERS  
Extensive telephone exp. req. BSEE also req.
- ENGINEERING WRITERS
- QUALITY CONTROL ENGINEERS  
Live and work on the Beautiful San Francisco Peninsula!

Please direct inquiries to:

E. Jack Shannahan  
Employment Manager

LENKURT ELECTRIC COMPANY, Inc.  
1105 County Road San Carlos, California  
If more convenient, call—collect LYtel 1-8461

**SALES ENGINEERS**

We are placing on the market several new products including recording and controlling instruments and require Sales Engineers for our Houston, St. Louis, Chicago, Detroit, and Cleveland districts. Prefer Electrical, Mechanical, or Chemical Engineers. Can offer excellent opportunities for qualified men. Successful candidates will be given a factory course at Waterbury before assignment to one of the above districts.

Write Mr. H. E. Beane, Vice President,

**THE BRISTOL COMPANY**  
Waterbury 20, Connecticut

**SEMI-CONDUCTOR PHYSICIST**

One of the strongest manufacturers of semi-conductor devices seeks ten (10) semi-conductor physicists with varying range of experience (B.S. and advance degrees) located in warm sunny climate. New division offers exceptional challenge with assured future and most satisfying income. Wide salary range. Send resume. No fee.

**MONARCH PERSONNEL**  
28 East Jackson Chicago 4, Illinois

**THREE PRODUCTS MANAGERS  
SALARY \$15,000+**

Planning new products, programming into manufacturing, customer liaison, market planning. Experienced in the fields of semi-conductors, vacuum tubes, power tubes, miniature and sub-miniature tubes. Company client assumes all employment expenses.

ESQUIRE PERSONNEL INC.

202 South State Street, Chicago 4, Illinois

**SEARCHLIGHT SECTION**

**Antique  
TELEPHONES**

As is complete, decorative purpose \$12.00. Working order, inter-comm. \$15.00. Ext. on dial \$17.50. talking circuit only. Write for complete list. All shipments F.O.B., Simpson, Pa.  
TELEPHONE ENGINEERING CO.  
Dept. E-50, Simpson, Pa.



CIRCLE 460 ON READER SERVICE CARD



**MANUFACTURERS'  
REPRESENTATIVES**

IN THE ELECTRONIC INDUSTRY

**SAMUEL K. MACDONALD, INC.**

manufacturers representatives over 25 years  
1531 SPRUCE STREET, PHILA. 2, PA.

Territory:  
Pennsylvania • New Jersey  
Delaware • Maryland  
Virginia • West Virginia  
District of Columbia

Other Offices:  
Pittsburgh  
Baltimore  
Washington, D.C.

**T/I**  
**needs an S-C product engineer**  
**whose design philosophy**  
**is reliability**

to develop and improve diodes,  
 regulators, rectifiers,  
 capacitors, resistors

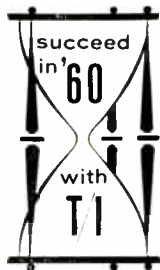
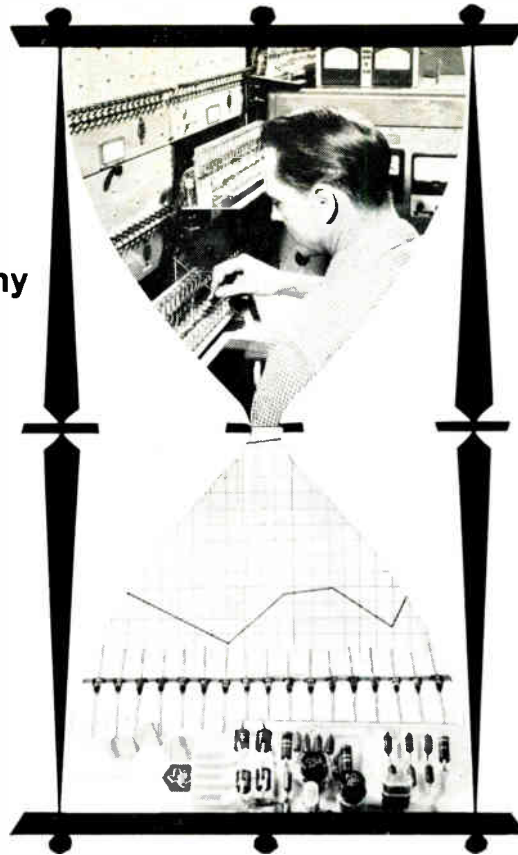

At TI's Semiconductor-Components division, product engineers of integrity have the opportunity of putting their talents to work in an atmosphere where reliability is the only acceptable design philosophy. Here the daily challenge is to make the world's best semiconductor products at the lowest possible cost without sacrificing dependability. ■ As a TI S-C product engineer it would be your responsibility to strive constantly to adopt new techniques and technologies toward improvement, simplification and increased reliability of existing processes and products. ■ We now require product engineers to undertake challenging key assignments in reliable design, development and evaluation of ultra-fast computer diodes, tunnel diodes, rectifiers, controlled rectifiers, voltage regulators, resistors, and tantalum and other advanced types of capacitors. ■ You qualify as a product engineer for semiconductor component projects if you have a degree in Electrical Engineering, Physics or Physical Chemistry and at least three years experience in diode, capacitor or resistor design and circuitry.

**OTHER PROFESSIONAL POSTS AVAILABLE:**

- Component Packaging Engineers
- Circuit Development Engineers
- Test Equipment Engineers
- Electronic Sub-Systems Engineers  
(Standard and Modular)

INTERVIEWS in your area will be held in the near future. If you qualify for positions described, please send resume immediately to C. A. BESIO, DEPT. 117.



SEMICONDUCTOR - COMPONENTS DIVISION  
 POST OFFICE BOX 312 • DALLAS, TEXAS

*for complete information about TI's Semiconductor-Components division, send coupon for "TIPS" today.*



TEXAS INSTRUMENTS INCORPORATED  
 Semiconductor-Components Division  
 P. O. Box 312, Dept. 117, Dallas, Texas

Please send me TIPS containing complete information about currently available TI S-C professional careers in my field, and related information.

NAME \_\_\_\_\_  
 ADDRESS \_\_\_\_\_  
 CITY \_\_\_\_\_ STATE \_\_\_\_\_  
 My professional field is \_\_\_\_\_  
 My specialty is \_\_\_\_\_



# Hermetically Sealed Connectors

CONSECO connectors represent an achievement of more experience in design and manufacture of glass-sealed hermetic items than can be found in any other organization in the United States. This unique, specialized "know how" is at your service in these available units, or for consultation on applications not normally stocked.



**MINCON  
HERMETIC  
SEALED  
CONNECTOR**

**MINIATURE  
CONNECTOR**

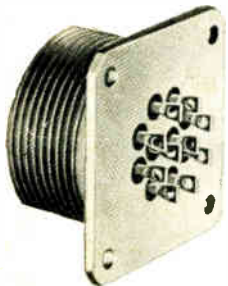

**MULTIPLE  
CONTACT  
MS  
TYPE  
CONNECTOR**

Really rugged, CONSECO connectors provide genuine hermetic sealing. They are engineered out of top technical experience to meet military specifications and to perform under the toughest going.

Write for **FREE literature.**

## Connector Seals Corp.

300 North Lake Ave. • Pasadena, California  
TWX PASA 8581

# INDEX TO ADVERTISERS



Audited Paid Circulation

Ace Plastics Co. ....	35	* Curtis Universal Joint Co., Inc. ....	182
* Acton Laboratories, Inc. ....	129	* Curtiss-Wright Corp. ....	112
* Airborne Instruments Labs. ....	21		
Allen-Bradley Co. ....	127		
American Electronics Inc. ....	21		
* American Lava Corp. ....	103	* Dale Products, Inc. ....	121
* Amphphenol-Borg Electronics Corp. Cable & Wire Division ....	131 106	* Daven Company ....	3rd Cover
Avnet Electronics ....	63	* Dialight Corporation ....	167
		Dorne & Margolin, Inc. ....	155
		* Driver Co., Wilbur B. ....	62
		* Driver-Harris Company ....	33
		* du Pont de Nemours & Co., E. I. Explosives Dept. ....	64
* Ballantine Laboratories, Inc. ....	141	Eastern Air Devices Inc. ....	27
Barker & Williamson, Inc. ....	141	* Eitel-McCullough, Inc. ....	30
* Bead Chain Mfg. Co., The. ....	163	* Electro Motive Mfg. Co., Inc. ....	105
Beaver Gear Works, Inc. ....	167	* Electro-Pulse, Inc. ....	123
* Bendix Corporation ....	66, 67	Electronic Engineering Company ...	107
Bendix Pacific ....	115, 173	* Electronic Instrument Co., Inc. (EICO) ....	161
Products Division Missiles. ....	175	* Electronic Measurements Co Inc. ....	80
* Bird Electronic Corp. ....	45	Engineered Electronics Company ...	156
* Bircher Corporation ....	170	* Erie Pacific Division, Erie Resistor Corp. ....	158
Blaw-Knox Company ....	151	Excello Corporation ....	111
Boesch Mfg. Co., Inc. ....	135		
Borden Chemical Company, Resinite Dept. ....	16	* Fairchild Semiconductor Corp. ....	118, 119
* Bourns Laboratories, Inc. Trimpot Div. ....	10	Fansteel Metallurgical Corp. ....	148, 149
Bristol Company, The. ....	151		
British Industries Corporation. ....	171		
Bruning Co., Charles. ....	132		
* Burnell & Co., Inc. ....	3		
C B S Electronics. ....	71	* Gamewell Co. ....	72
* Centralab A Div. of Globe-Union Inc. ....	7	Gardner-Denver Co. ....	32
Christie Electric Corp. ....	31	* General Ceramics Corp., Division of Indiana General Corporation. ....	2
Cinema Engineering ....	117	* General Electric Co. Apparatus ....	113
Clarostat Mfg. Co. ....	61	Heavy Military Division. ....	131
* Clevite Corp. Clevite Transistor ....	12, 43	Defense Electronics Division. ....	173
Connector Seals Corp. ....	180	Lamp Division. ....	137
Consolidated Avionics Corp. ....	112	* General Magnetics, Inc. ....	73, 74
Consolidated Electroynamics ....	53, 152, 153	* General Precision Equipment Corp. Kearfott ....	70
* Continental-Diamond Fibre Subsidi- ary of the Budd Company. ....	57	Gries Reproducer Corp. ....	171
Continental Electronics Mfg. Com- pany ....	51		
* Cossor Limited ....	168		
* Cross Co., H. ....	160		
Cubic Corp. ....	137		

\* See advertisement in the June, 1959 Mid-Month  
ELECTRONICS BUYERS GUIDE for complete line  
of products or services.





## CURTIS HELPS THIS SWITCH LIVE TO A RIPE OLD AGE

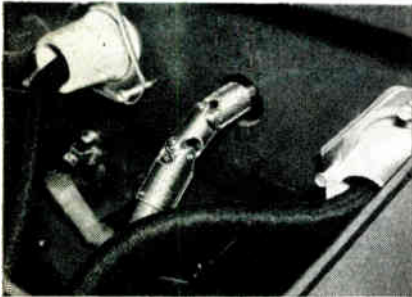
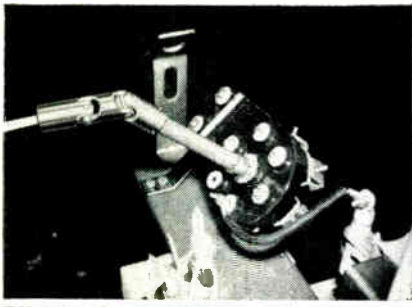

Pad-mounted transformers for underground power distribution systems are built to last a lifetime. They require a minimum of maintenance. Settings are changed infrequently. But when a change is required, this switch must operate smoothly and surely. To insure a long, dependable life, without freeze-ups or rust-outs, the manufacturer equipped it with a Curtis C-646 1" O.D. Stainless Steel double universal joint.

This kind of dependability is the stock-in-trade of Curtis joints — size for size the strongest universal joints designed for industry. Selected materials, precision engineering, continuous testing, inspection and quality control at every stage of manufacture — these are some of the things that make Curtis joints your most dependable buy.

**14 SIZES ALWAYS IN STOCK**  
**3/8" to 4"**

Not sold through distributors. Write or phone REpublic 7-0281 for latest catalog, free engineering data and price list.

# CURTIS

**UNIVERSAL JOINT CO., INC.**

195 Birnie Ave., Springfield 7, Mass.

As near to you as your telephone. Exclusively a manufacturer of universal joints since 1919

Thermal Controls, Inc.	121
Thompson-Ramo-Wooldridge	26
Transitube	161, 163
Transradio, Ltd.	171

United Aircraft Corp. Ketty Dept.	109
--------------------------------------	-----

United Transformer Corp.	2nd Cover
--------------------------	-----------

Varian Associates	28
-------------------	----

Veeder-Root, Inc.	75
-------------------	----

Vitramon, Inc.	77
----------------	----

White, S. S.	39
--------------	----

\*

### CLASSIFIED ADVERTISING

F. J. Eberle, Business Mgr.

EMPLOYMENT OPPORTUNITIES 177-179

EQUIPMENT  
(Used or Surplus New)  
For Sale ..... 178

### ADVERTISERS INDEX

Bristol Company	178
Esquire Personnel Service	178
General Electric Company	177
Honeywell	178
Lenkurt Electric Company, Inc.	178
Monarch Personnel	178
Pennsylvania State University	178
Telephone Engineering Company	178
Texas Instruments Incorporated	179

\* See advertisement in the June, 1959 Mid-Month ELECTRONICS BUYERS GUIDE for complete line of products or services.

This index is published as a service. Every care is taken to make it accurate, but ELECTRONICS assumes no responsibilities for errors or omissions.

## do you know what's expected from semi-conductor materials?

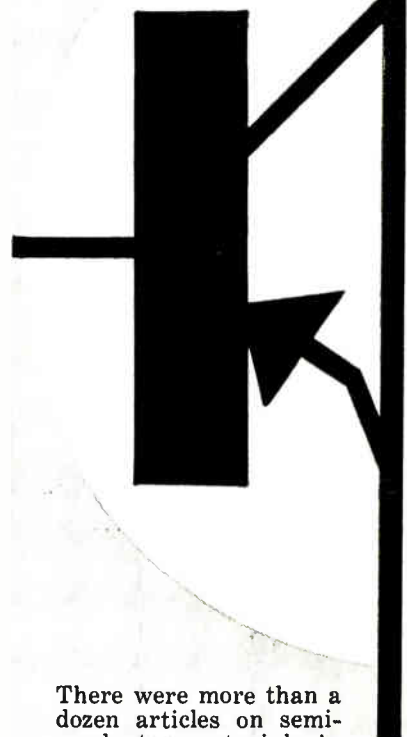

There were more than a dozen articles on semi-conductor materials in **electronics** in recent months. Each was specially edited to give you all key facts, ideas or trends — and there's more coming! Accurate **electronics'** reporting tells you what's happening now . . . what's *expected* in materials and components. Don't miss dozens of articles on basic subjects edited to keep you informed, help make your research, development, sales and marketing plans pay off. It pays to subscribe to **electronics** (or renew). Fill in box on Reader Service Card now. Easy to use. Postage free.

## FIND WHAT YOU NEED IN **electronics**



# Convert

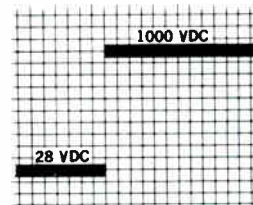

# Invert



# Change



## **Daven solves your solid-state power supply problems!**

Take advantage of Daven's experience in designing extremely compact, light-weight, high temperature units, which can withstand the most severe altitude, shock, and vibration environments. Let us engineer solid-state supplies for your missile-borne, airborne, shipborne, underwater or ground support equipment.

### **Converters**

- DC input voltage from 6 volts to 230 volts
- DC output voltage from 1 volt to 15 kilovolts
- DC output current from microamperes to 100 amps
- Dynamic regulation, ripple, stability as required

### **Inverters**

- DC input voltage from 6 volts to 230 volts
- AC output from 20 VA to 2500 VA
- 60-400-800-1600-2000 cycles per second
- One, two or three phase, any voltage level
- Voltage and frequency regulation 0.1% to 10% as required
- Output waveform — sine or square wave

### **Frequency Changers**

- 20 VA to 2500 VA
- Change to or from any of these frequencies: 60-400-800-1600-2000 cycles per second
- Voltage and frequency regulation 0.1% to 10% as required

Write for complete information, including your application and requirement data.

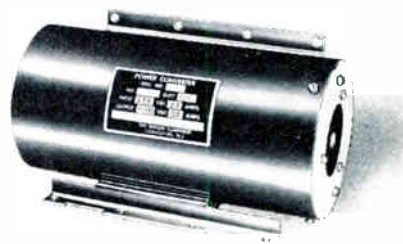

THE **DAVEN** CO.



LIVINGSTON, NEW JERSEY

TODAY, MORE THAN EVER, THE DAVEN © STANDS FOR DEPENDABILITY

Now...for high-frequency applications to 250 Mc—in oscillators, drivers, power amplifiers

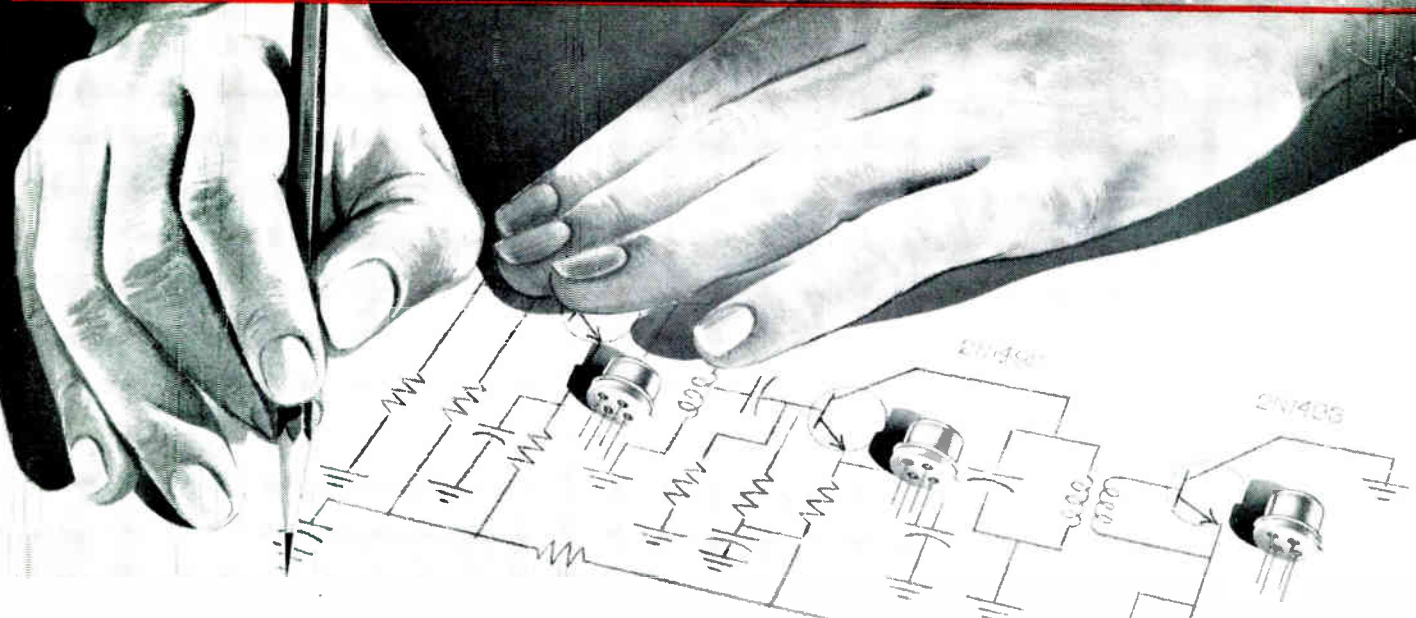

# New RCA Silicon Mesa Transistors

Three new -RCA N-P-N high-frequency medium-power transistors, 2N1491, 2N1492 and 2N1493, designed specifically for industrial and military communications equipment in the 30-Mc to 250-Mc range

These three new RCA high-frequency silicon transistors can provide ½-watt minimum useful power output in a crystal-controlled transmitter at 70 Mc.

Each of the three new RCA types is controlled for power output and power gain to facilitate use in integrated circuit designs. For example, in a high-frequency circuit where the 2N1491 acts as an oscillator, the 2N1492 as a driver, and the 2N1493 as an rf power amplifier, each type delivers ample power to drive the following stage and provide output of 0.5 watt at 70 Mc. All three types, packaged in JEDEC TO-12 case with ½" leads, feature a dissipation rating of 1/5 watt at 100°C and a maximum junction temperature of 175°C.

RCA high-frequency silicon Mesa transistors were developed in cooperation with the U. S. Air Force, Wright Air Development Division, and initially produced in cooperation with the Air Material Command on an Industrial Preparedness Measure for Military Devices.

Call your RCA Field Representative today for details. For technical bulletins on these three types, write RCA Semiconductor and Materials Division, Commercial Engineering, Section E-19-NN-3 Somerville, N. J.

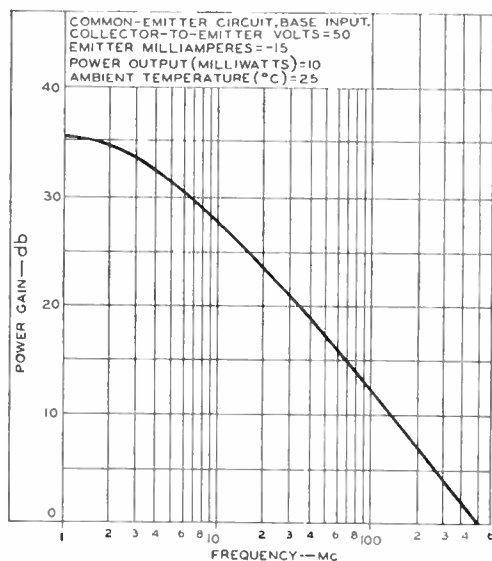

TYPICAL POWER GAIN—RCA 2N1492 and 2N1493

RATINGS AND CHARACTERISTICS				
Maximum Ratings, Absolute Values:	2N1491	2N1492	2N1493	
Collector-to-Base Voltage	30	60	100	max. volts
Emitter-to-Base Voltage	1	2	4.5	max. volts
Emitter Current	-50	50	-50	max. ma
Junction Temperature	175	175	175	max. °C
Characteristics at Ambient Temperature 25 °C:				
Max. Output Capacitance	5	5	5	μmf
Min. Power Gain at 70 Mc.				
with 10-milliwatt output	13	—	—	db
with 100-milliwatt output	—	13	—	db
with 500-milliwatt output	—	—	10	db

EAST: 744 Broad Street, Newark 2, N. J., Humboldt 5-3900 •  
NORTHEAST: 162 Second Avenue, Needham Heights 94, Mass.,  
Hillcrest 4-7200 • EAST CENTRAL: 714 New Center Bldg.,  
Detroit 2, Mich., Trinity 5-5600 • CENTRAL: Suite 1154, Mer-  
chandise Mart Plaza, Chicago 54, Ill., Whitehall 4-2900 • WEST:  
6355 E. Washington Blvd., Los Angeles 22, Calif., Raymond  
3-8361 • SOUTHWEST: 7905 Empire Freeway, Dallas 7, Texas,  
Fleetwood 7-B167 • GOV'T: 224 N. Wilkinson St., Dayton 2,  
Ohio, Baldwin 6-2366; 1725 "K" Street, N.W., Washington,  
D.C., Federal 7-8500.

AVAILABLE  
FROM YOUR  
RCA DISTRIBUTOR



The Most Trusted Name in Electronics  
RADIO CORPORATION OF AMERICA